

Electronics[®]

April 19, 1965

75 cents

A McGraw-Hill Publication

Below: David Sarnoff reviews electronics' past 35 years: page 100

Cold-cathode tubes to count and store: page 80

Dosimeter measures laser radiation: page 93

35th anniversary—the experts look ahead: page 99



Sweep a fraction of a cycle or a frequency band of several kilocycles ...as slow or as fast as you wish with these Frequency Synthesizers

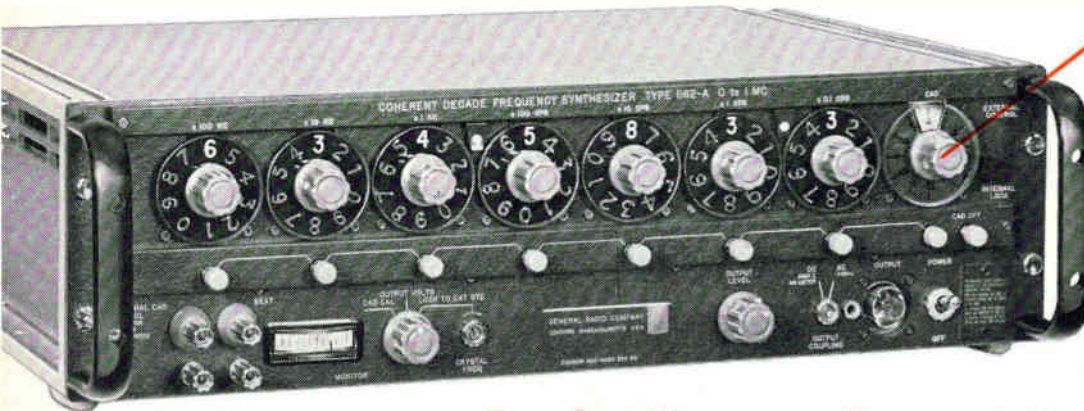

The Continuously Adjustable Decade (CAD)

An optional module of GR's new Coherent Frequency Synthesizers allows manual or electronic sweeping of the frequency range, entirely or partially, at sweep widths as great as 1 Mc/s. Control range is selectable, in decade steps, by pushbuttons. With this CAD module and some simple external circuitry, you can perform a variety of sweep-frequency measurements, complete with precision markers.

For Oscilloscope Presentation...

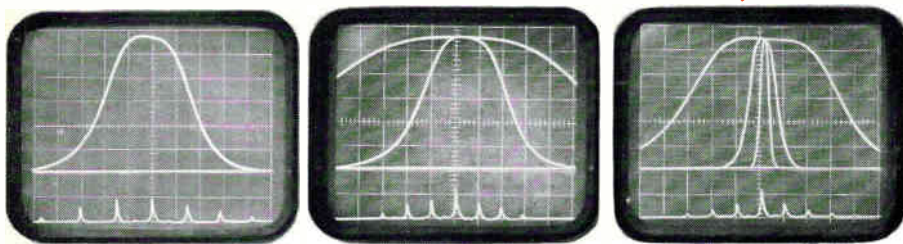

1.5-c MARKERS
3-c Pass Band

1.0-c MARKERS
3-c and 10-c Pass Bands

10-c MARKERS
3-c, 10-c, 50-c Pass Bands

Here GR's 100-kc synthesizer is sweeping 3-, 10-, and 50-cycle filter pass bands. Notice that the center-frequency and side-frequency markers (generated with the aid of simple external circuits) are precisely located on the bottom trace.

For X-Y Recording...

Sweeping the CAD also produces a directly proportional frequency at the BEAT terminals. This frequency, when applied to a frequency-to-voltage converter such as the GR Type 1142-A, provides a linear x-axis whose scale length is selectable by pushbuttons. The scale length can be set from millicycles to kilocycles.

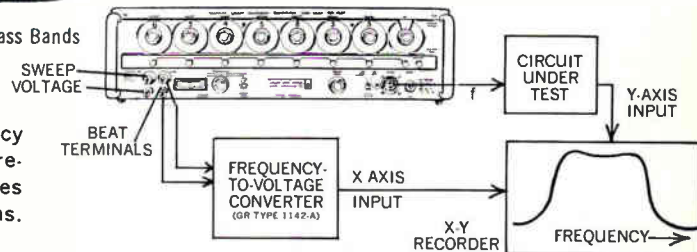

Now let's take a look at some of the other features of these GR synthesizers

Frequency is quickly and precisely set by dials on the digit-decade modules; it takes less time than dialing a telephone number. As few as 3 and as many as 7 of these modules can be supplied on an instrument. Each additional module increases frequency resolution by a factor of 10. A new remotely programmable module can be substituted for any of the standard modules to provide local/remote operation of any or all decades up to, and including, the 100-kc-per-step decade. A third module, the Continuously Adjustable Decade, can be included to provide manual or electronic sweeping of a range as great as 1 Mc/s or as small as desired. The CAD also adds two or more significant figures in selection of frequency.

All the synthesizer's signals are frequency coherent

with the output of a single, built-in, room-temperature primary crystal oscillator. Output level is adjustable up to 2 volts into 50 ohms. The 3 basic models produce maximum frequencies of 100 kc/s, 1 Mc/s, and 12 Mc/s, respectively. Each can be ordered initially with the minimum of 3 digit-decade modules; additional decades, the continuously adjustable decade, and/or remotely programmable modules can be ordered as the need arises.

All these features of GR's new frequency synthesizers provide the laboratory or production-test area with a significantly new measuring capability at a reasonable price. Prices start at \$3200 for a 100-kc model with 3 digit-decade modules. A total of 60 standard models are presently offered.

Please write for complete information.

IN CANADA: Toronto 247-2171, Montreal (Mt. Royal) 737-3673
IN EUROPE: Zurich, Switzerland - London, England



GENERAL RADIO COMPANY

WEST CONCORD, MASSACHUSETTS

BOSTON NEW YORK, N. Y., 964-2722 CHICAGO PHILADELPHIA WASHINGTON, D. C. SYRACUSE DALLAS SAN FRANCISCO LOS ANGELES ORLANDO, FLA. CLEVELAND
(W. Concord) 646-0550 (Ridgefield, N. J.) 943-3140 (Oak Park) 848-9400 (Ft. Washington) 646-8030 (Rockville, Md.) 946-1600 454-9323 FL 7-4031 (Los Altos) 948-8233 469-6201 425-4671 896-0150

Circle 900 on reader service card

get speed and data density of magnetic tape...

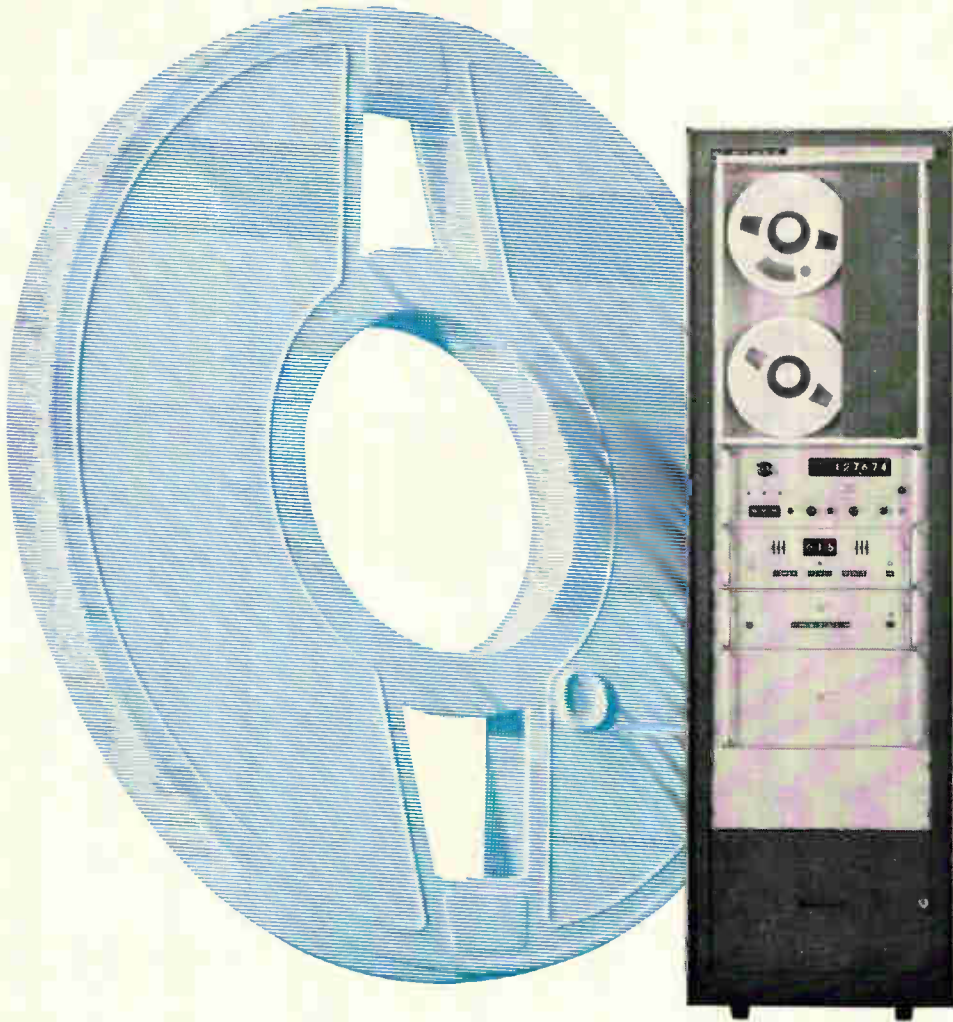

—with new standard digital data acquisition systems!

ADD: The advantages of standard systems—complete system specifications, immediate delivery, proven reliability, low cost **TO:** The benefits of magnetic tape recording and data processing

AND GET: Fast automatic measurement of dc volts, low-level dc, ac volts, resistance and frequency recorded on an incremental recorder in computer compatible format—as fast as 10 channels per second—with up to 440,000 unattended measurements and recordings.

Heart of these magnetic tape systems, as of other Dymec 2010 Data Acquisition Systems, is the DY-2401C Integrating Digital Voltmeter, a floated and guarded instrument which lets you measure extremely low-level signals even in the presence of severe common mode and superimposed noise. The 2401C measures dc voltages to 1000 volts with 300% overranging on the lower ranges. It also measures frequency 10 cps to 300 kc, and you can add an optional converter to measure ac and resistance.

The newest of Dymec's standard systems comes in two models, the 2010J and the 2010H, which differ only in scanning capability. With the 2010J you can measure up to 200 3-wire channels, or measure up to 100 channels with the 2010H System.

Now from nine standard systems you can select a wide variety of input capabilities and recorded output, including printed paper tape, punched tape, punched cards ... and magnetic tape. Prices of the newest systems: DY-2010H, \$15,365; DY-2010J, \$17,415.

Data subject to change without notice. Prices f.o.b. factory.

Call your Dymec/Hewlett-Packard field engineer for more information or for a demonstration of a standard digital data acquisition system.

DYMEC
A DIVISION OF HEWLETT-PACKARD COMPANY



DEPT. E-4, 395 PAGE MILL ROAD, PALO ALTO, CALIF. • PHONE (415) 326-1755 TWX 415-492-9363

ADD

AUTORANGING **ac** TO **dc** MEASUREMENTS

WITH YOUR hp 3440A DIGITAL VOLTMETER

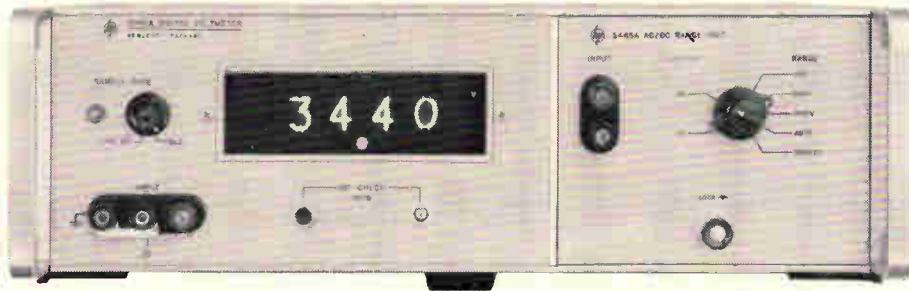

Now your Hewlett-Packard solid-state 3440A DVM lets you measure ac (50 cps to 100 kc) or dc signals 10 to 1000 volts full scale. Just connect directly to the input terminals of the 3445A, select manual range or automatic ranging—or program range remotely. Signal common may be connected up to 500 v dc above ground. Permanent test records are available on all functions, including polarity, decimal, function and overload, with accessory J74-562A Printer for a 1224 code (J76-562A for a 1248 code).

The specs tell the story of new versatility for the 3440A, \$1160, today's best DVM buy. Other plug-ins that make the 3440A your most flexible digital voltmeter include the 3441A Manual Ranger Selector, \$40; 3442A Automatic Range Selector, \$135; 3443A High-Gain/Autorange Unit, \$450; 3444A DC Multi-Function Unit, \$575. Then check your hp field engineer or write for complete data to Hewlett-Packard, Palo Alto, California 94304, Tel. (415) 326-7000; Europe: 54 Route des Acacias, Geneva; Canada: 8270 Mayrand Street, Montreal.

SPECIFICATIONS, 3445A (plugged into the 3440A)

Voltage range 4-digit full-scale readings of 9.999, 99.99 and (ac and dc): 999.9 v; 5% overrange capability, indicator.

Voltage accuracy (ac): from 20°C to 30°C, including ±10% line variations. 50 cps—20 kc, ±0.1% of reading ±2 counts. 20 kc—50 kc, ±0.1% of full scale ±2 counts. 50 kc—100 kc, <±0.3% of full scale ±2 counts. Temperature coefficient = ±0.005%/°C from 0—20°C and 30—50°C.

Voltage accuracy (dc): ±0.05% of reading ±1 digit, including 10% line variation, +15°C to +40°C (±0.1% ±1 digit 0°C to +50°C).

Range selection (ac): Manual, automatic, remote; auto reading <2 sec; max. remote ranging time 40 msec.

Range selection (dc): Manual, automatic, remote; auto reading <1 sec; max. remote ranging time 40 msec.

Function selection: ac or dc, front panel.

Input impedance: 10 megs shunted by <20 pf, all ac ranges; 10.2 megs, dc.

Input filter (dc): response time <450 msec to a step function to within 99.95% of final value; 30 db ac rejection at 60 cps on 10, 100 and 1000 v ranges, increasing at 12 db/octave.

	10 v range	100 v range	1000 v range	
Common mode	dc	90 db	70 db	50 db
rejection (dc):	60 cps	70 db	50 db	30 db

Price: \$525.

Data subject to change without notice. Price f.o.b. factory

HEWLETT  **PACKARD**
An extra measure of quality

12502

Electronics

April 19, 1965

Volume 38, Number 8

Page 4	Readers Comment
8	People
10	Meetings
15	Editorial
17	Electronics Newsletter
63	Washington Newsletter
147	New Products
192	New Books
195	Technical Abstracts
201	New Literature

Electronics Review

Page 33	Double play	36	Prodding the Pentagon
33	It's a SNAP	36	Circuits by the batch
34	X marks the spectrum	39	Logical solution
34	On the track	40	Automatic identification
35	Sharp voltmeter	40	Color tv: 2 against 1
35	Hearing the heart		

Electronics Abroad

203	Computer-conscious	205	In the rough
203	New leaf in papermaking	205	Computer at the ores
204	TSR-2 fallout	206	Stress on IC's
204	Mideast customs	206	Irish stew
		207	Around the world

Probing the News

131	The Pentagon's global network
135	Automating our air-defense control
142	Ban on bugging?

Technical Articles

Components	80	Using cold-cathode tubes to count and store Miniature tubes switch with input pulses at up to megacycle speeds Graham Jeynes, Mullard, Ltd.
Circuit design	90	Designer's casebook Pulse-width and peak discriminator; zero-crossing detector; generator is a modulator
Instrumentation	93	The dark side of the laser Dosimeter measures the danger level of direct or reflected laser beams J. J. Schlickman and R. H. Kingston, MIT
Special report	99	The 35th anniversary of Electronics Review and outlook
	100	Electronics' first 35 years (Cover) RCA's David Sarnoff reminisces and looks ahead Lewis H. Young, Editor
	104	The future of electronics in 1930 Predictions from our first issue
	106	A forward look at electronics Looking farther into the future
	109	Wonderland for consumers New electronic products will make life easier Daniel A. Noble, Motorola, Inc.
	114	Cramming more components onto integrated circuits 65,000 components on a single chip? Gordon E. Moore, Fairchild Semiconductor
	117	Changing the nature of research for space A quantum jump in technology is necessary Albert J. Kelley, NASA
	119	Light on the future of the laser The inventor sees promising applications T.H. Maiman, Korad Corp.
	122	More and faster communications Phone vision may be carried on laser beams Henri Busignies, ITT
	124	Computers to run electric utility plants Computers may run a nation's electric generating system Nathan Cohn, Leeds and Northrup Co.

Electronics

Editor: Lewis H. Young

Senior editors

Technical: Samuel Weber
News: Kemp Anderson, Jr.

Senior associate editors: John F. Mason, George Sideris

Department editors

Avionics: W.J. Evezia
Circuit design: Michael Elia
Communications: Alexander A. McKenzie
Components: Michael F. Tomaino
Consumer electronics: Richard Lipkin
Industrial electronics: Louis S. Gomolak
Instrumentation: Carl Moskowitz
Manufacturing: George Sideris
Military electronics: John F. Mason
New products: William P. O'Brien
Solid state: Jerome Eimbinder
Space electronics: Joel A. Strasser
Staff writers: Leon H. Dulberger, Stanley Zarowin

Regional editors

Boston: Thomas Maguire, editor; Robin Carlson
Los Angeles: William B. Wallace, editor; June Long
San Francisco: Laurence D. Shergalis, editor; Mary Jo Jadin
London: Derek Barlow, editor

Copy editors

Howard Rausch, Sally Powell, Walter Barney

Graphic design

Art director: Saul Sussman
Assistant art director: John C. Wright, Jr.
Editorial production: Ann Mella
Production editor: Arthur C. Miller

Editorial secretaries: Claire Benell, Mary D'Angelo, Lynn Emery, Kay Fontana, Carolyn Michnowicz, Lorraine Rossi, Lorraine Werner

McGraw-Hill news service

Director: John Wilhelm; **Atlanta:** Fran Ridgeway; **Chicago:** Bruce Cross;
Cleveland: Arthur Zimmerman; **Dallas:** Marvin Reid;
Detroit: Donald MacDonald; **Los Angeles:** Michael Murphy,
Ron Lovell; **San Francisco:** Margaret Ralston, Ed. Addeo;
Seattle: Ray Bloomberg; **Washington:** Arthur L. Moore, Glen Bayless,
Charles Gardner, Herbert W. Cheshire, Seth Payne

McGraw-Hill world news service

Bonn: Richard Mikton; **Brussels:** Arthur Erikson; **London:** John Shinn;
Mexico City: Wesley Perry; **Milan:** Bruce Bendow;
Moscow: Donald Winston; **Paris:** Dan Smith;
Rio de Janeiro: Leslie Warren; **Tokyo:** Marvin Petal, Charles Cohen

Circulation manager: Hugh J. Quinn

Reprints: T.M. Egan

Publisher: C.C. Randolph

Electronics: April 19, 1965, Vol. 38, No. 8

Printed at 99 North Broadway, Albany, N.Y.
Second class postage paid at Albany, N.Y.

Subscriptions are solicited only from those actively engaged in the field of the publication. Position and company connection must be indicated on orders. Subscription prices: United States and Possessions and Canada, \$6.00 one year, \$9.00 two years, \$12.00 three years. All other countries \$20.00 one year. Single copies, United States and Possessions and Canada 75¢. Single copies all other countries \$1.50.

Published every other Monday by McGraw-Hill Inc. 330 West 42nd Street, New York, N.Y. 10036. Founder: James H. McGraw, 1860-1948.

Subscribers: The Publisher, upon written request to our New York office from any subscriber, agrees to refund that part of the subscription price applying to copies not yet mailed. Please send change of address notices, subscription orders or complaints to Fulfillment Manager, Electronics, at the address below. Change of address notices should provide old as well as new address, including postal zone number if any. If possible, attach address label from recent issue. Allow one month for change to become effective.

Postmaster: Please send Form 3579 to Fulfillment Manager, Electronics, P.O. Box 430, Hightstown New Jersey 08520

Readers Comment

And then I invented . . .

To the Editor:

In the frantic days of radio receiver design, some 35 years ago, one of the exciting events was the introduction of automatic volume control. I was then in the midst of this excitement, being responsible for the designs of all the radio receivers for the Jackson-Bell Co. (later the Packard-Bell Electronics Corp.). Automatic volume control brought with it tuning indicators, generally d-c millimeters to indicate minimum r-f amplifier plate current at resonance.

Nobody liked the looks of a meter on the front panel of a home radio, so all sorts of ingenious ideas were proposed. Among those that I remember well was a gas discharge tube filled with neon, connected so that the length of the glow was proportional to a voltage or current associated with the r-f amplifier d-c network.

Imagine my surprise to see that it has been reinvented by Mullard, Ltd.! I hope they do not spend too much money on a patent application. The prior art might jump up and bite them.

I shall now go back to my lab and work on a new idea I just had. I think that if one were to insert a wire grid between the filament and plate of a thermionic valve . . .

Richard G. Leitner
Coleman & Associates
Los Angeles

Price of apartheid

To the Editor:

I read with interest and a certain amount of disgust your article on "Price of apartheid" [Jan. 11, p. 209]. We do not mind your stating facts about South Africa, and you are also entitled to speculate as to the reason why the government does not introduce television into South Africa. But what is disgusting are the infamous lies about radio services.

You indicate that we cater only to the English and the Dutch and that there is increasing pressure for services for the country's black majority which speaks a variety

Operating Temperature Range of Aluminum 'Lytic Capacitors Extended to -55 C, +125 C

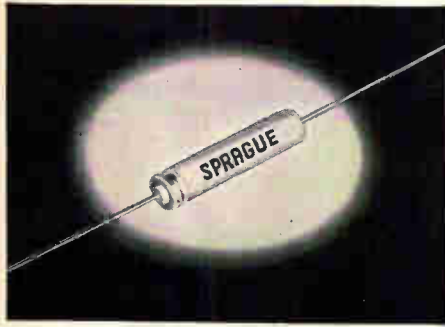

Type 600D Extralytic® Capacitors are the first commercially-available aluminum electrolytics to extend their operating temperature range to -55 C, +125 C at voltage ratings up to 150 volts d-c.

Although Type 600D Capacitors, a recent development of the Sprague Electric Company, cost only half that of corresponding tantalum foil units, they have comparable performance characteristics and offer the advantage of generally being smaller and significantly lighter than military-grade tantalum foil capacitors of equivalent ratings.

Sprague Type 600D Extralytic Capacitors are only one-third the weight of their tantalum equivalents. In a case size of 3/8" x 2-3/16" it is possible to obtain a capacitance of 850 µF at 5 WVDC or 26 µF at 150 WVDC.

This significant advancement in the manufacture of aluminum electrolytics was made possible by increased foil purity, improved oxide systems, and newly developed methods of etching that yield higher etch ratios. An improved capacitor seal design and the development of a unique new electrolyte are two other factors contributing to their outstanding performance characteristics.

Extralytic Capacitors display excellent stability over their entire temperature range. Even at -55 C, their capacitance drop is very small. The operating and shelf life of 600D Capacitors is comparable to or better than that of foil tantalum capacitors.

For complete technical data, write for Engineering Bulletin 3455 to Technical Literature Service, Sprague Electric Company, 35 Marshall St., North Adams, Massachusetts 01248.

6 Reasons Why SPRAGUE is a Major Resistor Supplier

FILMISTOR® PRECISION FILM RESISTORS



metal-film, molded case

Distinct limited temperature coefficients and low tolerances to meet exacting application requirements. Rugged end cap construction for long-term stability and reliability. Superior resistance to humidity and mechanical damage. Surpass MIL-R-10509E requirements. Send for Bulletin 7025B.



deposited-carbon, molded case

Approach precision wirewounds in reliability and stability, yet are smaller in size and have lower self-inductance. Low, controlled temperature coefficient. Dense molded case provides outstanding humidity protection. Send for Bulletin 7000A.



deposited-carbon, conformal coated

Full rated load operation at 70 C with no wattage derating. Assured uprated loads at lower operating temperatures. Ideal for circuitry where small size, humidity resistance, and close tolerance (±1%) are required. Send for Bulletin 7005A.

CIRCLE 270 ON READER SERVICE CARD

KOOLOHM® CERAMIC-SHELL POWER WIREWOUND RESISTORS

Exclusive ceramic-insulated resistance wire permits "short-proof" multilayer windings for higher resistance values. Standard and non-inductive designs. Non-porous ceramic shell for moisture protection and electrical insulation. Axial-lead, axial-tab, and radial-tab styles. Send for Bulletins 7300B, 7305, 7310.

CIRCLE 273 ON READER SERVICE CARD

GLASS-JACKETED POWER WIREWOUND RESISTORS



Ferrule terminals soldered to metallized ends of glass casing for true hermetic seal. Virtually failure-proof, even in extremely corrosive industrial and salt atmosphere. Standard and non-inductive windings. External meter-multiplier types also available. Send for Bulletins 7350, 7420, 7421.

CIRCLE 274 ON READER SERVICE CARD

For complete technical data, write for engineering bulletins on the resistors in which you are interested to: Technical Literature Service, Sprague Electric Company, 35 Marshall Street, North Adams, Massachusetts.

ACRASIL® PRECISION/POWER WIREWOUND RESISTORS



silicone-encapsulated

Combine the best features of both precision and power wirewound types. Resistance tolerances to ±0.05%. Unusually tough encapsulation protects against shock, vibration, moisture, fungus. Meet MIL-R-26C requirements. Smaller than conventional wirewounds, yet greater in stability. Send for Bulletin 7450.

CIRCLE 271 ON READER SERVICE CARD

BLUE JACKET® VITREOUS ENAMEL POWER WIREWOUND RESISTORS



All-welded end cap construction with special vitreous coating for long-term dependability. Axial-lead style for conventional wiring or on printed boards. Tab terminals for higher wattage applications. Meet MIL-R-26C requirements. Send for Bulletins 7400B, 7410D, 7411A.

CIRCLE 272 ON READER SERVICE CARD

STACKOHM® POWER WIREWOUND RESISTORS



Flat silhouette permits stacking of resistor banks in close quarters. Aluminum thru-bar simplifies mounting and conducts heat from resistance element. Vitreous enamel protective coating. Meet MIL-R-26C performance requirements. Send for Bulletin 7430.

CIRCLE 275 ON READER SERVICE CARD

SPRAGUE®

THE MARK OF RELIABILITY

Sprague and *®* are registered trademarks of the Sprague Electric Co.

db db db db
FOR MAXIMUM GAIN

\$\$\$\$\$\$
AT MINIMUM COST...

You Can't Beat MADT* Communications Transistors

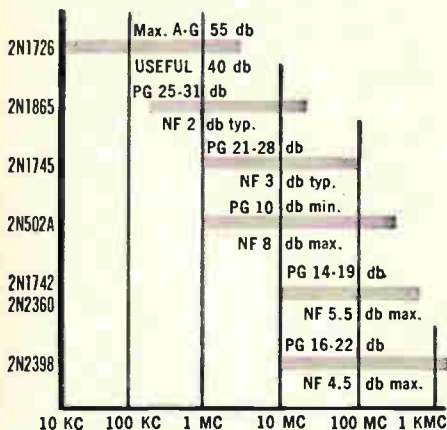

MADT Communications Transistors are now available in production quantities from Sprague Electric. For complete information on these and other MADT High-Performance Amplifier Transistors, write to Technical Literature Service, Sprague Electric Co., 35 Marshall St., North Adams, Massachusetts.

*Trademark of Philca Corp.



Sprague and "S" are registered trademarks of the Sprague Electric Co.

of native dialects. The facts are that we cater for three services for the white population—English and Afrikaans—and for the “black majority” we cater for no less than seven languages, namely North Sotho, South Sotho, Zulu, Tswana, Xhosa, Venda and Tsonga, each of which has its own service; there are also part-time services for colored and Indians and, what is more, the black majority are even allowed a certain amount of time on our two white services.

F. F. Velleman
 Johannesburg, South Africa

South Africa does indeed have more than the two radio services mentioned. But the article's point is that tv is still a long way off despite South Africa's technical ability to introduce it.

Negative reactance

To the Editor:
 Regarding negative reactances, assume the ideal amplifier in the circuit below:

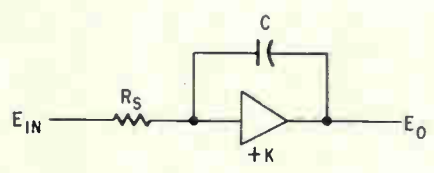

Since, as Clarence I. Jones mentioned [Feb. 22, p. 4], the circuit oscillates when $\beta K \geq +1$, it should be apparent that the circuit will oscillate since $K > 1$ and

$$\beta = j\omega RC \left(\frac{1}{1 + j\omega RC} \right) = \frac{j\omega RC}{j\omega RC + 1}$$

which $\rightarrow +1$ as $\omega \rightarrow \infty$ i.e., $K\beta$ becomes equal to and greater than $+1$ at some frequency ω_0 where the real part of $\beta \geq \frac{1}{K}$.

To put it another way, the circuit which Jones gives is a very common one, but it is usually called a multivibrator (at least when you add the source resistance, R_s and ground it at E_{in}).

Since negative reactances appear so valuable, perhaps Jones will furnish readers the exact schematic of a tested and proven negative-reactance circuit.

David B. Fraser
 Dynasciences Corp.
 Fort Washington, Pa.

The illustrations were intended to be no more than that. While the R(-C) circuit is stable, it has an infinite transient response to a step-input function. Therefore (and also from a basic energy consideration) you cannot have a true negative capacitor or inductor at d-c or at infinite frequency.

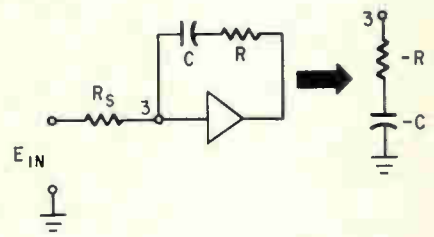
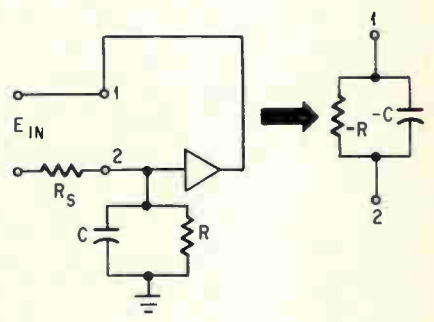

The circuit illustrated does act as a multivibrator in practice because of the infinite transient mentioned, coupled with the fact that the amplifier saturates. It is not because there is significant gain as $\omega \rightarrow \infty$. This could easily be prevented by inserting a single lag if the problem did exist. The following circuits were stable in actual practice.

Clarence I. Jones
 Pittsburgh

Klystron life-span

To the Editor:
 After reading your article, “Klystron substitute” [March 22, p. 39], I can't help but wonder where you obtained the 5,000-hour figure for life span of klystrons.

Here at BMEWS site 1, we have many Varian VA-842 klystrons that have operated over 30,000 beam-hours and are still going strong. Just last week we had one go over 40,000 hours on the filaments, and is just shy of the same on beam-hours.

Seems like a difference of four years!

George K. Hahn Jr.
 RCA BMEWS Project
 Thule, Greenland



who offers more semiconductor testing experience than TI?

NO ONE!

... and you can profit from *our* experience. Whether your automatic testing problem is in production, quality control, reliability, or evaluation, TI can solve it. Innovating state-of-the-art solutions is a regular occurrence at TI such as the technique for *dynamic* testing of transistors, diodes, integrated circuits and modules. It's our business to stay ahead.

TI-built test equipment is dependable, flexible, has anti-obsolесcent features and is economical. It is backed by an engineering organization with more than a decade of experience in manufacturing, installing and servicing of semiconductor test equipment. For the latest information, write TI's test equipment specialists, the Industrial Products Group.

INDUSTRIAL
PRODUCTS
GROUP



TEXAS INSTRUMENTS
INCORPORATED
P. O. BOX 66027 HOUSTON, TEXAS 77006
118 RUE du RHONE GENEVA, SWITZERLAND

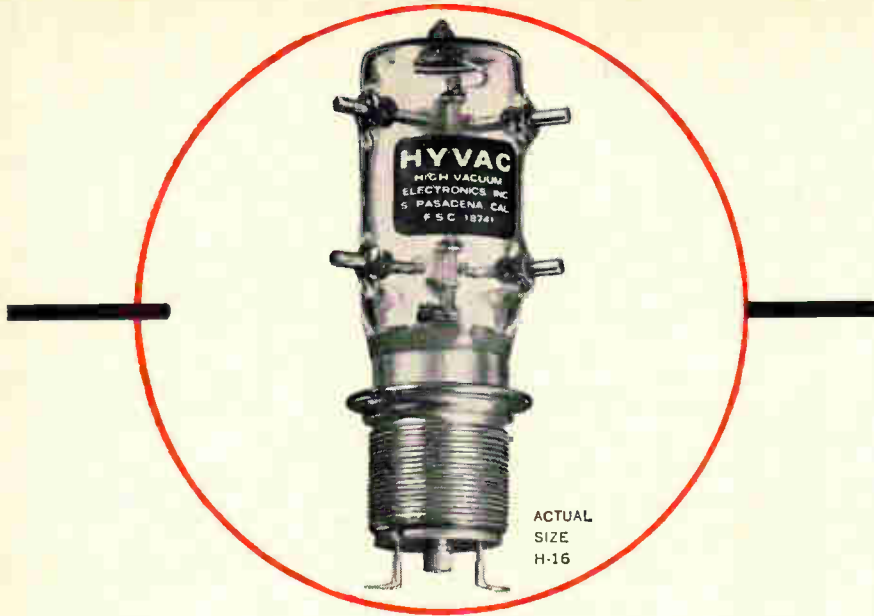

Why Hyvac puts a high voltage relay in a vacuum—
one word... **RELIABILITY!**

VACUUM RELAY RELIABILITY means short contact travel, low contact mass, contacts free of oxides and pitting and minimum contact bounce. These long-life reliability features are made possible only because of operation in a high vacuum dielectric. Vacuum technology has made high reliability, long life high voltage switching practical, with considerable savings in space and weight. Developed for high voltage, high peak current applications, Hyvac relays are well suited and widely used in radar, communications, pulse forming networks, ECM, sonar, medical electronics, antenna switching and antenna couplers, microwave systems and switching in explosive atmospheres. Hyvac's broad line and "Quick Reaction Time" is geared to your most critical delivery schedule. We have the high vacuum experience, design and production capability to provide special modifications of our standard off-the-shelf designs in unbelievably short order. Hyvac, a company small enough to be responsive... large enough to be responsible. Check the brief specifications of our "H" series:

HYVAC TYPE	H-8	H-9	H-11	H-12	H-14	H-16	H-17
Contact Arrangement	SPDT	SPST	SPST	SPDT	DPDT	DPDT	SPDT
Rated operating voltage (kv dc)	20	20	12-air 18-oil	8-air 12-oil	8-air 12-oil	12-air 18-oil	25
Continuous current, *max. (amps-rms)	15	15	15	15	15	15	25
Operating time, max (ms)	15	15	18	18	18	20	25
Coil voltage, nominal (vdc)	26.5	26.5	26.5	26.5	26.5	26.5	26.5
Approx. price (1-9 pcs)	\$98	\$98	\$105	\$110	Factory quote		

*Carry only

For complete technical information, contact your nearest sales engineering representative, or write directly to us.

HYVAC

HIGH VACUUM ELECTRONICS INC. • 538 MISSION STREET
SOUTH PASADENA, CALIFORNIA • PHONE: (213) 682-2149 • TWX 213-449-2552

People

When production problems snag output at Texas Instruments Incorporated's semiconductor plant in Dallas, **Patrick E. Haggerty's** secretary knows she can probably find her boss on the production line, trying to solve the problem. Haggerty, TI's 51-year-old president, works anywhere at the plant in sports shirt and slacks—10 hours a day, 6 days a week. He generally wears a suit and tie only for formal occasions.



But in his new job as a vice chairman of Defense Secretary Robert S. McNamara's advisory committee on defense, Haggerty may be spending less time in Dallas and more time in Washington—wearing a suit and necktie.

Haggerty's background indicates he knows his way around in Washington. He spent the war years in the capital working on Navy electronics programs.

It's not hard to take your work home when you're a woman who likes to cook and you direct a laboratory that develops, among other things, solar ovens. **Maria Telkes**, director of Melpar, Inc.'s new solar-energy applications laboratory at Falls Church, Va., uses a solar oven for barbecues on the patio of her suburban Washington home.



In her new job at Melpar, a subsidiary of the Westinghouse Air Brake Co., Miss Telkes is in charge of development of devices to convert solar energy into electrical energy. Applications include solar panels for space vehicles.

Miss Telkes, who has a doctorate in physical chemistry, started specializing in solar-energy conversion projects at the Massachusetts Institute of Technology. She designed the first solar-heat system for a house near Boston.

TV Transmitting Tube For CHANNEL MOON, On Target, On Frequency

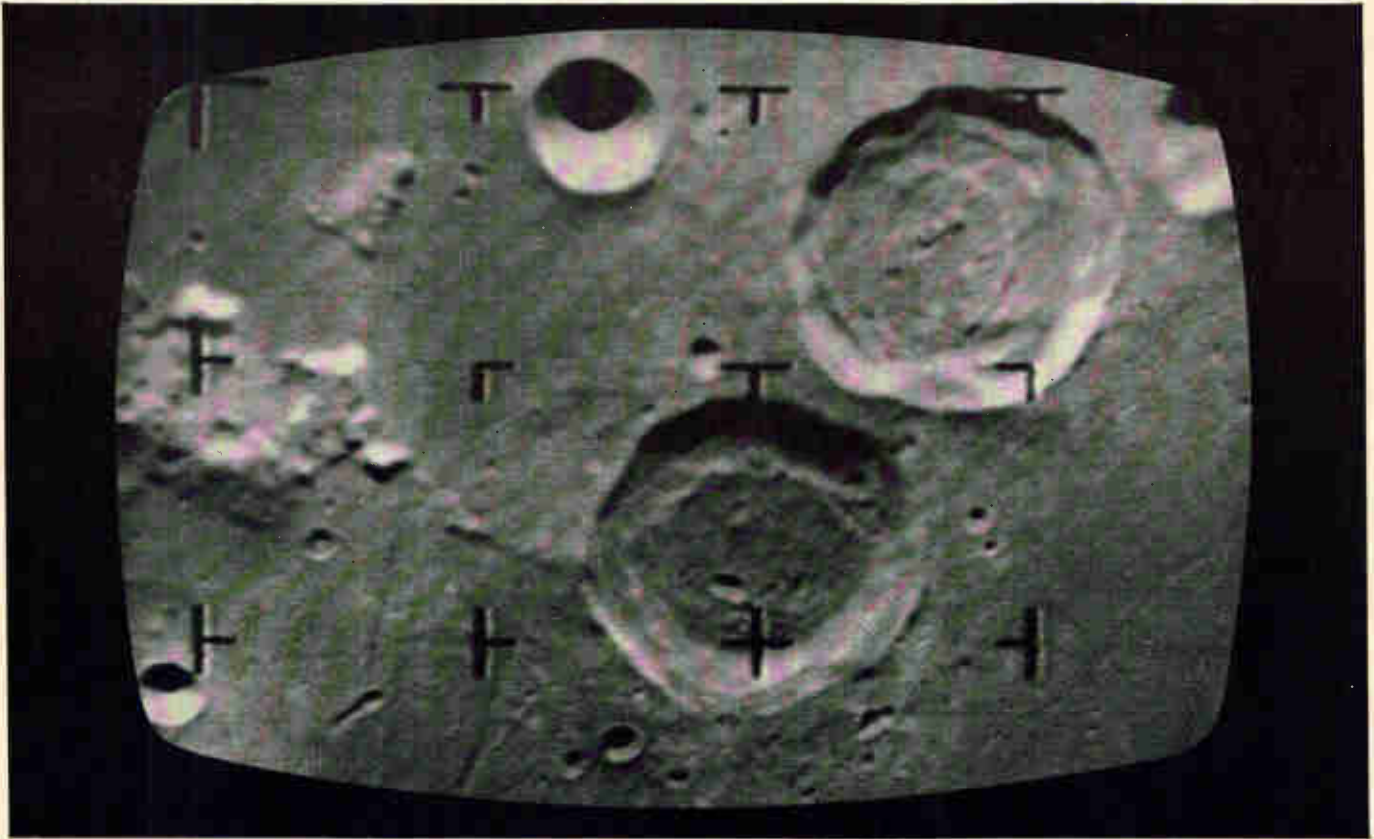

The ML-7855 frequency stable Machlett UHF planar triode transmitted all of the moon pictures—sharp and clear—for Rangers 7, 8, and 9. On frequency, and at full power within seconds, the ML-7855 powered TV transmitters have been an outstanding success. In space, in the military service, in the nation's airliners—wherever the highest reliability and performance is required, use of Machlett planar triodes demonstrates the continuing confidence in the capability of the Machlett organization. Whether you require high power/high voltage triodes or tetrodes, UHF planar triodes, X-ray tubes, vidicons, or need assistance in research or design development, write: The Machlett Laboratories, Inc., Springdale, Conn. 06879. An affiliate of Raytheon Company.

MACHLETT

ELECTRON TUBE SPECIALIST

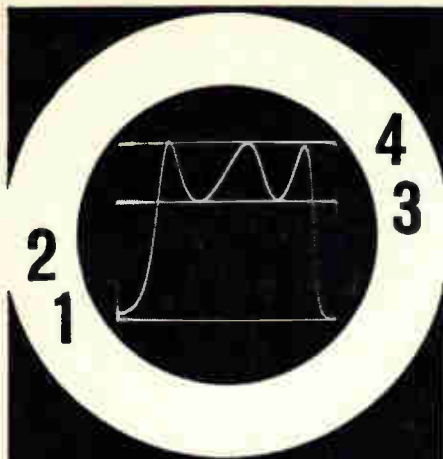

see **4** response
traces on single-
trace scope

measurement by comparison
up to 1,200 mc



NEW

JERROLD SOLID-STATE 3-POSITION COAXIAL SWITCHER

Model TC-3 \$295⁰⁰

Turn any single-trace oscilloscope into a 4-trace scope; insert two reference traces automatically in addition to test trace and baseline. These references have advantage of permanent relative accuracy over scribed or painted lines.

Results are repeatable, as accurate as your reference attenuators. Generator and scope drift do not affect accuracy of measurements. Frequency from dc to 1,200 mc extends usefulness of comparison technique well into the UHF band. The TC-3 Coaxial Switcher can save you thousands of dollars in speed and accuracy. Write for literature.

**JERROLD
ELECTRONICS**

Industrial Products Division,
Philadelphia, Pa. 19132
In Canada: Jerrold Electronics,
60 Wingold Ave., Toronto 19, Ont.
Export: Rocke International,
13E, 40th St., New York, N.Y. 10016

**SWEEP GENERATORS • AMPLIFIERS
PRECISION ATTENUATORS • COMPARATORS**

Meetings

IEEE Lectures on Microelectronics, IEEE; Chicago Lane Technical Institute, Chicago, Apr. 5, 12, 19, 26.

Institute of Environmental Sciences Annual Technical Meeting and Equipment Exposition, IES; Sherman House, Chicago, Apr. 21-23.

Marine Sciences Instrumentation Symposium, ISA; Dupont Plaza Hotel, Miami, Fla., Apr. 21-23.

Numerical Control Society Annual Meeting, NCS; La Salle Hotel, Chicago, Apr. 21-23.

Society of American Value Engineers National Convention, SAVE; Statler-Hilton Hotel, Boston, Apr. 21-23.

Technical Conference, IATA; Miami Beach, Apr. 22-30.

National Topical Meeting, ANS; Statler-Hilton Hotel, Detroit, Apr. 26-28.

American Physical Society Spring Meeting, APS; Sheraton-Park, Shoreham, Washington, D.C., Apr. 26-29.

Anti-Missile Research Advisory Council Meeting, IDA; Institute for Defense Analyses, Arlington, Va., Apr. 26-30.

Rocky Mountain Bioengineering Annual Symposium, IEEE, USAF Acad., Fitzsimmons Gen. Hospital, et al; Brown Palace Hotel, Denver, May 3-4.

Annual Technical Conference, ASQC; Biltmore Hotel, Los Angeles, Calif., May 3-5.

American Astronautical Society Annual Meeting, AAS, IIT Research Institute; Conrad Hilton Hotel, Chicago, May 4-6.

Packaging Industry Annual Conference, IEEE; Milwaukee Inn, Milwaukee, Wis., May 4-6.

"Post-Apollo Missions" Meeting, AAS; The Conrad Hilton Hotel, Chicago, May 4-6.

ICA Annual Conference, ICA; Hilton Hotel, Pittsburgh, May 4-7.

Institute on Electronics and Automation in Publishing, Amer. Univ.; International Inn, Wash., May 10-13.

Design Engineering Conference, ASME; New York Coliseum, New York, May 17-20.

Society of Photographic Scientists and Engineers Annual Conference, SPSE; Sheraton-Cleveland Hotel, Cleveland, May 17-21.

Aerospace Fluid Power Systems and Equipment Conference, SAE; Statler-Hilton Hotel, Los Angeles, May 18-20.

Digital Equipment Computer Users Society Spring Technical Meeting, DECUS; William James Hall, Harvard University, Cambridge, Mass., May 20-21.

Electronic Reliability Conference, IEEE; Carnegie Foundation Building, N.Y.C. May 21.

Computing Meeting, NYU; Stony Brook, L.I. Campus, May 21.

Microelectronics Annual Symposium, St. Louis Section of IEEE; Chase Park Plaza, St. Louis, Mo., May 24-26.

Armed Forces Communications and Electronics Association Annual Convention, AFCEA; Sheraton-Park Hotel, Wash., May 25-27.

Bicentennial Space Symposium and National Conference, NASA, St. Louis Bicentennial Commission; Chase-Park Plaza Hotel, St. Louis, May 26-28.

Symposium on Analysis Instrumentation ISA; Sheraton-Mt. Royal Hotel, Montreal, May 26-28.

Cybernation, Automation and Human Responses Annual Conference, ICR; Americana Hotel, N.Y.C., May 27-29.

IEEE Annual Communications Convention (Including GLOBECOM VII), CTG/IEEE; University of Colorado, Boulder, Colo., June 7-9.

National Electronic Packaging and Production Conference (NEP/CON'65), EPP; Long Beach Arena, Long Beach, Calif., June 8-10.

Call for papers

NEC Technical Sessions on Consumer Electronics, IEEE; McCormack Place, Chicago, Oct. 25-27. **May 3** is deadline for submitting 75-word abstract to James S. Aagaard, Electrical Engineering Dept., Northwestern University, Evanston, Ill. 60201.

SPIE Technical Symposium, SPIE; Jack Tar Hotel, San Francisco, Aug. 16-20. **May 1** is deadline for submitting 300-word abstract to Mr. H. E. Gustafson, Co-chairman Technical Program, 2800 Seventh Street, Berkeley 10, California.

Announcing item #5 in the Fluke '65 Pacesetter Line

Here's the new "State of the Art" Fluke 540B Transfer Standard. AC-DC transfer accuracy is 0.01% to 50 kc without curves or tables. Fail-Safe overload protection prevents inadvertent damage to thermocouple and precision resistors. Internal galvo and thermocouple go together for perfect impedance match. DC input reversal switch. Turnover error <math><0.01\%</math>. Search meter marks percent of rated input. Low price, \$895 ready to go.

The battery-operated solid state Fluke 540B Transfer Standard is available in bench or rack versions. Voltage range is 0.25 to 1000 volts in 14 ranges. Galvanometer resolution is 0.0012%/scale division at rated input. Accessories include A40 Current Shunts for thermal AC/DC current transfers to 10 amps and A55 Thermal Converters for extension of frequency range to 50 MC.



FLUKE • Box 7428, Seattle, Washington 98133 • Phone (206) 776-1171 • TWX: (910) 449-2850

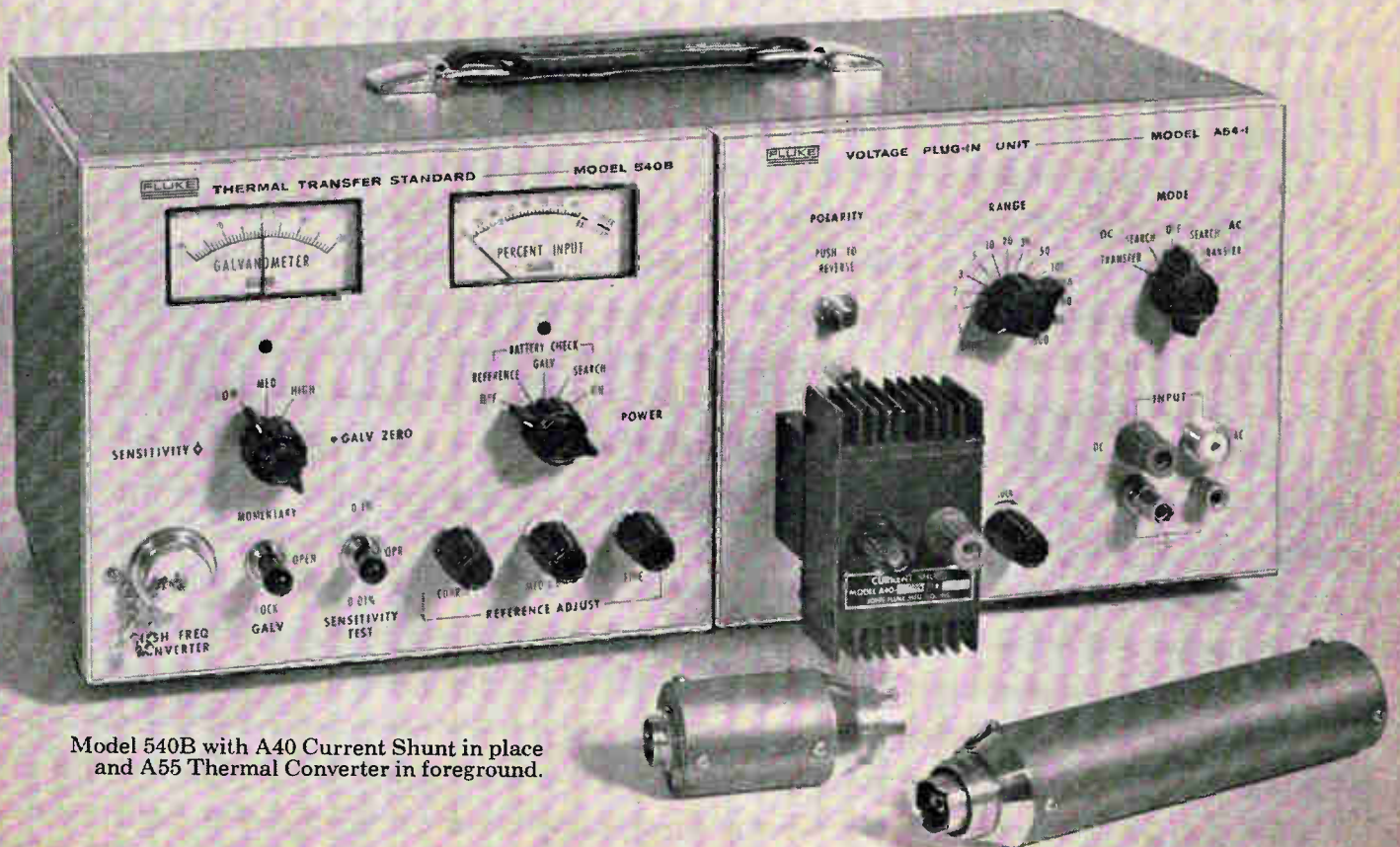

Model 540B with A40 Current Shunt in place and A55 Thermal Converter in foreground.

FROM GUDEBROD—A CONSULTANT'S REPORT

SURVEY of HARNESS
TYING OPERATION
for
Your Company

Area Code 215, WA 2-1122 • TWX 215-869
ROS. SILK CO., INC.
FOUNDED IN 1870

Silks Division
PHILADELPHIA, PENNSYLVANIA

OFFICES •

NEW YORK, NEW YORK
25 West 34th Street, Area Code 212
BURBANK, CALIFORNIA
1636 Ontario Street, Area Code 818
PHILADELPHIA, PENNSYLVANIA
19464 TWX

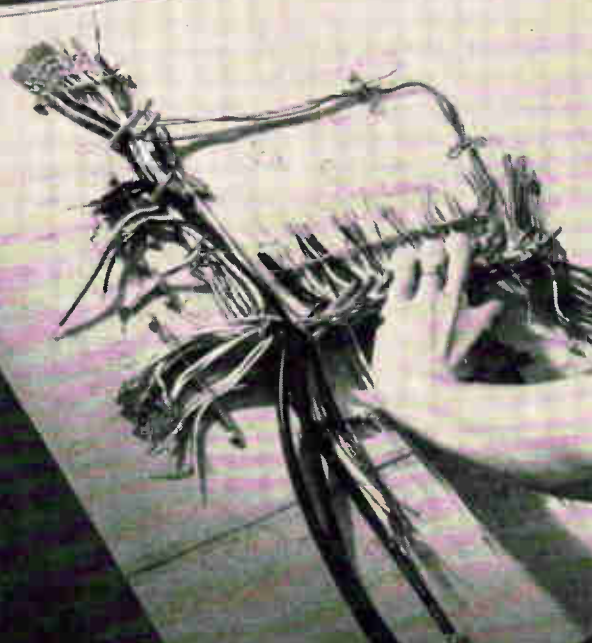

so that you may improve your harnesses

... while you save money, too!

**GIVE YOUR HARNESS OPERATION
A FULL REVIEW ... with this
Gudebrod Survey (AT NO COST TO YOU, OF COURSE)**

"Improve" is the guide-word of the electronics field—but has your harness operation kept pace? If you could improve your harness product—and save money at the same time—wouldn't you be interested? Where do you go for help in achieving this desirable situation? To Gudebrod—there is no comparable source for such help in the industry. That's why management at the Gudebrod Electronic Division is offering to make a Consultant's Report on your harness department operation. With self-interest they believe that improving the state of the art in the industry will improve their own business atmosphere. So—why not take advantage of Gudebrod's wealth of tape engineering experience and knowledge—there is no cost or obligation attached to it!

STANDARDS

To improve your standards specifications, Gudebrod can suggest tapes for high or low temperature use, for fungistatic qualities, for burnproof features, for vacuum use, as well as for material specifications and for tensile strength. The more than 200 types of flat tape in the Gudebrod line are specially designed, not only to meet various specifications but to facilitate the tying operation. Production quantities of tape especially for your use can be made if necessary. With this intimate knowledge of lacing tape, the recommendations contained in the Gudebrod Consultant's Report will help your Standards Engineer—to improve your product and to save money.

METHODS

In designing lacing tapes to meet various specifications, the Gudebrod research and de-

velopment operations have kept in mind the basic idea of producing tapes that "tie themselves." The originator of the flat braided tape which did so much to improve wire harnessing and at the same time tremendously increase the safety factor for workers, Gudebrod continues to pioneer in the use of better materials, and in a closer regard for specifications. Taking advantage of the "tie-ability" of Gudebrod tapes is important to your Methods Engineer. The recommendations contained in the Gudebrod Consultant's Report will help your Methods Engineer to improve your product and save money.

PRODUCTION

Implementing the requirements of the Specifications and Methods Engineers in economical operation is the problem of the Production Engineer. Gudebrod can show how to use the Cable-Lacer, how to take advantage of dispensing packages, cut lengths, special rigs and other labor speeding and easing means. Whether your harness work is custom or production there are ways of improving your operations that may not have occurred to you—that's why the recommendations contained in the Gudebrod Consultant's Report will help your Production Engineer—in improving your product—in saving money.

SURVEY AND CONSULTANT'S REPORT —FREE

Here is all you have to do—write or phone Gudebrod. At your convenience a Gudebrod representative will complete a survey working with your Standards, Methods and Production Engineers. This will be reviewed by engineers at the Gudebrod Home Office. Written recommendations will be prepared and sent to you. There will be absolutely no cost or obligation. Why not get your Consultant's Report under way—get in touch with Gudebrod today.



UDEBROD BROS. SILK CO., INC.

FOUNDED IN 1870



Electronics Division

12 SOUTH 12th STREET, PHILADELPHIA, PENNSYLVANIA 19107

Area Code 215, WA 2-1122

Circle 13 on reader service card

New from Fairchild... a dual beam scope with unmatched sensitivity



*Technological Obsolescence

High gain extends dual beam measurement capabilities without time sharing.

For low signal level work requiring a dual beam display without time sharing the new Fairchild Type 708A provides sensitivity of $10 \mu\text{v}/\text{cm}$ —an order of magnitude higher than any other commercial dual beam scope. In electromedical research, transducer or servo work, and in many other applications this unmatched sensitivity permits analysis of signals without external preamplification.

Other electrical features of the Type 708A include DC to 500 kc band-width (down 3db), risetime of 700 ns, a high resolution CRT driven by transistorized amplifiers and six modes of operation for each beam.

Physically, too, the 708A is unique. Its universal bench and rack mount packages this scope in just 7" of vertical rack space. For convenience all controls are mounted on the front panel. Numerous accessories are available. **Price of the Type 708A, including CRT filter: \$995.**

Your Fairchild Field Engineer will be glad to supply complete data on the new 708A. Or write Fairchild Scientific Instrument Dept., 750 Bloomfield Ave., Clifton, N. J.

FAIRCHILD

DU MONT LABORATORIES
SCIENTIFIC INSTRUMENT DEPARTMENT

1. Two separate computer pulse trains displayed on one time base.
2. Dual beam presentation of low noise factor of 708A indicate usability at $10 \mu\text{v}/\text{div}$ sensitivity. One beam with narrow and one with full bandpass.
3. Electrocardiogram (EKG) waveform using the 708A's very low noise factor, high gain amplifiers.

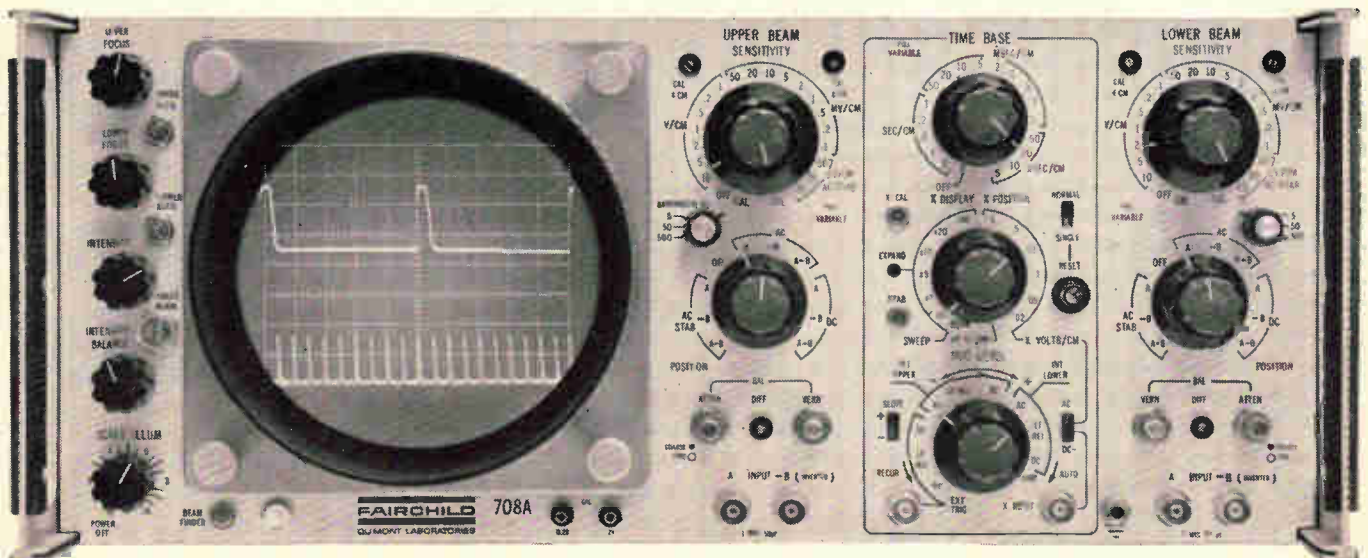

Editorial

Bright, exciting future

The electronics industry stands on the threshold of a fabulous and exciting future that no other endeavor can hope to match.

Electronics equipment—and electronics engineers—will change the nature of civilization. They will automate man's labor; they will extend his life and educate his children; they will control his travel; they will predict his weather and control it; they will supply him with an even greater variety of entertainment. Electronics as a technology is moving into every aspect of man's activity. Soon one will not be able even to define "electronics" because it will be so encompassing.

These are a few of the predictions that industry leaders made for Electronics as the magazine celebrates its 35th anniversary with this issue. Thirteen leaders of industry, science and technology have tried to look ahead (pages 106 to 126). Their predictions have one factor in common: all are grandly optimistic and supremely confident.

In April 1930, scientists and engineers were also supremely confident about the future, even though the depression was beginning and short-range economic prospects were dismal. Radio, which was almost all there was of electronics, faced stiff competition from the talking motion picture.

Today's industry too has some short-run economic problems. The leveling off of military spending and the shifting of military procurement to new areas has hurt a lot of suppliers, and has put many engineers out of work.

But the predictions in this issue clearly indicate that the industry has the potential to overcome these difficulties and leave them behind as an insignificant pulse in the history of elec-

tronics. In the thirties, the industry laid the groundwork for the development of a fabulous consumer device: television. World War II delayed its exploitation; but the postwar world took to television as to no other appliance in history.

The war itself and the subsequent splurge for defense spurred the development of a new segment of technology: radar, navigation, aircraft fire control, countermeasures, and finally missile control. Probably the industry will never again see such a demand for military products, although space exploration may take up some of the slack. But the brightest potential lies in the industrial, commercial, and consumer areas. What is needed, of course, are some truly imaginative new products. RCA's David Sarnoff offers a way to decide whether your product meets that demand. "Ask yourself," he says, "Is there anything that can do the same thing as well or better?" If not, you have a winner.

The predictions of this issue stake out some clear areas, for investigation, and not all of them are blue-sky. For example, Dr. Daniel Noble sees the development of flat television screens impeded badly by the need for a new scanning system. Dr. T. H. Maiman points out that many laser applications are waiting for a great improvement in efficiency of the light emitters. And Dr. Henri Busignies worries that television's use will be slowed by the paucity of wideband carriers.

Two estimates are repeated again and again: the future of electronics lies with the integrated circuit and the computer.

Achieving the levels described in this issue will not be easy. It will take a major change in management philosophy, so that companies become more aggressive, more alert and more receptive to new ideas. It will take a change among engineers, who will have to be more imaginative, more creative and more willing to learn about advanced technology. Too many engineers slammed the door on formal learning when they were handed their college diplomas.

For the past 35 years, Electronics magazine has observed and reported the most exciting technological happenings in history. According to the experts, though, we haven't seen anything yet. The most interesting, most important, and most exciting developments are yet to come. We expect to report them too.

The Remarkable New Line of Clifton MOTORS and TACHOMETERS is important to YOU!

SERVO MOTORS



TEMPERATURE COMPENSATED MOTOR TACH



MOTOR TACHOMETERS

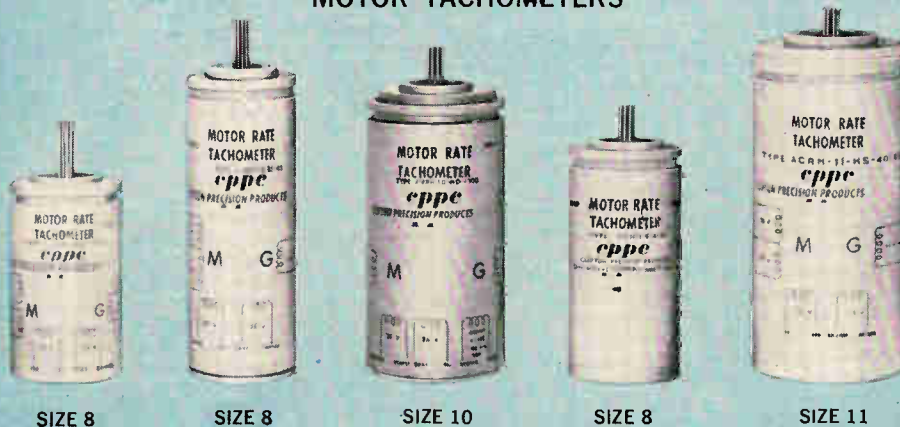

In this new line of motors and tachometers, Clifton has overcome to a significant degree, many limitations inherent in current servo motor designs.

For instance, the incompatibility of efficiency and a linear speed torque curve plagues servo motor users. We have designed a motor which will minimize this conflict. Efficiency has been improved by factors as large as 40% at no expense to speed torque linearity. Thus Clifton motors can give you: more torque for the same power input or same torque with less power consumption; better theoretical acceleration; a cooler more reliable motor with high capacity for being "over-driven" if necessary. These improvements have been achieved without degeneration of air gap or single phasing considerations.

Response time is another important area of improvement in our motors. Certain of our units are specially designed to reduce inertia and increase torque, thereby offering: decreased dead zone, increased slew rate, reduced velocity error.

A further refinement in our servo motors is: lower and more uniform starting voltages with levels as low as 1% of control phase voltage. This, of course, increases the dynamic range of a servo system.

In addition, our servo motors and tachometers are using less heat vulnerable materials such as: improved high temperature resistant magnetic wire; improved lubricant;

improved slot insulation; welded leads; flanged and shielded bearings; glass to metal seals, and high temperature resistant impregnation. As a result our motors can withstand temperatures considerably above the standard 125°C.

Motor Rate Tachometers

Because of the improved torque to inertia designs mentioned previously, no generator is necessary in situations where inherent self damping is sufficient. Smaller generators with less output, less length and less power consumption can now be used when needed. Synchro length *full drag cup* motor tachometers are now possible—a great saving in size and weight over the present long, heavy units.

In addition to a wide variety of off-the-shelf units, we custom design servo motors and tachometers with special requirements of torque, inertia, and temperature resistance. We are eager to serve your standard or custom needs. Clifton Precision Products, Division of Litton Industries, Clifton Heights, Pa., and Colorado Springs, Colo.

cppe

CLIFTON
PRECISION PRODUCTS
DIVISION OF LITTON INDUSTRIES



Electronics Newsletter

April 19, 1965

Kilowatt laser forecast for '66

An advance in laser technology may lead to continuous-wave output near the 100-watt range this year and near the kilowatt level by next year. The trick is rapid heat dissipation, made possible by the development of new tubes constructed of layers of metal and quartz.

Tubes made from quartz or Pyrex alone dissipate heat poorly; in the new tubes, copper, molybdenum or tungsten is used for the inner layer. This technique doesn't solve the problem of overheated mirrors.

Cryoelectric computer at GE

Researchers at the General Electric Co.'s computer laboratory in Sunnyvale, Calif., indicate that the company is well on its way to developing a practical cryoelectric computer built of cryotrons and other superconducting devices.

"Despite published pessimism to the contrary, cryoelectric devices promise to be among the first true batch-fabricated devices to be used in digital computer," said John W. Bremer, manager of cryotron systems at the lab, during an IEEE symposium in Los Angeles. Bremer said that present cryotron logic speeds of 5 to 10 megacycles are competitive and that the cost per logic circuit will be low. He added that 5,000 logic gates can be made at a single time, using thin-film techniques.

Bremer expects cryoelectric computers to evolve as parallel processors built of many functional units.

Autonetics orders \$15 million in IC's

The Autonetics division of North American Aviation, Inc. has placed \$15 million worth of orders for integrated circuits with four manufacturers. The circuits will be used in the production of inertial guidance, digital computer, flight control and ground support equipment for Minuteman II. Texas Instruments Incorporated will be the chief supplier; at \$9,875,649, its share was the largest single order for monolithic integrated circuits ever received. The other awards: the Westinghouse Electric Corp., \$3,787,900; the Radio Corp. of America, \$1,300,920; and the General Electric Co., \$153,042.

Avionics concerns seek Boeing order

Avionics companies are scrambling for a share of the Boeing Co.'s \$600-million order from United Air Lines, Inc., for the model 737 jetliner. Sources close to Boeing say it doesn't want to be committed to its usual suppliers. Boeing is also said to be considering new avionics systems for the craft.

Delay line amplifies, too

A solid state delay line, developed at the Sperry Rand Corp.'s research center at Sudbury, Mass., gives signal amplification as well as a variable time delay. The device, made of yttrium iron garnet, operates at X-band frequencies. A 35-decibel gain generated in a half-inch-long YIG delay line required liquid helium temperatures of about 2° Kelvin. The researchers say that "significant gain" has also been attained at higher, liquid nitrogen temperatures.

Attenuation of signals by delay lines has been a drawback in radar and electronic countermeasure systems.

Electronics Newsletter

F-111 electronics may be pooled

The General Dynamics Corp., prime contractor for the F-111 fighter-bomber, may buy all the electronics equipment for the craft under a blanket contract. **The company is reportedly considering a plan to pool requirements so that all 19 subcontractors would purchase basic electronic components from the same four or five manufacturers.**

Last week, the Pentagon awarded the company its first production contract, totaling \$1.5 billion, for 431 Navy and Air Force craft.

Thin film limiters challenge ferrites

Microwave limiters and circulators made from magnetic thin films may be on the market within two or three years, competing with the solid ferrite types now in common use. Studies of permalloy films at microwave frequencies conducted at France's National Center of Scientific Research have shown such promise that Lignes Telegraphiques et Telephoniques has indicated interest in making commercial products, according to A. J. Berteaud, an official at the center's Laboratory of Magnetism and Solid State Physics.

Limiting action has been achieved at frequencies of 10 and 35 gigacycles in thin films deposited on glass substrates. Maximum power of 4 kilowatts was used, and limiting action began at a level of 0.1 kilowatts.

The most interesting characteristic of the thin film limiter, says Berteaud, is that its response time is much faster than ferrite types, so it can be used to protect delicate semiconductors.

France withdraws ELDO objections

France has withdrawn her objections to the ELDO-A satellite launch program, clearing the way for development of the three-stage rocket. ELDO, which stands for European Launcher Development Organization, plans to orbit a 2,800-pound satellite into a 300-mile circular orbit by 1967.

French firm has bright color tube

Compagnie Francaise de Television has been pushing the Secam method of color tv transmission but it has a new color tube for home receivers that will operate any system and, the company says, is four times brighter than the shadow mask tubes normally employed.

CFT says that because its tube requires only low-voltage circuitry, it will cut the cost of color receivers substantially. The tube achieves its brightness by increasing to 90% the number of usable electrons from the three cathode ray guns. Special electrodes on the outside of the tube diverge the electrons when they are moving comparatively slowly; other color tubes diverge them at high speed.

The company said the tube is nearly ready for production.

Addenda

About half a dozen electronic desk calculators being developed or ready to hit the market are being designed with integrated circuits; the calculators will represent the first large-scale commercial use of IC's, outside the computer industry. . . . After several failures, the Bunker-Ramo Corp. finally succeeded in installing the nils-deep electronic oceanographic array at the Navy's Autec site off the Bahamas. . . . Siemens & Halske A.G. of West Germany has ordered 26 Radio Corp. of America Spectra 70 computer systems at a cost of more than \$9 million; this is the first major order for the series.

IDEAS

from SYLVANIA Electronic Components Group

RECEIVING TUBES

Improved color TV performance using one less tube



Color television set designers can now reduce costs and components while improving performance in one simple step. This is due to a new circuit design which, with a Sylvania Type 9KC6 tube, can do triple duty—as a chroma bandpass circuit, a burst amplifier circuit and a color killer circuit.

Previously, TV color circuitry called for either two stages of chroma amplification, or one stage of luminance plus one stage of chroma. These are being obsoleted by the newer method.

The Sylvania 9KC6 bandpass circuit provides chroma output comparable to previously used circuits, plus burst signals slightly higher than those obtained with previously used circuits. This performance is obtained with an input signal directly from the video detector.

In addition, automatic chroma gain bias can readily be added to the control grid. This is not easily accomplished in all other circuits. The

second control grid which provides color killer action can also be used as a more economical method for controlling chroma gain.

The Sylvania Type 9KC6 dual grid controlled pentode, featuring a frame grid first control grid, was designed for application in chroma bandpass, burst amplifier and color killer circuits. The circuit shown here is unique in its use of the second control grid. This grid switches plate current on to supply a chroma signal to the color demodulators during color reception. During monochrome reception, the second control grid turns the plate current off and gates the screen current on in coincidence with a burst signal. The amplified burst signal is removed from the screen by means of a tuned circuit.

CIRCLE NUMBER 300

in capsule

Diodes—new high conductance all-purpose series, with special advantages for computer designs.

Integrated Circuits—the widest range of logic for the widest range of applications.

Cathode Ray Tubes—a new double-deflection 19" CRT increases console display density.

Microwave Diodes—why GaAs varactors are ideal for harmonic generation.

Readouts—planar display tubes for 5/8" to 2 1/2" character sizes.

Transistors—new 200 mw low-noise devices for a range of high-frequency applications.

CHROMA BANDPASS, BURST SAMPLING AND COLOR KILLER CIRCUIT

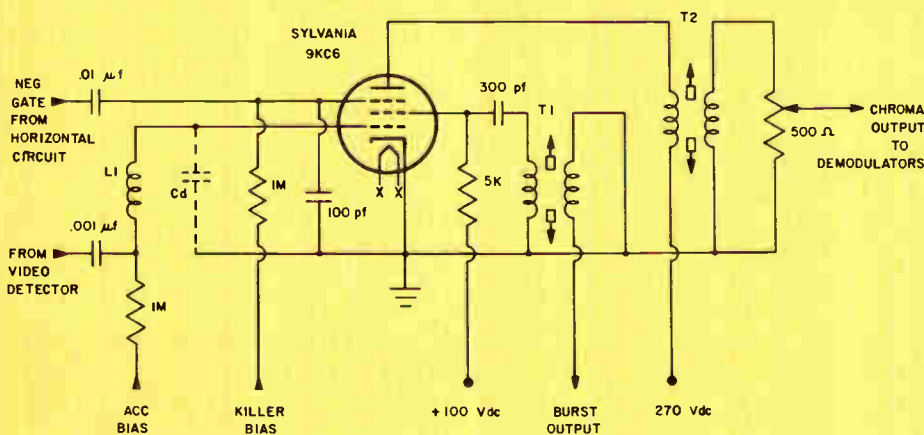

How readout character size relates to viewing distance

The variety of sizes and configurations in Sylvania's growing line of planar display tubes is meeting requirements ranging from laboratory instruments to large status control boards. Within the range of the alphabetical and numerical characters available, there is a type to fulfill virtually any need.

Traditionally, planar gas-glow tubes readout in a brilliant orange, their natural color. This color is often favored because of the eye's acuity to bright orange under conditions of high ambient light. On special order, Sylvania will supply these devices in glass envelopes especially processed to display yellow or ruby red characters.

Antireflection tube coatings are also available.

All readout tubes in the Sylvania line are single plane designs of the DC-operated, cold cathode type. The individual segments which form the characters are physically located on an insulating substrate; this is positioned behind a common anode of open screen mesh. With characters of this type, the confusing crisscross of overlay wires, common to older readout devices, is eliminated.

Life expectancy, one of the many strong points of planar gas-glow readout tubes, is in the order of tens-of-thousands of hours. Brightness is consistent throughout this long life.

CIRCLE NUMBER 301

PLANAR DISPLAY TUBES

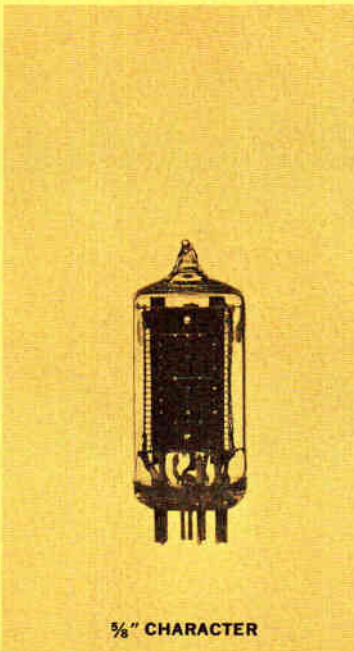

5/8" CHARACTER

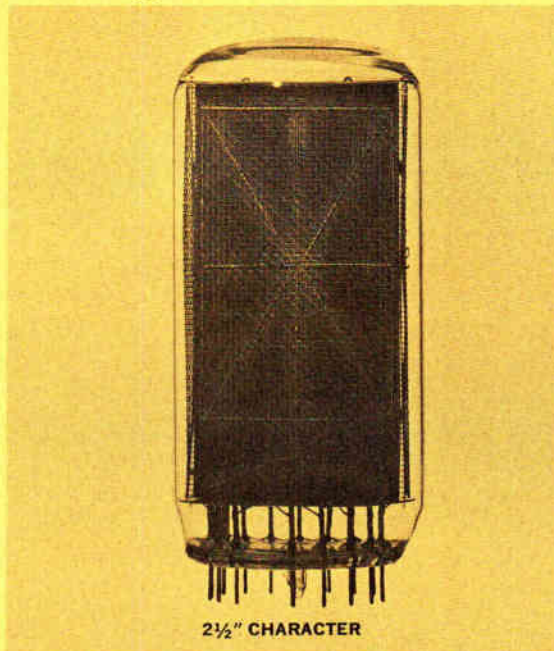

2 1/2" CHARACTER

SPECIFICATIONS

RATINGS AND CHARACTERISTICS				
Minimum Anode Voltage				170 Volts DC
Switching Voltage				50 Volts DC
Light Output				200 Foot Lamberts
Viewing Angle				150 Degrees
Color				Orange
SYLVANIA TYPE	CHARACTER HEIGHT (Inches)	NUMBER OF SEGMENTS	MAXIMUM ANODE CURRENT (Ma)	VIEWING DISTANCE (Feet)
NUMERICS				
SY62N	5/8	8	8	25
SY125N	1 1/4	11	12	40
SY175N	1 3/4	11	15	50
SY250N	2 1/2	11	20	100
ALPHANUMERICS				
SY125A	1 1/4	14	12	40
SY175A	1 3/4	14	15	50
SY250A	2 1/2	14	20	100



LITERATURE CHECK LIST. For copies of Sylvania publications listed here, circle indicated number on Reader Service card.

Sylvania Integrated Circuits—description of Sylvania's Universal High-level Logic line; contains circuit and logic diagrams, characteristics curves, typical specifications, etc. (SM-2945). **Circle number 307.**

Sylvania Counter Tube Handbook—describes operating principles, circuit design practices, and typical applications (ET-3911). **Circle number 308.**

Guide to Sylvania Industrial & Military Cathode Ray Tubes—typical specifications for Sylvania's complete line of oscilloscopes, radar indicators, video recorders, industrial monitors, receiver check tubes and flying spot scanners (ET-3914). **Circle number 309.**

Electron Tube Application Notes—designer's guide to the Do's and Don't's of electron receiving tube applications (ET-3907). **Circle number 310.**

Low-Noise Mixer Diodes—describes Sylvania's line of microwave mixer diodes, gives electrical and mechanical information with curves and packaging data (SM-2948). **Circle number 311.**

Sylvania 300mw T-4 Photoconductors—summary data including general features and technical characteristics of T-4 cadmium-sulfide photoconductors (ET-2953). **Circle number 312.**

25" Rectangular Color TV Picture Tube, Tentative Engineering Data—characteristics and ratings of Sylvania's new 25" rectangular color bright 85™ picture tube (ET-2951). **Circle number 313.**

Tunnel Diodes Measurements Technical Report—technical information about Sylvania's Tunnel Diode line (SM-2960). **Circle number 314.**

2N2784 Micropower Transistor—contains electrical characteristics, typical curves and life test data for the Sylvania 2N2784 transistor (SM-2943). **Circle number 315.**

Silicon Varactors—describes Sylvania's D4800 series of silicon varactors (ET-2984). **Circle number 316.**

NPN Germanium Alloy Transistors—oval-shaped units for high stacking density; describes 8 typical circuits (SM-3929). **Circle number 317.**

Phosphor Characteristics for Cathode Ray Tubes—provides phosphor reference data, screen data, persistence and decay characteristics, spectral energy distribution curves, and other characteristics of CRT phosphors (ET-3952A). **Circle number 318.**

New high conductance series for tomorrow's computer designs

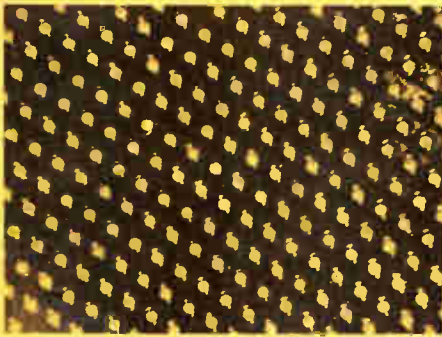

Alloy junctions during batch processing

shows a current leakage of 25 nanoamps, the D-6625 measures 5 na and the D-6625A just 1 na. At 150°C, with the same 175V reverse voltage, the new Sylvania types show 2 μ a and 1 μ a respectively, compared with 5 μ a in the 1N459A. Similar improvements are evident in the D-6623 and D-6624 series.

But these are not computer diodes

only! The three new series are actually high-temperature, high-conductance, general-purpose devices. As a result of a new protected junction, these diodes show excellent stability in relation to time, as well as extremely low leakage currents. And because of Sylvania's new improved batch processing, there is a high degree of uniformity from product to product.

CIRCLE NUMBER 302

A new silicon-alloy diode series offers a greatly improved combination of features of special interest to designers of industrial and military computers. For example, one of these, Sylvania's D-6625, surpasses the standard 1N459A in several vital respects, rendering it obsolete for several applications.

Especially significant to the computer industry is the new device's ultra-low leakage current. At a reverse voltage of 175V, where the 1N459A

PERFORMANCE COMPARISONS			
BV_r V_f @ 100 ma I_r @ V_r 60V I_r (150°C) V_r 60V	1N457A	D-6623	D-6623A
	@ 100 μ a >70V	@ 10 μ a >70V	@ 10 μ a >70V
	<1.0V	<1.0V	<1.0V
	25 na	5 na	1 na
	5 μ a	2 μ a	1 μ a
BV_r V_f @ 100 ma I_r @ 125V I_r (150°C) @ 125V	1N458A	D-6624	D-6624A
	@ 100 μ a >150V	@ 10 μ a >150V	@ 10 μ a >150V
	<1.0V	<1.0V	<1.0V
	25 na	5 na	1 na
	5 μ a	2 μ a	1 μ a
BV_r V_f I_r @ V_r 175V I_r (150°C) @ V_r 175V	1N459A	D-6625	D-6625A
	@ 100 μ a >200V	@ 10 μ a >200V	@ 10 μ a >200V
	<1.0V	<1.0V	<1.0V
	25 na	5 na	1 na
	5 μ a	2 μ a	1 μ a

INTEGRATED CIRCUITS

Your status report on a complete line

The sixteen circuits shown here add up to the most complete integrated logic circuit line available today. "Complete" not just because of total numbers, but because of the special advantages of SUHL—Sylvania Universal High-level Logic.

With its newly expanded SUHL line now totaling 16 families, Sylvania offers the widest range of logic for the widest range of applications.

A major SUHL advantage is its inherent flexibility which allows it to be designed into a diversity of situations. This versatility is the result of SUHL's own special characteristics: high fan-out and fan-in, high speed, high noise immunity and high capacitance drive. Other features include low power capacitance, TTL input geometries, and optimum pin connections.

The newest SUHL circuits are the SG-50 and SG-150 series, a Quad OR gate and a Quad 2-Input OR Expander. With these two circuits, you

can OR up to eight levels without loss of fan-out using just two flat packs. OR-ing with SUHL logic is accomplished without an increase in power supply requirements.

As a part of a continuing program

of product upgrading, several of these 16 basic circuits show small, but important, style changes added in recent weeks to existing products.

FOR A LOOK AT THE COMPLETE LINE, TURN PAGE.

CIRCLE NUMBER 303

FUNCTION	SYLVANIA'S COMPLETE LINE OF DIGITAL INTEGRATED CIRCUITS			
	MILITARY -55°C to 125°C		GROUND SYSTEM AND INDUSTRIAL 0°C to 75°C	
	MP* FO 15	MS* FO 7	IP* FO 12	IS* FO 6
Dual 4-Input Nand/Nor Gate	SG-40	SG-41	SG-42	SG-43
Expandable Quad 2-Input OR Gate	SG-50	SG-51	SG-52	SG-53
Single 8-Input Nand/Nor Gate	SG-60	SG-61	SG-62	SG-63
Exclusive—OR with Complement	SG-90	SG-91	SG-92	SG-93
Expandable Triple 3-Input OR Gate	SG-100	SG-101	SG-102	SG-103
Expandable Dual 4-Input OR Gate	SG-110	SG-111	SG-112	SG-113
Expandable Single 8-Input Nand/Nor Gate	SG-120	SG-121	SG-122	SG-123
Line Driver (Double Fan-out Minimums)	SG-130	SG-131	SG-132	SG-133
Quad 2-Input Nand/Nor Gate	SG-140	SG-141	SG-142	SG-143
Quad 2-Input OR Expander	SG-150	SG-151	SG-152	SG-153
Dual 4-Input OR Expander	SG-170	SG-171	SG-172	SG-173
Dual 4-Input AND Expander	SG-180	SG-181	SG-182	SG-183
Set-Reset Flip-Flop	SF-10	SF-11	SF-12	SF-13
Two-Phase SR Clocked Flip-Flop	SF-20	SF-21	SF-22	SF-23
Single-Phase SRT Flip-Flop	SF-30	SF-31	SF-32	SF-33
J-K Flip-Flop	SF-50	SF-51	SF-52	SF-53

*MP—Military Prime, MS—Military Standard, IP—Industrial Prime, IS—Industrial Standard

This is SUHL*...the total logic line

*Sylvania Universal High-level Logic

DUAL 4-INPUT NAND/NOR GATE

SG-40
SG-41
SG-42
SG-43

(+) LOGIC
 $L = \overline{A \cdot B \cdot C \cdot D}$
 $K = \overline{E \cdot F \cdot G \cdot I}$

(-) LOGIC
 $L = \overline{A + B + C + D}$
 $K = \overline{E + F + G + I}$

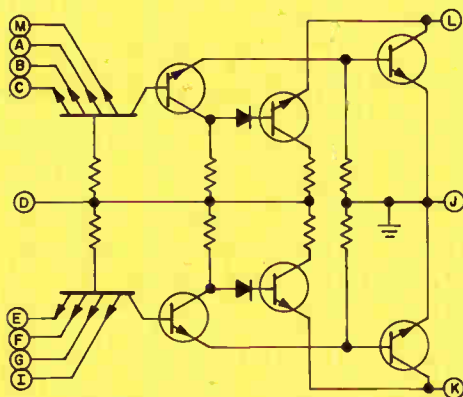

EXPANDABLE TRIPLE 3-INPUT OR GATE

SG-100
SG-101
SG-102
SG-103

(+) LOGIC
 $L = (A \cdot B \cdot C) + (E \cdot F \cdot G) + (H \cdot I \cdot K) + \dots$

(-) LOGIC
 $L = \overline{(A/B/C) \cdot (E/F/G) \cdot (H/I/K) \dots}$

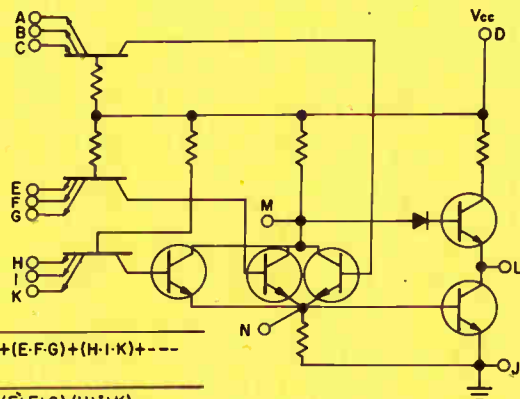

EXPANDABLE QUAD 2-INPUT OR GATE

SG-50
SG-51
SG-52
SG-53

(+) LOGIC
 $K = \overline{A \cdot N + C \cdot B + E \cdot F + G \cdot H \cdot I}$

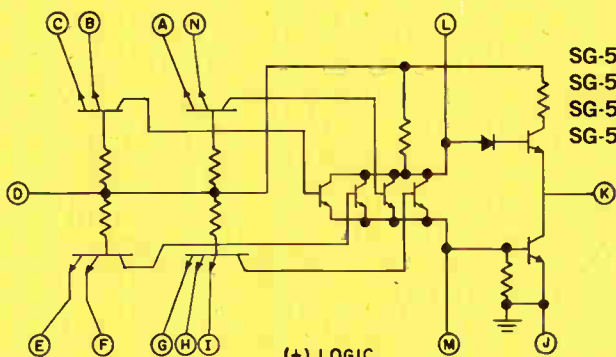

EXPANDABLE DUAL 4-INPUT OR GATE

SG-110
SG-111
SG-112
SG-113

(+) LOGIC
 $L = (A \cdot B \cdot C \cdot N) + (E \cdot F \cdot G \cdot H) + \dots$

(-) LOGIC
 $L = \overline{(A + B + C + N) \cdot (E + F + G + H) \dots}$

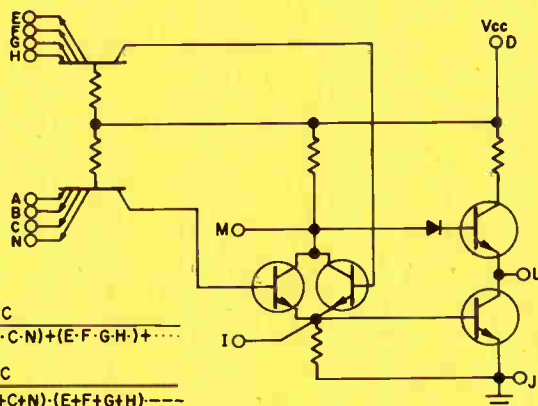

SINGLE 8-INPUT NAND/NOR GATE

SG-60
SG-61
SG-62
SG-63

(+) LOGIC
 $L = \overline{A \cdot B \cdot C \cdot D \cdot E \cdot F \cdot G \cdot I}$

(-) LOGIC
 $L = \overline{A + B + C + D + E + F + G + I}$

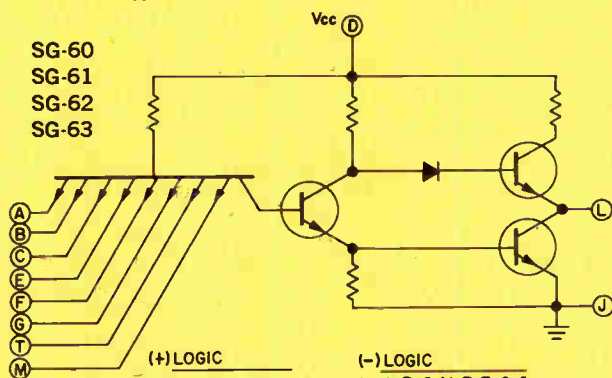

EXPANDABLE SINGLE 8-INPUT NAND/NOR GATE

SG-120
SG-121
SG-122
SG-123

(+) LOGIC
 $L = \overline{A \cdot B \cdot C \cdot D \cdot E \cdot F \cdot G \cdot H \cdot N \dots}$

(-) LOGIC
 $L = \overline{A + B + C + D + E + F + G + H + N \dots}$

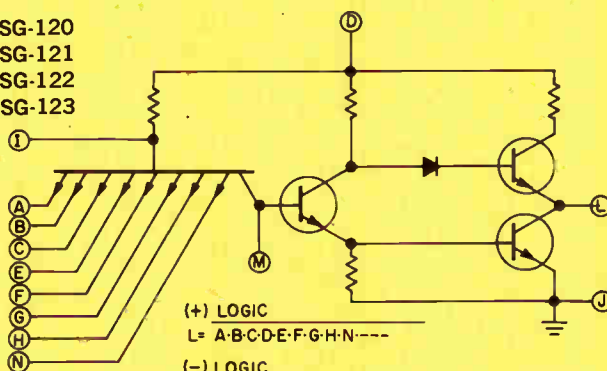

EXCLUSIVE - OR WITH COMPLEMENT

SG-90
SG-91
SG-92
SG-93

(+) LOGIC
 $K = \overline{(A \cdot B \cdot C) + (E \cdot F \cdot G)}$
 $L = \overline{(K \cdot M \cdot N)}$
 $L = \overline{A \cdot B \cdot C + E \cdot F \cdot G + \bar{M} + \bar{N}}$

(-) LOGIC
 $K = \overline{(A + B + C) \cdot (E + F + G)}$
 $L = \overline{(K + M + N)}$
 $L = \overline{(A + B + C) \cdot (E + F + G) \cdot \bar{M} \cdot \bar{N}}$

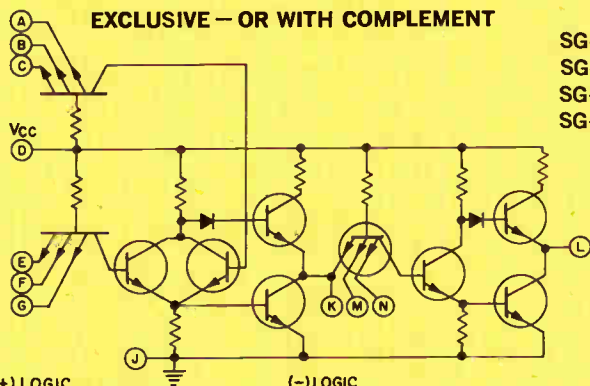

LINE DRIVER

SG-130
SG-131
SG-132
SG-133

(+) LOGIC
 $K = \overline{E \cdot F}$

(-) LOGIC
 $K = \overline{E + F}$

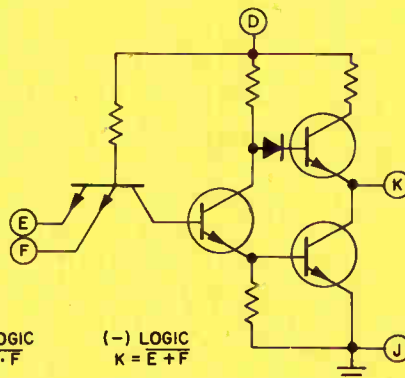

QUAD 2-INPUT NAND/NOR GATE

SG-140
SG-141
SG-142
SG-143

(+) LOGIC
C = A·B
G = E·F
K = H·I
N = L·M

(-) LOGIC
- C = A+B
- G = E+F
- K = H+I
- N = L+M

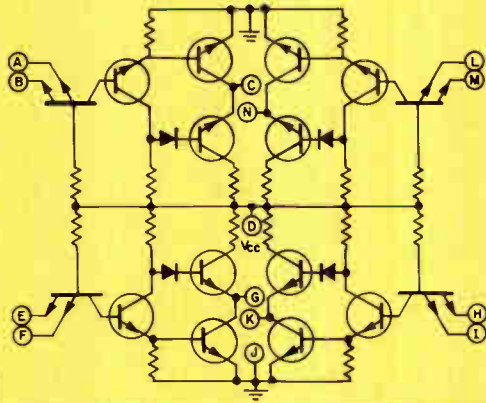

SET-RESET FLIP-FLOP

SF-10
SF-11
SF-12
SF-13

(+) LOGIC

$$L = \bar{B} + \bar{C} + \bar{M} + \bar{K}$$

$$K = \bar{E} + \bar{F} + \bar{I} + \bar{L}$$

(-) LOGIC

$$L = \bar{B} \cdot \bar{C} \cdot \bar{M} \cdot \bar{K}$$

$$K = \bar{E} \cdot \bar{F} \cdot \bar{I} \cdot \bar{L}$$

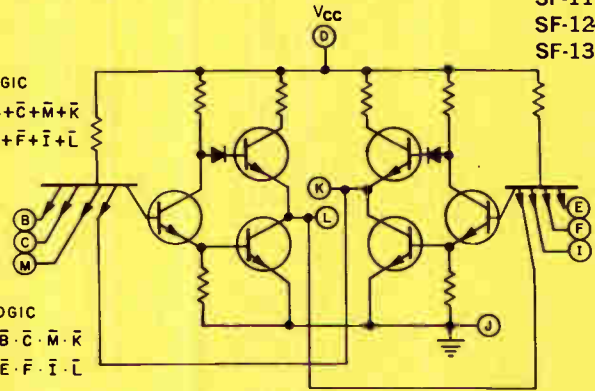

QUAD 2-INPUT OR EXPANDER

SG-150
SG-151
SG-152
SG-153

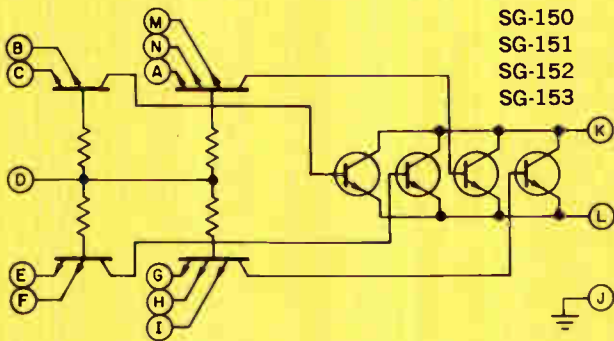

TWO-PHASE SR CLOCKED FLIP-FLOP

SF-20
SF-21
SF-22
SF-23

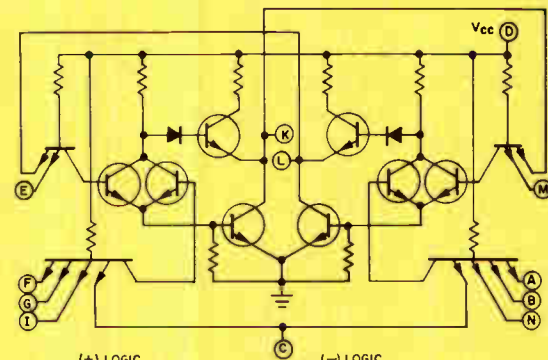

(+) LOGIC

$$K = (F + G + I + C) \cdot (M + L)$$

$$L = (A + B + N + C) \cdot (E + K)$$

(-) LOGIC

$$K = (F \cdot G \cdot I \cdot C) + (M \cdot L)$$

$$L = (A \cdot B \cdot N \cdot C) + (E \cdot K)$$

DUAL 4-INPUT OR EXPANDER

SG-170
SG-171
SG-172
SG-173

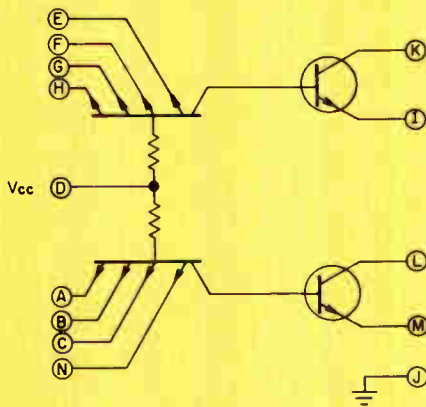

SINGLE-PHASE SRT TRIGGERED FLIP-FLOP

SF-30
SF-31
SF-32
SF-33

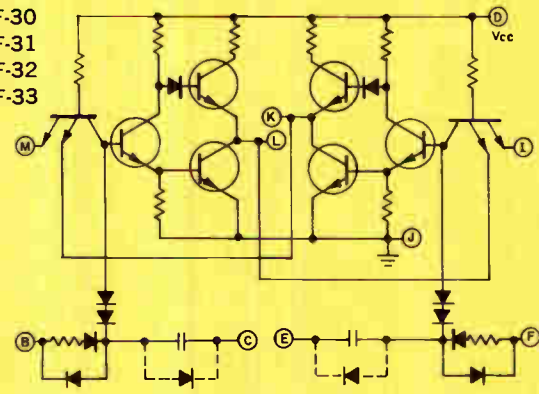

DUAL 4-INPUT AND EXPANDER

SG-180
SG-181
SG-182
SG-183

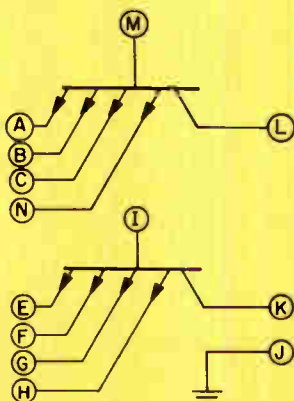

J-K FLIP-FLOP

SF-50
SF-51
SF-52
SF-53

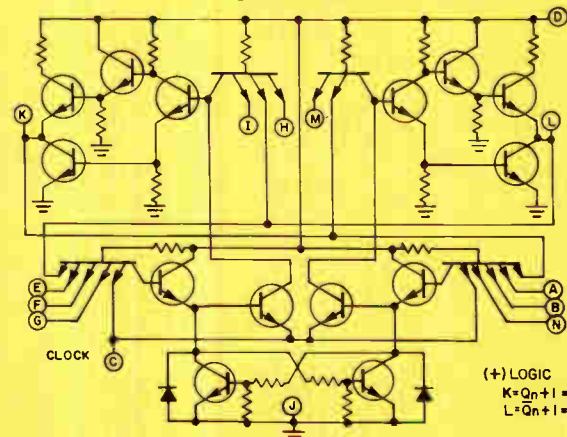

(+) LOGIC

$$K = Q_n + I = J \cdot Q_n + K \cdot Q_n$$

$$L = Q_n + I = J \cdot Q_n + K \cdot Q_n$$

Why you should use GaAs varactors for harmonic generation

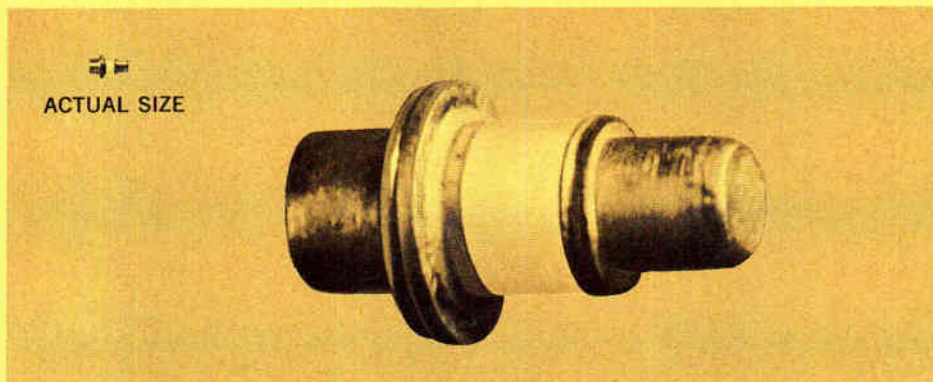

Where frequency generation above 3 Gc is your concern, the newest gallium arsenide varactors should be the obvious choice. The inherent superiority of Sylvania's new varactor series is clearly evident in the cut-off frequency vs. breakdown voltage capability curve shown here.

The further facts are these: (1) the best commercially available silicon varactor with a 30-volt breakdown is rated at approximately 160 Gc; (2) a 30-volt gallium arsenide device has a capability exceeding 300 Gc.

Three ranges of breakdown voltage

are available with cut-off frequencies from 250 to 350 Gc. These units have proven their capability to deliver over 100 mw of output power at 35 Gc.

The Sylvania D-5240, D-5250 and D-5260 series are all epitaxial gallium arsenide units. They feature a bonded contact and are hermetically welded in a standard ceramic MCM package.

All units are temperature cycled to liquid nitrogen to insure mechanical strength. Both storage temperature and operating junction temperature are rated at 200°C max.

CIRCLE NUMBER 304

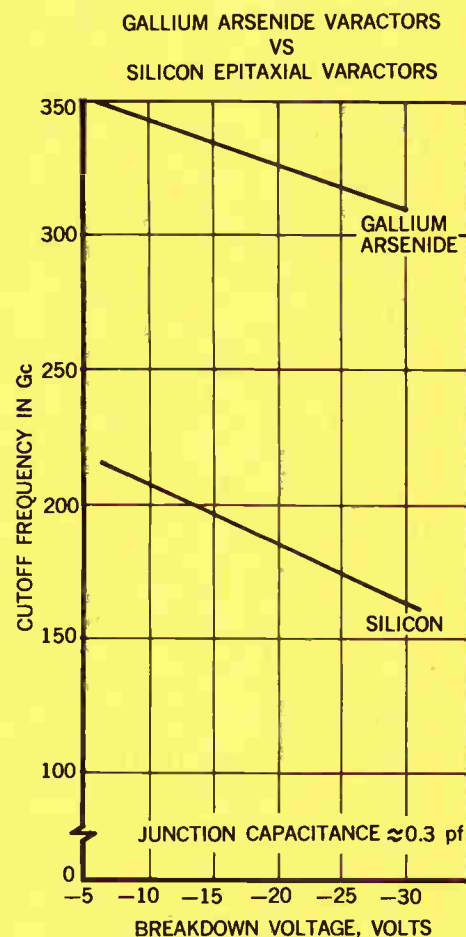

PRODUCT MANAGER'S CORNER—DIODES

Vendor certification, what it can mean to you

The time and cost your company devotes to incoming inspections can be virtually eliminated.

A strong claim such as this becomes a reality only if the vendor has both the intent *and full capability* of standing behind it. Sylvania does this with its Vendor Certification program.

One strong common goal shared by Sylvania and its customers is vital to everyone—*rule out defective components before they get into expensive equipment*. This is more than a joint interest. It's essential to you; it's essential to us.

Here's how you profit with Sylvania Vendor Certification. You save valuable in-plant inspection time. You save the cost of expensive equipment, plant space and inspection time. You

are assured of product reliability. You reduce warranty expenses.

Let's illustrate this by talking diodes for a moment. In determining your order, Sylvania and you work closely in defining your product parameters. From there, a set of tests is planned that will assure a technically perfect diode or rectifier to custom-fit your objectives. In working with experts whose specialty is diodes, you will know that *only* sensible evaluation tests will be performed. Costly tests that are technically invalid, or even superfluous, will be automatically eliminated.

Sylvania's team of experts follows the product from design and material selection, throughout assembly and virtually right into your doors. Syl-

vania's engineering depth in equipment design, materials, research and development, manufacturing and quality control assure the built-in quality that makes the difference: the quality that enables us to stand behind Sylvania Vendor Certification.



Don McKelvey
D. G. MCKELVEY

How to increase display density in your large screen console

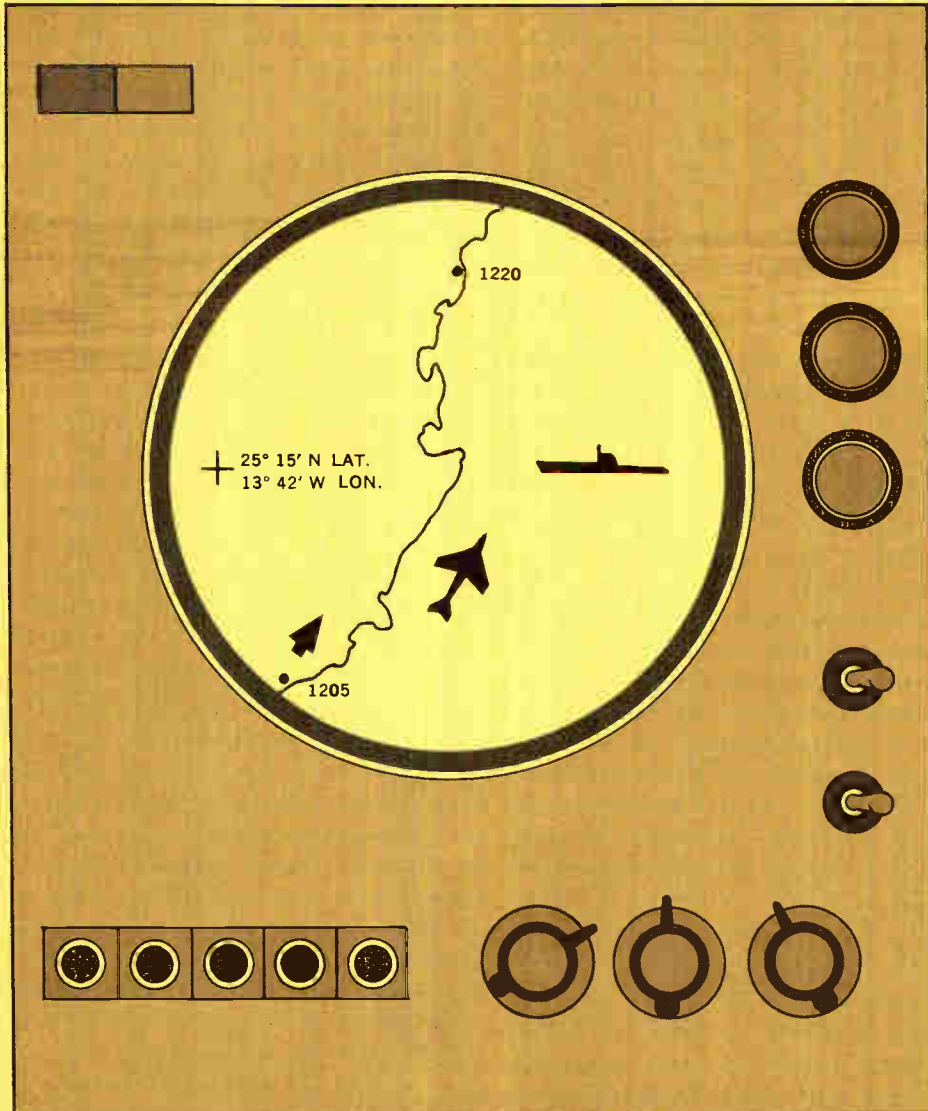

The most effective CRT display area ever offered for console use is now available from Sylvania. Stated in another way, the electrostatic-deflected 19" round SC-3895 can display more data with greater definition in a given display area. This is the result of the tube's high resolution, designed in by Sylvania engineering techniques using new, high-brightness phosphors.

Greater legibility and more consistent resolution are always evident in the SC-3895's display of alphas, numerics, or any other type of computer-produced display matter.

This 19" cathode ray tube does not stop at the basics of large display area, brightness and long life reliability. It represents a new stride in the state of the art of large screen console displays.

At the time of installation into the console, the tube takes a minimum of adjustment to produce an optimum picture. Still another important feature is this CRT's high writing rate of one million inches per second, the result of both electrostatic deflection and Sylvania custom engineering.

The same high standards of engineering that go into this tube are found in the production of other Sylvania CRT's for console display use. These include 10", 12" and 16" sizes as well.

CIRCLE NUMBER 305



HOT LINE INQUIRY SERVICE

Use Sylvania's "Hot Line" inquiry service, especially if you require full particulars on any item in a hurry. It's easy and it's free. Circle the reader service number(s) you're most interested in; then fill in your name, title, company and address. We'll do the rest and see you get further information almost by return mail.

BUSINESS REPLY MAIL

No Postage Stamp Necessary if Mailed in the United States

POSTAGE WILL BE PAID BY

SYLVANIA ELECTRONIC COMPONENTS GROUP

Sylvania Electric Products Inc.
1100 Main Street
Buffalo, New York 14209

Dept. 444

FIRST CLASS
Permit No. 2833
Buffalo, N.Y.



New 200mw low-noise devices to fill UHF void

CAPACITANCE vs REVERSE BIAS (2N918)

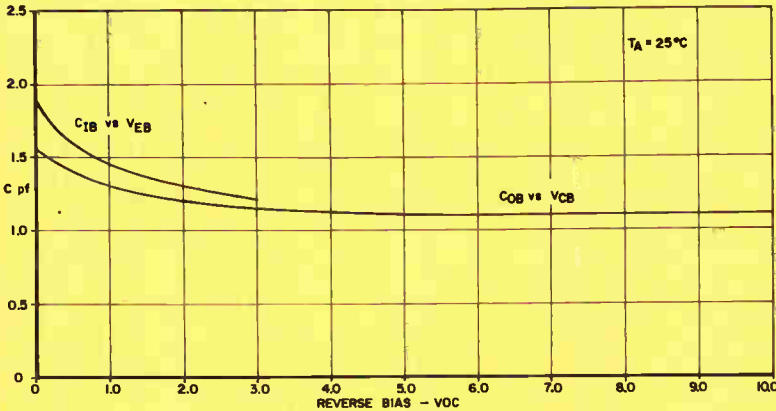

BETA vs COLLECTOR CURRENT (2N918)

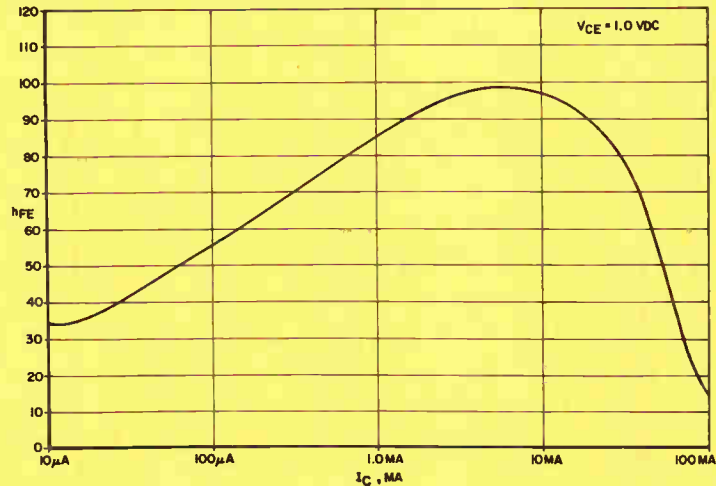

Until just recently there were no transistors suited to 500-megacycle range amplifier applications. The well-known 2N929 and 2N930 were useful in the 100 mc range but there was no transistor for higher frequency amplification and oscillator use.

Now two new silicon epitaxial passivated transistors are proving themselves in such high frequency applications as local oscillators, non-neutralized IF amplifiers and non-saturating switching circuits having rise and fall times of less than 3 nanoseconds. The new improved low-noise Sylvania 2N917 and 2N918 take over

where the 2N929 and 2N930 leave off. They are expressly designed for use at 500 mc and above, with up to 1.3 Gc coverage for maximum frequency of oscillation.

Several of the characteristics in these devices are truly outstanding. For instance, the 2N918's noise figure is a low 6.0 db. It has a high gain (of 90 @ $I_c = 3$ mils) and typical frequency response of 900 mc F_t . Excellent radiation resistance is also evidenced. The unit's absolute maximum ratings at 25°C include collector-to-base voltage of 30V, collector-to-emitter voltage of 15V, and junction

temperature measuring +200°C.

Sylvania supplies both of these UHF transistors in the standard TO-18 package with four leads and also in the hermetically sealed TO-51 coplanar outline with three leads.

ELECTRICAL CHARACTERISTICS AT 25°C

Collector Cutoff Current, I_{CBO} (@ $V_{CB} = 15V$)	10 na max.
Collector Base Breakdown Voltage, BV_{CBO}	30V min.
Collector Emitter Sustaining Voltage, BV_{CEO}	15V min.
D.C. Current Gain, h_{FE} (@ $I_c = 3.0$ ma)	20 min.
High Frequency Current Gain, h_{FE}	6.0 min.
Output Capacitance, C_{ob} (@ $V_{CB} = 10V$)	1.7 pf max.
Input Capacitance, C_{ib} (@ $V_{EB} = 0.5V$)	2.0 pf max.
Noise Figure, NF	6.0 db max.

CIRCLE NUMBER 306

SYLVANIA

SUBSIDIARY OF
GENERAL TELEPHONE & ELECTRONICS GTE

NEW CAPABILITIES IN: ELECTRONIC TUBES • SEMICONDUCTORS • MICROWAVE DEVICES • SPECIAL COMPONENTS • DISPLAY DEVICES

NAME _____

TITLE _____

COMPANY _____

ADDRESS _____

CITY _____ STATE _____

Circle Numbers Corresponding to Product Item

300	301	302	303	304	305	306	307
308	309	310	311	312	313	314	315
316	317	318					

Please have a Sales Engineer call



HOT LINE INQUIRY SERVICE

Need information in a hurry? Clip the card and mail it. Be sure to fill in all information requested. We'll rush you full particulars on any item indicated.

You can also get information using the publication's card elsewhere in this issue. Use of the card shown here will simplify handling and save time.

12:05



"Home for lunch" is just one of the facts of livability in North Carolina. And livability is just one of the reasons why North Carolina leads the Southeast in industrial growth. For *all* the reasons, write Governor Dan K. Moore in Raleigh (in confidence, of course).

GO NORTH CAROLINA
WHERE GOOD GOVERNMENT IS A HABIT



SUPRAMICA® 555 ceramoplastic coil forms for underseas cables

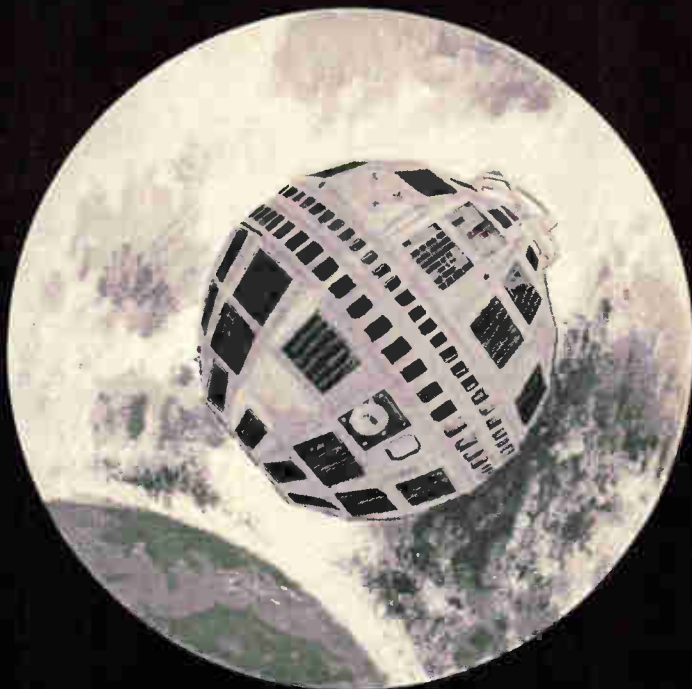

SUPRAMICA 555 ceramoplastic coil forms for Telstar® Satellite



MYCALEX® 410 glass-bonded mica mounting brackets and SUPRAMICA 555 ceramoplastic gyro parts for Nike-Hercules

THE STORY OF MYCALEX IN COMMUNICATIONS

For more than 25 years, Mycalex Corporation of America has been privileged to work with scientists and engineers of the Bell System on selected assignments from underseas cables to space projects.

We are especially proud to have helped play a part in a significant new Electronic Switching System, which makes possible a number of dramatic improvements in telephone service. In contrast with conventional electromechanical relays, which switch in about 1/1000th of a second, electronic switching operates in millionths of a second,

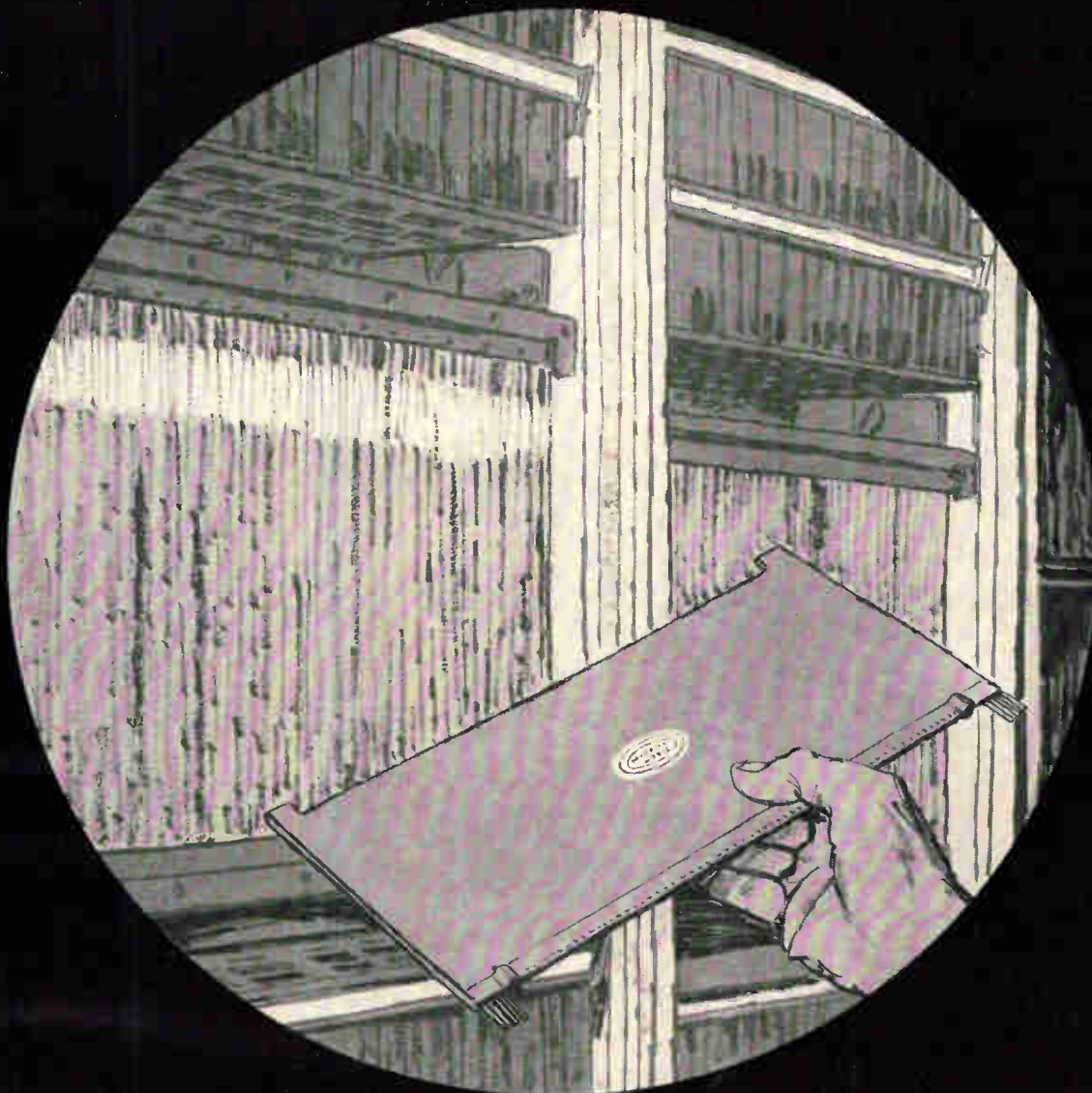

And now...MYCALEX 400-2 glass-bonded mica panels in the memory package of ESS—Electronic Switching System for telephones

adding new speed to communications.

Keystones of this electronic system are a number of aluminum plates with vicalloy "brain cells" bonded to them. These magnetic dots store the permanent information to control the system. *To support and position these aluminum plates, the Bell System sought an unusual material which offered a high degree of dimensional stability.*

After an intensive materials evaluation program, they chose glass-bonded mica which is precision-machined to shape before various metal details are

attached. Mycalex Corporation working with Bell Telephone Laboratories, and the Western Electric Company developed an acceptable glass-bonded mica product designated as MYCALEX 400-2. MYCALEX 400-2 is currently one of the approved products specified for the Electronic Switching System.

To find out more about MYCALEX glass-bonded micas, SUPRAMICA ceramoplastics, and SYNTHAMICA® synthetic mica and how they can work for you, write for our new 36-page, full color catalog.



MYCALEX
CORPORATION OF AMERICA

*World's largest manufacturer
of ceramoplastics, glass-bonded mica
and synthetic mica products*

125 Clifton Boulevard, Clifton, N.J.

Let's talk facts about trimmer capacitor reliability

**Only JFD gives you these design advantages... in the industry's
broadest product line—over 500 standard models**

Widest choice of drive mechanisms—
All seven are engineered for
greatest tuning linearity without reversals
and for the ultimate in repeatability.
Anti-backlash designs exceed
Mil-C-14409B requirements.

Versatile choice of five
dielectric materials to satisfy the
most varied design parameters.

Matched metalizing—Exclusive
JFD metalizing processes form a
homogeneous bond between dielectric and
metal parts. There are no air gaps to widen
tolerances and distort actual capacitances.

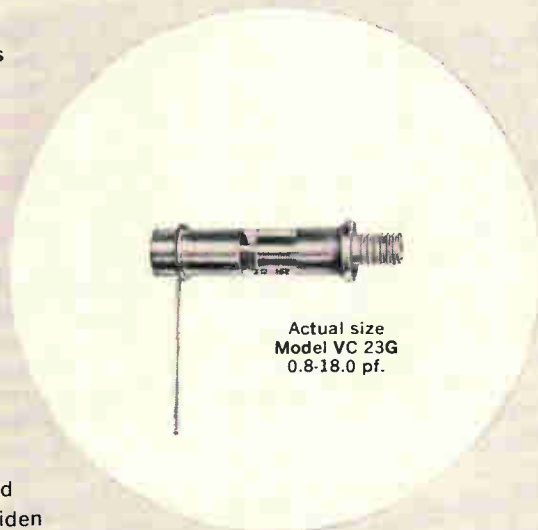

Actual size
Model VC 23G
0.8-18.0 pf.

Industry's most comprehensive
and advanced construction
variations assure you the degree of
reliability your application requires.

High level shock and
vibration resistance—A plateau of
90 g's is common... by far the
industry's highest. This is insured by
continuous monitoring in JFD's
shock and vibration laboratories.

High reliability of each individual
unit is assured through the industry's
most exacting quality control program.

**That's why more JFD trimmer capaci-
tors meet or exceed Mil-C-14409B than
all other makes combined. JFD trimmer**

**capacitors have been specified in the
Apollo, Gemini, Minuteman and L. E. M.
programs where high reliability is a must.**

SEND FOR JFD CATALOG C-64

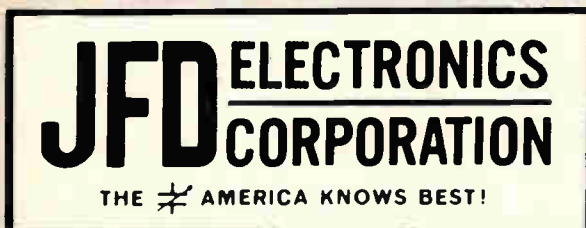

Components Division

JFD ELECTRONICS CORPORATION, 15th Ave. at 62nd St., Brooklyn, N. Y. 11219
JFD NORTHEASTERN, Ruth Drive, P. O. Box 228, Marlboro, Mass. 07152
JFD NEW YORK-NORTHERN, Damiano Pl., P. O. Box 96, New Hartford, N. Y. 13503
JFD MID-ATLANTIC, 313 E. Broad St., Palmyra, N. J. 08065
JFD MID-ATLANTIC-MARYLAND, P. O. Box 7676, Baltimore, Maryland 21207
JFD MIDWESTERN, 6330 W. Hermione St., Chicago, Illinois 60646
JFD MIDWESTERN-OHIO, P. O. Box 8086, Cincinnati, Ohio 45208
JFD WESTERN, 9 Morlan Place, Arcadia, California 91006
LCC STEAFX, 128 Rue de Paris, Boite Postale 51, Montreuil-sous-Bois, Seine, France
JFD ISRAEL LTD., Industrial Area B, Bldg. 23, Azur, Israel
DUCON CONDENSER PTY., LTD., Christina Road, Villawood, N.S.W., Australia
MURATA MANUFACTURING CO., LTD., Nagaoka Otokuni, Kyoto, Japan
STANDARD TELEPHONE & CABLES LTD., Footscray, Sidcup, Kent, England

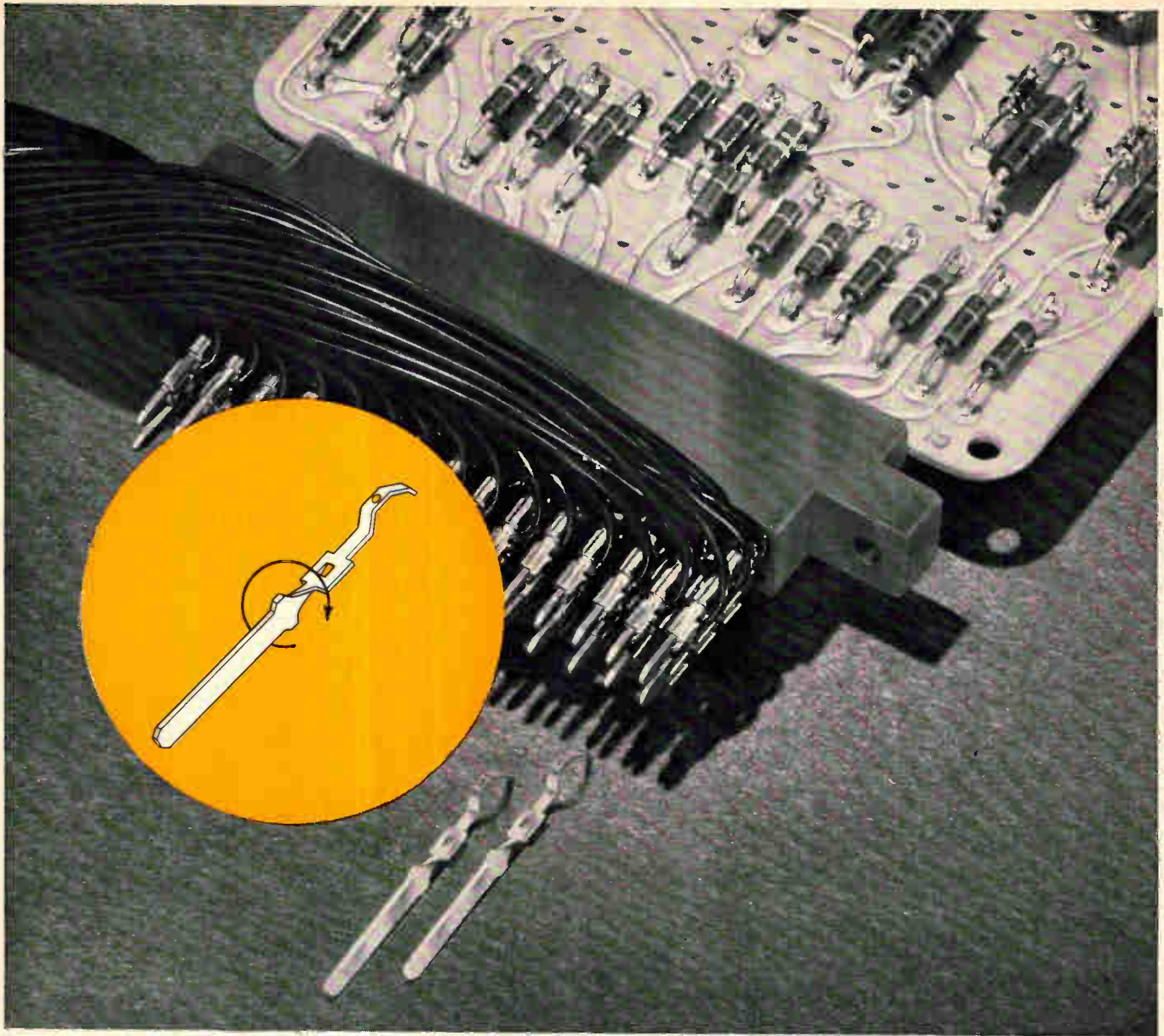

Here's a new twist for economy!

Our TERMI-TWIST* Connector features pre-loaded contacts which twist 90° on the vertical, permitting as dense as .125 inch spacing. You'll see it as a way to cut production costs without sacrificing quality. Because it was designed specifically to be compatible with AMP's new TERMI-POINT* wiring devices and automated wiring techniques.

Did we say "economy"? By terminating this connector on our programmable Coordinate Machine, you'll realize significant applied cost savings. We've held unit cost down, too . . . by utilizing selective plating in the form of gold "buttons" at the critical contact points.

Best of all, the tapered cantilever beam construction of our contacts eliminates most of the slippage, alignment and extraction problems of other automatically wired connectors. The TERMI-TWIST contact is located by a definite shoulder, followed by a twist action for firm positioning. Rear removal is accomplished with ordinary long nose pliers.

Now you can have all the advantages of automated wiring . . . plus features that only a sturdy, one-piece board edge connector can give you:

- Lowest per line cost
- Completely compatible with TERMI-POINT Terminals and Tools
- Shoulder and twist contact design assures firm, positive positioning and retention
- 24-karat gold buttons provide low contact resistance
- Integrated construction eliminates interfacing problems
- High potential and vibration resistance
- Contacts mounted on various centers

Now's as good a time as any to economize—especially when it means better performance. Write today for full details.

*Trademark of AMP INCORPORATED



A-MP* products and engineering assistance are available through subsidiary companies in: Australia • Canada • England • France • Holland • Italy • Japan • Mexico • West Germany

What do you need— a status symbol or a scope?

\$365.

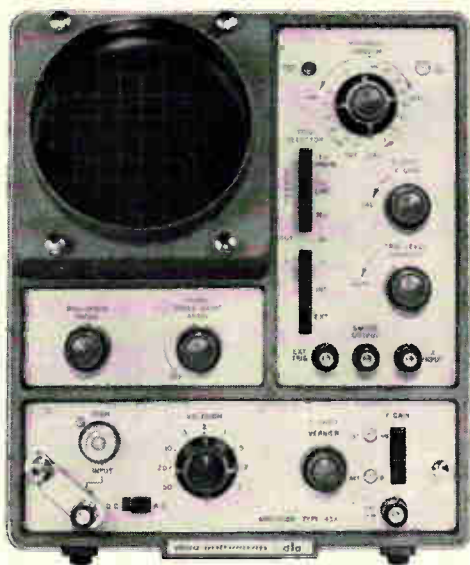

Now you have a choice—Data Instruments S43. For those who do not need the extras but who require reliability and performance in the essentials, it is the finest scope available. True, it concedes something to the glamor versions in the number of knobs—but it concedes nothing in way of performance or engineering. The main frame features a 4 inch precision flat face tube in a variety of phosphors with controlled edge lighting. A built-in time base provides sweep speeds up to 1 $\mu\text{sec}/\text{cm}$ with horizontal amplifier and trigger providing 10 X expansion to 400kc. Five plug-in amplifiers, ranging in price from \$80 to \$160, give the unit broad operating capabilities: 23 nanosecond rise time; sensitivities of 100mv/cm with 15mc bandwidth and $\pm 5\%$ accuracy. Narrow band and wide band differential amplification as well as tuned bandwidth to 32mc are also available.

There are two models in the 43 Series—the Single beam S43 at \$365 and the Dual beam D43 at \$399. Each instrument is fully guaranteed for one year, and complete servicing is provided.

If you don't need a status symbol but do require performance and reliability in the essentials, the S43 is the finest scope available. And at \$365 it is very available.

Data Instruments Div. • 7300 Crescent Blvd. • Pennsauken, N.J.

data instruments



Communications

Double play

Both on the ground and in the air, Comsat seems to be racking up successes. While engineers for the Communications Satellite Corp. were making minor adjustments to maneuver the spacecraft into a perfect hovering position over Brazil, the Federal Communications Commission met behind closed doors and reportedly decided in favor of Comsat's owning the communication system's ground stations in the United States.

For Comsat, the FCC's decision means cash in the till. The company will collect revenue from use of the stations as well as from users of the satellite's facilities.

For competing common carriers—like the American Telephone & Telegraph Co. and the International Telephone and Telegraph Corp.—the decision cuts out a huge potential source of revenue.

Competition. For the electronics industry, the decision portends stiff competition for contracts to build 50 to 60 ground stations across the United States. One company, the Hughes Aircraft Co., has already started planning to develop ground stations for sale to Comsat and possibly to foreign countries.

The FCC's decision was far from unanimous. Sources close to the six-member commission say there was plenty of in-fighting during the months that the question was under consideration.

Lobbyists for the common carriers had tried to pressure the commission to either let them own the stations or, at least, to divide them between the private companies and the government-sponsored Comsat. ITT led the fight for sole ownership; AT&T headed another camp that pressed for joint control. Both groups argued that, since they were responsible to the customer for

service, they should be allowed to exercise control over the ground stations.

Comsat had indicated it would start immediately to build ground stations if it won the FCC decision. A survey team has already selected



Early Bird gets last-minute check in laboratory.

a site in Brewster, Wash., of several hundred acres for a West Coast station and a similar-size site in Hawaii. Three stations will be needed for synchronous satellites, and a fourth if a medium-altitude satellite system should be adopted.

Comsat now leases AT&T's ground station in Andover, Maine, for the northeastern terminal. Construction on the Washington and Hawaii stations will start simultaneously and cost from \$5 million to \$10 million each. They will take about a year to build.

On the air. Transmission of the first commercial telephone service is scheduled to begin in about six weeks. Some commercial use of the satellite will be made before it becomes fully operational, however. On May 2, an hour-long television program is planned between Europe and the United States, Canada and Mexico.

Space electronics

It's a SNAP

A nuclear reactor, long-heralded as the power source for future space exploration, is undergoing its first test in space. Earlier this month, the Atomic Energy Commission and the Air Force, in a joint venture, orbited a 970-pound package called SNAP 10-A, that is directly converting heat from a nuclear reactor into 500 watts of power at 30 volts.

From early indications, SNAP, an acronym for Systems for Nuclear Auxiliary Power, is working well and will open the door to a new family of spaceborne power supplies.

Using the atom. The heat-to-electricity conversion is being performed by a Radio Corp. of America thermoelectric system made up of 120 silicon-germanium thermoelectric modules arranged in 40 strips around the outside of the spacecraft. Each module contains thermoelectric couples. Heat from the reactor is transferred to the modules through a closed-loop system that contains a liquid sodium potassium alloy.

When the experiment is completed after up to a year in an 800-mile orbit, the reactor will be shut down by a signal from the earth.

Still uncertain is the performance of an ion propulsion system that rode into orbit with the reactor. The tiny ion motor, which gets electrical power from SNAP, is designed to provide only two millipounds of thrust; but during a long space trip the minute push can accelerate a large spacecraft to many thousands of miles per hour. The purpose of the test was to see if the engine could operate for an extended time.

Still in doubt. Soon after the vehicle was placed in orbit, Air Force engineers radioed a signal

to the satellite, turning on the ion engine. But the moment the engine started up, ground station monitoring equipment started pick-

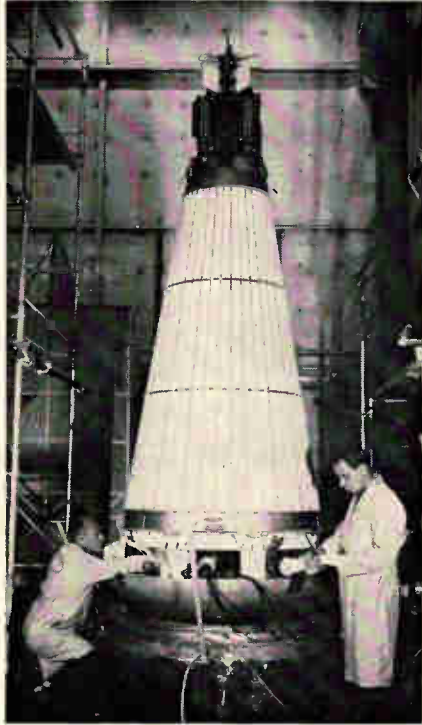

Technicians check first U. S. nuclear reactor-powered satellite, SNAP 10-A.

ing up an extremely high level of noise, making it impossible for engineers to tell whether the engine was operating properly. The engine was turned off pending an evaluation of the noise problem.

The ion engine was built for the Air Force by Electro-Optical Systems, Inc., a subsidiary of the Xerox Corp.

Previous SNAP satellites have had isotope generators, rather than reactors. Isotope generators are power sources which create energy by the passive fission decay of radioactive substances like plutonium, rather than by a controlled chain reaction.

X marks the spectrum

Radio astronomers listening to distant galaxies have the same problem that's faced by optical astronomers: too much distortion from the earth's atmosphere. Optical astronomers are solving the problem by rocketing television cam-

eras and telescopes into space. In a program now getting under way, radio astronomers will take the same tack: in two years they'll lift into a 3,700-mile circular orbit a solar-powered transceiver with an X-shaped antenna that will be five times the length of a football field.

Filtered out. The Radio Astronomy Explorer program, under the auspices of the National Aeronautics and Space Administration's Goddard Space Flight Center, is designed to measure the intensity, frequency and emission times of radio signals between 0.3 and 7 megacycles—a range that can barely be picked up by earth-based receivers, since frequencies below 10 megacycles are filtered out by the ionosphere.

One of the V sections of the 1,500-foot directional antenna will continuously look away from the earth. The other V section will point toward the earth, picking up terrestrial radio signals; the two sets of signals will be compared, so that stray terrestrial signals can be subtracted from the total radio "picture."

Radio signals will be transmitted to earth at 136 Mc by pulse-code modulation. Gravity-gradient stabilization will keep the antenna pointed in the correct direction.

Bends into tube. Each of the antenna's four legs will be wound around a spool during launch. When the 280-pound vehicle reaches its prescribed altitude, the antenna, made of a thin strip of beryllium copper alloy, will unwind. The strips will be prestressed to curl into long tubes for lateral strength. De Havilland Aircraft, Ltd., is developing the antenna.

In the future, the space agency may orbit even larger radio receivers. Longer antennas can pick up lower radio frequencies. In one project that is being considered, two satellites would be joined in space, providing an antenna several miles long. The antenna would act as an interferometer to make precise measurements of wavelengths. Hugh antennas of circular, rhombic, and other configurations may be orbital before 1970. Eventually, the space agency says,

a Yagi-type antenna, possibly 20 miles long, may be put together on the moon by astronauts.

Industrial electronics

On the track

Essentially, it's just a speed-limit sign that enforces its own commands; but the \$700,000 worth of electronic equipment for which Chicago's transit authority will open bids next month will be the city's first step toward an electronically controlled rapid transit system.

Though the system won't dispense with a motorman, it is the cornerstone of completely automated transit, says C. E. Keiser, the authority's operations manager.

The first batch of equipment will be installed on 17.4 miles of track on the Lake Street line. Later, the authority plans to spend nearly \$15 million to put the signal controls on the rest of the city network.

Swedish subway. A similar electronic system has been operating signals for the subway network in Stockholm, Sweden, for the past few months [Electronics, Dec. 28, 1964, p. 113]. And in California, the Bay Area Rapid Transit District recently started to test three competing computer-operated systems to operate an entire transit network for the San Francisco area [Electronics, March 22, p. 35].

Companies expected to submit bids for the Chicago project are the Westinghouse Air Brake Co.'s Union Switch and Signal division, the general Railway Signal Co. and the General Electric Co.'s Locomotive and Car Equipment division. All three have systems under evaluation in the Bay Area test.

The Chicago system will consist of a series of preset transmitters that send a signal denoting the proper speed for that zone of track. The train's receiving equipment will pick up the signal through the tracks, and the encoder will trans-

late it into a visual reading in the motorman's cab. If the motorman fails to follow a speed order within 2.5 seconds, automatic braking equipment on the train will be activated.

One per zone. The trackside transmitters—one for each zone spaced between 150 and 1,600 feet apart—will be programmed to send out one of four signals: 65 miles per hour (full speed), 35 miles per hour, 15 miles per hour and stop.

The equipment will be installed on 140 cars, and 100 transmitters will be distributed along the Lake Street tracks. The signaling system will operate in the 1- to 5-kilocycle range, although engineers haven't decided whether it will be pulse or frequency modulated.

On a mile per dollar basis, conventional electronic signal systems are estimated to cost twice as much as the Chicago system. In the conventional systems, the tracks between each zone are cut and insulated so that a signal transmitted in one zone will not travel into the adjoining zone. In the Chicago project, engineers have designed a coil-like impedance device, which will be set across the tracks at the end of each zone, to keep the signal from crossing zones.

Conventional equipment is relatively large, entailing a major installation project. The fully transistorized Chicago equipment is much smaller and will be installed by the transit system's regular maintenance men without moving rails or any trackside facilities.

Instrumentation

Sharp voltmeter

The Hewlett-Packard Co. has developed a radio-frequency voltmeter which it says has a resolution four times that of conventional instruments. The device, which won't be offered for sale before late this year, is said to take readings down to 50 microvolts, compared with a 200-microvolt limit

for conventional diode devices.

The secret of the high resolution, the company explains, is an incoherent sampling technique. It is similar to the procedure commonly used in high-frequency sampling oscilloscopes, but the input waveform is sampled at a sequence that is unrelated to the signal being measured. The coherent sampling techniques used in sampling oscilloscopes require that the sampler be phase-locked to the incoming signal because it is necessary to recreate the incoming waveform on the scope tube.

The incoherent technique requires only that the statistical information be retained, since the readout device is a meter. This greatly simplifies the circuitry by eliminating the phase-locking scheme, timing and delays. This sampling voltmeter is also able to measure accurately voltage waveforms with a high ratio of peak to root-mean-square value.

Convert to d-c. In conventional r-f voltmeters, a diode detects the r-f signal input and converts it to a d-c value. The d-c is then measured and displayed on a meter. Because of the nonlinear characteristics of the diode, the voltmeter scale is nonlinear. At the low end, the resolution becomes poor, and typically a minimum of 200-microvolts resolution is about the best available. Since the H-P scale is linear, resolution is as good as 50 microvolts.

The H-P device, tagged the 3406A Sampling Voltmeter, comes with an average-reading meter. However, true rms or peak reading measurements can be taken by connecting the proper meter externally. A bold circuit stores each sample until the next sample is taken.

Check the pulse. The incoherent sampling technique can best be explained by representing each sample by a pulse whose height is proportional to the amplitude of the input signal at the instant the sample is taken. The average, rms or peak value of the collection of pulses differs from the input signal by only a scale factor. But whether the pulses are scrambled or not before being added does not affect

the readout since the values are the same for the entire group. Although the waveform resulting from the incoherent sampling technique does not resemble the input waveform, the quantitative output remains the same because the measurement is the total of several cycles.

The instrument has a push button on the probe that will allow the indication to be retained on the meter after the probe is removed from the circuit. This permits measurements to be made in positions where it may be difficult for the operator to place the probe and read the meter at the same time.

Hearing the heart

The fetal heart beats so faintly that it can be detected only with complex and costly electrocardiographs—and even then the reading is "blurred" by background noises. Now a Navy research engineer, working on his own time at home, has drawn on his knowledge of ultrasonics for submarine detection and developed a small, relatively simple instrument that not only detects the heartbeat of an embryo as early as 10 weeks after conception, but also "hears" the



Gill movements of a goldfish are monitored by Richards using his ultrasonic instrument.

opening and closing of some heart valves.

During childbirth, a nurse can monitor the infant's heartbeat with the hand-held device aimed at the mother's abdomen. To monitor the fetal heart with an electrocardiograph, several electrodes must be attached to the woman's abdomen.

Disease detector. The developer, James R. Richards, an engineer at the Naval Research Laboratory in Washington, says the instrument is also being tested for studies of cardio-vascular diseases in adults. Richards is negotiating with several manufacturers for building and marketing the device, which he expects to sell for less than \$1,000.

The instrument emits a narrow beam of high-frequency sound that uses the doppler principle to detect slight movements of the fetal heart. The sound, transmitted at 6 megacycles, travels through semi-solids and liquids; when the beam hits an interface—a place where different types of tissue meet—part of the sound is reflected and returns at a different frequency. Thus a movement of the interface represents the beating of the heart. When the beam is focused on a heart valve, the valve's opening and closing can be monitored.

The echoes are picked up by the hand-held device and translated into audible frequencies or into electrical pulses, which can be viewed on an oscilloscope.

Military

Prodding the Pentagon

Like a parent who's sure he knows what is best for Junior, Congress has been manipulating Robert S. McNamara's allowance again. Once again, the chief issue is the proposal for a strategic manned bomber to succeed the B-52. Faced with a request from the defense secretary for \$39 million to spend on research and development, the Senate authorized an extra \$82 million to carry the

program into the project-definition stage. Project definition represents a tentative commitment to actual production, while McNamara, unwilling to commit himself, wanted funds only for long lead-time systems such as avionics and propulsion components.

The Senate acted on the recommendation of its Armed Services Committee in considering funds for fiscal 1966, which starts July 1. The authorization bill fixes a ceiling on appropriations to be voted later; it is not certain that the Senate will actually provide enough cash to carry out the new programs. Further, the House will have to agree; or if it doesn't, a Senate house conference will be necessary. And even if the extra money is actually voted, McNamara won't have to spend it unless the President tells him to.

Not really generous. The Senate also authorized funds for six attack submarines where McNamara wanted only four, and last month the House Armed Services Committee tossed in \$150 million for a nuclear-powered missile frigate that the secretary didn't want at all. But neither chamber was as lavish as the foregoing might indicate, for the Senate deleted \$100 million he wanted for 10 E-2A Hawkeye aircraft, plus funds for some cargo ships and gunboats, and the House unit had cut \$500 million from the \$6.6 billion requested for R&D, without specifying where the cuts should be made. Total Senate cuts brought the actual authorization down to \$13.4 billion below the \$15.3 billion requested for procurements, R&D, testing and engineering; if the House goes along with its committee, the figure will be trimmed \$500 million to \$14.8 billion.

Missiles vs. planes. The Pentagon chief has long been at odds with Congress over the manned bomber. He has serious reservations about the need for a successor to the B-52 in an age in which missiles will be the chief strategic weapon. McNamara believes that the B-52 fleet can be kept operational through the mid-1970's, and that if that isn't long enough, he can convert the F-111 fighter

bomber into a long-range strategic bomber to be called the B-111. The B-111 could be available in the early '70's at a much lower cost than a new bomber, even if a production decision is postponed for a few years, he contends.

The Senate committee rejected the B-111, however, and listened to the Joint Chiefs of Staff, who had unanimously recommended a start on project definition of the new bomber in the coming fiscal year. The Air Force says it will be ready to go ahead on project definition within a few months of getting the necessary funds.

The military voice carries. In authorizing the extra two nuclear attack subs, the Senate also approved a unanimous Joint Chiefs' recommendation that McNamara had turned down. The committee's report said that intelligence estimates "give no indication that the submarine threat posed by our potential enemies is diminishing."

The committee objected to the Hawkeye, a carrier-based early warning aircraft whose electronic subsystems have run into development problems, on grounds that procurement should be delayed until there was "some evidence that it would perform as intended."

Packaging

Circuits by the batch

By the end of the year, Texas Instruments Incorporated will be delivering custom arrays of integrated circuits with up to 150 logic gates, all interconnected by thin films, on a single chip of silicon. The company is already producing and delivering arrays with 12 to 20 gates, and plans to introduce them as catalogue items by the end of this year.

The gates used in the arrays are basic circuits that can be thin-film connected in various arrangements to form functional assemblies, such as shift registers, adders and counters for computers. Plans to make the 150-gate arrays were disclosed by Jack S. Kilby, TI's

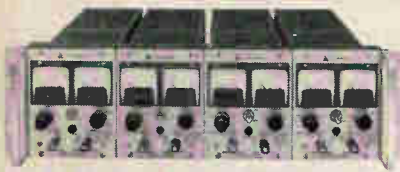

4 DC outputs in a single rack



1/4 rack and 1/2 rack models



Non-metered models available

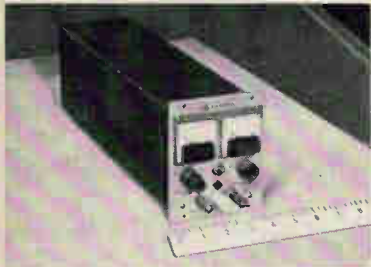

Minimum bench width



Flush chassis mounting



LRA-1 \$60.00

LRA-2 \$25.00

Rack adapters

Now... 2 NEW 0-120 VDC models in LAMBDA all-silicon LH series 1/4 and 1/2 rack Multi-Current-Rated™ power supplies

- Meet RFI Spec.—Mil-I-16910.
- Modular-Subrack design for bench, chassis and rack use.
- Regulation—.015% or 1 MV (line or load)



- Ripple—250 microvolts rms. 1MV P-P
- AC Input — 105-135 VAC, 45-480 CPS.
- 1/4 rack: LH 118, 121, 124, 127, 130—5³/₁₆" x 4³/₁₆" x 15¹/₂"
- 1/2 rack: LH 119, 122, 125, 128, 131—5³/₁₆" x 8³/₈" x 15⁵/₈"

Model	Voltage Range	CURRENT RANGE AT AMBIENT OF: (1)				Price (2)
		30°C	50°C	60°C	71°C	
LH 118	0-10VDC	0-4.0A	0-3.5A	0-2.9A	0-2.3A	\$175.00
LH 119	0-10VDC	0-9.0A	0-8.0A	0-6.9A	0-5.8A	\$289.00
LH 121	0-20VDC	0-2.4A	0-2.2A	0-1.8A	0-1.5A	\$159.00
LH 122	0-20VDC	0-5.7A	0-4.7A	0-4.0A	0-3.3A	\$260.00
LH 124	0-40-VDC	0-1.3A	0-1.1A	0-0.9A	0-0.7A	\$154.00
LH 125	0-40-VDC	0-3.0A	0-2.7A	0-2.3A	0-1.9A	\$269.00
LH 127	0-60VDC	0-0.9A	0-0.7A	0-0.6A	0-0.5A	\$184.00
LH 128	0-60VDC	0-2.4A	0-2.1A	0-1.8A	0-1.5A	\$315.00
New LH 130	0-120VDC	0-0.50A	0-0.40A	0-0.35A	0-0.25A	\$225.00
New LH 131	0-120VDC	0-1.2A	0-0.9A	0-0.8A	0-0.6A	\$320.00

(1) Current rating applies over entire voltage range. DC OUTPUT Voltage regulated for line and load.

(2) Prices are for non-metered models. For metered models add suffix (FM) to model number and add \$25.00 to price. For non-metered chassis mounting models, add suffix (S) to model number and subtract \$5.00 from non-metered price.



LAMBDA ELECTRONICS CORP.
515 BROAD HOLLOW ROAD • MELVILLE, L. I., NEW YORK • 516 MYRTLE 4-4200

4ways NEW

SPACE - SAVER PANEL METERS T.M.

WITH VALUABLE FEATURES
ENGINEERS HAVE
ALWAYS WANTED



**Minimum height design
to save panel space!**

NEW! 15% longer scale —
40% less space.

NEW! Crisp, low profile for
modular styling. Per-
mits the equipment designer to
achieve the ultimate in design.

NEW!

Quick clip
mounting saves
90% of normal
installation time.
No washers, nuts
or screws.

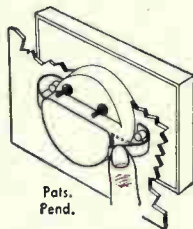

NEW! Recessed terminals
require less chassis
depth, leave more space for
components.

FOR YOUR APPLICATION,
MAY WE QUOTE ON YOUR
SPECIFICATIONS, OR HAVE
OUR REPRESENTATIVE CALL?

Experienced manufacturers of meters in
volume, for both commercial and military
applications, including ruggedized
and sealed meters to military standards

Designed and Manufactured by

DIXSON, INC.

METER DIVISION  DEPT. B

GRAND JUNCTION, COLORADO

Electronics Review

deputy director of semiconductors research and development, at an IEEE symposium in Los Angeles. The impact of the arrays, Kilby said, will be to drive the cost of the gates down to about 20 cents each within a couple of years.

Two approaches. TI is following two routes for making circuits in the array. One is to look for clusters of perfect circuits on each slice of silicon crystal, which may contain 400 or more individual gates. This is also the approach being followed by the Westinghouse Electric Corp., which has also been producing arrays. The good gates in the cluster are then interconnected by a standard pattern, which produces the function desired. This procedure can be expensive because imperfect circuits are usually scattered randomly over the slice, and many slices may have to be tested before a cluster big enough for a large array can be found. Still, Kilby says, TI frequently finds clusters of up to 50 good circuits on a slice, and has obtained clusters with up to 100. This eases the problem of interconnecting small arrays, but large arrays still require unique interconnection patterns that will bypass the bad circuit.

The other approach is to test all the circuits on a slice, feed the information on good and bad circuits into a computer, and have the computer design a special interconnection pattern for each array. Westinghouse is also trying this, and has an Air Force contract to research techniques for using a computer programed electron beam to form the interconnection pattern.

Negative approach. TI plans to use the computer output to run a machine that will make photographic negatives directly; the negatives are then used with a beam of light to etch interconnection patterns in thin films of metal deposited on the integrated circuits.

The machine is similar in concept to one developed for the Air Force by the National Cash Register Co. The procedure, which Kilby calls "discretionary wiring," will be used to form the interconnections between gates in the large arrays; this pattern will form the

second level of wiring in each array. The interconnection film is deposited on an insulating oxide. Under the oxide is the first level of wiring, the regular patterns that connect the components in each gate on the slice are similar to the patterns now used for individually packaged integrated circuits. If crossovers are required in the gate-interconnection wiring, they can be supplied by depositing a third layer of oxide and thin film. Additional crossovers can be made by tunneling signals through conductive paths in the silicon crystal.

Cheap connections. Kilby holds that transferring circuit interconnections to the slice can reverse the proportionately large cost of wiring in computers and other large systems using IC's. With prices of commercial quality gates (packaged two or four to a flatpack) tumbling to less than a dollar this year, the multilayer board used to interconnect the packages will cost more than the circuits themselves by the end of the year.

The smaller arrays being commercially introduced this year will be packaged in many cases in a regular 14-lead flatpack. Also being made available is a new flatpack, with plug-in pins facing down. These will come in two styles, one with 14 or 16 pins, and one with 30 or 40 pins. The pins will be spaced 100 mils apart, a dimension compatible with conventional printed circuit boards.

Commercial equipment manufacturers prefer the plug-in pins and wider spacing because the plug-in mounting conserves printed circuit board area and the spacing leaves plenty of room for insertion holes and circuit routing around pins. The Fairchild Semiconductor division of the Fairchild Camera & Instrument Corp. has also introduced packages with 100-mil plug-in leads, in conventional flatpack size. Others will use pins 125 mils apart. The TI arrays will also be supplied in packages with 30 to 40 ribbon leads spaced 50 mils apart, and in packages with up to 60 ribbon leads spaced 35 mils apart. The latter package is for high-density military and aerospace applications.

Computers

Logical solution

Packaging computer logic circuits is something like putting together an intricate jigsaw puzzle that has more than one solution. To solve this time-consuming problem, the International Business Machines Corp., the Radio Corp. of America and the Sperry Rand Corp. enlisted the computers they already had.

An IBM 7090, for example, is able to lay out an arrangement for 1,000 printed circuit cards for a logic section of IBM's System 360 in about 10 minutes. The same job would take a crew of engineers about a week.

The human touch. The machine may be faster than the engineer, but it's no better. In fact, IBM says, an engineer is usually able to add a few touches to improve the layout.

The job is to select from several dozen different printed circuit boards the most efficient packaging array. Of five or six billion possible combinations, several hundred are able to perform the computer's required logic functions adequately; but only a handful are able to do the job well. To a computer maker, a well-designed logic section in a machine is one that has the least number of cards needed to perform a maximum number of logic jobs, short interconnections between logic functions and few wasted components.

In the IBM and Sperry techniques, the card arrangement is worked out first, and then the wire interconnection routes behind the plug-in board are calculated. Sperry engineers laid out the Univac 1108 this way, using earlier and smaller Univac computers. But RCA engineers, in designing the Spectra 70, used their RCA 301 to perform both card layout and board wiring in one step.

On the other hand, engineers at Honeywell, Inc., have tried this technique and found that they got best results by combining the efforts of the computer with those of the engineer. The Honeywell people are still working on the process, concentrating on improving the in-

NEW Tiny 3/4 Watt 15-Turn Wirewound

TRIMMER

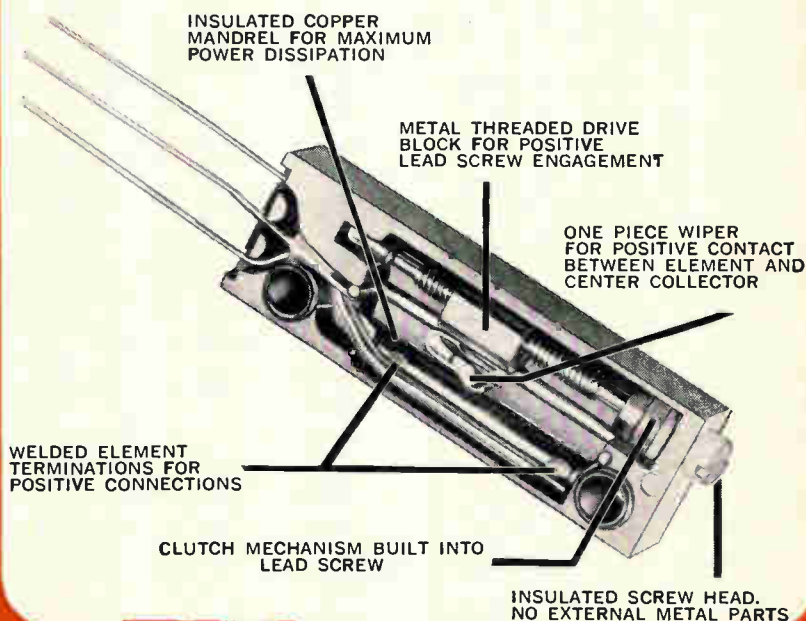

Series 160
1" x .320" x .180"

New Features (see photo) PLUS

Military Stability at Low Industrial Prices

Priced under \$3.00 each in production quantities because of CTS outstanding production capabilities.

Completely insulated and sealed in a diallyl phthalate housing with no exposed metal parts. Element terminations are free from mechanical strain because of low-resistance foil welded to the termination wire. All fixed electrical connections are welded into place.

Bare solid wire or Teflon insulated stranded leads available. Resistance range 100 ohms to 20K ohms. TC 70 PPM maximum.



Founded 1896

Write for Data Sheet 5160

CTS OF BERNE, INC.
BERNE, INDIANA

a subsidiary of

CTS Corporation, Elkhart, Indiana

PEERLESS IS THE BEST



PRECISION POTENTIOMETERS

QUALITY
•
PRECISION
•
RELIABILITY
•
EXPERIENCE

BACKED BY MORE THAN

25

YEARS OF CONTINUOUS LEADERSHIP
IN THE ELECTRONICS INDUSTRY.

WRITE FOR NEW POTENTIOMETER CATALOG
& COMPLETE TECHNICAL SPECIFICATIONS

PEERLESS

PEERLESS INSTRUMENT CO., INC.
90-15 CORONA AVE., ELMHURST, L. I., N. Y.
TELEPHONE 212 HI 6-1100

Electronics Review

teraction between man and machine rather than on completely automating the process.

Avionics

Automatic identification

When a civilian air-traffic controller picks up a military airplane's blip on his radar screen, he is usually unable to identify the craft without questioning the pilot by radio. But under a system being developed for all military aircraft, a transponder aboard each plane will receive the question from the controller's ground equipment and automatically radio back a code identifying the craft, its altitude, and perhaps an additional message.

What's in a name? The electronic system that's due to put an end to routine conversation between military pilots and traffic controllers is called AIMS, which is short for this mouthful of military jargon: Air Traffic Control Radar Beacon System/Identify Friend or Foe/Mark II Military Classified Systems. It will dovetail into the Federal Aviation Agency's automatic beacon system being developed for all commercial and military airplanes.

Many commercial craft already carry such automatic beacons and the FAA is developing ground equipment to receive these signals. In Atlanta this month, the agency plans to start testing two sophisticated alphanumeric receiving systems, developed by Texas Instruments Incorporated and the Raytheon Co.

The air-traffic control program is expected to be in full operation by 1970.

The AIMS program is expected to cost about half a billion dollars, most of it for ground equipment to be installed at traffic-control centers.

Automatic questioner. In areas of air-traffic congestion, sophisticated ground equipment will automatically query a plane's transponder the moment the craft is picked up on the controller's radar. In areas of less congestion, the

controller will throw a switch that will send out a signal which will interrogate all the planes in the area.

AIMS transponders are already being installed on some military aircraft, under the direction of the Air Force's system program office at Wright-Patterson Air Force Base, Ohio. All of the military services are involved in AIMS, and the gear that's being developed will be interchangeable between planes in one service and similar planes in another service.

Although 11 transponder models are either developed or under study, the military is trying to focus on four basic designs: the APX-64, the APX-67, and APX-68 and the KY-532.

High flyer. The APX-64, costing \$5,000 to \$6,000, is being produced by the Hazeltine Corp. for high-performance aircraft. Some modules are being delivered already, while other sections are still undergoing final tests. It's designed to operate at up to 100,000 feet.

The APX-67 will be manufactured by the Airborne Instruments Laboratory, a division of Cutler-Hammer, Inc. The transponder operates at up to 60,000 feet and is priced between the APX-64 and the APX-68. The APX-68 is a \$1,500 unit that can withstand pressures at altitudes up to about 20,000 feet; it will be installed on helicopters and other low-flying, low-performance aircraft. Made by the Admiral Corp., the APX-68 will be the most widely used beacon in the AIMS program.

The fourth model, the KY-532, is a transponder that's currently being used on the F-4 series of military fighter planes; it is being upgraded by the Collins Radio Co. so it can handle the same types and numbers of messages that are required under the AIMS project.

Consumer electronics

Color tv: 2 against 1

Despite the failure of a 45-nation conference in Vienna to agree on a single uniform system for color

television, there are strong signs that the United States' NTSC system and West Germany's PAL system may win by default.

Before the session got under way, there were three contenders for the all-European color system: NTSC (National Television Systems Committee), West Germany's PAL (phase alternation line) and France's Secam (sequency and memory). But when the meeting was over there were only two left: Secam and Quam (quadrature amplitude modulation). Quam's not a piece of hardware; it's a marketing philosophy dreamed up by the Radio Corp of America, which developed NTSC, and by Telefunken AG, which developed the PAL refinement of the American system. A combined German-American effort would be strong because it would start with an industry that's already in business, equipped with production lines and marketing organizations. Secam, is still only in the demonstration stage.

The NTSC and PAL people base their cooperation on the fact that their system are similar. Each can be transcoded easily to the other because both are quadrature amplitude-modulated. Secam, which is frequency-modulated, isn't easily transcoded to the other two systems. Only minor adjustments would have to be made for NTSC to broadcast PAL and vice versa.

Paper victory. Although France claimed victory at the meeting—because it received a majority of the votes—it may be only a paper triumph. Most of Secam's 22 votes came from Eastern Europe and Africa, where few countries are likely to introduce color tv for some time. The 17 votes for NTSC and PAL come from such advanced nations as Britain and Germany.

The calendar is also working against the French. Just days before the meeting began, the Soviet Union announced its support for Secam. But according to George Brown, vice president in charge of engineering at RCA and a delegate at the meeting, says Russia wants color tv by 1967—in time for the golden anniversary of the Red Revolution—and Secam isn't likely to be ready by then.

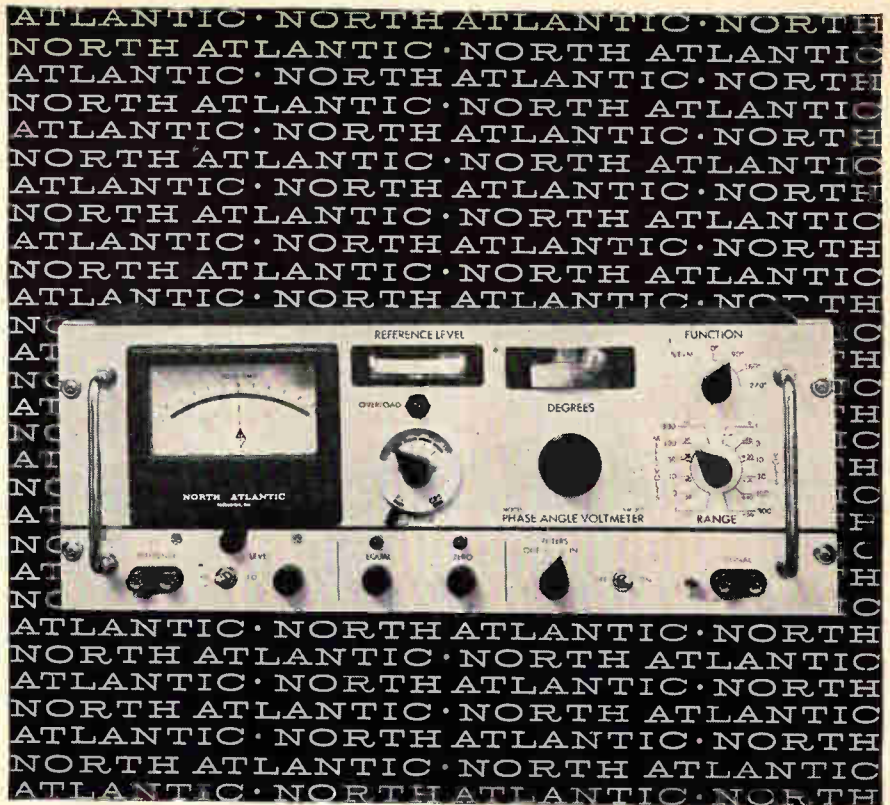

how to measure in-phase, quadrature and angle while sweeping frequency to 100 kc

North Atlantic's latest addition to the PAV line of Phase Angle Voltmeters* enables you to make measurements while frequency is varying over half-decades without recalibration. The VM-301 Broadband Phase Angle Voltmeter* provides complete coverage from 10 cps to 100 kc, and incorporates plug-in filters to reduce the effects of harmonics in the range of 50 cps to 10 kc with only 16 sets of filters. Vibration analysis and servo analysis are only two of the many applications for this unit. Abridged specifications are listed below:

Voltage Range.....	1 mv to 300 volts full scale
Voltage Accuracy.....	2% full scale
Phase Dial Range.....	0° to 90° with 0.1° resolution (plus 4 quadrants)
Phase Accuracy.....	0.25°
Input Impedance.....	10 megohms, 30μf for all ranges (signal and reference inputs)
Reference Level Range.....	0.15 to 130 volts
Harmonic Rejection.....	50 db
Nulling Sensitivity.....	less than 2 microvolts
Size.....	19" x 7" x 10" deep
Price.....	\$1990.00 plus \$160.00 per set of filters

North Atlantic's sales representative in your area can tell you all about this unit as well as other Phase Angle Voltmeters* for both production test and ground support applications. Send for our data sheet today.



NORTH ATLANTIC industries, inc.
TERMINAL DRIVE, PLAINVIEW, L. I., NEW YORK • Overbrook 1-8600

*Trademark

Need a follower-amplifier? Choose the appropriate all-silicon solid-state Philbrick Operational amplifier; use it in this circuit to provide isolation and impedance transformation with precise programmable gain.

APPLICATIONS

- Impedance transformation
- Measurement of voltage at high impedance
- Sample and hold
- Unloading of passive structures
- Precise unity-gain follower (when $n = 0$)
- Unloading of circuit capacitance (with positive capacitive feedback)

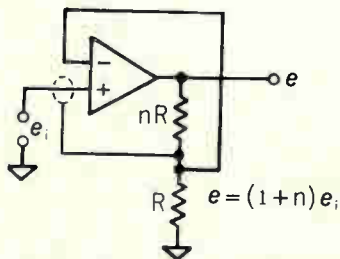

FOLLOWER WITH GAIN CIRCUIT

GENERAL

All of the following amplifiers are available from stock. The first three types utilize premium grade, hermetically sealed semiconductors. All are all-silicon, all solid state.

Philbrick Engineering Representatives

Ala.: Huntsville 536-8393; Ariz.: Phoenix 265-3629; Cal.: Los Angeles 937-0780, Palo Alto 326-9800, San Diego 222-1121; Colo.: Denver 733-3701; Conn.: Stratford 378-0435; Fla.: Ft. Lauderdale 564-8000, Orlando 425-5505; Ill.: Chicago 676-1100; Ind.: Indianapolis 356-4249; La.: New Orleans 242-5575; Md.: Baltimore 727-1999; Mass.: Wakefield 245-5100; Mich.: Detroit 838-7324; Minn.: Minneapolis 545-4481; Mo.: Kansas City 381-2122, St. Louis 966-3646; N.M.: Albuquerque 268-3941; N.Y.: DeWitt 446-0220, Lancaster TF 5-6188, Valley Stream 561-7791; N.C.: Winston-Salem 725-5384; Ohio: Dayton 298-9964, Westlake 871-8000; Pa.: Norristown 735-3520, Pittsburgh 371-1231; Tex.: Dallas 526-8316, Houston 781-1441; Utah: Salt Lake City 466-4924; Va.: Alexandria 836-1800; Wash.: Seattle 723-3320; EXP: N.Y.: New York 246-2133.

CANADA: Que.: Montreal 482-9750, Ont.: Toronto RU 9-4325.



SP2A....price (1-4) \$227.00



P25A, PP25A....price (1-4) \$154.00



P85A, PP85A....price (1-4) \$95.00



P65AU, PP65AU....price (1-4) \$35.00

*electronic analog
computing equipment
for modelling, measuring,
manipulating
and much else*



PHILBRICK

CHARACTERISTICS*

SP2A (modulator type)

ERROR CURRENT... $< 10^{-12}$ amp.

NOISE CURRENT ... $< 10^{-13}$ amp.

INPUT IMPEDANCE (with guard circuit) > 1 million megohms

TRACKING ERROR $< 0.01\%$ for unity-gain follower

OUTPUT SWING .. $\pm 10V$ @ 2mA see Philbrick for versions having greater voltage or current capability

P25A, PP25A (f.e.t. type)

ERROR CURRENT typically $< 10^{-10}$ amp.

INPUT IMPEDANCE of the order of 10^{12} ohms

COMMON MODE REJECTION $> 1000 : 1$

PACKAGING compact plug-in and wire-in series available

P85A, PP85A

ERROR CURRENT (when compensated) well below 100 nanoamperes

INPUT IMPEDANCE > 100 megohms

COMMON MODE REJECTION $> 10,000 : 1$

PACKAGING compact plug-in and wire-in series available

P65AU, PP65AU (economy types)

ERROR CURRENT (when compensated) well below 100 nanoamperes

INPUT IMPEDANCE > 20 megohms

COMMON MODE REJECTION $> 1000 : 1$

*measured at 25°C

For complete information, consult your local Philbrick Representative or Philbrick Researches, Inc., 22 Allied Drive at Route 128, Dedham, Mass. 02026 Telephone: (617) 329-1600

Bulk Gas

RESPONSE... by *Air Products*

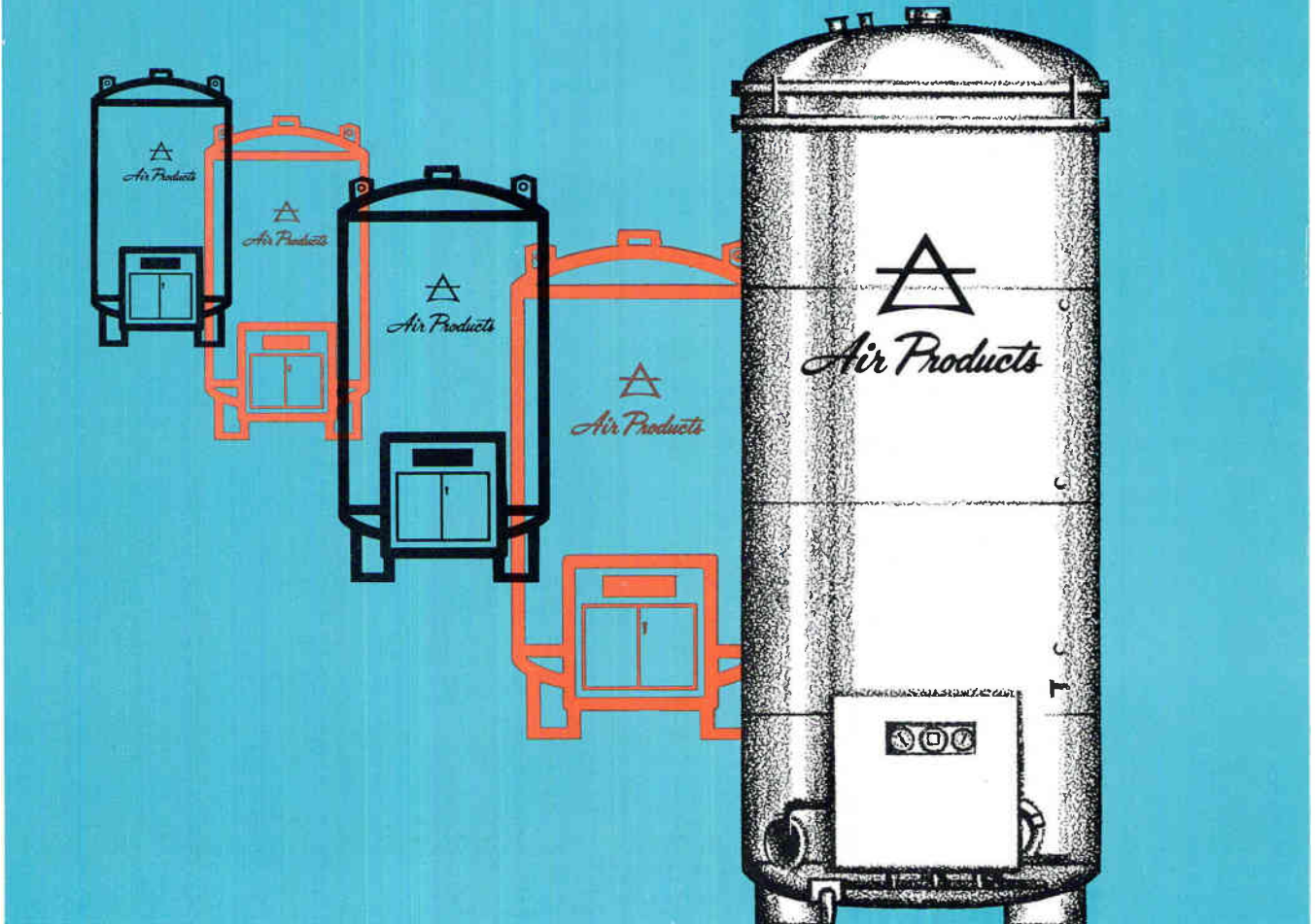

to supply your **OXYGEN, NITROGEN, ARGON, HYDROGEN requirements**

Gases . . . When and Where Needed

Name the gas . . . the purity . . . the quantity . . . and Air Products responds in a manner that meets your specific requirement.

A nationwide network of Air Products cryogenic production plants and distribution centers provides a readily available supply of a full line of industrial gases. The world's most advanced fleet of distribution equipment—tank-trucks, tank-trailers, and jumbo railway tank cars—delivers these liquefied gases to bulk storage units installed by Air Products on your property. From these bulk

liquid storage units, gases are drawn off automatically as needed in your operations. Tube-trailer deliveries are also available for the direct supply of gaseous product.

Computer programmed distribution makes possible economical, on-time deliveries . . . every time.

Specified Purity

Air Products advanced production technology combined with outstanding quality control disciplines yield the product purity dictated by your industrial gas applications.

Technical Service

In-depth technical service is a key factor in Air Products response to your demands. Technical service helps you use gases more efficiently and economically.

Gases and Better Ways to Use Them

Yes, response to the total needs of industrial gas customers is our business. To put this experience and know-how to work in your business write or phone the nearest Air Products sales office today. An Air Products "RESPONSE" Brochure presenting our capabilities is available on request.

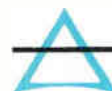

Air Products and Chemicals
INC.

Allentown, Pennsylvania

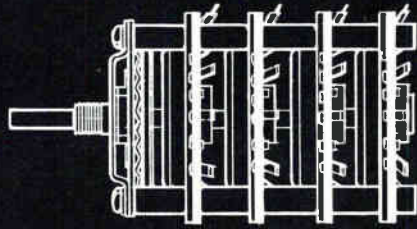

SHALLCROSS

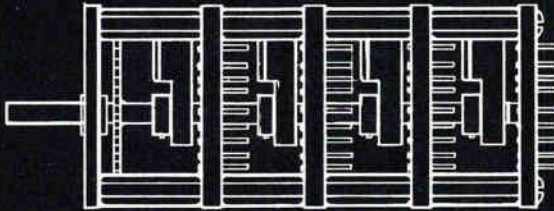

MFR. A

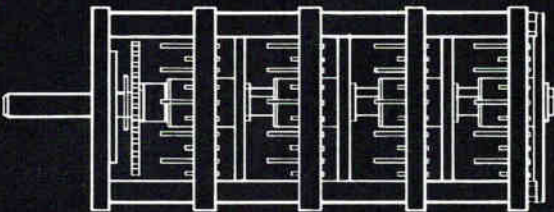

MFR. B

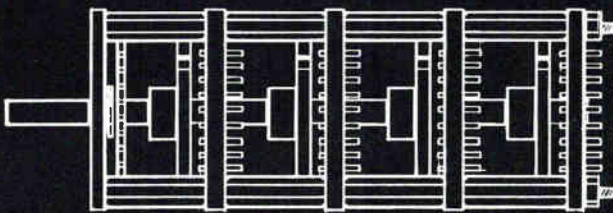

MFR. C

DRAWINGS APPROX. 3/5 ACTUAL SIZE

**ONLY ONE
OF THESE
4 LEADING
PRECISION ROTARY
SWITCH
EQUIVALENTS
IS REALLY
DIFFERENT**

THE SHALLCROSS SWITCH ALONE PROVIDES THESE STANDARD FEATURES:

REDUCED BACK PANEL DEPTHS ■ FLARED, EASILY WIRED TERMINALS ■ DUST PROTECTED CONTACTS AND ARMS ■ LOWER WEIGHT ■ LOWER COST PLUS REPRODUCIBLE SPECIFICATION SHEETS TO PROMOTE ACCURATE AND PROMPT CONTROL DRAWINGS.

The SHALLCROSS departure from conventional precision switch design provides the important operational, installation, and value advantages listed above. In addition to the exclusive characteristics associated with our Series 2 switch line, there are other features which are shared only in part by competitive equivalents. They include: (a) Diallyl phthalate anti-backlash rotors; (b) stainless

steel bushings and detent parts; (c) independently sprung dual-leaf wipers (silver); (d) epoxy fiber-glass stators; (e) integral contacts and terminals (silver).

The unique and near-unique combine in all SHALLCROSS switches to assure exceptional contact resistance vs load vs life

characteristics; low thermal emf and switching noise; positive detenting; mechanical reliability, versatility and Mil-S-3786 performance. A comparison of Shallcross Rotary Switch Series 4 (2½") and Series 1 (one inch switch line coming soon) with competitive counterparts may also be made with profitable results — we suggest your own evaluation.

Shallcross
SELMA, N. C.

SHALLCROSS SELECTED SWITCH DISTRIBUTORS

ALLIED ELECTRONICS
Chicago, Illinois

TAYLOR ELECTRONICS
Baldwin, New York

FORSBERG SALES
Brockton, Mass.

WESTEC ELECTRONICS
Whittier, Calif.

NEW CATALOG RS 100 DESCRIBES THE SHALLCROSS SWITCH LINE.



New all-solid-state TELCOM receiver covers 100-6000 mc range for Telemetry and Space Communications. Modern etched circuit modules throughout. Front panel plug-ins include IF Filters, Spectrum Display, Predetection Converter, and other modules.

DEMONSTRABLY SUPERIOR Telemetry Receiver

DCS's new TELCOM receiver in comparative tests demonstrates performance superiority in many important respects including:

Selectivity Distortion Noise Performance Spurious Rejection RFI Characteristics Modular Flexibility

TELCOM is a fundamentally new receiver design—a considerable departure from conventional design practices. Section by section, stage by stage, refinement, innovation and sound engineering practices have been applied to eliminate the many inadequacies of present-day receivers.

TELCOM is a true advancement in receiver technology — providing significant improvement in almost every important performance characteristic:

100% solid state... 100 to 6000 mc range... High RF selectivity... Low input VSWR... Meets all RFI requirements of MIL-I-26600... Low noise figure... Improved large-signal quieting... All spurious (not just image) down 60 db... Plug-in linear phase IF filters... Remote IF filter selection... No AGC

detuning... Reduced IM and harmonic distortion... Mean-of-peaks AFC prevents base line shifting... Ultra-linear AM and FM detection... Stable direct-coupled video amplifier... Accurate tuning indicators... Versatile front panel plug-ins, including logarithmic spectrum display unit, band-switching predetection converter, IF filters, and others... True modularity — interchangeability without adjustment or calibration... Precision extruded modules... Rugged chassis and module construction.



Try it yourself. Compare more than specifications — compare performance. Find out how much better your data can be with a TELCOM Receiver. Your local DCS representative will be happy to assist you in arranging a demonstration or evaluation.

DATA-CONTROL SYSTEMS INC. East Liberty Street Danbury, Connecticut 203-743-9241

WASHINGTON, D.C. 1225 19th Street	202-296-1640	ALBUQUERQUE First Nat. Bank Bldg. E	505-265-8033	PARIS (Techni.) 55 Rue Pierre Charron	Elysees 30-58
WINTER PARK, FLA. 116B Park Avenue	305-644-5654	LOS ANGELES 5316 W. Imperial Highway	213-678-7631	AMSTELVEEN (Technitron) Rottumerstraat 15	8533
HUNTSVILLE, ALA. 2109 W. Clinton Ave.	205-536-4907	SANTA CLARA, CALIF. 501 Washington St.	408-241-6820	ROME (Lampel) Via XX Settembre 27B	47.48.91
DAYTON Talbott Tower	513-224-9735	MUNICH (Technitron) Sonnenstrasse 14	55-78-32	STOCKHOLM K (Telare) Industrigatan 4	5433.17
HOUSTON 2100 Travis	713-227-5410	COPENHAGEN (Techni.) 24 Klosterstraede	Palae 2632	FELTHAM, ENGLAND (S.E. Labs) N. Feltham	Fel 5876

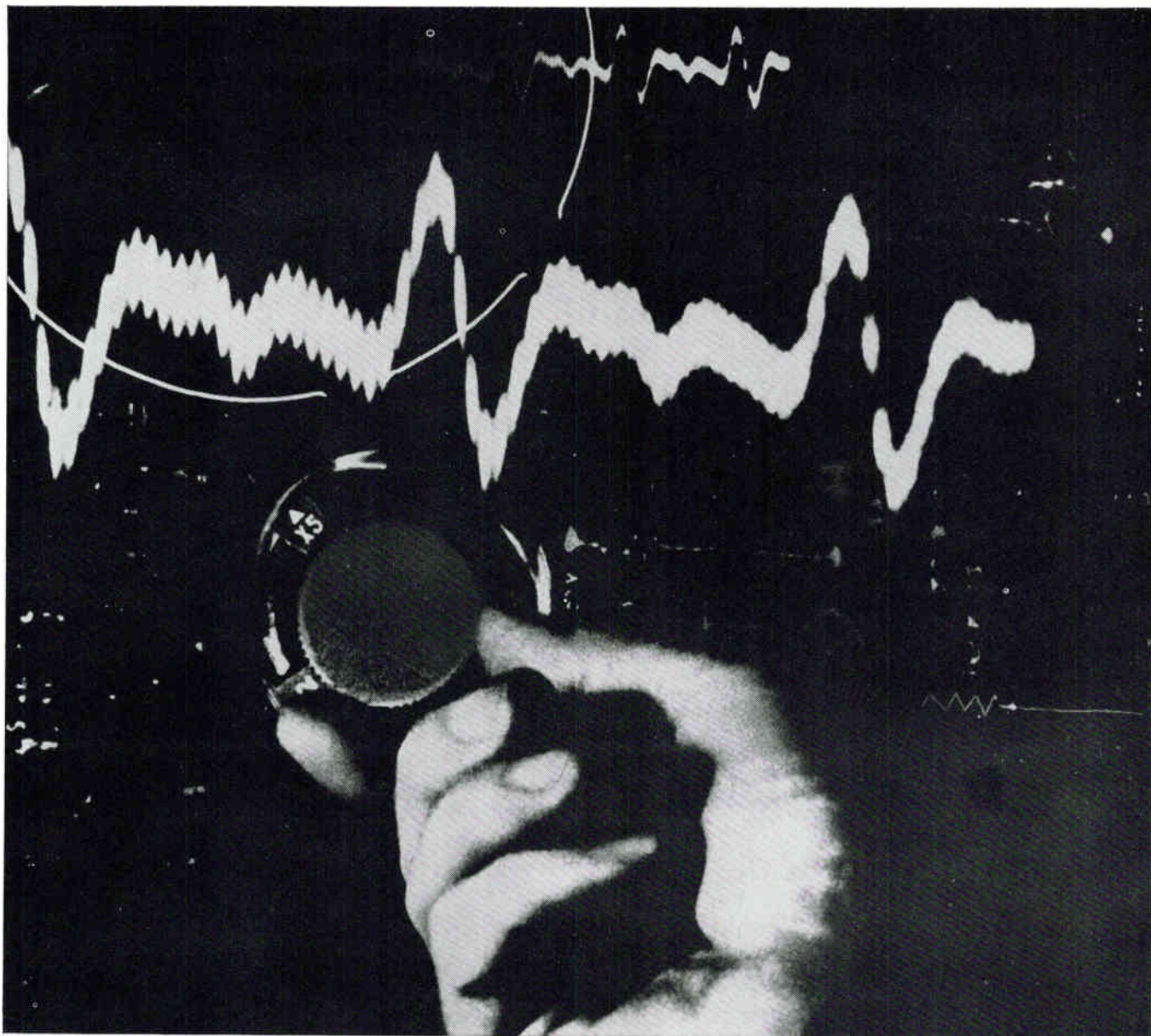

the product is only part of the deal

Ask the design engineer what he looks for when he selects electronic components . . . apart from the devices themselves. He will enumerate factors which never appear in a catalog or a data sheet.

Because important though these components are, they are not all-important. The experienced designer sees them only as part of a transaction which should provide him with research and applications know-how, technical data and assistance in many forms, and a willingness to share his problems before and after he has purchased the products.

This is the kind of support that goes with Mullard

products, and typical of it is Applications Engineering. At Mullard, teams of applications engineers are helping customers to use components to the best effect; liaising with research laboratories to achieve still higher performance; anticipating the needs of tomorrow.

Users of Mullard products benefit from this knowledge and experience in countless ways; indeed the whole of this applications research organization is virtually working for them.

If we are not serving your Company already, please let us know if we can help you.



Mullard

electron tubes · semiconductors
magnetic and other components

MULLARD LIMITED · MULLARD HOUSE · TORRINGTON PLACE · LONDON · WC1 · ENGLAND

18 OCTAVE RESISTANCE RANGE WITH HELIPOT'S NEW THIN-LINE CERMET TRIMMER



It's a Mil-spec trimmer completely in tune with MIL-R-22097B (type RJ12). Available in pin or lead versions, Helipot's brand new Model 56 Helitrim[®] potentiometer is less than 0.200 inch thick. And it sells for \$5.50 and down.

One-watt power rating (at 85°C) throughout its entire scale of resistances (10 ohms to 2 megohms) is made possible by the Cermet resistance element ... which, incidentally, provides essentially infinite resolution and freedom from sudden failure. For the complete score on the new Model 56 trimmer, just sing out for your local Helipot[®] rep.

Beckman[®]

INSTRUMENTS, INC.

HELIPOT DIVISION

FULLERTON, CALIFORNIA • 92634

INTERNATIONAL SUBSIDIARIES: GENEVA, SWITZERLAND;
MUNICH, GERMANY; GLENROTHES, SCOTLAND; PARIS, FRANCE;
TOKYO, JAPAN; CAPE TOWN, SOUTH AFRICA.

You need a pushbutton switch.



Bill, at the next board, needs a toggle switch.



Sam's looking for placard indicators.



Joe wants a switchlite.



Harry wants a hermetically-sealed switch.



Here's the easy way to get all the answers at once!

Just check the bingo card in this book for any or all of the Control Switch catalogs listed below. Or send us a card of your own.

If you get all of our catalogs you'll have it made.

First, because these catalogs cover a combination of switch types and switchlites that no other manufacturer can offer. So you get a concentrated reference.

Second, because some switch manufacturers don't make *any* of the switches we make. So Control Switch catalogs save wild goose chases.

Third, because we make only quality switches. For computers, aircraft, missiles, control panels, and such. So our catalogs (and your nearest Control Switch distributor) save time screening out switches that haven't got it.

Here's the list. Check the Reader Service Card number at the left for the catalogs you want.

- #233 *Condensed Switch Catalog 100*
- #234 *Basic Snap-Action Switch Catalog 110*
- #235 *Toggle Catalog 180*
- #236 *Indicator Light Catalog 120*
- #237 *Hermetic Switch Catalog 130*
- #238 *Switchlite Catalog 220*
- #239 *Pushbutton Catalog 190*



CONTROL SWITCH DIVISION
1420 Delmar Drive, Folcroft, Pennsylvania 19032

***New: increased power, compact size,
with the reliability of glass...***

4-amp glass rectifier



this small

5-watt glass zener



this small

Two more firsts from Unitrode®

These new units, with hard glass fused to the silicon surface — have the same voidless monolithic construction as the original Unitrode diodes and zeners of long-proven performance. Differing only in their slightly larger size, the new units offer higher power and higher surge capability with the same controlled avalanche and transient overload protection of the smaller devices. Unaffected by all military environmental testing, specified catalogue parameters are end-of-life limits.

New rectifier types are rated to 4 amps, PIV's from 50 to 800 volts, surges from 60 to 100 amps — all with controlled avalanche reverse characteristics.

New zeners, with 5 watt continuous ratings, fill the rating gap between 1 watt and 10 watt with low dynamic impedance and low leakage — voltage range is 6.0 to 400 volts. They withstand surges of 200 watts — two to three times that of conventional stud mounted 10-watt zeners. Axial leads make mounting a simple task. Write or call . . . Unitrode Corporation, 580 Pleasant St., Watertown, Mass. 02172. Tel: (617) 926-0404, TWX: (617) 924-5857.

Nationwide distribution by Compar.

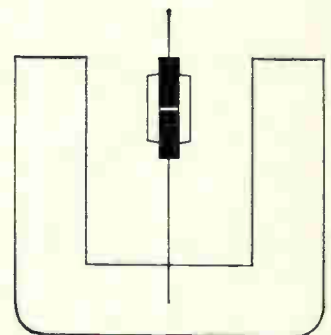

UNITRODE®
"better always/by design"

LOOK!

This Model 630 Integrating Digital Multimeter From Electro Instruments Is The World's

MOST VERSATILE

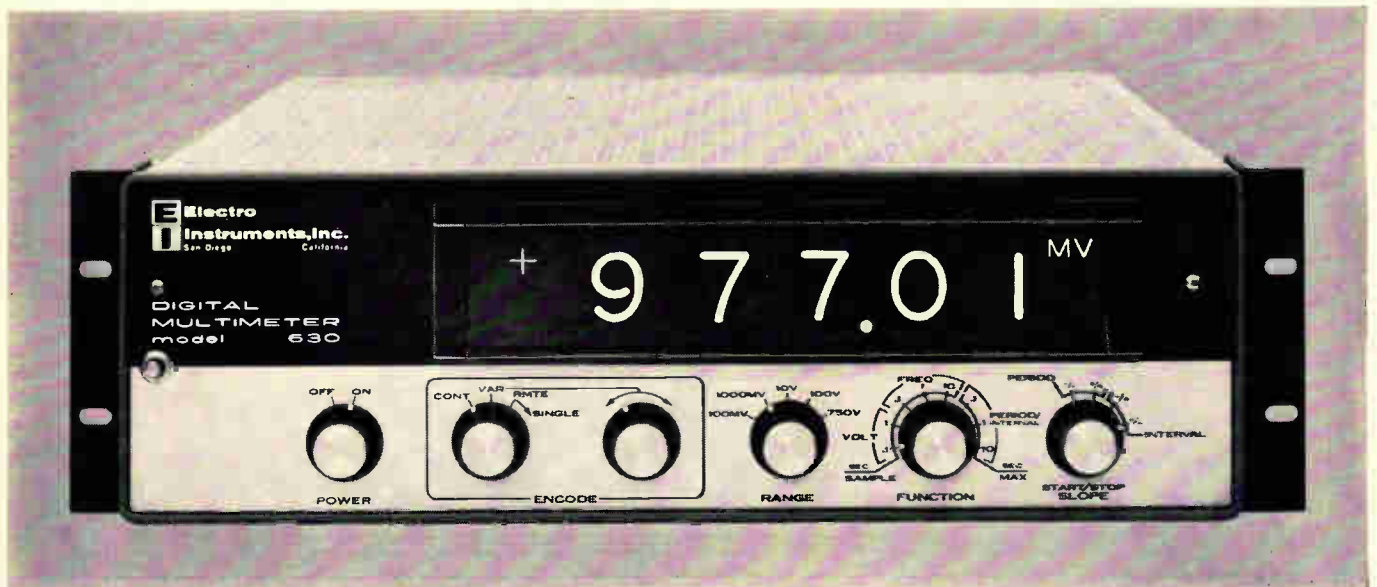

It has 1 megacycle frequency counter... eliminates errors in measurements near zero and/or involving polarity changes... lets you measure DC voltages, frequencies and time intervals with one instrument... has built-in storage to eliminate "rolling" of digits in readouts... and 1 microvolt resolution. And its price is only

\$3,295

Electro Instruments, Inc.

8611 Balboa Avenue San Diego, California 92112
Electro International, Inc., Annapolis, Md.





DELIVERS CLOSED-CIRCUIT TELEVISION SYSTEMS TO MEET YOUR REQUIREMENTS

COLOR cameras
ENVIRONMENT-RESISTANT cameras
HIGH-RESOLUTION cameras
INDUSTRIAL cameras
MINIATURIZED cameras
RADIATION-RESISTANT cameras
SELF-CONTAINED cameras
SPACE cameras
TEMPERATURE-EXTREME cameras
UNDERWATER cameras

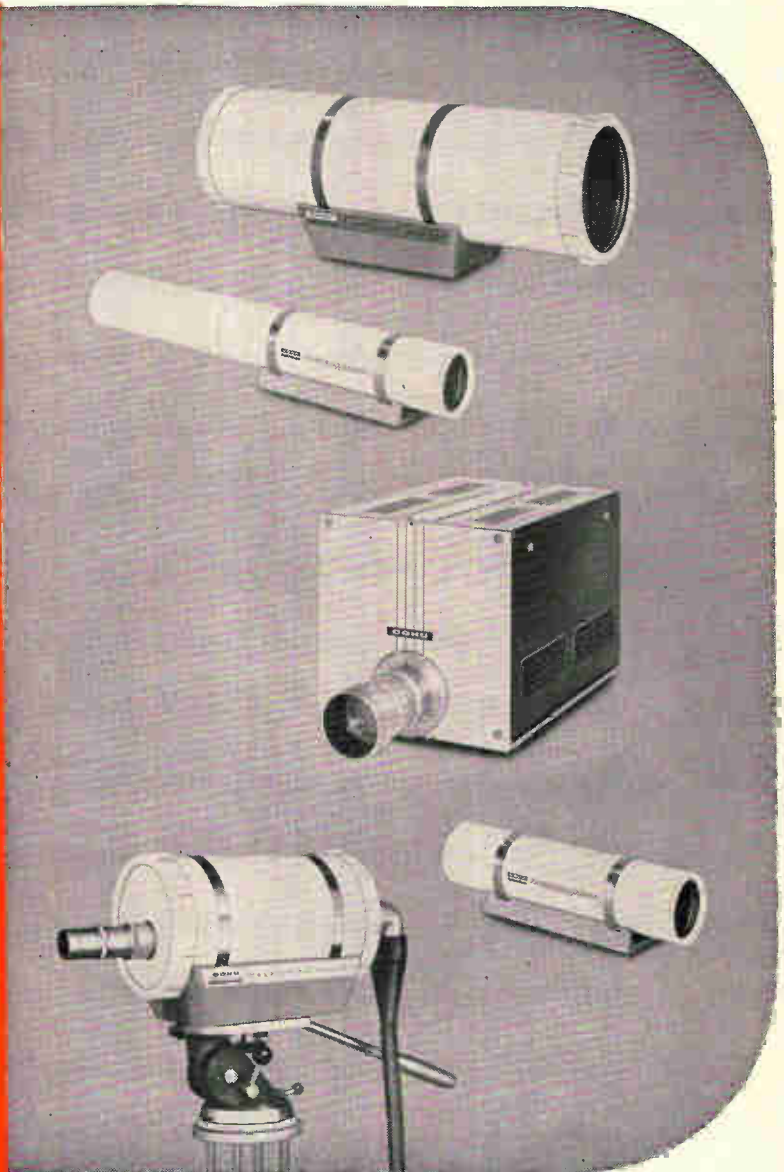

and ALL ACCESSORIES including monitors, control units, fixed-focus and zoom lenses, pan/tilt units, video cable, video switchers, synchronizing generators, cabling, tripods, vidicons...

WRITE for technical information and systems engineering. Representatives in all major cities.



Box 623
San Diego, California 92112
Phone (714) 277-6700

familiar faces from the world's broadest line of indicating relays

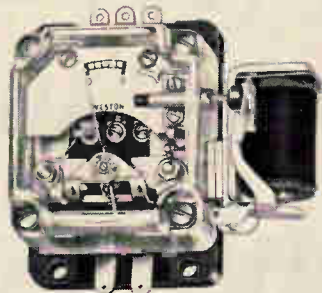

Model 813 Miniature — compact and lightweight; sensitive and Sensitrol (magnetic) contacts; single or double contact; ranges as low as 2-0-2 μ a.

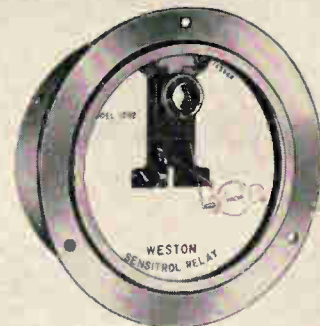

Model 1092 Sensitrol—low cost; all purpose; magnetically shielded; wide range adjustability; ideal for use in engineering breadboard circuits.



Model 705 Sensitrol—highly sensitive; surface or flush mounted; single or double, fixed or adjustable contact; ranges as low as 0.5-0-0.5 μ a.



Model 723 Sensitrol—sealed; shielded; internal reset; solder terminals; single or double magnetic contact; ranges as low as 1-0-1 μ a.



Model 1097 Ruggedized 3 1/2" Relay—LCCA type fully meets applicable portions of military ruggedized spec; sealed; long scale; shielded; solder terminals; single or double adjustable contacts.

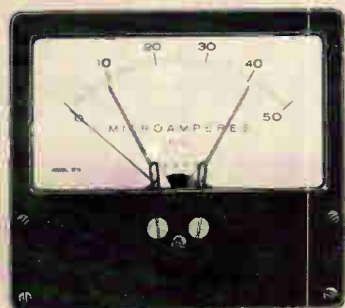

Model 1075 Photronic—operates without physical contact; single or double adjustable set points; continuous reading beyond set point; taut band frictionless mechanism; solid state switching circuit; ranges from 10 μ a.

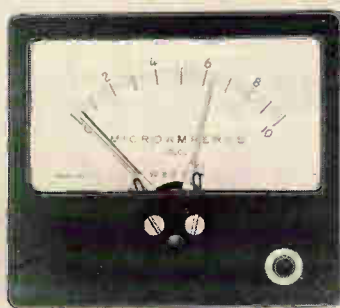

Model 1073 Mag Trak — long scale; shielded; positive contact; combines LCAA with magnetic attraction; self-contained reset; single or double adjustable contacts, ranges from 10 μ a.

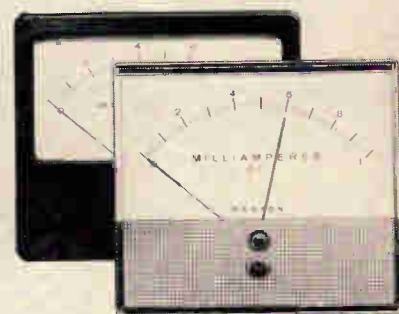

Model 1930/1940 Photronic—3 1/2" and 4 1/2" in either bakelite or plastic front; low cost; add-on power supply and solid state switching circuit; shielded; non-physical, adjustable contact.

QUALITY BY DESIGN



WESTON INSTRUMENTS, INC.

614 Frelinghuysen Avenue, Newark, New Jersey, 07114

Is this trip worthwhile?



It is...if a photographic approach to your data-recording needs makes sense

First tell us by mail or phone the parameters of your specific data-capture requirements. If photography is *not* a practical answer, we'll tell you so. If it is, we'll arrange a blackboard session for you with fellow engineers well qualified to point you to a solution without getting you lost in bewildering photo-technology.

Behind this offer there is something more than engineering depth. There's also a new line of Kodak films designed for such fast, compact, and outwardly simple processing that you get all the advantages that are inherent in photo-recording without need for space-, time-, and labor-consuming manipulation.

To find out whether your high-volume data-recording job is one where we (or even some other company) could help by talking, write to *Eastman Kodak Company, Special Sensitized Products Division, Rochester, N. Y. 14650*. Or call *716-325-2000, Ext. 5129*.

Kodak

Measuring task?

*an answer for every measurement—
dc voltage, dc current,
ac voltage, resistance.*

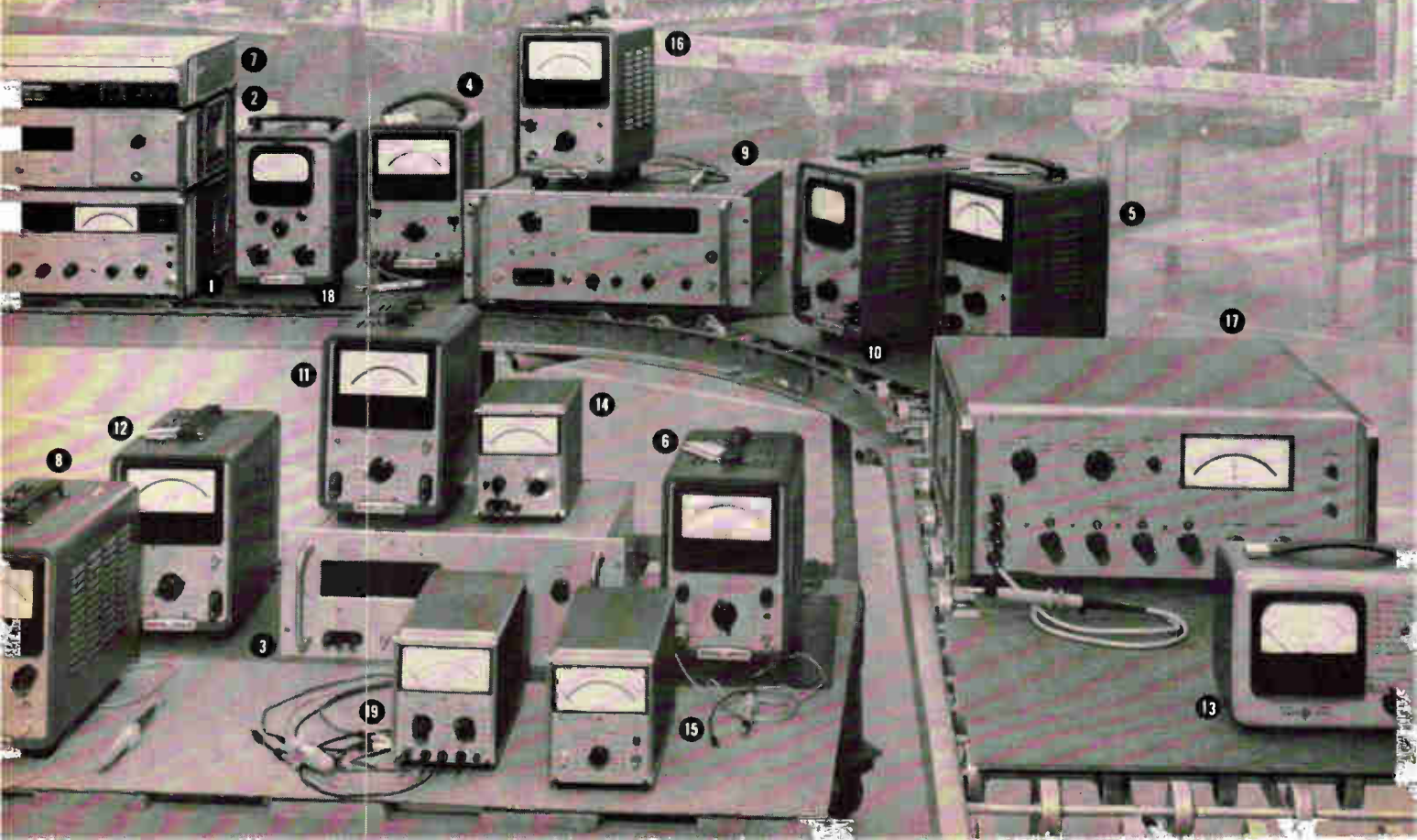

No matter what your basic measuring need, you'll find a fast, accurate electronic instrument from Hewlett-Packard just right for best results. A complete line of instrumentation is available from Hewlett-Packard for measuring dc voltage and current, ac voltage and resistance.

Each instrument offers the specified performance, with conservatively designed circuitry, long life and simple routine maintenance. Operation is easy, too, and each meter is value priced.

Several of the voltmeters offer extra accuracy with individually calibrated taut-band meter movements, the taut-band design providing increased accuracy and durability and the servo calibration matching each meter face to its own

particular movement. These movements are standard on the 400H, 400L, 403B, 410C, 411A, 412A, 413A, 425A, 740A, 741A and 3400A.

Brief specs in the chart describe the basic characteristics of the meters available. Call your hp field engineer for a demonstration of the instrument that will make your work easier. Or write for full details to Hewlett-Packard, Palo Alto, California 94304, Tel. (415) 326-7000; Europe: 54 Route des Acacias, Geneva; Canada: 8270 Mayrand Street, Montreal.



9779

DC Measurements	Primary Uses	Frequency Range	Voltage or Current Range	Input Impedance	Price
1 740A	DC standard, differential voltmeter; analog voltmeter, dc amplifier	dc, floating and guarded in all modes of operation	6-digit resolution, $\pm 0.01\%$ accuracy; input voltage ranges 1 mv to 1000 v full scale; null ranges 1 μ v to 1 kv	$>10^8$ ohms above 10 mv; $>10^8$, 1 mv to 10 mv; $>10^7$, 1 μ v to 1 mv (independent of null condition)	\$2350
2 3440At	Plug-in flexibility, digital voltage measurement, automatic polarity, printer output, plug-ins for current, resistance and ac	dc	9.999 v to 9999 v full scale (accuracy $\pm 0.05\%$ of reading ± 1 count); plug-in preamp allows 10 μ v resolution	10.2 megohms to dc	\$1160†
3 405BR	Digital voltage measurement, automatic range, polarity; 405CR has printer output	dc	0.001 v to 1000 v (accuracy $\pm 0.2\%$ of reading ± 1 count)	11 megohms to dc	\$1040 \$1085
4 412A	Precision voltage, current, resistance measurements	dc	1 mv to 1000 v full scale, 1 μ a to 1 amp	10 to 200 megohms, depending on range	\$ 400*
5 413A	DC null meter, dc voltmeter, amplifier	dc	± 1 mv to ± 1000 v end scale, 13 ranges	10 to 200 megohms, depending on range	\$ 350*
6 425A	Read μ v, μ a; 100 db amplifier; medical, biological, physical, chemical applications	dc	± 10 μ v to ± 1 v end scale, ± 10 pa to ± 3 ma end scale	1 megohm $\pm 3\%$ (voltmeter)	\$ 500*
7 Moseley 22	DC servo voltmeter for process control, data reduction and general laboratory use	dc	11 ranges, 3 mv to 300 v full scale	200 megohms per v full scale to 30 v; 60 megohms per v full scale at 100 v; 20 megohms per v full scale at 300 v	\$ 595
8 428B	Clip-on milliammeter, eliminates circuit loading; wide range, recorder output for dc to 400 cps	dc on meter, dc to 400 cps on recorder output	1 ma to 10 amps full scale, 9 ranges		\$ 600*
9 DY-2401B	Integrating digital voltmeter; measure voltage in presence of high common mode noise	dc—auto-ranging optional	99.999 mv to 999.99 v full scale in 5 ranges; optional 9.9999 mv range	10 meg, 10 v range and above; 1 meg, 1 v range; 100,000 ohms, 0.1 v range	\$3950
AC Measurements	Primary Uses	Frequency Range	Voltage or Current Range	Input Impedance	Price
10 400D	Wide-range ac measurements, high sensitivity	10 cps to 4 mc	0.001 to 300 v full scale, 12 ranges	10 meg, 15, 25 pf shunt	\$ 250*
11 400H	High-accuracy, wide-range ac measurements	10 cps to 4 mc	0.001 to 300 v full scale, 12 ranges	10 meg, 15, 25 pf shunt	\$ 325*
12 400L	Log voltages, linear db measurements	10 cps to 4 mc	0.001 to 300 v full scale, 12 ranges	10 meg, 15, 25 pf shunt	\$ 325*
13 403A	Battery-operated portable; fast, accurate, hum-free ac measurements	1 cps to 1 mc	0.001 to 300 v full scale, 12 ranges	2 meg, 15, 20, 40 pf shunt	\$ 275
14 403B	AC voltage measurements for lab or field; ac line or battery operation	5 cps to 2 mc	1 mv to 300 v full scale	2 megohms, 25, 50 pf shunt	\$ 310
15 3400A	True rms readings of complex ac waveforms; crest factor 10 at full scale	10 cps to 10 mc	0.001 to 300 v full scale	10 meg, 25 pf shunt	\$ 525
16 411A	Millivolt, db readings to gigacycle range	500 kc to 1 gc	10 mv to 10 v full scale, 7 ranges	Typically 200 k at 1 mc, 1 v	\$ 450*
AC-DC-OHMS	Primary Uses	Frequency Range	Voltage or Current Range	Input Impedance	Price
17 741A	Similar to 740A, adds ac differential, high-impedance voltage measurements	50 cps to 50 kc $\pm 0.1\%$	1 v to 1000 v full scale ac; similar to 740A on dc	1 meg, 5 pf shunt, ac	\$1475
18 410B	Audio, rf, vhf measurements, dc voltages, resistances	dc; ac-20 cps to 700 mc	dc, 1-1000 v full scale ac, 1-300 v full scale	dc, 122 meg, ac, 10 meg, 1.5 pf shunt	\$ 245**
19 410C	DC voltage; resistance, current; audio, rf, vhf measurements with ac probe	dc; ac-20 cps to 700 mc	dc v, 15 mv-1500 v full scale; dc amps, 1.5 μ a-150 ma full scale; ac v, 0.5-300 v full scale	dc v, 100 meg, ac, 10 meg, 1.5 pf shunt	\$425***

*Cabinet price, rack mount \$5 additional. **Cabinet price, rack mount \$20 additional. ***With hp 11036A AC Probe.

†Function plug-in required: 3441A Range Selector, \$40; 3442A Automatic Range Selector, \$135; 3443A High-Gain, Auto-Range Selector, \$450; 3444A Multi-Function Plug-In (dc volts, current, resistance), \$575; 3445A AC-DC Range Unit Plug-In, \$600.

Data subject to change without notice. Prices f.o.b. factory.

**A. King McCord,
President, Westinghouse Air Brake Company, says,**

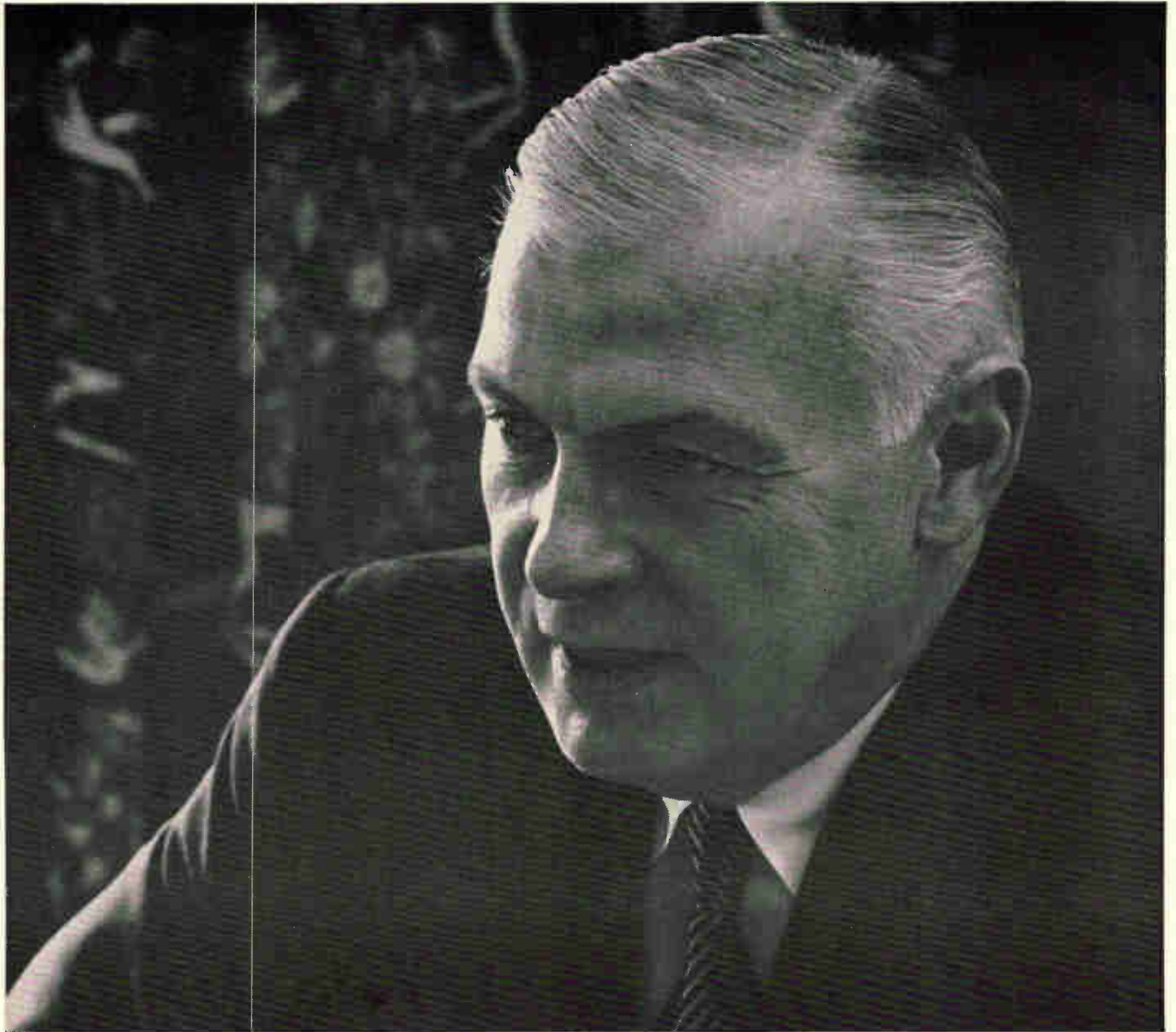

“We’ve introduced the world to WABCO with Industrial Advertising.”

“We gave *seven* individual companies a single corporate identity—virtually overnight. We let customers in thirty major markets know that Westinghouse Air Brake now ranks among the world’s most skilled and diversified suppliers—of earthmovers, drilling equipment, compressors,

automatic signal and control systems, electronic guidance detection and communications equipment, control valves, hydraulic and pneumatic cylinders, and—that’s right—air brakes. We told the story fast and inexpensively to hundreds of thousands of purchasing influences, with Industrial Advertising.”

Advertising cuts the cost of selling . . .

ASSOCIATION OF INDUSTRIAL ADVERTISERS



271 Madison Ave., New York, N. Y. 10016

*You expected the 31 kinds
of thinner, shorter, lighter
connectors we came up with
when we introduced
the Bendix "Pancake"
connector concept.*

Now read about the unexpected.

Last year when we introduced the Bendix® Pancake connector concept, we promised a full line. It's now out and available:

Over 8 sizes in wall and box mount, jam nut receptacle, straight plug and hermetic seal types. 25 insert patterns in 10 through 24 shell sizes (many MIL standard layouts); 16, 20 and Double-Density (24) contact sizes crimped and soldered; and potted versions with

straight and 90° potting boots. And every one a dependable off-the-shelf item.

And every one with all the Pancake advantages, too: Up to 50% less length and 60% less weight than comparable performance connectors. Up to 135 contacts in one connector. Increased pin contact bending resistance. Greater contact retention. Temperature capabilities to 392°F continuous operation. Perform-

ance in excess of MIL-C-26482C. And reduced failure rate through fewer components and increased materials capability.

For details on the full Pancake connector line, write us in Sidney, N. Y.

We know you'll be pleasantly surprised by what you find out.

But we expect you expected all of this from us all along.

Right?



*Now there's a type and size of thinner, shorter, lighter
Pancake connectors for virtually all aerospace applications.*

Scintilla Division



New IBM Component Insertion Machine automatically assembles circuit cards at high speed — cuts unit costs, eliminates faulty assembly

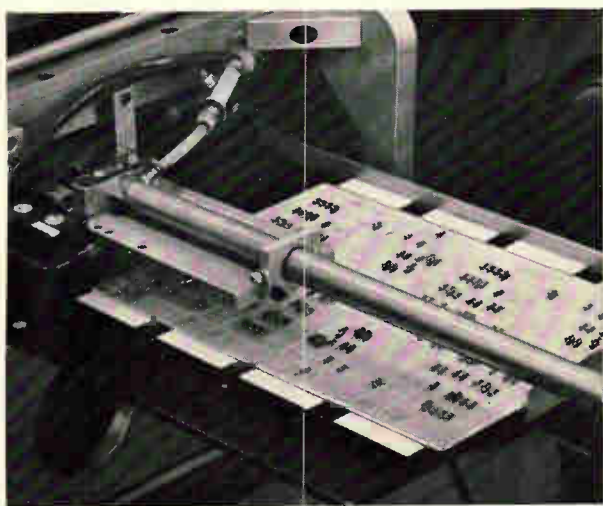

Circuit boards go in one end, perfectly assembled circuit packages come out the other.

We originally designed this machine to solve one of our own problems. Existing production equipment simply could not keep up with our need for

fast and reliable circuit board assembly.

The IBM Component Insertion Machine ME 501 not only solved that problem: it has saved us thousands of dollars a year by reducing unit assembly costs. Maybe it can do the same for you.

Because it's numerically controlled, the ME 501 can select components from 24 magazines in *any random sequence*. You decide the sequence you want to use then load the magazines with

the proper components.

The ME 501 then automatically hopper-feeds printed

circuit boards. It selects, positions, inserts and clinches up to 24 different ¼-watt resistors in printed circuit cards — at speeds up to 4500 components an hour. All automatically.

The IBM Component Insertion Machine features automatic self-checking. If a component cannot be inserted for any reason (faulty boards or faulty leads), the machine automatically repeats the attempt. If it fails a second time, it will stop and signal the operator. Once the operator corrects the problem, the ME 501 resumes automatic, self-checking operation.

Call us for more information or write: IBM Industrial Products Division, 1000 Westchester Avenue, White Plains, New York 10604.





MASTERMIND

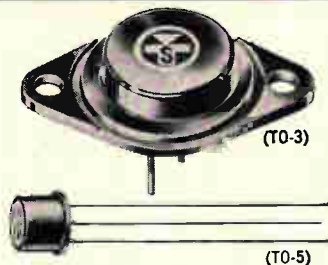

NPN SERIES 2N3232 THROUGH 2N3240 / PNP SERIES STC5648 THROUGH STC5652

These devilishly clever Industrial Silicon Power Transistors. Low cost, high quality, silicon power transistors specifically designed for industrial applications. The 2N3232-2N3240 series in the TO-3 header: maximum junction temperature of 200°C, D.C. power capabilities range from 117 to 200 watts, peak switched power ratings for approximately 20 times the D.C. ratings, maximum collector current capabilities range from 7.5 to 20 amps with BV_{CEO} ratings from 60 to 160 volts, saturation resistance values from 0.1 ohms @ $I_C = 10A$ to 0.8 ohms @ $I_C = 3A$.

The PNP series STC5648-STC5652 in the TO-5 package, are direct replacements for PNP germanium transistors. Use them as complementary drivers to the above NPN series. The PNP's are five basic types with D.C. power capability of 8.75 watts @ $T_C = 25^\circ C$, BV_{CEO} ratings are from 40 to 100 volts, maximum collector current from 1.0 to 3 amps, maximum $V_{CE(sat)}$ from 1.0 to 0.75 ohms at $I_C = 200$ ma and 1.0 amps.

For complete specifications and information so you can Mastermind your industrial applications circuitry at low cost, contact:

EAST GATE BOULEVARD, GARDEN CITY, NEW YORK 11532, 516 Pioneer 2-4100. TWX 510-222-8258

REGIONAL OFFICES:

CHICAGO, ILL. 60625, 5555 NORTH LINCOLN AVE., 312-271-0366-7, TWX 910-221-1304

LOS ALTOS, CALIF. 94022, 1 FIRST STREET, 415-941-2842. HUNTSVILLE, ALA. 35807, POST OFFICE BOX 1467

SILICON 
TRANSISTOR
CORPORATION

The PDP-8 is a powerful,
integrated-circuit computer.

It sits on a desk,
understands FORTRAN,
has 1.6 μ sec cycle time and
exceptional input/output
capability.

And it's yours for \$18,000
complete, software included.

digital

EQUIPMENT CORPORATION Maynard, Massachusetts • Washington, D. C. • Parsippany, N. J. • Los Angeles • Palo Alto • Chicago • Ann Arbor • Pittsburgh • Huntsville • Orlando

The PDP-8 is a high-speed, real time, general purpose digital computer with all the desirable features of the popular PDP-5 plus greater speed and, as is evident, considerably smaller size. Its 1.6 μ sec cycle time gives it a maximum computation rate of 312,500 additions per second, and its input/output rate is 625,000 words (7½ million bits) per second.



Besides FORTRAN, the software package includes an on-line debugging program which gives the user dynamic printed program status information and an on-line editing program which lets him add, delete, change or insert single lines or sections of his symbolic program. The system also contains a macro assembler, floating-point software, elementary function subroutines in single- and double-precision arithmetic, and utility, diagnostic, and maintenance routines.

An input/output bus system permits simple connection of numerous standard and custom devices without changes in the central processor. Standard options include analog/digital and digital/analog converters, analog multiplexers, magnetic tape, paper tape, and drum memory systems, cathode tube displays, card punch and readers and other devices.

For information about the PDP line of computers (including the new medium-sized PDP-7 and the large-scale PDP-6), ask any computer expert. For user handbooks and technical specifications, call any Digital Equipment office or the main office: DIGITAL EQUIPMENT CORPORATION, Maynard, Massachusetts 01754. Telephone: 617 897-8821.

TWX: 710 347-0212. Telex: 092-027. Cable: DIGITAL MAYN.

1000 Microfarads

KEMET: #1 MAKER OF SOLID TANTALUMS leads the industry...1000 microfarads. When your specs call for higher capacitance than standard solid tantalums, don't settle for wet electrolytics out of habit. Specify new KEMET super-cap "A" Series capacitors. They give you the highest solid tantalum ratings available today: 1000 microfarads 6 VDC, 680 microfarads 10 VDC, 390 microfarads 15 VDC, and 39 microfarads 60 VDC. KEMET "A" Series capacitors come in standard size

cases in a wide range of capacitances and voltages and will operate from -55°C to +85°C with no voltage derating. More details? KEMET "A" Series capacitors meet or exceed requirements of MIL-C-26655B, have extremely low D. C. leakage, low dissipation factor and high capacitance stability. Find out for yourself. Just call your local KEMET distributor. For more technical data write: Union Carbide Corporation, Kemet Department, 11901 Madison Avenue, Cleveland, Ohio 44101.

"Kemet" is a registered trade mark of Union Carbide Corporation.



ELECTRONICS

KEMET REGIONAL SALES MANAGERS

WEST COAST
D. R. OGDEN
Union Carbide Corporation
Kemet Department
2770 Leonis Boulevard
Los Angeles, California 90058

MID-WEST AND SOUTH
K. S. COLLART
Union Carbide Corporation
Kemet Department
P. O. Box 6087
Cleveland, Ohio 44101

MID-ATLANTIC
R. H. ROBECKI
Union Carbide Corporation
Kemet Department
1341 Hamburg Turnpike
Wayne, New Jersey 07472

EAST COAST
J. G. EGAN
Union Carbide Corporation
Kemet Department
1341 Hamburg Turnpike
Wayne, New Jersey 07472

Washington Newsletter

April 19, 1965

Hughes to propose 20,000-channel satellite for Comsat

By May, the Hughes Aircraft Co. will offer to build a 20,000-voice-channel synchronous satellite for the Communication Satellite Corp.

The satellite, 9 feet in diameter and 9 feet long, would have a 100-watt radiated power capacity and 20 decibels of antenna gain. Over 1,000 ground stations could use it for 10 years, Hughes says. The satellite, model 307, would have fewer than 2,000 parts, compared with 3,300 on Early Bird I.

Hughes contends that it could build the satellite for \$10 million to \$12 million, a figure comparable to the cost of the 1,200-channel model 304 that it is proposing to Comsat for the initial global system, which will follow the Early Bird series. This system is due to be in operation by 1967. Model 307 would take 15 to 20 months to perfect. Currently, Comsat is considering three approaches for the satellite system: medium-altitude random-orbiting satellites, medium-altitude phased-orbiting satellites, and Hughes' synchronous 304 system.

Hughes contends its model 307 could be used by ground stations that cost about \$1 million, compared with about \$2.5 million for the model 304.

Year-long study on patents planned

The field of patents continues to get White House attention. President Johnson has established a commission "to evaluate our patent system and to identify possible improvements in it." The Presidential Patent Commission will study changes of government inaction in international patent matters; it will also look into rising costs and mounting backlogs in applications to the Patent Office, and consider whether the patent system, basically unchanged since 1836, still fulfills its purpose.

The year-long study may bring one or more of these results: adjustment in patent-fee systems; short-circuiting of the present procedures that require exhaustive searches and reviews before patents are issued; and a broader push for U.S. leadership in international patent protection.

Meanwhile, the White House is putting down a Senate rebellion against its flexible patent-title policies. The Senate drive would put practically all new ideas developed under federal financing into the public domain.

Under legislation being pushed by the White House, the present administrative policy would receive congressional sanction. Under this policy, contractors in many situations can keep title to patents developed through federally financed research and development.

The present policy requires the government to retain title to inventions it pays for where the national security or welfare are involved, or where the government is solely responsible for developments in a field of technology. Otherwise, contractors are allowed considerably more leeway in retaining title to patents though they must give the government a royalty-free license.

House unit to study Aerospace Corp.

The House Armed Services subcommittee—under pressure from aerospace concerns, the military and the General Accounting Office—will begin hearings late this month or early next into the operation of the Aerospace Corp., a nonprofit concern that provides technical manage-

Washington Newsletter

ment and performs advance planning and research for the missile and space programs for the Air Force.

The subcommittee will investigate the degree to which the Air Force relies upon such companies and whether more of the type of work these concerns perform should be parceled out to profit-making contractors or done by the military's own laboratories.

British may buy Mark II avionics

Since the British are likely to exercise their option to buy the General Dynamics Corp.'s F-111A fighter-bomber, they probably will buy the Mark II avionics system being developed for it. The British may invest \$1 billion in the F-111A as a replacement for their own TSR-2, which they've dropped because of high costs [see p. 204].

Conceptual studies of the integrated avionics package are now being carried out by the Autonetics division of North American Aviation, Inc.; General Dynamics; the Hughes Aircraft Co.; the Sperry Gyroscope Co., a subsidiary of the Sperry Rand Corp.; and the Westinghouse Electric Co. The Air Force hopes the Mark II system will be ready in late 1968.

The Air Force will soon begin comparison tests of five inertial navigation systems. It will select the one that performs best in the low-altitude, high-speed mission profile of the F-111, then begin a product-improvement program from which the eventual Mark II navigation system will evolve. It will test the systems of Autonetics; the Bell Aerosystems Co., a division of Textron, Inc.; General Precision Equipment Corp.; Litton Industries, Inc.; and the Nortronics division of the Northrop Corp.

Pentagon to spend less on computers

The Defense Department plans to buy \$41 million of computers in the year starting July 1, down from the current year's \$43-million investment.

For the past three years, the Pentagon has been shifting from lease to purchase of computers for its own use. It made its initial purchase in fiscal 1964, with a \$188-million order. With the completion of the coming year's program, 46% of the computers used by the military will be government-owned. The Pentagon estimates it will save \$91 million by owning rather than leasing this equipment, worth \$272 million.

But the department is resisting demands from some quarters in Congress and from the General Accounting Office that it furnish computers to its contractors rather than letting contractors lease them and charge the cost back to the government. A bill to require this is being considered by a House Government Operations subcommittee.

Profit elements: air and water

The current legislative drive to curb water and air pollution is expected to be a boon for electronics instrument makers.

The present \$1-million annual market for water-quality monitoring devices is likely to increase sharply as states, municipalities and industry step up purchases of devices to measure water's temperature, acidity, conductivity, dissolved oxygen, chlorides and turbidity. The Public Health Service also wants other factors monitored for which reliable equipment has not been developed. Needed are instruments to take coliform bacteria and nitrogen cycle radical counts, and measure biochemical oxygen demand.

For air pollution, the demand will be for infrared spectrometers and other analytical equipment that's both simple and inexpensive.

This is DEI's Solid State Receiver

It's new

Tunes in the range of 100 to 2300 mc

Superior performance characteristics

The TR-711 is virtually spurious free

Sets the standard for comparison

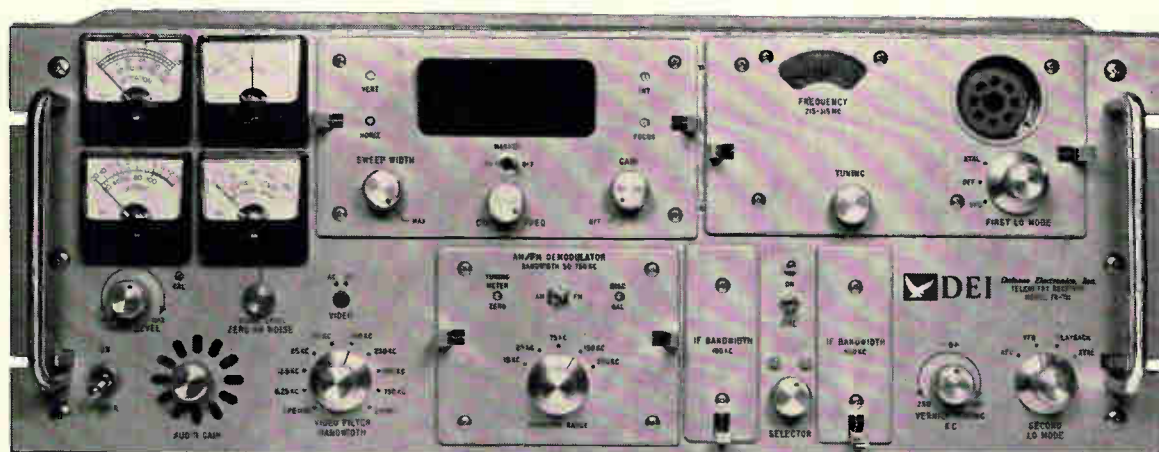

The TR-711 Receiver is modular in construction and can be supplied with a complete complement of plug-in modules including RF tuning units from 100 to 2300 mc, IF amplifiers with 10 kc to 3.3 mc bandwidths, AM, FM, and phase demodulators, and plug-in spectrum display unit, oscilloscope, predetection up and down converter, or high capture ratio discriminator. Any combination of plug-in modules can be utilized, thus providing unlimited receiving combinations adaptable to any known or projected telemetry system.

Characteristics and accessories are described in Bulletin TR-711.

Defense Electronics, Inc.
Rockville, Maryland



DEI
RESEARCH
DEVELOPMENT
MANUFACTURING

ROCKVILLE, MD. (301) 762-5700, TWX: 301-427-4660; SHERMAN OAKS, CALIF. (213) 872-2870, TWX: 213-732-2742; COCOA, FLA. (305) 632-5442; INT'L., ROCKVILLE, MARYLAND.

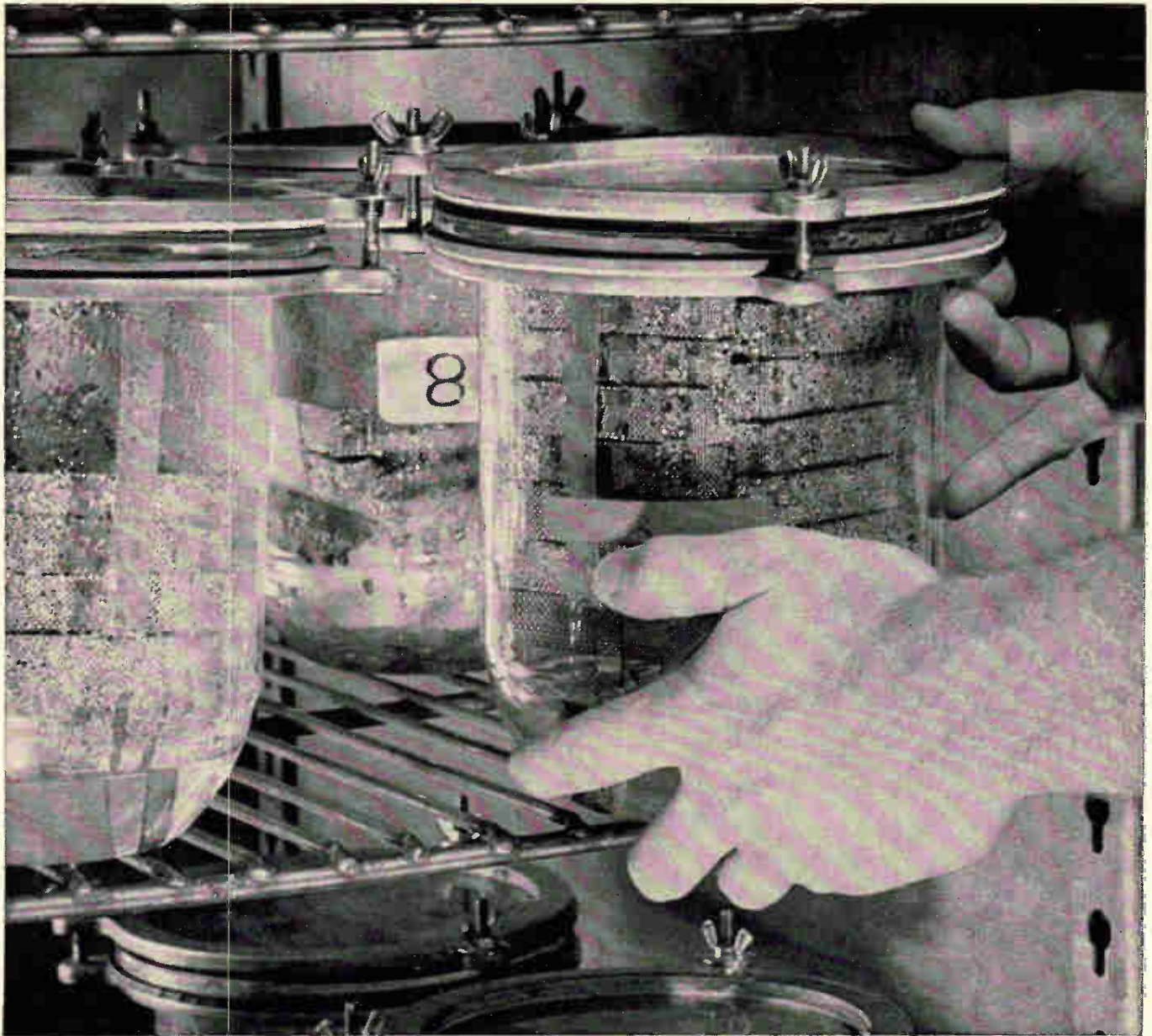

RESISTOR PROVING GROUND: MOISTURE RESISTANCE

For 120 hours Stackpole resistors are drenched in 100% relative humidity at 66°C, in the toughest moisture resistance test the Industry can offer. Still they work perfectly. Such severe testing indicates the care and control that goes into the continual resistor development program. Additional tests are conducted to determine load life and noise

level. Maybe some aspect of our in-depth testing interests you. If so, let our resistor development engineer discuss it with you. Write or call: Don Kirkpatrick, Manager-Engineering, Electronic Components Division, Stackpole Carbon Company, St. Marys, Pennsylvania. Telephone 814 834-1521. TWX 814 826-4808.



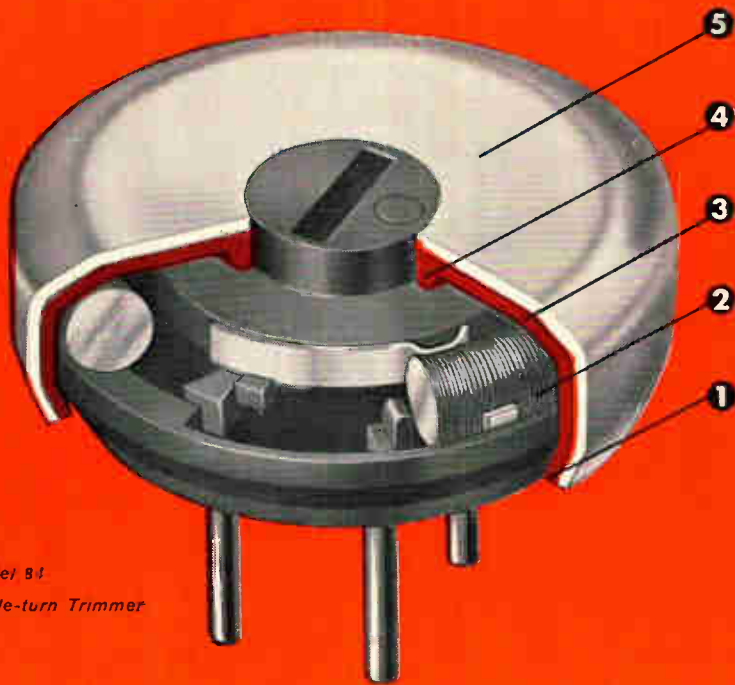

Model 84
Single-turn Trimmer

WHAT'S NEW IN TRIMMERS?

Unique silicone rubber lining providing Military performance at industrial prices

No other trimmer gives you the superior performance of Spectrol's new model 84 at *any* price. Check these unique construction features which assure military reliability at industrial prices.

- 1 Silicone rubber lined cover is crimped to the base completely sealing the unit against dust and moisture. No adhesives are used in any of the assembly operations.
- 2 Largest resistance element available in any 1/2 inch trimmer is made possible by placing the element against the silicone-rubber lined metal cover. No thick-walled plastic cases or insulators are necessary. Larger element means larger wire and better resolution as well as higher maximum resistance value.
- 3 Silicone rubber lined cover provides a true voltage breakdown barrier.
- 4 Packing gland sealing of the shaft is provided by the unique molded rubber-lining permitting full potting or immersion.
- 5 Metal case provides greater heat dissipation, avoids hot spots and allows high power rating of 1 1/2 watts at 50°C. For printed circuit applications, plastic base contacts PC board.



SPECIFICATIONS		MODEL 84
Standard Resistance Range . . .		50Ω to 100K
Standard Resistance Tolerance		± 5%
Power Rating		1 1/2 Watts at 50°C.
Operating temperature Range		-65 to +175°C.
Rotation		320° Fixed stops (continuous available)
Case Dimensions-inches		5/32 H x 1/2 Dia.
Unit Prices (84-3-8)		
1-9		\$3.95
500		\$2.60

Call your nearest Spectrol distributor for immediate off-the-shelf delivery at factory prices. Samples of the model 84-3-8 available for industrial and military users. For your sample write on your company letterhead direct to Spectrol, San Gabriel.

SPECTROL ELECTRONICS CORPORATION

1704 South Del Mar Avenue
San Gabriel, California

Adams Court
Plainview, L. I., New York

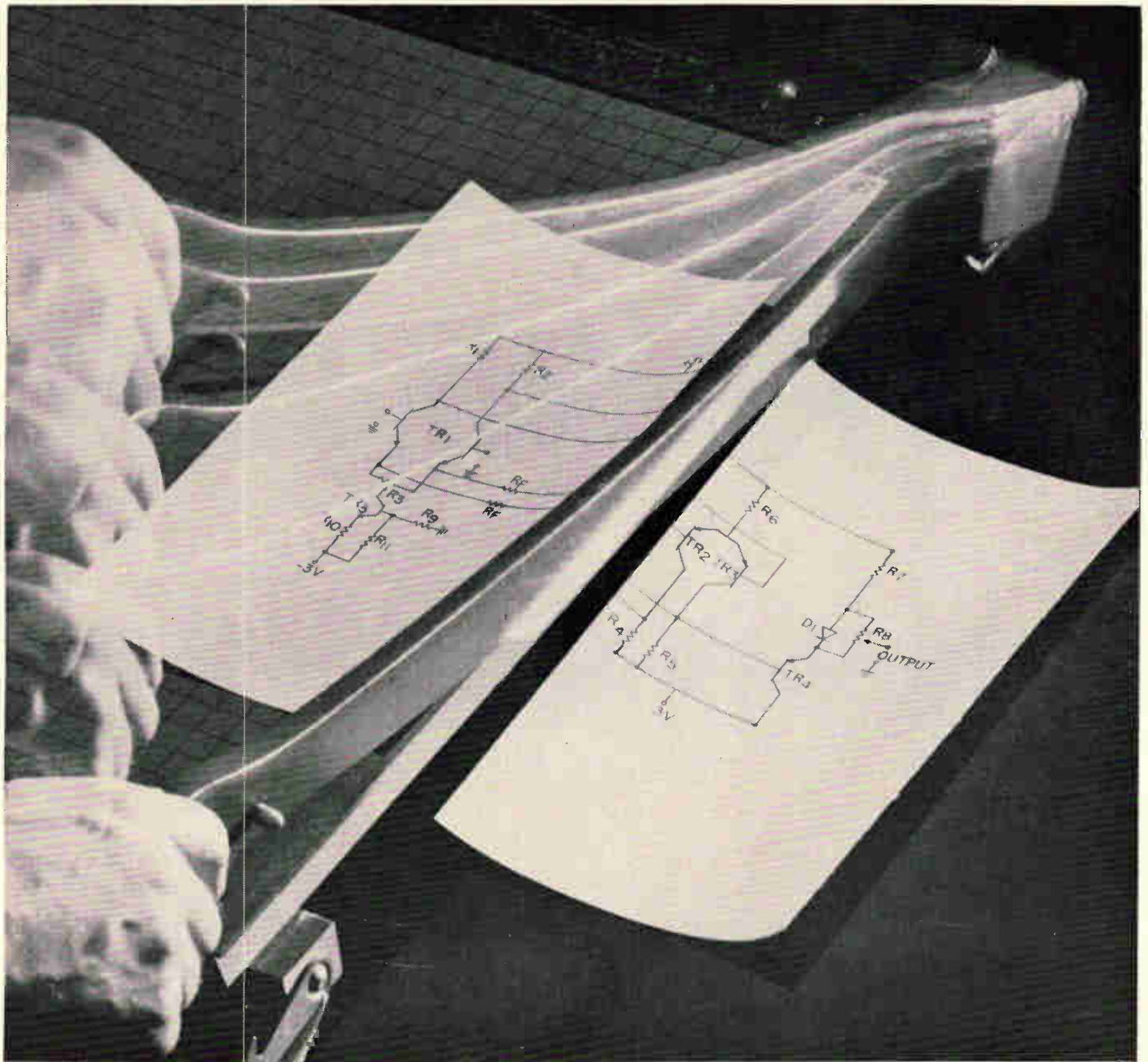

CUT STAGES WITH NEW MICROPOWER TRANSISTORS

NEW MICROPOWER TRANSISTORS WITH HIGHER BETA, increase circuit performance and reduce power requirements. As symbolized in the amplifier circuit above, amplification stages may be eliminated. The PNP 2N2605A with minimum beta of 150 at 10 μ A and exceptionally low leakage, is one result of the improved Sperry epitaxial construction. New Micropower transistors from Sperry are the NPN 2N2484, — 2N3117. Their small geometry is more resistant to radiation and it provides lower capacitance for higher speed. A natural extension of these advantages is found in our new PNP Differential Amplifiers, with such characteristics as betas of 100 to 200 at 10 μ A, and an I_{CBO} of 5 nA. Matched for both switching and linear applications, these dual transistors in one package give greater micropower circuit versatility and flexibility. For the best in Micropower devices, check Sperry . . . we were first to "check in" with Micropower transistors. **SPERRY SEMICONDUCTOR, Dept. M1, Norwalk, Connecticut 06852.**

SPERRY

DIVISION OF
SPERRY RAND
CORPORATION



Is it true that the Heinemann Series AM12 is the most popular OEM-type magnetic circuit breaker on the market?

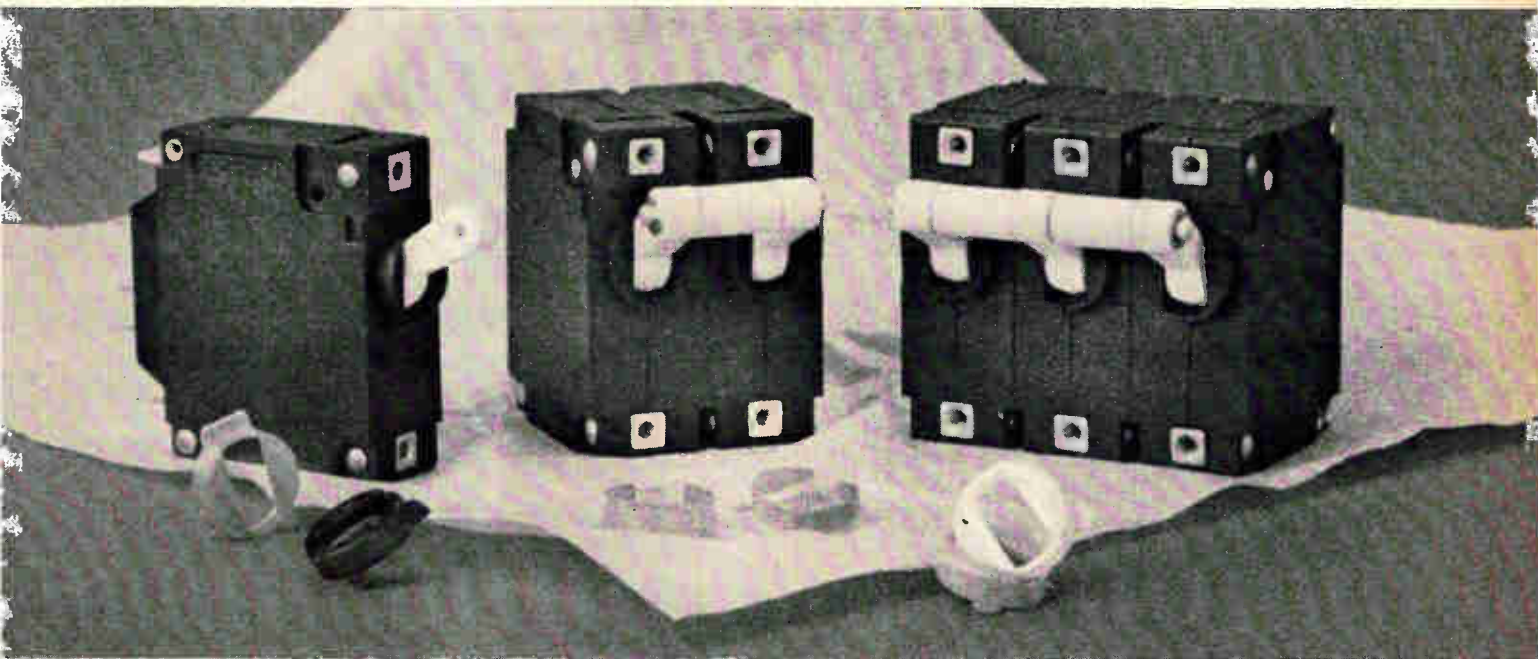

Not anymore.

You're looking at three reasons why. Our new Series JA breaker line.

The new Heinemann JA breaker is one-third smaller and lighter than the AM12.

It is much easier to install (there are no square panel cuts to make).

It is more attractively packaged (note the white handles and the snap-on color caps).

Yet it is available with all the same features and options.

And it carries the same five-year guarantee.

There is one hitch, though. The JA's top current rating is 20 amps, not 50.

But then we're not charging as much for it either.

(For detailed specifications, write for Bulletin 3350. First edition now on press.)



eeyyaaahhh !!

Anything Over 68°C And They Scream The Place Down

They're uncanny little chaps. And Hitachi has given them a special name. The CRITESISTOR. This is short for Critical Temperature Resistor. They're so advanced in design and performance ... so simple in construction ... so much ahead of any other type of thermistor that Hitachi has taken out world-wide patents. And mass production is already well under way. ■ As a result of a highly systematic study of materials and production methods Hitachi was successful in discovering this new element. One which has critical resistances that change by two to four orders at 68°C. ■ The components of the Critesistor are vanadium oxide, basic metal oxide and acid metal oxide. And when operated at a region near critical temperature, these elements have an especially high sensitivity to the temperature and temperature variations, by the use of alpha thirty times larger than that of the ordinary thermistor. This results in temperature curve characteristics that are more acute than any other thermistor. ■ The Critesistor's obvious and ideal role is as a thermal alarm element. At optimum temperatures it will instantly trip a bell alarm to all branches of a system. It can offer 100 branches as a maximum. ■ For complete technical data on this new development by Hitachi please write your request to the addresses below.



HITACHI SALES CORPORATION: 333, N. Michigan Avenue, Chicago 1, Ill., U.S.A. Tel: 726-4572/4 / 666, 5th Avenue, New York, N.Y. 10019, U.S.A. Tel: 581-8844 / 12715, S. Daphne Avenue, Hawthorne, Calif., U.S.A. Tel: 757-8143
 HITACHI, LTD., DUESSELDORF OFFICE: Graf Adolf Strasse 37, Duesseldorf, West Germany Tel: 10846

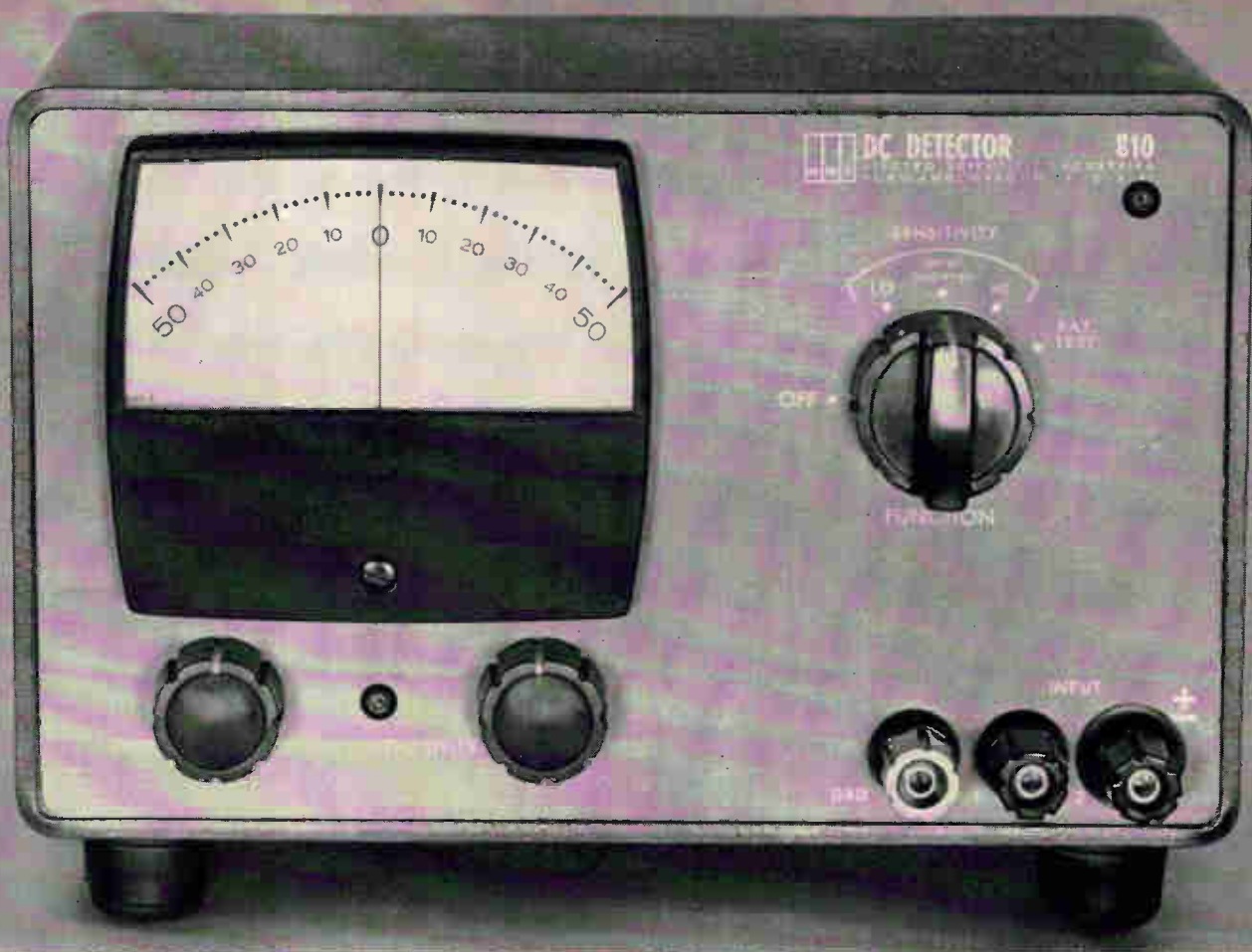

Hello, cruel world!

For all its sensitivity (1 microvolt), our new null detector is built to take the world's hard knocks, shocks and overloads up to 500 volts.

By all the old rules of the game, a null detector this sensitive would have to be handled with kid gloves.

But in our new model 810, we used solid state circuitry to design an instrument that's super sensitive without being delicate. You can overload it as much as 500 volts across the terminals or from either terminal to ground without burning it out. And you don't have to contend with tapping keys, sensitivity switches or other annoying protection devices.

What this new ESI Null Detector amounts to is a truly universal galvanometer replacement. It has the freedom from drift and ac pickup you get with suspension type galvanometers. Plus the high sensitivity and ruggedness you get only from an electronic null detector.

The price of our remarkable instrument is \$295. Perhaps it isn't such a cruel world after all. ESI[®], 13900 NW Science Park Drive, Portland, Oregon (97229).

Model 810 Null Detector

Usable sensitivity: 1 microvolt

Input impedance: 1 megohm

Portable battery operation: Inexpensive 6 volt battery supplies 30 milliwatt power requirement for more than one year and provides complete common mode isolation from the power line.

Input guarding and filtering: Fully guarded with 70 db of ac pickup rejection.

Response characteristics: Fast response at all sensitivity settings over a wide range of source impedances. Rapid recovery from severe overload.

Price: \$295



the
least important thing
about this new
low cost
germanium
power transistor
is that it
saves you money

Practically anyone can build a power transistor a little cheaper nowadays, and it's a rare occasion when you find a so-called "low cost" device that doesn't have a few built-in compromises on efficiency, performance or reliability.

Motorola's new 2N3611-18 series is one of these rarities — these devices not only carry a price tag up to 50 per cent lower than comparable units, they also offer performance advantages you just couldn't buy before at this price level. (\$.78, 100-up).

For example . . .

HIGH GAIN	20 min. @ 7 A
HIGH FREQUENCY RESPONSE	$f_r = 700 \text{ kc @ } .5 \text{ A}$
LOW, LOW LEAKAGE	$I_{c10} = \text{only } 40 \mu\text{amp @ } V_{c1} = 2 \text{ V}$

All this, plus excellent beta linearity, 85 watts power dissipation and a reliable, space-saving (low silhouette) hermetically sealed, cold-weld TO-3 package, represents the most compromise-free power transistor value on the market today.

Which is why we say the money it saves you isn't nearly as important as the peace of mind it'll bring you — and your customer!

2N3611-18 Series: 7A, PNP Germanium Power Transistors . . . available now from your Motorola distributor. For more information, write Dept. TIC, Motorola Semiconductor Products, Inc., Box 955, Phoenix, Arizona 85001.

506-4



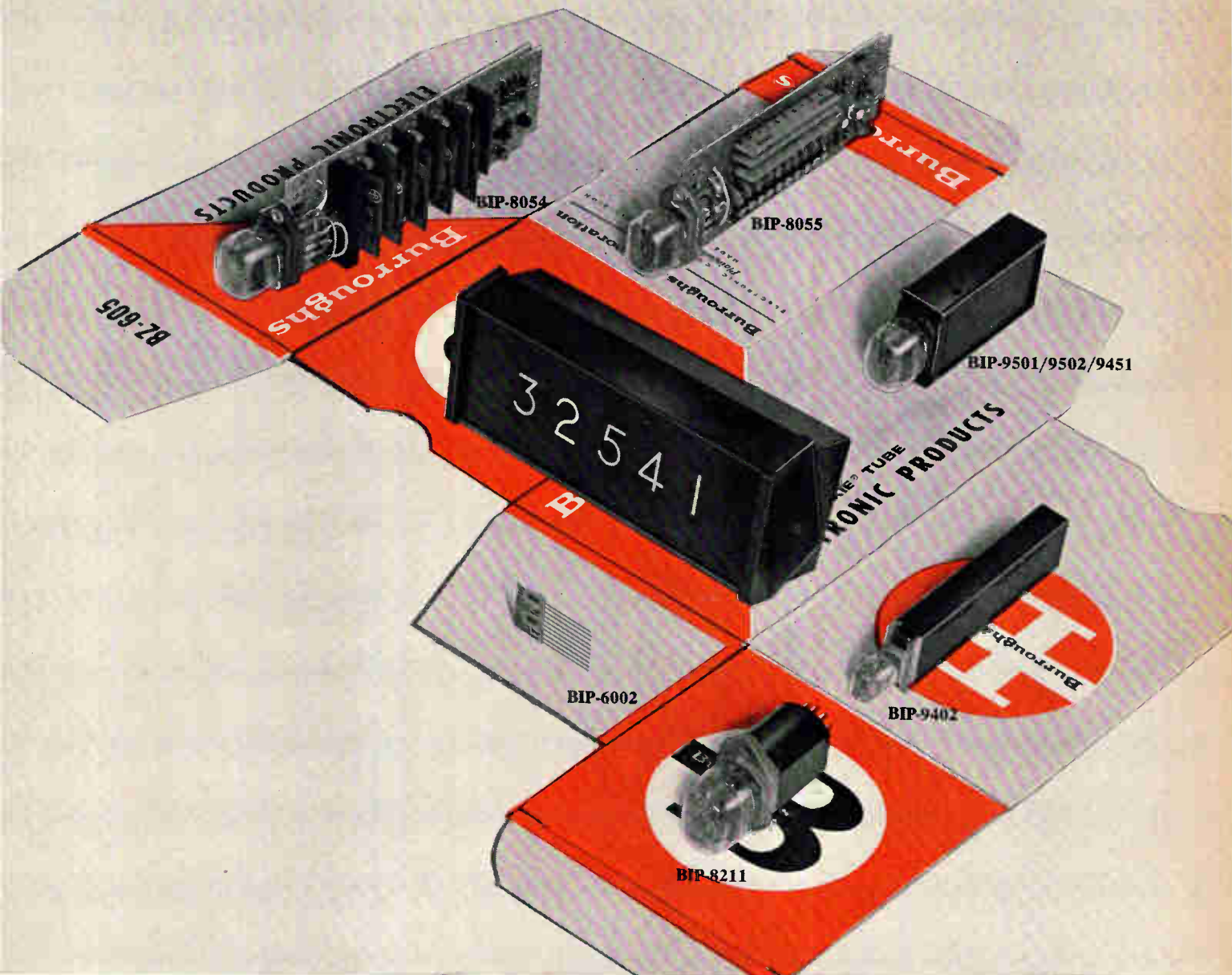

When Burroughs wraps up the package, your readout costs you less.

When you buy a NIXIE® tube package, you get a driver module designed with your input requirements in mind plus the finest readout available, at an extremely low cost per function.

For instance, 1000 lot prices for new driver modules, including rectangular NIXIE tube readout, are as follows: • BIP-9451, a BCD to decimal decoder with memory in a new hybrid circuit package, \$35.50 • BIP-9501, a 10-bit memory driver module, \$32.50 • BIP-9402, the world's smallest BCD to D decoder with memory, \$49.00.

And these are only the most recent additions to a line which already includes a 150 KC uni-directional counter (BIP-8055), \$50.00 with tube; a 110-KC bi-directional counter (BIP-8054), at \$80.00 with tube, and a wide variety of socket pack drivers and decoder/drivers which range in price from \$28.50 to \$35.50, including readout. All prices apply in 1000 quantities.

Burroughs readout packages save you electrical and mechanical design time, and they are available.

Write for complete information on NIXIE indicator tubes and associated driver modules.



Only Burroughs manufactures NIXIE Tubes.



Burroughs Corporation

ELECTRONIC COMPONENTS DIVISION
PLAINFIELD, NEW JERSEY

STANCOR STANDARD TRANSFORMERS



RECTIFIER



POWER



STEP-DOWN



FILTERS



CHOKES



PLATE

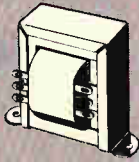

CONTROL



ISOLATION

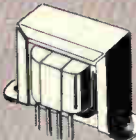

FILAMENT



TERMINAL

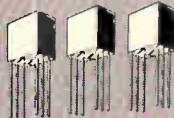

TRANSISTOR

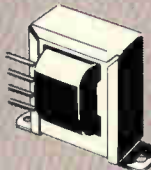

AUDIO



When you use STANCOR STANDARD Transformers you are assured of . . .

Immediate Availability—sold by over 150 Industrial Electronic Distributors in major marketing areas — AT OEM PRICES IN ANY QUANTITY.

Highest Quality—Stancor has specialized in manufacturing millions of standard transformers, time-tested and field-proven for over 35 years.

Competitive Prices—mass production facilities—to supply its extensive distributor organization—enable Stancor to manufacture at lowest costs.

Stock In Depth—over 300,000 transformers stocked in Chicago with branch warehouses at Dallas, Los Angeles and New York.

Service Replacement—available from over 1000 Industrial and Service Parts Electronic Distributors located in 525 cities throughout the U.S.

Write for Standard Catalog CS-102.

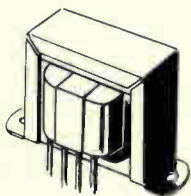

FILAMENT TRANSFORMERS A Stancor Standard

Over 75,000 in stock ranging from 100 to 10,000 of over 100 types.

Specification Ranges

- Primary Voltage 115-230 volts, 50/60 and 400 cycle.
- Secondary Voltage 2.5 to 25.2 volts
- Secondary Current 0.6 to 51 amperes



**STANCOR ELECTRONICS
ESSEX WIRE CORPORATION**
3501 W. Addison Street • Chicago, Illinois 60618



In products, performance, purpose . . . Essex measures up!

High capacity wet slug tantalum capacitors MIL-C-3965 styles CL64 and CL65

ACTUAL SIZE

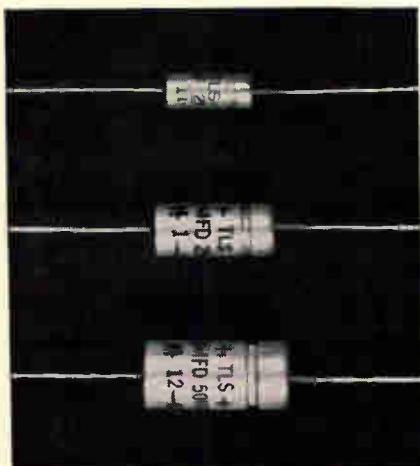

gives added protection to the end seal, permitting leads to be bent at 90° to the body.

TLS and TLS-E capacitors are available in ratings from 1.7 mfd, 125 WVDC to 650 mfd, 6 WVDC, in either insulated or uninsulated case. Operating ambients range from -55°C to +125°C. For complete details, write or call Mallory Capacitor Company, a division of P. R. Mallory & Co. Inc., Indianapolis, Indiana 46206.

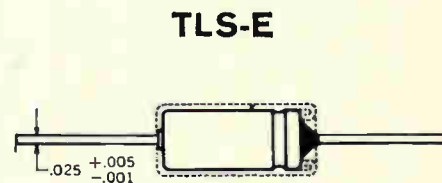
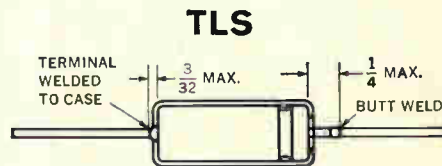

Mallory type TLS wet slug tantalum capacitors meet requirements of MIL-C-3965C for Styles CL64 and CL65.

TYPICAL PERFORMANCE CURVES TYPE TLS CAPACITORS

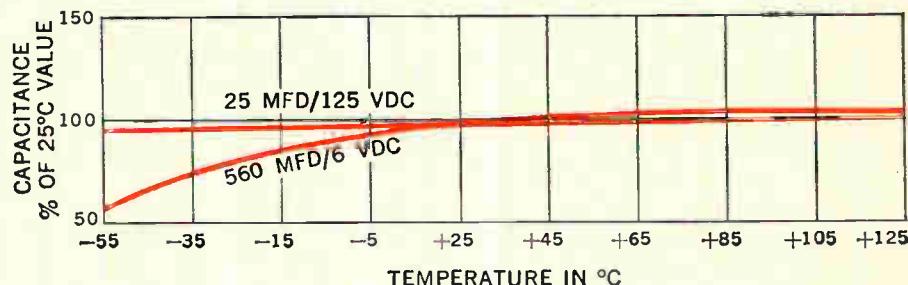
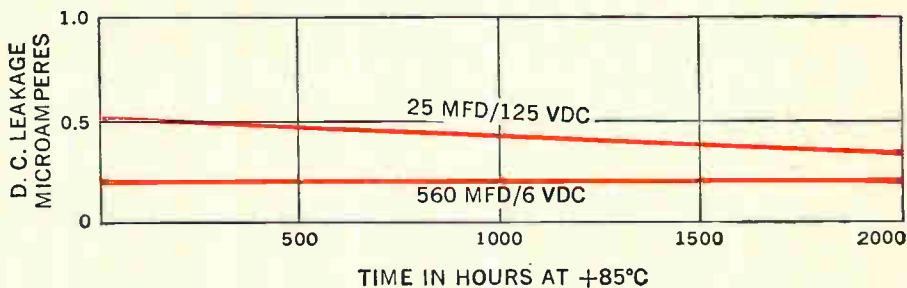

They offer mfd-volt ratings that are as much as 40% higher per unit volume than most comparable tantalum units. Exceptionally low DC leakage, an accurate index of tantalum capacitor reliability, makes these capacitors well suited for use in RC timing networks and instrument circuits, especially in high-density packaging where small size is important. For example, 100 mfd, 25 volt units have a maximum DCL of 10 microamperes at 125°C; other values have comparably low leakage. Electrical characteristics have good stability over the full temperature range.

Type TLS-E is a special configuration of the TLS. It features a new design with epoxy bead over the welded junction at the positive lead. This design permits use in "cordwood" packaging or mounting on printed circuit boards with case clear of surface. The epoxy strengthens the weld junction and

WET SLUG, FOIL AND SOLID TANTALUM CAPACITORS



24-Hour CAMBION® DIAL-A-PART Service

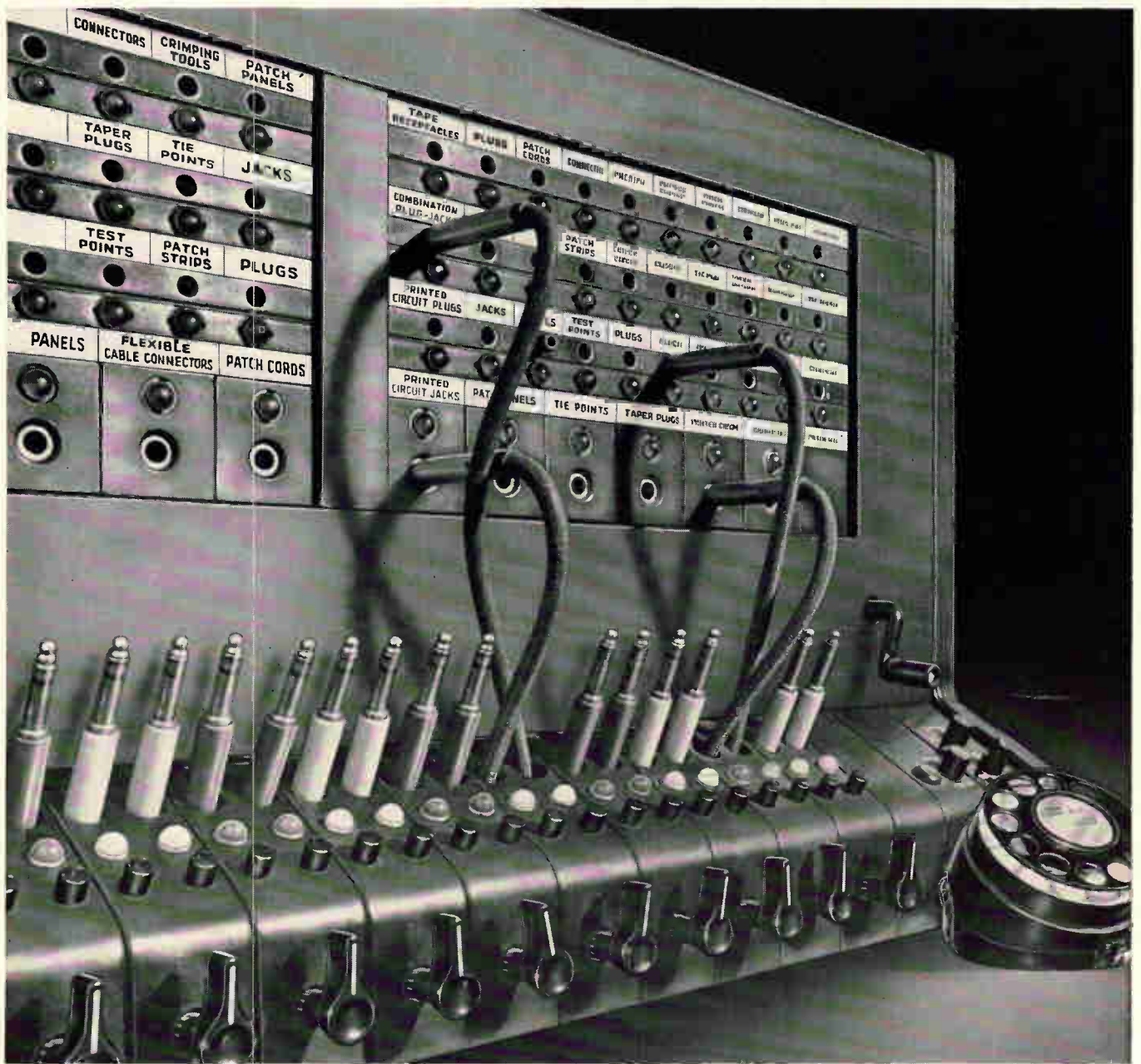

Our "store" never closes for connectors, plugs, jacks and 15,000 other items.

When you need that all-important connector part and you need it in a hurry — DIAL-A-PART! Any time! Anywhere you are! Call (617) 876-2800 any time around the clock Monday through Friday. It's the best thing to do with a dime when you're looking for guaranteed reliability in any kind of connectors, plugs, jacks, patch cords, test points, tie points, patch strips, taper plugs, tape receptacles, patch panels, printed circuit plugs, printed circuit jacks, flexible cable connectors, crimping tools, combination plug-jack, etc.

Exclusive, new DIAL-A-PART 24-hour service, originated by CAMBION, provides the first step to fully automated ordering in electronics. You get whatever part you need by the fastest

means available — without delays for lengthy order processing.

When you're down to the last connector in the barrel, join the fight to your nearest telephone. Select the parts you need from your easy-to-use catalog 700 and contact your local CAMBION distributor. If you want just a few pieces for a single prototype or a million units for high production, there is a CAMBION distributor close by to give you on-the-spot delivery.

Choose CAMBION service for all your component connector problems, techniques and special arrangements. Only CAMBION offers the widest possible choice of fully guaranteed connectors, jacks, plugs or terminals. You can't afford the risk of less. Call now... Call any time DIAL-A-PART... (617) 876-2800, Cambridge Thermionic Corporation, 401 Concord Avenue, Cambridge, Massachusetts 02138.

CAMBION®

Standardize on CAMBION... The Guaranteed Electronic Components

**If you enjoy
hooking up
two transistors for
a one-transistor
job...**

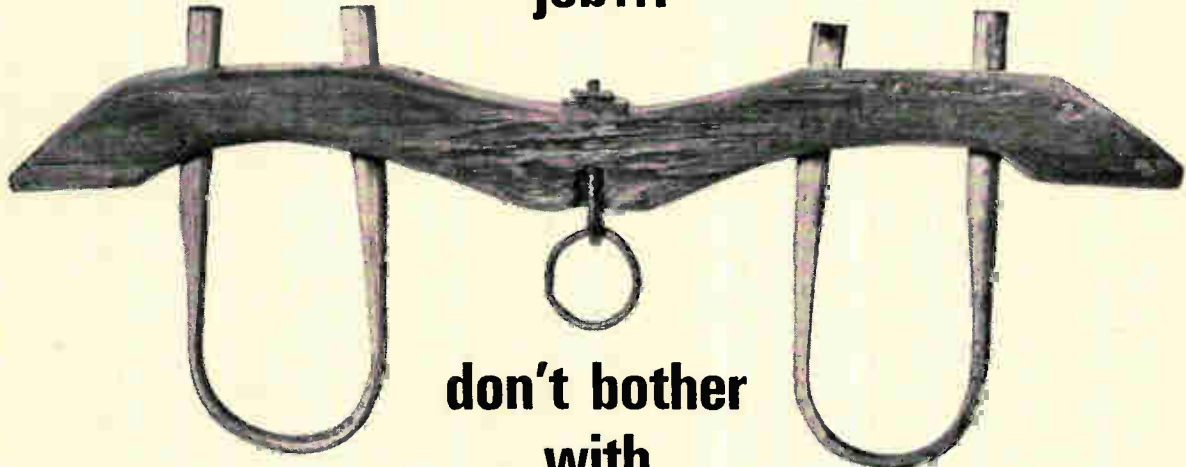

**don't bother
with
Honeywell's
65-amp
germanium**

Paralleling two transistors is an adequate way to get the current capacity you need, but it's no longer necessary. Many designers find that Honeywell's 65-amp germanium transistor not only replaces two smaller ones — it delivers many fringe benefits in system simplification.

The 65-amp family is only one segment of the comprehensive Honeywell germanium power transistor line. Others range from 3 to 150 amps. Write today, or call your Honeywell salesman or distributor, for specifications on a power transistor just right for your system.

Honeywell

SEMICONDUCTOR PRODUCTS
1177 Blue Heron Boulevard Riviera Beach, Florida

HONEYWELL INTERNATIONAL: sales offices in all principal cities of the world.

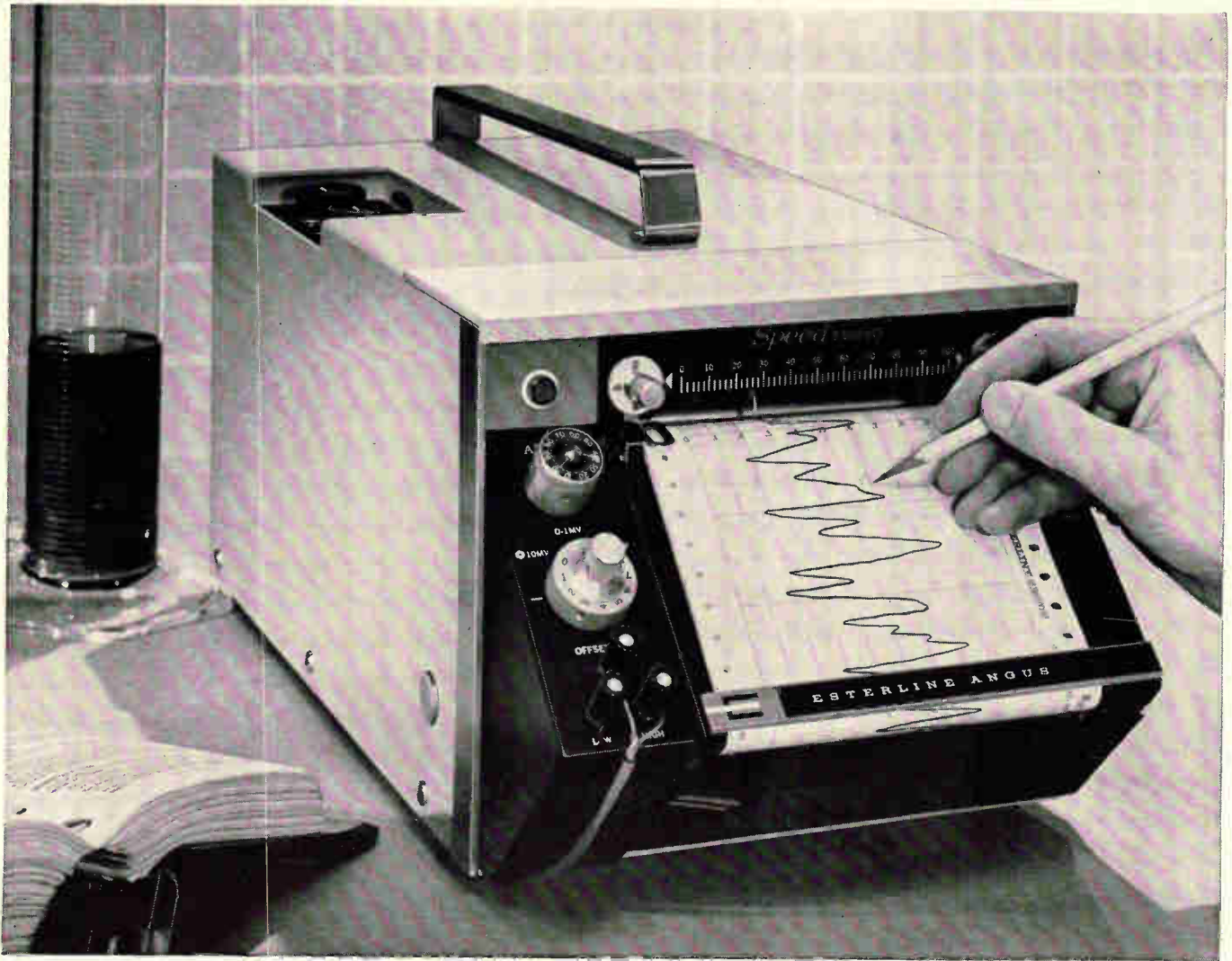

1/8 second response
 +
 adjustable zero, adjustable span } = the only high speed AZAS recorder

Eight times faster than most, the Esterline Angus Speed Servo Recorder can now be ordered with Adjustable Zero, Adjustable Span. It features:

- 1/8 second response.
- Circuitry capable of handling 4 cps signals without significant attenuation.
- The ability to measure any calibrated span from 1 to 100 millivolts full scale without the bother of range cards or changes in internal connections. Even higher levels of span and zero adjustment may be obtained with optional voltage dividers.
- Zero displacement of ± 100 millivolts.
- Simple controls for rapid selection of span and zero.
- 100,000 ohms maximum source impedance.
- High impedance potentiometric input circuitry.
- A unique shuttle servo motor with no drive cords to break or gears to wear.

- One piece construction of the drive coil, pen assembly and sliding contact to provide low inertia.
- A feedback potentiometer of virtually unlimited life.
- 14 immediately adjustable chart speeds.

The Speed Servo with AZAS easily records selected small span signals from such problem sources as strain gauge bridges, thermocouples, thermistors, photocells and the like.

In addition to the Speed Servo, the Series "S" line includes Milliammeters, Microammeters and Event Recorders.

Write us for detailed Series "S" catalog.

Speed Servo—Registered

ESTERLINE ANGUS INSTRUMENT COMPANY, INC.
 Box 24000 E • Indianapolis, Indiana 46224

ESTERLINE ANGUS



Excellence in instrumentation for over 60 years

Technical Articles

Using cold-cathode tubes to count and store: page 80

In the conclusion of this 3-part series, we examine how the cold-cathode tube can be used in logic systems in such applications as industrial controls, instrumentation, and production machinery. Miniature tubes can switch input pulses accurately at up to megacycle speeds.

The dark side of the laser: page 93

Even reflected beams from a laser can cause eye damage. This dosimeter measures the energy of a reflected laser pulse as a safeguard against such damage. It measures the total energy exposure per laser pulse and uses a modified gamma-radiation dosimeter as a high-impedance voltmeter.

Electronics' 35th anniversary: page 99

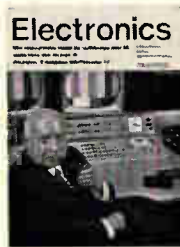

RCA's David Sarnoff made a prediction in the first issue of Electronics. Television made it come true 20 years later. For this anniversary issue, General Sarnoff reminisces about the past 35 years and looks into the future. Photographer Dick Saunders posed Sarnoff in front of color tv monitors, symbolic of Sarnoff's battle for color.

Predictions, Then and now: page 104

In the first issue of Electronics, seven industry leaders offered their views of what was ahead for the young industry. Their predictions are reprinted exactly as they appeared in that issue. We asked their modern counterparts to do the same thing. You can compare the observations of both groups.

The experts look ahead: page 109

Six experts write technical articles describing what they see in the future for their specialties in electronics:
Consumer electronics—Daniel A. Noble
Integrated circuits—Gordon Moore
Space electronics—Albert Kelley
Lasers—T.H. Maiman
Communications—Henri Busignies
Industrial electronics—Nathan Cohn

**Coming
May 3**

- Finally, transistorized communications for the military
- Resistors and components in silicon devices
- Communications and control on Gemini spacecraft

Using cold-cathode tubes to count and store

New low-voltage tubes can be used in logic systems in industrial controls, instrumentation, or on the production line. Last of a 3-part series.

By Graham Jaynes

Mullard Radio Valve Co., a division of Mullard Ltd., Mitcham, Surrey, England

Stepping tubes—cold-cathode devices in which a visible glow discharge is transferred from cathode to cathode—have been widely used for many years to count pulses. Today, improved decade counters can do much more. Miniature tubes can switch input pulses accurately at up to megacycle speeds, making them very attractive for semiconductor logic systems. Coupled to transistor gates, the new tubes can count pulses, store them in logic matrixes, and add, subtract, divide or multiply pulses as needed. All this information can be fed to complex circuits and read off when desired. These practical logic systems can be used in industrial processing controls, instrumentation, small business machines, and manufacturing production lines. Chains of tubes can be fed inputs from optical sensing systems to count objects, measure and compare time intervals and program pulse information. This versatility is combined with low cost, circuit simplicity and low-power consumption.

Stepping tubes in scaler circuits

Stepping tube circuits used for random pulse counting, frequency division, pulse train generation, timing, and batching pulses are based on scaler circuits (diagrams on p. 81).

The tubes are cascaded, usually with the tenth

or zero cathode of each stage driving a coupling circuit inserted to amplify and shape the output into guide pulses to drive each succeeding stage.

The basic decade circuit displays random pulse counts visually. This scaler circuit can also be used for frequency division or pulse train generation. In this case, the input is a fixed frequency source, and suitable output signals are obtained by selecting the desired output cathodes of each stepping tube in the chain.

Measuring time intervals

The basic scaler circuit can measure a time interval in an external circuit. A pulse opens an input gate from a fixed frequency source, and a second pulse closes the gate. In the interval, the scaler counts the cycles from the fixed source and determines the time.

The scaler circuit can be modified to generate accurate time intervals or alternatively for batching processes in a production line.

Assume, for example, that cathodes 5, 6 and 7 of the units, tens and hundreds stages are brought out to an AND gate and a one kilocycle signal is applied to the input gate. If an external signal opens the input gate, the circuit counts from zero and obtains an output from the AND gate 0.765 seconds after the input gate opens. This method can be used to terminate any required timing period.

In batching, the number of articles to be counted is preselected by connecting the required output cathodes in the scaler to the AND gate. The input signal consists of a train of random pulses, each pulse corresponding to one article. Thus, when the preselected number is reached, the AND gate operates and the output signal terminates the count.

The author



Graham Jaynes is head of the cold-cathode and cadmium-sulfide device group at Mullard Radio Valve Co. His group develops new devices and explores circuit applications. He holds the City and Guild's full technological certificate in electrocommunications and engineering.

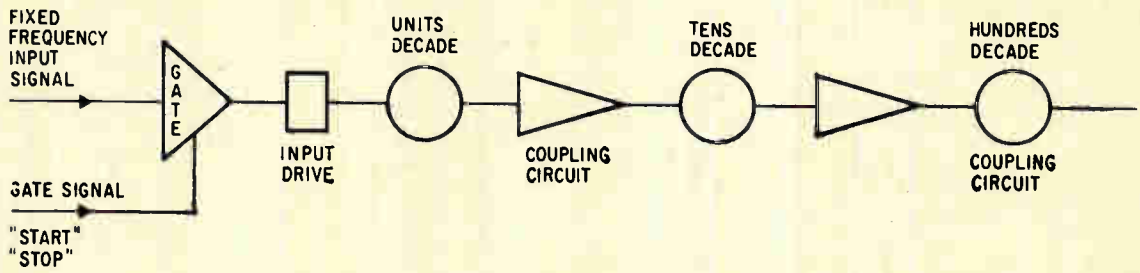

Decade circuit displays random pulse counts visually. Transistor coupling circuits, between each decade, guide pulses to drive the next stage.

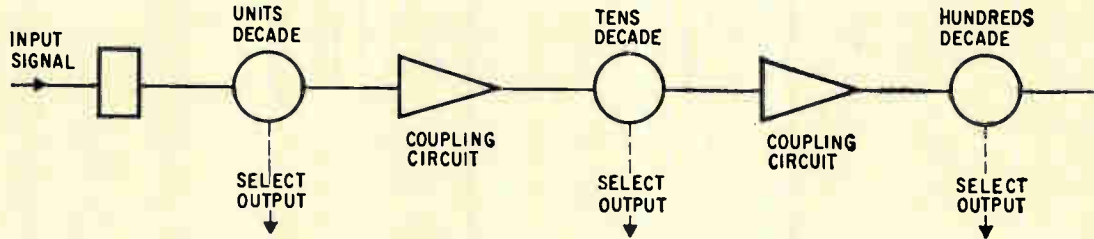

Basic scaler, used to measure a time interval between gated pulses, is driven by a fixed frequency signal.

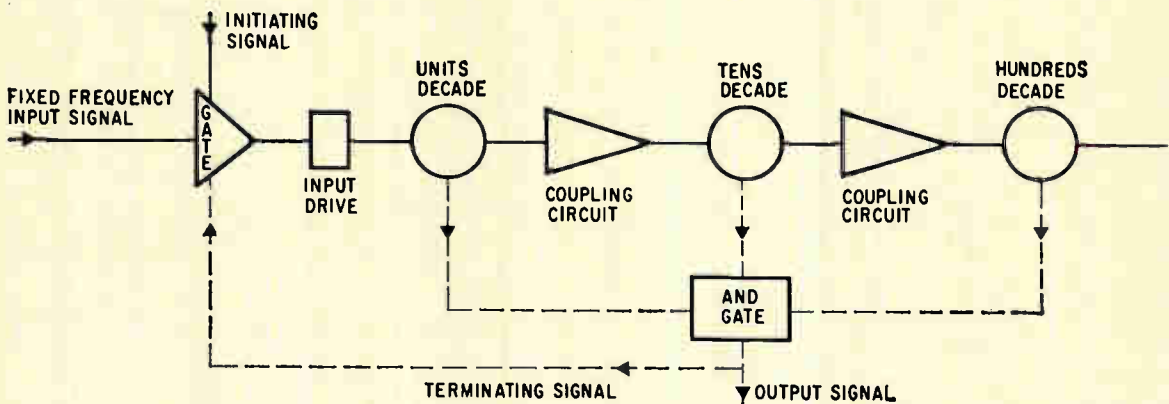

Scaler circuit for generating an accurate time interval obtains an output count from the AND logic gate after the input gate is opened.

A typical decade scaler intended for accurate timing applications is shown on page 82. The coupling circuits each consist of a single transistor current amplifier followed by a pair of transistors in cascade that drive the guide A cathodes of the succeeding stepping tube. The guide B waveform is derived from the guide A circuit through an integrator network. The coupling circuits operate directly from an external signal at speeds up to one kilocycle or at 400 pulses per second from the output of a previous stage.

The stepping action in the second and succeeding stages is actuated by the pulse leaving K_9 in the previous tube. There is only a small delay in stepping a chain of tubes from, for example, 0999 to 1000. This circuit is particularly useful for accurate timing and fast batching applications where a coincident signal from a cathode AND gate is required. A triggered blocking oscillator drives the units stepping tube to define the magnitude

of the guide pulses when the input signal may be only a spike of short duration.

The light-sensitive input circuit on page 83 is used to count objects on a production line. The cadmium sulfide cell can sense objects of 0.2 square centimeters. With an illumination of 2000 lux, falling to 10 lux when the small object obstructs the cell, a counting speed of at least 25 cycles per second may be obtained.

Waveforms that fit

Scaler circuit design is primarily concerned with the generation of suitable waveforms for driving the first, and succeeding stepping tubes in the chain.

Negative rectangular pulses would be ideal for driving the guides of a stepping tube, but are difficult to generate without considerable circuit expense. There are three types of waveforms which can be obtained with low-cost circuits, and these

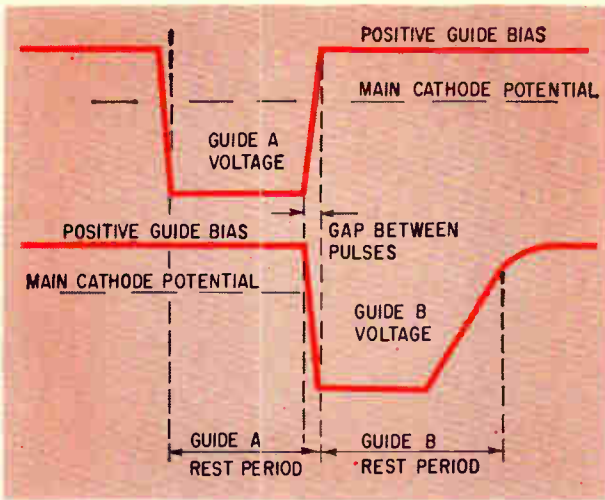

Waveforms to drive the guide cathodes are produced by a blocking oscillator. Gap between pulses should be less than 5% of the minimum guide pulse duration given for the tube.

waveforms are most commonly used for driving a double pulse stepping tube.

Blocking oscillator drive

The output waveforms of a typical blocking oscillator are shown above. The output pulses differ from ideal negative rectangular waveform pulses

in two important respects.

First, although the discharge period of rest on the guide A cathodes is well defined, the trailing edge of the guide B pulse is relatively long, owing to the decay time of residual energy in the transformer. Since the discharge remains on the guide B cathode until the guide B potential rises above the main cathode potential, it is important to design the guide B rest period as one shown in the diagram, and not the period for which the pulse amplitude is at the maximum value. Second, when the oscillator switches from the guide A to the guide B period, a gap occurs between the end of the guide A pulse and the arrival of the guide B pulse.

This gap should be less than 5% of the minimum guide pulse duration; otherwise, the anode voltage may rise sufficiently during the gap to cause breakdown again at the previously primed main cathode.

Integrated pulse drive

A negative rectangular pulse can be generated for the guide A cathodes and integrated to form a delayed signal for the guide B cathodes. A typical pair of guide waveforms are shown in the diagram at the top of page 86.

The discharge steps to the guide A cathode when the rectangular pulse is applied. At the

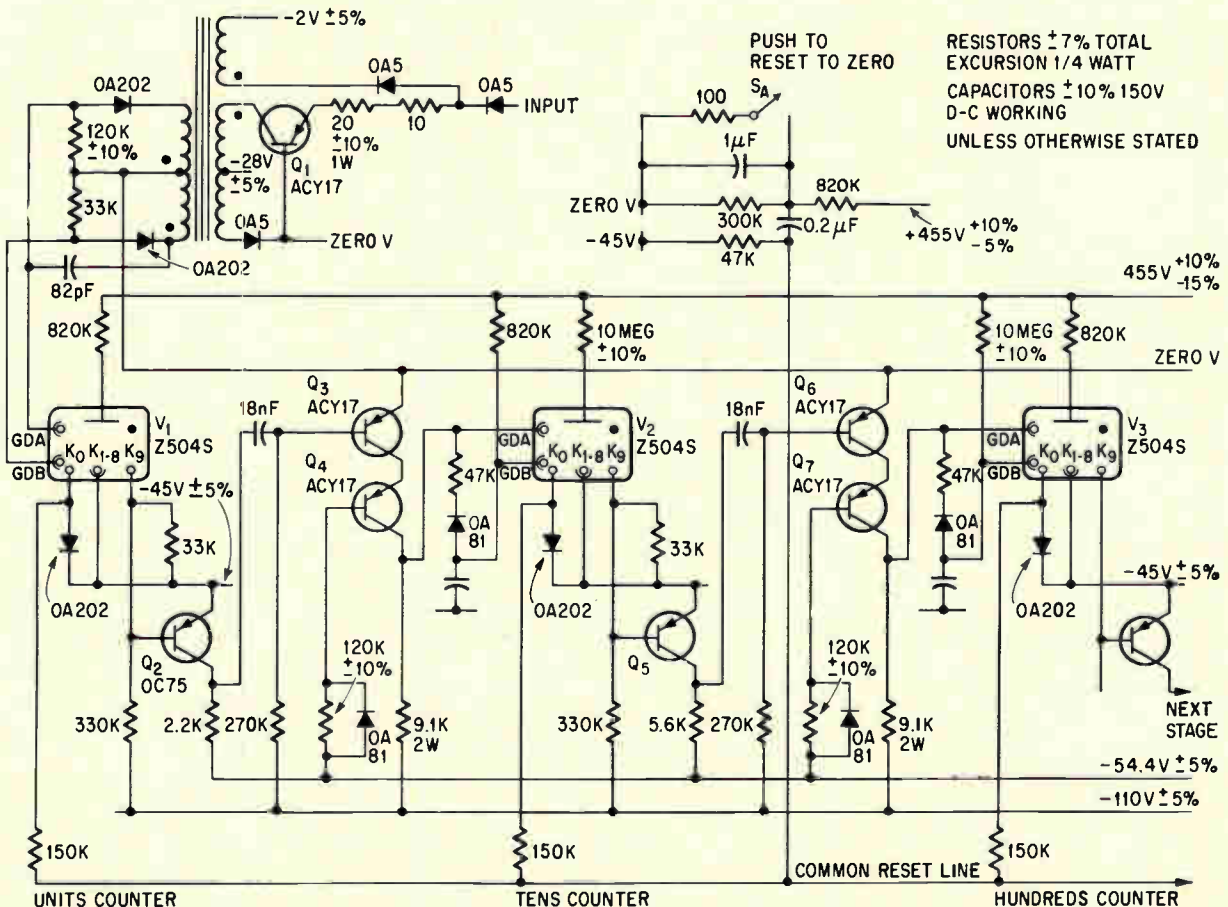

A typical transistor-coupled decade scaler intended for accurate timing applications.

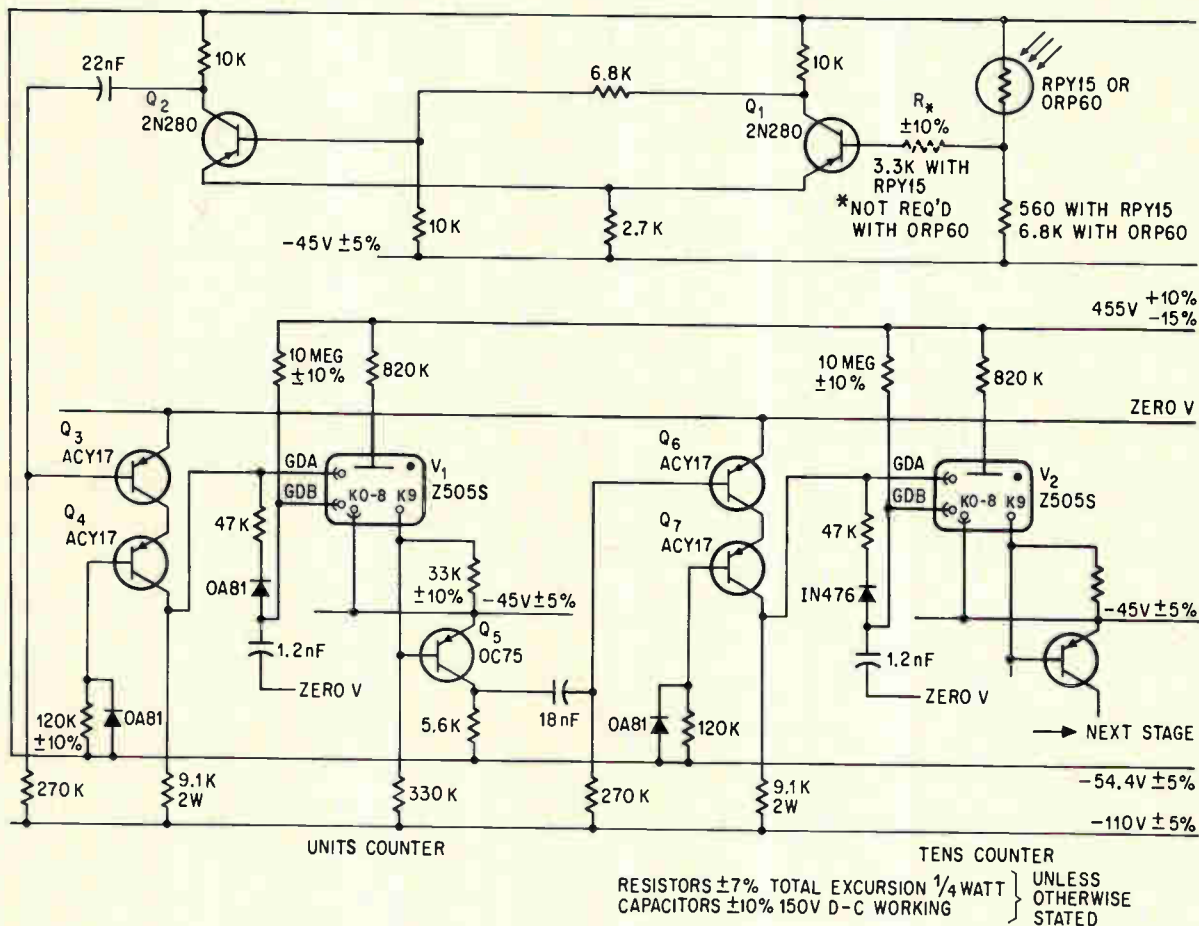

Counting circuit with photocell input, coupled to stepping tubes, is used to count and batch small objects on a production line.

same time, the guide B potential starts to fall exponentially towards the potential of the guide A cathodes. At the end of the guide A pulse, the discharge transfers to the guide B cathode and the integrator network then charges again until the time shown as t_k in the diagram. At this point, the guide B cathode assumes a positive potential and the discharge steps to the next main cathode.

With this drive, the discharge cannot transfer from the guide A to the guide B cathode until the guide A pulse ends and the anode potential rises to permit primed guide B breakdown. The effective duration of the guide B pulse is, therefore, the period between the end of the guide A pulse, and the time t_k at which transfer to the next main cathode occurs.

Differentiated and integrated pulse drive

The most common guide pulse waveforms are given on page 86. Basically, the input to the guide A cathodes is a differentiated negative pulse and the input to the guide B cathodes is an integrated negative pulse. These pulses can be obtained by amplifying a sigle voltage or current step function. To ensure that the discharge rests for the desired period on the guide A cathodes during transfer,

the guide A potential should remain negative compared with guide B.

The effective guide B pulse amplitude is the potential difference between the guides after cross-over, and is represented by the lower waveform. To transfer the discharge to a guide B cathode, the effective guide B pulse amplitude must exceed 45 volts and the period after this amplitude is reached must exceed that necessary for reliable operation of guide B. Transfer to the main cathode is accomplished, as before, when the guide B potential becomes positive with respect to the main cathode potential.

A stepping multiple store

Although stepping tubes were originally used almost exclusively in scaler circuits, they are now found in a wide range of control applications, where pulse programing and similar logic functions are required.

The circuit shown on page 87 forms the basis of a multiple store, one of the latest developments in circuit design. Such a store is useful in small business machines and in industrial machine tool control. A series of stepping tubes is connected as a decade counter chain and driven from a com-

Tube structure and operation

A typical stepping tube has thirty identical rod-shaped cathodes equally spaced in a circle around a central anode, as shown below. The structure is enclosed in a glass envelope filled with a mixture of gases at low pressure.

The cathodes are divided into three interleaved groups of ten: main cathodes K_1 to K_{10} , guide A cathodes GDA_1 to GDA_{10} and guide B cathodes GDB_1 to GDB_{10} . A discharge between the anode and one main cathode appears as an orange-red or bluish glow at the tip of the cathode.

The glow can be read off from an external escutcheon which, in a decade tube, bears the numbers zero to 9, corresponding to the main cathodes.

In most stepping tubes, the main cathodes are brought out to separate base pins, so that an output signal can be obtained from the cathode on which the discharge rests.

Simple pulse counters that indicate the number of input signals received have main cathodes K_1 to K_{10} connected and brought out to a single base pin. The zero cathode, K_0 , is connected separately to the next decade stage and provides an output signal to reset the count to zero. The glow is stepped from one main cathode to the next by drive circuits connected to the guide cathodes. Guide pulses may be added or

subtracted by controlling their order: to add, the pulses are transferred clockwise; to subtract, they are transferred counterclockwise.

How the stepping tube works

The basic circuit for a double-pulse stepping tube is shown below, right. The main cathodes K_1 to K_{10} are either returned to the common negative line or to an output circuit. The two groups of guide cathodes are held positive with respect to the main cathodes. The anode is connected through a resistor to the main voltage supply.

The glow discharge results when the supply voltage exceeds the breakdown voltage between the anode and a given main cathode. As the discharge forms, the anode voltage falls to its maintaining level so that no breakdown can occur to any adjacent cathode.

Stepping the glow

If the glow discharge rests on, for example, main cathode K_8 , the two adjacent guide cathodes GDB_8 and GDA_8 are primed by the discharge on K_8 . The breakdown voltage required between the anode and these two guides is, therefore, substantially less than the voltage which would establish breakdown between the anode and any unprimed guide cathode (see diagram on p. 85).

When a negative pulse is applied to the guide A cathodes, so that the voltage between them and the anode exceeds the minimum voltage for primed cathode breakdown, a discharge is established between the anode and GDA_8 , but not between the anode and the unprimed guide A cathodes. The anode voltage then falls to a lower value and the previous discharge path to K_8 is extinguished. The discharge now primes the adjacent GDB_8 , and GDB_8 deionizes. When the guide A pulse ends and a negative pulse is applied to the guide B cathodes, a discharge if formed between anode and GDB_8 , and the GDB_8 discharge is extinguished.

At the end of the guide B pulse, the guide B cathodes return to the positive guide bias level, and the anode potential reaches a level greater than the anode-to- K_8 breakdown potential— K_8 now being primed by the discharge to GDB_8 —a discharge is formed to K_8 . The anode potential then falls to the maintaining potential of the anode-to- K_8 path and the discharge to GDB_8 is extinguished.

Requirements to step the discharge

All 30 anode cathode gaps are identical and the same requirements must be met to step the discharge to either main or guide cathodes.

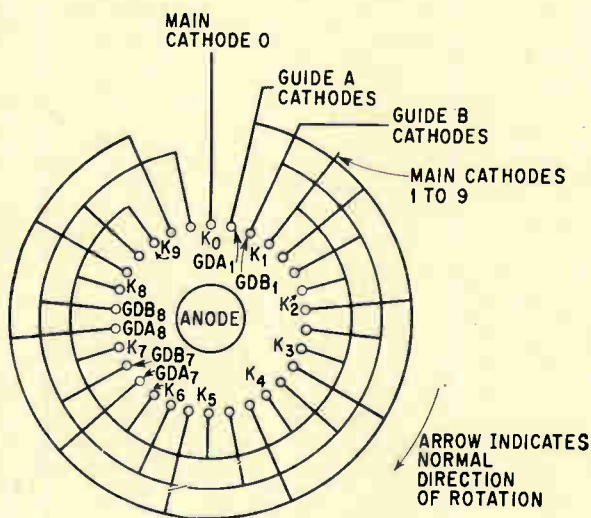

Typical stepping tube has thirty cathodes arranged around a central anode. Glow discharge is stepped from one main cathode to another by drive circuits connected to the guide cathodes.

Basic circuit for a double-pulse stepping tube, showing connections to the guide cathodes and main cathodes.

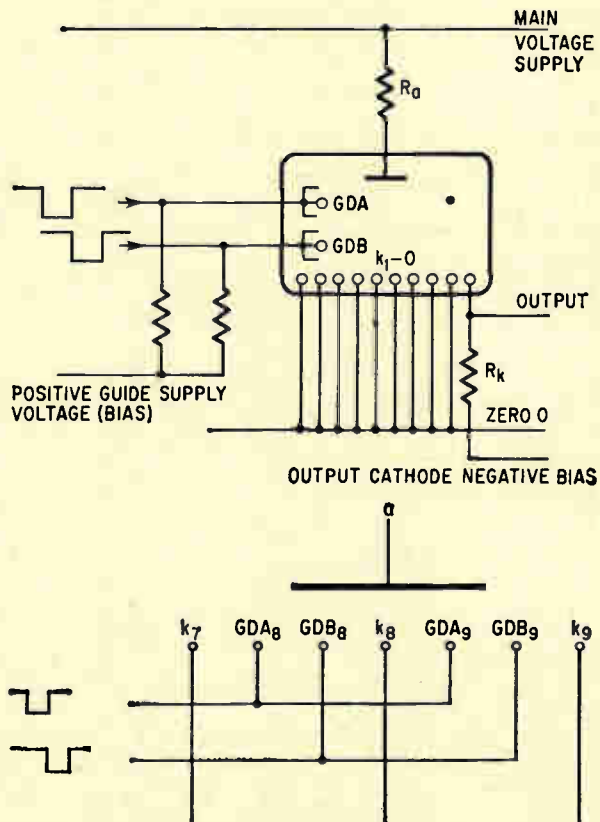

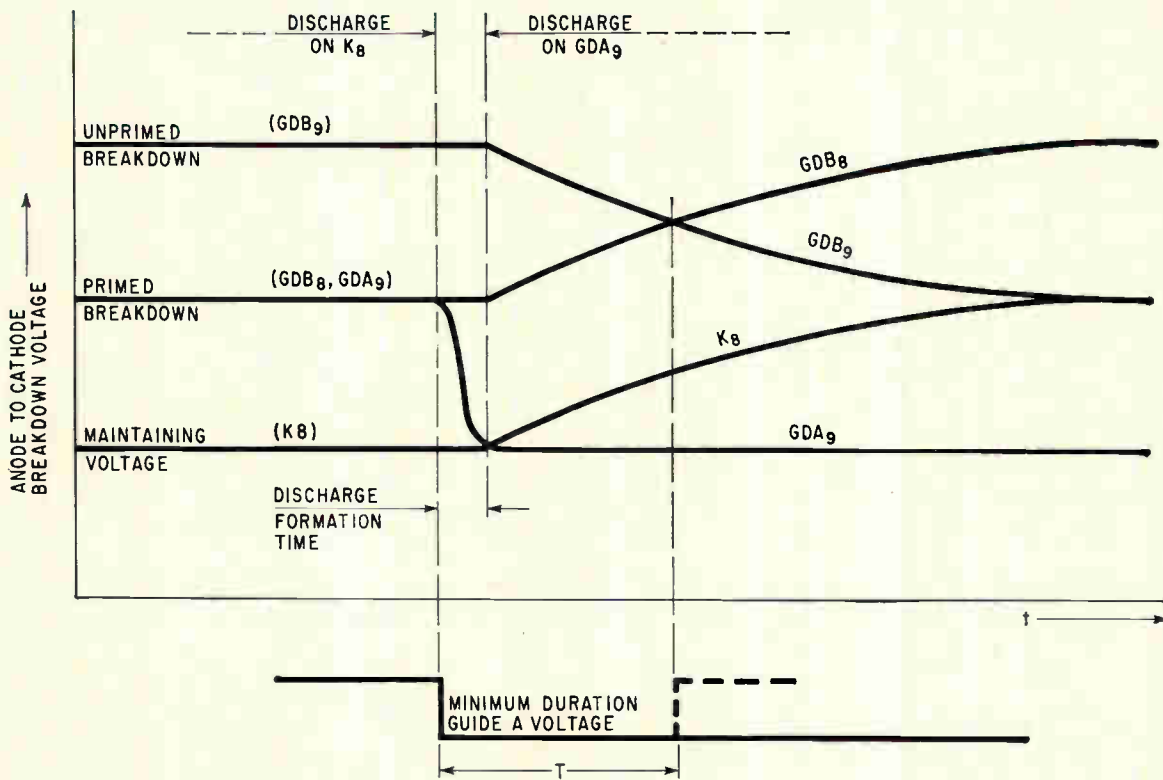

Ignition voltage of anode cathode gaps during main cathode to guide A cathode transfer. The same requirements must be met to step the discharge from guide A to guide B and from guide B to the next main cathode.

The negative guide pulse must be applied long enough for three processes to take place: formation of the discharge to the GDA_n and extinction of the discharge to the main cathode K_n , priming of the adjacent GDB_n , and deionization of GDB_n .

The three breakdown voltage levels in the tube immediately before and during the guide A pulse are shown in the diagram above. The lowest level is the breakdown voltage of a main cathode which, due to the intense priming of the discharge, corresponds to the maintaining voltage of the anode-cathode gap. The center level corresponds to the breakdown voltage of the two primed anode-cathode gaps which are adjacent to the main discharge.

Cathodes which are two or more steps away from the discharge are virtually unprimed, and their breakdown voltage is represented by the upper line in the diagram.

To ensure that the discharge is transferred from GDA_n to GDB_n and not backwards to GDB_n when a guide B pulse is applied, discharge time must be at least equal to T in the diagram. When this condition is satisfied, the breakdown voltage of GDB_n will be less than that of any other guide B cathode in the tube and correct transfer will occur.

The output signal

When the discharge in a stepping

tube rests on a main cathode, a current nearly equal to the anode current flows to the next cathode. This current can be used directly to operate a transistor circuit, or to develop a voltage across a resistor in the main cathode lead.

For reliable operation, the maximum positive voltage on any main cathode must be held to about 10 volts below the positive guide bias. Otherwise, the discharge may fail to transfer to the next guide A cathode because of current sharing between the output cathode and the preceding guide B cathode. This safety margin compensates for discharge, but also restricts the output which can be obtained from the tube.

In applications where the maximum amplitude of output pulse is required, the value of the output resistor may be increased and the resistor returned to negative bias. This bias should be held below within the maximum level given for the tube. With a greater value on K_n , the discharge will transfer correctly to GDA_n , and then to GDB_n , but may finally step back to K_n instead of forward to K_1 .

Reset to a zero main cathode

The glow discharge can be returned to a particular main cathode, in many cases K_n , for the start of a new operation.

For reset, the voltage difference

between the anode and the reset cathode is increased to a value greater than the unprimed breakdown voltage of the cathode.

Two methods can be used to reset the discharge. In one case all the guide and main cathodes except the reset cathode are set to a potential greater than the difference between the unprimed cathode breakdown voltage and the tube maintaining voltage. The anode voltage then rises above the unprimed breakdown voltage to the reset cathode and discharges to this cathode.

The discharge applying a negative pulse to the reset cathode also resets the discharge. The large voltage difference between the anode and the reset cathode causes breakdown to this cathode.

The table on page 87 lists the main characteristics of representative steeping tubes. A number of tubes with characteristics almost identical to those of the first two listed cover a range of operating frequencies up to 50 kilocycles, and are available in both Europe and the United States. (Russian articles in the technical press indicate the use of a similar range of guide tubes in the U.S.S.R., but specifications of these devices are not available.) The third tube represents a group that operates at speeds up to one megacycle, but offers less than ideal output for visual display.

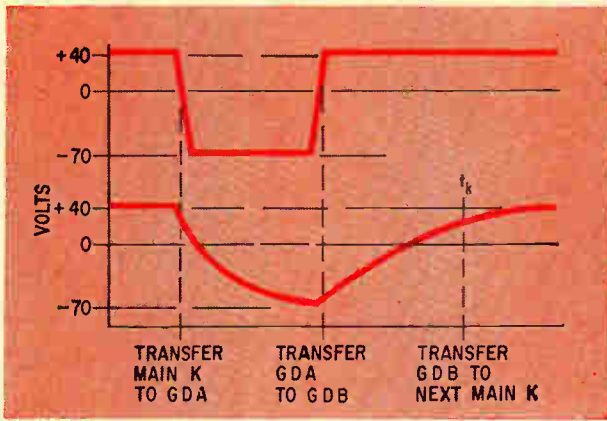

Negative rectangular pulse, generated for the guide A cathodes, is integrated to form a delayed signal for the guide B cathodes.

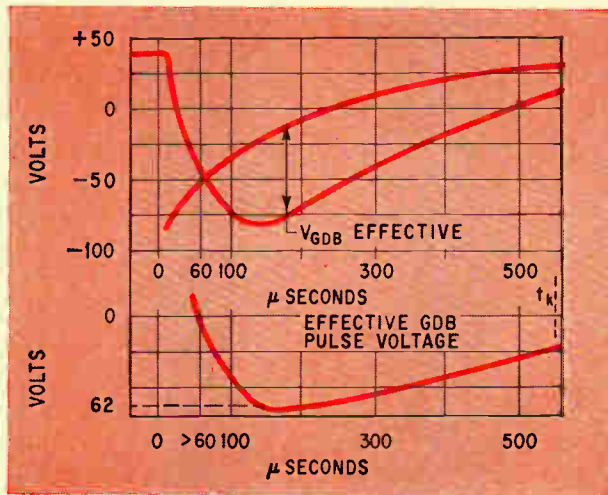

Typical differentiated and integrated pulses for the guide cathodes are the final and most common guide pulse waveforms for counter tubes.

mon guide pulse generator. Instead of regenerating the guide pulses for each stepping tube of the chain, the transistor circuits gate the common guide pulses to each tube as required.

The transistor gates also control the anode current to a series of numerical indicator tubes. The indicators are connected between the transistor gates and a negative line through ten cathode switches. Like numerals in the indicators are connected and returned to one cathode switch. The cathode switch circuit may use either cold-cathode tubes or semiconductors.

How the circuit counts

During counting, all cathode switches are open. The guide B pulses are applied directly to each tube in the chain, but the guide A pulses are applied to the tubes through diode gates D_1 , D_2 and D_3 , D_4 , etc.

In the absence of control signals at terminals DG_1 , DG_2 , all the gating transistors Q_2 , Q_3 are in full conduction so that the guide A cathodes are

clamped at zero volts during the guide A pulse period. With only attenuated guide A pulses applied to the tubes, no discharge is formed to the guide A cathodes and the stepping mechanism is inhibited.

An input signal can be routed to any decade simply by raising the potential of the gate control terminal—say DG_1 for the first decade—to a positive potential. Transistor Q_1 cuts off, the guide A diode gate no longer clamps the guide A cathodes, and full guide A pulses may be applied to the tube.

A carry signal for the next tube in the chain is obtained when the discharge steps off the K_0 cathode of the first tube. Transistor Q_2 connected to K_0 is cut off and its collector potential falls. The next guide A pulse steps the discharge off K_0 , so that transistor Q_2 conducts again, and the positive pulse applied to the base of Q_3 switches this transistor off. The removal of the zero voltage clamp at diode D_4 coincides with the guide A pulse applied to diode D_3 so that a full guide A pulse is applied to tube V_2 . The full guide A pulse, followed by a guide B pulse, steps the discharge in V_2 to the next main cathode. The time constant $C_1 R_1$ is selected so that transistor Q_3 is cut off for the duration of the guide A pulse, but conducts again before the arrival of the next guide A pulse. The second decade, V_2 , therefore receives one guide A pulse for every ten guide A pulses applied to V_1 . The third decade receives, in the same manner, 100th, 200th, 300th, etc. guide A pulses.

This gated circuit counter feeds information into any decade in the chain by applying a d-c signal to one of the control terminals, DG .

Information display

To display the information stored in the counter, the carry circuits are inhibited. Full guide A and B pulses are applied to each stepping tube so that all the decades are stepped synchronously. In addition, the cathode switches are synchronized with the guide pulse generator to open and close

Example of dynamic display

Pulse from guide pulse generator	Instantaneous count			Cathode switch closed
	Hundreds decade	Tens decade	Units decade	
0	1	0	5	9
1	2	1	6	8
2	3	2	7	7
3	4	3	8	6
4	5	4	9	5
5	6	5	0	4
6	7	6	1	3
7	8	7	2	2
8	9	8	3	1
9	0	9	4	0
10	1	0	5	9

Characteristics of representative stepping tubes

Tube No.	Maximum operating frequency	Minimum input pulse width	Input pulse amplitude (in volts)	Anode supply voltage (in volts)	Output current	Output pulse amplitude (in volts)	Dimensions
General-purpose counter:							
Z504S	5 Kc	60+60 μ s	-100	475	340 μ a	35	1.3 inch x 1.1 inch dia
Fast random pulse counter:							
Z505S	50 Kc	6+ 6 μ s	-100	500	800 μ a	24	1.3 inch x 1.1 inch dia
Counter up to one megacycle:							
EZ10B	1 Mc	0.5 μ s	-100	580	1.5 ma	7	1.9 inch x 0.85 inch dia

in sequence, from 9 to 0.

The carry circuits are inhibited by changing the bias on line P from -80 to +10 volts. All transistors are then cut off and full guide A pulses are applied to all the stepping tubes.

During display, the anode potential of each numerical indicator tube rests at -80 volts, except when the discharge in the corresponding stepping tube steps to K₉. At that point in tube V₁, for

example, transistor Q₂ connected to K₉ is cut off. Transistor Q₃ conducts, and the anode voltage of the numerical indicator rises from -80 to zero volts for the duration of the K₉ rest period.

To display a stored number, say 5, a positive pulse is applied to the anode of the numerical indicator tube only when cathode switch 5 is closed. Pulses of current will then flow to number 5 for a tenth of the total cycle time, but no current

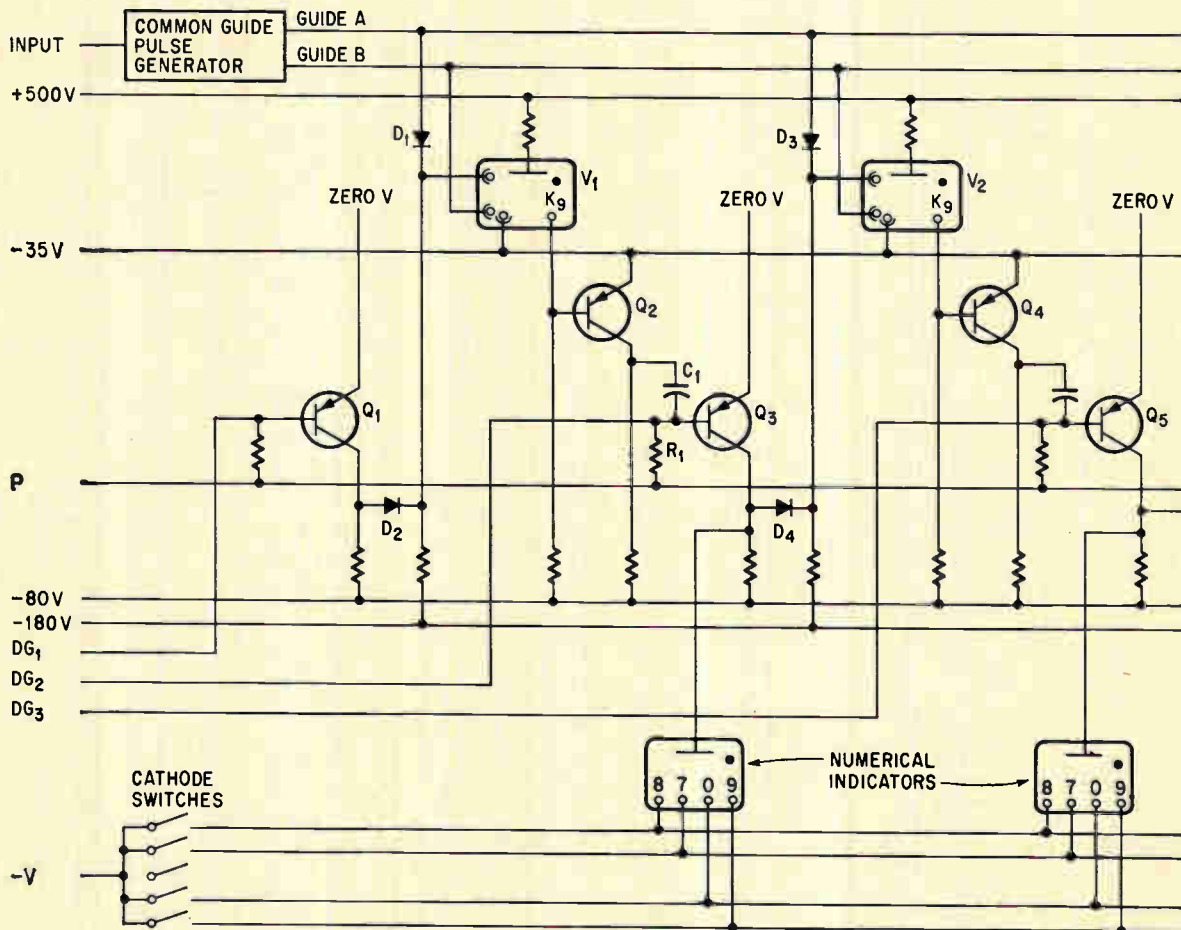

Basic multiple store circuit, used where pulse programming and similar logic functions are required. Transistor circuits gate the common guide pulses to each tube.

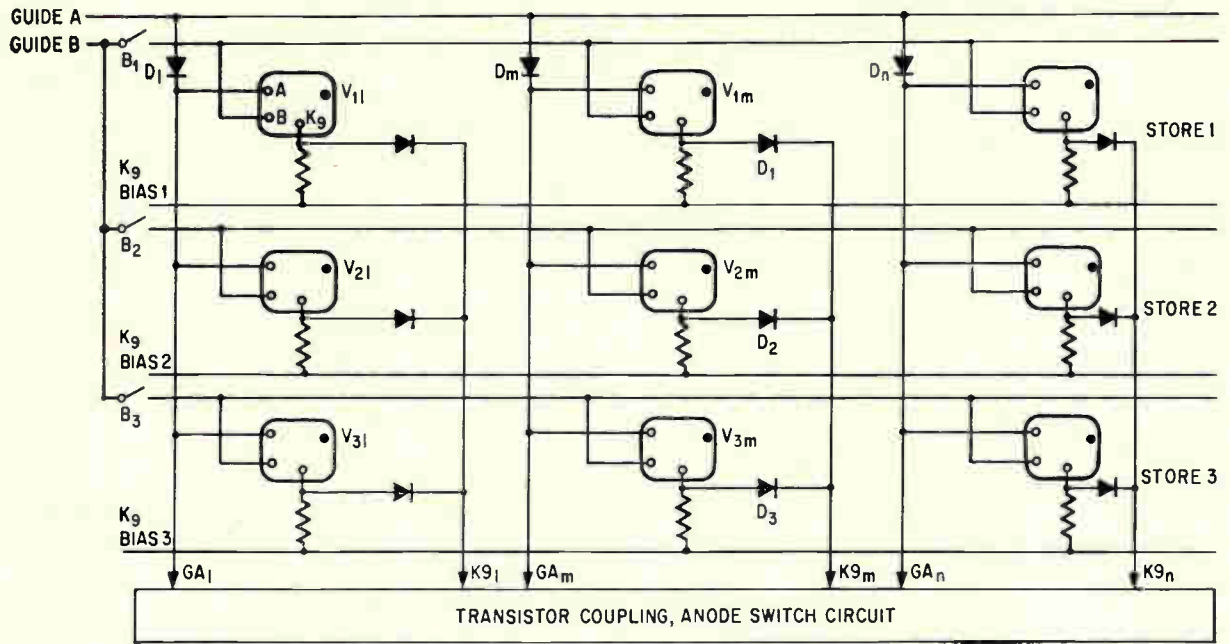

A three-store stepping tube circuit used to store, process and display several bits of information. Pulses read in to any tube in any store, are controlled by logic circuits.

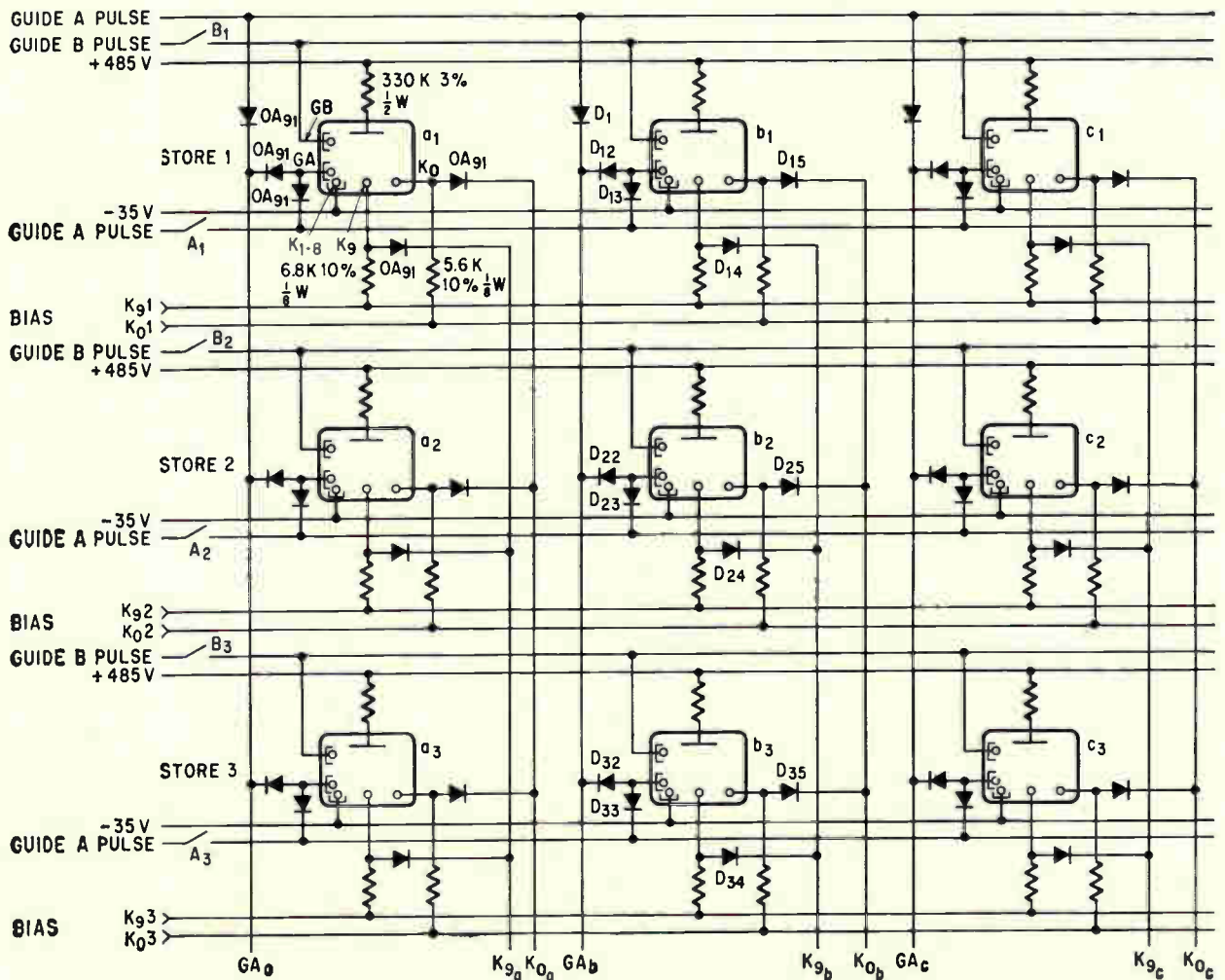

Multiple store circuit used to transfer pulses from one store to the next. Three-store stepping tube circuit is modified for pulse transfer by introducing an alternative guide A supply through the OR gate diodes, D_{12} , D_{13} .

will flow to any other number. With the stepping tubes and cathode switches operating in synchronism at a speed of about 500 pulses per second, an apparently continuous display of number 5 will be obtained.

To illustrate this display mechanism clearly, the individual steps in one ten-pulse cycle are shown in the table on page 86. The numbers stored the hundreds, tens and units decades are 1, 0 and 5.

When the first pair of pulses from the guide pulse generator is applied to the circuit, the units decade is stepped from position 5 to 6, and cathode switch number 8 is closed. The second pulse steps the units decade from 6 to 7 and the cathode switch 7 is closed and 8 reopened. In this manner, when the units decade steps to K_9 , cathode switch number 5 is closed and current flows to this number in the indicator. This process is repeated after each subsequent set of ten pulses so that the discharge in the units decade always reaches K_9 when the cathode switch number 5 is closed.

The sequence for displaying the content of the other decades is the same.

The display is nondestructive. The count originally stored can be retained at the end of the display period simply by terminating the display after an integral number of ten pulse periods.

The multiple store

Where it is necessary to store, process and display more than one piece of data, the basic multiple store circuit on page 87 may be extended, and any number of stores may be connected in a matrix. As the number of stores increases, the economics of the system become even more attractive, because only one set of transistor gates, numerical indicators and cathode switches is required.

The three processes required in a multiple store are information read-in, display, and transfer of information from one store to another to add, subtract, multiply and divide.

Read-in

A simplified diagram of a three-store circuit is given on page 88. Information can be fed to any tube in any store by cross-point matrix logic. The tube is selected by applying both guide A "column" and guide B "line" pulses to the circuit.

If pulses are to be fed to tube V_m in store 2, column m is selected by switching off the transistor connected to the guide A input terminal in the transistor coupling gate, and switch B is closed to apply guide B pulses to store 2. Thus, when a train of guide A and B pulses is applied to the store, only tube V_{2m} will receive both guide pulses, and its beam will rotate.

To carry the pulses down the chain in store 2, the K_9 cathodes of store 2 are connected to the coupling circuit by returning the K_9 bias of store 2 to -35 volts. The K_9 bias of the other stores is returned to -42 volts so that diodes D_1 and D_3 remain cut off even when the discharge is resting on K_9 in these stores.

Display operation

The process of information display is basically the same as described earlier. All the transistor gates are switched off so that the discharger of the stepping tubes in all stores can be rotated continuously and in synchronism. The store to be displayed is then selected by raising its K_9 bias level to -35 volts, so that only this store may operate the anode switch circuit. The unwanted stores are returned to a K_9 bias level of -42 volts.

Transfer process

To transfer information from a tube in one store to tube in a succeeding store, a train of ten pulses is applied to the first tube. After the discharge steps to K_0 , the remainder of the pulses go to the second tube as well. For example, if the content of the first tube is 7, the discharge steps to the K_0 cathode after 3 pulses. The remaining seven pulses are then applied to the first tube, to return the count to its original value, and to the second tube.

A number of additional features must be added to the multiple store for information transfer. These features are shown in the diagram of a complete store given at the bottom of page 88.

Consider transferring the content of tube a in store 1 to tube c in store 3. To rotate beams of all tubes in store 1 while permitting store 3 to operate as a counter, an alternative guide A supply is introduced through D_{12} D_{13} D_{22} D_{23} etc. The discharge in a_1 is rotated once around the tube by closing switch A_1 and applying ten guide A and B pulses to store 1.

An output pulse can be obtained at any K_0 cathode with a circuit the same as the K_9 output circuit. Thus, with the K_0 bias of store 1 at a -35 volts, an output is obtained from column a when the discharge reaches the K_0 cathode of tube aI . This output pulse operates auxiliary circuits to switch off the gate transistor of column c . Further guide A pulses thus cause the discharge in tube c_3 to step around the tube. The count stored in the "unwanted" store 2 is unaffected. Switch A_2 is also closed and the discharge in each tube of store 2 makes one complete rotation and returns to the original indicated count.

Finally, to obtain carry pulses down the chain of store 3, the K_9 bias is raised to -35 volts, to couple this store to the transistor gating circuits.

Construction and uses

The stepping tube multiple store was developed as the main store of an electronic desk calculator design. This design requires three stores each of twelve decades, and achieves an input counting speed of 20 kilocycles per second. present circuit requires only three stores, any number of stores may be added.

Acknowledgement

The author expresses his appreciation to the directors of Mullard, Ltd. for permission to publish this article.

Designer's casebook

Designer's casebook is a regular feature in Electronics. Readers are invited to submit novel circuit ideas, packaging schemes, or other unusual solutions to design problems. Descriptions should be short. We'll pay \$50 for each item published.

One discriminator senses pulse width and height

By Ronald G. Ferrie

Communications and Controls Co., Pittsburgh

Command-control systems need pulse-width discriminator circuits that are simple, reliable and versatile. An advantage of the circuit shown below is that it can be made to discriminate both pulse height and pulse width. It has been used successfully in several control applications.

The circuit discriminates in the following manner: Transistors Q_1 and Q_2 are connected to form a Schmitt trigger whose upper threshold voltage is designated V_{UT1} . Transistor Q_1 is normally cut off and Q_2 is kept in the saturated state by the voltage divider consisting of R_2 , R_4 , and R_5 . When Q_2 is saturated, the voltage at the base of Q_3 is $I_2 R_3 + V_{2SAT}$, where V_{2SAT} is the collector-to-emitter saturation voltage of Q_2 , and I_2 is the emitter current of saturated transistor Q_2 . When the input voltage is greater than the sum of V_{UT1} and the zener voltage of D_1 , transistor Q_1 becomes saturated, causing Q_2 to be cut off. When Q_2 is cut off, capacitor C_0 charges through resistor R_0 .

The voltage across the capacitor expressed as a function of time is

$$V_C = [V_{2SAT} + R_3 I_2] \epsilon^{-\frac{t}{R_0 C_0}} + V \left[1 - \epsilon^{-\frac{t}{R_0 C_0}} \right]$$

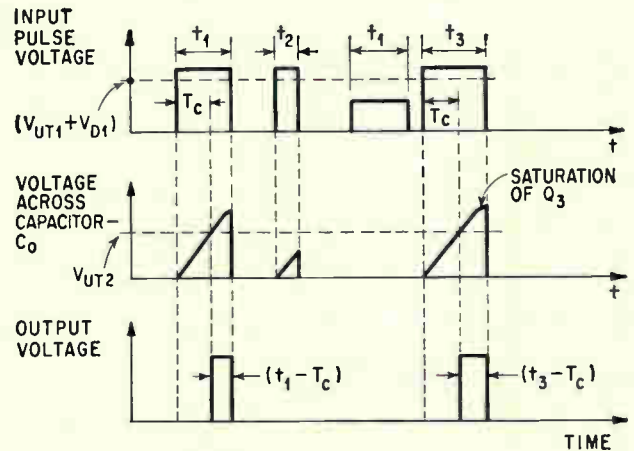

Various samples of input pulse shapes illustrate circuit operation. For these samples, $t_1 > T_c$, $t_2 < T_c$ and $t_3 > T_c$. No output pulse occurs for input pulse width less than T_c or input pulse height less than $V_{UT1} + V_{D1}$.

Capacitor C_0 charges until V_C reaches the upper threshold voltage V_{UT2} for the second Schmitt trigger consisting of Q_3 and Q_4 .

The charging time required for this is

$$T_c = R_0 C_0 \ln \left[\frac{V - V_{2SAT} - R_3 I_2}{V - V_{UT2}} \right]$$

An output signal occurs when V_C equals V_{UT2} . The output signal lasts until the input signal decreases to the lower threshold of the Q_1 - Q_2 Schmitt trigger, causing it to return to the normal state (Q_1 off, Q_2 on). Capacitor C_0 discharges through Q_2 .

The waveshapes above show the output and

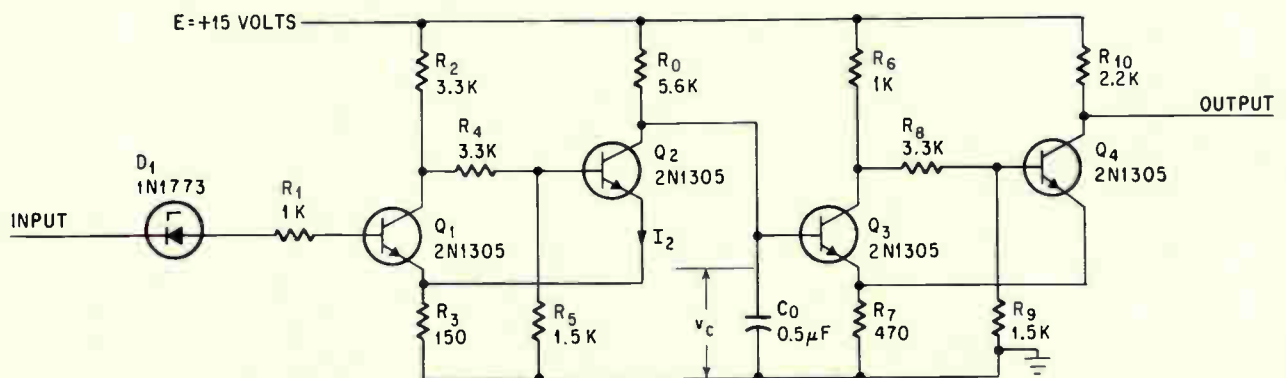

Pulse width and height discriminator consists basically of a zener diode, Schmitt trigger (Q_1 and Q_2), capacitor C_0 , and another Schmitt trigger (Q_3 and Q_4). Input pulse width or height determines if Q_1 - Q_2 trigger will be on a long enough to permit C_0 to charge to a voltage that will cause Q_3 - Q_4 trigger to produce an output pulse.

capacitor voltages for various input pulse shapes. No output voltage appears when the input pulse width is less than T_C , or if the input pulse amplitude is less than the sum of V_{UT1} and the D_1 zener voltage of D_1 .

This circuit was used in the receiver of a pulse-

width modulated telemetry system. Two similar circuits—each with a different time constant—discriminated three pulses of specific lengths. The shortest of the three pulses was a “no-go” command, the next longer pulse was a “go” command, and the longest pulse was a synchronizing signal.

Zero-crossing detector provides fast sync pulses

By Stephen Prigozy

Trygon Electronics, Inc., Roosevelt, N.Y.

Synchronizing a circuit's operation with the proper line frequency is often necessary. In applications where phase-control of rectifier power supplies uses silicon controlled rectifiers, a sharp pulse of relatively short duration that occurs at each zero crossing is required.

In the circuit shown below, transistors Q_1 and Q_2 comprise a differential amplifier. The collectors of Q_1 and Q_2 are connected to the AND gate consisting of D_5 , D_6 , D_7 and R_8 .

The center tapped transformer, T_1 , steps down the line voltage and provides a-c signals to the bases of Q_1 and Q_2 that are exactly 180° out of phase. D_1 , D_2 , D_3 and D_4 are clipping diodes that protect the base-emitter of either transistor from excessive forward or reverse voltage.

During positive and negative half-cycles of the line frequency, the differential amplifier is unbal-

anced; that is, either Q_1 is on and Q_2 off, or Q_2 is on and Q_1 off. Under these conditions, one diode—either D_5 or D_6 —is at -5 volts. D_7 conducts, and as a result no output pulse occurs.

However, when the instantaneous line voltage is zero, the differential amplifier is balanced because there is no a-c voltage on either base. The collectors of Q_1 and Q_2 both swing to $+2.5$ volts causing the AND gate to produce an output pulse of about 2 volts amplitude and 20 microseconds duration.

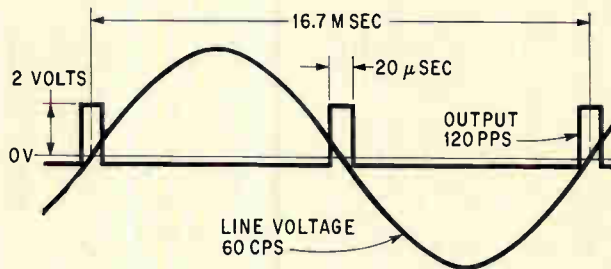

Center-tapped transformer provides 180° voltage phase shift at bases of Q_1 and Q_2 . Differential amplifier is always unbalanced except when line is exactly at zero volts. Each time line frequency crosses zero volts, circuit provides short output pulse.

Pulse generator circuit doubles as modulator

By D.L. Patillo

Autonetics division of North American Aviation, Inc. Anaheim, Calif.

By introducing a simple switch, the variable frequency unijunction transistor pulse generator can be converted to a pulsewidth modulator. The pulse width can be controlled by an external d-c signal, and the circuit could be useful in control and telemetering applications. Switch position determines whether the circuit shown on page 92 acts as a pulse generator or a pulse width modulator.

When the switch is connected to contactor 1 of switch S_1 , the circuit is a pulse generator. The pulse repetition frequency is variable from 13 to 25 kilocycles, and the duty cycle may be set any-

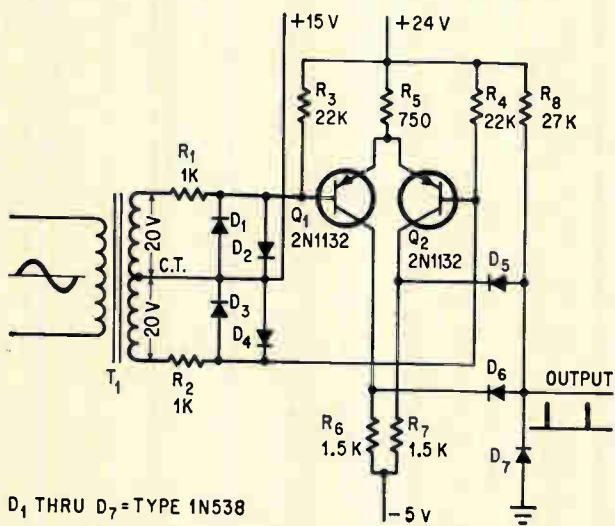

D_1 THRU D_7 = TYPE 1N538

Output pulse frequency is twice line frequency.

where from 0% to 100% for the component values and type numbers shown. Maximum output current is greater than 100 milliamperes at 100% duty cycle. Rise and fall times are less than one microsecond each.

The relaxation oscillator composed of unijunction transistor Q_1 , resistors R_2 and R_3 , and capacitor C_1 , generates a sawtooth voltage waveform at the emitter of Q_1 . The oscillator is isolated by the emitter follower Q_2 . The emitter follower output waveshape is added to the voltage output of the $R_7-R_8-R_9$ resistor divider at the tap of potentiometer R_8 , and the summed voltage is compared with the zener voltage of D_2 through the base-emitter junction of Q_4 . The d-c level of the sawtooth voltage varies directly as the position of the arm of R_8 . Increasing the d-c voltage level causes the pulse width to increase, as shown in the voltage waveshapes at the right.

The collector-to-emitter voltage of Q_4 is a square wave whose duty cycle is variable and depends on the voltage at the arm of R_8 . Q_3 is an output power amplifier; the output voltage waveshape is the same as the Q_4 collector-emitter waveshape. Resistor R_{12} provides a slight regeneration that improves the switching time.

Zener diode D_1 provides a fixed voltage reference for the resistor bridge, which makes the duty cycle relatively independent of input voltage variation.

Resistor R_8 varies the duty cycle. If the frequency range must be extended, different values of C_1 can be switched into the circuit.

When the switch S_1 is connected to contactor 2, the circuit becomes a modulator whose output pulse width varies with the level of an external d-c signal.

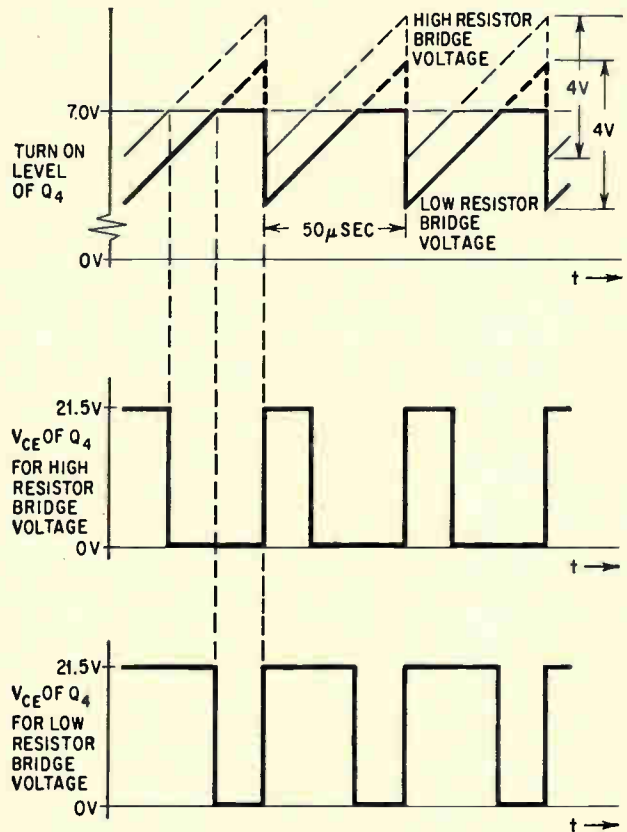

Pulse output is amplified by Q_3 and has the same waveshape as the voltage across the collector-to-emitter of Q_4 .

The duty cycle of the resultant square wave is modulated by the input d-c level. The pulse width sensitivity varies as the value of R_6 .

This circuit dissipates very little power.

EXT DC SIGNAL MODULATOR INPUT

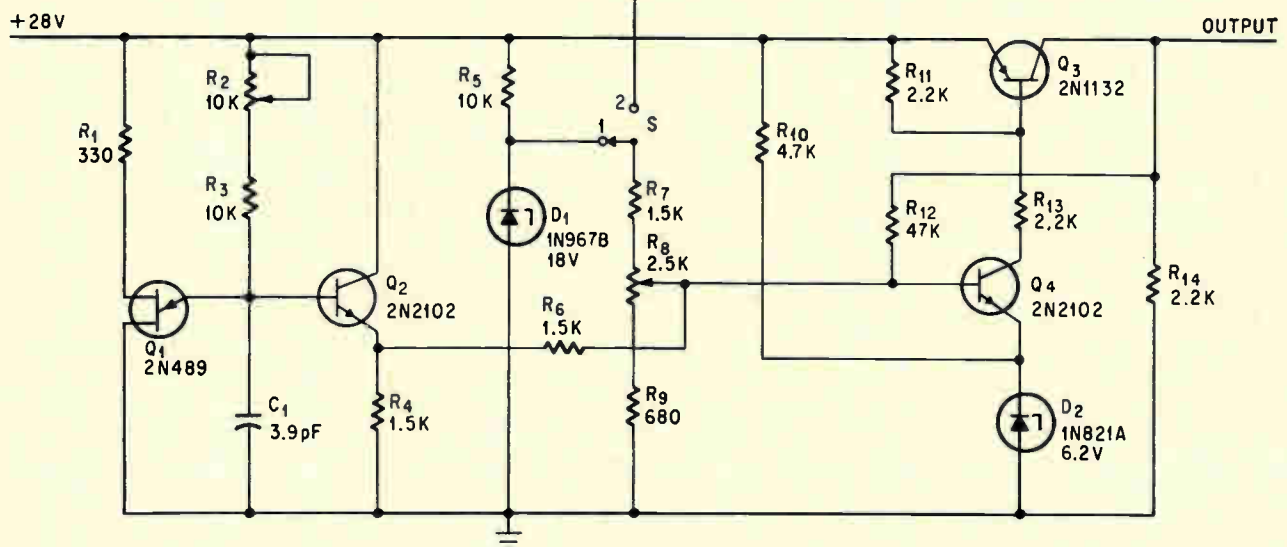

Circuit is pulse generator when switch is connected to contactor 1, or pulse width modulator when switch is connected to contactor 2. Generator frequency is adjusted by potentiometer R_2 . Modulator pulse width varies as external d-c signal voltage.

The dark side of the laser

Damage to vision is a constant hazard. Now a dosimeter can measure the danger level of direct or reflected laser beams

By J.J. Schlickman and R.H. Kingston,

Lincoln Laboratory, Massachusetts Institute of Technology, Lexington, Mass.

The direct beam of a laser can cause severe eye damage. So can a reflected beam, even when the reflecting surface is not mirror bright. Cases of temporary blindness have been reported by a number of researchers and efforts have been made to reduce the hazard.

A dosimeter that measures the energy of a reflected laser pulse has been developed as a safeguard against eye damage. Readings of the dosimeter will tell when the radiation has reached the danger level. Data obtained from experiments on eye damage in rabbits was used to develop and calibrate the laser dosimeter.

Several groups of workers have studied the biological effects produced by ruby laser radiation. These studies have indicated the serious possibility of eye damage resulting from not only specularly but even diffusely scattered light from the beam target. This radiation hazard motivated the con-

struction of a relatively simple instrument whose prime purpose is to measure the level of reflected energy from a target surface and indicate visually the existence of possible danger to the observer's eye.

The pulsed laser dosimeter is so named because it measures the total energy exposure per laser pulse and utilizes a modified gamma-radiation dosimeter as a high-impedance voltmeter. In addition, the observer is provided with an absolute means of determining the radiation dosage, since the calibrated scale is a linear function of energy density.

The instrument's dynamic range encompasses all the known normal mode lasers operating within the S-1 spectral response (6,000 to 10,000 angstroms) of the detector. Provisions have not been made, however, for work with Q-spoiled lasers, which produce pulses having a rise time of 0.5 to 1 nanosecond and a duration of only a few nanoseconds. This is due to design difficulties and a lack of quantitative data about such lasers.

The authors



J.J. Schlickman received his bachelor's degree in physics from Northeastern University in 1962, and did the work on optically-excited ionic and semiconductor lasers that led to this article at MIT's Lincoln Laboratory. He is now with the Sperry Rand Research Center at Sudbury, Mass.



Now on leave from Lincoln Laboratory, Robert H. Kingston is a visiting faculty member at Stanford University. He has done research on transistors, semiconductors' surface properties, masers and lasers. A consultant to the Department of Defense, he received his doctorate in solid state physics from the Massachusetts Institute of Technology in 1951.

Eye damage

At the Medical College of Virginia, W. J. Geer-aets, M.D., professor of ophthalmology, and W. T. Ham, Jr., Ph.D., chairman of the biophysics department, experimented with the effects of ruby laser irradiation on rabbits' eyes and determined that total pulse energies of 0.7 joules per square centimeter on the retina are sufficient to produce retinal lesions. This data was obtained for retinal spot sizes of approximately 1 millimeter and pulse lengths of 175 microseconds and longer.

In terms of the energy density in a scattered or reflected beam incident on the surface of the eye or the cornea, this corresponds to beam energy densities of 5×10^{-6} joules per square centimeter for ruby radiation at 0.69 microns and 10^{-5} joules per square centimeter for the longer wavelength radiation of neodymium-doped glass at 1.06 microns.

Critical levels for normal mode ruby and neodymium lasers

Laser	Wavelength (Microns)	Approx. Diffraction Limit (Microns)	Corneal Critical Density (Joules/cm ²)	Retinal Critical Density (Joules/cm ²)	Maximum Working Density (Joules/cm ²)	Pulse Length (microseconds)
Ruby.....	0.694	10	5×10^{-6}	0.70	5×10^{-7}	>175
Nd ³⁺	1.060	15	1×10^{-5}	1.40	1×10^{-6}	>175

This calculation assumes that the light incident on the cornea emanates from a point source and is based on a normal pupil diameter of 3 millimeters and that the spot that is formed on the retina of the eye by the focusing action of the cornea is a function of the wavelength of the incoming light (diffraction-limited).

The direct laser beam, due to its parallelism or lack of divergence, could also focus to such a small spot; however, such direct exposure to a beam is extremely hazardous under any circumstances.

For diffusely scattered laser radiation from a finite spot size on the target, the hazardous level is reduced if the image on the retina is larger than the diffraction-limited size. This special situation is also considered in the use of the instrument.

Since some microscopic organic damage is suspected at energies below those which produce observable lesions, a factor of 10 below the lesion-producing level has been chosen as the maximum working level for laboratory and field experiments. The data is summarized in the table above.

Scattering the light

The laser dosimeter is designed to measure the total light energy from one laser pulse with readout related to possible eye damage. Instrument calibration is such that a 10% scale deflection is the working maximum, while a full scale deflection indicates an energy level sufficient to cause lesion formation.

The sketch in the middle on the opposite page shows the circuit of the instrument. Laser radiation enters the field lens and is focused onto the diffusion plate. The prism and focusing plate are used for aligning the instrument with ordinary light prior to making a measurement.

The Bendix dosimeter is an inexpensive (\$25 list) pocket instrument designed to monitor total gamma radiation over several days or a week. In this application, it is used as a sensitive electrometer. In normal radiation-monitoring, the pocket dosimeter (see drawing at bottom of opposite page) is zeroed by charging the quartz fiber and its support to approximately 160 volts with respect to the ion chamber walls. Under these conditions the hairline indicator reads zero. Ionizing radiation entering the charged pocket instrument will cause the electrometer to lose charge. A full scale reading is obtained when the electrometer voltage has dropped to approximately 90 volts, as indicated in the drawing.

In the laser dosimeter, the electrometer of the pocket dosimeter is zeroed and capacitor C is

charged to approximately 160 volts. The charging switch is then opened. Laser light from one pulse is directed into the collecting or field lens and focused onto the diffusion plate. The diffusion plate scatters the light so that entire photocathode surface of the phototube is illuminated. Scattering is necessary to overcome any nonuniformities on the cathode surface. The light pulse produces current in the phototube and allows the parallel capacitance consisting of C₁ and the dosimeter to discharge. When the pulse ends, the current through the phototube ceases and the net loss of charge is proportional to the integrated energy in the light pulse.

Phototube-electrometer circuit

When operated at 250 volts, the 925 phototube used in the instrument has a rated dark current (no incident light) of 0.0125 microamperes. Working voltage in the electrometer circuit, however, is only 160 volts, and the dark current of typical tubes at this voltage has been found to be two orders of magnitude less. This low leakage allows the dosimeter to be calibrated linearly and without compensation for charge leakage during the normally short interval between the time the capacitor is charged and the laser pulse reading is made.

The requirement was established for a full scale reading on the dosimeter for a laser pulse of critical energy density (5×10^{-6} joules per square centimeter for ruby). Considering the optical efficiency of the dosimeter and the efficiency of the photocathode surface, this translates to a loss of 0.07 microcoulombs of charge from the capacitor for a critical energy density pulse. Since the loss of voltage across the capacitor for a full scale deflection is 70 volts, the capacitance, C₁, is 1,000 picofarads. This value is calculated from the formula

$$C_1 = \frac{Q}{\Delta V}$$

$$C_1 = \frac{0.07 \times 10^{-6}}{70} = 1,000 \text{ pf.}$$

Actually, no auxiliary capacitor is required because the Bendix electrometer used in the instrument—model 686, with a range of 0 to 600 roentgens—already has the required 1,000 picofarads.

Although the phototube-electrometer circuit should integrate the energy for any pulse shape, pulses narrower than 25 microseconds or individual spikes of one microsecond or less will not be measured correctly. This results from the high peak

photocathode currents which would be required at the total energy level to be measured. Current saturation in the 925 phototube thus limits operation of this device to these minimum pulse lengths.

Using the dosimeter

The purpose of the dosimeter is to establish the magnitude of danger to the human eye from a direct or reflected laser beam. Since an accidental misalignment of a target or the movement of an object through the beam can send it bouncing around a lab, a survey of typical reflection paths will isolate those locations where extra caution may be required.

First, the location of any scattering or reflecting

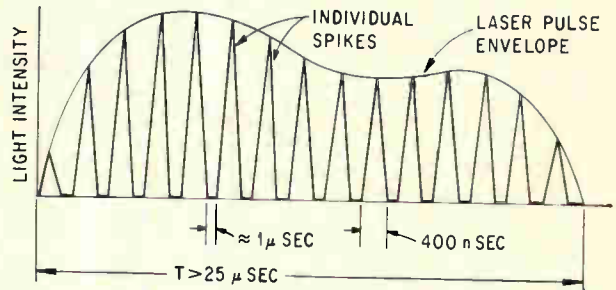

Individual spikes in the laser pulse are essentially triangular in shape and must have a base width of at least 400 nanoseconds to prevent phototube saturation. Also, a pulse of critical density must last at least 25 microseconds, or readings will be incorrect.

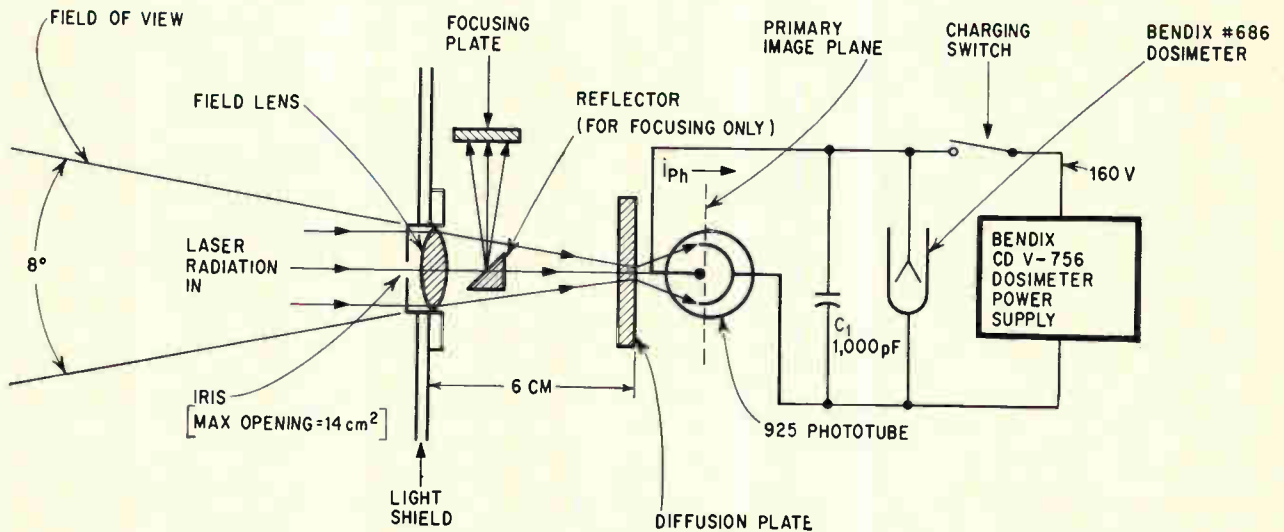

Laser radiation is focused onto the diffusion plate which in turn illuminates the photocathode surface. The capacitor is charged first to 160 volts, then the power supply switch is opened. The loss of charge during the time the phototube conducts is proportional to the energy of the light pulse.

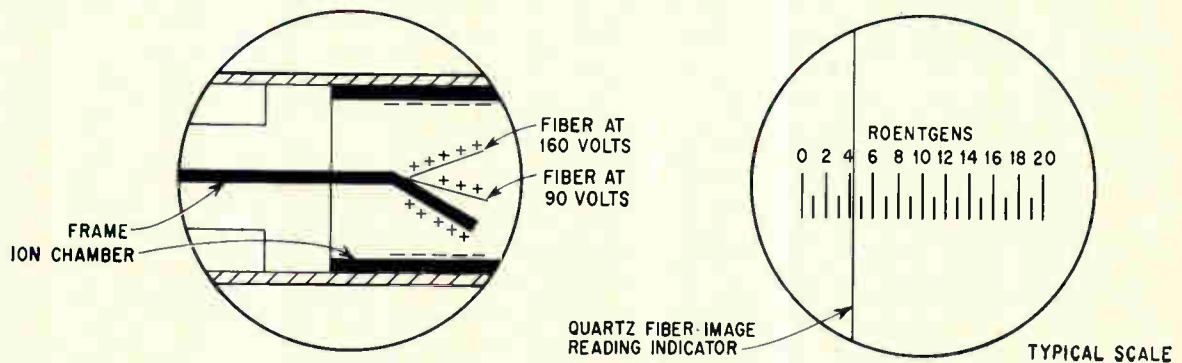
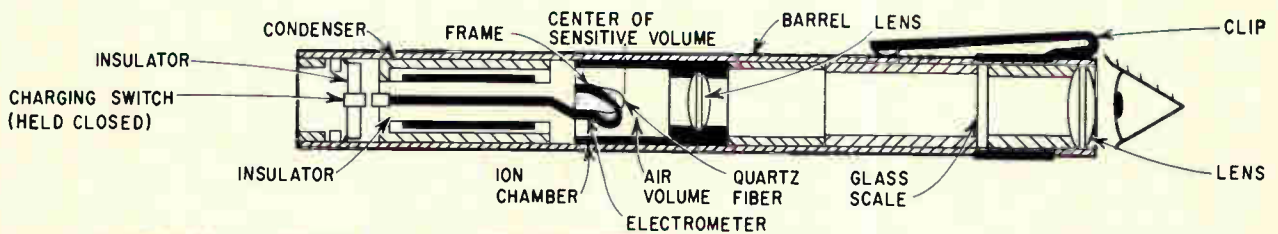

Fountain-pen type dosimeter normally used as monitor for ionizing radiation serves as electrometer and readout device in laser dosimeter. Typical scale shown for one model of radiation dosimeter is calibrated from 0 to 20 roentgens and is not recalibrated for experimental laser dosimeter.

Lasers and eye damage

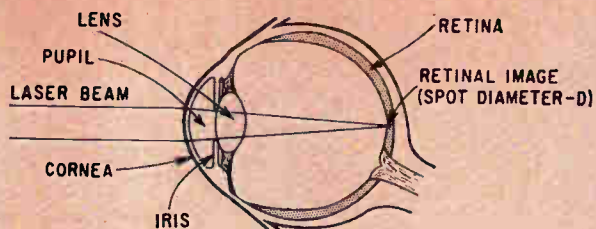

Cornea of the eye focuses incoming light to an image on the retina, and energy density is greater at the retina than at the cornea.

If a laser beam is focused by the cornea of the eye on the retina, as shown in the drawing, above left, coagulation of the retina tissue can occur. This often results in a destruction of vision over the affected part of the retina.

These permanent lesions, as they are called, are a useful criterion of eye damage because they are directly visible in an ophthalmoscope, the common instrument for eye examination. The lesion forms within three to five minutes after the eye receives the laser pulse. A plot of laser pulse power versus duration for eye lesion in rabbits is shown above at the right.

A permanent lesion does not mean total blindness, but it does normally mean blindness over the area of the lesion. If the damage occurs in the most critical area of the retina—which in humans is a small region near the center about 0.2 millimeter in diameter—the loss of vision can be severe enough to keep a person from reading

newspaper type and similar details. If the damage occurs in other areas of the retina, vision will be affected less severely. This means that the effects of the same size lesion can range from severe to negligible. As many as 50 laser-produced lesions, in fact, have been used in eye surgery with no significant loss of vision.

At approximately half the energy density at which mild, barely detectable lesions are produced, some microscopic damage is still suspected, but its exact nature and magnitude are unknown.

Research in laser-produced eye damage has been conducted largely with rabbits, primarily because a large amount of data on the effect of intense light on eyes has been accumulated with these animals during the past 10 years; correlations between rabbits' and men's eyes have been worked out. In the past two or three years researchers have been working with rhesus monkeys, but this data has not

been refined to the point where it can serve as a criterion.

Being a considerable distance from the laser source is no safeguard against eye damage. When a laser beam bounces off a reflector it normally spreads over a larger solid angle than the original beam. The energy in a given area of the beam therefore becomes less as the distance from the scatterer increases. This effect would suggest that the farther away from the scatterer the observer is, the less the danger of eye damage. However, the cornea of the eye focuses distant objects to a smaller size on the retina than near objects. Thus, while the energy entering the cornea is less for distant objects, the energy density at the retina can be higher. It is in fact true that for a given laser spot size on a scatterer, the energy density at the retina can be critical—will form a lesion—at one distance and be less than critical at a shorter distance.—Carl Moskowitz

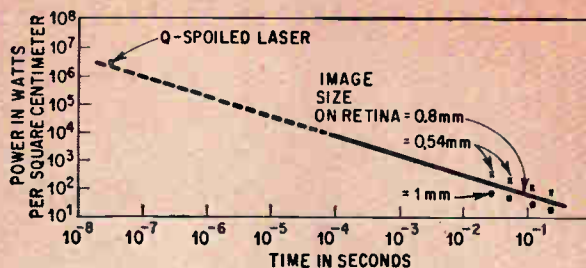

Time and energy relations for very mild, barely detectable lesions in rabbit eyes were developed by Dr. W. J. Geeraets and W. T. Ham, Jr., at the Medical College of Virginia.

surface is found. The dosimeter is then placed where the eye will be, as in the sketch at the lower left, page 98. Next, the dosimeter is focused: an incandescent light is used to illuminate the scatterer. The field lens is adjusted until a sharp image is obtained on the focusing plate. The illuminating source is then removed and the reflector moved out of the way. A measurement is then taken using the full opening of the instrument lens. A reading higher than 10% of full scale indicates a probable hazard and it is essential that proper shielding be arranged.

In many cases, scattering of an unfocused beam from a diffused surface will produce a retinal image larger than the diffraction limit. In this case, the size of the spot may be measured using carbon paper or exposed film and the instrument sensitivity adjusted accordingly. The size of the laser spot on the scatterer and the distance between scatterer and dosimeter field lens determines the size of the lens opening—the f-number—that is to be used.

The lens opening for various spot sizes and distances from scatterer to eye is given by the accompanying curves shown on the opposite page.

As an example of how the instrument is used, assume the laser spot size on the scatterer is 1 cm and that the danger at 200 cm is to be evaluated. For these conditions, the graph (Case 1) gives a lens setting of f-20; using these settings, a laser pulse having critical energy density will produce a full scale deflection of the dosimeter. This is the danger level for a permanent eye lesion; only readings less than $\frac{1}{10}$ of full scale should be considered free of serious danger.

Consider next a 0.1-cm spot and its effect at 100 cm (Case 2). Here the setting falls between f-4.5 and f-2.8. When the point is between two settings, as in this case, the smaller f-number (larger iris opening) will give a higher reading for the same amount of incident light and provide an extra margin of safety. Again, a full scale dosimeter reading indicates critical retinal energy density and only

$\frac{1}{10}$ full scale or smaller readings should be considered relatively safe.

Examine next any spot size at a distance from the eye that gives an f-1.4 setting on the diffraction limited line of the graph, such as $D_0 = 1$ cm and $L = 3,000$ cm. At the diffraction limit the size of the laser spot on the retina of the eye will be the smallest possible. This produces the maximum possible concentration of energy on the retina for a given laser pulse. To the left of this line the retinal energy density is less because the retinal image is larger; to the right, the retinal energy density is constant for a given energy density reaching the eye, since all energy is concentrated in the diffraction-limited spot.

The dosimeter optics are such that the ambient light must be reduced when stops from f-4.5 on down are used. At these settings the light-gathering ability of the lens is great enough to cause a slow drift in the zero setting for normal lighting levels. It is only necessary to decrease lighting until drift becomes negligible.

Calibration

For steady-state calibration (figure at top left, page 98), the iris is set at full opening. A filtered tungsten source and a thermopile (made by Eppley



Front view of dosimeter shows lens with scribed marks for lens openings coming between those normally used in photography. Hand-held device is a standard light source used for calibration.

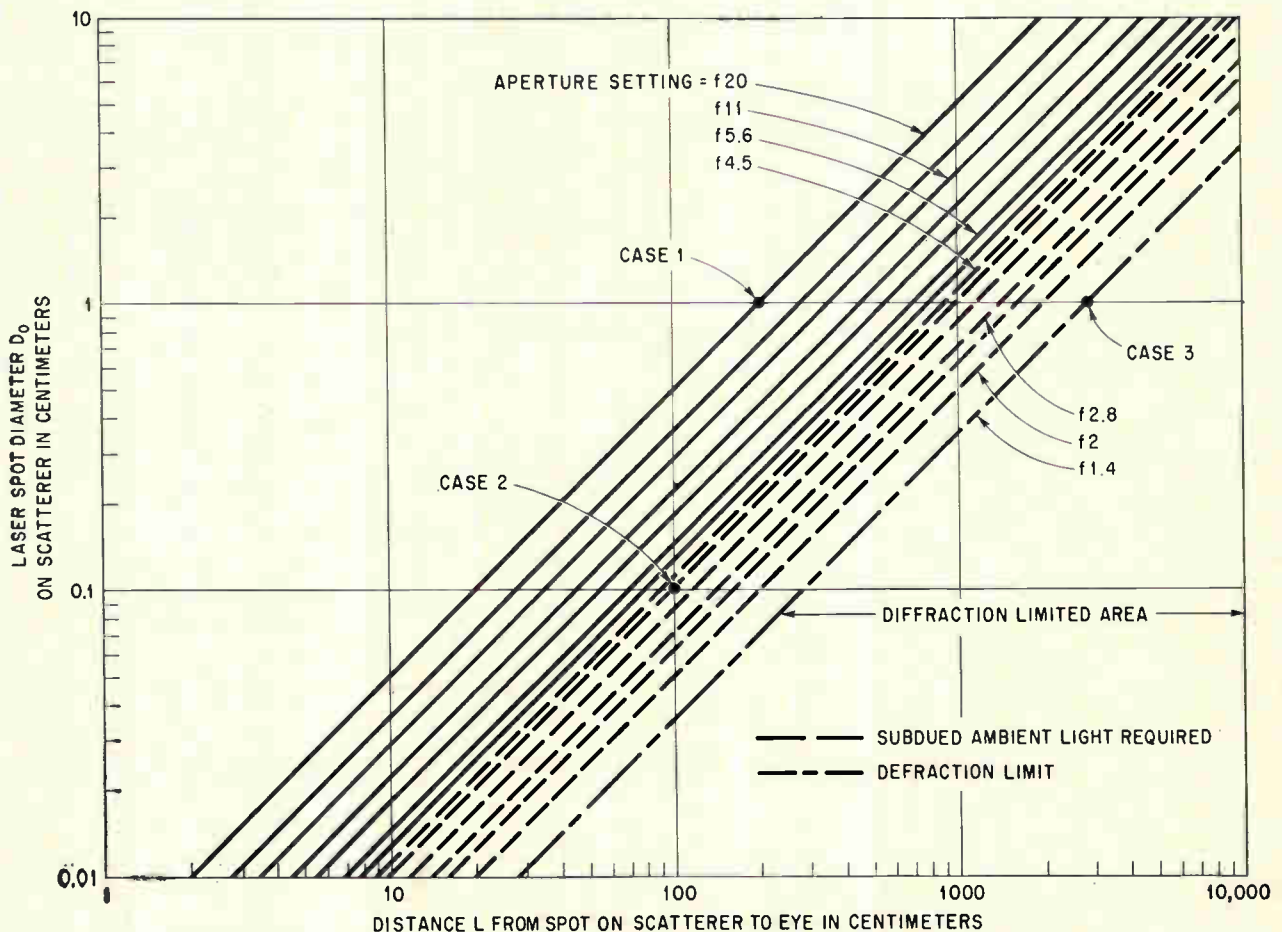

Curves used to find the correct aperture setting or lens opening for a particular laser spot size and distance from the eyes. A full scale reading for these settings is equal to the critical energy density at the retina.

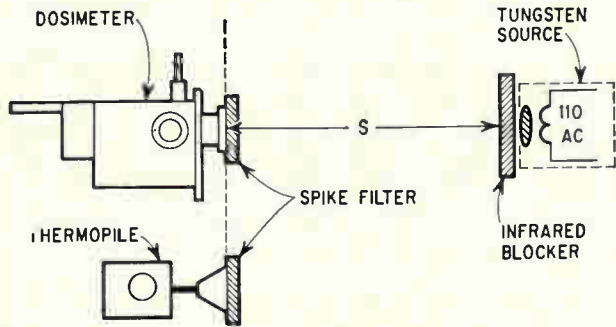

Instrument can be calibrated with a standard tungsten light source and a standard thermopile.

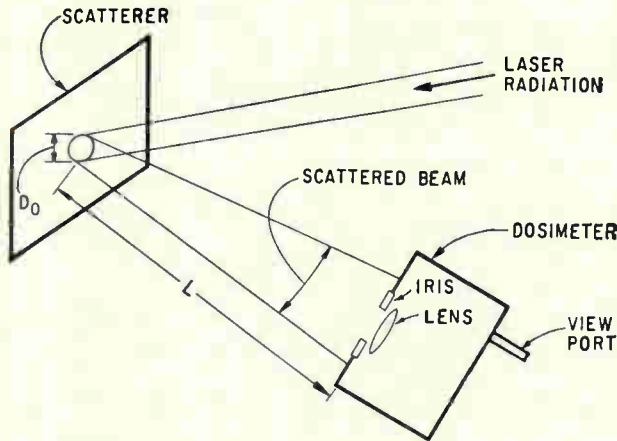

Lens of the dosimeter is placed where the eye would be. Readings must consider spot-size on scatterer, distance to dosimeter and iris opening.

Laboratories, Inc.) are used as optical standards. The thermopile measures the power density of the tungsten source in the wavelength region of the spike filter. The spike filters should have a pass band that is centered at the laser wavelength and is less than 400-angstroms wide. The length of time this source must illuminate the dosimeter to reach a total energy density of 5×10^{-6} joules/cm² for ruby, for example, is then calculated.

The position of the phototube is then adjusted until the calculated exposure time yields a full-scale deflection. A similar calibration procedure may be followed with data for neodymium-doped glass.

When a laser with a known output is available, a third calibration procedure may be used. It consists of setting up the dosimeter at a known distance from a good Lambertian reflector (which produces uniform scattering), such as powdered MgO or BaSO₄, and then computing the energy density. Once the calibration has been accomplished, the instrument is also useful as a joulemeter.

A small, filtered light source has been built to check the instrument's long-term repeatability and avoid frequent recalibration. In practice, this source is placed into the lens holder at a fixed distance from the phototube and a repeatable full-scale discharge rate is obtained. This reference source is

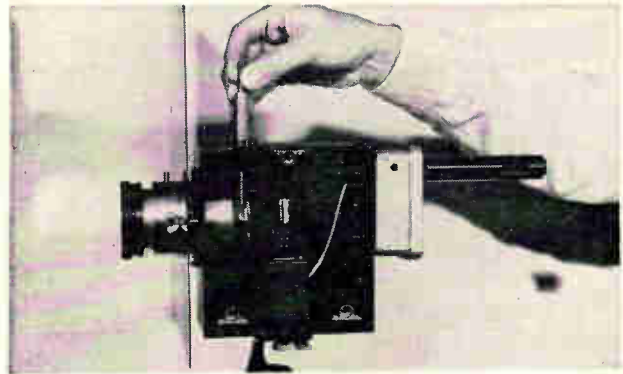

Side view of dosimeter with cover removed shows lens (a Cooke triplet), focusing adjustment, phototube, and viewing part with power supply.

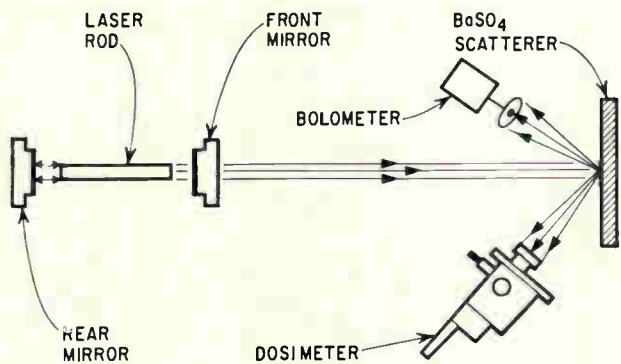

Bolometer is used in dynamic test to show dosimeter linearity for pulse durations from 175 to 350 microseconds, the range of interest for normal mode lasers.

shown in the photograph above and on page 97.

An instrument may be designed for monitoring Q-spoiled systems, based essentially on the same principles as the present model but using a dosimeter with less capacitance. This lower capacitance device should allow reliable readings for 10^{-8} second pulses, since the required photocathode current decreases in proportion to the capacitance.

Acknowledgment

The authors gratefully acknowledge the technical assistance of H.R. Favreau in the development and construction of the prototype instrument; L.J. Coyne for dosimeter and flashlamp measurements, and M.E. Fitzgerald for dosimeter measurements.

Many helpful criticisms resulted from discussions with S. Kern, J. Dennis, J. Rotstein, and H.E. Ziemann. Thanks are also due the Massachusetts Institute of Technology Occupational Medical Service staff.

The Lincoln Laboratory is operated with Air Force support.

References

1. M.M. Zaret, et al., Science 134, 1525, 1961.
2. V.T. Tomberg, Optical Masers, XIII, Brooklyn Polytechnic Press, 1963, p. 505.
3. R.A. Malt and C.H. Townes, New England J. Med., 269, 1417, 1963.
4. W.T. Ham, Jr., et al., Acta Ophthalmologica, Sup. 76, 60, Report on Symposium on Research in Light Coagulation, Mar. 22, 1963.
5. L. Goldman, New Scientist 21, 284, 1964.
6. S. Fine, E. Klein, and R. E. Scott, IEEE Spectrum Vol. 1, No. 4, p. 81, 1964.
7. W.T. Ham, Jr., and W.J. Geeraets, private communication.

35th Anniversary

electronics

electron tubes—their radio, audio, visio and industrial applications

radio
sound pictures
telephony
broadcasting
telegraphy
carrier systems
beam transmission
photo-electric cells
facsimile
amplifiers
phonographs
measurements
receivers
therapeutics
television
counting, grading
musical instruments
traffic control
metering
machine control
electric recording
analysis
aviation
metallurgy
beacons, compasses
automatic processing
crime detection
geophysics

The future of the electronic art:

Thomas A. Edison H. P. Davis
Dr. Lee DeForest Dr. W. R. Whitney
J. Ambrose Fleming Dr. F. B. Jewett
Dr. Robert A. Millikan

The power pentode: B. V. K. French
Sound-picture problems: Dr. A. N. Goldsmith
Tuned rf. amplifiers: Dr. Louis Cohen
Photo-electric cells: Dr. H. C. Rentschler
Magnetic storms: Dr. A. E. Kennelly
High frequency fields: W. C. White
Ocean telephony: Dr. H. E. Mendenhall
Electronic measurements: J. W. Horton
Tubes in industry: S. M. Kintner
Beyond the electron: Dr. Vladimir Karapetoff



A MCGRAW-HILL PUBLICATION

APRIL 1930



Your future is in television. David Sarnoff told radio broadcasters in 1947 at Atlantic City convention. Today he is equally confident about color tv. Sarnoff calls tv the most important factor in the growth of electronics.

A prophet takes stock

The first 35 years of Electronics

David Sarnoff, a leader of the industry since Electronics' first issue, remembers how things were and predicts how they will be

By Lewis H. Young

Editor

It hardly seemed the time for optimism. In April 1930, the United States was in its worst depression: businesses were failing, money was scarce and unemployment was spreading. But that month, in the first issue of *Electronics*, the leaders of an industry which had grown up around the vacuum tube were voicing great expectations (see page 104).

Thomas A. Edison said, "Applications are almost infinite. They open a field for research in physics, chemistry, electricity, heat and light beyond imagination."

Equally hopeful was Dr. Lee De Forest, the inventor of the three-electrode vacuum tube. He forecast great strides in medicine, agriculture, avia-

tion, communications and television.

From the hard-hit field of radio—which meant 90% of the electronics industry—came the amazing prediction of a bright future for electronics. The prophet was David Sarnoff, president of the Radio Corporation of America. At that moment radio was facing a crisis: talkies were luring people by the millions out of their homes, away from radios. Even worse, a lot of the businessmen in the radio field were aware that the motion picture theaters were tightly controlled by a few men who didn't intend to enlarge their close-knit group.

Sarnoff addressed himself to that problem and with unruffled prescience. He wrote, "I have not been worried by the fact that two or three organizations have control of the theaters of this country, because there are only 20,000 theaters in the United States. Potentially, there are 26,000,000 theaters in this country awaiting development. Every home can ultimately become a theater itself."

Television, 20 years later, proved Sarnoff right.

David Sarnoff, onetime ship wireless operator, is now chairman of the board of a Radio Corp. of America that is 14 times its 1930 size. To many who have known him since his early days in the radio industry, Sarnoff has been a stormy petrel associated with battles in the industry. Blunt and outspoken, the small, roundish Sarnoff has built RCA by combining financial shrewdness with the ability to recognize and encourage the technical developments that have great commercial potential.

Because he has been intimately connected with, and often responsible for, so much of what has happened to the electronics industry in the past 35 years—and because he has been so accurate a prophet—we asked Sarnoff to reminisce, and then to tell us what he saw ahead for the electronics industry.

The best and the worst

For the budding electronics industry, the thirties were tumultuous. "The biggest problem," Sarnoff says, "was finding money. A lot of people had to give up research and development." Then he adds proudly, "We always found money for R&D."

It was a time of struggle over patents and of rapid business evolution. New channels of distribution for marketing were opened. The radio industry was fighting with the American Society of Composers, Authors and Publishers and with the American Federation of Musicians.

Executives of the day were vigorous and hungry, sometimes boisterous, as they battled furiously with each other—men such as Atwater Kent, De Forest, Eugene MacDonald, Allen B. Du Mont, and David Sarnoff. They competed through their products and with each other. Sarnoff's favorite summation of the period: "Competition brings out the best in products and services and the worst in men."

The thirties were also a time of disappointment and failure. The innovators were not always rewarded. Sarnoff complains, "Too often, the people who succeeded were the followers, not the leaders."

From the conflicts came progress. "Battles are not enjoyable but they are part of life," Sarnoff comments.

Sarnoff looks like a benevolent grandfather today; he now avoids the controversy that once he thrived on. But he still enjoys a victory. On the day we interviewed him, he chortled happily over the capitulation of a bitter competitor; earlier that day, the Columbia Broadcasting Co., after holding out for years, had announced it would start telecasting in color next year.

Not in the dictionary

As Sarnoff smoked his pipe and remembered the past, he pondered—in response to a question—the most significant development of the last 35 years. Then he offered two. He said, "Two changes have opened the way to nearly all of today's electronics products and services. One is the broadening of the useful radio frequency spectrum by 1,000 times and more. The other is the transformation of basic circuitry by solid state electronics.

"Thirty-five years ago," he continued, "electronics' role was limited to radio communications. Electronics itself was an unfamiliar word and it did not appear in any standard dictionary. This was the radio industry and it performed all of its functions in a narrow-frequency range forming less than one-tenth of one percent of the spectrum we employ today."

Other veterans of the industry remember how Sarnoff and MacDonald, a fierce competitor who had built the Zenith Radio Corp., differed over what to call the industry. MacDonald liked the word "radionics"; Sarnoff stoutly held out for "electronics."

Later, the same potagonists were to clash over the name of another important development. MacDonald advocated "radiovision"; Sarnoff shrugged that off as hard to pronounce, and held out for the simpler word "television."

Since those early arguments over what to call it, Sarnoff has continued to have something to say about television. He can be stubborn about a decision. He was determined that RCA would stay in the tv business. His determination held even when others abandoned the fight for color. He continued to push color telecasting and the manufacture of color receivers after everybody else in the industry had stopped.

Through all those years, television has fascinated him. He put it this way, "To make tv practical, we had to combine almost all of science and technology—engineering, chemistry, design, optics, materials, glass technology." And television demonstrates Sarnoff's key rule for a successful product. He says, "The permanency of any new development is really measured by this test: is there anything that can do the same thing as well or better? Reproducing images is television's job, and nothing else does it so well."

He credits tv with being the most important factor in the growth of the electronics industry dur-

ing the past 35 years. According to Sarnoff, "Television has been the principal reason why electronics has been the nation's fastest growing postwar industry. The initial thrust was supplied in the first postwar decade by black-and-white television. The story is now being repeated in color."

Is there anything left for television after color tv? "There's a lot," he replies, "mural tv, a picture on the wall; tv for the home, a monitor that replaces the doorbell; and worldwide television that lets everybody see and hear, any place in the world." He adds, "Generally, if you are interested enough to hear somebody, you'd like to see them too."

View of the future

Looking ahead, Sarnoff believes that what has happened in electronics is nothing compared to what will happen. "Growth of the industry is the result of interplay between two forces," he says. "First, the tremendous advances in information handling and communications have made possible the complex industrialized society we have in this country today. This, in turn, has produced a steadily growing need for the most advanced electronics techniques and systems."

Sarnoff believes the pattern will not only continue but rapidly accelerate. He says, "The next five years alone should see electronic data processing increase from today's 22,800 computer systems, with an accumulated value of \$6 billion, to an estimated 53,000 systems, valued at over \$12 billion. Similarly, in the next five years, the number of color tv receivers is expected to increase more than six times, to about 19 million sets from today's three million."

Electronics will touch every aspect of human life, Sarnoff believes, even to prolonging life itself. He predicts, "Ultraminiature electronic devices implanted in the body will regulate damaged human organs. Electronics will replace defective nerve circuits. Laser beams will perform bloodless surgery. The medical diagnosis and the latest treatment will be prescribed by computers and transmitted to doctors everywhere in the world."

Communications face a revolution too, he adds, "With ultraminiaturized equipment transmitting over laser beams and through communication satellites, anyone will be able to communicate with anybody else, anywhere, at any time, by voice, sight, or written message. Participants will be in full sight and hearing of one another through small desk instruments and three-dimensional color tv screens on the wall."

Brave new world

Sarnoff believes electronics will have an impact on a lot of nonelectronic developments too. He paints a fascinating picture of a civilization straight out of science fiction. From techniques developed for space exploration, new forms of transportation will emerge. Cities at opposite points of the globe will be no more than a few hours apart.

Around the earth, a network of weather satellites will predict next season's floods and droughts, and extremes of heat and cold. Ultimately, worldwide long range meteorological theory will lead to control of the weather and climate.

Space will become hospitable and able to sustain human habitation. Permanent bases will be established on the more habitable planetary neighbors, and from these a stream of televised reports,



Remember the "old" World's Fair of 1939? One of the attractions was that newfangled invention, television. Here Sarnoff presides over ceremonies that officially began television service in the United States.



What's next for tv? Sarnoff believes one possibility is a flat picture screen that you can hang on the wall like a picture. The basis of the "mural tv" screen is an electronic light amplifier.

inanimate and living matter, will flow to earth.

Human nature and human inertia have always slowed the rate of electronic technological innovation even from its earliest days. Sarnoff smiles when he remembers how, when shipboard wireless was just getting started, some wireless-set salesmen had to give the captain of a ship a gold watch before the master would allow a radio set to be brought aboard.

A few years later, the broadcasters fought the record player. Sarnoff still bristles when he recalls that other radio manufacturers called his phonograph "a toy." Then, in the thirties, there was similar opposition from a lot of radio men to the development of television. They said tv would take too great an investment and were certain nobody would have a tv set for a long, long time.

Today's developers will meet the same kind of inertia, but there is a difference now, says Sarnoff. The rate of technical progress is so fast that the man who stands in its way will be bowled over. He continues, "It is no longer possible to hold back invention."

Sarnoff believes that electronics will affect more than just the physical aspects of existence. He believes it will profoundly alter human behaviour. He expects computers to make deep adjustments in the social pattern by altering work habits and sharply reducing working hours.

He believes "We are facing a time when the problem of leisure may be more important than the problem of labor. What man does with his

leisure will be the prime concern."

Under such circumstances, education will be different too. "Education will be radically affected by the computer," he says, "Electronic devices, and computer techniques and systems, will open the roads to a lifetime of self-instruction for millions of people. Better education will alter the quality of our lives at work and at home."

Not by bread alone

All this fits into another of the world's most harrasing problems, one Sarnoff thinks causes the difficulties we face today. He put it this way: "The advance of man spiritually has not matched the advance of science and technology. There is a gap. Electronics can make a great contribution in spreading knowledge and religion.

"The most important thing is man himself. He needs more than material things in life. If all he had was plenty to eat and drink there would still be conflict. What is needed is a cultural advance as well as a scientific one.

"You cannot expect a man with an empty stomach to be spiritual very long. Still, if his basic needs are fulfilled and there is no spirit, that isn't any good either."

As Sarnoff see it, "Any science must remain the servant of man. The true role of electronics during the next 35 years will be to release man's mind for the creative thinking that must be done if the impact of science is to be harmonized with man's spiritual, social and political needs."

THE FUTURE SERVICE OF

From the first issue

The editors present timely messages from seven great are shaping present developments in the tremendously

By THOMAS A. EDISON



Discoverer in 1883 of "the Edison Effect," the first-known evidence of electronic action in a vacuum

I HAVE been asked by the editor of *Electronics* to answer the question "What will be the greatest service to humanity to be rendered by vacuum tubes?" To this question my reply can only be that such verdict belongs to the future.

Other questions put to me concern what future applications of electron tubes I foresee, in power transmission, in talking pictures, in chemistry, in medicine, in education? I am also asked whether we may not expect tremendously increasing powers and capacities in future vacuum-tube design and operation, just as in the past the powers of early lighting generators have been increased.

The applications are almost infinite with the three kinds of tubes. They open a field for research in physics, chemistry, electricity, heat and light, beyond imagination.

Improvement in rectifying tubes will, I feel, reach a point which will enormously simplify the transmission of power over great distances.

By DR. LEE DEFOREST

Inventor of the three-electrode vacuum-tube

HAVING watched the first slow growth of the audion as wireless detector, amplifier of radio and telephone currents, and oscillator for almost any frequency, until at last it underlies the entire structure of radio, it is naturally a source of deep pride to observe its entrance into many other fields of man's activity and progress.

Now that 100 kw. power tubes are a reality of daily manufacture it requires no daring imagination to predict that in the field of power conversion and transmission the free electron confined in glass and copper will soon replace tons of electric generators. Direct-current high-tension transmission over unprecedented distances may be one result. And by contrast, oscillator tubes of minute dimensions will enable physicists to generate undamped wave-trains having frequencies approaching the infra-red; and supply new tools for auto-graphing the electron and exploring inter-electronic space.

In the realm of Medicine new sciences of therapeutics and diagnosis, of gland and growth and life control, of bacteria culture and elimination, will be founded on man's new knowledge of the electron and his ability to harness its myriad frequencies in the cause of human health.

Similarly in Agriculture for accelerating plant growth, the elimination of pests, both plant and insect, we shall become



largely independent of seasons and climatic accidents.

In Aviation the electron will become man's faithful pilot ever at the controls, a piercer, or annihilator, of fog, and fending against blind accident. Likewise in Navigation at sea. In Industrial processes of many sorts, where today the electron is unknown, tomorrow it will serve as founder, laborer, and guide, in processes of smelting, welding, sorting, indicating, measuring—with an efficiency in time, results, and accuracy of which today we little dream.

Whereas in the fields of Communication and Television by radio and wire, for entertainment, education and culture, in school, theatre, and the home—its present great accomplishments are but vague hints, mere promises of the immeasurable benefits and transformations which the Electron and its Tube have in store—all for the betterment and peace of humanity, to make more easy the lot of labor, and to the enlargement and enrichment of life.

By PROF. J. AMBROSE FLEMING

University College, London, England
Inventor of the thermionic rectifier

[BY CABLE]



IN 1904 I invented the rectifying valve for wireless reception. It formed the starting point for great improvements, giving us wireless telephony and broadcasting. In large size it will be used in the future to rectify a.c. current for railway electrification and electrical transmission of power. In three- and four-electrode form, it is the essential element in talking pictures and television. Its employment in cable work will increase earning power by making possible multiple cable telegraphy. Perhaps even trans-Atlantic television will become possible.

By DR. R. A. MILLIKAN

California Institute of Technology, Pasadena
The first experimenter to isolate and measure the electron



THE Mergenthaler typesetting machine involves little more than levers and cams, physical devices invented thousands upon thousands of years ago—so enormous and so cumulative may be the influence upon the future of the introduction of a single new physical principle. No new physical appliance ever invented has found such a multitude of enormously important practical applications in so short a time as has the vacuum tube amplifier. This gives some slight indication of the magnitude of the influences upon the future of the race of the invention of the electron tube.

ELECTRONICS TO MANKIND

pioneers and leaders who laid the foundations and expanding art and science of the vacuum tube

By H. P. DAVIS

Vice-President Westinghouse Electric & Manufacturing Co.

I FEEL strongly that the whole subject of electronics is going to be very far reaching in its effects on the electrical industry, and that the vacuum tube has a great future not only in radio but in other fields than radio. In these applications vacuum-tube devices will take many forms other than the well-known and standard types we now know.

Meanwhile power ratings of electronic tubes are being increased at a rapid pace. Whereas in the development of the electric lighting art it was almost a generation before a 200-kilowatt generator was produced, yet in a few short years the once-feeble phenomenon of electron emission has been expanded to a scale of 200 kw. and larger, in a single tube. And we have only begun. Tubes have almost unlimited possibilities, it would seem, as rectifiers, converters, transformers, arresters, etc., on power lines and in industrial applications.

In the daily life of the world, during the next decade, electron devices seem destined to create changes as sweeping and revolutionary as those of the past 50 years.

By DR. W. R. WHITNEY

*Vice-President General Electric Company
Director Research Laboratory*

MOST scientists dislike predicting futures of anything. But I rather like to think that there is no end to the service which the application of electron tubes may bring about. In addition to what this journal calls the radio, audio, and visio, there is certainly also the multo, but not the ultimo.

Electron tubes are already changing alternating into direct current, and direct into alternating. They are changing frequencies from one value to another. They are altering wave shapes, and picking out for service any part of successive waves which is wanted. They are cutting off or heading off currents in place of switches, circuit breakers and lightning arresters, and are giving us such assets as electric fevers, for high-frequency biological researches.

When we realize that small glass vacuum tubes do so many things not done a few years ago, we naturally look anticipatively toward corresponding apparatus of metal, designed for large scale operation.

Heretofore, when electric power was shoved about, rotated, reversed, switched or modified, it was necessary to move large masses of metal, but electronics seems to separate the mass or weight of apparatus from its electrical properties, so that



in a sense we may leave the masses fixed, and just move or direct, put brakes on, or stop, the electricity itself.

Electron tubes were developments from incandescent lamps. But we no longer make use of the light they give, and many modern glass tubes are already metal coated. It isn't much of an extension to proceed without the glass or the modified forms of bases or the limited sizes which were evidently determined by lamp bulb conditions. We are probably still just slow and unappreciative.

And, in addition to the foregoing obvious applications, the tubes will doubtless become necessary in future services where we cannot now recognize any want, just as occurred in the case of the X-ray tube, which is an electronic device, which was neither wanted nor anticipated. Having seen our bones, we ought now to see what more we can see.

By DR. FRANK B. JEWETT

President Bell Telephone Laboratories

THE future applications of vacuum-tube devices, particularly the three-electrode thermionic vacuum tube, are perhaps best indicated by their past. Designed originally for use as detectors of radio telegraph signals, they were in 1914 developed to the point of being regularly utilized as amplifiers or repeaters in transcontinental wire telephony. In 1915 they were employed both at transmitting and receiving stations in the first transoceanic radio telephony, and in 1924 in high speed suboceanic cable telegraphy. During this same period two- and three-electrode vacuum tubes found extensive use in the field of radio broadcast and in numerous applications where the valuable rectifying and amplifying properties of thermionic vacuum tube devices were advantageous.

Today a great many thousand vacuum tubes of all sizes and descriptions are in use in the communication networks of the Bell System and other numerous thousands in similar networks throughout the world. The number of tubes involved in radio broadcast and in special services throughout the world is extremely large.

During the past fifteen years, as a result of fundamental research and development work, great improvements have been made in the character and efficiency of electronic devices as well as in the enlargement of the field of possible useful application. Starting with the erratic and inefficient tubes handling almost infinitesimally small amounts of energy, the research and development work thus far done has resulted in producing rugged relatively efficient devices which in some cases are designed to handle in a single unit many kilowatts of energy. The end of the progress of this research and development work is not as yet in sight.



A forward look at electronics

Now the modern counterparts of those leaders of science and industry who looked into the future in the first issue of *Electronics* predict what lies ahead in the next 35 years of the technology

By C.H. Townes

Provost of the Massachusetts Institute of Technology and developer of the maser for microwave amplification

The proliferation and power of electronics is even more obvious to us now than it was 35 years ago. Its rate of change becomes ever more rapid, and man's ability to solve technological problems ever more impressive. Even the vision of the seven seers of 1930 failed to encompass such things as atomic energy, the transistor, or maser amplification.



It's true that electronics has continued to grow enormously. But the vacuum tube has, at least from a relative point of view, recently been on the way out—replaced by a tiny speck of solid material.

It's true we have controlled oscillators down close to the infrared (and far beyond), but by atomic action rather than the vacuum tube.

It's true we have transoceanic television, but through the development of powerful rockets and solar cells.

Are all these things now electronics? Yes, in a sense, because the vigorous and penetrating field of electronics has adopted and adapted them. Electronics, and all that it embraces, will surely continue to be in the forefront of the fascinating exploration of the universe and of man himself which lies ahead; it will continue to eliminate drudgery, solve living and health problems, and provide toys and entertainment.

Where are the areas of possible great developments, at the moment seemingly unattainable, but yet worth man's vigorous efforts and not contrary to our most sure understanding of the universe? Of those which have some relation to present electronics, enormously cheaper power is one. We have not come close to turning the mass of matter around us efficiently into heat or electrical power.

Another is our mastery of the small, or of the complex. Computing components have steadily and amazingly decreased in size since early vacuum

tubes and relays. But they are still very large by comparison with a few atoms, which should be all that is required to carry out most elementary computing processes.

In the cell or in the human brain, nature has far outstripped our ability to pack together elements which carry out coordinated and complex operations. Our circuit elements are still enormously large, clumsy, and expensive to make by comparison with the complex molecular organization and control practiced everywhere by living organisms.

Clearly we can make remarkable progress in organizing information and controls with presently foreseeable techniques. This should help us understand and better adapt the complex situations of nature and of man. But the key to building flexible information and control systems on the scale of a few molecules per element is something which still eludes us, and which could radically change our electronics of the future.

By Eiichi Goto

Associate professor of physics, the University of Tokyo, and developer of the parametron

In computer development in the past the emphasis has been primarily on the search for new devices and new principles. Now we have the basis for exploring the technology of computer manufacture so that we can reduce its cost drastically. This is likely to lead to a vast expansion of applications.



Because of improved production techniques, the price of a computer can be reduced by a factor of 10 every decade. This would mean that a computer priced at \$1 million today would cost only \$10,000 by 1985, only \$1,000 by 1995.

As we accomplish a price drop of this magnitude, the computer will realize many of those ideas which were once regarded as pipe dreams.

For instance, inexpensive and portable automatic

translating machines would help remove the misunderstanding among nations that has been a barrier to world peace since the time of the Tower of Babel. Until now, the usual approaches have been the laborious learning of other languages or the arduous attempt to impose an international standard language such as Esperanto. With an automatic translating machine, people of different tongues could understand each other instantly and effortlessly. I think such a device is possible in the next 30 years.

I believe all experiments in engineering and physics will be controlled by computers in the future, thus accelerating man's search for knowledge at a phenomenal rate. The researcher will write a program and let the computer operate; then with knowledge gained from this computer run, he could write another more sophisticated program to learn more, and so on. Today the cost of a computer often limits its use as a research tool. Few researchers have access to computers which cost several million dollars. The day is not far off when researchers and students will have access to computers equivalent to the fastest one now available.

Improvement of manufacturing techniques will make the exciting but expensive inventions of today commonplace within 30 years. The television-type telephone is certain to become standard household equipment once the costs are brought down to within the reach of the householder.

In Japan, which now suffers from a labor shortage, there is impetus to automate everything. The 125 miles-per-hour trains which began regular service with the opening of the new Tokaido line are computer controlled; the driver is along just for the ride. In manufacturing industries, transfer lines and manipulators will handle most materials, and industrial tv will be used to monitor the processes.

By H.M. Barlow

Pender Professor of electrical engineering,
University College, London

Thirty-five years ago, one of my predecessors and professors, Sir Ambrose Fleming, said that electronics was destined to play a very vital part in our developing technology. But even he, the inventor of the two-electrode thermionic valve, did not fully realize the tremendous impact this technology was to have. Much of the structure of the present technological age is built around electronics and there can be little doubt that this phenomenon will gather momentum as time passes.

We can see a vast extension of two-way closed circuit television linked up with speech channels, so conferences and discussions can be held by simply dialing, thus ending a lot of expensive and time-consuming travel. High speed data transmission and teletype will be the means of exchanging



written correspondence between businesses instead of the slower letter mail.

To do these things, we shall need all that satellite radio relay and transoceanic cables can give. In addition we will have to use waveguide tubes developed to carry long-distance telecommunication channels by millimeter waves. This will come first overland and later, following the pattern of the long-distance telephone cable, around the world.

Computers will assume a steadily increasing role yielding information quickly and accurately as the basis of important decisions in finance, organization and administration.

Electronic automatic control of machines and manufacturing processes will develop until it dominates the work of industry. Traditional machining processes will in some cases be replaced by cutting with spark or high intensity maser and laser beams. Spray painting will be done with the aid of electrostatic precipitation; and cleaning will be the job of supersonic waves in liquids.

In all these enterprises, solid state electrical circuits will make an essential contribution to the techniques employed. Highly skilled people will be required to design, operate and maintain this vast expansion of electronic applications. The task of education and training for our future needs is indeed a formidable one and it has not yet been taken seriously enough.

By S. G. Herwald

Vice President, Westinghouse Electric Corp.

Today's prognosticator of the future of electronics can be sure of only one thing: the technologies and functions involved will be revolutionary in character and probably cannot be predicted because of the blinders imposed by current frontiers of knowledge. Regardless of the nature of the still-to-be-discovered knowledge, however, its applications will be intended for the benefit of mankind.



We can anticipate electronics' serving the basic function of extending the capabilities of man, in a sense becoming an extension of the human being, extending by vast amounts how far he can see, hear and speak, what he can comprehend and calculate, and his control over greater amounts of power. And this, in turn, will lead to a unique ability of electronics to provide man with the information he needs to realize his dreams of conquering disease and poverty and of exploring the universe.

Certainly the information explosion brought about by electronics will profoundly affect every facet of human activity: social, economic, scientific, and quite possibly political as well.

We can expect homes in which all activity is controlled by pushbuttons, medical care based upon data transmitted by sensing devices im-

planted within the body, and hours of leisure in which boredom is avoided only by automatic excitation of one or more senses, or perhaps a sight-seeing trip to the moon.

Less glamorous, but possibly of more practical interest, is how electronics will affect business.

Highly sophisticated and relatively inexpensive information retrieval systems will revolutionize marketing practices. A manufacturer would at all times have at his fingertips up-to-the-minute, accurate and comprehensive data on the location and size of his markets; critical performance, delivery and price considerations governing product acceptance; competitive data, etc., plus accurate forecasts of trends affecting the value of each of these variables. Obviously, with the efficiency of the marketing function thus enhanced, distribution and over-all manufacturing costs would be greatly reduced. The benefits to the over-all economy are obvious.

We are already assured that the information explosion brought about by electronics holds greater promise for the benefit of man than the sum total of his other intellectual conquests.

By Dr. C. Guy Suits

Vice President and Director of Research, General Electric Co.

In forecasting future developments in science and technology, one useful rule of thumb is this: anything that can happen probably will.

With this in mind, let's consider the research outlook in three fields: lighting, electronic living, and information science.

The production of artificial light has been one of the outstanding scientific and technological challenges of modern man—and it still presents great future prospects. Since the early carbon filament lamp, light lumens per electrical watt have risen from 1 or 2 for the carbon lamp, to 15 or 20 for the tungsten lamp, and to a range of 50 to 80 or more for fluorescent and vapor lamps. Still, the most efficient modern lamps produce far more heat than light. Spectacular future improvements in light sources are certain to be made.

For electronic living, solid state technology will provide the advances. New solid state devices—including transducers, sensors, generators, and converters—will conveniently change energy from one form to another. Among these two-way conversions will be electricity/light, electricity/heat, electricity/sound, and a-c/d-c.

In addition to energy conversion, the traditional electronic functions of controlling and amplifying electric currents will be accomplished in more efficient, compact, and economical units.

Solid state components, by their nature, are adaptable to miniaturization, so their versatile electronic functions are certain to come in smaller and



more useful packages in the future.

They'll be used not only in our manufacturing and industrial control technology, but also in the home and in personal service to individuals.

The great advances now being made in the information sciences—including the development of improved computer machinery—also stem from solid state electronic research and development. High-speed processing of information is one antidote for the increasing complexity of modern civilization. Presently the computer is being applied largely in industry, but its future use will pervade all modern living, including the home.

In the years ahead, it will become increasingly easy for man to communicate directly with the computer—without the help of the programmer and his stock of esoteric computer languages. Machines that can read instructions typewritten in English are on the horizon, and will no doubt be followed closely by sophisticated devices that will be able to respond to the spoken word.

The future also should see increased utilization of centralized processing facilities, including data banks that can be queried from remote locations. These banks will greatly influence education, medicine and law, retailing and government functions.

By Dr. James B. Fisk

President, Bell Telephone Laboratories

Science and technology advance so rapidly that even educated guesses today often fail to anticipate tomorrow accurately. A new discovery may change the course of future electronics in unexpected ways.

The future of electrical communications, on the other hand, is more nearly predictable. With the present range of science and the power of technology, we can develop almost any reasonable system—at a cost. The real problem is deciding on purpose, objectives, goals—and what we are willing to pay; doing a quality job which is service- and man-oriented.

We expect that by the year 2000, electromechanical telephone switching will be largely replaced by electronic systems; that there may be as much data communications between machines as voice communications between people; that the continents will be linked by communications satellites as well as highly sophisticated cables; and that information from telephone, teletypewriter, telewriter or facsimile will travel simultaneously over the communications network, and that communication users will be brought into face-to-face contact.

How long before these communications services will be available for widespread use will depend on how quickly the electronics industry can develop better, more economical, and more reliable devices and systems. I am certain that the industry can meet this challenge.



The experts look ahead

A wonderland for the consumer

An imaginative scientist paints an exciting picture of the future for consumer electronics. He sees new products creating a world where the living is easy

By Daniel E. Noble

Vice President, Motorola, Inc., Phoenix, Ariz.

In the future we can expect electronics to find new applications for the consumer in communications, comfort, convenience, computation and credit. To these we can add fun and games, health, and education. As man's leisure time increases in the years ahead, electronics will move rapidly into the toy, sports, games and entertainment markets.

Predicting how electronics will be applied to consumer products during the next 25 to 50 years is not difficult if one thinks only qualitatively and ignores the quantitative considerations. For example, if we ignore such limitations as spectrum space, cost, convenience, necessity, and practicability and concentrate only on unlimited feasibility, we can predict some marvelous developments. We could have flat two-way television communications units on every wrist or in every pocket to provide worldwide communications. We might even stretch our prognostication—with some touch of probability—to three-dimensional tv with stereo sound to supply entertainment, medical diagnosis, treatment information, accelerated education, remote shopping and instant banking.

Qualitatively, potential computer applications are limited only by imagination, and it doesn't

cost very much to imagine. We can picture a computer in every home to plan, schedule, and control meal preparation and program the cleaning operations. It could record and remind the householder of all social engagements; teach and control the children; and finally calculate and pay the income tax. The family could spend the greater part of the time summoning selected entertainment programs from the depths of an unlimited solid state memory system by merely dialing them.

Such predictions are so extreme they encourage us to restrain our projections, at least to a very small degree, by the introduction of some quantitative discipline.

I would place my prognostications in three categories: the things we can do, the things we would like to do, and the things we probably will do. I believe if we can't do some of the things we would like to do to change the gathering complexity of governmental procedures, we may be unable to do any of the "probable" things either. Unless we find new electronic methods to help cope with the constantly rising complexity of governmental decision-making, our whole system may degenerate to one of complete futility. Number one on my list of importance is the continuing development of computer technology and the application of this technology to handle government procedures at city, state and federal levels.

The computer age

Computer technology is probably the pivot around which the entire proliferation of electronic applications will swing over the next 50-year period. We are approaching an age of control, or a bit more generically, an age of electronic informational processing.

While the computer may be the hinge upon which the door to the future will swing open, the

The author



Dr. Daniel E. Noble is group executive vice president in charge of four technical products divisions of Motorola. He is one of the most imaginative and articulate leaders of the electronics industry. Yet he is realistic enough to believe that only about half of what he has written will actually happen. He leaves it to the reader to determine which half.

integrated circuit is the key to that door. A multitude of electronic applications heretofore considered impractical will be realized because of the unique characteristics of integrated circuits. Their small size, weight, and power consumption, and the improvement in performance and the reduction in costs they make possible open up many new directions.

For the legal profession, the computer will provide a procedural revolution. The first use will be for storage and retrieval of legal precedent decisions. Eventually (perhaps within 50 to 100 years), the computer will replace the judge and the jury, and the resolution of trial facts will be less emo-

tional and more objective and factual than those rendered by humans.

The computers, of course, will be assembled with advanced integrated circuit subsystems. They, in turn, will advance our research, our processing and our circuit design to evolve improved and more effective integrated circuits for universal application to mass-produced consumer goods.

Tv sets, radio sets, a variety of home appliances, automobile equipment, school and office equipment, and recreational supplies of all kinds will be assembled with integrated circuits. Controlled rectifiers and integrated circuits will be used to program and control clothes-washing machines,

What hasn't happened

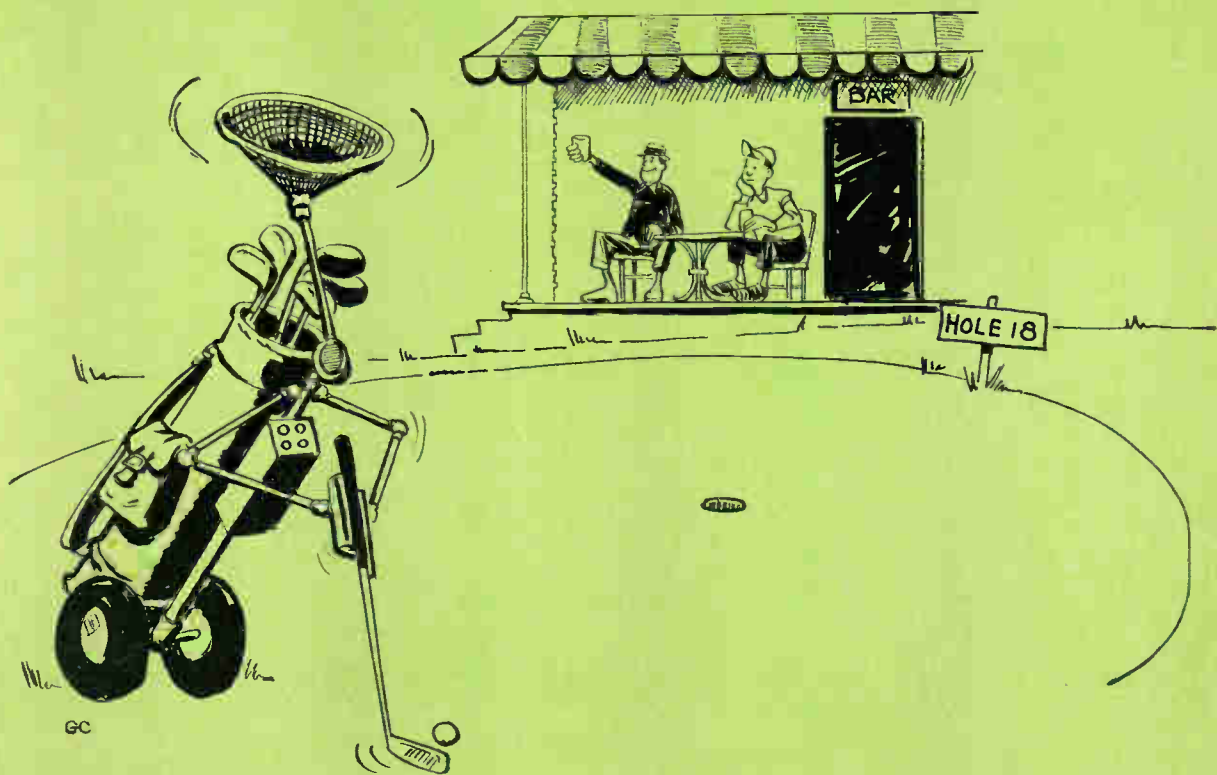

I couldn't pass up this opportunity to reconsider some of my favorite inventions—some more than 10 years old—which have not yet been placed on the market. The electronics industry has been slow to recognize the obvious need of the consumer and the sure bonanza for the manufacturer. Wouldn't you like:

A traffic light alerter? An automobile could be equipped with color sensors and associated activating equipment. After the car is stopped for a red light, the sensors will respond when the light turns green, signaling the activating mechanism to automatically blow the horn—of the car behind you.

An automated golf player? If we equip a golf cart with radar ranging equipment, an impulsor and a radio,

it will play the 18 holes of golf for you, then relay the accumulated score back to the clubhouse where you are sitting on the porch watching the scoreboard and sipping martinis. A push button would allow the introduction of a random error to facilitate betting.

A stereo symphony concert with the missing link of realism? A home stereo outfit will have a tape reproducer which is programmed to phase in the sounds of coughing, whispering, creaking chairs and rattling paper to duplicate the live concert.

Even though these products have not won acceptance, I am reluctant to push another one which I am assured is a certain winner: two-way worldwide pocket television for individual communications. If anybody

wants a two-way tv set to chat with a premier in South Africa or with a girl friend in Paris, I'm not going to help him any.

But why stop there? I'd equip each of the pocket sets with a computer translator that would convert any received language to English. Then, you could understand your conversational partner on the other side of the world and make faces at him at the same time.

I think I would also make it a multiple function device and include a pattern recognition function to whisper the name of the friend I just bumped into and whose name I can't remember.

If one is really going to predict, why be miserly about it?

—Daniel E. Noble

dish-washing machines, refrigerators, air-conditioners, illumination, electric stoves, and other household appliances.

The first major change in the fabrication of color tv receivers will be the use of integrated circuits; the second change will be the introduction of solid state flat screens which may operate on the principle of the injection laser. For such equipment, however, one very important "quantitative" element is still missing today: the solid state scanning system.

TV in your purse

The development of the flat tv screen would make possible pocketbook tv sets with solid state screens and integrated circuitry.

While I reject the idea quantitatively (even if I let the scanning problems slip by) that we will wish to provide individuals with two-way pocket tv communications equipment, I do believe that two-way voice communication equipment for personal worldwide communication use will be available. Considering the potential annihilation of the last vestiges of privacy, I hope it doesn't become too available.

Far more important than personal communications, either for telephone conversation or for radio tv communication, would be the use of tv and computer systems for teaching and for supplying information of all kinds. Large, flat tv screens will be used in schools with an individual tv screen installed at each pupil's desk. The use of advanced computer-type teaching machines, as well as taped teaching programs and live tv programs, will become a routine part of teaching procedures. Playing taped lectures and demonstrations, the isolated country schools will have available the same selected high-quality lecture series and illustrations as those provided for the students in the urban areas.

Shopping by television

Imaginations can run wild with the concept of shopping by tv in the future. The housewife will sit at home and shop by dialing the selected store for information about the merchandise wanted. Demonstrations, displays and sales pitches will come from a library of taped information—tape at first, but more sophisticated solid state memories with no moving parts will be used later.

At the same time, you will be able to dial a central library for information which can be supplied in the form of printed matter, oral presentation, or taped documentary information. For entertainment, you may dial a particular play or novel, or musical comedy, or variety show, which will also be served up any time, from a central solid state library.

The main barrier to such service is a limited spectrum space and narrow-band wire connections. Perhaps the only solution is one suggested some years ago: connect each dwelling with a coaxial cable to provide wideband service. Such service,

or course, could carry two way communications for visual display and perform all functions we've been discussing and more.

Voting systems could be included for city, state and national voting.

With this equipment installed, we could obtain national preferences for entertainment. The customer could register the degree of satisfaction or dissatisfaction with what he saw through a coded system which would weigh the votes with proper reference to the education and general competence of the voter. Simple coding could indicate the level of education achieved such as high school or college; for the advertising experts, it would also identify the income category.

Easier Retrieval

Perhaps one of the most important developments to come, fundamental to the continuing progress of our scientific culture, is the radical change from the present library systems to electronic systems for storing and retrieving information. The new library will go beyond simple storing and retrieving. It will include the correlation and selection of viable new combinations. Only through the development of an electronic library system can we hope to deal with the explosive generation of new information.

Without such assistance, it would be impossible to scan the sea of mediocre material to select the essential data and information needed as references for the work in hand. Without such a system, science and engineering will wallow in a perpetual state of redundancy. Ignoring the quantitative restraints, we can readily visualize international libraries with access by wire, by satellites, and by other communications means, to any part of the world. Information, and data could be routed through a translator for a user who might be in a foreign country.

In the automobile

Another essential electronic application of the future is the introduction of electronic systems for traffic management to reduce and eventually to eliminate the present annual slaughter on the highways. The means are available for complete automatic control which can take control of the car out of the hands of the occupants. But this is beyond quantitative reason, at least for the next 25 years.

First, we will introduce controls to reduce the danger at every traffic intersection in the country where multiple accidents have occurred. Then, computer traffic management will control urban traffic patterns to facilitate the steady flow of vehicles and eliminate the dash-and-stop technique now employed in all the cities in the nation.

Computerized traffic

Traditional traffic engineers will be replaced by electronic computer specialists who will be the traffic engineers of this age. Eventually we must

introduce automatic control.

To facilitate computer programing, cars can be equipped with automatic speed controls that can be operated by coding devices imbedded in the road, or by short-range radio signal devices along the roadside. Someday, individual cars will be banned from the central areas of a city and transportation will be handled by electronically controlled vehicles or moving platforms, or combinations of moving platforms and vehicles. A passenger will be able to transfer to a continuously moving vehicle to facilitate continuous rapid transportation to all parts of the city.

The automobile will use more and more electronic devices. Electronic ignition will become standard equipment—and soon. Eventually, cars will be powered by turbines, and finally, by electric motors when new batteries, new electric energy sources (possibly fuel cells), or atomic energy electric sources are available.

Before too long, the car radio will add supplementary equipment for radio communication with other vehicles. With it, a driver will be able to call for emergency assistance.

It would be nice to think that we could also apply an automatic sensor system to a driver for the purpose of stopping the car automatically when the driver's alertness degraded below some standard control level, but the human system's response to its organic computer will continue to confound all efforts to control or rationalize the behavior related to car driving.

Wonderland

Electronics will create a wonderland with new home appliances, instant banking, and medical electronics. Taking an optimistic viewpoint, we can see packaged power systems for homes, especially those isolated from the main power lines. We can expect houses to be designed with automatic cleaning and maintenance built in. Air purification equipment will be standard for home installation, and automatic window washers and pest control systems will be available.

We can extrapolate the development of instant banking to the point where money will be obsolete. By inserting a coded card into a device, a customer will be able to pay for items in the store, or for items ordered from the home. Instantly and automatically, the credit status will be checked and the amount of the transaction will be entered as a debt or cleared as paid through the bank computer.

Undoubtedly, elaborate automatic data processing systems for merchandising and for controlling stock in supermarkets and department stores will be developed. Smaller stores will have a simplified extension of the system. Clothing stores, hardware stores, and shoe stores, with thousands of items in stock (or out of stock, as the case may be), will use a low priced data processor that will check on the availability of the product and indicate its location, if the product is available.

Rx: electronic diagnosis

In the medical field, electronic sensors and measuring equipment desperately needed for medical diagnostic procedures will be developed. In addition, there will be a general trend toward greater and greater use of computer diagnostic systems. While it would be possible for the measuring equipment to be attached directly to the patient, it is more probable that a series of separate measurements will be programed into a computer, so that the computer can search all relevant stored bits and serve up the diagnosis. Then the machine will spell out references on handling similar cases, and recommended procedures for treatment. The computer's memory will be much less fallible than the doctor's. Obviously, microcircuitry will be used to measure the patient's important physiological parameters automatically, then transmit and receive them at a central monitoring point in the hospital.

New breed of engineer

While electronics will have a profound effect upon the general culture of our country in a rising new scientific age, the changes which have been anticipated will have a truly spectacular effect upon the electronic industry. Integrated circuits will be used very early for all digital equipment design. There will be a gradual switch from component circuitry to integrated circuitry for all linear systems.

Electronic engineers will change to keep pace. They will have to be part chemist, metallurgist, physicist, mathematician, and special material and circuit expert.

Components will always be with us, but integrated circuitry will improve performance for some applications, and will improve reliability and decrease size, weight and cost for all mass-produced equipment. The role of the discrete component may be restricted to products which are ordered in small quantities and manufactured in job lots.

Ultimately, automatic machinery will produce integrated circuits with variations introduced by changing the processing program or the materials and masks in the successive stages of fabrication. Most large electronic companies will have facilities for designing and developing integrated circuits, but unless they have requirements for very large quantities, the production of the circuits will be carried out under contract by the semiconductor products companies.

Computers are the key

History suggests that new devices and new techniques seldom displace the old technology completely. Radical changes in concentration of effort or emphasis occur, but old methods hold on where the economics and the new methods are not compatible. Improvements introduced over the years may eventually wipe out the economic incompatibility, and the old methods will then fade away.

I have suggested that the computer and the integrated circuit technology are central forces influencing the rapid pattern of technological change in the electronic art. To achieve the revolutionary changes predicted, a wide range of computers, large and small, high-cost and low-cost, must be made available. Before we can manufacture small computers with now available high-capacity memories, it will be necessary to develop a new form of low-cost solid state memory. Neither the core nor tape bit storage systems fit the pattern adequately.

Although we can visualize the possibility of stor-

technologies for a multitude of inventory and other control problems. Scanning is the quantitative block which makes our qualitative projections so very, very uncertain.

I wonder if this limitation isn't just as serious as the one delaying the development of a viable system for the generation of power through atomic fusion. Failure to solve this latter problem (with the search for solutions leaning on electronics all the way), will end in a disastrous fuel famine, as our sources of fossil fuels become exhausted. It's a race to finish painting the fence before the paint is all gone.

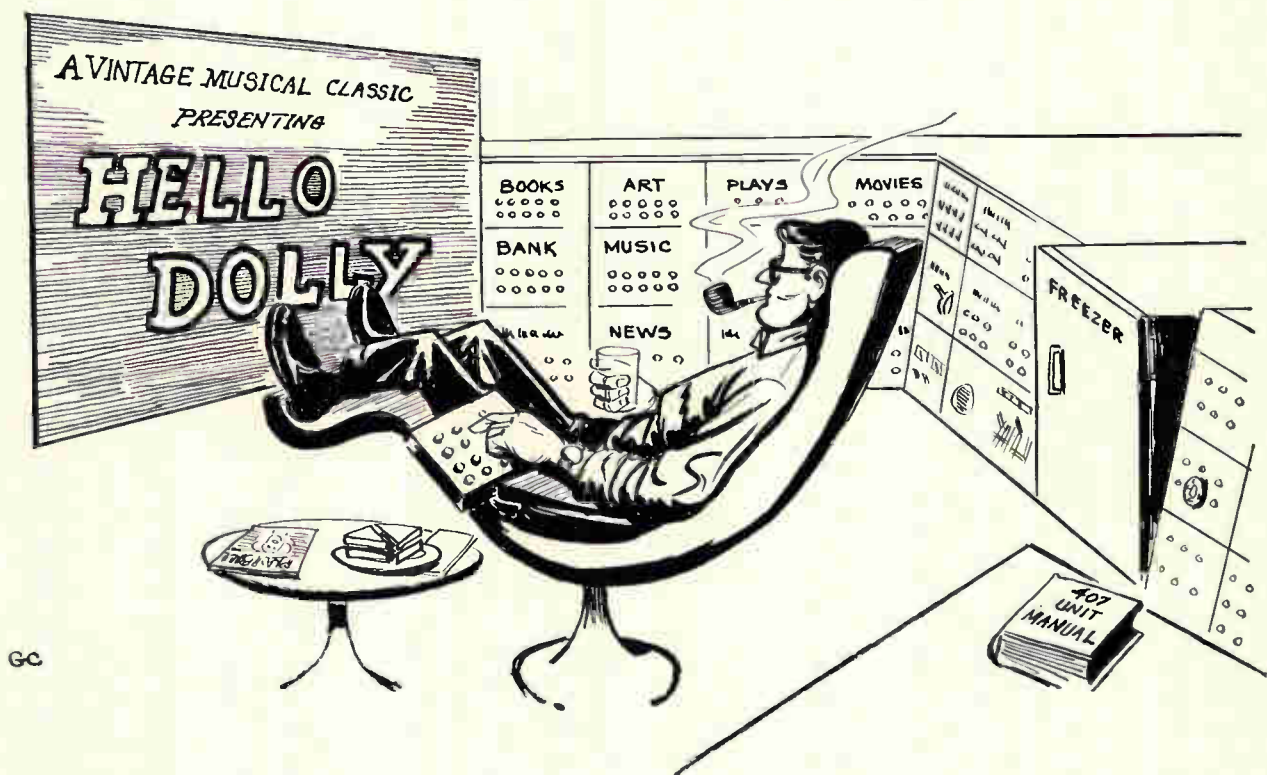

ing tens of thousands of bits on a single tiny silicon chip, we have no satisfactory means for scanning to store and retrieve the bits. Placing a matrix of bits in a vacuum tube for electron tube scanning introduces limiting factors which are not tolerable except for highly specialized or high-cost applications.

For the needed advances in computer technology and for the development of a solid state tv screen, the missing link is a high speed solid state scanning system. We might visualize a mosaic of injection lasers to provide light for a tv screen, but there is no simple adequate means for scanning and modulating the light to produce the picture.

The lack of a low-cost, high-capacity memory and the lack of the solid state tv screen (with both depending upon some new approach to scanning) are the greatest barriers to the development of versatile, low-cost teaching machines, library systems, and the wide spectrum use of computer

So, we had better keep the electronics technology rolling right along if we expect to win this particular human "race."

Perhaps the most significant of all trends in terms of the potential influence, is the rising capability for worldwide communications [see pages 122 to 124]. We have seen the beginning of worldwide tv with the satellite programs. Someday worldwide tv will be as common as our nationwide programs. With supersonic speed of transportation (made possible only by the use of electronics) shrinking the size of the earth, and with the rise of worldwide communications, the distance between countries shrinks to the equivalent of the distance between adjacent cities.

The free exchange of ideas and the rising level of mutual understanding evolving from the increased communications of all kinds will be the most important force toward the ultimate banishment of the idiocy of international war.

The experts look ahead

Cramming more components onto integrated circuits

With unit cost falling as the number of components per circuit rises, by 1975 economics may dictate squeezing as many as 65,000 components on a single silicon chip

By Gordon E. Moore

Director, Research and Development Laboratories, Fairchild Semiconductor division of Fairchild Camera and Instrument Corp.

The future of integrated electronics is the future of electronics itself. The advantages of integration will bring about a proliferation of electronics, pushing this science into many new areas.

Integrated circuits will lead to such wonders as home computers—or at least terminals connected to a central computer—automatic controls for automobiles, and personal portable communications equipment. The electronic wristwatch needs only a display to be feasible today.

But the biggest potential lies in the production of large systems. In telephone communications, integrated circuits in digital filters will separate channels on multiplex equipment. Integrated circuits will also switch telephone circuits and perform data processing.

Computers will be more powerful, and will be organized in completely different ways. For example, memories built of integrated electronics may

be distributed throughout the machine instead of being concentrated in a central unit. In addition, the improved reliability made possible by integrated circuits will allow the construction of larger processing units. Machines similar to those in existence today will be built at lower costs and with faster turn-around.

Present and future

By integrated electronics, I mean all the various technologies which are referred to as microelectronics today as well as any additional ones that result in electronics functions supplied to the user as irreducible units. These technologies were first investigated in the late 1950's. The object was to miniaturize electronics equipment to include increasingly complex electronic functions in limited space with minimum weight. Several approaches evolved, including microassembly techniques for individual components, thin-film structures and semiconductor integrated circuits.

Each approach evolved rapidly and converged so that each borrowed techniques from another. Many researchers believe the way of the future to be a combination of the various approaches.

The advocates of semiconductor integrated circuitry are already using the improved characteristics of thin-film resistors by applying such films directly to an active semiconductor substrate. Those advocating a technology based upon films are developing sophisticated techniques for the attachment of active semiconductor devices to the passive film arrays.

Both approaches have worked well and are being used in equipment today.

The author



Dr. Gordon E. Moore is one of the new breed of electronic engineers, schooled in the physical sciences rather than in electronics. He earned a B.S. degree in chemistry from the University of California and a Ph.D degree in physical chemistry from the California Institute of Technology. He was one of the founders of Fairchild Semiconductor and has been director of the research and development laboratories since 1959.

The establishment

Integrated electronics is established today. Its techniques are almost mandatory for new military systems, since the reliability, size and weight required by some of them is achievable only with integration. Such programs as Apollo, for manned moon flight, have demonstrated the reliability of integrated electronics by showing that complete circuit functions are as free from failure as the best individual transistors.

Most companies in the commercial computer field have machines in design or in early production employing integrated electronics. These machines cost less and perform better than those which use "conventional" electronics.

Instruments of various sorts, especially the rapidly increasing numbers employing digital techniques, are starting to use integration because it cuts costs of both manufacture and design.

The use of linear integrated circuitry is still restricted primarily to the military. Such integrated functions are expensive and not available in the variety required to satisfy a major fraction of linear electronics. But the first applications are beginning to appear in commercial electronics, particularly in equipment which needs low-frequency amplifiers of small size.

Reliability counts

In almost every case, integrated electronics has demonstrated high reliability. Even at the present level of production—low compared to that of discrete components—it offers reduced systems cost, and in many systems improved performance has been realized.

Integrated electronics will make electronic techniques more generally available throughout all of society, performing many functions that presently are done inadequately by other techniques or not done at all. The principal advantages will be lower costs and greatly simplified design—payoffs from a ready supply of low-cost functional packages.

For most applications, semiconductor integrated circuits will predominate. Semiconductor devices are the only reasonable candidates presently in existence for the active elements of integrated circuits. Passive semiconductor elements look attractive too, because of their potential for low cost and high reliability, but they can be used only if precision is not a prime requisite.

Silicon is likely to remain the basic material, although others will be of use in specific applications. For example, gallium arsenide will be important in integrated microwave functions. But silicon will predominate at lower frequencies because of the technology which has already evolved around it and its oxide, and because it is an abundant and relatively inexpensive starting material.

Costs and curves

Reduced cost is one of the big attractions of integrated electronics, and the cost advantage continues to increase as the technology evolves toward

the production of larger and larger circuit functions on a single semiconductor substrate. For simple circuits, the cost per component is nearly inversely proportional to the number of components, the result of the equivalent piece of semiconductor in the equivalent package containing more components. But as components are added, decreased yields more than compensate for the increased complexity, tending to raise the cost per component. Thus there is a minimum cost at any given time in the evolution of the technology. At present, it is reached when 50 components are used per circuit. But the minimum is rising rapidly while the entire cost curve is falling (see graph below). If we look ahead five years, a plot of costs suggests that the minimum cost per component might be expected in circuits with about 1,000 components per circuit (providing such circuit functions can be produced in moderate quantities.) In 1970, the manufacturing cost per component can be expected to be only a tenth of the present cost.

The complexity for minimum component costs has increased at a rate of roughly a factor of two per year (see graph on p. 116). Certainly over the short term this rate can be expected to continue, if not to increase. Over the longer term, the rate of increase is a bit more uncertain, although there is no reason to believe it will not remain nearly constant for at least 10 years. That means by 1975, the number of components per integrated circuit for minimum cost will be 65,000.

I believe that such a large circuit can be built on a single wafer.

Two-mil squares

With the dimensional tolerances already being employed in integrated circuits, isolated high-performance transistors can be built on centers two thousandths of an inch apart. Such a two-mil square can also contain several kilohms of resistance or

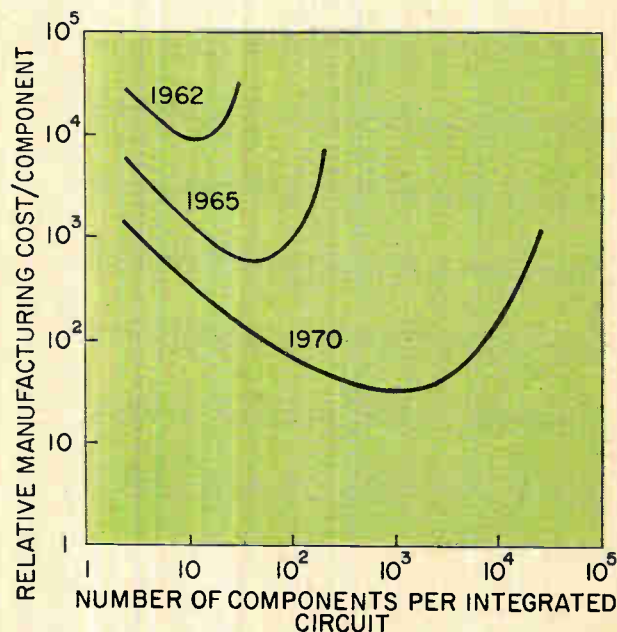

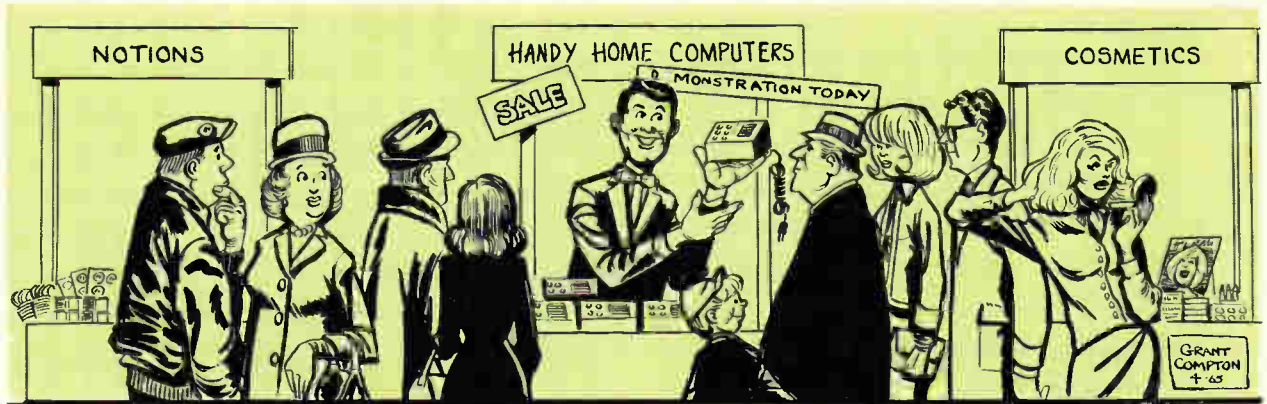

a few diodes. This allows at least 500 components per linear inch or a quarter million per square inch. Thus, 65,000 components need occupy only about one-fourth a square inch.

On the silicon wafer currently used, usually an inch or more in diameter, there is ample room for such a structure if the components can be closely packed with no space wasted for interconnection patterns. This is realistic, since efforts to achieve a level of complexity above the presently available integrated circuits are already underway using multilayer metalization patterns separated by dielectric films. Such a density of components can be achieved by present optical techniques and does not require the more exotic techniques, such as electron beam operations, which are being studied to make even smaller structures.

Increasing the yield

There is no fundamental obstacle to achieving device yields of 100%. At present, packaging costs so far exceed the cost of the semiconductor structure itself that there is no incentive to improve yields, but they can be raised as high as is economically justified. No barrier exists comparable to the thermodynamic equilibrium considerations

that often limit yields in chemical reactions; it is not even necessary to do any fundamental research or to replace present processes. Only the engineering effort is needed.

In the early days of integrated circuitry, when yields were extremely low, there was such incentive. Today ordinary integrated circuits are made with yields comparable with those obtained for individual semiconductor devices. The same pattern will make larger arrays economical, if other considerations make such arrays desirable.

Heat problem

Will it be possible to remove the heat generated by tens of thousands of components in a single silicon chip?

If we could shrink the volume of a standard high-speed digital computer to that required for the components themselves, we would expect it to glow brightly with present power dissipation. But it won't happen with integrated circuits. Since integrated electronic structures are two-dimensional, they have a surface available for cooling close to each center of heat generation. In addition, power is needed primarily to drive the various lines and capacitances associated with the system. As long as a function is confined to a small area on a wafer, the amount of capacitance which must be driven is distinctly limited. In fact, shrinking dimensions on an integrated structure makes it possible to operate the structure at higher speed for the same power per unit area.

Day of reckoning

Clearly, we will be able to build such component-crammed equipment. Next, we ask under what circumstances we should do it. The total cost of making a particular system function must be minimized. To do so, we could amortize the engineering over several identical items, or evolve flexible techniques for the engineering of large functions so that no disproportionate expense need be borne by a particular array. Perhaps newly devised design automation procedures could translate from logic diagram to technological realization without any special engineering.

It may prove to be more economical to build large systems out of smaller functions, which are

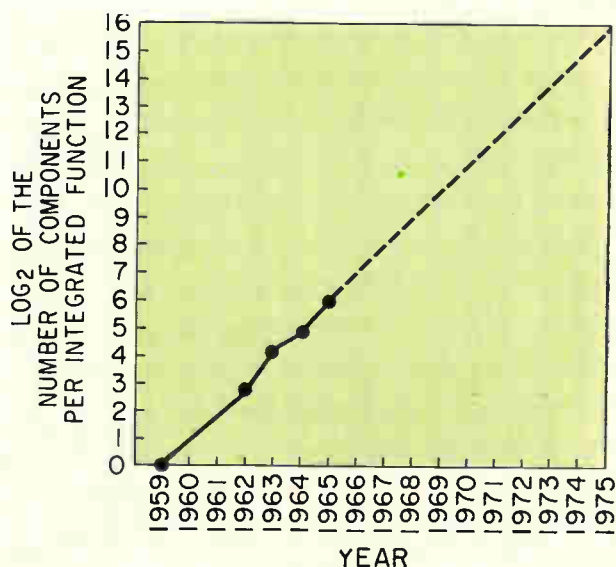

separately packaged and interconnected. The availability of large functions, combined with functional design and construction, should allow the manufacturer of large systems to design and construct a considerable variety of equipment both rapidly and economically.

Linear circuitry

Integration will not change linear systems as radically as digital systems. Still, a considerable degree of integration will be achieved with linear circuits. The lack of large-value capacitors and inductors is the greatest fundamental limitations to integrated electronics in the linear area.

By their very nature, such elements require the storage of energy in a volume. For high Q it is necessary that the volume be large. The incompatibility of large volume and integrated electronics is obvious from the terms themselves. Certain resonance phenomena, such as those in piezoelectric crystals, can be expected to have some applications for tuning functions, but inductors and capacitors will be with us for some time.

The integrated r-f amplifier of the future might

well consist of integrated stages of gain, giving high performance at minimum cost, interspersed with relatively large tuning elements.

Other linear functions will be changed considerably. The matching and tracking of similar components in integrated structures will allow the design of differential amplifiers of greatly improved performance. The use of thermal feedback effects to stabilize integrated structures to a small fraction of a degree will allow the construction of oscillators with crystal stability.

Even in the microwave area, structures included in the definition of integrated electronics will become increasingly important. The ability to make and assemble components small compared with the wavelengths involved will allow the use of lumped parameter design, at least at the lower frequencies. It is difficult to predict at the present time just how extensive the invasion of the microwave area by integrated electronics will be. The successful realization of such items as phased-array antennas, for example, using a multiplicity of integrated microwave power sources, could completely revolutionize radar.

The experts look ahead

Research for space enters the electronics age

A space agency executive predicts a quantum jump in technology now that the problems of sending up a payload have been solved.

Present techniques aren't good enough for deep space communications

By Albert J. Kelley

Deputy director, NASA Electronics Research Center, Boston

The author



As deputy director of NASA's new Electronics Research Center, Dr. Albert J. Kelley will help determine the direction research in space electronics takes. After graduating from the U. S. Naval Academy and serving aboard ship as an officer, he turned technical, earning a doctorate at MIT. Before joining NASA, he was project manager of a missile for the Navy Bureau of Weapons.

Exploration of space will start a new round of technological advances that will affect the entire electronics industry. From an analysis of the satellite and probe experiments of the past few years, we are beginning to learn how stringent the space requirements of tomorrow will be.

A quantum jump in performance and reliability is necessary. Today's electronic equipment, though sophisticated beyond the imagination of the pioneers of 35 years ago, is inadequate, or at best marginally adequate, for use in future space flights.



We have been engaged in what has been called the rocket phase of space technology, in which the major technical effort has been to improve rocket boosters so that space vehicles can carry heavier loads. Until this year, the Atlas Agena propulsion system was the most powerful the United States possessed. It could blast 5,900 pounds into a 300-mile orbit. The Saturn I, which was tested successfully in February, can launch 15,000 pounds into the same orbit. In a few years, the Saturn V power-plant will be able to orbit 250,000 pounds.

Information, please

To use this increased thrust effectively, we must have the proper electronic equipment to handle information in the spacecraft—to tell the vehicle where to go, and how to get there and to relay back to earth what the vehicle is doing and what its instruments are sensing. Thus there is a new importance to electronics on space flights. During the flight lifetime of the vehicle, electronic equipment supplies the elements which must constantly be alive, the devices which generate intelligence, the systems which transform a passive piece of metal flying through space into an active device gathering and transmitting information. We move into the electronics phase of space technology.

One indication of what this will mean to the electronics industry can be seen from a breakdown of space costs. Today, nearly 50% of the NASA budget is spent directly for the research, engineering, production, maintenance and operation of electronics equipment. With most of the agency's new facilities constructed and the major R&D effort on propulsion past its peak, the percentage of money to be spent on electronic gear should rise. It is estimated that nearly 70% of the cost of a spacecraft and 90% of tracking data and acquisition expenditures go into electronic activity or gear.

Tough environment

Space electronics is a relatively new field, with no inventory of proven components, techniques or practices. The environment in which the electronic equipment must operate is the most severe any gear has ever faced.

The equipment must work in temperatures which

range from hundreds to degrees below zero to thousands of degrees above. It must operate in a hard vacuum that has not been duplicated exactly on earth, and in the severe radiation of high-energy particles. It has to be long-lived, as well. A round trip to a planet, for example, will require operation for several years without repair or preventive maintenance. Reliability will have to be built in.

It is already clear how such requirements will change some concepts and approaches to equipment.

In guidance and control, we can expect to see more hybrid systems, particularly optical-inertial systems. There will be trade-offs among optical, inertial, earth-based and terminal guidance systems. New guidance and control systems will have to live off the environment, using what is available aboard the spacecraft or in the surrounding space; adaptations of concepts developed originally for earth-based usage will not be satisfactory. We should see extensive use of such products as the electrostatic gyro, when a large electrical power supply is aboard the vehicle, and such concepts as gravity gradient stabilization when it is not.

Long, long track

The tremendous distances involved in deep space reduce communication capacity and increase tracking uncertainties. Ways to solve the problems introduced are easy to visualize but difficult to realize. It is easy to suggest increasing the transmitter power or antenna gain of the spacecraft—but hard to accomplish it within the limitations of a space vehicle. One concept which shows promise is based on increasing the efficiency of the spacecraft transmitter power tube so that it yields increased output power while the input power is fixed. There is great potential in increasing the cross-sectional receiving area of earth-based antennas.

But the greatest return may come from something radically new: the use of other parts of the electromagnetic spectrum. Communications in the submillimeter spectrum may reap some of the advantages of both microwave and laser communications. The most effective applications of lasers may come in deep space communications. If we can learn how to utilize the laser beam effectively and

efficiently as an information-carrying mechanism, we will be able to cover almost all of space except for local atmospheric areas around some planets.

Closer relations between instrumentation and data processing will lead to improved information systems concepts and information technology. The instrument can be considered as the generator of information and the computer as the processor or translator of that information into usable terms. Integrating the information sensor and the information processor so that more data reduction takes place at the sensor will improve system performance and efficiency.

Reliability of a new order

Reliability has been and will be one of the greatest problems in space electronics. In the years just ahead, we will expect electronic equipment to operate with a reliability tens of times greater.

Reliability will itself require a new look. Products for space vehicles are few-of-a-kind articles; there is no large production base from which to acquire an accumulation of statistics. Achieving reliability will require more emphasis on engineering than on mathematics. There will be more emphasis on making all items of a small lot work perfectly than on determining how many items of a large

lot should be rejected. The increased weightlifting capability of the new boosters will permit reasonable redundancy in electronic equipment and greater system reliability.

Space technology requires new electronic devices, components, and systems not yet invented; and the equipment we need cannot be obtained by extrapolation from present techniques. Shortening the cycle of development and manufacture will require a broad program of planned research throughout the country, particularly in the industrial laboratory and in market analysis and requirement studies. Research will have to be closely coupled to development and marketing. Currently only one out of every 2400 research ideas is profitable. We have to improve on such random or Monte Carlo selection.

Companies which are successful in space electronics will have research and development organizations which can provide techniques and technology synthesized to meet exacting requirements. There will be no immediate production bonanza, because the volume of equipment required is relatively small. Increased emphasis on research and the shortening of the research-development-manufacture cycle may turn out to be the most important spin-offs of the space program.

The experts look ahead

Light on the laser's future

Currently the favorite of science fiction and comic strips, the device will find countless practical applications; its inventor sees uses ranging from surgery to lighting to discharging clouds

By T.H. Maiman

President, Korad Corp., a subsidiary of Union Carbide Corp, Santa Monica, Calif.

The author



T.H. Maiman produced the first working laser while he was a physicist at Hughes Aircraft Corp. Later, he established a laser group at a new company called Quantatron. When the company faltered, the laser group was set up as a separate company, with Maiman as president.

No device has captured the imagination of the public so quickly as the laser. Writers of science fiction and comic strips have grasped it eagerly because of its potential as a death ray and a pocket disintegrator. In real life, however, most of the activity surrounding the laser has been confined to research and development, with only a few practical applications such as range finding, mending torn retinas in eye surgery, and welding in manufacturing. But once problems of control and effi-

ciency are solved, applications will truly be limited only by engineer's imagination and ingenuity.

Much of the general excitement about the laser comes from its ability to produce and control coherent light and to generate tremendous power densities.

Although the overall efficiency of present lasers tends to be very low—from less than a hundredth of one percent to several percent at best—they can produce energy densities that far exceed those generated by any other device. Most lasers emit energy in a well-collimated beam generating peak power densities greater than 10^9 watts per square centimeter. If the beam is focused with a mirror, power densities are many times higher, as high as 10^{14} watts per square centimeter.

Other potentially useful properties are the low

plications that is even longer: in communications, range finding, computers, surveillance and reconnaissance, long distance photography, medicine, dentistry, metal-working, and chemistry.

Before most of these can be realized, certain limitations of the laser—chiefly the low over-all efficiency and power handling capability and the restriction to fair weather—must be conquered. Price is another drawback; a laser currently costs anywhere from \$500 for the most inexpensive low-power model to more than \$50,000 for sophisticated high-power versions.

Optically pumped solids

Historically, the first category of lasers is the optically pumped solid. When I built the first operating laser, I pumped a ruby crystal with the

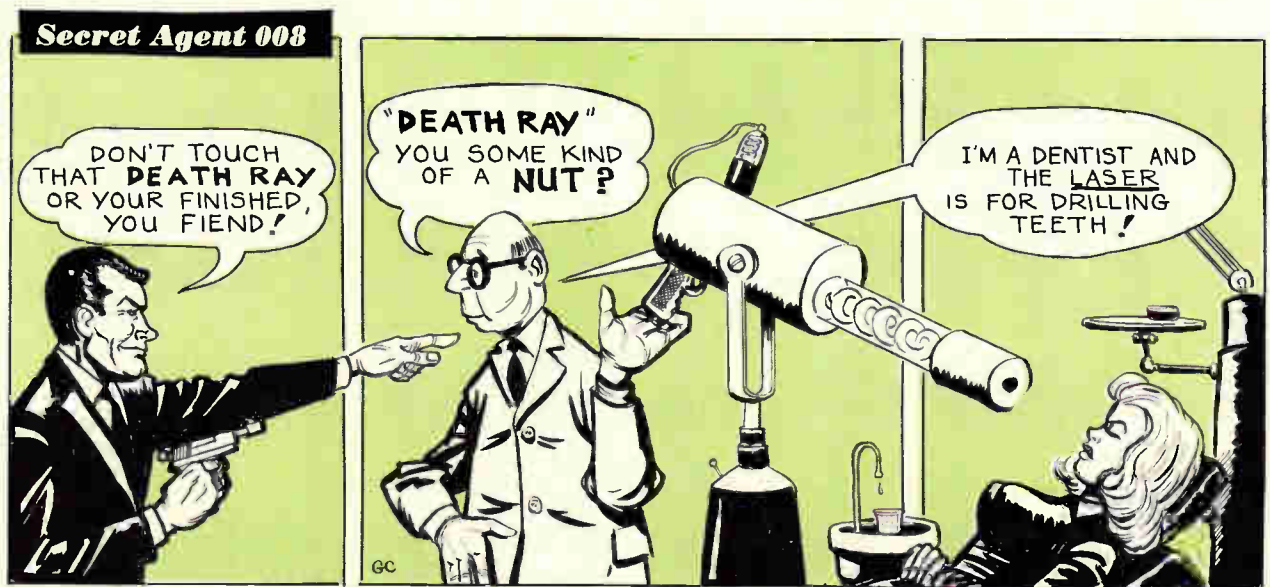

divergence of the beam (as little as 10^{-2} to 10^{-4} radians), the laser's narrow frequency spectrum (so called temporal coherence) and its ability to amplify images.

Theory into practice

Since the first laser was demonstrated on May 31, 1960, a technology of extraordinary breadth and diversification has developed. One reason is that scientists see in the laser a device that relies on much of the theoretical physics they have been studying: quantum mechanics, solid-state theory, and electronic modulation of electromagnetic radiation.

Almost everyone who has done some experimenting with the laser has predicted uses. Some of these proposals strain credulity, such as paint removal, weeding, gravestone engraving, tree-felling, hog-stunning (prior to slaughter) and amusement park optical rifles.

But you can make a list of realistic potential ap-

lications that is even longer: in communications, range finding, computers, surveillance and reconnaissance, long distance photography, medicine, dentistry, metal-working, and chemistry.

Most optically pumped lasers use one of two kinds of pulses: the conventional long pulse or the giant pulse. In the long pulse mode, the laser generates a pulse that lasts about one millisecond. This operation can produce pulse energies greater than a kilojoule with ruby or neodymium-doped glass crystals.

In the giant pulse mode, energy is first stored in the laser crystal and then released quickly by a fast-acting switch. Peak powers in excess of one gigawatt can be produced using a power oscillator; over five gigawatts have been generated by an oscillator amplifier system.

Continuous-wave power of several watts has also

been generated by optically pumped lasers. Recently, a YAG crystal was made to generate c-w power at room temperature when pumped by a source with a tungsten filament.

The over-all efficiency of a typical optically pumped laser is about one percent. Low efficiencies appear to be inherent in their operation. Although brute force techniques will increase the pulse energy somewhat, sizable energy storage facilities will be required. This, in turn, should lead to the development of noncapacitive energy storage techniques which employ chemical or electrochemical batteries.

The peak power of giant-pulse lasers will increase in the future, but only if the materials can be formed into large areas. Repeated operation at power levels near one gigawatt per square centimeter causes damage to the crystal, and finally its complete destruction.

Average pulse powers as well as c-w powers will climb into the hundreds if not thousands of watts in the future. We should also see efficiencies climbing to 5% or 10%, and an extension of the wavelength span of approximately 0.6 to 2.7 microns. Passing the output from a giant pulse laser through a nonlinear crystal and obtaining the second or third harmonic output appears promising for expanding into the higher frequency regions.

Further research will produce new materials that will add new wavelengths and much better crystal quality. With better crystals, laser light will have a higher brightness.

Semiconductor lasers

Semiconductor lasers have many advantages over optically pumped lasers but the chief one is this: the electrical input is directly converted to laser light without the intervention of an optical pump source. These devices can be directly modulated to microwave frequencies. When cooled cryogenically they have a relatively high efficiency of 20% to 50%. They are compact and can operate on low voltage. Several watts of c-w power and hundreds of watts of pulse power have been produced by semiconductor lasers.

So far, the main semiconductor material for laser work has been gallium arsenide, which provides coherent output at 0.84 micron. Other compound semiconductors and various alloy combinations of these compounds provide a wavelength span of about 0.6 micron to 8 microns. Since the alloys can be of varying composition, almost any given wavelength in this entire region can be obtained. Other types of lasers can provide outputs only at certain specific wavelengths.

The future of semiconductor lasers is clear: their compactness and ease of modulation make them directly applicable to short-range communications, optical radar, radiative interconnections and other computer applications.

Gas lasers

Gas lasers cover the broadest expanse of the

spectrum, generating light at wavelengths all the way from 0.3 to 100 microns. The most common gas laser has used a mixture of helium and neon, although almost all gases (including air and water vapor) will lase somewhere in the spectrum.

Unlike the two solid-state lasers, most gas lasers operate c-w normally. But they operate with the lowest efficiency of the three groups—usually not more than a few hundredths of one percent at any one frequency, and less than 0.1% when simultaneously oscillating at a group of frequencies. Extremely high coherence (spectral purity), measured in cycles per second at a center frequency of some 4×10^{14} cps, has been exhibited.

Unlike other laser types at present, the gas laser generates a rich visible output spectrum. A laser that uses ionized xenon has produced as much as five watts c-w power in several visible lines.

The extreme coherence and frequency stability of the gas laser suggest applications in coherent detection, superheterodyning, and doppler radar. Also, it could serve as the oscillator in master oscillator-amplifier techniques.

Ancillary equipment

Laser technology will stimulate great improvements in ancillary optical equipment. Optical waveguides will have to be made which can seal out the weather and meet the needs of high transmission and low cost. Modulator techniques have been and will surely continue to be extended. Beam-deflecting methods can be expected to be developed that will make possible wide-angle, rapid scanning. Energy storage and display devices which make use of laser techniques will also be developed.

Today, the major market for lasers is a curiosity market in instruments and research tools. But the market will grow rapidly as applications are perfected. Already in limited use or slated for use in the near future are these applications: welding of small metal parts, range finding, short-range communications, cloud-height indication and other weather diagnostics, plasma diagnostics, Raman spectroscopy, Schlieren photography, chemical emission spectroscopy, retina coagulation, metrology (precision length measurements) and cancer research.

Future applications

Looking far into the future, I predict that lasers will be used in such diverse tasks as gem cutting and even cattle branding. Lasers some day will find their way into hospital operating rooms to perform bloodless surgery. I can envision laser automobile ignition systems with matching laser radar speed traps; lasers for jungle-clearing and for replacing klieg lights; lasers to discharge clouds and for high-voltage transmission lines.

I believe the laser industry will grow at a rate of about 50 percent a year for at least the next five years. During this period, the industry will improve reliability, cut costs and perfect the reproducibility of laser equipment.

The experts look ahead

More and faster communications

Communications face worldwide expansion, predicts this veteran of the industry. He forecasts phonevision carried on laser light beams around the world

By Henri Busignies

Senior Vice President, International Telephone and Telegraph Corp.

The need for man to communicate with another human being is as old as man himself, but industrial development has made communications the most indispensable tool of progress. In the near future, the world will see an unprecedented growth of electrical communications of all kinds: telephone, phonevision, data, print, handwritten text, and pictures. More and more communications will become electronic.

I believe the day will come when most documents and letters will be transmitted electronically and machines will talk to machines directly.

Education will soon begin to rely on communications to a greater extent. Remote sub-centers of education will have the standing and quality of their parent educational centers and will carry educational programs into the home with radio, television and telephone. The home telephone line, carrying both voice and pictures, will be used without affecting the circuit for ordinary telephone communications.

Three revolutions

Since I started to work as a radio engineer (there were no electronics engineers in the twenties), three significant electronic developments have influenced the technological evolution of communications

mightily: the improved vacuum tube amplifier, the transistor, and now the integrated circuit.

The improvement in tube amplifiers allowed higher power radio transmission at higher and higher frequencies. In the solid state revolution, transistors replaced the vacuum tube in many applications, providing more efficient service, reducing power consumption and allowing more flexibility in much smaller space. The application of integrated circuits has barely started, but integrated electronics will have an impact on the technology of communications for many years to come.

Building on a giant base

Already huge by any measure, the telecommunications industry will grow more than five times in the next 35 years. Today, there are about 184 million telephones in the world; gross plant investment of operating phone companies is estimated at from \$75 billion to \$100 billion; and the telephone companies alone employ over two million people. By the year 2000, the number of telephones will have grown to over one billion; phone company plant investment will have increased to \$500 billion; and employees will have jumped to more than 10 million.

Rate of growth will be faster in Europe and the rest of the world than it will be in the United States (see chart below).

The author



Dr. Busignies has worked in the area of communications for 37 years, ever since he joined ITT in 1928. He holds 140 patents on devices for air navigation, radar and communications. He has been general technical director of ITT since 1960, and senior vice president since January

	Now		Year 2000	
	Telephone in millions and percent of the world total		Telephones in millions and percent of the world total	
U. S.	88	48%	300	25%
Europe	55	31%	500	42%
Rest of world	38	21%	400	33%
Total	184		1,200	

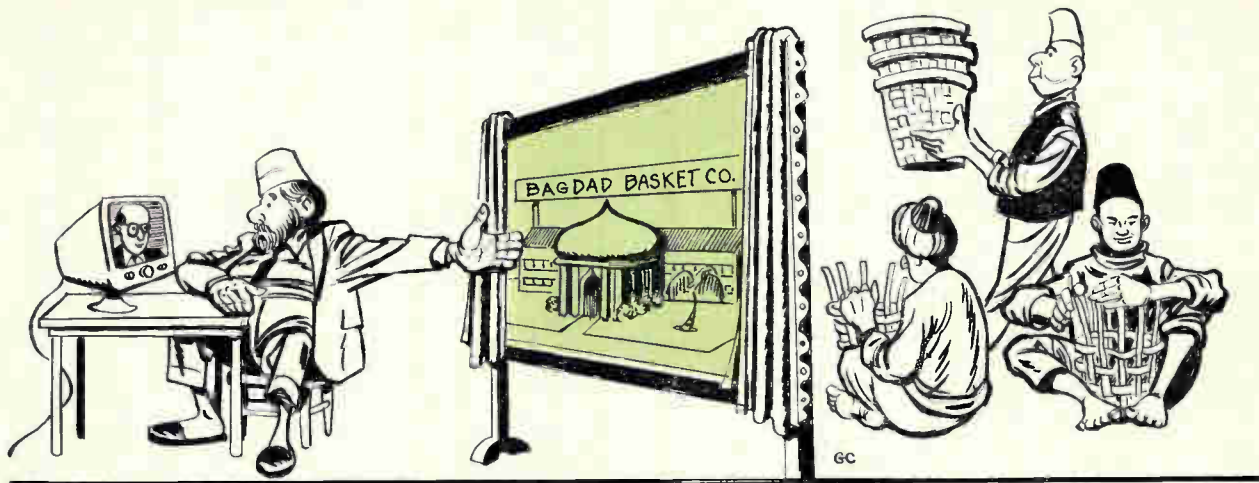

While I have talked primarily about telephones, because they provide a clear example, you must remember that many telephone terminals will have additional jobs in the future—some already do—such as data terminals, print terminals, or phone-vision stations.

Acceptance of phonevision will progress slowly, but surely, slowed by the expense, lack of availability of long distance wide-band transmission facilities and the special traffic switching equipment needed. The answer may be laser light beams guided in an optical tube that will carry thousands of video pictures simultaneously.

Still, I think communications transmission will not be restricted to voice conversations alone. Worldwide communications will transmit whatever kind of signal can be carried on the standard communication channel of 3 to 4 kilocycles. That would include data at medium speed, facsimile and slow scan television.

Planning to operate a worldwide network of a billion telephones will be a Herculean task, requiring unprecedented technical planning and unprecedented cooperation among countries.

To illustrate the magnitude of the problem in the year 2000, we can show that if half the telephones could dial each other directly, the worldwide telephone networks would have to be able to make 12.5×10^{15} different connections (500 million \times 250 million) in seconds.

More than the assembling of hardware is involved. Here are some other requirements:

- A worldwide numbering system giving every main telephone and extension a discrete number of no more than 12 digits so it can be reached by dialing (or pulsing) from any other telephone.
- A worldwide complex of switching centers with great capabilities. When a telephone number is dialed or pulsed anywhere in the world it will be routed efficiently—around sections congested with traffic or in trouble—to its destination.
- A coordinated set of signals—and the methods of generating and translating them—so that the switches will know what to do and how to do it.

- A coordinated transmission plan so that people can talk after a connection has been set up.
- Automatic methods of accounting.
- Coordination of operating, maintenance, commercial and other functions.

All this means new equipment: fast switches and signaling systems, high velocity four-wire transmission facilities, very flexible common controls in switching system and equipment that can handle bands of various widths.

More on the phone

Telephony will still be dominant in the year 2000, compared to the number of data or facsimile transmissions. The desire of people to talk apparently knows no bounds. Telephony will evolve in several ways.

Connections will have to be set up much faster; two seconds will seem as long as 10 seconds does now or as 10 minutes did 35 years ago.

A user will find it easier to get connections; fewer errors will result. Voice recognition systems will allow a caller to announce the number he wants.

Telephone service to people on the move—in cars or airplanes or trains or ships, on foot or on horseback—will be relatively common and as good as from fixed stations.

By the year 2000, seeing along with talking will be common. To accomplish this we need to expand wideband transmission systems greatly, and to develop switching systems with essentially unlimited bandwidth capability.

Transmission will be much better. It will carry face-to-face conversation whether the customer is using an ordinary telephone—of the year 2000 vintage—or some kind of a hands-free device.

And of course, most of the recent innovations such as push-button pulsing and greatly improved communication systems for businesses, will be commonplace long before the year 2000.

Transmitting text

In 35 years, we shall also see a huge increase

in the transmission of text material.

Next to talking and seeing, the written word can convey atmosphere and flavor which no data processing machine can produce. A greatly increased demand for speed and a shifting cost balance in favor of electrical transmission will displace the mails for much business correspondence.

Impact of space

Broadcasting and television technologies will be affected by progress in the space industry. When it becomes practical to have large space stations circling the world, they will carry broadcasting and tv with very great range. Even though a synchronous satellite transmitter would need a high power output, the service produced would be so considerable that it could be economically justified.

Space communications have already reached a magnitude of achievement that we radio engineers of the first generation would once have deemed incredible. For example, the Pioneer 5 probe in orbit around the sun transmitted signals to the earth over a distance of 52,000,000 miles.

Such an achievement points out the potential of communications in space. One of the next dramatic steps will be voice communication with our

explorers on the moon in the 1970's.

Integrated circuit technology will be the force that provides many of these developments. For example, with such circuits we will be able to produce economically the hand-free loud speaking telephone and the wireless handset.

They will enable us to code the voice or other signals at the terminal itself so that the signal will proceed with little distortion, by carrier or by pulse code modulation. And the signal will travel with many other voice or data signals on the same pair of wires or on small coaxial cables; or by radio if the terminal is mobile. At the switching center, which will be semielectronic or fully electronic, the signals will be directed toward other switching offices or toward the long distance lines.

When pulse code modulation is used, the voice or data or picture information will be coded at the origin and times so that a gate reserved for it at the switching exchanges will channel it to its destination with a minimum of complication.

By the year 2000, many more submarine cables will span the oceans; they will be able to handle up to one-channel tv. Optical tubes will have progressed to the point where they will handle very large bandwidths under water, making long distance phone vision practical across the oceans.

The experts look ahead

Computers for the electric utility industry

An instrument engineer sees a hierarchy of computers controlling a single electric generation system for the entire country. Greater use of communications and advanced controls will minimize operating costs.

By Nathan Cohn

Vice President, Leeds & Northrup Co., Philadelphia

Regrettably, the power of prophecy is withheld from most of us. All one can do in technological forecasting is to project today's unresolved problems and objectives into happy solutions. Pursuing

that course to predict what will happen to electronics in the electrical utility industry, just one slice of industrial electronics, leads to the conclusion that computers are the key to the future.

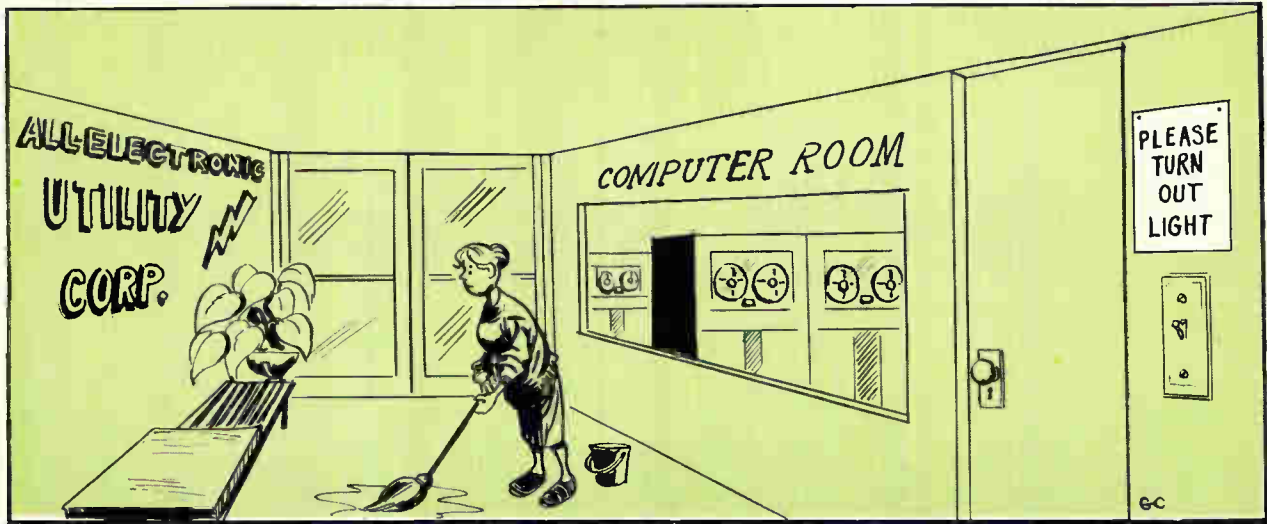

A hierarchy of computers will run automatic power plants and will tie the United States together into a single electrical system.

To talk about the future, I must first look at the past and the present.

Thirty five years ago, when the first issue of *Electronics* was going to press, the word electronics was not part of the vocabulary of the nation's power industry. All totaled, the utilities in the United States could generate about 40 million kilowatts of electricity. Automatic controls, which were just being introduced, were electrical or mechanical or occasionally a combination of the two.

At that time, each power company operated as if it were the only one in the world, serving its customers with power it generated itself. The generating plant was crude by today's standards. Automatic combustion and feedwater controls were being added only to new stations under construction. And utility engineers were just looking at automatic system frequency and time error controls to help regulate the speed of turbine generators.

System dispatching—allocating how much electricity each of the utility's plants would generate—was a manual function. A few of the more advanced companies had established centralized offices which received information by telemetry from plants and strategic points in the system. In those days, telemetry was exclusively direct current in nature and clear isolated wire channels were required from

the transmitting point to the central receiving office equipment.

Later, in the thirties, was born the concept of tying adjacent utilities together electrically to share generating capacity and reserves. But to make the idea work, automatic controls had to be developed to schedule stable interchanges between the utilities. In 1937, the answer evolved in a technique called "tie-line bias regulation," and it is still the basis of interconnected power systems today.

A requirement for automatic control was, and is, continuous information about power flow at all points of the interchange, even though they are far apart, too far for direct wire telemetry. Electronics first big entry into the utility market was in the application of telemetry over power line carriers.

In the three decades that have elapsed, the power industry has grown sharply, doubling in capacity every 10 years. And the need for electronics equipment has grown faster.

Today, U.S. generating capacity is over 240 million kilowatts. Some generating stations are so big they can each produce more than a million kilowatts. And the interconnection concept has spread across the nation.

Trend of the future

If you look inside a modern fuel-burning generating station you can see a future for electronics. A typical plant requires simultaneous coordinated control for 50 to 100 different variables, including temperatures, pressures, flows, speeds, and electrical characteristics. Equipment to regulate these variables is slowly becoming electronic. The move has just started, but you can see the trend of the future.

- The new equipment will be based on solid state technology.
- Simulation techniques will help develop the equipment which will be to provide smooth and

The author



Nathan Cohn has seen automation grow in the electric utility industry ever since he graduated from the Massachusetts Institute of Technology in 1927 and joined the Leeds and Northrup Co. The holder of many patents, he was instrumental in developing the tie-line bias concept for joining utility systems.

safe regulation of the plant over a wide range of loading without hunting for the set variable.

- Digital computers already calculate plant performance and monitor safety. More will be used for this and other purposes tomorrow. In a few cases, computers have been applied to automatic control functions with either analog loops or in direct digital control.

- A few plants have used computers for the sequential start-up and shutdown of individual units, procedures that have become exceedingly complex. The evidence is still not clear whether enough economic justification exists for this application.

Interconnected systems have grown in size so that today there are only five spanning the entire continental United States. (See map below). The largest, made up of 150 utilities, some private and some public, operating in parallel, extends from east of the Rocky Mountains to Florida and eastern Canada.

Major technical effort has been exerted to load the individual generators of the system automatically for the most economical operation. Initially, the technique was to preprogram a loading schedule manually. Then, in the late 1950's, units were loaded automatically by centralized analog computers, whose input variables were measured by electronic devices. Five years ago, utility men started using digital computers for this function. Generally, the machines reset analog control systems to optimize the generating output of an area. But they do other jobs too: compute advantageous interchanges with neighboring utilities and forecast when to bring additional generators on line or take them off. In a few places, direct digital control is doing what utility men call automatic economic dispatch, automatically assigning outputs to many generating plants based on each station's individual operating efficiency and economic makeup so electricity is generated at minimum cost.

Predicting the changes

With this broad technological base, the utility industry will move into still greater usage of electronic equipment. Before the year 2000, I believe we will see these 12 technological developments:

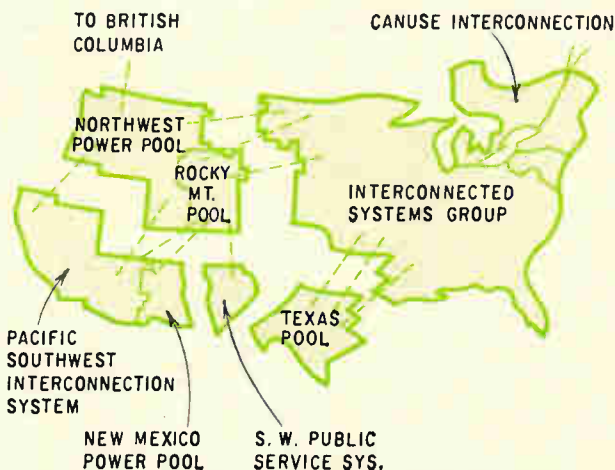

1. The present five interconnection systems will become one, providing coordinated parallel operation from the Pacific to the Atlantic and taking advantage of load and time zone diversities. The jigsaw-like map will become one piece again.

2. Automatic control applications will be multiplied as there is recognition that all the control problems of the interconnected system are inter-related.

3. New advanced control concepts will be developed to take advantage of changing control theory.

4. A centralized pool of computers will talk to area computers and through them to station and unit computers. This hierarchy will provide highly automated system operation with minimum, if any, human intervention anywhere on the power inter-connection.

5. Information on generating unit efficiencies will be continuously computed and fed to the automatic control equipment so that optimized loading assignments will be made on a basis of plant operating conditions that prevail, rather on those that are assumed to occur.

6. Transmission loss computations will be freed of present limiting assumptions, and will be dynamically computed, with use on the basis of the actual system configuration and operating conditions.

7. Pools of adjacent utilities within an interconnection will automatically adjust their interchange levels continuously so that over-all economy of the pool, rather than economy within a given company, is optimized.

8. Pool computers will not only determine and maintain optimum loading of operating machines and tie lines, but will forecast customer demand and reserve requirements and will automatically bring units on or take them off the line.

9. By appropriately monitoring selected conditions, computers will be able to diagnose incipient difficulties, and will provide warning before such difficulties occur, avoiding costly interruptions of operation.

10. Advances in electronic components and circuitry, particularly integrated circuits and micro-electronics will solve complex problems. The controls will be small, low in cost, and dependable. They will be modular so they can be replaced easily.

11. Microwave or more advanced communications techniques will be developed and expanded so that telemetering and control channels will be available at economic cost throughout the nationwide interconnection, permitting pertinent information to be gathered and displayed wherever required.

12. Plentiful and inexpensive communications channels, and new metering techniques will make it unnecessary to read meters at customer premises. The consumption will be automatically telemetered to a centralized billing computer that will compute energy and demand charges and mail the customer his bill.

If your blip is a blooper, you'll know it in 10 seconds.

Once you start using Polaroid Land film, you'll wonder how you and your oscilloscope ever got along without it.

In 10 seconds, you get an on-the-spot record. You can study it, attach it to a report, send it as a test record along with a product shipment, or file it for future reference.

You have a choice of 5 films for oscilloscope recording.

The standard film has an A.S.A. equivalent rating of 3000. You can get it both in pack film [Type 107] and roll film [Type 47]. They both give you 8 pictures $3\frac{1}{4} \times 4\frac{1}{4}$ inches. This emulsion is also available in 4 x 5 sheets [Type 57].

And for extremely high-speed oscilloscope recording, there's Polaroid PolaScope Land film [a roll film, Type 410].

It has an A.S.A. equivalent rating of 10,000. It can discover traces too

fleeting for the human eye: such as a scintillation pulse with a rise time of less than 3 nanoseconds.

Because these films are so sensitive, you can use small camera apertures and low intensity settings. Every shot is a sharp, high-contrast image that's easy to read.

To put these films to work on your scope, you need a camera equipped with a Polaroid Land Camera Back.

Most oscilloscope camera manufacturers have one.

For instance: Analab, Beattie-Coleman, BNK Associates, Fairchild, EG&G, General Atronics, Hewlett-Packard and Tektronix.

You can get the full story by writing to Polaroid Corporation, Technical Sales Department, Cambridge, Massachusetts 02139 [or directly to the manufacturers mentioned above].

About the only thing we can't tell you is how to keep your blips from being bloopers.

"Polaroid" and "PolaScope"®

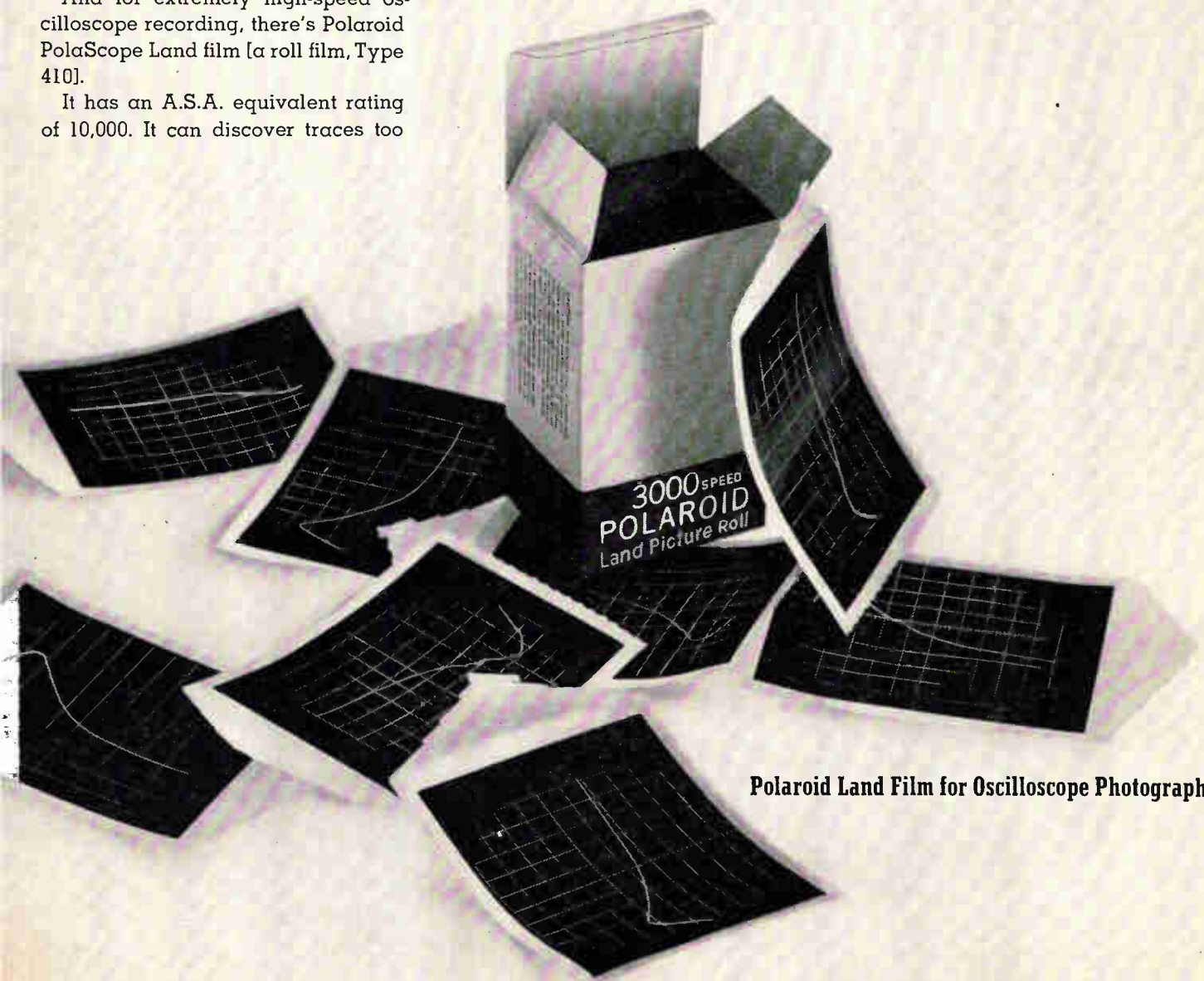

Polaroid Land Film for Oscilloscope Photography.

A new featherweight champ...

with a record like
the big boys



Meet the Offner Dynograph® Recorders' baby brother—a new 2-Channel Portable Recorder. It incorporates every good feature you want in a portable oscillographic recorder, and it's priced under \$1,300.

The Type K Dynograph provides unusual sensitivity in a very small package. Total weight is less than 40 pounds. You can select either ink or heat rectilinear, or ink curvilinear recording. What's more, the specs are

excellent: sensitivity range—2mv/div to 10v/div; common mode rejection—1000:1 or better; linearity—0.5%; measurement range—0.002 to 400 volts.

If you need heavyweight performance in a lightweight recording package, contact your local Offner Division Sales Engineering Representative. He can tell you all about the new Type K Dynograph 2-Channel Portable Recorder. Or, write direct for Data File 721.

Beckman®

INSTRUMENTS, INC.

OFFNER DIVISION

SCHILLER PARK, ILLINOIS • 60176

INTERNATIONAL SUBSIDIARIES: GENEVA, SWITZERLAND; MUNICH, GERMANY;
GLENROTHES, SCOTLAND; PARIS, FRANCE; TOKYO, JAPAN; CAPETOWN, SOUTH AFRICA

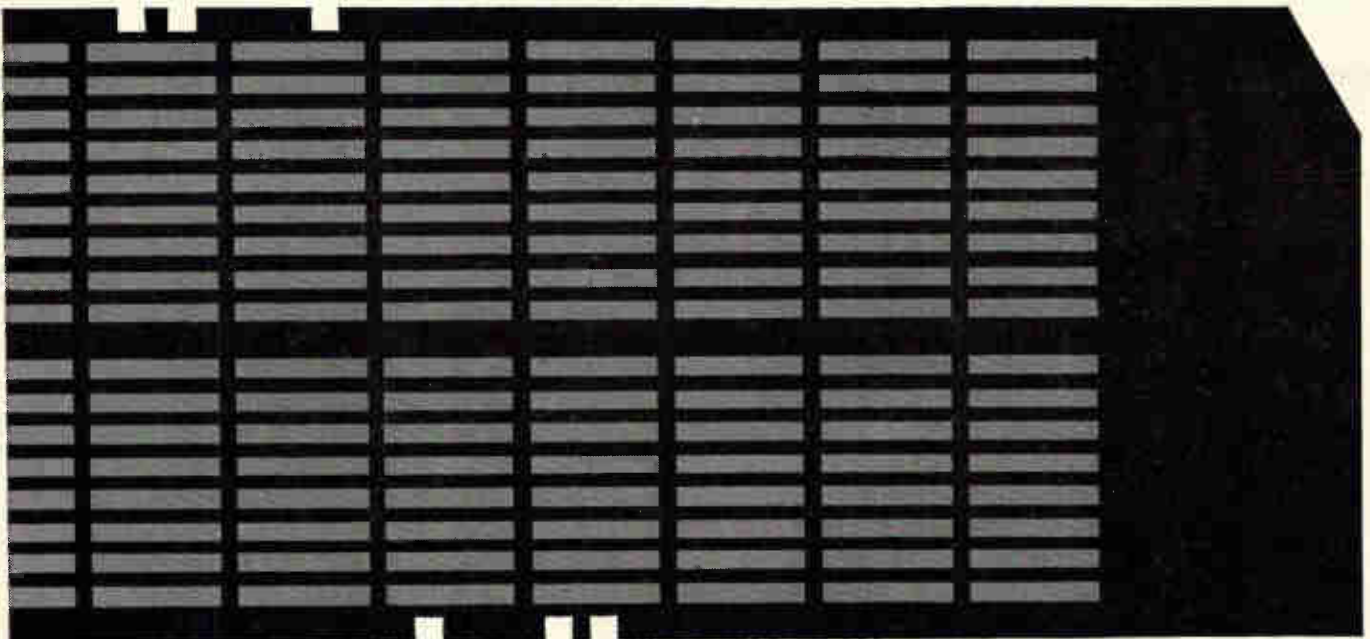

The Long Awaited Breakthrough In EDP

Via Magnetic Iron Oxides The rapidly developing science of Electronic Data Processing has received an impetus of explosive significance through the stepped-up use of magnetic iron oxide coated cards.

Handling mass storage and retrieval of voluminous data and utilizing advanced random access techniques, in some cases the cost per 10,000 alpha-numerical characters has been driven down to as low as one-tenth of their former costs!

Engineering the 'packing density' of the data into radically tighter units on the cards has brought EDP within the pocketbook range of scores of companies not previously in the 'live prospect' class.

Pfizer, as a major supplier of magnetic iron oxides congratulates the EDP industry for its enterprise. Pfizer for its part will continue to provide the chemical purity and uniform magnetic properties that make their product a standard of reliability.

Yes — Pfizer stands ready and willing to dispense all pertinent, technical information. Write Department 75

**MINERALS
PIGMENTS
& METALS**
DIVISION CHAS. PFIZER & CO. INC.



Dept. 75, 235 East 42nd Street
New York 17, N.Y.

SPECIAL INTRODUCTORY OFFER

FREE

Because electronic and control engineers have a lot of questions that need current, quick, clear answers and because books written by specialists in various branches of electronic and control engineering have those answers, the Electronics and Control Engineers' Book Club has been organized. It brings to your attention outstanding books in your field that you might otherwise miss.

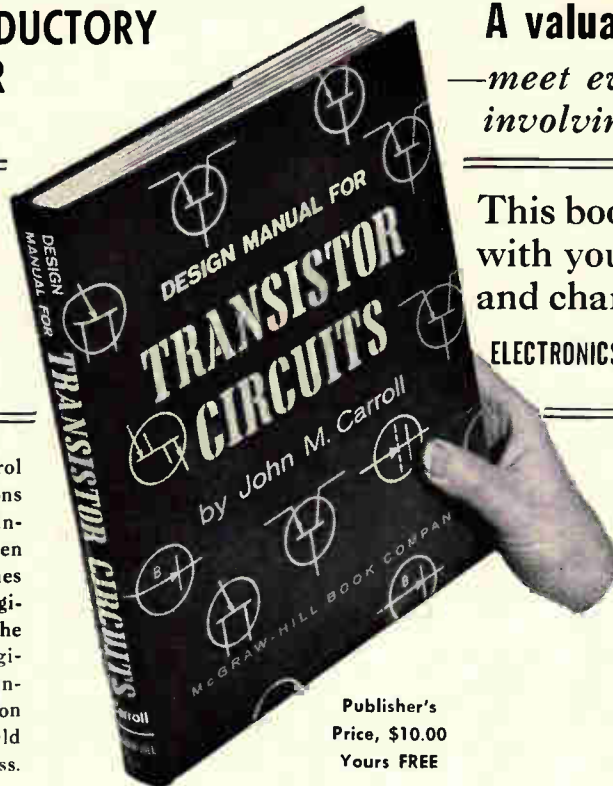

Publisher's Price, \$10.00
Yours FREE

A valuable guide to help you meet everyday design problems involving transistors

This book will be given to you with your first selection and charter membership in the ELECTRONICS AND CONTROL ENGINEERS' BOOK CLUB

Design Manual for Transistor Circuits
By John M. Carroll

Author, Modern Transistor Circuits, and Transistor Circuits and Applications; Managing Editor, Electronics

OUTSTANDING SELECTIONS AT SUBSTANTIAL SAVINGS.

Possibly just one idea from one of these books could mean more to you in actual dollars and cents than many times the cost of the book. By taking advantage of this special introductory offer you will receive absolutely FREE a copy of *Design Manual for Transistor Circuits*, together with your choice of any one of these twelve books as your first selection—at the special club price. (If you already have Carroll's work, you may take another of the books listed in the coupon as your gift copy.)

Selections cover the sound, hard core of electronic and control engineering practice. These books suggest the quality of the volumes that are available to you as a Club member. All books are chosen by editors and specialists whose thoroughgoing understanding of the standards and values of technical literature is your guarantee of authoritativeness.

FOR EXAMPLE — SEE COUPON.

The Club will describe all forthcoming selections to you. Periodically you will receive free of charge *The Electronics and Control Engineers' Book Club Bulletin*, as issued. This gives complete advance notice of the next main selection as well as a number of alternate selections.

From this point on, the choice is yours. If you want the main selection you do nothing; the book will be mailed to you. If you want an alternate selection or if you want no book at all for that particular period, you notify the Club by returning the convenient card enclosed with your *Bulletin*. We ask you to agree only to the purchase of four books in two years. Certainly out of the large number of books in your field offered during this time there will be at least four you would buy in any case. By joining the Club you will save, in cost, about 15 per cent from publishers' prices.

YOUR NO-RISK GUARANTEE

Remember, the goal of this economical technical reading program is your satisfaction. We ask you to take no risk whatever. If you are not delighted with the volumes you receive for this introductory offer, return the books within ten days and your membership will be cancelled without further obligation. So while this offer is in effect, put your coupon in the mail today!

Here's a wealth of practical information to help you meet everyday design problems involving the use of transistors and other semiconductor devices. Conveniently arranged for easy use, this information—in the form of articles, design charts, nomographs, and actual ready-to-use circuits—covers a wide range of applications—from simple one-transistor "push-pull" amplifiers . . . to complex computer switching circuits.

MAIL ENTIRE COUPON FOR FREE BOOK AND SELECTION

The Electronics and Control Engineers' Book Club
330 West 42nd Street, New York, N. Y. 10036

Please enroll me as a member of the Electronics and Control Engineers' Book Club. I wish to take as my first selection the book checked below:

- Electronic and Radio Engineering, 4th Ed. *** by F. E. Terman. Publisher's Price, \$16.00. Club Price, \$13.00.
- Information Transmission, Modulation, and Noise** by M. Schwartz. Publisher's Price, \$12.50. Club Price, \$10.05.
- Mathematics for Electronics with Applications** by H. M. Nodelman and F. W. Smith, Jr. Publisher's Price, \$7.00. Club Price, \$5.95.
- Digital Computer and Control Engineering *** by R. S. Ledley. Publisher's Price, \$14.50. Club Price, \$12.35.
- Electronic Designers' Handbook *** by R. W. Landee, D. C. Davis, and A. P. Albrecht. Publisher's Price, \$18.50. Club Price, \$15.75.
- Electronic Measuring Instruments** by Harold E. Solsson. Publisher's Price, \$7.50. Club Price, \$6.40.
- Magnetic Tape Instrumentation** by G. L. Davies. Publisher's Price, \$9.50. Club Price, \$8.10.
- Electrical Engineering for Professional Engineers' Examinations** by John D. Constance, P.E. Publisher's Price, \$10.00. Club Price, \$8.50.
- Electronic Switching, Timing, and Pulse Circuits** by J. M. Pettit. Publisher's Price, \$8.95. Club Price, \$7.60.
- Adaptive Control Systems ***, Edited by Eli Mishkin and L. Braun, Jr. Publisher's Price, \$17.50. Club Price, \$14.85.
- Transistor Circuit Design *** by the staff of Texas Instruments Incorporated. Publisher's Price, \$15.00. Club Price, \$12.75.
- Control Engineer's Handbook ***, Edited by J. C. Truxal. Publisher's Price, \$23.50. Club Price, \$19.95.

I am to receive FREE with the book checked above a gift copy of *Design Manual for Transistor Circuits* or an alternate gift copy* of

Bill me for my first selection at the special Club price, plus local tax, and a few additional cents for delivery costs. Forthcoming selections will be described to me in advance and I may decline any book. I need only take 4 books in two years of membership. All further selections I choose will be at the member's special price.
* Titles marked with an asterisk carry an extra \$1.00 charge.

(Print)
Name

Address

City State Zip Code

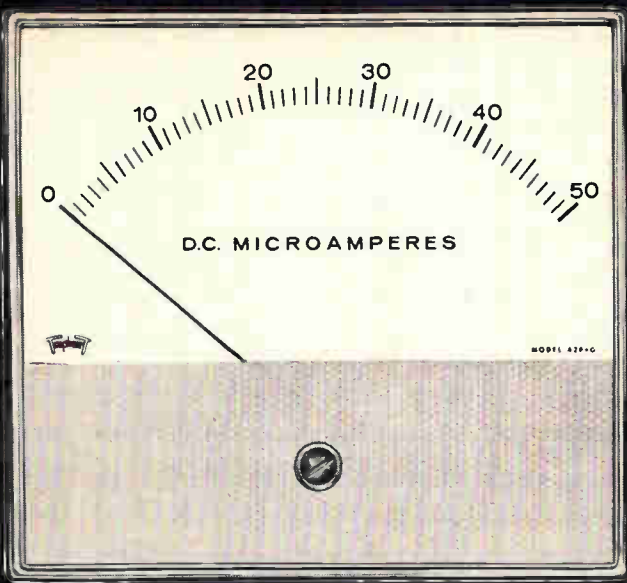

now you see it

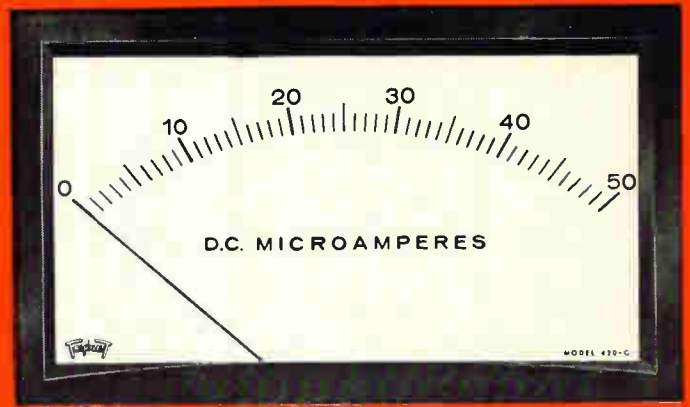
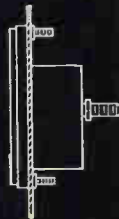

now you don't



THE PANEL INSTRUMENT WITH BUILT-IN FLEXIBILITY

New Triplet G-Series panel instruments offer a design that features a greater degree of flexibility and interchangeability. Handsome bezel type mounting is available for modern picture window appearance and behind the panel mounting. Flat insert shields may be painted any desired color, or imprinted with your company logo or operating instructions.

- 1** Triplet DC panel instruments are self-shielded—exact—reliable.
- 2** DC instruments have the famous Triplet BAR-RING movements, more torque, faster response and greater ruggedness.
- 3** One-piece die-cast frames and precision machined pole-pieces to control instrument characteristics.

Available in three popular sizes: 2½", 3½", 4½" models with standard black molded dustproof cases and clear molded plastic fronts.

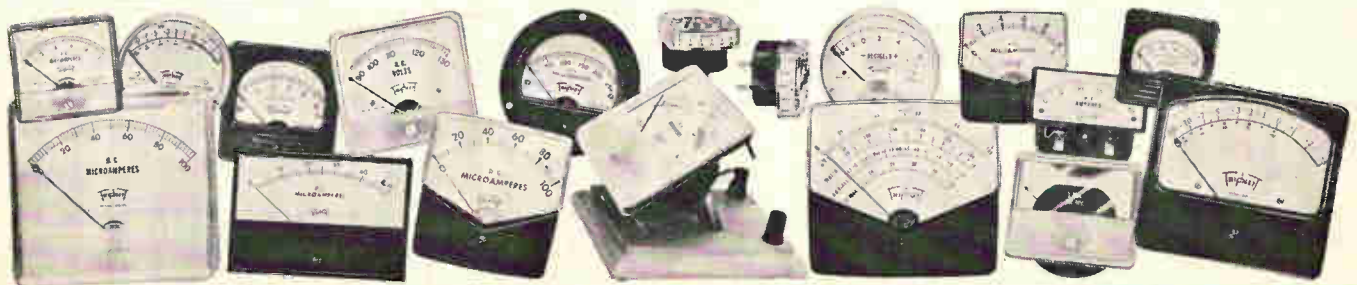

TRIPLET ELECTRICAL INSTRUMENT COMPANY, BLUFFTON, OHIO

CONSIDER COLORADO

...where there's room to grow... Industrial elbow room. On the plains and in the mountains.

Consider 39 fully improved industrial development areas located in as many communities throughout the State. Ample reserves of electricity, natural gas and water. Construction costs equal to, or lower than many areas of the United States. A highly skilled, highly stable labor force—with educational levels that rank among the highest in the nation. Add Colorado's climate and outdoor advantages to attract and hold personnel and you have every reason to consider industrial Colorado for your business expansion or relocation.

For complete information on the capabilities of industrial Colorado, address your inquiry to Dwight E. Neill, Director, Division of Commerce and Development, 17 State Services Building, Denver, Colorado.

INDUSTRIAL COLORADO



D-374 B

Probing the News

Communications

The Pentagon's global network

Automatic switching centers will replace the present patchwork with a unified Defense Communications System

Last week, Washington was in frequent communication with Saigon, West Berlin and other trouble spots around the world. The exchange was vital for Washington to find out what was going on, and for the U.S. commanders in the field to know how to handle the local situation.

Quick, reliable, secure communications are especially important to the new military philosophy of selective response—retaliation in proportion to the enemy's action. Washington must know at once what the situation is in any given spot, it must put those details into context, and it must call the shots

on what weapons U.S. forces should use and on what scale the counterattack should be.

I. Global network

To insure quick, fail-safe communications on a global basis, the Defense Department is converting its existing patchwork of military

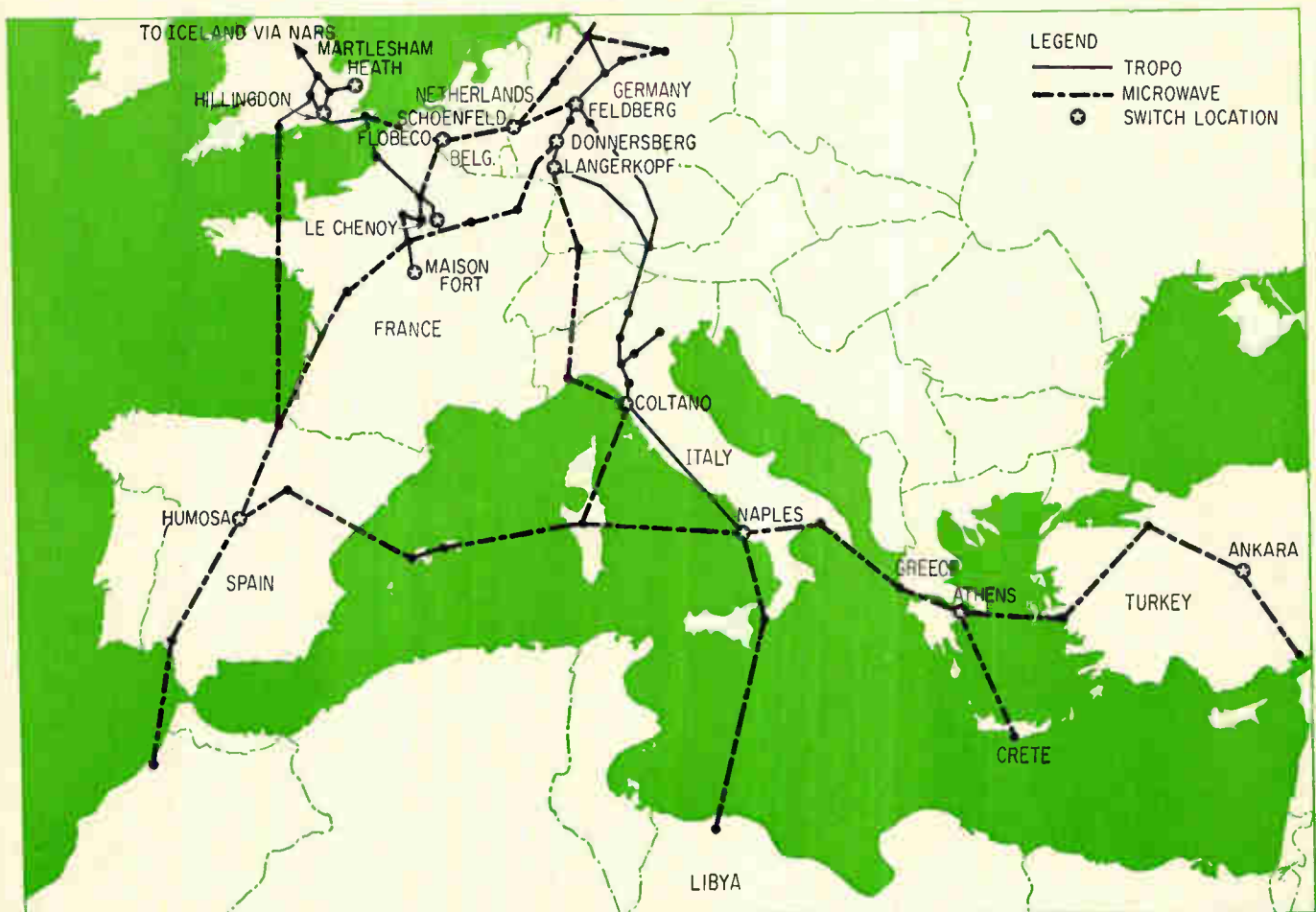

Map shows 14 of the 21 switching centers to be built for the Pentagon's communications system. One more will be built in Panama and six in the Pacific and the Far East.

communications links into an automatic worldwide network [Electronics, Oct. 19, 1964, p. 93]. To do this, it will build 21 automatic switching centers in 15 countries overseas. Sites for four of the centers are being prepared now and the electronic equipment for them is in production.

These switching centers—comparable in function to electronic telephone exchanges—will connect military communications routes in Europe, the Far East and the Caribbean. In addition to the 14 switching centers pinpointed on the map (p. 133), one will be built in Panama, and six in the Pacific and Far East—at Guam and Okinawa, in the Philippines, at Taiwan, and at Fuchu and Itazuke, Japan. The program will cost an estimated \$40 million and will be completed by 1969.

The switching system will tie together existing troposcatter and microwave point-to-point communications, as well as high-frequency, vhf and uhf links, land lines and underwater cable terminals.

II. Autovon

Once the centers are operational, the Defense Communications System (DCS) will provide direct-dial communications within seconds between decision makers and any military station in the world. It will also provide voice and data transmission service between widely separated military units at push-button speed.

The DCS, built on work already started by the individual services, will be a single automatically switched communications system, consisting principally of the worldwide Autovon (automatic voice) network and an automatic digital network called Autodin. In some cases, Autodin will have separate switching centers. In others, the centers will be with the Autovon facilities.

Domestic scanning. The domestic Autovon is being built on the Army's Scan (Switched Circuit Automatic Network) that already criss-crosses the United States. Approximately 60 analog switching centers will be built in the continental U. S. and overseas.

The overseas Autovon, which will consist primarily of lines

owned by various governments, will include all of the global network except the continental United States, Alaska, Greenland, Iceland and Bermuda. Hawaii and Puerto Rico are part of the overseas network. The Hawaiian lines will be leased from the Hawaiian Telephone Company, just as lines in the continental U. S. are leased from operating telephone companies.

Transportable stations will also be required for Autovon. At Athens and Ankara, the switching centers will be installed at fixed locations, but they will be designed to meet the specifications for transportability. They will be capable of being readily removed and reinstalled elsewhere, or relocated in vans which can be transported in C-130 aircraft.

III. Autodin

The Autodin system is being built up from five data switching centers the Air Force has been operating in the U. S. for several years. Four additional "switches" are being installed in the U. S. The Philco Corp. has a \$31.4 million contract to install 10 Autodin stations by the summer of 1969 in Alaska, Hawaii, Guam, Japan, Okinawa, the Philippines, Panama, England, Germany and France.

Secure communications, involving transmission of classified information, will be accomplished principally through Autodin, using digital coding techniques. Survivability will be sought principally through redundancy.

IV. Priority

Electronic memory and logic circuits will recognize user priorities, preempt entire routes for high priority messages, and monitor hot-line stations. A call from the President or the Secretary of Defense, for example, would automatically go through, and users of lower precedence would be disconnected from any line necessary to complete the circuit.

Autovon will include sophisticated memory and logic circuits in the switching centers which will permit four classes of priority, preemption of lines for higher priority calls, setting up conference and broadcast calls, and hot line service.

Priority ranks designated 0 to 4 are designed into the system, with service preference according to rank. Priority 4 is for normal routine calls. Priority 0 is the highest ranking. For signaling priorities between four-wire switching centers, 0 to 4 tone pairs corresponding to the digits will be used.

The common-control circuits will pre-empt a line on which a low-priority call is placed if a high-priority call encounters all trunks busy. A pre-emptive warning tone will be sounded and the line seized.

Conference arrangements can be made by Autovon for 3 to 26 conferees. At least one switching center in each country overseas will be chosen to perform the operator-controlled functions of the network. Arrangements can be made for conferences or announcements.

Recorded announcement facilities will be provided at each switching center.

A dial assistance switchboard will be built into selected switching centers in each country. All traffic requiring the services of an operator for information, directory, intercepting, conferencing and recording will be handled at these positions.

The memory associated with the system is a ferrite-core array with a 6000-word capacity, 44 bits per word. The ferrite core was chosen as an extremely reliable device for registering digits, translating codes, and providing storage for class-of-service indications. The memory is electrically alterable so codes and services can be changed rapidly.

V. Four-wire system.

The switching centers will use principally a four-wire system to provide the required frequency capability—up to 50 kilocycles. Matrices of Correed (glass-encapsulated contacts) with electronic controls will be similar to those in the electronic automatic exchange designed by the Automatic Electric Co., a subsidiary of General Telephone & Electronics Corp. in Northlake, Ill., for commercial telephone switching [Electronics, Oct. 19, 1964, p. 71].

Switching paths will be completed by using relays and Correed assemblies in the trunk and line circuits, and Correed as-

semblies in the matrices.

The typical Correed assembly is a cluster of reed capsules surrounded by two coil windings—an operate winding and a hold winding. Each capsule contains two magnetic reeds; when the coil is energized, they are magnetized in such a way as to attract each other. The reeds have contact ends of diffused gold, and because they operate in a sealed capsule their life is reportedly measured in billions of operations. They are considered immune to corrosion.

VI. Future system

By 1970, the Pentagon expects

to have the basic automatic switching system in use. The "ultimate" DCS will include tie-ins to satellite communications and to air-ground systems, such as Soft Talk and Vocom [Electronics, Sept. 21, 1964, p. 97]. It will permit cutovers to commercial telephone networks. Transportable switching centers for special military needs will be designed for tie-ins.

Present work. Prime contractor for the overseas Autovon switching network is Automatic Electric, which has started production of component assemblies under a \$16.8 million contract.

The Air Force also has the

responsibility for the overseas Autovon centers, and one at Shepard Air Base, Texas, for training. The task has been assigned to Col. Donald W. Roberts, deputy for communications systems at Electronic Systems division, Hanscom Field, Mass.

The Defense Communications Agency recently decided to expand the role of the Air Force program, known as the 490L, to include some of the overseas trunk lines in addition to the switching centers.

Maj. Thayne C. Green, is 490L program manager, and Maj. Donald E. Kinney engineering manager.

Military electronics

Automating our air-defense control

Norad's plans rely on a computer to be housed deep below a Colorado mountain. It will use the latest techniques in data processing and control

If the **United States** should ever be attacked from the air, the first official warning would be a series of flashing lights on a small cathode-ray tube. By late summer, this display will no longer be activated by a human operator, but by a computer. It will also be moved into a command-and-control center buried below 1,500 feet of granite, deep in

Cheyenne Mountain near Colorado Springs, Colo.

The message would come from one or more of the North American Air Defense Command's sensors around the continent and as far away as Britain. It would have passed through a digital computer before being displayed.

The operator on duty would

point a light-gun at the flashing trace on the display to acknowledge the warning and turn it off. The operator would then press certain buttons on his display console to ask the computer for any additional information it might have.

Thus a well-rehearsed routine would get under way that would set off a chain reaction, marshalling

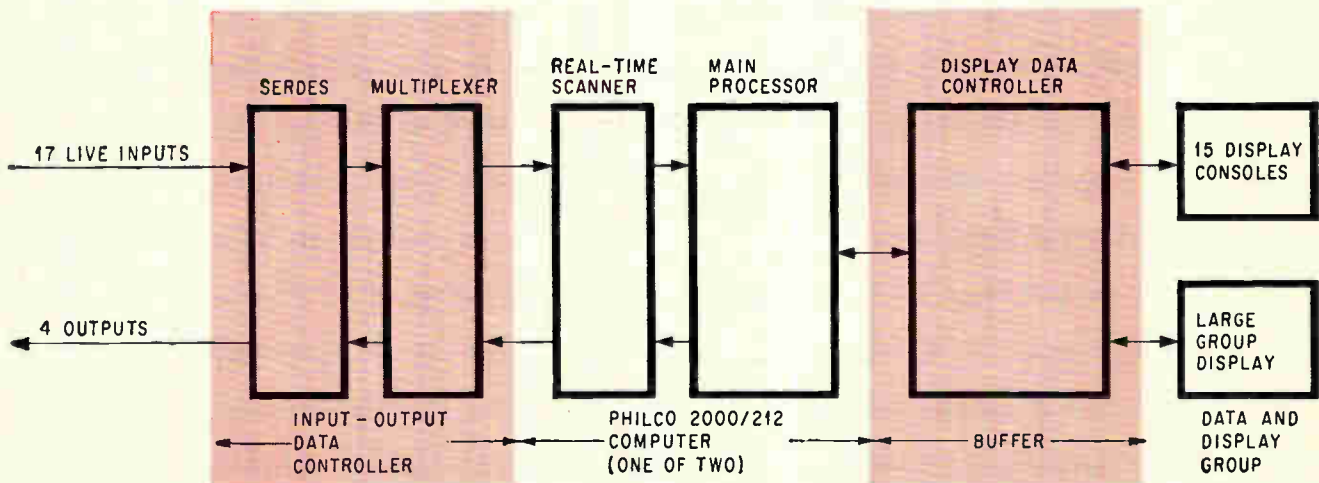

Configuration of Norad's underground command post. Two computers, equipped with automatic switching, provide system redundancy. A Philco 1000 (not shown) is used off-line for sorting, transferring and printing functions, and for card-to-tape conversion.

COMMUNICATIONS PROBLEMS



SEND YOUR
UHF-VHF
PROBLEMS
TO SINCLAIR

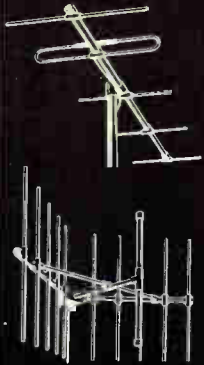

MULTICOUPLERS — use one antenna to simultaneously transmit and receive up to 24 systems . . . with high isolation between channels, low insertion loss and low maintenance costs. Multi-couplers for the 30MC to 10KMC range — specials to meet unusual problems.

DUPLEXERS — for the ultimate in isolation between Tx and Rx for dual simplex or full duplex operation. Separation as low as 0.5 MC at full power load of 250 watts. Perfect for base or repeater station or mobile operations. Frequency ranges from 30 MC to 960 MC — as small as 2" x 4" x 6".

ANTENNAS — a complete line — Isorays . . . Yagis . . . Ground Plane . . . Corner Reflectors . . . Base Station . . . Mobile — for frequency ranges from 30 MC to 470 MC. Gains from 0 db to 20 db. Rugged enough to withstand 125 mph winds with 1/2" ice coating — small enough to fit in a rear view auto mirror.



Also, a complete quality line of Band Pass and Reject Filters, Mounting Accessories and Antenna Hardware. Clip the coupon, attach to your letterhead, and we'll send complete details.

SINCLAIR RADIO LABORATORIES, INC.

523 FILLMORE AVENUE, DEPT. P
TONAWANDA, NEW YORK
IN CANADA: 21 TORO ROAD
TORONTO, ONTARIO

Name _____ Title _____

Company _____

Address _____

City _____ State _____



Operators of large-screen display can request new maps, additions to maps, and a variety of information listed in tabular form along-side the map.

ing all of the nation's strength. Information would be sent to the Strategic Air Command, Tactical Air Command, National Military Command Center, Civil Defense headquarters and to Canada's Chief of Staff Committee.

I. Underground center

The excavation that will contain Norad's command-and-control center will comprise 154,000 square feet. It will consist of 11 buildings with self-contained power units, water supply and other facilities, and will be capable of operating during a nuclear attack.

It will cost about \$88 million—\$20 million for research, training, design and engineering, \$35 million for equipment, and the rest for construction. The Mitre Corp. designed the system. The Burroughs Corp. was prime contractor for hardware, and the Systems Development Corp. prepared the computer program.

Information sources. The center receives information automatically from 17 sources—eight Norad regions in the U.S., four Dewline sites in Canada, BMEWS (ballistic-missile early-warning system) stations, in Alaska, Green-



Display console converts digital and video information into figures, symbols and television images on this cathode ray tube.

land and England, one Nudets (nuclear-detection system) network and one bomb-alarm network. In addition, 20 or more sources report by telephone, teleprinter, or by other means; their information is keyed into the system manually. These sources include Spadats—the space detection system—and the Joint Chiefs of Staff.

The crew at the center discards irrelevant information like scheduled domestic airline flights, but keeps close track of unidentified aircraft and foreign airliners such as the twice-weekly Moscow-Havana Aeroflot run up and down the U. S. East Coast.

II. Communication Modes

When data reaches the center, it goes into an input-output data controller designed by the Philco Corp. The controller, an assembly of logic elements, converts the serial input signals into parallel data that the computer can use. The controller also converts parallel output from the computer into serial form for transmission to distant sites. It is a serializer-deserializer, called Serdes.

Teleprinter. Much of the information that arrives at the center is encoded for a teleprinter. Some of this information is not printed, but goes directly into the controller. The encoded information is made up of a series of pulses. Seven pulses comprise a character; these consist of one positive start pulse, five data pulses—which may be positive or negative—and a negative stop pulse. Nine characters make up a word.

It takes the controller a few milliseconds to collect nine characters in a shift register; while in one cycle—1.5 microseconds—it transfers the word to the computer memory. The computer, therefore, is not tied up while data is coming in.

When information is sent manually from the sensor—as in the case of radar tracking units—the station operator puts it into proper format. Otherwise the controller would not accept it.

Data from nuclear-detection sources (Nudets) arrives as a digital signal, similar to that in a teleprinter but using a different code. The controller enters the bits into a shift register, as with a teleprinter, until a complete word is

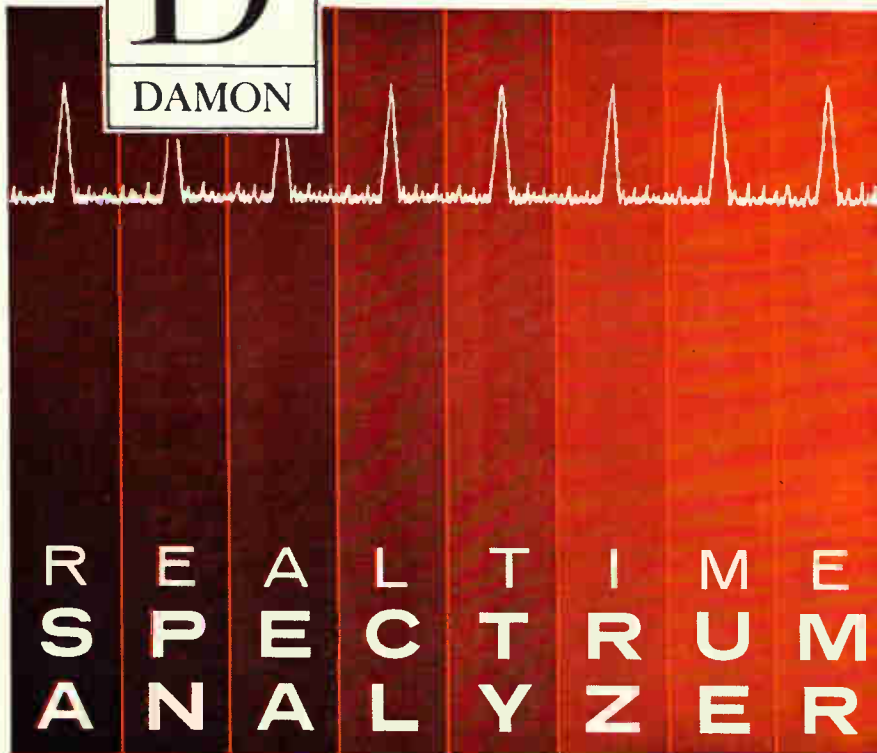
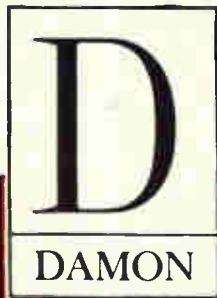

Gaussian or Chebyshev Crystal Filters

Solid State Electronic Commutation

Uniform Frequency Response

Damon's Multifilter Spectrum Analyzers are adaptive to signal rate, filter time constant or display response. A unique frequency-sharing principle permits optimum utilization of filters for maximum economy. In analysis bands from 100 cps to 10 Mc, multipole crystal filters with bandwidths from 5 cycles to 100 Kc resolve closely spaced signals having large amplitude ratios.

These state-of-the-art Analyzers are illustrative of Damon's capabilities in frequency information retrieval and analysis. Other significant examples include the Telstar Comb Filter and the SPASUR Detection Preselector.



Write for Real Time Multiple Filter
Spectrum Analyzer Brochure.

Spectrum Analyzer
Model 5187A

DAMON ENGINEERING, INC.

240 HIGHLAND AVENUE

NEEDHAM HEIGHTS, MASS. 02194 (617) 449-0800



Qualified Electronics Technicians

(Where do you find them?)

Many Companies will tell you the best source is their present staff of technical personnel. These men have the necessary aptitude and ambition . . . can be readily up-graded through a planned electronics training program.

Since 1934 Cleveland Institute has developed such programs for hundreds of leading companies . . . has provided thousands of men with practical, useable knowledge of electronics theory and fundamentals. These men understand the "why" of electronics . . . can install, maintain, troubleshoot, and repair the sophisticated equipment you're using today, and will be using in the years ahead. Learn how CIE can "tailor" an Electronics Training Program to your specific needs. Its effectiveness and economy will amaze you. Send coupon today for FREE brochure. Cleveland Institute of Electronics, Dept. E-11, 1776 E. 17th St., Cleveland, Ohio 44114.

SEND COUPON TODAY

Cleveland Institute of Electronics

Dept. E-11, 1776 E. 17th St., Cleveland, Ohio

Gentlemen: I am interested in learning more about your Electronics Home Study Programs. Please send complete information.

Name _____

Title _____

Company _____

Address _____

City _____ State _____ Zip _____

Accredited Member, National Home Study Council.

assembled. Then it transfers the word to the computer memory.

Bomb-alarm data, on a teleprinter line, is converted into a parallel word in a Western Union converter, which then transfers the word to the controller and from there to the computer memory.

Sine waves. Data from BMEWS is not encoded for teleprinter, but arrives at the center as a digitally modulated sine wave. The controller recognizes the presence or absence of the sine wave, as it does the positive or negative teleprinter pulse, and stores the information, bit by bit and character by character. Six bits form one character, three characters make a word, and three words comprise a message. The controller converts this serial input into parallel form for the computer in much the same way it handles the teleprinter data.

Data referee. With its multiplexer unit, the controller keeps track of the status of the 17 inputs. Whenever a complete word has been assembled, the multiplexer sends it to the computer memory. A real-time scanner in the computer monitors the controller's output and places each word in the proper location in the memory.

III. Processing and displays

Two standard Philco 2000/212 computers are used, one as a back-up. Each computer has a magnetic-core main memory and a magnetic-drum auxiliary-storage capability. Storage capacity is 32,000 words.

The computer is equipped with 11 magnetic tape units, with room for 16. These units perform up to four simultaneous read or write operations, at a transfer rate of 90,000 characters per second.

Controller for display. A display-data controller connects the computer and input-output data controller with the 15 data-display consoles and data-presentation equipment. This is a buffer unit containing logic to direct information from the computer to the display consoles that request it.

The console converts the digital data provided by the computer into visual images on a cathode-ray tube. The operator, by pushing buttons, may call for any specific information from the computer. For example, he may request a map of North America with the

Norad regions superimposed. He may then want the BMEWS sites added, plus any targets the radars are picking up. In case of a missile attack, he could request complete information on each missile being tracked: its launch site, its target, and predicted time of impact. This information would be displayed in tabular form alongside the map.

Light-gun. When a new and unknown track appears on the display, it arrives with flashing lights. To tell the computer he has seen it, the operator aims a light-gun at the new signal. The flashing then stops and the track is displayed as a steady signal.

The light-gun is also used to move a specific portion of the display to another part of the screen in case the section under scrutiny is overcrowded. The computer permits the operator to move any part of the display in discrete steps in any direction.

The display, white on a black background, is continually being refreshed, or rewritten, at a rate faster than the phosphor decay time. How frequently this is done depends on the amount of information displayed and the time it takes the electron beam to trace it out. The slowest rate is once every 20 milliseconds.

The usual display of either diagram or tabular information is generated by a random scan. Under program control, the electron beam is made to hop, skip and jump to any point on the screen to generate the desired trace. Different parts of the display may be generated in any desired order.

Closed-circuit television is also available at the display consoles. The standard television scan is used for this; the electron beam scans left to right for each of 525 lines. The television display provides special information, such as weather maps or tabular information about the readiness or availability of defense units.

Small screen. The console display is 14 by 10½ inches on a round electrostatic tube 19 inches in diameter. The spot, which scans the screen to produce the display, is about 30 mils across. Two sizes of characters or symbols are available: ¼ inch and ⅜ inch high.

The program provides X and Y coordinates for each character dis-

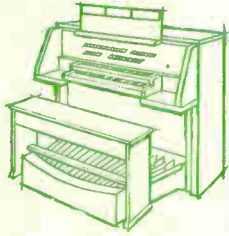

1. In electronic organs using tuning capacitors, maintenance of correct pitch is directly dependent on capacitor reliability.

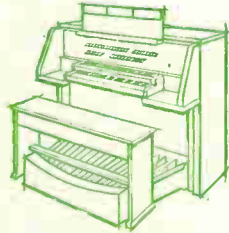

2. That's why the Hammond Chord Organ relies on 95 capacitors of "Mylar".

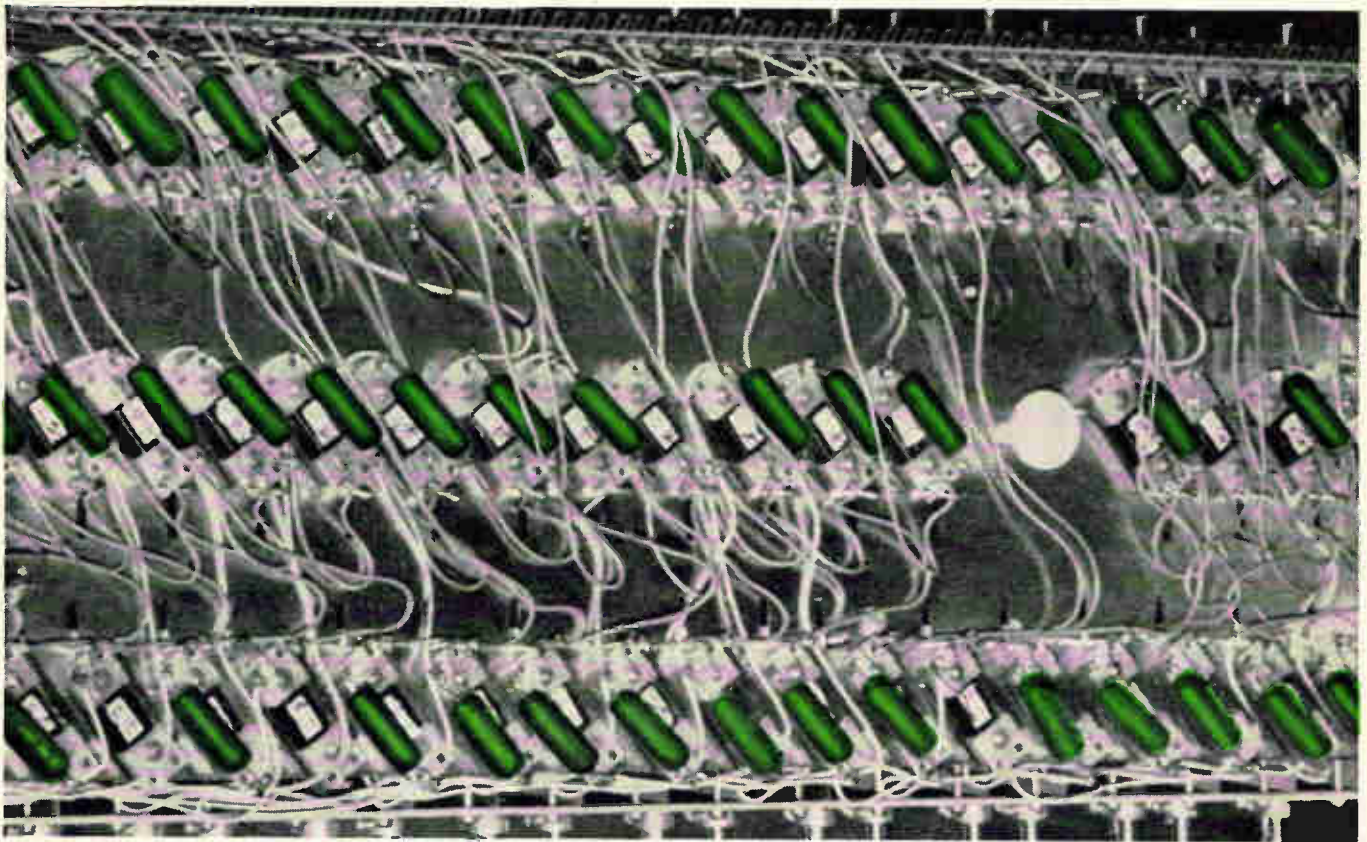

This is a section of Hammond's exclusive tone wheel generator from the Grand 100 organ. 94 capacitors of

"Mylar" in sizes of .1 and .25 microfarads are used here, with 56 others in the amplifier and other circuit locations.

Until capacitors of "Mylar" were developed, the usual electronic organ capacitor dielectric was paper. In unusually humid situations, paper dielectrics can absorb moisture, causing them to leak, change capacitance and interfere with the operation of the organ.

Hammond Organ Company avoided these problems by enclosing paper capacitors in metal cans. This was expensive and bulky. Then Hammond engineers switched to capacitors of "Mylar". End of problem.

Today Hammond uses capacitors of "Mylar" in all organs for many purposes. There are 150 capacitors of "Mylar" in the Grand 100, where tuning is controlled by Hammond's exclusive tone wheel generator. In this case the additional benefit of small size was instrumental in

the decision to choose capacitors of "Mylar".

Not only do capacitors of "Mylar" give Hammond consistent reliability plus substantial savings in space . . . *but they cost no more, and often less, than paper capacitors.*

Reliability—proved in use by Hammond for 10 years, proved in 23,000,000 unit hours of intensive Du Pont sponsored independent testing—is just one important advantage of capacitors of "Mylar". For complete data that may help in your design problems, write Du Pont Co., Rm. 2310-A, Wilmington, Delaware 19898. In Canada: Du Pont of Canada, Ltd., P. O. Box 660, Montreal, Quebec.



only DU PONT makes



BETTER THINGS FOR BETTER LIVING . . . THROUGH CHEMISTRY

*Du Pont's registered trademark for its polyester film.

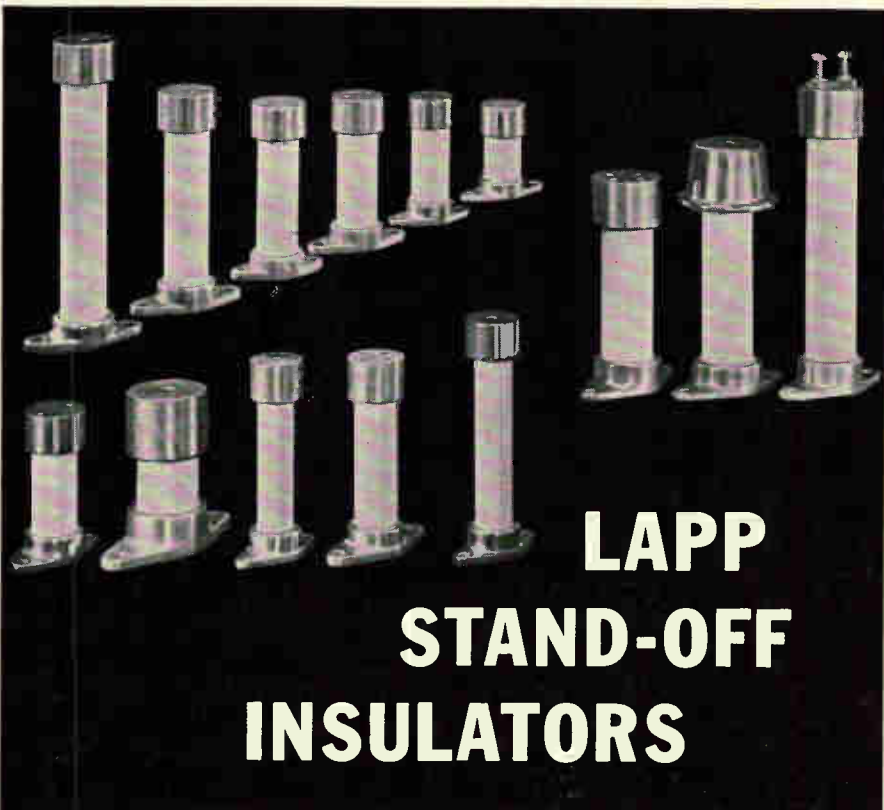

LAPP STAND-OFF INSULATORS

...in all these standard sizes
to save you time
and money

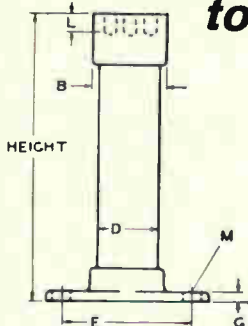

Other tapped hole
sizes or arrangements
available on special
order.

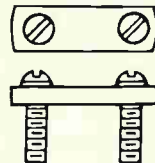

ORDER
KEEPER
SEPARATELY

STAND-OFF INSULATOR DIMENSIONS IN INCHES

(STOCK HEIGHTS LISTED BELOW)

Cat- log No.	Material	Cantilever Strength inch-pound	Height in inches	B	D	E	G	L	M	N	P	Q
14761 24229	Porcelain Steatite	375 450	4-6-8	1 $\frac{3}{8}$	1	2 $\frac{1}{4}$	$\frac{3}{16}$	$\frac{5}{32}$	$\frac{5}{32}$	$\frac{1}{4}$ -20	$\frac{1}{4}$ -20	$\frac{5}{16}$
14760 24114	Porcelain Steatite	600 700	4-6-8-10	1 $\frac{3}{8}$	1 $\frac{1}{4}$	2 $\frac{3}{8}$	$\frac{7}{32}$	$\frac{3}{8}$	$\frac{5}{32}$	$\frac{1}{4}$ -20	$\frac{1}{4}$ -20	1 $\frac{1}{16}$
22408 41775	Porcelain Steatite	1200 1400	6-8-10-12	1 $\frac{3}{8}$	1 $\frac{1}{2}$	2 $\frac{7}{8}$	$\frac{1}{4}$	$\frac{7}{16}$	$\frac{5}{32}$	$\frac{1}{4}$ -20	$\frac{1}{4}$ -20	1 $\frac{3}{8}$
13981 24110	Porcelain Steatite	1800 2100	6-8-10-12	2 $\frac{1}{4}$	1 $\frac{3}{4}$	3 $\frac{3}{4}$	$\frac{1}{4}$	$\frac{5}{16}$	1 $\frac{1}{32}$	$\frac{5}{16}$ -18	$\frac{3}{8}$ -16	1 $\frac{1}{4}$
42588	Porcelain	4000	6-8-10-12	3 $\frac{3}{8}$	2 $\frac{1}{2}$	5	$\frac{3}{8}$	$\frac{1}{2}$	1 $\frac{1}{32}$	$\frac{5}{16}$ -18	$\frac{3}{8}$ -16	2



Insulators shown are standard.
Similar insulators available with
caps or bases on both ends.

WRITE for Bulletin 301-R.
Lapp Insulator Co., Inc.,
230 Sumner Street, LeRoy, N. Y.

played, whether in a line or scattered at random about the screen. The program specifies which character is to be displayed, and the display controller causes the electron beam to trace it out.

The program must also provide X and Y coordinates for each end of every straight-line segment displayed. All diagrams and maps are put together from a series of long and short straight-line segments.

Large screen. Any display, except closed-circuit television, on any of the 15 small display consoles may be transferred to a large 12- by 16-foot wall display for viewing by the entire staff. Each of the 15 operators has a specified area of responsibility. Using the large screen, he can call attention to any activity.

The large display, designed by Optomechanisms, Inc., of Plainview, N.Y., contains a small cathode-ray tube that is photographed on 35-millimeter film by three separate cameras. The film is processed within the unit, and the three frames move into a projector containing three lenses with red, green and blue filters. The frame associated with each color is projected onto the large screen through the appropriate filter. Since all three frames are projected simultaneously and are precisely registered, the colors mix to produce one of seven colors. For a red track, for instance, only one shutter will operate, and that frame will be projected only through the red filter. For white, all three shutters will operate, and those lines or symbols will be projected through all three filters.

Slight delay. The only long delay, from the time the signal is received by the input-output data controller until it is projected on the large display, is the 11 seconds required for photographing the cathode-ray tube and processing the film. Thus the large-screen display can be updated every 11 seconds. There is no noticeable delay at the display console. To put a display on the large screen, the operator merely sets up the display on his own console, then presses a button.

Hard-copy printout of tabular information on the display is available to each controller from a type-

writer-like printer attached to each console. This allows such tabular information to be retained indefinitely, a requirement sometimes encountered in tests or in training.

The computers, controllers and consoles, along with associated equipment, have been assembled for test and debugging at a site near the present Norad command post. Test, evaluation and modification of the system will continue after the move into Cheyenne Mountain, until early in 1966. At that time, Norad will take occupancy and assume responsibility for the system. Full operation will begin later in 1966.

IV. Communications reliability

While the command-and-control system is being tested, a complex communications system is being installed in the underground site. Underground coaxial cable radiates from the site in six spokes tied to a gigantic ring. Should any one of these spokes fail, automatic switching equipment will connect an alternate path. These cables are enclosed in steel conduit, welded, and buried in concrete.

The ring, in turn, is connected to an American Telephone and Telegraph Co. communication system, which is laid underground to Lamar, Colo., 200 miles away. Contact with the outside world is established at Lamar.

The Mountain States Telephone and Telegraph Co., a subsidiary of AT&T, is installing a military version of a solid-state system under construction at Succasunna, N. J.

The electromagnetic pulse that follows a nuclear blast could damage sensitive electronic equipment. Although the underground complex is well shielded, all of the equipment was designed for maximum protection against such pulses. To further insure against this type of damage, however, a unique system of waveguides was devised. Corridors connecting the various parts of the complex are rectangular, about 10 feet wide and 12 feet high, and lined with steel. Light fixtures in the corridors were designed as tuning stubs. The result is a waveguide that will attenuate frequencies below 75 megacycles. In this way, electromagnetic pulses entering the complex will be attenuated as they pass between buildings.

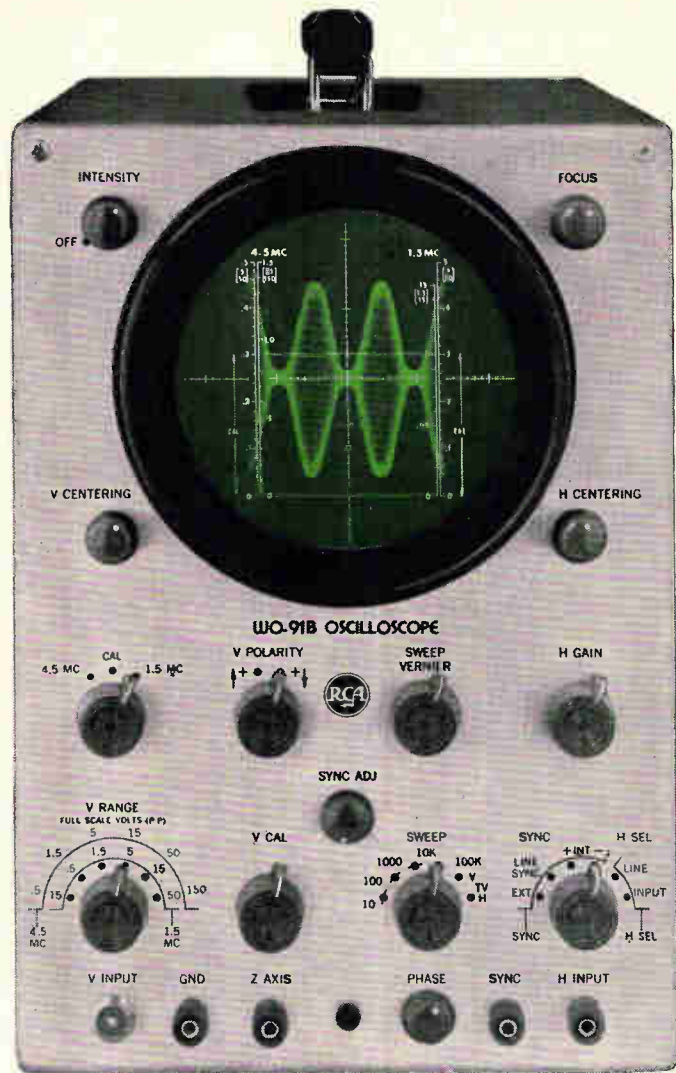

The famous RCA 5-inch scope NOW WITH MORE FEATURES TO SIMPLIFY YOUR JOB

Here's the latest model of the famous RCA 5-inch scope: the **NEW WO-91B**

- Provision for connecting signals directly to the vertical deflection plates of the CRT. Permits observation of high frequency RF waveforms, such as trapezoidal and wave-envelope modulation patterns.
- Two-stage sync separator simplifies checking of TV horizontal and vertical sweep synchronization... provides exceptionally solid lock-in action on composite TV signals.
- Choice of wide-band or high-sensitivity, narrow-band display.
- Complete with RCA WG-300B Direct/Low Cap. Probe and Cable.

• Optional at slight extra cost: RCA WG-354A slip-on capacitance-type voltage-divider probe that extends the range of the scope to permit observation of signal pulse amplitudes up to 5000 volts. RCA WG-302A slip-on RF/IF/VF signal tracing probe for RF applications from 100 Kc to 250 Mc.

- WO-91B Scope: **\$249.50***
- WG-354A Probe: **\$ 7.50***
- WG-302A Probe: **\$ 8.50***

Ask to see it at your Authorized RCA Test Equipment Distributor.

*Optional distributor resale price. All prices subject to change without notice. Prices may be slightly higher in Alaska, Hawaii and the West.

RCA Electronic Components and Devices, Harrison, N. J.



The Most Trusted Name in Electronics

FOR
DRILLING
AND ROUTING
CIRCUIT BOARDS
AND
REINFORCED
RESINS

SOLID CARBIDE

◀ DRILLS

◀ FLUTED
ROUTERS

◀ FIBERGLASS
ROUTERS

UNEQUALLED METAL REMOVAL
COMPANY SERVICE, QUALITY
AND SELECTION INCLUDING:

1. World's largest inventory of centerless ground drill blanks and finished tools ready-for-shipment.
2. Fifteen centerless grinders in production of drills and rotary carbide tools.
3. Every size carbide drill, ground from-the-solid... the smallest — .008" diameter to the largest — 1.500" diameter.
4. Precision ground to 5 micro-inch finish or better.
5. Delivery from stock, through our distributors, of any standard solid carbide tool in 48 hours.

Your assurance of product quality, lowest cost and dependable service is the fact that the nation's leading carbide tool users are placing their tool contracts with The Metal Removal Company.

THE METAL REMOVAL COMPANY
1859 W. Columbia Avenue
Chicago, Illinois 60626

Plants Located in CHICAGO • LOS ANGELES • SAN JUAN



MASTER TOOL AND WHEEL
MAKERS FOR THE WORLD

Industrial electronics

Ban on bugging?

Congress and the FCC are seeking ways to stymie electronic spying

By Lewis Beman

Washington News Bureau

Progress in electronics has not only enabled man to explore space, it has made it remarkably easy for him to probe the secrets of his friends and rivals on the planet earth.

Government officials and corporate executives with secrets to discuss never know whether they are being watched or overheard. They know that walls do, indeed, have ears, and that space-age miniaturization is constantly making those ears smaller and more sensitive.

Sunday supplements now advertise inexpensive telephone taps and concealed tape recorders. For \$18.95, you can buy a parabolic microphone that picks up conversations a block and more away. So can any common eavesdropper or blackmailer.

Curbs on the manufacture and use of such devices are inevitable. But how soon will they come? Who will order them? And how badly will they hamper the science of electronic surveillance, which many government officials consider

necessary for protection against criminals?

I. Where the action is

Congress. Sen. Edward V. Long initiated hearings in the Senate Administrative Practices subcommittee last month that could provoke action. The Missouri Democrat says he will push for legislation after the hearings end, some time this spring. He hasn't settled on an approach yet, but says the climate for some restriction is "excellent" in this session.

Rep. Cornelius E. Gallagher, a Democrat from New Jersey, hopes to begin hearings soon before the House Committee on Government Operations when a special subcommittee is reestablished. Gallagher feels strongly about the invasion of privacy. Recently he suggested that last year's Civil Rights Act be amended to make electronic snooping a violation of that law. He is also ready to recommend laws against the manufacture, distribution and sale of devices for electronic surveillance.



"The martini with the transistorized olive and omnidirectional toothpick goes to table 15."

These are not the first such hearings—Congress has discussed such laws since 1959 without enacting any—but this time they may produce results. The new congressional pressure will probably discourage government agencies from electronic snooping in many nonsensitive areas. Inspectors for the Food and Drug Administration, for example may be forced to give up the hidden tape recorders, which are intended to document attempts at bribery.

State laws. A number of states are considering following Illinois' lead in banning the use of all electronic listening devices. Some states have already prohibited their use by private parties and restricted their use by the police.

The courts. The United States Supreme Court and lower courts have begun to look more critically at certain electronic surveillance practices as possibly exceeding constitutional bounds. And they may be coming around to the view that the right of privacy outweighs any rights of eavesdropping, even by law-enforcement agents.

Some time ago, the Supreme Court said that only where there had been a "physical intrusion" into a suspect's home or office to plant a listening device was there an illegal invasion of privacy. But the doctrine was broadened considerably by the 1961 Silverman decision, in which the court said that driving a "spike mike" into the wall was enough of a trespass to invalidate any evidence that might have been gathered.

Now, of course, physical intrusion isn't necessary to bug a room.

Chief Justice Earl Warren has said, "The fantastic advances in the field of electronic communication constitute a great danger to the privacy of the individual."

The Supreme Court may have to face the issue squarely within the next year or so. State courts are already facing it. Last month a New York City judge ruled that a state law allowing electronic surveillance under a court order was unconstitutional.

The judge, Nathan R. Sobel, said on March 1 that any electronic eavesdropping would violate procedural safeguards set up under the Fourth Amendment (against illegal searches) and Fifth Amendment

THESE ARE THE FEATURES OF THE NEW

Aeme  Electric

VOLTROL* STABILIZER

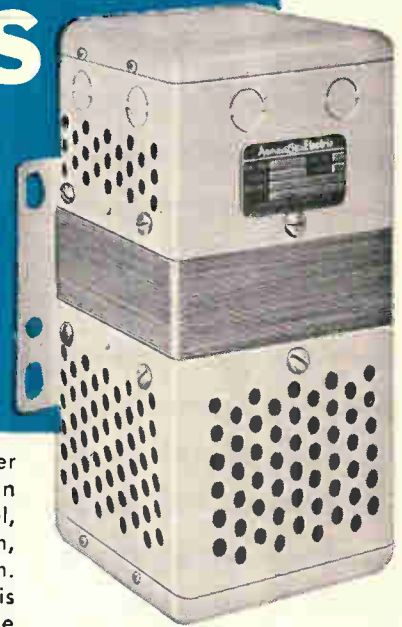

We've spent years developing a new stabilizer that incorporates all the improvements that can be expected from improved lamination steel, improved magnet wire, improved insulation, improved capacitors and improved design. As a result, the new VOLTROL Stabilizer is far advanced in performance. These are some of the features you can expect in the new VOLTROL Stabilizer.

✓ **FAST RESPONSE TO LINE VOLTAGE FLUCTUATION** Voltage recovery in milliseconds on ordinary 3% to 5% line voltage fluctuations. Not more than 2 cycles (1/30th second) on sudden voltage drops or voltage surges of 15%.

✓ **AUTOMATIC PROTECTION AGAINST OVERLOADS** Short circuit in the powered equipment or severe overload causes output voltage to drop to zero, automatically protecting stabilizer and equipment.

✓ **AUTOMATIC ADJUSTMENT OF LOW VOLTAGE OR HIGH VOLTAGE** A continuous, low voltage or high voltage input is corrected to nominal, $\pm 1\%$, without causing excessive heating or other damage to stabilizer.

✓ **OUTPUT TAPS FOR RECTIFIER CONNECTION** Most types are available with output taps to supply a regulated voltage to a rectifier.



UNENCLOSED TYPES FOR OEM APPLICATIONS

The VOLTROL Stabilizer can be supplied without end covers for use as part of the equipment system. Unenclosed types cost less.

Write for Bulletin 09-B03 which describes and illustrates the many features incorporated in the VOLTROL Stabilizer to provide added advantages to you.

Aeme  Electric

Engineers and Builders of...

314 Water Street, Cuba, New York

Canadian Representative: Polygon Services, Ltd.

50 Northline Rd., Toronto 16, Ont.

*VOLTROL is a registered trademark of Acme Electric Corp.

SA 3808-3114

REGULATED POWER SUPPLIES
STATIC POWER RECTIFIERS
VOLTAGE STABILIZERS
VOLTAGE REGULATORS

You can pack more than 2000 bits per cubic inch into a MicroBIAX array.

If you're designing ground or space borne data systems, contact Ken Kinkopf at Raytheon Computer. Phone: (714) 546-7160.

He'll send you a sample element.

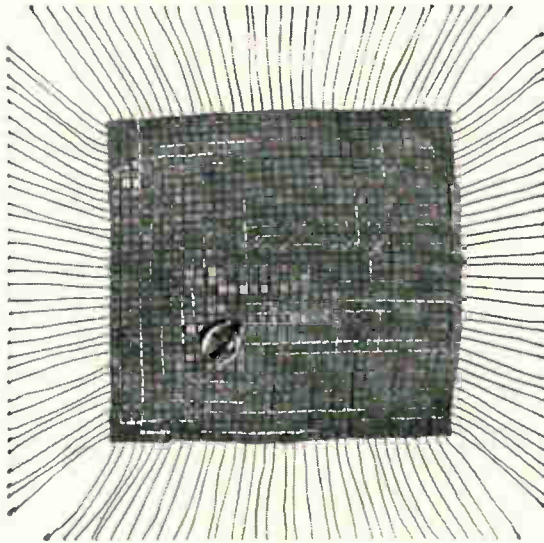

1156 BIT TWO-WIRE MICROBIAX LOOM

This remarkable bit-density is made possible by the new MicroBIAX memory element, a tiny ferrite multi-aperture core less than 0.050 inch high — approximately one fifth the size of the standard BIAx unit. MicroBIAX is designed specifically for two-wire memory systems. It so simplifies the array wiring scheme that your system costs less, is far more reliable.

MicroBIAX gives true non-destructive readout at 2 megacycle rates, with readout at up to 10 megacycles in custom systems.

MicroBIAX operates throughout a -55°C to $+100^{\circ}\text{C}$ temperature range at low power levels.

Standard products from Raytheon Computer's BIAx and MicroBIAX line make up the world's fastest special-purpose memories.

For complete details and specifications on memory systems, arrays and elements, write for Data File B-105E. Raytheon Computer, 2700 S. Fairview Street, Santa Ana, California 92704.



(against self-incrimination). If this position is upheld by the U. S. Supreme Court it will mean an end to "bugging" by police to obtain evidence that is admissible in court. Most experts say such practices would probably be continued, however, to furnish "leads."

Court action. Only one case involving an FCC ruling has come to trial so far—for using an illegal frequency. Private detectives in Washington used frequencies assigned to aircraft guidance systems to bug the hotel room of a natural-gas-pipeline executive.

The detectives were found guilty and given jail sentences. These frequencies are popular for surreptitious listening because they usually don't transmit voice.

The FCC. For a year the Federal Communications Commission has been studying regulations that would bar the nonofficial use of radio devices for electronic eavesdropping. These will probably be adopted before summer.

FCC officials don't think their new regulations will cut deeply into radio snooping. Illegal devices are available to anyone—there are no laws regulating their manufacture—and, as the agency's enforcement chief, John C. Harrington, says, "You have to be pretty stupid to get caught using them."

But the commission says eavesdroppers should be put on notice of the FCC's interest.

II. An expanding market.

The size of the market for eavesdropping gear is about as clandestine as the products themselves. Many companies don't want it known that they're in the field; many say they supply equipment mainly to discover other people's bugs. Others insist they sell only to the federal government and to police departments. But the market is clearly broadening.

Ralph V. Ward, vice president of Mosler Research Products, Inc., in Danbury, Conn., one of the biggest makers of electronic surveillance equipment, says that for 10 years after his company entered the business, sales were limited to law-enforcement agencies. Two years ago, Mosler decided to sell also to "licensed detectives." The reason: "mainly that the field is spreading into industry now."

This infinite resolution multi-turn pot does not depend on a fragile wire... 100,000,000 revolution life!

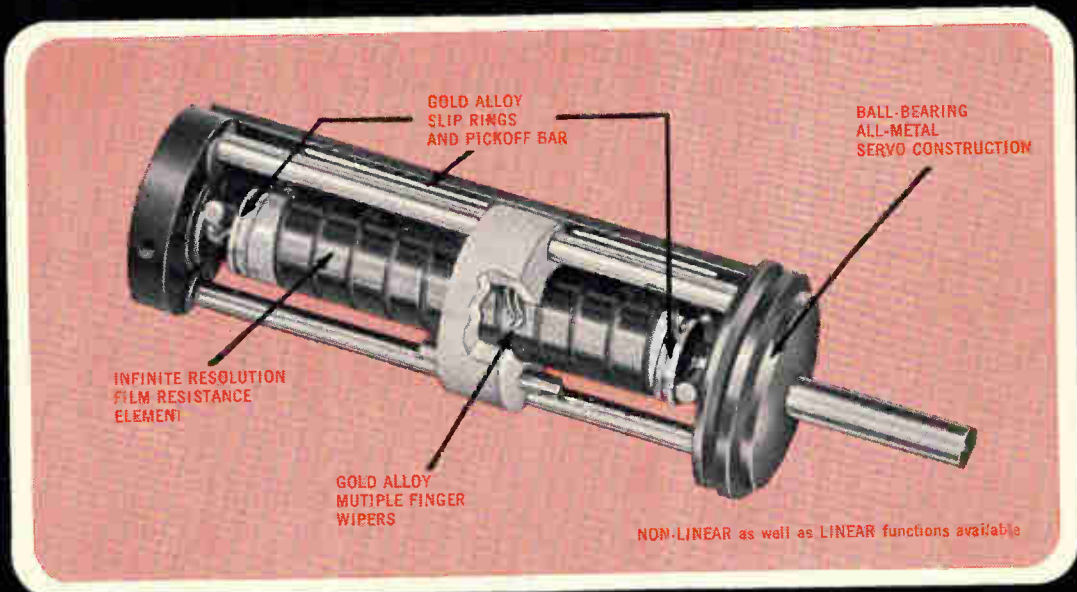

Only CIC pots use multi-fingered, precious metal wipers contacting a broad-band, continuous film resistance element, providing infinite resolution and high reliability through the inherent fail-safe properties of this design. The mirror-smooth surface of the resistance element permits the use of light pressure, low mass wipers with individual fingers tuned to different natural frequencies, giving long life, even under the most severe environmental conditions.

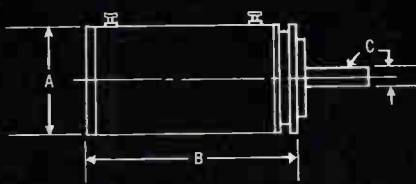

SPECIFICATIONS FOR 10-TURN MODELS

MODEL No.	0010	7810	7812	200010
A	.50	.875	.875	2.0
B	1 1/2 Max.	1 3/4 Max.	1 1/4 Max.	2 5/8 Max.
C	.0957 .0921	.1875 .1870	.1250 .1245	.2500 .2495
BEST LINEARITY	0.075%	0.025%	0.05%	0.01%



COMPUTER INSTRUMENTS CORPORATION
86 MADISON AVENUE, HEMPSTEAD, L.I., N.Y. / 516 IV 3-8200













■ Please send me, without obligation, the C.I.C. catalog.
(All information must be filled in below.)

Name _____
 Position _____
 Company _____
 Address _____

**If you can find one resistor
that's best for all precision applications**

...buy it

**...don't think you will.
That's why we make all these different types...can recommend without bias**

 <p>MOLDED DEPOSITED CARBON Low cost, most popular MIL-R-10509</p>	 <p>COATED DEPOSITED CARBON Industry's first precision film, MIL-R-10509</p>	 <p>MOLDED METAL FILM Best MIL-R-10509 performance, hi-rel option</p>	 <p>COATED METAL FILM Smallest size resistor for MIL-R-10509</p>
 <p>ULTRA RELIABILITY METAL FILM MIL-R-38101, Minuteman .0001%/1000 hr.</p>	 <p>HIGH RELIABILITY METAL FILM MIL-R-55182, 4 sizes, glass-hermetic</p>	 <p>LOW COST METAL FILM 100 ppm T.C. Molded or coated types</p>	 <p>MINIATURE METAL FILM Saves space, 1/20 watt, 1% tolerance</p>
 <p>PRECISION POWER WIREWOUND Miniature, 1/2 to 15 watts, 25 ppm T.C.</p>	 <p>ENCAPSULATED WIREWOUND MIL-R-93, humidity and shock resistant</p>	 <p>UNENCAPSULATED WIREWOUND Instrument grade, low cost Wirewound stability</p>	 <p>MATCHED METAL FILM Matched to 3 ppm T.C. and/or .02% tolerance</p>

Write for Precision Resistor Selection Chart...complete data in handy 11" x 17" size



INTERNATIONAL RESISTANCE COMPANY

PHILADELPHIA, PA. 19108

Triacs switch to higher voltages

Now rated at 240v, they simplify circuitry and are virtually immune to line transients

Triac a-c semiconductor switches now are available for use in 240-volt lines. The Triac (a coined name for the three-electrode, a-c device) has previously been available for 120-volt 60-cycle applications.

The new gate-controlled Triac is designed for static switching and phase control in many light industrial and consumer products, such as commercial and consumer lamp dimmers, electric dryers, ranges, washers, washer-dryer combinations, heat pumps, humidifiers, room air conditioners, wall and warm air furnaces, business machines and commercial cooling equipment.

The Triac makes possible much simpler control circuitry than silicon controlled rectifiers. For example, in both static switching and manual full-wave phase control circuits, the Triac makes possible a three-to-one component reduction. This circuit simplicity is extremely important, according to the manufacturer, because it gives designers who may never have worked with solid state control before the confidence to use a Triac control circuit.

Triac is suited for static switching primarily because it offers longer life than relays. In phase control, the Triac makes possible reductions in size, weight and installed costs, as compared to thyristors, adjustable transformers, saturable reactors and magnetic amplifiers.

The Triac is in effect a power integrated circuit, consisting of a pnpn switch in parallel with an npnp switch, together with an npnpn gating region. It performs like two scr's in an inverse-parallel connection, but is virtually immune to line transients which might damage unprotected silicon controlled rectifiers. The Triac generally does not require protective circuitry.

Minimum breakdown voltage in



either direction is ± 400 v. Two rms forward current ratings are available: 6 amperes—models SC40D (stud-mounted) and SC41D (press-fit); and 10 amperes—SC45D (stud-mounted) and SC46D (press-fit).

The 6-ampere devices can handle a tungsten lamp load of 1,200 w, a resistance load of 1,440 w and a one-cycle surge current of 50 amps peak. The 10-ampere units

can handle a lamp load of 2000 w, a resistance load of 2400 w and a peak one-cycle surge current of 80 amps.

The new Triacs are priced at from \$3.72 for the SC41D to \$5.60 for the SC45D in 100-lot quantities. Engineering samples are available immediately; quantities in 60 days.

General Electric Co., Schenectady, N.Y.
Circle 349 on reader service card.

DTL circuits for use in commercial computer

The WC-200 series is said to be the electronics industry's first line of diode-transistor logic (DTL) integrated circuits for commercial computer applications. Typical performance characteristics of the new line include switching times of 25 nsec, power consumption of 7.5 mw and fanout of 11 per gate function. Fanout per gate function is the output capacity of a single

gate in terms of the number of gates it, in turn, can drive. The operating temperature range of the new commercial WC-200 line is 0° to 75°C. The new circuits are available in the standard glass Kovar G style flatpack $\frac{1}{4}$ in. by $\frac{1}{8}$ in. with 14 leads, and in type TO packages. Prices of the commercial integrated circuits range from \$3.70 to \$9.50 per unit, depending on their complexity.

Westinghouse Electric Corp., Box 2278, Pittsburgh, Pa. 15230.

Circle 350 on reader service card

...and for twice the power from Mobile Communications Equipment, without radical design changes, there's the new Amperex 8458



Xenon flash tube aids laser pumping

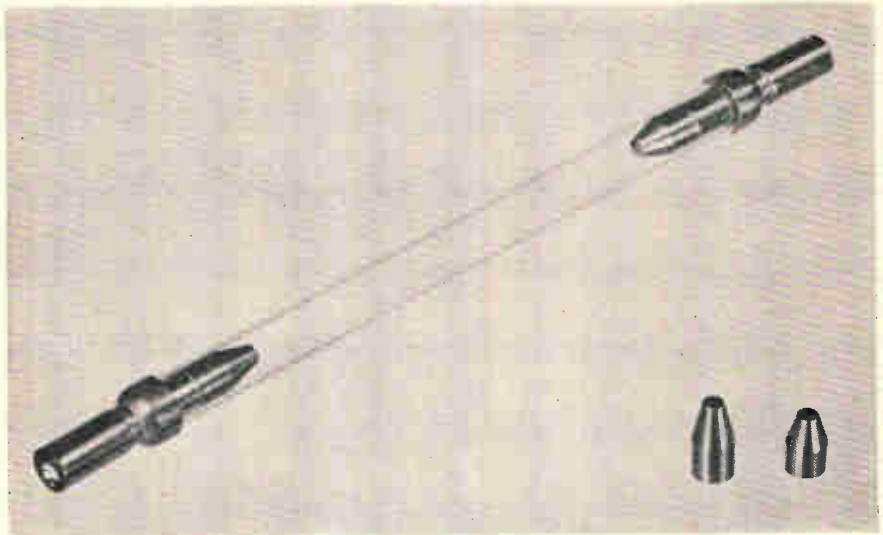

The C3-601 is a linear xenon flash tube that is particularly useful for laser pumping and other applications requiring a high speed, high energy light source. It has a 600 joules/pulse input capability and spectral characteristics closely approximating natural sunlight. Important advantages of the tube include concentric arc electrodes that localize the arc in the center of the quartz envelope and guard against quartz devitrification at electrode contacts. Also featured are improved electrode feedthroughs that

are specially treated copper connectors designed for optimum electrode heat sinking. Maximum operating voltage is 3,000 v; maximum average power, 70 w; low firing voltage, 900 v; minimum life at maximum power in free air, 5,000 flashes; light output at maximum power, 2750 horizontal candlepower seconds; flash rate, 6 per minute; typical arc resistance at peak current, 0.3 ohm.

Xenon, Inc., 10 Wheeler Court, Watertown, Mass. [351]

Ceramic capacitors come in small packages

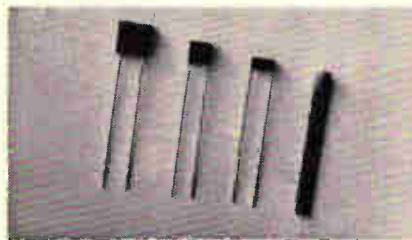

A complete line of general-purpose ceramic capacitors has been designed for miniature and subminiature electronic packaging. The capacitors are produced from Neolythic ceramic, a new poly-

planar dielectric construction resulting from a new processing of modified barium titanate. The Neolythic construction affords a smaller package size to capacitance ratio than previously available in the capacitor industry, according to the manufacturer. The featured product in the line is the new Nailhead case size (0.2 in. by 0.1 in. by 0.1 in.). This capacitor, the EPC04, has a capacitance range of 10 pf to 0.027 μ f. Series EPC Neolythic ceramic capacitors are designed for use in filters, coupling networks, phase shifting and most general-purpose circuitry found in commercial, industrial and military applications. They are available in radial-lead, epoxy-encased rectan-



If the world renowned Amperex 6360 is—as virtually all designers of mobile communications equipment agree—a truly great tube, its new derivative, the Amperex 8458 is an even greater one! For in addition to the great performance, great low-profile convenience, and great reliability of the earlier twin tetrode, the new 8458 can be counted on to deliver 30 watts of useful power at 175 Mc from less than 1.2 watts of drive power.

To drive the 8458, Amperex has developed a second new twin tetrode, the 8457, a 13.5 volt heater version of the 6360. It is ideally suited for use as a cascaded doubler-multiplier, driving the 8458 as a straight-through amplifier in the 150-175 Mc band. This combination of new Amperex tubes provides extremely stable power output under low voltage conditions, since more than sufficient drive is available. Because the profile heights of these two new tubes are identical with the older 6360, modification of existing circuit designs can be made with resulting improved power and performance.

Both tubes incorporate a 13.5 volt center-tapped heater; are internally neutralized and have indirectly heated oxide-coated cathodes.

8458 SIGNIFICANT CHARACTERISTICS CLASS C RF AMPLIFIER AT 175 Mc

	CCS	ICAS
DC Plate Voltage	400	450 volts
DC Grid No. 2 Voltage ..	155	200 volts
DC Grid No. 1 Voltage ..	-59	-50 volts
DC Plate Current	85	110 ma
Useful Power Output . . .	20	30 watts
Drive Power	1.0	1.2 watts

Both the 8457 and 8458 are immediately available in production quantities from stock.

For complete data on these and other Amperex tubes for mobile communications applications, write: Amperex Electronic Corp., Tube Division, Hicksville, L. I., New York 11802.

Amperex®

IN CANADA: PHILIPS ELECTRON DEVICES LTD., TORONTO 17, ONT.

KLIXON
CIRCUIT BREAKERS

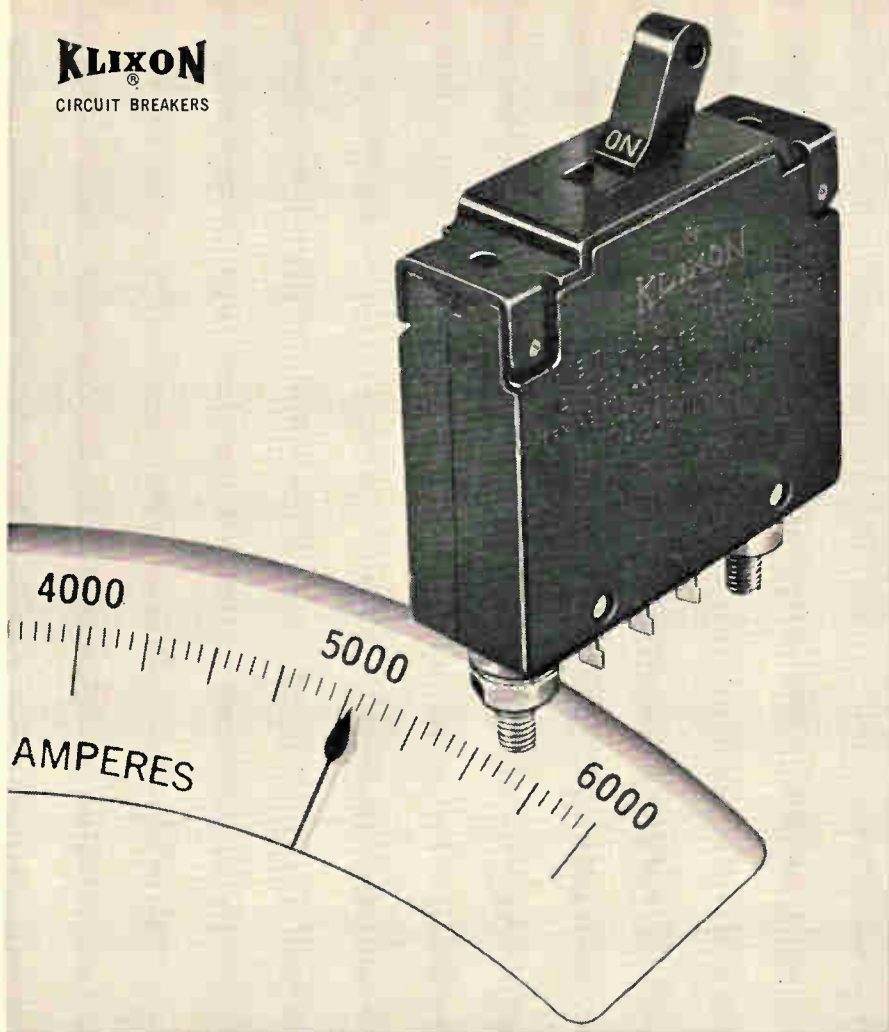

When magnetic circuit breakers must have high rupture capacity ...TI DELIVERS!

KLIXON® 4MC Series Magnetic Circuit Breakers are unique! They combine high rupture capacity — up to 5000 amp at 32 v-dc — with power dissipation 20% less than any other units in the 0.050 to 50 amp range.

Wide choice of design options! The 4MC Series are the only circuit breakers of their type with optional built-in switches for remote indication. Two types of tripping action are also available: time delay to prevent nuisance tripping on transient overloads; instantaneous tripping on overloads greater than 125%.

Bulletin CIRB-31 gives you complete details. Get a copy from your distributor or TI in Attleboro, Mass. For immediate information call: Harold Damberg, Sr. Product Engr. at 617-222-2800.

DISTRIBUTORS

CALIFORNIA, Culver City
Western Electromotive, Inc.

FLORIDA, Miami
Aviation International Corp.

ILLINOIS, Chicago
Newark Electronics

MASSACHUSETTS, Canton
Engineering Supply Company

MASSACHUSETTS, Natick
Lafayette Industrial Electronics

MISSOURI, Kansas City
Engineering Supply Company

NEW YORK, Lynbrook, L. I.
Peerless Radio Corp.

OHIO, Cleveland
Pioneer-Standard Electronics, Inc.

OHIO, Dayton
SREPCO, Inc.

OKLAHOMA, Tulsa
Engineering Supply Company

OREGON, Portland
Almac Electronics Corp.

TEXAS, Dallas
Engineering Supply Company

TEXAS, Houston
Engineering Supply Company

WASHINGTON, Seattle
Almac Electronics Corp.

KLIXON
CONTROL PLANTS IN
Attleboro, Mass. • Versailles, Ky.
Richmond Hill, Ontario
Holland • Italy • Australia
Argentina • Brazil • Mexico



METALS & CONTROLS INC.
5004 FOREST ST., ATTLEBORO, MASS.
A CORPORATE DIVISION OF
TEXAS INSTRUMENTS
INCORPORATED

New Components

gular, as well as axial-lead round tubular configurations. All series EPC Neolythic ceramic capacitors meet or exceed the electrical and environmental specifications of MIL-C-11015.

Electron Products, 1960 Walker Ave., Monrovia, Calif. [352]

Class E relays plug into p-c boards

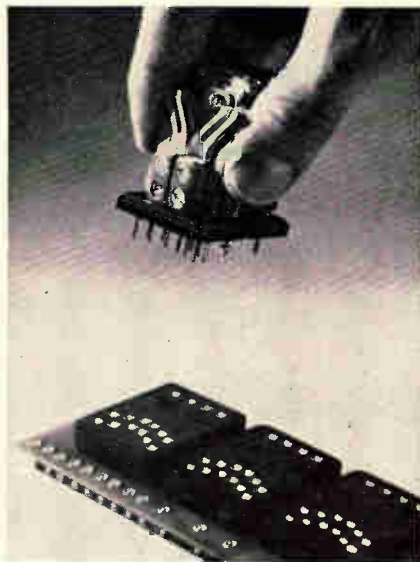

A socket now available gives plug-in convenience to Class E relays, when used for printed-circuit board applications. The terminals of the series ETA socket are plugged in and soldered to the p-c board. Matching PC terminals of the Class E relays can then be inserted into the socket, rather than into the circuit board itself, thereby eliminating the need for soldering, and providing for instantaneous removal and replacement. Although Class E relays with p-c terminals are not new, no convenient method for removal and replacement was ever devised, according to the manufacturer. The ETA socket which accommodates a series EPC relay with either a single- or double-wound coil, and up to 4C spring combinations, now make this possible. Also available, to complete the package, are a protective plastic cover, a cover retaining clip, a terminal reinforcement plate, and two locking pins to hold the relay

secure against shock and vibration. The relay may be stored and inserted into the socket with cover fully in place as a protection against damage until placed in service.

Automatic Electric Co., a subsidiary of General Telephone & Electronics, Northlake, Ill., 60164. [353]

Snap-action switch rated at 20 amps

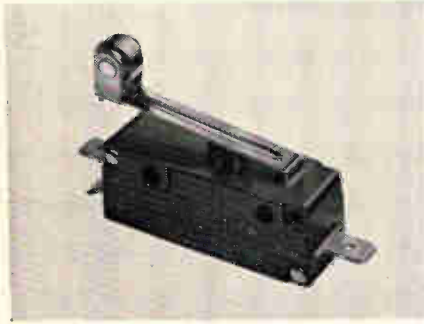

Series 2600 snap-action switches feature differential travel of less than 0.005 in. Median life exceeds 500,000 operations at full load, and these switches are UL listed at 20 amps, 125-250 v a-c, 1 hp 125 v a-c, 2 hp 250-v a-c. Nine standard actuator variations and spdt, spst normally open or spst normally closed models are available. McGill Mfg. Co., Valparaiso, Ind. [354]

Easily removable indicator light



A nylon-encased pilot light has been designed for installation and removal from the front of panels. Measuring only 3/8 in. wide (lens) by 1 1/2 in. in length, the Ampillum indicator light is available with either flush-mount or raised lens in five standard neon colors: natural,

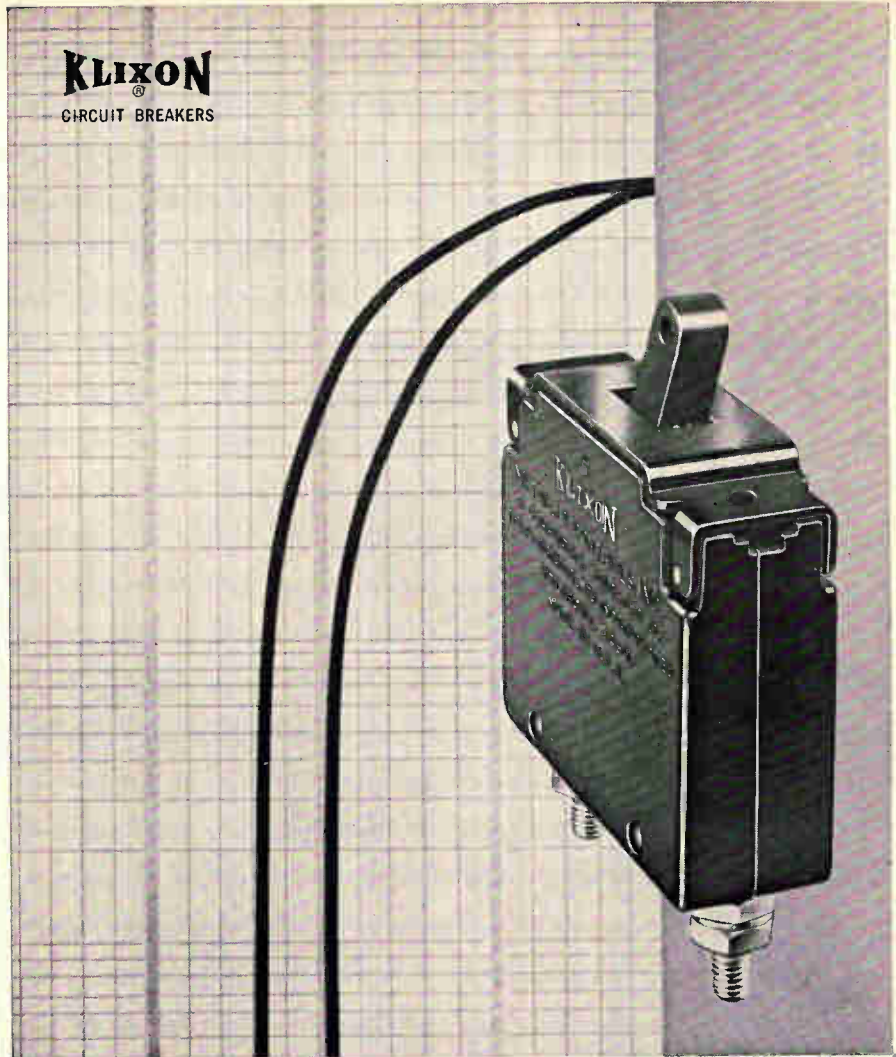

When magnetic circuit breakers must have low power dissipation ...TI DELIVERS!

Power dissipation is 20% less than with other units in the 0.050 to 50 amp range, when you specify KLIXON® 4MC Series Magnetic Circuit Breakers for protection of circuits and components against current surges, transients, sustained overloads and short circuits. Moreover, rupture capacity is high . . . up to 5000 amp at 32 v-dc.

Other desirable features include: optional built-in switches for remote indication or control; trip-free operation; 5 to 15 ms response at 200% rating; 10,000 mechanical cycles at 100% rating; off-the-shelf delivery of most types from distributors.

Bulletin CIRB-31 gives you the whole story. Get a copy today from your distributor or TI in Attleboro, Mass. For immediate information call: Harold Damberg, Sr. Product Engr. at 617 222-2800.

DISTRIBUTORS

CALIFORNIA, Culver City
Western Electromotive, Inc.

FLORIDA, Miami
Aviation International Corp.

ILLINOIS, Chicago
Newark Electronics

MASSACHUSETTS, Canton
Engineering Supply Company

MASSACHUSETTS, Natick
Lafayette Industrial Electronics

MISSOURI, Kansas City
Engineering Supply Company

NEW YORK, Lynbrook, L. I.
Peerless Radio Corp.

OHIO, Cleveland
Pioneer-Standard Electronics, Inc.

OHIO, Dayton
SREPCO, Inc.

OKLAHOMA, Tulsa
Engineering Supply Company

OREGON, Portland
Almac Electronics Corp.

TEXAS, Dallas
Engineering Supply Company

TEXAS, Houston
Engineering Supply Company

WASHINGTON, Seattle
Almac Electronics Corp.

KLIXON
CONTROL PLANTS IN
Attleboro, Mass • Versailles, Ky.
Richmond Hill, Ontario
Holland • Italy • Australia
Argentina • Brazil • Mexico



METALS & CONTROLS INC.
5004 FOREST ST., ATTLEBORO, MASS.
A CORPORATE DIVISION OF
TEXAS INSTRUMENTS
INCORPORATED

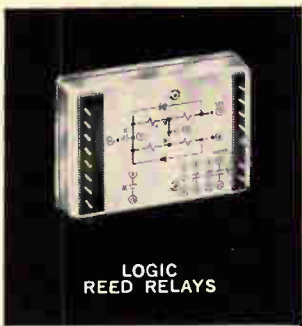

LOGIC REED RELAYS

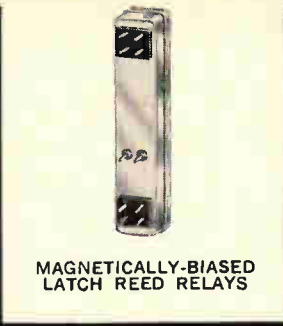

MAGNETICALLY-BIASED LATCH REED RELAYS

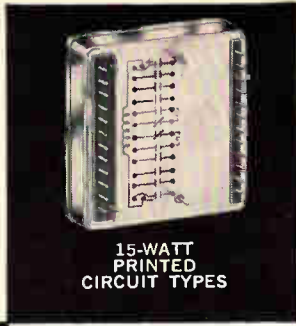

15-WATT PRINTED CIRCUIT TYPES



CROSSPOINT REED RELAYS



MINIATURE 1-2 POLE PC TYPES



4-WATT, 1-12 POLE MOLDED REED RELAYS



"TRUE" FORM C REED RELAYS . . . many styles.



CUSTOM PACKAGING to individual requirements

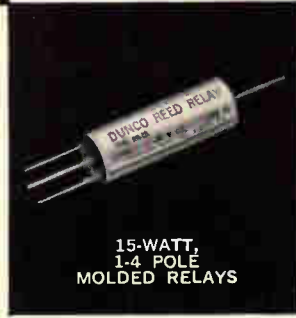

15-WATT, 1-4 POLE MOLDED RELAYS

New Components

red, yellow, amber and orange. The wedge-type construction of the housing permits the Ampillum to be snapped into a 0.312 in. diameter mounting hole on the panel without the need for mounting hardware or tools. The one-piece panel indicator light is designed with integral 125 v or 250 v a-c neon lamps rated for 25,000 hours at nominal voltage. (Incandescent models are available on special order). Six-inch leads, stripped on the free ends, are supplied with each unit. The smaller-than-standard size of the 312 series Ampillum and the ease of installation are said to make it ideal for use in test equipment and other applications where space is a restricting factor.

AMP, Inc., Harrisburg, Pa. [355]

Stable transformers meet MIL-T-27B



New, multitapped reference transformers are rugged, hermetically sealed units manufactured and guaranteed to MIL-T-27B. Input is 27 v at 400 cycles. The output ranges from 0.01 v to 0.32 v with 15 voltage taps on secondary. Output is tapped at 0.010 v, 0.031 v, 0.134 v, 0.155 v, 0.176 v, 0.196 v, 0.217 v, 0.238 v, 0.258 v, 0.300 v, 0.320 v, with 100,000 ohms load. These transformers are of extremely stable design with a total full load tolerance of only $\pm 0.1\%$. They are both electrostatically and magnetically shielded to nullify interference. The transformers are mu-metal encased and MIL rated

Name your REED RELAY!

If you don't find it at Struthers-Dunn, chances are you won't find it anywhere. Here's an idea of the range of standards and specials available to you in the world's broadest line. Save time! Try us *first!*

LEARN MORE! Write today for Reed Relay Catalog C.

STRUTHERS-DUNN, Inc.

Pitman, New Jersey 08071

tel: 609-589-7500

twx: 609-589-1548



SALES ENGINEERING OFFICES IN: Albuquerque • Atlanta • Belmont, Calif. • Boston • Buffalo
Charlotte • Cincinnati • Clearwater, Fla. • Cleveland • Clifton • Dallas • Encino • Englewood
Glen Ellyn, Ill. • Houston • Kansas City • Memphis • New York • Phoenix • Pittsburgh • St. Louis
St. Paul • Salt Lake City • San Antonio • Seattle • Southfield • Wichita • Wilmette. Canadian Licensee:
Renfrew Electric Co., Ltd., Toronto. Export Department 1505 Race St., Philadelphia, Penna. 19102, U.S.A.

to operate at 105°C for 10,000 hours. They are tested at 500 v to assure reliability. Units are MIL type TF4RX01AH. Case size is 1 $\frac{5}{16}$ in. by 1 $\frac{5}{16}$ in. by 1 $\frac{3}{4}$ in. high. Weight is 5 oz.

United Transformer Corp., 150 Varick St., New York, N.Y., 10013. [356]

Power relay features auxiliary contacts

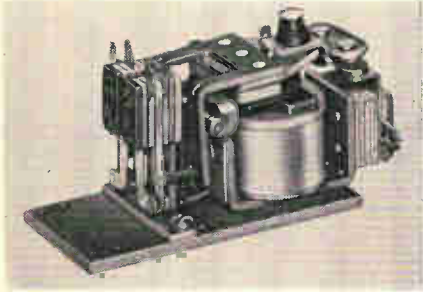

To provide auxiliary control in combination with power switching, spst double-break, normally open 50-amp power contacts are combined with 5-amp dpdt contacts in a new relay, designated type 88D. The heavy-duty silver cadmium oxide, gold flashed, 50-amp contacts are mounted on special contact arms that provide positive contact wiping action as contacts make and break. The high reliability relay structures includes an exclusive, low friction, pin type armature hinge design for uniformly high contact pressure and long service life. The 5-amp auxiliary contacts are silver cadmium oxide and can be supplied in combinations to two pole, double throw. The relays are available for a-c operation to 230 v and d-c to 110 v.

Magnecraft Electric Co., 5565 N. Lynch, Chicago, Ill., 60630. [357]

Precision resistors have varied dimensions



High-speed, subminiature precision wire-wound resistors are available. They can be supplied in a variety

MODULES POTTED IN

TIMONIUM

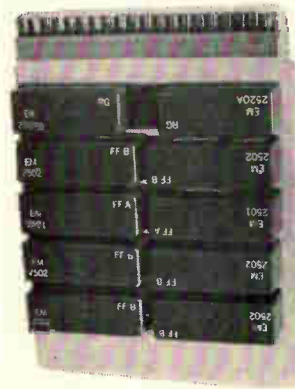

DUAL DECADE COUNTER

Comprises two independent counter chains which can be used in a variety of counter modes. Basic configuration consists of two separate decade counters with reset capability; however, for applications such as digital clocks, "divide-by" functions other than 10 can be provided.

- Standard digital module families to 250 KC and 2 MC
- Power supplies
- Special function boards
- Specialized designs at "off-the-shelf" cost and delivery

EMC

ELECTRONIC
 MODULES
 CORPORATION

1949 GREENSPRING DRIVE • TIMONIUM, MD.
 CLEARBROOK 2-2900 TWX-301-252-0723

MUCON LEADS in the RACE for SPACE



When it comes to space
scrimping

Try TIGHT FITTING

SLIM-CAPS SUBMINIATURE CERAMIC CAPACITORS

.060 MAXIMUM DIAMETER

Working voltage 25 VDC. W.E.P.A.
Spec. 102 nickel leads available for
welding.

26 STOCK VALUES

Part No.	Capac. mmf.	Tol.	Max. Body Length
SC-1	1.0	±25%	.100"
SC-2.5	2.5	±25%	.100"
SC-5	5.0	±25%	.100"
SC-7.5	7.5	±25%	.100"
SC-10	10	±25%	.100"
SC-15	15	±25%	.100"
SC-22	22	±25%	.100"
SC-33	33	±25%	.100"
SC-47	47	±25%	.100"
SC-68	68	±25%	.100"
SC-82	82	±25%	.100"
SC-100	100	±25%	.100"
SC-150	150	±25%	.100"
SC-220	220	±25%	.200"
SC-330	330	±25%	.200"
SC-470	470	±25%	.200"
SC-680	680	±25%	.200"
SC-820	820	±25%	.200"
SC-1000	1000	±25%	.200"
SC-1500	1500	±25%	.200"
SC-2500	2500	±25%	.250"
SC-3300	3300	±25%	.250"
SC-4000	4000	±25%	.250"
SC-5000	5000	±25%	.250"
SC-7500	7500	±25%	.250"
SC-01	10000	±25%	.250"

Republic Electronics makes a broad
line of Mucon Subminiature Ceramic
Capacitors to meet any requirement.

Write for Catalog "A."

REPUBLIC ELECTRONICS CORP.

176 E. 7th ST., PATERSON, N. J. 07524
201-279-0300

New Components

of dimensions ranging from 0.093
in. by 0.188 in. to 0.5 in. by 0.2 in.
The resistors are fully encapsulated
and designed to meet the require-
ments of MIL-R-93-C. Tempera-
ture coefficients are in the order of
2 ppm/°C with matching tempera-
ture coefficients of 1 ppm/°C. Long
term stability is 0.0025%. Shunt
capacitance is as low as 0.2 pf,
dependent upon size and value. The
units are suitable for cord-
wood packaging for use in high-
speed switching circuits.

Marstan Electronics Corp., 135 Albany
Ave., Freeport, L.I., N.Y. 11520. [358]

Thermistor operates at high temperature

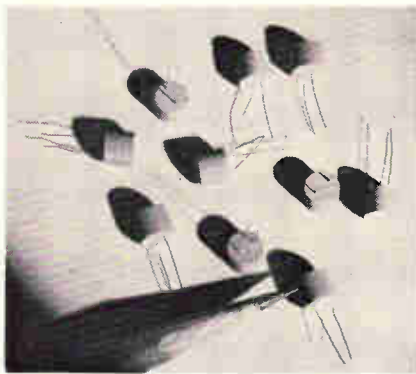

The 1100-Plus is said to be the first
thermistor to provide strong elec-
trical signals in ambient tempera-
tures up to 1,600°F. The device is
expected to find wide use by manu-
facturers of thermal controls. Based
on a tin oxide system, the thermis-
tor is 3/8 in. in diameter by 3/8 in.
thick with 1/2 in. platinum lead
wires. Its response time and sta-
bility over the range of conditions
encountered in appliance applica-
tions are compatible with sensors
now used. In addition, ratings can
be varied by changing the size of
element or type of encapsulation.
The strong signal and solid state
nature of the device are expected
to reduce the cost of control sys-
tems in appliance manufacture.
The standard 1100-Plus elements
are available from stock for test or
evaluation. Shipment for product
quantities is in 8 to 10 weeks, and
prices are competitive with those of



WHERE QUALITY COMES FIRST

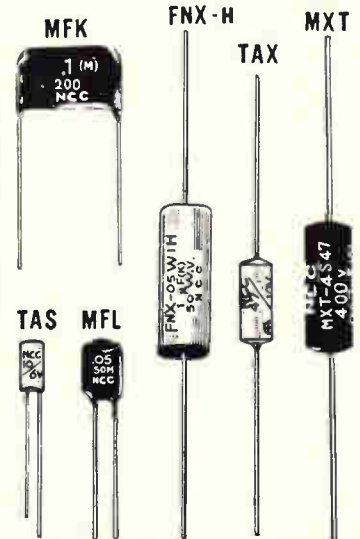

POLYESTER FILM CAPACITOR:

	Capacitance Range:	Voltages
TYPE MFL Dipped Flat Shape	.001 MFD to .47 MFD	35, 50, 100, 200V.DC
TYPE MFK Dipped Flat Shape Non-Inductive Construction	.01 MFD to .22 MFD	100, 200, 400, 800V.DC
TYPE MXT In Plastic Tube	.001 MFD to .22 MFD	100, 200, 400, 800V.DC

METALLIZED POLYESTER FILM CAPACITORS

TYPE FNX-H Mylar Wrapped Semioval With Epoxy End Seal	1 MFD to 10 MFD	50v.DC.
---	-----------------	---------

SOLID TANTALUM CAPACITORS

TYPE TAX MIL-C-26655A Hermetically Sealed	1 MFD to 220 MFD	3, 6, 10, 15, 20, 25, 35v.DC
TYPE TAS Sealed with Epoxy Resin	1 MFD to 220 MFD	3, 6, 10, 15, 20, 25, 35v.DC

MATSUO ELECTRIC CO., LTD.

HEAD OFFICE :

3-5, 3-CHOME, SENNARI-CHO, TOYONAKA-SHI,
OSAKA, JAPAN.

TOKYO OFFICE :

25-2, CHOME, KANDA AWAJI-CHO, CHIYODA-KU,
TOKYO, JAPAN.

Cable Address "NCC MATSUO" OSAKA

other thermostatic devices used by the appliance trade.
The Carborundum Co., Niagara Falls, N.Y. [359]

Deflection yoke features large i-d

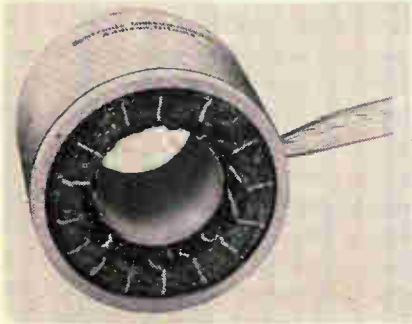

A 60° deflection yoke, type Y66, has been designed for 2 1/8-in. neck diameter Charactron crt's and precision displays. Close angular tolerances for the display arc made possible by precise yoke construction. Twisting or distortion of characters in alphanumeric displays is negligible. The Y66 has minimum LI² (energy stored in magnetic field), fast recovery, ultimate focus, low residual magnetism and minimum stray fields. It is available with push-pull or single-ended windings in a wide range of impedances for solid state or vacuum tube circuitry. High speed cores, for random access computer read-outs and other high speed applications, can be supplied if required. Delivery is three to four weeks. Price is under \$275.

Syntronic Instruments, Inc., 100 Industrial Road, Addison, Ill. [360]

Magnet actuates control switch

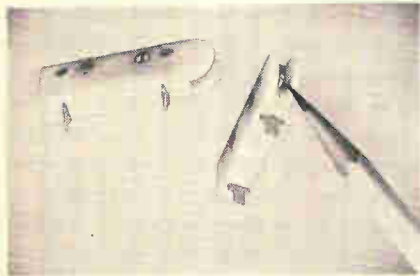

The explosion-proof Seal-X is a magnetic switch for any control application. It is an spst, Form A

PUBLIC SERVICE
PARIS

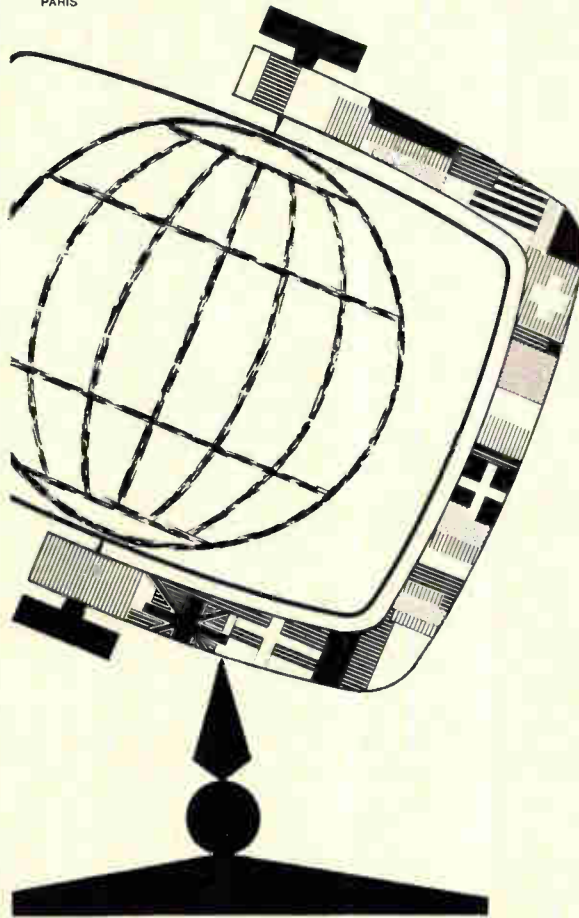

All the great names will be there . . . and you wouldn't?

INTERNATIONAL SHOW RADIO TELEVISION

from 9 to 19 September 1965

PARIS

(Porte de Versailles—Hall Monumental)



For information on the
International Show Radio-Television

please return questionnaire to:
SDSA, 16 rue de Presles, PARIS 15e—Tel.273.24-70

Mr. (please print)

Company

Complete address

Products manufactured

Signature

Undersigned's position in the firm

Suppress lead wire errors

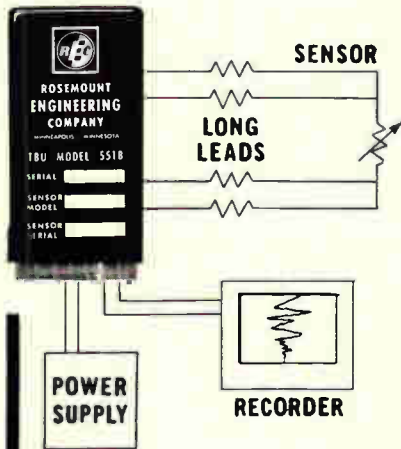

Now you can make accurate resistance temperature measurements even with long, unequal lead wires. The REC Triple Bridge Unit:

- Suppresses lead resistance changes to 5 ohms.
- Suppresses variable or unequal resistances.
- Trims out calibration differences.
- Provides standardized 10 mv. DC output.

Single units or 10 TBUs and power supply are packaged for standard 19" rack. Multiple units provide convenient change of temperature ranges and sensors. Write for Bulletin 6612.

A complete precision line

Rosemount designs and manufactures high quality precision equipment in these lines:

- Air data sensors
 - Total temperature
 - Pitot-static (de-iced)
- Immersion temperature sensors (including cryogenic)
- Surface temperature sensors
- Pressure transducers
- Accessory equipment
- Aeronautical research

For more information please write for the REC catalog. Specific questions welcomed.



**ROSEMOUNT
ENGINEERING
COMPANY**

4900 West 78th St. • Minneapolis 24, Minn.

New Components

reed capsule actuated by the movement of a permanent magnet. The magnet is controlled by a spring-loaded button, which may be actuated by push buttons, mechanism encoders, levers, solenoids, or any other device capable of exerting a 2- to 6-oz force over a distance of $\frac{3}{8}$ in. The small, versatile Seal-X is packaged in a high impact-resistant nylon fiberglass case designed for multiple mounting. Model C-6501 has a case with guides on both sides of the push-button mechanism. Model C-6502 does not have guides. The long-life switch is designed for electric keyboards, control panels, r-f band switching, microphones, and telephones. Life expectancy is in excess of 100 million operations. Contacts are gold alloy for low resistance. Open switch capacitance is 0.2 pf, max. Operating speed is up to 100 cps. Switching voltage is 150 v max with power up to 10 va. Model C-6501 measures 1.640 in. long by $\frac{1}{2}$ in. wide by $\frac{1}{4}$ in. deep, not including terminals. Model C-6502 is 0.483 in. long by $\frac{1}{2}$ in. wide by $\frac{1}{4}$ in. deep, not including terminals, which extend 0.113 in. beyond the width.

James Electronics, Inc., 4050 N. Rockwell St., Chicago, Ill., 60618. [361]

Tiny lever switch has a 30° throw



A subminiature lever switch, type 184, is engineered for applications requiring precision two- or three-position switching. The new Acorn, featuring a switching section only 1 in. in diameter, has been devel-

oped to provide the original equipment manufacturer flexibility and reliability in a compact lever switch. Using a newly developed coil spring and star wheel cam mechanism to assure positive indexing, the new switch can be fabricated so that the lever will either index to both sides or provide a momentary spring return to the off or neutral position. Only $1\frac{1}{8}$ in. high and $\frac{1}{2}$ in. wide, the new lever switches can be mounted in groups, either vertically or horizontally. The switch has a 30° throw and sections are available with up to 22 clips. Switch sections can be made with glass silicone stator and Kel-F rotor or the manufacturer's new molded diallyl-phthalate stator and phenolic rotor. Price is \$1.20 each in quantity, with delivery normally made about six weeks after receipt of order.

Oak Mfg. Co., a division of Oak Electro-Netics Corp., Crystal Lake, Ill., 60014. [362]

Transducer withstands rugged treatment

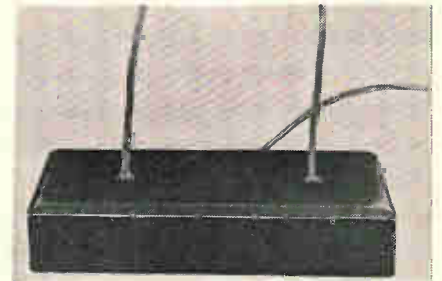

A new Electrosonic BAR transducer has been developed for use in ultrasonic cleaning devices that require extreme operating environment conditions and demand high reliability. It can perform continuously for over 3,000 hours. It can be operated while undergoing rapid temperature cycling. Capable of being started at 0°F, it can be heated instantly to 212°F. The reverse temperature-shift can also be used. This transducer can be operated under air-loading for a short time and will withstand violent physical punishment including extended periods of vibration and the impact of dropping to a concrete floor from 10 feet or more. Linden Laboratories, Inc., P.O. Box 302, State College, Pa. 16801. [363]

Photocircuits can solve your PRINTED CIRCUIT PROBLEMS

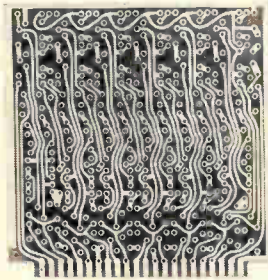

*Here are the solutions
to some typical problems
we have recently received.*

SOLDERABILITY TROUBLE

PROBLEM: We manufacture low-cost radios and intercoms. In the past 6 months, soldering problems have substantially increased manufacturing costs, through excessive inspection and touch-up time required after wave soldering. Nothing seems to help. Have you a suggestion?

SOLUTION: The new CC-4 printed circuit process may be your solution. This patented technique deposits ductile copper which, according to one user's letter, "solders like a dream." As to cost-cutting — customers report an up-to-80% reduction in after-soldering touch-up and inspection costs as a result of CC-4 using printed circuits.

MINIATURIZING WITH MULTILAYER

PROBLEM: Five years ago we considered converting some of our miniaturized designs to incorporate your newly-developed multilayer printed circuits. We found the price too high. Has today's price-picture changed?

SOLUTION: The situation has changed radically. Chances are the cost of what you need would be about 50% lower today — although an exact figure would be unrealistic without seeing your actual boards. Multilayer use is increasing so rapidly that we anticipate another 50% cost reduction during the coming year. *Caution:* Be sure not to compare the cost of one 8-layer multilayer to just the piece-cost of four two-sided boards with an equal interconnection capability. Many manufacturers adopt multilayers after an analysis of system interconnection costs, including such factors as eliminated hardware, reduced assembly labor, and lower inspection expense — all important cost-cutting advantages of using multilayer printed circuits.

HOW DO PERSONNEL GET PRINTED CIRCUIT KNOW-HOW?

PROBLEM: We are diversifying into a type of equipment requiring printed circuits. None of our engineers is very familiar with

them. Our men are faced with specifying printed circuit base materials, platings and tolerances. How can we train some of them so they can intelligently design and specify printed wiring boards?

SOLUTION: Our Standard Circuit Division was specifically set up to help medium-quantity users of printed circuits who need to cut through time-consuming procurement procedures. It manufactures a range of boards with a limited number of choices of such variables as base materials, platings, tolerances, etc. These can be combined to fulfill a wide variety of manufacturing requirements — with the least possible loss of time, and at the lowest possible cost. The Standard Circuit Division greatly simplifies your procurement, permits a minimum of paperwork, reduces board costs and delivery times, and completely eliminates tool charges! It even permits published price lists, so you can figure your own printed circuit costs in advance.

PRINTED CIRCUIT PATTERNS FROM PENCIL SKETCHES

PROBLEM: Our Drafting Department prepares our printed circuit artwork-masters from pencil sketches provided by Engineering. Every time we have a rush program, the workload in Drafting always seems to be abnormally heavy and we fall 2 or 3 weeks behind schedule waiting for artwork. Is there a way to get printed circuit patterns faster?

SOLUTION: Oversized master artwork for printed-circuit patterns is not only slow, but subject to error — and unnecessary! The Master Circuit System, developed by Photocircuits, converts an engineer's pencil-sketch into accurate 1:1 circuit patterns quickly and inexpensively, by means of recently-developed automatic equipment. Documentation is greatly simplified, too. Photocircuits' six MCS machines can handle over 300 patterns per week, to handle your rush requirements. Incidentally, the Master Circuit System slashes time and costs for multilayer artwork even more drastically.

*(If you have a problem in printed
circuitry, let us hear from you.)*

 **Photocircuits**
CORPORATION
Glen Cove, New York • Anaheim, California



MICROWAVE SWITCHES VARIABLE ATTENUATORS

- 500 mc to 12.4 gc frequency range
- High Isolation
- Extremely low insertion loss

The hpa 3500 Series of Microwave Switches is ideal for such applications as ECM receiver switching and low-power antenna switching in phased arrays. Completely solid state, this single-pole, single-throw switch features a switching speed of 300 nsec open to closed, 100 nsec closed to open. As variable attenuators the hpa 3500 Series can be used for power leveling and signal modulation applications. Size is 1 1/8" x 1" x 3/4". Price: \$275.

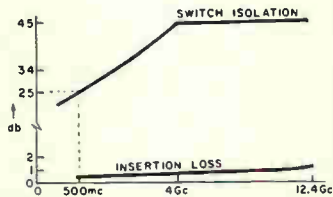

Write for more information.



hp associates
620 PAGE MILL ROAD,
PALO ALTO, CALIF. 94304,
(415) 321-8510

An Affiliate of Hewlett-Packard Co.

New Instruments

Capacitance/inductance meter

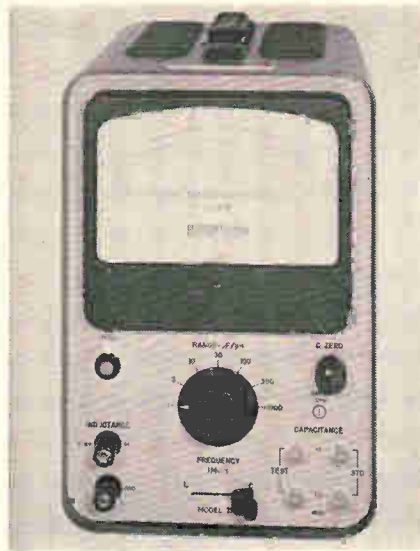

Model 71A provides accurate, high resolution measurements of capacitance and inductance with a speed and convenience comparable to that of voltage readings with a vtm. The instrument's measuring capabilities of 0 to 1,000 pf and 0 to 1,000 μ h are covered in seven ranges in a 1-3-10 sequence and measurements are directly read from the meter, which has a 6-in. mirror scale.

The internally supplied 1-Mc test signal is crystal controlled. The instrument operates with low test levels as required for many semiconductor measurements. Terminals at a rear panel permit application of an externally supplied d-c bias up to ± 200 v to the test specimen.

Linear d-c output is proportional to the meter reading; this output extends the range of application beyond laboratory measurements to include production testing as well as a variety of control functions.

Used in conjunction with such accessories as the model 52B d-c voltage comparator or the model 53A miniature voltage comparator, the model 71A provides high speed automatic go/no-go testing with provision for control of materials handling equipment. Connected to a digital voltmeter with binary coded output, facility for both

digital readout and data logging is provided.

Used with appropriate capacitive or inductive transducers, the model 71A serves as the read-out device in the measurement of a wide variety of quantities, and provides means for a number of process control functions. Price is \$675. Boonton Electronics Corp., Parsippany, N.J. 07054. [381]

Impulse magnetizers for heavy-duty use

A new line of impulse magnetizers is now in production. All units store electrical energy in a large capacitor bank. Assemblies are magnetized by discharging the capacitors through an ignitron tube (for unidirectional current flow) into an external magnetizing fixture. Users of permanent magnets normally purchase the permanent magnet material in a fully de-magnetized condition. This eliminates handling problems in their assembly operations and keeps the magnets from picking up magnetic particles and dirt. After final assembly, the permanent magnet portion of the assembly must be magnetized. The new magnetizers do this. A suitable magnetizing fixture is connected to the front panel terminals; the



SIMPLEST ...

MOST EFFICIENT ...

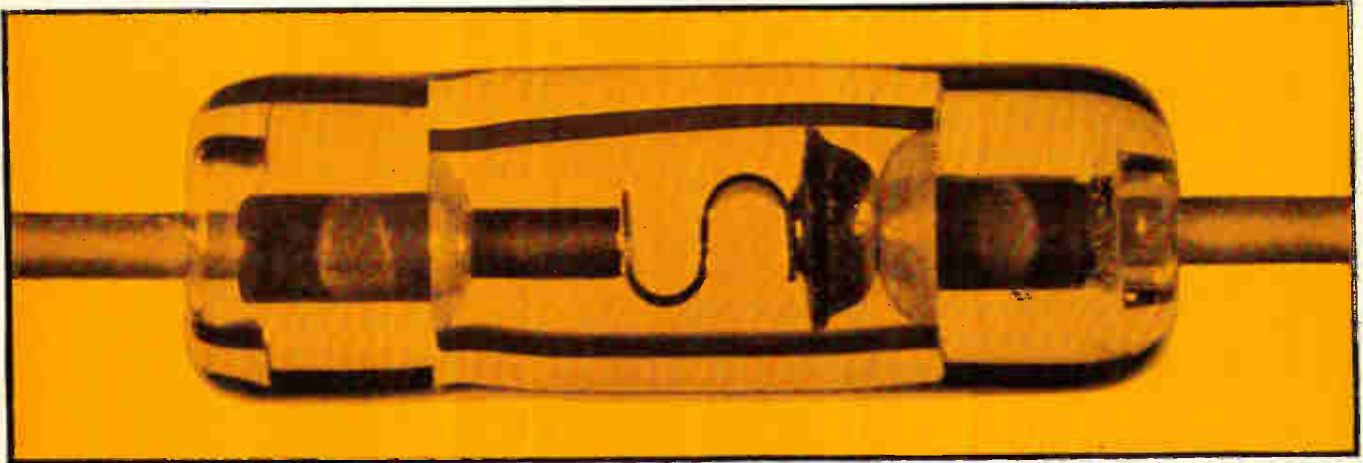

Two Terminal – Solid State *MEMORY*

ITT SEMICONDUCTORS

FOUR-LAYER DIODES

Basic Alarm Circuit

Figure 1 shows a basic alarm circuit that lights a signal lamp when either a momentary or a steady alarm condition occurs. This circuit eliminates contact chatter problems and allows low power circuits to energize high current lamps.

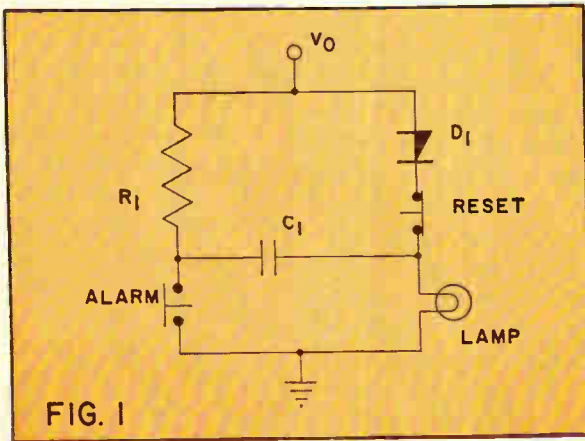

FIG. 1

How It Works

The operating cycle for the circuit is as follows: In the pre-alarm condition, C_1 charges up to the supply voltage (V_0). The switching voltage (V_s) of the 4-layer diode (D_1) is selected to be greater than V_0 and less than $2V_0$. D_1 is OFF in the pre-alarm condition. When a momentary or a continuous alarm condition occurs, the normally open alarm contacts close. These can be mechanical, electro-mechanical or electronic, as long as point "A" of C_1 is grounded, momentarily, so as to drive D_1 above V_s . D_1 turns ON and switches the supply voltage across the signal lamp. The holding current of D_1 (I_h) is selected to be less than the current required by the signal lamp. When the alarm condition is corrected, the normally closed reset contacts are opened and the circuit returns to its original state.

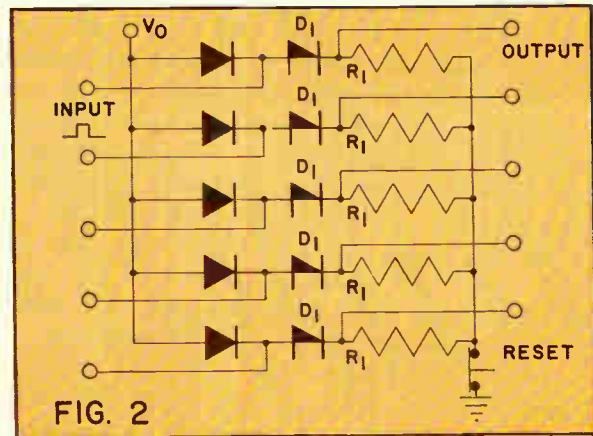

FIG. 2

Storage Circuit

The use of 4-layer diodes in a basic memory or storage circuit is shown in figure 2. A momentary pulse on any of the inputs will produce a DC level change at any of its outputs until the entire memory is reset by interrupting a single circuit.

Operation

The switching voltage of the 4-layer diodes is selected to be greater than the supply voltage (V_0). A momentary positive pulse on any of the input lines will turn ON the associated 4-layer diode which will conduct through R_1 . The positive output level developed across R_1 will remain until all the 4-layer diodes are reset by opening the common return circuit.

Write for additional application information including design data for alarm circuits, memory units, core drivers, etc. Ask for bulletin E-507. ITT Semiconductors Division, International Telephone and Telegraph Corporation.

semiconductors division



WEST PALM BEACH, FLORIDA . . . SHOCKLEY LABORATORIES. PALO ALTO CALIFORNIA . . . LAWRENCE, MASSACHUSETTS

From EG&G...
2 new cold cathode
**TRIGGER
SWITCH TUBES**



KN-6B Krytron

A new 10 KV hold-off tube. Capable of switching in less than 0.1 μ sec. Small and extremely rugged. Applications: switching gallium arsenide cells for solid state lasers, discharging spark chambers, nanosecond pulse generators, radar beacon modulators, triggering xenon flash tubes and triggered spark gaps. Eight other types of Krytrons are also available.



KN-12 Krytron

A cold cathode, radiation-hardened vacuum switch tube for Exploding Bridge Wire systems used in missile stage separation, motor ignition, etc. Switches in less than 1 μ sec. Requires no filament power.

For high peak current requirements of up to 3000 amps, and short anode delay times of less than 1 μ sec., EG&G offers a complete line of cold cathode trigger tubes. These feature: dark/cold starts, instant firing keep-alive, high hold-off voltage, negligible jitter, wide ambient temp. range, rugged and reliable design. For complete information, write Edgerton, Germeshausen & Grier, Inc., 160 Brookline Avenue, Boston, Massachusetts 02215, or phone 617-267-9700. Cable address: EGGINC, Boston.



New Instruments

assembly to be magnetized is placed in the fixture, and the capacitors are discharged, causing the assembly to be fully magnetized. Use of short, heavy current pulses means that smaller, lighter equipment can be used to magnetize a given size assembly than would be the case if a d-c electromagnet were used. Further, in many cases, where magnetic field shape is complex, no d-c electromagnet could be adapted to do the job. With impulse magnetizing, the complex shapes become routine, using simple wire coils and steel keepers. The units are designed for heavy duty, industrial use. Silicon high-voltage rectifiers are used in conjunction with heavy duty power transformer and charging resistors. Discharge is through a suitably rated ignitron tube. Relays used are plug-in types for easy maintenance. Greenville Electronics Co., 418 W. Cass St., Greenville, Mich. [382]

Multimeter offers digital presentation

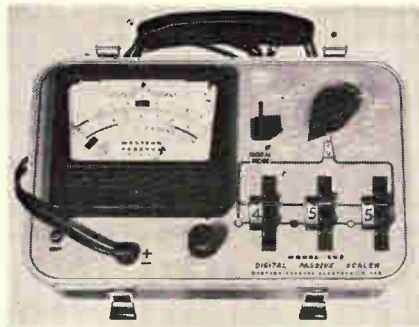

This first of a new generation of instrument applies program techniques to manual measurements. Called the digital passive scaler concept, the new equipment is said to virtually eliminate misinterpretation in a passive measurement system having inherent accuracies expressed as a percent of indicated value. The first of the new devices is a three-significant-figure digital for the measurement of d-c and a-c voltage from 0.1 to 1,000 v in 4-decade ranges; d-c current from 10 μ a to 10 amps in 6-decade ranges; and resistance from 1 ohm

DC POWER SUPPLIES

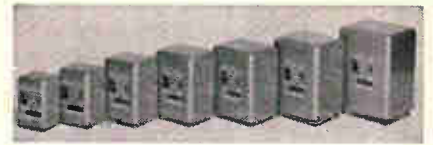

CONTINUOUS VOLTAGE COVERAGE—4.7 to 60 vdc.
Input: 105-125 vdc, 50-400 cps
Regulations: From $\pm 0.05\%$
Ripple: From .002% or 1 mv, rms
Temp. Coeff.: From $\pm 0.01\%/^{\circ}\text{C}$
Voltage Adjustments: $\pm 5\%$
Max. Temp. of Base: 65 $^{\circ}\text{C}$

- WIDE VARIETY OF CURRENT RATINGS
- ELECTRONIC SHORT CIRCUIT PROTECTION
- FULLY REPAIRABLE
- 7 STANDARD SIZES (OVER 450 MODELS)
- PRICE RANGE **\$45-\$225**



INSTRUMENTS: EEM ('63-64 Pg. 902)
EBG (1964 Pg. 462)
POWER SUPPLIES: EEM ('64-65 Pg. 1341)
EBG (1963 Pg. 307)
VOLTAGE STANDARDS: EEM ('64-65 Pg. 929)



390 CAPITOL AVE., HARTFORD, CONN.
Circle 210 on reader service card

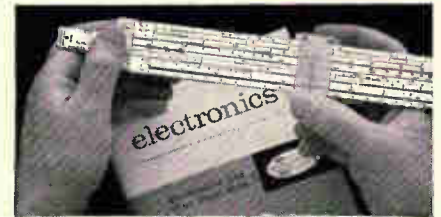

**NEW!
ELECTRONICS SLIDE RULE
WITH INSTRUCTION COURSE**

Professional, all-metal 10" slide rule . . . designed specifically for engineers and technicians. Comes with four lesson AUTO-PROGRAMMED Instruction Course. Carries special scales to speed solution of reactance and resonance frequency problems. Has handy decimal point locator plus widely use formulas and conversion factors not found on any other rule. Can be used for conventional computation, too. Made to our rigid specs by Pickett, Inc. Rule, AUTO-PROGRAMMED Instruction Course and top-grain leather case . . . just \$14.95. Satisfaction warranted of your money back. Cleveland Institute of Electronics, 1776 E. 17th St., Dept. E-104, Cleveland, Ohio 44114.

SEND COUPON TODAY

Cleveland Institute of Electronics

1776 E. 17th St., Dept. E-104, Cleveland, Ohio 44114

- Send FREE brochure only . . . without obligation.
- Send Electronics Slide Rule with Instruction Course and leather case. I'm enclosing \$14.95.

Name _____
(Please Print)

A leader in Electronics Training . . . since 1934

THINK COPPER...for high-performance alloys

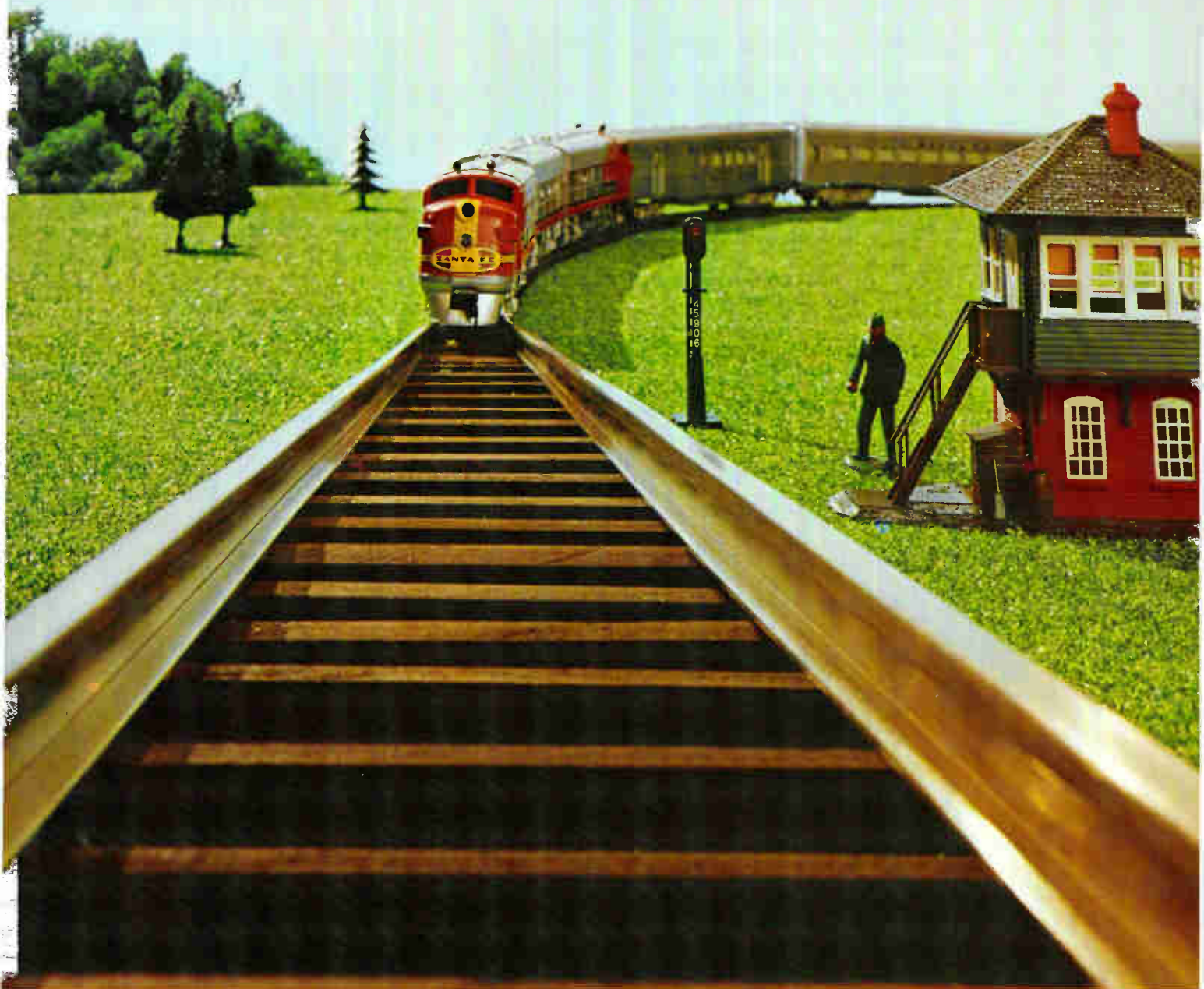

Electricity travels first class via modern coppermetals

Tiny printed circuit or giant bus bar—modern coppermetals developed at Anaconda's Research and Technical Center have what it takes to carry current best. In addition, today's conductive copper alloys offer the electrical/electronic designer a full range of physical and mechanical properties—almost limitless combinations to meet your most sophisticated design requirements.

When you think electrical conductivity, think copper. And take a fresh look at the versatile, high-performance alloys Anaconda offers today.

64-0962

ANACONDA[®]
AMERICAN BRASS COMPANY

Think copper. And when you do...

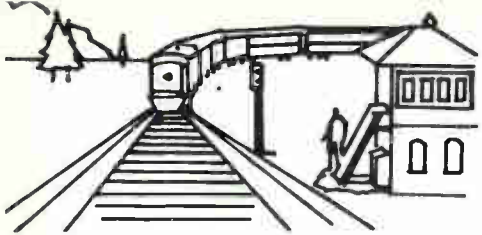

... THINK ANACONDA

for the broadest range of copper alloys and sizes and for experienced technical services



liquid-cooled hollow conductors

To meet needs of heavy current density applications, especially where space limitations confront the designer, Anaconda provides liquid-cooled hollow conductors in a wide variety of sizes, types and cross sections.

Among recent advances made possible by conductors of this type are high-field magnets for basic research, synchrotrons and other particle accelerators for atomic studies, bus systems for electromechanical operations requiring currents of 100,000 amp or more, and silicon-diode rectifier heat sinks.

With water-cooled conductors in stator bars, ratings of turbo-generators have been increased $2\frac{1}{2}$ times without increasing the floor space they occupy.



"ELECTRO-SHEET" for R.F.I. shielding

Economical Anaconda "Electro-Sheet" copper foil is proving itself to be highly effective in radio frequency interference (R.F.I.) shielding applications.

One recent series of tests (complete data on request) followed the procedures of MIL-Std-285. Over the entire frequency spectrum, copper foil by Anaconda showed attenuation characteristics as good as those of copper mesh and galvanized steel.

"Electro-Sheet" is available in long lengths and easily joined widths from 6" to 64". Joints are simpler to make and more dependable than those made in other shielding materials. In addition, this low-cost copper foil is readily bonded to a variety of building materials, using any of a number of different types of adhesives.



conductive and springable coppers

Some coppermetals have extraordinary springability. Duraflex® superfine-grain phosphor bronze, for example. In special fatigue-test apparatus, Duraflex contact springs were deflected at 1 cps from the initial free position to 77,000 psi bending stress. After 4,000,000 deflections—no permanent set, no loss of load, no breakage.

In applications where cost is an important factor, check the performance of Ambronze 430—one of the most economical of the fine spring alloys available from Anaconda. Its average electrical conductivity: 27% IACS. Its modulus of elasticity in tension: 16,050,000 psi hard, 17,300,000 annealed.

ANACONDA[®]
AMERICAN BRASS COMPANY



THE HOUSE YOUR NEEDS BUILT

Since its establishment in 1961, Anaconda's impressive Research and Technical Center has been dedicated to finding new ways for coppermetals to serve you better.

The results? New alloys. New mill forms. A new world of facts about coppermetals and their unique capacity for meeting industry's fast-changing needs.

Here is the taproot of Anaconda technical assistance in the field.

If there is a coppermetal answer to your problem, the man from Anaconda has it or can get it for you quickly through the Research and Technical Center. Anaconda field metallurgists are ready to serve you in offices from coast to coast.

Write today for handy, helpful technical information on any of the following alloys and products:

Liquid-cooled hollow conductors
Electro-Sheet
Spring alloys

Anaconda American Brass Company, Waterbury, Connecticut 06720. In Canada: Anaconda American Brass Ltd., New Toronto, Ontario.

64-0952

New Instruments

to 1 megohm in 6-decade ranges. Model 300 features long-term stability, simplicity of operation, multifunction capability and freedom from power-line isolation. Anyone can dial and read it accurately within 1% of numerical indication with precise repeatability, according to the manufacturer. In addition to digital, this new equipment provides conventional analog display as a search mode. A fail-safe protection system safeguards against accidental overload. A controlled power ohmmeter is absolutely safe for semiconductor circuit measurements and a Wheatstone bridge provides precise resistance measurements. Priced at \$350, the instrument is said to show great promise to fit the gap between conventional analog multimeters and the expensive, sophisticated digitals.

Western Reserve Electronics, Inc., 12430 Euclid Ave., Cleveland, Ohio 44106. [383]

Pulse converter tests microwave receivers



An economical source of fast rise r-f pulses is available for microwave receiver testing. Model 45 converts a conventional pulse generator to provide 60 Mc r-f pulses with envelope rise and fall times of 0.1 μ sec. No battery or 120 v a-c power is required since the energy of the 10-v input signal itself is converted to provide the 60 Mc output. Input and output impedances are 50 ohms and output level is 0 dbm into a 50-ohm load. The center frequency is trimmer adjustable $\pm 10\%$. Single pulses, double pulses, complex pulse trains, or a

continuous d-c level can be applied to the input with a corresponding 60 Mc result at the output. Model 45 is ruggedly built in a heavy duty drawn aluminum housing with BNC connectors at each end. Overall size, not counting connectors, is 2½ by 2½ by 4 in. Price is \$89.50. Arvee Engineering Co., 11263 Washington Blvd., Culver City, Calif. [384]

All-solid-state frequency standards



A quartz oscillator with frequency drift specified less than 5 parts in 10^{11} in 24 hours is announced. Short term stability for models 106A and 106B quartz frequency standards is 1.5 parts in 10^{11} for periods as short as 0.1 sec. Sinusoidal output frequencies of 5 Mc, 1 Mc, and 100 kc are available from both models; these are buffered so that load changes from open to short circuit will affect the output by less than 2 parts in 10^{11} . The heart of these oscillators is an extremely stable 2.5 Mc quartz crystal mounted with other critical components in a proportionately controlled double oven. An external voltage, connected to the oscillator, can be used to provide a fine adjustment of output frequency. The usual coarse and fine mechanical adjustments are also provided. The all-solid-state frequency standards also feature very high spectral purity. The company says the exceptional spectral purity of the 5-Mc output invites compound frequency multiplication. Spectra only a few cycles wide may be attained, even after multiplication well into the Gc region. Possible applications for the oscillator include microwave spectroscopy, analysis of oscillator

PORTABLE LONG-TERM RECORDER HAS REAL-TIME PLAYBACK



Model 17373
LT/FM*
Recorder/
Reproducer

Weighing only 35 pounds, Geotech's Model 17373 Recorder/Reproducer provides highest quality recording for laboratory or field applications. This suitcase-size LT/FM* unit records 7 channels of low-frequency data on a 14" reel of 1/2" tape continuously for 10 days. Operating speed is IRIG-standard 15/160 ips.

Real-time playback at ultra-slow-speeds, an LT/FM exclusive advantage, permits monitoring while recording and makes possible exact signal reproduction. Dynamic range equal to that obtained in audio frequencies is produced by this unique flux-responsive playback system. Because drift compensation is not required, all channels are available for recording on a full-time basis.

All electronics are solid state. Power requirements: 24 volts dc, center tapped; ac optional.

PRICE: \$8,750, FOB Dallas.

SPECIFICATIONS

Model	17373
(1) Tape Speed	15/160 ips
Channels	7
FM Data Frequency Range	dc-17 cps
FM Center Frequency	84.4 cps
Recording Time	10 days
(2) Playback Channels	1
(3) Dynamic Range	40 db
(4) Power Consumption	9 watts

- (1) Speeds from .03 through 0.1 ips available on special order.
- (2) Switchable to any recorded channel.
- (3) RMS basis, without compensation.
- (4) 7 channel record, 9 watts; 7 channel record and 1 channel playback, 12 watts.

* Long-Term/Frequency Modulation

THE GEOTECHNICAL CORPORATION

DEPT. 45 • BOX 28277
DALLAS, TEXAS 75228
PHONE 214 • BR 8-8102



"Geotech Serves
the Sciences"

New Instruments

and multiplier spectra, satellite doppler shift measurements, advanced communications and navigation systems, and as a high-stability frequency source for use in primary frequency and time standard systems.

Hewlett-Packard Co., 1501 Page Mill Road, Palo Alto, Calif. [385]

R-f millivoltmeter features portability

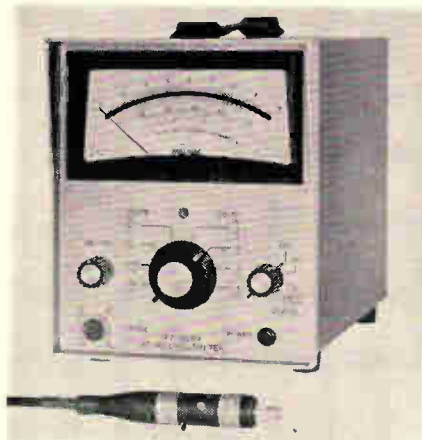

A truly portable r-f millivoltmeter is announced. Due to its solid-state circuitry, there is no warm-up time or heat rise. The instrument operates on internal nickel cadmium batteries with built-in charger. It also operates on line voltage of 115/230 v a-c, 50 to 1,000 cps. Measuring range is 1 mv to 3 v full scale (lowest reading, 200 μ v), with 100/1 divider to 300 v full scale. Frequency response is 10 kc to 1.2 Gc. Model MV-928A is priced at \$775.

Millivac Instruments, Inc., P.O. Box 997, Schenectady, N.Y., 12301. [386]

Accurate and sensitive milliwatt/wattmeter

A newly designed milliwatt/wattmeter features an accuracy approaching that of a dynamometer, with sensitivity, burden, power factor and frequency response comparable to that of an electronic wattmeter. This performance is attributable to a simple design uti-

we are your best bet
for electronic materials

"What did you say?" "WE SAID, WE ARE YOUR BEST BET FOR ELECTRONIC MATERIALS!"

We are a primary fabricator and supplier of high purity metals and alloys, compound semiconductors and thermoelectric cooling materials.

PHONE AREA CODE 509 747-6111

TWX 509-328-1464 Telex 032 610

IMMEDIATE SHIPMENT BY AIR PRE-PAID

COMINCO PRODUCTS, INC.

electronic materials division

818 West Riverside Ave.,
Spokane, Washington 99201

5603

Circle 212 on reader service card

NORTON Magnetic Tape Heads



SERIES 5500

- CROSSTALK—40DB
- +75°C Temperature Operation

Send now for complete technical literature.

NORTON

ASSOCIATES, INC.

240 Old Country Road, Hicksville, N. Y.

lizing two field-proven proprietary developments: the Transquare true rms transducer, and the bifilar suspension meter movement. These combine to assure high accuracy, long term stability, and trouble-free operation. Available as a single or multiple range instrument, the a-c milliwatt/wattmeter has frequency response from 30 cps to as high as 15 kc, with negligible burden—in some cases as low as 1 millivolt-ampere; sensitivity of 10 mw; and a wide operating power factor range of unity to as low as 10%; accuracy is $\pm 1\%$ full scale. Prices start at \$1,500 and vary according to particular specifications. Greibach Instruments Corp., 315 North Ave., New Rochelle, N.Y. [387]

Crystal-controlled frequency standard



A new portable, crystal-controlled frequency standard provides frequencies ranging from 0.5 cps to 600 kc. Model CU-2 multiple frequency standard features an accuracy of 0.0005%. Frequency selection is by means of a 13-position selector switch and a 4-decade multiplier switch. Output voltage is a square wave with amplitude adjustable to 20 v peak-to-peak. Both single ended and balanced output signals are provided. Model CU-2 is designed for calibration and test use wherever precision reference or clock frequencies are needed. It replaces both the variable oscillator and frequency counter normally used, and eliminates the time required to adjust and monitor these instruments. The unit is packaged in a 7 in. by 7 in. by 12 in. case complete with carrying handle. Unit price is \$670.

Anadex Instruments Inc., 7833 Haskell Ave., Van Nuys, Calif. [388]

TAKE YOUR PICK . . .



EVERY ONE HAS A VOLTAGE TOLERANCE OF ± 1 VOLT

Typical Characteristics			Some Proven Applications
	Z82R10	Z100R10	
BREAKDOWN VOLTAGE DC (in Dark or Light) MAX	115	150	Reference Voltage Sources Regulated Power Supplies Oscilloscope Calibrators Photo Multipliers Zener Diode Voltage Sources Digital Voltmeters Timing Circuits Overvoltage Protection Suppressed Zero Voltmeters Frequency Dividers Indicating Voltmeters
REFERENCE VOLTAGE (measured at)	82 ± 1 (2.0 MA)	100 ± 1 (3.0 MA)	
VOLTAGE REGULATION (variation in reference voltage exhibited by individual tube) LESS THAN 1 VOLT CHANGE FROM	0.3 to 10.0 MA	0.6 to 12.0 MA	
TEMPERATURE COEFFICIENT (TYPICAL)	-2mv/°C	-9mv/°C	
LIFE EXPECTANCY (hours)	30,000 hours	30,000 hours	
Tentative specifications subject to change without notice.			

The above specifications represent only 2 of the 19 different voltage regulator tubes available. Other voltages available are 82, 91, 100, 103, 105, 110, 115, 139 and 143. For more detailed specifications, write for Signalite Application Newsletter Supplement #1 or contact us and describe your particular applications. If there is a glow lamp to meet your needs, we'll have it. If there isn't, we can design it.

Signalite INCORPORATED
NEPTUNE, NEW JERSEY • AREA CODE 201-775-2490 • TWX 201-775-2255



High-level logic integrated circuits

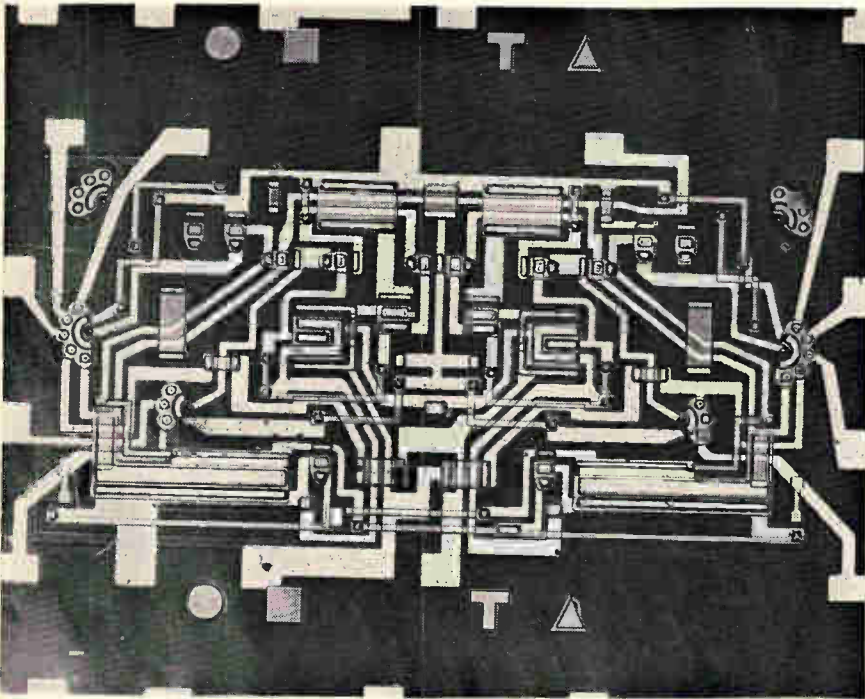

A new series of 20-Mc flip-flops now available allows up to three inputs at J and K terminals for AND logic and triggers on clock pulses as narrow as 20 nsec. The new devices are said to be the result of more than a year of extensive research, engineering and close liaison with systems designers.

The SF-50 J-K flip-flop series is expected to simplify many systems problems. Up to 20% fewer cans are required while maintaining the high speed, noise immunity, fan out, capacitance drive and low power characteristics of the SUHL

(Sylvania universal high-level logic) line of integrated circuits. The new flip-flops have three J and K terminals that can be used as data inputs. They also provide the AND function right at the input to the flip-flop so that external gates normally required in J-K type circuits are not necessary. Through the use of a charge storage diode and a charge control transistor, the SF-50 series J-K flip-flops can operate with clock trailing edges as long as 200 nsec.

Sylvania Electric Products Inc., 100 Sylvan Road, Woburn, Mass. [371]

Integrated logic microcircuits

A new line of integrated logic microcircuits for commercial and industrial applications carry type numbers HMC-1001, HMC-1002 and HMC-1003. They are fabricated within monolithic silicon substrates using advanced planar epitaxial techniques. Thermal com-

pression bonding at the substrate is accomplished with aluminum to aluminum connectors made possible by the company's aluminum to silicon bonding process. The microcircuits are available in modified 10-lead JEDEC TO-5 Koldweld seal structures. The HMC-1001, -2 and -3 function respectively as a NAND/nor gate, line driver and binary element. Prices for the 1001 are \$15.60 for 1 to 99 and \$12.50 for

Available at these Distributors

EAST

BINGHAMTON, N. Y.—Federal Electronics
P. O. Box 208/PI 8-8211
PHILADELPHIA 23, PENN.
Almo Industrial Electronics, Inc.
412 North 6th Street/WA 2-5918
PITTSBURGH 6, PENN.—Radio Parts Company, Inc.
6401 Penn Ave./361-4600
NEWTON 58, MASS.—Greene-Shaw Company
341 Watertown Street/WO 9-8900
CLIFTON, N. J.—Eastern Radio Corporation
312 Clifton Avenue/471-6600
NEW YORK 36, N. Y.—Harvey Radio Company, Inc.
103 West 43rd Street/JU 2-1500
BALTIMORE 1, MD.—Radio Electric Service Company
5 North Howard Street/LE 9-3835

SOUTH

BIRMINGHAM 5, ALA.
Forbes Distributing Company, Inc.
2610 Third Avenue, South/AL 1-4104
WEST PALM BEACH, FLA.—Goddard, Inc.
1309 North Dixie/TE 3-5701
RICHMOND 20, VA.—Meridian Electronics, Inc.
1001 West Broad Street/353-6648

MIDWEST

BATTLE CREEK, MICH.—Electronic Supply Corporation
94 Hamblin Ave./P.O. Box 430/965-1245
MINNEAPOLIS 62, MINN.—Admiral Distributors, Inc.
5333 Cedar Lake Road/545-0223
INDIANAPOLIS 25, IND.
Graham Electronics Supply, Inc.
122 South Senate Avenue/ME 4-8486
CLEVELAND 1, OHIO—The W. M. Pattison Supply Co.
Industrial Electronics Division
777 Rockwell Avenue/621-7320
CHICAGO 30, ILL.—Merquip Electronics, Inc.
4939 North Elston Avenue/AV 2-5400
CINCINNATI 10, OHIO—United Radio, Inc.
1308 Vine Street/241-6530
KANSAS CITY 11, MO.—Walters Radio Supply, Inc.
3635 Main Street/JE 1-7015
ST. LOUIS 17, MO.
Electronic Components for Industry Co.
2605 South Hanley Road/MI 7-5505

WEST

DALLAS 1, TEXAS—Adleta Company
1907 McKinney Ave./RI 1-3151
HOUSTON 1, TEXAS—Harrison Equipment Company, Inc.
1422 San Jacinto Street/CA 4-9131
SAN DIEGO 1, CAL.
Electronic Components of San Diego
2060 India Street, Box 2710/232-8951
LOS ANGELES 15, CAL.—Radio Products Sales, Inc.
1501 South Hill Street/RI 8-1271
LOS ANGELES, CAL. 90022—Kierulff Electronics
2585 Commerce Way/OV 5-5511
MOUNTAIN VIEW, CAL.—Kierulff Electronics
2484 Middlefield Road/968-6992
DENVER, COLO.—L. B. Walker Radio Company
300 Bryant Street/WE 5-2401
SEATTLE 1, WASH.—C & G Electronics Company
2221 3rd Avenue/Main 4-4355
PHOENIX, ARIZ.—Midland Specialty Co., Inc.
1930 North 22nd Ave./258-4531
ALBUQUERQUE, N.M.—Midland Specialty Co., Inc.
1712 Lomas Blvd., N.E./247-2486
TUCSON, ARIZ.—Midland Specialty Co., Inc.
951 South Park Ave./MA 4-2315

Ask for a complete catalog

DELCO RADIO

DIVISION OF GENERAL MOTORS • KOKOMO, INDIANA

A COOL 400 V



Delco Radio's new DTS 413 and DTS 423 power transistors, are conservatively rated at 75 and 100 watts. Our standard TO-3 package assures low thermal resistance (junction to heat sink 1.0°C per watt) for cool power. The silicon element gives you high voltage protection, high frequency response and low saturation voltage.

The price is low (less than 3¢ a volt for sample quantities) for two reasons: special inter-digitated geometry of the devices and our unique 3D* process for high yields.

Now you can reduce current, the size of other components, and increase efficiency in high energy circuits. Vertical and horizontal TV outputs, for example.

Your Delco Radio Semiconductor distributor has these two new power transistors on his shelf. Call him today for data sheets, prices and delivery.

*Triple sequential diffusion

RATINGS	DTS 413	DTS 423
VOLTAGE		
V _{CEO}	400 V (Max)	400 V (Max)
V _{CEO} (Sus)	325 V (Min)	325 V (Min)
V _{CE} (Sat)	0.8 (Max)	0.8 (Max)
	0.3 (Typ)	0.3 (Typ)
CURRENT		
I _c (Cont)	2.0A (Max)	3.5A (Max)
I _c (Peak)	5.0A (Max)	10.0A (Max)
I _B (Cont)	1.0A (Max)	2.0A (Max)
POWER		
	75 W (Max)	100 W (Max)
FREQUENCY RESPONSE		
f _t	6 MC (Typ)	5 MC (Typ)

FIELD SALES OFFICES

UNION, NEW JERSEY*
Box 1018 Chestnut Station
(201) 687-3770

SANTA MONICA, CALIFORNIA*
726 Santa Monica Blvd.
(213) 870-8807

DETROIT, MICHIGAN
57 Harper Avenue
(313) 873-6560

SYRACUSE, NEW YORK
1054 James Street
(315) 472-2668

PALO ALTO, CALIFORNIA
201 Town & Country Village
(415) 326-0365

CHICAGO, ILLINOIS*
5151 N. Harlem Avenue
(312) 775-5411

General Sales Office:
700 E. Firmin, Kokomo, Ind.
(317) 452-8211—Ext. 500

DELCO RADIO

Division of General Motors

*Office includes field lab and resident engineer for applications assistance.

VACTEC

Cds or CdSe



Solves your photocell problems

This extremely compact cell was custom-designed by Vactec for a special readout and information transfer application. It combines low resistance (3-4 K Ω at 2 ft-c), and the highest possible sensitivity that could be achieved in the tiny TO-18 enclosure. These cells also provide a highly reproducible decay time.

Let Vactec design a unit for your specific application, or select from the complete standard line of cadmium sulfide and cadmium selenide photocells. They are available as low cost plastic-covered thin wafers, as well as hermetically sealed in transistor enclosures with diameters up to 1.1".

Vactec also supplies a complete line of selenium photovoltaic cells. Write for free catalog today. Specify Bulletin SPV-4 for selenium, or Bulletin PCD-3 for cadmium sulfide and cadmium selenide types.



*
Enlarged
Ten
Times

VACTEC

INC.

1209 OLIVE WAY ST. LOUIS, MISSOURI 63130
Phone Area 314, PA. 6-0633

Circle 214 on reader service card

Look to the Leader

PERMACOR[®]

For Every Electronic Powdered IRON CORE Need!...

As the world's largest producer of iron cores, Permacor has the capability and facilities to supply any requirement or meet any specification you may have.

Write for Complete Information

PERMACOR[®]

A Division of Radio Cores, Inc.

9540 Tulley Ave., Oak Lawn, Ill.
Phone: 312-GARDen 2-3353

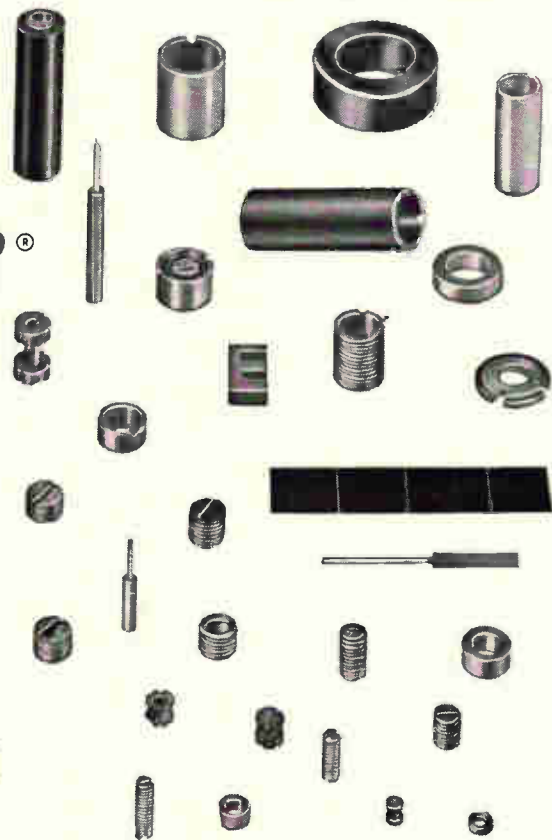

New Semiconductors

100 to 999; for the 1002, \$31.50 for 1 to 99 and \$25.20 for 100 to 999; and for the 1003, \$36.10 and \$28.90 for 1-99 and 100 to 999, respectively.

Hoffman Semiconductor Division, El Monte, Calif. [372]

Scr's can handle extra-high power



Newly developed silicon-controlled rectifiers have approximately 20% higher power handling capacity than previous models. The highest power device is rated at 1200 v prv and 470 amps rms. In a typical circuit, a pair of these scr's can control up to 300 kw of a-c power on a 480-v line. The new units also feature a 5500-amp peak one-cycle surge current rating, which is said to be 10% higher than previous models. Excellent dynamic characteristics are also featured. Especially suitable for 480-v applications, the new scr's can simplify circuitry, increase reliability, reduce power losses and improve circuit predictability. Military and industrial uses include primary phase control, a-c and d-c motor speed control, h-v crowbars, temperature control, welding control and general a-c power switching applications. The C291 series scr's feature an optional, detachable heat sink version designated the C29120. This device offers a 10% higher current capacity than other high-

power devices, thereby increasing efficiency. Rated single phase current output for the C29120 is 280 amps average at 20°C ambient temperature with 1500 linear feet per minute of air. The scr has low forward voltage drop, hence low losses. It is available on a stud (C290), flat mounted with a clamping ring (C291) or on a high-velocity fin (C29120). It has a guaranteed minimum di/dt, or ability to switch into high currents from a high blocking voltage at high repetition rates, of 50 amps per μsec . Guaranteed dv/dt, or capacity to block high voltages at a fast rise of forward blocking voltage, is 100 v per μsec to 80% of rated voltage. General Electric Co., Schenectady, N.Y. [373]

High-voltage integrated choppers

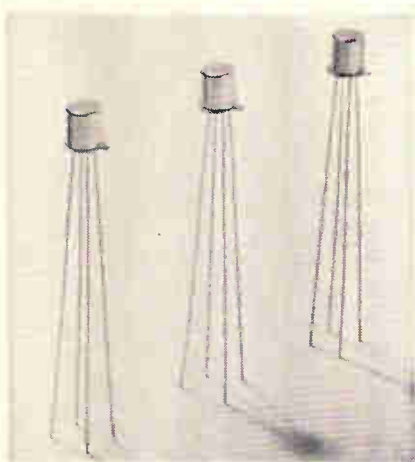

Fourteen different types of integrated choppers now available have emitter breakdown voltages as high as 50 v, and offset voltages as low as 25 μv . The circuit designer can now buy dual-emitter devices at matched-pair prices. Three series of integrated choppers are available — the general-purpose 3N105-107, the 3N90-95, and the 3N100-104. Prices start at \$5 in 100 quantities. The devices are manufactured by the company's exclusive silicon epitaxial junction process, which combines the advantages of alloyed, epitaxial, and planar techniques, and provides extreme ruggedness and parameter stability.

Crystalonics, Inc., 147 Sherman St., Cambridge 40, Mass. [374]

ON GUARD against CIRCUIT DAMAGE!



Airpax Series AP3 and AP4 electromagnetic circuit protectors incorporate design and construction features which ensure positive protection for a guaranteed life in excess of ten thousand operations. Trip action is unaffected by conditions of severe shock or vibration and the protectors operate normally over a wide temperature span. Each type is available in three time delay calibrations. Delay, to prevent nuisance tripping under harmless transients, is accomplished by an integral hydraulic-electromagnetic mechanism.

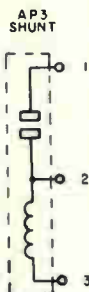

HERMETIC SEAL

TRIP FREE
50V DC
120 OR 240V RMS
60 TO 400 CPS
50 MA TO
20 AMPS
-40°C TO 100°C

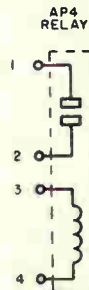

Phone 228-4600 (301)

TWX 301 · 228-3558

CAMBRIDGE DIVISION, CAMBRIDGE, MARYLAND

SHAPE OF THINGS TO COME?



YOU CAN ORDER TODAY!

Ultra Carbon's flat glass package can make your dreams a reality. ULTRA/FGP[®] is here... ready to protect your integrated circuits with a hard, monolithic glass and Kovar* alloy body. A compatible lid can be fused in place with existing sealing equipment without heat damage to the delicate circuitry. Molecular adhesion gives the required seal hermeticity... is accomplished right in your own plant to assure proprietary rights. Several sizes are already in production... will be stocked as soon as our current order backlog is filled.

Yes, ULTRA/FGP is here today... why not investigate, now? Then, you'll also be ready for the ULTRA shapes of tomorrow! Post Office Box 747, Bay City, Mich. 48709.

*TM of Westinghouse Electric Corp.



New Subassemblies and Systems

Digital logic system improves computers

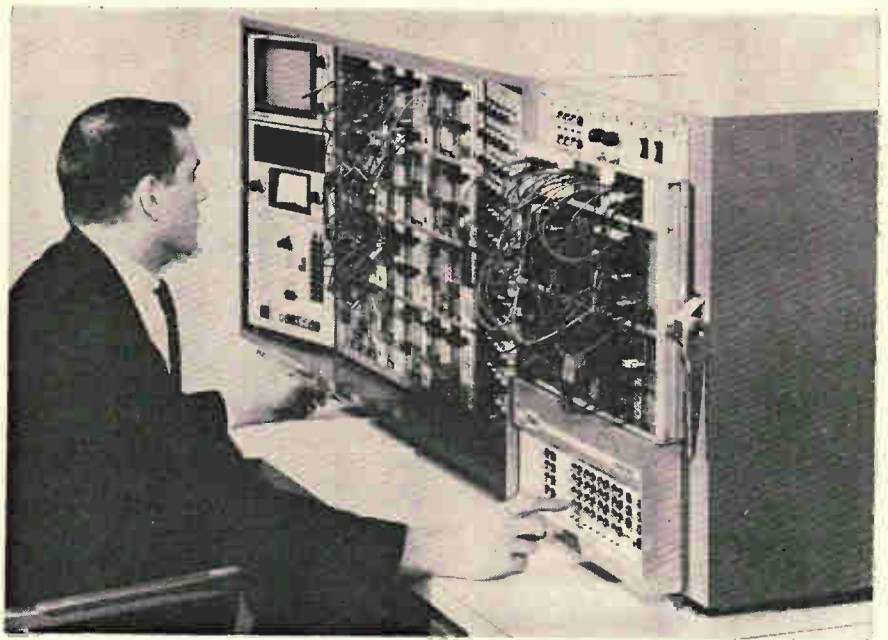

A new, low-cost, general-purpose digital logic system adds hybrid capabilities to small analog computers. The DES-30 digital expansion system may be linked to any general-purpose analog or digital computer, or may be used autonomously as an aid to digital instruction or design. When used with the manufacturer's TR-48 general purpose analog computer, the DES-30 makes possible the solution of problems of far greater complexity than those solvable by the TR-48 alone. For example, the hybrid system can provide economic solutions to advanced problems such as statistical calculations, Fourier analysis, transport delay simulation, incremental and iterative computations. It also provides facilities for storage and playback.

In the DES-30, digital operations are performed by modular building blocks designed to relieve the programmer of details of timing, loading, and other circuit considerations associated with digital logic systems. All facilities are designed to provide the necessary interface or features to enhance hybrid problem set-up with a minimum of programming and debugging effort.

DES-30 features include buffer-

ing of all outputs to provide maximum noise immunity and fan out. Inputs and outputs to the components, as well as control signals, are terminated at a plug-in patch bay which permits the interconnecting of digital circuits with patch cords and plugs much like those of an analog computer. Pre-programmed patch panels are utilized to shorten time on computer and for program repeat.

Other features of the DES-30 include: synchronous logic, internal clock and provisions for external signal triggering, a 540-hold removable patch panel, and one type of flip-flop module which can be enabled as a shift register, counter, or as four individual flip-flops. Operations can be as slow as 1 cps, moreover, single step operation for debugging procedures is accomplished by push button. Price is from \$4,950.

Electronic Associates, Inc., Long Branch, N.J. [401]

Active crystal filters for variable bandwidth

The CF series can be used as an i-f filter in a spectrum analyzer, as a band-pass filter in a frequency

Opportunities for

Design & Development Engineers in Electronic Signal Processing

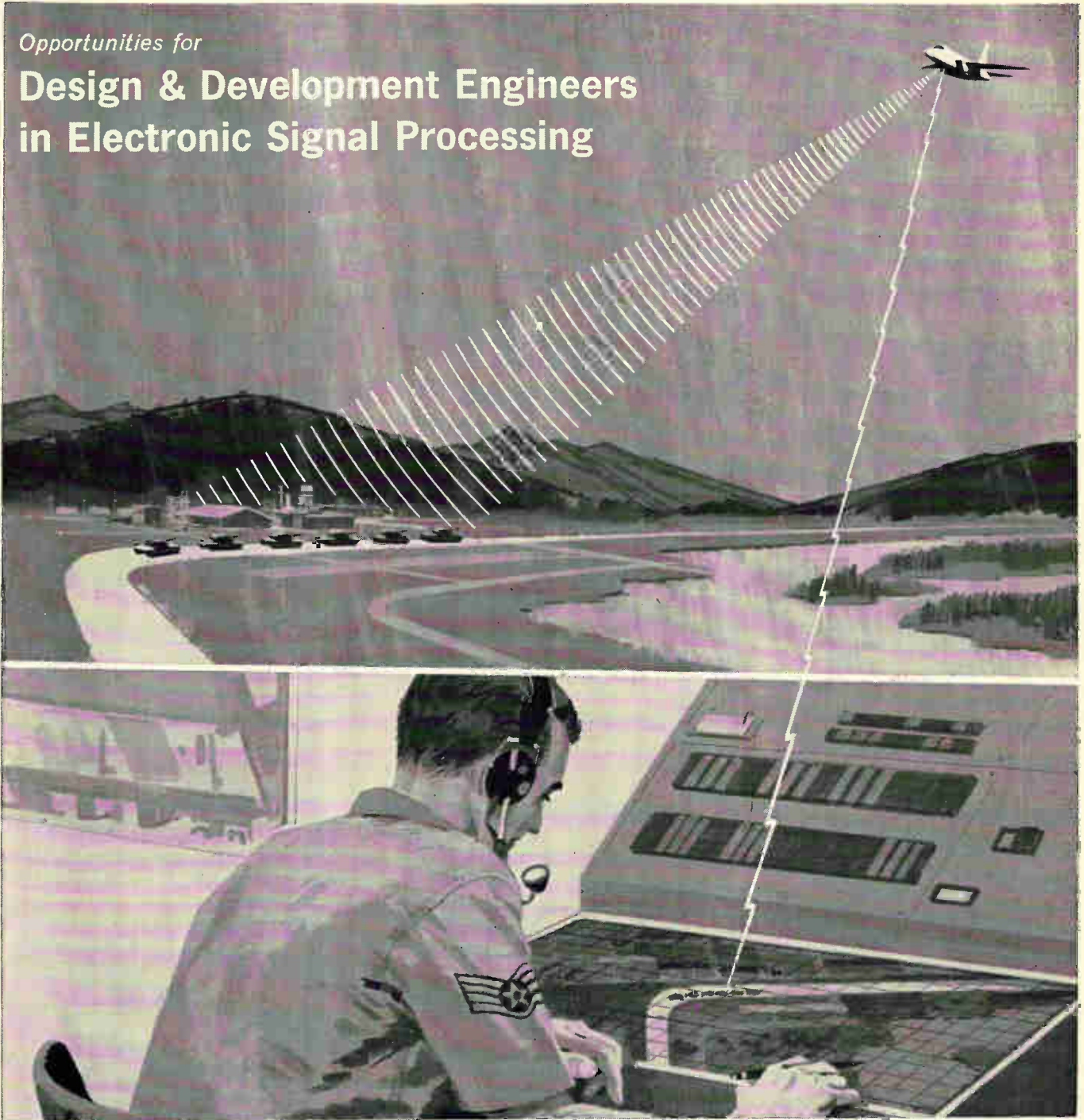

Design and development activities in the field of Electronic Signal Processing are rapidly expanding today at HUGHES Aerospace Divisions.

Development of systems utilizing advanced correlation and matched filter techniques for *High-Resolution Radar*, *Acoustic Detection & Classification* and *Pulse Doppler Radar* is being accelerated.

Specialists in Signal Processing, Circuit Design, Mechanical Design, Packaging Design, Performance Analysis and Project Engineering will be interested in the outstanding assignments now available.

Graduate engineers with experience in wide-band video amplifiers; high-resolution cathode ray tube circuits and applications (including ultra-linear sweep, gamma correction and dynamic focus); high-voltage power supplies; low-jitter timing circuitry; high-speed analog sampling circuitry; precision film transports; ultra-high speed film development; scan conversion systems; synthetic array radar systems; imagery recording, or similar fields—are invited to submit resumes.

For immediate consideration
please write:

Mr. Robert A. Martin
Head of Employment
HUGHES Aerospace Divisions
11940 W. Jefferson Blvd.
Culver City 50, Calif.

Creating a new world with electronics

HUGHES

HUGHES AIRCRAFT COMPANY
AEROSPACE DIVISIONS

An equal opportunity employer

U. S. CITIZENSHIP REQUIRED

WRAP-AROUND MAGNETIC SHIELDS

APPLIED IN SECONDS

**Cut to any size or outline
with ordinary scissors**



Co-Netic and Netic foils are ideal for initial laboratory or experimental evaluation . . . also for production applications and automated operations. Dramatically enhance component performance by stopping degradation from unpredictable magnetic fields. When grounded, foils also shield electrostatically. They are not significantly affected by dropping, vibration or shock, and do not require periodic annealing. Available in thicknesses from .002" in rolls 4", 15", and 19-3/8" wide. High attenuation to weight ratio possibilities. Every satellite and virtually all guidance devices increase reliability with Netic and Co-Netic alloys, saving valuable space, weight, time, and money.

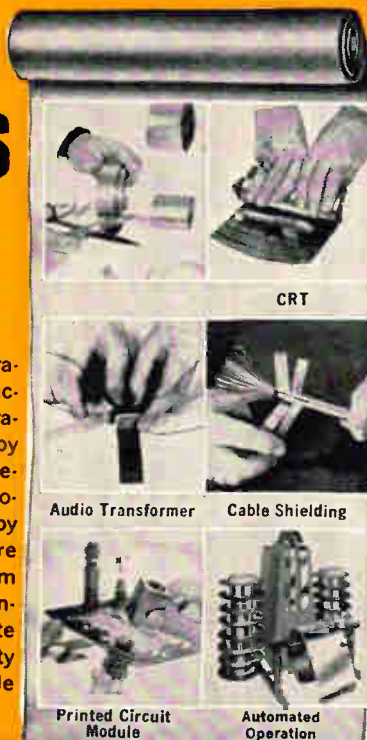

MAGNETIC SHIELD DIVISION

Perfection Mica Company

1322 N. ELSTON AVENUE, CHICAGO 22, ILLINOIS

ORIGINATORS OF PERMANENTLY EFFECTIVE NETIC CO-NETIC MAGNETIC SHIELDING

Circle 215 on reader service card

NEW 1/2 INCH TWO WATT PHOTOCELLS



**AVAILABLE
NOW!**

Additional data plus new 16 page photocell manual for design engineers free on request.

Clairex now offers a new "5M" Series of photoconductive cells with two watts power dissipation in a rugged, hermetically sealed metal case only .490" in diameter. Available in all standard Clairex CdS and CdSe photosensitive materials offering numerous combinations of response time, sensitivity and spectral response. Suitable for direct relay operation and many other applications.

CLAIREX

"The LIGHT Touch in Automation and Control"

8 West 30 Street, New York, N. Y. 10001, 212 MU 4-0940

New Subassemblies

synthesizer, or in other applications where bandwidth must be adjustable and controllable. This series of active crystal filters is available with center frequencies in the range of 100 kc to 1 Mc. Other center frequencies as high as 10 Mc can also be supplied on special order. The bandwidth of these filters can be controlled by either a d-c control voltage or an a-c (sawtooth, for example) control voltage. The bandwidth tuning range is 50 to 1 in the 100-kc filter and 40 to 1 in the 1-Mc filter. The narrowest bandwidth is 1/10,000 of the filter center frequency; for example, the bandwidth of the 1-Mc filter is 100 cps and can be controlled through the range of 200 to 2,000 ohms. Stability is excellent. CF filters contain matched crystals to increase skirt selectivity at the narrowest bandwidth. Filters may be cascaded to provide high skirt selectivity at the 60-db point. These active filters are supplied in a metal housing measuring approximately 2 in. by 2 in. by 2 in. They are individually decoupled, shielded and encapsulated. Each filter contains complete circuitry including crystals, transistors, etc. They must be energized from an external source of power (+100 v d-c and -13 v d-c, 2.5 w). Price for one to four is \$95 each.

Polyphase Instrument Co., Bridgeport, Pa. [402]

Pinboard-controlled sequence programmer



The AMP-MAD pin-board control sequence programmer is a general purpose, 50-step pulse sequence generator with six independently programmable output channels. Pro-

graming is accomplished by inserting diode pins into a pinboard on the front panel. Model 506 consists of a variable frequency clock, a shift register/driver assembly, a diode pinboard, seven output buffer amplifiers and self-contained power supplies. Sequencing frequency is continuously variable from 100 cps to 10 kc by means of a potentiometer on the front panel which controls an all-magnetic 50-bit shift register. Four modes of operation are provided: external clock, manual single step, single frame, and automatic repetitive. The sequence generator is recommended for the testing and evaluation of complex sequential digital systems. It may also be used as a command generator for automatic control systems, or as a binary word generator.

AMP Inc., Harrisburg, Pa. [403]

Paper-tape reader tests malfunctions

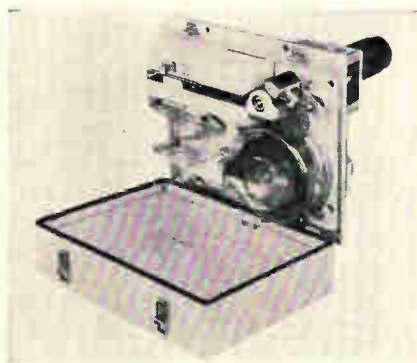

Simplified tape movement, easy cartridge loading, and compact, lightweight design feature a new paper-tape reader that has been developed as a program loader and malfunction testing device for the control computer of a new tactical missile system. The reader requires less than a cubic foot of space and weighs only 25 lb. It is $8\frac{1}{8}$ in. high, 10 in. wide, and 13 in. deep. Functioning inside the missile vehicle with the operational control computer, the unit employs a continuous-loop tape cartridge with up to 150 ft of perforated tape stored in a rugged magazine. Its tape movement is simplified by means of a clutched capstan assembly. Only a shaft with clutch moves, turning the capstan and providing

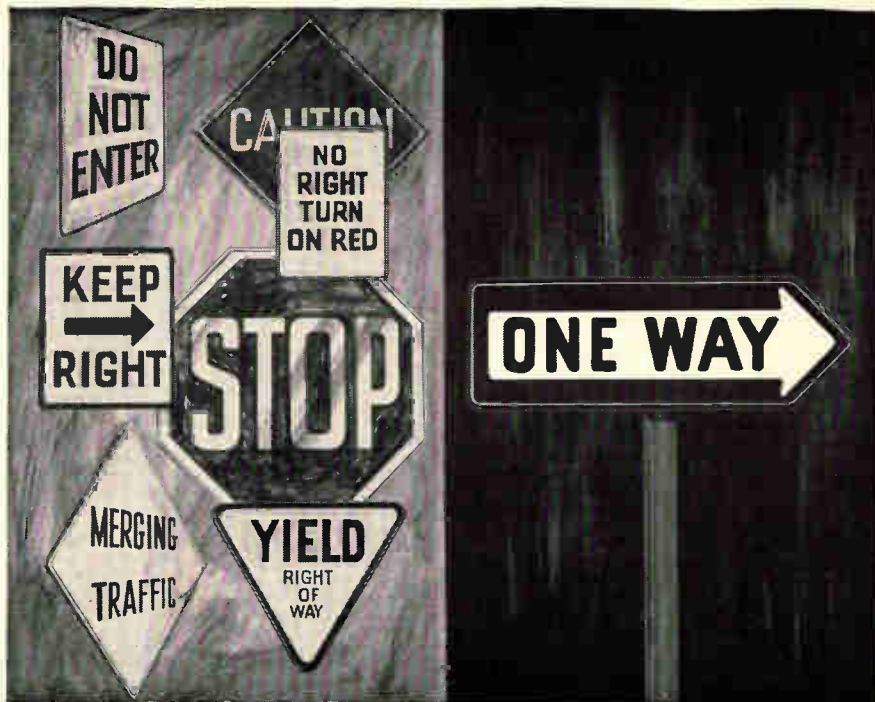

There's only one way to go...computerized filter and transformer design

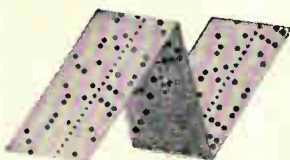

Here's the newest, shortest way to accuracy and top performance in filters and transformers: design by computers.

It's your fastest route. Computer designs take minutes instead of hours. No crossroads or by-passes, either. Computer design explores possible approaches, guides you straight to the best solution when you're in a hurry.

And no detouring for trial-and-error prototype costs. Designs are "performance tested" before production starts. Genisco's computer method searches through existing designs and singles out any that can be used.

Your filters and transformers arrive on time and at lower shipping cost because Genisco plants are on the map in key market areas. Price quotations are fast and accurate. There's never any guessing about costs with Genisco computer design of filters and transformers.

Find out how this new design capability can put you on the right track. Write today for complete information.

COMPONENT DIVISIONS: Combined Sales and Application Engineering Departments

WESTERN UNITED STATES
6320 West Arizona Circle Los Angeles, Calif. 90045
Phone: (213) 776-1411 TWX: 213-670-4765

EASTERN UNITED STATES
111 Gateway Road Bensenville, Ill. 60106
Phone: (312) 766-6550 TWX 312-766-7048

Genisco

TECHNOLOGY CORPORATION





telephone quality handsets

There is no higher standard for handsets. Specify famous Stromberg-Carlson . . . known to telephony since 1894.

Both models shown incorporate push-to-talk switches and high-gain receivers and transmitters.

No. 33 lightweight handset is furnished with a rocker bar switch.

No. 35 comes with a button switch, or with both the button and rocker bar switches.

Write for complete technical data.

**STROMBERG-CARLSON
CORPORATION**

114 Carlson Road • Rochester, N.Y. 14603

Circle 216 on reader service card

NEW! and NOW!

IRRADIATED

Polyolefin Shrinkable Tubing
PENNTUBE[†] V

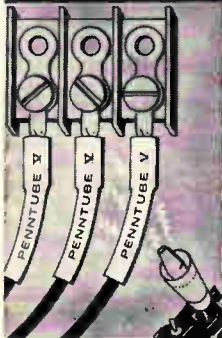

from
**PENNSYLVANIA
FLUOROCARBON
COMPANY**

2:1 shrink ratio.
Meets
all applicable
specifications.

Write for product data
sheet and free sample
NOW!

**P PENNSYLVANIA
FLUOROCARBON CO., INC.**
Holley Street & Madison Ave.,
Clifton Heights, Pa.
Phone: (215) MADison 2-2300
TWX: 215-623-1577

Export Dept. Room 5710 Empire State Bldg. N.Y. 1, N.Y.

One source for:

TEFLON* TFE
Shrinkable
(Penntube-I-E)

*Du Pont Reg. T.M.

TEFLON FEP
Shrinkable
(Penntube-IISMT)

IRRADIATED
Polyolefin Shrinkable
(Penntube V)

†Penna. Fluorocarbon Reg. T.M.

WIRE-WOUND RESISTORS



Fixed

Adjustable

AXIAL LEAD TYPE RESISTORS



COMPOSITION RESISTORS



METAL OXIDE FILM RESISTORS



RHEOSTATS



CONTROLS



POTENTIOMETERS



Trimmer

Multi-turn

JRM

JAPAN RESISTOR MFG. CO., LTD.

26, 2-chome, Minamihama-cho, Oyodo-ku,
Osaka, Japan.

Circle 217 on reader service card

New Subassemblies

positive tape acceleration. This design reduces maintenance and at the same time makes mechanism checking and replacement easy when necessary. Said to be ideal for repetitive program playing in general usage, the new tape reader operates unidirectionally at 15 ips (150 cps) stop on sprocket hole and at 100 cps stepping character to character. It utilizes 0.003-in.-thick, 1-in.-wide Mylar tape.

Cook Electric Co., Data-Stor Division,
6401 Oakton St., Morton Grove, Ill.
[404]

D-c amplifier boasts low noise and drift



A wideband, differential d-c amplifier, model D-25, is designed for precision, low-level data acquisition with low noise and drift levels. Silicon semiconductors are used exclusively to assure dependability. Conservative design techniques make the model D-25 reliable under extreme environmental and signal conditions. Choppers are not used, eliminating hash, intermodulation and spikes. A complementary stage, incorporated in the output, combines with an efficient integral power supply to provide outputs capable of driving high current loads, such as high speed galvanometers. Large loop gain with computer-determined neutralization assures long term stability and accuracy with immunity from

output capacitive loads of any value. Gain range is 10-1000; linearity, $\pm 0.01\%$ full scale; input impedance, 20 megohms; output impedance, 0.25 ohm; size, 2 in. by 5 1/4 in. by 16 1/2 in., price, \$500. Bay Laboratories, Inc., 20160 Center Ridge Road, Cleveland, Ohio. [405]

Six-font drum changes codes

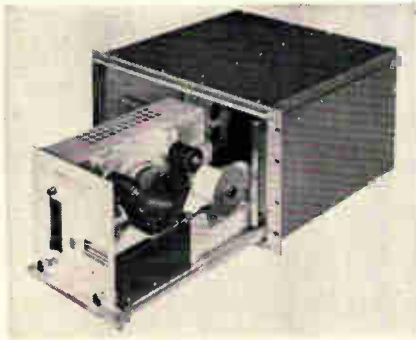

This digital printer uses a six-font print drum to provide for changing mechanically from one four-line binary code to another. To change the input character code, the print drum is simply indexed so that the desired font vs character code coincides with a key-way on the print-drum shaft. Thus, circuit changes are not required to accommodate a change of coding. Each font has its characters in a sequence that matches the particular code it is to be used with. The three selectable codes are 8421, 4221, and 2421. Priced in the \$1,500 range (\$1,250 to \$2,000, depending on quantity and columns), any number of columns may be specified from 1 to 12. Printing rate is 20 lines per second. Price includes rack/table cabinet as shown. The illustration shows the printer mechanism pulled forward on glide rails for paper loading. Franklin Electronics, Inc., Bridgeport, Pa., 19405. [406]

High-speed gate for linear signals

The LG100, one of 20 modules in the M100 high-speed counting system, achieves high-speed gating of linear signals up to 200 Mc in the range of ± 1 v with 1% linearity. The unit can be gated at rates up

We've Done It Again!

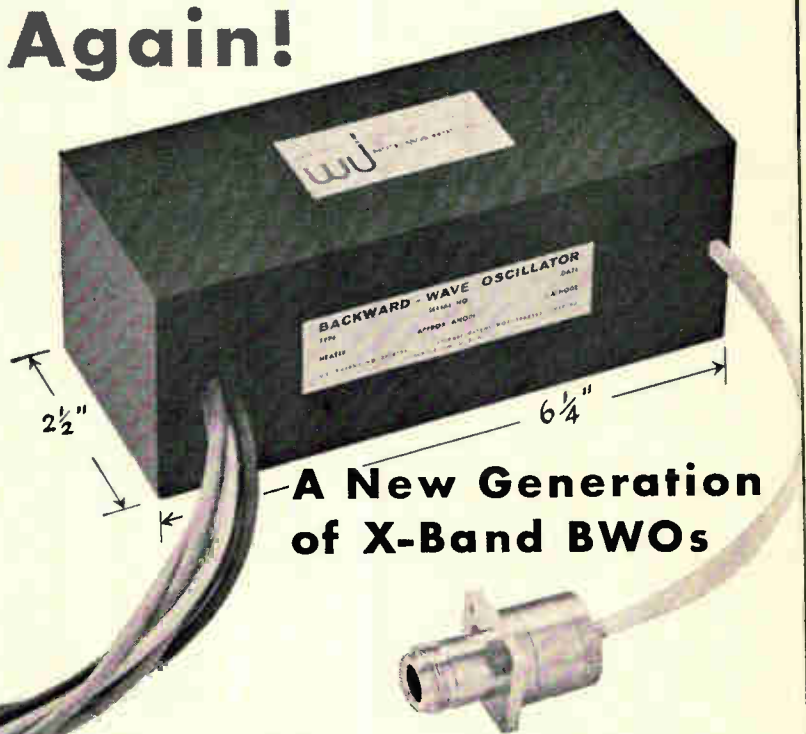

A New Generation of X-Band BWOs

Meet the WJ-2001 and WJ-2001-1, providing advantages of—

- Greater Power Output
- Lower Helix Voltage and Cathode Current
- Smaller and Lighter Weight

And yet, these tubes retain the well-known advantages of the entire Watkins-Johnson BWO line—the extremely smooth tuning characteristics, uniform power output over the band, the long-life reliability.

Specifications

	WJ-2001	WJ-2001-1
Frequency	7.0 - 12.4 Gc	8.2 - 12.4 Gc
Power Output	25 mW min.	50 mW min.
Helix Voltage	1600 V max.	1600 V max.
Cathode Current	12 mA max.	12 mA max.

Both are 2 1/2" square by 6 1/4" long and weigh 2.8 pounds.

Information in more detail available from representative in your area, or from Applications Engineering

WATKINS JOHNSON COMPANY

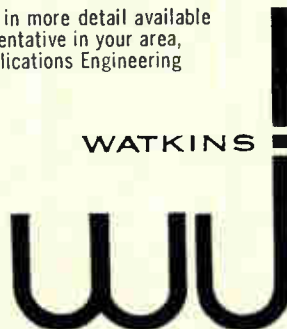

3333 HILLVIEW AVENUE
STANFORD INDUSTRIAL PARK
PALO ALTO, CALIFORNIA 94304

NEW TRANSISTOR TV TUNER



VHF V-AS11



UHF U-AS11

MITSUMI transistorized TV tuners are the most reliable TV accessories because of their unique design and high quality. Electronic reliability is maintained by carefully selected material and strict quality control.

Mechanical reliability is completely guaranteed. Spurious radiation have been eliminated in line with FCC standards.

Mitsumi Electric Company Limited is one of top electronic apparatus manufacturers in Japan. The Mitsumi poly-varicon and IFT have been put into 80% of the total transistorized radio set produced in Japan. Mitsumi Electric Company specializes in the manufacture of poly-varicon, IFT oscillator coils, variable registers, FM tuners, TV tuners, micro motors, CdS photoconductive cells and sockets.



MITSUMI ELECTRIC CO., LTD.

Head Office: Komae Kitatama, Tokyo, Japan
New York Office: 11 Broadway, New York 4, N.Y., U.S.A.

Circle 218 on reader service card

New Subassemblies

to 75 Mc by standard M100 logic pulses of -700 mv. Both the pass and gate circuits are completely direct coupled as in the entire M100 system. The opening and closing gate transients are each zero integral and the pedestal is adjustable from 50 mv. The LG100, packaged as a dual unit, is priced at \$450 and is available immediately from stock.

Edgerton, Germeshausen & Grier, Inc.,
35 Congress St., Salem, Mass. [407]

Journal data transmission system

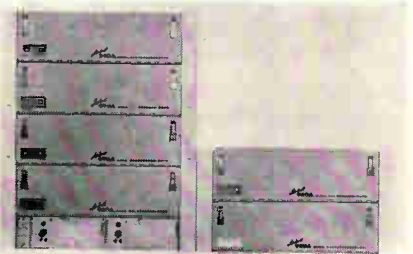

The 960A journal data transmission system is announced. Designed for economical usage, the supervisory feature of the 960A can be used to actuate a recorder when a train approaches its associated sensor. It may also be utilized in such a manner that a small number of recorders, located in a centralized control center, could serve a larger number of sensors. If desired, the flexible 960A can transmit sensor information from one trackside location and in addition carry a voice channel through the utilization of the company's 5249A speech plus data channel. The temperature of each wheel journal is measured by an infrared sensor which produces an amplitude pulse proportional to temperature. The 960A converts this pulse to a duration pulse and transmits it as frequency shift data over a communication channel. It is then converted back to an amplitude pulse at the receiver. A permanent record is made of the information on a stylus recorder tape. An inordinately high amplitude pulse indicates a defective journal or hotbox. The 960A has the advantage of using frequency shift keying

FREE
FILE
FOLDER
FULL OF
NOISE
GENERATOR*
INFO



ELGENCO INC.
NOISE GENERATORS
1552 EUCLID AVENUE
SANTA MONICA, CALIF. 90404
PHONE 451-1635 (AREA CODE 213)

Please rush the free folder

Name _____
Title _____
Company _____
Address _____
City _____ State _____

*SOLID STATE and TUBE-TYPE DC to 5 mc

Circle 228 on reader service card

TOP QUALITY...

PRIMO

MICROPHONES

Highly sensitive microphone with excellent frequency characteristics

TYPES:

- Uni-Directional
- Velocity
- Magnetic
- Crystal
- Dynamic
- Condenser etc.

For catalog write to:

PRIMO CO., LTD.

2043 MURE, MITAKASHI, TOKYO, JAPAN



Uni-Directional
Model: UD-802

Circle 176 on reader service card

so the pulse amplitude at the receive terminal is free from errors due to minor changes in transmission path attenuation. The short duration voltage peaks from the infrared detector are reproduced at the receive terminal as flat-topped pulses of uniform duration. This shaping of the pulse is done in such a manner that the recorder presents a more accurate and consistent chart record. The frequency shift signals using pulse-duration modulation have a tolerance for circuit irregularities such as noise, level changes, impedance mismatches and coding pulses normally found on open wire lines.
Lenkurt Electric Co., Inc., 1105 County Road, San Carlos, Calif. [408]

Aerospace-oriented video amplifier



The Vidamite C-401 is a new aerospace-oriented, wide-band video amplifier. It offers miniaturization, pulse and sine wave capability for space communications, ground support, data acquisition, processing, tv data link and modular test equipment applications. Bandwidth is 60 cps to 200 Mc; gain is 30 db nominal with 40 to 60 db optional. Gain flatness is ± 0.5 db; input impedance, 50 ohms; output impedance, 100 ohms; noise, less than 40 μ v equivalent input.
Conductron Corp., 343 South Main St., Ann Arbor, Mich., 48107. [409]

Sweeping oscillator offers ultrastability

A 20-cps to 200-kc ultrastable sweeping oscillator is available with low distortion. Residual f-m is less than 5 cps. Maximum sweep width up to 20 kc is featured for sweeping the entire audio spectrum as well as very narrow filters. Dis-

"WHERE'S THAT TAPE OF 'THE ALLIGATOR GLEE CLUB AT CARNEGIE HALL'?"

Oh, hello Rip! You got here just in time. Drop that demo on the bench and listen to this tape. It's part of a new batch that Station 16 just sent in — even worse than the ones I was telling you about.

Worse? I'll say! Sounds like a sped-up playback of "Concerto for Seagulls and Fish Pier"! But I thought you said you were getting groans and burps?

That's what's rough — the stations NEVER know what kind of interference they'll get next! You told me I don't need two separate filters — how is this one Krohn-Hite black box going to clear up the confusion?



Because the 315-A is two filters . . . matter of fact, three, on one chassis. As I get it, your radio-telephone transmissions are being loused up by all kinds of noise and interference — above, below, or right in the middle of the intelligence band, and never in the same place twice. Now start that "Screaming Meemy" tape again, while I plug the 315-A into the monitor output and listen through the filter with these earphones. At the stations, they'd do just about the same on live transmission, except that when they had set the filter to maximize the intelligence, they would just switch it right into the line at any convenient a-f stage. . . . I see what you mean — I can barely make out the voice, with a horrible hash above it and below it too. Now let me switch to band-pass, and move in from the ends with both cut-offs independently. I'll spin through that top decade below 200 kc fast, since for this work you'd never hear the difference. But I just dropped out a thump somewhere down around 30 cycles — probably someone chopping liver! Here you are . . . listen to this . . . clear as a bell!

So far so good. But keep listening. Just about here I think a pig got stuck — skewered real good at about 2 kc. Watch the gain!

Owwwww — I just found it! Quick — let me find a real DEEP null for my aching ears! We turn to band-reject, sneak in from the sides with both dials, and . . . I think somebody just told that pig "down boy! 60 db down!!" Listen for yourself. That makes both types we've cleaned up!

I think you've just made yourself a sale. But wait a minute — you said the 315-A is THREE filters. What's the third function?

High-pass! ALSO tuneable all the way from 20 cps to 200 kc, with the same 24 db per octave attenuation outside the pass band. And if you ever get squawk patterns in the same spots, don't forget — the dials are direct reading and calibrated to 10%. Log 'em and kill 'em fast. Now — how about lunch to celebrate, at a low-decibel restaurant?

I'm with you!



KROHN-HITE CORPORATION

580 Massachusetts Avenue, Cambridge 39, Mass.
Area Code 617 491-3211

Pioneering in Quality Electronic Instruments

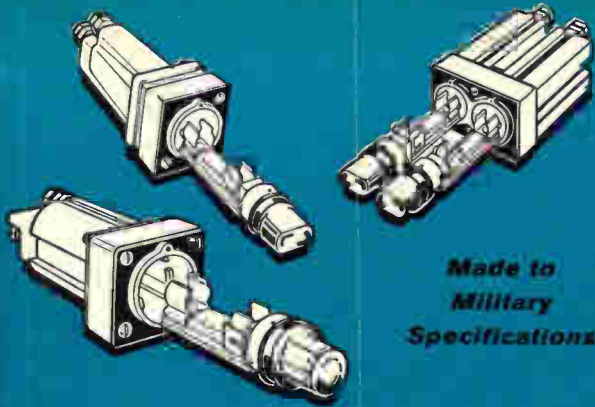

Made to
Military
Specifications

BUSS FUSEHOLDERS

● LAMP INDICATING SERIES HG

Quick, positive, visual identification of faulted circuit. Transparent knob permits indicating light to be readily seen.

Fuses held in clips on fuse carrier which slides into holder and locks in place with bayonet type knob.

Holder designed for panels up to 1/8 inch thick.

BUSS

Write for BUSS
Bulletin SFB

BUSSMANN MFG. DIVISION, McGraw-Hill Co., St. Louis, Mo. 63107

Screw type knob
designed for easy
gripping, even
with gloves. Has
a "break-away"
test prod hole
in knob.

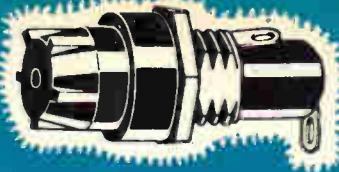

Screw type slotted
knob that is
recessed in holder
body and requires
use of screwdriver
to remove or insert it.

BUSS Space Saver Panel Mounted Fuseholders

● Fuseholder only 1 7/8 inches long, extends just 29/32 inch behind front of panel. Takes 1/4 x 1 1/4 inch fuses. Holder rated at 15 ampere for any voltage up to 250.

● Military type available to meet all requirements of MIL-F-19207A.

BUSS

Write for BUSS
Bulletin SFH-10

BUSSMANN MFG. DIV., McGraw-Hill Co., St. Louis, Mo. 63107

BUSS®: The Complete Line of Fuses..

Circle 179 on reader service card

Circle 179 on reader service card

To order reprints from Electronics

Fill in, cut coupon below, insert in envelope and mail to:

Electronics reprint dept.

330 West 42nd Street, New York, N. Y. 10036

Reprint order form

For listing of reprints available see the reader service card

To help expedite mailing of your reprints please send cash, check, or money order with your order.

Electronics 35th Anniversary Special Section

Send me copies of Key no. R-72 at 50¢ each.

For reprints of previous special reports fill in below:

Send me reprints of Key no. (s) @ ¢ each

For prices see the reader service card.

Name

Number and Street

City, Zone No., State

New Subassemblies

tortion is less than 3%. The P-141A plug-in head is designed specially for use with the Marka-Sweep model 1500 basic rack and the Vara-Sweep model 860F. It is designed for audio applications, meeting demand for a stable, low-frequency oscillator. Price is \$475; delivery, five to six weeks. Kay Electric Co., Pine Brook, N.J. [410]

Telemetry transmitter meets NASA specs

Model 447 is an f-m telemetry, solid state transmitter designed under NASA Spec 50M60230. It delivers 2 watts output power minimum, operates in an ambient temperature range of 20°C to 80°C,

and has an input power of 29 v d-c with ground isolation and reverse input protection capabilities. International Electronic Research Corp., 151 W. Magnolia Blvd., Burbank, Calif. [411]

Display modules for binary input

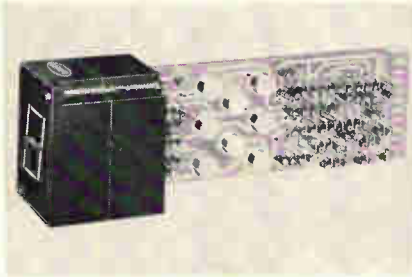

Integral translator-drivers now permit seven segment display modules to operate from binary-coded deci-

mal input. The translator-driver requires only seven instead of the usual ten transistors. Translation is provided by diode gates. The required components are compactly mounted on a glass-epoxy circuit board and securely attached to the separable rear portion of the display module. Memory may be added if necessary. Amplification of the input signals is also provided when insufficient current is available from the logic circuit. Standard circuits are available for many conditions.

Dialight Corp., 60 Stewart Ave., Brooklyn, N.Y., 11237. [412]

Solid-state amplifier in compact package

A copper heat sink to dissipate more efficiently the heat generated by two power transistors permits

of Unquestioned High Quality...

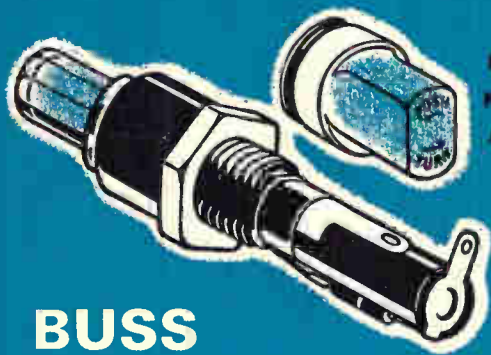

FLATSIDED
KNOB ALSO
AVAILABLE

BUSS FUSEHOLDERS

LAMP INDICATING SERIES HJ AND HK
FOR $\frac{1}{8}$ x 1 AND $\frac{1}{8}$ x 1 $\frac{1}{2}$ INCH FUSES

Quick, positive, visual identification of faulted circuit. Bayonet type, *transparent* knob permits indicating light to be readily seen.

Fuseholder designed to withstand severe vibration. Terminals held mechanically as well as by solder.

Holder can be used in panels up to 3/16 inches thick.

BUSS

Write for BUSS
Bulletin SFB

BUSSMANN MFG. DIVISION, McGraw-Edison Co., St. Louis, Mo. 63107

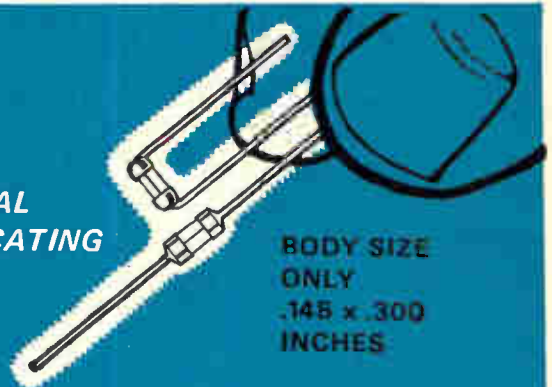

VISUAL
INDICATING

BODY SIZE
ONLY
.145 x .300
INCHES

BUSS Sub-Miniature PIGTAIL TRON FUSES

For use on miniaturized devices,— or on gigantic multi-circuit electronic devices.

Glass tube construction permits visual inspection of element.

Smallest fuses available with wide ampere range. Twenty-three ampere sizes from 1/20 thru 15 amps.

Hermetically sealed for potting without danger of sealing material affecting operation. Extreme high resistance to shock or vibration. Operate without exterior venting.

BUSS

Write for BUSS
Bulletin SFB

BUSSMANN MFG. DIVISION, McGraw-Edison Co., St. Louis, Mo. 63107

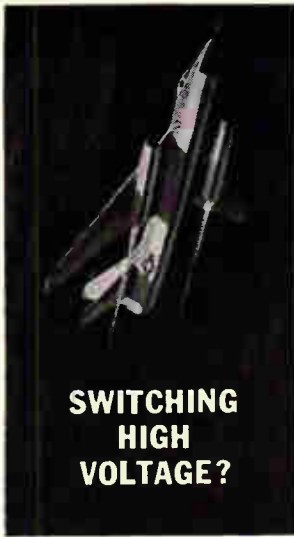

**SWITCHING
HIGH
VOLTAGE?**

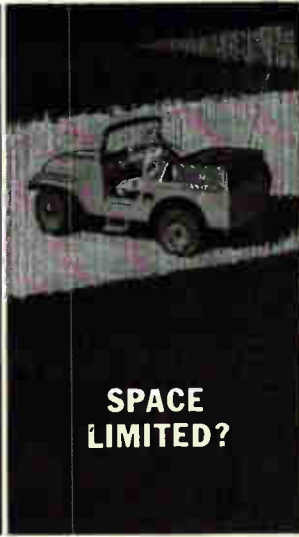

**SPACE
LIMITED?**



**FAST
ACTION
DESIRABLE?**

The Solution Is Jennings Vacuum Relays

Here's why. High strength vacuum dielectric requires only minimal contact separation to withstand high voltage. Consequently vacuum relays can be made extremely small and will operate at high speed. Further, the absence of oxides and contaminants insures low, stable contact resistance for utmost reliability. In addition many of these relays are specially designed for superior performance in high shock and vibration environments or at high altitudes. Jennings vacuum relays have already

proved their worth in such applications as airborne, mobile, or marine communications systems for antenna switching, switching between antenna couplers, tap changing on RF coils, switching between transmitter and receiver, pulse forming networks, and heavy duty three phase switching in radar power supplies.

Illustrated are only a few of the many Jennings vacuum transfer relays available to solve your specialized applications. More detailed catalog literature is available on request.

New Subassemblies

housing of a 100-w d-c amplifier in a compact, anodized aluminum package 5 in. high by 6 in. deep by 4 in. wide. The all-solid-state amplifier for airborne servo systems is of modular design and has a capability of 100-w output from d-c to 50 kc into a 5-ohm load. The gain is adjustable by varying the amount of feedback. The front panel has a pull-out handle facilitating the stacking of several units on a standard 5 1/4-in. rack. The amplifier weighs 5 lb, draws 28 v d-c at 5 amps, 15 v d-c at 6 ma.

Atlantic Instruments and Electronics Inc., 50 Hunt St., Newton, Mass. [413]

High accuracy servo actuator

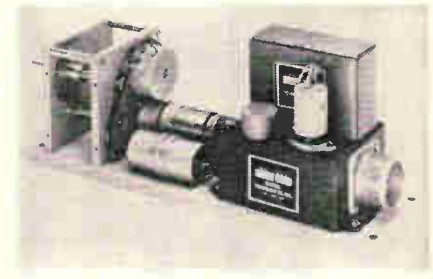

Model CS133 actuator is an entire versatile servo symbol complete with power supply, motor, gearing, transistorized amplifier, and feedback element packaged into a single, easy-to-use module. All electrical connections are made at one end by means of an MS electrical connector. The mechanical output is in the form of a 0.25-in. D shaft. Overall system accuracy is 0.2% from electrical input to mechanical output. Models are available with output torques of 100 in. oz to 750 in. oz. Output speeds are 30°C/sec and higher. The unit is available for 1 and 2 speed synchro, d-c or a-c command signals. The only power required is 115 v, 400 cps or 60 cps line. Model CS133 is also available with an auxiliary potentiometer or synchro output. It is rated for operation from -55°C to 100°C. Applications include: remote actuator for airborne or ground support equipment; for proportional control of doors, valves, and other loads; for positioning of

	TYPE RJ1A	Operating voltage (16 mc) 2 kv pk Continuous current (16 mc) 7 amps rms Length 1 1/16" Weight 1 oz.
	TYPE RF10	Test voltage (60 cycle) 20 kv pk Continuous current (16 mc) 25 amps rms Interrupting rating 5 amps dc at voltages up to 10 kv. Length 5 1/4"
	TYPE RB1R	Test voltage (60 cycle) 18 kv pk Continuous current (60 cycle) 15 amps rms Operate time 3 millisecs max. Length 2 1/2" max.
	TYPE RE6B	Test voltage (60 cycle) 30 kv pk Rated operating voltage (16 mc) 15 kv pk Continuous current 9 amps rms DC interrupting rating 25 kw (not to exceed 5 amps or 10 kv)

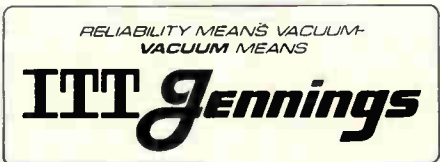

JENNINGS RADIO MFG. CORP., 970 McLAUGHLIN AVE., SAN JOSE, CALIF. 95108, PHONE 292-4025

optics, levels and linkages in response to remote signals. The CS133 is also available with a variety of modifications for customer applications to achieve unusually low static, velocity and acceleration errors.

Control Technology Co., Inc., 41-16 29th St., Long Island City, N.Y. [414]

High-stability local oscillator



A new, solid state, local oscillator source provides a minimum of 5 mw power output at 2,880 Mc. Long term frequency stability is 1 part per million per year after the initial six months' aging period. Stability is achieved with an extremely stable, oven-regulated crystal-controlled oscillator at 45 Mc. This primary oscillator is followed by a series of transistor amplifiers and varactor multipliers to deliver the required output power at 2,880 Mc. Model MX-108 operates from a line voltage of +28 v d-c.

The Micro State Electronics Corp., a subsidiary of Raytheon Co., 152 Floral Ave., Murray Hill, N.J. [415]

Charge amplifiers withstand 50 g shock

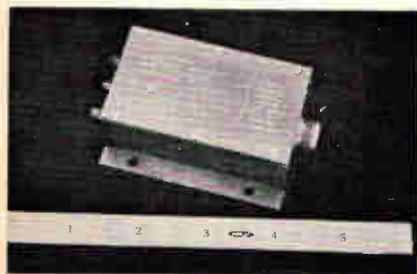

A new, airborne charge amplifier has been introduced for use with piezoelectric accelerometers and high intensity microphones where

This is Vitro Electronics' Telemetry Receiver

It is Type 1037A

It is not new

It is thoroughly field-proven

It is in its fifth production run

It is the standard for comparison

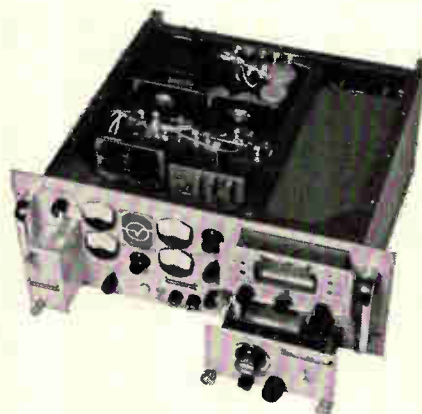

The 1037A is still the only advanced type telemetry receiver that is in full production with a long and successful history of field-proven performance and reliability. The 1037A offers a wide choice of off-the-shelf plug-in RF tuners covering a range of 55-2300 mc and the most versatile group of IF demodulators available which include true phase with long or short loop, linear phase for special PCM applications, phase tracking, high capture ratio, phase lock, FM and AM for all known telemetry formats. Integral plug-in predetection converters and spectrum display units optional. Improved adjacent channel rejection and optimum combination of RF nuvistors and solid state design avoid the dynamic range problems inherent in solid state RF tuner designs.

Vitro Electronics is also the only manufacturer with a complete line of off-the-shelf solid state pre- and post detection combiners, dual diversity receivers, up and down converters, multicouplers, preamplifiers, etc.

*For a complete new catalog or additional details please write to
Vitro Electronics, 919 Jesup-Blair Drive, Silver Spring, Maryland.*

Vitro

VITRO CORPORATION OF AMERICA
90 PARK AVENUE • NEW YORK, N. Y. 10016



Fiberglass reinforced thermoplastic molding compounds are solving problems of precision, strength and reliability in dozens of electrical-electronic applications.

Get FREE Manual of physical and dielectric properties of high performance FRTP® materials for electronics!

Fiberglass reinforced thermoplastic injection molding compounds have extra dimensional stability, strength, precision molding characteristics, and improved dielectric properties. Such advantages make these high-performance materials ideally suited to a wide range of connectors, coil forms, mountings, receptacles, frames, housings and structural parts for a variety of electronic components. Investigate these materials for your product today.

FREE ENGINEERING MANUAL

New manual is most complete compilation available of data on FRTP's. Pages of charts, tables, applications and comparisons of properties. Send for your free copy today.



FIBERFIL, INC.
Evansville 17, Indiana

Circle 226 on reader service card

boxed in by a die problem?

use the
theory of probability
to solve your problems



This is where experience counts! Chances are Photoforming by Hamilton will get you quickly from the drawing board stage to prototype production of thin, flat, odd-shaped precision parts. No dies . . . no burrs . . . no bent edges . . . no stresses . . . no delays when parts are produced by the Hamilton process called Photoforming. Another plus, Photoformed parts can be heat-treated, plated, or formed according to your specifications. Write for the facts—you'll get useful data on Hamilton's Photoforming and other facilities.

INDUSTRIAL AND MILITARY PRODUCTS DIVISION

HAMILTON
WATCH COMPANY
LANCASTER, PA.

182 Circle 182 on reader service card

New Subassemblies

long cables are required. Designated model FT-3512, the new variable gain amplifiers have the ability to drive cable with the capacity of 0.06 μ f max up to frequencies of 10 kc. Output voltage is 5 v peak to peak. The transistorized instruments include a line driver and provision for connecting an external filter. Required power source is 28 v d-c; application of reversed power supply polarity will not cause damage. Operating over a temperature range of -65°F to $+200^{\circ}\text{F}$, the unit will withstand 50 g shock and function at vibration levels up to 25 g peak and 31 cps to 2 kc.

Gulton Industries, 212 Durham Ave., Metuchen, N.J. [416]

Switch/display matrix features versatility



A versatile, modular switch control panel for pushbutton switches is being introduced. The KB switch-display matrix is designed to accommodate a new line of pushbutton switches whose faces are $\frac{3}{4}$ -in. square. It permits up to 256 code combinations from a single encoding switch, using an 8-bit binary output. One square foot of panel space can contain 256 switches. Conventional switch panels now require 4 to 5 times as much panel space. The control panel and display is especially applicable to control output of a logic

Electronics | April 19, 1965

circuit—for computers, general business machines, tape coding equipment, machine tools, airline traffic control and military control systems. The switching matrix is built up with small plug-in encoding and power switches. It can be designed and assembled to customer specifications. Switches can be arranged in squares, rectangles, lines, triangles—or any pattern desired. Individual switches plug in the matrix like tubes, can be replaced in less than a minute. They provide both light display and push-button control in one unit.

Micro Switch, a division of Honeywell, Inc., Freeport, Ill. [417]

Decade counter has hybrid circuits

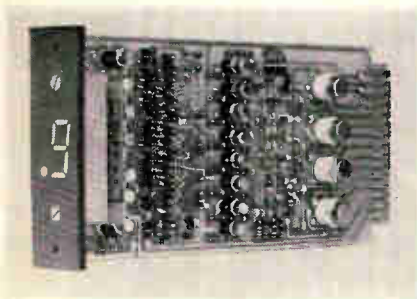

Model BCD8 integrated circuit decade counter uses a hybrid combination of integrated circuits, transistors, and silicon-controlled rectifiers to obtain fast counting rates, high reliability, and versatility. It can be used as a 3-Mc decade counter, or 8-line BCD to decimal display, or 1-Mc shift register. To go from one operational mode to another, only the connector wiring has to be changed; no changes are required on the module board. An internal logic memory is also part of model BCD8. The display features wide angle viewing and is seven segment in-plane with 100,000-hour bright lamps. The modules mount on 1-in. centers. Supply requirements are 12 v at 260 ma for logic circuit and 5 v at 60 cps for lamp display. Size is 1 in. wide by 3 in. high by 6 in. deep. Temperature range is 0°C to over 65°C. Weight is 4 oz. Production quantities of 100 to 199 cost \$97 each. Usual delivery is in 4 weeks.

Robotomics Research, division MB Electronics, 4504 North 16th St., Phoenix, Ariz., 85016. [418]



FLORIDA WELCOMES YOUR INDUSTRY

"YOU HAVE MY PERSONAL PLEDGE... that the full resources of the Governor's office and the Florida Development Commission will be placed at your disposal to assist you in establishing your company in Florida.

"You may expect this same cooperation from every Florida financier, business man and industrialist, and every municipality.

"I further pledge you a healthy business climate, an expanding market and a future limited only by imagination, effort and initiative.

"Take the initiative!

Write, wire or phone today!"

ATTEND
FLORIDA INDUSTRIES
EXPOSITION
ORLANDO
APRIL 27-30



INDUSTRIAL

Florida

HAYDON BURNS, GOVERNOR



Mr. Charles W. Campbell, Chairman
Florida Development Commission
Dept. 4447-C
Tallahassee, Florida 32304

Please send me brochure, "Why Your New Plant Should Be Located in Florida," containing the facts about FLORIDA's opportunities for New Industry, the 12 Billion Dollar Consumer Market, Labor, Climate, Schools, Favorable Tax Structure, Natural Resources.

NAME.....

FIRM NAME.....

ADDRESS.....

CITY.....STATE.....ZIP.....

FLORIDA FOR CONVENTIONS—Write for free information on Florida's wonderful facilities for your group meeting.

good things
very often come
in small packages



NEW!

multi- channel reed

from **S&G Electronics**

Here's a printed circuit plug-in module that's no bigger than a pair of dominoes.

S&G Electronics' new Multi-Channel Reed is available for either two or three channel operation. Its extensive frequency range allows over 40 channels of operation. This tiny reed relay module is ideal for portable applications like pocket paging—as well as for telemetry and remote control use. WRITE us now for full details.

multi-channel reed

Another fine product from
the leaders in
the resonant reed field.



 **ELECTRONICS**
SARGENT & GREENLEAF, Inc.
ROCHESTER, NEW YORK 14621

New Microwave

Microwave receiver covers 0.5 to 10 Gc



Model RSG-2 Lab-Cvr, a low-cost microwave receiver covering the 0.5-to 10-Gc range, serves in a wide variety of laboratory and field applications involving a-m and f-m signals. The instrument uses any signal or sweep generator as the local-oscillator source. Typical tangential sensitivity for the 1-Mc bandwidth is -87 dbm, while the minimum detectable signal for 1-kc modulated signals is -115 dbm. The receiver includes a broadband crystal mixer, an 0- to 99-db precision attenuator, and a meter that provides direct readings in decibels for 1-kc modulated inputs on full-scale ranges of 0-80 db, 0-10 db, and 0-2 db. Front-panel outputs

include i-f, a-m video, f-m video, and recorder drive. Typical applications include: insertion-loss measurements over wide attenuation ranges; detection of spurious outputs from harmonic chains and other microwave oscillators; antenna-pattern measurements; rfi testing, field-strength measurements and path-loss surveys; noise-figure measurements; detection of a-m and f-m beacon or data-link transmissions; and spectrum analysis and monitoring. The unit is 5 in. in height and 17 in. wide. The price is \$1,425. Delivery is from stock.

Melabs, 3300 Hillview Ave., Stanford Industrial Park, Palo Alto, Calif. [421]

Elliptical waveguide replaces rigid type

Helix elliptical waveguide is designed to replace rigid waveguides of all microwave relay and radar applications in the 3.7 to 11.7 Gc range. It consists of a convoluted copper tube of elliptical cross-section. It can be supplied with factory attached connectors which mate to standard rectangular flanges. The flexible waveguide has attenuation

equal to or lower than conventional rigid rectangular waveguide. The attenuation is generally one-fourth that of flexible waveguide and one-tenth that of flexible coaxial cables, sometimes used for transportable electronic systems.

The waveguide was designed originally for transportable emergency restoration radio systems. When it was found that the performance was equal to or better than that of conventional rigid waveguide, the designs were ex-

All the numbers
fit to print —

MODUPRINT

These uniquely versatile instruments count at **HIGHER SPEEDS** (40 or 80 per second), print **MORE INFORMATION** on tape — with **LONGER LASTING** plug-in components — than any remotely comparable equipment... and at **substantially lower costs!**

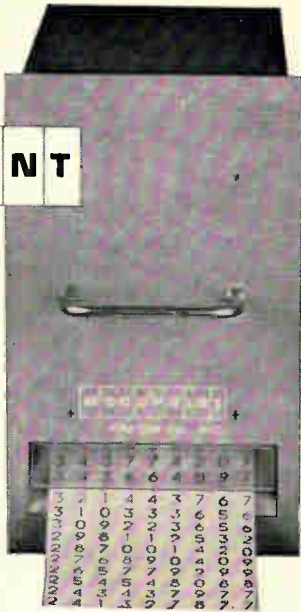

Three sizes (using 2½", 4" or 6" tapes) print count, time, date or data. The smallest unit, for instance, can have 6 digits counting plus a 2-digit index, or two 4-digit registers or three 3-digit registers. The largest unit can have five 4-digit accumulating channels — or as you wish. Just wire in and operate — nothing more! Parallel input, too! The variations are almost infinite and are yours to choose as your requirements dictate. Now you can print all the data you must keep — at surprisingly low cost.

For further information write for Bulletin 602

Made in U.S.A. by
PRESIN COMPANY, INC.
Box 3245, Bridgeport, Conn.
Phone: 203-333-9491

Circle 219 on reader service card



Siemens surge voltage protectors

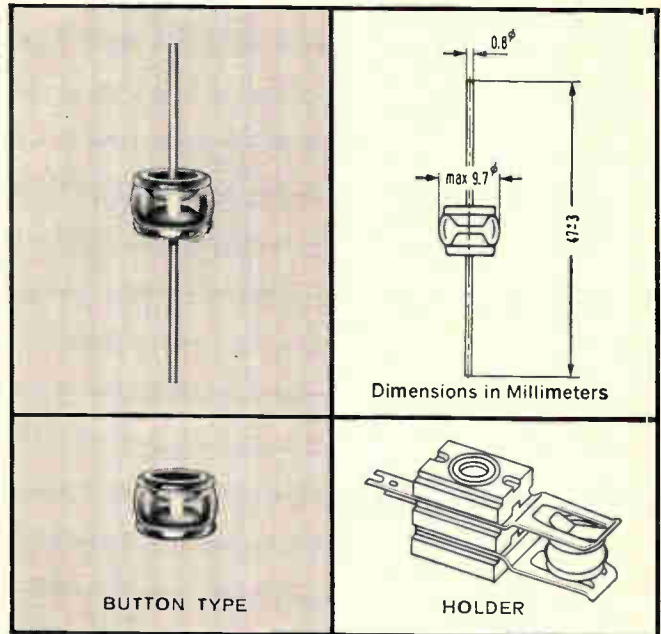

BUTTON TYPE

HOLDER

The cost of surge voltage damage to delicate equipment runs high. Telecommunications and signaling apparatus, the entire range of solid state circuitry are completely vulnerable to uncontrolled surges, causing immediate damage. Due to short circuits, lightning flashes, electrical overloads or static charging, surge voltages may range from 200 to several thousand volts. In a community wide test, up to 600 surge voltages were recorded in a 10,000 hour period.

Low cost surge voltage protectors developed by Siemens give instant reaction—in .4 microseconds! Protectors shown here cost under one dollar in quantity. All fully protect valuable equipment and do a job that cannot be done by air gap or carbon block protectors.

These gas-filled glass protectors, installed between supply line and equipment, not only absorb the surge but reset automatically for continuous protection. In this price range the only proven arc-suppressors with a current carrying capacity up to 5,000A. Low capacitants (2 p F) for HF use. Standard models have a nominal DC striking voltage of 230V to 800V.

Immediate delivery from stock in White Plains, N.Y. 14 standard models available. Custom-designed also for particular applications.

Write now for full information on Surge Voltage Protectors

SIEMENS AMERICA INCORPORATED
Components Division
230 Ferris Avenue, White Plains, N. Y.

In Canada:
SIEMENS HALSKE SIEMENS SCHUCKERT (CANADA) LTD.
407 McGill Street, Montreal 1, P.Q.



Lepel

Induction Heating's Most
Trusted and Creative
Craftsmen Since 1926

High Frequency

INDUCTION HEATING UNITS

- for
- BRAZING
 - MELTING
 - SOLDERING
 - ZONE REFINING
 - HEAT TREATING
 - CRYSTAL GROWING
 - BOMBARDING
 - PLASMA TORCH

ELECTRONIC TUBE GENERATORS

Kilocycle Frequency Units

Megacycle Frequency Units

Dual Frequency Units

WORK HANDLING EQUIPMENT AND ACCESSORIES

FREE APPLICATION ENGINEERING SERVICE—Our engineers will process your work samples and submit recommendations.

SALES AND SERVICE FACILITIES THROUGHOUT
THE UNITED STATES AND CANADA

WRITE FOR NEW LEPEL CATALOG

Lepel HIGH FREQUENCY LABORATORIES, Inc.
55th St. & 37th Ave., Woodside 77, N. Y. C.

Circle 220 on reader service card

Circle 185 on reader service card

185

ENGRAVE EVERYTHING FROM 6 FT. PANELS TO TINY NAMEPLATES

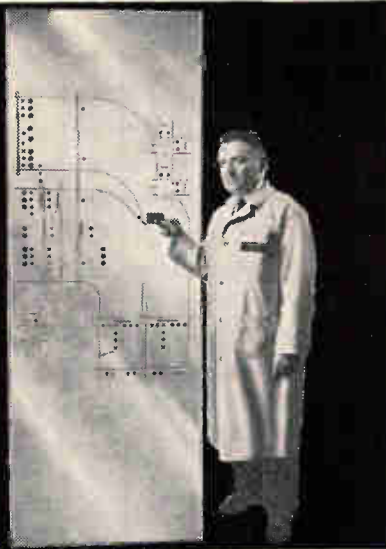

Tracer-guided arm guides the worker—
makes everyone a skilled engraver.

Convenient—It's right in the plant when and where you need it.

Accurate—Positive depth of cut with automatic depth regulator. 15 accurate ratios.

Speedy—Self-centering work holder cuts set-up time in half.

Ask for complete, illustrated catalog EE-14

new hermes engraving machine corp.

154 WEST 14th ST., NEW YORK 11, N. Y. Chicago, Atlanta, Dallas, Los Angeles, Montreal

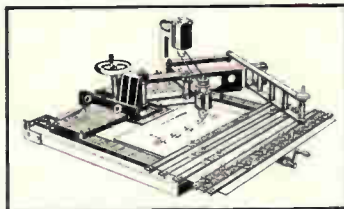

New Microwave

tended to cover a number of radio bands. The cost is approximately \$3 per foot, and since this material eliminates the numerous bends, twists and other special configurations, the overall cost of the run is less than half that of a conventional system. Simplified installation techniques provide additional savings.

Andrew Corp., Box 807, Chicago, Ill. 60642. [422]

Signal sampler covers broad band

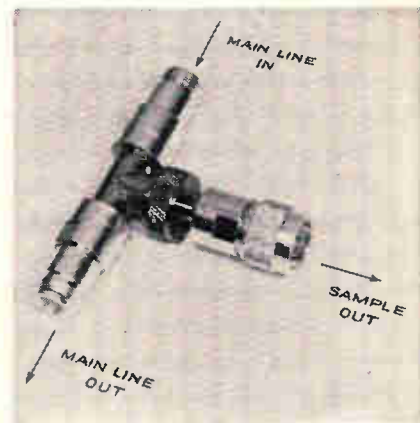

A new signal sampling device for r-f and microwave circuits uses capacitive coupling with a wide range of adjustment to take a sample from the main signal line. Covering all frequencies through X band (12.4 Gc), the model TSS-1 is basically an r-f T connector with a movable leg. Capacitance between the signal line and the sample line is varied simply by moving the leg towards or away from the main line. A knurled locking nut maintains the leg in position once the desired capacitance is established. The coupling is adjustable from less than 10 db to over 40 db. Main line vswr depends on the degree of coupling; for example, coupling of 10 db results in a typical vswr of 1.3:1 or less; with 30 db coupling the vswr is 1.15:1 or less. Dissipation losses are negligible. Ideal for frequency sampling and power monitoring, the TSS-1 is equipped with type N female connectors for attachment to the main signal line,

CEI's New Frequency Extender

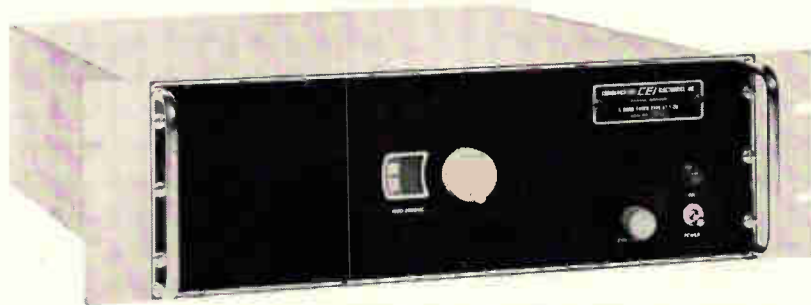

Tunes 1 to 2 gc, Converts Signals to 160 mc

CEI's new Type FE-1-2 Frequency Extender covers 1 gc to 2 gc in a single band, converting signals to a 160 mc IF output. This can be tuned on CEI series 900 VHF receivers and other units which receive 160 mc. (Further, utilizing our Type IFC-21 Converter, the 160 mc signal can be reduced to 21.4 mc for input to a demodulator system such as the CEI Type DM-4.)

The Frequency Extender uses a four-section YIG preselector which is

tracked electronically throughout its range, thus avoiding complex mechanical drives. Reliable and easy to operate, the FE-1-2 is wholly solid state except for the ceramic triode in its highly stable local oscillator. Consuming just 25 watts (average), the unit requires only 5¼ inches of rack space.

For details on this and other CEI products, please write:



COMMUNICATION ELECTRONICS INCORPORATED

6006 Executive Boulevard, Rockville, Maryland 20852, Phone (301) 933-2800

and a type N male for the sample line. Price is \$50, with delivery from stock.

Telonic Engineering Co., 480 Mermaid St., Laguna Beach, Calif. [423]

Plug-in circulators span 600 Mc to 12 Gc



Strip line plug-in circulators have been developed to cover the frequency band from 600 Mc to 12 Gc. Model CC-3, illustrated, has insertion loss of 0.3 db and isolation of 25 db over a frequency band of 5.4 to 5.9 Gc. Its maximum thickness is 1/2 in., and maximum diameter is 1 1/2 in. Units can be designed to be used in 1/16 in. or 1/8 in. dielectric-filled strip line.

Hyletronics Corp., 185 Cambridge St., Burlington, Mass. [424]

Amplifier-multiplier serves as r-f source



A new Ku-band, solid state amplifier-multiplier is designed for use as a radio-frequency source in airborne navigational systems. The compact type WX-30133 features conduction cooling and an output response which is flat over an 0.5% frequency range. The unit produces a minimum of 100 mw at 13.3 Gc by multiplying a 92-Mc, 3-mw input signal by a factor of 144. D-c input power is presently 50 w and will be reduced in future models. The unit measures 2 1/2 in. by 3 in. by 4 1/2 in. and weighs 2 lb.

Westinghouse Electronic Tube Division, Elmira, N.Y. [425]



Everything you need to know about tapes you can carry in your hip pocket

It's Mystik's new Select-A-Tape Guide. Here, in a pocket-size, full color edition is a complete catalog of Mystik Tapes. It's the fastest way to find the right tape for any given application.

For easy reference, the guide is indexed by type of tape—masking, packaging, protective, printable and special purpose. Over 100 tapes right at your fingertips! Each tape, its backing material and adhesive, is described in detail, along with physical characteristics, advantages and principal uses.

A word of warning. Once people pick up our new pocket-size Select-A-Tape Sample Guide, they can't put it down. They pocket it instead. So watch it. Mail the coupon below and get yours free of charge. Then you won't have to borrow somebody else's.



A DIVISION OF BORDEN CHEMICAL COMPANY

FREE SELECT-A-TAPE SAMPLE GUIDE!

Takes the guesswork out of tape selection. Gives physical characteristics of all Mystik tapes, typical applications, sizes, principal advantages. Send for your copy today. MYSTIK TAPE, INC., 1700 Winnetka Ave., Northfield, Ill.

NAME _____
 COMPANY _____
 ADDRESS _____
 CITY _____ STATE _____ ZIP _____



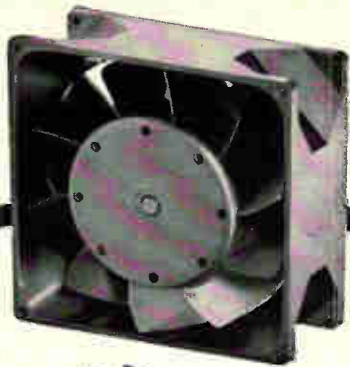

New

**SHADED-POLE
Model 2500
PAMOTOR**

**Miniature
Axial Fans**

- 20,000+ operational hours at 45°C
- Low-cost design
- All metal construction
- Unexcelled performance and reliability
- Only 4½" x 4½" x 2" in size
- 50-60 cycles at 110 or 220 vac
- In stock for immediate delivery

Write for technical data on the Model 2500 and other PAMOTOR axial fans to:



New Production Equipment

Die bonder features automatic scrubbing

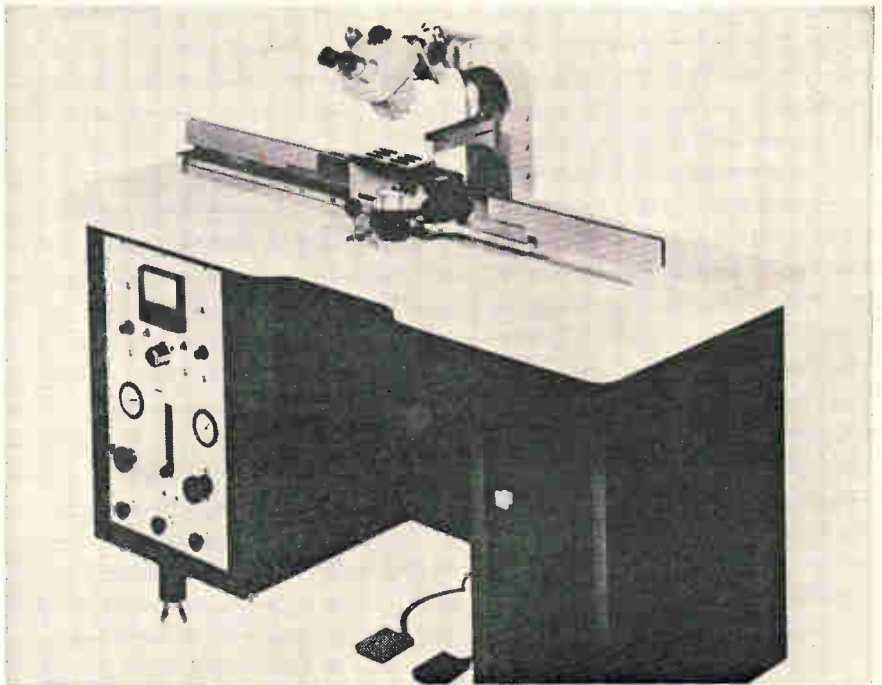

An improved die bonder featuring automatic scrubbing action has been introduced to the semiconductor industry. The scrubber is mounted in a lateral arm on the new bonder, and scrubbing takes place automatically as a die is placed on a header. This scrubbing action, in many cases, eliminates the need for pre-forms, and it permits bonding of dice which have no gold backing.

The duration of the automatic scrubbing action is preset and the stroke is adjustable. In addition, a foot switch on the equipment provides a manual override for extending the duration of the scrubbing action in the event a satisfactory bond has not been made. The scrubbing action is independent of the unit's pulsating force arrangement and can be used separately or in concert with it. This feature, coupled with the in-line, rapid indexing belt handling system, results in the bonding of dice at speeds heretofore unattainable, according to the manufacturer.

In all die bonding operations, production rate is a major consideration. To achieve maximum production rate, it is important to control automatically as many factors as possible which affect the

quality of the bond. This die bonder provides a visual inspection of the die prior to pickup, simplified orientation, automatic temperature control, automatic die and header positioning and automatic control over the forces generated by the vertical movement of the die attach needle.

Hevi-Duty Heating Equipment Co., Watertown, Wis. [451]

**Machine solders
glass diode leads**

An automatic, 12-station soldering machine is announced for the soft soldering of tinned copper lead wires into both ends of a glass diode. The machine produces 1800 diode assemblies per hour. In operation, an automatic, adjustable feed deposits a constant amount of solder into the diode end cavities. Two 0.030 in. diameter tinned copper leads are then fed and cut off at the proper length. Ejection of the completed assembly is automatic. Optional equipment includes an automatic diode loading mechanism and a dry box.

Federal Tool Engineering Co., 1386 Pompton Ave., Cedar Grove, N.J. [452]

VLF/LF TRACKING RECEIVERS FOR LOW COST PRECISE FREQUENCY CALIBRATION



- Portable or rack mount TRACOR Model 890 and 892 VLF/LF Receivers are all solid state, two channel units that compare local frequency standards with the national standard of frequency and uniform time broadcast by NBS from Ft. Collins, Colorado.
- Both Model 890 and 892 VLF/LF Receivers provide high performance reception of WWVL (20 kc/s) and WWVB (60 kc/s). Comparisons with an accuracy of parts in 10^{11} with one day averaging are easily obtained. Typically, one part in 10^9 can be obtained in one hour in daytime.
- Phase shifting for tracking is accomplished by a true electronic servo, not simply a VCO. No periodic adjustment is necessary. To prevent false tracking, an electronic switch stops the phase servo when no signal is present. A front panel warning lamp lights. Tracking resumes automatically when the carrier returns.
- The chart recorder has a full-scale reading of 100 microseconds (two microseconds per minor division). No templates are necessary for chart interpretation.
- Sensitivity of 0.05 microvolts assures reliable tracking under adverse conditions anywhere in the United States. A TRACOR passive antenna is supplied with Model 890 and 892 Receivers.
- The TRACOR Model 892 VLF/LF Receiver has a SULZER Model 1B frequency standard built in. It is a compact, rugged 1 mc/s frequency source with a frequency stability of $\pm 2 \times 10^{-9}$ per 24 hours. Thus, a stabilized 1 mc/s frequency source, which can be continuously compared with NBS transmission, is provided.

For immediate information telephone 512-476-6601. Write TRACOR, Inc., 1701 Guadalupe Street, Austin, Texas 78701, for literature.



REPRESENTATIVES IN PRINCIPAL CITIES
Circle 221 on reader service card



OKI HIGH POWER MM-WAVE KLYSTRON This New Klystron Produces 12 Watts C.W. at 55KMC

- * Excellent frequency stability
- * Long operating life
- * Ceramic structure

OKI Electric announces a new klystron to meet the needs of researchers in the mm-wave field. The Model KC-55B, or KC-31A, is a two-resonator fixed-tuned klystron oscillator, and packaged with a permanent magnet.

Frequency and output are as stable as a frequency standard. Its unique ceramic structure gives it long life for such high power output.

The frequency range of OKI's new KC-series can be arranged to meet your specific needs. We'll be happy to help you work out specification details. Write us today.

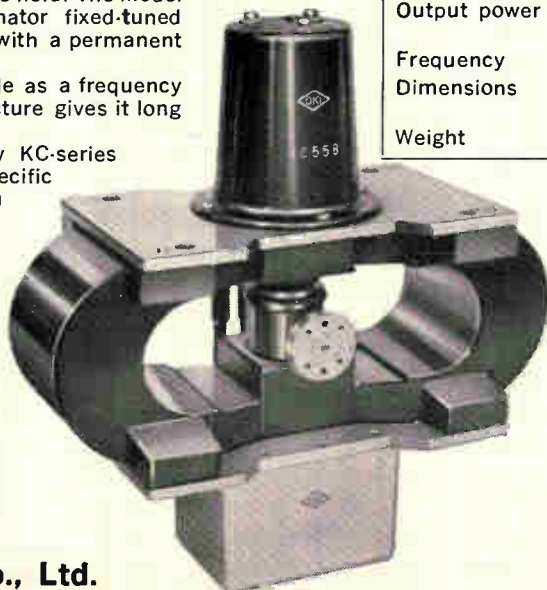

Type number	KC-55B	KC-31A
Heater voltage	7.5V max.	7.5V max.
Resonator voltage	3.9KV dc max.	3.0KV dc max.
Resonator current	70mA max.	60 mA max.
Output power	12 watts (Typical)	7 watts (Typical)
Frequency	55Gc \pm 2Gc	31Gc \pm 1Gc
Dimensions	9 1/3" x 8 3/5" x 3 9/10"	same as left
Weight	13 lbs. 7 oz.	same as left

Although the KC31A and the KC55B outwardly appear the same, they have been made with different components to do specific jobs.

Additional information concerning KC-55B, or KC-31A, and other OKI mm-wave tubes now covering 15.5-105Gc, is available at the location shown below:

Okielectric Industry Co., Ltd.
202 East 44th Street, New York 17, N.Y. Tel: MU2-2989



What can solid-state photomixers do for you that nothing else can?

As detectors and mixers for emitter and laser radiation, semiconductor photomixers offer you some extraordinary opportunities. Look what our L4500 series of diodes can do:

They can extend your spectral coverage into the far infrared—to 5.7 microns, as compared with the photomultiplier and TWT limit of 1 micron.

They can extend your transit-time frequencies to 18 Gc, with RC cutoff frequencies beyond 40 Gc—exceeding that of the best photomultipliers.

They can eliminate bulky power-supply requirements—power consumption within the device is negligible.

They can improve operating reliability—offering the same basic advantages of stability that have prompted the use of semiconductor devices in many other areas.

They can save you a substantial amount of money. Just ask for prices and compare!



Any disadvantages? About the only one we can think of is the absence of gain within devices presently available. Easily remediable with a low-noise preamp. It should be noted in this connection that the L4500 series offers an excellent signal-to-noise ratio. And that quantum efficiency is higher than that of tubes. Coherent *minimal* detectable powers are approximately 10^{-16} watts.

The full spectral range of 0.4 to 5.7 microns is covered by a series of silicon, indium arsenide and indium antimonide diodes.

Our photomixer/detector diodes are available in a variety of package configurations for mating to BNC-type plugs, and in miniature Dewars for optimum performance in the far infrared region.

For full information and prompt technical help, call, write or wire John Roschen. Or circle the Reader Service card. (Phone: 215-855-4681.)

SOLID-STATE PRODUCTS OPERATION

PHILCO
A SUBSIDIARY OF Ford Motor Company
 LANSDALE DIVISION · LANSDALE, PA
 In Canada, Don Mills Road, Don Mills, Ontario, Canada

Crystal-clear epoxy is room-curing

Crystal-Clear is said to be the first absolutely water-clear epoxy casting resin and adhesive to be developed. This room-curing formulation can be used in various thicknesses without the slightest discoloration. It combines ultraviolet light resistance with strength and clarity. Crystal-Clear, a low viscosity material that readily pours, eliminates the necessity for machining solid acrylic pieces to get desired shapes. On the other hand, Crystal-Clear can be easily machined and also can be used to patch or bond other clear plastics.

In a thin film, Crystal-Clear can be used as an optical adhesive because of its perfect optical clarity and its high tensile strength. As a potting and encapsulating compound, the material offers extremely

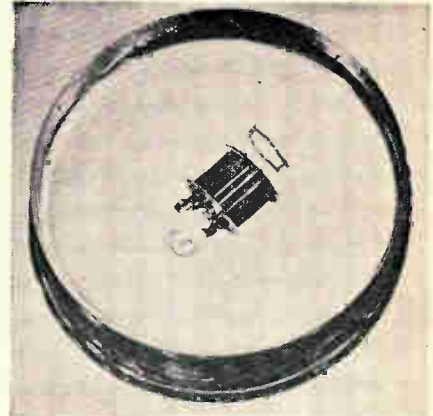

low shrinkage and high dielectric strength. Other important properties are resilience, shock resistance, and the ability to be polished to an extremely high lustre.

Allaco Products, 238 Main St., Cambridge, Mass. [441]

Highly purified cleaning solvent



A highly purified cleaning solvent has been engineered especially to meet the stringent specifications of the electronics and aerospace industries. Called Dowclene WR, the chlorinated hydrocarbon complies with the requirements for solvent cleaning specified by NASA. Dowclene WR is said to be less than half as expensive as common fluorinated white room solvents, based

on volume. From the standpoint of purity, the new solvent has a combined soluble and insoluble residue count of less than one part per million. Particulate matter is closely controlled by solvent filtration. Particulate matter count is a measure of quality adhered to by contractors in the aerospace and electronics industries. The new solvent, designed for use in environmental (white room) applications, has a maximum allowable vapor concentration of 500 parts per million and no fire or flash point measurable by standard methods. Solvent activity is balanced about midway between the common fluorocarbons and trichloroethylene. Dowclene WR has no visible effect on most insulating coatings. Mature Dowclene WR solvent can be reclaimed for other solvent applications in an ordinary chlorinated hydrocarbon distillation unit through minor modifications. It is especially suited for ultrasonic cleaning requirements, with an optimum cavitation temperature of 145°F.

The Dow Chemical Co., Midland, Mich. [442]

Unusual Resistor T.C.s

From -80 PPM/° to +6,000 PPM/° C.

RCL specializes in unusual resistor temperature coefficients for engineers involved in transistor circuitry, zener diode temperature compensation, and temperature measuring devices. Values range from 10 ohms to 5 megohms . . . all are available with axial or printed circuit leads . . . all meet all applicable Mil-specs. Write for specs, prices and information on special tolerances.

RCL

Electronics, Inc.
One Hixon Place, Maplewood, N. J.
(Area Code 201) 763-2820
TWX 201-761-5462

Circle 222 on reader service card

A HEATH-BUILT ELECTRONICS LAB FOR RESEARCH & EDUCATION

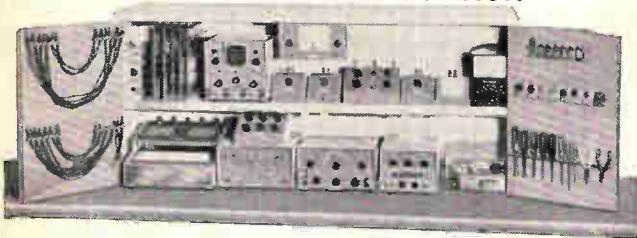

(Available As A Coordinated System Or As Individual Units)

Complete Lab Station \$1100 (less optional cabinet)

Educators and researchers will find this lab station the most modern and complete group of its type in the industry today! Designed by Heath in close association with Dr. H. V. Malmstadt of the University of Illinois and Dr. C. G. Enke of Princeton University, the EU Series provides researchers in both the physical and life sciences a solid foundation in the principles, design and use of electronic instrumentation plus the highly accurate equipment necessary for their work. The system includes factory assembled & calibrated test equipment, special purpose lab instruments, special experimental groups featuring "solderless" spring-clip connectors and the authoritative Malmstadt-Enke text "Electronics for Scientists." Send for Free brochure today for complete details!



HEATH COMPANY, Dept. 67-4
Benton Harbor, Mich. 49023

- Please send free 8-page EU-100 Brochure.
- Please send free 100-page Heathkit Catalog.

Name _____

Address _____

City _____ State _____ Zip _____

EK-160

Circle 223 on reader service card

FEATURE FOR FEATURE... DOLLAR FOR DOLLAR...

DELTRON SP SERIES SILICON POWER SUPPLIES ARE YOUR BEST BUY!

37 models - up to
1200 WATTS
output

DUET®
TWIN AMPLIFIER
controls voltage or current
with automatic
electronic crossover

COMMAND®
NON-DISSIPATIVE
pre-regulator . . . 1000 times
faster response than other
type pre-regulators



ALL SILICON
regulation
... operation at
71°C

**0.01%
REGULATION!**
No over- or undershoots!
Free from RFI

High performance . . .
yet less weight . . . smaller
size . . .
LOWER COST

No question about it . . . Deltron has combined more advanced features . . . higher performance . . . finer control . . . in the higher wattage ranges . . . and at lower prices.

A complete range of 37 models . . . from 0-100V and up to 100 amp outputs . . . in half rack sizes for lower power models, and full rack sizes, with minimum panel height, for higher power units.

To get the full story . . . or arrange a demonstration . . . write to . . .

Deltron inc.

FOURTH AND CAMBRIA STREETS, PHILADELPHIA, PA. 19133
PHONE: (215) 739-1101 TWX: (215) 569-8686

Circle 191 on reader service card



Model 300
DIGITAL PASSIVE SCALER

SYMPTOM:

Mysterious demise of semiconductors . . . Unexplained death of delicate electronic devices.

DIAGNOSIS:

Excessive power accidentally applied during resistance measurements.

Rx DPS Model 300

Strict control of measurement power on all ohmmeter ranges. Won't damage semiconductors EVER!

THE SAFE OHMMETER is just one applicational advantage of the versatile Model 300. Get all the facts today on this unique digital instrument for your voltage, current and resistance measurements. Write for brochure describing this new concept.

WESTERN RESERVE ELECTRONICS, INC.

12430 EUCLID AVENUE
CLEVELAND, OHIO 44106
Phone: (216) 791-5112

New Books

Solid state

Semiconductor Controlled Rectifiers. F.E. Gentry, F.W. Gutzwiller, Nick Holonyak Jr. and E.E. Von Zastrow. Prentice Hall, Inc., 384 pp., \$15

Considering the widespread use of pnpn devices, it is surprising that a book such as this has not appeared sooner. Semiconductor Controlled Rectifiers has an intelligent blend of theory and application material, which should make it appealing to the student and working engineer. It covers gate-turnoff controlled devices, light-activated controlled switches, bilateral switches, and Shockley four-layer diodes (briefly), as well as conventional three-terminal silicon controlled rectifiers.

Two of the authors helped write the General Electric Silicon Controlled Rectifier Manual (the third edition, containing 410 pages, was published last year for \$2). They've drawn on this experience to help produce Semiconductor Controlled Rectifiers, but a considerable amount of material in this book is new and does not appear in the GE manual. Even material that does appear in the GE manual has been reexamined and rewritten. This includes the manual's chapter on cooling controlled rectifiers and cooling fin design. This material could have easily been left out of both this book and the GE manual, however, since it applies to all types of semiconductor devices and is adequately covered in previous literature.

All in all, Semiconductor Controlled Rectifiers is a useful addition to the engineer's library even if it does overlap some of the material in the GE Silicon Controlled Rectifier Manual.

Motorola course

Integrated Circuits, Design Principles and Fabrication
Motorola Inc. Semiconductor Products
Division Engineering Staff
McGraw-Hill Book Co., 374 pp. \$12.50

This book is based on material presented in the Motorola integrated circuit course. Tuition for the one-week course was \$450 ex-

cept for a European version given early this month in Paris which cost \$300. At \$12.50, this book represents quite a saving.

The Motorola course has received such wide publicity that a book based on it is bound to receive wide-spread attention. This is the first of two volumes based on the course. A publication date for the second volume has not, as yet, been set.

The first volume covers the design of semiconductor and thin-film integrated microcircuits, including theory and processing from initial material processing, through device packaging and reliability testing. Special processes, such as compatible methods (thin-film passive elements on semiconductor substrates containing active elements), and the parasitic-less monolithic process, are discussed in detail.

Index for engineers

Manual of Electromechanical Devices. Douglas C. Greenwood
McGraw-Hill Book Co., 338 pp., \$12.50

This manual has an excellent index covering a wide variety of devices used in electromechanical applications. By using the index, the reader is instantly directed to material on devices such as reed relays, servomotors, clapper solenoids, etc.

Descriptive material is understandable by both electrical and mechanical engineers. Information presented covers areas such as magnets, electromagnets, motors, switches, controls and timing devices. However, since areas not covered include recorders, plotting devices, metering and computer components, some electronics engineers may not find this reference book applicable to their work.

Recently published

Selected Papers of Norbert Wiener, including Generalized Harmonic Analysis and Tauberian Theorems, M.I.T. Press, 454 pp., \$12.50.

American Microelectronics Data Annual, G.W.A. Oumner and J. MacKenzie Robertson, Macmillan Co., 940 pp., \$22.50.

ONE TEST EQUALS ONE THOUSAND GUESSES



INDIUM SOLDER KIT

This ingenious kit contains 13 Indalloy solders and 5 fluxes plus full instructions and an Indium test chart . . . all supplied by the pioneer processor of INDIUM. We've faced Indium questions many times since 1934 . . . and research workers, development engineers turn to us for help on the answers. They know our quality is always delivered as ordered, yet competitive in price! Write us about your questions on Indium in any form.



EXPERIMENTAL INDIUM SOLDER KIT
COMPLETE \$16.50

MANY FORMS AVAILABLE: INDIUM metals and alloys—
all purities • Pre-forms • Wire • Plating Bath • Foil •
Ribbon • Compounds • Powders. Write for bulletin:

INDIUM

CORPORATION OF AMERICA
DEPT. L • 1676 LINCOLN AVENUE • UTICA, NEW YORK
Circle 224 on reader service card

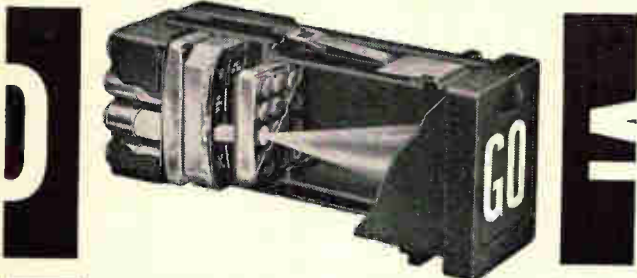

Send today for complete information on the only readout that works like a rear-projector, uses film to display anything (even colors!), gives you 12 message positions all in a single plane, and plugs in and out from the front for quick lamp replacement. All that and it's only 1½" x 1-1/16"! Just think what its bigger brothers can do . . .

INDUSTRIAL ELECTRONIC ENGINEERS, INC.
7720 Lemona Avenue • Van Nuys, California
Phone: (213) 787-0311 • TWX (213) 781-8115
Representatives in Principal Cities

Circle 225 on reader service card

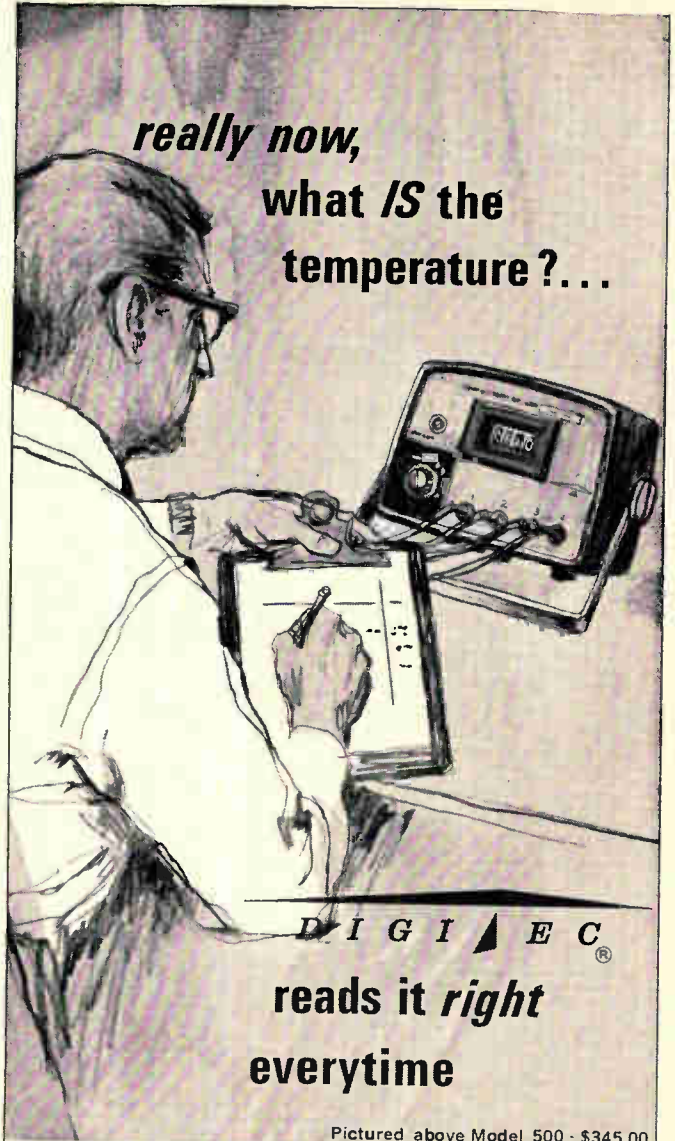

really now,
what *IS* the
temperature?...

DIGI ▲ E C
reads it *right*
everytime

Pictured above Model 500 - \$345.00

precision digital measurement of temperature
reading directly in degrees C or F

THERMISTOR BASED
(Series 500)

Accuracy to 0.15°
Covering -50 to +100° C
Interchangeable Probes

PLATINUM BULB
(Series 530)

Accuracy to 0.70° F
Covering -390 to +1000° F
Interchangeable Probes

THERMOCOUPLE
(Series 560)

Accuracy to 4° F
Covering -328 to +2000° F
For use with I-C } Thermocouples
CH-AL }
CU-C }

OPTIONAL: BCD OUTPUT FOR PRINTER

Update your literature files . . .
send for 32-page, D-65 catalog

DIGI ▲ E C BY UNITED SYSTEMS CORPORATION

918 Woodley Road, Dayton 3, Ohio (513) 254-3567

stocking representatives throughout the world

Circle 193 on reader service card

Do you need
an amplifier
to fit in this
space . . . today?

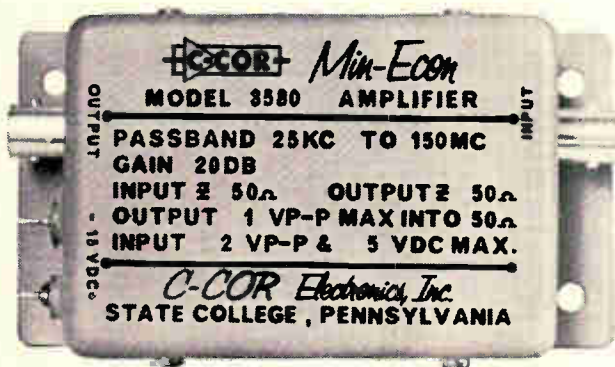

We have many . . .
The new *Min-Econ*

This is a full-size photograph of a typical Min-Econ amplifier. Each one in our new line is this small, and economically priced. Utilization of standardized packaging techniques and common parts wherever possible permits this approach. We have over a dozen designs **on the shelf** for immediate delivery. They will deliver sizeable linear output power, with good isolation between output and input. These units are not "flea-power" devices as are many so-called "amplifier modules." They are silicon solid-state units. The model 3580 picture here is a video amplifier, with a pass band of 25 kc to 150 mc, 20 db gain, and 1 volt p-p output capability. The price: \$150.

Among other video amplifiers are:

Model	Passband	Output	Price
3581	20 cps to 60 mc	1 v p-p	\$70.00
3582	20 cps to 10 mc	2 v p-p	80.00
3585	10 cps to 3 mc	55 v p-p	90.00

Bandpass models include 10% bandwidths at center frequencies from 100 to 500 mc. Prices around \$150.

Let us send you more information on this remarkable new line — and let us solve your special amplifier problem with units of **any** size. Amplifiers are our specialty.



C-COR Electronics, Inc.

P. O. BOX 824 • STATE COLLEGE PA. • 16801

We keep moving ahead . . .

to stay ahead in electronics

Reprints Available from Electronics

Special Reprint Offer: For your reference file—a complete set of Special Reports reprinted from the pages of Electronics in 1964. A total of 207 pages of valuable and informative articles combined in an attractive folder. The reports are individually bound. The special discount price for these reprints is \$2.50 which includes both handling and shipping costs. Order now using the coupon at the bottom of this page. The following reprints are included in this offer:

Field Effect Transistors—A report on metal-oxide-semiconductor (MOS) and junction field-effect transistors. 64 pages.

Electronics Telephone Switching—World-wide developments in fast, recorded logic, telephone switching that will replace all existing systems by the year 2,000.

Direct Digital Control In Industry—This report analyzes seven DDC computer systems used in process control by seven major companies.

Transistor Heat Dissipators—A survey of this industry including market data, list of manufacturers, and tips on buying these devices. Included are 7 outstanding technical articles giving the newest applications of these devices and how to make best use of them. 32 pages.

Oceanography—A survey of the growing electronics technology associated with underseas exploration. 15 pages.

Magnetics—A report on what's new in today's magnetic technology. 24 pages.

Digital Instrumentation—A look at some new techniques in instrumentation. 16 pages.

Modern Electronic Packaging—How to locate, connect and afford protection for electronic devices and components. 16 pages.

Remember to refer to this special offer when you order. Price is \$2.50 for the complete set or you may order them individually at 50¢ per copy.

Send your order to:
Electronics Reprint Dept. 330 West 42nd Street
New York, N.Y. 10036

A2

Reprint order form

For reprints of the latest special report:

Experiments On Gemini

Send me . . . reprints of Key no. R-71 at 50¢ each.

For reprints of previous special reports:

Send me . . . reprints of Key no(s) . . .
at . . . ¢ each.

For complete set of special reports (See above offer)

Send me . . . complete set(s) of special reports.

Name

Number & Street

City, State, Zip code

Technical Abstracts

Performance simulation

LOCS: Reports on "unbuilt machines"
M. S. Zucker
International Business Machines Corp.,
Yorktown Heights, N. Y.

A new logic and control simulator (LOCS) can simulate on the IBM 7090 computer the performance of any data-processing machine, whether that machine has been built or not. All that is needed is an encoded machine description and a set of test programs. For software analysis, the simulator causes the IBM 7090 to produce the same outputs as the test machine; for hardware analysis, performance statistics and diagnostic data can be produced without any of the actual hardware.

The five parts of LOCS are a language, a monitor, a translator, an assembler, and an executor. The designer feeds the specifications of the test machine into the 7090 in LOCS language. The computer translates this into symbolic language, then assembles this symbolic specification into machine language and executes the result, along with test programs which have been supplied either in symbolic form or in some language such as Fortran. The result is a listing of clock readings at the beginning and end of execution and at other points selected by the designer, together with the computer results and diagnostic data that would be obtained if the actual machine were being used instead of the 7090. The simulator also prints out the number of times certain critical operations took place during the run, together with the results.

A complete and detailed specification of a conventional stored-program, parallel-arithmetic, binary computer requires approximately one thousand LOCS statements. These include definitions of storage, specific logical subassemblies and the instruction set. Program steps which require several instructions in the test machine but only one instruction in the 7090, or vice versa, must also be specified. A less complete specification for soft-

ware evaluation requires only about 200 statements.

The simulator has successfully predicted the performance of a number of machines or subassemblies. It provides a valuable tool in the choice of alternative designs.

Presented at the IEEE International Convention, New York, Mar. 22-26.

Measuring voltage to 5 ppm

A system for accurate d-c and a-c voltage measurements

F.L. Hermach, J.E. Griffin and
E.S. Williams

Electrical Instruments Section,
Electricity Division, National Bureau of
Standards, Washington

A new system has been developed at the National Bureau of Standards for calibrating and using d-c and a-c standards. Composed of equipment normally available in a standards laboratory, the system is capable of short-time precision of 5 parts per million for d-c measurements and 15 parts per million of rated voltage for a-c measurements.

The measuring system consists of a group of saturated standard cells; a six-dial universal ratio set modified by the addition of a control box so that it may be used as an accurate potentiometer; a simplified volt box of the Silsbee type; a new differential thermocouple a-c/d-c comparator; and an inductive voltage divider for low a-c voltage measurements. The inductive voltage divider is also used to calibrate the universal ratio set. Also needed are a picoammeter, used to assist in checking certain insulation resistances, and the standard complement of a-c and d-c meters.

For a-c measurements, a new type of transfer standard was designed — a differential-thermocouple voltage comparator. This unit contains two identical voltage converters, each consisting of a chain of resistors in series with the heater of a 10-milliampere thermocouple. The two thermocouple outputs are connected in opposition and to a galvanometer.

When a measurement is being made, the two voltage converters are in parallel with a d-c source

McGRAW-HILL
BOOKS

Just Published

INTEGRATED CIRCUITS Design Principles and Fabrication

Prepared by the Engineering Staff,
Semiconductor Products Div., Motorola
Inc.

Provides valuable information on how to put integrated circuits to work for you in a wide range of practical applications. From initial material processing through device packaging and reliability testing, all phases and aspects of integrated circuits are treated. Acceptor doping . . . hole-electron spin asymmetry . . . recombination and generation . . . the gaussian distribution . . . diffusion time . . . sheet resistance . . . and many other subjects are covered. 370 pp., 298 illus., \$12.50. Payable \$6.50 in 10 days, and \$6 in one month

OPTOELECTRONIC DEVICES AND CIRCUITS

Just Out. Treats the theory, operation, and application of optoelectronic systems. By S. Weber, Electronics. 368 pp., 473 illus., \$15.00. Payable \$7 in 10 days, \$8 in one month

MATHEMATICAL BAFFLERS

An entertaining and stimulating collection of 125 recreational problems. Includes the best from Litton Industries' Problematical Recreation Series. By A. Dunn, Litton Industries. 200 pp., illus., \$6.50

MICROWAVE FILTERS, IMPEDANCE-MATCHING NETWORKS, AND COUPLING STRUCTURES

Just Out. Shows how to design microwave devices for a wide variety of practical uses. By G. Matthaei, L. Young & E. Jones. 1079 pp., illus., \$22.50. Payable \$8.50 in 10 days, and \$7 for 2 months

10 DAYS' FREE EXAMINATION

Convenient Mail Service

Direct from McGRAW-HILL

McGraw-Hill Book Co., 04-L125
327 W. 41st St., New York, N. Y. 10036
Send me book(s) checked below for 10 days on approval. In 10 days I will remit for book(s) I keep plus few cents for delivery costs, and return unwanted book(s) postpaid. (If you remit with coupon, plus local tax, we pay delivery costs—full refund and return privilege.)
 Motorola—Integrated Circuits, \$12.50
 Weber—Optoelec. Devices & Circs., \$15.00
 Dunn—Mathematical Bafflers, \$6.50
 Matthaei—Microwave Filters, Impedance-Match. Ntwks. & Coupl. Struc., \$22.50
 Check here if you wish to pay on terms
Name
Address
City State Zip
Company
Position
For price and terms outside U.S.
write McGraw-Hill Int'l., N. Y. 10036 04-FL4



Toshiba silicon planar transistor for UHF TV tuners

M9010

Characteristics ($T_a=25^\circ\text{C}$)

OUTLINE UNIT INCHES

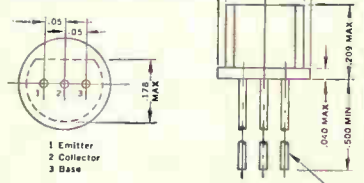

V_{CB0}	20V	Max.
V_{CE0}	12V	Max.
V_{EB0}	2V	Max.
I_c	50mA	Max.
T_j	125°C	Max.
I_{CBO} ($V_{CB}=15V$)	0.5 μ A	Max.
h_{FE} ($I_c=8.0mA$, $V_{CE}=10V$)	20	Min.
P_o ($f=930Mc$, $I_c=10mA$, $V_{CB}=10V$)	8.0 mW	Max.

The Toshiba M9010 is a silicon n-p-n oscillator designed to work in combination with the Toshiba M8482, a silicon point-contact mixer diode capable of extremely low noise operation. The M9010 provides greater stability than possible with germanium oscillators, and is available separately or as a combination unit with M8482.

The M9010 silicon planar is the newest development from Toshiba—one of the world's foremost manufacturers of quality electronic components and finished assemblies, for industry, entertainment and communications requirements.

■ **Overseas Offices** ● **New York:** 20th Fl., The Bank of New York Bldg., 530 Fifth Avenue, New York, N.Y. 10036. **Chicago:** Room 1238, Board of Trade Bldg., 141 West Jackson Boulevard, Chicago, Illinois 60604. **San Francisco:** Merchants Exchange Bldg., 465 California St., San Francisco, Calif 94104.

f_T ($I_c=8.0mA$, $V_{CE}=10V$)	1200 Mc	Typ.
C_{ob} ($V_{CB}=10V$, $f=4Mc$)	1.9 pF	Max.

M8482 (Tentative)

OUTLINE: DO-7

Characteristics ($T_a=25^\circ\text{C}$)

V_R	-5V	Max.
I_F	30mA	Max.
$I_{F\text{ peak}}$	90mA	Max.
N_F (@ $f=887\text{ Mc}$, $f_{IF}=43.5\text{ Mc}$)	14 dB	Max.

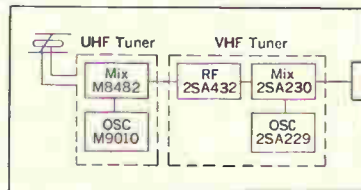

that is nominally equal to the a-c voltage being measured. The outputs of the thermocouples are adjusted to a null on the galvanometer. One converter is then switched to the a-c source, and a null on the galvanometer obtained by adjusting the d-c voltage. The a-c and d-c voltages are then equal, and the d-c voltage can be measured with the volt box and the potentiometer. Reversing the d-c voltage, repeating the measuring sequence and averaging the readings eliminates the d-c reversal errors in the thermoelement.

With the dual converters, errors from drifts and other uncertainties, which limit the accuracy of the single thermoelement system, are sharply reduced. The dual principle also allows for simultaneous, precise comparison of a-c and d-c voltages.

With the system of intercomparisons, the accuracy achieved depends only upon the standard cells, the very stable inductive divider and the difference between the a-c and d-c voltages in the comparator. D-c voltages from 0.5 to 1,000 volts can be measured with an uncertainty of less than 20 ppm and a-c voltages from 20 to 20,000 cycles per second to an uncertainty of 40 parts per million.

Presented at the 1965 IEEE International Convention, New York, March 22-26.

Ultrasonic spectroscopy

The pulse-echo test for nondestructive inspection has been modified to cover a wide range of frequencies simultaneously.

Otto R. Gericke, U.S. Army Materials Research Agency, Watertown, Mass.

Ultrasonic inspection procedures for nondestructive testing of materials are based upon the pulse-echo principle, by which pulses of ultrasonic energy are injected into a test specimen and the echoes from discontinuities are picked up and displayed. By connecting a linear time-base to the X-axis of an oscilloscope, the echoes can be displayed as a function of the pulse travel time. If the sound velocity of the specimen is known, the screen

Tokyo Shibaura Electric Co., Ltd. Tokyo, Japan

Toshiba Quality Since 1875

Technical Abstracts

of the oscilloscope can also be calibrated to display the defect distance.

However, to determine the severity of the defect properly, its magnitude must also be known. To provide information about the geometry of defects, the ordinary pulse-echo test, which uses a practically monochromatic sound signal, has been modified to cover a wider range of test frequencies simultaneously. This multiple frequency method is called ultrasonic spectroscopy.

Two methods of expanding the spectrum of the pulse-echo frequency have been found usable. The first excites the transducer with the output of a swept-frequency generator of constant amplitude. However, to receive the echoes, the generator output is passed through an electronic gate, which is opened and closed at a rate higher than the sweep rate.

The second method excites the transducer with a rectangular pulse generator. The duty cycle is kept low by keeping the pulses short compared with the interval between them. There are a number of limitations with the pulse method. The maximum signal that can be applied to the transducer for a good signal-to-noise ratio, and the pulse width, when adjusted for the best performance, can result in the breakdown of the transducer. As a result, compromises must be made between the uniformity of the spectrum and the signal-to-noise ratio.

The proper transducer was selected by using the swept frequency generator and observing the frequency response. The ultimate choice was made for the best frequency response after comparing commercial piezoelectric transducers known to provide sufficient sensitivity for pulse-echo testing. In addition to determining the geometry of defects in materials, the spectroscopic method provides a new approach to nondestructively determining the microstructure of materials, especially polycrystalline metals.

Presented at the 1965 IEEE International Convention, New York, March 22-26.

Mallory Film Resistors

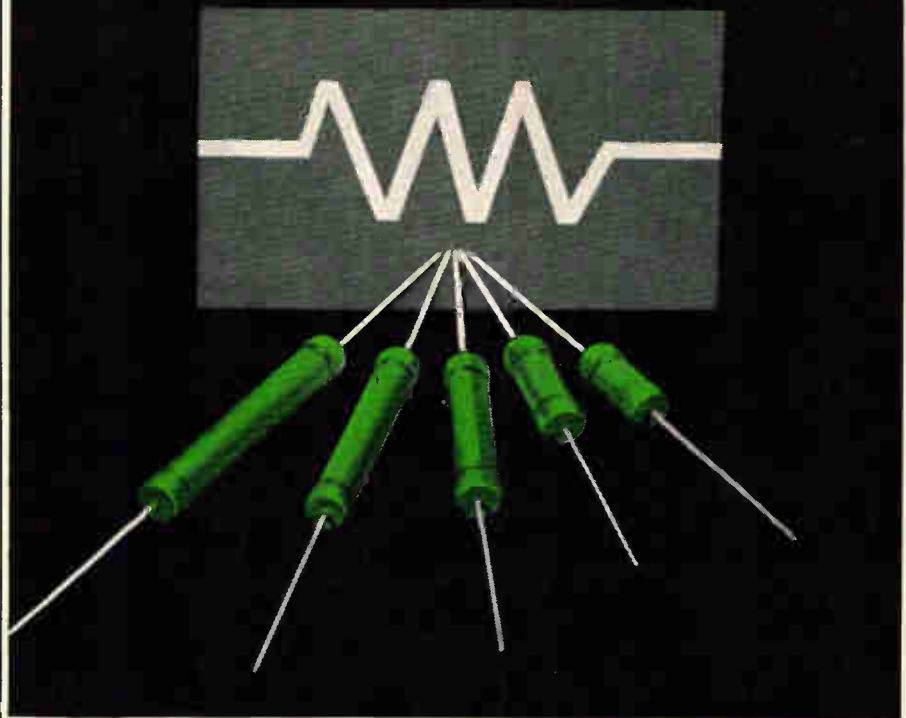

now in wider resistance range

Type MOL metal oxide film resistors now cover more resistance values than ever before, at both the high and low ends of the list.

In the 2-watt size, for instance, you can get resistances from 30 to 500,000 ohms. More values are now available also in the 3, 4, 5 and 7 watt ratings.

This broadened range has been made possible by continuing Mallory developments in applying and controlling the metal oxide film. At the same time, the MOL line's exceptional properties of stability, humidity resistance, low noise and flame resistance have not only been retained but improved.

For complete data and a quotation, write to Mallory Controls Company, Frankfort, Ind.—a division of P. R. Mallory & Co. Inc.

MALLORY

MICROWAVE ELECTRONICS

the fastest growing segment of electronics industry, provides unusual growth opportunities. New positions are now available at MICROWAVE ASSOCIATES INC., the broadest based microwave component developer and manufacturer in the U. S.

We welcome your resume if you are interested in any of the positions below. All inquiries will be considered in confidence and replied to as expeditiously as possible.

HEADQUARTERS SALES GROUP REQUIRES,

microwave component sales engineers to service OEM and government accounts and provide technical backup to sales representatives. Must have 2-3 years experience in microwave sales and familiarity with component applications in systems. Product line covers waveguide, strip-line, coaxial, and solid state hardware and devices.

SEMICONDUCTOR PRODUCTION ENGINEERS

1.) New state-of-the-arts program requires Production Engineer to solve problems relating to processing of silicon slices. Will have direct responsibility and authority for improving yields and quality of silicon slicing, lapping, photomasking techniques and operations.

B.S. degree with experience in silicon processing, particularly with diffusion, planar and mesa techniques. Knowledge of cost reduction techniques essential.

2.) Production Engineer needed in P-I-N device manufacturing. Responsibility for process and equipment, and jig procurement. Assist in design modifications to improve yield and processes.

B.S. degree plus minimum 3 years experience in semiconductor production or design engineering. Knowledge of planar or mesa epitaxial silicon devices preferred.

Contact Director Professional Personnel

MICROWAVE ASSOCIATES, INC. BURLINGTON, MASS.

A SUBURB OF BOSTON

An Equal Opportunity Employer



E. E.'s

for FEE-PAID Positions
WRITE US FIRST!

Use our confidential application for professional, individualized service . . . a complete national technical employment agency.

ATOMIC PERSONNEL, INC.
Suite 1207L, 1518 Walnut St., Phila. 2, Pa.

ADDRESS BOX NO. REPLIES TO: Box No. Classified Ad. Div. of this publication. Send to office nearest you.
NEW YORK, N. Y. 10036: P. O. Box 12
CHICAGO, Ill. 60611: 645 N. Michigan Ave.
SAN FRANCISCO, Cal. 94111: 255 California St.

POSITION VACANT

Communications Engineer—FM Solid State
To Locate in Miami, Florida. Require capable engineer with demonstrated experience in solid state FM two-way communications equipment. Must be able to independently launch projects and carry through to completion. Excellent working conditions, fringe benefits, advancement opportunity with leading national company. Send resume and salary requirements. P.O. Box 308, Riverside Station, Miami, Florida.

Your Inquiries to Advertisers Will Have Special Value . . .

—for you—the advertiser—and the publisher, if you mention this publication. Advertisers value highly this evidence of the publication you read. Satisfied advertisers enable the publishers to secure more advertisers and—more advertisers mean more information on more products or better service—more value—to YOU!

Employment

Electronics

Opportunities

QUALIFICATION FORM FOR POSITIONS AVAILABLE

ATTENTION: Engineers, Scientists, Physicists

This Qualification Form is designed to help you advance in the electronics industry. It is unique and compact. Designed with the assistance of professional personnel management, it isolates specific experience in electronics and deals only in essential background information.

The advertisers listed here are seeking professional experience. Fill in the Qualification Form below.

Strictly Confidential

Your Qualification Form will be handled as "Strictly Confidential" by Electronics. Our processing system is such that your form will be forwarded within 24 hours to the proper executives in the companies you select. You will be contacted at your home by the interested companies.

What To Do

1. Review the positions in the advertisements.
2. Select those for which you qualify.
3. Notice the key numbers.
4. Circle the corresponding key number below the Qualification Form.
5. Fill out the form completely. Please print clearly.
6. Mail to: Classified Advertising Div., Electronics, Box 12, New York, N. Y. 10036.

COMPANY	SEE PAGE	KEY #
ATOMIC PERSONNEL, INC. Phila. 2, Pa.	198	1
BENDIX CORP. Pioneer-Central Div. Davenport, Iowa	179*	2
COLUMBIA UNIVERSITY Nevis Laboratory Irvington-On-The-Hudson, New York	179*	3
ELECTRONIC COMMUNICATIONS, INC. St. Petersburg, Fla.	180*	4
GENERAL DYNAMICS/ELECTRIC BOAT Groton, Conn.	180*	5
GENERAL DYNAMICS/FORT WORTH Fort Worth, Texas	72*	6
McDONNELL Electronic Equipment Div. St. Louis, Mo. 63166	199	7
MICROWAVE ASSOCIATES, INC. Burlington, Mass.	198	8
MONSANTO St. Louis, Mo. 63166	179*	9
RESEARCH ANALYSIS CORP. McLean, Va. 22101	175*	10

* These advertisements appeared in the April 5th issue.

(cut here) (cut here)

Electronics Weekly Qualification Form For Positions Available

(Please type or print clearly. Necessary for reproduction.)

Personal Background

Name
Home Address
City Zone State
Home Telephone

Education

Professional Degree(s)
Major(s)
University
Date(s)

Fields of Experience (Please Check)

4-19-65

- | | | |
|--|--|---------------------------------------|
| <input type="checkbox"/> Aerospace | <input type="checkbox"/> Fire Control | <input type="checkbox"/> Radar |
| <input type="checkbox"/> Antennas | <input type="checkbox"/> Human Factors | <input type="checkbox"/> Radio—TV |
| <input type="checkbox"/> ASW | <input type="checkbox"/> Infrared | <input type="checkbox"/> Simulators |
| <input type="checkbox"/> Circuits | <input type="checkbox"/> Instrumentation | <input type="checkbox"/> Solid State |
| <input type="checkbox"/> Communications | <input type="checkbox"/> Medicine | <input type="checkbox"/> Telemetry |
| <input type="checkbox"/> Components | <input type="checkbox"/> Microwave | <input type="checkbox"/> Transformers |
| <input type="checkbox"/> Computers | <input type="checkbox"/> Navigation | <input type="checkbox"/> Other |
| <input type="checkbox"/> ECM | <input type="checkbox"/> Operations Research | |
| <input type="checkbox"/> Electron Tubes | <input type="checkbox"/> Optics | |
| <input type="checkbox"/> Engineering Writing | <input type="checkbox"/> Packaging | |

Category of Specialization

Please indicate number of months experience on proper lines.

	Technical Experience (Months)	Supervisory Experience (Months)
Research (pure, fundamental, basic)
Research (Applied)
Systems (New Concepts)
Development (Model)
Design (Product)
Manufacturing (Product)
Field (Service)
Sales (Proposals & Products)

Circle Key Numbers of Above Companies' Positions That Interest You

1 2 3 4 5 6 7 8 9 10 11 12 13 14 15

EMPLOYMENT OPPORTUNITIES

The advertisements in this section include all employment opportunities—executive, management, technical, selling, office, skilled, manual, etc.

Look in the forward section of the magazine for additional Employment Opportunities advertising.

— RATES —

DISPLAYED: The advertising rate is \$52.00 per inch for all advertising appearing on other than a contract basis. Contract rates quoted on request.

An advertising inch is measured $\frac{7}{8}$ " vertically on a column—3 columns—30 inches to a page.

Subject to Agency Commission.

UNDISPLAYED: \$2.70 per line, minimum 3 lines. To figure advance payment count 5 average words as a line. Box numbers—count as 1 line.

Discount of 10% if full payment is made in advance for 4 consecutive insertions.

Not subject to Agency Commission.

LET'S SWAP RESUMES



The McDonnell Electronic Equipment Division is currently engaged in more than 200 projects and programs. Its advanced developments span the sciences from thin-film circuitry through complete systems; temperature problems range from cryogenics through extremes of reentry heating.

Present and planned programs have created these career opportunities at the managerial level:

Responsible for concept, design, analysis and development of electronic equipment in areas of: MICROELECTRONICS—COMPUTERS & AUTOMATION—SPACE INFORMATION SYSTEMS—SURFACE COMMUNICATIONS—TRAINERS & SIMULATORS—PROCESS CONTROLS—AUTOMATED CHECKOUT—BIOMEDICAL SYSTEMS—ASW—NUCLEAR STUDIES—ECM & ECCM.

McDonnell's educational assistance program plus the convenience of nearby St. Louis and Washington Universities are additional incentives to select the *Electronic Equipment Division* for your career.

To arrange for convenient interview, please complete the attached coupon. All information will be confidential.

MCDONNELL P. O. Box 516, St. Louis, Missouri 63166
Att: W. R. Wardle, Engineering Employment Office, Dept. V-419

Name _____ Home Address _____
 City & State _____ Phone _____
 Present Position _____
 Primary Experience Area _____ No. of years _____
 Education: AE _____ ME _____ Math _____ Physics _____ Chem _____
 EE _____ Bus. Adm. _____ Other _____
 Degree: BS _____ MS _____ PhD _____
 date _____ date _____ date _____

MCDONNELL ELECTRONIC EQUIPMENT DIVISION
An Equal Opportunity Employer

SEARCHLIGHT SECTION

- CLASSIFIED ADVERTISING
- BUSINESS OPPORTUNITIES
- USED OR SURPLUS EQUIPMENT

PERFECT FOR ELECTRONICS!

Practically New
ONE STORY AIR COND.
65,000 SQ. FT.

MODERN PLANT • 16 ACRES
Bennettsville, S. C.

BINSWANGER

1420 Walnut St., Phila., Pa. 19102 • PE 5-0202

CIRCLE 952 ON READER SERVICE CARD

Color DIAL TELEPHONES \$10.95

Factory rebuilt Western Electric in white, beige, ivory, pink, green, or blue. If 4 prong plug is required add \$2.00. Fully guaranteed. Write for free list. All shipments FOB.



SURPLUS SAVING CENTER
Dept. E-4195
Waymart, Pa.

CIRCLE 953 ON READER SERVICE CARD

**PURCHASING AGENTS — USERS — JOBBERS
RETAILERS — MANUFACTURERS**

**SATISFY YOUR ELECTRONIC REQUIREMENTS
WITH UNCLE SAM'S SURPLUS**

\$869,234 SEALED BID SALE

BID OPENING DATE: FRIDAY—APRIL 23—10:00 A.M.

featuring
ELECTRICAL & ELECTRONIC EQUIPMENT & ACCESSORIES

- ELECTRICAL MOTORS
- MOTOR GENERATORS
- POWER SUPPLY
- PHOTOGRAPHIC FILM & PHOTOGRAPHIC EQUIPMENT
- POWER DISTRIBUTION EQUIPMENT
- TRANSMITTERS
- ELECTRONIC TUBES

PROPERTY LOCATED: Camp Drum, N. Y., Griffiss AFB, N. Y.,
Ft. Tilden, N. Y., N. Y. Naval Shipyards

Call or write for Free Catalog NO. 18-S-65-82

Defense Surplus Sales Office
P. O. Drawer No. 1, Dept. EN
Bush Terminal Station
Brooklyn, New York 11232
A.C. 212, Sterling 8-5000, Ext. 875

Learn how you can participate in future sales—including electronics—write: DSBDO, Dept. P, DLSC, Battle Creek, Mich. 49016. Ask for pamphlet HTB.



CIRCLE 951 ON READER SERVICE CARD

MINOR SWITCH

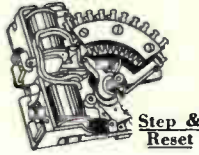

Two coils, step and reset; 10 steps and off. Single level switches have bridging wipers, others non-bridging. Listed below are stock numbers and prices for switches with bronze wipers and contacts. The same switches can be obtained with any or all levels with gold plated contacts and wipers.

Volts	1 level		2 level		3 level	
DC	Stk #	Price	Stk #	Price	Stk #	Price
8- 12	R960	15.00	R977	15.75	R642	16.50
25- 36	R975	15.00	R978	15.75	R600	16.50
48- 60	R976	15.00	R979	15.75	R645	16.50
100-125	R643	15.75	R644	16.50	R646	17.25
Off-normal springs; 1A, 1B; #ONS1						1.00
(Please specify if required)						extra

GOLD PLATED WIPERS AND CONTACTS
AVAILABLE AT 2.50 EXTRA PER LEVEL.

350 MA FULL WAVE BRIDGE RECTIFIER FOR 115 VAC
OPERATION OF ANY 100 VDC STEPPER; #PS350 . . . 3.50

RELAYS BY UNIVERSAL

Consider the advantages when you order from Universal: Over 2,000,000 in 20,000 different types in stock . . . Most makes . . . Average shipment within 48 hours . . . and . . . you can count on Universal dependability. Send for latest 60 page catalog #E which illustrates our wide range of relays.

"Satisfaction is on the other end of your telephone"

Universal RELAY CORP.

42 WHITE ST., NEW YORK 13, N. Y. • WALKER 5-6900

The BEST WAY:

- TO BUY Surplus Electronics
- TO SELL YOUR Surplus Electronics

IF YOU INQUIRED about Signal Generators, we would send you a listing of 34 types: G.R.#1001A, H.P. #608B, etc. etc. up thru X-Band. But Signal Generators is only 1 of the 52 categories by which we classify our tremendous stock of choice materiel. Turnover is too fast to keep up with a general catalog, but we keep category lists current . . . so please tell us your specific needs!

WE KEEP 3 FILES by category:
INVENTORY . . . WANTS . . . OTHERS HAVE

If your WANTS inquiry drops into a slot unmatched in the other 2 files, chances are that tomorrow it will be matched by a new card in one of the others.

SO if you HAVE MATERIAL, surplus to your needs, or want to update, tell us about it and price it . . . same as we price whatever we offer for sale . . . and we try to make our prices tempting. There may be a hole in our inventory or wants file that will absorb your material fast.

Write . . . Wire . . . Phone . . .

R. E. GOODHEART CO., INC.
P.O. Box 1220-E Beverly Hills, Calif. 90213
Area 213 Phones 272-5707, 276-9349.
Messages: 275-5342

CIRCLE 954 ON READER SERVICE CARD

CIRCLE 979 ON READER SERVICE CARD

SEMICONDUCTORS MAJOR BRANDS

INTERGRATED CIRCUITS • DIF. AMPS DARLINGTONS • POWER DIODES & TRANSISTORS • SPECIAL DEVICES

Write for Catalog 5-1

SEMICONDUCTOR SALES OF CALIF.
1063 Perry Annex Whittier, Calif.
(213) 696-7544

CIRCLE 955 ON READER SERVICE CARD

RADAR AUTO-TRACK & TELEMETRY ANTENNA PEDESTALS 3 & 10 CM. SCR 584 AUTOTRACK RADARS. M-33 RAOAR TPS-10 SEARCH. APS-45 TPS-100 HT. FINOERS. WX RADARS. FPN-32CCA. APS-10 APS-15B APS-27 (AMTI) SEARCH. ■ ■ ■ APN-102 DOPPLER. DOZENS MORE CARCINOTRONS. PENS. 25-5-1-2-3-6 MEGAWATT PULSE MODULATORS. CAVITIES. PULSE TRANSFORMERS. IF STRIPS. WAVEGUIDE. BENDS 200 MC. 1 KMC. 3 KMC. 6 KMC. 9 KMC. 24 KMC. RF PKGS.

RADIO RESEARCH INSTRUMENT CO.
550 5TH AVE., NEW YORK 36, N. Y. JU 6-4691

CIRCLE 956 ON READER SERVICE CARD

INDUSTRIAL—RECEIVING SPECIAL PURPOSE TUBES

BEST QUALITY—LOWEST PRICES

Semiconductors—All Types

FREE CATALOG—write

ROBERT G. ALLEN CO.

P.O. Box 1882 Dept. E-1, Beverly Hills, Calif. 90213
Phone (213) 657-1583

CIRCLE 957 ON READER SERVICE CARD

FREE...CATALOG BARRY ELECTRONICS

512 BROADWAY 212-WALKER 5-7000
NEW YORK 12, N.Y. TWX-571-0484

CIRCLE 958 ON READER SERVICE CARD

LET THIS
SEARCHLIGHT
SECTION
SELL FOR YOU

SEARCHLIGHT EQUIPMENT LOCATING SERVICE

No Cost or Obligation

This service is designed to help you, the reader of SEARCHLIGHT SECTION, to locate used or rebuilt equipment not currently advertised.

HOW TO USE: Check the ads in this SEARCHLIGHT SECTION to see if what you want is advertised. If not, print clearly the specifications of the equipment and/or components wanted on the coupon below, or on your own letterhead.

THIS IS A SERVICE TO OUR READERS. THIS PUBLICATION DOES NOT BUY, SELL OR STOCK EQUIPMENT OR MATERIALS OF ANY TYPE. Your requirements will be brought promptly to the attention of the used equipment dealers advertising in this section. You will receive replies directly from them.

Obviously, the list of such advertisers is limited by comparison with the over 63,000 subscribers to ELECTRONICS, all directly engaged in the electronics industry. A small "EQUIPMENT WANTED" advertisement in the SEARCHLIGHT SECTION will bring your needs to the attention of ALL who read ELECTRONICS. The cost is low.

SEARCHLIGHT EQUIPMENT LOCATING SERVICE

CLASSIFIED ADVERTISING

c/o Electronics

P. O. Box 12, N. Y., N. Y. 10036

Please help us to locate the following used equipment:

.....

.....

NAME

TITLE

COMPANY

STREET

CITY.....ZIP CODE.....

STATE..... 4/19/65

New Literature

Microwave catalog. Electronic Specialty Co., 4561 Colorado Blvd., Los Angeles, Calif., 90039, has published a short-form catalog describing noise sources, TR and ATR tubes, duplexers, pulsed attenuators, and backward-wave oscillators.

Circle 461 on reader service card.

Battery products. Battery Division, Sonotone Corp., Elmsford, N.Y., 10523, has released a new product facility brochure on the history and capability of its rechargeable nickel-cadmium batteries. [462]

Silicone-coated resistors. RCL Electronics, Inc., 1 Hixon Place, Maplewood, N.J., has prepared a booklet devoted exclusively to series T silicone-coated resistors of the precision power wire-wound type. [463]

Compact scr supplies. Harrison Laboratories, a division of Hewlett-Packard, 100 Locust Ave., Berkeley Heights, N.J. A new bulletin describes six models of scr supplies that feature small size, weight, ripple and price. [464]

Technical ceramic compositions. American Lava Corp., Manufacturers Road, Chattanooga, Tenn., 37405. Property chart No. 651 contains mechanical and electrical characteristics of ALSiMag technical ceramic compositions. [465]

Square pulse bonder. General Electric Co., Schenectady 5, N.Y. Bulletin GED-4975A describes a square pulse bonder for uniform surface bonding of leads to microminiature circuitry. [466]

Conformal coatings. Zicon Corp., 63 East Sandford Blvd., Mount Vernon, N.Y., has prepared the first bulletin of a series called "Vapor Spray Coating Facts", a technical information sheet on conformal coatings. [467]

Microwave radio system. Lenkurt Electric Co., Inc., San Carlos, Calif. An eight-page brochure contains details on the 76E microwave radio, a broadband system for use in the frequency bands between 12.2 and 13.25 Gc. [468]

Digital averaging technique. Nuclear Data, Inc., P.O. Box 451, Palatine, Ill. An electronic averaging technique that extracts weak signals from backgrounds of non-filterable, random electrical noise is described in a new 16-page booklet. [469]

Precious metals. Sigmund Cohn Corp., 121 South Columbus Ave., Mount Vernon, N.Y., has made available a 12-page bulletin entitled "Precious Metals and High Purity Nickel as used in Temperature Measurements". [470]

Digital voltmeter. Non-Linear Systems, Inc., P.O. Box 728, Del Mar, Calif., offers a four-page bulletin on the model

4401 versatile digital voltmeter that measures voltage peaks as well as static voltages. [471]

Aerospace material. The Beryllium Corp., Reading, Pa. Lockalloy, a new alloy that combines the properties of aluminum and magnesium base alloys with the superior properties of beryllium, is described in an eight-page bulletin. [472]

Toroid data. Ferroxcube Corp. of America, Saugerties, N.Y. Bulletin 301 contains specifications for toroidal ferrite cores with initial permeabilities higher than 5,000. [473]

Microwave devices. Microwave Devices, Inc., Farmington Industrial Park, Farmington, Conn. Short form catalog 1-65 covers a broad line of microwave components and test instruments. [474]

Tuning fork oscillator. Solid State Electronics Corp., 15321 Rayen St., Sepulveda, Calif., offers a bulletin on the model TF-120 silicon transistorized reference frequency oscillator. [475]

Analog division modules. General Magnetics, Inc., 135 Bloomfield Ave., Bloomfield, N.J. Bulletin MM110 describes solid state, microminiature analog division modules. [476]

Proportional temperature controller. Metals & Controls Inc., a corporate division of Texas Instruments Inc., 34 Forest St., Attleboro, Mass., announces a bulletin on the Klixon 4CT proportional temperature controller with adjustable temperature range and scr output. [477]

Switches. Stearns-Lyman Electronic Corp., 12 Cass St., Springfield, Mass., 01101. A four-page brochure covers the many features and capabilities of a line of magnetic reed and rotary stepping switches. [478]

Voltmeter calibration. Cohu Electronics, Inc., Box 623, San Diego, Calif., 92112. Field calibration of digital voltmeters is described in bulletin 5-23. [479]

Pressure actuated switches. Meletron Corp., 940 North Orange Drive, Los Angeles, Calif. A new short form catalog covers over 50 models of pressure actuated switches. [480]

Miniature potentiometer. Helipot Division of Beckman Instruments, Inc., 2500 Harbor Blvd., Fullerton, Calif., 92634, offers a data sheet on model 57, a miniature 10-turn pot meeting MIL-R-22097B specs. [481]

Digital voltmeter. Auto Data Inc., 5121 Weeks Ave., San Diego, Calif., 92110, has published an engineering data sheet on the model 2300 series digital multimeters. [482]

NOW! ANOTHER NEW DC POWER SUPPLY SERIES FROM D/B

BIG IN PERFORMANCE SMALL IN SIZE

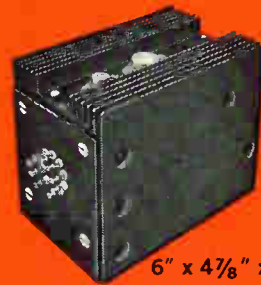

6" x 4 7/8" x 3 3/4"

ALL SILICON 30S SERIES

These new All Silicon DC Power Supplies feature exceptional reliability over a wide range of voltages. The advanced design permits more power in a smaller package at less cost per watt.

Regulation: 5MV • Ripple: 1MV RMS max.
• Remote Sensing • Remote Voltage Adjust • Remote Fuse Connection • Over-Load Protection (Automatic current limiting up to 40V).

MODEL	NOMINAL VOLTAGE (VOLTS)	CURRENT (MA)	
		±5% V ADJ.	±10% V ADJ.
30-3S	3	—	3000
30-6S	6	2800	2520
30-10S	10	2250	2025
30-12S	12	2000	1800
30-15S	15	1700	1530
30-20S	20	1450	1305
30-24S	24	1250	1125
30-26S	26	1100	990
30-28S	28	1100	990
30-30S	30	975	877
30-40S	40	800	720
30-50S	50	600	540
30-100S	100	300	270

JUST OUT!
THE NEW D/B
SHORT FORM
CATALOG IN
WALL CHART
FORMAT (A-65)



D B DRESSEN-BARNES ELECTRONICS CORP.

250 N. VINEDO • PASADENA, CALIF.
681-0643 • TWX: 213-449-2556

re-
net-
tric
abri-
are
g and
tions
dy-
of
by
gths
and
pecial
r fi-
the
high
social

roni
led
ct

ction
chnol-
ractical
proposals
try.
within
blem
in a
un-
on-
our-
of a
i a
re-
sec-
ic In-
tr cir-
ted of
AVES
ele.
why
han
his
tom
This
a by

RF and Microwave Filters Now Computer-Bred

Laguna Beach, Calif. — The application of a digital computer to the engineering design of RF and microwave filters has been incorporated as standard production procedure at Telonic Engineering Co.

According to a spokesman for the firm, a PDS 1020 computer is being employed, programmed to cover production designs of low-pass and band-pass filters with frequencies from 30Mc to 6Gc. An individual program, established for each basic filter type, is entered into the computer together with the parameters of the filter requested by the customer.

Speeds Deliveries

Among other benefits it provides, the computer cuts design time, from days to minutes by supplying production with the individual values and precise dimensions of all parts needed for assembly. It even selects standard modular elements from an inventory list, to expedite manufacture of the filters so designed. Based on the performance of the computer, the company has instituted the availability of 3-day delivery on many filter types.

In addition to the speed-up in deliveries, a higher level of product performance is assured through use of the computer, as was determined during early testing of the system. It is believed that the computer will pay for itself in a relatively short time.

Computer

cat
by

Ele
Aw
Co

s
and
thro
gyr
in
ca
in
exp
also
tec

I
o
h
th
best
laser
uniqu
show
spe

high
at l
a s
wi
fa
to
ne
sol
no

te
b

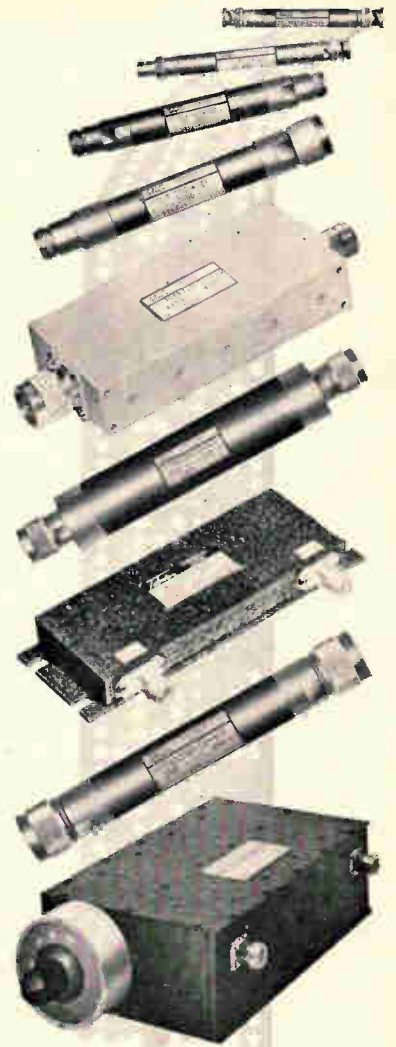

NOW, FILTERS COMPUTER-BRED

Telonic RF and microwave filters are now provided with a great new level of quality, accuracy, and availability. Each individual design requirement is automatically processed by digital computer to guarantee performance and quick delivery. The program to meet your own filter specifications is already on tape—the design takes only seconds.

If you're looking for low-pass or band-pass units in the 30Mc to 6Gc range, fixed or variable, cavity or interdigital, tubular or tunable, look first to Telonic, where technical progress is measured in terms of service to the customer and quality of the product.

Telonic
Engineering Co.

Division of Telonic Industries, Inc.
480 Mermaid St., Laguna Beach, California
Tel: (714) 494-7581 TWX 714-673-1120

Representatives in all principal cities

Electronics Abroad

Volume 38
Number 8

East Germany

Computer-conscious

Computers have long been neglected by East Germany's flourishing electronics industry, with development at least three years behind the West's. Judging not from what was shown but what was promised at the Leipzig Fair last month, the Communist government is apparently trying to close the gap.

The Communists showed their newest computer, the Robotron 100—but they talked mostly about the Robotron 300, a faster and more sophisticated version that is still two years away.

Far behind. The Robotron 100, made in the Zeiss plant in Saalfeld, is years behind the latest Western models. It has a serial addition and subtraction time of 0.5 millisecond, and attains input and output rates of only 100 punched cards a second.

The Robotron 300 will be three times as fast, and will use punched and magnetic tape. Comparable with the Siemens 3003 made by Siemens & Halske AG in West Germany, it will employ a fast printer still being developed in East Germany. Its transistors will come from West Germany and Japan.

Smaller unit. A desk-size digital computer, the Cellatron SER 2b, has been on the market for a year and seems to satisfy East Germany's needs for this type of equipment, with enough units left over for export. Made by Büromaschinenwerke AG und Verwaltung, in Thuringia, it has an average access time of 20 milliseconds with a 5-millisecond operation time for addition or subtraction. Input goes over either an electric typewriter or a punched tape. One unit uses 750 transistors, 2,500 diodes and 10 relays.

In trying to cope with Eastern



Cellatron computer demonstrated at Leipzig Fair. East Germans make small computers and import biggest ones from the West.

Europe's burgeoning bureaucracy and labor shortage, German planners need hundreds of medium-size and large high-speed computers. Also, prices must now cover costs and provide for a profit, too, so more precise accounting is required; hence the rush to adopt electronic data-processing in administration and production.

Western salesmen. As in most countries in Eastern Europe, the most active foreign companies are British and French. Their representatives at Leipzig stressed large computers, aware that that's what the German Communists need most from abroad.

Elliott-Automation, Ltd., of Britain, installed its 503 model last year at the Dresden Technical University Computer Center: it is considered the most modern computer in operation in East Germany.

Another British concern, International Computers and Tabulators, Ltd., says it is negotiating to sell its new model 1900 in East Germany this year; West Germany will receive its first 1900 machine only next autumn.

Compagnie des Machines Bull, of France, says nine of its Gamma 10 computers will be delivered in East Germany this year and next,

primarily for commercial and industrial applications. The Germans hope to buy one or more Gamma 40's for research purposes.

Industrial conversion. One of East Germany's two manufacturers of television receivers is converting to computers. The Rafena works of VEB—initials of the German words for People's Own Company—is retraining workers and changing production lines to turn out computer components. By 1969, the 6,000-employee plant near Dresden will be making only systems for electronic data processing.

Unlike other industries that have drastically changed production lines, VEB does not anticipate using teachers or technical personnel from other Soviet-bloc countries. This leads observers to believe that East Germany is making its computer effort outside the framework of Comecon, the Eastern counterpart of the Common Market in Western Europe.

Great Britain

New leaf in papermaking

The manufacture of paper involves a list of variables almost long enough to fill the 600-foot segment that rolls out of a big mill every minute. The sheet's speed and weight must be carefully controlled for each grade of paper; so must the consistency of the mixture of pulp and paper from which the stock is formed; so also must the amounts of clay and other additives that provide the surface finish. Another major variable is temperature.

The United States computer industry achieved its first real success in papermaking in January when the Harding-Jones Paper Co. attained complete close-loop con-

trol with an IBM 1710 process-control system [Electronics, Jan. 25, p. 33]. Now a smaller, less-comprehensive system at the Oxford University Press introduces on-line computer control to British paper-making.

Five variables. The system controls the five basic variables on the "wet end" of Oxford's Wolvercote paper mill, the stage before the paper is cut and dried. A. W. Sidebottom, the mill's general manager, expects that computers will eventually control the entire process, including the cutting of pulp fibers, insertion of additives to the paper stock, and drying.

Further control should be relatively easy, he says, now that the complex wet stage is under computer guidance. The system was developed jointly by Wolvercote and by Elliott Process Automation, Ltd., a member of the Elliott Automation Group of companies.

Superette. The Elliott computer's store is like a neighborhood grocery compared with the 1710's supermarket of 20,000 characters of main memory backed up by a two-million-character disk file. The British system uses fewer than 8,000 words of 18 bits. The computer, named Arch, requires no backup stores; by using more sophisticated programming in future installations, Elliott engineers figure they can reduce storage requirements even further.

The crucial variables are the speed with which paper fiber is deposited out of the slurry onto a moving wire screen, and the rate at which the screen advances. After excess water is drained off through the screen, the resulting web is passed through rollers and driers, then is reeled up as finished paper.

Dial a grade. Only four grades of paper are under computer control now, though ultimately Wolverton expects to control 80 grades with the system. An operator sets dials corresponding to the grade of paper and tonnage desired, thus determining the value of the variables. Then he presses a button.

Three computer outputs set up a beta gauge, which uses beta rays to measure the thickness and, in-

directly, weight of the paper at the end of the mill, about a quarter-mile from the head. It takes minutes for the paper to go through the machines; the central system compensates for this delay. A feedback control signal, derived from the beta-gauge measurement, then adjusts the operation to the variables that the operator has dialed.

Equations govern controls. Feedback-control equations have been derived for each grade of paper. These set up a series of algorithms, or step-by-step procedures for solving mathematical problems—in this case the conditions for producing the desired grade of paper as quickly and efficiently as possible.

The computer analyzes incoming data to determine trends. If these differ from the constants being used in the algorithm that is currently controlling the mill, the computer adjusts the control algorithm. Then, using the revised algorithm, it sends correction signals to the plant's controller inputs.

Revising the revisions. The equations that determine the adjustments are subject to revision themselves, by an off-line program, to insure that the best possible constants are used to adjust the control algorithm.

When production of one grade of paper is finished, the computer performs a gradual transition to the next grade ordered by the operator. As soon as the beta-ray gauge indicates that the new quality is correct, the computer begins a new count of the tonnage produced. Changes in grade of paper takes less than 5 minutes with computer control, compared with 10 to 15 minutes when done manually.

TSR-2 fallout

The Labor government's cancellation of the TSR-2 aircraft project delivered a \$660-million blow to Britain's electronics industry. That's how much avionics equipment was expected to be included in the tactical-strike-reconnaissance jet plane, which was scrapped under the budget that was intro-

duced early this month.

One of the hardest hit is Ferranti, Ltd., which indicated that 1,200 employees might be affected. Ferranti had contracts to develop terrain-following radar, the moving-map display, the stable platform, an airstream-direction detector system, and service test equipment.

A spokesman for Elliott-Automation, Ltd., said the cancellation probably would cut the company's 1965 sales by 5%.

In place of the TSR-2, the government has taken an option to buy F-111A's, the United States' new long-range jet fighter formerly designated the TFX. There is still a possibility that British electronics companies will supply equipment for these planes and for Phantom jets, being supplied for the Royal Navy by the McDonnell Aircraft Corp. in St. Louis.

Lebanon

Mideast customs

Little more than three miles off the Lebanese coast, a darkened freighter heaves to and waits in the night. Soon, all lights out, a high-speed motor launch darts to the side of the ship. With quiet efficiency born of long experience, the crew picks up crates of transistor radios. Then, with an eye out for Lebanon's miniature coast guard, the smugglers' launch makes a run for one of the obscure coves that dot the country's 150-mile coastline.

Smuggling is a time-honored business in this land of shrewd businessmen. There is almost no kind of article of commerce—from precious stones to automobiles—that is not brought ashore illegally. Cigarettes and transistor radios seem to be special favorites.

Ignoring customs. In one 18-month period, from January, 1963 to July, 1964, Japanese industry sources estimate that 350,000 radios were exported to Lebanon. Lebanese sources estimate that

only half that number passed customs.

Smuggling of radios is a wholesale business. Amateurs are dissuaded because the overhead is high—boats, crews, palm-greasing. Profits are not as huge as with precious stones and narcotics. Competition is keen among retailers, and the price of radios—both legal and smuggled—is kept down. For example, the six-transistor Koyo, made in Japan, sells for about \$13, and Hitachi transistor radios retail from about \$19 to \$28.50.

Black market. Some wholesalers specialize in reselling smuggled radios. They mix them in with their regular stock and invoice them to retail outlets at the usual prices, pocketing the difference; if they pass along part of the discount, the retail outlet always gets an invoice indicating the purchase of sets cleared by customs. The retailer keeps part of his stock hidden in case of a raid by customs agents.

As in legitimate trade, Lebanon acts as a funnel for contraband destined for the Arab world. Radios are shipped in trucks or on burros over two chains of mountains into northern Syria—principally Aleppo—then down to Damascus and points south.

Belgium

In the rough

Historically, the most accurate sifter of diamonds from batches of worthless stones has been a five-foot-high, self-propelled device called woman. Such a device is too flighty for mass production; but by the end of this year the Société Minière de Bakwanga, a mining company in the Congo, may have an electronic machine that, in one minute, spots rough industrial diamonds among 3,000 stones of all kinds.

The machine has been developed by ACEC (Ateliers de Constructions Electriques de Charleroi), a Belgian electronics company. It

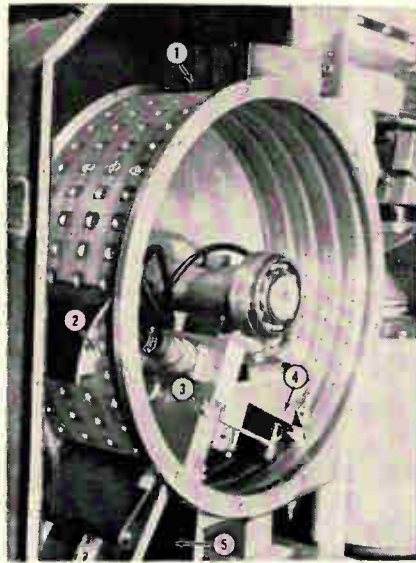

Diamond-sorting drum, covered with holes, sifts 3,000 stones a minute. 1 is loading station, 2 a jet for blowing off excess stones, 3 a bank of photomultiplier tubes, 4 selective ejector jets and 5 an x-ray guide.

distinguishes the high-grade stones by their high transparency to x-rays—about 10 times that of other minerals generally found in diamond-bearing deposits. A photoelectric principle wouldn't work because other minerals sparkle as brightly as diamonds, but differently.

Drummed into order. The stones are fed by a vibrating screen onto a drum (see photo) that contains 188 holes arranged in four tracks. The holes have diaphragms, sized to handle stones from 0.8 to 8 millimeters in diameter. The drum is kept under a high vacuum so that each diaphragm sucks up stones as it passes the pickup position 40 times a minute. As the drum carries the stones toward the reading station, a jet of compressed air blows off excess stones, leaving just one on each diaphragm. The blown-off stones are recirculated to the loading station.

Photomultiplier. At the reading station, fluorescent screens convert the transmitted x-ray energy that passes through each stone into visible light, which energizes a photomultiplier tube. A high pulse output—in tens of microamperes—means a diamond; a low pulse output means a worthless stone. The

tube's output is amplified in silicon transistor circuits, then passed through logic circuits which, in turn, feed a signal to electrically controlled compressed-air valves inside the drum. The valves blow diamonds into one discharge chute and rejected stones into another.

The logic circuits also continuously check for presence of x-rays, supply of stones, supply of compressed air and the like, and sound an alarm if a fault is found. Loss of diamonds among the rejected stones runs between 0.5% and 1% of the original diamond content, according to ACEC. About 97% of the worthless stones are separated from the diamonds.

Canada

Computer at the ores

Now that computers have gained a foothold in the steel industry, they're trying to move into the plants that supply the mills with iron ore. Before summer, an ore-pelletizing plant at Point Noire, P. Q., plans to begin operations with a Honeywell 610 process-control computer system.

The plant will convert ore into heat-hardened balls for use in basic steelmaking furnaces. The operation usually requires 200 employees, but with the Honeywell, Inc., computer it will need only 75 workers.

The system is part of a \$50-million project by a consortium of five United States companies, three Canadian and one Italian, all headed by Pickands Mather & Co. of Cleveland.

Electronic supervisor. The computer will direct the unloading of ore from 100-car trains at the pelletizing plant, also its weighing and processing. It will integrate 518 analog inputs of such factors as temperature, pressure and flow, and will monitor 443 alarm points. The computer has an 84,000-word drum memory and a 4,000-word core.

The weighed ore will be mixed with water and stored in large



**Find
the
product...
Fast!**

It's quick and easy to locate any of the thousands of electronic and allied products in your **Electronics Buyers' Guide**. All are listed clearly and unmistakably, cross-indexed with end use terms synonyms and newly devised terms. And, all advertisers in the EBG are carefully cross-referenced to their catalog-advertisement. EBG has the most complete, accurate and authentic product listings in the industry!

Electronics Buyers' Guide

A McGraw-Hill Publication
330 West 42nd Street,
New York, N. Y. 10036

bins. The slurry will be mixed later with bentonite, a binding agent, and poured into balling drums. The resulting pellets will then be heat-hardened, sized and stored in silos or loaded directly aboard ore freighters for transport to steel mills on the Great Lakes.

Many tasks. The computer system at the pelletizing plant will monitor the bearing and stator temperatures of the plant's large motors, automatically start and stop the conveyors for 20 different handling and routing systems, total the plant's production at 36 points, act as a data logger to build a mathematical model of the process for future plant operation under direct digital control, and provide process guides for various operators throughout the pelletizing complex.

It will also keep track of running times of all heavy equipment so that it can create preventive maintenance schedules in conjunction with an IBM 1620 data-processing system.

Italy

Stress on IC's

One of Italy's biggest manufacturers of semiconductor diodes and transistors has begun a bold move into the young European market for integrated circuits.

Società Generale Semiconduttori (SGS) expects that integrated circuits will comprise 20% of its sales by the end of this year and 50% in 1968. The company has taken the following steps:

- Announced plans for a new plant in Rennes, France, and begun training employees in the manufacture of integrated circuits and other products.

- Begun to prepare its headquarters plant in Milan to become Italy's first producer of integrated circuits.

- Planned immediate production of integrated circuits at SGS-Fairchild, Ltd., a British company it owns jointly with the Fairchild

Camera and Instrument Corp. of the United States.

- Disclosed that it plans to build a facility in Sweden, but declined to give any additional information.

U.S. interest. SGS itself has three equal owners: Fairchild, Telettra, and Ing. C. Olivetti & Co., S.p.A. Fairchild supplies most of the technology.

The French plant, scheduled for completion this year, is expected to be in full production by next spring. Most of the employees probably will be women; SGS brought 30 French girls to Milan to learn production methods.

Ireland

Irish stew

Tiny Ireland used to be noted less for technological enterprise than for the literary endeavors of giants like Yeats, Joyce, O'Casey and Shaw. Since 1958, however, its government, using a minimum of blarney and a maximum of tax concessions, has wooed and won industries from the United States, Britain, West Germany and other industrial powers.

For six years the agricultural republic's expansion in industry was an almost undiluted success. The program includes capital grants and ready-made industrial facilities at duty-free Shannon Airport. The gross national product has climbed at an average rate of better than 5% a year. Recently, however, Ireland's industrial expansion has received some setbacks.

A Sony Corp. plant has ended production of television receivers, transistor radios and other electronic equipment. The Japanese-owned plant employed 100 workers, mostly women, to produce 7,000 articles a month representing exports worth about \$600,000.

Raytheon closing. Of 22 plants built since 1958 at the Shannon Airport industrial site, only two others have closed: a Raytheon Co. facility that manufactured electronic instruments, and a sub-

subsidiary of Chicago Dynamics, Inc., a maker of bowling-alley equipment.

But the trend may continue upward in 1965 after all. The Shannon Airport Development Co. says six companies will build plants there this year. The companies have not been identified, but one is reported to be American and the other Western European.

K. M. Miyatake, Sony's managing director, blames the shutdown of his plant on two factors: increased competition in the semiconductor field and imposition of a 15% surcharge on imports by Britain.

Around the world

Japan. The Japan National Railway says it has test-operated a computer-piloted train around a one-mile loop at its research institute in Tokyo. A PB-250 computer, made by the Packard-Bell Electronics Corp., guided the unmanned six-coach train at 22 miles an hour. Signals from the computer were relayed by microwave transmitters to a waveguide installed along the tracks. Railway officials say the system operated the train at various speeds and worked switches. The railway hopes to introduce remote-controlled operations late in 1970 on an extension of its new 320-mile Tokaido line between Tokyo and Osaka.

France. The metro, Paris' subway, is considering an automatic ticket-taking device made by Litton Industries, Inc. The equipment "reads" magnetically coded tickets to differentiate between first- and second-class, and reduced-rate passes that are issued to students, the blind, handicapped veterans and others.

Pakistan. A component-manufacturing plant, Pakistan's first, has been approved by the government. The million-dollar facility will be built in Lahore, West Pakistan. Private domestic investors are to own 80% of the company; Philips Gloeilampenfabrieken, N. V., of the Netherlands, will own the rest.

PLACE THE STYLUS, PUNCH A HOLE ○ PLACE THE
 STYLUS, PUNCH A HOLE □ PLACE THE STYLUS, PUNCH A HOLE △
 PLACE THE STYLUS, PUNCH A HOLE ○ PLACE THE STYLUS, PUNCH A HOLE ○ PLACE,

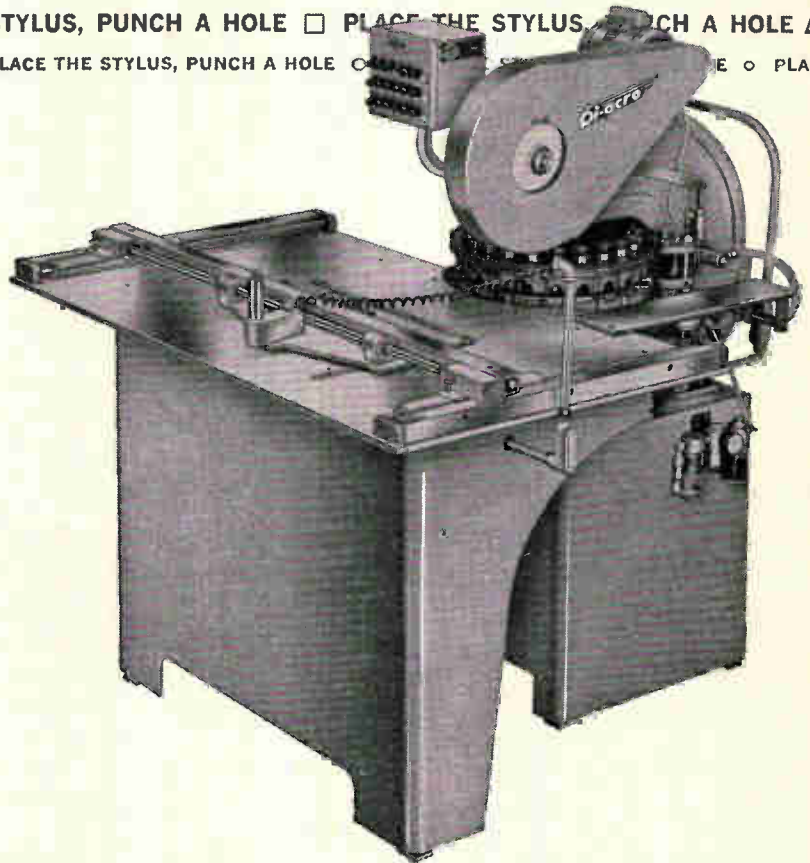

FASTER THAN A HOLE A SECOND!

This is a brand new turret punch press. Electrically linked to a floating stylus. Trace the template, touch the button — punch your holes.

The feather-touch stylus floats on recirculating ball bearings. Accurate within .005" of the template. Eighteen punch and die sets always ready, always perfectly aligned. Change

setups fast as you can drop in a new template.

Capacity: up to 2" dia. hole in 14 ga. steel blank up to 19"x24". Over 500 standard and "special" punches and dies from stock. Custom shapes to your order.

Call your Di-Acro distributor for the big 44-page Punching Catalog. It's brand new, too!



DI-ACRO

A Division of Houdaille Industries, Inc.
 434 Eighth Avenue, Lake City, Minnesota 55041



Di-Acro manufactures a complete line of benders, rod parters, brakes, press brakes, press brake dies, shears, notchers, rollers, punch presses, layout machines, spring winders and punches and dies. Write for catalog.

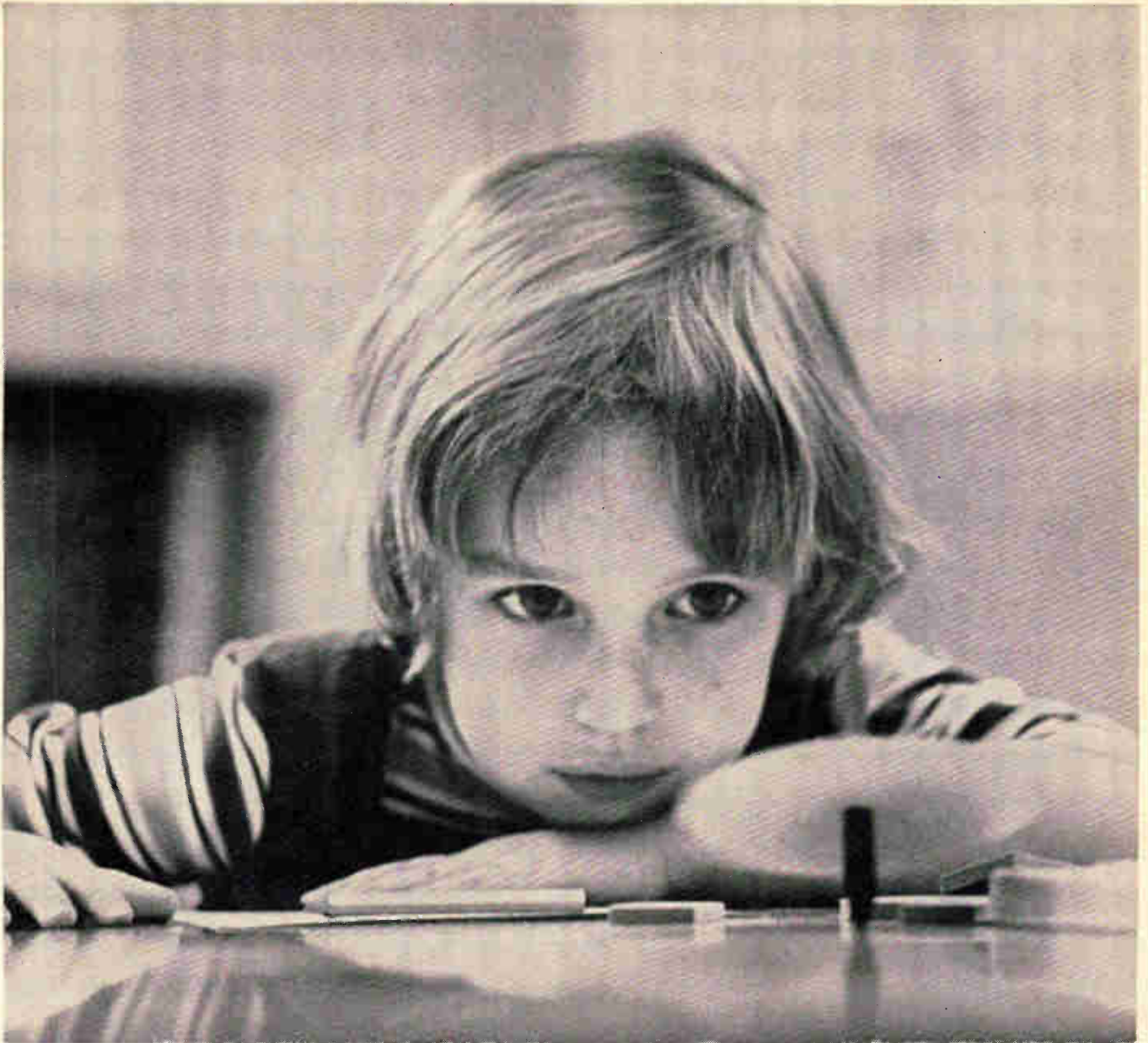

Investment Opportunity

Her dreams will be the realities of tomorrow—sleek, shiny birds will aim at the moon and cars will whisk her from city to city on cushions of air.

But dreams and children alike must have the proper atmosphere to thrive. Freedom and stability provide this. It is our task to foster this atmosphere in the present and protect it for the future. We have an investment in it for our children.

You can protect this investment by joining with other leading American businessmen to promote the Treasury Department's Payroll Savings Plan for U. S. Savings Bonds. The Treasury's plan works for stability in our economy and strength in the defense of our liberties.

By fostering the love of individual freedom and the economic well-being of the nation, it provides a strong, steady foundation that will not waver under the challenges of tomorrow.

When you bring the Payroll Savings Plan into your plant—*when you encourage your employees to enroll*—you are investing in the dreamers of our today. In the engineers, scientists and teachers of our tomorrow. In America's future. In freedom itself.

Don't pass this investment opportunity by. Call your State Savings Bonds Director. Or write today directly to the Treasury Department, United States Savings Bonds Division, Washington, D. C., 20226.



In your plant...promote the PAYROLL SAVINGS PLAN for U.S. SAVINGS BONDS



The U.S. Government does not pay for this advertisement. It is presented as a public service in cooperation with the Treasury Department and the Advertising Council.

Electronics advertisers

April 19, 1965



■ AMP Incorporated Garceau, Hargrave & McCullough Inc.	31	■ Dynage Inc. F.W. Prella Advertising	160	Machlett Laboratories Inc., The Fuller & Smith & Ross Inc.	9
■ Acme Electric Corporation Scheel Adv. Agency	143	Eastman Kodak Company The Rumrill Company Inc.	53	Mallory & Company, Inc. P.R. The Aitkin-Kynett Company	75, 197
Airpax Electronics Inc. Welch, Mirabile & Co. Inc.	169	Edgerton, Germeshausen & Grier Inc. Reach, McClinton & Co. Inc.	160	Matsuo Electric Co. Ltd. Asahi Advertising Agency Inc.	154
Air Products & Chemicals Inc. Arthur Falconer Associates Corp.	43	Electro Instruments Inc. Teawell Inc. Advertising	50	McGraw-Hill Book Co.	130, 195,
Amperex Electronics Corp. Sam Groden Incorporated	148, 149	Electro Scientific Industries Nadler & Larimer Inc.	71	Metal Removal Company, The Advertising Producers Associated Inc.	142
Anaconda American Brass Company Wilson, Haight & Welch Inc.	161, 162, 163	Electronic Modules Corporation Ray Thompson & Associates	153	Minerals Pigments & Metals Div. of Chas Pfizer & Co. Inc. Newark, Posner & Mitchell Inc.	129
Beckman Instruments Inc. Helipot Division Erwin Wasey, Ruthrauff & Ryan Inc.	47	Elgenco Incorporated Lewco Advertising	176	■ Mitsumi Electric Co., Ltd. Dentsu Advertising Ltd.	176
Beckman Instruments Inc. Offner Division Erwin Wasey, Ruthrauff & Ryan Inc.	128	Esterline Angus Instrument Company Inc. Caldwell, Larkin & Sidener-Van Riper Inc.	78	Motorola Semiconductor Products Inc. Lane and Bird Advertising Inc.	72
Bendix Corporation Scintilla Division MacManus, John & Adams Inc.	57	Fairchild Scientific Instruments Dumont Laboratories Division The Roger & Wilbur Co. Inc.	14	■ Mullard Ltd. Stuart Adv. Agency Ltd.	46
Borden Chemical Company, Mystik Tape Inc. Fuller & Smith & Ross Inc.	187	Fiberfil Inc. Tri-State Advertising Co. Inc.	182	■ Mycalex Corp. of America Feeley Advertising	28, 29
■ Brush Instruments, Div. of Clevite Corp. Carr Liggett Adv. Inc.	3rd Cover	Florida Development Commission Alfred L. Lino & Associates Inc.	183	Mystik Tape Inc. Division of The Borden Chemical Company Fuller & Smith & Ross Inc.	187
Burroughs Corporation Conti Advertising Inc.	73	Fluke Mfg. Co. Inc. John Bonfield Associates Inc.	11	New Hermes Engraving Machine Corporation Doner-Harrison Inc. Advertising	186
■ Bussmann Mfg. Co. Div. of McGraw Edison Co. Henderson Advertising Company	178, 179	General Radio Company K.E. Morang Company	2nd Cover	North Atlantic Industries Inc. Murray Heyert Associates	41
■ C-Cor Electronics Barash Advertising	194	Genisco Technology Corporation Getz and Sandborg Inc.	173	North Carolina Dept. of Conservation & Development Bennett Advertising Inc.	27
Cambridge Thermionic Corporation Chirurg & Cairns Inc.	76	Geotechnical Corporation Evans, Young & Wyatt Adv.	164	■ Norton Associates Inc. J.J. Coppo Co. Inc.	164
■ Clairex Corporation Michel Cather Inc.	172	Gudebrod Bros. Silk Co. Inc. Lee Ramsdell & Co. Inc.	12, 13	OKI Electric Industry Co. Ltd. Standard Advertising Inc.	189
Cleveland Institute of Electronics Carr Liggett Advertising Inc.	138, 160	Hamilton Watch Company Beaumont, Heller & Sperling Inc.	182	Pamotor Inc. Harry P. Bridge Co. The	188
■ Clifton Precision Products Co. Div. of Litton Industries Ivey Adv. Inc.	16	■ Heath Company Advance Advertising Service Inc.	191	Peerless Instrument Co. Inc. Mark Snyder Incorporated	40
Cohu Electronics, Kin Tel Division Erwin Wasey, Ruthrauff & Ryan Inc.	51	Heinemann Electric Company Thomas R. Sundheim Inc.	69	Pennsylvania Fluorocarbon Company Ernest William Greenfield Inc.	174
Colorado, State of Buchen Advertising Inc.	132	Hewlett Packard Associates Lennen & Newell Inc.	158	■ Perfection Mica Company, Magnetic Shield Division Burton Browne Advertising	172
Cominco Products Inc. McKim Productions Limited	164	■ Hewlett-Packard Company Lennen & Newell Inc.	2, 54, 55	■ Permacor, A Div. of Radio Cores Inc. Sander Rodkin Advertising Agency	168
Communication Electronics Inc.	186	High Vacuum Electronics Inc. Balsam Advertising Inc.	8	■ Philbrick Researches Inc. George A. Culver Advertising Inc.	42
■ Computer Instruments Corp. Dickerman Advertising Inc.	145	Hitachi Ltd. Dentsu Advertising Ltd.	70	Philco Corporation Lansdale Division Batten, Barton, Durstine & Osborn Inc.	190
Controls Company of America The Harry P. Bridge Company	48	Honeywell Semiconductor Products Div. Neals & Hickok Inc.	77	Photocircuits Corporation Duncan-Brooks, Inc.	157
■ CTS Corporation Burton Browne Advertising	39	■ Hughes Aircraft Company Foote, Cone & Belding Inc.	171	Polaroid Corporation Doyle, Dane, Bernbach Inc.	127
Damon Engineering Inc. L.K. Frank Co., Inc.	137	Indium Corporation of America Inc. Darvoe, Breck & MacFarland Inc.	193	Presin Company Inc. Ted Sommers Inc. Advertising	185
Data Control Systems Martin K, Speckter Associates Inc.	45	Industrial Electronic Engineers Inc. Gumpertz, Bentley & Dolan Adv.	193	■ Primo Company Ltd. General Advertising Agency	176
Data Instruments Div. of Industrial Electronic Hardware Corp. A.D. Adams Advertising Inc.	32	IBM Corp. Industrial Products Div. Marsteller Inc.	58	R C L Electronics Inc. Morvay Advertising Agency	191
Defense Electronics Inc. GLM Associates Inc.	65	International Resistance Company Arndt, Preston, Chapin, Lamb & Keen Inc.	146	Radio Corporation of America Al Paul Lefton Company	4th Cover, 141
■ Delco Radio Division of General Motors Corporation Campbell-Ewald Company	166, 167	ITT Semiconductors West, Weir & Bartel Inc.	159	Raytheon Computer Company Jay Chiat and Associates	144
Deltron Inc. Benn Associates	191	■ J F D Electronics Corporation Michel Cather Inc.	30	Republic Electronics Corporation Seymour Charles Advertising Inc.	154
Di-Acro Corporation Charles E. Brown Adv.	207	Japan Resistor Mfg. Co. Ltd. Samko Sha Adv. Agency Co. Ltd.	174	■ Rosemont Engineering Company The Erie Savage Company	156
■ Digital Equipment Corporation The Rumrill Company Inc.	60, 61	■ Jennings Radio Manufacturing Corp. L.H. Waldron Advertising	180	S D S A Publi-Service	155
Dixon Inc. Gail Advertising Company	38	Jerrold Electronics Corp. Irving Gould Advertising Inc.	10	■ Sargent & Greenleaf Inc. Wolff Associates Inc.	184
Dressen-Barnes Corporation Writing and Advertising Inc.	201	Krohn-Hite Corporation Stern/Frank Advertising Inc.	177	Shallcross Manufacturing Company J.T. Howard Advertising Agency Inc.	44
DuPont de Nemours & Co. Inc. E.I. Batten, Barton, Durstine & Osborn Inc.	139	■ Lambda Electronics Corporation Michel Cather Inc.	37	■ Siemens America Inc. Mann-Wesley Inc. Advertising	185
■ Dymec, A Div. of Hewlett Packard Company Lennen & Newell Incorporated	1	■ Lapp Insulator Company Inc. Wolff Associates Inc.	140	■ Signalite Incorporated Armand Richards Advertising Agency	165
		Lepel High Frequency Laboratories Inc. Apex Graphic Company	185	Silicon Transistor Corporation A.D. Adams Advertising Inc.	59

Executive, editorial, circulation and advertising offices: McGraw-Hill Building, 330 West 42nd Street, New York, N.Y. 10036. Telephone Area Code 212-971-3333. Teletype TWX N.Y. 212-640-4646. Cable: McGrawhill, N.Y. Officers of the Publications Division: Shelton Fisher, President; Vice Presidents: Joseph H. Allen, Operations; Robert F. Boger, Administration; John R. Callahan, Editorial; Ervin E. DeGraff, Circulation; Donald C. McGraw, Jr., Advertising; Sales: Angelo R. Venezian, Marketing. Officers of the Corporation: Donald C. McGraw, President; Hugh J. Kelly, L. Keith Goodrich, Executive Vice Presidents; John L. McGraw, Treasurer; John J. Cooke, Vice President and Secretary. Title R registered U.S. Patent Office; © copyright 1964 by McGraw-Hill, Inc. All rights reserved, including the right to reproduce the contents of this publication, in whole or in part.



To order reprints

from Electronics

fill in, cut out

coupon below,

insert in envelope

and mail to:

**Electronics Reprint
Dept.**

330 West 42nd Street

New York, N. Y. 10036

Reprint order form

For listing of reprints available see the reader service card

To help expedite mailing of your reprints please send cash, check or money order with your order.

For reprints of the latest Special report:

Electronics 35th Anniversary Special Section

Send me reprints of key no. R-72 at 50¢ each.

For reprints of previous special reports fill in below:

Send me reprints of key no.(s) at ¢ each.

For prices see the reader service card.

Name
 Number & Street
 City, State
 Zip Code

Sinclair Radio Laboratories Inc. John E. Hayes Company Inc.	136
Spectrol Electronics Corporation Bonfield Associates Inc.	67
Sperry Semiconductor Div. of Sperry Rand Corporation Armand Richards Advertising Agency	68
Sprague Electric Company The Harry P. Bridge Co.	5, 6
Stackpole Carbon Company Meek and Thomas Inc.	66
Stancor Electronics Division of Essex Wire Corporation Bonsib Inc.	74
Stromberg-Carlson Corporation The Rumrill Company Inc.	174
Struthers-Dunn Inc. The Harry P. Bridge Company	152
Sylvania Electric Products Inc. Kudner Agency Inc.	19 to 26
■ Teleonic Engineering Company Jansen Associates	202
Texas Instruments Incorporated Industrial Products Group Robinson-Gerrard Inc.	7
Texas Instruments Incorporated Metals & Controls Inc. Horton, Church & Goff Inc.	150, 151
■ Tokyo Shibaura Electric Co. Ltd. Hakuhodo Incorporated	196
Tracor Inc. David G. Benjamin Inc.	189
Triplett Electrical Instrument Company Burton Browne Advertising	131
Ultra Carbon Corporation Church & Guisewite Advertising Inc.	170
Union Carbide Corporation Kemet Division J.M. Mathes Incorporated	62
Unitrode Corporation Chirurg & Cairns Inc.	49
United Systems Inc. Advertising & Merchandising Inc.	193
Vactec Inc. Ron Coleman Agency	168
Vitro Corporation of America Buchen Advertising Inc.	181
Watkins-Johnson Company William C. Estler Public Relations	175
Western Reserve Electronics Inc. Ritchie & Sattler Inc.	192
Weston Instruments Incorporated G.M. Basford Co.	52

Classified advertising

F.J. Eberle, Business Mgr.	
Employment Opportunities Equipment (Used or Surplus New) For Sale	198 199-200

Classified advertisers index

Allen, Robert G Co.	200
Atomic Personnel, Inc.	198
■ Barry Electronics	200
Binswanger Corp.	199
Defense Logistics Services Center	199
■ Goodheart Co., Inc., R.E.	200
McDonnell	199
Microwave Associates, Inc.	198
■ Radio Research Instrument Co.	200
Surplus Saving Center	199
Semiconductor Sales of Calif.	200
■ Universal Relay Corp.	200

Advertising sales staff

Gordon Jones [212] 971-2210
Advertising sales manager

Atlanta, Ga. 30309: Gus H. Krimsier,
Michael H. Miller, 1375 Peachtree St. N.E.,
[404] TR 5-0523

Boston, Mass. 02116: William S. Hodgkinson
McGraw-Hill Building, Copley Square,
[617] CO 2-1160

Chicago, Ill. 60611: Robert M. Denmead,
J. Bradley MacKimm
645 North Michigan Avenue,
[312] MO 4-5800

Cleveland, Ohio 44113: Paul T. Fegley, 55
Public Square, [216] SU 1-7000

Dallas, Texas 75201: Richard P. Poole, The
Vaughn Building, 1712 Commerce Street,
[214] RI 7-9721

Denver, Colo. 80202: Joseph C. Page, David
M. Watson, Tower Bldg., 1700 Broadway,
[303] AL 5-2981

Houston, Texas 77025: Kenneth George,
Prudential Bldg., Halcombe Blvd.,
[713] RI 8-1280

Los Angeles, Calif. 90017: Ashley P.
Hartman, John G. Zisch, 1125 W. 6th St.,
[213] HU 2-5450

New York, N.Y. 10036:
Donald R. Furth [212] 971-3615
Frank LeBeau [212] 971-3615
George F. Werner [212] 971-3615
500 Fifth Avenue

Philadelphia, Pa. 19103: William J. Boyle,
Warren H. Gardner, 6 Penn Center Plaza,
[215] LO 8-6161

San Francisco, Calif. 94111:
James T. Hauptli, 255 California Street,
[415] DO 2-4600

London W1: John W. Patten, Edwin S.
Murphy Jr., 34 Dover Street,
Hyde Park 1451

Milano: Ludovico Greco, 1, via
Baracchini Phone: 86-90-617

Frankfurt/Main: Gerd Hinske, 85
Westendstrasse Phone: 77 26 65 and
77 30 59

Geneva: Michael R. Zeynel, Joseph Wuensch,
2 Place du Port 244275

Paris VIII: Denis Jacob, 17 Avenue
Matignon ALMA-0452

Tokyo: Nobuyuki Sato
Shiba, Minato-ku (502) 0656

Osaka: Kazutaka, Miura, 163, Umegae-cho,
Kita-ku [362] 8771

Nagoya: International Media Representatives,
Yamagishi Bldg., 13, 2-Chome,
Oike-cho Naka-ku

Hugh J. Quinn: [212] 971-2335
Manager Electronics Buyers' Guide

David M. Tempest: [212] 971-3139
Promotion manager

Milton Drake: [212] 971-3485
Market research manager

Richard J. Tomlinson: [212] 971-3191
Business manager

Theodore R. Geipel: [212] 971-2044
Production manager

■ For more information on complete product line see advertisement in the latest Electronics Buyers' Guide

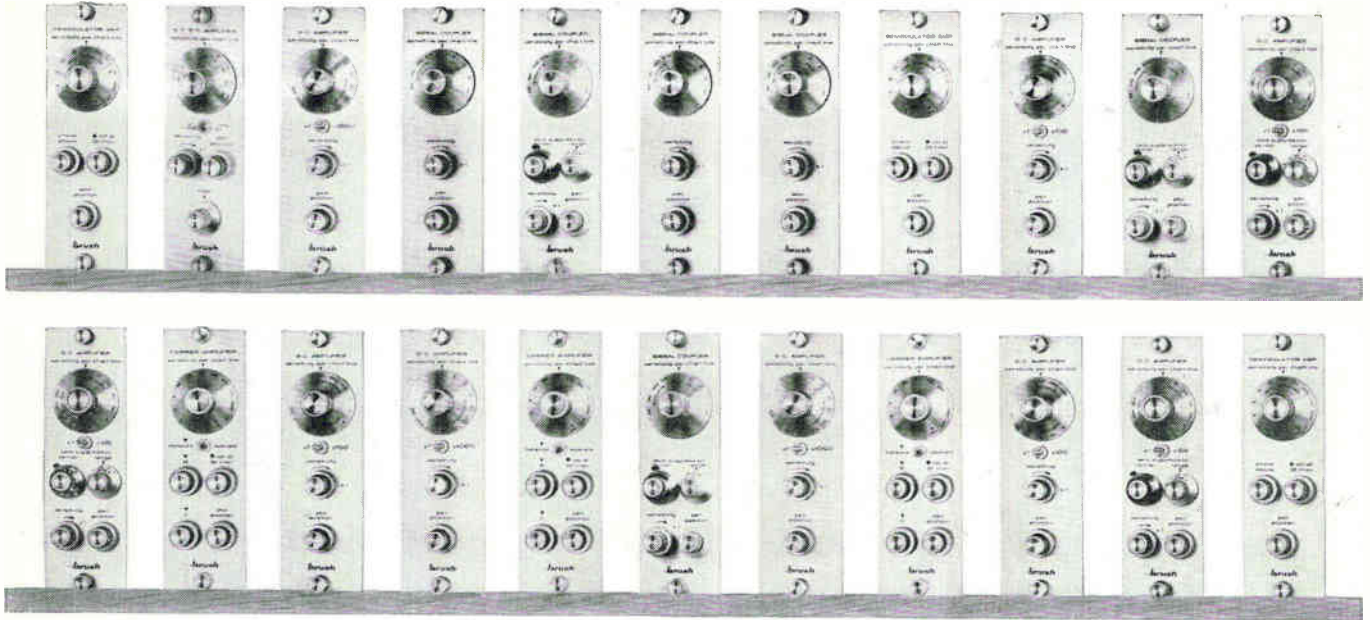

Brush has an "off-the-shelf" preamplifier for almost any recording requirement that comes to mind.

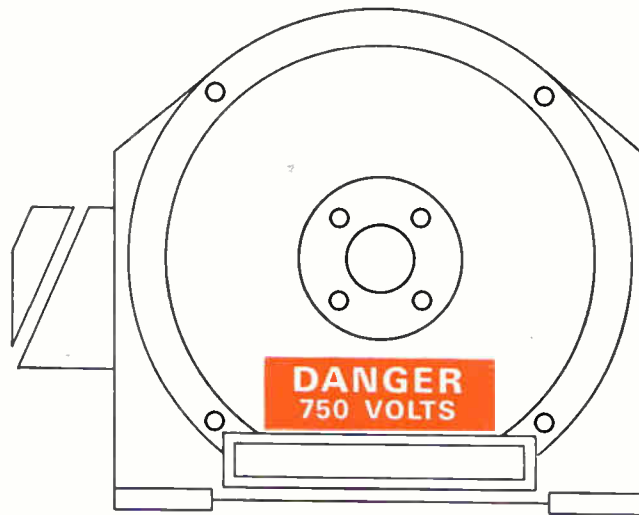

Take high voltage motors for instance.

Recording *their* electrical performance is especially tough. But thanks to a new free-floating, high gain Brush preamplifier, (second from left, top row) it's just another job. This newest addition to the Brush line of 22 different preamplifiers accepts signals up to 1000 volts DC OFF-GROUND, potential differences to 1000 volts DC; plugs into any advanced model Brush Direct Writing Recorder; eliminates possibility of damaged equipment, disruptive downtime and



danger to personnel. Surprised that Brush stocks such a highly specialized preamplifier? Don't be. And don't be surprised either, when the folks at Brush promise to meet *your* direct-writing recording requirements with an optimum-performance system of "off-the-shelf" modular sub-systems. They can . . . better and faster than anyone else in the business. See for yourself. Write: Brush Instruments Division, Clevite Corporation, 37th & Perkins, Cleveland, Ohio 44114.



CLEVITE
brush INSTRUMENTS DIVISION

Circle 901 on reader service card



HOW A NEW KIND OF RCA TRANSISTOR... Will Help Man Land On the Moon

To walk upon another world for the first time in human history is probably the greatest adventure ever planned. Yet by the turn of this decade man expects to set foot upon the moon.

Already the first step has been successfully taken; unmanned spacecraft have been directed to the lunar surface. But the final conquest will require an ingenious system of space logistics that will not only land astronauts on the moon, *it will also return them safely to an orbiting vehicle on which they will travel back to earth!*

Such a complex feat will be facilitated by "landing and rendezvous radar" that both tracks and guides the astronauts' capsule to the moon's surface—and then back again to the craft orbiting in space.

Basic to this space communications and guidance system will be a new RCA "overlay" transistor—a device which can generate stronger signals at higher frequencies than any transistor ever made. And yet this transistor requires only about the same power as the ignition system of your car.

Not science-fiction, but here today, RCA "overlay" transistors already are helping to forecast weather and plot jet stream courses by rocket sonde... identify friend or foe (IFF) with airborne "beacons"... detect enemy ground movement by portable radar.

Advancing the art of electronics in space and earth travel is another way in which RCA solid-state technology is serving industry and the national defense.



New RCA "Overlay" Transistor. In an area smaller than the head of a pin, this unique device contains 156 microscopic transistor junctions connected in parallel for maximum power amplification at extremely high frequencies.



The Most Trusted Name in Electronics

...and the world's most broadly based electronics company

Circle 902 on reader service card

RCA ELECTRONIC COMPONENTS AND DEVICES