

# Electronics®

What's new in micropower transistors: page 76  
Microelectronic probe in monkey's brain: page 90  
Production tips for engineers: page 106

February 22, 1965

75 cents

A McGraw-Hill Publication

Below: New telemetry dish is part of missile range buildup: page 94



# MEASURE TRANSISTOR FUNCTIONS DIRECTLY

from 25 to 1500 Mc

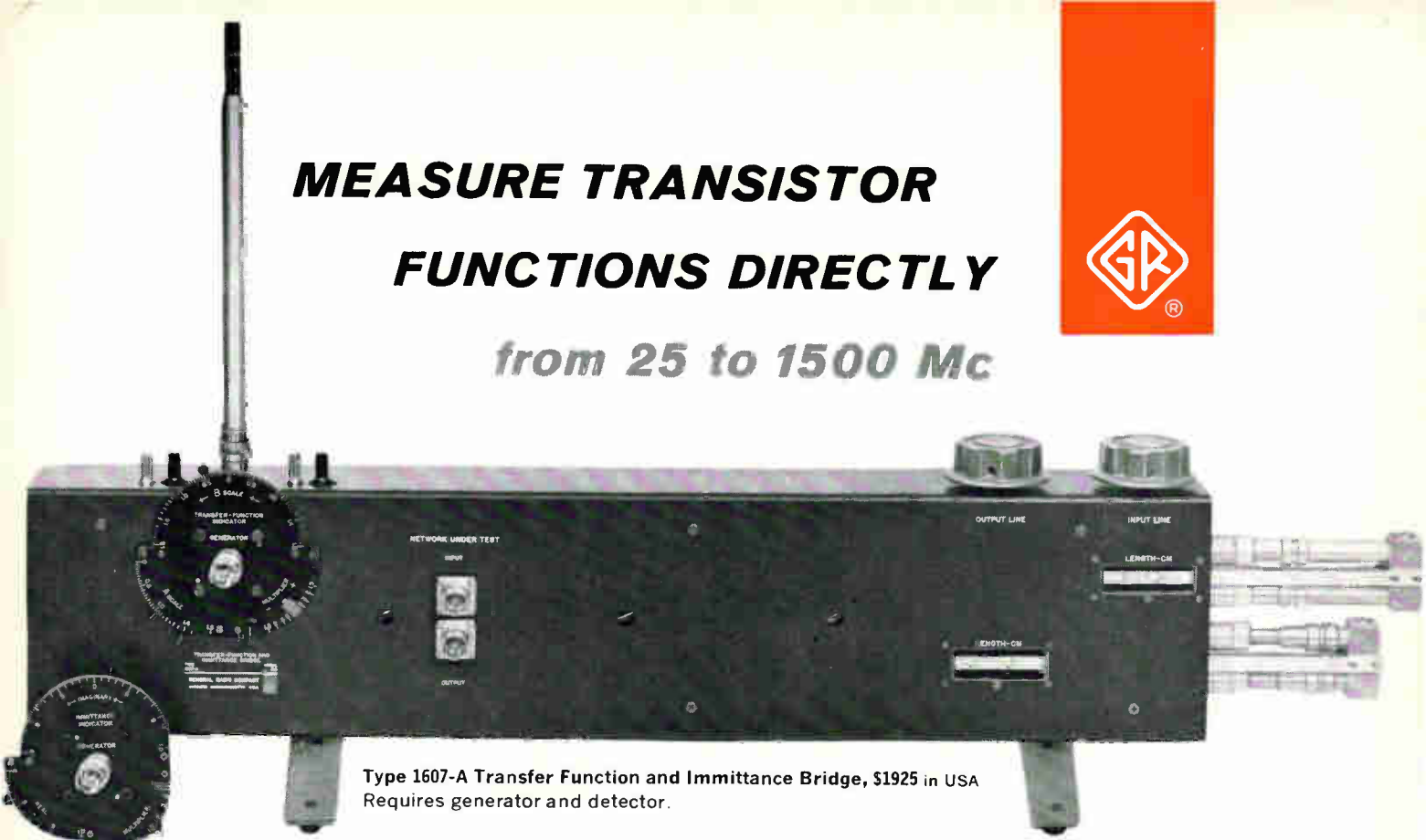

Type 1607-A Transfer Function and Immittance Bridge, \$1925 in USA  
Requires generator and detector.

$h_{ob}$ ,  $h_{oe}$ ,  $h_{fb}$ ,  $h_{fe}$ ,  $h_{ib}$ ,  $h_{ie}$ ,  $h_{rb}$ ,  $h_{re}$ ,  
 $Y_{ob}$ ,  $Y_{oe}$ ,  $Y_{fb}$ ,  $Y_{fe}$ ,  $Y_{ib}$ ,  $Y_{ie}$ ,  $Y_{rb}$ ,  $Y_{re}$ ,

and all open-circuit impedance parameters.

- ★ The accuracy and wide frequency range of this bridge make it a natural for the engineering laboratory
- ★ Ideal for production-line testing too; semi-skilled personnel can operate it easily. For rapid transistor measurements, it can be set up for direct meter readout of the magnitudes of  $h_{fi}$  and  $h_{re}$ .
- ★ Built-in provision for biasing up to 2.5 amperes, with bias circuits effectively isolated from circuits under measurement.
- ★ Nine different mounts available for commonly used transistors and tubes — both socket and long-lead mounts for 0.1-inch and 0.2-inch diameter pin circles, tetrode transistor mount, 7-pin miniature tube mount, etc.
- ★ Operates with very low rf levels on unknown — essential for accurate measurements of transistors and other nonlinear devices.
- ★ Bridge is completely passive — stability of calibration is dependent only on permanent physical dimensions.
- ★ Versatile: Bridge also measures  $\mu$ ,  $Y_{21}$ ,  $Y_{12}$ ,  $Y_{11}$ ,  $Y_{22}$ , etc. of tubes;  $Z_{11}$ ,  $Z_{22}$ ,  $Z_{21}$ ,  $Z_{12}$ ,  $Z_{11}$ ,  $Y_{22}$ ,  $Y_{21}$ ,  $Y_{12}$ ,  $I_2/I_1$ ,  $I_1/I_2$ ,  $E_2/E_1$ ,  $E_1/E_2$  of networks;  $R$ ,  $L$ ,  $C$ ,  $Z$ , and  $Y$  of diodes and components; and  $Z$ ,  $Y$ , and VSWR of coaxial lines.

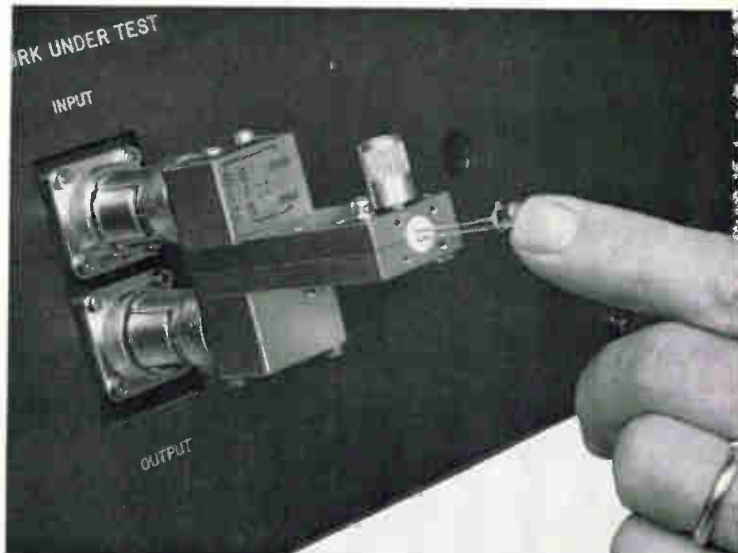

Rapid vhf-uhf measurements are now possible with new long lead Transistor-Mounts — you no longer have to cut semiconductor leads. These mounts "swallow" the leads, eliminating their effects from the measurement.

IN CANADA: Toronto 247-2171, Montreal (Mt. Royal) 737-3673  
IN EUROPE: Zurich, Switzerland — London, England



## GENERAL RADIO COMPANY

WEST CONCORD, MASSACHUSETTS

NEW YORK, N. Y., 964-2722  
(Ridgely, N. J.) 943-3140

CHICAGO  
(Oak Park) 848-9400

PHILADELPHIA  
(Ft. Washington) 646-8030

WASHINGTON, D.C.  
(Rockville, Md.) 946-1600

SYRACUSE  
454-9323

DALLAS  
FL 7-4031

SAN FRANCISCO  
(Los Altos) 948-8233

LOS ANGELES  
469-6201

ORLANDO, FLA.  
425-4671

CLEVELAND  
886-0150

Circle 900 on reader service card

# MEASURE VOLTAGE, FREQUENCY, RESISTANCE



DY-2010B  
Data Acquisition System

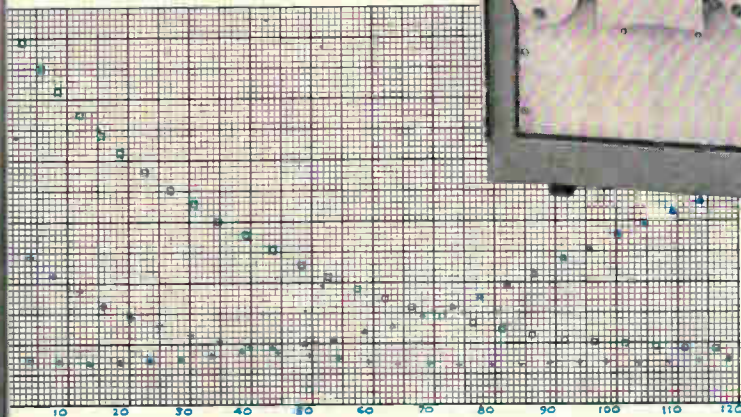

# THEN DIRECTLY MAKE X-Y PLOTS

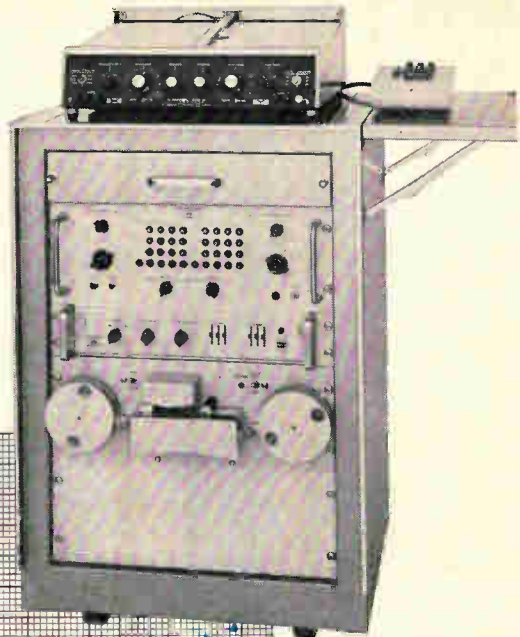

DY-2030B  
Data Plotting System

## When digital data is more meaningful in graphical form:

You can get an accurate x-y recording of the data you measure in the time it takes to unload a tape from one system and on to another. Measure with a Dymec 2010 Series Data Acquisition System, and just add the DY-2030 Data Plotting System and DY-2734A Punched Paper Tape Editor. No other equipment, no intermediate steps required, and the total capability costs less than \$22,000.

With any of three DY-2010 systems providing a recorded output on punched paper tape (but differing in input capabilities) you can measure data from up to 200 three-wire sources. Measurements of dc volts, low-level dc, ac volts, resistance and frequency are made by the floated and guarded DY-2401B Integrating Digital Voltmeter, heart of each versatile 2010

system. Then the data can be played back immediately on the DY-2030 Plotting System.

The tape editor in the system lets you (1) plot any channel on punched paper tape against real time recorded on the tape, (2) plot any channel on the tape against any other channel on the same tape, (3) plot any recorded channel against an internally generated step. Variables can be plotted in either x or y coordinate, with scale factor set for each, and independent of each other.

All of these Dymec systems are fully specified and priced, and may be ordered from the catalog. And never before have comparable capabilities been available at the price. \$10,800 for the DY-2010B, for example, plus as little as \$10,875 for the 2030B with 2734A Editor.

*Data subject to change without notice. Prices f.o.b. factory.*

# DYMEC

A DIVISION OF HEWLETT-PACKARD COMPANY

DEPT. E-2, 395 PAGE MILL ROAD, PALO ALTO, CALIF

• PHONE (415) 326-1755 TWX 415-492-9363

9406

# UNPRECEDENTED

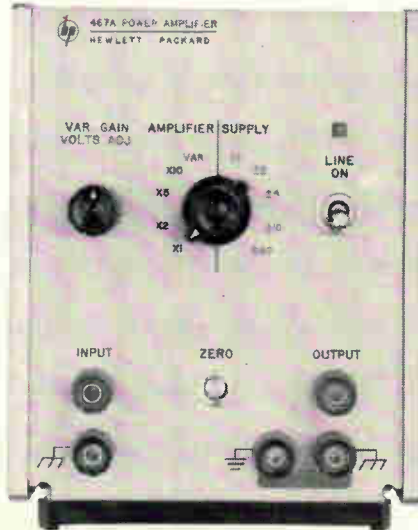

## PRECISION

with this versatile new hp power amplifier supply!

Use it to drive magnetic cores  
ultrasonic transducers  
recording galvanometers  
servo motors

Or to amplify oscillator outputs  
to supply dc power  
for environmental testing

Precision features derived from premium components and multiple feedback techniques make the new hp 467A Power Amplifier Supply a unique instrument of its type. It's a 10 watt peak power amplifier and,  $-20$  to  $+20$  volt dc power supply. Features include low distortion ( $<0.01\%$ ), low drift, and  $0.3\%$  gain accuracy. The chart indicates the excellent frequency response of this general-purpose solid-state instrument. Other features of the 467A include low output impedance, and protection from short circuits or input overloads to 200 volts peak to peak.

The specs tell most of the story. Relate them to your task, then get complete information from your hp field engineer or write Hewlett-Packard, Palo Alto, California 94304, Tel. (415) 326-7000; Europe: 54 Route des Acacias, Geneva; Canada: 8270 Mayrand St., Montreal.

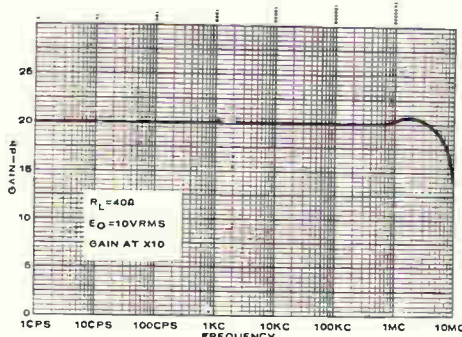

### SPECIFICATIONS

#### Power amplifier

Voltage gain: fixed steps X1, X2, X5, X10; variable 0 to 10, resolution better than  $0.1\%$  of full output

Accuracy:  $\pm 0.3\%$ , dc to 10 kc with load of 40 ohms or greater

Frequency response (fixed steps):  $\pm 1\%$ , dc to 100 kc;  $\pm 5\%$ , dc to 1 mc

Output capacity:  $\pm 20$  v peak at 0.5 amp peak

Distortion:  $<0.01\%$  at 1 kc,  $<1\%$  at 100 kc,  $<3\%$  at 1 mc

Input impedance: nominal, 50 K shunted by 100 pf

#### DC power supply

Voltage range:  $> \pm 20$  v,  $\pm 10$  v,  $\pm 5$  v,  $\pm 2$  v,  $\pm 1$  v; continuously variable vernier between ranges, resolution  $>0.1\%$  of full output

Current: 0.5 amp

Load regulation:  $<10$  mv for load change from 0 to 0.5 amp

Line regulation:  $<10$  mv for  $\pm 10\%$  change in line voltage

#### General

Output impedance: nominal 5 milliohms in series with  $1 \mu$ h

Capacitive load:  $0.01 \mu$ f or less does not cause instability

Ripple and noise:  $<5$  mv p-p

Current limit: approx. 800 ma

Input-output: front panel, banana terminals for input, output, chassis; rear panel, BNC terminals for input, output; signal leads may be floated 200 v dc above chassis

Price: \$575

Data subject to change without notice. Price f.o.b. factory.

**HEWLETT**  **PACKARD**  
An extra measure of quality

# Electronics

February 22, 1965  
Volume 38, Number 4

Page 4	Readers Comment
8	People
10	Meetings
15	Editorial
17	Electronics Newsletter
61	Washington Newsletter
139	New Products
175	New Books
176	Technical Abstracts
183	New Literature

## Electronics Review

Page 43	Series war	46	Lowering the bloom
44	Bank on this	48	A closer look
44	Autec: progress report	48	Talking on light
45	Locked laser beams	50	Ranger's sharper eyes

## Electronics Abroad

185	End of the road	187	Buildup
185	Microwave networks	187	Southern skies
186	Superconductors	188	NATO scoreboard
186	\$1 million gamble	189	Around the world

## Probing the News

123	Electronics for the ocean depths
126	Mixed bag makes a multiprocessor
128	Backtalk from the student is approved behavior
131	What Pentagon will buy: a preview

## Technical Articles

### I. Design

<b>Solid state</b>	76	<b>New masking techniques for micropower transistors</b> Conventional methods can't produce small enough geometries R. W. McGinnis and W. D. Roehr, Motorola, Inc.
<b>Circuit design</b>	82	<b>Impedance matching with nonlinear loads</b> The right filter can eliminate or exploit harmonics to improve circuit efficiency M.B. Covington Jr. and A.I. Sinsky, Bendix Corp.
<b>Circuit design</b>	86	<b>Designer's casebook</b> Pulse width converted to pulse sequence; new ways to improve transistor bias stability; multi's output duration controlled by input

### II. Applications

<b>Advanced technology</b>	90	<b>Monkeys and microelectronics</b> Thin-film receiver tied to animal's head picks up orders that alter his behavior William Liben, Johns Hopkins University
<b>Military electronics</b>	94	<b>Updating the missile range: Part 1 (Cover)</b> New instrumentation is needed as space exploration becomes the main concern John F. Mason, military electronics editor

### III. Manufacturing

<b>Production</b>	106	<b>Production tips</b> Small parts are aligned and assembled by vibration; oxide-poisoning problem solved by hole in grid cup; ferris wheel programs insertion of components
-------------------	-----	---

Title R registered  
U.S. Patent Office;  
© copyright 1965  
by McGraw-Hill, Inc.  
All rights reserved,  
including the right to  
reproduce the contents  
of this publication,  
in whole or in part.

# Electronics

**Editor:** Lewis H. Young

**Senior editors**

Technical: Samuel Weber  
News: Kemp Anderson, Jr.

Senior associate editors: John F. Mason, George Sideris

**Department editors**

Avionics: W.J. Evezia  
Circuit design: Michael Elia  
Communications: Alexander A. McKenzie  
Components: Michael F. Tomaino  
Industrial electronics: Louis S. Gomolak  
Instrumentation: Carl Moskowitz  
Manufacturing: George Sideris  
Military electronics: John F. Mason  
New products: William P. O'Brien  
Solid state: Jerome Eimbinder, G.G. Tirellis  
Space electronics: Joel A. Strasser  
Staff writer: Leon H. Dulberger

**Regional editors**

Boston: Thomas Maguire, editor; Robin Carlson  
Chicago: Cletus M. Wiley, editor; Leslie Krimston  
Los Angeles: William B. Wallace, editor; June Long  
San Francisco: Laurence D. Shergalis, editor; Mary Jo Jadin  
London: Derek Barlow, editor

**Copy editors**

Howard Rausch, Sally Powell, Stanley Zarowin

**Graphic design**

Art director: Saul Sussman  
Assistant art director: John C. Wright, Jr.  
Editorial production: Ann Mella  
Production editor: Arthur C. Miller

Editorial secretaries: Claire Benell, Mary D'Angelo, Lynn Emery,  
Kay Fontana, Carolyn Michnowicz, Lorraine Rossi, Lorraine Werner

**McGraw-Hill news service**

Director: John Wilhelm; Atlanta: Fran Ridgeway; Chicago: Bruce Cross;  
Cleveland: Arthur Zimmerman; Dallas: Marvin Reid;  
Detroit: Donald MacDonald; Los Angeles: Michael Murphy,  
Ron Lovell; San Francisco: Margaret Raiston, Ed. Addeo;  
Seattle: Ray Bloomberg; Washington: Arthur L. Moore, Glen Bayless,  
Charles Gardner, Herbert W. Cheshire, Seth Payne

**McGraw-Hill world news service**

Bonn: Richard Mikton; Brussels: Arthur Erikson; London: John Shinn;  
Mexico City: Wesley Perry; Milan: Bruce Bendow;  
Moscow: Donald Winston; Paris: Dan Smith;  
Rio de Janeiro: Leslie Warren; Tokyo: Marvin Petal, Charles Cohen

Circulation manager: Hugh J. Quinn

Reprints: T.M. Egan

**Publisher: C.C. Randolph**

**Electronics:** February 22, 1965, Vol. 38, No. 4

Printed at 99 North Broadway, Albany, N.Y.  
Second class postage paid at Albany, N.Y.

Subscriptions are solicited only from those actively engaged in the field of the publication. Position and company connection must be indicated on orders. Subscription prices: United States and Possessions and Canada, \$6.00 one year, \$9.00 two years, \$12.00 three years. All other countries \$20.00 one year. Single copies, United States and Possessions and Canada 75¢. Single copies all other countries \$1.50.

Published every other Monday by McGraw-Hill Inc., 330 West 42nd Street, New York, N.Y. 10036. Founder: James H. McGraw, 1860-1948.

Subscribers: The Publisher, upon written request to our New York office from any subscriber, agrees to refund that part of the subscription price applying to copies not yet mailed. Please send change of address notices, subscription orders or complaints to Fulfillment Manager, Electronics, at the address below. Change of address notices should provide old as well as new address, including postal zone number if any. If possible, attach address label from recent issue. Allow one month for change to become effective.

Postmaster: Please send Form 3579 to Fulfillment Manager, Electronics, P.O. Box 430, Hightstown New Jersey 08520

## Readers Comment

### Secret of feedback

To the Editor:

The authors of "Using negative reactances for independent phase and attenuation" [Dec. 14, pp. 45, 46] fail to point out that their "negative impedance converter" will either saturate or oscillate because of the positive feedback connection, when built with any real amplifier. I am sure readers would like to know what their secret is.

Thomas V. Saliga

National Aeronautics  
and Space Administration  
Greenbelt, Md.

■ The author replies:

To defend the diagrams in the article, we go back to basic feedback network theory. Any basic electronics text will develop the fact that a circuit will oscillate if, and only if,  $\beta K$  is real and equal to or greater than unity, where  $K$  is the amplifier gain and  $\beta$  is the feedback gain. In the cases illustrated,  $K$  is positive and greater than one, but  $\beta$  would be determined by the source impedance which may easily be controlled to yield a  $\beta K$  product which is stable.

This material is ordinarily introduced in the first electronics course for an electrical engineer. Our secret is out.

Clarence I. Jones  
Director, Research and Development  
Alan I.W. Frank Corp.  
Pittsburgh

### Follow that car

To the Editor:

I am puzzled by some aspects of W. E. Osborne's article ["Farewell to free time on city parking meters," Dec. 28, p. 72].

First, he has estimated the temperature of his infrared source to be about 300°F. I do not know of any external part of an automobile which normally operates at this temperature at city speeds or less, and suspect that his sensor is detecting a considerably lower temperature. Probably the detector is seeing either the rear end of the exhaust pipe or that part of the

(Advertisement)

## New Bridge Design For Safe, Accurate, Easy Measurement of 'Lytic Capacitors



The Sprague Model 1W2A Capacitance Bridge introduces new, improved technical refinements as well as restyling for added attractiveness and ease of operation. Built by capacitor engineers for capacitor users, it incorporates the best features of bridges used for many years in Sprague laboratories and production facilities.

### Precision Measurements over Entire Range from 0 to 120,000 $\mu$ F

The internal generator of the 1W2A Bridge is a line-driven frequency converter, and detection is obtained from an internal tuned transistor amplifier-null detector, whose sensitivity increases as the balance point is approached. It has provision for 2-terminal, 3-terminal, and 4-terminal capacitance measurements, which are essential for accurate measurement...  $\pm 1\%$  of reading +  $10\mu\mu$ F... of medium, low, and high capacitance values, respectively.

### No Damage to Capacitors

The model 1W2A Capacitance Bridge will not cause degradation or failure in electrolytic or low-voltage ceramic capacitors during test, as is the case in many conventional bridges and test circuits. The 120 cycle A-C voltage, applied to capacitors under test from a built-in source, never exceeds 0.5 volt! It is usually unnecessary to apply d-c polarizing voltage to electrolytic capacitors because of this safe, low voltage.

### Complete Specifications Available

For complete technical data on this precision instrument, write for Engineering Bulletin 90,010A to Technical Literature Service, Sprague Electric Company, 35 Marshall Street, North Adams, Massachusetts.

45SP-128-63

Circle 5 on reader service card

# Did you know Sprague makes...?

## MAGNETIC LOGIC DEVICES



Core-diode and core transistor magnetic shift registers and magnetic counters for switching and storage applications in computer and logic circuitry.

CIRCLE 277 ON READER SERVICE CARD

## MOLDED PULSE TRANSFORMERS

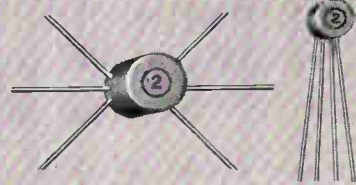

Miniature Pulse Transformers with tough molded cases for increased protection against physical damage and severe atmospheric conditions.

CIRCLE 278 ON READER SERVICE CARD

## NANOSECOND PULSE TRANSFORMERS IN TO-5 TRANSISTOR CASES

Special design offers distinct advantages: (1) Mini-fied size. (2) Welded hermetic seal. (3) Increased reliability. (4) Compatibility with transistor mounting techniques.



CIRCLE 279 ON READER SERVICE CARD

## SOMETHING NEW IN COUNTING TECHNIQUES

Simple yet versatile, low-cost yet reliable counters available for predetermined (2 to 11) or selectable (5 through 10) counting cycles.



CIRCLE 280 ON READER SERVICE CARD

## DYNACOR® BOBBIN CORES



Series "300" Cores with logical flux values in popular physical sizes are stocked in production quantities for fast delivery. They're value engineered for quality with economy!

CIRCLE 282 ON READER SERVICE CARD

## HERMETICALLY-SEALED TO-5 ENCASED SWITCH CORES

Designed especially for high-speed, low-power switching up to 100 kc, adaptability with conventional transistor packaging techniques, and performance under MIL-S-21038 environmental conditions.



CIRCLE 281 ON READER SERVICE CARD

## ELECTRONIC MODULES TO CUSTOMER REQUIREMENTS



Custom packaging is no novelty at Sprague's Special Products Division, where "specials" are continually being developed and produced with countless variations in electrical characteristics and mechanical configurations.

CIRCLE 283 ON READER SERVICE CARD

For application engineering assistance (without obligation, of course) on any of the above products, write or call the Special Products Division, Sprague Electric Company, 35 Union Street, North Adams, Massachusetts.

45SP-111-63 R4

# SPRAGUE®

THE MARK OF RELIABILITY

'Sprague' and '®' are registered trademarks of the Sprague Electric Co.

# EXTRALYTIC

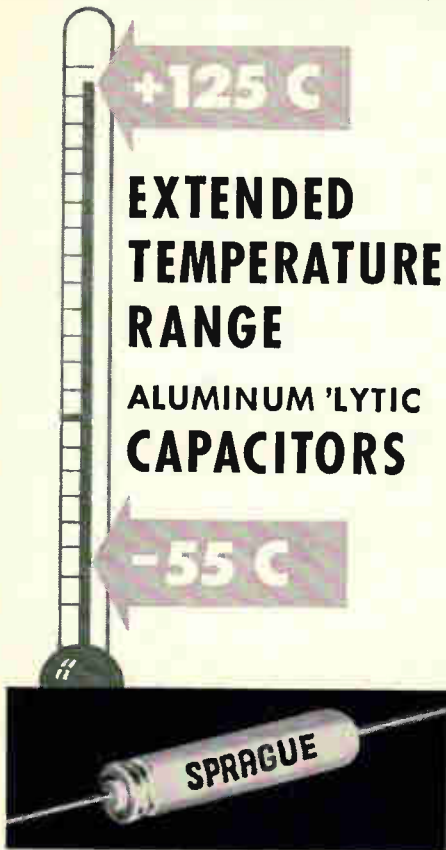

## EXTENDED TEMPERATURE RANGE

## ALUMINUM 'LYTIC CAPACITORS

- Voltage ratings to 150 vdc, unlike other so-called "wide temperature range" aluminum electrolytics with compromise voltage ratings only to 60 volts.
- Capacitance stability over entire temperature range. Even at  $-55\text{ C}$ , capacitance drop is very small.
- Operating and shelf life comparable to or better than that of foil tantalum capacitors.
- Less expensive than foil tantalum capacitors, yet meet electrical requirements of proposed military specification MIL-C-39018.
- Smaller and lighter than tantalum capacitors in equivalent capacitance values and voltage ratings.

For complete technical data, write for Engineering Bulletin 3455 to the Technical Literature Service, Sprague Electric Co., 35 Marshall St., North Adams, Mass. 01248

45C-4144



Sprague® and '®' are registered trademarks of the Sprague Electric Co.

radiator which is visible through the front grill.

If the radiator is his IR source, then there may be some trouble with reliable triggering in cold weather. Furthermore, air-cooled rear engines are available in cars now, and such cars may have IR outputs incompatible with his meter reset unit.

I am also puzzled by his objection to photoelectric units because pranksters can reset them with a flashlight. A similar objection applies to his unit. Somebody could wave a cigarette in front of his parking meter to reset it.

What is needed is a sensor which specifically requires the presence of a ton or so of metal, and yet is not awkward to use nor subject to prankish resetting.

One way to do this might be to place a pair of drive and sense loops several feet across beneath the parking area. The sense coil should form a square figure 8 with reversed windings in the two halves of the 8, and the drive coil a square 0 about it. With such a pattern, the total electromagnetic coupling between the drive and sense loops depends on the difference in amount of magnetically permeable material present over the two halves of the sense coil, and so would conveniently respond to the entry and departure of cars.

This drive-sense pair could be made part of the feedback loop of a marginal low-frequency oscillator, which would go into oscillation if there were magnetic asymmetry over the sense coil—the situation that would occur when the car entered or left the parking space. Its output could drive circuitry similar to that which Mr. Osborne used for his two-transistor IR detector. The loops could be laid in narrow slots inexpensively circular-sawed into the pavement and covered with tar, so the total cost would not be prohibitive.

This is the kind of situation which engineers doing commercial work rather than military design may have to deal with more commonly in the future, as electronics moves further into social matters. Often the problem will involve not merely the a priori physical situation, but a more complicated question involving legal credibility, resistance to tampering, etc. What

may be a perfectly valid solution to the first problem may fail in its relation to a social and legal structure.

Frederick W. Kantor  
Consultant  
New York

### ▪ The author replies:

Measured temperature on engine block, muffler and exhaust exceeds 300 degrees F. Radiator averages 175. The sensor detects the block or the radiator. Air-cooled rear engines, however, might not be detected.

A discussion of false triggering with a photocell or infrared device is relative, through the cigarette false-triggering is far less likely. No convictions would be attempted if a violator alibied.

I would like to stress that the program in Whittier was simply an experiment and not an attack on motorists.

W. E. Osborne

### A Replacement

To the Editor:

In my article "Very low frequencies are going back to work" [Jan. 11, p. 80], some of the superscripts were misplaced in a few equations.

The expression

$$R_{1,n} = R_{1,n}n^2 \text{ should read } R_{1,n} = R_{1,n}n^2 \text{ and } aI^2 \text{ should read } R_a I^2$$

The equation for multiple resistance should be:

$$R_m = R_a + R_{1,n}n^{-2} = R_c$$

and the equation for downlead resistance is

$$R_d = R_a n + R_{1,n}n^{-1} + R_{c,n}$$

J. C. Walter

Potomac River Naval Command  
Washington

### Help wanted

To the Editor:

I am preparing a tri-service history on the development of tactical military communications. Your readers possess a wealth of information in this field. Any data, recollections, or suggestions of written and graphic sources will be greatly appreciated, acknowledged, and credited where applicable. Information concerning developments and events prior to 1920 is particularly desired.

David L. Woods

1245 Via Del Mar  
Winter Park, Fla.



# slash semiconductor testing costs

with

- faster programming — simplified digital switching
- absolute device protection — programmable clamps and limiters
- individually programmable test times— 50 millisecs to 5 secs
- more accurate testing — 0.5% accuracy

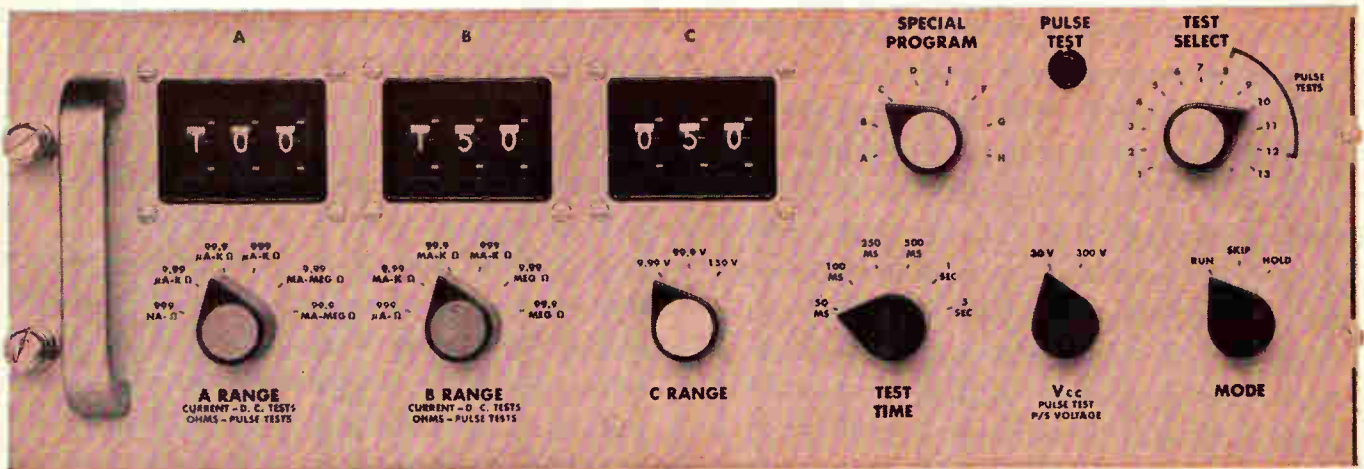

The Model 658 Transistor/Diode Test System provides: digit-switch programming from 1 nano-amp to 2 amps with readout from 0.3 nanoamp; d-c and pulse testing; tests in any random sequence. The 658 is expandable up to 48 tests. Testing modules fit in a separate drawer holding eight units; rack enclosures are available. Using digit-switches you can read test results directly. With the 658, you get *socket control*—shortest lead lengths from device to test circuit. Test sockets are interchangeable. You cannot find a more flexible, economical system.



write for information

INDUSTRIAL  
PRODUCTS  
GROUP



**TEXAS INSTRUMENTS  
INCORPORATED**

P. O. BOX 66027 HOUSTON, TEXAS 77006  
7 RUE VERNONNEX GENEVA, SWITZERLAND

# NEW

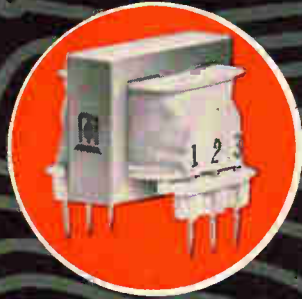

**OPEN FRAME  
PRINTED CIRCUIT  
TRANSFORMER**

## MICROTRAN

**for industrial applications  
with military quality  
at commercial pricing**

Wherever and whenever critical performance is demanded, Microtran is on the job. Our roster of noteworthy programs include Polaris, Apollo and Minuteman. For assurance of the ultimate in reliability and confidence of perfect performance... call Microtran to do its part.

NEW Industrial Grade Miniature Printed Circuit Transformer • Specifically designed for transistorized Control and Instrumentation applications • Molded-in terminals provide fixed mounting centers usually found only in expensive molded transformers • Size  $\frac{7}{8}$ " x 1" x 1". Weight: 1 oz.

Immediate delivery from distributors

Write for detailed catalog

 **MICROTRAN** company inc.

145 E. Mineola Ave., Valley Stream, N.Y. (516) LO 1-6050 • TWX:516-593-2685

NEW WESTERN PLANT: MICROTRAN WEST, GARDENA, CALIF

## People

On the wall of Rear Adm. Ignatius J. (Pete) Galantin's Pentagon office hangs a picture of the admiral and the late President Kennedy. The two are awaiting a Polaris missile test firing. Look closely. The admiral's fingers are crossed.



The test was a success, but it wasn't luck. As Director of Special Projects, Galantin directed the research, development and production program for the Polaris and the deep-submergence systems project. He brought to the job a firsthand knowledge of submarines; in World War II he commanded one in the Pacific and earned a Navy Cross and three Silver Stars.

Electronics companies will soon be hearing more of Galantin. On March 1, he moves up to vice admiral and takes over as Chief of Naval Material, a post in which he will boss the Navy's \$10-billion-a-year spending program. Clue for contractors: send the admiral an apple. He keeps a refrigerator full of them in his office, eats one a day.

The man behind Honeywell, Inc.'s new H-20 process-control computer system is S.D. (Toby) Harper, a former lieutenant commander in the British Navy who is now a United States citizen.



In 1962, Harper urged Honeywell to develop a small, efficient, fast computer for process control. The first H-20 came off the production line recently.

Harper became familiar with computers while working on electronic telephone exchanges for the British post office. In 1957, Honeywell brought him to the U.S., where he served as project manager of the H-800 and helped to design the Datamatic 1000. He is now director of engineering for Honeywell's Special Systems division, which developed the H-20.

## High Energy Physics and Machlett High Power Electron Tubes

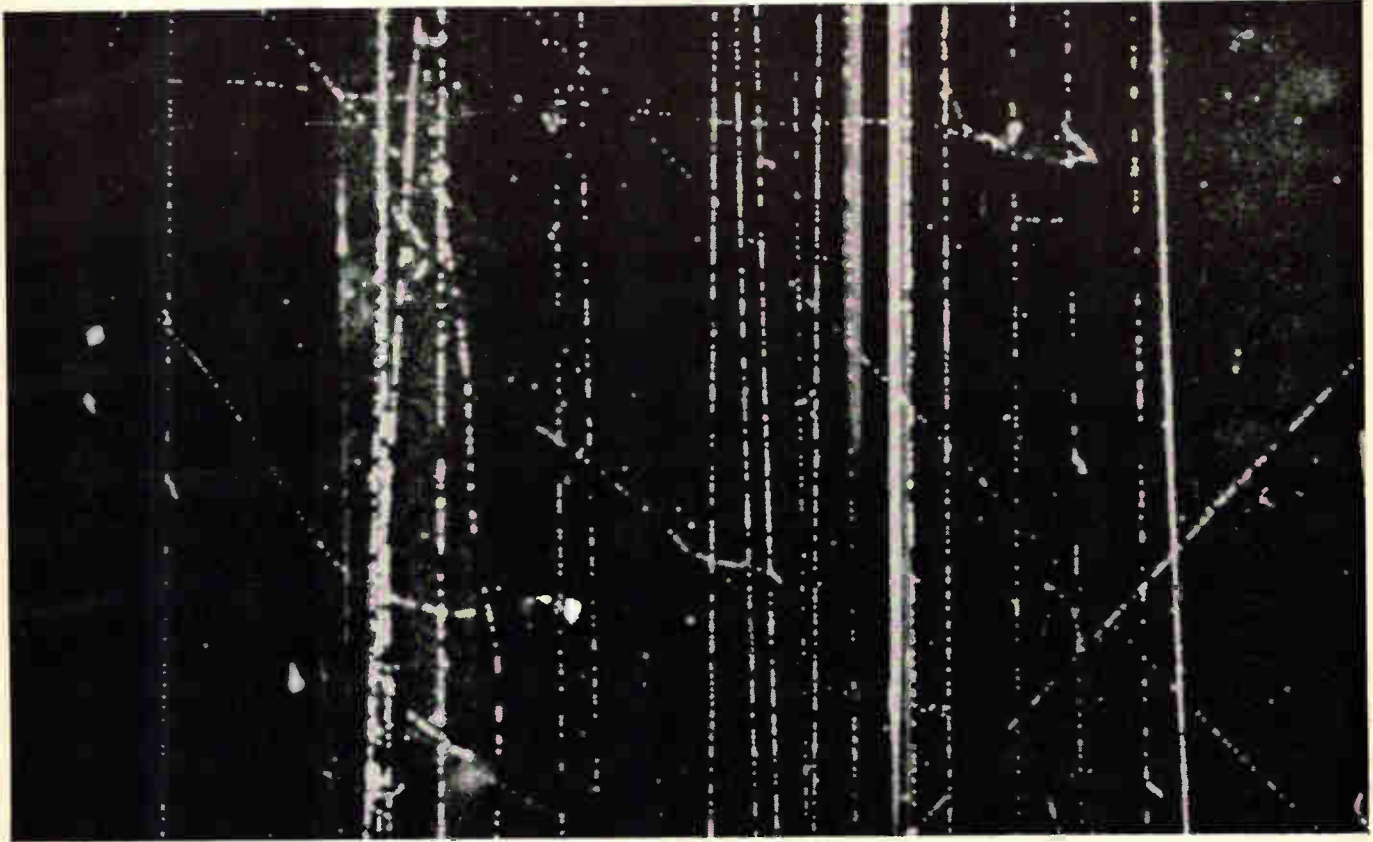

High energy physics, as represented by this "hydrogen bubble chamber" photo and Machlett's high power electron tubes, have had a long association in the nation's foremost Particle Accelerators—helping to accelerate protons from the early cyclotron (22 million electron volts) to the modern synchrotron (33 billion electron volts). Reasons for this long association lie in the performance reliability of Machlett tubes, and reflect continued confidence in the capability of the Machlett organization. Whether you require high power/high voltage triodes or tetrodes, UHF planar triodes, X-ray tubes, vidicons, or you need assistance in research or design development, write: The Machlett Laboratories, Inc., Springdale, Conn. 06879. An Affiliate of Raytheon Company.

**MACHLETT**

ELECTRON TUBE SPECIALIST

**Best way to check  
coaxial-cable  
attenuation, return loss**

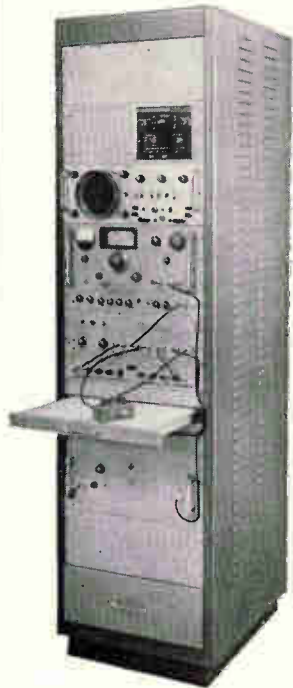

**JERROLD  
CABLE  
TEST SET  
model 1900**

**\$5,850.00**

For fast and extremely accurate quantitative measurements of return loss (VSWR), nominal impedance, and attenuation in coaxial cables, you should have a Jerrold Cable Test Set. The Model 1900 is a complete rack-mounted and enclosed unit consisting of a Model 900-B Sweep Signal Generator, Model FD-33 Comparator, Model AV-50R Attenuator, Model SCA-213C-5BR Amplifier, two RF Bridges (Models KSBV-5B and KSBV-57B), a set of miscellaneous attenuator pads, standard terminations, cable set, jacks, and plugs. The oscilloscope and the Moseley-type translator illustrated here are optional, as are a Model SD-8A Slow-Speed Sweep Driver.

In addition to its capabilities in checking coaxial cable, the Model 1900 Test Set is of course an ideal means of testing impedance, gain, attenuation, and VSWR of all electronic components.

Write for complete technical literature.



**JERROLD ELECTRONICS**  
Industrial Products Division  
Philadelphia, Pa. 19132

In Canada: Jerrold Electronics, 60 Wingold Ave., Toronto 19, Ont.  
Export: Rocke International, 13 E. 40th St., New York 10016  
**SWEEP GENERATORS • PRECISION ATTENUATORS  
AMPLIFIERS • COMPARATORS**

**Meetings**

Electromagnetic Compatibility Spring Conference, SAE; Orlando, Fla., Feb. 23-24.

Electronics Standards Committee F-1 Meeting, ASTM; Sheraton Park Hotel, Washington, Feb. 23-24.

Training Conference on Department of Defense Project 60, ASQC; Hotel Westward Ho, Phoenix, Mar. 6.

Particle Accelerator Conference, AIP, NSG/IEEE, NBS, USAEC; Shoreham Hotel, Washington, Mar. 10-12.

EIA Spring Conference, EIA; Statler Hilton Hotel, Washington, Mar. 16-19.

ISA National Conference on Instrumentation for the Iron and Steel Industry, ISA; Pick-Roosevelt Hotel, Pittsburgh, Mar. 17-19.

Management Conference on Operations Research, Systems Engineering and Electronic Data Processing, University of Pennsylvania, Philadelphia, Mar. 17-19.

Society of Broadcast Engineers Annual Meeting, SBE; Shoreham Hotel, Washington, Mar. 21.

IEEE International Convention, IEEE; N.Y. Coliseum and New York Hilton Hotel, New York, Mar. 22-25.

Society of Motion Picture and Television Engineers Semiannual Conference and Exhibit, SMPTE; Ambassador Hotel, Los Angeles, Mar. 28-Apr. 2.

Association of Electronic Manufacturers National Convention, AEM, Inc.; New York Hilton Hotel, New York, Mar. 29-Apr. 1.

Electron Beam Annual Symposium, Pennsylvania State University, Alloyd Corp.; Pennsylvania State University, University Park, Pa., Mar. 31-Apr. 2.

Electronic Parts Distributors Show, Electronic Industry Show Corp., New York Hilton and Americana Hotels, New York, Mar. 31-Apr. 4.

IEEE Seminar on Space Vehicle Reliability, IEEE; Airport Marina Hotel, Los Angeles, Apr. 2.

National Packaging Exposition, AMA; McCormick Place, Chicago, Apr. 5-8.

IEEE Lectures on Microelectronics, Chicago Section of IEEE; Chicago Lane Technical Institute, Chicago, Apr. 5, 12, 19, 26.

Cleveland Electronics Conference, Cleveland Electronics Conference, Inc., IEEE, ISA, CPS, Western Reserve University, Case Institute of

Technology; Cleveland Public Auditorium, Cleveland, Apr. 6-8.

Conference on Impact of Batch-Fabrication on Future Computers, PGEC/IEEE; Thunderbird Hotel, Los Angeles, Apr. 6-8.

Airlines Electronic Engineering Committee General Session, AEEC of ALCAC; Eden Roc Hotel, Miami Beach, Apr. 7-9.

IEEE Region 3 Meeting, Robert E. Lee Hotel, Winston-Salem, N.C., Apr. 7-9.

Electronic Components International Exhibition, FNIE, SDSA, Parc des Expositions (Fair Grounds), Paris, Apr. 8-13.

IEEE Region Six Annual Conference, Las Vegas Convention Center, Las Vegas, Apr. 13-15.

Telemetry National Conference, AIAA, IEEE, ISA; Shamrock-Hilton Hotel, Houston, Tex., Apr. 13-15.

Specialists Conference on Thin Film Action Devices, G-ED/IEEE, NASA; Johns Hopkins University, Baltimore, Apr. 14-15.

Numerical Control Society Annual Meeting and Technical Conference, NCS; La Salle Hotel, Chicago, Apr. 21-23.

Society of American Value Engineers National Convention, SAVE; Statler-Hilton Hotel, Boston, Apr. 21-23.

Anti-Missile Research Advisory Council Meeting, IDA; Institute for Defense Analyses, Arlington, Va., Apr. 26-30.

Rocky Mountain Bioengineering Annual Symposium, IEEE, USAF Acad., Fitzsimmons Gen. Hospital, et al; Brown Palace Hotel, Denver, May 3-4.

Packaging Industry Annual Conference, IEEE; Milwaukee Inn, Milwaukee, Wis., May 4-6.

**Call for papers**

**Northeast Electronics Research and Engineering Meeting (NEREM '65)**, NEREM; War Memorial Auditorium, Prudential Center, Boston, Nov. 3-5. **June 30** is deadline for submitting both 600-1,000 word condensed version of paper in triplicate and 35-40 word abstract to Franklin H. Blecher, Boston Section, IEEE, 313 Washington St., Newton, Mass. 02158.

A Fluke '65 Pacesetter is a solid state differential voltmeter which has twice the range, ten times the sensitivity, weighs half as much, works from plug or rechargeable battery, costs about the same, and holds the same classic quality as every vacuum tube Fluke Meter ever built. Here are two new ones. Write for details. Call your Fluke rep for a demonstration.

Series 871 DC Differential Voltmeters and 873 AC/DC Differential Voltmeters are available in both line and combination line and rechargeable battery powered models. DC and AC accuracies are 0.03% and 0.2% of input, respectively. Range is 0 to 1100 V. Full scale null sensitivity is 1 millivolt. Reference is stable to better than 50 PPM per year.



FLUKE • Box 7428, Seattle, Washington 98133 • Phone: (206) 776-1171 • TWX: (910) 449-2850

Model 871AB DC Differential Voltmeter

Model 873AB AC/DC Differential Voltmeter

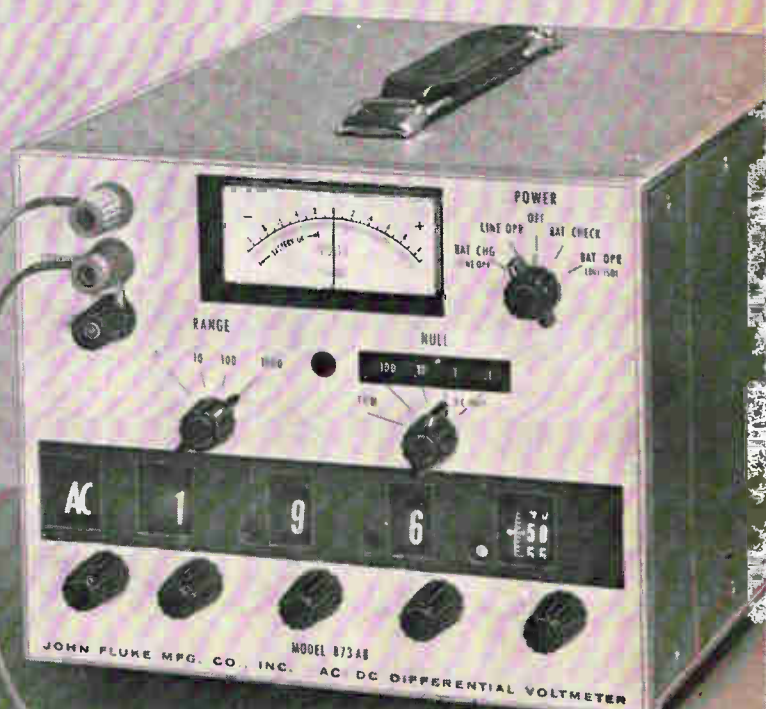
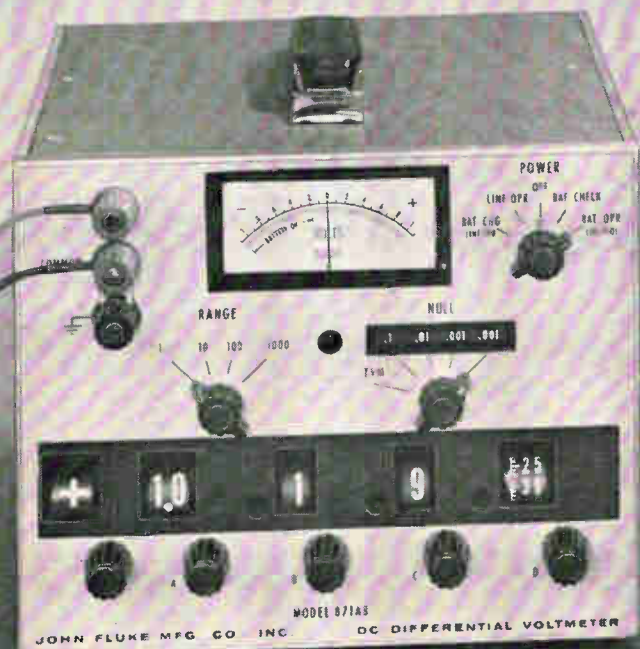

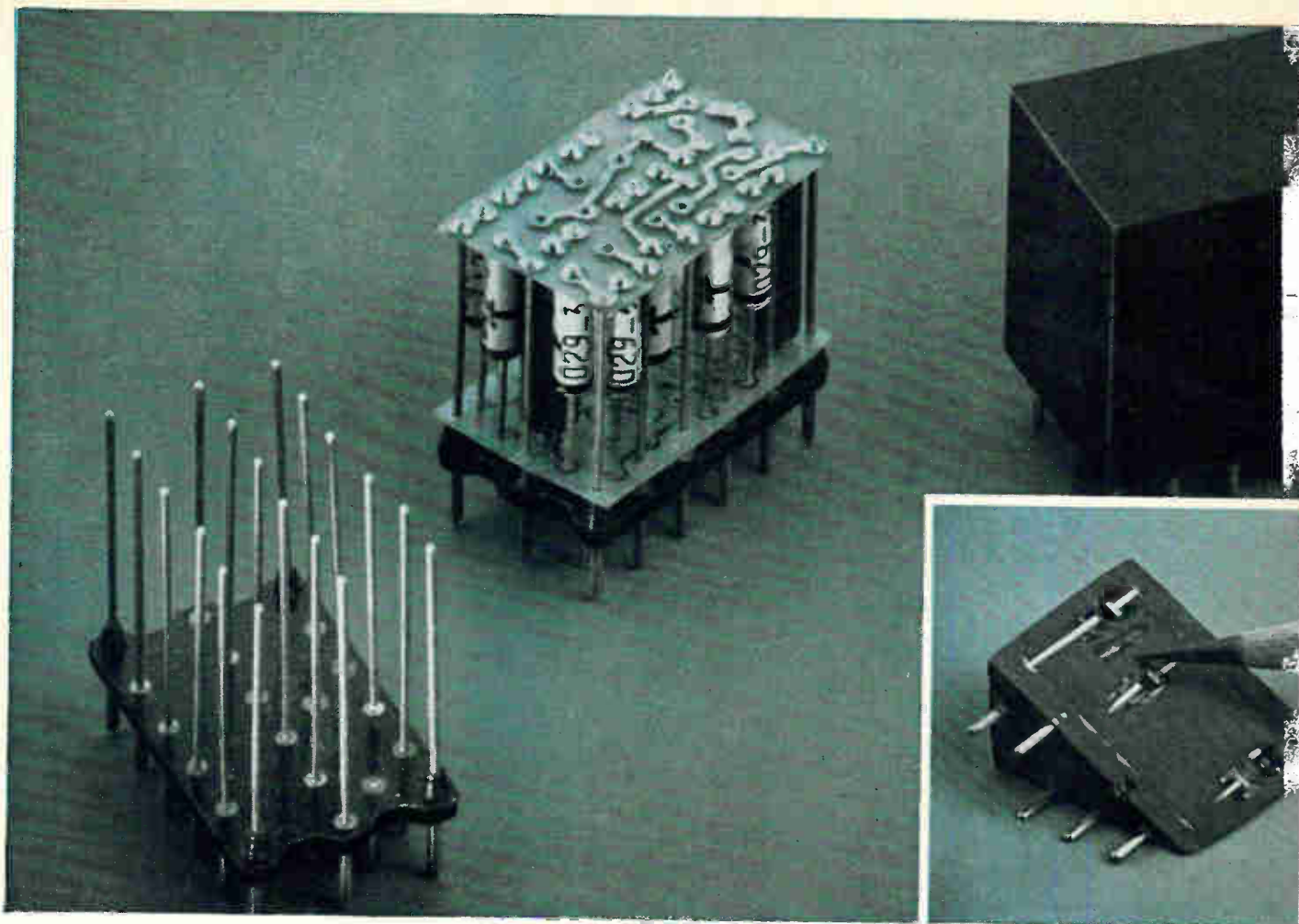

## News Briefs



**For transparent protection** of electronic components and systems, specify Sylgard® 182 resin . . . a colorless, solventless silicone. Designed for potting, embedding or encapsulating electronic circuits, it is applied as a low viscosity fluid . . . cures without exotherm . . . forms a resilient embedment that permits visual inspection. When necessary to repair circuits, Sylgard 182 resin can be cut away . . . replaced with new material after repair. Tensile strength from 800 to 1000 psi and long service life at temperatures of -65 to 200 C assure circuit integrity.

CIRCLE 290 ON READER-SERVICE CARD



**Designed specifically** to meet the requirements of MIL-I-8660A, Dow Corning® 4 compound retains its grease-like consistency and electrical properties over the broad temperature range of -60 to 200 C (-70 to 400 F) . . . won't dry out or harden. Used as a dielectric seal for connectors, terminations . . . in many applications to protect against moisture. Dow Corning 4 compound seals out corrosion and corona, increases surface resistivity of plastic parts. Can be applied to metals, ceramics, plastics, rubber, other insulating materials.

CIRCLE 291 ON READER-SERVICE CARD

# New silicone molding compound makes solid packaging practical

Dow Corning® 306 molding compound provides a durable, dimensionally stable, void-free package for electronic components and modules that is moisture resistant . . . assures component reliability. This new encapsulant, designed for transfer molding, has a useful temperature range of -65 to 250 C for 1000 hours or more.

Components and connections within cordwood modules for example, are completely protected . . . withstand the severe mechanical shock and vibration of high "G" forces. And modules are repairable! Expensive modules can be salvaged by removing Dow Corning 306 molding compound with a suitable solvent, making needed repairs and remolding.

Other features of Dow Corning 306 molding compound that add up to component reliability include: low dielectric losses at high frequencies and at high operating temperatures . . . high "Q" is maintained. Heat distortion point above 450 C (842 F) means leads stay sealed during soldering. Self-extinguishing,

with outstanding radiation resistance, this encapsulant shields components from tough environments. And, it is available in a range of colors for color coding.

When transfer molded in multiple cavity molds, this new packaging material lends itself to high speed production with extremely low rejection rates . . . parts release easily and cleanly from the mold . . . are exceptionally easy to deflash . . . all factors which reduce costs. For low cost production of high reliability systems in a package that offers maximum environmental protection, investigate Dow Corning 306 molding compound.

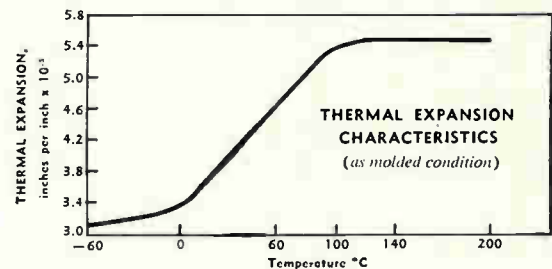

CIRCLE 289 ON READER-SERVICE CARD



Heat shrinkable silicone rubber tubing can save time and labor where quick and easy fabrication of a close fitting dielectric covering for splices, leads, or components is required. Use it for connector boots . . . cable break-outs . . . in hundreds of applications. Silastic® 1410 tubing is supplied in an expanded form. When heated to 300 F or higher, shrinks to 1/2 diameter. Shrinkage in length is less than 5%. Standard tubing of Silastic 1410 rubber is available in a variety of diameters and in lengths up to 20 feet.

We'll be pleased to forward full information on these and other materials that aid reliability and performance. For details or prompt technical assistance write to Dept. 3914, Electronic Products Division, Dow Corning Corporation, Midland, Michigan 48641. For a free sample, write on company letterhead describing your application . . . or phone for the name of the Dow Corning representative in your area.

**DOW CORNING**

CIRCLE 292 ON READER-SERVICE CARD

# 100 mc

# 10 mv/cm

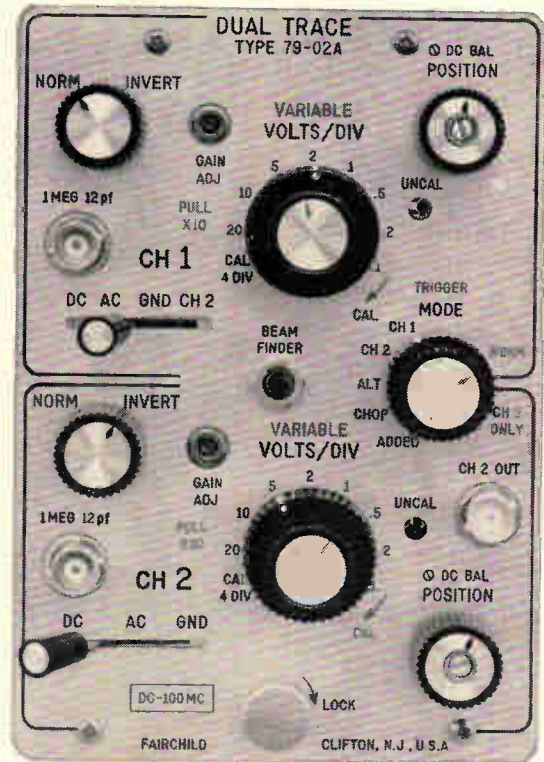

## EVERY SCOPE EXCEPT FAIRCHILD HAS NOW DEPRECIATED A BIT

*New all solid state dual trace plug-in gives Fairchild scopes 100 mc bandwidth and 10 mv/cm sensitivity.*

Fairchild has just extended the capabilities of Series 765 oscilloscopes to new ground. Now these scopes—alone—meet the higher bandwidth and sensitivity demands of so many present-day applications. Every Series 765 scope, old or new, becomes an even more versatile instrument than ever. And all solid state design affords size, weight and reliability advantages no tube scope can match. **Another first from Fairchild . . .** a solid state scope that fully outperforms tube scopes in all specifications. A new dual trace plug-in—Type 79-02A—provides full 100 mc bandwidth with sensitivity of 10 mv/cm. This combination of bandwidth and sensitivity is unique; no other direct-reading scope available today can approach it.

Let the Fairchild field engineer show you how you can update your precision instruments with new generation Fairchild scopes. Call your local Fairchild field engineer for a demonstration in your laboratory or ask him for application assistance and detailed specifications. Write Fairchild Scientific Instrument Dept., 750 Bloomfield Ave., Clifton, N. J.



\*Technological Obsolescence

## FAIRCHILD

DU MONT LABORATORIES  
SCIENTIFIC INSTRUMENT DEPARTMENT



---

Editorial

---

## Bridging a technical gulf

Every electronics man who ever considered moving into medical electronics has come up against the same prickly problem: how to blend his technical resources with the physician's biological expertise.

One approach to this has worked so well at the Dow Corning Corp., a manufacturer of silicon metal and silicone fluids and materials, that the company has established a medical products division whose sales goal is \$3 million this year even though the division is only three years old. Although Dow Corning's interest has been primarily in materials for surgical use—sponge, tubing, heart valves and fluids—the same idea and concepts can be applied by an electronics company. And the nicest part of the plan is that it doesn't take a lot of money.

In 1959 Dow Corning—which is jointly owned by the Dow Chemical Co. and the Corning Glass Works—established a tiny organization called the Center for Aid to Medical Research. It consisted of two chemists and half a secretary. Its job was to answer medical doctors' requests for clinical information about any Dow Corning product.

This simple organization has been received enthusiastically by the medical profession. It has already handled 10,000 letters from doctors, and receives an average of one medical visitor a day at its offices in Midland, Mich. Its staff, expanded to four chemists and two secretaries, gives about 90 talks a year to medical groups to describe successful medical applications of the company's products.

Why the success? Dow Corning has filled a void. Medical researchers tell us that generally they find industry is not very helpful. A young doctor doing medical research at the University of Michigan explained the kind of dilemma he runs into: "Some time ago, we needed an oscillator for a device to stimulate the bladder. Where do you go to find out about such an oscillator?"

The doctor doesn't want to get involved with a lot of electronic equipment. All he really wants is a place to go where he can get information in

a form he can understand and use. Even the researchers admit they are nearly illiterate when it comes to reading most electronics catalogs, reports and articles.

If you examine the center's operation, you find some specific things to do and to avoid. Dow Corning has always operated the facility as an information center, not a business for profit. When the center started producing business, the company protected it from the taint of commercialism by establishing the separate medical products division.

Secondly, to be as useful as possible, the center has been staffed with first-rate technical people. Doctors are demanding, but they have proven to be the best promoters of the center. Silas A. Braley, the young chemist who heads the center, said, "We get a lot of attention because one doctor can give another doctor a specific name and address to write to for help."

Thirdly, the center's chemists have worked diligently to learn medical language. They use medical dictionaries and spend as much time as possible talking with doctors. Like any profession, medicine has developed a jargon of its own that's practically a foreign language. One example of a term that often causes trouble is "compatibility." To some medical men the word means the blood will dissolve a substance. To others, it means the human body does not react with the material. Dow Corning's center avoids such ambiguous words unless it defines them.

Although establishing such an information center appears to be an easy way for a company to earn a reputation in medical electronics, it's not as simple as it seems. The doctors want service and they want it fast. But the worst pitfalls are legal ones. For example, if you work with a medical researcher to develop an electronic instrument, who owns the patents? A company has to do a lot of compromising, and may have to buy rights to devices it helped to develop. Or the medical researcher may not want to get involved in legal matters and may prevent patenting the device by publishing a description of it.

And an electronics company can be held liable or deleterious effects of medical experimentation with its products.

Whether you as an engineer or your company has a future in medical electronics can be answered only by experience. Braley warns that starting such an information center is necessarily a gamble.

Is anybody in the electronics industry willing to gamble?

# TOGETHERNESS



**A great motor...**



**a great tach...**

## make a great motor tachometer

Look at these parameters in a "synchro size" size 8 full drag cup motor rate tachometer.

We chose a Clifton motor with good torque (.275 in-oz), low power consumption (3 watts/phase) and high acceleration (120,000 rad/sec<sup>2</sup>), and added a tachometer with exceptionally high output for length. Combining them produced a tachometer with the lowest inertia in the industry for the size, output and torque.

One further ingredient was added. This component (and our whole, new line of servo motors and tachometers) is produced by a quality-minded company deeply experienced in the design and manufacture of

**Small: .75" diam x 1.241" length**

**T/I: 90,000 rad/sec<sup>2</sup>**

**Output: .3V/1000 rpm**

**Nulls: .015V max**

**Power Consump. <3W/phase**

rotating components. Look to CLIFTON for leadership in the servo motor and tachometer field.

Clifton Precision Products, Division of Litton Industries, Clifton Heights, Pa., Colorado Springs, Colo.

**cppe**

**CLIFTON** PRECISION PRODUCTS  
DIVISION OF LITTON INDUSTRIES



---

# Electronics Newsletter

---

February 22, 1965

## EIA sees gains from plane deal

The decisions by Great Britain and Australia to buy a total of \$1 billion worth of warplanes and other military equipment from the United States could open a \$175 million market for the U.S. electronics industry.

Although British companies are expected to try to fill the order for much of the radar and communications gear on the planes, the Pentagon believes U.S. electronics concerns will be getting sizable orders [see story on p. 185]. The dollar figure came from the Electronic Industries Association.

The U.S. and Britain also have agreed to expand their existing program of cooperation in defense research and development. Among the areas of joint exploration being considered: antisubmarine warfare, Army field communications, tactical air defense, and vertical- and steep-takeoff and landing aircraft.

## Low-cost core memory

A low-cost mass core memory introduced by the Ferroxcube Corp. may shake up the computer industry. Ferroxcube's Megabit 53-13 offers computer makers memory modules of five-million bit capacity and 12-microsecond cycle time for 1½ to 2 cents a bit—10% to 25% less than comparable memories, according to the company.

Ferroxcube will try to sell the memory to competitors of the International Business Machines Corp., whose Series 360 models use large core stores at prices previously considered unbeatable, except in high production.

The company received much technical and financial assistance from the U.S. Philips Trust, which is linked to the giant Dutch electronics concern, Philips Gloeilampenfabrieken N.V. Ferroxcube ascribed its low price to development of automatic core-threading machinery and a unique circuit technique that eliminates 30% of the semiconductor driving circuitry usually required in core memories.

## Fairchild enters microwave market

A new microwave transistor marks the entry of the Fairchild Semiconductor division of the Fairchild Camera & Instrument Co. into the high-performance microwave transistor market. Fairchild's new microwave group has introduced a planar epitaxial silicon transistor capable of an output of 1 watt at 1 gigacycle—about double that of commercially available power transistors.

Called the MT1038, the transistor has a guaranteed efficiency of 40% and is designed to operate as both an oscillator and a large signal very high frequency or ultrahigh frequency Class C amplifier.

## Computer-sharing goes commercial

Computer time-sharing, a technique previously limited to military and academic research projects, is going commercial in the Boston area. Keydata Corp., Cambridge, Mass., a subsidiary of Charles W. Adams Associates, Inc., is offering engineering and business subscribers immediate and direct access to a computer center through teletypewriters set up at subscribers' plants.

The first computing center is equipped with a Digital Equipment Corp.

---

# Electronics Newsletter

---

PDP-6. Keydata, believed to be the first company to offer such a commercial service, plans additional centers in New York and other cities.

## Sylvania planning push in monolithics

Getting ready to challenge the leaders of the integrated-circuit market is Sylvania Electric Products, Inc., a subsidiary of the General Telephone & Electronics Corp. The company has developed a full line of logic circuits; now it's spending several million dollars to expand production facilities at Woburn, Mass. Batteries of automated stitch bonders, flatpack sealers and other high-speed production machines are being installed in the plant. The production goal is 1.2 million circuits a year.

## Brief laser action attained chemically

Two University of California scientists have succeeded in obtaining laser action directly from a chemical reaction.

Jerome V.V. Kasper and G.C. Pimentel recorded coherent infrared radiation when a mixture of hydrogen and chlorine was exploded by flash photolysis. The resulting hydrogen chloride showed five inverted rotational-vibrational pairs, which gave coherent radiation at about 3.8 microns. Action lasted 15 to 20 microseconds, Kasper reported, and reached a peak power of about 10 watts.

Irwin Wieder, a researcher of the Interphase Corp. in Palo Alto, Calif., has been working in the same area with an oxygen and acetylene mixture. He notes that one advantage of using a chemical reaction for the laser medium was the possibility of utilizing the infrared as well as the visible and ultraviolet portions of the spectrum.

Wieder said the chemical laser has vast potential because it's light and easy to handle. Some reactive systems may also be able to provide continuous actions, he added.

## Beam hits satellite 950 miles away

After several failures, Air Force researchers finally succeeded in bouncing a laser beam off the Explorer 22 satellite. The experiment's success supported hopes that the system could be used for geodetic work—measuring distances between points on the earth for mapmaking [Electronics, Jan. 11, 1965, p. 42].

Sharpshooting scientists at the Air Force Cambridge Research Laboratory in Bedford, Mass., "hit" the 950-mile-high satellite three times in the past month. Other teams around the country haven't yet reported results.

## Addenda

The Columbia Broadcasting System will be one of the first United States customers for Philips' new Plumbicon television cameras. The Dutch company's U.S.-based unit, North American Philips, Inc., is setting up production schedules for both black-and-white and color cameras. . . . In Sweden, electronics dealer Johan Uno Norman was sentenced to 10 months in jail [Electronics, Jan. 11, p. 210]. He was found guilty of trying to obtain military electronics secrets for the Soviet Union.

. . . The Hoffman Electronics Corp. is placing on the market a solar cell priced at \$5.95. . . . The Communications Satellite Corp. has bowed to the FCC and will throw the development and production of a 24-satellite defense communications network open to competition rather than give a sole source order to the Hughes Aircraft Co.

*This month's Highlight*

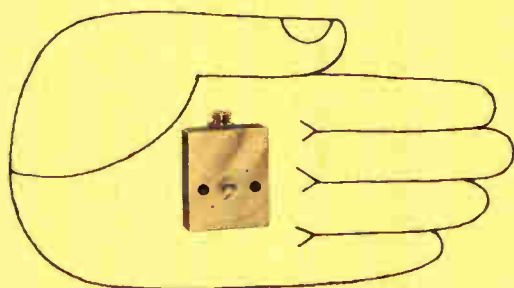

## Sylvania announces the industry's first hot carrier millimeter diode

The hot carrier phenomenon occurs when the temperature of the current carriers exceeds that of the lattice of atoms through which they flow. In conventional devices, the current carrier temperature is equal to the lattice temperature. Previously unexploited, the hot carrier principle is now beginning to be extended into non-bulk semiconductors.

Over a bandwidth of 60-80 Gc, Sylvania's newest diode has a minimum sensitivity of  $-40$  dbm. min. On special order its sensitivity can be optimized at specific frequencies within this range.

This unusual performance is an important characteristic of Sylvania's D-5298 millimeter diode, the first commercially available diode based on the

hot carrier principle. Because of materials, techniques and the nonrectification phenomenon, this device is less susceptible to electrical overloading than previously available millimeter detectors.

Another advantage that suits this new diode to radio astronomy and power monitor detector usage is its excellent performance at extreme temperature ranges.

Outwardly similar to other available devices, this newest millimeter diode is offered in a lightweight aluminum integrated package. As a result of this, no holder is needed to put the device to work, e.g., its face becomes the waveguide mounting flange.



in capsule

**display systems**—new readout techniques for the fastest information-processing systems...

**color television**—specifics on a new 25" rectangular member of the color bright 85 picture tube series...

**silicon power rectifiers**—a full line of medium-power devices, ideal where space or weight are at a premium...

**cathode ray tubes**—a mite-sized low-power heater-cathode assembly that suits CRT's for transistorized uses...

**readout tubes**—an expanded line of gas-glow alpha-numeric indicator tubes for information displays...

**diodes and rectifiers**—the industry's broadest line for commercial, computer, military and entertainment applications.

**microwave diodes**—a millimeter diode based on the hot carrier principle, for radio astronomy and power monitor detector use...

...all in this issue of IDEAS, Sylvania's new publication for component and circuit designers.

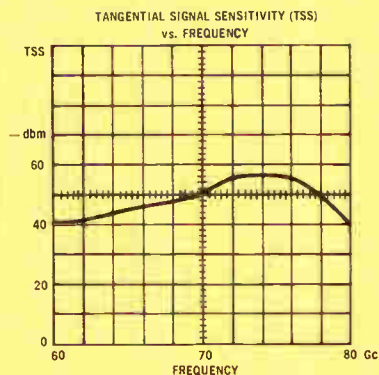
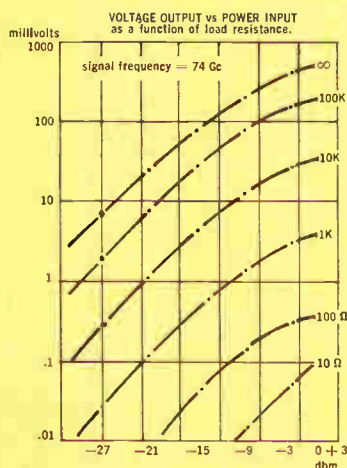

...a new capability

# "single-plane" automatic display systems: uniquely Sylvania, uniquely flexible

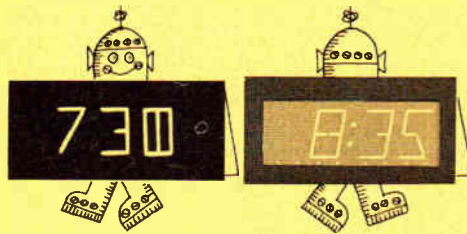

With the information-processing revolution, the role of automatic electronic displays has grown increasingly large. Several readout approaches, each with its own advantages, have been offered to the industry. The original equipment manufacturer is left with the choice of which system best fills his need within a reasonable cost-performance ratio.

Sylvania's approach to this problem was to settle on the two basic methods which offer the strongest advantages. Both types keep pace with the fastest information-processing systems and, at the same time, they offer good solutions wherever cost-performance ratio is a consideration.

Both methods are fully electronic, combining high-speed translating circuits with the most reliable electronic readout devices. Together the translators and readouts can even display numeric and alphanumeric information faster than the human eye can absorb.

The systems are based on the familiar techniques of solid-state electroluminescence (EL) and reliable gas-glow tubes. Both are extremely fast and have proven long life. But, by making available two highly-efficient display devices, Sylvania can meet virtually any readout requirement.

Basic Sylvania display systems include a converter which receives the input information from a computer, teletypewriter, data link, punched tape, typewriter—or other information source. From the converter, the information is instantaneously translated into the required multisegment code, passed through holding circuits so that it stays displayed once it is set up, and then used to drive the EL or gas-glow tube readouts.

Both EL and gas-glow tubes use a format of 7 to 14 segments to make the 10 numerals, the 26 letters of the Roman alphabet, and other special symbols. Additional segments can be added for special symbolic alphabets.

Electroluminescent panels are produced in a wide variety of sizes, ranging from ½" high to 6" or more. Gas-glow tubes are made in character heights of ¾", 1¼", 1¾" and 2½". Unlike other types of electronic readout in which characters are stacked, both Sylvania readouts are single-plane displays which are legible from substantial distances. The characters can be clearly seen, without viewing error, from almost any angle.

The EL panel produces a green light which closely matches the response curve of the human eye. The gas-glow display produces a bright orange-red color, readable at a good distance in normal light. Yellow and ruby red are also available in gas-glow.

Sylvania offers a wide choice of methods for switching the display segments, and for translating input information into the 14-segment code. The choice of switching and translating circuits depends on the source of the input information, how fast the display must be updated, what kind of power is available, and other considerations such as available space and cost.

Transistor switching circuits are used with gas-glow displays. Silicon controlled rectifiers or reed-relay switches are used with either type of display. Very efficient switching matrixes of electroluminescent-photoconductive materials, incandescent lamps plus photoconductive gates, or nonlinear-resistance switching matrixes have been successfully used to translate and switch for EL displays. They also can be used for gas-glow readouts.



BLOCK DIAGRAM OF BASIC SYLVANIA DISPLAY SYSTEM.

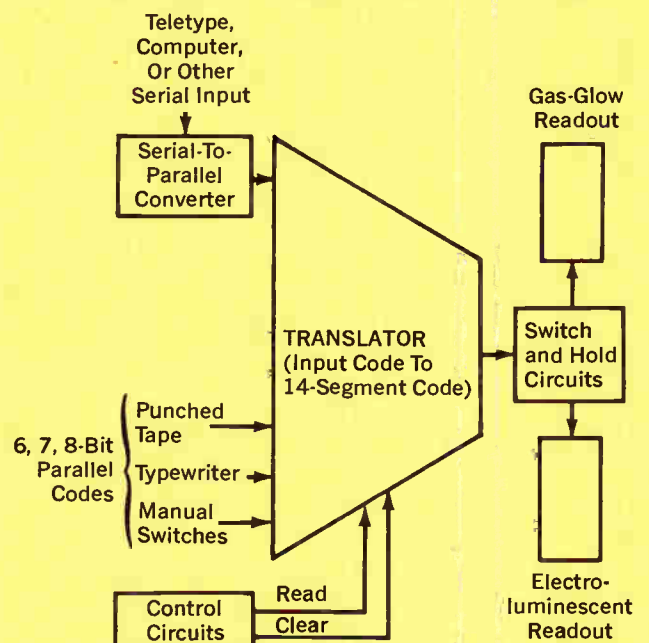



## new color bright 85<sup>®</sup> picture tube means a bright future for 25" color tv

Since Sylvania's announcement in mid-1964 of a revolutionary new color picture tube with a long list of advantages, the company has made the color bright 85<sup>®</sup> tube available in three models with more to come. The three: a 19" rectangular 90° tube, a 21" round 70° type, the 25" rectangular 90° model. General information on the last-mentioned tube, available now in a free Sylvania brochure, ET-2951, is summarized here.

The rectangular 25" color bright 85 tube has all the advantages of the other types in the series—among them: increased monochrome brightness, natural reds, superior contrast, more vivid images, the best color registration yet.

The tube itself, Sylvania's Type RE25BP22, has a picture measuring 19.875" x 15.575" in either color or black and white. Its three electrostatic-focus color guns, spaced 120 degrees apart, work in a 295 square-inch minimum assured projected area. The guns' axes are tilted toward the tube's axis to assure the three beams' convergence at the shadow mask. Internal magnetic poles govern each beam's radial convergence and also give supplemental control to the beams horizontally.

The shadow mask and aluminized screen are an assembly on the inner surface of the tube's spherical filter glass faceplate. The mask is spherical metal with graded holes.

The 3-color, phosphor dot screen is actually a tight pattern of minute dots arrayed in triangular groupings. Each group is made up of individual green-, blue- and red-emitting dots aligned with a corresponding hole in the shadow mask.

The big differences in all color bright 85 tubes are due chiefly to the new red-emitting phosphor, europium-activated yttrium vanadate, as well as Sylvania's unique "dusting" process for screening the tube's face-plate.

**TYPICAL LIGHT-OUTPUT CHARACTERISTICS**

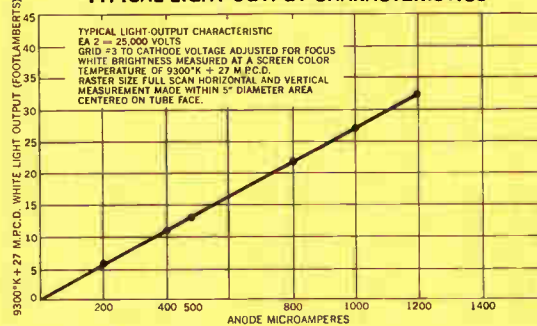

**CUTOFF DESIGN CHART**

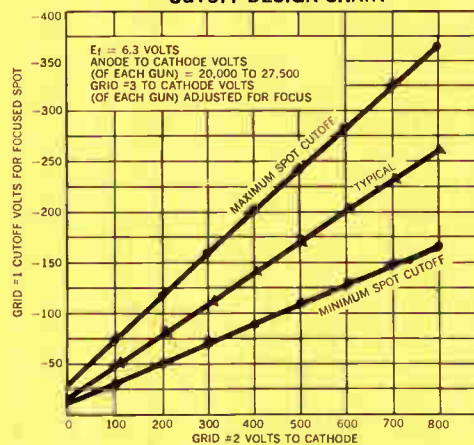

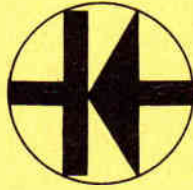

highlight in Sylvania's medium power silicon rectifier line:  
**more power in a DO-5 package**

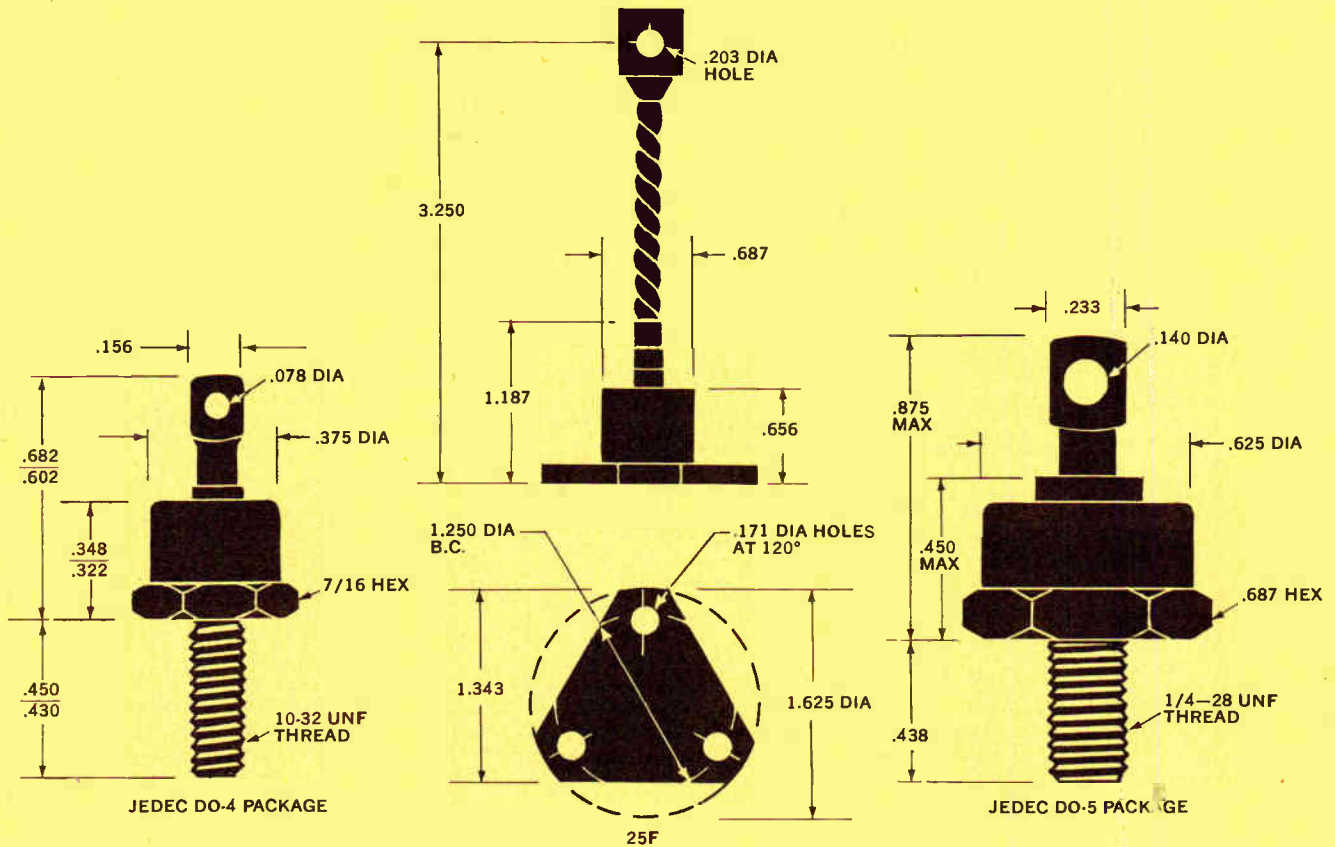

**3-6-12 AMPERE LINES (DO-4)  
 STUD-MOUNTED**

Current Rating	Thermal Resistance Per Watt Between Junction and Base
3 Amp 3 amperes at 150°C and 1.5 amperes at 175°C case temperature.	4°C
6 Amp 6 amperes at 150°C and 3 amperes at 175°C case temperature.	4°C
12 Amp 12 amperes at 150°C and 6 amperes at 175°C case temperature.	2°C

**THE 25 AND 35 AMPERE LINES ARE ALSO  
 AVAILABLE WITH FLANGE-MOUNTING**

Current Rating	Thermal Resistance Per Watt Between Junction and Base
25 Amp 25 amperes at 140°C and 10 amperes at 170°C case temperature.	1°C
35 Amp 35 amperes at 140°C and 15 amperes at 170°C case temperature.	1°C

**25-35-50 AMPERE LINES (DO-5)  
 STUD-MOUNTED**

Current Rating	Thermal Resistance Per Watt Between Junction and Base
25 Amp 25 amperes at 140°C and 10 amperes at 170°C case temperature.	1°C
35 Amp 35 amperes at 140°C and 15 amperes at 170°C case temperature.	1°C
50 Amp 50 amperes at 140°C and 15 amperes at 170°C case temperature.	1°C

Sylvania's medium-power silicon rectifiers are ideal for applications where space or weight are at a premium. These devices are designed to fit the broadest variety of rectifying needs.

An added advantage is that Sylvania offers a 50 amp line in the DO-5, a package which is usually limited to 35 amps in competitive lines.

Among the general characteristics of Sylvania silicon power rectifiers in the 3-50 ampere line are:

- reliable operation up to 175°C case temperatures
- reverse current to 10 ma peak at rated PRV

— junction temperatures to 190°C maximum  
 Complete reliability is assured through hermetic sealing and 100% inspection, including an X-ray check of junction contacts, a surge test, reverse current test and a dynamic oscilloscope reverse check for flutter, drift and hysteresis. All units in this group are immediately available in either positive or negative bases.

There are over 500 types to choose from in Sylvania's complete line with current ratings from 3 to 450 amps and ranging up to 1200 volts.



# CRT operates 400 hours on a number 6 battery cell

Because of a mite-sized device, Sylvania now has the broadest line of compact, lightweight CRT's. These tubes are used primarily in transistorized designs calling for portability, ruggedness and operating efficiency. The device that makes these characteristics possible is a unique low-drain heater-cathode assembly that consumes less than 6 percent the power requirements of conventional cathode ray tubes. The assembly is adaptable to virtually any Sylvania industrial or military CRT.

Even with a 1.5-volt heater rating and 140 ma current rating the assembly's performance compares with that of conventional 6.3-volt, 600 ma heater-cathode assemblies. Since ratings are this low, equipment temperatures are cooler, thereby giving longer service life.

As for size, the low power heater

cathode is just .050" in diameter and .011" thick, a result of Sylvania research and development in power metallurgy and tube technology. Compared with the conventional type, the low power assembly has an external radiating surface of .0054 square inches versus .136", a ratio of 25:1.



Tubes in this low heater power line show a remarkably low drain on battery supplies. For example, a No. 6 cell operating two hours a day provides between 350 and 400 hours of life. Even an or-

dinary "flashlight" D battery will give 15 hours of life.

Here are some of the tubes where this very low heater power is a standard feature:

**SC-3511, SC-3551, and SC-3802:** electrostatic focus and deflection CRT's with very high deflection sensitivity. Each uses helical-resistor post-deflection acceleration to achieve high writing rate and freedom from pattern distortion.

**3BGP1:** a compact, rectangular direct view oscilloscope tube for portable oscilloscope and radar use. 1½" x 3" direct viewed with electrostatic focus and deflection.

**3BMP:** a 3" direct viewed tube with round glass screen and flat faceplate. Electrostatic deflection and focus with post-deflection acceleration.

CIRCLE NUMBER 304

## a caret for readout system designers

Virtually any readout application can be ideally filled with Sylvania gas-glow indicator tubes. With bright, red-orange characters measuring ¾, 1¼, 1¾ and 2½ inches, Sylvania's line includes the most popular sizes available.

One of the big advantages of the gas-ionization readout is its excellent legibility. Sylvania's gas-glow tubes read easily under a variety of ambient lighting conditions and at relatively long distances. (The SY-1303, a tube with 2½" characters, provides clear readout at 100 feet in normal ambient light.) Other important factors affecting readability are brightness and viewing angle. These tubes average more than 160 foot lamberts in intensity and can be read from a wide 150° viewing angle. And there is also the advantage of single-plane viewing which eliminates the criss-crossing wires common to some other readouts.

The ¾" indicator tube is available in the numeric model. All other sizes are supplied in either numeric or alphanumeric models. The alpha-

numeric tube has a single anode and 15 metallic cathodes. In addition to displaying letters A through Z and numerals 0 through 9, it offers another feature in the cathode at the base of the viewing area which lights to form a caret. This caret can represent any special symbol, such as an eighth of a point on a stock quotation board or an on-time signal at an airport.

With its 170-volt DC operation, the displayed characters are controlled by changing segment potential by 50 volts to meet the 12v dropout requirement, an operation that can easily be done with transistors. A binary (hold) circuit can be provided by combining switching stages with a second transistor.

Main uses include almost all information displays of a changing nature. This includes teaching machines, remote controlled meter gauges, silent paging systems, and scoreboards. Many more applications are being found as the display field continues to develop.

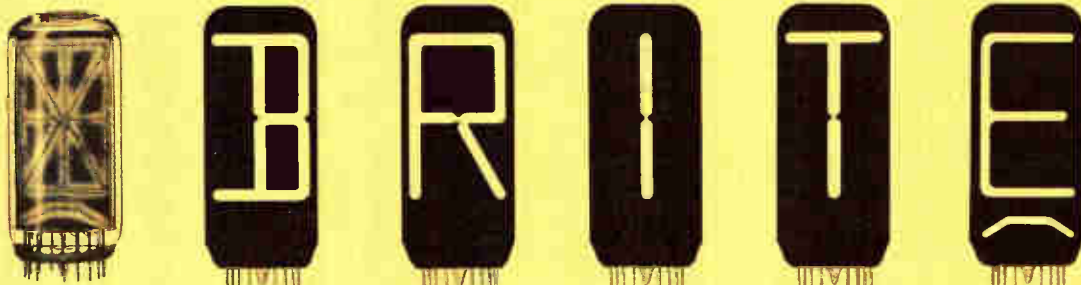

CIRCLE NUMBER 305

# Sylvania offers the industry's broadest line of diodes and rectifiers

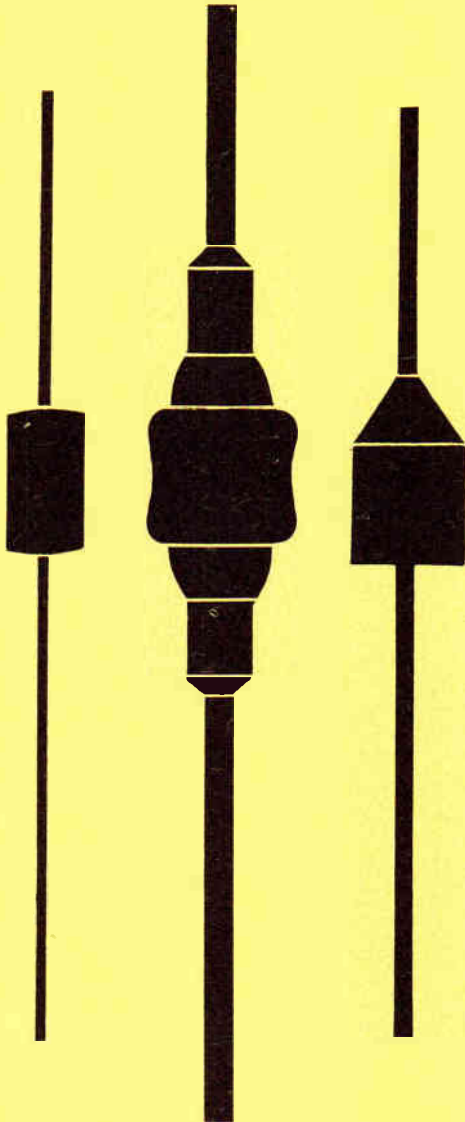

Design engineers, faced with the problem of specifying a variety of diodes and rectifiers into a single circuit or series of circuits, usually have to go to a number of vendors to make their selections. This results in lost design time, consultation with multiple sources and availability problems. And it occasionally means basic differences in product design continuity between separate manufacturers.

The widest range of forward conduction currents, breakdown voltages, leakage currents, switching speeds, capacitances, temperatures and power dissipation capabilities is now available from one single source. Sylvania, producer of the first commercial diode, has the industry's broadest line of diodes and rectifiers for commercial, computer, military and entertainment applications. Stringent quality control methods and precision manufacturing techniques assure parameter uniformity and lot-to-lot reliability.

#### DF 2 Germanium Point Contact in the DO-7 Package.

Applications: General purpose and computer use; Radio or video detector; Varistor

Typical Power Rating—80 mw

Temperature Range: —55°C to +90°C

Typical Characteristics: Forward Current @ 1 V—5 to 25 ma

Reverse Voltage—10 to 80 V • Reverse Resistance—500K ohms

Speed—.5-4 nanoseconds • Junction Capacitance—1 to 2 pf. @ 0 V

#### DF 4 Silicon Point Contact in the Large Solder Seal Package.

Applications: UHF Frequency Mixer up to 1000 MC

Temperature Range: —55° to +100°C

Typical Characteristics: Forward Current @ .5 V—10 ma

Reverse Current @ .5 V—50µa • Overall Noise Factor—12 to 15 Db

#### DF 5 Germanium Gold Bond in the DO-7 Package.

Applications: General purpose high conduction and medium speed switching.

Typical Power Rating—80 mw

Temperature Range: —55° to +90°C

Typical Characteristics: Forward Current @ .8 V—100 ma

Reverse Voltage—10-125V • Reverse Resistance—2 megohms

Speed—40-500 nanoseconds • Junction Capacitance—. to 2 pf. @ 0 V

#### DF 7 Silicon Alloy Junction in the DO-7 Package.

Applications: Audio and chromatic detector, Stabistor, clamp and variable capacitors

Typical Power Rating—250 milliwatts

Temperature Range: —65° to +200°C

Typical Characteristics: Forward Current @ 1 V—100 ma

Breakdown Voltages—200 V • Reverse Currents—2 to 50 nanoamps

#### DF 8

High voltage switch version of DF 7—incorporates switching speeds of .1 to 1 µsec with higher reverse currents.

#### DF 22 Silicon Epitaxial Planar in the DO-7 Package.

Applications: High conduction, fast switching such as logic circuits, high frequency detectors, clippers and choppers.

Typical Power Rating: 300 milliwatts

Temperature Range: —65° to +175°C

Typical Characteristics: Forward Current @ 1 V—100 ma

Reverse Voltages—50-120 V • Reverse Currents—10-50 nanoamps

Speed—3-10 nanoseconds • Junction Capacitance—1 to 2 pf. @ 0 V

#### DF 23 Silicon Alloy Junction in .200" Diameter Epoxy Package.

Applications: Rectifier—medium power.

Typical Power Rating: 750 milliwatts

Temperature Range: —55° to +150°C

Typical Characteristics: Forward Current @ .9 V—750 ma

Reverse Voltages—to 1000 V

#### DF 24

Same as DF-4 except in the DO-7 Package.

#### DF 26 Silicon Diffused Junction in .150" Diameter All Glass Package.

Applications: Rectifier—medium power.

Typical Power Rating: 1 watt @ 100°C

Temperature Range: —55° to +200°C

Typical Characteristics: Forward Current @ 1 V—1.0 A

Reverse Voltages—to 1500 V

#### DF 27

Same as DF-26 except in .200" Diameter Epoxy Package with temperature range up to 150°C.

#### DF 28

Same as DF-22 except whiskerless construction in microminiature (.060" dia.) glass package with power dissipation capabilities to 500 mw.

#### APPLICATION CHART (with suggested types)

	HIGH TEMPERATURE OPERATION 150-200°C	LOW TEMPERATURE OPERATION TO +90°C
GENERAL PURPOSE	Silicon Alloy Junction, IN459	Germanium Point Contact, IN191
HIGH CONDUCTANCE	Silicon Alloy Junction, IN459A Silicon Diffused Junction, IN645	Germanium Gold Bond, IN100 Germanium Gold Bond, IN270
HIGH CONDUCTANCE MEDIUM SWITCH	Silicon Alloy Junction, IN629	Germanium Gold Bond, IN276
HIGH CONDUCTANCE FAST SWITCH	Silicon Epitaxial Planar, IN3731	
RECTIFICATION	Silicon Diffused Junction, IN2071A	
UHF	Silicon Point Contact IN82A + IN82AG	
VARIABLE CAPACITOR	Silicon Alloy Junction, IN3182	
STABISTOR	Silicon Alloy Junction, IN816	

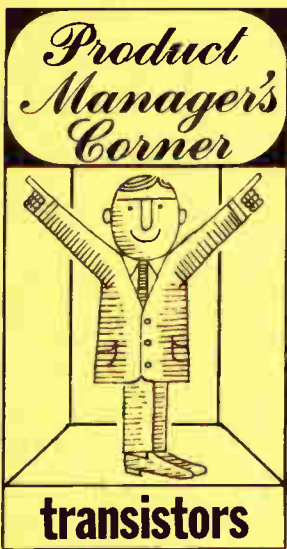

transistor types, ad infinitum!

Ever get suspicious that transistor data books are getting fatter simply because of "Specs-manship"? There have been few actual breakthroughs in the history of transistors; yet we're all aware that literally thousands of type numbers are registered and advertised.

New devices with true problem-solving value are few and far between. Many such nuggets become lost to the active designer since the time available for his evaluation of glamorous-looking data sheets and the weeding of the wheat from the chaff is never sufficient to assure him he can search them out.

When the designer does note a transistor specification with value-plus features, his job has really just begun. Other questions need answering:

Can the supplier produce the device in sufficient volume for the designer's program need? Can the supplier provide the user with the stability of characteristics essential to meet specific operating and environmental conditions of the application? This kind of information is seldom offered in data sheets and ads.

To get answers, the designer must further complicate his plight by spending valuable time with the possible vendors. The designer knows full well the inherent danger in planning ahead without assurance on all details.

Yet such new device developments, designed to solve a circuit designer's need, do become available and are supportable.

Here's a case in point of one such device that was designed to be a problem-solver, and did indeed prove itself—the 1.0 Gc minimum  $f_T$  Silicon Planar Epitaxial Transistor, type 2N2784. Its design merits are clear cut:

1. Much improved gain bandwidth (typ. 1.3 Gc) and storage time (typ. 4.0) Nsec)
2. Low-level amplifier (typ.  $H_{FE}$  of 50 at 200  $\mu A$  Ic)
3. Micropower requirements
4. Built-in quality

The 2N2784 is the prime specification for a line that has been in continually increasing production since its announcement at the March, 1963 IRE meeting. Sylvania production experience has established the type as a sound product objective. This has resulted in ready availability of sample or production quantities from distributor and factory at realistic prices (e.g., \$3.25 for 1000 to 4999 units). The designer can be assured this unit is quite producible with stabilized distributions!

As a result our 2N2784 has won a place in several hi-reliability aerospace programs on the merits of its performance and reliability. Extensive reliability data has been accumulated for this product.

This sample of Sylvania's development, production and reliability team effort on the 2N2784 illustrates Sylvania's policy of helping solve designers' needs through a coordinated device program, from device concept to consumer in-plant acceptance of the product.

We'd be happy to send you more data on the 2N2784. Just call your Sylvania sales engineer or circle the number indicated below on the reader service card.



*Bill Hogan*  
W. D. HOGAN

CIRCLE NUMBER 307



HOT LINE INQUIRY SERVICE

Use Sylvania's "Hot Line" inquiry service, especially if you require full particulars on any item in a hurry. It's easy and it's free. Circle the reader service number(s) you're most interested in; then fill in your name, title, company and address. We'll do the rest and see you get further information almost by return mail.

**BUSINESS REPLY MAIL**  
No Postage Stamp Necessary if Mailed in the United States

POSTAGE WILL BE PAID BY

**SYLVANIA ELECTRONIC COMPONENTS GROUP**

Sylvania Electric Products Inc.  
1100 Main Street  
Buffalo, New York 14209

Dept. E

FIRST CLASS  
Permit No. 2833  
Buffalo, N. Y.

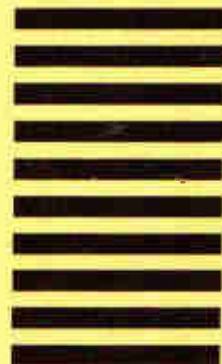

# new marketing group formed

The designer of electronic systems can now specify a world of products from a diversified, fully equipped single source.

All Sylvania electronic components have been placed into a single marketing organization, the Electronic Components Group. In effect, the move combines into one team all of the company's capabilities in its extensive semiconductor, tube,

microwave device, readout device and special component lines.

Information on any Electronic Component Group product can be gotten quickly and completely from any of its sales offices. Every office is staffed with sales engineers fully qualified to advise you on your problem. You are invited to contact any of the offices listed below.

## SALES OFFICES

### BALTIMORE

31 Allegheny Avenue  
Towson 4, Maryland 21204  
301-823-2550

### CHICAGO

2001 North Cornell Avenue  
Melrose Park Illinois 60160  
312-379-2525

### DALLAS

100 Fordyce Street  
Dallas, Texas 75207  
214-741-4836

### DAYTON

333 West First Street  
Dayton, Ohio 45402  
513-223-6227

### DETROIT

7800 Intervale Ave.  
Detroit, Michigan 48238  
313-933-8765

### FLORIDA

1520 Edgewater Drive, Calmar Bldg.  
Orlando, Florida 32804  
305-241-9681

### FORT WAYNE

4740 Coldwater Road  
Fort Wayne, Indiana 46805  
219-483-1145

### LOS ANGELES

6505 East Gayhart Street  
Los Angeles, California  
213-723-5371

### MASSACHUSETTS

Wakefield Office Building  
North Avenue  
Wakefield, Mass. 01880  
617-245-7263

### MINNEAPOLIS

2211 E. Hennepin Street  
Minneapolis, Minn. 55413  
612-332-6583

### NEW YORK

1000 Huyler Street  
Teterboro, New Jersey 07602  
201-288-9484

### NEW YORK—UPSTATE:

Johnson Street  
Seneca Falls, New York 13148  
315-568-5881

### SYRACUSE

5700 West Genesee Street  
Camillus, New York 13031  
315-672-3111

### PHILADELPHIA

4700 Parkside Avenue  
Philadelphia 31, Penna. 19131  
215-477-5000

### SAN FRANCISCO

1811 Adrian Road  
Burlingame, California 94010  
415-697-3500

### WASHINGTON, D.C.

1120 Connecticut Avenue, N.W.  
Washington, D.C. 20036  
202-337-6600

**SYLVANIA**  
SUBSIDIARY OF  
GENERAL TELEPHONE & ELECTRONICS **GTE**

NEW CAPABILITIES IN: ELECTRONIC TUBES • SEMICONDUCTORS • MICROWAVE DEVICES • SPECIAL COMPONENTS • DISPLAY DEVICES

NAME \_\_\_\_\_

TITLE \_\_\_\_\_

COMPANY \_\_\_\_\_

ADDRESS \_\_\_\_\_

CITY \_\_\_\_\_ STATE \_\_\_\_\_

Circle Numbers Corresponding to Product Item

300      301      302      303      304  
305      306      307



## HOT LINE INQUIRY SERVICE

Need information in a hurry? Clip the card and mail it. Be sure to fill in all information requested. We'll rush you full particulars on any item indicated.

You can also get information using the publication's card elsewhere in this issue. Use of the card shown here will simplify handling and save time.

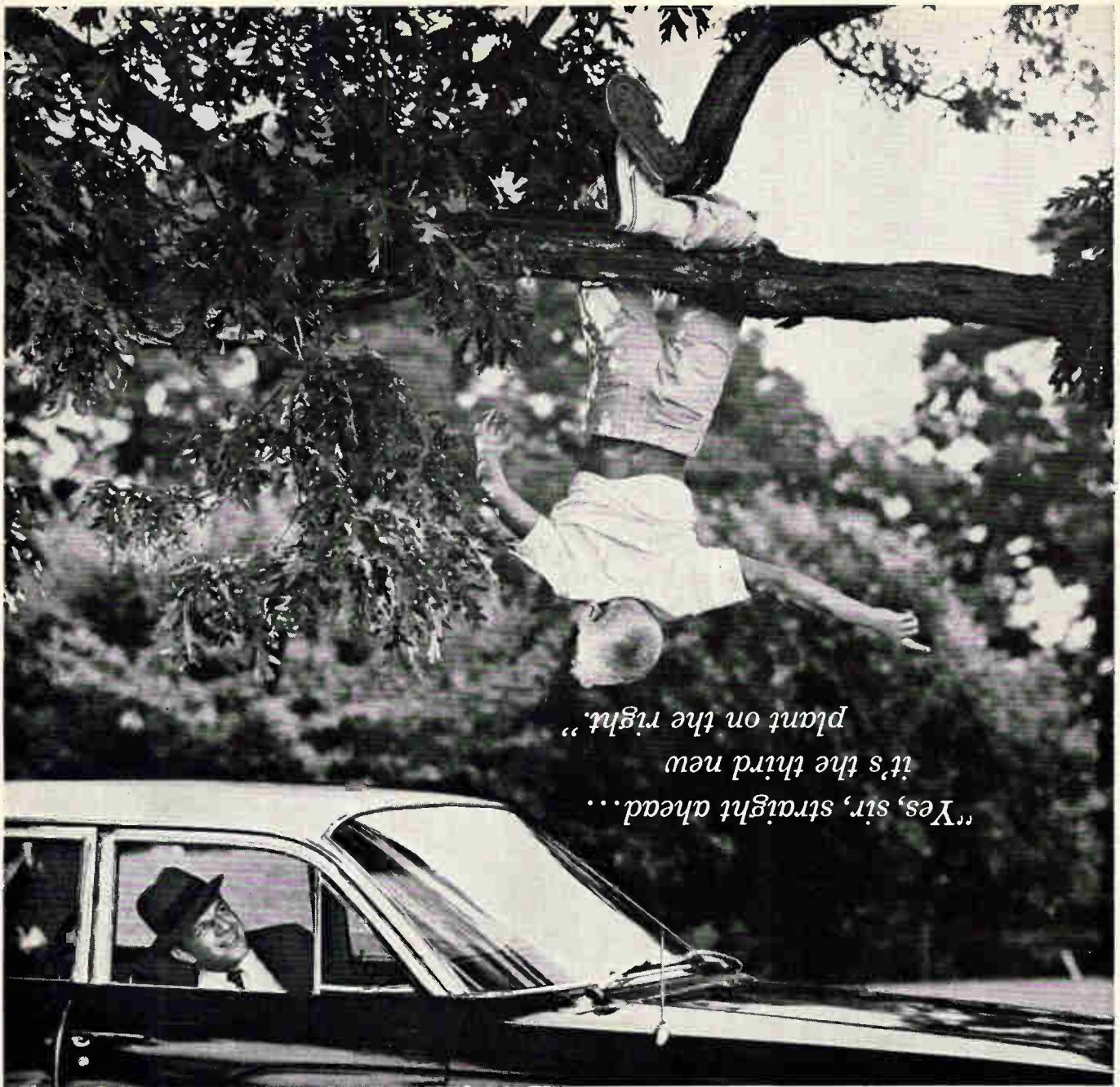

*"Yes, sir, straight ahead...  
it's the third new  
plant on the right."*

## **In 1964 alone, 546 new and expanded plants paced North Carolina's industrial growth. What's here for you?**

Growth, like Good Government, is a habit in North Carolina. Companies thrive here because the business climate is right. They find people who work hard. A string of 20 Industrial Education Centers that turn out willing workers trained to employer specifications—at no expense to industry. All the advantages of being close to the nation's

population centers without sharing their problems. These are some of the reasons North Carolina has led the Southeast in industrial growth in the past decade. There's more you should investigate. Write

Governor Dan K. Moore, State Capitol, Raleigh, for an industrial information package . . . free (and confidential) of course.

# **GO NORTH CAROLINA**

WHERE GOOD GOVERNMENT IS A HABIT

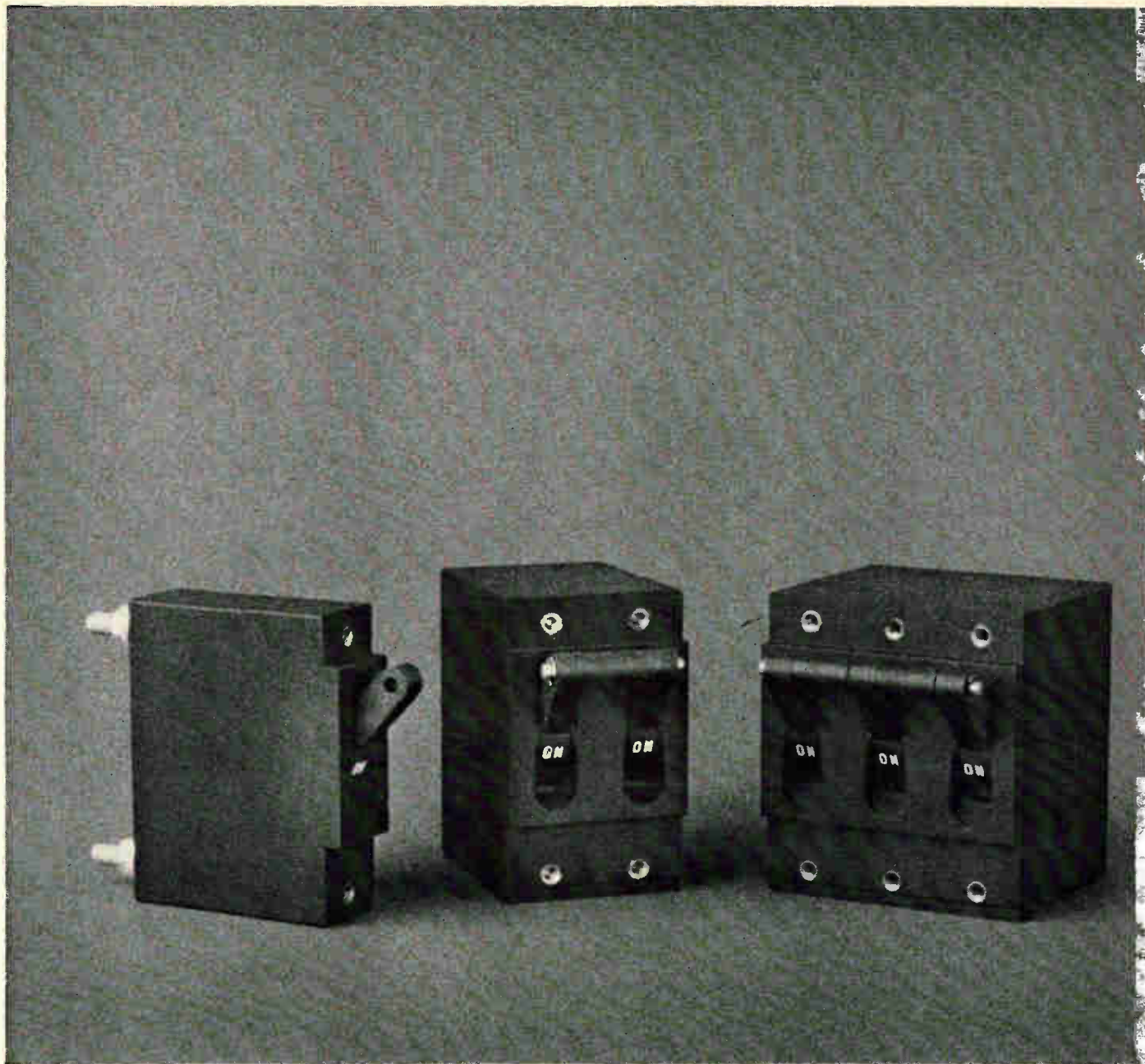

**Is it true that the Heinemann Series AM12 is the most popular OEM-type magnetic circuit breaker on the market?**

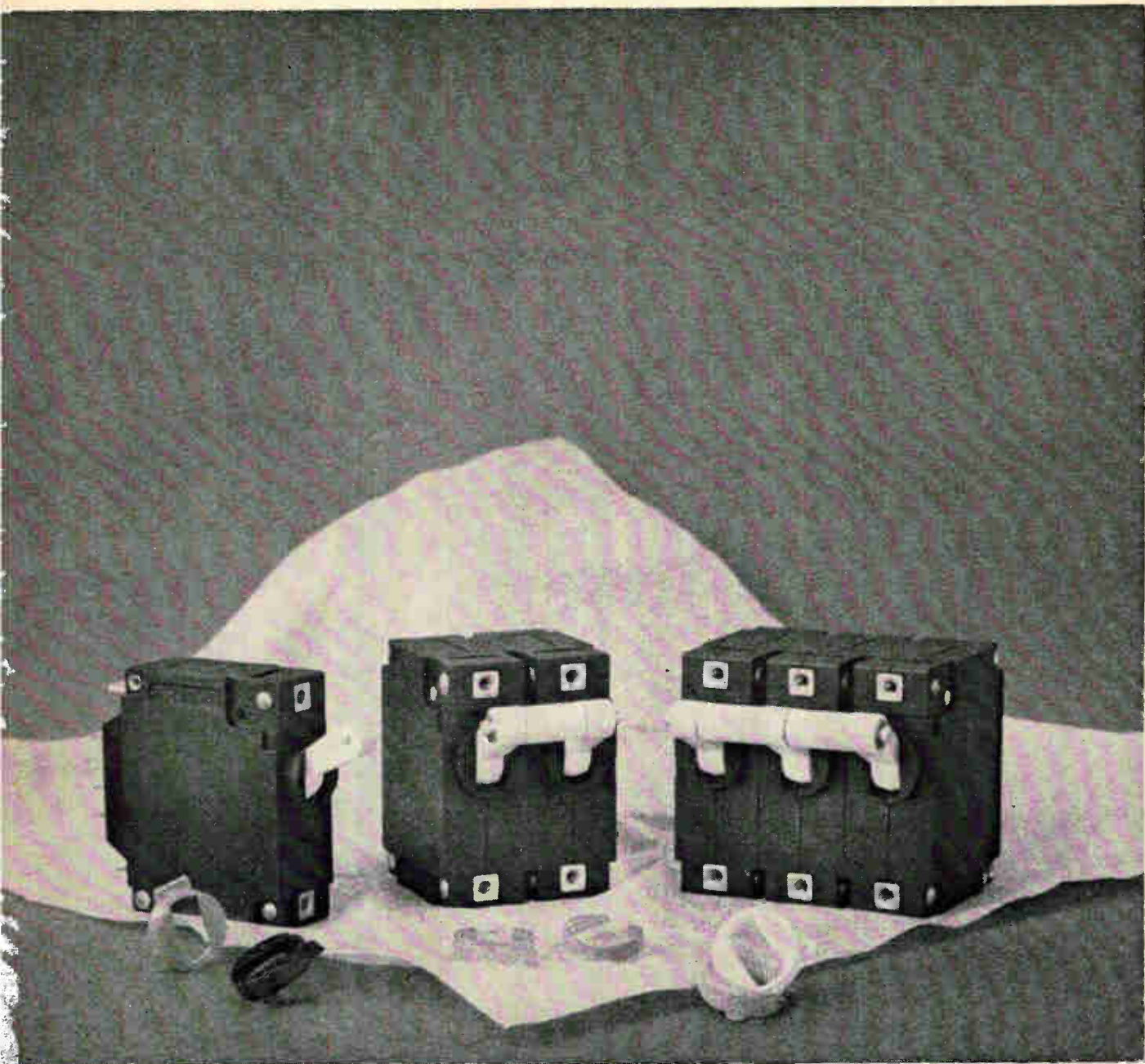

**Not anymore.**

**You're looking at three reasons why. Our new Series JA breaker line.**

**The new Heinemann JA breaker is one-third smaller and lighter than the AM12.**

**It is much easier to install (there are no square panel cuts to make).**

**It is more attractively packaged (note the white handles and the snap-on color caps).**

**Yet it is available with all the same features and options.**

**And it carries the same five-year guarantee.**

**There is one hitch, though. The JA's top current rating is 20 amps, not 50.**

**But then we're not charging as much for it either.**

(For detailed specifications, write for Bulletin 3350. First edition now on press.)

**Heinemann Electric Company**

2600 Brunswick Pike, Trenton, N. J. 08602



**NOW, THINK "HIGH VOLTAGE" WHEN**

## **Video Amplifiers ■ Core Drivers ■ Voltage Regulators ■ Inductive Loads**

Truly, the circuit designer can literally "throw away the book" when designing transistor circuits using Motorola's new high voltage silicon epitaxial annular transistor series — at least as far as previous voltage limitations are concerned.

A new series of Motorola silicon annular transistors, fabricated using special techniques for achieving high voltage performance, offers devices with collector-emitter voltages ( $BV_{CEO}$ ) up to 175 volts... with no sacrifice in saturation, gain, or high frequency performance!

Note that these other key performance values are equal to or exceed those of ordinary low-voltage devices!

- **0.4-volt Saturation Voltage** — lower than most non-epitaxial silicon transistors now available!
- **$h_{FE}$  — 100 to 300 @ 50 mA** — Comparable to any!
- **200 mc Gain-bandwidth Product** — True high frequency performance!

New applications for these devices are virtually unlimited. For example, they're ideal for your high-speed video amplifier designs. Or, for high-voltage core driving circuits... high-voltage regulators... or even for operating directly from line voltage sources — eliminating expensive transformers entirely!

See how these advanced Motorola transistors fit into your future designs. Call your nearest Motorola representative today for complete details. For NPN polarity devices, specify Motorola annular types 2N3498 thru 2N3501 — for PNP types, specify 2N3494-7 & 2N3634-7 silicon annular transistors. Or write: Motorola Semiconductor Products Inc., Dept. TIC, Box 955, Phoenix, Arizona 85001.



# Here's How Annular Transistors Break The High Voltage Barrier

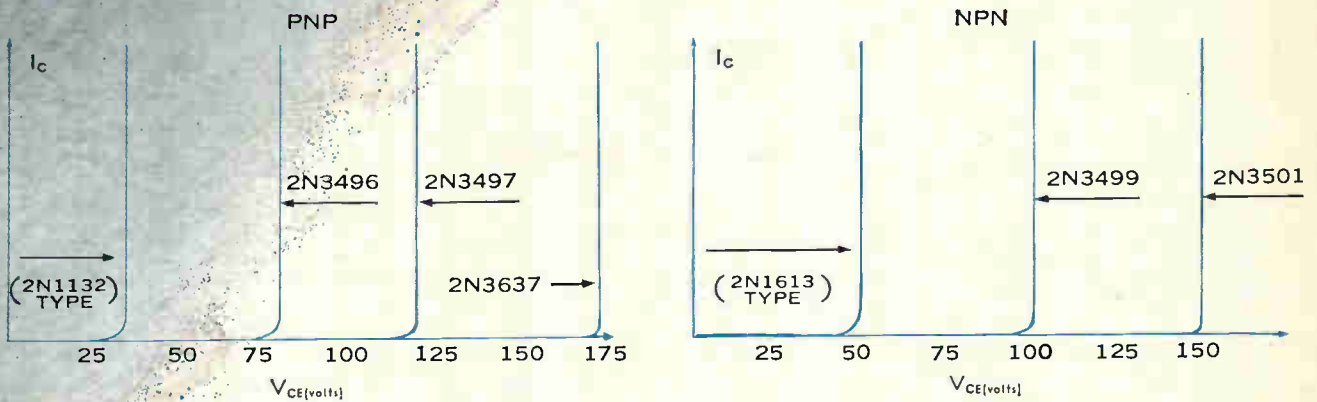

## 140-Volt Peak-To-Peak Output Video Amplifier

... using new high-voltage annular transistors!

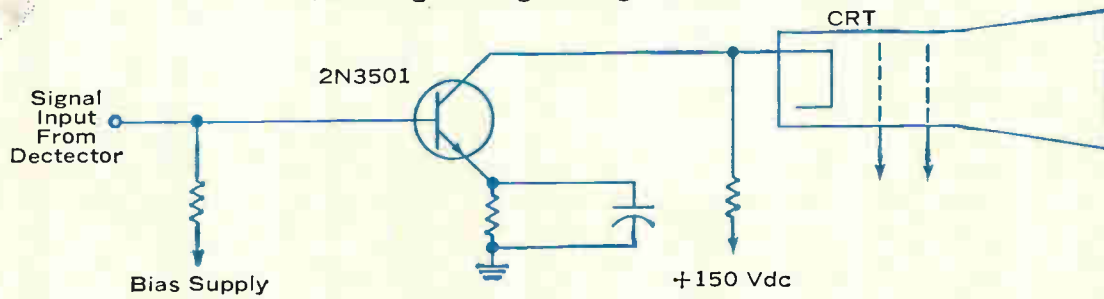

# YOU DESIGN TRANSISTOR CIRCUITS!

## BOTH PNP and NPN TYPES AVAILABLE

### PNP

### PNP

### NPN

CHARACTERISTIC	TYPE	MIN.	MAX.	UNIT	CHARACTERISTIC	TYPE	MIN.	MAX.	UNIT	CHARACTERISTIC	TYPE	MIN.	MAX.	UNIT	
Collector-Emitter Breakdown Voltage* (BV <sub>CEO</sub> ) (I <sub>C</sub> = 10 mA, I <sub>B</sub> = 0)	2N3494 /96	80	—	Vdc	Collector-Emitter Breakdown Voltage (BV <sub>CEO</sub> ) (I <sub>C</sub> = 10 mA)	2N3634 /36	140	—	Vdc	Collector-Emitter Breakdown Voltage* (BV <sub>CEO</sub> ) (I <sub>C</sub> = 10 mA, I <sub>B</sub> = 0)	2N3498 /99	100	—	Vdc	
	2N3495 /97	120	—			2N3636 /37	175	—			2N3500 /01	150	—		
DC Forward Current Transfer Ratio (h <sub>FE</sub> ) (I <sub>C</sub> = 100 μA, V <sub>CE</sub> = 10 Vdc) (I <sub>C</sub> = 1 mA, V <sub>CE</sub> = 10 Vdc) (I <sub>C</sub> = 10 mA, V <sub>CE</sub> = 10 Vdc) (I <sub>C</sub> = 50 mA, V <sub>CE</sub> = 10 Vdc) (I <sub>C</sub> = 100 mA, V <sub>CE</sub> = 10 Vdc)	All Types	35	—		DC Forward Current Transfer Ratio (h <sub>FE</sub> ) (I <sub>C</sub> = 0.1 mA, V <sub>CE</sub> = 10 Vdc) (I <sub>C</sub> = 1 mA, V <sub>CE</sub> = 10 Vdc) (I <sub>C</sub> = 10 mA, V <sub>CE</sub> = 10 Vdc) (I <sub>C</sub> = 50 mA, V <sub>CE</sub> = 10 Vdc) (I <sub>C</sub> = 150 mA, V <sub>CE</sub> = 10 Vdc)	2N3634 /36	40	—		Collector Saturation Voltage* (V <sub>CE(sat)</sub> ) (I <sub>C</sub> = 10 mA, I <sub>B</sub> = 1 mA) (I <sub>C</sub> = 50 mA, I <sub>B</sub> = 5 mA)	All Types	—	0.2	Vdc	
	All Types	40	—			2N3635 /37	80	—			All Types	—	0.25		
	All Types	40	—			2N3634 /36	45	—			DC Forward Current Transfer Ratio* (h <sub>FE</sub> ) (I <sub>C</sub> = 0.1 mA, V <sub>CE</sub> = 10 Vdc) (I <sub>C</sub> = 10 mA, V <sub>CE</sub> = 10 Vdc) (I <sub>C</sub> = 150 mA, V <sub>CE</sub> = Vdc)	2N3498 /500	20	—	
	All Types	40	—			2N3635 /37	90	—				2N3499 /501	35	—	
	2N3494 /96	35	—			2N3634 /36	50	150				2N3499 /501	75	—	
Collector Saturation Voltage (V <sub>CE(sat)</sub> ) (I <sub>C</sub> = 10 mA, I <sub>B</sub> = 1 mA)	2N3494 /96	—	0.3	Vdc	Collector Saturation Voltage (V <sub>CE(sat)</sub> ) (I <sub>C</sub> = 10 mA, I <sub>B</sub> = 1 mA) (I <sub>C</sub> = 50 mA, I <sub>B</sub> = 5 mA)	2N3635 /37	100	300		Output Capacitance (C <sub>ob</sub> ) (V <sub>CE</sub> = 10 Vdc, I <sub>E</sub> = 0, f = 100 kc)	2N3498 /99	—	10	pf	
	2N3495 /97	—	0.35			2N3634 /36	40	—			2N3500 /01	—	8		
Output Capacitance (C <sub>ob</sub> ) (V <sub>CE</sub> = 10 Vdc, I <sub>E</sub> = 0, f = 100 kc)	2N3494 /96	—	7	pf	Output Capacitance (C <sub>ob</sub> ) (V <sub>CE</sub> = 20 N, f = 100 kc)	2N3635 /37	40	—		Gain-bandwidth Product (f <sub>T</sub> ) (V <sub>CE</sub> = 20 Vdc, I <sub>C</sub> = 20 mA)	2N3498 /99	—	10	mc	
	2N3495 /97	—	6			2N3634 /36	150	—			2N3500 /01	—	8		
Current-Gain — Bandwidth Product (f <sub>T</sub> ) (I <sub>C</sub> = 20 mA, V <sub>CE</sub> = 10 Vdc, f = 100 mc)	2N3494 /96	200	—	mc	Current-Gain — Bandwidth Product (f <sub>T</sub> ) (V <sub>CE</sub> = 30 V, I <sub>C</sub> = 30 mA, f = 100 mc)	2N3635 /37	200	—							
	2N3495 /97	150	—												

\*Pulse width ≤ 300 μsec, Duty Cycle = 2%

## HOW CAN THE OTHERS GIVE YOU GOOD SERVICE...

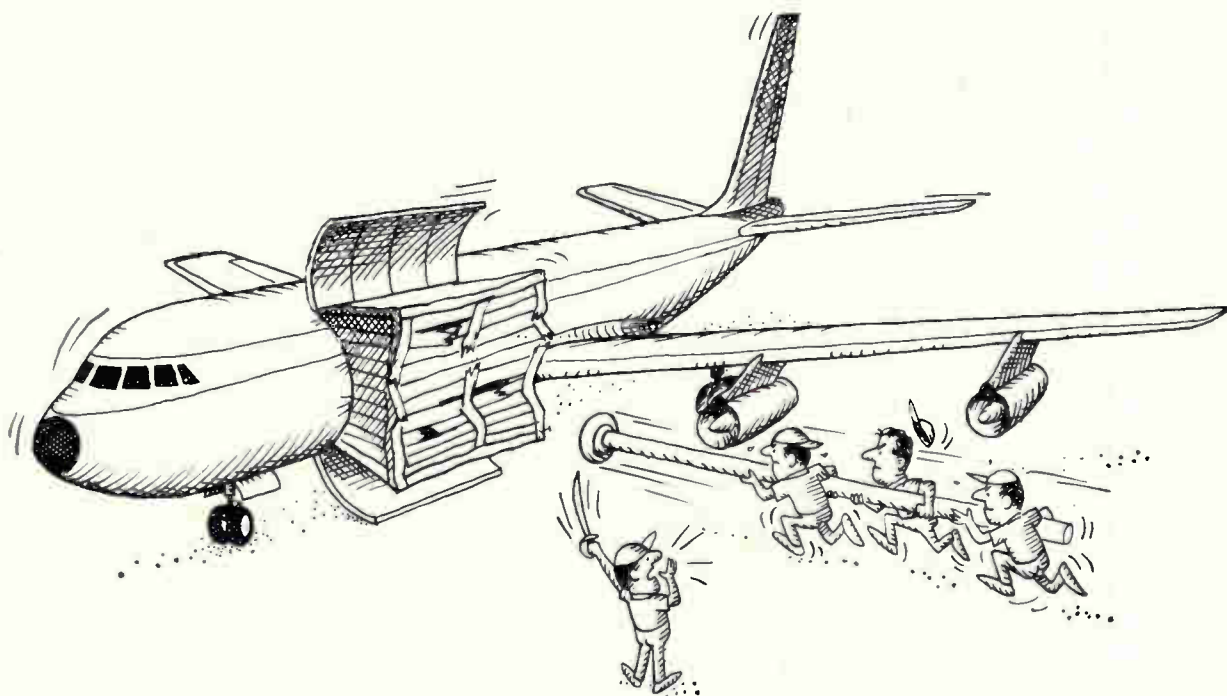

## WHEN THEY CAN'T EVEN GET IT ON THEIR PLANE?

When you ship outside cargo by Flying Tigers, it gets on the plane... easily. There's no bending, slamming or jamming of cargo that won't quite fit into side-loading jet freighters. The reason—Tigers' huge break-away Swingtail-44. This Tiger swings its whole tail assembly aside to load two box car-lengths of cargo straight in.

That's a BIG part of the story, true. But perhaps the most crucial chapters are those devoted to Tiger service. And those chapters read like this:

- Skyroad Air/Rail/Truck System (Or: How to Ship Anything Anywhere In One Package, With Only One Bill)

- Expedited Door-to-Door Pickup & Delivery
- Scheduled Service
- Non-Stop Overnight Service
- Two-Way Radio Trucks
- Teletype Advance Manifest System
- Many Late Night Flights
- Specialized Experience

Each chapter has details that make your problems no problem at all. Main theme of our whole story—truly fanatic personalized service.

What's your story? We'd like to hear it, word for word. Why not call and tell it to us?

*the airfreight specialist*

**FLYING TIGER LINE**



30-gage computer wire for miniaturization of circuits has tough new insulation. The material: KYNAR\* — Pennsalt vinylidene fluoride plastic. Even in 5-mil wall thickness, KYNAR affords exceptional mechanical strength and cut-through resistance. Wire insulated with KYNAR is available in long lengths... goes smoothly through automatic wire-wrap machines... cuts and strips cleanly, bends readily, doesn't stretch, stays put when formed.

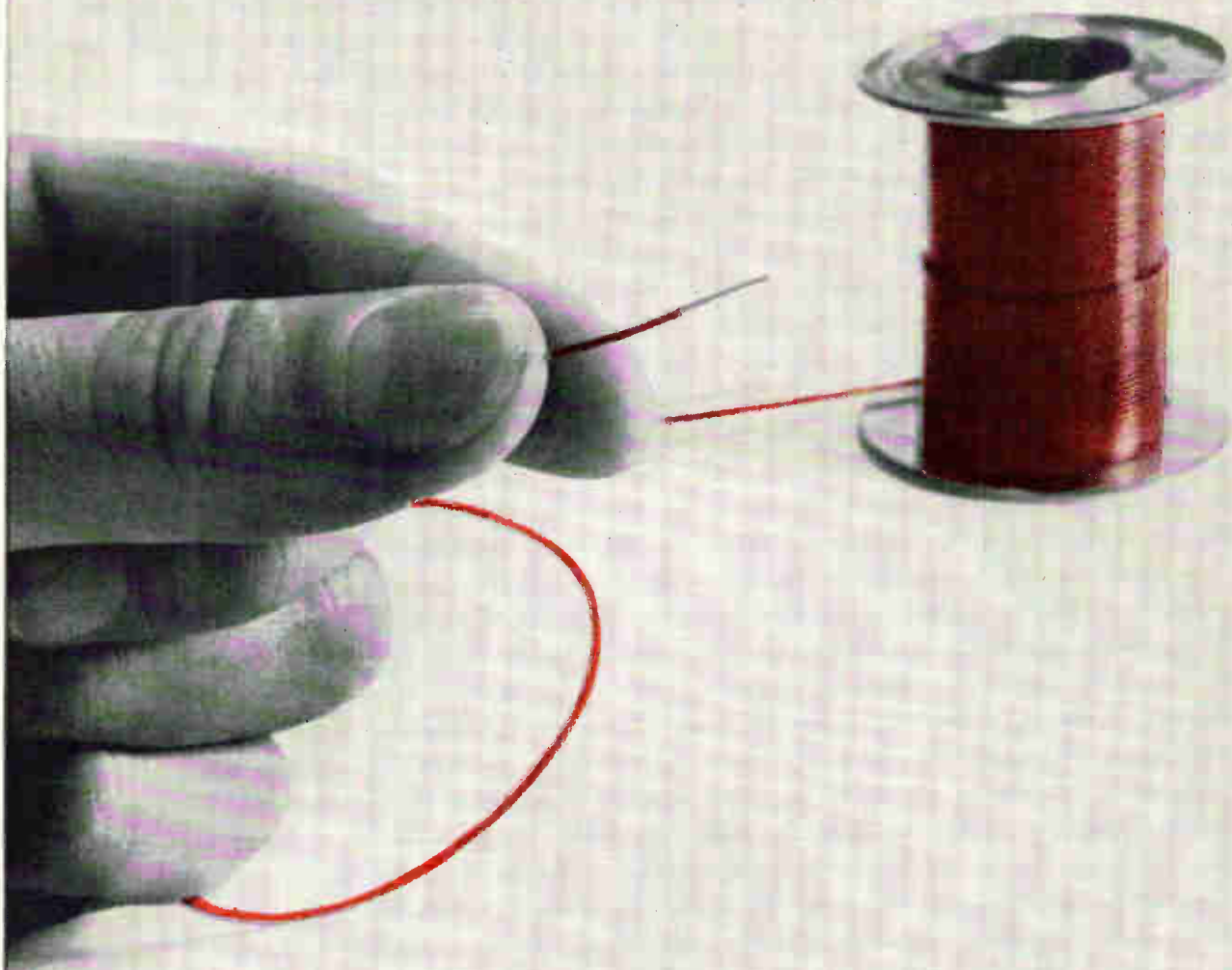

Write for information and the names of leading manufacturers who supply wire insulated with KYNAR. Plastics Department, Pennsalt Chemicals Corporation, 3 Penn Center, Philadelphia, Pa. 19102.

***Kynar... a fluoroplastic that's tough!***

\*KYNAR is a registered trademark of Pennsalt Chemicals Corporation.



# FROM GUDEBROD—A CONSULTANT'S REPORT

SURVEY of HARNESS  
TYING OPERATION  
for  
*YOUR COMPANY*

Area Code 215, WA 2-1122 • TWX 215-800  
**ROS. SILK CO., INC.**  
FOUNDED IN 1870

*Silks Division*  
PHILADELPHIA, PENNSYLVANIA

**OFFICES •**

NEW YORK, NEW YORK  
25 West 34th Street, Area Code 212

BURBANK, CALIFORNIA  
1636 Ontario Street, Area Code 818  
TYLVA 19464

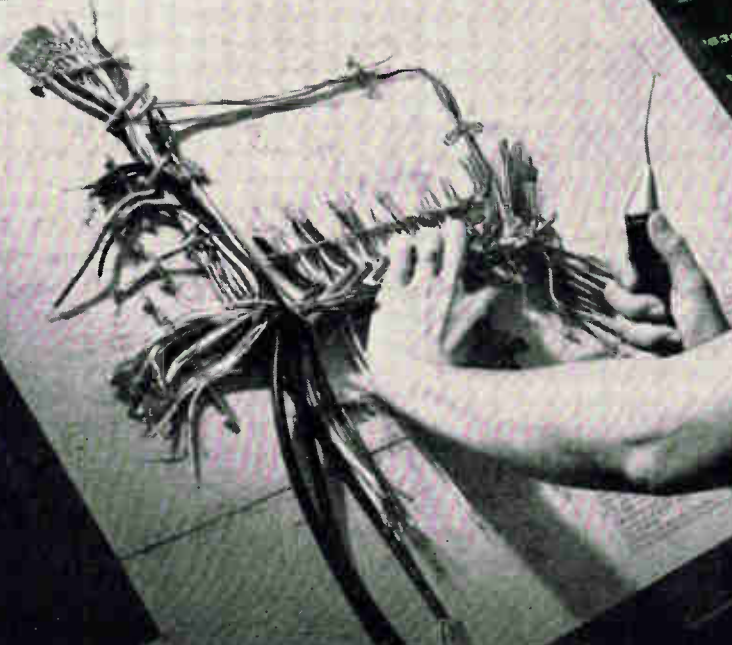

... so that you may improve your harnesses  
... while you save money, too!

**GIVE YOUR HARNESS OPERATION  
A FULL REVIEW ... with this  
Gudebrod Survey (AT NO COST TO YOU, OF COURSE)**

"Improve" is the guide-word of the electronics field—but has your harness operation kept pace? If you could improve your harness product—and save money at the same time—wouldn't you be interested? Where do you go for help in achieving this desirable situation? To Gudebrod—there is no comparable source for such help in the industry. That's why management at the Gudebrod Electronic Division is offering to make a Consultant's Report on your harness department operation. With self-interest they believe that improving the state of the art in the industry will improve their own business atmosphere. So—why not take advantage of Gudebrod's wealth of tape engineering experience and knowledge—there is no cost or obligation attached to it!

#### STANDARDS

To improve your standards specifications, Gudebrod can suggest tapes for high or low temperature use, for fungistatic qualities, for burnproof features, for vacuum use, as well as for material specifications and for tensile strength. The more than 200 types of flat tape in the Gudebrod line are specially designed, not only to meet various specifications but to facilitate the tying operation. Production quantities of tape especially for your use can be made if necessary. With this intimate knowledge of lacing tape, the recommendations contained in the Gudebrod Consultant's Report will help your Standards Engineer—to improve your product and to save money.

#### METHODS

In designing lacing tapes to meet various specifications, the Gudebrod research and de-

velopment operations have kept in mind the basic idea of producing tapes that "tie themselves." The originator of the flat braided tape which did so much to improve wire harnessing and at the same time tremendously increase the safety factor for workers, Gudebrod continues to pioneer in the use of better materials, and in a closer regard for specifications. Taking advantage of the "tie-ability" of Gudebrod tapes is important to your Methods Engineer. The recommendations contained in the Gudebrod Consultant's Report will help your Methods Engineer to improve your product and save money.

#### PRODUCTION

Implementing the requirements of the Specifications and Methods Engineers in economical operation is the problem of the Production Engineer. Gudebrod can show how to use the Cable-Lacer, how to take advantage of dispensing packages, cut lengths, special rigs and other labor speeding and easing means. Whether your harness work is custom or production there are ways of improving your operations that may not have occurred to you—that's why the recommendations contained in the Gudebrod Consultant's Report will help your Production Engineer—in improving your product—in saving money.

#### SURVEY AND CONSULTANT'S REPORT —FREE

Here is all you have to do—write or phone Gudebrod. At your convenience a Gudebrod representative will complete a survey working with your Standards, Methods and Production Engineers. This will be reviewed by engineers at the Gudebrod Home Office. Written recommendations will be prepared and sent to you. There will be absolutely no cost or obligation. Why not get your Consultant's Report under way—get in touch with Gudebrod today.



**UDEBROD BROS. SILK CO., INC.**

FOUNDED IN 1870



*Electronics Division*

12 SOUTH 12th STREET, PHILADELPHIA, PENNSYLVANIA 19107  
Area Code 215, WA 2-1122

Circle 35 on reader service card

# Your graphite look like cheese?



Even the best specialty graphite grades like the one shown in the 200x magnification on your left have a coarse, porous, non-uniform structure. This cheese-like body won't stand up to an oxidizing atmosphere or to close tolerance machining.



That's why the photomicrograph at your right is important news for those concerned with glass-to-metal seals, metal molds, crucibles, epitaxial heaters, etc. It shows the result of an exciting breakthrough in conventional production technology... *New Poco Graphites*. A wide selection of these new graphites is now available from Poco Graphite Incorporated, a subsidiary of

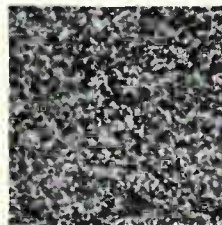

The Pure Oil Company. The composition of Poco graphite is unlike any other. It is virtually isotropic, with a density as high as 1.88 gm/cm<sup>3</sup>. It can be machined to within 0.0001 inch, and its resistance to oxidation far surpasses that of other graphites.

These advantages add up to important savings through longer useful life in applications that require superior graphite grades.

For detailed information, address your inquiry to: Poco Graphite, Inc., P. O. Box 6118, Dallas, Texas 75222. Area code 214-BR6-7111, ext. 751.

**Poco Graphite** *Incorporated*  
A subsidiary of The Pure Oil Company



**Cinch**  
ELECTRONIC  
COMPONENTS

# ONLY .045" square tail hermaphroditic connectors\* with the TAIL STABILITY you need FROM FOR AUTOMATIC WIRE WRAPPING CINCH

\*Intermateable with Elco's products sold under Elco's trademark VARICON

The outstanding reliability and popularity of Cinch's hermaphroditic printed circuit connectors\* has stemmed from the fork-like design of the engaging or mating section of the contact. Now CINCH has improved on the terminating section, to assure the rigidity and stability required for programmed wire wrapping. The entire contact provides a single one-piece thickness construction for optimum durability and performance.

The contacts are available individually in bulk for mounting in P.C. boards or in molded insulator as shown.

Complete technical and application data on these new Cinch connectors is given in our Bulletin PBM-66, available from your local Cinch sales office or by writing to Cinch Manufacturing Company, 1026 South Homan Avenue, Chicago, Illinois 60624.



\*Manufactured under license agreement with Elco Corporation

**CINCH**

DIVISION OF UNITED-CARR

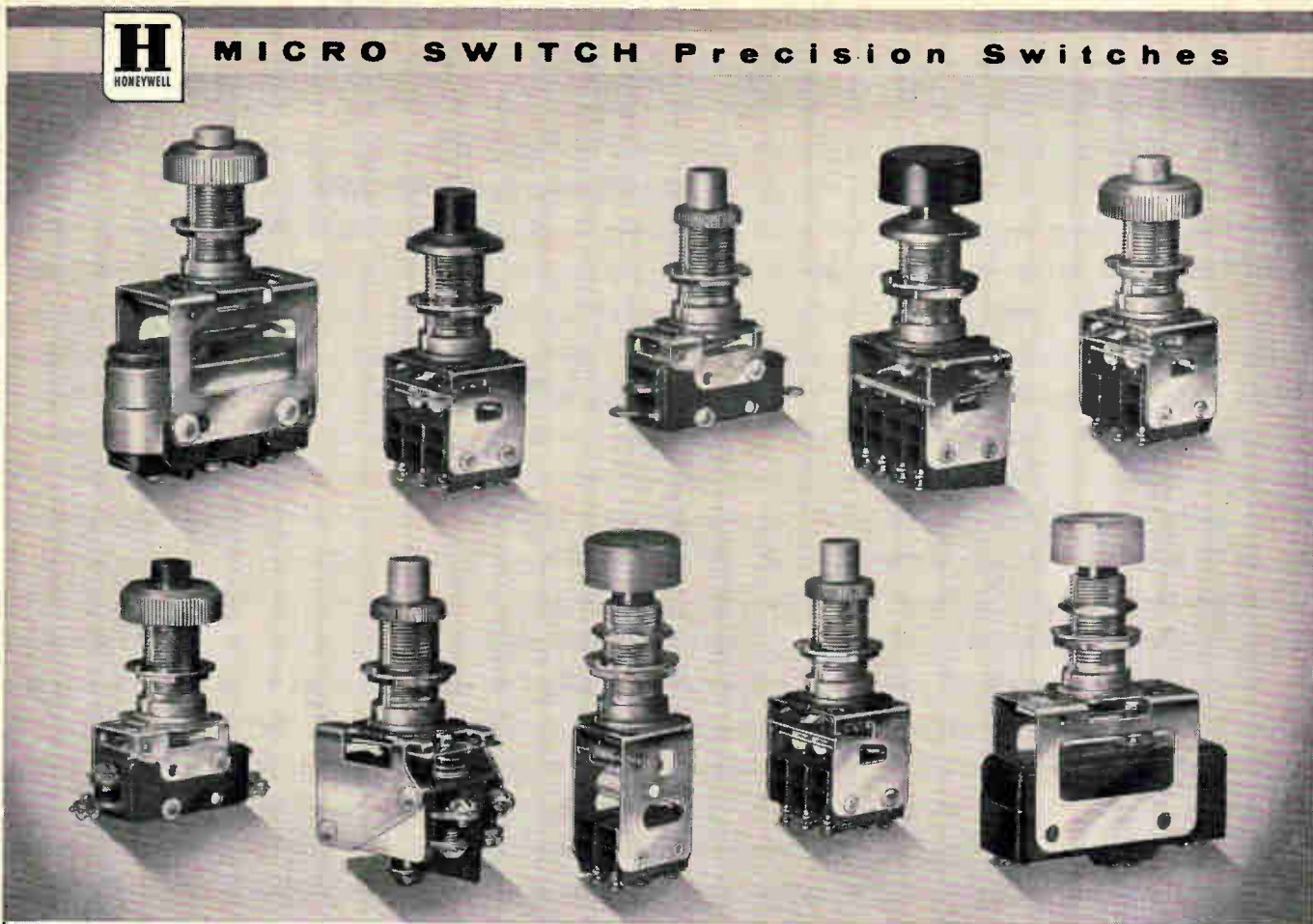

# New Modular Pushbutton Switches

8 pushbutton units in 3 colors



3 facenuts with optional seal



30 switch units with wide selection of operating characteristics contact arrangements and circuitry.

New Series 6 modular components are making it practical to custom-build pushbutton switches on a growing variety of jobs—both small and large.

Pushbutton units, buttons, facenuts, and switching units are all off-the-shelf items. They may be assembled in hundreds of different combinations—all without special tools.

Series 6 offers a wide array of operating characteristics. Either momentary or alternate contacts. Enclosed snap-action switch units for dry circuit or heavy-duty power requirements. Switch units available with 1, 2, 3, or 4-pole double-

throw, and 2-circuit double break. Optional coil-equipped modules provide magnetic detent with remote release of contacts. Optional sealing facenut seals panel-to-bushing, bushing-to-button. Modules are easy to assemble without special tools.

For information call a MICRO SWITCH Branch Office or Distributor (see Yellow Pages). Or write for Data Sheet 233.

HONEYWELL PRESENTS  SCIENCE ALL STARS • SUNDAYS 5:00 E.S.T.



## MICRO SWITCH

FREEPORT, ILLINOIS 61033

A DIVISION OF HONEYWELL

IN CANADA: HONEYWELL CONTROLS LIMITED, TORONTO 17, ONTARIO

SEE OUR EXHIBIT IEEE SHOW, NEW YORK, MARCH 22-26

HONEYWELL INTERNATIONAL—SALES AND SERVICE OFFICES IN ALL PRINCIPAL CITIES OF THE WORLD. MANUFACTURING IN UNITED STATES, UNITED KINGDOM, CANADA, NETHERLANDS, GERMANY, FRANCE, JAPAN.



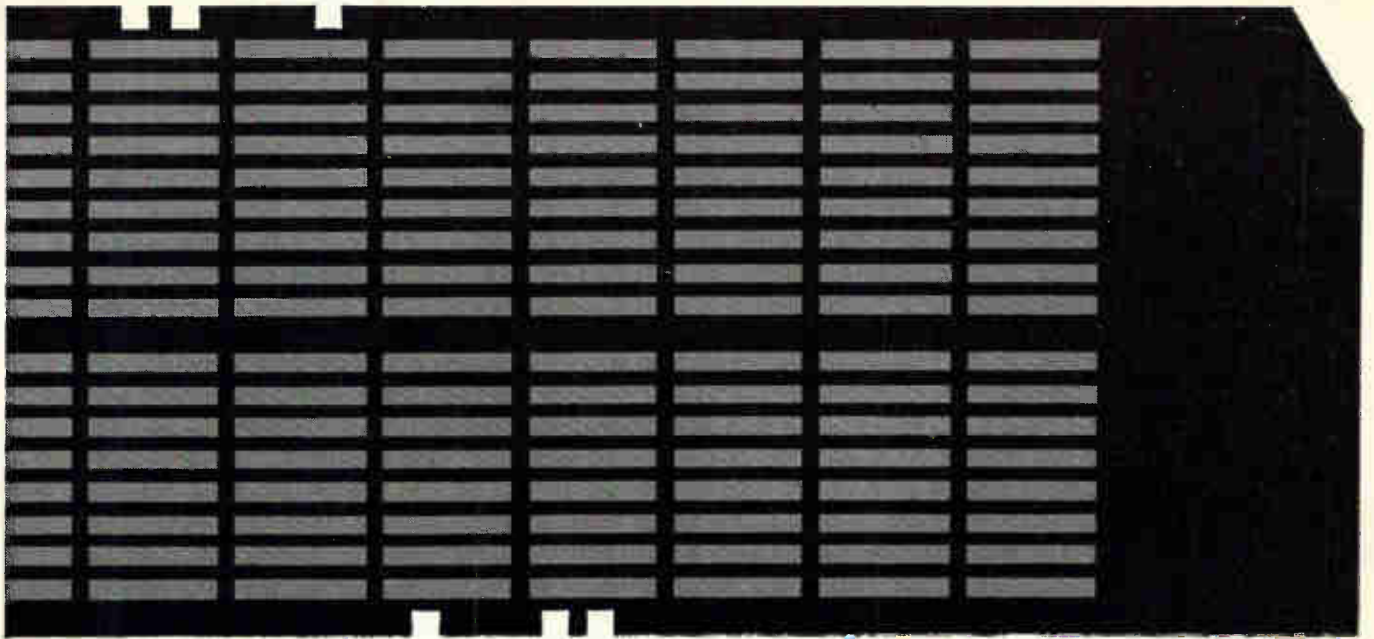

## The Long Awaited Breakthrough In EDP

**Via Magnetic Iron Oxides** The rapidly developing science of Electronic Data Processing has received an impetus of explosive significance through the stepped-up use of magnetic iron oxide coated cards.

Handling mass storage and retrieval of voluminous data and utilizing advanced random access techniques, in some cases the cost per 10,000 alpha-numerical characters has been driven down to as low as one-tenth of their former costs!

Engineering the 'packing density' of the data into radically tighter units on the cards has brought EDP within the pocketbook range of scores of companies not previously in the 'live prospect' class.

Pfizer, as a major supplier of magnetic iron oxides congratulates the EDP industry for its enterprise. Pfizer for its part will continue to provide the chemical purity and uniform magnetic properties that make their product a standard of reliability.

Yes — Pfizer stands ready and willing to dispense all pertinent, technical information. Write Department 75

**MINERALS  
PIGMENTS  
& METALS**  
DIVISION CHAS. PFIZER & CO. INC.



Dept. 75, 235 East 42nd Street  
New York 17, N.Y.

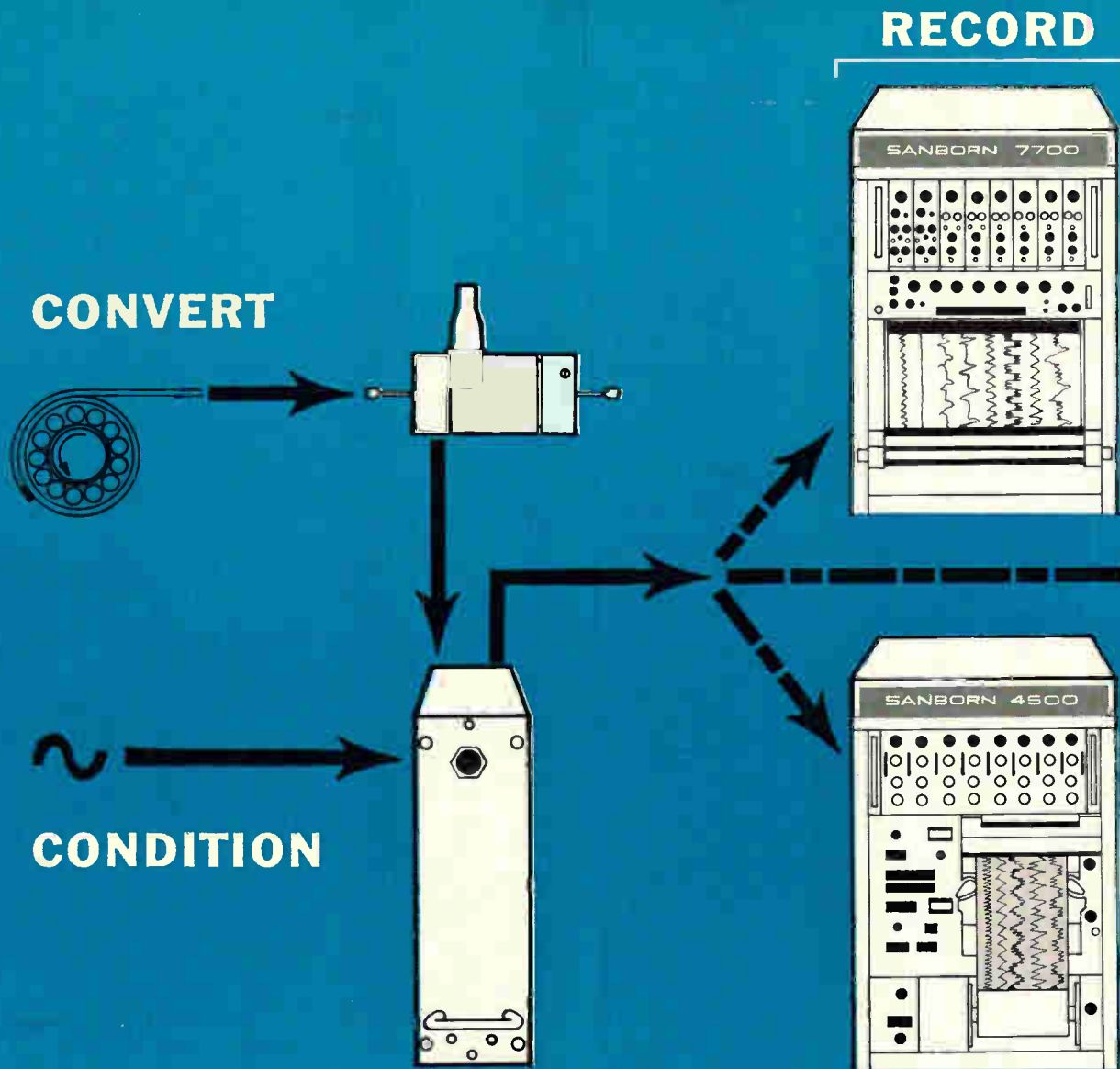

## Put your data in the form most useful to you

**Reliable Sanborn instrumentation puts your data in the form most useful to you,** with minimum set-up time and simple, straightforward operating control. Only a few of the many possible functions and versatile variations of these compatible instruments are shown here—for measurement and data handling applications in scientific and industrial research, production and environmental testing, quality control, communications, telemetry and process control.

**To translate and signal-condition variables,** Sanborn makes a wide range of compact, low-cost linear motion, velocity, pressure and force transducers of the differential transformer type . . . wideband and narrow band dc data amplifiers with floating inputs isolated from floating outputs . . . and individual signal conditioners,

for use in Sanborn systems or as unit amplifiers to drive scopes, meters, etc., in general purpose dc, carrier, phase-sensitive demodulator, logarithmic, high gain, frequency meter, frequency deviation and accelerometer types.

**To get clear, permanent proof of dc to 150 cps test or measurement results** in graphic, analog form—with rectangular coordinate traces of 4 cycles/mm resolution even at small amplitudes—Sanborn thermal writing oscillographs give you complete freedom of choice in number of channels, signal conditioning flexibility, packaging and price. Wide choice of plug-in signal conditioners equip any channel to your specific inputs . . . or when individual-channel flexibility is not needed (e.g., up to 8 channels of strain gage or low level DC signals), systems can be equipped with low cost 8-

amplifier-channel modules on a single chassis. Systems range from portable 100 mm wide chart single-channel models to 6- and 8-channel systems with all-solid-state plug-in signal conditioners. Most have response range from dc to 150 cps within 3 db, at 10 div p-p. Max. sensitivity depends on signal conditioner used, can be as high as 1 uv/div. Two chart speeds in 1-channel systems, four in dual-channel systems, nine in 4- to 8-channel systems (all electrically controlled, except dual-channel systems).

**For immediate readout of dc to 5 kc signals,** high frequency optical oscillographs provide up to 25 channels of precise traces on 8" ultraviolet-sensitive charts, with one set of galvanometers. Choice of four types of 8-channel amplifier modules allows recording sensitivities from 500 uv/inch to 500 mv/inch; optional plug-in permits sys-

# STORE

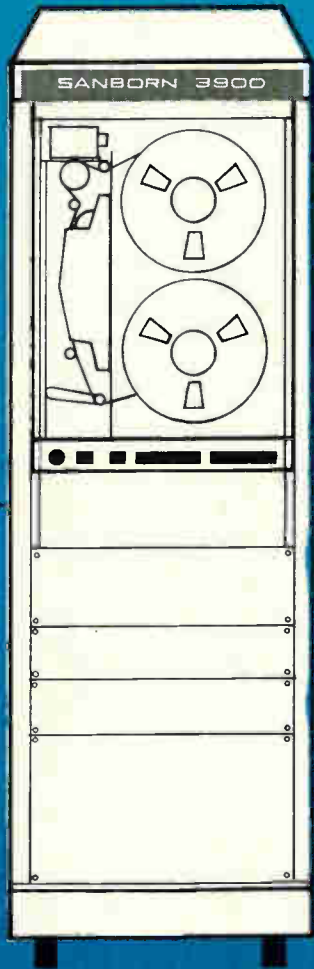

# DISPLAY

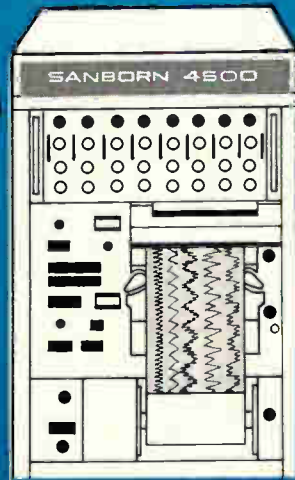
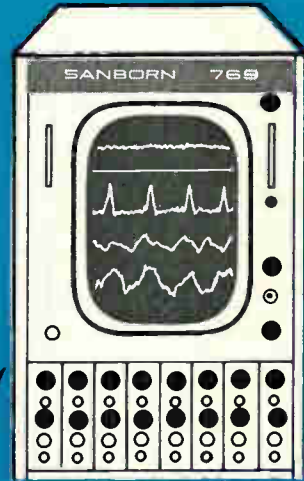
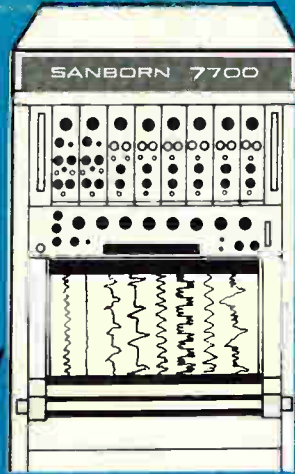

## ... see Sanborn

tem to drive 3900 Series tape recorders; front panel controls position traces anywhere on chart without mechanical positioning of galvanometer; traces may overlap and occupy full chart width. Paper loading in normal room light, full development a few seconds after exposure, permanency by chemical fixing if desired, and nine paper speeds from 0.25 to 100 inches/sec are additional features of these new 4500 Series optical oscillographs. Complete 8-channel systems from \$6950.

To store data from dc to 250 kc in its original electrical form and play it back with the time base expanded or compressed by ratios as high as 32:1 — on a scope, graphic recorder or numerical readout — new 3900 Series Tape Systems offer IRIG-compatible instrumentation performance at substantial savings. System prices from \$8900 (7-chan-

nel) to \$13,370 (14-channel). All have unique new H-P transport of simple design with high, maintenance-free reliability . . . 6 electrical speeds with no capstan change . . . 40 db or better S/N ratio, 0.2% p-p flutter (0-1 kc, 30 & 60 ips) . . . all-solid-state plug-in electronics, with record and reproduce amplifiers on the same cards . . . integral footage counter accurate to 99.95% . . . easy snap-on reel loading . . . console, rack or portable case housing. Bandwidths available are (at 60 ips) Direct: 100-100,000 cps. Std., 100-250,000 cps Wideband; FM: 0-10,000 cps Std., 0-20,000 cps Wideband. Low-cost 4-channel 1/4" tape systems also available with different transport, same electronics, portable case packaging.

To display variables under investigation — in analog or numerical form — Sanborn 760 Series scopes present up to eight bril-

liant traces simultaneously on a long-persistence 17" screen, allow positioning and amplitude adjustment of individual traces . . . and compact new 5601A Numerical Readout displays three 0.6"-high illuminated numerals and decimal point in each of four channels, with adjustable sampling rate, flashing decimal point for rate display, and capability of driving H-P 562A Digital Recorder for print-out.

Call your local Hewlett-Packard Sales Engineer for specifications and expert application help on any of these Sanborn instruments, or write: Hewlett-Packard, Sanborn Division, 175 Wyman Street, Waltham, Mass. 02154

**HEWLETT  
PACKARD**  **SANBORN  
DIVISION**

**50% more display area**  
**... plus**  
**added**  
**capabilities**  
**for the**  
**same price**

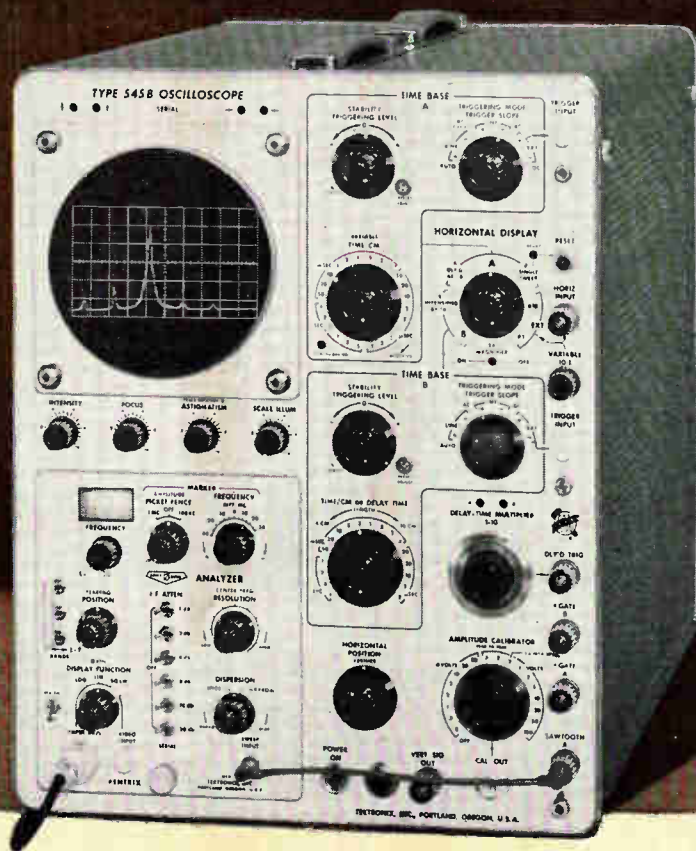

# IMPROVED 545B oscilloscope

The Type 545B is an improved version of the Type 545A, which has proved itself of great service to a multitude of laboratories and industries throughout the years and has been considered a standard by which other oscilloscopes can be judged.

- Internal no-parallax illuminated graticule
- Bright 6-cm by 10-cm display area
- Small spot size, uniform focus
- Fixed-tuned delay line
- Triggering beyond 30 Mc
- Sweep Delay
- Single Sweep
- Sweep Magnifier

## plus plug-in unit adaptability

- 1 accepts one of 17 letter-series plug-ins for differential, multi-trace, sampling, other laboratory applications, or
- 2 accepts one of many new spectrum analyzer plug-ins (L-10A, L-20, L-30, others) for frequency-based displays, or
- 3 accepts one of 2 new dual-trace plug-ins (1A1 or 1A2) for 50 mv/cm at dc-to-33 Mc —with the Type 1A1 also offering 5 mv/cm at dc-to-23 Mc dual-trace, and approximately 500  $\mu$ v/cm at 2 cps-to-14 Mc, single trace.

But to hear the complete story, call your Tektronix Field Engineer. He will know if a Type 545B offers the best solution to your measurement problem. If the Type 545B appears to be the answer, try it. Use it in your own application—with one of your letter-series plug-ins or one of the new spectrum analyzer or dual-trace plug-in units.

Type 545B Oscilloscope (without plug-ins)	\$1550
Type L-20 Spectrum Analyzer Plug-In Unit	\$1995

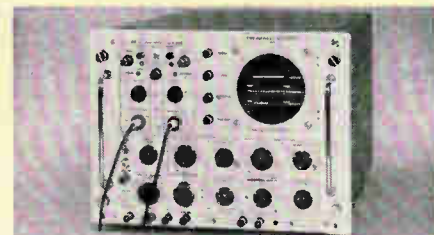

Rack Mount Model Type RM545B	\$1650
Type 1A2 Dual-Trace Plug-In Unit	\$ 325
Type 1A1 Dual-Trace Plug-In Unit	\$ 600

U. S. Sales Prices f.o.b. Beaverton, Oregon

**Tektronix, Inc.**

P. O. BOX 500 • BEAVERTON, OREGON 97005 • Telex: 036-691  
 TWX 503-291-6805 • Phone: (Area Code 503) 644-0161 • Cable:  
 TEKTRONIX • OVERSEAS DISTRIBUTORS IN OVER 30 COUNTRIES.  
 TEKTRONIX FIELD OFFICES in principal cities in United States.  
 Consult Telephone Directory.

Price at \$1550 is the same as the Type 545A and includes two probes.  
 Full field-engineering services back up every instrument.

Circle 42 on reader service card

# Electronics Review

Volume 38  
Number 4

## Computers

### Series war

Computer makers are losing sleep, and small wonder.

Into the bitterly contested data-processing arena, Honeywell, Inc., introduced this month still another series of computers, intended to battle the International Business Machines Corp.'s System 360, announced last April, and the Radio Corp. of America's Spectra 70, unveiled in December.

Even as Honeywell executives in Boston boarded a New York-bound plane to unveil their new line, IBM public relations men rushed out an announcement of still another machine, the IBM 1130, taking some of the play from the Honeywell debut.

**Series oriented.** Honeywell's new series confirms the trend that has been developing ever since IBM introduced the 360. To compete, a company has to have a series of computers whose capabilities range from small to powerful and whose programing is mutually compatible. Said Walter Finke, president of Honeywell's Electronic Data Processing division, "It's no longer a one-machine business. You need a line to respond to the needs of the marketplace."

As if to underline that statement, on the same day, General Precision, Inc., announced it was out of the commercial computer business. The company had built the small-scale LGP-30 and 21 and the medium-scale RPC 4000.

**Take your pick.** To cover both small and large users, Honeywell has five basic machines in Series 200:

- **H-120**, a small-scale computer whose rental starts at \$860 per month. Cycle time is three microseconds.

- **H-200**, a machine introduced 15 months ago, which served as a

model for the other machines. Honeywell has already delivered about 200 of these. It leases for \$1,325 a month.

- **H-1200**, a management information or real-time system, whose rental starts at \$2,200 per month.

- **H-2200**, a large-volume data processor that is a redesigned version of the H-2200 Honeywell introduced last year. This later design can communicate with other computers and can operate eight pieces of peripheral equipment simultaneously while computing. Rental begins at \$3,550 per month.

- **H-4200**, the most powerful machine in the line, which can handle 16 input-output operations simultaneously. Leasing costs range from \$9,500 to \$26,500 per month.

claims, are slightly more powerful and cost slightly less than IBM counterparts, though it is hard to compare model for model. For example, the H-200 falls between the models 30 and 40 of the System 360; it is more powerful than the model 30 but less powerful than model 40.

RCA, on the other hand, has taken dead aim at IBM's replacement market. Its Spectra 70 series was altered so a user can pull out an IBM 360 and replace it with an RCA machine with no change in programing or operation.

**Microcircuits: two views.** IBM has designed hybrid microelectronics into every machine in the System 360 series. Honeywell's director of engineering, Charles J.



Computer Series 200 is introduced by Honeywell's Electronic Data Processing division president, Walter Finke, and Claude H. Smith, marketing vice president.

**Optional features.** Honeywell's new series will make a dent in the sales of some of its older machines, particularly the H-1800. Still, Honeywell thinks some users whose main application is scientific problem-solving will continue to buy the H-300. To keep costs of the Series 200 machines low, Honeywell offers certain features primarily of use to the scientific users—like floating point arithmetic—as options only on machines bigger than the H-1200.

Honeywell will assault the IBM fortress on a line of performance per dollar. Series 200 machines, it

Michaels, believes it is economical at this time to use microcircuits only in the biggest machine. So the H-4200 will have some silicon monolithic circuits in the main processor—about 7,000 of them. In a few places where high power would burn out monolithic devices—like the driver circuits for x-y memory—Honeywell will use hybrid microelectronics.

The company is negotiating with several concerns to supply integrated circuits. Only Honeywell's own semiconductor division, which offers a line of low-power integrated circuits, has been definitely

excluded. In fact, Honeywell's president James Binger concedes that the company had quietly dropped its line of integrated circuits two months ago to concentrate on power transistors. Honeywell has decided to make its own hybrids.

One hole in the Honeywell Series 200 is mass memory. There is none, but Finke promises that a line would be announced in March.

**IBM's newest.** Honeywell's plans to bill the H-120 as the cheapest honest-to-God computer on the market were dealt a fatal blow by IBM's announcement of the 1130 computing system. It will start leasing at \$695 a month, \$165 less than the H-120, and is the first IBM computer to rent for less than \$1,000 per month.

Although it will use the same hybrid microcircuits as the machines in the System 360 series, the 1130 is not part of the series. It is a machine designed primarily for scientific problem-solving. One computer man put it in the same general class as IBM's current 1620 machine, but the new one is 20 times faster and costs about half as much.

## Instrumentation

### Bank on this

A New York bank advertises that you have a friend at the Chase Manhattan; but the day may come when he won't even speak to you. Why? Because he has no heart, only semiconductors.

A Miami manufacturer, Milgo Electronic Corp., has developed an automatic bank teller that accepts coins, checks and bills (\$1, \$5, \$10 and \$20) but rejects counterfeits, and gives you a receipt—all with only a few whirrs and clicks. Called the Lectro-Teller, it will be installed this fall in banks in seven Southern states.

**For deposits only.** With Lectro-Teller, banking is strictly a one-way proposition, and the way is "in." The machines will accept deposits, but won't cash your check.

A depositor places bills in a slot, one at a time. The machine scans the bill and indicates its denomination on a viewing screen. If the depositor agrees that the number is correct, he presses the "deposit" button, and activates a conveyor belt that carries the bill inside. A separate slot is provided for coins. Bills and coins are recorded automatically on the deposit sheet; the customer must enter the checks.

**Sealed in plastic.** When the depositor presses the "transaction completed" button, the cash and checks, and a copy of the deposit slip, are sandwiched between two sheets of plastic and sealed. The package continues by conveyor belt to a storage compartment, where bank personnel can pick it up at the end of the day.

It's all done with 105 semiconductor devices—30 silicon gate turn-off switches, 25 photoconductive cells and 50 transistors. Banks



Banking by machine is provided by electronic device called Lectro-Teller.

will be able to lease the equipment at \$125 per month or buy it for \$3,500.

A modified version of the Lectro-Teller may be used in self-service gas stations in California later this year. It will accept paper money (in advance), shut off the gas pump when the tank is full, and then provide change.

**What, no stamps?** Still another version is planned for supermarkets. This one will accept cash

payments for utility bills, validate the bill and issue a receipt. Banks may eventually install deposit stations in supermarkets, too.

## Military electronics

### Autec: progress report

Big strides will be taken this spring and summer toward developing the Navy's \$125-million natural deep-water laboratory in the British-owned Bahamas [Electronics, April 6, 1964, pp. 106-109]. The electronics industry will start bidding soon on some major sections of the Atlantic Undersea Test and Evaluation Center (Autec), which is scheduled to be operational in mid-1966.

Autec is being built off the eastern edge of Andros Island in a unique natural trough, called the Tongue of the Ocean, that is 100 miles long, 20 miles wide and 6,000 feet deep. The center is being designed to test and evaluate equipment and techniques for undersea warfare.

**Acoustic equipment.** Within weeks, industry will be invited to bid on a data-processing system for the acoustics range to analyze the noise produced by ships and submarines. The signature of these controlled noises, compared with fish noises and others that naturally occur in the ocean, could indicate how to keep submarines quiet and to camouflage unavoidable noise.

Although the components will be off-the-shelf equipment, the complete, integrated system will probably have to be tailored for the Navy. The contract will be awarded by the Navy Purchasing Office; manager of the project will be the David Taylor Model Basin.

The Bureau of Ships will award a contract shortly for the installation of hard cable to connect a terminal dolphin—an ocean platform built on pilings—to the main data-processing area on shore.

The acoustics range is one of three Autec ranges. The others are



Map of Autec, the Navy's \$125-million project in the Bahamas designed to test and evaluate equipment and techniques for undersea warfare.

for testing sonar and weapons.

**Sonar calibration.** Early in March, the Bureau of Ships will award a six-month study contract for a fixed sonar calibration range. Although the contract will be relatively small, electronics companies are eager for the job because they hope to get the inside track on the large contract to supply the hardware later. The equipment order probably won't be awarded until after the first of the year. The Navy Underwater Sound Laboratory will manage the project.

**Weapons range.** This summer,

the first hydrophone system will be installed in the weapons range. Underwater cables will carry signals from a deep-water hydrophone array to a shallow reef, where less expensive cable will run above the surface to the tracking stations. The final leg, connecting the system to the main base, will be microwave.

The range will include a launch platform and five tracking stations; four more tracking stations will eventually be added, some on shore and others on platforms in shallow water.

Initially, the deep-water range will be about 35 miles long and 5 miles wide; later it will be expanded to 70 by 10 miles for testing more advanced weapons. The range will be used to study weapons launched underwater, on the surface and from the air.

The prime contractor for this part of Autec is the Federal Laboratories division of the International Telephone & Telegraph Corp. The Bureau of Naval Weapons is project manager.

## Communications

### Locked laser beams

The possibility of practical communication by laser beams moved a step closer when scientists at Bell Telephone Laboratories succeeded in synchronizing, for the first time, the phase of oscillations of two separate helium-neon lasers.

The feat is roughly comparable to constructing a radio receiver that stays tuned to the desired program once the dial has been set approximately to the frequency of the broadcasting station. It isn't just a matter of constructing a very stable receiver, but one that follows every slight variation of the transmitter.

Part of the problem is the high frequency at which the laser works— $5 \times 10^{14}$  cycles per second, compared with a representative broadcast station's  $7.8 \times 10^5$  cycles per second. When frequencies must be accurately matched, their difference is measured in phase—any difference in the time at which the sine waves of frequency start. The experimental lasers are matched to a third of a degree of phase.

**Control loop.** Two lasers are set up side by side with the output beam from the uncontrolled laser reflected at right angles towards a multiplier phototube. However, part of the uncontrolled output is deflected by a half-silvered mirror along a line parallel to the original direction. Another part passes through and impinges on the photo-



Interference rings are formed when two laser beams are at the same frequency at a constant phase difference. John Rodda, left, and Louis Enloe of Bell Telephone Laboratories developed the method of locking two beams in phase.

multiplier surface. Output from the controlled laser is also deflected at right angles by the half-mirror and likewise falls upon the phototube. Output from the phototube is fed through a low-pass filter to the transducer that changes the frequency of the controlled laser. The piezoelectric transducer expands or contracts, moving a mirror at one end of the optical resonator to produce a slight frequency change in the desired direction.

**More control possible.** Phase lock has been maintained even when the uncontrolled laser frequency changed  $\pm 50$  megacycles and the beam was reduced by 50 decibels. This control could be extended to a wider frequency by inserting an amplifier in the feedback loop.

Scientists at Bell Labs, a research subsidiary of the American Telephone & Telegraph Co., explain that locking the beams will enable them to use homodyne detection in future communications systems. This technique doubles the signal-to-noise ratio and provides other simplifications.

Although initial experiments required a vault with a shock-

mounted concrete table, the circuits have been so improved already that the vault has now been discarded.

The experiment was carried on by Louis H. Enloe and John L. Rodda. They believe they have a good chance of developing a measuring set that will permit exact determination of laser amplitude to about 0.1 db and phase to about one degree. Present techniques allow measuring amplitude to within about 3 db and phase to within roughly 45 degrees.

---

### Advanced technology

---

#### Lowering the bloom

When the Marlboro man lights up on television, his obvious satisfaction isn't shared by the cameraman. In fact, the sudden glare of the match is a signal that the camera is going to need some quick adjustment to overcome the effects of "blooming," or washout of picture detail, caused by the sudden increase in light intensity.

Blooming has caused trouble where illumination varies rapidly and the tv camera must handle a wide range of light intensities. Typical situations include viewing a star field, tracking a missile's re-entry against a dark sky, making day-and-night battlefield surveillance, broadcasting news or sports events and monitoring industrial processes.

**Beam control.** Two General Electric Co. researchers, Edward G. Nielsen and S. Peter Stranddorf, have developed an automatic beam control system that appears to solve this problem. With their system, a camera chain can adapt instantaneously to a wide range of light intensities without the attention of an operator.

In tv camera tubes, the image is represented by a pattern of electronic charges built up on a target element. An electron beam scans the target, typically 30 times a second, and reads out the information and simultaneously erases the charge in preparation for the next image. If the beam's current density is too low, it may not completely erase the charge in areas of the target representing high light levels. On subsequent scans, the charge spills over adjacent areas and washes the picture. Although the beam current can be adjusted manually to compensate for the washout effect in one area of the picture, too great an increase can cause a loss of shading, so that the picture has too much contrast.

The GE automatic beam control consists of analog computer logic that samples the output signal from the camera tube and establishes a reference voltage that is a measure of the instantaneous charge on the target. This voltage is then used to adjust the beam continuously to accomplish complete erasure. The adjustment takes less than 200 nanoseconds.

The key feature of the control circuit, GE engineers say, is the ability to use the video signal itself as a measure of the instantaneous target charge. This requires a high degree of system stability and precise regulation of voltages.



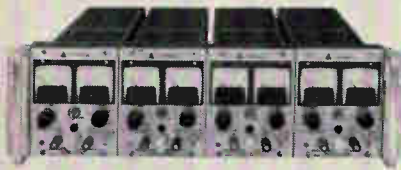

4 DC outputs in a single rack



1/4 rack and 1/2 rack models



Non-metered models available



Minimum bench width



Flush chassis mounting



LRA-1 \$60.00

LRA-2 \$25.00

Rack adapters

## LAMBDA LH line offers maximum flexibility

### All-silicon 1/4 and 1/2 rack

## Multi-Current-Rated™ power supplies

- LH series models available up to 60 VDC, up to 9 amps in 1/4 & 1/2 rack models.
- Meets RFI Spec.—Mil-I-16910.
- Modular-Subrack design for bench, chassis and rack use.

- Regulation—.015% or 1 MV (line or load)
- Ripple—250 microvolts rms. 1MV P-P
- AC Input — 105-135 VAC, 45-480 CPS.
- 1/4 rack: LH 118, 121, 124, 127—5<sup>3</sup>/<sub>16</sub>" x 4<sup>3</sup>/<sub>16</sub>" x 15<sup>5</sup>/<sub>16</sub>"
- 1/2 rack: LH 119, 122, 125, 128—5<sup>3</sup>/<sub>16</sub>" x 8<sup>3</sup>/<sub>8</sub>" x 15<sup>5</sup>/<sub>16</sub>"

Model	Voltage Range	CURRENT RANGE AT AMBIENT OF: (1)				Price (2)
		30°C	50°C	60°C	71°C	
LH 118	0-10VDC	0-4.0A	0-3.5A	0-2.9A	0-2.3A	\$175.00
LH 119	0-10VDC	0-9.0A	0-8.0A	0-6.9A	0-5.8A	\$289.00
LH 121	0-20VDC	0-2.4A	0-2.2A	0-1.8A	0-1.5A	\$159.00
LH 122	0-20VDC	0-5.7A	0-4.7A	0-4.0A	0-3.3A	\$260.00
LH 124	0-40-VDC	0-1.3A	0-1.1A	0-0.9A	0-0.7A	\$154.00
LH 125	0-40-VDC	0-3.0A	0-2.7A	0-2.3A	0-1.9A	\$269.00
LH 127	0-60VDC	0-0.9A	0-0.7A	0-0.6A	0-0.5A	\$184.00
LH 128	0-60VDC	0-2.4A	0-2.1A	0-1.8A	0-1.5A	\$315.00

(1) Current rating applies over entire voltage range. DC OUTPUT Voltage regulated for line and load.

(2) Prices are for non-metered models. For metered models add suffix (FM) to model number and add \$25.00 to the price. For non-metered chassis mounting models, add suffix (S) to model number and subtract \$5.00 from the non-metered price.

SEND FOR LAMBDA CATALOG

 **LAMBDA ELECTRONICS CORP.**

515 BROAD HOLLOW ROAD • MELVILLE, L. I., NEW YORK • 516 MYRTLE 4-4200

SALES OFFICES AND REPRESENTATIVES CONVENIENTLY LOCATED IN MAJOR CITIES

LA-159

**Improved latitudes.** The GE beam control increases by a factor of 1,000 the latitude (range of brightness above and below the average in the scene that the camera can accommodate) of a conventional tv camera chain. Nielsen believes that an improvement by another factor of 10 is possible through refinements in the circuit.

The system is being adapted for military and space applications and is being incorporated in a telescope-mounted camera for use at an astronomical observatory. Although the first effort has been with image orthicon camera chains, GE is engaged in a major program to extend the technique to infrared vidicons and other camera systems.

### A closer look

A field ion microscope, which can perceive objects as small as 2 to 3 angstroms across, has hitherto been available only as a custom-built model. Now the Materials Research Corp. has made one commercially available. It costs \$15,000—about half the price of an electron microscope, which has a 5- to 10-angstrom limit.

The field ion microscope operates near absolute zero and in a high electrical field, making some materials unsuitable for observation. At present, its use is limited to certain solid-state materials; it may, for example, provide more knowledge about semiconductor grain boundaries and the causes of metal fatigue. Electron microscopes have a wider application and can be used to study living cells.

**Four-front attack.** The field ion microscope contains four subsystems: electrical, vacuum, cryogenic and optical.

The sample to be viewed must be etched down to a needle point a few angstroms wide. It is placed in an evacuated chamber and cooled to  $-258^{\circ}\text{F}$ , the temperature of liquid hydrogen. When a high electrical field (about 100,000 volts per centimeter), is created, the needle acts as a positive electrode, and field evaporation occurs, "cleaning" foreign ions from the

surface of the sample. Part of the electrical field in the chamber is distorted by the sample, and equipotential contours assume the shape of the sample.

After the "cleaning," the field is reduced and a small amount of an inert carrier gas, such as helium or neon, is allowed to seep into the chamber. The electrical field transforms the gas atoms into positive ions, which are repelled by the positively charged sample and propelled against a fluorescent screen. The image created by the ions that strike the screen is a magnified projection of the sample. A vacuum of  $10^{-10}$  torr is maintained in the system so that extraneous ionized particles will not interfere with the image projection.

**Head of the scope.** All four of the subsystems are built into the head of the microscope, which is essentially a liquid hydrogen dewar on the bottom of which is mounted a vacuum chamber. The chamber has six service ports. Three are for the vacuum system: one each for the pump, the thermocouple vacuum gage, and a micrometer leak valve to control gas pressure. One of the remaining three ports has a phosphor screen and fiber optic window, where direct contact photographs can be made. Video tape recordings can also be made by attaching an image intensifier to the fiber optic window. Another port is for putting in auxiliary apparatus, and the third is the high-voltage input.

The microscope can also be operated as a field-emission microscope, by reversing polarities in the high voltage supply.

### Space electronics

#### Talking on light

The National Aeronautics and Space Administration is still undecided as to which Gemini spacecraft will be used to test laser communication—or whether it will test it at all during the Gemini program.

Scientists know they can pack more information on a laser beam than on a radio beam; they think laser communication will be better through deep space, and they also believe the beam will be able to pierce the ion plasma sheath that surrounds a craft and blocks radio communication during reentry.

Although the laser test is tentatively slated for Gemini 10's flight, the Geminis 7 and 11 are also in the running. A decision may come when NASA assesses the results of the laser's first airborne test, which was scheduled for last week. In this test, a more prosaic craft—an F-100 jet at the White Sands Missile Range—was to be used in simulated space-to-earth communications with a system developed by the International Business Machines Corp.

**Slaved labor.** A NASA FPS-16 tracking radar was to lock onto the aircraft and aim a slaved optical receiver at it. The ground receiver consists of a light-collecting reflector system, a photomultiplier capable of sensing the laser beam, and a low-power laser beacon.

The airplane's laser transmitter is aimed manually at the ground beacon. When the beacon is lined up, the operator starts talking into a microphone. Circuits in the laser transmitter modulate the sound into electrical pulses, which are

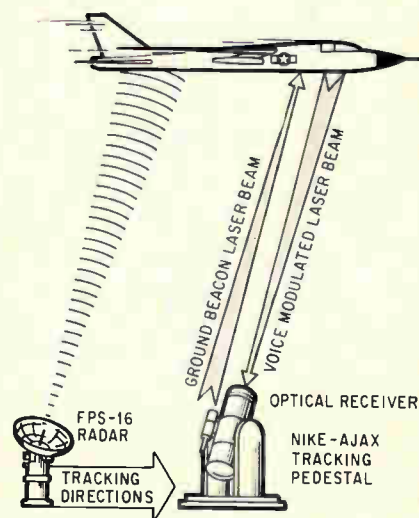

In test of laser space communication, radar locks onto plane and directs slaved optical receiver. Operator in plane aims laser transmitter manually.

***New; increased power, compact size,  
with the reliability of glass...***

## **4-amp glass rectifier**



*this small*

## **5-watt glass zener**



*this small*

# ***Two more firsts from Unitrode®***

These new units, with hard glass fused to the silicon surface — have the same voidless monolithic construction as the original Unitrode diodes and zeners of long-proven performance. Differing only in their slightly larger size, the new units offer higher power and higher surge capability with the same controlled avalanche and transient overload protection of the smaller devices. Unaffected by all military environmental testing, specified catalogue parameters are end-of-life limits.

New rectifier types are rated to 4 amps, PIV's from 50 to 800 volts, surges from 60 to 100 amps — all with controlled avalanche reverse characteristics.

New zeners, with 5 watt continuous ratings, fill the rating gap between 1 watt and 10 watt with low dynamic impedance and low leakage — voltage range is 6.0 to 400 volts. They withstand surges of 200 watts — two to three times that of conventional stud mounted 10-watt zeners. Axial leads make mounting a simple task. Write or call . . . Unitrode Corporation, 580 Pleasant St., Watertown, Mass. 02172. Tel: (617) 926-0404, TWX: (617) 924-5857.

Nationwide distribution by Compar.

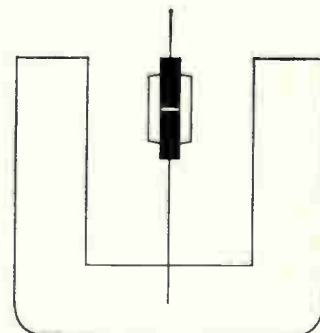

**UNITRODE®**

*"better always/ by design"*

then modulated into pulses of infrared light. The technique, called pulse-frequency modulation, varies the frequency at which the laser emits bursts of light in relation to an incoming information signal. The pulsed beam is detected on the ground and converted back into electrical pulses, which are then demodulated into sound.

### Ranger 8's sharper eyes

Ranger 7 sent back beautifully detailed television pictures of the moon's surface, but Ranger 8, which was scheduled to be fired about Feb. 20, is expected to produce even better ones. The reason: an improved vidicon camera tube.

Radio Corp. of America engineers who designed the cameras for the spacecraft say the improved tube provides 100% more sensitivity and 25% higher resolution than

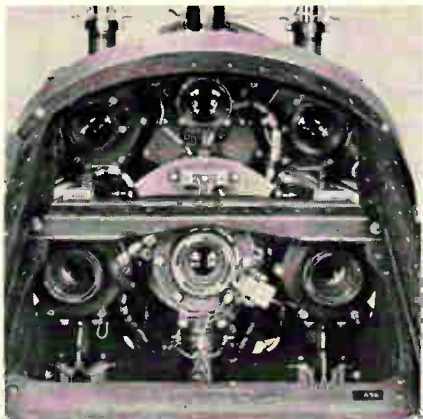

Six television "eyes" peek out of Ranger. Tube improvements sharpen its perception of lunar surface.

Ranger 7's. The camera was expected to perceive craters about 1½ feet in diameter, half the size of those Ranger 7 saw.

**Ninth wave.** Two of Ranger 8's six tv cameras were equipped with the improved tube. Ranger 9, slated to be launched about March 19, will carry five of the new tubes.

RCA won't disclose how it boosted sensitivity. But John Stumpf, production engineering manager of vidicons for RCA, says output has been increased to 20 nanoamperes from 10 nanoamperes

at 0.4 foot-candle-seconds. Resolution was stepped up to more than 1,000 lines from about 800 lines. To achieve this, RCA scientists installed a finer mesh in the tube and processed the thermionic cathode differently.

The finer mesh—1,500 lines per inch instead of 750—introduces less noise, thus improving the signal-to-noise ratio. By changing the chemical technique of converting the cathode's basic carbonates, the engineers obtained a uniform surface, which produced a more concentrated, denser bundle of beams.

**Lower temperature.** A new dark heater also was added to improve reliability, boost efficiency and lower operating temperatures. The white heater used in Ranger 7, the designers found, wasn't strong enough to withstand the on-off cycles for long periods. The new device, which boosts emissivity to 6 from 3, is made of rhenium tungsten instead of pure tungsten, which is more brittle. The new material, which lasts four times as long as pure tungsten, is coated with aluminum oxide impregnated with tungsten; this provides a more efficient transfer of heat to the cathode. The dark heater operates 200°K cooler with the doubled emissivity.

### Space salvage

An experimental military communications satellite hitchhiked a ride into space this month—but it got off at the wrong stop.

The satellite, a 69-pound package of electronic equipment, rode up atop a Titan III C and after a few somersaults and other acrobatics, including repeated stops and starts to test the Titan's versatility, was placed in a 1,500-mile high orbit. At this point the test satellite was supposed to be kicked into a highly elliptical orbit by its self-contained rocket. But something went wrong, and the satellite ended up circling the earth in the same orbit as its parent Titan rocket—smack in the middle of the Van Allen belt.

**Radiation's effects.** The satellite's planned role in military communi-

cations tests has been washed out. But the shot is not a complete failure; scientists now hope to learn something about how the high radiation belt affects the electronic equipment aboard the satellite, called LES I, for Lincoln Experimental Satellite. The craft, powered by solar cells, broadcasts in the X-band (8,000 megacycles). It was designed and built by the Lincoln Laboratory of the Massachusetts Institute of Technology.

Engineers say they are getting good-quality telemetry and X-band signals from LES' transponder, the first all solid-state one in space.

**Spinoff.** Also working well was an earth-sensing and antenna-switching system that was designed to provide directional transmission of signals from a spinning spacecraft without elaborate stabilization techniques. LES has eight transmitting horn antennas. As the craft spins, an electronic switching system, using optical detectors, shifts the transmitting signal to the one horn facing the earth.

Still in doubt was the operation of a magnetic system to prevent temperature imbalance on the face of the satellite. LES spins on one axis only. When one side of a satellite is pointed to the sun for an appreciable time, it gets hot, while the other side gets cold; the severe imbalance can harm solar cells and electronic gear inside the craft.

**Twist in space.** To overcome this problem, LES designers connected solar cell panels at each end of the satellite to a set of electromagnetic coils inside the craft. When the panels on one end of the satellite are exposed to the sun, current flows to the coils, creating a magnetic field. The field interacts with the earth's magnetic field and produces a twisting force which alters the angle of the spinning satellite.

LES has 18 square panels covered with solar cells to generate electrical power. It operates only in sunlight.

A command signal from the ground can turn off the telemetry transmitter. A timer is supposed to turn off LES' power at the end of two years, so that it will not clutter up the radio spectrum.

# Why settle for too little or pay for too much in a digital voltmeter?

...now you can get  
exactly what you need at a  
sensible price from KIN TEL

These eight KIN TEL instruments, plus off-the-shelf accessories, meet every known requirement for digital voltmeters. This means you no longer have to over- or under-buy. You just select the one instrument that delivers the exact degree and combination of speed, accuracy, stability, adaptability, range, and reliability your particular applications call for.

**Militarized Digital Voltmeter (Model 412).** Rugged, programmable, differential input. Auto ranging, displays polarity. Measures AC and  $\pm$ DC potentials between 0.001 and 999.9 volts. Accuracy is 0.01% (of reading)  $\pm 1$  digit for DC, 0.1% of full scale for AC. Designed to MIL-E-4158A. Ideal for use in automatic systems. Price, in quantities of five or more: \$10,000.

**DC Digital Voltmeter (Model 864A).** New! High speed, solid state, programmable, modular construction. Measures 0.000 to  $\pm 999.9$  volts to an accuracy of 0.02% of full scale  $+0.01\%$  of reading ( $23^\circ\text{C} \pm 1^\circ$ ) or 0.05% of full scale ( $10^\circ\text{C}$  to  $40^\circ\text{C}$ ) within approximately 0.02 second - within 0.005 second when programmed to any single range scale. Bidirectionally follows inputs changing as fast as 10 volts per second on the low range, 100 volts per second on the 100-volt range, or 1000 volts per second on the high range. Has electrical outputs for BCD, BCD excess-3, or 10-line parallel signals which are accessories. Price: From \$3180.

**AC/DC Digital Voltmeter/Ratiometer (Model 551).** New! First to bring you 5-readings-per-second speed with mercury-wetted relays. Full 5-digit, measures DC from 0.0000 to  $\pm 999.99$  volts to an absolute accuracy within 0.005% of full scale  $+0.005\%$  of reading, AC from 30 to 10 kc between 0.0000 and 999.99 volts to an accuracy within 0.05% of full scale  $+0.05\%$  of reading. Ratio accuracy is 0.005% of full scale  $+0.001\%$  of reading. Adaptable without modification to fit a variety of data-logging systems. Ideal for laboratory use. Accessories include projection readout, BCD mercury-relay output, 10-line mercury-relay output, and AC converter. Price (without optional visual readout) for the basic 5-digit instrument with buffer register and auto/manual/command range: \$4150.

**DC Digital Voltmeter and Ratiometer (Model 507D).** Measures voltages between  $\pm 100$  microvolts and  $\pm 1000$  volts, ratios between  $\pm 0.0001:1$  and  $\pm 999.9:1$  with 0.01% (of reading)  $\pm 1$  digit accuracy. Accessories permit AC/DC and AC/AC ratio measurements. Stepping switches guaranteed for 2 years. Price: \$3835.

**DC Digital Voltmeter (Model 501B).** Four-digit, fifth-digit over-ranging. Measures DC between  $\pm 100$  microvolts and  $\pm 1000$  volts, with 0.01% (of reading)  $\pm 1$  digit accuracy. Automatic or programmable range; auto polarity. Combines the useful accuracy of a 5-digit voltmeter with the price advantage of a 4-digit voltmeter. Stepping switches guaranteed for 2 years. Price: \$2995.

**DC Digital Voltmeter (Model 501BZ).** Similar to Model 501B (see above). Circuit is automatically and continually calibrated against a Zener diode reference source instead of against an unsaturated mercury-cadmium standard cell. For submarine and other special environment applications. Price: \$3160.

**AC/DC Digital Voltmeter (Model 502B).** Gives you AC accuracy within 0.1% of reading; over-ranging on both AC and DC; automatic ranging and remote (programmable) control. Measures DC between  $\pm 100$  microvolts and  $\pm 1000$  volts, AC from 30 cps to 10 kc between 1 millivolt and 1000 volts. Five-digit readout. Stepping switches guaranteed for 2 years. Price: \$4245.

**AC/DC Digital Voltmeter (Model 502BZ).** Similar to the Model 502B (see above). Circuit is automatically and continually calibrated against a Zener diode reference source instead of against an unsaturated mercury-cadmium standard cell. Price: \$4410.

*Write for detailed literature or a demonstration of any of these exceptional instruments. Representatives in all major cities. All prices FOB, San Diego, Calif. (Additional export charge.)*

Visit our Booth Number 3602  
at IEEE Show, March 22-25

Box 623

San Diego, California 92112

Phone (714) 277-6700

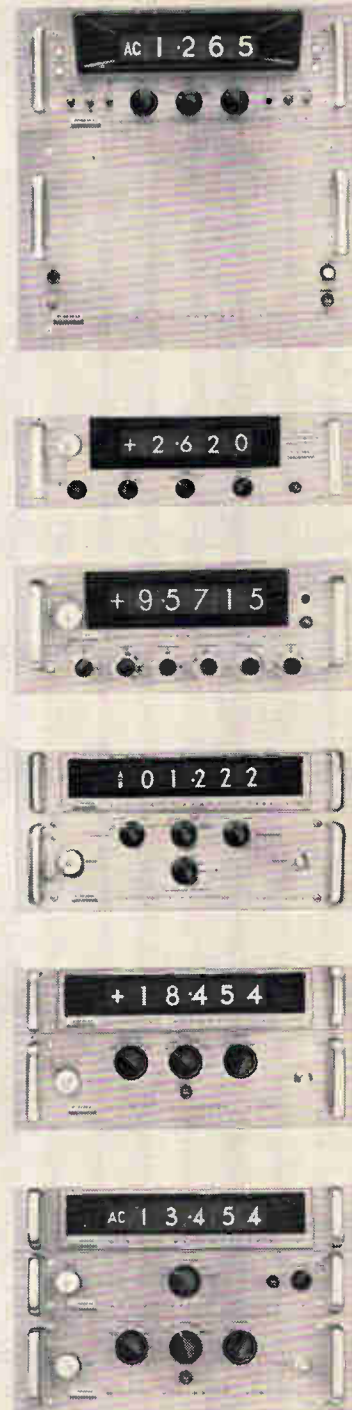

## Sigma relay idea of the month.

# A simple way to control a slave relay accurately at a predetermined voltage level.

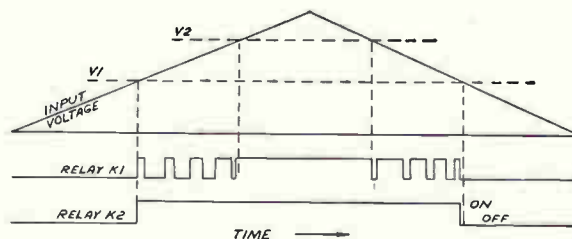
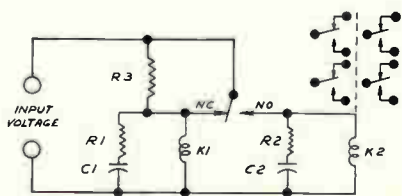

Here's a circuit idea you may be able to use or adapt to help solve a current design problem. It's a close differential relay circuit that operates and releases a slave relay at a predetermined voltage level with essentially a zero deadband. One interesting application of this circuit is in the precise control of a process requiring a particular concentration of chemicals. The sensing relay (a Sigma Series 4) has to respond to the minute output of a conductivity bridge. A four-pole slave relay (a Sigma Series 44) controls respectively: 1. flow of the chemical. 2. heating equipment. 3. stirring equipment. 4. indicator lights.

Such a circuit is equally applicable for servo-control, temperature, pressure, battery charging, humidity, and salinity controls. It can be used on

DC or, with rectifiers, on AC. Here's how it works:

When the input voltage rises to V1, the pickup voltage of K1, its NC contact opens, inserting R3 in series with its coil. R3 is chosen so that it will then cause K1 to drop out. If the input continues to rise, a voltage V2 will be reached above which R3 can no longer cause dropout of K1. Thus, if the input is between V1 and V2, relay K1 will oscillate at a rate determined by capacitor C1. The resulting pulses are fed to an integrating capacitor and relay K2 which provides the final load contacts.

If you have a relay idea or can show us how to improve this one, we would like to hear from you. Your relay idea could be the next one we publish.

# Sigma relay of the month.

## A new 5 amp. 4PDT general pur- pose relay with a 50 pps response rate.

Here's a new Sigma relay (Series 44) you will find particularly useful for on-off applications in computer, telephone and control equipment and for general purpose usages. It has a load capability from low or intermediate levels to 5 amperes, and a 50 pulse per second response rate.

It is a miniature relay yet it carries all loads up to 5 amps more efficiently and reliably than comparable types. This is made possible by its unique contact pile-up which allows a 30% greater cross-sectional area of the switch members.

Its response rate is higher (50 pps) because of its small, low-mass armature design. And there are more advantages to the Series 44:

Long life reliability—Life expectancy, 400,000 operations at 5 amps—5 million operations at intermediate loads.

Easy circuit maintenance and trouble shooting—Cover can be removed without taking relay from socket. Front position of armature and contacts makes it simple to trouble shoot system circuits...by mechanically operating armature or by isolating circuits by inserting insulators between contacts.

Check out all the features of the Sigma Series 44 for yourself.

Test and compare it with the make you are now using—free of charge. Just send for the new Series 44 bulletin and a free relay redemption certificate. Fill out the certificate and return it to us. Your Sigma Series 44 relay will be sent to you—free of charge.

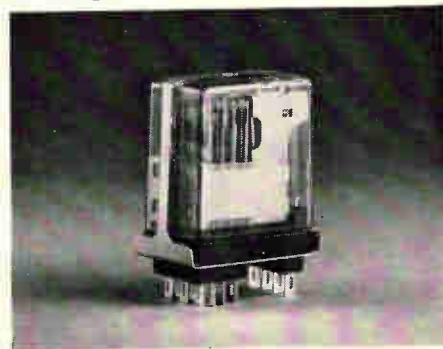

SIGMA DIVISION  SIGMA INSTRUMENTS INC  
Assured Reliability With Advanced Design/Braintree 85, Mass.

# Almost an electrometer? The new all-silicon Model P2A Differential Operational Amplifier edges one decade closer to the electrometer range than the famous Philbrick Model P2, at no increase in cost.

## DESCRIPTION

The new Philbrick P2A can be used as an electrometer to measure currents less than  $10^{-12}$  amperes routinely, yet it exhibits unusual voltage stability. Briefly, it is an all-silicon, solid-state, high gain differential operational amplifier with no inherent common mode error and with fully floating input. Model SP2A is a plug-in amplifier with the same circuit as the P2A but has the additional benefit of guarded inputs. The P2A is mounted in a die-cast aluminum case measuring  $4\frac{1}{8}'' \times 1\frac{1}{8}'' \times 1\frac{1}{8}''$ . Model SP2A is wired on an etched-circuit glass board with 15-terminal gold-nickel edge connectors and shielded by an exoskeletal nickel-plated steel case measuring  $3\frac{1}{8}'' \times 1\frac{1}{2}'' \times 2\frac{3}{8}''$ .

## CHARACTERISTICS:

TYPICAL INPUT OFFSET CURRENT .....  $< 10^{-12}$  amp.  
 INPUT IMPEDANCE (to common) .....  $> 10^{12} \Omega$   
 CURRENT NOISE ....  $< 10^{-13}$  amp.  
 OUTPUT ..... 2 ma at  $\pm 10$  V  
 TYPICAL VOLTAGE OFFSET (0°C to 65°C) ..... 3 mV  
 DELIVERY ..... From Stock  
 PRICE ..... \$227.00 each (1-4)

For complete technical data, get in touch with your Philbrick Engineering Representative or  
 Philbrick Researches, Inc.,  
 22 Allied Drive at Route 128,  
 Dedham, Mass. 02026.  
 Telephone: 617-329-1600.



**ELECTRONIC  
 ANALOG  
 COMPUTING  
 EQUIPMENT  
 for  
 MODELLING  
 MEASURING  
 MANIPULATING  
 and  
 MUCH ELSE**



**PHILBRICK**

## APPLICATIONS

Models P2A and SP2A may be used with virtually any gain in the measurement of voltage or current from high impedance sources, as integrators or sample-and-hold circuits having exceptional holding ability, as wide-range logarithmic amplifiers, for precise differential amplification and for many other applications. Some examples:

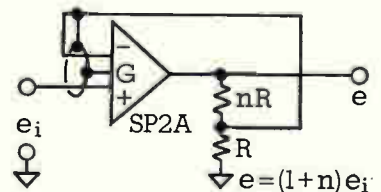

FOLLOWER-AMPLIFIER

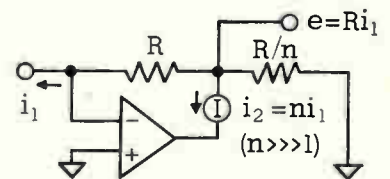

CURRENT AMPLIFIER  
 CURRENT-TO-VOLTAGE TRANSDUCER

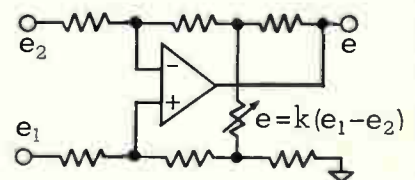

ADJUSTABLE-GAIN SUBTRACTOR

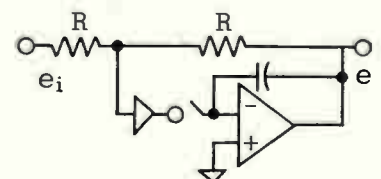

TRACK-AND-HOLD CIRCUIT



# Astrodata's New Astrolock\*<sup>TM</sup>-loop FM Subcarrier Discriminator



# Stability

Within  $\pm 0.01\%$  of center frequency for 24-hours after a 5-minute warm-up.

# Linearity

Better than  $\pm 0.02\%$  of full bandwidth, best straight line.

The Astrodata Model 402-201, all solid-state FM subcarrier discriminator utilizes the new Astrolock phase-frequency detector, crystal-referenced, FET chopper-stabilized VCO, and current mode loop filter, which are proprietary developments of Astrodata, Inc.

This completely new and different type of locked-loop discriminator gives performance exceeding that of both conventional phase-locked-loop and pulse-averaging types of discriminators.

The new crystal-referenced, FET chopper-stabilized VCO provides state-of-the-art performance in stability and linearity, without a temperature controlled oven.

The Astrolock detector, with its composite phase-frequency characteristic, assures positive lock-in at any signal

level within the 66 db dynamic range. True locked-loop performance is provided for deviations up to  $\pm 40\%$ , with specified linearity. A quadrature detector mode of operation, selected by a switch on the front panel, provides correlation detection for extremely low S/N signals.

The Model 402-201 introduces a new method of tape-speed compensation in which the reference frequency is processed in the frequency domain. As a result, tape speed compensation is perfect at any fixed frequency from lower bandedge to upper bandedge, and is better than 30 db for intelligible frequencies up to a modulation index of 4. Deviations of more than  $\pm 3\%$  anywhere in the band can be accommodated. No adjustments are necessary.

With this new Astrodata Tape Speed Compensation system, the over-all

stability for a given data channel is that of the data discriminator alone, whereas in a conventional system the over-all stability is the sum of the stabilities of both the data discriminator and the reference discriminator.

A complete line of accessories is available for use with the Model 402-201. Channel Selectors and Low Pass Filters are provided for all standard IRIG and Constant Bandwidth center frequencies up to 300 kc. Six discriminators and one common power supply mount in a rack adapter which occupies a panel space of 7-in. x 19-in.

For complete technical information on Astrodata's unique Astrolock-loop FM Subcarrier discriminator and full line of telemetry components, call your local Astrodata engineering sales representative or write to us directly.



**ASTRODATA INC.**

P. O. Box 3003 • 240 E. Palais Road • Anaheim, California 92803

24 \*Trademark TEL. (714) 772-1000 • TWX 714-776-3760 • FAX • TELEX 06-78828 • CABLE ADDRESS • ASTRODATA, Anaheim



Every fifth employee a quality-control "bluecoat"! This extra attention is part of

# BOURNS TOTAL VALUE

In most electronic-component companies, a ratio of one quality-control worker in every ten employees is considered adequate. In many firms, the figure is one in fifteen. At Bourns—where blue means quality control—one employee out of every five wears a blue coat.

This fact just begins to reveal the emphasis that Bourns places on quality and reliability. With inspectors on every line, at every key assembly station...with 100% final inspection... Bourns far exceeds the QC effort of most component manufacturers.

In 1957 Bourns pushed its standards to a new peak by

creating its now-famous Reliability Assurance Program. In this program—unique in the potentiometer industry—monthly samples are taken at random from stock and tested for conformance to all electrical and environmental specifications established by Bourns. These checks, conducted in addition to other quality-control measures, make Bourns products the most thoroughly tested of their kind.

In fact, this program makes reliability a product in itself. You can always recognize it by the name Bourns on the label.

THIS IS BOURNS TOTAL VALUE / Always your best value in potentiometers

## EXCLUSIVE RELIABILITY PROGRAM

The Bourns Reliability Assurance Program is the only one of its kind in the potentiometer industry. Its primary goal is reliability! It frequently requalifies all standard models to insure conformance with published specifications. It also makes available free test data, saving you the time and expense of quality verification. Conducted in *addition* to quality control, it makes Bourns potentiometers the most thoroughly inspected and tested units available.

## SUPERIOR QUALITY CONTROL

One-fifth of all Bourns employees work in quality control or reliability monitoring. This is one of the highest personnel ratios of QC employees and inspectors in the electronics industry. In addition, all standard Bourns products undergo extensive in-process and 100% final inspection. These facts help account for the company's return rate of only 0.2% (2 units returned of each 1000 shipped!), one of the lowest on record.

## MOST ADVANCED PRODUCTS

As the pioneer in adjustment potentiometers, Bourns has set the standards for an entire industry—in new products, in product improvements, in materials, in processes. Innovations such as the RESISTOX® carbon and PALIRIUM® film

elements and the virtually indestructible SILVERWELD® termination demonstrate that Bourns is constantly pushing the standards higher.

## LARGEST SELECTION

Bourns offers the world's largest selection of potentiometers and an extensive line of precision potentiometers, relays and micro-components. This single-source capability means less shopping around, avoidance of costly specials.

## BEST AVAILABILITY

The factory maintains a constant reserve of more than 500,000 units. In addition, more than sixty distributors across the nation carry complete stocks of Bourns adjustment potentiometers. Whatever you need in potentiometers, you can depend on Bourns for an off-the-shelf answer.

## OUTSTANDING APPLICATIONS HELP

Bourns maintains a staff of ten professional Application Engineers whose sole job is to give you technical assistance. Each of these specialists serves a specific geographic area. All are extremely able and anxious to help you cut time, corners and costs.

## LONGEST EXPERIENCE, RELIABILITY

Bourns—originator of the TRIMPOT® lead-screw-actuated potentiometer—has

been making adjustment potentiometers longer than any other manufacturer. Bourns products have the longest reliability record, too, having performed successfully in every major U.S. missile and space program. And the record continues: in today's world-wide markets, far more adjustment potentiometers bear the Bourns label than any other.

## COMPETITIVE PRICES

Depth of product line and high production efficiency allow Bourns to meet or beat the prices of competitors—despite its heavy extra expenditure for product reliability. Furthermore, Bourns "holds the line" on prices while continually upgrading its products. In those cases where a Bourns unit is slightly more expensive, you can be sure that the small extra cost means considerable extra value. It is a firm Bourns policy *never* to compromise quality for price.



# BOURNS

BOURNS, INC., RIVERSIDE, CALIFORNIA  
Manufacturing Facilities  
RIVERSIDE, CALIFORNIA; AMES, IOWA  
Subsidiaries  
TORONTO, CANADA; ZUG, SWITZERLAND

TRIMPOT is a registered trademark of Bourns, Inc.

MANUFACTURER: TRIMPOT® & PRECISION POTENTIOMETERS, RELAYS; TRANSDUCERS FOR PRESSURE, POSITION, ACCELERATION

©1965, BOURNS, Inc.

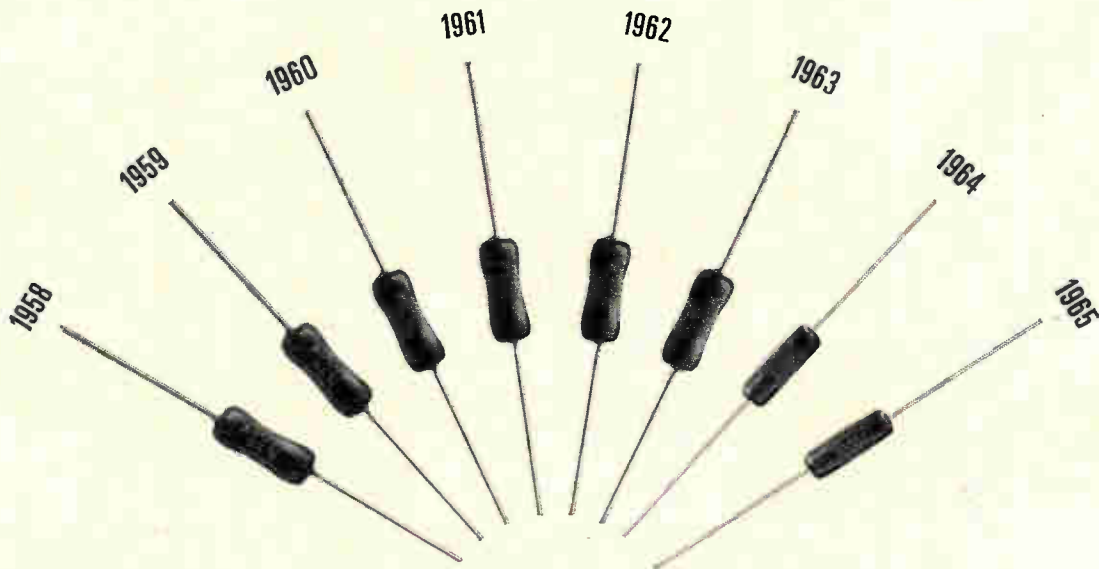

## The eighth year of significant improvements in CORNING® precision resistors

You'd never know it just by looking at them, though. Our engineers don't even have tail lights to change from year to year.

But on the little things inside, they're tigers.

Take TC, for example. Back in 1958, our CORNING® N-Insulated Series of resistors went on the market with a TC of  $\pm 500$  ppm. Not too bad, not too good.

We went to work on it and whittled the TC down to  $\pm 300$  ppm in our 1960 model. In 1961, we'd squeezed TC down to  $\pm 200$  ppm—it was getting tougher.

Then, in the 1962-63 versions of CORNING RN Resistor types, we screwed the TC down to  $\pm 150$  ppm.

And last year, in the CORNING® NA Resistor Styles, we held TC to  $\pm 100$  ppm. But TC isn't everything.

Soon we will announce a major advance in the over-all stability and performance of CORNING precision resistors—once again improving our basic glass tin oxide component which already holds well-established benchmarks for long, flat load-life performance.

Actually, we made a big interim improvement in that stability with the CORNING® NA-Resistor. Look at the Design Tolerances we've assigned to the Characteristic D NA-Resistor— $\pm 1.9\%/20,000$  hours for the NA55D and NA60D;  $\pm 3.2\%/20,000$  hours for the NA65D, and  $\pm 4.3\%/20,000$  hours for the NA70D—all calculated within 3 sigma limits.

These Design Tolerances include the 1% purchase tolerance and all  $\Delta R$  due to TC and load-life drift.

With the CORNING NA-Resistor as

with no other precision resistor you've ever used, you *know* the parameters of its performance under load.

### PHYSICAL CHARACTERISTICS

Mil Type	Corning Type	Wattage	Resistance (ohms)	
			Min.	Max.
RN55D	NA55D	$\frac{1}{8}$	51	150K
RN60D	NA60D	$\frac{1}{8}$	10	249K
RN65D	NA65D	$\frac{1}{2}$	10	500K
RN70D	NA70D	$\frac{3}{4}$	51	1 Meg.

Order from your nearby Corning distributor, or write for full technical data to Corning Glass Works, 3913 Electronics Dr., Raleigh, N. C.

**CORNING**  
ELECTRONICS



# PLASTICOTE<sup>®</sup> WIRE & CABLE by CHESTER

**CHESTER CABLE CORP.**

A Subsidiary of Tennessee Corporation

**CHESTER, NEW YORK**

(See reverse side)



**COAXIAL CABLE** — Chester Cable Corp. offers a complete line of coaxial cable for military and commercial applications. Manufactured in accordance with MIL-C-17, JAN-C-17 and commercial specifications. Constructions include solid, air-spaced and foam dielectrics with conventional braid shields or flat copper tape shields, having PVC or polyethylene jackets. Custom designed constructions of triaxial cable and high frequency-high voltage cable are also available.

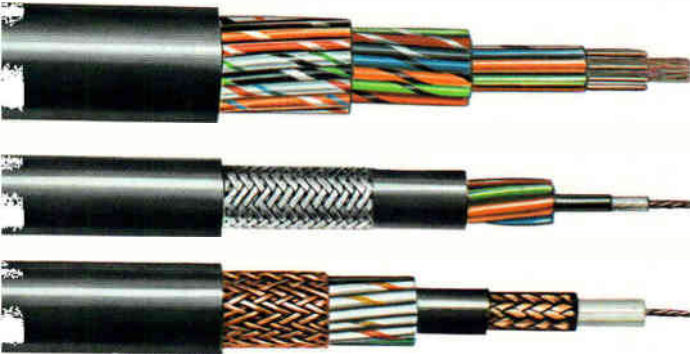

**MULTI-CONDUCTOR CABLE** — Wide range of custom designs available, manufactured in accordance with such industry standards as MIL specs., U/L, CSA, IPCEA, EIA, IMSA, ASTM, etc.

Chester Cable Corp. is a preferred source for quality electronic and electrical cable, insulated and jacketed with thermoplastic materials such as polyvinylchloride, polyethylene and nylon. Custom designs of shielded or unshielded cable include: Control Cable · TV Camera Cable · Missile Cable · Intercom Cable · Computer Cable · Special Hi-Voltage Cable and Parallel Bonded Ribbon Cable.



**MIL-SPEC WIRE** — Made in accordance with specifications MIL-W-16878 (Types B, C & D), MIL-W-76B (Types LW, MW & HW) and MIL-W-5086A for electronic systems. Available in single or multiple constructions, shielded or unshielded, with or without nylon or PVC jackets.



**WIRE AND CORD FOR THE APPLIANCE INDUSTRY** — U/L and CSA approved, 60°C — 80°C — 90°C — 105°C appliance wiring material — SVT, SJT, ST cord, SJTO & STO oil-resistant cord, SJT & ST oil-proof cord, SPT cord with or without individually insulated ground wire. Used for washers, dryers, refrigerating, air conditioning, vending, heating, X-ray and other electrical and electronic equipment.

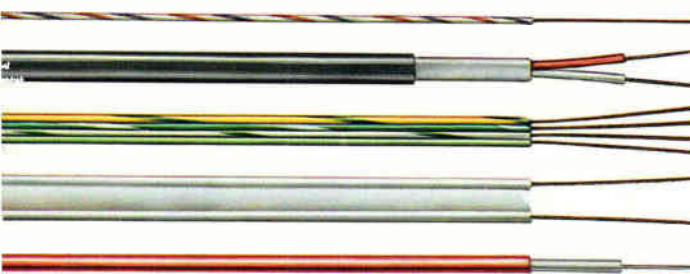

**RADIO AND TV CIRCUIT WIRE AND CABLE** — U/L and CSA approved, 60°C — 80°C — 90°C — 105°C appliance and radio circuit wire, microphone cable, shielded and unshielded audio circuit wire, twin lead antenna wire, phonograph cable, parallel-bonded color convergence ckt. cable, braided hook-up wire, hi-anode wire, hot chassis lead, balun-coil wire, shielded constructions with spiral, braided, aluminum-Mylar tape and conductive materials; all available in Thrif-T-Bond® tinned over-coated conductors.

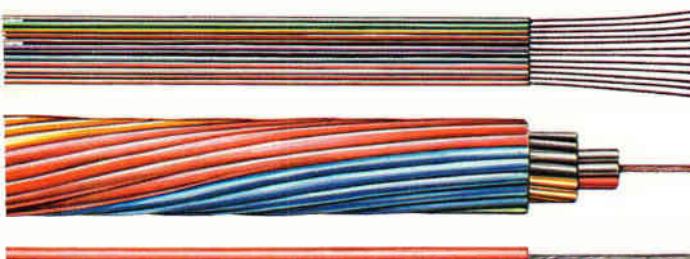

**MISCELLANEOUS WIRE AND CABLE**—Machine Tool Wire · Bus Drop Cable · Flexible Test Lead Wire · Municipal Signal Cable · Low Energy Circuit Control Cable · Station Control Cable · Inter-Office Communication and Signaling Cable · Deep-Well Submersible Water Pump Cable · Gas Tube Sign and Oil Burner Ignition Cable · Intercom Cable · Gasoline and Oil Resistant Wire · Computer Cable · Uninsulated Bus Wire · Parallel and Jacketed Cord · Braided Ground Strap, and special custom designed cable for your applications.



Write or phone for further information.

**CHESTER CABLE CORP., A Subsidiary of Tennessee Corporation, CHESTER, NEW YORK 10918**

Phone: 914 - 469-2141 · TWX: 914 - 469-7011

Printed in U.S.A.

---

# Washington Newsletter

---

February 22, 1965

## Navy managers to guide projects

Without waiting for an expected Defense Department directive, the Navy is moving quickly to put managers on high-priority projects. The directive, which will be submitted to Pentagon boss Robert S. McNamara for approval March 1, makes mandatory a project manager for jobs urgently needed for national defense, for those of top-level interest, for extremely expensive or complex systems, and for those to be used by more than one service agency.

The manager, a military man, will have authority to cut red tape in any department to get the job done. The Navy has hitherto split up most of its project development among various bureaus; within a year it hopes to catch up with the Air Force and the Army in the number of projects handled by a manager. Of the Air Force's 100 projects now under some form of project management, less than 20 will satisfy the new regulations; almost all of the Army's 30 will be in line.

Contractors generally favor the plan. A spokesman for the American Machine & Foundry Co. says: "We know where to go to get a quick answer."

## Arm-twisting to end gold drain

The electronics industry sees some arm-twisting in the Johnson Administration's "voluntary" program aimed at solving the chronic balance-of-payments problem.

Companies that maintain manufacturing operations overseas or use imported components are being told they're expected to limit their direct investments abroad, their deposits in foreign banks and their holdings of foreign financial assets.

While this program is billed as voluntary, the implied alternative, direct federal controls on companies' overseas investments, is so distasteful that businessmen are expected to cooperate.

The Commerce Department will counsel restraint only on investments to be made in industrial countries that tend to accumulate dollars that can be turned in for United States gold, especially Japan and some Western European countries.

## Bids sought for Poseidon

The Navy is calling for project-definition proposals for its new Poseidon missile by early next month. Contracts for the definition studies, which are to last six to seven months, will be awarded in late March or early April.

The Poseidon dollar seems certain to go to the same companies that produced earlier versions of the Polaris missile. Drawing up proposals are the Massachusetts Institute of Technology's Instrumentation Laboratory for the guidance system, the General Electric Co. for fire-control systems, the Raytheon Co. for guidance system and the Lockheed Aircraft Corp. as prime contractor for over-all project.

## Navigation satellite getting boost?

The Navy is reportedly negotiating with industry for production of a small, lightweight receiver that surface ships can use with the Transit navigation satellites. Printed readout of navigational data is provided. Navy brass won't confirm it, but it's understood that they are highly

---

# Washington Newsletter

---

pleased with the performance of the system, which provides positions accurate to hundreds of yards.

The unit was developed under contract by the Johns Hopkins University Applied Physics Laboratory, which also contributed heavily to development of the basic Transit system and the more precise and larger satellite navigation equipment that is currently used by the Polaris submarines.

Work is also under way to outfit planes with satellite navigation equipment. This step is still considered to be three years or more away from perfection, however.

## **Bigger ears for Mars probe**

The National Aeronautics and Space Administration will need at least two more 210-foot-diameter antennas for its worldwide deep-space tracking network if Congress approves the agency's Project Voyager plan to land an instrumented capsule on Mars in 1971.

A prototype facility to be finished in 1966 is already under construction by the Rohr Corp. at Goldstone, Calif. The two additional facilities will probably be built in Australia and Spain, with a possible third one in South Africa.

NASA has 85-foot-diameter dishes at these sites now, but needs the larger antennas if it is to obtain the maximum scientific data from the \$1.2-billion Project Voyager. The 85-foot-diameter dishes can only receive about 8 bits per second from a Mars spacecraft, compared with 74 bits per second for the larger antennas.

Money for the additional antennas probably will be requested next year. Cost per facility is around \$18 million to \$20 million.

## **Merged union would be tougher**

Tougher labor bargaining is in prospect for electronics companies if the powerful United Auto Workers take over the 300,000-member United Electrical Workers union. UAW President Walter Reuther is working for a merger.

A combined union, with a total membership of about 1.6 million, would put up a stronger front in negotiations with electrical manufacturers, particularly the General Electric Co. and the Westinghouse Electric Corp.

## **Contracts imminent on avionics orders**

Contracts for several major military avionics systems are about to be awarded.

The Navy will choose between the AC Spark Plug division of the General Motors Corp., the Sperry Rand Corp., North American Aviation, Inc., for development of the Integrated Light Attack Avionics System for use aboard the A-7A aircraft.

The Air Force will select three or more contractors from 10 competitors for pre-project definition studies of the Mark II system to be used on the F-111A fighter-bomber. And the Navy is expected to authorize Teledyne, Inc., to proceed with the integrated helicopter avionics system (IHAS) which has been delayed for months. Under Defense Department pressure, the Navy has now dropped several IHAS subsystems to reduce its cost.

The Army has called for proposals by Feb. 25 for research and development of an avionics package for the light observation helicopter.



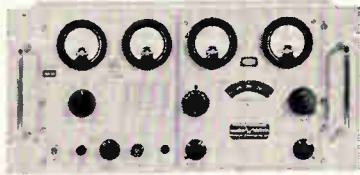

- **TMR-2A:** 215 to 265 mc Tuning Range; VFO or XTAL controlled, FM or PM.  
FM demodulators—Wideband, Narrowband, Phase lock.  
Phase Demodulators—Short loop.  
Pre-D: Plug-in record and playback modules.

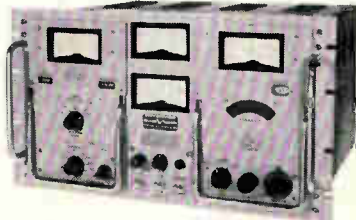

- **TMR-5A:** 55 to 2400 mc; Tuning Units VFO or XTAL controlled, AM/FM, PM.  
FM Demodulators—Wideband, Narrowband, Phase lock.  
Phase Demodulators—Short loop.

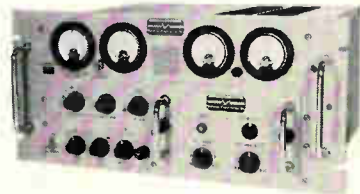

- **TMR-6:** 50 to 1000 mc; Fixed Frequency XTAL controlled RF Tuning Units. AM, FM or PM.  
FM Demodulators—Wideband, Narrowband, Phase lock.  
Phase Demodulators—Long loop.  
Pre-D: Plug-in record modules.

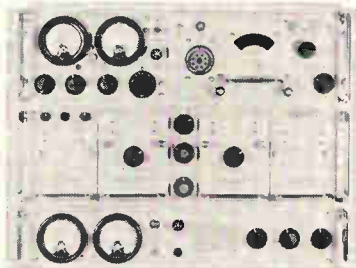

- **TR-101:** 100 to 2400 mc; Tuning Units VFO, XTAL controlled and Automatic Phase Control. AM, FM or PM.  
Dual Data Channels.  
FM Demodulators—Wideband, Intermediate, Narrowband.  
Phase Demodulators—Long loop, Short loop.



- **TR-711:** 100 to 2300 mc; Tuning Units VFO, XTAL controlled and Automatic Phase Control. AM, FM or PM.  
FM Demodulators—Wideband, Intermediate band, Narrowband.  
Phase Demodulators—Long loop, Short loop.  
Plug-in display unit or Pre-D record and playback modules, or oscilloscope.
- These receivers are compatible with TDC and DC series Diversity Combiners and the PRU-1 and PD-101 Predetection Record/Playback units. Plug-in IF bandwidth determining modules and plug-in demodulators are used in these receivers. Other options are described in individual receiver data sheets.

## DEI TELEMETRY RECEIVERS...

Technically Superior  
Reliable by design  
Modular for flexibility  
Available now

Telemetry receivers are very important at DEI. Development and planning never stop. We consider new requirements, new components and the constant need to advance telemetry system performance. It is a rare telemetry receiving function that cannot be met by a DEI catalog receiver/module combination.

DEI receivers that have been in use for many years are updated by module changes to achieve new system characteristics. System modifications are introduced with minimum interruption when the DEI modular approach is used.

For your telemetry applications, consult DEI, the company where receivers and receiving systems are constantly being improved.

*Write or call DEI for your copy of detailed specification sheets.*



**DEI**  
RESEARCH  
DEVELOPMENT  
MANUFACTURING

*Defense Electronics, Inc.*  
Rockville, Maryland

ROCKVILLE, MD. (301) 762-5700, TWX: 302-427-4660; SHERMAN OAKS, CALIF. (213) 872-2870, TWX: 213-783-2742; COCOA, FLA. (305) 632-5400, TWX: 305-632-5442; WILLOW GROVE, PA. (215) 659-5051; INT'L. ROCKVILLE, MD.; CABLE: DEIUSA

# ANNOUNCING



## The best buy in digital voltmeters since NLS invented them

4 digits

$\pm 0.01\%$  precision

high common mode rejection

transistor circuits



\$985

**W**hat's the catch? There isn't any. That's the beauty of the new NLS 5005—a "big-league" digital voltmeter selling at a stunningly low price.

So how does NLS do it? Basically, through volume production and a breakthrough in relay technology (3 years in the making).

Here's what you get with every NLS 5005 (these are standard features—not options):

- Full 4-digit resolution.
- Accuracy of  $\pm 0.01\%$  of reading  $\pm 1$  digit—no other 4-digit dvm is more accurate . . . at any price.
- High common mode rejection—106 db min. @ 60 cps, even with  $1k\Omega$  source unbalance.
- Input filter.

- All-transistor circuitry.
- High temperature operation—in test at temperatures above  $150^\circ\text{F}$ , it continued to operate even when the case was too hot to touch.
- Accessories to measure AC,  $\Omega$  and low-level DC—with plug-in connection.
- Quality workmanship—by the company that originated the digital voltmeter.

One word of warning—even though NLS is producing the 5005 in volume, demand could possibly exceed the supply for a short time. Therefore, we suggest you order early. To do so . . . or get more information or arrange for a demonstration, contact NLS or nearest NLS engineering center (listed in eem).



Originator of the Digital Voltmeter

**non-linear systems, inc.**

Del Mar, California, Phone: (714) 755-1134 TWX: 714-277-3191

See it at the N. Y. IEEE Show—Booth 3047-49.

# If you want express service for air shipments, remember:



## there's only one Air Express.

In name, in speed, in service there is only one Air Express.

What's in it for you if you use Air Express? It means your shipments get priority after air mail on every scheduled airline in America. On every flight. Even during peak night rush hours.

It means you have at your fingertips the biggest fleet of trucks in

the business. Thousands of trucks that speed deliveries between you, the airports and your customers. (Being a joint venture of all 39 scheduled airlines and R E A Express gives Air Express definite advantages.)

It means pickup within 2 hours of your call. Delivery to any of 21,000 U.S. cities by sunset tomorrow.

And, very often, at the cheapest rate—frequently cheaper than surface carrier!

So if you ship from 5 to 50 pounds anywhere in the U.S.A., you're missing a bet unless you check Air Express. Call your local R E A Express office and try us.

Air Express outdelivers them all ... anywhere in the U.S.A.

*For booklet "When Air Express?" write Emil Seerup, Vice President, R E A Express, Dept. C2, 219 E. 42nd St., New York, N.Y.*

**Air Express**  
Division of R E A Express



*Only one recorder/reproducer  
can update your data analysis  
better than any other...*

# It's called Ticor II



**Want on-line reduction capabilities in the lab, complete RFI shielding, reliable single sideband recording, or serial PCM? Start by reading a copy of TICOR II's specs. You'll discover 1.5-mc performance previously thought impossible—like TICOR II's time base comparison between events, held within  $\pm 0.5 \mu\text{sec}$ , anywhere on the tape. Let our coast-to-coast team of experts show you how it's done. TWX 510-866-7099.**

**Mincom Division** **3M**  
COMPANY

300 South Lewis Road, Camarillo, California

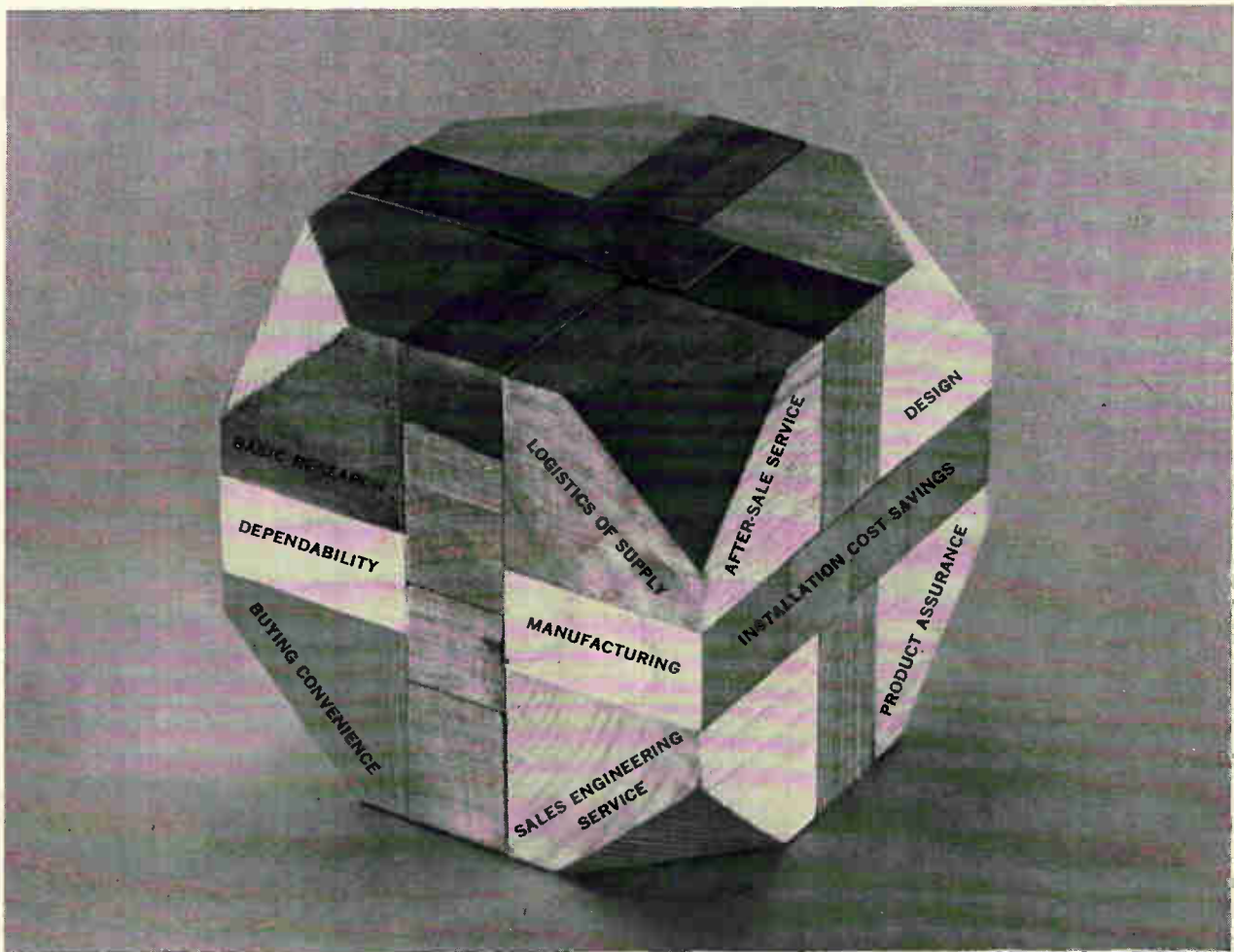

## Solution to "A dollar's value for every dollar spent"

ITT Cannon's Assurance of "Total Value" Program is designed to provide customers with maximum value in all interconnection areas at the lowest total cost. Backed by ITT Cannon's specialized knowledge and years of experience, it is a program whose sole objective is to provide TOTAL VALUE for your purchase through benefits and savings not only in cost but in time and effort. When you specify ITT Cannon as your source of supply, for one connector or a thousand, Assurance of "Total Value" begins at the design stage and is methodically carried through every facet of manufacture, assembly, maintenance and

logistics of supply. This assurance is applied to routine purchases as well as to meet specific "Value Engineering Clauses" under government contract or company sponsored programs. On all connector products, ITT Cannon provides you with "a dollar's value for every dollar spent." For information, or our booklet "Assurance of Total Value," write: ITT Cannon Electric, 3208 Humboldt Street, Los Angeles, California. A division of International Telephone & Telegraph Corporation.



Our 50th Year  
©1965 ITT CANNON ELECTRIC INC.

# ITT CANNON

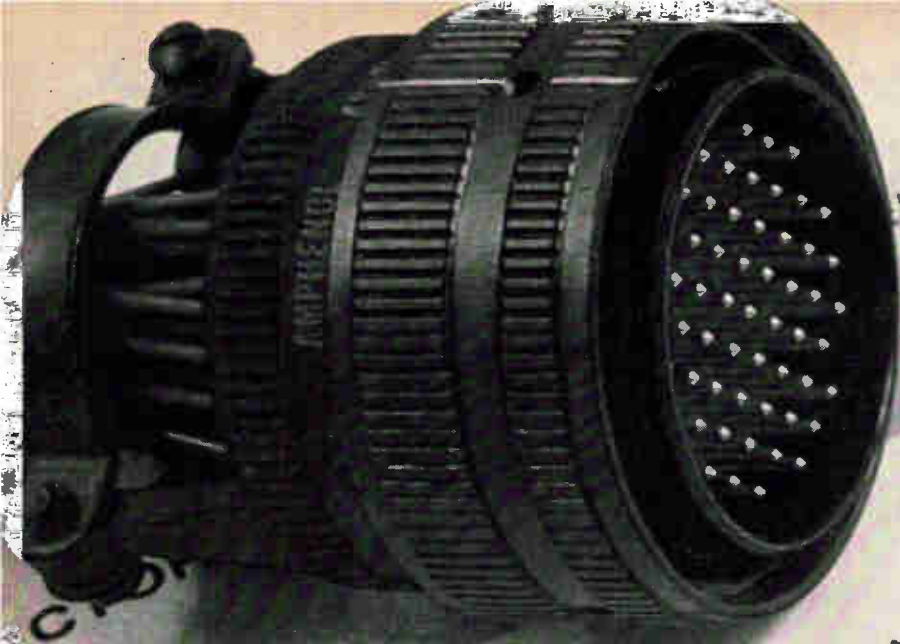

MATING INTERCHANGEABILITY STUDY  
OF  
MIL-C-26500 AND NAS-1599  
CONNECTORS  
REPORT NO. C-1-300

NOIS 60650

***An up-to-date report  
on MIL-C-26500 connectors***

The MIL-C-26500 connector has been called the most nearly perfect environmental connector yet produced for the space age.

No other connector is made to such tight dimensional tolerances for perfect mating. A compression seal measured in thousandths of an inch at the insert interfaces prevents entrapped air or contaminants from interrupting electrical performance



under altitude cycling. This positive environmental seal is what you get with the Amphenol MIL-C-26500 connector.

Maybe you've heard claims like: "Interchanges with MIL-C-26500." Or "Intermates with MIL-C-26500."

In too many cases, they do not mate with an accepted MIL-C-26500 connector like the one in the picture.

They will couple with the Amphe-

rol connector. They look like the Amphenol connector. They may even check out on some routine tests. But one of two things happens when you mix an unqualified connector with the military version of the 26500 connector: (1) An interfacial gap which defeats the whole concept of a sealed connector, or (2) interfacial compression, resulting in extreme galling or wearing of the coupling mechanism.

Mixing MIL-C-26500 connectors with unqualified connectors is never recommended by either Amphenol or the military.

Check the facts for yourself. A new engineering report is now available on request: "Mating Interchangeability Study of MIL-C-26500 and NAS-1599 Connectors." Amphenol Connector Division, 1830 S. 54th Avenue, Chicago, Illinois 60650.



AMPHENOL-BORG ELECTRONICS CORPORATION

Specify Amphenol . . . the leading name in cable, connectors, RF switches, potentiometers, microelectronics



## 1 1/2" MOTORS & GEARMOTORS

1000 INCH POUNDS TORQUE

Choose the exact speed-torque combination you need—up to 1000 inch-pounds (500 inch-pounds continuous). Globe's 1 1/2" pm d.c. motors alone or with planetary gearing, governor or brake give you 1/30 hp. continuous duty. With Globe 1 1/2" motors you don't need to shop for a speed reducer—just name your speed and our application engineer will recommend the ratio (22 standard ratios) and armature winding (21 standard windings). Motors are for use with 4 to 115 v.d.c. Write for Bulletin BG. Globe Industries, Inc., 2275 Stanley Avenue, Dayton, Ohio 45404, U.S.A. Tel.: 513 222-3741.

**GLOBE**

**GLOBE  
INDUSTRIES,  
INC.**

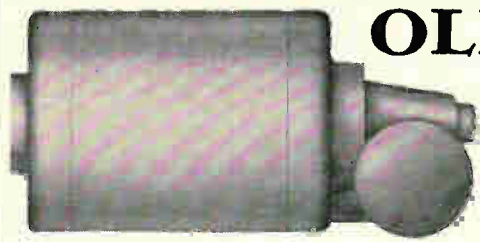

**OLD**

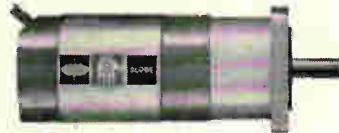

**NEW**

1-19/32" dia. x  
4" to 5-3/16" long

## SMALLER COMMERCIAL GEARMOTORS

Globe Type CFC commercial planetary gearmotors offer 83 ratios from 4:1 to 46,656:1 with torques up to 1000 oz. in. in both hysteresis synchronous and induction units just 1/4 the size of right-angle gearmotors of comparable output. Type CFC motors operate on 115 v.a.c., 60 cycles, with sync speeds of 1200, 1800 and 3600 rpm or induction speeds of 1000, 1500 or 3450 rpm.

Globe commercial gearmotors are totally enclosed, maintenance-free, space saving and economical. Request Bulletin CGM. Globe Industries, Inc., 2275 Stanley Ave., Dayton, Ohio 45404, U.S.A. Tel.: 513 222-3741.

**GLOBE**



SS motor



SS governed



SS planetary

## FAMILY OF 7/8" D.C. MOTORS

Basic Type SS p.m. motor produces up to 0.3 oz. in. @ 10,000 rpm continuous; 19 standard windings plus specials can meet your speed, torque, and power requirements. Size; 7/8" dia. x 1 3/8"; weight is 2 oz. Voltages 4 through 50 v.d.c. or more. MIL specs. Mechanically governed SS motors can regulate speed within 2%; electronic governors, within a few parts per million. Gear reducers further extend usefulness to 300 oz. in. torque; 21 standard planetary ratios, 28 standard spur gear ratios. If you need a still smaller motor, ask about Type SD (3/4" dia.) or VT (5/8" dia.). Request Bulletin SS from Globe Industries, Inc., 2275 Stanley Avenue, Dayton, Ohio 45404, U.S.A. Tel.: 513 222-3741.

**GLOBE**

**GLOBE  
INDUSTRIES,  
INC.**



# GET THE EXACT SPEED YOU NEED IN ONE SMALL PACKAGE FROM GLOBE

When you need an exact output speed, check with Globe first. We may be able to save you the time (and money) it takes to shop for the correct a.c. or d.c. motor and a separate speed reducer. Globe precision miniature gearmotors are based on modular designs—permits furnishing a custom gearmotor with virtually standard components. And because Globe a.c. motors are basically hysteresis-synchronous design, you don't pay a premium for close speed regulation.

**GLOBE INDUSTRIES, INC.**

PRECISION MINIATURE A.C. & D.C. MOTORS, ACTUATORS,  
TIMERS, CLUTCHES, BLOWERS, FANS, MOTORIZED, DEVICES



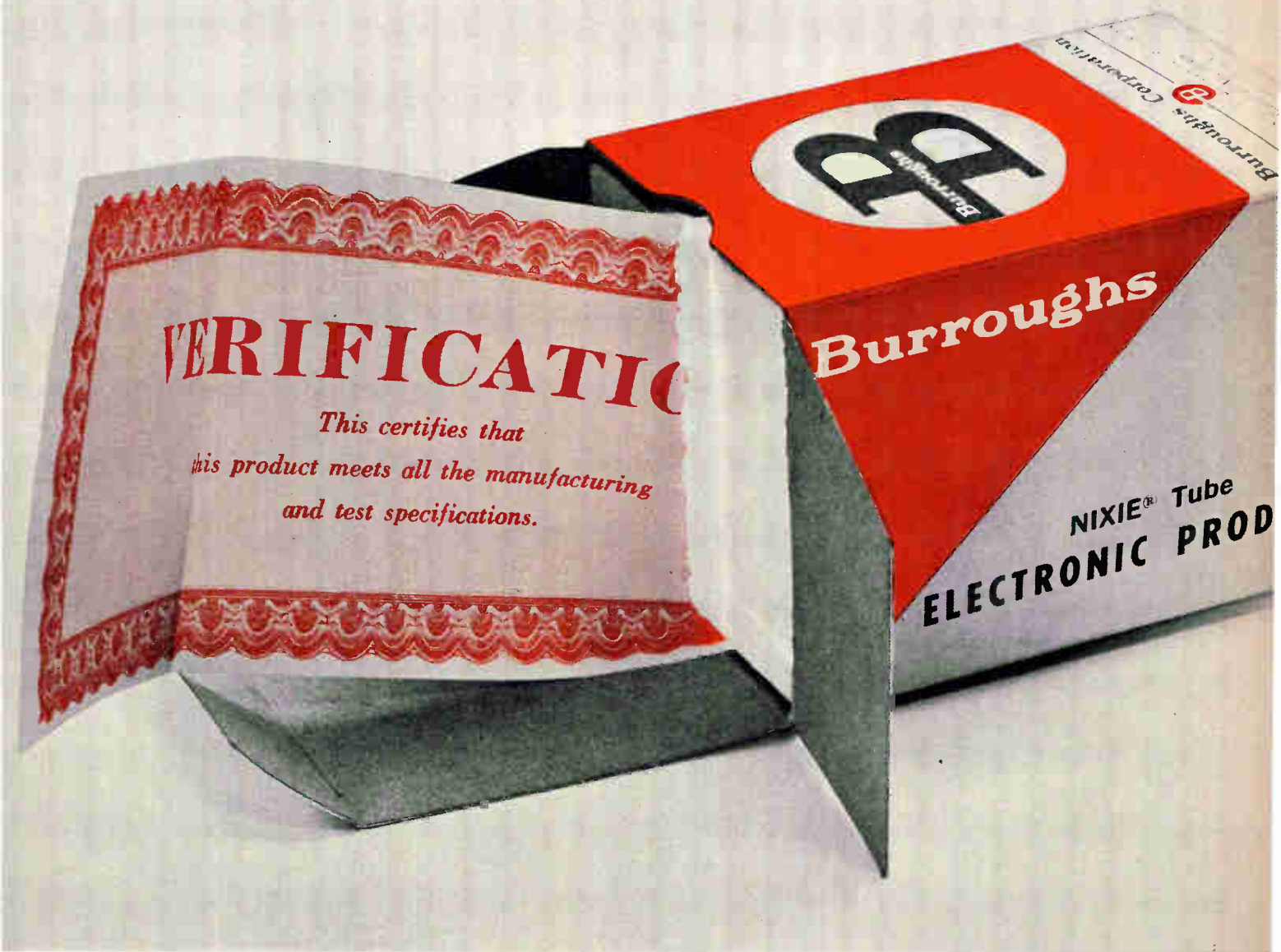

## 8 Years of life tests are part of the package

Complete verification of product claims is one of the things included in the package when you buy a Burroughs readout. We happen to feel it's the manufacturer's responsibility to prove his claims . . . not the specifying engineer's.

That's why for 8 years Burroughs has been continuously testing and improving Nixie® Tubes. When you buy a long life Nixie Tube, you know we've had its counterpart operating continuously for over 50,000 hours. Our average life figures (600,000 hours) and MTBF figures (1,000,000 hours at 90% confidence

level) are solid fact, proven over and over in our own plant, as well as in our customers' equipment. Those tubes haven't faded or failed partially, either . . . they're bright as new (which of course means they're brighter than any other readout going).

And remember Nixie Tubes are smallest size, lightest weight, most readable and simplest to drive.

So don't check out your readout claims the expensive way. Just specify Burroughs Nixie Tubes . . . they've been checked out for you.

*Write for the new NIXIE Tube catalog.*



*Only Burroughs manufactures NIXIE Tubes.*



**Burroughs Corporation**

**ELECTRONIC COMPONENTS DIVISION  
PLAINFIELD, NEW JERSEY**

# Your Comparative Reference Guide to CEC Oscillographs, Accessories and Support Equipment

CEC Datagraph® Recording Oscillographs—  
the standards of the industry

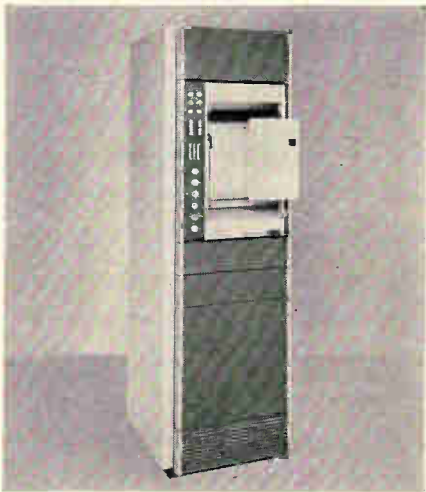

**Type 5-133** — The instrument that has established the present state-of-the-art, the 5-133 can record 36 or 52 channels of data on 12-inch-wide light-sensitive paper without chemical processing; its overall capabilities exceed the most demanding technological requirements. The 5-133's static magnetic lamp power supply provides a start-restart time of *less than a second*, regardless of input voltage variations. Available RFI certified (including the remote control unit), the 5-133 offers such other advantages as: slot-exit capability up to 160-inches-per-second; adjustable grid line intensity; record/event numbering selected by front panel switch; automatic record length control, continuously variable from 0 to 150 feet; 12 recording speeds, pushbutton selectable; galvo light intensity controls; and modular construction for maximum convenience and efficiency.

**Type 5-119** — A truly universal oscillograph, the 5-119 has become a popular, proven performer for laboratory, mobile, airborne and marine use. The 5-119 accepts all three types of record magazines making it possible to utilize every known photographic technique. Both 36- and 50-trace models are available.



**Type 5-114** — Versatile, accurate and rugged, the 5-114 records data of static and transient nature on 18 or 26 channels. 225-foot records on 7-inch-wide paper are produced at speeds from 1/2 to 115 ips; and the many CEC galvanometers available for use with this instrument permit the recording of dynamic phenomena in the frequency range of d-c to 5000 cps.



**Type 5-124** — This is the low-cost oscillograph that's making industrial history. Weighing only 40 lbs. for complete portability, the 5-124 offers big recorder capability in a small-size package. Every instrument provides up to 18 channel print-out recording, integrated drive, push-button control and extreme simplicity of operation.

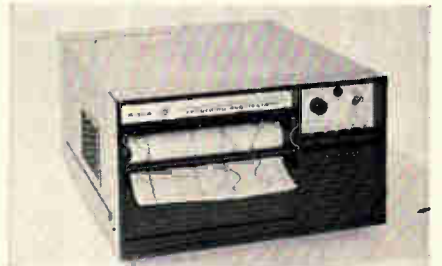

**Type 5-118** — The 5-118 is ideal where minimum size (5.5" x 7" x 10" with magazine) and light-weight (13.6 lbs. with loaded magazine) are required. Standard features include 28 volt d-c operation, 9-channel trace capacity, plus one dynamic reference trace, thermostatically controlled magnet block heaters, and trace interruption.



# Comparative Datagraph Oscillograph Reference Chart

	TYPE 5-114	TYPE 5-118	TYPE 5-119	TYPE 5-124	TYPE 5-133
DATA CHANNELS	18	9 Others Available	36 or 50	6, 12, or 18	36 or 52
RECORDING SPEEDS	28 speeds .45 to 115 ips	.5 ips or 1.0 ips Others Available	16 speeds 0.1 to 100 ips or .16 to 160 ips	5 speeds .125 to 32 ips .25 to 64 ips or .5 to 128 ips	12 speeds .1 to 160 ips
FREQUENCY RANGE	D-c to 5000 cps	D-c to 5000 cps	D-c to 8000 cps or D-c to 13,000 cps	D-c to 13,000 cps	D-c to 13,000 cps
METHOD OF RECORDING	Conventional	Conventional	Conventional or Direct Print	Direct Print	Direct Print
RECORD WIDTH LENGTH	7 inches to 225 feet	3.5 inches to 70 feet	12 inches to 475 feet	7 inches to 200 feet	12 inches to 475 feet
FEATURES	Reference traces, Precision timing	High environmental, minimum size, (5.5 x 7 x 10"), weight (13.6 lbs.)	Direct print, immediate access (DataFlash) or conventional recording, on line processing (DataRite)	Portable, low cost	Today's most advanced instrument

## CEC Accessories and Support Equipment

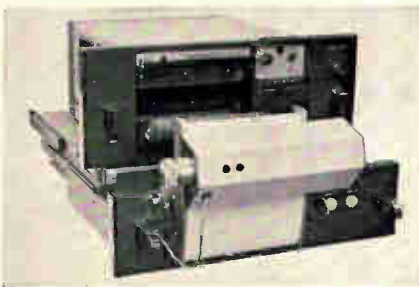

**Type 5-061-2 DATAFLASH Takeup Accessory** – Adaptable to any existing CEC 5-124 Oscillograph, the 5-061-2 permits readout of records at speeds up to 4 inches-per-second at frequencies from d-c to 13,000 cps. Top speed is 64 inches-per-second. With this exclusive CEC development, the 5-124 requires only 1 second to readout. This instrument may be mounted in a standard RETMA 19" rack, and is so reliable it is virtually maintenance-free.



**Type 1-163 d-c Amplifier** – CEC's solid-state 1-163 provides a high in performance and reliability never before attained by any comparable amplifier. This instrument will damp and deflect all CEC galvos to full scale rated deflection, and has the capability to properly damp and drive all other recording galvanometers currently available. Frequency response –  $\pm .5\%$  to 10 kc;  $\pm 3\%$  to 20 kc. Calibrated vernier gain – 1 to 20.

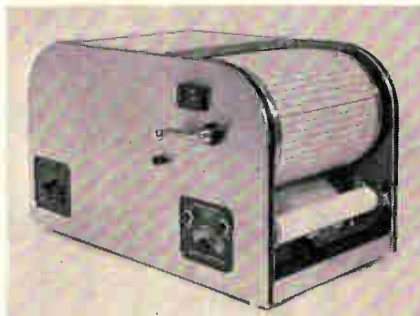

**Type 23-109B Oscillogram Processor** – The 23-109B is completely self-contained, needing only electric power for operation. The compact, motorized unit develops and dries oscillograms wherever oscillographs are used. Easy to operate and portable, the processor can be used by personnel with no previous photographic laboratory experience.



**CEC Technical Supplies** – These include all photographic supplies needed to operate CEC DATAGRAPH oscillographs: print-out papers, recording papers and developing solutions.

For complete information on any CEC oscillograph, accessory or support equipment, call or write CEC Data Recorders Division for Kit #7008-X3.

**CEC**  
CONSOLIDATED  
ELECTRODYNAMICS

A SUBSIDIARY OF BELL & HOWELL/PASADENA, CALIF. 91109  
INTERNATIONAL SUBSIDIARIES: WOKING, SURREY, ENGLAND  
AND FRIEDBERG (HESSLEN), W. GERMANY

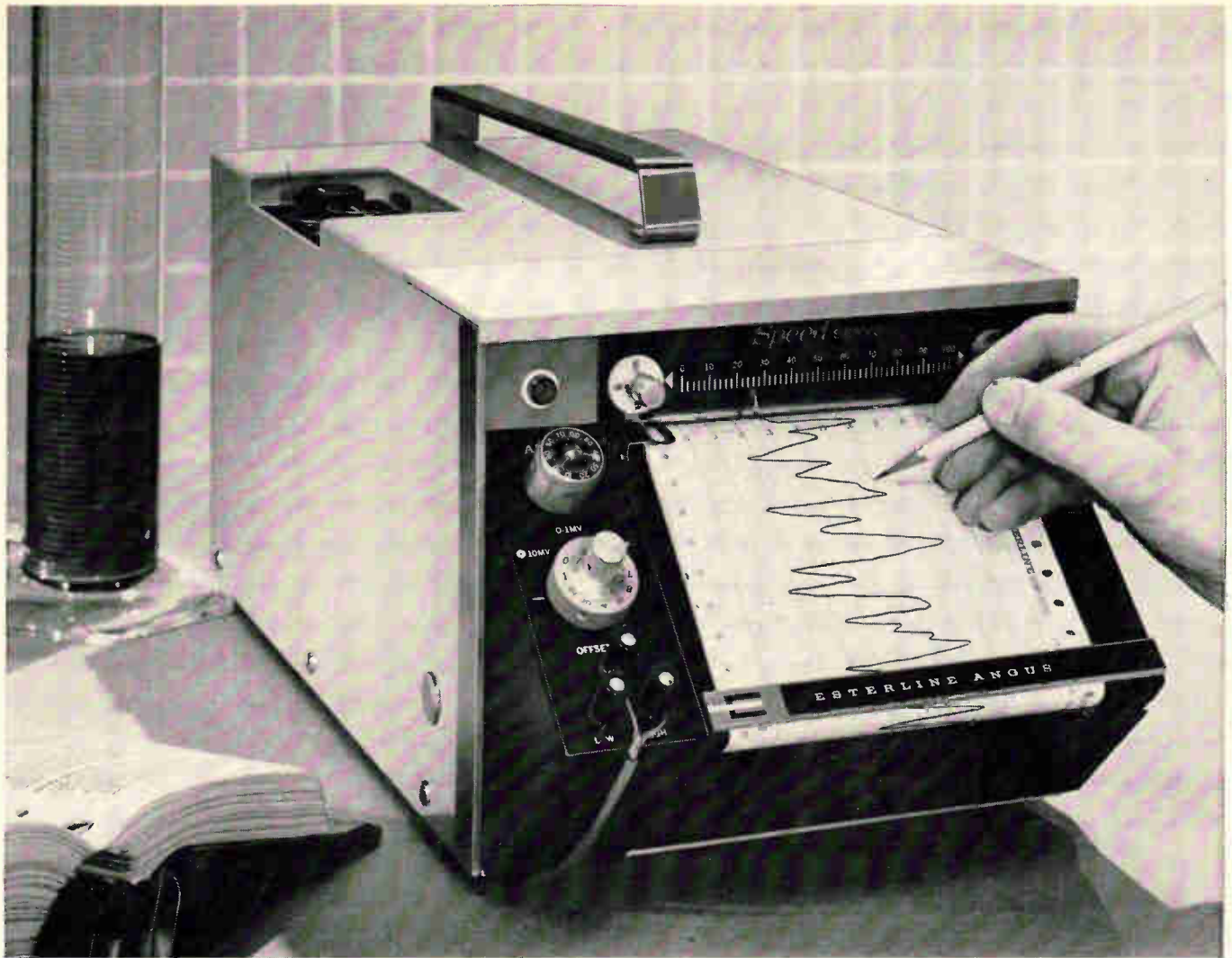

1/8 second response  
 +  
 adjustable zero, adjustable span } = the only high speed AZAS recorder

Eight times faster than most, the Esterline Angus Speed Servo Recorder can now be ordered with Adjustable Zero, Adjustable Span. It features:

- 1/8 second response.
- Circuitry capable of handling 4 cps signals without significant attenuation.
- The ability to measure any calibrated span from 1 to 100 millivolts full scale without the bother of range cards or changes in internal connections. Even higher levels of span and zero adjustment may be obtained with optional voltage dividers.
- Zero displacement of  $\pm 100$  millivolts.
- Simple controls for rapid selection of span and zero.
- 100,000 ohms maximum source impedance.
- High impedance potentiometric input circuitry.
- A unique shuttle servo motor with no drive cords to break or gears to wear.

- One piece construction of the drive coil, pen assembly and sliding contact to provide low inertia.
- A feedback potentiometer of virtually unlimited life.
- 14 immediately adjustable chart speeds.

The Speed Servo with AZAS easily records selected small span signals from such problem sources as strain gauge bridges, thermocouples, thermistors, photocells and the like.

In addition to the Speed Servo, the Series "S" line includes Milliammeters, Microammeters and Event Recorders.

Write us for detailed Series "S" catalog.

Speed Servo—Registered

**ESTERLINE ANGUS INSTRUMENT COMPANY, INC.**  
 Box 24000 E • Indianapolis, Indiana 46224

# ESTERLINE ANGUS



*Excellence in instrumentation for over 60 years*

# Technical Articles

---

**New  
masking techniques  
for micropower  
transistors:  
page 76**

Almost daily, the applications for micropower circuitry grow—in space electronics, superfast computers, and even consumer products. Traditional methods of building transistors for such applications are unsatisfactory because the micropower transistor has to be so small. New techniques, however, now produce tiny transistors with very low capacitance.

**Impedance matching  
with nonlinear loads:  
page 82**

To improve the efficiency of a circuit, particularly to obtain maximum power transfer from a generator or source of power to a load, a designer has to do a careful job of matching impedances. Harmonic currents can improve or lessen a circuit's performance and must be handled properly.

**Monkeys and  
microelectronics:  
page 90**

Scientists have known that an animal's behavior can be altered by applying electronic pulses to its brain. Until recently, the big problem was getting equipment small enough to use on the animal. Microelectronics solves the dilemma nicely. At Johns Hopkins University, thin-film devices were used to build a receiver that is tied to a monkey's head.

**Updating the  
missile ranges:  
page 94**

The mission of the nation's missile ranges is shifting to include more space tests and fewer missile shots. That means new instrumentation is needed from Cape Kennedy all the way down range. In this article, we examine the new telemetry and communications equipment for the range and how it works.

---

**Coming  
March 8**

- More new instrumentation on the missile ranges
- Better filters with FET's
- Displaying transducer data directly
- Special feature: product development —how it shows up at the IEEE show

# New masking techniques for micropower transistors

Runout problems are solved for the small geometry devices needed in complex computer circuitry

By Robert W. McGinnis and William D. Roehr

Motorola Semiconductor Products, Inc., Phoenix, Ariz.

**Silicon-transistor manufacturers** are moving steadily toward the goal of miniature devices with extremely low capacitances that can operate at a level comparable to leakage current in the transistors of only a few years ago. They're doing it with techniques that can produce the tiny geometries which are essential for micropower transistors.

The ever-increasing complexity of computer circuitry has made it necessary to develop high-speed, low-current transistors, suitable for micropower logic, that reduce power supply requirements.

For example, suppose a large scientific computer containing about half a million transistors is being operated from a 12-volt automobile battery. If the

current level for each transistor is maintained below 50 microamperes, the computer will operate from the battery for almost six hours (assuming that half of the devices are on at a given time). The power dissipation would be comparable to that of a 150-watt light bulb. However, a similar computer operated at a more conventional current level of 20 milliamperes would operate for only 54 seconds and dissipation would be over 50 kilowatts.

### Important characteristics

Until recently, switching at current levels in tens of microamperes presented many problems. A transistor must have three important characteristics to

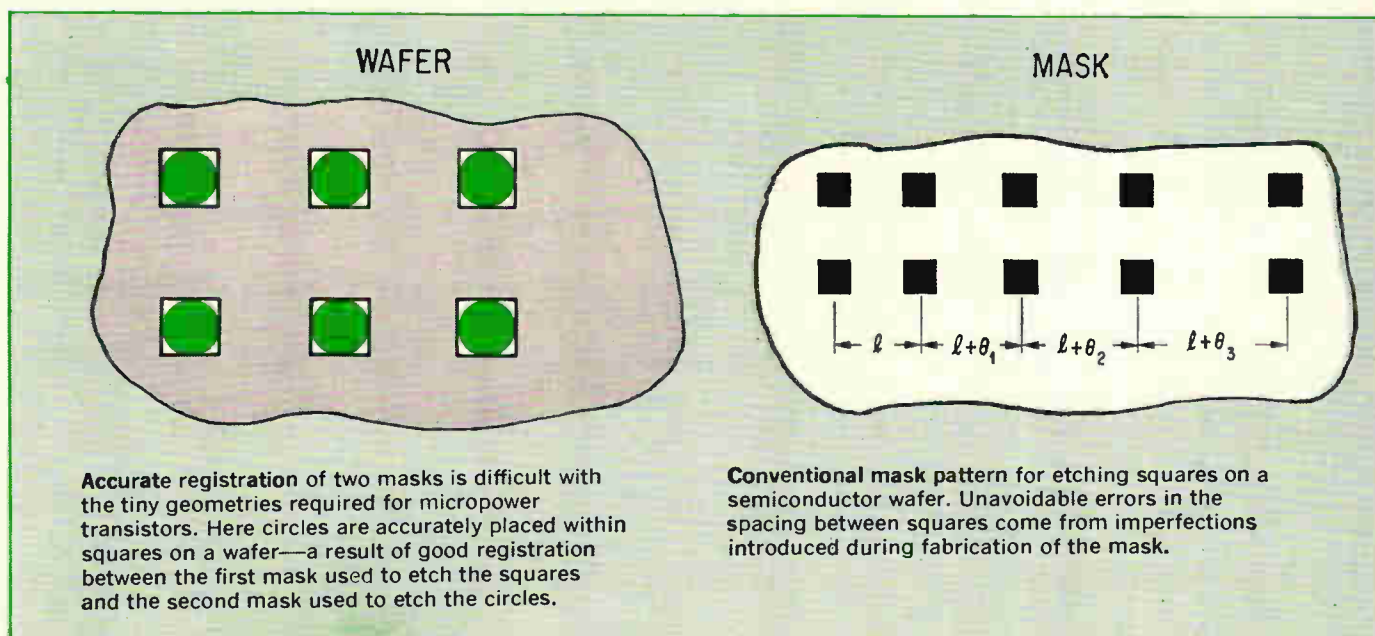

operate at very low current levels: adequate gain, leakage currents that are extremely low, and very low capacitance. While the need for the first two characteristics is more obvious, obtaining low capacitance is also essential in designing a transistor for efficient micropower switching service in conventional or integrated circuitry.

Of particular interest is  $C_{ob}$ , the junction capacitance from base to collector including the stray capacitance introduced by the can, which primarily determines the rise and fall times. The emitter-to-base junction capacitance,  $C_{ib}$ , is also important, however, because delay time is proportional to the sum of  $C_{ob}$  and  $C_{ib}$ . The range of values for the sum of these capacitances in a micropower transistor is from one to ten picofarads.

Transistor gain-bandwidth product and storage-time characteristics, normally used to specify computer transistor capability, are unimportant when specifying a micropower transistor. Gain-bandwidth product is meaningless because of the low current levels used. Storage time is also meaningless because it is so small compared to the other switching-time intervals. The figure of merit for a micropower transistor is simply  $C_{ob}$ .

To turn a transistor on, sufficient charge  $Q_{OB}$  must be injected to change the voltage on the base-to-emitter junction so that the emitter becomes forward biased, and the required collector current is produced. The latter is accomplished by the charge  $Q_A$  which changes the voltage and capacitance at the collector-to-base junction. To turn the transistor off,  $Q_A$  must be removed. In addition, the excess charge  $Q_X$  resulting from operation in saturation must also be removed.

### Charge equations

The reason that only junction capacitance is the important transistor characteristic becomes evident

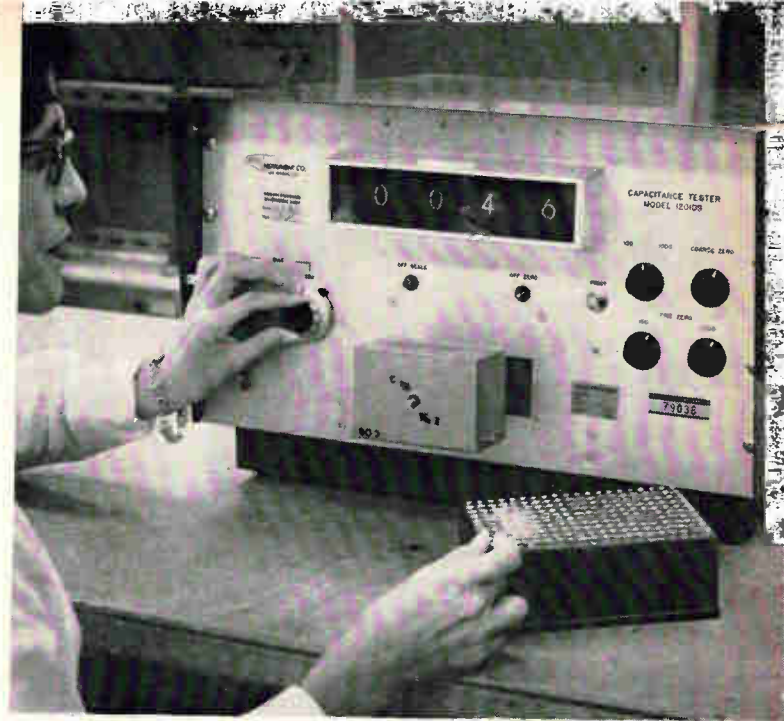

Technician checking total capacitance (can, junction and bonding island) for a 2N3493 transistor with a reverse bias of two volts. Meter reading is 0.46 picofarad 0.7 picofarads is guaranteed maximum at three volts.

upon examining the charge required for switching. The transistor charge,  $Q_{OB}$ , which must be injected during the delay time interval to bring the emitter base junction voltage to the threshold of current injection is approximately

$$Q_{OB} \approx (V_{OB} + V_{TF})(C_{ib} + C_{ob}) \quad (1)$$

where

- $C_{ib}$  = Emitter-to-base capacitance
- $C_{ob}$  = Collector-to-base capacitance
- $V_{OB}$  = Reverse base bias voltage
- $V_{TF}$  = Emitter-to-base forward voltage at threshold of conduction

The charge moved during the rise-time interval or

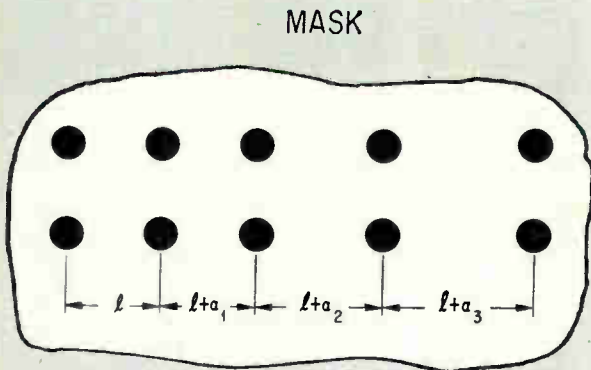

Conventional mask pattern for etching circles on a semiconductor wafer. As with the mask containing the squares, errors occurring during mask fabrication produce uneven spacing between circles.

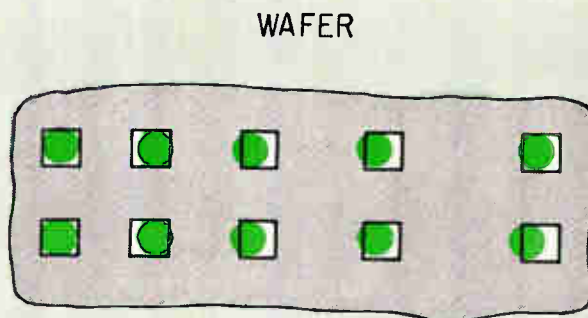

Pattern from two conventional masks. The first mask was used to etch the squares. When the second mask was used, one circle was perfectly aligned with the square shown in the upper left-hand corner. Because of imperfections in both masks, most of the remaining circle-square sets were out of alignment.

fall-time interval  $Q_A$  is given by:

$$Q_A \approx \frac{I_C}{\omega_T} + \Delta V_{CB} C_{ob} \quad (2)$$

where  $\omega_T$  = gain bandwidth product (rad/sec.)

During the storage-time interval, the expression for the charge  $Q_X$  moved is:

$$Q_X \approx T_x \left( I_{B1} - \frac{I_C}{B_o} \right) \quad (3)$$

where  $I_{B1}$  = Turn-on base current

$T_x$  = Lifetime of excess charge or storage time constant

$B_o$  = Current gain at edge of saturation

For a constant-current drive signal,  $I_B$ , switching time during any interval may be obtained by substituting the value of  $Q$  calculated from equations 1, 2 or 3 in

$$\Delta t = \Delta Q / I_B \quad (4)$$

Reduction of charge,  $Q$ , increases switching speed while reduction of drive current,  $I_B$ , reduces speed.

The charge  $Q_{OB}$  is independent of current levels and is simply the product of the voltage swing and junction capacitance. For low values of turn-on base current,  $I_{B1}$ , delay time becomes rather long and is inversely proportional to the turn-on current.

Since the collector current is low in micropower circuits, the charge represented by the  $I_C/\omega_T$  term in equation 2 becomes relatively unimportant and may be dropped from the equation.

The expression for the active charge reduces to:

$$Q_A \approx \Delta V_{CB} C_{ob} \quad (5)$$

Rise and fall times can be long because of the low base drive currents used; they are inversely proportional to base drive current.

The excess charge,  $Q_X$ , accumulated in the transistor base during the storage-time interval approaches zero at low levels because  $I_{B1}$  is small and the transistor storage-time constant,  $T_X$ , usually is also small with low-level operation. Since the drive-off base current is also small, the storage time follows the changes in  $T_X$  with current and becomes only slightly less than the storage time which occurs at high current levels. The storage time, particularly at low collector-current levels, is considerably less than the other transient time periods for the micropower transistor and may be neglected. The delay, rise, and fall times are significant and follow the form.

$$t = CV/I \quad (6)$$

where  $CV$  = change in charge

$I$  = current producing change in charge

### Processing problems

Traditional manufacturing techniques cannot produce the very small geometries required for low-capacitance devices. With the advent of protective-oxide-layer technology, the size of transistors could be reduced but two problems remained. The first was concerned with the lack of resolution of the mask geometry on the wafer; the second involved runout, the incorrect alignment or registration between masks.

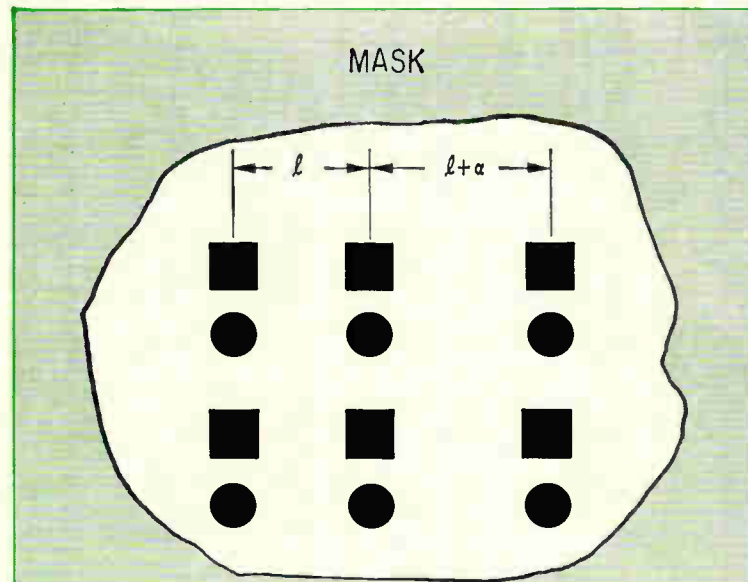

A single mask is used to contain both squares and circles. Imperfections introduced during production result in spacing variations between elements.

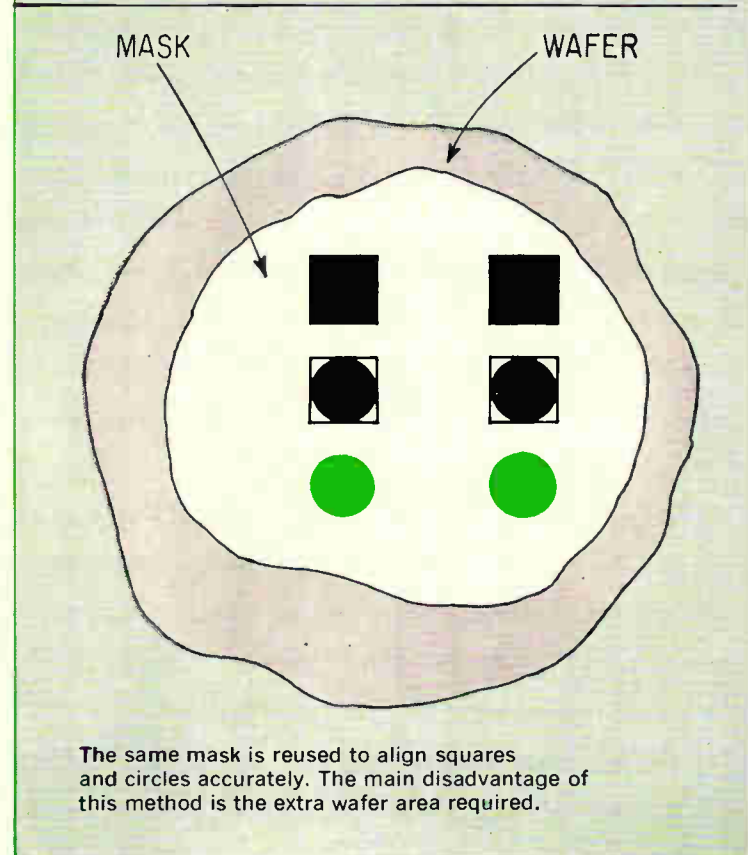

The same mask is reused to align squares and circles accurately. The main disadvantage of this method is the extra wafer area required.

### Resolution

For many years, the semiconductor industry used photoetching emulsions that were originally intended for the etching of metal parts in aircraft. Recently, the suppliers of these emulsions improved photoresist techniques to the point where lines could be resolved to a width of one micron ( $10^{-4}$  cm). This resolution capability is adequate



## WAFER

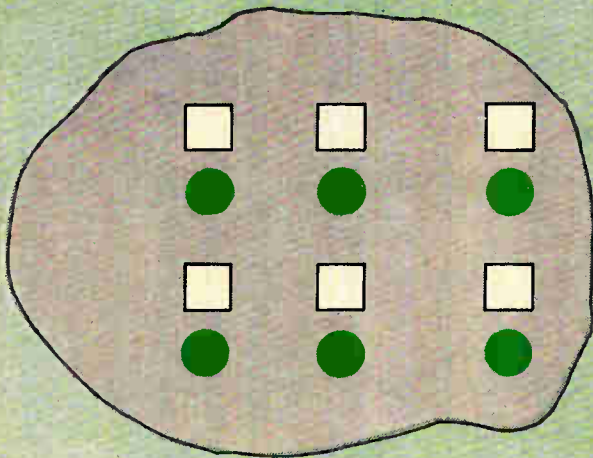

The single mask permits etching of both circles and squares simultaneously. The imperfect spacing between mask elements is transferred to the wafer.

## WAFER

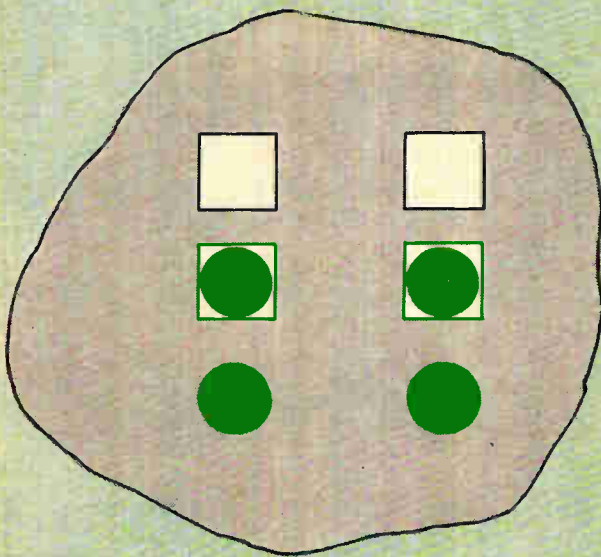

The middle row depicts perfectly aligned squares and circles. The circles at the bottom are left over from the first masking process. The squares at the top are left over from the second masking process.

for etching patterns in the oxide of the smallest geometry devices now planned.

### Runout

The solution to the problem of runout between masks came through the use of a new photographic technique. To illustrate how it works, consider the problem of placing a circle in a square on a matrix

of positions on a semiconductor wafer as shown in the bottom left diagram on page 76.

Using conventional masking techniques, two masks would be needed, one with squares and the other with circles. The masks are shown on pages 76 and 77. A perfectly made mask would have the spacings between elements repeated exactly on the matrix; however, due to unavoidable imperfections in mask production, the spacing  $l$  might become  $l + \theta$  between some elements. If the pattern on the mask is then etched into a wafer, the etched patterns will, of course, have the same variations in spacing as the mask.

The wafer then undergoes a diffusion step (for example, a base diffusion) and in the process an oxide layer is regrown in the squares previously etched. Now the wafer is ready for etching of the circles. The second mask containing the circles will also have variations in spacing between elements. However, an error in this mask, say  $l + \alpha_1$ , may not equal the error  $l + \theta_1$  in the mask for the squares. If one of the circles is carefully aligned with one of the squares, it is likely that only that pair will be aligned; the remaining pair of circles and squares will not be aligned, as shown in the bottom, right diagram, page 77. The illustrations are purposely exaggerated to show how alignment problems become appreciable for very small geometry devices.

### Masking techniques

Runout problems can be solved by a new masking technique in which the circle and square are put on the same mask as shown at the top of page 78. Now, variations in the relative positions of the elements on the matrix are not important. First, the circles and squares are etched in the wafer as shown above, left. As before, the spacing variations will be repeated on the wafer. However, after the diffusion cycle is completed, and an oxide layer is grown on the surface, the circles can be accurately placed in the squares or vice versa by reusing the same mask. The variations in spacing of elements on the wafer are exactly the same as the variations on the mask and therefore all the circles will fit in all the squares as shown.

Although this technique uses up extra space on the wafer—the main disadvantage of the process—it is not a serious problem for the very small devices made in this manner.

Only one mask pattern having the elements used in fabricating the 2N3493 micropower transistor is shown on page 80. It represents one of an entire matrix of identical patterns. The masking procedure for the circle and square example is used to make an etch cut through the protective oxide. This is the base area of the transistor. There is a small unused area below the actual base that also receives a base diffusion. During the base diffusion, oxide is regrown in the regions previously opened. Now, the same pattern on the same mask is aligned over the diffused areas. Then, the entire mask is translated upward so that the

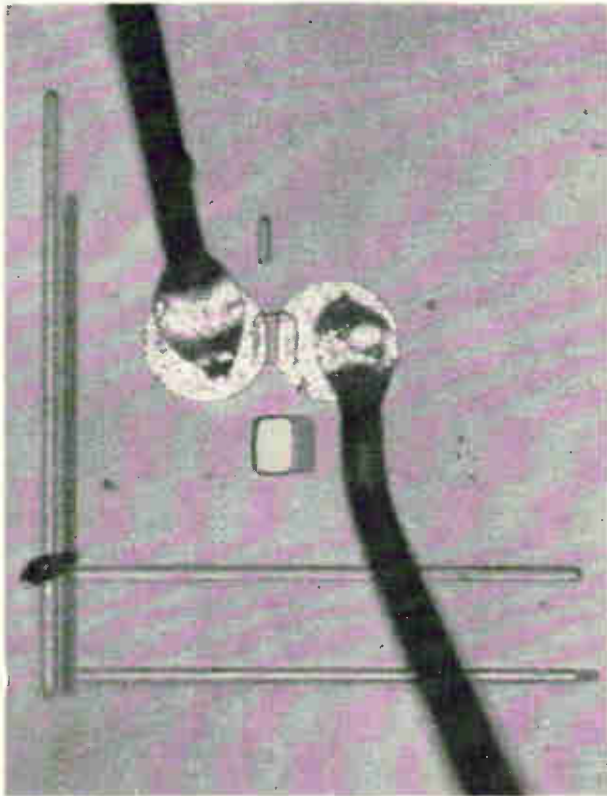

Unretouched photograph of the 2N393 mounted on the header. The two one-mil diameter wire leads attached to the bonding islands dwarf the actual transistor.

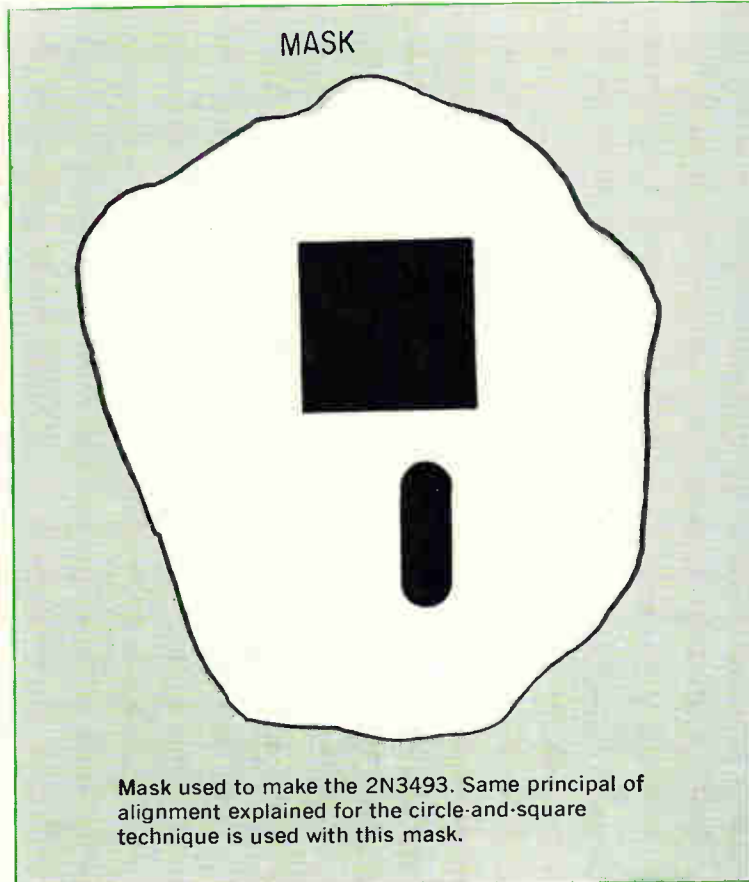

Mask used to make the 2N3493. Same principal of alignment explained for the circle-and-square technique is used with this mask.

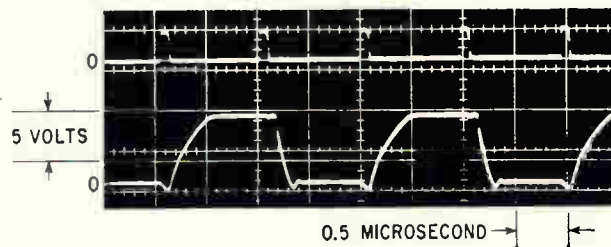
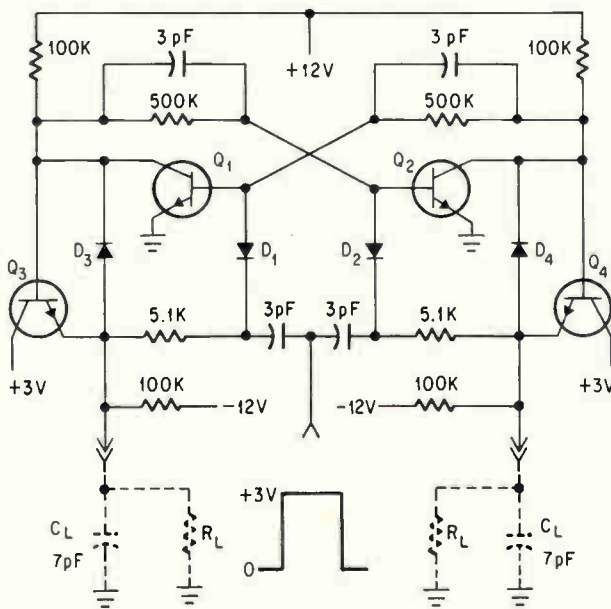

small pattern fits exactly into the larger base area.

Every mask pattern on the wafer, shown top left, p. 81, will have the same relative orientation between the large and small patterns. This step forms the etched-clean region for the emitter diffusion. After the emitter diffusion, the mask is again used to allow a cut to be made through the oxide over the base region so that a contact can be made to this area, shown in the top right diagram on page 81.

Finally, a different mask is used for the formation of the metal contact areas. The spacings for this mask are not as critical as they are for the other steps. The spacings between the various etch-cut areas can be made very small and virtually every device on the wafer will have exactly the same spacing.

This is the method used to make the 2N3493 micropower switching transistor, a device with a collector-to-base junction capacitance of approximately 0.1 picofarad. The metal bonding area adds another 0.1 picofarad and the package adds still another 0.2 picofarad. With these low values of capacitance, the 2N3493 can switch rapidly at current levels in the microampere region. The active area of the 2N3493 occupies fewer than  $8 \times 10^{-7}$

Low-power flip-flop circuit using 2N3493 micropower transistors. The circuit power drain is only 6.6 milliwatts.

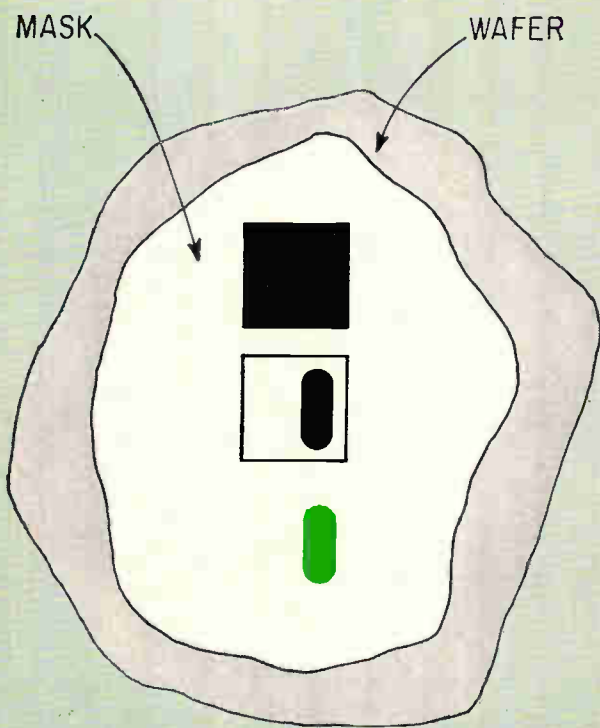

Accurate alignment of the two patterns is shown in the center. Lower pattern is leftover from the first masking process.

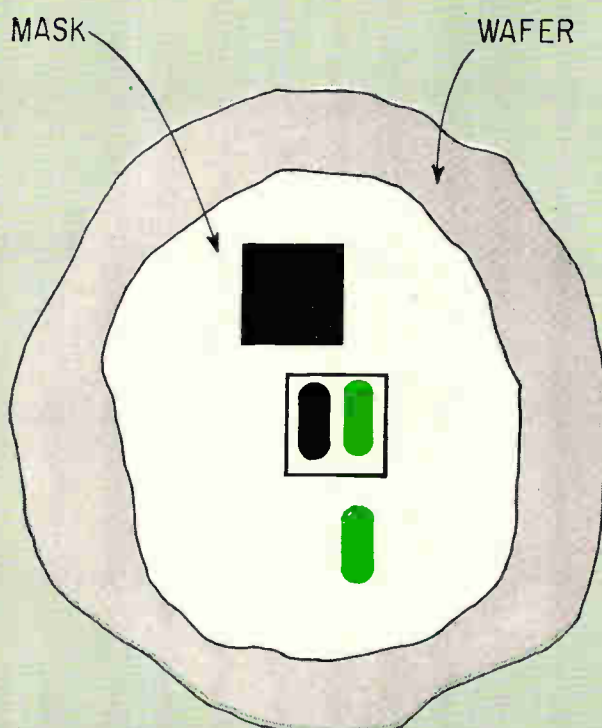

The same mask is reused twice. The first reuse aligns the two patterns. The second reuse produces a pattern for the base contact.

square inches, which is less than 1/500 of the area of the chip on which it is made.

### Micropower flip-flop

The flip-flop circuit shown on page 80 illustrates the performance available from the 2N3493. Circuit capacitance values were empirically determined because stray circuit capacitance and the capacitance of components such as resistors and sockets made it difficult to determine the exact capacitance of the 2N3493.

The on collector currents for the flip-flop transistors,  $Q_1$  and  $Q_2$ , are about 120 microamperes. The emitter-follower transistors,  $Q_3$  and  $Q_4$ , drive load currents up to 1 milliamperes and load capacitance up to 50 picofarads. Diodes  $D_1$  and  $D_2$  couple the negative-going waveform directly to the load when  $Q_1$  or  $Q_2$  turn on. In this way a fast transition time is obtained even when the emitter followers are being turned off. The emitter-follower transistors, however, are not allowed to turn off completely; the -12 volt supply maintains a minimum current of 120 microamperes to speed the recovery of the trigger network.

A pnp transistor complementary to the 2N3493, now being developed, will permit the use of complementary circuitry, further enhancing the speed-power performance.

### R-f amplifier

Transistors made by this new manufacturing

technique are being evaluated for small-signal r-f amplifier applications. Because of negligible capacitance between the various device regions, these r-f amplifier transistors are stable over a wide current and frequency range and can operate at power gains approaching their maximum available gain without the need for any neutralization circuitry.

### The authors



Robert W. McGinnis came to Motorola, Inc., from Bell Telephone Laboratories. Before embarking on his current assignment, integrated-circuit research and development, he handled the development of the 2N3493 micropower transistor.



William D. Roehr is the manager of the circuit-assembly design section. He has been with Motorola since graduating from San Jose State College in California in 1957. He provides circuit-design support to Motorola's field personnel and customers.

# Impedance matching with nonlinear loads

The right filter can eliminate or exploit harmonics to provide maximum transfer of power

By M. Bryan Covington Jr. and Alan I. Sinsky

Bendix Corp., Baltimore

**Harmonic currents** flowing from the generator to a nonlinear load can improve or lessen circuit efficiency, depending on how the designer handles impedance matching. In some circuits impedance mismatching can be avoided by using an all-harmonic rejection filter in either the generator or load circuits. In other cases, described later, the designer retains the harmonic currents and puts them to work to increase circuit efficiency.

Impedance matching is most commonly used to obtain maximum power transfer from a generator or source of power to a load. A transformer or a network of reactances changes the load impedance to a value that will allow the source to deliver maximum power.

In linear circuits the transformed load impedance can be made equal to the complex conjugate

of the source impedance. However, for sources like tetrodes, pentodes and transistors, where output voltage limiting may occur, maximum power transfer does not occur when the load impedance is matched to the source impedance because of the effects of the voltage limiting.

The choice of transformer depends primarily on the frequency of operation. With untuned loads at low frequencies, the transformation can be accomplished most easily by an iron-core transformer. At frequencies of 200 kilocycles to 100 megacycles per second the same result can be obtained by resonant coupling. At still higher frequencies, lumped constant techniques are not practical, but an impedance match can still be attained with quarter-wave transmission-line transformers and other distributed constant matching devices formed from open-conductor coaxial or waveguide transmission lines.

Most engineers are familiar with matching techniques for loads consisting entirely of linear elements. In the case of nonlinear loads, matching is not as simple or as well understood. Nonlinear components are considered those whose impedance values are not fixed but rather are a function of the applied current or voltage. The impedance of nonlinear components can be resistive (rectifier or detector diodes, varistors); inductive (saturable reactors), or capacitive (varactor diodes).

The basic reason for the difficulty in matching to the impedance of nonlinear loads is that the application of a single-frequency sinusoidal voltage produces a resultant current waveform containing not only the fundamental but also harmonic components. If no consideration is given to these harmonics flowing in the load, the designer will have difficulty making a satisfactory impedance match.

Typical load circuits containing nonlinear de-

## The authors



M. Bryan Covington contributed to the design of power amplifier circuits for the Spadat radar. He has been associated with the Electronically Steerable Array Radar (ESAR) program since its inception in 1958 and directed the ESAR design group which developed a 30-kilowatt transmitter module for L-band operation.



With Bendix since 1957, Alan I. Sinsky was responsible for the design of the transmitter module for the Spadat radar. He participated extensively in the design, development and evaluation of transmitter components for the ESAR AN/FPS-46 (XW-1).

vices of the three basic types—rectifier diode, saturable reactor, varactor diodes—are shown below. The nonlinear device is outlined and the primary path of the harmonic currents is indicated.

Since the spectrum covered by nonlinear devices ranges from subaudio to microwave frequencies design problems with nonlinear loads are not confined to any one range.

For a general understanding of matching to nonlinear loads, consider a series circuit consisting of a perfect rectifier and a resistive load. Three possible ways to operate this circuit are: a) without a filter, b) with a second-harmonic rejection filter, such as a simple parallel-tuned circuit resonant at the second harmonic frequency and with negligible reactance at all other frequencies, and c) with an all-harmonic rejection filter. The filters may be located in either the generator or load sections of the circuit. Input voltage, output current, and filter-voltage waveforms for a circuit are shown on page 85.

Determining the circuit components for maximum transfer of power is the most difficult for case b, requiring trial and error to obtain the desired cur-

rent waveform (the sum of the voltages across the generator, diode, filter and load must equal zero). The current waveforms shown apply for a load resistance of one ohm with a one-volt peak input.

Complete elimination of harmonic currents can be achieved in case c. The current and voltage waveforms obtained are unusual in that the output current waveform contains fundamental plus d-c components, but no harmonics. In this arrangement, the output fundamental waveform is a sine wave of the same frequency as the generator. The d-c component is represented by the displacement of the sine wave above the horizontal axis. The waveform of the voltage across the filter does not contain fundamental and d-c components, since the impulse created by the diode exactly cancels both the fundamental and d-c components. Some of the data obtained with and without filters is tabulated in the table shown on page 84.

The tabulated results show the effect of the filters on the effective load  $R_{IN}$  seen by the generator, and efficiency. The variation in  $R_{IN}$  illustrates the effect on the input match to a non-linear load, if consideration is not given to harmonic current flow.

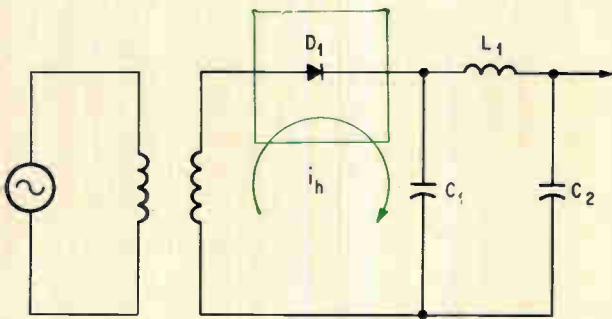

Typical rectifier load circuit consisting of rectifier diode  $D_1$  and a filter consisting of  $C_1$ ,  $C_2$  and  $L_1$ .

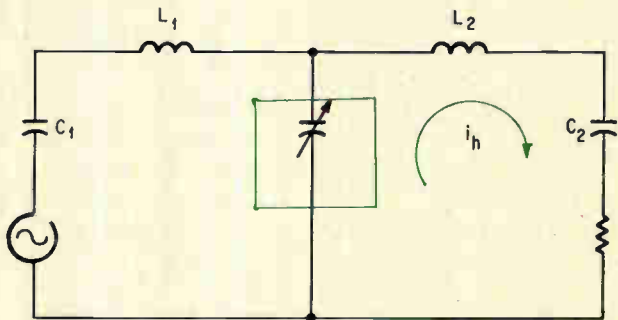

Varactor multiplier circuit.  $C_1$  and  $L_1$  are tuned to the fundamental frequency.  $C_2$  and  $L_2$  are series tuned to the desired harmonic frequency.

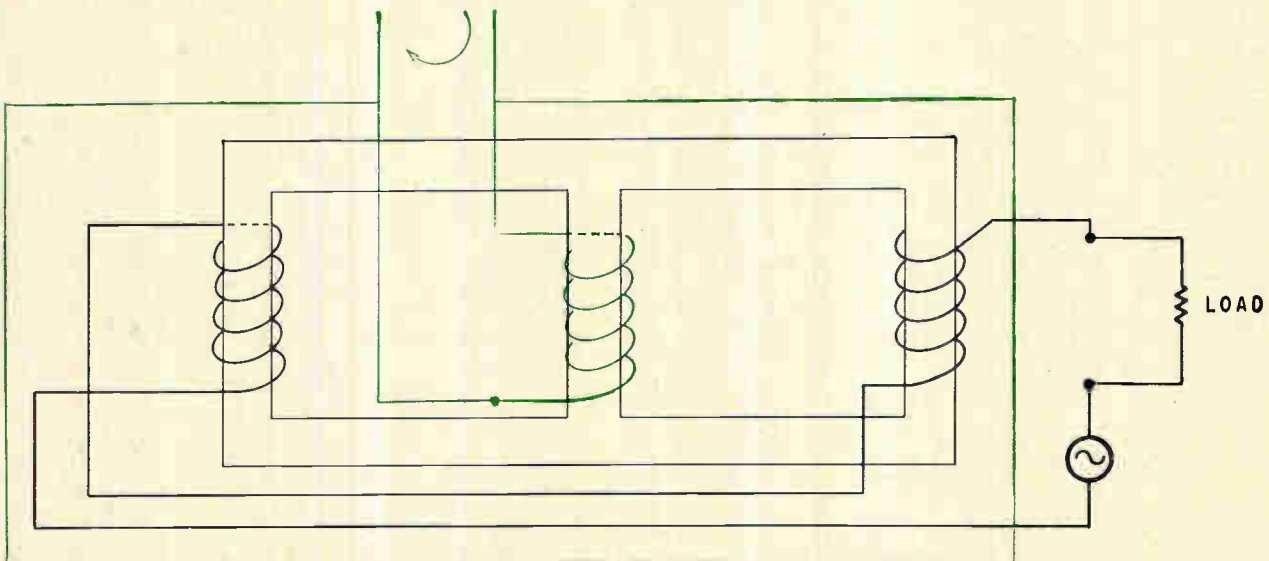

Magnetic amplifier load circuit. The current flowing through the center winding controls the reluctance of the magnetic circuit.

# Comparison of modes of operation

Filter	Funda-mental current $I_1$ (peak) (amperes)	Effective load seen by generator $P_{IN}$ (ohms)	Power delivered to load $P_{IN}$ (watts)	$I_{DC}$ (amperes)	Funda-mental power delivered to load $P_1$ (OUT) (watts)	D-c power delivered to load $P_{DC}$ (watts)	Harmonic power delivered to load $P_{HAR}$ (watts)	Eff = $\frac{P_1(OUT)}{P_{IN}}$	Con-duction angle
None.....	0.50	2.00	0.250	0.32	0.125	0.099	0.026	0.50	180°
2nd harmonic.....	0.42	2.38	0.210	0.34	0.088	0.113	0.009	0.42	214°
All harmonic (low pass)	0.33	3.00	0.167	0.33	0.056	0.111	0.000	0.33	~360°

The principles discussed may be applied to the design of matching circuits to take advantage of nonlinear load characteristics or to reduce the problems caused by harmonic currents.

One example of the former is to insert an all-harmonic reject filter into the input of a cathode-driven class B amplifier circuit. Under this condition the tube will always operate with current and voltage waveforms like those shown for case c, regardless of the drive level. This means that an ampli-

tude-modulated signal can be amplified in a class-A mode but with twice the plate efficiency possible with the conventional class-A amplifier. The plate current waveforms that exist in a conventional class-A amplifier and in the class-B amplifier with the all-harmonic filter are compared at right. The higher efficiency of the class-B amplifier results from the reduced average plate current required of the plate supply. Unlike the conventional class-B amplifier which has 180° conduction angle, a 360° conduc-

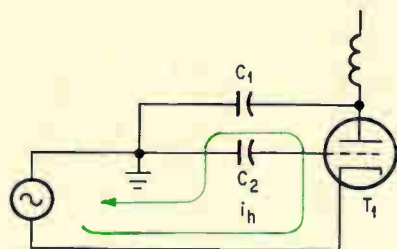

Input circuit for a cathode-driven amplifier. Capacitors  $C_1$  and  $C_2$  are electrode voltage blocking capacitors.

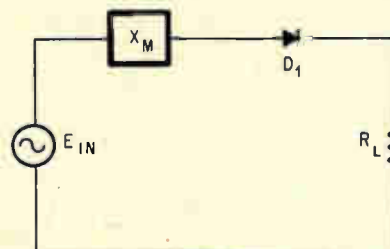

Simple equivalent circuit for a generator stage and a rectifier load. The reactance  $X_m$  represents the total impedance to the flow of harmonic current caused by a filter in either stage.

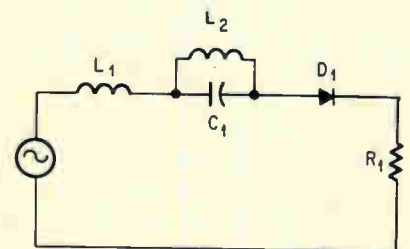

Tuned rectifier circuit. The transformer leakage inductance is represented by  $L_1$ . Capacitor  $C_1$  is series resonant with  $L_1$  at the fundamental frequency.  $L_2$  provides d-c bypass for  $C_1$ .

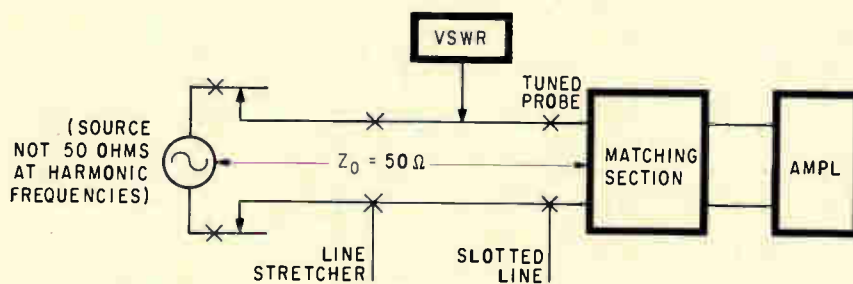

Circuit for measuring input match as a function of input cable length.

CLASS A AMPLIFIER

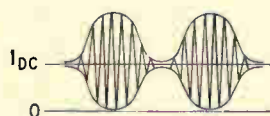

CLASS B AMPLIFIER WITH FILTER

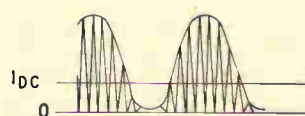

Waveforms represent plate current obtained for amplitude-modulated signals with class-A and class-B amplifiers. The class-B amplifier includes a harmonic rejection filter.

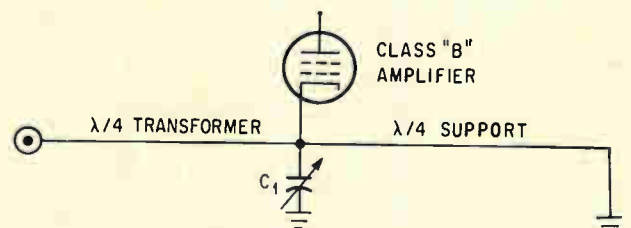

Input matching section for cathode-driven amplifier. Capacitor  $C_1$  serves as a trimmer and a harmonic current bypass capacitor.

INPUT VOLTS

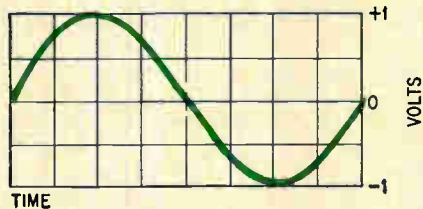

OUTPUT CURRENT  
CASE (a)  
NO FILTER

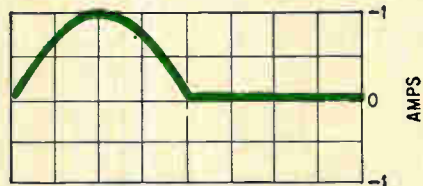

CASE (b)  
2ND HARMONIC  
FILTER



CASE (c)  
ALL HARMONIC  
FILTER

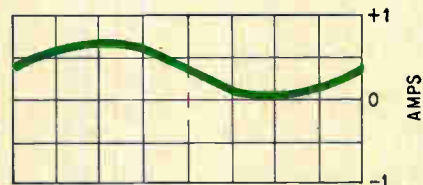

FILTER VOLTS

CASE (b)  
2ND HARMONIC  
FILTER

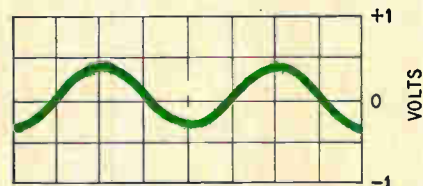

CASE (c)  
ALL HARMONIC  
FILTER

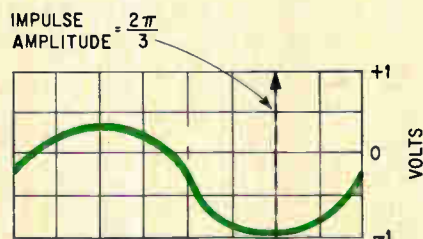

Top waveform is the generator voltage. The other waveforms depict the circulating currents and the filter voltages for the top, center circuit on page 84.

tion angle is achieved, resulting in reduced harmonic generation in the output.

To avoid the problems caused by harmonic currents, designing a typical amplifier for class-B operation can be considered. In the design of cathode-driven class-B power amplifiers for use at ultrahigh frequencies, a common procedure is to design a matching section between the amplifier input and a standard 50-ohm coaxial input line at the fundamental frequency. If harmonic currents are not properly shunted in the matching section, the length of transmission line between the load and the source affects the circulation of harmonic current and results in variations of impedance and power output as a function of cable length.

Referring to the impedance measuring circuit on page 84, this would be demonstrated by a varying VSWR on the slotted line section as a function of line-stretcher position. It would also be possible to observe a variation in harmonic voltage on the line as a function of line stretcher position.

The solution to this problem is to insert a shunt path within the matching section network for all higher harmonics so that no harmonic voltages are built up at the amplifier input terminals. In the case of microwave amplifiers it is essential that higher-order input cavity modes be checked to assure that resonance does not occur at harmonics of the input frequency. This harmonic bypass approach can be used both to stabilize and control the input match of microwave amplifiers. One possible configuration which can be used is shown at the bottom right of page 84.

The variable capacitor serves the dual purpose of compensating for tube variations and providing a bypass for harmonic currents. Typically, input VSWR's of 1.2:1 can be maintained regardless of the variation in generator impedance. These particular amplifiers have been used in the 500-Mc range but the results apply at any frequency.

In the tuned rectifier circuit shown on page 84, the regulated output will be affected by the leakage inductance in series with the diode rectifier. It is incorrect to assume that regulation might be improved by tuning out the circuit inductance by means of a series capacitor. The series inductance,  $L_1$ , represents the sum of transformer and circuit inductances. The parallel inductance,  $L_2$ , provides a d-c path around the capacitor. This circuit approaches the ideal all-harmonic rejection filter described in case c. This approach to matching would be correct only if a linear element was involved but is not the correct solution when the nonlinear diode is included. Actually, the regulation will be degraded by the addition of a series capacitor. The only solution in the case of this nonlinear circuit is to decrease the series inductance.

The input match can be affected by as much as 50% and the fundamental current efficiency by as much as 33% in a rectifier or class-B amplifier circuit by insufficient compensation in the matching network for harmonic currents.

# Designer's casebook

Designer's casebook is a regular feature in Electronics. Readers are invited to submit novel circuit ideas, packaging schemes, or other unusual solutions to design problems. Descriptions should be short. We'll pay \$50 for each item published.

## Pulse width converted to pulse sequence

By Carl A. Budde

Electronic Specialty Co., Los Angeles

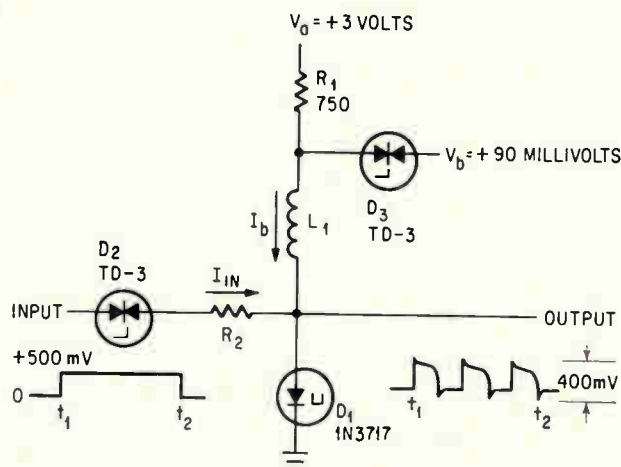

Inductance value of  $L_1$  and input pulse length determines the number of pulses in the output series.

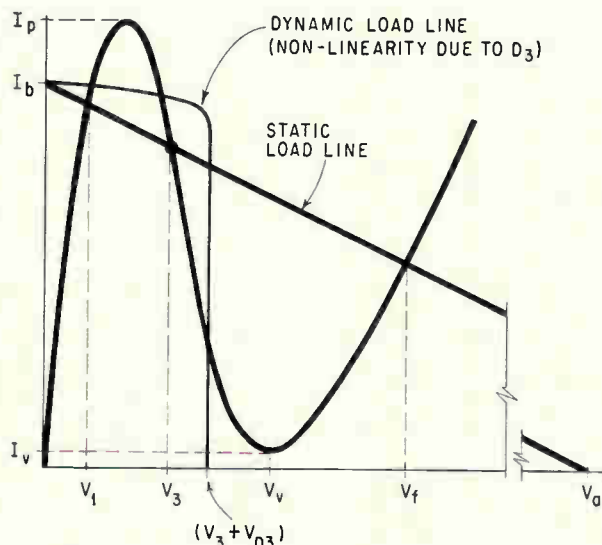

A tunnel-diode one-shot multivibrator, shown at the left, can produce a number of pulses in series, proportional to the width of an input pulse. This circuit eliminates the need for a continuously running clock pulse, and can be used in analog-to-digital hybrid systems.

Initially, the tunnel diode is biased below its peak current level  $I_p$ , and the voltage across it is  $V_1$  (55 millivolts for type 1N3717). The value of resistor  $R_1$  required to bias the tunnel diode in this state is

$$R_1 = \frac{V_0 - V_1}{I_b}$$

where the bias current  $I_b = 0.8 I_p$  and  $V_b$  is the applied voltage.

To assure sufficient drive and fast turn-on, the input current  $I_{in}$  must be  $1.1 I_p - I_b$ . The operating point is  $V_3 = \frac{1}{2} (V_v + V_p)$  and the bias voltage is  $V_b = V_3 - V_{D3}$ , where  $V_{D3}$  is the voltage drop across backward diode  $D_3$  during switching.

When the current  $(I_{in} + I_b)$  through the tunnel diode exceeds  $I_p$ , the tunnel diode starts to switch toward its high voltage state,  $V_t$ . When this happens, the current in inductor  $L_1$  decreases towards  $I_v$ .

The bias voltage  $V_b$  and the voltage across the dynamic impedance of  $D_3$  does not exceed the valley voltage  $V_v$  during the switching time. This insures that the current will decrease until  $I_v$  is reached and  $D_1$  reverts to its low-voltage state.

Backward diode  $D_3$  establishes the load line for the tunnel diode. When  $D_2$  is in its low-voltage state, bias current builds up via resistor  $R_1$  and not through the back-biased backward diode  $D_3$ . A large resistor  $R_1$  reduces the circuit recovery time constant  $\tau = L_1/R_1$ .

The value of  $L_1$  is determined by the required pulse width, and the following simple approximation:

- $V_1$  is the voltage across the tunnel diode when it is biased in the low voltage state by  $I_b$ .  $V_3$  is the circuit operating point. The tunnel diode will be driven to the valley point  $I_v$ , because the voltage  $V_3 + V_{D3}$  is less than the valley voltage  $V_v$ . The knee in the dynamic load line is due to the zener characteristic of  $D_3$ .



$$L_1 = P.W. \left( \frac{V_{D3}}{I_b - I_v} \right)$$

For example, if a series of one microsecond pulses is required, and the voltage and current conditions in the circuit are  $V_{D3} = 90$  millivolts,  $I_b = 4$  milliamperes and  $I_v = 0.1$  ma;  $L_1$  must be 25.7 microhenries.

The recovery time, required by the circuit to reset before another pulse can be generated, is given by

$$T_r = \frac{L_1}{R_l} \ln \left( \frac{V_3 - R_l I_v}{V_3 - R_l I_p} \right)$$

$$\text{where } R_l = \left( \frac{V_1}{I_b} \right) - \left( \frac{V_{D3}}{I_b - I_v} \right)$$

In the circuit given, the recovery or interpulse time calculated from this expression is  $T_r = 1.9$  microseconds.

## New ways to improve transistor bias stability

By Leonard L. Kleinberg and  
Richard C. Lavigne

National Aeronautics and Space Administration  
Goddard Space Flight Center, Greenbelt, Md.

**The limitations** of monolithic microcircuit manufacturing techniques restrict the maximum resistance value that can be used in a microcircuit to 100,000 ohms. Because of this, a number of standard circuits, when constructed in microcircuit form, had to be redesigned for minimum quiescent power dissipation and maximum bias voltage stability.

A method of biasing a grounded-emitter amplifier that results in significant quiescent voltage stability and minimum power dissipation is shown in the circuit diagram at the right. Transistor  $Q_2$  stabilizes the quiescent output voltage of the amplifier transistor  $Q_1$ . The expression for the output voltage variation as a function of the transistor betas and base-emitter voltage variation can be obtained as follows:

$$E_{OUT} = E_C - I_1 R_M$$

Since the base-emitter voltages for similar transistor types are almost always equal

$$I_2 = \frac{E_C - 2E_{be}}{R_{B2}}$$

and the base current of  $Q_1$  is also the base current of  $Q_2$

$$I_{B2} = \frac{E_C - 2E_{be}}{\beta_2 R_{B2}} = I_{B1}$$

$$I_1 = \beta_1 I_{B1} = \frac{\beta_1 (E_C - 2E_{be})}{R_{B2} \beta_2}$$

Solving the first equation for  $I_1$

$$I_1 = \frac{E_C - E_{OUT}}{R_M}$$

and equating the result with  $I_1$  from above

$$\frac{E_C - E_{OUT}}{R_M} = \frac{(E_C - 2E_{be}) \beta_1}{R_{B2} \beta_2}$$

Solving for  $E_{OUT}$

$$E_{OUT} = E_C - \frac{E_C R_M \beta_1}{R_{B2} \beta_2} + \frac{2E_{be} R_M \beta_1}{R_{B2} \beta_2}$$

Taking the total derivative of  $E_{OUT}$  with respect to  $E_{be}$ ,  $\beta_1$  and  $\beta_2$  gives

$$dE_{OUT} = \frac{2R_M \beta_1 dE_{be}}{R_{B2} \beta_2} + \left[ \frac{2E_{be} R_M - E_C R_M}{R_{B2}} \right] \left[ \frac{\beta_2 d\beta_1 - \beta_1 d\beta_2}{\beta_2^2} \right]$$

The second term of this expression becomes neg-

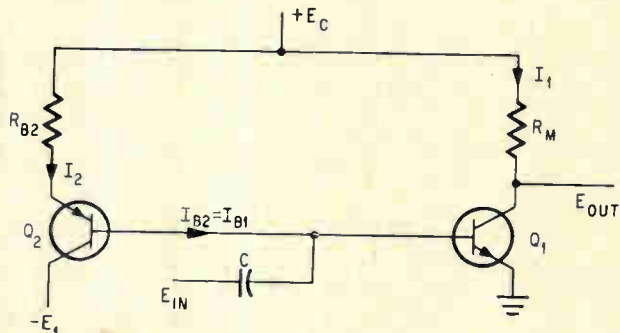

Transistor  $Q_2$  provides bias current for  $Q_1$  and stabilizes the quiescent output voltage. For transistors with high and approximately equal  $\beta$ 's, equal  $\beta$  thermal variations, and  $R_{B2} = 2R_M$ , the output voltage stability is equivalent to the thermal stability of the base-emitter voltage drop. (Assuming the base-emitter voltage drop and thermal stability are approximately equal for  $Q_1$  and  $Q_2$ ). In the circuit tested  $Q_1 = 2N930$ ,  $Q_2 = 2N2605$ ,  $R_{B2} = 100K$  and  $R_M = 50K$ .

ligible, especially for  $\beta_2 > 50$ , and the equation reduces to

$$dE_{OUT} \approx \frac{2R_M \beta_1 dE_{be}}{R_{B2} \beta_2}$$

In the circuit shown, the resistor values were selected to maintain the ratio

$$\frac{\beta_1}{\beta_2} = \frac{R_{B2}}{2R_M}$$

The quiescent output voltage variation caused by changes in  $\beta$  (due to temperature and aging), reduces to the simple relation

$$dE_{OUT} = dE_{be}$$

When the circuit was subjected to a temperature change of  $40^\circ\text{C}$ , the output voltage variation was approximately 110 millivolts, about 10 millivolts more than expected; this was attributed to changes in circuit resistor values and unequal variations of

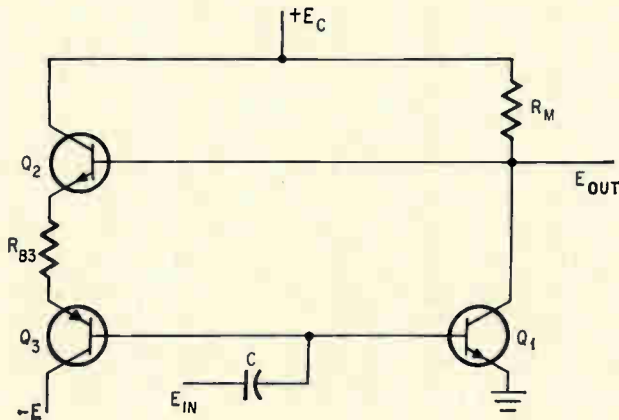

Self-biasing is achieved through the addition of a transistor connected in a feedback configuration between the output voltage and the bias network.  $Q_1=Q_2=2\text{N}930$ ,  $Q_3=2\text{N}2605$ , and  $R_{B3}=R_M=100\text{K}$ .

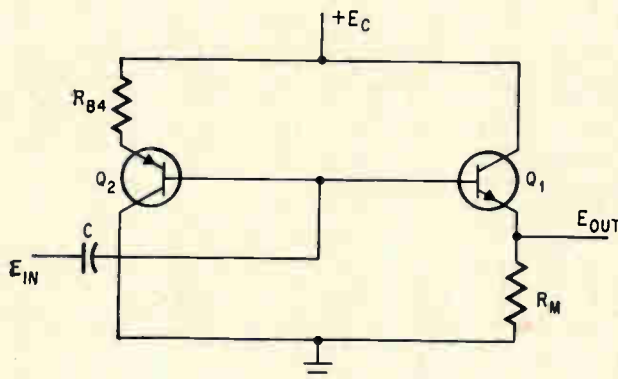

Transistor-biased emitter follower has output voltage stability similar to that of the transistor-biased grounded-emitter amplifier. Input impedance of transistor-biased emitter follower is  $\beta$  times greater than the input impedance of a resistor-biased emitter follower.  $Q_1=2\text{N}930$ ,  $Q_2=2\text{N}2605$  and  $R_{B4}=R_M=100\text{K}$ .

$\beta_1$  and  $\beta_2$  with temperature.

With  $E_C = +20$ -volts and  $R_{B2} = 100$  Kilohms, only 5 milliwatts is dissipated in the bias circuit and 8 mw in  $Q_1$  and  $R_M$ .

The top circuit on the left is similar to the preceding circuit, but the bias stability is achieved by self-biasing through transistors  $Q_2$  and  $Q_3$ . The output voltage is given by

$$E_{OUT} = \frac{E_C + 3E_{be} \left( \frac{R_M \beta_1}{R_{B3} \beta_3} \right)}{1 + \frac{R_M \beta_1}{R_{B3} \beta_3}}$$

When  $\frac{R_M}{R_{B3}} = \frac{\beta_3}{\beta_1}$  and  $d\beta_1 = d\beta_3$

the change in output voltage is  $dE_{OUT} = 3dE_{be}$ .

The bottom circuit shown is a transistor-biased emitter-follower. The quiescent output voltage is given by

$$E_{OUT} = (E_C - 2E_{be}) \left[ \frac{R_M}{\left( \frac{\beta_2}{\beta_1} \right) R_{B4} + R_M} \right]$$

and the stability of the output voltage is

$$dE_{OUT} = -dE_{be}$$

when  $\frac{\beta_1}{\beta_2} = \frac{R_{B4}}{R_M}$  and  $d\beta_1 = d\beta_2$ .

The input impedance of this emitter follower is

$$Z_{IN} = \frac{\beta R_M}{2}$$

(where  $\beta = \beta_1 \approx \beta_2$ ) and is approximately  $\beta$  times greater than the input impedance of a typical resistor-biased emitter follower.

Typical values of  $dE_{be}$  and  $d\beta$  are 2.5 mv/degree C and 0.6 percent/degree C, respectively.

## Multi's output duration controlled by input

By Joseph R. Giroux

Raytheon Co., Whalen, Mass.

An input pulse of T milliseconds duration applied to the circuit on the next page, produces an output pulse T + 96 milliseconds long. This circuit can be applied in systems where the duration of an available pulse must be extended so that a control or protective function can be maintained for a longer period.

The basic circuit consists of a Schmitt trigger

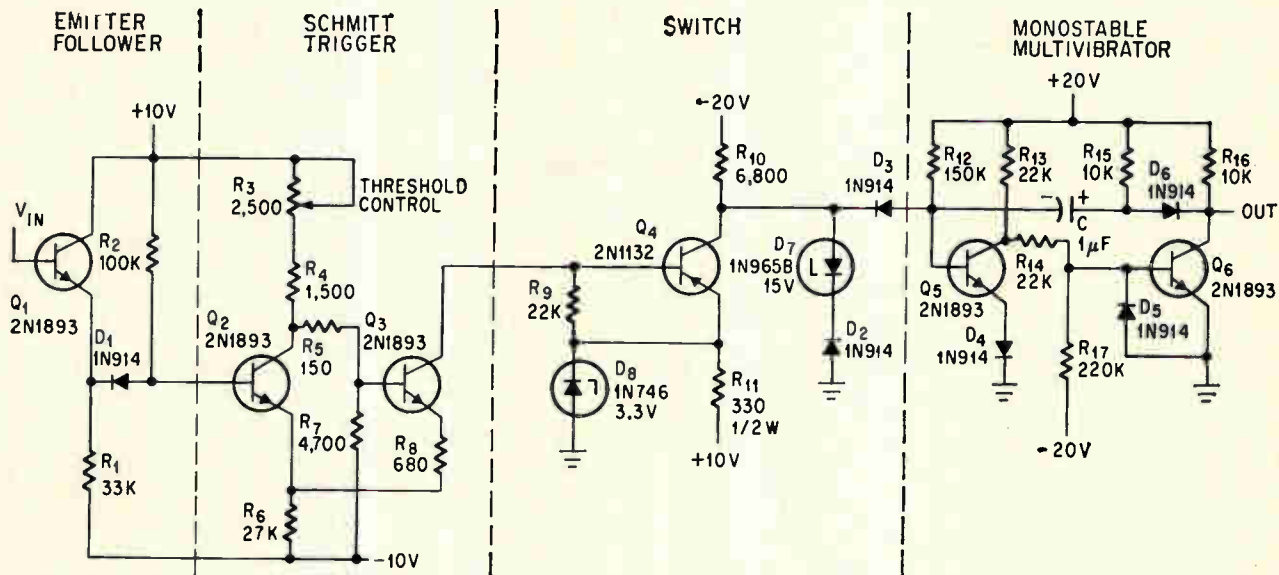

Output pulse is 96 milliseconds longer than input pulse. The monostable multivibrator is turned on simultaneously with the Schmitt trigger. The switch isolates the multivibrator from the circuit and prevents the capacitor from discharging while the Schmitt trigger is on. When the Schmitt trigger turns off, the capacitor discharges through  $R_{12}$ , and the multivibrator remains in the on state for its basic period.

and a monostable multivibrator coupled by a transistor switch.

When the monostable multivibrator is triggered, it remains in the on state as long as  $V_{IN}$  is above the threshold level of the Schmitt trigger. As  $V_{IN}$  drops below the turn-off level of the Schmitt trigger, the multivibrator performs normally, its output pulse duration determined only by its R-C time constant (in this circuit,  $R_{12}$  and C).

The circuit operates as follows:

The Schmitt trigger is off when the amplitude of  $V_{IN}$  is less than the threshold level. Thus,  $Q_2$  is cut off and  $Q_3$  conducts. The emitter voltage of  $Q_4$  (approximately equal to the collector voltage of  $Q_3$ ) must be high enough so that the Schmitt trigger action is not disturbed by saturating  $Q_3$ . The  $Q_4$  emitter voltage must also be high enough to isolate the multivibrator through  $D_3$ . The collector current of  $Q_3$  is essentially the base current of  $Q_4$ , and is large enough to saturate  $Q_4$ . When  $Q_4$  is saturated, its collector is at +3.2 volts. The base of  $Q_5$  is at +1.2 volts, back-biasing  $D_3$  and isolating the multivibrator. Diode  $D_2$  prevents forward conduction in the zener diode  $D_7$  when  $Q_4$  is saturated.

When the Schmitt is triggered, the collector current of  $Q_3$  and the base current of  $Q_4$  are zero. The voltage developed at the collector of  $Q_4$  due to zener diode  $D_7$ , triggers the multivibrator and holds the base of  $Q_5$  negative to prevent the discharge of the one-microfarad timing capacitor.

The multivibrator is isolated by the back-biased diode  $D_3$  and returns to its original state 96 milli-

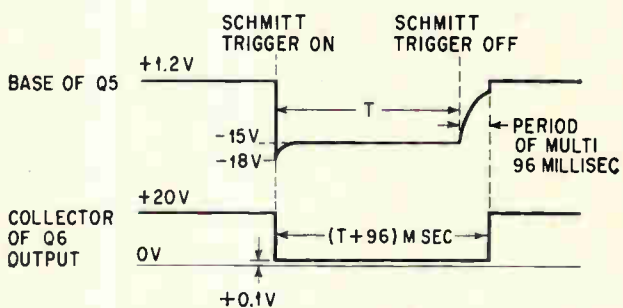

Input pulse turns Schmitt trigger on for a time, T, and the multivibrator is turned on for the same length of time. When the Schmitt trigger is turned off, the multivibrator remains in the on state for a period determined by  $R_{12}$  and capacitor C.

seconds after the Schmitt trigger is turned off. A 5% variation in the zener voltage of  $D_7$  results in only a 1% change in the multivibrator period.

The 96-millisecond period of the multivibrator has been increased by an amount equal to the length of the input trigger.

In the emitter-follower,  $D_1$  and  $R_2$  provide compensation for the temperature variation of the  $Q_1$  base-emitter voltage.

The value of resistor  $R_9$  (in this circuit  $R_9$  is 22,000 ohms) connected to the collector of  $Q_3$  and the base of  $Q_4$ , must be large enough for only a negligible amount of  $Q_3$  collector current to be diverted from the base of  $Q_4$ . If a germanium transistor is used for  $Q_4$ ,  $R_9$  must be small enough to divert any  $I_{CBO}$  current so that  $Q_4$  will not be continuously saturated at higher temperatures.

# Monkeys and microelectronics

Tiny receiver, tied to animal's head, receives orders that alter his behavior and give clues about his brain

By William Liben

Johns Hopkins University, Silver Springs, Md.

**Even by monkey standards**, Gog, Domi and Mal act strangely.

Their behavior changes instantaneously from passive to hyperactive and from friendly to aggressive and back again. They jerk their arms and legs involuntarily. Right after a meal that would make an ordinary monkey avoid food for hours, Gog sometimes puts away another dinner unashamedly.

Their behavior, which is studied closely by scientists at the National Institute of Mental Health, is governed by electrodes in the animals' brains. For the experiments, a seven-ounce microelectronic receiver is tied to a monkey's head and the animal reacts to signals sent by medical researchers at the other side of the room.

The doctors are studying variations in the animals' reactions to electronic stimuli on the brain. One specific goal is to see whether a monkey free to wander within a plastic cage reacts differently from one in a restraining seat that's similar to a baby's high chair, with only holes for arms, legs and tail.

## Electronics on the brain

The seven-ounce receivers were designed at the Applied Physics Laboratory of Johns Hopkins University. Their pulsed outputs are applied through electrodes that have been surgically inserted inside the monkeys' skulls.

One problem that had to be considered in designing the receiver was that the brain of a living animal presents a variable resistive load of from

2,500 to 10,000 ohms. For this experiment it was vital to keep current to the brain constant at all times.

Pulses of a specific frequency and amplitude, applied at specific points on the brain, have been found to result in specific actions by the monkey. The output signals vary from zero to one milliamperere at repetition rates up to 300 pulses a second and at widths up to 10 milliseconds.

To make the receiver small, light and self-powered, the designers relied on thin-film techniques. Even the antenna is contained within the housing and unaffected by stray signals. As a byproduct of their work, the engineers have an exceptional opportunity for using and evaluating different fabrication methods for thin-film microelectronics.

The transmitter had no size requirement, so its construction posed no problems.

## Mercury cells for power

Solar cells were ruled out as a power supply for the receiver because the illumination in the laboratory is inadequate. The designers decided to power the receiver with dry cells.

The receiver must operate continuously until the batteries run down. Since it is impossible to check the pulses during operation, it is important that the batteries' voltage be maintained constant during their lifetime. For this reason, mercury cells were selected. The mercury cell's output voltage is almost constant during the cell's useful life. It is an efficient power source for its size and weight.

Nine mercury cells, each rated at 1,000 milliamperere-hours, are connected in series to supply 12 volts to the receiver for about 150 hours of continuous operation. This represents a good design voltage and adequate life. The cells weigh 110 grams and account for about half of the receiver's weight.

## The transmitter

The operation of the transmitter can be understood with the help of the block diagram at the

### The author



William Liben is in charge of microelectronics research engineering at Johns Hopkins University's Applied Physics Laboratory. He received his doctorate from the Massachusetts Institute of Technology.



Gog a rhesus monkey, raises his right hand on command

bottom of this page. Multivibrator  $M_1$  produces d-c pulses of controlled width and repetition rate. Multivibrator  $M_2$  produces a continuous sinusoid of frequency that can be varied between 100 and 500 kilocycles per second.

When the outputs of  $M_1$  and  $M_2$  are added, the result is a series of bursts of frequency  $f$ , whose repetition rate is fixed by  $M_1$ . The frequency, pulse width and repetition rate are independently controlled by the transmitter. The added pulses are applied to gated mixer,  $B_2$ .

The 15-megacycle output of oscillator  $B_1$  is applied simultaneously to the gated mixer. Normally,  $B_2$  is biased off. When a pulse arrives,  $B_2$  turns on and the r-f pulse amplitude-modulates the 15-megacycle sine wave at frequency  $f$ . The output of gated mixer  $B_2$  is amplified to a suitable level for driving the antenna. The r-f power amplifier can supply peak power pulses of 50 watts. The transmitter is contained in two sections as shown below.

### The receiver

The receiver circuit is shown at the top of page 92. The antenna is coupled to a two-stage amplifier (first substrate). Feedback is used to increase gain at 15 megacycles. One path is provided by the bypass capacitor connected across the emitter resistor of transistor  $Q_{15}$ . The other is provided by the 75-picofarad capacitor connected to the emitter of  $Q_{14}$ . Some negative feedback also occurs through the 51,000-ohm resistor connected between the collector and base of  $Q_{15}$ .

The following two stages (second substrate) perform the functions of initial r-f detection, amplification, filtering, limiting and frequency discrimination. The signal applied to the discriminator is an r-f

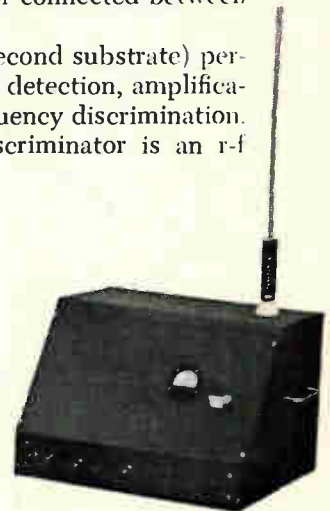

Transmitter, housed in two sections, fabricated with discrete components. Low-power section is at left; high-power section and antenna are at right.

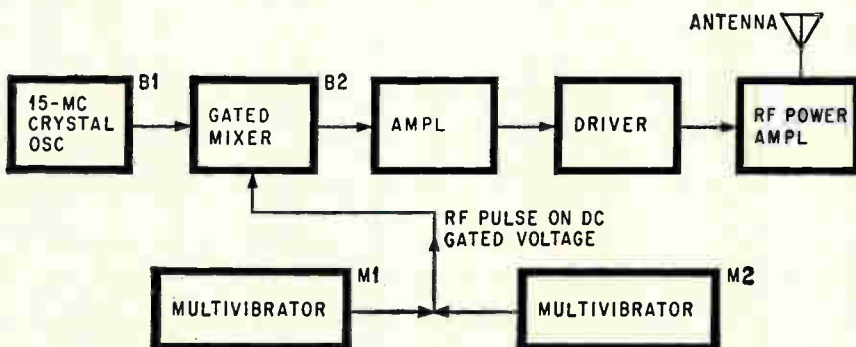

Power amplifier stage of transmitter provides peak power pulses up to the 50 watts needed to overcome the receiver insensitivity that is due to the short antenna.

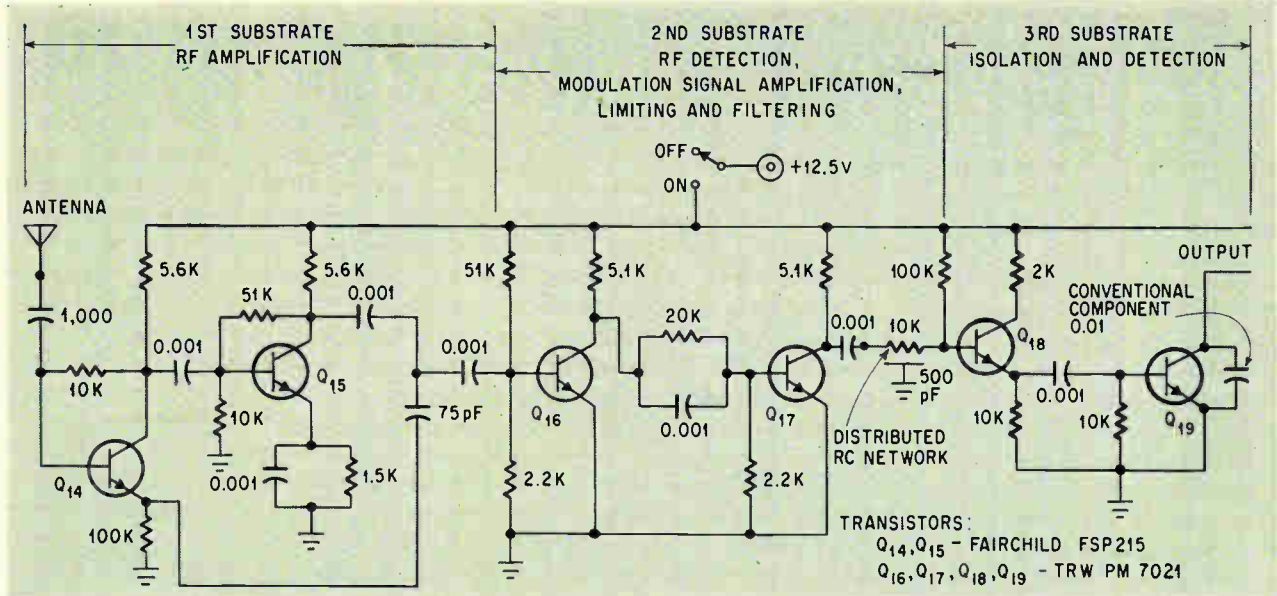

Microelectronic receiver circuit uses three substrates containing thin-film passive components. Each substrate also contains two transistor chips cemented in place. A fourth substrate provides for terminal connections; it also holds a 0.01-microfarad capacitor, the only conventional component used in the receiver.

One of four metal evaporation masks used in making the receiver. Openings are etched to a copper sheet mounted in a steel frame. Only four masks were required to perform the sequence of six depositions in the vacuum chamber.

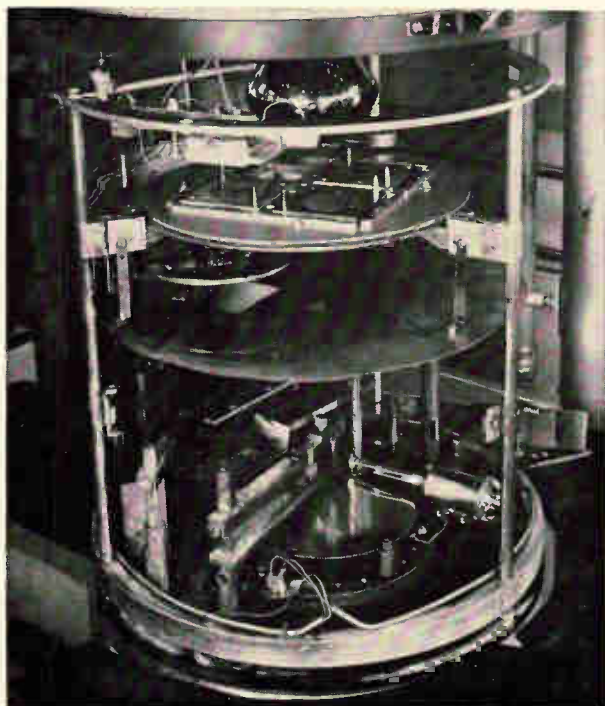

Four-position mask changer deposits resistors and capacitors by evaporation in vacuum chamber.

output discriminator has the same pulsewidth but the r-f pulse amplitude is determined by the value of  $f$ , which is set between 100 and 500 kilocycles. The discriminator is a distributed-parameter resistor-capacitor represented by the 10,000-ohm resistance and 500-picofarad capacitance shown in the second substrate portion of the circuit. Such thin-film devices are easily made by using a resistive film for one or both conductive capacitor plates.

The last two transistors (third substrate) present a fixed high-impedance load to the discriminator. The r-f pulse is rectified and applied to the load. The 0.01-microfarad capacitor, across the collector and emitter of  $Q_{19}$  filters out pulse ripple.

The receiver's total current drain is only seven milliamperes, allowing 150 hours of operation from one set of batteries.

### Building the receivers

All passive components used in this receiver, including the 0.01-microfarad filter capacitor, are

### Sequence of depositions

First evaporation: silicon monoxide under all R and C positions using mask 1

Second evaporation: conductors and first capacitor plates using mask 2

Third evaporation: resistors using mask 3

Fourth evaporation: silicon monoxide for capacitor dielectric and to cover resistors using mask 1

Fifth evaporation: conductive interconnections and capacitor second plates using mask 4

Sixth evaporation: silicon monoxide protective film on resistors and capacitors using mask 1

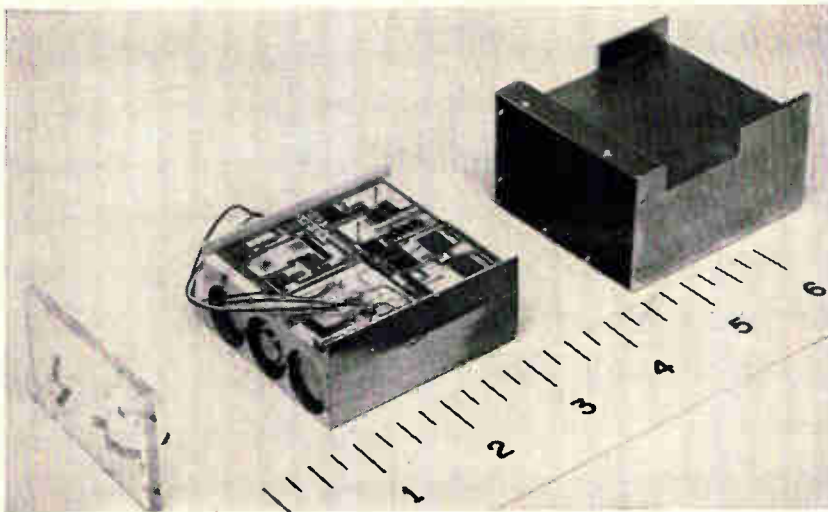

The 15-Mc thin-film receiver. The end plate at left has a screw at its top right-hand corner, which turns the receiver on. Center unit, made of plastic, reveals the circuit on top and three of the nine mercury cells at left. Remainder of the plastic housing is at right.

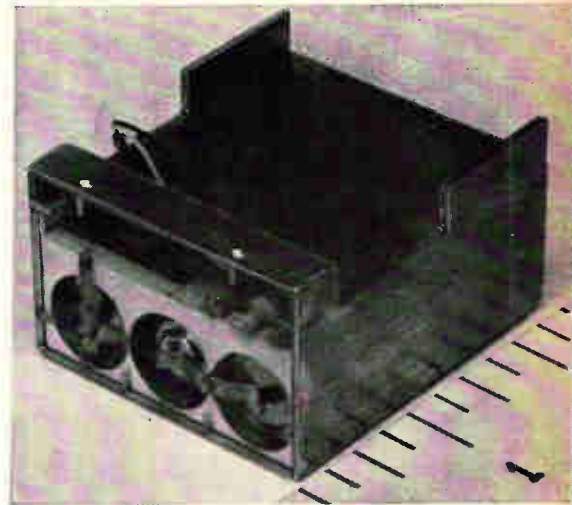

Assembled receiver weighs seven ounces. With batteries removed, receiver weight is only three ounces. Length and width are both about 2.5 inches. Unit can operate continuously for about 150 hours after being turned on with screw at upper right of receiver.

easily made by thin-film techniques. A conventional .01-microfarad capacitor was used because it was originally thought that a higher-value capacitor was necessary. The nine batteries are arranged in one three-by-three layer approximately two inches by two inches square. The receiver circuitry is divided into three sections, each contained on a separate substrate, with a fourth substrate used for the add-on capacitor and terminals. The glass substrates are cut from 0.040-inch-thick microscope slides.

The thin-film resistors and capacitors are deposited by evaporation in a vacuum chamber. The location, width and length of these films are fixed by metal evaporation masks, made by etching the required openings into a sheet of copper 0.003-inch

thick and mounted in a steel frame. A typical mask is shown in the center of page 92.

The circuit is deposited by a series of six depositions in a vacuum chamber, using four different masks. The mask changer is shown at the bottom of page 92. The sequence of depositions is given in the table on page 92.

The materials include chromium for the resistors, aluminum for conductors and capacitor plates, and silicon monoxide for the capacitor dielectric. The sheet resistance of the chromium is 400 ohms per square; the resistors are 0.01 inch or wider. The capacitor deposition provides 0.0063 microfarads per square centimeter. Where required, wires are bonded with either an ultrasonic bonder or a thermo-compression bonder using a heated wedge. The transistors are cemented in place.

For this application, the receiver antenna had to be inside the plastic receiver housing. For this reason, only a two-inch length of wire could be used. This inefficient antenna imposed the 50-watt output requirement on the transmitter to supply sufficient signal to the receiver. The short antenna also made the receiver insensitive to r-f interference.

In the receiver, shown above, the block holding the nine mercury cells and supporting the circuit substrates is made of plastic, as is the housing. A screwdriver-operated battery switch is in the end plate. A view of the assembled receiver is shown above and a close-up view of the thin-film section of the receiver is shown at the left.

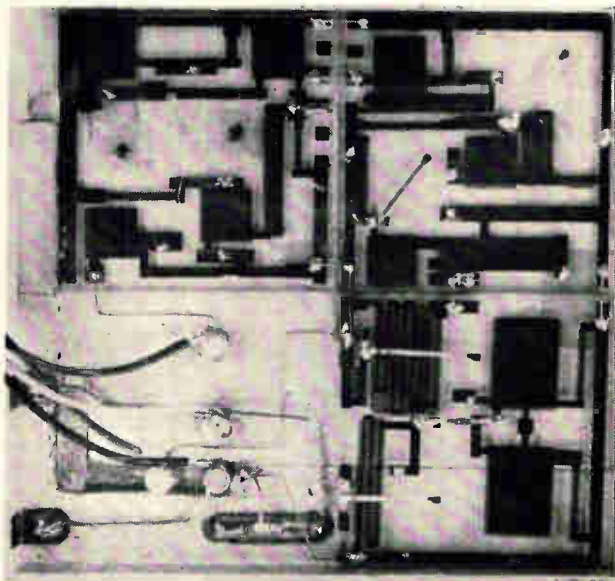

Close-up of thin-film receiver circuit. Each of the four square glass substrates measures one inch square.

#### Acknowledgment

The design, fabrication and debugging of the two receiver-transmitter systems were conducted by J.G. Bebee, A.J. Cote Jr., R.A. Freiberg, S.H. Gordon, H. Halstead, F. Jurgens, M.A. Karp, H.J. LaBelle and L.A. Twigg. The program conducted by the National Institute of Mental Health was planned by Dr. Bryan Robinson and is currently under the direction of Dr. Haldr Rosvold.

# Modernizing the missile range: Part I

Instrumentation at stations from Florida to South Africa is being updated as space exploration expands. New telemetry gear will be sensitive enough to report an astronaut's heartbeat in the moon

By John F. Mason

Military electronics editor

**Dramatic changes** are taking place on our missile ranges. Before the end of the year, 85% of the telemetry gear on the Atlantic missile range will be replaced. Everywhere, new communications equipment is going in, new pulse radars are being installed and continuous-wave radar networks are being expanded. Slowly, the separate ranges are becoming an integrated global network.

In addition to installing new equipment, engineers at the ranges are using their ingenuity to debug systems already installed, to calibrate them, and to learn how to use them as effectively as possible. Another effort is to make operational gear do extra duty. Telemetry equipment, for example, will be used for range safety. If information should be telemetered from a missile that engine performance or vehicle attitude has degenerated to unsafe limits, a real-time readout could trigger a destruct command rather than simply store the information for an edifying postmortem.

On Grand Bahama Island, a big telemetry dish is going to be hooked up with pulse radar, several miles away, so that a computer will advise either one when the other picks up the target and where it should turn to find it.

Besides the work going on at the ranges, research and development effort for programs of the future continues at an active pace at the various government and industry centers throughout the United States.

The reason for this general overhaul of the missile ranges is to support Apollo, the manned lunar mission, and approximately 70 other ambitious missile and space programs already under way. The orbital path of Apollo, for example, will cover 40- to 50-million square miles—nearly one-fifth of the earth's surface. Launched from Cape Kennedy, Fla., Apollo will travel down the Atlantic missile range some 1,500 miles, where, near the island of Antigua,

it will go into earth orbit. Three orbits or less later, it will be injected into the trans-lunar ellipse. A period of post-injection tracking will follow as the spacecraft heads toward a landing on the moon.

Down below, thousands of engineers, scientists and technicians will be monitoring every possible aspect of the flight from ground-based stations throughout the world, from ships and aircraft.

## Global network

Integration of the Atlantic missile range and the Pacific missile range became a physical fact when Pretoria, South Africa, an Atlantic range station, tracked its first satellite, launched from the Pacific range, in November, 1960. Three and a half years later, in May, 1964, the Defense Department made it an organizational fact by putting all of the Atlantic range and most of the Pacific range under single management. The new agency, called the National Range Division, NRD, of the Air Force Systems Command, is headed by Lt. Gen. Leighton I. Davis.

The Atlantic range was named the Eastern Test Range, ETR, and the Pacific range, the Western Test Range, WTR.

From the launching site at Cape Kennedy, the ETR stretches down through the Bahamas, Eleuthera, San Salvador, Grand Turk, Antigua, Ascension and Pretoria. It will eventually extend to a station somewhere on the coast of the Indian Ocean. Gaps in this 10,000-mile range are filled by nine instrumented ships and 15 aircraft.

The WTR's launch site is at the Vandenberg Air Force Base in California. The range reaches into the Pacific, with stations in Hawaii, Canton Island, Midway, Wake and Eniwetok. These stations are supplemented by five ships and five aircraft. The two ranges meet at 90° east longitude in the Indian Ocean.



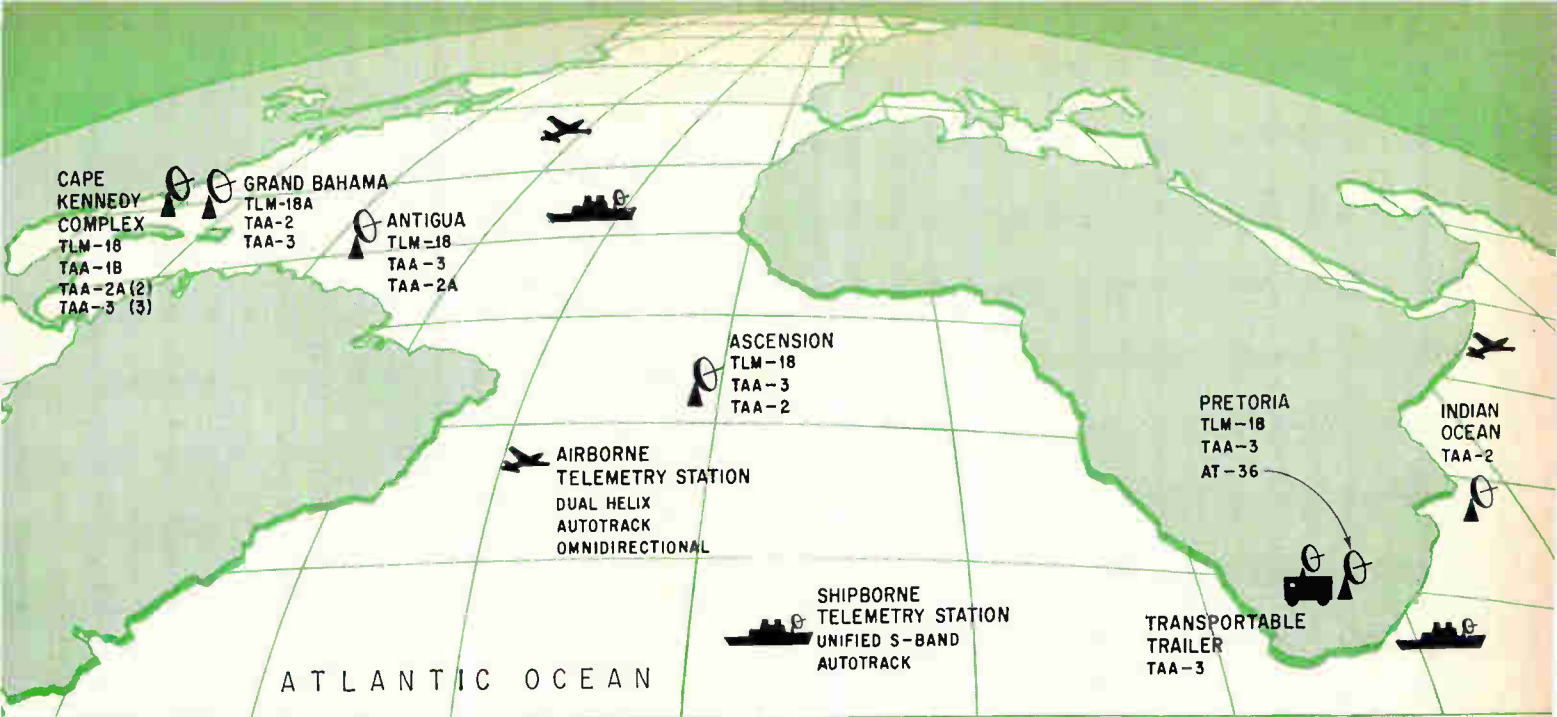

Telemetry receivers. Most of those shown are already installed and operational; the others will be in by 1969.

The Satellite Control Facility at Sunnyvale, Calif., with its global network for polar orbital missions, is also integrated with the NRD in its operation and planning. Later, the facility will be physically integrated with the other NRD ranges. Sunnyvale's stations are at Kodiak, Alaska; Kaena, Hawaii; New Boston, N. H., and Vandenberg AFB, Calif.

Other ranges, such as the ones at White Sands, N. M. and Eglin AFB, Fla., are not part of the National Range Division, but their instrumentation is available when needed.

The day-to-day operation of the ETR is conducted by the Guided Missiles Range division of Pan American World Airways, Inc. As prime contractor to the Air Force, Pan Am has responsibility for the planning, engineering, operation and maintenance of the range. That includes everything from delivering ham and eggs to the mess halls of the downrange tracking stations to supporting the Air Force in planning new instrumentation techniques for missions 15 years from now. Pan Am has nearly 7,000 employees on the Eastern Test Range. Its contract for fiscal 1965 ran to about \$110 million.

Operation and maintenance of the electronic instrumentation on the range is handled by the Radio Corp. of America, under subcontract to Pan Am. RCA has 3,600 employees on the range, 600 of whom are electronics engineers. The other 3,000 are electronics technicians. RCA's subcontract amounted to about \$37 million for 1965.

### Telemetry

Nearly \$50 million will be spent, from fiscal 1964 through 1968, on a vast telemetry modernization program for the Eastern Test Range. Half of that sum is already under contract or earmarked for specific gear.

Among the aims of the modernization project are these:

- To handle more telemetry data generated by the more sophisticated space missions.
- To provide more real-time, or at least near real-time, readout for manned missions and other complicated flights.
- To receive all modulations. In the past, range users often had to set up their own ground equipment to support their missions.
- To shift from very high frequency to ultra high frequency.
- To provide more accuracy and reliability.

New requirements have emerged since the time telemetry reception was standardized in the 215- to

### The role of telemetry

Telemetry is almost the only way to learn what went wrong when a missile fails to perform its mission.

The function of telemetry instrumentation is to make measurements of physical phenomena aboard a missile or spacecraft in flight and to transmit these measurements to the ground. The information is obtained by transducers on board the vehicle. The outputs of the transducers are transmitted to the ground by the telemetry system. Multiplexing permits several channels of information to be transmitted over a single radio-frequency carrier (commonly referred to as a link).

Examples of remote measurements are: determinations of missile temperatures, structural stresses, hydraulic pressures, biomedical measurements (such as electrocardiogram), vibration and performance of the guidance system.

The end products of a telemetry system are: recordings of internal functions for postflight analysis, real-time displays of telemetry data, acquisition information to aid ground radars in first locating the missile, and determination of component failure so that missile reliability may be increased.

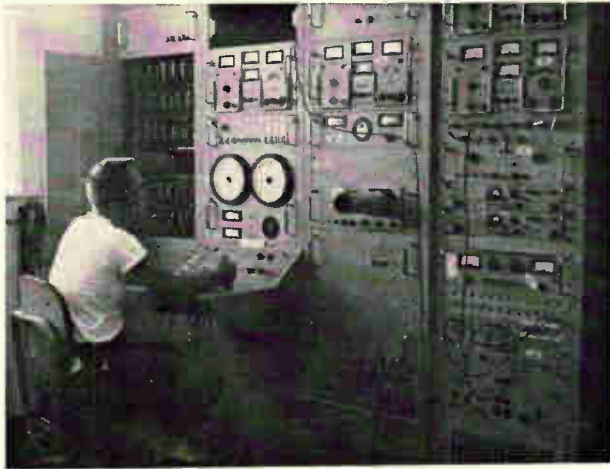

With a small lever on the console (above), an operator maneuvers the 85-foot TAA-2 telemetry antenna (right), at Grand Bahama Island. Extremely sensitive, the big dish often picks up a missile while it's still on the launch pad at Cape Kennedy, 163 miles away. The antenna and control console, which consists of the first three racks, were designed and built by Radiation, Inc. The first rack contains the servo electronics; the second rack the antenna controls, and the third, auxiliary equipment such as power supplies. Tracking receivers in the second and third racks were built by Defense Electronics, Inc. The fourth rack contains a predetection recorder built by the same company.

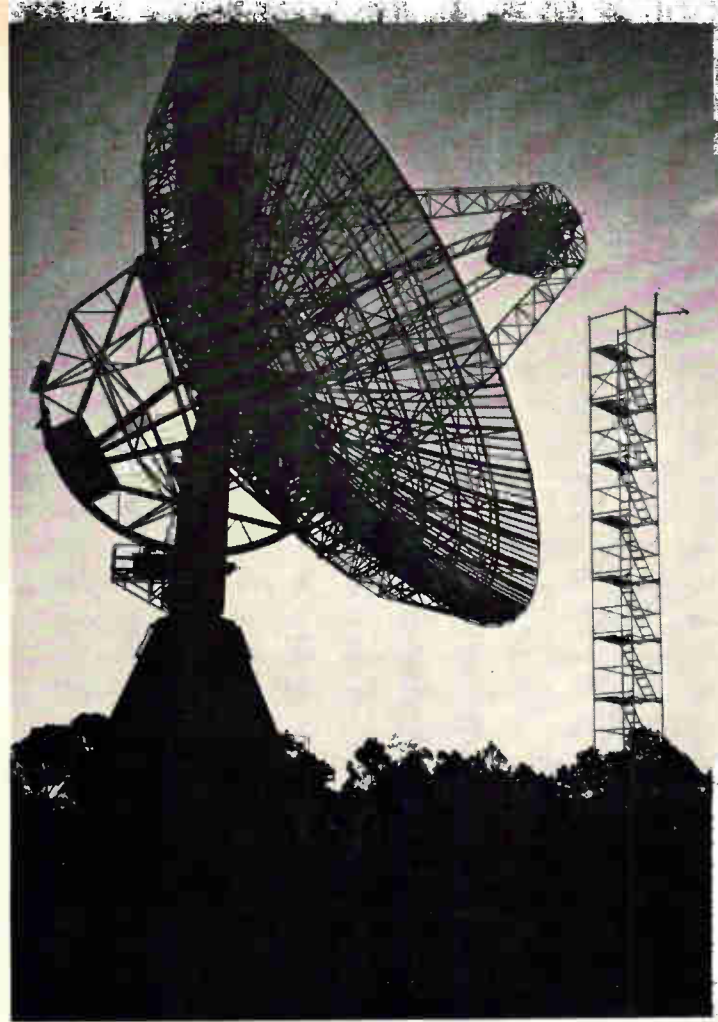

a variety of new demodulators that can revive weak signals and linearize data. A number of procedures, never possible before, can now be tested.

For both telemetry and point-to-point communications, the range is turning to orthogonal systems to get higher bit rates within a given bandwidth. For example, two identical frequency sine waves, 90° out of phase, will not interfere with each other when coherently detected. For communications, a bandwidth of three kilocycles will be able to handle close to six kilobits per second.

#### Data compression

The National Aeronautical and Space Administration is working on data compression techniques, whereby only new, unexpected information is sent, rather than a continuous, repetitive stream of reports on static conditions. An astronaut's pulse rate, for example, may normally be 75 a minute. The only information needed on the ground by the medical monitors, in this case, would be a message advising that the pulse rate was above or below normal. More sophisticated data compression techniques are also under investigation.

Data compression allows more information to be sent over a given channel, and thus frees more channels for sending error control signals. Companies working on data compression include the Mitre Corp., Lockheed, Inc., Radiation, Inc., the Philco Corp., and the Bendix Corp. The Electronic

Systems division of the Air Force System's Command is monitoring NASA's efforts in this area.

#### Signal enhancement

The ever-present problem of pulling weak signals out of noise may be partially solved by combining real-time predetection signals. ESD plans to issue requests for proposals to bid on developing such equipment in the near future.

Signals from two or more receivers will be combined at the first i-f to obtain the advantages of polarization, space, and frequency diversity reception. They will then be recorded and demodulated. The result will be a stronger, more clearly discernible signal.

#### Phase linearity

ESD will soon conduct a study of phase-linearity problems found in telemetry receivers and recorders. The causes and effects of nonlinearities will be investigated with the aim of improving the phase characteristics of receivers and recorders. At the same time, ESD plans to establish phase-linearity specifications for future receivers and recorders.

#### Communications interface

Since the telemetry data requires more bandwidth than available communications links can handle, it will be necessary to condense the telemetry data before it is interfaced with the communi-

cation equipment. There are a number of approaches to the problem of condensing information.

Time-base expansion, for example, is one method. This involves making recordings and playing them back at slower speeds. It is a near real-time system, but not real time. Then there are data editors—computers that examine the data and look for the most significant changes and only transmit these changes.

Because of the various communications links used, signal conditioning is a problem. Each station has to have specialized equipment before it can retransmit data. Communication links include high-frequency teleprinter and voice as well as undersea cable and aircraft retransmission.

Right now the communications links are overworked. And the load will become heavier when telemetered data, received at the range stations, must be retransmitted not only to the launch site but to control centers for in-flight control of space missions.

Communications satellites planned for range use, later, will provide a number of additional channels.

### Display

The data is displayed at range stations on direct writing recorders, optical oscillographs and digital display equipment. Analog-recording equipment will remain the primary means for telemetry data display and recording. It is simple, and there is a lot of it on the range. Digital devices, which offer a more reliable and automatic approach to detecting specific data levels and displaying in-tolerance and out-of-tolerance conditions, will be needed for sophisticated space missions. The use of digital printers is increasing because they record data permanently and provide data history in numerical form.

### Range stations

Not only is instrumentation being changed, but stations are being moved. Because of their locations, some stations are gaining in importance, others are being phased out, new ones are being built and more ships and aircraft are on order.

A new telemetry system for the ETR launch area is being built with stations at Merritt Island, Fla. and Grand Bahama Island. These stations are needed to prevent the loss of data caused when dense plasma formed in the exhaust of rockets attenuate radio-frequency signals.

Being closest to the launch pad, the Merritt Island station receives lift-off data. Before Merritt Island loses the booster because of exhaust flame, the booster is high enough to get through to the Grand Bahama station.

The Merritt Island station will be the main telemetry center for the entire range. It will cover all prelaunch and support tests. It will also receive, record, separate and display telemetry data. Separated data will be converted to forms suitable for system verification and transmission to the con-

soles that display range-safety data, the biomedical condition of astronauts, and data needed in the real-time computer center.

Data from stations down the range will be displayed in real time at Merritt Island. The amount of data will be limited by the communications bandwidth available. Magnetic tapes from down-range stations will be returned to Merritt Island for processing. Analog records in strip-chart form or oscillographic magnetic-tape copies and computer tapes will be prepared at the request of the user.

### Grand Bahama Island

The first station off the mainland of Florida is Grand Bahama Island. The island is 83 miles long, one-half to 10 miles wide, and is made of coral limestone and white sand and dotted with scrub pines. The highest elevation is 30 feet. The pale green water around the island's many cays and off its beaches is warm, inviting and filled with sharks. (Cay is a Carribean word for a strip of land, usually coral reef, large enough to be habitable.)

On the northern shore, the TAA-2 telemetry dish (see cover) stands high as a cliff and faces the Cape. The parabolic antenna is 85 feet in diameter and weighs 140 tons. The reflector can rotate in elevation from the horizon to zenith in nine seconds. It is capable of continuous azimuth motion, moving 360 degrees in 36 seconds.

The sensitive tracking device, which was made by Radiation, Inc., has been known to start picking

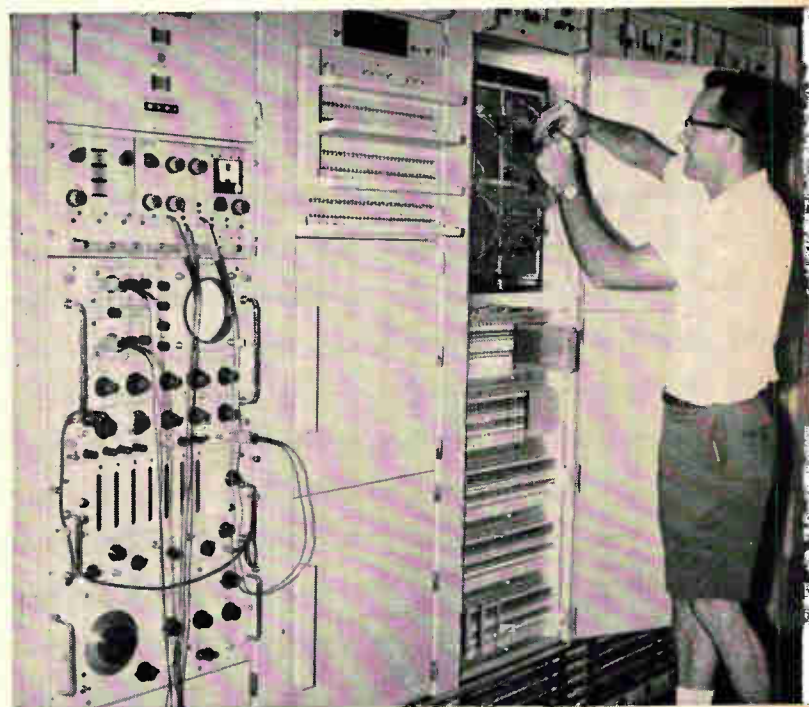

Data recovery is handled by new equipment, built by Texas Instruments, Inc. The Ultraloc pcm system processes and displays missile and spacecraft data received by the big antenna. George Brown is telemetry leader at the island.

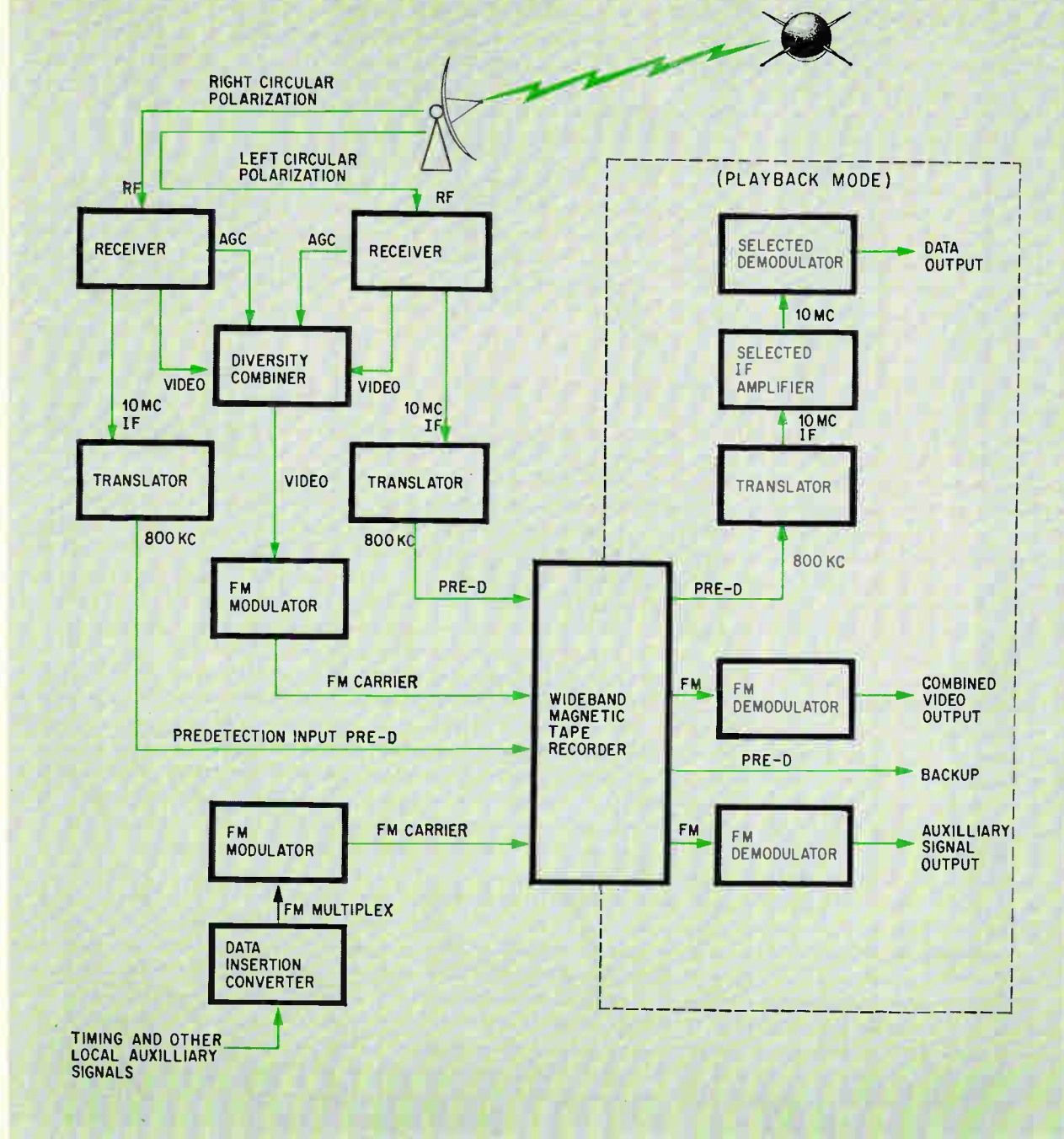

Predetection techniques have produced a real breakthrough in operational procedure of the missile range telemetry system. With pre-d, all known types of modulation can be received and recorded with common equipment.

260-megacycle region and most data was of the frequency-modulated type. Now, frequencies extend from 100 to 2,300 Mc. Bit rates range from a fraction of a cycle per second for deep-space probes, to the megacycle region. And pulse-code-modulation, pcm, has become the most favored modulation technique—mainly because it behaves in such a predictable way and because, with pcm, it is easy to trade bandwidth for sampling rate.

For new programs coming up, frequency modulation, f-m, as well as phase modulation, p-m, amplitude modulation, a-m, single-side band, ssb, and frequency shift keying, fsk, will be used. Other modulations that are typical at the Cape are f-m/

f-m, pam/f-m/f-m, pdm/f-m, and pdm/f-m/f-m.

### Predetection

The real breakthrough in operational procedure has come through the development of a receiver/recorder system that employs predetection techniques.

With this technique the entire signal is recorded at the output of the receiver intermediate-frequency stage. Later, the tape recordings are reproduced and the most appropriate demodulator is used to recover the data. By using the predetection technique, all known types of modulation can be received and recorded with common equipment.

Since the various types of data transmission can be accommodated without changing the operational setup of the station, time and money will be saved. The complex demodulation and analysis processes are handled later at centralized computation facilities.

Predetection does not actually improve the signal but it does provide more versatility and stave off obsolescence. Soon, all of the receiving and recording gear will be replaced by predetection gear.

Defense Electronics, Inc. and the Space General Corp. built the predetection system, designated the TRKI-12, specifically for the range program. Sixty percent of the system was developed from scratch. The receivers, display units and tape recorder are completely new. A new concept of patching was used—coaxial patching with matched impedances throughout.

### Data handling

After reception, the data handling problem will be simplified by converting all modulations to a standard pcm digital format for retransmission and for direct entry into digital computers.

This procedure represents a great improvement over the present one. For example, on the range today an f-m/f-m signal comes out of the receiver and must go into a bank of 18 discriminators, each of which feeds oscillographs or strip chart recorders. If a pam ground station is in the same room, signals from its receiver have to be run through synchronizer channel gates and error-correction equipment. Also, more strip chart recorders are required. If there are pdm decommutators, too, the result is a room filled with racks upon racks of gear for every kind of signal.

The new approach is to take each kind of signal and, by the most direct conversion route available, get it into pcm binary digital format as soon as possible. It is then compatible with computer language.

### Data separation

The data separation portion of each station consists of frequency-division-multiplex, fdm, and time-division-multiplex, tdm, equipment. The objective in the design of this gear is to eliminate, or reduce, the time needed to set up and calibrate data separation equipment. A second objective is to reduce data degradation caused by data separation and handling manipulations.

Fdm equipment consists of solid-state discriminators, both fixed and tunable, that demodulate frequency-multiplexed channels. The ETR plans to buy a number of tunable discriminators to handle the increasing use of nonstandard subcarrier frequencies and bandwidths for projects such as Titan, Minuteman and Ranger.

The range now uses tdm decommutators for separating pam or pdm signals and providing analog voltage outputs for display. The pcm demultiplexers now in use separate the digital signals in each channel and convert them to analog signals



photographs by John F. Mason

The equipment to calibrate and test the TRKI-12 predetection recording system was built by Defense Electronics, Inc. It is now undergoing acceptance testing at Patrick Air Force Base before being installed at Merritt Island.

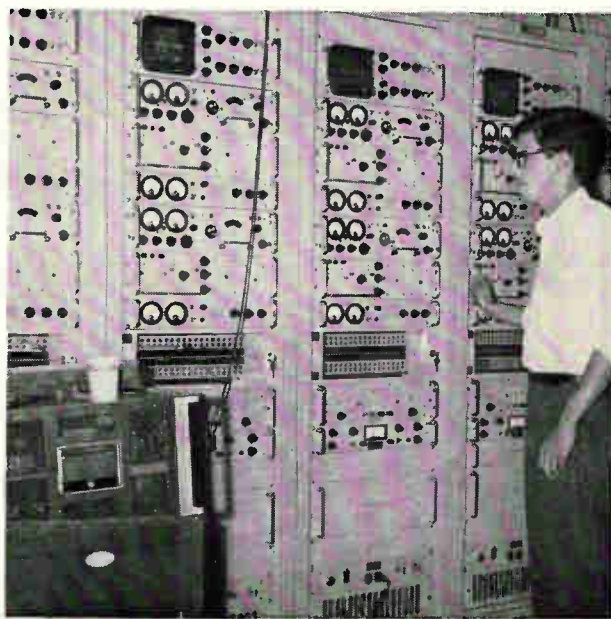

Section of the 15-rack TRKI-12 predetection system that shows the modular diversity receiver and dual display equipment. The system is being prepared at Patrick Air Force Base, Fla. for shipment and installation downrange.

for display. The pcm equipment can also arrange pcm data on magnetic tape for computer entry. To minimize complexities inherent in the tdm gear, a common digital format will be used. The data outputs from all tdm equipment will be in identical binary format. New tdm gear will be needed to arrange pam, pdm, pcm, and pacm data for driving digital recorders, digital readout devices, data conversion and communications equipment.

### New demodulators

The predetection equipment opens the door to



Dual conical spiral feed on the TAA-2 telemetry antenna covers the 130 Mc to 2,300 Mc range.

## Telemetry antennas

Designation	Frequency range in Mc	Gain in decibels	Aperture in feet	Polarization	Type	Feed
TAA-1B	225-260	18	6' x 6'	right- or left-circular	array	monopulse
TAA-2A	100-2,300	31	85-ft	right- or left-circular	parabolic	dual-conical log-spiral
TAA-3	225-2,300	22	30-ft	right- or left-circular	parabolic	dual-conical log-spiral
TAM-1	130-2,300	12		right- or left-circular	array	cavity
AT-36	100-2,300	28.5	60-ft	horizontal & vertical	parabolic	onset wave-guide
TLM-18	100-1,000	28	60-ft	vertical, horizontal, right and/or left circular	parabolic	wave-guide & rotating lens

up signals before the missile is even off the launch pad at Cape Kennedy, 163 miles away. Normally, however, it begins receiving soon after lift-off, when the vehicle has climbed to about 90,000 feet. It continues to track the missile into its midcourse phase. For short-range missiles, Grand Bahama covers the terminal phase.

The station furnishes magnetic tape recordings, direct-writing records and data display. Real-time data separation and display will always be needed at this station for command and control and range safety purposes. Part of the data will be transmitted to Merritt Island for real-time display. This station will also support orbital missions when not occupied with launch operations.

### **Eleuthera**

The next island in the ETR chain, Eleuthera, is not important as a telemetry station. This beautiful, white strip of decomposed coral has more vegetation than Grand Bahama and more elevation—its highest spot is 120 feet. It extends for 90 miles, never wider than five miles and often as narrow as a few hundred feet. On an airborne radar scope, Eleuthera looks like a crooked line drawn by a child.

Eleuthera's main job is operating Mistram, a continuous-wave radar installation that determines position and velocity of missiles and spacecraft. Engineering solutions to some of this complicated system's problems will be described in the Mar. 8 issue of *Electronics*.

### **San Salvador**

San Salvador, a round, hot sandpile, seven or eight miles across and spotted with a number of brackish lakes, has an operating telemetry station. Very soon, however, and to almost no one's disappointment, it will be shut down.

The station did important work when short-range missiles were being tested. As recently as July, San Salvador was active in tracking a re-entry experiment called Asset. Using a telemetry receiver in the 9-gigacycle region, the engineers successfully received good signals through the plasma sheath as the missile plunged back into the atmosphere from an altitude of about 200,000 feet.

### **Grand Turk**

Known as "the Rainless Isle," Grand Turk covers an area of 12 square miles, is only a few feet above sea level, and looks like a rectangular San Salvador. The engineers who work there were highly amused by a travel article in *The New York Times* that described Grand Turk as a tropical paradise.

Grand Turk is scheduled to lose some of its telemetry tasks but to gain others. For the Gemini program, it will get transmitter and receiver equipment for pcm telemetry; a command and control system will be installed, and new data handling gear will give real-time readout from Gemini back

to the Goddard Space Flight Center in Maryland, to Patrick AFB, Fla., and to the Manned Space Flight Center in Houston.

Using a special telemetry receiver, Grand Turk also cooperated in the Asset reentry experiment but results were inferior to those at San Salvador. Reception was only intermittent at this location.

### **Downrange**

The land-based downrange telemetry stations are at Antigua, Ascension, and Pretoria, South Africa. A future site will be built in the Indian Ocean area. These stations cover midcourse and terminal phases of intermediate range ballistic missile and intercontinental ballistic missile trajectories, synchronous-orbit satellites for the Defense Department and NASA, and NASA's space probes until the Deep Space Instrumentation Facility (DSIF) can acquire them. The DSIF consists of large antennas in Goldstone, Calif., South Africa, and Australia.

Downrange stations on the Eastern Test Range are widely separated and must therefore have excellent receiving sensitivity. Their main products are magnetic-tape recordings of telemetry data. Limited mission results are transmitted to Antigua by h-f, ssb, teleprinter and voice communications. From Antigua, information is sent by subcable to Merritt Island.

### **Antigua**

No one laughs when Antigua is called a tropical paradise. It has rolling hills, wild orchids, bougainvillea, pineapple palms and sugarcane. A jagged coastline traces secluded inlets and fine white sandy beaches.

One spot in the southwest portion of the island is 1,330 feet high. The tracking station itself is on a hilltop overlooking a bay on the northern coast. It is 1,250 miles from the Cape.

The job of the engineers on the island is to provide telemetry support for the terminal phases of short-range missiles and midcourse coverage of ICBM tests. The station's telemetry antennas include a brand new TAA-3 and a TLM-18 modified to receive between 100 and 1,000 Mc. In 1966, Antigua will get its first TAA-2A.

The telemetry station at Antigua is more than doubling its equipment and its expected work load. In March, 1964, the station had 32 racks of telemetry equipment. The building has been enlarged to make room for a total of 142. By March, 1966, all these should be filled. Being installed are the new wideband receivers, the TRKI-12 predetection equipment, and real-time readout gear. Only 10% of the equipment now in the station is real-time readout while 90% of it only receives and records. This ratio will soon be changed to half and half.

Also going in are pen and oscillographic recorders, analog bar charts, digital bar charts, digital displays, data separation equipment, digital-to-analog and analog-to-digital converters, time-division multiplex equipment, fixed and tunable dis-

criminators and wideband tv recorders.

### Ascension

Ascension Island, 5,160 miles downrange in the South Atlantic, is small, volcanic and hilly. Round, and less than seven miles across, it is called "the rock" by the men who work there.

Ascension has instrumentation for determining missile impact locations and for acquiring mid-course and parking orbit data from satellites and deep space probes. Space vehicles launched from the Cape into a 106-degree-azimuth parking orbit pass almost directly over Ascension. The island also serves as a central h-f communications relay station for the next station, Pretoria, South Africa,

and for ships in the vicinity. Real-time display is analyzed at Ascension and then forwarded to Merritt Island via Antigua and the subcable.

Ascension's TAA-3 will soon be operational, and in 1967 it will get a TAA-2A.

### Pretoria

The last land-based range station in the ETR chain at this time is Pretoria, 7,100 nautical miles from the Cape. It is on the Grootfontein Bombing Range of the South African Air Force, just 18 miles from midtown Pretoria. This city in Transvaal Province is 400 miles inland from the Indian Ocean and 4,593 feet above sea level. The whole area rests on a high plateau of rolling pasture land, covered

## How an engineer lives on the range

"We often work seven days a week. We're on call 24 hours a day. And we never know when we'll be transferred to another station. But I wouldn't want to work anywhere else. I'm anxious to get up in the morning and go to work."

Bob Barringer, radar manager at Grand Bahama Island, was answering questions that many engineers have asked. What's it like, working on the missile range? Who works there? And how would it work out for me?

Barringer is an expert on the subject. He's an electronics engineer and has worked on the range for the Radio Corp. of America for the past nine years.

"We get to work with the best equipment available. It's always about as close to the state-of-the-art as you can get without working in research and development."

At that moment we rounded a turn in the rough, sandy road, over which Barringer was driving his new Corvair. White and glistening in the distance was the 29-foot dish of the new TPQ-18 radar.

"Eighty percent of our work involves a test of some kind, using operational equipment. You have to prepare for it, monitor it, and then have a critique. What went wrong? And how can we improve the operating technique for the next time? Twenty percent of the work is pre-

ventive maintenance.

"We have to think fast, be able to take responsibility—you can't have dependent types down here—but nevertheless life is more relaxed than it is in the States. We work hard, but for some reason without too much tension." Barringer looked tan, healthy and happy. His wife likes her home on the range, too, he said. They live in a very comfortable trailer, parked right on a million-dollar beach.

"Who comes down and why?" he asked, repeating my question. "Engineers and technicians who just want to make money as well as those who want to make money and enjoy life down here. Those here just for the buck don't last. The man who brings his snorkle gear and takes an interest in the opportunities of the island usually stays."

"We get a 30% bonus for working downrange; 40% at Ascension because it's a pretty barren place with no chance to take dependents. We get 28 days home leave in addition to our regular vacation each year. This can total as much as 50 days vacation a year. Food is free, and it's good, and your room is free. Movies are free and Scotch and sodas in the club are 25 cents."

Barringer waved at two local children walking along the road. They smiled and waved back.

"Many of us have been in the service—usually the Air Force—and have attended service training schools, often the one at Keesler Air Force Base, in Mississippi. I had



Supplies, food and mail are delivered to the men stationed at the various cays off Grand Bahama and on Great Abaco Island by this SA-16 amphibious plane.



mainly with low, coarse grass and clumps of trees.

The Pretoria station supports launches not only from the Cape, but from the Western Test Range. It provides midcourse coverage for the long-range ICBM's launched from the Cape and it plays an important role in the confirmation of orbits and the injection of vehicles launched from the WTR into higher orbits. The remote location of this station, and the diversified nature of the support offered, call for a high degree of ability and flexibility within the station. H-f communication, teleprinter and voice, links the station to Ascension and ships.

The Pretoria station is operational now but new and updated equipment is scheduled for installation through 1969. The station now has a modified

AT-36 antenna and will soon have a TAA-3. It will get multiband preamplifiers later this year.

### Indian Ocean

A new telemetry station is planned for a still undisclosed spot in the Indian Ocean area this year. It will cover the lunar and interplanetary trajectories of Ranger, Surveyor and Mariner, when the transfer injection occurs in the South African area. Trajectories of this type pass beyond the line of sight of the Pretoria station and the DSIF. After reaching an altitude of several thousand miles, the spacecraft again comes within view of the DSIF station and the range's task is completed.

The Indian Ocean station will permit telemetry

a year of electronics schooling in the Air Force."

"After RCA hires you, they train you in the specific range system you'll be working on. They don't expect to pick up people who already have missile range experience."

We had arrived at the TPQ-18 by then and went into an air-conditioned van where three engineers looked up from some specs they were studying and asked if we wanted coffee. All three echoed Barringer's enthusiasm for working on the range.

The next day at Eleuthera, Bob Pickett, also of RCA, and recently appointed lead engineer for Mistrum, provided more answers to what it's like to work on the range. Pickett is 32 years old. He has been moved five times in two years, but, like Barringer, wouldn't work anywhere else. He feels lucky to be stationed on Eleuthera. It's a beautiful island; his family is with him; and, like the TPQ-18 crew at Grand Bahama, Pickett feels he is working with fine equipment on exciting projects.

"There is opportunity on the range for technicians to advance to field engineers. Here, a man can get to be a field engineer without an engineering degree. And he does real engineering work.

"If he is really good, he won't be bored. The skilled, competent man will be used on a new system when one is installed. This keeps his work fresh and different."

Pickett has a master's degree in electronics and has been a college professor. His wife and two sons enjoy living on Eleuthera. They have many friends among the other range-employee families and the dependents who live next door at the U. S. naval base. —J.F.M.

Engineers at Antigua spend Sunday afternoons with their families at the many beaches and good hotels throughout the island.



Antigua is a choice assignment. It has fine beaches, like this one at the Hawksbill Hotel, rolling hills, wild orchids and sugarcane. The telemetry station at Antigua is more than doubling its equipment and workload.



Dependents don't accompany the dozen or so men who live at each of the remote sites, like this one on Little Carter Cay off Grand Bahama Island. The tall antenna mast supports all the cay's antennas—one for Udop, another for the TRC-24 radio, and a microwave reflector directed toward the main site at Grand Bahama. Six small cays off Grand Bahama Island and three on Great Abaco Island are instrumented.





## Command and control

The new ultrahigh-frequency steerable antenna at Antigua transmits command signals to orbital vehicles, such as Gemini and Apollo, and range safety commands to powered vehicles, such as Saturn and Centaur.

Now undergoing engineering tests, the system uses a 16-foot, parabolic antenna with a helical feed. The beamwidth is 8.5 degrees; operation is between 406 and 500 megacycles.

The antenna's design represents a marked improvement over previous gear of its kind. Equipment that has been in use at Antigua for the past year must be preset to a certain azimuth and elevation for a specific time. The antenna is fixed and can receive only while the vehicle is passing through its 16.5-degree beam. The antenna of the new system is pointed toward the vehicle by a servo-driven pedestal in response to synchro-control signals from radar or tracking telemetry, or from a computer. The antenna can also be positioned by using handwheels on the control console. The new gear is made by Temec, Inc., a division of the Cubic Corp.

reception from spacecraft launched in California and injected into orbit over the Madagascar Straits. Some of these orbits can't be seen from Pretoria.

Data received here will be stored on magnetic tape and recorded on paper chart or film rolls. Real-time display is necessary for analysis of mission status or progress. The station will be linked to Pretoria and Ascension by h-f radio teleprinter and voice. The new station will get a modified TAA-2.

### Communications

When telemetry data from a missile or spacecraft is received at one or more ground stations, aircraft or ships, it must be retransmitted to a number of other places. Data must be sent back to the Cape, to other ranges and to NASA centers.

The communications network now used for this purpose has long been overworked. With the expansion of space projects, the problem will get even worse.

More information is being generated by more complex missions, and more sites have to know what is going on. Rockets used for space probes, for example, are now powered by more stages, or engines, and each of them generates a lot of information that an enormous number of people in different places want to receive as quickly as possible.

Vehicles that are now able to change direction in flight cause a large number of communication channels to be busy that were idle before. Fuel cutoff and re-ignition by programed or ground control requires more ground communication, as will the complex task of rendezvous in space.

### Building the network

Besides preparing for a heavier data load to be transmitted, the increased manned and unmanned space activity is calling for a fully-integrated global network. Work toward this end is under way on all

the nation's missile ranges—on the ETR, the WTR and the stations operated by NASA.

To organize this integration, communications control centers have been established at the Cape, Antigua, Ascension, and Arguello. These centers will switch and route transmissions and handle quality control.

### Range control center

The communications control center at Cape Kennedy, still under construction, will be the biggest, and the interface point for all circuits to and from the ETR via commercial communications to such points as the WTR, White Sands Missile Range, N. M., the North American Air Defense Command in Colorado Springs, the Strategic Air Command, the Eglin Air Force Base range in Florida, the Satellite Control Facility at Sunnyvale, Calif., the Integrated Mission Control Center in Houston, the Goddard Space Flight Center in Maryland and the Defense Communications Agency in Washington.

The three-story center, when operational, will be the key spot for handling multirange, fully-integrated global projects. It will enable the ETR to function as either the lead range or as a support range in a multirange mission. It will cut down on the time now required between launches. Range safety operations will be more accurate and effective. And it will be able to support several missions at the same time. The center was designed to satisfy range-user needs for the next ten years.

Heart of the system will be two Control Data Corp. (CDC) 3600 computers. When these two computers are set up at the Cape, the installation will probably be the largest real-time computer center in the world. The CDC systems will replace the IBM 7090 now in use.

All information coming up to the Cape from the downrange stations, aircraft and ships will go into these computers. Position and velocity information

about a ballistic missile will come in from the continuous-wave radar, Mistram, at Eleuthera, for example and from the FPQ-6 pulse radar, at Antigua. The computer will calculate, on a real-time basis, the missile's impact point. This information will be switched immediately and sent down the communications chain to the Atlantic Range Instrumentation Ships, waiting to watch the missile reenter the atmosphere in the south Atlantic or Indian Oceans.

An important portion of the center is the range instrumentation control system. This is a digital supervisory control and communications system that executes rapid message exchange between the Cape and downrange stations. Serial digital transmission is employed by means of standard wireline, data modems operating via the range subcable. A single 3-kc voice channel is used in the downrange link and for the uprange link.

In the downrange direction, message address discrimination is accomplished by means of binary coding, while in the uprange direction, the 3-kc channel is frequency-multiplexed to provide about 500 cycles of bandwidth for independent use by each downrange station.

The center will have an audio communications system, a programmable patching system, a weather center, and an expanded weather information network display system.

### In the West

By July, the existing WTR will have a communications control center similar to the one at Cape Kennedy. It will extend voice, teleprinter and data circuits to Cape Kennedy, Pt. Pillar, Calif., and Oahu, Hawaii.

In Oahu, a communications control center will be installed from which voice, teleprinter and data circuits will be extended to Kokee Park, Hauai; Canton Island; Johnston Island, Wake, Midway, and Eniwetok tracking stations.

High and medium-powered, h-f/ssb, radio terminals will be operated from Vandenberg, Oahu and Eniwetok for communication and instrumentation ships and aircraft operating in the WTR area.

The prime interface point between the global network and other instrumentation inputs, however, will be Cape Kennedy.

### Major goals

The Air Force plans to increase capacity by using new advances such as satellites to improve circuit reliability and transmission accuracy. It will buy systems compatible with the worldwide Defense Communications System, the NASA communications system, commercial systems and those of other ranges. Other goals are to increase the number of secure links—those that can't be intercepted—and to increase the speed of handling information traffic.

A major communications need, right now, is for links to transmit data on bandwidths greater than 3-kc from downrange stations to the Cape. Except

for one 45-kc composite channel on the underwater cable for uprange transmission of telemetry, the present range data system is limited to standard 3-kc and 4-kc channels.

A new underwater cable going in between the Cape and Grand Bahama will provide about 1-Mc transmission bandwidth when it's ready next year. This new link will be used to handle, on a real-time basis, the greater volume of data expected from the expanded telemetry and tracking systems in the Grand Bahama area.

Bioastronautic missions need wide bandwidth to transmit television information from manned spacecraft to downrange stations and then to the Cape. A bandwidth of 4.5 Mc is needed to relay high-resolution color television. Until this is available, slow-scan tv must be used.

None of the present communications methods can satisfy the needs for wideband telemetry transmission. Underwater cable circuits provide a bandwidth of about 1 Mc, with 2 Mc possible next year. Troposcatter radio and microwave can meet the bandwidth needs between line-of-sight points, but increases in bandwidth over longhaul h-f paths are severely limited by propagation anomalies. Communications satellites, when they become available for range use, will provide a much needed boost in wideband links.

In the meanwhile additional h-f, ssb, high-power radio terminals will be used to augment long-haul circuits to stations downrange such as Antigua, Ascension, Mahe in Africa and in ships and aircraft.

### New techniques

The techniques being studied to provide higher bit rates for telemetry, described earlier, will also be applied to communications. These include orthogonal systems and data compression.

Error control, which consists of automatic detection and correction of errors, will also be used to improve range communications. A big effort is already under way to develop new techniques for accomplishing this. The accuracy sought permits one error in one million bits. At present, it is common for one error to occur in a thousand bits.



### The cover

TAA-2 telemetry dish, 85 feet in diameter, at Grand Bahama Island picks up signals from missiles still on the launch pad at Cape Kennedy, 163 miles away. Radiation, Inc. built the antenna. Photograph by John F. Mason.

# Production tips

Production tips is a regular feature in Electronics. Readers are invited to submit brief descriptions of new and practical processes, assembly or test methods, and unusual solutions to electronics manufacturing and packaging problems. We'll pay \$50 for each item published.

## Small parts are aligned and assembled by vibration

By David E. Felker and Glenn S. Fowler

The Western Electric Co., Allentown, Pa.

A vibratory technique is used at the Allentown Works of the Western Electric Co. to load the parts of transistor headers into ceramic fixtures. The fixtures then go into a furnace to make the glass-to-metal bonds that hermetically seal the leads in the headers. Each fixture carries 100 headers.

Vibration accomplishes about 95% of the fixture-loading operation, at much lower cost than with hand assembly or automatic indexing machines that load the parts into the ceramic fixture one at a time. Individual assembly previously was necessary because visual inspection of the header seals required clear glass and there weren't enough available forms of this material. In all, 10 parts had to be fitted together: the metal platform of the header, three pieces of glass tubing and three pieces of glass cane.

Redesign of the platform and the development of a clear glass preform, which replaces the tubing and cane, reduced the number of parts to five and made vibratory loading practical and economical.

Now six ceramic fixtures are placed into openings in a large metal plate so that the plate and fixture surfaces are flush. The plate is on a vibrating base. A large number of header platforms are placed on the plate, where they hop around until they settle into cavities in the fixture.

Each platform has a square tab on the flange. Each platform rotates in its cavity until the tab drops into a slot, assuring proper orientation of the holes in the platform.

The headers move around the plate, loading all the fixtures. After several minutes of vibration, the few cavities still empty are loaded by hand.

The same method is used to load the glass preforms into the platforms, which now represent the cavities in the fixtures.

To complete the assembly, leads must be placed in the three holes in each preform and platform. Because the preform is round and therefore un-

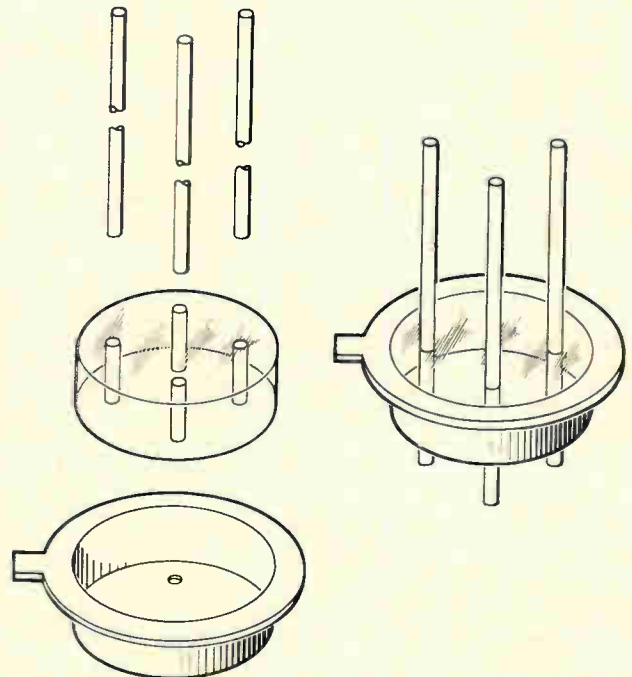

Three leads, a glass preform and a platform are assembled to form the header.

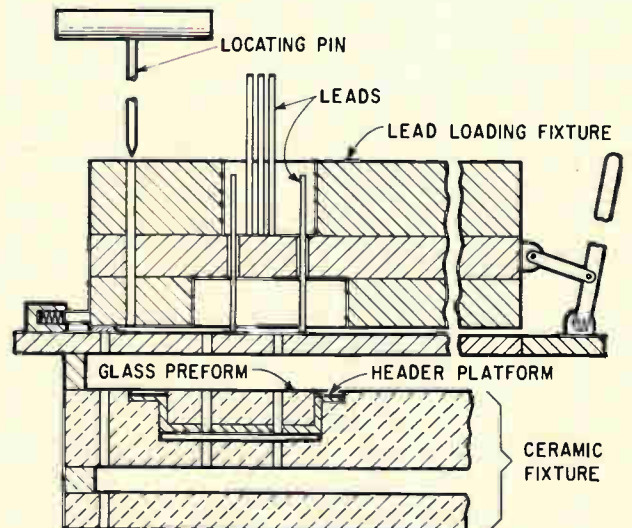

Lead-loading fixture. When the leads are oriented, the top part of the fixture will be moved to the left so the leads drop into the preform and platform subassembly in the ceramic fixture.

oriented, the holes in the preform and platform are not aligned. The use of a lead-loading fixture and the orbital motion induced by vibration takes care of this problem. The loading fixture goes on top of the ceramic fixture.

The upper part of the loading fixture is a sliding block, with a counterbored hole pattern that matches the pattern in the ceramic fixture. At the base of each counterbore are three small holes corresponding to the holes in each platform. Under this is a stationary block with another matching hole pattern.

Initially, the sliding block is positioned so the holes are blind. Leads are loaded in the block by vibration. Then the block is moved so the leads can fall down to the surfaces of the preforms. Meanwhile, the vibration causes the preforms to orbit. As they orbit, the holes in the preform align with the leads; the leads fall into the preforms and are stopped at the correct height by the base plate of the ceramic fixture.

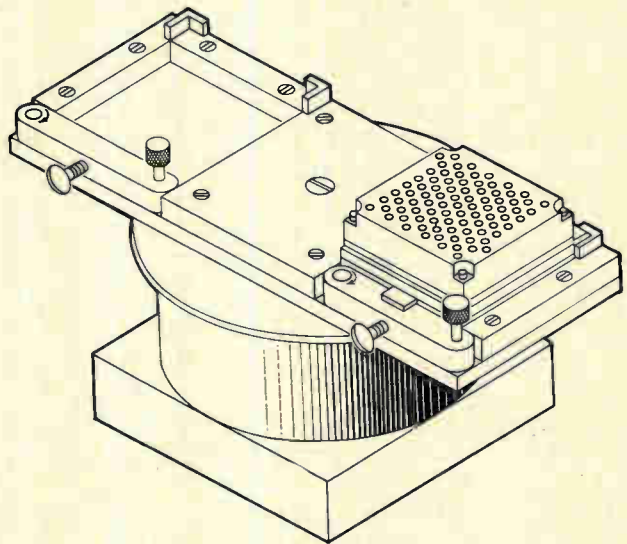

Ceramic and lead-loading fixtures in place on vibratory base.

## Oxide-poisoning problem solved by hole in grid cup

By Roger Finnell and John McDonald

Edgerton, Germeshausen & Grier, Inc., Boston

If cathode contamination is lowering production yields and shortening the operating life of electron tubes despite careful control of cathode spraying, processing and handling, look for a gas trap in the cathode assembly. Gas liberated from such traps may be poisoning the cathode's oxide coating. Then look for a way to vent the gas trap.

Edgerton, Germeshausen & Grier, Inc., solved the gas-trap problem by drilling a hole in the grid cup used in its cathode-ray tubes. A complete changeover to vented grids lowered to 1% the reject rate due to cathode problems. The cathodes show no sign of contamination.

The solution is applicable to any type of vacuum or gas-filled device. The gas trap can be detrimental even if it's not in a cathode assembly. Besides poisoning cathodes, unwanted gas can cause voltage breakdown between device elements. Contamination can also cause premature failure of devices that have been baked out in high vacuum and filled with high-purity gases.

The problem and solution are not as obvious as they may seem. The problem was undetected for eight years. The way in which other causes had

to be ruled out first shows how subtle the problem is.

EG&G's traveling-wave cathode-ray tubes have a cathode-grid assembly similar to those used in television picture tubes. However, the amount of cathode contamination that can be tolerated is lower than usual because the tubes write at  $10^{10}$  to  $10^{12}$  trace-widths per second. This requires highly active cathodes and close control of grid emission.

Grid emission must pass a rigid test. The tube is operated at rated voltages and biased above cut-off for 30 minutes. Then 3,000-speed Polaroid film is exposed to the tube for 30 seconds. If there is any visible exposure on the film, the tube is rejected.

Analysis of reject tubes showed 90% of the scrap was due to cathode contamination, with gas the

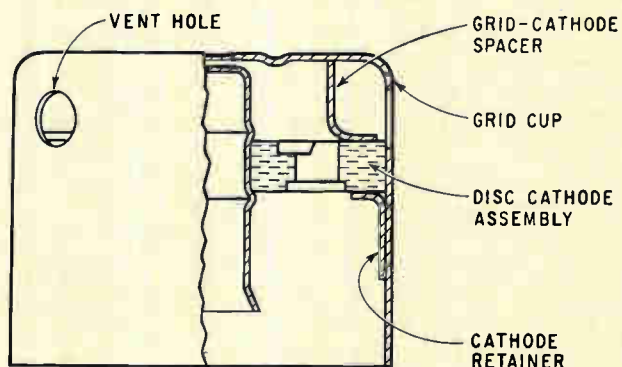

Vent hole allows trapped gas to be evacuated rapidly from grid cup.

probable contaminant. The usual measures for pinpointing the gas source were tried: checking parts quality control, reworking exhaust systems, adjusting bakeout temperatures and times, etc. Break-down and aging procedures were changed also in an attempt to increase emission current.

Having eliminated processing as the cause of the unwanted gas, EC&G took a closer look at the cathode-grid assembly itself. Surprisingly, a gas trap was found in grid cups that had snug-fitting spacers or disc-cathode assemblies.

Cups with drilled vent holes were tried in test

assemblies. The holes allowed the cups to be evacuated rapidly. There was no damage to the emissive coating. The cathode-to-grid current was excellent during a 500-hour life test.

The elimination of the gas trap has brought several additional production advantages. Break-down and low-voltage aging can be done together, automatically; this was not practical before because emission currents were inconsistent. Satisfactory cathode activity is obtained with shorter high-voltage aging time; fewer tubes need reaging, and there is less emission slump.

## Ferris wheel programs insertion of components

Miniature "ferris wheels" go round and round at the Hewlett-Packard Co., Palo Alto, Calif., to feed components to printed-circuit boards in the right sequence for assembly.

With the wheels, which are made for less than \$20 each, workers load up to 8,000 components a day—a rate approaching that of automatic-insertion equipment. A circuit board can be loaded, trimmed, dip-soldered and tested in 15 minutes, one-fifth the time required for loading with the Lazy-Susan bin technique. Lazy Susans cost about \$75.

The wheels are made by bending a strip of aluminum into a one-foot-diameter drum. Two rounds of Plexiglass form the sides of the drum. It is mounted on a U-shaped base.

Resistors and diodes are put on the wheel in rows of 50 on double-faced adhesive tape. The sequence of the tapes is numbered on the drum circumference.

The components are prepared, 50 at a time, in a two-ton Denison multipress. A die cuts and bends the component leads. The tooling cost is about \$400.

Component manufacturers ship Hewlett-Packard components packaged "body to body" so they can readily be slipped into the multipress in rows of 50.

The press operator picks up each row of components with adhesive tape and places the tape on a 20-by-7-inch cardboard. Two of these are taped on the drum, providing 66 rows of components.

Larger components, mainly transistors and capacitors, are prepared for insertion by a lead-cutting and forming machine. These components are kept in bins at each work station. The assembler loads them "by exception"—referring to a pattern board.

The technique works best if the boards are designed for components lined up in rows.



As wheel revolves, the assembler picks up a component and puts it in the circuit board in numbered sequence.



Adhesive tape lifts a row of 50 components out of the press after the press has cut and formed the leads.

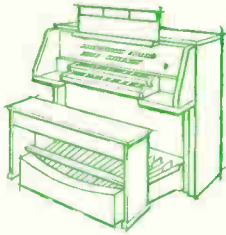

**1. In electronic organs using tuning capacitors, maintenance of correct pitch is directly dependent on capacitor reliability.**

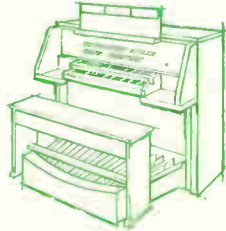

**2. That's why the Hammond Chord Organ relies on 95 capacitors of "Mylar".**

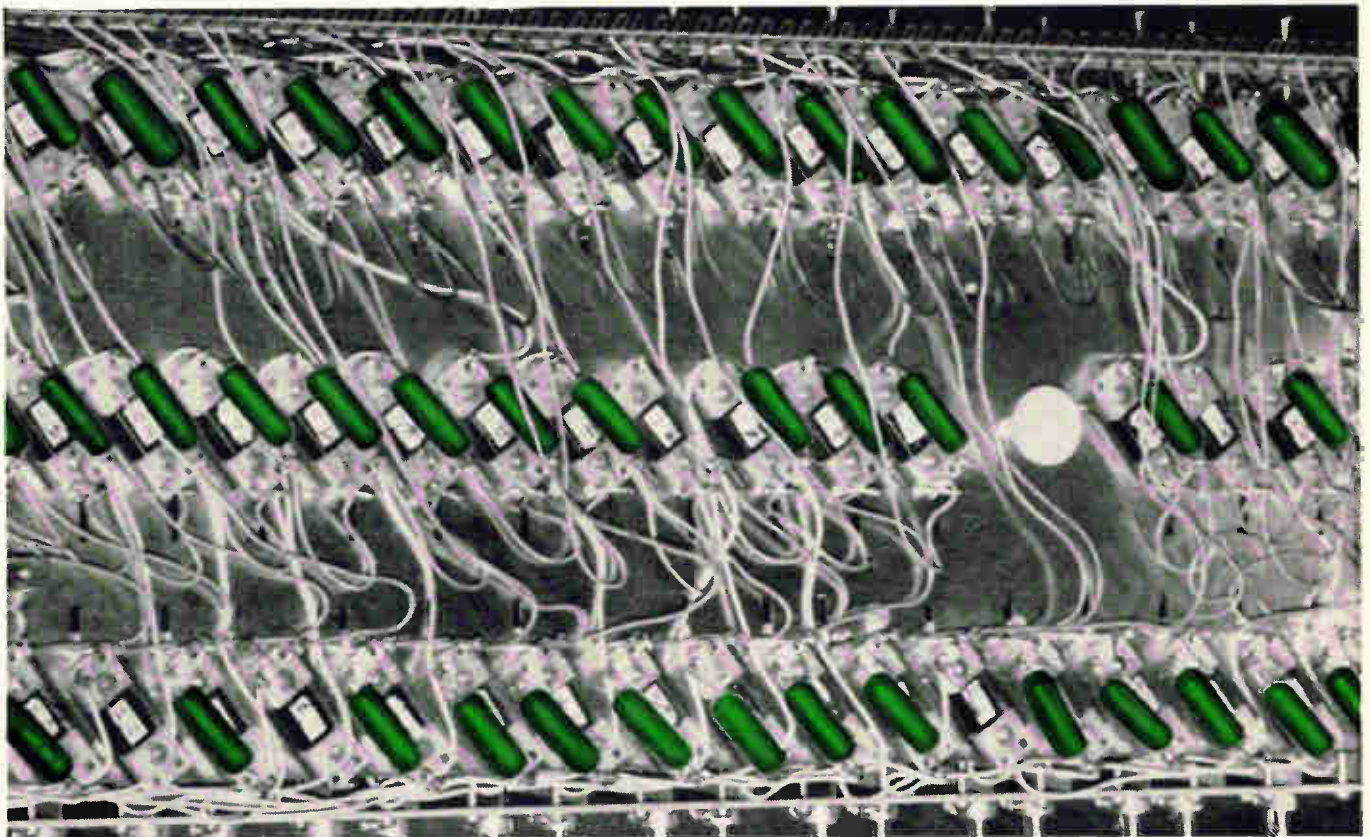

This is a section of Hammond's exclusive tone wheel generator from the Grand 100 organ. 94 capacitors of

"Mylar" in sizes of .1 and .25 microfarads are used here, with 56 others in the amplifier and other circuit locations.

Until capacitors of "Mylar" were developed, the usual electronic organ capacitor dielectric was paper. In unusually humid situations, paper dielectrics can absorb moisture, causing them to leak, change capacitance and interfere with the operation of the organ.

Hammond Organ Company avoided these problems by enclosing paper capacitors in metal cans. This was expensive and bulky. Then Hammond engineers switched to capacitors of "Mylar". End of problem.

Today Hammond uses capacitors of "Mylar" in all organs for many purposes. There are 150 capacitors of "Mylar" in the Grand 100, where tuning is controlled by Hammond's exclusive tone wheel generator. In this case the additional benefit of small size was instrumental in

the decision to choose capacitors of "Mylar".

Not only do capacitors of "Mylar" give Hammond consistent reliability plus substantial savings in space . . . *but they cost no more, and often less, than paper capacitors.*

Reliability—proved in use by Hammond for 10 years, proved in 23,000,000 unit hours of intensive Du Pont, sponsored independent testing—is just one important advantage of capacitors of "Mylar". For complete data that may help in your design problems, write Du Pont Co., Rm. 2310-A, Wilmington, Delaware 19898. In Canada: Du Pont of Canada, Ltd., P. O. Box 660, Montreal, Quebec.



BETTER THINGS FOR BETTER LIVING... THROUGH CHEMISTRY

\*Du Pont's registered trademark for its polyester film.



# Silicone Rubber Adhesive/Sealant solves 1000 production problems ...permanently



New General Electric silicone rubber adhesive sealants are ready-to-use, permanent and waterproof. Available in a variety of colors (white, black, red, aluminum and translucent), RTV sealants set up in minutes and cure in air to form a tough, flexible bond. They won't shrink, crack, harden or peel, even at temperatures from  $-75^{\circ}\text{F}$  to  $+500^{\circ}\text{F}$ . Like all silicones, RTV's resist moisture, weathering and ozone.

In either the non-sagging form or the free flowing form, RTV makes an excellent caulk, gasket, encapsulant, electrical insulator, sealer, laminate and general stick-um. Here are eight ways this unique do-it-yourself rubber solves production problems or reduces manufacturing time. Look around in your plant. You'll think of many more.



1. RTV-108 provides instant, "see-through" insulation as well as vibration resistance and environmental protection. RTV needs no pre-mixing; is applied directly from the tube.



2. RTV seals filament condenser plates in dielectric heaters. Reasons: RTV resists high temperature, insulates electrically, locks out conductive contamination.



3. RTV seals AN connectors, terminals and wire harness joints and other flexible parts. It will absorb shock and vibration, eliminating the fatigue failure of connections.



4. RTV bonds sheeting into desired configuration in low volume production of cylindrical air ducts for dielectric heaters. Results: production costs cut more than 300%.



5. RTV laminates layers of mica sheeting and plates in production of plate condensers. Results: improved operational reliability, assembly time cut from 24 hours to 20 minutes.



6. RTV eliminates need for screws and drilling when used to affix name plates and decorative emblems on any surface. Results: no unsightly rust drainage; plates stay put indefinitely, but can be cut loose when desired.



7. RTV seals out moisture and dust, making cases, cabinets and chassis completely and quickly weatherproof. An excellent material for vibration dampening in electronic equipment.



8. RTV bonds vent units and ducts in new Hotpoint range, seals areas of metal-to-metal contact to prevent escape of cooking vapors. RTV is damping medium for vent motor, reducing sound and vibration.

Will a dab of RTV in the right place shorten your production time? Find out. RTV comes in 3 oz. and 12 oz. tubes and in polyethylene cartridges for use with automatic pressure guns. For more information on these new silicone rubber adhesive-sealants, write to: Sect. N2124, Silicone Products Department, General Electric Company, Waterford, New York.

GENERAL  ELECTRIC



**Check the Q's on this  
new Collins Micro Inductor  
...And the size**

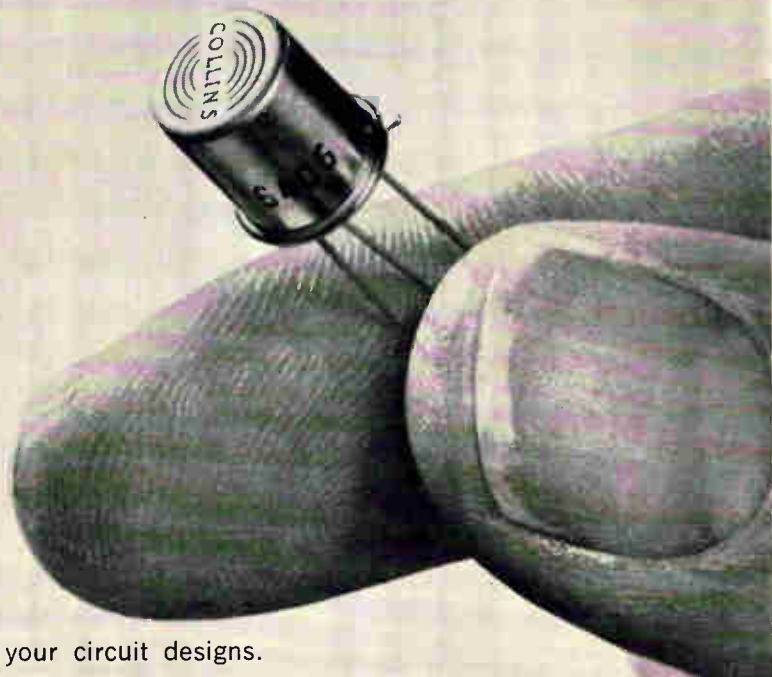

They mean new flexibility for your circuit designs.

Q's exceeding 30 @ 20 KC and 120 @ 200 KC—in a transistor-size package—are available from stock in inductance values of 1 MH to 500 MH.

Priced as low as \$2.00, this all-new Micro Inductor meets MIL-T-27A, Grade 4, Class R. It can be inserted either manually or by machine. It has essentially no external magnetic field and no capacitive coupling to nearby circuitry. And hermetic sealing gives you long-term stability in resonant circuit applications.

For complete specs and prices, write or call us today.

COLLINS RADIO COMPANY, Components Division, 19700 Jamboree Road, Newport Beach, California • International Division, Dallas.

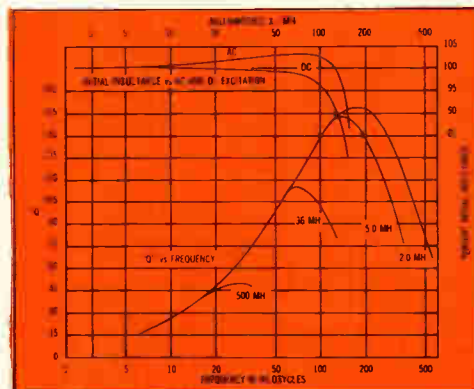

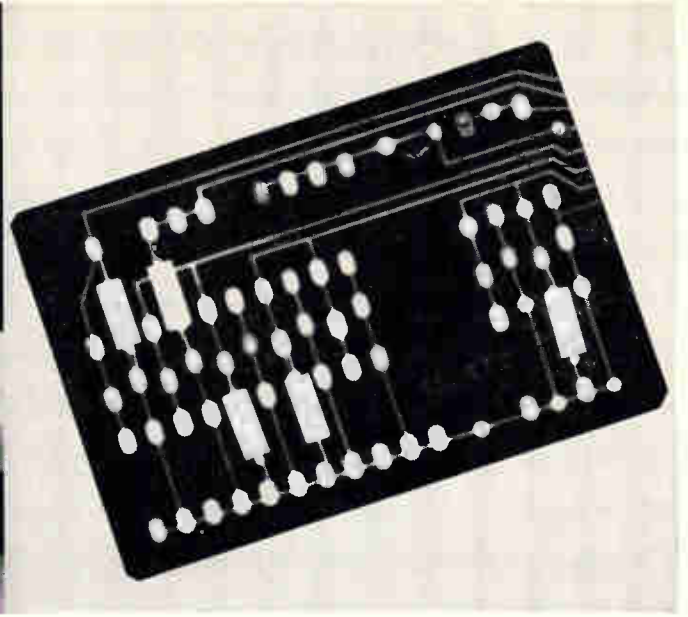
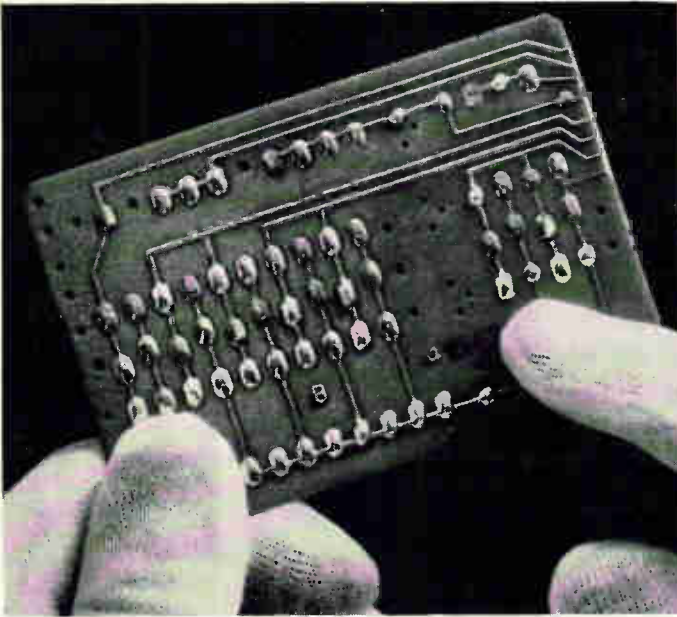

***Heat it,  
test it,  
touch it...***

***or simply X-ray  
it with Ansco  
Superay***

There are several ways to test the quality of a printed circuit: infra-red; running voltage tests; or just physical inspection.

But the surest way of finding discontinuity or tiny imperfections is to get a radiograph on Ansco Superay® 'H-D' Industrial X-ray film.

This ultra-fine grain Class I film has very high contrast. It provides the ultimate in image quality, extending the effective range of radiographic interpretation by recording detail which would be marginal in conventional films. Superay 'H-D' maintains its high definition characteristics and maximum image quality throughout the full KvP range.

For further details, see your Ansco X-ray Representative. Or write X-ray Dept., Box E 222



GENERAL ANILINE & FILM CORPORATION

140 WEST 51 STREET · NEW YORK 10020

# WRITE A SPEC FOR YOUR IDEAL POWER SUPPLY

## YOUR REQUIREMENTS

(Fill in and compare with our standard specifications)

VOLTAGE REGULATION \_\_\_\_\_

CURRENT REGULATION \_\_\_\_\_

VOLTAGE RIPPLE (RMS) \_\_\_\_\_

CURRENT RIPPLE \_\_\_\_\_

OTHER REQUIREMENTS \_\_\_\_\_



# THEN Compare\* IT WITH SORENSEN'S NEW QRC SERIES

First, start with voltage regulation of  $\pm 0.005\%$  line and load combined ■ Then, add voltage ripple of 1 mv RMS ■ Current regulation of  $\pm 0.05\%$  of maximum current output ■ Current ripple as low as 1 ma RMS ■ Transient response 50  $\mu$  sec. to return to  $\pm 20$  mv band ■ Excellent stability, typically 0.05% for 8 hours (after warm-up) ■ Resolution approximately 0.01% ■ Input versatility 105-125/200-240 VAC, 50 to 400 CPS ■

Then, build in every conceivable design feature like: High efficiency ■ Constant voltage/constant current crossover (so sharp the units never leave the specified regulation bands) ■

Constant voltage/constant current indicator lights ■ Vernier controls on both voltage and current adjustments ■ Output voltage and current meters ■ Voltage and current programming ■ Series parallel operation ■ Remote sensing ■ No turn-on, turn-off overshoots ■ Plug-in control boards ■

Price? How about \$450 for 0-40 volts, 0-8 amps, in a 3½" high package? Still want to compare? For more information on the QRC series, call your local Sorensen representative, or write: Sorensen, A Unit of Raytheon Company, Richards Avenue, South Norwalk, Conn. ■ Or use Reader Service Number 200 ■



### ELECTRICAL AND MECHANICAL SPECIFICATIONS

MODEL NUMBER	OUTPUT VOLTAGE RANGE (VDC)	OUTPUT CURRENT RANGE (AMPS)	VOLTAGE REG. (LINE & LOAD COMBINED)	VOLTAGE RIPPLE RMS	CONSTANT CURRENT RANGE	CURRENT REGULATION	CURRENT RIPPLE RMS	RACK HEIGHT (INCHES)	PRICE
QRC20-8	0-20	0-8	$\pm 0.005\%$ or $\pm 1$ mv	1 mv	0-8	$\pm .05\%$ or $\pm 4$ ma	2 ma	3½	\$410
QRC40-4	0-40	0-4	$\pm 0.005\%$ or $\pm 1$ mv	1 mv	0-4	$\pm .05\%$ or $\pm 2$ ma	1 ma	5¼†	315
QRC40-8	0-40	0-8	$\pm 0.005\%$ or $\pm 1$ mv	1 mv	0-8	$\pm .05\%$ or $\pm 4$ ma	2 ma	3½	450
QRC40-15	0-40	0-15	$\pm 0.005\%$ or $\pm 1$ mv	1 mv	0-15	$\pm .05\%$ or $\pm 8$ ma	4 ma	5¼	575

†Half rack.

Circle 113 on reader service card

# Be a celebrity!

## Rediscover simple, reliable, economical TESTING

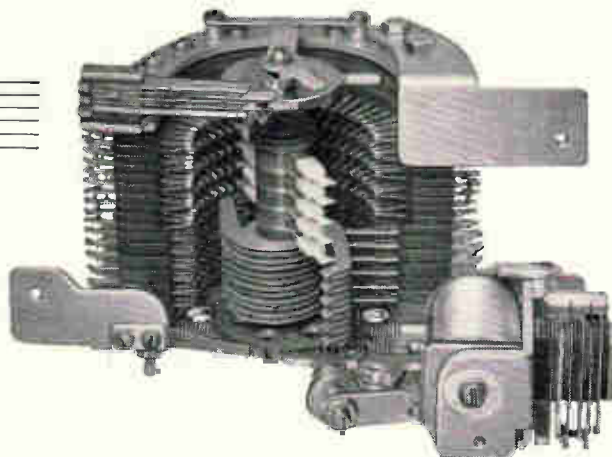
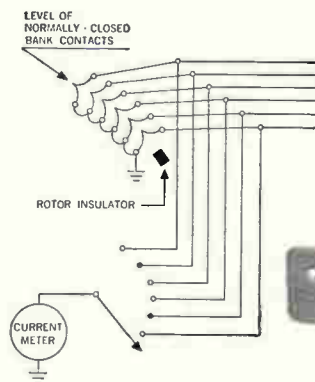

The switching of circuits being tested, in sequence, for continuity, resistance and insulation characteristics is a common application for rotary stepping switches. One such circuit is shown above, using a rotary stepping switch with normally closed contacts.

If you have a problem in monitoring, where input and output must be completely isolated and where the circuits under test must be positively open or positively closed,

let us help put you in the limelight.

Ask the men who wrote the book! Let us show you how rotary stepping switches can save you time, money and space in the design of your circuit-switching gear. To start the applause, ask for your personal copy of our new 160-page book, "How to Use Rotary Stepping Switches." Just contact your AE representative, or write the Director, Control Equipment Sales, Automatic Electric, Northlake, Illinois 60164.

Celebrity's Handbook

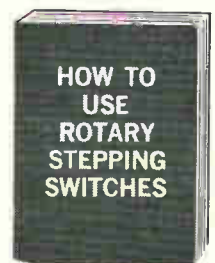

***AUTOMATIC ELECTRIC***  
SUBSIDIARY OF  
GENERAL TELEPHONE & ELECTRONICS **GTE**

# New "Next Generation" Digital Voltmeter catches information other DVMS miss

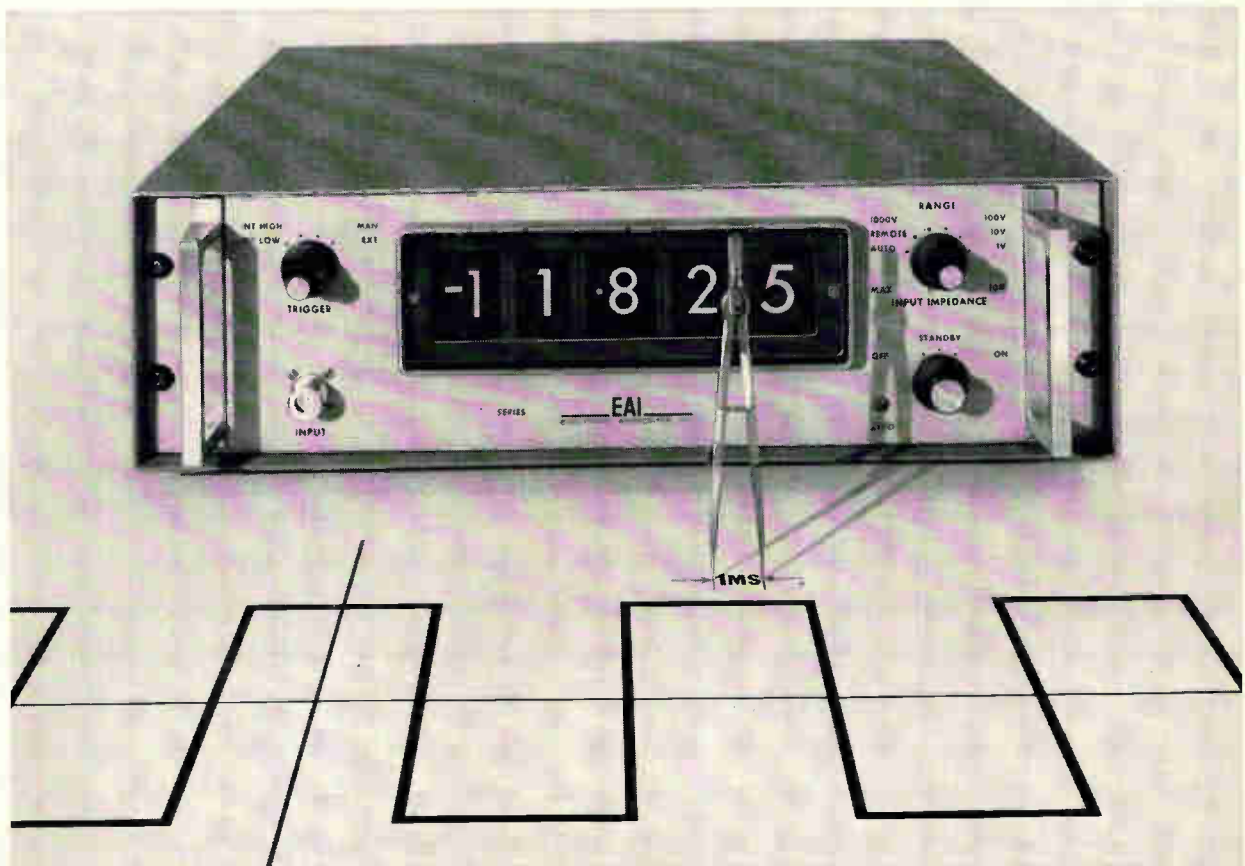

A new reading every millisecond, possible at low cost only on the new EAI "Next Generation" digital voltmeters, assures you of more complete signal tracking. This high speed, made possible by the 1 millisecond conversion time of the Series 6000 programmable and Series 6001 fully automatic ranging DVMS, will greatly increase your ability to make significant readings. In addition, these "Next Generation" DVMS also offer programmable filters for normal and common mode rejection and high-reliability, simplified all-solid-state circuitry. You are fully protected by EAI's established guarantee of .01% + 1 digit absolute accuracy for a minimum of six months. This is an all-inclusive specification (traceable to the Bureau of Standards) for absolute accuracy on all voltage ranges and over the complete temperature range. And yet the Series 6000 can be delivered for as little as \$2,950. Write for full details on the new Series 6000 and 6001 instruments as well as the complete line of systems quality digital multimeters and accessories.

All prices F.O.B. Long Branch, New Jersey. Prices apply U.S.A. only.

**EAI**<sup>®</sup> ELECTRONIC ASSOCIATES, INC., Long Branch, New Jersey

ADVANCED SYSTEMS ANALYSIS AND COMPUTATION SERVICES/ANALOG COMPUTERS/HYBRID ANALOG-DIGITAL COMPUTATION EQUIPMENT/SIMULATION SYSTEMS/SCIENTIFIC AND LABORATORY INSTRUMENTS/INDUSTRIAL PROCESS CONTROL SYSTEMS/PHOTOGRAMMETRIC EQUIPMENT/RANGE INSTRUMENTATION SYSTEMS/TEST AND CHECK-OUT SYSTEMS/MILITARY AND INDUSTRIAL RESEARCH AND DEVELOPMENT SERVICES/FIELD ENGINEERING AND EQUIPMENT MAINTENANCE SERVICES.

# Today — Raytheon Microwave Technology is Solving These Problems —

The quest for answers is leading industry into many new and more complex scientific disciplines. Here are some solutions from the field of electronics which may help to provide an insight into your problems. Today, Raytheon microwave technology is solving these problems. Tomorrow perhaps it can help you.

## **Problem: Improve the power/pound ratio in transportable radar systems.**



Modern military radars go wherever the fighting man goes and consequently must be lightweight and readily transportable. Under battlefield conditions, the amount of gasoline required to generate primary power can be a critical logistical problem.

Working with major system manufacturers, Raytheon has developed microwave tubes that operate with high efficiency and low voltages to provide far more output power per input pound of gasoline. These crossed field amplifiers are so compact and lightweight that they also permit substantial reductions in system size. Raytheon has built more of them than any other manufacturer and has proven their long-term reliability in many field applications.

Crossed field amplifiers are a product of the Tube Operation of Raytheon's Microwave and Power Tube Division.

## **Problem: Develop a laser powerful enough to open up a vast array of new application possibilities.**

In the laser field, one-watt output represents a tremendous amount of energy when generated under continuous-wave as opposed to pulse conditions. Raytheon's new LG12 argon laser, now in production, has this capability, making it suitable for a host of applications where insufficient power previously prohibited the use of lasers. Some of these are in laser reconnaissance systems, optical data processing systems, bright display work, underwater signalling, tracking and other oceanographic applications.

Operating in the single transverse mode, the LG12's one-watt output is over the range of 4545 to 5145 angstroms in the blue-green portion of the visible spectrum. Even more dramatic

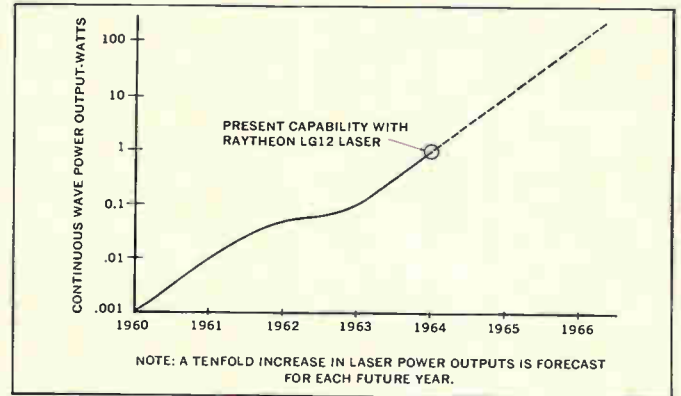

breakthroughs in laser continuous-wave power outputs are expected to be achieved by Raytheon in the months to come as illustrated by the graph above.

Lasers are a product of the Laser Advanced Development Center of Raytheon's Microwave and Power Tube Division.

## **Problem: How to prevent the rapid deterioration of flavor in preserved foods.**



To help solve this problem in biological research, Raytheon recently developed for one of its customers a microwave generator that produces power of a precise, required frequency. By using the generator to permeate the food enzymes with microwave energy, it is hoped that the usual rapid deterioration of food flavor can be prevented. This will thereby extend the usable life of foods. Still another area where microwave generators by Raytheon are being utilized is gas plasma research. Additional application possibilities include pasteurization and sterilization, chemical synthesis, curing materials, polymerization of plastics, and setting up unusual chemical reactions.

Microwave generators are a product of the Special Electronic Equipment Operation of Raytheon's Microwave and Power Tube Division.



Write us in detail about your problem. Data on specific products is also available by contacting Raytheon Company, Microwave and Power Tube Division, Department 3036, Waltham, Massachusetts 02154

# This infinite resolution multi-turn pot does not depend on a fragile wire... 100,000,000 revolution life!

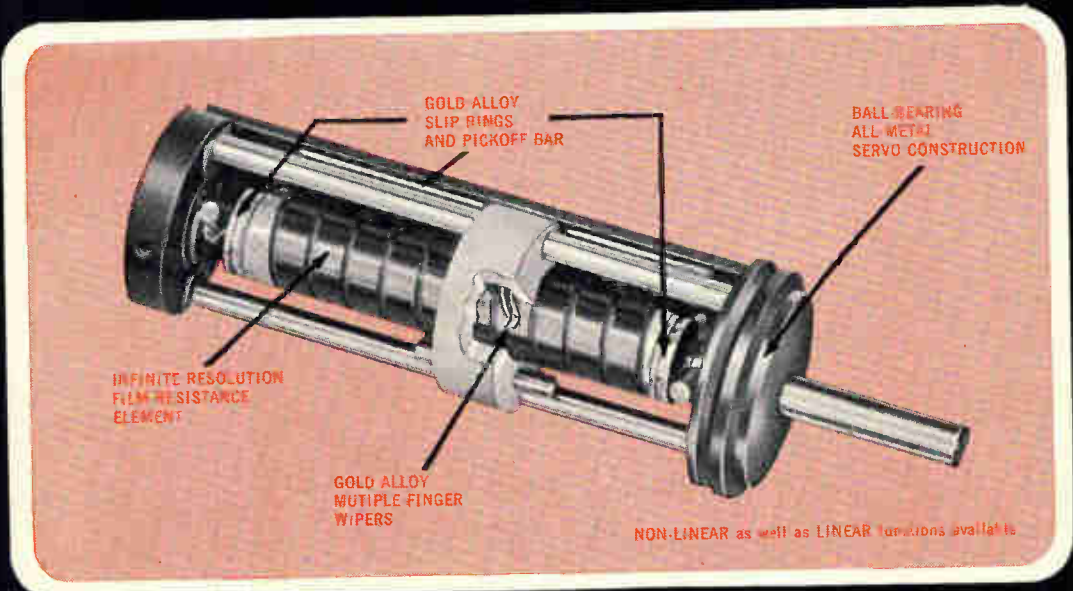

Only CIC pots use multi-fingered, precious metal wipers contacting a broad-band, continuous film resistance element, providing infinite resolution and high reliability through the inherent fail-safe properties of this design. The mirror-smooth surface of the resistance element permits the use of light pressure, low mass wipers with individual fingers tuned to different natural frequencies, giving long life, even under the most severe environmental conditions.

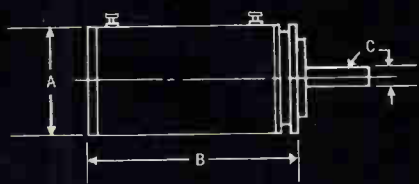

### SPECIFICATIONS FOR 10-TURN MODELS

MODEL No.	5010	7810	7812	20010
A	.50	.875	.875	2.0
B	1 1/2 Max.	1 1/4 Max.	1 1/4 Max.	2 1/2 Max.
C	.0937 .0932	.1875 .1870	.1250 .1245	.2500 .2495
BEST LINEARITY	0.075%	0.025%	0.05%	0.01%



**COMPUTER INSTRUMENTS CORPORATION**  
82 MADISON AVENUE, HEMPSTEAD, L.I., N.Y. / 516 IV 3-8200

■ Please send me, without obligation, the C.I.C. catalog.  
(All information must be filled in below.)

Name \_\_\_\_\_  
 Position \_\_\_\_\_  
 Company \_\_\_\_\_  
 Address \_\_\_\_\_



*eeyyaaahhh !!*

### Anything Over 68°C And They Scream The Place Down

They're uncanny little chaps. And Hitachi has given them a special name. The CRITESISTOR<sup>®</sup>. This is short for Critical Temperature Resistor. They're so advanced in design and performance ... so simple in construction ... so much ahead of any other type of thermistor that Hitachi has taken out world-wide patents. And mass production is already well under way. ■ As a result of a highly systematic study of materials and production methods Hitachi was successful in discovering this new element. One which has critical resistances that change by two to four orders at 68°C. ■ The components of the Critesistor are vanadium oxide, basic metal oxide and acid metal oxide. And when operated at a region near critical temperature, these elements have an especially high sensitivity to the temperature and temperature variations, by the use of alpha thirty times larger than that of the ordinary thermistor. This results in temperature curve characteristics that are more acute than any other thermistor. ■ The Critesistor's obvious and ideal role is as a thermal alarm element. At optimum temperatures it will instantly trip a bell alarm to all branches of a system. It can offer 100 branches as a maximum. ■ For complete technical data on this new development by Hitachi please write your request to the addresses below.



Tokyo Japan

HITACHI SALES CORPORATION: 333, N. Michigan Avenue, Chicago 1, Ill., U.S.A. Tel: 726-4572/4 / 666, 5th Avenue, New York, N.Y. 10019, U.S.A. Tel: 581-8844 / 12715, S. Daphne Avenue, Hawthorne, Calif., U.S.A. Tel: 757-8143  
HITACHI, LTD., DUESSELDORF OFFICE: Graf Adolf Strasse 37, Duesseldorf, West Germany Tel: 10846



# Six remarkable instruments in one!

*Unprecedented performance from the new Hewlett-Packard:*

#### AC Differential Voltmeter

Highest accuracy of any "touch-and-read" instrument, 20 cps to 100 kc, 1 mv to 1000 volts, 1 megohm input impedance, < 5 pf shunt

#### DC Differential Voltmeter

0.02%  $\pm 10 \mu\text{v}$  accuracy, 0 to 1000 volts, 7 ranges,  $10^9$  ohms constant input impedance

#### DC Standard

0 to 1000 volts, to 20 ma current, 0.02% accuracy, 1 ppm voltage resolution, 0.003%/day, 0.005%/month stability

#### High-impedance AC Voltmeter

$\pm 2\%$  floating ac voltmeter, 1 mv to 1000 volts, 1 megohm input impedance, < 5 pf shunt

#### High-Impedance DC Voltmeter

$\pm 2\%$  floating dc voltmeter, 1 mv to 1000 volts,  $10^9$  ohms input impedance

#### Power Amplifier

Unity voltage gain with up to 20 ma available at output terminals for any input, 0 to 1000 volts dc, accuracy  $\pm 0.02\%$

**Turn the page to learn what this totally unique combination of performance characteristics means to your measuring tasks. Use the handy tear-out postcard for complete data and a demonstration!**

*See the 741A and other new Hewlett-Packard instruments at the I. E. E. Show, New York City, March 22-25, 3500 Aisle, 3rd Floor.*

HEWLETT  PACKARD



## Use the 741A:

- To measure high ac voltages without drawing reactive currents
- To measure regulation, stability of inverters, ac power supplies
- To measure ac voltages in circuits where capacitance loading is critical
- To measure high accuracy ac servo voltages
- For precision transducer measurements
- For precision attenuation measurements
- For power supply regulation, stability measurements
- For thermocouple measurements
- To calibrate digital voltmeters
- As a dc standard for transfer measurements
- As a high voltage dc standard source
- For floating, high impedance ac voltage measurements
- For floating, high impedance dc voltage measurements
- As a low-level null detector
- To record long-term drift measurements
- As a power amplifier

## Gentlemen...

Please send complete technical data on the new 741A

Please have my field engineer arrange a demonstration

NAME \_\_\_\_\_

TITLE \_\_\_\_\_

COMPANY \_\_\_\_\_

STREET \_\_\_\_\_

CITY \_\_\_\_\_

STATE \_\_\_\_\_ ZIP \_\_\_\_\_

# performance unequaled -

## from the hp 741A AC-DC Differential Voltmeter DC Standard Priced under \$1500!

A truly state-of-the-art instrument to give you measurements you've never been able to make before, plus a 0.02% dc standard at a top-value price. Use the new hp 741A as a dc standard source, an ac and dc differential voltmeter, a high-impedance ac and dc electronic voltmeter and a power amplifier — six instruments in one! All of them offer unique performance capabilities to help you in scores of measuring tasks.

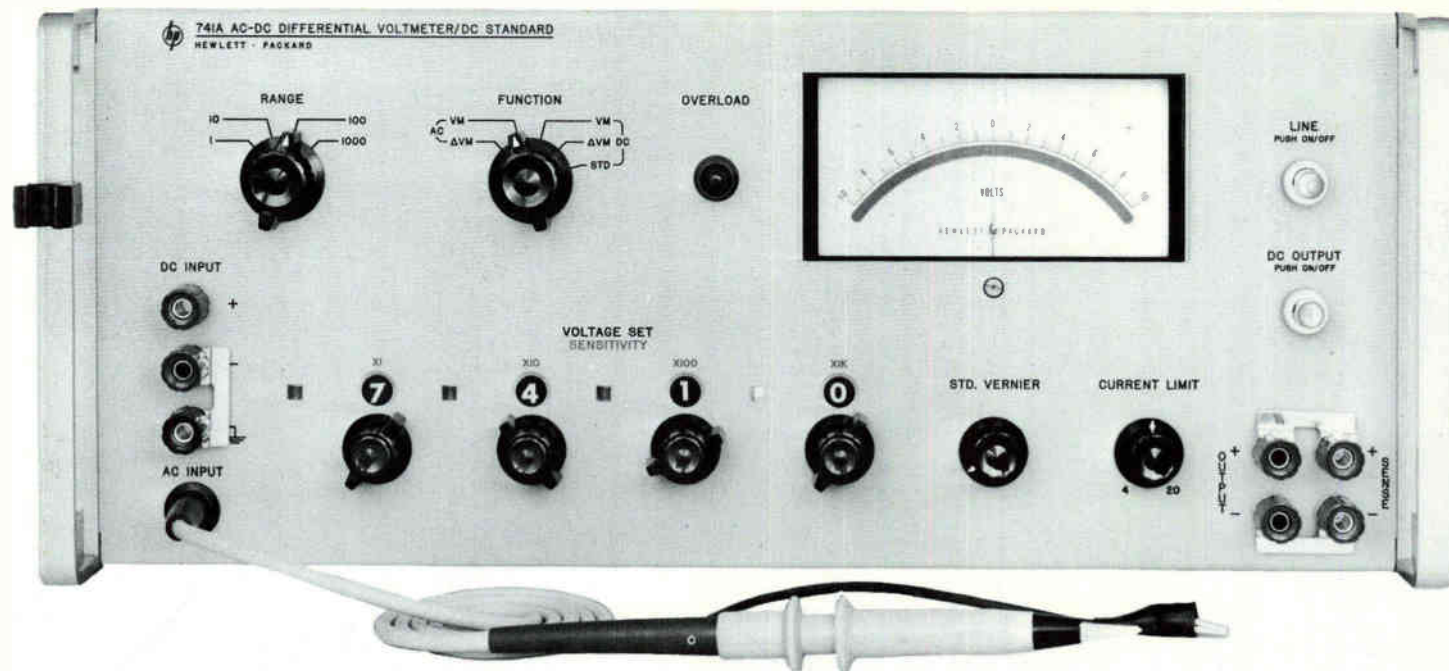

### AC DIFFERENTIAL VOLTMETER

Measure ac, 0.1 to 1000 volts, with an accuracy of  $\pm(0.05\% + 0.01\%$  end scale) from 100 cps to 10 kc;  $\pm(0.1\% + 0.01\%$  end scale) from 50 cps to 50 kc;  $\pm(0.2\% + 0.01\%$  end scale) from 20 cps to 100 kc. A low-capacitance probe (less than 5 pf at the tip) permits measurements in circuits where capacitance loading is critical. Ideal, too, for measuring high ac voltages, since the source is not required to supply high reactive currents. Accuracy is maintained independent of null conditions. Recorder output permits drift regulation measurements on oscillators and ac sources.

### DC DIFFERENTIAL VOLTMETER

Measure 0 to 1000 v in 7 ranges with an accuracy of 0.02%  $\pm 10 \mu\text{v}$ , and input impedance greater than  $10^9$  ohms on all ranges, independent of null. Here's totally unique performance to be compared with conventional dc differential voltmeters, whose input impedance is low except at null. Thus, the 741A is ideal for drift measurements, with accuracy independent of null conditions. Stability is 0.003%/8 hours and 0.005%/month.

### DC STANDARD

The 741A delivers accurate dc voltages from 0 to 1000 volts at currents up to 20 ma. Front-panel current limit control is useful for protecting external circuits from damage. Floating output allows either positive or negative ground with remote sensing. Accuracy is 0.02% of the indicated setting and stability is the same as that of the dc differential voltmeter. Voltage setting is indicated by 4 digits, with the remainder of the reading shown on the front-panel meter. Output resolution is 1 ppm on any range, directly readable on the front panel.

### HIGH-IMPEDANCE AC/DC VOLTMETER

With ranges from 1 mv to 1000 volts, the 741A is a  $\pm 2\%$  floating dc voltmeter with input impedance greater than  $10^9$  ohms on all ranges. It also is a  $\pm 2\%$  floating ac voltmeter from 1 mv to 1000 volts, with the low capacity probe providing a 1 megohm input impedance ( $< 5$  pf shunt) on all ranges.

### POWER AMPLIFIER, RECORDER OUTPUT

The 741A may be used as a dc power amplifier, or impedance converter, in any of its four voltmeter modes of operation. The input voltage can be 0 to 1000 volts and is reproduced at the output terminal within  $\pm 0.02\%$ . Input impedance is  $10^9$  ohms, and 20 milliamps of output current is available.

The reference supply in the 741A consists of a temperature-controlled zener diode and maintains the high stability specified. This supply can be compared with a standard cell and measured differentially with the 741A without disassembling the instrument.

*All this—and the 741A is priced at only \$1475!*

Demonstrations of this remarkable new instrument are available from your local Hewlett-Packard field engineer. Call him for complete information or use the attached postcard for technical data from Hewlett-Packard, Palo Alto, California 94304, Tel. (415) 326-7000; Europe: 54 Route des Acacias, Geneva; Canada: 2870 Mayrand St., Montreal.

*Data subject to change without notice.  
Price f. o. b. factory.*

First Class Permit  
No. 201  
Palo Alto, Calif.

## BUSINESS REPLY MAIL

No Postage Necessary if Mailed in the United States

POSTAGE WILL BE PAID BY —

## HEWLETT-PACKARD COMPANY

Department E, 1501 Page Mill Road  
Palo Alto, California 94304

HEWLETT  PACKARD  
An extra measure of quality

Report from

## BELL LABORATORIES

Chemist W. G. Guldner examines apparatus for "flashing" thin-film samples to remove gases for analysis. Helical tube is xenon flash surrounding vacuum chamber indicated in drawings below.

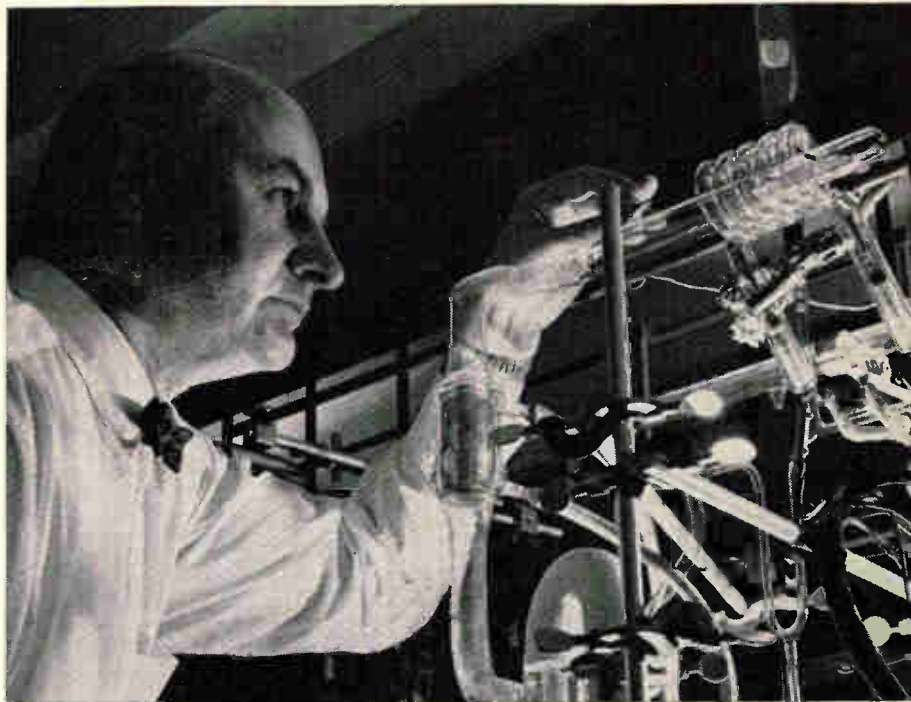

### "FLASHING" THIN FILMS FOR QUANTITATIVE ANALYSIS

In making tantalum thin-film circuits, the tantalum is deposited on a substrate. Nitrogen is added during the deposition to form tantalum nitride, which helps stabilize resistance and capacitance values. After a film is formed, one then needs a quantitative analysis of the amount of nitrogen and other gaseous elements it contains.

A new technique has been developed at Bell Laboratories to perform

this analysis quickly and accurately. As shown in the photograph above and in highly simplified form in drawing A, a sample of a film on its substrate is placed in a glass vacuum chamber. This chamber, surrounded by a xenon flash tube, is then subjected to a one-millisecond flash of light. As indicated in drawing B, the light energy is selectively absorbed by the film and has little effect on the substrate or on the walls of the glass chamber.

The film is vaporized, and the temperature is high enough to dissociate the tantalum nitride.

Drawing C illustrates the chamber after the flash. Tantalum atoms have been driven to the inside walls of the chamber and are there condensed. Most of the released nitrogen and other elements are now in gaseous form within the chamber. These are pumped out for analysis by gas chromatography or other means.

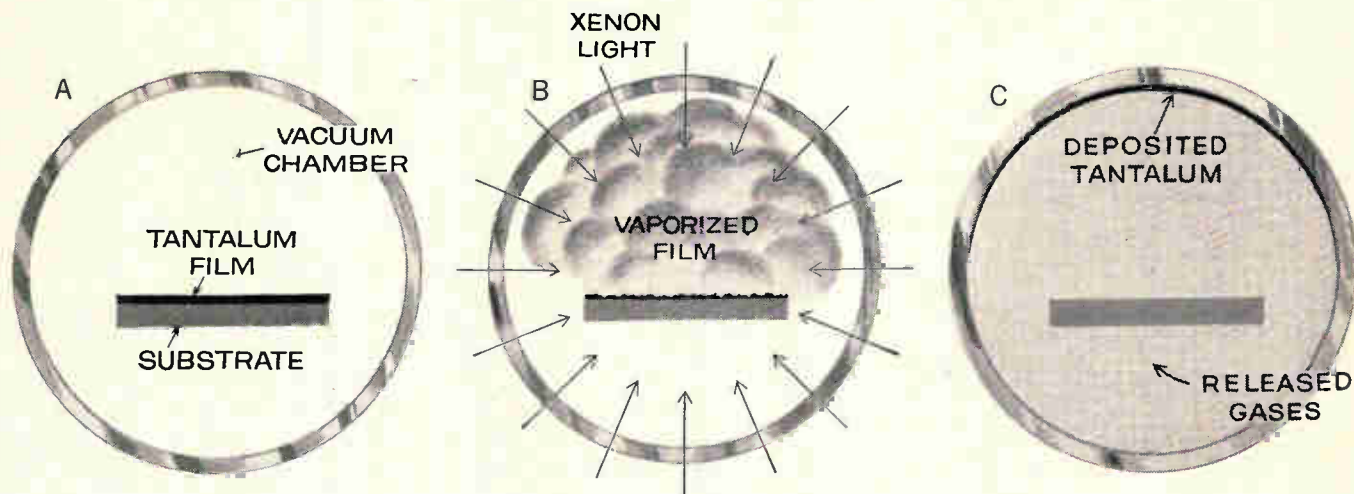

**Bell Telephone Laboratories**  
Research and Development Unit of the Bell System

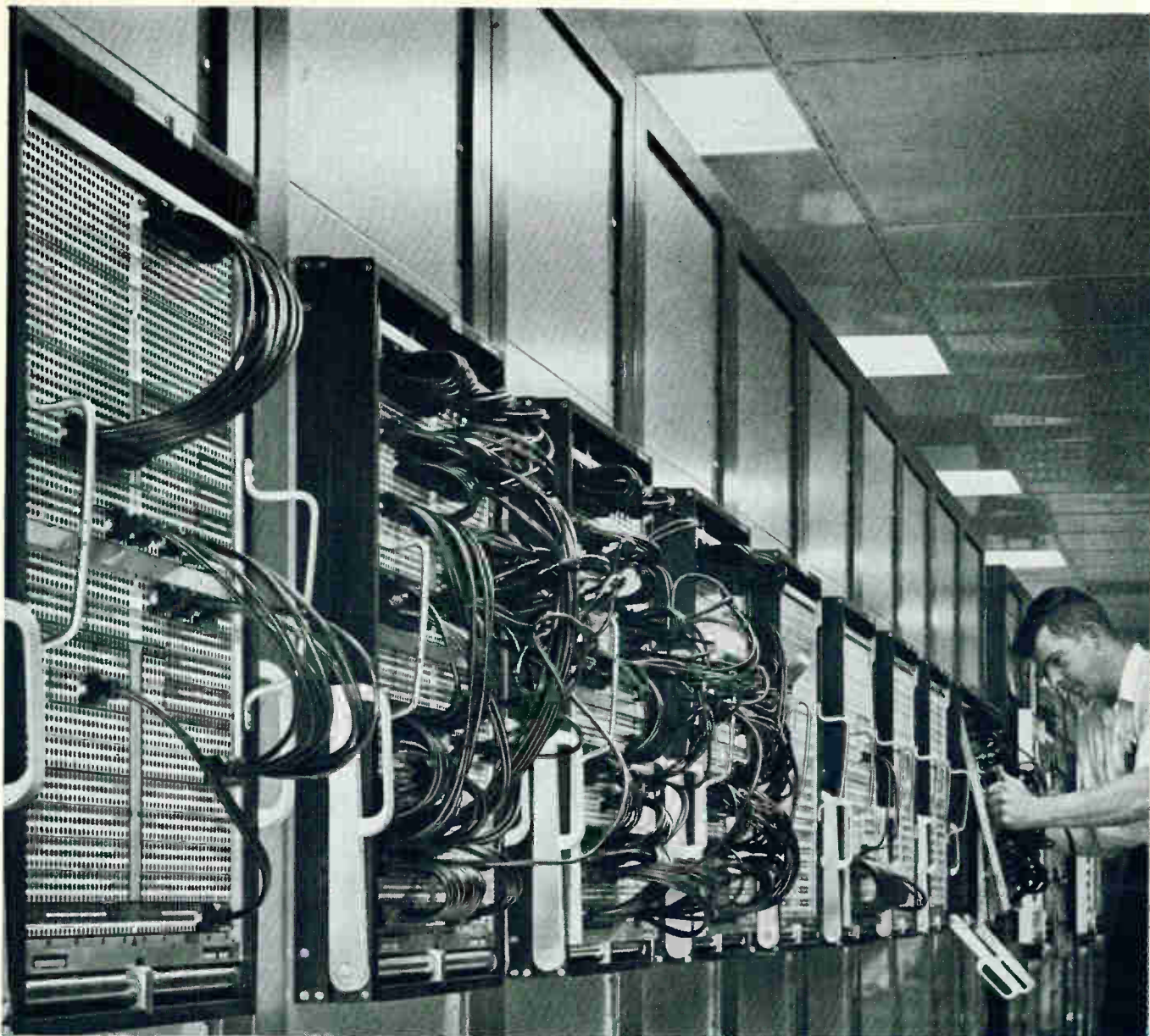

## Ever take a rocket's pulse?

These A-MP\* Patchboard Programming Systems at Textron's Bell Aerosystems Company's rocket propulsion test laboratories do just that! They take the rocket engine's pulse, vibration, acceleration, pressure, temperature, and other instrumentation data—and route it from the several test cell control rooms to the master recording center. Arteries of shielded twisted pair patchcords carry the instrumentation data to the vital organs of the test complex: conditioning and calibration equipment, strip chart recorders, digital and analog magnetic tape recorders.

AMP's Patchboard Programming Systems are the ideal answer to the pre-programming flexibility and quick-change patching requirements so essential to the installation. Minor checks can be made at the test cell control rooms by means of the programming systems located in these areas while the programming systems in the Data Recording Center permit rapid switching from one test complex to another without downtime. Gold

plated contacts and precision construction assure constant, reliable performance.

Our SYSCOM Division is a unique *one-source* supplier for a complete line of programming devices serving such installations across the country. Why not discuss your specific programming needs with our engineering staff. They are trained to assist you in the selection and operation of programming systems, whatever the application. Write for the free catalog which includes information on Patchboard Programming Systems and information on other A-MP programming devices.

★Trademark of AMP INCORPORATED



A-MP\* products and engineering assistance are available through subsidiary companies in: Australia • Canada • England • France • Holland • Italy • Japan • Mexico • West Germany

# Probing the News

Military electronics

## Electronics for the ocean depths

Now the industry can get to work on new systems and devices needed for the Navy's \$280-million deep submergence program

By John F. Mason

Military Electronics Editor

**Electronic components** and equipment for the Navy's \$280-million deep submergence systems program will be operating in a new and harsh environment that presents both a challenge and opportunity to the electronics industry. [Electronics, Nov. 30, pp 83-84].

Precise requirements for the electronics on three types of submersible vessels have now been spelled out. Joseph C. Cestone heads the committee for sensors, navigation and communication and David

Gold directs the committee for integrated controls and electronics.

Contracts for electronic equipment will be awarded piecemeal. They will be time-phased so that gear can be installed as the vehicles are ready for it.

### I. Proposals

Three submersible ships will comprise the Navy's initial search and rescue operation: a two-man rescue vehicle, a two-man search vehicle and the Fish, an unmanned

search vessel.

• Proposals for the two-man rescue vehicle will be out by summer and the contract will be awarded in the fall. The prototype ship will be capable of a descent to 6,000 feet to rescue 12 survivors at a time from a sunken submarine. It should be finished by Dec. 1967. Plans call for six fully-operational vehicles of this type.

• Proposals for the two-man search vehicle will be issued six months after those for the rescue

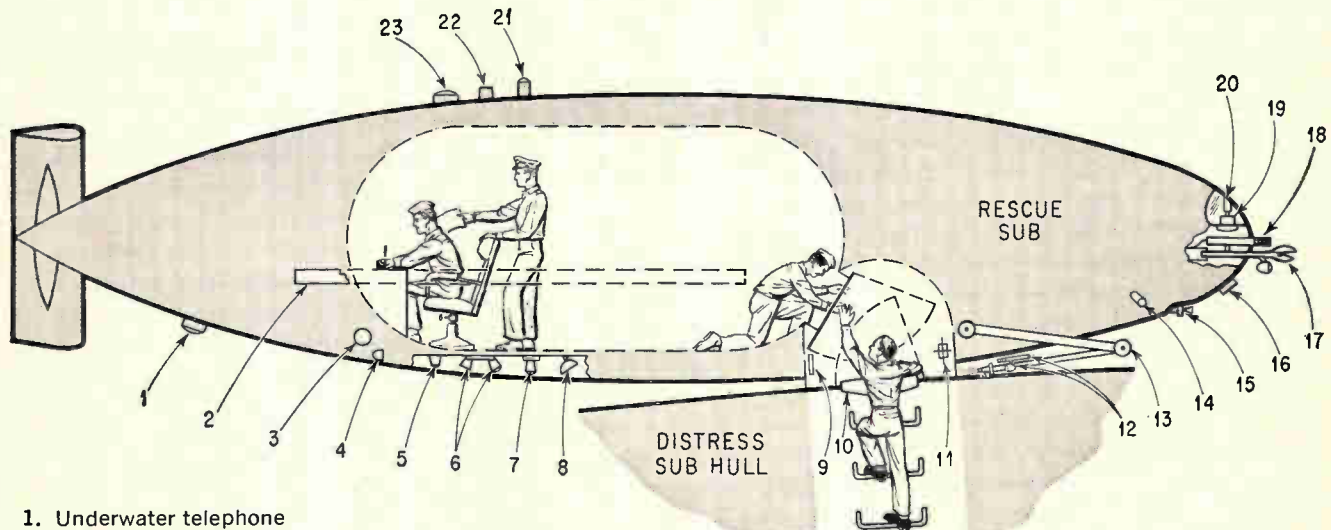

1. Underwater telephone
2. Side-looking sonar
3. Reel for secondary mission
4. Mounting location for magnetometers
5. Altitude sonar
6. Doppler sonar
7. Beacon release
8. Floodlight
9. Radiation probe
10. Hatch

11. Mounting location for ultrasonic probe
12. Tv and lights on wrist of manipulator
13. Manipulator attaches hook during mating operation
14. Listening hydrophones (2)
15. Short-range sonar (vertical and horizontal axis)

16. Vertical-track profile sonar
17. Cable cutter (retractable)
18. Tv camera and light
19. Retractable sonar dome
20. Main pilotage sonar
21. Omnidirectional sonar
22. Depth sonar
23. Underwater telephone

Rescue vehicle carries two-man crew; it can rescue 12 men at a time from a sunken submarine. The vehicle is 10 feet in diameter, 25 feet long, weighs 50,000 pounds, and is powered by battery.

vessel. The prototype will explore the ocean to a depth of 6,000 feet. Four fully operational models to be built later will be able to go down to 20,000 feet.

• Work on the unmanned Fish will get under way with requests for proposals late next year. The Fish, to be towed by a mother ship, will search the ocean bottom and send its findings back by cable.

## II. The cruel sea

"Transducers have never operated at such depths before, nor even been tested under such pressure," Cestone says. "The solution may be in repackaging to protect them from the pressure, or in building transducers that will withstand the pressure without protection."

Sonars will have to be studied with these alternatives in mind. They will be tested at various ocean test ranges and in the Model Basin, Marine Engineering Laboratory, Annapolis, Md.

**Microelectronics.** Modular construction will be used throughout, with microelectronic circuits "if we can get them and if they're reliable," Cestone says. "Microelectronics will help solve the heat dissipation problem. The heat must get out of the equipment.

"Humidity in the equipment is a problem. It stays at about 99% all the time," Cestone says.

The rescue vehicle must be sturdy enough to be dropped from an aircraft into the water. Problems of vibration and shock will have to be solved.

Other equipment requirements are size, weight and volume. These must all be low. Multiple functions will be performed by single items. David Gold, whose job it is to integrate the sensors, will use one display for as many sensors as he can. Sonar and television, for example, might share one display.

In the Polaris program some of the transistors used in the original design were suddenly discontinued, and the whole module had to be redesigned.

To keep this from happening in the deep submergence program, David Gold wants assurance that any component he buys will be in production for at least the next five or ten years.

He can accomplish this, and eliminate duplication of effort in circuit design, by standardizing

specifications for approximately 300 components to be used in the program. The components will not be proprietary. Although his standardization program has no official sanction, the NAFI (The Naval Air Facility, Indianapolis) is supporting the effort by asking designers to conform to Gold's specifications. It is Gold's hope that all naval programs will adopt his specs. His first job will be to convince other committees in the deep submergence program. He is still working on the specification manual and says it will be distributed to industry when it's finished.

## III. Mating is the problem

With some modifications and repackaging most of the sonars can come from other programs. One sonar, however, must be developed from scratch—the short-range sensing device that will be needed by the manned vehicles if the water is muddy and the crewmen can't see through the last three or four feet to a target. This may be required for docking with the mother ship, but more probably, it will be needed for finding the hatch of a sunken submarine, especially if muddy water is eddying over it.

The problem of mating a vehicle with the submarine in distress is considered to be the knottiest in the entire program. Besides poor visibility, currents make it difficult for the rescue vessel to hover directly over the hatch and settle down on it. If the sub is lying more than 45° on its side, mating will not be attempted.

Two types of sonar have been suggested for this extremely short-range work: a scanning, high-frequency image-forming sonar and a high-frequency sonar of either a frequency-modulated carrier or short-pulse type, arranged in a dual system to present a stereoscopic image to the operator.

The first type is large, heavy, complex and insufficiently developed. Even if someone should develop a model without these liabilities, the committee feels it would be difficult to develop a display that would be easy to read.

The second, more likely, approach would probably operate at 1.5 megacycles and have ranges of 15, 30 and 100 feet. Range resolution would be 1% full-scale, and angular resolution, 1°. Requests for

proposals will go out to industry before the end of August.

**Altitude/depth sonar.** Sonar is needed to tell how close the craft is to either the surface or the ocean bottom. It must be able to determine this distance to the nearest foot. Sonars now in deep-submerging vessels do this but for the new craft they will have to be reduced in size and weight. The Edo Corp., Straza Industries and the Bendix Corp. make them.

**Sector-scan and forward-track.** Profile sonars are needed to avoid obstacles and aid in pilotage. Straza Industries has such equipment on the bathyscaphe Trieste and the Alvin, a small research submarine, but again this gear is too big for the deep submergence program. Straza is building, in-house, a prototype that will be one-fifth the size.

To avoid an obstacle, the pilot must be warned of it at least 300 yards away to give him time to change course. Horizontal scanning will be done by an f-m scanning sonar on a frequency of 70 to 90 kilocycles. The vertical scanner, however, may use a simple split-transducer to indicate bearing deviation. This is the system used in acoustic torpedos. Experiments are currently in progress to see how well this works out. Frequency might be 60 kc. The transducer would be about 2 by 4 by 2 inches, and weigh one pound.

## IV. Searching the sea bottom

For detecting small objects on the ocean floor, side-looking sonar will be used on the manned submersibles and on the unmanned Fish. The side-looking sonar produces, on a special strip recorder, a chart showing a representation of the shape of objects protruding above the ocean floor. There is no acoustic return from areas of the ocean bottom that are shielded by an object. The speed of sound limits the rate at which an area can be searched. This limit is approximately ¼ square mile per hour for objects of one-foot size.

The equipment proposed will detect a 10-foot object at a range of 1,000 yards, and will transmit at 150 kc. With the 10-foot resolution, the sweep speed can be in the range of three to five knots. Consideration is also being given to a side-looking sonar capable of one-

foot resolution. This equipment would operate at higher frequency, and consequently have shorter range. The speed would be limited to about one knot.

Westinghouse Electric Corp. built a side-looking sonar for the Trieste but so far it's still in its crate. "We plan to test it to see if it is suitable for our purposes," Cestone says.

Three other sonars will be off-the-shelf items with minor modifications: an omnidirectional sonar, directional-listening hydrophones, and a pinger that makes sounds which are easily tracked by the mother ship or submarine.

## V. Navigation

Since the Fish will be towed, it won't need equipment for navigation, observation, or communication, except, of course, a telemetry package to relay its findings back to the mother ship.

The attitude and heading indicator picked for the prototype rescue vehicle consists of a small gyrocompass to indicate azimuth and a small vertical gyro to indicate the vertical. For the operational submersible, however, Cestone wants both functions to be performed by a gyrocompass. He believes a smaller, lighter and more accurate gyrocompass than those now available can be developed. Azimuth indications to accuracies of five minutes of arc for most latitudes are needed for the search mode.

**Velocity indicator.** Doppler velocity indicators will be used to measure ground speed for docking, hovering and navigation. A typical application of this equipment might use a two-transducer doppler system, with broad (30°) beams. The thrust of the propulsion unit will be controlled by the doppler output to keep the vehicle stationary in currents up to two knots. The Janus Control Corp. and the Raytheon Co. have both built such equipment for shallow water, down to 300 feet. The General Electric Co. built one for the Polaris subs that would operate down to more than 15,000 feet. It was never used, however, since it takes 50 kw of power to operate it. The gear is now on the USS Observation Island, a surface-ship laboratory for electronic equipment.

**Automatic tracker.** Keeping a



Rescue and salvage vehicles will eventually retrieve large numbers of survivors at a time, also objects as big as submarines.

manual record of the track of a search vessel is a full-time job for a crew member and still doesn't prevent time-consuming backtracking. The Trieste crew learned this while looking for the Thresher in the summer of 1963. The following year, they installed an automatic tracker. A smaller version of this plotter, which is controlled by a digital computer, is to be developed for the submergence program.

**Rate gyros.** A rate package to measure roll, pitch and yaw may not be needed if this information can be obtained from the gyrocompass. If it is needed, however, the Navy will probably ask for an automatic, computer-run system.

**Beacons.** Pinger and transponder beacons will be dropped to the floor of the sea for navigational reference points. There will be heavy procurement of off-the-shelf equipment.

**Observation.** Existing vidicon tv cameras will probably be adequate for the program. Improvements will consist of reduction in size of cameras and controls and higher scan rates for better resolution. The committee believes that high-sensitivity devices such as the image orthicon are not sufficiently developed for use at this time.

The use of lasers is considered unlikely now. The basic limitation is the backscatter level, and not light transmission. Even if a high-power, blue-green laser is developed, it is questionable if its use offers advantages for either illumination or optical echo-ranging applications. Lasers are at best several years away.

## VI. Communication

Most communication equipment

is available from other programs. That old standby (since 1949), the AN/UQC-1E underwater telephone, will probably be used. The PRC-27 uhf-band radio may be used for two-way voice communication between the rescue vehicle and its support ship.

Communication between the rescue vehicle and a distressed sub is more complicated. Crew members trapped in a sunken sub without power try to signal by tapping the hull. To detect and locate such sounds, the rescue vehicle will have low-frequency hydrophones. Once the two vehicles are mated, the rescuers will want to talk with the submarine crew before opening the hatch.

Electroacoustic ceramic transducers located on the exterior of the rescue vehicle will be placed on the surface of the distressed sub's escape hatch. Identical transducers will be installed inside the submarine's escape hatch. High-frequency excitation (200 kc to 3 Mc) of the rescue vehicle transducer will enable direct telephone communications between the vehicles, as well as transmission of power, up to several kilowatts.

An alternate method of telephone communication would use a feed-through connector in the submarine escape hatch plate through which a sound-powered phone connection between the two vehicles would be established after mating.

Cost will probably determine which approach is used.

**Telemetry.** While telemetry packages are fairly standard, Cestone recommends that telemetry techniques used for missile systems be studied in an attempt to reduce weight.

# Mixed bag makes a multiprocessor

Special buffers, adapters and programs talk a kind of esperanto so that assorted brands of computers can work together

**Getting different brands** of computers and peripheral equipment to work in concert is akin to conducting a United Nations session without interpreters. Most likely, the participants think differently and understand only their own language.

Nevertheless, the computer facilities staff at Rome Air Development Center, at Griffis Air Force Base, Rome, N. Y., has gotten four types of computers and more than a dozen peripheral systems made by nine manufacturers to work concurrently or independently on different problems at the same time. The system is called Intip, for Integrated Information Processing.

Other time-sharing multiprocessors are usually made up of compatible memories, data processors and input/output sections. Two features distinguish Intip: all of its sections can be different, and one computer runs the complex.

This was accomplished by devising adapter and buffer subsystems as links, and by developing programs and other software that integrate operations of the machines.

While most planned applications for the concept are for the Air Force and government, "industry and business fallout looks promising," says Milton Rosenberg, chief

of the computer engineering section of RADC.

Companies that require different types of computers to solve their problems could link them for better efficiency. The military wants this, too, but it is specifically concerned with improving the compatibility and flexibility of command and control equipment and enabling the main frame of large, general-purpose computers to be considerably more efficient in "use time."

## I. A model tool

The present complex will be used as a research and development tool as part of RADC's reliability central program—the Air Force's clearing house for reliability data. It is also serving as a model for an RADC-managed reconnaissance imagery interpretation project that the Univac division of the Sperry Rand Corp. has built for the Air Force.

Rosenberg and his staff also hope to install consoles at various laboratories at the center, so engineers can use the computers without leaving their work. Software is being developed so that the engineers can pose problems in fairly plain language, instead of computerese. The computer would ask for additional instructions until it was told enough to solve the problem.

In some respects, the Intip program is similar to two other military computer programs—Mac, another multiple access plan, and Adam, which is concerned with advanced data management systems. These are software programs designed to improve the ease with which men can use computers.

## II. Bigger and bigger

Piece by piece, Intip is growing larger. One intent of this R&D program is to determine the feasibility of allowing up to 16 computers and system control elements to be linked with 64 peripheral instruments or input/output channels.

The computer which runs the system is a Control Data Corp. 160A. Also wired to the system are two Thompson Ramo Wooldridge, Inc. RW CM-400 computers and a CDC 1604B computer. Two Reeves Instrument Co. analog computers are connected through an analog-digital/digital-analog converter made by Adage, Inc.

Input/output consoles include an Electrada Corp. Datacom 408 and Bunker Ramo BR-85 with visual displays. Up to 10 typewriters may be installed. There is also a General Dynamics Corp. SC 3000 output printer; and data can be entered by telephone lines through a Collins Radio Co. GSC-4 modulator-demodulator and a Vitro Corp. remote flexo-writer. A microwave link to one of the laboratories at RADC is also being installed. External mass memories include magnetic tape units made by Univac, Radio Corp. of America, and TRW, and disk files made by Control Data and Laboratory for Electronics.

## III. Building a network

To convert this mélange into one big brain, the CDC 160A is programmed to accept a problem and arrange for stored programs to

### Equal time

The Integrated Information Processing system at Rome Air Development Center has also wrestled successfully with the problem of time-sharing, a feature of some other large military computer systems. Time-sharing, which is starting to catch hold in commercial computers as well, is a technique that enables several operators to use the computer at essentially the same time.

The use is not simultaneous; the computer is equipped and programmed so that it works the different programs alternately. In Intip, the computer is on-line to an input/output console only during the time a single key of a typewriter, for example, has closed the contact that sends a single character into the computer. This takes only a few microseconds. In the interval before the operator presses another key—a fraction of a second—the computer works on other jobs.



# Obviously photography is the neat way to capture information and record data

You would like to try it. (You have heard that photographic processing is now so fuss-free and compact that it can go on all by itself in unmanned spacecraft.)

But photo-technology may not be your game. And your needs are special.

Wouldn't it be nice to talk them over with some fellow engineers who live photo-technology day in and day out?

You don't have to turn into any more of a photo-technologist yourself than you want to be. New developments can make such a carefree attitude realistic.

Tell us what you want to accomplish. If we think you're over-optimistic we'll tell you. Otherwise, we'll invite you to Rochester for conversations with the two or three men best qualified to tell you exactly what to do or whom

to see for the results you seek.

We have quite an assemblage of photo-engineers to draw on.

We are, after all,

**Kodak**

*Call or write Eastman Kodak Company, Special Sensitized Products Division, Rochester, N.Y. 14650, 716-325-2000, Ext. 5129.*



work on it. The computer either processes the data itself, or allocates it to another computer.

The CDE 160A "wires in" the other computers through an electronic switch which is the heart of the multiprocessor. The switch is analogous to a high-speed telephone crossbar exchange.

**Matchmaker.** Each computer or peripheral device is connected to the exchange through a relatively inexpensive adapter unit which matches voltage levels, word lengths and control lines to a common interface. Information, data and commands may thus readily be communicated between dissimilar devices of different design regardless of manufacturer.

A display interface buffer is used as a concentrator and controller for several consoles, typewriters and the microwave data link. It processes input/output to and from the devices, makes required code conversions, and communicates with the system through the exchange.

Although the buffer is not required, it speeds up the system operation by performing tasks which would otherwise have to be done by the executive computer. The adapters and the buffer were designed by James N. Pope, Jr., electronics engineer, and John B. McLean, research engineer, both of RADC, and developed by Control Data.

#### IV. Memory blocks

In order to allow simultaneous use of the systems by multiple users, the core memory of the 160A control computer is divided into 512-word blocks. The one in use now has 16 of them. The blocks are arranged to allow simultaneous use of core memories by many different and unrelated programs. Protection of such blocks from all other programs in the computer is accomplished either by software in the executive control program or by a hardware modification to the 160A which is analogous to an electronic key. Since most programs require more than one 512-word block of information in order to operate, the programs in the blocks are linked to other program blocks, either in the computer core or called into the computer core when required from one of the ex-

ternal disks or tapes by a method of overlays. All input/output is referenced symbolically by the job program and actually executed by the Executive Control Program in the 160A.

**All together now.** Having use of the segmented memory, the 512-word blocks, and the Executive Control Program (ECP) appears to give each operator simultaneous access to the system with all other operators. Each operator's job program is independent of all others in the machine. In addition, each job program is completely independent of the equipment configu-

ration, since all allocation of computer time and auxiliary memory storage (drum, disk, tape, etc.) is under the direct and sole control of the ECP. Thus the operator is no longer concerned with which computer is being used or with where or how his data is stored.

A system control officer is the only human allowed to communicate with or control the ECP. It is his job to mount and demount tape files as the system requires them, to assign user priorities and to detect system failures. He can also fit specific equipment to a specific job program.

---

## Consumer electronics

# Backtalk from the student is approved behavior

New educational television system may permit communication between pupil and teacher

"Sorry, you're wrong because . . .," said the voice on the television set when the student pressed a button to indicate his answer to a question. Simultaneously, one of the pictures on his quartered tv screen bloomed to fill the entire surface. Except in experiments, it hasn't happened yet, but such give-and-take would go a long way toward solving educational television's major drawback: the student's inability to communicate with the teacher.

A new system called Educasting may have an answer. Temple University in Philadelphia plans to test it this summer to see if it is indeed an effective teaching tool.

**Press a button.** Briefly, the system works like this: When the teacher pauses to ask multiple-choice questions, the student's tv monitor switches from one classroom view to four views in quadrants of the screen. Each quadrant corresponds to an answer; the stu-

dent, who is wearing earphones, is told to press one of the four buttons that correspond to the quadrants. By doing so, he selects matching audio and video responses. The quadrant he has chosen expands until it fills the screen and the audio tells him either that he is right, adding a word of approval and an explanation, or that he is wrong, and why. The video illustrates the explanation.

The student still can't talk to the teacher—but he has the illusion that he can.

In an earlier Educasting system [Electronics, May 4, 1964, p. 32] a student was only able to get an audio answer.

The tv system is being offered by Educasting Systems, Inc., New York, which was formed by Tutor Tape Laboratories, Inc., New York, developer of the equipment, and International Correspondence Schools, Scranton, Pa., which prepares the educational programs.

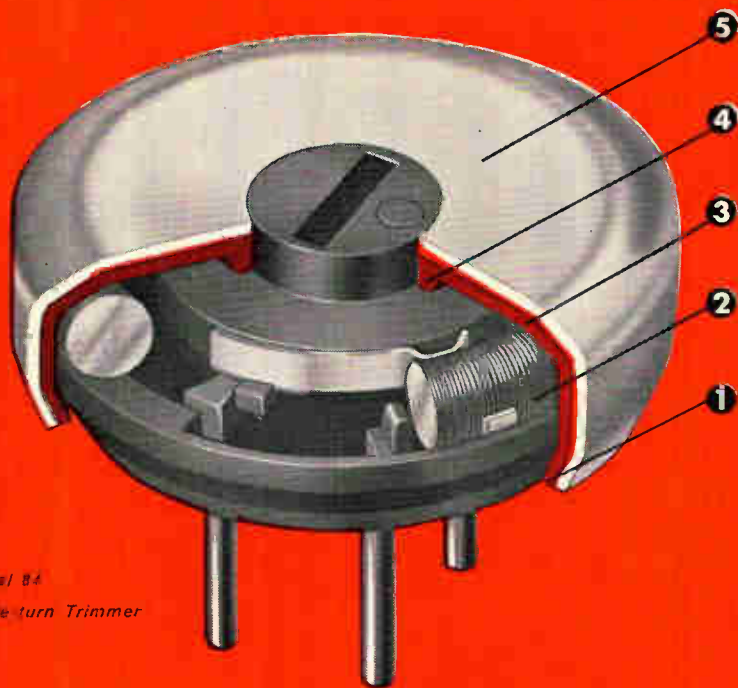

Model 84  
Single-turn Trimmer

# WHAT'S NEW IN TRIMMERS?

## Unique silicone rubber lining providing Military performance at industrial prices

No other trimmer gives you the superior performance of Spectrol's new model 84 at *any* price. Check these unique construction features which assure military reliability at industrial prices.

- 1 Silicone rubber lined cover is crimped to the base completely sealing the unit against dust and moisture. No adhesives are used in any of the assembly operations.
- 2 Largest resistance element available in any 1/2 inch trimmer is made possible by placing the element against the silicone-rubber lined metal cover. No thick-walled plastic cases or insulators are necessary. Larger element means larger wire and better resolution as well as higher maximum resistance value.
- 3 Silicone rubber lined cover provides a true voltage break-down barrier.
- 4 Packing gland sealing of the shaft is provided by the unique molded rubber-lining permitting full potting or immersion.
- 5 Metal case provides greater heat dissipation, avoids hot spots and allows high power rating of 1 1/2 watts at 50°C. For printed circuit applications, plastic base contacts PC board.



### SPECIFICATIONS

	MODEL 84
Standard Resistance Range . . .	50Ω to 100K
Standard Resistance Tolerance	± 5%
Power Rating . . . . .	1 1/2 Watts at 50°C.
Operating temperature Range	-65 to +175°C.
Rotation . . . . .	320° Fixed stops (continuous available)
Case Dimensions-inches . . . .	5/32 H x 1/2 Dia.
Unit Prices (84-3-8)	
1-9 . . . . .	\$3.95
500 . . . . .	\$2.60

Call your nearest Spectrol distributor for immediate off-the-shelf delivery at factory prices. Samples of the model 84-3-8 available for industrial and military users. For your sample write on your company letterhead direct to Spectrol, San Gabriel.

# SPECTROL ELECTRONICS CORPORATION

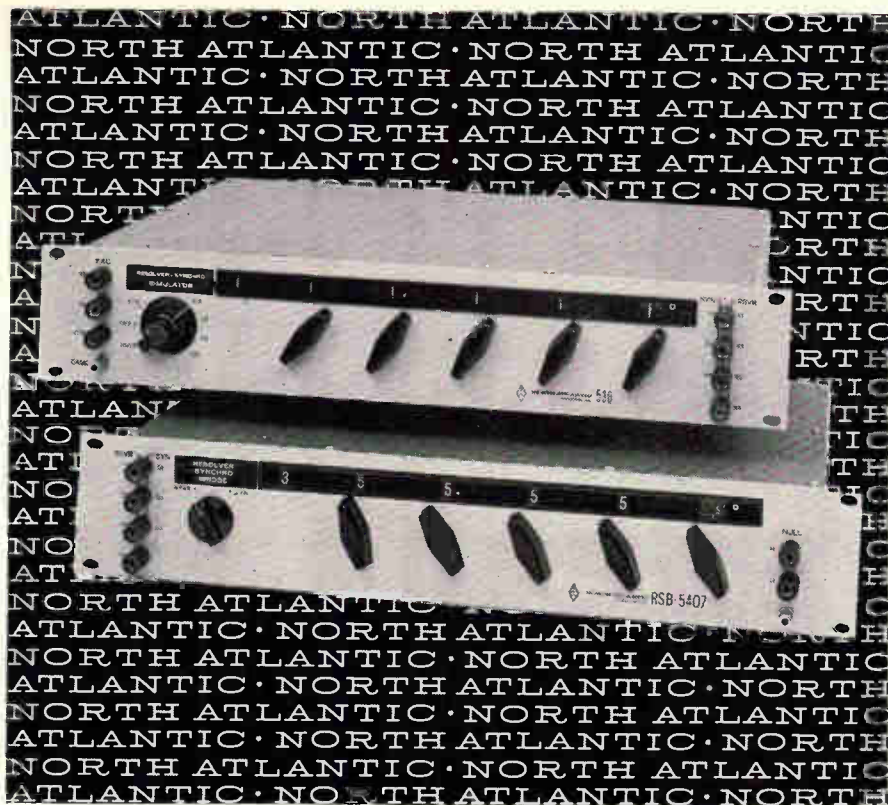

## you are looking at the state-of-the-art in resolver/synchro testing

These two instruments provide the widest measurement capability available today for resolver/synchro testing. Each is a dual-mode unit, measuring both resolvers and synchros. Series 530 Simulators are ideal transmitters, and Series 540 Bridges are ideal receivers.

In addition to their dual-mode capability in 3½" of panel space, both series provide in-line decimal readout continuously switched through 360°, 2 second accuracy at any angle, and input/output isolation.

#### SERIES 530 SIMULATORS FEATURE

- Resolution 0.001°, 1°, or 5°
- Dual 26/115 volt excitation
- Switch selected line-line voltages 11.8, 26, 90, and 115 volts
- Low matched output impedance

#### SERIES 540 BRIDGES FEATURE

- Resolution 0.0001°, 1°, or 5°
- 500K input impedance
- Constant null-voltage gradient at all line-line voltages
- Unaffected by null detector loading

Prices range from \$1480.00 to \$2680.00

The flexibility of these instruments meets every need for rapid and accurate testing in the engineering laboratory, in production, and in ground support equipment. Used with a Phase Angle Voltmeter, they provide a complete facility for component or system test.

Programmable models with decade or binary input are also available. Your North Atlantic representative will be glad to arrange a demonstration. Call or write him today.



**NORTH ATLANTIC** industries, inc.  
TERMINAL DRIVE, PLAINVIEW, L. I., NEW YORK • Overbrook 1-8600

The Emerson Radio & Phonograph Corp., Jersey City, N. J., is considering producing the special Educating tv sets, which are expected to cost 25% more than a regular set.

Temple will have no difficulty in adding the extra voice channels because it operates a closed-circuit tv station. Conventional stations will have to multiplex their sound carrier to add four subcarriers. This requires an experimental license from the Federal Communications Commission, because there are no established standards for such tv broadcasting.

Ira Kamen, director of Educating, says that Philadelphia's uhf Channel 17, which is considering the system, will seek such a permit.

**Elbowed off.** When the student selects his answer and the corresponding quadrant is magnified to the full-screen size, the other three quadrants are in effect forced off the screen.

The complex circuitry needed to enlarge one quadrant to fill the entire screen was developed by Harold W. Walker, a consultant of Educating. The heart of the receiver is its special kinescope drive unit. Usually, the sawtooth waves generated in the receiver deflection circuitry move the beam across the screen in 52 microseconds and down the screen in 1/60 of a second. To make one quadrant fill the screen, however, special sawtooth waves are switched in. These waves have twice the normal slope and hence move the beam from left to right in 26 microseconds and from top to bottom in 1/120 of a second. The beam thus rests off the screen during the time the three unwanted quadrants would be scanned on a normal television set. The periods when the beam rests and when it scans depends on which quadrant is chosen.

Brightness-correcting circuits are included because the beam is only on the screen one-quarter of the time. Walker also has several methods for improving the resolution, which is halved by the magnification.

Fordham University's radio station, WFUV-FM, is planning an audio-only Educating course for the spring. The New York City uhf tv station, WNYC, has tested the method using only audio for student response.

# What Pentagon will buy: a preview

Series of briefings to spell out changing policies

By Herbert W. Cheshire

Washington News Bureau

The big buildup in strategic weapons is over. With defense spending for the foreseeable future pegged at its present level or slightly below it, the Pentagon buying policies are changing; it will tell interested contractors exactly how at a series

### Briefing schedule

Los Angeles, Ambassador Hotel, March 3-4  
New York, Americana Hotel, March 16-17  
Chicago, Conrad Hilton Hotel, March 31-April 1  
Dallas, Marriott Motor Hotel, April 14-15  
Washington, Sheraton Park Hotel, April 28-29

of briefings across the country in the next two months.

The briefings were originally scheduled for last fall. They were postponed because the Administration feared that Barry Goldwater would make political capital of them; Goldwater was attacking President Johnson for defense cut-backs and for not pushing new weapons developments.

### I. Big, but no bigger

In essence, here is what the manufacturers will be told:

The defense market is no longer a growth market—but it remains a substantial one. Though the emphasis on strategic weapons—inter-continental missiles, bombers and Polaris submarines—is over, and so, to a lesser extent, is the expansion in conventional forces ordered by President Kennedy, the spending level will continue well above that of the 1950's. The pattern, however, is changing.

From now on, the emphasis is on quality rather than quantity—

## THESE ARE THE FEATURES OF THE NEW

Acme  Electric

## VOLTROL\* STABILIZER

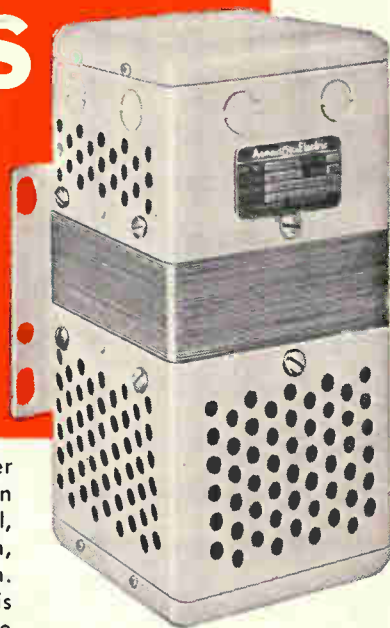

We've spent years developing a new stabilizer that incorporates all the improvements that can be expected from improved lamination steel, improved magnet wire, improved insulation, improved capacitors and improved design. As a result, the new VOLTROL Stabilizer is far advanced in performance. These are some of the features you can expect in the new VOLTROL Stabilizer.



**FAST RESPONSE TO LINE VOLTAGE FLUCTUATION** Voltage recovery in milliseconds on ordinary 3% to 5% line voltage fluctuations. Not more than 2 cycles (1/30th second) on sudden voltage drops or voltage surges of 15%.



**AUTOMATIC PROTECTION AGAINST OVERLOADS** Short circuit in the powered equipment or severe overload causes output voltage to drop to zero, automatically protecting stabilizer and equipment.



**AUTOMATIC ADJUSTMENT OF LOW VOLTAGE OR HIGH VOLTAGE** A continuous, low voltage or high voltage input is corrected to nominal,  $\pm 1\%$ , without causing excessive heating or other damage to stabilizer.



**OUTPUT TAPS FOR RECTIFIER CONNECTION** Most types are available with output taps to supply a regulated voltage to a rectifier.



### UNENCLOSED TYPES FOR OEM APPLICATIONS

The VOLTROL Stabilizer can be supplied without end covers for use as part of the equipment system. Unenclosed types cost less.

Write for Bulletin 09-B03 which describes and illustrates the many features incorporated in the VOLTROL Stabilizer to provide added advantages to you.

Acme  Electric

Engineers and Builders of...

312 WATER STREET, CUBA, NEW YORK

Canadian Representative: Polygon Services, Ltd.  
50 Northline Rd., Toronto 16, Ont.

\*VOLTROL is a registered trademark of Acme Electric Corp.

SAA 3806-3114

REGULATED POWER SUPPLIES  
STATIC POWER RECTIFIERS  
VOLTAGE STABILIZERS  
VOLTAGE REGULATORS

# New! Double performance



in  
a  
single  
wide band log amplifier



20 kc to 220 mc  
200 kc to 220 mc  
in one unit... at one low price

## **KAY** Logafier 1025-B

- Full 80 db Dynamic Range  
For Only 0.5 v in
- Widest Frequency Range
- Precision Meter

The 1025-B gives overall response, and at the same time gives detailed, easily seen measurements of points on the curve as far down as 80 db. The unit permits highly accurate viewing of the skirts and sharp slopes of band pass filters, single side-band filters, traps, etc. A control gives expansion of the top critical points simultaneously with the log display. 80 db log range, also available as undetected RF signal.

### SPECIFICATIONS

<b>Frequency Range:</b> 20 kc to 220 mc.	<b>Top Expand Control:</b> Variable over 0 to 10 db range.
<b>Flatness:</b> 500 kc to 100 mc, $\pm .5$ db. 20 kc to 220 mc, $\pm 1.0$ db.	<b>Input Impedance:</b> 50 ohms, higher over restricted frequency bands on request.
<b>Logarithmic Accuracy:</b> $\pm 2$ db	<b>Output Load:</b> 50 ohms
<b>Dynamic Range:</b> Full scale 40 db, 60 db or 80 db.	<b>Dimensions:</b> 5½" x 12½" x 19"
<b>Input Signal:</b> 0.5 volts for 80 db 0.16 volts for 60 db 0.05 volts for 40 db	<b>Weight:</b> 23 lbs. <b>Price:</b> \$795.

**VISIT US AT THE IEEE SHOW Booths 3311-3317**

For Complete Catalog Information, Write

**KAY ELECTRIC COMPANY**  
MAPLE AVENUE, PINE BROOK, N.J., PHONE (201) 226-4000

on performance, rather than production. In research and development, the Pentagon will attempt to program carefully and concentrate its resources. It won't support intellectually challenging but militarily questionable projects. It will push component developments in fruitful areas to the breadboard model stage and use them to improve existing weapons systems—but it will pull them together into totally new systems only rarely.

**Counting the cost.** Any new weapons systems that are started must meet stern tests of cost effectiveness; that is, they must show such a gain in military capabilities over existing systems as to warrant clearly the increased costs inevitably involved. In many cases, they will have to be adaptable to use by more than one service.

The new emphasis reflects the fact that the urgency of the late 1950's and early 1960's, when there were fears that we lagged behind the Soviet Union militarily, has been replaced by confidence that we are decidedly stronger than the Russians.

**More guns for less money.** The Defense Department will, however, devote increasing effort to tactical weapons for peripheral wars. This means a growing market for a wide range of less expensive and less complicated weapons.

Competition is thus much tighter for the contractor. He will have fewer jobs to bid on, but if he is to survive, he must not specialize too narrowly and he must be ready to abandon an area once the Pentagon loses interest in it.

So much for the contractor's strategy; tactically, he must be, above all, efficient. The Pentagon will continue its insistence on lowering costs. Further, it will look with great favor on the contractor who delivers dependable defect-free products that can be easily maintained.

### II. The hard facts

The discussion of the trends in defense development and production and cost reduction efforts will take place on the first day, along with a spelling out of the technological challenge of the next decade. The second day's programs will consist of panel discussions by civilian and military representa-

tives from each service on present and future equipment needs in electronics, avionics, communications, missiles, aircraft and ships.

The briefing officials will highlight these major trends in procurement policy:

- Continued emphasis on shifting from cost-plus-fixed fee to fixed price and incentive contracts.

- Greater reliance on project definition before starting major new development programs, to avoid costly program changes or cancellations and to reduce overruns.

- Expansion of the contractor evaluation program so that the Pentagon has such documented proof of a contractor's good past performance it can relax administrative controls over him.

- Greater use of multi-year procurement, assuring the contractor of long-term volume in return for lower prices.

- Emphasis on "breakout." This entails pulling out of a prime contract items that the government can procure more cheaply on its own, principally by bypassing the prime's markup.

- The possibility of tying together the research and development phase and follow-on production of military equipment into a single life-cycle contract that would be awarded competitively.

- Procuring on the basis of "real costs" rather than the low dollar bid. Real cost takes into account such additional costs as logistics support and maintenance requirements as well as production costs.

### III. Technological needs

The slackening of interest in new strategic weapons does not mean that there are no major technological challenges. The Pentagon wants, for instance, to increase the penetrability of enemy defenses by intercontinental missiles. This involves use of missile decoys, maneuverable warheads, multiple warheads on a single missile and missiles having the capability to jam the enemy's electronic detection systems.

**Cast of characters.** The briefings will bring out top civilian Pentagon officials and the chief military commanders of Army, Navy and Air Force procurement and research and development agencies. Anyone interested may attend.

**NEW**

Plug-in  
Heads

**SWEEP  
STEEP  
SKIRTS**

20 cps - 120 mc



Stable  
Manual  
Control

SMOOTH

Residual FM  
Less Than

Drift  
Less Than

**5 cps below 5 mc**  
**10 cps below 35 mc**

**±.0005% for 1 min.**  
**±0.1% for 3 hrs.**

**NEW P-855 HEAD:** Ultra-stable narrow band electronic sweeping oscillator designed specifically for steep-skirt filter applications. Frequency range, 2-32 mc in 12 bands. Output agc-controlled, 1v rms into 50 ohms. Output blanked during retrace at least 80 db down for use with logarithmic amplifier.

Sweep widths continuously variable from residual to maximums of 40 kc at 2 mc to 800 kc at 35 mc.

Extremely low residual FM and fre-

quency drift for sweeping filters with sharp rise and decay times. Fundamental frequencies for low distortion and no spurious output. **Price: \$595.**

**NEW P-856 HEAD:** 10-120 mc **Price: \$595.**

**P-130 HEAD:** 100 cps-2 mc **Price: \$375.**

**P-141 HEAD:** 20 cps-200 kc **Price: \$475.**

### **New! Exclusive SLOPE-SPEED Control Model 8050**

- Eliminates Ringing
  - Makes Time on the Straightaway
  - Slows Up for the "Curves"
- Optional at \$245.

**VISIT US AT THE IEEE SHOW Booths 3311-3317**

For Complete Catalog Information, Write

**KAY ELECTRIC COMPANY**

MAPLE AVENUE, PINE BROOK, N.J., PHONE (201) 226-4000

# LET'S SWAP RESUMES

The McDonnell Electronic Equipment Division is currently engaged in more than 200 projects and programs. Its advanced developments span the sciences from thin-film circuitry through complete systems; temperature problems range from cryogenics through extremes of reentry heating.

Present and planned programs have created these career opportunities at the Managerial level:

Responsible for concept, design, analysis and development of electronic equipment in areas of:

- MICROELECTRONICS • COMPUTERS & AUTOMATION • SPACE INFORMATION SYSTEMS • SURFACE COMMUNICATIONS • TRAINERS & SIMULATORS • PROCESS CONTROLS • AUTOMATED CHECKOUT • BIOMEDICAL SYSTEMS • ASW • NUCLEAR STUDIES • ECM & ECCM.

McDonnell's educational assistance program plus the convenience of nearby St. Louis and Washington Universities are additional incentives to select the **Electronic Equipment Division** for your career.

To arrange for convenient interview, please complete the attached coupon. All information will be confidential.



**MCDONNELL**, P.O. Box 516, St. Louis, Missouri 63166

Att: W. R. WARDLE, Engineering Employment Office, Dept. V-222

Name \_\_\_\_\_ Home Address \_\_\_\_\_

City & State \_\_\_\_\_ Phone \_\_\_\_\_

Present Position \_\_\_\_\_

Primary Experience Area \_\_\_\_\_ No. of years \_\_\_\_\_

Education: AE \_\_\_\_\_ ME \_\_\_\_\_ Math \_\_\_\_\_ Physics \_\_\_\_\_ Chemistry \_\_\_\_\_

EE \_\_\_\_\_ Bus. Adm. \_\_\_\_\_ Other \_\_\_\_\_

Degree: BS \_\_\_\_\_ MS \_\_\_\_\_ PhD \_\_\_\_\_

date \_\_\_\_\_ date \_\_\_\_\_ date \_\_\_\_\_

**MCDONNELL**

**ELECTRONIC EQUIPMENT DIVISION**

An equal opportunity employer



# BOURNS TRIMPOT® POTENTIOMETERS

World's largest selection — longest record of reliability

Units shown approximately 3/5 actual size.

## TRIMPOT® POTENTIOMETERS—UNSEALED



General-Purpose Wirewound Model 200. Max. temp. 105°C / L, S, P terminals / 0.50 watt at 70°C / 10 ohms to 100K.



General-Purpose RESISTON® Carbon Element Model 215. Max. temp. 125°C / L, S, P terminals / 0.25 watt at 50°C / 20K to 1 Meg.



High-Temperature Wirewound Model 260. Max. temp. 175°C / L, S, P terminals / 1.0 watt at 70°C / 10 ohms to 100K.

## TRIMPOT POTENTIOMETERS—HUMIDITY PROOF



General-Purpose RESISTON Carbon Element Model 235. Max. temp. 135°C / L, S, P terminals / 0.25 watt at 50°C / 20K to 1 Meg.



General-Purpose Wirewound Model 236. Max. temp. 135°C / L, S, P terminals / 0.8 watt at 70°C / 10 ohms to 100K.



Micro-Miniature High-Temperature Wirewound Model 3000. Max. temp. 175°C / P terminals / 0.5 watt at 70°C / 50 ohms to 20K.



Micro-Miniature High-Temperature RESISTON Carbon Element Model 3001. Max. temp. 150°C / P terminals / 0.20 watt at 70°C / 20K to 1 Meg.



Sub-Miniature High-Temperature Wirewound Model 220. Max. temp. 175°C / L, W terminals / 1.0 watt at 70°C / 10 ohms to 30K / Mil-Spec style RT10 and meets MIL-R-27208A.



High-Temperature Wirewound Model 224. Max. temp. 175°C / L, S, P terminals / 1.0 watt at 70°C / 10 ohms to 100K / Mil-Spec style RT12 and meets MIL-R-27208A.



Ultra-Reliable High-Temperature Wirewound Model 224-500. Max. temp. 150°C / L, P terminals / 0.5 watt at 70°C / 100 ohms to 20K. Performance and reliability statistically verified to customer.



High-Temperature, High-Resistance RESISTON Carbon Element Model 3051. Max. temp. 150°C / L, S, P terminals / 0.25 watt at 50°C / 20K to 1 Meg / Mil-Spec style RJ11 and meets MIL-22097B.



High-Temperature High-Resistance PALIRIUM® Film Element Model 3052. Max. temp. 175°C / L, P terminals / 1.0 watt at 70°C / 20K to 1 Meg.



High-Temperature, Low-Resistance PALIRIUM Element Model 3053. Max. temp. 175°C / L, P terminals / 0.5 watt at 70°C / 2 ohms to 100 ohms.



High-Temperature Wirewound Model 3010. Max. temp. 175°C / L, P terminals / 1.0 watt at 70°C / 10 ohms to 100K / Mil-Spec style RT11 and meets MIL-R-27208A.



High-Temperature RESISTON Carbon Element Model 3011. Max. temp. 150°C / L, P terminals / 0.25 watt at 50°C / 20K to 1 Meg / Mil-Spec style RJ11 and meets MIL-R-22097B.



High-Temperature High-Resistance PALIRIUM Element Model 3012. Max. temp. 175°C / L, P terminals / 1.0 watt at 70°C / 20K to 1 Meg.



3/8"-Square Wirewound Model 3280. Max. temp. 175°C / L, P, W terminals / 1.0 watt at 70°C / 10 ohms to 50K.



3/8"-Square RESISTON Carbon Element Model 3281. Max. temp. 150°C / L, P, W terminals / 0.5 watt at 50°C / 20K to 1 Meg.



1/2"-Square, High-Temperature Wirewound Model 3250. Max. temp. 175°C / L, P, W terminals / 1.0 watt at 70°C / 10 ohms to 50K / Mil-Spec style RT22 and meets MIL-27208A.



1/2"-Square High-Temperature RESISTON Carbon Element Model 3251. Max. temp. 150°C / L, P, W terminals / 0.50 watt at 50°C / 20K to 1 Meg / Mil-Spec style RJ22 and meets MIL-R-22097B.

## BOURNS® SINGLE-TURN POTENTIOMETERS



3/4"-Diameter Micro-Miniature High-Temperature Humidity-Proof Wirewound Model 3301. Max. temp. 175°C / W, P, S terminals / 0.5 watt at 70°C / 10 ohms to 20K.



3/4"-Diameter Micro-Miniature High-Temperature Humidity-Proof RESISTON Carbon Element Model 3301. Max. temp. 150°C / W, P, S terminals / 0.25 watt at 70°C / 10K to 1 Meg.



Sub-Miniature Wirewound Model 3367. Max. temp. 105°C / P, S terminals / 0.5 watt at 70°C / 10 ohms to 20K / meets steady-state humidity.



Sub-Miniature RESISTON Carbon Element Model 3368. Max. temp. 105°C / P, S terminals / 0.25 watt at 50°C / 20K to 1 Meg / meets steady-state humidity.

## LOW-COST COMMERCIAL POTENTIOMETERS



Wirewound TRIMIT® Potentiometers Models 271, 273, 275. Max. temp. 105°C / L, S, P terminals / 0.5 watt at 25°C / 50 ohms to 20K.



RESISTALOY® Carbon Element TRIMIT Models 272, 274, 276. Max. temp. 105°C / L, S, P terminals / 0.2 watt at 25°C / 20K to 1 Meg.



Wirewound E-Z-TRIM® Potentiometer Model 3067. Max. temp. 85°C / S, P terminals / 0.5 watt at 25°C / 50 ohms to 20K / Priced under \$1 in production quantities.



Carbon Element E-Z-TRIM Potentiometer Model 3068. Max. temp. 85°C / S, P terminals / 0.2 watt at 25°C / 20K to 1 Meg.

## SPECIAL-PURPOSE POTENTIOMETERS



High-Power (2 watts) High-Temperature Wirewound Model 207. Max. temp. 175°C / L terminals / 2 watts at 50°C / 100 ohms to 100K. As Rheostat Model 208, available 100K to 200K.



High-Power (5 watts) Humidity-Proof Wirewound Model 3020. Max. temp. 200°C / L terminals / 5.0 watts at 25°C / 100 ohms to 50K.



Dual-Element Wirewound TWIN-POT® Potentiometer Model 209. Max. temp. 135°C / L terminals / 0.50 watt (each element) at 70°C / 10 ohms to 50K.



15 watts, High-Temperature Wirewound Model 3030. Max. temp. 265°C / L terminals / 15 watts at 25°C / 10 ohms to 10K.



Radiation-Resistant, High-Temperature Wirewound Model 3040. Max. temp. 350°C / W terminals / 150 megarad / 5 X 10<sup>15</sup> neutrons per sec. / 5.0 watts at 70°C / 500 ohms to 20K.

## PANEL-MOUNTED POTENTIOMETERS



Most models are available with panel mounting. Unique design permits quick factory assembly to "on-the-shelf" units. In addition, mounting screws, brackets and clip brackets are available to meet almost any mounting requirement.

## KEY TO TERMINAL TYPES

- L=Insulated stranded leads
- S=Solder lugs (includes panel-mounting bushing on Models 3367S, 3368S, 3300S and 3301S only)
- P=Printed-circuit pins
- W=Uninsulated wires (edge-mounting 3250, 3251, 3280 and 3281).

Write TODAY for detailed specifications on any model in the large BOURNS® Potentiometer and TRIMPOT® Potentiometer line AND a list of factory representatives.

**TRIMPOT® means BOURNS, BOURNS means QUALITY, so remember...**

**Don't MIL-SPECulate... SPECify BOURNS.**

TRIMPOT is a registered trademark of Bourns, Inc.



*Oscillators  
Available Separately*

*Use either  
Oscillator...*

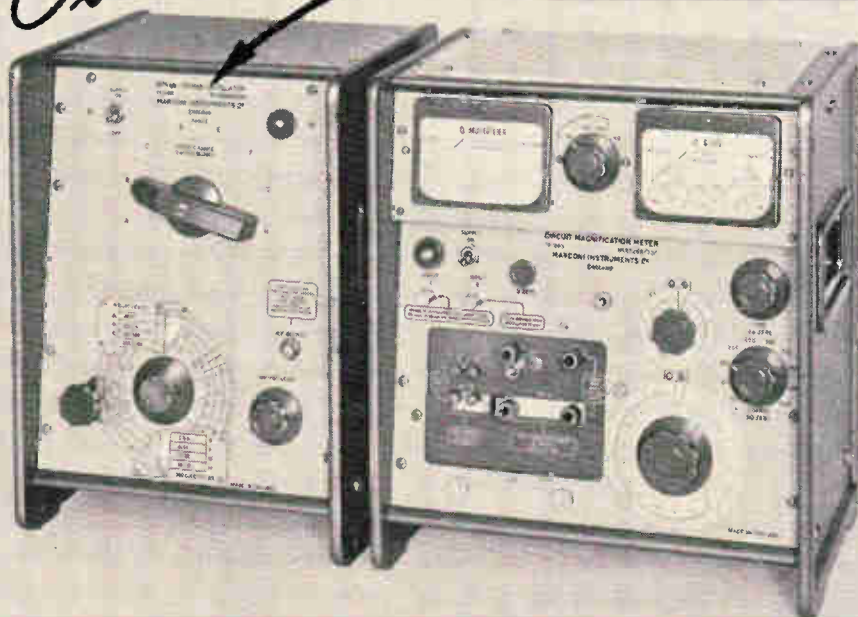
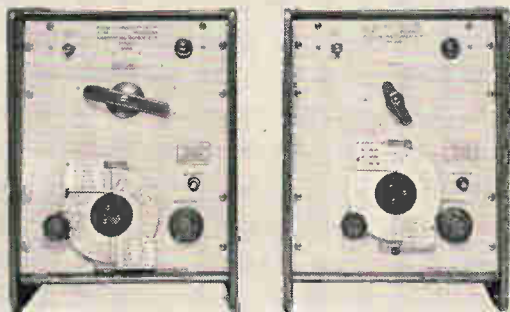

## THE **ONLY** Q-METER COVERING 1KC TO 300MC

### Q-METER MODEL 1245

- Frequency Range: 1kc to 300mc
- Q Range: 5 to 1000
- Delta Q: 25-0-25
- Tuning C: 7.5 to 500 pf
- Price: \$520

### POWER OSCILLATOR MODEL 1246

- Frequency: 40kc to 50mc calibrated 1% accuracy when used with Q-Meter or matching unit
- Output: Up to 4V into 50 $\Omega$
- Output impedance: 0.5 $\Omega$  or 50 $\Omega$  when using matching unit TM5726 supplied
- Price: \$330

### POWER OSCILLATOR MODEL 1247

- Frequency Range: 20mc to 300mc calibrated 1% accuracy when used with Q-Meter or matching unit
- Output: Up to 4V into 50 $\Omega$
- Output impedance: 0.5 $\Omega$  or 50 $\Omega$  when using matching unit TM5727 supplied
- Price: \$330

The Marconi Model 1245 Q-METER features dual measuring circuits and add-on oscillators for flexibility and reduced cost. Outstanding stability, fully regulated power supplies, high accuracy and precision controls are a few of the many features. The oscillators, available separately, supply high outputs up to 4 volts into 50 $\Omega$  for use as bridge drivers, power oscillators, etc. A demonstration in your own plant can be easily arranged.

The Q-METER in theory and practice . . . a 36-page booklet plus literature on the above units is available upon request.



# MARCONI INSTRUMENTS

*Division of English Electric Corp.*

111 CEDAR LANE, ENGLEWOOD, NEW JERSEY  
Main Plant: St. Albans, England

# DON'T try all these tests on any other resistor!

11-watt unit  
enlarged 2½ times



**OHMITE Series 99**  
Insulated, Axial Lead Wire-Wound Resistors  
"molded" in vitreous enamel  
...a new development in protective coatings.

- Proved by over **24,500,000** unit-hours of load-life testing as of Oct. 1, 1964.
- Meet MIL-R-26C requirements.
- 1½, 2¼, 3¼, 5, 6½, 9, 11-watt sizes.
- Get the whole story on this important development. Write for Bulletin 103.



**SOAK IT IN SOLVENT!** Soak a Series 99 resistor in any organic solvent used in degreasing and flux removal. Then try to rub off the markings. You can't; they're *part* of the coating.

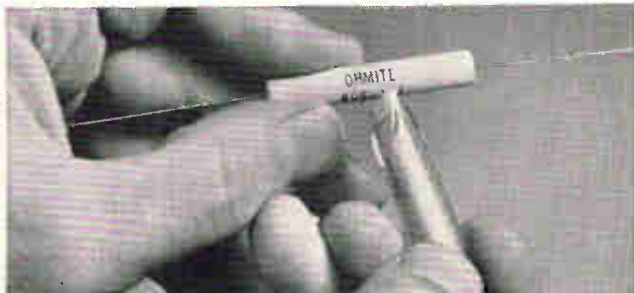

**ABRADE IT!** Use a glass fiber eraser, for example, on the markings. Rub them hard. Nothing happens. The markings don't come off, because they are vitreous ceramic, *fired into* the molded vitreous coating.

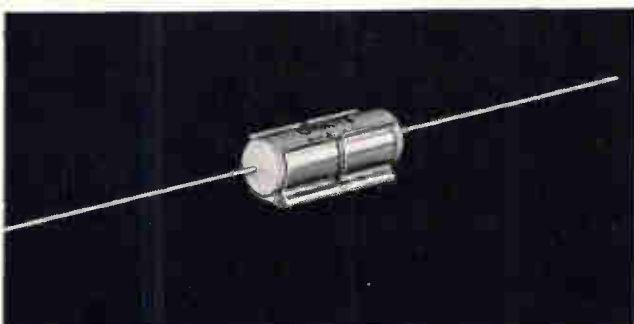

**TORCH IT!** Withstands temperatures of 1500°F without a sign of deformation. No other vitreous-enameled resistor will stand 1500°F without burning, softening, or dripping away. There's absolutely no effect on markings either.



**BEND THE LEAD** at the resistor body! There's no damage. Conventional (dipped) vitreous-enameled resistors have a meniscus at this point which ruptures, damaging the coating. Series 99 (molded) have no meniscus.

**CLIP IT!** Insert a molded Series 99 resistor into a metal clip. Don't baby it. The hard coating which provides 1000 VAC insulation won't cut, chip, or scratch. On a metal chassis, heat-sink action may increase wattage rating as much as 100%.



## OHMITE

MANUFACTURING COMPANY  
3610 Howard Street, Skokie, Illinois 60076  
Phone (312) ORchard 5-2600

RHEOSTATS • POWER RESISTORS • PRECISION RESISTORS • VARIABLE TRANSFORMERS  
TANTALUM CAPACITORS • TAP SWITCHES • RELAYS • R. F. CHOKES • SEMICONDUCTOR DIODES

# MONEY SAVER

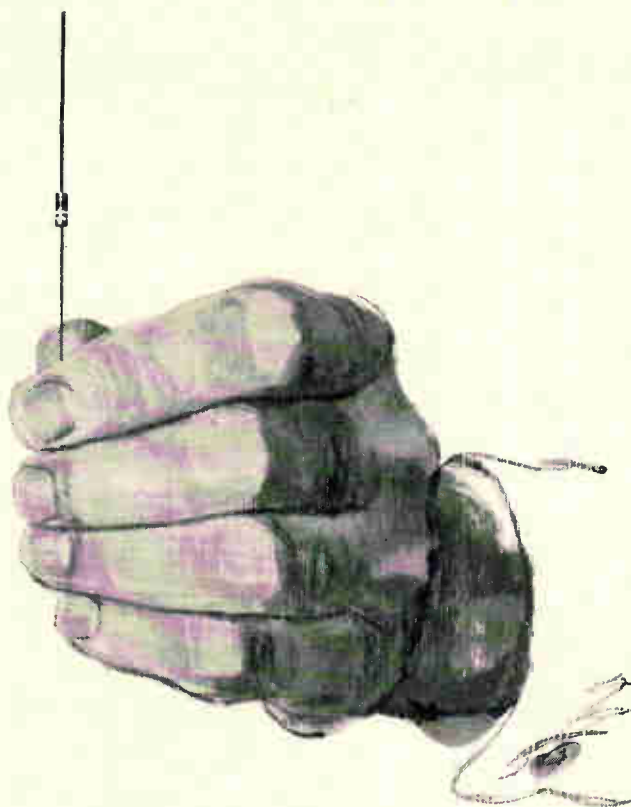

## FIRST COMMERCIAL 1/4 WATT COMPOSITION RESISTOR

This is the first domestic 1/4 watt resistor designed and priced for commercial and industrial applications. Cost savings are substantial. Check these...

### ACTUAL SAVINGS\*

	1000 LOT	5000 LOT	10,000 LOT	25,000 LOT
GBT-1/4 5% tolerance	10%	18%	22%	22%
GBT-1/4 10% tolerance	9%	13%	16%	16%
GBT-1/4 20% tolerance	3%	7%	9%	12%

\*Actual savings for 10 ohms to 1.0 meg., based on lowest published prices for domestically produced 1/4 watt fixed composition resistors.

Corrugated strip packaging is standard. Lead tape reels, body tape reels and oriented bulk packaging are also available. Write for samples, literature and prices.



INTERNATIONAL RESISTANCE COMPANY

PHILADELPHIA, PA. 19108

## Light-pulsar array improves data recording

Solid-state technique provides greater reliability, longer life, and easier integration into recording equipment

A new optoelectronic light-pulsar array, FLPA-200, is intended primarily as a data recording device. The array contains 576 light-emitting, diffused silicon, planar diodes (arranged in three adjacent 6-column, 32-row arrays to form an 18 by 32 diode matrix). The diodes emit light to produce dot patterns which can then be recorded on photographic emulsions by contact printing. Monolithic construction on large area silicon substrates provides precise positioning of the individual diodes, resulting in efficiently arranged, nonambiguous, easily read photographic data block recordings.

The solid state technique for digital data recording provides greater reliability, longer life, and greater ease of integration into recording systems than previous methods involving cathode-ray tubes and close-tolerance optical systems. This technique also provides greater immunity from radio frequency interference and vibration effects encountered in military and other environments. Another indirect advantage is provided by the closer adherence of the recorded data to a specified geometrical arrangement than is possible with other recording methods. This improvement in recorded out-

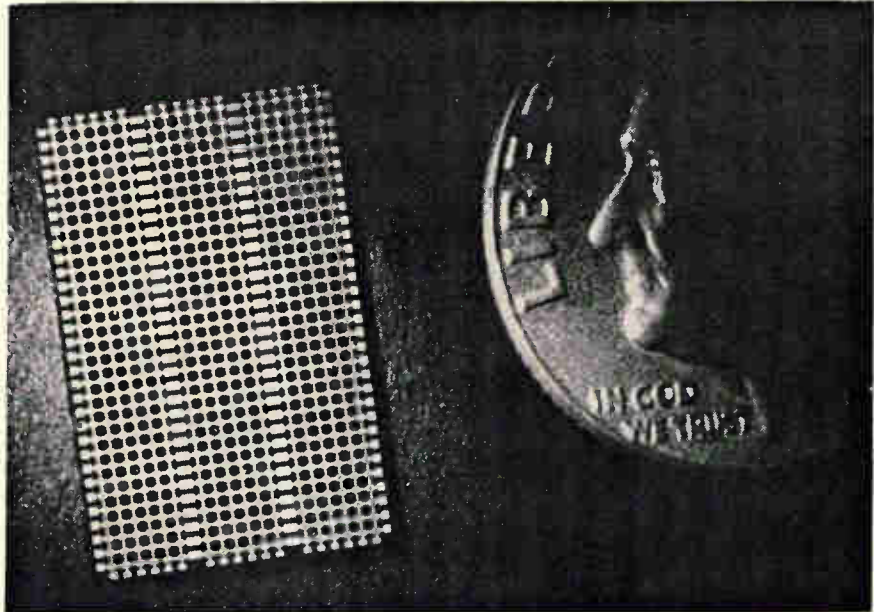

Light-emitting diode array, shown with a 10-cent piece, is designed for application as a digital data recording head.

put quality improves the ability of machine reading equipment to provide error-free readout.

The array is 18 elements wide by 32 elements long. Electrical connection is made by means of 18 anode leads and 32 cathode leads which are brought out of the sensor head assembly via multiple-conductor cable and terminated in a connector plug. Connections to the silicon chip are arranged to minimize current densities in the device metalization. The package body may float electrically or be referenced to 6 v negative with respect to the anode.

Each light-emitting diode in the array measures 0.002 in. by 0.002 in. Center-to-center spacings are 0.018 in. each way in three blocks of 6 by 32 devices each. Array size (to corner-device centers) is 0.344 in. by 0.559 in. Over-all package size of the integrated digital data recording head is  $\frac{7}{8}$  in. cube. Distance of silicon surface below the package face, equivalent optical

path in air, is 0.006 in. The package is designed for minimum thermal resistance from the array to the side mounting surface. When operating near maximum power rating, mounting support should be kept below  $+60^{\circ}\text{C}$ .

The diodes in the array are operated in the reverse bias mode. With a d-c voltage source between 5.8 and 13.3 v, the maximum pulse length is 160 msec at 25 ma or 10 msec at 100 ma. Duty cycle is 50%. Approximate black-body-equivalent color temperature of the emitted light is  $2500^{\circ}\text{K}$ . Intensity is sufficient to expose panchromatic type film to saturation with a 3 msec pulse when the diode-to-film space is 0.001 in. Light emission can be seen with the unaided eye in a dimly-lighted room.

Price of the FLPA-200 is \$1,800 each for 1 to 20; \$1,500 each for 20 to 100.

Fairchild Semiconductor, 545 Whisman Road, Mountain View, Calif.

Circle 350 on reader service card

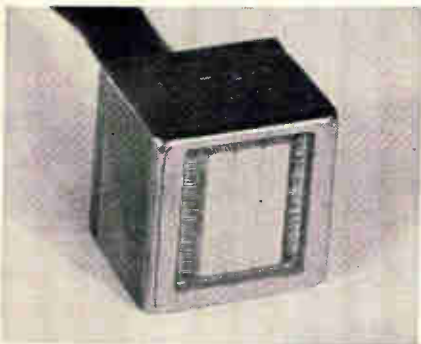

Integrated digital-data recording head has an over-all package size of  $\frac{7}{8}$  in. cube

# The Next Time You Need Counters Count on Janus...



## HERE'S WHY:

① Janus high-speed counters and related products are application-engineered, with you the system designer in mind. ② They incorporate such outstanding user features as all-silicon circuitry, counting rates to 2 mc, easy-to-read in-line displays,  $-20$  to  $+85$  deg. C operating temperature ranges. And ③ Janus counting products are available now off-the-shelf for your immediate installation and use.

\*Above, the Model B100-2 high-speed counter can count at rates to 2 mc and features a unique latching display circuit. The Janus product lines also include: Decade Dividers / Forward-Backward Decade Counters / Frequency Counters / Counter-Timers / Digital Clocks.

A complete new technical catalog and brochure is available now. Write for your free copy today.



**JANUS CONTROL CORPORATION**  
HUNT ST. · NEWTON, MASS. · TEL. 926-1037

## New Components and Hardware

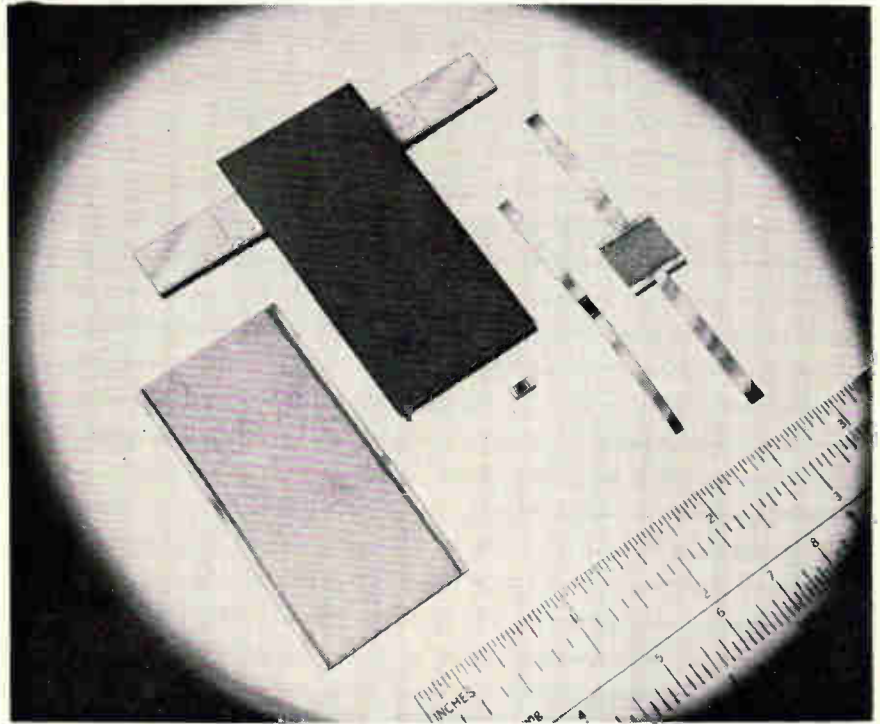

## Flat power resistors for stripline and r-f

Flat power resistors have been developed for stripline and other r-f applications. The new line of alumina or quartz-based units combines excellent r-f characteristics and power-handling capability, and the inherent long-term stability of evaporated metal protected by fused quartz, with the geometric compatibility required at frequencies above 1 Gc. Power levels range from 0.1 w to more than 100 w, with a standard resistance range of 20 ohms to 2,000 ohms. Tempera-

ture coefficient of resistance is less than 100 ppm/ $^{\circ}$ C, resistance change (full load at  $125^{\circ}$ C) is 0.5%/1,000 hours, and standard tolerances are 1%, 2% and 5%. Both the line width and ground plane spacing of the new resistors are maintained throughout the resistance portion. All units are non-inductive. Production quantity prices vary from \$2 to \$4 for the most common styles. Delivery is one to three weeks.

EMC Technology, Inc., 1133-35 Arch St., Philadelphia, Pa., 19107. [351]

## Neon lamp holds close tolerances

Close control of the operating characteristics of the type A078 neon glow lamp results in a lamp that is recommended for application in timing circuits, relaxation oscillators, and similar applications in electronic equipment where small variations in operating characteristics are required. The A078 features a high leakage resistance that per-

mits its use in critical circuitry without having to match individual lamps to resistors and capacitors. It has been designed and manufactured to exhibit and maintain its operating characteristics with little or no variation throughout the lamp's rated life. The A078 has a breakdown voltage rating in dark of 70 v d-c  $\pm$  4 v. Its maintaining voltage rating is 55 v d-c  $\pm$  5 v. Design current is 0.3 ma. Leakage resistance is rated at 10,000 megohms. This close-tolerance neon

## Light-pulsar array improves data recording

Solid-state technique provides greater reliability, longer life, and easier integration into recording equipment

A new optoelectronic light-pulsar array, FLPA-200, is intended primarily as a data recording device. The array contains 576 light-emitting, diffused silicon, planar diodes (arranged in three adjacent 6-column, 32-row arrays to form an 18 by 32 diode matrix). The diodes emit light to produce dot patterns which can then be recorded on photographic emulsions by contact printing. Monolithic construction on large area silicon substrates provides precise positioning of the individual diodes, resulting in efficiently arranged, nonambiguous, easily read photographic data block recordings.

The solid state technique for digital data recording provides greater reliability, longer life, and greater ease of integration into recording systems than previous methods involving cathode-ray tubes and close-tolerance optical systems. This technique also provides greater immunity from radio frequency interference and vibration effects encountered in military and other environments. Another indirect advantage is provided by the closer adherence of the recorded data to a specified geometrical arrangement than is possible with other recording methods. This improvement in recorded out-

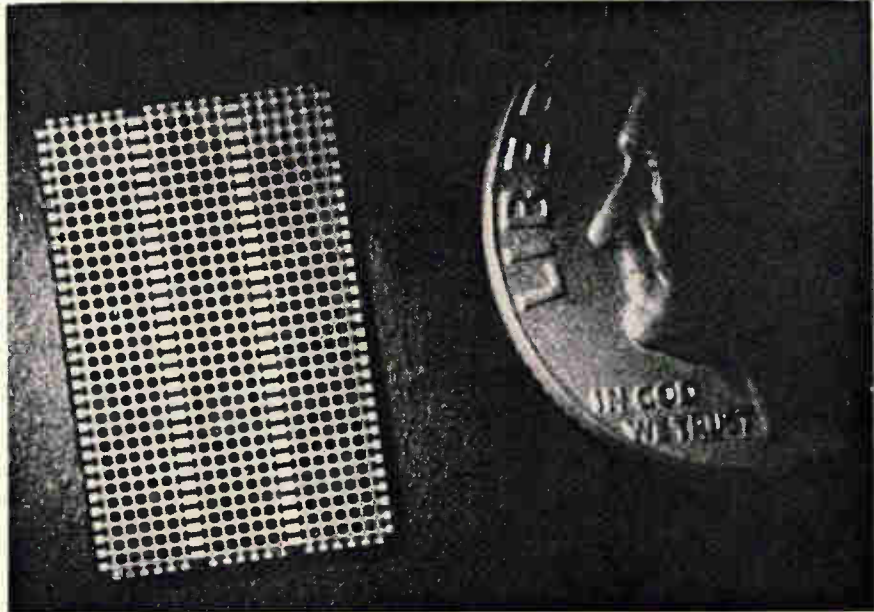

Light-emitting diode array, shown with a 10-cent piece, is designed for application as a digital data recording head.

put quality improves the ability of machine reading equipment to provide error-free readout.

The array is 18 elements wide by 32 elements long. Electrical connection is made by means of 18 anode leads and 32 cathode leads which are brought out of the sensor head assembly via multiple-conductor cable and terminated in a connector plug. Connections to the silicon chip are arranged to minimize current densities in the device metalization. The package body may float electrically or be referenced to 6 v negative with respect to the anode.

Each light-emitting diode in the array measures 0.002 in. by 0.002 in. Center-to-center spacings are 0.018 in. each way in three blocks of 6 by 32 devices each. Array size (to corner-device centers) is 0.344 in. by 0.559 in. Over-all package size of the integrated digital data recording head is  $\frac{7}{8}$  in. cube. Distance of silicon surface below the package face, equivalent optical

path in air, is 0.006 in. The package is designed for minimum thermal resistance from the array to the side mounting surface. When operating near maximum power rating, mounting support should be kept below  $+60^{\circ}\text{C}$ .

The diodes in the array are operated in the reverse bias mode. With a d-c voltage source between 5.8 and 13.3 v, the maximum pulse length is 160 msec at 25 ma or 10 msec at 100 ma. Duty cycle is 50%. Approximate black-body-equivalent color temperature of the emitted light is  $2500^{\circ}\text{K}$ . Intensity is sufficient to expose panchromatic type film to saturation with a 3 msec pulse when the diode-to-film space is 0.001 in. Light emission can be seen with the unaided eye in a dimly-lighted room.

Price of the FLPA-200 is \$1,800 each for 1 to 20; \$1,500 each for 20 to 100.

Fairchild Semiconductor, 545 Whisman Road, Mountain View, Calif.

Circle 350 on reader service card

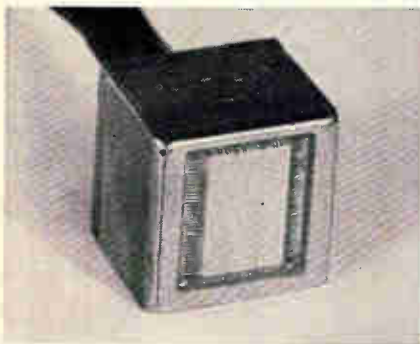

Integrated digital-data recording head has an over-all package size of  $\frac{7}{8}$  in. cube

# The Next Time You Need Counters Count on Janus...



## HERE'S WHY:

① Janus high-speed counters and related products are application-engineered, with you the system designer in mind. ② They incorporate such outstanding user features as all-silicon circuitry, counting rates to 2 mc, easy-to-read in-line displays,  $-20$  to  $+85$  deg. C operating temperature ranges. And ③ Janus counting products are available now off-the-shelf for your immediate installation and use.

\*Above, the Model B100-2 high-speed counter can count at rates to 2 mc and features a unique latching display circuit. The Janus product lines also include: Decade Dividers / Forward-Backward Decade Counters / Frequency Counters / Counter-Timers / Digital Clocks.

A complete new technical catalog and brochure is available now. Write for your free copy today.

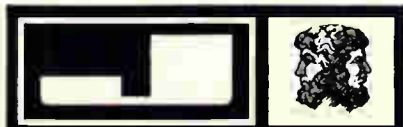

**JANUS CONTROL CORPORATION**  
HUNT ST. · NEWTON, MASS. · TEL. 926-1037

## New Components and Hardware

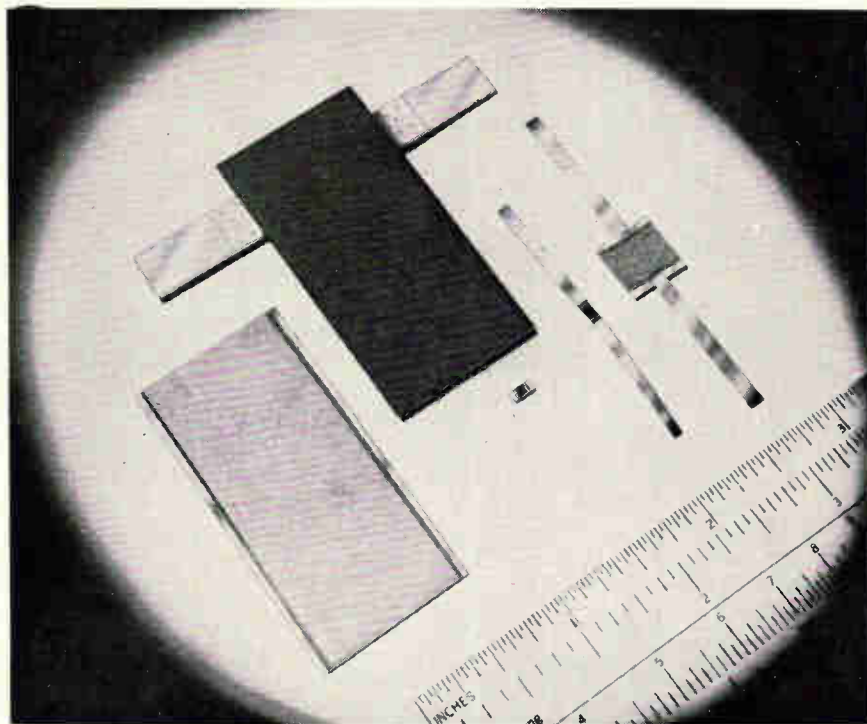

## Flat power resistors for stripline and r-f

Flat power resistors have been developed for stripline and other r-f applications. The new line of alumina or quartz-based units combines excellent r-f characteristics and power-handling capability, and the inherent long-term stability of evaporated metal protected by fused quartz, with the geometric compatibility required at frequencies above 1 Gc. Power levels range from 0.1 w to more than 100 w, with a standard resistance range of 20 ohms to 2,000 ohms. Tempera-

ture coefficient of resistance is less than 100 ppm/ $^{\circ}$ C, resistance change (full load at  $125^{\circ}$ C) is 0.5%/1,000 hours, and standard tolerances are 1%, 2% and 5%. Both the line width and ground plane spacing of the new resistors are maintained throughout the resistance portion. All units are non-inductive. Production quantity prices vary from \$2 to \$4 for the most common styles. Delivery is one to three weeks.

EMC Technology, Inc., 1133-35 Arch St., Philadelphia, Pa., 19107. [351]

## Neon lamp holds close tolerances

Close control of the operating characteristics of the type A078 neon glow lamp results in a lamp that is recommended for application in timing circuits, relaxation oscillators, and similar applications in electronic equipment where small variations in operating characteristics are required. The A078 features a high leakage resistance that per-

mits its use in critical circuitry without having to match individual lamps to resistors and capacitors. It has been designed and manufactured to exhibit and maintain its operating characteristics with little or no variation throughout the lamp's rated life. The A078 has a breakdown voltage rating in dark of  $70$  v d-c  $\pm 4$  v. Its maintaining voltage rating is  $55$  v d-c  $\pm 5$  v. Design current is 0.3 ma. Leakage resistance is rated at 10,000 megohms. This close-tolerance neon





# HELIPOT PACKS A LOT OF TRIMMER IN A MIGHTY SMALL SHELL

Smallest trimmer you can buy is the new Model 61 Helitrim<sup>®</sup> from Helipot. Height and diameter are 0.250 inches, weight about half a gram.

Cermet element and stainless steel case make it a tough little nut. It's rated for 1/2 watt at 85°C and operates up to 150°C. It's completely immersion proof, acceleration tested to 100 gs, and vibration tested to 30. And the Cermet element means essentially infinite resolution while it all but eliminates "sudden failure." Resistance values from 10 ohms to 1 megohm. For price and delivery information call your local Helipot<sup>®</sup> rep.

**Beckman<sup>®</sup>**

INSTRUMENTS, INC.

HELIPOT DIVISION

FULLERTON, CALIFORNIA • 92634

INTERNATIONAL SUBSIDIARIES: GENEVA, SWITZERLAND; MUNICH, GERMANY; GLENROTHES, SCOTLAND; PARIS, FRANCE; TOKYO, JAPAN; CAPE TOWN, SOUTH AFRICA

## New Components

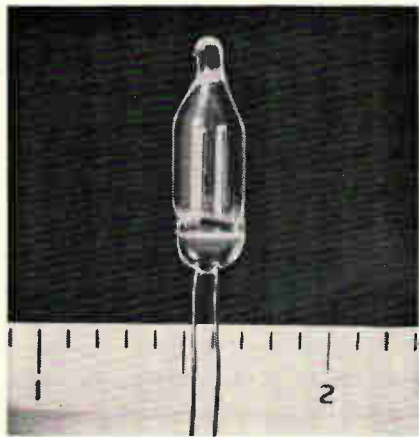

glow lamp is produced in a standard T-2 tube with the following dimensions: length of the tube,  $\frac{3}{8}$  in.; diameter of the tube, 0.244 in.; and length of lead wires, 1 in. Signalite, Inc., 1933 Heck Ave., Neptune, N.J. [352]

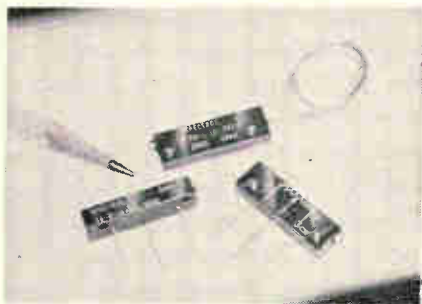

## Rectangular trimmer rated 1 w at 70°C

A new, small wirewound trimming potentiometer has been introduced. Model 46, measuring 1 in. long by 0.185 in. wide by 0.315 in. high, meets the requirements of MIL-R-27208 and is interchangeable with types RT10C2L and RT10C2P. It features a nonhygroscopic diallyl phthalate housing, and stops with an idler clutch and has a power rating of 1 w at 70°C and an operating temperature of -65°C to +175°C. The unit is available with 6-in. insulated stranded leads or p-c pins extending from either the narrow or broad side 90° from the shaft. Model 46 is available in standard resistance ranges from 10 ohms to 50,000 ohms. Price for the insulated leads version is \$7.45 in

1 to 9 quantity, and \$4.58 in 500 quantity. Spectrol Electronics Corp., 1704 South DelMar Ave., San Gabriel, Calif. [353]

## Hermetically sealed wirewound pot

Bobi 12 is a hermetically sealed wirewound potentiometer developed for use on printed circuits where high reliability and stability of operation are required. Basically, it is a variable resistor in a non-ferrous, moisture-proof, metal body. It has been adapted for logic module construction, in telephone equipment, by computer or electronics industries, when semipermanent adjustment of characteristics is desired. Power rating is 1 w at 70°C, temperature range -55 to +125°C climatic test, 56 days severity. Nominal values: multiple of E3 standard series from 47 to 10,000 ohms. Bobi 12 comes in different styles—mounting through a hole on front panel, soldering on printed cards either vertical or parallel. It can also be supplied with a locking unit. MCB, 11 Rue P Lhomme, Courbevoie, Seine, France. [354]

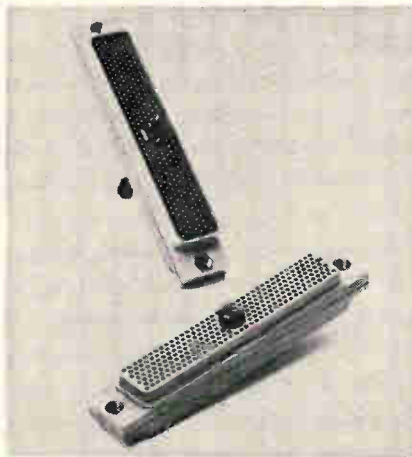

## Connectors withstand severe environments

Subminiature connectors designed to withstand extreme environmental conditions have been an-

# Available at these Distributors

### EAST

**BINGHAMTON, N. Y.**—Federal Electronics  
P. O. Box 208/PI 8-8211  
**PHILADELPHIA 23, PENN.**  
Almo Industrial Electronics, Inc.  
412 North 6th Street/WA 2-5918  
**PITTSBURGH 6, PENN.**—Radio Parts Company, Inc.  
6401 Penn Ave./361-4600  
**NEWTON 58, MASS.**—Greene-Shaw Company  
341 Watertown Street/WO 9-8900  
**CLIFTON, N. J.**—Eastern Radio Corporation  
312 Clifton Avenue/471-6600  
**NEW YORK 36, N. Y.**—Harvey Radio Company, Inc.  
103 West 43rd Street/JU 2-1500  
**BALTIMORE 1, MD.**—Radio Electric Service Company  
5 North Howard Street/LE 9-3835

### SOUTH

**BIRMINGHAM 5, ALA.**  
Forbes Distributing Company, Inc.  
2610 Third Avenue, South/AL 1-4104  
**WEST PALM BEACH, FLA.**—Goddard, Inc.  
1309 North Dixie/TE 3-5701  
**RICHMOND 20, VA.**—Meridian Electronics, Inc.  
1001 West Broad Street/353-6648

### MIDWEST

**BATTLE CREEK, MICH.**—Electronic Supply Corporation  
94 Hamblin Ave./P.O. Box 430/965-1245  
**MINNEAPOLIS 62, MINN.**—Admiral Distributors, Inc.  
5333 Cedar Lake Road/545-0223  
**INDIANAPOLIS 25, IND.**  
Graham Electronics Supply, Inc.  
122 South Senate Avenue/ME 4-8486  
**CLEVELAND 1, OHIO**—The W. M. Pattison Supply Co.  
Industrial Electronics Division  
777 Rockwell Avenue/621-7320  
**CHICAGO 30, ILL.**—Merquip Electronics, Inc.  
4939 North Elston Avenue/AV 2-5400  
**CINCINNATI 10, OHIO**—United Radio, Inc.  
1308 Vine Street/241-6530  
**KANSAS CITY 11, MO.**—Walters Radio Supply, Inc.  
3635 Main Street/JE 1-7015  
**ST. LOUIS 17, MO.**  
Electronic Components for Industry Co.  
2605 South Hanley Road/MI 7-5505

### WEST

**DALLAS 1, TEXAS**—Adleta Company  
1907 McKinney Ave./RI 1-3151  
**HOUSTON 1, TEXAS**—Harrison Equipment Company, Inc.  
1422 San Jacinto Street/CA 4-9131  
**SAN DIEGO 1, CAL.**  
Electronic Components of San Diego  
2060 India Street, Box 2710/232-8951  
**LOS ANGELES 15, CAL.**—Radio Products Sales, Inc.  
1501 South Hill Street/RI 8-1271  
**LOS ANGELES, CAL.** 90022—Kierulff Electronics  
2585 Commerce Way/OV 5-5511  
**MOUNTAIN VIEW, CAL.**—Kierulff Electronics  
2484 Middlefield Road/968-6992  
**DENVER, COLO.**—L. B. Walker Radio Company  
300 Bryant Street/WE 5-2401  
**SEATTLE 1, WASH.**—C & G Electronics Company  
2221 3rd Avenue/Main 4-4355  
**PHOENIX, ARIZ.**—Midland Specialty Co., Inc.  
1930 North 22nd Ave./258-4531  
**ALBUQUERQUE, N.M.**—Midland Specialty Co., Inc.  
1712 Lomas Blvd., N.E./247-2486  
**TUCSON, ARIZ.**—Midland Specialty Co., Inc.  
951 South Park Ave./MA 4-2315

Ask for a complete catalog

## DELCO RADIO

DIVISION OF GENERAL MOTORS • KOKOMO, INDIANA

# A COOL 400 V



Delco Radio's new DTS 413 and DTS 423 power transistors, are conservatively rated at 75 and 100 watts. Our standard TO-3 package assures low thermal resistance (junction to heat sink  $1.0^{\circ}\text{C}$  per watt) for cool power. The silicon element gives you high voltage protection, high frequency response and low saturation voltage.

The price is low (less than 3¢ a volt for sample quantities) for two reasons: special inter-digitated geometry of the devices and our unique 3D\* process for high yields.

Now you can reduce current, the size of other components, and increase efficiency in high energy circuits. Vertical and horizontal TV outputs, for example.

Your Delco Radio Semiconductor distributor has these two new power transistors on his shelf. Call him today for data sheets, prices and delivery.

\*Triple sequential diffusion

RATINGS	DTS 413	DTS 423
<b>VOLTAGE</b>		
V <sub>CEO</sub>	400 V (Max)	400 V (Max)
V <sub>CEO</sub> (Sus)	325 V (Min)	325 V (Min)
V <sub>CE</sub> (Sat)	0.8 (Max)	0.8 (Max)
	0.3 (Typ)	0.3 (Typ)
<b>CURRENT</b>		
I <sub>C</sub> (Cont)	2.0A (Max)	3.5A (Max)
I <sub>C</sub> (Peak)	5.0A (Max)	10.0A (Max)
I <sub>B</sub> (Cont)	1.0A (Max)	2.0A (Max)
<b>POWER</b>		
	75 W (Max)	100 W (Max)
<b>FREQUENCY RESPONSE</b>		
f <sub>t</sub>	6 MC (Typ)	5 MC (Typ)

#### FIELD SALES OFFICES

UNION, NEW JERSEY\*  
Box 1018 Chestnut Station  
(201) 687-3770

SANTA MONICA, CALIFORNIA\*  
726 Santa Monica Blvd.  
(213) 870-8807

DETROIT, MICHIGAN  
57 Harper Avenue  
(313) 873-6560  
SYRACUSE, NEW YORK  
1054 James Street  
(315) 472-2668

PALO ALTO, CALIFORNIA  
201 Town & Country Village  
(415) 326-0365  
CHICAGO, ILLINOIS\*  
5151 N. Harlem Avenue  
(312) 775-5411

General Sales Office:  
700 E. Firmin, Kokomo, Ind.  
(317) 452-8211—Ext. 500

## DELCO RADIO

Division of General Motors

\*Office includes field lab and resident engineer for applications assistance.

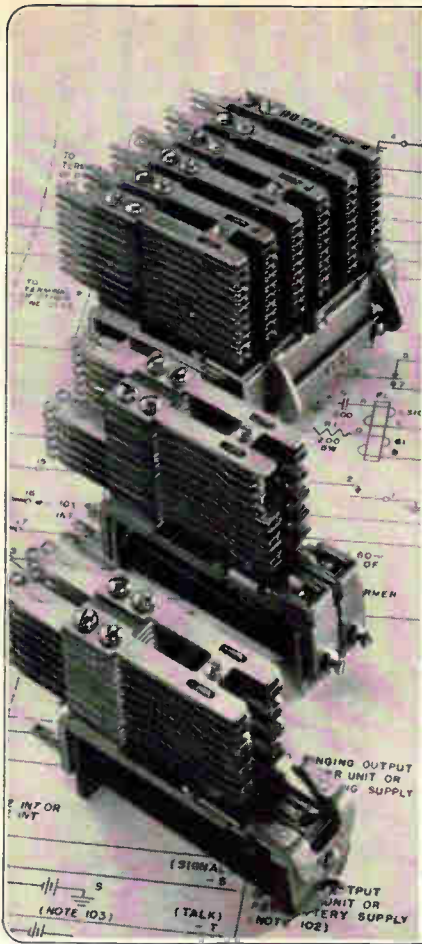

## telephone quality relays

There is no higher standard for relays. Specify Stromberg-Carlson . . . known to telephony since 1894.

**TYPE A:** general-purpose relay. Up to 20 Form "A" spring combinations.

**TYPE B:** multi-contact relay. Up to 60 Form "A" spring combinations.

**TYPE BB:** multi-contact relay. Up to 100 Form "A" springs.

**TYPE C:** two relays on one frame; mounts in same space as one Type A.

**TYPE E:** general-purpose relay; universal mounting; interchangeable with relays of other manufacturers.

Write for complete technical data.

**STROMBERG-CARLSON**  
A DIVISION OF **GENERAL DYNAMICS**  
114 Carlson Road • Rochester, N. Y. 14603

Circle 203 on reader service card

## New Components

nounced. The WSE series have crimp removable contacts, and will operate while energized without degradation under salt fog conditions as well as exposure to 100% oxygen and relative humidity. They will withstand vacuum conditions of  $10^{-4}$  mm mercury or better, temperatures over  $200^{\circ}\text{C}$ , thermal shock of  $-30^{\circ}\text{C}$  to  $+65^{\circ}\text{C}$ , and mechanical sawtooth shock of 78 g. The connectors are available in configurations of 14 to 244 22-gage contacts, with packaging densities of 110 contacts per sq in. They can be supplied with potting dams in lieu of pressure seals. Three weeks delivery is offered.

Hughes Connecting Devices, P.O. Box H, Newport Beach, Calif. [355]

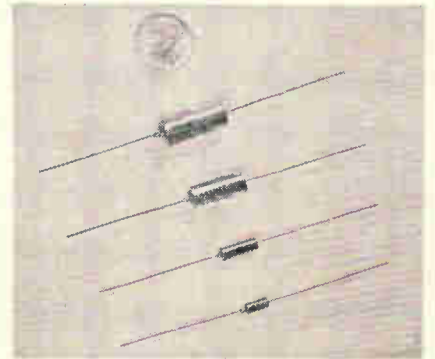

## Polar capacitor of solid tantalum

The J-series polar, solid tantalum capacitors are now available with a top voltage rating of 125 v d-c. Produced in a capacitance range from 0.0047 to  $10\ \mu\text{f}$  in four standard size, hermetically sealed cases, the ultraminiature capacitors contain no wet electrolyte, eliminating all risk of gassing or mechanical leakage. Ranging in length from 0.25 to 0.78 in., the capacitors have very low leakage current, typically less than  $1\ \mu\text{A}$  at  $25^{\circ}\text{C}$ , and a dissipation factor of 3% or less over the entire capacitance range. J-series 125-v capacitors are available in 20, 10, and 5% tolerance, with or without polyester insulating sleeves. They operate at rated voltage over temperature ranges from  $-80^{\circ}\text{C}$  to  $+85^{\circ}\text{C}$ . For  $125^{\circ}\text{C}$  op-

## LOW-LEVEL DC PREAMPLIFIERS

### IMPROVE RELIABILITY

A new series of low-level ACROSTAT DC Preamplifiers, epoxy potted, self-contained, operate from  $115\ \text{V} \pm 10\%$  AC, 2 watts. Model 104 amplifies signals of 1 micro-microwatt with a power gain of 330,000 in a single stage from thermocouples, strain gages, Hall devices, and other low-level DC sources. Input, output and AC supply are isolated and floating. Null stability is better than 10 microvolts over moderate environments, and 50 microvolts over severe environments.



Price only \$139.00 each, 1-5 units; quantity discounts; immediate delivery. Request Technical Bulletin No. 10.



**acromag**<sup>®</sup>  
INCORPORATED

15360 TELEGRAPH RD.

DETROIT 39, MICH.

Teletype:

DE 970

Phone: 538-4242, Area Code 313

eration, they are derated to only  $\frac{2}{3}$  of rated voltage.

Union Carbide Corp., Linde Division, Kemet Dept., 11901 Madison Ave., Cleveland, Ohio, 44101. [356]

## Rectangular cased ceramic capacitors

A line of ceramic capacitors has been introduced with capacitance values from 0.1  $\mu\text{f}$  through 2  $\mu\text{f}$ . They are available in both 100

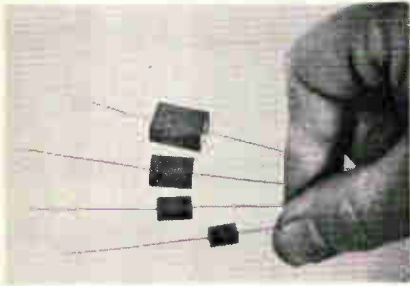

wvdc and 50 wvdc ratings. Temperature range is from  $-55^{\circ}\text{C}$  to  $+125^{\circ}\text{C}$ . The rectangular-cased units are offered at prices ranging from \$1.54 to \$8 in production quantities. Delivery is three weeks after receipt of order.

Chem-Electro Research, 11144 Penrose St., Sun Valley, Calif. [357]

## Heat dissipators cool semiconductors

A new series of heat sinks has been developed for TO-5, TO-7 and TO-9 case-type semiconductors. The TOR-50 miniature devices have numerous advantages, including increased heat dissipation, the elimination of special installation tooling, installation adaptability, and economy. They can be provided with either a 10-32 mounting stud or 10-32 tapped mounting hole, and can be installed with a  $\frac{5}{8}$ -in. box wrench. The hex-finned heat dissipator is secured to a 6063-T5 aluminum-alloy mount. Available for either prototype or quantity delivery, the TOR-50 is designed to solve numerous semiconductor heat-dissipation problems. It also serves as a convenient and economical mounting platform. Tor Mfg. Co., 16329 East Arrow Highway, Irwindale, Calif., 91707. [358]

## Ballantine Sensitive True-RMS RF Millivoltmeter

### Model 340

Price: \$760  
(with all accessories\*)

Measures True-Rms regardless of Waveform and Voltage

High, Uniform Accuracy and Resolution over entire 5-inch scale



## Measures 300 $\mu\text{V}$ to 3 V from 0.1 Mc to 1,000 Mc

Ballantine's Model 340 is a sensitive, wideband, rms-responding voltmeter with a basic accuracy of better than 4%. Its 5-inch voltage scales spread out the readings logarithmically. Thus you can make measurements to the same high resolution and accuracy at the bottom of the scale as you can at full scale.

Outstanding is the Model 340's rms-response to distorted sine wave voltages, regardless of their levels. This is most important at high frequencies since all known calibrating standards are based on rms-responding devices.

#### SPECIFICATIONS

<b>Voltage Range</b> ..... 300 $\mu\text{V}$ to 3 V	<b>Crest Factor</b> ..... 100 to 3 depending on voltage range
<b>Frequency Range</b> ..... 0.1 Mc to $>1,000$ Mc; calibrated to 700 Mc	<b>Scales</b> ..... Two logarithmic voltage scales, 0.95 to 3.3 and 3.0 to 10.6. One decibel scale, 0 to 10
<b>Indication</b> ..... True-RMS on all ranges, all voltages	<b>Mean Square DC Output</b> ... 0.1 V to 1.0 V dc. Internal resistance 20 kilohms. (For connection to recorder.)
<b>Accuracy</b> ...% of Reading 0.1 Mc — 100 Mc, 4%; 100 Mc — 700 Mc, 10%; above 700 Mc as sensitive indicator	

\*Accessories include a probe tip for in-circuit measurements, an adapter for connection to N or BNC, a T adapter for connection to a 50 ohm line, and a 40 db attenuator

Member Scientific Apparatus Makers Association

— Since 1932 —



**BALLANTINE LABORATORIES INC.**  
Boonton, New Jersey

CHECK WITH BALLANTINE FIRST FOR DC AND AC ELECTRONIC VOLTMETERS/AMMETERS/OHM METERS, REGARDLESS OF YOUR REQUIREMENTS. WE HAVE A LARGE LINE, WITH ADDITIONS EACH YEAR. ALSO AC/DC LINEAR CONVERTERS, AC/DC CALIBRATORS, WIDE BAND AMPLIFIERS, DIRECT-READING CAPACITANCE METERS, AND A LINE OF LABORATORY VOLTAGE STANDARDS FOR 0 TO 1,000 MHz.



**SEE IT...**



**SHOOT IT...**

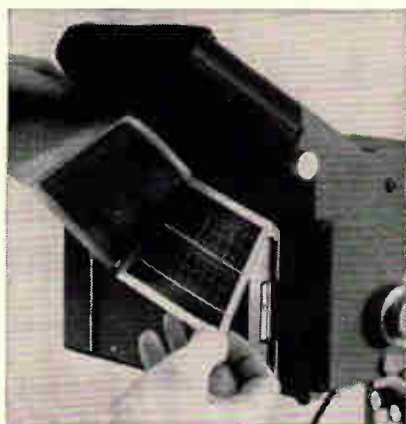

**HAVE IT...**

**WITH SCOPE CAMERAS BUILT BY THE LEADER... FAIRCHILD**

Available from the industry's most complete line of high precision scope cameras are models for high speed atomic research, radio astronomy, medical observations and general lab work. Prices start at \$350. Application assistance is available from your local Fairchild Field Engineer. Call him, or write for details, then compare design features. Fairchild Scientific Instruments, 750 Bloomfield Ave., Clifton, N. J.

**FAIRCHILD**

DU MONT LABORATORIES  
SCIENTIFIC INSTRUMENT DEPARTMENT

**New Instruments**



**Microminiature linear accelerometer**

A rugged new accelerometer—one-twentieth the size of its predecessor but half as expensive, more accurate and more reliable—is being produced. The solid-state GG322 represents a new concept in silicon element manufacture and a pioneering application of a silicon beam for an accelerometer, according to the manufacturer. The simplified design of the new unit is said to be responsible for its lower cost and increased reliability. The only movement is the slight bending of the silicon beam. The beam, diffused with two piezoresistive strain elements on each side, provides the basic sensing element.

The GG322 weighs only 1 oz and is 1.1 in. long and 0.65 in. in diameter. The company says it is suitable for control systems in space vehicles, missiles, aircraft, helicopters and torpedos, as well as for a wide range of instrumentation and telemetry applications. Among its major performance features are: a full scale range of  $\pm 2$  g to  $\pm 2,000$  g; versatile excitation capability, using either d-c or a-c; threshold, 0.0005% of full scale; linearity of 0.05% to half scale; hysteresis, 0.003% of full scale.

Honeywell Aeronautical Division, 2600 Ridgway Road, Minneapolis, Minn., 55440. [381]

**General-purpose component bridge**

Model B-521 component bridge offers measurement ranges of 1 milliohm to 1,000 megohms, 1 picofarad to 5 farads, 1 microhenry to 500,000 henrys, in 10 ranges for each parameter, to an accuracy of  $\pm 2\%$  for most values. Its transformer-ratio-arm circuit enables it to make two-, three-, or four-terminal measurements, either balanced

or unbalanced. Even high impedances may be measured without disconnecting the circuitry into which the component under measurement is wired, since the shunt effect of undesired impedances is eliminated. A Kelvin configuration automatically guards out shunt effects of long cables; hence, the B-521 is well suited for remote measurements. The unit will measure the transfer admittance of 3- or 4-terminal networks — transistor parameters or transformer voltage

# More than 50% of all taut band meters in use today are Weston

There is no better proof of reliability than acceptance! From the largest production capability available today, you can choose any size, function, accuracy, mounting and style.  
World's standard for measurement and display

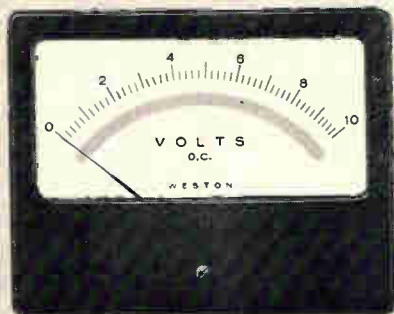
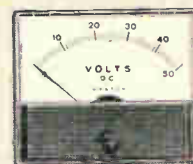
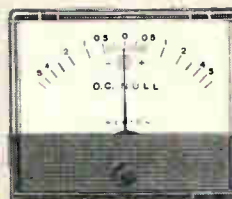
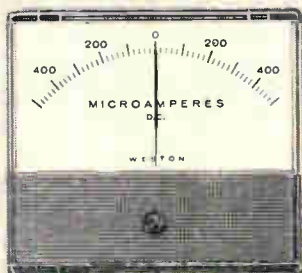
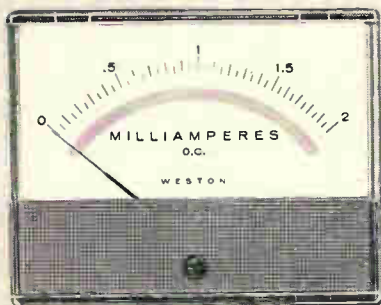
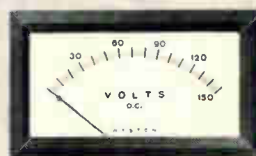
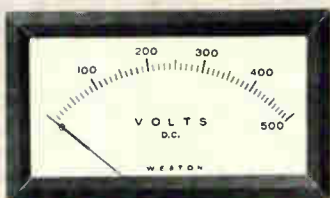
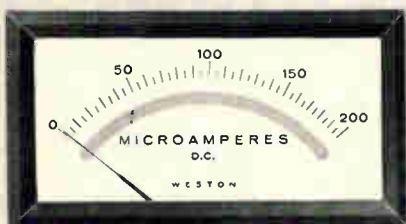

QUALITY BY DESIGN  
 **WESTON INSTRUMENTS, INC.**

614 Frelinghuysen Avenue, Newark, New Jersey, 07114

Circle 147 on reader service card

**ENGRAVE  
EVERYTHING  
FROM  
6 FT. PANELS  
TO TINY  
NAMEPLATES**

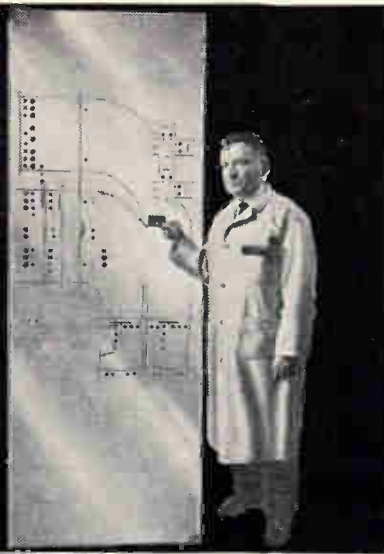

**Tracer-guided arm guides the worker—  
makes everyone a skilled engraver.**

**Convenient**—It's right in the plant when and where you need it.

**Accurate**—Positive depth of cut with automatic depth regulator. 15 accurate ratios.

**Speedy**—Self-centering work holder cuts set-up time in half.

Ask for complete, illustrated catalog EE-14

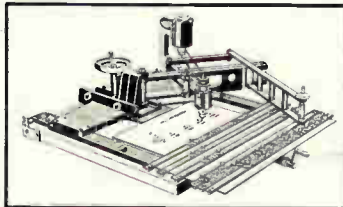

*new hermes engraving machine corp.*

154 WEST 14th ST., NEW YORK 11, N. Y. Chicago, Atlanta, Dallas, Los Angeles, Montreal

**NEW TRANSISTOR TV TUNER**



**VHF V-AS11**

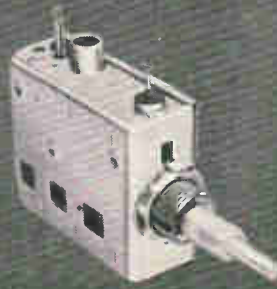

**UHF U-AS11**

MITSUMI transistorized TV tuners are the most reliable TV accessories because of their unique design and high quality. Electronic reliability is maintained by carefully selected material and strict quality control.

Mechanical reliability is completely guaranteed. Spurious radiation have been eliminated in line with FCC standards.

Mitsumi Electric Company Limited is one of top electronic apparatus manufacturers in Japan. The Mitsumi poly-varicon and IFT have been put into 80% of the total transistorized radio set produced in Japan. Mitsumi Electric Company specializes in the manufacture of poly-varicon, IFT oscillator coils, variable registers, FM tuners, TV tuners, micro motors, CdS photoconductive cells and sockets.



**MITSUMI ELECTRIC CO., LTD.**

Head Office: Komae Kitatama, Tokyo, Japan  
New York Office: 11 Broadway, New York 4, N.Y., U.S.A.

**New Instruments**



ratios. Components with superimposed d-c, such as chokes and polarized capacitors, may be measured without requiring zero adjustments or tedious substitution techniques. The transformers are so designed that very heavy shunt loading is possible without affecting accuracy. The bridge is easy to operate. Two front-panel knobs are adjusted until a single-sensitivity magic eye indicates null balance. Two dials display the real and imaginary components of an impedance simultaneously, with equally high resolution and accuracy.

Wayne Kerr Corp., 18-22 Frink St., Montclair, N.J. [382]

**Phase angle standard  
covers 30 to 10,000 cps**

Model 311/RT-1/717 primary phase angle standard is said to represent a major advance in the electrical measurements industry. This console is capable of either shifting phase angle, or measuring phase angle with an accuracy of  $\pm 0.02^\circ$  at most frequencies within the operating range of the equipment. The operating frequency can be adjusted continuously from 30 cps to 10,000 cps. Operation of this primary standard makes use of a self-calibrating principle that is independent from component errors or imperfections. This system of generating and measuring phase angle offers a degree of accuracy not previously obtainable, according to the manufacturer. Other features includes continuously variable output voltage with maximum obtainable output voltage level of 125 v rms. The input impedance of the phase measuring section is



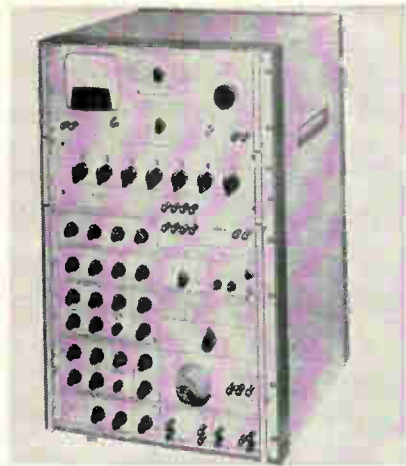

in excess of 10 megohms. Measurement and generating of phase angles are not affected by harmonics. Dytronics Co., Inc., 5566 N. High St., Columbus, Ohio. [383]

### Stable bridge measures inductance

A new bridge provides direct reading measurements of inductance over a range from 110 millihenries down to 0.0002 microhenry with a basic accuracy of 0.25%. Model 63H also measures series resistance directly over a range from 11,000 ohms down to 0.0002 ohm. The instrument is completely self-contained, including bridge circuitry, variable frequency test oscillator, detector, null indicator, and power supplies. The test signal is continuously adjustable in frequency from 5 kc to 500 kc, and in level, from effectively zero to approximately 3 v, open circuit. The design of the model 63H is such that the test current through the specimen is unaffected by the balance condition of the bridge, and once adjusted to a desired level it remains constant as the null is sought. This feature is particularly important in applications involving devices such as ferrite cores, whose permeability varies with excitation current. The design of the bridge circuit also eliminates interaction between the inductive and resistive arms, with the result that the annoyance and ambiguity caused by false nulls or sliding balance are avoided. Stability of the model 63H is excellent, with inductance drift typically less than 0.01% per day, permitting long term studies such

## the only thing NOT UNIQUE about the 610B is the name ELECTROMETER

The Keithley 610B Electrometer measures more parameters over broader ranges than any other dc test instrument! One compact measuring system now gives you the capability to investigate:

**VOLTAGE**—20 microvolts to 100 volts, without circuit loading ( $10^{14}$  ohms input resistance)

**CURRENT**— $10^{-15}$  ampere to 0.3 ampere

**RESISTANCE**—2 ohms to  $10^{14}$  ohms

**CHARGE**— $10^{-13}$  coulomb to  $10^{-5}$  coulomb

In addition, this neat package has only 200 microvolts per hour zero drift. That's ten times better than you can expect from any other tube electrometer, and it approaches the stability of costly vibrating reed devices. Unique, too, is the 610B's 1% meter accuracy, and its .005% unity gain output for impedance matching. An extra large 6-inch taut-band meter and two easy-to-read dials accent ease and convenience of operation.

The remarkably superior 610B replaces the 610A . . . and sells for the same price . . .

**\$565**

Send for Engineering Note  
on 610B Electrometer

#### other electrometers

Model 610BR	
Rack mounting 610B . . . . .	\$585
Model 621	
37 ranges, line operated. . . . .	\$390
Model 600A	
54 ranges, bat. operated. . . . .	\$395
Model 603	
50 kc bandwidth amplifier. . . . .	\$750

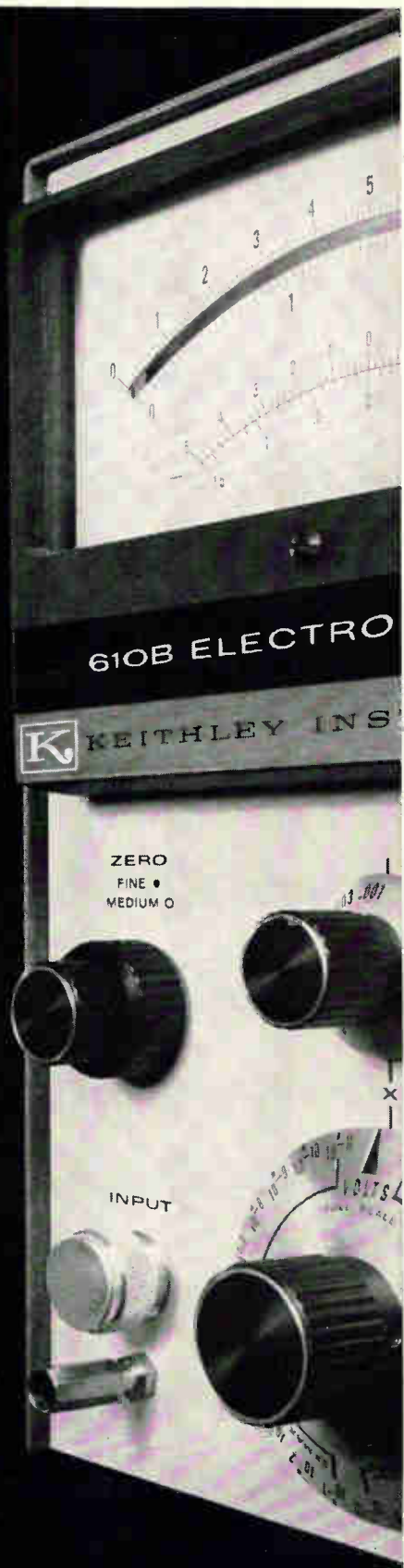

**KEITHLEY  
INSTRUMENTS**

12415 Euclid Avenue • Cleveland 6, Ohio

*dc microvoltmeters • differential voltmeters • high voltage supplies*

# HOW'S YOUR THERMISTOR IQ?

Want to learn more about these versatile, precision sensors? Here's FREE literature to help you.

## CAPSULE THERMISTOR COURSE BOOK

Ten quick, painless lessons on precision thermistors, their characteristics, and how they are used. Illustrates basic thermistor circuits, compares thermistors with other sensors, gives typical circuit design calculations, etc.

Ask for F.E.I. CAPSULE THERMISTOR COURSE BOOK.

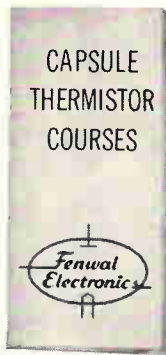

## THERMISTOR FACT FOLDER



An illustrated booklet which describes various thermistor types, including F.E.I. ISO-CURVE\* interchangeable thermistors, and how to apply them in measurement and control circuits.

Ask for F.E.I. THERMISTOR FACT FOLDER.

\*MADE UNDER PAT. 3109227 AND OTHERS. ISO-CURVE IS A TRADEMARK OF F.E.I.

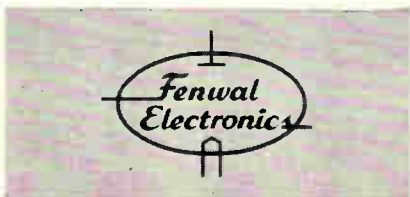

63 FOUNTAIN STREET, FRAMINGHAM, MASS.

## New Instruments

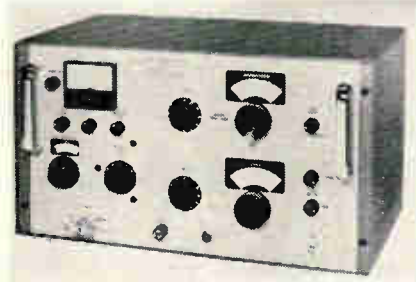

as temperature coefficient measurements or monitoring stabilizing cycles of inductors. Price is \$1,850. Boonton Electronics Corp., Parsippany, N.J. [384]

## X-Y plotter draws 2,000 lines per minute

A compact, solid-state X-Y plotter features high-speed line, alphanumeric and symbol plotting. The 3500 Dataplotter provides graphic display of computer-generated information on a 30 in. by 30 in. or 45 in. by 60 in. plotting surface. Its wide range of application includes data reduction, engineering plans and surveys, business graphs, and meteorological and aerospace data. In the off-line plotting mode, information can be fed to the plotter from magnetic tape, punched paper tape or cards, as well as entered manually from a keyboard. In the on-line mode, information can be fed directly from a computer. Speed and accuracy at low cost are the key features of the unit. It can draw lines to within 0.015 in. between two points and can position points to within an accuracy of  $\pm 0.05\%$ . Lines can be drawn by the plotter at speeds in excess of 2,000 per minute—plot-



WHERE QUALITY COMES FIRST

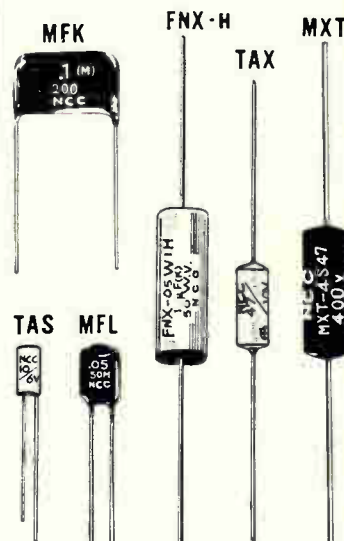

### POLYESTER FILM CAPACITOR

	Capacitance Range	Voltages
TYPE MFL Dipped Flat Shape	001 MFD to .47 MFD	35, 50, 100, 200V, DC
TYPE MFK Dipped Flat Shape Non-Inductive Construction	.01 MFD to .22 MFD	100, 200, 400, 600V, DC
TYPE MXT In Plastic Tube	001 MFD to .22 MFD	100, 200, 400, 600V, DC

### METALLIZED POLYESTER FILM CAPACITORS

TYPE FNX-H Mylar Wrapped Removal With Epoxy End Seal	1 MFD to 10 MFD	50V DC
--	-----------------	--------

### SOLID TANTALUM CAPACITORS

TYPE TAX MIL-C-26655A Hermetically Sealed	1 MFD to 220 MFD	3, 6, 10, 15, 20, 25, 35V, DC
TYPE TAS Sealed with Epoxy Resin	1 MFD to 220 MFD	3, 6, 10, 15, 20, 25, 35V, DC

# MATSUO ELECTRIC CO., LTD.

### HEAD OFFICE :

3-5-3-CHOME, SENNARI-CHO, TOYONAKA-SHI, OSAKA, JAPAN.

### TOKYO OFFICE :

2-5-2-CHOME, KANDA, AWAJI-CHO, CHIYODA-KU, TOKYO, JAPAN.

Cable Address "NCC MATSUO" OSAKA

ting points at the rate of 180 per minute using an alphanumeric symbol printer. The 3500 Dataplotter is priced at \$39,000 and delivery is 120 days from receipt of order. Electronic Associates, Inc., West Long Branch, N.J. [385]



### Monitor oscilloscope has multiple display

Series 7000 monitor oscilloscopes provide, in a miniature package, many of the features of laboratory-type scopes. The units offer "big scope" performance for continuous monitoring of analog tape record-reproduce systems, and other applications where multichannel dynamic signal display is desired. Features include bandwidths of 5 Mc  $\pm$  1 db; calibrated sensitivities of 0.1 v rms per in. to 10 rms per in. in seven steps; calibrated sweep rates of 0.01 to 100 kc in five steps, plus a 10  $\times$  vernier control for sweep rate of 1 Mc; extremely stable automatic triggering; and bright, sharp displays. Three-inch rectangular crt's with P-2 phosphors provide an aspect ratio and display which is similar to lab scopes. Seven modular units with their associated mounting frame and power supply occupy only 3½ in. of 19-in. rack mount space. Price for model 7000 monitor oscilloscope set, consisting of seven scopes with power supply, is \$2,750.

California Instruments Corp., 3511 Midway Drive, San Diego, Calif. [386]

### Solid-state precision calibrator

A new general-purpose power supply has the accuracy of a precision calibrator. High-stability, low-noise, silicon semiconductor devices and advanced solid-state circuit technology are the basis for this highly stable regulator. Char-

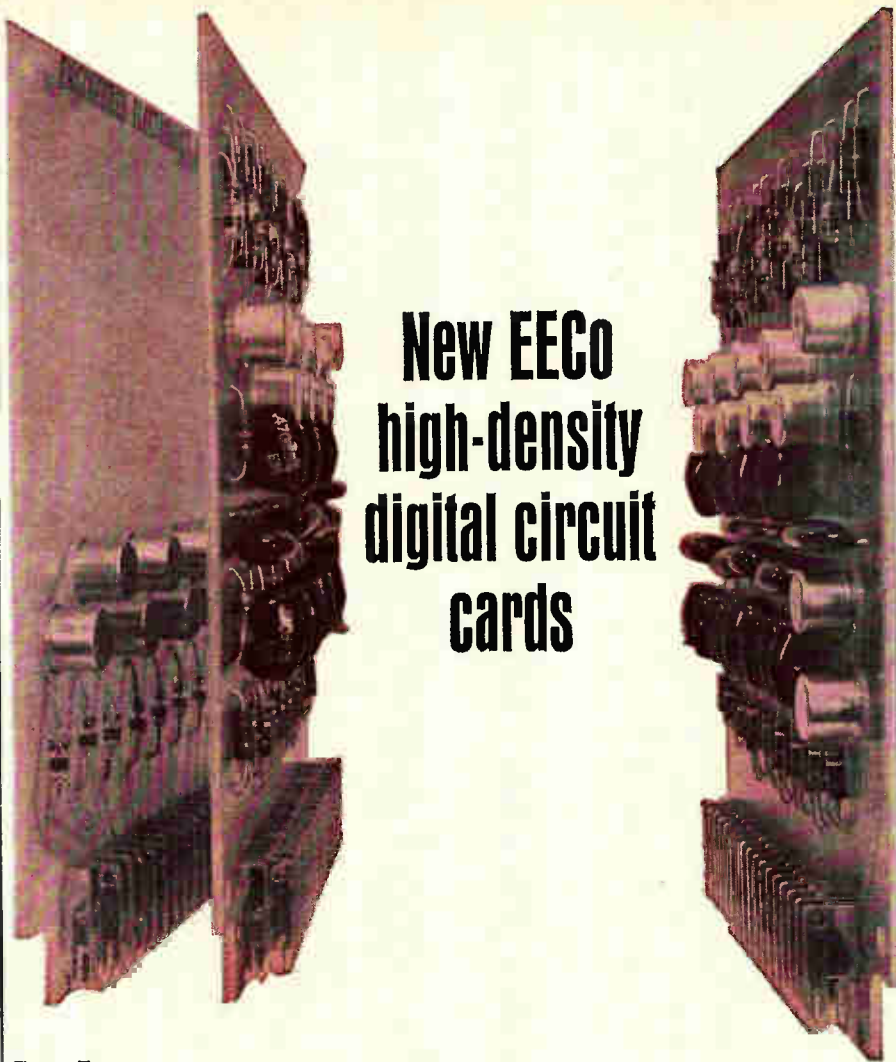

## New EECo high-density digital circuit cards

## bring economy to high-quality circuits

Try these high-density cards—up to twice the usual number of components. There couldn't be a better time! Because EECo has announced price cuts up to 35% on its GA Series line which contains more than 70 off-the-shelf modules for both synchronous and non-synchronous use . . . speeds up to 10 mpps.

How's this for value? Four flip-flops and a nand on a single 4½" x 5" card at \$9 per flip-flop. Result: substantial savings in hardware and wiring costs . . . plus patented short-circuit protection and EECo's lifetime warranty. All circuits use the widely accepted VARICON\* connector.

Write, wire or phone for complete information.

\*Trademark of ELCO Corp.

*LOOK TO EECo for...the world's most complete line of packaged digital circuit modules...breadboard equipment which allows a designer to change system modular complement at will—without soldering or other permanent type of attachment.*



**ENGINEERED ELECTRONICS Company**

1441 East Chestnut Ave. • Santa Ana, Calif.

Phone: (714) 547-5651 Cable: ENGELEX

**NOW! a NEW Shielded  
High Q Variable Inductor  
with exceptional stability!**



**The NEW  
Wee V-L**



ACTUAL SIZE

Adjustable Inductance range 0.10 $\mu$ h to 100,000 $\mu$ h in 0.300" by 0.400" molded case with 0.200" grid spacing.

**24 HOUR DELIVERY!**

The new Wee V-L now offers the design engineer these important advantages: Meets requirements of MIL-C-15305C; unitized epoxy molded construction; 73 stock values; and shielded for minimum coupling.

The Wee V-L is the newest product to join the Nytronics subminiature family of inductors, ceramic capacitors, precision wire wound resistors, thin film resistors and delay lines. Use coupon for engineering data!

**NYTRONICS**

Design leaders  
STANDARD components to meet  
CUSTOM requirements

550 Springfield Ave., Berkeley Heights, N. J.

**MAIL COUPON TODAY FOR COMPLETE  
ENGINEERING DATA ON THE NEW WEE V-L**

TO: NYTRONICS, INC. Dept. S  
550 Springfield Avenue, Berkeley Heights, N. J.

Please send complete engineering data on the Wee V-L

NAME \_\_\_\_\_

TITLE \_\_\_\_\_

FIRM \_\_\_\_\_

ADDRESS \_\_\_\_\_

CITY \_\_\_\_\_ STATE \_\_\_\_\_ ZIP \_\_\_\_\_

**NEW Ultra-Stable**

**Miniature  
Solid-State  
Oscillator**



Now—for microwave applications—an oscillator stable to 1 part in 100,000/°C from -54°C to +90°C... yet requiring only 28V DC power input, occupying less than 2.5 cubic inches, weighing only 5.8 ounces!

This exceptional performance is achieved by reliable solid-state circuitry, tuned by a miniature INVAR cavity with rigid dimensional stability. The oscillator can be tuned easily over a 10% band by set-screw, with optional varactor voltage tuning available for a 50 MC span.

Model DG504 operates at 1 GC with 20 milliwatt output power. The price? Only \$350 each — and less in quantity! For detailed data, write Sanders Associates, Inc., Microwave Products Dept., 95 Canal Street, Nashua, New Hampshire.

**CREATING NEW DIRECTIONS IN ELECTRONICS**  
**SANDERS ASSOCIATES, INC.**

Circle 205 on reader service card

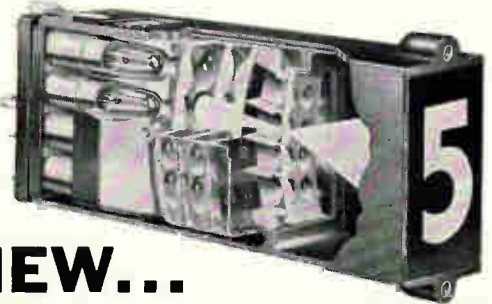

**NEW...  
MOST READABLE READOUTS NOW  
4-TIMES BRIGHTER!**

Human factors studies prove IEE rear-projection readouts are far more readable than other major types. Now, thanks to a new brightness-building lens system shown above (Pat. Pend.), IEE Series 10 readouts are 4-times brighter than ever. Your message reads sharp and clear, even at wide angles, long distances, in brightest light. Exclusive single-plane presentation assures crispness, not visual hash.

- IEE REAR-PROJECTION READOUTS OFFER THESE IMPORTANT FEATURES:
- 12 SINGLE-PLANE MESSAGE POSITIONS that may be displayed individually or in combination.
  - INFINITE DISPLAY VERSATILITY including colors, symbols, numbers, letters, words—anything you can put on film!
  - NO MOVING PARTS for unlimited life; easily replaceable lamps provide up to 30,000 hours of operation per lamp.
  - NO FILTERS, SCREENS, OR SHADES REQUIRED.
  - LOW VOLTAGE OPERATION (only 6.3 to 28 v, depending on lamp used).
  - AVAILABLE IN SEVERAL SIZES with max. character height 5/8" to 3 3/8".

SEND TODAY FOR COMPLETE NEW "READOUT DISPLAY SELECTOR GUIDE."

**IEE INDUSTRIAL ELECTRONIC ENGINEERS, INC.**  
7720 Lemona Avenue • Van Nuys, California  
Phone: (213) 787-0311 • TWX (213) 781-8115  
Representatives in Principal Cities

©1965 IEE

## New Instruments

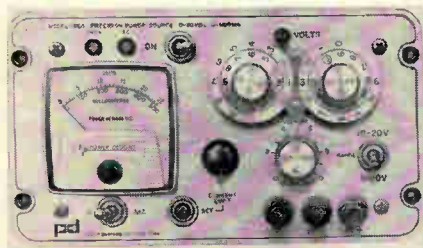

acteristics of the model 2005 permit dial readout of the output voltage to 5 places. Interpolation of the last place is provided by a potentiometer with a resolution of  $10 \mu\text{v}$ . Critical amplifier stages and a specially processed zener diode voltage reference are enclosed in a temperature controlled oven, thus avoiding the use of the conventional more complex chopper techniques. Design simplicity results in a low cost unit said to be half the size and weight of comparable instrumentation.

Power Designs Inc., 1700 Shames Drive, Westbury, N.Y. [387]

## Voltmeter combines digital, analog displays

Type 21B is said to be unique in that it measures and displays most of an unknown input value to 3.2 kv or 32 megohms in true digital form and indicates any remaining increment as an analog vernier that is immediately responsive to dynamic characteristics of the input. The instrument thereby retains the advantages of both digital and analog techniques. A single control selects both function and range for any measurement. There is no null-balancing procedure. Readout is fast and foolproof, since the same pair of linear scales is used for all measurements. After initial range selection, all measurements are made automatically including color coded polarity indication. The 21B does not sample the input but instead, measures and displays it continuously, thus a changing input does not produce unreadable digit hunting. Applications include twt voltage measurement, power supply monitoring, photomultiplier tube tests, h-v research, production

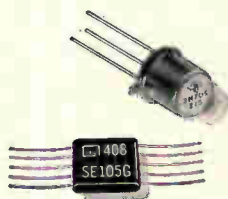

Need to say a lot  
in a little space?

(or make markings  
more durable...or  
more economical...  
or at higher rates?)

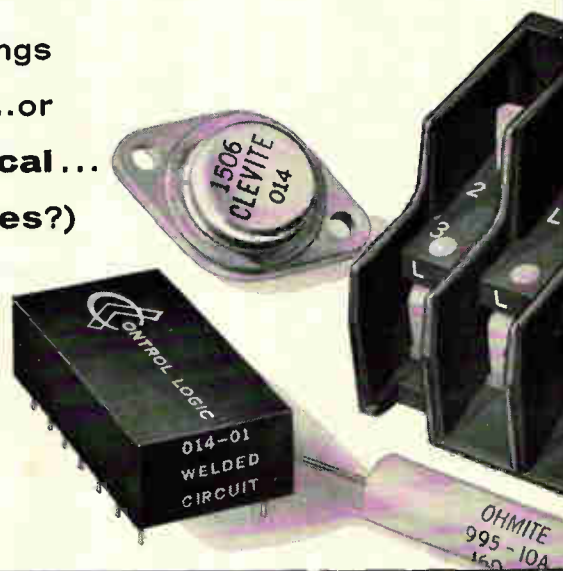

## We can show you how

We can show you how to identify products so they will resist extreme amounts of handling, abrasion, many solvents and other atmospheric conditions . . . or how to sequentially number and identify components with savings of more than \$50 per 1000 . . . or how to print trademark, type number, value and date code on 90 units a minute . . . or how to produce an imprint that remains readable after 1000 hours at  $200^{\circ}\text{C}$ . . . or get 10 digits and 2 letters in a micro-circuit area of  $0.090''$  — or 21 characters on a TO-5 case with interchangeable type number and date code . . . or save 75 cents of every dollar you now spend on buying, applying, inventorying and discarding obsolete preprinted labels.

The answers are in proven Markem machines, type and specialty inks, which daily produce better product or package identification by reducing costs, smoothing production control and increasing customer acceptance. And while Markem machines, type and inks are helping to produce better products through more complete and lasting identification, they frequently pay for themselves in the savings they make possible. Tell us what *you* make, what it must say, and for how long: we'll give you a specific recommendation and cost estimate right away. Write Electrical Division, Markem Machine Co., 305 Congress St., Keene, New Hampshire 03431.

# MARKEM

## Unusual stability

in miniature, surface-mounted platinum temperature sensors



Performance is excellent for such small sensors in the REC line of miniature surface sensors. Range covered is from  $-435^{\circ}\text{F}$ . to  $+1800^{\circ}\text{F}$ . Repeatability after 10 consecutive shocks from  $-320^{\circ}\text{F}$ . to  $300^{\circ}\text{F}$ . is within  $\pm 0.1^{\circ}\text{F}$ .

The easily attached sensors can be cemented, spot welded or clamped to surfaces. Cylindrical models fit around standard small pipe sizes.

REC surface sensors have elements of highest purity platinum wire, fully annealed and mounted so that the resistance wire is well isolated from any strain in the surface. Outer cases are platinum, stainless steel, epoxy compounds, or ceramic. Some have interchangeable bridge networks.

Write for Bulletin 9625.

### A complete precision line

Rosemount designs and manufactures high quality precision equipment in these lines:

- Air data sensors
  - Total temperature
  - Pitot-static tubes (de-iced)
- Immersion temperature sensors (including cryogenic)
- Surface temperature sensors
- Pressure sensors
- Accessory equipment and aeronautical research

For more information please write for the REC catalog. Specific questions welcomed.



**ROSEMOUNT  
ENGINEERING  
COMPANY**

4900 West 78th St. • Minneapolis 24, Minn.

## New Instruments



line tests or as a general lab instrument. Full scale ranges are: voltage, 320.0 mv to 3,200 kv; resistance, 320.0 ohms to 32.00 megohms. Total accuracy is better than  $\pm 0.1\%$  of full scale. Input impedance is 10 megohms  $\pm 0.2\%$ ; 1,000 v isolation to case ground is available if desired. Price is \$650; delivery one week.

J-Omega Co., 2278 Mora Drive, Mountain view, Calif. [388]



### Complex impedance and admittance meter

Series 100 complex impedance and admittance meter, using a new low-impedance plug-in model 100-PA-1004, has been developed for use in electroacoustical transducer measurements; laboratory and production testing of components such as resistors, inductors and capacitors; analysis of filters and resonant circuits; and the determination of the dynamic impedance of amplifiers, d-c power supplies and batteries. Values of R and X are presented on the panel meters and as d-c outputs for automatic sorting. Loci of R vs frequency, X vs frequency or R vs X may be recorded using strip chart or X-Y recorders. Frequency ranges from 100 cps to 200 kc. Im-

## Major Supplier of INDIUM

Dimensions and weights of Standard (99.99%) and 59 (99.999%) Grade Indium shapes available as follows:

**Ingots** - 321.5 tr. oz. (this size in Standard Grade only), 100 tr. oz., 10 tr. oz. **Sheets** - maximum width of 5 in., minimum thickness of 0.002 in. **Wire** - minimum diameter 0.01 in. **Ribbon** - minimum thickness 0.005 in., maximum width 0.75 in. **Powder** - several sizes from -100 to -325 mesh. **Shot** - approximate diameter  $\frac{1}{8}$  in. **Indium Compounds** - sulphate, chloride, oxide and hydroxide in crystal or solution form. Wide range of sizes of **Preforms** available in Standard and 59 Grades INDIUM and custom alloys based on these grades. Fabricated shapes include discs, spheres, squares, rectangles and washers. Very close tolerances maintained. Enquiries invited for special shapes, sizes and analyses.

### COMINCO PRODUCTS, INC.

ELECTRONIC MATERIALS DIVISION,  
818 West Riverside Ave., Spokane, Wash. 99201  
Phone 509 747-6111 Telex 032 610  
TWX 509-328-1464

5606

Circle 207 on reader service card

## More torque, Less weight

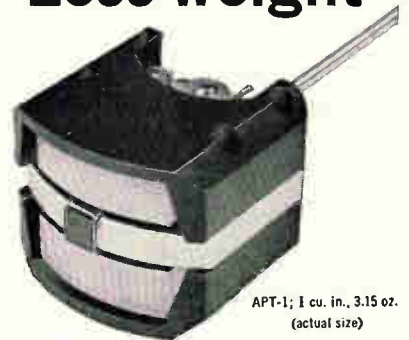

APT-1; 1 cu. in., 3.15 oz.  
(actual size)

### in moving coil mechanism

Stable, linear, accurate mechanism for indicating, control or recording systems. 1% linearity over  $18.0-18^{\circ}$  and greater accuracy assured by coil design with over 75% of winding "working" in high energy, uniform field air gap. Coil system weighs 0.85 gm, develops 26.4 mmg of torque; 31:1 T/W. Vibration resonance negligible; acceleration errors sharply attenuated. Standard pivots and jewels — custom damping — wide range of sensitivities.

# AMMON

AMMON INSTRUMENTS, INC.  
345 Kelley Street, Manchester, N. H. 03105

Circle 208 on reader service card

pedance ranges (full scale R and X) are 1, 2.5, 5, 10, 25, 50, 100, 250, 500, 1000, 2500, and 5000 ohms. Dranetz Engineering Laboratories, Inc., 11 Washington Ave., Plainfield, N.J. [389]

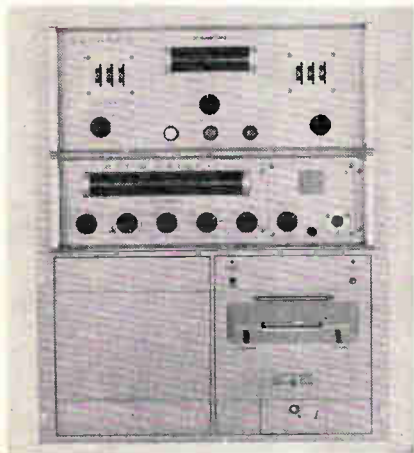

### Digital data logger for low-level use

The series 7000A data logging systems feature 600 points of input scan and a guarded differential, full five-digit digital voltmeter with preamplifier. Voltage ranges are from 10 mv full scale ( $0.1 \mu\text{v}$  resolution) to 1,000 v full scale. Recorded data is provided in the form of printed paper tape with a variety of other output options available. By simply changing input plug-in accessories, the system may be used for a-c or resistance measurements. Approximate price is \$10,000. Delivery is 45 to 60 days. Cimron Corp., 1152 Morena Blvd., San Diego, Calif., 92110. [390]

### Insulation test-sets offered in 10 models

A series of test sets now available offer electronics manufacturers simple and reliable insulation breakdown results on components, cable and equipment. Ten models are offered with voltage ranges between 0-3,000 and 0-40,000, and with v-a ranging from 2.5 to 3,000. The basic instrument provides a-c voltages but dual models may be specified in most instances for a-c/d-c. Each instrument includes a kilovolt meter, a current meter, and automatic overload limited circuits;

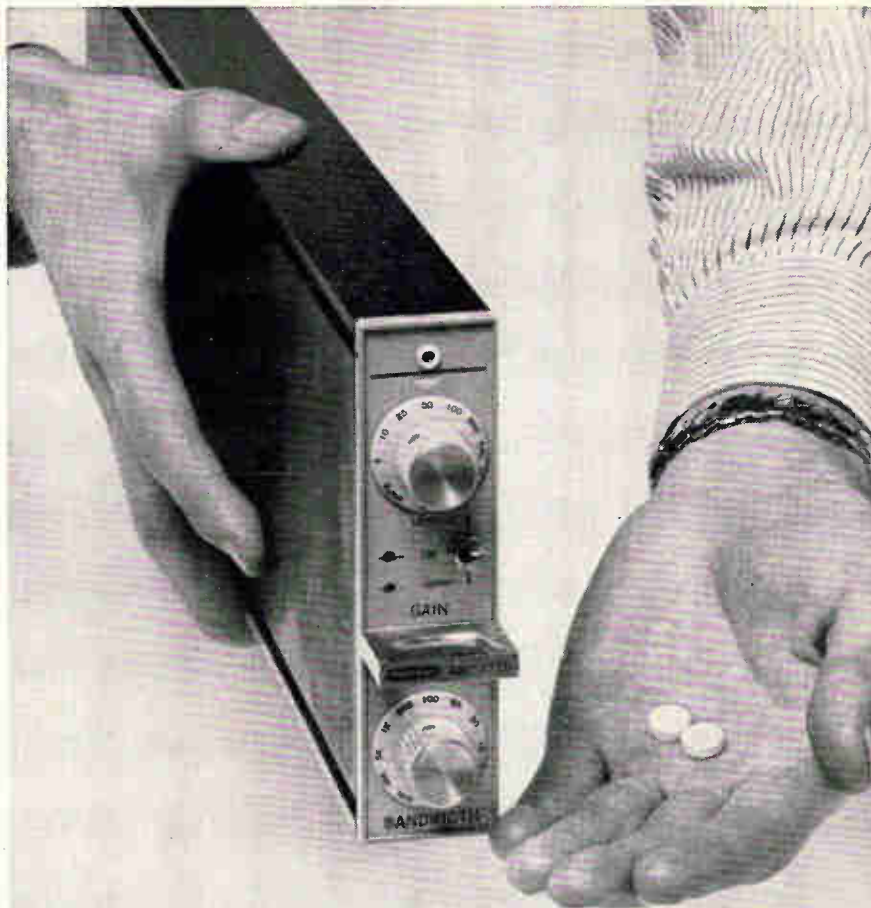

## Get permanent relief from amplifier headaches without system upset

For \$350 you can buy 200,000 aspirin tablets — enough to fight 100,000 headaches. For the same money you can get *permanent* relief from data-system problems with the Beckman AMPLEXER™ Differential Amplifier. It amplifies, filters, multiplexes, and has options for 11 switchable gains and 9 bandwidths.  Taking 200,000 aspirins could be unsettling. The AMPLEXER Amplifier settles in as little as 100 microseconds, depending upon the filter—and there are 184 to choose from! Also, your aspirin may not be buffered, but the AMPLEXER is. The 3 simultaneous outputs—commutated, filtered, and wideband—are fully isolated from the input. What else? It's wideband (dc to 50 kc), linear to  $\pm 0.005\%$ , and has gain accuracy to 0.01%, and gain stability of 0.005% for six months.  Write today for full details. Compare the performance and cost-per-channel of the exciting new AMPLEXER with other units—then use it in your next data system. Save the aspirin for non-users.

**Beckman®**

INSTRUMENTS, INC.

BERKELEY DIVISION

RICHMOND, CALIFORNIA • 94804

INTERNATIONAL SUBSIDIARIES: GENEVA, SWITZERLAND; MUNICH, GERMANY;  
GLENROTHES, SCOTLAND; PARIS, FRANCE; TOKYO, JAPAN; CAPETOWN, SOUTH AFRICA



**For Easy Handling**

Exclusive CAMBION® DIAL-A-PART 24 hour service places a complete supply of guaranteed panel and chassis hardware no further away than your nearest telephone. You get the convenience of instant ordering from a stock of more than 100 different handles designed to meet any kind of space limitation, environment, surface configuration, means of attachment and finish.

New slanted design makes this aluminum handle especially useful for lifting rack mounted components at an angle. Advanced form factor increases design freedom in equipment packaging. CAMBION Handle #1275 is 1.875" high overall, .625" in diameter and 4.562" long on hole centers. Plating and materials conform to military specifications. Available in black anodize or semi-frost finish. Add a new and modern look to your products with CAMBION Hardware. Call now . . . call any time . . . DIAL-A-PART (617) 876-2800. Cambridge Thermionic Corporation, 401 Concord Avenue, Cambridge, Massachusetts 02138.

**CAMBION®**

"DIAL-A-PART" SERVICE

Standardize on CAMBION...The Guaranteed Electronic Components  
Circle 209 on reader service card

**SERVO-CHART  
RECORDERS  
DON'T  
HAVE  
TO BE  
COSTLY!**

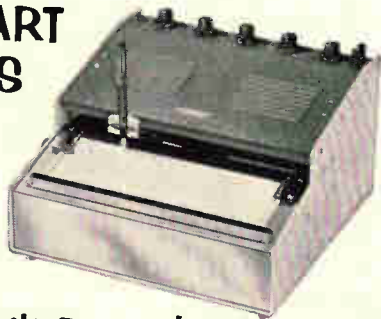

**This Heath-Built Recorder  
Costs Just \$199!**

Completely Factory Assembled & Tested!

Ready to use. True potentiometric input. Five adjustable ranges: 10, 25, 50, 100 & 250 mv plus plug-in 5-pin connectors for special ranges. Rapid chart advance; pen lift; paper tear-off guide; optional motor speeds; 10" chart; 1 sec. response. For full details on the famous Malmstadt-Enke Lab Series *Free*, simply tear out coupon and mail.

Assembled EUW-20A, Recorder, 20 lbs. . . . . \$199.00

**HEATH Built**

HEATH COMPANY, Dept. 67-2      Benton Harbor, Mich. 49023

Please send Free Folder on Malmstadt-Enke Lab Series and Free 1965 Heathkit Catalog.

Name \_\_\_\_\_  
(Please Print)

Address \_\_\_\_\_

City \_\_\_\_\_ State \_\_\_\_\_ Zip \_\_\_\_\_

EK-169R

# LIGHT FORCE Cherry Switch

MINIATURE  
E23-50H  
Lever Type

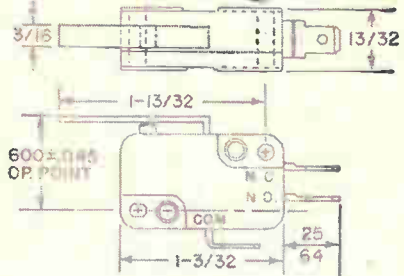

- Operating Force 3 oz. Max.
- 5 amp, 1/4 H.P. 125-250 V AC



The complete snap-action switch line!

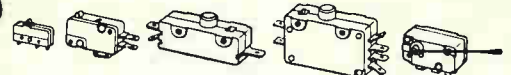

**Cherry Electrical Products Corporation**

P. O. Box 437-12      Highland Park, Ill.

IN CANADA: BARRY ELECTRIC LTD., REXDALE, ONTARIO

Circle 210 on reader service card

**PASS THE NAVY  
HAMMER TEST** WITH FLYING COLORS

Aeroflex Ladder Isolation Systems now make this possible. Your gear can meet the requirements of MIL-S-901 C without difficulties. Ladder isolation systems with an 85 lb. load have taken the punishing effects of a 400 lb. hammer on each of 6 faces. This type of performance during test guarantees field operation under the conditions of extreme shock. For additional information on Ladder Isolation Systems write to Dept. RZ-109.

**AEROFLEX LABORATORIES INCORPORATED**  
SOUTH SERVICE ROAD • PLAINVIEW • LONG ISLAND • NEW YORK 11803



**New Instruments**



metering accuracies are  $\pm 3\%$ . All standard models feature simultaneous metering of applied voltage and leakage current on separate meters.

Industrial Instruments Inc., 89 Commerce Road, Cedar Grove, Essex County, N.J. [391]



**R-f amplifier for field tests**

Twt amplifier AM/444 was built to meet the need for a compact broadband r-f amplifier capable of withstanding the rough treatment often encountered in antenna range and field test use. AM/444 can be driven by conventional lab signal generators and is typically used for antenna pattern measurements and for giving an extended dynamic range to r-f measurements. Power output is 20 w (4.0 to 8.0 Gc); 10 w (2.5 to 4.0 Gc, 8.0 to 10.0 Gc); 5 w (10.0 Gc to 12.0 Gc). Size is 12 in. by 9 in. by 8 in. Weight is approximately 20 lb.

Aero Geo Astro, Division of Keltec Industries Inc., 797 North Elgin Parkway, Fort Walton Beach, Fla. [392]

550  
500  
450  
400  
350  
300  
250  
200  
150  
100  
+50

**GLASS CLOTH INSULATING TAPE WITHSTANDS PHENOMENAL TEMPERATURE EXTREMES!**



**Mystik 7000 Hi-Lo Temperature Glass Cloth Tape** provides 4000 volt dielectric strength throughout a temperature range of  $-110^{\circ}$  F to  $+550^{\circ}$  F. Completely inorganic, it has a tightly woven, high tensile glass cloth backing and pressure-sensitive silicone adhesive. High temperature insulation for motors, generators, electrical equipment and appliances are but a few of its many applications. Printable, too! Mystik 7000 is just one of a host of special purpose Mystik electrical tapes you should know about. Call your Mystik man now or write Mystik Tape, Inc., Northfield, Ill.



**FREE SELECT-A-TAPE SAMPLE GUIDE!**

Takes the guesswork out of tape selection. Gives physical characteristics of all Mystik tapes, typical applications and sizes, principal advantages. Send for your copy today. MYSTIK TAPE, INC., 1700 Winnetka Ave., Northfield, Ill.

NAME \_\_\_\_\_  
 COMPANY \_\_\_\_\_  
 ADDRESS \_\_\_\_\_  
 CITY \_\_\_\_\_ STATE \_\_\_\_\_ ZIP \_\_\_\_\_



now  
available:

high-  
power  
Trygon  
half  
racks!

Up to 300 watts—precision regulated power—constant voltage—constant current—remote sensing—remote programming! Models for every application, from \$149. For the lab: self-cased; for systems: single or dual in 5¼" panel. Write today for complete specs. Dept. E-28.



**TRYGON**<sup>®</sup>  
**POWER SUPPLIES**  
Roosevelt, L. I., N. Y. (516) FReeport 8-2800

## New Semiconductors

### Stable, high-gain tunnel diodes

Microwave tunnel diodes have been developed that feature low noise at high frequency, coupled with high gain and excellent electrical stability. They are particularly suited to airborne applications because of their small size, light weight and simplified circuitry. For example, the tunnel diode r-f amplifier does not require pumping oscillators, needs only a small power supply and has low power drain. Also, the new tunnel diodes are highly resistant to shock and vibration and eliminate the need for cooling. Actual size of the diodes is approximately that of the head of a pin. Primary application for these germanium tunnel diodes is in h-f radio amplifier applications such as microwave relay links and phased array radar systems. They can also be used as self-oscillating mixers. The excellent h-f performance is achieved by junction capacitance as low as 0.09 pf. Stable gain exceeds 15 db. Because of their construction with glass sand-

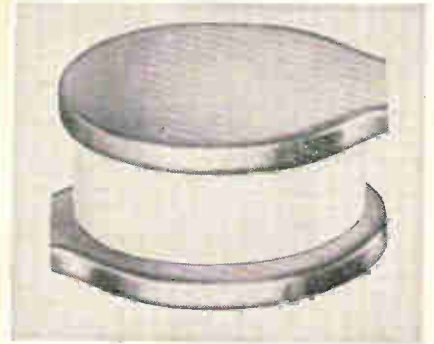

wiched between two germanium elements—forming the p-n junction on the outside—the diodes offer excellent mechanical stability and ruggedness. The glass has the same coefficient of thermal expansion as the germanium. Noise figures of 6 db at 10 Gc are possible. At 3Gc, amplifier noise is typically below 4 db; at 6 Gc, it is typically below 5 db. Prices range from \$30 to \$300 in lots from 10 to 99.

General Electric Co., Semiconductor Products Dept., Syracuse, N.Y. [371]

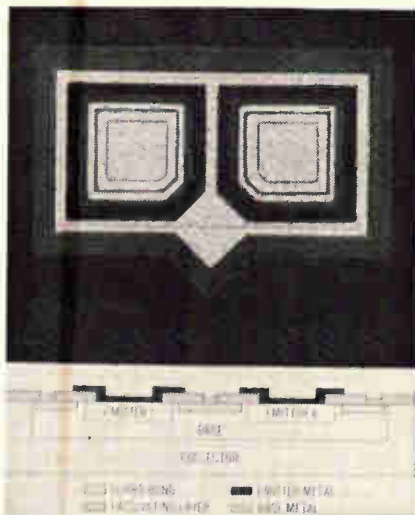

### Silicon epitaxial integrated chopper

An npn, integrated chopper transistor of the silicon epitaxial type has been announced. The ST5610-

5613 series chopper combines optimum performance characteristics of: high breakdown voltage, 20 v; low offset, 30  $\mu$ v; low dynamic resistance, 35 ohms; and low drift, 0.3  $\mu$ v/ $^{\circ}$ C. Channel stopping guard rings eliminate emitter-to-emitter channeling; low drift is eliminated by extended emitter contact metal; and ultrasonic aluminum wire bonding eliminates purple plague at the chip. The devices are available in four-lead TO-18 packaging. Transitor Electronic Corp., 168 Albion St., Wakefield, Mass. [372]

### Axial-lead, 2-ampere silicon rectifiers

The 20AG series of "no flange" axial-lead silicon rectifiers offers a forward current rating up to 2 amperes at 50 $^{\circ}$ C with a piv range of 200 to 1,000 v. The high one-cycle surge capability of 135 amps is

**ANDREW**



**SIMPLIFIES  
INSTALLATION PLANNING**



**HELIAX® ELLIPTICAL  
WAVEGUIDE Better than  
rectangular at half the cost!**



Continuous lengths . . . flexible. HELIAX elliptical waveguide eliminates the echo distortion caused by the numerous bends, twists, and flange joints of a conventional waveguide run. Attenuation is also reduced\*. HELIAX flexibility simplifies planning and handling. Installation requires only unreeling, attachment to tower, and connection to equipment. Write today, or ask your Andrew sales engineer for complete information on this new Andrew waveguide development!

\*At 6700 Mc, HELIAX elliptical waveguide loss is 1.5 db/100 ft. compared to 1.9 db/100 ft. for rectangular waveguide.

**28 YEARS OF ENGINEERING INTEGRITY**

**Andrew**  
CORPORATION

P. O. BOX 807 • CHICAGO, ILLINOIS U.S.A. 60642

EUROPEAN OPERATIONS: ANDREW CORPORATION, HOJSGAARDS—ALLE 02, HELLERUP, DENMARK

# SCR Thunderbolt MARK 10



# NOW

It's Delta's new Mark 10 SCR Capacitive Discharge Ignition System. It's the true electronic solution to one of the major problems of engine operation.

You read about it in the Oct. 5 edition of *ELECTRONICS*. Now it is the standard of the industry.

The Mark 10, using Silicon Controlled Rectifier Switching, provides brand new levels of engine performance and economy. Unaffected by extremes of temperature and operating conditions, the Mark 10 installs quickly and easily without re-wiring. It operates on any 12 volt negative or positive ground system.

**ASSEMBLED  
UNITS AT  
\$49.50**

from dealers  
or factory

**MARK 10  
DELTAKIT  
\$34.95**

available  
ONLY from factory

Dealer and distributor inquiries invited.



**DELTA  
PRODUCTS, INC.**

P. O. BOX 974  
GRAND JUNCTION, COLORADO

## New Semiconductors

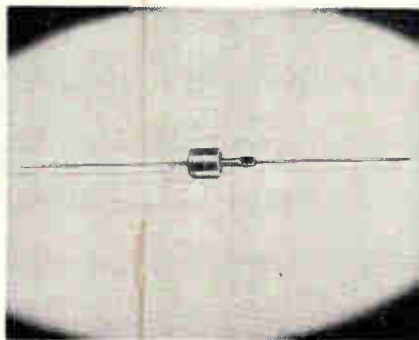

said to be unique for this size package. The units, with a case size measuring  $\frac{1}{4}$  in. in length and diameter, feature glass to metal seal reliability and are manufactured to exceed the requirements of EIA-NEMA Class B service per EIA Standard RS262. The price for the 20AG2 unit rated at 2.0 amps and 200 piv is 42 cents in quantities of 100 pieces.

Electronic Devices, Inc., 21 Gray Oaks Ave., Yonkers, N.Y., 10710. [373]

## MOS FET's ready for low-power use

Two new metal-oxide semiconductor field-effect transistors have been designed for general low-power applications up to 60 Mc. Both units are n-channel, depletion-type (the channel is electrically conductive even in the absence of applied voltages), silicon insulated-gate FET's with the gate offset toward the source to provide substantially reduced feedback capacitance. According to the manufacturer, the high-input impedance, large fanout capability and low capacitances make the MOS transistors ideally suited for electrometer amplifier, chopper amplifier, operational amplifiers for data processing equipment, r-f buffer amplifier and high-impedance audio circuit applications. In addition, the MOS transistors can accept large input signals and can provide improved cross-modulation performance in many circuit applications. Both FET's have a zero-signal drain current spread no greater than about 2 to 1. The 3N98, having the lower drain current, is advanta-

# R,D,D,M / RFS\*

\*  
Reception, Display, Detection, Monitoring RF Signals



## Type SR-212 VHF/UHF RECEIVING SYSTEM

**NOW**—for the first time—you can have frequency coverage of 30-1000 mc plus a signal display unit all in one equipment utilizing only  $3\frac{1}{2}$  inches of panel height.

This is possible because of ACL design ingenuity... solid state—modular type construction.

Reception—AM, FM and CW

Four IF bandwidths—20kc, 75kc, 150 kc and 3 mc. Controlled by front panel switch.

Four RF tuning bands: 30-100mc, 90-300mc, 250-500mc and 490-1000mc.

Solid state circuitry assures long MTBF.

Low power consumption — approximately 25 watts.

To get the whole story—noise figure, sensitivity, IF and image rejection, etc., write, wire or phone and we will send them along promptly.

**ACL** ASTRO  
COMMUNICATION  
LABORATORY

DIVISION OF KELTEC INDUSTRIES, INC.  
801 Gaither Road  
Gaithersburg, Maryland  
Phone: (301) 948-5210 TWX 710-828-9706

"RF Equipment for The Systems Engineer"

geous in amplifier applications requiring conservation of battery power, whereas the 3N99 can provide somewhat higher signal handling capability at the expense of slightly higher drain current. Maximum ratings for both are: storage temperature range,  $-65$  to  $+125^{\circ}\text{C}$ ; drain-to-source voltage,  $+32$  v; drain-to-substrate voltage,  $+32$  to  $-0.3$  v; gate-to-source voltage (d-c),  $+2$  to  $-6$  v; gate-to-source voltage (peak),  $\pm 15$  v; gate-to-substrate voltage (d-c),  $+2$  to  $-1$  v; drain current, 15 ma; power dissipation at  $T_A = 85^{\circ}\text{C}$ , 150 mw.

RCA Electronic Components and Devices, Harrison, N.J. [374]

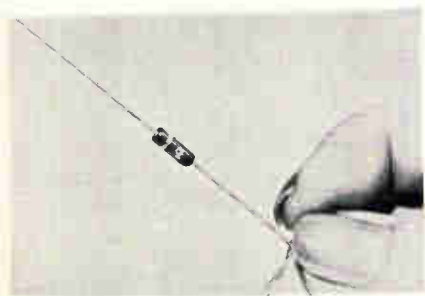

## Silicon zener diodes in 32 EIA types

A new series of 1-watt silicon zener diodes are housed in miniature, hermetically sealed glass cases. The devices are available in off-the-shelf production quantities at prices comparable with zeners of much lower dissipation rating, the company says. A further expansion of the Glass-Amp diode-rectifier line, the new zeners are being produced in 32 manufacturer registered EIA types (IN4162 through 4193), in a range from 10 through 200 v. A and B sub-types are available for tolerances of  $\pm 10\%$  (A) or  $\pm 5\%$  (B). The devices are interchangeable with more than 225 other zener types now available, and because of size, weight and insulation, have major advantages over top-hat, flangeless and plastic units, according to the manufacturer. Units are packaged in the Glass-Amp case, only 0.360 in. long and 0.150 in. in diameter, for which the company has just been assigned JEDEC outline number DO-29. They range in price (for quantities of 100 to 999) from \$1.10 for units

# MAGSENSE<sup>®</sup>

METER MONITOR

Now in lower-cost board form for mounting into your equipment

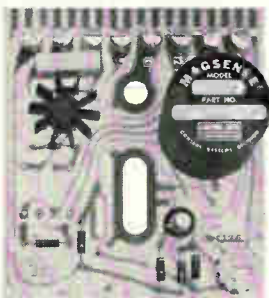

Model 70—\$60. Single Set Point



Model 77—\$99. Dual Set Point

The only solid-state comparators with

- 100 ms response
- 1  $\mu\text{a}$  sensitivity
- 100 billion power gain
- solid-state reliability

Here in lower-cost circuit board form are the same basic MAGSENSE units that have proved themselves in the extremes of polar cold, desert heat and space. The magnetic sensing devices detect and compare electrical currents less than 1  $\mu\text{a}$ —thereby accepting the output of thermocouples and strain gages directly *without amplifiers*.

Both the Model 70 with single set point and Model 77 with dual set points for detecting high and low limits are normally supplied with non-latching outputs for DC inputs with ranges of 100  $\mu\text{a}$ , 1 ma, 10 ma, or 100 ma. The Model 70 can also be supplied with latching or pulse outputs.

### BRIEF SPECIFICATIONS

**Response Time:** 100 ms max., 50 ms typical.

**Power Required:** 10 to 14 VDC at approx. 30 ma (70) and 50 ma (77) exclusive of load current.

**Output Load:** Up to 50 ma for Model 70, up to 100 ma for Model 77. 500 ma optional.

**Size:** 3" x 3.35" x 1.25".

**Weight:** Approx. 4 ounces.

**Mounting:** Chassis mounted or connector mounted. Holes for rear terminal mounting on meters.

**Electrical Connections:** Terminal wiring and plug-in edge connector similar to Elco 6007-18.

**Price and Delivery:** Model 70—\$60. Model 77—\$99. From stock.

### CONTACT THESE DISTRIBUTORS FOR COMPLETE INFORMATION OR DELIVERY FROM STOCK . . .

**Alabama (Florida Counties West of Jackson, Calhoun and Gulf)**  
The James Spader Co.  
P.O. Box 6074  
Birmingham, Ala. 35209  
(205) 879-1366

**S. California & Arizona**  
Perlmuth Electronics  
5057 W. Washington Blvd.  
Los Angeles, Calif. 90016  
(213) 931-1041  
TWX: 213 937-0629

**8068 Engineers Road  
San Diego, Calif. 92111  
(714) 278-6230  
TWX: 714 279-0272**  
2859 East Thomas Road  
Phoenix, Arizona 85016  
(602) 264-4934  
TWX: 602 255-0584

**N. California & Nevada**  
Heid & Mollard, Inc.  
1494 Oddstad Drive  
Redwood City, California  
(415) 365-1700  
TWX: 415 364-9000

**Meters, Inc.**  
1494 Oddstad Drive  
Redwood City, California  
(415) 365-1700  
TWX: 415 364-9068

**Colorado, Utah, Wyoming, Montana and South Idaho**  
Peterson Company  
4949 Colorado Blvd.  
Denver 16, Colorado  
(303) 333-3434  
TWX: 303 292-3277

**Peterson Company**  
521 West 4th North  
Salt Lake City, Utah  
(801) 355-7464  
TWX: 801 521-2536

**Florida (Except Counties West of Gadsden, Liberty and Franklin)**  
The D. E. Grantz Company  
5206 St. Regis Place  
Orlando, Florida  
(305) 855-9220

**Electro-Tech, Inc.**  
307 27th Street  
Orlando, Florida  
(305) 432-5589

**Georgia**  
Electro-Tech, Inc.  
690 Murphy Ave., S.W.  
Atlanta, Georgia  
(404) 753-4128  
TWX: 404 527-0189

**Northern Illinois, Northwest Indiana and Central Wisconsin**  
A & M Instrument, Inc.  
4801 N. Ridgeway Ave.  
Chicago, Illinois  
(312) 539-4460  
TWX: 312 222-9372

**Maryland and Virginia**  
Thomas H. Closs Co.  
21 W. Pennsylvania Ave.  
Towson, Maryland 21204  
(301) 925-4445

**Michigan & Indiana (Except Counties Lake, La Porte and Porter)**  
The Satulio Company  
4514 North Woodward  
Royal Oak, Michigan  
(313) 566-2375

**618 Cincinnati-Batavia Pike  
Cincinnati, Ohio 45244  
(513) 752-6683**

**Minnesota, Dakotas and Northwest Wisconsin**  
Pinkney and Assoc., Inc.  
1925 Nicollet Avenue  
Minneapolis, Minn. 55403  
(612) 338-0529  
TWX: 612 321-1345

**Miss., Arkansas, Louisiana and Texas (Except Six West Counties)**  
Butler and Land, Inc.  
5538 Dyer Street  
Dallas, Texas  
(214) 361-6631

**217 Bermac Building  
4101 San Jacinto Street  
Houston, Texas 77004  
(713) 523-8526**

**1034 Constance Street  
New Orleans, La. 70130  
(504) 524-0688**  
**Nebraska, Iowa, Kansas, Missouri & S. Illinois**  
Impala, Inc.  
7540 Lowell Street  
Overland Park, Kansas  
(913) 648-6901  
TWX: 913 642-8371

**247 South Pinecrest  
Wichita, Kansas  
(316) 682-3593**  
1011 Clifton Street, N.E.  
Cedar Rapids, Iowa  
(319) 362-2125

**Randolph and Coe Roads  
Middletown, Conn. 06458  
(203) 347-5629**

**New Mexico, Six West Texas Counties**  
Electronic Enterprises  
1900 Washington St., N.E.  
Albuquerque, N.M. 87110  
(505) 256-1585

**Metropolitan New York, Long Island and Northern New Jersey**  
A & M Instrument, Inc.  
48-01 31st Avenue  
Long Island City 3, N.Y.  
(212) 726-4343  
TWX: 212 672-1329

**Up-State New York**  
Osmann Component Sales Corp.  
830 Linden Avenue  
Rochester 25, New York  
(716) 586-4940  
5858 E. Molloy Rd.  
Syracuse 11, New York  
(315) 454-2461

**P.O. Box 245  
Vestal, New York  
(607) 785-9947  
TWX: 607 772-0209**

**Pioneer-Standard Electronics, Inc.**  
5403 Prospect Avenue  
Cleveland, Ohio 44103  
(216) 432-0010  
TWX: 216 574-9725

**2651 East Main Street  
Columbus, Ohio  
(614) 237-8515  
TWX: 614 759-0034**

**Srepco Electronics**  
314 Leo Street  
Dayton 4, Ohio  
(513) 224-0871  
TWX: 513 944-0430

**Oklahoma**  
Riddle and Hubbell  
302 S. Cheyenne Avenue  
Tulsa, Oklahoma  
(918) 585-5624  
TWX: 918 923-3173

**Eastern Pennsylvania, Delaware and Southern New Jersey**  
Robert K. Nye Associates  
P.O. Box 611  
Berwyn, Pennsylvania  
(215) 644-8479

**Electric Meter Service**  
1014 Vine Street  
Philadelphia 7, Pa.  
(215) 922-3422

**Washington, Oregon and Northern Idaho**  
Eicher and Company  
5 West Harrison Street  
Seattle 99, Washington  
(206) 284-1811

**Southern Wisconsin**  
Taylor Electric Company  
4080 N. Port Washington Road  
Milwaukee, Wis. 43212  
(414) 964-4321  
TWX: 414 964-4863

**CONTROL DATA CORPORATION**

**CONTROL SYSTEMS DIVISION  
4455 MIRAMAR ROAD, LA JOLLA, CALIFORNIA**

# FOR POSITIVE SHOCK PROTECTION

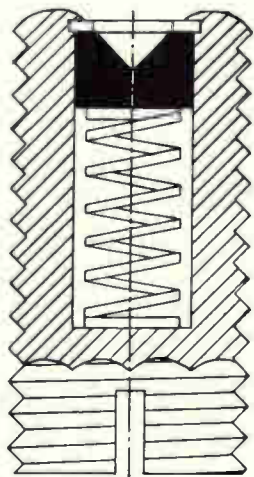

## USE BIRD CUSHION JEWELS IN INSTRUMENT ASSEMBLIES

Bird Jewel Assemblies mounted with resilient silicone rubber or spring cushioning provide inexpensive shock resistance for any instrument. Variable cushioning absorbs acceleration and deceleration shocks and severe vibratory stress without damage to pivot point.

Cushion Jewels maintain perfect alignment, through controlled jewel movement, provide greater accuracy and longer life. For only pennies more Cushion Jewels will protect your instruments.

**BIRD COMPLETE JEWEL ASSEMBLIES** are available in screws or bushings of any style, ready for product assembly. Our engineering staff is at your service for all your jewel bearing needs. Write for our catalog with full details on properties and uses of sapphire and glass jewels.

*Richard H. Bird* & CO., INC.  
1 SPRUCE STREET, WALTHAM, MASS. 02154

Serving Industry with Fine Jewels since 1913

## New Semiconductors

of  $\pm 5\%$  tolerance to 72 cents for units of  $\pm 20\%$  tolerance. Operating temperatures are over the range of  $-65^{\circ}\text{C}$  to  $+175^{\circ}\text{C}$  and storage temperatures are from  $-65^{\circ}\text{C}$  to  $+200^{\circ}\text{C}$ .

Semiconductor Products Group, General Instrument Corp., 600 W. John St., Hicksville, N.Y. [375]



## N- and p-channel silicon planar FET's

N-channel and p-channel field-effect transistors are available. Made specifically for low-level, low-noise amplifiers, low-level d-c choppers and h-f amplifiers, the silicon planar units feature high transconductance, low capacitances and extremely low leakage values. Typical values for n-channel silicon planar FET's, series UC100-UC130, are: noise figure (spot), 1.5 db max, 0.5 db typical; transconductance, 2,000  $\mu\text{mhos}$  max; capacitance, gate to drain, 1.5 pf max; leakage current, 0.1 na max; saturation current, 3 to 1 ratio. Over 50 types are currently available. A special test program provides for reliability testing to customer specifications by order or by specific families of devices.

Union Carbide Electronics, 365 Middlefield Road, Mountain View, Calif., 94041. [376]

## Zener diodes operate at 1 ma

A line of ultrastable, temperature-compensated zener diodes feature an order of magnitude reduction in

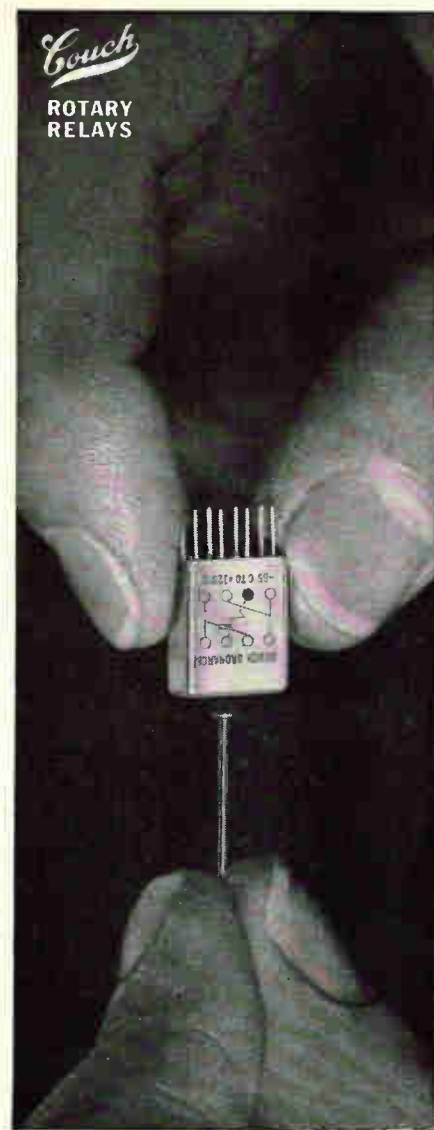

## good and small

This new Couch rotary relay is surprisingly microminiature when you consider the rugged construction inside and the specifications

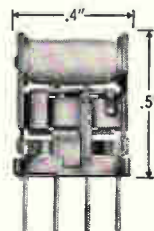

SIZE	.2" x .4" x .5"
TERMINAL SPACING	1/10" grid
RATING	.5 amp @ 30 VDC
COIL OPERATING POWER	150 mw
COIL RESISTANCE	60 ohms to 1,000 ohms
TEMPERATURE	$-65^{\circ}\text{C}$ to $+125^{\circ}\text{C}$
VIBRATION	20 G
SHOCK	75 G

Write for Data Sheet No. 9

RUGGED ROTARY RELAYS  Dynamically and Statically Balanced

## COUCH ORDNANCE INC.

3 Arlington Street, North Quincy 71, Mass., Area Code 617, CYPress 8-4147 • A subsidiary of S. H. COUCH COMPANY, INC.

power consumption. The PS1215 series operate at 1 ma instead of the usual 7.5 and 10 ma levels. Nominal zener voltage is 9 v d-c and maximum power dissipation is 500 mw at 25°C. With long-term stability of 0.1% (100 ppm) per year, the units are ideally suited to space application and other circuitry where stability is a prime consideration. The devices are available in 0.01, 0.005, 0.002 and 0.001% °C temperature coefficients. Package size is 0.33 in. diameter max by 0.53 in. long max; leads, 0.030 in. tinned Dumet. At the 100 level, the 0.01% TC PS 1215 costs \$4.70; the 0.005% PS1215A is \$6.10; the 0.002% PS1215B is \$10.50; and the 0.001% PS1215C is \$12.40.

TRW Semiconductors Inc., 14520 Aviation Blvd., Lawndale, Calif. [377]

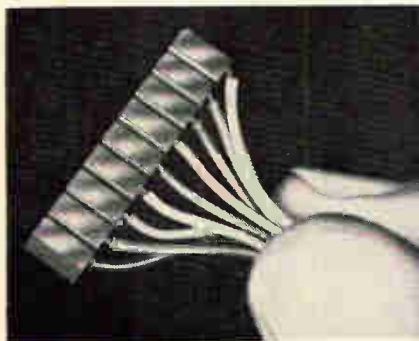

### Silicon n-on-p type photovoltaic cell

A new, silicon readout photocell of the n-on-p type is announced. The n-on-p configuration provides improved stability and lower reverse current. The NSL-701-9P is an array of nine photovoltaic cells constructed on a single piece of silicon. It is especially designed for the optical readout of punched paper tape or cards. Short circuit current is 0.275 ma minimum per segment, at 500 footcandles 2800°K. Output of each segment is matched with  $\pm 10\%$ . Maximum reverse current is 10  $\mu$ a at 0.5 v. Typical speed of response is 10  $\mu$ sec. The photocell is mounted on a rigid brass block. Overall dimensions are 0.200 in. by 0.880 in. by 0.140 in. thick, with 10 color-coded flexible leads each 4 in. long. Center-to-center spacing of segments is 0.100 in. National Semiconductors Ltd., 2150 Ward St., Montreal 9, Canada. [378]

**HIGH CURRENT!**  
**HIGH RELIABILITY!**



**HIGHEST VOLUMETRIC EFFICIENCY...  
of any capacitor with equivalent rating!**

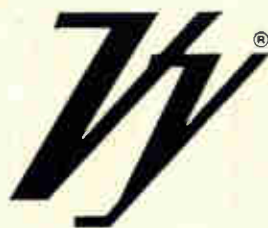
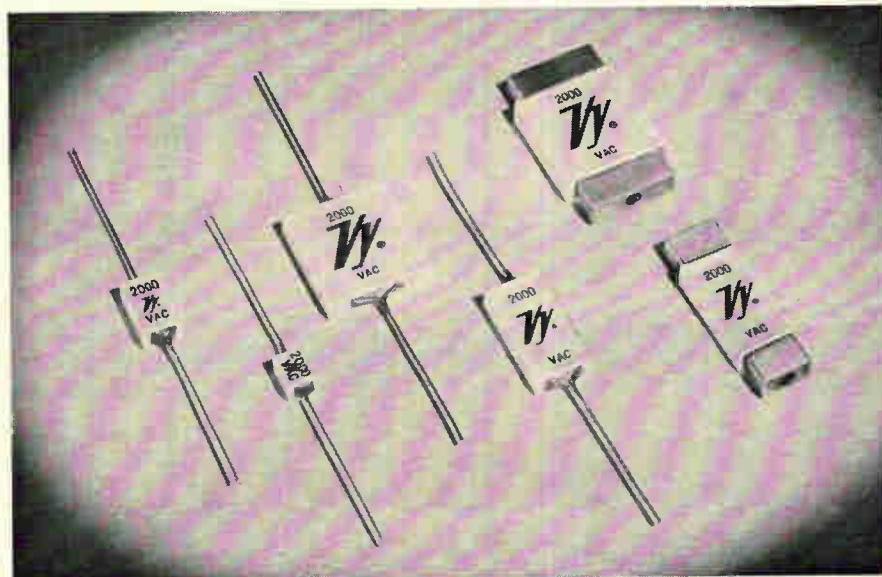

## HIGH CURRENT Porcelain Capacitors

The new line of "VY" High Current Capacitors is designed for maximum RF current operation. Low loss of the porcelain dielectric permits high current ratings and uniform heat dissipation throughout the entire temperature range. Capacitance range of 10 to 2000 pf is available in four case sizes with solder coated copper leads, and in two case sizes with brass heat sink terminals drilled and tapped for screw mounting.

Capacitance Range: 10 pf to 2000 pf  
Temperature Range: -55°C to 125°C  
Voltage Rating: to 2000 volts AC RMS  
Current Ratings: to 22 Amps RF  
Temperature Coefficient: 105 ppm/°C  
 $\pm 25$  ppm/°C  
Dissipation Factor: .001 max. at 25°C  
.003 max. at 125°C

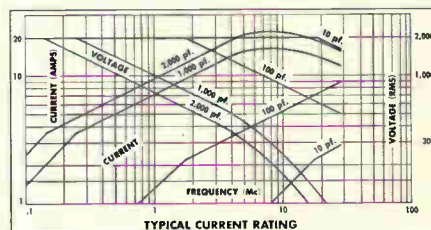

Write for Data Sheet P 12

© Vitramon, Inc., 1964

**Vitramon**  
INCORPORATED

Box 544 Bridgeport, Connecticut 06601

In United Kingdom contact:  
Vitramon Laboratories Limited  
Marlow Road  
Bourne End, Bucks  
England

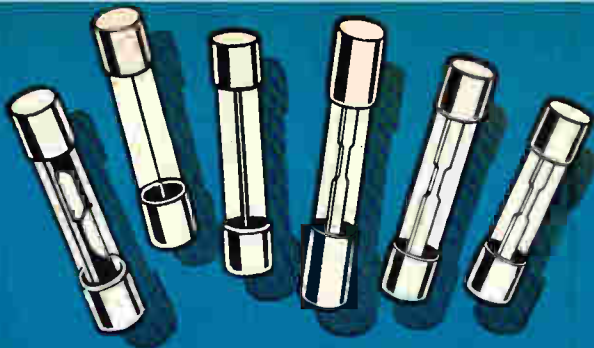

## BUSS

*quick-acting* Fuses

"Quick-Acting" fuses for protection of sensitive instruments or delicate apparatus;—or normal acting fuses for protection where circuit is not subject to starting currents or surges.

# BUSS

Write for BUSS  
Bulletin SFB

BUSSMANN MFG. DIVISION, McCraw-Edison Co., St. Louis, Mo. 63107

# BLOCKS

for  
**BUSS**  
FUSES



SOLDER  
TERMINALS

SCREW  
TERMINALS

Above standard types available in any number of poles—  
From 1 to 12... plus other types for every application....

# BUSS

Write for BUSS  
Bulletin SFB

BUSSMANN MFG. DIV., McCraw-Edison Co., ST. LOUIS, MO. 63107

# BUSS®: The Complete Line of Fuses.

Circle 165 on reader service card

Circle 165 on reader service card

### To order reprints from Electronics

Fill in, cut coupon below, insert in envelope and mail to:

Electronics reprint dept.

330 West 42nd Street, New York, N. Y. 10036

### Reprint order form

For listing of reprints available see the reader service card

To help expedite mailing of your reprints please send cash, check, or money order with your order.

1964 Complete Electronics Index, 40 Pages

Send me ..... copies of Key no. R-69 at \$1.00 each.

For reprints of previous special reports fill in below:

Send me ..... reprints of Key no. (s) ..... @ ..... ¢ each

For prices see the reader service card.

Name .....

Number and Street .....

City, Zone No., State .....



## New Subassemblies and Systems

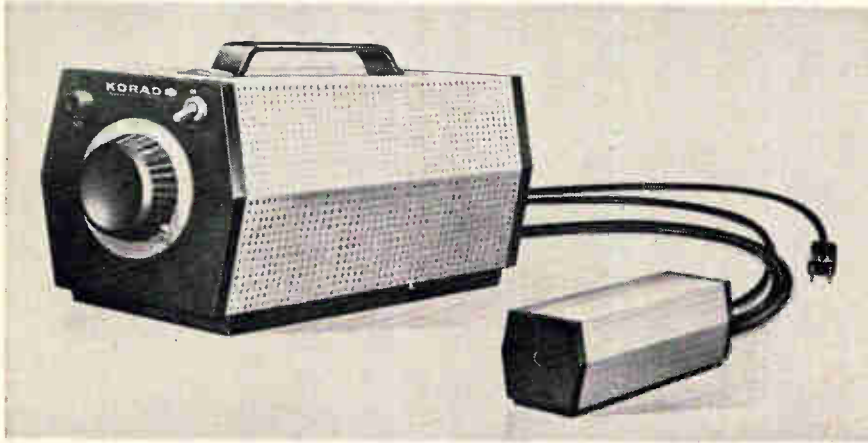

### Portable laser with YAG crystal

A portable yttrium aluminum garnet (YAG) laser now being produced is said to be the first com-

mercially available. The optically pumped laser is excited by long-life tungsten lamps to produce a

continuous output of  $\frac{1}{2}$  w at a wavelength of 1.06 microns. Power output may be varied continuously. All that is needed to operate the laser is a 110-v outlet. Because of its lightweight portability—combined weight of laser head and control unit is 20 lb—the new laser is especially suited for secure communications systems. It is also ideal, the company says, for ranging experiments when mounted on a telescope, for calibration of spectral data with an interferometer and for general laboratory use on optical benches. A YAG crystal, the manufacturer explains, has the narrowest linewidth and lowest threshold of any neodymium-doped material. A YAG laser is expected to be considerably less expensive to purchase and operate than a gas laser with the same power output. The YAG laser is limited only by the life of the tungsten lamps—approximately 2,000 hours—and they

# f Unquestioned High Quality...



SIGNAL  
ACTIVATING  
•  
LAMP  
INDICATING  
•  
SERIES  
HKA

## BUSS FUSEHOLDERS

FOR  $\frac{1}{8}$  x  $1\frac{1}{2}$  INCH BUSS GLD FUSES,  $\frac{1}{4}$  TO 5 AMPS.

When fuse opens, indicating pin completes a circuit that lights indicating lamp in holder and makes contact on external signal circuit. External signal can be an audible alarm or another lamp mounted at a distance, or it can operate a relay.

# BUSS

Write for BUSS  
Bulletin SFB

BUSSMANN MFG. DIVISION, McGraw-Edison Co., St. Louis, Mo. 63107

Circle 165 on reader service card

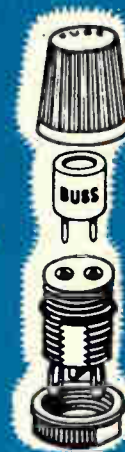

GMW FUSE  
and HWA  
FUSEHOLDER

FUSE SIZE  
ONLY .270 x .250  
INCHES

BUSS  
VISUAL  
INDICATING

## Sub-Miniature FUSE-HOLDER COMBINATION

For space-tight applications. Fuse has window for inspection of element. Fuse may be used with or without holder.

Fuse held tight in holder by beryllium copper contacts assuring low resistance.

Holder can be used with or without knob. Knob makes holder water-proof from front of panel.

Military type fuse FM01 meets all requirements of MIL-F-23419. Military type holder FHN42W meets all military requirements of MIL-F-19207A.

# BUSS

Write for BUSS  
Bulletin SFB

BUSSMANN MFG. DIVISION, McGraw-Edison Co., St. Louis, Mo. 63107

Circle 165 on reader service card



EDGERTON, GERMESHAUSEN & GRIER, INC.

## QUANTITATIVE LIGHT MEASUREMENT



**\$375**

### WITH THE EGG LITE-MIKE

Nanosecond response. Wide spectral and dynamic range. Meter measures average power. Permits scope display of wave shape, rise and fall time, duration, amplitude, and integrated light pulse energy in the visible and near infrared range (0.35 to 1.13 microns). All for \$375.

Provides light source evaluation in CW and pulsed lasers; flash photolysis; flash tubes and equipment; exploding bridge wires; material fluorescence; gallium arsenide signals. Also provides standard for light instrumentation.

Ten inches high; light in weight; built-in controls for sensitivity and ambient light balancing; swivel-mounted head aligns with source. Order direct from Products Division, 176 Brookline Avenue, Boston, Massachusetts 02215.



EDGERTON, GERMESHAUSEN & GRIER, INC.

## New Subassemblies

can be replaced easily and inexpensively. Designated K-Y1, the laser consists of a 3 by 3 by 7-in., water-cooled laser head connected by a power cable and dual water hose to a 10 by 10 by 20-in. control unit containing the variable power supply and closed loop cooling system. Inside the laser head, the Nd YAG crystal is mounted in a quartz tube between the tungsten lamps. Cooling water is circulated into the quartz tube, immersing the crystal, then through coils around the lamp-crystal assembly.

Korad Corp., 2520 Colorado Ave., Santa Monica, Calif., 90406. [401]

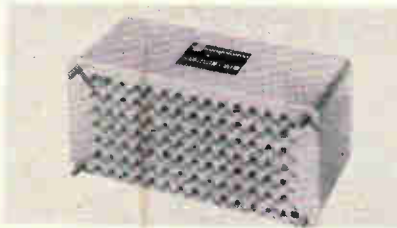

## Delay line features wide band

A new, wideband delay line features a delay to rise time ratio of better than 50 to 1, while maintaining low distortion of under 5%. It provides  $6.0 \mu\text{sec} \pm 1\%$  of delay, at an impedance of 120 ohms  $\pm 5\%$ . More than 90 close tolerance taps are provided. Overall attenuation is less than 3 db. This line is encapsulated in foamed epoxy resin, packaged in a hermetically sealed, cold rolled steel enclosure 3 by 3 by  $6\frac{3}{8}$  in., and is designed to meet the requirements of MIL-D-23859 over an operating temperature range of  $-55^\circ\text{C}$  to  $+125^\circ\text{C}$ . Price in small quantities is \$175.

Kappa Networks, Inc., 165 Roosevelt Ave., Carteret, N.J. 07008. [402]

## Lumped-constant delay line

This lumped-constant delay line features high delay in a small package, and provides 20 to 1 ratio of delay-rise time. Delay of this line

To order reprints  
from Electronics

fill in, cut out

coupon below,

insert in envelope

and mail to:

Electronics Reprint  
Dept.

330 West 42nd Street

New York, N. Y. 10036

### Reprint order form

For listing of reprints available see the reader service card

To help expedite mailing of your reprints please send cash, check or money order with your order.

For reprints of the latest Special report:

Electronics Markets 1965

Send me . . . . reprints of key no. R-67 at 50¢ each.

For reprints of previous special reports fill in below:

Send me . . . . reprints of key no.(s)

..... at . . . . ¢ each.

For prices see the reader service card.

Name .....

Number & Street .....

City, State .....

Zip Code .....



is 52  $\mu$ sec at an impedance of 1,000 ohms, packaged in 5 cubic inches. The unit is encapsulated in foamed epoxy resin, enclosed in a hermetically sealed, cold rolled steel case  $1\frac{1}{2}$  by  $1\frac{1}{2}$  by  $2\frac{1}{4}$  in., and is designed to meet the requirements of MIL-D-23859 over an operating temperature range of  $-55^{\circ}\text{C}$  to  $+105^{\circ}\text{C}$ . Price is \$75 in small quantity.

Kappa Networks, Inc., 165 Roosevelt Ave., Carteret, N.J. 07008. [403]

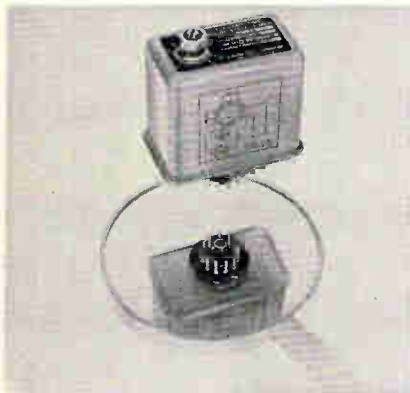

### Delay-on-break plug-in timer

This solid-state, plug-in module operates from a-c line when an external control contact is opened. With a built-in dpdt relay that will operate at the prescribed time interval, exhaust blowers can be sustained up to 5 minutes after other equipment stops, with  $\pm 1\%$  accuracy. For example: a paper drive motor can continue for a suitable time after a message has been printed, to allow full exit of the paper from an automatic printer. A conveyor can be automatically turned off when no material is being conveyed after a given time interval. The delay-on-break timer automatically resets itself if, during its preset time interval, normal function is resumed. Timing is adjustable.

Electro-Seal Corp., 938 North Ave., Des Plaines, Ill., 60016. [404]

# LITTLE CHOPPER



Bristol Subminiature Chopper  
Actual Size

# BIG PERFORMER

Where component space is limited—Bristol's  
Subminiature Chopper offers:

- 0.1 cu. in. size
- complete shielding
- radiation resistance
- airborne environmental ratings
- lowest noise level

Write for detailed spec sheet. **The Bristol Company**, Aircraft Division, 152 Bristol Road, Waterbury, Conn. 06720.

A subsidiary of American Chain & Cable Company, Inc. 4.7



**BRISTOL** . . . engineers for precision, builds for reliability

# Acts fast at set point

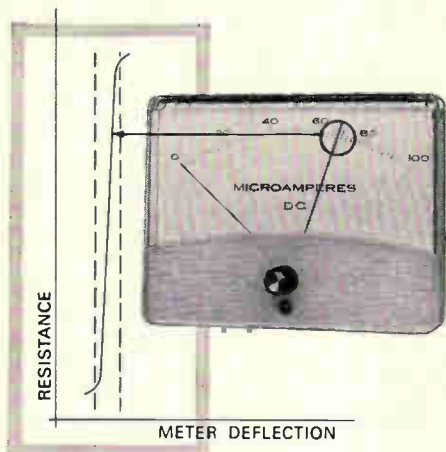

Almost instantaneous—that's the response at set point of API's contactless (optical) meter-relay. Control action at set point is triggered in no more than 10 to 20 milliseconds.

Highly efficient use of internal light results in a "slope" of at least 100 to 1 between the extremes of resistance of a photoconductor. This ratio insures fast response (see curve above).

Above all, API's contactless meter-relay is simple and direct in operation—and therefore reliable and easy to apply. It's sophisticated but not complicated.

You don't have to be an engineer to use it—but engineers appreciate it most.

## Details we almost take for granted

It's unaffected by ambient light ■ Indicates continuously, either side of set point ■ Inherently fail-safe ■ Unamplified signal from any variable ■ Set points can be as close as ½% of full scale ■ Pre-packaged circuits available.

Ever get so much for so little? All popular current and voltage ranges, including AC, plus temperature controlling models Ask for:

*Bulletins 33-D (Prices),  
35-C (Circuits), and 39 (Stock List)*



**Assembly Products, Inc.**  
Chesterland, Ohio • Tel: 216-423-3131

## New Microwave

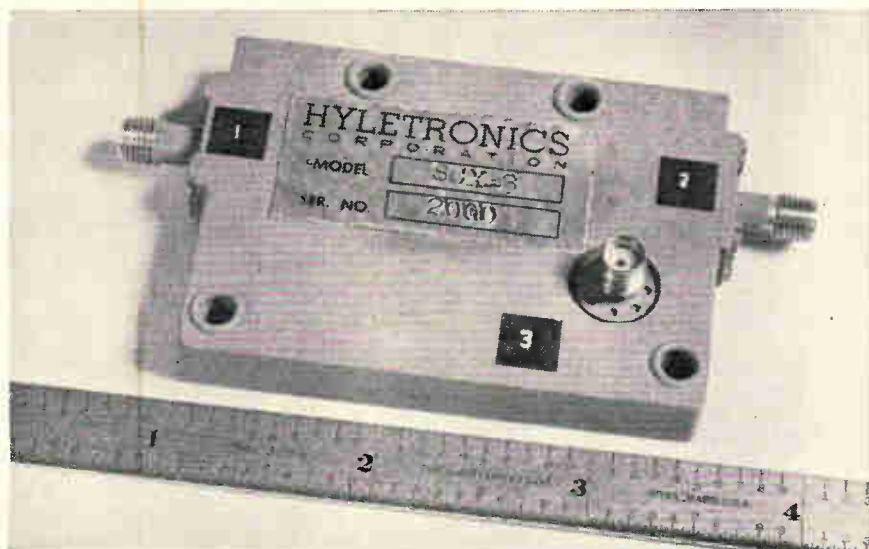

## Nanosecond switch covers 2.5 to 11 Gc

An spst, nanosecond diode switch has been developed to cover the full frequency band from 2.5 to 11 Gc. Model SCX-3 has a maximum insertion loss of 3 db and a minimum isolation of 30 db. Actual insertion loss is less than 1.5 db and isolation is well above 40 db over most of the frequency band. Switching time of less than 3 nsec has been measured, and modulating frequencies in excess of 30 Mc have been applied to this switch to achieve 100% modulation of r-f signals. Bias conditions are extremely low—as little as 5 mw of

drive power is required to maintain the low loss state. The switch contains a d-c block and a ground return as integral parts of the broadband design. The unit illustrated is designed with miniature connectors and packaging suitable for airborne and missile environments. Operation is possible over the temperature range from  $-55$  to  $+90^{\circ}\text{C}$ . The device should be particularly interesting to systems manufacturers working on advanced military systems.

Hyletronics Corp., 185 Cambridge St., Burlington, Mass. [421]

## L-band power source delivers 250 mw

Developmental type S-127 L-band power source contains a transistor-oscillator stage and a varactor-frequency-multiplier stage. It can be frequency-modulated. The compact and extremely rugged device can be operated from batteries or solar cells. Specifications include: power output, 250 mw; frequency, 1680 Mc; voltage, 16 v; current, 105 ma; efficiency, 15%; f-m characteristics, 0.5 Mc/v; spurious output,  $-30$  db; weight, 4 oz max; and size, 1.8 in. by 1.7 in. (excluding output connector). Possible applications in-

clude use as a telemetry transmitter for rocketsondes, gun probes, space probes, satellites and missiles.

Radio Corp. of America, Microwave Tube Operations Dept., 1000 South 2nd St., Harrison, N.J. [422]

## Water-cooled load handles high power

A water-cooled load for 2.6 to 3.95 Gc will absorb 25 kw average power for prolonged periods and remain cool enough to handle with bare hands. Peak power handling capability has been tested to 3.2

Mw. During recent full power tests, conducted for over five hours, throat temperature on the DBL-465 remained below 115°F and water temperature rose only 15°

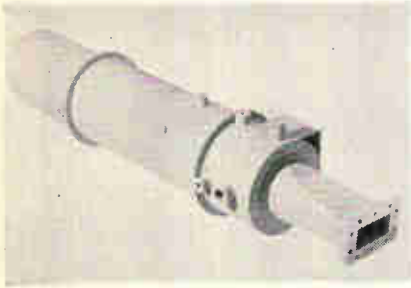

above normal. The DBL-465 features an optimized geometrical shape for increased peak power handling capacity and mechanical strength, an improved ceramic-to-metal bond to optimize heat dissipation and a tapered absorption coefficient to maximize power handling and minimize vswr. Water can be pumped through at the rate of 10 gallons per minute. Dimensions are 40 in. long and 7¼ in. outside diameter. Weight is 65 lb. Price is \$1,175.

DeMornay-Bonardi Division of Data-pulse, Inc., 780 S. Arroyo Parkway, Pasadena, Calif., 91105. [423]

## Traveling-wave tube operates at 4 Gc

A new ceramic-metal twt, type A-1318, operates at 4 Gc and has an overall efficiency of 40% that is constant at any output from 5 to 20 w. The tube is capable of operating during the launching of a satellite and is said to incorporate the latest advances in satellite-tube design, including highly effective heat transfer and ruggedization. Other features are a saturated gain of 40 db, a noise figure below 23 db, and a life expectancy of 50,000 hours—the result of a conservative cathode-current density of 65 to 140 ma/cm<sup>2</sup> and a low cathode operating temperature. The tube is 12 in. long, weighs 25 oz and employs a periodic permanent magnet focusing system using conventional magnet materials (Alnico VIII). It also has a single-stage collector and is conduction-cooled.

RCA Electronic Components and Devices, Harrison, N.J. [424]

*Does a metals problem have you  
up the creek without a paddle???*

*use the  
theory of  
probability  
to solve your problem*

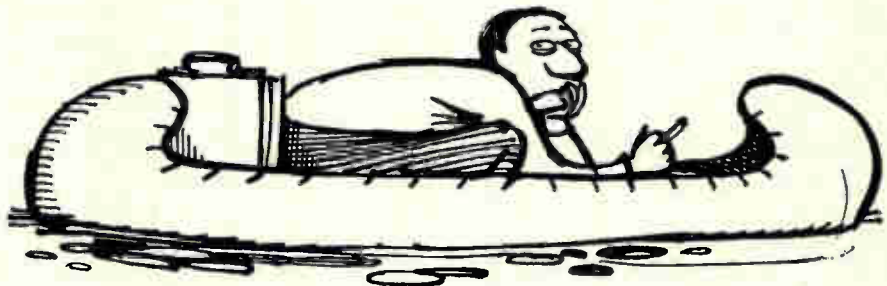

This is where experience counts! Chances are Hamilton has the answer for you . . . as we have for hundreds of others . . . whether it is ultra-thin tape for a computer, wire for a microscopic spring, or magnetic and high-temperature metals for missiles. The Precision Metals Division of Hamilton Watch has the metallurgical "know-how" and the unique precision production facilities to do the almost "impossible!" □ What can you lose? Before you give up . . . ask us. Invest a postage stamp and ask for the brochure on Precision Metals. You will receive facts and information that you can use.

 **HAMILTON**  
WATCH COMPANY

PRECISION METALS DIVISION • LANCASTER, PA.

## New Production Equipment

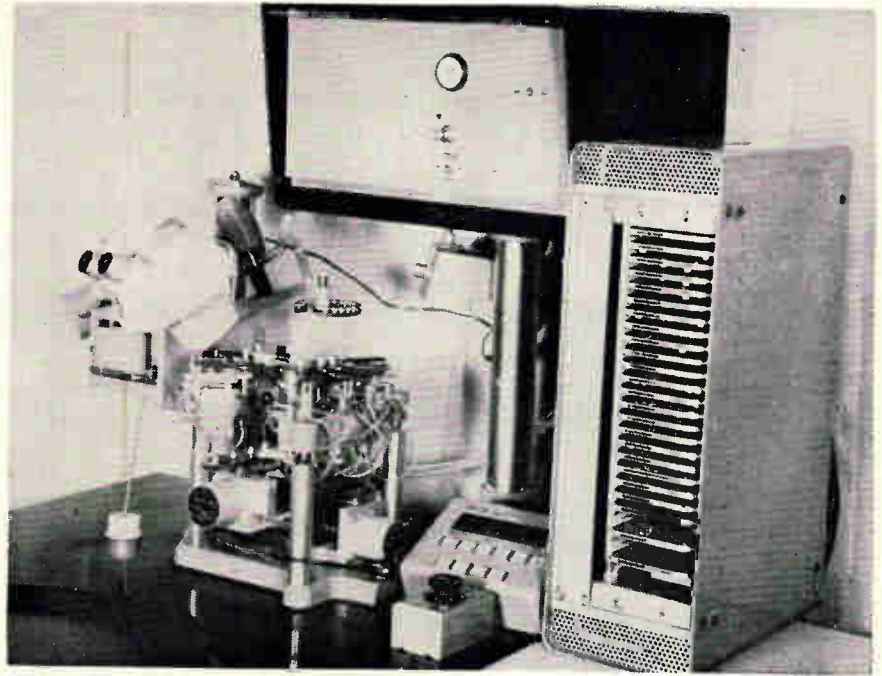

### Automatic probe with indexing table

Production line testing of semiconductor wafers and chips involving multiple point probing can be considerably improved, both in accuracy and speed, with the new model 323 automatic probe. This system is a standard unit that accommodates any combination of 20 probe tips with up to 8 ink markers, to which has been added an improved indexing work table, and an automatic indexing control package. The basic system is built around the manufacturer's precision probe-marker head. Up to 20 of these heads can be clustered and micropositioned over the work to within 0.00002 in. Probe contact force can be varied from zero to 8 grams, and is repeatable to  $\pm 0.02$  gram. The indexing table is ball-slide mounted, is virtually frictionless, and has no backlash. Indexing can be either manual or automatic, and extends over a full 2-in. sq. area. The automatic index settings are independent and can have different values for the X and the Y directions; the maximum index is 1 in.; the minimum is 0.00025 in. for the standard model. Indexing accuracies to within 0.0002 in. are maintained over the full 2 in. table travel. A push-button jogging control is provided and the work

chuck can be rotated for fast alignment. A special feature of this model is the off-wafer sensing probe which automatically raises the probes, indexes them to the next row, and reverses the travel when the edge of a wafer is reached. With this feature, probing is confined to the wafer itself, regardless of its size or shape, and valuable machine time is saved. This is a distinct advantage over ordinary probe systems that can operate only over a full rectangular probe pattern, either wasting time when small chips are being tested, or requiring manual indexing. After a given wafer has been probed, the chuck mounting permits the operator to lower it and move it clear of the machine, simplifying unloading and reloading.

Kulicke and Soffa Mfg. Co., 135 Commerce Drive, Industrial Park, Fort Washington, Pa. [451]

### Two-piece lead-wire welding machine

A new machine produces a two-piece lead by butt-welding a lead wire to a slug of larger wire (such



NOW AVAILABLE  
WITH EITHER  
VHF OR UHF  
COSTS LESS THAN \$250!

### NEW...SMALLEST BASE STATION DUPLExER (ONLY 2" HIGH)

Now—in a fourth or less of the space formerly required—you can stack a duplexer right with your transmitter and receiver... all at eye level. Only 2" of rack space needed for Sinclair's new VHF Duplexer... 3" for the UHF model. And these surprisingly compact units cost less than \$250!

Don't let the low price throw you! These new Model H-150 and H-450 duplexers are packed with all the dependable quality features of larger Sinclair base station duplexers. They allow simultaneous transmission and reception from a common antenna with sepa-

ration between frequencies as low as 3 Mc at 150 Mc and 5 Mc at 450 Mc. Returning to a new frequency—if desired—is easily done by retuning the cavities. Neither cable nor harness need be changed.

Though small in size, these new duplexers have standard power rates of 100 watts (optional ratings up to 200 watts are available). The temperature range of from -20°F to 150°F makes them exceptionally versatile in either base station or repeater station applications. Investigate today! Write for complete FREE information on all Sinclair duplexers, antennas and multiconplers.

SINCLAIR RADIO LABORATORIES, INC. 523 FILLMORE AVENUE, DEPT. 101, TONAWANDA, NEW YORK

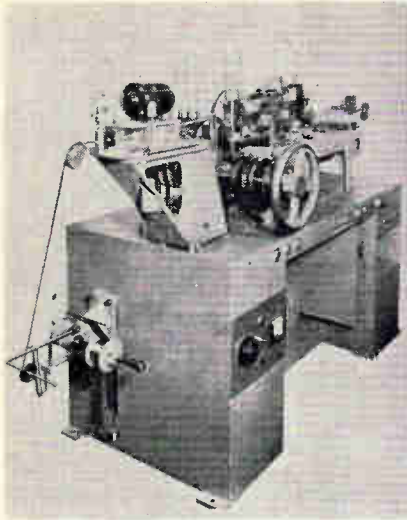

as Dumet). These weldments are used in various applications, one of which is in glass-to-metal seal body cases for crystal diodes. Both the lead wire and the slug wire are fed from spools, straightened, cut and welded automatically. Lead wire of up to 0.030 in. diameter can be welded to any diameter of slug up to 0.070 in., and the slug can be from 0.065 in. to 0.350 in. long. Machine No. 3485 features a variable speed drive and provides a production rate of 10,000 per hr and up. It measures 4 ft high, 5 ft long, and 2½ ft deep.

Kahle Engineering Co., 3322 Hudson Ave., Union City, N.J. 07087. [452]

## Electrically-heated 12-drawer oven

A new electrically-heated, 12-drawer oven is designed for batch processing of small parts in separate drawers. The oven, item P-273, has 12 kw heat input capacity with a maximum temperature of 500° F. The 12 drawers, two abreast and six high, are each 16 in. wide by 24 in. deep and 5 in. high. The drawers may be opened and closed individually so that certain work loads may be heated independently of others. The individual drawers also reduce heat loss and prevent the process interruption normally encountered with conventional doors. Item P-273 has horizontal air circulation and is equipped with indicating and excess temperature controllers and a batch timer. Grieve-Hendry Co., Inc., 1330 N. Elston Ave., Chicago, Ill., 60622. [453]

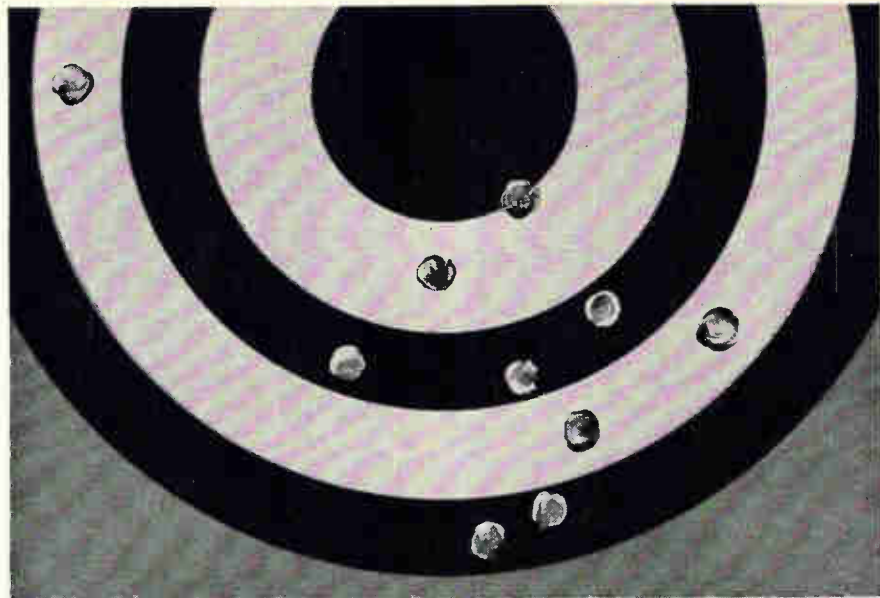

## NO NEAR MISSES



## with computerized filter and transformer design

On-target design—with no false starts and no near misses—is one big advantage you get in Genisco filters and transformers designed with the help of computers.

You get faster solutions because computer designs are achieved in minutes instead of hours—and you get on-time delivery and lower shipping costs because Genisco plants are spotted in key market areas.

Computer design also means greater accuracy and the elimination of guesstimation. You never have to settle for the first solution when you're pressed for time because our computer method investigates several design approaches almost instantaneously.

Trial-and-error prototype costs are cut out because designs are automatically "performance tested" before production starts. And price quotations are fast and accurate. There's never any guessing about costs with Genisco computer design of filters and transformers.

Zero in on this new filter and transformer design capability. Write for complete information today.

**Genisco**

TECHNOLOGY  
CORPORATION



**INSTRUMENTS DIVISION**  
(Wave Filters)  
9036 Winnetka Ave.  
Northridge, California  
(213) 341-4320

**CEECO DIVISION**  
(Wave Filters & Transformers)  
3223 W. Armitage Ave.  
Chicago 47, Illinois  
(312) 327-3130

**TRANSONIC DIVISION**  
(Transformers)  
808 16th Street  
Bakersfield, California  
(805) 327-5701

From the  
**WORLD'S**  
**LARGEST**  
**SUPPLIER**  
of SINGLE  
CRYSTALS  
**Laser Rods**

Continuous Operation  
at Room Temperature  
with Less than 3 Joules  
**Calcium Tungstate**  
doped with Neodymium  
from Stock 3mm x 2"

**\$695.00**

**Ruby Rods**

wide range of  
Sizes and Prices

**Neodymium**  
doped

GLASS LASER RODS  
**1/4" x 2" \$195.00**

**SINGLE CRYSTAL  
SUBSTRATES**

*Special Offer  
Till March 10*

50 Pieces—\$100  
For Any Listed Below

MgO · NaCl · KBr  
Al<sub>2</sub>O<sub>3</sub> · Spinel  
and many others  
1 cm x 1 cm x 1 mm

For Complete Literature  
Write Dept. E-6

**emi-elements, inc.**

Saxonburg Boulevard,  
Saxonburg, Pa.  
Phone: 412-352-1548

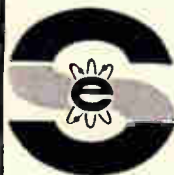

**New Materials**



**Epoxy silver solder in varied shapes**

A new conductive epoxy silver solder, E-Solder 3500, has been developed. It is a one-component, heat-cure system that requires no mixing before use. When heated to a temperature of 100°C or higher, 3500 melts to a soft, nonflowing, thixotropic mass. Continued heating will cause the material to cure to a hard, tough, infusible solid with a volume resistivity of 0.001 ohm-cm and excellent resistance to solvents, acids, bases and other chemicals. E-Solder 3500 is available in either powder or in the form of pre-shaped, preweighed pellets. These pellets may be supplied in a wide variety of shapes and sizes, and are ideally suited for semiautomated and automated assembly operations. Adhesion to almost any substrate is excellent, with tensile shear strengths of 1,500 to 2,500 psi representing aver-

age values obtained. Good bonds have been obtained on aluminum, stainless steel, tin, zinc, ceramics, glass and a wide variety of metallic and nonmetallic surfaces. E-Solder 3500 may be cured at temperatures ranging from 100°C to 200°C, with typical cure schedules of 30 minutes at 150°C, or one hour at 125°C. Since it is a thixotropic material, 3500 is ideally suited to bonding applications in confined spaces, where its nonflowing, nondripping characteristics prevent shorting out of nearby parts. E-Solder 3500 is recommended for production adhesive applications requiring electrically conductive bonds between a variety of surfaces, and in applications where the temperatures required for soldering or brazing cannot be tolerated.

Epoxy Products, Inc., 133 Coit St., Irvington, N.J. [441]

**Single-crystal  
silicon ingots**

Production of single-crystal silicon grown by the Czochralski method for epitaxy substrate and solar-cell blanks is announced. The crystals

are available in either N-type antimony doped to 0.005-0.020 ohm-cm or P-type boron doped to 8-12 ohm-cm. Ingots can be obtained in diameters to 37 mm and lengths to 225 mm, either "as grown" or centerless ground. Slices can also be supplied to specified thicknesses.



A low degree of compensation is inherent in both N- and P-type crystals. They are grown from polycrystalline silicon produced by an integrated process of trichlorosilane decomposition, with impurity levels of about 1.0 part per billion. Finished P-type single crystals have a typical donor impurity concentration of about 0.5 part per billion. The base price for "open spec" Czochralski-grown single crystal is 75 cents per gram in quantities of 1 kilogram or more. This base price is identical to the base price for the company's open spec float-zone-refined single-crystal silicon. The actual price of the latter crystal produced to tight specifications, however, ranges up to \$1.80 per gram for crystals below 300-ohm-cm, N-type or 1,000 ohm-cm P-type, depending upon specifications.



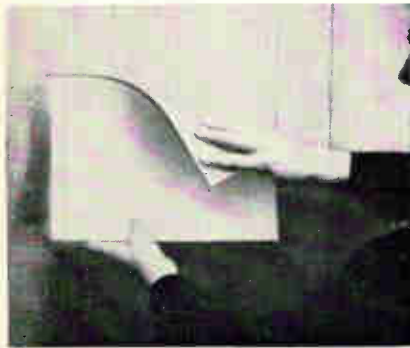

Dow Corning Corp., Hemlock, Mich., 48626. [442]



## Absorbent material for X-band and higher

A new material, Customabsorb 1001, is now being manufactured for use as a microwave absorber for X-band and higher frequencies. It consists of 3/8 in. thick flexible, multilayer, electrically conductive foam, with the facing surface coated white for optical reflectivity. The manufacturer claims this material has less than 1% power reflection and is relatively insensitive to incident angle. Temperature range is from -70°C to +150°C. It is easily die-cut or knifed to irregular shapes and can be cemented or fastened to any surface to provide an absorbing liner. It is available in any lengths and 2-ft standard widths.

Custom Materials, Inc., Alpha Industrial Park, Chelmsford, Mass. [443]

	Type UCSV 250 Capacity 125 to 250 PF Voltage 10 KV PK Current (16 mc) 40 Amps RMS
	Type JCSF 80 Capacity 80 PF Voltage 10 KV Current (16 mc) 30 Amps RMS
	Type CVDA 1000 Capacity 25 to 1000 PF Voltage 7.5 KV Current (16 mc) 125 Amps RMS
	Type UCSX 1000 Capacity 25 to 1000 PF Voltage 7.5 KV Current (16 mc) 45 Amps RMS

## NEW H-F MULTICOUPLER USES JENNINGS VACUUM CAPACITORS TO ACHIEVE HIGH Q

Jennings vacuum capacitors are used in the reactive filter network of Granger Associates Model 520F multicoupler. The multicoupler connects two h-f transmitters to a single broadband antenna, permitting both to transmit simultaneously without interference or interaction and without significant insertion loss. The high frequency range of 2 to 32 megacycles is divided into two channels, separated by an extremely narrow open band, to accommodate each transmitter. Jennings capacitors provide the low dissipation factor and high Q characteristics which make this close channel operation possible.

In addition the vacuum capacitors offer extra high voltage and current ratings at high ambient temperatures to provide a very comfortable margin of safety.

A high degree of reliability was required because the capacitors are used under oil in a sealed enclosure. Jennings vacuum capacitors met these requirements with ease. No field problems have ever occurred which could be related to either electrical or mechanical fault in the Jennings capacitors.

This proven application is only one of the hundreds in which Jennings vacuum capacitors have solved difficult circuit design problems. For any capacitive problem involving high power rf generating devices examine the advantages of Jennings capacitors. They have an unequalled record of exceptional performance in all sections of high power transmitters, dielectric heating equipment, antenna phasing equipment, electronic equipment from cyclotrons to electron microscopes.

At your request we will be happy to send more detailed information about our complete line of vacuum capacitors.

RELIABILITY MEANS VACUUM | VACUUM MEANS

*Jennings*

JENNINGS RADIO MFG. CORP., 970 McLAUGHLIN AVE., SAN JOSE 8, CALIF., PHONE Cypress 2-4025

# "HI-SPEED" high-frequency wire-wound resistors for fast rise time applications

- △ Response time as low as 20 nanoseconds.
- △ Designed for D/A converter applications (minimum "ringing").
- △ For use where low T.C. stability, and close tolerance of a wire-wound resistor must be combined with fast rise time.
- △ Typical distributed capacitance of a one megohm resistor is less than 0.8 PFD.
- △ Typical inductance of a 500Ω resistor is less than one microhenry.

Write for complete technical information.

# RCL

**RCL ELECTRONICS, INC.**  
General Sales Office  
One Hixon Place  
Maplewood, New Jersey  
(Area Code 201) 763-2820 TWX (201) 761-5462

**A TRUSTED NAME IN ELECTRONICS ...  
A NEW STANDARD OF QUALITY**

## DRAMATIC REDUCTION

formerly 77" h. x 33" w. x 33" d.

**now only**  
**29" h x 17" w x 17" d**  
**( 5 KW Audio  
Power Amplifier )**



All other models similarly reduced... (but in size only!) For instance, 10 KW Model, formerly 78" h. x 78" w. x 36" d., now only 48" h. x 34" w. x 24" d. CML Audio Power Amplifiers produce tremendous power in the smallest packages. Wide frequency range. Low distortion. Ideal for CW and pulsed operation,

acoustic testing, vibration testing, plasma tubes, ion propulsion engines. Perfect for marine installations. All units with wide range of output impedance taps. Air-cooled and vapor-cooled units. Full power available into low power factor loads. Call or write today for details.

**CML, Inc.**

A subsidiary of Tenney Engineering, Inc.  
350 Leland Avenue - Plainfield, New Jersey  
(201) 754-5502 • TWX: 201-756-2064



Circle 215 on reader service card

# INSTANT

Instant drafting with symbols and drawing details preprinted on tri-acetate sheets ready for use. Your own engineering details can be applied in seconds, rather than drawn in hours.

The STANPAT formula gives permanent adhesion without ghosting. Crisp, clean reproduction everytime on all types of tracing media. Excellent for microfilm reproduction.

Write today and find out how STANPAT can save you hours of routine drafting time. Literature and samples on request, or enclose your symbols for quote.



*faithfully serving  
the engineer for  
over two decades*

**STANPAT Products Inc.**

Whitestone 57, N.Y., Dept J-2  
Telephone: 212-359-1693

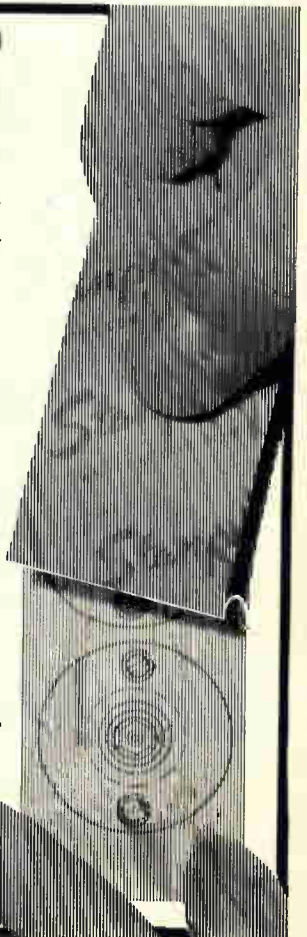

## New Books

### Nuclear Energy

Research, U.S.A.  
Albert V. Crewe and Joseph J. Katz  
McGraw-Hill, Inc., 1964  
218 pp., \$18

This well-illustrated book is concerned with basic research in the field of nuclear energy although a somewhat broader area of research effort might be inferred from the title. Only a modest technical background is required to understand the material presented; lack of knowledge of atomic energy is no handicap. In fact, the book is aimed at readers not closely acquainted with basic nuclear energy research. Scientists working in this field would probably find the depth of coverage for particular items insufficient.

But the individual who wants to expand a limited knowledge of this field couldn't find a better way to do it. The abundance of microphotographs, photographs and diagrams contribute immeasurably in this respect. For example, one set of x-ray pictures of a mouse that ate strontium 90, taken at weekly intervals, demonstrates the almost incredibly rapid spread of bone cancer that resulted.

Readers whose school days are far behind them will find the chapter on the new periodic table of particular interest—a large number of changes have been made in the table during the last 25 years.

One disturbing aspect of the book is its inclusion of a whole chapter of photographs of buildings operated by the Atomic Energy Commission. Many of the buildings look like public libraries or even college dormitories; the need for their inclusion in this book filled with otherwise excellent and meaningful illustrations is highly questionable.—J.E.

### Dictionary

Communications-Electronics  
Terminology Handbook  
Public Affairs Press, 1965  
547 pp., \$7

This collection of definitions was compiled by the Air University at Maxwell Air Force Base, Ala. That's probably why it's heavy with mili-

tary terminology. For example, there are definitions of 15 different phrases starting with Norad—for North American Air Defense—including Norad control center commander, Norad region and Norad sector commander.

Despite the military stress, the definitions are exceptionally clear and reasonably accurate. Entries are usually, but not always, given in alphabetical order—for example, phase-shift oscillator rather than oscillator, phase-shift. Acronyms and abbreviations appear under both the abbreviated and spelled-out form.

All things considered, this is a useful compilation worth its cost—despite the excessive influence of the military background of its originators.—J. E.

### Semiconductor physics

Physics of Semiconductors,  
proceedings of Seventh International  
Conference, Paris, 1964  
Dunod, Paris, 1964  
1368 pp., \$30

There were 200 papers submitted to the Seventh International Conference on the Physics of Semiconductors held in Paris during July, 1964. They are all printed here.

Obviously, the range of topics covered is fairly wide: for example, magneto-optical effects, band theory, semiconductor impurities, photoconductivity, and piezoresistance effects.

The book does not include the papers given at three symposia held in Paris at the same time on more specialized subjects. The symposia proceedings are being published separately.

The entire volume is printed in English and is freely illustrated.

### Recently published

**Fundamentals of Relay Circuit Design**, Alan R. Knoop, Reinhold Publishing Corp., 312 pp., \$15

**Linear Analysis of Electronic Circuits**, Glenn M. Glasford, Addison-Wesley Publishing Corp., 580 pp., \$15

**Radio Spectrum Utilization**, Joint Technical Advisory Committee, IEEE and EIA, 272 pp., \$10

**Electrons on the Move**, Sharon Banigan, editor, Walker and Co., 229 pp., \$5.95

**Value Analysis/Value Engineering**, American Management Association, 128 pp., \$6

**Analysis and Synthesis of Linear Time-Variable Systems**, Allen R. Stubberud, University of California Press, 108 pp., \$4.75

# DATA TRANSMISSION

By WILLIAM R. BENNETT  
and JAMES R. DAVEY

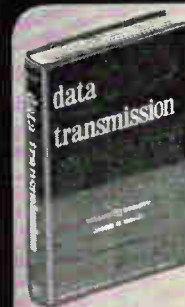

This book covers important principles of modern-day data communication. It treats early digital systems and their electrical analogs, as well as modern modulation methods.

Optimum spectral shaping of data signals to achieve maximum tolerance to noise, derivation of theoretical error rates for each modulation method, commonly encountered transmission impairments, and other subjects are discussed.

INTER-UNIVERSITY  
ELECTRONICS SERIES  
368 pages, 211 illus., \$14.50

## INFRARED PHYSICS AND ENGINEERING

By J. A. JAMIESON, R. H. McFEE, G. N. PLASS, R. H. GRUBE, and R. G. RICHARDS

Brings you in one source the essential physics, engineering, and analytical information required for the design of modern infrared systems.

688 pages, 234 illus., \$19.00

BUY THESE BOOKS AT YOUR BOOKSTORE  
OR MAIL THIS COUPON

McGraw-Hill Book Co., Dept. 22-L-222  
330 West 42 Street, New York, N.Y. 10036

Send me book(s) checked below for 10 days on approval. In 10 days I will pay for book(s) I keep, plus few cents for delivery costs, and return unwanted book(s) postpaid. SAVE MONEY: we pay delivery costs if you remit with coupon; same examination and return privilege.

- Bennett & Davey — Data Transmission, \$14.50  
 Jamieson, et al — Infrared Physics & Engineering, \$19.00

NAME (print) \_\_\_\_\_

ADDRESS \_\_\_\_\_

CITY \_\_\_\_\_

STATE \_\_\_\_\_ ZIP CODE \_\_\_\_\_

For prices outside U.S.,  
write McGraw-Hill Intl., N.Y.C.

22-L-222

It's brillig\*  
at \$495.



\* Humpty Dumpty, as characterized by logician Lewis Carroll in *Through the Looking Glass*, was a very clever fellow. He believed in making words do what he wanted them to do. In this particular context, Mr. Dumpty probably would have defined "brillig" as "a big DVOM buy," mainly because there's nothing . . . repeat . . . nothing in the price range of this portable solid-state 3-digit digital volt-ohm-meter that does so much and costs so little.

May we invite you to check the many brillig features of our Model 33 digital volt-ohm-meter? . . . and remember it has all of these features at \$495!



**Completely solid state . . . voltage accuracies to  $\pm 0.1\%$  and resistance accuracies to  $\pm 0.5\%$  of full scale,  $\pm 1$  count . . . plug-in printed circuit card construction throughout . . . in-line high-intensity readout (non-segmented) . . . automatic polarity switching with polarity displayed . . . full-time high impedance input . . . three voltage ranges in the same unit (10, 100, 1000 volts) and four resistance ranges (1K, 10K, 100K, 1000K) . . . 19-inch panel mounting optional . . . stock delivery. Brillig, huh?**



Also available . . . Model 34 DVOM with 4 voltage ranges (1, 10, 100, 1000) at \$595 . . . Model 35 High Speed BCD Converter at \$795 . . . and Model 36 High Speed Binary Converter at \$795. (They're also brillig. Write and see.)

**ROBACK CORP.**  
Huntingdon Valley, Pennsylvania  
215 ORchard 6-4000

## Technical Abstracts

### Low-noise Unibi

A low-noise integrated Unibi amplifier with novel biasing scheme and structure

H.C. Lin and E.A. Karcher  
Westinghouse Electric. Corp., Molecular Electronics division, Baltimore

In a-c amplifiers, capacitor coupling between stages is necessary to overcome bias instability. At low frequencies, the coupling capacitance is larger than can be provided in integrated form unless the input impedance of each stage is too high to be practical. Although high-input impedance can be obtained from a field-effect transistor, gate bias for the gate of the FET requires a resistor in the megohm range; this is also impractical for an integrated circuit.

The problem can be solved by using a forward-biased diode as the bias resistor. A diode can be made to represent an incremental resistance as high as 25 megohms. Two diodes can also be bypassed by a capacitor to form an equivalent low-pass or decoupling RC network.

When a field-effect transistor is biased through a forward-biased diode from a supply voltage, the gate voltage is very nearly equal to the supply, because there is very little voltage drop across the diode at low current. At low current, the shot noise of the diode is low. Thus, for the same incremental resistance, the diode should have a lower noise voltage than an ohmic resistance.

The authors have designed a complete circuit, which is a modification of the Unibi amplifier presented at the same conference last year. Two FETs are connected in series as a source follower. The difference in their drain currents is amplified by a Darlington amplifier. The output is fed back to the gate of the input through two forward-biased diodes to stabilize the d-c operating point. The input is coupled through a low-value capacitance, and the output derived from another Darlington stage.

Fabrication of high-voltage npn bipolar transistors and low pinch-off p-channel field-effect transistors

in the functional block is accomplished by using a thin p-type epitaxial layer and standard processing techniques.

The Unibi amplifier fabricated in this way was tested and found to have an input impedance of 5 megohms and an output impedance of 10,000 ohms. The minimum output voltage and gain were one volt rms and 250 respectively. The frequency range was 300 to 30,000 cycles per second, and the maximum power dissipation was 5 milliwatts. Noise figure with a 2.5-megohm source resistance was 3 decibels.

Presented at the International Solid State Circuits Conference, Philadelphia, Feb. 17-19.

### Gunn effect

C-w microwave oscillations in GaAs  
B. W. Hakki, Bell Telephone Laboratories, Inc. Murray Hill, N. J.

Coherent, continuous-wave oscillations have been produced in a wafer of gallium arsenide by the application of a d-c field. The power output was 15.5 milliwatts at a frequency of 4.35 gigacycles. Spectral linewidth of the c-w output signal at the half-power points was less than 10 kilocycles, indicating the phenomenon is relatively free from random modulation.

The gallium arsenide wafer was n-type, in the form of a wafer 75 by 250 by 250 microns, with ohmic contacts applied on the two large surfaces. When the field intensity in the material exceeded 3,000 volts per centimeter, the sample broke into oscillations. Apparently this is the instability previously reported by J. B. Gunn of the International Business Machines Corp. for this type of material.

When the peak d-c power dissipation per unit volume was increased and the device was operated on a pulsed basis, the r-f output power increased to a maximum of 1.83 watts at 4.96 Gc. The highest frequency observed was 29.6 Gc when the power was reduced. Efficiency of the device was less than 2%.

At the cost of r-f power output, the frequency of oscillation could be pulled over a range of 50% by

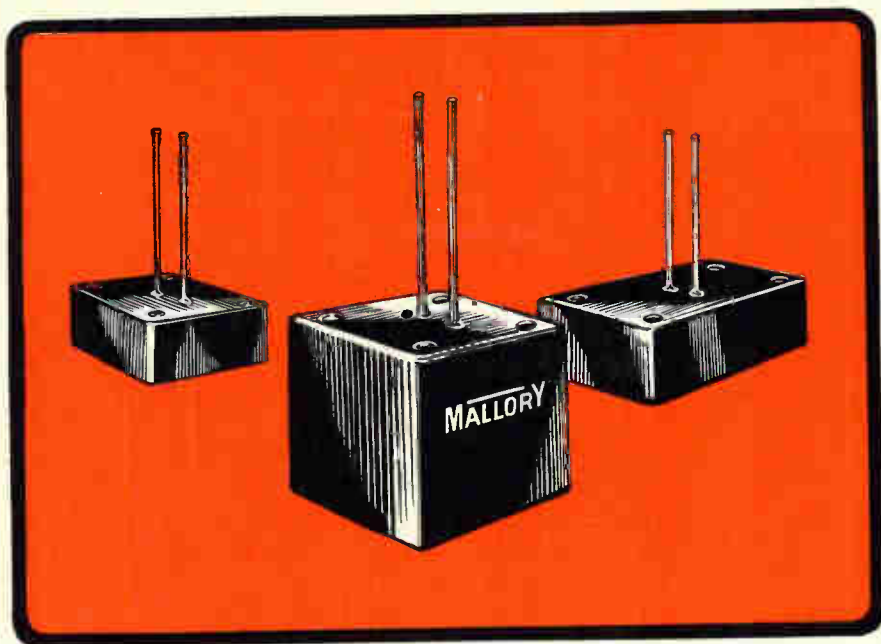

# Capacity by the inch

Among the special capacitor packages which Mallory has been supplying is the TMB series of modules. These have exceptionally high capacitance per unit volume. They are as much as 60% smaller than standard MIL foil or wet slug tantalum capacitors of equivalent rating. The TMB packages come in three sizes: a 1" cube,  $\frac{1}{2}$ " x 1" x 1", and  $\frac{1}{2}$ " x 1" x 1.4". In the 1" cube, for instance, you can get a maximum rating of

1100 mfd at 45 volts, at 85°C.

These packages consist of sealed wet slug tantalum capacitors inside a molded epoxy case. Their temperature range is  $-55^{\circ}\text{C}$  to  $+85^{\circ}\text{C}$ ; and with 33% voltage derating they can be used at  $+125^{\circ}\text{C}$ . Inserts for mounting, tapped with 4-40 threads, are molded into the case. Standard capacitance tolerance is  $\pm 20\%$ . The following range of standard ratings is available:

Case size	Range of ratings ( $+85^{\circ}\text{C}$ )
$\frac{1}{2}$ " x 1" x 1"	1200 mfd, 15V to 140 mfd, 110V
1" cube	2400 mfd, 15V to 360 mfd, 110V
$\frac{1}{2}$ " x 1" x 1.4"	2100 mfd, 15V to 220 mfd, 110V

Other ratings and sizes can be supplied to meet special needs. For complete data and prices, write or call Mallory Capacitor Company, a division of P. R. Mallory & Co. Inc., Indianapolis, Indiana 46206.

**MALLORY**

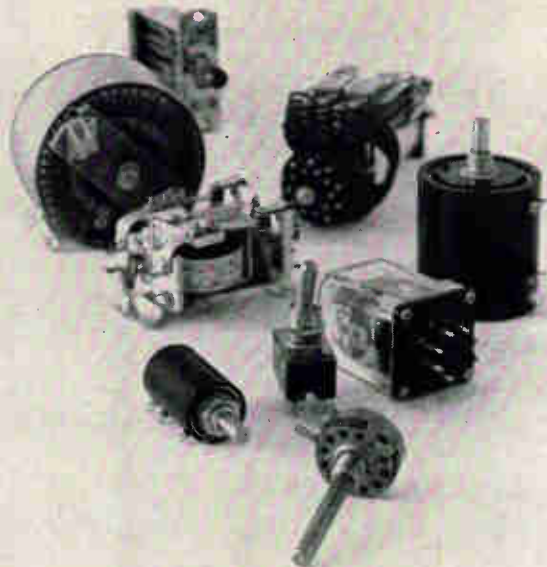

**what does it better  
and costs less than ever?**

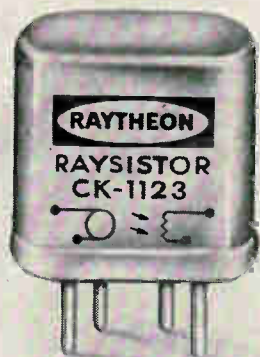

**this!**

In switching and control applications Raytheon Raysistors provide superior performance at substantially reduced prices. In production quantities, several Raysistor types can now be purchased at a unit cost of less than a dollar.

Raysistors are four-terminal opto-electronic components containing a light dependent resistor and a light source. They have no moving parts; are rugged with exceptionally long life and afford isolation between signal and control circuits. Raysistors make possible low-noise, pedestal-free switching of ac or dc signals over a wide dynamic range without transients — without wiper or contact chatter or sparking. Match the conventional components you may be considering for your switching or control design against these qualifications!

For technical data and sales information please write Raytheon Company, Components Division, Industrial Components Operation, Dept. 2011, Lexington, Massachusetts 02173.

**RAYTHEON**

## Technical Abstracts

proper tuning of the cavity used. The cavity was of the reentrant type operated in the dominant TEM mode.

Signal frequency as a function of temperature was observed between 300° and 76° K. Down to 100°K the frequency increased moderately. Below that, deterioration of the oscillations set in.

A lag was also found between the time at which voltage was applied and the onset of oscillations. Furthermore, the r-f oscillations attained their maximum value in a finite time that was dependent on the degree of coupling into the cavity. At 4 Gc, typical build-up time ranged from 10 to 25 nano-seconds.

Presented at the International Solid State Circuits Conference, Philadelphia, Feb. 17-19.

### Efficient microwave tube

The biased-gap klystron  
J. Walder and P.R. McIsaac  
School of Electrical Engineering  
Cornell University  
Ithaca, N.Y.

A multicavity ultrahigh-frequency klystron, commercially equipped with external cavities was modified so that a d-c potential could be applied across the interaction gaps. Although the tube was rated by its manufacturer as having an efficiency of 45%, when it was carefully tuned and the magnetic field adjusted for optimum output, an efficiency of 60% was obtained. Furthermore, with an accelerating bias applied across the next-to-last gap, an efficiency of 66% was obtained. This could be increased to more than 70% by operating the tube with its collector held at below ground potential.

The biased-gap tube was also found to have several other interesting applications. By applying the bias to the tube it was possible to obtain efficiencies in excess of 60% for a 5-to-1 range of power levels. This suggests that a single tube may be applied to a wide range of system requirements. Furthermore, it is possible to apply bias in such a way that for a constant drive level, the power output remains constant, as does the effi-

ciency at over 50%, but the phase can be varied over more than 180°. The phase change apparently can be made within nanoseconds; hence this might be of great value in electronically scanned, phased-array radar systems.

Presented at the Electron Devices Meeting, Washington, Oct. 30.

### Tripler design

Design and evaluation of a microwave tripler. C.B. Swan, Bell Telephone Laboratories, Inc., Murray Hill, N.J.

Conversion efficiencies for varactor harmonic generators in frequency multiplication can approach theoretical limits very closely when the circuit is essentially lossless and when the correct impedances are provided at the input, output and idler frequencies. Satisfying these conditions can be very difficult, if not impossible, with the usual procedure of "tuning up" an operating harmonic generator.

Passive circuit measurements, which enable the harmonic generator circuits to be optimized and evaluated independently at each of the important frequencies, simplify the problems. All the adjustable elements can be preset to their theoretically best positions, and in many cases can be replaced by simpler fixed structures which have less dissipation.

Evaluation of the diode in each of the circuits at the appropriate frequency gives an effective cutoff frequency for the diode in each circuit. Comparison of these cutoff frequencies with that of the diode when measured in a lossless (or very low loss) circuit gives an accurate measurement of the efficiency of the individual circuits.

With careful characterization of the diode and with the aid of computed data for input, output and idler impedances, one can preset each of the circuits to resonance at the correct diode bias, and the input and output couplings can be carefully preset under small signal conditions.

Using this technique, the total circuit losses of a 4 to 12 Gc tripler have been made as low as 5% of the input power. The overall conversion efficiency with a GaAs diode was about 80%.

Presented at the International Solid State Circuits Conference, Philadelphia, Feb. 17-19.

(ADVERTISEMENT)

## RF and Microwave Filters Now Computer-Bred

Laguna Beach, Calif. — The application of a digital computer to the engineering design of RF and microwave filters has been incorporated as standard production procedure at Telonic Engineering Co.

According to a spokesman for the firm, a PDS 1020 computer is being employed, programmed to cover production designs of low-pass and band-pass filters with frequencies from 30Mc to 6Gc. An individual program, established for each basic filter type, is entered into the computer together with the parameters of the filter requested by the customer.

### Speeds Deliveries

Among other benefits it provides, the computer cuts design time, from days to minutes by supplying production with the individual values and precise dimensions of all parts needed for assembly. It even selects standard modular elements from an inventory list, to expedite manufacture of the filters so designed. Based on the performance of the computer, the company has instituted the availability of 3-day delivery on many filter types.

In addition to the speed-up in deliveries, a higher level of product performance is assured through use of the computer, as was determined during early testing of the system. It is believed that the computer will pay for itself in a relative- (Cont. on page 188 Feb. 22 Electronics)

Computer Filters Now

re-  
tet-  
etric  
abrig  
are  
g and  
tions  
dy-  
of  
oy  
ths  
and  
ecial  
fi-  
the  
high  
ecial  
roni  
led  
ct  
ction  
chnol-  
ractical  
roposals  
ustry.  
within  
oblem  
in a  
un-  
ion-  
our-  
of a  
n a  
re-  
sec-  
c In-  
r cir-  
ted of  
AVES  
icle.  
why  
han  
his  
rom  
This  
n by  
tems

cati  
by  
El  
Aw  
Co  
s,  
and  
thro  
gy  
in  
c  
in  
exp  
als  
te  
l  
t  
the  
best  
laser  
unique  
show  
su  
high  
at  
a s  
w  
f  
m  
to  
nes  
so  
no  
a  
t



# EMPLOYMENT OPPORTUNITIES

Immediate Assignments with Federal Electric Corporation in

## COMMUNICATIONS SYSTEMS PLANNING

Federal Electric Corporation—a subsidiary of world-wide International Telephone and Telegraph Corporation—is a primary source of engineering support for major systems and holds contracts with all the military services, governmental agencies, other industries and ITT affiliates.

These openings call for high-level engineering contributors with broad background experience and extensive knowledge of standard U. S. or European system design and engineering specifications for large-scale telecommunication systems in one or more of the following areas.

- ... Land-line and submarine cable subsystems
- ... Microwave and tropospheric radio subsystems
- ... Voice and data transmission subsystems
- ... Signalling and switching subsystems
- ... Integration of the above subsystems to form an overall system.

An important prerequisite is the demonstrated ability to plan high quality systems in any of the above fields.

To arrange an interview, please forward your resume, including salary requirements, to: Mr. Ray Broglie, Room 33-V, Federal Electric Corporation, Industrial Park, Paramus, New Jersey.



FEDERAL ELECTRIC CORPORATION

INDUSTRIAL PARK, PARAMUS, NEW JERSEY

An Equal Opportunity Employer

## PINPOINT

### *your* **RECRUITMENT ADVERTISING**

to the Engineers  
and Technical  
Management men  
in the  
Electronics  
Industry . . .

When you need Engineers—remember this fact: **Electronics** serves thousands of engineers with the latest engineering developments and news of the electronics industry. Engineers read **Electronics** because its high calibre editorial content is *specially designed for them* . . . that's why your Employment advertising in **Electronics** can pinpoint a most concentrated source of experienced engineers. Your **MOST DIRECT LINK** to these qualified men is in the **EMPLOYMENT OPPORTUNITIES** section. For more facts, of placement of your ad,

For Rates and Information Write:

## Electronics

A McGraw-Hill Publication  
Classified Advertising  
Division

P.O. Box 12, New York  
10036



### **E. E.'s** for FEE-PAID Positions **WRITE US FIRST!**

Use our confidential application for professional, individualized service . . . a complete national technical employment agency.

**ATOMIC PERSONNEL, INC.**  
Suite 1207L, 1518 Walnut St., Phila. 2, Pa.

ADDRESS BOX NO. REPLIES TO: Box No. Classified Adv. Div. of this publication. Send to office nearest you.  
NEW YORK, N. Y. 10036: P. O. Box 12  
CHICAGO, Ill. 60611: 645 N. Michigan Ave.  
SAN FRANCISCO, Cal. 94111: 255 California St.

#### SELLING OPPORTUNITY AVAILABLE

European Manufacturer of semiconductors for entertainment field seeks aggressive distributors in U.S.A., Canada and Latin America. Reply to Box RW-6104, Electronics.

### EMPLOYMENT PROBLEM?

When you are in need of specialized men for specialized jobs, contact them through an employment ad in this publication.

## EMPLOYMENT OPPORTUNITIES

The advertisements in this section include all employment opportunities—executive, management, technical, selling, office, skilled, manual, etc.

Look in the forward section of the magazine for additional Employment Opportunities advertising.

#### — RATES —

**DISPLAYED:** The advertising rate is \$52.00 per inch for all advertising appearing on other than a contract basis. Contract rates quoted on request.

An advertising inch is measured  $\frac{3}{8}$ " vertically on a column—3 columns—30 inches to a page.

Subject to Agency Commission.

**UNDISPLAYED:** \$2.70 per line, minimum 3 lines. To figure advance payment count 5 average words as a line. Box numbers—count as 1 line.

Discount of 10% if full payment is made in advance for 4 consecutive insertions.

Not subject to Agency Commission.



# CHANGE JOBS PROFITABLY

Does one of these  
demanding descriptions  
fit you?

■ **SECTION MANAGER, TRANSMITTERS.** To direct aggressive development programs for state-of-the-art miniaturized RF transmitters. He should have ten years of experience in the design and engineering supervision of military communications equipment: it should have given him personal drive, demonstrated leadership ability, unusual technical understanding and keen administrative insight.

■ **SENIOR STAFF ENGINEERS, RECEIVERS.** Leadership capability sufficient for immediate assumption of key roles in vigorous development programs for solid-state micro-miniature receivers. Positions require six to eight years of experience and in-depth knowledge of receiver design fundamentals.

■ **PROJECT ENGINEERS, SPACE INSTRUMENTATION.** Technical ability of the very highest order is required. Six to eight years experience, preferably data handling, control, or analog instrumentation.

■ **DESIGN ENGINEERS, RF CIRCUITS.** With knowledge of state-of-the-art device and circuit technology. At least three years experience covering HF, VHF, UHF, or microwave applications.

If you qualify, your present job is not good enough. You can increase your personal satisfaction and professional rewards by contacting Electronic Communications, Inc., today.

ECI has built a solid, successful reputation in airborne communications, multiplexing and space instrumentation. The Company offers pleasant living conditions and unusual educational and cultural opportunities in St. Petersburg, Florida. And it offers you a chance to participate in further growth through technological contribution. Call collect Duane Meyer (813) 347-1121, or send him your resume at ECI, Box 12248B, St. Petersburg, Florida 33733. (An equal opportunity employer.)



**ELECTRONIC  
COMMUNICATIONS, INC.**  
St. Petersburg, Florida

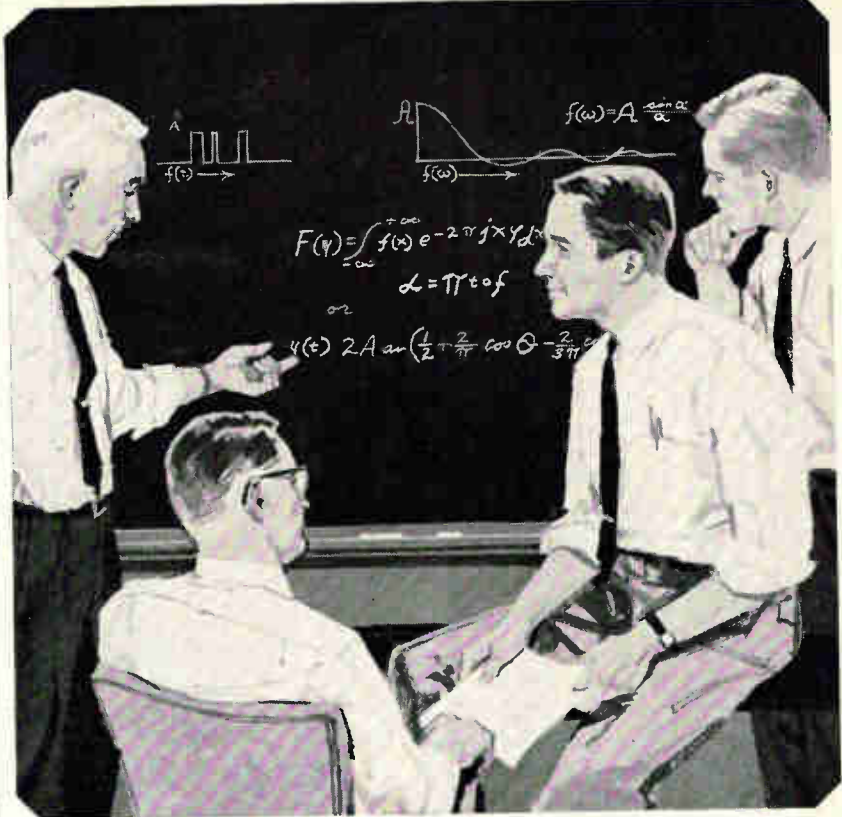

## Above all...the creative IDEA

From the very beginning, Motorola has been an "engineer's company"—an organization where every consideration was secondary to the newest technological development. As a result, Motorola has attracted the type of engineer and scientist who is noted, not for his ability to conform—but to create.

In this intellectually rarified atmosphere, the challenges to an engineer are great—but, of course, the rewards are commensurate.

Motorola does *not* need "engineers" per se, but there is always an urgent need for really *good* engineers and scientists—men who are inspired by this dynamic environment rather than afraid of it—men who shun monotony and search for diversified projects. If you are such a man, we would like very much to talk with you.

**SYSTEMS ENGINEERS** advanced R & D in radio communications systems related to Two-way, portable, mobile and radio-telephone equipment.

**EQUIPMENT DESIGN** high performance solid state receivers, transmitters, and data processing equipment for radar, communications, command and control, tracking and telemetry.

**FAMILIARITY WITH STATE-OF-THE-ART** statistical communications theory, advanced signal processing techniques, solid state r.f. techniques, ultra-reliability, antenna systems, advanced structural and thermal designs.

**SECTION MANAGER** direct engineers and support personnel in state-of-the-art communications, including r.f. systems and input-output devices.

**CHIEF ENGINEER** technical management of R & D group in advanced technology related to solid state r.f. communications.

**CIRCUIT DESIGN ENGINEERS** advanced R & D in receivers, transmitters, RF, digital, Color TV and automotive electronics.

**DEVELOPMENT ENGINEERS** advanced communications products in consumer, industrial and military electronics.

Excellent opportunities also available in Phoenix, Ariz.

Mr. W. H. HAUSMANN, Engineering Personnel Mgr., Dept. E, 4545 Augusta Blvd., Chicago 51, Illinois

An equal opportunity employer.



**MOTOROLA inc.**

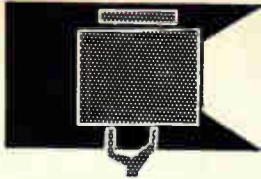

# SEARCHLIGHT SECTION

• CLASSIFIED ADVERTISING • BUSINESS OPPORTUNITIES  
• USED OR SURPLUS EQUIPMENT

STEPPING SIGMA HERMETICALLY  
SWITCHES KURMAN SEALED  
SENSITROLS WARD LEONARD  
STRUTHERS AUTOMATIC  
DUNN ELECTRIC  
ROTARY LEACH  
RACHET CLARE  
ALLIED EVENS  
LEDEX NOLD  
CLARE ANCE  
LEACH ALLIED  
MINIA CRAFT  
SIGMA LEDEX  
NORTH KEYING  
ELECTRIC PHILLIPS  
DORMEYER CONTROLS  
TELEPHONE AMPERITE  
TYPE WESTERN  
KURMAN ELECTRIC  
STEVENS CUTLER  
ARNOLD HAMMER  
CONTACT GENERAL  
MERCURY ELECTRIC  
SOLENOIDS GUARDIAN  
ADVANCE E CONTACTORS  
ALLEN BRADLEY PRICE ELECTRIC  
POTTER SQUARE D WESTON  
BRUMFIELD MINIATURE AIRCRAFT

## LARGEST STOCK OF RELAYS IN THE WORLD

PRODUCTION QUANTITIES MOST MAKES IN STOCK

Send for Latest Catalog

### Universal RELAY CORP.

42 WHITE ST. NEW YORK 13, N. Y. WALKER 5-6900

CIRCLE 951 ON READER SERVICE CARD

### Tiny work goes faster, better... with the new

### magni-focuser



Completely new, with precision ground matched prismatic optical glass lenses. Tiniest details look LARGE and CLEAR! Has new "Flip-up" lens plate. Light weight!

Write Today for Catalog EL 1/25, prices

### magni-focuser DIVISION

### EDROY PRODUCTS CO., INC.

130 W. 29th St., New York 1 • (212) LO 5-5226

CIRCLE 952 ON READER SERVICE CARD

★ **MINIATURIZATION** ★  
**SALE** [ 180,000 SEMICONDUCTORS  
150,000 RESISTORS  
100,000 ELECTROLYTICS AND TANTALYTICS ]  
WE BUY SURPLUS SEMICONDUCTORS TRANSISTORS UNLIMITED COMPANY  
462 Jericho Turnpike Mineola, L. I., N. Y. (516) 747-7221

CIRCLE 953 ON READER SERVICE CARD

## ARROW

### FREIGHT FORWARDERS

Sub. of LIFSCHULTZ TRANSPORT, Inc.

### FASTEST COAST TO COAST

5th & 6th DAY EAST COAST TO CAL., ARIZ., NEV., ORE. and WASH.

7th DAY TO EAST COAST from CAL., ARIZ., NEV., ORE. and WASH.

Specialists in Shipment of Electronics Products  
Call for information

NEW YORK — PHILADELPHIA  
BALTIMORE — BOSTON — NEW JERSEY  
HOLYOKE — NEW HAVEN — PROVIDENCE  
LOS ANGELES — SAN FRANCISCO — SEATTLE

CIRCLE 954 ON READER SERVICE CARD

## ACQUISITION WANTED

58 year old company seeks diversification through acquisition of equity position in science-oriented company. Seven figure cash available.

180-6011, Electronics  
645 N. Michigan Ave., Chicago, Ill. 60611

CIRCLE 955 ON READER SERVICE CARD

## FREE...CATALOG BARRY ELECTRONICS

512 BROADWAY 212-WALKER 5-7000  
NEW YORK 12, N.Y. TWX-571-0484

CIRCLE 956 ON READER SERVICE CARD  
**SAVE ON DIODES**

If you use Germanium or Silicon Diodes in quantities of 5000 to a million, get our low, low prices. Send specs or request samples.

RULAND MANUFACTURING CO.  
WATER TOWN, MASS. 617-924-8000

CIRCLE 957 ON READER SERVICE CARD

### SEMICONDUCTORS MAJOR BRANDS

INTERGRATED CIRCUITS • DIF. AMPS DARLINGTONS • POWER DIODES & TRANSISTORS • SPECIAL DEVICES

Write for Catalog S-1

SEMICONDUCTOR SALES OF CALIF.  
1063 Perry Annex Whittier, Calif.  
(213) 696-7544

CIRCLE 958 ON READER SERVICE CARD

RADAR AUTO-TRACK & TELEMETRY ANTENNA PEOESTALS 3 & 10 CM. SCR 584 AUTOTRACK RADARS. M-33 RADAR TPS-1D SEARCH. APS-45 TPS-100 HT. FINGERS. WX RADARS. PPN-320CA. APS-10 APS-15B APS-27 (AMT) SEARCH. ■ APN-102 DOPPLER-DOZENS MDRE. CARCINOTRONS. PPN'S. 25-5-1-2-3-6 MEGAWATT PULSE MODULATORS. CAVITIES. PULSE TRANSFORMERS. IF STRIPS. WAVEGUIDE. BENDS 200 MC. 1 KMC. 3 KMC. 6 KMC. 9 KMC. 24 KMC. RF PKGS.

RADIO RESEARCH INSTRUMENT CO.  
550 5TH AVE., NEW YORK 36, N. Y. JU 6-4691

CIRCLE 959 ON READER SERVICE CARD

### INDUSTRIAL—RECEIVING SPECIAL PURPOSE TUBES

BEST QUALITY—LOWEST PRICES

Semiconductors—All Types

FREE CATALOG—write

ROBERT G. ALLEN CO.

P. O. Box 1882 Dept. E-1, Beverly Hills, Calif. 90213

Phone (213) 657-1583

CIRCLE 960 ON READER SERVICE CARD

### Color DIAL TELEPHONES \$10.95

Factory rebuilt Western Electric In white, beige, ivory, pink, green, or blue. If 4 prong plug is required add \$2.00. Fully guaranteed. Write for free list. All shipments FOB.

Complete



SURPLUS SAVING CENTER  
Dept. E-2225  
Waymart, Pa.

CIRCLE 961 ON READER SERVICE CARD

### free catalog

### POTTING APPLICATORS MANUAL AND DISPOSABLE

6cc 12cc 30cc

FOR POTTING, ENCAPSULATING, AND SEALING OF MINIATURE COMPONENTS

PHILIP FISHMAN COMPANY  
7 CAMERON ST., WELLESLEY 81, MASSACHUSETTS

CIRCLE 962 ON READER SERVICE CARD

## SEARCHLIGHT EQUIPMENT LOCATING SERVICE

### No Charge or Obligation

This service is aimed at helping you, the reader of "SEARCHLIGHT", to locate Surplus new and used electronic equipment and components not currently advertised. (This service is for USER-BUYERS only).

How to use: Check the dealer ads to see if what you want is not currently advertised. If not, send us the specifications of the equipment wanted on the coupon below, or on your own company letterhead to:

Searchlight Section  
Locating Service

c/o Electronics

P. O. Box 12, N. Y., N. Y. 10036

Your requirements will be brought promptly to the attention of the equipment dealers advertising in this section. You will receive replies directly from them.

Searchlight Equipment Locating Service

c/o Electronics

P. O. Box 12, N. Y., N. Y. 10036

Please help us locate the following equipment components.

NAME .....

TITLE .....

COMPANY .....

STREET .....

CITY ..... 2/22/65

## New Literature

**Electronic switching.** Hathaway Instruments, Inc., 5800 E. Jewell Ave., Denver, Colo., 80222, has published a 56-page, full-color handbook that discusses relay principles and contact characteristics necessary for proper utilization of the Drireed switching concept. Circle 461 reader service card

**Tunnel diodes.** Kmc Semiconductor Corp., Parker Road, R.D. 2, Long Valley, N.J., offers a brochure containing technical specifications on a line of micro-wave, computer, detector and general purpose tunnel diodes. [462]

**Thermistor probes and rods.** Victory Engineering Corp., 136 Springfield Ave., Springfield, N.J. Technical bulletin MGR061 covers a comprehensive line of hermetically sealed-in-glass, high-reliability thermistor probes and rods that are impervious to harsh environments or electrically conductive or corrosive mediums. [463]

**H-v selenium rectifiers.** Recticon Corp., 22 Summit Grove Ave., Bryn Mawr, Pa. A 12-page, high-voltage, selenium rectifier design and specification handbook has been especially created as a reference source for design engineers. [464]

**Differential operational amplifier.** Zeltex Inc., 2350 Willow Pass Road, Concord, Calif., has literature available on the model 115 differential operational amplifier, a unit designed for amplification, isolation, and null detection. [465]

**Fixed ceramic capacitors.** JFD Electronics Corp., 15th Ave. at 62nd St., Brooklyn, N.Y., 11219. An eight-page catalog covers more than 165 types of Unice-ram microminiature fixed ceramic capacitors. [466]

**Miniature connectors.** Amphenol Connector Division, 1830 S. 54th Ave., Chicago, Ill., 60650, has issued a 48-page catalog on a complete line of miniature connectors for military and commercial applications. [467]

**Metal film resistors.** Electra Mfg. Co., Independence, Kansas, 67301. Precision metal film resistors, manufactured to exceed all performance characteristics of MIL-R-22684B, are described in a new bulletin. [468]

**Crystal sockets.** Connector Corp., 6025 No. Keystone Ave., Chicago, Ill., 60646. Data sheet 31A contains descriptive technical information, illustration and dimensional drawings of a new line of miniature and subminiature crystal sockets. [469]

**Precision machining techniques.** Waldman, Precision Products Division, 133 Coit St., Irvington, N.J., 07111. A four-page brochure describes special precision machining techniques for the electronics industry. [470]

**Motor starting capacitors.** Sangamo Electric Co., Box 359, Springfield, Ill., 62705. Bulletin 2228B covers types EM and MJ dry electrolytic motor starting capacitors. [471]

**Transistor chopper driver.** Solid State Electronics Corp., 15321 Rayen St., Sepulveda, Calif., 91343, offers a bulletin describing model TCD-101 silicon transistor chopper driver. [472]

**Traveling-wave tube.** Electronic Specialty Co., 4561 Colorado Blvd., Los Angeles, Calif., 90039, has available a data sheet on the tiny Beacotron, a matched-gain twt. [473]

**Solid-state oscillators.** Sanders Associates, Inc., 95 Canal St., Nashua, N.H. Bulletin TC-160 describes a new line of solid-state oscillators in a frequency range from 50 to 600 Mc. [474]

**Nickel-cadmium cells.** Gulton Industries, 212 Durham Ave., Metuchen, N.J. Hermetically sealed, nickel-cadmium cells in cylindrical configuration are described in bulletin V0119. [475]

**Advanced tower and antenna structure.** Dresser-Ideco Co., 875 Michigan Ave., Columbus 15, Ohio, has published a brochure describing the engineering, research, and development services it offers to broadcasters, industrial companies or governmental agencies engaged in planning, procuring or constructing antenna towers or antenna structures. [476]

**Swept signal sources.** PRD Electronics, Inc., 202 Tillary St., Brooklyn, N.Y., 11201. A two-page data sheet gives design features and specifications for the 720 series swept signal sources. [477]

**Semiconductor products.** Hoffman Electronics Corp., Hoffman Electronic Park, El Monte, Calif. Fifty-seven families of semiconductor products are included in a new 28-page catalog, broadest in the company's history. [478]

**Chopper relay.** Solid State Electronics Corp., 15321 Rayen St., Sepulveda, Calif. A four-page folder illustrates and describes model 98 solid state, spst chopper relay that features typical low noise of 25  $\mu$ V rms into a 10,000 ohm load. [479]

**X-Y plotter.** Electronic Associates, Inc., West Long Branch, N.J., has issued an illustrated brochure on the 30 in. by 30 in. series 205 Variplotter X-Y recorder. [480]

**Mercury standard cells.** Don Bosco Electronics, Inc., 16 Littell Road, Hanover, N.J. An eight-page catalog describes Mallory voltage reference standard cells that feature very high accuracy and dependability. [481]



## ENVIRONMENTAL DIGITAL MAGNETIC TAPE TRANSPORT



COMPLETELY  
COMPUTER  
COMPATIBLE

HIGH SPEED  
FAST START STOP  
LIGHT WEIGHT  
RELIABLE OPERATION  
HIGH DENSITY  
DIGITAL FORMAT  
IBM COMPATIBLE

APPLICATIONS

- AIRBORNE
- MOBILE
- SUBMARINE
- LABORATORY
- INDUSTRIAL

Write or phone for  
more information or  
assistance with your  
application.



**S-I ELECTRONICS, INC.**

103 Park Ave., Nutley, N. J. 07110  
Tel: 201-667-0055

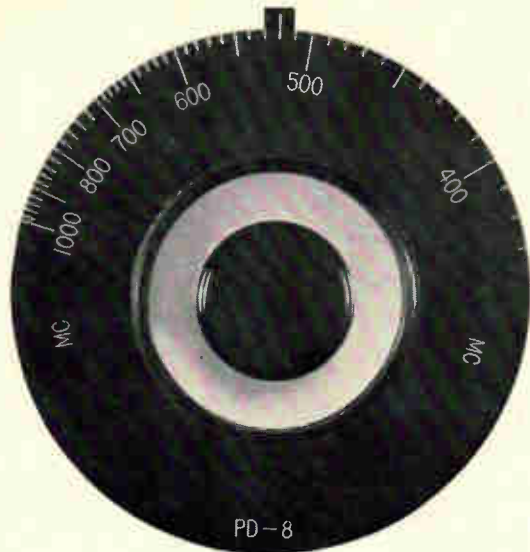

1

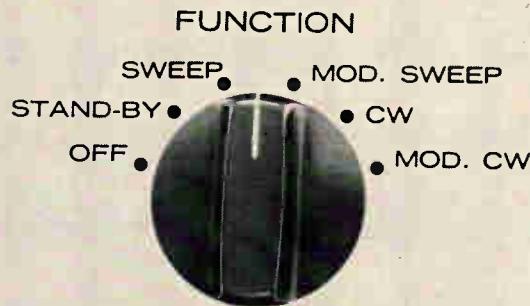

2

RF  
OUTPUT



3



4



5

## 4 WATTS...PD-8...PDQ...SWEPT RF

Telonic's PD-8 Sweep Generator not only provides quick test results, but is also PDA (accurate), PDD (dependable) and PDF (flexible). Look!

1. It's frequency range covers 330 Mc to 1010 Mc, ideal for testing, aligning and adjusting RF networks, transmission lines, attenuators, filters, and other passive devices.
2. The PD-8 can operate in four modes: swept RF, modulated swept RF, CW and modulated CW.
3. It provides up to 4 watts of output power that stays constant regardless of frequency, line voltage, or loading fluctuations. Devices such as solid state frequency multipliers can now be checked out at their on-line operating levels.
4. Input power levels can be selected over a wide range via the direct readout turret attenuator. It covers 3 to 59 db in 1 db steps.
5. It's Telonic all the way through — designed, field tested, and hand-crafted to give you maximum service in the lab or production for years to come.

If you're working at lower frequencies, also consider Telonic's PD-2 and PD-3 Sweep Generators, covering 20 to 100 Mc and 100 to 250 Mc respectively. All other features and specifications are the same as those found in the PD-8.

*Telonic's new catalog covering the PD Series and 27 other Telonic Sweep Generators and accessories in detail is yours on request.*



**Telonic** INDUSTRIES, INC.

60 NORTH FIRST AVENUE  
BEECH GROVE, INDIANA  
PHONE (317) STATE 7-3231  
TWX 317-635 4748

*Representatives in Baltimore, Boston, Chicago, Cleveland, Dallas, Dayton, Denver, Huntsville, Indianapolis, Los Angeles, New York City, Orlando, Philadelphia, San Francisco, Seattle, St. Louis, Syracuse and principal cities throughout the world.*

◆ SWEEP GENERATORS

◆ RF ATTENUATORS

◆ DETECTORS

◆ COAXIAL SWITCHES

## Great Britain

### End of the road

"The all-British plane is out. We are at the end of the road in the production of complicated weapons systems for an exclusively British market."

These words by the Minister of Aviation, Roy Jenkins, sum up the Labor Government's reasons for two decisions that rocked the aviation industry, jolted avionics makers, and came within six votes of causing the overthrow of the four-month-old regime of Prime Minister Harold Wilson.

Labor turned back a Conservative motion of censure by 306 votes to 301, the smallest margin so far in this Parliament.

**U. S. gains.** The biggest loser is Hawker Siddeley Aviation, Ltd., which had both development contracts that were canceled: the HS-681 tactical jet transport and the P-1154 vertical-takeoff strike fighter. In their place, Britain has ordered the Hercules C-130E, made by the Lockheed Aircraft Corp., and the Phantom F-4 jet fighter made by the McDonnell Aircraft Corp. The orders are valued at \$650 million.

But it's not a complete loss to British avionics companies. Plenty of British equipment is expected to be used on the Phantoms. The Royal Air Force will probably employ the Red Top infrared homing missile, developed by Hawker Siddeley, instead of the Sidewinder and Sparrow air-to-air missiles now used. British companies also are expected to supply much of the radar and communication gear.

**Reprieve for TSR-2.** Wilson has granted a six-month reprieve to the British Aircraft Corp.'s TSR-2, a supersonic, low-flying fighter that's competing with the American F-111. He has also promised continuation of the Concorde supersonic airliner program together



Roy Jenkins: "The all-British plane is out."

with the French, assuring that Britain will remain a leader in advanced avionics for civilian supersonic planes.

One electronics executive explains: "We have designed the nav aids and other equipment, and these are applicable to any other aircraft, whether of U. K. or U. S. design."

Britain also plans to replace the aging Shackleton radar-surveillance plane with the Comet 4 for use over the ocean. About 50 Comets are expected to be bought from Hawker Siddeley, with the avionics alone valued at \$15 million to \$20 million.

Further development contracts also will be given for the P-1127, a vertical-takeoff fighter designed jointly by Hawker Siddeley and the Northrop Corp. The Pentagon is considering buying this plane.

**Joint projects.** International projects such as the P-1127 may be the shape of things to come. Jenkins called for closer cooperation with the U. S. on vertical- and short-takeoff planes, a field in which British designers have a lead, and

with France on a light strike trainer with wings that can be folded back in flight, like those of the F-111.

He mentioned two other possible British-French ventures: a civilian "air bus" and an early-warning radar aircraft.

**Farsighted.** Some British electronics companies, having expected the worst for months, seem almost relieved that some decisions have finally been made. One official says: "It's bad news, all right, but it could have been a lot worse."

Pessimism among companies seems to vary inversely with the extent of their diversification. It's true that one-half of the British electronics industry's output goes to the military, but few companies rely entirely on government work; most of them are also active in industrial or consumer electronics. One large concern figures that military shifts may reduce its income 10% to 20% over the next five years.

## South Vietnam

### Microwave network

Behind the post office on Kennedy Square, a huge tower now dominates Saigon's skyline. It's the new terminal of a microwave telecommunication network that will serve 147,000 telephone handsets in nine cities in the southern part of this embattled country.

The network is being installed for the government by the Federal Electric Corp., a subsidiary of the International Telephone and Telegraph Corp. It consists of 49 voice channels, but can be expanded to 600 channels.

When it's completed, the network will include two major exchanges in Saigon and 21 smaller exchanges in other cities. Calls will be possible between cities without going through a Saigon exchange.

ITT calls the network the first step toward complete direct-distance dialing throughout South Vietnam, and says it's as modern and comprehensive as any phone service in Asia.

**On-the-job training.** The project involves a broad training program. Local labor had to be taught to install the system's steel towers, four of them rising 421 feet—the tallest guyed towers in Southeast Asia. Vietnamese engineers and technicians are now being trained to operate the system.

Besides Saigon, cities covered by the microwave network are Tay Ninh, Vung Tau, My Tho, Vinh Long, Can Tho, Long Xuyen, Rach Gia and Khanh Hung.

At Benmethout, work has begun on installing a 50-kilowatt radio transmitter that was supplied by ITT's Australian subsidiary. The transmitter will be the tallest guyed tower in Southeast Asia, according to ITT.

### Soviet Union

#### Thin-film superconductors

A Soviet physicist and theoretician hints that the Russians are trying to develop a room-temperature superconductor made of thin film.

Alexei Abrikosov has told the Soviet Academy of Sciences that the future of superconductors lies in films less than  $10^{-3}$  centimeter thick, and perhaps as thin as  $10^{-6}$  centimeter. Computer memory cells already have been made with film superconductors several square millimeters in area and "a few microns thick," he says.

He indicates that the Russians are abandoning the standard approach that uses permanent cryogenic magnets made of superconducting metals and alloys. Abrikosov notes that such materials are superconductive only near absolute zero and require bulky refrigeration equipment and complex controls.

**Potential.** The technological implications of superconductivity are almost infinite. Since its discovery



Alexei Abrikosov hints at work on room-temperature superconductor.

50 years ago by the Dutch physicist, Heike Kamerlingh-Onnes, the property has been mentioned as a basis for lossless transmission of power, enormously powerful electromagnets, and more efficient amplifiers, particle accelerators and computers.

Theodor A. Buchhold, technical consultant at the General Electric Co.'s Advanced Technology Laboratories, says, "Even if materials were developed that became superconductive at the temperature of liquid hydrogen [ $13.84^{\circ}\text{K}$ ], it would be of enormous consequence."

One approach in the United States involves attempts to synthesize organic substances that are superconductive at room temperature. But, according to Buchhold, such a material, organic or inorganic, still seems to be many years away.

**Nanosecond range.** Abrikosov says computers using superconductive memories can operate in less than  $10^{-8}$  second. And for applications outside the computer field, superthin films can handle current densities up to hundreds of millions of amperes per square centimeter.

As for two superconductive materials created last year—germanium telluride and strontium titanate—Abrikosov says they're not really semiconductors but "metals with peculiar properties of their own."

### Canada

#### \$1 million gamble

Under a 120-foot radome in Nova Scotia, Canada's Department of Transport is building a \$5-million ground station with so many innovations that the agency's chief engineer says it contains "\$1 million in technical gambles." The station, for use with communication satellites, is scheduled to be opened this year at Mill Village, about 80 miles southwest of Halifax.

Perhaps the biggest innovation is the use of a parametric amplifier, mounted directly in the antenna, instead of a maser amplifier. The engineer, O. L. Britney, says the parametric amplifier can be cooled with a closed-cycle refrigeration system, so that liquid helium doesn't need to be added before each pass of the satellite.

Other large ground stations, such as the one at Gilhooly Downs, B. C., use maser amplifiers.

**Twin transmitters.** The Mill Village station will use two transmitters, instead of the usual one, to send 10-kilowatt, 6,000-megacycle signals to the satellite. One transmitter will send telephone signals by single sideband; the other will transmit both telephone and television signals by frequency modulation. The transmitters will have identical, interchangeable power amplifiers.

The station will have an elaborate tracking system to handle both operational and experimental communication satellites at both low and high altitudes. Tracking will be both automatic and programmed.

Orbital elements of the spacecraft, determined beforehand, are converted in a general-purpose computer into angular-position information. A "steering tape" con-

tains the recorded angular-position data, which is converted into antenna-steering commands in the program-tracking and timing system. These signals are used for acquiring the satellite, later as a backup during the pass.

When the satellite is within the antenna beamwidth, the monopulse receiver locks onto the satellite's beacon signals and takes over control of the antenna drive system, keeping the antenna pointed at the satellite.



Antenna wire mesh of the mile-long east-west arm being inspected. Dark horizontal line just above ground is a motor-driven shaft that rotates the arm as much as 55° about its long axis.

## Australia

### Buildup

To meet mounting military pressures in Southeast Asia, Australia is beefing up her armed forces. Last month she reinstated military conscription. This month she ordered \$350 million worth of equipment from the United States. She also has been placing orders in Britain and France.

Citing the growing belligerence of Indonesia to the north, Prime Minister Robert Menzies has boosted military budgets, from \$678 million this year to \$966.5 million by 1968. The government also is expanding civilian agencies such as the Department of Civil Aviation and the Post Office, which operates all communications.

Indonesia, which maintains the world's fourth-largest army, has vowed to destroy neighboring Malaysia and has sent guerrillas to harass that new republic. Australia is sending combat troops to bolster Malaysia's defenses.

**Tons of electronics.** The new U. S. equipment includes 12 Hercules C-130 jet transports, 24 Grumman S-2E antisub tracker aircraft, and 10 Lockheed Orion P-3A planes that can be used as transports or as submarine hunters.

The P-3A, made by the Lockheed Aircraft Corp., contains 2½ tons of electronic, magnetic and sonic equipment. The Grumman will be used on the HMS Melbourne, Australia's only aircraft

carrier. They will have ultrahigh-frequency and low-frequency direction finders, doppler radar, low-altitude radar altimeters and uhf transmitter-receivers, as well as Jezebel passive long-range acoustic search gear, direction finders for electronic countermeasures, Sniffer submarine detectors that sense exhaust trails, Julie echo-ranging gear, automatic target computers and plotters, and retractable search radar under the fuselage.

Weapons include the Tartar surface-to-air guided missile, and anti-submarine torpedoes.

**New missile.** Three destroyers also were ordered in the U. S. at a total cost of \$130 million. They'll be armed with Australia's new antisubmarine missile, the Ikara, which sheds its rocket propulsion system on entry into the sea and then homes on its target up to 15 miles away. Guidance to the target is achieved by a radar pinpointing system.

The Royal Australian Air Force has ordered 10 Mirage III-B trainer fighters from France and two mobile radar controlling-reporting units from Decca, Ltd., in Britain.

### Southern skies

A new radio telescope, its mile-long arms extending in four directions, has begun preliminary observations of the southern sky.

The new instrument is the Mills Cross telescope, nearing completion at the Molonglo radio observatory 11 miles from Canberra. It is

the world's largest and most accurate cross-type radio telescope.

Designed by B. Y. Mills, a professor at the University of Sydney and built at a cost of \$1 million, the telescope should provide clearer pictures of the Milky Way than any now available, because its resolution—several minutes of arc—will be sharper than with existing telescopes that use dish antennas. Another advantage is its location in the Southern Hemisphere, facing the central—and astronomically most interesting—regions of our galaxy.

**Joint project.** A new astronomy center at Sydney, operated jointly by Sydney and Cornell universities, uses the Mills Cross and the 1,000-foot dish-shaped radio telescope in Arecibo, Puerto Rico [Electronics, Dec. 20, 1963, p. 29]. The center is preparing to catalog and chart 10,000 radio sources in the sky, and to gather data on up to one million others. The survey will take years.

In one night, the Mills Cross will be able to make one million measurements of radio emissions from celestial sources.

The new telescope's fine resolution requires a receiving aperture several thousand feet in diameter. The complete cross will combine signals from the two arms to produce resolution as fine as that produced by a dish-shaped antenna.

**Single-handed.** The east-west arm is already making test observations. It is mechanically tilted to any desired elevation. The north-south arm, scheduled to be operating late this year, is immobile but

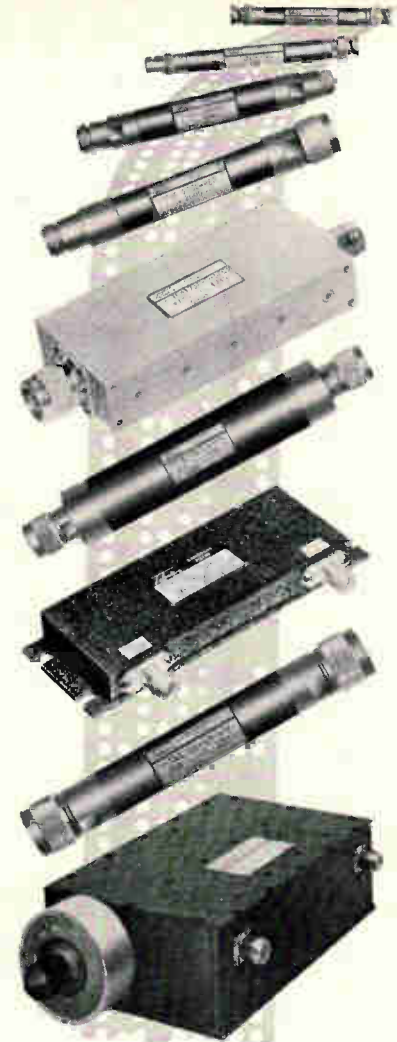

## NOW, FILTERS COMPUTER-BRED

Telonic RF and microwave filters are now provided with a great new level of quality, accuracy, and availability. Each individual design requirement is automatically processed by digital computer to guarantee performance and quick delivery. The program to meet your own filter specifications is already on tape—the design takes only seconds.

If you're looking for low-pass or band-pass units in the 30Mc to 6Gc range, fixed or variable, cavity or interdigital, tubular or tunable, look first to Telonic, where technical progress is measured in terms of service to the customer and quality of the product.

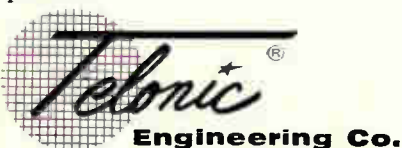

Division of Telonic Industries, Inc.  
480 Mermaid St., Laguna Beach, California  
Tel: (714) 494-7581 TWX 714-673-1120

Representatives in all principal cities

## Electronics Abroad

can be steered by adjusting the lengths of electrical path from each of the dipoles that comprise its line feed. At the principal operating frequency of 408 megacycles per second there are 4,248 end dipoles.

Signals from the north-south arm will enter 11 separate phase combinations, so that in effect the arm will receive signals from 11 strips of sky, each strip about three minutes of arc in height and 4° in width. The strips are separated by 1.4 minutes of arc in elevation.

The east-west arm receives signals from one strip of sky that has a three-minute arc width. The east-west strip is perpendicular to strips received by the north-south arm. In the small areas where east-west reception overlaps with north-south, the signals are correlated. The result is the equivalent of a conventional telescope having 11 "pencil" beams at 408 megacycles.

**Diagramming the sky.** Scanning is performed by the earth's rotation. The 11 correlated beams are combined to form, on a facsimile recorder, a continuous contour diagram of the sky's radio brightness. The telescope can also be steered rapidly to scan many areas of sky in one night.

At 111 Mc, the alternate frequency, there are only three simultaneous beams of resolution. This frequency was selected because it's the frequency at which ionized hydrogen clouds become opaque to radio emission. From measurements at the two frequencies, it should be possible to deduce much about physical structure of the galaxy and the Clouds of Magellan.

**U. S. trailing.** The United States National Academy of Science has expressed concern that Australia has passed the U. S. in radio astronomy and that the Soviet Union is completing an instrument that will put the Russians ahead too [Electronics, Nov. 30, p. 26]. The Soviet array at the Lebedev Physics Institute in Moscow is one kilometer (0.625 mile) in each direction in a range from 50 to 150 megacycles. It will resolve down to about six minutes of arc.

Italy also has a large array outside of Bologna, with crossed arms 620 meters long and enough power

to approach the Soviet instrument in resolution.

The best U. S. instrument is a crossed-dipole array in California, with one 2-mile and one 1-mile leg. Its 26-megacycle output puts its resolution far below the others.

## France

### NATO scorecard

Alliances have been completed among contenders for contracts to build an air-defense system for the North Atlantic Treaty Organization. Three consortiums have emerged, all led by United States companies. The prize is \$308 million in electronics business.

The project is called Nadge, for NATO air-defense ground environment [Electronics, Dec. 28, p. 113]. NATO has been vague about Nadge's goals, but it probably will improve the existing surveillance network from Norway to Turkey, and make some substantial additions to it.

**Computer control.** Additions to the present system will include medium-power radars, height finders, long-dwell-time radars and passive detection base lines for analyzing targets carrying gear for electronic countermeasures.

Data will feed into general-purpose computers that will be able to direct the air defense system automatically, although in fact the system will be operated semiautomatically.

**Timetable.** After seven years of studies and discussions, a timetable has been drawn for bidders. They had until Feb. 15 to submit general bids describing design ideas. By May 1 they're to spell out detailed technical proposals. Then company representatives will sit down with evaluating teams from NATO and argue about the nuts and bolts.

At the end of September, the evaluators will announce which plans are technically acceptable. The consortiums that pass this test will have 60 days in which to file cost estimates. Then, NATO



is supposed to award contracts to the lowest bidders.

**Three contenders.** Three consortiums are known to be in the race. One, led by Litton Industries, Inc., includes two other U.S. companies, the International Telephone and Telegraph Corp., and the Univac division of the Sperry Rand Corp.; four British firms, Elliott-Automation, Ltd., Associated Electrical Industries, Ltd., and J. D. Kier, a construction company; and one French company, Compagnie Générale de Télégraphie Sans Fil.

A consortium led by the Hughes Aircraft Corp. includes one British company, Marconi Instruments, Ltd.; a French company, Thomson-Houston; a Dutch concern, Hollandse Signaalapperten; Selenia of Italy and Telefunken AG of West Germany.

The Westinghouse Electric Co. heads a group including Decca, Ltd., of Britain and the International Business Machines Corp.

### Around the world

**China.** Peking has converted its telephone service to six-figure dialing, increasing its capacity tenfold over the old five-figure system. The government press agency says all the work was done by Chinese technicians with no interruption in service.

**Rumania.** Score a minor victory for NTSC, the United States' color television system that's competing with French and West German systems for acceptance throughout Europe. Specialists at the Bucharest Polytechnic Institute have endorsed the American system for Rumania.

**Britain.** An infrared laser of gallium arsenide is transmitting speech and music over short distances, according to Standard Telecommunications Laboratories, a subsidiary of the International Telephone and Telegraph Corp. The company says the system is suitable for communication across rivers and canals, and on construction sites where wires can't be used.

UP-DATE YOUR INFORMATION ON WORLD'S ELECTRONICS

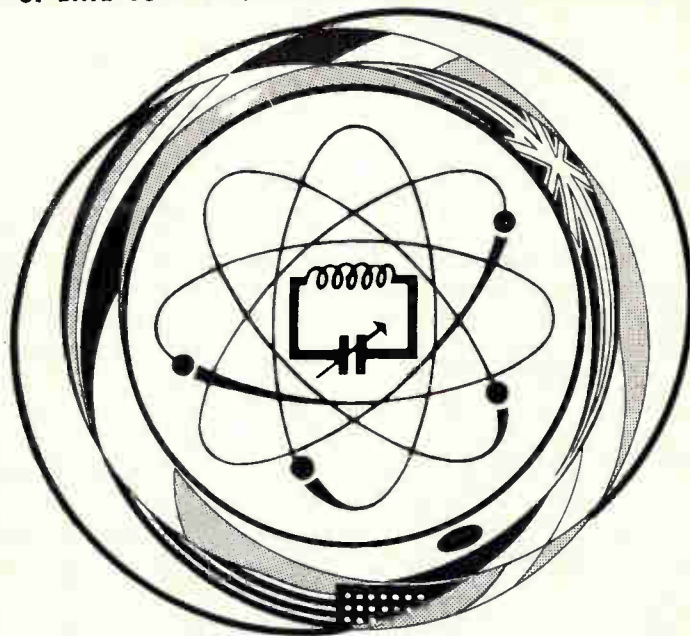

at the international exhibition of

# ELECTRONIC COMPONENTS

and at the international exhibition of

# AUDIO EQUIPMENT

**Paris Porte de Versailles  
From April 8 to April 13, 1965**

the world's greatest annual meeting in the electronics field. All components, tubes and semi-conductors, measurement & control equipment, audio-equipment.

for information and literature, please write to:  
S.D.S.A. 16, rue de Presles  
PARIS 15—Tel: 273 24 70

Official carrier to the Show: Air France  
Overseas Trade Show Department  
683 Fifth Avenue, New York, N. Y. 10022

Sponsored by FNIE

## INTERNATIONAL SYMPOSIUM ON MEMORIES TECHNIQUES

from April 5 to April 10, 1965  
PARIS 125 av. de Suffren.

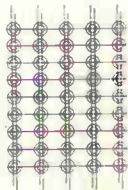

# High – power ssb your field?

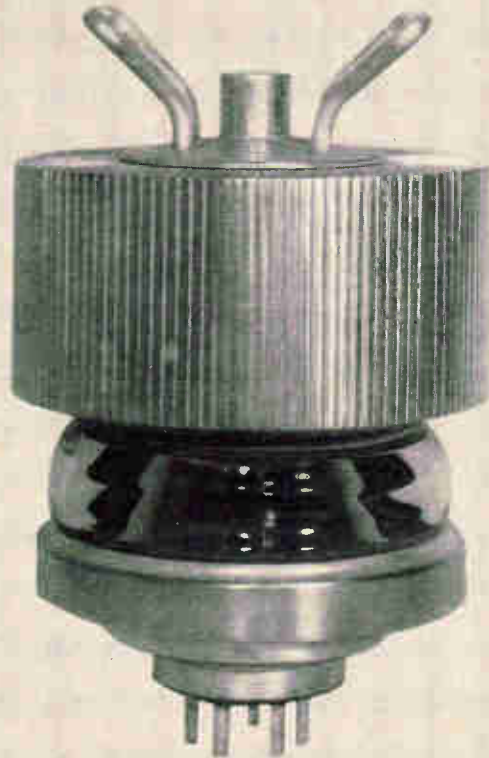

## ***Then take a good look at the Penta PL-210 Beam Pentode***

Several features mark the Penta PL-210 as an outstanding tube for linear amplifier applications. The tube will deliver up to 10,400 watts of useful power output<sup>o</sup>, Class AB<sub>1</sub>, with modest driving voltage and filament power requirements; it exhibits excellent third, fifth, and higher-order intermodulation distortion characteristics; and the input and grid-plate capacitances are unusually low for a tube of these capabilities.

Cooling air requirements, with the PL-210 in its companion PL-261A socket, are easily satisfied with low blower horsepower.

Add up all the advantages and you'll agree that the Penta PL-210 beam pentode is a tube worth investigating. For full details, write *The Penta Laboratories, Inc.*, 312 N. Nopal Street, Santa Barbara, California 93102.

<sup>o</sup>Actual useful power delivered to a load from a typical amplifier. So-called "plate power output" is approximately 10% higher.



A SUBSIDIARY OF RAYTHEON COMPANY

# Electronics advertisers

February 22, 1965



■ AMP Incorporated Garceau, Hargrave & McCullough Inc.	122	Corning Glass Works The Rumrill Company Inc.	58	Hitachi Ltd. Dentsu Advertising Ltd.	118
■ Acme Electric Corporation Scheel Adv. Agency	131	■ Couch Ordnance Inc. Culver Advertising Inc.	162	Industrial Electronic Engineers Inc. Gumpertz, Bentley & Dolan Adv.	152
Acromag Incorporated Tri-Art Associates	144	Defense Electronics Inc. GLM Associates Inc.	63	International Resistance Company Arndt, Preston, Chapin, Lamb & Keen Inc.	138
Aeroflex Laboratories Groody Advertising Agency Inc.	156	■ Delco Radio Division of General Motors Corporation Campbell-Ewald Company	142, 143	ITT-Cannon Electric Inc. West, Weir & Bartel Inc.	67
Air Express Div. of REA Express Ketchum, MacLeod & Grove Inc.	65	Delta Products Inc.	160	Janus Control Corporation L.K. Frank Co. Inc.	140
Ammon Instruments Inc. Culver Advertising Inc.	154	Dow Corning Corporation Church & Guisewite Adv. Inc.	12, 13	■ Jennings Radio Manufacturing Corp. L.H. Waldron Advertising	173
■ Amphenol-Borg Electronics Corp. Connector Div. Marsteller Inc.	68, 69	DuPont de Nemours & Co. Inc. E.I. Batten, Barton, Durstine & Osborn Inc.	109	Jerrold Electronics Corp. Irving Gould Advertising Inc.	10
■ Andrew Corporation The Fensholt Advertising Agency	159	■ Dymec, A div. of Hewlett-Packard Co. Lennen & Newell Incorporated	1	Kay Electric Company Josephson Cuffari & Company	132, 133
Assembly Products Inc. George Z. Griswold	168	Eastman Kodak Company The Rumrill Company Inc.	127	Keithley Instruments Inc. The Bayless Kerr Company	149
Astro-Communication Laboratory Admasters Advertising Inc.	160	Edgerton, Germeshausen & Grier Inc. Reach, McClinton & Co. Inc.	166	■ Lambda Electronics Corporation Michel Cather Inc.	47
Astrodata Inc. Bonfield Associates Inc.	55	■ Electronic Associates Inc. Gaynor & Ducas, Inc.	115	Machlett Laboratories Inc., The Fuller & Smith & Ross Inc.	9
Automatic Electric Company Kudner Agency Inc.	114	Engineered Electronics Company Barnes Chase Advertising	151	■ Mallory & Company Inc. P.R. The Aitkin-Kynett Company	177
■ Ballantine Laboratories Lang-Lawrence Advertising Inc.	145	Esterline Angus Instrument Company Inc. Caldwell, Larkin & Sidener-Van Riper Inc.	74	Marconi Instruments Armand Richards Advertising Agency	136
Beckman Instrument Inc. Berkeley Div. Erwin Wasey, Ruthrauff & Ryan	155	Fairchild Dumont Laboratories The Roger & Wilbur Co. Inc.	14, 146	Markem Machine Culver Advertising Inc.	153
Beckman Instrument Inc. Helipot Div. Erwin Wasey, Ruthrauff & Ryan	141	■ Federation Nationals Des Industries Electroniques Publi-Service Agency Inc.	189	Matsuo Electric Co., Ltd. Asahi Advertising Agency & Co.	150
Bell Telephone Laboratories N.W. Ayer & Son Incorporated	121	■ Fenwal Electronics Inc. Larcom Randall Advertising Inc.	150	McDonnell Electronic Equipment Div. John Patrick Starrs Inc.	134
■ Bird & Co. Inc. Richard H. Stanley R. Tippett & Associates	162	Fluke Mfg. Co. Inc., John Bonfield Associates Inc.	11	McGraw-Hill Book Co. Inc.	175
Borden Chemical Company, Mystic Tape, Inc. Fuller & Smith & Ross Inc.	157	Flying Tiger Line Cole, Fischer, Rogow Inc.	32	■ Micro Switch Div. of Honeywell Batten, Barton, Durstine & Osborn Inc.	38
■ Bourns Inc. Allen, Dorsey & Hatfield Inc.	56, 57, 135	General Aniline & Film Corporation Hazard Advertising Company Inc.	112	Microtran Company Inc. Packer Advertising Corp.	8
Bristol Company, The Chirurg & Cairns, Inc.	167	■ General Electric Co., Silicone Products Dept. Ross Roy Inc.	110	Minerals Pigments & Metals Div. of Chas. Pfizer & Co. Inc. Newmark, Posner & Mitchell Inc.	39
■ Brush Instruments, Div. of Clevite Corp Carr Liggett Adv. Inc.	3rd Cover	General Radio Company K.E. Morang Company	2nd Cover	Minnesota Mining & Mfg. Co. Mincom Division Reach, McClinton & Co., Inc.	66
Burroughs Corporation Conti Advertising Inc.	71	Genisco Technology Corporation Getz and Sandborg Inc.	171	■ Mitsumi Electric Co., Ltd. Dentsu Advertising Ltd.	148
■ Bussmann Mfg. Co. Div. of McGraw Edison Co. Henderson Advertising Company	164, 165	Globe Industries Inc. Odiorne Industrial Adv. Inc.	70	Motorola Semiconductor Products Inc. Lane and Bird Advertising Inc.	30, 31
■ CML, Inc. Keyes, Martin & Company	174	Gudebrod Bros. Silk Co. Inc. Lee Ramsdell & Co. Inc.	34, 35	Mystik Tape Inc. Division of The Borden Chemical Co. Fuller & Smith & Ross Inc.	157
Cambridge Thermionic Corporation Chirurg & Cairns Inc.	156	General Electric Co. Hazard Advertising Company Inc.	112	New Hermes Engraving Machine Corporation Doner-Harrison Inc. Advertising	148
Cherry Electrical Products Corporation Jd Culea Advertising Inc.	156	■ General Electric Co., Silicone Products Dept. Ross Roy Inc.	110	Non Linear Systems Inc. Barnes Chase Advertising Agency	64
■ Chester Cable Corporation Lewis Advertising Agency	59, 60	General Radio Company K.E. Morang Company	2nd Cover	North Atlantic Industries Inc. Murray Heyert Associates	130
■ Cinch Manufacturing Company Stral Advertising Company Inc.	37	Genisco Technology Corporation Getz and Sandborg Inc.	171	North Carolina Dept. of Conservation & Development Bennett Advertising Inc.	27
■ Clifton Precision Products Div. of Litton Industries Ivey Adv. Inc.	16	Globe Industries Inc. Odiorne Industrial Adv. Inc.	70	Nytronics Inc. The Stukalin Advertising Agency	152
Cohu Electronics, Kin Tel Division Erwin Wasey, Ruthrauff & Ryan	51	Gudebrod Bros. Silk Co. Inc. Lee Ramsdell & Co. Inc.	34, 35		
■ Collins Radio Company Tracy-Locke Company Inc.	111	Hamilton Watch Company Beaumont, Heller & Sperling Inc.	169		
Cominco Products Inc. McKim Productions Limited	154	■ Heath Company Advance Advertising Service Inc.	156		
■ Computer Instruments Corp. Dickerman Advertising Inc.	117	Heinemann Electric Co. Thomas R. Sundheim Inc.	28, 29		
Consolidated Electrodynamics Corporation Hixson & Jorgensen Inc.	72, 73	■ Hewlett Packard Company Lennen & Newell Inc.	2, 119, 120		
Control Data Corporation Barnes Chase Advertising	161				

# Electronics advertisers

February 22, 1965



■ Ohmite Mfg. Company The Fensholt Adv. Agency	137
Pennsalt Chemicals Corporation The Aitkin-Kynett Company	33
Penta Laboratories Kemble & Clapham Advertising	190
■ Philbrick Researches Inc. George A. Culver Advertising Inc.	54
Poco Graphite Inc. The Hal Mayer Company	36
Primo Ltd. General Advertising Agency	192
R C L Electronics Inc. Morvay Advertising Agency	174
Radio Corporation of America Al Paul Lefton Company	4th Cover
Raytheon Company, Industrial Components Div. Fuller & Smith & Ross Inc.	178
Raytheon Company, Microwave & Power Tube Division Fuller & Smith & Ross Inc.	116
Roback Corporation, The G. Walter Dashnau Associates	176
■ Rosemont Engineering Company The Erle Savage Company	154

S-I Electronics Inc.	183
■ Sanborn Co., A Div. of Hewlett Packard Co. Culver Advertising Inc.	40, 41
Sanders Associates Inc. Chirurg & Cairns, Inc.	152
■ Semi-Elements Inc. Axelband, & Brown Associates	172
Sigma Instruments Inc. The McCann-Marchalk Company Inc.	52, 53
Sinclair Radio Laboratories Inc. John E. Hayes Company Inc.	170
Sorensen Inc. Fuller & Smith & Ross Inc.	113
Spectrol Electronics Corporation Bonfield Associates Inc.	129
Sprague Electric Company Harry P. Bridge Co. The	5, 6
Stanpat Products Inc. Morton Advertising Inc.	174

Stromberg-Carlson Corporation The Rumrill Company Inc.	144
Sylvania Electric Products Inc. Kudner Agency Inc.	19 to 26
Tektronix Inc. Hugh Dwight Adv. Inc.	42
■ Telonic Engineering Company Jansen Associates	179, 188
Telonic Industries Inc. Burton Browne Advertising	184
Texas Instruments Incorporated Industrial Products Group Robinson-Gerrard Inc.	7
Trygon Electronics Inc. Carpenter Matthews & Stewart Inc.	158
Unitrode Corporation Chirurg & Cairns Inc.	49
■ Vitramon Inc. Ted Sommers Inc. Advertising	163
■ Weston Instruments Incorporated G.M. Basford Co.	147

## Classified advertising

F. J. Eberle, Business Mgr. Employment Opportunities Equipment (Used or Surplus New) For Sale	180-181 182
---	----------------

## Classified advertisers index

Allen, Robert G	182
Arrow Freight Forwarders	182
Atomic Personnel Inc.	180
■ Barry Electronics	182
Edroy Products Co. Inc.	182
Electronic Communications Inc.	181
■ Fishman Co., Philip	182
ITT Federal Electric Corp.	180
Motorola Inc.	181
■ Radio Research Instrument Co.	182
Ruland Manufacturing Co.	182
Semiconductor Sales of Calif.	182
Surplus Saving Center	182
■ Transistors Unlimited Co.	182
■ Universal Relay Corp.	182

## Advertising sales staff

**Gordon Jones** [212] 971-2210  
Advertising sales manager

Atlanta, Ga. 30309: Gus H. Krimsier,  
Michael H. Miller, 1375 Peachtree St. N.E.,  
[404] TR 5-0523

Boston, Mass. 02116: William S. Hodgkinson  
McGraw-Hill Building, Copley Square,  
[617] CO 2-1160

Chicago, Ill. 60611: Robert M. Denmead,  
645 North Michigan Avenue,  
[312] MO 4-5800

Cleveland, Ohio 44113: Paul T. Fegley, 55  
Public Square, [216] SU 1-7000

Dallas, Texas 75201: Richard P. Poole, The  
Vaughn Building, 1712 Commerce Street,  
[214] RI 7-9721

Denver, Colo. 80202: John W. Patten, David  
M. Watson, Tower Bldg., 1700 Broadway,  
[303] AL 5-2981

Houston, Texas 77025: Kenneth George,  
Prudential Bldg., Halcombe Blvd.,  
[713] RI 8-1280

Los Angeles, Calif. 90017: Ashley P.  
Hartman, John G. Zisch, 1125 W. 6th St.,  
[213] HU 2-5450

New York, N.Y. 10036:  
Donald R. Furth [212] 971-3615  
Frank LeBeau [212] 971-3615  
Georae F. Werner [212] 971-3615  
500 Fifth Avenue

Philadelphia, Pa. 19103: William J. Boyle,  
Warren H. Gardner, 6 Penn Center Plaza,  
[215] LO 8-6161

San Francisco, Calif. 94111:  
James T. Hauntli, 255 California Street,  
[415] DO 2-4600

London W1: Edward E. Schirmer, 34 Dover  
Street, Hyde Park 1451

Frankfurt/Main: Gerd Hinske, 85  
Westendstrasse Phone: 77 26 65 and  
77 30 59

Geneva: Michael R. Zeynel,  
2 Place du Port 244275

Paris VIII: Denis Jacob, 17 Avenue  
Matignon ALMA-0452

Tokyo: Nobuyuki Sato  
Shiba, Minato-ku (502) 0656

Osaka: Kazutaka, Miura, 163, Umegae-cho,  
Kita-ku [362] 8771

Nagoya: International Media Representatives,  
Yamagishi Bldg., 13, 2-Chome,  
Oike-cho Naka-ku

**Hugh J. Quinn:** [212] 971-2335  
Manager Electronics Buyers' Guide

**David M. Tempest:** [212] 971-3139  
Promotion manager

**Milton Drake:** [212] 971-3485  
Market research manager

**Richard J. Tomlinson:** [212] 971-3191  
Business manager

**Theodore R. Geipel:** [212] 971-2044  
Production manager

■ For more information on complete product  
line see advertisement in the latest Elec-  
tronics Buyers' Guide

**TOP QUALITY...**



## Primo

### MICROPHONES

Highly sensitive microphone  
with excellent frequency  
characteristics

**TYPES:**

- Uni-Directional
- Velocity
- Magnetic
- Crystal
- Dynamic
- Condenser #etc.

For catalog write to:  
**PRIMO CO., LTD.**  
2043 MURE, MITAKASHI, TOKYO, JAPAN

**Uni-Directional**  
Model: UD-802

Circle 192 on reader service card

Executive, editorial, circulation and advertising offices: McGraw-Hill Building, 330 West 42nd Street, New York, N.Y., 10036. Telephone Area Code 212-971-3333. Teletype TWX N.Y. 212-640-4646. Cable: McGrawhill, N.Y. Officers of the Publications Division: Shelton Fisher, President; Vice Presidents: Joseph H. Allen, Operations; Robert F. Boger, Administration; John R. Callahan, Editorial; Ervin E. DeGraff, Circulation; Donald C. McGraw, Jr., Advertising Sales; Angelo R. Venezian, Marketing. Officers of the Corporation: Donald C. McGraw, President; Hugh J. Kelly, Harry L. Waddell, L. Keith Goodrich, Executive Vice Presidents; John L. McGraw, Treasurer; John J. Cooke, Vice President and Secretary. Title R registered U.S. Patent Office; © copyright 1964 by McGraw-Hill, Inc. All rights reserved, including the right to reproduce the contents of this publication, in whole or in part.

# Electronics reader service

Use these handy post cards for more detailed information on: products advertised, new products, new literature.

Circle the number on the Reader Service post card that corresponds to the number at the bottom of the advertisement, new product item, or new literature in which you are interested.

Please print clearly. All written information must be legible to be efficiently processed.

If someone has beaten you to the post cards, you may obtain the needed information by writing directly to the manufacturer, or by sending your name and address, plus the reader service number, to Electronics reader service department.

All foreign inquires that cannot reach Electronics before the expiration dates noted on the Reader Service post card, must be mailed directly to the manufacturer. The manufacturer assumes all responsibilities for responding to inquiries. Electronics merely provides and clears requests for information from inquirer to manufacturer.

Correct amount of postage must be affixed for all foreign mailings.

## To subscribe to or to renew Electronics

Fill in the "For Subscriptions" area on the card if you desire to subscribe to or renew your present subscription to Electronics. Send no money. Electronics will bill you at the address indicated on the Reader Service post card.

## Multi-product advertisements

For information on specific items in multi-product advertisements which do not have a specific Reader Service number indicated write directly to manufacturer for information on precise product in which you are interested.

Feb. 22, 1965 Card Expires April 22, 1965 14

4

Name \_\_\_\_\_ title \_\_\_\_\_

Company \_\_\_\_\_

Address \_\_\_\_\_

For Subscriptions  
 new  renewal  
 3 years \$12.00  
 1 year \$6.00

1	20	39	58	77	96	115	134	153	172	191	210	229	248	267	286	305	324	343	362	381	400	419	438	457	476	495	514	962
2	21	40	59	78	97	116	135	154	173	192	211	230	249	268	287	306	325	344	363	382	401	420	439	458	477	496	515	963
3	22	41	60	79	98	117	136	155	174	193	212	231	250	269	288	307	326	345	364	383	402	421	440	459	478	497	516	964
4	23	42	61	80	99	118	137	156	175	194	213	232	251	270	289	308	327	346	365	384	403	422	441	460	479	498	517	965
5	24	43	62	81	100	119	138	157	176	195	214	233	252	271	290	309	328	347	366	385	404	423	442	461	480	499	518	966
6	25	44	63	82	101	120	139	158	177	196	215	234	253	272	291	310	329	348	367	386	405	424	443	462	481	500	900	967
7	26	45	64	83	102	121	140	159	178	197	216	235	254	273	292	311	330	349	368	387	406	425	444	463	482	501	901	968
8	27	46	65	84	103	122	141	160	179	198	217	236	255	274	293	312	331	350	369	388	407	426	445	464	483	502	902	969
9	28	47	66	85	104	123	142	161	180	199	218	237	256	275	294	313	332	351	370	389	408	427	446	465	484	503	951	970
10	29	48	67	86	105	124	143	162	181	200	219	238	257	276	295	314	333	352	371	390	409	428	447	466	485	504	952	971
11	30	49	68	87	106	125	144	163	182	201	220	239	258	277	296	315	334	353	372	391	410	429	448	467	486	505	953	972
12	31	50	69	88	107	126	145	164	183	202	221	240	259	278	297	316	335	354	373	392	411	430	449	468	487	506	954	973
13	32	51	70	89	108	127	146	165	184	203	222	241	260	279	298	317	336	355	374	393	412	431	450	469	488	507	955	974
14	33	52	71	90	109	128	147	166	185	204	223	242	261	280	299	318	337	356	375	394	413	432	451	470	489	508	956	975
15	34	53	72	91	110	129	148	167	186	205	224	243	262	281	300	319	338	357	376	395	414	433	452	471	490	509	957	976
16	35	54	73	92	111	130	149	168	187	206	225	244	263	282	301	320	339	358	377	396	415	434	453	472	491	510	958	977
17	36	55	74	93	112	131	150	169	188	207	226	245	264	283	302	321	340	359	378	397	416	435	454	473	492	511	959	978
18	37	56	75	94	113	132	151	170	189	208	227	246	265	284	303	322	341	360	379	398	417	436	455	474	493	512	960	979
19	38	57	76	95	114	133	152	171	190	209	228	247	266	285	304	323	342	361	380	399	418	437	456	475	494	513	961	980

## Business reply mail

No postage stamp necessary if mailed in the United States

Postage will be paid by

**Electronics**  
**Reader service department**  
**Box 444**  
**Hightstown, N.J. 08520**

First class  
 Permit no. 42  
 Hightstown, N. J.

Feb. 22, 1965 Card Expires April 22, 1965 14

4

Name \_\_\_\_\_ title \_\_\_\_\_

Company \_\_\_\_\_

Address \_\_\_\_\_

For Subscriptions  
 new  renewal  
 3 years \$12.00  
 1 year \$6.00

1	20	39	58	77	96	115	134	153	172	191	210	229	248	267	286	305	324	343	362	381	400	419	438	457	476	495	514	962
2	21	40	59	78	97	116	135	154	173	192	211	230	249	268	287	306	325	344	363	382	401	420	439	458	477	496	515	963
3	22	41	60	79	98	117	136	155	174	193	212	231	250	269	288	307	326	345	364	383	402	421	440	459	478	497	516	964
4	23	42	61	80	99	118	137	156	175	194	213	232	251	270	289	308	327	346	365	384	403	422	441	460	479	498	517	965
5	24	43	62	81	100	119	138	157	176	195	214	233	252	271	290	309	328	347	366	385	404	423	442	461	480	499	518	966
6	25	44	63	82	101	120	139	158	177	196	215	234	253	272	291	310	329	348	367	386	405	424	443	462	481	500	900	967
7	26	45	64	83	102	121	140	159	178	197	216	235	254	273	292	311	330	349	368	387	406	425	444	463	482	501	901	968
8	27	46	65	84	103	122	141	160	179	198	217	236	255	274	293	312	331	350	369	388	407	426	445	464	483	502	902	969
9	28	47	66	85	104	123	142	161	180	199	218	237	256	275	294	313	332	351	370	389	408	427	446	465	484	503	951	970
10	29	48	67	86	105	124	143	162	181	200	219	238	257	276	295	314	333	352	371	390	409	428	447	466	485	504	952	971
11	30	49	68	87	106	125	144	163	182	201	220	239	258	277	296	315	334	353	372	391	410	429	448	467	486	505	953	972
12	31	50	69	88	107	126	145	164	183	202	221	240	259	278	297	316	335	354	373	392	411	430	449	468	487	506	954	973
13	32	51	70	89	108	127	146	165	184	203	222	241	260	279	298	317	336	355	374	393	412	431	450	469	488	507	955	974
14	33	52	71	90	109	128	147	166	185	204	223	242	261	280	299	318	337	356	375	394	413	432	451	470	489	508	956	975
15	34	53	72	91	110	129	148	167	186	205	224	243	262	281	300	319	338	357	376	395	414	433	452	471	490	509	957	976
16	35	54	73	92	111	130	149	168	187	206	225	244	263	282	301	320	339	358	377	396	415	434	453	472	491	510	958	977
17	36	55	74	93	112	131	150	169	188	207	226	245	264	283	302	321	340	359	378	397	416	435	454	473	492	511	959	978
18	37	56	75	94	113	132	151	170	189	208	227	246	265	284	303	322	341	360	379	398	417	436	455	474	493	512	960	979
19	38	57	76	95	114	133	152	171	190	209	228	247	266	285	304	323	342	361	380	399	418	437	456	475	494	513	961	980

# Reprint service

All Electronics editorial matter available in reprint form:

For reprints of special reports and feature articles see list on right side of this page. Send your order to Electronics Reprint Department at the address indicated. To expedite mailing of your order for single reprints please send cash, check or money order with your order.

Bulk reprints of editorial matter can be ordered from current or past issues. The minimum quantity is 100 copies. The higher the quantity ordered, the more economical the cost per copy. Prices quoted on request.

To order reprints or for further information, please write to: **Electronics Reprint Department, 330 West 42nd Street, New York, N.Y. 10036.** Telephone: Area code 212 971-3140.

You may order the following reprints by key number using order form on page 164.

Prices for the below listed reprints unless otherwise specified are 1-10 copies 50¢ each; 11-24 copies 35¢ each; 25-99 copies 25¢ each; price for 100 or more is 20¢ each.

Key no. **R-69 1964 Complete Electronics Index**  
Catalogs all technical articles — newsletter items, Electronics Review, Electronics Abroad, and Probing the News stories, manufacturers mentioned in these articles plus a complete advertisers index.  
40 pages. \$1.00

Key no. **R-68 Designing Against Space Radiation**, 18 pages.

Key no. **R-67 Electronics Markets 1965**.  
24 page forecast report with 6 page foldout chart.

Key No. **R-66 Field Effect Transistors, Part III**  
16 pages.

Key No. **R-65 Field Effect Transistors, Part II**  
24 pages.

Key No. **R-64 Field Effect Transistors, Part I**  
24 pages.

Key no. **R-62 Electronic Telephone Switching**,  
16 pages.

Key no. **R-61 Direct Digital Control In Industry**, 24 pages.

Key no. **R-60 Transistor Heat Dissipators**,  
32 pages.

Key no. **R-58 Oceanography**, 15 pages.

Key no. **R-57 Magnetics**, 24 pages.

Key no. **R-56 The Case For Magnetic Logic**, 8  
pages. 35¢

Key no. **R-53 Digital Instrumentation**, 16  
pages.

Key no. **R-48 Modern Electronic Packaging**,  
16 pages.

Key no. **R-45 Today's Semiconductors**, 24  
pages.

Key no. **R-40 Tunnel Diodes**, [4 part series]  
26 pages.

Key no. **R-38 Family Tree of Semiconductors**,  
[22" x 11" foldout chart].

Key no. **R-31 1962 Electromagnetic Spectrum  
Chart**, [22" x 30" foldout chart].  
\$1.00

Key no. **R-30 Graphical Symbols For Electronic  
Diagrams**, [29" x 11" foldout  
chart].

Key no. **R-26 Lasers Devices and Systems**,  
[1961 4 part series] 23 pages:  
\$1.00

## Business reply mail

No postage stamp necessary if mailed in the United States

Postage will be paid by

**Electronics**

**Reader service department**

**Box 444**

**Hightstown, N. J. 08520**

First class  
Permit no. 42  
Hightstown, N. J.



4 Feb. 22, 1965 Card Expires April 22, 1965 14

Name \_\_\_\_\_ title \_\_\_\_\_

Company \_\_\_\_\_

Address \_\_\_\_\_

For Subscriptions  
 new  renewal  
 3 years \$12.00  
 1 year \$6.00

1	20	39	58	77	96	115	134	153	172	191	210	229	248	267	286	305	324	343	362	381	400	419	438	457	476	495	514	962
2	21	40	59	78	97	116	135	154	173	192	211	230	249	268	287	306	325	344	363	382	401	420	439	458	477	496	515	963
3	22	41	60	79	98	117	136	155	174	193	212	231	250	269	288	307	326	345	364	383	402	421	440	459	478	497	516	964
4	23	42	61	80	99	118	137	156	175	194	213	232	251	270	289	308	327	346	365	384	403	422	441	460	479	498	517	965
5	24	43	62	81	100	119	138	157	176	195	214	233	252	271	290	309	328	347	366	385	404	423	442	461	480	499	518	966
6	25	44	63	82	101	120	139	158	177	196	215	234	253	272	291	310	329	348	367	386	405	424	443	462	481	500	900	967
7	26	45	64	83	102	121	140	159	178	197	216	235	254	273	292	311	330	349	368	387	406	425	444	463	482	501	901	968
8	27	46	65	84	103	122	141	160	179	198	217	236	255	274	293	312	331	350	369	388	407	426	445	464	483	502	902	969
9	28	47	66	85	104	123	142	161	180	199	218	237	256	275	294	313	332	351	370	389	408	427	446	465	484	503	951	970
10	29	48	67	86	105	124	143	162	181	200	219	238	257	276	295	314	333	352	371	390	409	428	447	466	485	504	952	971
11	30	49	68	87	106	125	144	163	182	201	220	239	258	277	296	315	334	353	372	391	410	429	448	467	486	505	953	972
12	31	50	69	88	107	126	145	164	183	202	221	240	259	278	297	316	335	354	373	392	411	430	449	468	487	506	954	973
13	32	51	70	89	108	127	146	165	184	203	222	241	260	279	298	317	336	355	374	393	412	431	450	469	488	507	955	974
14	33	52	71	90	109	128	147	166	185	204	223	242	261	280	299	318	337	356	375	394	413	432	451	470	489	508	956	975
15	34	53	72	91	110	129	148	167	186	205	224	243	262	281	300	319	338	357	376	395	414	433	452	471	490	509	957	976
16	35	54	73	92	111	130	149	168	187	206	225	244	263	282	301	320	339	358	377	396	415	434	453	472	491	510	958	977
17	36	55	74	93	112	131	150	169	188	207	226	245	264	283	302	321	340	359	378	397	416	435	454	473	492	511	959	978
18	37	56	75	94	113	132	151	170	189	208	227	246	265	284	303	322	341	360	379	398	417	436	455	474	493	512	960	979
19	38	57	76	95	114	133	152	171	190	209	228	247	266	285	304	323	342	361	380	399	418	437	456	475	494	513	961	980

## Business reply mail

No postage stamp necessary if mailed in the United States

Postage will be paid by

**Electronics**

**Reader service department**

**Box 444**

**Hightstown, N.J. 08520**

First class  
Permit no. 42  
Hightstown, N. J.





**This is the Brush Mark 200, Series 1707**

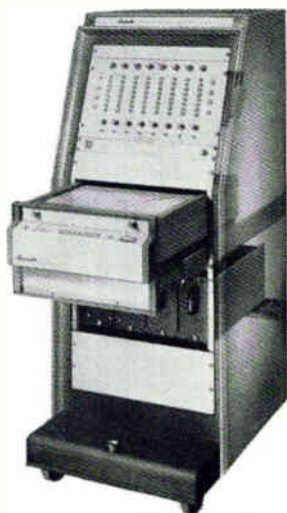

**...and so is this**



**...and so is this**

## **It's the only custom-built recorder that's standard**

*Your choice of combinations is almost infinite . . . with this new generation of the pace-setting Mark 200. Now you can eliminate "special" engineering time and costs. You specify your recording requirements. Then Brush quickly meets them with the perfect combination of off-the-shelf modular sub-systems. What's off-the-shelf at Brush . . . isn't even on the drawing board elsewhere. All the electronics are solid state.*

*Take your choice of penmotors: two channel 40 mm; high resolution 80 mm; eight channel "yes-no" event markers (all on one recorder . . . in any combination . . . on the same chart . . . on a common time base!)*

*Take your choice of oscillographs: vertical, pull-out horizontal or wide-view horizontal.*

*Take your choice of 32 different preamplifiers.*

And you're way ahead with Brush innovations that set new standards in oscillography. A contactless super sensor called Metrisite . . . "polices" pen position to assure better than 1/2% accuracy. Useful frequency response to 200 cps. True rectilinear motion. Pressurized inking produces traces so crisp and accurate you can't misread the signal. All this with over 10,000 channels of field performance! A new booklet has the complete story on the Mark 200, Series 1707. Write for it. Brush Instruments, 37th & Perkins, Cleveland, Ohio 44114.



**brush** **CLEVITE**  
INSTRUMENTS DIVISION

# OVERLAY POWER

17 WATTS  
@  
100 Mc

10 WATTS  
@  
260 Mc

# BREAKTHROUGH

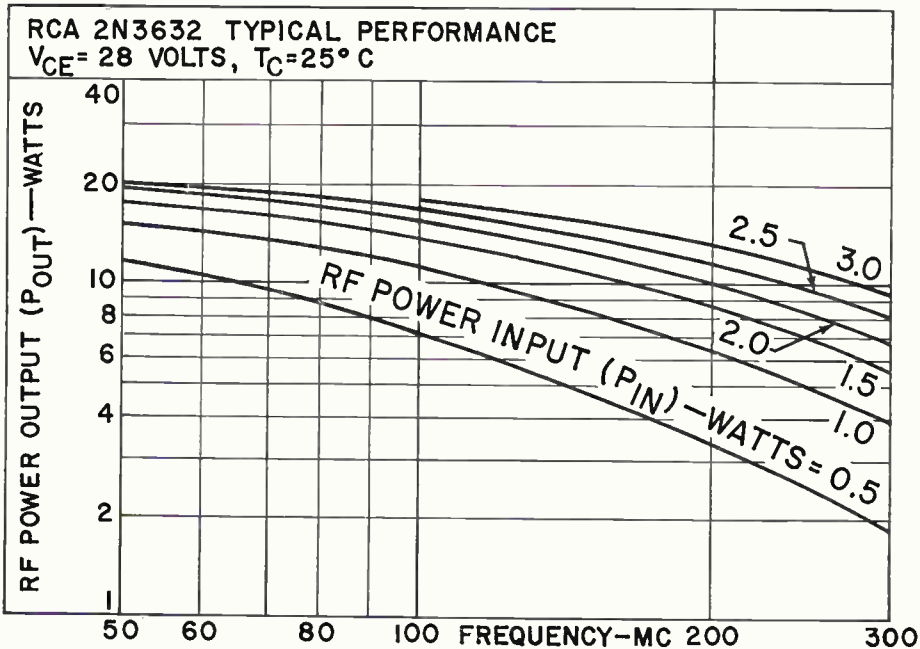

## RCA 2N3632 RF PERFORMANCE / DOLLAR BREAKTHROUGH

### Delivers 30 watts typ in low-cost 175 Mc all-transistor chain

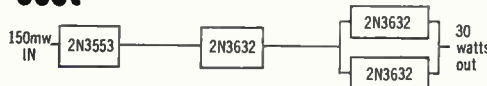

Now RCA introduces the 2N3632, new high output version of overlay type 2N3375, for 50 to 260 Mc applications. Utilizing RCA's multiple-emitter overlay construction for high efficiency, high-frequency performance and economy, 2N3632 offers:

- 13.5 Watts Min. Output at 175 Mc  
70% Min. Collector Efficiency
- $BV_{CEV} = 65V$  Min.
- $BV_{CEO} = 40V$  Min.
- $I_C$  Max. = 3 Amps
- $f_T$  at 150 ma = 400 Mc. Typ.



In an all-transistor chain with RCA-2N3553 or 2N3375, the 2N3632 can bring new reliability and new efficiency to military, commercial, and industrial mobile and portable equipment. Stud package (TO-60) with isolated collector, high breakdown voltages, and 100% RF testing make RCA-2N3632 an important new asset for new design and retrofit. For price and delivery see your RCA Representative or RCA Distributor. For technical data, write: RCA Commercial Engineering, Section IN2-4, Harrison, N.J.

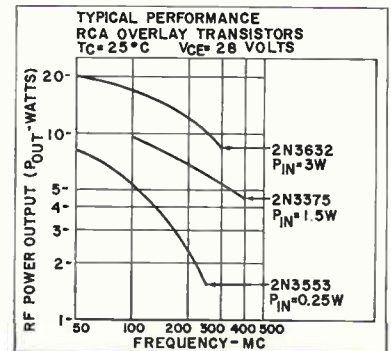

AVAILABLE THROUGH YOUR RCA DISTRIBUTOR  
RCA Electronic Components and Devices, Harrison, N.J.



The Most Trusted Name in Electronics

Circle 902 on reader service card