

Electronics®

Circuits that act like human reflexes: page 66

A survey of logic trainers: page 71

Packing data into a space recorder: page 84

August 24, 1964

75 cents

A McGraw-Hill Publication

Below: ceramic tubes find
new applications, page 50

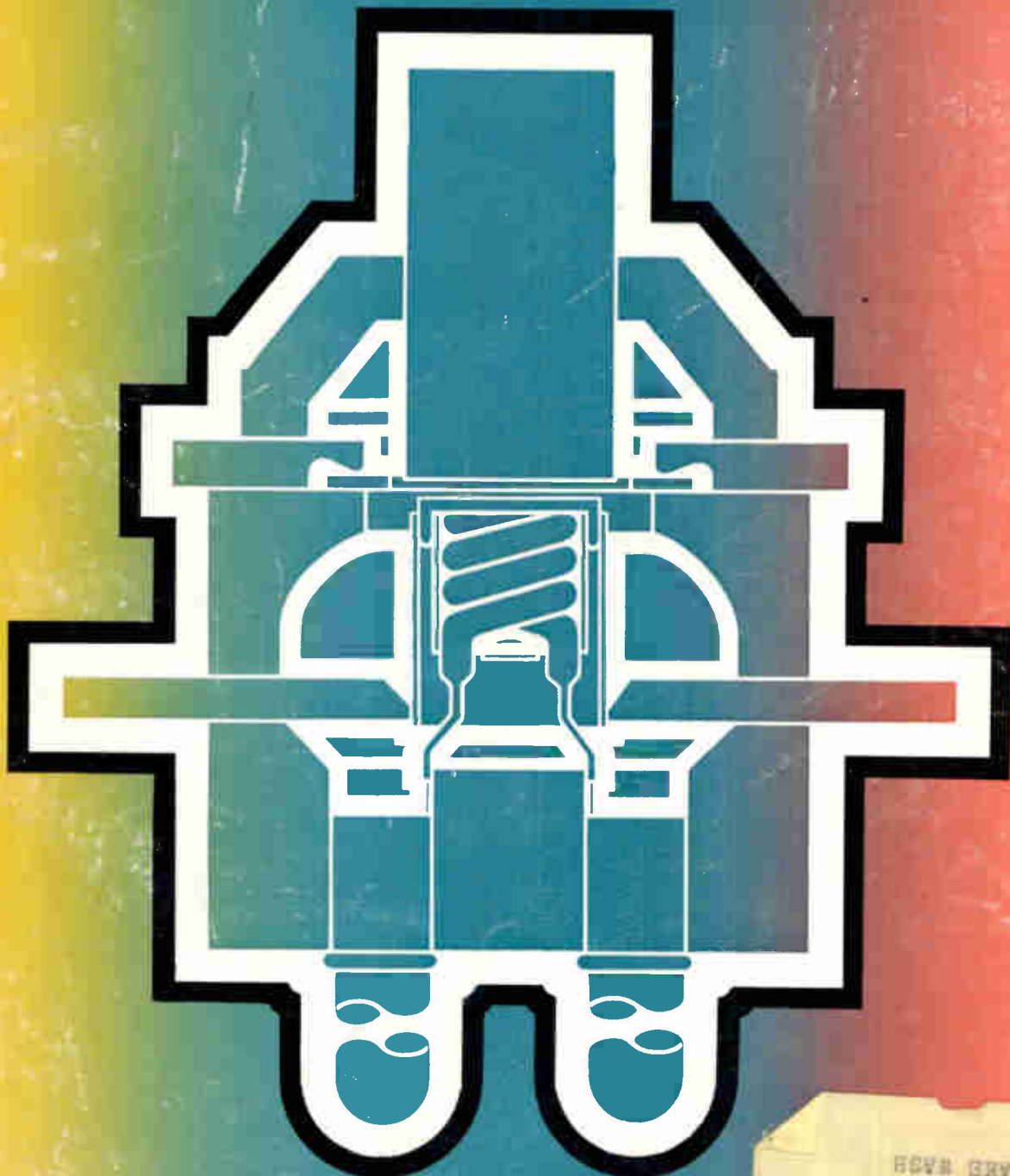



ULTRAMINIATURE TRANSISTOR TRANSFORMERS & INDUCTORS

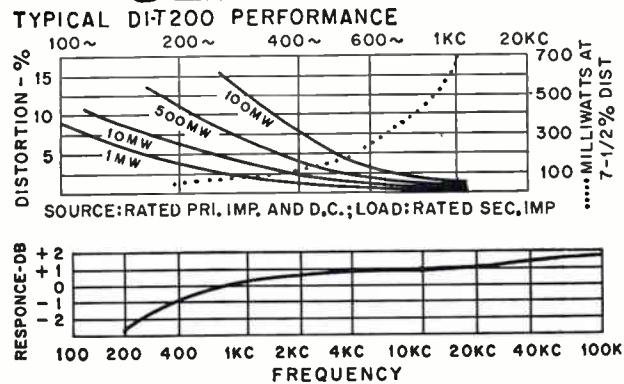

- ➔ DUMET LEADS
(gold plated, weldable and solderable)
- ➔ STRAIGHT PIN TERMINALS
(printed circuit application)
- ➔ HIGHEST PERFORMANCE
for size in the industry
- ➔ METAL ENCASED
(Grade 4, Ruggedized)

Type No.	Pri. Imp.	DCma† in Pri.	Sec. Imp.	Pri. Res.	Mw Level	Application
DI-T225	80 CT 100 CT	12 10	32 split 40 split	10	500	Interstage
DI-T230	300 CT	7	600 CT	20	500	Output or line to line
DI-T235	400 CT 500 CT	8 6	40 split 50 Split	50	500	Interstage
DI-T240	400 CT 500 CT	8 6	400 split 500 split	50	500	Interstage or output (Ratio 2:1:1)
DI-T245	500 CT 600 CT	3 3	50 CT 60 CT	65	500	Output or matching
DI-T250	500 CT	5.5	600 CT	35	500	Output or line to line or mixing
DI-T255	1,000 CT 1,200 CT	3 3	50 CT 60 CT	110	500	Output or matching
DI-T260	1,500 CT	3	600 CT	90	500	Output to line
DI-T265	2,000 CT 2,500 CT	3 3	8,000 split 10,000 split	180	100	Isol. or interstage (Ratio 1:1:1)
DI-T270	10,000 CT 12,000 CT	1 1	500 CT 600 CT	870	100	Output or driver
DI-T273	10,000 CT 12,500 CT	1 1	1,200 CT 1,500 CT	870	100	Output or driver
DI-T276	10,000 CT 12,000 CT	1 1	2,000 CT 2,400 CT	870	100	Interstage or driver
DI-T278	10,000 CT 12,500 CT	1 1	2,000 split 2,500 split	620	100	Interstage or driver
DI-T283	10,000 CT 12,000 CT	1 1	10,000 CT 12,000 CT	970	100	Isol. or interstage (Ratio 1:1)
DI-T288	20,000 CT 30,000 CT	.5 .5	800 CT 1,200 CT	870	50	Interstage or driver
DI-T204	Split Inductor (2 wdg)	§ .1 Hys @ 4 maDC, .08 Hys @ 10 maDC, DCR 25Ω §§ .025 Hys @ 8 maDC, .02 Hys @ 20 maDC, DCR 6Ω				
DI-T208	Split Inductor (2 wdg)	§ .9 Hys @ 2 maDC, .5 Hys @ 6 maDC, DCR 105Ω §§ .2 Hys @ 4 maDC, .1 Hys @ 12 maDC, DCR 26Ω				
DI-T212	Split Inductor (2 wdg)	§ 2.5 Hys @ 2 maDC, .9 Hys @ 4 maDC, DCR 630Ω §§ .6 Hys @ 4 maDC, .2 Hys @ 8 maDC, DCR 157Ω				
DI-T216	Split Inductor (2 wdg)	§ 4.5 Hys @ 2 maDC, 1.2 Hys @ 4 maDC, DCR 2300Ω §§ 1.1 Hys @ 4 maDC, .3 Hys @ 8 maDC, DCR 575Ω				

†DCma shown is for single ended usage (under 5% distortion—100mw—1KC)... for push pull, DCma can be any balanced value taken by 5W transistors (under 5% distortion—500mw—1KC) DI-T200 units have been designed for transistor application only... not for vacuum tube service. U.S. Pat. No. 2,949,591 other pending. Where windings are listed as split, 1/4 of the listed impedance is available by paralleling the winding. §Series connected; §§Parallel connected.

ALL STOCK UNITS MIL TYPE TF4RX Class "S" Available on Special Order

High Power Rating up to 100 times greater.
 Excellent Response twice as good at low end.
 Low Distortion reduced 80%.
 High Efficiency up to 30% better . . . compare DCR.
 Moisture Proof hermetically sealed to MIL-T-27B.
 Ultraminiature Size 5/16 Dia. x 3/8" H, 1/15 Oz.

The unique structural design of the DI-T200 series transformers and inductors provides the excellent electrical characteristics, high reliability and wide application possibilities inherent in the UTC DO-T family of miniaturized units. The DI-T200 series units employ the same high quality design found in UTC's DO-T, DI-T, and PIP lines. This unique transformer structural concept affords unprecedented power handling capabilities coupled with extremely small size. Further, the high degree of reliability has been dynamically proven in the field. These characteristics are basic in the structure, which is ruggedized, hermetically sealed, employing a completely rigid bobbin, eliminating stress and wire movement. The turns are circular in shape rather than square, eliminating turn corner stress, and effecting uniform wire lay. The coil wire and external lead are rigidly anchored terminal board fashion, employing no tapes and brought out through strain relief. The curves illustrated indicate the superior performance of these units compared to similar size units now on the market.

The leads are uninsulated 1" long, .017 Dumet wire, spaced on a .1" radius circle to conform to terminal spacing techniques of the "TO-5" case semiconductors and micrologic elements.

IMMEDIATE DELIVERY FROM STOCK



UNITED TRANSFORMER CORP.

150 VARICK STREET, NEW YORK 13, N. Y.

PACIFIC MFG. DIVISION: 3630 EASTHAM DRIVE, CULVER CITY, CALIF.
 EXPORT DIVISION: 13 EAST 40th STREET, NEW YORK 16, N. Y. CABLE: "ARLAB"



New Universal Counters Tailored to Your Measurements:

- ▲ MEASURE frequency: 0 to 300 kc, dc coupled; 10 cps to 300 kc, ac coupled (5223L)
0 to 2 mc, dc coupled; 10 cps to 2 mc, ac coupled (5233L)
- ▲ MEASURE time interval, 10 μ sec to 10^7 sec
- ▲ MEASURE period, 0 to 100 kc
- ▲ MEASURE period average: to 10^6 periods (5223L)
to 10^7 periods (5233L)
- ▲ MEASURE ratio, multiples of ratio

- ▲ Refined A and B trigger level controls for precise positioning of trigger points
- ▲ Readout: 5 rectangular close-spaced Nixies (5223L)
6 rectangular close-spaced Nixies (5233L)
- ▲ Input impedance of 1 megohm, sensitivity of 0.1 v rms
- ▲ Time base stability: ± 2 parts in 10^6 per week (5223L)
 ± 2 parts in 10^7 per month (5233L)
- ▲ High sampling rates (0.2 to 5 sec, variable), independent of gate time
- ▲ Display storage, for continuous display
- ▲ Automatic measurement unit, decimal display
- ▲ BCD code output for systems, digital recorders
- ▲ Self check in all function and multiplier positions
- ▲ Operate -20° to $+65^\circ$ C
- ▲ Small, compact, 3 $\frac{1}{2}$ " high, 16 $\frac{3}{4}$ " wide, 11 $\frac{1}{4}$ " deep, only 19 lbs.
- ▲ Solid state construction, low power consumption, high reliability
- ▲ Plug-in module construction for easy maintenance
- ▲ Low cost: hp 5223L, \$1450
hp 5233L, \$1850

Data subject to change without notice. Prices f.o.b. factory.

Call your nearby hp field engineer for a demonstration
in your own lab. Or write HEWLETT-PACKARD,
Palo Alto, California 94304,
Telephone (415) 326-7000;
Europe: 54 Route des Acacias, Geneva;
Canada: 8270 Mayrand Street, Montreal.

**HEWLETT
PACKARD**  *An extra measure of quality*

The new 5223L 300 KC Counter and the 5233L 2 MC Counter for your instrumentation needs.



Electronics

Editor: Lewis H. Young

Managing editor: John M. Carroll

Senior editors

Technical: Samuel Weber
News: Kemp Anderson, Jr.

Senior associate editors: John F. Mason, George Sideris

Department editors

Advanced technology: George V. Novotny
Avionics: W.J. Evanzia
Circuit design: Jerome Eimbinder
Communications: Alexander A. McKenzie
Components: Michael F. Tomaino
Computers: Stephen B. Gray
Industrial electronics: Louis S. Gomolak
Instrumentation: George J. Flynn
Manufacturing: George Sideris
Military electronics: John F. Mason
New products: William P. O'Brien
Solid state: G.G. Tirellis
Space electronics: Joel A. Strasser
Staff writers: Leon H. Dulberger, Peggy Jackson

Regional editors

Boston: Thomas Maguire, editor; Susan Turner
Chicago: Cletus M. Wiley, editor; Leslie Krimston
Los Angeles: Harold C. Hood, editor
San Francisco: Laurence D. Shergalis, editor; Mary Jo Jadin
London: Derek Barlow, editor

Copy editors

Howard Rausch, Sally Powell

Illustration

Art director: Howard R. Berry
Assistant art director: John C. Wright, Jr.
Editorial production: Ann Mella, Sandra A. Le Mond

Editorial secretaries: Claire Benell, Mary D'Angelo, Lynn Emery,
Kay Fontana, Carolyn Michnowitz, Lorraine Rossi, Lorraine Werner

McGraw-Hill news service

Director: John Wilhelm; Atlanta: Fran Ridgeway; Chicago: Bruce Cross;
Cleveland: Arthur Zimmerman; Dallas: Marvin Reid;
Detroit: Donald MacDonald; Los Angeles: Michael Murphy,
Ron Lovell; San Francisco: Margaret Ralston, Ed. Addeo;
Seattle: Ray Bloomberg; Washington: George Bryant Jr., Glen Bayless,
Charles Gardner

McGraw-Hill world news service

Bonn: Richard Mikton; Brussels: Arthur Erikson; London: John Shinn;
Mexico City: Wesley Perry; Milan: Bruce Bendow;
Moscow: Donald Winston; Paris: Dan Smith;
Rio de Janeiro: Leslie Warren; Tokyo: Marvin Petal, Charles Cohen

Circulation manager: Hugh Quinn

Reprints: T.M. Egan

Publisher: C.C. Randolph

Electronics: August 24, 1964, Vol. 37, No. 23

Printed at 99 North Broadway, Albany, N.Y.
Second class postage paid at Albany, N.Y.

Subscriptions are solicited only from those actively engaged in the field of the publication. Position and company connection must be indicated on orders. Subscription prices: United States and Possessions and Canada, \$6.00 one year, \$9.00 two years, \$12.00 three years. All other countries: \$20.00 one year. Single copies, United States and Possessions and Canada 75¢. Single copies all other countries \$1.50.

Published every other Monday by McGraw-Hill Inc. 330 West 42nd Street, New York, N.Y. 10036. Founder: James H. McGraw, 1860-1948.

Subscribers: The Publisher, upon written request to our New York office from any subscriber, agrees to refund that part of the subscription price applying to copies not yet mailed. Please send change of address notices, subscription orders or complaints to Fulfillment Manager, Electronics, at the address below. Change of address notices should provide old as well as new address, including postal zone number if any. If possible, attach address label from recent issue. Allow one month for change to become effective.

Postmaster: Please send Form 3579 to Fulfillment Manager, Electronics, P.O. Box 430, Hightstown, New Jersey 08520

Readers Comment

Patent lawyers

The complaint of George E. Row [July 27, p. 6] directed toward patent attorneys ignores an important factor inherent in modern technology and scientific achievement.

It seems evident that any intellectual endeavor toward solving a recurrent problem is eventually pursued by those who enjoy the challenge and work, resulting in the training and creation of experts who are then better equipped to solve future problems in the field of endeavor. Thus, in retrospect, it appears that the government previously chose to train technically educated examiners and developed rules of procedure to uniformly administer the patent laws. And quite logically, the inventing public responded by using patent attorneys to file applications handled in a quasi-adversary proceeding to have an equal footing with the examiner.

Mr. Row's implication seems to be that patent attorneys conspired to create a problem and then solved it themselves, whereas the profession was established in response to a need for solving specialized problems, and simply indicates that one can no longer be a jack-of-all-trades and master also.

As a private practitioner representing many individuals, I feel that Mr. Row has overlooked the fact that the cost of obtaining all the legal coverage to which an invention is entitled may mean the difference between success and failure in obtaining the full economic advantages which the invention should justify.

Donald Gunn

Hayden & Pravel
Houston

Negative resistance

My note in your Comment column [Apr. 26, 1963, p. 4] on Negative Resistance elicited written responses that continued for nearly six months. From them, it is evident that a basic, fundamental concept like "resistance" does not have a single, exact, universally ac-



New Universal Counters Tailored to Your Measurements:

- ▲ MEASURE frequency: 0 to 300 kc, dc coupled; 10 cps to 300 kc, ac coupled (5223L)
0 to 2 mc, dc coupled; 10 cps to 2 mc, ac coupled (5233L)
- ▲ MEASURE time interval, 10 μ sec to 10^7 sec
- ▲ MEASURE period, 0 to 100 kc
- ▲ MEASURE period average: to 10^6 periods (5223L)
to 10^7 periods (5233L)
- ▲ MEASURE ratio, multiples of ratio

- ▲ Refined A and B trigger level controls for precise positioning of trigger points
- ▲ Readout: 5 rectangular close-spaced Nixies (5223L)
6 rectangular close-spaced Nixies (5233L)
- ▲ Input impedance of 1 megohm, sensitivity of 0.1 v rms
- ▲ Time base stability: ± 2 parts in 10^6 per week (5223L)
 ± 2 parts in 10^7 per month (5233L)
- ▲ High sampling rates (0.2 to 5 sec, variable), independent of gate time
- ▲ Display storage, for continuous display
- ▲ Automatic measurement unit, decimal display
- ▲ BCD code output for systems, digital recorders
- ▲ Self check in function and multiplier positions
- ▲ Operate -20° to $+65^\circ$ C
- ▲ Small, compact, $3\frac{1}{2}$ " high, $16\frac{3}{4}$ " wide, $11\frac{1}{4}$ " deep, only 19 lbs.
- ▲ Solid state construction, low power consumption, high reliability
- ▲ Plug-in module construction for easy maintenance
- ▲ Low cost: hp 5223L, \$1450
hp 5233L, \$1850

Data subject to change without notice. Prices f.o.b. factory.

Call your nearby hp field engineer for a demonstration
in your own lab. Or write HEWLETT-PACKARD,
Palo Alto, California 94304,
Telephone (415) 326-7000;
Europe: 54 Route des Acacias, Geneva;
Canada: 8270 Mayrand Street, Montreal.

**HEWLETT
PACKARD**  *An extra measure of quality*

The new 5223L 300 KC Counter and the 5233L 2 MC Counter for your instrumentation needs.



NOW AVAILABLE FROM STOCK!



FM-AM SIGNAL GENERATOR

TYPE 202-H

RADIO FREQUENCY CHARACTERISTICS

RF RANGE: 54-216 MC
 RF ACCURACY: $\pm 0.5\%$
 RF OUTPUT RANGE:
 0.1 μv to 0.2 volts*
 *Across external 50 ohm load at panel jack
 ACCURACY:
 $\pm 10\%$, 0.1 μv to 50 K μv
 $\pm 20\%$, 50 K μv to 0.2 volts
 AUTO LEVEL SET:
 Holds RF monitor meter to "red line" over band
 IMPEDANCE: 50 ohms
 VSWR: < 1.2

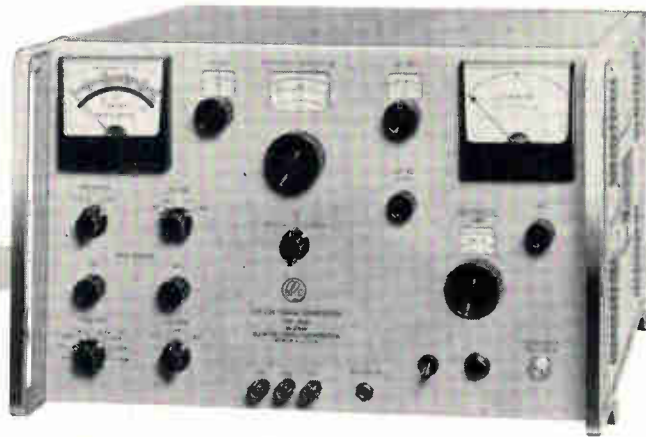

AMPLITUDE MODULATION CHARACTERISTICS

AM RANGE:
 Internal: 0-50%
 External: 0-100%
 AM ACCURACY:
 $\pm 10\%$ at 30% and 50% AM
 AM DISTORTION:
 $< 5\%$ at 30% $< 20\%$ at 100%
 $< 8\%$ at 50%
 AM FIDELITY:
 ± 1 db, 30 cps to 200 KC

FREQUENCY MODULATION CHARACTERISTICS

FM RANGE:
 Internal: 0-250 KC in 4 ranges
 External: 0-250 KC in 4 ranges
 FM ACCURACY: $\pm 5\%$ of full-scale*
 *For sine-wave
 FM DISTORTION:
 $< 0.5\%$ at 75 KC (100 MC and 400 cps modulation only)
 $< 1\%$ at 75 KC (54-216 MC)
 $< 10\%$ at 240 KC (54-216 MC)
 FM FIDELITY:
 ± 1 db, 5 cps to 200 KC
 SIGNAL-TO-NOISE RATIO:
 > 60 db below 10 KC

PULSE MODULATION CHARACTERISTICS

PM SOURCE: External
 PM RISE TIME: < 0.25 μsec
 PM DECAY TIME: < 0.8 μsec

MODULATING OSCILLATOR CHARACTERISTICS

OSC FREQUENCY:
 50 cps 7.5 KC 1000 cps 15 KC
 400 cps 10 KC 3000 cps 25 KC
 OSC ACCURACY: $\pm 5\%$
 OSC DISTORTION: $< 0.5\%$

PHYSICAL CHARACTERISTICS

MOUNTING: Cabinet for bench use; readily adaptable for 19" rack
 FINISH: Gray engraved panel; green cabinet (other finishes available on special order)
 DIMENSIONS:

Height:	Width:	Depth:
10 $\frac{3}{8}$ "	16 $\frac{3}{4}$ "	18 $\frac{3}{4}$ "

POWER REQUIREMENTS

202-H: 105-125/210-250 volts,
 50-60 cps, 100 watts

PRICE — 202-H: \$1365.00
 F. O. B. Rockaway, N. J.

The Type 202-H FM-AM Signal Generator covers the frequency range from 54 to 216 MC and is designed for the testing and calibration of FM receiving systems in the areas of broadcast FM, VHF-TV, mobile, and general communications. The generator consists of a three-stage RF unit, together with a modulating oscillator and power supply, all housed in a single cabinet which may be adapted for rack mounting.

The RF unit consists of a variable oscillator, a reactance tube modulator, a doubler, and an output stage. The modulator is specially designed for minimum distortion and operated in conjunction with the electronic vernier to provide incremental changes in RF output frequency as small as 1 KC. The RF output is fed through a precision, waveguide-below-cutoff variable attenuator; automatic RF level set is incorporated which maintains "red line" on the RF monitor meter over the entire band. The entire RF unit is shock-mounted for minimum microphonism.

An internal audio oscillator provides a choice of eight frequencies which may be used for either FM or AM modulation. A modulation meter indicates either FM deviation or % AM and is calibrated for sine-wave modulation.

A completely solid-state power supply furnishes all necessary operating voltages and may be switched for inputs of either 105-125 or 210-250 volts, 50-60 cps.

Model 202-J is also available for the 215-260 MC telemetering band.

BOONTON RADIO COMPANY

A Division of Hewlett-Packard Company



Visit Booths
 1407-1408
 At The
 Wescon Show

GREEN POND ROAD, ROCKAWAY, NEW JERSEY

Tel. 627-6400 (Area Code 201) TWX: 201-627-3912 Cable Address: Boonraco

Electronics

Page	4	Readers Comment
	8	People
	10	Meetings
	15	Editorial
	17	Electronics Newsletter
	37	Washington Newsletter
	107	New Products
	133	New Literature
	134	New Books
	137	Technical Abstracts

In this issue

Electronics review

Page	25	Color display	28	Laser lighthouses
	25	Looking with lasers	30	Poodle power
	26	Fast circuit costs less	30	Closed circuit Ph.D.s
	26	40 circuits at a time	30	Bomb-proof antennas
	27	Hollow antennas	32	Steel checkup
	27	En-route control	32	Toward all-Europe tv
	28	Lasers and you		

Probing the news

95	Nerve center for space probes
97	Scr's for 19-inch tv
98	Weapons for limited warfare

Technical articles

I. Design

Components	50	Putting ceramic tubes to work [cover] The ceramic tube is not new but a lot of its applications are—in circuits from uhf to audio James W. Rush Jr., General Electric Co.
Circuit design	56	Monostable circuits that need power only when they work Easy new approach to designing circuits that use minimum power Leonard L. Kleinberg, National Aeronautics and Space Administration
Circuit design	60	Designers casebook Amplifier adjusts to cancel unbalanced noise; circuit protects amplifier against short circuit; tunnel diode generates two microwave frequencies; high-efficiency voltage regulator

II. Application

Advanced technology	66	Circuits that act like reflexes An engineer applies Pavlovian conditioning to electronic circuits Karl C. Wehr, Westinghouse Electric Corp.
Computers	71	A survey of digital logic trainers Machines can help train engineers to design logic and computing circuits Stephen B. Gray, computer editor
Communications	84	Tripling recording density For project Gemini, engineers have miniaturized a recorder, and increased packing density with diphas recording A.S. Katz, Radio Corporation of America

Electronics

Editor: Lewis H. Young

Managing editor: John M. Carroll

Senior editors

Technical: Samuel Weber
News: Kemp Anderson, Jr.

Senior associate editors: John F. Mason, George Sideris

Department editors

Advanced technology: George V. Novotny
Avionics: W.J. Evezia
Circuit design: Jerome Eimbinder
Communications: Alexander A. McKenzie
Components: Michael F. Tomaino
Computers: Stephen B. Gray
Industrial electronics: Louis S. Gomolak
Instrumentation: George J. Flynn
Manufacturing: George Sideris
Military electronics: John F. Mason
New products: William P. O'Brien
Solid state: G.G. Tirellis
Space electronics: Joel A. Strasser
Staff writers: Leon H. Dulberger, Peggy Jackson

Regional editors

Boston: Thomas Maguire, editor; Susan Turner
Chicago: Cletus M. Wiley, editor; Leslie Krimston
Los Angeles: Harold C. Hood, editor
San Francisco: Laurence D. Shergalis, editor; Mary Jo Jadin
London: Derek Barlow, editor

Copy editors

Howard Rausch, Sally Powell

Illustration

Art director: Howard R. Berry
Assistant art director: John C. Wright, Jr.
Editorial production: Ann Mella, Sandra A. Le Mond

Editorial secretaries: Claire Benell, Mary D'Angelo, Lynn Emery,
Kay Fontana, Carolyn Michnowitz, Lorraine Rossi, Lorraine Werner

McGraw-Hill news service

Director: John Wilhelm; Atlanta: Fran Ridgeway; Chicago: Bruce Cross;
Cleveland: Arthur Zimmerman; Dallas: Marvin Reid;
Detroit: Donald MacDonald; Los Angeles: Michael Murphy,
Ron Lovell; San Francisco: Margaret Ralston, Ed. Addeo;
Seattle: Ray Bloomberg; Washington: George Bryant Jr., Glen Bayless,
Charles Gardner

McGraw-Hill world news service

Bonn: Richard Mikton; Brussels: Arthur Erikson; London: John Shinn;
Mexico City: Wesley Perry; Milan: Bruce Bendow;
Moscow: Donald Winston; Paris: Dan Smith;
Rio de Janeiro: Leslie Warren; Tokyo: Marvin Petal, Charles Cohen

Circulation manager: Hugh Quinn

Reprints: T.M. Egan

Publisher: C.C. Randolph

Electronics: August 24, 1964, Vol. 37, No. 23

Printed at 99 North Broadway, Albany, N.Y.
Second class postage paid at Albany, N.Y.

Subscriptions are solicited only from those actively engaged in the field of the publication. Position and company connection must be indicated on orders. Subscription prices: United States and Possessions and Canada, \$6.00 one year, \$9.00 two years, \$12.00 three years. All other countries \$20.00 one year. Single copies, United States and Possessions and Canada 75¢. Single copies all other countries \$1.50.

Published every other Monday by McGraw-Hill Inc. 330 West 42nd Street, New York, N.Y. 10036. Founder: James H. McGraw, 1860-1948.

Subscribers: The Publisher, upon written request to our New York office from any subscriber, agrees to refund that part of the subscription price applying to copies not yet mailed. Please send change of address notices, subscription orders or complaints to Fulfillment Manager, Electronics, at the address below. Change of address notices should provide old as well as new address, including postal zone number if any. If possible, attach address label from recent issue. Allow one month for change to become effective.

Postmaster: Please send Form 3579 to Fulfillment Manager, Electronics, P.O. Box 430, Hightstown, New Jersey 08520

Readers Comment

Patent lawyers

The complaint of George E. Row [July 27, p. 6] directed toward patent attorneys ignores an important factor inherent in modern technology and scientific achievement.

It seems evident that any intellectual endeavor toward solving a recurrent problem is eventually pursued by those who enjoy the challenge and work, resulting in the training and creation of experts who are then better equipped to solve future problems in the field of endeavor. Thus, in retrospect, it appears that the government previously chose to train technically educated examiners and developed rules of procedure to uniformly administer the patent laws. And quite logically, the inventing public responded by using patent attorneys to file applications handled in a quasi-adversary proceeding to have an equal footing with the examiner.

Mr. Row's implication seems to be that patent attorneys conspired to create a problem and then solved it themselves, whereas the profession was established in response to a need for solving specialized problems, and simply indicates that one can no longer be a jack-of-all-trades and master also.

As a private practitioner representing many individuals, I feel that Mr. Row has overlooked the fact that the cost of obtaining all the legal coverage to which an invention is entitled may mean the difference between success and failure in obtaining the full economic advantages which the invention should justify.

Donald Gunn

Hayden & Pravel
Houston

Negative resistance

My note in your Comment column [Apr. 26, 1963, p. 4] on Negative Resistance elicited written responses that continued for nearly six months. From them, it is evident that a basic, fundamental concept like "resistance" does not have a single, exact, universally ac-

New from Sprague!

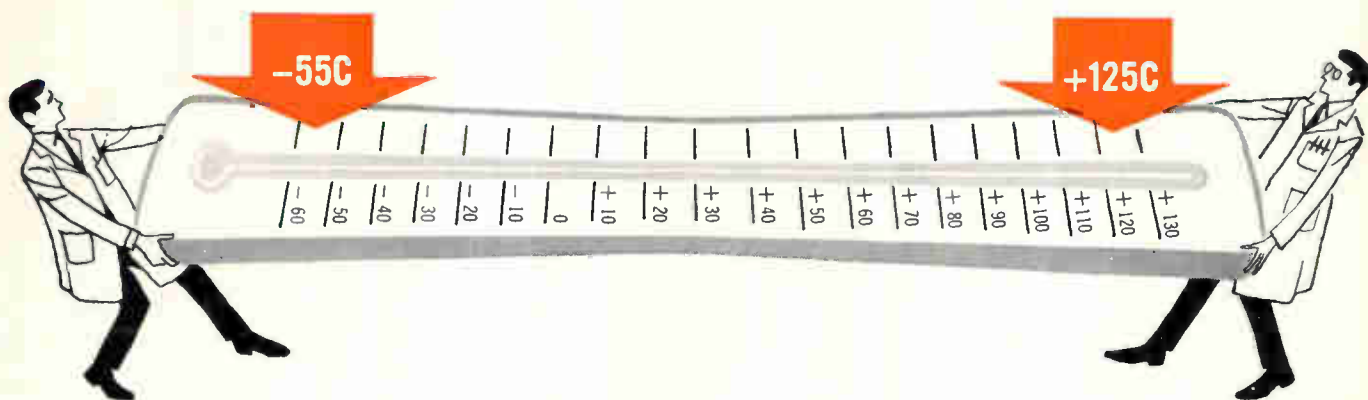

E-X-T-E-N-D-E-D T-E-M-P-E-R-A-T-U-R-E R-A-N-G-E

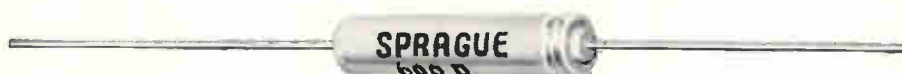

TYPE 600D **EXTRALYTIC*** ALUMINUM ELECTROLYTIC CAPACITORS

VOLTAGE RATINGS TO 150 VDC, unlike other so-called "wide temperature range" aluminum electrolytics with compromise voltage ratings only to 60 volts.

CAPACITANCE STABILITY over entire temperature range. Even at -55°C , capacitance drop is very small.

OPERATING AND SHELF LIFE comparable to or better than that of foil tantalum capacitors.

LESS EXPENSIVE than foil tantalum capacitors, yet meet electrical requirements of proposed military specification MIL-C-39018.

SMALLER AND LIGHTER than tantalum capacitors in equivalent capacitance values and voltage ratings.



For complete technical data, write for Engineering Bulletin 3455 to Technical Literature Service, Sprague Electric Company, 35 Marshall Street, North Adams, Massachusetts.

*TRADEMARK

SPRAGUE COMPONENTS

CAPACITORS
TRANSISTORS
RESISTORS
INTEGRATED CIRCUITS
THIN-FILM MICROCIRCUITS

PULSE TRANSFORMERS
INTERFERENCE FILTERS
PULSE-FORMING NETWORKS
TOROIDAL INDUCTORS
ELECTRIC WAVE FILTERS

CERAMIC-BASE PRINTED NETWORKS
PACKAGED COMPONENT ASSEMBLIES
BOBBIN and TAPE WOUND MAGNETIC CORES
SILICON RECTIFIER GATE CONTROLS
FUNCTIONAL DIGITAL CIRCUITS



*Sprague' and '®' are registered trademarks of the Sprague Electric Co.

db db db db
FOR MAXIMUM GAIN
 \$\$\$
AT MINIMUM COST...

You Can't Beat
MADT*
Communications
Transistors

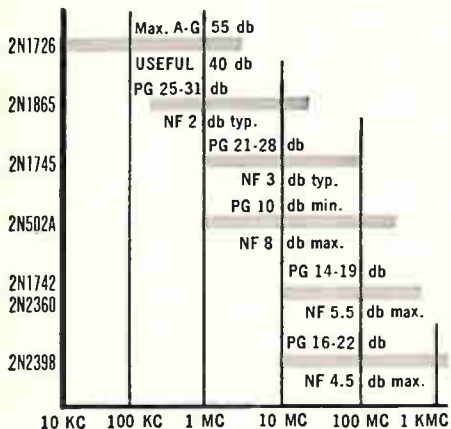

MADT Communications Transistors are now available in production quantities from Sprague Electric. For complete information on these and other MADT High-Performance Amplifier Transistors, write to Technical Literature Service, Sprague Electric Co., 35 Marshall St., North Adams, Massachusetts.

*Trademark of Philco Corp.



"Sprague" and "2" are registered trademarks of the Sprague Electric Co.
GET THE FULL STORY AT WESCON BOOTHS
 141 THRU 146

cepted meaning among the scientific and technical people typified by your many readers. This surprised me. It seems to me that "resistance" should mean the same thing to all these folks.

In an effort to move toward this goal, I offer the following as a start. Let the letter symbol, I, represent the current, in amperes, flowing at any instant, t , through an object (wire, meter, vacuum tube, spark gap, etc.). Let V represent the difference between the potential V_1 at the point where the current enters the object, and the potential V_2 at the point where the current leaves the object, in volts, V being positive when V_1 is greater than V_2 . Both I and V may be variable, as in the case of alternating current or an oscillatory discharge across a spark gap. Then I propose that the resistance of the object under consideration, in ohms, be defined as V/I .

There is nothing "static" about this. In the case of a spark gap, current I may be 10^{-3} ampere and V may be 30,000 volts at t , ($R = 3 \times 10^7$ ohms;) a few microseconds later, current I may be 1,000 amperes and V may be 500 volts ($R = \frac{1}{2}$ ohm); such a quantity is certainly dynamic, isn't it? It is also "variational."

Then what shall we say about dV/dI , which some electronics experts persist in calling the "resistance" of, let us say, a vacuum tube, between cathode and plate ("plate resistance")? Any competent mathematician will tell you that V/I and dV/dI are not the same thing; in fact, V/I could be + 250 at the same instant that dV/dI is -10 for the same object (perhaps a transistor or triode). Therefore we must not call them both the same thing. If V/I is resistance, then dV/dI is something else. Of course dV is in volts and dI is in amperes, so dV/dI may be expressed in ohms, but it is not resistance.

As another example, impedance is usually expressed in ohms, but no competent engineer would claim that impedance and resistance are synonymous when alternating current flows in a circuit having inductance or capacitance.

So, even though dV/dI may be measured in ohms, it is not resistance. Some call it "dynamic resistance," or "variational resist-

ance," but I believe it would be preferable to give it another name, such as "obstructance." Then one could talk about negative obstructance, or metastable resistance. But not negative resistance.

Wayne T. Sproull
 Western Precipitation division
 Joy Manufacturing Co.
 Los Angeles

Disaster-proof alarm

I am surprised that no disaster-proof alarm in the spirit of Conelrad and NEAR [May 18, p. 44], using telephone lines, is being considered. Telephone lines reach everywhere and have only a capacity load to ground. Telephone lines make excellent tone distributors with ground return. Opening the ground connection of the exchange's central battery supplies, and inserting a suitable tone generator, would accomplish this transmission.

The practical difficulties are small. If the system were to be used only for emergency signaling, any unbalanced tone across the phone lines that might be heard during a conversation, would hardly be important. Selective high-impedance receivers are available that are not sensitive to power-line frequencies. The actual alarm (shrieking device) could be powered from the phone line.

P. Hirschmann
 Haifa, Israel

■ Even if reader Hirschmann's system were feasible, it would require installation of an alarm receiver on every telephone line. If the government were to pay for this (and who else?) it might be cheaper to give each household a cheap receiver fixed-tuned to the strongest 24-hour broadcast station in the area and furnish free batteries to those who have no plug-in power.

Varactors

In the July 13 article, "Charge storage varactors boost harmonic power," capacitors 1 and 2 are interchanged in the 50 to 150 Mc tripler test-circuit schematic on page 46.

Gerald Schaffner
 Motorola, Inc.
 Semiconductor Products division
 Phoenix, Ariz.

This is what
diodes looked like



before
Unitrodes



REMEMBER?

Remember the fragile whisker so easily burned out? The cavity where, in time, contaminants were sure to degrade reverse characteristics eventually? The delicate construction that was likely to fail under thermal and mechanical stress? The limited service life even under the best of conditions?

Never again.

Unitrodes have changed all that with an entirely new approach to diode design. The silicon wafer is high-temperature bonded *directly* between the terminal pins, and a hard glass sleeve is fused to *all* exposed silicon. Result: a void-free junction that can't be contaminated. Broad current-carrying surfaces that can withstand 10 watt power overloads — continuously — with no after-effect. A one-piece unit indifferent to shock, vibration,

acceleration . . . unperturbed by thermal shock or cycling from -195°C to $+300^{\circ}\text{C}$.

And this small:



Naturally you'd expect performance like this to cost a bit more, and it does. Mainly because of rigid manufacturing standards and because *every* Unitrode[®] diode is 100% final tested. But if you're working in high reliability, you owe it to yourself to watch your Unitrode representative's 15-minute demonstration. We'd be happy to send him around with our entire line of diffused 3 ampere silicon diodes, fast switching rectifiers, 3 watt zeners, high voltage stacks and bridge assemblies. We never cease to be amazed ourselves. Write or call . . . UNITRODE CORPORATION, 580 Pleasant Street, Watertown, Massachusetts 02172. Tel: (617) 926-0404, TWX: (617) 924-5857.

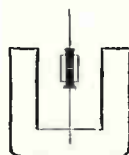

UNITRODE

[TETRODES]

NEW from **MACHLETT** an expanding line of tetrodes

Tube Type	Power Level RF Amplifier or Oscillator	Type of Cooling
ML-8170/4CX5000A	15 kw	Forced-Air
ML-8281/4CX15000A	35 kw	Forced-Air
ML-8545	300 kw	Vapor
ML-8546	300 kw	Water

**See them at WESCON
Booth 335-336**

For details, write: The Machlett Laboratories, Inc.,
Springdale, Connecticut. An affiliate of Raytheon Company.



People

If the armed forces accelerate their switch to transistorized equipment in the next few years, that multi-billion - dollar decision will be made by **Thomas P. Cheatham Jr.**, whose new job at the Defense Department bears the title of Deputy Director of Defense Research and Engineering for Tactical Warfare Programs.



The advisability of converting from vacuum-tube to transistorized equipment is not a simple problem, Cheatham says. Sometimes transistorized equipment doesn't hold up under all operating conditions.

There's also the problem of repair and maintenance. The man who can change a tube is not always able to repair sophisticated transistorized equipment.

Cheatham must also make sure that equipment being developed now will meet future needs up to five years from now. This requires a continual reassessment.

Cheatham, 41 years old, comes to the government from a vice presidency at Litton Industries, Inc. He has also been director of research and general manager of the applied science division for Melpar, Inc., consultant to the Norwegian Government, and served several research and teaching stints—at Boston University, Harvard University and at the Massachusetts Institute of Technology, where he received his master's and doctorate degrees in electrical engineering. He succeeds John L. McLucas, who held the post from May, 1962, until this summer when he became Assistant Secretary General for Scientific Affairs, North Atlantic Treaty Organization.

An outdoor sportsman, Cheatham expects to have little time for recreation. "I've just put my golf bag away for two years," he says.

What is his first impression of his new job? "I find it exhilarating," he says. "It's interesting to be on the other side of the fence."



Open along dotted line...

swing the tail assembly aside, and put in that out-size or super-heavy shipment that everyone else turned down. It's simple for a Flying Tigers' Swingtail-44, but impossible for a jet freighter.

If you've ever tried to ship a piece of freight longer than 10 feet, you know what we're talking about. The jet freighters, with their pre-palletized loading and rigid size limitations, just aren't made to handle outside freight.

The Swingtail-44, with its straight-in loading capabilities, is still the most modern prop-jet airplane in commercial operation built specifically for hauling freight. It takes on cargo from breadbox-size up to 84 feet long. That's about what you can get into two railroad boxcars.

Next time your shipment is turned down, call the airfreight specialist—Flying Tigers. We're listed in the Yellow Pages under "Airfreight Service." And we do mean service.

the airfreight specialist

FLYING TIGER LINE



Obviously from Sprague!



Sprague Filmistor[®] Resistors equal or surpass precision wirewounds in accuracy... stability... reliability... yet they're smaller in size!

Other key features include:

- Low, controlled temperature coefficients.
- Low inherent noise level.
- Negligible voltage coefficient of resistance.
- Tough molded shell for positive protection against mechanical damage and humidity.
- Available in 5 wattage ratings— $1/10$, $1/8$, $1/4$, $1/2$, and 1 watt.

For complete technical data, write for *Engineering Bulletin 7025B to Technical Literature Service, Sprague Electric Co., 35 Marshall St., North Adams, Mass.*



Sprague and *®* are registered trademarks of the Sprague Electric Co.

Meetings

AIAA/ION Astrodynamics, Guidance and Control Conference, American Institute of Aeronautics and Astronautics, Institute of Navigation; University of California, Los Angeles, Aug. 24-26.

Association for Computing Machinery Annual Conference, ACM; Sheraton Hotel, Philadelphia, Aug. 25-27.

WESCON 1964, 6th Region IEEE, Western Electronic Manufacturers Assoc.; Los Angeles Sports Arena and Hollywood Park, Los Angeles, Aug. 25-28.

International Conference on the Physics of Type 11 Superconductivity, Western Reserve University, Cleveland, Ohio, Aug. 28-29.

International Conference on Microwaves, Circuit Theory and Information Theory, Inst. Electrical Comm. Engrs. of Japan; Akasaka Prince Hotel, Tokyo, Sept. 7-11.

International Exhibition of Industrial Electronics, Swiss Industries Fair; Basel, Switzerland, Sept. 7-11.

International Convention on Military Electronics (MIL-E-CON-8), IEEE; Shoreham Hotel, Washington, Sept. 14-16.

Operations Research Society Annual International Meeting, Western Section of ORSA, ORSJ, University of Hawaii; Sheraton Meeting House and Princess Kaiulani Hotel, Waikiki (Honolulu), Sept. 14-18.

Ceramic-To-Metal Session, American Ceramic Society, Philadelphia, Sept. 17.

Annual Northwest Computing Conference, Northwest Computing Association, University of Washington Computing Center; University of Washington, Seattle, Wash. Sept. 17-18.

Engineering Management Annual Conference, IEEE-ASME; Pick-Carter Hotel, Cleveland, Sept. 17-18.

AIAA Military Aircraft Systems and Technology Meeting, (Secret), AIAA, USAF, and BuWeps; NASA-Langley Research Center, Va., Sept. 21-23.

AE-4 Electromagnetic Compatibility Conference, SAE; McDonnell Aircraft Corp., St. Louis, Mo., Sept. 22-23.

Profession Technical Group on Antennas and Propagation International Symposium, PTGAP/IEEE; International Hotel, John F. Kennedy International Airport, N.Y., Sept. 22-24.

Annual Communications Conference, Cedar Rapids Section of IEEE; Hotel Roosevelt, Cedar Rapids, Iowa, Sept. 25-26.

Canadian IEEE Communications Symposium, Canadian Region IEEE; Queen Elizabeth Hotel, Montreal, Sept. 25-26.

Society of Motion Picture and Television Engineers Technical Conference, SMPTE, Inc.; Commodore Hotel, New York, Sept. 27-Oct. 2.

Allerton Conference on Circuit and System Theory, University of Illinois, CTG/IEEE; Allerton House, Conference Center of the University of Illinois, Monticello, Ill., Sept. 28-30.

Physics of Failure in Electronics Annual Symposium, Rome Air Development Center, IIT Research Institute; IIT Research Institute, Chicago, Sept. 29-Oct. 1.

Tube Techniques National Conference, The Advisory Group on Electron Devices; Western Union Auditorium, New York, Sept. 29-Oct. 1.

Society for Information Display National Symposium, SID; Shoreham Hotel, Washington, Oct. 1-2.

Call for papers

Aerospace Conference and Exhibit, PTGAS/IEEE; Shamrock-Hilton Hotel, Houston, Tex., June 20-24. **Sept. 30** is deadline for submitting a 250 word abstract to Thomas B. Owen, 635 20th St., Santa Monica, Calif. 90402. Papers reflecting the latest thinking on Aerospace electrical/electronic equipment and systems are welcomed.

Electronic Components Conference, IEEE, EIA; Marriott Twin Bridges Motor Hotel, Washington, May 5-7. Deadline is **Nov. 2** for submitting five copies of a 500-word abstract to Bernard Schwartz, IBM Components Div., Poughkeepsie, N. Y. 12602. Topics include resistors; capacitors; connectors; connections and interconnections; printed wiring; materials for components; thin film devices; micro-miniaturization; conductors and cables; reliability and testing techniques; inductive devices; measurements.

DEPENDABILITY TO BUILD A NAME ON

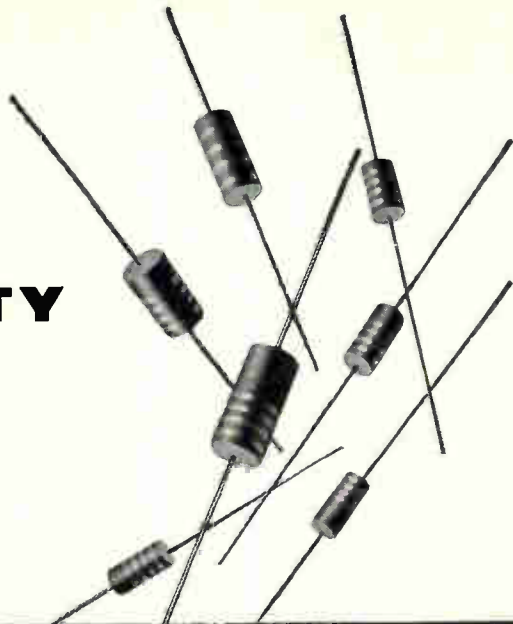

When you build precision computer systems like the UNIVAC 1050, exacting standards are a must. This new computer series developed by the UNIVAC Division of Sperry Rand Corporation brings quality, plus flexibility and economy to medium and small computing applications. Faultless performance of each component must support what has come to be expected of the whole. Reputation . . . of equipment . . . of company, rests upon accuracy and reliability. Such responsibility demands the best . . . Stackpole.

Stackpole resistors are 100% tested. Constant checks on solderability, load life and humidity-temperature characteristics insure highest quality. And each failure-proof resistor order gets to you on time, with "same day" shipment. Let us tell you more about them, write: Stackpole Carbon Company, Electric Components Division, Kane, Pa. Phone: 814-837-7000. TWX: 814-826-4808.



STACKPOLE
ELECTRONIC COMPONENTS DIVISION

**Color coded label
on reel**

Code printed on tape



Plastic waffle hub

**Protective metal
container with
color coded label**

Filing box

**Color coded
label
on box**



**Data notation area
on reverse**

The most important tape announcement in a decade

CEC announces a new family of magnetic tape which enables instrumentation recorders to deliver their full designed potential. Each tape records at the highest applicable resolution and sensitivity—with the greatest uniformity and lowest tape and head wear obtainable. This advance in instrumentation tape has been created for CEC by Eastman Kodak Company.

Long experience in the manufacture of magnetic tape recorder/reproducers had made CEC aware of a growing need: namely, a line of magnetic instrumentation recording tapes entirely compatible with today's advanced instruments, a state-of-the-art product that would enable modern equipment to deliver its full potential. CEC asked Kodak to develop the new recording tapes. It was a challenge to the resourcefulness of any firm, but we knew that if anyone could do it, Kodak could. The rigid requirements of film production, a similar process, had given Kodak excellent experience.

After extensive research and experimentation, Eastman Kodak developed four specific instrumentation tapes for CEC which, collectively,

meet the most advanced requirements of every data recorder. To achieve them, new production techniques were combined with the ultimate in quality control—more than 100 individual tests are made on each run of tape.

CEC magnetic instrumentation tapes introduce the *only* customer-oriented method of packaging & identification. Here are some of the innovations designed with you, the user, in mind:

- Only CEC tapes come shielded in metal containers—packed in cardboard filing boxes covered with protective plastic sleeves.
- Only CEC tapes are color-coded on the box, can and reel; even coded on the *tape* itself, for instant identification.

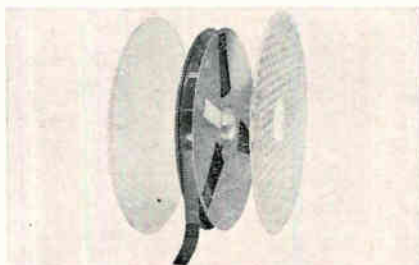

- Only CEC tapes are protected from shipping and storage damage by means of a plastic waffle hub,

thus preventing tape serration and flange deformation.

- Only CEC tapes provide a standard nomenclature for simplified identification and ordering. For example: S-1 standard, 100 kc; SX-1 standard extended, 300 kc; M-1 medium band, 600 kc; W-1 wide band, 1.5 mc.
- Only CEC tapes are so precisely differentiated that users are no longer subjected to the time-consuming burden of performance evaluation.

CEC Instrumentation Tape costs no more than the tape you are now using.

Write today for your CEC INSTRUMENTATION TAPE CHART. This special chart lists CEC tape categories, applications, and models of recorders for which each tape is recommended. Ask for CEC Chart DM-47-X1.

CEC

Technical Supplies Department

CONSOLIDATED ELECTRODYNAMICS
A SUBSIDIARY OF BELL & HOWELL/PASADENA, CALIF. 91109
INTERNATIONAL SUBSIDIARIES: WOKING, SURREY, ENGLAND
AND FRANKFURT/MAIN, GERMANY

Silicon Planar

NEW DIODE-TRANSISTOR MICROLOGIC

Epitaxial DT μ L with noise immunity greater than 1 volt

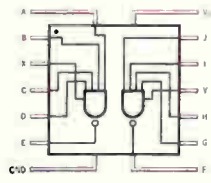
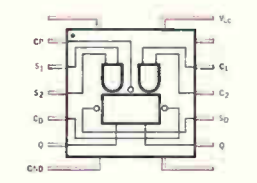
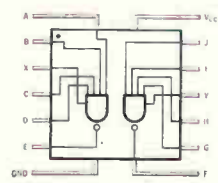
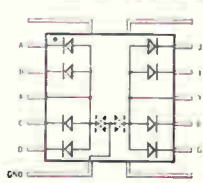
 <p>DUAL GATE—DTμL 930. Dual 4-input gate. Noise immunity 1 volt @ 25°C. Propagation delay: 25 ns. P_{dis} (@ 25°C): 5mW. Fan-out: 8 min.</p>	 <p>FLIP-FLOP—DTμL 931. RS or JK clock gated flip-flop. Noise immunity > .6V @ 25°C. Propagation delay: 50 ns. P_{dis} (@ 25°C): 20mW. Fan-out: 7 min.</p>	 <p>DUAL BUFFER—DTμL 932. Dual 4-input buffer and low impedance line driver. Noise immunity 1 volt @ 25°C. Propagation delay: 35 ns. P_{dis} (@ 25°C): 25mW. Fan-out: 25 min.</p>	 <p>GATE EXTENDER—DTμL 933. Dual-4 Diode extender to be used with Dual Gate or Buffer when increased fan-in is required.</p>
--	--	---	---

DT μ L is a Fairchild trademark.

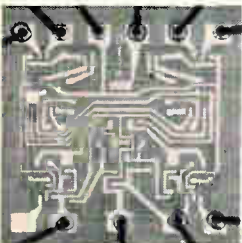

Highest DTL Noise Immunity—

Because of the epitaxial construction of Fairchild DT μ L*, the difference between threshold voltage and saturation voltage is the greatest of any diode-transistor logic. DT μ L is the only silicon Planar epitaxial DTL family now available. Worst-case noise immunity curves are contained in the data sheet.

Photo at left shows the 931 element—two flip-flops connected as a “master-slave” combination, eliminating the need for circuit delay elements.

Low Power, High Speed Combination—

DT μ L was designed to complement Fairchild’s existing digital integrated circuit line—already the widest in the industry. For diode-transistor logic, it offers the industry’s best combination of high noise immunity, low power dissipation, and low propagation delay. DT μ L elements are available in Fairchild’s new CERPAK flat ceramic package.

PRICES

DEVICES FOR FULL MILITARY TEMPERATURE RANGE (–55°C to +125°C)

	(Mixed)	(Single)		
	1-24	25-99	100-999	100-999
Dual Gate DT μ L 930	\$22.80	\$18.20	\$16.00	\$15.30
Flip-Flop DT μ L 931	30.00	24.00	21.00	20.00
Dual Buffer DT μ L 932	26.80	21.40	18.75	18.00
Gate Extender DT μ L 933	10.50	8.40	7.35	7.05

AVAILABLE FROM AUTHORIZED DISTRIBUTORS

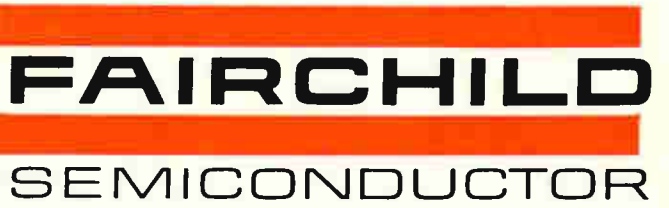

DISTRIBUTORS/STOCKING REPRESENTATIVES

AVNET Toronto, Canada, 789-2621 BOHMAN Orlando, Fla., 425-8611 CRAMER ELECTRONICS Newton, Mass., WO 9-7700 DART SALES Clarence, N. Y., 874-1212; Syracuse, N. Y., GL 4-9257 DENNY-HAMILTON San Diego, Cal., 279-2421 EASTERN SEMICONDUCTOR Syracuse, N. Y., 454-9247 E. C. ELECTRONIC SALES Minneapolis, Minn., 888-0102 ENSCO Cedar Rapids, Ia., 366-1591; Kansas City, Mo., EM 3-6000; St. Louis, Mo., PA 6-2233 HAMILTON Phoenix, Ariz., 272-2601; Culver City, Cal., 870-0236; Palo Alto, Cal., 321-7541; Seattle, Wash., 282-3836 HYER Englewood, Colo., 761-0754; Albuquerque, N. Mex., 268-6744; Salt Lake City, Utah, 322-5849 MARSHALL Scottsdale, Ariz., 946-4276; San Marino, Cal., MU 1-3292; San Diego, Cal., RR 8-6350; Redwood City, Cal., EM 6-8214 NORVELL Dallas, Tex., FL 7-6451; Houston, Tex., MO 5-0558 POWELL Beltsville, Md., 474-1030; Philadelphia, Pa., 724-1900 SCHLEY Watertown, Mass., WA 6-0235 SCHWEBER Westbury, L. I., N. Y., ED 4-7474 SEMICONDUCTOR SPECIALISTS Chicago, Ill., 622-8860; Minneapolis, Minn., UN 6-3435 SHERIDAN Cincinnati, Ohio, 761-5432; Cleveland, Ohio, 884-2001; Dayton, Ohio, 277-8911 SOLID STATE Chicago, Ill., 889-8033 STANDARD Buffalo, N. Y., TT 3-5000 TAYLOR Baldwin, L. I., N. Y., BA 3-8000 TEC-SEL Huntsville, Ala., 534-7304 VALLEY Winter Park, Fla., 647-1216; Baltimore, Md., NO 8-4900; Cherry Hill, N. J., NO 2-9337.

PLANAR: A PATENTED FAIRCHILD PROCESS FAIRCHILD SEMICONDUCTOR/A DIVISION OF FAIRCHILD CAMERA AND INSTRUMENT CORPORATION/313 FAIRCHILD DR., MOUNTAIN VIEW, CALIF./962-5011/TWX: 910-379-6435

Editorial

New road for the military

The military is still the electronics industry's biggest customer though it is not buying as much this year as last year and will be buying less and less in the years ahead.

The pattern of procurement is changing—there's less opportunity to snag a part of a giant contract because there are fewer big projects. But there are many more small projects. A company's chances to win a contract to build an ingenious solution to a small specific problem are better than ever.

What's needed is some old-fashioned product planning. In a commercial electronics company, one group of engineers continually scrutinizes the company's markets to identify customers' requirements. Then it recommends and designs new products to satisfy these needs. For a military electronics supplier today, product planning is an intelligence job—spying out potential contracts, learning what concept the sponsoring agency favors, and even finding out if the contracting officer has any pet technological fads. It is more cloak-and-dagger than engineering.

At last, the Pentagon shows signs of recognizing that all this spywork is ridiculous, and that even the military can benefit from some honest product planning. Defense Department planners are trying to encourage electronics companies to study military problems on their own. If a company can spot a problem that needs solving, and will invest some of its own money and talent to develop the solution, it stands a good chance of selling its solution to the military.

Naturally the military has a responsibility if this kind of product planning is to work. A company has to be able to patent its solution and maintain its proprietary rights.

Despite what military officers may tell you, there is no dearth of good problems. This was painfully evident when the Navy went into action off North Vietnam this month. While the Navy officially expressed complete satisfaction over the way its destroyers and aircraft performed, a good engineer might wonder why our destroyers were not able to identify the number of torpedo boats in the attack and why the Navy has no fire control capable of hitting a fast-moving target like a PT boat.

Yet both these deficiencies existed. In the second engagement, the U.S. destroyers were unable to determine exactly how many boats had attacked them. The official version says "three to six." The official excuse for this vagueness is bad visibility, darkness, and severe electrical storms. But weren't electronic techniques put on the ships to give them sight beyond the capability of the human eye?

The destroyers defended themselves by blasting patterns of heavy gunfire in the general area of the attackers because they had no fire control or weapon capable of hitting such a fast moving target as a PT boat. Yet these same ships had electronic antiaircraft fire controls that could knock down jets that fly far faster.

Omissions like these in the Navy's arsenal are not deliberate. A decade ago, the Pentagon decided to put its money into strategic projects—the big counterattack projects like Polaris, Titan, and Minuteman and the giant advance electronic warning systems like the Ballistic Missile Early Warning System and the Dew Line. That meant there wasn't any money for projects of the kind we are talking about. Happily, all that is changing too. The military has its big strategic projects in place and is ready to consider some of its tactical needs.



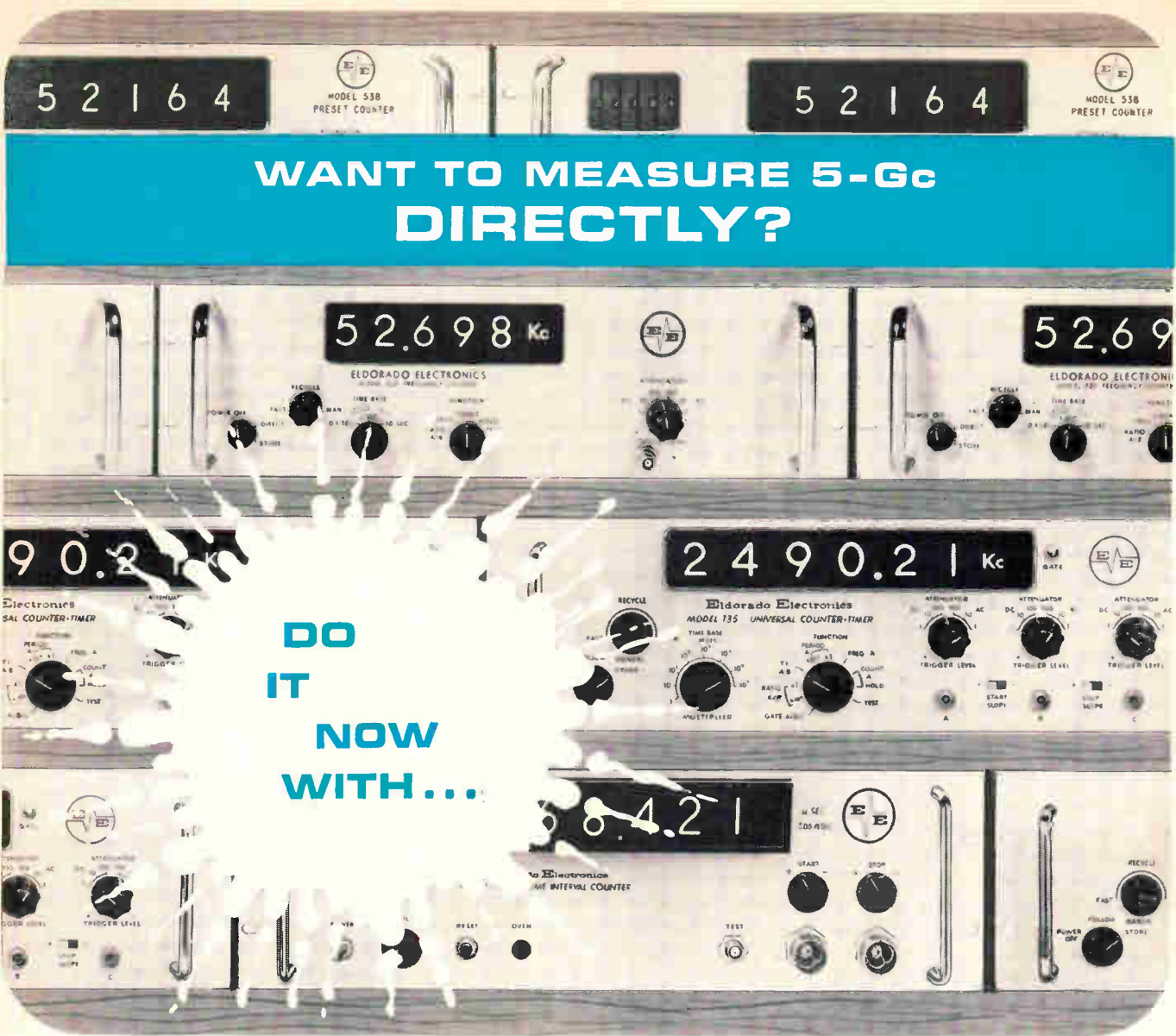

That can be a bonanza for electronics companies if they are willing to use initiative and creative engineering. It is not business that will come looking for you. The electronics companies will have to go out and fight for it.



**WANT TO MEASURE 5-Gc
DIRECTLY?**

**DO
IT
NOW
WITH...**

ELDORADO'S NEW MODEL 950 FREQUENCY COUNTER

-  **DIRECT COUNTING** without prescaling, heterodyning, or transfer oscillators!
-  **COUNTING RANGE:** 500 Mc to 5-Gc
-  **SENSITIVITY:** 50 mv rms
-  **INPUT IMPEDANCE:** 50 ohms

WESCON PREVIEW...

MODEL 950 WILL BE ON DISPLAY AND DEMONSTRATED IN OUR SUITE AT THE LOS ANGELES BILTMORE HOTEL, AUG. 24 THRU AUG. 28—HOURS, NOON TO 8:00 P. M. OR BY APPOINTMENT.



ELDORADO ELECTRONICS

601 CHALOMAR ROAD • CONCORD, CALIFORNIA, U. S. A.
Telephone (415) 686-4200

Electronics Newsletter

August 24, 1964

Next: GaAs laser without a junction?

The possibility of making semiconductor lasers with higher powers, using bulk materials without junctions, has been opened up by researchers at the Massachusetts Institute of Technology.

They have produced apparent laser action in a chunk of gallium arsenide by exciting it with a ruby laser. Up to now, lasing has been confined to a narrow junction between n- and p-type material.

J. J. Schlickman of MIT's Lincoln Laboratory has observed what appears to be a narrowing of the light spectrum emitted from a 1-by-3-millimeter piece of p-type gallium arsenide excited by a 3-by-0.25-mil ruby rod. The gallium arsenide used had a 10^{19} concentration of zinc impurities per cubic centimeter.

Working at 77°K, Schlickman focused the face of the ruby onto the highly polished gallium arsenide and monitored the surface and end emission. He noted that when the average input from the ruby was 10^4 watts per square centimeter, the end emission fell from 132 angstroms half-width to 80 angstroms.

Now the researchers are trying to get similar effects with n-type bulk materials.

Telcan developers in financial trouble

A developer of a home television recorder that last year surprised the industry with its low price of \$177 went into receivership in Britain this month.

The Nottingham Electronic Valve Co. never sold Telcan, a system that tapes audio and video for later playback.

Telcan's closest competitor is a device developed by the Winston Research Corp., a subsidiary of the Fairchild Camera & Instrument Corp. Winston says its device will be sold for \$300 to \$500.

Meanwhile Cinerama, Inc., the United States company that owns 51% of the invention through Cinerama Telcan, Inc., a joint venture with the Nottingham concern, said that it is continuing negotiations with an American manufacturer and still hopes to market Telcan by the fall of 1965.

The Telcan system uses a two-track, 9,000-foot tape spool that operates at 120 inches a second and records a half-hour program.

When the system was introduced, most industry observers were skeptical that such a machine could be produced and sold for \$177. Others, who saw a demonstration, thought the company might have made some technical breakthrough.

Representatives of Cinerama, which was reported to have paid more than \$1 million for its share in the joint company, flew to England last week for discussions, but would not disclose what took place.

Dilemma for Sylvania

Right after Sylvania Electric Products, Inc. sold its TR 500A Forward Air Control Pack (now designated AN/PRC-71) to the Air Force Special Air Warfare Forces (air commandos), improved technology at the Camden, N.J. plant of the Radio Corp. of America threatened Sylvania's chances for future orders.

The Sylvania unit is compact, weighs 51 pounds, and despite its \$15,000 price tag, is cheaper than the four separate, heavier units it will

Electronics Newsletter

replace; the new unit provides four transceivers: vhf/f-m, vhf/a-m, h-f/sab and uhf/a-m. It has been tried out in Thailand and South Vietnam.

Meanwhile, RCA has quietly come up with specifications for a similar unit that would be even lighter. It would weigh 30 pounds.

Rome Air Development Center likes the idea of a lighter unit and has asked the Air Force for authority to write performance requirements for one still lighter than the unit RCA proposes—one that weighs 20 to 25 pounds. If the Air Force agrees, Sylvania will have to scrap its 51-pound unit and start competing for the lighter one.

New way to cool hot tubes

A Czechoslovakian company has developed a way to cast aluminum alloy radiators for forced air cooling directly onto the anode of high-power tubes. The anode and radiator can then be processed as an integral unit. Up to now, brazed copper radiators that are heavy, expensive and easily damaged by overheating have been soldered to the anode.

At the Tesla Works at Roznov, tubes of up to 20-kw heat dissipation have been produced with the new process, and the company expects to produce 50-kw tubes shortly.

The use of aluminum reduces the weight of the radiator and eliminates oxidation during anode degassing. The process also requires lower flow rates for the cooling air and permits higher operating temperatures than soldering.

Oven business warming up?

The cost of microwave ovens may be slashed in half because of a new tube developed by the Amperex Electronic Corp. The one-kilowatt magnetron is 55% efficient, and is cooled by air rather than water. It, and the simple power supply and circuitry that go with it, should bring the cost of home microwave ovens down to about \$400 instead of the \$800 now charged for the cheapest microwave oven.

Amperex believes its new tube will create the long-delayed boom in microwave ovens for home use and predicts a \$35-million market by 1967.

Instead of an electromagnet to provide a field for the 20-cavity magnetron, Amperex uses a permanent magnet. Wallace Hickman, engineering section head of the company's microwave heating group says, "Operating the tube at 200°C instead of the usual 100°C permits a smaller design and use of air rather than water cooling. The main technical advance permitting this is the use of high temperature permanent magnets of the Ticonal Gg type, which retain magnetic strength at high temperatures."

The magnetron has a short heating time, obtained through use of a special thoriated tungsten filament, to eliminate the time delay components usually needed to control application of anode voltage. Other techniques used to reduce the tube's price are elimination of complex mechanical parts, use of self-jigging during assembly, and multiple use of common parts.

The mechanically rotating blade, or stirrer, used in microwave ovens to break up standing waves that cause cold spots in the oven's cooking cavity, is not required in the firm's recommended oven design. Instead, a broad-band magnetron-to-cavity coupling is used to eliminate standing waves.

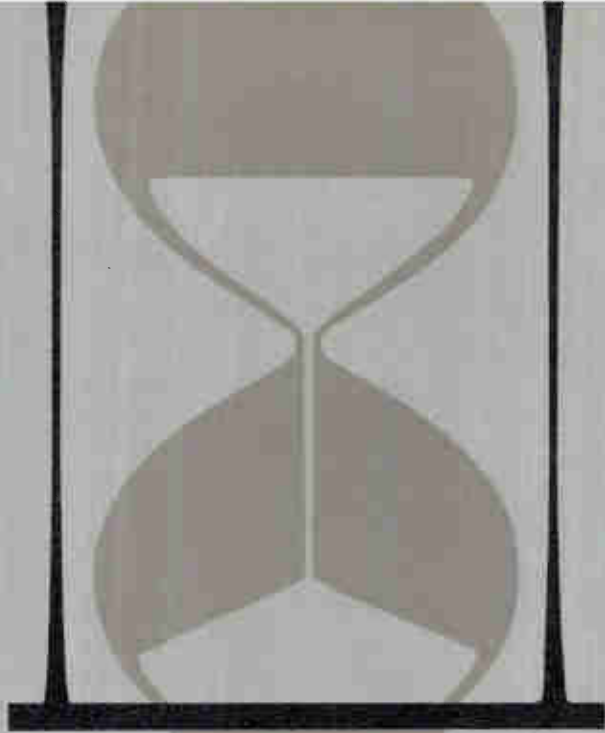

**Clare
mercury-wetted
contact relays**

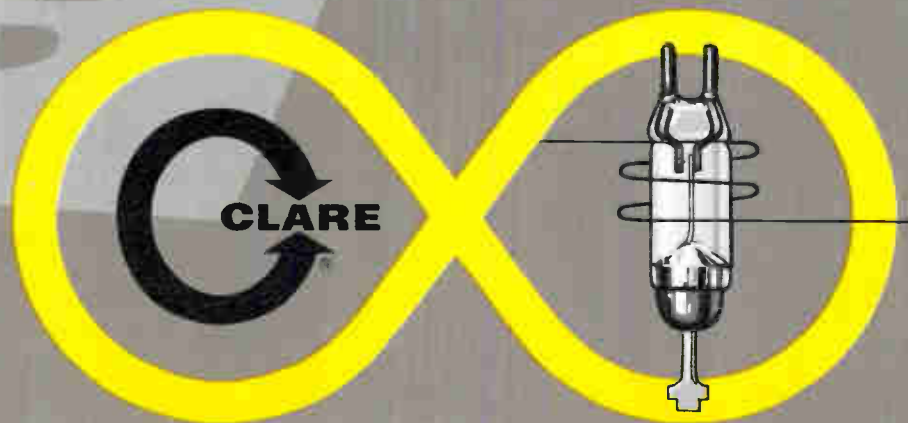

CLARE

mercury-wetted contact relays

FAST • SENSITIVE • BRIDGING OR NON-BRIDGING

no contact bounce • low, consistent contact resistance
versatile contact load capabilities • high power gain



For Wired Assemblies

Clare Mercury-Wetted Contact Relays are available with plug-in or solder terminals or AN connectors in contact multiples from one to four poles.

For Printed Circuits

Clare Mercury-Wetted Contact Relays are available as modules for mounting on printed circuit boards. Choice of enclosures: molded plastic, or steel for magnetic shielding.

As Complete Printed Circuit Board Assemblies

Clare designs and produces printed board assemblies from your circuits or "black box" assemblies.

MECHANICAL AND ELECTRICAL CHARACTERISTICS OF MERCURY-WETTED CONTACT RELAYS

Relay Type	Contact Arrangements (Note 1)	Contact Ratings	Maximum Single-Wound Coil Resistances (ohms) (Note 5)	Maximum Coil Power (Watts)	Nominal Operate Time at Maximum Coil Power (Milliseconds)	Just Operate Sensitivity (Milliwatts)	Connector Type
FOR WIRED ASSEMBLIES (Steel Cylindrical Enclosures)							
HG-1000	1 Form D	Note 2	25,000	2	3	250	8-Pin Octal
HGP-1000	1 Form D	Note 2	25,000	2	3	35-single side stable 7-bi-stable	8-Pin Octal
HG2A-1000	2 Form D	Note 2	45,000	3	4	620	8 or 11-Pin Octal, Solder-Hooks or AN Connector
HG 3A-1000	3 Form D	Note 2	45,000	3	4.5	620	11-Pin Octal, Solder-Hooks or AN Connector
HG 4A-1000	4 Form D	Note 2	58,000	3.5	5.5	780	14 or 20-Pin Miniature, Solder Hooks or AN Connector
HGS-1000	1 Form D	Note 3	25,000	2	1.3	5-single side stable 2.5-bi-stable	8-Pin Octal
HGS-5000	1 Form C	Note 3	25,000	2	1.3	5-single side stable 2.5-bi-stable	8-Pin Octal
HGSS-1000	1 Form D	Note 3	14,000	2	1.3	10-single side stable 5-bi-stable	8-Pin Octal (Note 4)
HGSS-5000	1 Form C	Note 3	14,000	2	1.3	10-single side stable 5-bi-stable	8-Pin Octal (Note 4)
HGSL-1000	1 Form D	Note 3	5,000	1.75	1.5-single side stable 1.2-bi-stable	115-single side stable 25-bi-stable	7-Pin Miniature
HGSL-5000	1 Form C	Note 3	5,000	1.75	1.5-single side stable 1.2-bi-stable	115-single side stable 25-bi-stable	7-Pin Miniature
FOR PRINTED CIRCUIT BOARD MOUNTING (Rectangular Steel or Molded Nylon Enclosures)							
HGM-1000	1 Form D	Note 2	4,300	2	4	550	Printed Circuit Pin Terminals on .10" Grid Spacing
HGPM-1000	1 Form D	Note 2	4,300	2	4	75-single side stable 20-bi-stable	
HGSM-1000	1 Form D	Note 3	8,000	1.75	1.5-single side stable 1.2-bi-stable	115-single side stable 25-bi-stable	
HGSM-5000	1 Form C	Note 3	8,000	1.75	1.5-single side stable 1.2-bi-stable	115-single side stable 25-bi-stable	
HG2M-1000	2 Form D	Note 2	15,000	2	4.5	600	

printed circuit board assemblies
Relays used have characteristics of HGM, HGPM or HGSM Relays. Number of poles limited only by dimensions of board.

notes: 1. Form D-SPDT-Make before break; Form C-SPDT-Break before make.
2. 5 amperes (max), 500 volts (max), 250 va (max), with required contact protection.
3. 2 amperes (max), 500 volts (max), 100 va (max), with required contact protection.
4. Short version of preceding HGS assemblies. 5. Multiple-wound coils also available.

Isolated contacts
for analog or
digital systems
...infinite life



Use the Reader Service Card / Complete data, circle 285. Concise story, circle 286.

C. P. CLARE & CO., GROUP 8N8, 3101 PRATT BLVD., CHICAGO, ILLINOIS 60645

a miniature eye for the '64 Tokyo Olympics



the

HITACHI
7038, 7735-A
7262-A, 8051
VIDICON

The miniature portable TV camera above will be used to cover the track and field events at the coming '64 Olympic Games in Tokyo. The eye of this micro-modular handy camera is a new half inch Vidicon. This particular model is in the experimental stage. Other types, however, are now available: 7038, 7735-A, 7262-A, 8051 plus some small Vidicons to choose from. For reliability and availability, specify a HITACHI Vidicon for your product. Write us for complete technical information and quotations.



Hitachi, Ltd.

Tokyo Japan

TOKYO, JAPAN

CABLE ADDRESS: "HITACHY" TOKYO

HITACHI SALES CORPORATION: 12715, S. Daphne Avenue, Hawthorne, Calif., U.S.A. Tel: 757-8143
333, N. Michigan Avenue, Chicago 1, Ill., U.S.A. Tel: 726-4572 4
666, 5th Avenue, New York, N.Y. 10019, U.S.A. Tel: 581-8844

HITACHI, LTD., DUESSELDORF OFFICE: Graf Adolf Strasse 37, Duesseldorf, West Germany Tel: 10846

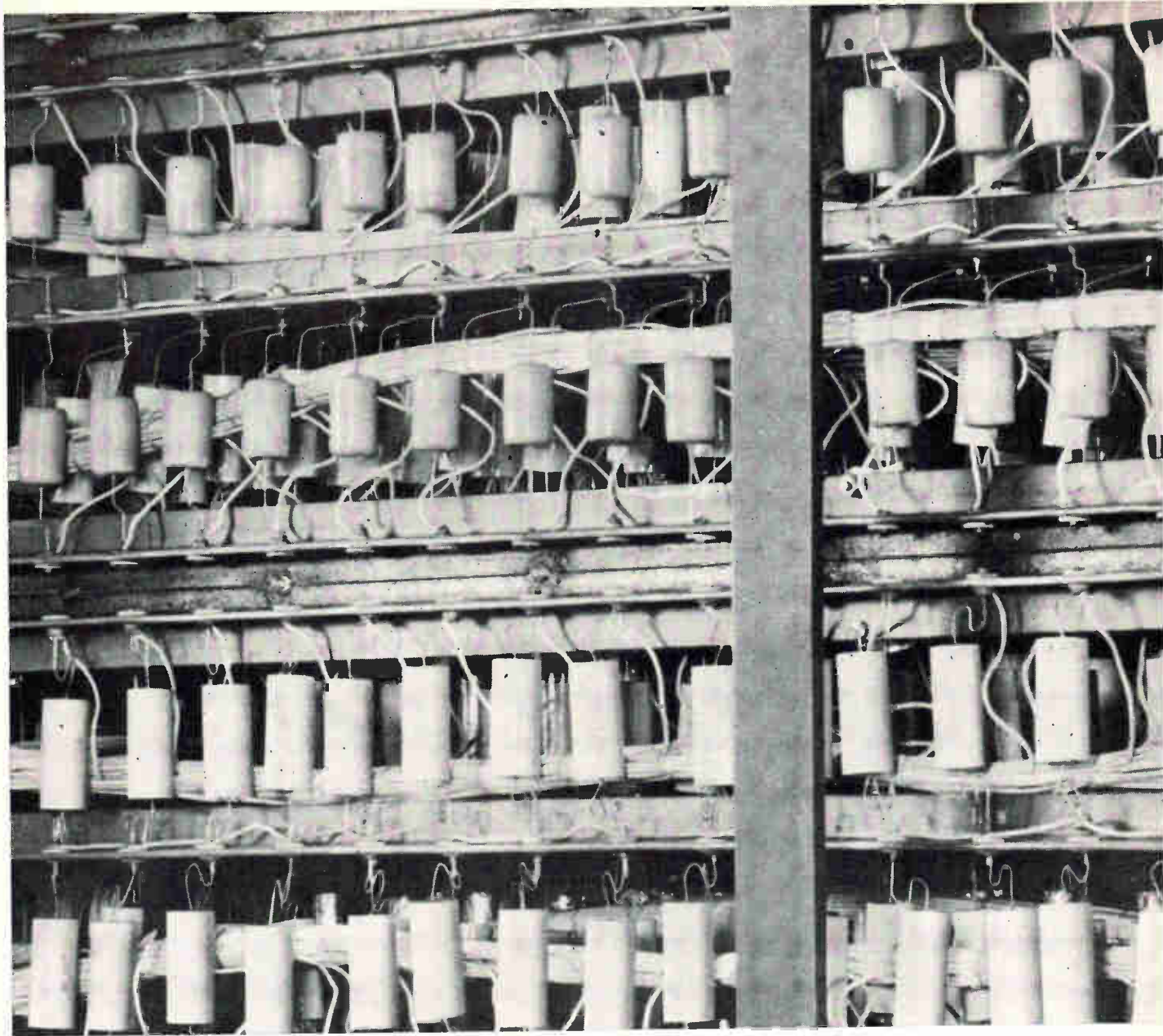

23,000,000 unit hours reliability of commercial

An extensive testing program has shown that commercial capacitors of "Mylar"* are very reliable and readily available from a number of suppliers. Capacitors from six manufacturers had a predicted life of 30 million hours between failures, based on average-size capacitors of "Mylar" used in radio and TV circuits.

Du Pont commissioned Inland Testing Laboratories of Cook Electric Company to conduct the reliability testing. The purpose of the tests was to answer these questions, "How reliable are capacitors with 'Mylar' as the dielectric?" and "Are they commercially available?"

The test involved 3,700 capacitors of varying constructions produced by 15 capacitor manufacturers from two

*Du Pont's registered trademark for its polyester film.

randomly selected lots of "Mylar", plus 4,000 laboratory-wound capacitors produced by Du Pont from 14 randomly selected lots of "Mylar". Large one-half microfarad units were used so that the area of film tested was equivalent to that of 100,000 tubular capacitors of the average size typically found in radio and TV circuits.

Twenty-three million unit hours of testing showed that very reliable capacitors of "Mylar" are commercially available. Of the commercial units tested, those from six manufacturers had an average failure rate of less than 0.03% per 1,000 hours, at rated voltage stress, of 800 V DC/mil. In terms of smaller capacitance units, usually found in radio and TV circuits, this failure rate can be extrapolated

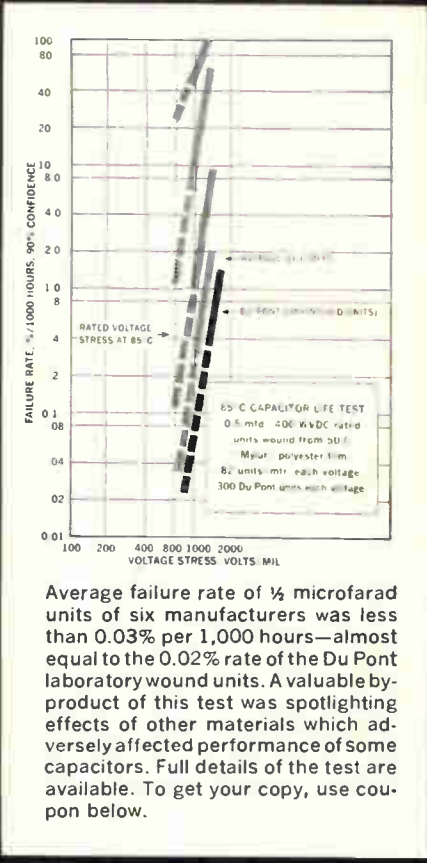
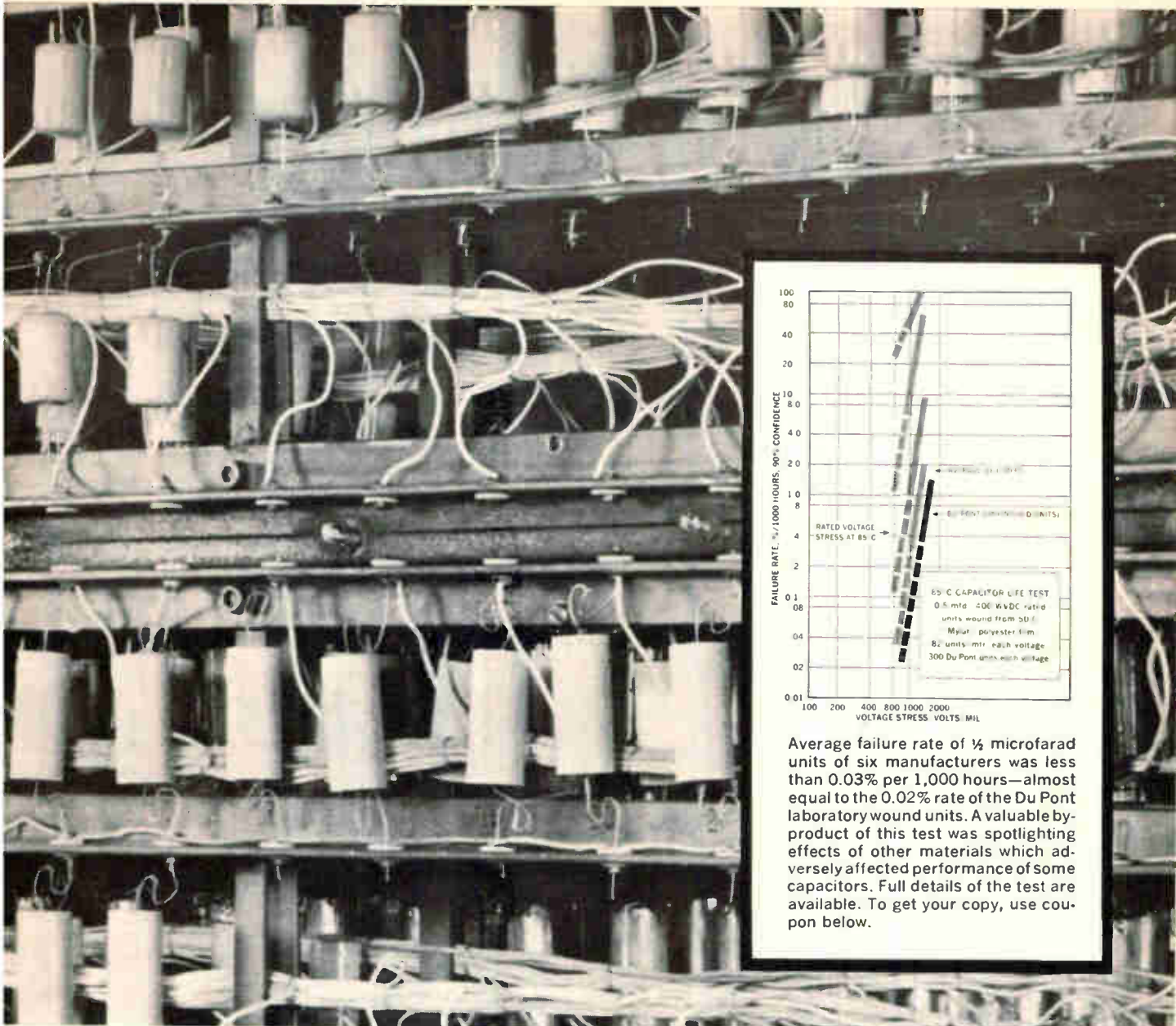

Average failure rate of 1/2 microfarad units of six manufacturers was less than 0.03% per 1,000 hours—almost equal to the 0.02% rate of the Du Pont laboratory wound units. A valuable by-product of this test was spotlighting effects of other materials which adversely affected performance of some capacitors. Full details of the test are available. To get your copy, use coupon below.

Commercial capacitors on test racks at Inland Testing Laboratories of Cook Electric Company in 23,000,000 unit-hour Du Pont reliability test.

of testing prove the capacitors of MYLAR®

to 0.003% or 30,000,000 hours between failures. When a lower voltage stress is used to obtain extra-high reliability, the failure rate can be extrapolated to less than 0.0001% per 1,000 hours.

Other significant and interesting results of the test are included in a comprehensive report which we would like to send you. It will provide data which can help you use low-cost, reliable and space-saving capacitors of "Mylar". For your copy, simply mail the coupon at right.

E. I. du Pont de Nemours & Company (Inc.)
 Film Department—N 10452 B-22
 Wilmington, Delaware 19898
 Please send me the reliability report.

Name _____ Title _____
 Company _____
 Address _____
 City _____ State _____ Zip _____
 Potential Application _____



BETTER THINGS FOR BETTER LIVING THROUGH CHEMISTRY

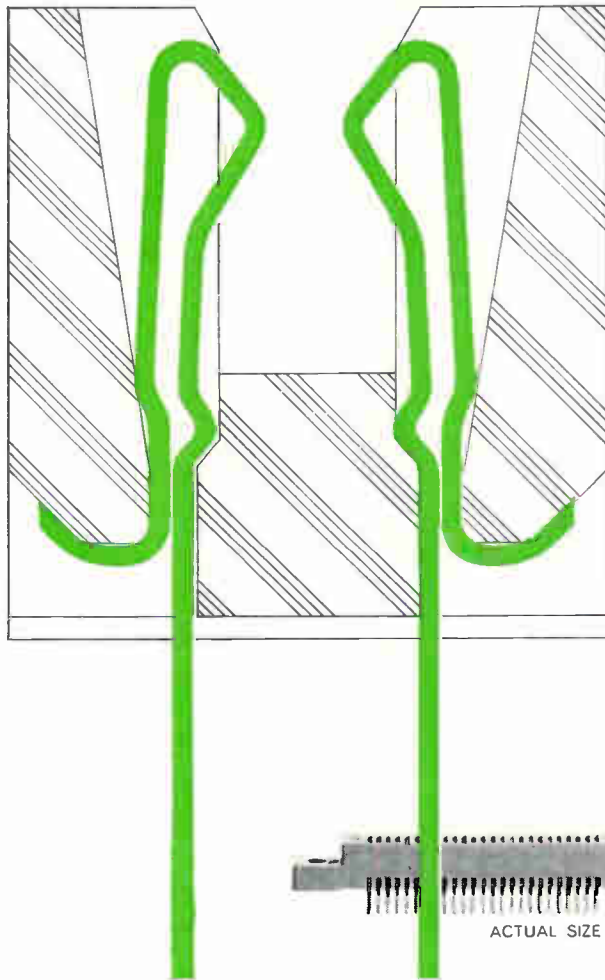

NEW SHORT-PATH CONTACTS FEATURED IN 0.050-INCH CENTERS MICROMINIATURE PC CONNECTORS

Ideal for use with integrated semiconductor or discrete component circuits, Winchester Electronics' rugged, economical PC connectors are industry's smallest.

Exclusive design wire contacts made of 50% IACS high-conductivity, beryllium copper, formed to offer exceptional resistance to vibration and shock loading, create a short, direct, low-resistance electrical path between board and backplane interconnection, rated at 1,400 volts RMS for contact-to-contact AC voltage breakdown value at sea level. This is just one of many outstanding reasons why Winchester Electronics' microminiature printed circuit connectors are more frequently being specified by space-conscious, performance-demanding microelectronics packagers.

Characteristics include: 0.050-inch centers. Flame-resistant, glass filled diallyl phthalate dielectric. Solder or weld-type terminations. Straight or offset tabs. Variety of mounting flanges. Choice of models

for 1/32 or 1/16-inch boards. Up to 50 positions. Conformance with applicable parts of MIL-C-21097B. High reliability. Precision construction.

The microminiature series is part of the most comprehensive line of standard printed circuit connectors available in the industry. It includes sizes, types and materials to meet nearly every military and industrial application. Winchester Electronics also offers complete lines of removable-crimp contact, miniature and subminiature rectangular, round, quick-disconnect/heavy duty, environmental and special-application connectors. Nationwide network of distributors, regional offices and representatives assures prompt delivery and engineering assistance. Write for new Catalog No. 364. Winchester Electronics, 19 Willard Road, Norwalk, Connecticut.

WINCHESTER ELECTRONICS
A DIVISION OF LITTON INDUSTRIES



Electronics Review

Instrumentation

Color display

A television system that scans a scene with a standard black-and-white vidicon camera and displays it in as many as six colors has been developed at the GPL division of General Precision, Inc.

The system can operate directly with a computer to provide on-line multicolor displays of print-out material. It is expected to have important applications in military command and control, ground control of spacecraft, medical electronics and wherever it is advantageous to display data in color.

The usual television display presents data as white on black or vice versa. The GPL system, called DataColor, transmits color information as shades of gray, denoted by variations in amplitude of the video signal. The color displayed is selected arbitrarily according to the brightness of the viewed subject.

How it works. The heart of DataColor is a transistorized level discriminator that converts the video into various combinations of three input signals driving the red, green and blue guns of a color-monitor cathode-ray tube. The level discriminator can be incorporated into a standard color monitor or receiver, or used as a separate unit. In GPL's feasibility model, a color receiver was modified by disconnecting the radio-frequency circuits, adding wide-band video amplifiers and connecting the breadboarded discriminator externally.

The level discriminator's response to brightness variations of the subject is designed to be continuous rather than discrete. In the continuous system, colors are generated according to an arbitrary response pattern built into the discriminator. Theoretically, infinite

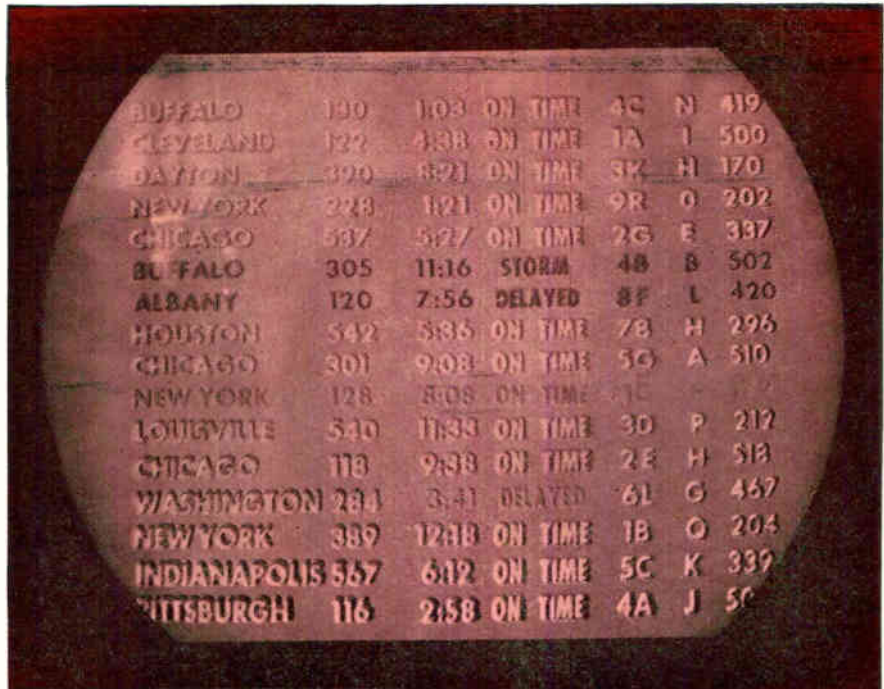

Color display shows flight schedule

colors can be produced, depending on the combinations of voltages reaching the guns. In a discrete system, the colors are arbitrarily assigned to a band of the gray scale, so that a color is produced in accordance with a range of gun voltages—for example, 0 to 0.25 v is red, 0.25 to 0.5 v is blue.

According to H. N. Oppenheimer, DataColor program manager, the continuous system has several advantages over the discrete. A slight change in voltage level, instead of resulting in an entirely incorrect color, causes only a minor shift in shading. Also, the system theoretically can produce an unlimited variety of colors, although five or six is the practical limit imposed by the human inability to discriminate slight changes in shade. GPL engineers also have found that a discrete system has unpleasant false-color outlining effects that are eliminated in the continuous system.

On-line operation. For on-line operation from a computer, the

black-and-white camera will view a flat-face cathode-ray tube through an optical system. The tube will display alphanumeric and graphic data as generated by a buffer-character generator combination driven by the computer. To display different colors on the monitor, the intensity of the data on the tube will be varied.

At present, the circuitry and limitations of the commercial shadow-mask tube of the monitor limit the system resolution to 300 tv lines, horizontally and vertically. However, GPL now has in the breadboard stage a high-resolution level discriminator and monitor, using a high-resolution shadow-mask tube made by the Radio Corp. of America, that will increase resolution to 600 tv lines.

Looking with lasers

Now lasers are helping in the study of molecules. The Perkin-Elmer Corp. is using a low-power laser as

a monochromatic light source in a new Raman spectrometer, used to analyze molecular structure. The company says use of the laser cuts the cost of the instrument in half—to about \$17,000—simplifies the optics and eliminates the special cooling techniques that were needed with mercury arc sources.

In the new spectrometer, the material being studied, usually dissolved in water, is subjected to light from the laser. The molecules emit light at the material's characteristic wavelength and intensity. When the amplitude of the generated light from the material is plotted against its wavelength, the result is called the Raman spectrum of the material. Since the spectrum varies with the wavelength of the light from the spectrometer, the light source must be stable and monochromatic.

The helium-neon continuous-wave laser used in the Perkin-Elmer spectrometer has a wavelength of 6,328 angstroms. Since this is a longer wavelength than that obtained from the mercury arc used in most other Raman spectrometers, it permits the technique to be used in more areas, such as in photoelectric materials.

Microelectronics

Fast circuit costs less

A high speed microcircuit that is cheaper than its conventional counterpart has been developed by Her-

Microelectronic element wired as part of a memory.

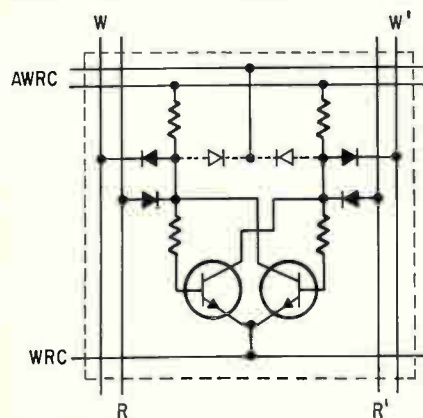

Stopper and his microcircuit

bert Stopper of the General Electric Corp. in Phoenix, Ariz.

The circuit, now in prototype, can be used as the storage element in buffer registers, accumulators and other intermediate memories where high-speed flip-flops are too expensive and where less costly ferrite core storage devices are too slow.

General Electric attributes the low cost of the circuit to a smaller number of parts and to less critical tolerances, which permit higher production yields than usual.

The performance speed can be as fast as 10 nanoseconds—the same speed as conventional storage elements consisting of gated-in and gated-out flip-flops. Although the GE microcircuit eliminates the usual gating requirements, it can provide auxiliary write-in and read-out functions when it is used in certain memory configurations.

Up to now, microcircuits have been unable to achieve such high speeds because of the slow-down effects of parasitic capacitances. Here, the capacitance effects have been eliminated by equalizing the voltage change on both sides of the capacitor, permitting faster switching action.

GE is incorporating the circuit into the design of its computers and expects it to be adopted in microcircuit logic throughout the computer industry.

Manufacturing

40 circuits at a time

A vapor deposition system that can produce up to 40 0.8-inch-square thin-film circuits at a clip is in use at the Raytheon Co.'s Missile Systems division, Bedford, Mass. The machine can deposit as many as 10 different materials on each circuit substrate during a single pump-down cycle of the vacuum system. Resistors, capacitors, connectors and protective oxide coatings in either single-layer or multilayer configurations are formed automatically.

Carter Pfaelzer, manager of the division's microelectronics facility (where circuits for several missile and radar applications are made), considers this the most versatile and automatic thin-film production machine now in use in the industry.

The machine represents an investment of several hundred thousand dollars, including research and development. But Raytheon considers the money well-spent:

- The basic mechanical, control and vacuum design of the machine can be scaled up, with little additional development effort, to produce deposition systems with much greater capacity, with no additional monitoring personnel costs. Materials sources and indexing apparatus are arranged in a circular pattern. The diameter of the circle, and hence the circumference, can be expanded in later models to get higher capacity.

- With automation, the labor content of each circuit is reduced, cutting production costs. If necessary, however, the machine will operate semiautomatically or manually.

- A greater variety of circuits can be produced with a wider choice of evaporated materials and deposition times.

- Most important, the uniformity, precision and reliability of the circuits are enhanced by the reduction of production variables and the possibility of human error.

Resistor tolerances of 5% are routinely met by the system. On

some recent runs, tolerances have hovered around the 1% or 2% mark. Metal, usually Nichrome, is used for resistance values up to 200 ohms per square. Cermets can be deposited for higher values. Resistances of several megohms can be deposited.

Giant console. The machine is large—about 3½ feet in diameter and 8 feet high. But it is dwarfed by the control console, which is 22-feet long. One man, pushing buttons and setting production parameters into the controls, can operate the entire system. Two men are generally used, however. One serves and watches the machine itself while the other monitors the control system. The operators talk with each other over an intercom system.

Among the automatically controlled operations are: the vacuum cycle, from power start-up to de-pump and shutdown; electrical parameters and control of the electron-beam guns and filaments which evaporate the materials; resistance and capacitance values of the deposited components; station indexing and operation of the shutters which allows the vapors to reach the circuit substrates; and substrate temperatures by station.

Self-stopper. Resistance values

Behind each of the 10 ports in the vacuum chamber is a deposition station. Larger console for automatic control is 22 feet long.

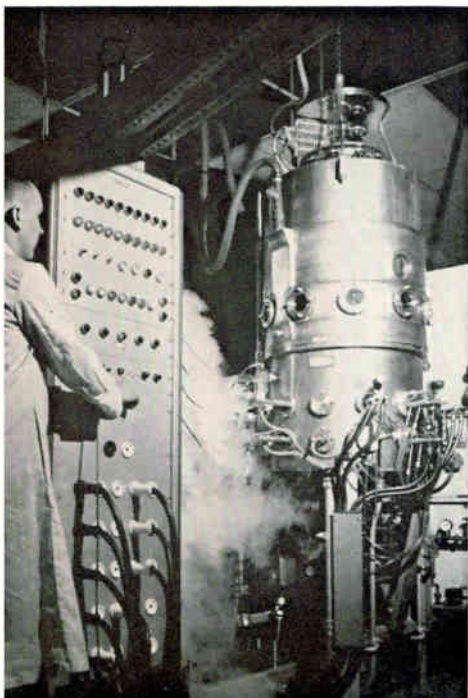

are monitored directly by measuring the sheet resistance of the material as it is deposited. Capacitance is monitored by a quartz-crystal microbalance. As the dielectric is deposited on the substrate, it is also deposited on an oscillator crystal, the frequency of which changes in proportion to the amount of dielectric deposited (oscillator-crystal manufacturers use the reverse of this process; they deposit material on a crystal to adjust its frequency). In effect, the circuit being produced tests itself and stops the evaporation cycle.

Hollow antennas

Another low-cost way of making extremely light, but very accurate and strong parabolic antennas has been developed by Electro-Optical Systems, Inc., of Pasadena, Calif. The company expects its antennas to compete with screen or plastic antennas for millimeter-wave applications, hand-held radar or communications sets, and aboard spacecraft.

The antennas are made of hollow nickel plate, with a wall thickness only about 0.001 inch. The structures weigh as little as 0.1 pound per square foot. The company has made one unfurlable device that is 10 feet in diameter and weighs only 7 pounds. Electro-Optical Systems says this is one-third the weight of standard antennas with equivalent reflector quality.

Old method, new use. The production method is a scaled-up version of electroforming, a method that has been used to make small, intricate components [Electronics, Sept. 11, 1959, p. 114] such as special waveguide and precision, stress-free helixes for traveling-wave tubes.

To make the egg-crate sections, called petals, a master, or model, is precision-machined from cast iron. Sheet aluminum is pressed against the master to form mandrels—one for each petal. The lightning holes are drilled in the mandrel. The mandrels are then electroplated with pure nickel. Finally, the aluminum mandrel is

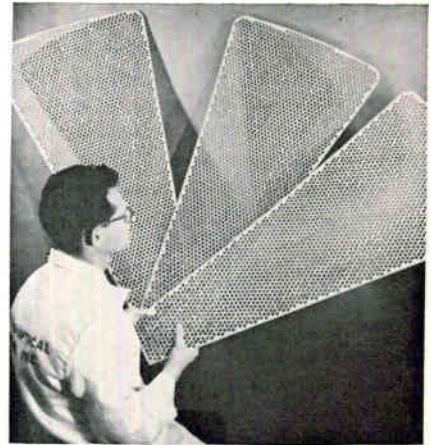

Parabolic sections, called petals, are made of hollow nickel plate only 1 mil thick.

etched out of the plated nickel shell. Small holes are made in the shell to allow the etchant to attack the aluminum.

For mass production, the mandrels could be rapidly shaped against the master by explosive forming and the holes stamped out. They can also be made of a low-melting alloy and removed by heating after plating—Cerro alloys, for example, melt at around 200°F. Or, plastic mandrels could be used. The company also uses electroforming to make parabolic solar-energy collectors and the tori that support large parabolas.

Accurate antennas. Because the antennas are made of true parabolic sections that are all exactly alike, their focusing accuracy is superior to other lightweight antennas, the company claims. Accuracies are in the 0.015-inch range.

Because of the egg-crate construction, strength-to-weight ratios are high. And because nickel is used, Electro-Optical says the antennas have a dimensional stability and resistance to environment almost that of stainless steel.

Avionics

En-route control

The Federal Aviation Agency has decided on computers built on the modular principle for its en-route

air-traffic control system. The first, an IBM System 360, model 50, selected in competitive bidding, will be installed next summer at the National Aviation Flight Experimental Center in Atlantic City, N.J., for operation in the fall.

FAA says that the two previous computers it had tried—a Univac 1218 and a Librascope Ambac—were the first stages in the development of a control system. The Univac can do straightforward jobs; it prints flight strips and calculates position. But it requires manual updating. The Librascope computer adds automatic updating and can warn if two planes are headed for the same place at the same time. It was the first large-scale solid-state commercial computer in use, and was as reliable as most military systems, but it did not have the capability that FAA needed.

Bigger and better. The IBM system does much more. It can keep track of known aircraft while continuing to scan for others. It has mosaic radar displays and better sequencing and flow control. The Atlantic City installation will have a 2.5 microsecond memory time and six output channels, each with a 3.2 million bit-per-second capacity.

Use of the modular concept will permit the agency to tailor each computer to the requirements of the location, depending on the traffic load to be controlled.

Jacksonville, Fla., may be the first area to get an operational traffic control system of the new design. Work there would begin soon after the experimental center starts operating.

Medical electronics

Lasers and you

The man who monitors much of the government-funded work on biological effects of lasers went beyond the blue-sky proposals this month and told engineers and physicists at the Boston Laser Conference exactly what biologists and doctors need from them.

The man is Capt. Martin S. Litwin of the Army Medical Research and Development Command. One need that he cited is the further development of lasers that function below 5,900 angstroms, preferably below 5,500—lasers that will emit the green and blue light that is absorbed by many biological systems. Another need is the development of continuous-wave lasers—of all wavelengths—powerful enough to cause biological change without the necessity of focusing.

Wavelength study. The most important immediate tasks for biologists, Litwin said, is to discover effects that are specific to particular wavelengths; there is no reason to think that all wavelengths have the same effect on all types of organisms. The long-term effects of laser radiation also must be studied, he said.

Litwin told the Boston conference that scientists are studying the possibility of generating coherent x-rays. As a tool in medical diagnosis, laser x-rays might produce less scatter and therefore provide clearer pictures.

Lasers for cancer. Lasers may help to treat malignancies some day, but meanwhile care must be taken to avoid their causing malignancies or other harmful effects, the conference was told. In addition to the obvious danger of retinal burns and other eye damage from laser beams, studies have shown that laser energy is sometimes fully absorbed by outer layers of the skin. In other instances the energy penetrates the outer skin to inflict burns on deeper levels.

Work by Dr. Leon Goldman of the University of Cincinnati has shown a possibility that chronic exposure to laser energy could induce malignancies. Goldman said at the conference that until more is learned about the possibility of delayed reactions of persons with certain types of sensitive skin, laboratory personnel should use caution in working with lasers.

The conference was also told of more than 100 documented instances of retinas being repaired with lasers.

Advanced technology

Laser lighthouses

Satellites and space vehicles in outer space may someday get their bearings from two laser beacons as much as a million miles away.

Joel B. Searcy, an astronomer at the Massachusetts Institute of Technology, suggests that two continuous-wave laser beams, rotating in opposite directions about the same horizontal axis, with their beams intersecting at the local vertical, could help to pinpoint the location and velocity of vehicles in space.

The beams, whose modulation frequencies would differ, could be detected by simple optical and electrical filters. As the space vehicle moved off the local zenith, the laser beams would reach it at different times. Computer measurement of the time difference would pinpoint the vehicle's location.

Two such stations would be needed to give range and velocity. Since the beams would be received regardless of the spacecraft's attitude, the ground system would require no steering and no large antennas or receiving stations.

Searcy points out that the continuous nature of the beam would be especially valuable in permitting velocity corrections during re-entry.

Receivers unlimited. If several twin beacons were used, coding patterns could be used, with corresponding electrical filters at the receiver end in the space vehicle. There would be no limit to the number of vehicles that could use the beam at any given time.

The laser system would also permit the spacecraft to pick up beams without having to send out any signals of its own that might disclose its position to an enemy.

Vehicles orbiting near the earth now use photometric, infrared and other horizon-sensing techniques. But the horizon itself is so vaguely defined and changeable that accuracy is impossible.

The proposed system is essentially a light-beacon technique; but



ELECTRONIC WARFARE

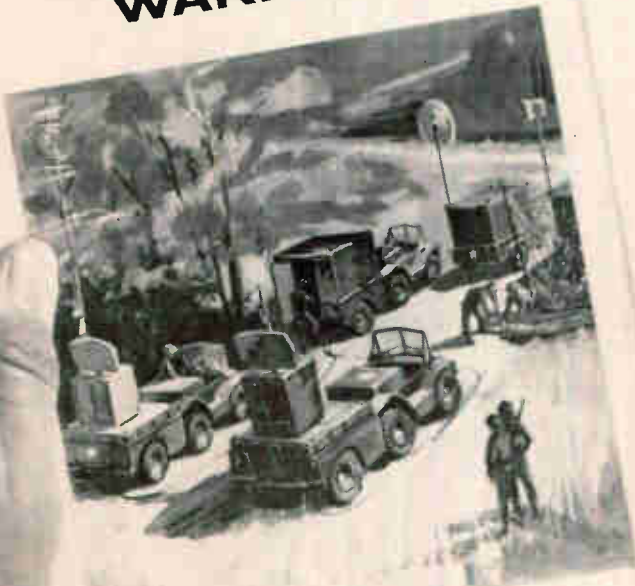

Modern field armies require the most advanced electronic equipment to insure mobility and maximum striking power.

ELECTRONIC WARFARE CAPABILITIES

INTRODUCTION

Melpar's exceptional research, development, and manufacturing skills have added many chapters to electronic warfare technology.

Since 1945, Melpar has been a major supplier of large airborne, ship-borne, and land-based electronic warfare systems and subsystems including passive and active electromagnetic reconnaissance systems, electromagnetic acquisition systems, electronic countermeasures equipment, and related ground support equipment.

Melpar has developed noise, deception, and communications jammers; radar decoys; specialized receivers such as swept superheterodyne mixed based, and crystal video; automatic direction finders; and complex antenna systems for such equipment.

Melpar's growth and success in Electronic Warfare continue to create new employment opportunities. There are openings for engineers and scientists with experience in microwave receiver design. If you feel that you are the person who can contribute to the Melpar story of achievement, write to: Manager, Professional Placement.

5th of a Series

MELPAR INC
A SUBSIDIARY OF WESTINGHOUSE AIR BRAKE CO.

3000 Arlington Boulevard, Falls Church, Va.

IN HISTORIC FAIRFAX COUNTY,
ONLY 10 MILES FROM WASHINGTON, D. C.

an equal opportunity employer

the lasers would provide monochromatic light sources, thereby permitting simpler detection optics and data processing on board the vehicle.

Theory and experimental data indicate that atmospheric attenuation of the laser beams would not be prohibitive, according to Searcy. Use of several such stations could get around the problem of local cloud covers. The stations would also be easy to install on the moon as an aid in lunar navigation.

Searcy has informally offered his idea to both the National Aeronautics and Space Administration and the military.

Poodle power

A poodle may one day power generators aboard spaceships far from the earth.

It won't be the usual sidewalk variety, however. It'll be a Snap Poodle, the legitimate offspring of two Atomic Energy Commission projects called Snap and Poodle. Snap—or Systems for Nuclear Auxiliary Power—is an effort to produce electricity out of nuclear power from reactors and radioactive isotopes. Poodle is the name of a search for a nuclear reactor for space propulsion.

The object is to eliminate extra power sources for equipment on board the spacecraft. Snap Poodle would catch the excess heat given off by the propellant, and convert it into electricity. It could permit nuclear-powered vehicles to carry larger transmitters and other electronic gear, and might allow more redundancy and versatility in the equipment carried.

Harnessing heat The Poodle engine consists of a pair of concentric cans surrounding a supply of the radioisotope polonium²¹⁰, which generates heat between 1,500° and 2,000° F. Vented liquid hydrogen flows over a network of helical fins that surrounds the center cannister. The hydrogen enters at extremely low temperatures and leaves at extremely high temperatures, producing a thrust of about one-fourth pound. TRW Space

Technology Laboratories hopes to harness the heat that would otherwise be dissipated after providing the thrust.

Under a \$48,431 contract from the Air Force, the company, a division of Thompson Ramo Wooldridge, Inc., will evaluate various thermo-electric generators, including those developed by the Monsanto Co. and the Radio Corp. of America.

Manpower

Closed circuit Ph.D.s

The State of Florida is investing \$1.5 million in an educational program designed to keep scientists and engineers technologically up to date. The program, called Genesys, will provide educational sub-centers in five Florida communities with a closed-circuit educational tv network whose center will be the University of Florida in Gainesville. The five communities are Cape Kennedy, Melbourne, Daytona Beach, Orlando and Gainesville.

For example, actual space programs can be televised from Cape Kennedy to the other centers. Each community will provide classroom and laboratory facilities which can be used independently as well as being tied into the tv system.

Television studios will be installed this fall and the program is expected to get under way at the start of the winter trimester, January 11. John L. Hummer, formerly director of scientific program development at the Northrop Space Laboratories in Hawthorne, Calif., has been named to administer the over-all program.

The Southern Bell Telephone Co. is supplying equipment for Genesys, including a number of special devices to handle duplexed broadcasting. The duplexing will enable students in each of the five sub-centers to signal instructors, ask questions and participate in classroom discussions.

Saves travel. The system is the

brainchild of Thomas L. Mart Jr., dean of engineering at the University of Florida. It's intended to solve Florida's major technical education problem. With scattered concentrations of relatively small companies in Orlando, at Cape Kennedy and in Melbourne it is difficult to provide educational facilities in each area because it would require either extensive duplication of classrooms and laboratories or considerable travel by the students.

The administrators expect that about 30% of the instruction will be over the tv network. Only those holding Ph.D. degrees will teach since the program will be allowed to award the masters degree and the doctorate under the state university system.

Space electronics

Bomb-proof amplifiers

Two amplifiers, destined for space use, have been operated in the pulsed neutron environment of the Sandia Corp's Godiva atomic reactor. They were designed by the General Electric Co. for use in a miniature tape recorder that will be subjected to the radiation of nuclear-electric power supplies. The design lessons learned, GE believes, can also be used to give stored missiles greater immunity to the radiation from an enemy nuclear attack.

The amplifiers are the first vacuum-tube circuits to operate at frequencies below 100 kilocycles while being bombarded with heavy pulses of gamma-neutrons. In the reactor, they were subjected to 3×10^{22} neutrons per square centimeter with neutron intensities greater than 10,000 electron volts. Total gamma dose, using water as a reference, was 10^9 rads and the gamma rate was 3×10^6 rads per second.

The amplifiers use GE's thermionic integrated micro module components. These are heaterless ceramic vacuum tubes. Emission is triggered by heating the tube to its operating temperature of 580°



**Before sunset tomorrow,
Air Express can deliver to
any of 21,000 U. S. cities.**

No one else can.

Your customer can be sitting in Salina, Kansas. Or in a thousand other cities across the country. Air Express is the best way to lay your product in his lap—quickly, safely, cheaply.

A joint venture of all 39 scheduled airlines and REA Express, Air Express puts at your fingertips a huge and highly efficient army of men and machines. 1,600 airplanes. 10,500 de-

livery trucks. 24,000 people.

You not only get super-fast delivery in the air, but the fastest delivery of all on the ground.

But speed isn't all. Air Express offers you other big pluses, too. Pickup within 2 hours of your call. One call, one waybill. Top priority after air mail on every scheduled airline in the country (especially important during peak

rush hours). Even armed surveillance for valuable packages, if you wish.

Best of all, Air Express is often your cheapest way to ship by air, too. That's why, if you ship from 5 to 50 pounds anywhere in the U.S.A., you're missing a bet unless you check Air Express. Just call your REA Express agent.

Air Express outdelivers them all...anywhere in the U.S.A.

Air Express

Division of REA Express



The molecular activity generated by this temperature is nearly identical to the molecular activity caused by nuclear radiation, so the tube can operate in a strong radiation environment.

In the reactor. Each test amplifier had a ceramic chassis containing platinum heating wires. The chassis was packed in insulation to retain the heat, and placed in an evacuated stainless steel cylinder. The package was not used for radiation shielding. Removing the air from the cylinder eliminated surface-leakage currents that would result from ionization of air during the 50-usec high intensity radiation pulse.

In earlier tests with digital circuits and multivibrators in the Chance-Vought reactor in Fort Worth, Tex., the circuits were subjected to a steady-state radiation environment and operated successfully for six months. Ceramic vacuum tubes were also used in the earlier tests.

Electronics abroad

Double check for steel

Tube Investments, Ltd. of London can determine both the number and types of impurities in steel by using x-ray and electron-beam backscattering.

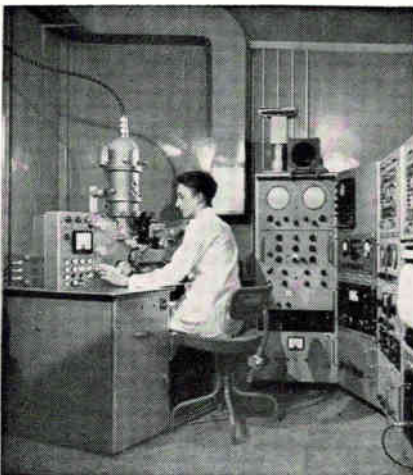

Electron-beam system gives both a qualitative and quantitative analysis of inclusions in steel.

The experimental system examines a piece of steel up to one-quarter-inch wide by two inches long and identifies all inclusions with a diameter greater than five microns. It examines a half-millimeter field in 30 seconds. X-ray techniques have been used for some time in nondestructive testing, but this system is considered the first to take advantage of the scattering properties, rather than the power, of an electron beam.

A specimen of steel is placed in a chamber where it is scanned by an electron beam. This causes an emission of x-rays from the steel and a backscatter of electrons from the beam. The backscatter, detected by scintillation counters, counts the number of inclusions. Three spectrometers, mounted within the chamber, identify the x-rays.

Comparing angles. Since the density of nonmetallic inclusions in the specimen differs from the density of the iron in steel, varying intensities of electron backscatter can be counted. To identify the inclusions, the spectrometers are preset for the expected inclusions—aluminum or manganese, for example—by adjusting the angle of a lithium fluoride crystal. Each inclusion, when scanned by the beam, causes x-ray emission at a unique angle. The spectrometers produce different pulses for each element and the logic circuits of a special-purpose computer compare the pulses and identify the inclusion. Three different elements can be recognized in one scan. Additional logic circuits categorize each inclusion into one of four size-groups.

The possibility of counting an inclusion more than once is eliminated by using a magnetic-drum intermediate storage that permits signals to be counted only if a similar signal was not present on the previous scanning line.

Toward all-Europe tv

The British Broadcasting Corp.'s research department believes it has the answer to foggy reception of television programs that originate on the Continent.

The answer is an electronic switching system that will convert a 625-line tv picture to a 405-line picture—or vice versa—in 50 nanoseconds at the turn of a switch.

The standard method, using a 405-line tv camera to rebroadcast a picture seen on a 625-line set, degrades picture quality. The new system is expected to overcome this problem and also help to unsnarl the complications in all-European tv broadcasting.

Britain now uses a 405-line system; most of the Continent uses a 625-line system, and France uses 825 lines. The BBC itself will use both 405 and 625 lines as it changes over to the more widely used 625-line standard.

Scanning the picture. The BBC converter divides each line of the incoming picture signal into 576 elements and feeds each element into a storage capacitor. The capacitors carry signal amplitudes corresponding to a vertical strip of the picture. This vertical aperture is shifted, element by element, across the picture. Thus the incoming signal is scanned by a 576-way switch that rotates once per line.

A second scanning-switch system, operating at the new line frequency, reads the signal in each capacitor to obtain the information needed to regenerate the line at the second line standard.

Converting the lines. The scanning circuits are diode-bridge and transistor circuits in two switching sections of 36 and 16 units. Operating at different speeds, the switches convert the active portion of each line. After each cycle, a shift register advances to connect a new input or output group to the 36-way switch.

The scanners do not provide synchronizing signals. A special computer generates the synchronizing waveform which is inserted automatically at the correct location in the system's output.

When a 625-line signal is being converted to 405 lines, the computer is driven by the 15,625-cps line-repetition rate of the input system. It divides by 81/125 to get the 10,125-cps signal for the 405-line system.

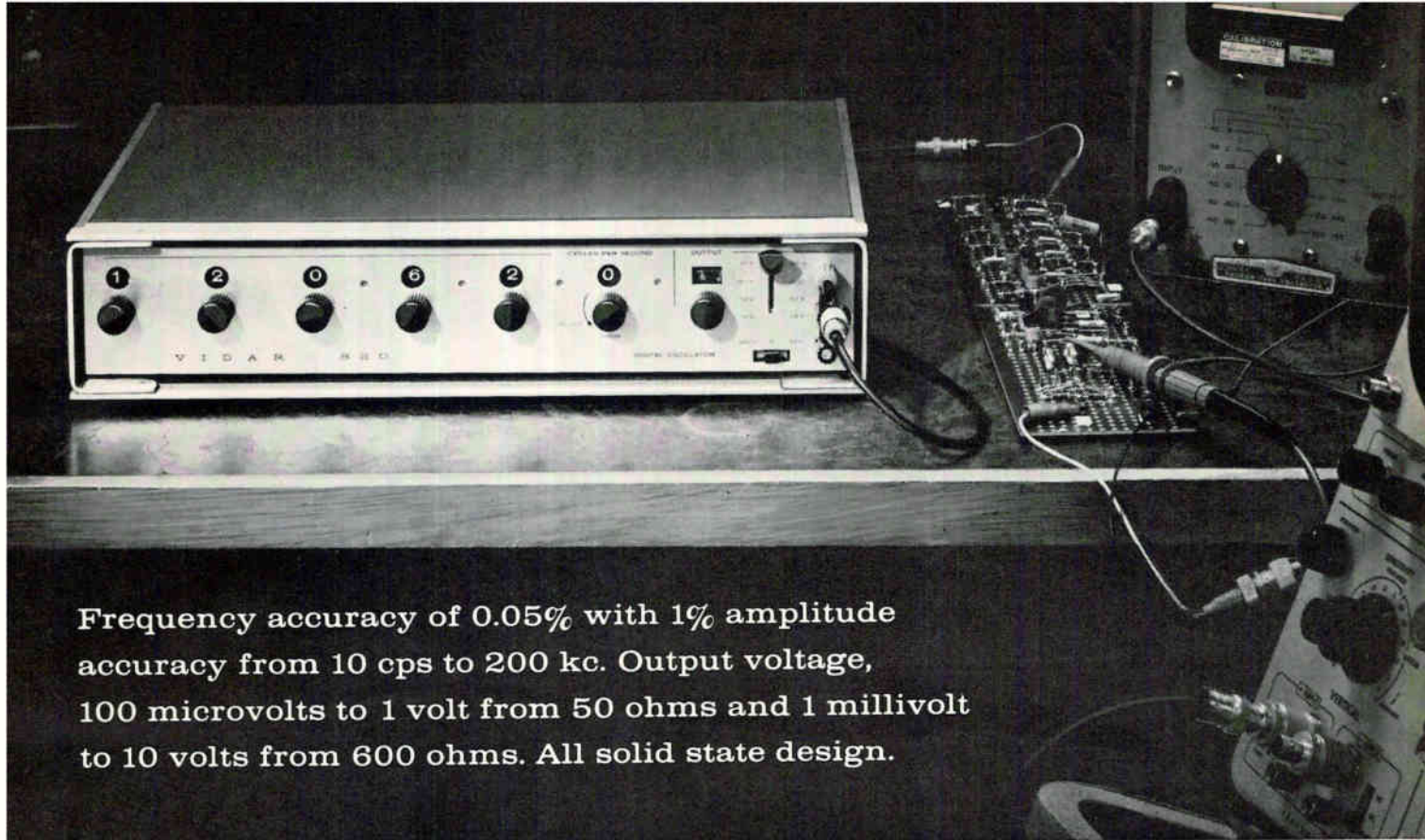

Frequency accuracy of 0.05% with 1% amplitude accuracy from 10 cps to 200 kc. Output voltage, 100 microvolts to 1 volt from 50 ohms and 1 millivolt to 10 volts from 600 ohms. All solid state design.

Announcing the Vidar 820 Digital Oscillator. This compact, good-looking instrument does the job of an audio oscillator, an AC voltmeter, and a counter for all applications requiring an accurate frequency source of known amplitude. Price \$945. Call your Vidar representative for a demonstration or write for details.

77 ORTEGA AVENUE
MOUNTAIN VIEW,
CALIFORNIA

VIDAR

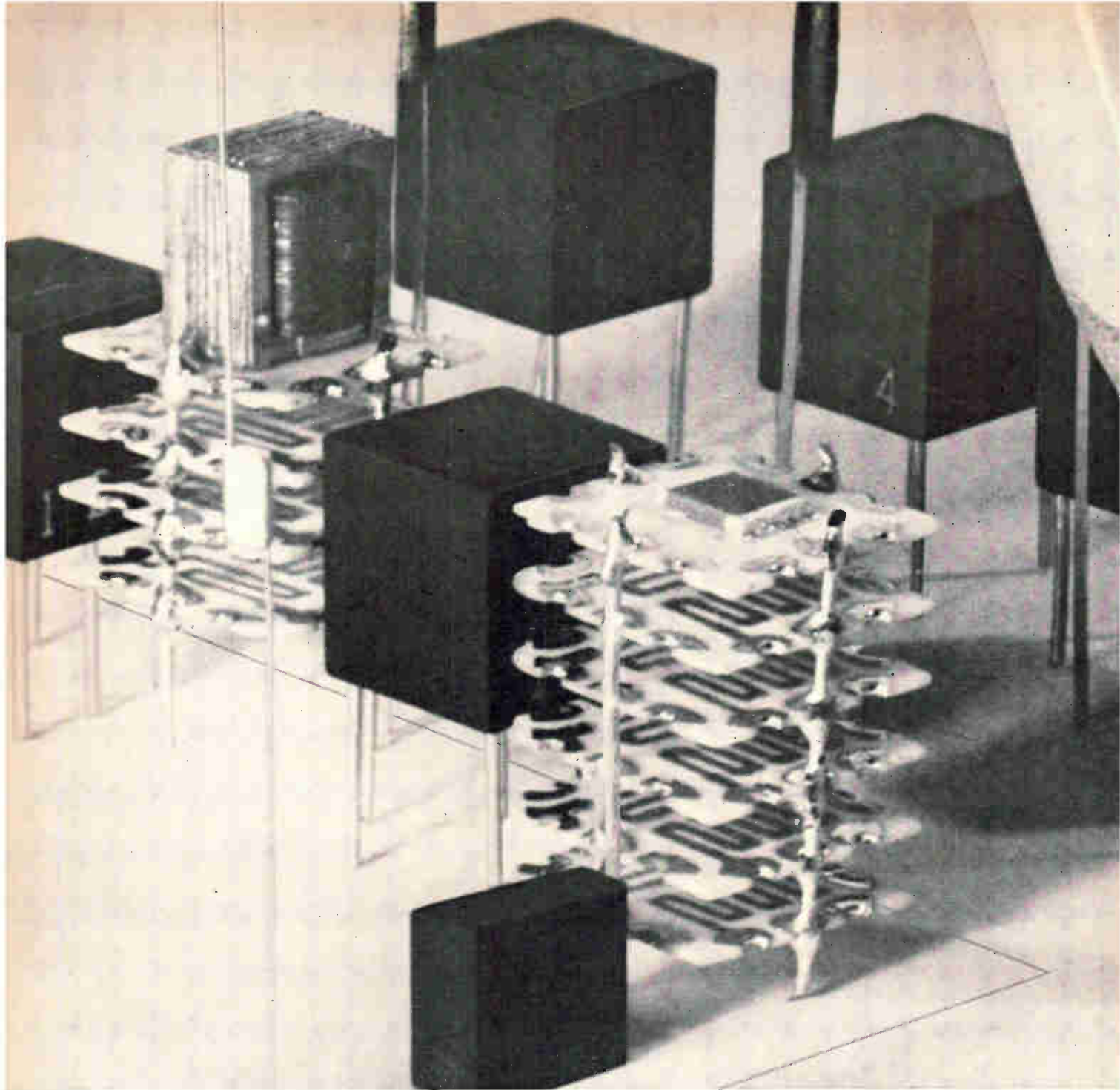

DISCRETE COMPONENTS: available from stock — all units shown actual size.

Micro-Resistors (one model available)		Micro-Capacitors (five models available)		Micro-Inductors (one model available)	
Range	10 Ω to 1 Meg	Range	10 pf to 1 mf	Range	0.1 Hy to 66 Hy
Tolerance	$\pm 2\%$ to $\pm 5\%$	Tolerance	$\pm 10\%$	Temp. Range	-65° to $+130^\circ\text{C}$
Temp. Range	-65° to $+175^\circ\text{C}$	Temp. Range	-55° to $+150^\circ\text{C}$	Size	0.250" cube
Power	0.1 W at 125°C	Dissipation Factor	2.5% max.	Environmental	MIL-T-27A
Size	0.1" x 0.03" x 0.05"	Size	As small as .060" dia. x .150"		
Environmental	MIL-R-10509 D	Environmental	MIL-C-11015 C		



CUSTOM FILM CIRCUITS ON CERAMIC SUBSTRATES
Made to your exact specifications. Contact factory for details.

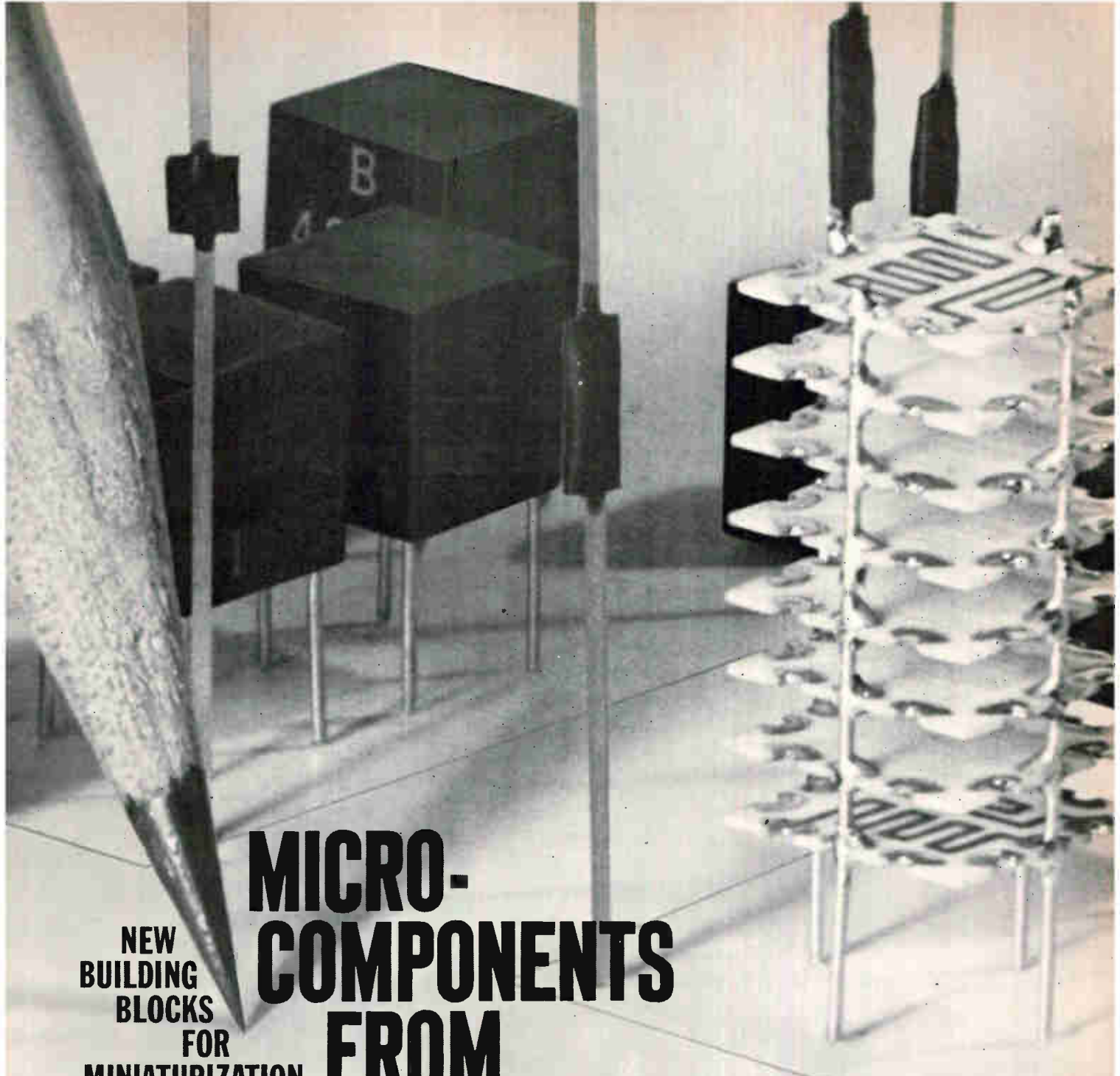

NEW BUILDING BLOCKS FOR MINIATURIZATION

MICRO-COMPONENTS FROM BOURNS

Here, from one source, is a complete family of Military Type micro-components for your high-density designs. The prices are competitive, the reliability is superior and the availability is now!

Take your choice: discrete components for hybrid circuitry and conventional micro-packaging or custom film circuits on ceramic substrates. Either way you get the highest available ratio of performance to size.

Bourns micro-components are the most thoroughly inspected and tested in the industry. They undergo 100% in-process and final inspections and are subjected to the relentless double-check of the Bourns Reliability Assurance Program. This program, created for Bourns TRIMPOT® potentiometers, is the only one of its kind. Its primary goal is reliability. It is conducted entirely in addition to a regular quality-control program that in itself exceeds the efforts of many other companies.

Also backing up these components is the actual Bourns record of reliability—16 years of participation in the most important programs of our time. In short, Bourns reliability is a fact—one you can put in your next micro-circuit. Write today for complete technical data.

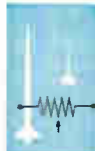

BOURNS

BOURNS, INC., TRIMPOT DIVISION
1200 COLUMBIA AVE., RIVERSIDE, CALIF.
PHONE 684-1700 · TWX: 714-682 9582
CABLE: BOURNSINC.

Micro-Transformers (all models available)	
Power	15 mw at 1 KC
Freq. Response	±1 db, 100 cps to 500 KC
Distortion, Max.	5% at 15 mw, 1 KC
Primary Impedance Range	50Ω to 100K
Secondary Impedance Range	3.2Ω to 10K
Size	0.250" cube
Environmental	MIL-T-37A



MANUFACTURER: TRIMPOT® & PRECISION POTENTIOMETERS, RELAYS, TRANSDUCERS FOR PRESSURE, POSITION, ACCELERATION. PLANTS: RIVERSIDE, CALIFORNIA; AMES, IOWA; TORONTO, CANADA

SEE BOURNS PRODUCTS AT WESCON, HOLLYWOOD PARK, BOOTH NUMBERS 363, 4, 5

TEST YOUR ZENER IQ!

See answers at bottom of page

QUESTION 2: The voltage regulator diode may be considered to be similar to a _____ when used for cathode bias purposes.
 A — filter capacitor
 B — relay
 C — battery



IR's diffused junction 1 watt flangeless Zeners span the voltage range from 6.8 to 200 volts, including rugged 1N1767-1802, and 1N3016-3051 series.

QUESTION 3: The voltage regulator diode is useful for protecting transistors, meters and other devices due to its ability to _____
 A — block voltage
 B — breakdown and pass current
 C — block current



Exceptional forward characteristics are displayed by IR's 10 watt stud mounted Zeners, including 1N2970-1N3015, 1N1351-1375, 1N1805-1836 6.8 to 200 volt rated series.

QUESTION 1: The "Zener effect" is actually a case of
 A — quantum-mechanical tunneling
 B — electrical discharge
 C — avalanche breakdown



Dependable voltage regulation begins with IR glass Zener diodes in 150, 200, 250 and 400 mw series, including almost all popular JEDEC types.

QUESTION 4: Zener diodes which have a relatively high breakdown voltage rating exhibit
 A — a negative temperature coefficient
 B — a positive temperature coefficient
 C — a zero temperature coefficient

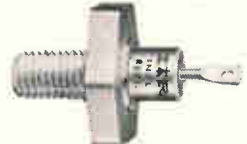

IR stud mounted 50 watt Zeners require only one mounting hole compared with the three positioned holes needed to mount the TO-3 package. This means a reduction of 30% in your time and labor costs!

QUESTION 5: The demonstrated industrial reliability of IR Zener diodes under a multitude of field conditions is
 A — 87.6%
 B — 91.9%
 C — 99.9%



You can get immediate delivery on IR temperature compensated glass voltage reference diode types 1N821 through 1N827A and 1N3154 through 1N3157 ...for ultra-stability in the 5.9 to 8.8 voltage range.

QUESTION 6: The breakdown voltage of a silicon Zener voltage regulator diode is dependent on
 A — the power rating of the diode
 B — the area of the PN junction
 C — the resistivity of the silicon



76 high reliability Zener types span the voltage range from 3.9 to 30 volts in IR's popular 1N1507-1N1517, 750 mw and 1N1518-1N1528 1 watt alloyed series...available in 5%, 10%, 20% voltage tolerances.

QUESTION 7: The dynamic resistance of a Zener diode is a function of
 A — junction capacitance
 B — lead inductance
 C — the dc current through the diode



Rugged, stud mounted, hermetically sealed IR voltage regulators in 3.5 and 10 watt alloyed packages in the popular 1N1588-1N1598 and 1N1599-1N1609 series have proven their dependability in hundreds of thousands of applications.

ARE YOU A ZENER WONDER-BOY??? If you got 5 out of 7 correct in this Zener quiz, you are definitely above average. If you checked 6 out of 7 correctly you are a budding Zener genius, and if you got 100% (7 out of 7) you are without doubt a Zener wonder boy. But you don't have to be a Zener genius to know that when you specify from the wide, wide IR Zener voltage regulator line, you get the *only* Zeners in the field with demonstrated industrial reliability of 99.988%. This is practical reliability proven under a multitude of field conditions. For a complete run-down on IR Zeners and reference elements, as well as a wide variety of other high reliability semiconductors, circle the Reader Service card number below to receive your copy of the International Rectifier 1964 Short Form Catalog.



INTERNATIONAL RECTIFIER

INTERNATIONAL RECTIFIER CORP., EL SEGUNDO, CALIF., PHONE OR 8-6281 • CABLE RECTUSA • REGIONAL OFFICES IN NEW YORK CITY, CH 4-0748 • FORT LEE, N.J., WI 7-3311 • SYRACUSE, N.Y. HE 7-8495 • CAMBRIDGE, MASS., UN 4-6520 • ARDMORE, PA., MI 9-3667, GR 3-3932 • SILVER SPRING, MD., JU 9-3305 • MIAMI, FLA., 445-5201 • CHICAGO, ILL., OR 6-4090 • CLEVELAND, OHIO, 734-4100 • DAYTON, OHIO, 223-7691 • HUNTINGTON WOODS, MICH., LI 8-1144 • ST. LOUIS, MO., TE 8-6333 • MINNEAPOLIS, MINN., 920-1200 • DALLAS, TEX., LA 1-0110 • LOS ANGELES, CALIF., OR 8-6281 • IN CANADA: TORONTO, ONT., PL 9-7581 • MONTREAL, QUE., VI 9-3571

Contact the International Rectifier Regional Office nearest you for the Authorized Distributor in your area.

Answers: 1-A; 2-C; 3-B; 4-B; 5-C; 6-C; 7-C

Washington Newsletter

August 24, 1964

Busy signal for McNamara

Now that the Department of Defense has decided that it wants its own communications satellite system, the Philco Corp. seems to have the inside track. The company has been studying a medium-altitude—6,000 miles—system under an Air Force contract. And it has spent more than \$3 million on special tools and equipment for in-house engineering.

The Pentagon's decision came as a surprise. Economy-minded Defense Secretary Robert S. McNamara had been opposed to a separate satellite system. But he changed his mind when he couldn't get a call through to South Vietnam over regular Pentagon circuits right after the North Vietnamese torpedo boats had attacked two U.S. destroyers. This convinced him that the military had to have its own communications facilities.

The military system calls for an early 1966 launch of 24 communications satellites, eight at a time with three Titan III-C boosters. They will be placed into near-synchronous, 18,000-nautical-mile equatorial orbits which will permit each satellite to be visible to a single ground terminal for about 20 hours at a time.

The ground network to the system will consist initially of 14 Army Satellite Communications Agency (Satcom) link terminals: six 40-foot-diameter dish transportable stations ordered from the Hughes Aircraft Co. in June at a cost of \$9.7 million, and eight existing Satcom terminals including four 30-foot transportable terminals built by the Bendix Corp. and the International Telephone & Telegraph Corp. and now located at Lakehurst, N.J.; Camp Roberts, Calif.; Helemenco, Hawaii; and Manila, the Philippines; two 60-foot fixed terminals at Fort Dix, N.J. and Camp Roberts, one 15-foot transportable terminal built by Hughes and located at Camp Roberts, and the 30-foot floating terminal on the USNS Kingsport.

NASA will open electronics center

The National Aeronautics and Space Administration will open its electronics research center Sept. 1 in temporary, rented quarters in Boston. By 1969, plans call for a \$60-million facility staffed by 2,100 employees including 700 scientists.

Winston E. Kock, vice president of research at the Bendix Corp., will direct the center. The deputy director will be Albert J. Kelly, director of electronics and control in NASA's Office of Advanced Research and Technology.

The center's research-and-development budget for the present fiscal year will be only \$2 million. This is expected to climb to \$8 million next year and to about \$50 million by fiscal 1969. Most of the current R&D work will be contracted to industry; when it's in full operation, the center plans to do some of the work itself.

FTC eases drive on foreign parts

The Federal Trade Commission has quietly downgraded its effort to tighten its regulations on disclosure of foreign-made components in radios and television sets.

In a confidential memorandum to its staff, the agency confined foreign-origin cases to those that involve a "primary functional element" that is not readily replaceable in this country, and to those cases that indicate a clear intent to deceive the public.

Washington Newsletter

In March, 1962, the FTC charged Motorola, Inc., with failing to disclose that it was using Japanese parts in radios. The subsequent investigation disclosed that the practice in question was so widespread that the agency dropped the case against Motorola last February and decided to broaden its rule. The Electronic Industries Association was invited to propose new language for the regulation, but the association has not done so.

The commission considers it a deceptive practice to fail to disclose the foreign origin of a major component if that fact might influence a consumer's decision on buying the radio or tv set. However, commission lawyers concede that this is a difficult condition to define.

The agency's attitude toward other industries has been similar.

Comsat seeks exclusive rights

The Communications Satellite Corp. has asked the Federal Communications Commission to give it exclusive rights to own and operate ground stations for its communications system. This request seems certain to be contested by utilities such as the American Telephone & Telegraph Co. Private concerns have long argued that they, not Comsat, should own the ground stations.

Comsat contends it needs ownership to provide the most efficient communications system possible. It also wants the FCC to prohibit the construction of any other nongovernment stations that might be used with Comsat's satellites.

Ground stations are planned for the northeastern, northwestern and southeastern sections of the United States, plus one in Hawaii, to service the initial satellite system.

The FCC has allowed 30 days for interested persons to file comments. A final decision is likely to be months away.

Pressure mounts for excise-tax cut

Political pressure is building up for ending or reducing 10% excise taxes next year, including the tax on consumer electronic products.

The Republican platform flatly calls for cuts in the taxes. Democrats, writing their platform, are under heavy pressure from congressmen to match the GOP stand.

President Johnson, whose Administration blocked attempts in Congress to cut excise taxes this year, told the National Association of Counties: "If prices remain stable, as they have, and prosperity continues as it has, we want to cut some of our excise taxes at least, and before too long to cut income taxes once more."

Job Corps seen electronics buyer

Passage of antipoverty legislation may give impetus to the development of teaching machines. They're considered certain to be tried in the Job Corps camps that are authorized in the new Economic Opportunity Act.

Four companies have been working with government officials on the education aspect of the war on poverty, and are considered front-runners for contracts to supply electronic equipment. They are Litton Industries, Inc., the International Business Machines Corp., the Westinghouse Electric Corp. and the System Development Corp.

Congress is expected to appropriate \$1 billion soon for the program. Of this, \$190 million would go to the Job Corps.

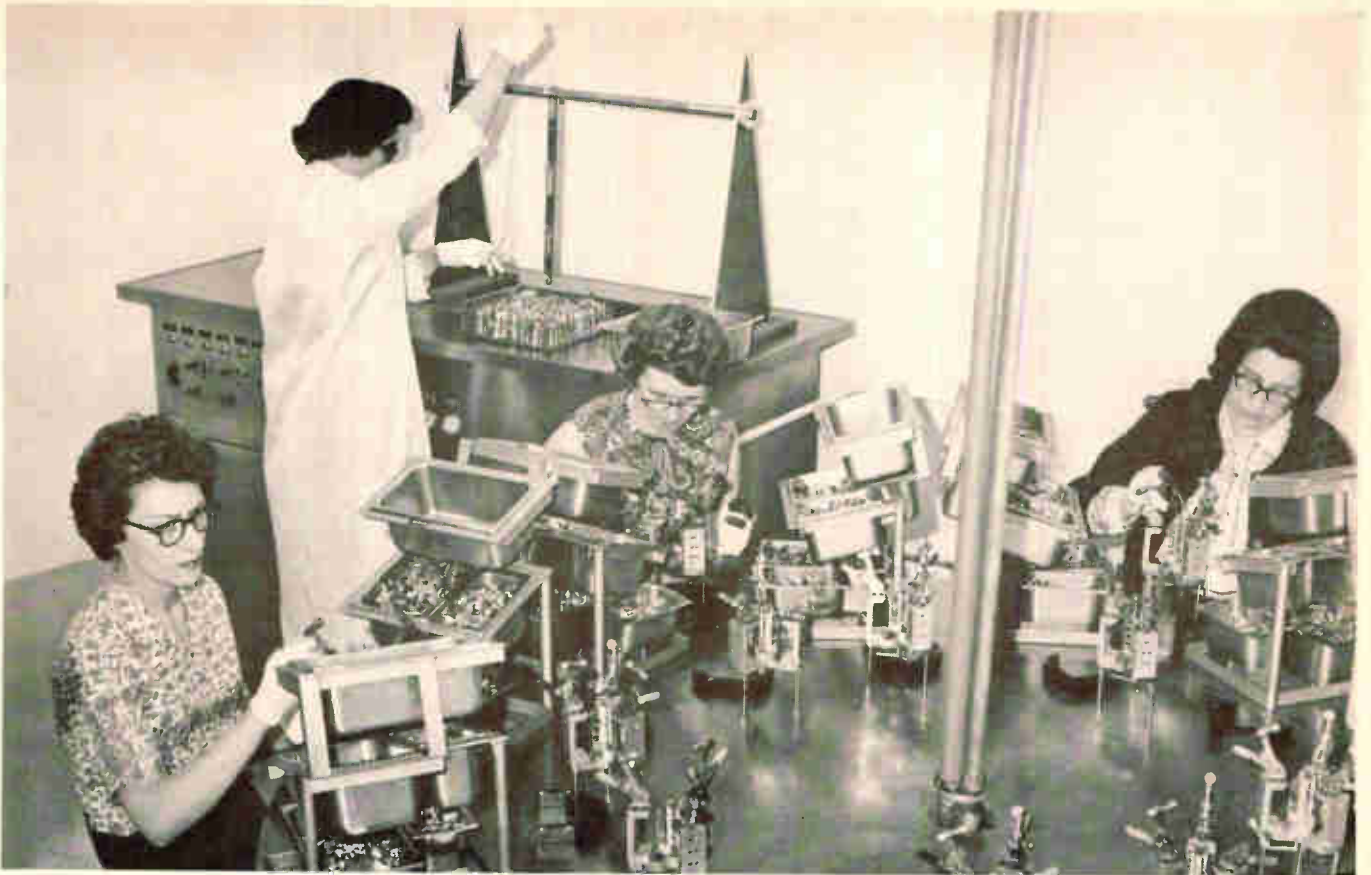

Because FREON solvents are nonflammable, virtually nontoxic and free from irritating odors, Rauland Corp. can safely locate its cleaning equipment directly at the end of its assembly line for maximum efficiency.

Rauland uses FREON® TF to “super-clean” color-TV picture-tube subassemblies

Cleaning of color-TV tube gun subassemblies is a critical operation because of the extremely high voltages to which they will be subjected. Any particulate matter not removed

could cause arcing and a blown tube . . . any leftover lubricants would seriously affect the rise time and service life of the tube. For this critical cleaning operation, the Rauland Corporation, Chicago—a division of Zenith Radio Corporation—uses FREON TF solvent.

Now, cleaning of the subassemblies is a quick, simple, low-cost operation . . . thanks to a cleaning system engineered and installed by a FREON solvent sales agent. This cleaning system uses FREON TF. The combined action of extremely low surface tension and high density enables FREON TF to penetrate minute crevices and effectively release and float away soils . . . even particulate matter. This results in complete, residue-free cleaning.

If you would like to investigate the many ways you can use FREON solvents in your cleaning operations, mail the coupon at the right.



This combination cleaning system was engineered specifically for the Rauland Corporation by G. S. Blakeslee Co., Chicago, Illinois. It is just another example of the complete cleaning system engineering you can expect from your representative for Du Pont FREON®.



After being cleaned in quick-drying FREON TF, the residue-free subassembly is ready immediately for final processing.

FREON®

SOLVENTS

Better Things for Better Living . . . through Chemistry



Du Pont Co., “Freon” Products Division
N-2430 E-2, Wilmington, Delaware 19898

Please send information on FREON solvents.
I am interested in cleaning_____

Name _____ Title _____

Company _____

Address _____

City _____ State _____ Zip _____

...shock to 25 g...vibration—10 g to 2,000 cps...up to 16 channels...and hand-carry

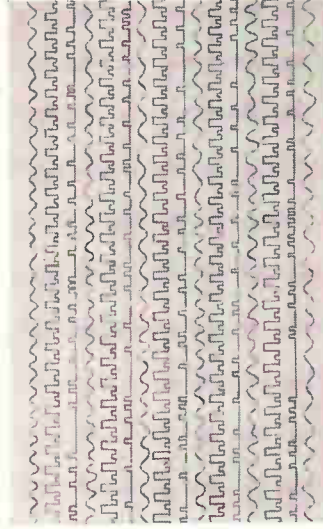

An instrumentation quality tape recorder/reproducer you can hand-carry to any test site

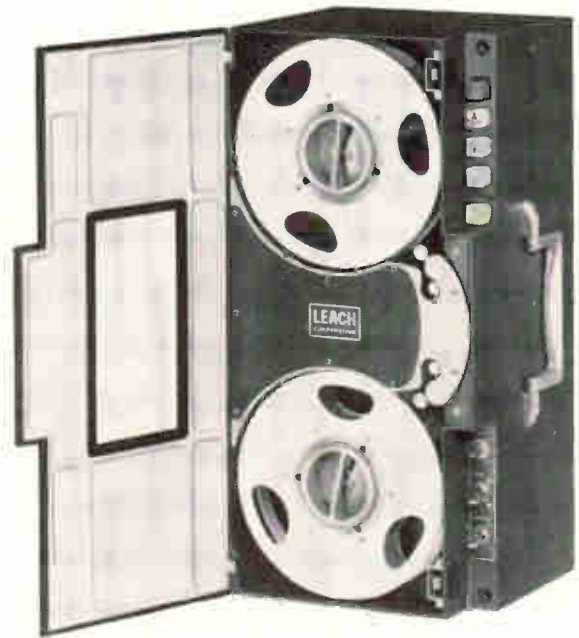

In stringent environments—or in the lab—no other instrumentation recorder/reproducer quite matches the performance of the LEACH MTR-3200 in weight—in size—in extended data bandwidth—in power consumption—in electronic options.

The new Leach MTR-3200 recorder, with all electronics for up to 14 direct and FM or 16 digital channels, has tape capacity of 2400' and weighs only 44 lbs. maximum. Frequency response in an extended range of 50 cps to 250 kc Analog, and DC to 20 kc FM is easily handled within the capabilities of this unit. Power requirements are only 55 watts @ 110 vac or 47 watts @ 12 or 24 vdc.

Flutter is less than 6% p/p through environment and less than 0.5% p/p in static conditions.

Seven speeds are offered, which are electrically selectable in speed pairs. Specialized bi-directional operation allows extended recording time. Modular electronic design permits many standard options, and even more on special order.

Exceeding standard IRIG specifications, the Leach MTR-3200 is suitable for a wide variety of applications where data collection requirements demand precision laboratory performance even in adverse environments of testing.

For complete technical data, write for bulletin MTR-3200-864.

LEACH CORPORATION

CONTROLS DIVISION

717 North Coney Avenue, Azusa, California • Phone: (213) 334-8211
Export: LEACH INTERNATIONAL S.A.

RAULAND *FLYING SPOT* SCANNER

APPLICATIONS UNLIMITED

- RADAR • COMPUTERS
- PHOTOGRAPHIC TECHNIQUES
- FILM TRANSMISSION

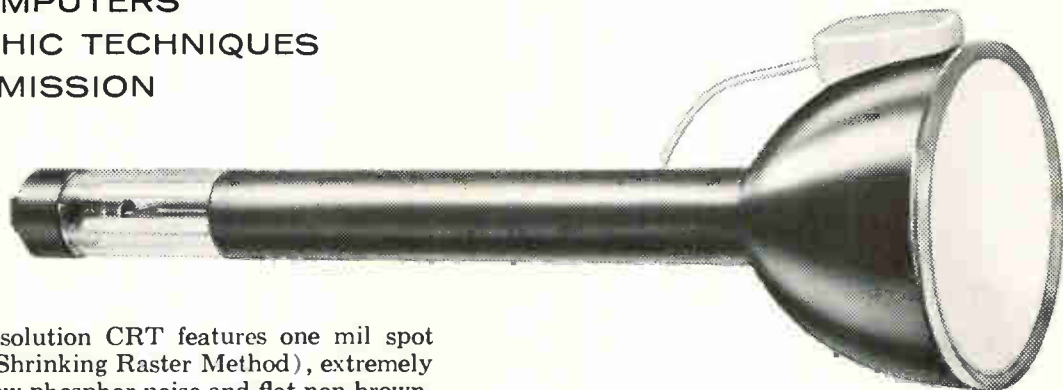

Rauland's 5" High Resolution CRT features one mil spot size (measured by the Shrinking Raster Method), extremely fine grain screen with low phosphor noise and flat non-browning face plate, ground and optically polished. Applications are limited only by the imagination; write for complete technical specifications.

ULTRAFAST SCAN CONVERTER STORAGE TUBE

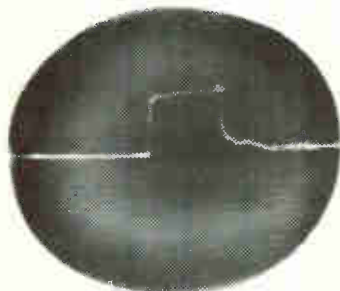

Photograph of a 24 nanosecond transient pulse as displayed on an ordinary television monitor.

Rauland's ultrafast Scan Converter Storage Tube records and stores transient phenomenon with pulse rise times of less than a nanosecond. The R6253 tube permits slow scanning techniques to be used for the relay of transient pulse data over narrow band systems. The pulse may also be recorded by conventional means — on magnetic tape, transmitted over inexpensive telemetry links, over communication cables, displayed on an ordinary television monitor and photographed using "box camera" exposure time. Relay or recording of pulses can be simultaneous with visual observation. It utilizes a distributed deflection system for the writing side and either magnetic or electrostatic deflection for readout of high speed phenomenon.

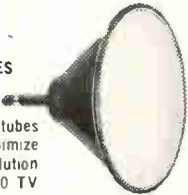
 <p>SCAN CONVERTER STORAGE TUBES</p> <p>Resolution Capability of 1000 TV lines. Erase Capability of 2 seconds or less. Any combination of electrostatic or magnetic deflection is available.</p>	<p>FLAT FACE DISPLAY TUBES</p>  <p>Rauland's flat face tubes (16", 22", 24") minimize parallax error. Resolution capability of 1000 TV lines at a brightness of 100 foot-lamberts. We will suit your specific requirements with any type of radar display tube in any size with any type phosphor or gun.</p>
--	---



The RAULAND Corporation

5600 JARVIS AVENUE
CHICAGO 48, ILL.
MULberry 5-5000

A subsidiary of

ZENITH
Radio Corporation
Chicago, Illinois

with Integrated Circuits the big problem ^{was} is testing

here are the BIG problem solvers



- 36 d-c tests
- 14 active leads
- Kelvin connections
- "Do it yourself" programming
- .05% power regulation
- Less than 1-mv long-term drift
- All logic types

MODEL 662

Digital readout for quality control and incoming inspection testing. Optional digital comparator provides accurate, repeatable trip points. Can be quickly programmed for both high *and* low limits on each of the 36 tests. Recording output for a tape punch, typewriter, card punch or digital printer. Both automatic and manual handling equipment can be furnished for a variety of devices.

MODEL 659A

A fast go/no-go instrument designed for high-volume production and incoming testing. Short test times permit a complete 36-test sequence in less than 2 seconds. Four programmable power supplies provided.

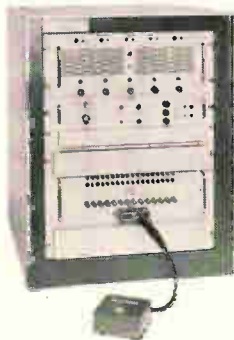

MODEL 659B

Similar to the 659A with space and connections for digital voltmeter. Includes two fixed power supplies and eight programmable power supplies.



INDUSTRIAL
PRODUCTS
GROUP



TEXAS INSTRUMENTS
INCORPORATED
P. O. BOX 66027 HOUSTON 6, TEXAS

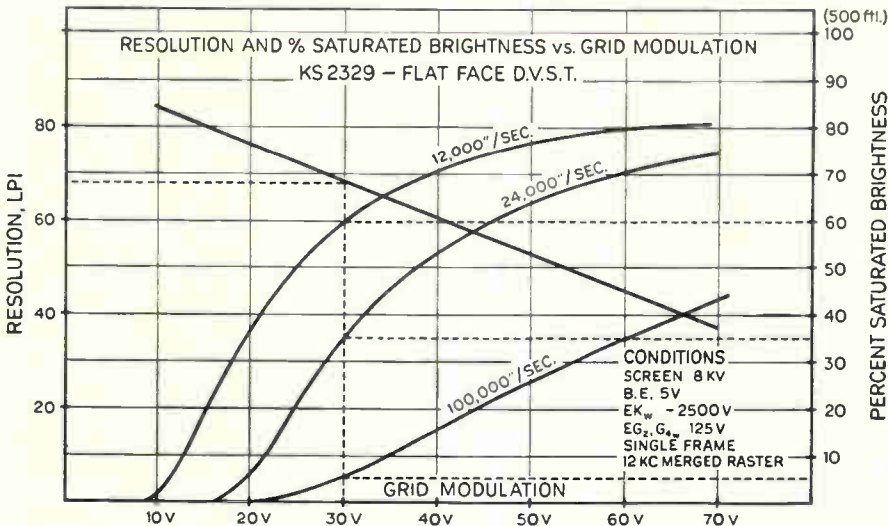

NEW STORAGE TUBE SHARPENS TRACKING SYSTEM'S VISION

The newest generation of tracking and radar systems demands a new generation of direct view storage tubes with improved dynamic display uniformity and resolution capabilities. Du Mont engineers have taken on this problem with marked success.

Case in point: the storage tube originally specified for the PPI of a certain missile tracking system (not Du Mont) lacked center-to-edge uniformity of writing, erasing and brightness. The area at the center of the screen built up a disproportionately high signal charge level. This increased background brightness to the point of obscuring nearby targets. The condition could be partially compensated by increasing storage electrode bias, but this reduced sensitivity to remote weak targets displayed in the peripheral area. Another alternative, equally unsatisfactory, was to erase the image completely every two or three minutes. This left the system blind during the interval required for a complete antenna rotation.

The problem was eliminated by the storage tube Du Mont designed and built for this application. This tube, Type KS2329, achieves substantially uniform dynamic characteristics over the entire storage surface. Resolution capability—600 TV lines in the useful diameter—is 60% greater than that of the original tube. And, with no increase in length, a 12% increase in useful diameter (to 9") was achieved.

Reliability in severe environments was another requirement. So, with its integral mu-metal shield, the Type KS2329 is potted in a resilient, fungus-resistant compound, and is fitted with multiple pin locking connectors and rugged mounting lugs.

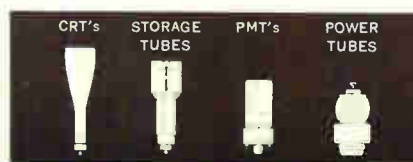

The final result was a significant advance in storage tube technology—or, from the customer's viewpoint, a tracking system with greatly improved vision. Now both strong and weak targets are displayed with excellent resolution, persistence and brightness. Additional features include internal feedback correction electrodes for high pattern geometry accuracy and zero DP current operation to overcome deflection non-linearities resulting from unpredictable collection of writing beam current and reflected flood beam current.

COMPACT PACKAGING

Another new storage tube developed by Du Mont packs unusual performance into a small envelope—and even that is designed to provide extra space for circuitry in the area around the yoke. This tube has a screen diameter of 5", overall length of only 8". Resolution is better than 125 lines/in.; writing speed is 300,000 in./sec. Since the tube has the same excellent integration characteristics as the KS2329, it is expected to find wide application as an indicator in airborne radars, or as a radar indicator and TV display monitor.

Other Du Mont storage tube developments include an on-axis writing gun. This considerable feat, never successfully accomplished in larger tubes, hinged on locating the flood gun or guns off-axis while retaining uniform illumination. The Du Mont tube does not depend on physical alignment to do this. Instead, three off-axis guns are used with split anodes which direct the beam from each toward or away from the tube axis. Uniform illumination is achieved, the write gun is located on-axis—and the DVST can replace a CRT with no change in deflection components.

CUSTOM DESIGN OR OFF-THE-SHELF

Over the years, the solution of many individual tube problems has resulted in the availability of more than 4,000 types of Du Mont tubes. These fall into four general categories: Cathode-ray Tubes, Photomultiplier Tubes, Power Tubes and Storage Tubes. The latter includes both direct view and electrical output tubes. If you need a special purpose tube, you'll probably find it listed in the latest Du Mont tube catalog. If it isn't, we will design and build it for you. For your copy of the catalog, write (letterhead, please) to Fairchild-Du Mont Laboratories, Dept. 8G, 750 Bloomfield Ave., Clifton, N. J.

FAIRCHILD

DU MONT LABORATORIES
ELECTRONIC TUBE DIVISION

... AT LAST — THE FIRST TRUE HYBRID COMPUTER

A completely new kind of signal processor, the Adage AMBILOG™ 200 computer is designed from the ground up to exploit the best of both analog and digital techniques. It combines parallel hybrid arithmetic with stored-program sequential operation.

High processing speeds (often ten times faster than comparably-priced conventional machines) and extensive input/output for both analog *and* digital data make AMBILOG 200 ideal for data acquisition, simulation, and information display.

PARALLEL HYBRID ARITHMETIC

AMBILOG 200 achieves high processing speeds through parallel organization of hybrid computing elements all operating simultaneously on analog and digital operands. Word length of digital operands is 15 bits; analog accuracy is .01%. A fast 30-bit digital accumulator augments the 15-bit hybrid arithmetic.

A typical configuration performs 12 additions, 2 multiplications and 1 division in ten microseconds.

Hybrid arithmetic, A/D and D/A conversion, comparison, and signal routing and conditioning are all carried out under direct control of the stored program.

SEQUENTIAL STORED-PROGRAM OPERATION

Fifteen and 30-bit data words are transferred at high speeds to and from memory and all other parts of the AMBILOG 200 under flexible stored-program control. Core memory word length is 30 bits; cycle time is 2 microseconds. Memory sizes up to 32,768 words are available, all directly addressable. Digital I/O devices include punched tape, typewriter, magnetic tape, and direct data channels. A unique multiple priority interrupt system permits complete servicing of interrupts in as little as 3 microseconds, and facilitates interconnection for multi-processor installations.

PROGRAMMING

Instruction word length is 30 bits, permitting simultaneous control of memory, source and destination selection, word rotation, and Boolean logical operations. The order structure includes provision for recursive indirect addressing and indexing, a number of conditional and unconditional jumps, and program traps.

The AMBILOG 200 Symbolic Translator permits programming in symbolic source language and is easily extended to accept any problem-oriented source language.

Software support includes programmer and maintenance training, installation and maintenance services, system programs, standard sub-routines, and complete documentation.

BROAD APPLICATION

Flexibility, economy, and real-time processing power make AMBILOG 200 a "natural" for

- Biomedical monitoring
- Seismic data processing
- Sonar and radar signal enhancement
- Test stand instrumentation.
- Programmed automatic checkout
- Factory test and inspection
- Communications research
- Process control
- Space-vehicle simulation
- Simulator trainers
- Telemetry receiving stations
- Visual display systems

For more facts, contact I. R. Schwartz, Vice President. 617-UN 4-6620.



Adage, Inc. welcomes employment inquiries from professional engineers.

Adage
INC.

Main Office and Factory
292 Main Street
Cambridge, Massachusetts 02142

West Coast Plant
1145 East Ash Avenue,
Fullerton, California 92631

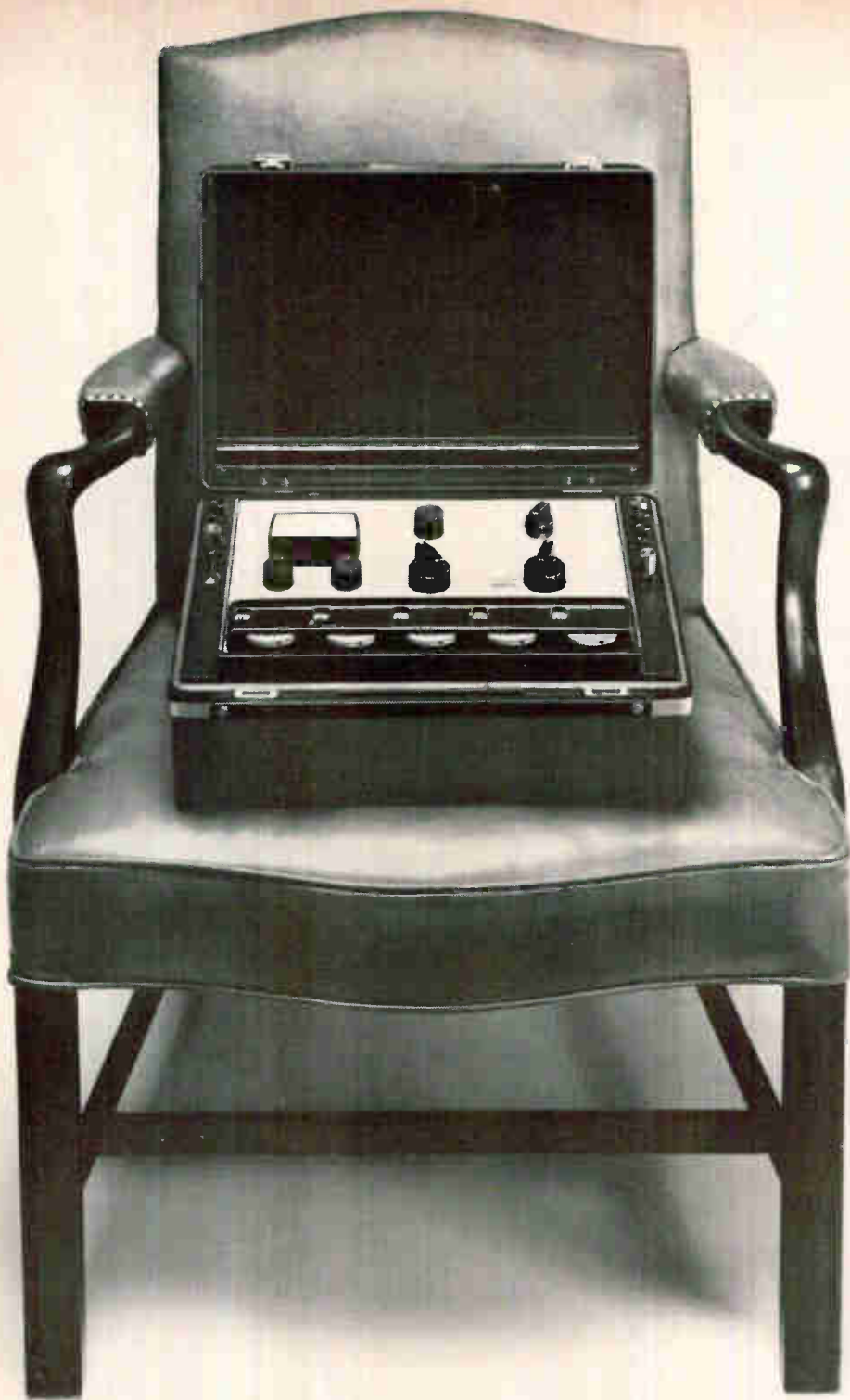

"I solemnly swear to tell the truth $\pm .003\%$ "

Our new Portametric Voltmeter testifies to an accuracy several times better than most laboratory potentiometers. This means it can easily double as a voltage calibration system for laboratory potentiometers, digital and differential voltmeters. It also serves as a precision voltage source.

Everything you need to start making measurements is included: five-dial potentiometer, voltbox, zener-regulated working voltage source, a portable reference standard cell and a solid-state null detector of high sensitivity. They're all conveniently built into the portable case, and you buy the works for one low price — \$895.

Up to now, there has been nothing on the market at this price with this kind of accuracy. We offer it as witness to ESI measurement capabilities and invite you to be the judge. ESI, 13900 NW Science Park Drive, Portland, Oregon (97229).

Model 330 Portametric Voltmeter

Voltmeter Ranges: 5–1 microvolt to 1200 volts.
Potentiometer Accuracy: ± 10 ppm of reading ± 1 ppm full scale on each range.
Voltbox Accuracy: ± 10 ppm.
Standard Cell Accuracy: ± 10 ppm.
Input Impedance: Infinite at null on ranges 1, 2 and 3. 10 megohms on ranges 4 and 5.
Battery Life: Approximately 1000 hours.
Null Detector: High-gain solid-state guarded detector; more than 5 microvolts dc sensitivity; input impedance: about 1 megohm.

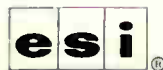

Electro Scientific Industries



COMPATIBLE COMBINATION

FOR ELECTRONIC EQUIPMENT



PRESTIGE CABINETS

Beautifully built electronic packaging distinguished in appearance and highly practical for housing a single piece of equipment or a large instrumentation system.



TRANS-AIRE BLOWERS

Prolong the life of sensitive electronic equipment and maintain its proper efficiency by dissipating excessive heat generated in the enclosure.



• WRITE FOR LITERATURE



BUD RADIO, INC.
WILLOUGHBY, OHIO

VISUAL RFI MEASUREMENTS

FASTER! MORE ACCURATE! MORE VERSATILE!



**SPECTRUM
SIGNATURE
ANALYZER
MODEL PA-210**

TYPICAL DISPLAY OF FM AND TV SIGNALS
DEMONSTRATING RAPID RFI SIGNAL IDENTIFICATION

- WIDEBAND DISPLAY! SWEEPS UP TO TEN TIMES RFI METER IF
- RAPID VISUAL ANALYSIS OF AM, FM, AND PULSED SIGNALS
- EXCEPTIONAL RESOLUTION ■ USE IT WITH ALL RFI METERS

EMPIRE[®] Spectrum Signature Analyzer PA-210 is a *Panadaptor* swept-band spectrum display instrument for use with Noise and Field Intensity Meters such as *Empire* Models NF-105, NF-205, and NF-112. Inherent with the PA-210 is the unparalleled combination of pioneering experience, specialized skills and reputation for quality earned by *Empire* instruments in the field of RFI measurements.

In spectrum surveillance operations, the *Empire* Spectrum Signature Analyzer greatly speeds identification of interference phenomena. Provides convenience in spectrum scanning, and is virtually indispensable in the rapid detection and analysis of interference, harmonics, sideband splatter, dynamic signal changes, instability, pulsed signals, multiple signals, wideband short-pulsed signals, and unusual types of noise.

Operating at fixed IF's obtained from the Field Intensity Meter, the PA-210 provides a CRT display of a band centered around the frequency to which the Field Intensity Meter is tuned. The PA-210 is equipped with four plug-in tuning units to ensure compatibility with all IF frequencies employed in existing Field Intensity Meters over the frequency range of 14 kc - 22 gc. Unlike similar instruments, the PA-210 may utilize pre-IF as well as post-IF pick-off. With pre-IF pick-off, the PA-210 sweeps up to ten times as wide as the IF bandwidth of the RFI instrument, opening new realms of application in wideband monitoring and signal searching. Contact your Metrics sales representative for technical information and applications engineering assistance.

SPECIFICATIONS

TUNING UNIT	COMPATIBLE IF	ASSOCIATED NOISE METER
T1, PA-210	225 kc/s	Empire T-X/NF-105
T2, PA-210	455 kc/s	Empire T-A/NF-105
	1600 kc/s	
T3, PA-210	10.7 Mc/s	Empire T-1/NF-105
	30.0 Mc/s	Empire T-2/NF-105
	42.0 Mc/s	Empire T-3/NF-105
	60.0 Mc/s	(Optional)
T4, PA-210	60.0 Mc/s	Empire NF-112 (All Heads)
	140.0 Mc/s	(Optional)
	160.0 Mc/s	(Optional)

- Sweep Width: Linear frequency scale:
 - T1 PA-210 — 0 to 20 kc
 - T2 PA-210 — 0 to 100 kc
 - T3 PA-210 — 0 to 1 mc
 - T4 PA-210 — 0 to 30 mc
- Sweep Rate: Continuously adjustable 1-60 cps, may be synchronized to line or external.
- Sensitivity: Full scale deflection with signal capable of providing full scale noise meter deflection (as low as 1 or 2 μ v, approx. 12 μ v full scale).
- Resolution: Adjustable. 10 cps to 1.0 kc minimum (Depends on the head in use).
- Power: 115 v (nom.), 50-400 cps. others on special order.
- Amplitude Scales: Linear, log (40 db), power (square law).
- 17" w x 8 3/4" h x 22" d, approximately 40 pounds.

ASK YOUR METRICS SALES REPRESENTATIVE ABOUT THE NEW SINGER TIME PAY AND LEASE PROGRAMS



THE SINGER COMPANY
METRICS DIVISION

915 PEMBROKE ST., BRIDGEPORT, CONNECTICUT
PHONE (203) 366-3201 • TWX 710-453-3483

Design and production of PANORAMIC • SENSITIVE RESEARCH • EMPIRE • GERTSCH instruments for measurement

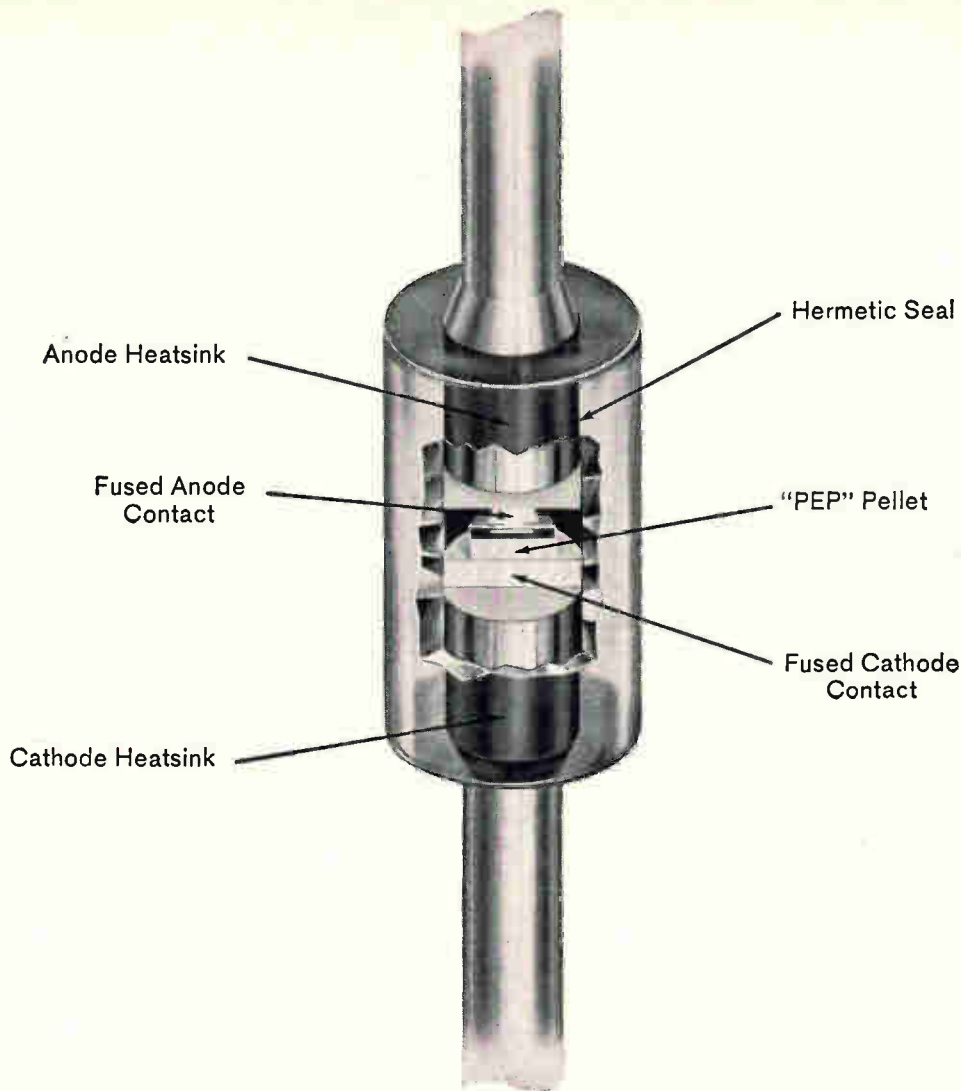

smaller than most... as rugged as they come... and inherently more reliable!

The new General Electric **Double Heatsink Diode** features a simplified design that eliminates the "S" strap, offers fused anode and cathode contacts, and provides increased power dissipation in less unit volume. Process stabilization at 300°C assures outstanding parameter stability. This combination of design and process control, coupled with the advantages of the DHD Planar Epitaxial Passivated pellet, offers outstanding electrical performance and device reliability.

To learn more about the performance and economic advantages the **Double Heatsink Diode** can offer your designs, see your Semiconductor Products District Sales Manager, or write Semiconductor Products Department, Section 16H160, General Electric Company, Electronics Park, Syracuse, New York. In Canada: Canadian General Electric, 189 Dufferin Street, Toronto, Ontario. Export: International General Electric, 159 Madison Avenue, New York 16, New York.

Comparison of General Electric "PEP" Diode Pellets

	1N4151-54	1N4148-49	SD-300	1N4150	SD-400	SD-800	
Breakdown Voltage BV @ 5 μ a	35-75	100	40		40	40	volts
Leakage Current I_r @ 30 volts, 25°C	50	50	0.1 @ 10V	50	50	50	nano-amps (max)
Capacitance C @ 0 volts C @ -10 volts	2-4	2-4	3	2.5	6	30 15	pico-farads pico-farads
Recovery Time t_r ($I_R = I_F = 10$ ma, re-recovery to 1 ma)	4	5	100	4	10	20	nano-seconds
Conductance typical I_F @ $V_F = 1$ volt, 25°C	100	150	100	250	400	800	ma

Available through your G-E semiconductor distributor

GENERAL  ELECTRIC

Technical articles

Highlights



Finding new applications for ceramic tubes: page 50

Although they are several years old, ceramic vacuum tubes are finding a lot of new applications. They are rugged, reliable, and can be miniaturized. At first glance they seem most useful in circuits which operate at ultrahigh frequencies or at the lower end of the microwave band. But they also can be used in audio, video and low-frequency applications. In addition, they are radiation-resistant.



Circuits that act like human reflexes: page 66

Pavlov's experiments with conditioned reflexes are famous. Now an engineer tries to apply the same technique to a computer. By designing circuits that can "pair"—relate one event to another—he hopes to increase the capability of data processors, without restrictions on the usual circuit design or programming.



A survey of digital logic trainers: page 71

Retraining engineers to design computers or computing circuits can be speeded up by commercially available logic trainers. In addition, these devices can be used to breadboard and design test circuits. Which one you choose depends on your needs.



Tripling data storage in a space recorder: page 84

Satellite experiments have pushed magnetic recording capability far beyond what was thought possible only a few years ago. For the Gemini space project, engineers have gone another step forward, tripling packing densities with a diphase recording technique.

**Coming
September 7**

- **Special Report: Transistor heat dissipators**
 - Profile of the industry
 - The thermal side of solid-state design
 - New devices to dissipate heat
 - A low-cost approach to liquid cooling
 - Choosing the right heat dissipator
- **Less noise in diode transistor logic circuits**
- **Electronics in the supersonic transport**

Attractive alternative at uhf: the ceramic vacuum tube

Circuit requirements for ultrahigh frequencies and the lower microwave bands are met by small ceramic triodes. They are useful too for audio, video and low radio-frequency applications

By James W. Rush Jr.

Tube Dept., General Electric Co., Owensboro, Ky.

With missile telemetering bands moving in to join the point-to-point and air-to-ground radio communications services that now occupy the ultrahigh-frequency and lower microwave regions of the frequency spectrum, designers are focusing their attention on equipment for these areas. Small ceramic vacuum tubes with planar electrodes provide an attractive design alternative to both varactor frequency-multipliers and klystrons. They deliver more power than varactors and are cheaper and more compact than klystrons.

Ceramic tubes are being designed also into a 15-Gc radar system, into a new uhf altimeter so sensitive it can tell the height of railroad tracks and telephone wires and into special communications equipment. They have been used in telemetering transmitters during the early suborbital Mercury space shots, as the continuous-wave beacon transmitter in the Pioneer IV space probe and in moon-bounce experiments conducted by amateur radio operators.

Low transit time, low grid-to-plate capacitance and low structural inductance are characteristics of ceramic tubes that improve their performance at high frequencies. Shot noise, flicker noise, induced grid noise and microphonics all are low. The ratio of transconductance to plate current is high and heater power requirements are low. The tubes resist high temperatures, low temperatures, mechanical shock and nuclear radiation.

Their ability to function in such hostile environments has led to communications and control applications in the frequency ranges from d-c to video and from the low to very high radio frequencies.

The 7910 and Y-1171 structures best exemplify the advantages of ceramic tubes in the uhf region. These two tube types differ from each other only in the internal diameter of the cathode. The thin ceramic shell minimizes capacitive loading caused by the characteristics of the insulating ceramic itself. The structure has the fewest possible radio-frequency discontinuities and has low lead inductance. It has been evaluated beyond 10 Gc in a reentrant oscillator circuit (drawing, page 51).

Plate efficiency

Plate efficiencies of 2% have been obtained at 9.5 Gc. Although this is low, compared to the plate efficiencies of traveling-wave tubes and magnetrons, it is high for grid-type vacuum tubes, and is equal to or better than that of most reflex klystrons. The triode oscillator is less voltage-sensitive than a klystron and uses a much simpler power supply. The sideband noise of the triode oscillator also is reported to be much lower than that of a klystron local oscillator.

The type 7910 ceramic tube is primarily a plate-pulsed oscillator; a typical tube will deliver about

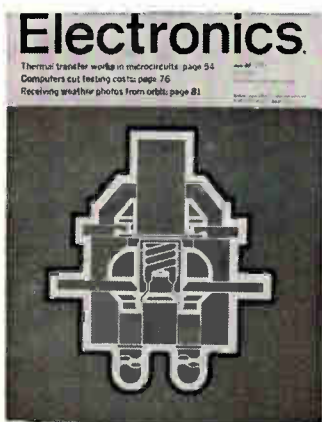

The cover

This cross-section of a General Electric ceramic tube shows the construction that makes such tubes rugged and resistant to mechanical shock. Art director Howard Berry placed the unusual shapes on a color spectrum.

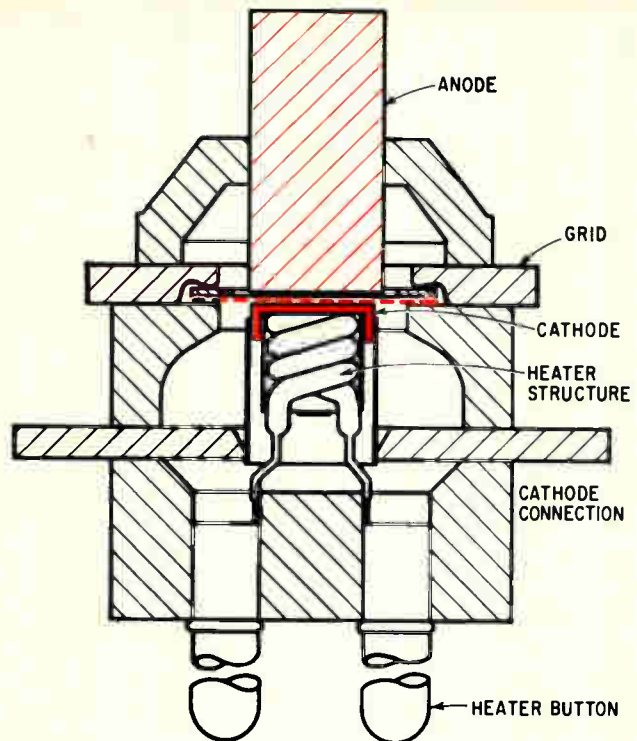
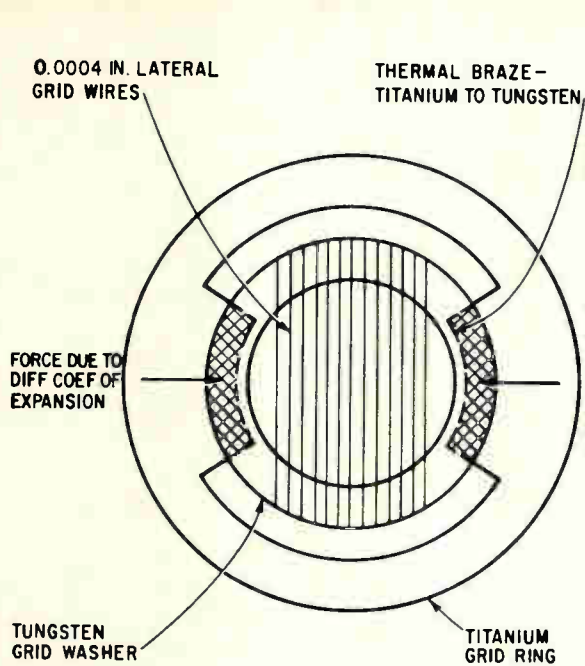

Plan view of a type 7077 triode (left) and cross section of the 7910/Y-1171. Conventional tube parts are in color.

100 watts of peak power at 5,700 Mc with a plate efficiency of about 17%. The Y-1171 is being designed for use as an X-band local oscillator. Sufficient power for this application is obtained over a 10% tuning range. One local oscillator weighed only two ounces excluding the high-voltage and heater leads.

Current density

One of the most significant features of the titanium-ceramic structure used in these tubes is its long life at high current densities. Several different life tests have been run in excess of rating to obtain a preliminary estimate of the tubes' longevity with high cathode loading. One tube was operated at about 0.8 amp/cm² for 5,000 hours without noticeable drop in power output at 925 Mc.

Nine 450-Mc oscillators using type 7486 tubes ran for 3,000 hours at 0.4 amp/cm² before the first failure occurred. This life test was run with heaters cycled off and on during the test. One of the nine units operated almost 10,000 hours without failure. A larger number of 7486's was life tested at 0.4 amp/cm² and no significant deterioration of tube characteristics was noted at 1,000 hours. Other tests at 1 amp/cm² were run for several hundred hours.

Operation at high current density reduces transit-time noise, raises stage gain, increases the gain-bandwidth product by providing more transconductance per unit of tube area, raises oscillator and power amplifier efficiencies by reducing transit-time losses and raises the maximum available power output by permitting a larger d-c input per unit tube area and better plate efficiency.

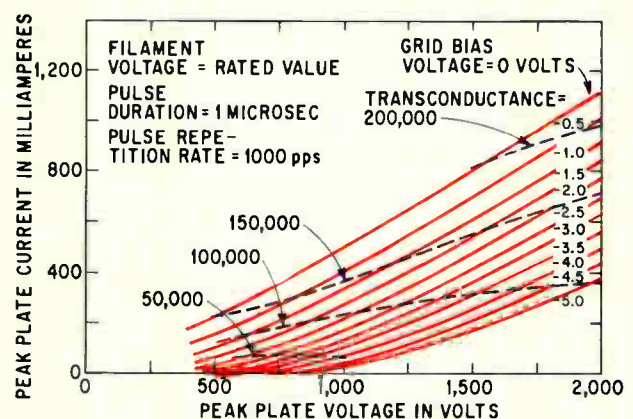

Average plate characteristics for pulsed operation

The usefulness of operating at high current density to reduce the noise figure became apparent in recent tests on the 7077 triode at 1,200 Mc. A typical tube showed a noise figure of about 8 db when operated at 0.2 amp/cm². But at 0.6 amp/cm², a 2 to 2½-db reduction in noise figure was noted.

Another example is the success in getting useful power outputs at X-band. It has been verified both by calculations and measurements that current densities greater than about 0.5 amp/cm² are essential. The Y-1171, as small as it is, will be rated for about 35 ma. of cathode current and a plate dissipation of about 4 watts. Destructive testing of this 7910/Y-1171 structure in good heat-sinks resulted in no seal failures with inputs as high as 15 watts. However, to insure good reliability, the structures will not normally be rated at this level.

The Y-1171 has operated with c-w power outputs

of almost 0.7 watt at 5,000 Mc and current densities of about 0.6 amp/cm². Plate efficiencies at this frequency are about 15% (or about 11% including heater power).

The performance of the 7910/Y-1171 structure was compared with the Siemens-Halske RH7C, a conventional gridded vacuum tube. At 5,000 Mc an efficiency of 8% at 0.78 amp/cm² was calculated for the latter using published performance curves. Since this does not include heater power, the overall efficiency drops to 5.4%. The RH7C gives more absolute power because a 25-watt input is permissible with proper heat-sinking.

At S and L bands the new family of ceramic tubes has been shown to operate efficiently in both strip-line and coaxial circuits. Cavity amplifiers for the 7077-7486 have been built to tune to 4,000 Mc. Strip-line circuits have been constructed using these two tube types up to at least 2,500 Mc. In the new telemetry band (2,200-2,300 Mc) the small 7486 gave about 3/4-watt power output with a gain of about 12 db. A frequency multiplier chain from a 50-Mc crystal has been built and evaluated as a power source at 2250 Mc. Preliminary evaluation of the Y-1223 developmental tubes indicates at least 10 watts of power at 2,250 Mc is available at a plate efficiency of about 30%.

Pulsed operation

Vacuum tubes, unlike solid-state devices, can be operated with very high ratios of peak to average power. For example, a duty factor of 1,000-to-1 is common. Average powers of watts become kilowatts of peak power. As a result of the higher voltages and currents possible in pulsed usage, higher plate efficiencies result. For example, the 7910 triode will produce about 100 watts of peak power at 5.7 Gc with a plate efficiency of about 16%. The development type Z-2867 gives about 2.4 kilowatts of peak power at 4,200 Mc with a plate efficiency of about 30%. This tube consumes only about 3.5 watts of heater power and has delivered one kilowatt at 6,000 Mc with about 13% plate efficiency.

This pulsed performance was measured in pulsed oscillator cavities tuned for maximum efficiency and power output. Recent radar applications, like phased-array antennas, require broadband pulse amplifiers with low phase distortion and phase shift. The high-transconductance, low-capacitance planar triode appears to be a natural choice for this application.

At rated class A conditions using double-tuned circuits, the 7768 has demonstrated measured gain-bandwidths up to 2,500 Mc. Transconductance with c-w operation was 50,000 micromhos. But 100,000 micromhos is available at 500 volts and about -0.75 volt bias and almost 150,000 micromhos is available at zero bias. These higher levels double or triple the gain-bandwidth products available for pulsed operation. The tube, when grid pulsed at 1,300 Mc with 500 d-c volts on the plate, gave about 15-db gain and 130 Mc bandwidth.

How ceramic tubes perform . . .

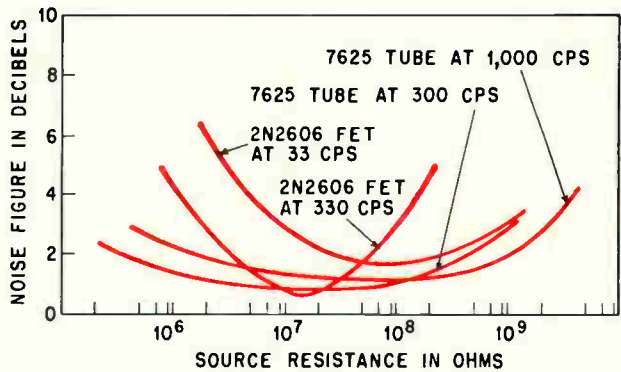

Comparison of noise figure versus source resistance for ceramic tubes and field-effect transistors

The approximate gain-bandwidth product is 4,000 Mc. This gain-bandwidth product would be useful at all power levels where no serious loading exists due to grid current. At -0.75 volt, limitation would occur at about +30 dbm output. The 7768 has insufficient cathode temperature for currents much over several hundred milliamperes peak.

Use of higher heater voltages or a shift to pulse-rated types like the Z-2867 would have grid-pulsed power outputs in kilowatts. These higher-level stages would give less gain per stage. The maximum duty factor would be limited by plate dissipation or possibly cathode back-heating or coating losses.

D-C to video applications

Flicker noise is one of the most difficult problems in low-level preamplifiers used at d-c, sub-audio and audio frequencies. The exact cause of this noise is not known. The general rule-of-thumb for reduction of flicker noise is to obtain maximum transconductance with minimum plate current. This can be achieved with the ceramic receiving tubes.

Shot noise also appears at these frequencies, and sufficient transconductance must be obtained to keep the value of equivalent shot-noise resistance to a minimum. The noise performance of any device also depends greatly upon the source impedance that it sees. Side-by-side tests have been conducted comparing the small planar ceramic triode with field-effect transistors. The results show that the tube gives noise figures equal to or superior to the field-effect transistor at room temperature. With the tube, optimum source impedances for minimum noise generally are higher, and the frequencies at which tube flicker noise tends to dominate are lower. The ceramic triode also exhibits lower noise figures than field-effect transistors over wider ranges of source resistance (above).

The ceramic tube is low in microphonics, or output generated by vibration of tube parts due to shock. The use of the high (mechanical) tension grid, and the rigidity of the planar construction, have reduced the microphonics to a very low level.

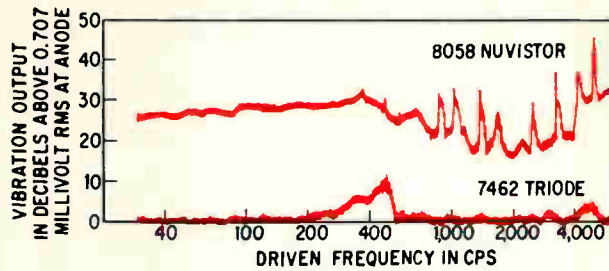

OPERATING CONDITIONS	8058	7462
PLATE VOLTAGE	+110 V	+150 V
PLATE RESISTOR	10,000 OHMS	10,000 OHMS
CATHODE RESISTOR	47 OHMS	82 OHMS
VOLTAGE GAIN	45	50
VIBRATION LEVEL	10 G	10 G

Comparison of vibrational output versus driven frequency for ceramic tubes and nuvistors

The low level of microphonics and the low-noise features at high source resistance, make these triodes attractive for infrared preamplifiers, strain-gage preamplifiers, ionization-chamber preamplifiers and other applications where very low-level signals must be amplified. Even when the low-level signals occur at low impedances the tube still has an advantage over the transistor because of the voltage step-up possible at this input.

The triodes of this new family exhibit very high gain-bandwidth products. These are calculated from the formula:

$(G)(BW) = g_m/2\pi C$, where C is the grid-to-plate capacitance, and g_m is the tube transconductance.

Tube type	Grounded grid (G)(BW) in Mc	Grounded cathode (G)(BW) in Mc
7077	1,600	440
7910	2,500	600
7913	2,700	540
7768	4,700	680
7588	2,700	580

Use of the grid-to-plate capacitance in the formula presupposes use of the tube in a grounded-grid connection and in this case the grid-to-cathode capacitance is not significant. In the grounded-cathode connection, the interstage capacitance, without allowance for Miller effect, would be the sum of grid-to-plate capacitance plus 1.5 times the cold grid-to-cathode capacitance. The factor of 1.5 accounts for the estimated rise in grid-to-cathode capacitance due to space-charge effects and dimensional changes when the heater is turned on. These calculations illustrate how the use of socketless circuits improves the gain-bandwidth product. The tabulated figures do not take into account the external circuit connections and are only for comparing tube-to-tube performance.

For comparison, the gain-bandwidth products for two of the best available conventional gridded vacuum tubes—the 416B and 417A—are 5,300 and 480, and 2,200 and 260, respectively. In further contrast, the 416B is recommended for use only under moderate shock and vibration conditions, with sufficient cooling to keep all seals cooler than

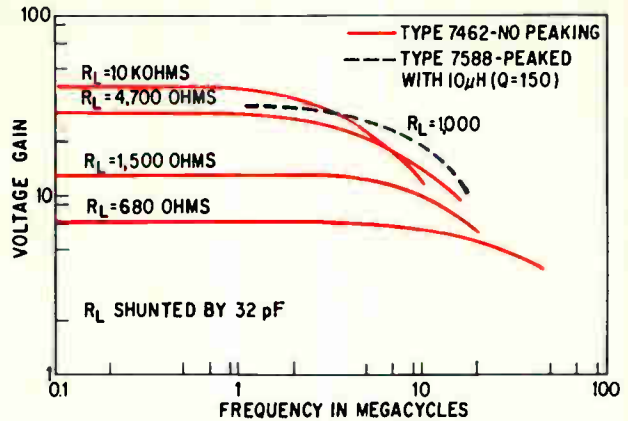

Single-stage gain versus frequency for ceramic-tube video amplifiers

150° C, and with programmed turn-on and turn-off procedures. However, the ceramic 7768 has no thermal, shock, vibration or transient limitations when used within its ratings. The seal temperature of 250° C is conservative, and with proper reduction of heater power, the tube can be operated for long periods of time at temperatures much higher than 250° C. The microphonic outputs of the 416B and 417A are much higher than the levels for the 7462, whose performance is shown in the chart above.

The new titanium-ceramic triodes can be applied at intermediate and very-high radio frequencies in the same manner as glass tubes, nuvistors and compactrons. But the ceramic tubes afford lower noise figures, more gain and gain-bandwidth per stage, more tolerance to shock and vibration, lower cathode-lead inductance, solder-in features or socketless circuits, resistance to high temperatures, tolerance of nuclear radiation, small size and low weight.

Some specific applications of the ceramic tube are: low-noise cascode preamplifiers, broadband telemetry preamplifiers, telemetry transmitters, stalo (stable local oscillator) crystal oscillators, broadband and narrow-band frequency multipliers, voltage detectors for instruments, sweep generators, and oscillators.

VHF usage

Efficient and useful performance is being obtained at frequencies up to 9.6 Gc. At L-band frequencies acceptable bandwidth products are being obtained. The gain-bandwidth products previously quoted apply to conditions where tube capacitances only were considered. Gain-bandwidth products of over 4,000 have been measured in functional circuits under class A pulsed conditions. In narrow-band coaxial cavities, X-band units are commercially available that provide more than sufficient power output for local oscillator use. The vacuum-tube cavity oscillator has been reported to be superior to klystron, magnetron and varactor local oscillators in very low-noise applications where the noise spectrum around the local oscillator is important.

The planar-gridded ceramic tube is being used

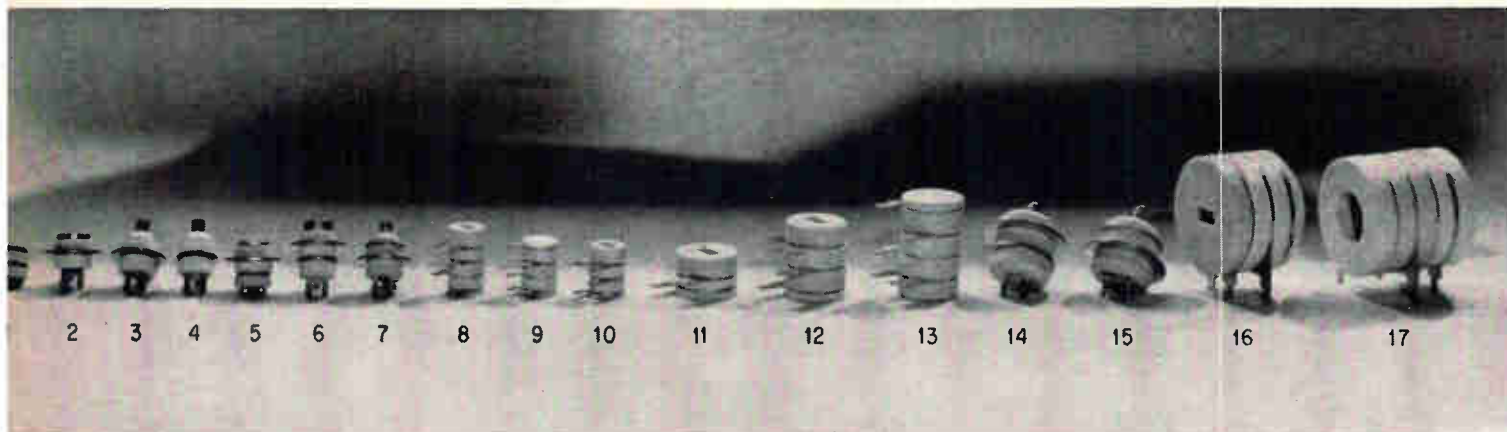

in grid-pulsed broadband amplifiers for Tacan (tactical air navigation), IFF (Identification friend or foe), DME (distance measuring equipment), and phased-array radar; plate-pulsed oscillators and amplifiers for Tacan, DME, beacons, and microwave links; continuous-wave oscillators for local oscillators up to X band; varactor drivers for frequency multipliers; c-w and pulse altimeters at the 4,200 and 4,300-Mc bands as well as for the lower bands, and super-regenerative receivers up to 5,000 Mc.

Also: telemetry transmitters particularly for the 2,200 to 2,300 Mc band; varactor-tuned oscillators; crystal-referenced frequency multiplier chains; command-guidance transmitters; uhf airborne communications; satellite transmitters; air-traffic control and site surveillance doppler radar and electronic countermeasures equipment.

Long life and reliability

Time and life tests have established a general life and reliability profile for the titanium ceramic structure. The earliest class A, B and C rated types are showing a quality-control failure rate of about 1% per 1,000 tube hours at maximum ratings. Most of the life tests of production-lot samples are conducted to 1,000 hours with some lots tested to 15,000 or 20,000 hours for information only. The 1% per 1,000 hour figure represents an average over about three years of production.

In practice, it is expected that the tubes will show much lower failure rates. For example, the 7077 type is classed as a "failure" in a life test for any

The author



James W. Rush, Jr. was born in Big Stone Gap, Va., and received his degree, in 1948, from the Virginia Polytechnic Institute. Upon graduation he joined the General Electric Co. He is now a consulting engineer in application engineering and helped develop the company's ceramic planar triode product line. He has been a senior member of the IRE since

1956 and is a licensed radio amateur, W4EWL.

one of several reasons, most of which would not cause equipment shutdown or failure. In addition, life tests are run at approximately maximum ratings for all characteristics all at the same time. The pulse types are not producing as low a failure rate as some of the other types but sufficient test data is not now available. The cathode temperatures necessary to provide the required peak emissions are not conducive to long life.

Planar vs coaxial designs

Nuvistors, pencil tubes and many other tube designs use coaxial structures. The active surfaces are concentric cylinders mounted inside each other. Besides requiring precise alignments in all phases of production, there are other disadvantages.

The coaxial tubes have much longer cantilevers than those of planar design. This results in less tolerance to destructive shock and vibration as well as more microphonic output. Because of the alignment problem, the closer spacings normally used in the planar design are not practical in coaxial construction; thus the high-frequency performance of coaxial tubes must necessarily be lower. If the frequencies at which the tubes are used are high enough, standing waves exist along the length of the coaxial tube structure. These lead to shortened life and other effects because unequal r-f currents are drawn from the cathode.

The planar design eliminates the need for supporting grid side-rods or cages and result in better high-voltage capabilities. However, an advantage of the coaxial design is the ability to heat more cathode surface with the same heater power. At the same cathode current densities, there seems to be no significant advantage of one configuration over the other as far as effects of reduced heater voltages are concerned. The planar structure does change internal dimensions with heater voltage because of the expansion of the cathode support cylinder. This effect can be minimized by rating the tube heater voltage for a desired service and regulating the heater voltage to $\pm 5\%$.

Search for seals

To reduce manufacturing costs of metal-ceramic

◀ Family of ceramic tubes

Photo	Tube types	Description
1	7266, 7841	Coaxial signal diodes
2	*Y-1069	Coaxial signal diodes
3	*Z-2971	Coaxial diode—large cathode flange
4	*Z-2971	n Coaxial diode—small cathode flange
5	77077, 7486, *Y-1032	Coaxial signal triodes
6	*Y-1266	Coaxial signal triodes
7	7910, *Y-1171, *Y-1124	Coaxial microwave triodes
8	8081, 8082, 8083	Lug "T" signal triodes
9	7462, 7720, 7625	Lug signal triodes
10	*Y-1012	Lug "T" signal diode
11	*Z-2692	Lug "T" cold cathode diode
12	*Z-2869	Lug "T" power diode
13	7295, 7588, *Z-2868, *Z-2870	Lug "T" power triodes
14	7768, 7913, *Z-2835, *Y-1291	Coaxial power triodes
15	*7911, Y-1274	Coaxial power triodes
16	*Z-2731	Lug "T" power diode
17	*Z-2354	Lug "T" power triode

*Types in development

Not shown are Y-1223 and Y-1236, high-dissipation equivalents to 7913 and 7911 respectively.

tubes, early laboratory work sought a simple sealing technique whereby the soldering material could be applied directly to the metal and ceramic surfaces to be bonded and a vacuum-tight seal obtained without prior metallizing. If all this could be done, the tube could be baked-out, pumped to a vacuum, and sealed all in one process.

The successful conclusion of this search resulted in a ceramic-to-metal seal using nickel as the soldering agent. Specially prepared ceramics also were developed to match the thermal coefficient of titanium metal. Titanium was found to be the best metal for this purpose. The nickel formed a eutectic bond to the titanium and a vacuum-tight ceramic wetting action.

The fabrication technique has been applied to a wide variety of structures useful from d-c to at least Ku band and capable of meeting the most demanding environmental requirements. Approximately 15 types have been registered with the Electronic Industries Association, with eight basic external configurations. There are about 15 additional designs in development (see photo at left).

Three basic external configurations are used: lug, lug "T" and coaxial cavity versions. The lug design can be soldered into printed circuits. The lug "T" is most useful for socketless circuits where the tube is mounted by a "T" bolt strip-line or cavity circuits.

A gold-flashed nickel plate has been applied to all types to permit soldering to the basic titanium tube element. This not only permits soldering into a printboard, but even coaxial elements can be soldered directly to the tube for improved electrical performance and mechanical ruggedness. Where sockets can be used and are desirable, they are commercially available in various designs.

Tube fabrication

All the tubes use the same basic sealing techniques. In some cases where coaxial seals are made, separate subassemblies are necessary. The basic concept was applied to tubes which had planar seals, and tubes could be mechanically stacked and sealed as one unit. For extra performance, some coaxial seals were used to reduce capaci-

tance and provide better mechanical features.

The stacked assemblies are vacuum treated and out-gassed at high vacuum and high temperatures. This insures their ability to operate under much more stringent conditions than either all-glass or all-metal tubes.

The sealed 7077 in most cases can be operated immediately. However, as with all vacuum tubes, it is prudent to age the tube for short periods to insure early life-stability and obtain a more uniform product. Types intended for pulse applications requiring up to 13 amperes per sq cm of emitting surface, usually require more post-sealing aging to obtain the desired emission. After sealing, aging and testing, the tubes are plated and tested to assure outgoing quality.

Ceramic-nickel-titanium seal

The ability to stack, seal and evacuate tubes in one operation has many advantages that help keep costs relatively low. However, to obtain high performance very tight control of tube spacing is required. The use of planar electrode surfaces reduces the problem in one of the three required dimensions and extreme accuracy need be obtained only between the two parallel planar surfaces. These two faces can be displaced laterally a few thousandths of an inch and not seriously affect the tube's characteristics. To reduce transit-time effects at a higher frequency and to obtain very high transconductance-to-plate current ratios, very close spacings are required. This is particularly true between the grid and cathode. The use of planar surfaces and the stacked sealing technique provides a high ratio of performance to cost.

Several other advantages result from the sealing technique developed. In addition to providing a seal that permits effective outgassing of tube parts prior to sealing, a structure capable of operating in any environment up to at least 600° C has resulted. The use of titanium, which is an efficient getter, eliminates the need for the added getter usually found in other tubes. At elevated temperatures, additional gasses are absorbed and excellent life at 450° C has been demonstrated.

Research and development

Work continues toward the improvement of the capabilities of the titanium-ceramic tube family. Many new applications are appearing and more are anticipated as a result of the new features that are forthcoming. The new development areas are: fast warm-up types, isolated heaters with 5 second or less warm up and directly heated cathodes for less than one second warmup; reduced heater power designs; more rugged structures for new generation intercept missiles; improvement in X-band performance and evaluation of the tube's capabilities at Ku-band; further reduction of microphonic outputs; less expensive designs for commercial and entertainment markets; high-dissipation anode design; and further evaluation of high-current-density capabilities.

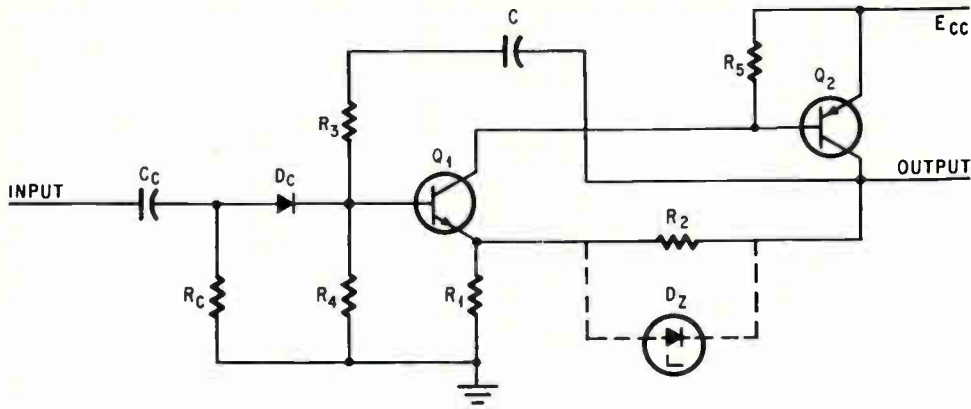

Basic complementary monostable circuit

Circuit Design

Monostable circuits need power only when they work

Easy new approach to monostable circuit design satisfies space requirements for minimum power dissipation

By Leonard L. Kleinberg

Goddard Space Flight Center, NASA, Greenbelt, Md.

Minimum power dissipation is a prime objective for the designer of satellite electronic systems. He can accomplish this with complementary monostable circuits that dissipate power only when they are in use. Such circuits are easy to design.

The basic configuration from which the circuits described in this article are derived is shown above. Normally, both transistors Q_1 and Q_2 are off because there is no biasing network to turn them on. If a positive trigger is applied to the input coupling network, consisting of C_c , D_c and R_c , both transistors quickly turn on. Regeneration takes place because the input trigger is amplified by the forward voltage gain $[1 + (R_2/R_1)]$ of the circuit, and fed back through C to the base of Q_1 in phase with the input trigger. If the attenuation of the amplified trigger, approximately equal to $R_4/(R_4 + R_3)$, is small, regeneration is rapid, and Q_2 is driven to saturation by Q_1 . Regeneration will take place if:

$$[1 + (R_2/R_1)] [R_4/(R_3 + R_4)] > 1 \quad (1)$$

As C begins to charge, the base voltage of Q_2 decreases exponentially, Q_2 comes out of saturation, negative regeneration again takes place and the circuit turns off. The base voltage required to remove Q_2 from saturation is approximately the supply voltage divided by the forward gain or $E_{cc}/[1 + (R_2/R_1)]$. In effect, a negative resistance with a magnitude of $-R_3R_1/R_2$ appears at the base of Q_1 in parallel with the input impedance seen at the base. If the resultant impedance is negative, switching takes place.

Equivalent circuit

The equivalent circuit for the basic configuration helps to determine an expression for the approximate conduction period for Q_1 and Q_2 . By taking a summation of the currents at point A, the following equation is obtained:

$$I_3 = I_1 + i_b \quad (2)$$

where I_3 = current flowing through R_3

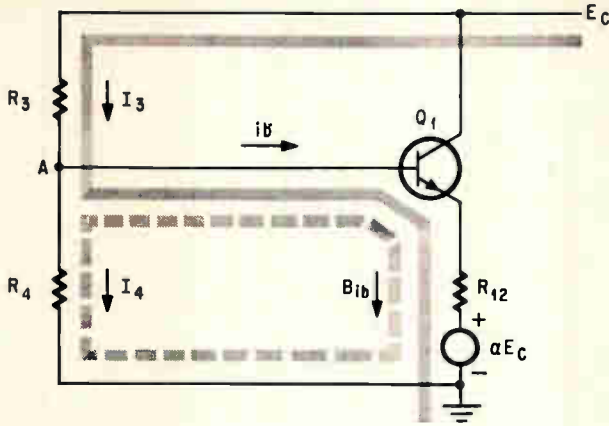

Equivalent complementary monostable circuit

I_4 = current flowing through R_4
 i_b = base current of Q_1

Next, by adding voltage drops along the loop indicated by the solid line, we obtain:

$$E_c - I_3 R_3 - (E_{be} + \beta i_b R_{12} + \alpha E_c) = 0$$

where $E_c = E_{CC} - E_{CE(SAT)2}$
 E_{CC} = Supply voltage
 $E_{CE(SAT)2}$ = Collector-to-emitter saturation voltage for Q_2
 E_{be} = Base-to-emitter voltage of Q_1
 β = Beta of Q_1
 $R_{12} = R_1 R_2 / (R_1 + R_2)$
 $\alpha = R_1 / (R_1 + R_2)$

Solving for I_3 :

$$I_3 = [E_c - (\alpha E_c + \beta i_b R_{12} + E_{be})] / R_3 \quad (3)$$

Now, by adding voltage drops along the loop indicated by the dashed line, we obtain:

$$I_4 R_4 - (\alpha E_c + \beta i_b R_{12} + E_{be}) = 0$$

solving for I_4 :

$$I_4 = (\alpha E_c + \beta i_b R_{12} + E_{be}) / R_4 \quad (4)$$

Substituting 3 and 4 in 2:

$$[E_c - (\alpha E_c + \beta i_b R_{12} + E_{be})] / R_3 = [(\alpha E_c + \beta i_b R_{12} + E_{be}) / R_4] + i_b$$

Simplifying the above equation and solving for i_b , we obtain:

$$i_b = [E_c(Y_3 - \alpha Y_{34}) - E_{be} Y_{34}] / (Y_{34} \beta R_{12} + 1) \quad (5)$$

where $Y_{34} = 1/R_3 + 1/R_4$
 $Y_3 = 1/R_3$

The voltage E_{R1} across R_1 is given by:

$$E_{R1} = \beta i_b R_{12} + \alpha E_c \quad (6)$$

Substituting 5 in 6:

$$E_{R1} = \beta R_{12} [E_c (Y_3 - \alpha Y_{34}) - E_{be} Y_{34}] / (Y_{34} \beta R_{12} + 1) + \alpha E_c \quad (7)$$

Simplifying equation 7:

$$E_{R1} = E_c (ETR) (1 + R_3/\beta R_2) - E_{be} (ETR) (1 + R_3/R_4) \quad (8)$$

where ETR (Expected Transfer Ratio) = $\beta R_{12} R_4 / (R_4 + \beta R_{12}) / [R_3 + (R_4 \beta R_{12}) / (R_4 + \beta R_{12})]$ (9)

The period t_o (time during which both transistors are on) is given by:

$$t_o = R_T C (\ln E_{R1} - \ln E_1 \alpha) \quad (10)$$

where

$$R_T = R_3 + (R_4 \beta R_{12}) / (R_4 + \beta R_{12})$$

In equation 10, E_{R1} is the voltage across R_1 as the transistors turn on and E_1 the voltage at which they turn off.

An important property of this circuit is that the pulse width may be varied by changing the forward gain. By varying R_2 the pulse width may be changed by a factor of ten or more.

Typical example

The following example is given to familiarize the reader with the use of some of the equations previously discussed.

From equations 8, 9, and 10, the pulse width may be obtained. For fast circuit operation, use low component values as shown below:

- | | |
|-----------------------|------------------------|
| $R_1 = 2.2K$ | $Q_1 = 2N338$ |
| $R_2 = 8.2K$ | $Q_2 = 2N1132$ |
| $C = 4600 \text{ pF}$ | β for $Q_1 = 50$ |
| | $E_{be} = 0.7V$ |
| $R_3 = R_4 = 100K$ | $E_{CE(SAT)2} = 0.1V$ |
| $R_S = 18K$ | $E_{CC} = 20V$ |

- $R_{12} = R_1 R_2 / (R_1 + R_2) = 1.73K$
- $R_4 \beta R_{12} / (R_4 + \beta R_{12}) = 46.4K$
- $ETR = 0.317$ (9)
- $E_{R1} = (19.9)(0.317)(1 + 100K/410K) - (0.7)(0.317)(1 + 100K/100K) = 7.4V$ (8)
- $E_1 = [E_{CC} - E_{CE(SAT)2}] / [1 + (R_2/R_1)] = 4.2V$
- $t_o = (1.464) (10^5) (4600) (10^{-12}) \ln (7.4/4.2)$ (10)
 $t_o = 400 \text{ microseconds}$

The circuit was constructed and tested with various pairs of 2N338 and 2N1132 transistors. The average pulse width obtained was 420 microseconds. Differences in pulse width were attributed to variations in transistor beta.

One might suspect that the circuit is more sensitive to spurious triggers than conventional monostable circuits. This is not the case since the required trigger voltage is several volts. An empirically derived expression for the approximate required trigger amplitude is:

$$E_{on} = \frac{G(.5)}{G - \alpha} + .5 \text{ where } G = \frac{R_4}{R_4 + R_3} \quad (11)$$

or $E_{on} = [.25 / (.5 - \alpha)] + .5$ volts when $R_3 = R_4$ (normal design condition)

One of the advantages of using the circuit is the

The author

Leonard L. Kleinberg is designing solid-state circuitry for use in meteorological satellites. He is a member of the Design Review Board at the Goddard Space Flight Center. Three years ago, when he was with the Lockheed Electronic Co., Plainfield, N.J., his article on emitter-coupled monostable multivibrator design appeared in Electronics [July 21, 1961, p. 86].

ease with which pulse widths in the microsecond range may be designed. For example, a 1-microsecond pulse may be obtained with: $R_1 = 820$ ohms, $R_2 = 5K$ potentiometer, $R_3 = R_4 = 10K$, $C = 240$ pf, $R_5 = 1.2K$, $Q_1 = 2N930$, $Q_2 = 2N995$.

Zener diode added

By placing a zener diode across R_2 (see above) the loading effect of βR_{12} on R_4 and the effect of power supply variations is made negligible. The operation of the circuit is the same as before until the voltage across R_2 reaches the zener voltage, E_z . At this time the forward gain is unity and regeneration ceases. Both transistors are operating on the linear portion of their characteristic curves, provided the supply voltage is greater than $E_z (1 + R_4/R_3)$. The input impedance is now $\beta^2 R_1$. When the zener diode conducts, the voltage across R_3 and C remains constant and is equal to $(E_z - E_{be})$. The current through R_4 is essentially the current through R_3 and C , and is decreasing exponentially. When the current through R_1 decreases to where the zener diode can no longer conduct, regeneration takes place and the circuit turns off.

Analysis of the circuit by adding voltage drops, leads to an expression for t_o (when the zener diode is used):

$$(E_{R4} - E_{be} + E_z) R_4 / (R_3 + R_4) = E_{R4} \quad (12)$$

$$E_{R4} = (E_z - E_{be}) (R_4 / R_3) \quad (13)$$

$$i_{R3} = [(E_z - E_{be}) / R_3] e^{-t/R_3 C} \quad (14)$$

$$E_{R4} = i_{R3} R_4 = R_4 / R_3 (E_z - E_{be}) e^{-t/R_3 C} \quad (15)$$

$$E_{R1} = R_4 / R_3 (E_z - E_{be}) e^{-t/R_3 C} - E_{be} \quad (16)$$

$$t_o = R_3 C \ln(E_z - E_{be}) - \ln R_3 (E_{R1} + E_{be}) / R_4 \quad (17)$$

$$E_{R1} / R_1 = I_z + (E_z / R_2) \quad (18)$$

$$E_{R1} = E_z R_1 / R_2; I_z = 0 \quad (19)$$

$$t_o = R_3 C [\ln(E_z - E_{be}) - \ln(R_3 / R_4) (E_z R_1 / R_2 + E_{be})] \quad (20)$$

For periods in the microsecond range, a time constant twice the value of the pulse width is used. For periods of several seconds duration the time constant is chosen to be one half the desired period. For a 20- μ second period, choose $R_3 = 10K$ and $C = 3,900$ pf. Let $R_3 = R_4$. Once the zener diode has been selected the only parameter that is required is the ratio R_1/R_2 . If small rise and fall times are required, the values of R_1 , R_2 and R_5 must be small.

With $R_5 = 1.8K$ and $R_1 = 450$ ohms, solving Equation 20 for R_2 , yields $R_2 \approx 1000$ ohms. The

zener diode is a Texas Instruments type 653C8.

Capacitor eliminated

Another complementary monostable circuit may be designed that does not depend upon C for determining the period designed. The circuit is the same as the basic circuit (see above) except C is short circuited. If a positive trigger is applied to the coupling network, and the condition for Equation 1 is satisfied, the circuit will generate and remain in the "on" condition. What, then, permits the circuit to return to the "off" state?

A 1000-ohm Texas Instruments Inc. Sensistor is used as R_1 . This device has a 54-second time constant and a positive temperature and power coefficient. While the circuit is on, the Sensistor's resistance increases as a function of time. When the value of resistance reaches that point where the product of the forward and backward gains is less than unity, the circuit turns off.

A typical choice of component values is $R_3 = R_4 = 10K$, $R_1 = 1K$ Sensistor, and $R_2 = 2.5K$ potentiometer. The period (on-time) is determined by R_2 . In this example the period is 30 seconds and is repeatable if 3 to 5 minutes are allowed for "off" time. Temperature affects the period, but by using another Sensistor for R_4 , the dependence upon temperature is reduced.

Further modification

The circuit shown on p. 59 is an extension of the monostable circuit employing zener diodes. Since a constant voltage appears across R_3 and C , C can be eliminated and a constant current obtained. The sink for the constant current is a capacitor, producing a linear voltage sweep. By placing capacitor C_1 between the base of Q_1 and ground, a good sawtooth waveform should be obtained. Resistor R_4 is placed in series with C_1 to enable the circuit to be latched "on." The positions of R_4 and C_1 are not interchangeable for if they are reversed a sawtooth oscillator is obtained (providing a starting mechanism such as a trigger pulse is available).

The operation of the circuit begins with a positive trigger turning on both transistors. Zener diode D_1 is conducting and voltage E_{R4} across R_4 is sufficient to latch the circuit.

$$E_{R4} = (E_{z1} - E_{be}) (R_4 / R_3) \quad (21)$$

Voltage E_{R4} must be large enough to provide

Circuit characteristics

Circuit I: Basic configuration

Advantages

- High degree of insensitivity to spurious triggers
- Easy to design
- Capable of short pulse widths (0.5 usec)
- Pulse width may be varied over a large dynamic range by changing the gain

Disadvantages

- Limited to low duty cycle
- Pulse width is beta-dependent

Circuit II: Basic configuration with zener diode placed across R_2

Advantages

- Same as Circuit I with addition of insensitivity to variations in beta

Disadvantages

- Low duty cycle operation
- Output is not a square wave, although leading and trailing edges are sharply defined

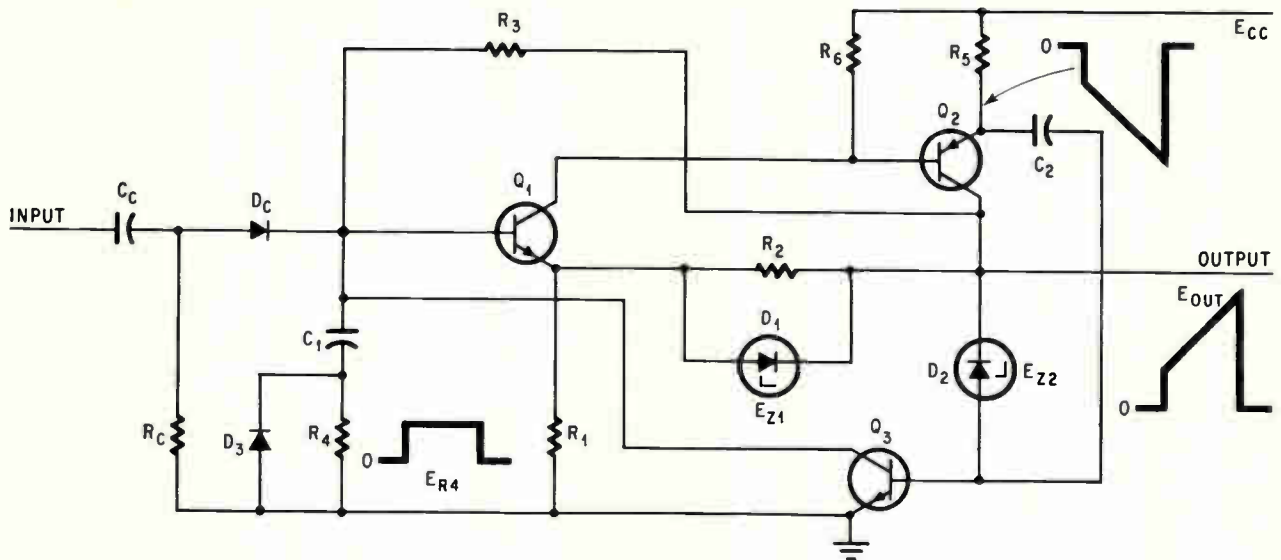

Modified complementary monostable circuit

current for E_{z1} and R_2 . Resistor R_5 is chosen so that the current E_{R4}/R_4 that flows through it does not saturate Q_2 . As C_1 charges, the voltage across R_1 increases linearly. The collector voltage of Q_2 is $E_{z1} + E_{R1}$. When their sum reaches E_{z2} of zener diode D_2 , the turn-off process begins.

The voltage on the collector of Q_2 is given by:

$$E_o = E_{R1} + E_{z1} = E_{R4} + E_{C1} + E_{z1} - E_{be} \quad (22)$$

or

$$E_o = \frac{(E_{z1} - E_{be})(1 + R_4/R_3) + (E_{z1} - E_{be})t/R_3C_1}{(E_{z1} - E_{be})t/R_3C_1} \quad (23)$$

When $E_o = E_{z2}$, Q_3 begins to conduct, decreasing the forward bias at the base of Q_1 , and discharging C_1 . The voltage across R_5 goes more positive and is coupled back through C_2 to the base of Q_3 , discharging C_1 even more. When C_1 is completely discharged the transistors are no longer conducting. The on-time is given by:

$$t = R_3C_1 \frac{[E_{z2} - (E_{z1} - E_{be})]}{(1 + R_4/R_3)(E_{z1} - E_{be})} \quad (24)$$

As a design example, suppose it is desired to generate a two-second gating pulse. Begin by choosing the zener diodes, $E_{z1} = 7.8\text{v}$ and $E_{z2} = 22\text{v}$. The next quantity to be determined is the ratio R_4/R_3 . Since the zener voltage is 7.8 volts, a ratio of unity for R_4/R_3 would raise the output voltage

to $22 - 7.8$ or 14.2 volts, leaving a sweep voltage of 7.8 volts. If R_1 is 1K, a two-volt jump is sufficient to maintain D_1 in conduction.

Referring to Equation 21 and using E_{R4} as 2.7 volts, $R_4/R_3 = 0.38$. Choose $R_3 = 510\text{K}$ and $R_4 = 270\text{K}$. This allows an adequate value for the ratio of R_4/R_3 and permits R_3 to be large enough so that a reasonable value of C_1 may be used. From Equation 24, $C_1 = 4.25$ microfarads.

The maximum current that will flow through R_1 is:

$$i_{\max} = (E_{z2} - E_{z1})/R_1 = (22 - 7.8)/1\text{K} = 14.2\text{ma} \quad (25)$$

If the supply voltage is 30v, the maximum value of R_5 is:

$$R_{5\max} = \frac{(E_{CC} - E_{z2})/i_{\max}}{(30 - 22)/14.2} = 560 \text{ ohms.} \quad (26)$$

An arbitrary value of 330 ohms was chosen—sufficiently below $R_{5\max}$ to permit saturation of Q_2 . Resistor R_2 is chosen so that it draws 0.5 ma. This insures the turn-off process. Resistor R_6 depends upon the base capacitance of Q_2 . Diode D_3 reduces overshoot.

The circuits were designed so that when they are not in operation, both transistors are off and do not dissipate power. This principle, although specifically developed for satellite electronic systems, should eventually find wide application in control and computer circuitry.

Circuit III: Basic configuration with capacitor C eliminated

Advantages

- Capable of long periods
- Permits design without large, unreliable capacitors

Disadvantages

- Difficult to describe mathematically
- Low duty operation (10% max.)

Circuit IV: Modified configuration

Advantages

- Develops long periods
- Capable of high duty cycle
- Develops a linear sweep
- High input impedance

Designer's casebook

Designer's casebook is a regular feature in Electronics. Readers are invited to submit novel circuit ideas, packaging schemes, or other unusual solutions to design problems. Descriptions should be short. We'll pay \$50 for each item published.

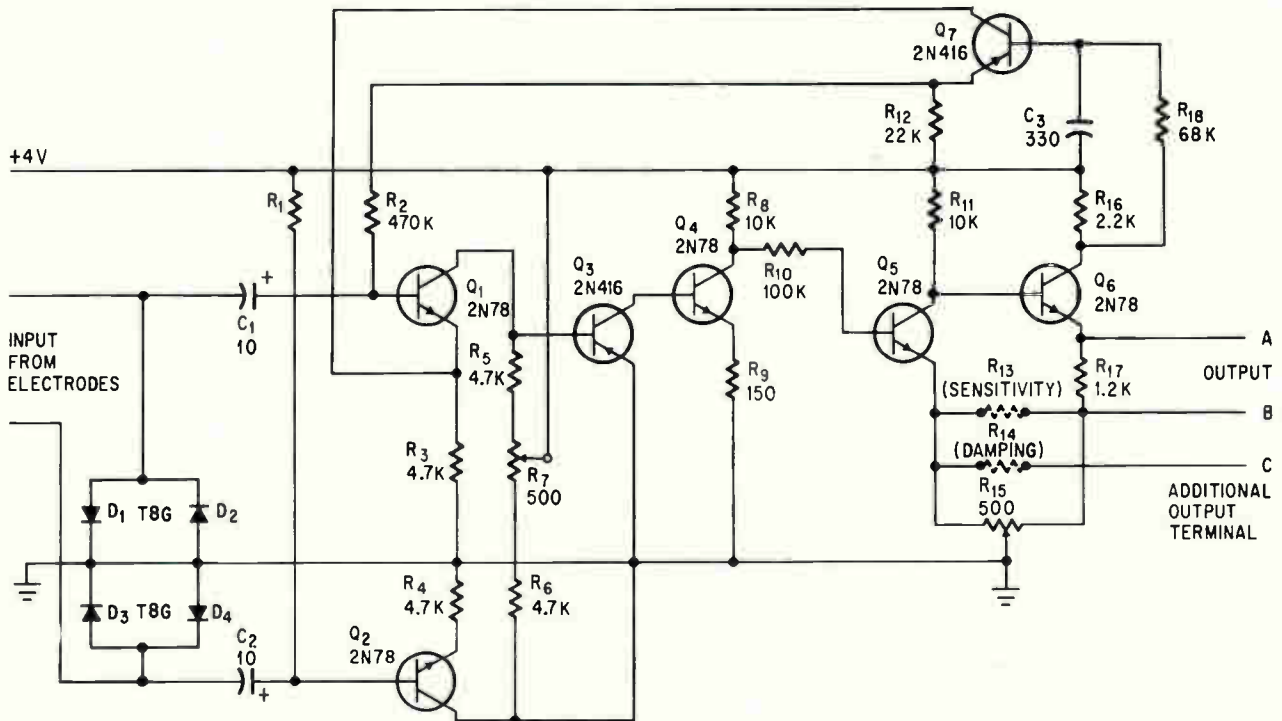

Low-level a-c amplifier circuits provides automatic temperature compensation.

Amplifier can be adjusted to cancel unbalanced noise

By Joseph R. Smith Jr.

National Aeronautics and Space Administration
Moffett Field, Calif.

Signals from electrodes attached to a person's body had to be amplified for input to an electrocardiograph. A compact amplifier was needed that would amplify low-level signals in the presence of relatively large variable noise signals, and that would operate on a low voltage supply. The a-c amplifier shown met the requirements.

The circuit provides a high common-mode rejection ratio—approximately 10,000 to 1—and adjustable cancellation at the input for unbalanced noise signals. Cancellation for unbalanced noise is particularly important in biomedical applications because the input terminals are often widely separated on the body and noise levels may differ.

The circuit's adjustable voltage gain eliminates the need for matched input transistors. Operating on a four-volt d-c supply, the circuit requires eight milliwatts of power to produce a one-volt peak-to-

peak output with a 3.6-millivolt input signal.

The input terminals are connected by balanced leads to separate electrodes that may be attached to a person's body. A diode network, connected between the input terminals, prevents saturation of transistors Q_1 and Q_2 by large noise signals that may appear at the input terminals. The diodes form low-resistance paths to ground for large input signals.

The collector of Q_1 is connected directly to the base of Q_3 , and the collector of Q_2 is connected directly to the collector of Q_3 . If identical signals are applied at each input terminal, corresponding voltage variations appear at the collectors of Q_1 and Q_2 . Thus there is no net voltage change between the base and emitter of Q_3 .

The arrangement of Q_1 , Q_2 and Q_3 allows conversion from a double-ended input to a single-ended output, and at the same time provides for common-mode rejection. In common mode rejection, equal voltage variations with respect to ground, applied at the input terminals, do not produce a signal at the amplifier output. Transistor Q_3 operates in effect as a current source producing a current at its collector proportional to the signal from the bridge formed by Q_1 and Q_2 .

Adjustable noise cancellation is provided by potentiometer R_7 , which is connected directly to the power supply. By changing the position of

the variable contact of R_7 , the gain of one transistor amplifier is increased while the gain of the other transistor amplifier is reduced. This arrangement allows balancing of the circuit when the noise levels at the two input terminals are unequal.

A direct-coupled amplifier consisting of Q_4 , Q_5 and Q_6 follows Q_3 . A choice of output terminals is provided.

A network for automatic temperature compensation is included in the circuit. Capacitor C_3 , connected to the base of the feedback transistor Q_7 , bypasses alternating current signals so that only d-c signals are fed back to the input of the amplifier. Negative feedback is employed so that the d-c signals returned to the input transistor Q_1 are of opposite polarity to the d-c output variations of the amplifier. And consequently the returned signals

serve to cancel these variations.

An additional resistor R_{13} may be connected in parallel with the zero-adjust potentiometer R_{15} , and an additional output terminal may be coupled through R_{13} to the emitter of Q_5 . Resistors R_{13} (typically 10 ohms) and R_{14} (typically 330 ohms) serve as sensitivity and damping resistors respectively, required when a galvanometer is connected at points B and C.

The circuit, when constructed with the component values shown, is operational about 20 seconds after application of power. The three decibel down points for the circuit are 0.3 cps and 70,000 cps.

In addition to use in medical electronics, this circuit should also find application as a preamplifier in high-fidelity audio systems.

Circuit protects amplifier against short circuit

By Edward Segatis

Amperex Electronic Corp., Hicksville, N.Y.

A circuit was required to protect the transistors in the power-output stage of a three-watt audio amplifier against damage when the load was short-circuited. The portion of the circuit shown within the dashed box provided the protection.

The addition to the amplifier circuit gives continuous protection under constant operation with a shorted load, and with maximum signal input. With the output terminals short-circuited, the overall gain of the amplifier is reduced by 20 db.

During normal operation, the protective portion of the circuit does not affect the maximum power output, sensitivity, frequency response or harmonic distortion of the circuit.

The block diagram shows the three basic components of the protective circuit—a sensing device, a reference voltage source, and a variable impedance switch.

The sensing device compares the output voltage across the load with a low reference voltage, and biases the variable impedance switch so that the signal is permitted to pass through the amplifier. If the load is short-circuited, the sensing device activates the variable impedance switch which in turn, inhibits amplification by reverse-biasing the driver. The power delivered to the load is kept to a minimum.

The variable impedance switch does not cut off the driver when a short circuit occurs. It reduces the gain to one. Thus a signal at the input to the driver will not be amplified, but will appear at the load. A low-level signal at the output will be de-

tected by the sensing device and will actuate the variable impedance switch to restore gain in the driver stage. By proper selection of the sensing device, the point at which gain will be restored can be preselected. The sensing device must, and does, differentiate between a small signal level and no signal at all.

For the amplifier circuit shown, the 25-volt d-c source together with the voltage-divider network consisting of R_{12} and R_{13} , establish an 82.5-millivolt reference voltage at the anode of D_1 . This reference voltage keeps transistor Q_4 cut off when no output signal is present at the load. Transistor Q_4 is the variable impedance switch shown in the block diagram. With Q_4 cut off, a high resistance (approximately 33,000 ohms) is placed in the emitter circuit of driver transistor Q_1 so that the bias voltage is changed to a value at which very little gain is obtained.

With normal load and signal conditions, the germanium diode D_1 rectifies the output signal making point B positive. This positive voltage, acting through the base resistance of 6,800 ohms, brings Q_4 into saturation. When Q_4 is saturated, the driver stage is restored to its optimum bias point for driver operation.

The power which must be present at the load to

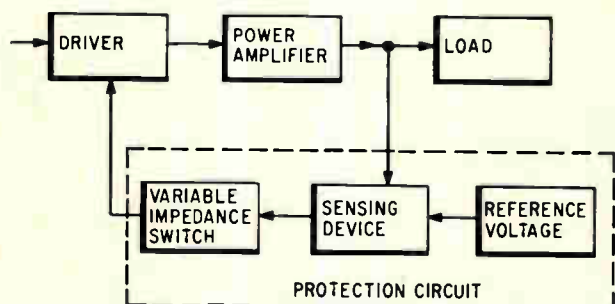

Block diagram for the audio amplifier driver and output stages.

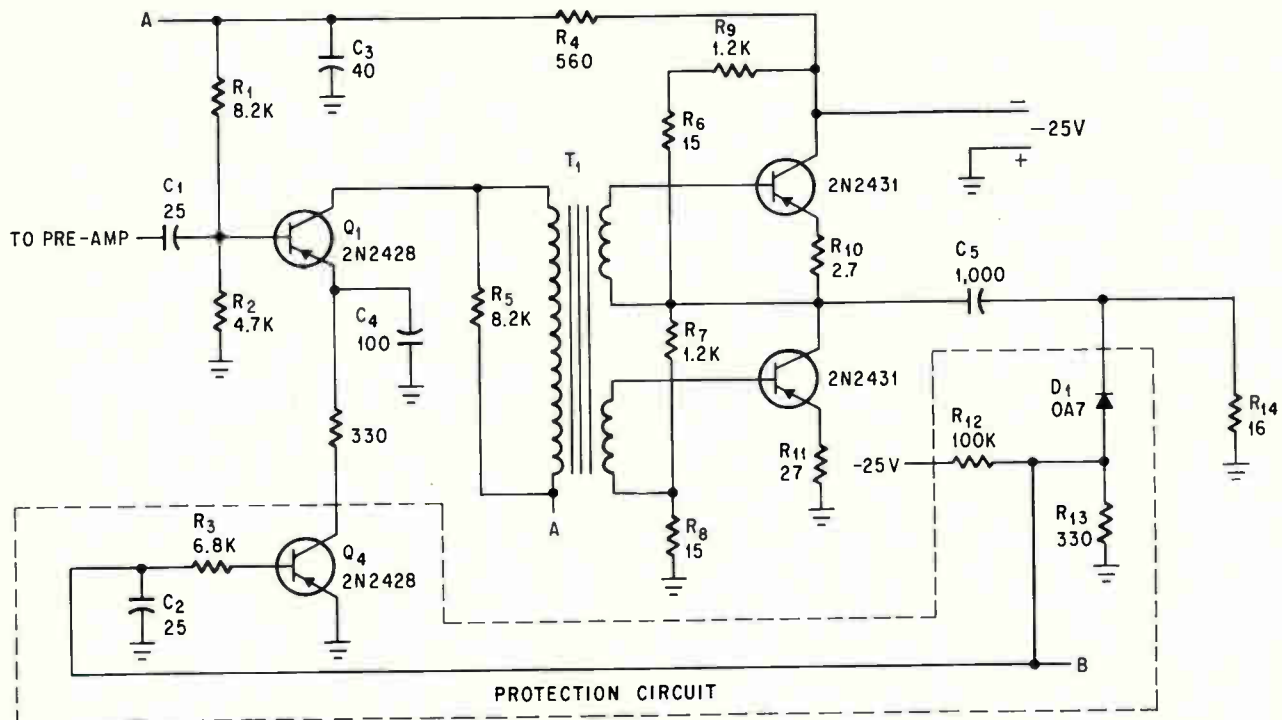

The protective portion of the circuit is contained within the dashed lines.

provide sufficient voltage at point B to activate Q_4 is 10 milliwatts. A 10-milliwatt output power level creates an audio signal which is well below the normal listening level.

The protective addition to the circuit functions automatically and does not have to be reset. The audio-amplifier power output and driver stages shown were designed for use in tape recorders,

phonograph amplifiers and in general audio-output circuitry. Additional possible applications for the protective circuit are squelch control in radio receivers and voice control in transmitters.

The audio-output transformer T_1 is type No. MEX512B, manufactured by Todd Electric Co., Yonkers, N. Y. Its frequency response is from 100 cps to 15 Kc (2-db down points).

Tunnel diode generates two microwave frequencies

By Daniel R. Revall, Timothy F. Murphy, and Koryu Ishii

Department of Electrical Engineering, Marquette University, Milwaukee, Wis.

An inexpensive method was devised to generate two independent microwave frequencies using a conventional commercial tunnel diode. The two frequencies were not harmonically related to each other as they had been in previous tunnel-diode bifrequency generation.

The microwave bifrequency oscillation was obtained at frequencies of 683 Mc (f_1) and 7565 Mc (f_2) using a Texas Instrument Inc. A650 tunnel diode, packaged in a JEDEC TO-18 case. Bifrequency oscillation had previously been observed with a General Electric Co. 1N3219A tunnel diode (7140 Mc and 8920 Mc)¹ and a GE 1N3718A tun-

nel diode (618 Mc and 11,480 Mc).² Microwave harmonic generation has also been attained with the same tunnel diode³ used to generate the two independent frequencies.

The TO-18 case of the A650 is used as the cathode. Both cathode leads are cut off and the anode lead is shortened. The diode is mounted at the center of a tapered RG-52/U (X-band) waveguide as shown.

The waveguide mount has essentially the same construction as that used for the 1N3219A, the 1N3718A, and the A650 when they were operated in the harmonic mode.¹⁻⁴ The only difference in construction is that new film resistors, composed of a mixture of graphite and shellac, are used instead of resistors composed of graphite and polystyrene Q-dope. The new mixture improves the resistive film which previously had a non-uniform composition and rough contact surface.

The first film resistor (placed in series with the diode) provides a resistance of 7 ohms. The mixture of graphite and shellac has a weight ratio of 1 to 6.6 and an approximate thickness of 0.08 inch.

The second film resistor (placed in parallel with

the bias supply) has a resistance of two ohms. It is made of the same mixture but the weight ratio is 1 to 2.2 and the thickness is 0.150 inch.

Both resistive films are directly deposited in layers on the retaining disk and base of the tunnel-diode mount. The film resistors are baked at 105°F for 24 hours and the surfaces are then sanded to obtain smooth contact surfaces. The total area of the two-ohm film resistor is reduced by one-third from areas of the resistors in the previous experiments.

The resistive cutoff frequency for an A650 tunnel diode is 1390 Mc with a negative resistance of 20 ohms, a total capacitance of 25 pf, and a series resistance of one ohm.⁵

The principle of bifrequency oscillation has been recently described.² Oscillation at the lower frequency, 683 Mc, can be explained by the conventional lumped-parameter circuit concept. The lower frequency is far below the resistive cutoff frequency of 1390 Mc. The higher frequency, 7565 Mc, is believed to have been obtained because the TO-18 case acts as a cavity resonator.

The lower frequencies, f_1 , observed with the SA-84WA Spectrum Analyzer are plotted for values of bias voltage as shown. The higher frequencies, f_2 , observed with the RW-T microwave receiver are also plotted for values of bias voltage. The frequency deviation for the higher frequency because of bias voltage changes is also shown. In this figure,

the deviation of the higher frequency (Δf_2) is expressed in terms of the deviation of the lower frequency (Δf_1). By examining the figures, it can be

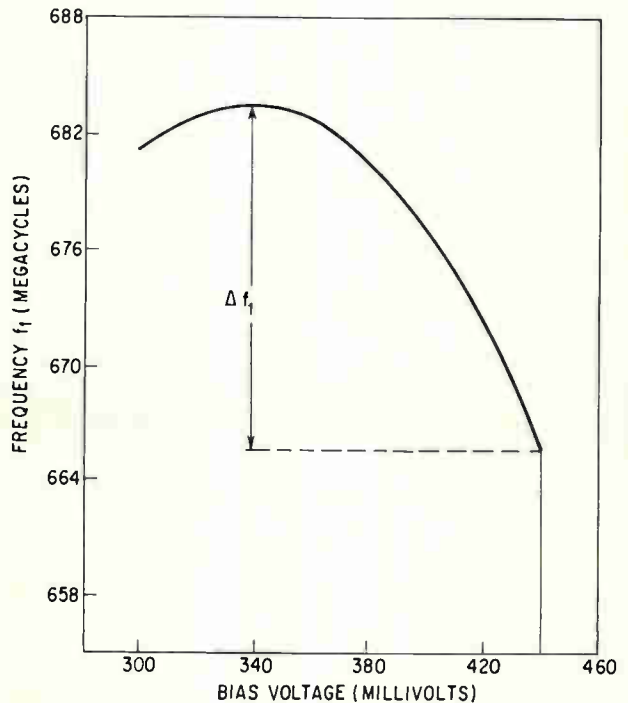

Low-frequency characteristic for the A650

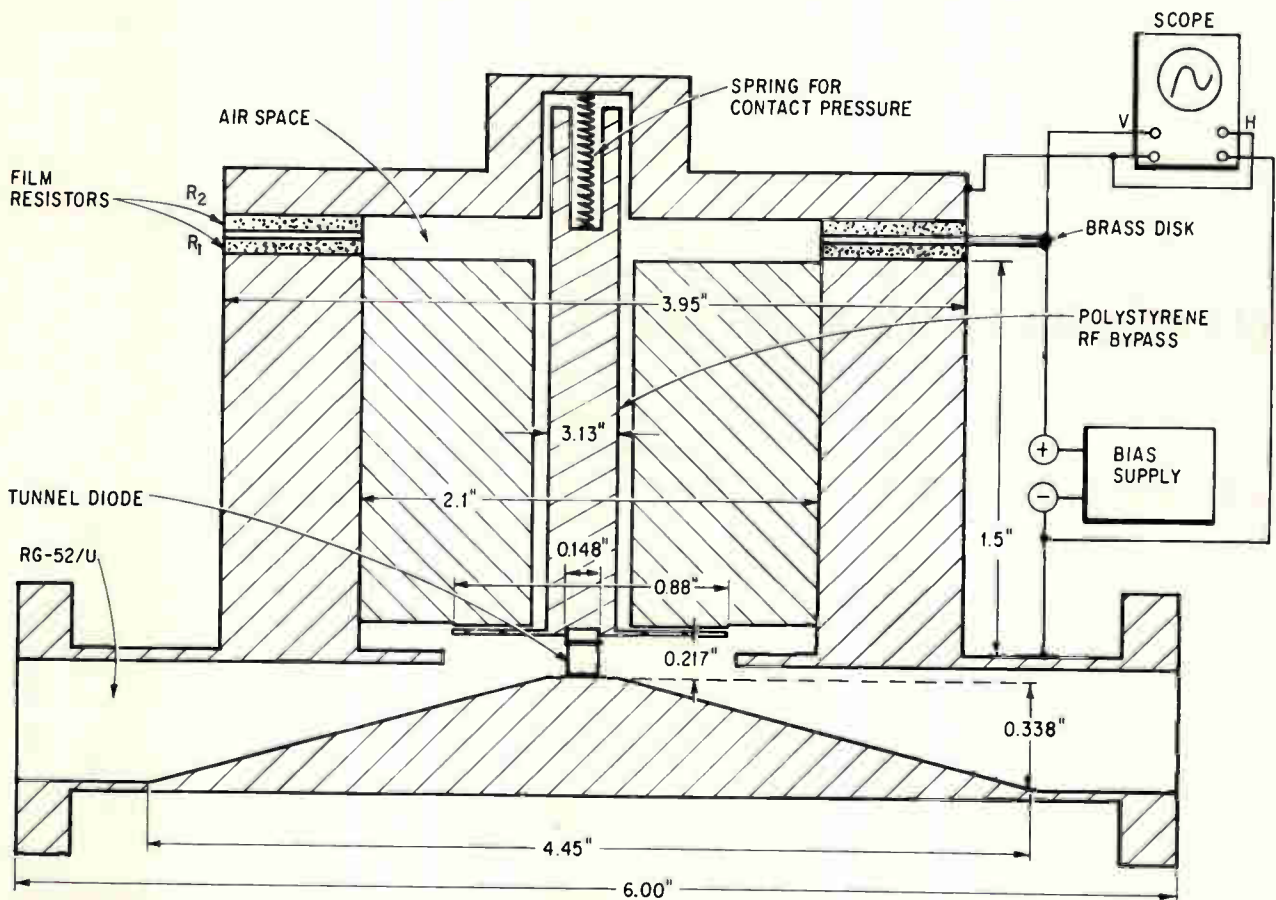

Cross-sectional view of tunnel diode mounting arrangement

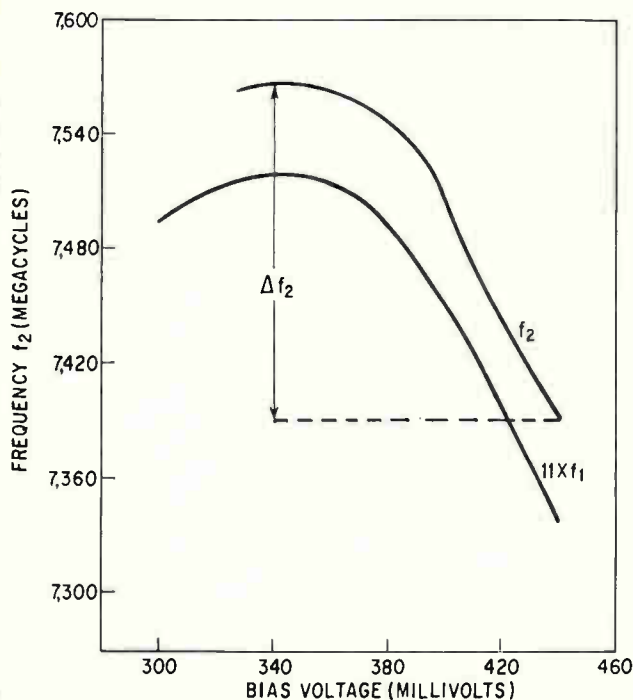

High-frequency characteristic (f_2) and postulated eleventh harmonic of f_1

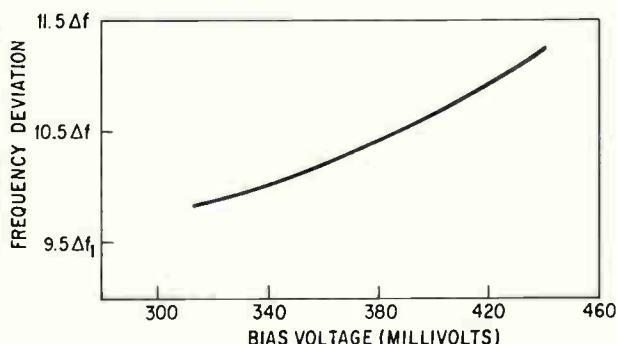

High-frequency deviation characteristics in terms of Δf_1

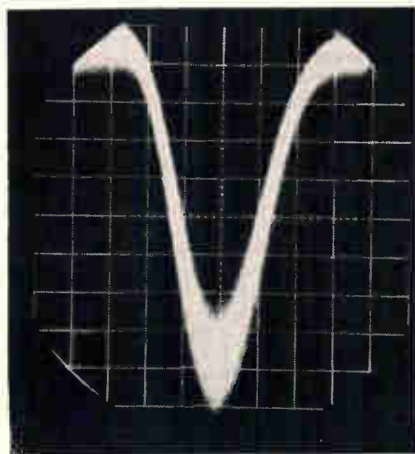

Output waveform observed on oscilloscope. The bias voltage is 340 millivolts; the output amplitude is 20 db above noise; the frequency is 7565 Mc.

seen that the observed frequencies are not harmonically related. The frequency deviation plot shows that $\Delta f_2 \neq K \Delta f_1$ where K is a constant integer and represents a harmonic of 683 Mc, the assumed fundamental. Since K is not a constant integer, the two frequencies are not harmonically related. The frequency deviation curve was plotted using the output obtained at a bias voltage of 440 millivolts as a reference. If it is assumed that $f_2 = 11f_1$, then an eleventh harmonic curve may be obtained. Since no points on the eleventh harmonic curve coincide with or overlap the high-frequency curve when the two curves are superimposed, the conclusion again is that f_1 and f_2 are not harmonically related. Finally, the observation of only two outputs strongly indicate that true bifrequency oscillation is attained. If these outputs were not distinct and independent, other harmonics should have been found. In their absence, however, it must follow that bifrequency oscillation was obtained.

The output waveform obtained at 7565 Mc is shown below.

Acknowledgment

The authors thank J.A. Stefancin, S. Krupnik, Jr., and J.E. Billo for their assistance.

References

1. K. Ishii and C.C. Hoffins, Oscillation Frequency of Microwave Tunnel Diodes, Proc. IEEE, Vol. 51, pp 485-486, March, 1963.
2. S.V. Jaskolski and K. Ishii, Multifrequency Microwave Generation Using a Large Capacitance Tunnel Diode, IEEE Trans. on Microwave Theory and Techniques, Vol. MTT-13, No. 3, pp. 361-362, May, 1964.
3. G. Folland, S.V. Jaskolski, and K. Ishii, Harmonic Generation of Microwave Frequencies Using an Ordinary Tunnel Diode, to be published in Solid State Design.
4. C.C. Hoffins and K. Ishii, Microwave Tunnel Diode Operation Beyond Cutoff Frequency, Proc. IEEE, Vol. 51, pp 370-371, Feb. 1963.
5. Texas Instrument Bulletin No. DL-S 622878, July, 1962.

High-efficiency voltage regulator

By Carl Andren

Applied Physics Laboratory,
Johns Hopkins University, Silver Spring, Md.

A high-efficiency (90% to 97%) voltage-regulator circuit was needed for use with solar cell supplies in satellites. It was necessary for the circuit to draw constant power during the normal battery lifetime, and to present a constant resistance when the battery had been nearly discharged. A 10-volt, 1-ampere output was desired.

A block diagram of the circuit designed to meet the requirements is shown. A sample of the output voltage is compared to a reference voltage by the comparator stage which contains a differential amplifier. The comparator stage produces an error voltage which controls the Schmitt trigger circuit. The trigger circuit, in turn, commands the driver

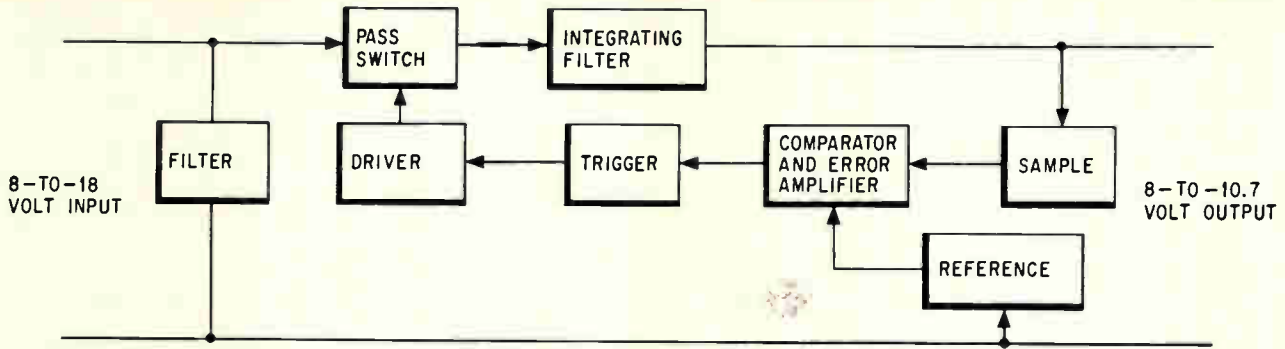

Block diagram of the 10-volt 1-ampere regulated supply.

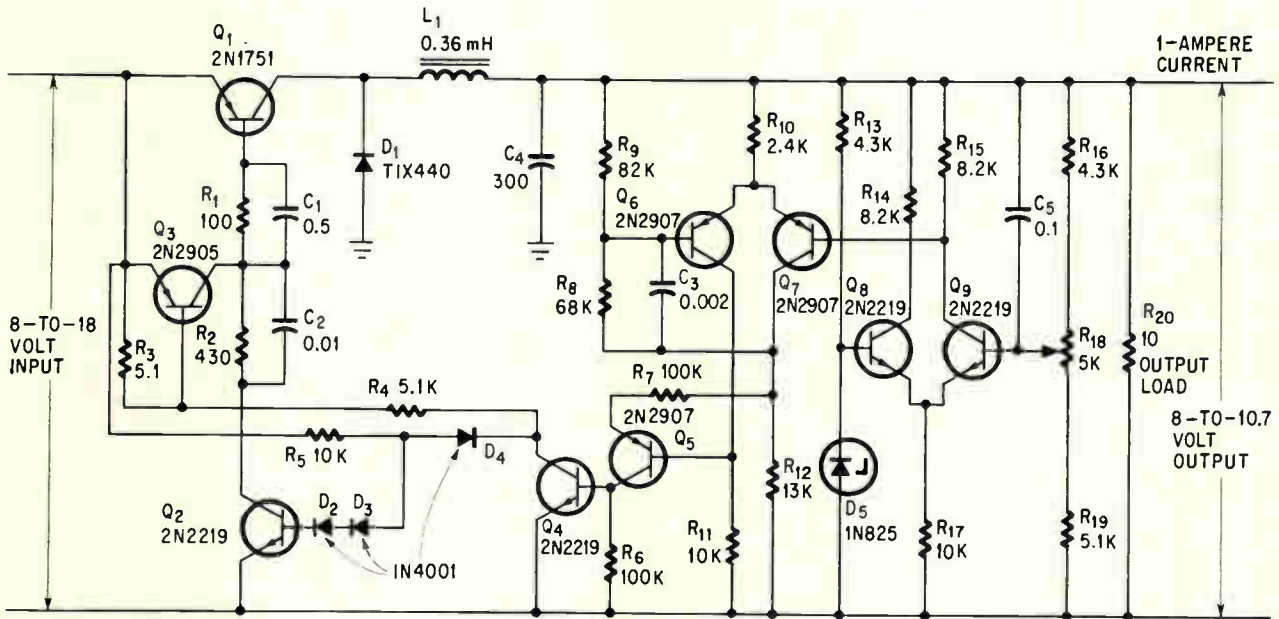

The circuit allows efficiencies from 90% to 97% depending upon the input voltage.

and, finally, the pass switch is turned on or off depending on the magnitude of the error voltage. When the pass switch is on, the signal voltage is applied to the integrating filter stage.

When the output voltage is too high, the large error voltage causes the trigger circuit to flip "off". This causes the driver circuit to turn off the pass switch. Without power applied to the integrating

filter, the output voltage soon begins to fall. When the output voltage drops sufficiently, the trigger circuit flips back to the on state. The driver then turns the pass switch on again.

The circuit shown above is basically a chopper regulator. The regulator maintains the output voltage constant when the input voltage is higher than the desired voltage by interrupting (chopping) the flow of current into the filter for discrete intervals. If the input voltage falls below the desired output voltage, the pass switch is kept on continuously.

The pass-switch stage is responsible for the greatest power loss. The driver stage is designed to minimize this loss. The driver stage maintains Q_1 , the pass-switch transistor, saturated when it is conducting and switches it rapidly (rise and fall times are under one microsecond) during turn-on and turn-off.

The output voltage and efficiency obtained for various input voltages is shown at left. The circuit efficiency drops off at high input voltages because of increased switching losses (the chopper switches more often).

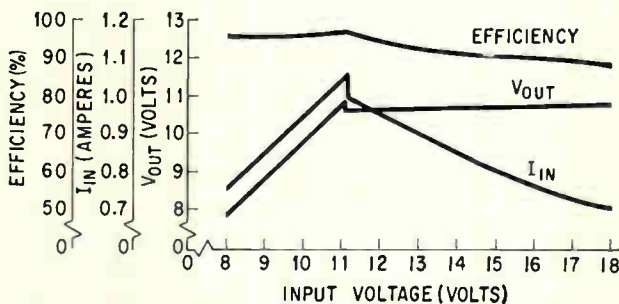

The characteristics of the regulated output plotted for various input voltages.

Conditioned-reflex circuits

Pavlov's dog is teaching old computers new tricks that may lead to pattern recognition without programming

By Karl C. Wehr

Westinghouse Electric Corp., Baltimore

If machines, like people and animals, could be conditioned to respond with specified reflexes, they could perform a variety of new jobs. Practical applications for conditioned-reflex machines might include aircraft identification, automatic pattern recognition and memory, visual monitoring and print reading.

A conditioned-reflex machine has been simulated on a high-speed digital computer. It can be implemented easily, in permanent form, with commercially available logic modules.

Conditioned-reflex behavior was first observed by Pavlov in his famous experiments with the salivating dog. The phenomenon, long a tool for behavioral scientists, has been used by W. Ross Ashby of the University of Illinois to lay the groundwork for conditioned-reflex circuits. His work draws on basic probability theory.

Conditioned reflex

The conditioned reflex can be described as the automatic association of a new sensory stimulus, or input, with an inborn reflex to produce a conditioned response to the new stimulus. A dog has an inborn reflex which causes the animal to salivate whenever food is put in front of him. Pavlov's ex-

periments showed that if a bell is rung, just before the food is presented, each time the dog is fed, the dog will salivate at the ringing of the bell even when no food is presented. This conditioned reflex continues as long as it is reinforced, from time to time, by a reinforcement stimulus related to the inborn reflex—that is, by giving the dog food after the salivation caused by the ringing of the bell.

If this phenomenon of conditioned reflex is considered as a "pairing", B follows A, C follows B, D follows C, etc, and if a machine could be conditioned to respond to a number of such pairings, indefinitely long chains of these pairings could be formed to generate sequences of planned actions, similar to a stored program in a digital computer.

In this way a machine could be conditioned to perform tasks, not in the usual manner of built-in discrete wiring connections or by precise tape programming, but by conditioning the machine to pairs of events.

The practical advantages of building a circuit network that can act on conditioned reflex are numerous. As an example, it is possible to envision conditioning a polystable system to give a null response to patterns representing "norms" of environmental and physiological parameters describing the condition of an astronaut on an extended space flight. Any abnormalities in these parameters would produce a positive response from the system, which could then trigger appropriate alarm, diagnostic and corrective procedures.

On an extended space mission, it is reasonable to assume that the astronaut's norms would change in time, and it would be desirable to recondition the polystable system to these new patterns. This could be done by having the astronaut perform predetermined exercises from which the new norms and hence the new patterns could be established. A

The author



Karl C. Wehr, a graduate of Oklahoma State University, worked on logical design and system evaluation of an experimental electronic telephone system for the Bell Telephone Laboratories before coming to Westinghouse Electric Corp. He is a senior engineer in charge of their advanced digital processing development program.

simple training sequence would condition the system for the new patterns—i.e. for a condition C, action 2 would bring about condition B.

Conditioned-reflex model

In consultation with the Surface division of the Westinghouse Electric Corp., Ashby has proposed and mathematically defined a model which exhibits the characteristics of conditioned reflex. The model has been implemented with a network of 100 independent polystable elements, each element being a state-defined, digital, sequential circuit. This means that each element of the network can exist in any one of a set of four internal states, as defined by a state-transition table which describes its response to a particular input stimulus. A typical element state transition table is shown at right, and the corresponding sequential state-transition diagram is shown below it.

As an example, if the internal state of the element is presently state 4 and an input stimulus B is applied, the internal state will change to state 2. If, then, an input stimulus D is applied, the element will go to state 3. A further stimulus C will leave the element in the internal state 3. This last state is called an equilibrated state, since the input stimulus produced no state change. The logical representation of this typical element is shown on page 69, the four internal states of the element and the input stimuli are defined as:

Internal state 1 = $\overline{X}Y$
 2 = $X\overline{Y}$
 3 = $X\overline{Y}$
 4 = XY

Input stimulus A = $\overline{R}\overline{S}$
 B = $R\overline{S}$
 C = $R\overline{S}$
 D = RS

Like a biological system, this array of 100 elements develops a conditioned-reflex action by establishing a relationship between a conditioning stimulus and a reinforcing stimulus, which represents the response it is desired to produce each time the conditioning stimulus is applied. The network does not inherently contain this reflex, or relationship, but develops it after repeated application of stimuli.

The conditioning stimulus may be any arbitrary pattern appropriately encoded as digital inputs to each of the 100 polystable elements. Similarly, the reinforcing stimulus is any arbitrary pattern, and

	INTERNAL STATE			
	1	2	3	4
A	3	2	1	4
B	1	4	3	2
C	4	2	3	1
D	1	3	2	4

INPUT
STIMULUS

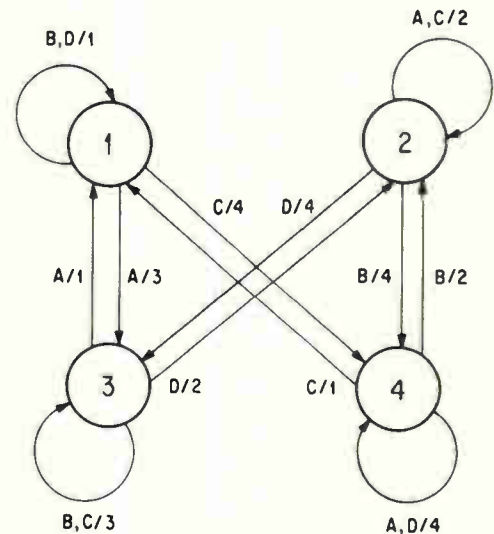

Typical element state-transition table defines the behavior of each element under given stimuli, top. The same information can be represented in a sequential state diagram, bottom.

it defines the desired conditioned response for each element. The complex over-all behavior of the model is derived by observing collectively the action of all the individual polystable elements.

The basis of the conditioned-reflex behavior in the model lies in Ashby's theorem on conditioned reflex, which states that each element of the model must converge to an equilibrated state specified by the pattern representing the conditioned response, regardless of the pattern specified as the conditioning stimulus, after a sufficient number of training trials.

This is stated mathematically, for a single element of the system, as follows:

Given E, a set of states representing all the pos-

sible internal states of an element, such as the four states in the example given.

A, a subset of E, representing the reinforcement stimulus or the desired response,

μ , a mapping of E into E, representing a rest stimulus (a mapping is the selection of the states that are produced in the element as a result of one given stimulus, and is represented by a horizontal line in the state transition table on page 67; for example, the mapping for the input stimulus A comprises end states 3,2,1,4 under initial conditions 1,2,3,4, respectively)

a, a mapping of E into E representing the conditioning stimulus (the state transition table may have a different composition for the conditioning stimulus than for the rest stimulus).

σ_A , a stochastic (stochastic: changing the probabilities of the various possible responses at random) reinforcement operator, selective for subset A; this is an operator applied to the element after every sequence of μ , a. If, after μ , a, the state x of the element is a desired state, that is a state from subset A, then the reinforcement operator has no effect and the new state remains unchanged at $(x) = x$; if the element is not in a state from subset A, the operator σ_A changes its state to one of the possible states out of set E, at random. The stochastic operator σ has no direct Pavlovian parallel, but is required by theory to achieve the eventual convergence to the desired response.

The conditioning stimulus a is defined as an arbitrary selection of one or more of the possible input stimuli, and is analogous to the ringing of the

bell in Pavlov's experiments. The reinforcement stimulus A is defined as the desired response of the element to the conditioning stimulus, and corresponds to salivation in the dog. A rest state is also defined as the state to which the element will go on application of a rest stimulus μ . This additional stimulus is necessary, since the machine, unlike the dog, will not stop "salivating" of its own accord, but has to be made to move away from the desired state between trials.

Thus, the sequence of stimuli applied to each element of the system for each conditioned-reflex trial is: $\dots \mu a \sigma_A \dots \mu a \sigma_A \dots$. Conditioned reflex is demonstrated if, after repeated application of the sequence $\dots \mu a \sigma_A \dots$, the system converges to a state in subset A.

The theorem proving that conditioned-reflex circuit action is possible also requires that the stimulus sequence $a\mu$ operating on E must contain more than one possible state, that is, there must be different responses to each of the stimuli a and μ . For convenience, the sequence $a\mu\sigma_A(x)$ is represented by ϕ .

Theorem

If x, a member of set E, satisfies $\phi(x) = x$, not once but an indefinite number of times n, then x lies in subset A with a probability of $P = 1$.

If $\phi^n(x) = x$, then $\lim P [\phi^n(x)] x = x/x$ does not lie in $A = 0$ where $0 < n \leq N$, as the upper boundary N approaches infinity.

In other words, if an element repeatedly goes to the same state upon the application of stimulus sequence ϕ , ($\phi(x) = x$ continually), then the probability of this occurring if the state is not in subset A approaches zero as the number of trials increases.

Proof: suppose x is not in subset A. Let ϕ be applied an indefinite number of times; as x is not in subset A, $\sigma_A(x)$ would be, over a long enough sequence, all states in E. But since the stimulus sequence $a\mu$ operating on $[\sigma_A(x)]$ is x, therefore $a\mu$ operating on E is also $= x$ (a single state). However, as required in the theorem, $a\mu(E)$ must contain more than one state, so the assumption that x is not in subset A is wrong, and x must lie in subset A.

Model simulation results

The conditioned-reflex model was simulated on a high-speed, general-purpose IBM 7094 digital computer. The program, consisting of three principal parts, was designed to simulate the activity of a network of 100 four-state polystable elements, each having two states of equilibrium per input stimulus.

Part one of the program generates the state transition tables, and otherwise specifies the network elements to produce the logical behavior described above.

The second part of the program specifies the μ and a mappings and the σ_A operator of the experiment. The mapping information, arbitrarily selected for each experiment, is entered on punched cards prepared by digitally encoding four-color patterns

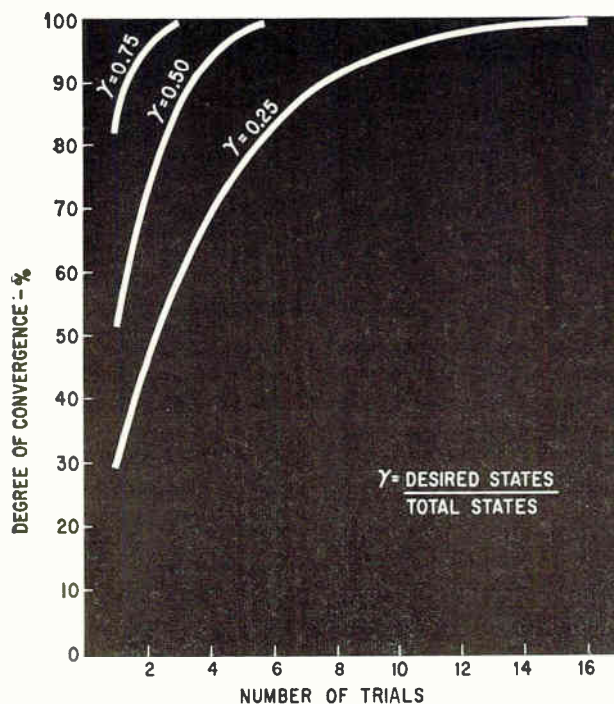

The degree of convergence for an array of 100 four-state polystable elements, such as used in the experiments, can be shown to vary with the value of ratio γ .

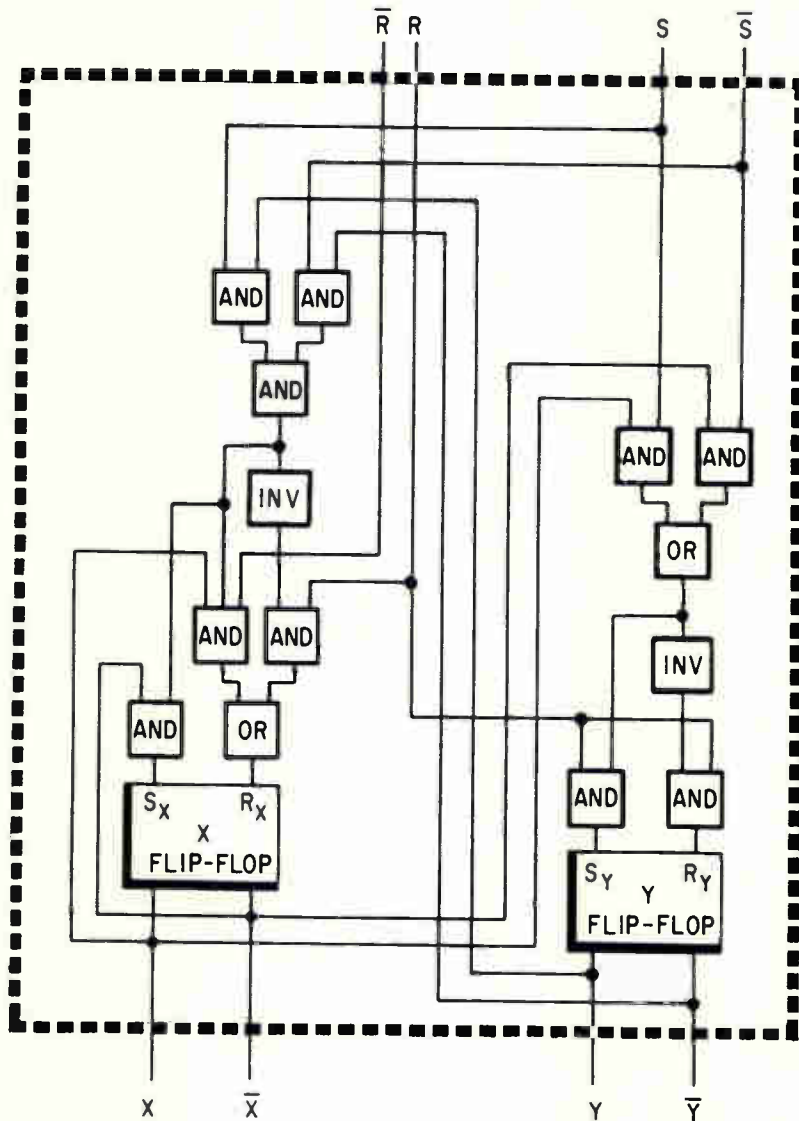

Logical implementation of a typical polystable element, with inputs R and S and outputs X and Y, can be built using standard digital logic modules for gates and flip-flops.

on a 10-by-10 grid array (in the figure on p. 70, the four colors are shown as black, white and two shades of gray; in the logic table, the states are represented simply as 1,2,3,4). By specifying the desired response A for each element, the reinforcement stimulus is applied to the individual elements according to the rule established above for operator σ_A . In addition, in this part of the program, a randomly selected internal state is specified for each element as the initial state of the element for each experiment.

The conditioning and reinforcement stimulus patterns were chosen arbitrarily, both in the case of the conditioning stimulus (a), analogous to bell ringing, and in the case of the reinforcement stimulus (A) analogous to the desired response, such as salivation. The particular experiment shown in figure on page 70 simulates the case where a certain shape of aircraft will automatically produce the desired response of "FOE" from the network; any other two four-color patterns could have been chosen.

The output of the computer was translated into

the terms of the four colors, reassembled and displayed in the patterns shown. In each group of three patterns, the first one shows the initial state (after the rest stimulus), the second the response of the network to the conditioning stimulus shown at center top, and the third the reinforcement stimulus (desired response). As the number of trials increases, the network responds to the conditioning stimulus with greater similarity to the reinforcement stimulus, and by the seventeenth trial it reaches this desired response exactly.

In part three of the program, the μ and a mappings and the σ_A operator are repetitively applied to each element, and the activity of the system recorded. Of interest is the number of elements found in the desired state after each application of the μ and a mappings. This count, expressed as a percentage of the total number of elements (100), represents the degree of convergence of the system as a function of the number of trials. The results of several experiments, in which the ratio of the number of desired states (subset A) to the total number of internal states per element was varied

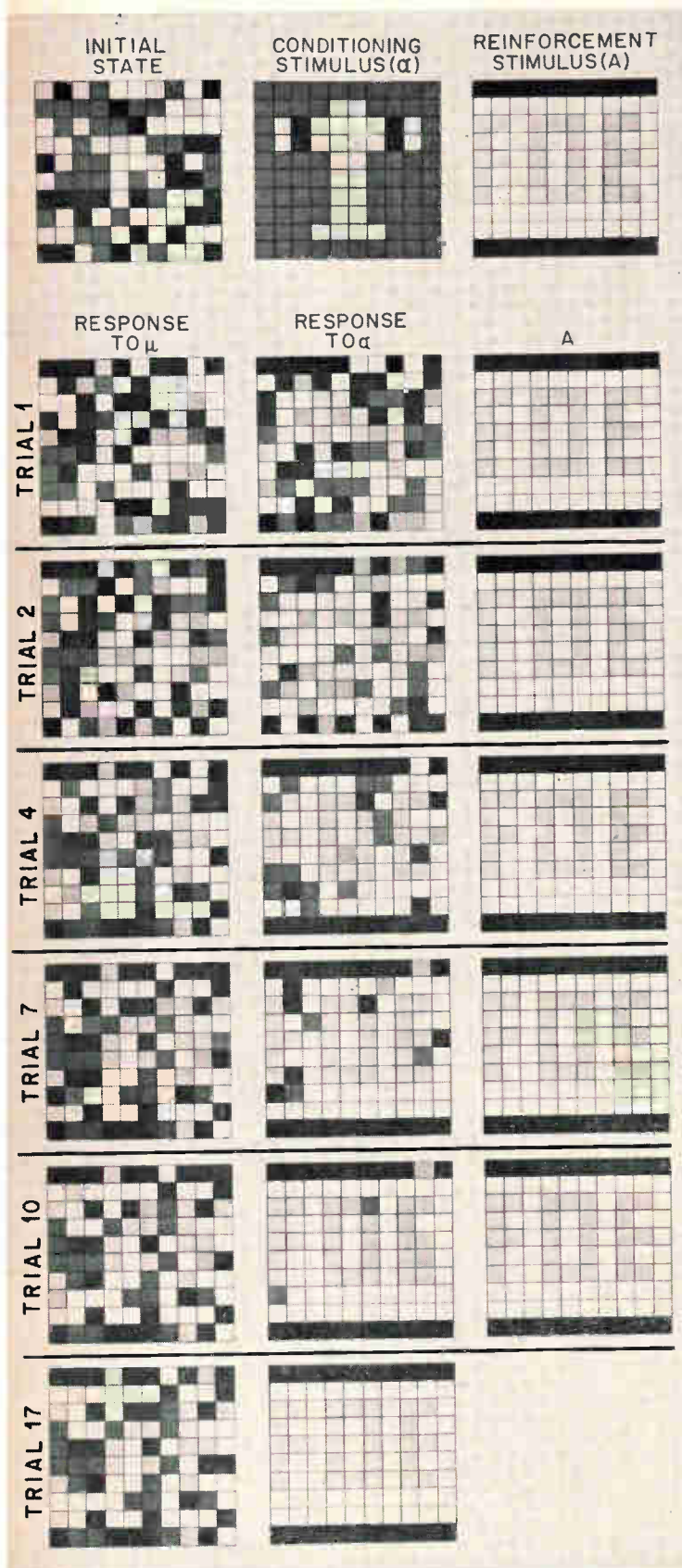

Experimental simulation of 100-element array on computer. The four different states are represented by white, light gray, dark gray and black. Convergence of 100% is reached, in this case, in 17 trials; in any succeeding trials, the conditioned reflex will have been firmly established.

for a system of four-state elements, are shown on page 68.

The significance of this family of curves is the high degree of convergence that can be realized when the subset A is chosen to include only 25% of the total number of possible states. The results of a typical conditioned-reflex experiment are reconstructed in the patterns shown at the left, using white, two shades of gray and black for the four states. The initial state of the system, the conditioning stimulus and reinforcement stimulus are shown at the top. Response of the system to successive trials of μ , α , σ_A is shown in the remaining panels. The initial state of the system was selected at random, and contained only 29% of the elements in the desired states. After 17 trials, 100% convergence was achieved. However, 81% convergence was reached after the fourth trial, and the emergence of the desired response is clearly visible.

This threshold of intelligibility varies widely with the pattern used and the degree of visual contrast (number of colors) used in the pattern. Preliminary experiments with binary patterns, i.e. black and white patterns on a 10×10 array, suggest that the threshold of intelligibility occurs near 87% convergence and is slightly lower for four-color patterns. The results indicate that although 100% convergence may be desirable, it is not necessary for meaningful system response. If the threshold of intelligibility is set at 85% convergence, the number of trials required in any one given experiment is reduced, usually, by 50%.

A demonstration model of the polystable system has been designed using commercially available digital modules to implement the logical structure shown on page 69. The 100-element array can be implemented with about 130 standard circuit modules. The response of the elements is displayed on a panel consisting of 100 incandescent lamps, each lamp corresponding to one of the polystable elements in the array. The model is operated by pressing buttons. This corresponds to the application of a conditioning stimulus and reinforcement stimulus. The stimuli are specified by two arrays of 100 locking pushbuttons. The operator can insert any arbitrary pattern by pressing the appropriate button. For convenience, the rest stimulus is prewired to all polystable elements in the array.

Bibliography

- W.R. Ashby, *An Introduction to Cybernetics*, Chapman and Hall, London, 1958.
- W.R. Ashby, "Design for a Brain", John Wiley and Sons, Inc., New York, 1960.
- M.A.B. Brazier, K.F. Killam, and A.J. Hance, *Sensory Communications*, Editor, W.A. Rosenblith, M.I.T. Press and John Wiley and Sons, Inc., New York, 1961.
- H.S. Fitzhugh, *Some Considerations of Polystable Systems*, IEEE Transactions on Military Electronics, Vol. MIL-7, No. 2 and 3, April-July, 1963.
- C.F. Hazelwood, R.L. Preger, K.C. Wehr, *An Electronic Network Which Demonstrates Conditioned Reflex*, Internal Report NL-281, Westinghouse Electric Corp.
- R.L. Preger, *Polystable System Simulation Capability*, Internal Report NL-231, Westinghouse Electric Corp.
- K.C. Wehr, J.E. Urban, *Conditioned Reflex Demonstrator*, Internal Report NL-286, Westinghouse Electric Corp.
- J. Wortis, *Pavlovianism and Clinical Psychiatry*, Recent Advances in Biological Psychiatry, Vol. 4, 1962.

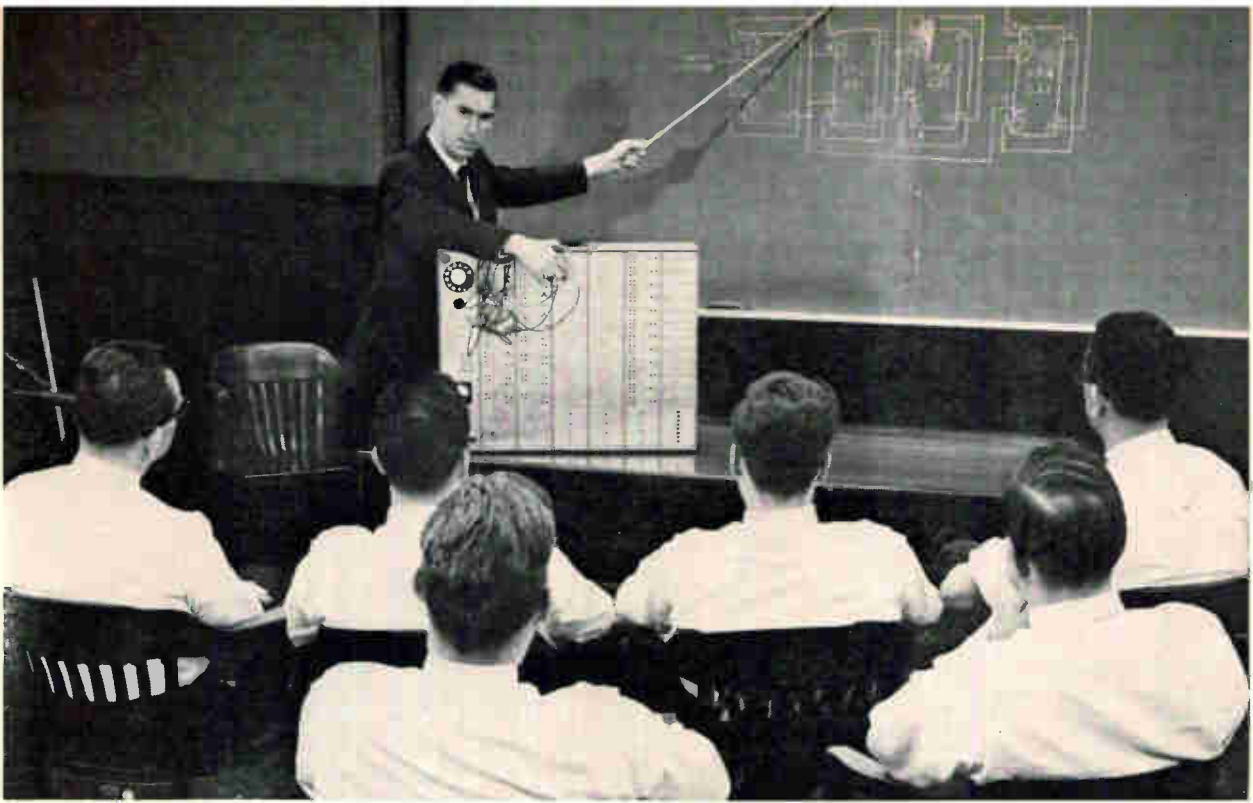

Engineers undergo retraining in the design of digital circuits, such as a binary-coded decimal counter, using a Vitro logic trainer.

Computers

A survey of digital-logic training devices

About 20 companies make trainers, which are also useful for breadboarding computing circuits and for test-checkout equipment

By Stephen B. Gray

Computer Editor

Since 1960, when Epsco, Inc., displayed the first logic trainer at the Wescon show in Los Angeles, digital training devices have become common equipment in engineering classrooms and laboratories. Now they're also being used by companies in breadboarding.

As companies enter new areas of technology or diversify into new markets, one of their biggest problems is the retraining of engineers. The task is most difficult when the expansion is into com-

puting circuits and the computer field, the fastest-growing segments of the electronics industry.

Sometimes a company uses trainers for something more immediate than training. One data-handling laboratory used a set of logic panels from a trainer to help it convert from analog to digital equipment. Its engineers worked out circuits on paper, then patched them up on the trainer's logic panels. When they were satisfied with the performance of these breadboards, the engineers ordered

commercial modules to build the actual systems. Later they reused the trainer to train personnel to operate the new equipment.

The National Aeronautics and Space Administration uses eight Control Logic consoles for training engineers in digital techniques, for simulating and designating systems, and for breadboarding test circuits that check out other equipment.

But education remains the most common use of trainers. As companies intensify their efforts in the computer market, they are relying more and more on trainers to acquaint their engineers with the principles of digital logic. At least 20 concerns now manufacture training devices.

The General Motors Institute in Flint, Mich., training ground for many GM executives, uses three Epsco trainers in its classrooms. Two seniors are assigned to each trainer, which is racked into a console with an oscilloscope, pulse generator and other test equipment. After a subsystem is wired up on each trainer, the subsystems are patched together to form a simple digital computer.

The Vitro Corp. of America designed its first trainer to help teach digital techniques to Navy men and to help the company's programmers visualize a computer's internal operations.

The Philco Corp. designed its units to help teach fundamentals of digital circuits to technicians in preparation for training in computer maintenance.

There are as many kinds of training equipment as there are uses for it. Desk-top devices are available for as little as \$795, with either fixed or variable layout; fixed-layout panels can be assembled in many combinations to provide large numbers of circuits; plugboard machines permit training under the most realistic conditions; and circuit cards with front-panel logic symbols and jacks offer the greatest number and variety of circuits.

All the training devices that Electronics Magazine has examined—except those made by Philco and Scientific Development—are based on standard transistorized digital circuits so the devices can be used for breadboarding. That means when an engineer has satisfied himself with a configuration he has built on a trainer, he can order off-the-shelf components to build the equipment. Another nice feature of designing this way is that the wiring of the final equipment is exactly the same as that in the breadboard.

Desk-top trainers

Six desk-top devices permit translation of logic diagrams into operating circuits. In this way, an engineer can set up equivalents of textbook examples, and examine the effects of circuit loading, timing differences and input-signal variations upon circuit performance. Without previous circuit-design experience, a student can easily set up circuits as directed by an instructor or a laboratory manual, or work his way through textbooks, examining the performance of circuits that he might otherwise only partially understand.

The first three of these desk-top trainers have a fixed complement of circuits. The Control Logic console consists of several panels, each with a fixed circuit arrangement. The Vitro trainer features individual removable modules; circuit cards are plugged into the adapters in the Packard-Bell device.

Most trainer circuits are student-proof; they are designed to prevent damage to the equipment regardless of the interconnection.

For the engineer, an oscilloscope or voltmeter or both can be used to examine and measure the actual operating parameters. For the training of technicians with limited electronics backgrounds, circuit operations can be traced satisfactorily with the indicator lamps.

Because these desk-top trainers are all built from standard logic modules, they are compatible with other standard digital elements such as magnetic-tape recorders, magnetic-drum or core memories, punched-tape or punched-card systems, automatic electric typewriters and cathode-ray displays. The trainers may be connected to any of these peripheral devices for instruction or testing.

Epsco

The Epsco, Inc., logic trainer (p. 73, left) was the first of its kind. It consisted, in 1960, of two panels with a total area of 16 by 19 inches, either mounted in a metal console or rack rack-mounted. It weighed 30 pounds. There were eight RST (reset-trigger) flip-flops with direct reset and gate set and reset inputs, eight flip-flop indicator lamps, four 5-input diode OR gates, twelve 2-input diode AND gates, six 2-input NOR gates, four inverting and four non-inverting amplifiers, one power amplifier, two delay multivibrators, eight indicator drivers, one clock oscillator with terminals for external timing capacitors, and a pulse-shaping input buffer.

The present Epsco trainer, brought out in 1961, has been simplified and also expanded in variety. It now consists of a single panel. The flip-flop direct-reset lines have been tied together, so they can be operated by a toggle switch or reset input. A direct-set input was added to each flip-flop. Two AND gates were removed, and two other ANDs were changed to five-input gates. Three of the NOR gates were replaced by logic gates for direct-coupled transistor logic; connected in parallel for a NOR gate, in series for a NAND gate, or in series-parallel combinations.

The digital circuits used are the Epsco 200-kc S100 series, of which 49 are used in the trainer. The circuits are encapsulated in rectangular cans, which mount in either 9-pin or 14-pin sockets. The trainer has a unit tester for checking out the trainer modules. Because it brings all terminals out to pin jacks, the unit tester also permits the use of a circuit that is not contained in the trainer.

The manual controls include three single-pole double-throw switches, with nearby jacks supplying logic one and zero, so that the switches can be con-

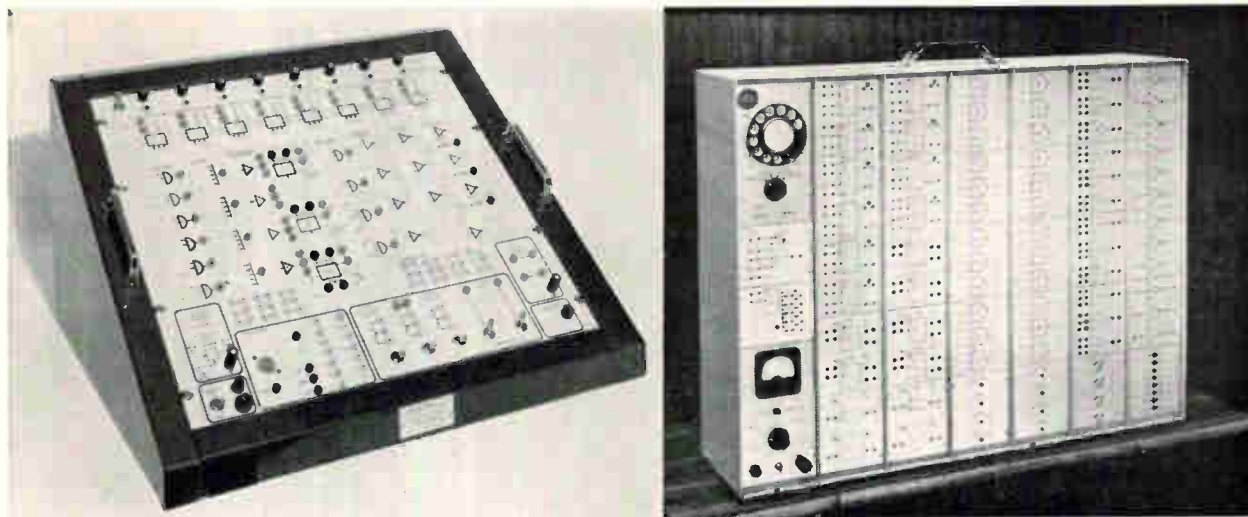

Desk-top logic trainers, in fixed configuration (left) by Epsco and in variable layout (right) by Vitro.

ected as signal selectors, for inserting data or controlling logic operations. Two momentary toggle switches provide 10-microsecond negative pulses for manual pulsing applications such as data insertion, a-c triggering of flip-flops, generation of one-shot events, and set and reset operations. The flip-flops can be set by individual pushbuttons.

There are seven sets of junction boxes, each consisting of six jacks wired in common. The test lamp can be used for tracing the signal flow when the trainer is operated at low speed, or for trouble shooting.

Two models are available. Model A, without internal power supply, is for multistation installations where a central power supply is available; Model B has a self-contained supply operating from 115 volts a-c.

Epsco supplies a 68-page manual to help users. It has sections on Boolean algebra, descriptions of the individual circuits with waveforms, application rules and loading instructions, demonstration set-ups for static operation of gating circuits, for flip-flop operation and binary-decimal conversion.

Also supplied with the trainer is a 168-page logic handbook containing chapters on number systems, Boolean algebra, truth tables, Venn diagrams, Karnaugh maps, arithmetic and logical operation of a hypothetical computer, and 33 application notes on counters, registers, comparators, conversion, adders and other circuits.

Digital Electronics

The Digiac 3010 logic trainer was the second on the market; it was introduced in 1961 by Digital Electronics, Inc. It contains 68 circuits based on the series 50 plug-in printed-circuit cards. There are 16 RST flip-flops with a-c signal inputs and indicator lamps, eight AND and eight OR gates, four inverters, four emitter followers, four NOR gates, a four-bit digital-to-analog converter, four auxiliary display lamps and eight single-pole double-throw switches. The clock operates at 10 kc, and can be

slowed down by adding external capacitors. The timing of the two one-shot multivibrators can be altered similarly.

The 3010 is housed in a sloping-front console; it can also be mounted in a 19-inch rack. The 115-volt power supply is built in. The 3010 has been designed so that it cannot be damaged by any incorrect front-panel patching connections. Two manuals are supplied: one for familiarization, the second for logic experiments.

Also available, in a vertical-front cabinet, is the 3010 in combination with a 3011 panel, which contains eight AND and eight OR gates, to permit more complex circuits to be wired.

The Digiac 4000 is a classroom demonstrator version of the Digiac 3010, with the front panel enlarged to three by four feet.

Oread

The desk-top logic trainer made by the Oread Electronics Laboratory has the simplest layout and also the least variety of circuits. At the University of Kansas, several Oread trainers form the basis for a digital laboratory that is part of a course in logical design of digital computers.

The trainer is housed in a sloping-front cabinet, and can be mounted in a 24-inch-wide relay rack. The LT-100 trainer uses 51 Oread K-series logic modules, which are small cubes 0.78 inch square by $\frac{1}{8}$ inch high, mounted in standard nine-pin miniature sockets. The trainer has 26 NAND gates, six inverters, nine flip-flops with neon drivers and indicators, and a 10th neon driver and indicator. There is also a clock generator that supplies continuously variable pulse rates, from 0.2 cps to 2,500 cps, in four ranges, and a pushbutton for manual pulses. The flip-flops are simple set-reset types, with slide switches that convert each to trigger operation by connecting the set and reset inputs.

The Oread trainer comes with 10 college-level experiment sheets; these give various circuits to be



Breadboard and training kit, by Packard Bell, has circuit cards that are plugged into adapters.

patched up, then questions based on the circuit operation. One experiment involves calculating the average delay produced by the NAND gate. One question asks how this delay compares with the inverter-element delay. Other experiments involve circuits such as pulse distributor networks, shift registers and flip-flop networks.

Control Logic

The basic student console by Control Logic, Inc., made up of several 19-inch logic panels, is a junior version of the two larger Control Logic rack-type trainer. It contains 23 logic circuits.

The standard student PE1-1 console contains a panel of 10 indicator lamps: a control panel with six single-pole double-throw switches, two test lamps and a manual pulser. It also has a clock generator panel with a power amplifier, pulse shaper, two counter flip-flops, two delay multivibrators each with vernier control for pulse duration, two AND gates, two logic inverters, a clock multivibrator, a switch for manual pulse and one for manual reset, and a program panel, with eight sockets for plugging in the eight separate circuit modules supplied with the trainer, with the inputs and outputs brought out to 10 jacks for each socket. The standard set of eight modules includes four flip-flops and four other modules each containing two AND, OR, NAND and inverter circuits.

These four panels do not take up all of the console space; two blank panels can be replaced with other circuit panels when desired. Two models of the basic student console are available, one with the Control Logic 100-kc series of 15-pin welded circuit modules, the other with the 2-Mc series. A

built-in power supply is optional.

The trainer is accompanied by a 50-page detailed analysis and 12 application notes.

Vitro

The digital trainer introduced last year by Vitro Laboratories a division of the Vitro Corp. of America, has some interesting variations, shown in the photo on page 73, right.

This 40-pound trainer, 27 inches wide, has more than 30 plug-in modules that can be provided in various assortments. The pulse generator provides rates of 1 cps, 10 kc and 100 kc, plus a telephone dial for manual pulsing. The module below the pulse generator is an analog-digital converter; one input is a variable voltage available at the power supply module, the other is the output from four counter flip-flops applied to binary-weighted resistors to generate an analog voltage. When the counter output to the resistor matrix equals the applied analog voltage, the comparator amplifier applies a stop signal to the counter. Both analog-to-digital and digital-to-analog conversion can be performed.

The trainer provides flip-flops, AND and OR gates, inverters and followers, single shots with terminals for external computers, delay units based on single shots, a diode module, pushbutton switches and a reset driver in addition to the pulse generator, analog comparator and the 115-volt a-c power supply. Other modules include a decimal display with Nixie tube, lamp driver with lamps, and a ramp generator.

The trainer has several versions. Model 1842 is pictured; model 1843 is for lecture display. It consists of a panel, four to six times the size of the 1842, and consists only of front panels and jacks. It is patched to a rear-mounted model 1842, which can be removed at any time for separate use. Model 1844 is two vertical rows smaller than the 1842, and model 1845 contains half the modules of the 1842.

The trainer modules are based on the Vitro 500-series of plug-in modules, which have 15-pin connectors. It was found cheaper to rearrange the 500-series circuits so that jacks could be soldered directly to the circuit board, rather than connecting the pins to the trainer module jacks.

Vitro sees a market for this device in executive training courses, in high schools, for mathematicians who know Boolean algebra but have no knowledge of the hardware, and in training technical personnel such as electrical power engineers. A course outline for use with 1842 trainer covers 120 hours of instruction, divided equally between theory and practice.

Packard Bell

The MBK1 breadboard and training kit (photo above) made by the computer division of Packard Bell Electronics, permits bench-top or rack-mounted evaluation or demonstration of any of the standard Packard Bell germanium 200-kc, 1-Mc or 5-Mc digital modules.

The circuit board is plugged into the back of an adapter, and the plastic symbol card associated with the circuit is placed on the front of the adapter. The single row of jacks, at the left of the circuit, is for inputs; the double row at the right for outputs.

Basic to the breadboard kit are an indicator panel, component panel, signal generator and power supply, with two adapters that hold six modules each. More six-module adapters can be added as needed.

Two standard groups of circuit boards are suggested. The first includes 14 200-kc boards for general demonstrations, with flip-flops, Schmitt-trigger and shift-register multivibrators, inverters and gates. The second has 25 boards—a larger number of those in the first kit—plus a decade counter, display drivers and other gates.

The signal generator panel provides clock signals from 1 cps to 5 Mc, depending on which of the three series of multivibrator cards is used. Also on this panel are two manual pulsers and two sets of four static logic-level switches.

The 137-page Packard Bell manual on digital module application has been rewritten to include application information on the breadboard kit. It includes sections on logic design, module descriptions, application rules and examples.

Fixed-panel trainers

For those whose needs go beyond the limited complexity of circuits that can be built up on a desk-top trainer, fixed-panel consoles provide a greater number and variety of circuits. There are two makers of large rack-type consoles that stand on the floor. Both feature panels containing fixed configurations of logic circuits, plus a panel into which any of the company's compatible circuits may be plugged.

The large number of circuits available on these consoles permits studying the relationship of circuit techniques to complex network performance, asynchronous and clocked signal transfer, test procedures for equipment checkout and maintenance, and redundant-design techniques.

These consoles may be operated, as can the other trainers, at pushbutton rates to demonstrate operating sequences using the indicator lamps, or at high frequencies using oscilloscope waveforms to illustrate such functions as transfer timing, the effects of interstage delay, and input-output sequencing.

Control Logic

Programmable digital circuit panels made by Control Logic, Inc., are available with either 100-kc or 2-Mc welded circuit modules, and in either single-bay (PE1-10) or double-bay (PE1-101) cabinets, both including power supplies and forced-air cooling. The PE1-10 is shown above.

The standard complement of 11 panels for the PE1-10 consists of over 100 circuits: two storage

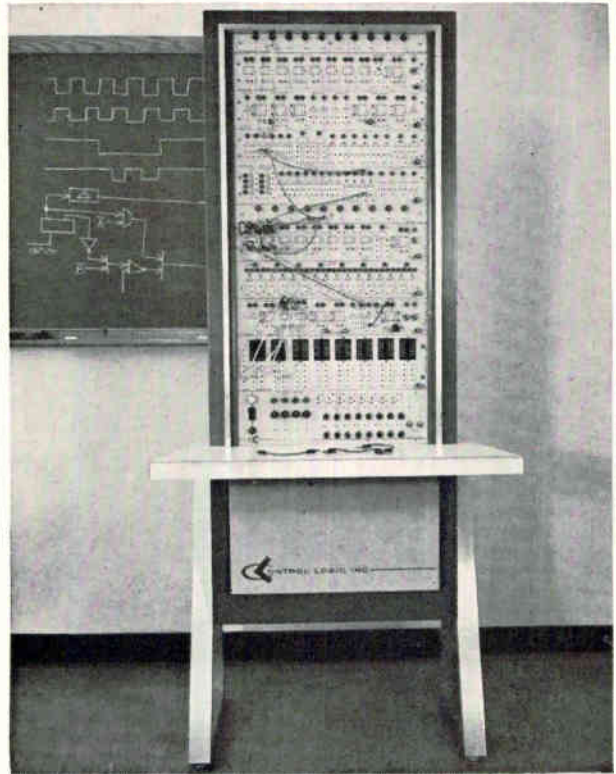

Fixed-panel console by Control Logic, for various combinations of panels.

registers with eight flip-flops each; a control register panel with eight flip-flops for making preset counters and shift registers; a panel of 10 NAND and six AND gates; a diode control panel with four ORs, eight ANDs, four inverters and two strobe networks; a panel of 16 inverter control gates; a clock generator panel and a "program" panel as on the basic student console; a pulse-forming panel with six one-shot multivibrators, two ANDs, two ORs and two inverters; two readout panels with 10 lamps each; and a control panel with d-c supply voltages, eight single-pole single-throw and eight single-pole double-throw toggle switches, and two manual pulsers. However, any combination of panels may be selected from 17 available panels, and all but the control and input-output panels are available in both speeds.

The drive capability of different circuits is given by a number next to the input jacks; the load capability is indicated by numbers next to the input jacks.

The PE-101 usually contains 23 panels in its two bays, with over 200 circuits. The standard complement includes all the panels of the PE1-10, with twice as many of the register and gate panels as the single-bay console. It also has five readout panels; an amplifier panel with 10 inverters, three power amplifiers and a reset amplifier; and a logic register panel for reversible counter, shift register and accumulator circuits, with four trigger flip-flops, pulse shaper and power amplifier.

With each system are included applications brochures and a set of specifications for each cir-

cuit, including functional description and design criteria.

Epsco

The other supplier is Epsco, Inc., which offers 18 different panels for 19-inch rack mounting. All use the S100 series of 200-kc circuit modules, and have front-panel configurations similar to those in the Epsco desk-top logic trainer.

Six flip-flop logic panels are available, three models with 12 three-input (set, trigger and direct reset) flip-flops, for storage and control registers, frequency dividers, and preset and feedback counters, and three models with seven 7-input (set, reset, trigger, gated set and reset, direct set and reset) flip-flops for more complex operations, such as forward-backward counters, shift registers and accumulators. One model in each group is for driving transistor loads; the others are for different numbers of diode-gate loads.

The remaining panels contain the same circuits as in the desk-top trainer, but more variety is available in the panels: three different OR gates, two types of AND gates.

One circuit that does not appear in the desk-top trainer is an emitter follower. The panel contains eight pnp and eight npn emitter followers.

The test panel permits up to six modules to be connected in any configuration, for test or evaluation. The timing panel is the only one that contains more than one type of circuit: a clock multivibrator, manual pulser, four delay multivibrators, two flip-flops, two 3-input AND gates and two inverter amplifiers. The variety of circuits permits generation of multiple-phase or multiple-frequency clock trains and other complex pulse sequences.

Front-panel logic modules

A leading attraction of front-panel logic modules is that they provide the largest possible variety of circuits, permitting a training system to be tailored exactly to the situation, from a dozen circuits up to a small-scale computer.

There are half a dozen makes of digital logic modules that lend themselves to training use because they have front-panel logic-function diagrams. These diagrams are either printed on the front of the module or on the front of the special case holding a circuit card, or on a plastic card in front of an adapter into which a circuit card is plugged.

All the front-panel logic modules here, except the last one, are available as standard cards or encapsulated circuits. Thus, after a system has been breadboarded and tested on the front-panel-diagram modules, it can be wired up with the cards or plug-in cans with a minimum of time.

Digital Equipment

The digital circuits made by the Digital Equipment Corp. are available in two types of packages: system modules on printed-circuit boards,

and laboratory modules in aluminum cases with front-panel diagrams (p. 77, top). Both series come in three frequency ranges: 500 kc, 5 Mc and 10 Mc. Not all card circuits are available as laboratory modules.

Power connections are made automatically when the laboratory module is plugged into the 19-inch mounting panel, which holds nine modules. The circuits available include a flip-flop with built-in output amplifiers, indicator light, complement input and two inverter gates; diode NOR gate; inverter; one-shot; both variable and crystal clocks; level and pulse amplifiers; single-pole double-throw relay; level standardizer; push-button pulse generator; and a tube pulser for a signal compatibility with vacuum-tube circuits. Most logical operations with Digital Equipment modules are performed with saturating pnp transistor inverters, connected in series or parallel to form AND or OR gates.

A kit of nine 500-kc modules is available for educational and industrial training: inverter, NOR, four flip-flops, delay, variable clock and pulse generator, with a mounting panel and power supply. The handbook on laboratory modules discusses number systems, module circuits and loading rules, and provides eight types of experiments for the logic kit, from counters to d-c converters. The appendix goes into BCD (binary-coded decimal) codes and logic, and Boolean algebra.

A basic selection of 500-kc modules is also available with circuit illustrations enlarged four times for classroom use; these are available with either military standard or Digital Equipment symbols. The units are one foot high, and as many as 10 of them can be plugged into a wall-type mounting panel. Also, five of the 500-kc laboratory module types are available with military standard logic symbology, rather than Digital Equipment symbology, on the front panel.

H-W Electronics

Logic circuits made by H-W Electronics, Inc., are available in Data-Pac cards or Data Bloc modules with diagramed front panels (p. 77, bottom, left) in 1-Mc, 5-Mc or 10-Mc series. The circuits include a flip-flop, shift register, four-stage counter and decade scaler; AND, OR and NOR gates; adjustable and fixed delays; crystal and variable clocks; pushbutton pulse generator and pulse standardizer. Power is connected as the modules are inserted in H-W card cases, as in the H-W engineering training aid (p. 77, bottom right).

The flip-flop module contains one flip-flop with indicator lamp, two inverters, and a transformer-coupled pulse gate. The inverters provide inverted pulses for the set, clear or complement inputs of the flip-flop; the pulse gate at the output is for re-inverting the pulse to provide a negative-going waveform in applications, such as counters, that require a shift or carry pulse to drive the next stage.

One logic unit (Logic A) contains three transistor-inverter stages, which can be connected in various configurations, including a half adder.

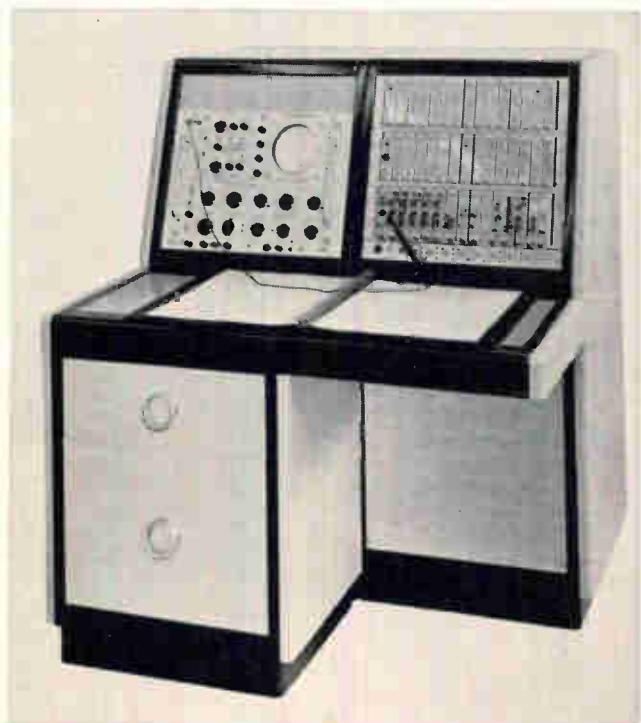
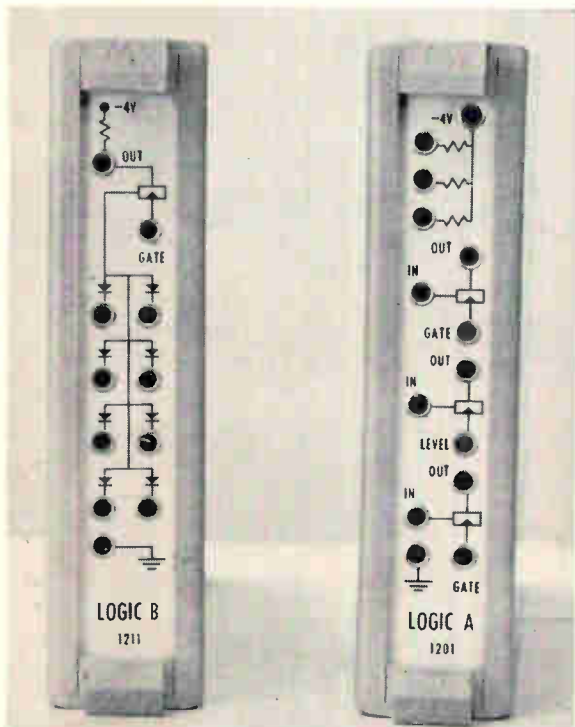
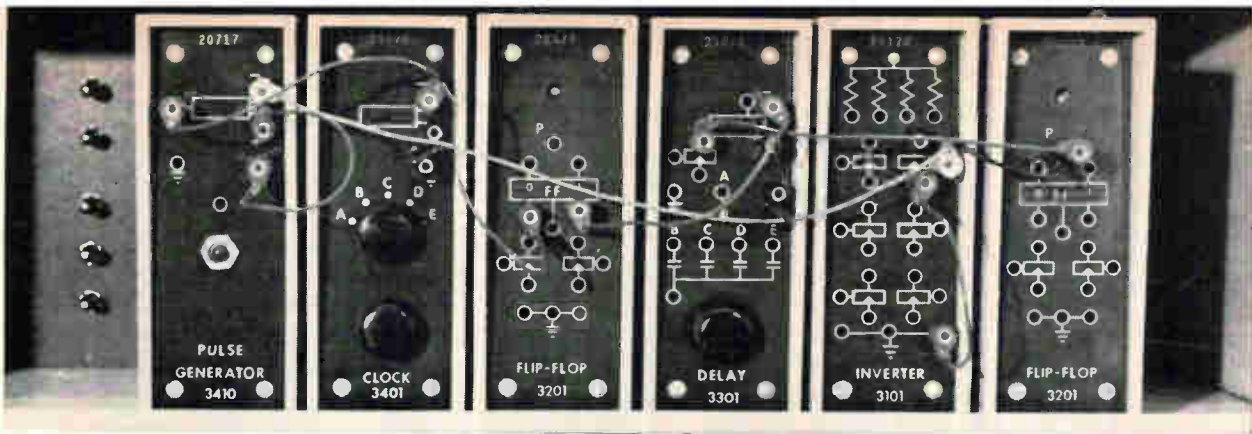

Front-panel logic modules by Digital Equipment (top) and H-W Electronics (bottom left); training aid incorporating H-W modules (bottom right).

Engineered Electronics

Two of the series of logic circuits made by Engineered Electronics Co., the T and the U series, have breadboard accessories with front-panel logic diagrams and jacks.

The T-series is available in cylindrical plug-in cans or as circuit cards, with maximum operating speeds ranging from 250 kc to 1 Mc, and up to 5 Mc for one flip-flop, which has an integral emitter follower at the trigger input.

The breadboard kit for the T-series plug-in cans consists of 19-inch panels, for mounting in racks (page 78, left) or in one of two special portable suitcases. The systems development panel holds up to eight circuits, with pin connections brought out to banana jacks, over which fit plastic circuit-symbol cards that indicate input and output connections. Other panels provide indicators and also binding posts for external components; a signal generator panel has eight toggle switches (with lamps) for data insertion, five-frequency multi-

brator, pushbuttons for d-c reset signals and for single clock pulses.

Over 100 different T-series modules are available, in various frequency ranges and circuit configurations. The 18 flip-flops include reset-set-trigger, reset-set and trigger types, most of them with emitter followers on one or both outputs plus gated and shift-register types. The AND and OR gates are available in pulse, d-c and direct-coupled transistor logic types. There are also a half adder-subtractor, relay drivers, emitter followers, and exclusive-OR, NOR, NAND and AND-OR gates.

A 56-page manual of laboratory exercises accompanies the T series, including sections on Boolean algebra, d-c and pulse logic, flip-flops, counters, adders and subtractors, NOR and NAND circuits, ring counters and pulse-width detection.

The U series is available in 1-Mc or 10-Mc silicon-transistor circuits, either on printed-circuit cards or in transfer-molded modules of the cylindrical plug-in type, with 13-pin bases or rectangular style with wire leads. The breadboard system uses

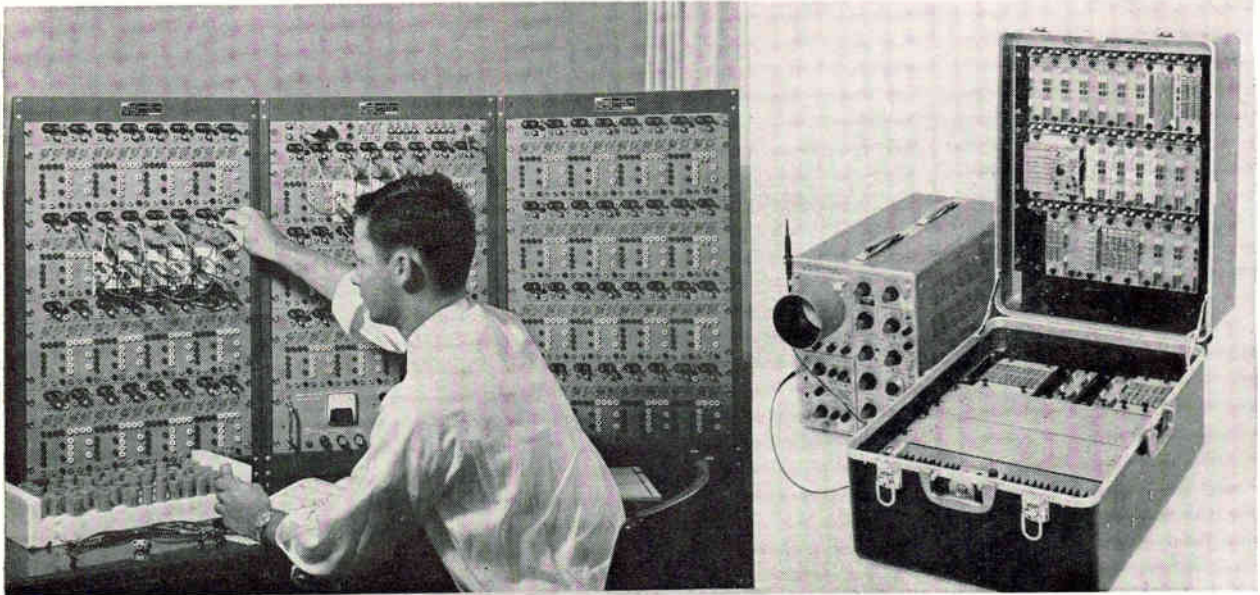

Front-panel cards show logic diagrams for T-series circuits (left) and high-speed U-series modules (right), both by Engineered Electronics.

circuit cards in either a special portable suitcase (above, right), or rack mounting, or a table-top horizontal console enclosure. The cards are plugged into adapters that snap into the breadboard equipment, which then provides the required power.

A plastic circuit-symbol card for the particular circuit fits on the front of the adapter to show input and output connections and part number. The rail assembly for suitcase or rack mounting accommodates nine adapters and includes 18 indicator lamps for signal monitoring. Front-panel connectors are of the wasp type.

The clock generator is a special module with a permanent front panel. It contains a 10-Mc oscillator and controls for generating a variety of pulse patterns, which can be started either by pushbutton or by an external logic signal.

Also available are adapters with three, six or nine connectors using Burndy, taper-pin Kennedy or solder-lug Cannon connectors. These adapters occupy one, two or three spaces in the rail assembly, and are useful in assembling small logic systems to be stored for future use; while in storage, the circuit card can be removed for other applications, and the wiring left as is. After a circuit has been tested in breadboard, it can be removed and installed in a 19-inch card file with 27 permanent connectors (not shown in photo), for later installation in a final system.

Other items include a test adapter into whose front a circuit card is inserted, and an N/10 scaler consisting of a 1-2-4-5 decade that provides the N/10 signal and also the code outputs of the four individual flip-flops, with toggle switches for selecting the polarity of each flip-flop output.

Harmon-Kardon

Interconnections to the Facilogic modules (p. 79, top), made by Harmon-Kardon, Inc., may be made

either on the front or the rear of each module, so that a system may be breadboarded on the front and the connections then transferred semi-permanently to the rear. Or, relatively permanent connections, such as clock or trigger lines, may be rear-connected, leaving the front less cluttered.

The Facilogic modules available in 250-kc or 5-Mc series are electronically identical to the Harmon-Kardon 200 and 400 series of encapsulated modules, with the addition of built-in indicator lamps on all modules used for logical operations. Facilogic modules include flip-flops, with dual gated clock inputs to both the set and reset sides in addition to the d-c set and reset inputs, plus NAND-AND and NOR-OR gates, one-shot, emitter follower, pushbutton pulse generator and Nixie indicator, among others. Unclamped circuits, used throughout, minimize the possibility of short-circuit damage. The NAND and NOR modules include direct and complementary outputs, so that AND and OR circuits are also available.

The Facilogic modules have power and ground connections that are made automatically when the module is plugged into the special mounting frame. The Facilogic modules are 1½ by ¾ by 3 inches, and 33 of them plug into a 19-inch rack that is 7 inches high.

Another configuration available includes a metal console with 33 modules and room for 33 more, plus an 18-switch panel and power supply. The Facilogic application handbook contains circuits for counters and registers.

Tech Serv

The FPP plug-in logic modules (p. 79, center) made by Tech Serv, Inc., use the same circuits as the company's low-cost 40-kc DigiBit cards. All power connections are made automatically when the modules are plugged in. Each 19-inch module

case holds 10 single-width units, occupying 5½ inches of rack height.

The FPP modules include a control and reset package for connecting relays and other contact-operated devices into digital networks. The package also produces a control output from a manual pushbutton or an external clock, plus a manual reset for flip-flops. There are three similar flip-flops, all with indicators: a standard flip-flop; a shift register flip-flop; and a flip-flop with switch-controlled output selection, permitting choice of either the zero or one output for connection to other circuits, useful in setting up predetermined counts.

The clock module provides a choice of adjustable repetition rates in two ranges, selected by a toggle switch; synchronization control is also provided. A relay unit provides two dry-reed relays with transistor drivers; each relay has one pair of normally-open contacts. Other modules include AND or OR gates, inverter, lamp and driver, one-shot, input amplifier and pulse generator.

Another Tech Serv product for breadboarding and instruction in digital circuits and techniques is the DigiLab, which contains 40 of the DigiBit circuit cards. The DigiLab console is 18 inches wide, 12 inches high and 14 inches deep.

The mounting plates, at one end of each of the cards, are screwed to the vertical part of the console, so that the entire card projects forward. Connections are made by sliding, onto slots in the near ends of the cards, the Edg-on solderless connectors that terminate both ends of the jumper wires. The horizontal portion of the console contains eight indicator lamps, a chart that identifies each numbered logic card and its input and output connection slots, and controls that include a power switch, manual-pulse button, clock-rate selector switch, external input jack, and a button that manually resets the flip-flops. The DigiLab operates from either 115-v a-c power or 12-v batteries.

The 40 DigiBit cards contain 16 reset-set flip-flops with direct set and reset and a diode-coupled reset, 12 diode AND and 12 diode OR gates, eight RC AND gates, six inverters, a five-frequency clock (0.5, 1, 20, 1,000 and 10,000 cps), eight indicator drivers, two one-shot multivibrators, a signal shaper and a reset circuit.

The DigiLab handbook describes each circuit and gives its schematic and input-output waveforms, then presents eight experiments with a binary-coded decimal counter, excess-three counter, ring counter, serial-input shift register, complementary comparator, octal counter, serial binary adder, and code converter.

Systems Engineering

A card demonstrator (above, bottom) is available from Systems Engineering Laboratories, Inc., for assisting the design engineer and systems man, for acquainting personnel with the operation of specific types of circuits, and in teaching digital logic. The unit holds 9 of the 10 Systems Engineering circuit modules: two-input and four-input NORs;

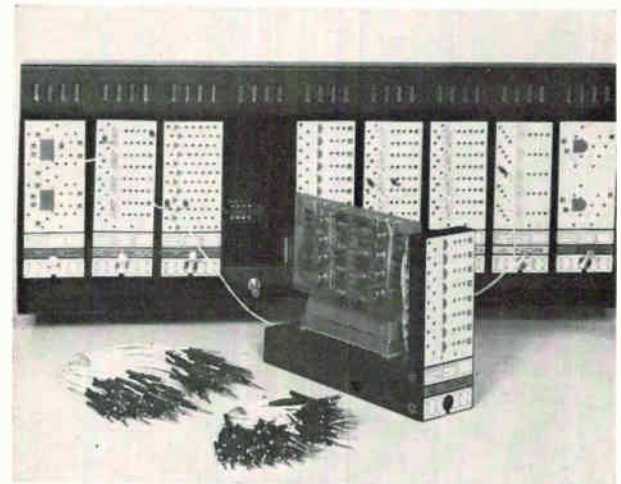
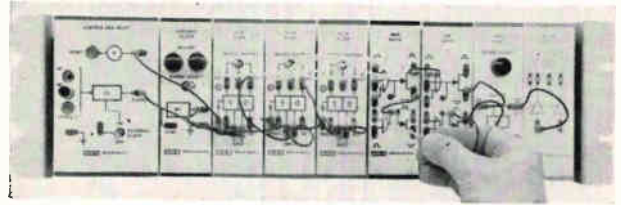
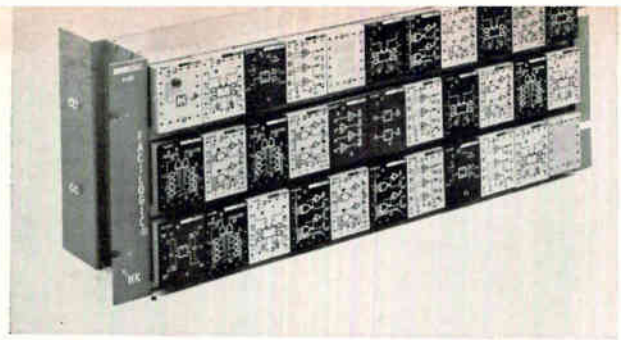

Front-panel logic modules by Harmon-Kardon (top), Tech Serv (center) and Systems Engineering Laboratories (bottom)

flip-flop; both binary and BCD (binary-coded decimal) flip-flops for counters and shift registers; one-shot; differentiator; buffer; crystal oscillator; and Nixie driver.

Power connections are made when the cards are inserted into the card cage. Front-panel indicators show the actual state of flip-flops, NOR circuits, one-shots and so on.

Scientific Development

This fall, the Scientific Development Corp. will begin production of logic modules for the hobbyist market. The modules will be in interlocking, closed plastic cases with logic symbols on the covers, and will operate on house current.

The modules will accept both pulse and level inputs, and will include an oscillator clock, manual pulser, indicator lamps, flip-flops, AND and OR gates, and power supply.

Plugboard trainers

Two companies have gone one step further in training an engineer to use logic modules. In prac-

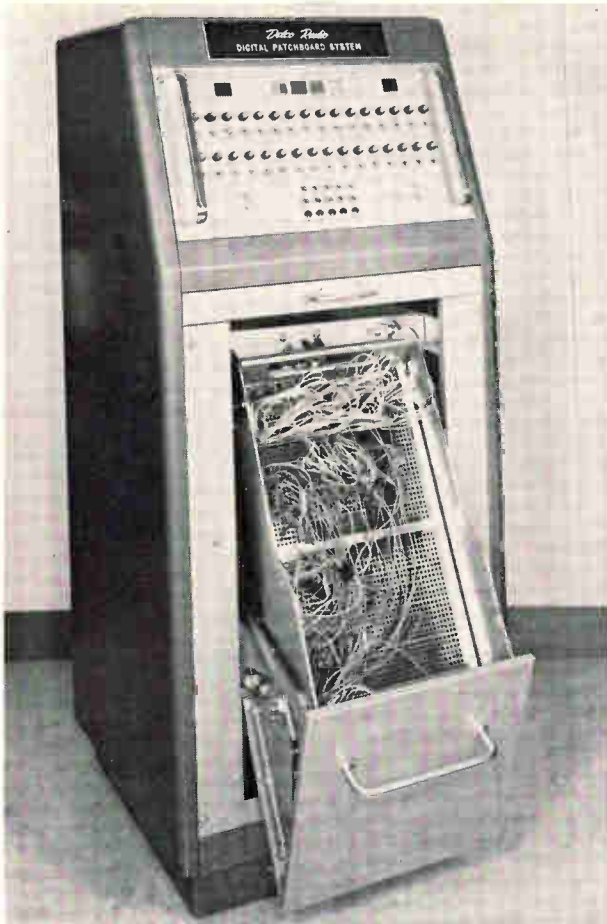

Plugboard trainer by Delco Radio for teaching or checking out digital systems

tice, he would not have the convenience of front-panel logic symbols to help him wire up the circuits, but only numbered jacks. These jacks are provided, on removable plugboards, in systems that include card cages for inserting standard circuit cards, and lamps and switches to show circuit operation.

Delco Radio

General Motors' Delco Radio division has a plugboard digital logic unit (photo above) for educational purposes as well as for designing and checking out digital systems.

Two models are available. One has a card cage that holds up to 20 Delco Radio type CD logic cards. The 16 cards suggested as the best configuration include flip-flops, inverters, NAND gates, indicator drives, one-shots and multivibrator. The four remaining card slots accept any CD card desired.

The second model has two card cages for up to 52 cards, with 10 empty slots for any CD card desired. The free-running frequency of the CD 203 multivibrator is 175 kc; this can be changed by adding capacitors at the plugboard. The unit contains a built-in power supply that operates from 115 v a-c.

Connectors at the rear of the unit are wired to the plugboard for connecting the unit to other

equipment. In the one-cage model, 16 of the 26 front-panel monitoring lamps are wired permanently to the 16 flip-flops, and the remaining 10 lamps are available at the plugboard. The 16 flip-flops can be loaded with ones or zeros from 16 front-panel three-position switches and a load switch. Two switches are available at the plugboard.

In the two-cage model, 32 lights and 32 switches are connected to the 32 flip-flops. Ten test points are also on the front panel, along with four BNC connectors.

Control Logic

The PE-2 programable logic system, made by Control Logic, has the logic circuit inputs and outputs brought out through their card connectors to numbered positions in a plugboard receiver. The circuits are connected by inserting plugwires into removable plugboards. Any logic-circuit card can be inserted into any slot of the card cages, including an intermix of high and low-speed circuits.

With the plugboard system, a number of students can wire up circuits on different boards and try them out on a single PE-2 system, instead of having a separate system for each student.

The PE-2, which was shown for the first time at the 1963 Nerem (Northeast Electronics Research and Engineering Meeting), permits several design concepts to be evaluated by programing several boards, one for each concept. When the design is fixed, the engineer can proceed directly from plugboard pin locations to system-manufacturing wiring diagrams.

The PE-2 is available in three models with 2-, 4- and 6-card cages holding 150, 300 or 450 logic circuits. The control panel contains lamps and switches. The standard Control Logic panels for control and input-output can be used with the PE-2.

For training only

Two manufacturers have made devices specifi-

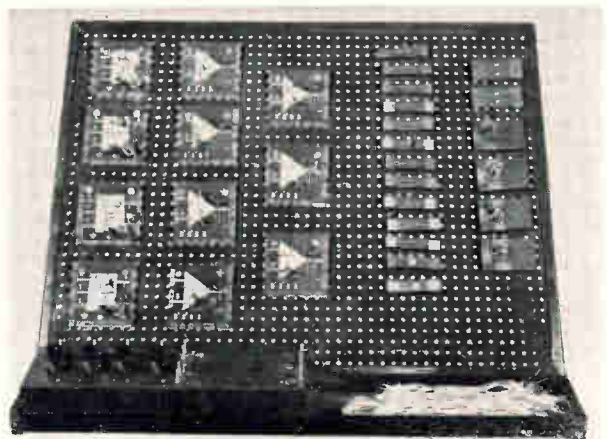

Computer fundamentals laboratory unit, made by Philco for student use, has clip leads for interconnections.

cally for logic training. The Philco Corp. student laboratory kit and lecture demonstration unit are used in classes taught by Philco's Techrep division, and are also marketed as training devices. The Computer Control Co. has demonstrator logic modules that are the same, with some small circuit differences, as the modules used in the company's 6B4 combination digital computer trainer and logic demonstrator, developed for the Naval Training Device Center in Port Washington, N. Y.

The two Philco units are the only logic-training devices that provide instruction below the black-box level and then go on to working with prewired logic circuits. In Philco schools the instructor, after giving a general introduction to digital computers and a thorough grounding in number systems, gives lectures on diode and transistor logic circuits, showing their operation on the demonstration unit.

The students then use circuit-analysis units in the laboratory to construct the same types of circuits and check them out. Some other training devices have "component panels"; these are terminal boards, mainly for wiring in load resistors, or capacitors to change multivibrator timing, rather than for building up complete circuits.

Obviously, to understand the operation of the circuit-building portions of the Philco devices requires a background in electronics. The course for computer maintenance technicians, taught at the Philco Technological Center in Philadelphia, consists of four 12-week quarters. Pulse and digital circuits are not taught until the third quarter, after 24 weeks of courses in the fundamentals of electronics, mathematics, vacuum tubes, transistors and test equipment. The Computer Control demonstrator requires no knowledge of electronics, nor do the other trainers described in this survey.

Philco

The "computer fundamentals laboratory circuit analysis unit," made by Philco's Techrep division, consists basically of two modules: a flip-flop and a logic module, as shown, opposite page. There are also resistors, capacitors, diodes and transistors mounted on small printed-circuit boards and interconnected with snap-on clip leads, for building circuits to be studied and analyzed by the student. A switchbox contains four switches that provide the zero and one levels, and also hold three standard flashlight cells for power (-3 v and $+1.5$ v). The modules are attached to the display board with pegboard hooks.

The student uses the components to construct diode logic circuits, such as AND and OR gates, then goes into two-level diode logic. Transistor logic comes next, with emitter followers, inverters and gates. Diode-transistor logic is followed by flip-flops, including resistor-coupled and diode- and transistor-triggered types.

After building and analyzing basic circuits using the individual components, the student combines the flip-flop and logic modules in various circuits. The logic module consists of two inverters and a

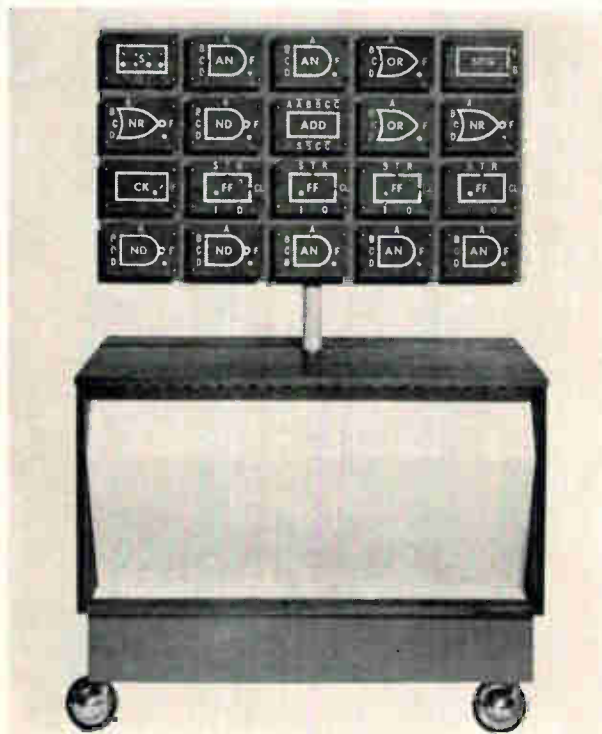
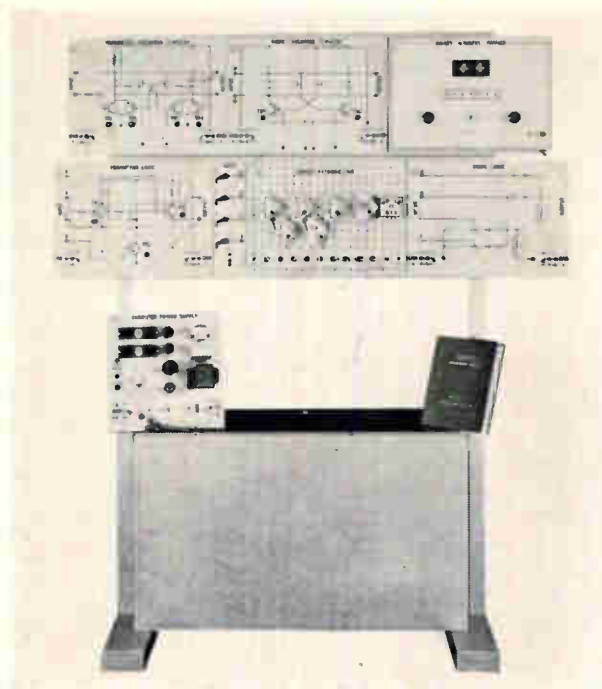

Demonstration unit (top) by Philco is for computer fundamentals; computer logic classroom demonstrator (bottom) is by Computer Control.

NOR gate, which can be interconnected to form a two-input AND, OR, or NOR, or AND with an inhibited input, or a NOT circuit.

The manual provides instruction in connecting the modules to form logic circuits, adders, subtractors and so on. A v_{in} and v_{om} are connected to indicate readout. After each circuit has been constructed and its operation observed, questions

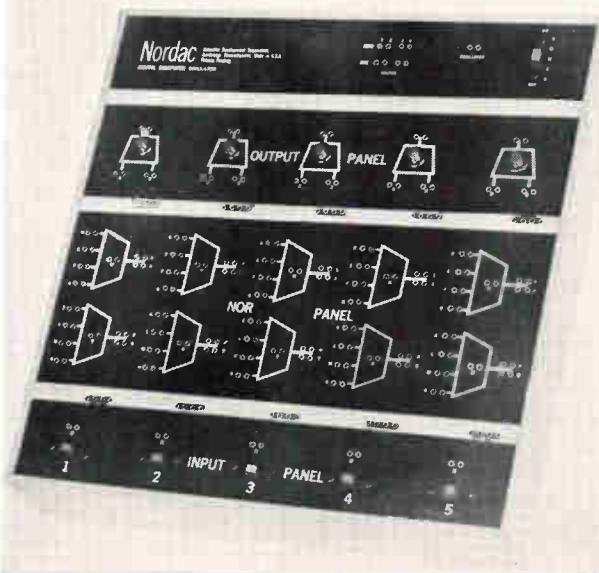

follow, asking, for example, for the Boolean expression of certain outputs, or for a circuit to be drawn using a different type of logic.

Philco's digital computer fundamentals unit (p. 81, top) is a lecture demonstration unit that combines a set of components and modules similar to those in the Philco lab unit, and logic and flip-flop panels whose circuits are completed by plugging in diodes, resistors, capacitors and shorting wires. All the circuits in this unit operate on -4 and $+8$ volts, from a regulated power supply.

A circuit-patching peg board (bottom row center in photo) is used for mounting the flip-flop and logic modules to demonstrate counters, registers, adders and subtractors, and logic circuits built up of AND, OR, NOR, NOT inhibit and differentiator circuits. The logic modules have plug-in covers with logic symbols on the front and printed-circuit wiring on the back that connects the two inverters and NOR in each module to form the circuit indicated on the cover. Indicator lamps show the condition of the output; the reset-set-trigger flip-flops contain lamps for the zero and one outputs.

The four component-substitution panels are for diode logic, transistor logic and for diode-triggered and transistor-triggered flip-flops. The diode-logic panel demonstrates, for example, four-input diode or resistor logic, or two-level diode logic. The transistor logic unit contains three transistors for making up circuits such as inverters, emitter followers and series or parallel gates. The diode-triggered flip-flop unit demonstrates current and voltage modes of operation, and can also be connected as free-running and one-shot multivibrators.

A fifth panel is provided for training in binary numbers, with two Nixie tubes to indicate the decimal number and seven neon lamps for the binary equivalent. Two 10-position switches control the indicator, and a selector switch permits operation of either display or both. The binary numbers are divided into groups of three for conversion to octal numbers.

The course outline for a lecture-demonstration course in digital computer fundamentals using this unit includes lectures on number systems, diode and transistor logic, and multivibrator and computing circuits, and takes 104 hours.

The two units are used at the Philco Technological Center residence school in Philadelphia for digital computer courses, for instructing Philco field engineers, and in many schools outside Philco.

Computer Control

Designed for classroom instruction at both sec-

Industrial Control trainer for Norpak modules (top) by Square D; logic-circuit experimenter (center) by Navigation Computer; Nordac NOR-gate hobby item (bottom) by Scientific Development.

ondary-school and university levels, the computer logic demonstrator (p. 81, bottom) made by the Computer Control Co. holds up to 20 logic modules, each five by seven inches, large enough to be seen from 30 feet away. The display panel is supported by a mast that rotates half a circle, allowing the instructor to set up various module combinations from behind the console where the modules and cords are readily accessible, and then rotate the panel to face the students.

The 37 modules, supplied with the demonstrator and stored in the base cabinet when not in use, consist of one single-pulse generator, one low-frequency clock, two modules of four toggle switches each to provide zeros or ones, four flip-flops, six shift registers, three full adders, and six AND, four OR, six NAND and three NOR gates.

Most of the modules contain lamps to indicate whether the output is zero or one. Power connections are made as the modules are slipped in place. The demonstrator operates from 110 v a-c.

Supplied with each demonstrator is a workbook containing a course outline, an introduction to computers and 40 experiments, which go from the AND operation, through half and full adders and subtractors, to comparators, parity generators and pattern generators.

Other trainers

Three devices will not fit into the previous categories. The first is for teaching the use of industrial-control logic modules; the second is a compact experimenter for testing or demonstrating modules; the third is a simple configuration of NOR gates that is usually advertised in hobby magazines.

Square D

A trainer for industrial-control logic modules is made by the Square D Co., the manufacturers of Norpak static logic elements. The Norpak logic simulator (p. 82, top) is intended both as an educational kit and, for the circuit designer, to check logic circuits. The simulator may be used to set up the equivalent of relay control circuits, counters, shift registers, stepping switches and other data-handling circuits.

The simulator contains eight indicator lamps, six pushbutton switches—four normally open and two normally closed—and four toggle switches. Various combinations of standard encapsulated logic elements are available. For typical control functions, the suggested combination is one module of six NOR gates and one module of 20 NORs, an OR module consisting of 21 silicon diodes for making up OR gates with any number of inputs, and two RC time-delay modules that provide delays from 0.1 to 9 seconds.

The top row of terminals in a NOR module is for power connection. In each NOR circuit are five pairs of terminals: three pairs for input; one pair of input terminals controlled directly to the tran-

sistor base, as a biasing input for triggering in special applications; and one pair of output terminals.

For typical logic functions, the suggested combination is two modules of six NOR gates and two of 20 NOR gates. For counter or shift-register functions, the suggestion is one module of six NORs, one of 20 NORs, and one module of four capacitive transfer gates.

The simulator, which operates from a 115-v line, accommodates a variety of other modules in the Norpak line, such as a binary-coded decimal decade counter, a transfer memory, and other time-delay modules with larger delays. The Norpak manual includes logic fundamentals, application data on each type of element, servicing instructions and typical application circuits, such as industrial monitoring annunciator, and shift registers as used with conveyor belts.

Navigation Computer

The model 1320B Experimenter (p. 82, center) by Navigation Computer Corp. has a top-mounted 18-pin connector that accepts the Navcor 300 and 400 series of logic modules, or any other 18-pin module. The pins are brought out to jacks, for testing or demonstrating the module. The Experimenter provides a pulse generator with variable interval and amplitude, with frequency from 5 to 50 kc; a pushbutton for manual pulsing; two outputs 180 degrees out of phase with each other; and a variable-voltage power supply for marginal checking. Ten switches provide either of the two variable-voltage squarewave outputs at 10 output jacks.

A series of eight instruction modules was designed as a companion to the Experimenter: OR, AND, NOR, NAND, exclusive OR, flip-flop, one-shot, and multivibrator clock. The flip-flop can be connected for storage, complementing binary counter or shift-register stage. The fiber-glass circuit boards have the power jacks in the corners as support posts; the circuits are connected with alligator-type clip-leads.

Scientific Development

Priced in the hobbyist range and brought out at the end of 1962, Nordac (p. 82, bottom) is called an electronic digital computer kit by its maker, the Scientific Development Corp., which also manufactures the Minivac relay-storage "computer simulator." It consists of a panel 15 by 15 by 3 inches, containing 10 NOR gates, five pushbuttons for input and five output lamps, and operates from 45-v batteries.

A 228-page manual has chapters on assembling the Nordac, introduction to the components circuits and to basic electronics, comparison of Nordac functions with those of a digital computer (input, processing, storage, output), logical decisions and arithmetic. The more complex circuits include flip-flops, binary counters, adders and shift registers. An auxiliary oscillator kit is available for repetitive operations.

Space-borne recorder triples packing density

Designed for Gemini, the recorder packs 2,730 bits onto each inch of track for as long as four hours and dumps the accumulation in 10 minutes

By A.S. Katz, Radio Corp. of America, Camden, N.J.

Scientific experiments carried out by space satellites have introduced new requirements for magnetic recording. Miniature recorders are asked to store huge quantities of information over a period of an hour and a half, the usual time it takes a satellite to orbit the earth, and then spew out all the data to the ground in as little as 10 minutes, the time the satellite is in sight of a ground receiving station.

For the Gemini project, the two-man orbital program, engineers at the Radio Corp. of America have devised a unique recording solution to these new requirements. With a lightweight recorder-reproducer, two channels of digital data are recorded simultaneously at a rate of 5,120 bits per second and a tape speed of $1\frac{7}{8}$ inches per second (ips). That means the packing density is 2,730 bits per linear inch on each track—nearly twice the highest packing density available in standard magnetic recorders and two and a half times the best available in telemetry recorders.

The device, operating on pulse code modulation can store data for four hours, the tape running at a speed of $1\frac{7}{8}$ inches per second. A complete readout takes place at $41\frac{1}{2}$ ips in 10.9 minutes, 22 times faster than the recording rate. Still, the error rate is less than one in 10^5 bits.

By way of comparison to other equipment, the highest packing density available in magnetic tape recorders is about 1,200 to 1,500 bits per linear inch. Usual telemetry recorders operate with a packing density that varies from 600 to 1,000 bits per inch.

Primarily responsible for the improved performance is the device's use of diphase recording. The technique is essentially a phase-modulated carrier process similar to that used extensively for data communications over narrow bandwidth channels.

Because diphase recording is self-clocking, no synchronous clock track—needed for nonreturn to zero techniques—has to be recorded. Elimination of clock information is also a great advantage at high packing densities because tape skew displaces such a track so badly that interrogation between clock pulses becomes impossible.

The new system is also insensitive to extreme variations of playback signal amplitude that occur in the recording of short wavelengths because of tape imperfections or poor contact between head and tape.

Diphase recording

The diphase recording technique depends on the change or lack of change in phase of a carrier signal within a bit cell. For an all-zero message, the phase of the signal is changed only once during each bit cell. Whenever a one appears in the content of the return to zero (rz) message, two phase changes are caused to occur within a bit cell. The first change occurs at the leading edge of the bit cell and the next in the center of the bit cell. The relative simplicity with which standard rz data is encoded into the diphase format allows the use of digital circuits exclusively.

The diphase signal to be recorded can be treated as shown in the waveforms on page 85 and the block diagram below it.

A simplified diphase system shows the underlying principles. Naturally, with extremely high data rates, circuit techniques are far more complex. Assume that the digital data to be recorded is in rz format with an accompanying clock; the desired output in the reproduce mode is in the standard nrz form. However, any standard digital data formats may be easily accommodated.

Inverted rz data and clock signal are fed to two

RECORD SYSTEM

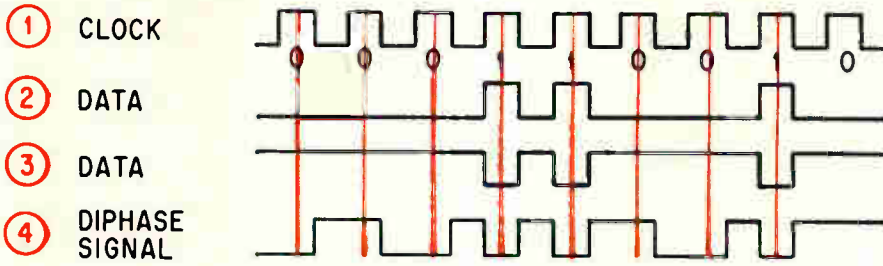

REPRODUCE SYSTEM

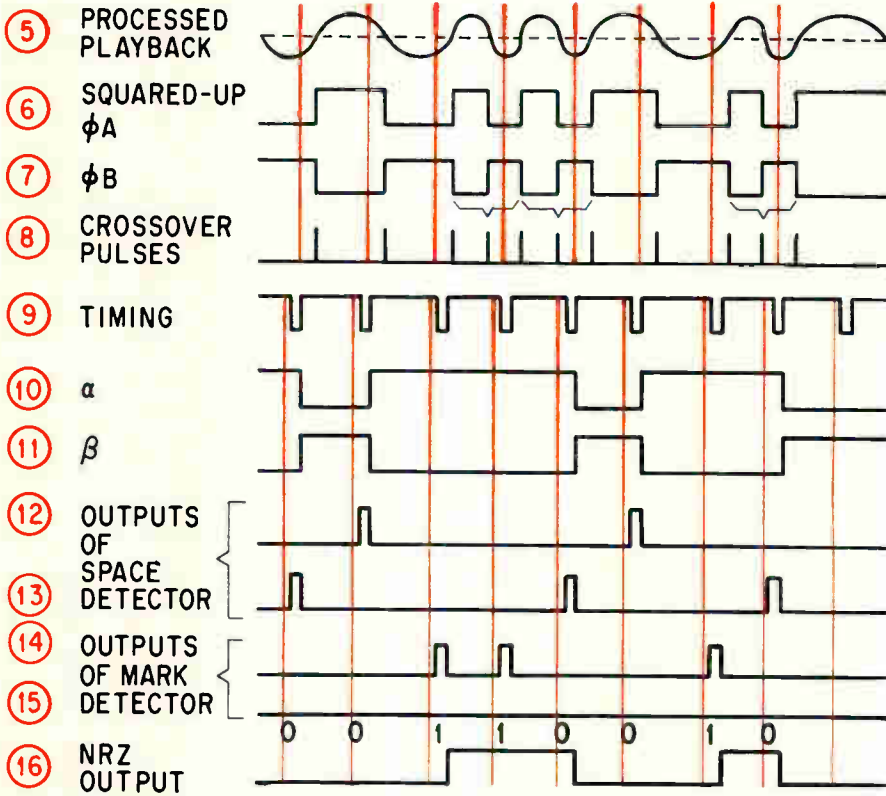

Diphase system waveforms at left are identified by colored numbers and by letters in the block diagram below. For the example shown, r_z data and clock combine negative-going edges to produce the diphase signal. In reproduction, the playback signal is squared and combined with its complement to derive the crossover pulses for oscillator error correction. The phase of the diphase signal is interrogated by timing pulses. Detection of a one (mark) or a zero (space) is dependent on the change—or lack of change—in the polarity of the diphase signal at the sampling times of any two consecutive timing pulses. The combined signals provide nrz output.

RECORD SYSTEM

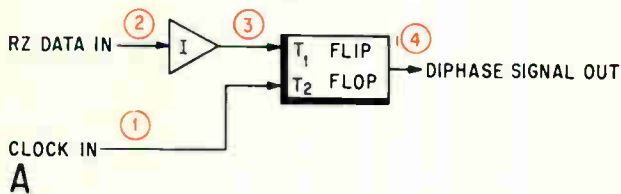

PHASE LOCKED OSC

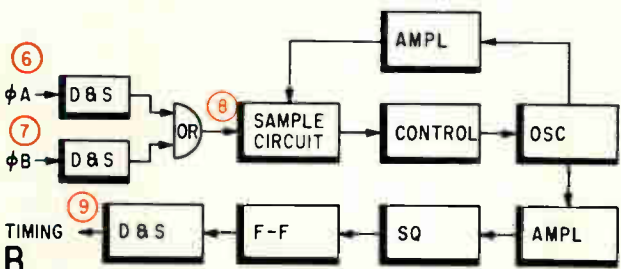

DECODER

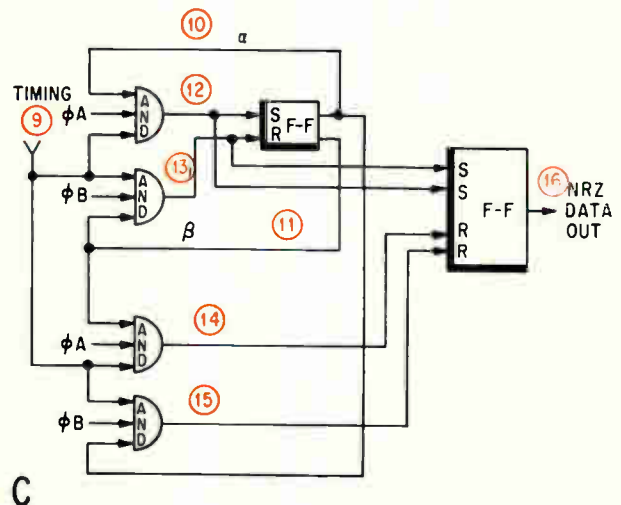

Recording system (A), phase-locked oscillator (B) and decoder (C) of the diphase recording system.

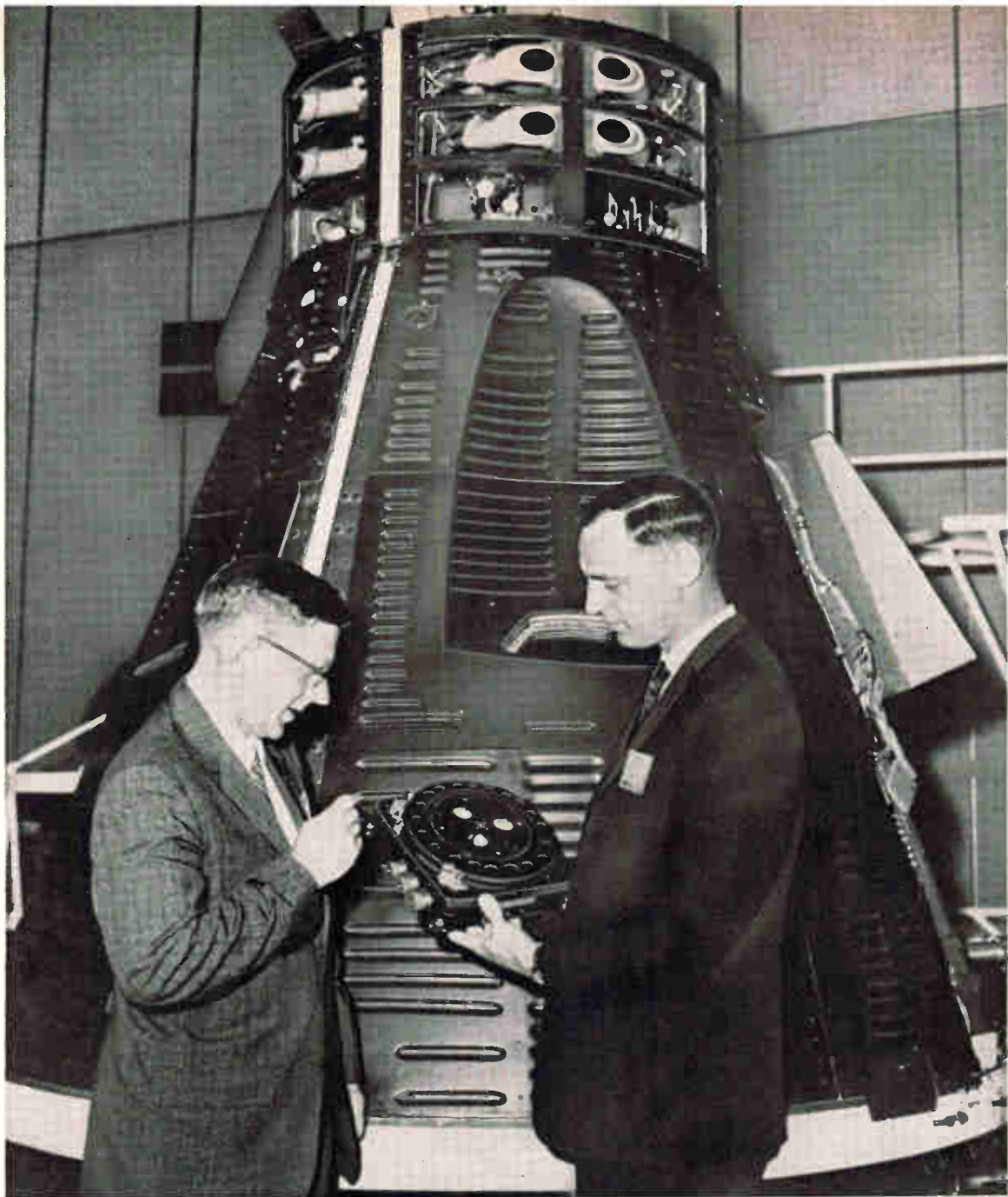

William Grubb of the McDonnell Aircraft Corp. (left) and Jack Myers of the Radio Corp. of America with the recorder-reproducer in front of a mock-up of the National Aeronautics and Space Administration Gemini spacecraft.

independent trigger inputs of a binary flip-flop so the flip-flop undergoes a transition on each negative-going edge of either the clock or the data. As shown in the waveform chart, a logical zero is represented in the diphase code by a square wave at half the data rate. Each time a logical one is received, a phase transition occurs in the center of the bit cell so that the mark is represented by a square wave at the data rate. The output of the flip-flop is the diphase signal. This signal is then fed to the record amplifier whose output is a diphase signal that is fed into the recording head.

Choosing gap width

The magnetic tape is d-c erased to conserve power, since weight and power are at a premium.

Although d-c erase results in higher distortion and noise than a-c erase, the ill effects are negligible

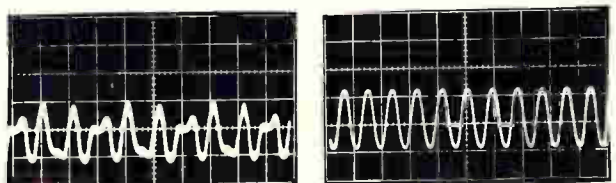

Accurate detection of data, and alternate one-zero nrz message, as played back from the head (left) and the diphase signal from the tape (right). The signal has been filtered through an Inter-range Instrumentation Group standard pcm premodulation filter.

here. With the diphase technique, detection of the output data depends only on the cross-over points of the reproduced signal and this process is insensitive to low-level noise. The magnetic head used is an RCA-developed high-quality instrumentation type with a gap width approximately one-third the recorded wavelength. For example, at a packing density of 3,000 bits per linear inch, the wavelength is equal to 330 microinches; the gap width in this case is 100 microinches.

The criterion of gap width at a third the wavelength is based on empirical data substantiated by preliminary mathematical analysis.

Although the exact gap-width dimension is not critical, tests conducted with a head whose gap was much wider than one-third wavelength resulted in a deterioration in resolution of the reproduced signal. Tests conducted using a head with a narrower gap width caused an accentuation of the high-frequency components of the reproduced signal that were extremely difficult to compensate.

Noise reduction

During the reproduce mode, the signal picked up by the magnetic head is fed to the playback amplifier. The signal is amplified approximately 60 decibels, filtered and then equalized to compensate for the effects of the head-to-tape system. The equalized signal is then fed to an input coupler where approximately 40 db of hard limiting is provided, with the result that the system is insensitive to 40 db of amplitude variation in the reproduced signal.

Hard limiting, or clipping, is accomplished by slicing a portion of the playback signal and greatly amplifying that portion, as shown above right, using transistor switching logic so that the center of the signal, where signal to noise is the greatest, is amplified and utilized. The hard limiting in this case is essentially the same as the limiting in a frequency-modulation discriminator in standard f-m systems.

Because the system can operate satisfactorily through a large variation in playback signal amplitude, a high degree of reliability and extremely low data drop-out exists. The output of the input coupler is the recorded diphase signal and its complement that are fed to the phase-locked oscillator circuits and simultaneously to the decoder circuits.

To supply the timing information required by the detection circuit the system employs a phase-locked oscillator circuit. The detection process can best be explained by looking at the timing signal and one phase of the diphase signal. The phase-locked oscillator has placed the timing pulses in the last three quarters of the bit cell. It is required now only to interrogate the phase of the diphase signal with consecutive timing pulses so that if a change in polarity of the diphase signal has occurred between any two consecutive timing pulses, a zero or space is detected. If, however, the polarity of the diphase signal is identical at the sampling times of two consecutive timing pulses, a mark has



Hard-limiting results in regeneration of the playback signal.



RECORDED 1-0 DIPHAASE FORMAT
(5,120 BPS, TAPE SPEED 1-7/8 IPS)



REPRODUCED SIGNAL AT
PLAYBACK AMPLIFIER
(AFTER EQUALIZATION)

(112.6 KBPS, TAPE SPEED 41.25 IPS)



LIMITED REPRODUCE SIGNAL

Signal at the output of the recording amplifier (top), reproduced signal at the playback amplifier after equalization (middle) and squared-up diphase signal after hard limiting (bottom).



The miniature recorder-reproducer designed for the two-man Gemini spacecraft, weighs 14.5 pounds and uses only 12.5 watts of electric power.

occurred. Essentially, the detection of a mark or space is dependent upon the change (or lack of change) in polarity of the diphasic signal at the sampling times of any two consecutive timing pulses. The logic circuits shown in C on page 85 and the associated timing waveforms on page 85 give the exact technique used for detection. Phase B of the diphasic signal is required in implementation of the detection system to insure reliable detection. The positioning of the timing pulses is extremely important. The generation of these timing pulses in their proper position is accomplished by the phase-locked oscillator (plo) circuits as shown in B (page 85).

The diphasic signal (phase A) and its complement (phase B) are differentiated and the positive-going edges are combined in an OR circuit so that a pulse is derived at the leading and trailing edges of the diphasic signal. The output of the OR gate is fed to a sampling circuit where it is used to sample the phase of a sine wave originating from a voltage-controlled oscillator. The circuits are so arranged that a zero error voltage will be derived if the cross-over points of the oscillator sine wave are coincident with the sampling pulse.

If, however, the phase position of the oscillator signal and the sampling pulses are not coincident, an error voltage is derived that is fed to the control circuit of the oscillator.

The control circuit consists of a voltage-controlled capacitor connected so the error voltage will change the capacitance in the resonant circuit of the oscillator, thereby causing a change in the phase of the oscillator signal. This process continues on a closed-loop basis until coincidence occurs and zero error voltage is obtained. A phase-locked oscillator can be locked to a signal in which there is a fixed-frequency component that is present at all times. In a diphasic message there are zero crossings at twice the bit rate, with some crossings deleted owing to message content. For this reason, a phase-locked oscillator, locked to twice the bit rate, is used in the timing extractor.

Filter action

The phase-locked oscillator is, in effect, a narrow-band tracking filter and has the effective Q necessary. Because of this effective Q , timing derived from such a circuit will be carried over short message dropouts.

The author



A.S. Katz joined the Radio Corp. of America in 1957. He has concentrated on work in magnetic-recording design and has patents pending on pulse-measurement equipment, a new digital recording/playback method and diphasic recording technique. He is with the Communications Systems division of RCA as design project engineer for the Gemini recorder program.

The higher the effective Q , the longer the dropouts that can be tolerated. The Q has been chosen so timing will be maintained over 100 consecutive dropouts (much more than will normally occur in any magnetic tape system).

The effective Q of the plo refers to the ability of the plo to provide accurate timing pulses in the absence of input crossover information. Thus, as the Q is increased, the plo timing extractor will continue to provide accurate timing pulses during data-dropout intervals. The Q of the plo actually chosen for Gemini allows for normal operation over a dropout of 10 or less consecutive bits. The trade-off made is that this plo requires a minimum of 12 bits to lock up initially. This is normally not a problem in standard telemetry recorders since at least one second is allowed for start-up time, which provides ample time for the plo to be locked up prior to requirements for accurate data detection. The selection of the desired Q is based on particular parameters for any given recording system; specifically, required start-up time, maximum expected dropout, and desired bit-rate stability.

The output of the oscillator is amplified, phase positioned, squared up, and divided by two (since its basic rate is at twice the data rate). The timing pulses are then differentiated and fed to the detector circuits for detection of the diphasic signal and in the conversion process from diphasic to nrz.

Since the phase-locked oscillator has tracking ability, the frequency variations in the reproduced signal caused by wow and flutter of the tape transport will be followed and high-frequency jitter will be eliminated. Output data bit-rate variations of less than 0.1% per second per second are readily achieved with this system.

Gemini equipment

A diphasic signal processing technique similar to that described has been used in the pcm recorder-reproducer provided for the Project Gemini space program. Error rates of approximately 1 in 10^6 have been achieved on this recorder at a packing density of 2,730 bits per linear inch.

Another digital diphasic recording system based on the one described here was recently developed by RCA to accommodate an ultrahigh data rate.

To utilize the diphasic technique at high data rates, all digital logic circuits used are high-speed types operating at 10 megacycles. The recording technique is essentially the same as that already described. However, owing to the extremely high data rate, the sampling technique could not be used. Detection is performed instead using a delay-and-add principle of the reproduced diphasic signal and its complement. Timing extraction is achieved using a Foster-Seely discriminator in conjunction with the standard phase-locked oscillator.

Acknowledgment

The author thanks M. Frankfort and G. Newcomb who contributed significantly to the development of the RCA diphasic recording system.

Now...
Six 10-amp Relays
for Punishing
Applications



Having trouble specifying relays for space radiation environments? Cryogenic temperatures? Peak overload? "Mil-Spec-plus" conditions? Babcock now offers a choice of six rugged, high-reliability relays to solve hard-to-specify dilemmas.

Overload is typical. In firing squib circuitry, each BR-19 withstands a 500 amp capacitive discharge for 3 milliseconds ... 50 times its rated load. The next Ranger lunar spacecraft will carry Babcock BR-19s instead of solid state switching devices. Each is required to undergo an 80 amp surge decaying to 16 amps steady state ... half again their nominal rating.

New techniques have been developed for handling the unique demands of space environments. Special models for NASA are now regularly performing at LOX and LN₂ temperatures. Others are operating equally well at -300 C. High gamma or neutron radiation problems have also been solved. Hardened models have shown no measurable degradation after absorbing 0.9×10^6 Roentgens of gamma radiation. Many of these specially hardened units are operating dependably in USAF and NASA space vehicles today.

What's your punishing application problem? Chances are, we can help. Send for complete information.



BR-7: Standard hi rel series. SPDT or DPDT contact forms.



BR-9: Magnetic latching version DPDT only.



BR-14: Standard 4PDT series.



BR-18: Magnetic latching version of 4PDT series.



BR-19: All welded version of standard BR-7. SPDT or DPDT.



BR-20: All welded version of magnetic latching BR-9. DPDT only.

BABCOCK
RELAYS

A DIVISION OF BABCOCK ELECTRONICS CORPORATION
 3501 HARBOR BLVD., COSTA MESA, CALIF. • 546 2711

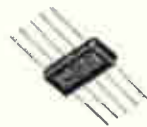

A little look at electronics in

Atlanta

High productivity. For every dollar of wages paid, an Atlanta manufacturer of electronic measuring instruments can expect \$3.76 in value added by manufacture. In Chicago he would gain only \$2.90; in New York-New Jersey, \$2.64 (U. S. Census figures). Atlanta's large labor pool also permits a high degree of selective hiring.

Trained engineers and technicians. In 1964 Atlanta's 19 colleges and universities will grant over 1300 Bachelor of Science degrees — more than 200 in electrical engineering and physics. Nearly 300 technicians graduate here yearly.

Proximity to aerospace and atomic energy installations. Atlanta is at the center of some 26 military, NASA, AEC, and airframe manufacturing installations, including Thiokol Solid Rocket Booster Plant, Marshall Space Flight Center, Cape Kennedy.

Transportation. Close liaison between manufacturer and customer and rapid freight service are guaranteed by Atlanta's transportation facilities. Seven airlines offer non-stop service from Atlanta to more than 50 cities; 75 truck lines provide scheduled service to every major market in the nation; 7 railroads operate into and out of the city over 13 main lines.

Independent research capabilities. Georgia Tech's Engineering Experiment Station, Emory University, the University of Georgia, plus a number of private companies offer a wide range of research capabilities on a contractual basis to business and industry.

Ask for an analysis of your company's probable success in Atlanta as prepared by Georgia Tech's Industrial Development Division. Check coupon; mail with your company letterhead. All inquiries confidential.

Please send me the following reports and other information as checked below:

1. Calculators and Computers—A Manufacturing Opportunity in Atlanta
2. Electronic Testing and Measuring Instruments—A Manufacturing Opportunity in Atlanta
3. Electronics—A Manufacturing Opportunity in Georgia
4. I would like information on the following aspect(s) of Atlanta's economic and general make-up (list) _____
5. I want to know my company's prospects for success in Atlanta as analyzed by Georgia Tech's Industrial Development Division. We would be interested primarily in a new plant warehouse sales office other _____



"Forward Atlanta"
Paul Miller, Development Manager
Atlanta Chamber of Commerce
1318 Commerce Building
Atlanta, Ga. 30303 Phone: 521-0845

Name _____ Title _____
Company _____
Product _____
Street _____
City _____
State _____ Zip Code _____

CONFIDENTIAL

Report from

**BELL
LABORATORIES**

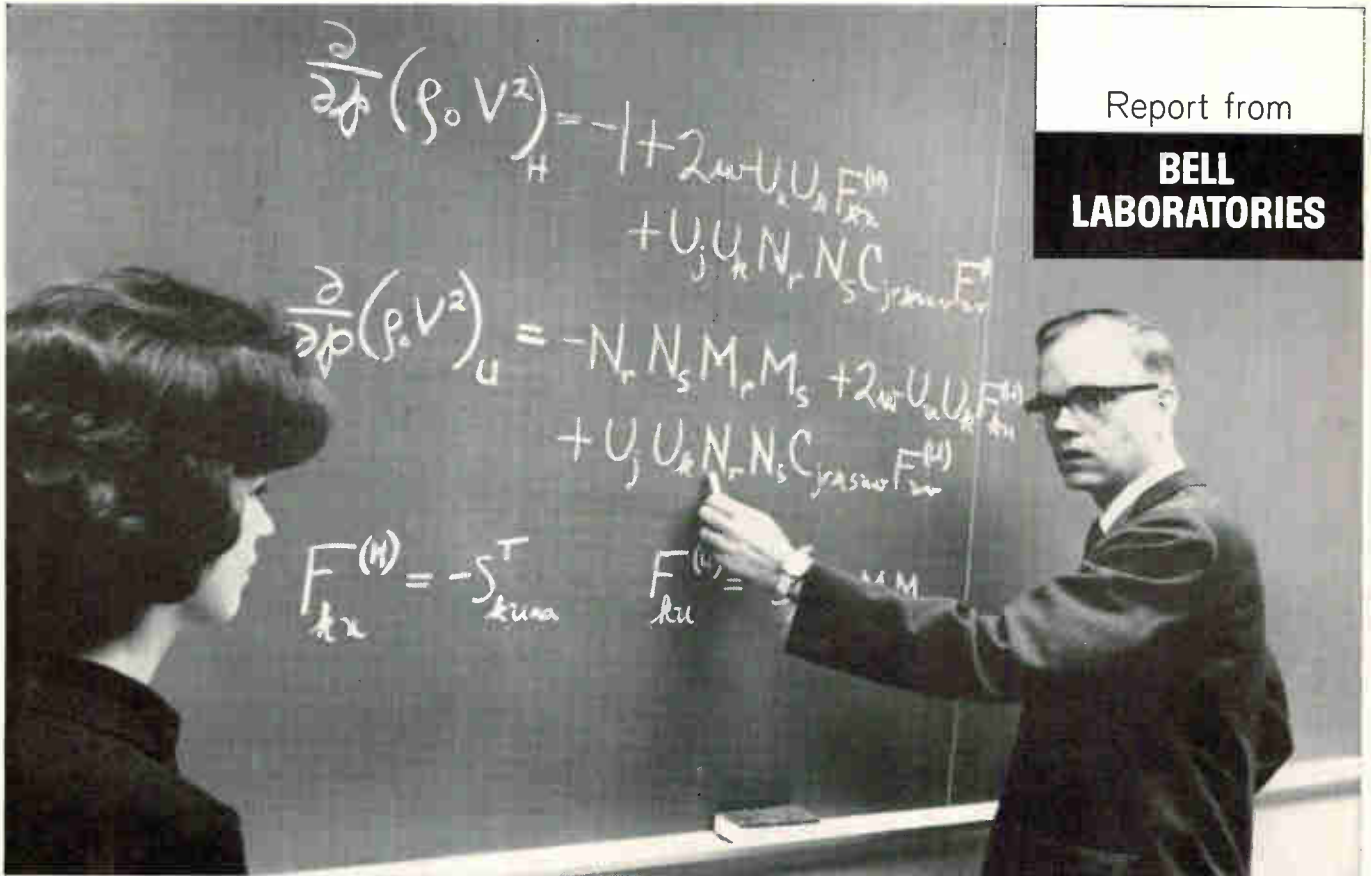

Mathematician W. S. Brown and program design trainee Mrs. L. A. Needham discuss an application of ALPAK programming to wave propagation in crystals under pressure.

ALGEBRA ON A DIGITAL COMPUTER

○	PHI(3,0)				
○	NUMERATOR				
		A	A	A	Q
		4	3	2	1
○	-288	0	0	0	3 3
	1152	0	0	0	3 4
○	-1896	0	0	0	3 5
	1656	0	0	0	3 6
	-816	0	0	0	3 7
○	-2	1	0	0	5 1
	1	1	0	0	5 2

A portion of the printout from an ALPAK computation: each row represents a polynomial term consisting of a coefficient and five exponents; the variable names appear as column headings. The first term is thus $-288A_1^3Q^3$. ALPAK can handle polynomials and rational functions in several variables, as well as truncated power series and systems of linear equations with rational-function coefficients.

Much laborious manipulation of routine algebraic expressions can be eliminated by a computer programming system devised at Bell Laboratories. Called ALPAK (Algebra PACkage), the new system makes it possible to perform algebraic calculations on a digital computer at ten thousand times human speed.

Digital computers work with numbers, not algebraic symbols. But algebraic expressions include numbers as coefficients and exponents. For example, the term

$$3x^2y^4z^5$$

can be written in the form

$$3 \quad 2 \quad 4 \quad 5$$

where 3 is the coefficient and 2, 4, and 5 are, respectively, the exponents of x, y, and z. This numerical representation permits a computer to perform algebraic addition, subtraction, multiplica-

tion, division, substitution, and differentiation. The exponents and coefficients are reassociated with the variables at the output.

Unlike the human algebraist, the digital computer does not become weary and make mistakes. It can quickly carry to completion computations that hitherto seemed prohibitively long. For example, at the left is a printout of the result from a computation related to a telephone traffic problem. The problem involved 9 linear equations in 9 unknowns, with a total of over 800 terms. The computer running time was six minutes: the time required for a human mathematician to work the problem and check the answer would be approximately one year. BELL TELEPHONE LABORATORIES ...World center of communications research and development.



FROM DELCO NINE NEW SOLUTIONS TO CURRENT PROBLEMS



These are our latest: the DTG-1000 and 2000 series. Rugged 15 and 25 ampere germanium Nu-Base† transistors specifically designed for high-peak power switching applications.

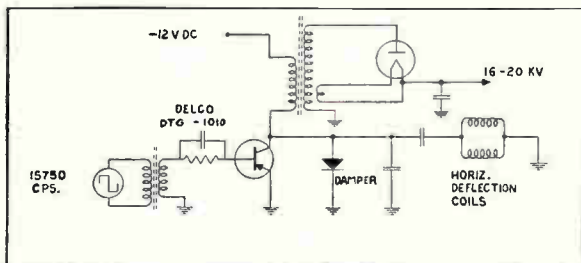

Video horizontal deflection with the Delco DTG-1010

These devices are ideal for high-current inverter applications, high-voltage TV Horizontal and Vertical circuits, and automotive ignition applications. Nu-Base construction with H.K.†† spares you from junction "hot spots," too, so you don't have to worry about secondary breakdown.

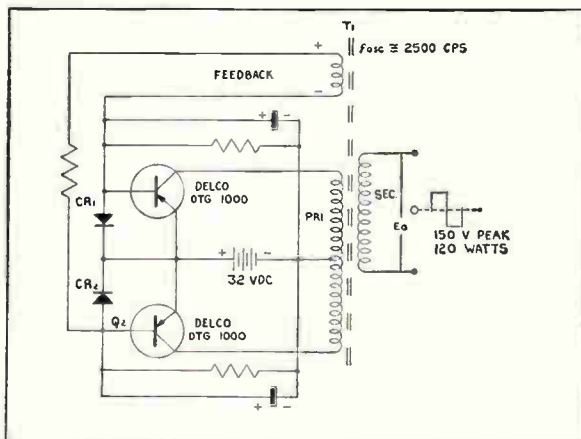

DC to AC inverter using Delco DTG-1000

Parameter stability is assured by Delco's Surface Passivation Ambient Control process. And the extremely low leakage of these de-

vices gives you all the circuit design flexibility you could ask for.

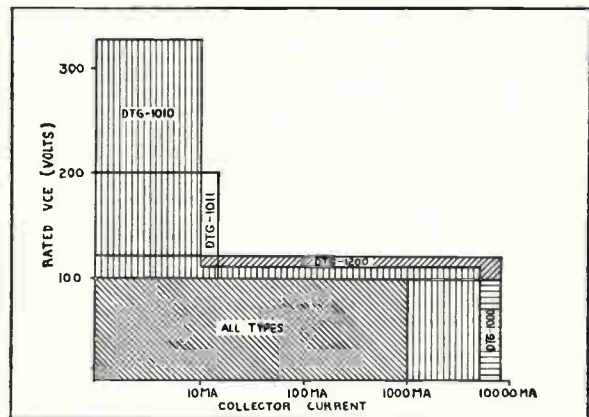

Recommended operating region DTG-1000 series

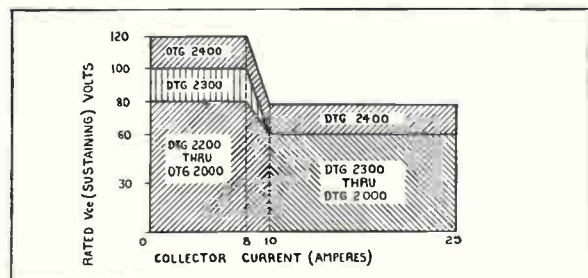

Recommended operating region DTG-2000 series

Your nearest Delco semiconductor distributor or any of our sales offices will be glad to give you more information about these new transistors. And about our other Nu-Base transistors. The 5 and 10 amp. units.

Just drop us a letter or give us a call. Anytime.

†Delco drift field non-uniform diffused base construction
††Delco hydrokinetic alloy process

Union, New Jersey*
324 Chestnut Street
(201) 687-3770

Palo Alto, California
201 Town & Country Village
(415) 326-0365

Syracuse, New York
1054 James Street
(315) 472-2668

Detroit, Michigan
57 Harper Avenue
(313) 873-6560

Santa Monica, California*
726 Santa Monica Blvd.
(213) 870-8807

Chicago, Illinois*
5151 N. Harlem Ave.
(312) 775-5411

General Sales Office: 700 E. Firmin, Kokomo, Ind., (317) 452-8211—Ext. 500
*Office includes field lab and resident engineer for applications assistance.

DELCO RADIO 
DIVISION OF GENERAL MOTORS, KOKOMO, INDIANA

See us at the
Wescon Show, Booths 188-189.

NEW 30,000,000 WATT RADAR SYSTEM!

L/UHF dual-frequency, pencil-beam radars pioneer new concepts in super power research systems

LTV Continental Electronics Division is systems contractor for two unique radar systems now in operation at White Sands Missile Range: the AN/FPA-22 and the AN/FPA-23. Each system is powered by two Continental 30 megawatt transmitters: one L-band, one UHF. Peak transmitter power is 30 megawatts; average power is 30 kilowatts. Pulse width for both systems is $1\mu\text{s}$ and $10\mu\text{s}$. Pulse forming lines are triggered by ignitrons; timing pulses come from an exciter/synchronizer. Both techniques are outgrowths of other LTV Continental Electronics contracts.

Electronics for the two systems are almost identical: the AN/FPA-22 uses an 84-foot dish antenna, the AN/FPA-23 uses a 30-foot dish.

The AN/FPA-22 UHF system has a range of 1100 nautical miles: the AN/FPA-22 L-Band system, 2000 nautical miles. The AN/FPA-23 UHF system has a range of 440 nautical miles: the AN/FPA-23 L-Band system, 710 nautical miles.

Other Continental radar transmitters have been used at Trinidad, Prince Albert, all transmitters at all three BMEWS sites, MIT El Campo Laboratory, Stanford University and Nike-Zeus R & D sites. Earlier radar work led to the development of the AN/FPT-5 transmitter for MIT Millstone Hill Laboratory. Among many other notable achievements, this transmitter bounced signals off Venus in 1958.

For information on these and similar super power radar projects, write Department 25, Continental Electronics Manufacturing Co., P. O. Box 5024, Dallas, Texas 75222.

LTV *Continental Electronics*
A DIVISION OF LING-TEMCO-VOUGHT, INC.

*UHF waveguide, filter,
transmission line and
mode suppressors*

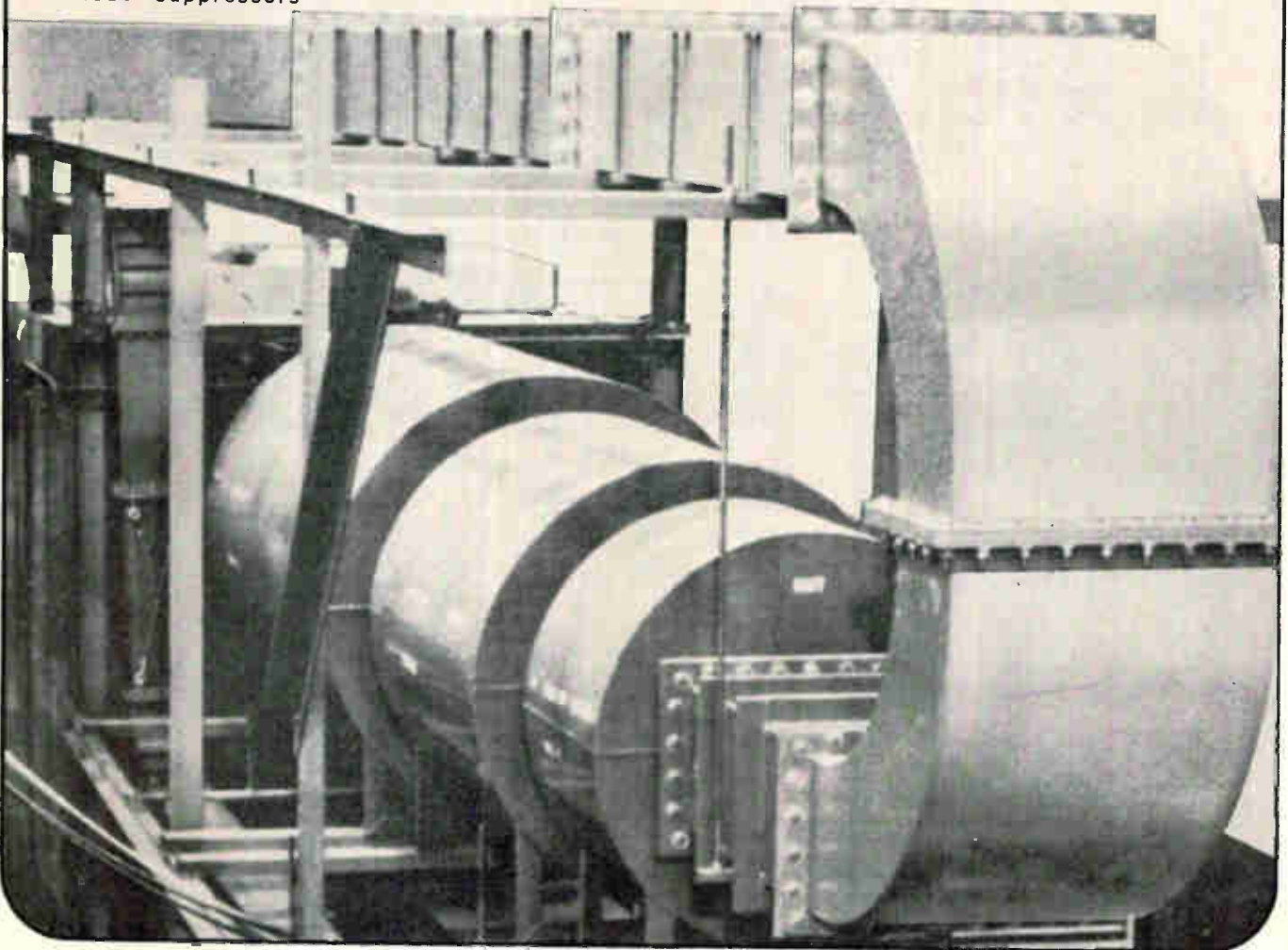

Now...a fluoroplastic film with a new balance of properties.

The material: Kynar*, Pennsalt vinylidene fluoride resin.

Its properties: outstanding strength and toughness... plus a unique combination of inertness, stability, high dielectric strength, resistance to ultra-violet and nuclear radiation. □ Typical values: Strength—7,000 psi at 77°F. Stability—up to 300°F for periods greater than two years. Dielectric strength—1280 volts per mil. Radiation resistance—100 megarads without measurable degradation.

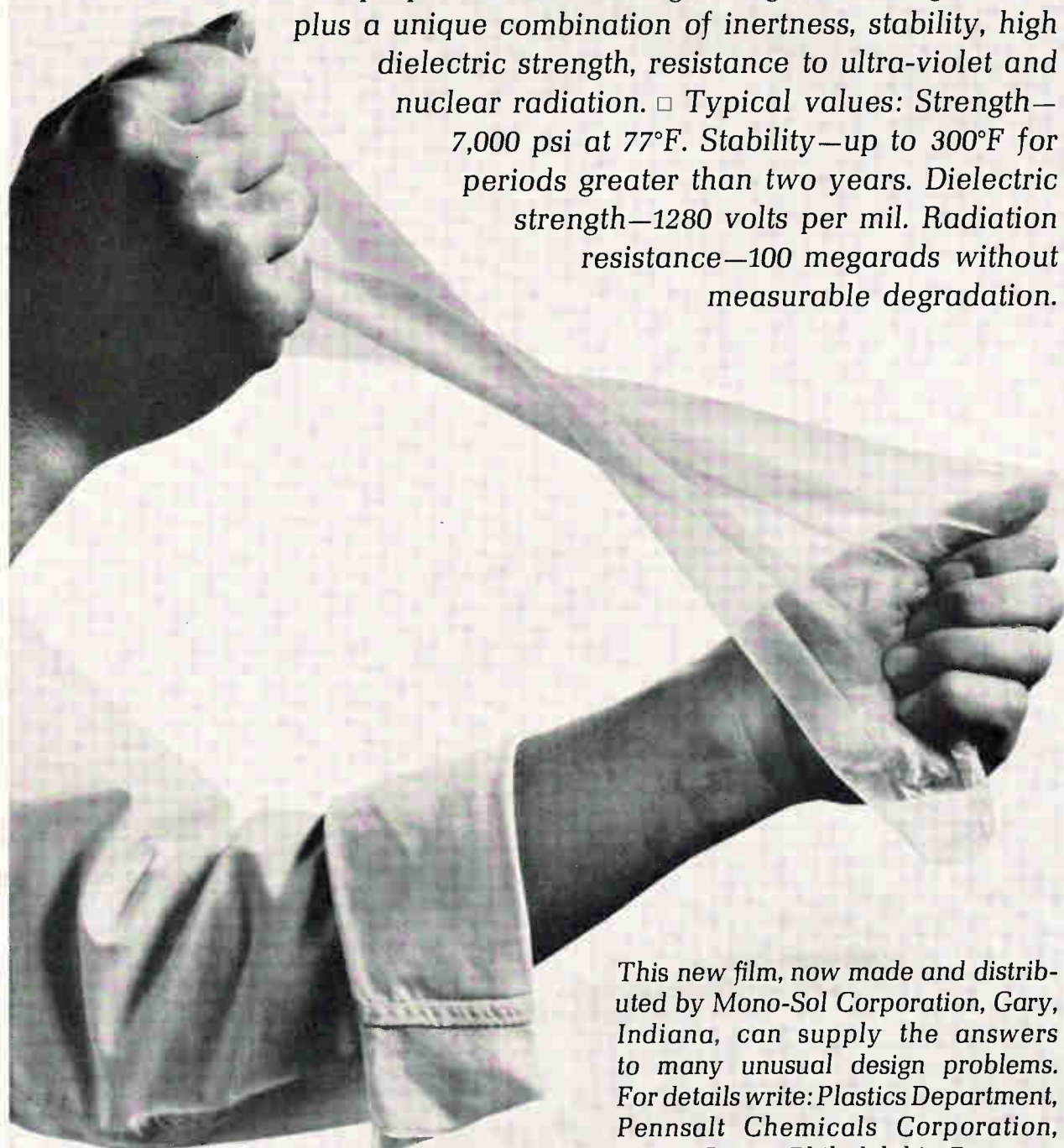

This new film, now made and distributed by Mono-Sol Corporation, Gary, Indiana, can supply the answers to many unusual design problems. For details write: Plastics Department, Pennsalt Chemicals Corporation, 3 Penn Center, Philadelphia, Pa. 19102

Kynar... a fluoroplastic that's tough!

**"Kynar" is a Registered Trademark of Pennsalt Chemicals Corporation.



Probing the News

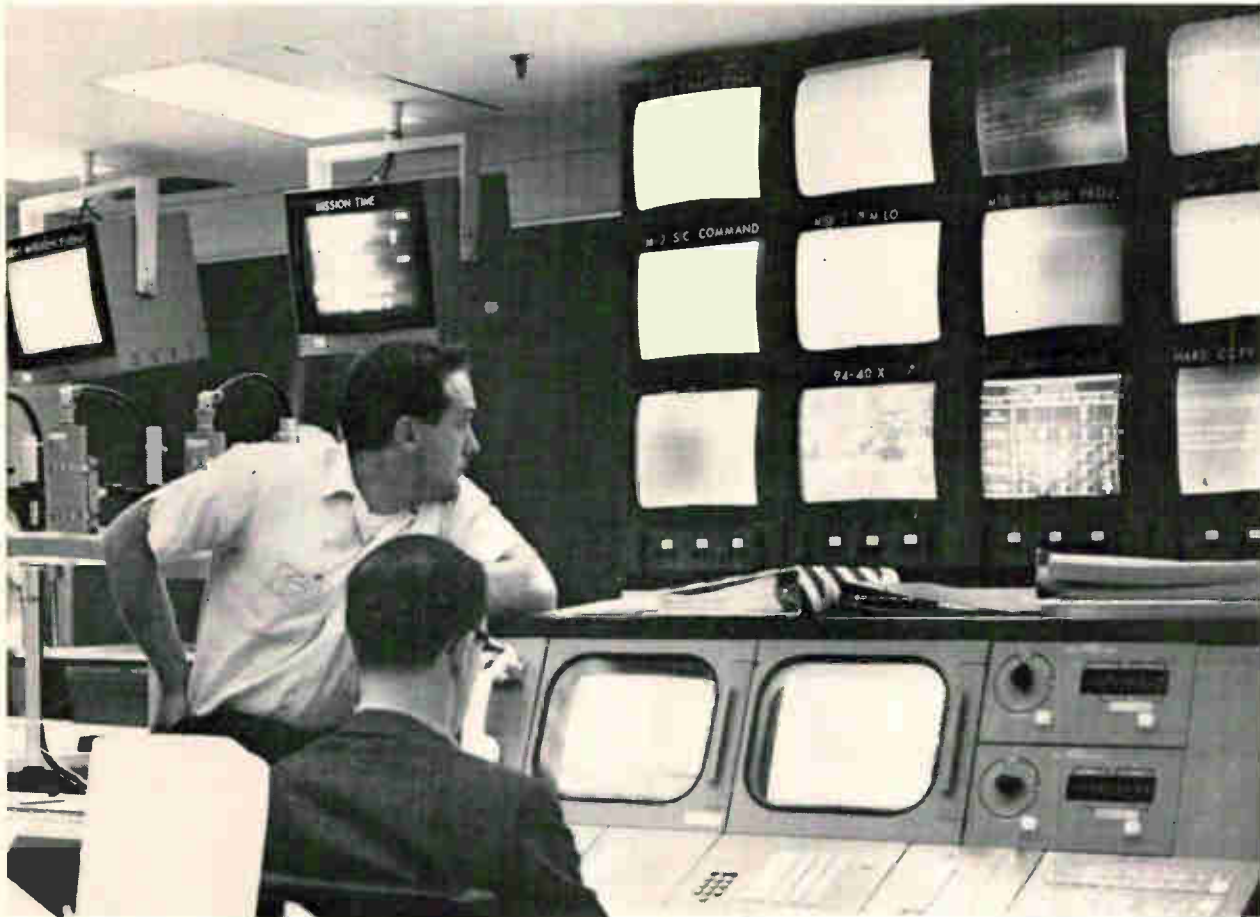

Television monitors show status of communications systems, computers and mission events.

Space electronics

Nerve center for space probes

A new command center at the Jet Propulsion Laboratory will guide space flights to the moon and beyond

By Ron Lovell

McGraw-Hill World News

As **Ranger 7** sped to its target on the moon to take the historic lunar pictures, its progress was followed and controlled by equipment in a band-new four-story command center built to handle deep-space probes.

And while the headlines were

still being written, the men at the Space Flight Operation Facility at the Jet Propulsion Laboratory in Pasadena, Calif., were getting ready for their next job: two eight-month-long Mariner probes to Mars, scheduled for November.

The additional capability of the

\$14.6-million center was urgently needed to handle the Mariner probes, the Pioneer spacecraft, the unmanned Surveyor and Lunar Orbiter moon-reconnaissance vehicles, and the two final Ranger missions to be launched early next year. The center will also monitor the Apollo

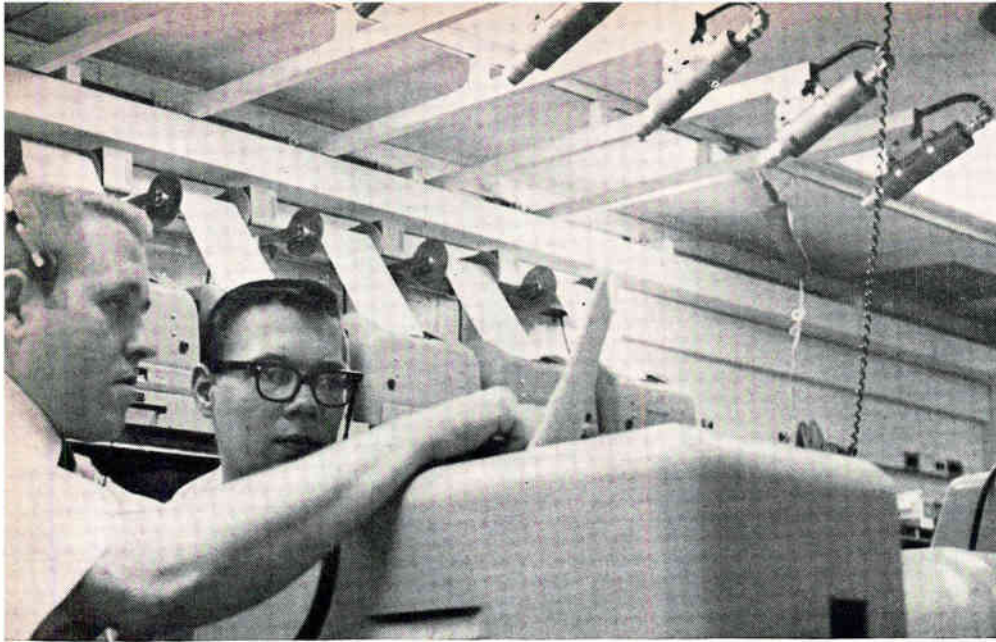

Closed-circuit television cameras monitor the raw teletype data in the communications center.

manned mission to the moon, although primary Apollo control will be from the Integrated Mission Control Center that the National Aeronautics and Space Administration is building in Houston.

Three electronic systems. The command center can already control two simultaneous probes and monitor a third. Soon it will be able to handle four missions. Everything but the computer section of the facility was operating for the Ranger 7 flight. The computers in the old, cramped headquarters at JPL had already been programed, so they were used.

Three major electronic systems—data processing, communications and display and control—make it possible for the center to handle an entire mission, from testing through launch and space flight operation.

The launch takes place at Cape Kennedy. Then the center goes into action.

Data from the spacecraft also is being received at stations of the deep-space network at Cape Kennedy, Fla.; Johannesburg, South Africa; Madrid, Spain; Woomera, Australia; and Goldstone, Calif.

At each station the data is recorded on magnetic tape, and portions of it are simultaneously transmitted to JPL by high-speed data lines, teletype or microwave radio. As soon as it's received, it is again recorded on magnetic tape and sent

into the computer system for processing.

I. Data Processing

There are two identical computer systems—a primary and a back-up. Each consists of an IBM 7094 central processor, an IBM 7040 computer for input/output to the 7094, an IBM 7288 data communications channel common to both systems and an IBM 1301 disc file with a 54-million-character storage capacity. The system converts the data from the spacecraft and speeds it to the proper areas for analysis.

There are nine consoles through-

out the center to display and control information. Each has input-output and print-out capability so that personnel in any of nine points can follow a flight's progress, insert information into the data-processing system, or request and receive information.

II. Communications

Various areas of the flight-operation facility are connected with each other and with the outside world by telephone, teletype and radio. The center also acts as a main switchboard for the instrumentation facility's communications systems, routing data back and forth between the stations and the facility.

The communications system relays test and flight information to and from Cape Kennedy. It is also part of NASA's worldwide communications system, relaying to headquarters information from NASA flight and test operations in the Pacific Ocean.

Subsystems. There are five separate and independent communications subsystems: television, voice, telephone, teletype and data transmission.

Cohu Electronics, Inc., of San Diego, Calif., manufactured the closed-circuit television system that consists of over 100 cameras and 200 monitors. Television cameras monitor areas on all four floors, display raw teletype data as it is received, and provide visual intercommunication between various

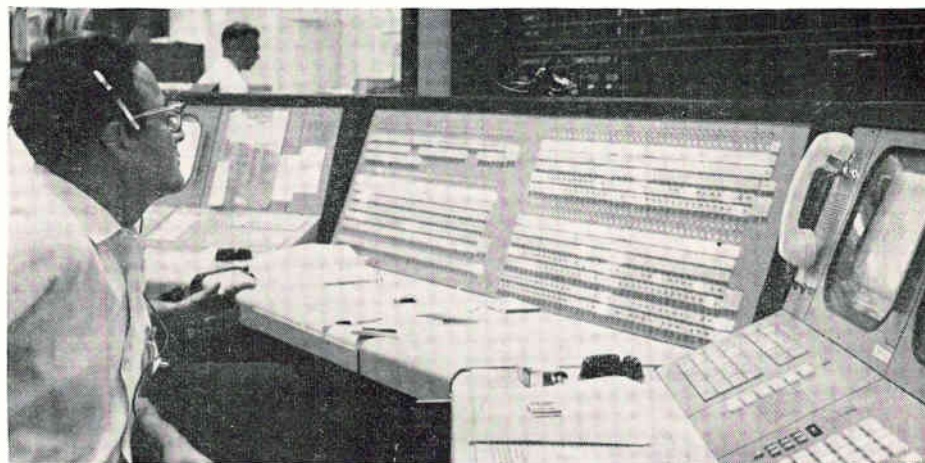

Control console in communications center and large status board in background follows performance of the tracking stations and the status of communications between the center, the tracking stations and the spacecraft.

areas. The system displays information in raw form by training a camera on, for example, a hastily drawn sketch or a message placed on a table.

Designed by JPL and developed by the Pacific Telephone Co., the operational voice-subsystem consists of intercom and telephone communications among individuals or groups in conference-call networks. The intercom is a set of 20 preassigned stations with microphones and speakers at each station. The conference network is a party-line system. The people on the line use headsets to talk and listen. They don't have to select or dial different stations. They are also linked to the deep space instrumentation station.

There are two types of telephone service, both with push-button phones. One is used inside the building; the other is hooked up to the outside. The teletype substitution controls 36 incoming and 36 outgoing commercial teletype lines and a public address system.

The high-speed data system handles information that cannot be transmitted over the standard teletype system. Such data is carried by f-m radio signals on as many as seven separate lines. The data system also includes the microwave link to Goldstone.

III. Display and control

The most varied system at the center is the one for display and control. It ranges from blackboards to black boxes and can display information to all areas of the facility in formats tailored to the user's requirements.

The major part of the system is the mission status board in the main operations area. The displays are remotely controlled and posted from the main data-processing control console, right in front of the board. The scientists and engineers at the board can control the mission by using the input-output consoles, computers, teletype, closed-circuit television, intercom and public address systems in front of them.

Special consoles provide for selection of computer programs, requests for display of stored information, or the entering of data into the computer system.

The operations area in front of

the mission status board contains the main data-processing control console. Designed by the Tasker Corp., it consists of input-output devices, a Burroughs card reader, a Motorola TP 3000 printer for high speed messages, a General Dynamics/Electronics SC 3070 printer with a special modification to print 120 characters for high-speed, bulk printing of data, an Amilgo 30 × 30 plotter and a Dymec 11 × 17 plotter to present digital data in graphic form.

View from the gallery. A glass-enclosed gallery for visitors, above the display board, provides a van-

tage point for the press and visiting dignitaries. There is also a platform to accommodate commercial television cameras, which are manned by JPL personnel.

The Space Flight Operations Facility is the culmination of a program that began in 1961 with a series of studies undertaken by the lab and several industrial companies. It has profited from the experience gained in the early Ranger missions and the Mariner 2 mission to Venus, with the Ranger providing information on handling short-duration flights and the Mariner on handling longer flights.

Solid state

Scr's for 19-inch tv

Big-screen transistor sets get assist from new devices

By Laurence D. Shergalis

Regional Editor

The development of high-powered gate turn-off silicon controlled rectifiers brings the day of the large-screen transistorized television set nearer. The devices make possible the design of horizontal-output stages for sets as large as 19 inches. The previous limits was 11 inches.

The Semiconductor division of Fairchild Camera & Instrument Corp. has just developed a GTO that can control 10 amperes. Texas Instruments, Inc. is sending tele-

vision designers samples of a 5-amp GTO and is supplying 10-amp devices to the space program.

The Emerson Radio & Phonograph Corp. is already using a Texas Instruments' gate turn-off scr in 11-inch sets that will be introduced this fall. Emerson plans to follow that with larger models, building up to a 21-inch set by mid-1965.

A basic problem in designing a transistorized television receiver is creating a horizontal sawtooth

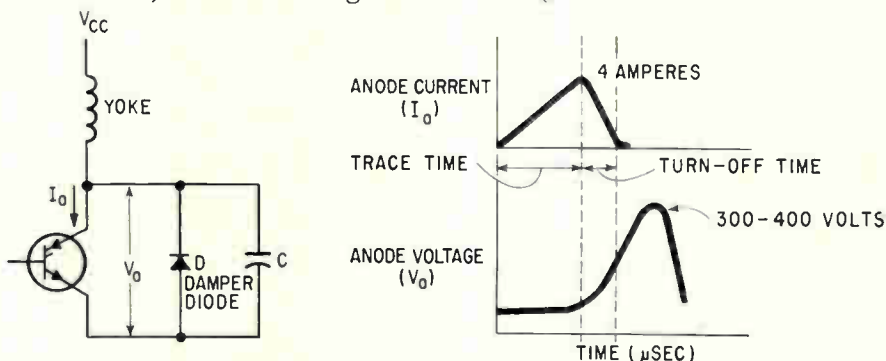

Simplified horizontal-sweep circuit (left). The turn-off time (see waveform at right) is minimized to limit heat generation in the controlled rectifier.

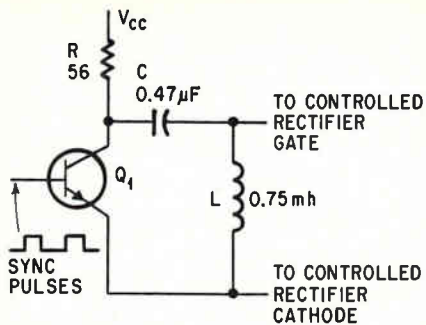

New driver circuit. Sync pulses saturate the driver transistor permitting capacitor C to charge.

sweep current of up to several amperes which is linear so as to avoid distortion of the picture. Also the semiconductor device used must be capable of withstanding the flyback voltage of several hundred volts. This combination of requirements demands a device capable of saturation at low voltages (achieved by using epitaxial material) and the ability to block high voltages.

While the new devices can lick this problem, TI says there is one more hurdle: making the cost of semiconductor circuits competitive with that of the tube circuits now used in large-screen sets. When that comes, transistor tv will be off and running.

New geometry. Texas Instruments has not yet disclosed details on its candidates, but Fairchild is talking about its new device. Fairchild made changes in the conventional GTO geometry to reduce turn-off time from around 10 microseconds to 1 microsecond, and control 10 amp instead of 1 amp. Regular scr's aren't practical for the tv application. Conventional gate turn-off silicon controlled rectifiers have a turn-off gain B_{off} (ratio of anode current to gate current, of between 2 and 5). The Fairchild GTO has a B_{off} of about 30. Thus, only about 1/30th the current flowing through the device is needed to turn it off.

The advantages of fast turn-off can be illustrated by considering the simplified horizontal sweep circuit. When the silicon controlled rectifier conducts, the yoke current rises, deflecting the electron beam. After 27 microseconds, the current must be interrupted and returned to zero. Current is diverted to capacitor C, and the voltage across

C rises to about 300 to 400 volts. This is the flyback voltage. The decaying anode current through the controlled rectifier and the increase in anode voltage due to the capacitor charging occur at the same time. The shorter this overlap, the less the power generated in the controlled rectifier and the less heat generated. The goal in developing a new device was to achieve fast turn-off before substantial buildup of flyback voltage. With conventional silicon controlled rectifiers, average power reached before turn-off could be 10 watts. With the new device, the average power reached is about 1 watt.

Limited application. While the new Fairchild devices can handle the power requirements for 19-

inch tubes, their application will probably be limited to somewhat smaller sets because the horizontal supply has additional functions in a television receiver. The device is expected to be used only in solid-state receivers and not as a replacement for tubes. In a television circuit, it can turn off up to 4 amperes in less than one microsecond, and supply flyback voltage of about 4,000 volts.

Fairchild is also working on a higher current unit. No type numbers have been assigned as yet.

While the horizontal sweep circuit is essentially the same as that used in conventional transistorized receivers, the new drive circuit shown has been developed for use with the new device.

Military electronics

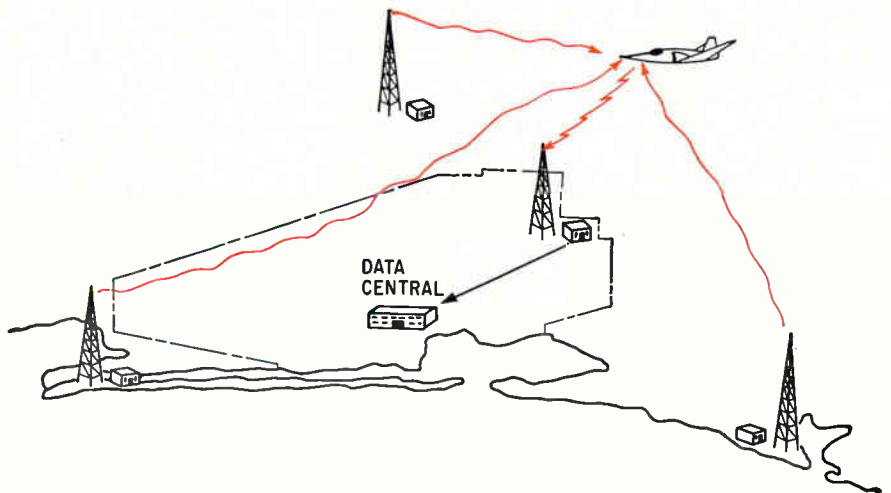

Hyperbolic grid-type system could be used to locate an aircraft involved in weapons effectiveness tests. The readout would be on the ground instead of in the aircraft.

Weapons for limited war

A big range in Florida is being instrumented to test their capability and endurance

By John F. Mason
Senior Associate Editor

The Air Force is planning to create a huge electronic test range for weapons that might be used in

limited wars like the one in South Vietnam.

The program—called WET for

TRIPLET

EXTRA QUALITY IS HIDDEN*

MODEL 630 V-O-M PRICE \$49.50

Standard Of The Industry



USES UNLIMITED:

- Field Engineers
- Application Engineers
- Electrical, Radio, TV, and Appliance Servicemen
- Electrical Contractors
- Factory Maintenance Men
- Industrial Electronic Maintenance Technicians
- Home Owners, Hobbyists

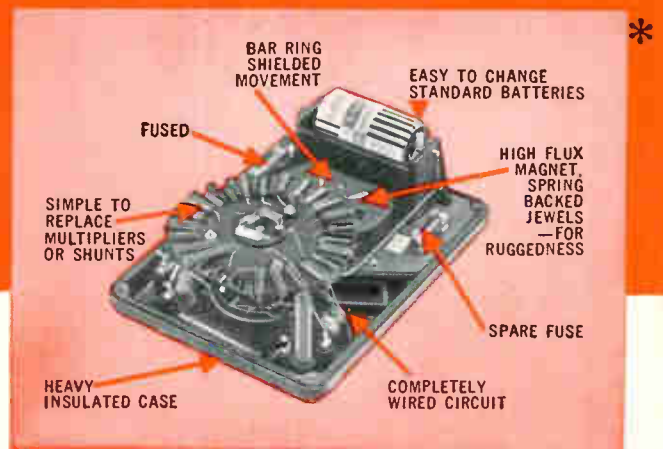

FACTS MAKE FEATURES:

- 1** Popular streamlined tester with long meter scales arranged for easy reading. Fuse protected.
- 2** Single control knob selects any of 32 ranges—less chance of incorrect settings and burnouts.
- 3** Four resistance ranges—from .1 ohm reads direct; 4½ ohm center scale; high 100 megohms.

Attention to detail makes the Triplet Model 630 V-O-M a lifetime investment. It has an outstanding ohm scale; four ranges—low readings .1 ohm, high 100 megs. Fuse affords extra protection to the resistors in the ohmmeter circuit, especially the X1 setting, should too high a voltage be applied. Accuracy 3% DC to 1200V. Heavy molded case for high impact, fully insulated.

*630A same as 630 plus 1½% accuracy and mirror scale only \$59.50

TRIPLET ELECTRICAL INSTRUMENT COMPANY, BLUFFTON, OHIO

RANGES

DC VOLTS	0-3-12-60-300-1,200-6,000 at 20,000 ohms per volt.
AC VOLTS	0-3-12-60-300-1,200-6,000 at 5,000 ohms per volt.
OHMS	0-1,000-10,000.
MEG OHMS	0-1-100.
DC MICRO-AMPERES	0-60 at 250 millivolts.
DC MILLI-AMPERES	0-1-2-12-120 at 250 millivolts.
DC AMPERES	0-12.

DB: -20 to +77 (600 ohm line at 1 MW).

OUTPUT VOLTS: 0-3-12-60-300-1,200; jack with condenser in series with AC ranges.

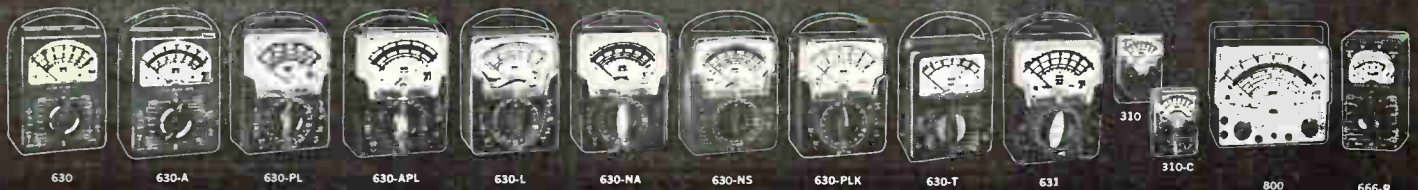

THE WORLD'S MOST COMPLETE LINE OF V-O-M'S. AVAILABLE FROM YOUR TRIPLET DISTRIBUTOR'S STOCK



how much should high reliability transformers cost?

The extra costs of Raytheon high reliability transformers can be and often are surprisingly small. Of course, should you require complete, quantitative, ultra-high reliability, then the program must be priced accordingly.

As a supplier of magnetic components for Minuteman and Apollo, Raytheon is eminently qualified to meet your most exacting specifications for high reliability transformers. If your budget or time requirements do not allow for a complete high reliability program, we can tailor a program that meets your reliability needs within your monetary and scheduling limitations. We can also assist you in establishing your own reliability specifications.



Full facts on Raytheon's High Reliability Program for its wide range of transformers are contained in a new eight-page brochure. Write or call for your free copy, Raytheon Company Magnetics Operation, Foundry Avenue, Waltham, Massachusetts 02154. Telephone 899-8400



weapons effectiveness testing—will use a range 50 miles in radius and extending 70,000 feet upward over Eglin Air Force Base, Fla. The test area will be instrumented to study, in a realistic environment and with unprecedented precision, conventional bombs, short-range air-to-ground missiles, machine-gun fire for strafing runs, and other limited-warfare weapons.

WET, one of the most extensive of the test programs at Eglin, is another step in the Defense Department's shift in emphasis from strategic to tactical weapons.

The tests are supposed to tell the Air Force exactly what it can expect from existing weapons, as well as those to come: how effective they are, how they can be used to best advantage, and how well they survive under combat conditions and in extreme climates.

Because of the high priority given to the development of limited-warfare weapons, the Air Force already has installed cameras, timing receivers, oscillographs, beacons and checkout gear at an interim range that will soon be ready for use. The big job is to design and build a completely new test range by mid-1966; however, contracts have not yet been awarded.

The program is under the command of the Air Proving Ground Center, Air Force Systems Command.

Position data

One of the most demanding tasks will be to provide the range with a time-space position system that will constantly show the ground control operator the exact whereabouts of 16 mobile test vehicles such as aircraft, tanks and ships, and 10 fixed ground elements.

One solution might be a low-frequency grid system similar to Ioran D with the readout on the ground rather than in the plane. An alphanumeric display would probably help the operators identify all the elements quickly.

To back up the system that is finally chosen, the large network of tracking radars used on the Electromagnetic Test Environment Range nearby will also be used to track the aircraft and missiles operated in the WET range.

These radars have been used for

some time to keep tabs on the aircraft that carry all kinds of electronic countermeasures gear from simple aluminum foil dropped from a plane to confuse enemy radar to more sophisticated devices which develop false doppler-shift frequencies that give enemy radar phony velocities.

The electronic countermeasure radar network was recently improved and will be a good backup for WET. All the radars have been tied together to form an integrated tracking system. One radar will detect an approaching aircraft. Range and bearing information goes automatically to an IBM 7094 central computer, which determines where all the other radars should turn to acquire the target. Instructions are then sent, thus slaving all the radars to the one that first picked up the target.

Performance data on aircraft involved in a test will also be needed on the ground to feed into the test results. The parameters of a plane's fire-control system must be recorded at the time of fire, as well as the plane's velocity, altitude and attitude. This will be sent automatically by data link and fed into a computer.

Scoring

Systems using new techniques, will have to be developed for scoring. For example, the system now being used for a fighter in contest with a ground-based anti-aircraft battery is far too slow. Cameras are used instead of guns, and it takes time to find out who got off the first shot.

The new system calls for a scoring device that will determine at once the status of all targets, and will advise everyone concerned, within one-tenth of a second, who was "killed." For example, everyone involved will be told that aircraft X has been "shot down" and should therefore be ignored as it leaves the battle area.

One technique under study, that might provide this thorough information quickly, would involve a laser. Both the fighter and the anti-aircraft battery could be equipped with collimated laser guns, optical receivers, timers and data linked to a ground-based data central. The central compares the time of receipt of each opponent's

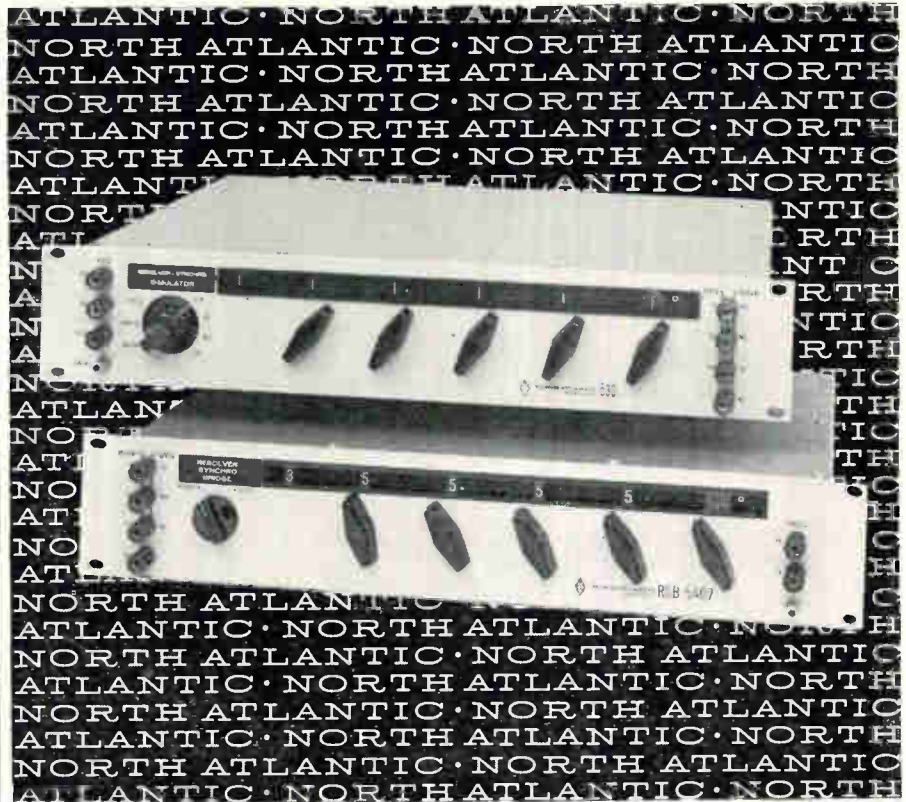

you are looking at the state-of-the-art in resolver/synchro testing

These two instruments provide the widest measurement capability available today for resolver/synchro testing. Each is a dual-mode unit, measuring both resolvers and synchros. Series 530 Simulators are ideal transmitters, and Series 540 Bridges are ideal receivers.

In addition to their dual-mode capability in 3½" of panel space, both series provide in-line decimal readout continuously switched through 360°, 2 second accuracy at any angle, and input/output isolation.

SERIES 530 SIMULATORS FEATURE

- Resolution 0.001°, 1°, or 5°
- Dual 26/115 volt excitation
- Switch selected line-line voltages 11.8, 26, 90, and 115 volts
- Low matched output impedance

SERIES 540 BRIDGES FEATURE

- Resolution 0.0001°, 1°, or 5°
- 500K input impedance
- Constant null-voltage gradient at all line-line voltages
- Unaffected by null detector loading

Prices range from \$1480.00 to \$2680.00

The flexibility of these instruments meets every need for rapid and accurate testing in the engineering laboratory, in production, and in ground support equipment. Used with a Phase Angle Voltmeter, they provide a complete facility for component or system test.

Programmable models with decade or binary input are also available. Your North Atlantic representative will be glad to arrange a demonstration. Call or write him today.



NORTH ATLANTIC industries, inc.
TERMINAL DRIVE, PLAINVIEW, L. I., NEW YORK • Overbrook 1-8600



These frequency-diversity type radars, used now in the electronic counter-measures test range, will also be used for the new weapons effectiveness tests. The radar with the round radome is the AN/FPS-26, the large, exposed dish is the AN/FPS-24.

blast, determines who won, and automatically transmits the news to the participants.

Scoring the effectiveness of ground strafing is another concern at Eglin. The system used today could easily have been devised during World War I. A 15-foot

panel is placed on the ground, the fighter makes a strafing run over it, and someone goes out and counts the holes.

Engineers of the Targets and Scorers division of the Research and Technology division at Eglin are working on two scoring tech-

niques for noncooperative targets.

Acoustics. One technique is acoustical and can be used for scoring a variety of projectiles—50-caliber machine-gun fire, 20-millimeter and 7.62-millimeter shots. This device can also be used in a helicopter to detect ground-weapons fire.

The system consists of two major components: an airborne unit installed in the tow target, and a ground-based quick-readout computer. The airborne portion detects and translates the magnitude of acoustical shock-wave pulses into miss distance. It then transmits this information via a telemetry link to the receiver station on the ground or in the cockpit of the tow aircraft. The receiver station processes the telemetry signal and presents the miss-distance data.

The system, known as the Olle Bulow Miss Distance Indicator, Model LYTH-22, was designed and built by the Olle Bulow Co. of Sweden. It has already been evaluated at Eglin, and the results show promise. The Targets and Scorers division has asked for authority to order two prototypes that meet

PAKTRON'S NEW 50-volt capacitors are

more stringent specifications. The equipment at Eglin handles 1,500 rounds of machine-gun fire a minute. The engineers would like one that handles up to 8,000. They would also like to test the technique for air-to-air missiles, helicopter warning and ground strafing.

Doppler shift. The second system Eglin is evaluating derives miss-distance information from a doppler shift. It was designed for scoring air-to-air missiles. Known as Bidops, for bi-doppler scoring system, the device consists of an airborne unit installed in a target (tow or drone), and a ground-based quick-readout computer.

The airborne unit transmits and receives two carrier frequencies, compares their phase, and transmits this phase information via telemetry link to the ground station. The ground station receives the telemetry signal, recovers the doppler phase measurement, and processes this measurement into miss-distance information.

The Air Force is also developing a self-contained system in the tow aircraft; this system would handle its own data-processing and re-



Tow target is equipped with a microphone to determine acoustically the miss-distance of a projectile. An airborne telemetry transmitter gets the information to the ground and back to the fighter pilot. The tow target and miss-distance system are of Swedish design.

coding.

Bidops was developed as a proprietary item by the Traid Corp. of Fullerton, Calif. Production and marketing rights were sold by Traid to Babcock Elec-

tronics, Inc., of Costa Mesa, Calif.

Tests planned

Tests will be run on old as well as new systems. The F-105 fighter, for example, which has been

.. mite size mylar*



New miniature high performing Mylar* film/foil capacitor for quality transistorized circuits. Epoxy coated for excellent moisture resistance. Uniform size. Capacitance value to 0.47 mfd with tolerance to $\pm 5\%$.

The "white" series has an internal design to protect the high performance Polyester film and an external design to satisfy any circuit construction system.

Detailed information available on request.

*DuPont

Working Voltage: 50V DC

Tolerance: $\pm 5\%$, $\pm 10\%$, $\pm 20\%$

Dissipation Factor: 4×10^{-3} max. @ 25° C, at 1 KC

Temperature Stability: 4% max. deviation from 25° C value in range of 0° C to 85° C, at 1 KC



PAKTRON

DIVISION ILLINOIS TOOL WORKS INC.
1321 LESLIE AVENUE • ALEXANDRIA, VIRGINIA

WATCH DEI

DUAL TELEMETRY/SURVEILLANCE SIGNAL ANALYZER

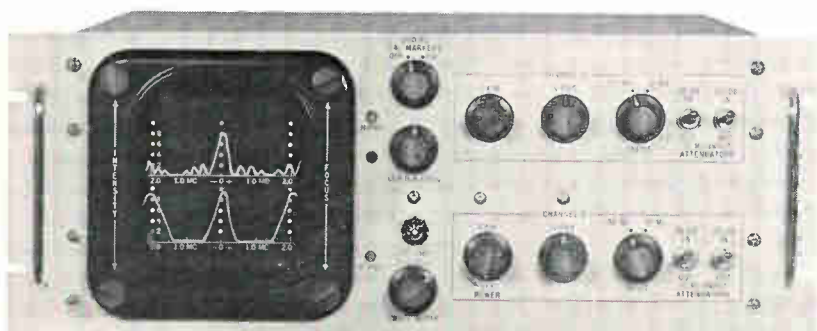
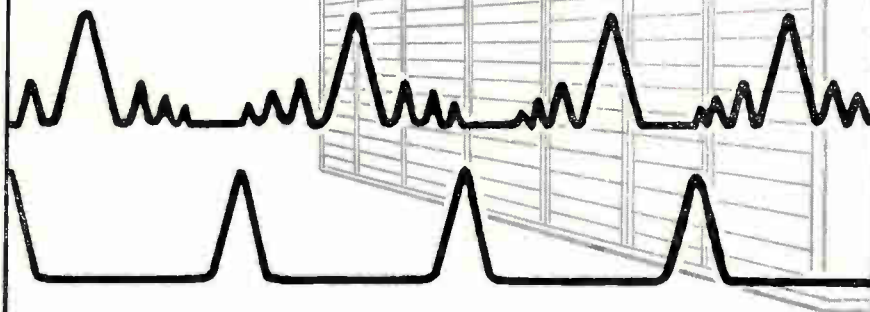

- Provision for 10 mc and 30 mc input
- 10 kc Resolution
- 4 mc Sweep Width
- 5 inch CRT

Significant advances have been engineered into this double-duty signal display and analyzer unit . . . the SA-101 Signal Analyzer from Defense Electronics, Inc.

Capable of monitoring a 30 or 10 mc input frequency, the unit is particularly useful for work with predetection telemetry equipment. It permits simultaneous viewing of any two of four available signals (two 10 mc or two 30 mc signals or any combination).

The latest in DEI's SA display series, the SA-101 also provides greater sweep width . . . from 0 to 4 mc; with better resolution . . . 10 kc; larger and brighter display; and bigger . . . five-inch dual gun . . . CRT with calibration markers. The 2-in-1 display package also saves precious ground station telemetry receiving system space—yet is versatile enough for connection to ordinary oscilloscopes for remote displays.

Before choosing your signal display and analyzer unit, why not take a close look at the SA-101 . . . and Watch DEI.



DEI
RESEARCH
DEVELOPMENT
MANUFACTURING

Defense Electronics, Inc.

ROCKVILLE, MARYLAND

PHONE (301) 946-2600 TWX 301-949-6788
SHERMAN OAKS, CALIFORNIA PHONE (213) 812-2870

around for a long time, will be carefully monitored as it goes through its paces in a simulated battle area at night. The newer F-4C will be tested under the same conditions. And tests will be run to learn how well a man on the ground, without visual aids, can detect high-speed planes coming in at low level.

Other questions the Air Force will try to answer include: What kind of tracking accuracy can be expected from surface-to-air weapons that track automatically when they engage high-speed aircraft coming in at tree top level? What is the hit probability in this situation when tracking is manual rather than automatic?

The answers to these questions are still approximate. None has the digital precision needed for planning a battle or predicting its outcome.

Other operational systems will be tested to discover how they can be used to best advantage. The Air Force will test the F-111 to determine where the variable-sweep wings should be positioned for the most effective strafing. Air-to-ground weapons have to be tried out to select the best ones for the F-4C.

Research and development. The Air Force will also use the range to test prototypes of weapons still being developed all over the country. It wants to know how weapons can be improved by modification, and how completely new concepts will work out. How can target acquisition from low-flying planes be improved? What effect does speed have on low-altitude target acquisition? The Army and Navy are interested in the results of this test because practically no test data under controlled conditions exists.

Big questions. Which survives better, a fighter flying at Mach 0.9 or at supersonic speeds? What effects do electronic countermeasures have on the survivability of low-flying planes? How can the cockpit configuration be improved for low-altitude flights? What are the best munitions for attacking specific targets? And how effective are infrared weapons for air-to-ground use at night? This is another tactic that is practically untested.

The Air Force hopes to get some answers to these big questions soon.

UNIQUE...

first low level solid-state unit joins industry's most versatile line of telegraph relays

Radiation's new solid-state low level to high level neutral relay is the first of its kind. The unit, Model 9338, is designed for such applications as conversion of low level computer outputs to higher telegraph levels, and for computer/computer switching.

This advanced relay features modular construction and unlimited service life without maintenance. Because it operates at an input level of ± 6 v at 50 to 100 μ a, conducted and radiated RFI are greatly reduced.

Radiation Telegraph Relays are supplied with octal bases in three standard models (at right). They can replace all electromechanical units except in rare applications. These versatile units are completely solid state, and are powered by input loop current alone.

Special Plug-In Adapters are available in all popular types (examples at right), and permit you to update your present system easily and quickly. Radiation can also supply special adapters, units wired for direct replacement, or devices on plug-in printed circuit cards.

All Radiation Solid-State Relays operate at speeds up to 2400 bits/second with less than 3% distortion. Input is essentially resistive. They do not induce transients in the line as do electromechanical units. And a unique Radiation circuit protects inputs against abnormal line conditions such as spikes and overvoltages.

In addition, Radiation Relays are extremely resistant to environmental extremes. They require no adjustment, and will operate for an indefinite period of time without attention.

Radiation engineers will be glad to assist if you have a unique application or would like help in evaluating system requirements. Write for information, or describe your needs. Products Division, Dept. EL-08, Radiation Incorporated, Melbourne, Florida.



RADIATION
INCORPORATED

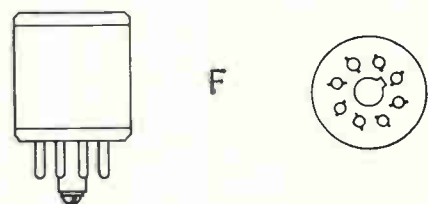
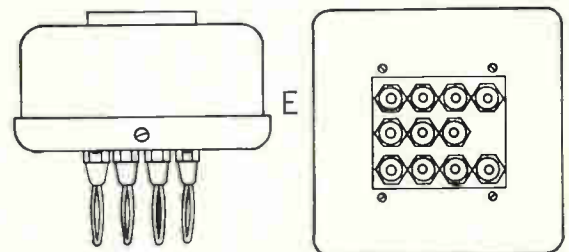
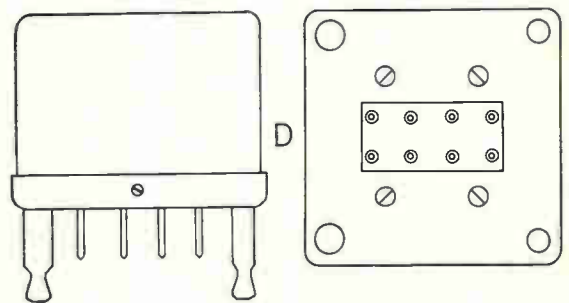
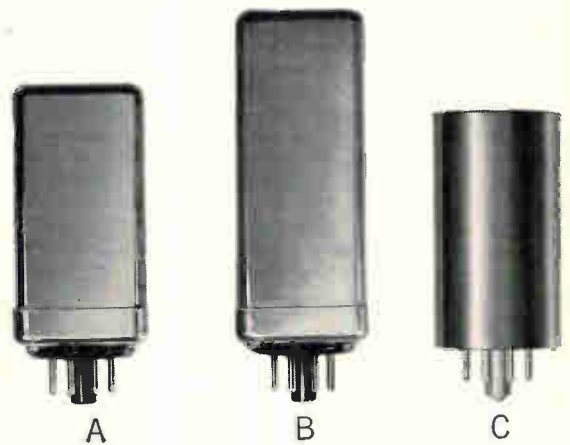

RADIATION SOLID-STATE RELAYS

Type	Model	Body Size	Figure
Neutral	9214	1.46 x 2.86	A
Neutral	9220	1.46 x 2.86	A
Polar	9212	1.46 x 3.66	B
Univ.	9218	1.38 x 2.63	C
Low Level	9338	1.38 x 2.63	C

Note: Other configurations are available, including plug-in circuit cards.

Standard Plug-In Adapters

Octal-to-Western Electric 255-A
Octal-to-Western Union 202-A
Octal-to-Octal

D
E
F

Note: Other adapters are available, or units can be wired for direct replacement.

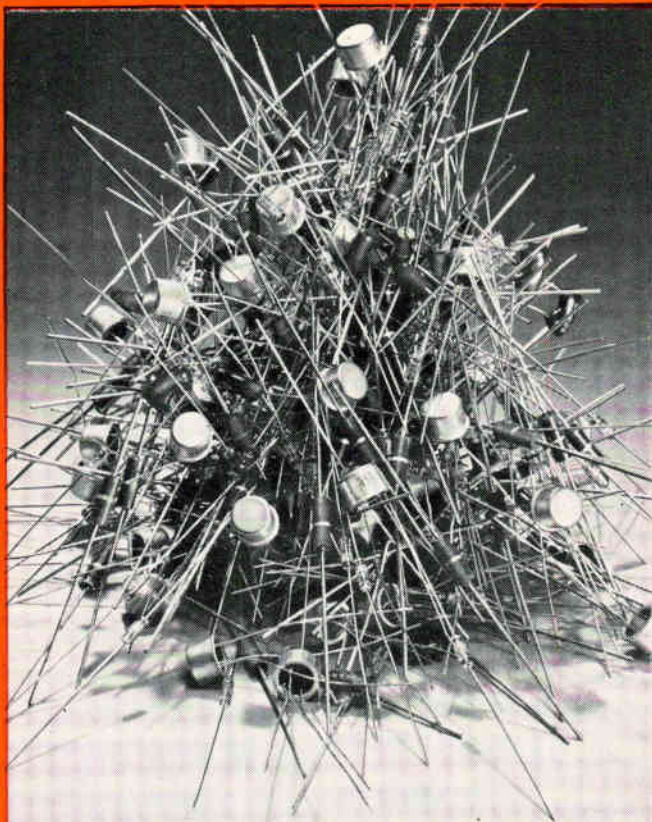

0010111010001011

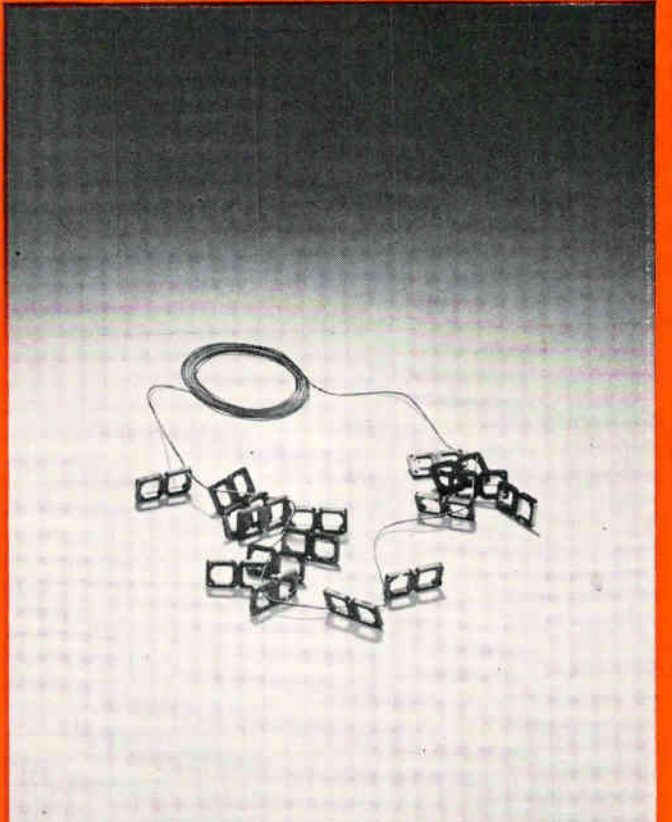

0010111010001011

Check the bits, the same, aren't they, but, does your **BINARY SEQUENCE DETECTOR** know this?

There is a mountain of difference between the ordinary binary sequence detector (left) that uses a whole pile of transistors, diodes, resistors and capacitors and the AMP MADNETIC* Binary Sequence Detector that just uses ferrite cores and wire. That's a *big* difference when you think of how one component failure or malfunction can affect a binary lock.

And that's only one of the big differences! Our Binary Sequence Detector offers others. For instance:

- No standby or non-operating power is required, even to retain *memory* of lock word.
- No shifting or chance of accidental alteration of lock word—it's wired in.
- Checks for proper "key" by testing each sequence—can also be modified into a "word" detector.
- Rejects simultaneous application of "1" and "0".
- Operation assured over a temperature range of -50°C to $+75^{\circ}\text{C}$.

If you're dealing with electronic locks, command and control circuits, or segments of multiple event fixed time programmers, you'll want to get the different story on our Binary Sequence Detector. Our evaluation unit will do just that. Write today for further information.

Want to see what the difference really is? Then try our evaluation unit . . . a 16-bit Binary Sequence Detector complete with drivers . . . you jumper in your "lock" word . . . unit tests every sequence of 2^{16} combinations.

Here are the vital statistics:

AMP Part No.: **396978-1**

Voltage Range: **+24 V DC to +32 V DC**

Temperature Range: **-50°C to $+75^{\circ}\text{C}$**

Average Current at 1 KC Bit Rate:

40 ma. maximum @ 28 V

Average Current at Rest: **0 ma.** @ 28 V

Information Input: **+5 V** (minimum) for
5 μ seconds into 1 K Ω load

Output Pulse: **+5 V.** for Correct Sequence
Signal-to-Noise Ratio \geq 15 to 1
Load Impedance 250 Ω minimum

*Trademark of AMP INCORPORATED



A-MP* products and engineering assistance are available through subsidiary companies in: Australia • Canada • England • France • Holland • Italy • Japan • Mexico • West Germany

VISIT US AT WESCON SHOW AUGUST 25-28, 1964, BOOTH 209-212

Converter translates charge to frequency

This technique solves conversion problems presented by high-impedance transducer data

A new analog-to-frequency converter permits the analysis of data from high impedance transducers such as piezoelectric devices. Model 261 converts charge to frequency rather than voltage to frequency. It also converts voltage to frequency with the throw of a switch.

Heretofore, voltage-to-frequency converters have solved data acquisition problems from low-level transducers such as strain gages, load cells, or thermocouples, but they were unable to do good jobs with crystal transducers or similar devices with impedances of 1,000 megohms or more. In fact, these impedances are so high that using a preamp with even a small amount of cable is difficult because of capacitance.

The new solid-state converter is charge-sensitive rather than voltage-sensitive. With it, the voltage drop across the input circuit and line capacitance are kept at zero. No charge is stored. All the information is translated into frequency for subsequent processing.

General description. High sensitivity in the voltage mode enables the 261 to operate directly from the low-output transducers such as thermocouples, strain gage bridges, and electrochemical devices such as biomedical sensors. True floating input with guard shielding assures virtual immunity to a-c or d-c common-mode voltages in spite of source unbalances. High input impedance virtually eliminates errors due to loading of the source. This

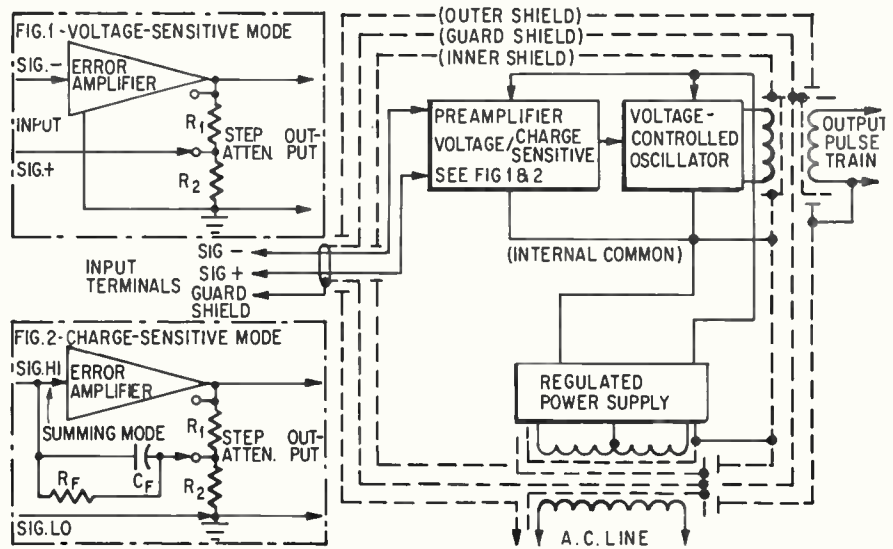

Contained within the shield complex is the instrument itself. It consists of a preamplifier, a voltage-controlled oscillator, and a regulated power supply. In the charge mode the preamplifier is connected in an operational-amplifier configuration. The input charge from piezoelectric transducers is applied to the high signal terminal. The output of the amplifier produces whatever voltage is necessary to provide an equal and opposite charge flow through C_F to the summing junction. Resistor R_F provides d-c stabilization and also establishes the lower cutoff frequency.

feature, in combination with the ability to set sensitivity precisely, reduces system set-up time by eliminating the need for calibration of the transducer-converter combination. Extremely high gain of the preamplifier provides insensitivity to input capacitance such as may be introduced by the transducer cable when operating in the charge mode. By eliminating the need for external preamplification of millivolt signals or further conditioning of piezoelectric outputs, the 261 can reduce system cost and complexity and increase reliability and accuracy. Fast response, combined with the ability to recover quickly from large overloads, makes the instrument suitable for use in commutated systems.

Model 261 develops output pulses at a rate precisely proportional to input voltage or input

charge. Since the output pulse-train is from a 50-ohm source, it is often used to give several thousand feet of physical separation between the voltage-controlled oscillators and the recording equipment. The pulses are reshaped and frequency is normally divided by two in the recording or multiplexing equipment at the tape recorder.

Features of the converter include input sensitivities of 50, 100, 200, 500, 1000, 2000, 5000, and 10,000 picocoulombs full scale. Frequency response is 10 cps to 20 kc. Noise is less than 5 picocoulombs peak or 1% of full-scale, whichever is larger, with 10,000 pf of cable.

The 261 is packaged in modular form with six modules filling a seven-inch-high rack housing.

Vidar Corp., 77 Ortega Ave., Mountain View, Calif.

Circle 301 reader service card

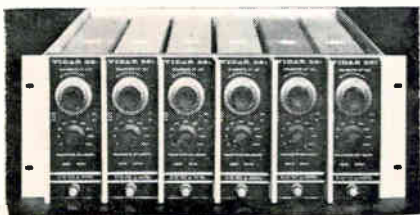



ENGELHARD brazing alloys assure stronger, more economical brazes in Jennings vacuum capacitors

Jennings Radio Manufacturing Corp., San Jose, California, is the world's largest producer of non-thermionic electronic components . . . building ceramic vacuum capacitors for high-powered communications in ground and airborne systems throughout the world.

One of the most important factors in capacitor reliability is the quality of the brazing material which joins the housing to the seals. The brazing material must be of the highest grade, with low emission characteristics, and free of impurities which could impair the vacuum. A strong, durable braze must be produced to contain the vacuum and resist physical damage throughout the life of the capacitor. The brazing operation must be performed easily, and with consistently excellent results (for once completed, vacuum components are difficult to repair).

The brazing alloy for this particularly demanding job: Engelhard Silvaloy 301 pre-formed brazing rings. The rings provide high purity and exceptional bonding strength. They assure uniform brazing, containing the exact amount of alloy needed, and are cutting 25% to 50% from the cost of materials and labor in this operation.

The test of this quality is in Jennings' own quality control: each vacuum capacitor is subjected to voltages as high as 150 kv to prove that the ceramic housing has been effectively bonded to its copper seals.

This is just one of many critical applications where Engelhard brazing alloys are contributing reliability, while cutting labor and material costs.

For complete details, write to the Technical Service Department today.

118



Some other **ENGELHARD** products

LIQUID GOLD produces an excellent heat barrier when applied to metals and other surfaces. Solutions are easy to use. Resulting metallic films are highly efficient reflectors of infra-red, often permit important weight reduction of substrate materials.

SILVER SHEET AND STRIP is available in virtually any size and thickness for manufacture of electrical contacts and other components. Forms include coin, sterling and fine silver. In addition, alloys and sintered materials are provided to customer specifications.

PRECIOUS METAL SHEET is supplied in widths from 1" to 12" in gold, palladium, iridium, rhodium, platinum and alloys. Thicknesses range from 0.008". Standard mill items are used in a wide range of fabrications and assemblies.

SILVER BRAZING with easy-to-use Engaloy™ 440 provides high strength, corrosion resistance, and a minimum of diffusion into base metals for high-temperature joining. This dependable new brazing alloy renders maximum service for all high-temperature conditions.

RHODIUM PLATING is simple with Engelhard electroplating solutions. Rhodium deposits provide outstanding protection against surface corrosion, reduce electrical noise in moving parts. Efficiency is improved wherever long-wearing, oxide-free components are required.



New Components and Hardware

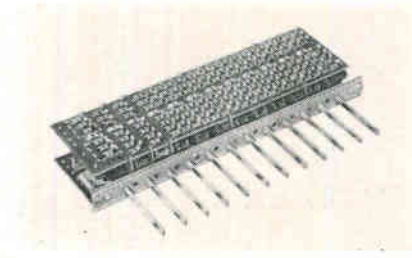

Highly flexible pushbutton switches

Power-rated pushbutton switches, type 130, are listed by Underwriters' Laboratories, Inc. Type 130 is a highly flexible universal device for complicated low-power switching plus integral pushbutton switching of 125-v (a-c), 6-amp line power. It is said to provide even greater circuit flexibility than do rotary switches. These power-rated switches can be supplied in multiple banks—up to 18 buttons per bank—or as a complete subassembly with lighted pushbuttons. The pushbuttons can provide switching configurations up to dpdt per button per side, with up to six contacts per button. Double-sided switches provide configurations up to 4pdt, with up to 12 contacts per button. Contacts normally are of the shorting type (make-before-break); however, non-shorting type (break-before-make) can be supplied upon request.

Oak Mfg. Co., Division of Oak Electro/Netics Corp., Crystal Lake, Ill. 60014. [311]



Dual concentric pot rated ¼ w at 70° C

A 5/8-in. diameter, concentric-composition dual potentiometer is available in both military and commercial versions. These units measure

2 3/8 in. deep from the mounting surface. They are rated at ¼ w at 70°C, derated to 0 w at 120°C, per MIL-R-94B. Resistance range, linear, is 500 ohms to 2.5 megohms; 10% log taper, 5,000 ohms to 2.5 megohms. Electrical rotation is 260° ±3%. Military types meet characteristic X of MIL-R-94B for vibration, moisture resistance and insulation resistance. Inner shaft diameter is 0.125 in. A wide range of bushing and shaft lengths can be supplied.

Centralab, The Electronics Division of Globe-Union Inc., P.O. Box 591, Milwaukee, Wisc. 53201. [312]

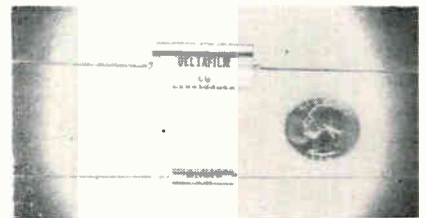

Tiny capacitors designed for missiles

A series of high-stability subminiature capacitors incorporate metalized electrodes and an exclusive glow-discharge deposited dielectric. The dielectric is only 1.0 micron thick, or 1/100th the thickness of a human hair. The LG capacitors have advanced applications for missile and satellite programs, or other electronic packages where small size and high reliability are essential. Operating over the temperature range of -55°C to +125°C without voltage derating, they exhibit volume reduction by a factor of 2 to 3 for most ratings when compared to polyethylene terephthalate capacitors, according to the manufacturer. They also provide outstanding capacitance stability and insulation resistance, and have high resistance to shock, vibration (Grade 3) and radiation. Capacitors will withstand life testing at 140% of rated d-c voltage for a period of 250 hr at 125°C. Units are available in values from 0.1 to 4.0 µf, 50 v d-c. Dimensions range

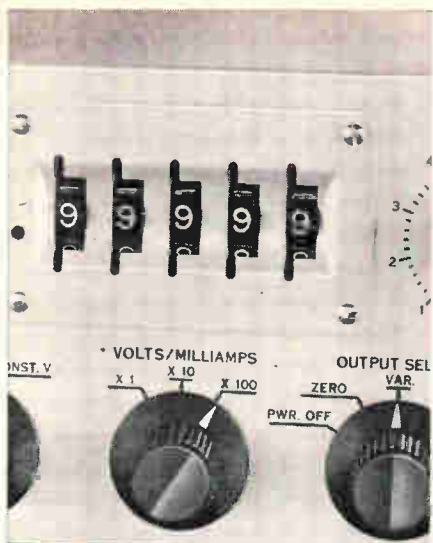

VOLTAGE / CURRENT REFERENCE SOURCE

with

0.001%

STABILITY



Model TC-100.2BR

- output: 0 to 100 V at 200 ma; 0 to 100 ma at 100 V
- absolute accuracy: 0.01% voltage; 0.02% current
- resolution: 100 m μ V voltage; 100 μ ma current
- output selection: 3 ranges 1, 10, 100 V/ma full scale
- extremely low ripple and noise
- complete short circuit protection
- completely solid state
- price \$2200.00
- complete line of solid state voltage and current reference sources available — all with 0.001% stability

Write for Bulletin No. 112 to:

PAR **PRINCETON**
APPLIED RESEARCH CORP.
Dept. D
Box 565, Princeton, New Jersey

New Components

from 0.174 in. diameter by $\frac{3}{4}$ in. long to 0.562 in. diameter by $1\frac{1}{4}$ in. long.

Dearborn Electronic Laboratories, Inc.,
P.O. Box 3431, Orlando, Fla. [313]



Pulse transformer built with stand-off feature

A pulse transformer has been designed with four stand-off legs to provide air clearance between unit and mounting board in coupling circuits. Only 0.5 by 0.35 by 0.25 in., the transformers have winding inductance up to 1 mh. are available with two windings having ratios of 1:1, 1:2, 1:3, 1:4. and withstand a high-voltage test of 150 v d-c maximum. Capable of operating in temperatures from -55° to $+85^{\circ}$ C. units have four leads of No. 24 Awg tinned copper wire. Gold-plated Dumet wire, as well as winding ratios other than those specified, are available on request. Transformers are encased in epoxy. Price in small quantities is under \$25 each.

PCA Electronics, Inc., 16799 Schoenborn St., Sepulveda, Calif. [314]

Image intensifier uses fast-decay phosphor

In high-speed photography where an image-intensifier tube is used, the limiting factor in taking a rapid sequence of photos is the decay time of the intensifier's output phosphor. The image must decay fast enough before the next photo is taken so that the previous image is not superimposed on the new image. The English Electric Co. has developed an image intensifier

tube (model P829A) with a P16 phosphor having a decay time of $\frac{1}{4}$ μ sec. This means that photographs can be taken every $\frac{1}{4}$ μ sec or less, depending on how much the image moves in between photos. If the image moves or is deflected, there is less danger of superimposition and the previous image need not decay completely to be distinguished from the new image.

Calvert Electronics, Inc., 220 E. 23rd St., New York 10. [315]

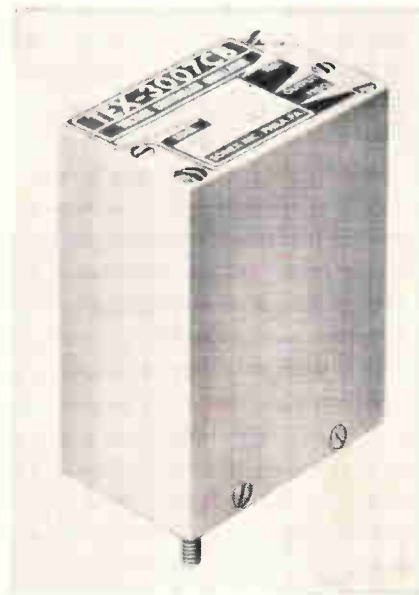

Oscillator meets aircraft requirements

A constant-bandwidth voltage-controlled oscillator features an isolated input. Model TEX-3007CB was developed for aircraft and missiles. The isolated input permits the use of transducer output voltages of different polarities without the necessity of readjustment. The device covers all of the Aerospace Industries Association's proposed f-m constant bandwidth frequencies from channel 1C through 22C and from channel 2CW through 22CW. Deviation from 1C through 22C is ± 2 kc; from 2 CW through 22 CW it is ± 4 kc. Temperature stability of the oscillator is within $\pm 1.5\%$ dbw from the best straight line over a range from -20° to



BUSS quick-acting Fuses

"Fast Acting" fuses for protection of sensitive instruments or delicate apparatus;—or normal acting fuses for protection where circuit is not subject to starting currents or surges.

BUSS

Write for BUSS
Bulletin SFB

BUSSMANN MFG. DIVISION, McGraw-Edison Co., St. Louis, Mo. 63107



Actual Size
Only 1-5/8 inches long...
Extends just 29/32 inch
behind front of panel

BUSS Space Saver Panel Mounted Fuseholder

- Fuseholder takes 1/4 x 1 1/4 inch fuses. Converts to 9/32 x 1 1/4 inch fuses simply by changing screw type knob. Holder is rated at 30 ampere for any voltage up to 250.
- Also available in military type which meets all requirements of MIL-F-19207A.

BUSS

Write for BUSS
Bulletin SFH-10

BUSSMANN MFG. DIV., McGraw-Edison Co., ST. LOUIS, MO. 63107

BUSS: 1914-1964, Fifty years of Pioneering...

Circle 113 on reader service card

Circle 113 on reader service card

Available Now...

CAMBION® THERMOELECTRIC COOLING MODULES

Standard Items
At Your Local
Distributor!



Another significant "first" from CAMBION, makers of *guaranteed* electronic components!

CAMBION Thermoelectric Cooling Modules are now available "off the shelf" at your local distributor. No delays from ordering custom-made models. Invaluable in spot cooling of electronic components, crystal holders, memory stacks and computer circuit banks. Also useful for infrared, medical and instrumentation applications, and for maintaining temperature stability in critical processes. CAMBION coolers combine *higher* heat pumping capacity with low current requirements. Currently available: the new 3970-1 40-Watt Assembly, the 20-Watt 3951-1, the 7-Watt 3950-1, and the new low current 1500 milliamp, 3-Volt Model 3952-1. For local availability contact your CAMBION distributor. For engineering assistance and specifications write: Cambridge Thermionic Corporation, 208 Concord Ave., Cambridge, Mass. 02138.

CAMBION®

Standardize on CAMBION...The Guaranteed Electronic Components

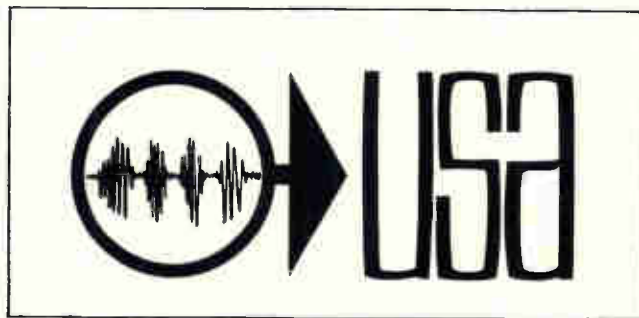

See Us At
The United States Exhibition
Stockholm Technical Fair
Area 540
October 2-9, 1964
Stockholm, Sweden
A Trade Expansion Activity
United States Department Of Commerce

New Components

+85°C. The unit weighs 5.5 oz. Dimensions are 1.58 by 1.03 by 2 in. high. Price is about \$400. Sonex, Inc., 20 E. Herman St., Philadelphia 19144. [316]

Extruded heat sinks for semiconductors

Extruded heat sinks are announced for high-power semiconductors.

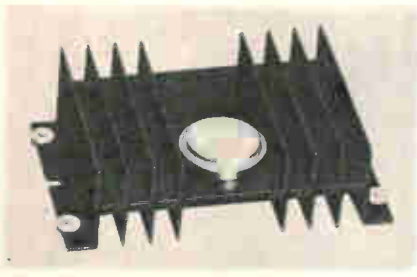

The E-1 and E-2 series extrusions sharply reduce case and junction temperatures for improved electrical characteristics and longer life. Performance at 80 C case temperature is 25 w; weight, 1.5 oz.; size, 3 by 4½ by 1¼ in.; fins, 16; thermal resistance, 2.05°C per w; OEM price range, from 90 cents to 70 cents.

International Electronic Research Corp., 135 W. Magnolia Blvd., Burbank, Calif. 91502. [317]

Power relays for aerospace

Hermetically-sealed power relays for aerospace use are available in 25 amp (3 pst), 50 amp (3 pst) and 100 amp (spst) configurations with and without auxiliary contacts. The



line features a pancake-shaped magnet that cuts weight and reduces size. A balanced armature enhances vibration and shock resistance—15 g vibration at 750 cps, 12 g at 750 to 1,500 cps; 50 g of impact shock. Hermetic sealing (glass-to-glass fusion and metal-to-metal welding) permits efficient and reliable performance in ambient temperatures ranging from -65° to 125°C. The line meets requirements of MIL-R-6106D; the 25 amp relays conform to MS27997-D1 and D2.

Cutler-Hammer Inc., 243 North 12th St., Milwaukee, Wisc. 53201. [318]

New Developments in Electrical Protection



GMW FUSE
AND HWA
FUSEHOLDER
FUSE SIZE
ONLY .270 x .250
INCHES

BUSS Sub-Miniature FUSE-HOLDER COMBINATION

Light-weight, protective device for spacetight applications. Fuse has window for inspection of element. Fuse may be mounted alone or used in holder.

Holder can be used with or without knob. Knob makes holder water-proof from front of panel.

Military type fuse FM01 meets all requirements of MIL-F-23419. Military type holder FHN42W meets all military requirements of MIL-F-19207A.

BUSS

Write for BUSS
Bulletin SFB

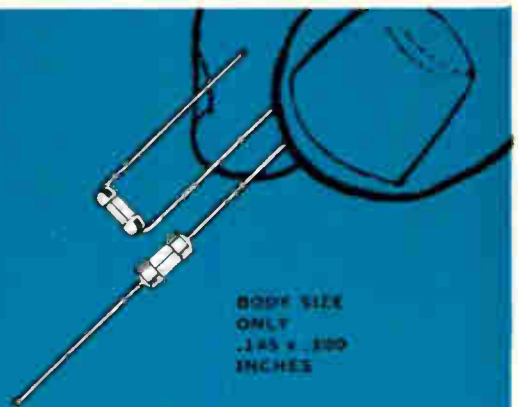

BODY SIZE
ONLY
.145 x .200
INCHES

BUSS Sub-Miniature PIGTAIL TRON FUSES

Use Tron fuses where space saving is vital—on miniaturized devices—or on gigantic multi-circuit electronic devices.

Hermetically sealed for potting without danger of sealing material affecting operation. Extreme high resistance to shock or vibration. Operate without exterior venting.

BUSS

Write for BUSS
Bulletin SFB



Ultra-sensitive relays

HELPFUL DATA FOR YOUR CIRCUITRY IDEA FILE

The circuit drawing below indicates just one of the hundreds of ways many manufacturers utilize Micropositioner® polarized relays to solve complex control problems.

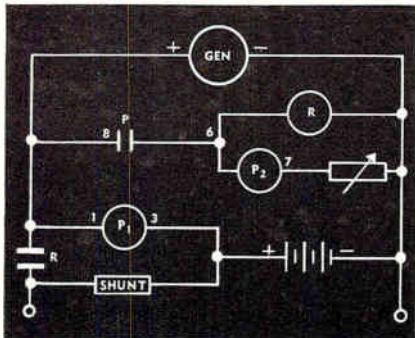

BATTERY REVERSE CURRENT DETECTOR

Among the many applications for the Barber-Colman Micropositioner in the railroad and industrial fields is that of reverse current protection between the generator and battery on diesel locomotives and industrial trucks. In the circuit illustrated, the Micropositioner, P₁, is energized when the generator voltage exceeds the battery voltage by approximately one-half volt. A secondary relay, R, connects the generator to the battery and simultaneously energizes an auxiliary coil, P₂, on the Micropositioner which aids the main coil in holding the contact closed until a predetermined amount of reverse current is flowing from the battery. The point of drop-out is controlled by the variable resistor in series with the auxiliary coil. This system offers accurate control of the points at which the generator is connected and disconnected from the battery, thereby eliminating unnecessary discharging of the battery or hunting between generator and battery control.

BARBER-COLMAN MICROPOSITIONER® POLARIZED D-C RELAYS

Operate on input power as low as 40 microwatts. Available in three types of adjustment: null seeking... magnetic latching "memory"... and form C break-make transfer. Also transistorized types with built-in preamplifier. Write for new quick reference file.



BARBER-COLMAN COMPANY
DEPT. H, 1259 ROCK STREET, ROCKFORD, ILLINOIS

New Instruments

Digital counter with 0.1-v sensitivity

A six-digit counter is designed to provide automatic, high accuracy measurements. It has a 2-Mc counting range for frequency measurements. It also measures period, multiple period averages, and frequency ratios. Sensitivity is 0.1 v; ranges of 1, 10 and 100 v are provided; and time base stability is two parts per million per month. Transistor circuits mounted on interchangeable plug-in, epoxy-fiber-glass circuit boards are used throughout. Power dissipation is so low that no cooling blower is required. Measurements are displayed by the model 4W modular in-line digital readout. Price of the model 2810 is \$1,240.

Non-Linear Systems, Inc., P.O. Box 728, Del Mar, Calif. [351]

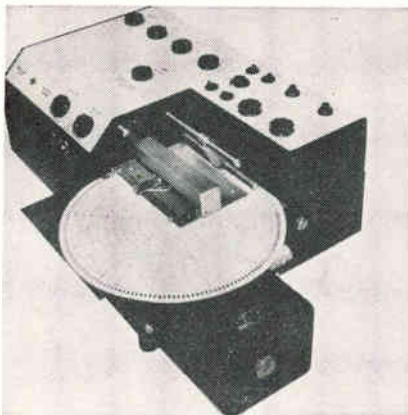

Servo chart drive for polar recording

A servo chart drive has been designed for level recording where the directional position of a polar chart must be servo-synchronized to the signal source. Model 130 is useful in measurement and recording systems ranging from laboratory to shipboard sonar studies where it is used as a position indicator or plotter. Applications include recording antenna and microphone directional response, calibration and response measurements of

underwater transducers, and directional noise studies. Maximum dynamic error is -0.5° at chart speed of $10^\circ/\text{sec}$; maximum static error is $\pm 0.2^\circ$. Standard drive ratio is 1 to 1; other ratios are available. Price is \$1,400.

B&K Instruments, Inc., 3044 W. 106th St., Cleveland 11. [352]



Radiometer measures pulsed and steady light

A radiometer system has been developed that is claimed to be more precise and versatile than any other now commercially available. Model 580 consists of an indicator and a detector head. These units establish a simple, convenient technique for the absolute measurement of pulsed and steady-state light sources across a wide dynamic range, according to the manufacturer. Provision is made for scope display of waveform as well as meter readout. The 580's simplified operation can be carried out by a technician, with his findings acceptable as valid by researchers, scientists and development engineers. The readouts are absolute measurements, repeatable in the lab or in the field, and traceable to accepted reference standards. Specifications include: available spectral coverage of 200 millimicrons to 1,150 millimicrons and a temporal range from steady state to 1 nsec. Dynamic range of the

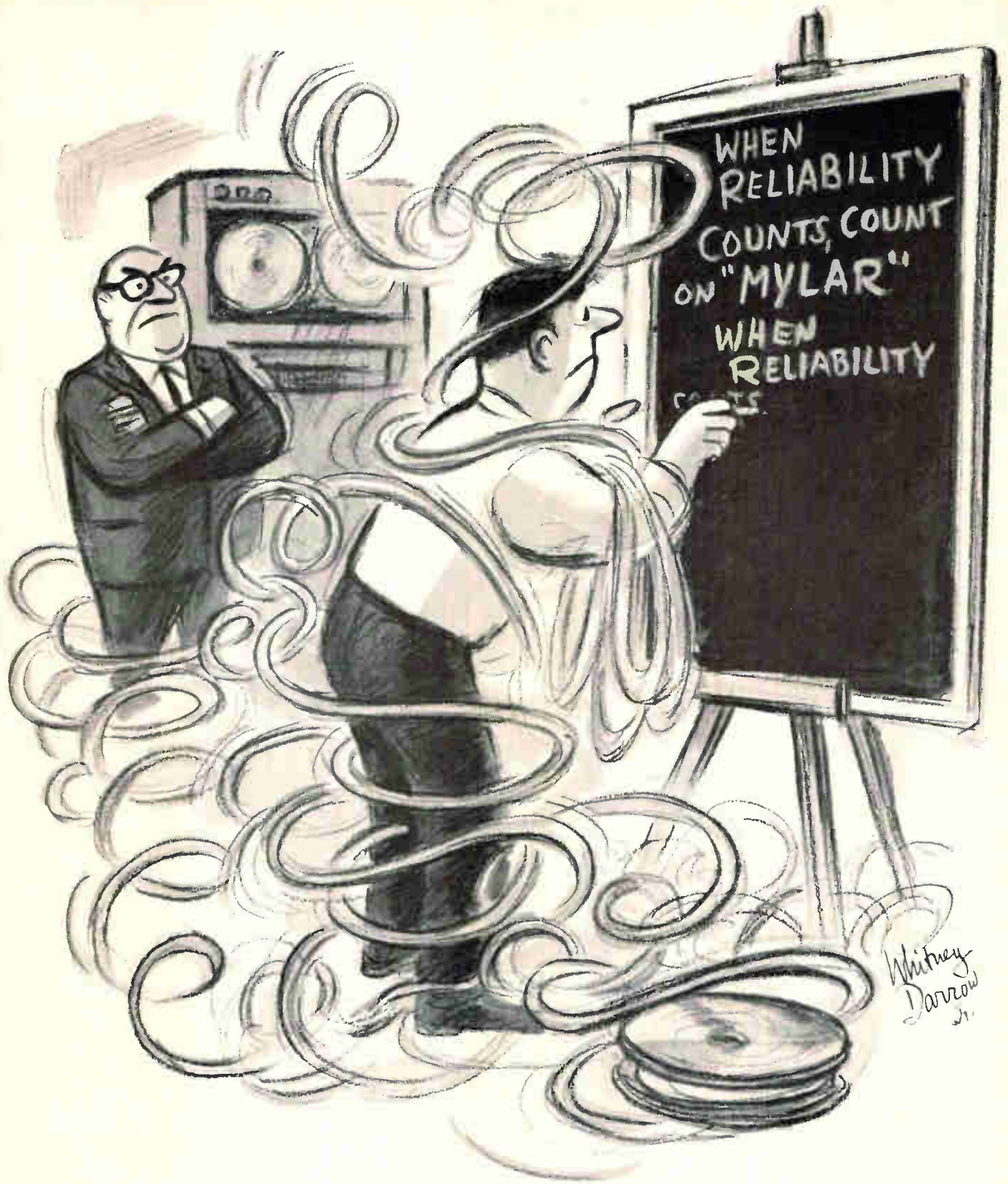

It would be difficult to conceive of anyone but the rawest novice not knowing the advantages of tapes of "Mylar"*. After all, for ten years "Mylar" has been far and away the first choice for EDP work. Good reasons, too. "Mylar" is strong (a tensile strength

of 20,000 psi), stable (unaffected by temperature or humidity changes) and durable (can't dry out or become brittle with age.) There's no need to write it 50 times . . . just once: When reliability counts, count on "Mylar!" *Du Pont's registered trademark for its polyester film.

DU PONT
REG. U.S. PAT. OFF.
 Better Things for Better Living
 . . . through Chemistry

only DU PONT makes
MYLAR[®]
 POLYESTER FILM



A TRIGGERED, CALIBRATED, WIDEBAND OSCILLOSCOPE FOR \$235

Don't settle for an uncalibrated repetitive time base oscilloscope when the budget is tight. All the features of the professional instrument are in the S51A (see the abridged specs below) one of a full range of quality oscilloscopes from Data Instruments. Call or write today for a demonstration by your local representative or for full specifications!

Vertical Amplifier	DC—3 mc at 100 mv/cm
Input Attenuator	9 compensated steps, 100 mv/cm-50V/cm accuracy $\pm 5\%$
Time Base	6 calibrated speeds 1 μ s/cm-100 ms/cm $\pm 5\%$
Triggering	Automatic to 1 mc plus trigger control
DC Coupled Unblanking	5" flat faced CRT operated at 3 KV
Phosphor	P31 standard, P7 available
Dimensions	7" x 15½" x 8"
Weight	16 lbs.
Price	\$235.00

data instruments



7300 CRESCENT BOULEVARD PENNSAUKEN, NEW JERSEY 609-662-3031
A Division Of
INDUSTRIAL ELECTRONIC HARDWARE CORP.

New Instruments

instrument in steady state irradiance is 3×10^8 , and in pulsed irradiance is 3×10^9 . Requiring no set-up time, valid light data is acquired in minutes instead of the hours, or even days, of other techniques, according to the manufacturer.

Edgerton, Germeshausen & Grier, Inc.,
160 Brookline Ave., Boston, 15. [353]



Strain indicator is accurate to 0.1%

This portable strain indicator has a square-wave carrier circuit that makes it insensitive to lead wire capacitance. Conventional strain indicators, according to the manufacturer, must use short lead wires and be carefully balanced to maintain system sensitivity and accuracy. The square wave carrier design of the new indicator allows 0.01 μ f of distributed capacity with practically no loss of sensitivity or accuracy. The instrument is a null-balance type, accurate to 0.1%. It will accept all standard strain gage circuitry with resistance values from 50 to 2,000 ohms. Gage excitation voltage is approximately 1.5 v. This reduced voltage allows the smallest presently available strain gages to be used with the HW-1 without danger of gage damage from overheating. Range of the instrument is $\pm 30,000$ microinches. Gage factor range is continuously variable between 1.5 and 4.5. The

rugged, 7-lb instrument is suited for stress analysis work in the automotive, missile, aircraft and construction industry, and R&D laboratories. Price is \$495.

Strainsert Co., 24 Summit Grove Ave., Bryn Mawr, Pa. 19010. [354]



Voltmeter measures rms, average, or peak

An electronic voltmeter has been developed for accurate measurement of true rms, average, or peak values of a wide range of voltages and waveform. Model 321 is not limited to the measurement of pure sine waves to obtain the specified accuracy. It measures sine, distorted sine, complex, pulse or random signals whose frequency components lie within the designated frequency range. Five-inch logarithmic voltage scales make it possible to specify uniform resolution and accuracy in percent of indication over the entire length of the scale. Rms, average and peak voltage ranges are 100 μ V to 330 V, 300 μ V to 330 V and 300 μ V to 330 V, respectively; with frequency ranges of 5 cps to 4 Mc, 10 cps to 1 Mc and 10 cps to 1 Mc, respectively. Accuracy is 2% of indication over the entire length of the scale. The manufacturer says this advantage is not possible with a linear-type scale meter. Price is \$650.

Ballantine Laboratories, Boonton, N.J. [355]

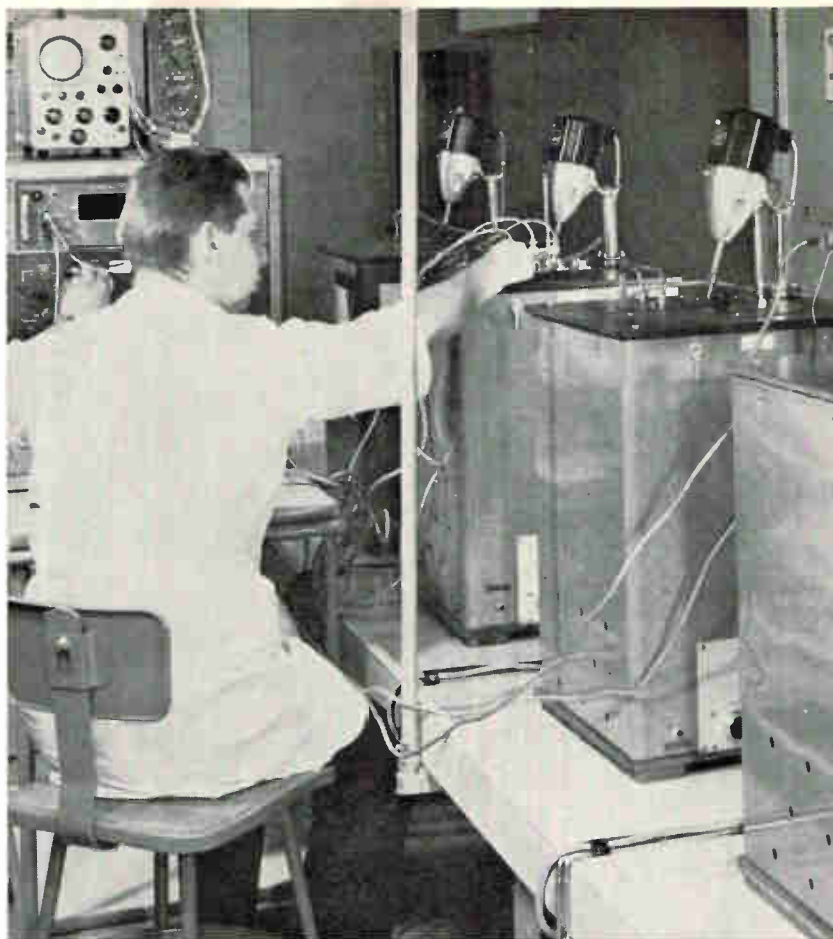

How to calibrate a sensitive Temperature Transducer

Do what the gentleman at Micro-Systems, Inc.* (in the picture) is doing. Lower it gently into the warm, luxuriously isothermal interior of a Hallikainen Constant Temperature Bath.

Why Hallikainen? Because Micro-Systems' customers insist on having their transducers calibrated to within 0.1°F accuracy. Hallikainen Baths of the type shown above better this stringent spec ten times over. That's why Micro-Systems have taken delivery on 15 Hallikainen Baths over the past three years.

Whether you're calibrating thermometers, filled system temperature instruments, or Piezo-Resistive Temperature Transducers, one of the 27 different Constant Temperature Baths you'll find on tap at Hallikainen will answer your needs. They offer control ranges that begin at -100°F and end at 1300°F, proportional and proportional with reset temperature control modes, and exclusive Jet-Stir Impeller agitation that banishes temperature gradients from your bath.

Why not dip your problems into the world of Hallikainen Constant Temperature Baths? We've prepared a packet of warm literature to help you get a feel for the subject.

*Division of Electro-Optical Systems, 170 N. Daisy Ave., Pasadena, California

HALLIKAINEN

Instruments

Dept. E

1341 Seventh St./Berkeley, California 94710

New Semiconductors



Germanium back-diodes for video detector use

Germanium back-diodes, MS-1040 through MS-1043, are designed for use from uhf through X band. They feature low video impedance, suiting them for matching into transistor video amplifiers. Tangential sensitivity is said to be typically 6 db better than point-contact detector diodes, and burnout ratings are improved by a factor of 5 to 10. The MS-1040 series is an alloy junction structure fabricated in hermetically-sealed, low-inductance ceramic-to-metal pill packages, suited for stripline, coax or waveguide applications. In addition, a cartridge adapter makes the devices usable in standard detector mounts. Typical usages include: high-tangential-sensitivity tunable detectors, doppler mixers, vswr measurements, and broadband tunable detectors through X band. Micro State Electronics Corp., 152 Floral Ave., Murray Hill, N.J. [331]

Vhf power transistors deliver from 1 to 17 w

Silicon vhf power transistors are announced with outputs from 1 to 17 w. Ratings that are available cover a wide range: frequency up to 260 Mc, power gain from 4 to 10 db, BV_{CEO} up to 140 v with higher ratings available on request, and collector dissipations from 3 to 25 w. The 2N3327 features a 5-w power output with 5 db gain at 260 Mc and requires only a 28-v collec-

tor supply. The majority of these 27 vhf power transistors are in isolated-collector, ceramic-insulated stud packages, while the lower-power devices are in TO-5 enclosures.

National Semiconductor Corp., Commerce Road, Danbury, Conn. [332]

Silicon transistors are 100% power-tested

Two new silicon power transistors can be switched through peak power up to the product of their maximum voltage and current. This is 2 kw for the 2N3470 series, rated at 10 amps I_C through 200 volts V_{CE} . This series also features ultrahigh gain (typically 1,000 at 2 amps)—ideal for use in amplifiers and regulators. The 2N3432 series is rated at 7.5 amps I_C through 250 volts V_{CE} . Both transistors are free from second breakdown within the complete range of maximum current-voltage ratings, require no derating for actual operating conditions because they are 100% power tested, and are guaranteed for the life of the original equipment in which installed.

Westinghouse Semiconductor Division, Youngwood, Pa. [333]

P-i-n diodes permit new modulation method

The first of a series of planar, passivated p-i-n diodes, type 3001, make possible a new method of modulating r-f signals from vhf through C-band. When placed across a transmission line and forward-biased, these diodes act as an absorption-type attenuator, allowing sine-wave, square-wave, and pulse modulation and switching, each without frequency pulling of the c-w source. Units feature low residual series resistance, very low capacitance and high speed, providing turn-on or turn-off times of 20 nsec for an on-off ratio of greater than 30 db. Planar geometry

with surface passivation insures long-term stability and reliability. The units are especially useful where the lowest possible residual series resistance and junction capacitance are required for high on/off switching ratios. The 3001 features back voltage greater than 150 v, output capacitance of less than 0.7 pf, capacitance of less than 0.3 pf at regulated voltage of -50 v, and residual resistance of less than 1.5 ohm. It is enclosed in a hermetically sealed miniature glass package 0.175 in. long and 0.070 in. in diameter. Price is \$15 for from 1 to 99 units and \$10 for from 100 to 999.

HP Associates, 620 Page Mill Rd., Palo Alto, Calif. [334]

RTL microcircuit line offers high conformity

A series of nine RTL (resistor transistor logic) silicon epitaxial integrated circuits have been developed with pattern accuracy to 1 micron and perfect topological registration. Series SD-2000 circuits are standard 15 mw-per-node, 10-Mc RTL functional blocks. Special, proprietary photolithographic techniques provide precise dimensional

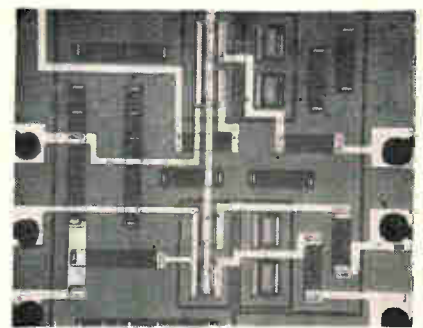

control, with resultant high uniformity and quality. The series provides full logic capability. Memory and counting functions are achieved by a half-register element designed for the very reliable two-phase clock system. Designers may select from any of four different gates. Fan-ins of any number from 2 to 6 are possible from combinations of dual 2-input and dual 3-input units. The basic node is designed for a fan-out of 5, but it can

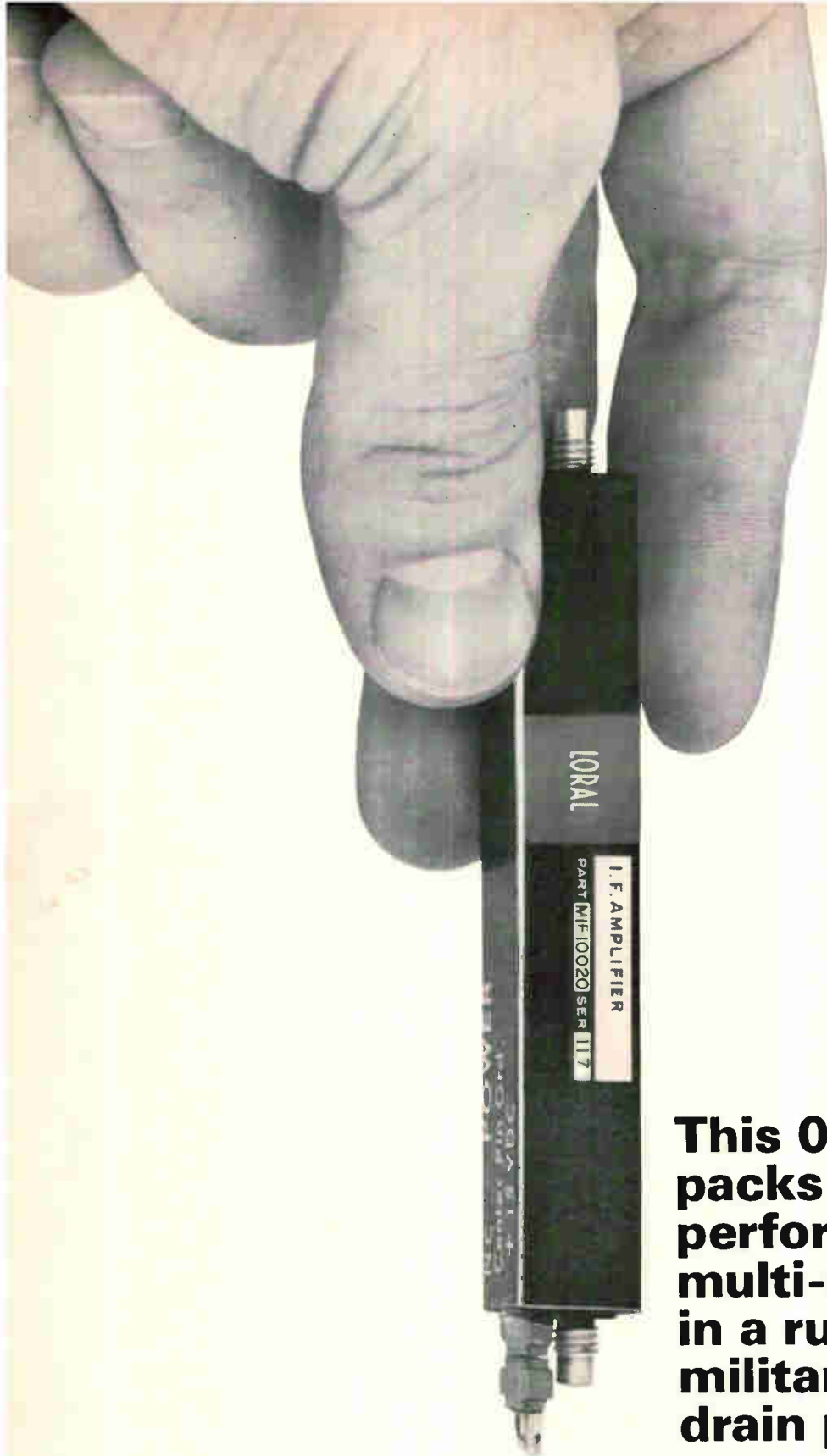

This 0.4 cu. in. strip packs all the performance of a multi-stage IF Amplifier in a rugged, militarized, low power-drain package

Microminiaturization of our IF, IF video and video amplifiers does not sacrifice performance or toughness. All Mil Spec.; readily customized. For brochure and full information write:

Advanced Products,
Loral Electronic Systems
 A DIVISION OF LORAL ELECTRONICS CORPORATION
 825 BRONX RIVER AVENUE, THE BRONX, NEW YORK, 10472.

Specification highlights, microminiature IF amplifiers

	MIF-30-10A	MIF-60-20A	MIF-100-20A	MIF-160-20A
Center frequency	30mc	60mc	100mc	160mc
Bandwidth @ 3db	10mc	20mc	20mc	20mc
Noise figure max.	6db	6db	7db	10db
Gain	70db	70db	70db	70db
Input Impedance	50ohms	50ohms	50ohms	50ohms
Temperature range	-55°C to +85°C			
Power Supply	+15 volts at 30 ma			

MOVE AHEAD IN DIGITAL SYSTEMS WITH NCR, LOS ANGELES

Move now into a better life, a more rewarding career. Developments such as the newly announced NCR 315 RMC (Rod Memory Computer), first commercially available all-thin-film main memory, tell you that EDP technology is moving fast at NCR Electronics Division. At NCR you have opportunity in the present tense—opportunity to conceive, design and produce digital systems that will bring business automation to 120 countries. If you are stimulated by a creative atmo-

sphere... if you can make original contributions in any of the areas listed on the opposite page... if you would like to combine a good living with the good Southern California life... investigate NCR now.

NCR

The National Cash Register Company
ELECTRONICS DIVISION
2815 W. El Segundo Blvd., Hawthorne, Calif.
Telephone: Area Code 213-757-5111
an equal-opportunity employer

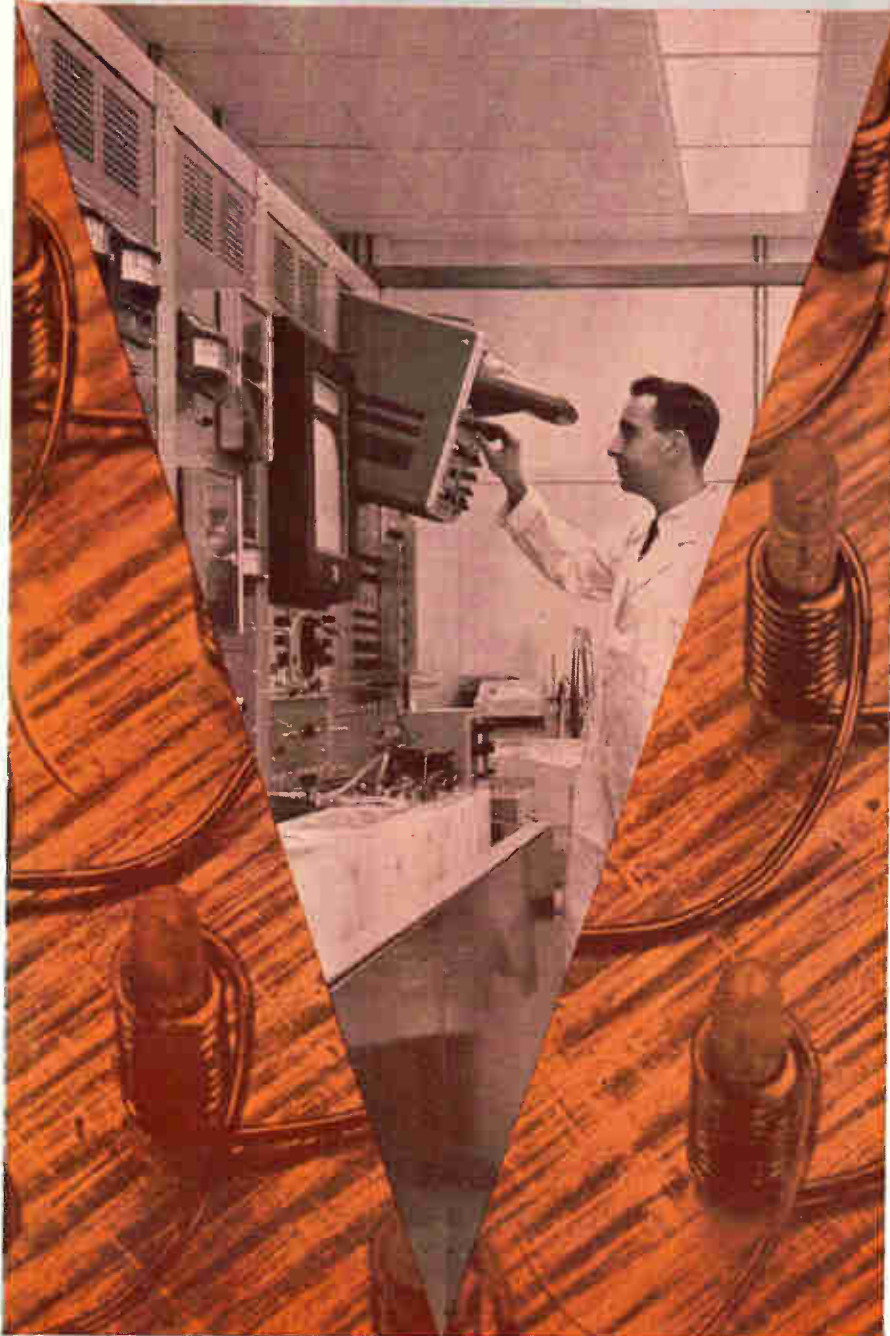

New Semiconductors

be expanded up to 25 with a buffer element. The 15-mw standard logic circuits are significant in terms of their simplicity and economy, offering system speeds of 5 Mc for five levels of logic between memory stages and two-phase clocking that eliminates spurious triggering caused by poor timing. Series SD-2000 include flip-flop, half-adder, dual 2-input gate (illustrated on p. 118), 4-input gate, counter adapter, half-shift register, buffer, dual 3-gate input, and 3-input gate. They are available in either TO-5 or flat lateral lead packages. Single order prices range from \$18.75 to \$50.25 for TO-5 packages.

Molectro Corp., 2950 San Ysidro Way, Santa Clara, Calif. [335]

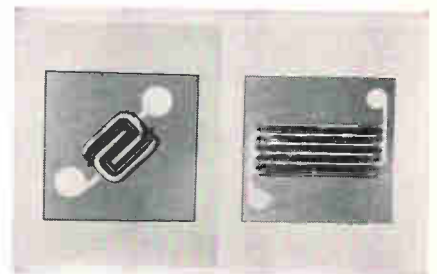

Field-effect transistors for analog switching

Twelve new Unifet field-effect transistors have been developed for analog switching applications such as commutators and analog-to-digital converters. Characterized by two new geometries, the 2N3376/87 series offers low on resistance r_{ds} , low drain-gate capacitance C_{dgs} , and low drain cutoff current $I_{D(OFF)}$. Zero offset voltage, high input impedance, elimination of the need for drive transformers and radiation tolerance are a few of the advantages of Unifets over single- or dual-emitter choppers. Two package types are available for each device: the four-lead, isolated-gate TO-18 (even part numbers) and the FlatPac 0.100 in. by 0.050 in. (odd part numbers). Classification of devices from each geometry depends on pinch-off voltage V_p . The 2N3376/77 and 2N3382/3 have a low V_p of 1 to 5 v with moderate

r_{ds} of 1,500 and 300 ohms max, respectively. The 2N3380/1 and 2N3386/7 have a higher V_p range, 4 to 9.5 v, with very low r_{ds} values, 600 and 150 ohms max respectively. The narrowband V_p 2N3378/9 and 2N3384/5 Unifets are stringently selected for differential applications where an r_{ds} match and identical turn-on characteristics are desired. V_p range is only 1 v, 4 to 5 v; r_{ds} is 750 and 180 ohms max for these two devices. The 2N3376-81 maximum C_{dgs} is 3 pf for the modified TO-18 devices, and 2 pf for the FlatPac Unifets. The 2N3382-87 offers C_{dgs} and C_{sgs} of 6 and 5 pf for the different packages. Maximum $I_{D(OFF)}$ on the entire series ranges from 0.4 to 2.5 na. Also ideal for high-frequency amplifiers, the 2N3376/87 series provides high transconductance g_{fs} per unit C_{sgs} and drain current with zero gate voltage. Typical g_{fs} range is from 1,500 to 8,000 μmho .

Siliconix Inc., 1140 W. Evelyn Ave., Sunnyvale, Calif. [336]

Laser diode packaged in TO-5 transistor can

An injection laser diode has been developed that is completely contained in a compact, rugged type TO-5 transistor can. Operation of the device is optionally noncoherent at room temperature or coherent at 77°K, accomplished through immersion of the diode in liquid nitrogen. Typical threshold current density is 3×10^3 amps/cm²; max, 6×10^3 amps/cm². Output wavelength is 8,450 angstroms; and peak power output, 10 w. Typical beam divergence is 8 degrees; dynamic



resistance, 0.1 ohm; and response time, 2 nsec. According to the manufacturer, availability of this diode makes it possible for university and

research laboratory personnel to acquire low-cost, precision equipment to study the coherent radiation of the gallium arsenide diode. Price of a single laser diode in the TO-5 package is \$360.

Maser Optics, Inc., 89 Brighton Ave., Boston, Mass., 02134. [337]

Monolithic integrated differential amplifier

An integrated differential amplifier, model D13001, features a common mode rejection of over 100 db at 60 cps and temperature stability of better than $3 \mu\text{V}/^\circ\text{C}$. The company says that the new unit cannot be duplicated with discrete components for the same price, which is less than \$100. Other features include $1 \mu\text{V}/^\circ\text{C}$ tracking without trim pot (unaffected from -50 to $+100^\circ\text{C}$), drift of less than $5 \mu\text{V}/\text{day}$, referred to input (generator resistance = 1,000 ohms), and offset of less than 5 mv, referred to input. Gain is 400 at 1 kilocycle. $R_T = 1 \text{ K}$, or 1,500 with external trim.

Amelco Semiconductor, 1300 Terra Bella Ave., Mountain View, Calif. 94042. [338]

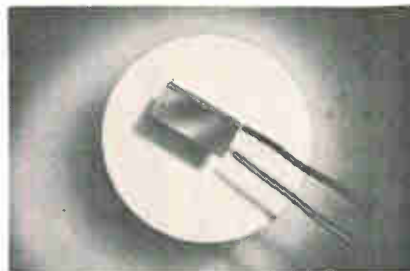

Silicon solar cells are n-on-p types

First in a new series of n-on-p silicon photovoltaic cells is type NSL-703P. Output of this cell at 500 foot candles is 400 μa minimum (with a 1,000-ohm load); open circuit voltage, 0.42 v. Average speed of response is 15 μsec . The photocell measures 0.394 in. long, 0.197 in. wide and 0.010 in. thick; with flexible leads, 4 in. long. Prices range from \$2 to \$4 depending on quantity.

National Semiconductors Ltd., 230 Authier St., Montreal 9, Canada. [339]

LOOK INTO THESE OPENINGS AT NCR, LOS ANGELES, FOR COMPUTER ENGINEERS

ADVANCED MECHANISMS SPECIALIST
Position will entail analysis and advanced design of complex mechanisms and applied mechanics problems. Experience highly desirable in design of computer peripheral equipment, such as disc files, drums and drum memories; floating-head background helpful. Should be equally skilled in mathematical analysis and laboratory measurements. PhD preferred.

SYSTEMS/COMMUNICATIONS DESIGNER
This senior position will involve analysis and advanced design of on-line, real-time systems. Requires BSEE, MSEE desired, with good knowledge of digital computer technology.

ADVANCED MAGNETIC RECORDING SPECIALIST
Intermediate to senior engineer with BS degree, MS desired, with 3-4 years' experience in advanced magnetic recording techniques. Requires detailed knowledge of media, circuitry and magnetic head design.

PROGRAMMERS/SYSTEMS ANALYSTS
To design, specify and implement a general-purpose system-simulator program for the purpose of evaluating the design and performance characteristics of computer processors, peripherals and systems. AB degree or equivalent experience in math, business or related fields. Minimum of 3 years' experience in programming medium to large-scale computers. Experience should include coding in machine language. Prefer man experienced in simulator or compiler program development.

INTERMEDIATE AND JR. COMPUTER ENGINEERS
Experienced graduate EE's with 3 to 5 years in logic design and transistorized circuit design of digital equipment. Assignments will entail logic and circuit design of buffer storage units and digital peripheral equipment.

To arrange an interview, please send resume immediately, including training, experience and salary history, to Bill Holloway, Personnel Department, or telephone collect.

NCR

The National Cash Register Company
ELECTRONICS DIVISION
2815 W. El Segundo Blvd., Hawthorne, Calif.
Telephone: Area Code 213-757-5111
an equal-opportunity employer



New Subassemblies and Systems



Midget amplifier weighs 4.3 grams

A tiny i-f amplifier has been developed for use in aerospace radar and communications systems work. Built for high reliability, the 60-Mc bandpass unit measures $\frac{3}{8}$ by $\frac{3}{8}$ by $\frac{3}{4}$ in. and weighs 4.3 grams. It uses 18 ma of current at a voltage of 12 v d-c. Over-all bandwidth is 8.7 Mc and over-all gain is 42.5 db. Four synchronous, single-pole bandpass networks provide the frequency selectivity. The amplifier is made with molecular electronic functional blocks and welded modular construction for high-density electronic packaging. Each individual stage of the unit is shielded for electromagnetic isolation.

Westinghouse Electric Corp., Box 2278, Pittsburgh, Pa. 15230. [371]

Logic modules permit high-density assembly

Miniature logic-system building blocks for computing and memory systems operating at speeds to 5 Mc are offered in five new series of plug-in digital logic modules. They are available in commercial, computer, industrial, fast industrial and



high-speed series, which differ only in operating speed and price, and in the use of germanium or silicon semiconductors. Modules in all series are 1.8 by 1.4 by 0.4 in. A versatile mother-card relationship permits any arrangement of 6 modules or 12 logical functions on a $4\frac{1}{2}$ -in. card with 0.6-in. spacing. In use, the modules provide system density approaching that of micro-electronic assemblies, with the additional service and low-cost advantages of open-card construction. Modules available are either gated or twins, with provisions for increasing the fan-out without using additional space, thus minimizing the number of modules required in a system. Prices start at \$6.

Avron, Inc., 212A Depot Rd, Huntington Station, N.Y. [372]

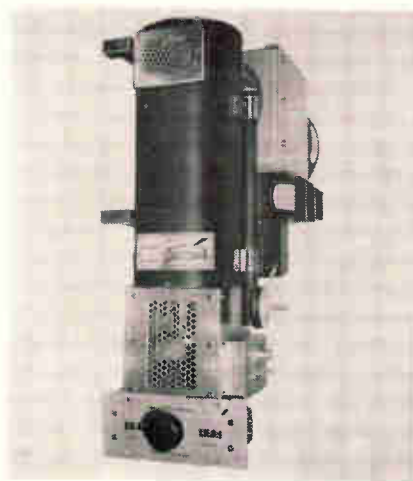

Tetrode amplifier provides 1-kw output

Recent trends in voice and data communications systems necessitates the use of higher powers and rapid adjustment. Model 11014A tetrode amplifier can be used to update low power systems or as a basic component in new designs. It is furnished complete with blower, manual tuning systems, and digital readout. Broadband input and output matching techniques eliminate mechanical variable coupling. No neutralization is required. Cooling is done efficiently with maximum heat transfer re-

quiring only one blower. Temperature stability is insured by maximum bandwidth designs. Power output is 1 kw; frequency range, 225 to 400 Mc; tube type, GL6942; power gain, 13 db; nominal impedance input and output, 50 ohms; power input, 50 w; maximum input vswr, 2:1.

Microwave Cavity Laboratories, Inc., 10 N. Beach Ave., LaGrange, Ill. 60525. [373]

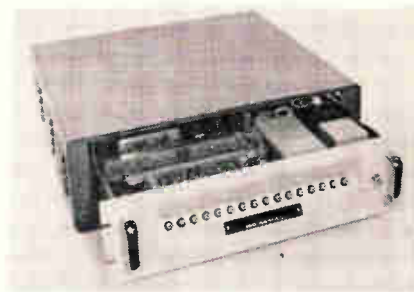

Resolver-to-digital converter system

A precise, shaft-angle encoding system, the model RIDC 4162-1000 converter, is completely self-contained, incorporates all-solid-state electronics, and requires only 28-v, 400-cps excitation. Output digital data is continuously available in 16-bit, parallel-binary form; and a visual display of angle data is presented. System accuracy is within one bit. The operating model to be displayed will receive analog input from a dual-speed (1 X and 16 X), pancake-type resolver. Data outputs will be presented in both analog and digital form, with the analog data accurate to 10 sec of arc.

Reeves Instrument Corp., Garden City, N.Y. [374]

Parametric amplifier for retrofitting

A parametric amplifier for use in the 225 to 260-Mc band is one of a series designed for retrofitting existing equipments. In addition to the basic unit, this remotely controlled system includes a second-stage, high-gain buffer amplifier, automatic noise figure test equipment, and a complete spare channel that can be switched into op-

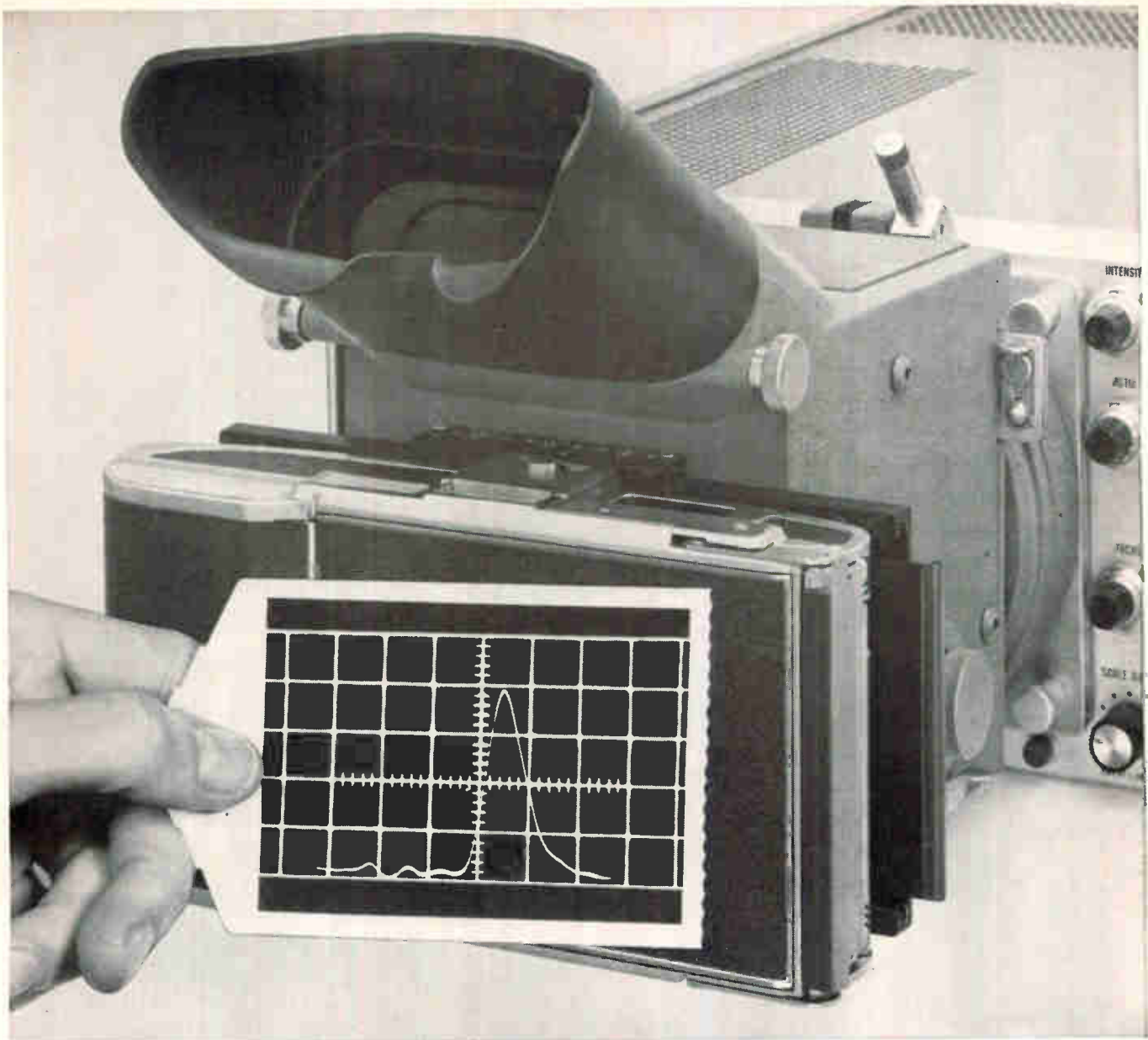

HOW TO FILM AN ULTRA-FAST LASER PULSE

Fairchild Scope Camera and Polaroid Land® 10,000 Film capture pulse with 9 nsec rise time on 4 cm scan

This photo shows the duration and shape of a single shot, 20 megawatt ruby laser pulse. It was made by a Fairchild Oscilloscope Camera mounted on the new type 757 Fairchild ultra-high writing rate scope. The Camera was fitted with a Polaroid Back using Polaroid Land 10,000 speed film. With the scope armed for single sweep, the camera set at f/1.9, and the shutter on bulb, the laser was fired. The film had not been pre-fogged in any way, but as you can see, it was unnecessary: the 9 nsec pulse rise time was recorded on 4 cm scan with the clarity and contrast usually seen only in multiple exposures. The versatility of Fairchild Oscilloscope Cameras matches their high performance. That's one reason more of them are in use today than any other kind. Such features as precision control of object-to-image ratios and a data chamber for recording written data on the print are examples of this versatility. For details on models and prices, write Fairchild Scientific Instruments, Dept. 107, 750 Bloomfield Ave., Clifton, N. J.

©Reg. TM of Polaroid Corp.

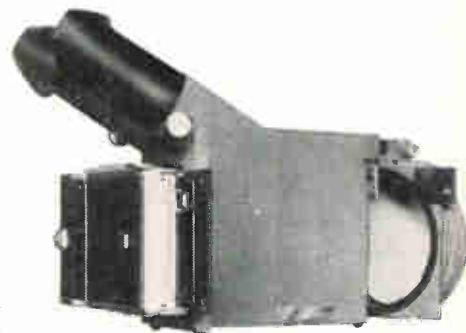

Swing-away feature of Type 453A Camera adds to convenience. All models available with new Polaroid Film Pack Backs.

FAIRCHILD

DU MONT LABORATORIES
SCIENTIFIC INSTRUMENTS DEPARTMENT

She's welding wires

$\frac{1}{6}$ th the size of a human hair...

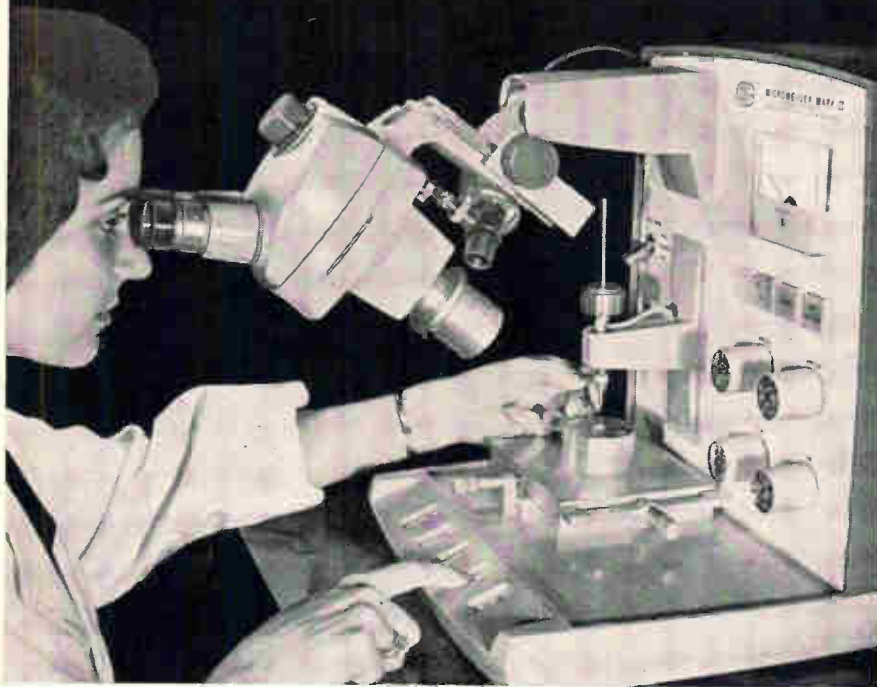

Engineer StereoZoom into your product as a component, or use the complete microscope . . . for quality-control inspection, for production-line fabrication and assembly . . . of micro-miniature parts and products.

... using Aerojet-General's MICROWELDER Mark II, teamed with Bausch & Lomb's StereoZoom® Microscope

With very little training, this girl learned to weld wires that are almost too small to see. The Bausch & Lomb StereoZoom Microscope incorporated in the Mark II helps her perform the delicate operation easily and precisely. StereoZoom gives her big, sharp *three-dimensional* images of the subminiature parts and microwelder tip.

The Commercial Products Division of Aerojet-General Corporation, Azusa, California, developed and is marketing the Mark II for welding wires as small as .0005 inch in diameter for microelectronic

application. To provide operators with bright 3-D magnification of the minute work, Aerojet chose the Bausch & Lomb StereoZoom . . . an optically-superb instrument, ruggedly built for hard industrial use.

If you have a small-parts assembly or inspection problem, there's a Bausch & Lomb StereoZoom to fit your requirements—24 models with magnification ranges from 3.5X to 120X. Call your dealer, or write Bausch & Lomb Incorporated, 62308 Bausch St., Rochester, N. Y. 14602

BAUSCH & LOMB

In Canada, write Bausch & Lomb Optical Co., Ltd., Dept. 623, Scientific Instrument Division, 16 Grosvenor St., Toronto 5, Ont.

New Subassemblies

eration when desired. The package is designed for outdoor antenna mounting, and the enclosure includes heating and cooling equipment to permit continuous operation over the temperature range from -54°C to $+54^{\circ}\text{C}$. The low frequency lends itself to the use of

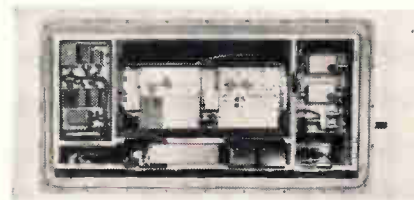

stripline techniques, which permits the pump attenuator, power monitor, and frequency monitor to be included in the paramount mount. Stability characteristics of the system have been improved by the use of four-port circulators. Because of its outdoor mounting, all functions are remotely, including fault-location signals. Conveniences such as remotely resettable circuit breakers are also included. Paramount noise figure is 2.0 db, including the effects of a 16-db second stage; gain, 40 db nominal. Unit measures 12.5 by 18 by 39 in.

Airborne Instruments Laboratory, Deer Park, L.I., N.Y. [375]



Step-servo system gives fast response

A step-servo system, known as Tormax, comprises a size 20 variable-reluctance, three-phase step-servo motor and an electronically matched, three-phase scr printed-circuit board controller. Major features include high torque at high pulse rates; fast stop-start response

—down to 2.8 millise; long life— up to 1 billion cycles, and step angle of 15° per pulse. Applications include high-speed computers, X-Y plotters with high torque requirements, digital flight simulators, paper transport systems, altitude-indicator drive systems and digital instrument recorders. Tormax can also be used as a stepping drive with encoders or as a valve positioner; incremental positioning drive for moving data forms, a variable position servo, antenna actuator and in other types of remote control actuator applications. Tormax is priced at \$150. IMC Magnetics Corp., 6058 Walker Ave., Maywood Calif. [376]

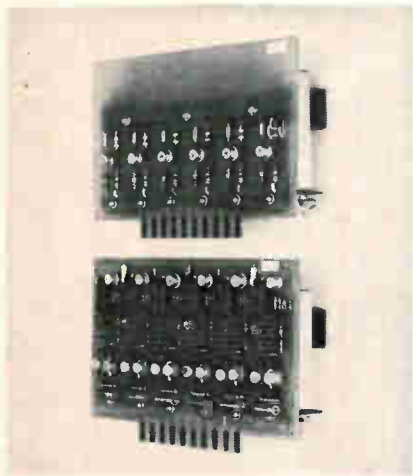

Resonant reed modules for remote control

Operation over a temperature range of -55° to +85°C is a feature of these new tone encoder and decoder packages. Control and monitoring of multiple functions may be accomplished over a single pair of wires or a single radio channel. Tone oscillators are held to a frequency stability of ±0.1%. No feedback adjustment is used in the oscillator, and stability is achieved less than one sec after power is applied. The oscillator's output is emitted less than one millise after it is keyed. Response time of the decoder is approximately 100 millise. Modules are offered in both three-tone and six-tone packages.

Meson Electronics Co., 148 So. Fitzhugh St., Rochester, N.Y. 14608. [377]

LIGHTWEIGHT CHAMPION OF THE T-R RELAYS



Actual Size

**TYPE RJ1A
2KV PK (16 MC)
7 AMPS RMS (16 MC)
1³/₁₆" LONG
ONE OZ.**

Ounce for ounce the RJ1A controls more power than any other relay in the world. It will handle 2 KW average power into a 50 ohm load at VSWR 1:1 at 2 to 32 megacycles. And since it was designed for high volume production it offers the utmost economy.

The high strength vacuum dielectric guarantees a tremendous internal overvoltage safety factor — more than double the rated peak test voltage. Resistance is low (.010 ohms) and remains low and stable for the life of the relay.

The RJ1A is ideally suited for such applications as airborne, mobile, or marine communications systems for switching between antennas, antenna couplers or transmitters, or between transmitters and receivers. In sonar equipment they are being used as long life relays to switch 25 amp, 100 milliseconds pulses to transducers.

For higher power applications Jennings offers a complete line of vacuum transfer relays not much larger than the RJ1A. These relays are available in peak test voltages up to 38 KV Peak and continuous current ratings up to 75 amps RMS.

Write for more detailed information on the RJ1A and Jennings complete line of vacuum transfer relays.

RELIABILITY MEANS VACUUM / VACUUM MEANS

Jennings

JENNINGS RADIO MFG. CORP., 970 McLAUGHLIN AVE., SAN JOSE 8, CALIF., PHONE CYpress 2-4025



SPECIFY TELEPHONE TYPE COMPONENTS BY Stromberg-Carlson

Thoroughly proved in telephone switching operations, Stromberg-Carlson components bring a new high in quality and reliability to many industrial applications.

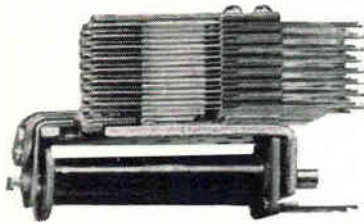

RELAYS Types A, B, BB, C and E. All standard spring combinations are available. Send for our Bulletin T-5000R3.

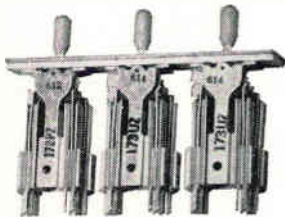

KEYS Broad selection of push-button, cam and twist types. Send for Bulletin T-5002R2.



HANDSETS High-efficiency models; standard or with switch assemblies. Send for Bulletin T-5017R.

Plus all other telephone switchboard components. For technical data on the full Stromberg-Carlson line, write to Industrial Sales Department.

STROMBERG-CARLSON
A DIVISION OF GENERAL DYNAMICS
114 CARLSON ROAD • ROCHESTER 3, N. Y.

New Microwave

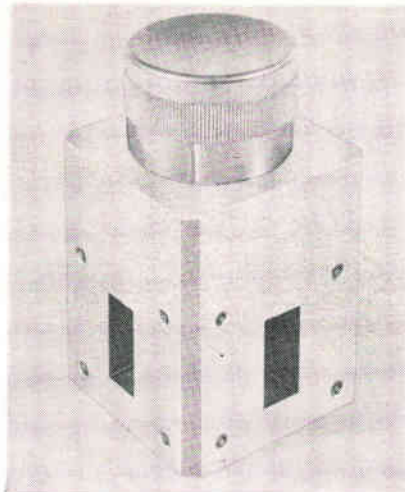

Manually operated waveguide switches

Manually operated waveguide switches are available for 2.6 to 18 Gc with vswr typically 1.05, insertion loss typically 0.05 db and isolation typically 55 to 60 db. Three configurations are offered: spdt (DB-614), dpdt (DB-612) and sp3t (DBF-615, F-size only). All designs use a solid waveguide passage through a rotor between ports to provide precise switching with maximum retention of r-f characteristics. A spring-loaded, detent mechanism moves the rotor to a fully open port position. Action is positive. The rotor cannot be stopped at a damaging between-ports or mid-port position. Indicator terminals are provided to permit hookup to panel indicator lights or interlocks. The switch meets the environmental requirements of MIL-T-21200. Applications include bench tests, ground support systems, radar, telemetry, radio astronomy and microwave communications. Prices start at \$245. DeMornay-Bonardi, 780 S. Arroyo Pky., Pasadena, Calif. 91105. [391]

S-band klystron weighs only 35 pounds

The X3029 S-band klystron, using periodic permanent magnets for beam focus, allows weight reductions of more than 80% below com-

parable klystrons using permanent or electron magnets, according to its manufacturer. The new klystron would have applications in phased-array radar and airborne or satellite communications. The X3029 was designed for 75-kv peak output and has been tested to 100 kv. It is 5 in. in diameter and 24 in. long. Frequency is 2,855 Mc; beam voltage (peak), 26 kv; beam current (peak), 9.4 amps; and gain, 60 db. Eitel-McCullough, Inc., 301 Industrial Way, San Carlos, Calif. [392]

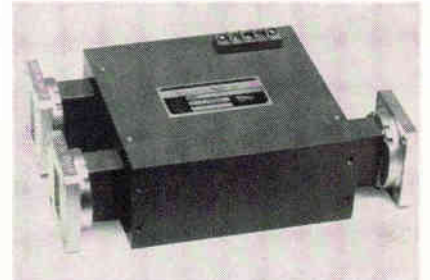

Switched circulator for broadband use

R-f switching over the entire 7- to 11-Gc band in 20 μ sec or less is provided by model J1790A switched ferrite circulator. Designed for spdt switching, the unit has an insertion loss of 0.5 db maximum, isolation of 20 db minimum, and vswr of 1.2 maximum. It measures 26½ cu. in. and has WR-102 flanges. A small solid-state driver for the switched circulator is also available. Melabs, 3300 Hillview Ave., Stanford Industrial Park, Palo Alto, Calif. [393]

Solid-state phase shifter designed for X-band

A solid-state, 180°, X-band phase shifter has been announced. Model PSW794A typically has a 1-nsec phase-shift change over any 5% bandwidth within X-band, permitting high modulation rates. It completely eliminates the hysteresis effect in phase-shift that is normally present in ferrite phase-shifters. The unit has a maximum vswr of 1.3 to 1. Typical insertion

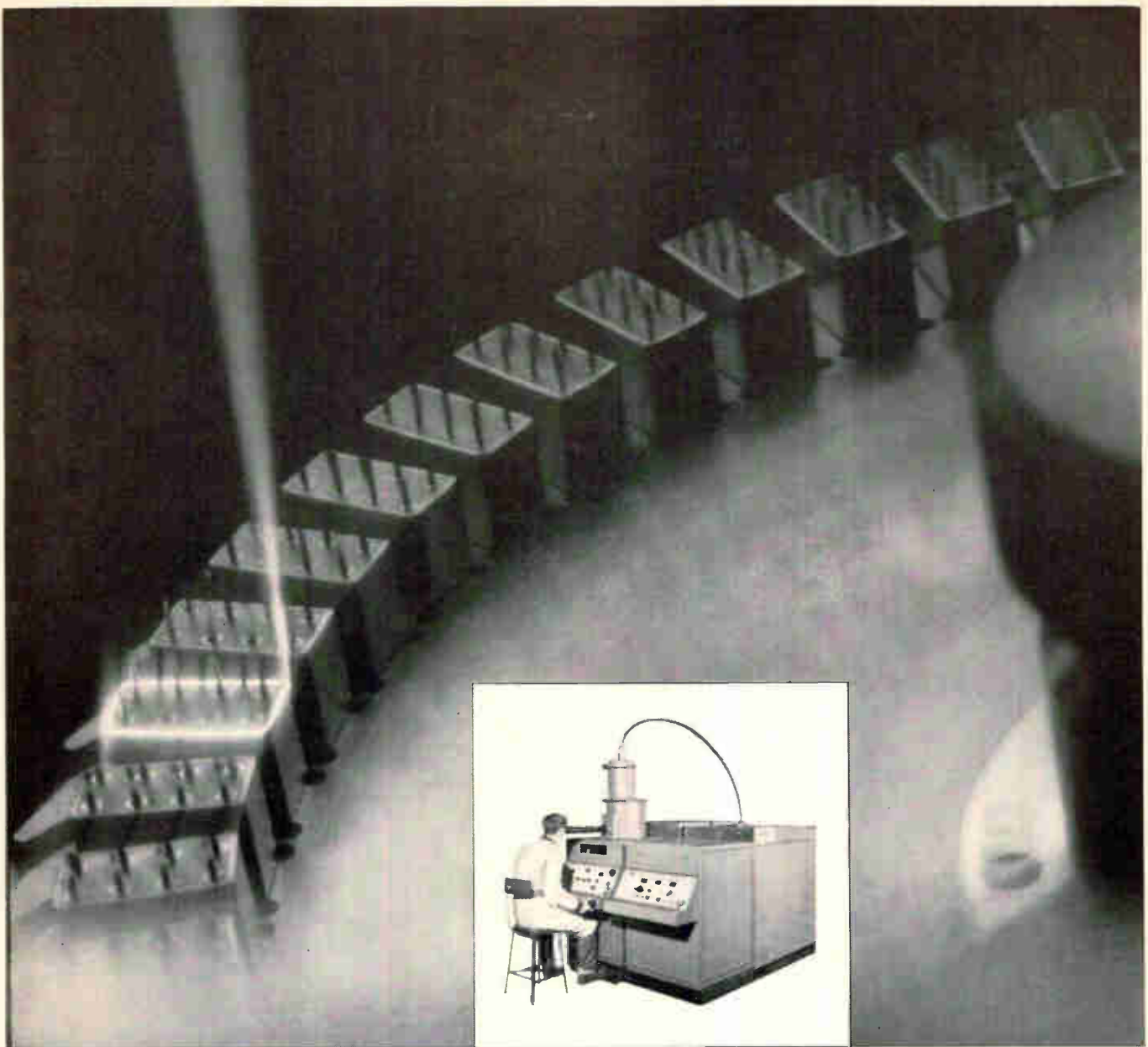

Why three leading relay manufacturers use the Hamilton Standard Electron Beam Welder to seal subminiature relays

The Hamilton Standard Electron Beam Welder can be programmed precisely enough to seal a crystal case type relay in a few seconds, with production rates up to 250 units an hour. It allows engineers to design for lowest weight and highest reliability, because the high energy density of the beam concentrates all the heat in a remark-

ably small area. Contamination is eliminated because electron beam welding takes place in a vacuum. Physical and electrical properties remain unchanged because electron beam welding involves very low heat input.

Filtors, Inc., General Electric (Waynesboro), and the Leach Relay Division have all found the Hamilton

Standard Electron Beam machine an important tool in crystal case relay manufacture. Other companies have discovered its value in many different problems of microelectronic production. To find out how it can help **you**, send for bulletin. Write: Manager, Electron Beam Systems, Hamilton Standard, Windsor Locks, Connecticut.

Hamilton Standard DIVISION OF UNITED AIRCRAFT CORPORATION • WINDSOR LOCKS, CONNECTICUT

**U
A**

LAPP HEAVY-DUTY STAND-OFF INSULATORS

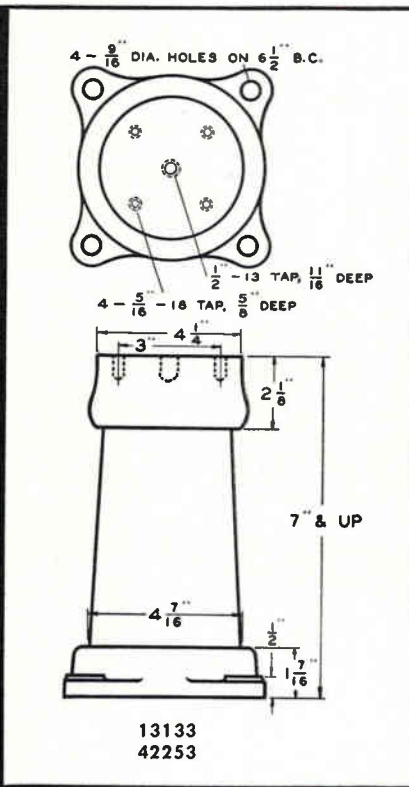
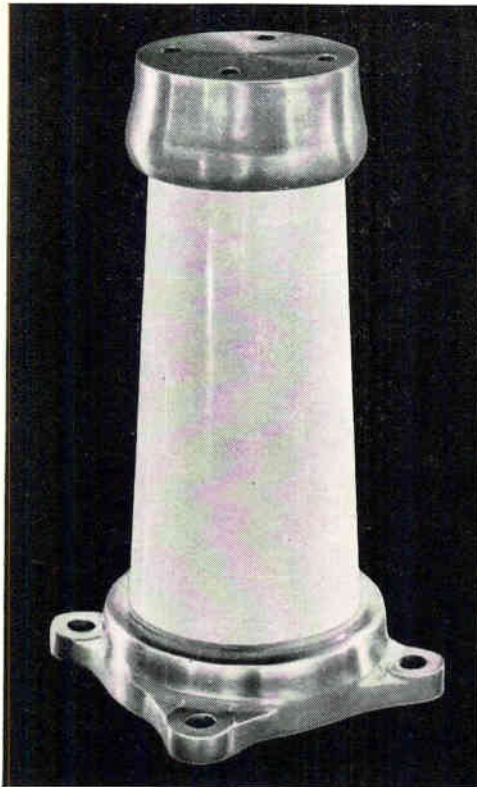

...in all these
standard sizes to save
you time and money

FLASHOVER AND RADIO RATINGS							
DRY FLASHOVER 60 kv eff.			RADIO RATING kv eff.				
Height in inches	13133	9063 26006	13133	42253	9063	26006	
6	37	*48			12½	23	
8	57	*62	13½	25	15¾	29	
10	*71	*72	16	30	18	33½	
12	*82	*80	18	33½	20	37	
14	*92		20	37			
16	*101		21½	40			
18	107		22½	41			

NOTE: *indicates in stock.

Other sizes available on special order, for fast delivery,
and at a price you know is fair. Write for Bulletin 301-R.

Lapp

Lapp Insulator Co., Inc.,
221 Sumner Street,
LeRoy, N. Y.

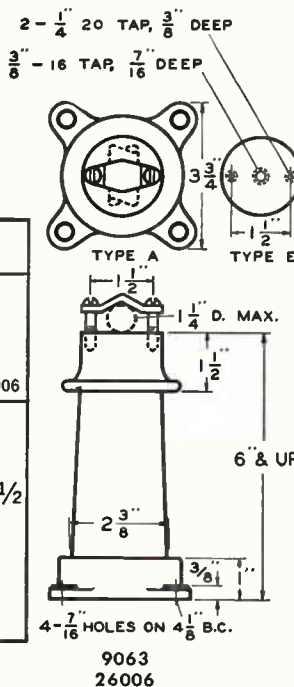

New Microwave

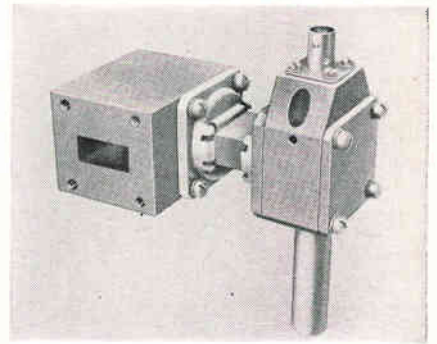

loss through the entire phase-shift range is 1.5 db, and the dynamic shift range exceeds 180°. Less than 0.1 w drive power is required. Applications include parametric amplifiers, low-power (receiving) phased antenna arrays, phase bridges, impedance bridge circuits, interference systems, low-power phase modulators and frequency-modulation systems.

American Electronic Laboratories, Inc.,
Richardson Rd., Colmar, Pa. [394]



Variable attenuators exhibit constant phase

A series of ultra-flat variable attenuators feature constant phase for all attenuation settings. Maximum phase variations of $\pm 1.5^\circ$ in octave bands from 30 to 1,000 Mc and $\pm 2.5^\circ$ in octave bands from 1,000 to 4,000 Mc are available. Typical characteristics for model 504 are: frequency range, 500 Mc to 1,000 Mc; attenuation range, 0 to 25 db; attenuation flatness (0 to 20 db), ± 0.5 db; vswr, 1.30 max; insertion loss, 0.3 db max; r-f power, 25 w max; connectors, type N; price, \$375 each.

Premier Microwave Corp., 33 New
Broad St., Port Chester, N.Y. [395]



THIS NEW X-Y RECORDER
CONTRIBUTES SIX
MAJOR IMPROVEMENTS
TO THE STATE-OF-THE-ART

MOSELEY 

an affiliate of Hewlett-Packard

*Trade Mark Pat. pend.

9429

- New, exclusive AUTOGRIP® hold-down for any size paper to 11" x 17"
- 100 microvolts/inch sensitivity at one megohm input resistance
- AC input ranges to 5 millivolts/inch
- 120 db common mode rejection at line frequency
- Multi-contact flat mandrel potentiometers for unprecedented reliability
- Time sweeps for either axis with automatic reset and adjustable sweep length

These improvements, coupled with proven Moseley quality and precision, make the Model 7000A the most advanced X-Y recorder available today. Available, too, is the companion model 7030A, same as 7000A but accepts paper to 8½" x 11", without ac inputs. Model 7000A, \$2575; Model 7030A, \$1795. Call your Moseley/Hewlett-Packard field engineer or write: F. L. MOSELEY CO., 433 N. Fair Oaks Ave., Pasadena, Calif. 91102.

CIRCLE 129 ON READER SERVICE CARD

High torque, Self-shielded

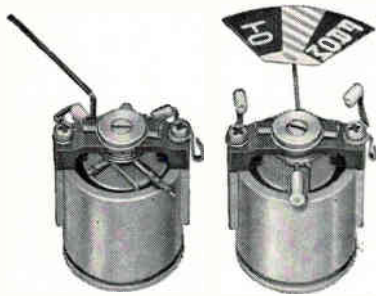

AI-2 (actual size)

moving coil mechanism

Versatile mechanisms for critical indicating and control systems have "On-off", "+, -", "Go-no go", null, left-right, or scale indicators. High torque, self-shielded core magnet design permits grouping of functions in small panel space. Moving coil weighs 100 mg less and provides at least 10% more torque than best previously available mechanism of this type. Wide choice of sensitivities; synchro or standard mounting.

AMMON

AMMON INSTRUMENTS, INC.
345 Kelley Street, Manchester, N. H. 03105

Circle 201 on reader service card

Reed Relays

3 mA. to 50 Amp.



**BIG or SMALL ...
We Make Them All!**

Shown is a husky series type 50 Ampere reed switch coil with a Form A switch (Form C available too). Also a tiny Form C relay to handle 250mA for 10 x 10⁶ cycles with only 3mA input. Standard or special coils are available with or without reed switches. Special coils with 2 and 3 windings to provide various percent ϕ (mmf).

Write for catalog and prices of our standard line of magnetic reed relays. For special requirements, give complete details for quotation.

Coto-Coil

COMPANY INC.
65 Pavilion Ave.
Providence, R.I. 02905
Phone: (401) 941-3355

130 Circle 130 on reader service card

New Production Equipment



Ultrasonic system for critical cleaning

This cleaning system consists of a heated tank with transducers, vapor condensing jacket and an ultrasonic generator. Solvents such as Freon TF, Freon azeotropes, Freon blends and commonly used vapor degreasing solvents can be selectively heated between 70 and 230°F for the cleaning process. Organic soils, lint, dust and metal chips are ultrasonically removed by the unit. The system is designed for cleaning of electronic components and equipment, precision instruments or other critical parts, where gentle handling and thorough cleansing are necessary. The single heated tank is 12 in. by 12 in. by 6 in. deep and has a removable water-cooled condensing jacket which allows ultrasonic scrubbing in heated solvents and minimizes solvent evaporation losses. In addition to dip cleaning the cooling jacket provides for vapor rinsing. The generator features variable output, and timer control for continuous operation.

Blackstone Ultrasonics Corp., Sheffield, Pa. [421]

Viewing system aids in microfabrication

A precise, cost-reducing, optical and illumination system, just released to the electronic packaging industry, permits microwelding and microsoldering operations to be maintained at maximum production rate with fatigue-free and fault-free operator control. Special

illumination devices are prescribed in combination with the vernier/work/viewer systems for highlighting fixed spot positions and for providing proper work-area illumination by high-intensity Macro Flood light. Systems are available with fully stereoscopic 2.5 X and 4 X visual amplification viewers to which may be added a monocular magnification multiplier for a close look at a specifically defined area at 5 X and 8 X respectively. The vernier/work/viewer system attaches to any work table or directly to microwelding and microsoldering machines and fixtures. Prescription engineers will make recommendations as to requirements for specific work areas.

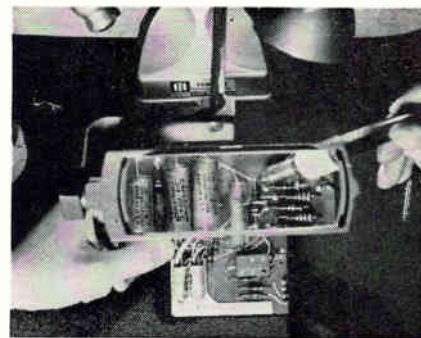

Price of the 2.5 X system is \$114.50; the 4 X system, \$144.50; the monocular magnification amplifier, \$20.

EdnaLite Research Corp., 210 N. Water St., Peekskill, N.Y. [422]

Airblast machine cuts silicon shapes

A special abrasive airblast machine is said to offer increased production and lower total costs to companies involved in the cutting of round silicon shapes for use in rectifiers. The machine handles work of the type usually accomplished by ultrasonic machining. With the airblast equipment, masking is used and 70 or more silicon slices may be cut into multiple small shapes in a single cycle of 30 to 45 minutes. The machine's built-in variable controls allow increased production when

silicon process specifications permit. Proper precautions in the procedure itself and in selection of the abrasives used will result in chip-free edges on the silicon product, according to the manufacturer. The Pangborn Corp., Hagerstown, Md. [423]

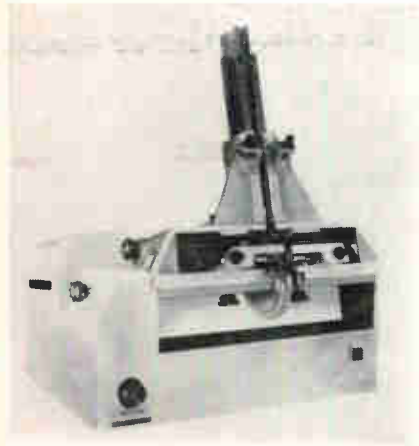

Component processor trims and forms leads

Designed to trim and form electronic components' axial leads, without stressing or nicking, at variable rates from 1,800 to 10,000 per hr., the Bend-Amatic 200 processes microdiodes and other components up to 1 in. in diameter and 2 in. long. It handles leads of resistors, capacitors and diodes up to the maximum manufactured length and trims them as short as 0.070 in. from the component body. The unit also features two-minute setup by means of control knobs that adjust the feed chute and trimming and forming tools to desired component and lead dimensions. A vernier scale, graduated in increments of 0.001 in., provides pre-programming capability for all dimensions and assures the same accuracy in future reruns. A variable-speed control motor drives cams through a timing belt to provide quiet operation with a minimum of shock and vibration. Permanent pre-lubrication of all moving parts minimizes component-lead contamination and machine maintenance. The machine measures 24 by 13 by 18 in. Price is \$2,995.

Develop-Amatic Engineering, 923 Industrial Ave., Palo Alto, Calif. [424]

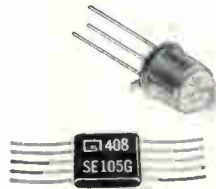

Need to say a lot
in a little space?

(or make markings
more **durable**...or
more **economical**...
or at **higher rates**?)

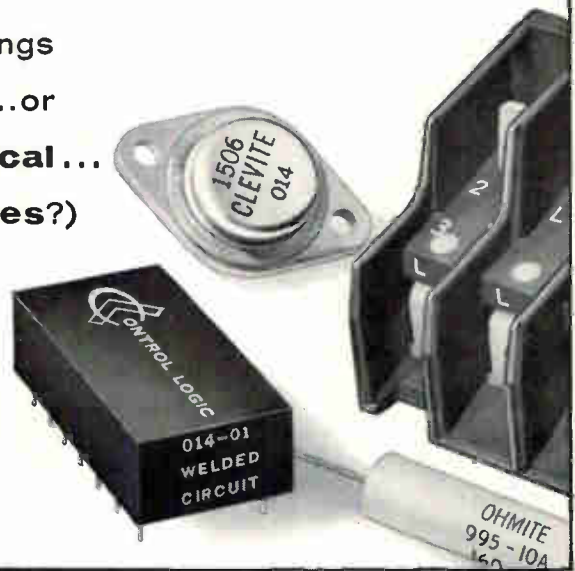

We can show you how

We can show you how to identify products so they will resist extreme amounts of handling, abrasion, many solvents and other atmospheric conditions . . . or how to sequentially number and identify components with savings of more than \$50 per 1000 . . . or how to print trademark, type number, value and date code on 90 units a minute . . . or how to produce an imprint that remains readable after 1000 hours at 200°C. . . . or get 10 digits and 2 letters in a micro-circuit area of 0.090" — or 21 characters on a TO-5 case with interchangeable type number and date code . . . or save 75 cents of every dollar you now spend on buying, applying, inventorying and discarding obsolete preprinted labels.

The answers are in proven Markem machines, type and specialty inks, which daily produce better product or package identification by reducing costs, smoothing production control and increasing customer acceptance. And while Markem machines, type and inks are helping to produce better products through more complete and lasting identification, they frequently pay for themselves in the savings they make possible. Tell us what *you* make, what it must say, and for how long: we'll give you a specific recommendation and cost estimate right away. Write Electrical Division, Markem Machine Co., 305 Congress St., Keene, New Hampshire 03431.

MARKEM

For Quality
Reliability & Price
"Fox" Electrolytic Capacitors

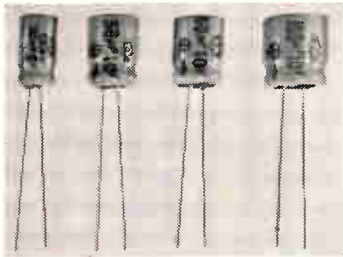

- *Electrolytic Capacitors
 - *Solid Aluminium Capacitors
 - *Solid Tantalum Capacitors
- All Sizes & Types Available

FOX ELECTRONICS CO., LTD.
Export Dept. 1, 4-Chome
Honkamata, Ohta-ku, Tokyo
Head Office: Shiga Pref. Japan

Circle 132 on reader service card

Reprint order form

Send to: Electronics Reprint Dept.
330 West 42nd Street
New York, N. Y. 10036

For listing of reprints available see the reader service card.

To help expedite mailing of your reprints please send cash, check or money order with your order.

For reprints of the latest special report:

Oceanography

Send me reprints of key no R-58 at 50¢ each.

For reprints of previous special reports fill in below:

Send me reprints of key

no. (s) at ¢ each.

For prices see the reader service card.

Name

Number & Street

City, State

Zip code

New Materials

**Bright gold process
for industrial use**

The E-70 bright gold process is designed to produce electro-deposits of 23 K with relatively low stress and extremely smooth grain structure. Optimum brightness is obtained by operating the solution slightly above room temperature and in the neutral range. The E-70 bath is of special value in industrial applications where abrasion and wear-resistance are required to meet the Type 2 classification of MIL-G-45204. It is also well adapted to processing of printed-circuit boards, connectors, contacts, diodes, switches, relays and glass and ceramic seals.

Engelhard Industries, Inc., 113 Astor St., Newark 14, N.J. [411]



**Coated Mylar sheets
shed moisture**

A line of evaporated thin-film coatings on Mylar has been developed. Resistance ranges are continuous from 3 to 500 ohms per square, $\pm 10\%$ tolerance. Sheets are 12 $\frac{3}{4}$ in. by 5 in. by 0.0005 in., 0.001 in., 0.002 in., 0.003 in., or 0.005 in. Sheet ends are silver-banded and a dielectric coating provides moisture protection. The sheets can easily be sheared and punched to form a wide variety of configurations for use in waveguides, antenna and cable shielding, and special low-power area heating.

EMC Technology, Inc., 1133-35 Arch St., Philadelphia, Pa. 19107. [413]

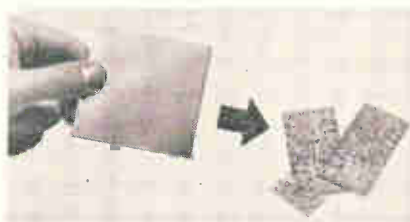

**Metal-clad epoxy glass
has high peel strength**

A weldable metal-clad epoxy glass, called ultra-glas, utilizes the ultra-bond process. This process indicates excellent reliability with either high-purity nickel or Kovar. Tests have shown a peel strength, metal to epoxy, of 15 to 22 lb. per in. of width. Machinability and plating of holes are excellent due to the ultra-bond resin, a thermo-setting material that machines without gummy residue. Available in ultra-glas core thickness from 0.002 and up, the base laminate meets the requirements of MIL P 13949 "B", type GE or GF. Standard cladding for Kovar is 0.002, high-purity nickel (MIL-N-1915 3) is 0.003. The metal-clad epoxy glass is available in sheet sizes of 6 by 12 in.

Fortin Plastics, Inc., 28687 Golden State Hwy., Saugus, Calif. [412]

**Resin flux improves
printed circuits**

Availability of No. 414 printed-circuit resin flux has been announced. The formula is designed specifically for minimal solvent evaporation in foam-fluxing. No. 414 formula is completely noncorrosive and nonconductive, yet provides excellent fluxing power on oxidized leads as well as clean leads and boards.

Kenco Alloy & Chemical Co., P.O. Box 24, Hazel Crest, Ill. 60429. [414]

New Literature

Delay lines. Columbia Technical Corp., 24-30 Brooklyn-Queens Expressway West, Woodside, N.Y. 11377, offers a characteristic guide for electrically variable delay lines, in graph form, which plots the product (delay time \times bandwidth) versus frequency and costs. Circle 451 on reader service card

Universal calibrator. Abbey Electronics Corp., 143 Old Country Road, Carle Place, L.I., N.Y. An illustrated bulletin contains information on the MC-10, an accurate, secondary standard source of voltage, current and resistance. [452]

One-part silicone sealants. General Electric Co., Waterford, N.Y. Bulletin S-2B serves as a guide to five different one-part silicone rubber adhesive/sealants, including the new RTV-106, which will withstand continuous exposure to temperatures up to 500° F. [453]

Silicon diodes. ITT Semiconductors, Inc., National Transistor Division, 500 Broadway, Lawrence, Mass. Bulletin B-104R covers miniature glass silicon computer diodes. [454]

Microwave equipment. Raytheon Co., Microwave and Power Tube Division, Burlington, Mass. 01804. The latest technical information package deals with microwave super power packages, pulse modulators, and 150-kw high purity cooling systems. [455]

Drilling machines. Nashoba Engineering Corp., Route 62, West Concord, Mass. A brochure sets forth the advantages of numerically-controlled, multiple-spindle drilling machines for both the job-shop and the production-shop in drilling printed-circuit boards, circuit modules and the like. [456]

Electronic chopper. Solid State Electronics Co., 15321 Rayen St., Sepulveda, Calif. A catalog sheet describes model 70 silicon transistor chopper, a solidly encapsulated unit designed alternately to connect and disconnect a load from a signal source. [457]

Coaxial cable. Phelps Dodge Electronic Products Corp., 60 Dodge Ave., North Haven, Conn. A 17-page technical bulletin covers the use of Foamflex coaxial cable for communications. [458]

Systems capabilities. Wiancko Engineering, 255 N. Halstead Ave., Pasadena, Calif. A 29-page brochure presents complete systems capabilities ranging from subsystems and components to complete instrumentation for rocket tests. [459]

Dummy gages. Microdot Inc., 220 Pasadena Ave., S. Pasadena, Calif. Weldable dummy strain gages are described and illustrated in brochure DSG-1. [460]

Magnetic logic in space. Di/An Controls, Inc., 944 Dorchester Ave., Boston, Mass. 02125, has published a report on the applications and reliability of magnetic circuit elements used in satellites and space vehicles. [461]

Glass reed relays. Wheelock Signals, Inc., 273 Branchport Ave., Long Branch, N.J. A 24-page catalog describes a line of protected glass reed relays which range from miniature through standard sizes. [462]

Power supplies. Kepco Inc., 131-38 Sanford Ave., Flushing, N.Y. 11352. A 52-page catalog B-648 contains complete specifications for a line of voltage and current regulated power supplies. [463]

Mechanical part position indicating. Industronics, 9776 Arlington Ave., Riverside, Calif., has available technical brochures illustrating and describing a new concept of mechanical part position indicating. [464]

Impedance-matching amplifier. Industrial Electronics Corp., P. O. Box 862, Melbourne, Fla. 32901. Bulletin IEC 400 describes model IM60 low-impedance matching amplifier which permits conversion of high-impedance outputs to low-impedance galvanometers and similar loads. [465]

Laboratory power supplies. Electronic Research Associates, Inc., 67 Factory Place, Cedar Grove, N.J., has available a technical bulletin on all-silicon, wide-range laboratory power supplies. [466]

Galvanometric recorders. Texas Instruments, Inc., Industrial Products Group, 3609 Buffalo Speedway, Houston, Tex. 77006. Bulletin R-520 describes the company's line of galvanometric recorders. [467]

Flat-pack sealer. Kulicke and Soffa Mfg. Co. Inc., 135 Commerce Drive, Industrial Park, Fort Washington, Pa., has released a product sheet describing a system for sealing glass, Kovar and ceramic flat packages. [468]

R-f coaxial filters. Bird Electronic Corp., 30303 Aurora Road, Cleveland, O. 44139, offers a six-page guide on how to specify an r-f coaxial filter to avoid over-design. [469]

Power amplifier. Leach Corp., 1123 Wilshire Blvd., Los Angeles 17, Calif. Bulletin TA-10664 contains technical data on a newly developed solid-state, 10-w, r-f power amplifier. [470]

Weldable thermocouples. Microdot Inc., 220 Pasadena Ave., South Pasadena, Calif. Data sheet WT-1A describes weldable thermocouples that are electrically isolated. [471]

NEW! FREE! NEW! FREE! NEW!

FREE! NEW! NEWARK 1965 INDUSTRIAL ELECTRONICS CATALOG!

LISTING



GROWING SILICON POWER TRANSISTOR LINE



Three new additions to RCA's growing family of 200°C. silicon transistor types, RCA-2N3440,* -2N3441, and -2N3442 offer these important design and application features:

- Freedom from second breakdown
- New, high dissipation packages
- Flange cases offer easy heat sinking
- Expanded coverage from 12-volt operation to transients up to 450 Volts
- Meet industrial and military requirements

*Flanged version of 2N3440, 40256

- Immediate Delivery from Stock
Factory OEM Prices

NEWARK CATALOG 80

- Industry's Most Complete Catalog
- Over 640 Pages • Over 70,000 Items
- Over 600 Standard Brand Lines
- Eight Stocking Warehouses
- Over \$6,000,000 Industrial Electronics Inventory

NEWARK ELECTRONICS CORPORATION

Main office and warehouse • Dept. EL
223 West Madison • Chicago, Ill. 60606

Authorized RCA Warehouses in:

CHICAGO, ILL.

(312) ST 2-2944

CINCINNATI, OHIO

(513) 421-5282

DENVER, COLORADO

(303) SK 7-3351

DETROIT, MICHIGAN

(313) JO 4-5490

LOS ANGELES AREA

(213) OR 8-0441

Other Newark Warehouses in:

GRAND RAPIDS, MICHIGAN

(616) 452-1411

NEW YORK CITY

(212) AL 5-4600

SAN FRANCISCO AREA

(415) 593-1881

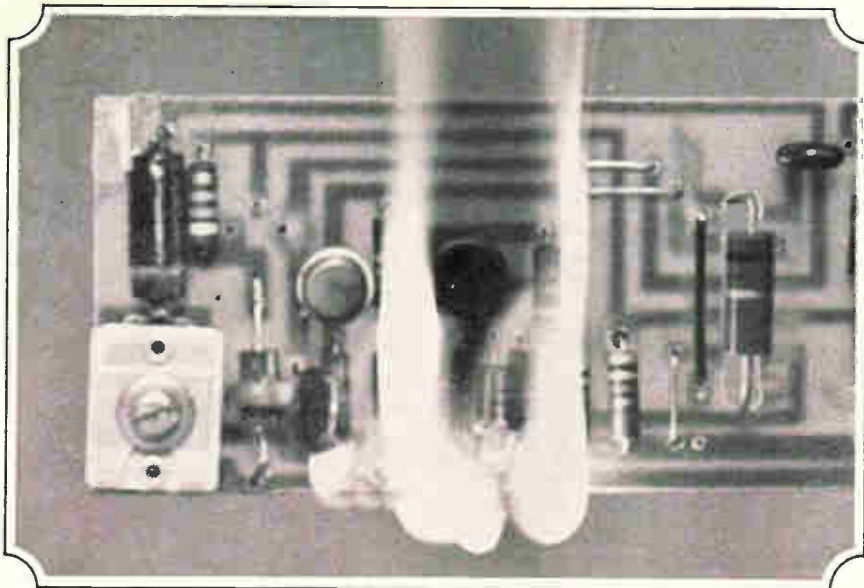

PREVENTION IS A HYPERSENSOR

HYPERSENSORS, "NANOSECOND FUSES," PREVENT COSTLY TRANSISTOR BURN-OUTS.

Save a transistor; save a circuit; save a computer; save a mission. Solid state Hypersensors react in time to prevent transistor burnout... in nanoseconds... and they can be reset over and over again with application of only 12 V. Standard units, TO-18 transistor size, rated 10 to 300 ma, available from stock. Subminiature, axial lead Hypersensors made to order. For information, write or phone, 1100-1 E. Ash Ave., Fullerton, California, 92631. Phone: 871-1930 (714)

QUALTRONICS CORPORATION

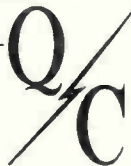

Circle 205 on reader service card

COMINCO

HIGH PURITY METALS
AVAILABLE FORMS

clip and save

Product	ALUMINUM	ANTIMONY	ARSENIC	BISMUTH	CADMIUM	GOLD	INDIUM	LEAD	SILVER	TIN	ZINC
BARS	✓	✓	✓	✓	✓	✓	✓	✓	✓	✓	✓
SHEETS	✓				✓	✓	✓	✓	✓	✓	✓
WIRE	✓				✓		✓	✓		✓	✓
POWDER		✓	✓	✓	✓	✓	✓	✓	✓	✓	✓
SHOT		✓		✓	✓	✓	✓	✓	✓	✓	✓
ROD	✓			✓	✓		✓	✓	✓	✓	✓
RIBBON							✓	✓			
PRE-FORMS	✓				✓	✓	✓	✓	✓	✓	✓
SALTS					✓		✓				

COMINCO PRODUCTS, INC.

electronic materials division

818 West Riverside Avenue, Spokane, Washington 99201

Phone Area Code 509 RI 7-6111 • TWX 509 328-1464

3602

134

Circle 134 on reader service card

New Books

Tape recorders

Magnetic Tape Recording

H.G.M. Spratt

D. Van Nostrand Co., Princeton, N.J.

1964, 368 pp., \$10.50

Although the author does not tell us for whom his book is intended, the material will make it possible for the technical or semitechnical worker in related fields to acquaint himself with the basics of magnetic recording. By use of the rather complete references in the book, the reader can delve deeper into the theory.

The twelve chapters cover magnetism, sound reproduction, principles of magnetic recording, tape materials, manufacture and testing, special applications, trends and standards.

As can be seen from this list, the approach is largely through sound recording; however, this second edition does have a number of modifications that explore the problems of pulse (data) and video recording. Nearly every chapter has additional material, well integrated with that from the first edition, to cover these new fields.

The text is well illustrated with line diagrams. A few photographs have been used, mostly of British equipment. Some circuits are given, including both tubes and transistors. Some passages cover magnetic recording on motion-picture film, disks, etc., as well as on tape. While the book was written and printed in England, an American will have little trouble with the language. A few word usages are different: Americans speak of the "skew" in head alignment, while the author uses "tilt", and "reels" become "spools".

The newcomer to the field of magnetic recording will find this one of the most comprehensive texts now available. The worker already deeply involved in this field, however, is not likely to find that it adds much depth to his knowledge.

W. Earl Stewart,
Vice President,
Manufacturing Facilities
Standard Register Co.
Dayton, Ohio

Electronics | August 24, 1964

Switching in space

Switching Theory in Space Technology
Howard Aiken and
William F. Main, editors,
Stanford University Press,
Stanford, Calif.,
375 pp., \$11.50.

This book should really be entitled "Proceedings of the Symposium on the Application of Switching Theory in Space Technology". There appears to be something of a vogue now to camouflage the publication of proceedings by not mentioning them in the title. This book is simply the proceedings of the symposium held at Sunnyvale, Calif.

The symposium was rather long on switching theory and reasonably short on space applications. The first eleven papers are rough mathematical papers on switching theory by such experts as Polya and Gato. All of these papers require the reader to have a firm mathematical background; some even require familiarity with a previous paper by the author. This reviewer was unable to find any specific space orientation in these papers.

The twelfth paper breaks into the open with a treatise on how ferrites can be machined. This is followed by eight papers of an engineering type. New memory and switching devices up to 1962 are nicely presented. Very little is said about their application to space; in fact, only two papers out of the twenty-five have the word "space" in their titles. One of these talks of the probabilities of successful missions, and the other describes a bandwidth-conserving telemetry system.

The book will serve as a good reference volume for anyone dealing with information systems, whether he is concerned with space applications or not. The reader should, however, buy the book for what it is and not for what he might be led to believe it is from the title.

David H. Schaefer
National Aeronautics and
Space Administration
Goddard Space Flight Center
Greenbelt, Md.

HAVE YOU CONSIDERED USING PHOTOCELLS?

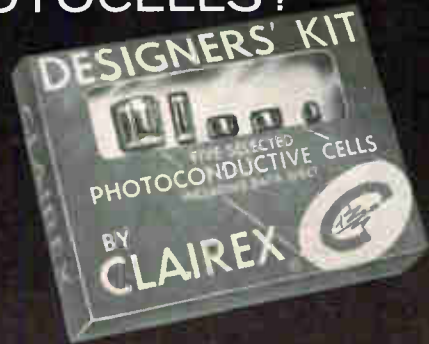

WE'VE JUST MADE IT EASY FOR YOU . . .

New! — from Clairex — a selection of photoconductive cells, varying in sensitivity, spectral response, speed and size to suit most applications, and including the CL505, CL603A, CL704L, CL707 and CL902 — in convenient kit form complete with technical data — only \$10.00.

Free On Request —
Designers' Kit Information
plus New 1964 Edition
16 page Designers' Manual

CLAIREX

"The LIGHT Touch in Automation and Control"

8 West 30 Street, New York, N. Y. 10001, 212 MU 4-0940

Circle 202 on reader service card

TWO NEW MAGNELINE® INDICATORS FROM PATWIN



SERIES 12000



SERIES 16000

Subminiature ($7/32$ " character) Series 12000 and large ($9/16$ " character) Series 16000 indicators now broaden both ends of Patwin's line. Both of the new series feature the famous Magneline principle for reliability and long life. Like to know more?

Write, or phone 203-756-3636
for free literature

See us at WESCON—Booth 129

PATWIN® ELECTRONICS

A DIVISION OF THE PATENT BUTTON COMPANY
WATERBURY, CONNECTICUT • 06720

Circle 135 on reader service card

135

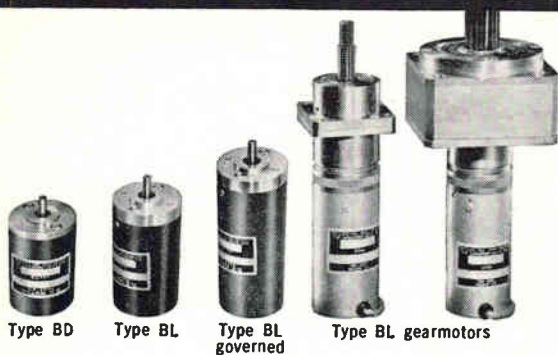

1 1/2" D.C. MOTOR FAMILY

Globe 1 1/2" diameter Type BD and BL permanent magnet motors meet almost any combination of requirements you may have in the continuous duty range to 0.04 HP at 10,000 rpm. For example, the motors alone have 42 different standard armature windings for voltages up to 115 v.d.c. Integral speed governors can be furnished to control speed within 3% in the 3,000 to 12,000 rpm range; for more accurate control an electronic governor can be provided. Planetary gearboxes have 24 standard ratios, thus putting you in command of enormous torques, such as 550 lb. in. at 1.3 rpm. (1000 in.

lb. intermittent). Integral radio noise filters can be furnished. In short, Globe can meet your need exactly from virtually standard components. Request Bulletin BDL—Globe Industries, Inc., 1784 Stanley Avenue, Dayton 4, Ohio.

GLOBE

Circle 203 on reader service card

NEW! Deluxe



1200°F FLAMELESS BLOW TORCH

THE HECO/TORCH . . . fast, safe, concentrated heat for softening, forming, molding, patching, drying, thawing, preheating, plastic welding, soldering, vacuum degassing and bending • Exclusive switch control for infinite temperature variation from ambient to 1200°F • Full 3000 FPM heat in an instant . . . burnout-proof damper adjusts heat profile • Heavy, no-tip base with lugs for permanent mounting, removes for portable use • Adjusts vertically over 180° arc • Precision-made with brushless, maintenance-free, fan-cooled induction motor . . . long-life heaters . . . self-lubricating porous bronze bearing • Can also use as cooling blower. Today's best value in heat guns at only \$59.95, 115 volt 60 cycle. 220 volt 60 cycle available at slight addl. cost. Complete with cord, handle and stand. SEND FOR COMPLETE DETAILS AND LOCAL SOURCE: Heinze Electric Co., 685 Lawrence St., Lowell, Mass. 01853. Telephone (617) 457-7556.



HECO TORCH made by
Heinze Electric Company
Heat Torches and Guns • Fans • Blowers

Circle 204 on reader service card

*precise
control
a problem?*



It won't be if you use an Aeroflex "brushless" DC torque motor. The only torquer designed for limited angular excursion. Successfully used on:

- Mid-course motor for Mariner and Ranger
- Satellites
- Horizon sensors for Saturn V
- Throttle control for automated trains
- Aero-space stabilized platforms
- Antenna and tracking mount drives

For free specification charts on torquer performance, write to Dept. RB-106.



AEROFLEX LABORATORIES
INCORPORATED
South Service Road, Plainville, L. I., New York
(516) MYrtle 4-6700

136 Circle 136 on reader service card

• PRODUCT DEVELOPMENT ENGINEER

Development work on analytical scientific instruments including gas chromatographs, scanning calorimeters and elemental analyzers with major emphasis on data handling.

Education or experience in low-noise analog data handling, digital circuitry and solid state semiconductor circuitry is required. Requires a BSEE with graduate work desirable plus 4 to 5 years applicable professional experience.

Send resume to Mr. Howard Moran,
Perkin-Elmer, Main Avenue Plant,
Norwalk, Connecticut. An equal
opportunity employer.

PERKIN-ELMER

Electronics | August 24, 1964

Technical Abstracts

Steerable arrays

On the application of electronically steerable antenna arrays to space telemetry systems. W.M. Mazer and B. Kit, ITT Corp., Falls Church, Va.

Electronically steerable antenna arrays can increase the performance of spacecraft telemetry systems. The results of studies of the properties of the phased array and recent component developments now enable consideration of the steerable array for telemetering systems and communication satellite repeaters.

Present spacecraft telemetry transmission requires complex precision attitude control or mechanical antenna pointing. Also, in spacecraft where the telemetry transmission permits operation of only one antenna element at any time, the failure of any component can result in catastrophic degradation of performance—if any performance at all.

The electronically steerable array will reduce or eliminate the need for complex attitude controls or pointing devices. The output pattern of a steerable array is a superposition of the outputs of many antenna elements. This redundant character of the antenna array and its associated circuitry tends to increase the system reliability. With the steerable array it is possible to obtain increased directivity, which, for a fixed data transmission rate, tends to reduce the power required to drive a large number of antenna elements.

The steerable array requires some means of confining the direction of the beam transmitted from the spacecraft to the receiving site. At distances close to the earth, it is possible for the array to steer itself by infrared sensing. Discrimination in spectrum and geometry among the earth, the moon, and the sun can be accomplished by relatively straight-forward techniques.

At great distances, it is a complex problem to distinguish the earth from other celestial bodies by infrared sensing. In this case, it is necessary and practical to steer the array from a source external to the spacecraft. An unmodulated beacon is transmitted from the receiving site

to the spacecraft. In the spacecraft the beacon is translated in frequency. The data modulates the translated frequency, and the modulated signal is then amplified and transmitted back to the receiving site. The configuration of the antenna elements and the properties of phased array permit the array to be directed at the receiving site independent of the spacecraft attitude or rotation.

The steerable array theory is based upon the Van Atta array. Advantages and possible methods to eliminate the disadvantages of the Van Atta configuration are presented in this paper with suitable block diagrams to complement the discussions.

Presented at the National Telemetering Conference, June 2-4, Los Angeles

Scr drives

Thyristor drives—a design engineer's appraisal. D.V. Bennett, System Control Division, Westinghouse Electric Corp., Buffalo, N.Y.

Static silicon controlled rectifier drives can and do outperform their rotating counterparts. Thyristor, or scr, drives range from fractional up to 12,000 horsepower sizes. Little power is needed to turn on the scr, so large amounts of drive power can be controlled by low-level signals. This allows drive systems to be simplified, yet have the response, stability and accuracies needed in machine-tool applications.

The scr has a wide range of ratings for use in drive system: a size 3 cell rates at 16 amperes, a size 9 at 250 amperes. Westinghouse uses two basic voltage ratings: a 400-volt cell for drives using up to 240 volt d-c motors; an 800-volt cell for drives using 480 volt d-c motors. Because the scr has a low forward voltage drop at high junction temperatures, fairly simple heat sinks can be used.

Up to and including 10-horsepower d-c drives, convection-cooled sinks are used; above 10 hp forced cooling is used. Forced cooling lets the designer use a small heat sink, rated for 10 hp and

Save time with these tested transistor design circuits

Here's a ready source of quick, time-saving answers to your transistor circuit problems... practical guidance on essential phases of today's semiconductor developments. Because these three volumes bring you the successful work of practicing engineers, every topic has permanent reference value and contributes to the Library's usefulness in your work.

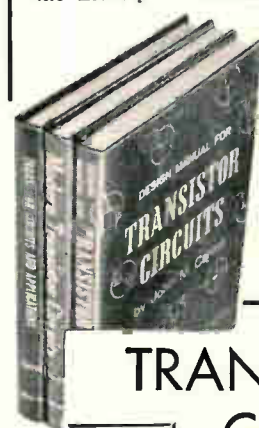

You'll have at your fingertips hundreds of *proved* transistor circuits—with all the necessary design information and component values required to utilize them in your own designs—and save valuable man-hours of time and effort.

TRANSISTOR CIRCUITS LIBRARY

Edited by
John M. Carroll
Managing
Editor
Electronics

3 vols. 932 pp.,
1735 illus. and
tables, \$24.95—
payable \$8.95 in
10 days, \$8.00
monthly

Praise by
experts...

"... a valuable
reference to
the circuit de-
signer and en-
gineer."
—*Electronics*

"... useful to
those who are
entering the
field of semi-
conductor cir-
cuit design."
—*Control*

"... a conven-
ient and com-
prehensive
source of trans-
istor information."
—*Radio-Elec-
tronics*

These three big manuals supply hundreds and hundreds of transistor circuits ready to be adapted to your specific needs... give valuable material on transistor characteristics, structures, and techniques. Articles, photographs, design charts, nomographs, and ready-to-use circuits cover a vast range of applications... from simple one-transistor "push-pull" amplifiers... to complex computer switching circuits with high-power transistors. You get data and circuits for home-entertainment and broadcast equipment... computer and servomechanism circuits... missile, aircraft, and satellite equipment... and many more.

Library includes...
Transistor Circuits and Applications
Modern Transistor Circuits
Design Manual for Transistor Circuits

Save \$5.05. Bought separately, books would cost \$30.00. But under special Library offer, they come to you at a \$5.05 saving—and you may pay in small, convenient installments.

SEE LIBRARY 10 DAYS FREE Direct from Publisher

McGraw-Hill Book Co., Dept. L-824X
327 W. 41st St., N. Y. C. 10036

Send me the Transistor Circuit Library. In 10 days I will (check one) remit full price of \$24.95; or only \$8.95 in 10 days and \$8.00 monthly. Otherwise I will return books postpaid. (If you remit in full with coupon, plus local tax, refund and return privileges still apply.)

Name

Address

City State Zip

Company

Position

For price and terms outside U. S. write McGraw-Hill Int'l., N. Y. C. 10036 L-824X

Reprint order form

Send me complete set(s) of special reports listed below at \$2.50 per set.

Name

Number of street

City, State, Zip code

SPECIAL OFFER

Reprints of Special Reports from Electronics

Now, for your reference file a complete set of special reports reprinted from the pages of Electronics in the past year. 155 pages of valuable and informative articles. Each report surveys the field it covers, reporting and discussing, the latest techniques and developments. Each report is individually bound and they will be sent to you together in an attractive folder. The discount price for the complete set, which includes both handling and shipping cost is \$2.50. The following reports are included in this special offer:

Oceanography, 15 pages.

Magnetics, 24 pages.

Digital Instrumentation, 16 pages.

Modern Electronic Packaging, 16 pages.

Electronic Markets New Directions, 1963-64-67, 24 pages.

Today's Semiconductors, 24 pages.

Materials for Space Age Electronics, 16 pages.

Radio Frequency Interference, 24 pages.

Remember when you order refer to this special offer or [Use coupon at top of this page]

Send your order to:
Electronics Reprint Dept.
McGraw-Hill Inc.
330 W. 42nd Street
New York, N. Y. 10036

below, in circuits designed for up to 60 hp.

The inability of the simple scr bridge-type drive to regenerate limits performance only when the armature current approaches zero. Thyristor drives, capable of regeneration by using dual converters can be built. But, this requires multiple scr power supplies that allow power to flow to the motor in both directions. This design is only economical on larger hp drives, above 1000 kilowatts.

For most drives Westinghouse uses magnetic amplifiers, the flux reset method, to control the scr. The advantages are a static design needing no maintenance, giving inherent output balance with no bias adjustments, less time delay than with ordinary magnetic amplifiers, and isolation.

Most static d-c drives are regulated through motor voltage feedback and resistance-drop compensation. Normal speed range is 8 to 1 with $\pm 5\%$ regulation. Adding a high-gain preamplifier, speed range can be extended to 100 to 1 with an accuracy of $\pm 2\%$ regulation. Replacing voltage feedback and resistance-drop compensation with tachometer feedback, gives $\pm 0.5\%$ regulation. Finally, using a current feedback loop inside the speed feedback loop gives accuracies of $\pm 0.1\%$.

Besides an over-all efficiency at full load and top speed of about 94% and a power factor at top speed of about 85%, an scr drive has many installation advantages. One is that main a-c leads can be brought directly into the power unit's circuit breaker. This results in short d-c lines going to the main drive units with a minimum of external wiring.

Presented at the 28th Annual Machine Tool Electrification Forum, May 26 and 27, Buffalo, N.Y. Sponsored by the Westinghouse Electric Corp.

Biomedical microelectronics

Micro-miniature high-impedance f-m telemetering transmitter for bio-medical research. W. Ko and E. Yon
Engineering Design Center
Case Institute of Technology, Cleveland

A modified tunnel-diode f-m transmitter, about the size of an aspirin, was implanted in rabbits and rats to collect data on heart and muscle

responses without the use of wire transmission.

In the basic tunnel-diode-oscillator circuit, a backward diode was used to bias the oscillator so that the frequency would not be sensitive to d-c bias. The capacitance of a varactor was controlled by the input signal voltage, which modulates the oscillator frequency.

The transmitter developed for this study had low power drainage (1.2 milliamperes at 0.2 volts), good input sensitivity, frequency response and temperature stability, and high input impedance.

Implant tests were made on rats to transmit electrocardiograph data, and in the rear leg muscle of a rabbit to transmit electromyograph data. Twelve implants were made. The difficulties encountered were: low temperature sterilization, migration of implanted units, mechanical damage to the units, leakage of body fluid into the transmitters, malfunction of magnetic switches, and failure of the electrodes to pick up expected amplitude of signals. The first four problems were solved satisfactorily. The two involving switches and electrodes are still being studied.

At present, the longest continuous data on the electromyograph is five days. However, transmitters that were implanted for two to five months were found on recovery to be in good working condition.

Since the test time with implanted units is limited by the useful life of the battery, it is necessary to power the transmitter by some external source.

A study is being made on providing power to the transmitter by radio induction at one megacycle per second. Magnetic energy from an external source is coupled into a detector unit with three mutually perpendicular coils, each with rectifiers. Because of the small amount of power required, the transmitter may also be powered by several other techniques: by a silicon solar cell of one square centimeter, three feet from a 60-watt lamp; by a single thermoelectric generator operating at several hundred degrees temperature difference; or by many series thermocouples operating at 10° C temperature difference; and by many of the body potentials.

Presented at the National Telemetering Conference, Los Angeles, June 2-4.

Electronics QUALIFICATION FORM FOR POSITIONS AVAILABLE

ATTENTION: Engineers, Scientists, Physicists

This Qualification Form is designed to help you advance in the electronics industry. It is unique and compact. Designed with the assistance of professional personnel management, it isolates specific experience in electronics and deals only in essential background information. The advertisers listed here are seeking professional experience. Fill in the Qualification Form below.

Strictly Confidential

Your Qualification Form will be handled as "Strictly Confidential" by Electronics. Our processing system is such that your form will be forwarded within 24 hours to the proper executives in the companies you select. You will be contacted at your home by the interested companies.

What To Do

1. Review the positions in the advertisements.
2. Select those for which you qualify.
3. Notice the key numbers.
4. Circle the corresponding key number below the Qualification Form.
5. Fill out the form completely. Please print clearly.
6. Mail to: Classified Advertising Div., Electronics, Box 12, New York, N. Y. 10036.

COMPANY	SEE PAGE	KEY #
JET PROPULSION LABORATORY Pasadena, California	139	1
MOTOROLA INC. Military Electronics Div. Scottsdale, Arizona	140	2
THE NATIONAL CASH REGISTER CO. Electronics Div. Hawthorne, California	120-121	3
PERKIN-ELMER Norwalk, Conn.	136	4

----- (cut here) ----- (cut here) -----
Electronics Weekly Qualification Form For Positions Available

(Please type or print clearly. Necessary for reproduction.)

Personal Background

Name
 Home Address
 City Zone State
 Home Telephone

Education

Professional Degree(s)
 Major(s)
 University
 Date(s)

Fields of Experience (Please Check)

82464

- | | | |
|--|--|---------------------------------------|
| <input type="checkbox"/> Aerospace | <input type="checkbox"/> Fire Control | <input type="checkbox"/> Radar |
| <input type="checkbox"/> Antennas | <input type="checkbox"/> Human Factors | <input type="checkbox"/> Radio—TV |
| <input type="checkbox"/> ASW | <input type="checkbox"/> Infrared | <input type="checkbox"/> Simulators |
| <input type="checkbox"/> Circuits | <input type="checkbox"/> Instrumentation | <input type="checkbox"/> Solid State |
| <input type="checkbox"/> Communications | <input type="checkbox"/> Medicine | <input type="checkbox"/> Telemetry |
| <input type="checkbox"/> Components | <input type="checkbox"/> Microwave | <input type="checkbox"/> Transformers |
| <input type="checkbox"/> Computers | <input type="checkbox"/> Navigation | <input type="checkbox"/> Other |
| <input type="checkbox"/> ECM | <input type="checkbox"/> Operations Research | <input type="checkbox"/> |
| <input type="checkbox"/> Electron Tubes | <input type="checkbox"/> Optics | <input type="checkbox"/> |
| <input type="checkbox"/> Engineering Writing | <input type="checkbox"/> Packaging | <input type="checkbox"/> |

Category of Specialization

Please indicate number of months experience on proper lines.

	Technical Experience (Months)	Supervisory Experience (Months)
Research (pure, fundamental, basic)
Research (Applied)
Systems (New Concepts)
Development (Model)
Design (Product)
Manufacturing (Product)
Field (Service)
Sales (Proposals & Products)

Circle Key Numbers of Above Companies' Positions That Interest You

1 2 3 4 5 6 7 8 9 10 11 12 13 14 15

CHECK THE FOLLOWING LIST FOR JPL NEEDS

✓ TELECOMMUNICATIONS ENGINEERS

● SR. RESEARCH ENGINEERS

MS plus 5 years experience in RF systems and/or circuitry. Development work in RF sub-system. Work concerned with wide-band RF frequency multipliers & with frequency synthesizers characterized by low phase jitter & high spectral purity. BS with MS desirable. Two to 4 years experience in design and analysis of microwave antennas & microwave components desirable. General familiarity with antenna measurement techniques. Design and analysis of feed systems & wave guide components for large ground antennas.

✓ DATA SYSTEMS & APPLICATIONS PROGRAMMERS

For planning & application of real time computer data systems for specific flight projects.

● APPLICATIONS PROGRAMMERS

Responsible for the development of analysis programs for orbit determination, mid-course guidance & spacecraft telemetry data. These programs will be integrated into a real time multi-computer system.

● SYSTEMS PROGRAMMERS

Responsible for the planning of a real time multi-computer programming system and the incorporation of the real time system with the IBSYS job shop system. Experience in programming systems for spacecraft & wind tunnel data acquisition & display also desired. BS or MS with 3 to 5 years programming experienced required.

Send complete resume to:
Personnel Dept. 8

or visit



JET PROPULSION LABORATORY

4814 Oak Grove Drive
Pasadena, California

"An equal opportunity employer." Jet Propulsion Laboratory is operated by the California Institute of Technology for the National Aeronautics and Space Administration.

The Future is Here

As the Western Center of Motorola's Military Electronics Division advances into the further miniaturization of electronic components and systems, exciting and rewarding career opportunities are created — in inverse ratio to the diminishing size of operational sub-assemblies for military equipments and aerospace hardware.

To engineers and scientists of demonstrated capability Motorola currently offers these specific opportunities.

- | | |
|-------------------------------|----------------------------|
| Antennas & Propagation | Integrated Circuitry |
| Solid State R.F. | Reliability Analysis |
| Microwave Techniques | Parts Reliability |
| Missile & Space | Reliability Program |
| Instrumentation | Coordination |
| Operational Support Equipment | CW Transponders |
| | Radar & Radar Transponders |
| | Guidance & Navigation |
| | Command & Control |
| | Space Communications |
| | Signal Processing |
| | ECM, CCM & Surveillance |
| | Tracking & Telemetry |

SIZE - WEIGHT

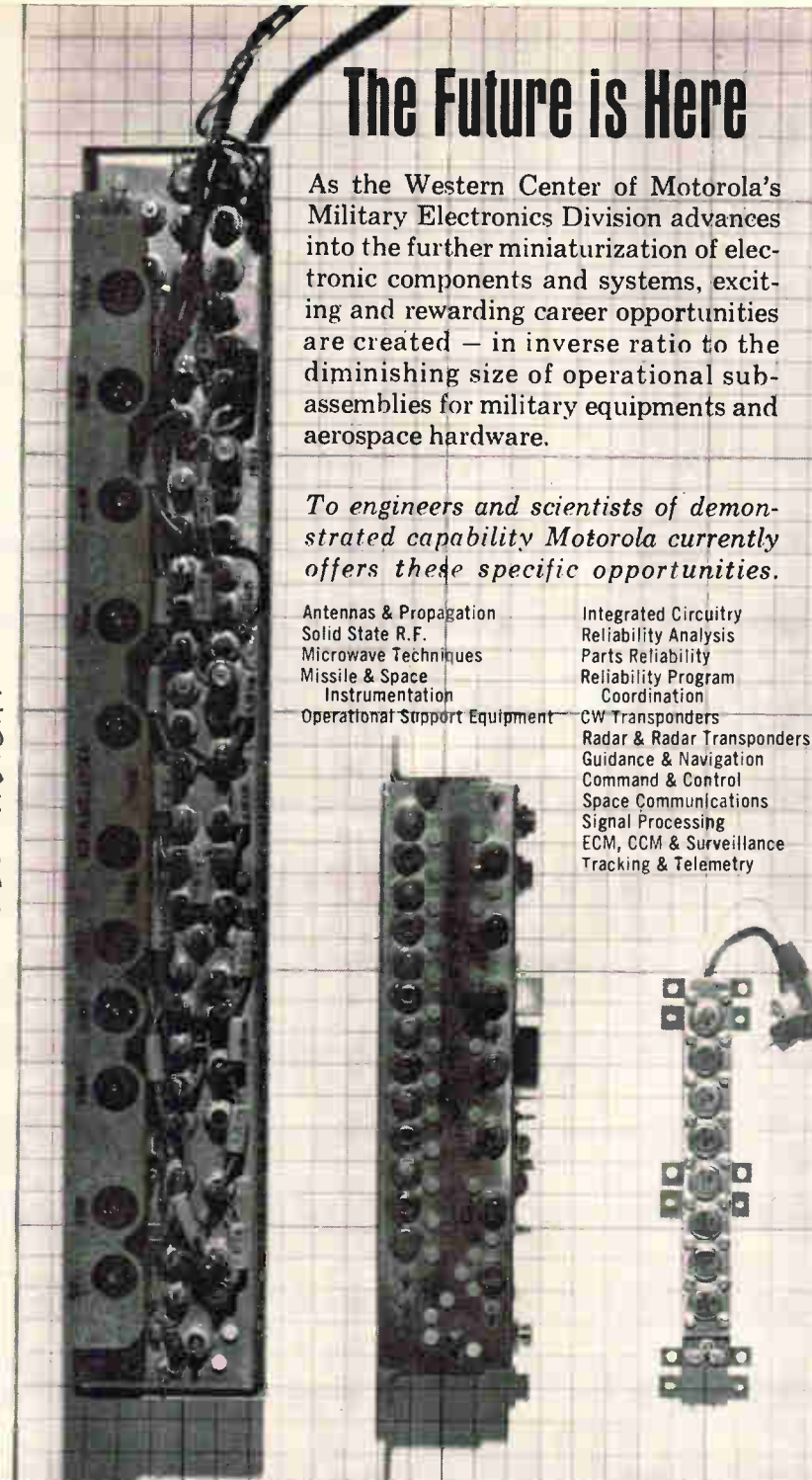

1956

1960

1964

TIME - YEARS

Contact Phil Nienstedt, Manager of Recruitment, Department 658

MOTOROLA



in PHOENIX

Military Electronics Division • Western Center • P.O. Box 1417, Scottsdale, Arizona
MOTOROLA ALSO OFFERS OPPORTUNITIES AT CHICAGO, ILLINOIS — AN EQUAL OPPORTUNITY EMPLOYER

ADDRESS BOX NO. REPLIES TO: Box No.
Classified Ad. Div. of this publication.
Send to office nearest you.
NEW YORK 10036: P. O. Box 12
CHICAGO 60611: 645 N. Michigan Ave.
SAN FRANCISCO 94111: 453 California St.

POSITION VACANT

Chief Engineer—Broadcast and CCTV. Truly a one-time opportunity for the managing design engineer to take over the Engineering Division of an already successful corporation still growing by leaps. The man that will dare in design but pride in thoroughness will find his life's career waiting for him. Must have video design experience with cameras and associated equipment. Mid-Atlantic coast location. B.S.E.E. required plus management training. Age 35-45. Send resume and photo to P-1968, Electronics.

SEARCHLIGHT SECTION

(Classified Advertising)

BUSINESS OPPORTUNITIES

EQUIPMENT - USED or RESALE

SIGNAL GENERATORS

HEWLETT-PACKARD. 616 A	1800 MC to 4000 MC	750.00	
TRANSITRON. SG-153	(Same as HP 616 B)	700.00	
COLE INSTRUMENTS	TS 413 B; U 75 KC to 40 MC	175.00	
POLARAD	GB-2 with G-8 Plug-in	4450 MC to 8000 MC	650.00
POLARAD	GB-2 with G-711 Plug-in	6950 MC to 11000 MC	650.00
POLARAD	MSG-1. 950 MC to 2100 MC	600.00	
POLARAD	MSG-2A. 2000 to 4600 MC	600.00	
FEDERAL RADIO	Model LX-1. 8 MC to 330 MC	150.00	
GENERAL RADIO	605 B. 9.5 KC to 50 MC	175.00	
GENERAL RADIO	1330 A Bridge Oscillator	5 KC to 50 MC	275.00
SPERRY MICROLINE	Frequency Meter. 600 to 3500 MC	75.00	

SWEEP GENERATORS

KAY ELECTRIC	Model I.K. Vari-sweep	250.00	
KAY ELECTRIC	Model 110 A Mega-sweep	200.00	
KAY ELECTRIC	Model SKV Ligna-sweep	450.00	
JERROLD ELECTRONICS	Model 900	450.00	
NEW LONDON INSTRUMENT CO.	Model 901 H.	Transeconductance Analyzer	395.00

See previous issues for more equipment. Send for Flyers.
All material in excellent condition. All prices F.O.B., San Francisco, Cal., subject to prior sale.
Send for Listing and Flyers.

Marty's Mart

1236 Market St., San Francisco 3, California
Phone: UNDERhill 3-1215

CIRCLE 950 ON READER SERVICE CARD

OVER 2,000,000

RELAYS

IN STOCK!

Send for Catalog 55
Universal RELAY CORP.

42 WHITE ST., N.Y. 13, N.Y. • WAlker 5-6900

CIRCLE 951 ON READER SERVICE CARD



U.S. ARMY EE-8

Telephone fully reconditioned at 2 for \$35.00. Any number can be used on same line. Wire 2c per ft. or \$65.00 per mile. Write for complete telephone list.

TELEPHONE ENGINEERING CO.
Dept. E-8214
Simpson, Pa.

CIRCLE 952 ON READER SERVICE CARD

Electronics | August 24, 1964

AUTOTRACK ANTENNA MOUNT

300 degree azimuth, 210 degree elevation sweep with better than 1 mil. accuracy. Missile velocity acceleration and slewing rates. Amplidyne and servo control. Will handle up to 20 ft. dish. Supplied complete with control chassis. In stock—immediate delivery. Used world over by NASA, USAF. TYPE MP-61-B. SCR-584.



SCR 584 RADARS

AUTOMATIC TRACKING 3 CM & 10 CM
Our 584s in like new condition, ready to go, and in stock for immediate delivery. Ideal for telemetry research and development, missile tracking, satellite tracking, balloon tracking, weather forecasting, anti-aircraft defense tactical air support. Used on Atlantic Missile Range, Pacific Missile Range, N.A.S.A., Wallops Island, A.R.M.A. Write us. Pulley Disc: MIT Rad. Lab. Series, Vol. 1, pps. 207-210, 228, 284-286.

NIKE "AJAX" MOUNTS

Complete antenna mounts, as new, in stock for immediate delivery. Also airborne missile guidance pkgs.

PULSE MODULATORS

MIT MODEL 9 PULSER

1 MEGAWATT—HARD TUBE
Output 25 kv 40 amp. Duty cycle .002. Pulse lengths .25 to 2 microsec. Also .5 to 5 microsec. and 1 to 5 microsec. Uses 6C21. Input 115v 60 cycle AC. Mfr. GE. Complete with driver and high voltage power supply. Ref: MIT Rad. Lab. Series, Vol. 5, pps. 152-160.

500KW THYRATRON PULSER

Output 22kv at 28 amp. Rep. rates: 2.25 microsec. 300 pps. 1.75 msec 350 pps. .4 msec 2500 pps. Uses 6C22 hydrogen thyatron. Complete with driver and high voltage power supply. Input 115v 60 cy AC.

2 MEGAWATT PULSER

Output 30 kv at 70 amp. Duty cycle .001. Rep rates: 1 microsec 600 pps. 1 or 2 msec 300 pps. Uses 5948 hydrogen thyatron. Input 120/208 VAC 60 cycle. Mfr. GE. Complete with high voltage power supply.

15KW PULSER—DRIVER

Phase multivibrator type pulse generator using 3E29. Output 3kv at 5 amp. Pulse lgths .5 to 5 microsec. easily adj. to .1 to .5 msec. Input 115v 60 cy AC. \$475. Ref: MIT Rad. Lab. Series, Vol. 5, pps. 157-160.

MIT MODEL 3 PULSER

Output: 144 kw (12 kv at 12 amp.) Duty ratio: .001 max. Pulse duration: .5, 1 and 2 microsec. Input: 115 v 400 to 2000 cps and 24 vdc. \$525 ea. Full desc. Vol. 5, MIT Rad. Lab. series, pgs. 140.

MICROWAVE SYSTEMS

C-BAND RADAR

250 KW output, C-band, PPI indicator, 5C22 thyatron modulator. Antenna hi gain parabolic section. Input 115 volts 60 cycle AC. complete \$2750.00.

300 TO 2400MC RF PKG.

300 to 2400 MC CW Tunable. Transmitter 10 to 20 Watts. Output. As new \$475.

X BAND DOPPLER SYSTEM

AN/APN-102 G.P.L., ANT/RCVR/XMTR PKG. 4 Beam Pulsed Jamms Planar Array—New \$1,600 ea.

AN/TPS-ID RADAR

500 kw 1220-1350 mcs. 160 nautical mile search range P.P.I. and A. Scans. MITI. thyatron mod. 5J26 magnetron. Complete system.

AN/APS-15B 3 CM RADAR

Airborne radar. 40 kw output using 725A magnetron. Model 3 pulser. 30 in. parabola stabilized antenna. PPI scope. Complete system. \$1200 each. New.

10KW 3 CM. X BAND RADAR

Complete RF head including transmitter, receiver, modulator. Uses 2442 magnetron. Fully described in MIT Rad. Lab. Series Vol. 1, pps 616-625 and Vol. 11, pps. 171-185. \$375. Complete System \$750.

AN/APS-27 X BAND RADAR

Complete 100 kw output airborne system with AMTI, 5C22 thr. mod. 4J52 magnetron, PPI. 300 deg az sweep, 60 deg. elev. sweep, gyro stabilizer, hi-gain rev. Complete with all plugs and cables \$2800.

M-33 AUTO-TRACK RADAR SYSTEM

X band with plotting board, automatic range tracking, etc. Complete with 1 megawatt acquisition radar.

L BAND RF PKG.

20 KW peak 900 to 1040 MC. pulse width .7 to 1.2 microsec. Rep rate 180 to 420 pps. Input 115 vac. Incl Receiver \$1200.

3KW RCA PHONE & TELEG XMTRS

2-30 MC. 10 Autotone channels plus MO. Input 220 vac. 30-60 cycles.



Radio-Research Instrument Co.
560 5th Ave. New York 36, N.Y.
Tel. JUdson 8-4691

CIRCLE 955 ON READER SERVICE CARD

INDUSTRIAL ELECTRON TUBES

0A2	.75	4CX300A	35.00	12AU7WA	1.35	807	1.85	5777	100.00
0A2WA	1.50	4D32	12.50	12AX7W	1.15	807W	3.00	5778	100.00
0A3	.85	4E27	10.00	12AY7	1.10	809	5.00	5787	1.25
0B2	.65	4J50	80.00	12SA7GY	1.00	810	18.85	5800	6.00
0B2WA	1.25	4J52	50.00	12SK7Y	1.00	811	2.50	5803	4.00
0B3	.90	4J63	100.00	12SY7	1.00	811A	4.50	5814WA	1.25
0C3	.60	4PR60A	50.00	X-13	175.00	812A	4.50	5825	12.50
OD3	.50	4X150A	11.75	C16J	30.00	813	14.75	5829WA	1.35
C1A	10.00	4X250B	22.50	HK-24	4.00	814	4.00	5836	35.00
1AD4	2.00	5ABP1	20.00	25T	8.50	815	4.00	5837	35.00
1AE4	1.25	5BP1A	15.00	26A7GT	3.00	816	2.50	5840	1.50
1B24A	19.00	5C22	17.50	26Z5W	1.25	826	12.50	5841	3.50
1B35A	2.50	5CP1	5.00	28D7W	3.50	828	17.50	5845	4.00
1B63A	10.00	5CP1A	10.00	35T	10.00	829B	10.00	5854	.50
1D21 5N4	6.00	5J26	50.00	83	1.25	832A	7.50	5876A	13.00
C1K	5.50	5LP1	12.50	KU-99	16.50	833A	38.75	5879	1.25
1P21	30.00	5R4GY	1.35	101D	1.00	838	5.00	5886	4.00
1P28	16.50	5R4WGB	5.00	101F	2.25	842	7.50	5894	16.75
1Z2	3.50	5R4WGY	2.50	101L	2.25	845	15.00	5899	1.50
2-O1C	12.50	5R1A	30.00	FG-105	25.00	849	50.00	5906	3.00
2A1A	8.50	5Y3WGT	1.35	242C	15.00	851	75.00	5915	.95
2A515A	6.00	6AC7W	.85	249B	10.00	866A	2.00	5927	15.00
2BP1	10.00	6AG7Y	1.25	249C	8.85	872A	5.00	5931	2.50
2C39A	10.00	6AH6WA	3.00	250R	15.00	884	1.35	5948 1754	50.00
2C40	10.00	6AJ5	1.00	250TH	28.50	902A	5.00	5949 1907	75.00
2C43	10.00	6AK5W	1.00	251A	50.00	913	15.00	5963	.90
2C51	1.00	6AK5WB	2.50	259A	2.50	920	2.00	5964	.75
2C53	7.50	6AL5W	.60	V-262	150.00	923	1.75	5965	.60
2D21	.75	6AM6	1.55	262B	3.50	927	2.00	5993	4.00
2D21W	1.00	6AN5	1.50	FP-265	15.00	931A	5.00	6012	4.00
2E24	3.50	6AO5W	1.00	271A	12.50	959	1.00	6080	2.85
2E26	3.00	6AR6	.75	274A	2.50	R-1130B	12.00	6080WA	4.00
2J42	60.00	6A5GW	1.25	275A	5.00	1603	3.75	6080WB	10.00
2J51	50.00	6A57G	2.25	276A	7.50	1613 6F6	1.25	6082	3.35
2J55	25.00	6AU6WA	1.00	279A	150.00	1614 6L6	2.00	6115A	50.00
2K22	70.00	6AU6WB	1.25	287A	2.50	1619	.50	6130/3C45	6.50
2K25	12.50	6B4G	4.50	300B	4.50	1620 6J7	3.50	6146	3.00
2K26	25.00	6BA6W	.85	304TH	35.00	1624	1.00	6146A	3.75
2K28	20.00	6BE6W	1.25	304TL	35.00	1625	.75	6146B 8298A	4.25
2K29	25.00	6BF7W	1.75	310B	5.00	1655 6SC7	.85	6146W 7212	4.75
2K33A	200.00	6BH6W	2.75	311A	5.00	2050	1.35	6159	3.75
2K41	20.00	6BL6	20.00	328A	4.50	ZB-3200	200.00	6161	50.00
2K44	125.00	6BM6A	25.00	348A	3.50	5545	20.00	6197 6CL6	1.25
2P21	25.00	6C4WA	.85	349A	3.50	5550 415	35.00	6216	2.25
2X2A	1.35	6C21	35.00	350B	3.50	5557 FG-17	4.50	6236	95.00
3B4	1.50	6D4	1.00	352A	10.00	5559 FG-57	7.50	6252	16.50
3B24 (WE)	1.00	6DJ8	1.85	355A	7.50	5560 FG-95	16.50	6293	4.50
3B24W	3.50	6F4	3.50	371B	2.50	5586	150.00	6299	37.50
3B25	3.00	6GJ	7.50	403B	3.00	5639A	2.50	6316	50.00
3B28	3.00	6J4	2.00	404A	5.00	5642	2.00	6336	6.50
3C22	30.00	6J4WA	2.50	407A	3.25	5647	3.00	6336A	9.75
3C23	4.00	6J6W	.85	408A	2.25	5651	.85	6360	4.00
3C24	4.00	6L6	7.50	416B	17.50	5654 6AK5W	1.50	6386	6.00
3C45	6.00	6L4	2.50	417A	6.00	6096	1.50	6390	80.00
3CX100AS	12.50	6L6GAY	1.25	420A	3.00	5667 889RA	150.00	6442	17.50
3D21WA	10.00	6L6WGB	2.00	GL-434A	25.00	5670	1.00	6528	9.00
3D22	7.50	6L6Y	1.75	450TH	47.50	5672	1.10	6550	3.50
3DP1A	5.00	6Q5G	3.50	450TL	50.00	5675	4.50	6676 6CB6A	1.00
3E29	10.00	6SA7WGT	2.00	VA-508	350.00	5678	1.50	6678 6U8A	1.35
3GP1	3.50	65A7Y	1.50	QK-531	45.00	5686	1.75	6700	30.00
C3J A	10.00	65J7WGT	1.35	QK-532	45.00	5687	1.15	6807	20.00
3J21	125.00	65J7Y	.85	QK-549	45.00	5687WA	3.00	6829	3.00
3KP1	9.75	65K7Y	.85	575A	17.50	5691	4.50	6879	8.35
3RP1	8.50	65L7WGT	1.25	673	15.00	5692	3.00	6883	3.00
3WP1	15.00	65N7W	.75	677	45.00	5693	3.00	6893	3.25
4-65A	10.00	65N7WGT	1.15	BL-696	30.00	5696	1.00	6939	7.50
4-125A	25.00	65U7GY	1.00	715B	4.00	5702WA	2.50	7077	18.85
4-250A	27.50	6V6GY	1.00	715C	25.00	5703WA	2.50	7167	1.30
4-400A	38.00	6X4W	.70	719A	15.00	5704	1.50	7586	2.50
4-1000A	75.00	6X5WGT	.85	721B	6.00	5718A	.75	7895	2.50
4B31	15.00	6Y6	.75	725A	25.00	5719	.65	8002R	25.00
4C35	17.50	7C24	150.00	BL-800	25.00	5721	70.00	8008	6.00
4C35A	22.50	7MP7	25.00	803	6.50	5751	1.15	8013A	5.00
4CX250B	25.00	10KP7	25.00	804	10.00	5762 7C24	150.00	8121	17.50
4CX250K	50.00	12A77WA	1.15	805	10.00	5763	1.50	9005	3.50

ALL TUBES ARE NEW, INDIVIDUALLY CARTONED, FULLY GUARANTEED

western engineers

ELK GROVE, CALIFORNIA
SUPPLIERS OF ELECTRON TUBES SINCE 1932

Prices FOB
Min order \$10

CIRCLE 953 ON READER SERVICE CARD

MINIATURIZATION IS OUR BUSINESS!

- ★ TRANSISTORS
 - ★ DIODES
 - ★ TRANSFORMERS
 - ★ ELECTROLYTICS
 - ★ TANTALYTICS
 - VOLUME CONTROLS AND SWITCHES
- New surplus only. Large or small quantities available.

We also buy new surplus stock.
WRITE FOR LATEST FREE CATALOG
Transistors Unlimited Company
462 JERICHO TURNPIKE, MINEOLA, N. Y.
516 PI 7-7221

CIRCLE 954 ON READER SERVICE CARD

PROFESSIONAL SERVICES

GIBBS & HILL, Inc.
Consulting Engineers
Systems Engineering
Operations Research • Development
Field Studies • Design • Procurement
Power • Transportation • Communications
Water Supply • Waste Treatment
393 Seventh Avenue New York 1, N. Y.



■ AMP Incorporated	106
Garceau, Hargrave & McCullough Inc.	
Adage Incorporated	44
Fuller & Smith & Ross Inc.	
Aeroflex Laboratories	136
Groody Advertising Agency Inc.	
Air Express Div. of REA Express	31
Ketchum, MacLeod & Grove Inc.	
Ammon Instruments Inc.	130
Culver Advertising Inc.	
Atlanta Chamber of Commerce	90
Tucker Wayne & Company	
Babcock Relays	89
Jay Chiat and Associates	
Barber-Colman Company	114
Howard H. Monk & Associates Inc.	
Bausch & Lomb, Inc.	124
Wolff Associates Inc.	
Bell Telephone Laboratories	91
N.W. Ayer & Son Inc.	
■ Boonton Radio Company, A Div. of	
Hewlett Packard	2
George Homer Martin Associates	
■ Bourns Inc., Trimpot Division	34, 35
Allen, Dorsey & Hatfield Inc.	
Bud Radio Inc.	46
Allied Advertising Agency Inc.	
■ Busmann Mfg. Co., Div. of	
McGraw Edison Co.	112, 113
Henderson Advertising Company	
Cambridge Thermionic Corp.	112
Chirurg & Cairns, Inc.	
Clairex Corp	135
S. Paul Sims Co.	
Clare & Company, C.P.	19, 20
Reincke, Meyer & Finn Adv.	
Cohu Electronics, Kin Tel Div.	3rd Cover
Erwin Wasey Ruthrauff & Ryan	
Cominco Products Inc.	134
McKim Adv. Limited	
■ Computer Instruments Corp.	111
Dickerman Adv.	
Consolidated Electrodynamics Corp.	12, 13
Hixson & Jorgensen Inc.	
Continental Electronics Sub.	
of Ling Temco Vought	93
Evans, Young, Wyatt Advertising	
Coto Coil	130
The Williams Company	
Data Instruments, Div. of	
Industrial Electronic Hardware Corp.	116
A.D. Adams Advertising Inc.	
Defense Electronics Inc.	104
Compton Jones Associates	
■ Delco Radio	92
Campbell-Ewald Company	
DuPont De Nemours &	
Co. Inc., E.I.	22, 23, 39, 115
Batten, Barton, Durstine & Osborn Inc.	
Eldorado Electronics	16
Sturges & Accessories	
Electro Scientific Industries Inc.	45
Nadler and Larimer Inc.	
Engelhard Industries Inc.	108, 109
Keyes, Martin & Company	
Fairchild Dumont Laboratories	43, 123
The Roger and Wilbur Co. Inc.	
Fairchild Semiconductor	14
Johnson & Lewis Inc.	
Flying Tiger Line	9
Hixson & Jorgensen, Inc.	
Fox Electronics Co., Ltd.	132
Nichiden Adv. Ltd.	
General Electric Co.,	
Semiconductor Products Dept.	48
Ross Roy Inc.	
Globe Industries Inc.	136
Odiorne Industrial Adv. Inc.	
Hallikainen Instruments	117
Hal Lawrence Incorporated	
Hamilton Standard, Div. of	
United Aircraft Corporation	127
Cunningham & Walsh Inc.	
Heinz Electric	136
Reynolds & Foster Inc.	
■ Hewlett Packard Company	1
L.C. Cole Company Inc.	
Hitachi Ltd.	21
Dentsu Advertising Ltd.	
■ International Rectifier Corporation	36
Communication Associates	

■ Jennings Radio Mfg. Corp.	125
L.H. Waldron	
■ Lapp Insulator Co., Inc.	128
Wolff Associates, Inc.	
■ Leach Corporation	40
Hixson & Jorgensen Inc.	
Loral Electronics Corp.	119
Pritchard, Wood Incorporated	
Machlett Laboratories Inc., The	8
Fuller & Smith & Ross Inc.	131
Markem Machine	
Culver Adv. Inc.	
McGraw-Hill Book Co. Inc.	137
Moseley, F.L.	129
L.C. Cole Company	
National Cash Register Co.	120, 121
Allen, Dorsey & Hatfield Inc.	
Newark Electronics Corporation	133
Stral Advertising Company Inc.	
North Atlantic Industries, Inc.	101
Murray Heyert Associates	
Paktron, Div. Illinois Tool Works	102, 103
Inc.	
Raymond E. Finn & Associates	
Patwin Electronics Company	135
Graceman Advertising Inc.	
Pennsalt Chemicals	94
Aitkin-Kynett Co., The	
Perkin-Elmer	136
Rozene Adv. Agency Inc.	
Princeton Applied Research Corp.	110
Mort Barish Associates	
Qualtronic Corp.	134
Gerald C. Smith Associates	
■ Radiation Inc.	105
G.M. Basford Company	
Radio Corporation of America	4th Cover
Al Paul Lefton Co.	
Rauland Corporation The	41
Burton Browne Advertising	
Raytheon Company	100
Fuller & Smith & Ross Inc.	
■ Singer Company, Metrics Div.	47
Sprague Electric Co.	5, 6, 10
The Harry P. Bridge Co.	
Stackpole Carbon Co.	11
Meek and Thomas Inc.	
Stromberg-Carlson Div.	
of General Dynamics	126
The Rumrill Company Inc.	
Texas Instruments Incorporated	42
Industrial Products Group	
Robinson-Gerrard Inc.	
Triplett Electrical Instrument Company	99
Burton Browne Advertising	
■ United Transformer Corp.	2nd Cover
Bradley Rosen & Kaus Adv. Inc.	
Unitrode Corporation	7
Chirurg & Cairns Inc.	
Vidar Corporation	33
Bonfield Associates, Inc.	
Winchester Electronics Div.	
of Litton Industries	24
West, Weir & Bartel Inc.	

Classified advertising

F. J. Eberle, Business Mgr.	
Professional services	141
Employment opportunities	139, 140
(Used or Surplus New)	
For Sale	140, 141

Classified advertisers index

Jet Propulsion Laboratory	139
Marty's Mart	140
Motorola Inc.	140
■ Radio Research Instrument Co	141
Telephone Engineering Co.	140
■ Transistors Unlimited Co	141
■ Universal Relay Corp	140
■ Western Engineers	141

Advertising sales staff

Gordon Jones: [212] 971-2210
Advertising sales manager

Atlanta, Ga. 30309: Gus H. Krimsier, Michael H. Miller, 1375 Peachtree St. N.E., [404] TR 5-0523

Boston, Mass. 02116: William S. Hodgkinson, McGraw-Hill Building, Copley Square, [617] CO 2-1160

Chicago, Ill. 60611: Robert M. Denmead, Daniel E. Shea, Jr., 645 North Michigan Avenue, [312] MO 4-5800

Cleveland, Ohio 44113: Paul T. Fegley, 55 Public Square, [216] SU 1-7000

Dallas, Texas 75201: Dick Poole, The Vaughn Building, 1712 Commerce Street, [214] RI 7-9721

Denver, Colo. 80202: John W. Patten, David M. Watson, Tower Bldg., 1700 Broadway, [303] AL 5-2981

Houston, Texas 77025: Kenneth George, Prudential Bldg., Halcombe Blvd., [713] RI 8-1280

Los Angeles, Calif. 90017: Ashley P. Hartman, John G. Zisch, 1125 W. 6th St., [213] HU 2-5450

New York, N.Y. 10036: Donald R. Furth [212] 971-3616 Frank LeBeau [212] 971-3615 George F. Werner [212] 971-3617 500 Fifth Avenue

Philadelphia, Pa. 19103: William J. Boyle, Warren H. Gardner, 6 Penn Center Plaza, [215] LO 8-6161

San Francisco, Calif. 94111: James T. Hauptli, 255 California Street, [415] DO 2-4600

London W1: Edward E. Schirmer, 34 Dover Street, Hyde Park 1451

Frankfurt/Main: Mathee Herfurth, 85 Westendstrasse Phone: 77 26 65 and 77 30 59

Geneva: Michael R. Zeynel, 2 Place du Port 244275

Paris VIII: Denis Jacob, 17 Avenue Matignon ALMA-0452

Tokyo: Shigeo Chiba, 1, Kotohiracho, Shiba, Minato-ku (502) 0656

Osaka: Kazutaka Miura, 163, Umegae-cho, Kita-ku [362] 8771

Nagoya: International Media Representatives, Yamagishi Bldg., 13,2-Chome, Oike-cho Naga-ku

R.S. Quint: [212] 971-2335
General manager
Electronics Buyers' Guide

David M. Tempest: [212] 971-3139
Promotion manager

Milton Drake: [212] 971-3485
Market research manager

Richard J. Tomlinson: [212] 971-3191
Business manager

Theodore R. Gelpel: [212] 971-2044
Production manager

■ For more information on complete product line see advertisement in the latest Electronics Buyers' Guide

Executive, editorial, circulation and advertising offices: McGraw-Hill Building, 330 West 42nd Street, New York, N.Y., 10036, Telephone Area Code 212-971-3333, Teletype TWX N.Y. 212-640-4646, Cable: McGrawhill, N.Y. Officers of the Publications Division: Shelton Fisher, President; Vice Presidents: Joseph H. Allen, Operations; Robert F. Boger, Administration; John R. Callahan, Editorial; Ervin E. DeGraff, Circulation; Donald C. McGraw, Jr., Advertising Sales; Angelo R. Venezian, Marketing. Officers of the Corporation: Donald C. McGraw, President; Hugh J. Kelly, Harry L. Waddell, L. Keith Goodrich, Executive Vice Presidents; John L. McGraw, Treasurer; John J. Cooke, Vice President and Secretary. Title R registered U.S. Patent Office; © copyright 1964 by McGraw-Hill, Inc. All rights reserved, including the right to reproduce the contents of this publication, in whole or in part.

Look what KIN TEL brings you in a DC voltage standard for just \$1995!

outside view:

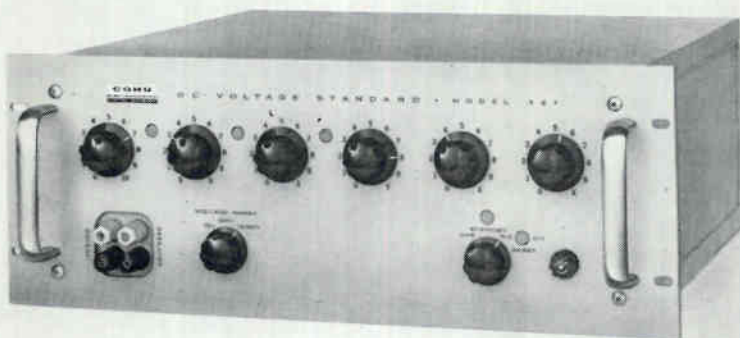

diagrammatic view:

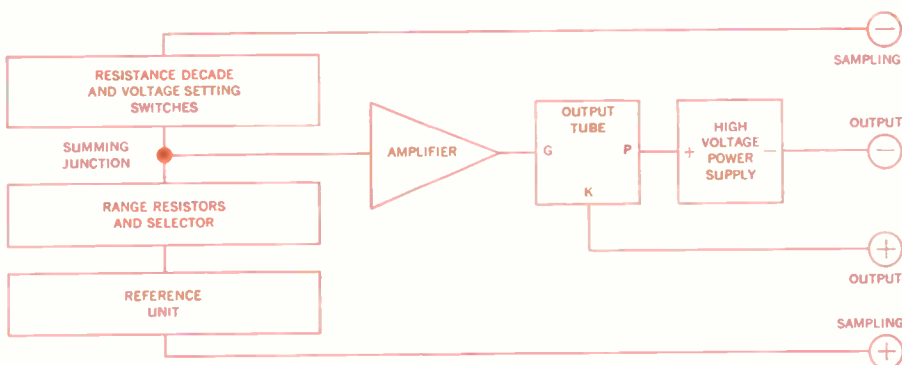

engineer's view:

MODEL 321
DC VOLTAGE STANDARD

0 to ± 1111.110 volts

10 volt, 100 volt, 1000 volt ranges

10- μV , 100- μV , 1-mv steps

current up to 25 ma

0.01% accuracy

0.0025% voltage output
stability/8 hours

0.005% voltage output
stability/30 days

0.001 ohm source impedance

floating output

overcurrent protection

Write today for detailed information or a demonstration of this latest voltage standard in the KIN TEL line. Representatives in all major cities. All prices F.O.B., San Diego, California. (Additional export charge.)

Box 623
San Diego, California 92112
Phone (714) 277-6700



Visit our Booth 1017 at WESCON, Sports Arena, Los Angeles, August 25-28

Circle 901 on reader service card

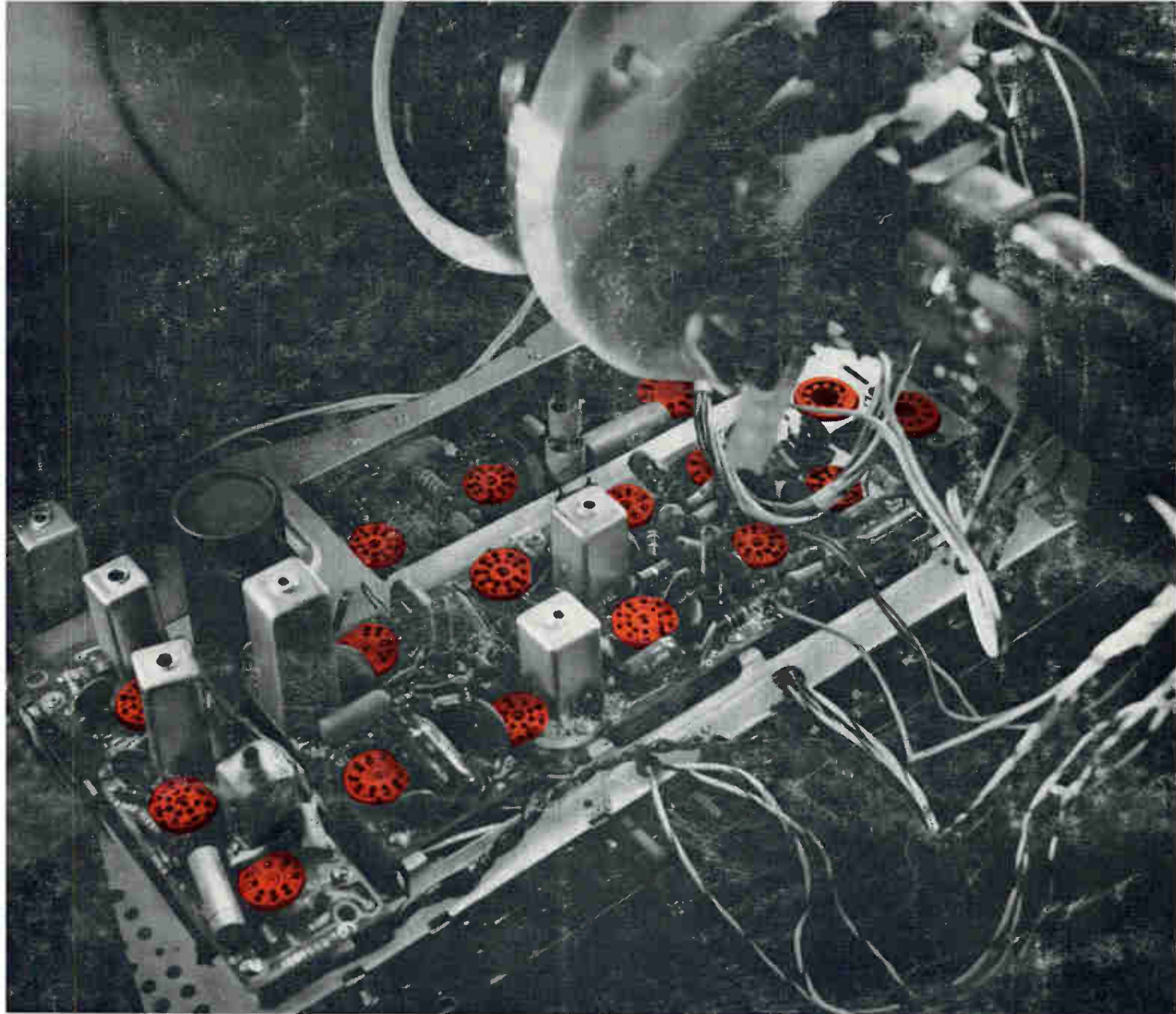

For the best possible color-TV picture

THESE SOCKETS NEED COLOR-TV RECEIVING TUBES BY RCA

In today's growing and highly-competitive color-TV market, your company's reputation rides on the performance of the color sets you manufacture.

That's why it's so important that you specify dependable RCA COLOR-TV RECEIVING TUBES for every socket.

**What's so special about RCA
COLOR-TV RECEIVING TUBES?**

As pioneer of today's compatible color TV, RCA has accumulated knowledge of color-TV circuitry that is unmatched in the industry. This knowledge has enabled us to select and develop the group of receiving tubes that best meet the exacting requirements of today's high-fidelity color TV.

The tubes have been field-proven in thousands of color-TV sets across the nation.

Samples of each week's production of RCA COLOR-TV RECEIVING TUBES are given exhaustive tests, under actual field conditions, in our Tube Reliability Laboratory. The performance of these sample tubes must meet rigid quality standards before their respective production lots are released to the warehouses.

This group of RCA tubes offers color-TV manufacturers the best combination of price, performance and reliability on the market today.

RCA ELECTRONIC COMPONENTS AND DEVICES, HARRISON, N.J.

RCA DISTRICT OFFICES - EAST: 32 Green St., Newark, N.J. 07102, (201) 485-3900 • MID-ATLANTIC: 605 Marlton Pike, Haddonfield, N.J. 08034, (609) 428-4802 • MID-CENTRAL: 2511 East 46th St., Building Q2, Atkinson Square, Indianapolis, Ind. 46205, (317) 546-4001 • CENTRAL: 1154 Merchandise Mart Plaza, Chicago, Ill. 60654, (312) 527-2900 • WEST: 6363 Sunset Blvd., Hollywood, Calif. 90028, (213) 461-9171



The Most Trusted Name in Electronics

1578