

Electronics®

Thermal transfer works in microcircuits: page 54

Computers cut testing costs: page 76

Receiving weather photos from orbit: page 81

July 27, 1964

75 cents

A McGraw-Hill Publication

Below: new photon-coupled devices
find applications, page 58

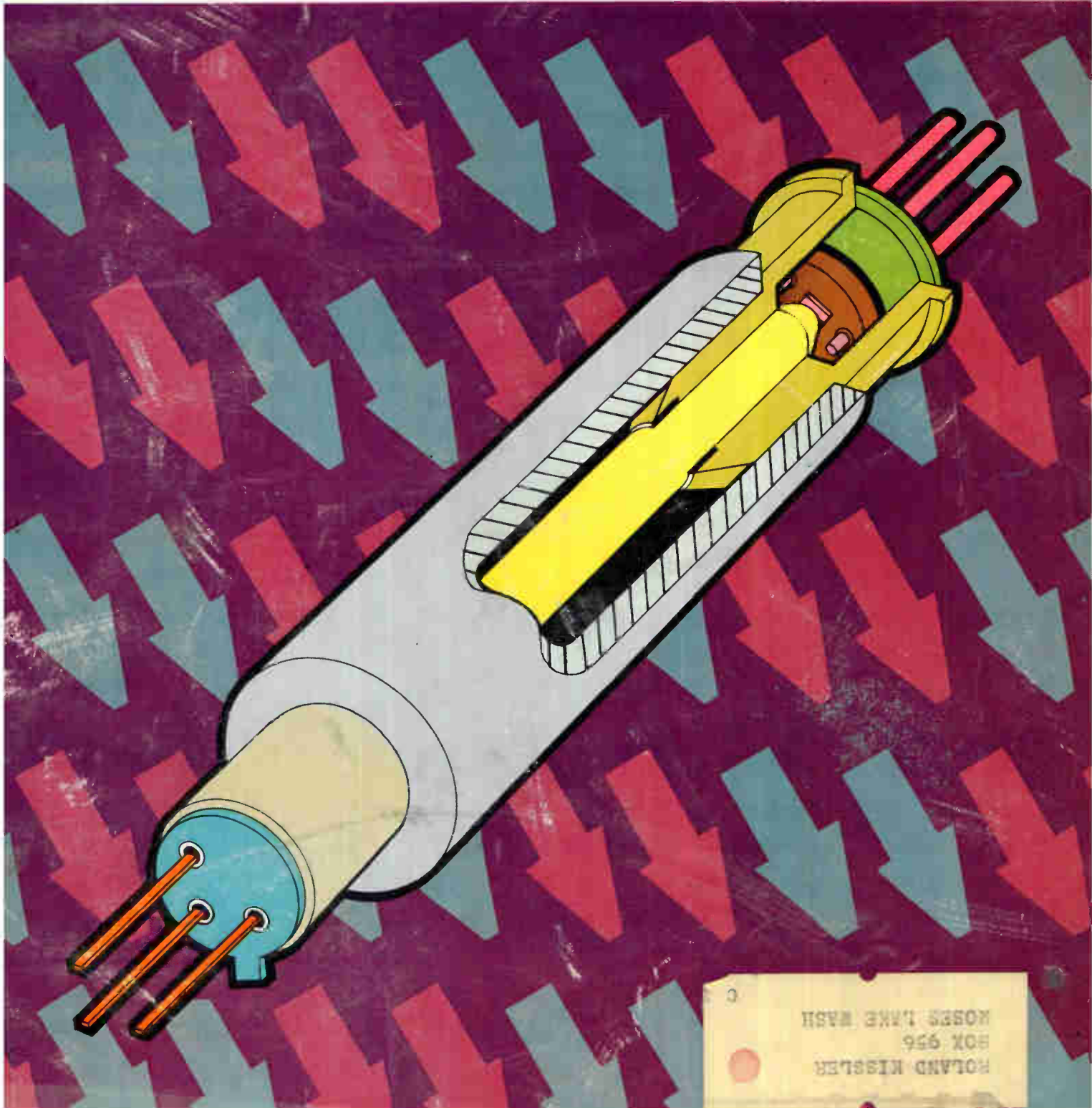

AUDIO TRANSFORMERS

DO-T No.	Pri. Imp.	D.C. Ma. in Pri.	Sec. Imp.	Pri. Res. DO-T	Pri. Res. DI-T	Mw Level	DI-T No.
DO-T44	80 CT 100 CT	12 10	32 split 40 split	9.8	11.5	500	DI-T44*
DO-T29	120 CT 150 CT	10 10	3.2 4	10		500	
DO-T12	150 CT 200 CT	10 10	12 16	11		500	
DO-T13	300 CT 400 CT	7 7	12 16	20		500	
DO-T19	300 CT	7	600	19	20	500	DI-T19
DO-T30	320 CT 400 CT	7 7	3.2 4	20		500	
DO-T43	400 CT 500 CT	8 6	40 split 50 split	46	50	500	DI-T43*
DO-T42	400 CT 500 CT	8 6	120 split 150 split	46		500	
DO-T41	400 CT 500 CT	8 6	400 split 500 split	46	50	500	DI-T41*
DO-T2	500 600	3 3	50 60	60	65	100	DI-T2
DO-T20	500 CT	5.5	600	31	32	500	DI-T20
DO-T4	600	3	3.2	60		100	
DO-T14	600 CT 800 CT	5 5	12 16	43		500	
DO-T31	640 CT 800 CT	5 5	3.2 4	43		500	
DO-T32	800 CT 1000 CT	4 4	3.2 4	51		500	
DO-T15	800 CT 1070 CT	4 4	12 16	51		500	
DO-T21	900 CT	4	600	53	53	500	DI-T21
DO-T3	1000 1200	3 3	50 60	115	110	100	DI-T3
DO-T45	1000 CT 1250 CT	3.5 3.5	16,000 split 20,000 split	120		100	
DO-T16	1000 CT 1330 CT	3.5 3.5	12 16	71		500	
DO-T33	1060 CT 1330 CT	3.5 3.5	3.2 4	71		500	
DO-T5	1200	2	3.2	105	110	100	DI-T5
DO-T17	1500 CT 2000 CT	3 3	12 16	108		500	
DO-T22	1500 CT	3	600	86	87	500	DI-T22
DO-T34	1600 CT 2000 CT	3 3	3.2 4	109		500	
DO-T51	2000 CT 2500 CT	3 3	2000 split 2500 split	195	180	100	DI-T51
DO-T37	2000 CT 2500 CT	3 3	8000 split 10,000 split	195	180	100	DI-T37*
DO-T52	4000 CT 5000 CT	2 2	8000 CT 10,000 CT	320	300	100	DI-T52
DO-T18	7500 CT 10,000 CT	1 1	12 16	505		100	
DO-T35	8000 CT 10,000 CT	1 1	3.2 4	505		100	
*DO-T48	8,000 CT 10,000 CT	1 1	1200 CT 1500 CT	640		100	
*DO-T47	9,000 CT 10,000 CT	1 1	9000 CT 10,000 CT	850		100	
DO-T6	10,000	1	3.2	790		100	
DO-T9	10,000 12,000	1 1	500 CT 600 CT	780	870	100	DI-T9
DO-T10	10,000 12,500	1 1	1200 CT 1500 CT	780	870	100	DI-T10
DO-T25	10,000 CT 12,000 CT	1 1	1500 CT 1800 CT	780	870	100	DI-T25
DO-T38	10,000 CT 12,000 CT	1 1	2000 split 2400 split	560	620	100	DI-T38*
DO-T11	10,000 12,500	1 1	2000 CT 2500 CT	780	870	100	DI-T11
DO-T36	10,000 CT 12,000 CT	1 1	10,000 CT 12,000 CT	975	970	100	DI-T36
DO-T1	20,000 30,000	.5 .5	800 1200	830	815	50	DI-T1
DO-T23	20,000 CT 30,000 CT	.5 .5	800 CT 1200 CT	830	815	50	DI-T23
DO-T39	20,000 CT 30,000 CT	.5 .5	1000 split 1500 split	800		50	
DO-T40	40,000 CT 50,000 CT	.25 .25	400 split 500 split	1700		50	
DO-T46	100,000 CT	0	500 CT	7900		25	
DO-T7	200,000	0	1000	8500		25	
DO-T24	200,000 CT	0	1000 CT	8500		25	
DO-TSH	Drawn Hipermalloy shield and cover 20/30 db						DI-TSH

DCMA shown is for single ended usage (under 5% distortion—100MW—1KC) for push pull, DCMA can be any balanced value taken by 5W transistors (under 5% distortion—500MW—1KC) DO-T & DI-T units designed for transistor use only. U.S. Pat. No. 2,949,591; others pending.
 *Series connected; §§Parallel connected → *Units newly added to series

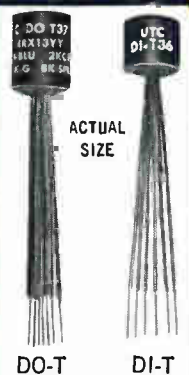

DO-T & DI-T

Transistor TRANSFORMERS and INDUCTORS

NOW! Hermetically Sealed to MIL-T-27B

*16 New Items Added to Stock Line
IMMEDIATE DELIVERY FROM STOCK

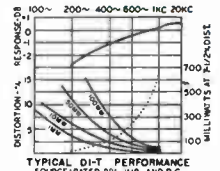
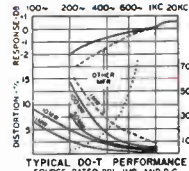

- High Power Rating up to 10 times greater
- Excellent Response twice as good at low end
- Low Distortion reduced 80%
- High Efficiency up to 30% better . . . compare DCR
- Moisture Proof hermetically sealed to MIL-T-27B
- Rugged Grade 4, completely metal cased
- Anchored Leads will withstand 10 pound pull test
- Printed Circuit Use (solder melting) nylon insulated leads
- Suited to Clip Mounting use Augat #6009-8A clip

INDUCTORS

DO-T No.	Inductance Hys @ ma	DO-T DCRΩ	DI-T DCRΩ	DI-T No.
*DO-T50 (2 wdg.)	\$.075 Hy/10 ma, .06 Hy/30 ma	10.5		
	\$.018 Hy/20 ma, .015 Hy/60 ma	2.6		
DO-T28	.3 Hy/4 ma, .15 Hy/20 ma	25		
	.1 Hy/4 ma, .08 Hy/10 ma		25	DI-T28
DO-T27	1.25 Hys/2 ma, .5 Hy/11 ma	100		
	.9 Hy/2 ma, .5 Hy/6 ma		105	DI-T27
DO-T8	3.5 Hys/2 ma, 1 Hy/5 ma	560		
	2.5 Hys/2 ma, .9 Hy/4 ma		630	DI-T8
DO-T26	6 Hys/2 ma, 1.5 Hys/5 ma	2100		
	4.5 Hys/2 ma, 1.2 Hys/3 ma		2300	DI-T26
*DO-T49 (2 wdg.)	\$.20 Hys/1 ma, .8 Hys/3 ma	5100		
	\$.5 Hys/2 ma, 2 Hys/6 ma	1275		

POWER TRANSFORMERS

*DO-T400	Pri 28V 380-1000 cycles, Sec 6.3V @ 60 ma
*DO-T410	Pri 28V 380-1000 cycles, 2-Sec 6.3 @ 30 ma each
*DO-T420	Pri 28V 380-1000 cycles, Sec 28V @ 20 ma (Isol. Electrostatic Shld.)

UNITED TRANSFORMER CORP.

150 VARICK STREET, NEW YORK 13, N. Y.

PACIFIC MFG. DIVISION: 3630 EASTHAM DRIVE, CULVER CITY, CALIF.
 EXPORT DIVISION: 13 EAST 40th STREET, NEW YORK 16, N. Y.

CABLE: "ARLAB"

Write for catalog of over 1,200 UTC HIGH RELIABILITY STOCK ITEMS IMMEDIATELY AVAILABLE from your local distributor.



CALIBRATE YOUR OSCILLATOR AGAINST THE U.S. FREQUENCY STANDARD

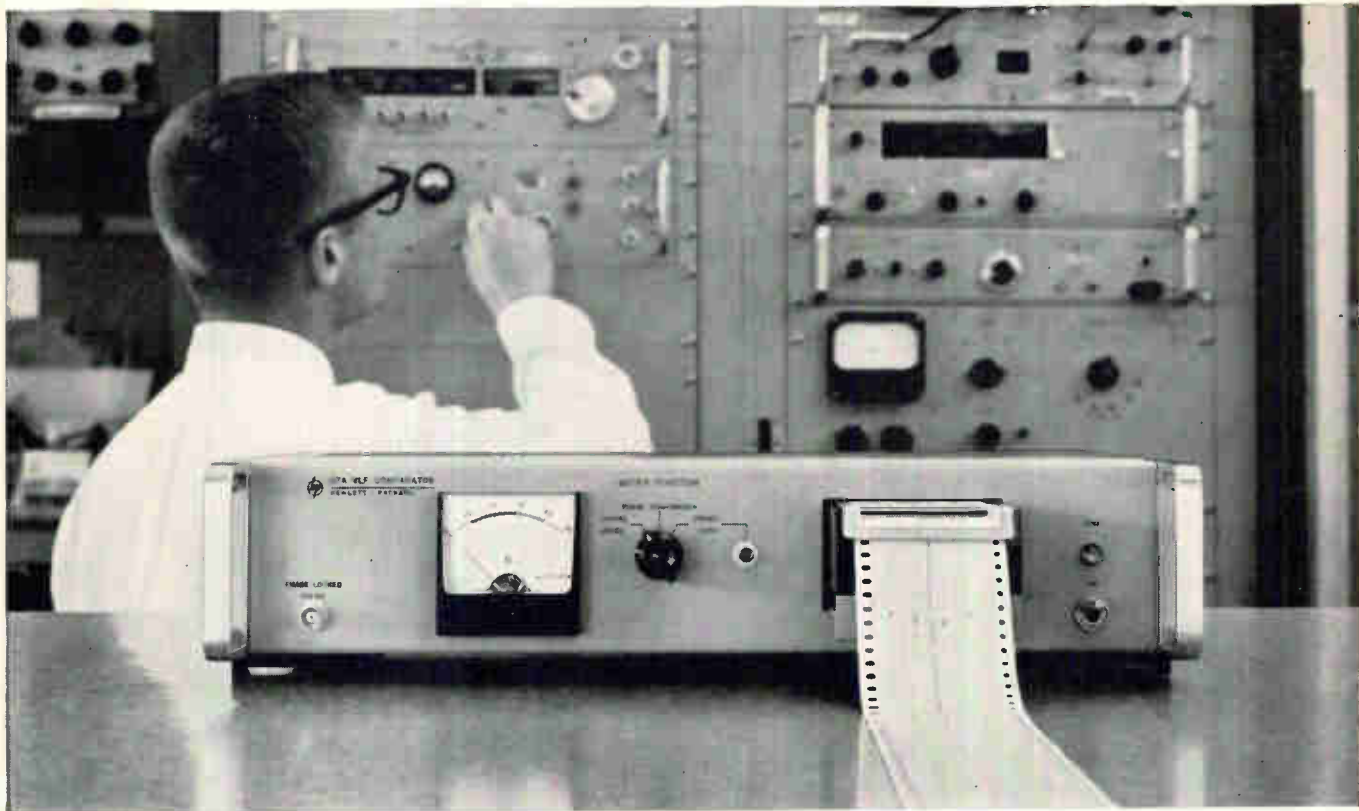

New hp 117A VLF Comparator for only \$1150

Here is an easy, precise and inexpensive way to calibrate your own oscillator against the United States Frequency Standard... whether it's the time base in your electronic counter or your laboratory frequency standard. The new hp 117A VLF Comparator provides all the features needed for frequency standardization. You need no other instruments.

The 117A makes accurate phase comparisons between local oscillators and the 60 kc U. S. Frequency Standard broadcast by the National Bureau of Standards on WWVB.

This instrument makes comparisons with an accuracy approaching 1 part in 10^{10} over an 8-hour period. WWVB broadcasts a signal capable of being received at a precision of about 5 parts in 10^{11} during a 24-hour period.

The 117A employs an electronic servo system that permits the utilization of the WWVB signal to phase lock a voltage controlled oscillator. The local standard is then compared to this phase-locked oscillator and a continuous phase difference recording is made on a built-in strip chart recorder. Templates are furnished for direct reading of recorder charts. A front panel meter shows signal level, satisfactory phase lock with WWVB, or phase comparison, depending on switch setting. The 117A provides a 100 kc phase-locked output accurate enough to use as a

local standard during stable propagation conditions. External recorder outputs are included for recording phase comparison and signal level.

Check your oscillator requirements and consider the advantages of a fast VLF U. S. Frequency Standard transfer, then ask your Hewlett-Packard field engineer for all the information.

SPECIFICATIONS

USFS input:	60 kc (WWVB carrier)
Sensitivity:	1 μ v rms into 50 ohms
Local standard input:	100 kc, 1 v rms into 1000 ohms (1 mc option)
100 kc phase-locked output:	20 v rectangular positive pulses into 5000 ohms
Phase stability:	± 1 μ sec, 0-50°C
Chart width:	50 μ sec or 16 $\frac{2}{3}$ μ sec (internal switch)
Chart speed:	1 inch per hour, others available upon request
Size:	3 $\frac{1}{2}$ " high, 11 $\frac{1}{2}$ " wide, 16 $\frac{3}{4}$ " deep, 15 lbs.
Price:	\$1150 including 60 kc antenna

Data subject to change without notice. Price f.o.b. factory.

**HEWLETT
PACKARD
COMPANY**



An extra measure of quality

1501 Page Mill Road, Palo Alto, Calif. 94304, (415) 326-7000. Sales and service in all principal areas. Europe, Hewlett-Packard S.A., 54 Route des Acacias, Geneva, Switzerland; Canada, Hewlett-Packard (Canada) Ltd., 8270 Mayrand St., Montreal, Que.

New Sanborn Tape System

7 CHANNELS plus monitoring track

**6 ELECTRICAL SPEEDS without
capstan change**

40 db or better SIGNAL/NOISE RATIO

0.2% P-P FLUTTER

IRIG compatibility

for under \$9,000



Now you can have precision instrumentation tape system performance at *substantially lower cost than ever before*, with this completely new Sanborn 3900 Series incorporating a specially-designed Hewlett-Packard transport. The primary objective was to provide a highly flexible, reliably useful system with *stable tape motion, simple operation and no maintenance* — at a significantly *lower cost*. These objectives have

been successfully accomplished, in a system which has:

- Greatly reduced interchannel crosstalk with a new magnetic head assembly design using improved shielding.
- High signal/noise ratio, gentle tape handling and reduced tape wear, through precisely controlled tape tension, driving and braking torques, and guide element designs.
- Plug-in solid-state electronics with record/reproduce amplifiers on the same cards, and equalization plug-ins necessary only for speeds to be used.
- No need for maintenance or lubrication, except for cleaning tape path.
- Built-in footage counter accurate to 99.95%.
- Quick, easy snap-on tape reel loading.
- Cabinet, rack or portable case mounting.

Check the key specifications here, then call your local H-P Field Engineering Office for complete details and prices. Or write Sanborn Company, Industrial Division, 175 Wyman Street, Waltham, Massachusetts 02154.

SERIES 3907A (7-channel), 3914A (14-channel)

SPEEDS	6, electrically controlled, pushbutton selected, 1½ to 60 ips; other speed ranges optional. Max. start 2 sec., max. stop 1 sec.; ±0.25% max. variation in tape speed at nominal line frequency.
TAPE	7-channel ½"; 14-channel 1"; 2400 feet 1.5 mil, 3600 feet 1.0 mil; 4800 feet 0.65 mil; 10½" reels.
RECORDING MODES	Direct, FM or Pulse Record/Reproduce via interchangeable solid state plug-in electronics; 7-channels in 7½" panel space. Single-ended inputs, push-pull with optional coupler. Adjustable input/output levels.

Circle 2 on reader service card



BANDWIDTH	RESPONSE	SIGNAL/NOISE RATIO (RMS)
Direct (60 ips) 100-100,000 cps	± 3 db	40 db
FM (60 ips) 0-10,000 cps (Wideband systems available soon — 250 KC direct, 20 KC FM)	± 0, -1 db	44 db without flutter compensation 48 db with flutter compensation
P-P FLUTTER (30 & 60 ips)	0-1 KC, 0.2% max. 0-5 KC, 0.5% max.	
CONTROLS	Power, Stop, Play, Reverse, Fast Forward, Record; all can be remotely controlled	

PRICES (f.o.b. Waltham, Mass.) (Systems represent two of many choices available. Prices are correspondingly lower for fewer speed filters, or where direct record/reproduce electronics are specified, and higher when filters for all six speeds are ordered.)

Complete 7-channel system for FM recording and reproducing, with filters for 3 speeds, extra (8th) channel for monitoring, and console cabinet: \$8900

Same system, for 14-channels: \$13,370

SANBORN 
A DIVISION OF HEWLETT-PACKARD

Electronics

Page 4	Readers comment
8	People
10	Meetings ahead
15	Editorial
17	Electronics newsletter
43	Washington newsletter
111	New products
132	New literature
135	New books
136	Technical abstracts

In this issue

Microelectronics	54	Low-frequency integrated circuits Thermal transfer makes possible new oscillators, filters and delay networks for below 100 cps W.T. Matzen and R.A. Meadows, Texas Instruments
Solid state	58	Optoelectronics at work (cover) New components use photon coupling in applications from amplifiers to demodulators, oscillators to mixers Irwin Wunderman, hp Associates
Components	68	Stray signals can't throw this desensitized switch It discriminates between r-f energy and a d-c pulse with an extra zener junction J.M. Gault and R.J. Sanford, Naval Ordnance Laboratory
Circuit design	72	Designers casebook Displaying the contents of a computer register; added transistor decreases multivibrator reset time; nomograph shows phase-shift angle; positive-pulse generator; buffer amplifier supplies bipolar output
Computer	76	Automatic circuit tester Digital computer saves time and money and increases capability in production testing Kenneth Wakeen, Digital Equipment Corp.
Space electronics	81	Bird's eye view of the weather Meteorological satellites will send cloud pictures Here's a ground station to receive them C.M. Hunter and E. Rich Jr., NASA
Communications	88	Tropo goes commercial AT&T prepares to use a new solid-state system that's been proved by the military Alexander A. McKenzie, Communications editor

Electronics review

Page 27	Instant radar maps	30	Out, damned spot
27	Ceramic that foams	32	Superpower triodes
28	Numerical sculpture	32	SAC speedup
28	Shocking shrimp	34	More power
29	The littlest Biax	34	Which way is down?
29	Thin films of glass	34	No cheating
30	Thin-film first		

Probing the news

99	Homemade ground stations
101	The state of the unions
106	Microsurgery in color tv

Technical articles

I. Design

Microelectronics	54	Low-frequency integrated circuits Thermal transfer makes possible new oscillators, filters and delay networks for below 100 cps W.T. Matzen and R.A. Meadows, Texas Instruments
Solid state	58	Optoelectronics at work (cover) New components use photon coupling in applications from amplifiers to demodulators, oscillators to mixers Irwin Wunderman, hp Associates
Components	68	Stray signals can't throw this desensitized switch It discriminates between r-f energy and a d-c pulse with an extra zener junction J.M. Gault and R.J. Sanford, Naval Ordnance Laboratory
Circuit design	72	Designers casebook Displaying the contents of a computer register; added transistor decreases multivibrator reset time; nomograph shows phase-shift angle; positive-pulse generator; buffer amplifier supplies bipolar output
Computer	76	Automatic circuit tester Digital computer saves time and money and increases capability in production testing Kenneth Wakeen, Digital Equipment Corp.
Space electronics	81	Bird's eye view of the weather Meteorological satellites will send cloud pictures Here's a ground station to receive them C.M. Hunter and E. Rich Jr., NASA
Communications	88	Tropo goes commercial AT&T prepares to use a new solid-state system that's been proved by the military Alexander A. McKenzie, Communications editor

Electronics

Editor: Lewis H. Young

Managing editor: John M. Carroll

Senior editors

Technical: Samuel Weber

News: George Sideris

Senior associate editor: John F. Mason

Department editors

Advanced technology: George V. Novotny

Avionics: W.J. Evanzia

Circuit design: Jerome Eimbinder

Communications: Alexander A. McKenzie

Components: Michael F. Tomaino

Computers: Stephen B. Gray

Consumer electronics: V.S. Acunto

Industrial electronics: Louis S. Gomolak

Instrumentation: George J. Flynn

Military electronics: John F. Mason

New products: William P. O'Brien

Solid state: G.G. Tirellis

Space electronics: Joel A. Strasser

Staff writers: Leon H. Dulberger, Peggy Jackson

Regional editors

Boston: Thomas Maquire, editor; Susan Turner

Chicago: Cletus M. Wiley, editor; Leslie Krimston

Los Angeles: Harold C. Hood, editor

San Francisco: Laurence D. Shergalis, editor; Mary Jo Jadin

London: Derek Barlow, editor

Copy editors

Howard Rausch, Sally Powell

Illustration

Art director: Howard R. Berry

Assistant art director: John C. Wright, Jr.

Editorial production: Ann Mella, Sandra A. LeMond

Editorial secretaries: Claire Benell, Lynn Emery,

Kay Fontana, Lorraine Rossi, Lorraine Werner

McGraw-Hill news service

Director: John Wilhelm; Atlanta: Fran Ridgeway; Chicago: Bruce Cross;

Cleveland: Arthur Zimmerman; Dallas: Marvin Reid;

Detroit: Donald MacDonald; Los Angeles: Kemp Anderson, Michael Murphy,

Ron Lovell; San Francisco: Margaret Ralston, Ed. Addeo;

Seattle: Ray Bloomberg; Washington: George Bryant Jr., Glen Bayless,

Charles Gardner

McGraw-Hill world news service

Bonn: Richard Mikton; Brussels: Arthur Erikson; London: John Shinn;

Mexico City: Wesley Perry; Milan: Bruce Bendow;

Moscow: Donald Winston; Paris: Dan Smith;

Rio de Janeiro: Leslie Warren; Tokyo: Richard Halloran, Charles Cohen

Circulation manager: Hugh Quinn

Reprints: T.M. Egan

Publisher: C.C. Randolph

Electronics: July 27, 1964, Vol. 37, No. 21

Printed at 99 North Broadway, Albany, N.Y.

Second class postage paid at Albany, N.Y.

Subscriptions are solicited only from those actively engaged in the field of the publication. Position and company connection must be indicated on orders. Subscription prices: United States and Possessions and Canada, \$6.00 one year, \$9.00 two years, \$12.00 three years. All other countries \$20.00 one year. Single copies, United States and Possessions and Canada 75¢. Single copies all other countries \$1.50.

Published every other Monday by McGraw-Hill Inc. 330 West 42nd Street, New York, N.Y. 10036. Founder: James H. McGraw, 1860-1948.

Subscribers: The Publisher, upon written request to our New York office from any subscriber, agrees to refund that part of the subscription price applying to copies not yet mailed. Please send change of address notices, subscription orders or complaints to Fulfillment Manager, Electronics, at the address below. Change of address notices should provide old as well as new address, including postal zone number if any. If possible, attach address label from recent issue. Allow one month for change to become effective.

Postmaster: Please send Form 3579 to Fulfillment Manager, Electronics, P.O. Box 430, Hightstown, New Jersey 08520

Readers Comment

3-D electronics

Congratulations on your excellent 3-D reproduction of an electronic module [June 15, p. 26]. . . .

The main weakness in this approach to 3-D is in the confusion as to distance from the viewer, and scale. I recommend that in your next venture you use Jayne Mansfield as reference; she should hold it over her heart.

Lawrence A. Shaw
St. Paul, Minn.

Diversification

Your editorial, "The challenge of change" [June 15 p. 15], brings up an important point. It mentions that on the average it takes about five years to develop a new product and to establish a capable marketing organization, sometimes even longer. You bring up the importance of diversification in view of the leveling off of our defense spending, and you mention particularly the field of industrial electronics as having great promise.

Many medium-size and smaller companies in the United States are not aware of one short-cut for diversification. There are thousands of counterpart companies in Europe and Japan that are eager to cooperate with their brother companies in the U.S. In the process, valuable exchange of knowledge and of products can be achieved.

Electronics companies in foreign countries have not been as dependent on defense spending as have our companies here. Consequently they have developed products which are precisely the kind we are seeking, in consumer electronics and in industrial applications. On the other hand, these companies have not had government-sponsored research as we know it here. Therefore they are behind in technical capabilities and in basic research facilities.

Evidently a great deal can be gained by an exchange between these two diversely oriented groups of manufacturers. Most American electronics companies, when they sell abroad, think of extending

Now from Sprague!

AN INDUSTRY FIRST!

**GUARANTEED TRUE
CHOPPING SPEED**

**SPAT[®] SILICON TRANSISTORS
2N3317, 2N3318, 2N3319
ARE A LONG LEAP AHEAD!**

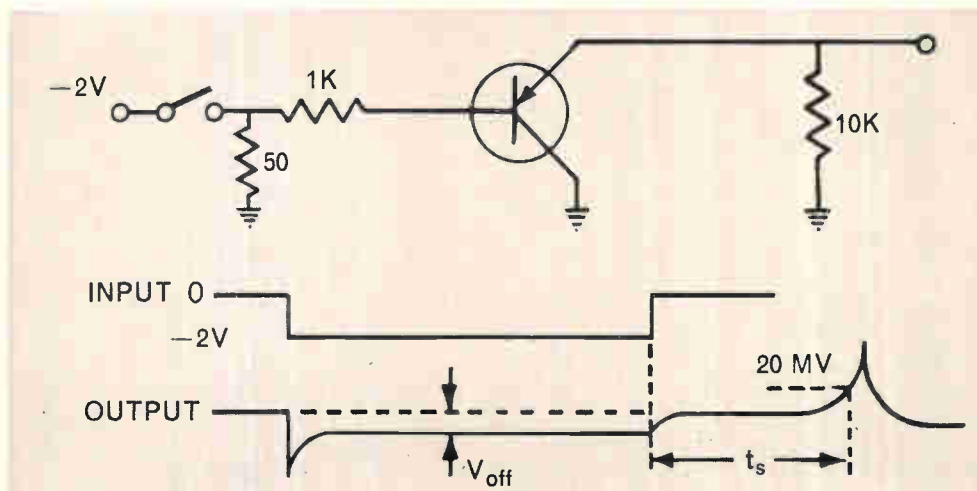

Check the superiority of SPAT[®] 2N3317 Series Transistors
in this comparison of t_s in chopper circuitry!

TYPE	t_s (typ.)	t_s (max.)
SPRAGUE 2N3317 SERIES	150	250
Competitive Epitaxial	900	Not Specified
Competitive Planar	1000	Not Specified
Competitive Alloy	1500	Not Specified

For complete technical data, write to: TECHNICAL LITERATURE SERVICE,
SPRAGUE ELECTRIC COMPANY, 35 MARSHALL ST., NORTH ADAMS, MASS.

SPRAGUE COMPONENTS

TRANSISTORS
CAPACITORS
RESISTORS
MICROCIRCUITS
INTERFERENCE FILTERS

PULSE TRANSFORMERS
PIEZOELECTRIC CERAMICS
PULSE-FORMING NETWORKS
TOROIDAL INDUCTORS
ELECTRIC WAVE FILTERS

CERAMIC-BASE PRINTED NETWORKS
PACKAGED COMPONENT ASSEMBLIES
BOBBIN and TAPE WOUND MAGNETIC CORES
SILICON RECTIFIER GATE CONTROLS
FUNCTIONAL DIGITAL CIRCUITS

SPRAGUE[®]
THE MARK OF RELIABILITY

*Sprague' and '®' are registered trademarks of the Sprague Electric Co.

(Advertisement)

Pulse Network Problems Solved by Experienced Systems Engineers

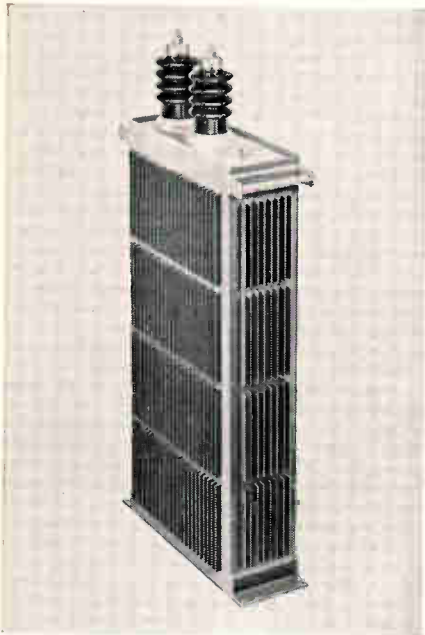

Typical Large Pulse-Forming Network designed by Sprague to meet a specific customer need.

Prompt cooperation on customers' pulse network problems is readily available from Sprague Electric Company's Pulse Capacitor and Network Section.

Sprague has much to offer to designers of radar systems, laser systems, tube testing systems, and other specialized systems. A highly-technical special engineering section devoted exclusively to pulse capacitors and networks includes *systems* as well as pulse network engineers. *Sprague can help you with your problems because Sprague fully understands your problems!*

But Sprague service does not end here. Following up the design aspect, these specialists can quickly and efficiently estimate pulse network sizes and prices for bidding purposes. They are also equipped to give quick reaction capabilities for your breadboard and prototype units.

A pioneer in pulse networks, Sprague is a major supplier of custom units from less than 1 KV up to 500 KV over a broad range of power levels.

For application engineering assistance, or additional information, write to Pulse Network Section, Sprague Electric Company, 35 Marshall St., North Adams, Massachusetts.

45PN-104-63

their method of selling in the U.S.; i.e., through sales representatives. This is why so often opportunities inherent in cooperation between manufacturers are overlooked.

If any of the readers of this letter care to have a reprint of our recently published booklet, *Know-How Is Our Most Important Product*, we shall be glad to mail a free copy.

S.V. Hart
Electronic Engineers International
57 Levant St.
San Francisco 14.

Ferroacoustic storage

The article entitled "Ultrasonic Approach to Data Storage" in your May 4 issue [p. 67] has impelled me to disclose proprietary thinking in a comparable area. In my view the basic concept involved here holds great promise for future generations of computers.

A configuration I propose for a high-speed, high-capacity ferroacoustic storage consists of a spirally deposited magnetic film on a rod or tube substrate with a characteristic of high acoustic velocity. Longitudinal anisotropy for the film is assumed.

Recent studies of the means to propagate pressure pulses at high velocity for the instrumentation of plasma research has revealed the ability to generate pressure wave fronts of 0.4 microseconds at propagation speeds of nearly 40,000 feet per second in materials such as sapphire and beryllium (Poulter Laboratories Technical Report 010-60, Stanford Research Institute).

The dependence only upon acoustic energization is a significant aspect of the ferroacoustic storage. Extrapolating this concept to higher orders of logical manipulations, one can speculate on the formation of an integrated arithmetic assembly on an acoustic substrate with transducer-initiated command generating a pseudo clock, as manifested by the traversing compression wave.

Consider a cylindrical surface onto which is deposited thin-film microcircuits and input/output connections to "induction pads." A close-fitting tube, in near contact, surrounding the acoustic cylinder over its active length comprises the

interface to wired input/output elements. The interface is formed on the inner surface of the tube with mating pads to the "induction pads" on the cylinder. It is contemplated that energy will be transferred across the interface by induction through the medium of the traversing compression wave.

Spatial distribution of the microcircuits and conductors in relation to the actuating compression wave provides, for example, predetermined delays and facility for feedback and carry-forward functions. Parallel entry with serial-parallel data manipulation for sorting, shifting, or arithmetic operations are suggested.

The advantages envisioned for this design concept are small size, high speed, minimum standing power, minimum wiring connections, and ultimate low cost.

N. A. Moerman
Roslyn Heights, L.I., N.Y.

Independent inventor

B. McFarlane [June 29, p. 4] bemoans the passage of the bill raising patent fees. He indicates that these fees will "stifle and starve the independent inventor."

I am somewhat of an independent inventor. Two patents issued. About six applications on file. Live in a rented room. Drive a '55 Chevy. Was glad to see the fees go up. Even wrote my congressman urging approval of the measure. The \$60 fee paid for a patent is a pittance beside the \$600 fee charged by the lawyer who files the application. It is not the Patent Office charges which stifle me—it is the argot in which patents are written. That is what is stifling. It forces me to engage an attorney. It raises my cost by a factor of 10.

The judges appointed to hear patent cases should be engineers rather than lawyers. The legal argot would disappear very quickly and patents would be written in understandable engineering language. I could then prepare by own applications. The patent lawyer would be eliminated.

Let the fees go up. Get rid of the patent lawyers.

George E. Row
Rowco Engineering Co.
Indianapolis, Ind.

There was a worried look on Steve's face as he met my cab outside the government office building.

"Where've you been?" he wailed. "We're scheduled in five minutes!"

"What's got you grounded, Dad?" I gave him the presentation booklets to carry and kept the flip charts. "You look as if the Russians had just landed on the moon."

"I don't like the way things are going," Steve said gloomily as we went inside and punched for the elevator. "When the Ajax crew came out of their meeting, they looked as if they'd been given the deed to the Pentagon."

"Have they got anything we haven't?" The elevator door opened and we stepped in.

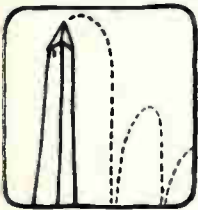

"Not as far as I can find out. But we haven't got anything they haven't, either."

"Don't be too sure," I said as the elevator slowed for our floor. "What kind of shock and vibration data did they show?"

"How should I know? The usual shake-table tests, all the required g's and frequencies, I suppose. What else could you do, throw it off the Washington Monument and count the number of times it bounces?"

The first part of the presentation went as smooth as a jet at thirty thousand. Then I hit clear air turbulence.

"This is a resume of the shake table results in accordance with the required Mil Specs," I was saying. "As you see, there's no appreciable distortion of output. And here," I flipped to the next chart, "is a record of electrical performance under the maximum transients of the shock and vibration history of Frontiersman III¹. As you know, that was an earlier version of the vehicle for which we are quoting this component."

Colonel Walsh leaned forward across the table and his eyes glinted like fixed bayonets as he said, "You people had no components on Frontiersman III."

"No," I said "this was simulated. But we asked the Air Force inspector to witness the tests, and he has certified that we reproduced the max mechanical inputs within five per cent."

"I'd like to know how you did that," the colonel challenged.

"You mean you want the technical details?" I asked him.

"If you don't mind," said the colonel. Coming from him, this was an expression of profound interest.

I shot a glance at Steve. He looked like a little boy who



has just found out there really is a Santa Claus.

"Well, to start with," I said, "on our copy of the Frontiersman III telemetry tape they hadn't included the time code. So we began by re-recording it with time code in modified IRIG B format from an EECO 858 Time Code Generator/Reader². Of course, it wasn't the original time. Just an arbitrary indication for marking and searching purposes."

"Of course," the colonel said. "Go on, please."

"Then we read out the entire tape onto strip charts and eyeballed them for maximum g's. We selected three time segments that contained the most severe conditions, and noted the start and finish times of the segments selected. You know, you can read hours, minutes and seconds by eye from the strip-chart trace of the time code."

"I know," said the colonel drily.

"We rewound the mag tape and switched the EECO 858 Time Code Generator/Reader to the reproduce mode. In that mode, it accepts the time-code channel as input and visually reads out hours, minutes and seconds on high-visibility Nixie indicators, at any speed from one twentieth to two hundred times the recording speed. So with the 858 and the tape deck, we had a complete manual search system³. Am I making myself clear?"

"As a cloudless day in May," said Colonel Walsh, "and I hope EECO is paying you a commission."

"On the contrary," I said, "I still consider myself in debt to them for selling us that 858. Anyway, using the 858, we re-recorded the selected segments of the shock and vibration history onto a single tape. Then we were all set to read that tape into the shake table any number of times. Considerably more realistic, of course, than an artificial program at a limited number of prescribed frequencies and g levels, or even frequency sweeping."

"Why couldn't you simulate the entire burning period as your test?" he demanded.

"We did," I said, "on a couple of articles, just to make sure. But it wouldn't be feasible to spend that much time on every article. You see, we're making it part of our proposal that every article be acceptance-tested this way."

"Mmm," said the colonel. "Miss Roundtree, please remind me to recommend a similar procedure for critical components in future RFP'S."

"Yes, Colonel," Miss Roundtree said.

Steve was beaming as foolishly as a victim of anoxia. I could see he was already mentally spending his extra-sales bonus.

When the presentation was over Colonel Walsh made the rare gesture of standing up and shaking hands warmly as we started to leave.

Later that afternoon Steve and I were having a martini with Miss Roundtree in the hope of finding out how we did. A little underhanded, but strategically sound.

"That was an outstanding presentation," she told us. "The colonel was deeply impressed. Especially by the shock and vibration simulation⁴. Too bad you're not going to get the contract." "We're not g-- Wha-a-a--"

"I shouldn't be telling you this, but Ajax came up with exactly the same idea. It must be the next logical step in environmental testing. Funny, they even used an EECO 858 Time Code Whatchamacallit to process the tape. But their component happens to be an ounce and a half lighter and point oh eight cubic inch smaller than yours. Too bad. Better luck next time."

You can't win 'em all⁵.



1 "Frontiersman" is a figment of our copywriter's imagination, of course. But in reality EECO timing equipment has been used at missile ranges throughout the U.S. with every major missile and space program since 1951, including Matador, Bomarc, Nike, Redstone, Atlas, Titan, Polaris, Minuteman, or you name it and we helped time it.

2 This compact unit generates IRIG B-format BCD time code (modified to omit days) and occupies only seven inches of rack space. You who have to watch the bucks (and who doesn't, these days) will be happy to know that an EECO 858 costs little more than you'd expect to pay for either the generating or the reading function alone.

3 By adding an 859 tape search unit, either right away or later, you can convert your EECO 858 into an automatic search system. Then all you have to do is preset the start and stop times on decimal switches. The system advances at search speed to the preset start time, then automatically switches to playback and reads out the desired segment.

4 The application described in our story is one of the latest and most interesting, but there are hundreds of other technical, scientific, industrial and medical uses for the 858 — wherever you need to time-mark analog data so you can look it up and play it back later. Dynamic testing laboratories find it particularly valuable.

5 But Ajax won with the help of an EECO 858 Time Code Generator/Reader. So can you. Circle reader card number for full information. You'll also receive FREE engineering drawing and specifications of Terrific Terri the Test Engineer. **ADULTS ONLY.** (Minors don't buy much digital timing equipment.)

EE 3-79R2

NEW MINIATURE PLANAR TRIODES... FREQUENCY STABLE...HIGH CATHODE CURRENT

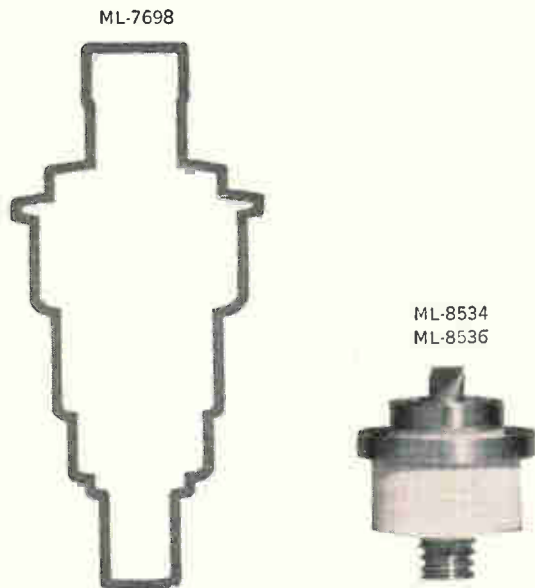

Same ratings... $\frac{1}{3}$ size

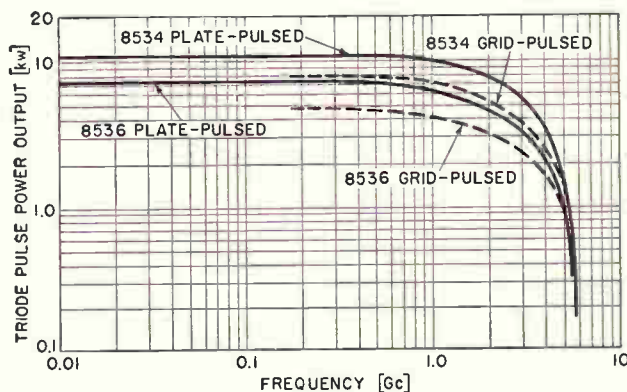

As UHF plate or grid pulsed amplifier

The same fast frequency stable performance—100 times faster than normal—is obtained with both the miniature ML-8534 and ML-8536 planar triodes. Both tubes employ the Phormat (matrix) cathode. Both allow use of variable duty cycle operation without noticeable frequency shift. But the ML-8534 and ML-8536 miniature planars are only $\frac{1}{3}$ the size of the ML-7698 and permit significant reductions in cavity and equipment size. Ratings: ML-8534, plate pulsed, 3500v, 5.0a; grid pulsed, 2500v, 5.0a. ML-8536, plate pulsed, 3500v, 3.0a; grid pulsed, 2500v, 3.0a. For complete data on miniature planar triodes, write: The Machlett Laboratories, Inc., Springdale, Connecticut. An affiliate of Raytheon Company.

MACHLETT
ELECTRON TUBE SPECIALIST

People

Harper Q. North, newly elected president of the Electronic Industries Association, pioneered in semiconductor technology. He received his doctorate in physics from the University of California at Los Angeles in 1947, the year before the transistor was introduced. His interest in the new field led him, in 1949, to the Hughes Aircraft Co. where he initiated work on semiconductors. In 1954 he founded Pacific Semiconductors Inc., a subsidiary of Thompson Ramo Wooldridge Inc., and served as its president until 1961 when he was named board chairman of TRW Electronics Inc. Since 1962, he has been vice president of TRW, responsible for coordinating all research and development. Away from the office, he shares his 12-year-old son's enthusiasm for baseball and occasionally helps his 16-year-old daughter with chemistry.



John S. Sayer, vice president of the Auerbach Corp., is the principal investigator in a study of the use of scientific and technical information being conducted for the Department of Defense. Sayer plans to interview 1,500 of the 36,000 technical employees of the armed services, to learn the type and use of data acquired by them. The information will then be analyzed to discover how effectively technical data is being used in research, development and engineering. Before joining Auerbach, Sayer was the executive vice president and general manager of Documentation, Inc., where he directed information processing. Previously, at E. I. duPont de Nemours & Co., he headed development of critical path method scheduling.



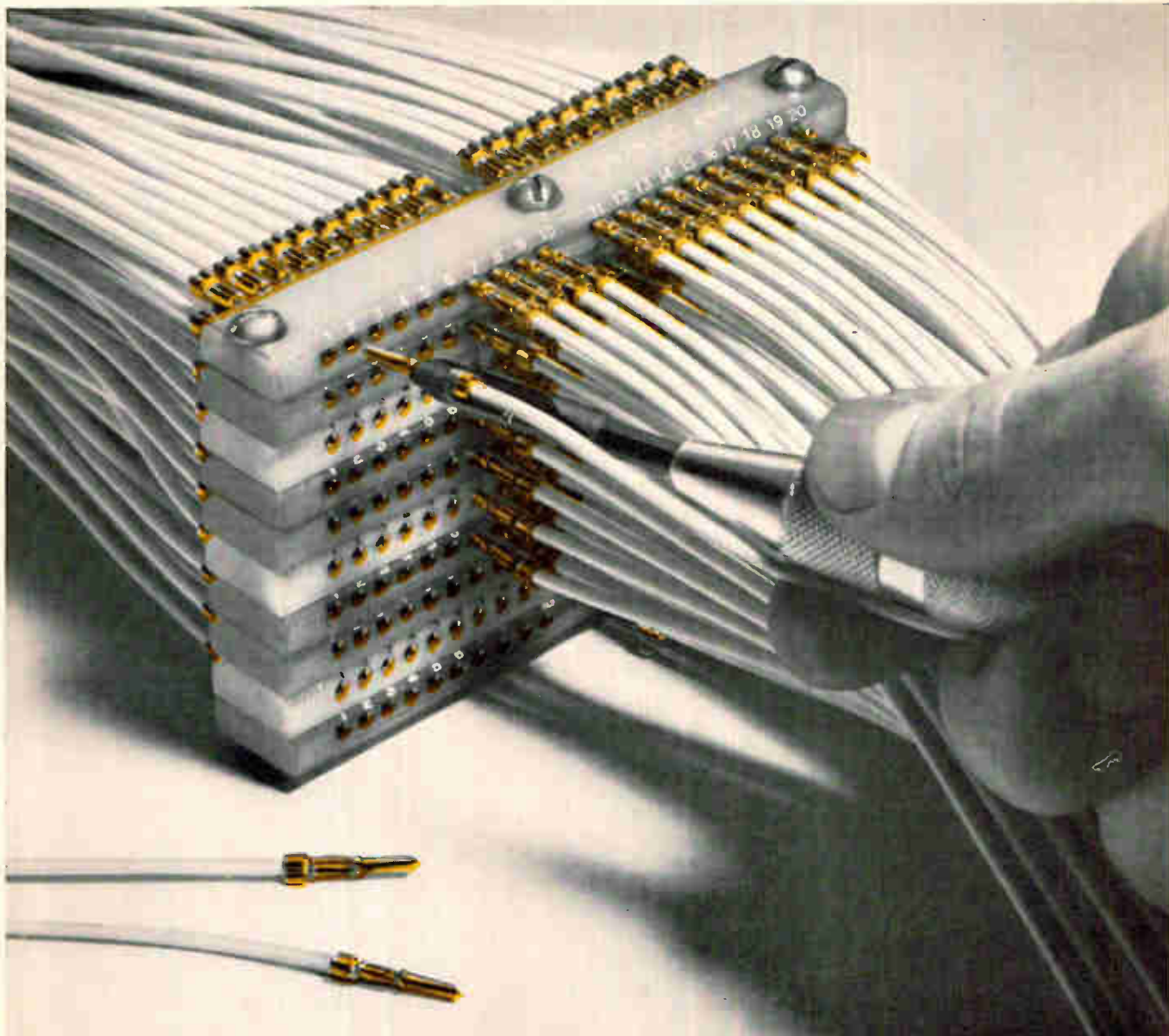

How small can a pin be?

It can be within a mere few thousandths of an inch of the outside diameter of the wire insulation. Or even less. That's the way we engineer our A-MP★ Taper Pins.

Anywhere the wire fits, our pins fit. That's the kind of density that gives you the extra design space you need.

With nominal retention strength of 25 pounds, our taper pins assure peak mechanical and electrical characteristics. Even when subjected to temperature cycling of -85°F to $+500^{\circ}\text{F}$, and being vibrated at 150 cps, 20 g accelerations, these taper pins hold fast. And they become better with age—joint resistance decreases, while joint disengagement forces increase. Combine this with a taper design that makes pins self-cleaning and self-locking and you've got reliable performance under the toughest conditions.

Want further assurance? Check these features:

- Our matched crimping tools eliminate cold solder joints, burnt and brittle insulation
- Automatic application for lowest installed cost

- Pre-insulation prevents flash-over and possible shorting
- One piece solid molded blocks and two piece for customer assembly
- Standard configurations, 10, 20 and 30 cavities

So why look further? We have the most complete line of taper products in the industry. Pins stamped and formed, uninsulated and insulation piercing types, screw machine with insulation support and pre-insulated types. Plus all kinds of companion items, such as vertical entrance blocks, taper bus bar and taper tab blocks. Write today for complete information.

★Trademark of AMP INCORPORATED



A-MP★ products and engineering assistance are available through subsidiary companies in: Australia • Canada • England • France • Holland • Italy • Japan • Mexico • West Germany

New from Sprague!

FILMITE® 'K' POLYCARBONATE FILM CAPACITORS

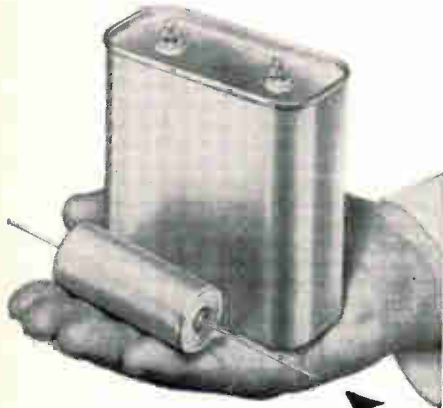

COMPARE!

The tubular polycarbonate film capacitor and the rectangular oil-impregnated paper capacitor are both rated 10 μ F, 100 VAC, 400 cycles.

- More than 13 times smaller than paper capacitors of equivalent rating.
- Unusually high capacitance stability over entire temperature range.
- Low dissipation factor — extremely desirable where high current capabilities are required.
- Low dielectric absorption over a broad frequency/temperature spectrum.
- Extremely high insulation resistance — superior to many commonly-used film dielectrics.
- Capacitance tolerances to $\pm 0.25\%$.
- For critical applications such as tuned circuits, analog computers, digital circuits, etc.

For complete technical data, write for Engineering Bulletins 2700 and 2705 to Technical Literature Service, Sprague Electric Company, 35 Marshall Street, North Adams, Massachusetts.

45C-4125R1

SPRAGUE®

THE MARK OF RELIABILITY

'Sprague' and '®' are registered trademarks of the Sprague Electric Co.

Meetings

Research Conference on Instrumentation Science, ISA; William Smith College, Geneva, N.Y., Aug. 3-7.

UAIDE Annual Meeting, Users of Automatic Information Display Equipment; International Hotel, Sepulveda and Century Blvds., Los Angeles, Aug. 12-14.

Quantification of Human Performance Symposium and Workshop, University of New Mexico, EIA M-5.7, Subcommittee on Human Factors; University of Mexico, Albuquerque, N.M., Aug. 17-19.

Symposium of Ultra Low Frequency Electromagnetic Fields, NBS Central Radio Propagation Lab. and National Center of Atmospheric Research; Boulder Laboratories, Boulder, Colo., Aug. 17-20.

Electronic Packaging International Symposium, University of Colorado Cahners Publishing Co.; University of Colorado, Boulder, Colo., Aug. 19-21.

Distributor-Manufacturer-Representative Conference, WESCON; Ambassador Hotel, Los Angeles, Aug. 24.

AIAA/ION Astrodynamics Guidance and Control Conference, American Institute of Aeronautics and Astronautics, Institute of Navigation; University of California, Los Angeles, Aug. 24-26.

Association for Computing Machinery Annual Conference, ACM; Sheraton Hotel, Philadelphia, Aug. 25-27.

WESCON 1964, 6th Region IEEE and Western Electronic Manufacturers Assoc.; Los Angeles Sports Arena and Hollywood Park, Los Angeles, Aug. 25-28.

International Conference on Microwaves, Circuit Theory and Information Theory, Inst. Electrical Comm. Engrs. of Japan; Akasaka Prince Hotel, Tokyo, Sept. 7-11.

International Exhibition of Industrial Electronics, Swiss Industries Fair; Basel, Switzerland, Sept. 7-11.

International Convention on Military Electronics (MIL-E-CON-8), IEEE; Shoreham Hotel, Washington, Sept. 14-16.

Operations Research Society Annual International Meeting, Western Section of ORSA, ORSJ, University of Hawaii; Sheraton Meeting House and Princess Kaiulani Hotel, Waikiki, Honolulu, Sept. 14-18.

Ceramic-To-Metal Session, American Ceramic Society, Philadelphia, Sept. 17.

Annual Northwest Computing Conference, Northwest Computing Association, University of Washington Computing Center; University of Washington, Seattle, Wash. Sept. 17-18.

Engineering Management Annual Conference, IEEE-ASME; Pick-Carter Hotel, Cleveland, Sept. 17-18.

AIAA Military Aircraft Systems and Technology Meeting (Secret), AIAA, USAF, and BuWeps; NASA-Langley Research Center, Va., Sept. 21-23.

Professional Technical Group on Antennas and Propagation International Symposium, PTGAP/IEEE; International Hotel, John F. Kennedy International Airport, N.Y., Sept. 22-24.

Annual Communications Conference, Cedar Rapids Section of IEEE; Hotel Roosevelt, Cedar Rapids, Iowa, Sept. 25-26.

Canadian IEEE Communications Symposium, Canadian Region IEEE; Queen Elizabeth Hotel, Montreal, Sept. 25-26.

Call for papers

Allerton Conference on Circuit and System Theory, University of Illinois, CTG/IEEE; Allerton House, Conference Center of University of Illinois, Monticello, Illinois, Sept. 28-30. **August 15** is deadline for submitting 100 word abstract to W. R. Perkins, Dept. of Electrical Engineering, University of Illinois, Urbana, Ill.

Tri-Service Conference on Electromagnetic Compatibility, U. S. Army, Navy, Air Force; Museum of Science and Industry and Illinois Institute of Technology, Chicago, Nov. 17-19. **August 15** is deadline for submitting 150 word abstract to IIT Research Institute, 10 W. 35th St., Chicago. Papers are invited on interference prediction, equipment design, instrumentation, measurement techniques, interference reduction measurements, etc.

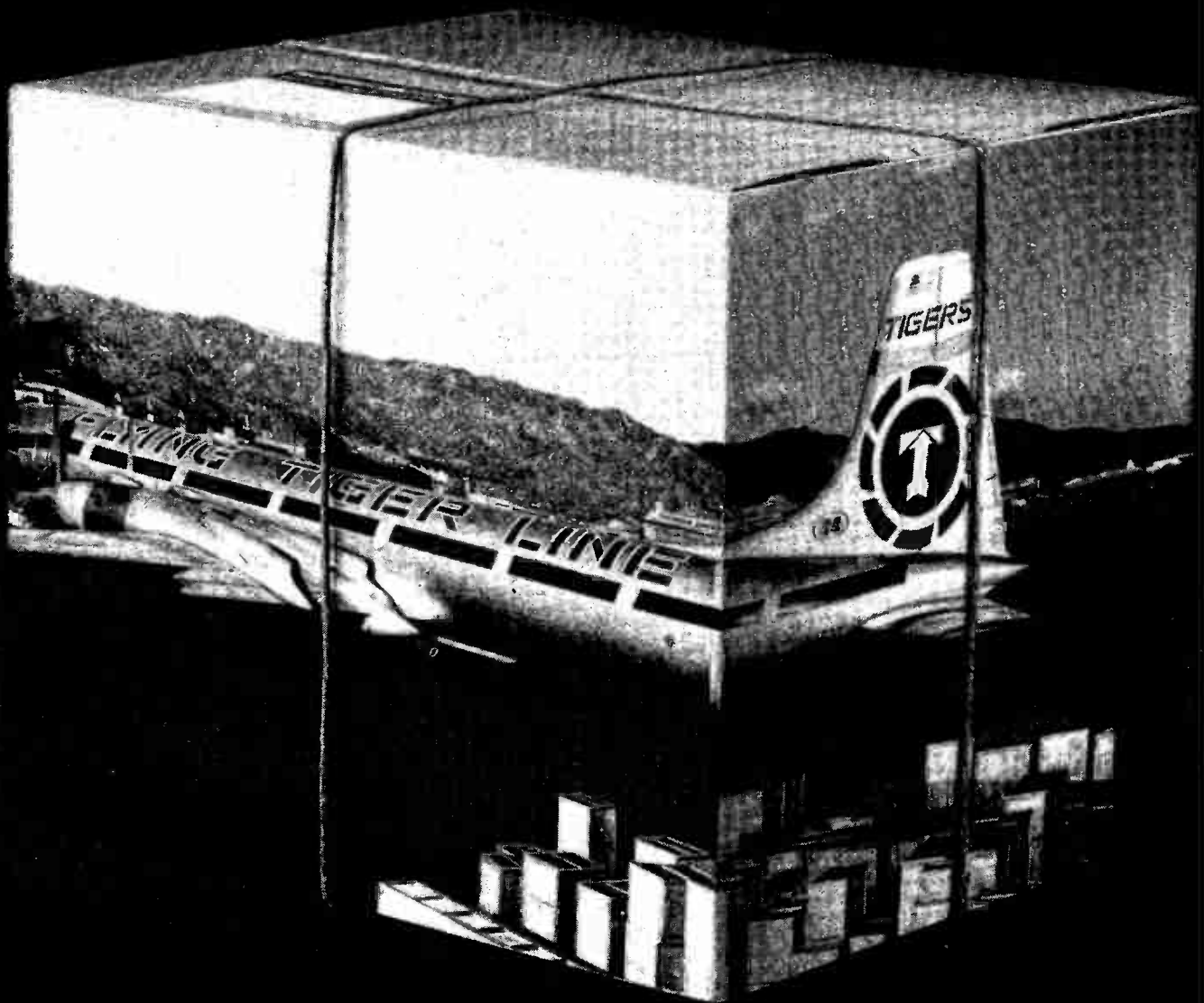

Package Deal

Do you ship regularly to many customers in or around distant cities? Flying Tigers now has a new plan that combines the low cost of surface parcel post with the speed and convenience of airfreight.

All you do is consolidate your surface parcel post shipments for a single general area of the country into one shipment. You address and pre-meter each package at the applicable zone rate within the destination area. Flying Tigers then flies the consolidated shipment at special bulk

rates to a major post office in the destination area. Parcels are distributed by surface parcel post to your customers.

This Flying Tigers' service can keep you competitive in markets where you have neither a warehouse nor inventory. It can even save you money over straight surface parcel post, and will help you reach new markets.

Have your Flying Tigers man explain all the details of this package deal. We think you'll buy it.

first in airfreight with airfreight first **FLYING TIGER LINE**



Hewlett-Packard sweepers that demand comparison ...

in the complete hp 690 Series Sweep Oscillators.

BRIEF SPECS—NEW LOW PRICES

MODEL	FREQUENCY (gc)	POWER (maximum leveled across band)	ACCURACY (center frequency)	PRICE
691B	1-2	at least 60 mw	±10 mc	\$3550*
692B	2-4	at least 40 mw	±10 mc	\$3350*
H01-692B	1.7-4.2	at least 15 mw	±10 mc	\$3650*
693B	4-8	at least 15 mw	±20 mc	\$3350*
H01-693B	3.7-8.3	at least 5 mw	±20 mc	\$3650*
694B	8-12.4	at least 10 mw	±30 mc	\$3450*
H01-694B	7-12.4	at least 5 mw	±40 mc	\$3750*
695A	12.4-18	at least 10 mw	±1%	\$3500
696A	18-26.5	at least 10 mw	±1%	\$4500
697A	26.5-40	at least 5 mw	±1%	\$6500

Option 01: Internal leveling, 691B/692B, \$325; 693B, \$375; 694B, \$400 extra.

*GRID-LEVELLED "A" MODELS NOW \$350 LESS.

Data subject to change without notice. Prices f.o.b. factory

Designed with you in mind ... that's why the hp 690 sweep oscillators offer a

1 to 40gc

unique combination of features to simplify and increase the dependability of your measurements. Now these user-designed features are available to 40 gc. The "extras" (not duplicated in other similar instruments) range from exclusive PIN diode leveling and modulation to such convenience exclusives as easy x-y recording capability, outstanding marker visibility; and the instrument, only 8¾" high, fits right into your test stand.

Multiple Sweep Modes

Independent sweep modes for unparalleled versatility:

Start-Stop Sweep: Set end points anywhere in the frequency range on slide rule scale. Sweep up or down just by pushing the Start-Stop button. Markers appear on rf output.

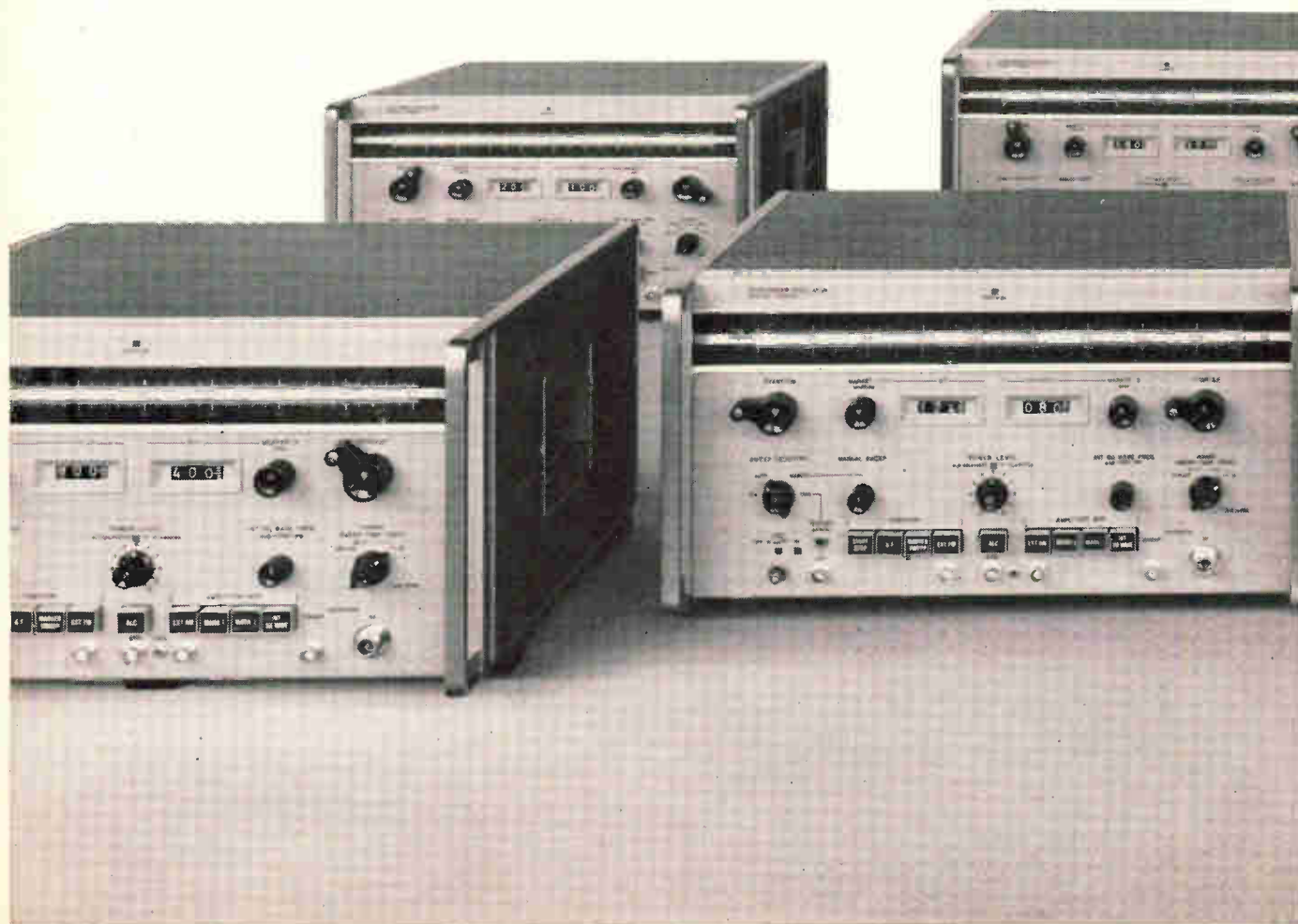

...compare the details with any and all other sweepers!

Marker Sweep: Expand any small area of the major sweep merely by setting independent Marker controls and pushing the Marker Sweep button. End points set on error-free digital readouts. Sweep up or down the Marker range.

Delta F Sweep: A symmetrical sweep about a center frequency ...useful for calibrating narrow band devices. Just press the Δ F button, and get the industry's only accurately-calibrated narrow sweeps.

Manual Sweep: The 690's are the only sweepers offering Manual Sweep for detailed investigation of a localized area. For x-y recording tedious setup time becomes a thing of the past.

Sweep Speeds

With Sweep Selector in Automatic, the 690's provide recurrent sweeps, continuously adjustable in 4 ranges, 0.01 to 100 seconds. Or you can sync the sweep with line frequency.

For scope presentation, output power, on except during retrace, offers a zero baseline and eliminates transients at the start of a sweep. Automatic pen lift circuit on two slowest speeds permits easy x-y recorder use. Sweep voltages for both scope and recorder are provided concurrent with swept rf.

Modulation, Leveling

Pushbutton selection is standard for external AM or FM or internal square wave modulation, 950-1050 cps. PIN diode modulators are offered in the more popular "B" models. By

absorbing rf in response to the modulating signal they end frequency pulling and other troublesome effects associated with BWO grid modulation.

Two leveling options are offered: external closed loop, which eliminates transmission line problems and delivers leveled power where you need it, or internal leveling for less critical applications. Maximum usefulness of leveling capabilities is demonstrated in your ability to use reflectometer techniques without the conventional ratiometer. For more information on ratio-meterless reflectometry write for Application Note #61.

Models listed in the chart include three standard extended-range instruments for special but popular applications. "A" models differ from "B" models only in the elimination of the PIN modulators, slightly increased power output and lower price. Other models with special ranges are available for narrow sweeps or different frequency breaks. All tubes have 2500 hour warranty through 18 gc. The specified accuracy of each model in the 690 Series covers all sweeps, plus rf output in CW mode.

You'll want to put all the capabilities of the hp 690 Series Sweep Oscillators to a rigorous test on your bench. Call your Hewlett-Packard field engineer. He'll make it possible. Or write Hewlett-Packard Company, Palo Alto, California 94304, Tel. (415) 326-7000; Europe: 54 Route des Acacias, Geneva; Canada: 8270 Mayrand St., Montreal.



flexible sweep functions
highest available accuracy
today's easiest operation

**HEWLETT
PACKARD**



An extra measure of quality

9295

NEW! SILICON PLANAR ZENERS

Fairchild introduces a unique line of general purpose Zener and reference diodes

GENERAL PURPOSE ZENERS 6.2V to 33.0V

- Low impedance
- Low voltage tolerance
- Low leakage at voltages approaching breakdown level
- Silicon Planar Reliability

REFERENCE ASSEMBLIES

- Wide variety of operating voltage ranges
- Low dynamic impedance
- Low leakage near breakdown voltage
- Variety of packages

Fairchild temperature compensated voltage reference elements provide a wide variety of reference voltages with the advantages of reduced installation time and cost, reduced space, and simplified circuit design. Packaged in TO-18, TO-5 or custom epoxy packages, they also offer high thermal and shock resistance.

M-CR* REFERENCE DIODES *Multi-Current Range

- Low TC: from 1mA to 15mA
- Wide operating current range
- Low leakage: 200nA @ 3.0V, 25°C max
- High reliability—Silicon Planar single-chip construction
- Low impedance: 10 ohms

This unique new Fairchild family of Multi-Current Range reference diodes offers the engineer new design freedom. The broad operating current range allows the designer to select a device which meets specific circuit requirements—rather than design a circuit around available device characteristics. Low, nearly constant TC allows a single off-the-shelf Fairchild M-CR type to meet many different design requirements. Also, current supply amplitude is no longer a critical design factor.

100 μ A REFERENCE DIODES

- Low TC over wide temperature range
- Low dynamic impedance at 100 μ A
- Low leakage at biases approaching reference voltage

These single-chip Silicon Planar devices are temperature compensated voltage reference elements especially designed for applications in which available power is limited.

IMMEDIATELY AVAILABLE FROM DISTRIBUTORS & STOCKING REPRESENTATIVES

AVNET Toronto, Canada, 789-2621 BOHMAN Orlando, Fla., 425-8611 CRAMER ELECTRONICS Newton, Mass., WO 9-7700 DART SALES Clarence, N.Y., 874-1212; Syracuse, N.Y., GL 4-9257 DENNY-HAMILTON San Diego, Cal., 279-2421 EASTERN SEMICONDUCTOR Syracuse, N.Y., 454-9247 E. C. ELECTRONIC SALES Minneapolis, Minn., 888-0102 ENSCO Cedar Rapids, Ia., 366-1591; Wichita, Kan., MU 3-3751; Kansas City, Mo., EM 1-9600; St. Louis, Mo., PA 6-2233 HAMILTON Phoenix, Ariz., 272-2601; Culver City, Cal., 870-0236; Palo Alto, Cal., 321-7541; Seattle, Wash., 282-3836 HYER Englewood, Colo., 761-0754; Albuquerque, N. Mex., 268-6744; Salt Lake City, Utah, 322-5849 MARSHALL Scottsdale, Ariz., 946-4276; San Marino, Cal., HU 1-3292; San Diego, Cal., BR 8-6350; Redwood City, Cal., EM 6-8214 NORWELL Dallas, Tex., FL 7-6451; Houston, Tex., MO 5-0558 POWELL Beltsville, Md., 474-1030; Philadelphia, Pa., 724-1900 SCHLEY Watertown, Mass., WA 6-0235 SCHWEBER Westbury, L.I., N.Y., ED 4-7474 SEMICONDUCTOR SPECIALISTS Chicago, Ill., 622-8860; Minneapolis, Minn., UN 6-3435 SHERIDAN Cincinnati, Ohio, 761-5432; Cleveland, Ohio, 884-2001; Dayton, Ohio, 277-8911 SOLID STATE Chicago Ill., 889-8033 STANFORD Buffalo, N.Y., TT 3-5000 TAYLOR Baldwin, L.I., N.Y., BA 3-8000 TEC-SEL Huntsville, Ala., 534-7304 VALLEY Winter Park, Fla., 647-1216; Baltimore, Md., NO 8-4900; Cherry Hill, N.J., NO 2-9337.

FACTORY SALES OFFICES

HUNTSVILLE, ALA., 536-4428, 4423 SCOTTSDALE, ARIZ., 946-6538 PALO ALTO, CAL., 321-8780 SHERMAN OAKS, CAL. TR 2-1380; ST 8-8701 ENGLEWOOD, COLO., 761-1735 ORLANDO, FLA., CH 1-2596 OAK PARK, ILL. VI 8-5985 COLLEGE PARK, MD., 779-6868 BEDFORD, MASS., 275-8450 MINNEAPOLIS, MINN., UN 6-3301 ENDWELL, N.Y., 754-2600 JERICHO, L.I., N.Y., ED 4-8500 POUGHKEEPSIE, N.Y., 454-7320 SYRACUSE, N.Y., GR 2-3391 DAYTON, OHIO 228-1111 JENKINTOWN, PENN. TU 6-6623 SEATTLE, WASH. AT 2-5344 CANADA OFFICE: TORONTO, ONTARIO 782-9230.



FAIRCHILD
SEMICONDUCTOR

Editorial

Commercial road for electronics

To diversify or not to diversify? That's the burning question for many suppliers of military electronics.

For those who realize that the answer is "yes" but wonder how to go about it, a measure of help is coming. The Research Institute of the Illinois Institute of Technology, together with Electronics magazine, will sponsor a conference Dec. 1 and 2 in Chicago on "The commercial road for electronics". More on this later.

For those who haven't yet decided that they should diversify the arguments continue to pile up on the affirmative side. In mid July, Business Week magazine (July 18) estimated that military procurement would continue to decline 4% a year for the next five years. That's a total slash of close to 15% from current levels, which are already making some electronics companies unhappy—currently military procurement is off \$1.8 billion.

If suppliers are to replace this sales volume, it's clear that they'll have to find other markets.

On the other hand, some military suppliers are so used to doing business with the government that they don't know how to get started in other markets. They don't know how to develop commercial products, how to manufacture them, or how to market them.

Early in July, the American Management Association held a conference to investigate conversion of military industry and featured some speakers from the Pentagon. Most of the attendees' purpose in coming seemed to be to find out whether any military contracts were up for grabs. They wouldn't even listen to urgings that they start making plans to diversify.

Obviously, management that won't even listen to talk about diversification isn't going to diversify. You can preach until your are blue in the face about responsibility to employees, the community or national economy, but they won't budge.

We feel strongly that suppliers of military electronics should diversify as fast as is consistent with good business practice.

The electronics industry can never be strong as long as it is built on the shifting sands of government procurement. Companies cannot plan their product planning, their engineering or their production as long as their businesses can be wiped out by a whim of a bureaucrat or of Congress.

For a company that does want to diversify, the big question is, "How?"

There are many pitfalls for the company and for the individual. Is it possible to retrain an engineer who has spent all of his professional life working on military projects? Can such an engineer—accustomed to complex solutions, damn-the-cost engineering, and way-out-technology thinking—convert to simple, straightforward engineering that uses inexpensive, reliable components and touches advanced technology sparingly?

There are no answers yet. But the December conference may offer a few.

Conference speakers will not discuss whether to diversify. They'll be operating on the assumption that listeners want to diversify and are anxious to learn how. There will be four sessions: product planning, engineering, manufacturing and marketing. All will present information of the how-to type.

For example, in the session on product planning, one speaker will compare product planning for military business with product planning for commercial markets. Others will discuss how to plan in consumer, industrial and medical electronics.

As plans for the conference crystallize we'll keep you informed.



These silicon planar transistors are under a quarter*

AMPLIFIER APPLICATIONS

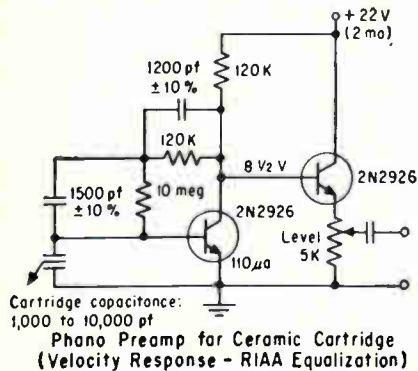

SWITCHING APPLICATIONS

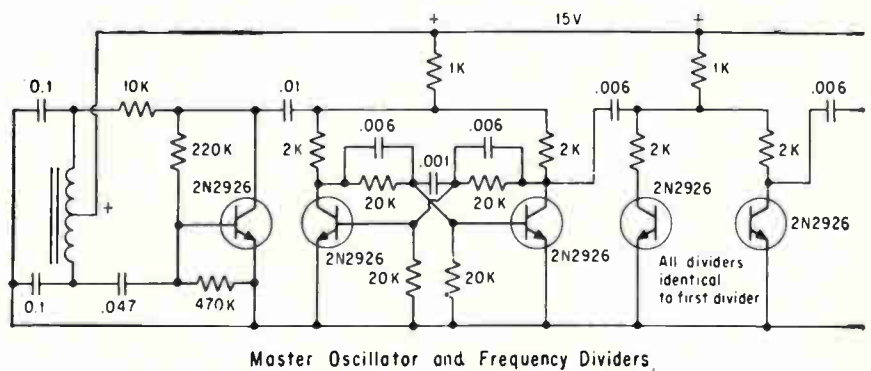

Type 2N2926 offers 2 to 1 beta spread, tight parameter control, high reliability

The new G-E 2N2926 is a planar passivated, high performance, high value silicon transistor made possible by advanced manufacturing techniques, highly reliable encapsulation, and utilization of the full-line distribution of h_{fe} .

The 2N2926 is a type provided in 5 beta categories, each with a 2-1 beta spread. Each beta category is color coded, and the per cent of the total order shipped in each category is set.

The 2N2926 is only one of the growing number of types in our "Economy Line" of transistors. Millions of units in use in the field for over two years have proven them rugged and reliable. They are probably the toughest transistors made today.

Find out how you can enjoy high performance with real savings by designing equipment utilizing all 2N2926 beta categories in proportions compatible with this "full line distribution" type. See your General Electric District Sales Manager, or write Section 16G166R, Semiconductor Products Department, General Electric Company, Electronics Park, Syracuse, New York. In Canada: Canadian General Electric,

189 Dufferin Street, Toronto, Ont. Export: International General Electric, 159 Madison Avenue, New York, 16 N. Y.
*22¢ in 100,000 quantities; 24¢ in 10,000 quantities.

2N2926 ABSOLUTE MAXIMUM RATINGS (25°C)

Voltages			
Collector to Emitter	V_{CE0}	18	V
Emitter to Base	V_{EB0}	5	V
Collector to Base	V_{CB0}	18	V
Current			
Collector (Steady State)*	I_C	100	ma
Dissipation			
Total Power (Free air at 25°C)**	P_T	200	mw
Total Power (Free air at 55°C)**	P_T	120	mw
Temperature			
Storage	T_{STG}	-30 to +125°C	
Operating	T_J	+100°C	

*Determined from power limitations due to saturation voltage at this current.

**Derate 2.67 mw/°C increase in ambient temperature above 25°C.

GENERAL  ELECTRIC

Electronics Newsletter

July 27, 1964

Around-the-world missile project dies

Scratch another missile project. Project Pluto, the Air Force-Atomic Energy Commission program for a nuclear ramjet engine, is dead. Pluto was intended to develop a unique missile capable of around-the-world flight at speeds up to 2,000 miles an hour. To avoid radar detection, the missile would have flown to its targets at low altitudes and, presumably, been guided by terrain-following radar and other advanced electronics systems.

The AEC on July 13 ordered its Livermore, Calif., lab to close down the reactor development and test effort, "because of a lack of a firm military requirement" for the missile. The end came when Defense Secretary Robert S. McNamara vetoed the recommendation of a Department of Defense review group for a minimum flight-test program. The Pentagon wouldn't pay for flight tests. As of July 20, McNamara hadn't ordered contractors to stop work, but he was expected to do so at any moment. Contractors are Ling-Temco-Vought, Inc., for the airframe, and the Marquardt Corp., for the engine.

Since 1956, the AEC and the Air Force had spent some \$200 million on the program. Ling-Temco-Vought's latest contract involved \$12 million for the year ending September 30.

Three computers run steel mill

The most sophisticated computer network for production control is now operating on-line at the Park Gate Iron & Steel Co., Rotherham, England. The network links three digital computers supplied by English Electric-Leo Computer Ltd. One computer controls the others to produce steel products tailored to the customers' specifications. The system is part of an \$88-million facilities development that will step up plant output from 425,000 to 800,000 ingot tons a year.

The English Electric Ltd.'s Metals Industries division coordinated all the electronic systems. The control system includes three KDN2 computers, two with 8,192-word memories and one with a 4,096-word memory. Cathode-ray-tube tabular displays for operator information were supplied by Marconi Ltd. and a solid-state voice communications system was supplied by Marconi International Marine Ltd.

One computer directs over-all plant operations from orders to finished steel. The second is an on-line unit that controls reheating the steel billets and forming and cooling them. The third controls the flying shear that cuts the steel to the ordered length. A major advantage of interconnecting the computer operations is reduction of waste in the cutting stage.

Flatpack standards are nearly ready

After almost a year of work, the Electronic Industries Association's microcircuit applications committee is about ready to propose an industry standard for microcircuit packages.

The committee is expected to propose a series of packages ranging in body area from 3/8 inch square down to 3/16 inch by 1/4 inch, with a total of 10 to 16 leads on two opposing sides. The standard may be refined further to specify the dimensions between usable lead areas instead of body size.

Still undetermined is whether the committee will also propose a series

Electronics Newsletter

of flatpacks, $\frac{1}{4}$ inch square to $\frac{3}{8}$ inch square, with a total of 12 to 24 leads on all four sides.

Ion propulsion works in space

The National Aeronautics and Space Administration operated an ion-propulsion engine in space on July 20. It was the first announcement of a successful test flight of an ion engine. The Air Force tried one, unsuccessfully, at least 20 months ago [Electronics, Dec. 28, 1962, p. 8].

The test proved that the ion stream can be neutralized with electrons after it passes accelerator electrodes. The ions did not flow backward and reduce thrust. Nor did spurious radio-frequency signals swamp the command system.

Two small ion engines were sent aloft on a rocket. One, built by NASA's Lewis Research Center, was turned on and off several times. The other, built by the Hughes Aircraft Co., failed to operate, apparently because of short circuits in its power supply.

Similar small battery-powered ion engines can be used to adjust positions of satellites. Large systems, with nuclear-electric power sources, could make satellites maneuverable and propel interplanetary-range spacecraft. The first test of a nuclear-powered ion engine will be made early in 1965 by the Air Force. Electro-Optical Systems, Inc., is developing the engine.

Tropo conquers a mountain

The 128-mile Philippine radio link between Manila and Baler, terminus of the new Pacific telephone cable, will be a series of microwave hops and one unusual 78-mile tropo circuit. To span the mountains in the path, Radio Engineering Laboratories, Inc. will supply to General Telephone & Electronics International, Inc., a 1-kilowatt, 2 gigacycle tropo system that will be beamed at the ridge and diffracted over it.

GE gets computer allies in Europe

The General Electric Co. has now carved a foothold for its computer business in all three major European market areas. It has just reached a manufacturing and design licensing agreement with Associated Electrical Industries Ltd. Associated will make and sell the GE/PAC 4000 computer in England.

Allgemeine Elektrizitäts-Gesellschaft will be supplied with GE 412 computers for installation in German steel plants. In France, General Electric is negotiating a deal to buy into La Compagnie des Machines Bull [Electronics, May 4, 1964, p. 36].

One of the new, and unexpected, results of l'affaire Bull is the formation of a joint subsidiary by two French electronic giants. DeGaulle's government had asked the Compagnie Generale d'Electricite and Compagnie Generale de Telegraphie sans Fil to save Bull's slipping computer business. Then although neither company had been very active in computers before, they put together a subsidiary that will concern itself with computers and industrial electronics equipment.

Sylvania sells its twt production line

Sylvania Electric Products Inc., is getting out of the traveling-wave-tube business. The company, a subsidiary of General Telephone & Electronics Corp., is selling its twt operation in Mountain View, Calif., to the Microwave Electronics Corp., of Palo Alto. Sylvania will continue its klystron production and its other microwave tube lines produced at Williamsport, Pa.

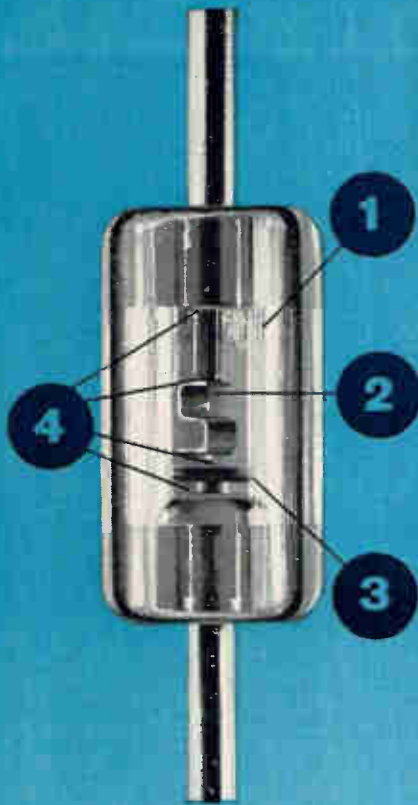

Ordinary diode
trouble spots



Unitrode
trouble spots

That's
reliability!

(1) Void in conventional diode becomes contaminated by trapped impurities, degrading diode characteristics. Unitrode® diodes have no void — the silicon dice is high-temperature bonded *directly* between the terminal pins, and hard glass is fused to all exposed silicon. Electrical performance is fixed, permanently. And because they're simpler, Unitrodes are smaller . . . in fact, this small: 

(2) Whisker can be burned out by surges, and contacts broken by vibration. Unitrodes have no whisker — their broad contact surfaces withstand continuous 10-watt power overloads, thermal shock and cycling from -195°C to $+300^{\circ}\text{C}$.

(3) Exposed silicon dice can easily be tipped, cracked or contaminated in assembly. The Unitrode dice — sandwiched between terminal pins and sealed in hard glass — is practically invulnerable.

(4) Delicate construction increases chances of faulty assembly — loose solder balls, double whiskers, flaking gold, defective glass seal, distorted elements. One-piece Unitrodes are so simplified, trouble-free and rugged that characteristic readings do not change through all MIL-S-19500 environmental testing . . . and performance will not deteriorate throughout a long service life.

This kind of reliability has to cost a little more — but it's essential for electronic packages that require all the performance possible in the smallest space. Allow our representative a few minutes to demonstrate the entire Unitrode line of diffused 3-ampere silicon diodes, fast switching rectifiers, 3-watt zeners, high voltage stacks and bridge assemblies, and ask him for the Unitrode Reliability Manual. Just write or call . . . UNITRODE CORPORATION, 580 Pleasant Street, Watertown, Massachusetts 02172. Tel: (617) 926-0404, TWX: (617) 924-5857.



UNITRODE

Our first Microglass diode customer came in a helicopter

The MICROGLASS diode was still secret. But somehow word leaked out. So, lo and behold, one sunny morning a helicopter landed at our front door. Out popped our first customer — eager for more information.

He was sworn to secrecy. And given the MICROGLASS story.

There was only one thing that we couldn't then provide: life test data. But now we can. Today MICROGLASS diodes have successfully completed several thousand hours on extended life tests under military standard conditions.

Write for further information: Hughes Semiconductor Division, 500 Superior Ave., Newport Beach, California. Or just phone. You needn't come in a helicopter.

HUGHES

HUGHES AIRCRAFT COMPANY
SEMICONDUCTOR DIVISION
NEWPORT BEACH, CALIFORNIA



PRIMARY ELECTRICAL CHARACTERISTICS

STANDARD HUGHES TYPES	Min. Bv @ 100µA (volts)	MIN. FORWARD CURRENT @ 1V (mA)	MAX. REVERSE CURRENT			MAX. CAP @ 0 Volts (pf)	REVERSE RECOVERY AND CONDITIONS ≡				Max. Time (nsec)
			@ 25° C (µA)	@ 150° C (µA)	@ V (volts)		I _r (mA)	V _R (volts)	I _{rec} (mA)	Ckt —	
9001	100	100	.025	100	20	3	10	6V	1	S-S	2
9002	100	30	.025	100	20	2	10	6V	1	S-S	2
9003	75 @ 5µA	200	.050	100	50	2	10	6V	1	S-S	2
9004	75 @ 5µA	100	.050	100	50	2	10	6V	1	S-S	2
9005	75 @ 5µA	20	.050	100	50	2	10	6V	1	S-S	2
9006	50 @ 5µA	300	.100	100	40	3	10	6V	1	S-S	2
9007	50 @ 5µA	200	.100	100	40	2	10	6V	1	S-S	2
9008	50 @ 5µA	100	.100	100	40	2	10	6V	1	S-S	2
9009	50 @ 5µA	20	.100	100	40	2	10	6V	1	S-S	2
9010	30 @ 5µA	10	.100	100	20	3	10	6V	1	S-S	2

≡ Additional Reverse Recovery Parameters Which are Guaranteed are: Conditions I_r = I_k from 10mA to 200mA Recovery Current = .1I_r Recovery Time ≤ 4 nsec

DESIGN CAPABILITIES:	DO-7	Silver Clad Nickel Leads	Silver Leads	Ribbon Leads	Rivet	Pellet
Power Dissipation (mW)	250	500	500	150	500	500
Average Rectified Forward Current (mA)	75	150	150	75	150	150
Forward Surge 1 sec (amps)	.5	1.0	1.0	.5	1.0	1.0
Forward Surge 1µ sec (amps)	2.0	4.0	4.0	2.0	4.0	4.0
Temperature, Storage	-65 C to 200 C					
Temperature, Operating (ambient)	-65 C to 200 C					
Temperature, Cycling (-65 C to 200 C) Method 1052 MIL-STD-750	24 Cycles					
Constant Acceleration, Method 2006 MIL-STD-750	30,000g					
Shock, Method 2016 (1.5 msec) MIL-STD-750	1,000g					
Shock, Method 2016 (1.5 msec) MIL-STD-750	1,500g					
Shock, Thermal (-65° to 200° C Instant Transfer) 5 cycles - 1 minute dwell	5 Cycles					
Vibration, (100 to 2,000 cps) Method 2056 MIL-STD-750	30g					
Vibration, Fatigue (60 cps) Method 2046 MIL-STD-750	20g					
Hermetic Seal Test (Dye Bomb 100 PSI)	24 Hours					
Lead Tension, Method 2036 MIL-STD-750	10 lbs	10 lbs	10 lbs	-	-	-

NOTE: Glass-Ambient Junction Diodes have exceeded the operating and storage life test conditions of MIL S 19500/116A and MIL S 19500/144:
 1,000 hrs Operating Life I_o = 50mA LTPD 10
 1,000 hrs Storage Life = 200° C LTPD 10

MICROGLASS diodes are .065" round x .050" long. Leaded versions: silver and nickel leads are .020" round x 1.36" long, ribbon leads are .025" x .003" x 0.70".

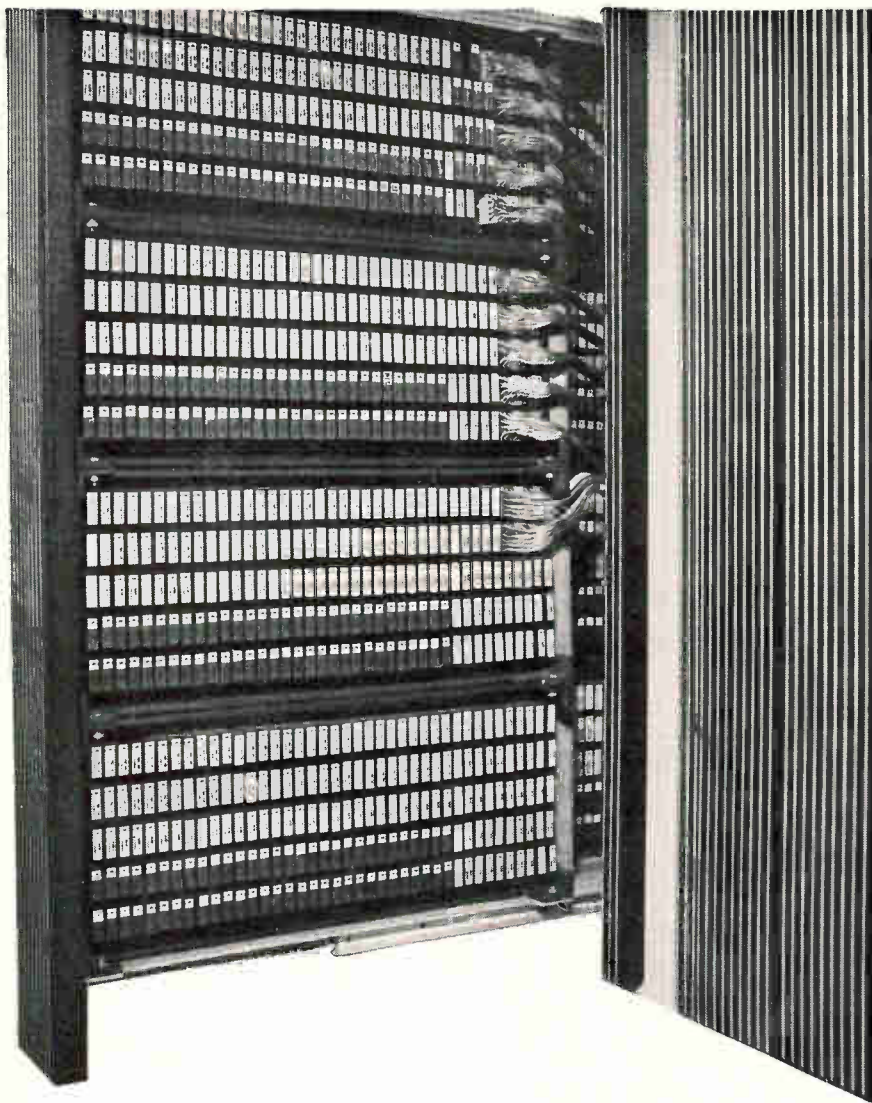

DIGITAL MODULES are available from stock in two sets of fully compatible resistor-transistor logic circuitry—for bit rates up to 200 kc; for bit rates to 1 Mc. More than a dozen types include: 4-input NOR • Counter Shift Register • Power Inverter • Emitter Follower • Complementary Driver • Differential • Filter (Decoupler)

How's this for digital density!

Compact new logic modules combine flexibility, reliability and economy

Radiation Logic Modules can be used in any configuration, type or number compatible with your digital system requirements. They can be mounted in vertical or horizontal drawers, in standard 19" racks, or on breadboards... fixed or removable. Because of their compact modular construction, packaging densities up to 137 modules per inch of panel height can be achieved in standard racks. There's no need for design compromise.

RELIABILITY Superior engineering and rigid component selection assure highest reliability: based on extensive tests, MTBF for low-speed NOR Modules exceeds 2,940,000 hours! The units are also packaged for rugged use. Constructed of welded circuitry molded in epoxy and mounted with high-density module connectors on cast aluminum frames. The resulting positive-contact units measure only 0.4" x 1" x 1.1" with a 0.25" pin protrusion.

ECONOMY Each module represents a fraction of the entire digital system. Each is designed for easy interrogation. Change or replacement is as simple as plugging in another unit. Thus, expensive downtime is reduced, costly benchwork completely eliminated.

APPLICATIONS ASSISTANCE Radiation offers the services of its engineering staff in the application of digital logic modules, or in helping solve your unique data problems. Write or phone for technical data sheets. Radiation Incorporated, Products Division, Department EL-07, Melbourne, Florida. Telephone: (305) 723-1511.



RADIATION
INCORPORATED

PRICE LIST—DIGITAL MODULES

Part Number	Description	Unit Price
503815G1	NOR—Medium Speed	\$ 10.38
503816G1	NOR—Low Speed	6.40
503818G1	Power Inverter—Low Speed	5.95
503818G2	Power Inverter—Medium Speed	10.69
503819G1	CSR—Low Speed	8.82
503819G2	CSR—Medium Speed	11.66
503819G3	CSR—Medium Speed	37.65
503820G1	MSMV "B" Side	7.74
503821G1	Diff (MSMV "A" Side)	9.68
503834G1	Filter (Decoupler)	7.55
503860G1	Compl. Driver—Low Speed	12.55
505694G1	Diode Gate	11.40
505703G1	D/A Converter	14.20
505704G1	Indicator Driver	14.15
506030G1	CSR-M1	21.20
507318G1	Emitter Follower—Low Speed	7.29
507318G2	Emitter Follower—Medium Speed	12.11
508334G1-G8	Octal Patch	4.20
508335G1-G2	Jumper Patch	4.84
508367G1	5 Volt Reference	196.20
508517G1	Module, Special Component	13.62
509050G1	Indicator Driver (Negative Coincident Input)	15.15

Specifications and prices subject to change without notice due to technological advances. Delivery, discount schedules and additional pricing information available upon request.



**SOME WE BUILD
TO FLY**

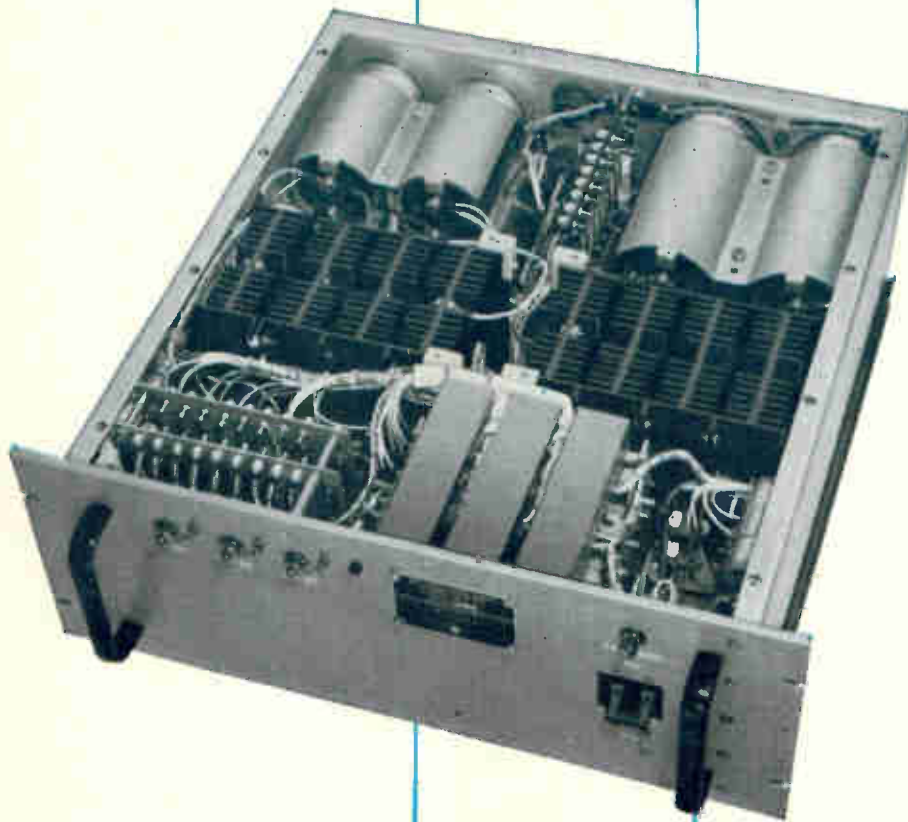

Exposed view shows accessibility of components in the Chatham Model R24-10R3 GSE highly regulated, multiple output power supply

Chatham Power Supplies and Frequency Changers for instrument and systems applications are custom-designed with a background of sophisticated experience in the development of ground support equipment. Chatham can deliver the total power supply requirements of any customer, with parameters, circuit requirements and configuration tailored to any set of conditions. Performance

**THESE
STAY
ON THE
GROUND**

can be held to any commercial requirement, or as tight as MIL-E-4158, MIL-E-8189 or MIL-E-16400 and tighter if the need requires. Design and production capabilities are backed by Chatham's environmental, physical and functional test facilities which are equalled by only a very few independent testing laboratories. Write for complete technical information about Chatham Power Supplies.

CHATHAM ELECTRONICS

LIVINGSTON, N. J. TWX: 201-992-7350

DIVISION OF TUNG-SOL ELECTRIC INC.

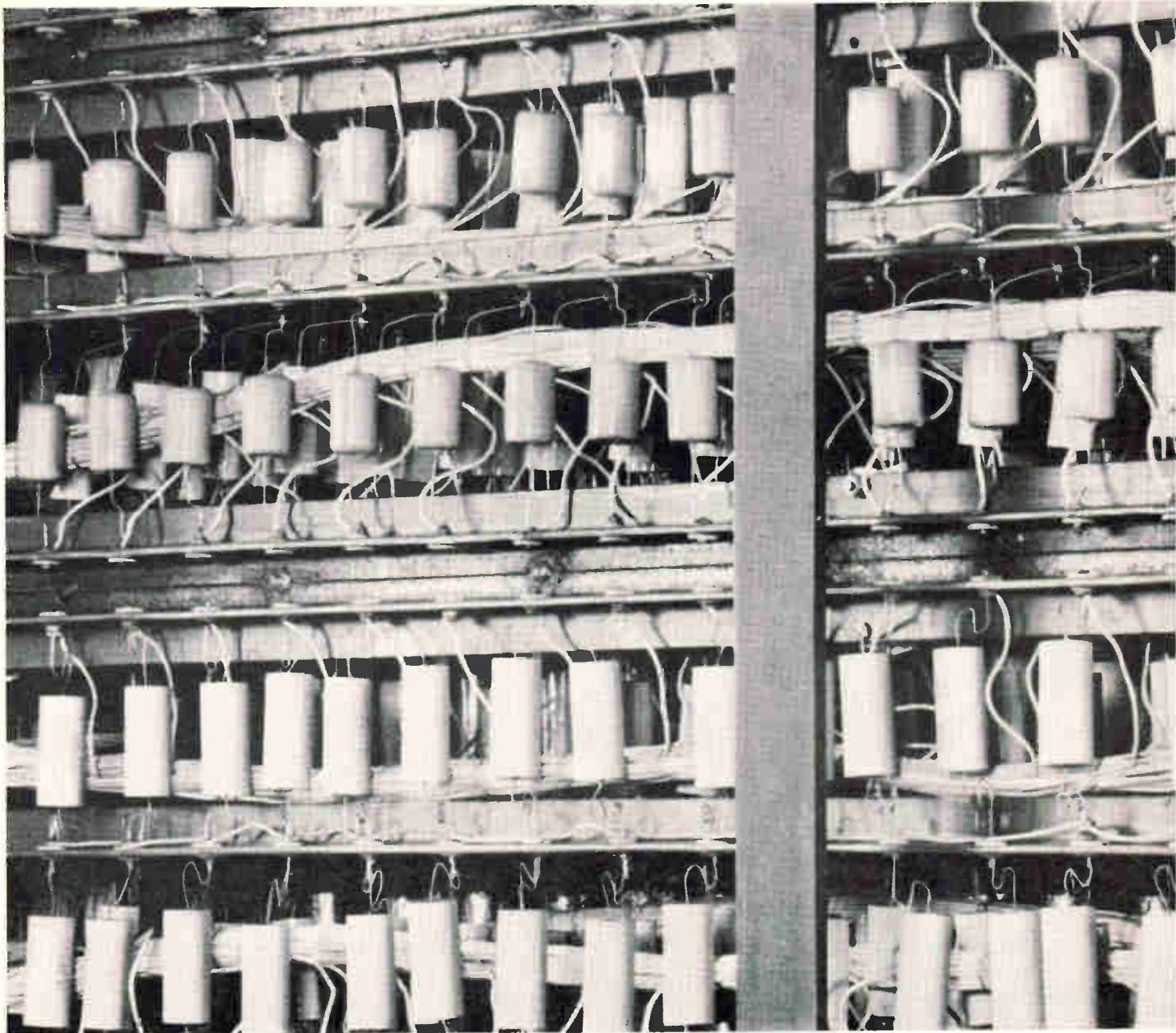

23,000,000 unit hours reliability of commercial

An extensive testing program has shown that commercial capacitors of "Mylar"* are very reliable and readily available from a number of suppliers. Capacitors from six manufacturers had a predicted life of 30 million hours between failures, based on average-size capacitors of "Mylar" used in radio and TV circuits.

Du Pont commissioned Inland Testing Laboratories of Cook Electric Company to conduct the reliability testing. The purpose of the tests was to answer these questions, "How reliable are capacitors with 'Mylar' as the dielectric?" and "Are they commercially available?"

The test involved 3,700 capacitors of varying constructions produced by 15 capacitor manufacturers from two *Du Pont's registered trademark for its polyester film.

randomly selected lots of "Mylar", plus 4,000 laboratory-wound capacitors produced by Du Pont from 14 randomly selected lots of "Mylar". Large one-half microfarad units were used so that the area of film tested was equivalent to that of 100,000 tubular capacitors of the average size typically found in radio and TV circuits.

Twenty-three million unit hours of testing showed that very reliable capacitors of "Mylar" are commercially available. Of the commercial units tested, those from six manufacturers had an average failure rate of less than 0.03% per 1,000 hours, at rated voltage stress, of 800 V DC/mil. In terms of smaller capacitance units, usually found in radio and TV circuits, this failure rate can be extrapolated

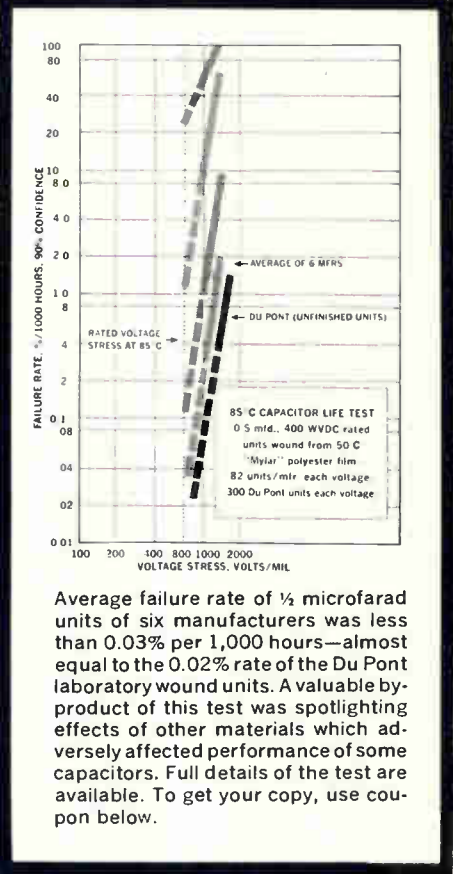
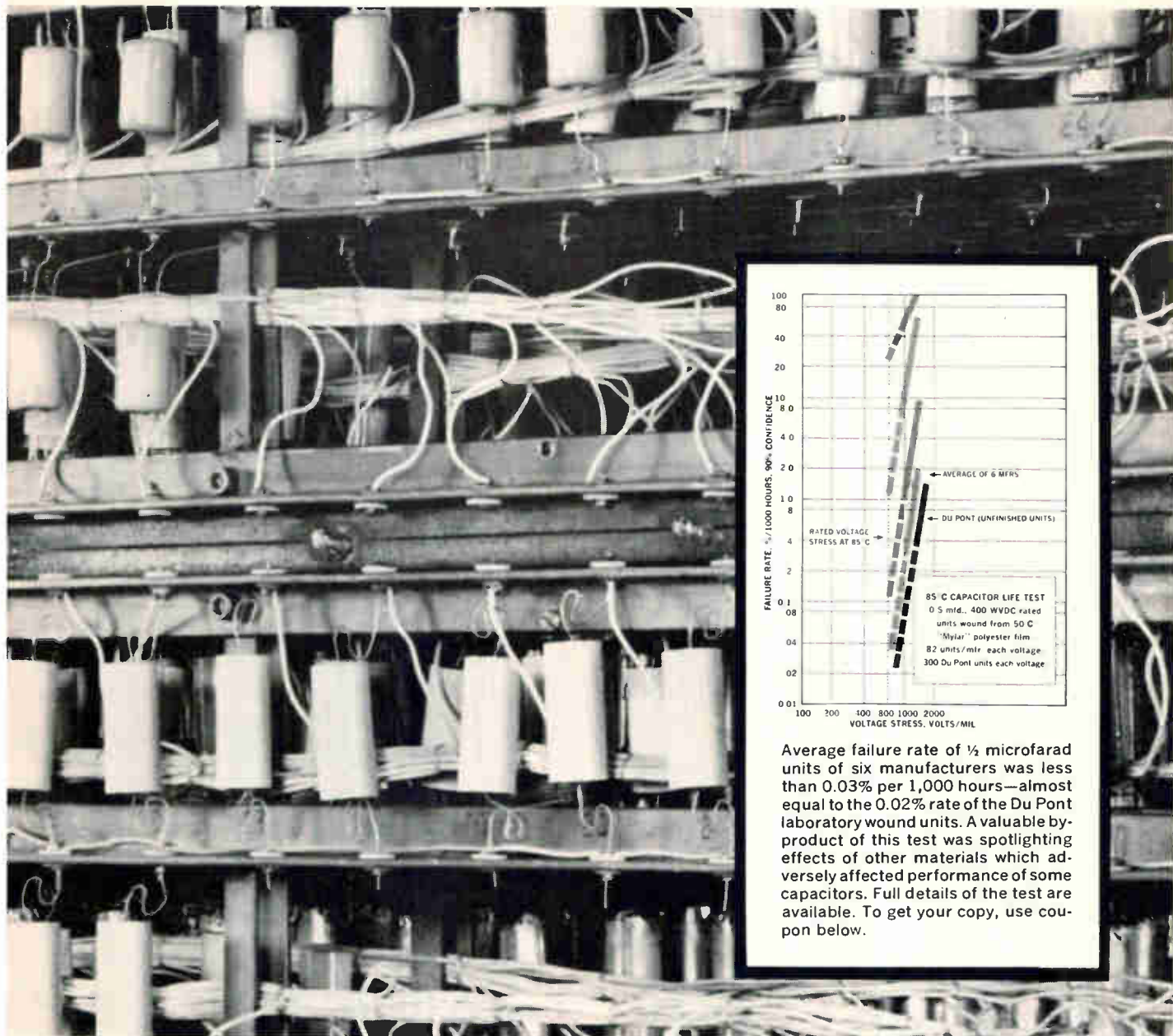

Average failure rate of 1/2 microfarad units of six manufacturers was less than 0.03% per 1,000 hours—almost equal to the 0.02% rate of the Du Pont laboratory wound units. A valuable by-product of this test was spotlighting effects of other materials which adversely affected performance of some capacitors. Full details of the test are available. To get your copy, use coupon below.

Commercial capacitors on test racks at Inland Testing Laboratories of Cook Electric Company in 23,000,000 unit-hour Du Pont reliability test.

of testing prove the capacitors of MYLAR®

to 0.003% or 30,000,000 hours between failures. When a lower voltage stress is used to obtain extra-high reliability, the failure rate can be extrapolated to less than 0.0001% per 1,000 hours.

Other significant and interesting results of the test are included in a comprehensive report which we would like to send you. It will provide data which can help you use low-cost, reliable and space-saving capacitors of "Mylar". For your copy, simply mail the coupon at right.

E. I. du Pont de Nemours & Company (Inc.)
 Film Department—N 10452 B-22
 Wilmington, Delaware 19898
 Please send me the reliability report.

Name _____ Title _____
 Company _____
 Address _____
 City _____ State _____ Zip _____
 Potential Application _____



BETTER THINGS FOR BETTER LIVING THROUGH CHEMISTRY

CLARE stepping & cam SWITCHES

provide longer service life •
greater switching capacity •
freedom from maintenance!

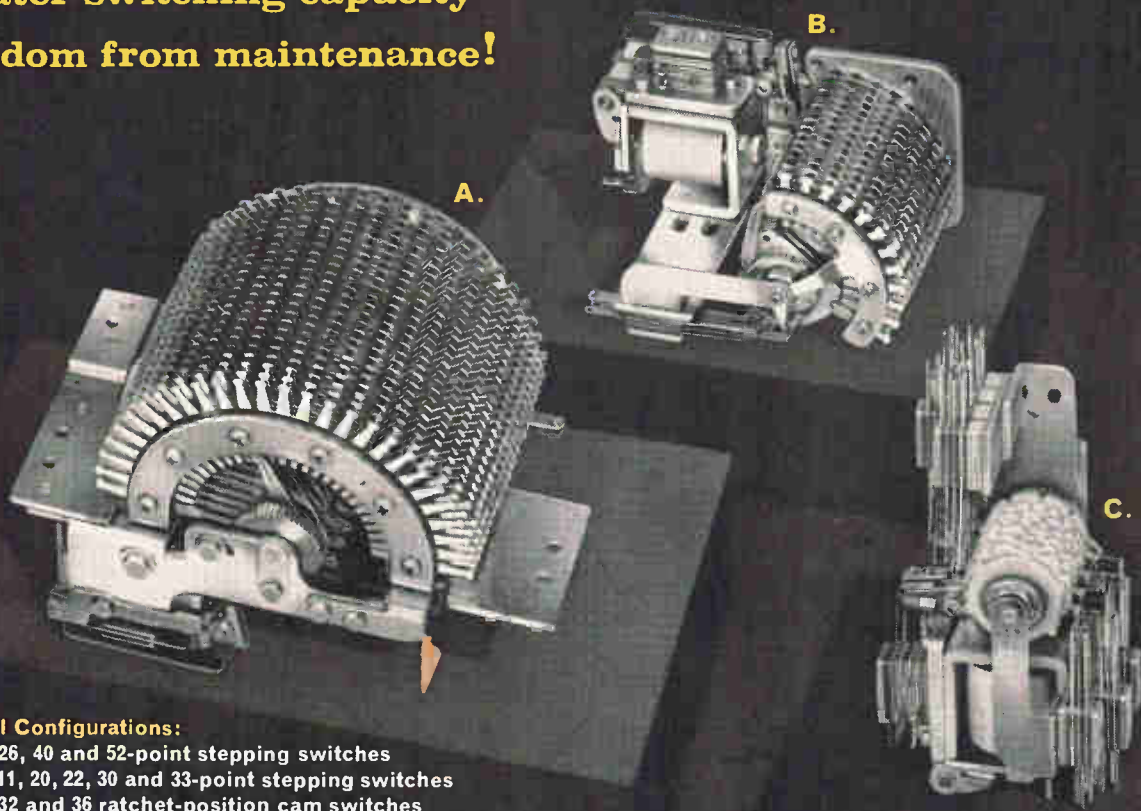

Typical Configurations:

- A. 20, 26, 40 and 52-point stepping switches
- B. 10, 11, 20, 22, 30 and 33-point stepping switches
- C. 30, 32 and 36 ratchet-position cam switches

CLARE Stepping and Cam Switches provide millions of steps with minimum maintenance. They are capable of handling extremely complex switching, counting, totalizing, selecting and sequencing operations. Special wiper configurations, shorting together all but one point in a level or leaving alternate points unshorted, are available.

Mechanical life of Clare Spring-Driven Stepping Switches ranges from 50,000,000 operations for switches with from 13 to 16 levels to 280,000,000 operations for from 1 to 4 levels. Cam switches range from 10,000,000 operations for switches with eight cams to 30,000,000 operations for two-cam switches.

Increased capacity of Clare stepping switches stems from a design which permits not only more levels per switch... but more levels in less space. For instance, the Clare Type 26 switch can provide twelve 52-point levels within a height of 4-11/16 in. This is but 11/16 in. higher than a comparable 52-point switch of eight levels. This compactness often allows more simplified circuitry when a single Clare switch can do the job which otherwise might require a multiple switch assembly.

For Complete Information on Clare Stepping and Cam Switches • Send for Clare Manual 601

Electrical and Mechanical Characteristics of Spring Driven Stepping Switches and Cam Switches

Type	Points per Level	Levels (max)	Total Points (max)	Operating Speeds		Nominal voltages and Coil resistances
				Self-Interrupt	Remote impulse	
210	10, 20 or 30	12	120			
211	11, 22 or 33	12	132			
20	20 or 40	16	480	60 steps per second at nominal voltage; 25°C	30 steps per second at nominal voltage with 66% "on" time; 25°C	6, 12, 24, 48, 60 and 110 vdc
26	26 or 52	16	624			1.5-600 ohms
200	Up to 8 cams with up to 6 contact springs per cam and 30, 32 or 36 steps per revolution					

ENCLOSURES: Hermetically-sealed enclosures or dust covers, with solder terminals or plug connectors, are available for all Clare Spring-Driven Stepping and Cam Switches.

Address: Group 7N6 C. P. Clare & Co., 3101 Pratt Boulevard, Chicago 45, Illinois. Cable Address: CLARELAY. In Canada: C. P. Clare Canada Ltd., 840 Caledonia Road, Toronto 19, Ontario. In Europe: C. P. Clare, Ltd., 70 Dudden Hill Lane, London NW 10, England.



Relays and related control components

Avionics

Instant radar maps

A display tube that will instantaneously show what an aircraft's side-looking radar sees is being developed for the Avionics Laboratory at Wright-Patterson Air Force Base, Ohio. The tube is, in effect, a real-time motion-picture machine.

Side-looking radar, unlike conventional radar, scans the ground line by line as the plane passes overhead. This scanning method produces a strip map with a resolution almost as good as in aerial photography [Electronics, Mar. 22, 1963, p. 22].

What the radar sees can be captured by a movie camera. This is fine for later analysis, but it isn't a real-time display. The radar strip map can also be synthesized in real time by a scan converter and a cathode-ray tube, but this arrangement is bulky, and space in a military aircraft is at a premium.

Erasable film. The new display tube, being developed by the Raytheon Co., is called a traveling-image storage tube. It looks like the blade end of an oar. Inside the evacuated tube is a belt driven by a slow-speed vacuum drive. The belt passes the viewing glass of the tube at a speed set by the aircraft's speed and altitude and by the pulse-repetition frequency of the side-looking radar.

The side of the belt that the radar operator sees is coated with a photosensitive material (Scotophox). When this material is swept by an electron beam containing the radar video information, a moving picture of the radar video is displayed. After the belt moves past the viewer, infrared light erases the electron-excited image.

The tube will display five shades of gray and will be readable even in broad daylight.



After slurry is poured into mold, it will rise like yeasty bread dough.

Packaging

Ceramic that foams

A potting compound that cures at 150° F and then protects electronic circuitry from temperatures up to 2500° F? It's true. A ceramic foam that will do just that has been developed at the National Aeronautics and Space Administration's Goddard Space Flight Center in Greenbelt, Md.

Ceramic foams have been used before to protect circuits. But almost invariably they require high curing temperatures and must first be foamed, then shaped to fit around the circuit. Another alternative is filling the package with tiny ceramic or glass beads.

Because of its low curing temperature, Goddard's ceramic composition can be poured directly into the package. It is applied as a slurry, then foams in place at about the same rate as yeasty bread dough. Goddard developed the foam to protect satellite electronics from the heat of nuclear power sources.

Mixing and curing. Inorganic ingredients are used for the slurry. Typical proportions are: orthophosphoric acid, 31 grams; aluminum hydroxide, 30 gm; bentonite, 1 gm; aluminum meta-phosphate, 6.5 gm; silicon dioxide, 1.2 gm; and metal powder, 0.15 gm.

The dry ingredients are mixed, then blended slowly with the acid. Vigorous stirring produces a chemical reaction that creates water of hydration, changing the mixture into a slurry.

The slurry is then poured around the circuit in a mold lubricated with silicone fluid. It takes about 30 minutes for the compound to become fully foamed.

If held at a temperature of 85° C, the compound cures in about eight hours. Raising the temperature to 150° C after two hours will speed the curing.

Varying density. Density of the foam can be varied in three ways:

- By varying the amount of slurry poured into a covered mold. The cover constrains the foam. The more slurry used, the smaller the cell structure will be, raising the density of the foam.

- By varying the size of the metal powder. Large particles cause large bubbles to form, lowering the density. Cell structure, however, is irregular.

- By varying the amount of metal powder.

Porosity can be varied from 5% to 90%, and density from 19 to 140 pounds per cubic foot.

Metal particles can vary in size from 150 mesh to smaller than 325 mesh; 200-mesh power is used in the formula cited previously. Metals such as aluminum, zinc and magnesium can be used. The silicon dioxide has a particle size of 20 microns—its function is to improve the viscosity of the green ceramic.

In color, too. To identify potted modules, the color of the foam can be varied by adding pigments, such

as chromium oxide for green and iron oxide for beige.

After curing, the ceramic can be cemented, cut with a hacksaw, shaped with a wood rasp, or ground on an abrasive wheel.

A patent disclosure has been filed by Alfred G. Eubanks and Ronald E. Hunkler of Goddard's materials research and development section.

Industrial electronics

Number-sculpting

It's a strange studio for a sculptor. No clay. No curlings on the floor. No pedestal. No chisel. No armature to support the figure. Just a 50-foot-high tank, a library of punched tapes, and a tape-reader.

The sculptor's assistant selects a roll of punched tape labeled "Venus de Milo," places it onto a tape-reader and pushes a button. Within a few hours, a replica of a famous lady will emerge, 6'8" high, with her measurements (55-39-51 in the vital dimensions) accurate to ten-thousandths of an inch.

No such studio exists yet. But it could well be a result of the collaboration of a famous sculptor, an inventor and some generous contributors.

Hero-size problems. The sculp-

tor, Robert Berks, discussed some problems of his art one day with Jacob Rabinow, president of Rabinow Electronics, Inc., a subsidiary of the Control Data Corp. He described the process that always results in distorted reproductions of heroic-size statuettes. He mentioned the Ford Foundation's concern about damage to art works, and the foundation's offer of \$250,000—to be matched by equal funds from other sources—to create a "museum" of numerical-control tapes of statuary masterpieces.

On July 21, Rabinow received his 115th patent—a method of milling copies of big statues accurately and quickly.

Underwater art. The key element is a machine tool inside a liquid-filled tank. The tool floats in the liquid, its blade touching a shell of bronze two inches thick filled with a light, rigid plastic. The liquid makes the hollow cutting-arm weightless, and eliminates the effects of temperature and vibration during milling.

The machine tool, as it mills the bronze, could be directed by a scribe tracing over the contour of a foot-high model of a statue. Unlike the mechanical scribe of this pantagraph, which uses levers to enlarge dimensions and introduces mechanical errors, the Rabinow unit could use a noncontacting tracer system to gather data for the

punched tape and later to guide the machine tool. Such a tracer system is already being used by the auto industry [Electronics, June 1, 1964, p. 64 and May 4, 1964, p. 102].

From the punched tape, masterpieces could be mass-produced in their original size.

The electronics of the numerically controlled system would be placed inside the tank, or connected by cable from a position outside the tank.

Shocking shrimp

For years, shrimp fishermen have been dragging chains in front of their trawling nets to shake shrimps out of the mud and sand so the nets can capture them. For years, fishermen have figured they could get more shrimps out of the ocean bottom if they could shock them awake. An electric shock causes a muscular reaction that makes shrimps jump.

An electronic generator that does the job by radiating high-power pulses into the water has now been developed for commercial use. It has been tested by the Department of Commerce's commercial fisheries gear research station in Panama City, Fla. One fishing fleet operating in the Gulf of Mexico, and another on the Atlantic coast have begun using it. Another fleet is still testing it.

Commercial system. The commercial system was developed by the Sea Technology Corp. of Sarasota, Fla. An output circuit, operating with a silicon controlled rectifier, radiates two pulses per second into the water through an electrode array. The array is stretched in front of the otter doors of the shrimping rig.

Pulse widths are less than one millisecond. Peak amplitude is 100 volts and nominal peak power is 140 kilowatts.

Power for 12 hours of trawling is provided by nickel-cadmium batteries made by Gould-National, Inc. A semiconductor inverter changes the direct current to alternating current. Induction is used to magnetically couple the power to

Sculpting statues under water with numerically controlled machine tools is described by Jacob Rabinow to sculptor Robert Berks. Frogmen in the sketch are a result of artistic license. Bust of President Kennedy on table was made by Berks.

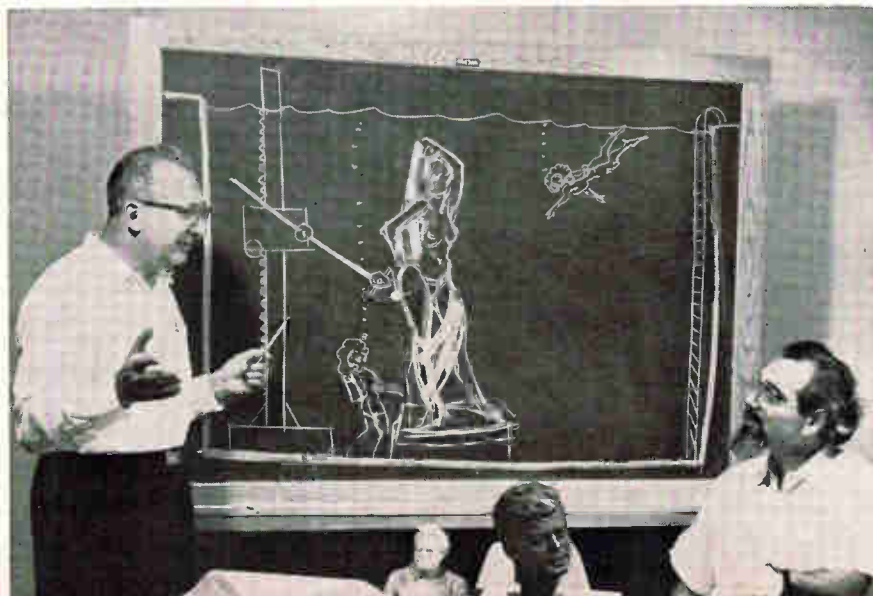

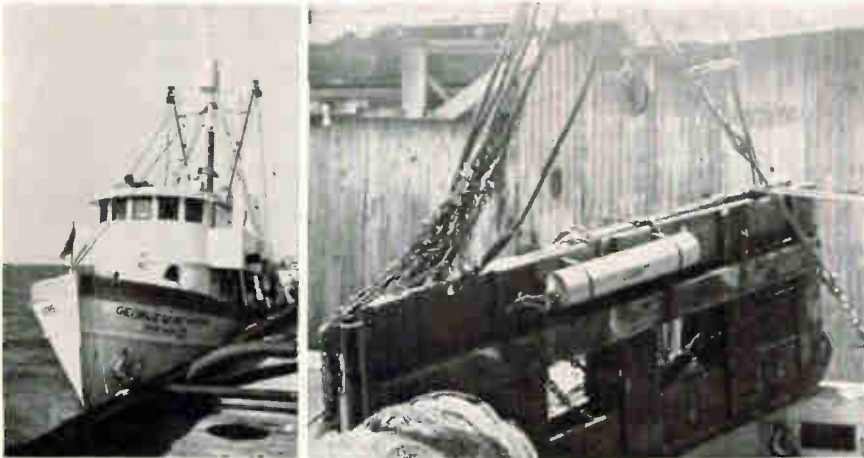

Government research vessel, the George M. Bowers, was site of sea tests. At right is a shrimping rig, with the pulse generator mounted on one of the otter doors.

the pulse generator. This eliminates the necessity of water-tight connections for cables and makes it easy to replace the batteries. The power supply fits into the pulse-generator housing.

Manufacturing

The littlest Biax

You've heard of the Flute, the Rope, the Twistor? No, these aren't dances. They're magnetic memory configurations. Now there's a new memory shape that could be called the Clarinet, or Licorice Stick, because that's what it resembles.

The memory consists of a Permalloy wire with pairs of tiny holes drilled at right angles to each other. Each pair of orthogonal holes constitutes a memory core, only a few thousandths of an inch long. Many such cores can be formed in a single wire by using a laser drill.

Microenergy memories. Prototypes have been made at the Radio Corp. of America's Aerospace Systems division in Burlington, Mass. Experimenters were looking for a memory so small and requiring such low driving power that it would be compatible with computers made entirely of integrated circuits. They think they have found the answer.

The units are a variation of the Biax configuration developed by

the Aeronutronics division of the Philco Corp. [Electronics, June 29, 1964, p. 61]. Regular Biax memories are assembled from individual, molded-ferrite cores with a nominal size of 0.05 by 0.05 by 0.08 inch. They are among the fastest memories made because the polarity of only the tiny amount of ferrite between the two orthogonal holes is switched, and the change in magnetic orientation is only 90° instead of the usual 180° domain reversal.

The RCA experimental units operate in the same way but because the magnetic volume between the orthogonal holes is much smaller they would require much lower switching power. Typical dimensions of the wire units would be 0.0001-inch diameter holes 0.005 inch apart, with the hole pairs 0.015 inch apart in the Permalloy wire. Each of these "cores" is joined by magnetic material to the next core. The cores are effectively isolated because the distance between pairs of holes is much greater than the distance between holes in a pair.

Laser drill. The key to the process for making the cores is a laser drill. Burton Clay, project engineer, explained why:

▪ Such small cores cannot be molded, with the holes, from ferrite. Nor can regular mechanical drills be made small enough. The tiny holes could be drilled by an electron beam in a vacuum chamber, but this would be a slower

process during which the material would heat up and lose its magnetic orientation.

▪ Lasers can drill microscopic holes in metal in a microsecond. There is almost no heat, so the wire keeps its magnetic orientation. Permalloy is oriented when the wire is made.

To make the cores, the laser is set up on an optical bench and aimed at the wire. One hole is drilled. The wire is moved slightly forward, rotated 90° and the second hole is drilled. The wire is then advanced the 0.015-inch spacing between cores and the process is repeated.

Clay thinks that refinements of the production method would provide an automatic method of producing core-type memories.

Thin films of glass

The Corning Glass Works can now make a thin-film version of its glass capacitors on the same production lines where it manufactures thin-film resistors. The production line at Raleigh, N. C., does not use vacuum processing, but makes passive microcircuit networks that resemble a cross between vacuum-deposited thin films and screened circuits.

Corning expects the new capacitors to meet military specifications. Their rating is 50 volts, from 100 to 5,000 picofarads. Capacitance is about 80,000 pf per square inch, and the dielectric constant is about 600. Tolerances of 5%, 10% or 25% can be held. Cost per capacitor is about the same as for discrete mica capacitors.

Compatible process. The capacitors are made by a process that is compatible with the high-temperature pyrolytic deposition that Corning uses to make tin-oxide resistors.

Layers of niobate-glass dielectric and gold electrodes are applied to the substrate. The capacitor is then fired; this bonds it to the substrate. Firing changes the glass to a crystalline substance similar to Corning's Pyroceram. The resistors are then deposited at 600° C. Copper

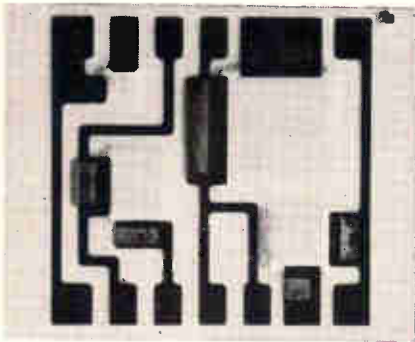

Thin-film circuit contains four resistors and four glass capacitors.

conductor paths can be applied directly over the capacitors.

The capacitors will be shown for the first time at the Western Electronic Show and Convention on Aug. 25.

Computers

Thin-film first

By mid-1965, the National Cash Register Co. plans to start deliveries of a new version of its NCR 315 computer, called the 315 RMC (rod memory computer). Unless another company beats it out, NCR will be first with a commercial computer whose main memory is made entirely of thin-film storage elements.

The memory is about half the size of the standard NCR 315 ferrite-core memory, eight times as fast and is part of a redesigned central processor unit. This unit could also be used to replace the central processors in existing NCR 315 and 315-100 computers, enabling them to execute about 100,000 instructions a second.

Some thin-film memories are now being used in commercial computers, as auxiliaries. The Univac division of the Sperry-Rand Corp. started using a thin-film control memory in the Univac 1107 in 1961. Three Univac military and aerospace computers use thin-film main memories.

Thin-film cylinders. Most thin-film memories take the shape of a flat plate. NCR uses a cylinder [Electronics, June 29, 1964, p. 65].

The basic memory element is a 0.010-inch diameter beryllium-copper wire, electroplated with a nickel-iron magnetic film, 4,000 angstroms thick and wrapped with a spiral copper ribbon. To assemble a memory module, the rods are inserted through a stack of 40 solenoid planes, in 16 rows of 66 rods each. The rods are provided with terminations for coincident-current operation.

The solenoids are spaced on 1/8-inch centers in all three dimensions, for a packing density of 5.2 bits per cubic inch. In the laboratory, NCR has reached a packing density of 7,000 bits per cubic inch by spacing the rods 50-thousandths of an inch between centers. Ultimate interest is in possible use of the rods for mass memory, to compete with drums, disks and tapes.

Each group of windings for 66 solenoids is made from a single wire by an automatic machine that winds a 10-twin coil at each solenoid position. When current is sent through these coils, the adjacent cylindrical thin film is magnetized on the rod through which current has also been sent. The cylindrical shape of the rod is said to allow for tight coupling between windings and magnetic material, so that large switching fields can be provided with reasonable currents and small inductances.

Average access time is 267 nanoseconds per digit; the read-restore or clear-write cycle time is 800 nsec.

The 315 RMC has a basic 60,000-digit memory (four bits per digit) made up of eight memory modules; the computer memory can be ex-

panded to 240,000 digits in increments of 60,000.

A 315 RMC with 60,000 alphanumeric character storage capacity will rent for \$6,000 a month; a standard 315 with comparable memory size rents for about \$5,000 monthly.

Also announced was the 321 communications controller, which links as many as 100 remote input-output machines to any 315 computer for on-line operation.

Components

Out, damned spot

No more blemishes on those french-fried potatoes; no more embarrassing spots still on your best necktie or vest just back from the cleaners. This is the prospect offered by an unusual photosensitive device developed by Sylvania Electric Products, Inc., a subsidiary of the General Telephone and Electronics Corp. Photocells will pick out dark spots on opaque objects, or find internal flaws in transparent or translucent materials such as glass or plastic, before they get to you. A typical application for the device is monitoring conveyor-transported objects in the food, textile and agricultural industries.

The new Sylvania photocell detects imperfections, which appear as dark spots, by responding to a reduction in light caused by dark areas. An ordinary photocell has limited sensitivity to small dark spots in random positions.

Cells in series. The dark-spot detector contains two strips of cadmium sulfide that form a number of small cells connected in series. Cell resistance increases when a blemish masks the light the cell would otherwise see. Because of the series hookup, the increase in resistance adds directly to the terminal resistance, raising sensitivity. A standard photocell comprises a number of small cells connected in parallel; the masking of a small area has little effect on the terminal resistance.

With a one-to-one optical sys-

Memory module consists of plated wires in a stack of solenoid planes.

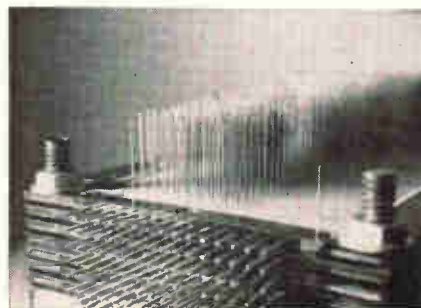

LAMBDA MULTI-CURRENT-RATED®

power supplies offer maximum flexibility for any application at any ambient to 71°C

NOW 0-60, 0-40, 0-20 VDC IN ¼ and ½ RACK MODELS

ALL
SILICON
Modular-Subrack
LH
SERIES



Lab
Ambient
30°C



Industrial
Ambient
50°C



Elevated
Ambients
60°C 71°C



CURRENT RANGE AT AMBIENT OF: (1)

Model	Voltage Range	30°C	50°C	60°C	71°C	Price (2)
LH 121	0-20VDC	0-2.4A	0-2.2A	0-1.8A	0-1.5A	\$159.00
LH 122	0-20VDC	0-5.7A	0-4.7A	0-4.0A	0-3.3A	\$260.00
LH 124	0-40VDC	0-1.3A	0-1.1A	0-0.9A	0-0.7A	\$154.00
LH 125	0-40VDC	0-3.0A	0-2.7A	0-2.3A	0-1.9A	\$269.00
LH 127	0-60VDC	0-0.9A	0-0.7A	0-0.6A	0-0.5A	\$184.00
LH 128	0-60VDC	0-2.4A	0-2.1A	0-1.8A	0-1.5A	\$315.00

(1) Current rating applies over entire voltage range. DC OUTPUT Voltage regulated for line and load

(2) Prices are for non-metered models. For metered models and front panel controls, add suffix (FM) to model number and add \$25.00 to the price. For non-metered chassis mounting models, add suffix (S) to model number and subtract \$5.00 from the non-metered price.

- AC INPUT—105-135 VAC, 45-480 cps
- REGULATION—Line or Load—.015% or 1 mV
- RIPPLE—less than 250 microvolts rms and 1 millivolt P-P
- TEMPERATURE COEFFICIENT— .015%/°C
- MEETS RFI SPECIFICATIONS—MIL-I-26600, Class 3
- CONSTANT CURRENT/CONSTANT VOLTAGE
- REMOTELY PROGRAMMABLE AND CONTINUOUSLY VARIABLE
- SIZE: LH 121, 124, 127 5³/₁₆" x 4³/₁₆" x 15¹/₂"
LH 122, 125, 128 5³/₁₆" x 8³/₈" x 15⁵/₈"
- RACK ADAPTERS
Model RA-1 for ruggedized mounting—Price \$60.00
Model RA-2 for conventional mounting—Price \$25.00

SEND FOR COMPLETE LAMBDA CATALOG.



LAMBDA ELECTRONICS CORP.
515 BROAD HOLLOW ROAD • MELVILLE, L. I. NEW YORK • 516 MYRTLE 4-4200

SALES OFFICES AND REPRESENTATIVES CONVENIENTLY LOCATED IN MAJOR CITIES
BE SURE TO VISIT LAMBDA'S WESCON SHOW BOOTH NO. 470-471 AT HOLLYWOOD PARK

tem, the dark-spot detector can spot a blemish $\frac{1}{32}$ of an inch in diameter in a $\frac{1}{2}$ -inch field. Lens systems can extend the field without loss of sensitivity. The photocell has detected $\frac{1}{16}$ -inch-diameter spots at conveyor-belt speeds of 150 feet a minute with 12-foot-candle average illumination on the face of the cell. Bridge circuits will compensate for thermally caused variations in cell resistance and offset a-c variations in the field light source.

Superpower triodes

A new design approach to high-power vacuum tube triodes has produced a significant increase in their power output and efficiency. Five of these superpower tubes can do a job that formerly needed almost triple that number.

The new technique, termed a breakthrough in power tube design by Machlett Laboratories, Inc., a subsidiary of the Raytheon Co., hurdles one of the major stumbling blocks to increasing the output of power triodes—the problem of electron interception by the grid.

In conventional tubes, one third to one fourth of the electrons emitted by the cathode are intercepted as they make their way to the plate. The relatively high grid

current that results represents a heavy loss of power.

Right to the plate. In the Machlett design, a magnetic field channels the trajectory of the electrons so that most of them miss the grid and find their way to the plate. As a result, the ratio of plate to grid current is about 100 to 1, compared with the usual 3 or 4 to 1.

The first tube incorporating the new design is Machlett's ML-8549, a nearly four-foot-high, water-cooled giant that puts out a whopping 60 megawatts of pulse power, with pulse widths up to 10 milliseconds. Pulsed-plate efficiency exceeds 90%. Another dividend of the new design is the unusually long duty factor (ratio of time on to time off) of 0.06. The usual duty factor for a tracking radar is between 0.0015 and 0.003.

The Machlett tube was developed to serve as a modulator in the new high-power tube-testing complex at the Rome Air Development Center, Griffiss Air Force Base, N. Y. The partially completed test center, designed to prove out future generations of r-f power devices for the Air Force, needed a hard-tube modulator capable of switching 5,400 amperes at a variable pulse repetition rate of from 1 to 1,000 cps and a duty factor of 0.06. Fourteen conventional tubes, operated in parallel could deliver the power but they would provide only a 0.01 duty factor. Machlett filled the bill with only five parallel tubes.

Other jobs. The ML-8549 can be used as a switch tube in pulse modulators for radar or similar applications. As a pulsed r-f amplifier operating at frequencies up to 30 Mc, it can deliver 10 megawatts with a driving power of only 33 kw, also at long pulse durations and high duty factors. The tube also can operate as a class C amplifier or oscillator with a c-w output in excess of 2 Mw with a drive of approximately 10 kw.

Machlett engineers feel that the tubes will have an important future

in industrial applications such as induction heating, a-m broadcasting, and in high-energy physics for plasma studies. Low-power versions of the ML-8549 tube are already being developed.

Communications

SAC speedup

The famous underground war room in Omaha, Neb., the nerve center of the Strategic Air Command, has been remodeled. Existing equipment is being replaced by the new 465L command and control system.

High-speed sending and receiving equipment, fast computers to store and process data from all over the world and a novel multi-color wall display system are being delivered under a prime contract with the Data and Information Systems division of the International Telephone and Telegraph Corp.

World-wide input. Basically, the 465L is a gigantic two-way communications system that funnels information to SAC headquarters at Offutt Air Force Base in Omaha and transmits operational instructions from there to the Air Force. Information is fed into the system by field stations called remote communications centrals. A message composer at a central converts a standard-form message into computer data. The data goes by way of switching computers to the central computer at Offutt or to a second computer at March Air Force Base in Riverside, Calif.

Messages travel to the data processing central at speeds varying from 750 to 3,000 words a minute. Errors are checked, inaccuracies are brought to the attention of an operator, priorities are assigned and the quickest route is chosen.

The special stored-program computer at Offutt has a word length of 48 data bits and two parity bits. It also has four high-speed core storages, each capable of holding 16,384 48-word bits. In addition, drum memories and magnetic tape storage are used for masses of information that back up the fast-

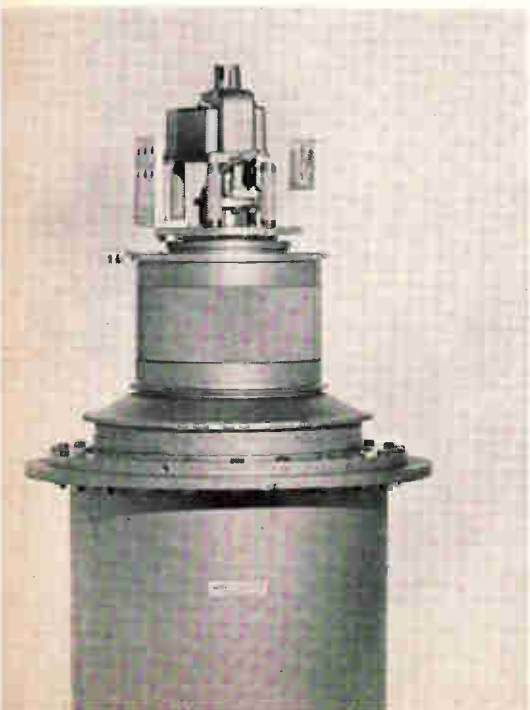

Mammoth tube stands nearly four feet high.

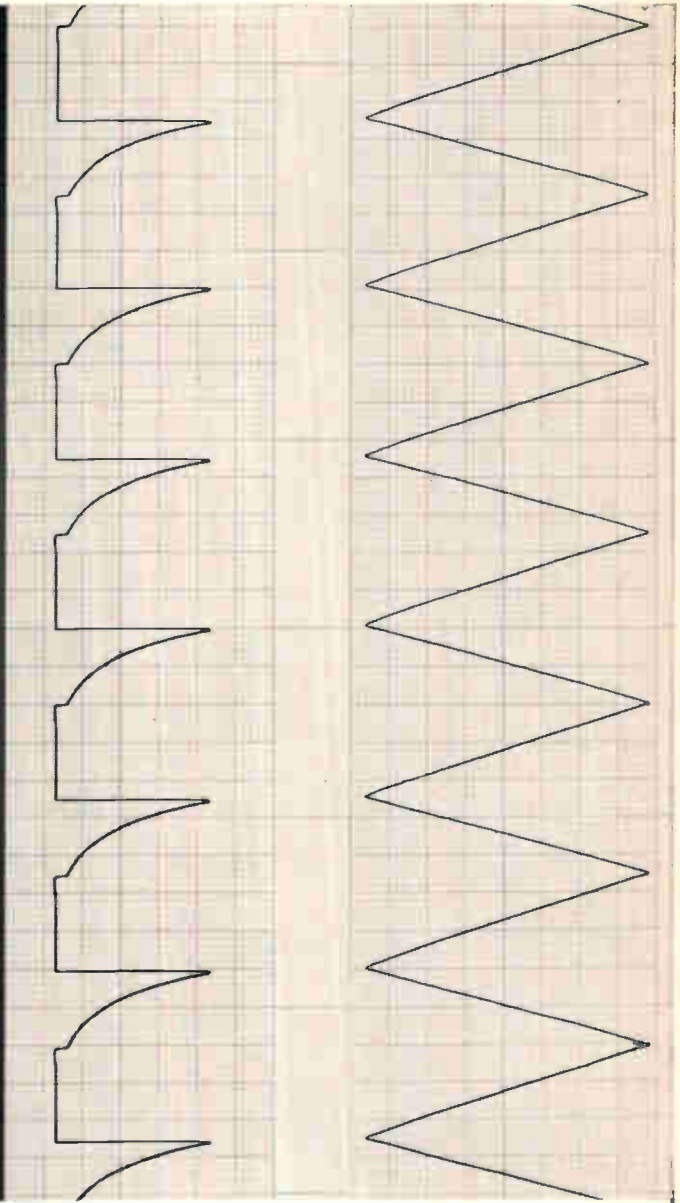
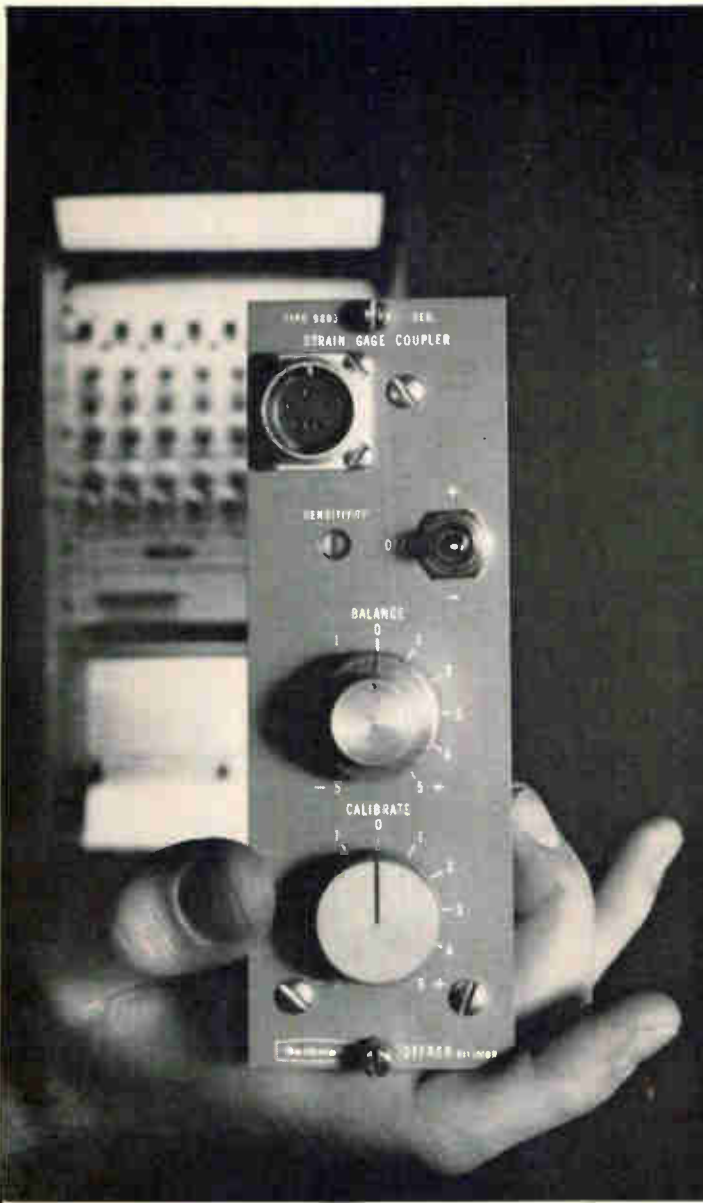

LOW-COST PLUG-IN INPUT COUPLERS ALLOW THE TYPE S RECORDER TO ACCOMMODATE A WIDE RANGE OF INPUT SIGNALS. 23 STANDARD COUPLERS ARE AVAILABLE.

OFFNER TYPE S DYNOGRAPH® IS SERVO CONTROLLED AT THE PEN POINT TO ASSURE LOCKED-IN ACCURACY.

Offner adaptability in ink rectilinear recordings

Only OFFNER offers the advantages of ink rectilinear recording with the flexibility of fast input coupler exchange. Servo loop at the stylus point forces locked-in accuracy. The OFFNER input couplers change the function of the amplifier system and provide all necessary bridge balancing, calibration and "computing" facilities...thus obviating the need for expensive special-purpose amplifiers.

Specifications:

Number of Channels	1-8 standard; to 24 special	•	Input Impedance	With preamp 2 megohms without preamp 1 megohm
Sensitivity	With preamp 1 μ v/mm to 5v/mm Without preamp 1mv/mm to 5v/mm	•	Warm-up Time	Instantaneous
Frequency Response	DC to 150 cps	•	Nominal Cost/Channel	With preamp \$1,250 Without preamp \$850
Phase Delay	2.5 ms \pm 0.05 ms, 0-120 cps	•		
Linearity	0.1% (full scale) for DC; or AC within maximum amplitude envelope	•		
Drift	(shorted input) With preamp 1 μ v/hr at max. gain Without preamp <0.05mm/hr	•		
Recording Amplitude	Full chart channel width from DC-40 cps with progressive reduction to 5mm at 150 cps	•		

Beckman®

INSTRUMENTS, INC.

OFFNER DIVISION
Schiller Park, Illinois

International Subsidiaries: Geneva, Switzerland; Munich, Germany; Glenrothes, Scotland

063-650

reaction core storage. Beyond this, disk files handle an additional 13 million words. The central processor has an access time of 2.5 microseconds and can execute 400,000 operations a second.

Color display. Information from the system is available by various types of printout; but for the SAC commander and his staff, masses of data must be quickly assimilated through use of large projection displays. Desired information can be reproduced on a 70-mm positive film in less than 15 seconds. Digital signals received from the data processor are converted into analog voltages which position a crt electron beam. An optical system projects the crt alphanumeric onto the film. Three images, correctly registered, carry all or parts of the same message. The projection light is split into the three primary colors by dichroic mirrors.

When each film image is present and illuminated, the colors combine to make white light, and the data appears normally. Absence of all but one film image produces single-color light for red, green or blue, as desired. When the identical image appears on two units of the film, resulting colors are cyan, magenta or yellow. In all, seven different colors are available to identify static, new or emergency information.

Six screens, each 16 feet square, are being installed at SAC headquarters. Maps or other transparencies can also be projected as a base for computer-derived information overlays.

More power

Police officers at the annual convention of the Associated Public Safety Communications Officers, in Norfolk, Va., will see on Aug. 5 the first public display of a line of transistorized two-way radios that can put out almost 60 watts of r-f power at ultra-high frequencies. This is almost double the power of existing commercial solid-state two-way radios operating at uhf.

The f-m sets are now in production at the General Electric Co.'s

Communications Products department, Lynchburg, Va.

GE thinks the development will increase the use of the uhf band (around 450 megacycles) and thus relieve the overcrowding of lower frequency bands. The higher power will permit uhf sets to be used in areas where reception is difficult.

Very high frequency. For customers who want to stay down at very high frequency, GE also has new vhf mobile units that put out 100 watts, and base stations with up to 330 watts. The sets use silicon transistors.

Other features in the sets are a new type of voltage regulation and a tuning search system.

The first protects frequency stability and provides stable squelch operation to insure that all calls are received. Even when the voltage from a vehicle battery surges with overcharge or drops off with heavy loads, receiver sensitivity and transmitter drive are unaffected.

The tuning circuit is used in sets that receive two frequencies. The circuit permits only the audio signal of the first station received to be heard by the operator.

The new GE line will be pitted competitively against the Motorola Co.'s all-transistor Motrac and Motran radios, already in use. The Radio Corp. of America's most comparable line is called Super-Carfone.

Space electronics

Which way is down?

A classic problem in satellite control is finding "down." This must be done accurately when an antenna has to point precisely at earth. A classic solution is to find the earth's horizon and determine the vertical from that.

The technique doesn't always work well. During Col. John Glenn's orbital flight, the horizon sensor was confused by a tropical storm and gave a vertical reading that was 10° off.

In an effort to eliminate such

errors, the National Aeronautics and Space Administration plans a project called Scanner. It will use a satellite in its research for better ways of sensing the horizon and in studying the best optical frequencies for horizon sensors—infrared, ultraviolet or visible light.

New radiometer. Part of the project is an improved infrared radiometer being developed at Langley Research Center, Hampton, Va. It will have a 0.025° field of view, instead of the 0.25° field of present sensors. This will enable it to peer more closely at the horizon.

Two of these radiometers would be mounted back-to-back on a spin-stabilized satellite with vertical orientation. One would sense wavelengths of 14 to 16 microns, and the other wavelengths of 20 to 35 microns or longer.

Electronics abroad

No cheating

A starting gate for swimmers is part of an electronic timer that was designed in Britain.

The starting circuit simultaneously operates a speaker at each starting position and vibrates the platform on which the swimmer stands. This overcomes two defects of the traditional starting gun. Deaf swimmers can't hear the gunshot, and competitors furthest from the sound hear it about 0.06 seconds after the gun is fired. The time lag gives the swimmers nearest the signal gun a head start.

To prevent cheating or false starts, the swimmers grasp bars. If they let go of the bar before the starting signal, an audible alarm is triggered and a disqualification rope drops into the pool. At the end of the race, as each swimmer finishes, he touches a rubber pad that then hits a metal plate, shutting off a timer.

The electronic timing and starting system is accurate to one millisecond. The timer is a one-megacycle crystal oscillator that feeds eight counting units by means of divider circuits.



Vidar 240 for full scale inputs from 0.1 vdc to 1000 vdc.



Vidar 241, a high level version of the Vidar 240.



Vidar 260 for direct conversion of mv signals without preamplification.



Vidar 211 for multiple-channel applications.



Vidar 2500 Series converts ac voltage, dc voltage, and resistance to frequency.

Voltage-To-Frequency Converters CHOOSE FROM THE BROADEST LINE

Vidar offers the widest selection of standard voltage-to-frequency converters currently available. There are standard Vidar converters to handle all these inputs: high and low-level dc voltage, ac voltage, and resistance. Here are details.

The Vidar 260 high sensitivity (5 millivolt level volts), high impedance, floating input voltage-to-frequency converter is well suited for direct connection to gage and thermocouple signals. Applications include 130 db common mode rejection, 160 cps and settling time of 0.2 ms. Price, \$1,290 in rackmount, cabinet, or module.

The Vidar 240 provides input ranges from 0.1 to 1000 vdc and accepts either input polarity without switching. Choose 0-100 kc or 0-10 kc full scale output. Available in rackmount, cabinet, or module. Prices range from \$790 to \$825.

The Vidar 241 is a high signal level version of the Vidar 240 offering input ranges from 10 to 1000 vdc, and choice of 0-100 kc, 0-10 kc, or 0-1 kc full scale outputs. Priced at \$515, the unit is available in rackmount only.

The Vidar 211 is intended for multiple-channel applications where high level signals are available and unipolar operation possible. It offers an input range of 0-10 v and choice of 1-100 kc, 0-10 kc, or 0-1 kc output.

Ten converters with power supply occupy only 3 1/2" of rack space. Price, approximately \$315 per channel.

The Vidar 2500, which converts ac or dc voltages and resistance to frequency, is a good choice for automatic checkout systems. Accuracy is 0.1% for dc and resistances and 0.2% for ac. Bandwidth 30 cps to 50 kc. Applications include laboratory measurements, data logging, equipment checkout, production sorting of components, and quality control testing. Prices range from \$500 to \$2,500.

In addition, please note that each converter is all solid state and offers $\pm 0.025\%$ linearity; stability of $\pm 0.1\%$ per week; $\pm 0.01\%$ per $^{\circ}\text{C}$; and $\pm 0.02\%$ for $\pm 10\%$ line voltage change.

For more information, or a demonstration, please call your Vidar sales engineer (listed in eem) or write to us at 77 Ortega Avenue, Mountain View, California. Telephone (415) 961-1000.

9 A

V I D A R

WHAT MAKES "INSTRUMENTATION CABLE" DIFFERENT?

It is no more like power or control cable than a Ferrari is like the old family sedan. Not knowing this can cause you a lot of grief: project delays, costly replacements, malfunctions.

THE THIN BLACK LINE On your schematics, instrumentation cable is a black line from launching pad to blockhouse or from one part of a computer to another. In the broadest sense, it connects data or signal sources with display or recording or control devices. Its function is to carry those signals unflinchingly and with the required reliability. In this day and age, it's no easy job.

WHAT CAN GO WRONG The improperly designed cable can simply fail. This has happened and at important sites. An untried saturant, lacquer or compound ingredient used in the cable may destroy the electrical integrity of this primary insulation. This sort of deterioration need not be sudden; only experts know which impregnants will migrate in a week or a month or more.

Or a relative lack of art in manufacture may create problems for the future. Under certain circumstances in use, variations in insulation thickness, conductor placement, or conductor unbalance in the cable lay-up may cause spurious or ambiguous signals to arrive at the display, recording or control panel. Your sharp, precise pulses become displaced in time, are a little too fuzzy, or are joined by other unwanted signals from another line.

DESIGN IS HALF THE STORY Configuration of conductors within the cable is important, for physical as well as for electrical reasons. For example, positioning of coaxial components within the cable is critical in order to assure maintenance of minimum standards of concentricity between the inner and outer conductors when the cables may be subjected to bending operations during installation work.

Selection of insulating, filler and

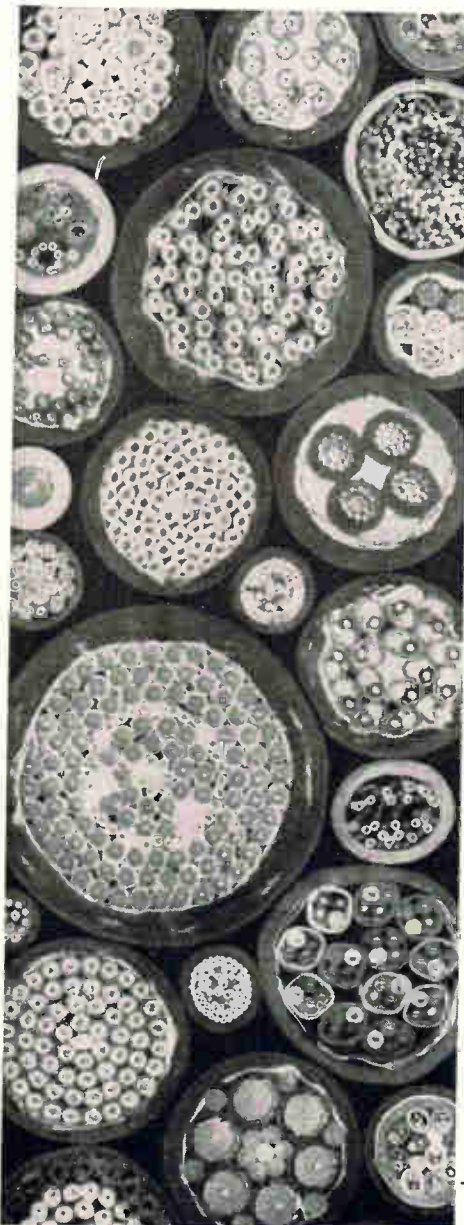

jacketing materials requires expert knowledge and judgment. Some materials, as mentioned above, tend to migrate. Others harden or soften with cold or heat. Some change their electrical characteristics in time. These are not fundamentally new problems in cable design, *but in instrumentation cable the standards are far more severe than ever before.*

MANUFACTURE IS THE OTHER HALF Even a properly designed cable may well become unacceptable sooner or later if it is not manufactured to new standards of precision. This requires stranding machines that reduce circular eccentricity to remarkably low figures and help assure insulation uniformity, insulating machines of considerable precision, and highly precise cabling equipment. It also requires, as is so often the case in precision manufacture, an indefinable skill on the part of machine operators.

ASK THE EXPERTS To protect the functioning of your system, there's only one way to make sure the thin black lines on your schematics become cables with the requisite dependability: have them designed by experts, in consultation with you, and constructed by experts.

Rome-Alcoa is, frankly, one of the very few companies that qualify. We've been designing and constructing these cables since their first conception. If you're going to need instrumentation cable soon, call us, the sooner the better.

We now have a 24-page booklet titled "Instrumentation Cables, Cable Assemblies and Hook-up Wires." In it, we describe instrumentation cable constructions, production, military specifications and our qualifications. For your copy, write Rome Cable Division of Alcoa, Dept. 27-74 Rome, N. Y.



ALCOA
ROME CABLE
DIVISION



**THIS NEW X-Y RECORDER
CONTRIBUTES SIX
MAJOR IMPROVEMENTS
TO THE STATE-OF-THE-ART**

MOSELEY 

an affiliate of Hewlett-Packard

- New, exclusive AUTOGRIP® hold-down for any size paper to 11"x17"
- 100 microvolts / inch sensitivity at one megohm input resistance
- AC input ranges to 5 millivolts / inch
- 120 db common mode rejection at line frequency
- Multi-contact flat mandrel potentiometers for unprecedented reliability
- Time sweeps for either axis with automatic reset and adjustable sweep length

These improvements, coupled with proven Moseley quality and precision, make the Model 7000A the most advanced X-Y recorder available today. Available, too, is the companion model 7030A, same as 7000A but accepts paper to 8½" x 11", without ac inputs. Model 7000A, \$2575; Model 7030A, \$1795. Call your Moseley / Hewlett-Packard field engineer or write: F. L. MOSELEY CO., 433 N. Fair Oaks Ave., Pasadena, Calif. 91102.

*Trade Mark Pat. pend.

9429

Circle 37 on reader service card



Type 230-A

10 to 500 MC POWER AMPLIFIER

— for Low-Level Applications





The BRC Power Amplifier Type 230-A is the ideal RF amplifier for low-level applications exhibiting a typical noise figure of 6 to 8 db. Three tuned, cascaded stages of grounded-grid amplification provide up to 30 db gain and a maximum power output of 5 watts. Typical applications include:

RECEIVER PRE-SELECTOR — The Type 230-A, when used as a pre-selector with conventional communications receivers, will readily provide fractional microvolt sensitivities.

TUNED SELECTIVE FILTER — BRC 230-A provides a convenient means for the selective amplification of RF signals in the 10 to 500 Mc. range with excellent rejection of undesired frequencies.

HARMONIC AMPLIFIER — The new power amplifier may be used to amplify desired harmonics in the output of signal generators and frequency synthesizers thereby extending their useful range.

FREQUENCY COUNTER PRE-AMPLIFIER — Type 230-A as a pre-amplifier for conventional frequency counters, such as the  524/525, will provide a 15 to 30 times improvement in input sensitivity. Remote, off-the-air frequency measurements of FM broadcast and communication transmitters may be readily performed.

RF MILLIVOLTMETER PRE-AMPLIFIER — When used as a pre-amplifier for RF millivoltmeters, such as the  411, the 230-A will provide 15 to 30 times improvement in sensitivity.

BOONTON RADIO COMPANY

A Division of Hewlett-Packard Company



GREEN POND ROAD, ROCKAWAY, NEW JERSEY

Tel. 627-6400 (Area Code 201) TWX: 201-627-3912 Cable Address: Boonraco

RF RANGE: 10 to 500 Mc.

BAND RANGES: 10-18.5 Mc. 65-125 Mc.
18.5-35 Mc. 125-250 Mc.
35-65 Mc. 250-500 Mc.

RF GAIN: 30 db (10-125 Mc.)
27 db (125-250 Mc.)
24 db (250-500 Mc.)

RF BANDWIDTH: >700 Kc.* (10-150 Mc.)
>1.4 Mc.* (150-500 Mc.)

*Frequency interval between points 3db down from max. response

RF OUTPUT:

RANGE: Up to 15 volts*

*Across external 50 ohm load
IMPEDANCE: 50 ohms.

CALIBRATION:

0.2 to 3 volts f.s.;
increments of approx. 5%.

1.0 to 10 volts f.s.;
increments of approx. 5%.

2.0 to 30 volts f.s.;
increments of approx. 5%.

ACCURACY: ±1.0 db of f.s. (10-250 Mc.),
±1.5 db of f.s. (250-500 Mc.).

LEAKAGE: Effective shielding is greater than 40 db.

RF INPUT:

LEVEL: ≤0.316 volts* (10-125 Mc.)

≤0.446 volts* (125-250 Mc.)

≤0.630 volts* (250-500 Mc.)

*For 10 volt output into 50 ohms
IMPEDANCE: 50 ohms

AM RANGE: Reproduces modulation of driving source 0-100% up to 5 volt max. carrier output

AM DISTORTION: <10% added to distortion of driving source

FM RANGE: Reproduces modulation of driving source except as limited by the RF bandwidth

FM DISTORTION: Negligible distortion added to distortion of driving source for deviations and modulation frequencies <150 Kc.

INCIDENTAL AM: <10% added to modulation of driving source at 150 Kc. deviation

MOUNTING: Cabinet for bench use; by removal of extruded strips suitable for 19" rack mounting

POWER REQUIREMENTS:

105-125/210-250 volts,
50-60 cps, 150 watts

Price: \$1200.00 F.O.B. Rockaway, N. J.

Need Capacitors in SPECIAL PACKAGES?

Here are a few we've made recently:

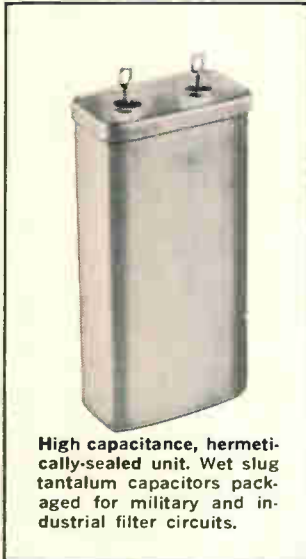

High capacitance, hermetically-sealed unit. Wet slug tantalum capacitors packaged for military and industrial filter circuits.



-55° to +125°C hermetically-sealed unit. Three Mallory HTA high-reliability aluminum electrolytics for industrial applications.



5400 mfd., 24 v., in a special mount. Four Mallory XTV wet slug capacitors in custom-designed geometry for an advanced missile program.

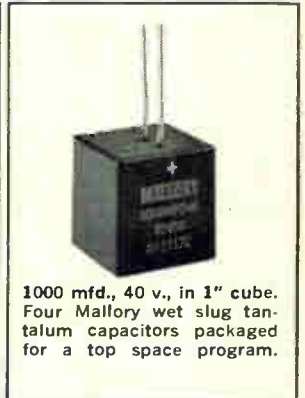

1000 mfd., 40 v., in 1" cube. Four Mallory wet slug tantalum capacitors packaged for a top space program.

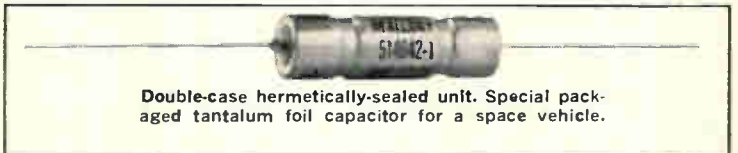

Double-case hermetically-sealed unit. Special packaged tantalum foil capacitor for a space vehicle.

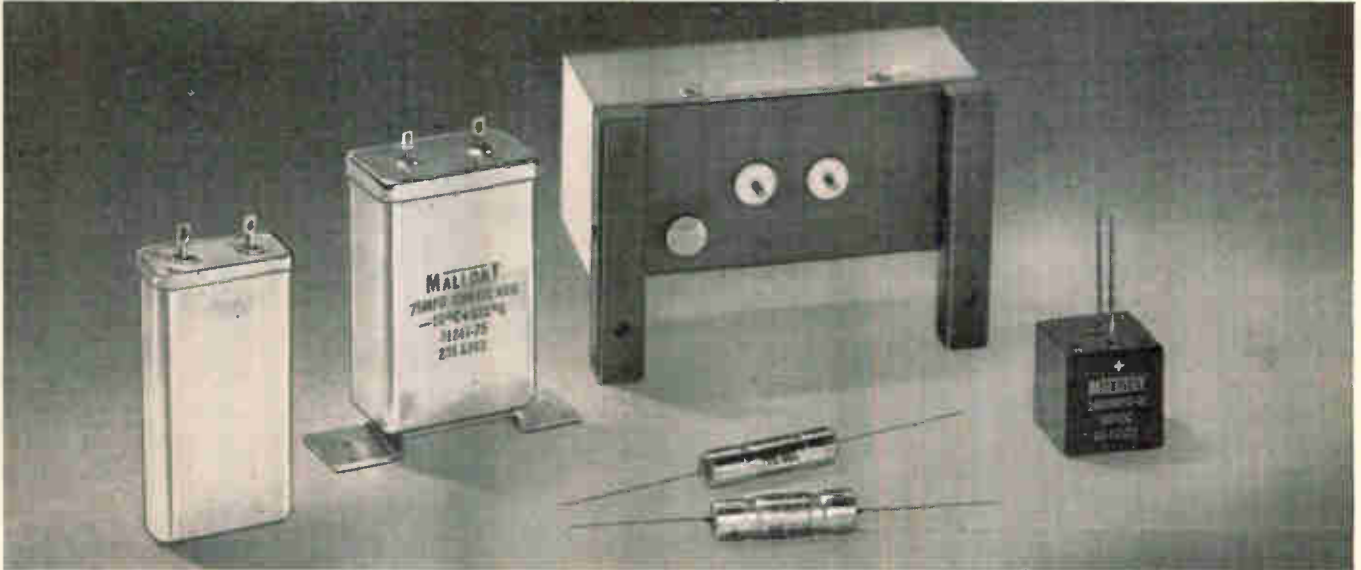

Packages have been designed for Apollo, Gemini, Pershing, TFX and other missile, space and aircraft programs. Whatever your packaging requirements, Mallory engineers can design and produce the capacity, reliability and geometry you need . . . quickly and economically. They have a full line of tantalum and aluminum electrolytic capacitors and years of experience to apply to your problem. Please write giving details such as capacity, working voltage, dimensions and environmental conditions. Or, request a consultation. Mallory Capacitor Company, Indianapolis, Indiana 46206—a division of P. R. Mallory & Co. Inc.



See us at WESCON—Booths 169-171, Hollywood Park



Some people call our inspectors fuss-budgets (but Speer customers think they're great)

The man up there in the picture is a member of Speer Carbon's Quality Control and Inspection team. He's checking a resistor lead for solderability—one of many tests that are S.O.P. for Speer fixed carbon resistors.

He's also one big reason why Speer customers are *happy* customers. They know they can rely on Speer electronic components for uniformity and performance—time and time again.

Actually, all of our inspectors are fuss-budgets. They just won't take anything for granted and we're glad. That's why Speer has one quality-assurance employee for every eight employees in production and one quality-assurance engineer for every seventy-five employees in production. And that holds for every manufacturing step ...from raw materials to the finished product.

Mil specs? Speer participates in industry committees that cooperate with military departments in writing them. What's more, our tests don't stop there. This year, 141,912,000 unit life test hours are scheduled for Speer resistors and 40,000,000 for Jeffers coils.

But just to keep the record straight, our inspectors don't deserve all the credit for Speer quality. The folks up and down the line, in all departments, have the same kind of pride in Jeffers' and Speer's performance that our quality-assurance employees have. And we suspect that Speer's multi-million dollar research and development program has something to do with it, too.

SPEER Carbon Co.



Dept. 487, St. Marys, Pennsylvania 15857
Speer Carbon Co. is a Division of Air Reduction Company, Inc.

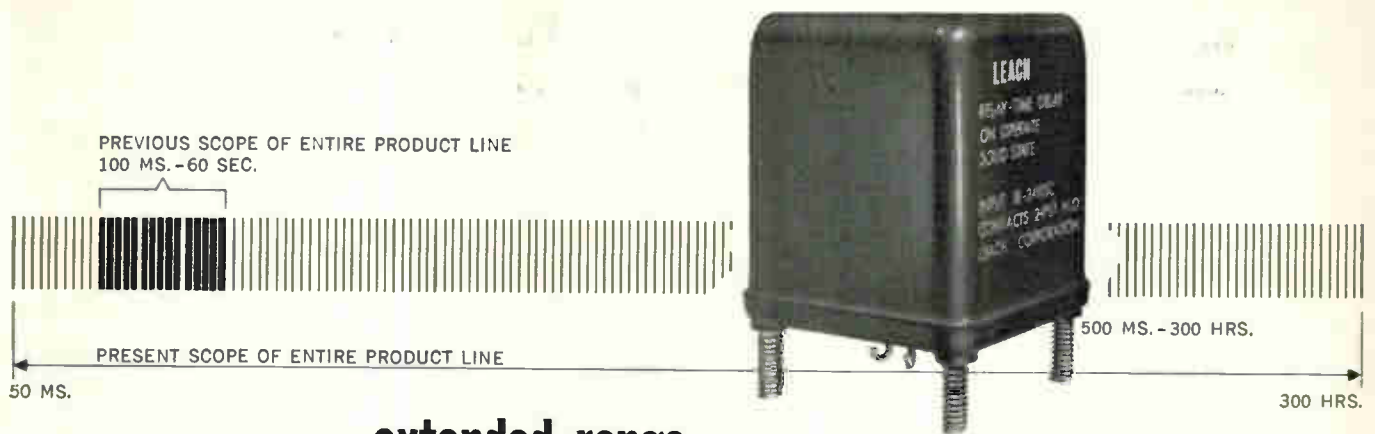

**extended range
smaller sizes**

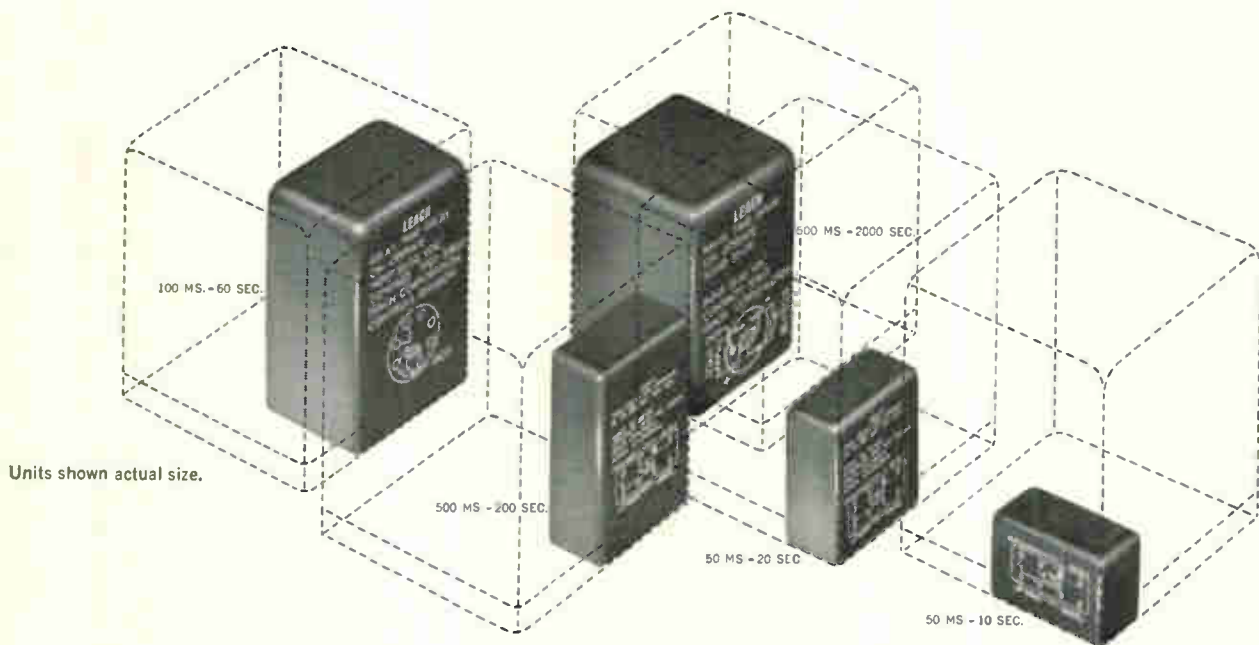

— now offered in Leach standard electronic time delay relays

Recent Leach developments in miniature magnetic cores, new applications in time base generators, and the complete redesign of Leach-patented unijunction circuits now make possible many additional maximum-performance features in standard time delays.

NON-DESTRUCT MEMORY is an example. In the event of interruption of input power, the non-destruct memory will maintain the timing count in the unit. Upon reapplication of power, the unit will continue timing as though no interruption had occurred. (Available in four of nine standard models.)

HIGH ACCURACY OVER A BROAD TEMPERATURE RANGE: $\pm 3\%$ from -20°C to $+71^{\circ}\text{C}$, $\pm 5\%$ from -55°C to $+85^{\circ}\text{C}$, $\pm 10\%$ from -55°C to $+125^{\circ}\text{C}$.

INHERENT RELIABILITY guaranteed by design simplicity and solid state silicon components. All units can be built to meet Minuteman reliability specs.

MANY OTHER FEATURES, including minimum power drain, fast automatic recycle and voltage regulation. Units are available with solid state or relay output, fixed or adjustable timing, and with delay on operate or release.

CHOICE OF 6 CONFIGURATIONS: Standard MS, Double Crystal Can (2), Crystal Can (2), and Half-size Crystal Can, with a wide variety of mounting and terminal configurations.

CUSTOM DESIGNS WITH SPECIAL CAPABILITIES can be produced to meet your most stringent requirements. Extended timers with up to 3 years delay. Accuracy to $\pm .02\%$. Multiple output programmed events.

FOR PROMPT DELIVERY of standard units, or regarding custom orders, see your Leach representative, or write, wire or phone:

LEACH
CORPORATION
CONTROLS DIVISION
717 North Coney Avenue, Azusa,
California • Phone: (213) 334-8211
Export: LEACH INTERNATIONAL S.A.

15 YEARS OF R & D AT INTERNATIONAL RECTIFIER ADVANCES U.S. MILITARY EFFORT

EL SEGUNDO, CALIF.—From the bottom of the sea to the farthest reaches of outer space... IR's components have demonstrated the success of fifteen years of research and development to advance the U.S. military effort.

Silicon rectifiers resulting from the programs have contributed to many highly varied military projects. Among them have been IR's superpower oil-cooled Rectifier Columns, which are a part of the Ballistic Missile Early Warning System (BMEWS), and HAYSTACK HILL—the largest research radar antenna ever built—designed around IR's superpower rectifier systems.

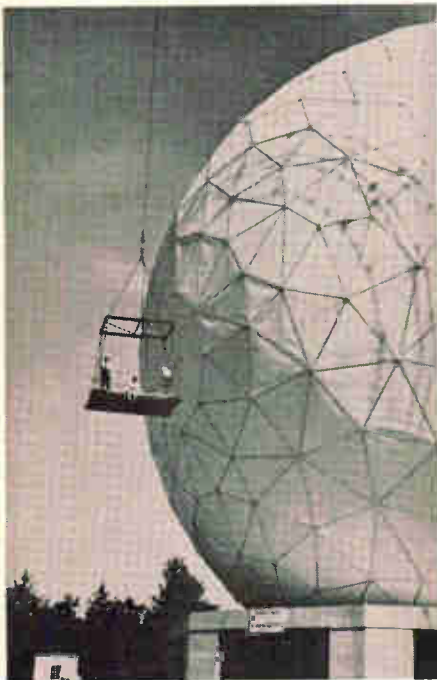

HAYSTACK HILL, TYNGSBORO, MASS.

Other notable military projects which have incorporated IR components are Polaris-equipped nuclear-powered submarines, which contain IR's 70 and 150 amp rated silicon controlled rectifiers,

supplied to function as 3-phase AC motor speed controls; and TIROS, NIMBUS, and Space Project 823 Satellites for which International Rectifier



NUCLEAR POWER SUBMARINE

produced solar cells which provided on-board power. Eight of the TIROS Weather Eye satellites contained IR's P/N type cells, and a new TIROS series will carry IR's N/P type, radiation resistant cells. All satellites launched have been highly successful, and IR continues to supply all cells for the entire project.

In terms of aerospace performance, IR solar cells and solar panels have logged millions of miles of space flight, providing an inexhaustible supply of electrical power under the most radical environmental conditions. Their reliability is clearly demonstrated by the fact that, after thousands of hours in orbit on a continuous duty basis, space vehicles incorporating IR solar cells are still transmitting data powered by their undiminished solar generators.

Other contributions by IR to the national military effort have been the development for the U.S. Naval Ordnance Laboratory of a de-sensitized silicon controlled rectifier which would respond to activation and yet be relatively insensitive to all radio frequencies; and Project Mercury, for which Dallons Labs, IR's Medical Electronics Division, subcontracted physiological data monitoring equipment by which Astronauts Glenn and Carpenter sent signals picked up at 14 tracking stations around the world.

These projects and hundreds more of paramount importance to the military defense effort of our nation have given International Rectifier a unique repository of experience in fulfilling research and development contracts and in developing new ideas for government agencies concerned with our country's defense.

To put this experience to work on your projects, contact Larry Dudley, Director of Government Liaison at International Rectifier Corporation, El Segundo, California, Telephone ORegon 8-6281.

SPACE PROJECT 823

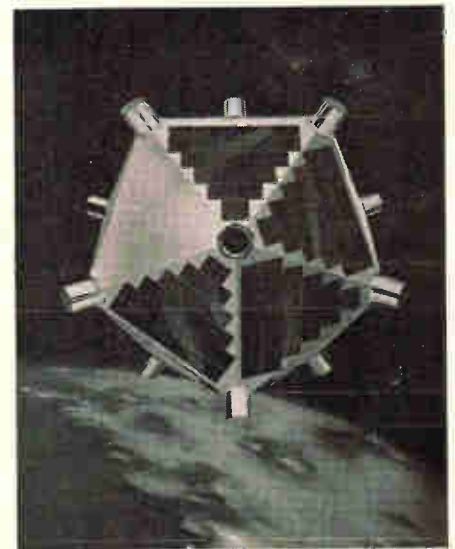

INTERNATIONAL RECTIFIER

INTERNATIONAL RECTIFIER CORPORATION 233 Kansas St., El Segundo, California

Washington Newsletter

July 27, 1964

Pentagon rejects ComSat proposal

Secretary of Defense Robert S. McNamara has decided to proceed with plans for an all-military communications satellite system, rather than lease capacity in the Communications Satellite Corporation's commercial system. The Defense Department wanted tighter United States control over the satellite system than the State Department thought politically wise.

McNamara's decision may not be final. There are some reports that ComSat may design its satellites so that military communications still could be handled if the Pentagon should change its mind. After international agreements for the commercial system are signed, the question of Pentagon participation in the commercial system may be reopened.

Representatives of 18 countries met in Washington on July 21 to hammer out international participation in the venture.

A design for the commercial system won't be selected much before the fall of 1965. The military system is scheduled for 1966. Officials say there would be plenty of time for the commercial system to accommodate military use if the Pentagon should change its mind.

Job corps studies teaching machines

The job corps in President Johnson's "war on poverty" looks like a potential market for companies involved with electronic teaching machines.

In teaching new skills to workers, the corps should seek new techniques for mass education, these companies reason. For months, Sargent Shriver's job-corps staff has been discussing advanced teaching techniques with representatives of the International Business Machines Corp., Westinghouse Electric Corp. and others. The discussions have touched upon the possible use of computer-based teaching systems.

The System Development Corp., a nonprofit research company that works only for government clients, is also working with Shriver's staff on the need for a computer system to handle information and internal control for the job corps. The clients think such a system is needed to keep track of the 200,000 trainees the corps is expected to enlist in the next couple of years. If not computerized, the paperwork could swamp the whole project, they say.

Congress is expected to act soon—before the Democratic National Convention—on legislation to create the job corps.

Nike-X radar ready for tests

The heart of the Nike-X antimissile system—the Multifunction Array Radar—is now operating in a test version at White Sands Missile Range, N. M.

But a decision on whether to produce and deploy the Nike-X won't come until the end of this year and possibly later. Although impressed by the system, Defense Secretary Robert S. McNamara wants answers to detailed technical, strategic and economic problems before coming to a decision.

Nike-X installations located around 20 cities containing 30% of the nation's populations would cost \$15 billion to \$17 billion to install and \$1 billion to \$2 billion a year to operate. McNamara believes that such

Washington Newsletter

a system should be accompanied by a fallout shelter program. Aside from the cost, another major question is what reaction the installation of the system would provoke from the Soviet Union.

The multifunction array, which combines the functions of three radars into one concrete-and-steel package, detects missiles at long ranges, tracks them, and discriminates between live warheads and decoys. Later versions, more sophisticated than the prototype at White Sands will be installed at Kwajelein Island in the Pacific Ocean.

Panel may assay automation's effects

Congress will create a national commission on technology, automation and economic progress before adjourning this year, according to Administration leaders. The bill has already been reported out by the House Labor Committee; the Senate Labor Committee will approve it soon. No serious opposition is expected.

The bill would authorize the President to establish a 14-member commission of experts outside the government. The commission would predict the impact of technological and economic changes, including shifts in defense spending, on production and employment for the next 10 years. The Commission would also define needs toward which new technologies might be applied, and recommend ways in which the government might ease the industries' adjustment to these changes.

The commission would report to Congress and the President by Jan. 1, 1966.

Pentagon plans more cost cuts

The Pentagon plans to intensify its cost-reduction drive. With great fanfare, Defense Secretary McNamara announced that savings in fiscal 1964 reached \$2.5 billion, a billion dollars above the original target. Furthermore, he promised savings at an annual rate of \$4.6 billion by fiscal 1968, an increase of \$600 million above the previous goal for that year. "We haven't begun to scratch the surface," McNamara declared.

Much of the saving is credited to a shift to competitive contracting. In the first half of fiscal 1964, 38.6% of prime contracts were awarded on the basis of price competition, 6% more than 1961. McNamara estimates that each dollar shifted into competitive procurement results in a 25-cent saving.

In addition, cost-plus contracts have dropped to 12.1% of the total from a high of 38% in mid-1960. Each dollar shifted from cost-plus to other types of contracts results in a saving of 10 cents, according to McNamara.

Pentagon officials give this breakdown of the \$2.5 billion saving during the past year: \$1.4 billion by "buying only what is needed" and by such cost-cutting techniques as value engineering; \$450 million from the shift from cost-plus and noncompetitive contracting; \$450 million by the closing of military bases and other reductions in operating expenditures.

One byproduct of the cost-cutting drive has been a reduction in engineer employment in defense industries. Defense officials say the trend leads to the dismissal of engineers who had been held in reserve by contractors. Extra engineers were not a great expense in a cost-plus environment and they enabled contractors to be in a better position to fight for contracts.

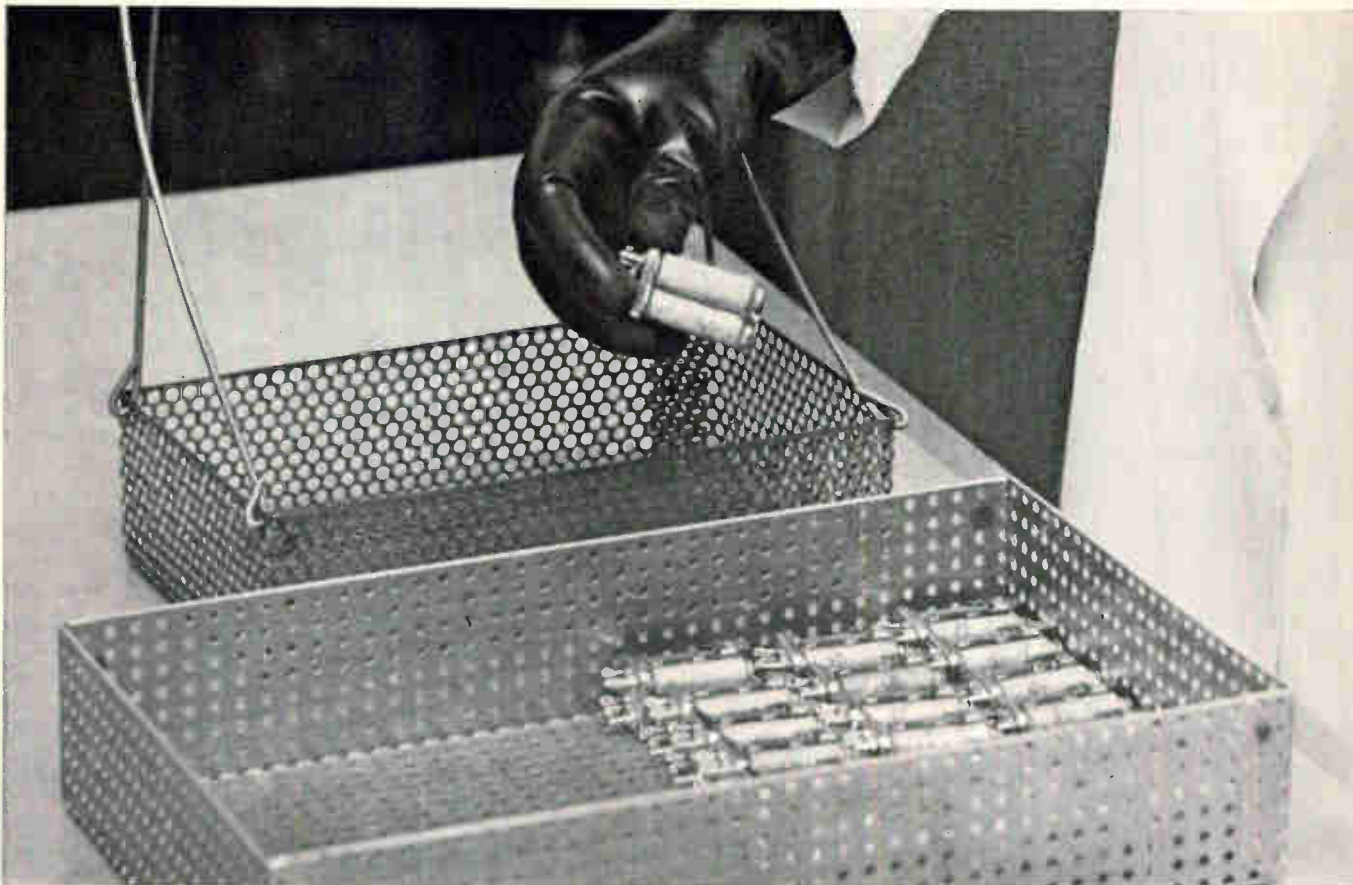

How Sigma Instruments, Inc., cut its reject rate to less than 1%!

PROBLEM: Absolute cleanliness of relay contacts is vital to the reliability of miniature remote-controlled switches. Sigma Instruments, Inc., Braintree, Mass., was previously cleaning contacts with a chlorinated spray, which distributed contaminants over a large area without completely removing them. In-plant rejects were as high as 55%.

SOLUTION: Relay contacts are now cleaned in an ultrasonic bath of FREON® fluorocarbon solvent coupled with vapor rinsing. Ultrasonic action, combined with the extremely low surface tension and high density of FREON, removes contaminants from the tiniest openings. Result: Sigma reports that

FREON solvents give them outstanding cleaning quality and that their reject rate has dropped to less than 1%.

Sigma also points out that FREON dries quickly and leaves no residue. Its very low toxicity and non-flammability permit operation without expensive ventilating equipment. What's more, the new system is economical to use because FREON can be recovered in readily available equipment—for re-use over and over again.

Wherever you have a cleaning problem, FREON solvents can improve operations and cut costs. First, send the coupon for information on cleaning.

FREON® 
REG. U.S. PAT. OFF.
 SOLVENTS Better Things for Better Living
... through Chemistry

MAIL COUPON FOR BOOKLET ON CLEANING

E. I. du Pont de Nemours & Co. (Inc.)
 FREON Products Division E-1
 N-2430 F, Wilmington, Delaware 19898

Name _____ Title _____

Company _____

Address _____

Please send new booklet on FREON solvents for precision cleaning.

I am interested in cleaning _____

I would like Du Pont to send a cleaning specialist.

Tektronix oscilloscope displays both time-bases separately or alternately

NEW TYPE 547 and 1A1 UNIT

DUAL TRACE

DC-to-50 MC
50 MV/CM
DC-TO-28 MC, 5 MV/CM

SINGLE TRACE

2 CPS-to-15 MC
500 μ V/CM
(CHANNELS 1 AND 2 CASCADED)

With automatic display switching, the Type 547 provides two independent oscilloscope systems in one cabinet, time-sharing a single-beam crt.

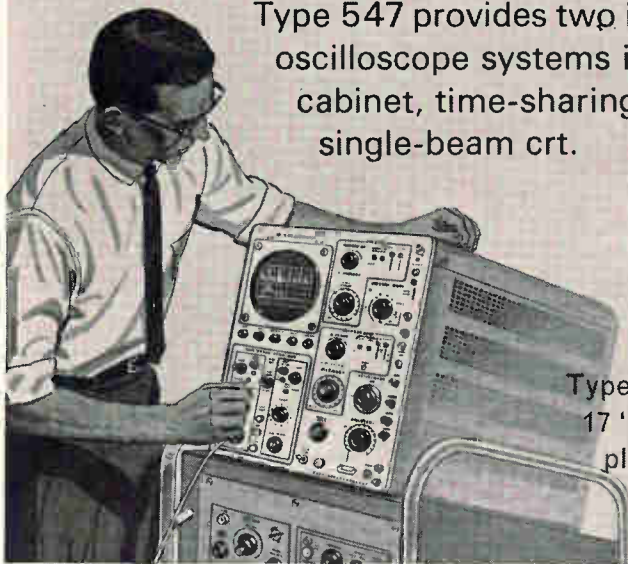

Type 547 also uses 17 "letter-series" plug-in units

Some Type 547/1A1 Unit Features

New CRT (with internal graticule and controllable illumination) provides bright "no-parallax" displays of small spot size and uniform focus over the full 6-cm by 10-cm viewing area.

Calibrated Sweep Delay extends continuously from 0.1 microsecond to 50 seconds.

2 Independent Sweep Systems provide 24 calibrated time-base rates from 5 sec/cm to 0.1 μ sec/cm. Three magnified positions of 2X, 5X, and 10X, are common to both sweeps—with the 10X magnifier increasing the maximum calibrated sweep rates to 10 nsec/cm.

Single Sweep Operation enables one-shot displays for photography of either normal or delayed sweeps, including alternate presentations.

2 Independent Triggering Systems simplify set-up procedures, provide stable displays over the full passband and to beyond 50 Mc, and include brightline automatic modes for convenience.

Type 547 Oscilloscope \$1875
(without plug-in unit)

Type 1A1 Dual-Trace Unit \$ 600

Rack-Mount Model Type RM547 . . . \$1975

U.S. Sales Prices f.o.b. Beaverton, Oregon

For a demonstration, call your Tektronix Field Engineer

Tektronix, Inc.

P.O. BOX 500 • BEAVERTON, OREGON 97005 • Phone: (Area Code 503) Mitchell 4-0161 • Telex: 036-691

TWX: 503-291-6805 • Cable: TEKTRONIX • OVERSEAS DISTRIBUTORS IN 25 COUNTRIES

TEKTRONIX FIELD OFFICES in principal cities in United States. Consult Telephone Directory

Tektronix Australia Pty., Ltd., Melbourne; Sydney • Tektronix Canada Ltd., Montreal; Toronto

Tektronix International A.G., Zug, Switzerland • Tektronix Ltd., Guernsey, C. I. • Tektronix U. K. Ltd., Harpenden, Herts

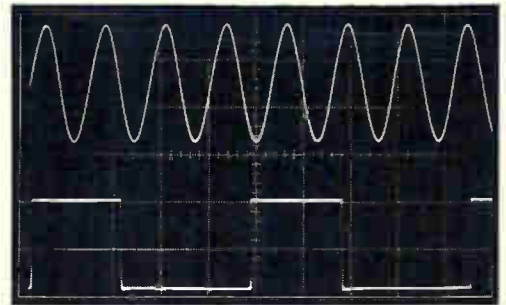

Single-exposure photograph.

2 signals — different sweeps

Upper trace is Channel 1/A sweep, 1 μ sec/cm.
Lower trace is Channel 2/B sweep, 10 μ sec/cm.

Using same or different sweep rates (and sensitivities) to alternately display different signals provides equivalent dual-scope operation, in many instances.

Triggering internally (normal) permits viewing stable displays of waveforms unrelated in frequency.

Triggering internally (plug-in, Channel 1) permits viewing frequency or phase differences with respect to Channel 1.

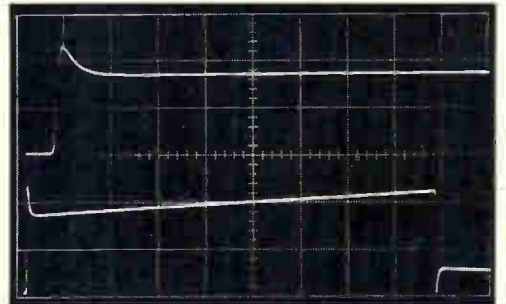

Single-exposure photograph.

same signal — different sweeps

Upper trace is Channel 1/A sweep, 0.1 μ sec/cm.
Lower trace is Channel 1/B sweep, 1 μ sec/cm.

Using different sweep rates to alternately display the same signal permits close analysis of waveform aberrations in different time domains.

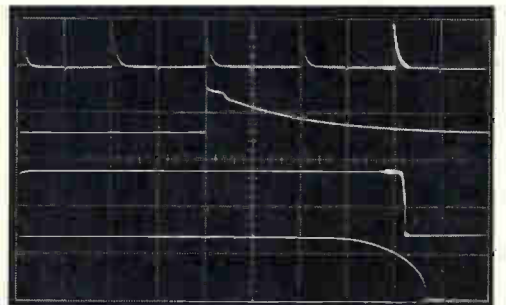

Single-exposure photograph.

2 signals — portions of each magnified

Trace 1 is Channel 2/B sweep, 10 μ sec/cm.

Trace 2 (brightened portion of Trace 1) is Channel 2/A sweep, 0.5 μ sec/cm.

Trace 3 is Channel 1/B sweep, 10 μ sec/cm.

Trace 4 (brightened portion of Trace 3) is Channel 1/A sweep, 0.5 μ sec/cm.

Using sweep delay technique—plus automatic alternate switching of the time bases—permits displaying both signals with a selected brightened portion and the brightened portions expanded to a full 10 centimeters.

B sweep triggering internally from Channel 1 (plug-in) assures a stable time-related display without using external trigger probe.



If you ship from 5 to 50 pounds anywhere in the U. S. you're missing a bet

...unless you check Air Express.

There are many reasons why. For example, you can actually ship a 20 pound package from New York to Chicago by Air Express for less than motor carrier (\$6.20 vs. \$6.82)...and at a sizable saving in time.

Among air cargo services, Air Express is often cheapest *and* quickest too.

Another point. Air Express rates are figured door-to-door. You only

have one call, one waybill.

And there's more. Air Express can deliver by sunset tomorrow to any one of 21,000 U.S. cities. Pickup is made within 2 hours of your call. Your packages get top priority on every scheduled airline after air mail.

On the ground, 10,500 delivery trucks speed deliveries between you, the airports and your customers. Com-

pare this with any other service.

Air Express is a joint venture of all 39 scheduled airlines and R E A Express. No wonder it gives you the best service in the air and on the ground.

Next time you ship from 5 to 50 pounds, try Air Express. Simply call your R E A Express agent.

Air Express outdelivers them all... anywhere in the U.S.A.

Air Express
Division of R E A Express



COMPLETELY
GNU



MINCOM'S NEW TIDAX 1.5-mc RECORDER/REPRODUCER

The new TIDAX is a head-on approach to your problems in telemetry and general instrumentation. This high-performance Recorder/Reproducer provides a full fourteen 1.5-mc tracks in one rack — with fully automatic equalization at all speeds. Wideband FM (DC to 500 kc) is available without modification. Signal-to-noise ratio (RMS/RMS) is 25 db at all speeds. TIDAX telemetry capabilities include simultaneous post- and pre-detection recording in PCM, PCM/FM, PAM/FM, PACM and FM-type carrier systems. Mincom's exclusive DC Top Plate is rugged, simple and reliable — full dynamic braking, instant push-button speed control, tape change from 1/2" to 1" in less than ten minutes. Write today for details and complete specifications.

Mincom Division **3M**
COMPANY

300 South Lewis Road, Camarillo, California • 320 Shaw Road, South San Francisco, California • 529 Pennsylvania Building, 425 13th Street, N. W., Washington, D. C. • 135 West 50th Street, New York, New York • Post Office Box 272, Fairborn, Ohio • 1230 Orange Avenue, Winter Park, Florida • 2121 Santa Anna Avenue, Dallas, Texas • Eltron Engineering Sales, Inc., 246 Walnut Street, Newtonville, Massachusetts

with Integrated Circuits the big problem ^{was} is testing

here are the BIG problem solvers



- 36 d-c tests
- 14 active leads
- Kelvin connections
- "Do it yourself" programming
- .05% power regulation
- Less than 1-mv long-term drift
- All logic types

MODEL 662

Digital readout for quality control and incoming inspection testing. Optional digital comparator provides accurate, repeatable trip points. Can be quickly programmed for both high *and* low limits on each of the 36 tests. Recording output for a tape punch, typewriter, card punch or digital printer. Both automatic and manual handling equipment can be furnished for a variety of devices.

MODEL 659A

A fast go/no-go instrument designed for high-volume production and incoming testing. Short test times permit a complete 36-test sequence in less than 2 seconds. Four programmable power supplies provided.

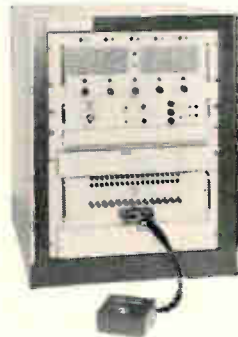

MODEL 659B

Similar to the 659A with space and connections for digital voltmeter. Includes two fixed power supplies and eight programmable power supplies.

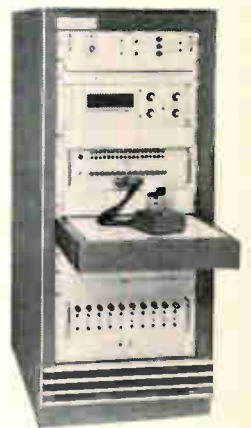

INDUSTRIAL
PRODUCTS
GROUP



TEXAS INSTRUMENTS
INCORPORATED
P. O. BOX 66027 HOUSTON 6, TEXAS

INTRODUCING the New, Versatile Thin-Line **VY**® Porcelain Capacitors

- * 0.5 pf to .01 mf
- * -55°C to +125°C operation
- * Ratings to 100 vdc

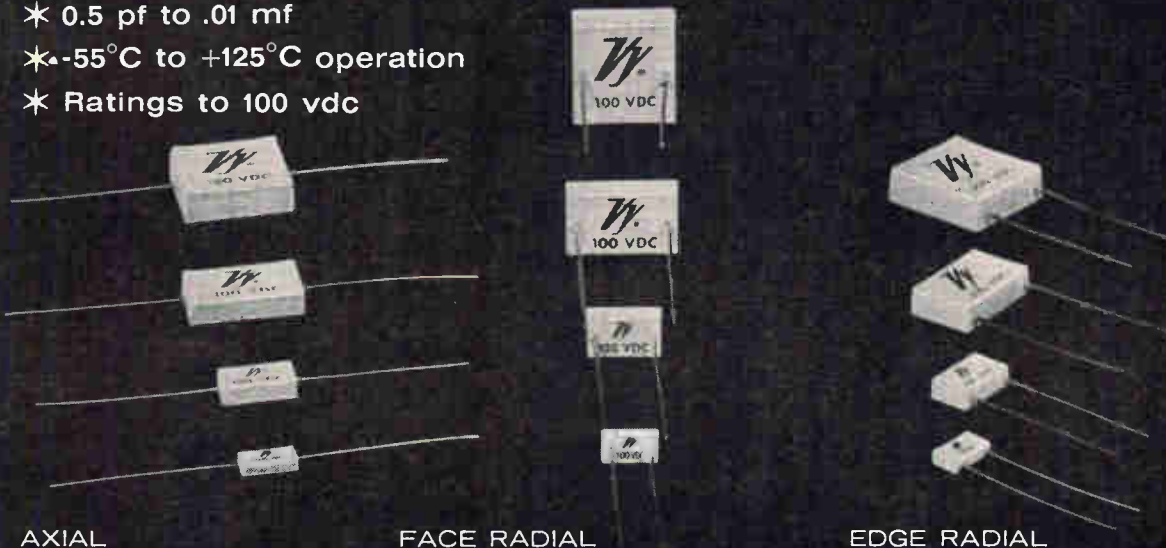

AXIAL

FACE RADIAL

EDGE RADIAL

... with outstanding electrical and physical characteristics to meet all your requirements for design and performance!

- * **CHOICE OF TEMPERATURE COEFFICIENTS**
+105±25 ppm/°C and 0±25 ppm/°C. (From +105±25 ppm/°C to -100±25 ppm/°C available.)
- * **CHOICE OF LEAD MATERIALS**
Solder Coated Copper, Dumet, Nickel A, etc.
- * **CHOICE OF LEAD CONFIGURATIONS**
Axial, Face Radial, Edge Radial
- * **THIN-LINE DESIGN**
- * **MONOLITHIC CONSTRUCTION**
- * **HIGH RF CURRENT CARRYING CAPABILITY**
- * **LOW DISSIPATION FACTOR**
- * **HIGH INSULATION RESISTANCE**
- * **WITHSTANDS SEVERE ENVIRONMENTAL CONDITIONS**
- * **TEMPERATURE STABILITY**
- * **FREQUENCY STABILITY**
- * **DEMONSTRATED RELIABILITY**

Specify these features in any combination to meet your requirements

New space-saving feature

Quality features in all "VY" Capacitors

© Vitramon, Inc. 1964

See us at WESCON, Booth Nos. 324-325.

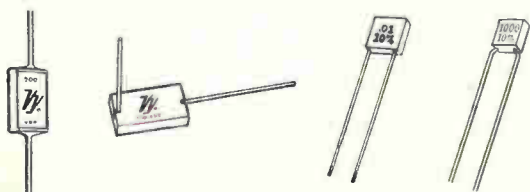

Vitramon
INCORPORATED

BOX 544 • BRIDGEPORT 1,
CONNECTICUT, U.S.A.

In United Kingdom contact:
Vitramon Laboratories
Limited
45 Holloway Lane
Harmondsworth, Middlesex
England

ASTRODATA

MORE THAN 1,000 STANDARD ADC'S FROM A LIBRARY OF 13 BASIC CARDS

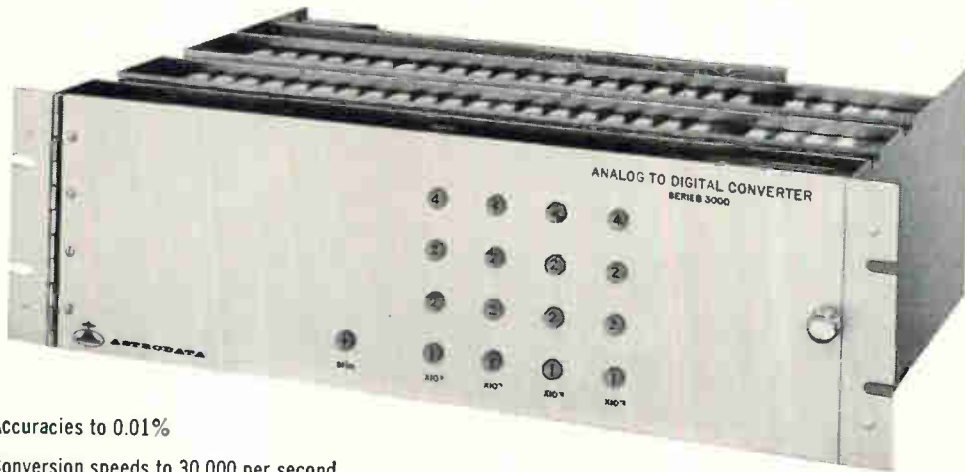

- Accuracies to 0.01%
- Conversion speeds to 30,000 per second

Astrodata low cost Series 3000 Analog-to-Digital Converters meet the requirements of virtually all data acquisition systems with 1088 standard production models. From these you can select the full scale range . . . speed . . . accuracy . . . sample-and-hold . . . resolution . . . output format best suited to your specific system.

Designed for easy integration into existing or new

data acquisition systems, standard features include individually buffered data output lines . . . adjustable output logic levels (clamped) . . . wiring installed for future addition of input amplifier or sample-and-hold circuits . . . front panel readout of data (including polarity) . . . and isothermal environment of converter network and reference voltage diode to assure maximum accuracy over wide temperature range.

Series 3000 ADC's ideal for use with time-multiplexed input data

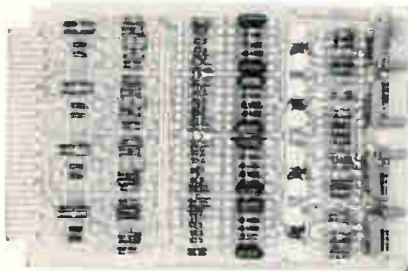

HIGH LEVEL MULTIPLEXERS

Model 155-83 low cost, high-level-input multiplexer module has been developed for high speed analog switching applications.

Inputs per card 6 one-wire or 4 two-wire
 Input Voltage ± 5 volts
 Switching Time $< 5 \mu\text{sec}$
 Crosstalk $\pm 0.01\%$
 Input Impedance 1000 megohms/number of switches in multiplexer group

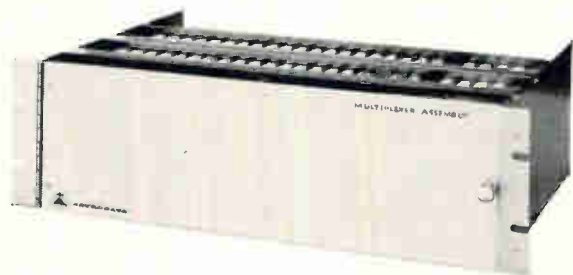

MULTIPLEXER ASSEMBLIES

Series 950 multiplexer assemblies consist of cards, shown at left, for single ended channels in multiples of 6 or differential channels in multiples of 4. Power supply and output buffer amplifier are included. Channel identification data can be furnished in binary or BCD form. The multiplexer channels can be addressed directly by computers or advanced sequentially to meet the requirements of specific systems applications.

17

Contact your nearest Astrodata representative today for a demonstration or write for technical literature giving complete specifications.



ASTRODATA INC.

240 E. Palais Road • Anaheim, California

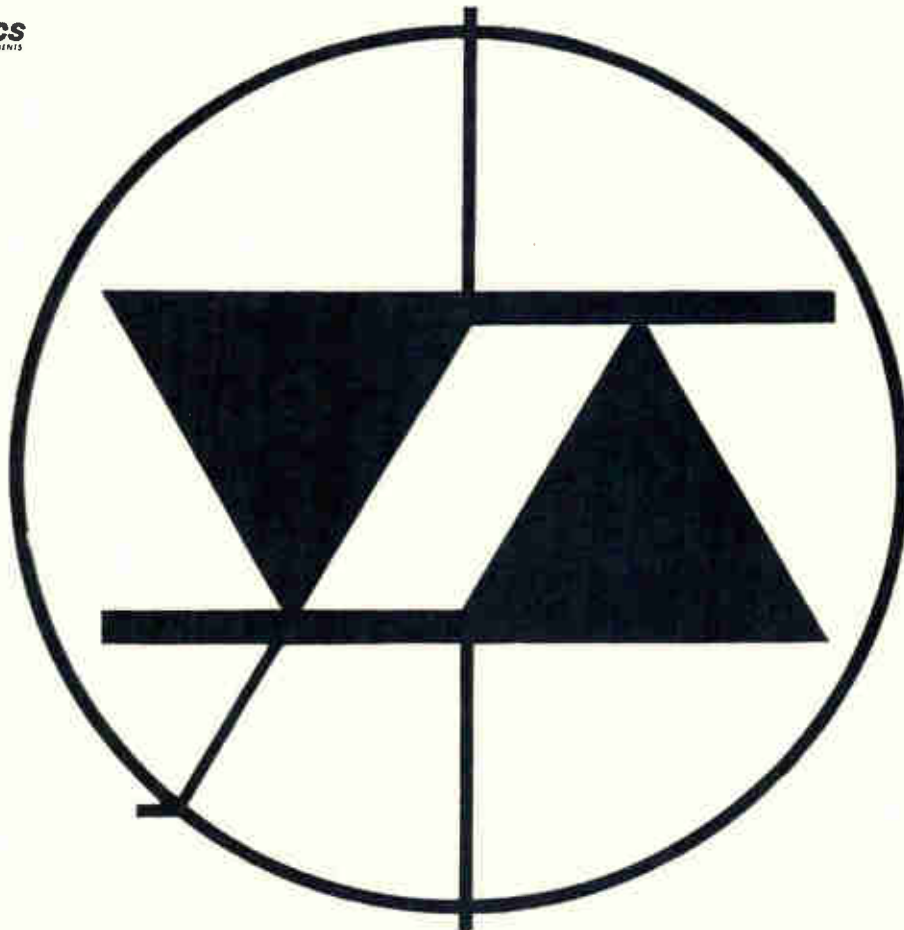

TRIAC

a new semiconductor simplifies AC full-wave control circuits . . . reduces circuit size and cost . . . and is now available in 6 amp and 10 amp ratings!

The "TRIAC" is a new three-electrode AC semiconductor switch which is triggered into conduction in either direction by a gate signal (it's actually a power "integrated" circuit). Basically related to the SCR, the TRIAC simplifies control of full-wave AC power by *reducing the number of power handling components*, by generally eliminating need for transient voltage suppression, and by reducing the size and complexity of the gate control circuits. The illustrated circuits show a simple full-wave AC static switch using the TRIAC, compared with the more complex circuit using

multiple SCR's necessary to perform the same function.

If you're interested in applications such as static power switching, temperature controls, lamp dimming, motor speed controls, and many others, you should look into the TRIAC, available in compact and rugged stud or press fit housings. You'll also be interested in the new DIAC (diode AC switch) to trigger the TRIAC and SCR's. See your G-E Semiconductor Products District Sales Manager today, or write Rectifier Components Department, Section 16G125R, General Electric Company, Auburn, New York.

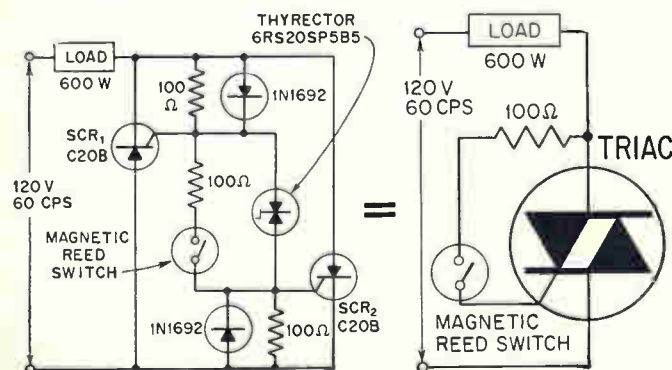

TRIAC Specifications		
	ZJ257	ZJ290
Breakover Voltage, V_{br}	± 200 volts min.	± 200 volts min.
Load Current, I_L	6 amps rms AC max. at stud temperature = 75°C, full conduction (600 watts incandescent lamp load)	10 amps rms AC max. at stud temperature = 75°C, full conduction (1KW incandescent lamp load)
Typical Gate Triggering Requirements		
V_g	± 3 volts, $T_J = 25^\circ\text{C}$	± 3 volts, $T_J = 25^\circ\text{C}$
I_g	± 50 milliamperes, $T_J = 25^\circ\text{C}$	± 50 milliamperes, $T_J = 25^\circ\text{C}$

Available through your G-E Semiconductor Distributor

GENERAL  ELECTRIC

Low-frequency integrated circuits achieved with thermal transfer

They make it possible to build smaller oscillators, filters and delay networks for below 100 cps

By W.T. Matzen and R.A. Meadows

Texas Instruments, Inc., Dallas, Tex.

The inability to obtain inductances or large resistances and capacitances in semiconductor integrated circuits has prevented the design of circuits requiring frequency response below 100 cycles per second. Now a technique has been developed that permits linear circuits, such as oscillators, filters and time-delay networks, to be designed for this range.

The technique, which uses thermal-electrical interactions in silicon, could be useful in many instrumentation applications of microelectronics, such as surgical implants in medical electronics and detection of low frequency transducer signals.

Basically, the method is to replace conventional resistors and capacitors with thermal transfer elements that can be fabricated in microcircuit size. Thermal propagation permits the functions of frequency selectivity and phase shift that, with electrical networks, would require large values of resistance and capacitance. For example, the lower frequency range of conventional RC oscillators that can be fabricated in integrated-circuit form is limited by present technology to a few hundred cycles. Using the technique described here, stable oscillators at frequencies lower than 10 cycles per second and low-pass filters with frequencies less than 1 cps can be realized in a size compatible with the standard integrated-circuit flat package. These filter and oscillator circuits, which use thermal transfer elements and other applications of thermal phenomena, are expected to have a significant effect on future semiconductor-network technology.

Thermal transfer element

The transfer element shown on p. 55 consists of a heater transistor and sensor transistor built into a common silicon substrate by means of conven-

tional semiconductor network technology. A sinusoidal current in the heater transistor produces a variation in power dissipation at the collector-base junction, causing a change in the junction temperature. The temperature fluctuation propagates through the bar to the emitter-base junction of the sensor, producing a variation of current in the sensor transistor and an output current. For a sine-wave input under small-signal conditions, all these quantities vary sinusoidally.

The transfer function of the thermal element is defined as

$$F = \frac{i_{out}}{i_{in}} \quad (1)$$

The frequency response of this function may be related to physical parameters using the expression

$$F(\omega) = A_1 \frac{T_s}{P_H} = A_1 \Psi(\omega) \Phi(\omega) \quad (2)$$

where

$$\Psi(\omega) = \frac{T_H}{P_H} \quad (3)$$

is the thermal impedance of the heater transistor,

$$\Phi(\omega) = \frac{T_s}{T_H} \quad (4)$$

is the propagation factor of the temperature wave from the heater to the sensor. A_1 is a constant, dependent upon heater and sensor circuits. P_H is the sinusoidal input power to the heater and T_H and T_s are the sinusoidal temperature swings at the heater and sensor, respectively.

Heat transfer analogy

The heat flow into the bar, the heater temperature and the sensor temperature are related through

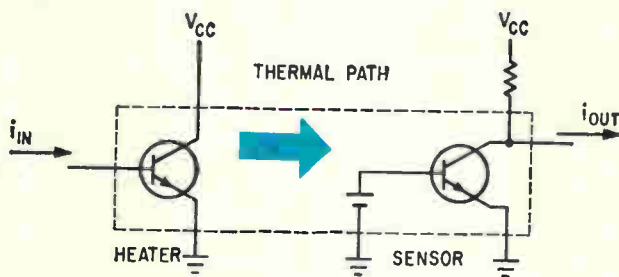
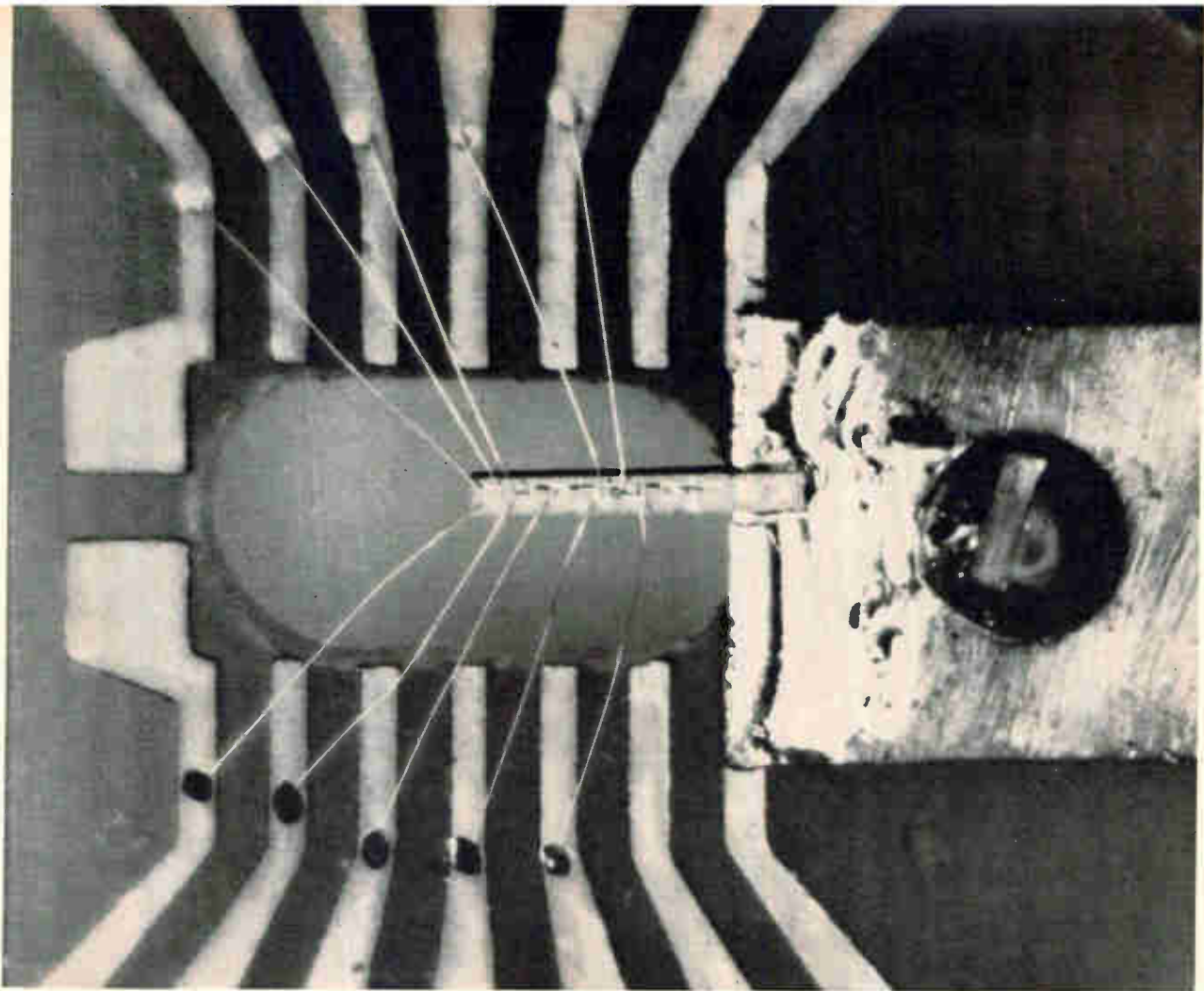

Thermal transfer element consists of heater and sensor transistors in a common silicon substrate.

▲ The bar used for the thermal filter and oscillator is mounted in a circuit board used for testing packaged semiconductor networks. The bar contains several transistors, and leads are brought out to contacts for five of these. Counting from the open end, the first transistor is the sensor and the fourth is the heater. Numbers 2, 3 and 5 are connected as diodes for monitoring steady-state temperature. The opposite end of the bar is soldered to a copper slug mounted to the circuit board.

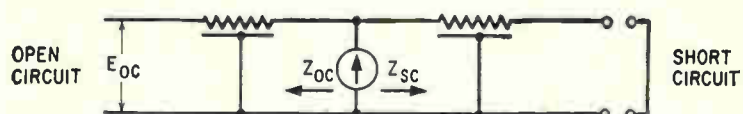
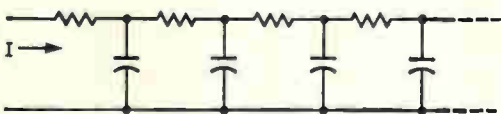
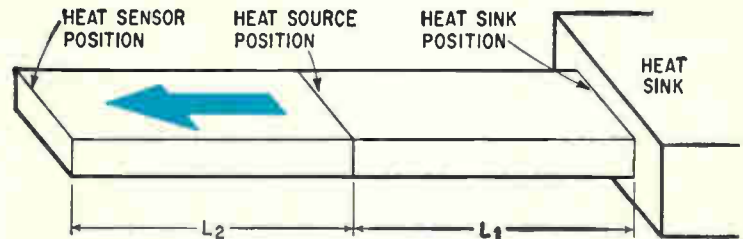
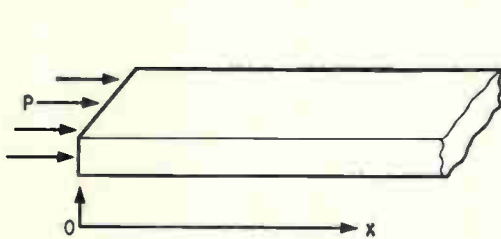

A

B

The heat-transfer analogy consists of a semi-infinite bar (A) and an RC transmission line, where heat flow is analogous to current and temperature to voltage. The configuration (B) of the transfer element has a thermal path to a heat sink; this limits the steady-state temperature rise. The response for the RC equivalent circuit is similar to that of a distributed low-pass filter. The useful component of heat comes from the flow of a-c energy (shown in color) from the heater to the sensor.

the classical heat-flow equation with appropriate boundary conditions. A simple configuration, shown on p. 55, may be used to establish these relationships. The semi-infinite bar has a heat source at one end. Semi-infinite denotes a bar placed at the origin of a set of x , y and z axes, with infinite length in the positive x direction.

The assumptions are that heat is applied uniformly across the end surface of the bar and that the top, bottom and sides are perfectly insulated. The solution to the heat equation is identical in form to that of an RC transmission line where heat flow is analogous to current and temperature to voltage. The analogy is shown on p. 55. The thermal bar is driven by a constant heat flow, P , which is independent of bar temperature. Analogously, a constant current, I , drives the transmission line. This establishes an input temperature

$$T_1 = P\Psi_0 \quad (5)$$

where T_1 corresponds to E_1 , the input voltage, and Ψ_0 , the characteristic thermal impedance, corresponds to the characteristic impedance Z . A traveling wave of temperature is established of the form

$$T(x, t) = T_1 e^{-\alpha x} e^{j(\omega t - \beta x)} \quad (6)$$

Based on these analogous relationships, the well-known transmission-line equations may be used to determine the transfer characteristics of a more complex structure.

The configuration used for the thermal transfer element is shown on p. 55. A thermal path to a heat sink is provided to limit the steady-state temperature rise resulting from the d-c power dissipation of the heater transistor. This configuration provides efficient a-c coupling between heater and sensor with good dissipation for the d-c power.

Transmission-line analogy

The transmission-line analogy for the thermal transfer element is an RC equivalent circuit with a response similar to that of a distributed low-pass filter. Measured amplitude and phase response for a thermal element is shown at the right. For frequencies approaching zero, the amplitude response approaches the value

$$F(0) = A_1 \frac{T_s(0)}{P_H(0)} = A_1 \Psi(0) \quad (7)$$

where $\Psi(0)$ is the d-c thermal impedance from the heat source to the heat sink.

The corner frequency—the frequency at which the magnitude of the response decreases by three decibels—is determined by $\Psi(0)$ and the heater-to-sensor spacing. For the geometry considered, the corner frequency is about 1 cps. This could be reduced somewhat by increasing the spacing L_1 and L_2 of the thermal bar.

Thermal feedback amplifier

The thermal transfer element can be connected as a feedback loop around an amplifier. For this case the transfer characteristic is

$$A' = \frac{-A}{1 + FA} \quad (8)$$

in which A is the open loop current gain of the amplifier and F is the thermal transfer function. The calculated transfer function A' is plotted for several values of A (p. 57). For low frequencies, feedback is negative and the amplifier gain is low. The peak in the response curve occurs at the frequency for which the thermal element has a phase shift of 180° and the amplifier becomes regenerative. Feedback is decreased at high frequencies, and the response approaches that of the open-loop amplifier.

Low-frequency oscillator

A low-frequency oscillator was realized using the feedback amplifier as a direct-coupled transistor circuit. As shown by equation 8, oscillation occurs at the frequency for which the thermal transfer function has a phase lag of 180° , provided that $|FA| \geq 1.0$. For example assume that at 180 degrees A is 200 and F is 0.005. Since F is negative for a phase shift of 180 degrees the denominator of equation eight becomes zero which is the condition for oscillation. The frequency of 180° phase shift (f_{180}) may be related to the physical constants of the bar, using the transmission line analogy. The thermal impedance presented to the source is the parallel combination of the input impedances of a short-circuit line and an open-circuit line.

Since the spacings L_1 and L_2 exceed one-quarter of a wavelength at f_{180} , it may be shown that each input impedance approximates the thermal characteristic impedance, Ψ_0 . As in the case of the RC

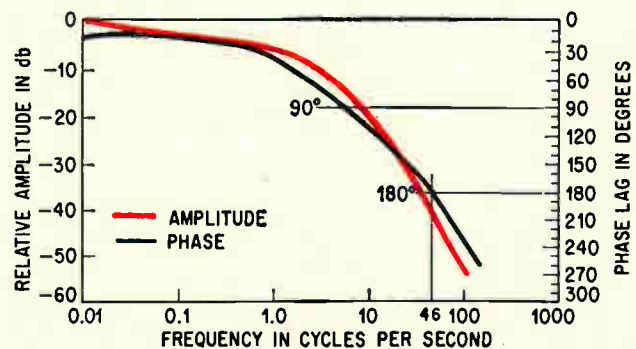
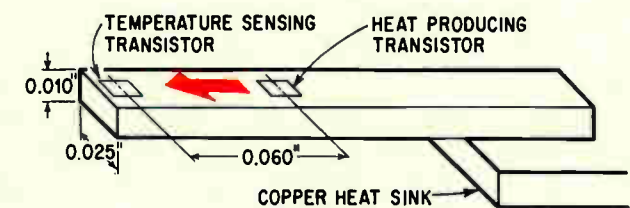

At the sensor junction, thermal transfer element generates 8.4 millivolts per watt of heater power at a frequency of 50 cycles. This voltage increases at lower frequencies. The bar is mounted in air, but others have been mounted on insulators of high thermal resistance.

line, the characteristic impedance has a phase lag of 45° . Similarly, the resultant input impedance of the bar has a phase lag of 45° .

From equation 2, the transfer function will have a phase angle of 180° when the propagation factor Φ has a phase lag of 135° —the thermal impedance Ψ lags by 45° as in the case of the analogous RC circuit. This corresponds to the relationship

$$\beta L_2 = \frac{3\pi}{4} \quad (9)$$

where

$$\beta = \sqrt{\frac{\omega \rho c}{2k}} \quad (10)$$

is the phase constant of the thermal wave through the bar. The physical constants of equation 10 are given above for silicon. From equations 9 and 10, the frequency of 180° phase shift is

$$f_{180} = \frac{k}{\pi \rho c} \left[\frac{3\pi}{4 L_2} \right]^2 \quad (11)$$

The calculated frequency for 180° phase shift at 300°K is 40 cps, compared with a measured value of 46 cps.

Temperature effects

Shown to the right, f_{180} for the thermal element varies approximately inversely with the absolute ambient temperature, T_A . This is as expected since, from equation 11, f_{180} varies directly with the thermal conductivity, k , which is inversely proportional to T_A . However, the measured oscillation frequency varies only 1% over an ambient temperature range of 50°C . Also, the substrate temperature is held practically constant for large changes in ambient temperature. This is because, at d-c, the amplifier and thermal feedback element comprise a negative feedback system that tends to maintain the substrates at constant temperature regardless of ambient temperature.

The average power dissipation of the source transistor decreases as ambient temperature increases, such that the substrate temperature increase equals the ambient temperature increase divided by the loop gain.

Although these experimental circuits use external components, they could be completely integrated into a common substrate using conventional semiconductor network technology.

The authors



Walter T. Matzen is manager of the Molecular Functions Branch of Texas Instruments, Inc. He obtained his doctorate in electrical engineering from Texas A&M in 1954.

Thermal constants for silicon at 300°K

k — Thermal conductivity	= 0.21 cal/sec cm $^\circ\text{C}$
c — Specific heat	= 0.181 cal/gm $^\circ\text{C}$
ρ — Density	= 2.33 gm/cm 3

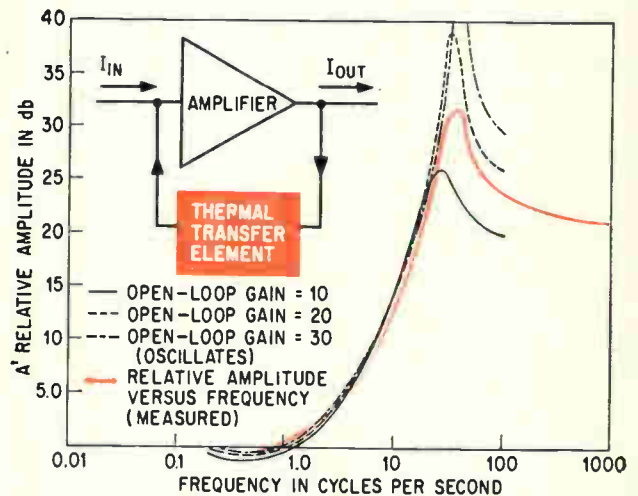

The peak in the response curve of the thermal feedback amplifier occurs at the frequency for which the thermal element has a phase shift of 180° . One curve represents a measured response for one value of the open-loop gain. This response is in good agreement with calculations.

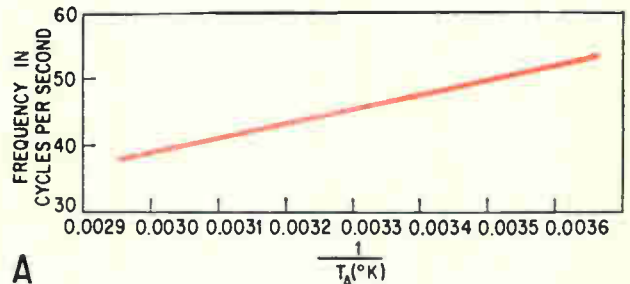

A

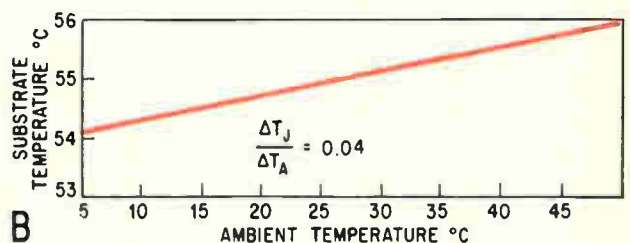

B

Frequency for a phase shift of 180° varies inversely with the absolute ambient temperature (A). The substrate temperature is essentially constant for large changes of ambient temperatures (B).



Robert A. Meadows, also of Texas Instruments, Inc., is investigating the dielectric properties of field-effect transistors. He is completing work on a master's degree in physics at Southern Methodist University.

Solid state

Optoelectronics at work

Photon-coupled devices provide electrical isolation in applications ranging from oscillators to signal generators, modulators to multiplexers.

By Irwin Wunderman,
hp Associates, Palo Alto, Calif.

Conventional devices such as transistors and vacuum tubes use electrons for coupling signals thru the device. Because of the electron's charge, such structures do not have a high degree of isolation between the input and output circuits. To achieve this isolation function, a transformer is often used to isolate various parts of a network. Magnetic coupling has the disadvantage of being limited in bandwidth, impractical at low frequencies, useless at d-c, and not unilateral.

The disadvantages of magnetic coupling, and many of the problems associated with electron coupling in general, such as internal feedback and extraneous pickup can be overcome by using photons—a beam of light—as the coupling medium.

The isolation afforded by the light beam is far superior to that of electron coupling because, when light is used as a signal carrier, the input and output circuits are electrically separate. Coupling between circuits at widely different potentials and over a frequency range from d-c to device cutoff is now possible.

A family of solid-state components has been developed to exploit the advantages of optical coupling. These consist basically of an injection-luminescent diode as a light source, a light pipe as an optical transmission medium, and a silicon photodetector.

When the diode is driven by an input signal, it emits a beam of infrared light, providing a photon stream proportional to the signal current. The stream travels through the light pipe to the detector. The detector's output current or voltage is then proportional to the diode's input.

The device is called an optic amplifier or a photon-coupled amplifier.

Properties of the amplifier

One version of the photon-coupled amplifier, the hpa 4302, consists of a gallium arsenide (GaAs) injection-luminescent diode irradiating a high-beta silicon phototransistor. The over-all current gain of the structure is close to unity with the base lead open. Under these conditions, the bandwidth is limited to several hundred kilocycles by the beta cutoff frequency of the phototransistor. Gain and bandwidth may be exchanged to some degree by connecting external conductance between emitter and base leads.

Where isolated coupling is required over greater

The cover



Photons are used, instead of electrons, for coupling circuits in a new family of solid-state components. The result: input-output isolation far beyond that of conventional devices.

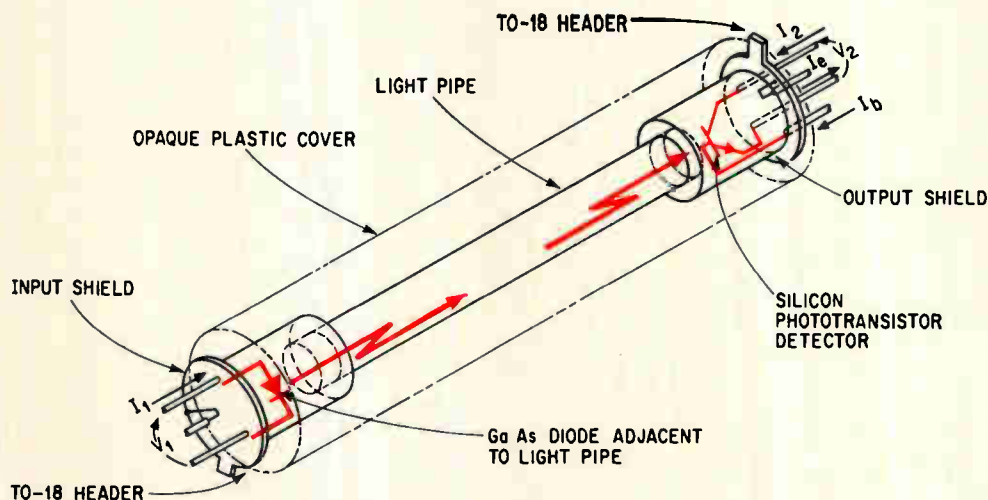

The basic configuration of the photon-coupled amplifier has three elements—the injection-luminescent diode input, the light pipe and the silicon phototransistor detector which provides the output signal.

bandwidths, the hpa 4301 photon-coupled isolators can be used. These have a silicon PIN photodiode instead of a phototransistor. The frequency response is greater by two to three orders of magnitude, with a correspondingly lower current gain. In both these structures the emission from the GaAs source is coupled to the photodiode photodetector by means of a coherent-image bundle of optic fibers. The hpa 4104 consists of the source and an optic bundle, and can be used with a detached detector. Similarly the hpa 4202 phototransistor and the 4201 PIN photodiode are separate components, each in a package with a fiber-optic window.

The use of a coherent-image optic bundle enables the active semiconductor area to be projected to the exterior area of the package, thereby minimizing the need for external optics. A generalized comparison of photon-coupled and electron-coupled devices is shown on page 60.

Basic device operation

The photon-coupled amplifier shown above is an hpa type 4302. The input is a gallium arsenide (GaAs) injection-luminescent diode that emits light (photons) approximately proportional to the number of electrons flowing in the diode. This proportionality exists because a large fraction of the minority carriers, which are injected under forward bias, recombine radiatively giving up their energy to form photons. However, only a portion of the photons so generated emanate from the semiconductor; the remainder are reflected from the surfaces and subsequently reabsorbed. The ratio of externally-emitted photons to the number of elec-

trons flowing in the diode is called the external quantum emission efficiency—typically 0.1% to 0.3%. It is the device designer's objective to maximize this efficiency and to transmit the photons to the detector.

From the electronic viewpoint, the input of the photon-coupled amplifier appears as a conventional diode. Gallium arsenide has an energy bandgap of 1.4 electron volts and at a given current, the voltage is a few tenths of a volt higher than for a silicon diode. The emitted photons have an energy corresponding to the bandgap (1.4 eV, or $\approx 9000 \text{ \AA}$). They propagate down the light pipe, and about 50% of them are usefully absorbed in the silicon phototransistor. This photocurrent is then amplified by the current gain of the phototransistor, a factor of several hundred. Output collector-to-emitter signal current is, therefore, comparable to the GaAs diode input signal current.

The configuration can be regarded as a high-gain transistor with two inputs; one a conventional base input, and the other a forward-biased diode electrically isolated from the transistor itself. Since the latter is spatially removed from and electrically independent of the output, a potential difference between the input and output does not affect the operation of the device.

Pulse response is limited by the cutoff frequency of the phototransistor. The light source responds to an electrical input in nanoseconds. The time of photon propagation along the light pipe is of the order of 0.1 nanosecond. Although some of the photons impinging upon the detector are reflected back to the source, this is independent of the output signal. Accordingly, the device exhibits completely

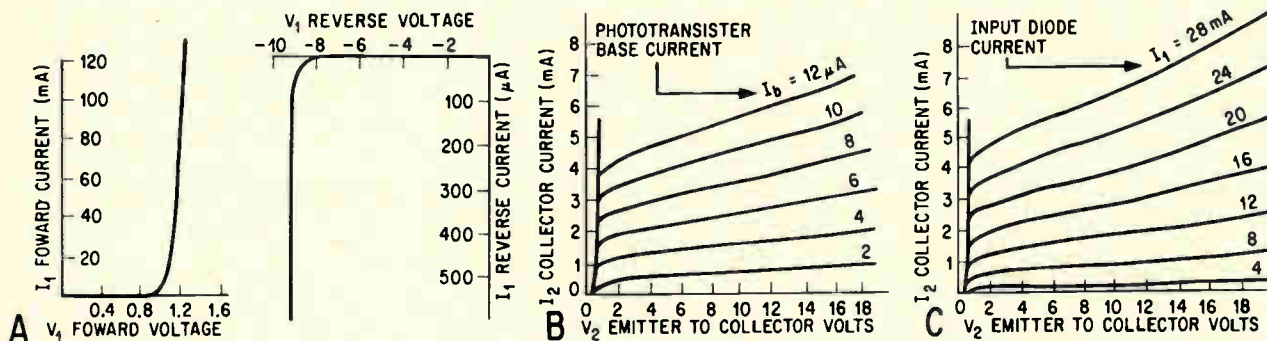

Volt-ampere characteristics of the photon-coupled amplifier include (A) the forward and reverse characteristics of the input diode, (B), those of the output phototransistor and (C), the current transfer characteristics for the entire structure.

unilateral photon signal transfer and is, therefore, electrically unilateral except for the slight parasitic output-input capacitance and very high leakage resistance.

Simple device model

The electrical properties are those of a GaAs diode at the input and a silicon phototransistor at the output. The conventional volt-ampere characteristics for each of these components and the entire configuration are illustrated above. The

forward transfer properties of the photo-coupled pair are similar to a transistor. The cans surrounding each component are not electrically connected to the semiconductors and can be used as electrostatic shields.

The basic circuit model for the structure is shown on page 61. Almost any equivalent circuit for diodes or phototransistors can be used in each portion of the device. For an input current level above two or three milliamperes, the photocurrent in the detector is approximately proportional to I_1 .

Characteristic properties of photon-coupled systems

Discreption	Advantages of photon coupling
Electrical isolation	Input and output circuits are electrically separate and isolated. Resistance between light source and detector can exceed 10^{16} ohms. The capacitance may be as low as .0001 picofarad.
Unilateral signal transfer	Signals are transferred unilaterally. Electrical conditions at the output of an optic amplifier are not reflected to the input. This permits independent design and operation of cascaded networks.
Minimal auxiliary components	Logical circuit functions can be achieved with minimal auxiliary components. Because input and output are separate, an optic amplifier can be interconnected with itself and its neighbors in a great variety of useful configurations.
Visual compatibility with man	If visible light is used, the electrical state of the system can be made directly apparent to man. This simplifies checkout, servicing, and reading out information.
Dual operability	It is possible to perform either optical or electrical operations on the signal such as light fibers or conducting wires for signal transmission and optical focusing for electrical impedance transforming.
Gain bandwidth product	Present liabilities of photon coupling Gain-bandwidth products that are now available are moderately low, typically 10^5 to 10^7 cps. Bandwidths range from 10^5 to 10^9 cps. Low gains are primarily due to the poor efficiency with which the light source converts input electrons into useful photons.
Linearity	Linearity over large ranges is poor. This should improve with increased light-source efficiency.
Technological difficulties	As with other new devices, many theoretical and technological difficulties exist. These include: incomplete understanding of injection luminescence mechanisms, problems of channeling photons from the region of generation to the photodetector, limited availability of specific energy light source materials, difficulty of attaining room temperature injection luminescent lasers.

At lower current levels the efficiency of the GaAs source falls off because of undesirable recombination which competes with the photogenerating process. This is analogous to the low-level beta fall-off in a transistor. In the simple equivalent circuits, a single effective output resistance and capacitance is used to characterize the emitter-to-collector properties.

Equivalent circuit

A detailed equivalent circuit is shown below. Approximate parameter values are defined in the table to the right of the circuit.

The input consists of a spreading resistance, r_1 , in series with the junction resistance r_e , shunted by the junction capacitance. At zero forward bias, the transition capacitance is about 100 picofarads. With appreciable forward current flowing, the diffusion capacitance (associated with stored charge) increases in proportion to current, and predominates. The parasitic resistance and capacitance to the input shield are included respectively as r_{s1} and C_{s1} . The conductance and capacitance between the GaAs input diode and the silicon output photodetector depends upon the length of the light pipe (and external shielding). For the type 4301, where the length of the pipe is such that the corona voltage exceeds 10 kilovolts, the leakage resistance is more than 10^{15} ohms and the capacitance, C_{ec} , is less than 0.01 pf. No other solid-state device can provide a comparable degree of isolation.

The symbol Φ_E is used to denote a photon flux of Φ_E photons per second emanating from the diode surface, of which Φ_P reach the photodetector.

The equivalent circuit of the output section is that of a conventional transistor. Impedance parameters are shown, enabling association of the physical resistance and capacitance mechanisms with the circuit model. A current generator ($I_p + i_p$) is used to represent the effect of the (d-c plus a-c) photon flux coupled from the input source. The

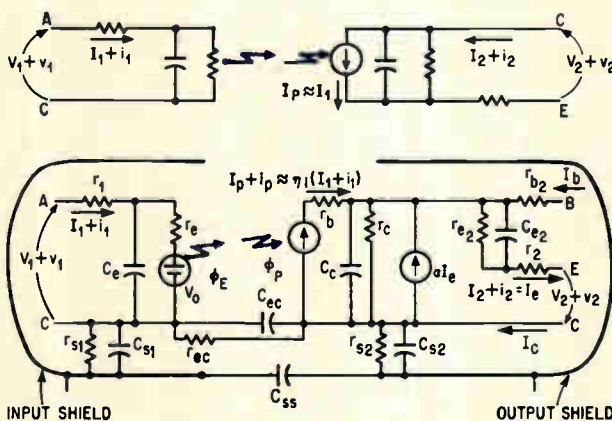

A single effective output resistance and capacitance characterize the emitter-to-collector properties of the simple equivalent circuit. A detailed equivalent circuit (below) for the electroluminescent diode and output phototransistor includes the parasitic impedances.

usual transistor collector-current generator, I_c , the collector junction resistance, r_c , and capacitance, C_c , are present. The resistance in series with the emitter lead is r_2 while the emitter junction is characterized by the parallel combination of r_{e2} and C_{e2} . At moderate current levels, the phototransistor current-gain, bandwidth product is approximately given by:

$$f_t = 1/2\pi r_{e2} C_{e2}$$

For small values of external load resistance R_L (and the base lead floating), the over-all cutoff frequency of the photon-coupled amplifier is:

$$f_c = (1 - \alpha) f_t$$

For larger values of R_L , the 3-db bandwidth is RC-limited and reduced to:

$$f_c = (1 - \alpha) / 2\pi R_L C_c$$

The base resistance is divided into two parts, the relatively large series resistance between collector and emitter being due to the sheet resistance of the photosensitive portion of the base layer. Both discrete base resistors represent a lumped approximation for the actual continuous resistance distributed between them.

Input current is the primary independent variable for the photon-coupled amplifier. Typical dependence of variables upon this parameter is shown on page 62. At low currents, the efficiency of the GaAs source is a monotonic function of the current. The a-c gain exceeds the d-c gain by a factor of two. The over-all current-transfer, cutoff

Approximate parameter values for equivalent circuit conditions: $I_1 = 30$ ma, $V_2 = 10$ volts

Parameter	Symbol	Nominal Value
Electroluminescent diode		
Series resistance	r_1	2 ohms
Junction resistance	r_e	1 ohm
Transition + diffusion capacitance	C_e	3000 pF
Forward voltage knee	V_0	1.2 volts
Parasitic coupling		
Leakage resistance to shield	r_{s1} & r_{s2}	$>10^9$ ohms
Semiconductor capacitance to shield	C_{s1} & C_{s2}	1 pF
Input-output resistance	r_{ec}	10^{15} ohms
Input-output capacitance	C_{ec}	0.01 pF
Phototransistor		
Collector capacitance	C_c	5 pF
Collector resistance	r_c	10^8 ohms
Current transfer ratio	α	0.997
Emitter junction resistance	r_{e2}	3 ohms
Emitter junction capacitance	C_{e2}	500 pF
Emitter "contact" resistance	r_{e1}	50 ohms
Base sheet resistance	r_b	300 ohms
Base contact resistance	r_{b2}	50 ohms
Over-all current transfer ratio	$\eta \equiv \frac{I_2}{I_1}$	0.3

Device ratings
 Maximum input-output voltage 10,000 volts peak
 Device dissipation at 25°C 100 mw for each device.
 Case-temperature-dissipation derating 2.5 mw/°C
 Instantaneous peak input current (I_1 peak) 500 ma

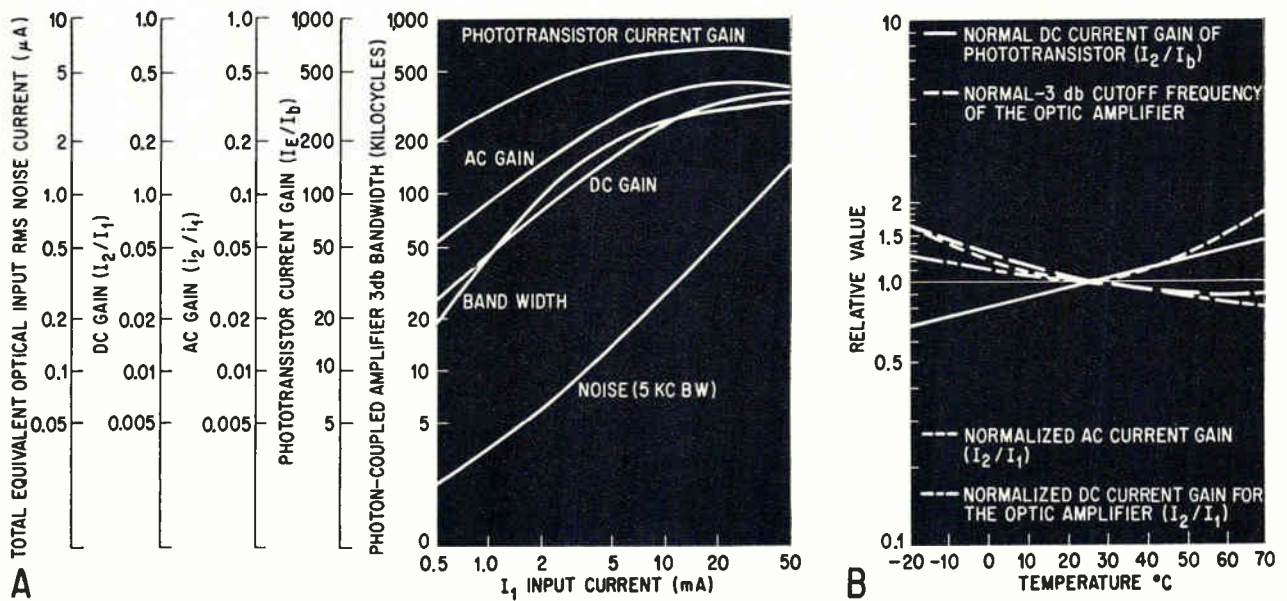

Parameters vary with the input current which is the primary independent variable for the photon-coupled amplifier (A). Some important parameters are temperature-dependent (B).

frequency (with the base floating and a short-circuit load) is essentially the same as the beta cutoff frequency of the transistor itself. The temperature dependence of the important parameters is shown above.

The HPA type 4104 GaAs light source and 4202 phototransistor have equivalent circuits and device ratings corresponding to their respective halves in the photon-coupled amplifier. The optically sensitive regions are 0.020-inch diameter circles on the surface of the light pipe. The model 4201 PIN photodiode has an equivalent circuit similar to that shown on page 61 (exclusive of all parameters to

the right of r_c) and C_c is about one picofarad. The photodiode has a response time of about 0.1 ns with a 50-ohm load and a quantum yield of 50%. Response to a step of light is characterized by 70% to 80% of the total response in 0.1-0.2 ns whereas the remaining portion of the response requires about 100 ns. To achieve these speeds a minimum reverse-bias voltage of 20 volts is needed across the diode to extend the depletion region from the p to the n material.

The frequency response of the GaAs, PIN photodiode optic isolator is limited by the injection-luminescence diode to about 100 Mc.

Applications for optic couplers

Photon coupling is used in the simple isolated amplifier and the small-signal linear amplifier

There are many potential applications for photon-coupled amplifiers.¹ Those which follow concentrate on use of the GaAs phototransistor, photon-coupled amplifier. Unless otherwise noted, the figures and discussion refer to type 4302 devices. The majority of these circuits have been built, or bread-

board ramifications have been examined.

Simple isolated amplifiers

The photon-coupled amplifier illustrated on page 63 can transfer and amplify signals without an electrical connection between the input and output

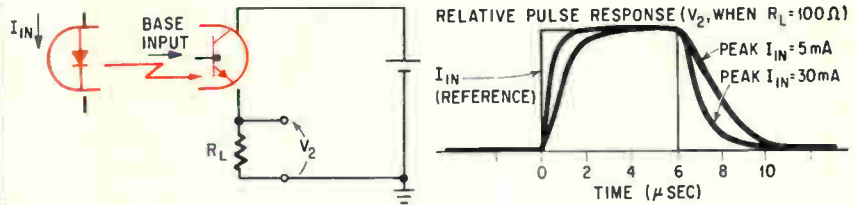

The simple isolated line coupler (A) has the basic circuit shown in (B) and exhibits the typical pulse response (C). Its isolation properties extends from d-c to the cutoff frequency of the device.

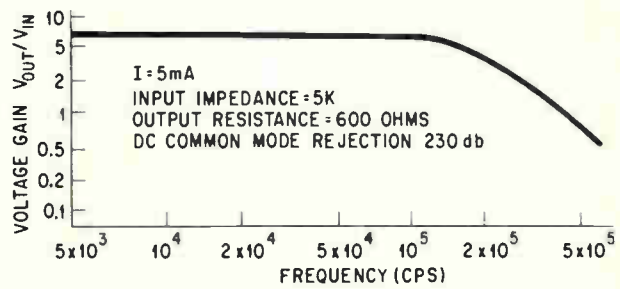
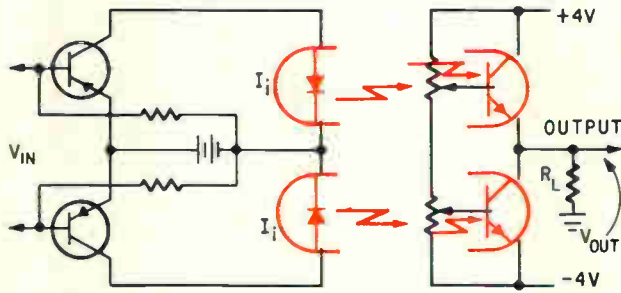

The small-signal linear amplifier has a common mode rejection of 230 decibels. Power gain occurs at the transistor input stage, in the optoelectric conversion at the GaAs diode and at the phototransistor detector.

circuits. The isolation property extends from d-c to the device cutoff frequency. It can be used over this frequency range to couple circuits that have no common connection and are at widely different potentials. The independent diode or transistor can itself be employed to replace its conventional counterpart in a circuit. Examples of applications are:

1. Remote sampling of current waveforms in existing diode circuits by replacing the in-circuit diode with the GaAs electroluminescent diode.
2. In transistor circuits, the functions of triggering, shifting of d-c signal level, or coupling where direct electrical connection is undesirable, by replacing a given transistor with the optic amplifier phototransistor.
3. In place of pulse transformers, particularly if d-c restoration of the signal is important.
4. Elimination of ground loops in large systems by avoiding multiple conductive paths between portions of the circuit. Large induced circulating currents and IR drops are prevented by utilizing optical coupling paths.
5. Isolating the separate black boxes in a large system to prevent a malfunction in one box from affecting the others.

If necessary additional amplification can, of course, be added to further increase the signal level.

Small-signal linear amplifiers

There are many applications which require direct-coupled linear amplifiers having floating inputs. This function is generally fulfilled by conventional amplifiers or transformer-coupled systems

using a modulated carrier frequency. The common-mode signal rejection that can be achieved by these systems is usually limited to about 160 decibels. The amplifier illustrated above has a common mode rejection of 230 db in addition to being less vulnerable to extraneous pickup. Optic amplifiers are used to couple the signal from a differential floating input transistor stage to the output. Power gain occurs at the transistor input stage, in the optoelectric conversion at the GaAs diodes, and at the phototransistor detectors. The composite gain and frequency response is shown.

Field-effect transistor preamplifiers can be used instead of, or in addition to, the input transistors to achieve high input impedance. As shown, the output phototransistors are electrically reverse-biased while being optically forward-biased. The resultant equivalent input noise properties are thereby improved.

Potential applications of the differential amplifiers include: 1) isolated current probes, or other instrument probes; 2) bridge output amplifiers, differential to single-ended couplers; 3) thermocouple, or other transducer amplifiers; and 4) signal ground loop isolators, floating-input null amplifiers.

High-voltage regulated supplies

In many systems, error feedback signals must be generated to maintain the system's equilibrium. For example, a voltage in the circuit is compared with a voltage standard or reference. One common use of this method is in a high-voltage regulated power supply which has reverse-biased semiconductor diodes as a reference. The limited range of reference standards, however, often prohibits a direct differential comparison.

A simple solution is provided through the use of the optic amplifier shown above.

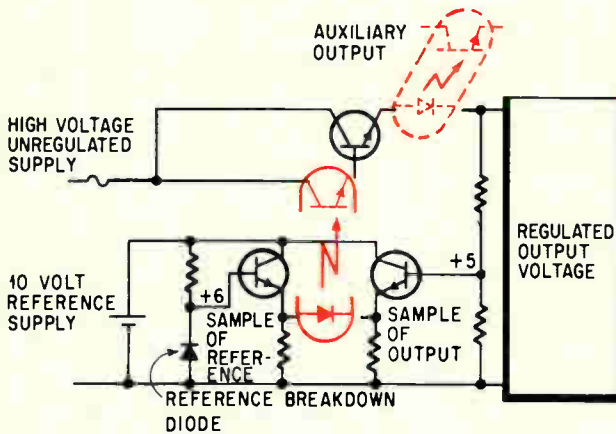

The high-voltage regulated power supply uses a photon-coupled amplifier for feedback control.

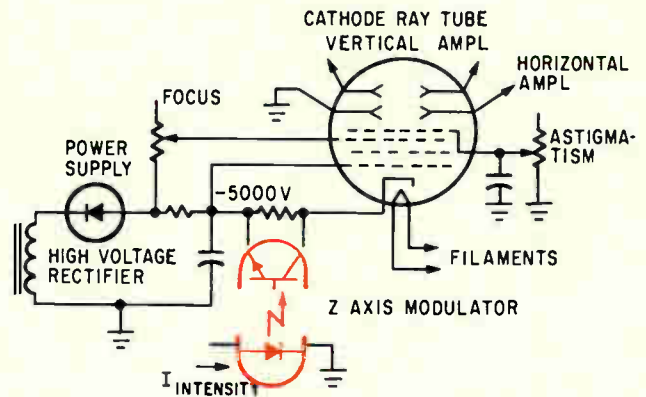

A relatively small grid-to-cathode signal for modulating the beam intensity is direct-coupled by optoelectronics.

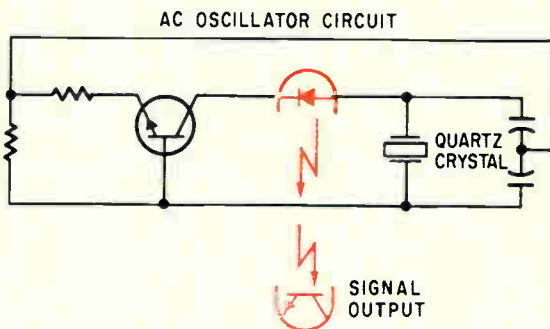

The crystal-controlled oscillator has an isolated output. The d-c bias current level is simultaneously monitored and can be used for automatic temperature compensation and amplitude control. The regenerative flip-flop in the oscillator uses the isolation coupling element down to d-c.

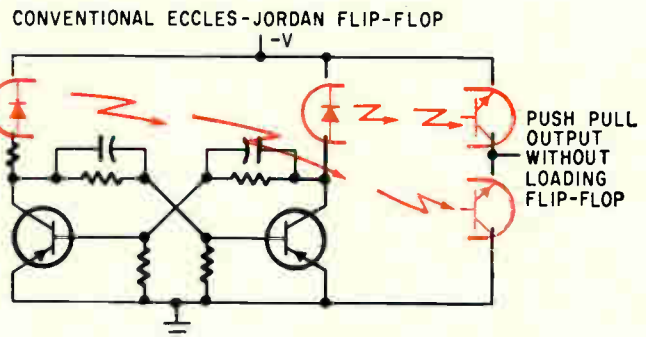

Under stable conditions, the GaAs diode is slightly forward-biased. A change in the regulated output potential alters the forward current. This change is coupled to the phototransistor which acts as a two-terminal controlled current source and compensates for the initial variation. From the volt-ampere characteristics shown on p. 60 it can be seen that the optic amplifier is very sensitive to input voltage changes. In more sophisticated systems, the feedback loop again can be increased and the thermal characteristics of the gallium arsenide diode can be directly incorporated in the design of the reference. An additional optic amplifier may also be used to sample the load current and control readout, overload protector or vernier controller.

Z-axis, cathode-ray tube modulator

Cathode-ray tubes require acceleration potentials in the kilovolt range. It is usually convenient to apply signals to the deflection plates at close to ground potential. The grid and cathode are then

several thousand volts negative with respect to ground. It is difficult to direct-couple to another circuit a relatively small grid-to-cathode signal for modulating the beam intensity. Generally this is accomplished by having a dual high-voltage supply (one for the grid and one for the cathode) and superimposing the control signal at a point where one supply returns to the ground. The additional capacitive loading of the high-voltage transformer and rectifier limits the bandwidth over which the intensity can be modulated. In addition, small differential variations between the two high-voltage supplies appear as large variations in intensity. The optic amplifier does not suffer from these difficulties. The simplicity of the coupling circuit shown above is apparent.

Oscillators and signal generators

Load variations degrade performance in many circuits. A crystal-controlled oscillator can have excellent frequency stability if load variations are

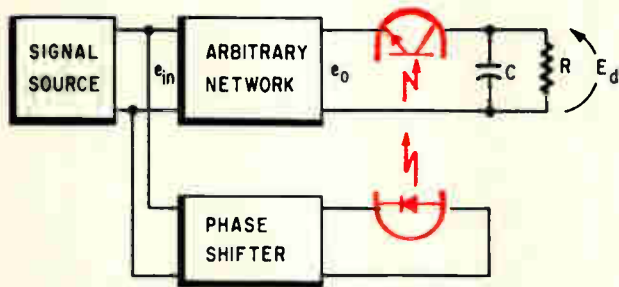

Photon-coupled amplifier provides narrow bandwidth for a phase-sensitive detection circuit and thus reduces noise.

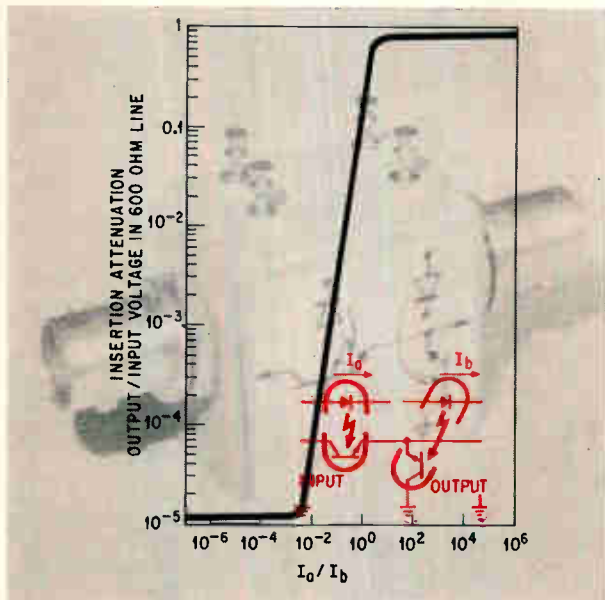

The simple coaxial-line modulator, insert, uses series and shunt phototransistors to form a photon-controlled attenuator. The insertion attenuation is for a two-element optic attenuator.

minimized. Isolation resistors may be used to reduce the effect of load changes.

However, the use of an isolation resistor decreases the available power output and the signal-to-noise ratio. Thus the spectral purity of the desired signal is decreased.

The photon-coupled amplifier or isolator can be used to achieve this isolation function since it possesses no output-to-input feedback. It appears (see p. 64) only as a passive element, a diode, in the regenerative loop. Load changes at the output will have no effect upon the performance of the oscillator itself. It is noteworthy that the oscillator d-c bias-current level is simultaneously monitored and can be used for automatic temperature compensation and amplitude control.

Photon-coupled oscillators can be designed with features other than isolated outputs. Many oscillators are possible using the optic section within the regenerative loop. The property of electrical isolation down to d-c permits a greater degree of

topological design freedom—in much the same way as the transformer proves useful in the design of a-c oscillators. Broadband regenerative circuits such as flip-flops and Schmitt triggers now can use an isolation coupling element that is analogous to the transformer, but extends to d-c. A great variety of new switching circuits using these components is possible.

Synchronous demodulators and detectors

If a reference waveform of a signal source is available, optic amplifiers may be used for phase-sensitive detection as shown at the left. A variable-frequency reference signal (sine wave, square wave, or pulse) is applied to a test network. In addition to driving the test network, the signal source supplies a replica of this excitation waveform, e_{in} , to the GaAs diode. The phototransistor rectifies the output of the test network, thereby providing a d-c signal proportional to e_o . By increasing C and R , the effective pass band of the detector can be made as narrow as desired without the attendant problem of tracking the signal-source frequency with a narrowband, or comb filter. The noise power of the system is, of course, reduced in proportion to the bandwidth. Phase as well as amplitude information can be resolved by maximizing E_d at each frequency by controlling the phase shifter.

Modulators, mixers, and time-varying switches

A simple coaxial-line modulator is shown at the left. The series and shunt phototransistors form a photon-controlled attenuator. This simple configuration has potential uses for: 1) general-purpose electronic potentiometers; 2) fast, automatic gain or level controls; 3) low-level, d-c to a-c choppers (or d-c level switch); 4) intentionally injecting spurious or random signals into systems for malfunction-susceptibility evaluation or noise measurement; and 5) mixing two, or more signals.

Other optically-controlled attenuator and amplifier combinations are possible. These operate independently of the potentials between the control and output ports. Their frequency response extends to d-c, and they do not introduce large extraneous signal transients in switching applications. The GaAs diodes might be acting simultaneously as envelope detectors, or mixers themselves, for very-high-frequency input signals.

It is also possible to form other modulator configurations using optic amplifiers. Many inputs can be used to feed a single line, or conversely, a single line may fan out to numerous signal paths as established by controlled phototransistors.

Optical switching applications can also be performed since the input and output halves of the optic amplifier can be provided separately. When the ends of hpa. types 4104 and 4202 are brought together, an optic amplifier is formed. They provide a coupling element that can be connected or disconnected by physical motion. Such optical switches have no contact bounce, produce minimal

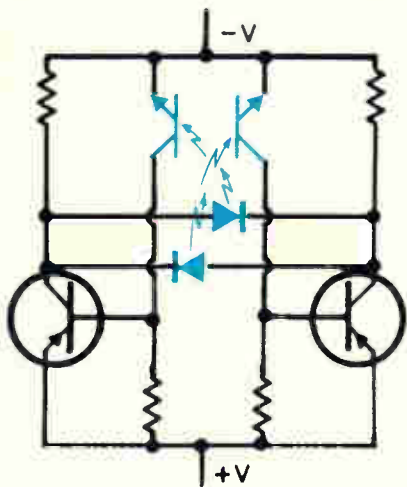

A

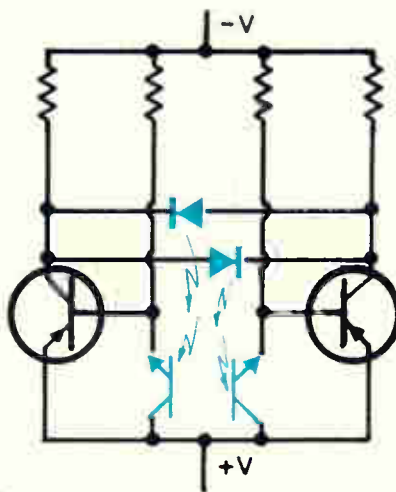

B

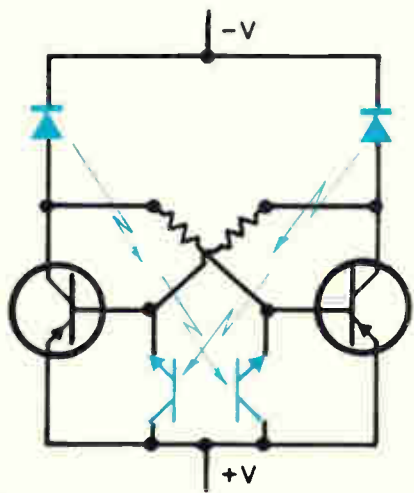

C

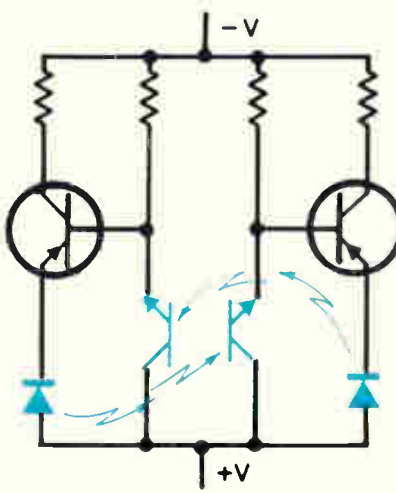

D

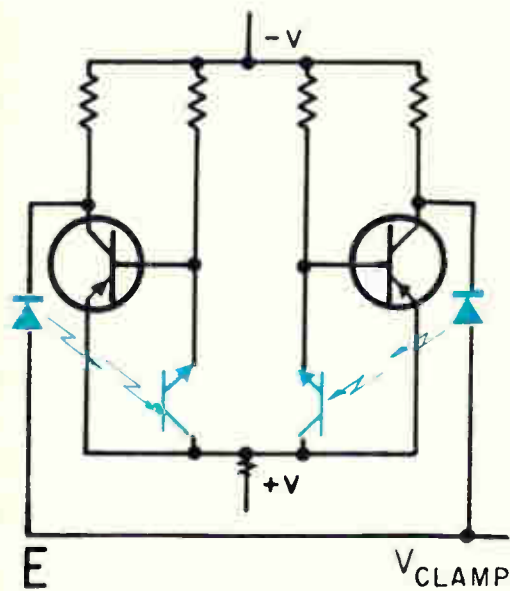

E

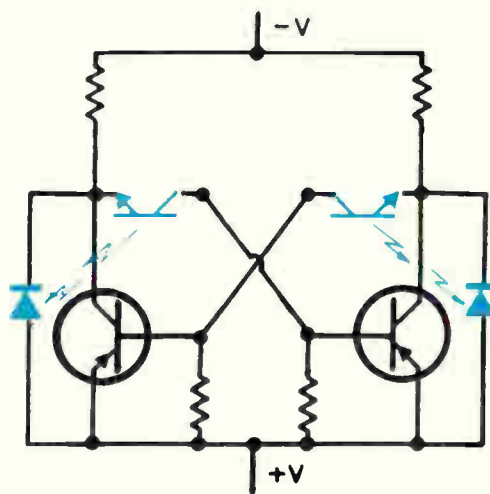

F

Six versions of the symmetrical Eccles-Jordan flip-flop circuit have photon coupling: between the collector-to-collector and the series-base element (A); between the collector-to-collector and the shunt-base element (B); between the series collector and the shunt-base element (C); between the series emitter and the shunt-base element (D); between the collector clamps and the shunt-base element (E), and between the shunt collector and the collector-base element (F).

on-off transients, minimize electrical changes during switching, and can provide varying degrees of coupling.

High speed relay

The conventional electromagnetic relay has survived as a high-usage component because of the flexibility afforded by its input-output isolation. Most of the applications of low-power relays for signal control can use the new solid-state optical devices with a resulting improvement in speed and reliability. It is possible to form relay-logic trees, turn-on-and-off circuits and provide interlocks. A comparison of the basic properties of these two systems is shown in the table below.

Multiplexers, commutators, and signal samplers

Modern information-handling systems involve signal commutation. In these systems, it is convenient for the time-sequencing controls to remain electrically separate from the information signals. The speed and isolation capabilities of photon-coupled devices make them well suited for such applications. Shown below is a simple multiplex amplifier in which each input is successively sampled. Information on the "n" parallel input channels is fed serially to the single-channel ampli-

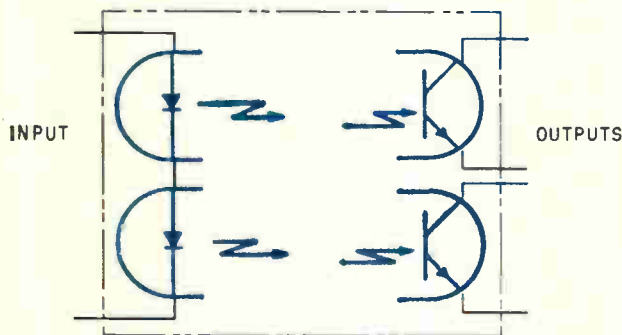

Optical devices improve the speed and reliability of the double-pole, single-throw relay.

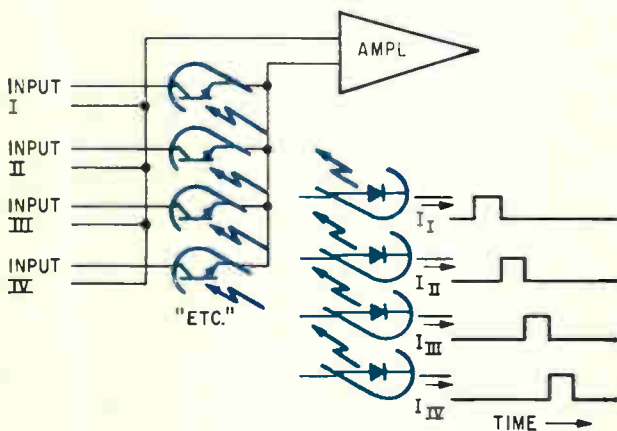

Information on the n-parallel input channels is fed serially to the single-channel multiplex amplifier. The time-sequencing controls are electrically separated from the information signals.

fier. If necessary, at a later point in the single-channel link, an additional decommutator can synchronously separate the "n" amplified signals. The single channel may itself involve a telemetry link, a pulse-coding system, or an isolated amplifier as shown earlier. One of the inputs can be shorted and another connected to a reference potential to provide an "n" channel amplifier with chopper stabilization of zero drift and gain.

If the phototransistor is designed for multiplexing applications, performance limitations such as differential phototransistor offset potentials, and speed of response are comparable to transformer-driven transistor switches. The optical device permits a periodic drive signals, and introduces smaller transients than do magnetic systems. Signal gains are less than with conventional transistors and the devices typically require greater drive power.

Acknowledgment

The work leading to the photoncoupler was jointly sponsored by the Air Force Avionics Laboratory Research and Technology Division and the Hewlett-Packard Co.

References

1. I. Wunderman, Photo-Coupled Circuits, Air Force Avionics Laboratory, Technical Documentary Report No. RTD-TRD-63-4260, Jan. 1964.

Comparison of electromagnetic relay and optic relay

Parameter	Electromagnetic relay	Optic relay
Maximum speed of response	1 cps to 10^3 cps	10^4 cps to 10^8 cps
Input-output resistance	10^9 to 10^{15} ohms	10^{15} ohms to ∞
Contact resistance "On"	Milliohms	Nominally 100 ohms
Leakage resistance across contacts	10^9 to 10^{12} ohms	10^8 to 10^9 ohms
Leakage capacitance through contacts	1 pf	5 pf
Input-output capacitance	2 pf	.01 pf
Output contact current limit	many amperes	100 ma
Maximum open contact voltage	100V to 2000V	20V to 50V
Maximum input-output voltage	10^3 V to 10^4 V	Virtually unlimited
Actuating power	10mw to 1 W	1mw to 100mw
Stored energy	Large inductive transients	Predominantly resistive input, no transients
Microphonics	Susceptible to vibration, shock; and contact bounce	All solid state (no moving parts)
Spurious radiated fields	Difficult to shield out radiated magnetic fields	Optical shielding from external environment is simple
Life	Limited to 10^3 to 10^8 cycles	Solid state, no known wear-out mechanism

The author



Earlier this year Irwin Wunderman was awarded a doctorate in electrical engineering by Stanford University. Since 1952, he has been working on solid-state devices. Wunderman has been with the Hewlett-Packard Co. for eight years; the last three have been spent in optoelectronic research of hp Associates, an affiliate of the company.

Stray signals can't throw this desensitized switch

It discriminates between r-f energy and a d-c pulse by using an extra zener junction

By John M. Gault and Richard J. Sanford

Spurious radio-frequency interference can trigger a semiconductor switch with disastrous results. For example, a circuit used with an explosive load such as a warhead detonator could be set off by a spurious r-f signal. The switch must be designed to reject unwanted r-f energy and accept the desired d-c pulse that triggers it.

The switch shown (page 69) meets these requirements. It is triggered by a small d-c signal. Any stray r-f signal, induced between the gate and cathode, will not energize the load. The device can be used instead of pnpn switches in applications where signal interference might be a source of trouble. Diagram B (page 69) shows a lumped component equivalent of the desensitized switch.

Tentative specifications of desensitized switch

Range of protection:

Anode: \pm 100 volts, dc to 29 Mc
Gate: 100 kc to 29 Mc

Gate firing signal:

+ 0.5 ma at 10 volts (maximum)

Current handling ability:

0.5 amps dc
10 amps for 5 milliseconds

Temperature range:

Operating - 65° C to + 80° C
Storage - 65° C to + 15° C

Interlead capacitance:

Approximately 60 pf between any two leads

Case:

T0-5 can

Weight:

approximately 1 gram

The firing level

The operation of the desensitized pnpn switch is best understood by examining the structure of an ordinary pnpn switch, on p. 69, bottom. Construction begins with a single crystal of pure silicon. Four alternating layers of p and n material form the three interacting pn junctions. In the diagram, from bottom to top, these junctions consist of the emitter or cathode, the collector, and the conjugate emitter or anode. The two lower junctions form, in effect, a high-gain npn transistor. The upper two junctions form a low-gain pnp transistor. Both transistors use the same collector. The normal alpha, or d-c common-base forward current, of each transistor increases with collector current at low currents. Since the transistors are connected for positive feedback, the device switches on when the collector current rises to such a value that the sum of the alphas exceed unity. A forward bias of about one-half volt must be placed across the emitter junction to raise the collector current to a value that will fire the switch. And so any d-c or r-f signal, which can raise the emitter to about one half a volt can fire the switch.^{1, 2, 3, 4}

Switching ability

Any pnpn switch has some inherent protection against r-f signals introduced at its gate lead. The capacitance of the emitter junction combines with the resistance around the gate contact to form a simple RC filter. This will attenuate a radio frequency signal.

In principle, an RC attenuator can give any amount of r-f protection desired. But practically, there is a trade-off between the desirable switching characteristics and good r-f filter characteristics. Good filter characteristics interfere with switching

ability, and at the upper limit of filtering, the switch may not work at all. The capacitance, C , is limited by the cathode area and by the maximum allowable doping level of the p-type base region. These, in turn are limited by the requirement that the device be a good switch. The resistance, R , is somewhat limited by the manufacturing technique used in making the junction. If R is made high, this will limit the current needed to fire the switch. Further, there is a stray capacitance shunting this resistance, and if the resistance is made too large, the shunt capacitance dominates the impedance and the filter becomes a capacitor divider. Finally, an RC attenuator always introduces an undesirable time delay in switching action.

It is desirable to supplement RC protection by a method that discriminates between r-f energy and the d-c pulse. The most obvious difference between these signals is that the r-f changes its polarity continually, whereas the d-c pulse does not. If a switch is to be fired by a positive d-c signal, but not by a negative one or by r-f, the negative half-cycles of the r-f can be used to produce an inhibiting or desensitizing signal to prevent the switch from firing.

The RC filter

The desensitized pnpn switch consists of a normal four-layer switch structure with the following modifications: A resistor is diffused around the periphery of the switch and connected in series with the gate. This resistance combines with an abnormally large emitter capacitance to form an RC filter which attenuates r-f signals introduced between the gate and cathode leads. Between the resistor and the gate lead is a diffused zener junction which breaks down at eight volts. This extra junction rectifies r-f signals applied between gate and cathode, and places a reverse bias on the emitter junction. This must be overcome before the r-f signal can fire the switch. In normal d-c operation the gate voltage is raised slightly above the zener breakdown voltage sending sufficient current through the emitter to fire the switch.

The zener junction in this device is unusual in two respects. It has a small capacitance to keep it from being bypassed by the r-f. The junction is also carefully isolated from the rest of the switch structure. The electrons injected into the p-region of the zener junction during the negative half-cycle cannot diffuse to the collector and fire the switch. The small capacitance is obtained by limiting the area of the zener junction. Zener isolation is achieved by diffusing the collector junction to a greater depth under the zener than under the emitter. This longer path greatly decreases the probability that an injected electron will reach the collector before being recombined.

Fabrication

Prototype switches were fabricated by lapping a

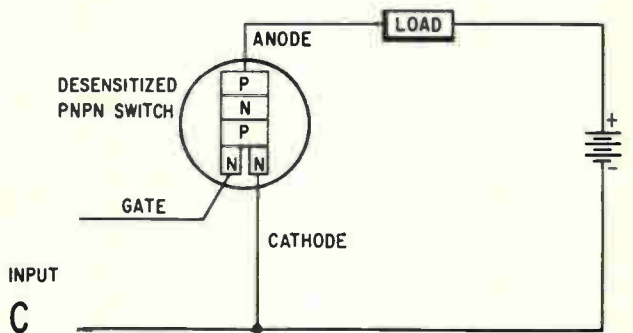
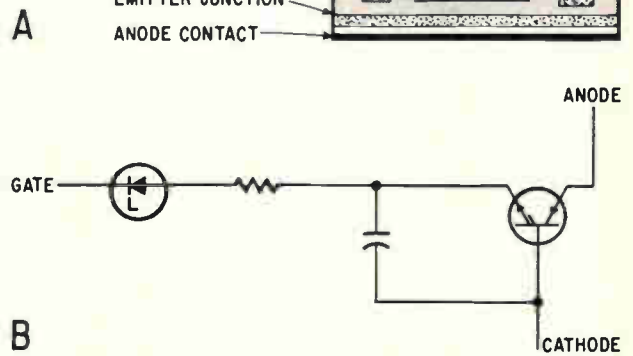
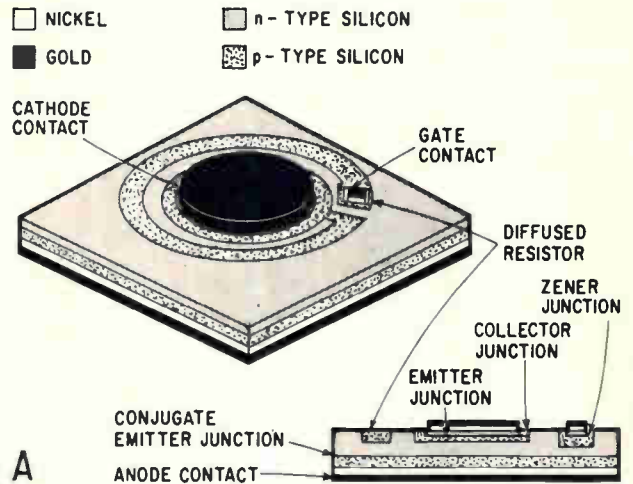

Radio-frequency signals are attenuated by a resistor diffused around the periphery of the switch (A). The lumped component equivalent of the desensitized switch is shown in (B). The load in circuit (C) will not be energized if an r-f signal is induced between gate and cathode.

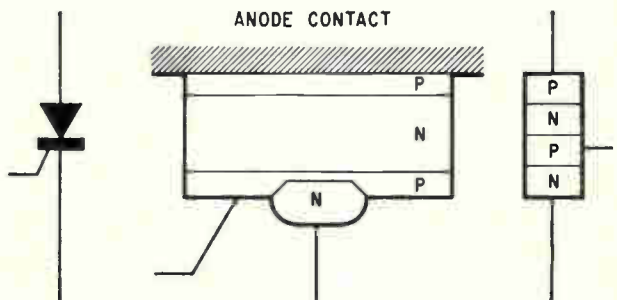

An ordinary pnpn switch can be fired by any d-c or r-f signal.

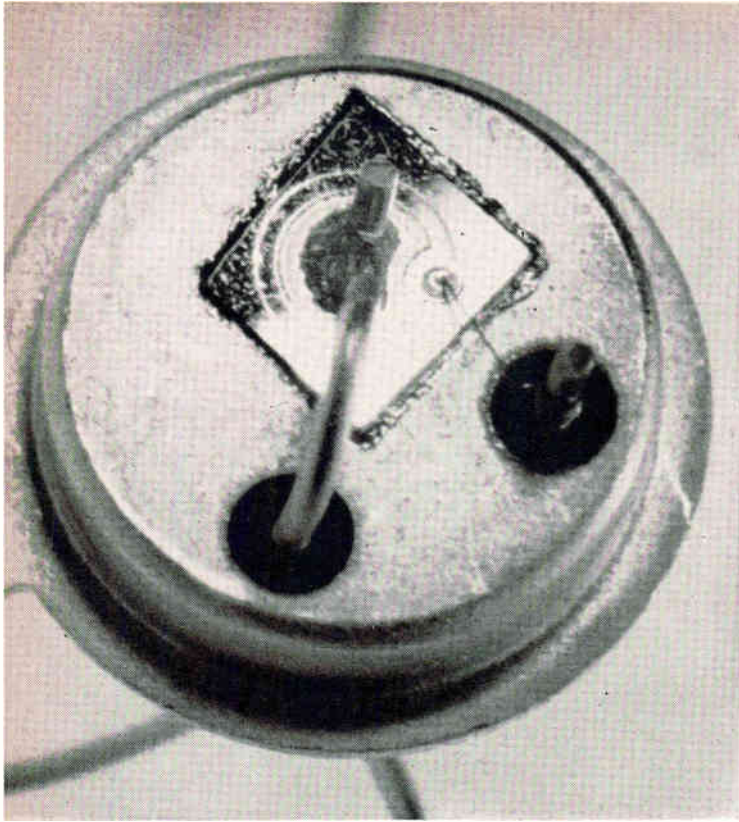

Desensitized silicon pnpn switch, prior to encapsulation.

group of 50 ohm-cm n-type slices of silicon to a thickness of about 0.008 inch. The slices were etched to remove lapping damage, and one surface of each slice was polished to a mirror finish. The slices were cleaned and oxidized for 16 hours in an ambient of wet oxygen at 1,170°C. The oxide was removed from small areas on the polished surface of the wafers with Kodak metal etch resist and a special mask; then oxide was removed from the entire unpolished surface of the wafers. The slices were diffused in boron for 140 hours at 1,150°C, creating junctions at a depth of about 0.0018 inch.

This diffusion produced the conjugate emitter (anode) junction and the thick p-type region needed to isolate the zener. The slices were reoxidized for two hours at 1,170°C. The oxide was removed from the collector and resistor areas and the slices were then reoxidized for 16 hours at 1,170°C. A portion of this oxide was removed for the cathode and zener junction diffusion which consisted of phos-

Desensitized switch . . .

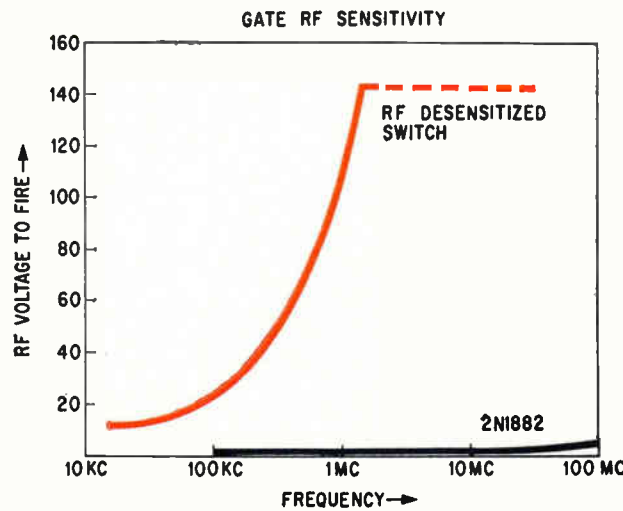

Median gate sensitivity of desensitized switch is compared to that of a conventional 2N1882 device.

phorous diffusion for one half hour at 1,130°C in an ambient of phosphorous pentoxide and oxygen. The slices were cleaned in hydrofluoric acid and oxidized for one hour at 1,170°C. After the oxide was removed from the cathode, zener gate, and anode surfaces, the surfaces were plated with nickel and gold. The slices of silicon were diced into units with a scribe-and-break process. Then, 0.002 inch diameter gold wires were bonded by thermal compression to the zener gate areas. The dice were soldered to TO-5 headers, etched, varnished and tested. The photo above shows a desensitized switch in this stage of fabrication. Caps were then welded on the headers to create a hermetic seal.

Gate sensitivity

Two lots of switches have been produced satisfactorily. Of the 17 switches in the final lot, all are less vulnerable to either gate or anode r-f signals than are conventional pnpn switches. The nine best

The authors



John M. Gault, physicist, heads microcircuit development for the International Rectifier Corp., El Segundo, Calif. His work on the desensitized switch was in cooperation with the Naval Ordnance Laboratory. He has aided in the development of various tantalum capacitors, selenium rectifiers and silicon integrated devices for industry. Gault was

born in Cameroon, West Africa, in 1924.



Richard J. Sanford is a physicist in the advanced engineering division of the Naval Ordnance Laboratory at White Oak, Md. He has investigated the hazards of electromagnetic radiation to solid state components and has two patent applications pending in that field. Off the job, he is an enthusiastic spelunker and pistol shooter.

... and its performance

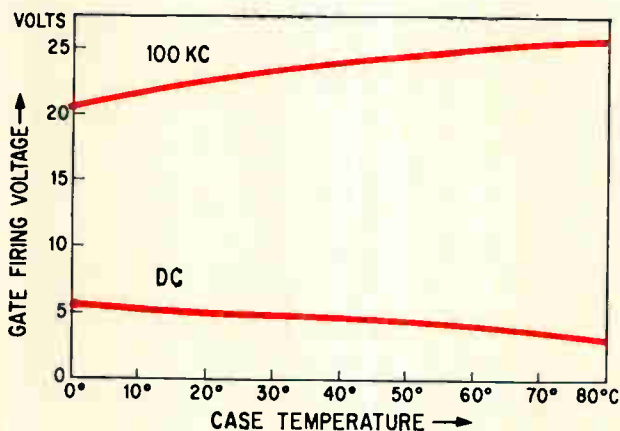

Response of gate r-f sensitivity (upper line) and d-c response (lower line) with temperature

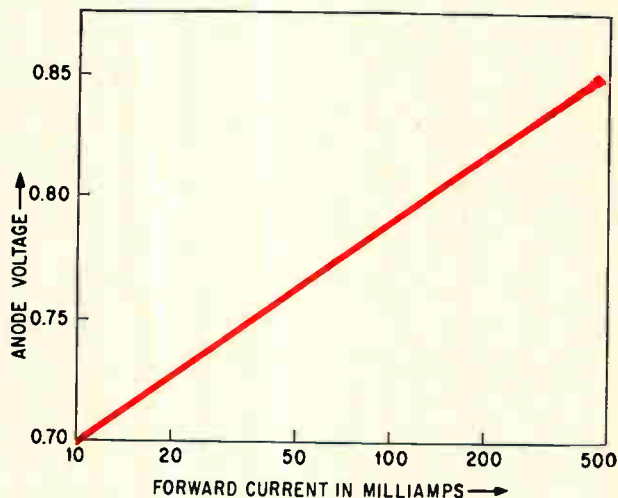

Voltage drop in conducting switch. Graph uses a semi-logarithmic plot.

switches were selected as representative of desensitized switches of the future. Their median gate r-f sensitivity is compared to the sensitivity of a typical conventional pnpn switch, in the graph on page 70. The sensitivity of the new switch decreases rapidly at frequencies above 100 kc, while the conventional switch remains sensitive to much higher frequencies.

The gate r-f sensitivity decreases with increasing temperature, although the d-c sensitivity increases with temperature. This is shown in the graph above left. When r-f is applied between anode and cathode, the switches are not fired by 100-volt signals at frequencies up to 29 Mc.

The forward voltage drop in the switch in its on, or conducting, state is shown above. A semi-logarithmic plot has been used. The current is an exponential function of voltage between 10 and 500 megacycles.

Other properties of the switch are shown in the table on page 68.

These prototype devices prove that pnpn switches desensitized to r-f energy can be fabricated. But further work is needed to go from a handful of prototypes to production. During further development, the tentative specifications can be changed, if necessary, to meet specific needs of military systems.

Cans and chips

The prototype units are housed in TO-5 transistor cans, which have rather poor power dissipation. Identical device chips could be mounted in small stud-mounted cans. This would increase the current-handling ability without changing the other

electrical characteristics. Slightly smaller chips could be mounted in TO-18 or microtransistor cans; they would be compatible with the larger cans if higher power dissipation were needed. Thus, the mass production of only one type of silicon chip could result in a series of desensitized switches covering a wide range of sizes and power capabilities.

The desensitized pnpn switch can be used in any location where radio frequency interference might be troublesome. The switch has a capacitance value of 60 picofarad between any two leads, presents very little resistance to a d-c signal, and can be used to isolate a section of a d-c circuit from unwanted radiation sources. At higher frequencies, a small conventional filter, or ferrite or carbonyl-iron attenuator can supplement an r-f blocking job without increasing the d-c resistance significantly.⁶

References

1. Lowry, et al. *Controlled Rectifier Manual*, General Electric Co., Auburn, N.Y., 1960.
2. Sanford, R.J., *RF Sensitivity of Controlled Rectifiers*, Naval Ordnance Laboratory Technical Report 63-56, Apr. 1963.
3. Sanford, R.J., *Can RFI-Control Prevent Weapons Failures?*, *Electronics*, Nov. 8, 1963.
4. Sanford, R.J., *RF Sensitivity of Controlled Rectifiers*, Second Hero Congress 1963 on Hazards of Electromagnetic Radiation to Ordnance, Apr. 30, May 1-2, 1963.
5. Gault, J.M., *Final Report*, U.S. Naval Ordnance Laboratory Contract No. N60921-7050, PNPn Tiode Semiconductor Switch, International Rectifier Corp., El Segundo, Calif., 1963.
6. Wood, et al., *Development of Broadband Electromagnetic Absorbers for Electro-Explosive Devices*, Second Hero Congress 1963 on Hazards of Electromagnetic Radiation to Ordnance, Apr. 30, May 1-2, 1963.
7. Sanford, R.J., *RF Desensitized Switch*, Naval Ordnance Laboratory Technical Report 64-43 (to be published).

Designer's casebook

Designer's casebook is a regular feature in Electronics. Readers are invited to submit novel circuit ideas, packaging schemes, or other unusual solutions to design problems. Descriptions should be short. We'll pay \$50 for each item published.

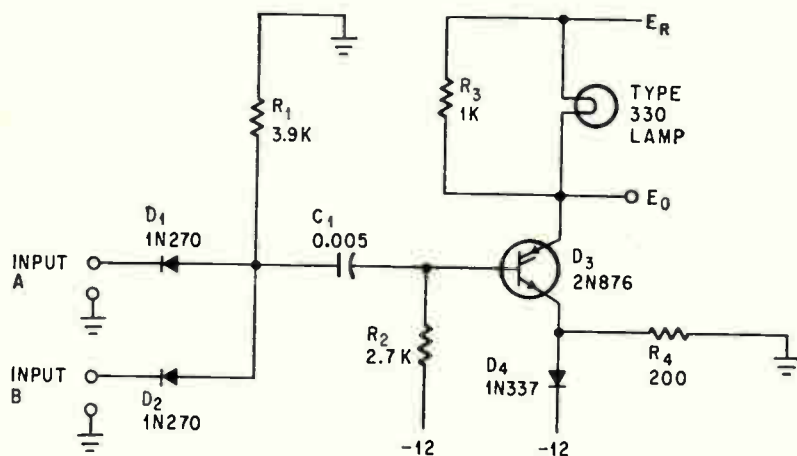

Register setting is held until circuit is reset by application of E_R . Waveforms depict input, output and reset voltages (right).

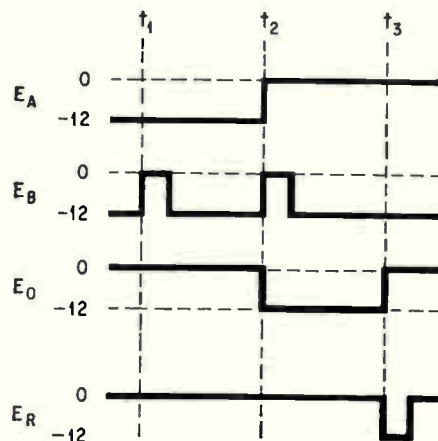

Displaying the contents of a computer register

By James J. Collins

Kollsman Instrument Corp., Elmhurst, N.Y.

An indicator circuit was needed that would sample the contents of registers in small special-purpose computers, then display the information by visual means. A silicon controlled rectifier, used as a combination register and lamp driver, provides the solution.

The computer register to be sampled is connected to input A, and input B is supplied with a 10-microsecond, 12-volt positive pulse. The state of the register is indicated by the lamp.

If the signal applied by the register at A is at its low level (-12 volts), D_1 will conduct. However, D_2 will not operate because the trigger voltage applied at B will make its cathode more positive than its anode. The negative voltage at the junction of the diodes will maintain the rectifier in the non-conducting state and the lamp will not light.

If the signal applied by the register at A is positive (actually at ground potential), the positive trigger pulse introduced at B results in a coincident positive voltage (an AND circuit gate voltage) being applied to the base of the silicon controlled rectifier. This causes the silicon controlled rectifier to conduct. The voltage placed across the incandescent lamp turns it on.

The level of the voltage triggering the scr is determined by R_1 and R_2 , which act as a voltage divider.

Because the output of this circuit also was used to drive a digital-to-analog converter, resistor R_3 was placed in parallel with the lamp as a precaution against its failure.

The circuit is reset by reverse-biasing the anode of the silicon controlled rectifier. The output lead, normally clamped to ground, is switched to -12 volts for 50 microseconds. Since the scr cathode is at -11 volts, this provides enough reverse bias for reliable resetting.

In the waveform diagram shown, the register is negatively set when sampled at time t_1 , and positively set when sampled at t_2 . Resetting occurs at t_3 .

Added transistor decreases multivibrator reset time

By Steven A. Bell

Bennett Respiration Products, Santa Monica, Calif.

Adding a low-cost conventional transistor to a free-running multivibrator circuit allows rapid resetting of the multivibrator and eliminates the need for a more expensive device, such as a unijunction transistor. In the circuit shown, the addition of Q_2 reduces by a factor of about 30 the time required to recharge capacitor C_1 .

Transistor Q_2 is saturated by the negative supply voltage applied through R_3 to its base. With Q_2 conducting and C_1 charged as indicated on the circuit diagram, the negative side of C_1 is clamped to ground through diode D_1 and Q_2 . Transistor Q_3

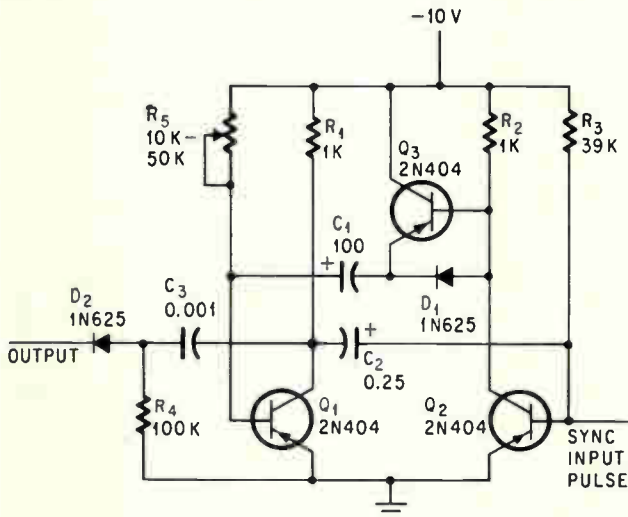

Addition of Q_3 and D_1 to a conventional astable multivibrator circuit allows rapid recharging of C_1

Resistor R_5 determines frequency

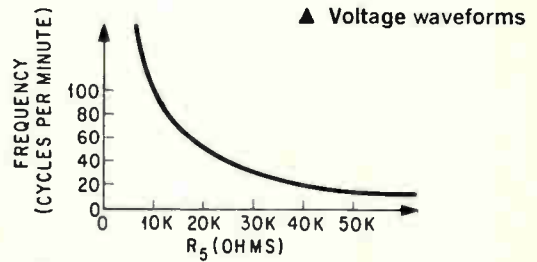
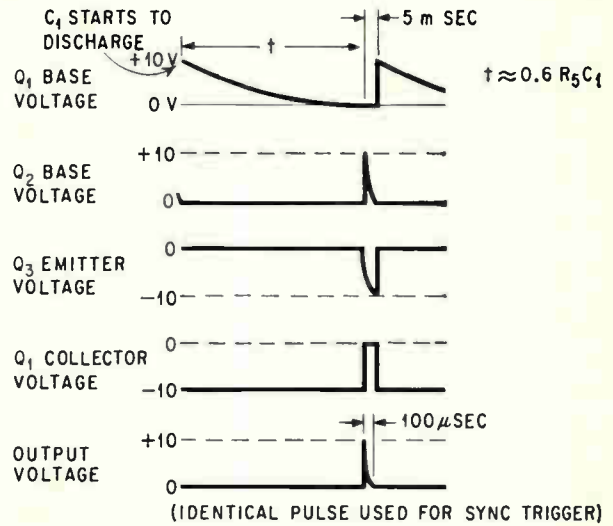

is off because its emitter-to-base junction is slightly back-biased by the forward conduction voltage across D_1 . Transistor Q_1 is also off because of the positive voltage placed at its base by the charged C_1 . Capacitor C_2 has been charged by the supply voltage. No current flows through R_1 .

Capacitor C_1 starts to discharge. The discharge path consists of R_5 , R_2 , and D_1 . When the negative-going voltage at the base of Q_1 drops to about -0.4 volt, Q_1 begins to conduct. Since the voltage across C_2 cannot change rapidly, a small initial flow of current through Q_1 produces a small voltage drop across R_1 and back-biases the emitter-to-base junction of Q_2 . Transistor Q_2 turns off rapidly.

A current path now exists from ground through the emitter-to-base junction of Q_1 , C_1 , the emitter-to-base junction of Q_3 , and R_2 to the negative supply. This current—initially 10 milliamperes—causes Q_1 to turn on rapidly and Q_3 to conduct heavily.

Transistor Q_2 is held off until C_2 discharges through R_3 and Q_1 . During this period, C_1 charges through R_2 , and the emitter-to-base junctions of Q_3 and Q_1 .

When C_2 has discharged sufficiently, Q_2 starts to conduct, Q_1 and Q_3 turn off, C_2 charges through R_1 and Q_2 , and the cycle is repeated.

If Q_3 and D_1 were not used in this circuit, the time required to recharge C_1 to a voltage approaching the supply voltage would be approximately $1.5 R_2 C_1$ or 150 milliseconds. Transistor Q_3 multiplies the charging current by the beta of the transistor (about 30) and reduces the time by the same factor.

Using a value of 50,000 ohms for R_5 , the circuit provides timing pulses which vary in frequency from 90 to 20 cycles per minute (or periods from 0.67 to 3 seconds). Capacitor C_1 recharges in less than five milliseconds.

Nomograph shows phase-shift angle

By M. Grelot
Vitry, Seine, France

The nomograph shown below gives the phase shift, ϕ , obtained at any specified frequency, f , in a resistance-capacitance phase-shifting circuit. If the values of resistance, R , and capacitance, C , are

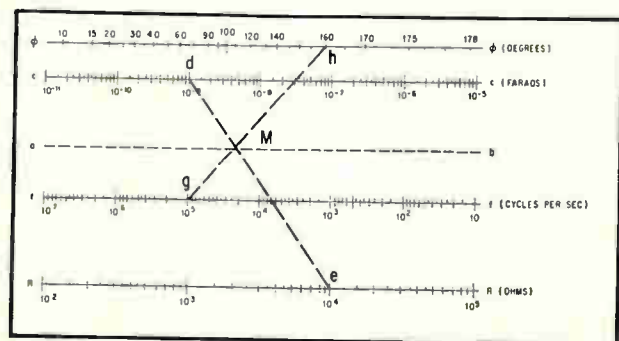

Nomograph simplifies phase-shift calculations.

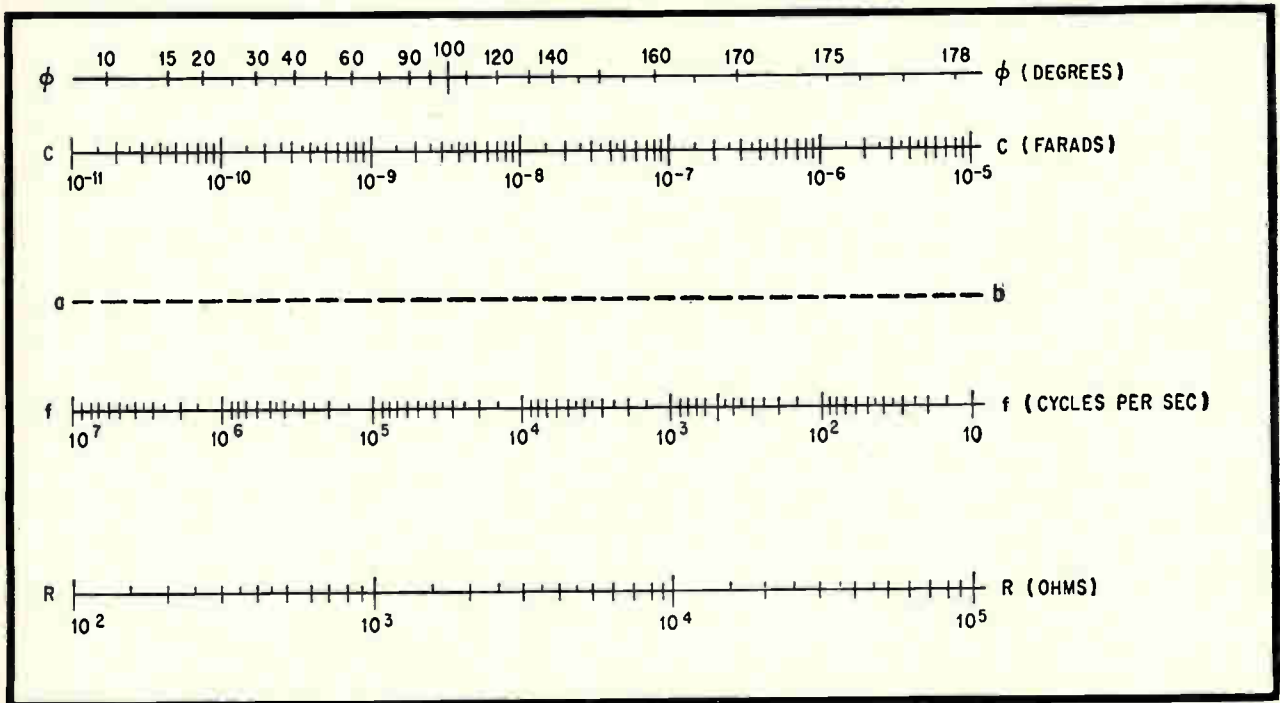

When three of the four quantities R, C, f, and ϕ are known, the fourth may be determined from the nomograph

unknown, suitable combinations may be selected for a given frequency of operation and desired phase shift.

If R, C, and f are known, the nomograph is used as follows:

- Draw a straight line between R and C. This line (d-e on the figure) determines point M on dashed line a-b.
- Draw another straight line (shown as g-h) through point M to the line for values of ϕ . Read the value of ϕ at which the line g-h intersects with the line

of values of ϕ .

In the example given, $R = 10,000$ ohms, $C = 0.001$ microfarads and $f = 0.1$ Mc. By using the nomograph, ϕ is determined to be 162° (see illustration).

When it is desired to choose values of R and C for a given phase angle and at a specified frequency, use the following procedure:

- Draw line g-h between ϕ and f, determining point M.
- Select any convenient values of R and C determined by a straight line drawn through point M.

Positive-pulse generator

By Richard J. Bouchard

Sanders Associates, Inc., Nashua, N.H.

In an automatic test set, a positive-pulse indication was required when a stepping switch passed through each of certain positions in its cycle. Generation of the positive pulse was needed when the switch stepped into positions 1, 3, 4, 5, 8 and

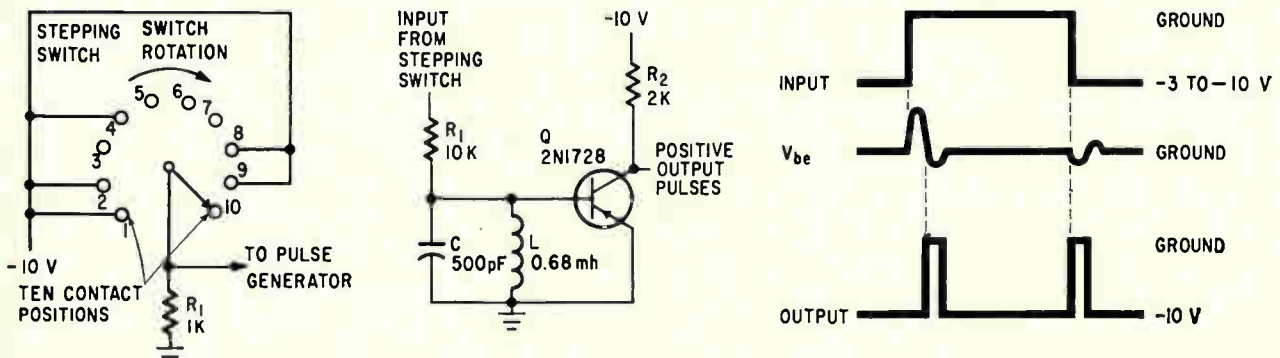

Rotation of the stepping switch, left, provides input pulses to the positive-pulse generator. The circuit center, generates positive pulses when the input pulse is applied or removed. The voltage waveforms are shown at the right; the output pulses occur when the transistor base voltage goes negative.

10, shown on the wiring diagram.

A simple circuit provides the solution by producing a positive output pulse at both the leading and the trailing edges of the input pulse.

If the input is at ground, transistor Q is off and the output is -10 volts. When the input signal is negative, R₁ and L provide a d-c path which clamps the base of Q to ground and the output returns to -10 volts. During the rise or the fall of the input waveform, the circuit resonates, producing a sinusoidal-type waveform at the base of Q. The negative portion of this waveform drives Q into saturation and the output switches to

ground. The result is a positive 10-volt output pulse, when the input pulse is either applied or removed.

With a step-function input, the voltage developed across the inductor of an unloaded RLC circuit will be an underdamped oscillation when $L/C < 4(R_1)^2$. Only one negative oscillation occurs because the low input impedance of Q, as it is driven into saturation, shunts the tuned network.

With the component values shown, a 10-volt pulse is produced at the output for every application or removal of an input greater than three volts. The output pulse is slightly delayed.

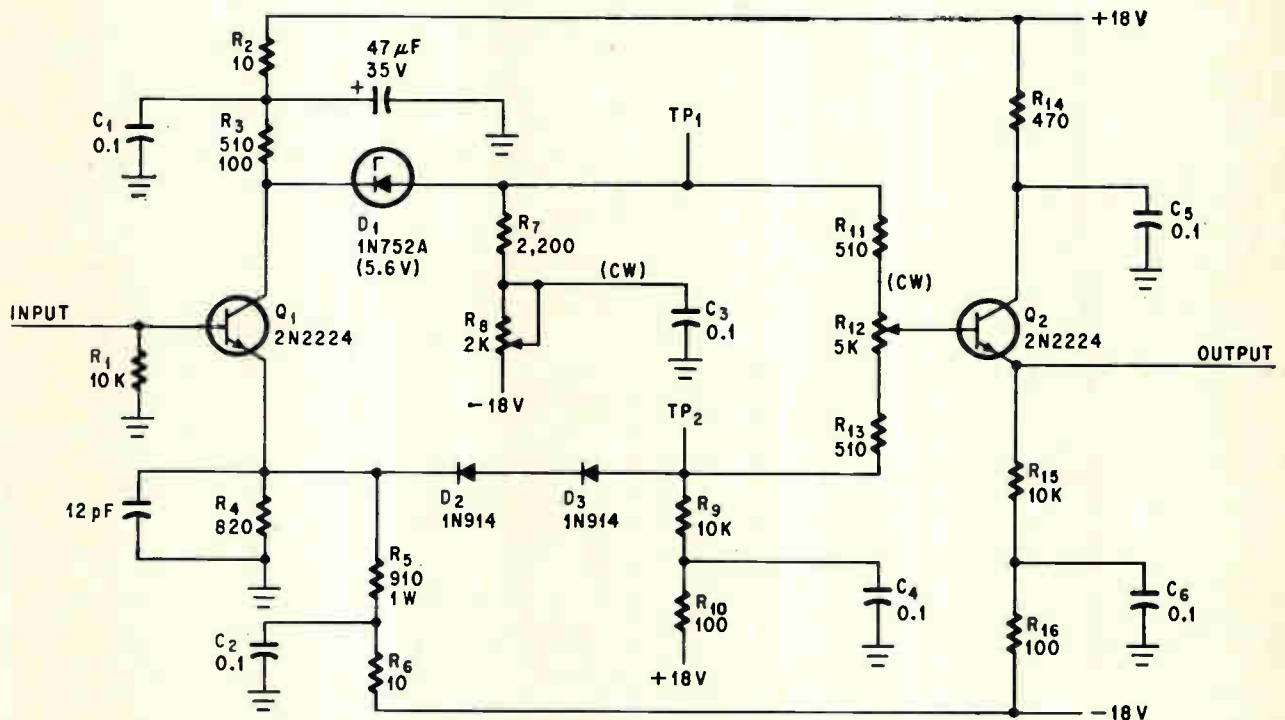

Output is continuously variable from zero to 3.5 volts with input from zero to -4 volts.

Buffer amplifier supplies bipolar output

By Freeman E. Smith

Raytheon Co., Wayland, Mass.

This circuit (above) corrects alignment inaccuracies between electrostatic deflection plates and the rectangular face of a cathode-ray tube. It can also be used if paraphase outputs are desired. By putting two of these circuits on one printed circuit card, the same information can be fed into both circuits and one polarity of output can be taken from one circuit and the other polarity from the other circuit. The result is identical signals that are 180° out of phase with each other.

If no inversion is required the circuit may be

used as a buffer or as an inverter and buffer if an inversion is required. It provides an output which is continuously variable over a range corresponding to the maximum positive to negative input signal excursion with a zero volt baseline. Normal operation is with a negative input signal but the circuit will work with a positive input as long as the amplitude is not large enough to saturate Q₁. With input signals from zero to -4 volts, the output goes from zero to ±3.5 volts.

Inverter amplifier Q₁ has a gain of approximately one. Therefore, signals identical but 180° out of phase are seen at its collector and emitter. Resistor R₈ varies the current in the collector resistor of Q₁ such that test point TP₁ can be set at the same voltage as TP₂ (typically +0.6 volt.) Under these conditions, R₁₂ can be varied without changing the baseline of the output signal since the d-c voltage level across R₁₁, R₁₂ and R₁₃ is constant.

The circuit is stable from 10° to 50°C.

Automatic circuit tester

A digital computer saves time and money in production-line checkout of digital logic modules

By Kenneth Wakeen*

Digital Equipment Corp., Maynard, Mass.

The job of production testing has become much too sophisticated for patch-panel and wired-chassis techniques, except on a limited basis. Combining transistors, diodes, and resistors and capacitors into operational circuits which are then tested as integral packages has multiplied the problems of control. The small computer is the logical tool of the system designer for production testing. The computer test system concept does more than automate production testing; it adds procedures impossible to carry out previously to present test capabilities.

Comparison

The figure at the right shows some typical circuits being tested by computer control. The flip-flop and inverter are tested for logic functions, saturation voltages, fan-in, fan-out, rise time, fall time, delay time, and sensitivity to signal and noise. The circuits are complex and manual testing is costly and slow.

The table below compares costs and speeds of testing the inverter manually and automatically.

	Manual test	Automatic test
Time	10 minutes	10 seconds
Operator rate and overhead	\$7.00/hour	\$7.00/hour
Cost/module	62.5 cents	1.4 cents
Rate/operator	50/day	3,200/day

Assuming only 50% utilization time on the automatic tester, the savings per day total \$980. Flip-flops, which are more complicated and require one-half to one hour in manual testing, can be

tested automatically at savings of about \$2,400 per day. A more realistic cost comparison considers capital investment and overhead. Manual test setups consist of a good oscilloscope, voltmeter, power supplies and pulse generators. The cost for this hardware is generally from \$4,000 to \$10,000. In addition, a separate switching box must be designed and built for each type of module tested.

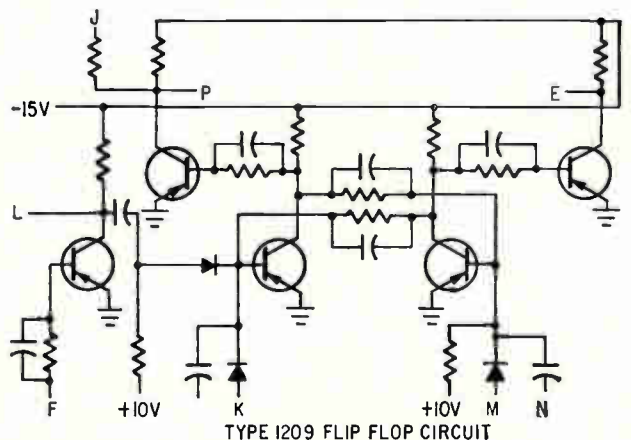
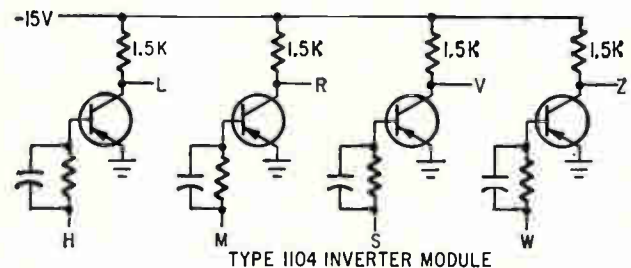

Typical logic circuits to be tested

*Now with Nexus Research Laboratory, Inc., Canton, Mass.

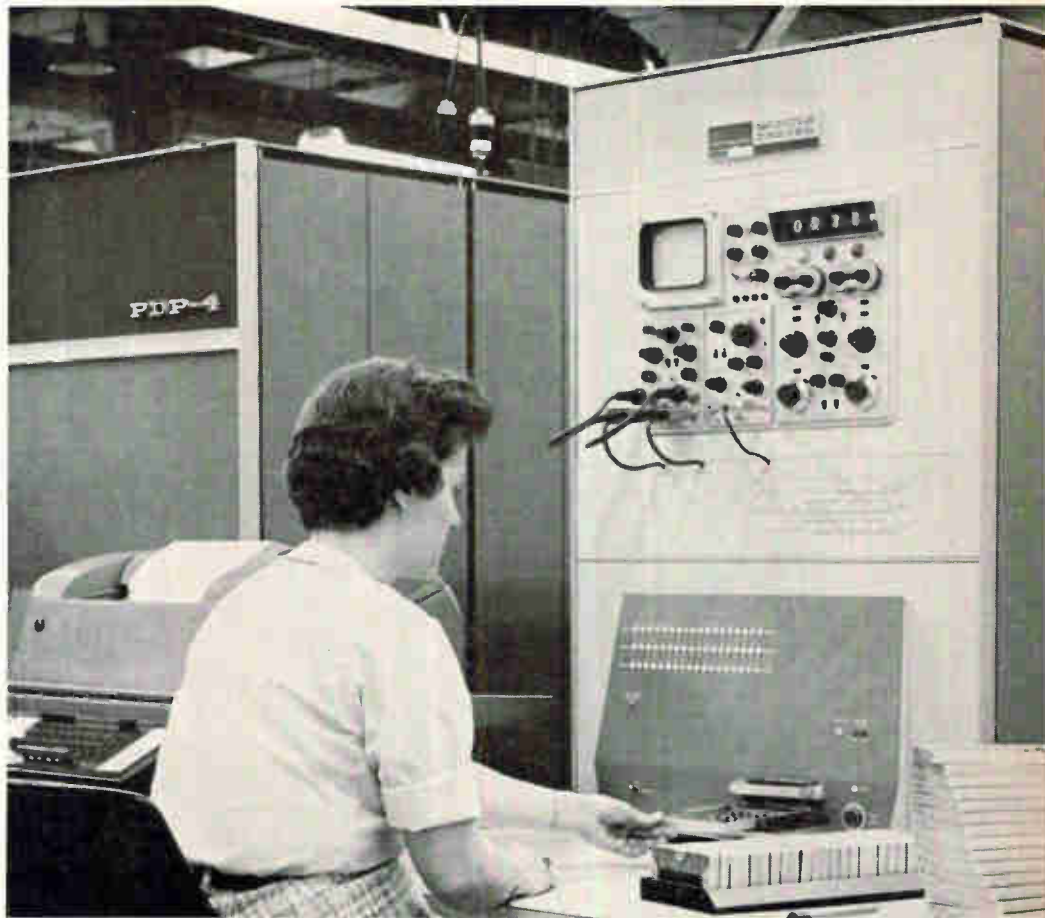

Production-line testing of digital logic circuits, showing tray of adapters, one for each type of module to be tested. A PDP-5 is used in the testing system described.

Each box costs about \$2,000.

A typical manual-test facility consisting of 24 stations represents an investment of from \$48,000 to \$80,000. The total output of such a test area with 24 operators is only 600 modules per day. By comparison, an automatic test facility will cost from \$70,000 to \$100,000 (\$30,000 of this is for a PDP-5 computer) and its total output is 3,200 modules per day with only one operator.

Automatic test system

The automatic module test system consists of three groups of equipment (see photo above):

- The central controller is a PDP-5 digital computer. It commands the testing functions, evaluates the readings, and controls the output devices.

- A test console which contains all of the necessary power supplies and analog metering.

- Input-output devices, consisting of a paper tape reader, a teleprinter, and a paper tape punch.

When the Digital Equipment Corp. built a system for its own use, the PDP-5 computer had not yet been developed, so the system was based on the PDP-4. With the advent of the PDP-5, it became possible to design a lower-priced testing system, and it is this system that is described here. Both the PDP-4 and PDP-5 emphasize flexibility in input-output functions. This flexibility permits the computers to service many types of peripheral

equipment, and to accept and feed out data at rates varying from one signal every several seconds to 125,000 a second in a PDP-4, or 166,000 a second in the PDP-5. These figures relate to computer cycle time, which is the time required to read information from memory and rewrite information back into memory. For the PDP-4, cycle time is eight microseconds; for the PDP-5, six microseconds.

The basic test operation consists of typing the module number on the teleprinter keyboard, plugging in the module to be tested, and plugging in an adapter. The system then starts the test sequence. If the test is successful, the tester prints out an OK about six seconds later. If the module fails the test, the tester stops the system and types out complete information on the failure.

In the printout (at left on p. 78) type 1104 four-stage inverters were tested. The first entry, typed by the operator, caused the appropriate test parameters to be brought from computer core memory and started the testing. The next five entries typed out by the computer indicated five modules successfully tested. The sixth module failed the load test, and the tester typed out the name of the test, the measurement limits (1,400 to 1,600 ohms), the actual reading (710 ohms), the input pin (H), the output pin (L), and the word, reject. The second reject to occur was due to a slow transistor tied to

1104 ← MODEL NUMBER SELECTED BY TYPING ON KEYBOARD

1104 OK
 1104 OK
 1104 OK
 1104 OK
 1104 OK
 1104

ALLOWABLE TEST LIMITS

LOAD TEST 1400 TO 1600 OHMS

710 H L REJECT

1104 OK
 1104 OK
 1104 OK
 1104 OK
 1104 OK
 1104 OK
 1104 OK
 1104 OK
 1104

OUTPUT PIN

INPUT PIN

ACTUAL READING

RISE

FALL

40 100 NS

60 108 S V REJECT

1104 OK
 1104 OK
 1104 OK
 1104 OK

▲ Production test printout, showing two rejects

Data-sheet printout, with complete logging of test results for one inverter module

▼ Measurement circuit for testing components and circuits

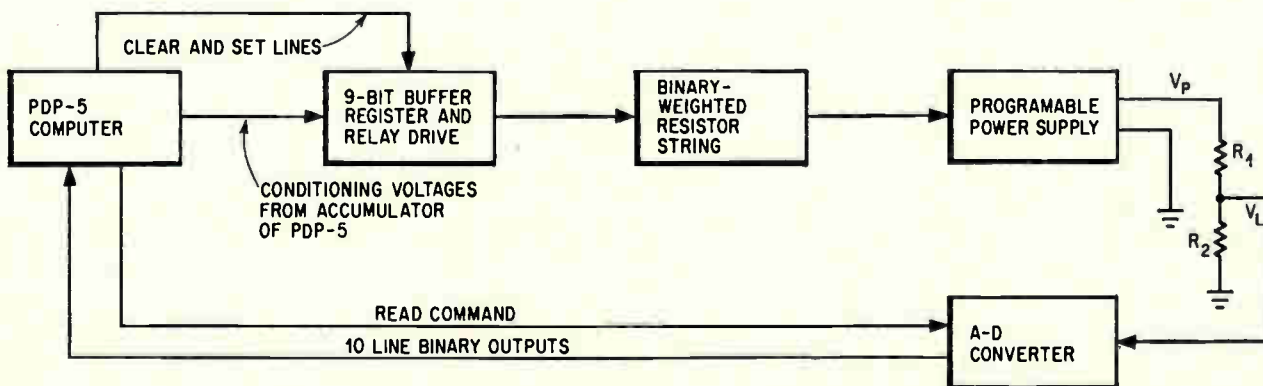

1104

LOAD TEST 1400 TO 1600 OHMS

1475 W Z

1490 S V

1505 M R

1475 H L

LWR LEV TEST -3.2 TO -3.7 VOLTS

-3.4 W Z

-3.4 S V

-3.4 M R

-3.4 H L

VCE TEST 0 TO 130 MV

70 W Z

90 S V

90 M R

80 H L

RISE FALL

40 100 NS

36 38 W Z

24 63 S V

23 61 M R

22 59 H L

OK

pin V, shown near the bottom of the printout.

The data printed out simplifies repair of a circuit. In the first case, the load resistor tied to pin L was replaced. In the second case, the transistor tied to pin V was replaced with one having acceptable rise and fall times.

Automatic failure analysis

Printout of test results on go, no-go testing makes repairs to modules easy; manual testing relies on the operator to read a meter, lights or oscilloscope. He must make 60 to 100 decisions to evaluate defective components, based on the combinations of test results.

Manual systems, of course, have no data-logging capability other than operator, pencil and paper. Other semiautomatic data-logging systems must be built, with a specific data-logging function in mind. With a computer, data logging is simple. The computer already is equipped to communicate with typewriters or card punches. The printout (at right on p. 78) shows the complete data presented by the computer for a tested 1104 module.

The headings can be changed easily to fit any situation. For example, the heading "LWR LEV TEST" can be made to read "VOFF" by modifying the information in the computer memory. Both headings refer to the collector voltage for a turned-off pnp transistor, but one may be preferred to the other in certain circumstances. In all cases, the test limits and actual test results are shown as well as the input pins, output pins and the test result.

To provide flexibility of programming of test conditions and test limits, the computer program can be modified by typing the new numbers into the proper locations in the memory. For example, voltage limits are stored numbers in the memory and the actual readings are compared to these stored numbers for go, no-go decisions. If it were necessary to change 3.7 volts to 3.5 volts, the operator would find the memory location of the 3.7 and type in the number 3.5.

For power supply flexibility, computers allow complete freedom as to the sequencing and delay between applied voltages (a feature often necessary to avoid destructive testing). The changes require only the modification of the stored program by typing the sequence of supplies required and the proper delays between applied voltages.

Frequently, certain inaccuracies which cannot be easily accounted for in any other test method can be modified by the computer. For example, in the measurement of the delay time of a flip-flop, the reading of the digital scope did not include the 100-nanosecond pulse width of the generator. This constant of 100 nsec was added to the readings received by taking advantage of the computer's add function.

Computer communications for testing

Computer applications to testing result from the use of programmable stimuli such as power supplies (digital-to-analog devices), and in analog-to-digital

converters. In the simplified sample circuit for measuring any device where a stimulus and a measurement are required (see figure at bottom of p. 78), a computer controls a programmable power supply, and a measuring device, in this case an a-d converter.

Readings from the a-d converter are fed back to the computer for storage and comparison. In this kind of test set-up, it is possible to test, under controlled conditions, such devices as diodes, transistors, resistors, relays, and circuit packages and modules containing these components. Measurements of resistance, current, and voltage are made so that components can be tested rapidly and economically.

In the output process, information to be transferred is taken from the computer memory on command and put into an accumulator—a temporary storage register in the computer. This information appears in binary form. The computer transfers this information into a buffer register, also in binary form and in the same order it appeared in the accumulator. By selecting a particular output command, any one of a group of registers is loaded with the binary information from the accumulator. When this operation is completed, the power supply produces an analog equivalent of the digital voltage. A typical technique for programming a power supply is shown in the figure below.

The output of the power supply depends on the amount of resistance in the programming string. Relays 1 through 9 are opened as needed by a nine-bit storage register.

Inputs from the accumulator are fed to eight capacitor-diode gates that control eight flip-flops. When these gate inputs are at zero volts and a command pulse also appears at the eight gates, a pulse is fed through the enabled gates, setting certain of the flip-flops to one state. Each flip-flop in turn operates a relay driver. A clear pulse is provided to set all the flip-flops to the zero state.

The binary-weighted output of the programmable

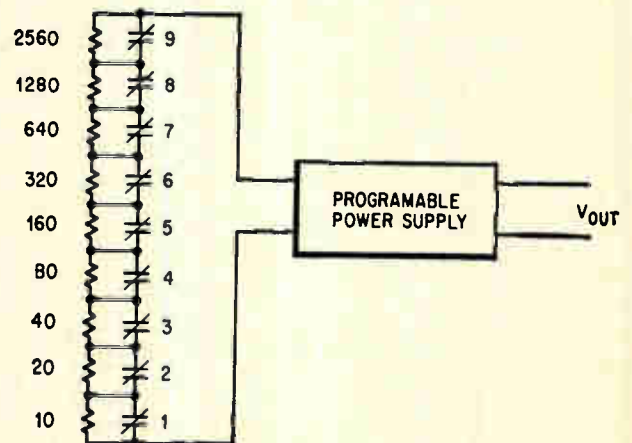

Technique for programming a power supply, with a binary-weighted resistor string controlled by normally-closed relay contacts. Output voltage is KR_{1n} , where K equals $IV/(100 \text{ ohms})$.

power supply can be any value from 0 to 51.1 volts in 0.1-volt steps. The individual bit values are:

Bit number	Voltage
1	0.1
2	0.2
3	0.4
4	0.8
5	1.6
6	3.2
7	6.4
8	12.8
9	25.6

For a reading of 0 volts, all bits of the register contain zeros. With ones in all bits, the voltage reading would be 51.1. To program 25.8 volts, the binary number would be 010 000 001; that is, 0.2 plus 25.6. To program 1.1 volts, the binary number would be 110 100 000; that is, 0.1 plus 0.2 plus 0.8.

The routine used by the computer to load the register is a simple two-instruction process:

Instruction	Meaning
LAC 1000	Load the accumulator with the number in memory location 1000.
IOT 6754	Clear and load the ones from the accumulator into the buffer register.

To carry out these instructions, the computer transfers the binary number from memory location 1000 to the buffer register. To produce the 25.8 volts cited above from the programmable power supply,

Computer routine

Inst. No.	Instruction	Remarks
1	LAC 5000	Load the accumulator with the contents of memory location 5000 (2.58 v binary)
2	6754	Store 010 000 001 in programmable power supply buffer (PPS now goes to 2.58 v)
3	6755	Convert a-d. A-D converter reads V_{out} and converts it to binary 010 011 000. (1.52 volts)
4	6756	Transfer the a-d converter binary output to the accumulator
5	DAC 5001	Store the contents of the accumulator in memory location 5001 for further reference
6	Jm s Compare	Compare a-d reading with minimum and maximum stored limits
7	END	End of test routine

The author



Kenneth Wakeen is chief engineer at the Nexus Research Laboratory. He designed the automatic circuit tester while he was manager of production engineering at the Digital Equipment Corp. He is married, has five children, and his hobbies are oil painting and golf.

the number in location 1000 would be 010 000 001.

After the programed voltage, V_P , is generated the analog voltage, V_L , must be measured. To do this, the computer issues a read command which causes the a-d converter, by successive approximations, to convert the reading to a binary number. For example if $V_L = 1.52$ volts, the binary number generated by the a-d converter is 010 011 000, assuming a value of 0.01 volt for the least significant bit; that is, $1.28 + 0.16 + 0.08 = 1.52$.

This information is now ready for the computer. A third command, "enter data from a-d," is issued and the 010 011 000 (1.52 volts) is transferred to the accumulator of the computer, destroying the previous information in the accumulator.

A typical routine used to program a voltage and measure is shown at left below.

Circuit testing

By expanding the number of buffer registers and with proper programming, the tests for a large number of modules or components can be stored simultaneously in the computer core memory. Information is loaded into the memory from paper tape. The memory contains instructions for testing the 1104, as well as 20 to 30 other module types. To select the testing sequence for 1104, simply type in "1104." The computer then compares this number to a stored table, which lists all modules that can be tested. If the number is mistyped or does not exist in the memory table, the computer types back a "no." indicating error in selection.

On correct selection, the operator need only load the test socket with the module to be tested, push the test button, and the test procedure is carried out automatically. The module goes through a load-resistance test, V_{CE} (collector-to-emitter terminal voltage) test, lower-level test (off-voltage), and rise and fall time tests, by expanding the concept of in-out transfer.

The programmable power supply is programed at 2.8 volts, and the computer controls the switching. This voltage is applied in sequence to each of the bases of the 1104 inverter pins H, M, S and W, as shown on page 78 at top left. The voltage is measured by sequentially connecting the a-d converter through similar switching to pins L, R, V and Z. The a-d converter measurements are then fed into the computer and compared against stored limits.

The computer can now take action based on test results, and print a readout. Similar techniques are used to measure lower levels and load resistance with different input voltages and test limits.

A-c rise and fall measurements are made by programming a digital-readout sampling oscilloscope and a pulse and sync generator. The digitized reading from the sampling oscilloscope is similarly fed into the computer memory for evaluation. This system depends on the analog readings that have been digitized rather than on a go, no-go type of comparator. Digitized readings allow for data-logging and easy modification of test limits and test conditions.

Birds-eye view of the weather

Nimbus I will send pictures automatically. Here's how to assemble a low-cost station to receive them

By Charles M. Hunter and Edward Rich Jr.

National Aeronautics and Space Administration,
Goddard Space Flight Center, Greenbelt, Md.

A topside view of the weather, taken from above by a meteorological satellite, will soon be beamed to anybody who cares to operate a relatively simple ground station.

Starting next month, when the Nimbus meteorological satellite is shot into orbit [p. 99], government agencies hope to keep at least one camera-equipped weather-eye in the sky at all times.

Nimbus I is scheduled to pass over the same area at the same time every day. One of its camera systems, called APT for Automatic Picture Transmission, will photograph a million-square-mile

area every 208 seconds and transmit the pictures to any suitable receiving station.

Ground stations no longer have to cost \$32,000, the price of a ready-made system. They're now within the reach of anybody—for example schools, airlines, television stations, farms and ship companies—for less than \$6,000, on a do-it-yourself basis.

Information will be disseminated regularly as to when and where the satellite will pass over any given area. This data will enable a ground station to point its antenna toward the satellite. Then a facsimile recorder will provide a picture of warm fronts and cold fronts within 500 miles of the station. It will also show vortexes indicative of storm centers, and cumulus clouds that result from agitation in the atmosphere.

Nimbus I will be followed by another Nimbus satellite, and then—around next winter—by a group of Tiros Operational Satellites, launched by the National Aeronautics and Space Administration and financed by the Weather Bureau. Of the first five operational vehicles, two will have a pair of APT systems apiece and the other three will each carry two Advanced Vidicon Camera Systems (AVCS). AVCS pictures, of higher resolution than APT's, will cover 250,000 square miles of earth. They will be stored on tape, and later read out over a central facility, permitting the assembling of a worldwide collection of weather photos.

The master plan calls for keeping two satellites orbiting the earth at all times, one equipped with APT and the other with AVCS. Ultimately, NASA hopes to come up with a single camera system that does both jobs—transmitting photos every 208 seconds and storing others on tape.

Picture coverage ranges from approximately 800 nautical miles on a side for the camera system on

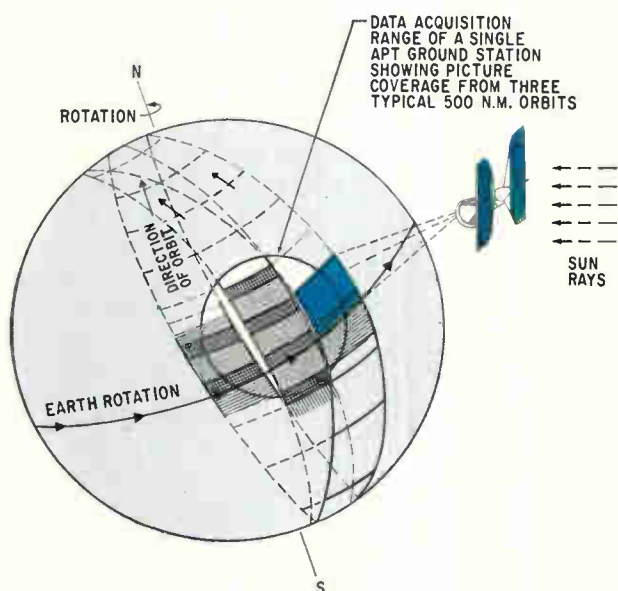

Ground coverage as seen by Nimbus's APT camera. Near-polar orbit will bring Nimbus over a single place at the same time every day.

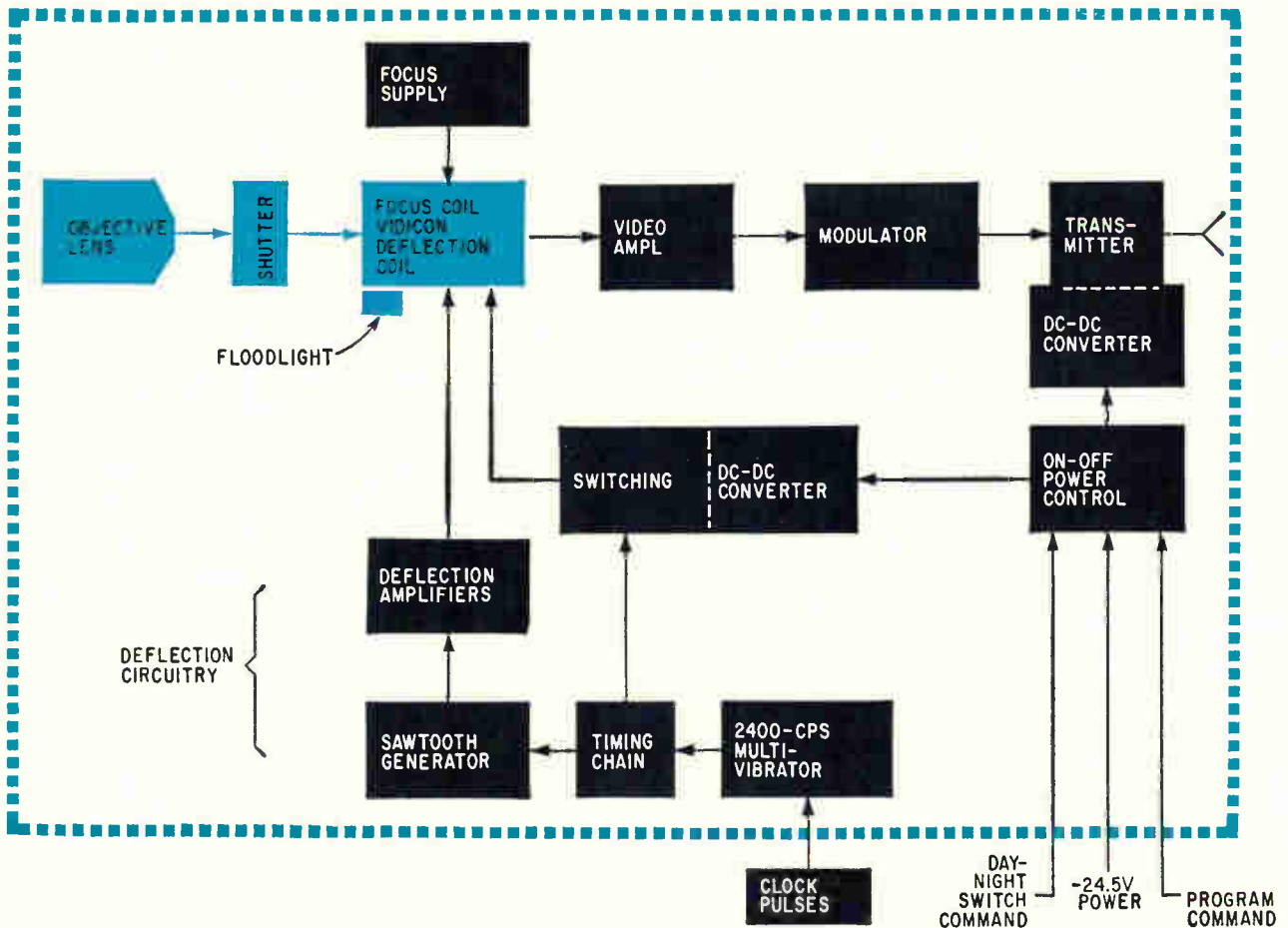

APT camera system on board the satellite transmits pictures to the ground every 208 seconds.

How the camera works

One reason why an APT ground receiver can be built with readily available equipment is that most of the work is done "upstairs."

The APT camera system is not only the photographer, but also the darkroom. What it sees, it transmits as signals that the ground receiver can easily handle.

The heart of the camera is a one-inch, 800-line storage vidicon. It looks at the earth through an $f/1.8$ 108°, wide-angle lens with a focal length of 5.7 millimeters, and a shutter.

The vidicon provides long-term image-storing capability. A polystyrene layer with high resistivity stores images for months in the form of distributed electrostatic charges.

The camera operates in automatic, repetitive cycles of picture-taking and readout. The vidicon has a programmed electrical sequence of "prepare," "expose" and "develop" before a picture readout.

Taking the picture

"Prepare" consists of bringing the gun side of the polystyrene to a uniform potential and erasing any residual charge from the preceding picture. During "expose" the shutter is operated, projecting the image onto the photoconductor. The "develop" operation consists of switching grid potentials so that the charge pattern is transferred from the vidicon's photoconductor to the polystyrene layer. This charge pattern is discharged by the electron beam during the readout process converting the image to a video signal. The entire prepare-expose-develop (PED) cycle takes eight seconds.

Readout takes place immediately after the PED cycle. The readout is four lines a second; for the 800-line vidicon this results in a 200-second readout time for each picture. This, with the eight-second PED cycle, results in a span of 208 seconds per picture.

A beam-pulsing technique, rather than continuous scan, is used during readout to provide the optimum dwell time for the electron beam on the target. It has been determined that 25-microsecond pulses at 4,800 pulses per second yield the best results.

Out comes the video

The video information is contained in the peak-to-peak value of the 25-microsecond pulse—approximately one millivolt peak-to-peak for a black picture. The white level approaches zero volts. The video signal is coupled to a low noise nuvistor preamplifier used as a cathode follower. This in turn drives a 24-kilocycle bandwidth video amplifier providing a one-volt peak-to-peak output of sampled video information, which is fed to the video detector. The input of the video detector is clamped to a negative supply voltage by a transistor switch during the interval between sampling pulses. This clamps out any random noise that might possibly be present in the video chain.

The video detector attenuates all frequencies above 1,600 cps at the rate of 24 decibels per octave (referenced to one-volt sine wave input). The smoothed output of the detector then contains the video variations, but without the 25-microsecond pulses.

Modulating the signal

The output of the detector is passed through a video

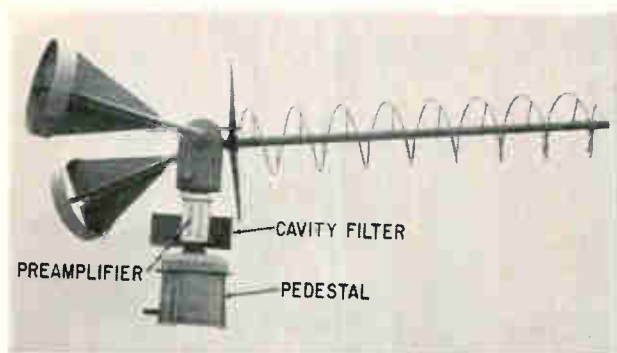

Helix antenna with eight turns is used at many APT receiving stations. A set of four cross-polarized yagi antennas would do the job for less money.



Picture taken with APT camera on Tiros VIII shows the West Coast of the United States.

switch to a balanced modulator to amplitude-modulate a 2,400-cps subcarrier. The subcarrier is derived from a master clock with a stability of one part per million which is more than adequate for standard facsimile receivers. This results in a double sideband modulated subcarrier with sidebands of 1,600 cps above and below the subcarrier frequency. The modulated subcarrier, in turn, frequency-modulates the 136.950-megacycle carrier of the transmitter.

Facsimile transmission

To start and synchronize the ground station's recording device—a helix and writing-blade facsimile machine—the camera system transmits a three-second, 300-cps start tone and five seconds of phasing pulses (a 12.5-millisecond, black-level pulse at the beginning of each line for 20 lines). This transmission occurs during the eight-second PED cycle and prepares the facsimile machine to receive video information and synchronizes it with the vidicon scanning beam. Then the picture is scanned, line by line, from the vidicon storage layer, and immediately transmitted to the ground.

Picture quality is measured in shades of gray detectable by the eye. In the present system it is possible to distinguish six or seven shades. This figure of merit depends on the noise and linearity of the systems. Minimum peak signal-to-rms noise ratios of 26 db have been consistently measured. This is calculated as $20 \log_{10}$ peak-to-peak signal/rms noise.

The APT camera system¹ was developed by the Radio Corp. of America under the direction of NASA's Goddard Space Flight Center.

Tiros VIII (380 nautical miles altitude) to approximately 1,450 nautical miles on a side for a satellite at an altitude of 750 nautical miles. The Tiros VIII satellite was launched Dec. 21.²

Transmitting the pictures

Both Tiros and Nimbus use a commercial telemetry transmitter manufactured by United Electro-Dynamics, Inc. At 136.95 Mc, it produces a five-watt frequency-modulated carrier. Deviation of the transmitter is 10 Kc and, allowing for a 30-Kc pre-detection bandwidth, the power requirement is five watts. Transmitter frequency stability over the temperature range is better than 0.01%. At the time and temperature of readout, the short-term drift is negligible.

For practical considerations, the Nimbus antenna is described here. When it is used as a basis for ground-station design under the worst conditions, the signal-to-noise margin is still adequate.

The antenna is a quadrupole mounted on the base of the spacecraft. It has the appearance of a dielectric-loaded, short-circuited transmission line, and has a radiation pattern similar to a standard dipole's. However, the pattern is distorted by both the spacecraft structure and the solar paddles; thus, for design purposes, the gain must be considered as one. Polarization is essentially linear, with a beam width of 122°. The satellite transmits signals of linear polarization with some right-hand components present because of atmospheric shift at low elevation angles. Normally, reception below 10° above the horizon is not practical and should not be considered in path-loss calculations. Initial Nimbus orbits are planned to be about 500 miles in altitude. This provides a slant range of approximately 2100 miles, and its associated path loss of 146.2 db. Slant-range is the line-of-sight distance from the spacecraft to the ground station, measured along the path radio waves travel.

Building a ground station

The APT ground station consists of an antenna, preamplifier, receiver and readout device. The requirements are easily satisfied.

The antenna system can vary widely in cost and complexity. The commercially available Nimbus ground stations use a single eight-turn helix with manual, remote control in both azimuth and elevation. This antenna has a gain of 10 db, referenced to an isotropic source, to a linearly polarized signal, and 12 db to one of circular polarization with right-hand components. Beam-width is 36° over a bandwidth of several megacycles.

Many variations are possible. Only two basic requirements must be satisfied: 10-db gain, and pointing capability to maintain carrier-to-noise level high enough to receive clear pictures.

Normally, orbital data and predictions are available and published shortly after a satellite is launched. With this information, a practical compromise is possible to greatly reduce the antenna system's cost. Rather than motorizing the antenna

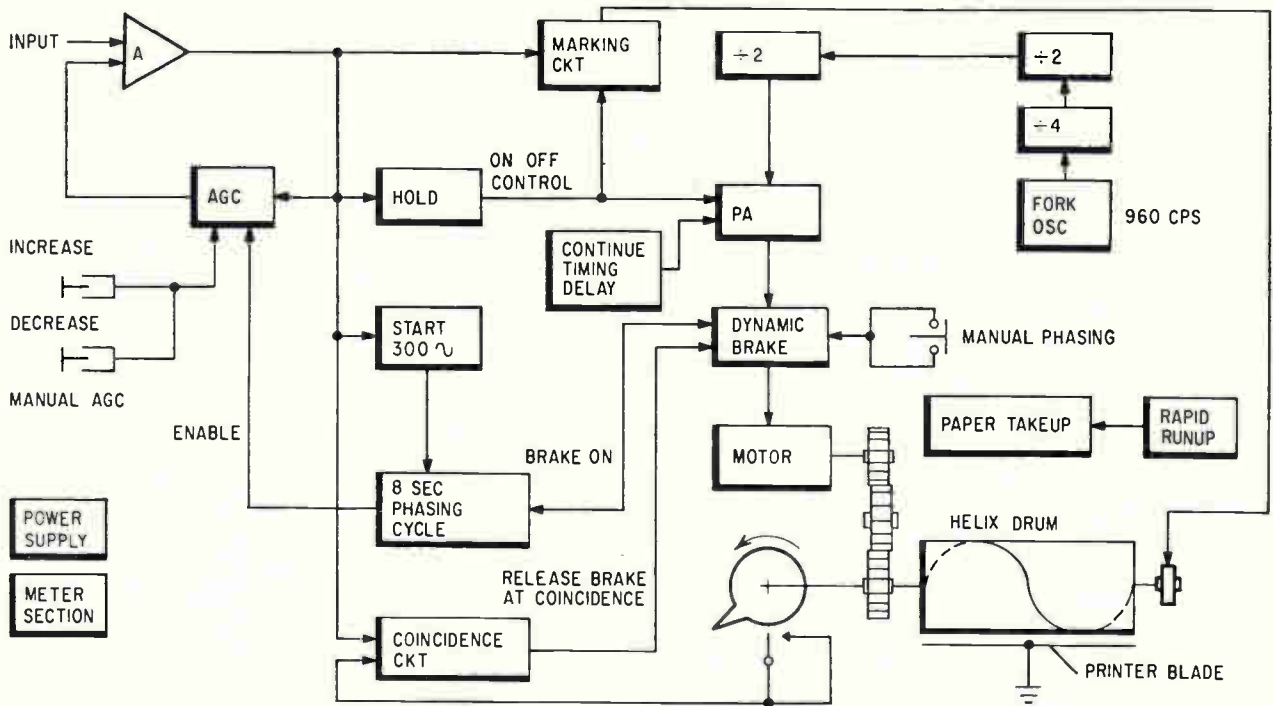

Paper-type facsimile machine could be used to receive satellite's readout. General circuitry techniques are shown.

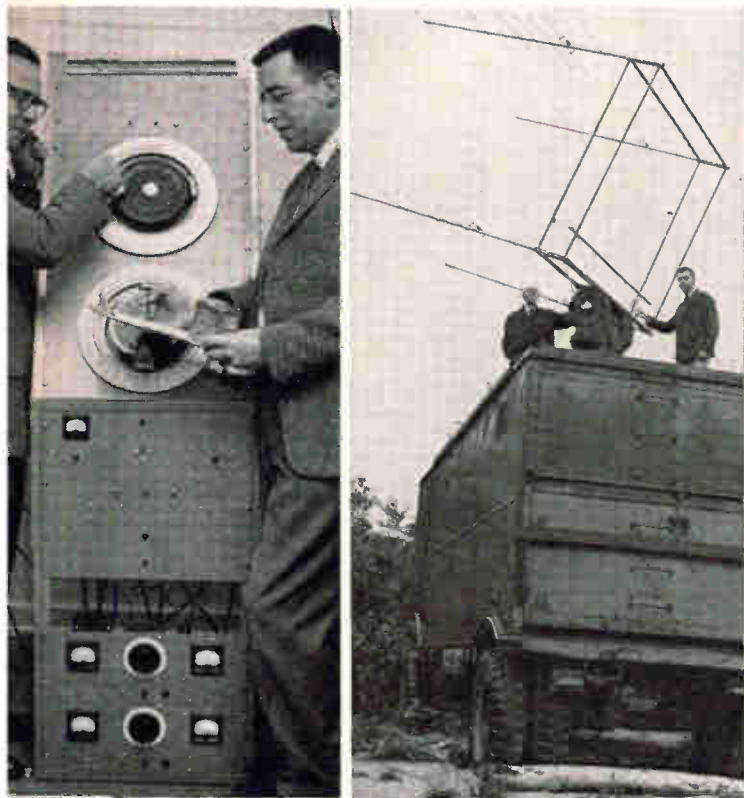

Canadian station at Ottawa has antenna programmer (left) to point the antenna directly at the satellite. Antenna at right was built by Danish Meteorological Institute from available radar equipment and has a gain of about 15 db.

and using the more complex helix, a set of four single cross-polarized yagi elements may be employed. Two of the elements are tuned to the horizon 180° apart. The center pair cover the area in between. When such an antenna is used and current fed in phase quadrature, an eight-element wide-spaced yagi has been shown to provide 12 db gain over isotropic sources. Beam-width is a cone that varies between 35° and 38° at the 3-db points. Bandwidth is only slightly less than the helix. Yagi design is a textbook operation and not critical.

The major drawback to such a system is adjustment in azimuth during every second orbit. This can be simplified by mounting the four elements on a single boom and rotating the boom with a light-duty antenna rotator. The antenna can be simply switched, in accordance with the satellite's position, with a coaxial switch. For a slight increase in noise because of exposure of all elements of the array to high sky temperatures, the antennas can be fed in phase. Such an array, built with student labor, would be quite inexpensive.

A typical antenna that could be used to receive the APT signals is a yagi with eight elements or more, with the first set mounted horizontally and the second set mounted vertically through a common boom. The reflector should be one-half wavelength, $(\lambda/2)$ with the radiator and the directors 5% and 10% shorter, respectively. Spacing between the reflector and the radiator should be 0.2λ , and between the remaining elements, 0.25λ .

The radiator should have 300-ohm folded dipoles, vertical and horizontal, connected to a balun and then to 50-ohm coaxial cable. Each folded dipole is fed in phase with a one-wavelength cable.

Comparative costs

Antennas

Scientific Atlanta, Inc., motorized-manual with TACO 8-turn helix	\$7,000
Telrex Laboratories cross polarized, 12 db, manual	500-1,000
Home-made cross polarized, rotatable, 4-bay parallel array	200

Receivers

Vitro Electronics Div., Vitro Corp. of America, Nems-Clarke telemetry receivers	\$1,400-2,400
Defense Electronics, Inc., general purpose f-m	2,000
Radio Corp. of America Carphone Model 150 (modified)	300
Nuvistor Converter and Hallicrafter f-m/a-m receiver	500
Commercial preamplifiers	400-1,000

Facsimile

Westrex, div. of Litton Systems, Inc. photofacsimile without automatic film processing	\$35,000
Alden Electronic and Impulse Recording Co.-paper	5,000
Muirhead Instruments, Inc., D-900-S-paper	5,000
Muirhead Instruments, Inc., D-700-S-photofacsimile	15,000

Numerous antenna plans have been proposed, most of which would satisfy the requirements. Some other antennas suggested are a spiral array (made by Telrex Laboratories), a modified discone or a log-periodic type.

The preamplifier

Available preamplifiers include types using nuvistors, transistors and tunnel diodes, as well as conventional tubes. For best performance, the preamp should be installed at the antenna. This might indicate a choice of either the transistor or tunnel-diode models to take advantage of the use of the coaxial cable for supplying power. However, based on economics as well as sustained good performance, the nuvistor type is the best compromise.

All of the available preamps offer, for the narrow bandwidth, a gain of 20 db or more with a noise figure of about 4 db. For outdoor installation, a preamp in a weather-proof box should be used. Preferably the box should be prefilled with an inert gas to reduce condensation. Suggested preamplifiers include Nems-Clarke models PE 204A or SSP 137 transistor types, a tube type by Tapetone, Inc., of Boston, or a nuvistor type by the Ameco Equipment Corp., Mineola, N. Y., model PV-144 modified to 137 Mc.

The receiver

Like the antenna, the receiver can vary greatly in cost and complexity. The basic requirements are simple and can be met quite easily by the receiving section of most mobile receivers. Equipment is plentiful for the 150 Mc f-m band, and modifications are minimal.

The unit chosen should have a sensitivity of -96 dbm (or $6 \mu v$) or better, a predetection bandwidth of at least 30 Kc, and a noise figure of less than 8 db. Most facsimile printers have an input of 600 ohms, thus an output at this impedance should be provided to balance it.

This direct approach is probably the most practical. Numerous telemetry receivers are available, but at substantially higher prices. Another possibility is the use of 144-Mc amateur-band receivers. Converter modifications, if any, are simple, because the frequency is close and the bandwidth sufficiently wide for APT. Modifications might include placing a capacitor across the tuned circuits to reduce the frequency by 7 Mc to 137 Mc. Low-frequency receivers for f-m are not common, but the military surplus market offers many interesting possibilities including the World War II SCR-609. Or old police radios could be used.

The facsimile recorder

Facsimile recorders of the helix and writing-blade type (rotating helix and fixed writing blade with paper coming between) provide duplication of the transmitted video signal in varying shades of gray on a white, electrolytic recording paper. Iron from the recorder's printer blade is deposited in the wet electrolytic paper by a marking current that varies in accordance with the received signal. On some recorders, a heater bar completes the electrolytic process by drying the paper and increasing the density of the recorded copy.

In general, facsimile equipment operation is as follows: the start tone, modulated at 300 cps, which is transmitted by the satellite (see p. 82) is detected to start the machine and enable phasing. The phasing pulses from the camera system cause the helix drive motor to fall out of synchronism and slow down until some type of comparator circuit (either electronic or mechanical) senses the in-phase condition and allows the drive motor to return to synchronism. Also, during phasing, an automatic gain-control circuit senses the received white level of one volt rms and sets up the amplifier gain commensurate with the transmitted video signal. To prevent a return of phasing pulses during picture printout, once phasing has been completed, they are locked out until reinitiated by the incoming start tone at the beginning of the next picture. On certain types of facsimile machines, phasing, after it has been accomplished on the first frame, is locked out until the end of the picture sequence, and the equipment is allowed to return to the standby condition.

These machines can easily be modified for rephasing on every picture if desired. Accurate motor drive of the helix is obtained from a highly stable source, usually using a tuning-fork oscillator and the necessary amplifiers and motor-drive circuitry. The picture is printed out by taking the double-sideband a-m signal from the receiver, demodulating and inverting the signal and passing it through a full-wave rectifier to supply the d-c marking cur-

rent that is inversely linear to the input-signal amplitude (maximum signal with minimum marking current or minimum signal with maximum marking current). This is necessary as the input signal is maximum for white while the electrolytic paper requires a maximum signal for black.

The facsimile equipment for the APT system must operate at 240 rpm to be compatible with the



Paper facsimile recorder is Alden dual mode model 9225. Muirhead and Fairchild Camera machines also may be employed.

satellite equipment, utilize a 2,400-cps carrier frequency and operate on an a-m double-sideband signal.

Several manufacturers of facsimile equipment have machines compatible with the transmitted signal.

Commercial facsimile recorders

The Mufax D-900-S Chart Recorder is manufactured by Muirhead & Co., of Beckenham, England. Muirhead also has a plant in Mountainside, N. J.

The machine was used in the research and development of the APT system, and is still used during checkout and qualification testing of each camera system. The D-900-S consists of three separate units: the power-supply chassis, electronics chassis and printer. The machine produces a 9-inch by 9-inch picture with a resolution of 90 lines per inch. A 600-ohm, balanced, 2-wire input is required at a level of zero to -25 db, referenced to 1 mw (600 ohms) with a recommended input of -10 dbm. An input-level tolerance of ± 2 db is required. The machine is set for operation over a black-to-white ratio of 32 db. The tuning-fork frequency is 1,000 cps. The recommended recording medium is Mufax electrolytic paper. The machine is sold for about \$5,000.

The Fairchild Camera & Instrument Co.'s Scan-a-Fax, modified for APT compatibility, is used in APT ground stations around the world. The Scan-a-Fax has a resolution of 100 lines per inch with an 8-inch by 8-inch picture. The machine is capable of 10 shades of gray, varying from black to white in conformity with the 1961 gray-scale chart, pattern 8, of the Institute of Radio Engineers. The machine operates on a black-to-white ratio of 32

Summary of system specifications

Frequency Modulated Receivers

Frequency range 136-137 Mc
 Predetection bandwidth—30 kc (min)
 Sensitivity—minus 96 dbm or better
 Noise figure—better than 8 decibels
 Audio output impedance—600 ohms balanced.

Preamplifier—Gain—20 decibels
 Input and output impedance—50 ohms
 Noise figure—4.5 decibels maximum

Antenna—Impedance—50 ohms
 Linear or circular right hand polarization gain—10 decibels (min)

Facsimile

Input impedance, audio—600 ohms
 Dynamic range black to white—32 decibels
 Writing speed—240 rpm
 Subcarrier frequency—2400 cycles per second
 Modulation—amplitude, double sideband
 Modulation sense—selectable positive or negative reproduction
 Start—automatic or manual, actuated by 300-cycle start tone
 Stop—automatic, by cessation of carrier
 Phasing—automatic, accomplished from 12.5-millisecond pulses at 4 cycles per second for 5 seconds. Lockout of phasing is desired at the end of 5-second phasing signal.
 Automatic gain control—required for optimum operation.
 Sets up during phasing and should then be locked out at the end of the phasing signal.
 Input range—0 to minus 30 dbm.

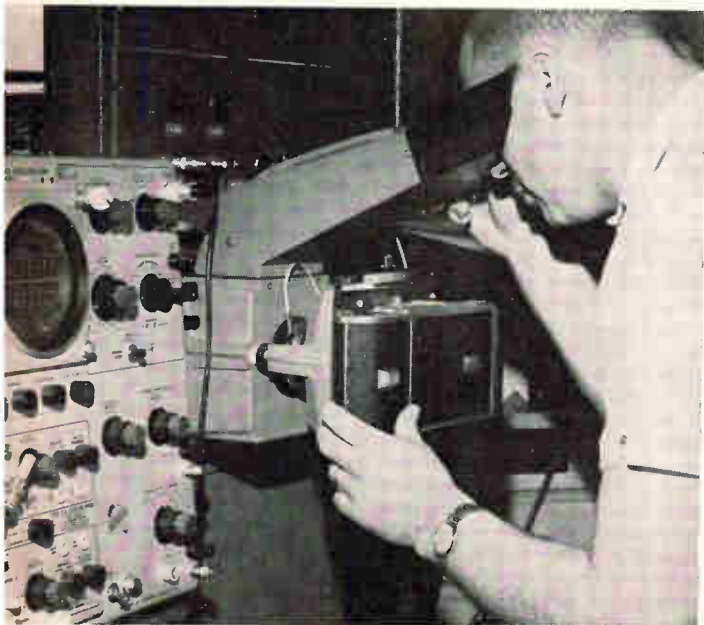

Canadians receive pictures by taking Polaroid photographs of an oscilloscope readout.

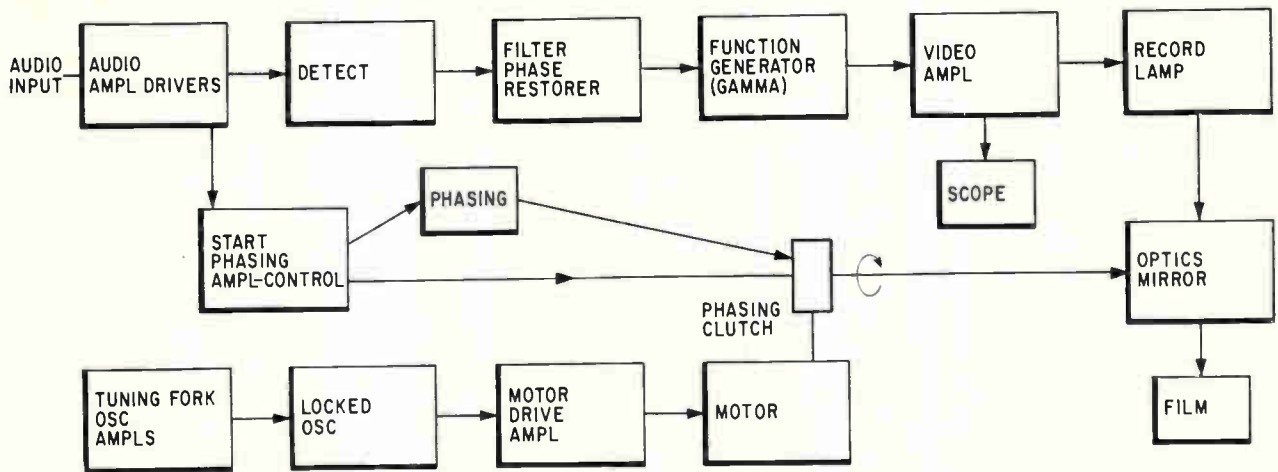

Photofacsimile, of the type made by Westrex, does a better job but costs more.

db referenced to 1 mw (600 ohms). Input impedance is 600 ohms with a recommended input level of -10 dbm.

The tuning-fork frequency is 960 cps. The equipment can use several manufacturer's electrolytic paper. Fairchild's type 36-A is designed for the machine. The machine is in one chassis and utilizes transistorized circuitry. The company declined to quote a price for a single unit.

The Alden Electronic & Impulse Recording Equipment Co. has a machine identified as the Alden Dual Mode Facsimile Recorder No. 9225. This machine is designed for APT operation at 240 rpm, as well as for operation as a standard 120-rpm facsimile recorder for weather maps. The recorder consists of three basic elements: the recorder head, transistorized electronics unit and a Mobile Uni-Rack. Either of the two operation modes can be selected by means of a switch. The manufacturer states that the picture is 10.5 by 10.5 inches, input impedance is 600 ohms balanced with an input range of 0 to -30 dbm, and utilizes Alfax type A2 paper which produces sepia tones rather than shades of gray. The equipment costs about \$5,000.

The Westrex Corp. has converted its standard photofacsimile model 3030 TP, for APT. The Westrex system is designed for automatic turn-on and automatic or manual phasing. Westrex is a division of Litton Industries, Inc. Phasing in this system, is also monitored on a built-in oscilloscope. The phasing pulses are gated into phasing-control circuitry during a five-second period. Gating is then disabled so that video peaks appearing in the video

composite do not cause false phasing. Synchronization is maintained over the duration of a frame through the use of a stable 2,400-cps tuning-fork oscillator. Video conversion is accomplished by modulating a R-1168 readout tube made by Sylvania Electric Products, Inc. The tube, in turn, scans the film by means of an oscillating mirror.

Circuitry is also included for gamma correction to compensate for nonlinearities in spectral response in optics and the readout tube and the particular film or paper being used. While this is a sophisticated system, it does provide a high-quality, high-resolution reproduction.

Map matcher

A data-reduction kit, which helps the station-owner identify local terrain from the APT pictures, is sold by the Aracon Geophysics Co. of Concord, Mass., for \$225. It includes a set of overlay maps, a large plotting board in the form of a circular slide rule, worksheets and instructions to help the user to match his pictures with familiar land masses and to match the published orbital information with the position of the satellite to aid in pointing the antenna. Aracon and the Weather Bureau can provide additional assistance in reading the pictures.

References

1. R.A. Stampfi and W.G. Stroud, Goddard Space Flight Center, The Automatic Picture Transmission (APT) TV Camera System for Meteorological Satellites, NASA Technical Note, NASA TN D-1915.
2. D.W. Holmes, National Weather Satellite Center, U.S. Weather Bureau, and C.M. Hunter, NASA Goddard Space Flight Center, WMO Bulletin, Vol. 13, No. 3, July 1964.

The authors



Charles M. Hunter is spacecraft manager for the Tiros Operational Satellite System at the Goddard Space Flight Center. He was technical officer for the APT system for two years. At 30 years of age, he is among the youngest of NASA's key technical personnel.



Edward Rich Jr. is a senior electronic development technician at Goddard. He worked for 10 years for the Signal Corps at Fort Monmouth, N.J. When he's not raising roses or collecting guns, he likes to bounce signals off the moon with his ham radio gear.

Tropo goes commercial

AT&T prepares to use tropospheric system
in U. S. with solid-state equipment for more reliable service

By Alexander A. McKenzie

Communications Editor

Solid-state transmitting and receiving equipment for a tropospheric transhorizon radio network will be delivered soon by Radio Engineering Laboratories, Inc., to the Long Lines department of the American Telephone and Telegraph Co. The network will be the first commercial overland telephone and telegraph system of its kind in the United States. Although the extent of the network has not been disclosed, the nature of tropo and the quality and amount of the equipment indicate an exacting demand for high transmission standards and high reliability on an overland relay route of considerable length.

Each radio terminal will employ quadruple diversity and will be equipped with four low-noise receivers using parametric amplifiers. These receivers will use threshold extension circuits of the f-m feedback type to enhance the signal-to-noise ratio during periods of extremely low signal strength. The four receivers will obtain optimum diversity reception by using post-detection or

baseband combining circuits that take full advantage of f-m signal-to-noise discrimination after limiting and deemphasis. In such a combining system, the composite output is always at least equal to the input from the receiver picking up the strongest signal. The noise-power ratio of the intermodulation distortion has been specified at more than 55 decibels, indicating that high-speed transmission of data is contemplated.

Success in the far north

During the last 10 years or so, the art of radio communication using both very high and ultra-high frequencies over nonoptical paths—those over which the transmitter cannot be seen from the receiver—has grown from nothing to a multimillion-dollar investment. Nonoptical radio-wave propagation was first employed for defense purposes in Arctic regions, where the better-known high-frequency communications techniques falter and sometimes fail for hours, owing to the effect of the aurora borealis. Such uses have already been described for the Bitter Sweet, Dew Line and White Alice systems linking Greenland, the Canadian Arctic and Alaska with defense installations to the south.

Bitter Sweet differs from the other systems in that it employs the E-layer of the ionosphere (a layer from 50 to 400 miles above the earth) to reflect, or bend, signals over the nonoptical path. While this mechanism is important, providing reliable teleprinter and even voice signals over distances from 600 to 1,200 miles per hop, it is limited to the radio frequencies between about 25 and 60 megacycles. It is mentioned here chiefly to differentiate clearly between it and the more versatile mechanism of propagation known variously as transhorizon tropospheric propagation, tropospheric forward-scatter, or just tropo. Its name derives from the region of the atmosphere, between the earth and an altitude of about seven miles,

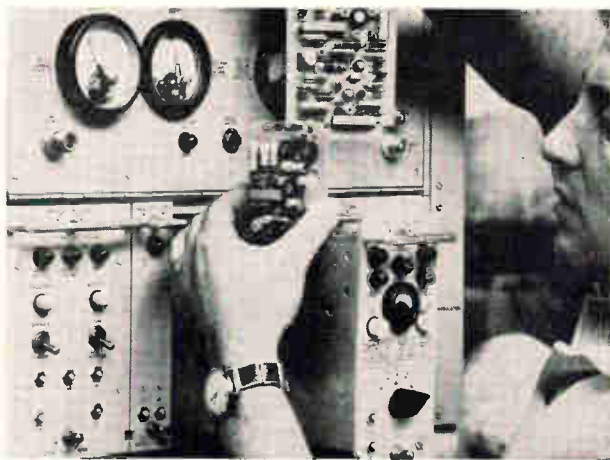

Solid-state exciter, with the modulation amplifier unit pulled out. Plug-in baseband-amplifier printed circuit cards are being removed.

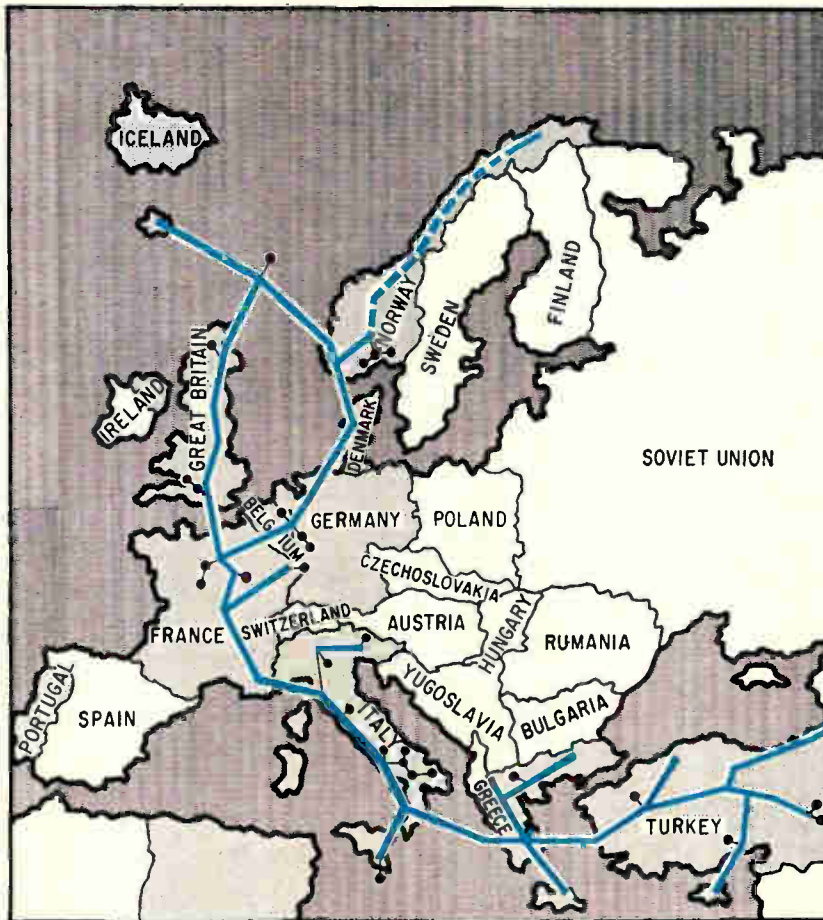

NATO communications system, Ace High, extends in a semicircle from eastern Turkey to the northern tip of Norway. This tropospheric network is 8,300 miles long, and the dashed portion has been in service since 1958. The short extensions, shown by light lines, are short-hop microwave links.

called the troposphere. Using frequencies from 400 to 8,000 megacycles, systems generally employ hops from about 100 to 500 miles.

Bending radio beams

How does a tropo system work? One theory is that the atmosphere is stratified into layers of varying size and thickness. Each layer comprises a discrete body of air, varying from the adjacent air in temperature and moisture content. These invisible cloud layers have different indexes of refraction owing to the differences in their temperature and moisture content. Thus, the boundaries between layers are reflecting surfaces. Radio signals reaching the surfaces are reflected, and the angle of reflection is equal to the angle of incidence.

Other workers have postulated radio clouds, blobs or similar scatterers. These are thought to refract a small portion of the radio energy back to the receiving location in much the same manner that we are enabled to perceive a distant searchlight beam as it illuminates moisture and dust particles of the air on a dark night. The terms "forward scatter" and "tropo scatter" derive from this explanation of the transhorizon radio phenomenon.

A ray from the transmitter, shown in the figure on page 91, is reflected in multiple fashion at the common volume (shown in color), having reached the region by following ordinary laws of radio propagation, bending slightly to follow the earth's surface. After scattering or refraction in the common volume, the signal is directed toward the receiver, obeying normal laws of propagation.

The figure also indicates that the height of the scattering volume varies with path length. Assuming unobstructed paths with zero horizon angles, the common, or scattering volume for each would be:

100 miles	1,000 to 6,000 feet
200 miles	2,000 to 10,000 feet
400 miles	10,000 to 70,000 feet

These elevations assume use of antennas with diameters of 30, 60 and 120 feet for 100-, 200- and 400-mile paths, and assume beamwidths that result at frequencies in the order of 800 megacycles. It is expected that the new AT&T system will operate at 2,000 megacycles, but the figures shown are representative.

Unpredictable signal

Since the exact nature of the tropo signal cannot be predicted mathematically, system design is pred-

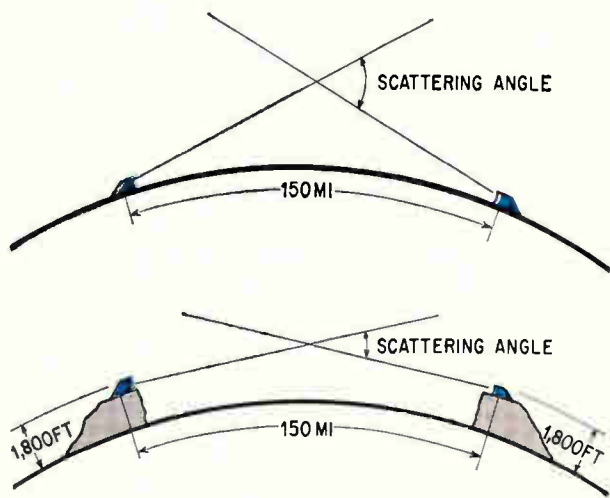

Two pairs of sites (color) for the same distance may produce considerably different angles. Since a small scattering angle is generally desired, sites with good elevation are chosen.

icated upon path-loss measurements and other empirical data derived from observations on many circuits. For communications engineers unaccustomed to dealing in transhorizon tropo figures, median signal levels from 40 to 100 decibels below free space come as a shock. The median signal (for example, about 80 db for 100 mc at 300 miles and a little more for 1,000 mc) is that value of a widely fluctuating signal that is exceeded just half the time.

The three types of fading that cause fluctuation of the signal are fast—sometimes as much as 20 fades a second on short paths—diurnal and seasonal. Long-term variations from summer day—the most favorable signal—to winter night—the poorest signal—may account for 10 to 15 db on a short path and about half as much on a 400-mile path. Transmission is better over water than land.

The short-term variations result from interference effects. Sometimes rays arrive in phase and reinforce each other to create a strong signal. At other times they arrive out of phase, tend to cancel out each other, and reduce the signal level. Like the long-term changes, these variations are greater and occur more frequently on a short path than on a

long path. Echoes, resulting from fast fading, can cause selective fading that produces distortion in wide-band transmissions. However, the high-gain antennas required reduce the delay time between direct and delayed signals to a point at which useful bandwidths of several megacycles can be obtained.

Path loss

The median signal figures are comparisons with free-space transmissions and should not be confused with the path loss experienced between transmitter and receiver in a tropo system. For example, on a typical 200-mile path the signal loss may be 200 db. This loss comprises several components. The free-space portion, following the inverse-square law, increases 6 db each time distance or frequency is doubled. Assuming a zero horizon angle, the over-the-horizon component of loss increases nearly 18 db each time the distance between terminals is doubled. It varies with frequency, increasing about 3 db each time the frequency is doubled. Since lower scatter angles [figure above, left] result in smaller path losses, it is important to site stations as high above surrounding terrain as is practicable. There are practical limits to the size of antenna to be used in overcoming other losses. Although gain increases with antenna diameter, it does not increase in the same ratio in tropo work as it does in conventional communications, because some rays reach a large antenna out of phase. The cost of increasingly powerful transmitters, assuming that they are even possible with current technology, sets an economic limit on the length of tropo paths. Until now, such paths have been used for military circuits, and domestically only for overwater hops.

Diversity reception

The phenomenon that limits the effectiveness of very large antennas—the fact that rays arriving by different paths are out of phase—works to advantage for diversity reception. The effectiveness of diversity also counterbalances the need for high power that would otherwise be necessary to insure continuous workable signal levels.

Tropo: history and mystery

Until well into the 1940s, many radio engineers believed that communication on frequencies in excess of about 40 megacycles required an optical path between transmitter and receiver, or at least—to compensate for optical refractive effects—a path based upon the concept of an earth having four-thirds the radius of the real earth.

This belief negated the experience of Guglielmo Marconi, father of practical radio communications, who in 1932 reported talking over a distance of 168 miles using a radio frequency of about 500 megacycles. Amateurs and other experimenters during the 1930s showed that nonoptical communication was often possible on frequencies of about 60 and 144 megacycles, even with very low-power transmitters and insensitive receivers,

although diurnal and day-to-day variations in signal strength were relatively enormous.

One group, of which the author was a member, under the direction of G.W. Pickard, inventor and experimenter at Seabrook Beach, N.H., found that over the sea, signals could be exchanged at a distance several times that to the horizon. Results of these observations were correlated by the late Ross A. Hull of the American Radio Relay League in West Hartford, Conn. With the help of Charles F. Brooks, director of the Blue Hill, Mass., and Mount Washington, N.H., Observatories, he showed a correlation between meteorological air masses and signal strength.

Later, with the advent of higher transmitter power—in the order of 50 kilowatts—moderate-gain antennas and frequency-modulation techniques, it was discovered that signals could be detected in the frequency range between 40 and 50 megacycles, at a distance beyond 300 miles.

When two antennas are separated by more than 100 wavelengths, variations of signal level are similar but occur at different times. The signal-to-noise ratios in the output of one receiver tend to be low when those in the output of the other are large. The present practical limit is reached in signal improvement with four receivers. The outputs of the four receivers are combined in such a manner that the output of the combiner represents at least the input to the unit receiving the best signal. Generally, each signal received in a quadruple-diversity system contributes to the final output signal to produce a total signal-noise ratio more favorable than that of the strongest signal alone.

Diversity can also be accomplished using two transmitters, each operating on a frequency that differs from the other by about 0.5% as shown in the diagram on page 92. These two signals are intercepted by only one high-gain receiving antenna, to which two receivers are connected.

Controlling reliability

The percentage of time in which a tropo circuit transmits perfect signals is a function of two kinds of reliability—that of the radio path and that of the equipment. Equipment reliability is of two kinds—its adequacy to perform within the working limits of the system, and its ability to function perfectly without breakdown.

Unlike high-frequency radio circuits, which can be blacked out by severe disturbances of the ionosphere through sun-spot activity or nuclear explosions, tropo propagation is inherently reliable. Some signal comes through at all times, no matter how weak. With statistical techniques in handling known data from existing tropo paths, it has been possible to design systems having desired reliabilities.

For example, a path over which a required signal is available 50% of the time for all hours of the year might have a path loss of 200 db. If the circuit must be 99.9% reliable, another 20-db gain may have to be added to the system, and the path loss is then expressed as 220 db. If it is desired to provide protection for the worst hour, the statistical distribution might show that another 3 db is re-

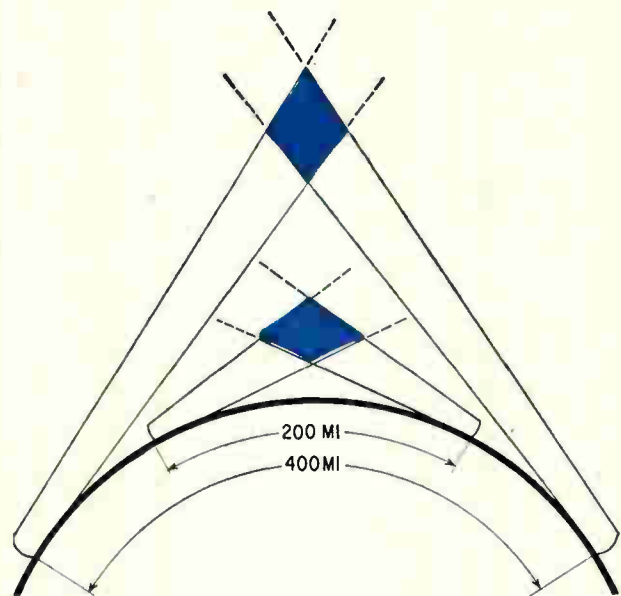

Scatter angle varies with path length so the scatter volume (color) occurs at different elevations in the troposphere. One characteristic of a short path is more rapid fading, owing to meteorological effects.

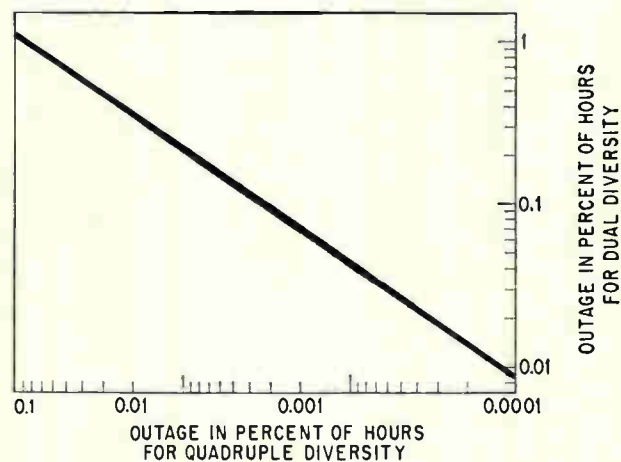

Improvement of quadruple diversity over dual-diversity reception are indicated by outage time in percent of hours. Outages in minutes per month range from 43.2 and 475.2 minutes to 0.04 and 3.6 minutes respectively for the extremes shown on the chart.

Often these signals were strong, providing excellent reception of music for several hours. At other times signals were weak and fading, entirely unsatisfactory for music reception and unreliable for communications.

Further exploitation of this mode of propagation was cut short by World War II, although there seems to be evidence that the inventor of f-m, Edwin H. Armstrong, was quietly collecting information that might have a bearing on what were then known as propagation anomalies. But Armstrong died in 1954 without making any formal contribution.

During the war, communications and radar people were bothered by occasional long-distance reception of signals that was unexpected by those who lacked knowledge of anomalous propagation. Considerable study, some of it at Radiation Laboratory, Massachusetts Institute of Technology, brought forth the theory of ducts—waveguides formed in the atmosphere by meteorological conditions

—to explain the radar and communications anomalies.

Postwar publication of earlier data, and careful study at the information available around 1950, made it clear that a new theory was needed to explain why signals propagated through some mechanism of the troposphere were so persistent as to rule out meteorological ducts as the sole cause. Nor could the median signal, received far beyond the horizon, be explained away merely by postulating an earth with a longer radius.

Because these phenomena were not thoroughly understood in the radio engineering community, a new schedule of television frequencies was assigned, in which it was assumed that television signals would hold to the quasi-optical nature ascribed to them by man. The resulting interference between stations on the same channel brought about a four-year freeze in the assignment of new stations, and prompted engineering measures of great economic significance.

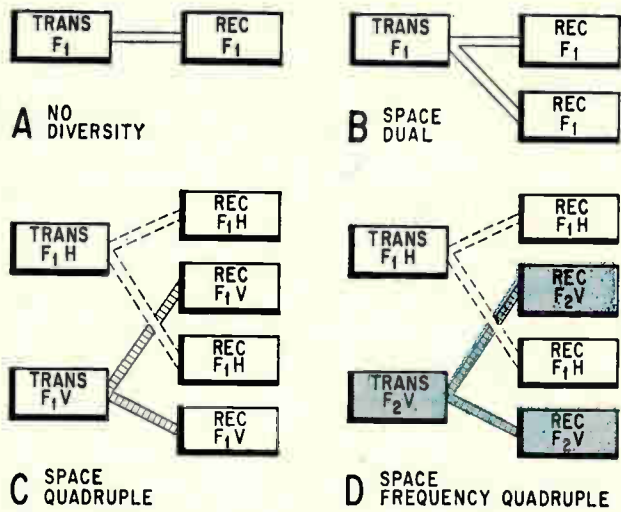

A NO DIVERSITY
B SPACE DUAL
C SPACE QUADRUPLE
D SPACE FREQUENCY QUADRUPLE

Communications systems with no diversity (A), dual space diversity (B), quadruple space diversity (C), and quadruple space-frequency diversity (D). Polarization is employed in (C) and (D).

quired, for a total of 223 db.

To attain the percentage reliability desired, transmitting and receiving equipment must be designed to provide the gain or suitable signal-noise ratio that will guarantee proper functioning of the system. The engineering tradeoffs must be studied carefully. Assuming it is possible to use a 100-kilo-watt transmitter instead of a 50-kw, the resulting gain is only 3 db. By contrast, relatively minor changes in receiver design may produce larger improvement. For example, typical receiver noise figures, with normal converters range from 7 to 8.5 db. Using a tunnel-diode amplifier, the figure is reduced to 3.5 to 4, while a parametric amplifier cuts the noise figure further, to 2 to 2.5 db.

Another important aspect of reliability involves the nature of the hardware and its maintainability. If components are chosen carefully, and if long-life transistors and varactors are used to keep down power consumption, equipment life becomes very long as contrasted with some electron-tube equipment in which lifetime has definite limits. Modular construction, plug-in replacement units and drawer construction make for quick repair of failing equipment, and also obviate the need for highly skilled maintenance personnel except at supply depots. Reliability is also enhanced by visual trouble signals, such as lights, and by a provision for quickly plugging in meters that show whether the circuit is functioning in the proper range of adjustment also enhance reliability.

Solid-state exciter

Radio Engineering Laboratories' 2600-series equipment will be used in the AT&T system.

For the 2-gigacycle, 132-channel system (300-channel ultimate capacity), noise and intermodulation distortion is kept low by using special solid-state techniques. Power amplification at the solid-state exciter output uses one traveling-wave tube to drive the klystron final power amplifiers.

Modulation, which is a critical function, is accomplished with a variable reactance-type modulator stabilized by a crystal-reference automatic frequency control circuit. The block diagram is shown opposite. The modulator consists of a Hartley oscillator with a tank capacitor made up of two series-connected, voltage-variable capacitor diodes. Modulation signals are applied to the center of the diodes, causing the frequency to vary around a rest value of 23.33 megacycles. The modulator and the tripler that follow are contained in a temperature-controlled oven, [picture] to minimize the effect of variations in loading and temperature on frequency stability.

The desired 70-megacycle component is amplified in the intermediate-frequency driver amplifier while the subcarrier sidebands are suppressed in a five-pole, flat-bandpass filter designed to minimize intermodulation distortion.

Although the reactance modulator is superior for wide frequency deviation and low f-m noise, it requires frequency stabilization. A small fraction of the i-f driver output is amplified and applied to a sampling switch that has very low forward-insertion loss—in the order of 0.1 decibel with isolation of 70 decibels between ports. Samples of the f-m signal and of the output from a 70-megacycle controlled reference oscillator are alternately applied to the demodulator by means of bias from the sampling oscillator.

The output amplitude is proportional to the frequency difference between the reference oscillator and the average frequency of the outgoing f-m signal. This error signal goes through a low-pass filter, is amplified in the error amplifier and rectified in the synchronous chopper demodulator. The resulting voltage, related in amplitude and polarity to the frequency difference, is filtered and applied to the reactance modulator with a polarity that causes its frequency to change in such direction as to reduce the error.

Receiver preamplifier

In the receiver, a parametric amplifier of the negative resistance reflection type provides 20 decibels of amplification with a noise figure of 2.5 decibels [block diagram outline opposite]. The varactor is contained in the idler cavity, which forms a parallel circuit. The pump or local oscillator frequency at 13,900 megacycles is lightly coupled to the cavity by a pump filter. An adjustable-waveguide short circuit is used for idler tuning. A coaxial inductive stub on one side of the varactor can be tuned to series resonance for the signal circuit. The low-pass filter at the other side of the varactor eliminates the pump frequency. This is followed by a broad-band coaxial transformer that raises the impedance of the signal source from 50 to 62 ohms over the entire frequency range of operation.

To obtain an amplifier input voltage standing-wave ratio (vswr) of no more than 1.2 to 1, waveguide circulators of inherently low insertion loss

and low vswr are used. A wave guide T-junction circulator at the input gives 24 decibels isolation. A second circulator with 24 decibels isolation couples the input signal into the parametric amplifier, and the amplified signal into the output isolator. Temperature is controlled within ± 5 degrees at 60 C.

The pump klystron is stabilized for frequency change, repeller modulation and power output, and does not require elaborate sensing and feedback controls. The klystron tuning is fixed, requiring no adjustment of pump frequency. Adjustment of the repeller voltage over a limited range achieves peak power output. Pump level is normally set for a nominal gain of 20 decibels.

The varactor is a silicon diffused epitaxial mesa type in a miniature pill mounting.

Post-detection combining

To take full advantage of diversity reception, it is necessary to combine signals from four receivers in such manner that the resultant signal is never poorer than that of the best receiver and usually some increment comes from several receivers. Equipment with maximal-ratio post-detection diversity combining is being supplied for the long lines system. This combining technique is also used in the Ace High 40-span tropo system of the North Atlantic Treaty Organization.

As shown in the block diagram page 94, the combining element is a highly degenerate cathode follower or solid-state equivalent circuit whose output is connected, for alternating current and direct current, to other receiver combining elements. The internal impedance, and thus the noise contribution of each receiver to the combined output, is controlled from direct voltage generated by sampling the thermal noise above the baseband. The noise amplifier comprises several stages of feedback amplification, an output rectifier and stabilized automatic gain control, to provide an appropriate control characteristic. The control automatically removes from the combined output a receiver that has failed, and operates an alarm.

Post-detection combining has certain advantages over predetection combining. It operates after the f-m signal has passed through the limiting and demodulating processes, and is practically immune to selective fading. This immunity results from the fact that the noise sample extracted above the baseband for combiner control is taken at several times the baseband frequency and from a relatively narrow noiseband. Selective fading, or radio-frequency phase reversals within the signal band, will therefore produce negligible effects.

Threshold extension

In an f-m receiver, the output signal-to-noise ratio varies linearly with radio-frequency signal as long as the signal is above threshold level. For r-f signals below threshold, the signal-noise ratio falls off more rapidly than the signal. Threshold represents the signal power that produces signal-

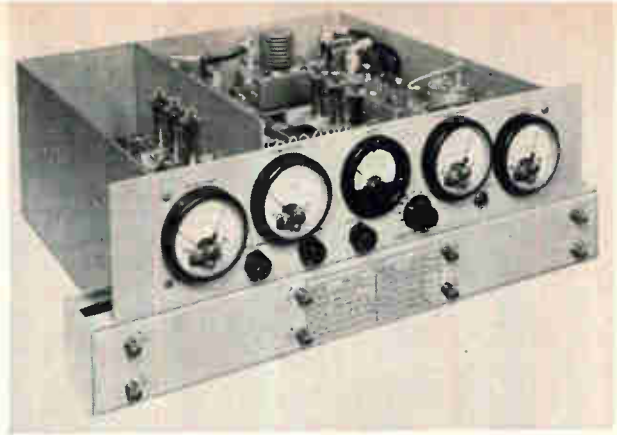

Up-converter in tropo transmitter employs a traveling-wave power-output tube but is otherwise solid state. Limit-type meters are a part of equipment reliability plan.

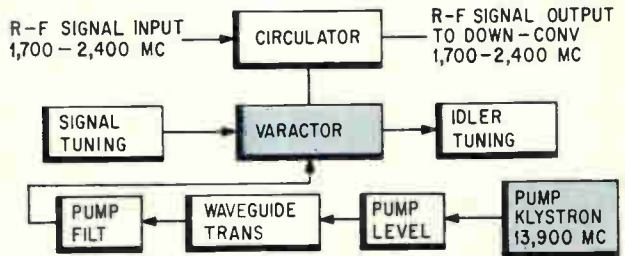

Parametric amplifier (varactor in color), used in the receiver's front end, improves signal-noise ratio over that of conventional amplifiers.

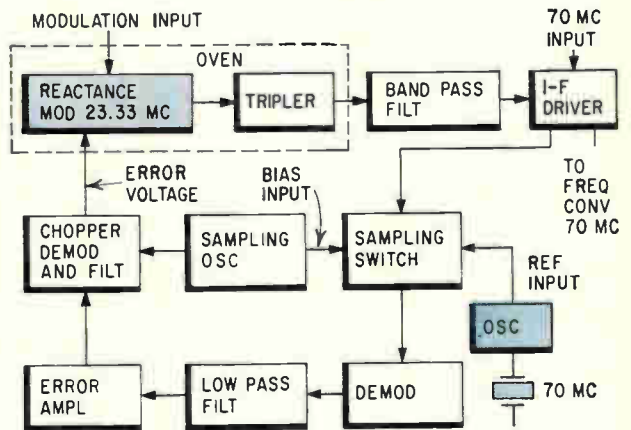

Low-noise, wide-deviation reactance modulator (color) requires frequency stabilization that is obtained by comparing average frequency output with a quartz standard (color) and correcting with an error voltage.

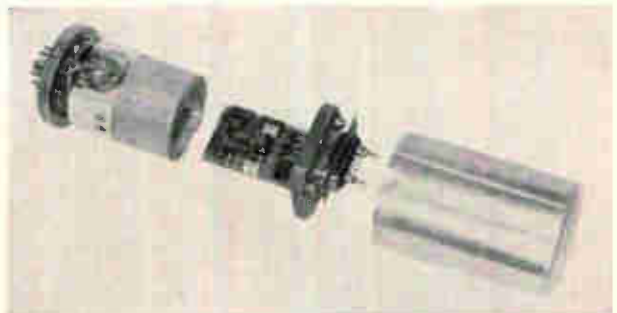

Reactance modulator is kept at a controlled temperature to reduce variations in frequency.

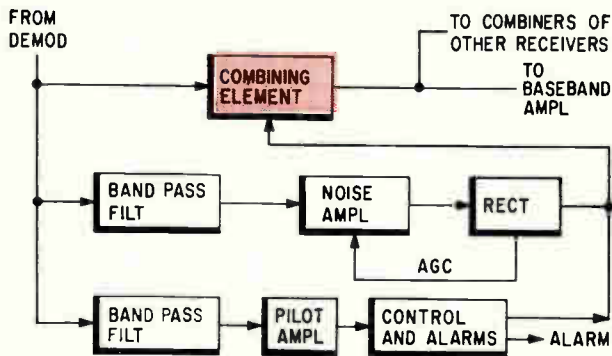

Baseband combiner, (color), used with each receiver, insures that the best contribution to the composite signal is obtained from each source. This method is in contrast to a simple switch that selects only the receiver with the strongest signal.

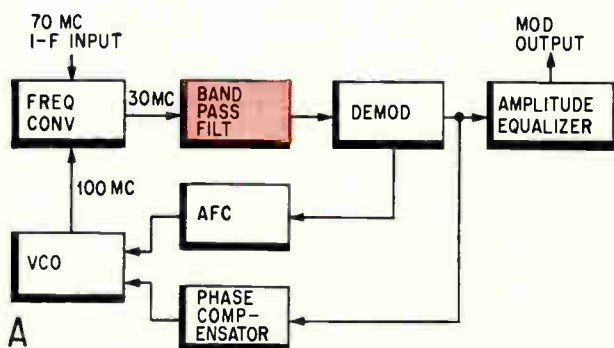

A

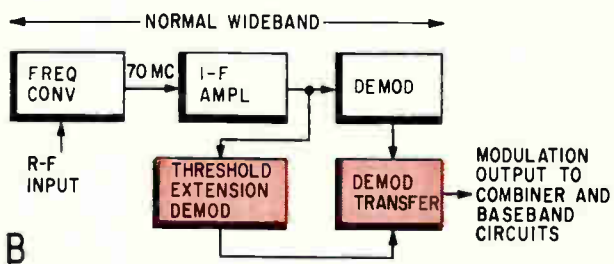

B

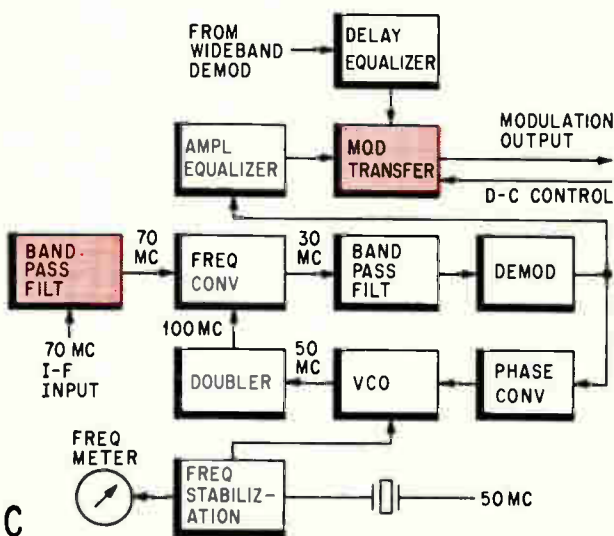

C

Basic f-m feedback threshold extension, depending upon narrowing (color blocks) pass band (A), showing how the principle is applied to a receiver (B) and the actual receiver in block form (C).

voltage peaks equal to noise-voltage peaks at the first nonlinear element—usually the amplitude limiter—of the receiver. The ratio of r-f signal power to noise power, or the carrier-to-noise at threshold, is 9 to 10 decibels.

Threshold level is a function of the receiver noise figure and radio bandwidth before limiting. Thus, to lower the threshold, it is necessary to lower the noise figure, or bandwidth, or both. Decreasing bandwidth for this purpose lowers the signal level to which the receiver output signal-noise remains linear. While system reliability is improved by increasing the tolerance of the receiver to input-signal level, the use of threshold extension is not a substitute for higher transmitter power.

Phase-lock techniques, used extensively in narrow-band communications and telemetry systems, are not suitable for wideband systems. The f-m feedback technique reduces the frequency deviation by a degenerative process before transmission through a narrow-band filter, lowering threshold without excessive distortion.

As shown in (A) of the basic diagram left, frequency deviation is reduced by a process of degenerative feedback around a typical loop. Out-of-phase deviation is obtained from a demodulator and voltage-controlled oscillator in combination.

The simplified block diagram (B) illustrates organization of a receiver for application of threshold extension when a signal falls below the normal threshold region.

The solid-state device of the type supplied in the AT&T equipment is shown at (C). The incoming signal frequency, at an intermediate frequency of 70 megacycles, is preprocessed in a bandpass filter. Degeneration of the f-m signal occurs in the frequency converter, owing to the out-of-phase local oscillator modulation from the voltage-controlled oscillator and multiplier.

The bandpass filter determines the threshold of the extension demodulator. The demodulator shown recovers modulation for baseband output and loop feedback. The feedback loop is completed by the indicated phase converter, voltage-controlled oscillator and frequency multiplier. The oscillator is stabilized by an automatic-frequency-control circuit that is referred to a local oscillator. The frequency meter provides a reference.

Demodulated output is amplitude-equalized and passed to a transfer circuit where either the threshold extension demodulator where either the threshold extension demodulator output or wideband demodulator output is selected. Transfer is automatic and normally takes place a few decibels above normal threshold. To compensate for the additional time required for the signal to travel through the threshold extension demodulator as compared with the wideband demodulator, a delay equalizer is inserted in the wideband path before the transfer function.

The author thanks Radio Engineering Laboratories, Inc., for technical information on the 2600 Series equipment which is the basis of AT&T's new tropo system.

When reliability counts, count on MYLAR®!

When you are recording or processing data, you want to be able to depend on your tape without worrying about it. If your tape is on a base of "Mylar"*—you can! "Mylar" is strong (a tensile strength of 20,000 psi). "Mylar" is stable (unaffected by temperature or humidity changes). "Mylar" is durable (no plasticizer to dry out or become brittle with age). "Mylar" is proven in use (a ten-year record of successful performance). When reliability counts, count on "Mylar".

*Du Pont's registered trademark for its polyester film.



BETTER THINGS FOR BETTER LIVING THROUGH CHEMISTRY

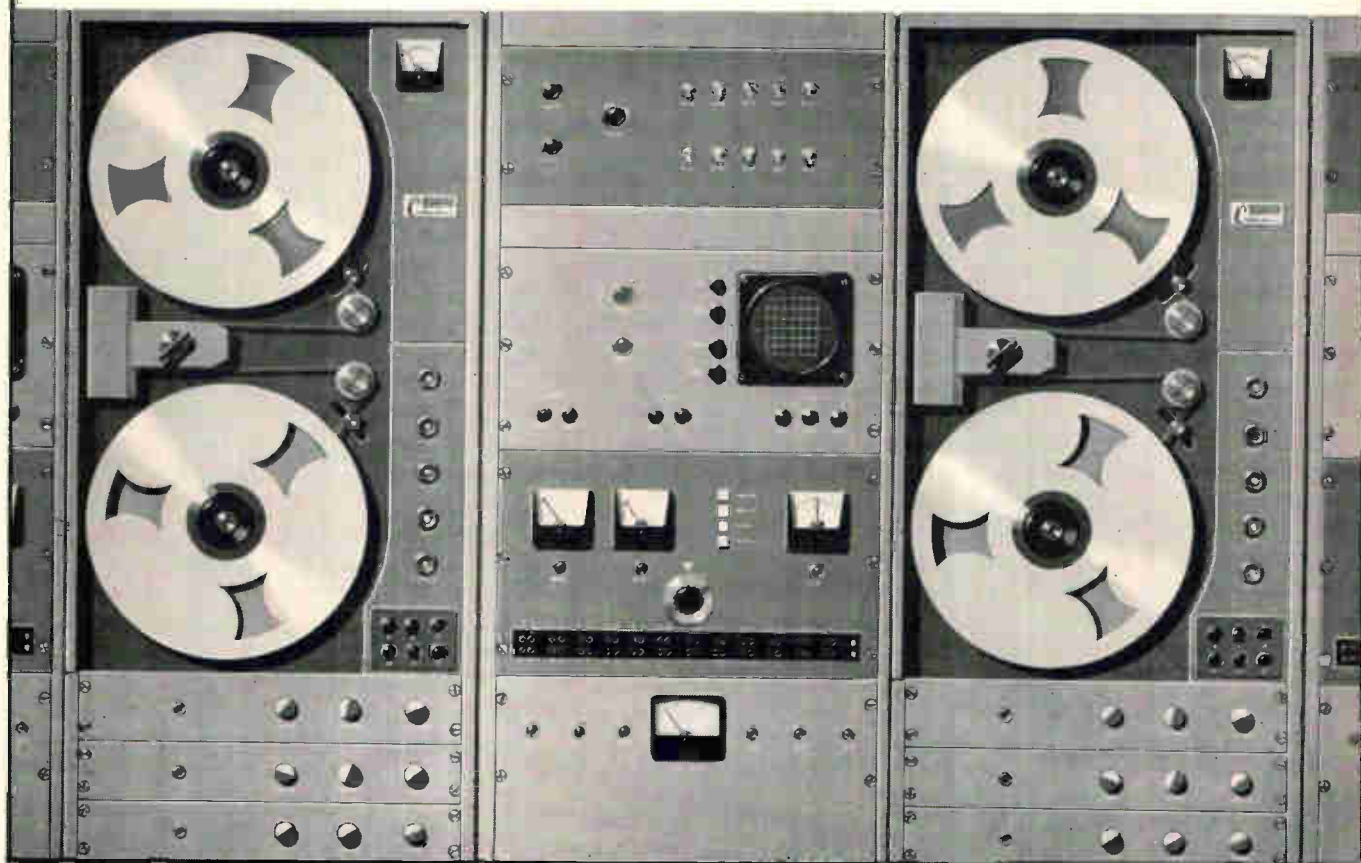

FROM DELCO NINE NEW SOLUTIONS TO CURRENT PROBLEMS



These are our latest: the DTG-1000 and 2000 series. Rugged 15 and 25 ampere germanium Nu-Base† transistors specifically designed for high-peak power switching applications.

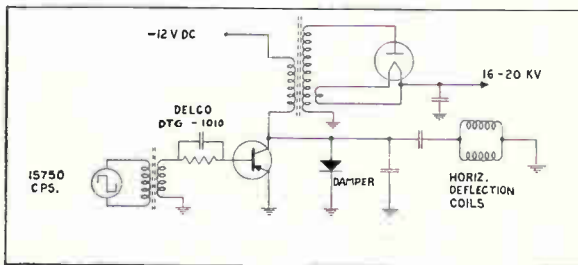

Video horizontal deflection with the Delco DTG-1010

These devices are ideal for high-current inverter applications, high-voltage TV Horizontal and Vertical circuits, and automotive ignition applications. Nu-Base construction with H.K.†† spares you from junction "hot spots," too, so you don't have to worry about secondary breakdown.

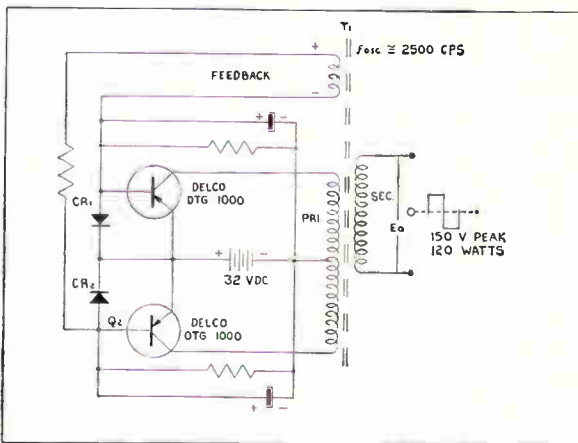

DC to AC inverter using Delco DTG-1000

Parameter stability is assured by Delco's Surface Passivation Ambient Control process. And the extremely low leakage of these de-

vices gives you all the circuit design flexibility you could ask for.

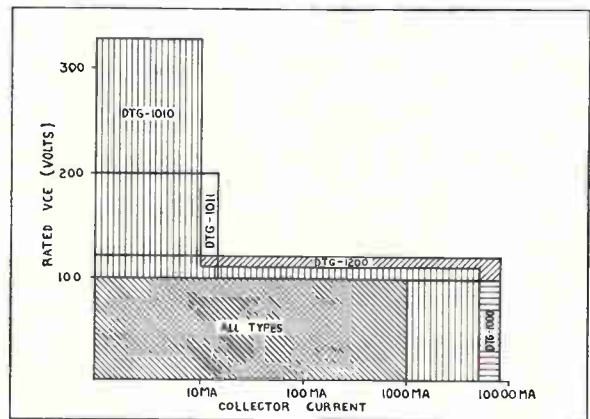

Recommended operating region DTG-1000 series

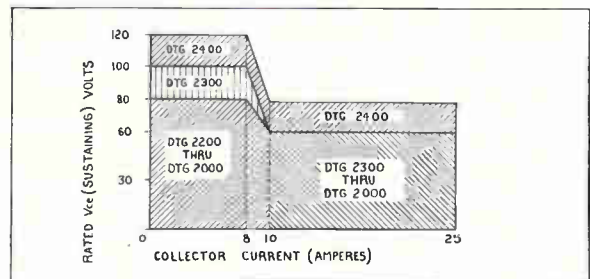

Recommended operating region DTG-2000 series

Your nearest Delco semiconductor distributor or any of our sales offices will be glad to give you more information about these new transistors. And about our other Nu-Base transistors. The 5 and 10 amp. units.

Just drop us a letter or give us a call. Anytime.

†Delco drift field non-uniform diffused base construction
††Delco hydrokinetic alloy process

Union, New Jersey*
324 Chestnut Street
(201) 687-3770

Palo Alto, California
201 Town & Country Village
(415) 326-0365

Syracuse, New York
1054 James Street
(315) 472-2668

Detroit, Michigan
57 Harper Avenue
(313) 873-6560

Santa Monica, California*
726 Santa Monica Blvd.
(213) 870-8807

Chicago, Illinois*
5151 N. Harlem Ave.
(312) 775-5411

General Sales Office: 700 E. Firmin, Kokomo, Ind., (317) 452-8211—Ext. 500
*Office includes field lab and resident engineer for applications assistance.

DELCO RADIO 
DIVISION OF GENERAL MOTORS, KOKOMO, INDIANA

Component failure rate: < 1 per 100,000,000 unit hours

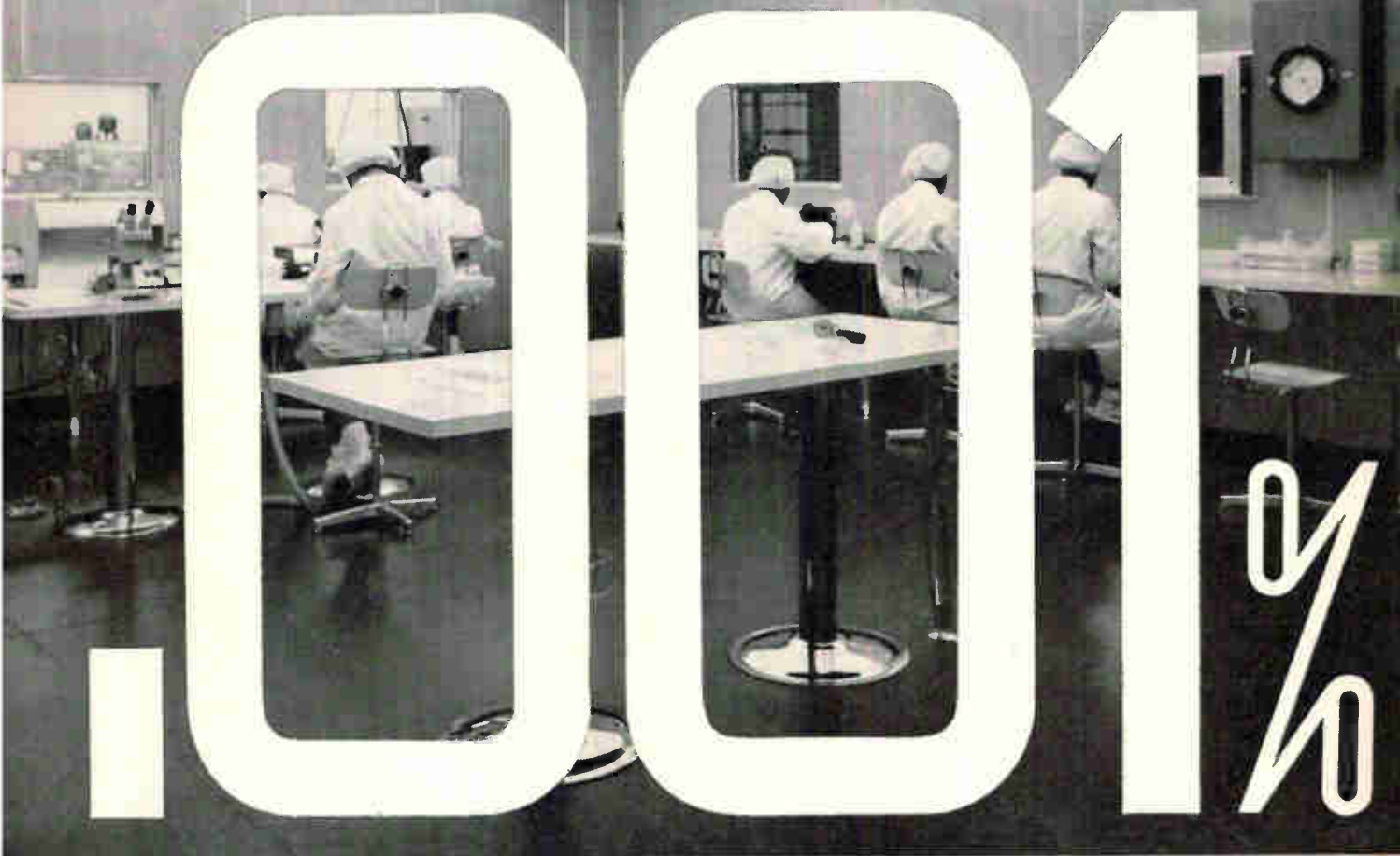

JFD high reliability program unique in piston trimmer capacitor industry

Only JFD can offer trimmer capacitors and tuners with a proved failure rate of less than 1 per 100,000,000 unit hours of operation... a failure rate that encompasses all parameters including Q, Δ C, dielectric strength, IR, min-max capacitance and torque.

The JFD white rooms are designed to maintain a dust particle control of 0.3 microns. Temperature, pressure and humidity are all closely controlled. Dust free anti-static clothing, special shoes and head coverings are standard for all personnel. All aspects of the program equal or exceed government specifications.

In the testing facilities units can be subjected to any

climatic or environmental condition required by Mil Specifications. All components undergo a "burn-in" testing at accelerated voltages and temperatures in special chambers, then are continuously monitored for minute increments of Δ C during vibration testing. Frequency range is 5-3,000 cps. Devices can also be simultaneously subjected to gravitational force to 90 G's.

JFD's lines of RVC capacitors and RLC tuners were exclusively specified for Apollo, Gemini, Minuteman and many other space and missile programs. That's why—when you specify any JFD component—you also specify dependability, quality and versatile performance.

SEND FOR JFD CATALOG C-64

Components Division

JFD ELECTRONICS CORPORATION, 15th Ave. at 62nd St., Brooklyn, N. Y. 11219
JFD NORTHEASTERN, Ruth Drive, P. O. Box 228, Marlboro, Mass. 07152
JFD NEW YORK-NORTHERN, Damiano Pl., P. O. Box 96, New Hartford, N. Y. 13503
JFD MID-ATLANTIC, 313 E. Broad St., Palmyra, N. J. 08065
JFD MID-ATLANTIC-MARYLAND, P. O. Box 7676, Baltimore, Maryland 21207
JFD MIDWESTERN, 6330 W. Hermione St., Chicago, Illinois 60646
JFD MIDWESTERN-OHIO, P. O. Box 8086, Cincinnati, Ohio 45208
JFD WESTERN, 9 Morlan Place, Arcadia, California 91006
JFD CANADA LTD., 51 McCormack Street, Toronto, Ontario, Canada
STANDARD TELEPHONE & CABLES LTD., Footscray, Sidcup, Kent, England
LCC STEAFIX, 128 Rue de Paris, Boite Postale 51, Montreuil-sous-Bois, Seine, France
JFD ISRAEL LTD., Industrial Area B, Bldg. 23, Azur, Israel
DUCON CONDENSER PTY., LTD., Christina Road, Villawood, N.S.W., Australia
MURATA MANUFACTURING CO., LTD., Nagaoka Otokuni, Kyoto, Japan

**JFD ELECTRONICS
CORPORATION**

THE \neq AMERICA KNOWS BEST!

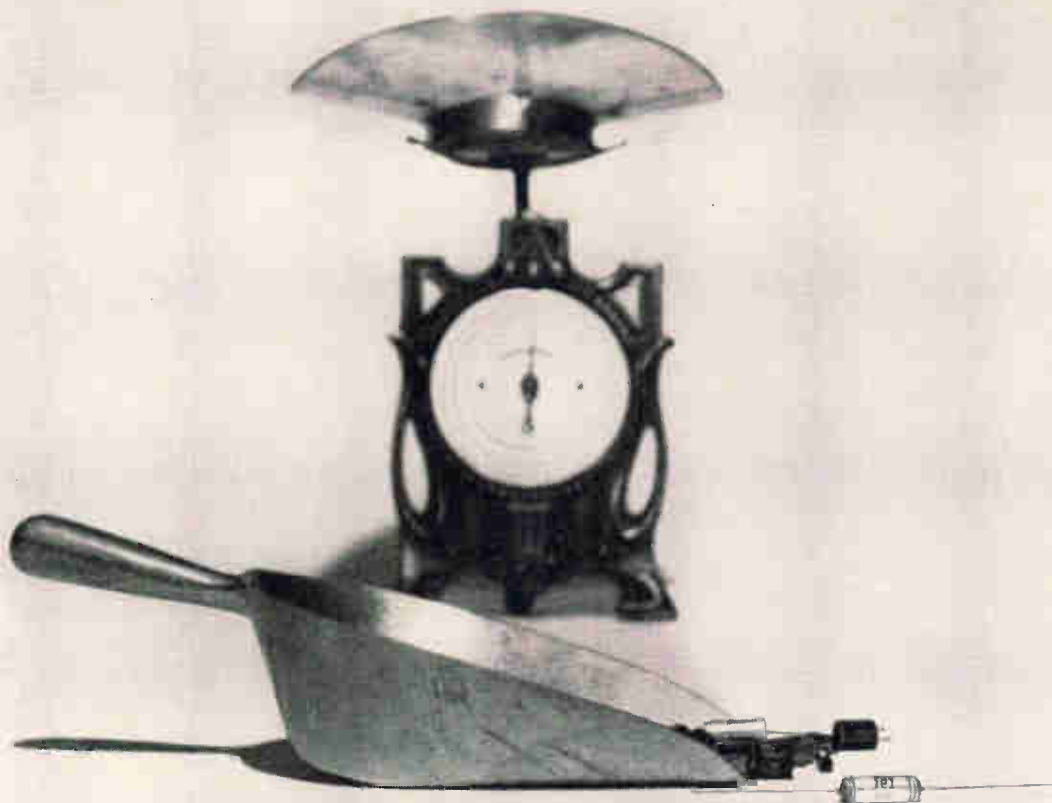

The last full measure of performance is built into every IEI design.

Today, progressive engineers in every field of electronics count on IEI to provide capacitors which will invariably deliver the superior performance required as modern circuits grow more and more sophisticated.

IEI has consistently and successfully pioneered the newest developments in aluminum and tantalum foil capacitors. In both wet and dry slug tantalums, IEI performance curves dramatically demonstrate a decided superiority over the usual MIL spec requirements.

IEI engineering starts where typical specifications leave off. Poured into every design are extra measures of research . . . materials . . . workmanship . . . test proce-

dures to provide quality far beyond the most stringent MIL specs.

Automated and other advanced manufacturing techniques assure better and faster production . . . high quality repeatability. A separate quality control department provides a 100% checkout for all capacitors of the five critical parameters with automatic QC instrumentation.

At IEI, **Quick Reaction Capability** is not just an empty phrase. Engineering and production facilities are geared to **deliver**—unbelievably fast! Let us demonstrate on your next requirement—whether routine assignment or special design problem.

Write for complete information.



INTERNATIONAL ELECTRONIC INDUSTRIES
Box 9036-12, Nashville, Tennessee

A DIVISION OF **SPS** STANDARD PRESSED STEEL COMPANY "Where reliability replaces probability"

Probing the News

Space electronics

Homemade ground stations to receive weather pictures from Nimbus satellite

From Vandalia, Ohio, to Bandung, Indonesia, they'll aim their antennas at the sky starting about Aug. 5

By Joel A. Strasser

Space Electronics Editor

Question: What does a high-school freshman in Ohio have in common with the Australian government's Weapons Research Establishment and Radio Suisse in Bern, Switzerland?

Answer: They're all building ground stations to receive weather reports from satellites in orbit.

The Nimbus I weather satellite, scheduled to be shot into orbit

about Aug. 5 by the National Aeronautics and Space Administration, will pass overhead at about noon every day at points around the world. It will be far easier to find than its predecessor, Tiros VIII, and easier to tune in on. Tiros VIII is in an orbit that is inclined to the equator and observers have to get advance orbital information from NASA to know when the satellite

will pass overhead.

The Weather Bureau wants the results of Nimbus's automatic picture transmission (APT) to be available throughout the world, especially to ship lines, television and radio stations, farms, airlines, and other organizations that need fast, accurate weather data. NASA has authorized two of its scientists to write an article (p. 81) on how to build a ground station for receiving APT weather pictures.

Homemade components. In Vandalia, Ohio, 14-year-old Mike Valentine has gathered technical information from NASA, the Weather Bureau and Electronics magazine, as well as some parts from the Alden Electronic & Impulse Recording Equipment Co.

Using a home-made radio-frequency preamplifier and a Heathkit f-m tuner, Mike intends to receive facsimile weather pictures with a helix antenna made from 54 feet of $\frac{3}{8}$ -inch aluminum tubing and as-



Window screen and bedspring are two ingredients of this homemade, eight-turn helix antenna for APT station built by graduate students at the University of Wisconsin. Ron Stewart adjusts azimuth and elevation while Dennis Thomson checks coordinates.

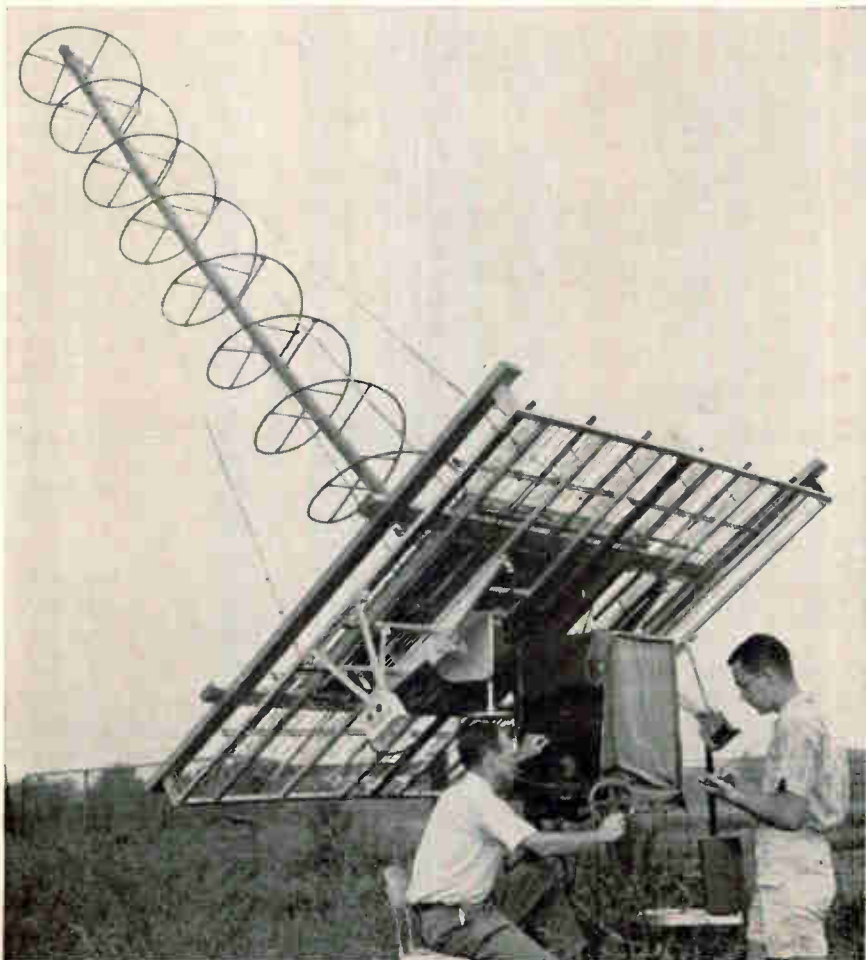



Ottawa station uses a scope for display, instead of a facsimile machine. R.S. Rettie of Canada's National Research Council, adjusts receiver while C.I. Taggart of the Meteorological Branch of the Department of Transport watches the signal on oscilloscope.

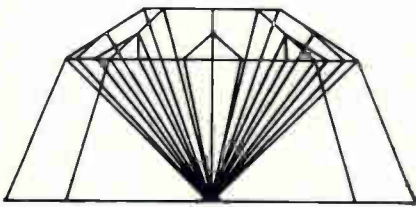

Canada's answer to the pointing problem. Each element of this stationary array covers a section of the sky in such a way that maximum gain occurs at about 22° above the horizon and at every 30° in azimuth. Eight "horns" (the structures that look like two right triangles placed together) feed preamps. RCA Victor Co. of Montreal will use this design.



Test readout is taken from a Fairchild-Stratos commercial station by Charles M. Hunter, Spacecraft Manager of NASA's Tiros Operational Satellite program. Hunter and Edward Rich Jr. describe on page 81 how to assemble a low-cost ground station.

sorted pieces of aluminum conduit. For a facsimile readout, he has been experimenting with a light beam from a neon bulb and an advancing rotating cylinder that his father helped him rig up.

Rooftop station down under. In Melbourne, Australia, the government weapons agency has combined commercial equipment with a homemade antenna, tripod and preamplifier to form a station suitable for picking up f-m signals from Nimbus I. The agency modified an Eddystone 770R vhf receiver to NASA specifications, assembled the entire station on a rooftop, and said it achieved satisfactory reception.

The antenna is a cross-yagi mounted on a tripod that is manually steered with a handwheel and permits movement in azimuth and elevation. Screw jacks are attached to each leg of the tripod for leveling, and built-in spirit level are provided to check the angle of the azimuth axis. The antenna may be locked in any position. It has a forward gain of 10 decibels and voltage standing-wave ratio of no more than 1.5.

Another "home-brew" station has been set up in Salisbury, southern Australia. That country's Bureau of Meteorology plans additional stations at Perth, Darwin and probably Cairns. These, in turn, will be linked to facsimile lines to provide cloud pictures.

Future stations will have crystal controlled receivers and remotely controlled antennas developed by the Weapons Research Establishment. J.W. Lillywhite, Australia's director of meteorology, concedes that the station is "in no way revolutionary," but he says it represents "an economical solution" to the problem of receiving pictures from Nimbus.

In Bern, Switzerland, Radio Suisse has assembled a station consisting of a helix antenna with a gain of 8 db, a Tapetone, Inc., converter (model 100), a conventional high-frequency receiver, a facsimile demodulator and a Muirhead D-900-S facsimile recorder. The station cost less than \$25,000 contrasted to the \$32,000 cost of a commercial receiving station.

Spring and Screen. Some stations are much more makeshift. At the

University of Wisconsin three graduate students have constructed one using a combination of surplus and homemade equipment. The collegians have built an eight-turn antenna using 0.5-inch copper tubing to form the helix, and copper window screen for the ground plane.

To support the helix, an 18-foot, 2-by-2-inch piece of wood was attached to the ground plane, with wooden dowling separating the helix from the support. A surplus military antenna—an SCR-658 400-Mc antenna attached to a tripod and nicknamed a "bedspring"—supports the helical antenna at the base. The station uses an old 108-Mc minitrack receiver that was used in the Vanguard satellite program with a 137-Mc converter on the front end, made by the Ameco Equipment Corp.; an f-m detector and a Magnecord tape recorder. The students plan to use a facsimile recorder or an oscilloscope-and-Polaroid-camera combination for the readout.

Other homemade stations are operating in Hong Kong, West Germany, Brazil, Anaheim, Calif. and elsewhere.

Britain's Meteorological Office has taken readouts from the Tiros VIII satellite, using the tracking station of the Royal Radar Establishment. The British plan to build a small station at Bracknell.

Clever Canadians. Canada has built a station at Ottawa that displays cloud-cover pictures on a high-resolution cathode-ray tube. The weather pictures on the scope are then photographed with a Polaroid camera. This is an alternative to the facsimile machine. The Canadians have also built a programer to point the antenna directly at the satellite to receive the strongest signals.

They have used all-solid-state circuitry with an oscillator phase-locked to the 2,400-cps subcarrier in the satellites' transmission system (p. 82). The oscillator's output is converted to 4 cps to obtain the sweep frequency for the scope display. The scope can then be used to reproduce the satellites' signal. The antenna programer has indicator circles for azimuth and elevation, with holes every two degrees. Based on orbital data, a pin is in-

serted into a hole corresponding to the satellite's location at every minute. A motor-driven pointer, which advances from pin to pin, so that it is always aimed at the satellite, guides the antenna. The Ottawa station uses a crossed-yagi antenna with 10-db gain.

Canada's requirements for APT data differ from those of the United States. The highest possible resolution is needed to get good pictures of ice conditions in Canada's coastal waters, in addition to weather information. So the received signal is recorded on magnetic tape to permit repeated playback into the display to obtain the best possible picture.

East and West. At the Bandung Institute of Technology's electrical engineering department, Indonesian engineers are working on a simple ground station to meet the needs of the island republic's weather forecasters while staying within a limited budget.

They have built a quadruple helical antenna with a 14 to 15 db gain and have converted a Collins Radio Co. VHF-101 receiver to receive the satellites' f-m signals. They are converting a Telephoto machine for recording the facsimile readout from the satellites.

Engineers at the Danish Meteorological Institute have built a station near Copenhagen that has been receiving pictures from Tiros VIII since Dec. 24. The Danes built a steerable yagi antenna with a gain of 9 db, and have access to another yagi antenna that was put together from available radar equipment. The latter has four yagis, is both manually steerable and autosteerable, and has a gain of about 15 db.

The U. S. Weather Bureau's instrument division is experimenting with a low-cost antenna programmer that can be used with commercially available stations.

The programmer automatically controls antenna slewing by using predetermined orbital data that is stored by manually positioning switches on a control panel.

The Weather Bureau uses a spiral array antenna for its experimental station.

About 50 of the antennas that will follow Nimbus's flight will be of commercial manufacture. Their prices range up to \$40,000.

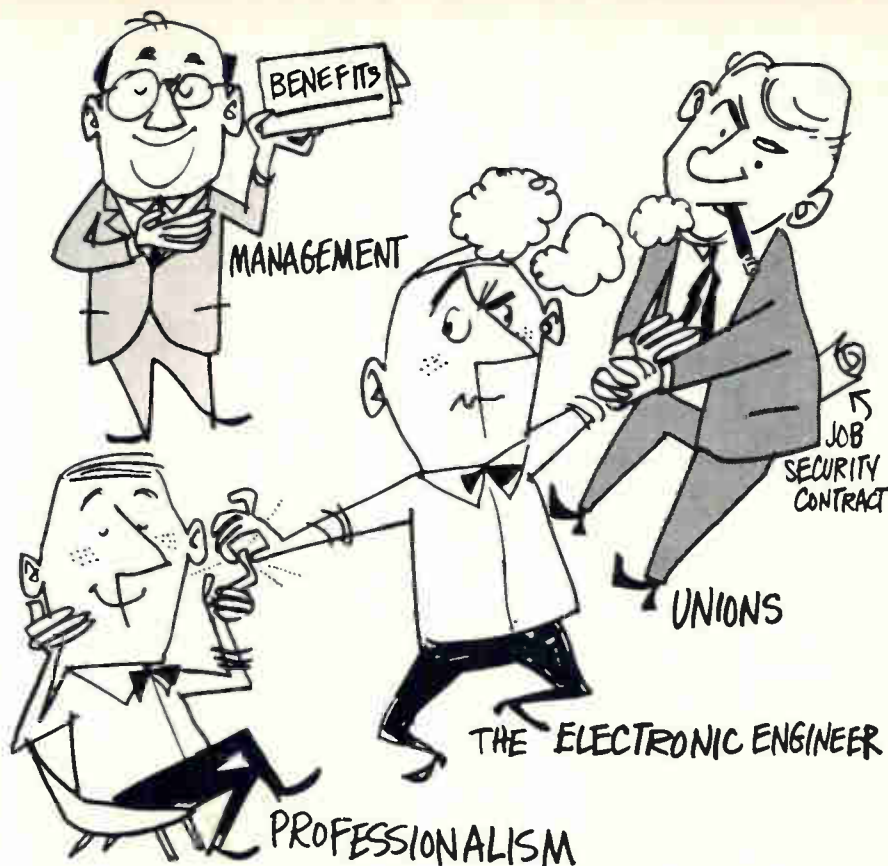

Manpower

State of the unions

They haven't benefited from layoffs of engineers.

But a new kind of organization seems to be evolving.

At the Boeing Co.'s sprawling plant in Seattle, nearly one-fourth of the engineers have been laid off as a result of cutbacks in military spending. Employment of engineers has nosedived from 10,500 to 7,800. Yet membership in the Seattle Professional Engineering Employees Association, the bargaining agent for Boeing's engineers has increased from 2,300 to 2,700 during that time. About 25% of Boeing's engineers are electronic or electrical.

The seeming paradox has attracted attention from students of labor relations. Some have wondered whether the change in the engineer employment situation in the United States—from one of prosperity to one of shrinking opportunities [Electronics, May 18, 1964, p. 105]—might start a boom

in engineer unions.

The answer at this time appears to be "No." A survey by Electronics magazine indicates that the Boeing situation is unusual. Union members among electronics engineers seem to be concentrated on the East and West Coasts. The magazine's reporters could find few members in the Midwest, South or New England.

I. Is it a bellwether?

Because of its apparent success, a lot of people are studying the SPEEA. Some of its more militant opponents have called its pact with Boeing a "sweetheart contract," because it gives the company the exclusive right to decide which, and how many, employees may be dismissed.

Traditionally, unions have fought

for a voice in determining the basis of layoffs. Today, with engineering layoffs on the rise, the agitation about layoffs is even stronger in those few areas where union membership is concentrated.

Boeing uses a "totem" system to which the SPEEA agreed. Under it, company supervisors determine an engineer's value by rating such traits as competence, diligence and potential on a 1-to-5 scale. The higher an engineer scores, the less likely he is to be laid off.

Usually, union philosophy is to insist on seniority in layoffs. The longer a man works for a company, the less likely he is to be dismissed by the company.

Youth hit hardest. Although seniority was not the chief consideration in the recent layoffs, they still seem to have hit hardest

at the young, inexperienced engineers who comprise the smallest segment of SPEEA membership. That may be one reason for the association's growth through adversity, according to James R. Randall, chairman of the executive committee. Another reason is the union's first aggressive organizing effort, instituted by John Jolly, who recently completed a term as president.

Some experts believe that engineers will eventually go to some form of union. In 1963, Prof. George W. Zinke, director of the Center for Labor Relations at the University of Colorado, did a study entitled "Unions of Professionals: Prototype for Coming Decades?"

Referring to SPEEA and similar associations, he wrote: "The presently organized unions of profes-

sional personnel are . . . indeed prototypes of unionization in the coming decades. They meet the problem of unionization versus professionalism by choosing new union tactics and strategies compatible with professionalism."

Because the SPEEA has chosen some new tactics, some people have called it a company union. Paul Staples, labor editor of the Seattle Times, disagrees. He concedes, "It's had a difficult time becoming effective because it has not had the power. But it is gaining strength and know-how and it is showing increasing muscle."

Prof. J. B. Gillingham of the University of Washington, an economist and labor relations expert, considers the SPEEA to be "rather ably led and reasonably aggressive".

Is it a union? Ever since its inception in 1944 to counter an organizing attempt by the International Federation of Technical Engineers, AFL, the SPEEA has stressed its role as a professional organization, deemphasizing the union approach. Only once—in 1953—did it even threaten to call a strike; it later decided that such action was not necessary.

A strike threat is not likely in the near future. Randall says the association believes that a strike for economic reasons would be unsound. Any possible strike would be on philosophical, rather than economic, grounds, he explains. A present difference with the company involves the definition of "professional." This is the kind of difference that conceivably could lead to a strike, Randall says.

Robert J. Sartell, an area representative, says the SPEEA "is not like a union, but an organization of engineers working to accomplish collectively what they are unable to accomplish individually."

E. E. Wachter, chairman of the Council of Engineers and Scientists Organization, confesses: "Our members know we're a union, but we don't use the word because they'd rather not hear it." The council is a loose amalgamation of engineering unions in Southern California.

The association's reluctance to engage in a test of strength may have a more practical basis. Gil-

Engineering union elections, 1962-1964

Company	Union	Date	Results
General Electric Corp. Drexel Hill, Pa.	Association of Engineers & Engineering Assistants	Nov. 1963	union decertified, 100-77 (technicians voted to retain union, 60-12)
Westinghouse Electric Corp. Newark, N.J.	Westinghouse Engineers Association	Nov. 1963	union installed for manufacturing engineers (11-10)
Radio Corp. of America Burlington, Mass.	Association of Scientists and Professional Engineering Personnel	Fall, 1963	union representation rejected (288-53)
Westinghouse Electric Corp. Lima, Ohio	Lima Westinghouse Salaried Employees Association	Sept. 1963	union discontinued (181-118)
Westinghouse Electric Corp. Cheektowaga, N.Y.	Westinghouse Engineers Association	Sept. 1963	union retained (of 271 eligible to vote, 175 for, 33 against, 11 for Federation of Westinghouse Independent Salaried Unions)
Western Electric Co. 24 major locations	Council of Western Electric Professional Employees	Aug. 1963	union representation rejected (4,375-2,582)
General Dynamics Corp. Aeronautics Division San Diego, Calif.	Engineers and Architects Association	July 1963	union decertified (2,149-1,388)
General Dynamics Corp. Pomona, Calif.	Engineers and Architects Association	June 1963	union decertified (565-542)
Leeds & Northrup Co. Philadelphia, Pa.	Professional Engineers & Scientists Association	March 1963	unions swapped (PESA replaced Leeds & Northrup Employees' Union, 80-50)
Sperry Gyroscope Co. Great Neck, N.Y.	International Union of Electrical Workers, AFL-CIO	May 1962	union representation discontinued (1,669-1,069) (technicians vote to retain, 345-198)

lingham, the Washington University labor expert, notes that the SPEEA represents only one-third of the engineers in its bargaining unit. "The union couldn't be militant," he says, "or else it would be bluffing. It doesn't have enough membership."

II. The strike weapon

The SPEEA's attitude toward strikes contrasts with that of another, stronger union—the Association of Scientists and Professional Engineering Personnel chapter in Camden, N. J.

Late in June, the chapter took a strike vote of its 1,200 members—among 1,500 engineers—at the Camden and Moorestown, N. J. plants of the Radio Corp. of America. The problem was layoffs.

The union contended—and an arbitrator agreed—that RCA had violated layoff procedures that were spelled out in the union contract. The union charged that the company proposed to dismiss too many high-seniority men.

The outcome of the vote has not been disclosed because the dispute was settled peacefully. But union officials have hinted that the engineers voted to strike, as they did in 1960 when five RCA plants in the Camden area were struck for six days.

Jobs dwindle. The Camden chapter's membership reflects a downward trend in union membership that follows a decline in engineering employment. Just one year ago, the chapter had 1,700 members representing 2,000 RCA engineers.

Unfortunately for the unions, they have made their greatest gains at defense-oriented plants that are the most susceptible to cutbacks in orders and layoffs of workers. This is especially true of electronics engineers.

In the present era of employment cutbacks, unions are especially concerned with job security. This issue appeals most to veteran engineers, who have the most to lose. Yet companies are hiring greater and greater percentages of new graduates. Last year, the biggest decline in the engineering profession was in the hiring of experienced electrical and electronics engineers. This dropped 28% from the previous year, while the hiring of new graduates increased 0.9%. This re-

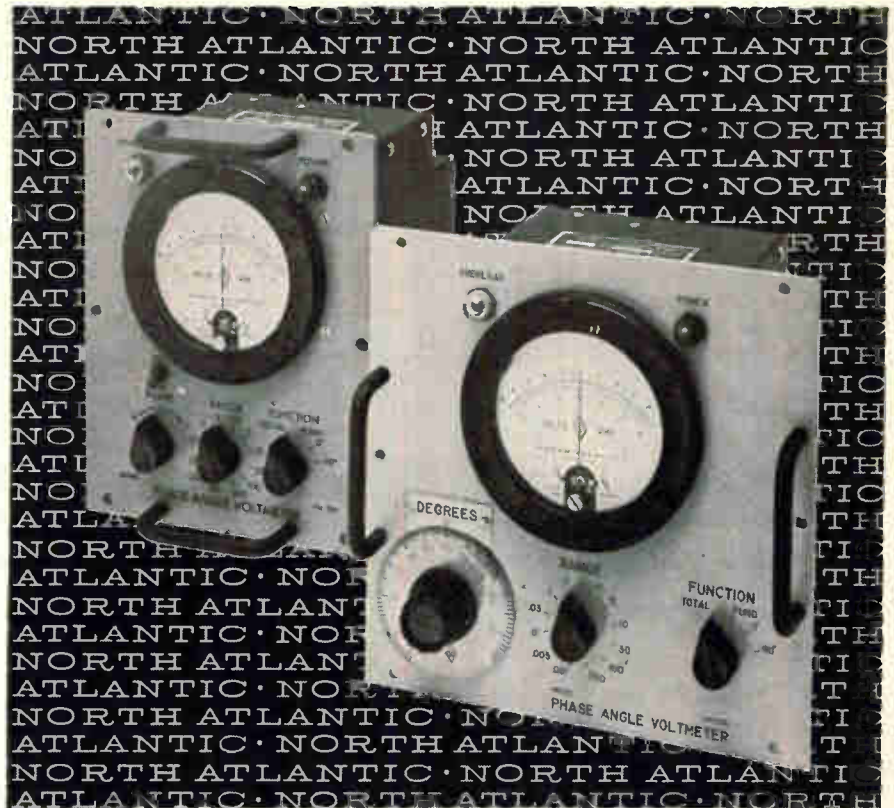

how to match a PAV to tough GSE specs

From its all solid state circuitry to its MIL-type hermetically sealed meter and plug-in amplifiers, every design feature of the Model VM-235 Phase Angle Voltmeter has been selected for rigorous service in Aerospace Ground Equipment.

Your North Atlantic man can quickly demonstrate how this rugged, miniaturized version of North Atlantic's famous PAV provides direct, accurate reading of phase angle, nulls, total, fundamental, quadrature and in-phase voltages—even under the roughest of military field conditions.

The VM-235's ability to meet tough system specs is demonstrated daily in operational and support equipment for USAF and Navy aircraft and missile programs. Its capabilities for complex measurements are shown in the abridged specifications below:

Voltage Range.....	1 mv to 300 v f.s., 12 ranges
Voltage Accuracy.....	±2% f.s.
Phase Accuracy.....	dial: ±1°; meter: ±3% of F.S. degrees
Signal Frequency.....	400 cps
Input Impedance.....	1 megohm
Reference Input.....	26 v or 115 v
Meter scale.....	3-0-3, 10-0-10 linear
Phase Angle Dial.....	2 scales, 90° (elec.) apart
Nulling Sensitivity.....	2 microvolts (phase sensitive)
Harmonic Rejection.....	55db (with filters)
Dimensions.....	8 ⁷ / ₁₆ " h. x 8 ¹ / ₂ " w. x 6 ³ / ₈ " d.

North Atlantic's field engineering representative in your area has full data on the VM-235, as well as modified versions for specific systems requirements. For his name, call or write today, or request Bulletin VM-235.



NORTH ATLANTIC industries, inc.
TERMINAL DRIVE, PLAINVIEW, L. I., NEW YORK • Overbrook 1-8600

FIRST REALLY PORTABLE

WIDEBAND RECORDER / REPRODUCERS

for field or airborne applications



P-4000

- **SMALLEST PORTABLE**—1 cubic foot, utilizing 10½" NAB reels
- **LIGHTEST WEIGHT**—45 pounds
- **LOWEST POWER**—60 watts
- **WIDEST BANDWIDTH**—1.2 megacycle at 120 ips
- **FIVE SPEEDS**—all automatically equalized



P-5000

- **CHOICE OF 3 BANDWIDTHS**—1.2 mc, 1.5 mc, 2.0 mc at 120 ips
- **WEIGHT**—85 pounds
- **SIZE**—2 cubic feet
- **BI-DIRECTIONAL OPERATION**
- **FIVE SPEEDS**—all automatically equalized
- **10½" NAB REELS**
- Portable or 19" Rack Mount configuration
- Available with 200 kc FM record electronics

FAIRCHILD

WINSTON RESEARCH
CORPORATION
A SUBSIDIARY OF FAIRCHILD CAMERA
AND INSTRUMENT CORPORATION

6711 SO. SEPULVEDA BLVD., LOS ANGELES 45, CALIF. • ORCHARD 0-3305 • AREA CODE 213
1625 "I" STREET, N. W., WASHINGTON 6, D. C. • NATIONAL 8-2588 • AREA CODE 202

sulted in an over-all decline of 19.5% in new hiring.

III. Why they're weak

Even at 33% representation, the SPEEA is relatively powerful among engineering organizations. Nationally, only 27,000 engineers—or 4.5%—belong to unions.

One of the biggest concentrations of union members among electronics engineers is in New York and New Jersey, where four companies have 4,000 members. The companies are the American Bosch Arma Corp., the International Telephone and Telegraph Corp., the Radio Corp. of America and the Ford Instrument division of the Sperry Rand Corp.

Arma's engineers comprise one of the few units affiliated with an industrial union. In 1956 the Engineers Association of Arma became Local 418 of the International Union of Electrical Workers.

Dreams of grandeur. One reason for the weakness of many engineering unions is that their potential members like to think of themselves as management. "They don't want to act like a union," Gillingham explains.

Some engineers oppose unions on principle. A spokesman for a large defense plant in Dallas says: "Walk through our parking lots and see the Goldwater-for-President stickers on bumpers, and you'll understand why unions have little success in Texas."

Christos T. Christy, president of the Engineers and Scientists Guild at the Lockheed Aircraft Corp. in Burbank, Calif., complains: "Approach an engineer to join and he says, 'I don't want to contribute to (James R.) Hoffa.'" Hoffa, president of the Teamsters Union, has been accused of illegal activities.

Apathy. Many engineers are apathetic, some in the belief that they're as well off without a union as with one. J. G. Tarr, a former executive secretary of the Southern California Professional Engineering Association, which represents engineers at the Douglas Aircraft Corp., explains:

"Companies aren't organized so you can strike effectively. There are enough supervisors to continue 80% of the work for at least a month. Production wouldn't be stopped, and the company feels

that it can pick up after a walkout by heavy overtime. Besides, we have no money to wage a six-month strike." Tarr's union represents 24% of Douglas' 4,775 engineers.

In August, engineers at the General Dynamics Corp. rejected the San Diego Chapter of the Engineers and Architects Association as their bargaining agent. Wachter, head of the council of which the association is a member, recalls what happened:

"The company exerted real pressure. The president spoke before every engineering group in the plant. The union wasn't equipped to do anything like that."

Along Route 128 near Boston, electronics plants have mushroomed in the past 15 years. But engineering unions are conspicuous by their absence.

"We have not given up," says an unsuccessful organizer for the American Federation of Technical Engineers, "but we see no immediate possibility of organizing there. The companies . . . are satisfying the demands of engineers on an individual basis; this is what is holding the line at present."

Mobile members. Unions' effectiveness is also hampered by their members' mobility. Arthur Carstens, administrator of labor programs at the University of California, Los Angeles, explains:

"Unions barely get their hands on people in their jurisdiction and the people are gone elsewhere." He suggests a return to the old craft-union organization. "Unions must organize without a special relationship to any company."

Whatever the reasons, engineering unions have been doing poorly at the polls. In 16 elections since 1960 involving electronics engineers, unions have been beaten 12 times. Only at two divisions of the Westinghouse Electric Corp. did engineers vote for a union. At two other plants, engineers voted to retain unions as their bargaining agents. But unions were rejected by engineers at seven plants, and ousted at five others where the unions had been representing engineers at the bargaining table.

Westinghouse engineers rejected unions at 24 plants. Other union defeats included votes at two General Dynamics plants and one of the Aerojet General Corp.

FIRST

2 MEGACYCLE

LABORATORY RECORDER/REPRODUCER

with new features for data collection and analysis

- **WIDEST BANDWIDTH** — 2.0 mc or 1.5 mc at 120 ips
- **LOWEST WOW AND FLUTTER** — 0.2% peak-to-peak from dc to 10 kc at 60 ips
- **LOW DISTORTION SIGNAL ELECTRONICS** — for RF or predetection recording
- **VARIABLE PHASE RESPONSE** — for signal analysis applications ($\frac{f_c}{10} = \pm 80^\circ$)
- **SEARCH AND SHUTTLE** — optional at 180 ips
- **FIVE SPEEDS** — 7½, 15, 30, 60 and 120 ips, all automatically equalized
- **Separate Switching of any combination of filter and equalizer while operating at any tape speed, for improved S/N ratios for certain types of data.**



L-6000

SOLID STATE AUTOMATIC GAIN CONTROL AMPLIFIER

- **DYNAMIC RANGE COMPRESSION** — switch selectable, 40 db input to 7 db output or 27 db input to 2 db output
- **TWO SELECTABLE INPUT RANGES** — 0.01 to 1.0 volt rms or 0.10 to 10 volts rms for nominal 1 volt peak-to-peak output
- **BANDWIDTH** — 10 cps to 8 mc
- **ATTACK TIME** — 1 microsecond
- **DISTORTION** — 55 db, predominately second and third harmonic
- **SIZE** — seven AGC units mount in 5¼" vertical across standard 19" rack
- **NO ADJUSTMENTS**

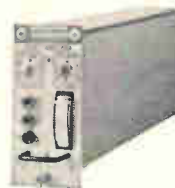

FAIRCHILD

WINSTON RESEARCH CORPORATION
A SUBSIDIARY OF FAIRCHILD CAMERA AND INSTRUMENT CORPORATION

6711 SO. SEPULVEDA BLVD., LOS ANGELES 45, CALIF. • ORCHARD 0-3305 • AREA CODE 213
1625 "I" STREET, N.W., WASHINGTON 6, D.C. • NATIONAL 8-2588 • AREA CODE 202

NEED 10,000 OR MORE A DAY...



HULL WILL GUARANTEE PRODUCTION

(with the new 99B horizontal transfer molding press!)



The new Hull 99B 25-ton, fully automatic transfer molding press, equipped with all controls for flawless, rapid production.

That's *one* capability.

Your "package" from Hull includes engineering, design of molds and fixtures, compound selection and the working setup. These—and the 99B transfer molding press—guarantee you higher production rates.

Of course, the versatile 99B molds more things than just cups, cases and shells. What do you produce?

Send for more details on the Hull guaranteed production package—and the 99B.

H-10

HULL
CORPORATION
4330 Davisville Rd.
Hatboro, Pennsylvania

Export Division:
1505 Race St., Philadelphia 2, Penna.

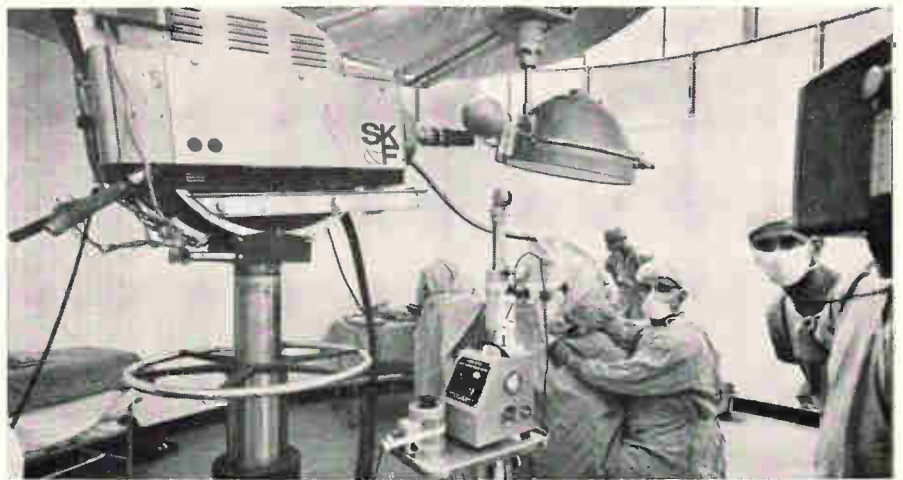

Surgeon looks up from microscope to check color-tv monitor.

Medical electronics

Microsurgery on color tv

Fiber-optics bundle allows a color camera to peer through microscope and televise an ear operation

By Laurence D. Shergalis

Regional Editor

Operating-room amphitheatres, the scene of so many climaxes in television dramas, are rapidly fading out of the medical scene.

Surgeons are far ahead of the script writers. They have been televising operations, in living color, to medical audiences for at least 15 years. Everybody gets a closeup of new techniques.

The latest refinement in the use of television in medicine is a method of watching microsurgery—operations on organs so small that the surgeon looks through a microscope as he performs the operation.

At the June convention of the American Medical Association in San Francisco, physicians in the San Francisco Civic Center watched surgeons at the San Francisco General Hospital performing a stapedectomy—an ear operation. This consists of removing the stapes, a small stirrup-shaped bone, and replacing it with a wire-and-plastic substitute to restore hearing.

The surgeon looked through a

microscope into the patient's ear, to operate on an area only five to seven millimeters in diameter. The audience watched as the color-tv picture was projected on a screen 9 by 12 feet. An audio hookup allowed them to ask the surgeon questions.

Fiber-optics. Between the color-tv camera and the microscope was a device that prevented the camera from interfering with the operation. The device was a bundle of 675,000 optical fibers, formed into a five-foot-long cable, optically coupling the camera with the microscope.

Small tv cameras can be coupled directly to microscopes, but color cameras are bulky. The fiber-optics arrangement keeps the camera out of the way so the surgeon can manipulate the microscope freely.

This was the second time such an operation had been televised live and in color. The first was in New Orleans in November, 1963.

Smith Kline & French Laboratories, of Philadelphia, worked for a year to develop the system used

in both operations.

Black dots. A few black dots still speckle the tv picture. These are caused by broken fibers in the bundle. But they don't detract from picture quality and are considered unavoidable. Engineers are working on ways to eliminate the dots, perhaps by undulating the cable so the dots move about while the picture remains stationary.

To avoid picture distortion, the ends of the fibers must remain in the same relationship to each other. But the cable itself can be bent freely.

One end picks up the scene by means of a partial mirror in a Zeiss binocular microscope. The microscope was modified for Carl Zeiss, Inc., by the Urban Engineering Co. of Hollywood, Calif.

Splitting the beam. At the camera, the bundle goes directly into the beam splitter, which separates the image into red, green and blue for transmission. The camera is a standard Radio Corp. of America model from which the relay lens and objective lens are removed.

Rotating couplings are placed at both ends so the ends of the bundle can be moved without moving the image. This allows the surgeon to move the microscope.

Illumination for the camera and the surgeon is provided by another fiber-optics bundle, which pipes light from a bright source to a lens under the microscope.

The bundle is not needed to televise regular operations. The camera can be kept out of the surgeon's way merely by placing a mirror over the operating table and aiming the camera at the mirror.

Doctors prefer color. Smith-Kline went to so much trouble to get

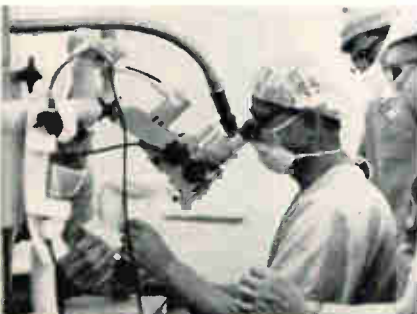

Fiber-optics bundle, connecting camera and microscope, is contained in this cable. Before an operation, a test pattern is used to line up optical system.

MAGSENSE®

METER MONITOR

Now in lower-cost board form for mounting into your equipment



Model 70—\$60. Single Set Point



Model 77—\$99. Dual Set Point

The only solid-state comparators with

- 100 ms response
- 100 billion power gain
- 1 μ a sensitivity
- "no contact" reliability

Here in lower-cost circuit board form are the same basic MAGSENSE units that have proved themselves in the extremes of polar cold, desert heat and space. The magnetic sensing devices detect and compare electrical currents less than 1 μ a—thereby accepting the output of thermocouples and strain gages directly *without amplifiers*.

Both the Model 70 with single set point and Model 77 with dual set points for detecting high and low limits are normally supplied with non-latching outputs for DC inputs with ranges of 100 μ a, 1 ma, 10 ma, or 100 ma. The Model 70 can also be supplied with latching or pulse outputs.

BRIEF SPECIFICATIONS

Response Time: 100 ms max., 50 ms typical.

Power Required: 10 to 14 VDC at approx. 30 ma (70) and 50 ma (77) exclusive of load current.

Output Load: Up to 50 ma for Model 70, up to 100 ma for Model 77. 500 ma optional.

Size: 3" x 3.35" x 1.25".

Weight: Approx. 4 ounces.

Mounting: Chassis mounted or connector mounted. Holes for rear terminal mounting on meters.

Electrical Connections: Terminal wiring and plug-in edge connector similar to Elco 6007-18.

Price and Delivery: Model 70—\$60. Model 77—\$99. From stock.

CONTACT THESE DISTRIBUTORS FOR COMPLETE INFORMATION OR DELIVERY FROM STOCK . . .

WEST

So. California & Arizona

PERLMUTH ELECTRONICS*
5057 W. Washington Blvd.
Los Angeles, Calif.
(213) 931-1041

8068 Engineers Rd.
San Diego, Calif.
(714) 278-6230

2859 E. Thomas Rd.
Phoenix, Ariz.
(602) 264-4934

No. California & Nevada

HELD & MOLLARD, INC.*
1125 Marshall Street
Redwood City, Calif.
(415) 365-1700

Washington, Oregon & No. Idaho

EICHER & COMPANY
5 W. Harrison
Seattle, Wash.
(206) 284-1811

Colorado, Utah, Wyoming, Montana and So. Idaho

PETERSON COMPANY
4949 Colorado
Denver, Colo.
(303) 333-5434

521 W. 4th North
Salt Lake City, Utah
(801) 355-7454

New Mexico, Six W. Texas Counties

ELECTRONIC ENTERPRISES

1900 Washington St., N. E.
Albuquerque, N. M.
(505) 256-1585

Miss., Arkansas, Louisiana & Texas (Except Six West Co.)

BUTLER & LAND
5538 Dyer Street
Dallas, Texas
(214) 361-6631

1845 Line Avenue
Shreveport, La.
(318) 422-0697

1034 Constance Street
New Orleans, La.
(504) 524-0688

Oklahoma

RIDDLE & HUBBELL
302 S. Cheyenne
Tulsa, Okla.
(918) 585-5624

MIDWEST

Neb., Iowa, Kansas, Missouri and So. Illinois

IMPALA, INC.
7540 Lowell Street
Overland Park, Kansas
(913) 688-6901

247 South Pinecrest
Wichita, Kans.
(316) 682-3593

1011 Clifton, N. E.
Cedar Rapids, Ia.
(319) 362-2125

P. O. Box 6164
Lambert Field, Mo.
(314) 522-1600

No. Illinois, N.W. Indiana and Central Wisconsin

A & M INSTRUMENT*
4801 North Ridgeway
Chicago, Illinois
(312) 539-4460

Minnesota, Dakotas, N. W. Wisconsin

PINKNEY & ASSOCIATES
1925 Nicollet Ave.
Minneapolis, Minn.
(612) 338-0523

INSTRUMENTATION SERVICES, INC.
917 Plymouth Avenue
Minneapolis 11, Minn.
(612) 521-6267

Michigan & Indiana (Except Counties Lake, La Porte & Porter)

THE SATULLO COMPANY*
4515 North Woodward
Royal Oak, Mich.
(313) 549-3910

618 Cincinnati-Batavia Rd.
Cincinnati, D.
(513) 752-6683

Eastern Wisconsin

TAYLOR ELECTRIC*
4080 Northport
Washington Rd.
Milwaukee, Wis.
(414) 964-4321

Ohio, East Kentucky, W. Pa. and W. Virginia

PIONEER STANDARD ELECTRONICS*
5403 Prospect
Cleveland, O.
(216) 432-0010

2651 East Main St.
Columbus, O.
(614) 237-8615

SREPCO DIVISION*
314 Leo St.
Dayton, O.
(513) 224-0871

EAST

Six New England States

ALVIN S. MANCIB COMPANY*
365 Walden St.
Cambridge, Mass.
(617) 864-2494

Randolph & Coe Roads
P. O. Box 467
Middletown, Conn.
(203) 347-5629

Metropolitan New York, Long Island, & N. New Jersey

A & M INSTRUMENT COMPANY*
48-01 31st Ave.
Long Island City, N. Y.
(212) 726-4343

513 Pennsylvania, Delaware & Southern New Jersey

ROBERT K. NYE ASSOCIATES
P. O. Box 611
S. 24 Woodside Rd.
Berwyn, Pa.
(215) 644-8479

ELECTRIC METER SERVICE*
1014 Vine St.
Philadelphia 7, Pa.
(215) 922-3422

Maryland, No. Virginia

THOMAS H. CLOSS
21 W. Pennsylvania Ave.
Towson, Md.
(201) 825-4455

SOUTH

North & South Carolina

SYSTEMS SERVICE CORPORATION
P. O. Box 17525
3748 Monroe Ave.
Charlotte 7, N. C.
(704) 377-3407

Georgia

ELECTRO-TECH, INCORPORATED*
690 Murphy Avenue
S. W.
P. O. Box 10857
Atlanta, Ga.
(404) 753-4128

Alabama (Florida Counties west of Jackson, Calhoun & Gulf)

THE JAMES SPADER COMPANY
512 North 18th St.
Birmingham, Ala.
(205) 252-7419

Florida (Except Counties west of Gadsden, Liberty, Franklin)

THE O. E. GRANTZ COMPANY
2513 Catalina Dr.
Orlando, Fla.
(305) 424-4057

*Stocking Representative

CONTROL DATA CORPORATION

CONTROL SYSTEMS DIVISION
4455 MIRAMAR ROAD, LA JOLLA, CALIFORNIA



BUSS quick-acting Fuses

"Fast Acting" fuses for protection of sensitive instruments or delicate apparatus;—or normal acting fuses for protection where circuit is not subject to starting currents or surges.

BUSS

Write for BUSS
Bulletin SFB

BUSSMANN MFG. DIVISION, McGraw-Edison Co., St. Louis, Mo. 63107



BUSS MBO
1/4 x 1-1/4
inch

BUSS ABC
1/4 x 1-1/4
inch

BUSS high interrupting capacity Fuses

For the protection of circuits capable of delivering currents as high as 25,000 amps. at 125 volts or 10,000 amps. at 250 volts.

BUSS

Write for BUSS
Bulletin SFB

BUSSMANN MFG. DIVISION, McGraw-Edison Co., St. Louis, Mo. 63107

BUSS: 1914-1964, Fifty years of Pioneering...

Circle 109 on reader service card

Circle 109 on reader service card

Was your guarantee dropped somewhere along the way?



Now everyone can afford to MONITOR SHOCKS in SHIPPING

One look and you know if the equipment was dropped or jarred in transit. No argument! G Dot Indicators cannot fail, are tamper-proof and accurate.

An indicating ball (Dot) is calibrated to a desired number of "G"s. If this level is exceeded in transit, the G-Dot shows it.

Create customer goodwill . . . guard the warranty you put on TV sets, office machines, pianos and appliances, glassware, food. The cost of shock protection? *Less than \$2.00 per package in user quantities!!*

G Dot Indicators are light and small. Can be glued, or fastened un-noticed in equipment, or containers, trucks, railroad cars.

Write, wire, phone today
for complete information and prices.

INERTIA SWITCH Inc.

Packaging Protection Division

311 West 43rd St., New York 36 • Telephone: (212) JUdson 6-5880



To order reprints:
fill in, cut out coupon below,
insert in envelope and mail to:
Electronics Reprint Dept.
330 W. 42nd Street
New York, N. Y. 10036

Reprint order form

To help expedite mailing of your reprints please send cash, check or money order with your order

For listing of reprints available see
Reader Service Card
For reprints of the latest Feature Article
Oceanography

Send me reprints of Key No. R-58 at 50¢ each.

For reprints of previous reports or articles fill in below:

Send me reprints of Key No[s]

@ ¢ each.

[For prices see Reader Service Card]

Name

Number of Street

City, State, Zip Code

living color because that's what doctors prefer. Without color it is difficult to tell diseased from healthy tissue, or to identify body fluids.

The company isn't even using videotape. Its engineers explain that taped operations wouldn't have the spontaneous quality and drama of live operations.

Although the company's business is ethical medicinal specialties, it has long promoted educational tv in medicine. As a service to medical organizations, it keeps a tv crew on the road full-time to televise operations for seminars and conventions of physicians.

Smith-Kline is a pioneer in the field. It began working on medical color tv around 1949, using the field-sequential camera designed by Peter Goldmark, president of CBS Laboratories of the Columbia

Broadcasting System. This type of camera, still used by the Ciba Corp., a pharmaceutical company, has a rotating color wheel in front of the lens and picture tube.

In 1956, Smith-Kline switched to the standard NTSC 525-line system—the standard broadcast color tv system—because it is compatible with available black-and-white tv receivers. In 1962, Smith-Kline participated in the first live color tv program from Europe using the Telstar I satellite.

In schools, too. Color tv is also being used educationally in medical schools and hospitals. The University of Michigan has permanently installed an NTSC system. Walter Reed Hospital in Washington also has an NTSC system. A field-sequential system has been used at the University of Pennsylvania in Philadelphia.



Audience of physicians sees inner ear magnified on 9- by 12-foot screen. Black dots are caused by broken fibers in the fiber-optics bundle.

...New Developments in Electrical Protection

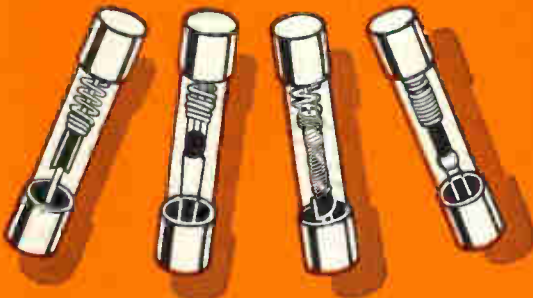

FUSETRON dual-element Fuses

time-delay type

"Slow blowing" fuses that prevent needless outages by not opening on motor starting currents or other harmless overloads—yet provide safe protection against short-circuits or dangerous overloads.

BUSS

Write for BUSS
Bulletin SFB

BUSSMANN MFG. DIVISON, McGraw-Edison Co., St. Louis, Mo. 63107



Actual Size

Only 1-5/8 inches long...
Extends just 29/32 inch
behind front of panel

BUSS Space Saver Panel Mounted Fuseholder

- Fuseholder takes $\frac{1}{4} \times 1\frac{1}{4}$ inch fuses. Converts to $\frac{9}{32} \times 1\frac{1}{4}$ inch fuses simply by changing screw type knob. Holder is rated at 30 ampere for any voltage up to 250.
- Also available in military type which meets all requirements of MIL-F-19207A.

BUSS

Write for BUSS
Bulletin SFH-10

BUSSMANN MFG. DIV., McGraw-Edison Co., ST. LOUIS, MO. 63107

FOR OFHC COPPER COMPONENTS

Call **JANNEY**

Call **JANNEY** for Forgings,
Extrusions, High Energy Rate Forming

Benefit from JANNEY's extensive experience in forming OFHC* Copper and other high conductivity alloys for electronic applications. We offer:

1. Engineering know-how in this field
2. Flexibility of operation
3. Comprehensive quality controls
4. Machining facilities
5. Capacities: primarily parts weighing between 2 and 6 pounds each and billet sizes ranging between 2½" and 5" in diameter.



**OFHC COPPER
ELECTRONIC COMPONENT**
(HER Formed for smoother finish, better parts, less metal loss, simpler tooling)



OFHC COPPER
(Ring Forging, Rough Machined)



OFHC COPPER
Components for Electronic Applications



OFHC COPPER
A housing that has been backward extruded and machined. Note solid end.

Challenge us with your problem.
Write, wire or phone.

JANNEY CYLINDER COMPANY

7401 STATE ROAD, PHILADELPHIA 36, PA.

Phone: (215) MAYfair 4-6600

*Reg. Amer. Mtl. Clifmax, Inc.

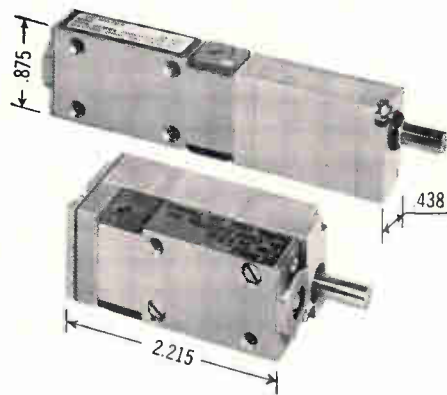

NEW FLAT GEARMOTORS

most compact/most torque

Globe Type VS d.c. gearmotors give up to 70 oz. in. torque (35 oz. in. continuous duty) in two packages, one with a frontal area as small as 0.4 sq. in.! Motor develops .0025 hp in the 8,000 to 17,000 rpm range; many standard armatures, 3 to 50 v.d.c. End mounted gearbox: 62 standard ratios from 7.88:1 to 25,573.65:1. Side mounted gearbox: 27 standard ratios. Case hardened gears. Units designed to meet MIL specs. Bulletin VSG. Globe Industries, Inc., 1784 Stanley Avenue, Dayton 4, Ohio.

GLOBE

GLOBE
INDUSTRIES,
INC.

Circle 201 on reader service card

When you need a better way to
MEASURE or CONTROL Temperature

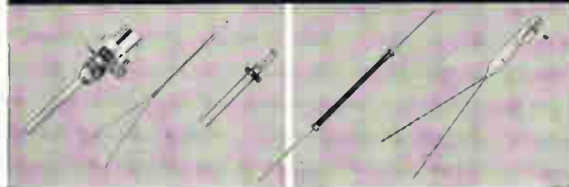

...Check F. E. I. Precision Thermistors

- Direct readout
- Exceptional accuracy
- Fast response
- High output level
- Excellent resolution
- High stability
- Small, rugged, versatile
- Interchangeable units available



Try them in your lab

F.E.I. experimental kits include an assortment of thermistor types with complete operating characteristics, application data, etc.

G700	4 thermistors	\$4.95
G701	10 thermistors	\$9.95
G200	12 thermistors	\$19.95



FENWAL ELECTRONICS, INC.
Dept. C, 63 Fountain St., Framingham, Mass.

Circle 202 on reader service card

Scr tester aids in standardization

Instrument also tests 4-layer and unijunction transistors in lab and for incoming inspection

A tester for silicon controlled rectifiers has been developed to help bring standardization into the industry. Correlation between manufacturers' production-line data and that produced in the laboratory has been difficult because of the different test equipment and procedures used.

The new tester incorporates special features for testing most existing four-layer devices and unijunction transistors. The MP-101 allows rapid, accurate testing with capabilities for failure analysis, parameter characterization, unit-to-unit parameter matching and vendor-sample evaluation. According to the

Model MP-101 scr tester also tests unijunctions and other four-layer devices.



manufacturer, this represents the first inexpensive test instrument that combines simplicity of operation with accurate measurement of the parameters of most nonlinear switching devices.

Designed for use both in the laboratory and for incoming inspection, the MP-101 incorporates an internal high-voltage current-limited power supply for the determination of forward and reverse breakdown voltages up to 500 volts, and of device leakage down to one microampere. A second test function provides for measuring gate characteristics by a continuously variable gate voltage and current supply. A high-impedance voltmeter and a series microammeter are used to monitor gate-firing voltage and current under various conditions of gate bias. Test functions are also provided for measuring holding current and forward "on" voltage with a forward current variability of from zero to one ampere. An added feature is the ability to determine the turn-off gain of gate turn-off scr's.

A special test fixture allows rapid testing of both stud-mounted packages and units with wire leads. In

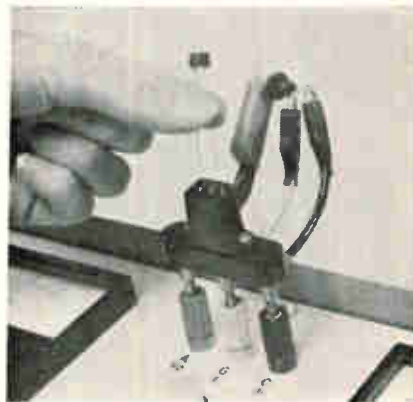

Special fixture allows testing of both stud-mounted units and devices with wire leads.

addition, the binding posts permit the use of special-purpose test fixtures outside of the unit.

An important feature in the design of the instrument is the fact that all internal circuits conform wherever possible to MIL-S-38103A. This is the latest military test standard for semiconductors used in high-reliability components. Instrument accuracy is 3% of full scale for all measurements. The price is \$589.

Sensory Systems, Costa Mesa, Calif.
Circle 301 reader service card

Integrated circuits in a family of six

Six new DCTL (direct-coupled transistor logic) integrated circuits have been developed for medium-speed, low-power digital computers. The new microcircuit family, which can comprise the entire logic section of a military or commercial computer, includes the MHM-4001 gate, 4101 double gate, 4201 adder, 4301 half-adder, 4501 register (illustrated), and 4401 buffer. The circuits are fabricated on a

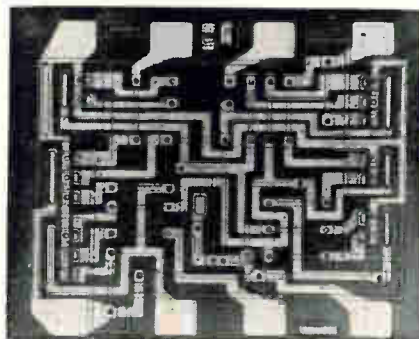

single silicon die by epitaxial deposition and planar diffusion. Worst-case fan-out for each of the first

five devices is four; for the buffer, 30. Propagation delay for the gate and double gate is 70 nsec; for the adder, half-adder and buffer, 140 nsec; and for the register, 210 nsec. Maximum power dissipation is 8, 6.8, 18, 14.5, 33.5 and 21 mw, respectively. All elements are designed for operating temperatures of -55° to 125°C . Storage temperatures of -65° to 200°C can be withstood. In 100-lot quantities, prices range from \$11.30 for the gate to \$30 for the register.

Honeywell Semiconductor Products Division, 1177 Blue Heron Blvd., Riviera Beach, Fla. [302]

KAY

ELECTRIC COMPANY

Maple Avenue, Pine Brook, Morris County, New Jersey

Frequency Range: 200 kc to 220 mc.
Flatness: 0.5 to 100 mc, $\pm .5$ db.
 200 kc to 220 mc, ± 1.0 db.
Log. Accuracy: ± 2 db.
Dynamic Range: Full scale 40, 60, 80 db.
Input: 0.5 volts for 80 db, 0.16 volts for 60 db, 0.05 volts for 40 db.
Expand Control: Top 10 db range.
Price: \$795.

NEW!
KAY

Logafiter

1025-A

200 kc to 220 mc Logarithmic Amplifier



New Components and Hardware



Compact, fully shielded audio input transformer

An audio input transformer, compact and guaranteed to MIL-T-27B, has been developed. Type TF4RX-17YY is encased in metal and hermetically sealed. It is shielded electrostatically and electromagnetically. Electrical parameters are: primary, 600 ohms; secondary, 600/150 ohms; frequency response, ± 0.5 db from 300 cps to 110 kc, within 1 db to 150 kc; maximum level, +10 dbm; distortion, $\frac{1}{2}\%$ or less; size, $1\frac{3}{4}$ in. square by $1\frac{1}{16}$ in. high max; weight, 200 grams max. United Transformer Corp., 150 Varick St., New York 13 [311]

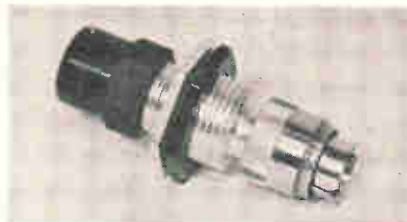

Co-ax cable connectors are easily installed

Quick-Grip connectors have been designed for all corrugated and smooth-sheath, air and foam-dielectric coaxial cables. The line covers r-f connectors for cables ranging in size from 0.062 to $3\frac{1}{8}$ in. diameter in all standard terminations. Applications include phased-array feed networks, pulsed data transmission and community tv systems. Illustrated is a bulkhead mounted GR-874, locking type connector for use on $\frac{1}{2}$ -in., 50-ohm, smooth-sheath, foam-dielectric cable. Features of the line include extremely low vswr, and rapid, simple, low-cost installation on cable. The Quick-

Grip cable attachment mechanism will withstand surge currents to the limits of the cable sheath, thus making the connector particularly useful in hardened communication link applications. In phased array or precision delay applications, Quick-Grip permits rapid, precise trimming of cable length for phase or delay adjustment.

Communication Dynamics Corp., 289 Nepperhan Ave., Yonkers 01, N.Y. [312]



High-megohm resistors are stable to 125° C

Resistances from 10^8 to 10^{14} ohms, with virtually no aging drift, are offered by the Pyromeg series HR1250 Ultra High Meg resistors. Units have an unspiralled resistance element and are stable up to 125°C. By filling the interior with nitrogen and then hermetically sealing the resistor, the manufacturer has provided complete protection of the resistance element. Applications include photocell and electrometer circuits, radiation detection devices and measuring equipment. The resistor is $1\frac{1}{4}$ in. long and $\frac{3}{8}$ in. diameter.

Pyrofilm Resistor Co., 3 Saddle Rd., Cedar Knolls, N.J. 17927. [313]

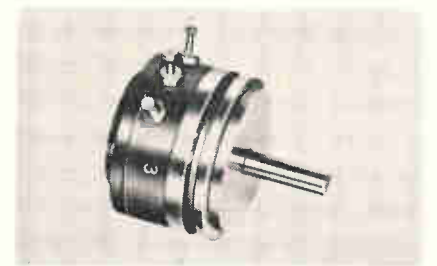

Servo-mount pot resists humidity

A single-turn servo-mount precision potentiometer of $\frac{7}{8}$ in. diameter is available in an all-plastic, moisture-resistant housing. Model 3580 ex-

ceeds steady-state requirements of MIL-STD-202B, Method 103. A special rotor design assures excellent wiper stability. The shaft is supported by precision ball-bearings for additional performance capability. Standard resistance range is 100 to 50,000 ohms; resistance tolerance, $\pm 3\%$ standard; resolution, 0.38 to 0.08%; linearity, $\pm 0.50\%$ standard; operating temperature range, -65° to $+125^\circ\text{C}$; power rating, 1.0 w at 70°C ; ganging, up to 24 cups; weight, 0.5 oz. Price is \$20 in quantities of 100 pieces.

Bourns, Inc., Trimpot Division, 1200 Columbia Ave., Riverside, Calif. [314]



Disk-type thermistor is reliable and fast

A line of disk-type thermistors has been designed to provide high reliability in making close-tolerance temperature measurements at remote locations and in preventing thermal runaway by serving as a temperature compensator for transistorized circuit modules. These characteristics, plus high stability, fast response and high power sensitivity, make the units ideal for mounting or electrical packaging. The disk is 0.4 in. in diameter and 0.144 to 0.149 in. thick. Resistance values are 1,000 ohms $\pm 1.5\%$ at 77°F and 207 ohms $\pm 1.5\%$ at 150°F . Time constant in still air is 40 sec at 25°C . Dissipation constant in still air at 25°C is 8 mw per degree centigrade.

Victory Engineering Corp., 136 Springfield Ave., Springfield, N.J. [315]

Oil-enclosed resistor in wirewound bobbin

A precision wirewound bobbin resistor which has its resistance element sealed in an oil-filled brass can is now being produced to special order. The SPR-106 is designed to fit applications that require ultra-precise matching, a low temper-

WATCH DEI

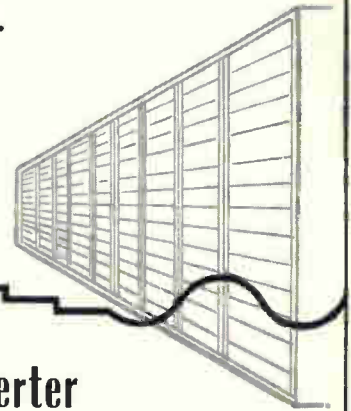

PCM D/A Converter

New 20 Channel D-A Converter "Package".

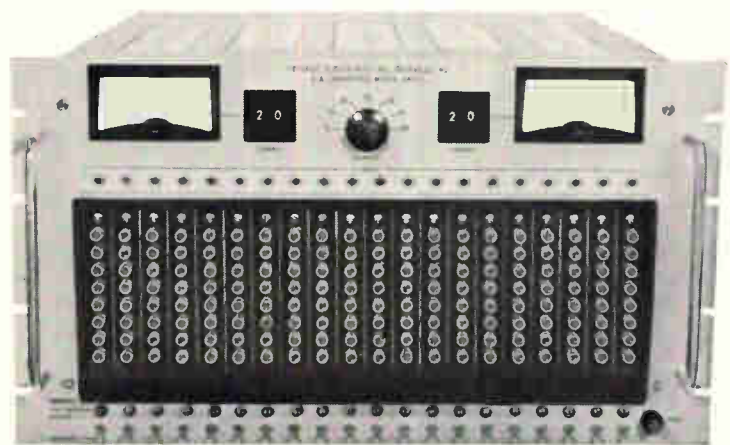

- Self-Contained Calibrator
- Integral Binary Display
- Self-Contained Power Supply
- High Linearity and Stability

The new modular DAC-2 from Defense Electronics, Inc. offers linearity of $\pm 0.1\%$ and overall accuracy of $\pm 0.25\%$ for digital-to-analog data conversion in PCM sub-systems . . . plus a self-contained calibrator and power supply.

The compact unit has 20 eight-bit, digital-analog converter channels, each with its own integral binary display. Storage of data samples in each channel is shown by eight incandescent lights.

A versatile and flexible d-a converter "package", DAC-2 permits calibration of any one or a selected group of channels without disturbing operation of remaining channels. Monitoring of percent of full-scale and output voltages by front-panel meters is also provided. Thumb wheel switches select the channels to be metered.

Input of each module is eight data lines and one transfer line and output furnishes sufficient current for driving analog displays, recorders and galvanometers. The unit will operate at word rates up to 100kc.

Ask for the DAC-2 Bulletin . . . Watch DEI



DEI
RESEARCH
DEVELOPMENT
MANUFACTURING

Defense Electronics, Inc.

ROCKVILLE, MARYLAND

PHONE (301) 946-2600 TWX 301-949-6788
SHERMAN OAKS, CALIFORNIA PHONE (213) 872-2870

CERAMIC INSULATORS ?



BIG

SHORT



TALL



SMALL

Lapp

LAPP HAS BEEN SOLVING INSULATING PROBLEMS FOR OVER 45 YEARS...

Lapp pioneered the application of electrical porcelain and steatite to the radio/electronic field. We've solved thousands of knotty insulating problems with down-to-earth engineering ingenuity and production ability. ■ Tube supports, stand-off insulators, gas-filled condensers, entrance insulators, porcelain water coils, antenna strain and spreader insulators, tower insulators . . . these are only a few of the many dependable insulators that bear the Lapp name. Hundreds and hundreds of special designs have been developed to meet tough specifications. ■ Send your next insulating problem to Lapp. We'll come up with an efficient answer quickly and economically. Lapp Insulator Co., Inc. Radio Specialties Division, 220 Sumner Street, LeRoy, N. Y. 14482.

New Components



ature coefficient and excellent stability. According to the manufacturer, the oil-enclosed atmosphere in which the resistance element is suspended provides the freedom from stress essential to precise performance. The SPR-106 has a power rating of 0.05 w and a resistance range of 100 ohms to 800,000 ohms. It can be provided in pairs matched to 0.03% with a stability ratio of $\pm 0.002\%$. Temperature coefficient is 0 ± 5 ppm/ $^{\circ}\text{C}$ in an operating range of 70° to 90°C . Temperature coefficient matching to ± 1 ppm/ $^{\circ}\text{C}$ is available. The unit has a body length of 0.625 in. and body diameter of 0.312 in. Leads are axial, $1\frac{1}{2}$ in. long. Dale Electronics, Inc., P. O. Box 488, Columbus, Nebr. [316]

Spiral cone antennas cover broad band

Two conical log-spiral antennas are designed for use in rfi measurements in the 200-Mc to 10-Gc range, as specified in MIL-STD-826. These light, 50-ohm antennas are of a broadband type with no tuning adjustments required, thereby saving measurement time. Their directional patterns assure good back-lobe suppression of signals originating behind the an-

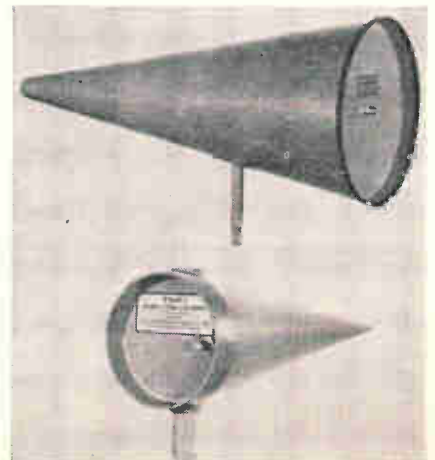

tennas. Equal response to signals radiated in the horizontal and vertical planes is assured by the circular polarization of the antennas. Price for the 200- to 1,000-Mc antenna is \$240; for the 1- to 10-Gc unit, \$250.

Stoddart Aircraft Radio Co., 6644 Santa Monica Blvd., Hollywood 38, Calif. [317]



Solid-state switches are fast-operating

A line of high-speed solid-state switches has been developed for telemetry and multiplexing systems. They also act as chopper relays in d-c amplifiers and synchronous detectors. A self-contained driver is completely isolated from the switch elements, which open and close in 0.5 μ sec. Switching frequencies from d-c to 500 kc may be used, and transient spikes are exceptionally small, typically less than 1 mv. Series 10 models have offset of less than 1 mv and can handle signal voltages of ± 40 v, while series 20 models have a lower offset of 100 μ v at signal voltages of ± 15 v. Both are $\frac{1}{2}$ in. by $\frac{1}{2}$ in. by 1 in. Price (spst) for the series 10 is \$49; for the series 20, \$69.

Brower Laboratories, Inc., Turnpike Rd., Rt. 9, Westboro, Mass. 01581. [318]

Hermetically sealed film resistors

Hermetic glass seals are the key to long-term stability and reliability, at moderate costs, for the type GEM precision film resistors according to the manufacturer. The resistors, which have evaporated metal-film elements, surpass characteristics C & E of MIL-R-55182. Three sizes are available—RNR 55, 60 and 65. They are rated at $\frac{1}{10}$, $\frac{1}{8}$, and $\frac{1}{4}$ w, respectively, at 125°C. Resistance values start at 50 ohms for all three sizes and range to 100,000 ohms for RNR55

EDGERTON, GERMESHAUSEN & GRIER, INC.



NOW UP TO 20KW AVERAGE POWER WATER-COOLED XENON FLASHTUBES FOR LASERS

A new family of water-cooled xenon flashtubes by EG&G allows laser-pumping at average powers of 4KW (FX-62A), 8KW (FX-65A) and 20KW (FX-67A). These unique tubes have been designed with special electrodes efficiently cooled by a concentric water feed method to meet present day needs for fast repetition pulse rates and long life. Other applications include projection cameras and optical or visual illumination sources.

TOTAL FLASHTUBE CAPABILITY EG&G has the industry's broadest line of xenon flashtubes including linear, helical, bifilar, annular, U-shaped and custom designs. Linear flashtubes, rated up to 3,000 joules per inch of arc length, are available.

Complementing its flashtube line EG&G also offers complete lines of trigger pulse transformers; chokes; cold cathode krytrons for trigger switching; ceramic-metal thyratrons for high energy switching; triggered spark gaps for crowbar protection; photodiodes, and instrumentation for nanosecond light detection; and equipment for driving flashtubes.

For detailed information on EG&G's water-cooled flashtubes write for data sheet FX-62A, FX-65A, FX-67A or contact EG&G Products Department, 176 Brookline Avenue, Boston, Mass. 02215. Phone: 617-267-9700. TWX: 617-262-9317.



EDGERTON, GERMESHAUSEN & GRIER, INC.
BOSTON • LAS VEGAS • SANTA BARBARA



These new General Electric lamps have 25,000-hour insomnia

They're made for wide-awake designers. For men who want a longer-lasting, dependable lamp for **Computer Systems • Displays • Read-outs • Aircraft Indicators • Switches • Etc.!**

If you're noodling over one of the above (including Etc.!), you'll want to check out new, reliable #2187 and #387. The leads on the wire terminal version, incidentally, are cleaned and solderable—at no extra charge. Or for quick, easy installation, you may find #387's midget flanged base more to your liking.

Send for Bulletin number 3-4365. It's the best way to find out which of these newcomers you can use best. General Electric Company, Miniature Lamp Department M-420, Nela Park, Cleveland, Ohio 44112.

No.	Volts	Candle Power	Amps	Design Life (average)	Filament	Bulb	Base
387	28	0.30 (approx.)	0.04	25,000 hrs	C-2F	T-1 3/4	Midg. Flanged
2187	28	0.30	0.04	25,000 hrs	C-2F	T-1 3/4	Wire Terminal

Progress Is Our Most Important Product

GENERAL  ELECTRIC

New Components

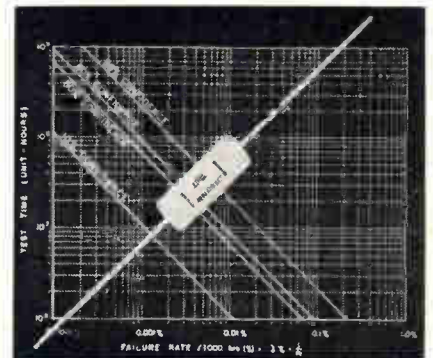

sizes; to 499,000 ohms for RNR 60 sizes; and, to 1 megohm for RNR65 sizes. Standard tolerance is $\pm 1\%$; special tolerances are available. Prices for standard units are approximately \$1.80 each in medium quantity lots.

International Resistance Co., 401 N. Broad St., Philadelphia 8, Pa. [319]



Resonant-reed relay follows audio orders

A 4-channel resonant-reed relay switches multiple circuits remotely by audio signal commands. The RD7 measures 1.23 by 0.67 by 0.64 in. and is designed for printed-circuit mounting. Signals to the multichannel resonant-reed relay can be transmitted over copper wire or r-f loop. Upon receiving a predetermined a-c signal, the selected reed (or reeds) resonates. Contacts on the reeds then perform the switching functions. The reeds can be tuned to provide over 50 separate control frequencies within a spectrum of 150 to 700 cps. The RD 7 is designed to operate in narrow bandwidths ($\pm 1.5\%$ max). It is highly sensitive, requiring only 15 mw normal drive level. Output is 1p4t or 2p2t.

Bramco Controls division, Ledex, Inc., College and South Sts., Piqua, Ohio. [320]

New Instruments



Decade voltage source with digital readout

Digital readout to 999 v in one-volt increments, and output accuracy of $\pm 0.5\%$ even when used by unskilled personnel, are features of this a-c decade voltage source. Applications for the model 200 include recalibration of a-c meters, transformer testing, voltage comparison, nulling, and design of rectification circuits. Input, at 115 v, can be any frequency from 60 through 1,000 cps. Output is adjusted in three decades by front-panel rotary switches that provide in-line window display of the voltage setting in units, tens and hundreds of volts. Accuracy of output is determined only by the setting of the pointer of a built-in meter to a red index line. Then any desired voltage from 1 to 999 v may be dialed by setting the output indicators at the desired numbers. Output capability is 10 ma. Price is less than \$400. Idalee Electronics Corp., 891 Fulton St., Valley Stream, N.Y. [351]



Stable power meter needs no accessories

A high-stability power meter, the PRD686, has been announced. According to the manufacturer, it can be used, without additional acces-

sories, with temperature-compensated and uncompensated thermistor mounts that have negative coefficient elements with operating resistances of 100 and 200 ohms. Full scale readings from 0.01 to 10 mw are covered in 7 steps, with a bridge accuracy to $\pm 3\%$ of full scale. With uncompensated thermistor mounts, the power range is limited to 0.1 mw at the low end with an accuracy of $\pm 5\%$ full scale. Two self-balancing bridges in the 686 render it essentially drift-free. Price is \$395.

PRD Electronics, Inc., 202 Tillary St., Brooklyn, 11201. [352]



Solid-state portable spectrum analyzer

A solid-state spectrum analyzer, model TA-2, with four plug-in modules, covers 20 cps to 27.5 Mc. Rugged printed-circuit boards are utilized for maximum reliability in the 40-lb. unit. The swept-band TA-2 and its interchangeable modules provide graphic spectrum analysis from audio through r-f, for applications in the field and in plants where bulkier units cannot be used conveniently. Its silver cadmium batteries are good for at

when conditions are critical...



the choice is atlee transistor clips



HERE'S WHY . . .

HOLDING POWER — atlee clips are specially contoured to flex under tension. Their grip actually increases as shock and vibration increases. **PROVEN RESULTS** — no visible shifting or twisting — no lead-breaking resonance — holding power unchanged by heat or constant use.



COOLING EFFICIENCY — atlee clips, acting as heat sinks, approach within 10% of "infinity". **PROVEN RESULTS** — operation of transistor at maximum ratings without life shortage.



ELECTRICAL INSULATION — atlee clips are available with Dalcoat B coating, an enamel combining twice the dielectric strength of Teflon with equal heat conductivity of mica. **PROVEN RESULTS** — proper electrical insulation from chassis and proper thermal behavior.

SEND FOR TRANSISTOR APPLICATION TABLE — A comprehensive listing of atlee clips for specific transistor application.

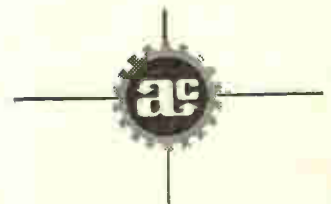

atlee corporation

2 LOWELL AVENUE • WINCHESTER, MASS.
PARKVIEW 9-5800

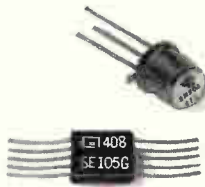

Need to say a lot
in a little space?

(or make markings
more **durable**...or
more **economical**...
or at **higher rates**?)

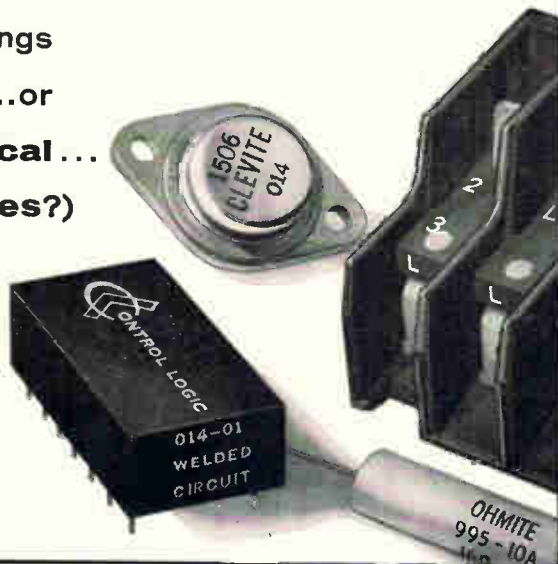

We can show you how

We can show you how to identify products so they will resist extreme amounts of handling, abrasion, many solvents and other atmospheric conditions . . . or how to sequentially number and identify components with savings of more than \$50 per 1000 . . . or how to print trademark, type number, value and date code on 90 units a minute . . . or how to produce an imprint that remains readable after 1000 hours at 200°C. . . or get 10 digits and 2 letters in a micro-circuit area of 0.090" — or 21 characters on a TO-5 case with interchangeable type number and date code . . . or save 75 cents of every dollar you now spend on buying, applying, inventorying and discarding obsolete preprinted labels.

The answers are in proven Markem machines, type and specialty inks, which daily produce better product or package identification by reducing costs, smoothing production control and increasing customer acceptance. And while Markem machines, type and inks are helping to produce better products through more complete and lasting identification, they frequently pay for themselves in the savings they make possible. Tell us what *you* make, what it must say, and for how long. we'll give you a specific recommendation and cost estimate right away. Write Electrical Division, Markem Machine Co., 305 Congress St., Keene, New Hampshire 03431.

MARKEM

New Instruments

least 4 hr. continuous operation and recharge automatically when the unit is plugged into line at the end of the day. Terminals on the back permit use of 12- to 28-v d-c external batteries. With minimum space, installation, power setup and adjustment requirements, the TA-2 finds use in laboratories, production lines, and on ships, aircraft and similar conveyances, enabling graphic swept-band measurements where tedious point-by-point techniques were formerly required. Singer Metrics division, The Singer Co., 915 Pembroke St., Bridgeport, Conn. [353]



D-c standard source and differential voltmeter

In a single unit only 7 in. high are combined a precision d-c standard source, a 0.01% differential voltmeter, a high-gain d-c amplifier, and a high-impedance d-c electronic voltmeter. Model 740A, as a calibrator source, puts out continually adjustable voltages up to 1,000. Voltages, indicated with 6-place resolution on four Nixie read-out tubes and a taut-band suspension-type meter, are accurate to 0.01%, and stable within 0.003% per month. As a differential voltmeter, the instrument offers an input impedance that remains greater than 1,000 megohms, regardless of null conditions, in contrast with usual differential voltmeters whose impedance drops sharply under off-null conditions. It compares d-c voltages from zero to 1,000 v with absolute accuracy of 0.01%. As a d-c power amplifier, the unit will give up to 60 db gain, with stability better than 0.001%, output up to 25 w. As a d-c voltage amplifier, with voltage output directly pro-

portional to meter deflection, it offers up to 120 db gain at isolated recorder terminals. The individually calibrated meter may be used as an electronic d-c voltmeter of 1% end-scale accuracy, with full scale ranges from 1 μ v to 1,000 v. Its floated and guarded input is of more than 1,000 megohms impedance on ranges from 0.1 v up, 100 megohms on the 10-mv range, and 10 megohms on others.

Hewlett-Packard Co., 1501 Page Mill Road, Palo Alto, Calif. [354]

Signal analyzer aids low-frequency studies

A multiple-input, low-frequency signal analyzer has been developed. This real-time, phase-lock tracking vibration analyzer accommodates from 2 to 100 transducers, and has a frequency range of 0.5 cps to 10 kc. The instrument is designed for use in shake-table work, rotating machinery studies, acoustical analyses, friction studies, or in any application where signals under 10 kc are undergoing study. The unit speeds up vibration analysis by simultaneously measuring—in real-time — power spectral density, cross power spectral density, random signal amplitude and transmissibility; or, in periodic analysis applications, measuring amplitude, phase and transfer functions. Other features include all-solid-state design, a 60-db dynamic sensitivity range and infinite frequency resolution.

Interstate Electronics Corp., 707 E. Vermont Ave., Anaheim, Calif. [355]



Filter synthesizer uses passive networks

Filter synthesizer model 10K-1M allows for high- or low-pass filters to be designed by means of nomo-

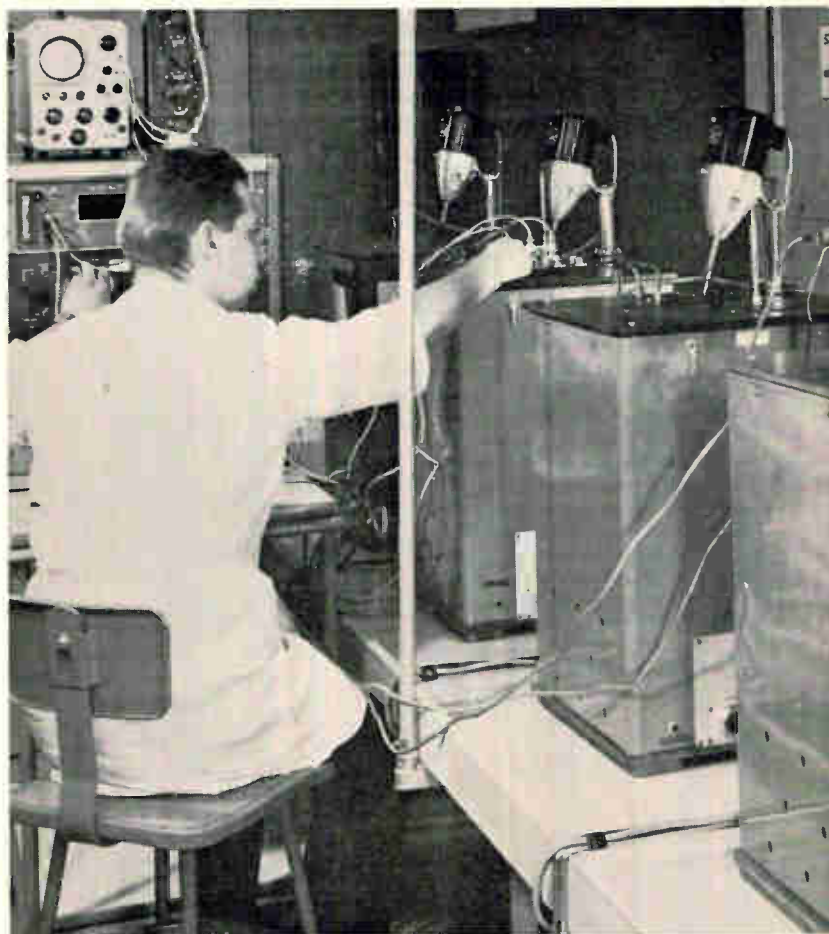

How to calibrate a sensitive Temperature Transducer

Do what the gentleman at Micro-Systems, Inc.* (in the picture) is doing. Lower it gently into the warm, luxuriously isothermal interior of a Hallikainen Constant Temperature Bath.

Why Hallikainen? Because Micro-Systems' customers insist on having their transducers calibrated to within 0.1°F accuracy. Hallikainen Baths of the type shown above better this stringent spec ten times over. That's why Micro-Systems have taken delivery on 15 Hallikainen Baths over the past three years.

Whether you're calibrating thermometers, filled system temperature instruments, or Piezo-Resistive Temperature Transducers, one of the 27 different Constant Temperature Baths you'll find on tap at Hallikainen will answer your needs. They offer control ranges that begin at -100°F and end at 1300°F, proportional and proportional with reset temperature control modes, and exclusive Jet-Stir Impeller agitation that banishes temperature gradients from your bath.

Why not dip your problems into the world of Hallikainen Constant Temperature Baths? We've prepared a packet of warm literature to help you get a feel for the subject.

*Division of Electro-Optical Systems, 170 N. Daisy Ave., Pasadena, California

HALLIKAINEN

Instruments

Dept. E

1341 Seventh St./Berkeley, California 94710

BURNPROOF LACING TAPE AT NO ADDITIONAL COST —FROM GUDEBROD



...and it's **BURNPROOF**

THE CABLE-LACER

increases worker
efficiency
by
25%



The first production tool available to ease, speed and improve the wire tying operation—producing tighter knots and more uniform harness.

Handle holds bobbin of cable lace, feeds as needed. Easily refilled. Eliminates handling long sections of tape, reduces splicing. Get your Production Department to investigate.

The specification of non-combustible materials in electronic equipment has, until now, required the use of special, higher priced lacings for harness tying. Through extensive work in their R&D Department, Gudebrod is producing two new burnproof lacing tapes—both available at no additional cost!

The first of their kind, these new tapes are made of Dacron* fibers and are flat braided for excellent handling and knotting qualities. In addition to meeting or exceeding all requirements for MIL-T-713A, the burnproofing exceeds ASTM-D626-55T.

Two types are being produced—Stur-D-Lace FLH, impregnated with a flame-proof fungistatic synthetic rubber finish, and Stur-D-Lace R impregnated with a flameproof fungistatic vinyl finish. Both are essentially stable at -100° to 350°F. Neither will burn, but they will melt when a hot flame is applied. Each type is available in seven different strengths. Gudebrod Technical Product Bulletin #6 gives details.

The introduction of burnproof lacing tapes at standard prices represents another advancement in cable lacing practice by Gudebrod. The Gudebrod line of lacing tapes covers the entire range of wire harness tying requirements for both military and commercial equipment. Send for the Data Book on Gudebrod Tapes.

*"Dacron" is Du Pont trade name for its polyester fiber.

New Instruments

graphs and built by the use of decade inductors and capacitors. The unit consists of passive elliptical function filters of several types. The frequency range extends from below 10 kc to above 1 Mc and impedance from 100 to 1,000 ohms. Attenuation up to 40 db is available.

Allen Avionics, Inc., 255 E. 2nd St., Mineola, N.Y. 11502. [356]



Operations recorder uses heat writing

New heat-writing models of Event/Riter recorders are available. The heatwriting system provides a continuous, constant-width trace at all chart speeds. An electrically heated wire stylus and special heat-sensitive chart paper make up a convenient, trouble-free writing system. The instruments can be obtained with as many as 42 channels in both portable and flush-mounting styles. The pressure-priming ink system, which utilizes individual ink wells and as many as six different ink colors, is also available in all models.

Texas Instruments Inc., 3609 Buffalo Speedway, Houston, Texas. [357]

Solid-state squaring unit generates test signals

A solid-state squaring device, model 520, is used to generate test signals. Input is 1 to 3 v p-p of almost any waveform including sine waves, square waves and pulses, from d-c to 5 Mc. Output is 20-nsec rise time squared waveform of the same frequency and similar symmetry as the input. Amplitude

GUDEBROD BROS. SILK CO., INC.

FOUNDED IN 1870

Electronics Division

12 SOUTH 12TH STREET, PHILADELPHIA 7, PENNSYLVANIA



is adjustable from 0 to 2 v peak. Applications include wideband and pulse amplifier testing, as well as radio-frequency testing when the device is used as a harmonic generator. Price is \$21.

Crane Electronics Corp., 1401 Firestone Road, Santa Barbara Airport, Goleta, Calif. [358]

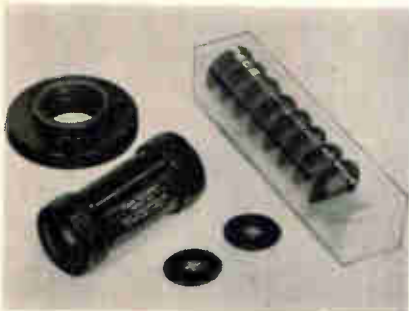

Accelerometer records magnitude of shock

A shock-recording accelerometer has been developed with ranges from 0-15 to 0-1,000 g. Incorporating a new damped seismic system to improve transient response, the model A12 records both positive and negative acceleration with accuracy of +10% of nominal range. Only 1½ in. in diameter and 2¾ in. long, its useful response range is approximately half its natural frequency which ranges from 40 cps on the 15-g range to 350 cps on the 1,000-g range. The unit operates reliably over an ambient temperature range of -30°F to +200°F. Major applications include recording shocks on containers of delicate instruments and equipment, missiles, aircraft landing gear and recovery parachutes. Pace Engineering Co., 13035 Satocoy St., N. Hollywood, Calif. [359]

LIGHTWEIGHT CHAMPION OF THE T-R RELAYS



Actual Size

TYPE RJ1A
2KV PK (16 MC)
7 AMPS RMS (16 MC)
1³/₁₆" LONG
ONE OZ.

Ounce for ounce the RJ1A controls more power than any other relay in the world. It will handle 2 KW average power into a 50 ohm load at VSWR 1:1 at 2 to 32 megacycles. And since it was designed for high volume production it offers the utmost economy.

The high strength vacuum dielectric guarantees a tremendous internal overvoltage safety factor — more than double the rated peak test voltage. Resistance is low (.010 ohms) and remains low and stable for the life of the relay.

The RJ1A is ideally suited for such applications as airborne, mobile, or marine communications systems for switching between antennas, antenna couplers or transmitters, or between transmitters and receivers. In sonar equipment they are being used as long life relays to switch 25 amp, 100 milliseconds pulses to transducers.

For higher power applications Jennings offers a complete line of vacuum transfer relays not much larger than the RJ1A. These relays are available in peak test voltages up to 38 KV Peak and continuous current ratings up to 75 amps RMS.

Write for more detailed information on the RJ1A and Jennings complete line of vacuum transfer relays.

RELIABILITY MEANS VACUUM | VACUUM MEANS

Jennings

JENNINGS RADIO MFG. CORP., 970 McLAUGHLIN AVE., SAN JOSE 8, CALIF., PHONE CYpress 2-4025

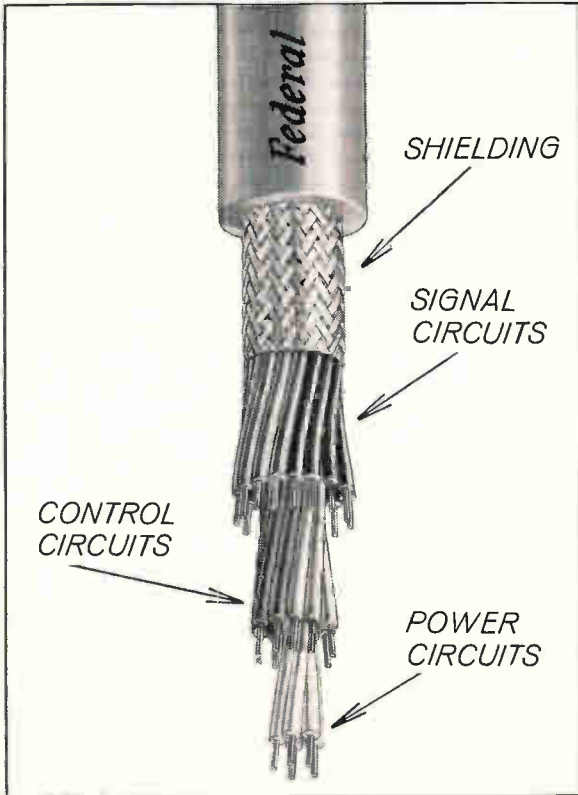

32 power, control & signal circuits in one Federal cable

This Federal multi-conductor cable will handle:

- 16 signal circuits
- 11 control circuits
- 5 power circuits

... all within one shielded jacket! This is a standard Federal cable available from stock.

Royal Electric has designed and built multi-conductor cables for a variety of applications ranging from office intercom systems to the vast BMEWS network.

For more information, contact your nearest Royal representative, or write Royal Electric Corporation, a subsidiary of International Telephone and Telegraph Corporation, Pawtucket, Rhode Island.

ITT ROYAL

Around the world ...

KYORITSU Measuring Instruments

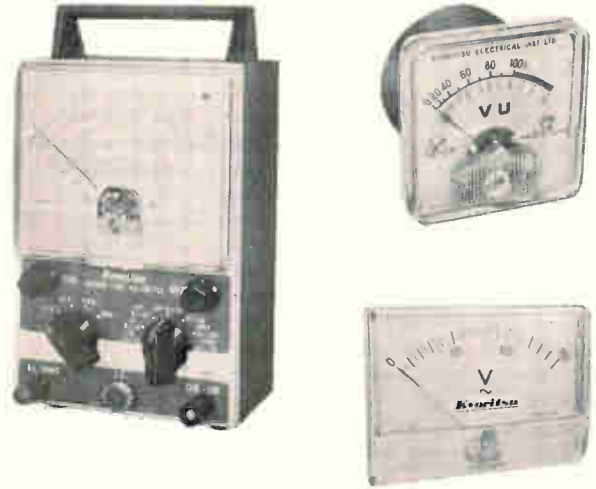

Kyoritsu

ELECTRICAL INSTRUMENTS WORKS, LTD.

120, Nakane-cho, Meguro-ku, Tokyo, Japan

Cable address: KYORITSUKEIKI TOKYO

Telex: TK 2849

Circle 203 on reader service card



*Induction Heating's Most
Trusted and Creative
Craftsmen Since 1926*

High Frequency INDUCTION HEATING UNITS

- | | |
|-----------------|-------------------|
| • BRAZING | • MELTING |
| • SOLDERING | • ZONE REFINING |
| • HEAT TREATING | • CRYSTAL GROWING |
| • BOMBARDING | • PLASMA TORCH |

ELECTRONIC TUBE GENERATORS

Kilocycle Frequency Units

Megacycle Frequency Units

Dual Frequency Units

- SPARK GAP CONVERTERS
- ACCESSORY EQUIPMENT

FREE APPLICATION ENGINEERING SERVICE—Our engineers will process your work samples and submit recommendations.

WRITE FOR NEW LEPEL CATALOG
Lepel HIGH FREQUENCY LABORATORIES, INC.

55th St. & 37th Ave., Woodside 77, N.Y.C.

Chicago Office for Sales & Service: 6246 W. NORTH AVE.

New Semiconductors

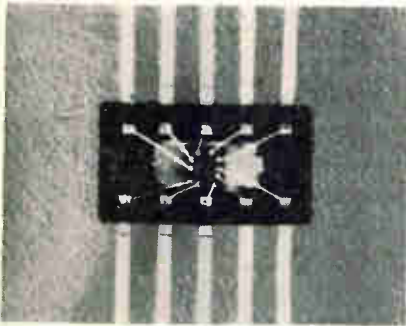

All-glass flat packs house Micrologic

Micrologic and Milliwatt Micrologic are now being offered in all-glass flat packs. The 9361 "black glass" package, developed by Corning Glass, is 145 mils wide, 265 mils long, and 50 mils thick after sealing. The packages have 10 leads, which are spaced on standard 50-mil centers. Each lead is 15 mils wide and 4 mils thick, and is fabricated from gold-clad No. 52 alloy lead material. To insure flat pack reliability, according to the manufacturer, the tested monolithic chip is attached to the bottom of the glass case by eutectic bonding techniques. Temperature stresses are avoided by hermetically sealing the lid and case at an oven temperature of 360°C, which is well below the eutectic temperature required to bond the chip to the case. Price per unit for Micrologic flat packs ranges between \$21.45 (PL 900, buffer) and \$46.48 (PL 905, half-shift register with inverter) in quantities of 100 to 999. For Milliwatt Micrologic flat packs, price per unit ranges between \$15.95 (PL911, four input gate) and \$43.55 (PL913, register) in quantities of 100 to 999.

Philco Corp., Microelectronics Operation, Lansdale Division, Lansdale, Pa. [331]

Silicon switches turn on at 69 nsec, off at 1.2 μsec

A line of pnpn, bistable, silicon switches feature turn-on speed of 60 nsec and turn-off of 1.2 μsec at 250 ma. The three-terminal devices

are designed for low-level triggering, such as cross-point matrix switching, core driving, digital information switching, pulse generators and memory elements. They are offered in both the TO-46 "pancake" and TO-51 microminiature coplanar packages, 100% production-tested for a true hermetic seal. Six types are available, with 20 μa or 200 μa gate sensitivity, in 15, 30 and 60 v.

Sylvania Electric Products, Inc., 100 Sylvan Rd., Woburn, Mass. 01801. [332]



Thermistors have positive coefficients

Two positive temperature-coefficient thermistors, types 802 and 834, switch or rapidly increase in resistance when their temperatures exceed a certain value. Five switching temperatures covering the range from 65°C to 155°C are available. A common use is to protect equipment from excessive temperature. When the design temperature exceeds a preselected level, the thermistor actuates a control circuit, which turns off the power and protects the equipment from overheating. The thermistor can be used to limit voltage and current or as a regulation device in electronic controls. It can also be used as small self-regulating heater. Dissipation constant for the 802 is 15 mw per degree centigrade at 25°C ambient with a maximum power dissipation at this temperature of 2 w and an insulation capability of 1,000 v. The 834 has a dissipation constant of 11 mw per degree centigrade with a maximum power dissipation at 25°C of 1½ w and an insulation capability of 600 v.

Westinghouse Semiconductor Division, Youngwood, Pa. [333]



Low-Noise High-Gain Amplifier



The PAR Model CR-4 Low-Noise Amplifier is designed for extremely small signal pre-amplifier applications and for use with PAR Lock-In Amplifiers to greatly extend their low level signal recovery capability.

The unit features:

- differential input
- high (50M) or low (20K) input impedance selectable by front panel switch
- 20 to 80 DB gain
- selectable bandpass 1 CPS to 300 KC
- long life Hg or rechargeable NiCd battery pack
- completely transistorized
- rugged printed circuit construction
- 6½" wide, 5" high, 8¾" deep
- easily panel mounted
- price without batteries: \$575.00
- also available; several optional features such as impedance matching input transformer and fast-recovery Model CR-4A with selectable bandpass from 10 CPS to 300 KC

Write for Bulletin No. 117 to:

PAR PRINCETON
APPLIED RESEARCH CORP.
Dept. D
Box 565, Princeton, New Jersey



SPECIFY TELEPHONE TYPE COMPONENTS BY Stromberg-Carlson

Thoroughly proved in telephone switching operations, Stromberg-Carlson components bring a new high in quality and reliability to many industrial applications.

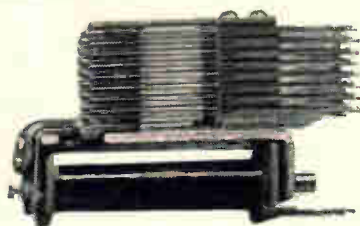

RELAYS Types A, B, BB, C and E. All standard spring combinations are available. Send for our Bulletin T-5000R3.

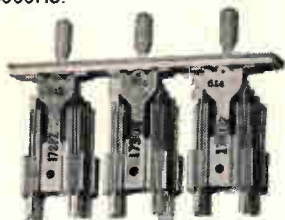

KEYS Broad selection of push-button, cam and twist types. Send for Bulletin T-5002R2.



HANDSETS High-efficiency models; standard or with switch assemblies. Send for Bulletin T-5017R.

Plus all other telephone switchboard components. For technical data on the full Stromberg-Carlson line, write to Industrial Sales Department.

STROMBERG-CARLSON
A DIVISION OF GENERAL DYNAMICS
114 CARLSON ROAD • ROCHESTER 3, N. Y.

New Subassemblies and Systems



All-silicon i-f amplifiers give video outputs

These all-silicon i-f amplifiers feature both video and high-power i-f outputs, and a new approach to gain control employing feedback. Provision for closed-loop age is built into the unit. Standard models are available with 30- to 120-Mc center frequencies and bandwidths to 20 Mc. A machined aluminum wrapper and a brass deck assembly are used in their construction. Materials and workmanship are of military grade throughout. The price for most standard units is \$325.

RHG Electronics Laboratory, Inc., 94 Milbar Blvd., Farmingdale, N.Y. [371]

Differential amplifier with low d-c drift

A new differential d-c amplifier designed for use in data acquisition systems is also suitable for test and measurement applications where bandwidth up to 1 kc is required. Features of model 855 are: self-contained design requiring no external power supply, use of solid-state components with no mechanical chopper, common mode voltage up to 500 v, and gain settings from 1 to 1,000 in seven fixed steps. D-c drift is low; settling time is short; input, output and chassis

are isolated. Gain accuracy can be calibrated to better than $\pm 0.05\%$, with stability of $\pm 0.02\%$ for 8 hours. Linearity is specified as $\pm 0.025\%$. Input resistance of 1 megohm does not vary as gain is changed; source impedance is 10,000 ohms max. Rated output full scale is ± 10 v or ± 10 ma whichever occurs first. D-c common mode rejection up to 160 db is obtained with optimum rejection selected with a polarity reversal switch. Price in quantity is approximately \$495.

Texas Instruments Inc., 3609 Buffalo Speedway, Houston, Tex. [372]



Data acquisition system operates rapidly

A multi-channel data acquisition system for thermocouple strain, and millivolt inputs, features speed and reliability. It is equipped with a 30-point relay scanner, a fully differential wide-band preamp with programable ranges and selectable filter, a solid-state high-speed a-d converter, and a 15-sec line printer. Specifications include $\pm 0.06\%$ system repeatability at 10 mv full scale, pinboard programming of gain and deletion, 140 db effective system common mode rejection at 60 cps and 1,000 megohms input impedance. Price of the 160-E1 Economy Systrac is \$11,700.

Systron-Donner Corp., 888 Galindo St., Concord, Calif. [373]

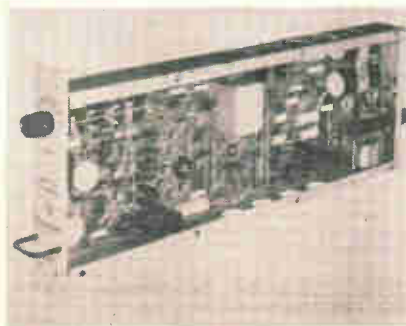



Preamplifiers cover wide dynamic range

Two r-f preamplifiers have been developed for use with existing or new receivers. The SP-130 covers 300 to 600 Mc with a max noise figure of 6 db (4.5 db typical) from -54°C to $+71^{\circ}\text{C}$. The SP-140 covers 300 to 1,000 Mc with a max noise figure of 8 db (5 db typical) over the same temperature range. The all-silicon design insures uniform characteristics over the temperature range and permits a gain variation specification of ± 2 db for the SP-130 and ± 2.5 db for the SP-140. Features include wide dynamic range, rugged encapsulated packaging, conformance to MIL-E-5400, Class II, and MIL-16400 environmental specifications and calculated mean-time-before-failure of over 250,000 hours. Total volume for each amplifier is 7.5 cu. in. including connectors, and weight is less than 4.5 oz.

Applied Technology Inc., 3410 Hillview Ave., Stanford Industrial Park, Palo Alto, Calif. 94304 [374]

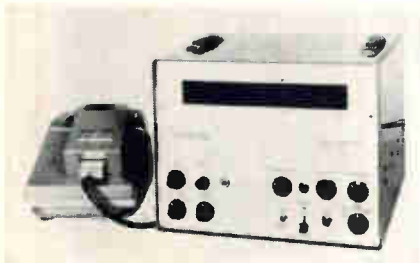

Digital integrator operates automatically

A solid-state electronic digital integrator, model CRS-11, is designed for use with a variety of analytical instrumentation such as gas chromatography, amino acid analysis and spectrophotometry. It features expanded dynamic range for fully unattended operation in a

NEW for Chirp RADAR SYSTEMS



PULSE COMPRESSION FILTERS

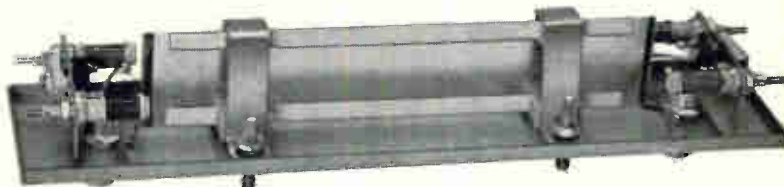

BREW 300 SERIES solid state dispersive delay lines are specifically designed for "chirp" radar systems. These units replace the complex circuitry of L-C filters and provide: maximum reliability through solid state media; increase in radar range; greater power utilization from output tube and maximum resolution of long duration pulses.

Designed to meet Mil requirements, these low cost light-weight filters provide compact high performance compression and expansion dispersive delay lines.

This series is available in a variety of standard units or may be custom designed to system requirements. Standard lines are available up to 5mc with band width to 2 mc and compression ratios up to 500/1. Typical size for a 5 mc filter is $2\frac{1}{4}'' \times 1'' \times 10''$.

For further information please contact:

BREW  **ELECTRONIC
DIVISION**
RICHARD D. BREW and COMPANY, INCORPORATED CONCORD, NEW HAMPSHIRE



how much should high reliability transformers cost?

The extra costs of Raytheon high reliability transformers can be and often are surprisingly small. Of course, should you require complete, quantitative, ultra-high reliability, then the program must be priced accordingly.

As a supplier of magnetic components for Minuteman and Apollo, Raytheon is eminently qualified to meet your most exacting specifications for high reliability transformers. If your budget or time requirements do not allow for a complete high reliability program, we can tailor a program that meets your reliability needs within your monetary and scheduling limitations. We can also assist you in establishing your own reliability specifications.



Full facts on Raytheon's High Reliability Program for its wide range of transformers are contained in a new eight-page brochure. Write or call for your free copy, Raytheon Company Magnetics Operation, Foundry Avenue, Waltham, Massachusetts 02154. Telephone 899-8400



New Subassemblies

wider range of applications. Input may come from any analyzer electrical output of 1 mv full scale or greater. Peak areas and retention times are visually displayed and printed in digital form. Proved solid-state, plug-in circuitry insures trouble-free operation. The CRS-11 is readily adaptable to process as well as laboratory operation. Computer-compatible output is available.

Infotronics Corp., 1401 S. Post Oak Road, Houston, Texas 77027. [375]

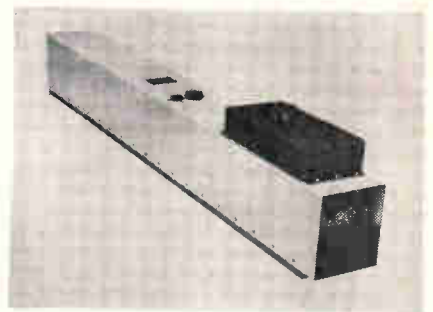

Helium-neon gas laser generates high power

A continuous-wave helium-neon gas laser, rated conservatively at 100 mw minimum c-w power output, can withstand shocks up to 10 g. Unlike most lasers of this type whose applications are confined to laboratory experimentation, the LG-10 can be incorporated into field systems in areas such as satellite tracking, long-range communications, target image surveying, high-speed photography, and the generation of radiation with ultra-stable frequencies. Only 57 in. long and weighing less than 50 lb, the laser uses two plasma discharge tubes optically coupled through a prism to produce a single high-intensity laser beam directed from one tube into a second parallel one. This makes it possible to generate the high-power output from the relatively compact laser. Model LG-10 is designed for optimum output at 6328 angstroms, but can produce coherent light at 1.15 or 3.39 microns with minor modifications. Price is under \$20,000. Raytheon Co., 130 Second Ave., Waltham, Mass. 02154. [376]

New Microwave



Spectrum analyzer draws only 40-w power

A portable microwave spectrum analyzer, weighing less than 35 lb., draws only 40 w of power as a direct result of its solid-state circuits and low-drain components. Model S-64 covers the frequency range of 10 Mc to 40 Gc. Employing a persistent 3½-in. square crt, the analyzer can display log (40 db), linear (26 db) or square law (13 db) as the dynamic range. Using triode cavity oscillators as I-o's—as opposed to the less stable klystron oscillators—f-m is less than 800 cps at C band, better at lower frequencies. The dispersion, or frequency width of display, is continuously variable between 10 kc and 5 Mc on one switch position, 1 Mc to 60 Mc on the other. Resolution bandwidth (3 db) of the S-64 is 1 kc to 100 kc, also variable. Sweep rate may be adjusted from below 1 cps to 100 cps. Price is \$4,980.

Pentrix Corp., 860 Shepherd Ave., Brooklyn, 11208. [391]



Rotary step twists cover broad band

A series of broad-band rotary step twists providing coverage throughout the full waveguide bandwidth is available in frequency ranges

from 8.2 to 40 Gc. Each unit is designed with segmented sections resulting in flat residual vswr (under 1.25) through its rotation, across any band in the frequency range, with an insertion loss of less than 0.1 db. Model 195 rotary step twist is used to change polarization in an antenna range system without uncoupling the system. To change 90° of polarization, it is necessary merely to loosen a thumbscrew, and rotate a knurled section 90°. The unit may also be used to scan a 90° sector by attaching a 90° elbow with a scanning device, loosening the thumbscrew, and manually rotating the scanner from 0° through 90°. A detent is provided at 45° for reference. Price range is from \$300 to \$400. Microwave Components and Systems Corp., 1001 S. Mountain Ave., Monrovia, Calif. [392]



Co-ax slotted section spans 2.0 to 12.4 Gc

Excellent electrical characteristics over the frequency range of 2.0 to 12.4 Gc are claimed for the N115A coaxial slotted section. The instrument is fitted with precision type N connectors and is designed for use with model Z116A universal carriage and model B200A tunable probe or B203A untuned probe. It is accurately machined from a solid block of aluminum alloy and carefully assembled to form a precision transmission line. Adjustable legs facilitate alignment with other test apparatus. Special precision type N connectors and a 0.100 in. wide terminally tapered slot reduce residual vswr to 1.04 at 2 to 8 Gc, 1.06 at 8 to 10 Gc and 1.1 at 10 to 12.4 Gc. Impedance is 50 ohms. In-

McLEAN

Presents

THE ULTIMATE IN PACKAGED COOLING

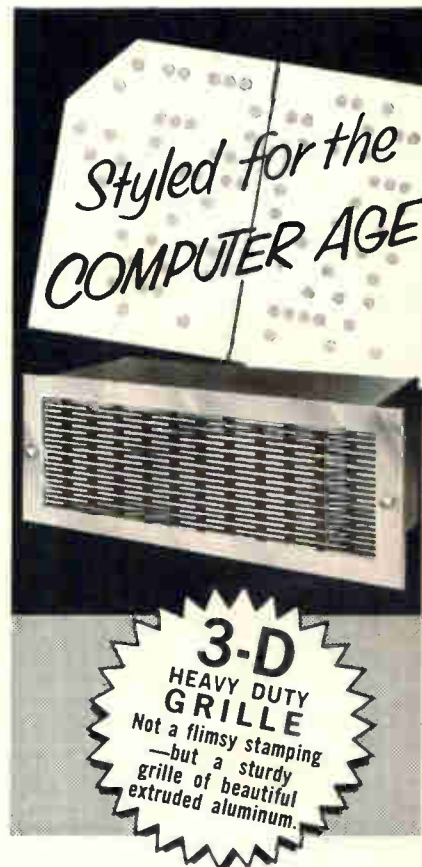

Filter element cannot be seen through grille . . . is deeply recessed for protection.

New "digital design" features sharp sculptured shadows for clean horizontal accents.

Fingertip accessibility to the filter. Filter may be easily removed without tools.

Brushed aluminum surface adds a high note of polished elegance.

Motors available with guaranteed life of 20,000 hours.

Over 100 models providing air deliveries from 150 to 1,000 CFM.

Panel sizes from 5¼" high to 10¾" high by 19" wide. Half size and special widths also available.



Send For
NEW
Illustrated
Brochure

McLEAN ENGINEERING LABORATORIES

P.O. Box 228, Princeton, New Jersey
Phone 609-799-0100 • TWX 609-799-0245
The Originator and Leader in Packaged Cooling
VISIT US AT THE WESCON SHOW, BOOTH 1841

THINGS ARE HAPPENING AT NCR, LOS ANGELES

A high-performance memory with a low price tag... space-saving philosophies in circuit design... dramatic acceleration in thin-film technology... this is the picture today at NCR Electronics Division.

At NCR you have opportunity in the present tense—opportunity to conceive, design and produce the digital systems that will bring business automation to 120 countries. Here is your chance to work with the men who created the NCR 315 system, the ROD memory, photochromic micro-image, the GRAM magnetic-card concept in random-access memories, the 420 Optical Journal Reader

—men responsible for many of the most advanced ideas in digital technology.

If you are stimulated by a creative atmosphere... if you can make original contributions in any of the areas listed on the opposite page... if you would like to combine a good living with the good Southern California life... investigate NCR now.



The National Cash Register Company
ELECTRONICS DIVISION
2815 W. El Segundo Blvd., Hawthorne, Calif.
Telephone: Area Code 213-757-5111
an equal-opportunity employer

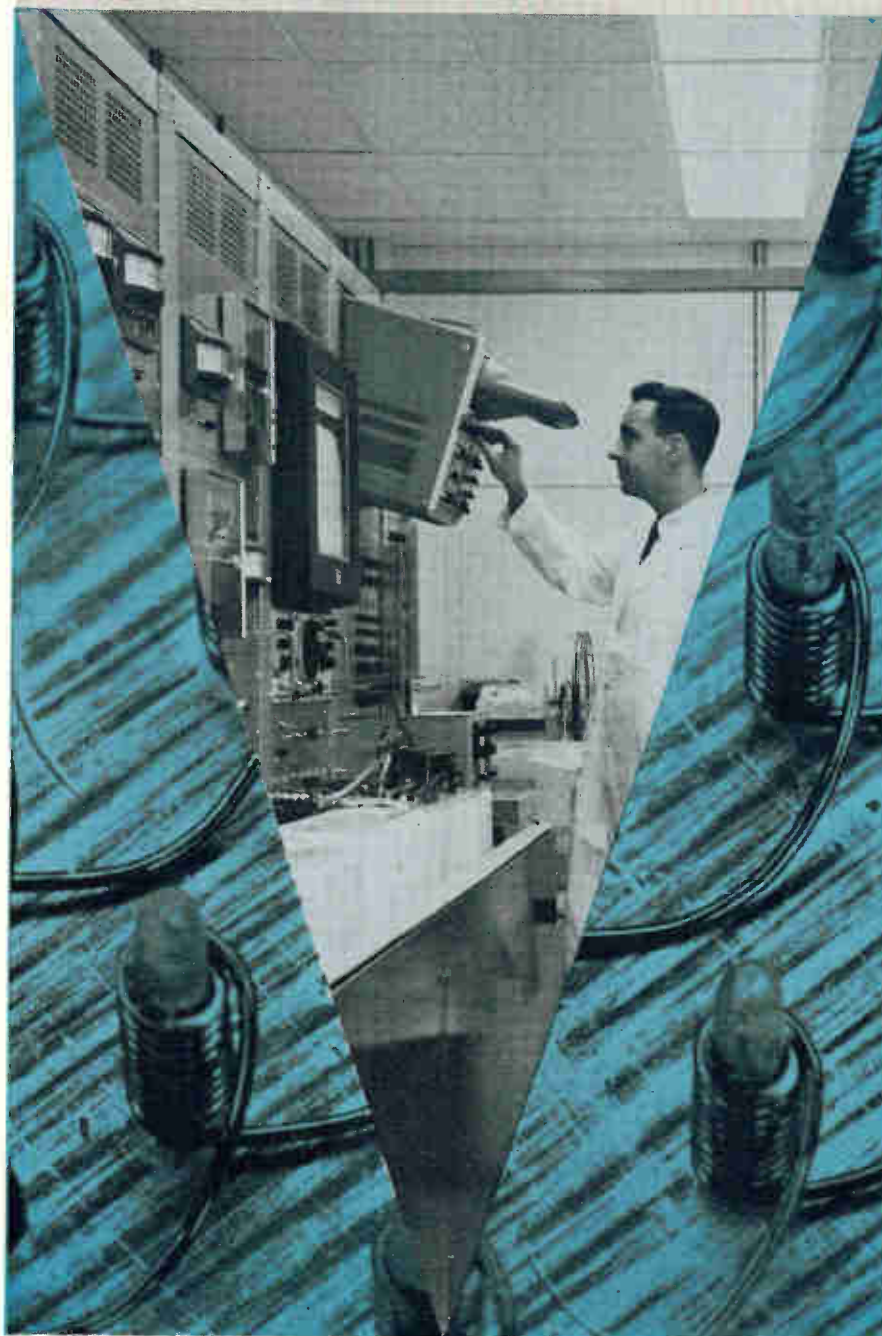

New Microwave

sertion length is $9\frac{1}{8}$ in. Price of model N115A is \$200
FXR, 25-15 50th St., Woodside, N.Y. 11377. [393]

Solid-state sources operate in X band

Two new X-band solid-state microwave signal sources are designed for use as local oscillators in radar equipment. The MS160 and MS170 are mechanically single-screw tunable in the 8.5 to 9.1 and the 9.0 to 9.6-Gc range respectively. Both are voltage tunable over a 1% bandwidth. The devices deliver 2 mw of output power minimum off a 25-v, 125-ma input with spurious harmonics at least 60 db down within the specified frequency bands. Frequency stability is 4 parts in 10^3 . Price is \$2,200 in 1-5 quantities.

Fairchild Semiconductor, 545 Whisman Road, Mountain View, Calif. [394]

Backward-wave oscillator is small and rugged

A volume of 13.5 cu. in., weight of 1.5 lb. and power consumption of less than 15 w make the SE-304 backward-wave oscillator ideal for airborne and space application in wide-band microwave systems. The tube can withstand severe shock and vibration without isolation mounting and requires no cooling for ambient temperatures up to 85°C. The delay line used is a precisely wound bifilar helix, whose dual r-f outputs are combined in a coaxial balun. A closely spaced hollow beam is employed for maximum efficiency. An oxide cathode is used, and under typical operations the current density is less than 200 ma/cm². A uniform focusing field is provided by a stabilized Alnico magnet and a precision-stacked field straightener. The straightener also reduces the tube's sensitivity to external transverse fields.

Stewart Engineering Co., subsidiary of Watkins-Johnson Co., Santa Cruz, Calif. [395]

New Production Equipment



Shearing tool removes integrated circuits

A precision shear for removing integrated circuits from carriers has been announced. The new hand tool progressively shears each lead to an exact, prescribed length. This progressive shearing, preferable to straight stamping, minimizes stress on component leads and glass seals. The tool utilizes a two-piece, precision-ground die and matching shear punch for efficient shearing and long life. Incorporated in the design is an extractor mechanism which gently removes the network from the die.

Texas Instruments Inc., P.O. Box 66027, Houston, Tex. 77006. [421]

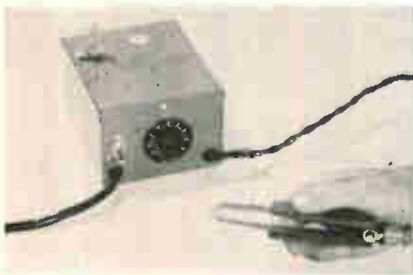

Thermal stripper handles small wires

A thermal wire stripper is available for use on the smallest-size wires and in extremely restricted space. Model G-1 Tiny-Therm features a miniature stripping head ($\frac{1}{8}$ in. by $\frac{1}{8}$ in.) at the stripping tip. Recommended stripping range is from No. 40 to No. 20 Awg. The handle weighs less than 2 oz. and is made of cork for cool and comfortable operation. Overall length is 6 in. Use of No. 20 Nichrome filament

wire reportedly permits extremely clean, smooth stripping with no nicks or cuts in the wire strand. The device strips plastic insulations from Teflon to low-melting vinyl materials.

Western Electronic Products Co., 107 Los Molinos, San Clemente, Calif. [422]



Laser metalworker for lab or production

Laser metalworking system model MW101 is available. Designed for either laboratory or production-line use, the compact, mobile console can readily perform such functions as microwelding, microperforating, micromachining, and microdrilling and grooving. The system offers provision for using any one of several available laser heads to obtain various output energies and pulse repetition rates, up to 1,500 joules and 50 pulses per sec. Location of both the laser head and the illuminating light directly over the work area make it possible to perform operations on both opaque and translucent materials. The optical equipment consists of an adjustable-intensity light source that can be focused to a bright spot anywhere in the control-free area. Water filters are available to remove the heat from the illuminating system, thus providing protection for sensitive materials. The laser beam itself is focused through a lens system to an intensely powerful spot

THINGS WILL HAPPEN FOR YOU AT NCR, LOS ANGELES

Look into these new openings for COMPUTER ENGINEERS

ADVANCED MECHANISMS SPECIALIST

Position will entail analysis and advanced design of complex mechanisms and applied mechanics problems. PhD preferred, with applicable experience. Should be equally skilled in mathematical analysis and laboratory measurements.

ADVANCED ELECTRONIC-MEMORY DESIGNER
Position entails design of word-select memories and memory circuits. Requires BSEE, MSEE desired, and at least 3 years' experience in the above-mentioned fields.

SYSTEMS/COMMUNICATIONS DESIGNER
This senior position will involve analysis and advanced design of on-line, real-time systems. Requires BSEE, MSEE desired, with good knowledge of digital computer technology.

ADVANCED MAGNETIC RECORDING SPECIALIST

Intermediate to senior engineer with BS degree, MS desired, with 3-4 years' experience in advanced magnetic recording techniques. Requires detailed knowledge of media, circuitry and magnetic head design.

PROGRAMMERS/SYSTEMS ANALYSTS

To design, specify and implement a general-purpose system-simulator program for the purpose of evaluating the design and performance characteristics of computer processors, peripherals and systems. AB degree or equivalent experience in math, business or related fields. Minimum of 3 years' experience in programming medium to large-scale computers. Experience should include coding in machine language. Prefer man experienced in simulator or compiler program development.

INTERMEDIATE AND JR. COMPUTER ENGINEERS

Experienced graduate EE's with 3 to 5 years in logic design and transistorized circuit design of digital equipment. Assignments will entail logic and circuit design of buffer storage units and digital peripheral equipment.

To arrange an interview, please send resume immediately, including training, experience and salary history, to Bill Holloway, Personnel Department, or telephone collect.

NCR

The National Cash Register Company
ELECTRONICS DIVISION
2815 W. El Segundo Blvd., Hawthorne, Calif.
Telephone: Area Code 213-757-5111
an equal-opportunity employer



NOW... high accuracy synchro/resolver testing

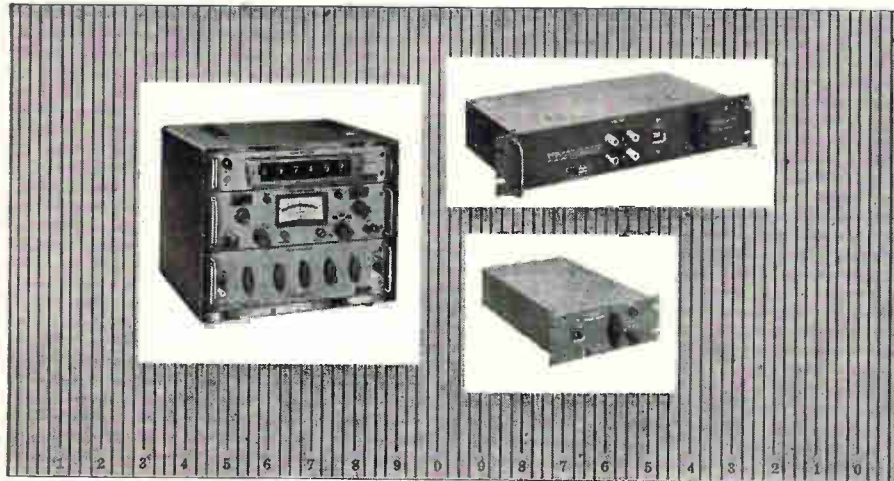

— GERTSCH STANDARDS AND BRIDGES REPLACE COSTLY ELECTRO-MECHANICAL METHODS

There is a Gertsch synchro or resolver instrument to meet virtually all requirements. Whether testing simple components or complete systems, you get accuracies up to 2 seconds-of-arc — accuracies maintained without constant checking and recalibration. These versatile units employ the same time-proven design techniques as Gertsch RatioTrans,[®] assuring high input impedance, low output impedance, and very low phase shift.

Minimum operator error. Angles are selected with positive detent knob — requires no critical adjustments. Direct-reading digital display reduces readout error.

Simplified circuitry — least susceptible to the effects of stray capacitance, pickup, loading.

Fewer accessories needed, hence less error from associated equipment.

Over 100 synchro/resolver test instruments are available from Gertsch — synchro standards, resolver standards, synchro bridges, resolver bridges. In addition to conventional, manually-operated units, all standards and bridges can be supplied as rotary solenoid, relay (programmable), and decade (.001° resolution) instruments.



Gertsch dividing heads (both manual and automatic), in combination with Gertsch phase angle voltmeters, provide complete checkout capabilities for AC rotating components.

Complete information on all Gertsch synchro/resolver test instruments is available. Write for bulletins on Synchro Bridges, Resolver Bridges, Synchro Standards, Resolver Standards, and/or Dividing Heads.



**THE SINGER COMPANY
METRICS DIVISION**

3211 S. La Cienega Blvd, Los Angeles, Calif. • Phone (213) 870-2761 • TWX 213-836-0466

Design and production of PANORAMIC • SENSITIVE RESEARCH • EMPIRE • GERTSCH instruments for measurement

New Production Equipment

that can attain peak power intensities of well over a million watts per sq cm. Standard magnification of the viewing system is 72 \times , but greater magnifications can be provided. There is provision for automatic water cooling of any laser head used. Safety devices automatically shut off the entire system should there be any failure in the provided water supply, thus protecting the valuable laser head. Another design feature is the integral compact power supply, suitable for servicing any head used.
Maser Optics, Inc., 89 Brighton Ave., Boston, Mass. 02134. [423]

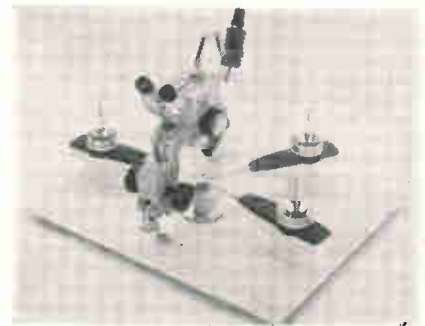

Probing test station for integrated circuits

A new series of probing micro-manipulators and test stations is designed for analytical testing of integrated circuits, thin-film circuits and individual semiconductor devices on laboratory or production scale. A true and accurate probe contact to areas as small as 0.0005 in. in diameter can be established almost instantly by means of a single joystick handle, reducing testing time to an absolute minimum. Probe pressures can be set-screw-adjusted over a continuous range of 2 to 200 grams, serving a wide variety of probing needs. Test station model D-400 incorporates 4 micromanipulators, integral sliding stage and a variable 20-80 power precision stereo-microscope. Other models feature from 2 to 8 individual test positions, while single manipulators are also available.

The Dumas Instrument Co., 2950 Baker St., Costa Mesa, Calif. [424]

New Materials

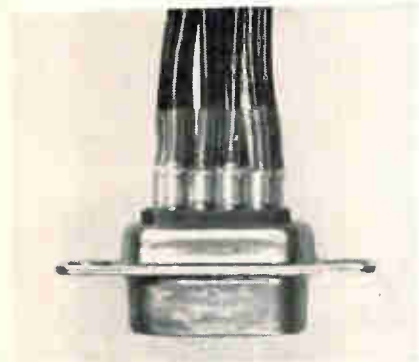

Fluoroplastic tubing shrinks to half size

A new irradiated expanded fluoroplastic tubing is available with elastic memory for heat-shrinking to half its original diameter. Called Thermofit Kynar, the tubing was designed primarily as a tough, flexible sleeve to relieve strain on soldered or welded electrical connections. It also provides excellent protection and insulation for delicate electronic components and heating-element connections. The basic ingredient is Kynar, a vinylidene fluoride resin. After extrusion, tubing is exposed to controlled-electron-beam (gamma) radiation to form a cross-linked, three-dimensional gel network. Irradiation strengthens the plastic material and permits it to retain its physical properties at high temperatures. The final step in production is expansion of the tubing to double its original diameter. In use, Thermofit Kynar shrinks at temperatures above 175°C with no danger of subsequent loosening or relaxation. It provides nearly 35% more transverse shrinkage at about half the curing temperature of other thermoplastic fluorocarbons. Pennsalt Chemicals Corp., 3 Penn Center, Philadelphia 2. [411]

Refractory materials for use as electrodes

Two new series of refractory metal composites have been tested and found to have superior cutting properties when used as electrodes

on electrical discharge machines. Wear rates are much less than for brass, copper-tungsten and other electrode materials. The new materials can be readily machined to close tolerances.

Rametco, Inc., P.O. Box 665, Clermont, Fla. [412]

Glass spheres are used as low-loss filler

Micron-sized hollow glass spheres used as a filler have a low-density, low electrical loss and low dielectric constant. The material has numerous aerospace applications as a high-temperature, low-weight resin filler. Applications include molding compounds, radomes, heat barriers, foams and casting resins.

Custom Materials, Inc., Alpha Industrial Park, Chelmsford, Mass. [413]



Microwave absorber made of flexible foam

New microwave absorber, Eccosorb HPY, is very lightweight polyurethane foam, in pyramidal shape, tapering to a sharp wedge tip. It is produced in 2-ft by 2-ft blocks, as a series of materials varying in thicknesses to achieve different low-frequency cutoffs in high performance. All thicknesses are perfectly flexible and capable of being mounted securely on surfaces of extreme radii of curvature. The recommended adhesive is Eccobond 87H. Reflectivity levels are maintained to at least 70 Gc and probably higher. Prices range from \$19.50 to \$50 per 2 ft-by-2 ft block depending on thickness. Emerson & Cuming, Inc., Canton, Mass. [414]

Manufacturing Quality Resistors under Rigid Reliability Control



Rohm

METAL FILM RESISTOR
CARBON

**TOYO
ELECTRONICS
INDUSTRY
CORPORATION**

P. O. BOX 103 CENTRAL
KYOTO, JAPAN



DO YOU PREFER SPECS TO SPECULATION? Here's a challenge from Interstate!

If you don't believe data sheet claims, ask for a demonstration ... make us prove our product.

At Interstate, we skip the fancy foot-work and weasel-wording. Here are the straight specs on our Series 450 Phase-Lock Tracking Filter that captures signals with S/N ratios to -38 DB. Compare its performance with that of any instrument of its kind. Then buy the one that stacks up best.

APPLICATIONS: Seeks out, captures, and locks on to signals in doppler phase-lock tracking / data signal recovery / frequency analysis / data frequency multipliers / telemetry data signal separation / instrumentation data systems.

SPECIFICATIONS:

Input Frequency Range: 100 cps to 120 kc
Tracking Bandwidth: 2.5, 5, 10, 25, 50 or 100 cps (selectable)
Input Signal Level: Approx. 1.0 V rms (signal plus noise)
Input Impedance: 10,000 ohms approx.
Output Signal Level: 1 V rms min.
Output Impedance: 500 ohms
Power Requirement: 105-125 or 210-250 V AC 50-400—75 watts or less (depending on options)
Dimensions: 19-inch rack mounted 17¼ inches deep excluding connectors and handles 5¼" high
Controls (standard): Sweep (time and rate). Set Frequency (coarse and fine). Bandwidth. Set/Acquire. Memory Out/In. Calibrate/AGC
Input Connectors: BNC Coaxial

Misc. Inputs: External Calibrate Freq. (0.1 V rms; 10,000 ohms); External Reference Freq. (0.1 V rms; 1000 ohms)
Internal Calibration Oscillator Freq: 10 kc (crystal osc).
Other Outputs (BNC Coax):
 Main Phase Detector Monitor: 0.5 V; 0.5 megohms
 Correlation Amplifier: -4 V @ 100%; 5000 ohms
 AGC Voltage: -8 V max.; less than 1 ohm. Output impedance with min. 10k load
 Reference Oscillator: 250 kc; 0.1 rms; 500 ohms
 VCO Frequency: 1 V rms; 500 ohms
 Phones: 2 V rms; 2000 ohms
 Correlation Relay: C-Type Contacts; AN Connector (mating connector supplied)
Front Panel Indicators:
 Frequency Meters: 0-120 kc, 0-24 kc
 Correlation Meter: 0-100%
 Set/Acquire Lights

For a copy of the full specifications, check the reader service card. Or ask about an in-person demonstration at your plant.

 **Interstate** ELECTRONICS CORPORATION
 707 EAST VERMONT AVENUE, ANAHEIM, CALIFORNIA
 Telephone 714-772-2222, TWX 714-776-0280
 A Subsidiary of Interstate Engineering Corporation Worldwide Representatives

New Literature

Wire taper. Possis Machine Corp., 825 Rhode Island Ave. South, Minneapolis, Minn., 55426. Model PWT-1 semiautomatic, bench-mounted wire taper is described in bulletin 6312HT. Circle 451 on reader service card

Silicon modules. Digital Equipment Corp., 146 Main St., Maynard, Mass. A 56-page brochure describes a new family of lower-cost, 10-Mc silicon circuit modules. [452]

Instrumentation. Electronic Associates, Inc., Long Branch, N.J. The first issue of an instrument-products newsletter called "Readout" is available. [453]

Potting and filling resin. Isochem Resins Co., 221 Oak St., Providence 9, R.I. A technical data bulletin fully describes Isochemrez 421, a low-cost, asphalt co-reacted potting and filling resin with excellent physical and chemical properties. [454]

Silicon diodes. National Transistor, 500 Broadway, Lawrence, Mass. Engineering bulletin C-101 describes a line of four-layer silicon diodes. [455]

Couplers. Microwave Development Laboratories, Inc., 87 Crescent Rd., Needham Hts., Mass. 02194. Bulletin CS-1 describes a line of sidewall multihole directional couplers. [456]

Pin and socket connectors. AMP, Inc., Harrisburg, Pa. An illustrated M-series catalog contains complete information on a line of pin-and-socket connectors with crimp, snap-in contacts. [457]

Semiconductor metals. Sigmund Cohn Corp., 121 S. Columbus Ave., Mt. Vernon, N.Y., has available a 16-page bulletin entitled "Metals and Alloys for Semiconductor Applications." [458]

Miniature switch. Cherry Electrical Products Corp., 1650 Old Deerfield Road, Highland Park, Ill. 60036. A catalog sheet describes a light-force, long-lever miniature switch, type E23-55H. [459]

Decade counter. Janus Control Corp., Hunt St., Newton, Mass., offers a technical data sheet describing model B100-2 high-speed decade counter that incorporates a latching storage readout feature. [460]

High-temperature compound. General Compounds Co., 6105 W. Washington Blvd., Culver City, Calif. A 4-page brochure describes GC-76, a high-temperature compound that eliminates locking and seizing of soldering tips. [461]

Isolated-output reference sources. Elcor, a division of Halliburton Co., 1225 W Broad St., Falls Church, Va. 22046. Bulletin 66-363 describes the A4R series of low-noise, isolated-output reference Isoplys. [462]

Circulators. Raytheon Special Microwave Devices Operation, 130 Second Ave., Waltham, Mass. An 8-page brochure describes high-power, differential phase-shift circulators. [463]

Digital computer. Packard Bell Computer, 2700 S. Fairview St., Santa Ana, Calif. 92704. A 4-page bulletin covers the PB440 digital computer with microprogrammed processor. [464]

Diode technology. Hughes Semiconductor Division, Newport Beach, Calif. A 6-page folder features a microglass diode, the first in a series of glass-ambient diffused-junction devices. [465]

Data systems. Epsco, Inc., Data System Products Division, 411 Providence Highway, Westwood, Mass. A well-illustrated bulletin discusses the company's facilities for the manufacture of data system products. [466]

Analog-to-digital converters. NP Laboratories, P.O. Box 226, Roselle, N.J. Technical data sheet GAD-200 describes a series of 10-bit and 12-bit a-d converters with conversion speeds of 1 μ sec per bit. [467]

Sampling oscilloscope. General Applied Science Laboratories, Inc., Stewart & Merrick Aves., Westbury, L.I., N.Y. An 8-page catalog describes the Lumatron model 120A high-speed sampling oscilloscope. [468]

Digital solar aspect systems. Adcole Corp., 330 Bear Hill Road, Waltham, Mass., 02154, has available a 16-page brochure on digital solar aspect systems. [469]

Cavity wavemeters. DeMornay-Bonardi, division of Datapulse Inc., 780 So. Arroyo Parkway, Pasadena, Calif. Direct-reading and micrometer-head cavity wavemeters for 2.6 to 140 Gc are discussed in a technical bulletin. [470]

Compact converters. Astrosystems Inc., 521 Homestead Ave., Mount Vernon, N.Y. A 4-page brochure covers compact and highly accurate synchro-and-resolver-to-digital converters. [471]

Incremental tape transport. Potter Instrument Co., Inc., 151 Sunnyside Blvd., Plainview, N.Y. A brochure describes an incremental tape transport that provides both writing and reading capability in a 300 character-per-second incremental feed mode using an IBM tape format. [472]

High-environmental tape recorders. Leach Corp., 1123 Wilshire Blvd., Los Angeles 17, Calif. Technical data brochure HETR-364 covers a broad product line of miniature, high-environmental tape recorders. [473]

Clutches and brakes. Vibrac Corp., Alpha Industrial Park, Route 129, Chelmsford, Mass. Catalog 20 covers a line of magnetic dry particle clutches and brakes for precision instruments and servo systems. [474]

TALENT

You'll find lots of it at Space Craft, Inc. Want proof? In the last two years alone our organization has made important contributions to all of these important space vehicle and spacecraft programs: SATURN I, SATURN I-B, SATURN V, TITAN III, CENTAUR, ATLAS AGENA, ATLAS MERCURY, RIFT, LANCE, JAVELIN, AMRAD, EOGO, OSO, IMP, MARINER B. ARIEL, FR-1, SAN MARCOS, MIM, INJUN, SERT, EXPLORER and the SATURN SATELLITES. Just one more point. In addition to talent, Space Craft employs generous amounts of creativity, experience, modern equipment and old-fashioned sweat on all of its programs. Need help solving some of your knottier problems? Your communication will bring us running.



Astrionics Division
Space Craft, Inc.
8620 S. MEMORIAL PARKWAY, HUNTSVILLE, ALABAMA

Circle 205 on reader service card

TR MICRO TV TUNER

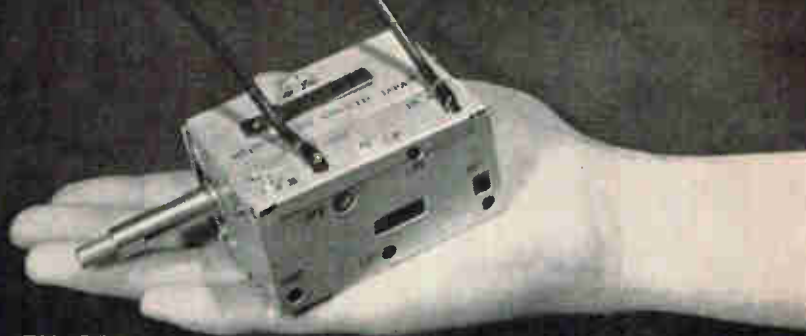

MODEL TU-15U

This MICRO TV TUNER, using 3 transistors, provides you with excellent performance while keeping high quality stability, thanks to our latest technical advancement. Spurious radiation meets the requirements of FCC and is guaranteed for performance of more than 40,000 operations. We also offer you many other lines of components for your use. Please write us asking for catalogs available on the following products:

Main Products
Polyvaricon, IF Transformers, Oscillator Coils, Antenna Coils, Variable Resistors, FM Tuners, TV Tuners, Micro-motors, Sockets.



MITSUMI ELECTRIC CO., LTD.

Head Office Komae, Kitatama, Tokyo, Japan.
New York Office 11 Broadway, New York 4, N.Y., U.S.A.

SPHINX MICRO-DRILLS

A complete stock of these Swiss-made micro-drills, known the world over as the standard of quality for high-precision instrument work, is maintained by Louis Levin & Son, Inc. For complete information, write for Catalog 62.

VARIOUS TYPES FOR IMMEDIATE DELIVERY

TYPE	RANGE OF SIZES
Straight shank	0.15-1.0 mm
Spirec pivot, right hand	0.10-3.0 mm
Spirec pivot, left hand	0.10-1.0 mm
Flat pivot	0.04-1.0 mm
Spirec center	0.10-0.7 mm
Other sizes and styles available on special request.	



LEVIN PRECISION COLLETS

Quality is never compromised in the making of Levin collets, made of the finest tool steel by highly skilled craftsmen. All stand-



ard dimensions are available from 0.0039 to 1 inch. For complete information, write for Catalog U.

LEVIN

LOUIS LEVIN & SON, INC., 3573 Hayden Avenue, Culver City, California, (213) UP 0-9555.

Exclusive Dealers: Russell-Molbrook & Henderson, Inc., New York and Los Angeles / Industrial Tool & Supply Co., San Jose / Marshall Tool & Supply Corp., Los Angeles / Royal-Tschantre, Baltimore / Morton L. Friedman Co., Chicago / Plus dealers in all important industrial centers



INSTRUMENT LATHE



MICRO-DRILL



TURRET LATHE



RADIUS TURNING



PRECISION COLLETS



PRECISION DRILL

Circle 206 on reader service card

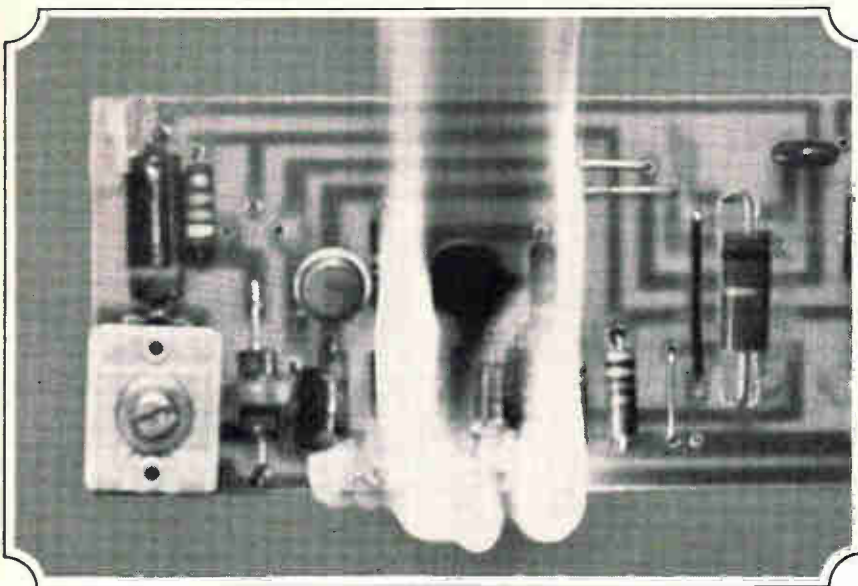

PREVENTION IS A HYPERSENSOR

HYPERSENSORS, "NANOSECOND FUSES," PREVENT COSTLY TRANSISTOR BURN-OUTS.

Save a transistor; save a circuit; save a computer; save a mission. Solid state Hypersensors react in time to prevent transistor burnout... in nano-seconds... and they can be reset over and over again with application of only 12 V. Standard units, TO-18 transistor size, rated 10 to 300 ma, available from stock. Subminiature, axial lead Hypersensors made to order. For information, write or phone, 1100-1 E. Ash Ave., Fullerton, California, 92631. Phone: 871-1930 (714)

QUALTRONICS CORPORATION

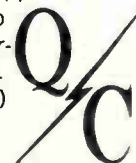

NEW

Packed with more important data than ever before... the 1964-65 issue of **Electronics Buyers' Guide**. Four great major sections: Product Listings; Product Advertising; Index of Electronics Manufacturers; Government, Other Agencies and Technical Services.

USED

Week in, week out, EBG is the industry's standard catalog-directory... a necessary working tool for the men who buy and the men who sell components, equipment, systems, materials and services.

Electronics Buyers' Guide

A McGraw-Hill Publication
330 West 42nd Street,
New York, N.Y. 10036

New Books

Engineering reference

Thesaurus of Engineering Terms
Engineers' Joint Council
1964, 302 pp., \$15.

Intended primarily as a vocabulary reference for indexing and retrieving engineering literature, this volume is the result of 18 months' efforts, involving ten review committees comprising 130 engineers and other scientists. There are 10,515 main terms and their cross-reference relationships, totalling over 80,000 entries.

The value of the thesaurus should be considerable, mainly as a basis for a standardized system of indexing and retrieval of the rapidly expanding volume of technical information. The Engineers' Joint Council undertook its development as part of a broad plan to improve the efficiency of technical information flow, with the ultimate objective of developing an engineering information center and communications network.

The volume's preface suggests its use by authors of technical articles as an aid in selecting more meaningful terms for titles, as keywords for indexing, for abstracts, and for concepts discussed in their articles. Such use of the preferred terms in article titling and indexing would indeed make information retrieval much easier than it is at present.

Under each entry, which may be a word or complex technical expression, the volume gives a note of its scope, a definition or a limitation of its meaning or usage, then lists related expressions and identifies each as either a broader-term reference that covers a class of concepts, or a narrower-term reference covering a subclass, or as preferred synonyms and related terms.

The thesaurus could thus be used to find a better word for a term, or to locate the word under which relevant literature is likely to be found, or even to learn whether a specific term refers to a general class or a narrow subclass of concepts.

Although all fields of engineering are covered, electronics and its related fields, including engineering optics, computer technology and

applied physics appear to be indexed with sufficient accuracy to locate the narrow specialties encountered today.

A discussion of the way in which terms were selected and how they can be used for various indexing procedures is included, as is a general description of the council's action plan and its principal objectives.

George V. Novotny
Advanced Technology Editor

Digital circuitry

Modern Digital Circuits
Samuel Weber, editor
McGraw-Hill, Inc., New York
1964, 355 pp., \$9.50

In his introduction to this volume, the senior technical editor of Electronics discusses the versatility of digital-type circuits. Their use has gone far beyond computer applications; they are now performing in a variety of functions such as communications, instrumentation and industrial controls.

The book is arranged in nine chapters; six of these are concerned with basic digital functions: counting, storage, conversion, switching and so on. The final chapters discuss specific applications.

The value of this collection is its presentation of design ideas that work, the product of the experience of many knowledgeable engineers who have contributed to Electronics. Emphasis was placed on articles which discussed design considerations in selecting material for this volume. Thus, as a general rule, the reader is shown how to vary a circuit under discussion so that he may custom tailor it for his own particular application.

The 109 articles are indexed. The book also has a unique method of presenting errata and providing additional background information on the material included. This is done through a short section of letters from Electronics' readers pertinent to the circuit articles included in the collection.

Computer-circuit designers and other digital circuit design engineers will find this collection a useful, up-to-date tool.

Jerome Eimbinder
Circuit Design Editor

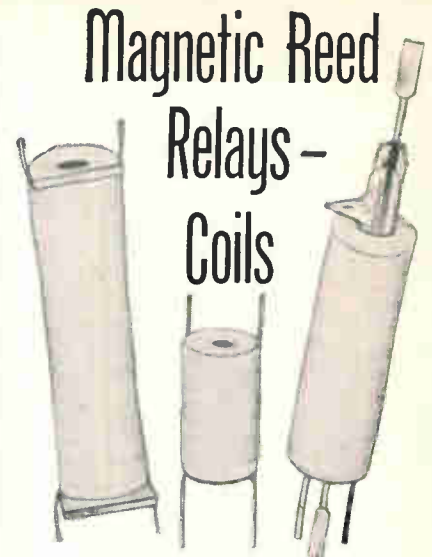

Basic and special REED RELAYS and/or COILS for high reliability and sophisticated switching.

Operating Inputs: low as 1mA. and 15mW.
Standard Coil Voltages: 6, 12, 24, 32, 48V in stock for immediate delivery.

Special Voltage or Resistance, multiple windings for flip flop, memory and crosspoint selection applications -- to customer specifications.

New Type SP Coils: for high voltage vacuum-type reeds, 1 1/4" lg.

Standard Coil Termination: 3" flexible leads. Also available with solid copper leads, printed circuit pins and rigid lugs -- silver plated or tinned.

Relay Contacts in Form A, B, C and latching.

Coto-Coil Write for Prices
COMPANY, INC.
65 Pavilion Ave.
Providence, R. I. 02905
Circle 207 on reader service card

Primo
MICROPHONES

A complete line of microphone cartridges and units for the OE market

Types:
* Velocity * Uni-Directional
* Dynamic * Crystal * Magnetic
* Condenser * etc.

For catalog write to:
PRIMO CO., LTD.
2043 MURE, MITAKASHI,
TOKYO, JAPAN

THERMOCOUPLE AMPLIFIER



MODEL 190

for

- RECORDER PREAMPLIFIERS
- OVEN CONTROLS
- GLASS FURNACES
- BEARING MONITORS
- METER PREAMPLIFIERS
- DC SHUNT AMPLIFIER

A new concept in solid-state DC amplifiers; no tubes, no transistors, no choppers. Typical gains 4000, $\pm 5 \mu\text{v}$ null stability; ten-year life. Price only \$84.00; quantity discounts, immediate delivery.

Request Technical Bulletin No. 19....



acromag

ACROMAG

INCORPORATED

15360 TELEGRAPH ROAD DETROIT, MICHIGAN, 48239
TELEPHONE (313) 538-4242 TELETYPE 313-538-4536

Circle 208 on reader service card

Technical Abstracts

Microprocessing

Electron- and laser-beam processing. Susumu Namba and Pil Hyon Kim, Institute of Physical and Chemical Research, Komagome Bunkyo-ku, Tokyo.

By drilling holes in various materials, the authors compared electron-beam and laser-beam equipment for welding and drilling in the manufacture of microelectronic circuits.

Advantages of lasers over electron beams were found to be: 1) simpler apparatus, because a vacuum is not needed; 2) reduced thermal loss by conduction; 3) shallower penetration allowing surface processing to be made in any desirable atmosphere.

Disadvantages were: 1) larger minimum spot obtainable than with the electron beam; 2) low power efficiency when the laser beam was used on highly transmissive or highly reflective materials; 3) impossibility of continuous processing or continuous output of high energy density; 4) difficulty of controlling the output intensity and beam direction of a laser.

In addition, drilling with a laser beam is easier than welding with it because of the high peak energy and the spiked pulse of the laser beam.

The electron-beam micromachining apparatus consists of an electron-beam chamber and a machining chamber, both evacuated to 10^{-5} millimeters of mercury. The beam is radiated from a tungsten hairpin filament of 0.2 mm diameter, and accelerated by 50 kilovolts. The intensity is controlled by the bias potential on a control grid. Two pairs of electrostatic deflectors adjust the spot position on the material that is on a movable carriage in the machining chamber.

The laser-beam micromachining apparatus consists of a 15-centimeter-long ruby rod 8 millimeters in diameter. The ends of the rod are coated with a dielectric multi-layer film that is fully opaque at one end and about 40% transmitting at the other. The ruby rod is supported inside two helical xenon

WHERE **QUALITY**
COMES FIRST

NCC

RELIABLE CAPACITORS

MYLAR FILM CAPACITOR



Type MFL (dipped flat type)



Type PMX (encased type)



Type PSM (encased type)

POLYSTYRENE FILM CAPACITOR



Type SFL

SOLID TANTALUM CAPACITOR



MIL-C-26655

Type TAX

MATSUO ELECTRIC CO., LTD.

HEAD OFFICE : 3-5, 3-CHOME, SENNARI-CHO, TOYONAKA-SHI, OSAKA, JAPAN.

TOKYO OFFICE : 25, 2-CHOME, KANDA AWAJI-CHO, CHIYODA-KU, TOKYO.

Cable Address "NCC MATSUO" OSAKA

flash tubes that are enclosed in an aluminum cylinder and cooled by compressed air. A capacitor, consisting of two 500-microfarad units, supplies the flash tubes with energy, and duration of their simultaneous flashes is controlled by varying the time constant of the discharge network. The trigger pulse that discharges the capacitor is suppressed whenever the reflector is used to view the material through the built-in microscope. The maximum input energy is 12.-500 joules. The laser beam is focused on the material by a lens with a focal length of 30 millimeters. The material can be moved independently in the x, y and z directions.

Presented at the Sixth Electron Beam Symposium, April 27-28, Boston.

Vlf transmission

Lf/vlf transmitter power requirements for global-range communication systems. H.F. Tolles and W. Koppl, The Martin Co., Denver.

Calculations of vertical field intensities at long ranges show the importance of choosing an optimum frequency for the particular application to global communications. Space wave communications in a bent waveguide mode between earth surface and the D layer can be calculated for frequencies up to 100 kc without appreciable error. For distances in excess of 1,200 miles the first order mode will predominate, simplifying the resulting expression for field intensity.

It is concluded that the optimum long range r-f carrier is 19 kc when only propagation losses are considered. The ideal frequency lies between 30 and 100 kc when atmospheric noise level is added to propagation losses. The optimum long-range frequency is somewhat higher than 100 kc when the effect of short antenna efficiencies is included. Interference from external sources will force the frequency as high as possible, consistent with permissible first-order-mode boundary losses.

Presented at IEEE-University of Pennsylvania Globecom VI, June 2-4, Philadelphia.

Unusual stability

in miniature, surface-mounted platinum temperature sensors

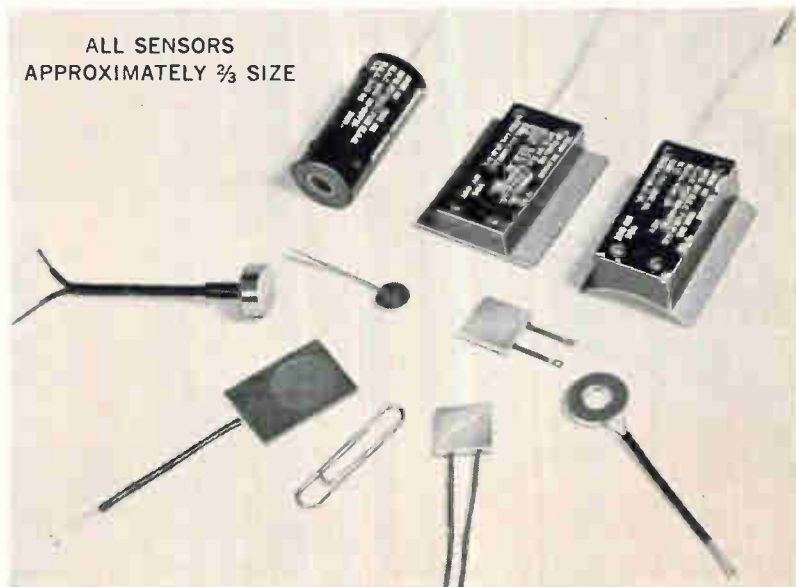

ALL SENSORS
APPROXIMATELY 2/3 SIZE

Performance is excellent for such small sensors in the REC line of miniature surface sensors. Range covered is from -435°F. to $+1800^{\circ}\text{F.}$ Repeatability after 10 consecutive shocks from liquid nitrogen at -320°F. to silicon oil at 300°F. is within $\pm 0.1^{\circ}\text{F.}$

The easily attached sensors can be cemented, spot welded or clamped to surfaces. Cylindrical models fit around standard small pipe sizes.

REC surface sensors have elements of highest purity platinum wire, fully annealed and mounted so that the resistance wire is well isolated from any strain in the surface. Outer cases are platinum, stainless steel, epoxy compounds, or ceramic, depending on the model. Some have interchangeable bridge networks to provide a choice of temperature-voltage relationships.

For more details, write for Bulletin 9625, Platinum Resistance Surface Temperature Sensors.

A complete precision line

Rosemount Engineering Company designs and manufactures high quality precision equipment in these lines:

- | | |
|--|--|
| Air data sensors | Surface temperature sensors |
| Total temperature | Pressure sensors |
| Pitot-static tubes (de-iced) | Accessory equipment and aeronautical research |
| Immersion temperature sensors (including cryogenic) | |

For more information please write for the REC catalog. Specific questions on any temperature or pressure problems are welcomed.



**ROSEMOUNT
ENGINEERING
COMPANY**

4900 West 78th Street • Minneapolis 24, Minn.

SPECIALISTS IN TEMPERATURE & PRESSURE MEASUREMENT



CALENDAR COUNT-DOWN

Every working day at the Western Center of Motorola's Military Electronics Division advances the state-of-the-art in our nation's aerospace telecommunications. One of many exciting breakthroughs achieved by Motorola engineers is the Unified S-Band System — which uses a single transmitter/receiver and carrier frequency for tracking, rendezvous, command, data transfer, telemetry, and voice link. Result: a reduction of one half in size, two thirds in weight, and three fourths in power required — a technological advancement which will play a key role in bringing NASA's Apollo program to successful fulfillment at the earliest possible date.

Motorola offers excellent opportunities to engineers and space scientists of demonstrated capability. *Specific opportunities are:*

Antennas & Propagation
Solid State R.F.
Microwave Techniques
Missile & Space
Instrumentation
Operational Support Equipment
Integrated Circuitry

Reliability Analysis
Parts Reliability
Reliability Program Coordination
Data Acquisition, Processing &
Display
CW Transponders
Radar and Radar Transponders

Guidance & Navigation
Command & Control
Space Communications
Signal Processing
ECM, CCM &
Surveillance
Tracking & Telemetry

Contact Phil Nienstedt, Manager of Recruitment, Department 657

MOTOROLA



in PHOENIX

Military Electronics Division • Western Center • P.O. Box 1417, Scottsdale, Arizona
MOTOROLA ALSO OFFERS OPPORTUNITIES AT CHICAGO, ILLINOIS — AN EQUAL OPPORTUNITY EMPLOYER

EMPLOYMENT OPPORTUNITIES



The advertisements in this section include all employment opportunities — executive, management, technical, selling, office, skilled, manual, etc.

Look in the forward section of the magazine for additional Employment Opportunities advertising.

— RATES —

DISPLAYED: The advertising rate is \$52.00 per inch for all advertising appearing on other than a contract basis. Contract rates quoted on request.

An advertising inch is measured $\frac{3}{8}$ " vertically on a column—3 columns—30 inches to a page.

Subject to Agency Commission.

UNDISPLAYED: \$2.70 per line, minimum 3 lines. To figure advance payment count 5 average words as a line.

Box numbers—count as 1 line.

Discount of 10% if full payment is made in advance for 4 consecutive insertions.

Not subject to Agency Commission.

ELECTRONIC ENGINEERS

New Opportunities at
Texas Instruments in Massachusetts

Metals & Controls, Inc., nationally known manufacturer of precision electromechanical controls, now has challenging openings for two electronic design engineers. These men will develop new solid state controls for applications in the appliance, electric motor, electronic and aerospace industries. Both positions offer project-type responsibility ranging from customer applications to manufacturing problems. Applications should have a BS or MS in electrical engineering and 2-4 years' experience, preferably in the design of low frequency or power-type circuits. Salary commensurate with experience. Outstanding TI benefits. For additional information call collect to Mr. C. Flanagan, Mgr., Precision Controls Engineering, at 617-222-2800, or write, sending confidential letter or resume, to Mr. T. M. Fowler, Director of Salaried Employment. Inquiries will receive immediate attention.

METALS & CONTROLS INC.

34 Forest Street, Attleboro, Mass.

A CORPORATE DIVISION OF

TEXAS INSTRUMENTS

INCORPORATED

An equal opportunity employer

ADDRESS BOX NO. REPLIES TO: Box No.

Classified Adv. Div. of this publication.

Send to office nearest you.

NEW YORK, N. Y. 10036: P. O. Box 12

CHICAGO, Ill. 60611: 645 N. Michigan Ave.

SAN FRANCISCO, Cal. 94111: 255 California St.

Electronic and Electro/Mechanical Technicians, designers, checkers, draftsmen and detailers—Work for leading firm of licensed professional Engineers. Write to United Engineers, 150 Causeway Street, Boston 14, Mass.

CLASSIFIED **SEARCHLIGHT SECTION** ADVERTISING
 BUSINESS OPPORTUNITIES EQUIPMENT - USED or RESALE

DISPLAYED RATE

The advertising rate is \$27.25 per inch for advertising appearing on other than a contract basic. Contract rates quoted on request. AN ADVERTISING INCH is measured 7/8 inch vertically on one column, 3 columns—30 inches—to a page. EQUIPMENT WANTED or FOR SALE ADVERTISEMENTS acceptable only in Displayed Style.

UNDISPLAYED RATE

\$2.70 a line, minimum 3 lines. To figure advance payment count 5 average words as a line. BOX NUMBERS count as one line additional in undisplayed ads. DISCOUNT of 10% if full payment is made in advance for four consecutive insertions of undisplayed ads (not including proposals.)

Send NEW ADS or inquiries to Classified Adv. Div. of Electronics P. O. Box 12, N. Y., N. Y. 10036

EMPLOYMENT

for all employment advertising including Positions Vacant or Wanted and Selling Opportunities Offered or Wanted.

SEARCHLIGHT

A national medium for Surplus New or Used Equipment and other Business Opportunities

PROFESSIONAL SERVICES

A dignified method for Specialized skills and services

Benefit yourself

by using these sections

Most useful to the advertiser

Most useful to the reader

For Rates and Information Write:

ELECTRONICS

Class. Adv. Div.,
 P. O. Box 12, N. Y., N. Y. 10036

OVER 2,000,000
RELAYS
 IN STOCK!

Send for Catalog 55
Universal RELAY CORP.
 42 WHITE ST., N.Y. 13, N.Y. • WALKER 5-6900

CIRCLE 952 ON READER SERVICE CARD

FOR SALE

1,000 Burroughs Beam Switching Tubes
 Type 6700
 Price \$16 each. Save over \$8 per tube.
 Price for quantities under 100 to be negotiated.
 For information write
FN-4742, Electronics
 265 California St., San Francisco, Calif.
 94111

CIRCLE 953 ON READER SERVICE CARD

Antique

TELEPHONES

As is complete, decorative purpose \$17.50. Working order, inter-comm. \$19.50 Ext. on dial \$24.50, talking circuit only. Write for complete list. All shipments FOB, Simpson, Pa.
TELEPHONE ENGINEERING CO.
 Dept. E-7274, Simpson, Pa.



CIRCLE 954 ON READER SERVICE CARD

RADAR AUTO-TRACK & TELEMETRY ANTENNA PEDESTALS 3 & 10 CM. SCR 584 AUTOTRACK RADARS. M-33 RADAR TPS-10 SEARCH. APS-45 TPS-10D HT. FINDERS. WX RADARS. FPN-32GCA. APS 10 APS-15B APS-27 (AMTI) SEARCH. ■ ■ ■ APN-102 DOPPLER. DOZENS MORE. CARCINOTRONS. PFNS. .25-5-1-2-3-6 MEGAWATT PULSE MODULATORS. CAVITIES. PULSE TRANSFORMERS. IF STRIPS. WAVEGUIDE. BENDS 200 MC. 1 KMC. 3 KMC. 6 KMC. 9 KMC. 24 KMC. RF PKGS.

RADIO RESEARCH INSTRUMENT CO.
 550 5TH AVE., NEW YORK 36, N. Y. JU 6-4691

CIRCLE 955 ON READER SERVICE CARD

An
Investment!

Productive advertising is an INVESTMENT rather than an EXPENDITURE.

"Searchlight" advertisers invariably report prompt and satisfactory results.

BE CONVINCED — send us your advertisement TODAY.

Address
 Classified Advertising Division

Electronics

P. O. BOX 12, N. Y., N. Y. 10036

V.I.S* SERVICE

FASTEST TO
BOTH COASTS



FOR YOUR
***VERY IMPORTANT SHIPMENTS**

2nd DAY
 between Chicago—
 Milwaukee and
 Eastern Terminals

4th DAY
 between Chicago—
 Milwaukee and West Coast

**LIFSCHULTZ
 FAST FREIGHT**

NEW YORK — CHICAGO — PHILADELPHIA — BOSTON
 HOLYOKE — BALTIMORE — BLOOMFIELD, N. J.
 NEW HAVEN — PROVIDENCE — MILWAUKEE
 LOS ANGELES — SAN FRANCISCO

CIRCLE 950 ON READER SERVICE CARD

*Why Can't
 You Remember?*

A noted publisher in Chicago reports there is a simple technique for acquiring a powerful memory which can pay you real dividends in both business and social advancement and works like magic to give you added poise, necessary self-confidence and greater popularity.

To acquaint the readers of this book with the easy-to-follow rules for developing skill in remembering names, places, figures, dates, business transactions, or even passages of literary content, the publishers have printed full details of their interesting self-training method in a new book, "Adventures in Memory," which will be mailed free to anyone who requests it. No obligation. Simply send your request to: Memory Studies, Dept. 186B, Chicago, Ill. 60614. A postcard will do.

CIRCLE 951 ON READER SERVICE CARD

**PROFESSIONAL
 SERVICES**

GIBBS & HILL, Inc.
 Consulting Engineers

Systems Engineering
 Operations Research • Development
 Field Studies • Design • Procurement
 Power • Transportation • Communications
 Water Supply • Waste Treatment
 393 Seventh Avenue New York 1, N. Y.



■ AMP Inc.	9	■ Lambda Electronics Corp.	31
Garceau, Hargrave & McCullough Inc.		Michel Cather Inc.	
Acromag Incorporated	136	■ Lapp Insulator Co., Inc.	114
Tri-Art Associates		Wolff Associates Inc.	
Air Express Div. of REA Express	47	Leach Corporation	41
Ketchum, MacLeod & Grove Inc.		Hixson & Jorgensen, Inc.	
Astrodata Inc.	51	Lebel High Frequency Laboratories Inc.	122
Bonfield Associates Inc.		Apex Graphic Company	
Atlee Corporation	117	Levin & Son, Inc., Louis	134
S. Gunnar Myrbeck & Company		M.R. Crossman Company	
Beckman Instruments Inc.,		Machlett Laboratories Inc., The	8
Offner Division	33	Fuller & Smith & Ross Inc.	
Erwin Wasey, Ruthrauff & Ryan Inc.		Mallory & Company Inc. P.R.	39
■ Boonton Radio Company,		The Aitkin-Kynett Co.	
A Div. of Hewlett Packard	38	Markem Machine	118
George Homer Martin Associates		Culver Adv. Inc.	
Brew and Co. Inc. Richard D.	125	■ Matsuo Electric Co., Ltd.	136
Allied Advertising Agency Inc.		Asahi Advertising Agency & Co.	
■ Bussmann Mfg. Co.,		■ McLean Engineering Laboratories	127
Div. of McGraw Edison Co.	108, 109	Healy Adv. Agency	
Henderson Advertising Company		Minnesota Mining & Mfg. Co.,	
Chatham Electronics, Div. of		Mincorn Division	48
Tung-Sol Electric Inc.	23	Reach, McClinton & Co., Inc.	
E.M. Freystadt Associates Inc.		Mitsumi Electric Co., Ltd.	133
Clare & Company, C.P.	26	Dentsu Advertising Ltd.	
Reincke, Meyer & Finn Adv.		■ Moseley, F.L.	37
Cohu Electronics Inc.		L.C. Cole Company Inc.	
Kin Tel Division	3rd Cover	National Cash Register Co.	128, 129
Erwin Wasey, Ruthrauff & Ryan Inc.		Allen, Dorsey & Hatfield Inc.	
Control Data Corporation	107	■ North Atlantic Industries, Inc.	103
Barnes Chase Advertising		Murray Heyert Associates	
Coto Coil	135	Primo Co., Ltd.	135
The Williams Company		General Adv. Agency	
■ Defense Electronics Inc.	113	Princeton Applied Research Corp.	123
Compton Jones Associates		Mort Barish Associates	
Delco Radio	96	Qualtronic Corporation	134
Campbell-Ewald Company		Gerald C. Smith Associates	
DuPont de Nemours &		Radiation Inc.	22
Co. Inc. E.I.	24, 25, 45, 95	G.M. Basford Company	
Batten, Barton, Durstine & Osborn Inc.		Radio Corporation of America	4th Cover
Edgerton, Germeshausen & Grier, Inc.	115	Al Paul Lefton Co.	
Reach, McClinton & Humphrey, Inc.		■ Raytheon Company	126
Electronic Engineering Co. of California	7	Fuller & Smith & Ross Inc.	
Compton Advertising Inc.		Rome Cable, Div. of Alcoa	36
Fairchild Semiconductor	14	The Rumrill Co. Inc.	
Johnson & Lewis Inc.		■ Rosemount Engineering Co.	137
■ Fenwal Electronics	110	Midland Associates, Inc.	
Larcom Randall Adv. Inc.		■ Sanborn Co., A Sub. of Hewlett Packard	2
Flying Tiger Line	11	Culver Advertising Inc.	
Hixson & Jorgensen, Inc.		Space Craft Inc.	133
■ General Electric Company,		Preiss and Brown Adv. Inc.	
Miniature Lamp Division	116	Speer Carbon Company	40
Batten, Barton, Durstine & Osborn Inc.		Hazard Advertising Company Inc.	
■ General Electric Company,		Sprague Electric Co.	5, 6, 10
Rectifier Components Div.	52	The Harry P. Bridge Co.	
Ross Roy Inc. Advertising		Stromberg-Carlson	
■ General Electric Company,		Div. of General Dynamics	124
Semiconductor Products Dept.	16	The Rumrill Company Inc.	
Ross Roy Inc.		■ Tektronix Inc.	46
Gertsch Products Inc.	130	Hugh Dwight Adv. Inc.	
Balsam Advertising Inc.		Texas Instruments Incorporated	
■ Globe Industries Inc.	110	Industrial Products Group	49
Odiome Industrial Adv. Inc.		Robinson-Gerrard, Inc.	
Gudebrod Bros. Silk Co. Inc.	120	■ Toyo Electronics Ind., Corp.	131
Lee Ramsdell & Co. Inc.		Dentsu Advertising	
Hallikainen Instruments	119	■ United Transformer Corporation	2nd Cover
Hal Lawrence Incorporated		Bradley Rosen & Kaus Adv., Inc.	
■ Hewlett Packard Company	1, 12, 13	Unitrode Corporation	19
L.C. Cole Company Inc.		Chirurg & Cairns Inc.	
■ Hughes Aircraft Company	20, 21	Vidar Corporation	35
Foote, Cone & Belding		Bonfield Associates, Inc.	
Hull Corporation	106	■ Vitramon, Inc.	50
The Michener Company Adv.		Ted Sommers, Inc.	
ITT—Royal Electric Company	122	Winston Research Corporation	104, 105
West, Weir & Bartel Inc.		Jordan Advertising Inc.	
Inertia Switch Inc.	108		
Harold Marshall Advertising Co.			
International Electronic Industries	98		
Buti-Roberts Advertising			
International Rectifier Corp.	42		
Communication Associates			
Interstate Electronics	132		
Jones, Maher, Roberts Adv.			
■ JFD Electronics Corporation	97		
Michel Cather Inc.			
Janney Cylinder Company	110		
John B. Ferguson Jr., Adv.			
■ Jennings Radio Mfg. Corp.	121		
L.H. Waldron			
Kay Electric Company	112		
Josephson, Cuffari & Co.			
■ Kyoritsu Electrical Instruments Works,			
Ltd.	122		
Nichiden Adv. Ltd.			

Advertising sales staff

Gordon Jones: [212] 971-2210
Advertising sales manager

Atlanta, Ga. 30309: Gus H. Krimsier,
Michael H. Miller, 1375 Peachtree St. N.E.,
[404] TR 5-0523

Boston, Mass. 02116: William S. Hodgkinson,
McGraw-Hill Building, Copley Square,
[617] CO 2-1160

Chicago, Ill. 60611: Robert M. Denmead,
Daniel E. Shea, Jr., 645 North Michigan
Avenue, [312] MO 4-5800

Cleveland, Ohio 44113: Paul T. Fegley, 55
Public Square, [216] SU 1-7000

Dallas, Texas 75201: Dick Poole, The
Vaughn Building, 1712 Commerce Street,
[214] RI 7-9721

Denver, Colo. 80202: John W. Patten, David
M. Watson, Tower Bldg., 1700 Broadway,
[303] AL 5-2981

Houston, Texas 77025: Kenneth George,
Prudential Bldg., Halcombe Blvd.,
[713] RI 8-1280

Los Angeles, Calif. 90017: Ashley P.
Hartman, John G. Zisch, 1125 W. 6th St.,
[213] HU 2-5450

New York, N.Y. 10036:
Donald R. Furth [212] 971-3616
Frank LeBeau [212] 971-3615
George F. Werner [212] 971-3617
500 Fifth Avenue

Philadelphia, Pa. 19103: William J. Boyle,
Warren H. Gardner, 6 Penn Center Plaza,
[215] LO 8-6161

San Francisco, Calif. 94111:
James T. Hauptli, 255 California Street,
[415] DO 2-4600

London W1: Edward E. Schirmer, 34 Dover
Street

Frankfurt/Main: Matthee Herfurth, 85
Westendstrasse Phone: 77 26 65 and
77 30 59

Geneva: Michael R. Zeynel,
2 Place du Port 244275

Paris VIII: Denis Jacob, 17 Avenue
Matignon ALMA-0452

Tokyo: Shigeo Chiba, 1, Kotohiracho,
Shiba, Minato-ku (502) 0656

Osaka: Kazutaka Miura, 163, Umegae-cho,
Kita-ku [362] 8771

Nagoya: International Media
Representatives, Yamagishi Bldg.,
13,2-Chome, Oike-cho Naga-ku

R.S. Quint: [212] 971-2335
General manager
Electronics Buyers' Guide

David M. Tempest: [212] 971-3139
Promotion manager

Henry M. Shaw: [212] 971-3485
Market research manager

Richard J. Tomlinson: [212] 971-3191
Business manager

Theodore R. Geipel: [212] 971-2044
Production manager

Classified advertising

F. J. Eberle, Business Mgr.
Professional services 139
Employment opportunities 138
Equipment
(Used or Surplus New)
For Sale 139

Classified advertising index

Lifschultz Fast Freight 139
Memory Studies 139
Metals & Controls Inc. 138
Motorola Military Electronics Division 138
■ Radio Research Instrument Co. 139
■ Universal Relay Corp. 139

■ For more information on complete product line
see advertisement in the latest Electronics Buyers' Guide

Executive, editorial, circulation and advertising offices: McGraw-Hill Building, 330 West 42nd Street, New York, N.Y., 10036. Telephone Area Code 212-971-3333. Teletype TWX N.Y. 212-640-4646. Cable McGrawhill, N.Y. Officers of the Publications Division: Shelton Fisher, President; Vice Presidents: Joseph H. Allen, Operations; John R. Callahan, Editorial; Ervin E. DeGraff, Circulation; Donald C. McGraw, Jr., Advertising Sales; Angelo R. Venezian, Marketing. Officers of the Corporation: Donald C. McGraw, President; Hugh J. Kelly, Harry L. Waddell, L. Keith Goodrich, Executive Vice Presidents; John L. McGraw, Treasurer; John J. Cooke, Vice President and Secretary. Title R registered U.S. Patent Office; © copyright 1964 by McGraw-Hill, Inc. All rights reserved, including the right to reproduce the contents of this publication, in whole or in part.

Electronics

Reader service

Use these handy post cards
for more detailed information on:
products advertised, new products,
new literature.

Circle the number on the Reader Service post card that corresponds to the number at the bottom of the advertisement, new product item, or the literature of the week selection in which you are interested.

Please print clearly. All written information must be legible to be efficiently processed.

All foreign inquiries that cannot reach Electronics before the expiration dates noted on the Reader Service post card, must be mailed directly to the manufacturer. The manufacturer assumes all responsibilities for responding to inquiries. Electronics merely provides and clears requests for information from inquirer to manufacturer.

Correct amount of postage must be affixed for all foreign mailings.

To subscribe to or to renew Electronics

Fill in the "For Subscriptions" area on the card if you desire to subscribe to or renew your present subscription to Electronics. Send no money. Electronics will bill you at the address indicated on the Reader Service post card.

Multi-product advertisements

For information on specific items in multi-product advertisements which do not have a specific Reader Service number indicated write directly to manufacturer for information on precise product in which you are interested.

Please give complete information

Name _____ Title _____

Company _____

Address _____

1	30	59	88	117	146	175	204	233	262	291	320	349	378	407	436	465	494	95
2	31	60	89	118	147	176	205	234	263	292	321	350	379	408	437	466	495	95
3	32	61	90	119	148	177	206	235	264	293	322	351	380	409	438	467	496	95
4	33	62	91	120	149	178	207	236	265	294	323	352	381	410	439	468	497	95
5	34	63	92	121	150	179	208	237	266	295	324	353	382	411	440	469	498	95
6	35	64	93	122	151	180	209	238	267	296	325	354	383	412	441	470	499	95
7	36	65	94	123	152	181	210	239	268	297	326	355	384	413	442	471	500	95
8	37	66	95	124	153	182	211	240	269	298	327	356	385	414	443	472	501	96
9	38	67	96	125	154	183	212	241	270	299	328	357	386	415	444	473	502	96
10	39	68	97	126	155	184	213	242	271	300	329	358	387	416	445	474	503	96
11	40	69	98	127	156	185	214	243	272	301	330	359	388	417	446	475	504	96
12	41	70	99	128	157	186	215	244	273	302	331	360	389	418	447	476	505	96
13	42	71	100	129	158	187	216	245	274	303	332	361	390	419	448	477	506	96
14	43	72	101	130	159	188	217	246	275	304	333	362	391	420	449	478	507	96
15	44	73	102	131	160	189	218	247	276	305	334	363	392	421	450	479	508	96
16	45	74	103	132	161	190	219	248	277	306	335	364	393	422	451	480	509	96
17	46	75	104	133	162	191	220	249	278	307	336	365	394	423	452	481	510	96
18	47	76	105	134	163	192	221	250	279	308	337	366	395	424	453	482	511	97
19	48	77	106	135	164	193	222	251	280	309	338	367	396	425	454	483	512	97
20	49	78	107	136	165	194	223	252	281	310	339	368	397	426	455	484	513	97
21	50	79	108	137	166	195	224	253	282	311	340	369	398	427	456	485	514	97
22	51	80	109	138	167	196	225	254	283	312	341	370	399	428	457	486	515	97
23	52	81	110	139	168	197	226	255	284	313	342	371	400	429	458	487	516	97
24	53	82	111	140	169	198	227	256	285	314	343	372	401	430	459	488	517	97
25	54	83	112	141	170	199	228	257	286	315	344	373	402	431	460	489	900	97
26	55	84	113	142	171	200	229	258	287	316	345	374	403	432	461	490	901	97
27	56	85	114	143	172	201	230	259	288	317	346	375	404	433	462	491	902	97
28	57	86	115	144	173	202	231	260	289	318	347	376	405	434	463	492	951	98
29	58	87	116	145	174	203	232	261	290	319	348	377	406	435	464	493	952	98

For Subscriptions [Check one box] New Renewal

[Check one box] Domestic and Canada 3 years \$12.00

1 year \$6.00 Foreign 1 year \$20.00

Products M'fd _____ services _____

First class
Permit no. 24327
Philadelphia, Pa.

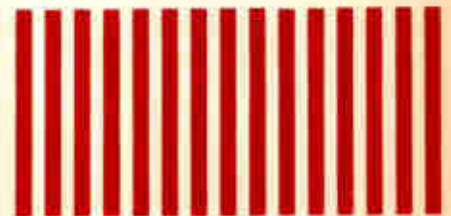

Business reply mail

No postage stamp necessary if mailed in the United States

Postage will be paid by

Electronics
Reader service department
Box 8635
Philadelphia, Pa. 19101

First class
Permit no. 24327
Philadelphia, Pa.

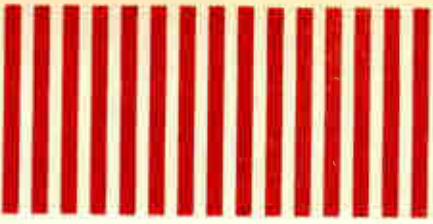

Business reply mail
No postage stamp necessary if mailed in the United States

Postage will be paid by

**Electronics
Reader service department
Box 8635
Philadelphia, Pa. 19101**

21 July 27, 1964/card expires Sept. 27, 1964 **14**
Please give complete information

Name _____ Title _____
Company _____
Address _____

1	30	59	88	117	146	175	204	233	262	291	320	349	378	407	436	465	494	953
2	31	60	89	118	147	176	205	234	263	292	321	350	379	408	437	466	495	954
3	32	61	90	119	148	177	206	235	264	293	322	351	380	409	438	467	496	955
4	33	62	91	120	149	178	207	236	265	294	323	352	381	410	439	468	497	956
5	34	63	92	121	150	179	208	237	266	295	324	353	382	411	440	469	498	957
6	35	64	93	122	151	180	209	238	267	296	325	354	383	412	441	470	499	958
7	36	65	94	123	152	181	210	239	268	297	326	355	384	413	442	471	500	959
8	37	66	95	124	153	182	211	240	269	298	327	356	385	414	443	472	501	960
9	38	67	96	125	154	183	212	241	270	299	328	357	386	415	444	473	502	961
0	39	68	97	126	155	184	213	242	271	300	329	358	387	416	445	474	503	962
1	40	69	98	127	156	185	214	243	272	301	330	359	388	417	446	475	504	963
2	41	70	99	128	157	186	215	244	273	302	331	360	389	418	447	476	505	964
3	42	71	100	129	158	187	216	245	274	303	332	361	390	419	448	477	506	965
4	43	72	101	130	159	188	217	246	275	304	333	362	391	420	449	478	507	966
5	44	73	102	131	160	189	218	247	276	305	334	363	392	421	450	479	508	967
6	45	74	103	132	161	190	219	248	277	306	335	364	393	422	451	480	509	968
7	46	75	104	133	162	191	220	249	278	307	336	365	394	423	452	481	510	969
8	47	76	105	134	163	192	221	250	279	308	337	366	395	424	453	482	511	970
9	48	77	106	135	164	193	222	251	280	309	338	367	396	425	454	483	512	971
0	49	78	107	136	165	194	223	252	281	310	339	368	397	426	455	484	513	972
1	50	79	108	137	166	195	224	253	282	311	340	369	398	427	456	485	514	973
2	51	80	109	138	167	196	225	254	283	312	341	370	399	428	457	486	515	974
3	52	81	110	139	168	197	226	255	284	313	342	371	400	429	458	487	516	975
4	53	82	111	140	169	198	227	256	285	314	343	372	401	430	459	488	517	976
5	54	83	112	141	170	199	228	257	286	315	344	373	402	431	460	489	518	977
6	55	84	113	142	171	200	229	258	287	316	345	374	403	432	461	490	519	978
7	56	85	114	143	172	201	230	259	288	317	346	375	404	433	462	491	520	979
8	57	86	115	144	173	202	231	260	289	318	347	376	405	434	463	492	521	980
9	58	87	116	145	174	203	232	261	290	319	348	377	406	435	464	493	522	981

or **Subscriptions** [Check one box] New Renewal
 [Check one box] Domestic and Canada 3 years \$12.00
 1 year \$6.00 Foreign 1 year \$20.00

Reprint service

All Electronics editorial matter available in reprint form:

For reprints of special reports and feature articles see list below. Send your order to Electronics Reprint Department at address indicated below. To expedite mailing of your order for single reprints please send cash, check or money order with your order.

Bulk reprints of editorial matter can be ordered from current or past issues. The minimum quantity is 100 copies. The higher the quantity ordered, the more economical the cost per copy. Prices quoted on request.

Bulk reprints can be made up with the cover of the magazine on the front page, and your advertising message on the back page.

To order reprints or for further information, please write to: **Electronics Reprint Department, 330 West 42nd Street, New York, N.Y. 10036.** Telephone: Area code 212 971-3140.

You may order the following reprints by key number using order form on page 108

- Key no. **R-58** Oceanography, 15 pages. 50¢. A survey of the growing electronics technology associated with underseas exploration.
- Key no. **R-57** Magnetics, 24 pages. 50¢. An Electronics special report on whats new in today's magnetic technology.
- Key no. **R-56** The Case For Magnetic Logic, 8 pages. 35¢
- Key no. **R-54** Resistors Improve Performance While Their Size Decreases, 6 pages. 25¢
- Key no. **R-53** Digital Instrumentation, 16 pages. 50¢
- Key no. **R-52** Advanced technology: Evaluating light demodulators, 8 pages. 35¢
- Key no. **R-51** Medical electronics: Electronic weapon against cancer, 5 pages. 25¢
- Key no. **R-49** Injection Laser Systems, [2 part series] 12 pages. 35¢
- Key no. **R-48** Modern Electronic Packaging, 16 pages. 50¢
- Key no. **R-47** Electronic Markets New Directions 1963-64-67, 20 pages. 50¢
- Key no. **R-45** Today's Semiconductors, 24 pages. 50¢
- Key no. **R-42** Materials for Space Age Electronics, 16 pages. 50¢
- Key no. **R-41** Telemetry Today, 7 pages. 25¢
- Key no. **R-40** Tunnel Diodes, [4 part series] 26 pages. 50¢
- Key no. **R-39** Radio Frequency Interference, 24 pages. 50¢
- Key no. **R-38** Family Tree of Semiconductors, [22" x 11" fold-out chart]. 50¢
- Key no. **R-31** Electromagnetic Spectrum Chart, [22" x 30" foldout chart]. \$1.00
- Key no. **R-30** Graphical Symbols For Electronic Diagrams, [29" x 11" foldout chart]. 50¢
- Key no. **R-29** Bionics, [4 part series] 19 pages. \$1.00
- Key no. **R-26** Lasers Devices and Systems, [4 part series] 23 pages. \$1.00
- Key no. **R-19** Medical Electronics, [7 part series] 42 pages. \$1.50

Prices for varying quantities of reprints can be quoted on request.



DELIVERS CLOSED-CIRCUIT TELEVISION SYSTEMS TO MEET YOUR REQUIREMENTS

COLOR cameras
ENVIRONMENT-RESISTANT cameras
HIGH-RESOLUTION cameras
INDUSTRIAL cameras
MINIATURIZED cameras
RADIATION-RESISTANT cameras
SELF-CONTAINED cameras
SPACE cameras
TEMPERATURE-EXTREME cameras
UNDERWATER cameras

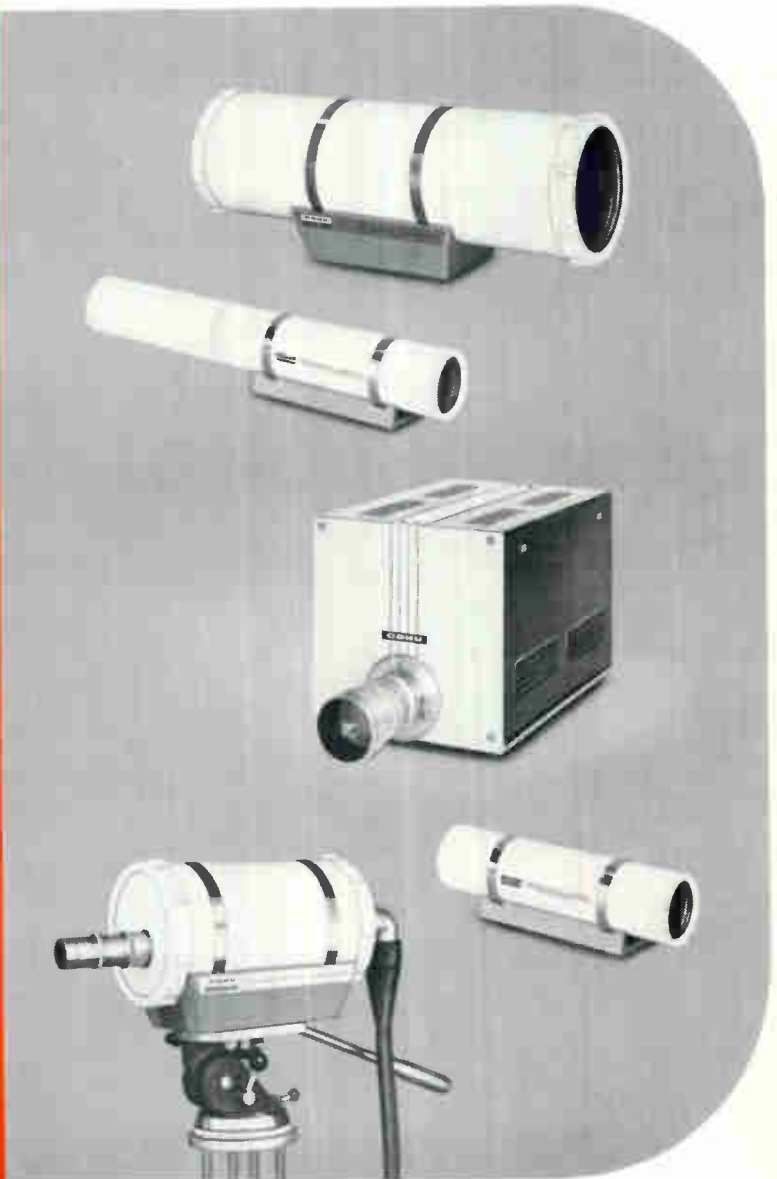

Visit our Booth 1017 at WESCON, Sports Arena, Los Angeles, August 25-28.

and ALL ACCESSORIES including monitors, control units, fixed-focus and zoom lenses, pan/tilt units, video cable, video switchers, synchronizing generators, cabling, tripods, vidicons . . .

WRITE for technical information and systems engineering. Representatives in all major cities.



Box 623
San Diego, California 92112
Phone (714) 271-6700

Circle 901 on reader service card

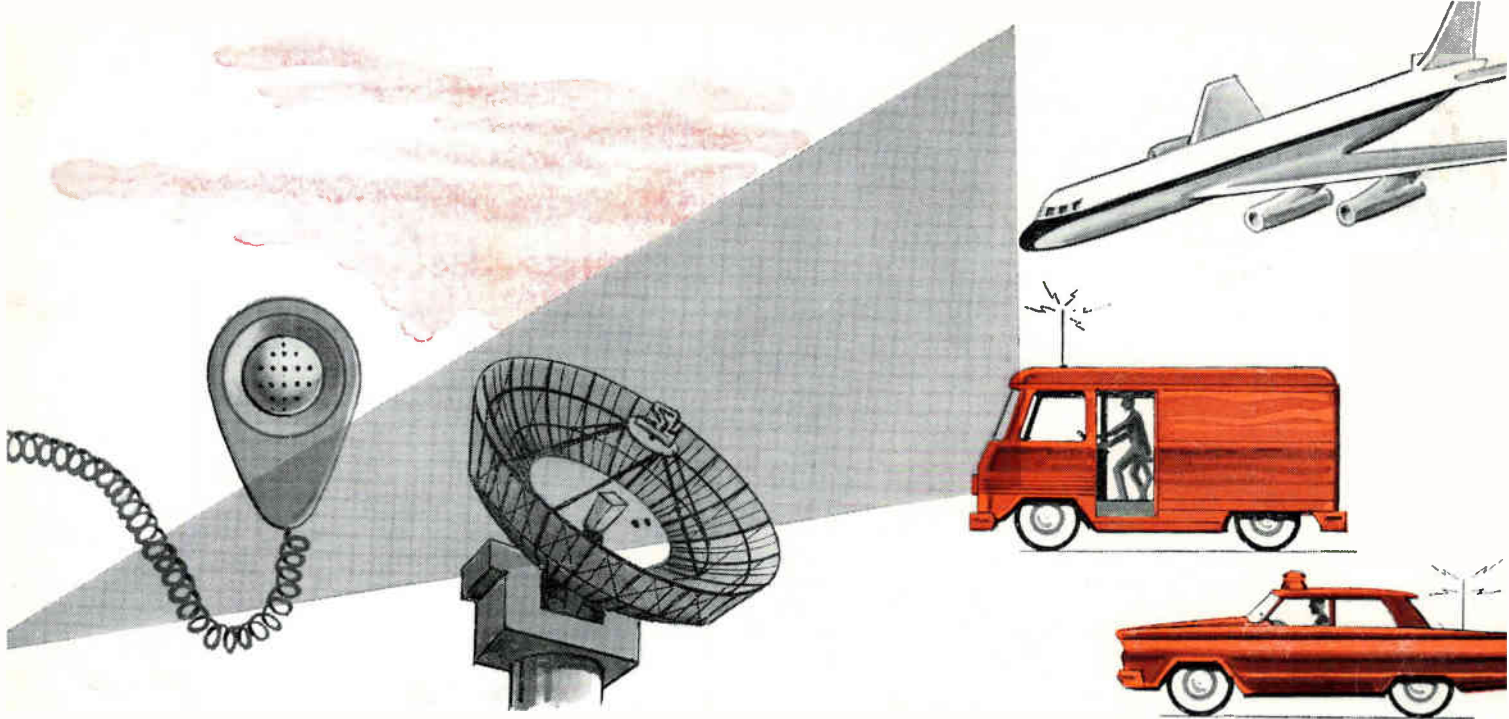

RCA-8121-8122-8072-8462

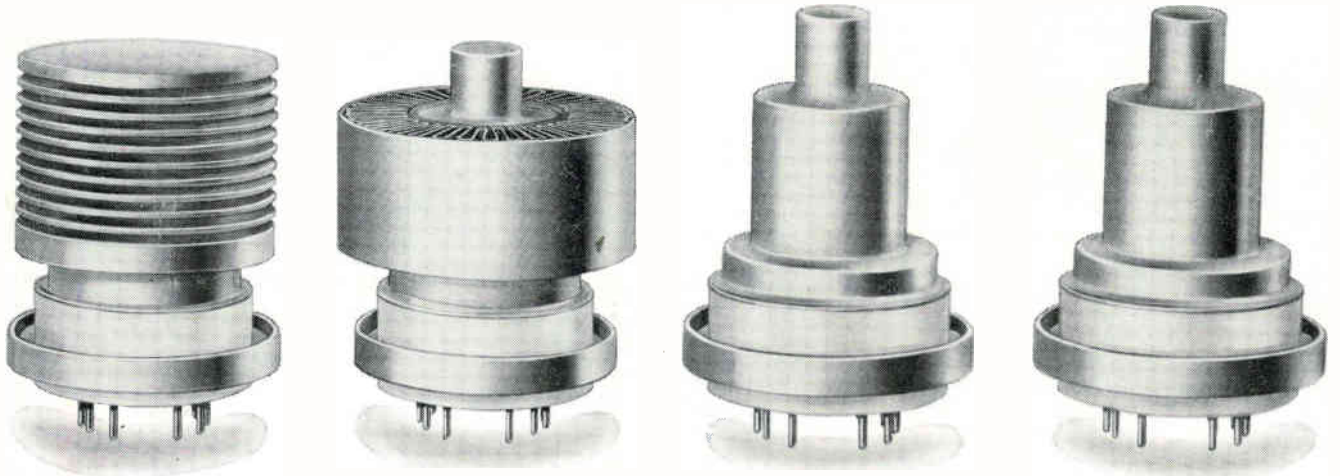

Make your choice RCA Ceramic-Metal Tubes for more RF Power in UHF Communications

Here are four members of the newest RCA family of ceramic-metal tubes... tetrodes already designed into compact, high-power equipment for airborne, fixed station, and mobile communications applications.

The four—each packing more RF power than previously available in tubes of comparable size—are designed expressly for UHF power use. Designers have specified them for use in aircraft communications systems, SSB linear amplifiers, localizer gear in GCA equipment, high-power deflection amplifiers for radar, mobile ground communications equipment and amateur radio transmitters.

RCA-8072 is conduction cooled and can be an ideal choice where space is at a premium. RCA-8462 features "quick heat" warm-up capability of less than 100 milliseconds in push-to-talk equipment. RCA-8121 and -8122 are air-cooled versions of the 8072 and offer higher power in devices of comparable size.

Special characteristics can be custom-designed to fill individual needs. For more information, see your RCA Representative. For technical data on specific types, write: Commercial Engineering, Section G-19-Q-2, RCA Electronic Components and Devices, Harrison, N. J.

ALSO AVAILABLE FROM YOUR AUTHORIZED RCA INDUSTRIAL TUBE DISTRIBUTOR

Typical CW Operation					
Type	Cooling	Maximum Plate Dissipation (Watts)	Plate (Volts)	Frequency (Mc)	Useful Power Output (Watts)
8072	Conduction	100*	700	50	110
				175	105
				470	85
8121	Forced-Air	150	1500	50	275
				470	235
8122	Forced-Air	400	2000	50	375
				470	300
8462 (Quick-heat)	Conduction	100*	700	50	110
				175	105
				470	85

*May be higher, depending on heat-sink design.



The Most Trusted Name in Electronics