

Electronics®

The changing face of the resistor: page 62

Fast inspection with numerical control: page 79

Combining transmitters automatically: page 87

May 4, 1964

75 cents

A McGraw-Hill Publication

Below: light-activated
controlled rectifier, page 53

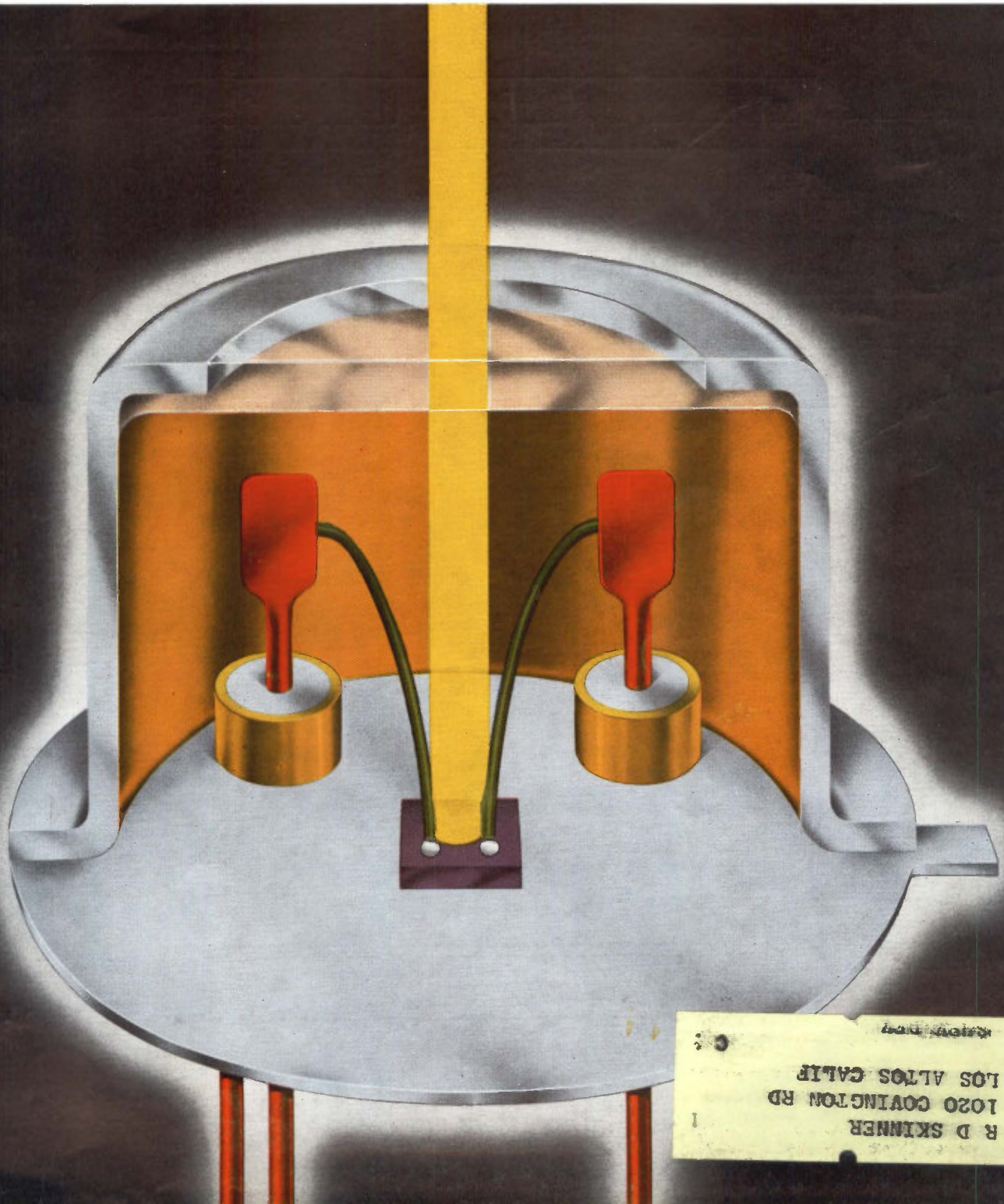



HERMETICALLY SEALED
NOW to MIL-T-27B

VARIABLE INDUCTORS

HIGH-Q plus HIGHEST STABILITY

IMMEDIATE DELIVERY FROM STOCK

For almost a third of a century UTC has pioneered in the development of transformers, electric wave filters, high Q coils, magamps and similar iron core components. Highest engineering talent plus the most complete facilities for research and testing has made UTC the leading

supplier in the industry for both stock and custom built components. UTC Variductors (stock variable inductors) have served as a simple solution to tuned circuit for almost 20 years . . . for oscillators, equalizers, filters, tuned radio circuits, etc.

NEW! - VERNIER

HVV VARIDUCTOR™ HERMETICALLY SEALED

**NARROW
 RANGE**

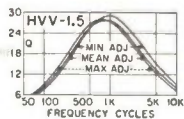

INDUCTANCE-HYS		HVV-1.5	
MAX ADJ.	1.8		
MEAN ADJ.	1.7		
MIN ADJ.	1.6		
	1.5		
	1.4		
	1.3		
	1.2		
	1.1		
	1.0		
	0.9		
	0.8		
	0.7		
	0.6		
	0.5		
	0.4		
	0.3		
	0.2		
	0.1		
	0.0		

APPLIED VOLTAGE AT 1KC

The HVV Variductors have been designed to emphasize extremely high stability with temperature, level, shock and vibration commensurate with the highest obtainable Q. They are ideal for precise matching to other components such as capacitors with standard 10% tolerance. Units are provided with a vernier adjustment variation of $\pm 10\%$ through 90° rotation of adjustment screw on top of case. Setting is positive. There are 12 units in the stock line with mean inductances ranging from .006 Hy to 150 Hys. Specific mean inductances other than stock items are available on special order. Manufactured and guaranteed to MIL-T-27B, MIL type TF4RX20YY. Drawn metal case: 1 1/8" long, 25/32" wide, 1-7/32" high (including adjustment screw); weight: 2 ounces. Effective Q over a wide frequency range and variation of inductance with applied AC voltage are illustrated for a typical unit. Patent pending.

HVC VARIDUCTOR™ HERMETICALLY SEALED

**WIDE
 RANGE**

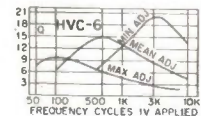

HVC units are usable over a wide frequency range and have high stability with temperature and voltage change. Nominal inductance values of 12 stock units in series range from .006 Hy to 150 Hys. The variable inductance range of each unit is +200%, -70% of nominal value through 90° rotation of adjusting screw on top of case. Setting is positive. Case size and weight is the same as HVV. U.S. Patent No. 2,879,489.

TVC VARIDUCTOR™

TVC Variductors are identical to the HVC units, but provide taps at 30% and 50% of total turns. Different taps are available on special order. U.S. Patent No. 2,879,489.

**WIDE
 RANGE**

VIC VARIDUCTOR™ COMMERCIAL GRADE



Nominal inductance values of 22 stock items in this series range from .0085 Hy to 130 Hys. Mean inductance may be varied +85%, -45% through 600° rotation of adjustment screw in side of case. Rugged die cast case: 1-11/13" long, 1 1/4" wide, 1-7/16" high; weight 5 1/2 ounces.

**AND "SPECIAL" CUSTOM BUILT UNITS
 TO YOUR SPECIFICATIONS**

Write for catalog of over
 1,200 UTC HIGH RELIABILITY
 STOCK ITEMS
 IMMEDIATELY AVAILABLE
 from your local distributor.



UNITED TRANSFORMER CORP.

150 VARICK STREET, NEW YORK 13, N. Y.

PACIFIC MFG. DIVISION: 3630 EASTHAM DRIVE, CULVER CITY, CALIF.
 EXPORT DIVISION: 13 EAST 40th STREET, NEW YORK 16, N. Y. CABLE: "ARLAB"

Measure
to
2500 mc



Make normalized
measurements

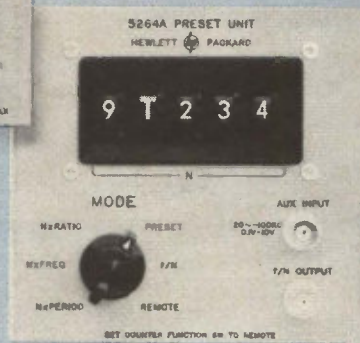

Measure voltage
with 6-digit resolution

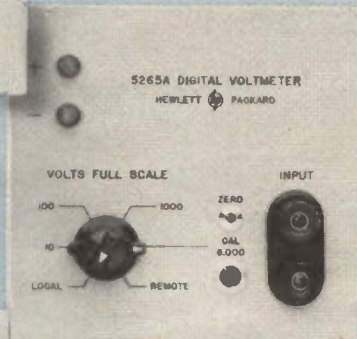

hp 5245L...
today's
most
versatile
counter

New plug-ins for the solid state hp 5245L Electronic Counter for new measuring capabilities. Lets you easily expand the usefulness of the 5245L by adding a plug-in when you need it.

NEW: hp 5254A Frequency Converter, \$825, extends measurement range to 2500 mc

hp 5264A Preset Unit, \$650, measures N x frequency, period, ratio, time N events, divides input by N; N can be 1 to 100,000

hp 5265A DVM Plug-in, \$575, six-digit measurement of dc, 10, 100 or 1000 volts full scale, accuracy 0.1% of reading

Other plug-ins:

5253B Frequency Converter to 500 mc, \$500
5261A Video Amplifier for 1 mv rms sensitivity, \$325
5262A Time Interval Unit, 1 μ sec to 10⁸ sec, \$300

The basic 5245L Counter offers a maximum counting rate of 50 mc with 8-digit resolution. And all these features are delivered with the counter, for \$3250:

- Time base stability better than 3/10⁶/day
- Display storage for continuous display
- Sample rate, independent of gate time, adjustable 0.1 to 5 sec
- Close-spaced Nixie tubes for easy reading
- Four-line BCD output for systems, recorders
- Remote programming capability
- Automatic decimal point, units indication
- Plug-in circuitry for easy maintenance
- Compact modular cabinet only 5 1/4" high

Data subject to change without notice. Prices f.o.b. factory.

Call your Hewlett-Packard field engineer for details and a demonstration. Or write Hewlett-Packard Company, Palo Alto, California 94304, Tel. (415) 326-7000; Europe: 54 Route des Acacias, Geneva; Canada: 8270 Mayrand Street, Montreal.

**HEWLETT
PACKARD**  *An extra measure of quality*



FM STEREO MODULATOR

TYPE 219-A



- Direct (L) & (R) Inputs
- SCA Input
- Internal Preemphasis
- Internal 1 KC Modulating Oscillator
- Peak Reading Output Meter
- Self-Checking Switchable Matrix

INPUT CHARACTERISTICS

LEFT (L) & RIGHT (R) INPUTS
Frequency Range: 50 cps — 15 KC
Level: 1.7 ± 0.3 volts rms*

*For 90% peak multiplex output with either a Left (L) or Right (R) input
Preemphasis: 75 μ sec preemphasis switchable in or out of circuit

SUBSIDIARY COMMUNICATIONS (SCA) INPUT

Frequency range: 20 — 75 KC
Level: 1.0 volt rms*

*For approx. 10% peak multiplex output

MODULATING OSCILLATOR CHARACTERISTICS

Osc Frequency: 1 KC
Osc Output: Switchable into either (L) or (R) input

SPECIFICATIONS:

The FM Stereo Modulator Type 219-A is designed to provide a multiplex output signal in accordance with FCC Docket 13506 when fed with Left (L) and Right (R) audio stereo channel inputs and/or subsidiary communications FM sub-carriers (SCA). The output of the modulator may be switched to provide either (L + R), (L - R), 19 KC pilot carrier, 38 KC residual carrier or the complete multiplex signal which can then be used to modulate a suitable FM Signal Generator. When used with the BRC Type 202-H, no external audio oscillator or other equipment is required.

A peak reading metering system, calibrated in % of system deviation, is provided for setting and monitoring the levels of the individual sub-carriers. The internal matrix may be switched from the normal condition to provide either (L + R) or (L - R) null for checking the matrix in the receiver under test. The modulator is completely self-contained and housed in a single cabinet which may be adapted for standard rack mounting.

BOONTON RADIO COMPANY

A Division of Hewlett-Packard Company



GREEN POND ROAD, ROCKAWAY, NEW JERSEY

Tel. 627-6400 (Area Code 201) TWX: 201-627-3912 Cable Address: Boonraco

OUTPUT CHARACTERISTICS

Level: 0 — 7.5 volts peak*
*Multiplex output
Residual Hum & Noise: > 60 db below 100% output
Crosstalk*: > 40 db below 100% output
*(L - R) Into (L + R)

METERING

Range: 0 — 10%* (19 KC and 38 KC only); 0 — 100%*
*Multiplex output; output adjustable 0 — 7.5 volts peak for 100%
Output Modes: Switchable for (L + R), (L - R), 19 KC pilot carrier, 38 KC residual carrier, or multiplex signal

PILOT CARRIER

Frequency: 19 KC
Accuracy: $\pm 0.01\%$

MONAURAL (L + R)

Fidelity: 50 cps — 15 KC ± 1 db*
* ± 0.2 db and $\pm 1.5^\circ$ relative to (L - R)

DOUBLE SIDEBAND SUPPRESSED CARRIER (L - R)

Frequency: 38 KC
Fidelity: 50 cps — 15 KC ± 1 db*
* ± 0.2 db and $\pm 1.5^\circ$ relative to (L + R)

SUBSIDIARY COMMUNICATIONS (SCA)

Fidelity: 20 — 75 KC ± 0.5 db

OSCILLOSCOPE SYNC SIGNAL

Frequency: 19 KC
Output Level: 0.5 volts rms

Price \$975.00; F.O.B., Rockaway, N. J.

Electronics

Page 4	Readers comment	
8	People	
10	Meetings ahead	
15	Editorial	
17	Electronics newsletter	
45	Washington newsletter	
113	New products	
137	New literature	
139	New books	
141	Technical abstracts	Advanced technology

Advanced technology

Instrumentation

Circuit design

Industrial electronics

Communications

Communications

Electronics review

Page 29	Picturephone	32	Multiple-choice quiz
29	Pirate radio	32	Shark deterrent
30	Vanishing barrier	34	Who's afraid of IBM?
30	Billion-dollar buy	34	Blind programmer
31	Zeroing in	34	Patent problems
31	More work for drones	36	Catching up
32	Technicians' society	36	L'affaire Bull

Probing the News

99	Testing equipment for limited war
102	Detroit's top secret: numerical control of milling
108	Electronic hope for the helpless

Technical articles

I. Design

Light-activated switch

It expands uses of the silicon-controlled rectifier by eliminating coupling and feedback problems
E. Keith Howell, General Electric Co.

Resistors improve while they shrink

A survey of what's new in discrete resistors, comparing performance and manufacture
Charles L. Wellard, American Components, Inc.

Ultrasonic approach to data storage

Ferroacoustic storage based on the delay-line principle looks practical
J. W. Gratian and R. W. Freytag, General Dynamics

Radar-tracking accuracy increased

Microwave refractometer measures compensation needed to correct for effect of the medium
C. H. Stewart and G. J. Vincent, ITT

Designer's Casebook

Combined feedback stabilizes amplifier; gate circuit eliminates pedestal effects; temperature sensor for strain-gage transducer; unijunction pulse generator

II. Application

Boredom-proof inspectors

Electronic techniques to work alongside numerically controlled machine tools
Edward V. Cordes, Jr., Warner & Swasey Co.

Foreign broadcasts get a stronger voice

Radio Free Europe feeds the output from two high-power transmitters into a single antenna
Earl L. Chubbuck, Jr., Radio Free Europe

Designing log-periodic antennas

A graphic technique establishes gain and beamwidth for a useful new antenna
George J. Monser, Sylvania Electric Products Co.

In this issue

Electronics

Editor: Lewis H. Young

Managing editor: John M. Carroll

Senior editors

Technical: Samuel Weber

News: George Sideris

Senior associate editors: Michael F. Wolff, John F. Mason

Department editors

Advanced technology: George V. Novotny

Communications: Alexander A. McKenzie

Components: Michael F. Tomaino

Computers: Stephen B. Gray

Consumer electronics: V. S. Acunto

Industrial electronics: Louis S. Gomolak

Instrumentation: George J. Flynn

Manufacturing: C.R. Whetstone

Military electronics: John F. Mason

New products: William P. O'Brien

Solid state: Michael F. Wolff, G.G. Tirellis

Space electronics: Joel A. Strasser

Staff writers: Leon H. Dulberger, Peggy Jackson

Regional editors

Boston: Thomas Maguire, editor; Alice M. Moyer

Chicago: Cletus M. Wiley, editor; Virginia T. Bastian

Los Angeles: Harold C. Hood, editor; Linda Hamner

San Francisco: Laurence D. Shergalis, editor; Mary Jo Jadin

Copy editors

Howard Rausch, Sally Powell

Illustration

Art director: Howard R. Berry

Assistant art director: John C. Wright, Jr.

Editorial production: Ann Mella, Sandra A. LeMond

Editorial secretaries: Claire Benell, Lynn Emery, Kay Fontana, Lorraine Rossi, Barbara Schubert, Lorraine Werner

McGraw-Hill news service

Director: John Wilhelm; Atlanta: Fran Ridgeway; Chicago: Bruce Cross;

Cleveland: Arthur Zimmerman; Dallas: Marvin Reid;

Detroit: Donald MacDonald; Los Angeles: Kemp Anderson, Michael Murphy,

Ron Lovell; San Francisco: Margaret Ralston, Ed. Addeo;

Seattle: Ray Bloomberg; Washington: George Bryant Jr., Glen Bayless,

Charles Gardner

McGraw-Hill world news service

Bonn: Richard Mikton; Brussels: Arthur Erikson; London: Derek Barlow;

Mexico City: Wesley Perry; Milan: Bruce Bendow;

Moscow: Donald Winston; Paris: Dan Smith;

Rio de Janeiro: Leslie Warren; Tokyo: Richard Halloran, Charles Cohen

Circulation manager: Hugh Quinn

Reprints: T.M. Egan

Publisher: C.C. Randolph

Electronics: May 4, 1964, Vol. 37, No. 15

Printed in Albany, N.Y. Second class postage paid at Albany, N.Y.

Subscriptions are solicited only from those actively engaged in the field of the publication. Position and company connection must be indicated on orders. Subscription prices: United States and Possessions and Canada, \$6.00 one year, \$9.00 two years, \$12.00 three years. All other countries \$20.00 one year. Single copies, United States and Possessions and Canada 75¢. Single copies all other countries \$1.50.

Published every other Monday by McGraw-Hill Inc. 330 West 42nd Street, New York, N.Y. 10036. Founder: James H. McGraw, 1860-1948.

Subscribers: The Publisher, upon written request to our New York office from any subscriber, agrees to refund that part of the subscription price applying to copies not yet mailed. Please send change of address notices, subscription orders or complaints to Fulfillment Manager, Electronics, at the address below. Change of address notices should provide old as well as new address, including postal zone number if any. If possible, attach address label from recent issue. Allow one month for change to become effective.

Postmaster: Please send Form 3579 to Fulfillment Manager, Electronics, P.O. Box 430, Hightstown, New Jersey 08520

Readers Comment

Buzzes and birdies

The Tanner "tv set counter" [Electronics Review, Apr. 20, p. 27] is clever and appears to fill a need. But, let's not overlook that it relies upon something we ought to get rid of—the radiation of interference-producing signals from receivers.

It seems to be difficult enough to encourage "clean" design in these consumer products. It would be unfortunate if the clamor for more sophisticated audience measurement were to scuttle future efforts to get rid of the "buzzes and birdies" cluttering broadcast and shortwave reception.

Ralph F. Patterson
Somerset, N.J.

Technical meetings

Your preview issue of the IEEE Convention [Mar. 13] is a bit bewildering. In your editorial [p. 5] you assert that both the technical papers and the exhibits "are not worth the effort." Then you conclude on the same page that "the electronics industry needs the event" and that "the advantages . . . outweigh its shortcomings."

I suppose that the apparent non-sequitur isn't really as bewildering as it seems at first glance. Technical meetings have been panned roundly in the past few years in the technical press for their shortcomings. But I have yet to see anyone get to the heart of the matter; that is, the real goals of these meetings.

Possibly the professional societies themselves are at fault for billing their symposia as the "latest look at state-of-the-art developments." When the meeting's technical program and exhibits fall short of this high aim, as they almost invariably must, then the critics scream about their worthlessness.

If, as you conclude, the advantages of the big electronics meetings outweigh their shortcomings, isn't this because they are meeting some honest-to-goodness professional needs? The average attendee doesn't really come to hear esoteric

Now from Sprague!

AN INDUSTRY FIRST!

**GUARANTEED TRUE
CHOPPING SPEED**

**SPAT[®] SILICON TRANSISTORS
2N3317, 2N3318, 2N3319
ARE A LONG LEAP AHEAD!**

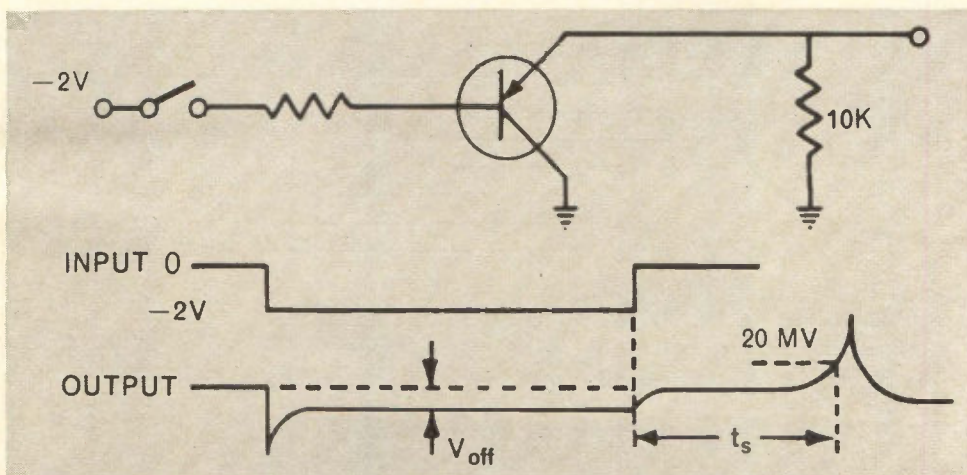

Check the superiority of SPAT[®] 2N3317 Series Transistors in this comparison of t_s in chopper circuitry!

TYPE	t_s (typ.)	t_s (max.)
SPRAGUE 2N3317 SERIES	150	250
Competitive Epitaxial	900	Not Specified
Competitive Planar	1000	Not Specified
Competitive Alloy	1500	Not Specified

For complete technical data, write to: TECHNICAL LITERATURE SERVICE,
SPRAGUE ELECTRIC COMPANY, 35 MARSHALL ST., NORTH ADAMS, MASS.

SPRAGUE COMPONENTS

TRANSISTORS
CAPACITORS
RESISTORS
MICROCIRCUITS
INTERFERENCE FILTERS

PULSE TRANSFORMERS
PIEZOELECTRIC CERAMICS
PULSE-FORMING NETWORKS
TOROIDAL INDUCTORS
ELECTRIC WAVE FILTERS

CERAMIC-BASE PRINTED NETWORKS
PACKAGED COMPONENT ASSEMBLIES
BOBBIN and TAPE WOUND MAGNETIC CORES
SILICON RECTIFIER GATE CONTROLS
FUNCTIONAL DIGITAL CIRCUITS



'Sprague' and '®' are registered trademarks of the Sprague Electric Co.

New from Sprague!

FILMITE® 'K' POLYCARBONATE FILM CAPACITORS

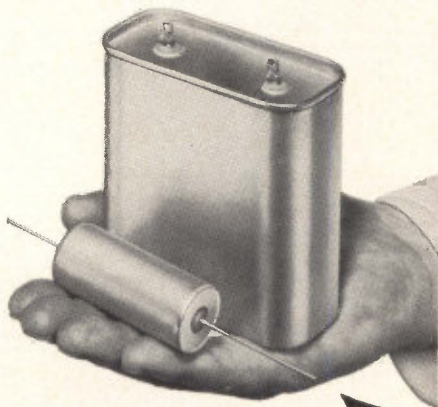

COMPARE!

The tubular polycarbonate film capacitor and the rectangular oil-impregnated paper capacitor are both rated 10 μ F, 100 VAC, 400 cycles.

- More than 13 times smaller than paper capacitors of equivalent rating.
- Unusually high capacitance stability over entire temperature range.
- Low dissipation factor — extremely desirable where high current capabilities are required.
- Low dielectric absorption over a broad frequency/temperature spectrum.
- Extremely high insulation resistance — superior to many commonly-used film dielectrics.
- Capacitance tolerances to $\pm 0.25\%$.
- For critical applications such as tuned circuits, analog computers, digital circuits, etc.

For complete technical data, write for Engineering Bulletins 2700 and 2705 to Technical Literature Service, Sprague Electric Company, 35 Marshall Street, North Adams, Massachusetts.

45C-4125R3



Sprague and *®* are registered trademarks of the Sprague Electric Co.

state-of-the-art technical papers that are over his head anyway. Nor does he want to view company exhibits that are only remotely related to his real engineering problems.

What I am suggesting is that despite the few protests to the contrary, these meetings are worthwhile. Like everything else of the kind, they are valuable to the individual engineer only insofar as he plans his participation discriminately.

Some improvements in paper selection, presentation techniques, and discussion procedures are in order. But let's be very careful that we don't throw away the baby with the bath water.

Roger M. D'Aprix

Utica, N. Y.

Waveguide

Here at Litchfield we have been working to establish the design and performance factors for a three-pitched femto waveguide. We are

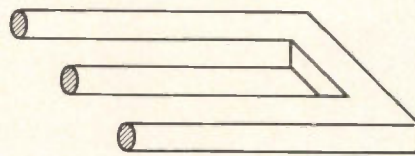

trying to establish the relationship between the circular cylinders at left and the rectangular-prism resonant cavity. So far we have had flat response through the top cylinder and low-pass response towards the bottom cylinder. The mode lattice has been difficult to establish for the left center cylinder, although it looks better than a Moreno cross guide coupler. Even and odd-mode impedance of parallel slab line has given us trouble. Where can I find data that will establish the susceptance of symmetrical irises?

Fred Standish

Litchfield, Conn.

- Try pulling a few more legs.

Storage tube

Your March 13 issue contains an item entitled Storage Tube Holds Television Image [p. 83]. It describes a highly sensitive camera

tube developed at the Imperial College of Science and Technology, London. Your readers may be interested to learn that this tube, in construction and performance, appears to be very similar to the Westinghouse magnetically focused SEC vidicon, WX-5419. Both tubes use a target consisting of a porous layer of potassium chloride. This type of target makes possible the outstanding performance characteristics claimed for these tubes.

The low-density potassium chloride target used in this Westinghouse tube was described in detail by G. W. Goetze and A. H. Boerio at the IEEE Electron Devices meeting at Washington, D. C., on October 31, 1963. This talk was reported in *Electronics*, Nov. 1, 1963, p. 17 and Nov. 8, 1963, p. 10.

The storage properties of a low-density potassium chloride layer were first described by G. W. Goetze at the Second Symposium on Photo-Electronic Image Devices held at Imperial College, London, in September, 1961. Development of the target was carried out at the Westinghouse Research & Development Center under a contract with the Aeronautical Systems Division of Wright-Patterson Air Force Base, Ohio (Technical Documentary Report No. ASD-TDR-63-84, Jan. 1963).

G.W. Goetze

Research & Development Center
Westinghouse Electric Corp.
Pittsburgh

Voltage-variable capacitors

I have just read the lead article in the April 6 issue of *Electronics*. I am dismayed.

Under the table on p. 49 you mention only three manufacturers of voltage-variable capacitors. You have omitted Eastron Corp.

For the record, Eastron is the third oldest manufacturer of voltage-variable capacitors, being preceded only by PSI (TRW Electronics) and Philco. Our manufacturing volume as well as our length of experience in this product area exceeds that of Crystalonics and Texas Instruments.

William E. Slusher
President

Eastron Corp.
Haverhill, Mass.

This is what
diodes looked like



before
Unitrodes



REMEMBER?

Remember the fragile whisker so easily burned out? The cavity where, in time, contaminants were sure to degrade reverse characteristics eventually? The delicate construction that was likely to fail under thermal and mechanical stress? The limited service life even under the best of conditions?

Never again.

Unitrodes have changed all that with an entirely new approach to diode design. The silicon wafer is high-temperature bonded *directly* between the terminal pins, and a hard glass sleeve is fused to *all* exposed silicon. Result: a void-free junction that can't be contaminated. Broad current-carrying surfaces that can withstand 10 watt power overloads — continuously — with no after-effect. A one-piece unit indifferent to shock, vibration,

acceleration . . . unperturbed by thermal shock or cycling from -195°C to $+300^{\circ}\text{C}$.

And this small:



Naturally you'd expect performance like this to cost a bit more, and it does. Mainly because of rigid manufacturing standards and because every Unitrode[®] diode is 100% final tested. But if you're working in high reliability, you owe it to yourself to watch your Unitrode representative's 15-minute demonstration. We'd be happy to send him around with our entire line of diffused 3 ampere silicon diodes, fast switching rectifiers, 3 watt zeners, high voltage stacks and bridge assemblies. We never cease to be amazed ourselves. Write or call . . . UNITRODE TRANSISTOR PRODUCTS, INC., 214 Calvary Street, Waltham, Massachusetts 02154, Tel: (617) 899-8988 TWX: (617) 894-9876.

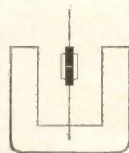

UNITRODE

**CONSIDERING VAPOR COOLING?
SELECT ONE OF MACHLETT'S
4 BASIC SYSTEMS...**

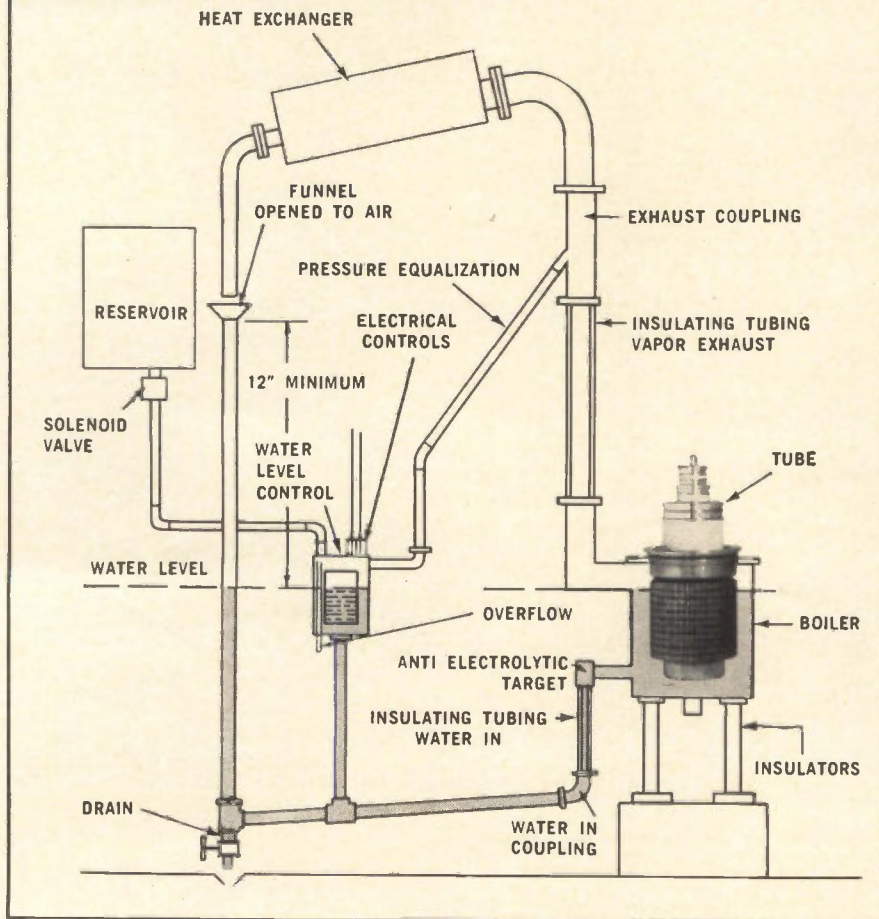

From 50kW to 500kW, Machlett offers four basic Vapor Cooling Systems for cooling high power electron tubes:

SYSTEM	TYPICAL APPLICATION
Vapor-Up (shown above)	General Broadcast (HF)
Vapor-Down	General & SSB Communications (HF)
Boiler Condenser	Industrial
Integrated	Special Service. Particularly suited to VHF.

System advantages include: 200-300% greater anode dissipation as compared to forced-air cooling; 10-20% greater anode dissipation over conventional water cooling; extremely large overload protection for anode; stable, quiet cooling; low water consumption; low operating costs.

Each of the above four systems is highly adaptable to a wide range of applications. Consider the advantages of each system—outlined in "Vapor Cooling," obtained by writing to The Machlett Laboratories, Inc., Springdale, Conn., an affiliate of Raytheon Company.



ELECTRON TUBE SPECIALIST

People

Choh Hsien Li was named to the new post of associate director of research at the Honeywell Research Center in Hopkins, Minn. Li is a native of Canton, China, one of 11 children of a brick manufacturer and his wife whose formal educations totaled three years. After graduating from Southwest Associated University in Canton, he rebuilt a steel rolling mill near Hong Kong. While he was visiting a brother in California in 1948, Communists seized the mill and executed his partner. Li stayed in the U. S., earning master's and doctor's degrees in metallurgy at the University of California at Berkeley. At the Honeywell Corp. since 1954, Mr. Li, 42 years old, is a leading researcher in translating dislocation theory—changes in crystal properties resulting from stress—into practical products. Using this theory, he has improved the performance of Honeywell's silicon transistors by modifying the etching and polishing processes to prevent damage to the delicate wafers.



Joseph A. Chambers will succeed William S. Wheeler as vice president and general manager of the Military Electronics Division of Motorola, Inc. Wheeler has been named to the new post of vice president for government - industry relations.



Chambers has been with Motorola since 1951, most recently as vice president and manager of the Western Center facility. Chambers plans to continue Motorola's policy of concentrating its activities in the peaceful uses of space and in tactical warfare, both of which are less subject to cutbacks than the strategic weapons business.

now — it'll work

No more checking needed — that "last" glance is for satisfaction. A 125V PNP complement did the trick — it eliminated one stage . . . reduced the size and power just enough.

	TO-46 Case	MAXIMUM VOLTAGES			I_{CBO} Max. @ 25°C (μA)	h_{FE}		$V_{CE}(SAT)$		f_T (MC)		TO-46 Case	MAXIMUM VOLTAGES			I_{CBO} Max. @ 25°C (μA)	h_{FE}		$V_{CE}(SAT)$		f_T (MC)
		BV_{CEO} (Volts)	BV_{CBO} (Volts)	BV_{EBO} (Volts)		Min.	Max.	@ I_C (mA)	Max. (Volts)				Typ. (MC)	BV_{CEO} (Volts)	BV_{CBO} (Volts)		BV_{EBO} (Volts)	Min.	Max.	@ I_C (mA)	
NPN	2N2518	125	80	8	.005	40	100	5	0.5	175	NPN	2N2460	100	60	8	.002	70	130	5	0.3	200
PNP	2N2599	-125	-80	-7	-.025	40	100	-5	-0.5	90	PNP	2N2591	-100	-60	-7	-.025	70	135	-5	-0.4	100
NPN	2N2519	125	80	8	.005	80	200	5	0.5	200	NPN	2N2461	100	60	8	.002	120	180	5	0.3	225
PNP	2N2600	-125	-80	-7	-.025	80	200	-5	-0.5	120	PNP	2N2592	-100	-60	-7	-.025	115	200	-5	-0.4	125
NPN	2N2459	100	60	8	.002	40	80	5	0.3	175	NPN	2N2462	100	60	8	.002	170	230	5	0.3	250
PNP	2N2590	-100	-60	-7	-.025	40	80	-5	-0.4	75	PNP	2N2593	-100	-60	-7	-.025	160	275	-5	-0.4	150

Thorough evaluation leads to a good decision. Many problems involving high voltage complementary transistors can be answered with the type numbers listed above — they represent the industry's largest high voltage line of complementary planar transistors. In fact, Sperry Semiconductor produces the industry's first full line of PNP/NPN Complementary Silicon Planar Transistors. Notice the close matching characteristics — we make them that way (not just pick a PNP that is close to an NPN). This is another example of Sperry's leadership of PNP low level silicon planar transistors. Our record of reliability is important — it validates our credentials for the future. Question them, inspect them, use them — they can help on your military projects and in your industrial control work. Whether you need volume production or personal attention in custom engineering — contact Sperry Semiconductor. □ Eastern Regional Office: 69 Hickory Drive, Waltham, Massachusetts; Midwest Regional Office: 3555 West Peterson Avenue, Chicago 45, Illinois; Western Regional Office: 1680 North Vine Street, Hollywood 28, Calif. Sales Representatives: Orbit Electronics, 250 Carroll Street, Fort Worth, Texas; Perrott Associates, Incorporated, 2321 East South Street, Orlando, Fla. □ Keep in touch — with SPERRY SEMICONDUCTOR, Norwalk, Connecticut.

SPERRY

DIVISION OF
SPERRY RAND
CORPORATION

Circle 9 on reader service card

from Sprague, of course!

SEPT[®]

**SILICON
PLANAR
EPITAXIAL
TRANSISTORS**

**Conforming to
ALL requirements of**

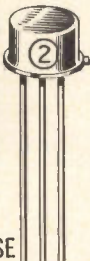
MIL-S-19500/251A(EL)
2N2219 
and **TO-5 CASE**

MIL-S-19500/255A(EL)
2N2222
TO-18 CASE

For complete technical data, write to:
**TECHNICAL LITERATURE SERVICE
SPRAGUE ELECTRIC COMPANY,
35 MARSHALL ST.
NORTH ADAMS, MASS.**

SPRAGUE[®]
THE MARK OF RELIABILITY

Sprague and *®* are registered trademarks of the Sprague Electric Co.

Meetings

EIA Workshop on Maintainability, EIA; Sheraton-Jefferson Hotel, St. Louis, Mo., **May 5-7.**

Electronic Components Conference, EIA, IEEE; The Marriott Twin Bridges Motor Hotel, Wash., D.C., **May 5-7.**

Aerospace Electronics Annual Conference, PTG-ANE, Dayton Section of IEEE; Biltmore Hotel, Dayton, Ohio, **May 11-13.**

Electronic Parts Distributors Show, Electronic Industry Show Corp.; Conrad Hilton Hotel, Chicago, **May 18-20.**

PTG-MITT International Symposium, IEEE; International Hotel, J.F.K. International Airport, New York, N.Y., **May 19-21.**

Organic Solid State Annual Symposium, Franklin Institute Labs; Philadelphia, Pa., **May 25.**

Tenth Annual Radar Symposium, Army, Navy, Air Force, University of Michigan Inst. of Science and Technology; Fort Monmouth, N.J., **May 26-28.**

Analysis Instrumentation Symposium, ISA; Sheraton Palace Hotel, San Francisco, Calif., **June 1-3.**

Reliability Training Course, ARINC Research Corp.; Statler Hilton Hotel, Washington, D.C., **June 1-5.**

Electromagnetic Windows Symposium, The Antenna Lab., Dept. of Electrical Engineering, Ohio State Univ., in conjunction with US Air Force; Ohio State Univ., Columbus, Ohio, **June 2-3.**

Telemetry National Conference, AIAA; Biltmore Hotel, Los Angeles, Calif., **June 2-4.**

Conference on Precision Electromagnetic Measurements, NBS, Radio Stds. Lab., IEEE PTG-IM, Inter. Scientific Radio Union, US Commission on Radio Measurements and Standards; NBS Boulder Laboratories, Boulder, Colo., **June 23-25.**

Fifth Joint Automatic Control Conference, Amer. Inst. Chemical Eng., ISA, IEEE; Stanford University, Stanford, Cal., **June 26-28.**

Conference of Vacuum Metallurgy, Vacuum Metallurgy Div., American Vacuum Society; Barbazon Plaza Hotel, New York, N.Y., **June 29-30.**

Rochester Conference on Data Acquisition and Processing in Medicine and Biology, U. of Rochester; U of R Whipple Auditorium, Rochester, N. Y., **July 13-15.**

Special Technical Conference on Nuclear Radiation Effects, IEEE PTG-NS, Radiation Effects Committee; University of Washington, Seattle, Wash., **July 20-24.**

Special Program on Language Data Processing, Harvard, Div. of Engineering and Applied Physics; Harvard Summer School, Cambridge, Mass., **Aug. 10-21.**

UAIDE Annual Meeting, Users of Information Display Equipment; International Hotel, Sepulveda and Century Blvds, Los Angeles, Cal., **Aug. 12-14.**

Symposium on Ultra Low Frequency Electromagnetic Fields, NBS Central Radio Propagation Lab. and National Center of Atmospheric Research; Boulder Laboratories, Boulder, Colorado, **Aug. 17-20.**

Call for papers

American Documentation Institute Annual Meeting, American Documentation Institute; Sheraton Hotel, Philadelphia, Pa., **October 5-8.** May 15 is deadline for submitting abstracts to Benjamin F. Cheyd-leur, Technical Sessions Chairman, Philco Corp., Willow Grove, Pa. 19090. Topics include: symbolization and transformation of information; information-seeking behavior; information in decision procedures, analysis, correlation, and indexing; document media, storage, and display; memory organization and search; information sciences; goals in education; information centers and networks.

National Communications Symposium, PTG on Communications Technology, IEEE; Utica, New York, **October 5-7.** Deadline is June 1 for submitting five copies of both a 100 word abstract and 500 word summary together with author's name, position title, company affiliation, and brief biography to Joseph L. Ryerson, Technical Program Chairman, Director of Communications (EMC), Rome Air Development Center, Griffiss Air Force Base, N. Y. Topics include communications subjects in the areas of systems, equipments, techniques and associated fields.

Machine-wired backplanes for "Burroughs" Computers now use hook-up wire insulated with "Kynar," Pennsalt vinylidene fluoride resin. Why "Kynar"? No cold flow or cut-through when wire is pulled tight around sharp corners. "Kynar" is tough ...withstands tension of machine application to backplane. Has U.L. approval for "Burroughs" B-5000 computer operation.*



Each "Burroughs" backplane is checked visually, tested electronically. Machine wrapping with Gardner-Denver "Wire-Wrap"† drastically reduces incidence of error; concentrates 100,000 circuits in same space that formerly allowed only 10,000 circuits.

†"Wire-Wrap" is a Registered trademark of Gardner-Denver Company.

For more data on "Kynar"...sources of hook-up wire insulated with "Kynar," write Plastics Department, Pennsalt Chemicals Corporation, Three Penn Center, Philadelphia, Pa. 19102.

"Burroughs" is a Registered trademark of Burroughs Corporation.

Kynar... a fluoroplastic that's tough!

*"Kynar" is a Registered trademark of Pennsalt Chemicals Corporation.



An urgent message to all users of airfreight:

There exists in the airfreight industry a situation that is important to you if the present low-cost airfreight service you are now receiving is important to you.

Low-cost airfreight service came into existence when The Flying Tiger Line Inc., and other all-cargo carriers first started scheduled operations. I quote as authority for that statement, Mr. Marion Sadler, President of American Airlines, Inc. He stated in a press release on March 19, 1964, "The new companies (including The Flying Tiger Line Inc.) started scheduled operations in 1947 with *reductions* of as much as 50% from the existing rates of the combination airlines. The combination carriers quickly met the new rates and in some cases went below them."

Freeze Out

He goes on to say that the all-cargo carriers charged "rate war," which is true because the combination carriers did not just go below the all-cargo carriers on *some* rates but almost all of them. This is not a new story in the free enterprise system. Big companies always try to freeze out little companies with price squeezes so they can later have the market to themselves and charge the public what they please. This is why our statutes are loaded with anti-trust and monopoly laws.

As Mr. Sadler goes on to say in his press release, the Civil Aeronautics Board did agree that there was a rate war and proceeded to set minimum rates for airfreight so the big carriers could not force the new carriers out of business while they were struggling to establish a *new industry providing low-cost, volume airfreight*.

This battle to eliminate us has continued on through the years and today is reaching new heights.

When the all-cargo carriers petitioned the Civil Aeronautics Board for certification, we predicted an annual volume of one billion ton miles of airfreight within the domestic United States. This has been achieved, adding together all the common carriage and contract tonnage moving today.

Service War

We have the case of a successful industry but no successful participants. The reason is the market is being supersaturated with excess competition. As a result, the volume of business is so divided up that all carriers are losing heavily.

Having failed to eliminate the all-cargo carriers by a rate war, the combination carriers are now en-

gaged in a service war. If the same amount of competition that is being applied today in the airfreight field on the transcontinental market were applied to the passenger market, we would have almost 60 trunk carriers operating between the East and West Coast. It takes no imagination to see what chaos would result from this kind of situation. All of the carriers would be in trouble and would be shouting to the Government to reduce the excessive amount of competition so that some carriers could survive.

This is the condition that Flying Tigers finds itself in today. The combination carriers are pouring on this excessive amount of competition at great losses to themselves, but they have passenger revenues to offset these losses. The Chairman of the Civil Aeronautics Board, Mr. Alan S. Boyd, said in a speech on February 14, 1964, "The Big Four (American Airlines, Inc., United Air Lines, Inc., Trans World Airlines, Inc., Eastern Air Lines, Inc.) lost more than 20 million dollars during the year ending September 30, 1963 — a loss emanating from revenues of 41 million dollars in all-cargo operations." Later, in the same speech he said, "Equally, however, we do not propose to ignore the losses incurred as a result [of all-cargo operations] which are now being paid for by the passenger."

Campaign of Attrition

So, while the combination carriers are suffering great losses providing this superfluous space, they are dividing the market up into such small bits that the all-cargo carriers are also taking heavy losses. By this kind of attrition, they hope and expect to be rid of us shortly. This can be attested to by another of Mr. Sadler's replies to a question as to what would happen to the all-cargo carriers if this situation continues. He said, "I guess they'll go out of business." This remark was quoted in the *Aviation Daily* of March 20, 1964, and in *Aviation Week* magazine, issue of March 30, 1964, page 26.

We realize that ordinarily you couldn't care less whether Flying Tigers goes out of business. You are not our keepers. But if we and the other all-cargo carriers should be forced to withdraw from competition, you may draw your own picture about where you will stand. We will give you a few brush marks for your picture:

A Wave Good-bye

1) The Civil Aeronautics Board cannot force the combination carriers to fly all-cargo equipment on any of their routes. These carriers add stations and

drop stations receiving all-cargo service at their own pleasure, without even asking the Civil Aeronautics Board. One case in point: American Airlines, Inc. had been serving Hartford, Connecticut for years with all-cargo equipment. On January 1, 1964, with no more than a wave goodbye, they stopped all-cargo service to Hartford. By the same token, once the all-cargo carrier competition is removed, the cargo jets now being flown by the combination carriers can be quickly converted to passenger configuration and put back into highly profitable passenger routes.

2) Without all-cargo equipment flying, all of your outsized shipments will be denied. There is simply no way to get them into a passenger jet. Check this for yourself.

3) Mr. Sadler's quote earlier says the combination carriers cut their rates in half when we went into business. Isn't it logical they would restore that cut, absent the all-cargo carrier competition? Particularly in view of the fact they are losing 20 million dollars per year flying all-cargo equipment?

4) If you have any doubts about what the combination carriers would do with airfreight rates absent the all-cargo carriers, let me tell you a true story about what they did with the aircoach business.

Story of Aircoach

After the war, numerous non-scheduled airlines went into the airline business. They got in without certificates because of the very loose and very vague regulations covering non-scheduled operations at that time. Many of them flew regularly-scheduled services for years before proper laws were enacted and cases went before the Supreme Court many times before the Civil Aeronautics Board was finally able to control the situation. But while they operated, they brought some innovations into the air transport industry. They invented "aircoach," which meant simply putting high density seating in the airplanes, thereby increasing productivity of the planes and reducing the fares drastically below the first class fare, which was the only one the combination carrier had in effect at that time. Aircoach fares fell to as low as \$80 for a transcontinental trip. The combination carriers who had never had this concept, soon followed suit. In 1956 you could go from Los Angeles to New York for \$80 on Trans World Airlines. The first class fare remained at \$154.

80% Rate Boost

Now, the non-skeds have been taken out of the common carriage business, even though they were making money on low-cost transportation. What has happened to aircoach in the hands of the transcontinental combination carriers? Today, an aircoach ticket from Los Angeles to New York is \$145 - 80% higher than when they had the competition, and only \$9 less than a first class ticket in 1957. In other words, "aircoach" has disappeared. And, don't think these increases have been a result of increased costs. Quite to the contrary, the cost per seat mile in jet

airplanes is far less than the piston planes of 1957. Anybody in aviation will verify that fact. We are of the firm belief that low-cost airfreight as we know it today will disappear, just as the aircoach business has disappeared, once the combination carriers can get rid of our competition.

The combination carriers have five principal sources of transport revenue: (1) airmail, (2) passengers, (3) excess baggage, (4) air express, (5) airfreight.

In the first four categories we are not able to give them effective competition. They receive 99.7% of the airmail and air express business. All-cargo carriers have never been given any consideration in setting prices on those two items, and of course, we do not carry passengers.

The revenues to the combination carriers on the first four of the above-named items range from 36¢ to 60¢ per ton mile. Revenues from airfreight on routes where we compete are about 15¢ per ton mile (but airfreight rates on routes where they don't have our competition are much higher). As Mr. Sadler says, airfreight revenues were also in the same bracket as the other four items until we came in and forced them down. Can you believe they won't go back up, absent the all-cargo carriers?

In Your Own Best Interest

We ask you to give some sober thought to the ideas and facts expressed in this letter. Decide for yourself what, in your own best interest, you should do with your airfreight shipment. Give it to the company whose total existence depends solely upon continuing to give you low-cost airfreight, or give it to the combination carriers and risk what might happen to low-cost airfreight, absent the all-cargo carriers?

We need a high volume of business to sustain this operation. High volume is the sole basis for low-cost airfreight. If you believe, as we do, that it is necessary to have us around to assure you of continuation of this low-cost air transportation, then we ask you to support us and other all-cargo carriers now with your traffic. We are taking our problem to you, the shipper, because you are the ones who can decide the issue by where you place your traffic - and you will be the ones who will benefit or suffer later from decisions you make today.

We need you and you need us, too, if you want to continue low-cost airfreight.

Sincerely,

Robert W. Prescott
President
The Flying Tiger Line Inc.
Lockheed Air Terminal
Burbank, California

Silicon Planar Epitaxial FASTEST COMPUTER TRANSISTORS

With the addition of the new 2N3303 and 2N3304, Fairchild can now provide high reliability silicon Planar epitaxial transistors for every high speed computer application. For complete specifications on any of the devices shown, write for data sheets.

NEW!

FASTEST SILICON PNP 2N3304

- $\tau_s = 30\text{ns (max)}$ @ $I_C = I_{B1} = I_{B2}$
- $f_T = 500\text{mc (min)}$ @ $I_C = 10\text{mA}$, $V_{CE} = 5.0\text{V}$
- $V_{CE (sat)} = 0.15\text{V (max)}$ @ $I_C = 1\text{mA}$, $I_B = 0.1\text{mA}$
- $V_{CE (sat)} = 0.16\text{V (max)}$ @ $I_C = 10\text{mA}$, $I_B = 1\text{mA}$
- $V_{CE (sat)} = 0.5\text{V (max)}$ @ $I_C = 50\text{mA}$, $I_B = 5\text{mA}$

FASTEST FILM DRIVER 2N3303

- $t_{ON} = 15\text{ns (max)}$ @ $I_C = 1\text{A}$, $I_{B1} = 100\text{mA}$
- $t_{OFF} = 25\text{ns (max)}$ @ $I_C = 1\text{A}$, $I_{B1} = I_{B2} = 100\text{mA}$
- $f_T = 450\text{mc (min)}$ @ $I_C = 100\text{mA}$, $V_{CE} = 5\text{V}$
- $V_{CE (sat)} = 0.7\text{V (max)}$ @ $I_C = 1\text{A}$, $I_B = 100\text{mA}$

COMPLEMENTARY SWITCHING TRANSISTORS

NPN

300 μA to 1.5A

LOW LEVEL LOGIC - 2N709

τ_s : 3ns (typ) @ 5/5/5mA

HIGH SPEED LOGIC - 2N2369A

τ_s : 6ns (typ) @ 10/10/10mA

HIGH SPEED CORE DRIVERS - 2N3014

τ_s : 8ns (typ) @ 10/10/10mA

2N2845

τ_s : 15ns (typ) @ 20/20/20mA

HIGH SPEED FILM DRIVER - 2N3303

t_{ON} : 10ns (typ) @ 1A/100mA

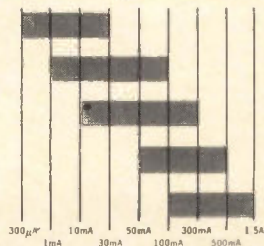

PNP

300 μA to 500mA

LOW LEVEL LOGIC - 2N3304

τ_s : 15ns (typ) @ 10/10/10

HIGH SPEED LOGIC - 2N2894

t_{ON} : 23ns (typ) @ 30mA/1.5mA

t_{OFF} : 34ns (typ)

HIGH SPEED CORE DRIVER - 2N2695

t_{ON} : 28ns (typ) @ 300mA/30mA

t_{OFF} : 110ns (typ)

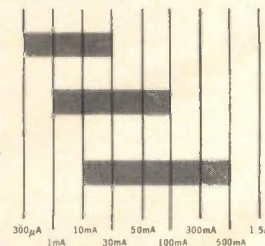

AVAILABLE DIRECTLY FROM DISTRIBUTOR STOCKS

FAIRCHILD

SEMICONDUCTOR

PLANAR: A PATENTED FAIRCHILD PROCESS

FAIRCHILD SEMICONDUCTOR/A DIVISION OF FAIRCHILD CAMERA AND INSTRUMENT CORPORATION/313 FAIRCHILD DR., MOUNTAIN VIEW, CALIF./962-5011/TWX: 910-379-6435

Lesson from Europe

Europe will not have color television until 1967, possibly not until 1968. The reasons (see Newsletter, page 17) are strictly commercial, not technical. European manufacturers believe there just isn't a market yet for color television sets.

This decision reflects the straightforward approach Europeans take in matters electronic. It's pragmatic, practical, very commercial and economic. One executive confided: "Our engineers don't try anything unless we can see a way to make money from it." And most European electronic firms (except a few computer builders) are enjoying handsome profits these days.

Engineers in the United States can learn a little from this down-to-earth approach. Sometimes you forget the simple and straightforward when you get caught up in the fervor of fast-moving technology and a wealth of research and development money.

Europe's peculiar circumstances have dictated such a realistic view. Building from widespread destruction after World War II, engineers could not afford the luxury of waste nor of complex and expensive techniques.

In addition, there has been no deep well of government money for research and development. In some countries, even Holland with its huge Philips Gloeilampenfabrieken electronics complex, money for military electronics has been scanty.

So what you see in Europe today represents mostly commercial development, accomplished with a minimum investment.

In general, engineers admit their technology trails that of the U. S. from two to five years. They carefully screen developments in America, grabbing what is immediately practical and economic and throwing the rest back. Research projects are terminated quickly when the prospects of success dim.

That hasn't ruled out some intriguing new work in pockets of technology, surpassing what has been done elsewhere. For example, Europeans have designed some superb electronic display tubes that are now sold in the U. S.

Touring European facilities and watching their down-to-earth approach to design gives you a fresh appreciation of practical engineering. In industrial applications, for example, multiaperture magnetic devices are used ingeniously in fail-safe circuits because they are reliable and inexpensive. The relay shows up in many communication applications because it can cost far less than semiconductor circuitry.

Some European engineers have zeroed in on technological areas that Americans have leapfrogged, such as cold cathode tubes.

Happily, some of this practical approach is returning to the U. S. When IBM introduced its system/360 last month [Electronics, April 20, page 101], experts noted that its microelectronic approach strongly resembled what is being done in Europe. Although many companies there are interested in microelectronics, almost nobody is building integrated circuits—combining active and passive elements on a single chip. The usual European approach is the hybrid, connecting transistor and diode chips to resistors. In fact, IBM's new system turned out to be the product of the company's world-wide engineering force, and the approach for system/360's unsophisticated microelectronics—unsophisticated by lab standards, that is—did come from Europe.

All this shows that solving many technical problems takes more than money. As military budgets are tightened in the U. S., more and more engineers will find that money isn't everything. There is still a place for straightforward practical engineering.

NEW!

MODE INDICATORS FOR VOLTAGE/CURRENT REGULATED POWER SUPPLIES

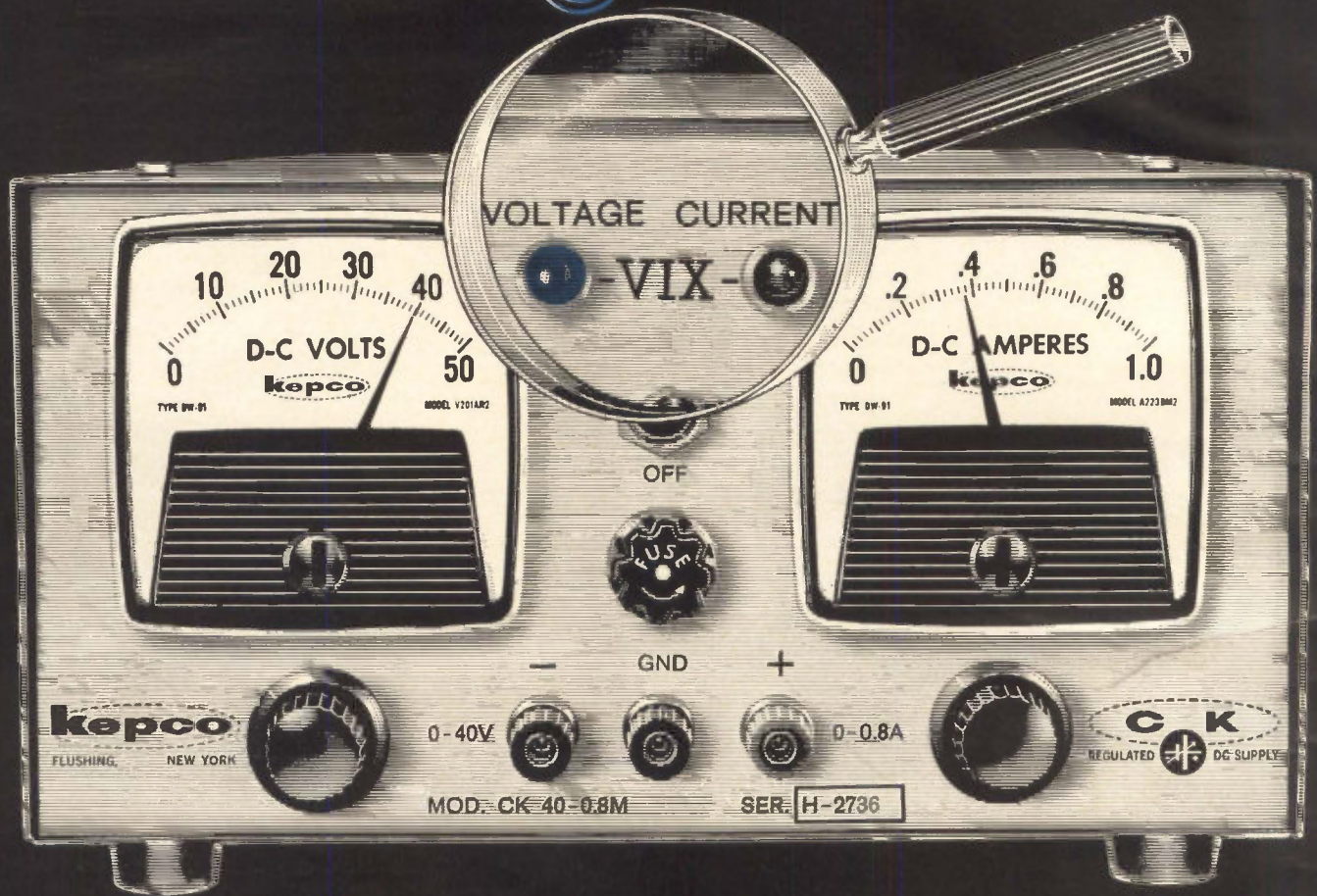

KEPCO TIME-**VIX*** INDICATORS

Kepco voltage/current regulated power supplies in the CK series now come equipped with voltage/current mode indicators called "VIX".

Time saving and added utility are provided by these indicators which show at a glance whether the power supply is in its voltage regulating mode or its current regulating mode.

This indication is especially useful in the Kepco CK Models since they have extremely sharp cross-over characteristics.

*VOLTAGE/CURRENT CROSSOVER INDICATORS

Send for complete data on
Kepco CK Models
featuring NEW "VIX" Indicators.

kepco

NEW **CK** SERIES
REGULATED DC SUPPLY

0.01% REGULATION and STABILITY

DC OUTPUT RANGE		MODEL	PRICE
VOLTS	AMPS		
0-2	0-8	CK 2-8M	\$330.00
0-8	0-5	CK 8-5M	330.00
0-18	0-3	CK 18-3M	290.00
0-36	0-1.5	CK 36-1.5M	290.00
0-40	0-0.8	CK 40-0.8M	255.00
0-60	0-0.5	CK 60-0.5M	290.00

131-38 SANFORD AVE. • FLUSHING 52, N.Y.
(212) IN 1-7000 • TWX# 212 539-6623
Cable Address: KEPCOPOWER, NEWYORK

Electronics Newsletter

May 4, 1964

Capital spending spurts in 1964

United States commerce and industry plans to add plants and equipment this year at a pace 12% faster than in 1963, according to the 17th annual McGraw-Hill survey of actual spending plans.

A typical increase is in automation, a key statistic for the electronics industry. Last year, industry spent more than \$7 billion on automation equipment. The figure is expected to climb to \$8.8 billion and stay at at the \$8-billion-plus level through 1967.

All industry, including nonmanufacturing companies, plans to spend a total of \$44 billion in 1964, up 8% from the rate planned last fall. Manufacturers plan a record \$18.5 billion in capital outlays, up 18% from 1963, and they expect to hold the level at \$18 billion for the following three years. The aerospace industry is the only one that plans a cut—2%—in capital spending. It expects sales in 1964 to rise only 1%, compared with an average gain of 8% predicted by other manufacturers. A 23% gain in aerospace sales is predicted by 1967.

Electronics sales are expected to rise 7% this year, and to continue rising. By 1967, the industry expects that sales will be up 21% from 1963. All industry expects research and development outlays to rise from \$12.5 billion last year to \$13.2 billion in 1964 and to hit \$14.7 billion in 1967. In electronics, R&D plans indicate a 7% rise this year and a 13% increase by 1967.

British hold off on color tv

Britain's plans for beginning color tv broadcasts as early as 1965 have collapsed. Instead, the postmaster general has decided to wait until after a decision by the International Radio Consultative Committee (CCIR) on one system for Europe. He says the earliest start for color tv will be 1967 or 1968.

The CCIR won't decide until next April. At its last conference [Electronics, March 6, 1964, p 17] it was unable to choose between the American, German or the French system. The British Broadcasting Corp. said it would go it alone, using the American color tv system, but then had second thoughts.

Meanwhile, engineers in Britain are saying the delay in selection of a European system is due not to a technical but a marketing stalemate. A German delegate to CCIR is supposed to have told his English counterpart:

"We are insisting on our system only because we know France demands theirs and that means a deadlock. We are just starting to sell black and white television and stereo in Germany. When we see a market for color television sets, we'll be willing to go along with England and accept the American system."

Inertial sensor is electronic

A gyroscopic sensor for inertial guidance that uses servos and micro-miniature electronics for measuring instead of precision mechanical techniques is being developed by the Bell Aerosystems Co., a division of the Bell Aerospace Corp.

The sensor has four degrees of freedom, with two accelerometers and two gyros. Because it does not require an inertial platform, it can be mounted directly on an airframe.

Helmut Schlitt, director of engineers at Bell Aerosystems, expects

Electronics Newsletter

details to remain classified for five years. He says the sensor should "revolutionize the self-contained inertial guidance market." Its accuracy is substantially greater than the best existing instruments, he says, and it is less expensive and more reliable.

The sensor has an instant reaction time and is not adversely affected by acceleration, temperature or vibration, Schlitt adds. Schlitt was a guidance expert on German V-2 rockets during World War II.

Another low-cost home tv recorder

Another entry is planned in the race to market a home tv tape recorder. A recorder to sell for under \$500 is being developed at the Illinois Institute of Technology. It has four tubes. A recorder shown last month by the Fairchild Camera and Instrument Corp. [Electronics, April 20, 1964, p 18], also aimed at a \$500 price, uses about 30 transistors.

Marvin Camras, who heads the institute's development group, is skeptical that the Fairchild recorder can be sold for \$500.

Camras says his unit uses a 7-inch reel of tape that makes 10 passes, requiring 6 minutes per pass, whereas Fairchild's 11-inch reel makes 4 passes and takes 15 minutes a pass.

Camras hopes to have picture contrast sharp enough to introduce his unit late this month or early in June. Camras also is trying to reduce tape speed for transverse recording, which could pack more information on less tape.

Sweden planning versatile planes

If Parliament approves, Sweden will spend \$2 billion for an airborne weapons system based on the Viggen multipurpose aircraft. The aircraft will be capable of Mach-2 speeds at high and low altitudes. Attack, reconnaissance and interception capabilities can be combined in one plane through use of a miniature digital computing center to handle automatic navigation, fire control and other functions. The Saab Aircraft Co. is prime contractor for the system, which is expected to involve about 1,500 companies on both sides of the Atlantic. Deliveries are scheduled to begin in 1969.

Philco will make color tubes again

The Philco Corp. will resume the manufacture of color-tv picture tubes next year. It will produce conventional three-gun tubes, drawing on know-how gained during development and production of the one-gun Apple tube during the 1950's.

Philco will also take another look at the Apple tube to see whether it would be worthwhile to resume its development. The Apple tube uses beam-indexing rather than conventional shadow-mask methods, and requires different circuitry in the receiver.

Army will order miniature vocoder

The Army's Electronics Research and Development Laboratory at Fort Monmouth, N. J., is planning to buy a microcircuit version of the AN/TSC-29 tactical vocoder. The developmental model, built by the Hughes Aircraft Co., uses transistors. At present, the Army is using only a few vocoders with vacuum tubes. The system codes speech into digital form and transmits it by radio, then converts the signals back to speech. It's one way of keeping voice messages secret. Transmission rate is 2,400 bits a second.

"Helping engineers match small motors to their products has reinforced our belief in offering what *you* want . . . not what *we* happen to have. That's why Barber-Colman is making new types of subfractional-horsepower motors—all of them easily tailored to individual product designs."

MacLean Kelley, sales manager
Electro-Mechanical Products Division
Barber-Colman Company

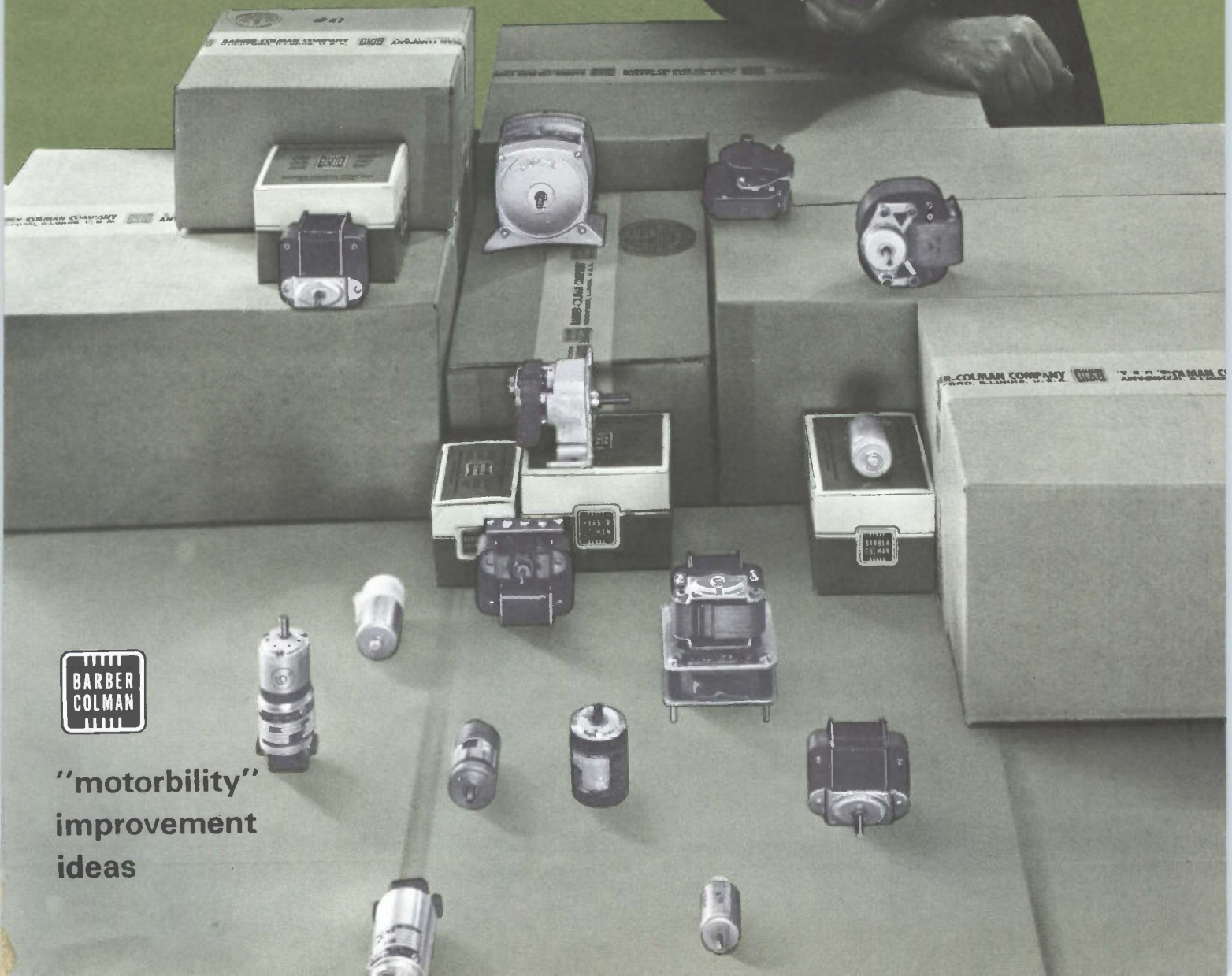
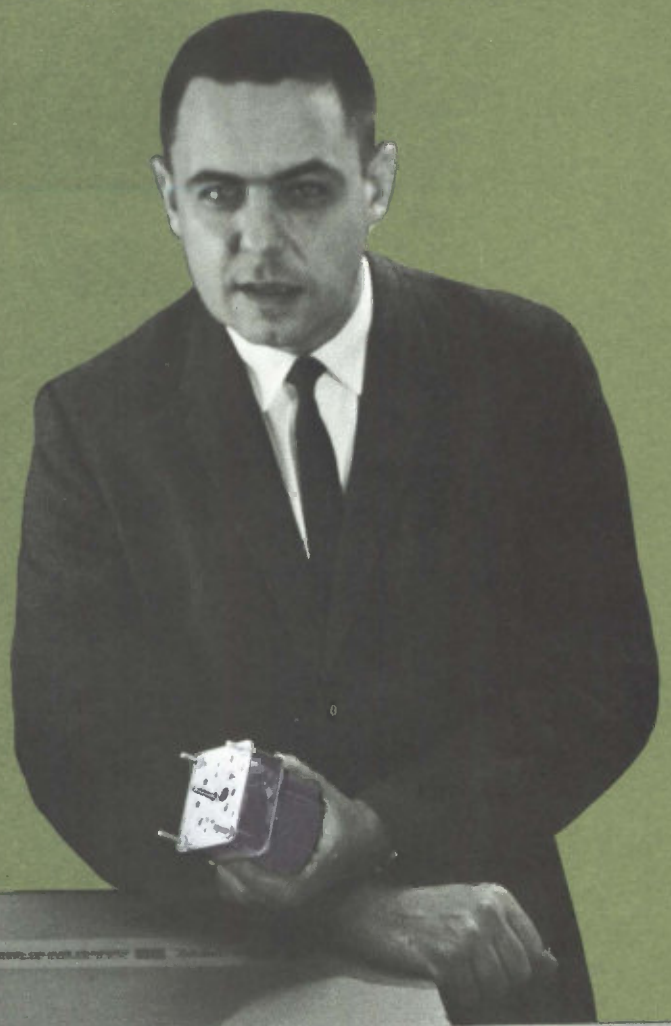

"motorbility"
improvement
ideas

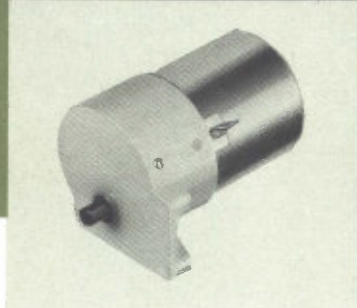
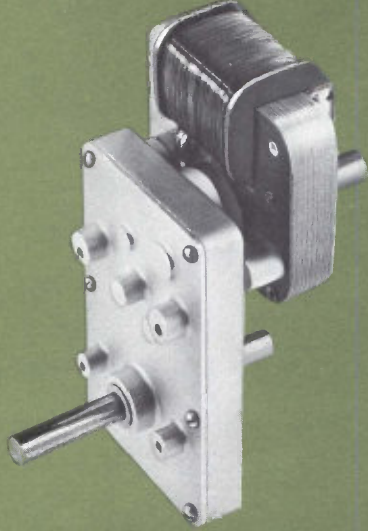

New SYAZ motor-gear train (far left) has max. 1/40 hp, 50 lb-in. for driving, indexing, timing, selecting, scanning, mixing.

Barber-Colman motors, both a-c and d-c, can be modified many ways to meet individual requirements. Shown above are standard precision d-c motor and two modifications.

New BYQH gear train (near left) for battery-powered motors uses molded plastic housing and gears.



Barber-Colman is adding new motors for more types of applications. Some new models are ready now . . . others soon will be. Look for more emphasis on modifying standard motors to meet specific product needs. Here is why:

More and more design engineers are recognizing that specification of a standard "catalog" motor too often forces them to compromise a product – in terms of cost, performance, size, and reliability – *even before it is produced*. A customer described his plight this way:

"Past experiences – not present needs – have been the designer's major guide when selecting small motors. One consequence is over-specification."

Cuts motor costs 50%

The progressive attitude toward small-motor selection is typified by those who outline *performance requirements of their product* – then count on a supplier to come up with the best motor to match those requirements. More than one OEM has gained significant cost savings after specifying optimum "motorbility:"

A chart-drive manufacturer cut motor costs 50% the first year he replaced instrument-type servo motors with Barber-Colman *reversible* shaded-pole motors.

An office-equipment maker realized major savings in service costs after we engineered a more rigid gear train with

heavier gears . . . multiplied the service life of his motors severalfold.

A host of similar values engineered for other OEMs suggests that Barber-Colman move still closer to the concept of "how can we modify basic motor models to meet specific product requirements?" To do this and still keep prices competitive, we are broadening our standard line of subfractional-horsepower motors.

Barber-Colman now has (and will continue to develop) new ranges, types, and sizes of motors and gearmotors for more different applications . . . and in a wider price range.

Price and reliability are compatible

How can we price motors competitively without compromising our established reputation for quality? One answer is the number of new materials now available. For example, in addition to hobbled gears, we now offer gears of molded alloy steel or plastic.

Barber-Colman's newest development – the SYAZ gear train shown above – is typical of a motor you might specify where economy is important and quality is essential.

The SYAZ geared motor is a flat, space-saving unit, designed for vending machines, office machines, photocopy equipment, and similar commercial or industrial products. Its die-cast housing encloses a grease-lubricated cluster of gears. Gear ratios from 11:1 to 1134:1 are available with a variety of Barber-Colman base motors – unidirectional, reversible, or synchronous types. Versatile mounting arrangements make the SYAZ adaptable to specific requirements.

Another example of high value for low-cost is our new BYQH gearhead for battery-powered motors. This package is only 1.29" in diameter, and provides speed reduction for applications needing up to 1 lb-in. of torque. It's an economical unit . . . both housing and gears are molded plastic.

These and other Barber-Colman motors tailored to individual applications are realizing substantial cost savings for many manufacturers. That's why a Barber-Colman sales engineer might be a valuable asset to *your* product improvement program. Call him soon, or write for detailed literature, outlining your power requirements.



BARBER-COLMAN COMPANY

Electro-Mechanical Products Division
Dept. B, 12155 Rock Street, Rockford, Illinois

KLEIN PLIERS *Speed up electronic wiring*

When the crystal set was a seven-day wonder, Klein long nose pliers were used to adjust the cat's whisker. Through the era of B and C battery sets, Klein kept pace by providing pliers specially adapted for electronic wiring.

Today, more than 100 different styles and sizes of Klein pliers are available to provide the exact tools needed for any job. Klein engineers have developed a special plier for wiring printed circuits; a high hardness

plier for cutting nickel ribbon wire; a transverse end cutting plier for cutting closely in confined spaces; extremely small pliers for wiring midget assemblies—and many others.

Klein has also developed special pliers to do special jobs requested by electronic manufacturers.

For better work done more quickly and at lower cost, be sure the pliers you use are exactly suited to the job . . . made by Klein, of course, "Since 1857."

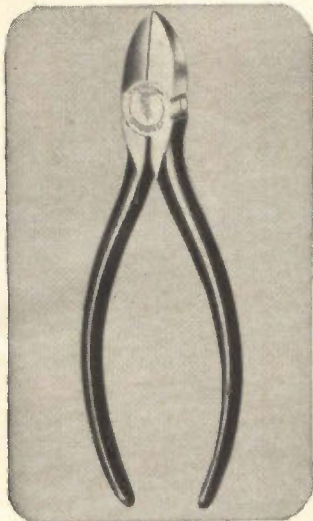

202-5C Oblique Cutting Plier with narrow nose. Available with coil spring. 5½-, and 6-in. sizes.

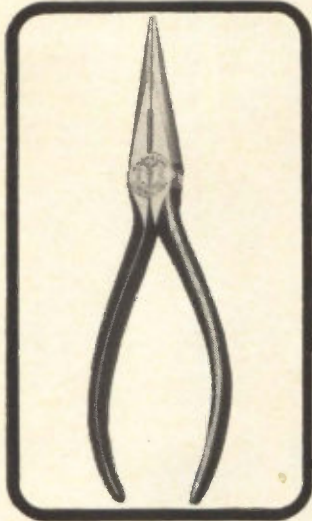

203-5C Long Nose Side Cutting Plier. Available in 5½-, 6½- and 7-in. sizes. Supplied with coil spring.

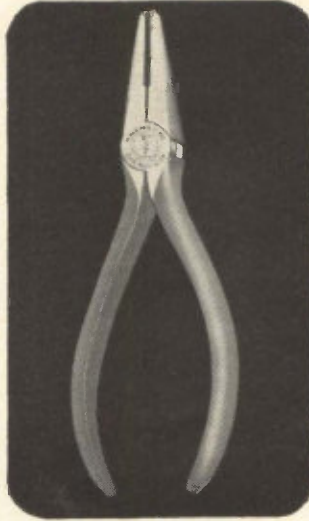

204-6C Transverse End Cutting Plier, 6-in. long. Supplied with coil spring to hold jaws open.

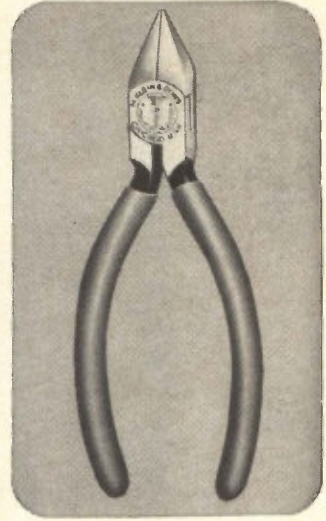

D209-5C Lightweight, Pointed Nose, Flush Cutting Plier. Supplied with coil spring to hold jaws open.

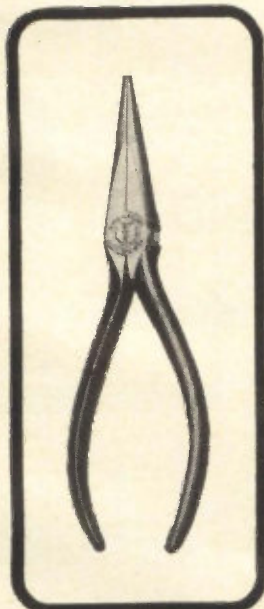

301-5C Long Nose Plier. Available in 5½-, 6½- and 7-in. lengths. Coil spring.

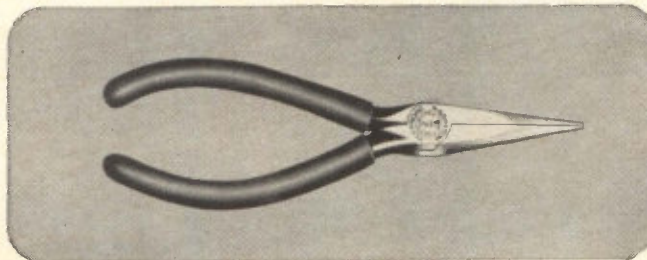

D307-5½C Slim Long Nose Plier for reaching into confined spaces. Yellow plastisol handles. Supplied with coil spring to hold jaws open.

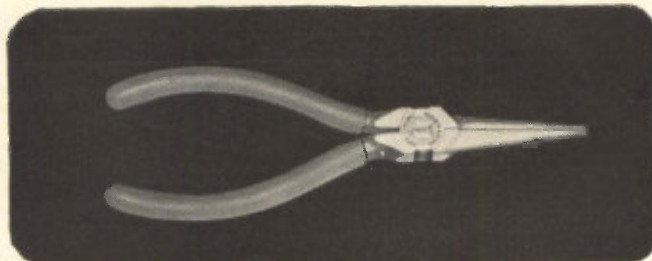

D310-6C Slim Long Nose Plier. Handles are yellow plastisol covered. Supplied with coil spring to keep jaws open.

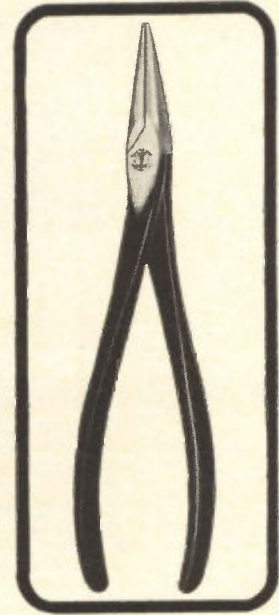

314-8 8-in. Long Nose Plier. Jaws have knurl.



Mathias **KLEIN** & Sons
Established 1857 Chicago, Ill., U.S.A.

INCORPORATED
7200 McCORMICK ROAD, CHICAGO 45, ILL.

See Your Distributor
Foreign Distributor: ITT Export Corporation, New York



Unlimited control and display opportunities

WITH MICRO SWITCH LIGHTED PUSHBUTTON ASSEMBLIES



Series 2 Lighted Pushbuttons introduce new custom answers for a wide variety of design problems. A broad selection of components and modular, snap-on assemblies provide unlimited possibilities.

Choice of round or rectangular displays for shape coding; four separate lamps in each unit allowing four-color display; variety of screen and hardware colors; 7, 15 or 20 amp. switch units, in sub-miniature or hermetically sealed assemblies; circuitry and electrical ratings you require; momentary or maintained switching action, with or without remote control.

For engineering assistance, call our Branch Office (see Yellow Pages), or write for Catalog 67.

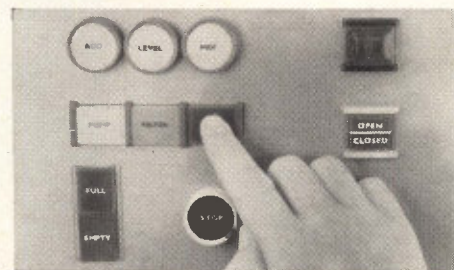

M I C R O S W I T C H

FREEPORT, ILLINOIS

A DIVISION OF HONEYWELL

IN CANADA: HONEYWELL CONTROLS LIMITED, TORONTO 17, ONTARIO

HONEYWELL INTERNATIONAL—SALES AND SERVICE OFFICES IN ALL PRINCIPAL CITIES OF THE WORLD. MANUFACTURING IN UNITED STATES, UNITED KINGDOM, CANADA, NETHERLANDS, GERMANY, FRANCE, JAPAN.

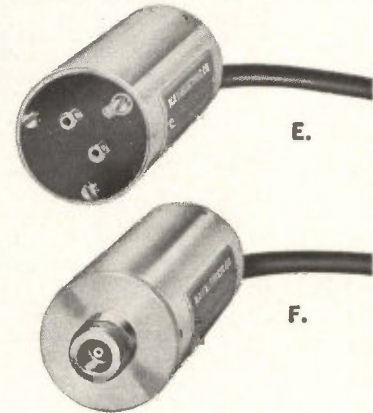
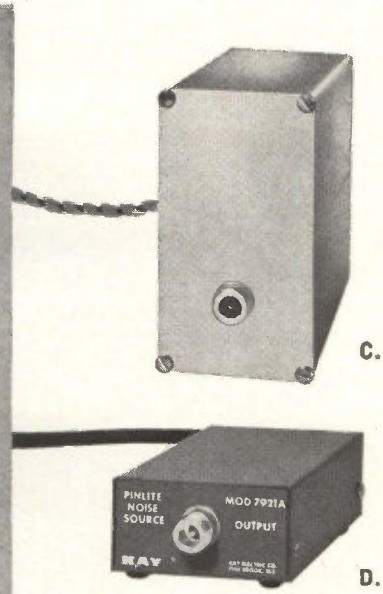
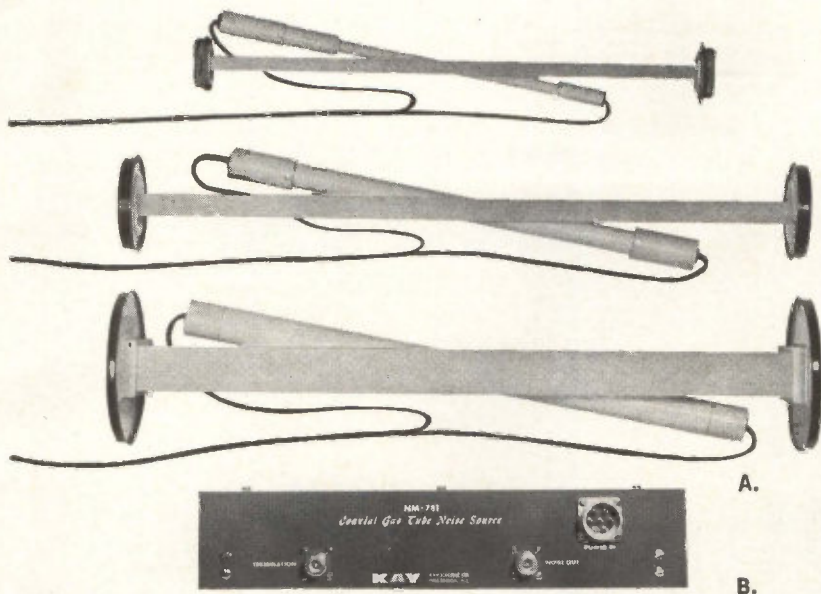

New Automatic Noise Figure Meter: **KAY 792-A**

Tuned input amplifier is continuously variable from 10 to 120 mc to give quick and easy operation with almost all receivers.

A self-contained, hot wire noise source gives low VSWR from 10 to 900 mc, and precisely known noise output, so that over-all system accuracy is less than ± 0.5 db.

The 792-A offers various variable impedance and balanced outputs, provides complete measurements up to 26.5 gc. It offers carefully metered noise figure ranges of 5 to 30 db for waveguide sources; and 0 to 20 db for hot wire and noise diode sources. Infinity is marked. Either 6 db or 15.2 db excess noise can be selected for maximum accuracy at either high or low noise figures.

The 792-A offers a wide operating range of input noise levels, 75 dbm to 0 dbm for a nominal 1.0 mc bandwidth. It requires only 33 db of external gain between its IF input and its lowest output noise source. Switched, panel-controlled attenuation of 41 db in one db steps and a highly effective AGC with a dynamic range of 40 db are provided.

To accommodate long term variations in system gain, a self calibrating feature is included. Manual operation including a variable gain control is front panel selected. Price: \$695. Pulsing Argon Supply: \$150.

- A. RG 48U — 53U Noise Heads: Argon waveguide noise sources: \$195, \$275.
- B. NM-781 Noise Head: 50 ohm coax., covers full 3000 mc UHF range: \$325.
- C. NC-780 Noise Head: 50 ohm coax. output. Covers TV-UHF frequencies. Provides expanded scale over 10-20 db range: \$245
- D. 7921-A Noise Head: Hot wire noise source from 10 to 900 mc: \$95.
- E. NB-300 Noise Head: Balanced 300 ohm output covers FM and TV frequencies: \$95.
- F. NC-240 Noise Head: Variable impedance output covers IF-VHF: \$95.

For Complete Catalog Information, Write

KAY ELECTRIC COMPANY
PINE BROOK, MORRIS COUNTY, N.J.



“Mylar” makes a smaller capacitor than paper

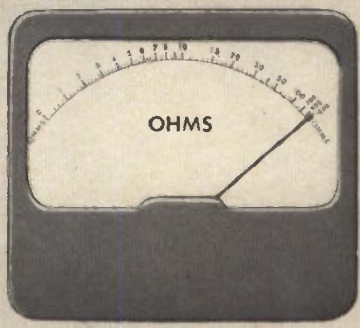

“Mylar” absorbs less moisture than paper

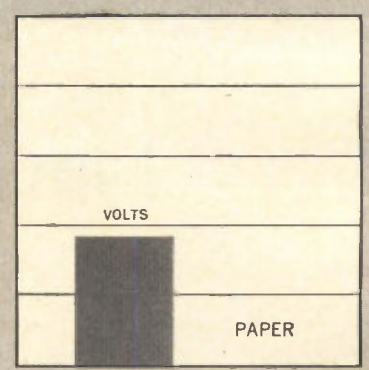
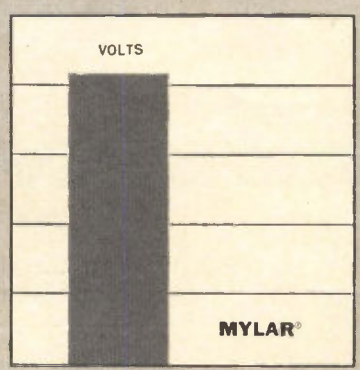

“Mylar” operates at higher voltage stress than paper†

and capacitors of “Mylar”* cost about the same as paper

Within the range of .001 to 1. MFD under 600 volts, you get the added dielectric strength, reduced leakage and greater stability of “Mylar” at equivalent cost to paper on a set-complement basis. Specify “Mylar”.



†At higher voltage stress “Mylar” operates with equal or better reliability than paper. *Du Pont registered trademark.

L I C O N[®]

this...

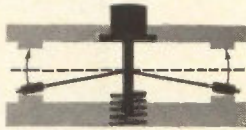

Exclusive Licon[®]
"Butterfly"[™] T.M.
Double-Break action

**makes
these...**

The Licon[®] Double-Break
Switch Line

**TYPE 16
SUBMINIATURE SWITCH**
1/4" thick, 25/32" long.
Rated 10 amps, 125/250 VAC,
30 VDC Ind.



**TYPE 11
MINIATURE SWITCH**
1/2" square, 1 1/4" long.
Rated 10 amps, 125/250 VAC,
30 VDC Ind.



**TYPE 22 DOUBLE-POLE
DOUBLE-THROW SWITCH**
Four independent circuits.
Rated 10 amps, 125/250 VAC,
30 VDC.



**TYPE 14 HEAVY
DUTY SWITCH**
Rugged basic switch.
Rated 20 amps, 125/250 VAC.



reliable

The most reliable*
Double-Break switches
you can use . . . in a wide
selection of
• circuitries
• terminal styles
• materials
• actuators
Send for facts catalog and
list of distributors. Request
sample/demonstration on
your letterhead.

*20 million mechanical cycles



LICON

DIVISION ILLINOIS TOOL WORKS INC.
6615 W. IRVING PARK ROAD • CHICAGO, ILLINOIS 60634

IN CANADA: CANADA ILLINOIS TOOLS LTD. • 67 SCARSDALE ROAD • DON MILLS, ONTARIO, CANADA

For



*clearly
better
prints...*

Ozafax[®] moist diazo sensitized materials!

The papers and films that meet nearly all diazo copying needs. Each provides smooth, flat, high-contrast copies that live longer under heavy use and handling.

OZAFAX STANDARD-WEIGHT WHITE STOCK. Four papers... four printing speeds... hundreds of uses. These popular papers copy *anything* written, drawn, typed or printed on translucent material. Copies are smooth and flat. Images sharp and black.

OZAFAX STANDARD-WEIGHT COLORED STOCK. These high quality tinted papers process as effortlessly as white stock and have the same intense black images. Colors are permanent—can't wash out. Available in 5 bright hues and 3 printing speeds.

OZAFAX LIGHT-WEIGHT WHITE STOCK... weighs 17% less than standard weight stock. Has less bulk, too... 320 prints fit where only 280 regular copies do. And you also save up to 33% on postage compared to standard-weight stock. Ozafax light-weight stock is available in 4 printing speeds.

OZAFAX SEPIA-IMAGE TRANSPARENTIZED INTERMEDIATE PAPER. Runs as fast as medium speed papers—and reprints fast, too. 100% rag paper base is transparentized for super translucency. It provides

superior contrast... copies faint details... intensifies weak originals.

OZAFAX SEPIA-IMAGE MATTE ACETATE INTERMEDIATE. For quality duplicate masters that reprint fast, there's no better film than this one. The image is sharp and dense. The background clean and clear. One side is frosted for easy addition of ink or pencil notes. Erases easily too.

OZAFAX SCALEMASTER SEPIA-IMAGE MATTE POLYESTER INTERMEDIATE FILM. Here's an intermediate with high dimensional stability for extremely accurate reproductions and reprints. It's durable... long-lived. Punishment proves it's next to impossible to tear. Matte surface on one side makes design changes easy, takes pencil or ink additions.

Contact your GAF Ozalid Representative for *free samples* of these quality products. Compare them with the moist diazo materials you're now using and you'll agree... OZAFAX moist diazo sensitized materials give clearly better prints.

 **OZALID**
REPRO PRODUCTS
GENERAL ANILINE & FILM CORPORATION
BINGHAMTON, NEW YORK



What's new in pressure measurement?

This low cost, completely stable electromanometer

The new CEC Universal Electromanometer System is destined to be the most popular ever produced. Why? Primarily because it provides outstanding accuracy and long-term stability. Reason: a new, simplified amplifier circuit.

The system consists of the 1-164 Servo Amplifier and one or more 4-336-0001 Precision Pressure Balances, differential and absolute. Ranges: ± 5 , ± 15 , ± 60 psid; 15, 30, 60 psia. With other CEC pressure balances available, total range capability

may be extended from 1.5 psi to 10,000 psi.

Additional advantages...

- Accuracy equals or exceeds that of precision mercury manometers; and virtually no maintenance is required.
- Sealed precision pressure balances are provided for making absolute measurements.
- The new system is housed in a cabinet for bench use, yet is readily adaptable for rack mounting.
- Being completely versatile, it is

ideal for all laboratory, field, and process control applications.

There's so much more you should know about this exceptional low cost electromanometer, we'd like to send you the complete story. If interested, just call or write for CEC Bulletin 1164-X5.

Transducer Division **CEC**
CONSOLIDATED ELECTRODYNAMICS
A SUBSIDIARY OF BELL & HOWELL/PASADENA, CALIF. 91109
INTERNATIONAL SUBSIDIARIES: WOKING, SURREY, ENGLAND
AND FRANKFURT/MAIN, GERMANY

Circle 27 on reader service card

FACTS...

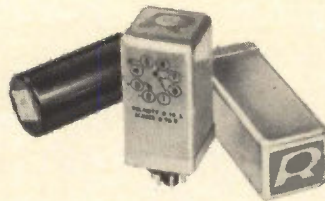

*about today's most
advanced solid state
telegraph relays*



RADIATION
INCORPORATED

Are all solid-state relays alike?

No. Some are transistorized versions of mechanical units, while others are partially solid-state. Radiation Telegraph Relays are all solid-state. There are no moving parts.

Why invest in solid-state relays?

Because they eliminate routine maintenance, require no adjustments, and cut costly downtime and service calls.

How long will they operate under normal conditions?

Indefinitely.

APPLICATIONS . . .

Which mechanical relays can solid-state units replace?

All known types . . . except those rare applications where no solid-state device can be used.

How many kinds would I have to stock?

Only three: Radiation supplies polar, neutral and universal types.

Can I simply plug in your relays and expect them to work?

Yes. But because there are so many different wiring options, an adapter plug may be required to match your particular system.

How do you power Radiation Relays?

You don't. A unique circuit (patent applied for) allows the unit to operate on input current . . . the signal itself supplies the power.

TECHNICAL . . .

What are the features of Radiation Relays?

Non-polarized output contacts, high MTBF . . . 73,000 hours of actual field test without failure, high speed . . . up to 2400 bits/second, low distortion . . . less than 1% at 1000 bauds, and low leakage . . . less than 5 μ a at 130 volts. The units provide long operating life with extremely high reliability, and are designed with special protective circuitry.

What type of protective circuitry?

Thanks to a unique Radiation design, the units are highly resistant to spikes and overvoltages. Not only do they provide a cleaner telegraph signal, but they are also protected against destruction caused by abnormal line conditions.

Suppose a Radiation Relay is badly overloaded . . . how do I check it out?

We can supply our Model 7110 Solid-State Relay Tester. Incidentally, it comes with an adapter for use with electromechanical units, too.

What if the unit's actually damaged by abnormal conditions . . . do I have to throw it away?

Absolutely not! Due to modular construction Radiation Telegraph Relays are repairable.

QUALITY ASSURANCE . . .

Are your relays guaranteed?

They certainly are. Radiation warrants Neutral Model 9214 and Polar Model 9212 against all defects of performance for a year after shipment . . . providing they're used under normal conditions.

How can I prove the superiority of Radiation Solid-State Telegraph Relays?

Simply phone or write Product Sales Manager at Radiation Incorporated, Products Division, Dept. EL-05, Melbourne, Florida. We will supply technical information, and, if you wish, have a Field Engineer provide a relay to test on the line of your choice.

Why not call today? Prove to yourself that Radiation Relays assure higher circuit efficiency, lower cost operation and dependable service!

Electronics Review

Volume 37
Number 15

Communications

Picturephone

Tom Swift's Phototelephone has advanced from fiction to fact. The feat of dialing a number to see as well as to hear has been accomplished in the Bell System's exhibit at the New York World's Fair. Engineers also have rushed similar equipment to Bell's exhibit at Disneyland in California, so that a few viewers will be able to dial the opposite coast for a look-talk.

Labeling the Picturephone an experimental way-station along the road toward two-way personal video, Bell engineers are hoping that audience reaction will supply ideas for designing and marketing. Further refinement and mass production can probably reduce the cost of each unit to between \$500 and \$1,000.

The three pairs of wires now needed for connecting two units must carry the equivalent of 125 telephone conversations, making toll charges more than 100 times as high as for voice alone.

Equipment. The vidicon camera tube has an $f/1.9$ lens, and its one-inch face accommodates a $\frac{3}{8}$ -by- $\frac{1}{2}$ -inch raster (the aspect ratio is almost the inverse of that employed in home tv). The field of view is 12 by 16 inches at three feet; depth of field is from lens to face of user is 29 to 48 inches. The vidicon works with illumination from 5 to 100 footcandles and uses a 2-to-1 interlace.

The picture tube provides 275 lines per frame, 30 frames and 60 fields a second for a picture measuring $4\frac{3}{8}$ by $5\frac{3}{4}$ inches. A dark glass faceplate is etched to eliminate reflection. Transistors are used throughout except in the vidicon and picture tube.

Bell engineers explain that black level is maintained at all times with a d-c restoration circuit, eliminating

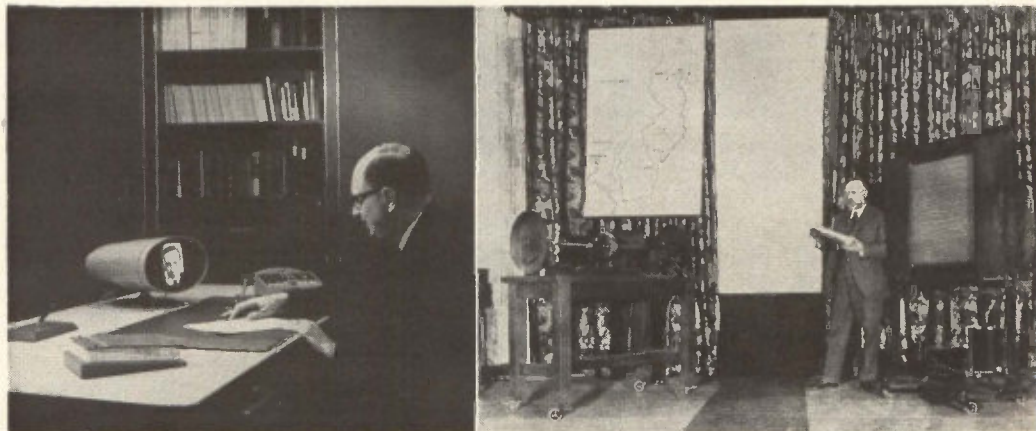

Larned Meacham, Bell Labs engineer and inventor who helped develop the latest visual telephone system at Holmdel, N.J., talks with Arthur Hall at Murray Hill, N.J. laboratories. In 1927 picture telephone tests, mechanical scanner at left sent picture-element signals to a screen in which 50 neon lamps were combined with a shutter to produce a crude halftone.

the need for a brightness control. A special interlace system couples horizontal and vertical oscillators to insure a frequency ratio that is exactly an integer plus one-half.

The Picturephone's video output includes a synchronizing signal that is much simpler than the one used in tv broadcasting. The broadcast output is a combination of horizontal and vertical sync with equalizing pulses spread across the broad top of the vertical blanking pedestal. The Bell approach is to eliminate all but the horizontal and vertical blanking pedestals, which are simply made a little higher and used for synchronization.

Hello from Hoover. Bell's first public demonstration of wired television took place 31 years ago when Walter Gifford, of the American Telephone & Telegraph Co., exchanged greetings with President Hoover. The picture was generated by mechanical image scanning and was displayed by a combination of 50 neon lamps and a shutter that produced the equivalent of a large coarse-screen halftone [see photo].

In 1956, Bell exhibited a desktop Picturephone system that used a single telephone line to transmit

a series of slow-scan images. Although suitable for transmitting documents, the pictures of people were sometimes odd. Because of the store-and-transmit technique, the picture might show a man's face one instant and the back of his head the next, without showing him turning.

The raster of 1956 was 600-cycle, 60-line and 40-dot. Today's 500,000-cycle, 275-line interlaced picture seems almost as clear as a small broadcast tv. And the picture moves naturally in synchronism with the speaker at the other end of the circuit, whether he's in a nearby booth or across the country.

Pirate radio

The British have appealed to the International Telecommunication Union, a United Nations specialized agency, for help against a young Irishman with a Panamanian ship and two 10-kilowatt transmitters. Ronan O'Rahilly has invested \$700,000 in the *Caroline*, a converted passenger vessel that operates in international waters off the coast of England. He plans to broadcast 12 hours of popular

music daily at a frequency of 1,507 kilocycles and, by selling six minutes commercial time each hour, expects to compete profitably with the state-owned British Broadcasting Corp.

Two other private radio ships are operating off the coast of Sweden and Holland as Radio Sud and Radio Veronica. A fourth, Radio Atlanta, is expected to begin broadcasting off the coast of England any day.

The British have asked the International Frequency Registration Board to remind Panama that under International Telecommunication Union radio regulations, "the establishment and use of broadcasting stations on board ships, aircraft or any other floating or airborne objects outside national territories is prohibited." The Panamanians would be asked by the union to examine the Caroline's license for radio equipment. In two previous cases, Panama withdrew its flag from pirates of the airwaves.

O'Rahilly, a true Irishman, insists that the British can't touch Radio Caroline.

Advanced technology

A vanishing barrier

A super-accurate star simulator, recently built by the Keuffel & Esser Co., has further blurred the barrier between electronics and optics.

The system's unprecedented accuracy—one second of arc, or 1/3,600 degree in both bearing and elevation—is achieved by intimately combining electronic techniques with modern optics. Looking at the system's circuits, it is hard to tell which is which: wires and optical fibers appear to be used almost interchangeably to carry information.

The two positioning servo loops are closed by optical paths, between a mirror and an electronic autocollimator whose output serves as the error signal. Two stars can

be displayed accurately; their magnitude is variable electronically and their intensity can be modulated optically with sine-wave signals from 0 to 100 cps.

Built under subcontract to the Kearfott division of General Precision, Inc., K&E's simulator will calibrate and test space-vehicle navigation star-trackers at Holloman Air Force Base, N. M. It is due for delivery this month.

K&E engineers are already planning their next system for the Air Force. Its accuracy is one-tenth of a second of arc.

Military electronics

Billion-dollar buy

Much of the electronic communications equipment the army is using today was built and issued shortly after World War II or during the Korean War. But better equipment is on the way—close to \$1 billion worth in the next few years.

Contractors are producing some of the equipment now, some won't be ready until fiscal 1969. Most of it is solid-state and represents a vast improvement over present equipment. The new gear is smaller, lighter, easier to maintain, easier to operate, more mobile, with far greater range and versatility and, generally, with triple the channel capacity.

Literally dozens of new types of radio, telephone and radio-teletypewriter equipment will be bought.

Just about everybody on the totem pole, from squad leaders to generals commanding field armies, is in line for new equipment.

Officers of the Army Electronics and Combat Development Commands outlined the replacement program to the Armed Forces Communications and Electronics Association at Fort Monmouth April 21. The briefing took all day.

Keep talking. The smallest of the new radios are the PRT-4 and PRR-9 transmitters and receivers, which will replace the old PRC-6 used by front-line squads. They are

not only far lighter, they provide hands-free reception. The soldier can keep his trigger finger where it belongs. A second, short-range channel keeps chatter in the area.

New workhorse. The biggest single item on the procurement list is the VRC-12 radio set, which will replace the GRC-3 series. This changeover, already starting in Europe, will cost \$355 million.

There are 22 configurations of GRC-3's. There will only be eight VRC-12's, greatly simplifying logistics. The new sets are modular and will be easier to maintain than wired sets.

The old sets split the 20- to 55-megacycle range into three bands, with a total of 370 channels, requiring a commander to maintain separate communications with infantry, armor and artillery. Each new set covers 30 to 76 megacycles and has 920 channels.

Today's range requirement is 36 kilometers, while the GRC-3 only reaches 24. The VRC-12's range is 48 kilometers.

Network atop network. The VRC-12's are for battalion use. Companies will also get 920-channel radios. Brigades and larger units rate 7,000-channel sets. And as units increase in size, the number of networks and the variety and cost of equipment multiplies.

At the top of the heap are big, multichannel radio systems for the command and other networks required by divisions, corps (four divisions) and field armies (three corps). These can have six to 96 channels, depending on the size of the force. And the networks may cover an area of 40,000 square kilometers, for a field army, with stations arranged about 40 km apart in a checkerboard pattern.

They will simultaneously handle voice, code and data. Link security will enable commanders to set up scrambled conference calls—at present, only individual teletypewriter circuits can be made secure. On the horizon are 600-word-per-minute electronic teletypewriters that will permit computer communications in the field. Present 100-wpm electromechanical machines don't type fast enough.

Zeroing in

Under an Army Weapons Command contract, the Emerson Electric Manufacturing Company is developing an improved M6 helicopter armament system that will enable pilots to aim their guns at specific targets instead of spraying bullets over a general area. The new system will also make life less hazardous for paratroopers—like the Vietnamese shown in the photo. New cut-out switches prevent the guns being fired inadvertently.

The original M6 armament system was also developed and produced by Emerson Electric under an Army Weapons Command contract and it is widely used in tactical support roles in Vietnam. It includes a dual 7.62-mm machine gun mount on each side of an Army helicopter plus necessary sighting and fire-control equipment.

Improvements. The improvements will permit correction of each turret, both in windage and elevation. In addition, the servo amplifiers and power supply voltage regulator have been redesigned to reduce thermal drift, which led to inaccurate firing in earlier systems. The amplifiers are of direct-coupled d-c design and use five silicon transistors. The input stage is a special temperature compensated design, using npn and pnp units back-to-back. Earlier M6 systems used a single npn common-emitter

transistor amplifier in the input stage.

The second stage uses an npn transistor as an emitter follower and the last stage is an emitter-coupled differential amplifier that drives a hydraulic servo valve. Voltage gain is 30; output power is 32 mw.

The improved voltage regulator is a five-transistor series circuit, consisting of a power transistor compound-connected with another unit as the series control element. A single unit is used as an amplifier and two additional units in a differential connection act as the comparator and amplifier. The regulator also uses several zener diodes as reference and temperature-compensation elements.

The improved system, like the present M6, can operate in either flexible or fixed mode. In the flexible mode, the target is sighted by means of an optical-mechanical sighting station operated by the co-pilot gunner. The fixed mode provides for firing the weapons from a pre-set "stow" position, and may be controlled by either the pilot or co-pilot. Total rate of fire is about 2400 rounds per minute.

More work for drones

Air Defense Command helicopter pilots at Tyndall Air Force Base, Florida, whose job it is to find and recover downed flying target drones in the choppy waters on the Gulf of Mexico, have recently asked for a little electronic help from the drone itself.

The drone used by the command—the Firebee Q2C built by the Ryan Aeronautical Co.—is not easy to spot from the air when weather conditions turn the water a certain color. All the drone contributes now toward its own rescue is its ability to stay afloat. To provide more cooperation, the pilots suggest that the drone carry a low-frequency (200 kc-400kc) radio beacon, with a range up to 30 miles, that would start transmitting the moment it comes in contact with salt water. Since helicopters and boats are both already equipped with low-frequency radio direction

finders, searchers would be able to home right in on a lost drone.

Hard to locate. Without a beacon, a silent, soggy drone can usually elude two or more helicopters for more than two hours. Some have been known to bob around in the Gulf for more than three months before they are found—by then, a long way from home base, so water-soaked that they are useless.

Last year, one-fourth of the 114 drones flown went down in the water. Six a year are usually lost in normal operations with from four to six more during the William Tell tournament held every year at Tynadall. At \$175,000 a drone, the bill for lost drones gets pretty high.

Although not an impressive sum by defense Department standards, a million dollars pays a lot of light bills in the White House.

Drones provide target practice for Air Defense Command fighter pilots using machine guns and infrared missiles. (Occasionally the command's ground force team uses the drones to test the anti-aircraft surface-to-air missile, Bomarc.) The Firebee is used as a flying target for missions lasting from 45 minutes to an hour. The power is cut at the end of the exercise, a parachute opens, and the drone falls safely to the ground. If, however, the ground controller should detect a malfunction that might cause the drone to fly away, or to fly over in-



Army helicopter loaded with Vietnamese paratroopers. Twin machine-gun mount in foreground is part of M6 armament system.



Helicopter pilots in search of drones, like the Firebee Q2C, downed in the water would like some help. They suggest a radio beacon in the drone.

habited areas, he will radio-instruct the drone to cut the engine at once and open the 'chute. If this takes place over land, ground crews can find the drone. If it occurs over the Gulf, the helicopter rescue squad is called in.

Whether the pilots get their request for a beacon remains to be seen. If they do, Defense Department procedures will delay initiation of research and development of the device for a year to 18 months. If the need does one day become hardware, other services as well as civilian agencies might be able to use such a device.

Manpower

Technicians' society

The first professional organization of engineering technicians was formed in Kansas City last month. It's called the American Society of Certified Engineering Technicians. All technicians accredited by the Institute for Certification of Engineering Technicians are eligible for membership. The membership now consists of the board of directors and the officers. But society officers have high hopes—100,000 members in a few years.

The new organization is sponsored by the National Society for Professional Engineers. But Robert G. Silva, president of the group and a designer for the Burns McDonnell Engineering Co. in Kansas City, says, "As soon as we're organized we'll be on our own."

Consumer electronics

Multiplex-choice quiz

New York City plans to use fm multiplex broadcasting this summer for adult education and retraining. The project depends on whether the city receives federal retraining funds of \$500,000 to \$700,000 for which it has applied.

The fm system, built by Tutor-



Push a button, get a question

tape Laboratories, Inc., is designed for programmed teaching. Recorded lessons are broadcast on four subcarriers by an fm radio station, or over the sound channel of a tv station. This is reportedly the first time a channel has been split four ways.

The use of four subcarriers permits two lessons to be broadcast simultaneously, or one lesson followed by questions with up to three possible answers apiece.

The latter method is proposed for New York's pilot program in group instruction. With this system, a student gets a control box with four pushbuttons and an earphone. He pushes the first button to hear a question. Then he pushes one of the three remaining buttons, according to his choice of answer. He has 10 seconds to make up his mind. If he answers wrong, he is given more information.

A receiver costing \$750 feeds the program into as many as 100 push-button units costing \$15. A home receiver costs about \$50. Audio response is 300 to 3,500 cycles, with consonant response to 5,000 cps.

The pilot program, outlined April 21 by the city's Department of Labor, would be a mathematics course (the city already televises reading lessons). Lessons prepared by the International Correspondence Schools would be broadcast over the Fordham University radio station, WFUV.

The labor department hopes the project will help people get high-school diplomas.

NASA's shark deterrent

Three electronic shark repellents have been bought by the National Aeronautic and Space Administration. NASA paid \$700 for each to the Hicks Research and Development Co. of Miami and is testing the device for possible inclusion in astronauts' survival kits.

Hicks says the Navy and Coast Guard also have expressed interest, as has the New Zealand Navy.

An appalling corollary could be a shark attractor. Attached to the hull of a warship, it could induce sharks to attack nearby enemy frogmen.

By the nose. The Hicks device is said to turn back sharks up to 75 feet away by generating underwater electromagnetic radiation, believed to affect a sensory organ in the shark's nose called the Ampullae of Lorenzini. These deep canals, filled with mucus, are thought to respond to temperature, pressure and electrical stimuli.

The instrument has a 36-inch underwater dipole antenna that radiates electromagnetic waves of frequencies through ultra-high. No one has yet identified the frequency that affects the shark, but whatever it is, it doesn't seem to bother other fish.

The circuit has an oscillator that drives relays, triggering secondary circuits to produce the final modified square-wave form. Four transistors and several silicon diodes are used. The output repetition rate is roughly one a second.

Power comes from light-weight batteries—either alkaline or mercury. The entire transmitter, packaged in either plastic or aluminum, weighs 1½ pounds and can operate for 18 hours.

The antenna can be mounted in various ways—including on a diver's air tank, his waist belt, or as flexible wires stitched along a leg of his wet suit.

Eel inspired. John Hicks, founder of the company and developer of the shark repeller, says his inspiration came from studies begun years ago with electric eels, which are essentially direct-current creatures.

In addition to the portable model,

Now—
all seven

MIL-R-27208A

and

MIL-R-22097B

potentiometers
from the factory
or your
local Bourns
distributor!

WIREWOUND (MIL-R-27208A)

RESISTON® CARBON (MIL-R-22097B, Characteristic B)

(units shown actual size)							
	MIL-SPEC STYLE RT10 Bourns TRIMPOT® Model 220	MIL-SPEC STYLE RT12 Bourns TRIMPOT® Model 224	MIL-SPEC STYLE RT11 Bourns TRIMPOT® Model 3010	MIL-SPEC STYLE RT22 Bourns TRIMPOT® Model 3250	MIL-SPEC STYLE RJ11 Bourns TRIMPOT® Model 3011	MIL-SPEC STYLE RJ12 - Bourns TRIMPOT® Model 3051	MIL-SPEC STYLE RJ22 Bourns TRIMPOT® Model 3251
Resistances	10Ω to 30K	10Ω to 100K	10Ω to 100K	10Ω* to 50K	20K to 1 Meg	20K to 1 Meg	20K to 1 Meg
Power Rating	1.0W	1.0W	1.0W	1.0W	0.25W	0.25W	0.50W
Humidity-Proof	YES	YES	YES	YES	YES	YES	YES

*MIL Spec shows following min. T.R.: RT10, 100Ω; RT22, 50Ω

These seven potentiometers not only meet the specs, they beat the specs. All seven have higher operating temperature, lower end resistance, better shock and vibration performance, lower temperature coefficient, higher dielectric strength and higher insulation resistance than the specs call for.

Where MIL-R-27208A sets a maximum operating temperature of 150°C for wirewound units, for example, Bourns gives you 175°C. And where MIL-R-22097B, Characteristic B, asks for 125°C in carbon units, Bourns gives you 150°C. In every important parameter, Bourns surpasses the requirements.

All seven models exceed MIL-STD-202B, Method 106, for cycling humidity. In addition, all units have solid electrical

TRIMPOT is a registered trademark of Bourns, Inc.

grade-A nickel, gold-plated pins suitable for soldering or welding. Carbon models have the exclusive Bourns RESISTON® film elements, and wirewound units feature the virtually indestructible Bourns SILVERWELD® termination. To be sure of specifications, don't MIL-SPECulate—SPECify Bourns!

Write now for qualification data, technical literature and list of stocking distributors.

If it's TRIMPOT®, it's BOURNS



BOURNS

BOURNS, INC., TRIMPOT DIVISION
1200 COLUMBIA AVE., RIVERSIDE, CALIF.
PHONE 684-1700 · TWX: 714-682 9582
CABLE: BOURNSINC.

MANUFACTURER: TRIMPOT® & PRECISION POTENTIOMETERS, RELAYS; TRANSDUCERS FOR PRESSURE, POSITION, ACCELERATION. PLANTS: RIVERSIDE, CALIFORNIA; AMES, IOWA; TORONTO, CANADA

Circle 33 on reader service card

the shark repeller can be constructed to power a network of dipoles stretched under water to protect bathing beaches. Or a dipole could be dropped over the side of a boat to protect nearby swimmers. The instrument might also protect survival rafts from sharks who like to taste fabric boats.

The Hicks device works only on salt-water sharks. The sharks and the transmitting problems are different in fresh water.

Another company is building and testing portable electronic shark repellents. Its design employs a pistol-grip handle and a single radiating element. It generates a pulsating direct current. The company is withholding technical information pending further tests, but zoologists are said to have given favorable reports.

Computers

Who's afraid of IBM?

Other computer manufacturers profess to be unworried, but International Business Machines Corp. has received millions of dollars in orders for its system/360 computer [Electronics, April 20, p. 101].

"We heard rumors for a long time about a super-computer and it didn't turn out to be so super," said one. Another commented—perhaps hopefully—that "delivery time for IBM's system is 20 months and by then it may be obsolete." A third attributed IBM's announcement of its system/360 to its need to "catch up to some of the new equipment put out by General Electric, Honeywell, Control Data and some others."

The customers see it differently. Among the firm orders that IBM has received have been one for \$40-\$50 million from C-E-I-R, Inc., an international research and data processing corporation, which is buying eight of the largest systems (model 70) and 16 of the smallest (model 30). There are said to have been 40 orders

in the Los Angeles area alone.

Other offerings. The new IBM system, although shrugged off by the competition as being no great threat, may cause prospective customers to wait and see what the 360 series can offer before committing themselves to a computing system. Among the recent entries into the computer market that may feel the pinch:

- The GE-415, a small-to-medium-class computer, is the General Electric Corp.'s first entry into the replacement market for large tabulating systems and small computers (estimated at about 7,500 machines). The 415, introduced in March, is the smallest member of the GE-400 series. Starting price is \$225,000.

- The Univac 1050, also in the small-to-medium class, was introduced in March. Purchase price ranges from \$100,800 to \$600,000.

- The H-200 series is the Honeywell Corp.'s first compact, low-cost business system, brought out to compete with the IBM 1400 series in the small computer market. Prices for this system range from \$129,000 to about \$500,000.

Blind programmer

A 17-year-old high school student, sightless since the age of eight, has developed a way for blind people to program and read out computer data.

Michael L. Lichstein, a senior at Walnut Hills High School in Cincinnati, worked out the system with researchers at the University of Cincinnati under a government grant. The computer translates the output data into braille symbols—minus signs and dots—which are printed on the back of the printout sheet at 10 lines a second. To read the output, a blind person turns the sheet over and runs his fingers along the symbols.

To "watch" the lights on the computer console, Michael built a light-sensitive probe that uses a photoelectric cell. By the changes in pitch that occur when the probe approaches the light, he knows whether the light is on or off.

An observer, watching a group working at the computer, has difficulty guessing which one is blind.

Michael's blindness is a result of retinal glaucoma. An operation saved his life but cost his sight.

He has taken enough advanced placement courses so that he will almost qualify as a sophomore when he enters Oberlin College in the fall.

Patent problems

Massachusetts Institute of Technology won an eight-year dispute over patent rights and rewards for invention of magnetic-core computer storage when the International Business Machines Corp. agreed last month to pay \$13 million in royalties to MIT. The agreement was entered into the records of a federal district court in New York City, officially ending the litigation.

Paving the way for the multi-million-dollar payment was official recognition by the Radio Corp. of America of the validity of the patent awarded in 1956 to Jay W. Forrester of MIT. RCA will be licensed by MIT to produce the magnetic-core memory.

The payment by IBM will cover its past uses of coincident-current-excited core memory systems and also future uses up to 1973 when the patent will expire.

The money, MIT said, will be used for strengthening its educational program. Forrester will share personally in the payment, but the amount is still being negotiated.

The ingredients of the formula for the IBM lump-sum payment were not disclosed, nor was it revealed whether it was worked out on a per-bit basis or as a percentage of computer market value.

Bargaining point. One thing appears likely: the \$13 million in the IBM agreement will establish a frame of reference for negotiations with other companies. Says one manufacturer: "We'll certainly drive hard on the point that IBM has about 80% of the computer business, and the rest of us split

**Why use a
Cyclic-to-natural
Code Converter
when it is no
longer necessary?**

**Now! Natural Code
Non-Ambiguous
Optical Encoders
Exclusive from
Wayne-George!**

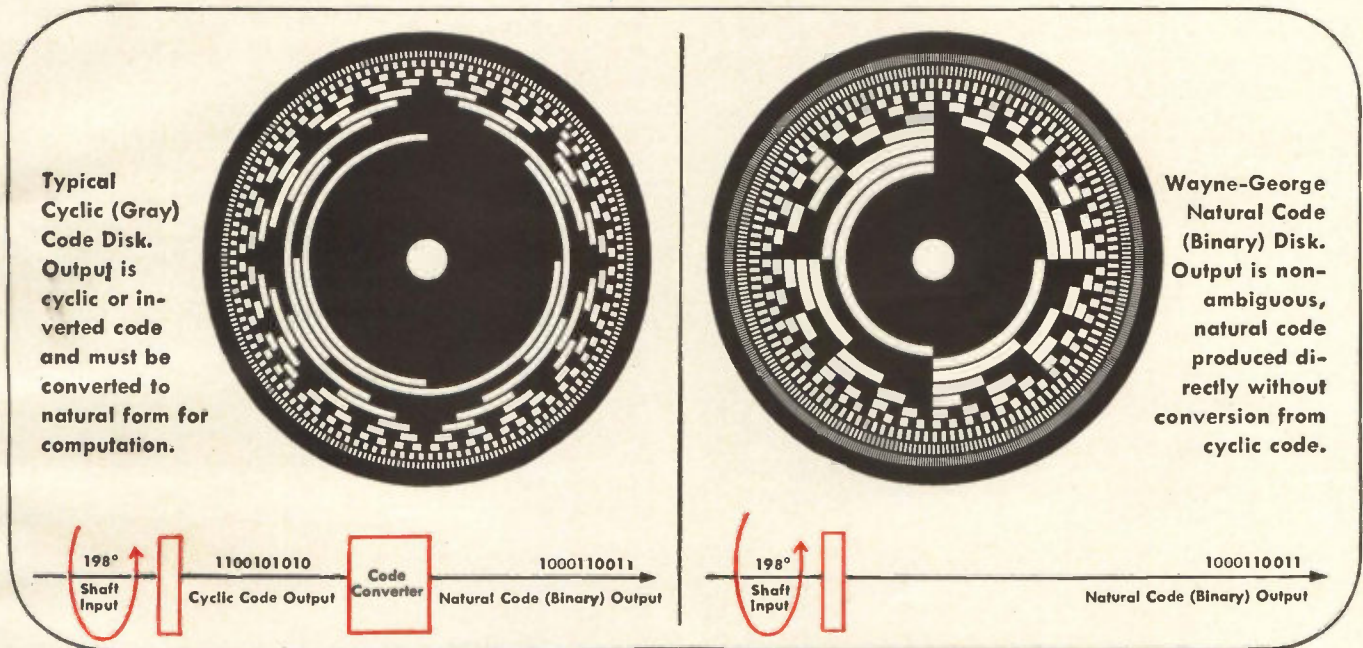

Only Wayne-George offers a complete line of optical shaft-angle encoders providing direct, non-ambiguous natural code outputs without code conversion. The new DIGISEC® and "N" Series DIGISYN® encoders completely obsolete encoders using inverted or cyclic (Gray) codes and their conversion equipment.

The DIGISEC and "N" Series DIGISYN encoders cover accuracies and resolutions (per turn) ranging from several minutes of arc to one second of arc. Natural binary, binary coded decimal or other natural codes are available. Outputs are DC levels in parallel form and are continuously available. There is no limit to interrogation rate. Integral code displays can be provided.

High reliability is attained through solid state circuits and long-life incandescent lamps using low voltages and low power.

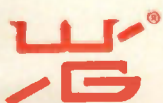
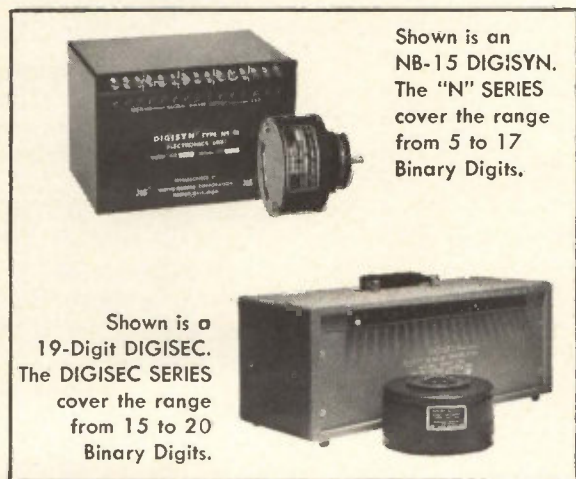

WAYNE-GEORGE CORPORATION

322 Needham Street, Newton 64, Massachusetts (617) 969-7300

up the remainder." On that basis, it would appear that MIT will receive in excess of \$16 million from computer makers. None of those queried believed there would be any changes in memory design to avoid paying royalties.

Manufacturers of special-purpose data-processing equipment may kick in another \$2 to \$3 million. One manufacturer estimates that the sale of core memories in this category will reach \$17 million in 1964 and \$29 million by 1969.

Microelectronics

Catching up

Electronics companies that did some foot-dragging on microcircuits are trying to make up for lost time. Some are plunging in boldly and making a big splash. Others are quietly but steadily building up a microcircuit capability.

One company, the Aerojet General Corp., which started from scratch three years ago, is investing \$500,000 this year to develop a strong thin-film line.

Vote for thin film. Aerojet's decision to get into thin films was spurred by the recent gains in integrated circuitry.

According to Mort Penberg, Aerojet's program manager for thin films, the company evaluated two approaches to microelectronics—integrated circuitry and thin films—and decided that thin films had the best potential. Among the steps Aerojet has taken along the thin-film route has been development of thin-film packing densities of more than 10^8 parts per cubic foot. Aerojet is working on refinements which should increase the density to 10^8 parts per cubic foot—equal to the packing density of integrated circuits.

High vacuum. To manufacture the thin films, Aerojet has developed a transport mechanism for thin-film deposition in an extremely high vacuum— 10^{-11} torr. The device is cylinder-shaped, 17 feet long and three feet in diameter. The chamber contains four turn-

tables, each holding eight masks. Using conveyor belts, a total of 120 substrates can be brought to any one of the thirty-two turntable masks at the evaporation wells. At this point, the turntable mask-holder is raised to engage with the substrate holder. Electron-beam technique is used.

Playing the field. The Centralab division of Globe-Union, Inc., is betting on both integrated and conventional circuits. The company turns out a million packaged electronic circuits a week. D. J. Jones, executive vice president, wants to be sure that microcircuits are essential in a particular application before using them. For one thing, Jones explains, microcircuits cost more. Designed around resistors and capacitors, those simple component functions wind up costing nearly a dollar apiece. Jones compares this to the fraction of a cent cost in packaged electronic circuits which have resulted from processes automated over the past two decades.

But during the past few months, Centralab has been integrating cased and uncased silicon semiconductor chips on thin ceramic substrates. It has also begun recruiting about 80 scientists and development engineers into a new corporate and applied research staff that should advance the company's position in semiconductors and integrated circuits.

Electronics abroad

L'affaire Bull

President DeGaulle's government has reversed its stand on the sale of stock by La Compagnie des Machines Bull to the General Electric Corp. Technology has won over chauvinism and Bull will be permitted to sell some of its stock to the American company which, in turn, will keep Bull up to date technically. Bull needs all the know-how it can get if it is to compete in the computer market.

In February, when Joseph Callies, the president of Bull, suggested the deal, there was a press

furor, national indignation and government refusal. General DeGaulle personally vetoed the idea and Bull was told to find a "national solution."

Bull was urged to work out a deal with a French bank and two other French electronic firms, Compagnie Generale de Telegraphie sans Fil and Compagnie d'Electricite. But neither of these companies had what Bull was looking for—special competence in computers.

Closed-door talks. It was believed that the representatives of Bull and General Electric stressed this deficiency in their closed-door sessions with government officials. The International Business Machine Corp.'s new system/360 has stirred up some waves in the computer market and the ripples may have been obvious to the French. Another reason for the decision may have been General Electric's declaration that if the French deal didn't work out it would look for another Common Market company, probably in West Germany.

Approval certain. The details of the arrangement between the two companies probably won't be released until after a stockholders' meeting on May 12th. Approval is virtually assured since the Callies family controls the Bull organization.

The betting in France is that Bull itself will become a holding company with major interests in three operating subsidiaries, one for military products, one to produce civilian goods, and one to market them. General Electric would be prohibited (on paper) from taking part in the military sector, but would be allowed to buy substantial blocks of stock in the civilian branches. Some French sources estimate that GE will own 49% of the civilian production section and 51% of the sales and marketing sections.

Face-saver. But some observers see the whole plan to split up Bull as nothing but a political face-saving device. How do you separate civilian from military products in a company as complex as Bull, they ask. Isn't General Electric bound to have its finger in everything?

SOME INSIDE FACTS ABOUT HALF-SIZE CRYSTAL CAN RELAYS

IT'S WHAT'S INSIDE THAT COUNTS. In Leach Series M250, 2 amp, 2PDT half-size crystal can relays, for example:

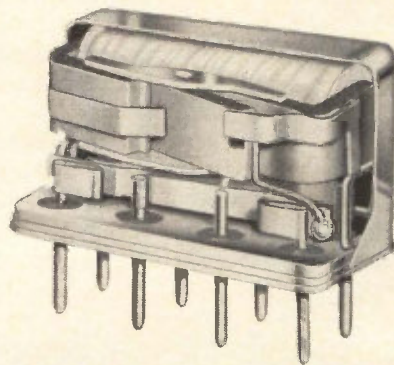

■ Contacts and motor assembly are built directly on the header. This simple but rugged construction eliminates internal wiring and its associated problems. ■ The Leach "balanced-armature" is made of a special magnetic iron for maximum fatigue resistance. ■ Teflon-insulated coil magnet wire, on a Teflon bobbin, results in a highly reliable coil at elevated ambients and guards against contamination. ■ Single coil design, and a highly efficient magnetic circuit, reduce nominal internal heat rise and provide improved relay sensitivity. ■ Contacts of a special alloy and high contact pressure provide low contact drop. ■ The M250 Series, like all Leach relays, is produced and assembled under carefully controlled environmental conditions and exacting testing procedures. It meets or exceeds the requirements of MIL-R-5757D. ■ Available with straight pin, gold-plated straight pin, and solder hook terminals, in your choice of seven standard mounting styles.

Leach offers the most extensive line of high environmental crystal can, balanced armature and other standard types of relays. Leach also will design and produce custom relays with special capabilities to meet your most stringent applications. For prices on standard units, or to discuss custom orders, phone or write:

LEACH
CORPORATION
RELAY DIVISION
5915 Avalon Blvd., Los Angeles 3, Calif.
Export: Leach International S. A.

SWITCH TO PHILCO...TO SWITCH

Save time and money. Use the industry's widest selection of semiconductor switches. Standard or customized assemblies

SWITCHING DIODES

All Philco Switching Diodes offer the user low insertion loss (with minimal or no tuning required), high isolation and broad bandwidths. There is a Philco Switching Diode to meet your every requirement. All diodes are replaceable on a do-it-yourself basis in the field. Inventory requirements are minimized—factory replacement down-time is eliminated!

For C-Band through X-Band

1 watt/1 nsec Germanium (L4100 Series)
4.5 to 11.5 Gc. • 20 frequency-optimized types • For use in Philco waveguide mounts

5 watt/10 nsec Silicon (L4700 Series)
4.5 to 12.0 Gc. • 21 frequency-optimized types • For use in Philco waveguide mounts

For K_u-Band

5 watt/10 nsec Silicon (L4750 Series)
13.0 to 17.5 Gc. • 10 frequency-optimized types • New "slimline" package covering all of K_u-Band—features low insertion loss with no tuning required.

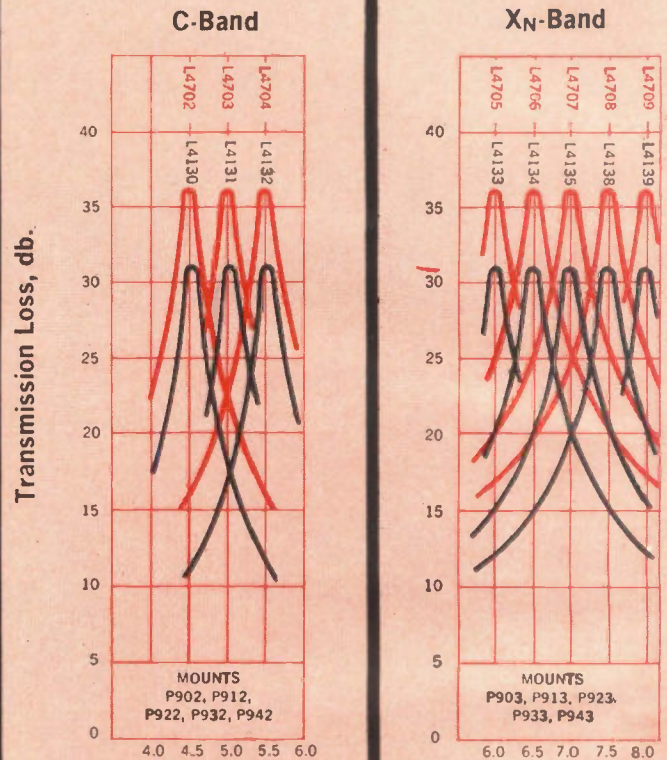

NEW PHILCO WAVEGUIDE SWITCH ASSEMBLIES

For C-Band through K_u-Band
(PS 1500 through PS 5500 Series)

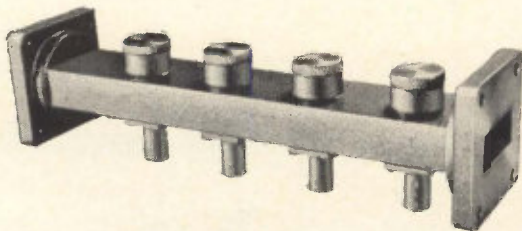

Designed for special applications. Offer many combinations of center frequency, bandwidth and switching ratio. Custom designs are available in all standard waveguide sizes from C-Band through K_u-Band. Types to meet nearly any specification, including units with different configurations and modes of operation available. Replacement diodes may be specified from Philco's standard lines. Field replacements require no tuning or readjustment in most cases. Down-time and inventory requirements are minimized.

Circle 38 on reader service card

NEW PHILCO BROAD BAND COAXIAL SWITCHES

VHF to X-Band (PS 9501 Series)



One of the most versatile switching devices in this industry! Extremely broad-band switching performance. Typically:

Bandwidth 100:1

Insertion Loss < 1 db

Isolation > 30 db

Bandwidth 300:1

Insertion Loss < 4 db

Isolation > 15 db

Obtain Amplitude Modulation > 85% over 100:1 bandwidths and > 50% over a 300:1 bandwidth at modulation rates to 1 Mc. Philco can also supply Coaxial Switches with lower Insertion Loss and higher Isolation for narrower band requirements at any frequency from DC to X-Band.

1 db to 30 db...DC to K_u-Band

and do-it-yourself components to meet virtually all your critical requirements from DC to K_u-Band.

XL-Band

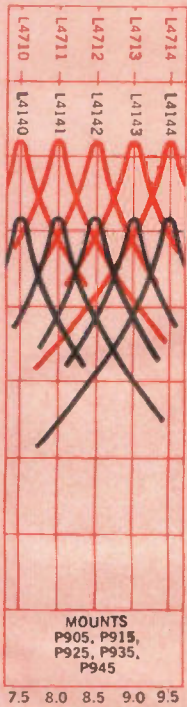

MOUNTS
P905, P915,
P925, P935,
P945

X-Band

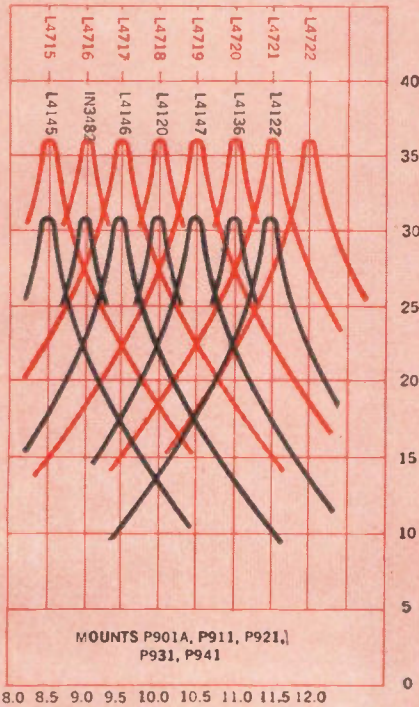

MOUNTS P901A, P911, P921,
P931, P941

K_u-Band

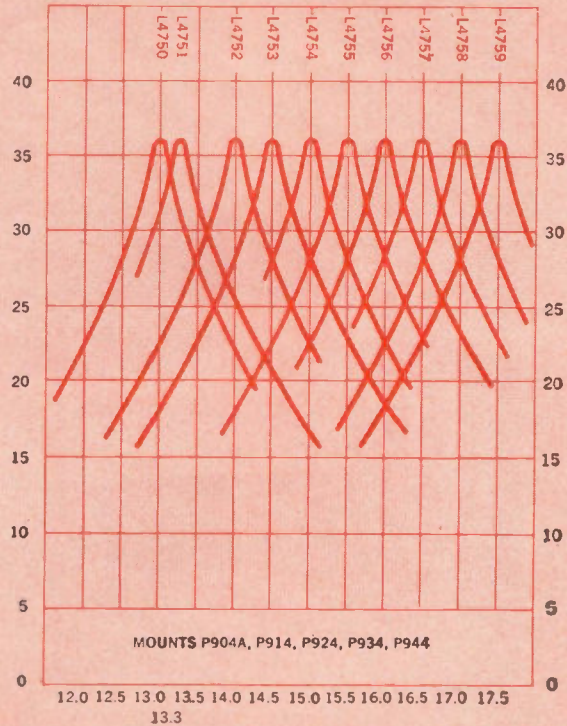

MOUNTS P904A, P914, P924, P934, P944

Frequency, Gc

PHILCO SWITCHING DIODE MOUNTS



NEW

MINIATURE SWITCH MOUNTS (P 910 through P 940 Series)

A mount for each standard waveguide size, C-Band through K_u-Band. Much smaller and lighter than standard mounts. Available in aluminum or brass, with or without choke-type flanges. Useable with all Philco Switching Diodes. Ideal for systems with stringent weight and size requirements.

STANDARD WAVEGUIDE TUNABLE MOUNTS (P 900 Series)

A mount for each standard waveguide size, C-Band through K_u-Band. For use with all Philco Switching Diodes. Diodes may be changed in the field. Tuning is available if necessary to provide minimum insertion loss.

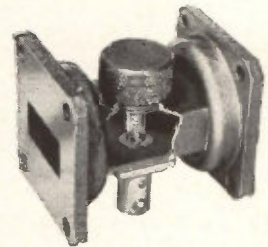

For semiconductor switches for any application from DC to K_u-Band, consult Philco. If it isn't a standard device, it can be customized from standard components or fabricated to meet your requirements. For information on special applications or for Data Sheets, write Department E5464.

**SPECIAL
PRODUCTS
OPERATION**

PHILCO[®]

A SUBSIDIARY OF *Ford Motor Company*

LANSDALE DIVISION, LANSDALE, PA.
In Canada: Don Mills Road, Don Mills, Ontario, Canada

Circle 39 on reader service card

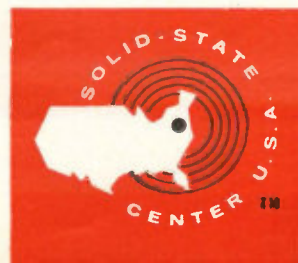

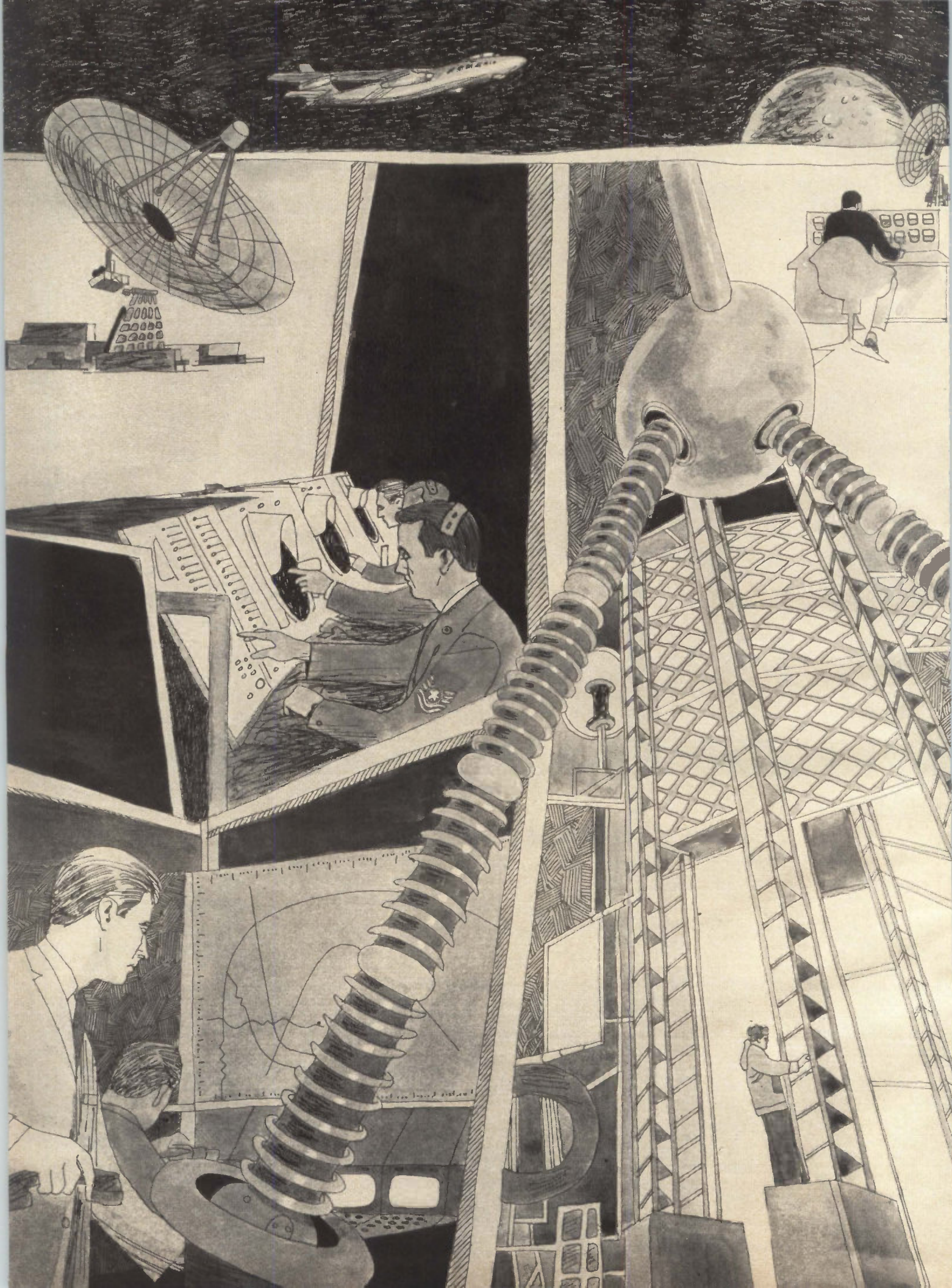

THE POWER TO COMMUNICATE...THROUGH ELECTRONICS

From beneath the seas to outer space, LTV is advancing the science of electronic communications.

Prime examples of this "power to communicate" are the super-power VLF (very low frequency) radio stations for U. S. and NATO naval communications with ships and submarines — signal achievements of LTV Continental Electronics Division, winner of every major VLF contract available in the past decade. LTV Continental also produces super-power transmitters that bounce signals off the moon and smash Voice of America programs through the Iron Curtain — plus commercial radio station and closed-circuit TV equipment.

LTV Temco Aerosystems Division is a leader in design and installation of airborne and space electronic com-

mand and control systems: data acquisition, processing and transmission. This division, for example, transformed B-47s into airborne command communications links for the Strategic Air Command. LTV Military Electronics Division produces advanced communications equipment for ground-air command and control, tracking and electronic display for space and defense efforts. LTV's Altec and University groups are leaders in sound systems of all types.

This power to communicate — through electronics — is an example of the versatile store of science and technology at LTV, leader in aircraft, missiles, space, mobile ground vehicles, ground and airborne communications, electronics and range services. Ling-Temco-Vought, Inc., Dallas, Texas.

Divisions and subsidiaries: LTV Altec • LTV Astronautics • LTV Continental Electronics • LTV Ling Electronics • LTV Michigan • LTV Military Electronics • LTV Range Systems • LTV Research Center • LTV Temco Aerosystems • LTV University • LTV Vought Aeronautics • Kentron Hawaii, Ltd.

Circle 41 on reader service card

LTV LING-TEMCO-VOUGHT, INC.

LTV Altec's "Giant Voice" horns provide base-wide voice command control at Hamilton AFB.

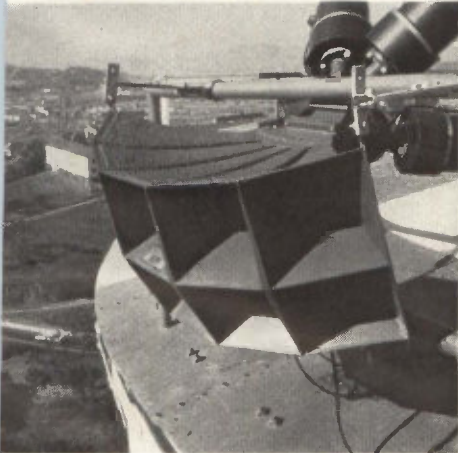

Tracking transponders for Titan III system are products of LTV Military Electronics.

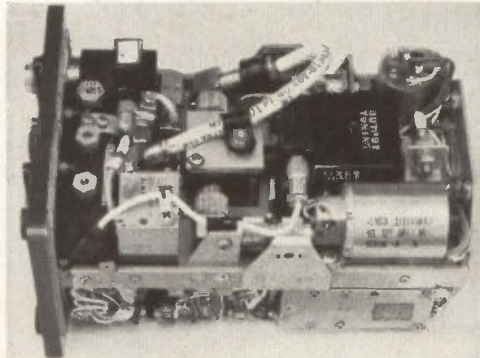

LTV Continental Electronics produces some of the finest commercial broadcast transmitters.

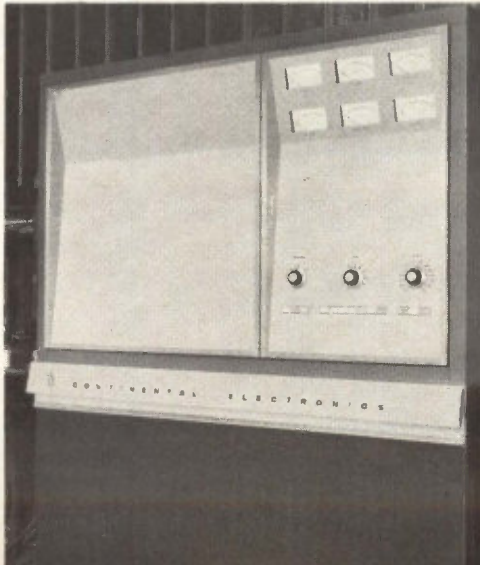

Sophisticated airborne electronic systems are a specialty of LTV Temco Aerosystems.

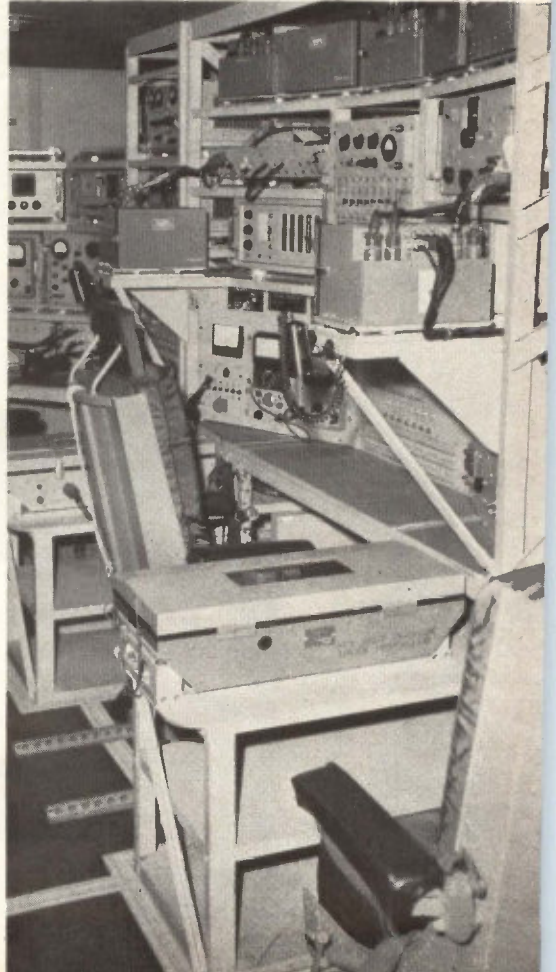

Bob Hope uses Altec M-20 condenser microphone at presentation of TV Guide Awards.



Announcing

MOTOROLA

PNP & NPN

OXIDE-PASSIVATED

SILICON

ANNULAR*

TRANSISTORS

*for every
High-Frequency
Application!*

High Current



PNP
2N3244, 45
NPN
2N3252, 53



- Optimum Switching
300 mA to 800 mA
- BV_{CEO} to 50V

New PNP and NPN silicon annular transistors designed for high-current line and core driver applications as high as 1 ampere. Featuring the 6-pointed geometry Star† transistors, and available in the high power-dissipation solid-header TO-6 package, these new Motorola devices are the fastest silicon switches available in their current range.

		Performance Specifications		
		BV_{CEO}	$V_{CE(SAT)}$ $I_C = 500 \text{ mA}$	f_t
		Volts (min)	Volts (max)	mc (min)
PNP types	2N3244	40	0.5	175
	2N3245	50	0.6	150
NPN types	2N3252	30	0.5	200
	2N3253	40	0.6	175

LOOK TO MOTOROLA FOR CONTINUED LEADERSHIP IN SILICON TRANSISTORS... The low-leakage annular process, monometallic construction for high-temperature reliability, and epitaxial high-frequency performance are only a few of the reasons why you should specify Motorola for your silicon transistor requirements.

Medium Current



- Optimum Switching . . .
10 mA to 400 mA
- BV_{CE0} to 60V

PNP
2N2904-07
2N2904A-07A

NPN
2N2218-22
2N2218A-22A



For complementary switching applications at medium-current ranges, Motorola offers both PNP and NPN silicon Star transistors. Designed specifically for general purpose switching and amplifier applications, the popular Star transistors are available in both the TO-5 and TO-18 packages. (New "A" versions feature a minimum beta of 40 from $100\mu\text{A}$ to 500mA).

Low Current



- Optimum Switching . . .
1 mA to 100 mA
- BV_{CE0} to 40V

PNP
2N3248, 49
2N3250-51

NPN
2N834
2N2501



With the addition of transistor types 2N3248-51 in the small-geometry configuration, Motorola is now able to offer both PNP and NPN low-level, ultra-high-speed annular devices for switching and amplifier applications. Available in the standard TO-18 package, these new logic devices will meet virtually all of your low-level logic switching requirements.

		Performance Specifications		
		BV_{CE0}	$V_{CE(Sat)}$ $I_C = 150 \text{ mA}$	f_t
		Volts (min)	Volts (max)	mc (min)
PNP types	2N2904-07	40	0.4	200
	2N2904A-07A	60	0.4	200
NPN types	2N2218-22	30	0.4	250
	2N2218A-22A	40	0.3	250 300

		Performance Specifications		
		BV_{CE0}	$V_{CE(Sat)}$ $I_C = 10 \text{ mA}$	f_t
		Volts (min)	Volts (max)	mc (min)
PNP types	2N3248	12	0.125	250
	2N3249			350
	2N3250	40	0.25	250
	2N3251			300
NPN types	2N834	15	0.25	350
	2N2501	20	0.2	350

Silicon annular devices featured on these pages are immediately available through your Motorola Semiconductor Distributor or District Office. Call them today!

* The Annular process provides true silicon oxide passivation and eliminates uncontrolled "channeling" and leakage to the edges of the transistor die. Patents pending.

† Trademark of Motorola Inc.



MOTOROLA Semiconductor Products Inc.

BOX 955 • PHOENIX, ARIZONA 85001 • A SUBSIDIARY OF MOTOROLA INC.

62E9

Save \$24,500 Annually in Power Costs

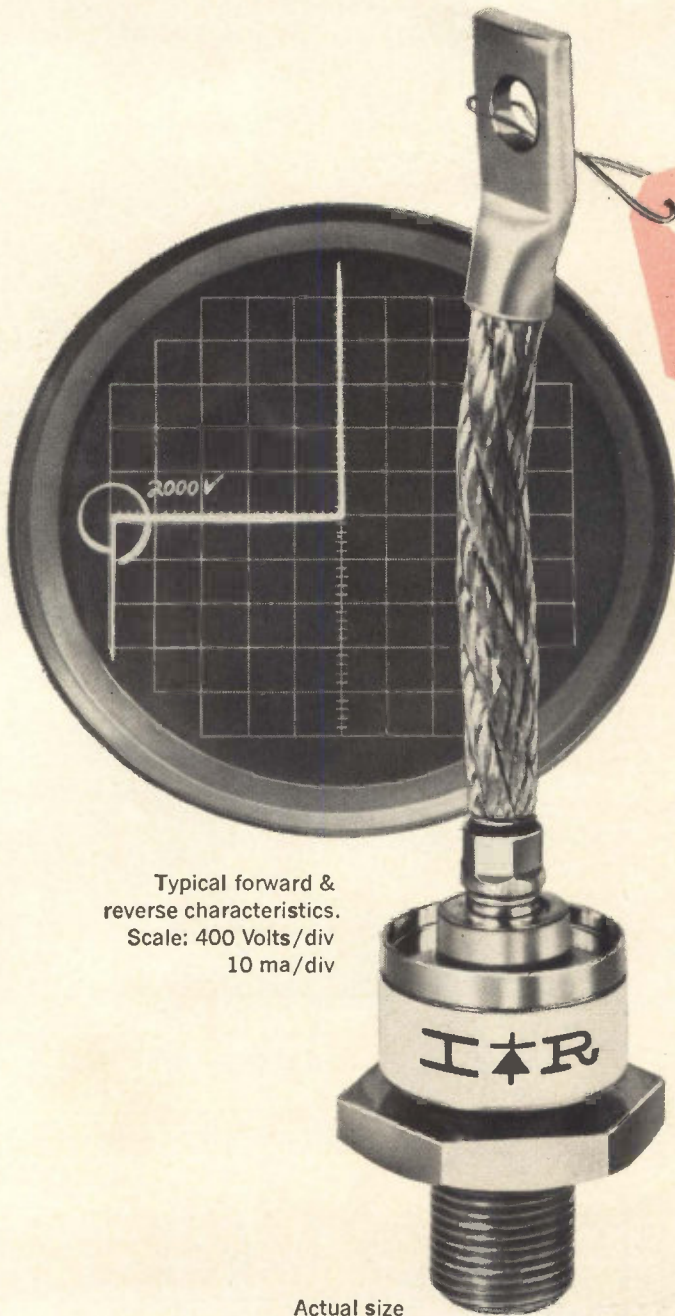

Typical forward &
reverse characteristics.
Scale: 400 Volts/div
10 ma/div

Actual size

*2000V Bulk
Avalanche
@150°C 200A*

By replacing two lower voltage devices with this single junction high power bulk avalanche rectifier in typical 100,000 ampere equipment operating continuously, you would save 280 KW. In a year this increased efficiency would add up to 2,450,000 KW hours, or \$24,500! (Based on \$0.01 per KW hour.)

But that's not all—size of rectifier units can be reduced as much as 30 to 40% . . . bulk avalanche characteristics assure workhorse reliability and protection against dangerous transient overvoltages . . . maximum peak ½ cycle surge current rating is 3000 amperes, and maximum peak reverse leakage current at 150°C is 16 ma.

ORDER YOUR EVALUATION SAMPLES TODAY!

To assure the fastest possible delivery, orders will be taken only at the factory. Prices for 1 to 24 pieces are as follows:

IR Type 200WAR80: 1100 Volts Min. Avalanche* (800 PRV) \$ 95.00
IR Type 200WAR160: 2100 Volts Min. Avalanche* (1600 PRV) \$198.00
*At 150° C.

Direct your order to: OEM SALES, International Rectifier Corporation, El Segundo, California. Terms: Net 30 Days



INTERNATIONAL RECTIFIER

INTERNATIONAL RECTIFIER CORPORATION: EL SEGUNDO, CALIFORNIA, PHONE OR 8-6281 • CABLE RECTUSA • REGIONAL OFFICES IN NEW YORK CITY, CH 4-0748 • FORT LEE, NEW JERSEY, WI 7-3311 • SYRACUSE, NEW YORK, HE 7-8495 • CAMBRIDGE, MASSACHUSETTS, UN 4-6520 • ARDMORE, PENNSYLVANIA, MI 9-3667, GR 3-3932 • SILVER SPRING, MARYLAND, JU 9-3305 • CHICAGO, ILLINOIS, OR 6-4090 • HUNTINGTON WOODS, MICHIGAN, LI 8-1144 • ST. LOUIS, MISSOURI, TE 8-6333 • MINNEAPOLIS, MINNESOTA, 920-1200 • DALLAS, TEXAS, 3511 HALL ST., LA 1-0110 • LOS ANGELES, CALIFORNIA, OR 8-6281 • IN CANADA: TORONTO, ONT., PL 9-7581 • MONTREAL, QUE., VI 9-3571

Contact the International Rectifier Office nearest you for the Authorized Distributor in your area.

Washington Newsletter

May 4, 1964

McNamara favors renting satellites

The Communications Satellite Corp. is expected to pick two firms early this month to run six-month studies on a basic system of medium-altitude satellites in random orbit, and to name the Hughes Aircraft Co. to do more studies on a synchronous satellite system.

Pentagon technical advisers are still urging Defense Secretary McNamara to insist on a separate military system. But the Secretary leans to buying time from the commercial system for military communications, and is expected to announce this decision shortly.

Pentagon merging contract offices

The Defense Department is consolidating contract administration offices in 29 cities where there are now separate offices operated by the various military services and the Defense Supply Agency. The offices handle inspection, contractor payment and related functions.

These consolidations, which are part of the Pentagon's cost-reduction program, will result in annual savings of about \$19 million and a cut of 1,800 employees.

House squeezes defense budget

Congress' worries over waste in military spending are taking firmer shape in the form of budget cuts and suggestions on how to trim procurement outlays. The House's defense appropriations bill for fiscal 1965 calls for procurements totaling \$13.5 billion, about \$2.2 billion less than the existing budget and \$300 million less than the Defense Department requested. The requests for avionics, electronics and telecommunications equipment have been cut by \$81 million.

The cuts in electronics are aimed at forcing the services to get more for their money with better specifications and by compiling technical data early enough after the research and development stage to permit competitive bids. The House Appropriations Committee would like to see defense contractors buy, rather than lease, data-processing equipment. This might be encouraged by having the government pay prime contractors a portion of the cost of computers they purchase with their own funds.

Business boost for poverty war?

Ideas for stimulating the economy in the face of declining defense outlays are coming thick and fast. One of the most novel would bring President Johnson's war on poverty into the act.

This year, the poverty program boils down to better education and training for youth in impoverished areas. But the program's chief, Sargent Shriver, is working up a package of business-backed ideas aimed at stimulating the general economy.

Among proposals discussed so far are easier credit for business, new tax incentives to spur research and development on commercial products, and more federal government financing of the high-risk projects that individual companies can't afford, such as the supersonic transport plane.

One of Shriver's aims is more business support for the whole anti-poverty effort. He wants a handful of substantial ideas to put into the second year's program. His chief aide in this effort is John Rubel, former

Washington Newsletter

assistant secretary of defense, now on loan from his job as vice president of Litton Industries, Inc.

Senators weigh conversion ideas

Sen. Joseph Clark's (D., Pa.) subcommittee on manpower and employment adds more ideas to the defense industry's conversion drive.

Some recommendations: 1) a Pentagon requirement that contractors prepare now for conversion to civilian work in the event that orders should be cut off; 2) a defense adjustment fund to help persons and communities affected; and 3) a thorough review of patent policy to assure that government-financed technology be available.

Industry-briefing plan is scrapped

The Pentagon plan for secret industry-by-industry briefings on long-range procurement and on research and development has been scrapped.

So many people wanted to attend that defense officials despaired of keeping the briefings secret. Only three top officials for each company were to be allowed, but with subcontractors and the companies that wanted to get in on briefings for more than one industry, numbers got out of hand. In place of these briefings the Pentagon will:

- Rely chiefly on the old method of technological briefings by the military services for segments of industry. Civilian officials will now participate, however.
- Hold unclassified regional briefings in major cities, under the sponsorship of the National Security Industrial Association.
- Brief industry associations, on request, on specific topics.

Bill would add to funds to hospitals

More money for electronic equipment in hospitals would be made available under a measure now working its way through Congress. The House Commerce Committee recommends a five-year extension of the Hill-Burton program for federal aid to hospital construction and equipment. A \$2.3-billion program is recommended—as much as the program has cost since it started 15 years ago. The bulk of the program is \$850 million for hospital construction and modernization, and \$500 million for such long-term-care facilities as nursing homes and diagnostic and treatment centers.

Civilian, military buying to merge

A joint procurement and supply system for items used by both military and civilian agencies is being worked out by the Defense Department and the General Services Administration.

Under a tentatively adopted plan, the Defense Supply Agency would be responsible for government-wide purchases of electronics, petroleum, medical, clothing and textile, and subsistence supplies. General Services would handle needs of civilian and military agencies for other common items excluding weapons. If current tests work out, the two agencies would split the procurement responsibility for upwards of three million commercial items.

Agencies are already moving in this direction. Under an agreement effective June 16, for example, Defense Supply will buy for the Federal Aviation Agency electronic tubes used by both the FAA and the military. The agreement covers approximately 600 of the 2,400 tube types that the aviation agency uses in air traffic control and navigation.

Here's how Martin Company saves \$16,000/year cleaning safety suits for TITAN II!

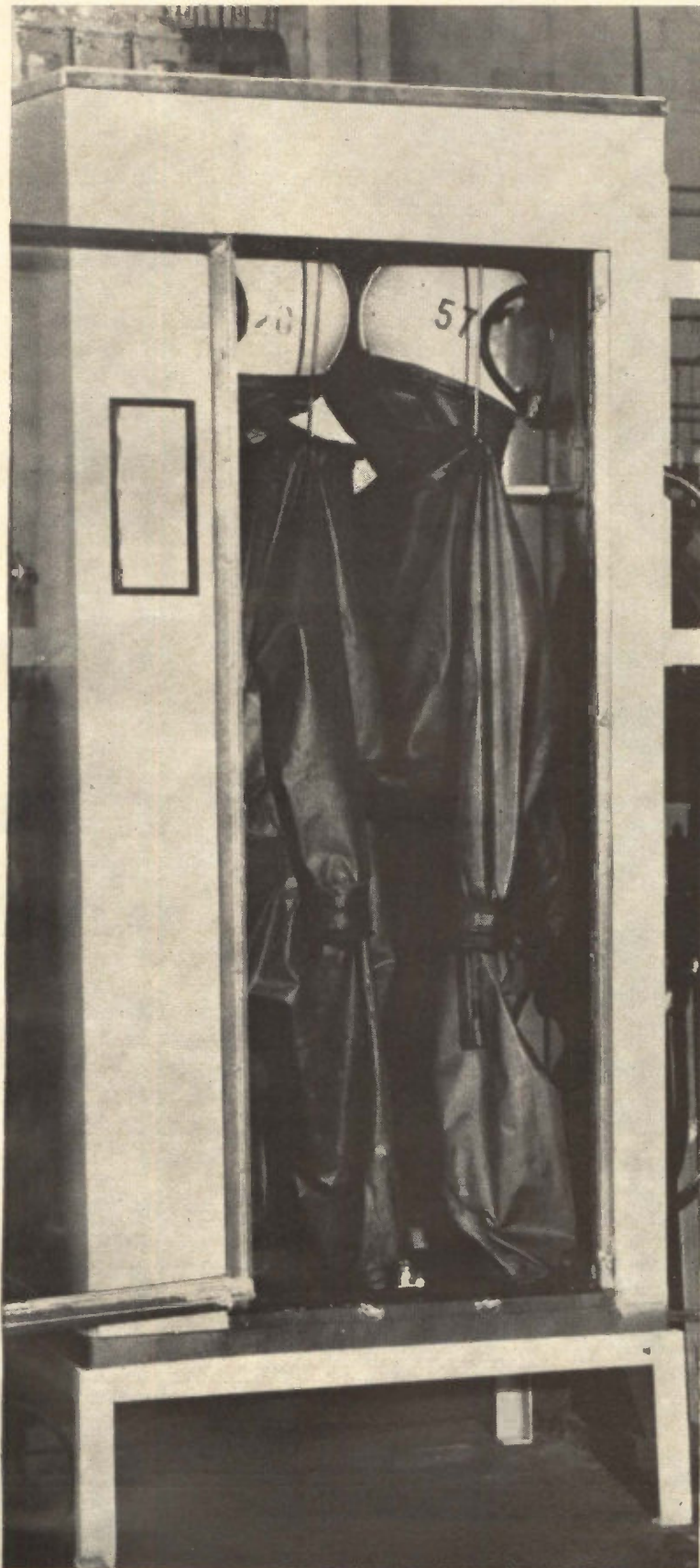

PROBLEM: It used to be an expensive and time-consuming job for Martin Company's Canaveral Division to clean these critical safety garments. The suits protect TITAN II launchstand personnel from toxic propellants during fueling and countdown. They must be cleaned after each wearing for toxicity and sanitation reasons. Formerly, Martin did this laboriously by hand with detergents at \$6.35 per suit.

SOLUTION: An entirely new cleaning system based on FREON fluorocarbon solvents. FREON is an efficient *selective* solvent. It quickly removes toxic fuels or vapors, oil, grease and dirt from the suit while not affecting plastic or metal parts in any way.

To clean the suits, Martin uses FREON in a modified shower cabinet, fitted with several nozzles to drench 2 suits thoroughly—both inside and out. Since adopting this system, cleaning time per suit has been cut from 1½ hours to 5 minutes; cost, from \$6.35 to \$1.10. So in one year, with 3,600 safety suits cleaned, that's a saving of \$16,000!

Martin also likes FREON because it is non-flammable, nonexplosive, and has very low toxicity—making it safe and easy for workers to handle. And—extremely important—contaminated FREON is easily purified for reuse over and over again.

Wherever *you* have a critical cleaning problem, components or assemblies, electronic, electrical or mechanical, it's quite possible FREON solvents could improve operations and cut costs. We'd be happy to discuss it with you! First step: send the coupon or Reader Service Card for our new cleaning booklet.

FREON®

solvents



Better Things for Better Living
... through Chemistry

MAIL COUPON FOR NEW BOOKLET ON CLEANING

E. I. du Pont de Nemours & Co. (Inc.)
FREON Products Division
N-2420E-5R, Wilmington 98, Delaware

Name _____ Title _____

Company _____

Address _____

Please send new booklet on FREON solvents for precision cleaning. (Offer good in U.S.A. only.)

I am interested in cleaning _____

I would like Du Pont to send a cleaning specialist.

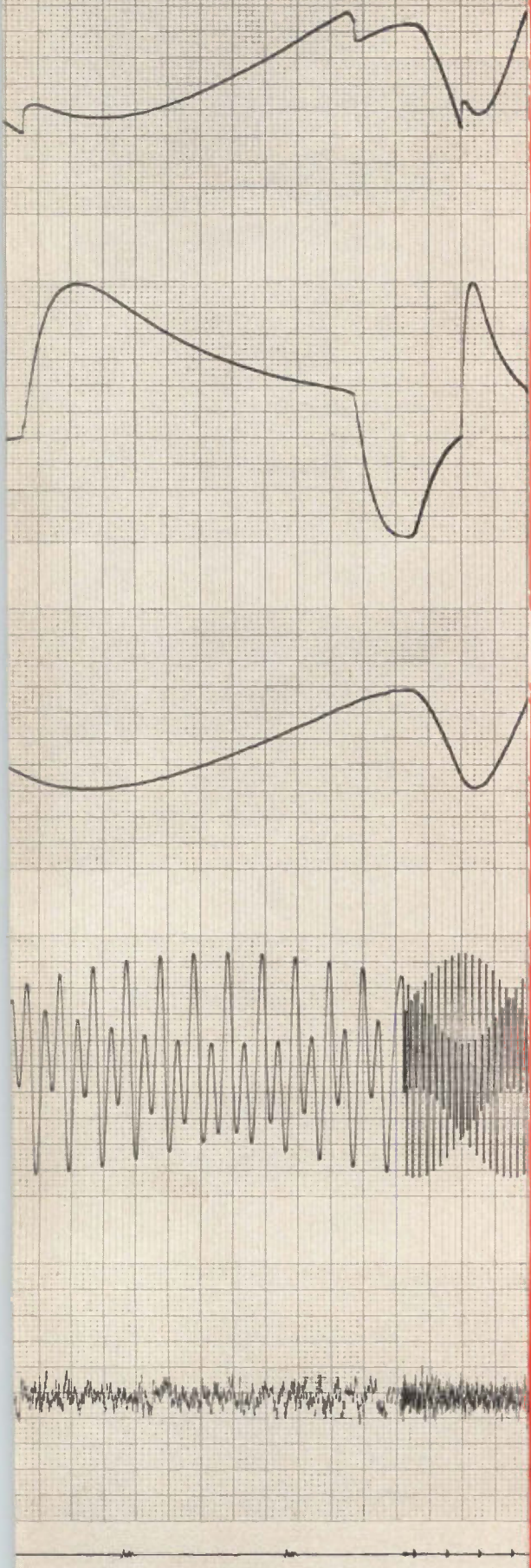

AC or DC, LOG or LINEAR

Record complex audio, noise signals, 5 cps to 100 kc . . . or DC voltages. In log mode, recording is on db basis, one chart div/db. On AC, seven ranges available from 100 mv f.s. to 100 v f.s. On DC, one 50 db range, 60 v full scale. (1400 Log Audio Preamplifier.)



ELECTRICAL, MECHANICAL FREQUENCIES

Measure pulse rates, Doppler effects, speed, fuel flow, RPM . . . 30 cps to 50 kc. Sensitivity 30 mv p-p to 10 kc, 150 mv p-p on 50 kc range. Expand any 10%, 20% or 50% to full scale. (2800 Frequency Meter Preamplifier.)



ACCELEROMETER OUTPUTS

Measure the output of any AC transducer, including piezo-electric types . . . p-p, zero-to-peak or average values, over 2 cps to 100 kc. Input impedance 1000 megohms. (3900 Accelerometer Preamplifier.)

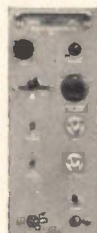

FREQUENCY DEVIATION FROM 400 CYCLES

Full-scale recording of ± 2.5 , ± 5 , ± 12.5 or ± 25 cps deviations from 400 cps, independent of input voltage waveform, over 0.5 v (zero to peak) to 225 v (zero to peak) range. Also available: 60 cycle center frequency model. (2600 400 cps Frequency Deviation Preamplifier.)



GYRO, SERVO or AC TRANSDUCER OUTPUTS

For analyzing servo system, AC transducer outputs by measuring magnitude of inphase or 180° out-of-phase AC signals with respect to 60, 400, 1000 or 5000 cps reference frequencies. Max. sensitivity 25 mv full scale. (1200 Phase-Sensitive Demodulator Preamplifier.)



AC POWER . . . 2 mw to 1.25 kw

Measure average AC or audio frequency power over 50 to 10,000 cps, with low insertion loss, input floating or grounded, calibration without disturbing test set-up. Resolve power factor angle in any quadrant with Hall-Effect multiplier. (2300 AC Wattmeter Preamplifier.)



TRUE RMS VOLTAGES, CURRENTS

Ranges: $\frac{1}{2}$ to 6 v per chart div. (25 to 300 v full scale), 1 to 100 ma (0.05 to 5 amps full scale), 20 to 5000 cps. Crest factor 5:1. (2500 RMS Volt/Ammeter Preamplifier.)

SIGNAL CONDITIONERS . . . OSCILLOGRAPHIC, MAGNETIC DATA and EVENT RECORDERS . . . DATA AMPLIFIERS . . . TRANSDUCERS

Measure more
"special"
signals

and read more from
the Sanborn
heated stylus record

Accurately condition and control the "special" signals you're interested in — and get a precise, permanent, high resolution record of the results on inkless Permapaper® charts — using a Sanborn direct writing oscillograph equipped with exactly the plug-in preamplifiers you need. They can be all alike — all different — or a combination of specialized types plus carrier, straight DC or similar units. Features typical of most of these preamps include: calibrated zero suppression; built-in calibration signal; function, attenuation, range, gain, balancing and position controls; front panel input and output connectors. You have the further flexibility of an extremely wide system choice: 1-channel portables . . . 2-channel mobile cart, portable case or rack-mounted versions . . . 4-, 6- and 8-channel consoles. And here are the combined advantages of Sanborn heated stylus recording:

- ¼ division LINEARITY (½% of 50 div. chart)
- 3.5 ms RISE TIME (10 div. deflection, 10% to 90%)
- 4 cycles/mm RESOLUTION even at small amplitudes
- NO DOWN TIME for filling reservoirs, priming, unclogging styli . . . no ink on your hands or clothes
- TRUE RECTILINEAR WRITING without linkages
- NO PARALLAX ERROR or "NEGATIVE" TIME ERROR . . . all styli contact chart along a fixed line common to all channels
- NO LOSS OF WRITING AT HIGH OR LOW TEMPERATURES . . . no pressurized, temperature-sensitive writing medium container
- RELIABLE, SIMPLE, FIELD-PROVEN ELECTRONICS . . . the only electromechanical transducer in the system is the recording galvanometer. Driver amplifier uses heavy current feedback with only linear, passive elements in the feedback loop.

Call the H-P Field Engineering Office near you for complete information and help on your specialized signal conditioning / recording / data amplification requirements. Or write Sanborn Company, Industrial Division, Waltham, Mass. 02154.

SANBORN 
A SUBSIDIARY OF HEWLETT-PACKARD

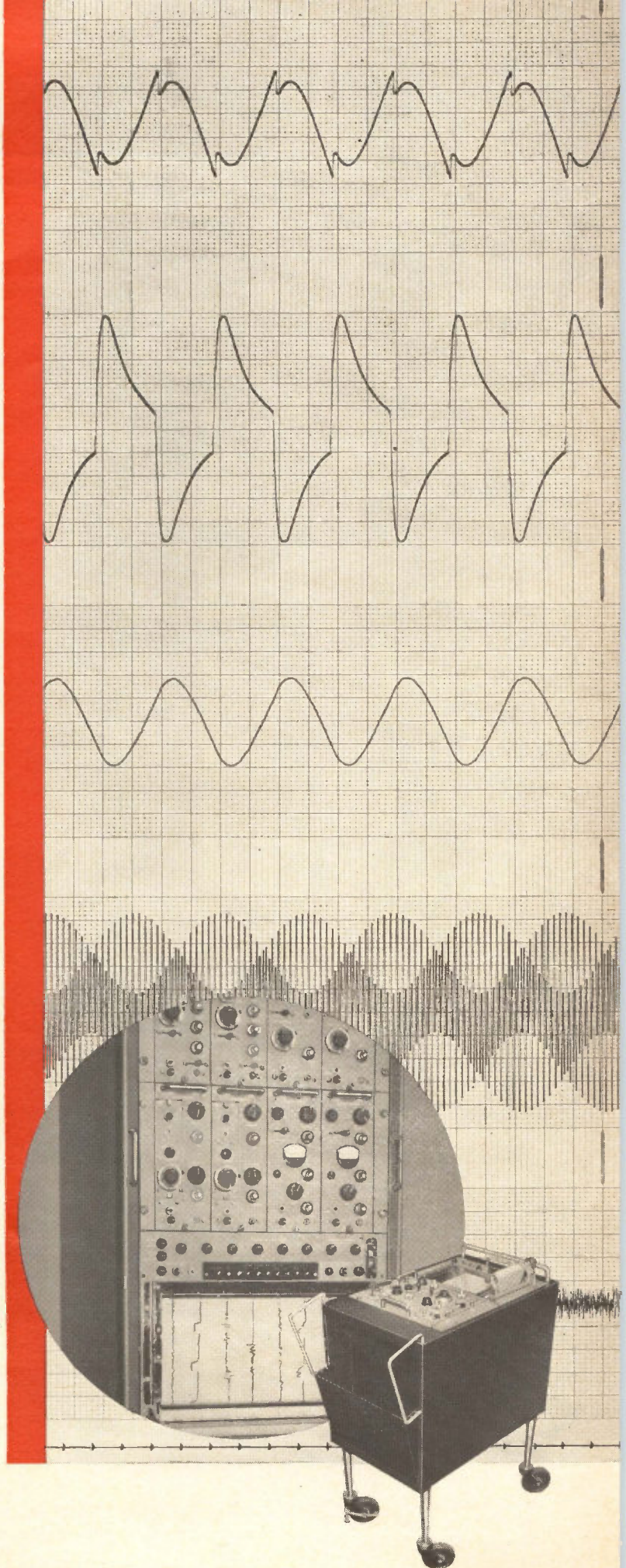

Opportunities for

Design & Development Engineers in Electronic Signal Processing

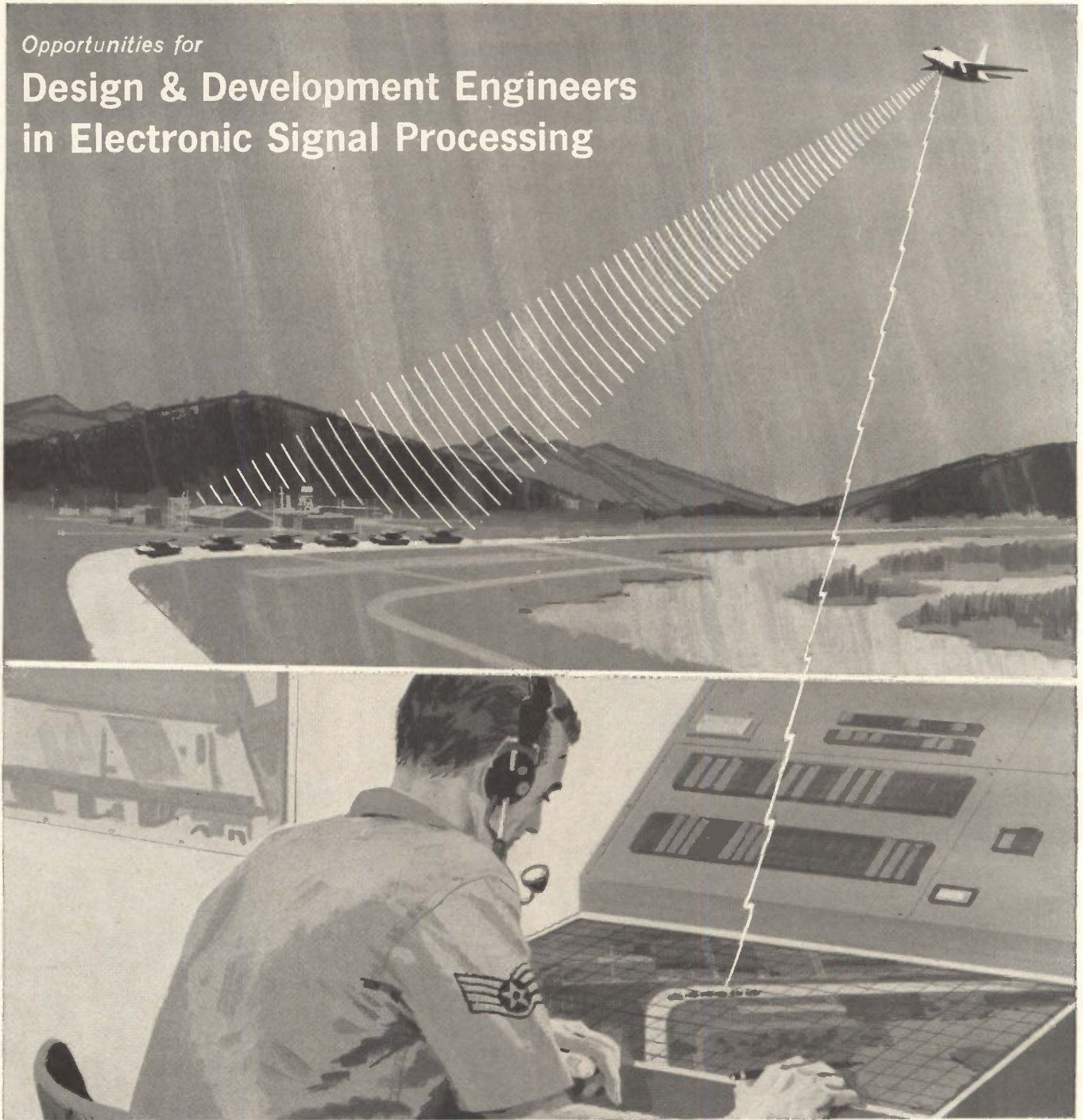

Design and development activities in the field of Electronic Signal Processing are rapidly expanding today at HUGHES Aerospace Divisions.

Development of systems utilizing advanced correlation and matched filter techniques for *High-Resolution Radar, Acoustic Detection & Classification* and *Pulse Doppler Radar* is being accelerated.

Specialists in Signal Processing, Circuit Design, Mechanical Design, Packaging Design, Performance Analysis and Project Engineering will be interested in the outstanding assignments now available.

Graduate engineers with experience in wide-band video amplifiers; high-resolution cathode ray tube circuits and applications (including ultra-linear sweep, gamma correction and dynamic focus); high-voltage power supplies; low-jitter timing circuitry; high-speed analog sampling circuitry; precision film transports; ultra-high speed film development; scan conversion systems; synthetic array radar systems; imagery recording, or similar fields—are invited to submit resumes.

For immediate consideration
please write:

Mr. Robert A. Martin
Head of Employment
HUGHES Aerospace Divisions
11940 W. Jefferson Blvd.
Culver City 69, Calif.

Creating a new world with electronics

HUGHES

HUGHES AIRCRAFT COMPANY
AEROSPACE DIVISIONS

An equal opportunity employer

U. S. CITIZENSHIP REQUIRED

slug SERIES TS

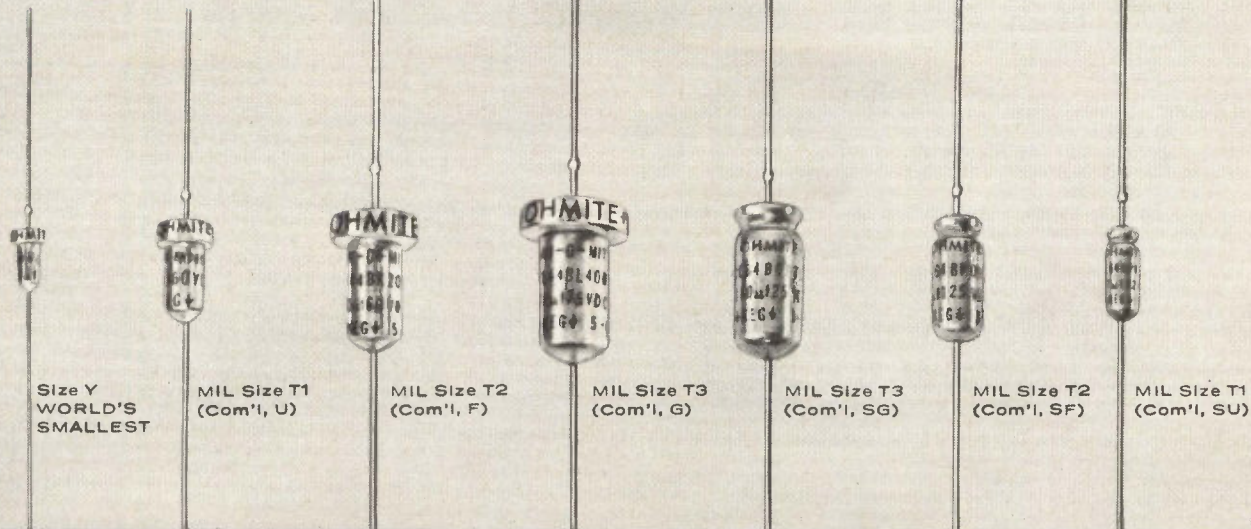

foil ETCHED OR PLAIN SERIES TF



wire SERIES TW

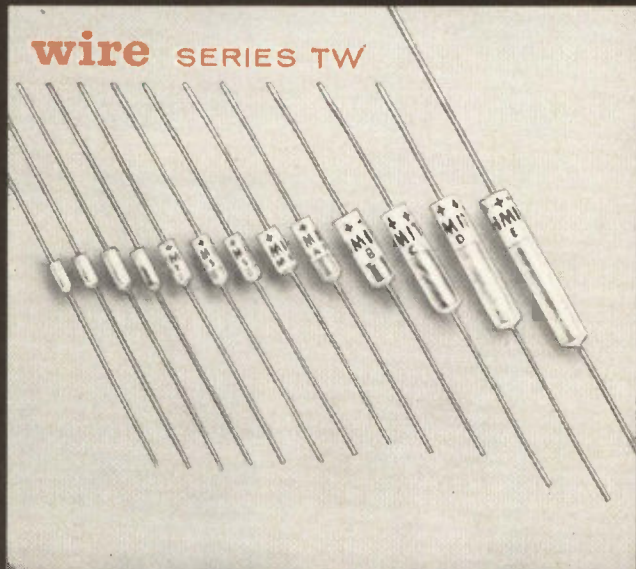

MIL or commercial—smaller sizes—delivery from stock—to meet all your needs

If you've been searching for an ultra-small hat-shaped wet slug capacitor, you've found it in Ohmite's exclusive Size Y shown above. It's half again smaller than MIL Size T1 (Com'l, U). Or if you've been looking for extra tiny tantalum wire capacitors for less critical applications, you can stop because they are to be found in the Series TW above. For your more routine requirements, try any Ohmite tantalum capacitor and be surprised by the unusually superior way it comes through evaluation tests. Wet slug and foil capacitors come in all MIL-C-3965C (new spec) sizes and meet all requirements. Literally, hundreds of capacitance values in all three types are carried in stock for quick procurement needs. Be sure your capacitor literature is up to date. Write for the bulletins shown below: No. 603, Slugs; No. 602, Foil; No. 148K, Wire.



RHEOSTATS • POWER RESISTORS • PRECISION RESISTORS • VARIABLE TRANSFORMERS
TANTALUM CAPACITORS • TAP SWITCHES • RELAYS • R.F. CHOKES • SEMICONDUCTOR DIODES



OHMITE
MANUFACTURING COMPANY

3610 Howard Street, Skokie, Illinois 60076
Phone: (312) ORchard 5-2600

“What this country needs is a good 5¢ computer diode”

“Psst, General Electric’s got it!”

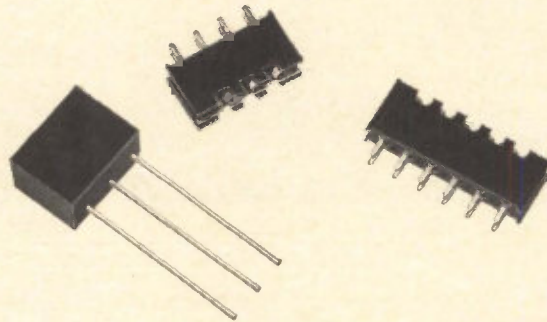

That’s right! Prices go down as low as a nickel (or less) for each diode in large quantity orders. Two different selenium diodes in three different packages give you computer circuit design freedom you never had before! The high current, high capacitance selenium diode is rated at 1 ma at 1 volt; the low current, low capacitance selenium diode is rated at 60 μ a at 1 volt . . . and both are available in the new 2, 4, and 6 paks. Electrically, they are suitable for 50 KC digital circuits, voltage stabilization, and phase detection circuitry. Parameters are produced by a

controlled vacuum system which gives a normal but *narrow* distribution. And the packages have been designed to withstand environmental extremes . . . and tested to *prove* that they do.

Our new selenium diodes are not only reliable and inexpensive, but they offer installation versatility that further reduces your cost. So if you have low-cost computer component specifications that you’d like us to evaluate, just drop a line to Section 16E121, Rectifier Components Department, General Electric Company, Auburn, New York.

GENERAL  ELECTRIC

Light-activated switch expands uses of silicon-controlled rectifiers

It eliminates coupling and feedback problems and opens up a variety of applications in opto-electronic circuits

By E. Keith Howell

General Electric Co., Rectifier Components Department, Auburn, N.Y.

Designers of industrial control systems are employing a new light-activated switch to simplify photoelectric controls and to improve upon the use of silicon-controlled rectifiers in other control circuits. One problem was that most photocells required complicated circuits involving relays, power supplies and extra stages of amplification. Another problem was that ordinary silicon-controlled rectifiers required electrical coupling of the control signal, which sometimes produced feedback and limited the functions that could be formed without excessive complexity of the control circuit.

The light-activated silicon-controlled rectifier operates the load directly, without intermediate stages of amplification. It achieves complete isolation between the control (triggering) signal and the power circuit, thereby permitting applications in previously inaccessible control circuits.

Light-operated power switch

The light-activated silicon-controlled rectifier is a pnpn switching device in which incident light

replaces, or adds to, the normal electrical gate current.

As the only available power switch that is light-operated, it extends the range of power, voltage and current-handling capabilities of light-sensitive resistors, diodes and transistors (see table). Its latching (holding) properties in direct-current circuits give the rectifier a built-in memory that can be valuable in opto-electronic logic circuits.

Being a high-speed power switch, the rectifier can directly activate solenoids, contactors, motors, lamps and similar 120-volt a-c loads more efficiently and at higher power levels than previous light-activated components. It can, therefore, be useful in card- and tape-reading, character recognition, static logic, general-purpose switching, phase control and monitoring. It is already being used in the preproduction stage of industrial-control and data-processing systems.

Characteristics and operation

The General Electric versions, types L8 to L9, are small rectifiers, similar to the C5 type, with glass windows to permit triggering by light as well as by the normal gate signals.^{1,2} Rated for 440 ma d-c at 25°C ambient, these units are available in grades from 25 to 2000 volts.

The L8 differs from the L9 only in the amount of incident radiant energy (light) required to initiate switching. Types L811 and L911 are the same as L8 and L9 except that the added base increases the current rating to 770 ma d-c at 25°C ambient. When the rectifier is mounted on a heatsink, the rating can be increased to 1.6 amperes of direct current for case temperature below 75°C.

Operation and circuit handling are similar to other silicon-controlled rectifiers except that the external resistance between gate and cathode—



Front cover

The cover illustration shows SCR with glass window for triggering by light thus permitting direct control of power. The gate connection permits modification of light sensitivity by an electrical signal on the gate. This new semiconductor device simplifies photoelectric controls and enables performance of many unique functions.

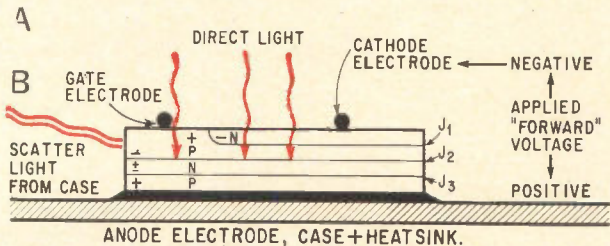
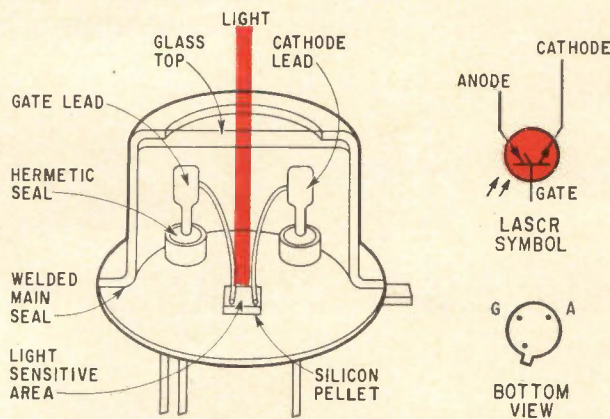

Construction (A) of the silicon-controlled rectifier includes a glass window to permit triggering by light. Current flows from anode to cathode when light enters the silicon **(B)** and creates electron pairs in the vicinity of the reverse biased junction J_2 .

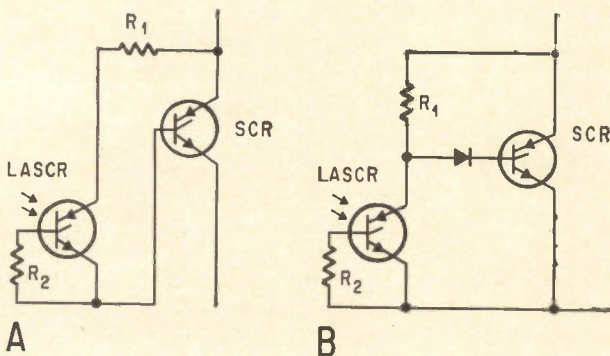

High power can be handled by circuit **(A)** using a light-activated rectifier as a gate amplifier to trigger a larger rectifier. Equivalent of normal closed contact circuit **(B)** is another useful configuration.

The author



E. Keith Howell joined GE's rectifier components department in 1962. He has specialized in application engineering and the preparation of technical literature in connection with the light-activated silicon-controlled rectifier and a three-electrode, symmetrical a-c switch.

He was graduated from North Carolina State College with a Bachelor of Science degree in electrical engineering, holds five patents and has 20 patent applications pending. He served in development engineering in the Radio and Television Department and the Outdoor Lighting Department since joining GE in 1948.

in addition to bias voltage and current—determines light sensitivity, because the gate current caused by light originates within the silicon pellet.

Thus electrical signals can be used to trigger the device as well as to modify the light sensitivity to give a shuttering effect. The gate connection also stabilizes the light sensitivity because the external resistance between the gate and cathode diverts some of the current generated internally by incident light around the junction. This serves to eliminate the effects of small leakage currents which, being variable, could affect stability.

How it's made

Construction of the rectifier pellet is illustrated at upper left. With the normally applied forward voltage, junctions J_1 and J_3 are forward-biased and they can conduct if free charge carriers are present.

Junction J_2 is reverse-biased, however, and blocks current flow. Light, entering the silicon, creates free hole- and-electron pairs in the vicinity of J_2 which are swept across J_2 , J_1 and J_3 to produce a small current from anode to cathode. As light is increased, this current increases, and the current gain of the npn and pnp transistor equivalents in the structure also increase. At some point the net current gain exceeds unity, and current will increase to a value that is limited only by the external circuit. The effect of an external resistance, connected between gate and cathode, is to bypass some current around J_1 , thus reducing the gain of the npn transistor region and requiring more light and higher current to reach the unity-gain switching point.

To design circuits with these rectifiers it is necessary to make sure that the triggering threshold of light at which the device begins to conduct, is met. The considerations to be taken into account for this are described in the panel accompanying this article. Following are some circuits in which these rectifiers are particularly useful.

Relay replacement

This rectifier is basically a semiconductor version of the electromechanical relay. When so used, the device has the solid-state virtues of compactness, completely static operation, freedom from contact "bounce" microsecond response, ruggedness and long life, plus the unique feature of complete electrical isolation between input and output. Some basic relay configurations are illustrated and described on p 55.

Latching: without a triggering input, the rectifier is equivalent to an open single-pole, single-throw contact, rated at 200 volts peak and 440 ma d-c (25°C). With input, it will switch, latch and deliver power to the load. The input may then be de-energized and the circuit reset externally, taking care not to introduce too great a voltage transient.

Half-wave SPST: The latching circuit with an a-c supply to the rectifier is used here. The equivalent circuit is a single-pole, single-throw contact in series with a silicon rectifier. The circuit is non-

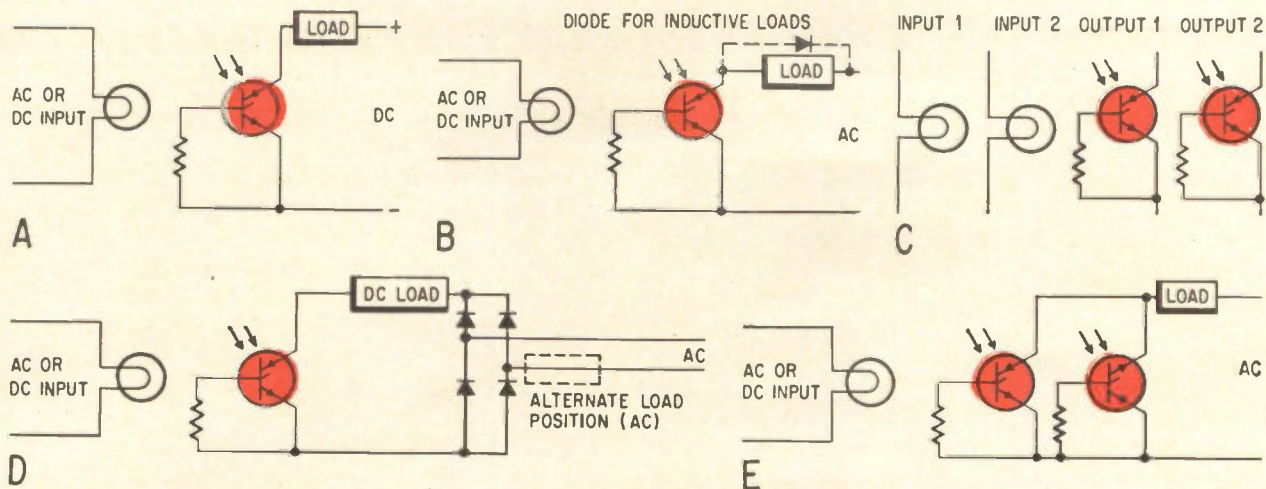

Basic relay configurations use the rectifier as: (A) d-c latching relay; (B) half-wave SPST switch; (C) full wave single-pole single-throw switch; (D) full-wave switch using two rectifiers, and (E) multipole input/multiple pole output combination.

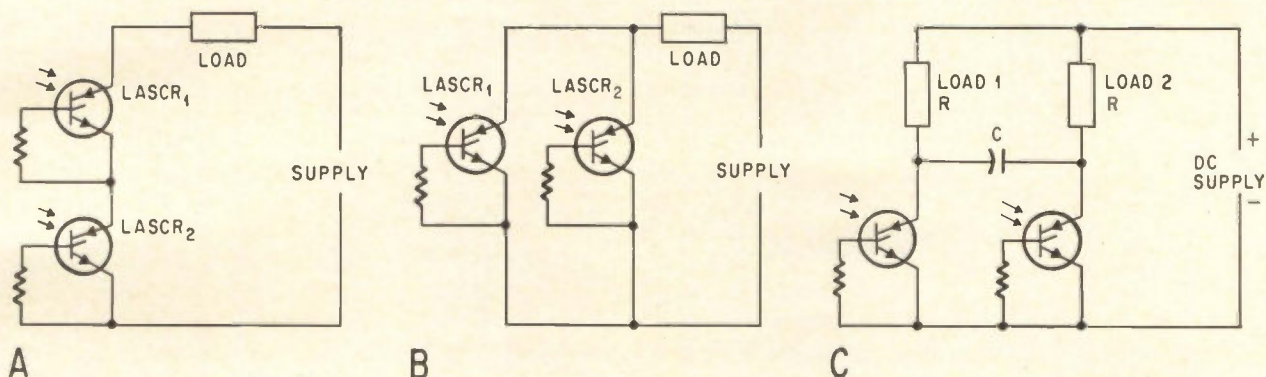

Logic functions of a light-activated rectifier are: (A) AND type where both inputs are required to energize the load and (B) OR type where either input will energize the load. Flip-flop or triggered multivibrator (C) uses inputs to rectifiers to activate the loads. For proper reset, RC must be greater than or equal to 100 microseconds.

latching on a-c, since the rectifier is reset for each cycle by the reversing supply voltage. The use of a diode across inductive loads allows stored coil energy to circulate current through the load while the rectifier blocks negative half-cycles of the supply. Relay or solenoid chatter is thus eliminated.

Full-wave SPST: A diode bridge converts the a-c supply to full-wave rectifier direct current. The load may be placed either in the a-c or d-c legs of the bridge. Care should be taken when using this circuit with inductive loads, since difficulty in rectifier commutation may be encountered.

Because of load power factor, rectifier current and supply voltage are not coincidentally zero. As load current goes to zero and the rectifier tries to commutate, a finite step of forward voltage will suddenly be impressed across it. This voltage step may possess sufficient rate of change of voltage to turn the rectifier on again.

The effect can be eliminated with d-c loads by placing a diode around the load. On a-c loads, a resistor connected between one side of the bridge and one side of the line eliminates this condition.

An alternate form of the full-wave SPST uses

two rectifiers for full-wave control. Caution must be observed with this circuit, because a slight dissimilarity in the two rectifiers' sensitivity to light can, under critical or slowly changing irradiation, cause half-wave conduction. With loads such as transformers, motors solenoids and relays, saturation of the load and an abnormally large current can result. Where such loads are used with slowly changing or limited range light levels, the bridge circuit is preferable.

The power-handling ability of any of these relay arrangements may be increased as desired by using the rectifier as a gate amplifier to trigger a larger silicon-controlled rectifier. Repositioning the light-activated rectifier with respect to the driven silicon-controlled component converts the circuit into the equivalent of a normally closed contact, a useful configuration in many monitoring and alarm circuits requiring load-current flow in the absence of light.

Opto-electronic logic

The unique binary nature of the light-activated rectifier makes it an ideal element for opto-elec-

tronic logic circuits. A selection of the more common types of logic functions, as performed by the rectifier, are shown on p 55.

The use of light in logic circuits permits complete electrical isolation between functions and eliminates any possible feedback between the functions. The relatively high current and voltage capabilities of the L8 and L9 enable logic and load-control functions to be performed at the same level, eliminating stages of amplification.

Circuit (C) is of particular importance in working with d-c control circuits. Variations of basic flip-flop circuits are numerous because the loads do not have to be equal and a silicon-controlled rectifier can be used in one leg for handling large loads.

In a d-c circuit, the light-activated rectifier will conduct current indefinitely, until turned off by externally removing the current. The coupling capacitor C momentarily reverse-biases the conducting rectifier when the nonconducting rectifier is triggered. With the proper choice of the coupling capacitor the first load can be quite different from the second. For example, one may be a one-ampere load and the other may be one milliamperere. If load currents higher than one ampere are required, a higher-current silicon-controlled rectifier may be used instead of one of the light-activated units.

Counting or delay circuit

When used with direct current, the rectifier will turn on with a short pulse of light and remain in that condition. Some control circuits require manual resetting, others require operation for a fixed time after being activated by the pulse of light with automatic resetting.

Simple and economical commutation (turning-off) for the rectifier in low-voltage d-c circuits can often be accomplished with a single boot-strapped unijunction transistor. The circuit may be used either as a pulser by differentiating the square-wave output with a capacitor, or as a light-activated time delay, by "stretching" the output square wave up to several seconds with suitable unijunction transistor constants.

When light hits the rectifier, the device delivers power to the load. The load voltage then energizes the timing-turnoff circuit. While the emitter capacitor C_1 is charging through R_1 to the peak-point voltage, C_2 charges rapidly to the load-voltage potential through R_3 . When the transistor eventually fires—determined by $(R_1 \times C_1)$ and the transistor constants—the output pulse from R_4 is coupled through C_2 and CR_1 to the rectifier cathode, raising cathode potential above supply voltage long enough for the rectifier to commute.

Variable on-time switch

In a-c control work, a short flash of light may be required to actuate a solenoid, counter or contactor for a definite period. For example, a solenoid-operated shear, controlled by a notch or hole in moving strip material, must have current applied for several cycles to complete its travel, even

though the light pulse received through the hole lasts only a fraction of a cycle. The circuit shown on p. 57 provides this delayed turn-off operation.

A random impulse of light fires the rectifier, applying current to the load. Capacitors C_1 and C_2 discharge through R_2 and R_3 , and through R_1 and the rectifier. As long as this capacitor-discharge current is higher than holding current I_H , the rectifier cannot commute, thus applying full-wave alternating current to the load. When the discharge current drops below I_H , the rectifier turns off at the next succeeding current zero, assisted by R_4 for inductive loads. Decreasing R_3 reduces the time the switch remains on.

The variable on-time switch, which is impulse-actuated, can turn on at any phase angle, but will turn off only at zero current. During conduction, the full sine wave is applied to the load, with virtually no harmonic distortion. Radio noise is therefore negligible.

This circuit is useful for operation of solenoids, contactors, small motors and lamps, particularly in conjunction with an optical programmer.

An optical programmer consists of a motor-driven paper tape with holes. Light passing through the holes, operates various rectifiers. This can be used to set up a predetermined program of operation of various devices such as machine-tool controls.

Smallest phase control

To provide a proportional control of low power with a small space, the light-activated rectifier may be triggered by a small lamp, with phase control provided by response time of the lamp filament.

The phase control circuit (p 57) uses a miniature lamp (No. 2128) that has a small, low-mass filament with a short delay time compared with most lamps. With a low applied voltage, the rectifier firing level for the lamp is reached in about three cycles. As applied voltage is increased, this time is reduced, reaching about one millisecond when it is directly across the rectifier terminals, thus providing phase control of the rectifier. Lamp voltage is removed when the rectifier fires, protecting the lamp and resetting it for the next half-cycle. Lamp and rectifier should be in direct physical contact for best results.

The circuit is useful for small heating elements, such as a soldering iron; or for dimming a lamp except at the low end of the range, where flickering occurs as a result of changes in lamp resistance.

Production-line flow monitor

This circuit has been used to monitor the smooth flow of small components down a high-speed conveyor chute. It can overlook or pass up, small self-clearing pileups, but will shut the line down rapidly in the event of an impending traffic jam.

As shown on p 57, the silicon-controlled rectifier is in series with a relay load, and is supplied from a 120-Volt a-c line. SCR_1 is normally off, being energized only when a fault occurs. With light on, the light-activated rectifier conducts current and

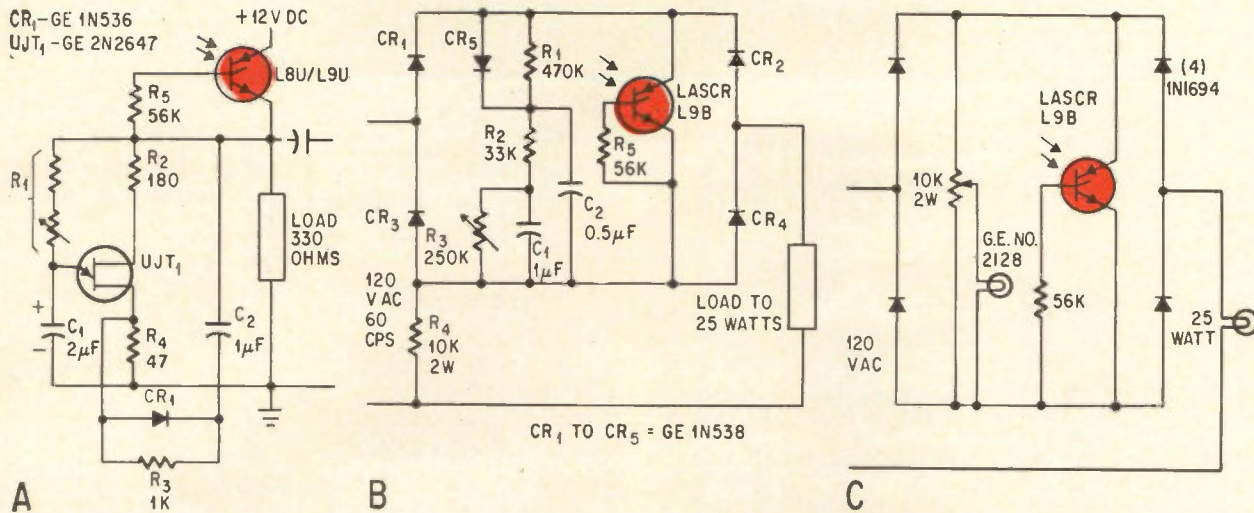

Applications of the rectifier switch include: variable pulse-width counting or delay circuit (A); impulse actuated variable on-line switch (B) and phase control (C).

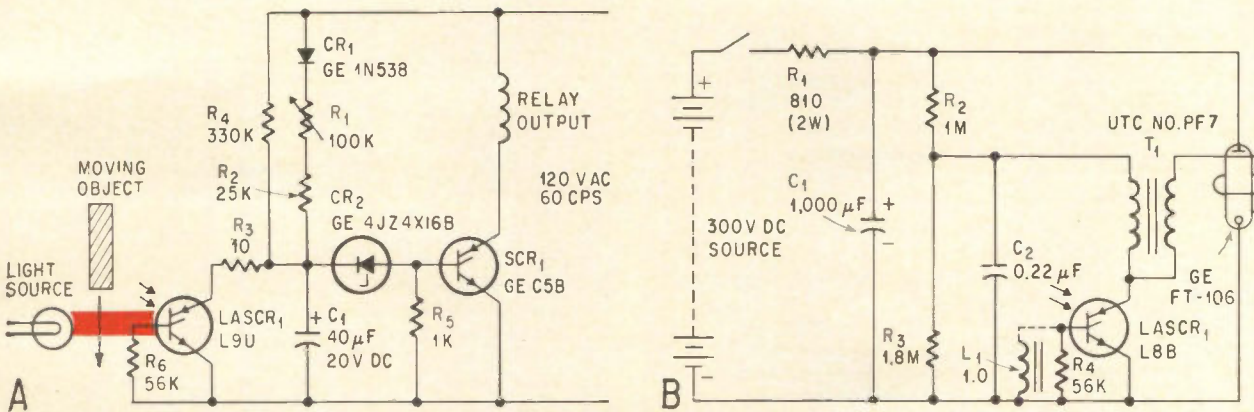

Circuit (A) will monitor the flow of a production line and shut it down in case of a jam. Modified with a rectifier, industrial flashgun circuit (B) triggers a slave unit used in multiple-light-source high-speed photography.

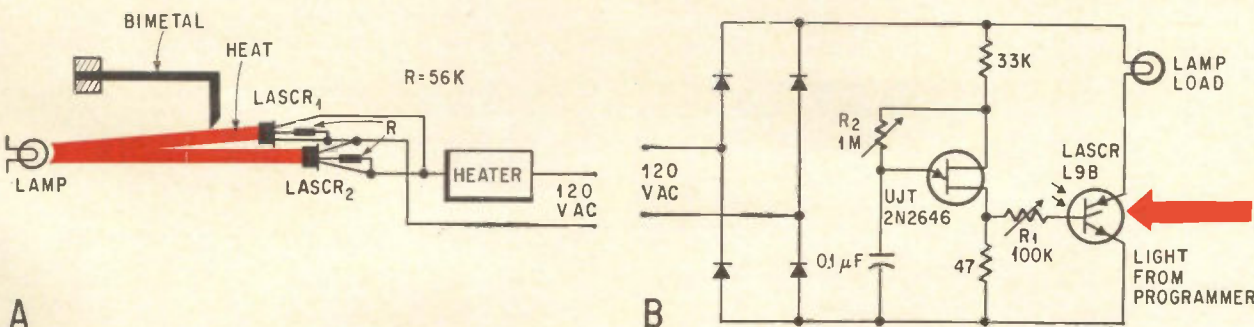

Rectifiers, lamp and a two-metal thermostat provide accurate temperature regulation (A). Unijunction transistor control circuit (B) provides preheating of the lamp by triggering the rectifier late in each half-cycle.

prevents voltage from building up across capacitor C_1 . Each time a passing component momentarily interrupts the light beam, the LASCR₁ is briefly commutated by the 60-cps a-c line. During these off periods, capacitor C_1 does start to charge toward the peak a-c line voltage through R_1 , R_2 and CR_1 , but is shorted to zero again as light is restored to

LASCR₁. If the light path to LASCR₁ is blocked for more than a few milliseconds, however, capacitor C_1 continues to charge unimpeded by LASCR₁ and, at a time determined by the time constant $C_1 \times (R_1 + R_2)$, it exceeds the avalanche voltage of CR_2 and fires SCR₁. SCR₁ then activates the load. Reset is automatic when light is restored to

Triggering the light-activated switch

The light-activated rectifier is triggered when the radiant energy falling on it exceeds a given level. The absolute value of this threshold is subject to change by junction temperature, by applied voltage, load impedance, supply frequency and gate condition. A production tolerance also must be taken into account. The equipment designer must see that the triggering threshold is adequately met under all conditions.

The triggering level for the L8 and L9 is given in terms of effective irradiance. This is related to total irradiance and illumination, and is given for the case of a tungsten lamp operating at 2,800° K color temperature.

For example, the L8 will trigger with incident irradiation of 0.010 watt per square-centimeter effective, which may be obtained from a 2,800° K tungsten lamp producing total irradiance of 0.04 watt per square centimeter, or 750 footcandles of illumination at the rectifier. This specification is based upon a junction temperature of 25°C, a supply voltage of six volts of direct current, a load resistance of 100 ohms and a gate-to-cathode resistance of 56,000 ohms.

Terminology

For the rectifier to be used most effectively, the terminology should be defined clearly. The term "light" in "light-activated silicon-controlled rectifier" refers to radiant energy. Technically speaking, however, light is electromagnetic radiation of such a frequency or wavelength as to be perceived by the human eye. Therein lies the fundamental difference between (physiological) photometric and (physical) radiometric systems.

In radiometry, the strength of the wave, or waves, is described in terms of power, or total flux, and of power-per-unit-area, for flux density. Frequency in cycles-per-second may be used, but wavelength is more common and is expressed in microns.

In photometry, the strength of the wave is expressed in terms of its effect upon the eye relative to a standard reference, and the units for flux and flux density are accordingly weighted in physiological effect. Frequency is expressed as color, with mixtures of waves of different frequencies often producing the same color as a single intermediate frequency.

Spectral considerations

The relative spectral response, typical of the human observer and of this rectifier, is a function of wavelength [see figure]. The luminosity curve for the human eye shows that twice as much power is required at 0.510 micron as is required to produce the same sensation of brightness at 0.555 micron. The rectifier responds to a much greater range of wavelengths than the eye,

extending slightly into the ultraviolet region but concentrated primarily in the near-infrared region. Since response is down to 50% at 1.09 and 0.76 microns, twice as much power is required for switching at these wavelengths as at one micron.

Relative response curves

Most light sources emit radiation whose wavelength is outside the visible region. Photometric measurements, concerned only with visual effects, do not indicate directly the effect upon silicon except when correlated with the total spectral output of the source. Therefore, if a particular LASCR triggers at 500 footcandles (visible) from a tungsten lamp operating at 2,800° K color temperature, the same LASCR will turn on at a different light intensity obtained from any other type of lamp, or even from the same lamp operating at a different color temperature.

Effective irradiance

To accurately specify and use the rectifier, radiometric units are required and must be weighed according to the response curve of the device. This is the "effective irradiance," H_E , which is expressed in terms of watts per square centimeter falling on the receiving surface.

Consider a rectifier that requires an "effective-irradiance-to-trigger", H_{ET} , of 7.5 mw/cm². If very narrow band radiation at one micron (such as from a laser) is directed on the pellet, a flux density of 7.5 mw/cm² will cause the device to trigger. If the wavelength is shifted to 1.09 microns (response down to 50%), the triggering flux density will be 7.5/0.5 or 15 mw/cm².

Now suppose we supply 5 mw/cm² at one micron. Then 2.5 mw/cm² additional energy will be required for triggering. This can be obtained by supplying 5 mw/cm² at 1.09 microns, because effective energy is additive.

For broad-band radiation, with a spectral distribution of energy H_λ , the total effective energy may be found by breaking up the wide band into many narrow bands, then multiplying the energy in each narrow band by the relative response, Y_λ , in the band, and then adding the resulting incremental effective energies together, thus $H_E = \text{total effective irradiance} = \int H_\lambda Y_\lambda d\lambda$.

The same method is used to evaluate the effective energy of light in which the relative response Y_λ is the "luminosity curve."

The equation above shows energy outside the response band does not contribute to the effective energy. Therefore the relationship between effective energy for the eye (light) and effective energy for silicon depends entirely upon the distribution of energy produced by a particular source. Similarly, the relationship between effective energy and total energy is source dependent.

LASCR₁. Circuit delay time can be adjusted from a few milliseconds up to several seconds with R₁.

Where solid state switching of the load is required, the relay shown can be replaced with the actual direct load, or by moving the SCR inside a diode bridge (C) full wave a-c output can be realized.

Electronic flash

There is a need in photography for a fast photo-sensitive switch capable of triggering the slave flashgun units used in high-speed photography. An industry-standard flashgun circuit can be modified with a light-activated silicon-controlled rectifier to

Measurement of H_B

Although there are several ways to calculate effective irradiance based upon lamp characteristics and physical dimensions, the accuracy of such calculations depends heavily upon data that is not generally available (see Ref. 2 for irradiance calculation details). Certainly the easiest way to determine effective irradiance is to measure it. The rectifier can be calibrated for current vs H_E simply by connecting it as a pnp device in series with a battery and microammeter. The ZJ227UX4 is a factory calibrated LASCR available for evaluation of lamps and optical designs. In essence, this provides a light meter calibrated in terms of mw/cm² effective upon the rectifier, thus eliminating the need for conversion from other units of measurement, such as footcandles.

The ZJ227UX4 is a valuable laboratory instrument that can be installed in prototype rectifier systems to measure the maximum and minimum light produced by whatever source and optical system is employed. By measuring the photo-current in the ZJ227UX4 and referring to its calibration curve, the available effective irradiance, H_E, is found. This can then be compared with the specified triggering requirements H_{ET} for the L8 or L9 to establish feasibility of the design.

Variations of H_{ET}

Since the total light-generated current in the light-activated rectifier is very low, the triggering level of these devices is much lower than in normal silicon-controlled rectifiers. As a result, the light-activated units exhibit greater sensitivity to operating conditions. The effective irradiance to the trigger (H_{ET}) is reduced by increasing anode voltage, increasing junction temperature, increasing the rate-of-change of anode voltage, and by increasing either gate-to-cathode resistance or externally supplied gate current. Therefore these devices should not be used as threshold detectors for light if accuracy is important. Stability is improved by holding temperatures, load currents and voltage constant and well below maximum.

Light sources

Tungsten lamps are well suited for operating the rectifiers. With proper choice of lamp and proper derating, excellent life and reliability can be achieved. For example, operating a tungsten lamp at half of its normal voltage extends its life about 10,000 times. This drop in voltage reduces the effective radiation about 20% of normal. Hence one must start with a lamp of higher power, but this is advantageous because it means a more rugged filament.

Xenon flash lamps are suitable sources for pulsed

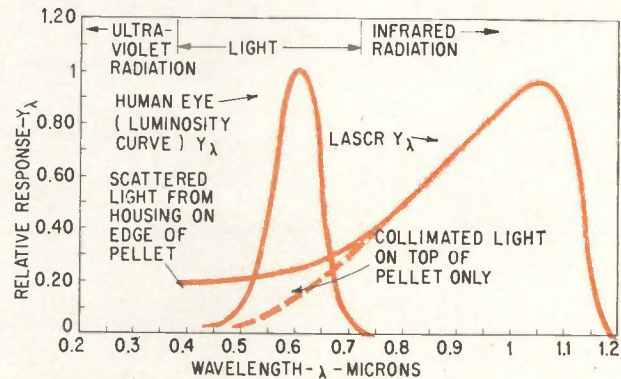

Relative spectral response characteristics of the human eye and the light activated rectifier as a function of wavelength.

triggering, and hence are useful for a-c phase-control or long-distance work. These lamps have very high peak output intensities and are a reasonably good spectral match to silicon.

Injection luminescent diodes of gallium arsenide, operating in either the laser or the noncoherent mode, are excellent sources for pulse triggering and will probably soon be useful for continuous work. The spectral match is practically perfect, and hence results in high radiant efficiency. These diodes operate at low voltage and can easily produce one-microsecond pulses of radiation. Since no visible radiation is produced, they are well suited for systems requiring visual security.

Optics

Innumerable lenses and reflectors are available that can increase irradiance on the rectifier, but always at the expense of restricting the "angle of view." The maximum irradiance that can be obtained with optical systems is limited to the emittance of the source.

Fiber optics provide the best coupling between a source and a rectifier. They can be used to couple several sources and several rectifier units in a complex matrix for logic operations.

Fiber optics can be obtained in flexible, noncoherent bundles that provide reasonably efficient transmission of light over circuit paths. For example, a fan-out array of bundles can be used to conduct light information from a closely spaced punched-hole data recording to a larger array of rectifiers. Glass-clad optical fibers can be potted in plastic to hold and protect arrays.

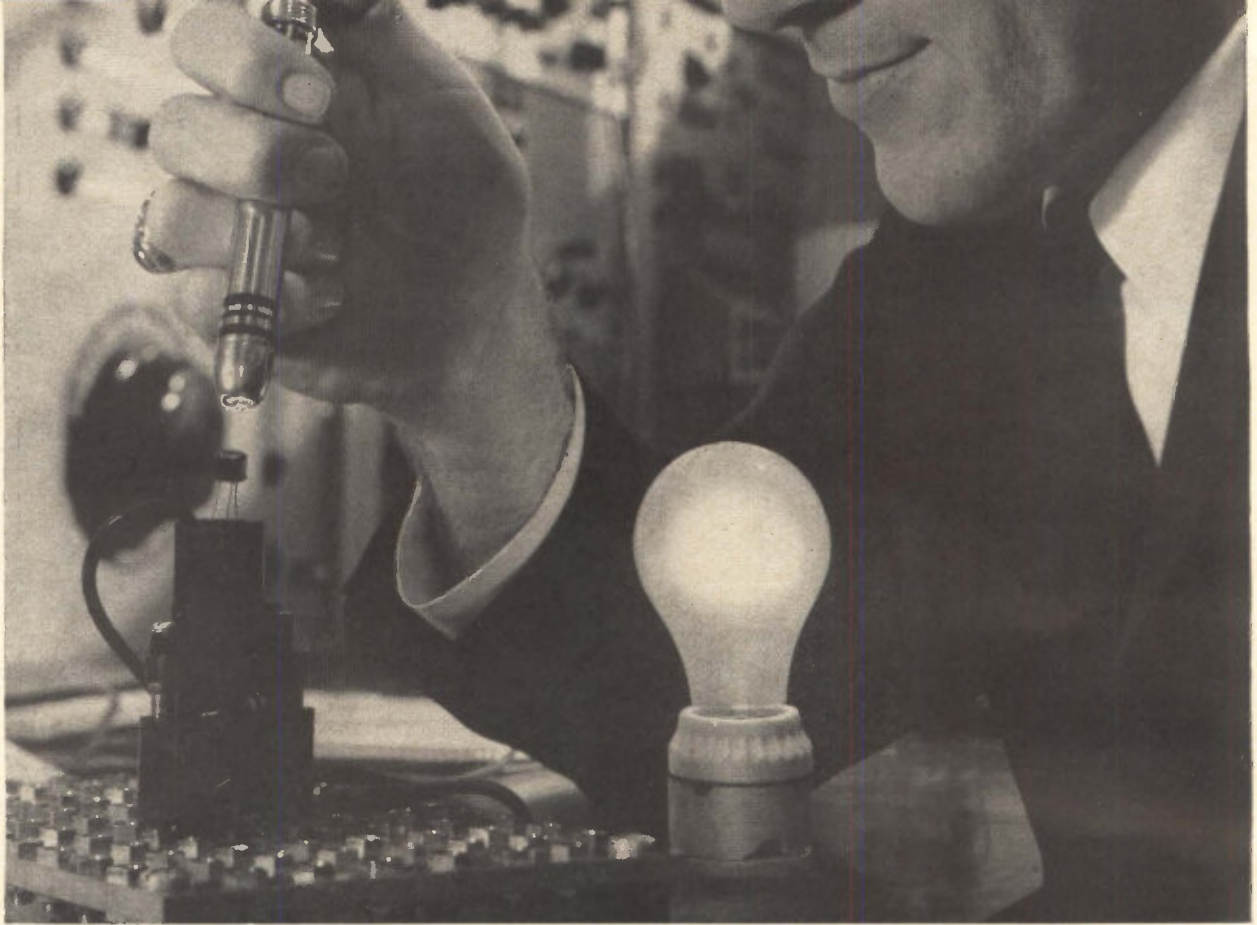

Breadboard of a light activated silicon controlled rectifier "relay" circuit controls the 60 watt lamp.

Editor's note

In addition to the General Electric Co., other companies supply light activated SCRs: Hoffman Electronics Corp., Solid State Products, Inc. and Texas Instruments, Inc. Some typical devices with manufacturers' ratings:

Mfgr:	Type Series	Package	Fwd blocking voltage	Max. fwd current	Light trigger intensity ¹
General Electric	L8	TO-5	25-200 V	1.6 a	0.68-10 mw/cm ²
	L9	TO-5	25-200 V	1.6 a	0.68-4.2 mw/cm ²
Hoffman	HLS	TO-5	25-200 V	200 ma	50-300 ft-candles
Solid State Products	3P	TO-18 (modified)	15-200 V	300 ma	30-150 ft-candles
Texas Instruments	LSX515	1/16" diam. (ceramic)	60 V	100 ma	5-17.5 mw/cm ²

(1) Conversion from ft-candles to mw/cm² is inadvisable since the light source must be defined when using ft-candles.

Operating characteristics of light-sensitive devices

Parameter	Photo-Transistor (PNP or NPN)	PNPN L8, L9, L811, L911	Photoconductive (Cds, Cd Se, etc)	Photovoltaic Si, Ge, Se	Photoemissive (Phototubes etc)
Max. Temp. Capability	85 C	100 C	65 C	150 C	65 C
Max Voltage	< 50 V D-C	200 V	500 V	V (generated)	1500 V
Type	Assymetrical	Assymetrical	Symmetrical	Assymetrical	Assymetrical
Current Capability	1 mA	1.4 A	10 mA to 1 A	150 mA	Up to 10 mA
Dissipation	50 mW	2 W	50 mW to 25 W	75 mW	10 mW → 1 W
Rise Time	2 μsec	2 μsec	0.2 ms → 100 ms	2 μs	1/10 μs
Fall Time	2 μs	2 μs (not t ₀)	Somewhat longer than rise time	10 μs	1/10 μs
Frequency Capability	50 kc	1 kc	1 kc (best Pbs)	50 kc	10 mc
Useful Operating Light Levels	1 — 50 ft cn	50 → 10 ⁴ ft cn	10 ⁻³ → 10 ³ ft cn	10 ⁻¹ → 10 ⁶ ft cn	10 ⁻⁶ → 10 ⁴ ft cn
Spectral Response	Visible → near IR	Visible → near IR	Visible → IR	Visible → near IR	UV → IR
Long Term Stability	Good	Good	Poor to Good	Best	Good
Adaptation Effects	None	None	Large (similar to eye)	None	Slight

Note — size: Photodiode smallest; photomultiplier tube largest

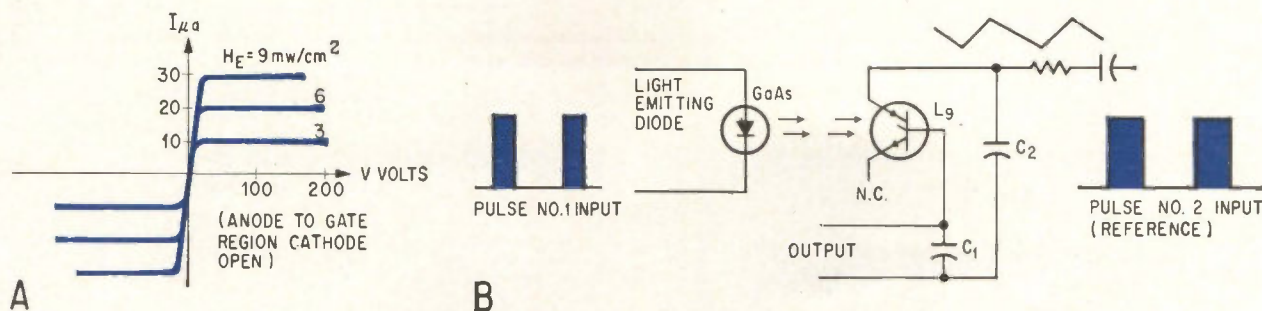

Typical voltage-current characteristics (A) of a rectifier as a symmetrical photo-transistor. A useful type of photo-transistor action is the phase-detection circuit (B).

serve as a fast-acting slave unit.

With switch S_1 closed, capacitor C_1 charges to 300 volts through R_1 , and capacitor C_2 , charges to approximately 200 volts through R_2 and R_3 . When the master flashgun fires, triggered by the flash contacts on the camera, its light output triggers LASCR₁, which then discharges capacitor C_2 into the primary winding of transformer T_1 . The transformer's secondary puts out a high-voltage pulse to trigger the flash tube. The flash tube discharges capacitor C_1 , while the resonant action between C_2 and T_1 reverse-biases LASCR₁ for positive turnoff. With the intense instantaneous light energy available from modern electronic flash units, the speed of the rectifier's response is only a few microseconds, leading to perfect synchronization between master and slave.

High levels of ambient light may also trigger the rectifier, and hence the slave, when a resistor is used between the gate and cathode. Although this resistance can be made adjustable to compensate for ambient light, the best solution is to use an inductance of at least one henry, which will be a low impedance for ambient light and a high impedance for a flash.

Precision two-step thermostat

The elementary bi-metal thermostat has problems of mechanical loading, slow make and break of contacts, and self-heating with current flow. Two light-activated rectifiers, a lamp and a thermostat can provide accurate temperature regulation with two-step power control.

As temperature increases, the thermostat blocks light from the rectifier, reducing the heater to half its power. A further increase in temperature causes the thermostat to block light from a second rectifier turning the heater off completely. Since there is no mechanical loading, the differential of this thermostat is very small and is determined primarily by optics and the change in light-sensitivity of the rectifier with temperature and voltage.

Lamp-switching circuit

For programmed operation of lamps in which switching is repetitive for a large number of on-off cycles, thermal stresses on lamps and on control are severe. A unijunction transistor control

circuit can provide preheating of the lamp by triggering the rectifier late in each half-cycle. The setting of R_2 will determine the minimum lamp current, as is required to maintain filament temperature just below the visible level. Gate resistor R_1 may be adjusted to control the rectifier's sensitivity to light. One unijunction circuit may be used in conjunction with several rectifier-and-lamp circuits by using a separate gate resistor (R_1) for each rectifier.

Temperature compensation

Since the rectifier's sensitivity to light is a function of junction temperature, some problems may be encountered where large variations in ambient temperature occur. If the changes in junction temperature caused by anode current are of negligible effect, some compensation for ambient temperature changes may be obtained by the use of a thermistor with series and parallel resistors in the gate circuit. Current is low in the gate circuit, permitting the use of a small thermistor that can follow rapid changes of temperature.

Photo-transistor action

The region between the rectifier's anode and gate of the rectifier behaves like a reasonably symmetrical photo-transistor. Typical voltage-current characteristics at several levels of irradiance are shown. This connection is used with the ZJ227UX4, which is a factory-calibrated unit used for measuring effective irradiance H_E (see panel accompanying this article).

The rectifier's photo-transistor action is useful in many ways, one of which is the phase-detector circuit.

The infrared emitting diode of gallium arsenide produces a pulse of radiation coincident with the input pulse. The L_9 charges capacitor C_1 to a voltage determined by the phase relationship between pulse 1 and the integrated wave derived from pulse 2. Optical coupling provides balanced operating and isolation.

References

1. GE, SCR Manual 3rd Edition, March, 1964
2. E. Keith Howell, The Light Activated SCR, GE Application Note 200-34

Resistors improve performance while their size decreases

Various kinds of miniature resistors are compared in capabilities and in method of production

By Charles L. Wellard

President, American Components, Inc., Conshohocken, Pa.

Resistor technology is moving rapidly into high-density packaging and is looking beyond toward fully integrated circuits.

Widespread use of these components in integrated circuits still seems to be a long way off. Therefore it is well to be familiar with miniature discrete resistors and their improved operation under increasingly severe conditions.

Since the resistor is the most extensively used electronic component, there is a growing demand for small, reliable resistors in modern miniature circuits. Miniature resistors comprise only 5% of present resistor sales, but that share is expected to climb to 20% by 1971 and 50% by 1976.

Materials compared

The basic materials in miniature resistors are essentially the same as those used in larger sizes. The most common materials are composition carbon, deposited carbon, metal films and glazes.

The table on p. 63 lists these materials and compares their capabilities. The information is an average of the best capabilities reported by contributing manufacturers, and does not imply that each manufacturer conforms to these standards.

In general, the better type of precision metal films offer the highest performance.

Composition carbon

The standard-size ½-watt composition-carbon resistor is still the workhorse of the radio-television industry. A mass of carbon is molded around two wires, and an insulator is molded around the carbon. This unit maintains a standard tolerance of 20%. It is used by the millions in industrial controls, radio, television, high-fidelity and stereo sets.

One miniature composition-carbon product is of slug-carbon construction. This component has the normal cylindrical shape with axial leads. It is used extensively in hearing aids, where initial tolerance and stability are not severe, and where economic factors are important.

The deposited-carbon resistor, introduced in 1937 or 1938, is a quality pyrolytic-carbon film-type component. The resistance material is deposited on a base in films of varying resistivity. The film characteristics can be controlled over a wide range.

The resistor is usually coated with epoxy or silicone to protect it from moisture. For higher performance levels, the resistor is sometimes molded in an insulating compound. Tolerances of deposited-carbon resistors can be held to 1%. They are being produced by the millions, but they are being gradually replaced by metal films of the evaporated, glazed or oxide types.

Little effort has been made to develop miniature resistors using a deposited-carbon process. This is because a metal film can do practically everything that a deposited-carbon film can do, only better.

While deposited-carbon types are slightly cheaper than metal films, many customers are willing to pay a little more for a far superior product. Deposited-carbon resistors are going into digital computers where stability is more critical than is required for composition-carbon types. They are used in television tuners where a 10% shift in resistor values during usage cannot be tolerated.

More ohms per square

Most of the activity in miniature discrete resistors has been in the use of metal films. Metal-film types take up less space for the same value of

American Components, Inc.

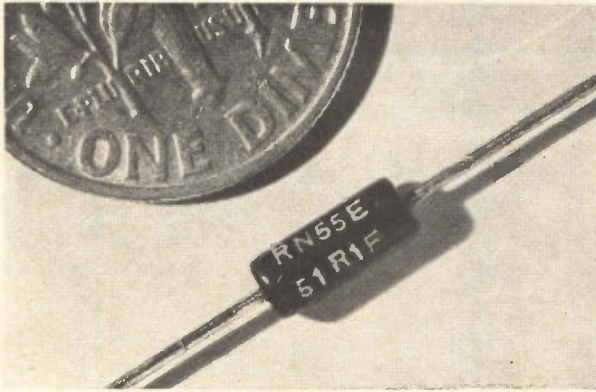

0.1 watt covered by specification

American Components, Inc.

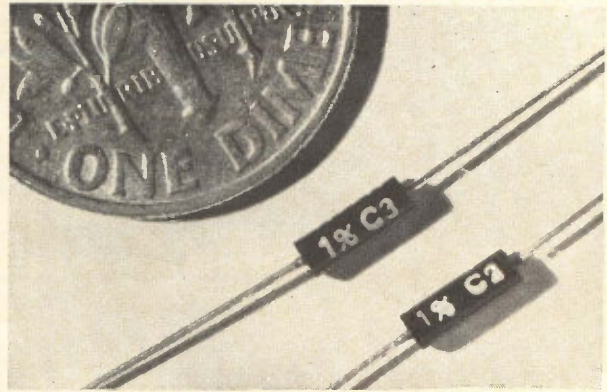

0.125 watt, molded

Electra Manufacturing Co.

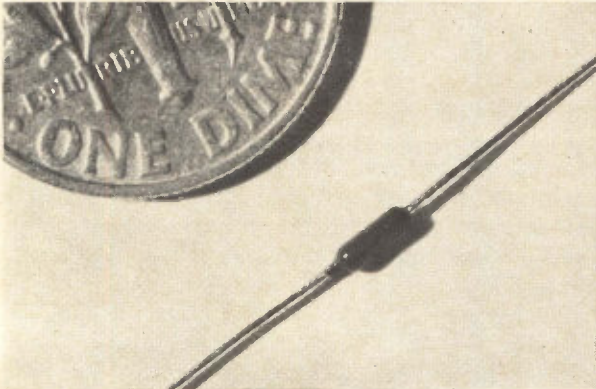

0.05 watt, conformal

American Components, Inc.

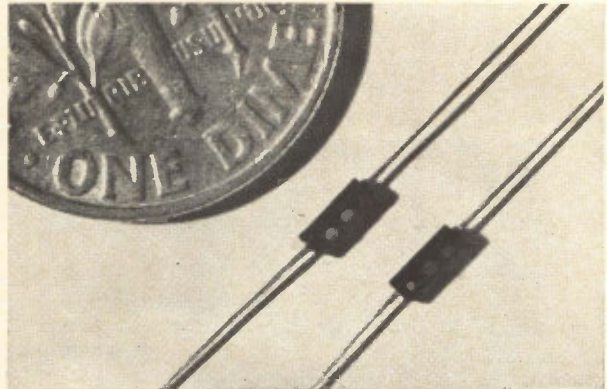

0.05 watt, molded

American Components, Inc.

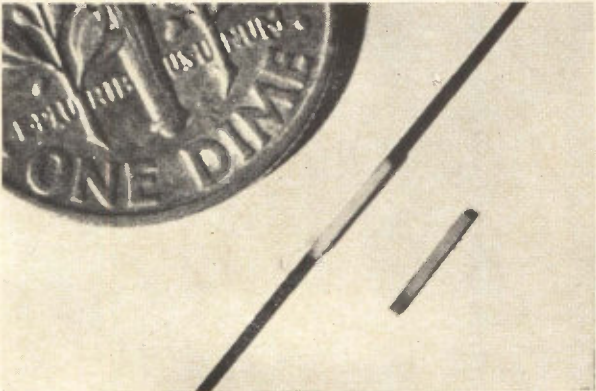

0.05 watt, flat

P.R. Mallory & Co.

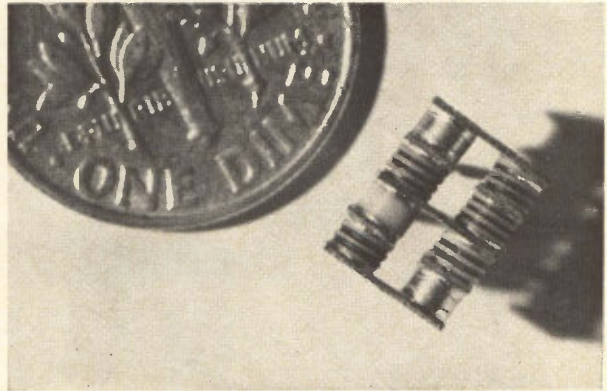

Pellet assembly

Resistive materials and their capabilities

Type of resistive material	Resistance range coverage-not helixed (ohms/square)	Temperature coefficient capability (ppm/°C)	Maximum operating temp. (°C)	1 year load stability (%)
Composition Carbon.....	10 to 10 ⁶	to ±500 medium range to ±2,500 high range	70	±10
Deposited Carbon.....	10 to 5,000	±500	125	±3
Metal Films.....	10 to 5,000	±25	125	±1
Glazes.....	10 to 10 ⁶	to ±300 medium range increasing at high ranges	125	±3

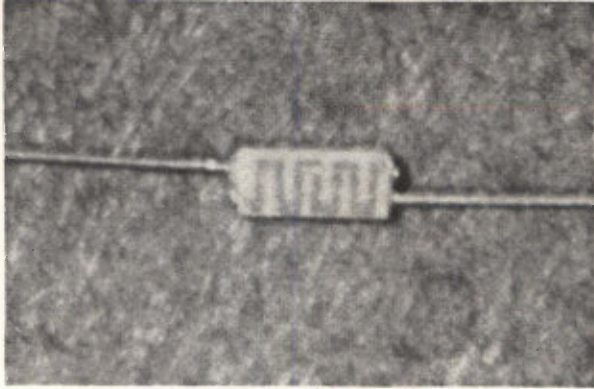

Flat cermet microplanar.

Electra Manufacturing Co.

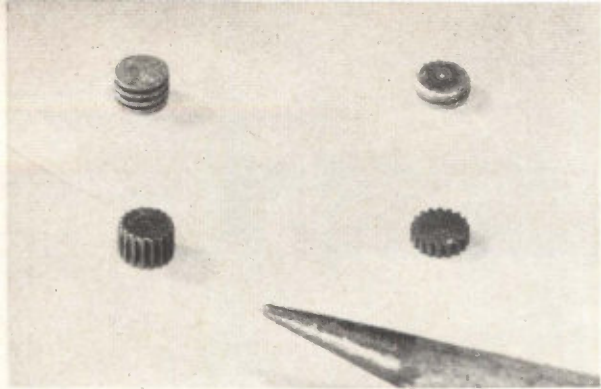

Spiral and fluted pellets.

P.R. Mallory & Co.

resistance than precision wire-wound types. Beyond 25,000 ohms, metal films result in great reductions in size. Manufacturers are delivering a full range of metal-film resistors at prices that are crowding out some carbon-composition types and the trend is expected to continue. The metal-film type is geared primarily to military equipment,

space and missile work, ground support equipment, radar, telemetering, communications, and any application that requires low temperature coefficients, high-temperature operation, and tight tolerances. Metal-film types are used in analog and digital computers.

The photographs on p. 63 show some examples of miniature metal-film resistors. The conformal-coated type are protected by coatings of epoxy or similar material.

The latest military specification covering precision metal-film resistors is MIL-R-10509E. The environmental requirements set forth in this specification are so stringent that only molded or encapsulated types can constantly meet them. At present, the smallest size covered in this specification is the military-style RN55, rated at 0.1 watt at 125° C. This unit is 0.270 inches long with a body diameter of 0.110 inch. RN55 is compared with two miniature molded types.

The noble metal film used in the construction of these resistors has a noise level well below that of carbon-composition and deposited-carbon types. The average level is less than 0.10 microvolt per volt. The advantages of miniature molded resistors include a marked increase in mechanical strength; more environmental protection, especially against moisture; high dielectric strength; and relative immunity from damage in handling, such as damage due to intimate contact with a soldering iron due to carelessness of an operator during insertion.

Although the molded units are somewhat larger than those of the conformal coated types for the same wattage rating, they nevertheless offer tremendous size advantage over the RN55 while maintaining the same performance levels. The military is now proposing additions to specifications to cover miniature resistor types. At least one style is scheduled for coverage during 1964, probably a 0.05-watt style.

Precision miniature resistors can be inserted into custom-made assemblies as individual components.

Electra Manufacturing Co.

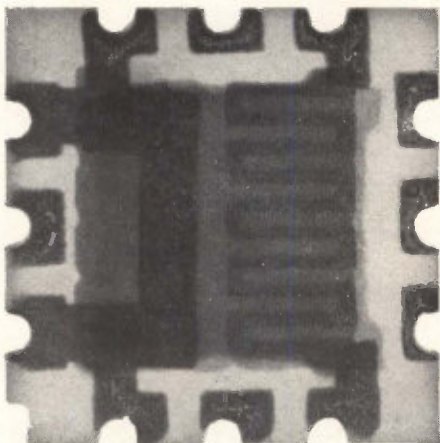

Evaporated R-C network.

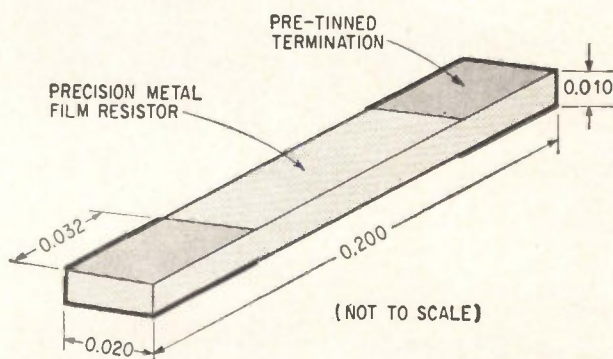

Construction of flat type, FE-1/20, not to scale.

Comparison of metal film specification limits*

Specification limits	Temp. cycle	Low temp. operation	Short time overload	Moisture cycling	Solder pot	1000 hrs. at 125° C.	1000 hrs. at 85° C.
Mil-R-10509E max.	±0.2%	±0.5%	±0.5%	±0.5%	±0.1%	±0.5%	Not applic.
Mil-R-19074A max.	±0.2%	Not applic.	±0.5%	±0.5%	±0.5%	Not applic.	±0.5%

* Specifications given for characteristics E and C. Characteristic E temperature coefficient is 0 ± 25 ppm/°C. Characteristic C coefficient is 0 ± 50 ppm/°C.

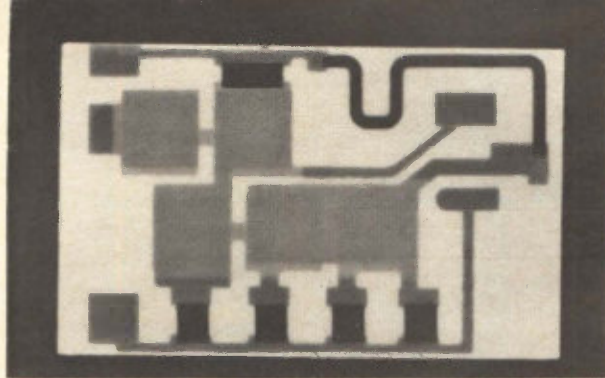

Resistor wafer in substrate.

CTS of Berne.

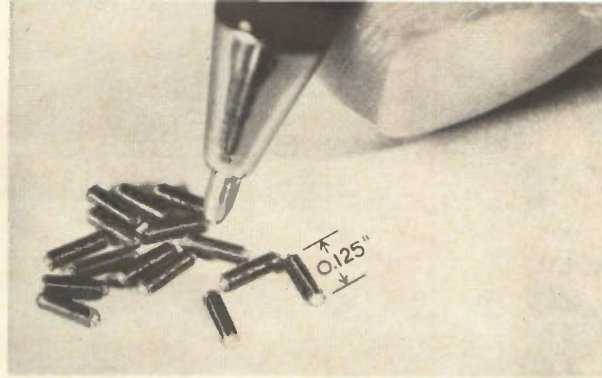

Mounting advantages for cordwood.

Yield problems, connected with the deposition of multiple components, are thus eliminated.

Glaze resistors are in direct competition with deposited-carbon and tin oxide types. Glaze resistors should cost less than the other two types when they are mass-produced more extensively.

Glazes, or liquid conductive materials, were developed by the Dupont Co. They consist of carbon and powdered metals, such as chromium or molybdenum, dispersed in a liquid glaze. Glazes compete with deposited-carbon and composition-carbon types and fill the performance gap between.

Circuit boards and substrates

Another miniature metal-film resistor is the flat type, designed for printed circuit boards. The body is box-shaped, usually longer than it is thick. Leads normally come out parallel to the length for plug-in to circuit boards. In some types the two leads are on the same axis; in others they are offset. A resistor of this type, FE 1/20 is shown on p. 64.

This precision flat microminiature resistor was designed to eliminate the yield problems connected with direct deposition of multiple resistors on a common base or substrate. The flat resistor can be attached directly to wafers or printed wiring boards. It has special high-conductivity substrates with fired-on terminations of noble metals. A precision metal film is deposited between the termination areas to the range of resistance desired. Two thin coats of a high-temperature silicone are applied over the film for protection and the unit can be supplied for direct soldering or with ribbon leads for soldering or welding.

Another type offering certain mounting advantages, particularly in miniature cordwood techniques is shown above. This miniature metal-film type is available up to 110 K.

Major emphasis has been placed recently on techniques for depositing thin-film resistance elements on a thin substrate. In most cases the substrate plates are 0.032 of an inch thick or less, with an area of one square inch or less. The width is usually within 50% of the length.

The techniques of using the materials shown in table on p. 63 are used to produce resistors as an integral part of the base substrate. In such cases, the substrate is usually a high-quality ceramic or glass, onto which has been fired a pattern of noble metal conductors. A portion of these conductive areas supplies the terminations across which the resistive element is applied.

From table 1, it would appear that the material with the most resistance per square would be the most desirable. But other aspects must be considered. Resistive materials with the most ohms per square are usually the least capable of holding the resistance value within required tolerances and of retaining their values with changes in temperature.

On the other hand, evaporated metal films can be applied through precision masks, by photographic techniques, or other pattern or matrix devices, to obtain a large number of squares, and thus a high resistance from their otherwise-limited range of ohms per square.

The ability of metal films to achieve the resistance desired in the first, or blank, stage of resistor construction is within 8% of the desired resistance. A groove or helical pattern is then cut around the blank to achieve the final resistance.

Up to 80% of the units that are produced have an inherent temperature coefficient of resistance within ± 50 ppm. per degree centigrade.

Since applying multiple resistors to a common substrate still involves severe technical problems, hybrid circuits are receiving considerable attention.

This year, about 90% of all miniature electronic equipment produced will be built with hybrid circuits. Hybrids combine the solid or integrated circuits and the individual, discrete miniature component. About 20% of these hybrid circuits are made up of the true solid-state circuits that are deposited directly on a substrate or formed in a solid block of silicon. And 80% of these hybrid circuits contain discrete components.

Shrinkage by the numbers

By 1971, it is estimated that half of the miniature equipment market will use hybrid circuits. Of these, 50% to 70% of the hybrids will be built with solid circuits, the rest will use discrete resistors.

Pellet-film resistors, made of a powder mixture of noble metals and their oxides, are being supplied in production quantities. These resistors are becoming increasingly popular in miniature circuits. The range of values, tolerance and temperature coefficients available in pellet components is approaching that of conventional components.

Pellet circuit elements are adaptable to automatic handling techniques in preassembly testing and circuit fabrication. The pellets shown on p. 64 show that the basic resistor design consists of a spiral of resistive material.

An alternate design is a fluted pellet, which is

YEAR	TYPICAL RESISTOR UNIT PRICE IN CENTS (OEM PRICES)																							
	1	2	3	4	5	6	7	8	9	10	11	12	13	14	15	16	17	18	49	50	51	52	53	54
1958	20 % 10 % 5 % CARBON COMPOSITION 1500 PPM/°C																	2% 1% CARBON FILM & SnO	1% → 0.1% METAL FILM					
1962	20 % 10 % 5 % CARBON COMPOSITION 1500 PPM/°C			2% CARBON FILM & SnO 500 PPM/°C										1% 200 PPM/°C					1% METAL FILM 100 PPM/°C					
1964	20 % 10 % 5 % CARBON COMPOSITION 1500 PPM/°C			2% CARBON FILM/SnO/GLAZED										1% ELECTRA 100 PPM/°C					METAL FILM					

CHRONOLOGY
OF RESISTOR
PRICE AND
PERFORMANCE

used for low resistance values and in very-high frequency applications. The pellet assembly shown on p. 63 demonstrates a method of high-density pellet packaging using solder-coated terminals and connectors. Resistor pellets and wafers can be packaged with solid-silicon circuits to provide electrical properties with tolerances that would be impossible without individual components.

The miniature resistors shown on p. 63 are finding considerable use in these hybrid circuits. Metal film resistors are offered in a selection of tolerances and temperature coefficients to match requirements with economy.

Tin oxide

The tin oxide resistor bridges the gap between composition-carbon and metal-film types. Tin oxide resistors are competitive with composition carbon and are cutting into the deposited-carbon types.

Offering more economy, but with limited properties, the tin oxide resistor fills a need that is less critical than that posed by metal films. Tin oxide resistors contribute an economic advantage, particularly for glassmakers. The stannous chloride used in tin oxide resistors can be deposited on a glass substrate, which is less costly than a ceramic substrate. The tin oxide resistor has a limited range of coverage, compared with metal film types. Tin oxide seldom produces a resistance range over 800 ohms per square. Also, the tin oxide resistor has a temperature coefficient of 200 ppm per degree centigrade. This is high compared with metal film. The table shown above presents a chronology of prices for the various resistor types discussed.

There is some activity among makers of wire-wound resistors to produce miniature resistors. Some wire-wounds are small, but none are as small as the subminiature types we have discussed. Limitations have to do with the wire size, the smallest being about half a mil. Miniature wire-wounds are limited to 5,000 ohms. However, wire-wounds may find some application in the very low values of re-

sistance, particularly under 50 ohms, where most metal-film manufacturers leave off. Applications would be limited, but an assured source of supply would be helpful to the user.

The user's responsibility

While the component manufacturer has a responsibility to produce a resistor of known reliability, and must state this reliability in common accepted terms, factors beyond the inherent qualities of the miniature resistor itself affect reliability.

The responsibility for a resistor rests not only with its manufacturer, but also with the user. Unreliability in miniature resistors and in other miniature electronic parts is usually caused by handling, misuse, misapplication or abuse from the time the component is received to the time it is put to use. Miniature resistors are more fragile than those of conventional size. Handling requires a softer touch, and soldering temperatures must be controlled more carefully.

A miniature unit does not act as a heat-sink barrier. While larger units are being soldered, the resistor itself acts as a heat-sink to reduce the temperature of the iron tip. It is not uncommon for a miniature unit to reach the temperature of the applying iron in less than eight seconds.

The author

Charles L. Wellard is the author of *Resistance and Resistors*, McGraw-Hill, 1960. He received a Bachelor of Science degree from the Massachusetts Institute of Technology in 1946 and a Master's from Carnegie Tech in 1947, both in electrical engineering. For the past three years he has been president of American Components, Inc. He also worked for three years at the Clifton Precision Products Co. as technical director of the systems division.



Ultrasonic approach to data storage

Ferroacoustic storage, based on a new delay-line principle, may offer competition to magnetic drums and tapes

By J.W. Gratian and R.W. Freytag

General Dynamics/Electronics, Rochester, N.Y.

Ferroacoustic storage is a new data storage concept with the advantages of solid-state, nonvolatile, updatable storage and nondestructive readout. Embodying a basic advance in sonic delay-line principles, the new memory has a capability of sequential access to data that tends toward the low cost, size and weight per bit of information that is typical of moving media such as magnetic tape, drums and discs; at the same time, the mechanical problems associated with these are entirely avoided.

The resolution of ferroacoustic storage memories, based on experiments with commercial nickel-iron tubing, indicates a potential of 10^8 bits per cubic foot with megacycle reading rates; future development of thin films with the necessary characteristics promises further order-of-magnitude improvement in capabilities.

The memories most widely used today fall into three major classes:

1). Magnetic tape, used mostly in input-output equipment, offers essentially unlimited capacity at minimum cost, size and weight per bit, but has access times of the order of seconds.

2). Matrixed discrete elements, such as cores and thin films, as used in central processing, permit access time of microseconds and less, but have smaller practicable capacity, and their cost, size and weight per bit are many times higher than for tape.

3). Magnetic drums or discs have intermediate characteristics with transfer rates (rate at which information is transferred into or out of the memory) of several hundred kilocycles, and afford capacities up to 10^9 bits for a few exceptionally large systems.

Delay line memories

Active interest in a fourth class of memory, the delay line, has been intensified recently. Its advantages include sequential address, which, when applicable, avoids cost and size limitations of wiring

and switching of matrixed memories, and solid-state construction, which avoids the mechanical limitations of moving media, a factor of growing concern especially in military applications.

However, conventional delay lines are seriously handicapped by the requirement for regenerating and recirculating circuits for each line. This circuitry becomes a major economic limitation when a number of lines are to be used as an alternative to a number of tracks on a drum or disc; furthermore, the stored data is lost when power is removed.

The ferroacoustic technique described retains the advantages of a delay line but overcomes its volatility problem by a technique that produces permanent recordings which can be erased, updated at will, and read out nondestructively indefinitely.

Basic principle

The material properties used in ferroacoustic storage are shown on page 68. With stress σ applied, induction for a given applied field H is greater than with stress absent. As shown in more detail on page 68, right, the application of a field H_1 , with $\sigma = 0$, produces a residual induction B_1 . However, when a stress pulse is applied simultaneously with H_1 , the induction increases so that a residual induction of B_2 exists when H_1 is removed, and this falls to B_3 when both H and σ are removed. When a stress pulse is subsequently applied to a sample in the B_3 state, the induction again increases toward B_2 , and this change of induction can then be used to indicate that a bit of information had been stored. Stress applied to an element in the B_1 state, however, produces a relatively small change of induction.

One way of using these properties is shown at top left of page 69, where the memory consists of a thin tube of magnetostrictive material, a central conductor, and an ultrasonic driving trans-

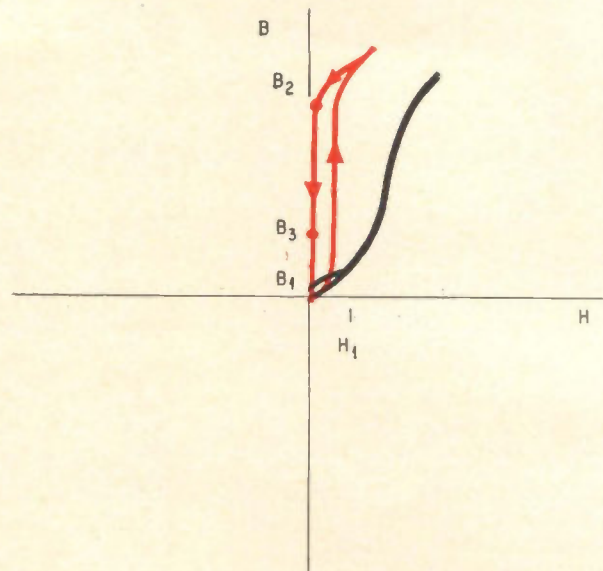
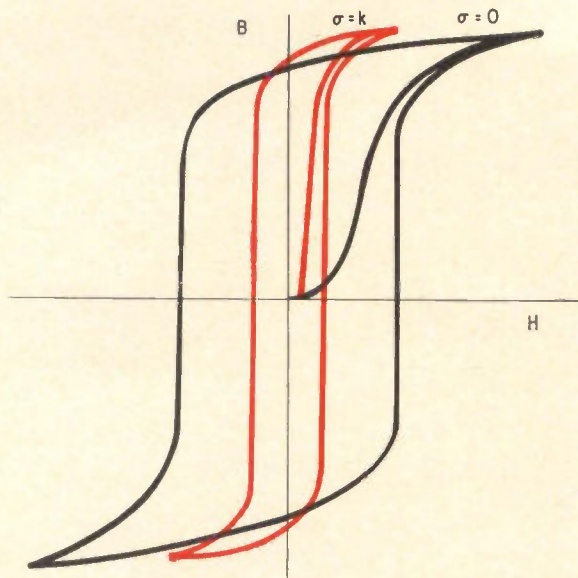

Magnetostrictive material B-H characteristic with no stress applied (left) shows a stress sensitivity (right) when stress is applied. This effect can be used to store signals.

ducer at the lower left end of the line. To write, an ultrasonic pulse is first sent down the line. After a delay, which determines the point reached by the ultrasonic pulse, a short current pulse is applied to the central conductor. This leaves an element of the line in the B_3 state of the figure above, right. To read, an ultrasonic pulse is again propagated down the line. After a delay corresponding to the address which is to be read out, the gate is opened momentarily to provide access to the voltage pulse induced in the central conductor as the passing ultrasonic pulse raises the induction of the addressed element from B_3 toward B_2 . If a one is represented by the B_3 state, the B_1 state corresponds to a zero. As the readout stress pulse travels through elements of the line in the B_1 state, only a relatively small change of induction and induced output voltage should occur.

For random-access applications of the type in which magnetic drums and discs are used, conventional timing or clock circuits would replace the delay circuit of the figure on page 69, top left. When information can be used in serial form, all bits on one line are read out sequentially as a single pulse travels down the line, without need for special timing circuits in the memory. Construction can be simplified, with a small loss in efficiency, by eliminating the separate axial conductor and making connections to the ends of magnetostrictive tube.

Operating modes

The techniques used in magnetic recording of digital data appear applicable to the ferroacoustic process. These include the conventional return-to-zero, non-return-to-zero, frequency-doubling, and phase-shift methods¹. The choice of these techniques will be determined primarily by application requirements. Three alternative modes of operation, however, depend on special characteristics of the

ferroacoustic technique and on properties of materials:

1). The data signals may be applied as axial polarizing currents in the form of positive pulses to represent ones; absence of a pulse then represents a zero.

2). Data signals may be applied as axial currents in the form of positive and negative pulses to represent ones and zeros, respectively.

3). The data signals may be applied to the transducer to generate strain pulses representing the data; the axial current pulse may then have fixed polarity.

Mode two offers greater versatility and is more compatible with current data-processing techniques, because it permits random-access updating and provides erasure and rewrite simultaneously without the intermediate erase operation required by mode one, but it is more difficult to achieve with commercially available materials. The major problem in mode one operation is how to obtain a usable signal-to-noise ratio. Unless high stresses are used, an appreciable remanence (corresponding to point B_1 of the figure above, right) is recorded for zero data signals. Since the storage medium is not perfectly uniform, subsequent passage of a readout pulse may generate a noise voltage comparable with the signal level. Mode three is limited to applications in which a complete line can be erased and all new data re-entered before applying a single H pulse to record the data.

Magnetostrictive driving

A magnetostrictive transducer of the form indicated permits a very simple construction consisting of a solenoid surrounding a short portion of the storage line, thus avoiding problems of matching and bonding alternative types of transducers. Since relatively high stresses are required for write-in, one of the most practical approaches is the resonant

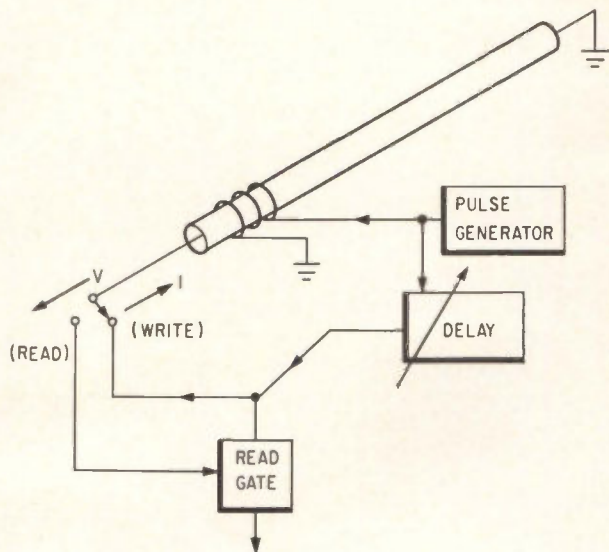

Ferroacoustic memory operates, as shown schematically, when transducer coil applies a pulse and the center conductor is energized.

line shown in the photo. The coil is placed at the center of the line and the ends of the line are left undamped. The application of a step-current input to the transducer propagates a unidirectional stress pulse (compressive for 50% nickel-iron alloys) along each half of the line. The pulses are reflected from the ends of the line as tensile stress pulses and at some later time merge directly within the center coil mentioned above. At this instant, the transducer current is turned off, thus reinforcing the tensile stress pulse.

This process is continued, alternately reinforcing tensile and compressive stress pulses, until the acoustic attenuation balances the gain in strain per cycle. Hence, a square wave applied at the proper fundamental frequency generates a continuously circulating, high-level stress pulse after an initial buildup of several cycles. The resulting simple system is functionally equivalent to a continuously rotating drum memory. A signal-to-noise ratio of 16 db and an operating rate above 300 kc were obtained with a solenoid 0.1 inch long and a line of 52 alloy having an outside diameter of 15 mils and a wall thickness of two mils.

Higher stress can be generated by materials having higher magnetostriction constants. However, because the material compositions for an optimum transducer and an optimum storage line are different, much of the constructional advantage of using magnetostrictive transducers would be sacrificed in the coupling and bonding of the two separate materials, e.g., a line of 50% nickel-iron and a transducer of 100% nickel.)

Piezoelectric driving

Piezoelectric transducers offer, in addition to higher stress, avoidance of the flux fringing and loss of resolution inherent in magnetostrictive transducers. Flux fringing in magnetostrictive transducers is caused by the fact the permeability of

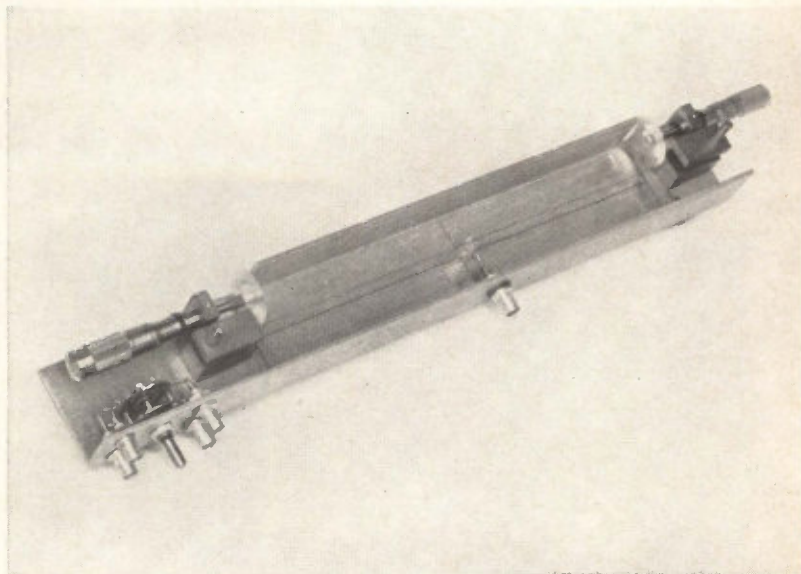

Experimental version of resonant line with a Magnetostrictive driver at the center of the line.

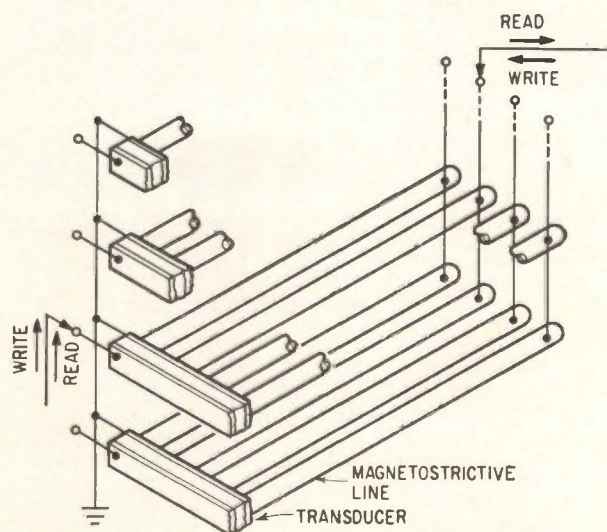

Matrixing increases the storage capacity of the ferroacoustic memory.

the transducer is approximately equal to that of the delay-line medium and thus the flux is not restricted to the transducer gap. Furthermore, the piezoelectric transducer is particularly adaptable to the construction of matrixed three-dimensional memories of the form indicated in the figure above. Clevite Corporation types PZT-4, and PZT-5 when operated at a low duty ratio (ratio of time on to time off), provide a non-resonant driving stress which is approximately equal to the 1,500 psi obtained with the resonant line of the figure at top right.

To provide higher stress for initial study over a broader dynamic range, a sonic horn with a 1:10 pressure transformation was added to increase the stress developed in the transducer. For the model of the figure at top of page 70, a 0.1-inch thick PZT-5 ceramic disc is sandwiched between a pair of horns, one of which is coupled to the storage line.

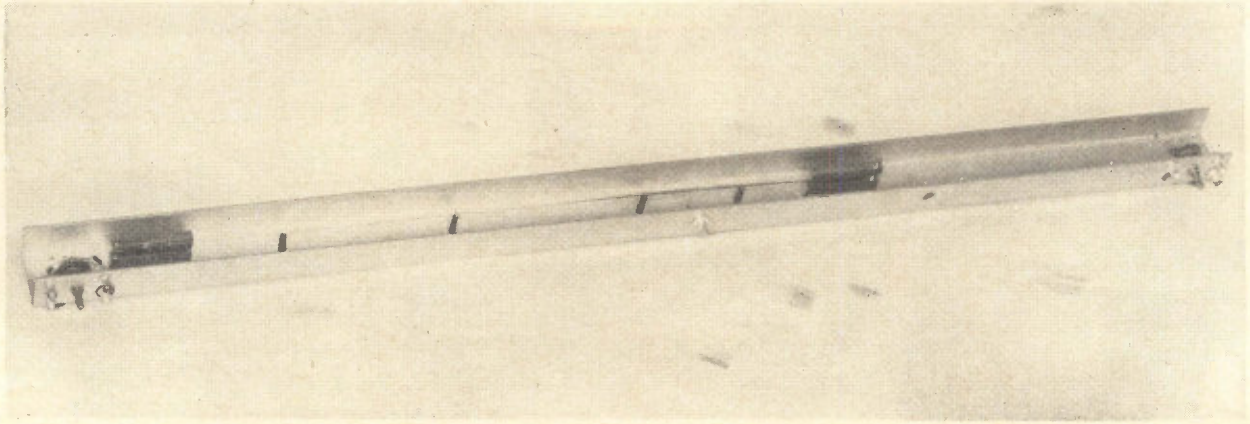

Experimental resonant line is driven by a driver coupled through a piezoelectric horn.

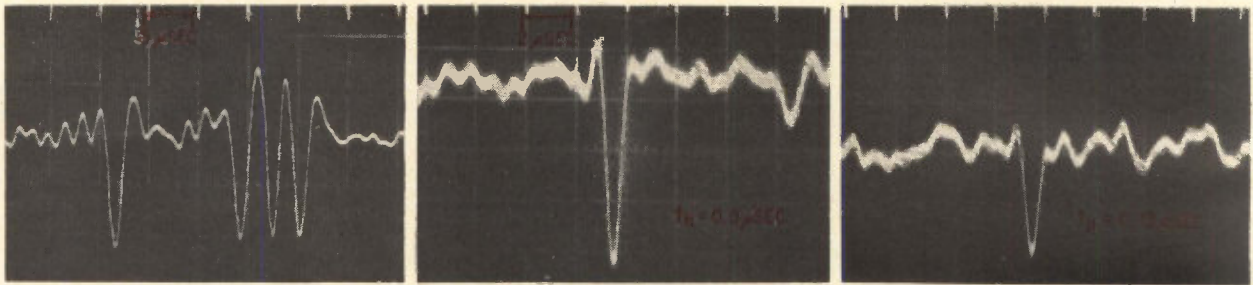

Oscillograms of output pulses show output for model using 0.1-inch thick ceramic driver, left, and for model with 0.024-inch thick ceramic driver center and right.

The small end of the other horn and the far end of the storage line are terminated in damping pads to prevent reflections. The first oscillogram (above, left) shows readout signal-to-noise conditions for a single pulse and for pulses packed to a minimum spacing of approximately three microseconds between peaks without appreciable loss of amplitude with mode one operation.

The second oscillogram (above, center) shows the one-microsecond resolution obtained with transducer thickness reduced to 0.024 inch. This represents the limit imposed by creep in magnetization with a storage-medium wall thickness of two mils. Creep in magnetization is the gradual increase in remanence as additional magnetizing pulses of the same intensity are applied. Repeated applications of polarizing field throughout the length of the line, such as occur when additional bits are recorded at other addresses, cause a gradual increase in remanence. This tends to mask or erase previously recorded bits so that the signal-to-noise ratio drops below a usable value. This effect can be avoided by mode three operation, in which a single H pulse effects write-in after all data has been entered on the line.

Calculations based on data from the horn-coupled model indicate that one-microsecond resolution can be obtained with direct piezoelectric drive, mode one operation, and tubing with one-

mil wall, the minimum presently found available in combination with an outside diameter of 5 to 10 mils. The corresponding packing density of six bits per linear inch for return-to-zero storage would allow 10^6 bits to be stored in a 2.6-inch cube, e.g., assuming that lines can be stacked on 10-mil center-to-center spacings. Improvements in line stacking in general are even more important than linear bit density because the number of bits per unit volume varies as the square of the line packing factor but only linearly with pulse resolution. For applications permitting sequential readout of a long column of data, however, linear bit density becomes more important and thin-film media will be advantageous.

Material properties

The most promising thin-film approach appears to be the use of a thin film deposited on a low-loss core material such as quartz in order to minimize acoustical attenuation. Another advantage expected from this approach is the higher strain sensitivity of fully annealed nickel-iron storage media. With homogenous line materials a low-temperature anneal is required to avoid recrystallization and the large increase in grain size which causes excessive attenuation² when acoustical wavelength is of the same order as grain size. This consideration becomes less significant when the magnetic material

forms only a small portion of the total cross-section of the line.

The improvement in strain sensitivity for annealed materials relative to cold-drawn materials is indicated by the magnetization curves (right) for tubular Carpenter "49-FM", having 49% nickel and 50% iron. Roughly, an order of magnitude improvement was observed for each of seven alloys of nickel, iron, and cobalt which were studied. Induction in those tests was measured in the circumferential direction, while a constant stress was applied axially. The relatively low transverse strain sensitivity indicated by the second graph, (bottom right) for stresses which act to increase induction beyond the value at zero stress was found to be typical of unoriented annealed materials in general. This result would imply poorer storage characteristics than those actually observed in dynamic tests of models. The sequence in which H and σ are applied, however, was found to be significant. The usual magnetization curves corresponding to the tips of the hysteresis loops for a fixed value of applied stress are shown as the solid lines of the second graph. The dashed-line curve, obtained by applying the increment of stress σ after H for each value of H, shows a substantial increase in induction relative to the solid-line curves. In the actual write-in process, the σ pulse is moving along the line during application of the H pulse. Consequently, the storage medium sees three different sequences of H_{on} , σ_{on} , H_{off} and σ_{off} . The more effective (H, σ) sequence observed in static measurements occurs at the leading edge of the moving stress pulse and is responsible for the relatively good dynamic results achieved in the examples given above.

Domain orientation of the storage medium offers further means of obtaining higher transverse-strain sensitivity. The use of a tensile stress bias is practical for storage media with positive magnetostrictive properties. Magnetic annealing and orientation produced by large percentages of cold reduction are other possible ways for drawn media. Thin films exhibit shape anisotropy (are more easily magnetized along one axis than along another at right angles to the first one) which, in the cylindrical configuration, acts to suppress radial directions of easy magnetization, thus offering improved transverse-strain sensitivity, as well as the improved response and resolution resulting from smaller high-frequency losses. Comparative evaluation of media processing costs, uniformity, efficiency, and output levels will be required to determine whether drawn media are preferable to thin films for memories of small to moderate speed and capacity.

Selection of material composition in this initial work was based primarily on the need for high strain sensitivity. As shown by Bozorth and Williams³, maximum strain sensitivity varies according to

$$\Delta_m = 0.77 \lambda_s B_s / K$$

where λ_s is the saturation magnetostriction, B_s is

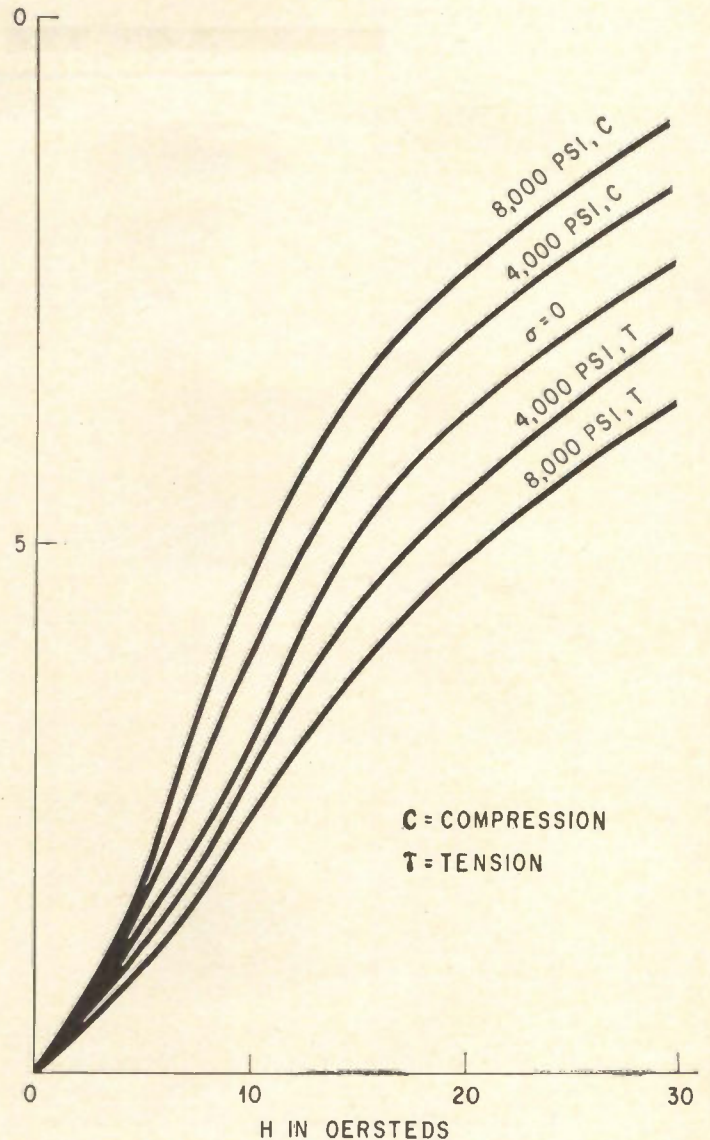

Magnetization curves for cold-drawn 49% nickel-iron show effect of stress.

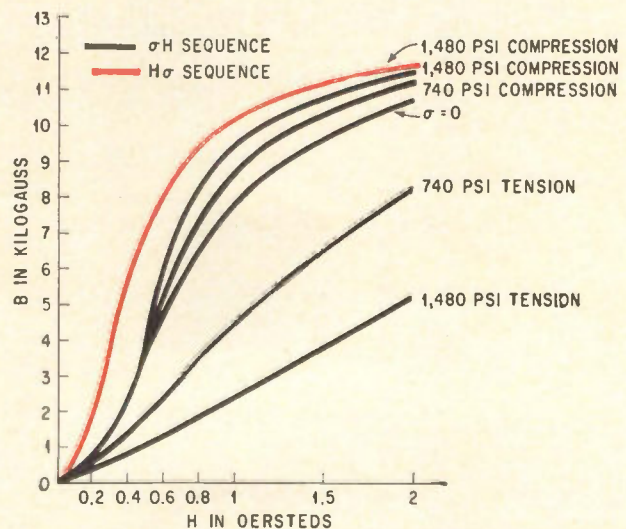

Magnetization curves for annealed 49% nickel-iron wire show effect of stress and of reversed driving sequences.

the saturation induction, and K is the anisotropy constant for a given material. This gives a maximum strain sensitivity, confirmed experimentally, in the vicinity of 60% nickel-iron when the corresponding constants for various compositions are substituted and allowance is made for the masking effects of internal strains as anisotropy K approaches zero. At 50 and 70% nickel-iron, Δ_m falls only about 25% relative to its maximum value at 60% nickel-iron. Fifty-two alloy, composed of 50% nickel with balance iron, falls in this range, is commercially available in thin-wall tubing, and was used in the models discussed.

The Δ_m criterion, however, can serve only as a tentative guide to material selection in ferroacoustic storage, for several reasons: First, it pertains to the maximum value of strain sensitivity for each material, and this maximum occurs at one relatively high value of induction. Second, only longitudinal strain sensitivity, in which stress and induction are measured along the same direction, is treated. Third, an external polarizing field is present during the measurement. By contrast, ferroacoustic storage makes use of transverse characteristics, remnant polarization, and at least two levels of remanence approached by different H, σ sequences. Consequently, several nickel, iron, and cobalt alloys are being studied statically to determine Δ under the particular conditions of ferroacoustic storage.

Signal-to-noise and output criteria

For mode two operation, criteria of performance in terms of the static measurements are derived as follows. Let ΔB the measured change in remanent induction resulting from a given $\Delta\sigma$ so that $\Delta B_H =$ change in remanence for a given $\Delta\sigma$ when the initial remanence is produced by H alone. Also, Δ

$B_H\sigma =$ change in remanence for a given $\Delta\sigma$ when the initial remanence is produced by H and σ .

For a perfectly uniform storage medium, the peak output signal is

$e_s = K (\Delta B_H\sigma - \Delta B_H)$, where K is a constant which includes the effects of the time derivative and pulse slope as determined by electrical and mechanical time constants.

Let u be a factor representing the uniformity of the medium such that $u_0 = 1$ corresponds to the average sensitivity, and the maximum and minimum limits are u_2 and u_1 , respectively. The minimum signal level and maximum noise level are then

$$e_{s \min} = K (u_1 \Delta B_H\sigma - u_2 \Delta B_H)$$

$$e_{n \max} = K (u_2 \Delta B_H - u_1 \Delta B_H)$$

Signal-to-noise ratio is

$$\frac{e_{s \min}}{e_{n \max}} = \frac{u_1 \Delta B_H\sigma - u_2 \Delta B_H}{\Delta B_H (u_2 - u_1)} = \frac{1}{u_2 - u_1} \left(\frac{u_1 \Delta B_H\sigma}{\Delta B_H} - u_2 \right)$$

Setting $u_2 \approx 1/u_1$, $\frac{e_{s \min}}{e_{n \max}} = \frac{u_1^2 R - 1}{1 - u_1^2}$, where $R = \frac{\Delta B_H\sigma}{\Delta B_H}$

Hence, if u varies ± 10 percent, e.g., in accordance with the commercial tolerance of the wall thickness of tubing, 10 db signal-to-noise could be expected for $R = 2$, or 20 db for $R = 3.6$. Output level is also a function of R :

$$e_s = K (\Delta B_H\sigma - \Delta B_H) = K \left(1 - \frac{1}{R} \right) \Delta B_H\sigma$$

$$\left\{ \begin{array}{l} \lim_{R \rightarrow \infty} e_s = K \Delta B_H\sigma \\ \lim_{R \rightarrow 1} e_s = 0 \end{array} \right.$$

for $R = 2$, $e_s = 0.5 K \Delta B_H\sigma$, i.e., half its maximum value for $R = \infty$. By comparison, operation at low values such as $R = 1.1$, e.g., would reduce the output to 0.1 of its maximum value and a signal-to-noise ratio of 10 db would require a uniformity of ± 1 percent. The ratio R varies with the values assigned to H and σ , as would be expected by consideration of the figure on page 68. Measurements on all materials studied have shown that ΔB decreases and R increases as H is decreased, but values of $R = 2$ or better are reached before ΔB and e_s fall below usable values.

Acknowledgement

Part of this work was conducted under National Aeronautics and Space Administration contract NASw-592. The authors also acknowledge discussion throughout the project and review of this paper by K. Clayton, mechanical design by R.F. Auld, construction and tests by C. Traino, crystallographic studies by Dr. F.C. Unterleitner, K. Mercer and Dr. E.G. Brock, and thin-film investigations by A.G. Balmer, Dr. C.E. Drumheller and F.J. Haskins.

References

1. A. Gabor, "High-density Recording on Magnetic Tape", *Electronics*, p. 73, Oct. 16, 1959.
2. W.P. Mason, *Physical Acoustics and the Properties of Solids*, D. Van Nostrand, Inc., 1958, pp. 130, 206.
3. R.M. Bozorth and H.J. Williams, "Effect on Small Stresses on Magnetic Properties", *Review of Modern Physics*, Vol. 17, No. 1, Jan., 1945.

The authors



Richard W. Freytag joined the Information Storage Section of General Dynamics/Electronics' Research Department in 1957, and is currently a senior engineer in military products engineering. He has done work in magnetic tape and drum recording, Hall effect devices, time compression and noise analysis. He received his BSEE from Ohio University in 1957 and has done post-graduate work at the University of Rochester.



J.W. Gratian is responsible for information-storage techniques development and consultation in General Dynamics/Electronics Military Products Engineering. Earlier associations were the Naval Ordnance Laboratory in 1941-3 and the University of Michigan in 1943-5. He holds a BSEE from the University of Illinois (1941), a master's degree from the

University of Rochester (1963), and 23 patents on electronic devices and circuits.

Radar-tracking accuracy increased

Refractivity of atmosphere may be approximated easily by measuring dielectric constant of the air with microwave refractometer

By Clarence H. Stewart and Gary J. Vincent

Colorado Research Division, ITT—Bell & Gossett, Inc., Broomfield, Colo.

Radar equipment is limited in accuracy by the varying medium through which it is propagated. The Colorado Research microwave refractometer is a device capable of making very precise measurements of the propagation medium, and is so stable that readings are absolute rather than relative. By measuring the refractivity of the atmosphere, it is possible to increase the accuracy of a tracking radar.

The permittivity of the atmosphere—the major factor in tracking errors—may be easily approximated by measuring the dielectric constant or refractivity of the air. Instrumentation capable of measuring refractivity on a real-time basis is essential. For many years, the only practical method involved conventional meteorological instrumentation, combined with the use of an empirically derived formula that relates the atmospheric re-

fractivity to the meteorological parameters; temperature, pressure, and humidity. This “indirect” method is highly subject to error, because of sensor errors and time constants, and also because of the uncertainty in the formula.

D. R. Hay of the University of Western Ontario designed a refractometer for balloon-supported soundings. Hay’s instrument has two capacitors which alternately control the frequency of an oscillator. One capacitor is sealed, and acts as a reference element. The second is open and samples the atmosphere. By comparing the oscillator frequencies with the reference capacitor and the sampling capacitor, the dielectric constant (and thus the refractive index) of the sampled medium is determined directly. Using a single oscillator reduces such problems as oscillator drift and temperature variations to second-order effects. However, measurements made with the capacitive technique were not absolute, because the device did not have long-term stability.

Microwave refractometer

The Colorado Research microwave refractometer is stable enough to perform absolute, rather than relative measurements of the dielectric constant. (This instrument is the result of a joint development effort by the National Bureau of Standards Boulder Laboratory and Colorado Research Division, ITT-Bell & Gossett, Inc.) The basic technique involves two precision microwave transmission cavities and associated circuitry. One of the cavities is ventilated, and acts as the sampling transducer. The second cavity is hermetically sealed and acts as the reference element. The output of a swept-frequency klystron oscillator is applied to the two transmission cavities (see block diagram at top of p. 74). The outputs of the cavities will have a relative timing which depends upon the resonant frequencies of the two cavities.

The introduction of atmosphere will affect the

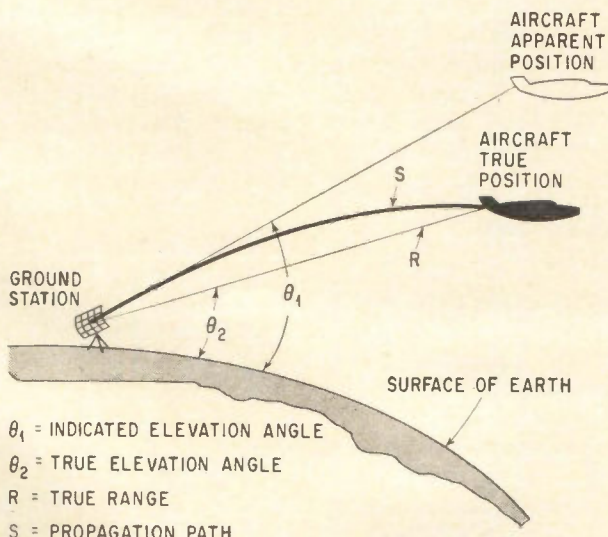

θ_1 = INDICATED ELEVATION ANGLE
 θ_2 = TRUE ELEVATION ANGLE
 R = TRUE RANGE
 S = PROPAGATION PATH

Refraction geometry illustrates difference in apparent and actual target locations.

resonant frequency of the sampling cavity as in the open-capacitor tuned circuit. The comparator in the unit detects the relative timing of the detected

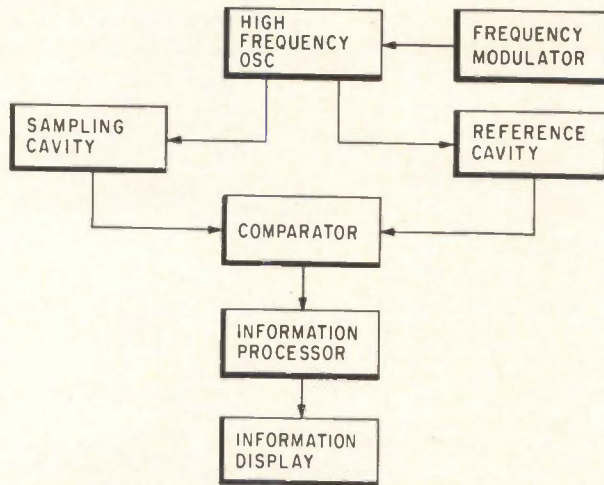

Basic technique employed in microwave refractometer is the comparison of signals passed through a sampling cavity vented to the propagation medium and a hermetically sealed reference cavity.

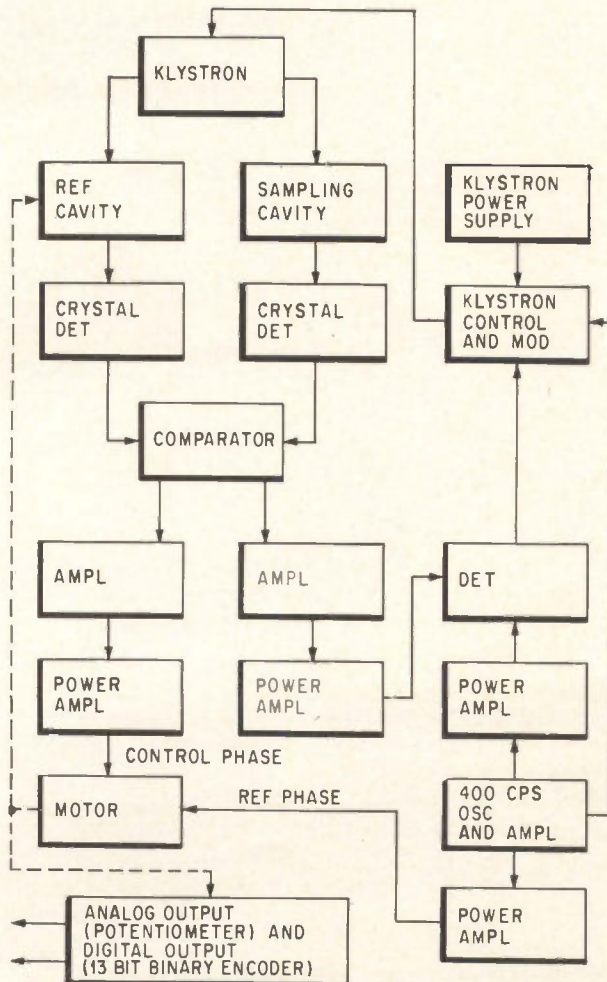

Complete refractometer illustrates use of servo motor to match cavity resonant frequencies, and afc loop to keep klystron centered on proper frequency.

outputs and converts this information into a suitable form for display or recording. Several methods have been implemented for performing the conversion. One of the earliest techniques involved the generation of a square wave whose duty cycle was a function of the relative timing of the two outputs. Integration of this waveform resulted in a voltage whose magnitude was proportional to refractivity. This method provided an output suitable for operating chart recorders and similar instruments, but was not optimum because of inaccuracies introduced by amplifier drift, variation of klystron tuning rate with age, and related problems associated with analog circuits.

The final unit (see diagram below, left) employed an X-band klystron frequency modulated by a 400-cps sine wave from a resonant-reed oscillator. The two cavity outputs are combined in the comparator, which produces two signals: one consists of the difference of the two cavity outputs; and the second, the sum. If both cavities resonate at the same frequency, the "difference" output is zero, and the sum output is an 800-cps signal.

Operating principles

If the dielectric constant of the contents of the sampling cavity changes, the difference output will be a signal containing a 400-cps component, the phase of which is determined by the direction in which the cavity resonant frequency was changed. This is applied, via a narrow-band amplifier, to the control phase of the servo motor. The motor drives a small tuning probe in the reference cavity, causing the resonant frequency of the reference cavity to exactly match that of the sampling cavity. If the center frequency of the klystron is not midway between the resonant frequencies of the two cavities, the sum output of the comparator will also contain a 400-cps component. This output, fed back through an AFC loop, maintains the center frequency at the correct point.

The motion of the tuning probe is converted into refractivity data by a shaft angle encoder—for digital output—or a precision potentiometer—for an analog output. The range of the digital readout is 0–400 N units, with a resolution of 0.1 N unit. This range is sufficient to cover virtually any condition from a hard vacuum to moist, sea-level atmospheres.

Calibration

Calibration of the system is accomplished with a reference cavity assembly fitted with a multi-turn dial. This cavity—has been calibrated by the National Bureau of Standards. It indicates resonant frequency as a function of dial setting. After the system is installed, the sampling cavity is evacuated and the mechanical portions of the servo system are adjusted for a read of 0.0N.

The accurate operation of the refractometer is dependent primarily on the mechanical stability of the microwave cavities. These are carefully fabricated, using special alloys, and then plated to obtain the

desired electrical properties. Additionally, each cavity is temperature compensated to provide an extremely low temperature coefficient (approximately $3 \times 10^{-8}/^{\circ}\text{C}$). The resulting instrument is relatively insensitive to variations in environmental conditions.

Need for computation procedure

In addition to the instrumentation requirements, it is necessary to determine computations necessary to correct the raw data. The necessary calculations include curve-fitting, application of Snell's Law, and numerical integration, which are all readily performed by conventional scientific computers—for which programs have already been written.

Definition of measuring techniques to be used is a more difficult task; in part, because requirements for high-accuracy correction have not existed for long. Therefore, definitive measurement procedures have not yet been developed, and there is considerable disagreement among the various researchers regarding the optimum techniques. Proponents of predictive techniques maintain that one-point (usually ground level) correlation of "average" refractivity functions will provide adequate precision in the majority of cases. At the opposite extreme would be the procedure of actually measuring the refractivity gradient along the entire propagation path with an aircraft carrying refractivity instrumentation.

Optimum technique

Generally, the optimum technique would lie somewhere between these extremes. A typical experiment would employ a refractometer at the ground station, plus one or two at intermediate points along the propagation path. Additional measurements could be provided by a second refractometer in the target and others obtained either by refractometers in aircraft or balloons. Multi-point correlation of the refractivity function can afford a much higher confidence level in the precision of the final results. The number of inter-

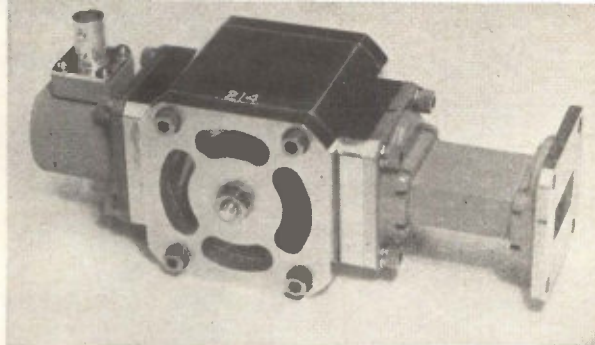

Sampling cavity is vented to atmosphere; resonant frequency varies in proportion to the atmosphere's dielectric constant.

mediate samples which should be taken is determined primarily by the prevailing meteorological conditions. During clear weather, particularly in dry, inland climates, relatively few measurements are required because of the spatial and temporal stability of such atmospheres. Coastal regions, or regions in which frontal activity is present, require an increased number of measurements since there is a high probability of significant refractivity gradients over short distances within much moist, unstable atmospheres.

Extreme conditions

One example of such a situation is a very high gradient condition known as a "duct." In a duct, the vertical gradient is sufficient to cause the propagation path to follow a course parallel to the surface of the earth. In tropical climates this condition may exist approximately 10% of the time, and may occur at any location at least occasionally. Ducts cannot yet be predicted with any degree of confidence, and may appear and disappear with little or no apparent warning. Another abnormal condition which may exist is a refractivity inversion, usually associated with a humidity inversion. Such a condition will cause the propagation path to bend upward. Depending upon the extent of the inversion, this condition could result in an elevation error greatly different from that predicted by any of the statistical techniques.

The authors



Clarence H. Stewart received his bachelor's degree in engineering from the University of Kentucky in 1949, his master's from Northwestern University in 1960, and is currently pursuing studies at the University of Colorado leading to a PhD degree. From 1943 until 1951 he was employed by several radio stations. In 1951, he joined Jansky & Bailey as a project

engineer. Primary duties included high frequency antenna design and propagation analysis. In 1955 he joined Bell & Gossett Co., becoming the chief engineer of the Electronics division. In 1960 he was transferred to Colorado Research Division of ITT-Bell & Gossett, Inc. (then Colorado Research Corp.) as manager of engineering and later became technical director. He holds patents for communications and switching systems and has published several articles on communications systems.



Gary J. Vincent received his bachelor of science in engineering degree from the University of Denver in 1959, and has done graduate work at the University of Utah (1960) and the University of Colorado (1963-64). From 1957 to 1959, he was employed by Denver Research Institute of the University of Denver as a staff research assistant. Primary activity was in

the field of digital computer circuits. From 1959 to 1961 he was employed by Sperry Utah division of Sperry Rand, in Salt Lake City, Utah, as a project engineer on ground support equipment for the Sergeant missile system. Specific areas included digital computer logic and circuit design, digital-to-analog conversion equipment, servomechanisms, and automatic test equipment. In 1961, he joined Colorado Research division, ITT-Bell & Gossett, Inc. (then Colorado Research Corp.), as project engineer.

Designer's casebook

Designer's casebook is a regular feature in Electronics. Readers are invited to submit novel circuit ideas, packaging schemes, or other unusual solutions to design problems. Descriptions should be short. We'll pay \$50 for each item published.

Combined feedback stabilizes amplifier

By Nicholas A. Wade

Menlo Research Laboratory, East Palo Alto, Calif.

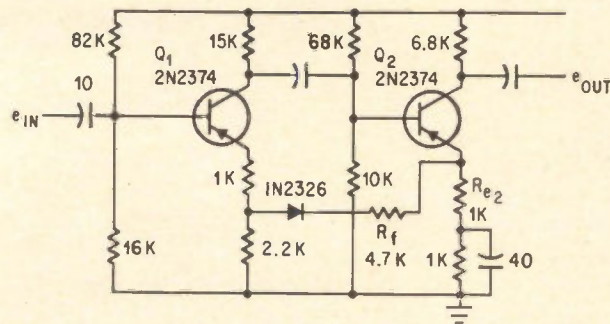

This two-stage, common emitter-common emitter amplifier can be used as a high-gain pulse amplifier in a servo system where space is limited and thermal stability is one of the major requirements.

The type of negative-positive feedback to be described here can be used only in two-stage common-emitter transistor amplifiers. It has proved effective in high-gain pulse amplifiers, where one of the major requirements is good thermal stability. This is usually obtained by inserting relatively high resistances in the common-emitter transistor legs.

As a typical example, a two-stage, small-signal amplifier using germanium pnp transistors is required for a servo application. The amplifier is to have a stability factor not exceeding five for each stage, an input impedance not less than 10 kilohms,

and an over-all gain of not less than 40 decibels.

With these design requirements, and using manufacturers' ratings for the transistors, the values of load resistors, bias, negative feedback resistors and expected gain are calculated using established design procedures.

After designing the circuit network, positive feedback is introduced using a simple calculation. First, assume that 0.5 milliampere of signal current flows through the collector of first-stage transistor Q_1 and that the input impedance of second-stage Q_2 is essentially equal to that of Q_1 . Then half the signal current reaches the input of Q_2 , producing approximately 1.5 ma in the collector of Q_2 , 180° out of phase with the input to Q_1 .

Positive feedback through R_f occurs because part of the emitter current of Q_2 cancels an equivalent amount of the out-of-phase current flowing in the emitter resistor of Q_1 .

To obtain the required amount of positive feedback current I_f , which must approximately equal I_{e1} , a current divider network is calculated using the following relationships:

$$I_{e1} = I_{e2} \frac{R_{e2}}{R_{e2} + R_f} \text{ and } R_f = \frac{I_{e2} R_{e2} - I_{e1} R_{e1}}{I_{e1}}$$

Substituting the assumed values of $I_{e2} = 1.5$ ma, and $I_{e1} = 0.25$ ma, then $R_f = 5,000$ ohms. (4,700 ohms was used.)

A capacitor in place of a diode can be used in the positive feedback loop. The choice of capacitor is determined by the desired low-frequency cutoff. For a three-decibel falloff at 10 cycles per second, the required C_f is 3.5 microfarads.

The amplifier shown here was built and tested and performed closely to the specifications, having an input impedance of 10,000 ohms, stability factor of five and over-all gain of 47 decibels.

Gate circuit eliminates pedestal effects

By Louis E. Frenzel, Jr.

McCollum Laboratories, Inc., Houston, Texas

Most circuits used for gating sinewaves and other analog signals require both positive and negative gating pulses for proper operation. The amplitudes of these pulses and the circuit itself must be carefully adjusted so that the gated signal does not appear on a d-c pedestal at the output. The circuit shown here eliminates pedestal effects and the need for dual-polarity gate pulses.

Transistors Q_1 and Q_2 act as a balanced shorting switch. With no gating pulse applied, both transistors are cut off because of the reverse bias supplied by $-V_{BB}$. The input signal is passed directly to the output through R_1 and R_2 . Since both collectors are at the same potential ($+V_{CC}$) no pedestal appears. If a positive gating pulse is applied from a flip-flop, single-shot or other source, Q_1 and Q_2 saturate and short both output terminals to ground, eliminating the input signal from the output.

The freedom from pedestal effects is traded for the need of balanced input and output circuits. If unbalanced sources and loads are required, transformers or differential amplifiers can be used.

The gate circuit should be driven by a positive pulse of 6 to 10 volts to ensure saturation of the transistors. $V_{ce(sat)}$ should then be about 0.05 to 0.1 volt for each transistor. If their collector-emitter saturation voltages are equal, they will cancel and no d-c will appear between the output terminals. If these voltages are not equal, as is usually the case,

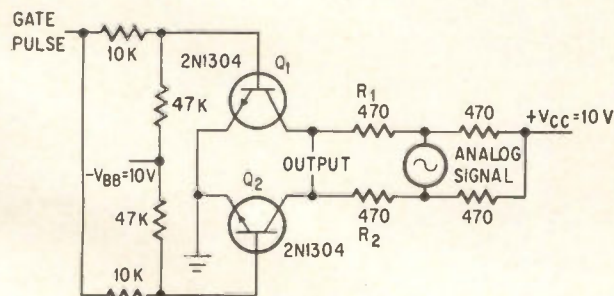

Only single polarity pulse is required to gate sinewave signal

there will be an offset voltage at the output. In a test circuit using unselected RCA 2N1304's, the offset was 16 millivolts, which was the d-c pedestal at the output. If this offset is too great for the application, the transistors should be matched or the circuit adjusted to minimize this condition.

This offset voltage places the lower limit on the analog signal to be gated. Using unselected transistors, the lower limit is about 100 millivolts rms. Using matched transistors (special chopper types available from several manufacturers should work well here), it should be possible to gate analog signals as low as 5 to 10 millivolts rms.

The upper analog voltage limit is a function of the collector supply voltage used and the maximum collector-emitter voltage rating of the transistor. For this circuit, 20 volts peak-to-peak would be a safer upper limit.

Temperature sensor for strain-gage transducer

By Sigmund Meieran

Kent, Washington

For strain-gage transducers in missile applications, the conventional built-in temperature compensation feature is of questionable value because of the steep temperature gradient that occurs in the relatively brief missile flight. The compensating feature is valid only for stable temperatures. For greater accuracies, the transducer should be calibrated for conditions of actual usage. If the temperature of the transducer is measured during the flight, the data can be corrected.

The common method of determining the temperature is to fasten a thermocouple to the transducer casing. The disadvantages of this method have generally been overlooked: Any surface-mounted thermocouple is affected by radiant heat, as well as by fluctuations in surface temperature due to convection.

Many strain-gage type transducers have temperature compensating resistors. These resistors reduce, but do not eliminate, thermal zero shift and thermal sensitivity. Their controlling action is to modify the excitation voltage on the strain-gage bridge to reduce the effect of temperature. The accompanying

Designer's casebook

resistance change in the transducer affects the current from a constant voltage source. This arrangement lends itself to a temperature-measuring scheme superior to the thermocouple.

By monitoring the current change through a dropping resistor between the voltage source and

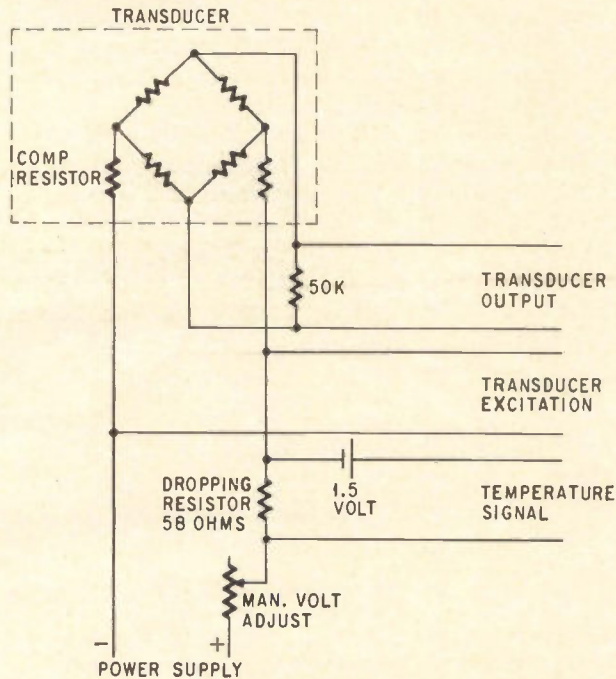

As the temperature increases, compensating resistance increases, reducing the current and voltage across the 58-ohm dropping resistor.

the transducer, a signal is available with a magnitude many times that of a thermocouple output. Furthermore, the change in current with temperature is nearly linear. A suitable arrangement for this measurement is shown on the diagram. The 58-ohm dropping resistor provides a reference voltage at room temperature (75° F) of almost 1.5 volts, that can be biased out with a standard dry cell battery.

As the temperature of the transistor increases, the compensating resistance also increases, thereby reducing the current and the voltage across the externally mounted dropping resistor. This in turn increases the voltage difference between the battery and the dropping resistor, providing an output of approximately 0.5 mv/deg F. For a temperature increase of 100° F, the sensor yields an output nearly equal to the full rated output of the transducer, a level compatible with both flight and laboratory instrumentation. Sensor output can be further increased by using larger drop resistances and higher biasing voltages. The sensor's near-linearity makes calibration fairly simple.

Unijunction circuit generates specific number of pulses

By Ronald Ferrie

Communications and Control Co., Pittsburgh, Pa.

Often a specific number of pulses is needed in applications such as systems checkout. The circuit shown in the diagram has the property of supplying, each time switch S_1 is operated, a number of pulses that is fixed by the value of supply voltage V_1 .

The circuit functions by transferring charge from capacitor C_1 (charged by V_1) to capacitor C_2 . The accompanying increase in voltage across C_2 causes the unijunction transistor to fire, thus discharging C_2 . The cycling continues until the voltage across C_1 has been reduced to $(V_p + I_p R_1)$.

The number of pulses the circuit will generate each time the switch is thrown is given by

$$N = \frac{C_1 (V_1 - V_p - I_p R_1)}{C_2 (V_p + I_p R_1 - V_v)}$$

provided that $V_1 \geq V_p + I_p R_1$, and where V_p , I_p , and V_v are the peak point voltage, the peak point current and the valley point voltage of the unijunction transistor, respectively.

The plot of experimental results for the circuit shows good agreement with the above equation.

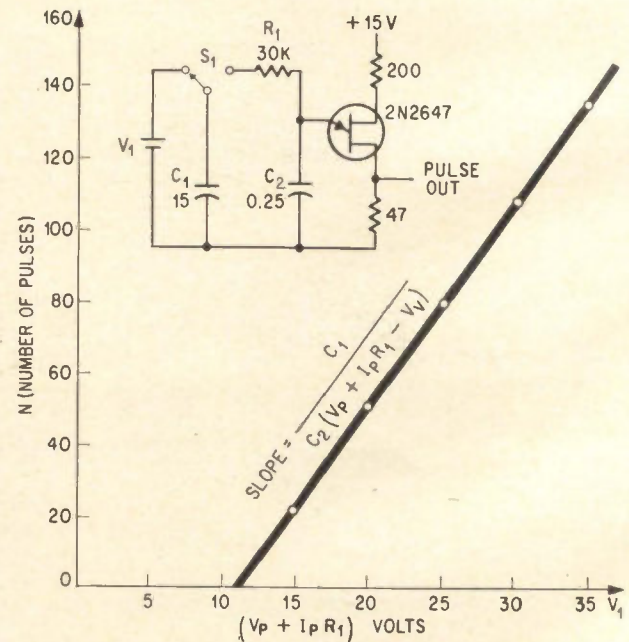

Pulse generation is accomplished by transferring charge from C_1 to C_2 .



Ballistic missile nose cones are among thousands of items being measured daily with numerically controlled inspection machines. Here the operator checks positioning of the inspection probes on a Pratt & Whitney six-coordinate measuring machine.

Industrial electronics

Boredom-proof inspectors

Electronic testing works alongside numerically-controlled tools; it reduces inspection times up to 98 percent

By Edward V. Cordes, Jr.

Manager, Numerical Control Dept., Warner & Swasey Co., Cleveland, Ohio

It used to take an inspector 125 hours to make the 800 measurements that are necessary before a jet-engine impeller blade is put to work. That's the equivalent of five days and nights without even a coffee break.

A numerically controlled inspection machine now does the job, records the results and prints them out, all in two hours—a time reduction of 98 percent.

Numerically controlled machine tools already have broken up many production bottlenecks in the aerospace and automobile industries. [See numerical control article on page 102] Now numeri-

cally controlled inspection is doing the same in quality-control and inspection departments.

Dull, tiring measurement sequences are especially susceptible to human error. But numerically controlled machines, immune to boredom and fatigue, operate just as efficiently at the end of the day as at the beginning. They bring substantial reductions in lead time and in the cost of designing and building gauging fixtures.

NC chronology

The first mechanically automated inspection machines were designed in prototype in 1949. The



Millionths-of-an-inch deviations on the transparent part are automatically measured and recorded with this Sheffield six-coordinate inspection machine. Two probes measure simultaneously, one within the hemisphere and the other on the outside surface.

first deliveries were made five years later.

Numerically controlled inspection was born in 1957 with the development of an autoset device. This uses instrument servos, servo amplifiers and phase-sensitive circuits to sense the position of a mechanical slide that moves an inspection probe. Signals from punched tape are run through a digital-to-analog converter and are then used to control three-dimensional movements of the inspection probe by means of the autoset.

Autoset changed the inspection-machine picture. Now all machine functions are controlled by directions contained on punched tape.

Gauging techniques

A numerically controlled inspection machine, such as might be used to measure auto engine blocks, has four basic components: the mechanical machine, the numerical control system, the probe or sensing head and the data readout or recording device.

The machine is usually a multi-axis type, often combining linear and rotary movements to inspect parts in either rectangular or polar coordinates. The probe, or sensing head, is positioned automatically, by slides on the machine, to a selected succession of points on the part to be measured. The probe is guided by the numerical positioning controls mounted on each of the slides. Punched tape furnishes the input X, Y, Z (length, width and height) and rotary coordinates defining the exact locations of the points to be checked.

To make a measurement of a part the punched tape is inserted into the tape reader, zero refer-

ences for the measuring probe are checked and the start button pressed to initiate the measuring cycle. The tape reader scans the first block of information and the controls automatically position the machine slides in all but one coordinate of the first point to be checked. These movements, called stationing motions, place the measuring probe directly opposite the point to be checked. The machine slide then moves the probe toward the part in the remaining coordinate to measure the dimension.

When the reading is completed, the machine retracts the probe and positions it to the second station on the part, controlled by information from the second block on the tape. The complete program proceeds until after the last probe measurement, when the probe moves to a clear position and stops. The part is then unloaded and a new part takes its place.

Numerical controls

The numerical positioning controls are types that have been used on machine tools such as engine lathes, turret lathes, boring mills, milling machines and combination milling-drilling-boring machinery centers. For measuring machines they usually are of the point-to-point type. They accurately position the probe to a point in space with little regard to the path taken. Continuous-path numerical control systems are usually much more elaborate and expensive than point-to-point systems. Continuous path regulates relative slide speeds to hold the probe path close to a predetermined curve.

These systems have seldom been used on measuring machines. It is usually more accurate to check a contour at a series of points by the simpler point-to-point method, determining whether the entire curve is within the desired limits.

Some point-to-point systems operate from precision rack, lead-screw or worm-and-wheel machine movements. The transducers in these systems for converting slide position to an analog voltage are potentiometers, synchros or resolvers. The input information, on punched tape, is in digital form. Digital-to-analog converters change the input numerical information into analog voltage form to match the output of the transducers on the machine. Electrical or hydraulic drives move each machine slide until its transducer signals that it has reached the point programmed in the tape.

Other kinds of controls employ encoders attached to the slide lead-screw or to a rack and pinion that drives the encoders to convert slide position into digital signals. This digital output is compared with the digital information from the punched tape to control slide position. Some systems use optical or magnetic pulse generators, mechanically connected to the slide lead-screw or rack and pinion. These units generate a pulse for each increment—for example (0.001 or 0.0001 inch)—of controlled travel of the machine slide. The pulses are counted to determine slide position.

Another group of controls is independent of lead-

screw and rack measuring devices. These include peg-bar and pawl arrangements, linear resolver scales, or optical grating (etched glass scale) to develop slide-position signals.

Another method in this group is the magnetic-lug master bar, a length of bar with magnetic lugs spaced at one-inch intervals, used as distance markers.

The peg-bar system and the magnetic bar break up full slide travel into one-inch segments, which are further divided into decimals by a one-inch travel micrometer slide position. The optical grating, scanned by a light and photocell arrangement, generates pulses representing machine slide movement. These are automatically counted to measure the distance moved.

Probing and recording

There are many methods for making the reading at each of the selected points, which accounts for the variety of measuring machines on the market. The approaches depend to some extent on the nature of the measuring probe used. The probes can be grouped into two types: on-off and displacement.

On-off probes

The on-off type produces a discrete on-off electrical signal when it makes contact with the workpiece. Electrical contact between the probe tip and the workpiece produces the signal in one kind of on-off probe. Other designs either open or close switch contacts behind the tip, producing a signal when the tip makes mechanical contact with the part. On-off probes yield either digital readouts or analog indications of measurements.

One method for obtaining a digital readout from an on-off probe uses an optical grating on the measuring slide. A readout device continuously displays the absolute position of the measuring probe in digital form. As the slide carries the probe forward toward the part to be measured, a stream of pulses is transmitted to the readout to correct its reading to the probe's changing position. At the instant of probe contact with the part, a signal halts the readout device and stops the probe. The digital readout display is now the absolute coordinate of the measured point. This infor-

mation is used for printout of the number on a strip chart, for producing punched tape or cards, or for a combination of these functions.

If the deviation of a measured point is desired, in addition to its absolute coordinate, the output of the readout is sent to an arithmetic unit. Here, the nominal point coordinate, as read from the input punched tape, is automatically compared with the measured coordinate. The difference is visually displayed or sent to a printout unit or tape punch.

Analog recording

A synchronized recorder provides an analog output from the electric-contact on-off probe. It operates when the probe is moving toward the part. When the probe reaches a position exactly 0.1000 inch before the nominal point, a signal from the numerical transducer on the moving axis starts a recording stylus across a chart. The stylus moves forward in synchronism with the probe motion, but much faster, to provide the desired magnification ratio so that the chart, read in tenths of an inch, represents thousandths of an inch on the part.

When the probe actually contacts the workpiece, the stylus sparks, marking the chart at the point reached. If the measuring probe touches the part at the theoretically perfect point, the recording stylus will already have advanced to a nominal reference line on the chart. The recorded dot falls on the nominal line, indicating zero deviation at the measured point. [see diagram, top of next page.]

If the part is oversize, the probe touches the part earlier, and the recording stylus marks the chart before the nominal line. The distance from the recorded dot to the nominal line is proportional to error and indicates that the error is on the plus side.

For undersize points, the recorded dot appears on the opposite side of the nominal line because the measuring probe travels beyond the nominal line in order to make contact. Each measured point on the part produces a dot on the chart, indicating error magnitude and direction. Between measurements, the chart is stepped forward to separate the dots.

The measuring probe can be designed to measure linear slide movements of the machine in both

New generations

Research and development in inspection seems to be taking two courses. Higher accuracy for the aerospace industry is pushing the state of the art not only of electronics, but of mechanics. On the other hand, in general industry, accuracy requirements can be met, but the need is for faster, more flexible inspection at lower cost.

For higher accuracy, new ways to measure length are being tried. Interferometer techniques have been applied and appear to work under controlled conditions. Possibilities of applying lasers to measurement have been considered. Tolerances that were previously unthought of are being contemplated so that inspection and measurement can keep abreast of the ability to

fabricate to precise dimensions.

New inspection methods are also being examined for general industry. One of the more advanced areas of work is in adaptive control. This is true on-the-line inspection, for the parts are evaluated for quality by continually monitoring the conditions of manufacturing during production. Automatic adjustments are made on the machine tool to correct for changes in environment, material and tool conditions.

Many other aspects of automatic and numerically controlled inspection are being studied. Where do we go from here? As far as automatic inspection is concerned, one good answer may be obtained by measuring the technological advances in all fields over the past 15 years and predicting at least a similar advance over the next decade.

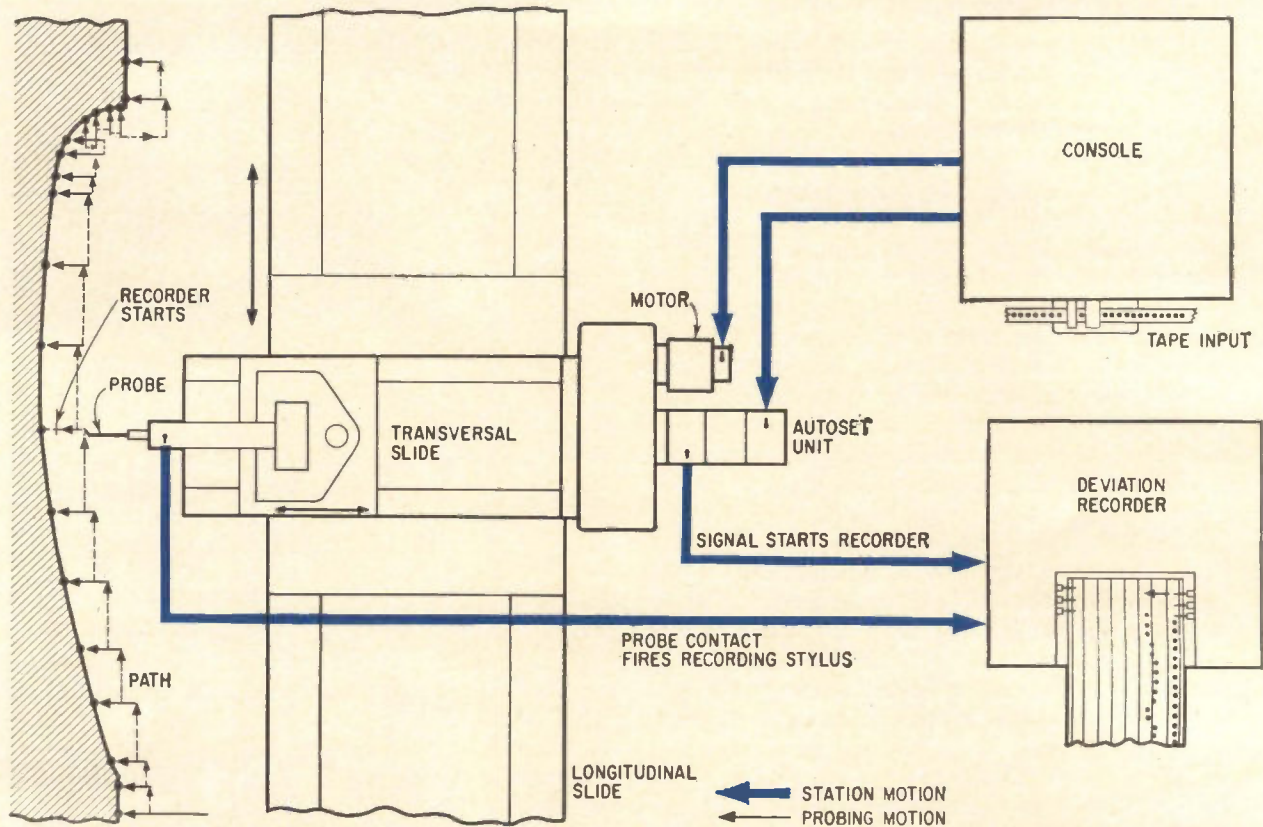

Inspection probe position is a combination of motor-drive and autosest position-sensing, directed by punched tape data. When the probe contacts the part a signal is sent to the deviation recorder. The stylus marks the chart, using spark recording. The dot, referenced to the line, shows whether there are any dimensional deviations.

increasing and decreasing directions. To record measurements made in opposite slide directions, the recorder is equipped with two sets of recording styluses, one for increasing and the other for decreasing motions. The styluses start from opposite sides, move across the chart and record the dots about two nominal lines on opposite sides of the chart. Deviation measurements on opposite sides of a part, therefore, appear across the chart from each other.

Displacement probes

A displacement probe produces an output proportional to the displacement of a movable plunger, or pivoted finger, within the body of the probe assembly. The sensing head of an electronic indicator, for example, employs this type of probe. Typically, the movable element displaces the excitation core of a differential transformer. The position of the core affects the electrical output of two transformer secondary coils wired to oppose each other. At a central position, the two outputs balance each other for minimum or null output. Signal outputs can be either digital or analog for readouts or chart recording.

The measuring machine using the displacement-type probe, after stationing the probe under numerical control, moves it toward the part to be measured. The numerical control system on this measurement axis stops the slide when the slide reaches the nominal coordinate of the point being

measured. If the surface of the part is perfect at this point, the probe tip will be displaced to its null position, indicating zero deviation. If the part is oversize or undersize, the tip is displaced beyond, or short of, its null position by an amount equal to the error of the part size. The voltage output of the probe is proportional to the size of the error and its phase indicates whether the deviation is plus or minus.

Digital readout

To convert the measured error to digital form, the output voltage is passed to a digital voltmeter. One type of voltmeter compares this output voltage with a reference voltage that rises in a series of steps. The steps are controlled by a digital coding circuit, which assumes a different state for each of the reference voltages applied to the comparison network.

When the reference voltage matches the output voltage of the displacement probe, the comparison sequence is stopped. The state of the digital coding circuit indicates, in binary-coded decimal or straight decimal form, the numerical value of the voltage. When the proper scaling factor is applied to convert from voltage to equivalent probe displacement, the numerical output represents the error in the measured part.

In digital form, in the coding circuit, the numerical output can be transmitted to output devices including visual, printout or punched tape.

Analog readout

For an analog or proportional indication of the error in the measured part, the output voltage of the displacement probe is sent to a pen recorder. Through an instrument servo, the recorder pen is driven across a chart to a position proportional to the input voltage.

For zero deviation in the part, and resulting null voltage from the displacement probe, the pen moves to a nominal line on the chart. Where the part varies from the correct dimension, the probe output voltage drives the pen to one side or the other of the nominal line, in proportion to the error in the part. Plus and minus deviations in the part are automatically recorded.

As an alternate to automatic recording of errors, the analog output can be transferred to a meter for manual reading and recording of needle deflection. The scale of the meter is graduated directly in linear measure for direct reading of errors.

On-off vs. displacement

Some inspection machines are designed to operate with either type of probe, depending on the nature of the job. The probe characteristics affect their use in each application.

The on-off probe, using electrical contact with the part as the actuating signal, has several favorable characteristics. An important one is measurement without pressure. At the instant the probe makes electrical contact with the part, the measurement is registered. If pressure should develop as the probe deflects in the time it takes to reverse the probe slide movement, this small deflection would occur after automatic recording of the measurement, and would not affect it.

The displacement probe, on the other hand, requires movement of its plunger or pivoted finger, usually under spring load. Spring force between part and gauge distorts both. Furthermore, this type of movement requires bearings or joints. Extremely careful design and manufacture of the bearings is necessary to keep play, friction and deflection from affecting the measurements. These problems are further complicated by side forces when the probing direction is not perpendicular to the surface being checked.

Pressureless measurement

Pressure-free measurement by the electrical contact on-off probe also permits the probe tip to be quite small; there is no chance that the measuring force will damage it or the part. Consequently, electrical contact probes consisting of needles of 0.0005-inch and 0.001-inch radius points are in everyday use in measuring machines incorporating this principle. Dimensions of these probes closely approach the ideal of measuring with a true point. The coordinates of the point probe can be defined precisely, in space, an essential feature in inspection of three-dimensional curved shapes.

Another advantage of pressureless measurement is that the probe-supporting structure can be very

thin and light, often consisting only of thin wire. Small holes, slots and grooves can be explored by point probes. For deep, twisted cavities, the supporting wire or rod can be bent to roughly the shape necessary to clear intervening obstacles.

The on-off probe has another desirable feature: it can measure in more than one direction. A point probe, canted in space relative to the XY, XZ, YZ rectangular planes, can be used for probing in the X, Y and Z directions. It can be zero-referenced accurately by making contact with reference surfaces on the part being measured, or a holding fixture in three directions [diagram next page].

The probe is also self-protecting. If it should make contact accidentally during a stationing motion in any direction, or during a probing movement against a grossly oversized part, the contact will stop the machine and signal the operator to investigate. Opposed to this are displacement probes, which are basically one direction devices. Because of this, they are more difficult to zero in on the stationing directions, and are less flexible than contact probes in application to parts requiring probing in several directions.

Continuous checking

Although most measurements on numerically controlled machines are point-to-point, there are



Turbine blades and other complex rocket engine parts are inspected on this Warner & Swasey three-coordinate machine at the Douglas Aircraft Co. in California. The base and parallel vertical black sides are of granite. This is one of the largest inspection machines ever built.

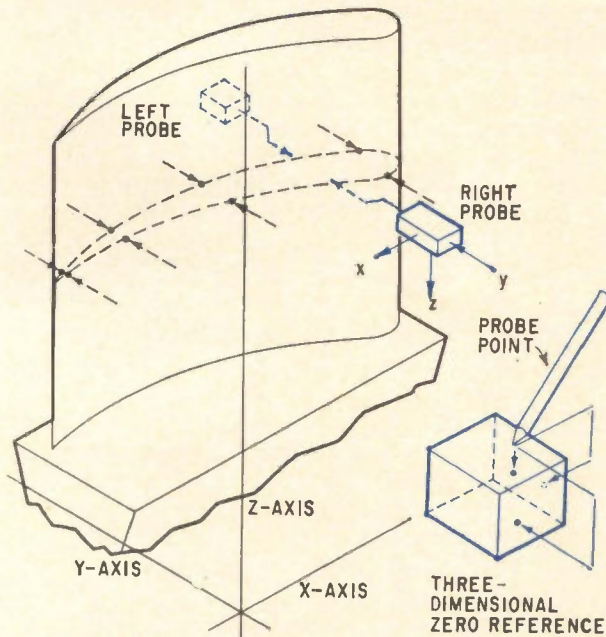

Airfoil inspection requires two probes, simultaneously measuring both sides of a part. Before the probes begin measuring they are zero-referenced by making contact either with a specified point on the part or with the reference surface of a holding fixture, as shown by the color enlargement.

applications where the geometry of the part permits continuous checking of sections. For example, in checking spherical parts or other figures of revolution, the measuring probe is first placed against the part. The part is then rotated continuously under the probe. Here is where the displacement type works best, as it can measure continuously and transmit the data to a strip chart recorder for continuous analog recording of the deviations. An on-off probe would not work, because it requires making and breaking of contact. Circular sections must be checked by programming an on-off probe to measure the part at a series of points along the curve.

For inspecting holes, the displacement probe is held against the side of the hole and rotated by a measuring spindle. This produces a continuous record of hole contour, which is interpreted for diameter, location and out-of-round conditions. An on-off probe, checking at points, must measure one or more diameters of the hole to determine its size and location.

Because they can measure in a continuous traverse, displacement probes are used to search for maximum and minimum thickness. This feature permits a displacement probe, mounted in a spindle, to check a contour by tramming at a series of points. Tramming is keeping the probe in constant contact with the part when it moves along the part surface. The spindle is positioned to points adjacent to the contour by tape controls. At each point, the maximum probe reading indicates part deviation.

A limitation of the electric contact on-off probe

involves the conductivity of the part. The contact signal is developed by passing a small current between the probe and the part. For nonconductive parts, either a conductive coating is applied to the part or a switch-type on-off probe is used. The internal switch contacts overcome the conductivity problem but this probe is subject to the same limitations of measurement pressure and single-probing direction as the displacement probe.

Typical inspectors

Taking a look at some typical tape-controlled measuring machines will give an idea of the complexities involved when these probes are installed in machines now being used in the automotive, metal-working and atomic energy industries.

Ten-ton inspector

One of the largest measuring machines is the Warner & Swasey SPU-3-S134 (bottom, p. 83). About 13 feet high and weighing more than 10 tons, this machine uses an on-off probe for inspecting complex parts in two linear and one rotary coordinate. A rotary indexing table, 50 inches in diameter, is mounted on T slots in a large granite base. Two parallel, vertical granite walls rise about the base, with a granite cross-member forming a bridge over the rotary table.

Both the vertical and horizontal motions are tape-controlled. Rotary table motion is not numerically controlled but is mechanically sequential, in fixed indexed steps. A typical index-step rotary motion would be 15° . The vertical probe arm is capable of a vertical telescoping movement in steps of 5 inches over a 20-inch range.

Linear coordinate dimensions for the horizontal and vertical slides are programed in the punched tape to the fourth decimal place. A standard remote recorder keeps track of the measured deviations. Magnification ratios of 20 to 1, 40 to 1, 80 to 1 and 160 to 1 can be selected by means of change gears. The maximum size of a part that this machine could handle would be 56 inches high, 44 inches in diameter (measured at reported accuracy of ± 0.002 inch) and not exceeding 4000 pounds.

An identical but smaller version is being used by the Rocketdyne division of North American Aviation, Inc., to inspect turbine blades and other rocket engine parts.

The author



aircraft wind tunnels, toll collection and statistics.

After graduating from Yale University with a major in electrical engineering, Edward V. Cordes, Jr., worked on electrical and electronic control recording devices. Prior to joining Warner & Swasey, he owned a company that designed and manufactured recording systems. Before that he was chief electrical engineer for Taller and Cooper, Inc., designing recording systems for

Six coordinates

An example of a six-coordinate tape-controlled measuring machine [opening photo] is built by the Pratt & Whitney Co., a subsidiary of the Fairbanks Whitney Corp. This machine inspects parts such as hemispheres and cones, about 20 inches in diameter. An inner gauge head checks the inner sidewall of the part and, in the same radial plane, an outer gauge head inspects the outside wall.

The part is mounted on a rotary table which is carried on a slide that provides radial motion in the horizontal direction. The inner gauge head moves in the vertical direction; the outer gauge head is mounted on a vertical slide on a column that also travels in the horizontal direction.

A yoke, pivoting on a horizontal axis, holds the outer gauge head and permits automatic adjustment of the probe attitude over 90° from horizontal to vertical positions. This adjustment sets the outer gauge head so that the probe's travel is normal to the surface for each measurement. An angular adjustment performs the same function for the inner gauge head.

Numerical controls on the X and Z linear movements use a master bar with lugs, spaced at one-inch intervals, mounted on each moving carriage. A motor-driven micrometer screw with one-inch range, mounted on the machine bed next to the bar, presets a magnetic pickup head to the decimal part of the dimension programed in the tape.

In positioning, a coarse position indicator geared to the movement of the machine slide determines the approximate stopping point. The indicator signals the magnetic pickup head to take control when the proper magnetic lug on the moving bar is almost in position over the pickup head. Feedback from the magnetic head then guides the machine's slide-drive motor until the selected lug is placed exactly above the center of the magnetic head.

The control for automatically rotating the gauge head to the perpendicular consists of a simple potentiometer because less accuracy is required.

The two gauging probes are of the displacement type (differential transformers) with an output proportional to the displacement of the moveable core from a null position.

Dual outputs

The output of the two heads is transmitted to two XY rectangular plotter recorders. In each recorder, the gauge output positions the recording channel along one axis. A signal, proportional to the angular position of the rotary table carrying the part, sets the pen along the other axis. The recorder plots the deviation of a point, from its nominal dimension, against its angular position about the axis of the part. By comparing the deviation outputs of the two gauge heads, the error in wall thicknesses at any point can be determined.

As optional equipment, a printer, tape perforator and card perforator are offered.

The machine can be operated on an incremental

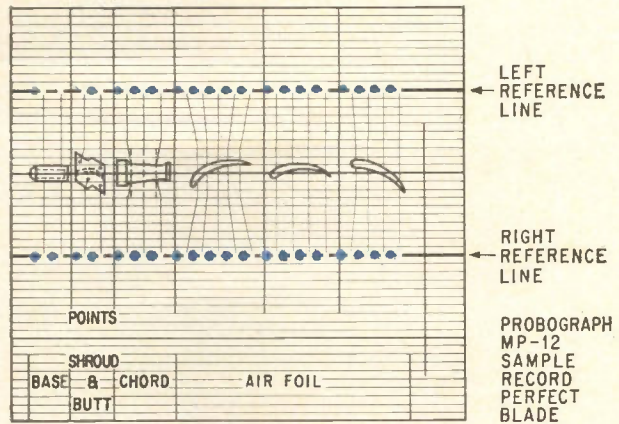

Simultaneous measurements mean less inspection time. With numerical control, the measurement signals from both probes are recorded along right and left reference lines. These lines represent theoretically perfect dimensions of opposite surfaces.

basis; that is, data from the tape automatically positions the two gauge heads against the inner and outer surfaces of the part at a selected level. The gage readings of part deviation are transmitted and recorded.

The part is then rotated to a new angular setting where the next set of gauge readings is recorded. This process is continued with the gauge heads at this level, until a full rotation has been made.

As an alternate to this incremental rotation, a continuous rotation could be made while the gauge heads are in contact with the part to be measured. The continuous measure of deviations is transmitted, and at the end of rotation the recorder prints out the smallest and largest that have been measured during the traverse.

After the table rotation another block of tape information is read and the gauge heads are repositioned for repetition of the sequence.

Five coordinates

Another machine for measuring the same type of part is the Sheffield Model TC-101, (shown on page 80). Figures of revolution up to 20 inches high by 20 inches in diameter can be accommodated.

The part is mounted on a hollow rotary table that is, in turn, mounted on a horizontal slide providing one rotary and one linear control movement. A column, forming part of the machine bed, carries an inner vertical slide and an outer vertical slide on precisely machined guides, or ways. The inner gauging cartridge measures the inner surface of the workpiece. The cartridge is mounted on the inner vertical slide by means of an arm that passes through the hollow center of the rotary table. The outer gauging cartridge is mounted on a horizontal slide, which in turn is mounted on the outer vertical slide of the column. Both X and Y motions are thus imparted to the outer gauging probe.

45 vs. 90

The probe in the gauging cartridge is the displacement type, using a differential transformer

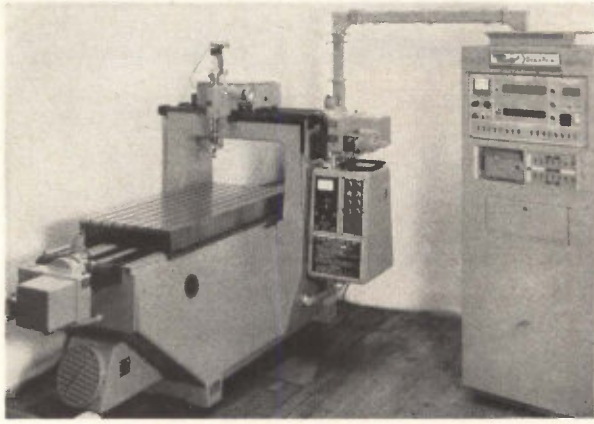

Automotive production engineers want more machine in less space. The universal measuring machine of the Moore Special Tool Co. is for high-precision inspections of plane-surfaces and holes.

with electrical output proportional to the deviations of the part. A feature of this machine is that the gauge heads are maintained at a fixed angle of 45° to the horizontal. This differs from the Pratt & Whitney machine, where the heads are adjustable and tape-controlled to maintain 90° to the measured surface at all times.

To minimize the problem of side forces on the probe resulting from nonperpendicular approach, a free-rolling ball forms the tip of the probe, rather than the conventional fixed ball.

Another problem raised by the nonperpendicular approach is correlation of tolerances. Since the tolerance on a dimension to a point on a surface is usually given in a direction perpendicular to the surface, a correction factor is required for measurements made in any other direction. In this machine, the correction factor is programed in the tape for each point measured.

The output of the gauging heads is passed to three meters and to an automatic typewriter for printout. The meter movements are analog indications of deviation in inner surface, outer surface and wall thickness. Digital printout of results includes these deviations, as well as the programed nominal positions of slides and rotary table as well.

The numerical control system for a linear axis is a modified Bendix Dynapoint (point-to-point) system. A hydraulic piston drives the slide along the axis. Linear motion of the slide is converted to rotary motion by a reversible ballbearing lead-screw that drives a set of geared resolvers. These resolvers provide a coarse indication of slide position.

Precise position is determined by means of an inductive transducer mounted next to the slide. It consists of a transformer coil wound around a rod in the form of a helix. A readout coil, carried on the machine slide, surrounds the rod without touching it.

After the slide has moved to approximately the final position, the helical transducer is automat-

ically rotated to a position corresponding to the last digits of the number dimensions programed in the tape. This is done through another set of resolvers geared to the rotation of the transducer. The slide then advances to its final position as indicated by a null output from the readout coil of the helical transducer.

For the rotary table, which requires an accuracy of only about 0.33° in rotary position, a resolver geared directly to the table controls the motion. A hydraulic motor, controlled through a servo valve by the resolver, positions the table.

Operation of this machine is similar to the previous one. Manual gauging, as well as automatic measurement, is possible. In automatic operation the part can be rotating in increments or rotated continuously for scan gauging.

Scan gauging

During scan gauging, the part rotates until a dimensional deviation exceeds a tolerance set into the machine. This causes a halt in the rotation, and at that point the position coordinates and the deviations measured by the probes are recorded. The table then indexes by a preset amount and, if the deviation is still outside the limits, the new deviations and position coordinates are printed out. Indexing continues this way until deviations fall within tolerance again, at which time continuous rotation and scan gauging resume.

Machines of this type have been in operation three years, measuring hundreds of points on each part with a speed and accuracy unattainable by conventional means.

Less space

The Moore No. 5 Universal Machine is for high-precision inspection of plane surfaces and holes. Longitudinal table travel is 48 inches, cross travel of spindle housing is 24 inches and vertical spindle travel is five inches. Additional vertical adjustment is by an indicator linkage and use of six-inch parallels furnished with the machine (12-inch maximum vertical capacity).

This machine features backlash take-up, four springs that keep the moving elements against the thrust face of the lead-screw, under 16 pounds of pressure. This reduces backlash to less than two millionths of an inch.

As an example of the accuracy of the machine, squareness of travel is 50 millionths of an inch over 24 inches, and trueness of spindle rotation is 10 millionths of an inch.

The Moore measuring machine uses a point-to-point numerical control system for the longitudinal and transversal motions. In this case, the nominal dimensions of the part in X-Y coordinates are programed in the tape, and deviations from nominal are read by the operator on the meter of an electronic gauge head of the displacement type.

The author thanks the Douglas Aircraft Co., Moore Special Tool Co., Inc., Pratt & Whitney Co. and Sheffield Corp.

Foreign broadcasts get a stronger voice

Radio Free Europe feeds two high-power transmitters into a single antenna and tunes either or both without lost air time

By Earl L. Chubbuck, Jr.

Chief, Transmitter Facilities, Radio Free Europe, Lisbon, Portugal

International shortwave broadcasting needs high power. Programs like those of Radio Free Europe must be pushed through all kinds of interference to listeners whose receivers are often insensitive. Directive transmitting antennas increase effective power but their cost eventually limits the size. Transmitter power cannot exceed the capability of existing tubes. One way to obtain more power is to combine the outputs of two powerful transmitters. This technique has the additional advantage that if one equipment fails, the other can be made to carry on. The combining equipment installed in Portugal automatically maintains output even when one or both transmitters are being tuned.

Steps to power

To minimize the effects of poor high-frequency propagation conditions and interference effects brought about by increased use of the spectrum, a number of engineering techniques have been used. Modern curtain-type antenna arrays provide gains in the order of 22 db but the cost-per-db improvement rises sharply beyond this point. Transmitter output power of 250 kw is available but this level appears to be an optimum based on presently available tubes. In addition to other plant changes designed to improve Radio Free Europe's facilities in Portugal, four combining units are being built for eight 50-kw transmitters presently in use. The combiner has already been used several months for two 100-kw transmitters on the 9, 11 and 15 Mc shortwave broadcast bands.

At completion of Radio Free Europe's current renovation project, the Portugal plant will have four 100-kw transmitters (now in use), an equivalent of four more 100-kw transmitters (actually eight 50-kw rigs now in operation but combined using the new

equipment) and four new 250-kw transmitters.

The equipment basically comprises four 90° phase-shift networks, three lagging and one leading as shown in the drawing. Point A is connected to the antenna and point B to the dissipative load. Both antenna and load have the same impedance. When transmitter input 1 and transmitter 2 have voltages V_1 and V_2 equal and in phase the voltages add when transferred to point A. Therefore the sum of the powers supplied by the two transmitters is fed to the antenna. Voltages V_1 and V_2 when transferred to point B are 180° out of phase and produce no power in the dissipative load.

If voltages V_1 and V_2 are of the same amplitude but 180° out of phase all the power will be delivered to the dissipative load and no power will go to the antenna. The power is distributed between antenna and dissipative load as the phases between V_1 and V_2 varies between 0° and 180°. Similarly it can be shown that if the phase of V_1 and V_2 are maintained at 0° the amount of power going into

The author



Earl Chubbuck received his bachelor's degree in Electrical Engineering from Syracuse University in 1940 in time to teach radio theory, radar, transmitters and antennas at various military schools. He worked for National Broadcasting Co. as an audio engineer besides handling radio facilities and allocations. He joined Radio Free Europe in 1958 where he is now chief of transmitter facilities in Lisbon, Portugal. Besides his membership in IEEE, Mr. Chubbuck's practical involvement in radio includes licensing for first class radiotelephone since 1935 and as an amateur (W2NTV) since 1934.

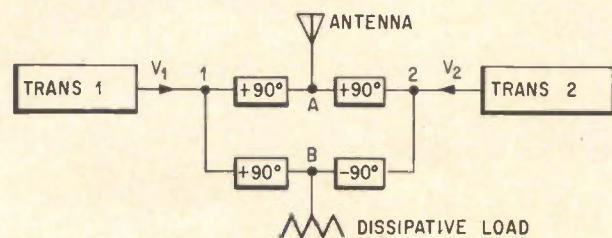

A

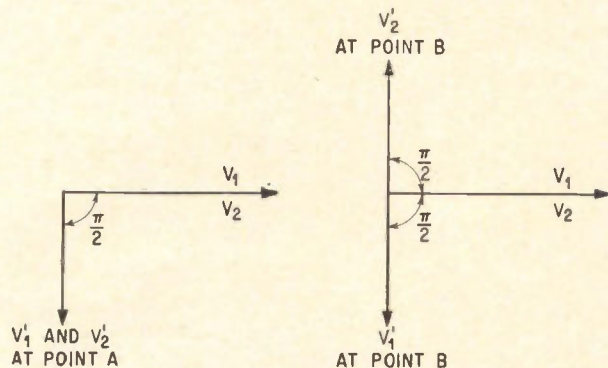

B

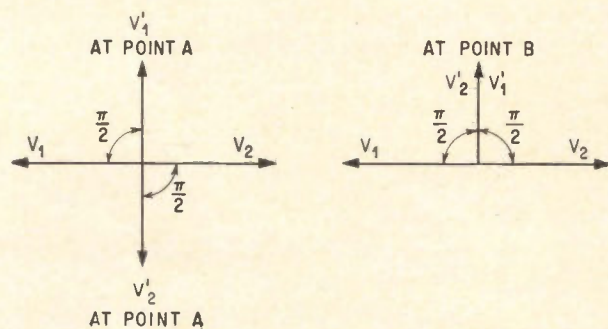

C

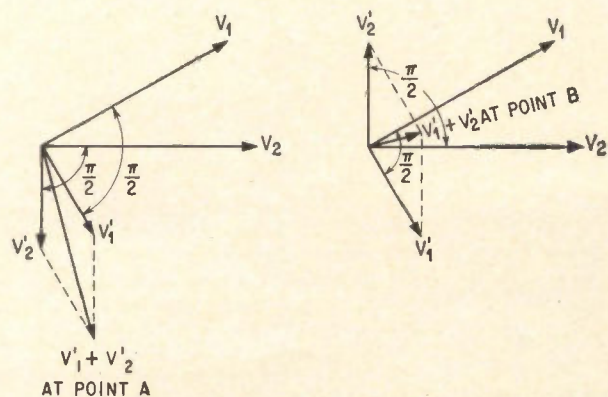

D

Phasing networks (A) permit total power to reach antenna with none going to dissipative load (B) except under out-of-phase conditions (C) when all power goes to the load. Under varying phase conditions, power is distributed between load and antenna (D).

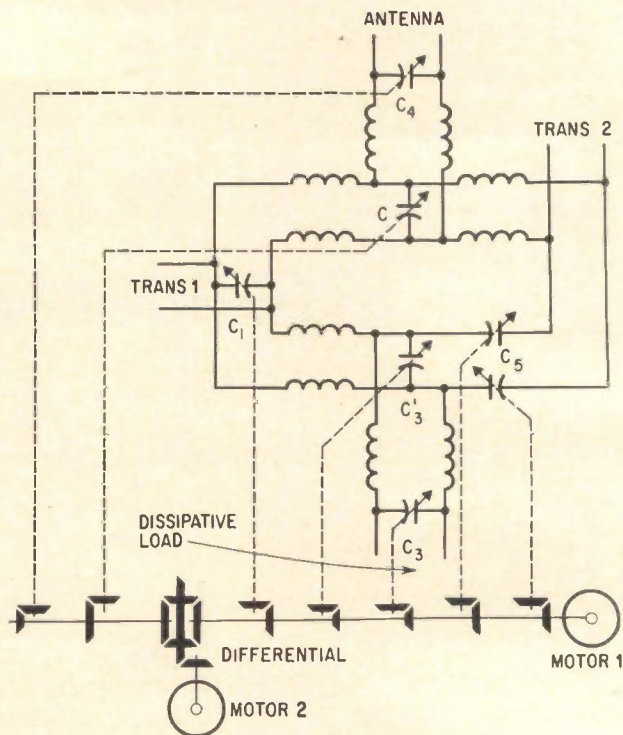

Two-transmitter combiner with motor-driven geared tuning and loading system

the dissipative load will increase and subtract from that going into the antenna as the amplitudes of V_1 and V_2 differ. If one transmitter is off completely the power of the other is distributed equally between antenna and dissipative load.

This type of combiner is desirable because it acts as an isolation device between transmitters; that is, one transmitter may be adjusted without affecting or feeding power to the other transmitter. One other requirement for proper operation of such a combiner is that the modulation voltages applied to the transmitters must be in phase.

The elements of the two-transmitter combiner with its associated motor-driven geared tuning and loading system are illustrated. The combiner is designed for 600-ohm balanced lines and will operate over the 9, 11 and 15 Mc. shortwave bands. Motor 1 tunes over these frequencies and varies all capacitors. Motor 2 controls antenna loading by varying only capacitors C and C_4 .

Automatic phasing

As noted, maximum power is delivered to the antenna only when the phase and amplitude of the output voltage are the same from each transmitter. A sampling loop coupled to the transmission line going to the dissipative load can be used as an indicating device when tuning either transmitter. Tuning for a null in this loop assures that maximum power is being fed to the antenna. However, any adjustment made on either transmitter varies the output phase over wide limits making this method tedious and time consuming. To speed up tuning an automatic phaser was devised as shown

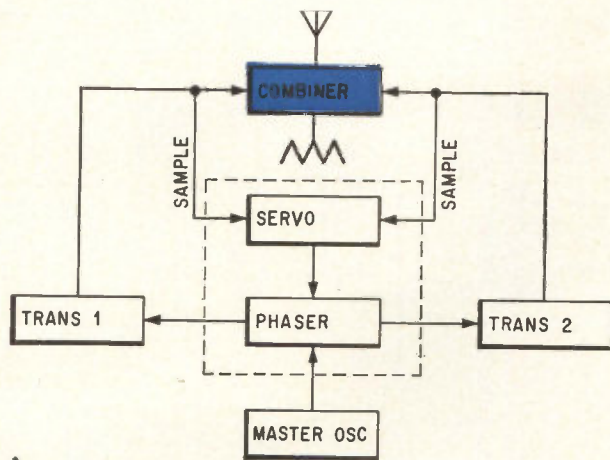

A

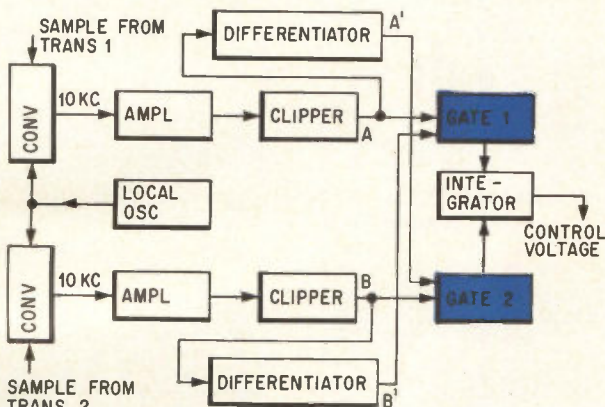

B

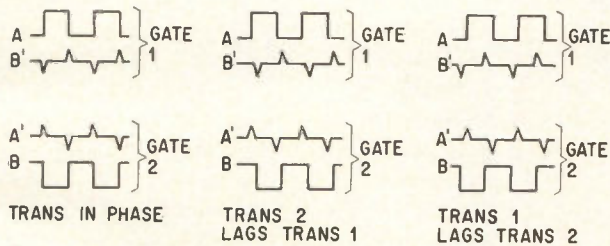

C

in the block diagram (above) for automation.

The automatic phaser comprises two basic units—a servomotor and phaser. The servosystem shown in greater detail tunes automatically. Radio-frequency samples from each transmitter taken at the combiner input terminals are fed out of phase to the converters and heterodyned down to 10 kc. These signals are amplified and clipped to produce square waves A and B. The square waves are then differentiated producing pulses A' and B'. Square waves from one sample and pulses from the other sample are fed to gated amplifiers. Each gate will conduct only when the square wave and pulse are simultaneously positive as shown. If square waves were used both gates would conduct at the same time during most of the cycle. When the phase of transmitter 1 advances, gate 2 will conduct. If transmitter 1 lags, gate 1 will conduct. The output of each gate is fed to an integrator, the output volt-

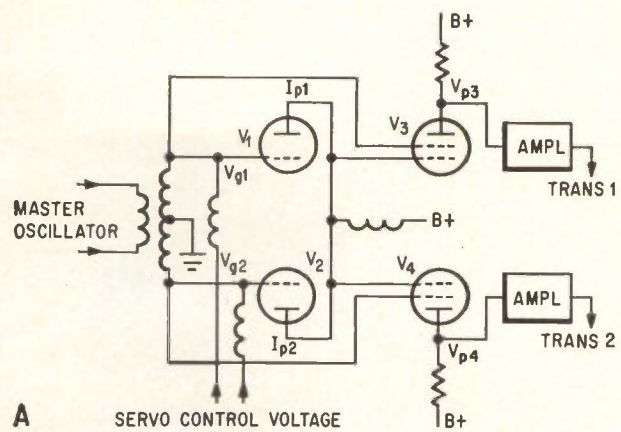

A

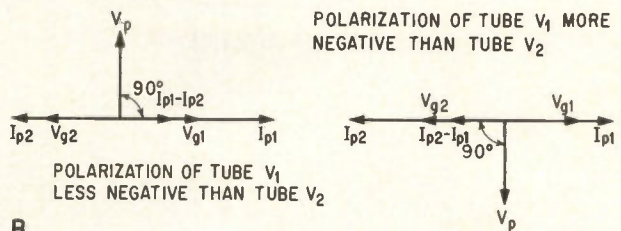

B

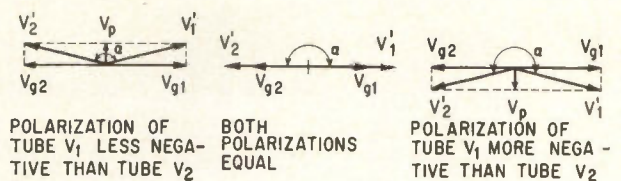

C

Simplified schematic of the phaser (A) showing polarization of tubes V_1 and V_2 (B) that affect the voltages in V_3 and V_4 to control drive voltages in proper phase for each transmitter (C) in place of crystal oscillator.

Basic automatic phaser (A) shown in greater detail (B) operates from gated amplifiers actuated by square waves from one sample and pulses from the other (C).

age of which is used to control the phaser unit.

In the simplified schematic diagram of the phaser, tubes V_1 and V_2 (variable transconductance type) are driven in push-pull by voltage from the servo. Input from the crystal oscillator used for carrier control is fed to the grids of these tubes. The plates of V_1 and V_2 are connected in parallel with a choke as a common load and the r-f component of the plate current through this choke is proportional to the grid voltage supplied by the servo. If there is a difference of polarity in voltage on the grids of V_1 and V_2 a voltage V_p will be developed across the choke advanced 90° with respect to the difference between I_{p1} and I_{p2} . The current $I_{p1} - I_{p2}$ is in phase with V_{g1} or V_{g2} depending on which is less negative. The voltage V_p developed across the plate choke will be proportional to the difference in potential applied to the grids.

Voltages V_{g1} and V_p are mixed in tube V_3 and

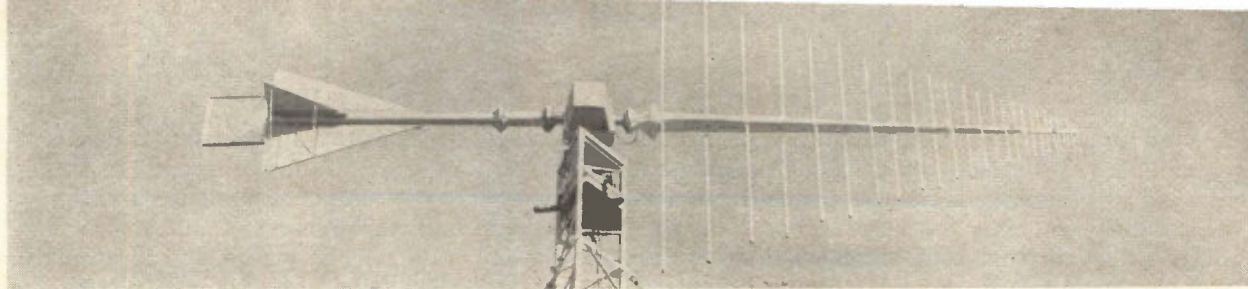

Log-periodic dipole structure uses transmission-line booms that are formed from 6-inch steel tubes. These are tapered down to reduce the wind area by telescoping in smaller sections of tubing. Wind sails on this type of antenna are necessary because the centroid of the wind area does not correspond with the center of gravity.

Communications

Practical log-periodic antenna designs

A graphic technique based upon angular dimensions establishes gain and beamwidth and converts dipoles to toothed types

By George J. Monser

Sylvania Electric Products Co., Mountain View, Calif.

Antennas that exhibit essentially constant performance over a frequency range of 10-to-1 are being used increasingly for civil as well as military communications. Despite this widespread application, simple design data for one of the most useful types—the log-periodic—has not been available until now.

The design constants of such structures, which evolved in a general way from a basic structure described in the literature nearly a decade ago, can

be expressed in terms of angles. When so defined, the antenna possesses a unique property: The dimensions of significance are logarithmically related and when an antenna is designed according to these criteria, it appears electrically similar throughout its operating band. The only dissimilarities are seen near the band edges. The band edges are, in turn, delineated by the structure size and the fineness with which the unit can be fabricated.

The pictorial sketch (below) is generally used as

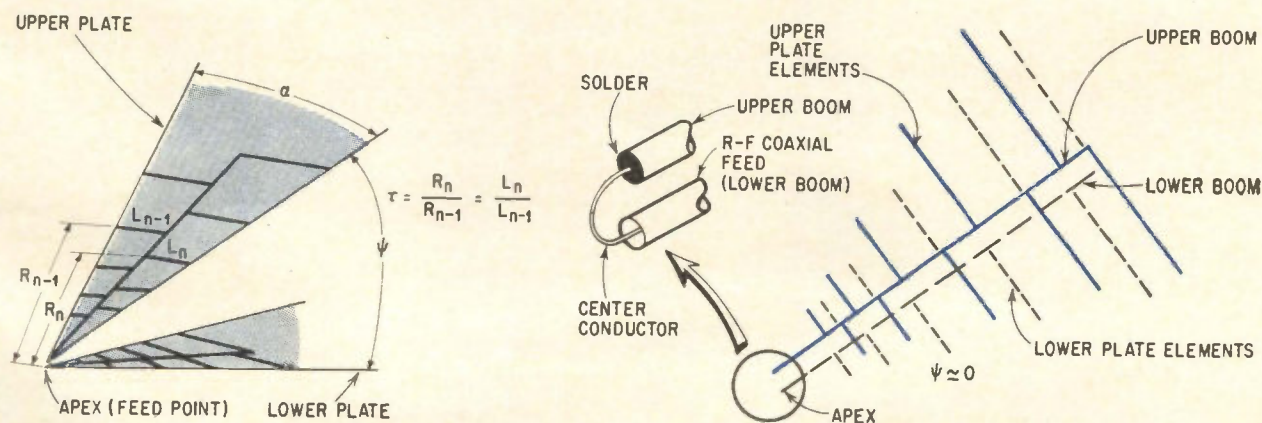

Pyramidal log-periodic structure (left) shows basic relationships between two plates (angle ψ and α and ratio τ). The antenna becomes a log-periodic dipole array when ψ , the angle between plates, is reduced almost to zero, (right). The infinite balun (inset) is a practical method of feeding the antenna.

the starting point in classical discussion of this antenna type. It is termed pyramidal log-periodic because of its geometry. The two identical structures are said to be set complementary to each other because if the angle of separation (ψ) between the plates is made nearly 0° (plates being parallel to

each other), the structure appears as it does at the right of the figure with corresponding elements diametrically opposite or complementary. A popular feed technique, the infinite balun, is also shown.

The important design parameters illustrated are ψ the separation angle between the plates, α the

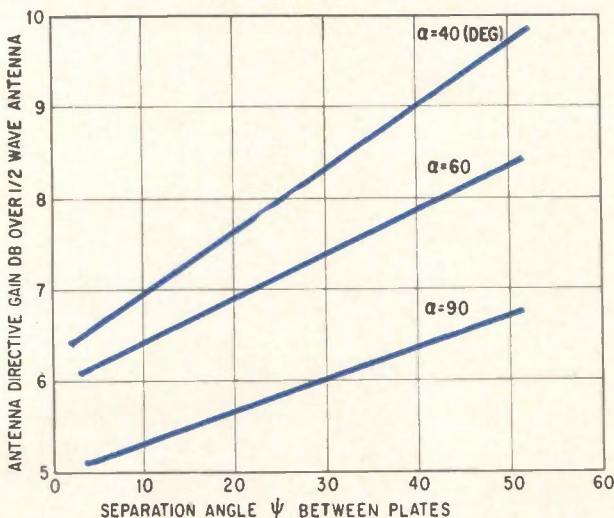

Choice of angular parameters and their effect on antenna directive gain referred to that of a half-wave dipole antenna.

Practical angular parameter variations and their effect on H-plane beamwidth between 3-dB points for an antenna having a 60° E-plane beamwidth.

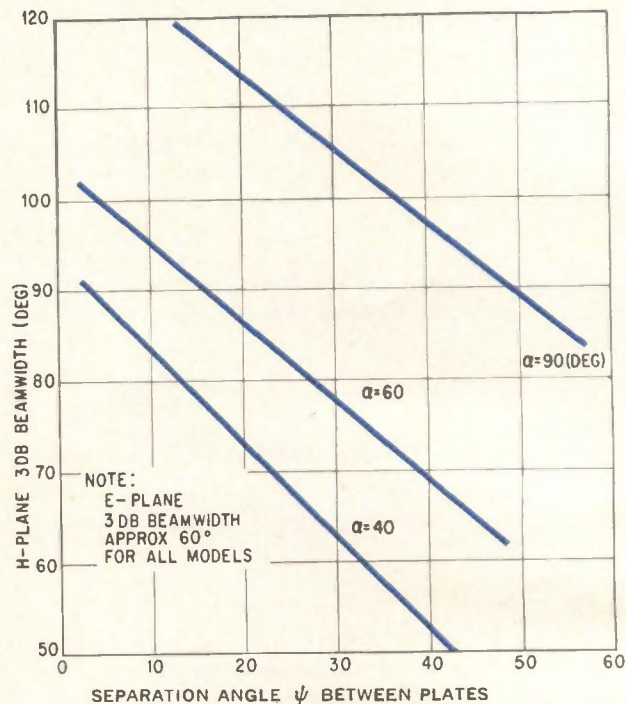

NOTE:
E-PLANE
3 DB BEAMWIDTH
APPROX 60°
FOR ALL MODELS

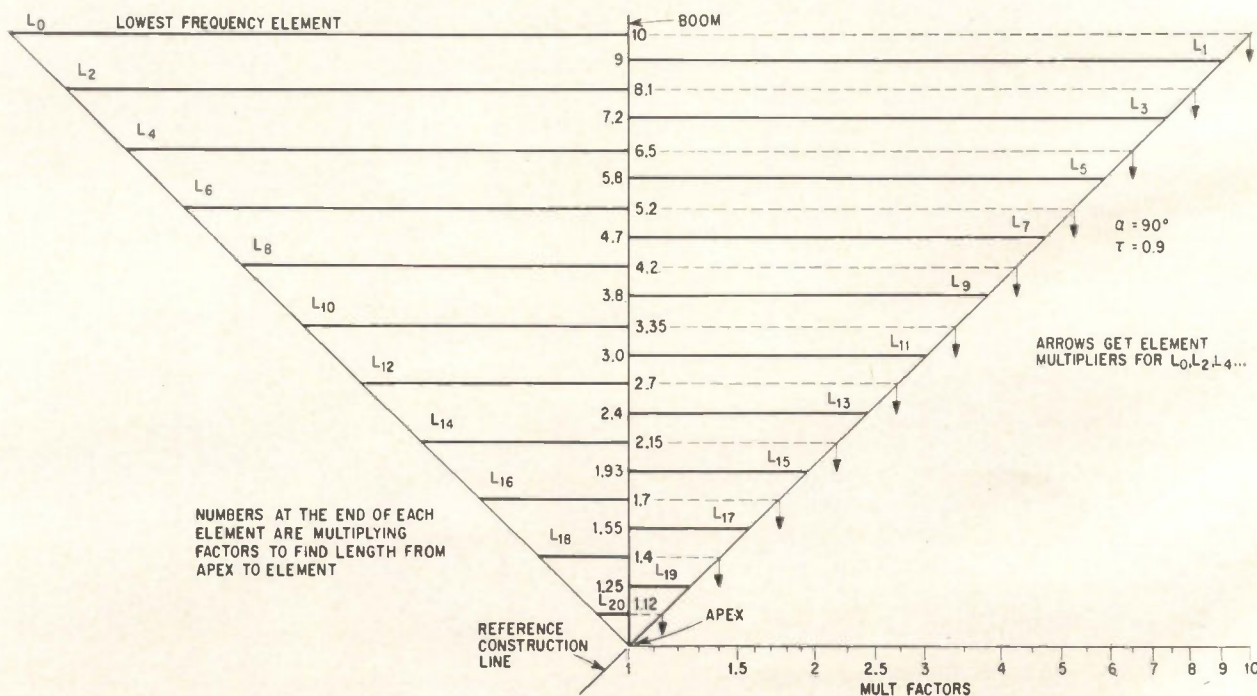

Chart of basic plate configuration is developed in normalized form for a 10-to-1 frequency band log periodic antenna employing two similar plates. Length of the lowest frequency element is determined as a quarter-wave distance corrected for velocity factor. Other simplified or specialized configurations are derived in later figures.

spread angle for each plate and τ the ratio between successive element length or the ratio of successive distances measured from the apex. A third angle β , not shown, represents a spread angle for each boom in proceeding from the apex to the rear of the antenna. In general, β is not a significant design constant.

To find simple design methods, considerable experimental data from many sources was reviewed. It was seen that, within variational tolerances, antenna gain and beamwidth could be represented as shown in the graphs (left) that show gain as related to plate-separation angle. These graphs indicate that several choices are generally afforded the engineer in selecting his design constants to meet the performance criteria. Minor lobe structure and front-to-back ratios for this type of antenna are generally satisfactory, except at the low end of the band. Units are frequently over-designed to remedy this situation.

The basic design concepts were then re-evaluated and the rest of the charts were developed. In these charts, combinations of design constants were made that permitted easy design variations. On each chart, one of the plates like that in the first illustration, is developed and displayed in normalized form over an approximately 10-to-1 frequency band.

When the design ratio τ is multiplied by itself, the result is equivalent to thinning out the antenna, that is, reducing the number of its radiating elements. The first step in such a development is shown above in the illustrative chart (left). Alternate even-ordered elements have been placed on the other side of the boom. A further variation from the basic design illustrative chart (right) shows that by using a smaller value of τ with the other design constants unchanged, fewer elements are required for a given bandwidth. However, when such a thinning-out procedure is applied, the antenna with fewer radiating elements tends to show more variations in performance across the band.

The illustrations in the conversion chart below show one method for converting the rod model to provide profile layouts. The areas indicated by the lettered designators are sometimes completely filled and a small spreading angle β is provided for each plate. This type of solid geometrical pattern is more familiar at very high frequencies.

Antenna Impedance

For log-periodic dipole arrays the impedance values range from about 60 to 100 ohms. Spacing between the feeders (booms) is generally set to give an impedance in the order of 100 ohms. As ψ is increased from 0° to 50° , the impedance increases to approximately 160 ohms. Thus, although a higher gain appears to be provided for ψ greater than 0° , a poorer match (more losses) to a 50-ohm line may result, unless a suitable matching transformer is used. That is, if a matching transformer is not provided, the difference in the measured gains may not be so great. Two design examples

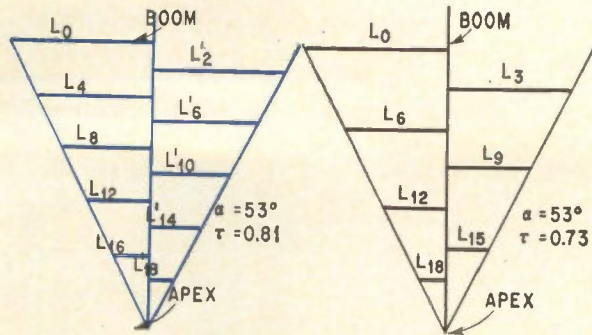

Illustrative chart shows that when the design ratio is multiplied by itself the number of elements is thinned out (left) by first placing alternate even-ordered elements on the same side of the boom.

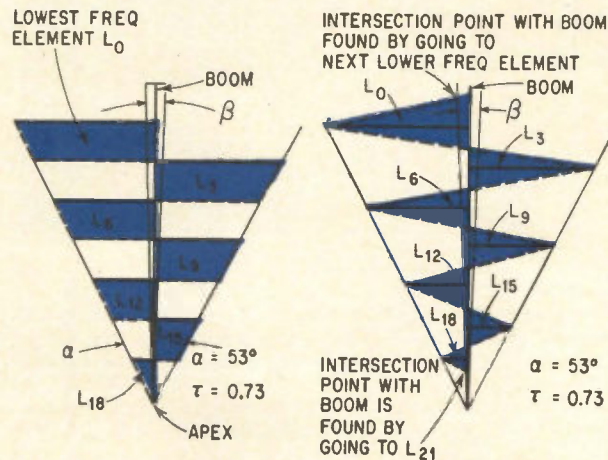

Conversion chart shows how the log-periodic rod model can be converted to a tooth or profile log-periodic type (left) or to a shark-tooth or zig-zag model, (right).

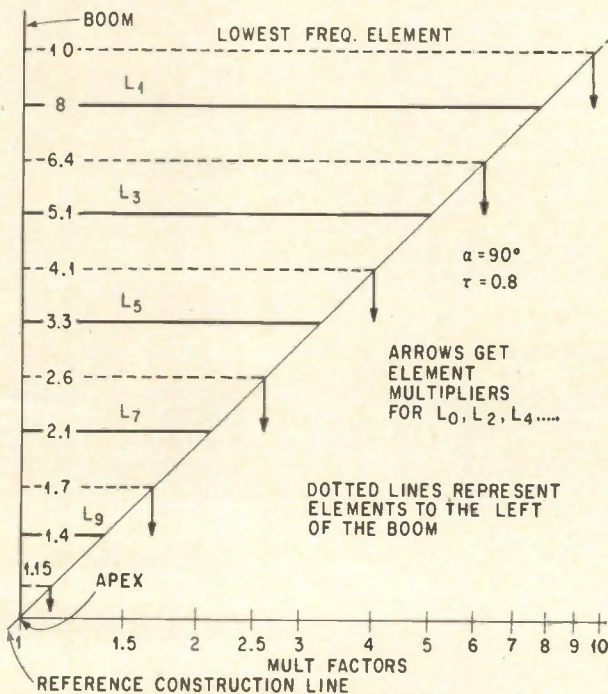
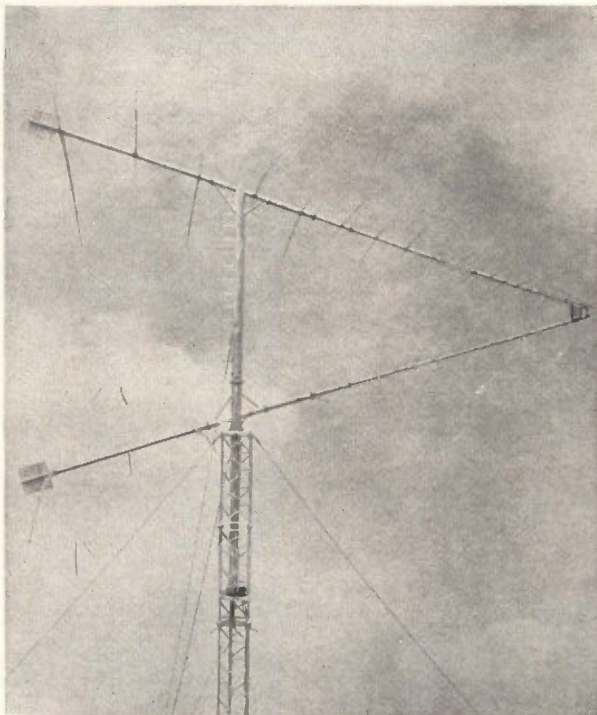

Chart showing thinned-out plate that has been simplified by reduction in the number of radiating elements. Here, the elements to the left of the boom are dashed.



Pyramidal log periodic dipole built by Antenna Products Co. for Project Mercury uses an offset straight element rather than either the common tooth design or the zig-zag. Frequency range is 6.5 to 40 Mc with a maximum vswr of 2 to 1. A tapered transformer is used inside one boom.

illustrate the use of these charts.

Design example 1:

Suppose it is desired to design a receiving antenna to operate from 50 Mc to 400 Mc and provide about 8 db gain referred to that of a half-wave dipole.

From the chart for gain vs separation angle, one suitable set of values is: $\alpha = 60^\circ$, $\psi = 45^\circ$. The value of $\tau = 0.9$ assures reasonable limits on the impedance fluctuations across the band. Selecting $\alpha = 53^\circ$, which allows some safety in the gain, the chart (above) for reduced angle α can be used.

Then, $f_0 = 50$ Mc; $\lambda_0 = 984/50 = 19.7$ feet; and $\lambda_0/4 = 4.9$ feet, which is the value of L_0 provided no over-design is used.

The author



George J. Monser is an engineering specialist at Sylvania Electronic Systems-West active in the preparation of technical proposals and studies dealing in advanced direction finding techniques for which his previous experience in radar and antenna work has prepared him. He received his Bachelor of Science degree in Electrical Engineering from Cornell University and

his Master of Science degree in Electrical Engineering from West Virginia University. His list of published papers includes several that have appeared in *Electronics*. He is a registered professional engineer in Arizona and West Virginia

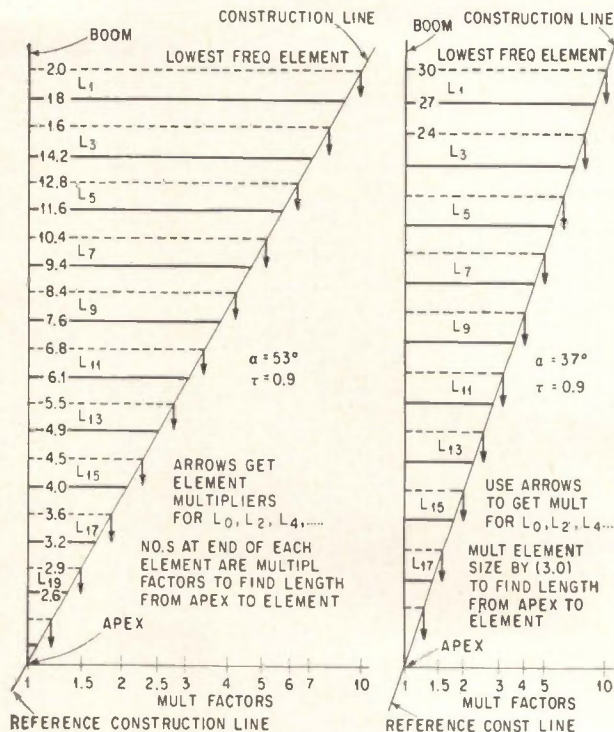

Chart for reduced angle α . Additional simplification in a single plate for which the angle α has been reduced from 90° to 53° (left) and to 37° (right). Elements to the left of the boom are represented by dashed lines to the right.

The next element, $L_1 = (18/20)(4.9) = 4.41$ feet (where 18/20 are multiplying factors from the left-hand reduced angle α chart. Similarly, $L_2 = (16/20)(4.9)$, $L_3 = (14.4/20)(4.9)$, etc.

The process is continued until element L_{20} is obtained. The ratio L_{20}/L_0 is slightly less than 50/400, the required frequency interval.

To find the element locations, measured from the apex, it is observed from inspection of the reduced angle α chart that the boom multipliers are twice the value of the element multipliers. Thus for the lowest frequency element, $R_0 = 2 L_0$. Similarly, $R_1 = 2 L_1$, $R_2 = 2 L_2$, etc.

Design example 2:

Suppose it is desired to design an antenna to operate from 100 Mc to 900 Mc and provide 6 db gain over a half-wave antenna. From the chart for gain vs separation angle: $\alpha = 90^\circ$, $\psi = 40^\circ$ and $\tau = 0.9$. Then the basic plate chart is used and the steps used in example 1 are followed, beginning with a different f_0 and λ_0 . Here, $f_0 = 100$ Mc and $\lambda_0 = 9.84$ feet. Also the boom multipliers and the element multipliers that must be applied are equal so that element locations (measured from the apex) are equal to the length of the particular element.

For the design from 100 Mc to 500 Mc (instead of 900 Mc) the smallest frequency element would occur sooner, leaving a considerable boom length without elements. This unused boom section can be removed or the design continued above 500 Mc as desired.

How do you take a picture of something you can't see?

Transient oscilloscope traces in the sub-nanosecond range move too fast for the human eye. How can you study them?

Use Polaroid 10,000-speed Land film. It's fast enough to make clear, high-contrast pictures of the most fleeting traces. And the results are fast, too.

Your pictures are fully developed in 10 seconds. If you are studying sequential traces, you can click off a full roll (8 exposures) in 20 seconds. Simply let the film stay in the camera back for 2 seconds, then pull the tab,

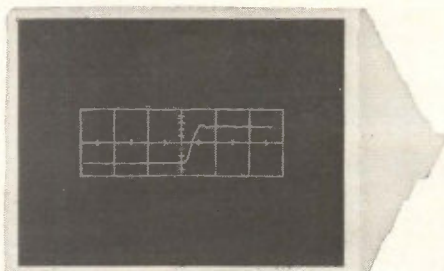

repeating the process for each exposure. Strip away the negative and you've got eight finished pictures.

The catalog name for this film is Polaroid PolaScope Type 410. It's panchromatic, responds best to blue phosphors such as P-11. The film's extreme sensitivity lets you use small camera apertures and low beam intensities too, so your trace pictures are really sharp.

Try Type 410 Land film the next time you need oscilloscope pictures. And see.

POLAROID®

Polaroid 10,000-speed Land film.

Circle 95 on reader service card



Instantly recognize shelf stock from package labels which tell all product facts — and picture the product as well. Using blank roll stock, economically print complete label in exact quantities. Change part or all of imprint in seconds.



Save costs of expensive decals, change date codes or other data in seconds. Direct printing with Markem cylindrical object printer, specialty inks and quick-change type saves label or decal purchase and application costs, permits quick changes in part or all of imprint.

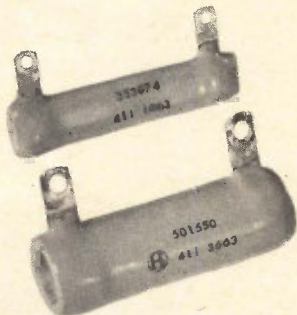

Production print irregular, concave surfaces at high speed, reduce labor costs of hand stamping or using manually-operated machine. Markem 200A offset Unitized. Printing Head prints up to 1800 pieces/hour, gives uniformly high quality prints, handles a range of sizes.

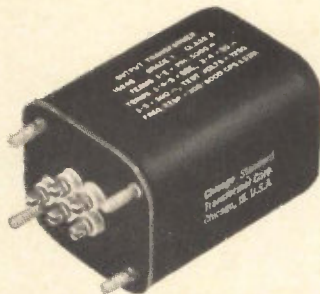

Direct-print complete identification on one or more surfaces, including all values, ratings, connection data, name and trademark — with greater speed, durability and economy than possible with hand stamping, labeling, nameplates, etc. Direct prints can't fall off, stay clean and readable for product's life.

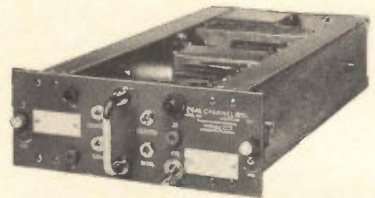

Prevent "outside source" delays, special production scheduling by using flexible, high-production in-plant Markem identification. Meet military specifications for durability and readability, print fixed and variable data simultaneously.

The best product identification usually costs the least

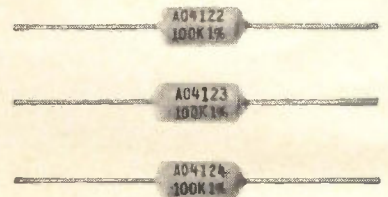

Sequentially number components and save \$50 per 1000 units. Printing the number, trademark, type number, value and date code by special Markem offset process saves label purchase, inventory, obsolescence and application costs. Change imprint, reset numbering unit in seconds. No wiping between imprints, no voiding numbers if component isn't printed.

Using proven Markem production identification techniques on your products and packages — as typified in the actual examples shown — reduces labor costs . . . prevents costly mistakes in sorting, shipping and use of the product . . . encourages reordering exact replacements made by you . . . helps establish future purchases by repeatedly registering your name with the customer.

And Markem machines, type and inks assure clean, durable and complete prints on the *surfaces, shapes* and

materials you must mark. Whether your identification involves MIL-spec inks, micro-miniature imprints, consecutive numbering, pilot or production runs, in-line or separate operation — Markem can tailor the right equipment and method to meet your needs and save you money. Ask your Markem Technical Representative to supply detailed recommendations — or write Electrical Industries Division, Markem Machine Co., Dept. 5, Keene, New Hampshire.

Free 12-page Catalog shows numerous electrical/electronic applications of Markem equipment. Write for your copy.



WINNER OF THE PRESIDENT'S  E-FOR-EXPORT AWARD

MARKEM

TECHNICAL ASSISTANCE AND INDUSTRY-PROVEN EQUIPMENT WORLDWIDE . . . TO HELP YOUR PRODUCT SPEAK FOR ITSELF

NEW NEW

TICOR II

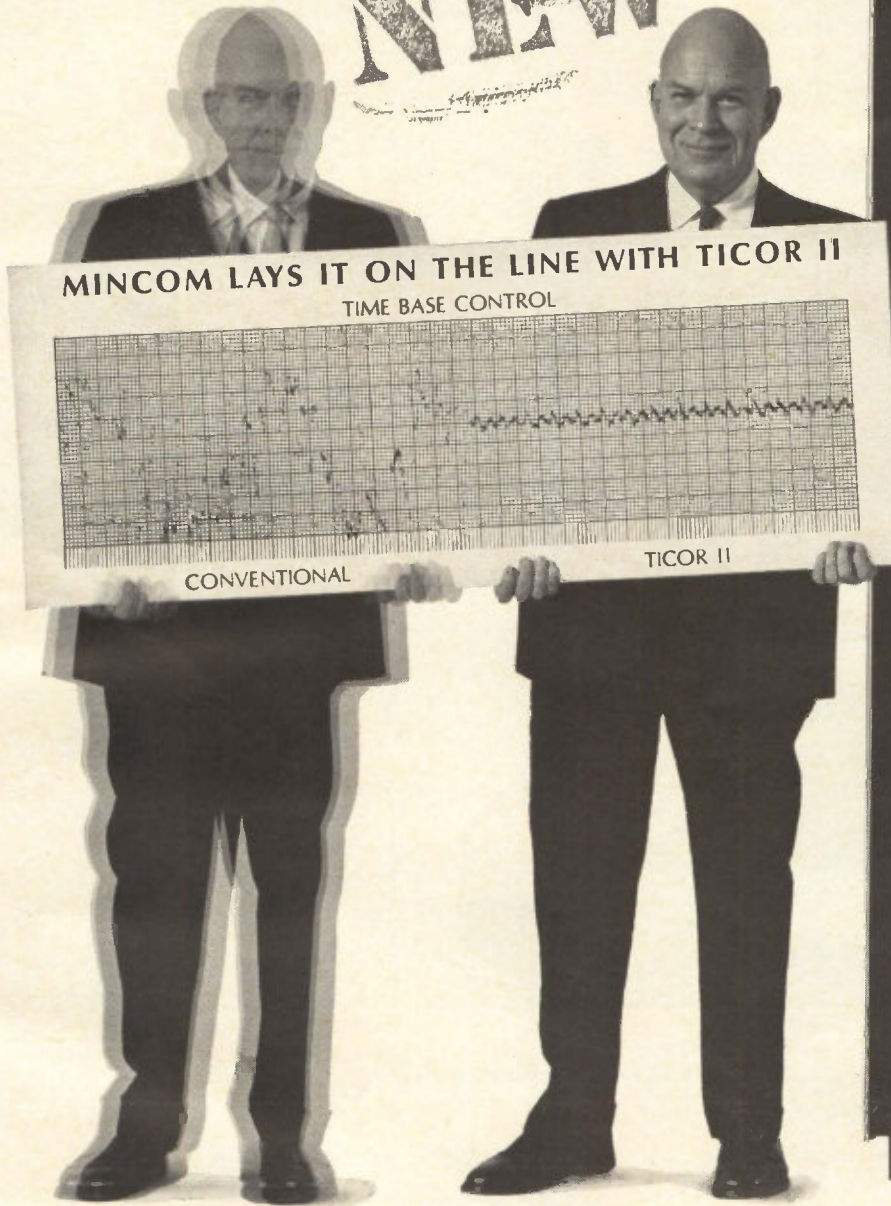

ON-LINE DATA REDUCTION...IN THE LABORATORY

Mincom's TICOR II 1.5-mc Recorder/Reproducer expands your existing data reduction capability to standards previously considered impossible. Radar recording, single sideband, serial PCM and other time-base-sensitive systems are now handled easily and dependably by TICOR II—fixed-head longitudinal recording of as many as fourteen channels. Flutter components below 200 cps are essentially removed. Time base correlation between events is held below $\pm 0.5 \mu\text{sec}$ anywhere on the tape. TICOR II's installation in your data reduction center enhances the value of all your current field and lab recording systems. Rapidly convertible from 1/2-inch to 1-inch tape operation. All solid state, one equipment rack, completely RFI-shielded. Write for specifications.

Mincom Division **3M**
COMPANY

300 South Lewis Road, Camarillo, California • 320 Shaw Road, South San Francisco, California • 529 Pennsylvania Building, 425 13th Street, N. W., Washington, D. C. • 135 West 50th Street, New York, New York • Post Office Box 272, Fairborn, Ohio • 1230 Orange Avenue, Winter Park, Florida • 2121 Santa Anna Avenue, Dallas, Texas • Eltron Engineering Sales, Inc., 246 Walnut Street, Newtonville, Massachusetts



This ACE strengthens America's hand

Sperry Utah's ACE † Computer makes split second decisions when it comes to testing complex electronic equipment such as missile guidance, aerospace and instrumentation systems. Capable of magnetic core storage of 1024 twenty-four word bits the ACE Computer provides all the loads, stimuli and marriage circuitry required for its task.

A part of the solid state construction of the ACE Computer is the A-MP★ MECA★ Interconnection system—a three dimensional system which interconnects component bearing modules mounted between current carrying conductor rails to achieve greater density, extreme flexibility in interconnection design and complete reliability. Each pluggable module fits snugly between the rails—resists vibration and provides redundant contacts at each rail connection to assure the

reliable performance required for simultaneous multiple testing at speeds limited only by the response-ability of the systems under test.

For your solid state construction why don't you consider the A-MP MECA Interconnection System? You get the benefits of three-dimensional circuitry, extreme reliability and interconnection layout expedited by a special A-MP MECA System graph layout method.

Write for complete details today.

†Trademark of Sperry-Rand Corporation

★Trademark of AMP INCORPORATED



AMP products and engineering assistance are available through subsidiary companies in: Australia • Canada • England • France • Holland • Italy • Japan • Mexico • West Germany

Probing the News

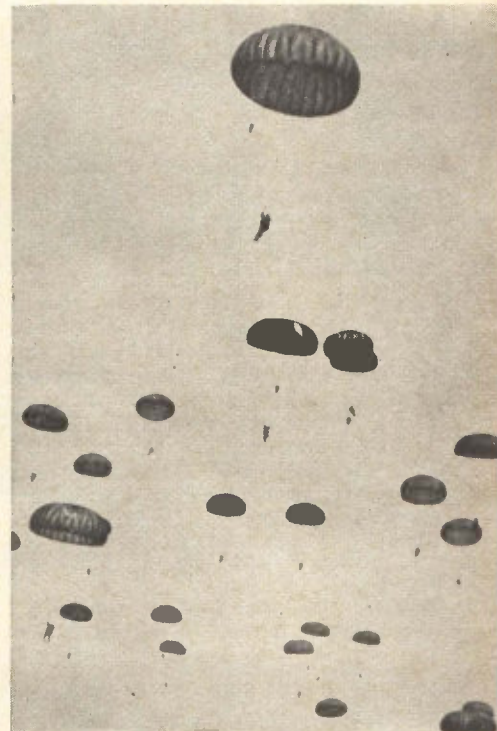

Paratroopers from the 101st Airborne Division board a C-135 at Fort Campbell, Ky. and fly to Turkey. From Turkey C-130's carry them east of the river near Andimeshk where they parachute to join Iranian infantry.

Military electronics

Equipment for limited war tested in Middle East

U.S. Strike Command wants smaller gear that will work anywhere. Communication network gets three-day tryout in Iran

By John F. Mason

Senior Associate Editor

For three days in mid-April, United States Army, Navy, Marine and Air Force elements fought side by side with Iranian forces in the Kingdom of Iran's rugged mountains and off its shores in the Persian Gulf.

The exercise was called Delaware, the Persian word for courageous. Its aim was to learn more about

limited war and the special equipment it requires. Delaware was the first exercise with allied forces and the first one in the Middle East.

One purpose of the maneuver was to see what unusual problems arise in a communications network airlifted to mountainous terrain.

Equipment failures and head-

aches that occur in unusual conditions are surprising. Radio transmitters that work well in semi-permanent installations may be unwieldy to move or impossible to erect in a new area. They may take up too much room, or be ruined by the weather. All these hazards are being studied, and recommendations for improved gear made.

The combined Iranian-U.S. forces were routing a hypothetical enemy, called "Sunland," that had invaded the northwest border of "Freeland"—as Iran was called in the joint military exercise sponsored by the Central Treaty Organization. Freeland, according to the script, couldn't repel the Sunland forces, so it asked the U.S. for help.

The Soviet press and radio complained that Iran's exercise to drive out enemy occupation troops was "provocative" and was creating "a tense situation near the southern border." Pravda said the mission of Strike Command as a whole was for waging "dirty wars."

The U.S. Strike Command (Stri-

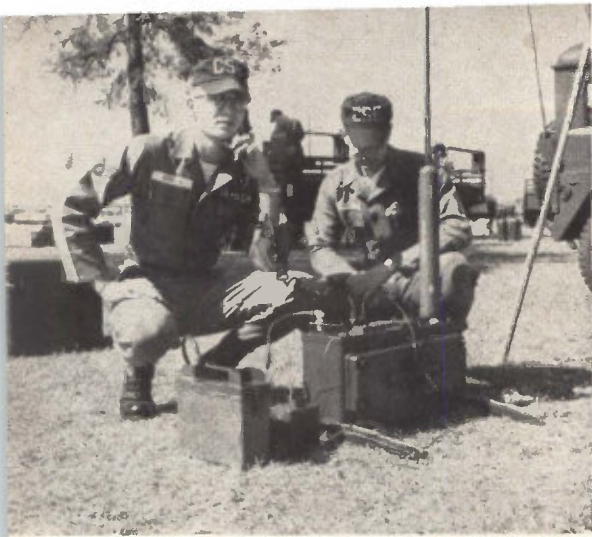

This 40-pound manpack radio was dropped at Delawar, and quickly put into operation by two men. Composed of two packages—a transceiver and a battery power supply and antenna—the AN/PRC-47 is single sideband, operates at from 2 to 12 Mc, provides 10,000 channels at one-hilo-cycle increments. It is used to start operating fast, before the bigger AN/TSC-15 is set up.

com) whose job it is to comply with requests for military aid, is accustomed to rushing men and equipment to remote spots for battles with imaginary invaders or with other U. S. forces.

Snow, heat and sand. The exercises—which have taken place in the Arctic, the tropics and the desert—are invaluable for training men for limited war and for evaluating the very special equipment they need.

The Administration believes the most likely kind of war the U. S. will have to fight will be a limited one. The big push, therefore, is for the right kind of military equipment.

Air, sea and land. The logistics for Delawar were carefully worked out. Stricom dispatched a brigade of the 101st Airborne Division from Fort Campbell, Ky. to a base in Turkey to await D-day. Two tactical fighter squadrons (18 F-100's each) from Cannon Air Force Base, N. M. flew to Iran, as did a troop carrier force of approximately 70 C-130 transport planes for troop and heavy equipment drop, and 18 C-133 cargo planes for heavy equipment air-land. Twelve C-135 jet transports carried the Army troops to Turkey. The Strategic Air Command provided KC-135 tankers to refuel the fighters on the flight from the U. S.

The U. S. Navy's Middle East Force provided one command ship and two destroyers. The Sixth Fleet sent one landing ship dock, one Marine rifle company and eight transport helicopters. In all, a U. S. military force of 6,800 men was sent to Iran.

Once deployed by Stricom, the American forces were under the command of Lt. Gen. Azhiri of the Imperial Iranian Army. Second in command was U. S. Major General G. S. Eckhardt, chief of the U. S. Military Assistance Advisory Group to the Iranian forces.

Battle plan. The battle plan for Delawar was carefully prepared. U. S. airborne troops were dropped in the Dezful area, near Andimeshk, east of a river. There they joined the Iranian 22nd Infantry Brigade. Together they moved north, seizing a number of objectives.

At the same time, the Iranian and U. S. Navy and Marines made landing assaults on the Iranian island of Kharg in the Persian Gulf. Iranian F-86's and U. S. Tactical Air Command F-100's provided close air cover for Army and Navy/Marine operations.

After the battle was over, Stricom once more took over, and moved the U. S. troops and equipment back to the United States.

Ready to go. To simulate probable conditions realistically, Stricom exercises are held in remote places where there are few or no communications networks.

Key Stricom officials always keep three bags packed, ready to go anywhere at any time. In much the same way, a complete communications system, equipped with the latest in Air Force, Army and Marine Corps gear, is always ready, trucks and all, to be loaded on C-130's and flown to a new trouble spot. Approximately 25 C-130's are needed to move a typical communications network.

Center for the network, or Communications Support Element, as it is called, is located at the Joint Task Force headquarters. The center provides command and control communications with the Army, Air Force, and Navy component headquarters, as well as lateral communications between the three components. Communications from each of the service headquarters

down to lower echelons are handled by the service itself.

Communications up from the Joint Task Force headquarters tie in at one or more of the nearest entry points of the Defense Communications System, DCS, the permanent military network that covers most of the world. The Delawar Joint Task Force center tied in to DCS at Ankara, Turkey, and Asmara, Eritea.

The DCS net enabled the Joint Task Force to communicate with Stricom headquarters at MacDill Air Force Base, Fla., the Joint Chiefs of Staff in Washington, and any of the unified commands.

High priority. Communications equipment is selected for capability and comes from all three services. Priority for new equipment is high, and the command is constantly on the lookout for improved gear.

From the Task Force up to the worldwide DCS, Stricom is now using the AN/TSC-25, a one-kilowatt, single sideband set with a capability of three voice and eight teletypewriter channels. Two sets, operating in the 2- to 32-megacycle range, should establish contact with at least two of the DCS entry points. Range is 1,500 miles or more.

From the Joint Task Force down to Air Force and to Army headquarters, as well as laterally between Air Force and Army, a two-way, single sideband system is used, the AN/TSC-15. It provides three voice channels and four 160-cycle multiplex teletypewriter channels. It operates in the 2- to 29.999-Mc high-frequency range.

The AN/MRC-73, used at Delawar, is a vhf/f-m carrier terminal used at both Army and Air Force headquarters to communicate with similar equipment (the TRC-24) at the Joint Task Force headquarters. The system, mounted on a ¾-ton truck, provides 12 telephone channels. Frequency extends from 50-600 Mc.

Another system used at Delawar was the radio wire integration station at the Joint Task Force headquarters. Housed in a ¾-ton truck, the station provides switched telephone service to an f-m voice radio system. A newer version of the station will be used for the first time during Desert Strike, a large exer-

cise scheduled for the middle of May in the desert area of California, Arizona, and Nevada. The new version will provide switched telephone service to any one of three radio systems. High-frequency single sideband is used to other command posts, f-m voice to vehicles in the field, and uhf to aircraft.

A system to be tested for the first time at Desert Strike is the AN/TRC-66. Originally built for the Air Weapons Control System, 412-L, the TRC-66 operates in the 4.4 to 5.0 gigacycle frequency range with a power output of one kilowatt. The system permits 60 voice channels over a single hop of 100 nautical miles, and 1,000 miles over tandem hops.

Equipment headaches. Delawar, and other exercises like it, continue to uncover problems and new requirements.

A long-suffering Army captain who has been bedeviled by electronic equipment mishaps on a number of Stricom exercises, had these observations to make:

"We have found there is no such thing as a good power generator in the size we want. Five kw is too small and 10 kw too big to carry two in one trailer. We'd like to see a smaller package with more power; 7½ kw would be fine.

"There is no high-frequency, single sideband, long-haul antenna that meets our requirements. We want durable, light weight, transportable antennas that a minimum of men can erect quickly. We want high-gain, broadband antennas with low-angle radiation for better reception at long distances. We've tried all sorts of antennas and we find that the old reliables—the rhombic, V, and 1-pole rhombic—work better than the new ones. The new log periodics don't have the gain that the V and rhombics have; they haven't been sturdy enough—the mast breaks. There is also a problem with the antenna radiating elements. These elements are woven into a nylon rope to act as support for the elements as well as acting as the guy for the element. But when the rope gets dusty and then wet, the combination produces current leakage.

"There are, of course, disadvantages to the old reliables, too: the rhombic takes up too much real

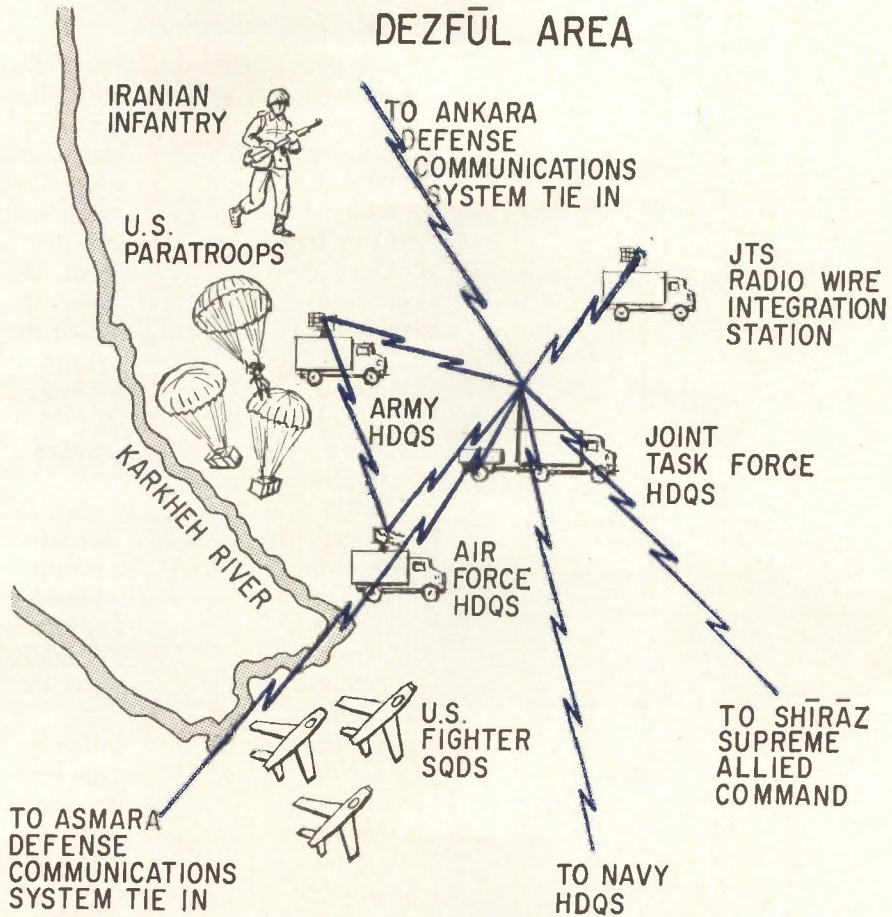

The Dezful area was the locale for much of Delawar, the joint Iranian-U.S. military exercise. The Joint Task Force headquarters controlled Army and Air Force headquarters and the Navy command ship in the Persian Gulf during deployment of their forces. It also tied in with the world-wide defense network at both Ankara and Asmara. The U. S. Strike Command used the radio-wire-integration station for the first time at Delawar.

estate. A system with four 400-foot legs is pretty unwieldy. The V takes up half this much space, but that's still too much, and it also suffers from a loss in gain. The one-pole rhombic is still experimental, and there are impedance matching and feedline problems.

"Erecting antennas in remote places can be a problem. In Washington state, at the Yakima firing range, the ground is covered with lava, which made driving in the pegs of the high-frequency radio antenna almost impossible.

"In Panama the soil is hard and granular. A cork-screw drill was used to dig a hole for the antenna but it succeeded only in pulling dirt neatly up to the surface and not securing the antenna in the ground.

"In Iran the soil was sandy, and erecting antennas was difficult as it will be in Desert Strike in California this month.

"All kinds of unexpected things go wrong. Baluns used for matching impedances are a source of trouble because when it rains they often fill up with water.

"We need multichannel, narrow-band, carrier equipment in a small package."

New radio set. Problems such as these are being cleared up. New equipment is being tested. For example, Stricom is looking forward to trying out a brand new radio set that will be used in Desert Strike this month for the first time. Designated the AN/TSC-38, the unit was built by the Collins Radio Co. It is sideband, and will have 10 kilowatts of power (existing sets have only 1 kilowatt). Gen. Paul D. Adams, commander in chief of Stricom, and his staff will use this set to direct Desert Strike, from Needles, Calif., and for establishing the long-haul link with the Defense Communications System.

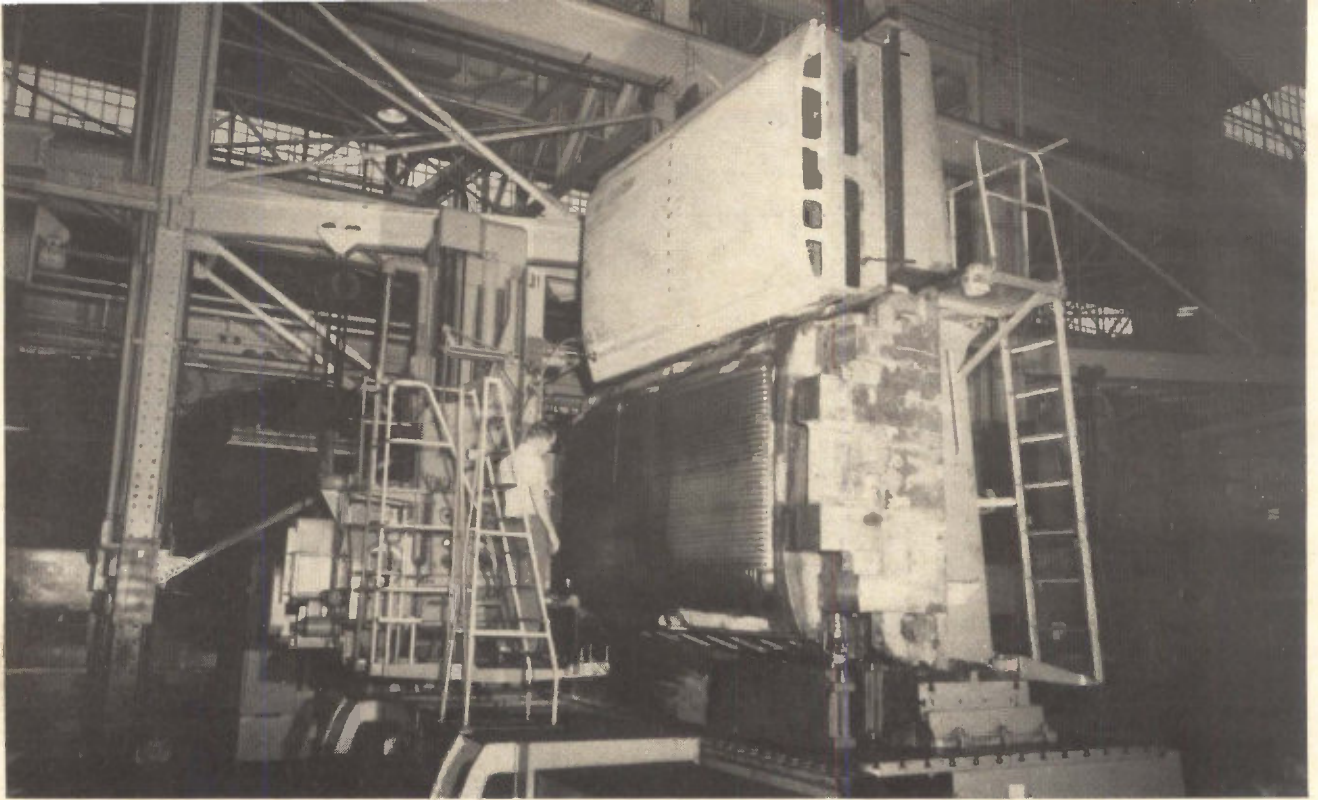

Die milling machine converts die models (top) to roughly finished dies (bottom).

Industrial electronics

Detroit's top secret: numerical milling control

Automakers are quietly experimenting with numerical control in die milling. Stakes are high in this industrial race

By Donald MacDonald

McGraw-Hill World News

Numerical control is secretly establishing a beachhead in Detroit. Experimentation in numerically controlled milling is already in advanced stages in some automakers' die shops. Automatic drafting looks like the next step.

Although the aircraft industry broadcasts its successes with numerical control, the auto industry closely guards its plans. One reason for secrecy is fear of union reprisals, especially in this year of contract negotiations. Another reason is the desire to beat competitors to the punch in an ever-changing market.

Milling with numerical control would chop nine months or more from the present three years be-

tween the drawingboard and completion of tooling for an all-new car. Industry sources see an eventual lead time of only a year or so, when the mountains of production drawings required for tooling up are also produced under numerical control.

Dies by the thousands

The auto industry requires hundreds of thousands of die sets to form sheet metal parts. One all-new Ford, for example, requires over 300 die sets—and the industry is expected to offer 240 models in 1965. Some body shapes require 8 to 10 stampings. Many dies must be duplicated for use on several production machines. In addition,

die models made with soft materials are needed to check die engineering and the fit of parts before the production dies are made.

It starts with clay. Understanding the potential importance of numerical die milling requires an understanding of the complex steps that now precede die-making.

Production engineers prepare two-dimensional drawings from a clay mockup of the car body. Interior fittings and structure are designed. Drawings are transferred to aluminum to prevent distortion, and templates are cut. Master carpenters laboriously fashion laminated wood die-forms, which serve as braille-like guides for conventional die-milling, or Kellering, machines.

These steps are time-consuming, especially the drafting. Draftsmen turn out thousands of drawings. Even the location of ashtrays is involved in each design step. Numerical control figures to make its greatest inroads in drafting and in the translation of the drawings into punched tapes to run numerically controlled die millers.

However, no researcher feels confident enough yet to suggest

Continued on p106



Siemens Components Center, Munich—Main Offices, Research, Manufacturing and Sales

This is Siemens

Siemens (pronounced zée-menz) was founded 116 years ago. It is the largest private employer in Germany and one of the largest business enterprises in the world. It employs more than 240,000 persons in factories and offices in 79 countries.

Siemens manufactures practically every type of electrical equipment from microminiature components to complete power stations—all world known for their high standards of quality.

Siemens products are found in homes, stores, factories, laboratories, trains, planes, ships, theatres... wherever men work, live and play.

For general information on Siemens, circle 250 on Reader Service Card.

SIEMENS & HALSKE AG · GERMANY

Subsidiary in the U.S.A.:

SIEMENS AMERICA INCORPORATED

350 Fifth Avenue, New York 1, N.Y.

In Canada:

SIEMENS HALSKE SIEMENS SCHUCKERT (CANADA) LTD.

407 McGill Street, Montreal 1, P.Q.

Siemens ferrite pot cores for adjustable, high-stability, high-Q coils



Pot cores meet the most critical requirements for filters used in multiplex and other carrier-frequency applications because of these advantages: easy adjustment to precise inductance, high stability, high Q, low distortion, and self-shielding that allows compact component density without regeneration or coupling.

In addition, Siemens pot cores offer uniform electrical characteristics month after month... made possible by Siemens' unique manufacturing controls.

Wide range of materials provides optimum properties for frequency ranges up to 40 mc for oscillating and filter coils... up to 400 mc for transformers.

Wide range of sizes. Diameters range from 0.22 to 2.75" including all International Standard Sizes. Most of the widely used sizes between 0.43" and 1.41" diam. are available for immediate shipment from stock at White Plains, N. Y.

Stability. Less than 0.2% change in permeability in 10 years at temperatures up to 70°C for typically gapped cores used in filter coils.

Frequency ranges, temperature coefficients:

Application	Ferrite Material	Initial Permeability	Frequency range mc/s	Rel. Temp. coeff. $\frac{\Delta \mu}{\mu}$ in ppm/°C at 20°C...60°C
Coils for filters and oscillating circuits	N 28	2000	up to 0.1	0.5- 1.5
	N 22	1100	up to 0.3	0.8- 2.0
	M 25	550	0.2-1.6	1.0- 3.0
	K 1	80	1.5-12	1.0- 6.0
	K 12	20	3-40	0-10.0
Transformers	T 26	2000	up to 0.3	0.5- 3.0
	T 26	2000	up to 3	0.5- 3.0
Wide-band transformers	N 22	1100	up to 10	0.8- 2.0
	T 7	2000	up to 100	0- 4.0
	K 1	80	up to 400	1.0- 6.0

*The temperature coefficient of a gapped core can be calculated as follows: $TCg = \frac{TC}{\mu} \mu_g$

Temperature coefficients are closely controlled, and with complete data available. (Siemens "Styroflex" polystyrene capacitors are widely used for temperature-compensating with pot cores.)

High Q value, with high stability, is typical. For example, a 26 x 16 core of N22 or N28 material A_L 315 at 100 kc shows a Q value of approximately 950. (Under special measuring

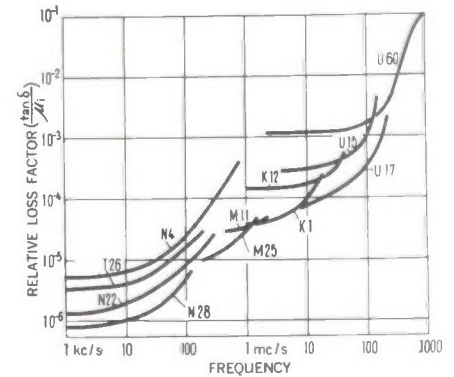

conditions with limitation of current, Q value is beyond 1000.)

Complete line of "hardware" includes coil formers with one to four sections, mounting assemblies for chassis or printed circuits, adjustment devices and keys. Formers are made of Makrolon (up to 125°C) and polystyrene.

A_L values (mH/1000 turns) of ferrite materials for some typical pot-core sizes

A_L values in parentheses are for pot cores *without* air gap.⁽¹⁾
Tolerance: $\pm 3\%$ unless indicated otherwise.

Dimensions in mm diam. x ht ⁽²⁾	Dimensions in inches	Type	Ferrite materials					T 26		N 30
			K 12	K 1	M 25	N 22	N 28	Tol.: $\pm 5\%$	Tol.: $\pm 10\%$	
7 x 4	.28 x .16"	B 65 511				100 (700)			160 250 (1000)	(2000)
9 x 5	.35 x .20"	B 65 521 ⁽³⁾	46	25 (95) 40	40 63	63 (850) 100	100 160		250 (1200)	(2500)
11 x 7 standard	.43 x .28"	B 65 531	46	25 (115) 40	40 63	63 160 100 (1200)	100 160		400 (1600)	(3200)
14 x 8 standard	.55 x .31"	B 65 541	20	40 (140) 40	40 100	40 160 100 (1500)	100 315 250 400	250	400 (2100)	(4200)
18 x 11 standard	.71 x .43"	B 65 651	25	25 (180) 40	40 63 100	63 250 100 (2000) 160	160 315 250 400	400	630 (2800)	(5600)
22 x 13 standard	.87 x .51"	B 65 661		40 (220) 63	100	100 315 160 400 250 (2600)	250 400 315	630	1250 (3800)	(7000)
23 x 17	.91 x .67"	B 65 571		40 (270) 63	63 100	160 400 250 (3300)	400 500	400 630	1250 (4900)	(9000)

¹Used for chokes and transformers in which losses and variations in permeability are of secondary importance.

²Sizes up to 70 x 42 mm are available. Data on request.
³Available only in tolerance $\pm 5\%$.

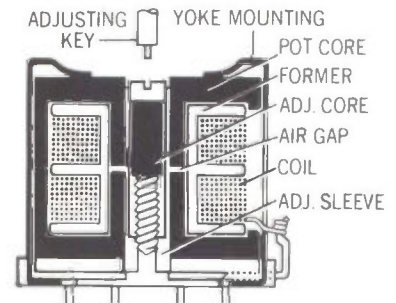

Other Siemens ferrite products include E cores, cylindrical and tubular rods, and recording heads. "Transfluxors" are available in a variety of shapes and materials for all types of logic circuits. Also switching and memory cores and complete matrices. Data available on request.

Siemens ferrite pot cores and *Transfluxors* are distributed by William Brand Electronic Components, Inc. and are available from leading sales representatives throughout the U. S.

CIRCLE 251 ON READER SERVICE CARD

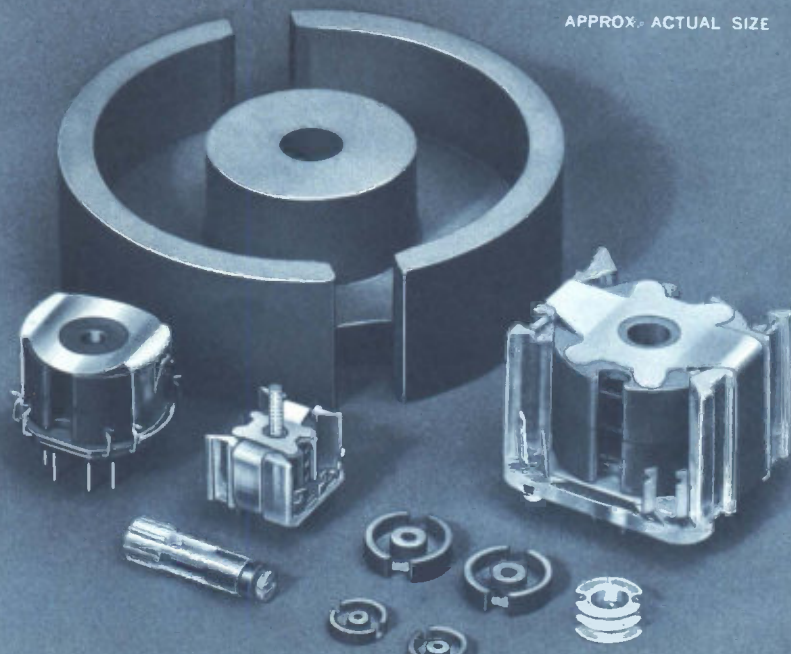

Siemens components available: Ferrite pot cores, *Transfluxors*, memory cores and matrices; capacitors (electrolytic, polystyrene, metallized plastic, metallized paper); deposited-film resistors; semiconductors; R. I. meters and screened cubicles.

Distributor for these electronic components:

WILLIAM BRAND
Electronic Components, Inc.

230 Ferris Ave., White Plains, N.Y.
Telephone: 914 WH 8-3434

In Canada:
SIEMENS HALSKE SIEMENS SCHUCKERT
(CANADA) LTD.
407 McGill Street, Montreal 1, P.Q.



COMPLEX PRECISION DRILLING SIMPLIFIED WITH LEVIN MICRO-DRILL PRESS

The problem: Drill precision small holes from the inside diameter of a small ring, then join with connecting right-angle holes. Formerly, holes had to be completely drilled through from OD to ID and then plugged. At Kershner Micro Corporation, Culver City, California, however, the problem was neatly solved with a Levin micro-drill press with which holes are precision drilled from inside only as far as required. This is only one of the many precision machining problems solved by Levin. Write us about yours.

Drill holes down to smaller than 5/1000 inch with sensitive Levin micro-drill presses. No sliding quills and splines to cause drag. Precision preloaded ball bearing spindle takes Levin WW collets.

LEVIN



INSTRUMENT LATHE



MICRO-DRILL



TURRET LATHE



RADIUS TURNING



PRECISION COLLETS



PRECISION DRILL

LOUIS LEVIN & SON, INC., 3573 Hayden Avenue, Culver City, California, (213) UP 0-9555.

Exclusive Dealers: Russell-Holbrook & Henderson, Inc., New York and Los Angeles / Industrial Tool & Supply Co., San Jose / Marshall Tool & Supply Corp., Los Angeles/Royal-Tschanter, Baltimore/Morton L. Friedman Co., Chicago/Plus dealers in all important Industrial Centers

Circle 201 on reader service card

NOW AVAILABLE

**A COMPLETE LINE OF
MINIATURE
TOGGLE SWITCHES**

UNITIZED BODY	One-piece "unitized body" reduces parts, weight, size to a minimum for ultra-miniature space requirements — maintains good specs.
ULTRA-TINY 1/2" SIZE	Supplied with miniature bat handles or plastic color-coded caps. Solid silver contacts and terminals. Easy wiring, good soldering ability.
5 AMPS @ 115 VAC	Overload over 100% Insulation over 100 megs Breakdown over 1000V Over 80,000 on/off cycles
IMMEDIATE DELIVERY	Available immediately from ALCO stock and thru your local distributor in SPDT, DPDT, 3PDT, 4PDT, momentary and center-off configurations.
LOWEST COST	SPDT \$1.65 — DPDT \$2.15 — 3 PDT \$3.85 — 4PDT \$4.85. Ask for O.E.M. quantity price schedule on the complete line of ALCO switches.

ALCOSWITCH
SEND FOR FREE CATALOG
Lawrence, Mass. Dept. E-50

Circle 202 on reader service card

Don't let the price tag fool you!

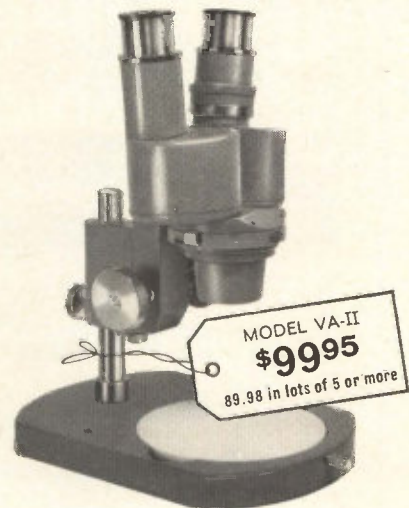

This is a genuine, full-quality Elgeet-Olympus STEREO microscope

Distortion-free optics, brilliant imagery. Ideal for quality control, inspection and assembly of miniature parts and circuits. Magnification: 8X to 40X. A complete range of coated achromatic optics is available. For details, write Elgeet Optical Co., Inc., 303 Child Street, Rochester, New York 14611.



Circle 105 on reader service card

105



Chrysler employee shaves clay an mockup of a sports car.

replacing many human draftsmen.

Computer input. Ideally, measurements would automatically be taken off the clay mockup and fed into a computer (an IBM 7090 or equivalent), which would prepare the tapes to run the numerically controlled die miller.

The big problem is obtaining precise digital information from the clay model. Proximity or contact probes to measure the model now exist in prototype. [For another report on measuring, see p. 79]. But since the model surface is imperfect, it should be evened out by a mechanical coating. Nobody wants to do this, because it would spoil the clay for re-use. The Ford Motor Co. alone has to buy about \$130,000 worth of clay a year.

Smoothing by electronics. Capacitance or photo-scanning methods can smooth the clay surface electronically. In one experimental scanner, a photo-cell detector measures the position of an angled light beam at any point on the model.

These outside measurements can then be punched into tape for the input to a numerically controlled

drafting machine. Ford is using an optical tracer, a 7090 computer, and a drafting machine to produce perspective drawings of car models from clay mockups.

Esthetics vs. mass production

While it is feasible to automate the drafting of the outside of the auto, the outside of the clay model can provide information on only about seven major dies. These include quarter panels, roof and deck lid.

These big panels pose a major problem in diemaking because the stylists are not restricted to mathematical curvatures on the car's outside. This introduces extra drafting and manual die-engineering steps, preventing maximum use of numerical control.

Getting in the car. Draftsmen must also make full-scale drawings of the inner surface of the car. But automakers are coming to realize that these shapes, while complicated to stamp, are the easiest to convert to numerical control. Since esthetics are not involved in, for example, a rib that strengthens a

only **4** basic materials... **1** ...mylar*...

...a new capacitor construction concept to give high performance and low cost. **Filmatic®** by Paktron

floor panel, it can be a mathematical shape.

Early recognition of this principle gave aircraft manufacturers their lead in numerical control. A landing-gear fulcrum, for example, is a symmetrical chunk of metal.

Mills for Ford. Ford owns one mill designed specifically for numerical control by the Giddings and Lewis Machine Tool Co. Three more are on order at \$250,000 each.

One has a stylus to follow the shape of a die model. Its output information directs the cutting of the final die.

No controls are specified for the other two mills. Ford can experiment with controls offered by the Bendix Corp., General Electric Co. and Pratt and Whitney Co., a subsidiary of the Fairbanks Whitney Corp.

Ford's Australian plant has also ordered a Giddings-Lewis mill. Ford has also bought two mills from the Cincinnati Milling Machine Co. without specifying a control system. Some earlier mills, designed to operate from punched cards, have been converted to tape.

The Fisher Body division of the General Motors Corp. has a highly advanced, numerically controlled Giddings-Lewis mill. It has an experimental tracer that takes dimensions from plastic die models. A purchase of a numerically controlled mill by the Chrysler Corp. is reported to be imminent.

Converting to tape. The new machines outmode the word "Keller," since that is a Pratt and Whitney trademark. The few mills operating full-time are conversions.

Converting tracer mills to numerical control is a problem; the tracer compensates for tool deflections. Thus numerical machines must be massively rigid to avoid deflection errors. But rigidity would allow use of more powerful motors and higher cutting speeds.

The precision of numerical control, in the order of two to three thousandths of an inch, provides another advantage. It makes "barbering" the dies relatively simple. Barbering is hand-grinding, filing and sanding of dies. According to experts, the new machines produce dies that need only prussian blue

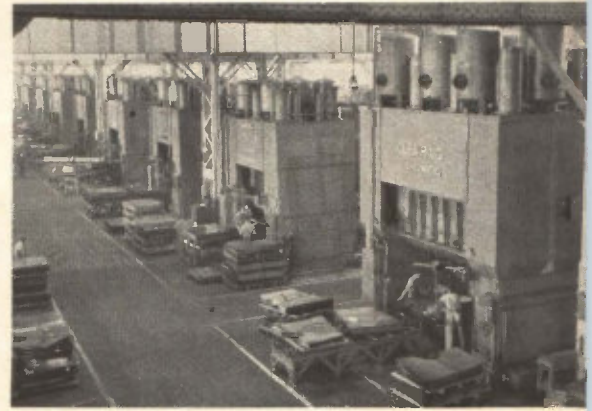

Press lines produce stampings for Chrysler cars and trucks near Detroit.

treatment, a process finding surface deviations that require finishing.

Price of independence. As far as is known, only one independent die shop, the Federal Engineering Co. in Detroit, has ordered a numerically controlled mill.

Even if a shop buys a machine, the problem is getting tapes. The automakers, using numerical control, will be able to make most of their own dies. This, according to sources, will pare the present 400 independents to about 40 shops.

...foil...

...leads...

...impregnant

This unique combination provides a rugged self-case, high lead strength, excellent moisture resistance, improved life, high volumetric efficiency . . . all at a considerable savings in cost.

Available in three case sizes.

Range:	.001 mfd. through .5 mfd.
Voltage:	50-100-200-400-600 WVDC
Tolerance:	± 10% & ± 20%

*DuPont

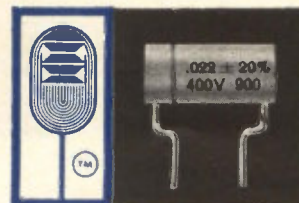

ACTUAL SIZE

Filmatic®
Capacitors
with
RIPPLEWELD™

i t PAKTRON
DIVISION ILLINOIS TOOL WORKS INC.
1321 LESLIE AVENUE • ALEXANDRIA, VIRGINIA

Electronic hope for the helpless

By Arthur Zimmerman

McGraw-Hill World News

Cripples may someday have the full use of their limbs restored with the help of microelectronic systems inside their bodies.

Already transducers, some smaller than shirt buttons, are being used in rabbits and rats. These combinations of a sensor, f-m transmitter and mercury battery have been broadcasting the electrical characteristics of an animal's heart and other muscles. Rugged enough to last indefinitely, they can also be a source of control impulses to rehabilitate limbs that were once useless.

The transducer output, triggered by the normal muscle in which it is implanted, could stimulate disabled muscles.

The transducer implants are being done at Highland View, a Veteran's Administration hospital in Cleveland. They are part of a biomedical program at the Case Institute of Technology.

A packaging problem. Transmitter circuit designs are fully developed, according to Wen Ko, assistant professor in Case's engineering division and supervisor of the institute's solid-state electron-



we've got your number

... in binary coded decimal format at 50,000 conversions per second, including sample and hold. Texas Instruments new Model 846 A-D Converter features 100 megohm input impedance, voltage ranges from 1 to 10 volts (manual or external selection) and 100 nanosecond aperture time.

Available options include three digits (± 999) or four digits ($\pm 1,999$), differential input, decimal or BCD display and digital to analog conversion capability. The 846 is another high-speed, high-accuracy instrument in TI's line of digital data handling equipment.

Model 844 and 845 high-speed Multiplexers are ideal companion instruments for use with TI A-D Converters.



Addressable, sequential and addressable/sequential models are available, sampling at 50,000 channels per second. Features up to 160 channels, variable frame length, accuracy $\pm 0.02\%$ full scale with input levels to ± 10 volts.

Write for complete information.

INDUSTRIAL
PRODUCTS
GROUP



TEXAS INSTRUMENTS
INCORPORATED
P. O. BOX 66027 HOUSTON, TEXAS 77006



Wen Ko and Gene Yon, project engineer, place rabbit in test holder. Current sent through wires in walls at right activate transmitter implanted in the rabbit.

ics laboratory. "The transmitter is now a package design problem."

The question is whether the transmitter should be shaped like a disk or a cylinder, or whether it should have the shape of the muscle in which it is to be used.

The group hopes eventually to devise a closed-loop system in which transmitters, implanted in healthy muscles, send signals to computer-like selection devices. The selectors would send signals to activate a mechanical aid or to stimulate muscles directly.

Studies elsewhere. Another research team, headed by J.B. Reswick, director of the engineering design center at Case, is working on the closed-loop system and the selection component.

Pacemakers have long been used to stimulate regular heartbeats and newer models can be implanted. Now researchers at the University of Minnesota report success in reducing artificially induced high blood pressure in an animal through use of a Baropacer. The new device, an electronic power pack, fired low-voltage signals into the carotid artery in the neck and within a month reduced the blood pressure of a dog from 225 to around 150. This was something that couldn't be done with drugs or surgery.

Scientists at the University of Washington in Seattle have studied telemetry from dogs and baboons and report significant developments in measuring the blood flow in animals. The implanted flow-meter broadcasts nearly 1,000 feet (more than 300 meters) consumes less than 200 milliwatts and weighs 150 grams.

About 20 other groups are trying to develop miniature transmitters. One study, conducted by R.S. McKay at the University of California, Berkeley, has resulted in a transmitter that can be swallowed.

"This field is increasing very fast," says Ko, "because efforts do yield results. Electronic devices simply are better than any other way of obtaining the data."

A 'primitive stage.' Although the stimulation technique is still "in a primitive stage of development," according to Ko, a simple stimulator design has been developed. This summer, the solid-state group at Case will participate in a study

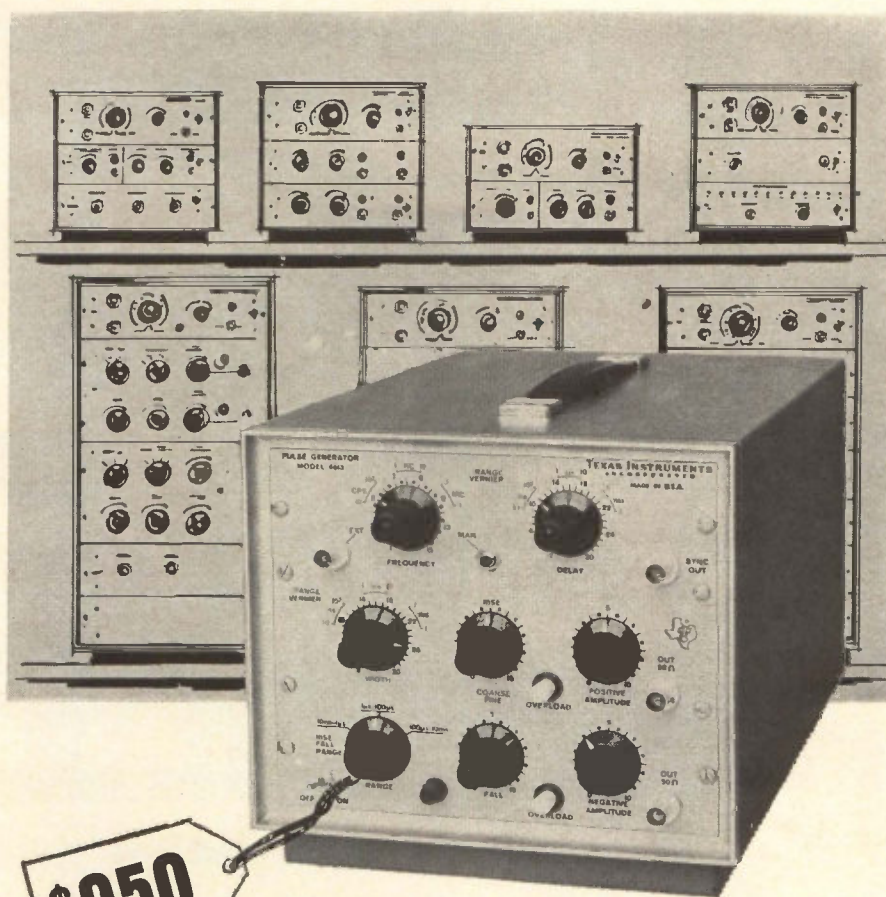

\$950

a new one off the shelf... quality, high-spec pulse generator

The Model 6613 General Purpose Pulse Generator fills the need for a low-cost, high-quality test instrument with exceptional performance specifications. It is a general purpose instrument ideal for most pulse applications such as testing integrated circuits, digital circuit design, system design and checkout, testing of diodes and transistors.

The 6613 provides coincident positive and negative pulses determined by an internal clock generator or external source, with rep rate variable in 6 steps. Pulse width and delay are also variable in 6 steps. Amplitude is variable from near zero to 10 volts, with overload protection provided. Solid-state circuitry is utilized throughout. The compact unit measures 8½ in. high, 8½ in. wide, 12 in. deep and weighs only 10 lb.

SPECIFICATIONS

Clock Pulse Repetition Frequency

15 cps to 150 cps	15 to 150 kc
150 to 1500 cps	150 kc to 1.5 mc
1500 cps to 15 kc	1.5 mc to 15 mc

Delay

30 to 300 nano-sec	30 to 300 microsecs
300 nanosecs to 3 microsecs	300 microsecs to 3 millisecs
3 to 30 microsecs	3 to 30 millisecs

Width

30 to 300 nano-sec	30 to 300 microsecs
300 nanosecs to 3 microsecs	300 microsecs to 3 millisecs
3 to 30 microsecs	3 to 30 millisecs

Pulse Amplitude—10 v into 50 ohms

Rise and Fall Times—variable; less than 10 nanosecs to 1 microsec, 1 microsec to 100 microsecs, 100 microsecs to 10 millisecs, minimum rise time typically 8 nanosecs

INDUSTRIAL
PRODUCTS
GROUP



TEXAS INSTRUMENTS
INCORPORATED
P. O. BOX 66027 HOUSTON, TEXAS 77006

663

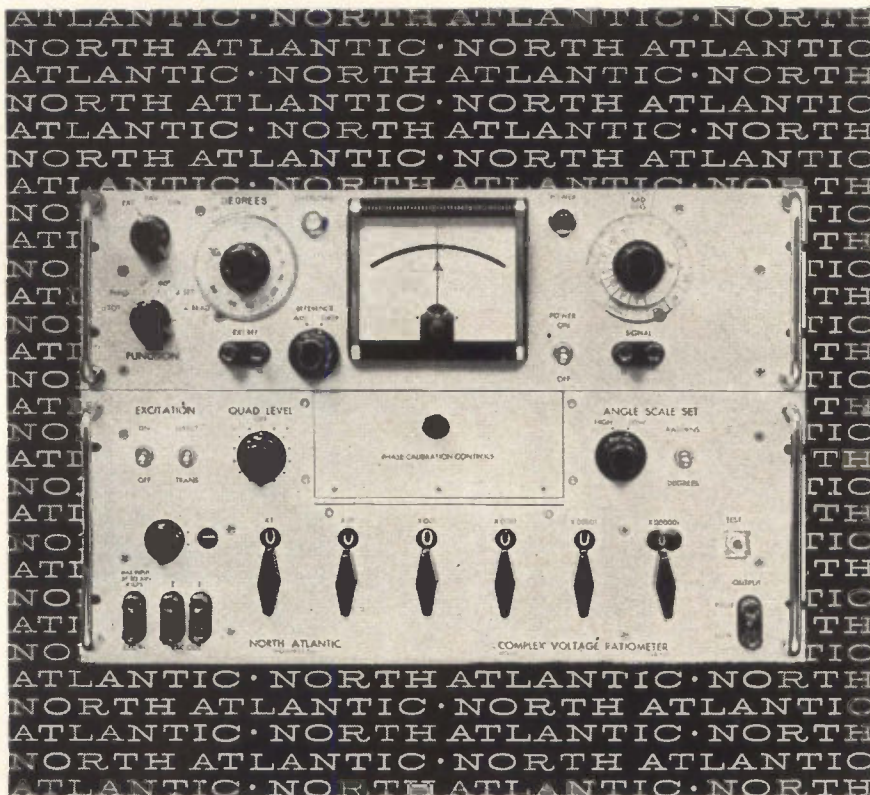

how to measure ac ratios regardless of quadrature

North Atlantic's Complex Voltage Ratiometer is a completely integrated test set for measuring grounded 3 terminal networks. By providing self-calibrated quadrature injection, the Model CVR-551 permits calibrated meter readings of phase angle up to 30° or 300 milliradians full scale, and, in addition, provides direct readings of in-phase and quadrature voltages. As an added feature, the integral Phase Angle Voltmeter* and AC Ratio Box can be used independently. Abridged specs follow:

In-Phase Ratio Range, R_T000000 to ± 1.111110 with full accuracy
In-Phase Ratio Error, ΔR_110ppm (typical for small angles)
Phase Angle Range, α	± 1.0 to ± 300 mr. (6 calibrated ranges) ± 0.1 to $\pm 30^\circ$ (6 calibrated ranges)
Phase Angle Error, $\Delta\alpha$	0.1mr. or .006° (for lowest ranges) 10mr. or 1° (for highest ranges)
Frequency	Any specified frequency, 50cps to 3KC
Bandwidth	$\pm 5\%$ with full accuracy
Phase Angle Voltmeter (used independently)	$\pm 2\%$ full scale 300 microvolts to 300 volts (13 calibrated ranges)
Inverting AC Ratio Box (used independently)	2 ppm terminal linearity .35f volts (300 volts max.)

North Atlantic's CVR* line includes 2 and 3 frequency models. All models available with optional 10 ppm Ratio Box control of quadrature injection.

Send for data sheet or contact your local North Atlantic sales representative now for complete information.

*Trademarks



NORTH ATLANTIC industries, inc.
TERMINAL DRIVE, PLAINVIEW, L. I., NEW YORK • OVERbrook 1-8600

program with researchers from the University of Michigan to determine requirements for the best stimulator design.

"We know if you stimulate too hard you can break the joint or burn the muscle," Ko says. Yet, "if you stimulate too softly, it is not enough to make the muscle do the work."

Ko predicts that the stimulator design will take at least as long to develop as did the transmitter circuit design. That took three years and four model changes.

Walking is complicated. Applying telemetry to medical subjects, Ko points out, is not pure engineering. "You don't really know what you want to do. Walking, for instance, is a highly complicated task. If you wanted to design a machine to reproduce this function, would you choose a wheel, or two or three wheels, or a skip-and-jump mechanism? A great deal of the developmental work is involved in discovering exactly what it is you want to do."

Another problem that requires further study is the effect of body tissues on the characteristics of a device after an implant. Short-term infections may change the properties of the device.

It is believed that it may take as much as three to four months to stabilize these conditions. The longest duration of a transmitter implant to date is four months.

Aid to medical research. Beyond its application in the closed-loop system for the disabled, the transmitter is expected to yield valuable new data for medical research on muscle waves (EMG), respiration

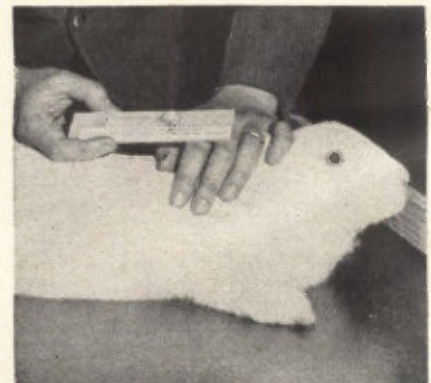

Transmitter implanted in rabbit is similar to model seen on card. It is potted with battery and magnetic switch.



Plastic bubble behind Ko is a clean room. Protective films filter out ultraviolet light.

waves (EEG) and brain waves (EEG). These are not nearly as well understood as heart waves (EKG), on which there already has been considerable research.

Scientists know what each portion of the heart wave means and can quite accurately diagnose the condition of the heart and related organs, but they are just beginning to decipher the other waves.

"In EMG," says Ko, "we know only that if a person is active, the muscles send out waves. If he is at rest, the waves are not as large."

Body dynamometer. The next device to be designed by the solid-state group will measure force, acceleration and displacement in an organ of the body when responding to exterior force. The principle of variable capacitance, as in a capacitance microphone, will be used. The circuit will be a modification of the fifth transmitter design. [Electronics, Sept. 20, 1963, p 15.]

All of the devices used by the Case engineers have been discovered by others. However, the solid-state group makes special versions of several components for its own uses. For instance, tunnel diodes made at Case are smaller and have less noise and greater sensitivity than commercial varieties. Backward diodes with large capacitance (300 to 500 picofarads) also are produced. When Case buys components, such as variable capacitors, it makes its selection from a lot, to get devices 10 to 50 times more sensitive than the average commercial component.

NEW! PORTABLE! . . . FOR CALIBRATING VOLTMETERS, RECORDERS, OSCILLOSCOPES

(and other ac and dc voltage-sensing devices)

. . . *Ballantine's New DC/AC Precision Calibrator*

- Portable
- 0-111 volts ac or dc
- RMS or peak-to-peak at 400 or 1000 cps
- 0.15% accuracy
- Digital read-out
- 10% line voltage change causes less than 0.05% change in output voltage

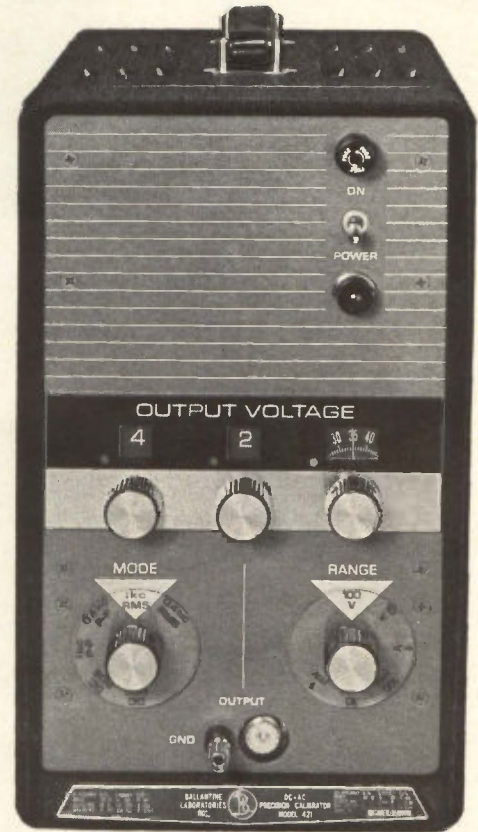

 **Model 421 Price \$600**

Ballantine's Model 421 DC/AC Precision Calibrator has been designed for easy portability so that it may be taken to the instruments to be checked or calibrated, rather than to require that these instruments be brought to the calibration department. Accuracy and stability of output under conditions of widely varying power line voltage and ambient temperature are necessary requirements. The specifications show how well these requirements have been met. Versatility of output including a wide range of voltage, choice of dc or ac, choice of 400 cps or 1000 cps, and a choice of rms or peak-to-peak, multiply the applications in which Model 421 is useful. A left-to-right digital read-out of whatever voltage is selected, plus the proper location of the decimal point, simplifies its use. There are no adjustments to make other than selecting the desired mode and amplitude. 19 inch relay rack versions are available for fixed installations.

Write for brochure giving many more details

— Since 1932 —

 **BALLANTINE LABORATORIES INC.**
Boonton, New Jersey

CHECK WITH BALLANTINE FIRST FOR LABORATORY VACUUM TUBE VOLTMETERS, REGARDLESS OF YOUR REQUIREMENTS FOR AMPLITUDE, FREQUENCY, OR WAVEFORM. WE HAVE A LARGE LINE, WITH ADDITIONS EACH YEAR. ALSO AC/DC LINEAR CONVERTERS, CALIBRATORS, WIDE BAND AMPLIFIERS, DIRECT-READING CAPACITANCE METERS, AND A LINE OF LABORATORY VOLTAGE STANDARDS 0 TO 1,000 MC.

... FREQUENCY MULTIPLIERS ...

another **AEL** major

BREAKTHROUGH!

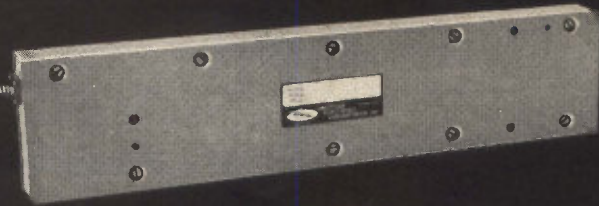

AEL AEL model MT829A

12% instantaneous bandwidth (1 Gc) at X-Band

This AEL frequency multiplier has a circulator built into the input circuit network to maintain an input VSWR of less than 1.5:1. Other specifications are:

- Input frequency S-Band
- Output frequency X-Band
- Input power Up to 1.5 watts
- Conversion efficiency 10 db

This is just one example of the outstanding developments that AEL is making in the field of frequency multipliers.

Do you have a requirement for a complex, state-of-the-art frequency multiplier? Then bring it to us for development. We concentrate on the really difficult problems. And with AEL, you can be confident that our extensive creative experience in the microwave field will be applied to your problem.

AEL is your most qualified source for custom development of FREQUENCY MULTIPLIERS operating from DC up through X-Band.

- 1** Wide band, medium power frequency multipliers
- 2** Narrow band, high power frequency multipliers

Write for complete details.



American Electronic Laboratories, Inc.
P. O. BOX 552, LANSDALE, PENNA. 19446 • (215) 822-2929
suburban Philadelphia

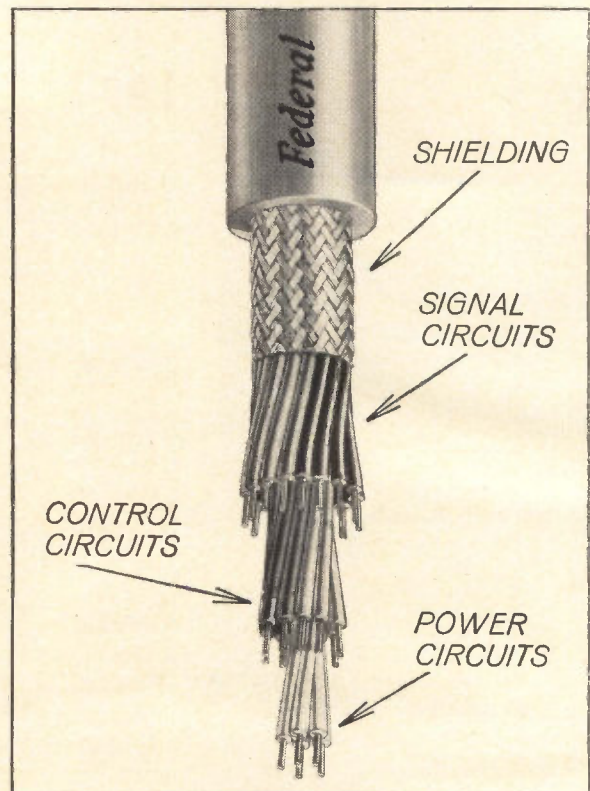

32 power, control & signal circuits in one Federal cable

This Federal multi-conductor cable will handle:

- 16 signal circuits
- 11 control circuits
- 5 power circuits

... all within one shielded jacket! This is a standard Federal cable available from stock.

Royal Electric has designed and built multi-conductor cables for a variety of applications ranging from office intercom systems to the vast BMEWS network.

For more information, contact your nearest Royal representative, or write Royal Electric Corporation, a subsidiary of International Telephone and Telegraph Corporation, Pawtucket, Rhode Island.

ITT ROYAL

Digital thermometer covers wide range

Interchangeable probes provide added flexibility in this thermistor-based, fully automatic unit

Meter-type thermometers are commonly limited to a narrow temperature range. They can cover wide ranges only by cumbersome range switching. The DigiTec series 500 digital thermometer, however, provides a solution to the problem of highly accurate measurement over a wide range of temperatures. It offers, in a single wide range, convenient digital readings instead of the usual meter deflections, and permits a resolution of 0.02% of span.

Model 500 covers 59°F to 122°F with an accuracy of $\pm 0.15^\circ\text{F}$. Model 501 has a range of 0°C to 100°C with a $\pm 0.15^\circ\text{C}$ accuracy. Model 502 is a special instrument having a fixed span of 20°C (set anywhere between -50°C and $+150^\circ\text{C}$) with an accuracy of $\pm 0.1^\circ\text{C}$.

The instrument is based on a null-seeking Wheatstone bridge circuit. It has all the advantages of the Wheatstone bridge circuit and, in addition, it is fully automatic and direct reading. Manual balanc-

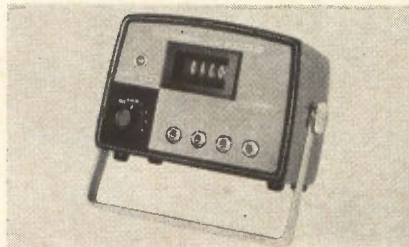

ing is completely eliminated. Principle of operation is illustrated in the block diagram.

Flexibility. The DigiTec thermometer is claimed to be inherently more flexible than any other known temperature-measuring device. A self-contained probe selector switch permits scanning of four temperature points. A complete line of interchangeable probes is available for solids, liquids, gases, or surface temperature measurement. The flexibility is enhanced by the availability of both optional analog output for strip chart recording, and optional binary-code-decimal digital output for digital printing or direct input

to computer applications.

Model 500 lists at \$345.00.

United Systems Corp., 918 Woodley Road, Dayton 3, Ohio.

Circle 301 reader service card

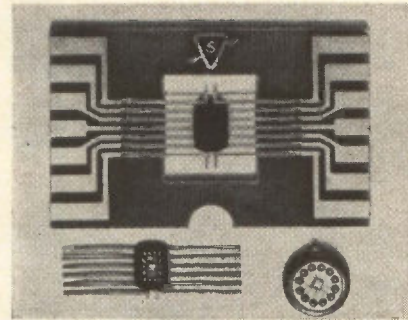

Integrated circuits offer 10-nsec switching

Low-cost, single-chip integrated circuits with switching speeds of 10 nanoseconds come in 11 types (9 gates and 2 flip-flops) that operate on a single power supply. Made on a silicon base, the circuits use the monolithic epitaxial technique which is said to provide greater noise protection, higher switching speeds and higher fan-out than most other commercially available integrated circuits. They have a high level logic swing of 0.38 to 3.4 v with worst case noise rejection up to 800 mv at room temperature, or 500 mv at an elevated temperature, and a capacitance drive capability up to 600 pf. They are designed to provide a fan-out capability of 7. The circuits are 0.050 in. square and are 0.006 in. thick, and contain the equivalent of 28 active and passive components on each chip. Prices range from \$9 to \$40 in quantity lots in to TO-5 package. Flat packs with glass tops and Kovar leads are available at slightly higher cost. Sylvania Electric Products, Inc., Woburn, Mass. [302]

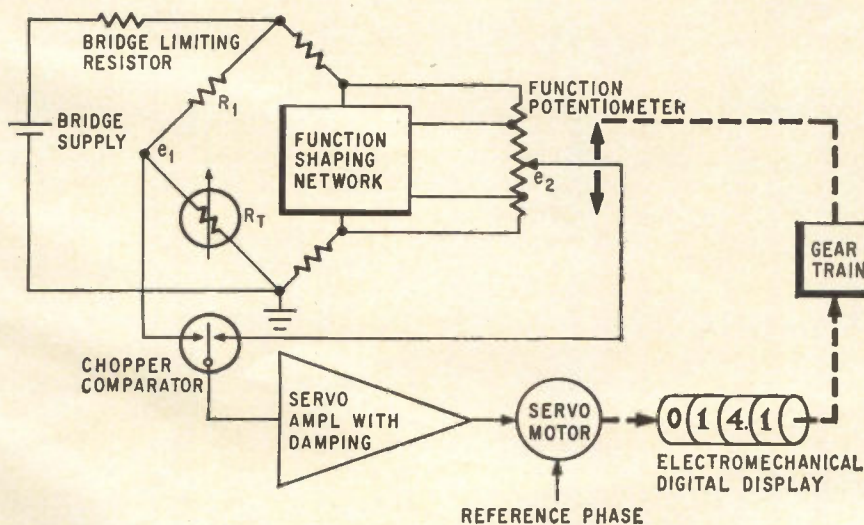

Chopper comparator compares the temperature-dependent half of the bridge (e_1) with the position of the slider of the function potentiometer (e_2). The servomechanism continually balances e_2 against e_1 , causing the temperature of the precision interchangeable thermistor probe R_T to be read out by the digital display directly in degrees of temperature.

Amplify 15 cps to 180 mc signals

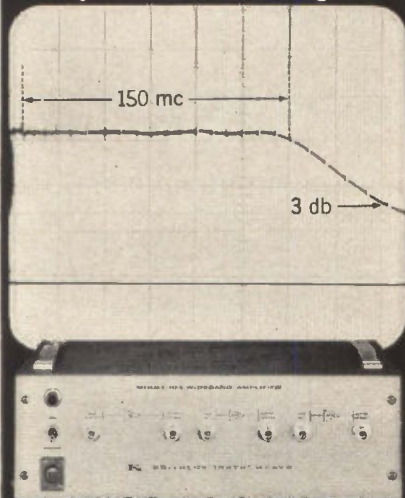

WITH NEW KEITHLEY 104

The Model 104 contains three separate amplifiers. Two amplifiers, each with a gain of 10 into 50 ohms and input impedance of 50 ohms, may be used individually or cascaded for an over-all gain of 100. (Two 104's may be cascaded for a maximum gain of 10,000.) A third amplifier having unity gain and one megohm, 10 pf input impedance is provided for impedance matching. It allows use of the x10 gain amplifiers in high impedance circuits and permits them to be used directly with other coaxial systems. Applications include use as a low level oscilloscope preamplifier and wideband pulse amplifier.

SPECIFICATIONS FOR EACH X10 GAIN AMPLIFIER

- Frequency: 3db, 15 cps to 180 mc; ± 0.5 db, 25 cps to 150 mc
- Gain into 50 ohm load: 10 (20db)
- Input impedance: 50 ohms
- Rise time: less than 3 nanoseconds
- Max. rms noise (referred to input): 35 microvolts (8db)
- Max. output into 50 ohm load: 1.4 volts, p-p

Price: \$675. Send for Engineering Note further describing the Model 104 Wideband Amplifier and accessories.



**KEITHLEY
INSTRUMENTS**

12415 Euclid Avenue • Cleveland 6, Ohio

New Components and Hardware

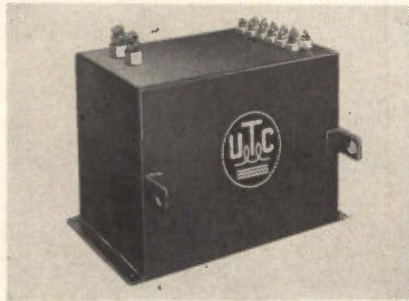

Filament transformer limits current

The transformer above controls current to the filament on high-power transmitting tubes operating in the kilowatt to megawatt ranges. Having multi-tapped inputs, it is designed to operate at an output of 12 v, 300 amp. Special design techniques are incorporated to limit current to 1,000 amps maximum output. This feature protects the tubes from excessive current surges and extends their life. The transformers are manufactured and guaranteed to MIL-T-27B. They are engineered to Grade 4, Class S, Life X, and withstand a 500-v test. United Transformer Corp., 150 Varick St., New York 13. [311]

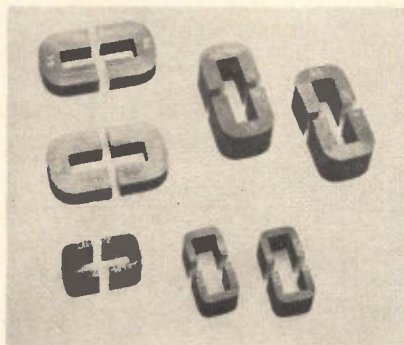

Four-mil C cores with low power losses

A new line of four-mil oriented C cores of silicon steel consists of units from the smallest size up to about 4½ inches in over-all length. The cores are produced by new manufacturing techniques with special emphasis on maintaining precise dimensional and electrical uniformity to assure easy assembly

and low power loss. The cores operate continuously in temperature ambients over 390° F without deterioration of the interlaminar bond, according to the manufacturer.

G-L Electronics, a division of G-L Industries, Inc., 300 Harvard Ave., Westville, N.J. [312]

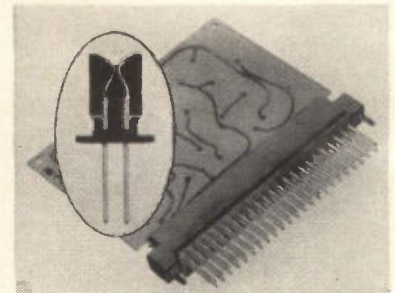

P-c receptacles have spring contacts

One-piece taper leaf spring contact with 0.045-in. square wire-wrap terminal is available in a new series of edge-type printed-circuit receptacles. The contact and terminal are forged in one piece from 0.045-in. square phosphor bronze, to eliminate welded joints. The spring tempered phosphor bronze has maximum retention characteristics and provides consistent performance under severe operating conditions. The square terminal post provides the optimum configuration for highly reliable electrical connections in high speed, wire-wrap production operations. Precision Connectors Division, Electronic Fittings Corp., 29 Sugar Hollow N. J. [313]

Standard studs are beryllia-insulated

A new line of beryllia-insulated studs, for double-ended stud transistor packages having all transistor elements isolated from the case, is available. The use of beryllia provides high thermal conductivity with complete electrical isolation. Brazing of pins to the beryllia surface eliminates glass from the stud. Standard copper studs are available in $\frac{7}{16}$ -, $\frac{9}{16}$ -, and $\frac{11}{16}$ -in.

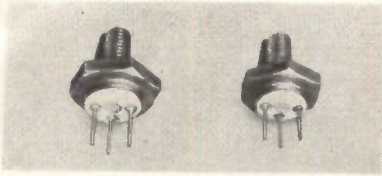

sizes, with a metallized and gold-plated pad on the beryllia disk for attachment of the die and for connection to the collector pin. Emitter and base pins are isolated. Pins are attached to the beryllia and the beryllia to the stud, by high-temperature, high-reliability brazing. National Beryllia Corp., 1st & Haskell Aves., Haskell, N.J. [314]

Indicator light meets military specs

An addition to the company's military series, the Astrolite also has many interesting commercial possibilities. It is said to be one of the smallest indicator lights available using a built-in 60,000-hr T-1 incandescent lamp, operating on 6 v and with a center-to-center spacing of $\frac{1}{8}$ in. A $\frac{3}{8}$ -in.-diameter plastic lens provides 180° visibility. Drake Mfg. Co., 4626 North Alcott Ave., Chicago, Ill. 60656. [315]

Edge connector for computer circuits

Flexible Reli-Acon edge connector is designed for computer, test equipment and card frame applications. The RD series provides the user with the option of utilizing its high density termination capability of up to 62 contacts for dual sided boards. Or, it provides an inexpensive method of common termination for each pair of contacts in the connector. The latter

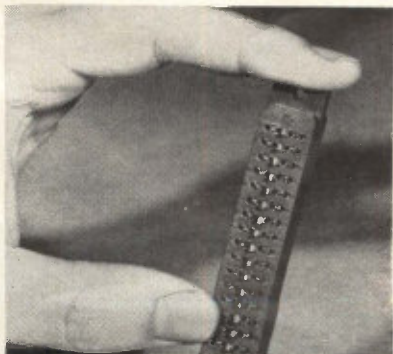

WATCH DEI

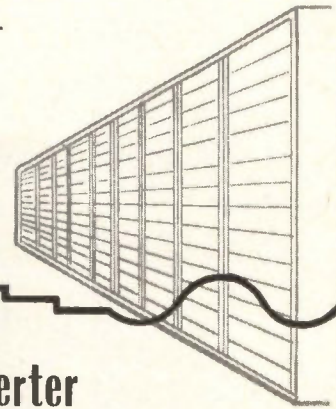

PCM D/A Converter

New 20 Channel D-A Converter "Package".

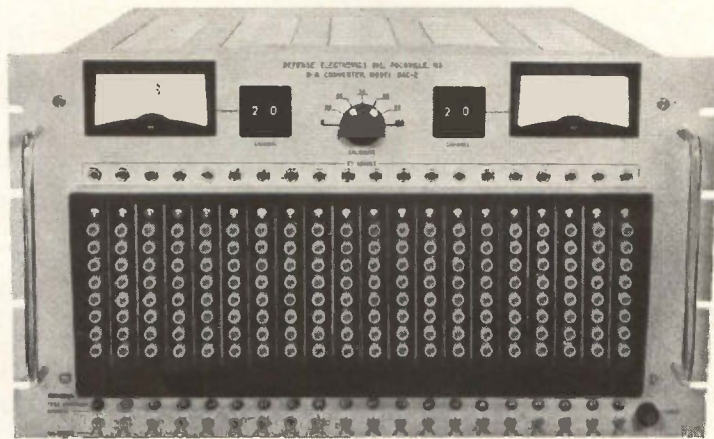

- Self-Contained Calibrator
- Integral Binary Display
- Self-Contained Power Supply
- High Linearity and Stability

The new modular DAC-2 from Defense Electronics, Inc. offers linearity of $\pm 0.1\%$ and overall accuracy of $\pm 0.25\%$ for digital-to-analog data conversion in PCM sub-systems . . . plus a self-contained calibrator and power supply.

The compact unit has 20 eight-bit, digital-analog converter channels, each with its own integral binary display. Storage of data samples in each channel is shown by eight incandescent lights.

A versatile and flexible d-a converter "package", DAC-2 permits calibration of any one or a selected group of channels without disturbing operation of remaining channels. Monitoring of percent of full-scale and output voltages by front-panel meters is also provided. Thumb wheel switches select the channels to be metered.

Input of each module is eight data lines and one transfer line and output furnishes sufficient current for driving analog displays, recorders and galvanometers. The unit will operate at word rates up to 100kc.

Ask for the DAC-2 Bulletin . . . Watch DEI



DEI
RESEARCH
DEVELOPMENT
MANUFACTURING

Defense Electronics, Inc.

ROCKVILLE, MARYLAND
PHONE (301) 946-2600 TWX 307-949-6788
SHERMAN OAKS, CALIFORNIA PHONE (913) 872-2870

Go ahead,
promise
long tube
life

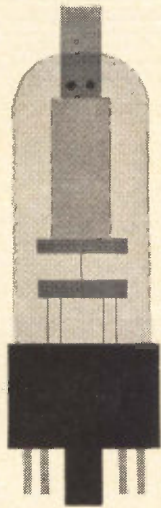

Superior
cathodes
will back
you up

Once your electron tubes are plugged into a circuit, your reputation will depend on the performance of the cathodes you use. Do you want tubes with long life, high shock resistance, uniformity, high-temperature tolerance, and various other desirable characteristics? Choose your cathodes from the broad Superior line. Write us for a copy of Catalog 51. Superior Tube Co., 2500 Germantown Ave., Norristown, Pa., 19404.

Widest choice of cathode alloys

Includes regular commercial materials, plus the versatile Cathaloy® series, developed by Superior before approval for production.

Cathaloy A-31. For extreme stress applications. 4% tungsten. Approximately twice as strong as tungsten-free alloys.

Cathaloy A-32. Contains 2% tungsten. Excellent emission, rapid activation, very low sublimation and interface impedance.

Cathaloy A-33. All-purpose cathode alloy. Combines high emission with freedom from sublimation and interface impedance.

Cathaloy P-50. Long-life passive alloy for high-reliability power output tubes requiring low grid emission.

Cathaloy P-51. 100% stronger than P-50 at high temperatures. For use in tubes subject to shock and vibration.

Nickel 220, Nickel 225, Nickel 230 and Nickel 233 ("330 Nickel"). Contain silicon and magnesium. Rapid activation.

Driver-Harris 399, 599 and 799. Silicon activated. Rapid activation, plus high-level d-c emission.

Widest choice of cathode forms

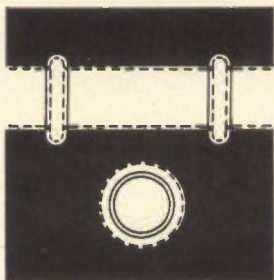

Seamless WELDRAWN.® No seam. Can be made to close tolerances.

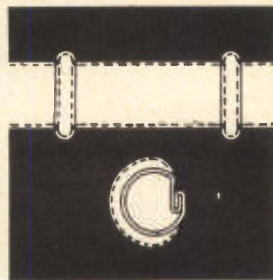

Lockseam.® Available with serrations, vertical rib or integral tab.

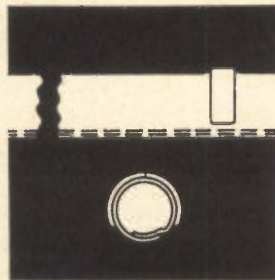

Lapseam. Gives tighter fit in mica. Available in rounds and shapes.

*Manufactured under U.S. patents



Disc cathodes. One of four basic types. Separate cap alloy. Close control of E-dimension. Shadow groove. Flared shank.

Superior Tube 

The big name in small tubing
NORRISTOWN, PA.

West Coast: Pacific Tube Company, Los Angeles, California

Johnson & Hoffman Mfg. Corp., Carle Place, N.Y.—an affiliated company making precision metal stampings and deep-drawn parts

New Components

is accomplished by a jumper bar made of contact material which spans the dual taper pin receptacles and positively interconnects the contacts. The RD connectors are available with contact spacing from 0.100 to 0.156 in. for either the single or bifurcated contact designs. Individual removal of damaged contacts is accomplished by a simple tool inserted from the front of the connector which releases the contact locking fingers and ejects the entire contact. A new contact can be inserted rapidly from the insulator's rear. Methode Electronics, Inc., 7447 W. Wilson Ave., Chicago, Ill. [316]

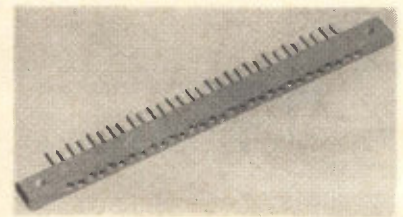

Test point connector admits 0.08 probe

A test point connector with conveniently located points to check printed circuitry is available. Type 672-27-53, a 30-contact unit, has cup terminations that accept "AMP 53" taper pins (if desired, solder cups can be supplied instead). The sockets are designed to admit and hold securely an 0.080 test probe. A staggered contact arrangement provides maximum creepage path for a 0.165 in. center-to-center spacing of 30 contacts on an overall body size of 6 1/8 in. Body material is glass filled diallyl phthalate type GDI-30 according to MIL-M-19833 specifications.

Continental Connector Corp., 34-63 56th St., Woodside 77, N.Y. [317]

Sealed thermostat protects equipment

Tiny thermostat designed for crystal ovens, or wherever costly equipment is to be protected from overheating, is hermetically glass sealed

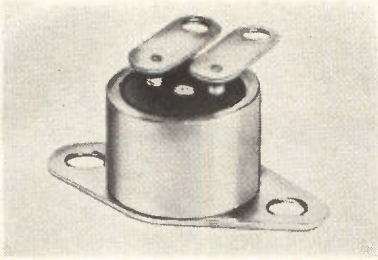

and heliarc welded. Contacts are arranged spst. Unit is ideal for narrow-differential applications, as low as 2 to 4 F. The No. 3305 is electrically rated at 2 amp, 115 v a-c, 50 kc; or 1 amp, 115 v a-c or 30 v d-c, 100 kc. Thermal ratings are -65 F minimum to +300 F max. Dielectric strength is 1,250 v rms, 60 cps for 1 minute. Price is from \$2.45 to \$10.00 per unit depending on quantity.

Elmwood Sensors, Inc., 1655 Elmwood Ave., Cranston, R.I. 02907. [318]

Miniature capacitors offer high precision

New line of high-precision miniaturized polystyrene and metalized Mylar capacitors features an operating temperature range of -55° to +200° C while maintaining tolerances as close as 0.05%.

Electronic Associates, Inc., Long Branch, N.J. [319]

Rack cabinet mounts 19- or 24-inch panels

Model R-147 rack cabinet features stressed skin construction with specially formed corners to provide rigid vertical support and horizontal strength. Design eliminates the need for high-cost angle reinforcement. Unit is available with either rear panels or doors and can be supplied with neoprene or rfi gasketing. The front of the cabinet has universal mounting holes and cabinets are available to mount either 19-in. or 24-in. panels. A top cap permits maximum ventilation and also protects the inside of the cabinet from direct water spray. The R-147 is well suited for use in ground support installations, testing labs, communications centers and industrial plants. It meets commercial and military specs.

Falstrom Co., Passaic, N.J. [320]

unsurpassed for PCM

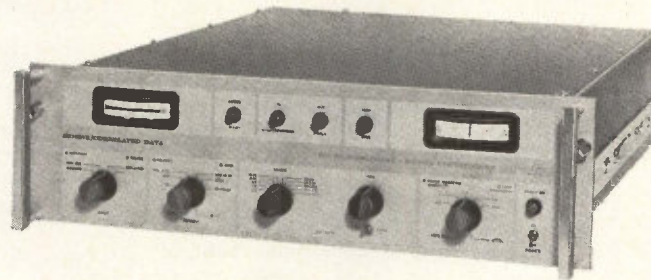

Bit synchronizer and signal conditioner

Near optimum performance in the establishment of bit sync and the reconstruction of noise-free information from serial PCM Telemetry data is accomplished with the Bendix-Pacific Model SC-1100 Bit Synchronizer and Signal Conditioner. This performance is provided over a wide range of bit rates and signal-to-noise ratios.

Model SC-1100 is readily integrated into a wide variety of telemetry and communications installations. It can be used as a PCM ground station element which recreates a bit rate clock and uniform data bits from serial PCM obtained from hardline or R-F communications link, magnetic tape, or signal simulators. It likewise can be applied as a regenerator for conversion of various telemetry patterns to direct and complement NRZ, and direct and complement Split-Phase formats. For complete information contact Bendix-Pacific, North Hollywood, California.

BRIEF SPECIFICATIONS

- All silicon semi-conductor circuitry.
- Continuous bit rate coverage from 8 to 1,000,000 BPS.
- Formats: RZ, NRZ, NRZ (1), NRZ (0), Split-Phase and RZ Bi-Polar.
- Positive sync status determination, display and contact closure down to S/N ratio of 0 db.
- Automatic baseline control loop for reducing errors.
- Selectable bit rate and code format.
- Incoming signal amplitude and sync loop error voltage.
- Reconstructed converted data to direct and complement NRZ and Split-Phase codes.
- Analog automatic phase control loop for lowest jitter in the reconstructed clock.
- Slide mounted for standard 19" rack, 5 1/4" high.



Also available—
complete PCM
and FM/FM
ground stations.

Bendix-Pacific Division



DATA COMMUNICATIONS • DYNAMIC CONTROLS • RADAR AND GUIDANCE • USW AND OCEAN SCIENCES.



ENGELHARD Thermometal® and contacts give this Briles circuit breaker “fire-and-ice” reliability

With two Hound-Dog missiles tucked snugly under its wings, the Boeing B-52 Stratofortress represents one of America's most potent jet-age weapons . . . a modern arsenal in flight capable of operating successfully in extremes of heat and cold.

And it is precisely in such extremes that Engelhard is making significant contributions to aerospace technology.

Engelhard metallurgical trail-blazing produced the Thermometal and contacts for this circuit breaker made by Briles Products, El Segundo, California — performing perfectly as the B-52 encounters extreme temperature environments at high and low altitudes.

Blazing new trails is just one more aspect of Engelhard metallurgical activities. For information write to Technical Service Department.

96



Some other

ENGELHARD products

GOLD COATING on printed circuits, knobs and other parts is simple and effective with Atomex® Solution. 24K gold is deposited by ionic displacement in a thin, dense, uniform protective layer. Atomex is the first practical gold coating solution with no free cyanide.

FUSED QUARTZ components are fabricated in all sizes and shapes for electronic use. For example: coil forms, vacuum furnace chambers, lamp bodies and high-voltage insulators. One millimeter thickness provides absolute protection against 10,000 volts. Transparent, translucent and optical grades available.

THIN WIRE AND FOIL are produced by Engelhard's Baker Platinum Division to meet rigid electronic design requirements. Both extruded and Taylor Process thin wire are available in diameters as small as .001". Thin-gauge foil is supplied in sheets up to 8" x 18".

PLATINUM-CLAD MATERIALS are custom produced for a wide variety of electronic applications. Clad thickness is held uniform to close tolerances. True metallurgical bond to base material prevents flaking and blistering under heat. Cladding is 100% dense.

SILVER PLATING with Silva-Brite® Solution protects components, increases conductivity. Plating is quick, easy, and non-critical at current densities from 10 to 40 amps. Operation at normal room temperature minimizes fumes and bath decomposition.



New Instruments



Monitor controls deposit thickness

Model DTM-2A deposit-thickness monitor works for all types of vacuum deposits. Its sensing unit is an all-transistor, crystal-controlled oscillator in a compact package. Mass is measured by evaluating the change in frequency of the resonating quartz crystal as a deposit builds up on its surface. Normal reproduceable accuracy is $\pm 2\%$. Frequency range is zero to 30 kc. The DTM-2A is a versatile instrument that can be used in the most elaborate process-control systems in the vacuum deposition field.

Sloan Instruments Corp., 331 N. Milpas St., Santa Barbara, Calif. [351]



Device adds d-c to inductance bridges

This self-contained device, when used in conjunction with any inductance bridge, measures inductance directly in henries with superimposed d-c up to 30 amp. These inductance measurements can be made even if the bridge used is designed for limited current. Accuracy of up to 1% may be obtained. Inductances vary from 0 to 50 hen-

ries with 1 amp maximum d-c to 0 to 0.25 henry with 30 amp maximum d-c, in five ranges. The frequency range is 50 to 100 cps and 150 cps to 5 kc.

Industrial Transformer Corp., Gouldsboro, Pa. [352]

Compact laser offers versatile mounting

Unusual mounting versatility is found in the model 600A Minilaser for university and industrial laboratories. The compact laser head is separate from the portable power supply and can be mounted easily in a vertical optical bench, a horizontal optical bench, or in an optical microscope. The laser operates at the standard 6,943-angstrom wavelength. Its output can be as high as five joules using selected ruby crystals. The nominal energy output range is 0.1 to 0.5 joule, depending on the reflectivity of the output end of the ruby rod. Repetition rate of the laser is approximately one pulse every 10 seconds. Pulse width is up to 0.5 millisecond, depending on the energy output. Price is \$995.

Maser Optics, Inc., 89 Brighton Ave., Boston, Mass. 02134. [353]

Analyzer identifies metals and alloys

The Electrospot Analyzer uses a new principle for the study of metal composition in the identification and sorting of metals and alloys. It identifies alloys of aluminum, copper, gold, iron (including the



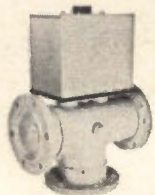

RC21F

VACUUM COAXIAL RELAYS OFFER HIGHEST RELIABILITY

Type RC21F-SPDT Impedance—50 ohms.
Frequency range—0 to 600 mc.
VSWR—1.03 at 200 mc and 1.09 at 600 mc.
Power rating—3 megawatt peak, 20 kw average at 500 mc.
Insertion loss—0.01 db max.

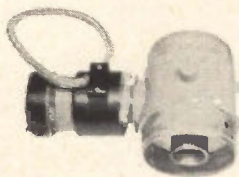

RC10

FOR HIGHER PULSE POWER AT HIGH FREQUENCIES

Type RC10-SPST Impedance—50 ohms.
Frequency range—0 to 100 mc.
Power rating—50 kw average to 60 mc.
VSWR—1.02 max. at 30 mc, 1.05 max. at 60 mc.

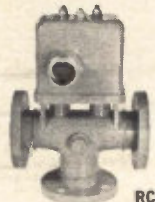

RC6

LOW CONTACT RESISTANCE STAYS PERMANENTLY LOW

Type RC6-SPDT Impedance—50 ohms.
Frequency range—0 to 150 mc.
Power rating—25 kw cw average, 30 mc. @ 1:1 VSWR.
Insertion loss—0.01 db max.



RC5

LOW INHERENT NOISE LEVEL AND LOW LOSS OPERATION

Type RC5-SPST Impedance—50 ohms.
Frequency range—0 to 100 mc.
Power rating—25 kw cw average at 30 mc.
VSWR—1.02 max. at 30 mc.

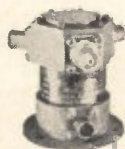

RC41

AVAILABLE IN A WIDE VARIETY OF SIZES AND CONNECTIONS

Type RC41-SPDT Impedance—50 ohms.
Frequency range—0 to 600 mc.
Power rating—2 kw average at 30 mc. for type C connectors, 7.5 kw for type MC.
VSWR—1.05:1 max.

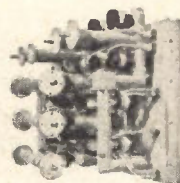

SIMPLE FITTINGS PERMIT EASY ASSEMBLY OF VACUUM RELAYS IN CROSSBAR NETWORKS

Vacuum coaxial crossbar switching systems, due to the inherent advantages of vacuum, offer the ultimate in reliability and speed. The components have been designed for modular expansion. This also allows switch replacement in seconds if necessary.

Jennings vacuum coaxial relays were specially designed to solve the problems of remote switching of coaxial lines of all standard sizes for television, communications, and radar transmitters at high frequencies and high power levels. We will be pleased to send more detailed literature on Jennings complete line of vacuum coaxial relays at your request.

RELIABILITY MEANS VACUUM / VACUUM MEANS *Jennings*

JENNINGS RADIO MFG. CORP., 970 McLAUGHLIN AVE., SAN JOSE 8, CALIF., PHONE CYPRESS 2-4025

New Instruments

stainless steels), lead, nickel, zinc and others by producing on the screen of the unit an identifiable "fingerprint" (or characteristic polar coordinate curve) of the alloy under test. It easily accommodates tube, sheet, rod, cast and wrought stock, and wire regardless of smallness of diameter. The analyzer weighs 25 lb and operates on 117 v a-c at 100 w.

Wescott Laboratories, Pinehurst, N.C. [354]

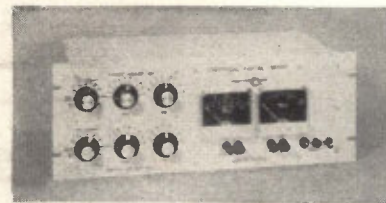

Digital servos for measuring liquids

Universal capacitance measurement servos (analog-digital type) are versatile units designed to cover a wide range of applications in any liquid having a dielectric constant of 1.2 or higher. Both the type GZ-18 noncompensating and GZ-26 density-error compensating units are immune to frequency transients and noise, and easily adapted to telemetry systems. Serial digital output can be supplied by adding a shift register. Analog outputs give both fine and coarse readings with a 32-to-1 ratio between. Range is 30 pf to 12,000 pf; accuracy, $\pm 0.5\%$ from -20° to $+75^\circ$ C. Response time is from zero to full scale in 1.2 sec with no overshoot.

Pioneer Central division of the Bendix Corp., Davenport, Iowa. [355]

D-c/a-c calibrator delivers up to 111 volts

A portable instrument for calibrating of voltmeters, oscilloscopes, recorders and other voltage-sensing devices, the model 421 has an output of 0 to 111 v a-c or d-c. The a-c may be rms or peak-to-peak at either 400 cps or 1,000 cps. Output voltage to four significant figures

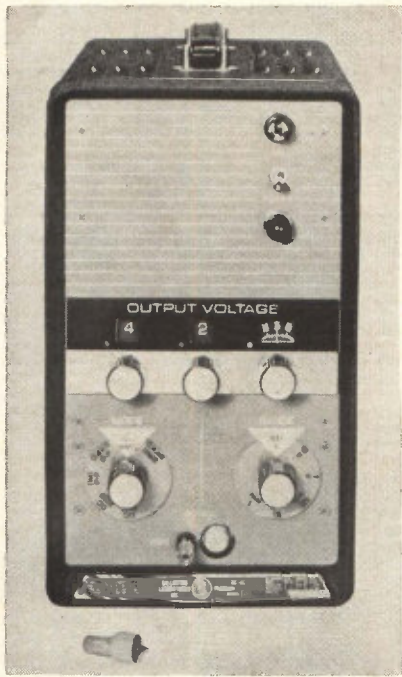

is indicated digitally from left to right. Accuracy is 0.15%. The accuracy guarantee holds for operation from a wide range of power-line voltages and ambient temperatures. The price is \$600. Ballantine Laboratories, Boonton, N.J. [356]



Voltage calibrator avoids short circuits

A precision voltage calibrator with accuracy of $\pm 0.05\% + 5$ mv, model VS-100BR operates over a range of 0 to 1,111 v d-c, 0 to 50 ma and features stability of 0.005% an hr, 0.02% in 30 days. Incorporating an ultrastable Zener reference and silicon transistors, it provides electronic short-circuit protection and 6-digit resolution. The instrument has a fast response regulator and a panel meter that measures output voltage and current. Major applications include voltmeter calibration, use as a d-c standard for thermal transfer a-c measurements, engineering and production-line testing and semiconductor testing. Calibration Standards Corp., 1031 Westminster Ave., Alhambra, Calif. [357]

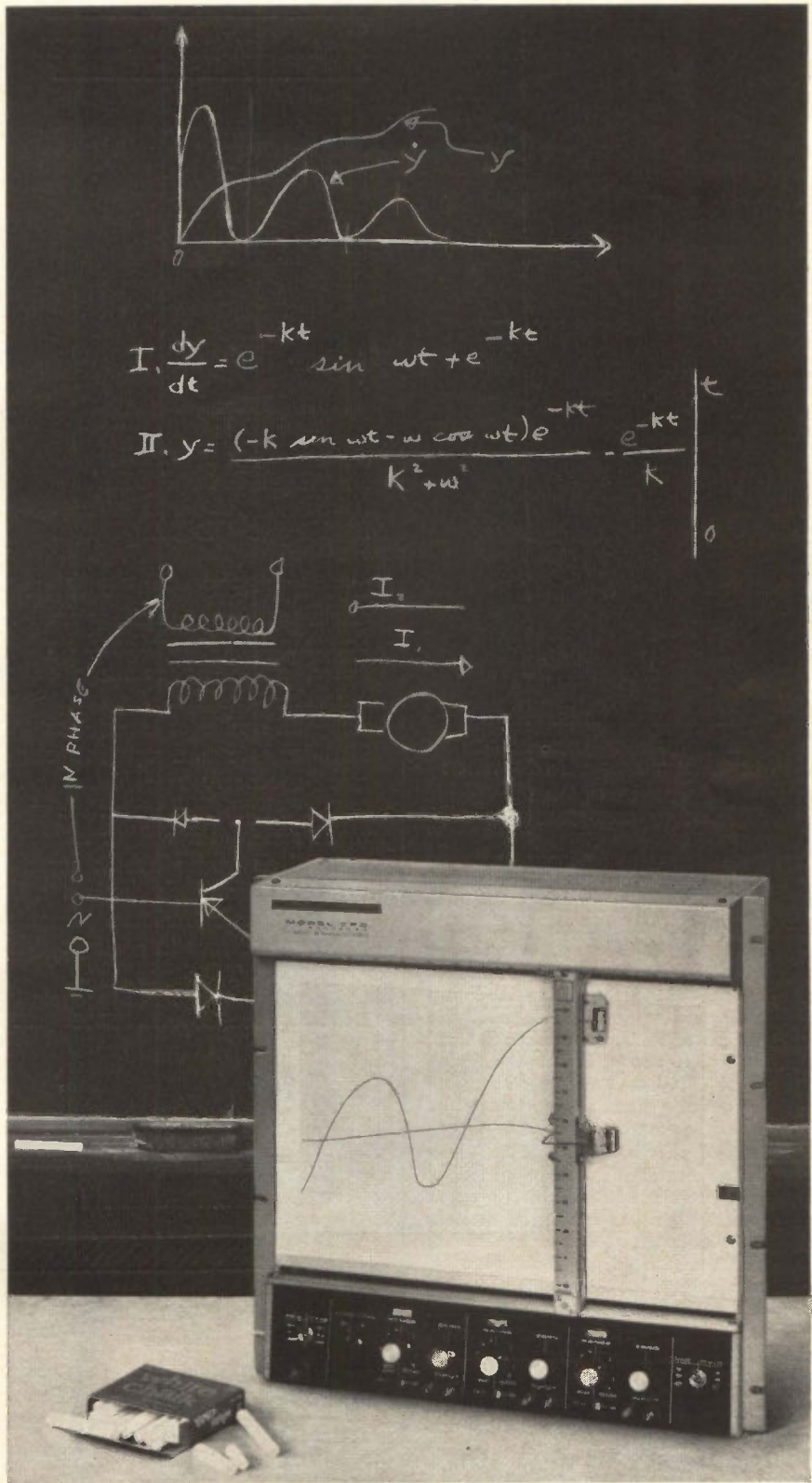

PLOT 2 AGAINST 1 SIMULTANEOUSLY!

DC signals representing related functions plot cartesian coordinate curves on standard 11" by 17" graph paper on the new 2 pen Moseley Model 2FRA. 1 megohm input impedance, 10 input ranges, 0.5 mv to 10 v/in.; alternatively, X-axis internal sweep permits plotting two variables against time, 0.5 to 50 sec./in. Accuracy $> 0.2\%$ of full scale, resettability $> 0.1\%$ of full scale. Servos isolated, free of ground. Event marker pen optional. Rack mount 19 $\frac{1}{4}$ " high. \$3,575. F. L. Moseley Co., 409 N. Fair Oaks Ave., Pasadena, Cal.

MOSELEY 
an affiliate of Hewlett-Packard

8146R

1x10⁻⁹ (torr)

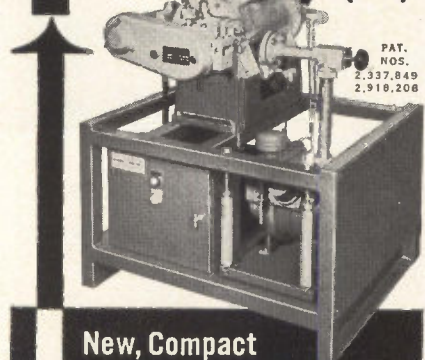

New, Compact **ULTRA-HIGH VACUUM**

Pumping Unit with
Constant Speed Over
Wide Pressure Range!

**BLANK-OFF PRESSURE:
LOWER THAN 1 x 10⁻⁹ TORR
SPEED (AIR):
140 LITERS/SECOND**

The new, Welch 3101A Turbo-Molecular Pumping Unit has a blank-off pressure lower than 1×10^{-9} torr and a constant speed (air) of 140 liters per second over a range of 10^{-2} to 10^{-9} torr. It combines a Welch No. 3101 Turbo-Molecular Pump (manufactured under a license of the Becker patent for the U.S.A. and Canada) with the well known Welch "Duo-Seal" No. 1397, two-stage mechanical pump in a completely assembled and tested package, ready for use.

The clean, vapor-free, No. 3101 Turbo-Molecular Pump embodies a major advance in the design of molecular pumps which permits the use of running clearance as much as ten times that of previous designs. Risk of damage by sudden air inrush, thermal expansion and dirt particles has been eliminated. Higher pumping speeds and pressure ratios than previously attainable, have been achieved.

APPLICATIONS

Wherever a vapor-free, high or ultra-high vacuum is required. TYPICAL USES: • Solid state studies • Semi-conductor production • Thin film metallizing • Purification of metals such as silicone and germanium • Optics coating • Separation of gases of different molecular weights • Space simulation chambers • Mass spectrometers • Roughing ion pump systems • Particle accelerator and target chamber evacuation • Evacuation of power tubes and x-ray tubes.

Send for Bulletin
3101A today!



WELCH THE WELCH SCIENTIFIC COMPANY
foremost manufacturers of scientific equipment

1515 Sedgwick St., Dept. 906, Chicago, Ill. 60610

New Semiconductors

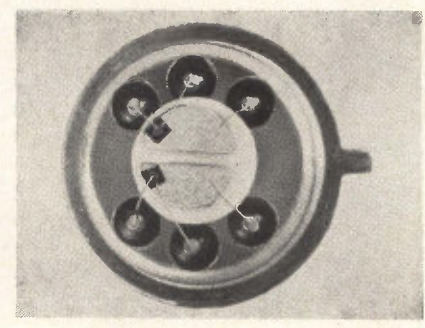

H-v transistor pair is single-packaged

Two high-voltage types of single-packaged complementary dual silicon transistors are offered for high-speed switching and d-c to uhf amplifier circuits. Available with pnp and npn Star transistors (MD 985), or pnp and npn low-circuit, small-geometry transistors (MD 986), the units make possible equipment space and weight reduction, as well as easier circuit assembly for the user. Both devices utilize two electrically isolated silicon annular transistors in a single 6-lead low-profile TO-5 package. Motorola Semiconductor Products Inc., Box 955, Phoenix, Ariz., 85001. [331]

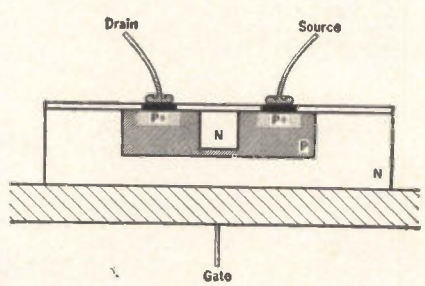

Field-effect transistor has low leakage

The cross-section of the 2N3277 field-effect transistor shows one way in which design helps to insure high performance. In addition to low leakage, low pinch-off voltage and high gain, this structure offers the advantage of having the conductive channel isolated within the semiconductor substrate. This eliminates noise-creating surface effects. The 2N3277 has the following electrical characteristics: input

impedance, 50 megohms at 1 kc; leakage, 0.4 nanoamp max, V_{DG} 10 v; noise figure, 0.7 db max, R_S equal to 10 megohms at 1 kc; transconductance, 100 μ mho minimum at 1 kc; drain resistance, 0.5 megohm minimum, V_{DS} equals 10 v; and gate pinch-off voltage, 5 v maximum with drain current at 1 nanoampere.

Fairchild Semiconductor, 545 Whisman Road, Mountain View, Calif. [332]

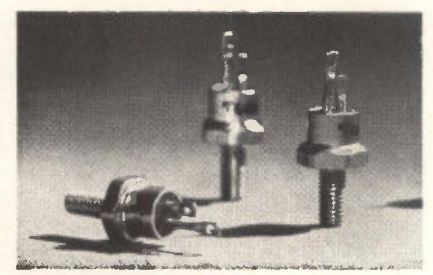

Stud-mounted scr's made by planar process

Said to be the industry's first planar silicon controlled rectifiers, the series TCR50-56 are stud-mounted and feature leakage as low as 10 μ a at 25° C. In addition to the reliability provided by the planar manufacturing process, the new device provides self-bias to assure greater stability at high temperatures. Minimum forward and reverse breakerover voltages of the units are: TCR50, 50 v; TCR51, TCR52, 100 v, 150 v; TCR53, 200 v; TCR56, 400 v. Prices for quantities of 1 to 99 range from \$7 for the TCR50 to \$23.65 for the TCR56. Transitor Electronic Corp., 168 Albion St., Wakefield, Mass. [333]

Epitaxial design for power devices

High-power silicon transistors are being manufactured with epitaxial construction. Units can switch 20 amp in less than 1 μ sec. Collector-to-base voltage of 120 or 150 v can switch 25 amp. Typical high-power switching applications for the types 2N3263, -4, -5 and -6 include switching control amplifiers, power gates, switching regulators, d-c to

d-c converters and d-c to a-c inverters. High circuit efficiency is also attained when the devices are used as d-c to r-f amplifiers and power oscillators.

RCA Electronic Components and Devices, Harrison, N.J. [334]

Silicon rectifiers handle high current

A diffused-junction silicon rectifier in a miniature (0.15 in. diameter, and 0.360 in. long), hermetically sealed glass package, has a rated recovery time of 100 nsec or less, which makes it ideal for high-frequency rectification and switching applications. The RG-100 Glass-Amp has a current rating of 1 amp and a high surge capability of 50 amps peak at 1 cycle. Units are available in voltage ratings of 200, 400 and 600 v.

General Instrument Corp., 65 Gouverneur St., Newark 4, N.J. [335]

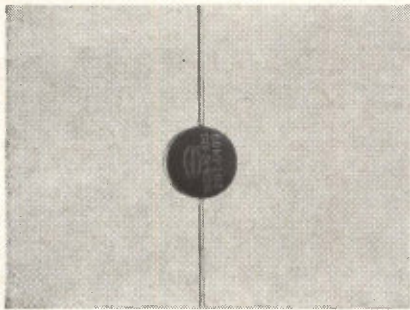

Medium-power rectifiers feature fast recovery

All-diffused, medium-power silicon rectifiers have an 85-nsec maximum reverse recovery time which provides outstanding efficiency and reduces radio frequency interference. The HCR-10 rectifiers are readily adaptable in the design of more efficient and compact high frequency inverters, ultrasonic generators and high power clamping in such circuits as pulse modulation with controlled rectifiers where high kickback voltages may destroy the scr's. Repetitive peak inverse voltages range from 50 to 200. Maximum forward voltage at 10 amp d-c at 25° C case temperature ranges from 0.9 to 1.00.

Hoffman Electronics Corp., Semiconductor division, El Monte, Calif. [336]

Technically unique, ultra sensitive

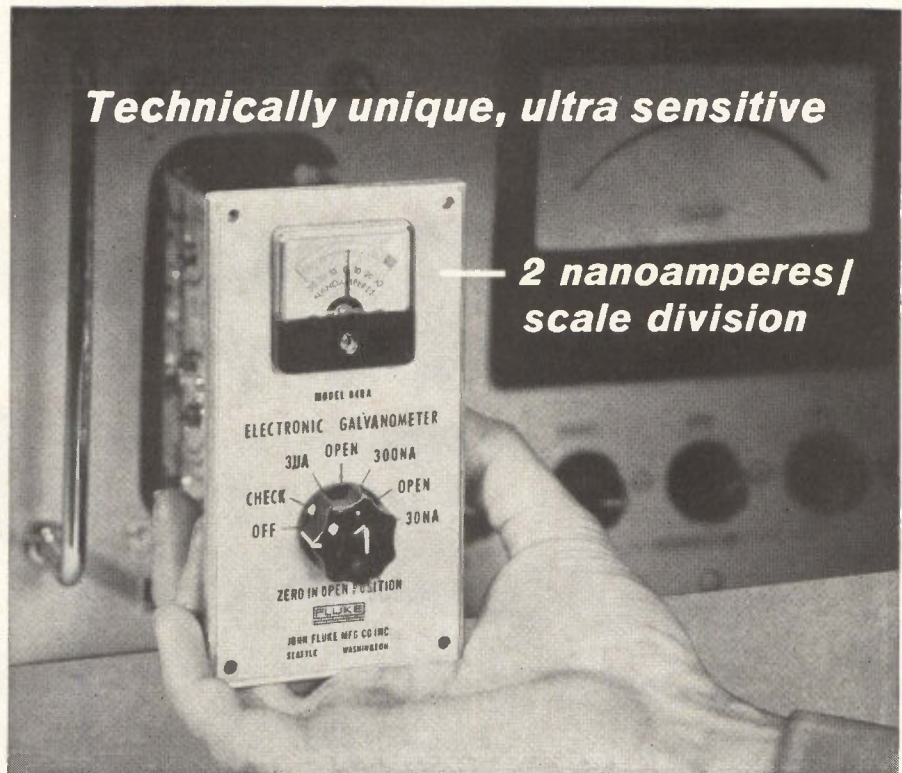

2 nanoamperes / scale division

New FLUKE Model 840A ELECTRONIC GALVANOMETER

Model 840A is a solid state electronic galvanometer of unique design, with 2 nanoamperes per scale division sensitivity.

Operable in any position, the Model 840A has better than 50 times the power sensitivity of the most sensitive light-beam galvanometer it is designed to replace in OEM applications. Current overloads of more than 110 db on the most sensitive range cause no damage.

Separate mounting case, mercury battery kit, or AC power pack are optional accessories. The instrument has passed rugged environmental tests; mechanical design includes flow-soldered glass-epoxy PCB's. Convenient recorder output provides 100 mv DC full scale on all ranges.

BRIEF SPECIFICATIONS

DC CURRENT SENSITIVITY:

- 30-0-30 nanoamperes, full scale (2 na/scale div.)
- 300-0-300 nanoamperes, full scale (20 na/scale div.)
- 3-0-3 microamperes, full scale (200 na/scale div.)

INPUT IMPEDANCE:

Approximately 150 ohms, all ranges

INPUT ISOLATION FROM CHASSIS:

Greater than 10^{10} ohms (100V maximum potential between chassis and input)

TEMPERATURE RANGE:

Operating: 0°C to 50°C
Storage: -40°C to 85°C

HUMIDITY:

0 to 90%

SIZE:

5½" high x 3" wide x 4¾" behind panel

PRICE:

A84-1 metal instrument case	\$175.00
A84-2 mercury battery kit	\$ 20.00
A84-3 AC power pack	\$ 5.00
	\$ 25.00

Prices and specifications subject to change without notice.

John Fluke Mfg. Co., Inc., Box 7428
Seattle, Wash. 98133. Tel. 206-776-1171



Send for complete specification data on Model 840A and new Catalog Digest 64A. Describes over 40 models of differential voltmeters, power supplies, voltage calibrators, micro-volt potentiometers and other Fluke precision test and measurement instruments. Lists nearest Fluke sales representative.



**ONLY
THIS
TUBE
SHIELD**



**MEETS
CHARACTERISTIC A**
of Mil-S-19786C (Navy)

- Reduces bulb temperature well over 50%.
- Puts no pressure on tube envelope during insertion or withdrawal.
- Requires no twisting motion to lock firmly in place.
- Absence of twisting and torque eliminates strain on fragile tube pins.
- Will not pull tube from socket upon withdrawal.
- Specially designed spring insert holds tube with firm "glovelike" grip.
- Rigid shell and spring insert combine to minimize vibration, shock and microphonics.
- Locks positively in place when snapping is closed.
- Full contact and firm pressure at mating base provide superior path for dissipating heat from tube envelope to chassis.
- Meets or exceeds all applicable requirements of MIL-S-19786C (Navy), MS-24233 and MS-24233 revised.

Shields for tube sizes T5½ and T6½ short, medium and long available from stock.

Complete specs and prices available in Atlee Bulletin S-1.

Write for your copy today.

atlee corporation



2 LOWELL AVENUE, WINCHESTER, MASS.

New Subassemblies and Systems

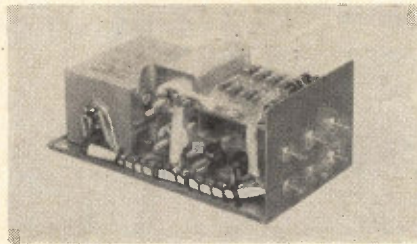

Module power supply for oscilloscopes

The 90202-M module supply provides accelerating and centering potential and heater power for a line of module oscilloscopes. It is designed to meet the requirements of MIL-E-16400. Input is 105 to 125 v at 60 cps. Output is 1,120 v d-c at 0.75 ma to 640 v d-c at 3.2 ma. Peak to peak ripple is 5.4 v at 0.75 ma load to 16.5 v at 3.2 ma. Unit measures 4 in. wide by 3 in. high by 7 in. long. It is supplied in sealed case with glass-to-metal terminals. Price is \$96.75.

James Millen Mfg. Co., Inc., 150 Exchange St., Malden 48, Mass. [371]

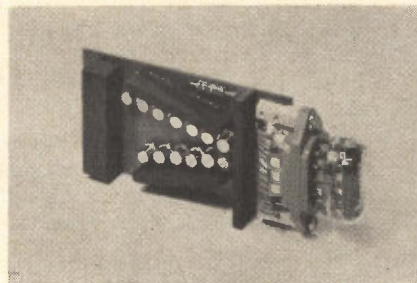

Memory modules for display systems

A line of low-cost readout driver packages with memory comes in two basic types, decimal input and binary-coded decimal input. They incorporate from 10 bits up to 16 bits of memory per module, making them suitable for use with either standard numeric Nixie tube types or with the recently developed alpha-numeric types. Units use a solid-state latching circuit as the basic memory element, thus requiring a minimum of components and connections. They will accept information in forms ranging from

d-c levels to 10- μ sec pulses. Standard modules use 12-v logic levels and trigger inputs; however, these can be modified if required to suit particular system requirements. Burroughs Corp., Electronic Components Division, Plainfield, N.J. [372]

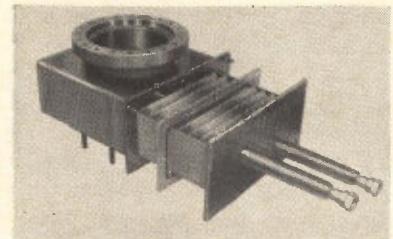

High-vacuum baffles avoid molecular creep

Series of 4, 6 and 10-in., chevron-type high-vacuum baffles, the GTC-MCB, achieve optimum trapping through an optically-dense, copper element uniformly cooled to liquid nitrogen temperatures. Molecular creep is prevented by a special antimigration shield and maximum conductance is reached by enlarging the baffle housing and openings, reducing overall height, and by using a chevron angle of 120 deg. The new baffles have very high pumping speed retention. To prevent out-gassing and to allow the units to be baked out under vacuum to 150 C, the baffle housing is made from stainless steel and only Viton gaskets are employed. General Technology Corp., 1727 Dublin Blvd., Hayward, Calif. [373]

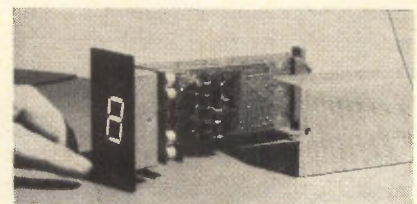

Decade counters with rates to 1 Mc

Two Robotomics decade counters, with counting rates to 1 Mc, are designed for wide-angle viewing of numerical information in a bright

inch-high in-plane display. This is accomplished without special optics. Models F1801 and F1802 are completely of solid-state design, using biquinary division with diode logic to convert to a 10-line electrical output. Seven silicon epitaxial transistors are used in the counting circuitry. The in-plane display uses a seven-segment numeral illuminated by incandescent lamps. The entire decade circuitry, including display, is contained on p-c boards and requires only one 12-v supply for operation. Specifications include 1.1-Mc counting rate and 0.9- μ sec paired pulse resolution for the F1802; d-c to 200-kc counting rate and 4.5- μ sec paired pulse resolution for F1801. Case dimensions for both are 1½ in. wide, 2¾ in. high and 6 in. deep. Each decade unit provides a 10-line diode output with a 4-v swing into a 22,000-ohm (or higher) load. Allegany Instrument Co., division of Textron Electronics, Inc., 1091 Wills Mountain, Cumberland, Md. [374]



Data logging system records capacitance

Model 701 data logging system is an adaptation of the model 701 capacitance measuring system to automatic data processing equipment. Direct reading accuracy is $\pm(0.01 + \text{one dial division})$, deviation resolution 1 ppm. System automatically records the two-or-three-terminal value of the capacitor being measured; the deviation from preset nominal; and the dissipation factor. All three values are recorded to the nearest dial division through newly-developed non-ambiguous encoders. Dates, control numbers, serial numbers, temperature and similar information can also be programmed and recorded simultaneously. Applications include use in quality assurance, repeated operational testing,

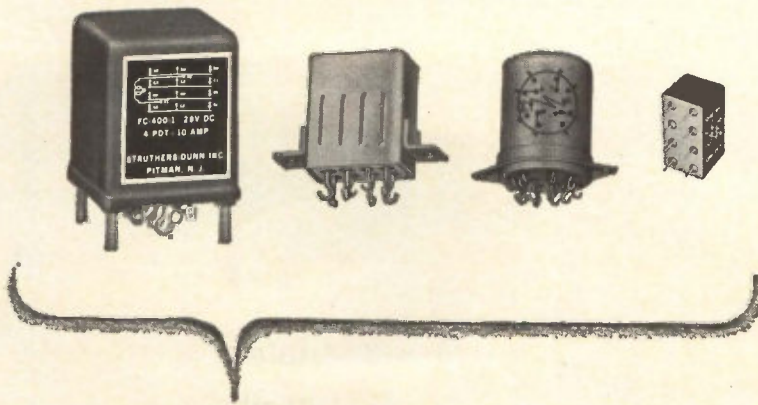

When you think about MIL-Spec relays...

Every manufacturer meets specifications.

Every one has Quality Control.

Every one tests and re-tests.

Every one talks reliability.

Every one has production controls.

Every one seals his relays.

Every one has a "broad line."

Every one has a clean room

(And every clean room is clean).

Every one tries to price competitively.

Every one offers fast service.

Every one has catalogs.

So why should you specify Struthers-Dunn relays, particularly?

BECAUSE . . . Struthers-Dunn has made more types of relays, including MIL-Spec relays, for more years than anyone else. Because Struthers-Dunn has learned more and is farther ahead in total capability. Because you can buy with more confidence. We have bulletins, too. Send for them. Write us at Pitman, N. J.

STRUTHERS-DUNN

Pitman, New Jersey

PIONEERS IN RELAY RELIABILITY



SALES ENGINEERING OFFICES IN: Atlanta • Boston • Buffalo • Charlotte • Cincinnati • Cleveland • Dallas • Dayton • Encino • Englewood • Houston • Kansas City • Las Vegas • Memphis • Newark • New York • Orlando • Pittsburgh • St. Louis • Salt Lake City • San Antonio • San Diego • San Mateo • Scottsdale • Seattle • Southfield • Wichita • Wilmette, Canadian Licensee: Renfrew Electric Co., Ltd., Toronto, Export Department: 1505 Race St., Philadelphia 2, Pennsylvania, U.S.A.



NOW
UP TO 20 KW
 AVERAGE POWER
WATER-COOLED XENON
FLASHTUBES
FOR LASERS

A new family of water-cooled xenon flashtubes by EG&G allows laser-pumping at average powers of 4KW (FX-62A), 8KW (FX-65A) and 20KW (FX-67A). These unique tubes have been designed with special electrodes efficiently cooled by a concentric water feed method to meet present day needs for fast repetition pulse rates and long life. Other applications include projection cameras and optical or visual illumination sources.

TOTAL FLASHTUBE CAPABILITY EG&G has the industry's broadest line of xenon flashtubes including linear, helical, bifilar, annular, U-shaped and custom designs. Linear flashtubes, rated up to 3,000 joules per inch of arc length, are available.

Complementing its flashtube line EG&G also offers complete lines of trigger pulse transformers; chokes; cold cathode krytrons for trigger switching; ceramic-metal thyratrons for high energy switching; triggered spark gaps for crowbar protection; photodiodes, and instrumentation for nanosecond light detection; and equipment for driving flashtubes.

For detailed information on EG&G's water-cooled flashtubes write for data sheet FX-62A, FX-65A, FX-67A or contact EG&G Products Department, 176 Brookline Avenue, Boston, Mass. 02215. Phone: 617-267-9700. TWX: 617-262-9317.



EDGERTON, GERMESHAUSEN & GRIER, INC.
 BOSTON • LAS VEGAS • SANTA BARBARA

New Subassemblies

precision sorting, and for studying or substantiating environmental effects on stability and reliability. Output device can be any of a large variety of machines including card punches or automatic electric typewriters.

ESI/Electro Scientific Industries, Inc.,
 13900 NW Science Park Drive, Portland,
 Ore. [375]

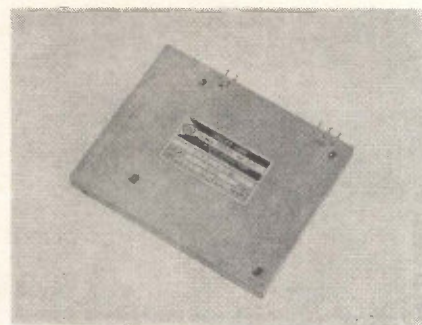

Delay line performs as serial memory

Magnetostrictive delay lines, intended for the 50 to 1,500- μ sec delay range, can be operated at any pulse repetition frequencies from 700 kc to 1.2 Mc in return-to-zero mode and are said to be ideal for use as serial computer memories providing a bit storage of over 3,000 bits per line when operated in the non-return-to-zero mode. Units have an input impedance of 300 ohms and an input current requirement of 40 to 50 ma. Output is terminated in 2,000 ohms and 50 pf. Signal-to-noise ratio is 10/1 dynamic (that is, when input is a complex code) and 30/1 static. Temperature stability is 1 ppm/deg C over a temperature range of 0 to 50 C. The DM544 series are priced at \$70 in the 1 through 30 quantity range.

Computer Devices Corp., 6 W. 18th St.,
 Huntington Station, N.Y. [376]

Compact transducer for encoding system

Mini-Microgon, a new high accuracy 2¹⁹ single-turn encoding system, which gives indications to better than 2.47 sec of arc, has been



developed. Transducer for the system is only $3\frac{3}{8}$ in. in diameter and 2 in. in length. It weighs only 40 oz. A $\frac{5}{16}$ -in. diameter hole down the center line of the shaft extends through the entire transducer, facilitating optical alignment of associated equipment or making it possible for a number of wires to carry information through a gimbal without requiring slip rings. The manufacturer claims that the small physical size and weight of the transducer greatly reduce the structural and mounting problems which are encountered in obtaining extremely accurate position information in digital form from theodolites, antennas and other precision instrumentation. Tests on systems indicate a standard deviation of under 0.8 sec of arc. Norden Div. of United Aircraft Corp., Norwalk, Conn. [377]

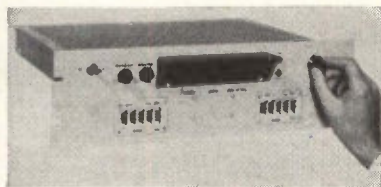

Counter provides variable time base

Variable time base electronic counter, with an integral two-channel time base programmer, features solid-state construction and wide-angle, long-life Nixie readout display. It provides direct digital readout in engineering units, such as, gallons per minute, lb per hr, rpm. It is designed for use with turbine flowmeters, tachometers, and other frequency generating transducers. An integral two-channel selector switch permits readout of either of two input channels. Each channel has an independently adjustable time base and can be set from

UNITRON

INCORPORATED

PRECISION 115V 400 CPS SINE WAVE FROM A 28V DC SOURCE

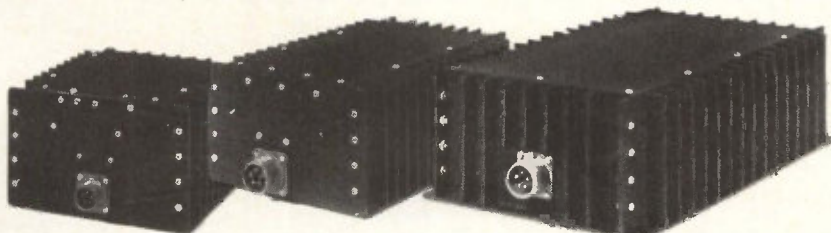

4S1125-1P
125VA

4S1250-1P
250VA

4S1500-1P
500VA

These high performance static inverters surpass the extreme conditions of applicable military and FAA specifications for airborne equipment and are available at economical prices from stock. In addition they feature • guaranteed reliability • protection of output from no load to short circuit under any and all conditions • the input is protected against reverse polarity, high transients and high input voltage • low distortion • voltage regulated • high efficiency • stable frequency • light weight.

Write For Information On These And Other Static Inverters

1624 N. FIRST ST.
BOX 1331

GARLAND, TEXAS
AC 214 BR 6-8591

OTHER UNITRON PRODUCTS
ON PAGES 129 & 131

Circle 204 on reader service card



ACTUAL
SIZE

NEW HIGH STABILITY SUBMINIATURE CRYSTAL UNITS IN TO-5 SIZE CASE

This new Bliley BK3 Series is vacuum sealed by koldweld process, without heat or flux, to minimize contamination. For applications that require low aging, precise calibration tolerances and high reliability in subminiature size. Range 10 to 125 mc. Short term stability 5×10^{-8} per day. Aging (at 75°C) 1×10^{-7} per week.

Bulletin 535 available.

Bliley

If you buy quality

BLILEY ELECTRIC COMPANY • ERIE, PENNSYLVANIA

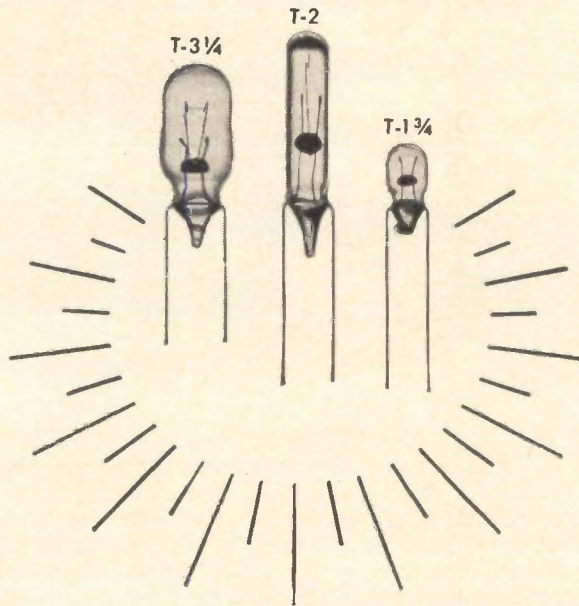

G.E. saves you time and money with clean, ready-to-solder leads on all lamps under 1/2" diameter

General Electric gives you pre-cleaned, ready-to-solder leads on all miniature, wire terminal-type incandescent lamps up to 1/2" bulb diameter. (There's no extra charge for cleaning.) Helps you cut production time and costs. Increases circuit reliability. For further information, write: General Electric Co., Miniature Lamp Department M-415, Nela Park, Cleveland, Ohio 44112.

Progress Is Our Most Important Product

GENERAL  ELECTRIC

New Subassemblies

0.0001 to 99.99 sec. Counter has a frequency range of 1 cps to 120 kc and an input sensitivity of 10 mv rms, 3 cps to 120 kc. Price is \$1,350. Anadex Instruments Inc., 7617 Hayvenhurst Ave., Van Nuys, Calif. [378]

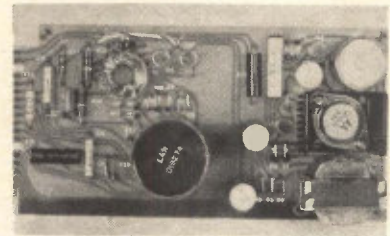

Solid-state magamp is p-c mounted

Producing a d-c voltage output signal proportional to a d-c milliamperere input signal, this operational amplifier is a completely solid-state device built around a magnetic amplifier. Self-contained, it is mounted on a single p-c card. Three basic sections make up the device—a magnetic amplifier providing a 0-10 v d-c max output signal isolated from the basic current input signal, a 5-kc magnetic core square wave generator to power the magnetic amplifier, and a 10-v d-c regulated power and reference supply for suppressed zero input signals. At a constant temperature of 25 C and a constant line voltage of 120 v a-c, the accuracy is better than ± 0.5 percent of full scale output for isolation amplifier with voltage gain of 10.

Leeds & Northrup, 4901 Stenton Ave., Philadelphia 44, Pa. [379]

Analog computer offers ease of programming

General-purpose analog computer, the AD-256, is designed with digital tie-in capability. Bipolar amplifiers provide both polarities of all problem variables, contributing to ease of programming, allowing the efficient use of amplifiers with non-linear solid-state elements, and terminating more computing components per patchboard. Integrator reset, operate, hold and time scale



are all controlled by logic signals. A separate patchboard programs a full complement of control logic elements such as logically controlled switches, comparators, gates, flip flops, and shift registers. This simplifies flexible repetitive and iterative operations and direct coupling with external digital systems.

Applied Dynamics, 2275 Platt Rd., Ann Arbor, Mich. [380]



Chart recorder prints weather maps

Designed for shipboard use, the MR-100 facsimile recorder prints weather maps, and radio-transmitted navigational charts showing sea or ice conditions and other information. Complying with all international standards, it can record transmissions originating in any part of the world. The 11-inch continuous chart recorder has speeds of 60, 90 and 120 scans/minute. Using inexpensive, moist electro-sensitive paper, it produces no odor or carbon dust, and causes no radio interference. Compact, modular mechanical construction and transistor circuitry are used for reliability and to reduce maintenance. High-stability frequency control is obtained by a precision frequency standard with stability of better than one part in a million.

Precision Marine, Inc., St. George Ave. & Kimball St., Woodbridge, N.J. [381]

UNITRON INCORPORATED

1000VA OF PRECISION 115V 400 CPS
SINE WAVE FROM ANY 60 CPS OUTLET

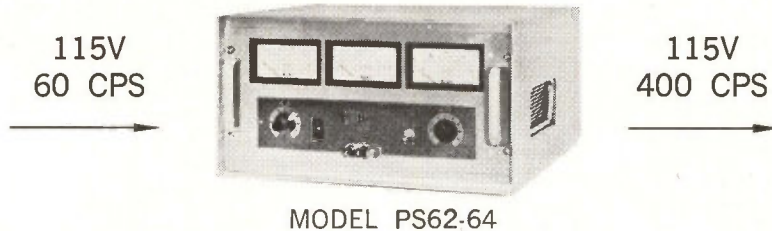

This unit offers freedom, versatility, and flexibility never before experienced in a 400 cycle power source. Rack mounted for powering complete ground systems or in the cabinet for laboratory, quality control, offsite presentations, and production. This unit features • precision and adjustable frequency • low distortion • voltage regulated • adjustable voltage • light weight for portability • complete metering • economically priced • overload and short circuit protected.

Write For Information On These And Other Frequency Converters

1624 N. FIRST ST.
BOX 1331

GARLAND, TEXAS
AC 214 BR 6-8591

OTHER UNITRON PRODUCTS
ON PAGES 127 & 131

Circle 205 on reader service card

NOW
AVAILABLE
AT CEI



Type SFM-1 Standard Frequency Multiplier



The SFM-1 Standard Frequency Multiplier is designed to take a 1-mc standard reference frequency signal and multiply it up to 50, 100, 500 and 1000 mc. This provides a VHF and UHF signal source with the same stability and accuracy as the reference source. All four output signals are available simultaneously at the rear panel.

Communication Electronics Incorporated

4908 HAMPDEN LANE BETHESDA 14, MARYLAND

Lepel

is proud to introduce

THE NEW INDUCTO-PLASMA UNIT



a controlled high temperature heat source for

- CRYSTAL GROWING
- SPHEROIDIZING
- VAPOR COATING
- HEATING FLUIDS
- LABORATORY RESEARCH



The new Lepel Inducto-Plasma unit is the result of extensive research and more than two years of experimental work with plasmas. Energized by a Lepel megacycle generator, this versatile unit provides a controlled high temperature plasma source which permits the use of oxidizing, neutral or reducing gas-mixtures. It is designed to accommodate accessories for crystal growing, spheroidizing, vapor coating, heat transfer studies in fluids, or other areas of research interest.

The Lepel Inducto-Plasma unit is also available without the sub-cabinet or the remote controls for the generator.

WRITE FOR BULLETIN F-101

Lepel HIGH FREQUENCY LABORATORIES, INC.

55th ST. & 37th AVE., WOODSIDE 77, N. Y. C.
CHICAGO OFFICE: 6246 WEST NORTH AVENUE

New Microwave



Tunable mounts for r-f detectors

Series CM-04 coaxial, in-line r-f tunable detector mounts offer versatility to both system designers and development engineers. The company has modified one end of its coax, rotary double-stub (Rodostub) tuner to accept a 1N23 or equivalent diode. The diode cartridge is held in place by a removable cap which contains a type BNC output jack for the detected signal. The Rodostub tuner is adjustable to maximize the r-f signal. It also provides a d-c return path for the diode or bolometer. The compact tunable mount has a type N male input plug. Two models cover a band from 0.4 to 10.0 Gc. A locking device and reference scale on the tuner provide stability and convenience in tuning.

Quantatron, a division of Teledyne, Inc., 1131 Olympic Blvd., Santa Monica, Calif. [391]

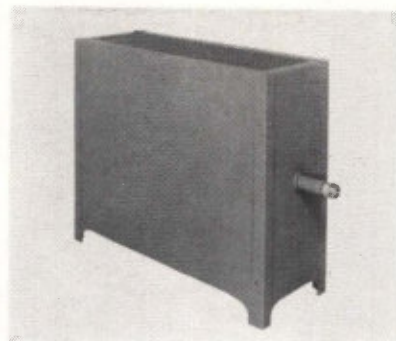

Coaxial dummy load is vapor-cooled

This vapor-cooled coaxial dummy load is oil filled and cooled by water evaporating inside a special oil-to-water heat exchanger. Any waste water, hot or cold, can be used. The 5,000-kw average power dummy

load uses 5 oz of water per minute, or a little over 2 1/3 gallons per hour. The resistor is a special high-temperature component, and the dielectric coolant can operate at 500° F. The dummy load is completely self-contained and does not require external operating power.

Electro Impulse Laboratory, Inc., 208 River St., Red Bank, N.J. [392]

Traveling-wave tube features low noise

Completely self-contained, the WJ-271 traveling-wave tube requires only an a-c line voltage and is adjustment-free. It offers a guaranteed maximum noise of 6.5 db over the frequency range 4 to 8 Gc. The amplifier package includes a shielded permanent magnet that is not adversely affected by adjacent p-m tubes or ferromagnetic material. The tube, with its integral power supply, weighs less than 17 lb., is 12 in. long (excluding connectors) and 4.75 in. high. Small signal gain is 25 db minimum and the saturated power output is nominally zero dbm. Environmental characteristics of the WJ-271 meet or exceed the corresponding requirements of MIL-E-5400, Class 2. Watkins-Johnson Co., 333 Hillview Ave., Palo Alto, Calif. [393]

Microwave detector stable at -35° to +85°C

A new microwave detector features extreme temperature stability from -35° to +85°C. It is a high-impedance device operating on the principle of majority carrier excitation by the r-f field. The majority carriers are raised to a higher mean energy state, and the energy at this excited state is referred to the energy level in the bulk semiconduc-



tor, resulting in a voltage output that is square law. The detection action is fast enough to follow each r-f cycle at frequencies up to a calculated 100 Gc, although the first in the company's new series is packaged in the 1N23 cartridge, limiting its upper frequency of operation to 18 Gc. The natural square-law response of the type-640 hot carrier diode makes them useful as a replacement for the 1N32 video detector. The diodes are also useful for generating harmonics and for mixing. Price is \$45. MSI Electronics, Inc., 116-06 Myrtle Ave., Richmond Hill, N.Y. 11418 [394]

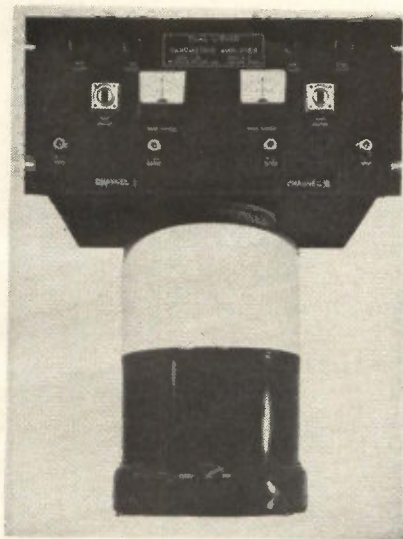

Parametric amplifier aids radio astronomy

On the market is a low-noise parametric amplifier, cooled to liquid nitrogen (77° K) temperature, for radio astronomy. Model L-4 can be supplied in single or dual channel at either the hydrogen-line frequency (1,420 Mc) or the OH-line frequency (1,667 Mc). The dual-channel version is particularly suited to double Dicke radiometry uses. The amplifier can be operated at room temperature for all but the most stringent applications, and can be cooled to liquid nitrogen temperature for ultra low noise operation. Unit has typical noise temperatures of 110° K at room temperature and 50° K at 77° K ambient. Bandwidth is 40 Mc at the 1-db points. Gain is nominally 18 db.

Microwave Physics Corp., 420 Kirby St., Garland, Tex. 75040 [395]

UNITRON INCORPORATED

400 CPS 3 ϕ TO 60 CPS 1 ϕ AT 3 5KVA
ALL SILICON SOLID STATE FREQUENCY CONVERTER

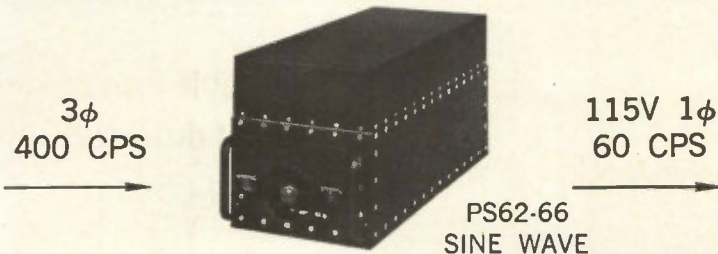

The Model PS-62-66 is an all silicon solid state frequency converter with proven performance in both airborne and air-transportable systems where precision 60 cycle is required from a 400 cycle source. This unit features

- proven reliability
- high performance
- high efficiency
- low distortion
- voltage regulated
- light weight
- 25,000 feet altitude
- MIL-I-26600
- excellent stability
- short circuit protection.

Write For Information On These And Other Frequency Converters

1624 N. FIRST ST.
BOX 1331

GARLAND, TEXAS
AC 214 BR 6-8591

OTHER UNITRON PRODUCTS
ON PAGES 127 & 129

Circle 206 on reader service card

HAVE YOU CONSIDERED USING PHOTOCELLS?



WE'VE JUST MADE IT EASY FOR YOU ...

Free On Request —
Designers' Kit Information
plus New 1964 Edition
16 page Designers' Manual

New! — from Clairex — a selection of photoconductive cells, varying in sensitivity, spectral response, speed and size to suit most applications, and including the CL505, CL603A, CL704L, CL707 and CL902 — in convenient kit form complete with technical data — only \$10.00.

CLAIREX

"The LIGHT Touch in Automation and Control"

8 West 30 Street, New York, N. Y. 10001, 212 MU 4-0940

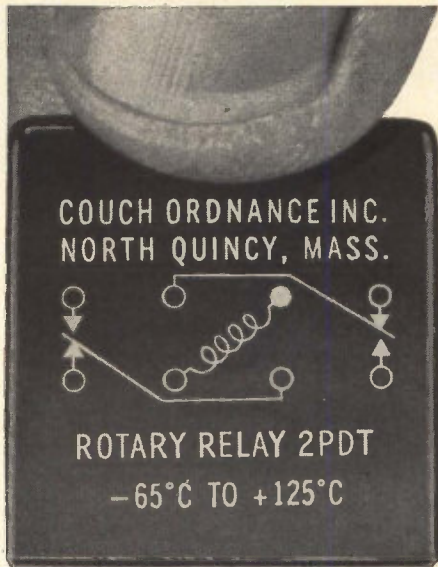

design simplicity

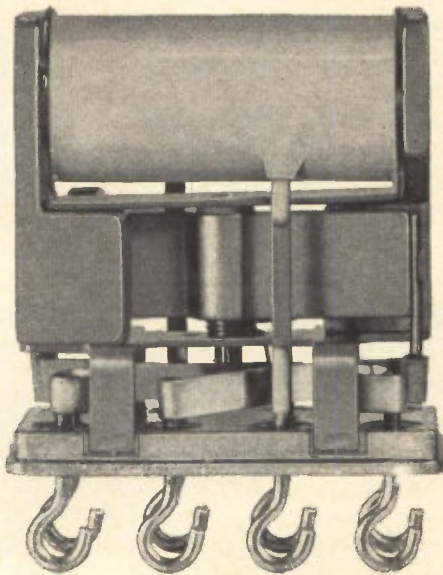

**25_{mw}
sensitivity**

COIL RESISTANCE (@ 25°C).....6250 ohms ± 10%
 MAXIMUM PULL-IN CURRENT.....2.0 ma DC
 MINIMUM DROP-OUT CURRENT.....0.2 ma DC
 NOMINAL OPERATING VOLTAGE.....26.5 VDC
 CONTACTS 2 PDT (2 FORM C).....1.0 amp @ 30 VDC

Write for Data Sheet No. 8

RUGGED ROTARY RELAYS  Dynamically and Statically Balanced

COUCH ORDNANCE INC.

3 Arlington Street, North Quincy 71, Mass., Area Code 617,
 CYPRESS 8-4147 • A subsidiary of S. H. COUCH COMPANY, INC.

New Production Equipment

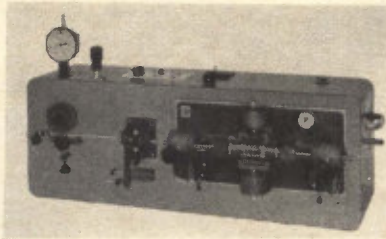

Automatic unit strips wire fast

Low-cost, fully automatic model 87 wire stripper will mass-produce finished wire leads at speeds up to 12,000 pieces per hr. A wire-length indicator (calibrated in either inches or millimeters) permits change in wire length by the simple turn of a knob. Model 87, measuring little more than 3 ft long, is capable of cutting and stripping lengths from 1 in. to 100 in. It will accommodate wire sizes from 12 to 26 Awg (or as small as 32 Awg with modifications). It will strip Teflon and other insulation without scraping or nicking the conductor. Price is \$1,395. Eubanks Engineering Co., P.O. Box 563, Monrovia, Calif. [421]

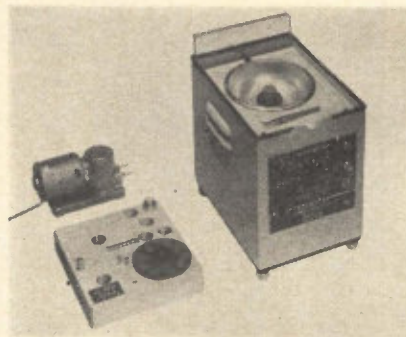

Vacuum rotor spinner coats substrates

This vacuum rotor spinner is designed for application of photoresist materials to silicon wafers and other substrates intended for solid-state and thin-film uses. The unit features continuous speed control from zero to 10,000 rpm and fast acceleration when used with small-diameter vacuum rotors. The model TMC-1 spinner is supplied

with a center-spinning vacuum rotor with a center 5/8 in. in diameter, and a 4-in. peripheral rotor for spinning many wafers at a time. Used with a 2-in.-diameter vacuum rotor, the TMC-1 will center-spin flat glass plates coated with metal films as used in thin-film applications. The coating machine is supplied with all accessories, including a vacuum pump, for \$745; less pump, \$695.

Chafin Laboratories, 909 N. First St., Phoenix 4. [422]

Vacuum attachment for encapsulating presses

Use of a new vacuum attachment with the company's molding presses assures denser packaging—with fewer voids—for such products as coils, motors, transformers or circuit modules. The accessory may be ordered for factory installation, or in kit form for retrofit to the firm's D, F and G series of presses now in operation. Semi-automatic operation is a design standard. Kits consist of accumulator, high-speed vacuum pump, control panels, solenoid-actuated valves.

Hull Corp., Davisville Road, Hatboro, Pa. [423]

Fast welder forms contact springs

The automatic Tweezer-Weld machine that performs 7,200 welds per hr is reportedly able to weld, slit and form complete contact spring assemblies at the rate of 3,600 per hr. The process starts with a tin-plated phosphorous bronze strip 0.016 in. ± 0.0005 in. in thickness and 0.098 in. ± 0.001 in. wide. A

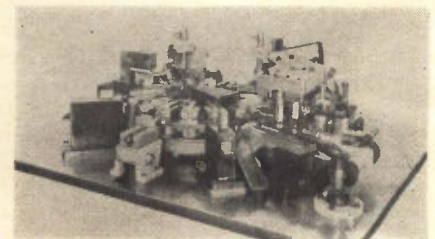

rapid air feeder feeds the strip from a reel through a wire straightener. It is then cut to lengths of 1.854 in., each of which is shaped and slit by punch and die. Gold ribbon is then welded to each side of the strip. The strip is bent 90°, and the latch finger is crimped. Another double bend is then made, and the assembly is formed into the final latch position. It is then automatically ejected.

Federal Tool Engineering Co., 1386 Pompton Ave., Cedar Grove, N.J. [424]



Vertical furnace operates to 4,000° F

A high-temperature furnace for laboratory and small parts production heat treating is announced. The VVC-L-40 has an 11-kw input and a maximum operating temperature of 4,000° F. The 5-in. diameter by 10-in. deep work space is insulated by foamed ceramic brick. Unit can be safely operated as an inert atmosphere or vacuum furnace. Heats to 4,000° F are obtained at a vacuum of 0.1 micron Hg or with neutral gases such as nitrogen or argon at atmospheric pressures. Hydrogen and cracked ammonia atmospheres may be used to 3,600° F with normal safety precautions. Cycle control is fully automatic. Recording controllers program pre-heat and high temperatures, the degree of vacuum, and partial pressure of protective gases. Furnace and vacuum system are enclosed in a cabinet 33 in. wide by 42 in. long by 36 in. high. Control panel is 24 in. wide by 15 in. deep by 72 in. high.

Ipsen Industries, Inc., Box 500, Rockford, Ill. [425]

NEW! BEAM-SAMPLING LASER ENERGY MONITOR

ACCURATELY MEASURES EVERY LASER PULSE DURING EXPERIMENTATION

Now, for the first time, you can obtain a direct readout of total energy or peak power of every laser pulse during your research. You can measure the energy output of a laser in action . . . and eliminate the need of interim laser operations for measurement purposes only.

The new MI-2 Laser Energy Monitor features a beam-sampling technique that permits the instrument to be directly incorporated into any test set-up. It permits you to obtain an unprecedented degree of reliability and control in your test procedures.

The Laser Systems Center's MI-2 provides direct meter readout of total energy in ranges from 0.003 joule to 1000 joules. Measure peak power? Yes! . . . up to one gigawatt! Factory calibrated for 6943 angstroms, the Laser Energy Monitor can be used with conversion charts to cover the spectrum from 0.35 to 1.13 microns. Connections are provided for observing peak power outputs with an oscilloscope or strip-chart recorder. Laser Energy can be conveniently read at any time during 30 seconds after laser operation because of a unique electronic holding circuit.

LSI's MI-2 Laser Energy Monitor is available now. It can add significantly to the progress of your laser research. For complete details, call or write today for Bulletin S 312-3.

THE MI-2 LASER ENERGY MONITOR . . .
NOTHING QUITE LIKE IT!

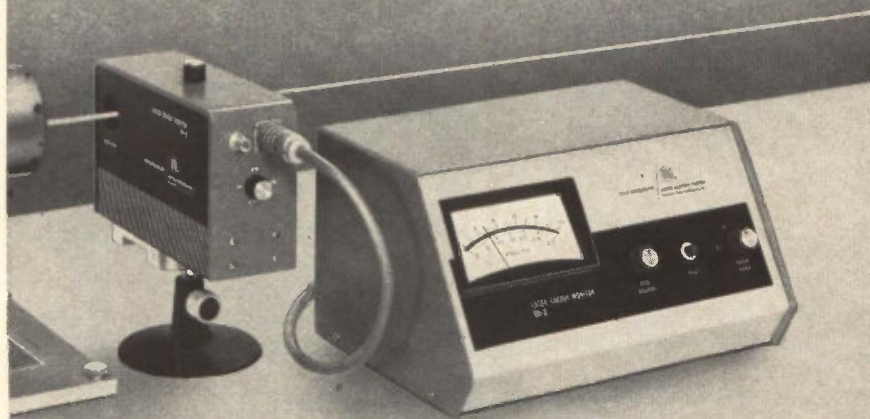

LEAR SIEGLER, INC.

LASER SYSTEMS CENTER

2320 WASHTENAW AVENUE
ANN ARBOR, MICHIGAN
TELEPHONE 313-665-8844

MASSA ACCELEROMETERS ELIMINATE PRETEST CALIBRATIONS

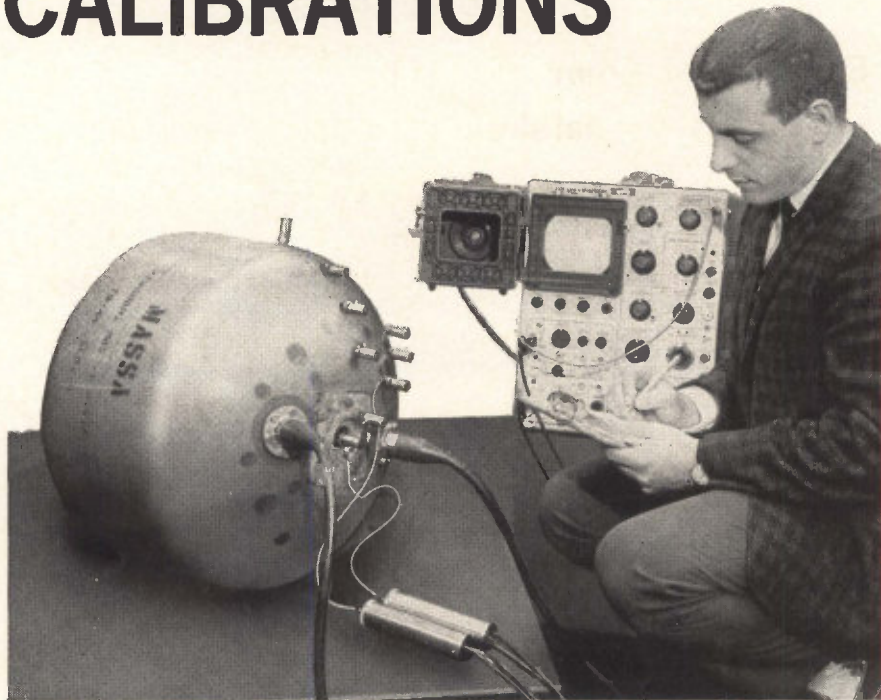

Massa accelerometers being used for analyzing the mode of vibration of the surface of a high power sonar transducer. The several accelerometers attached as shown indicate the exact amplitudes and phase at the various points over the transducer surface without need for expensive pretest calibrations for the accelerometers.

Many Massa Accelerometers have been performing in vibration test applications for as long as fifteen years without the need for recalibration. The reason for this extreme stability and reliability is the ADP crystal employed as the sensor element in all Massa Accelerometers. With this high degree of stability and reliability the need for costly pretest calibrations is eliminated. The savings in calibration man-hours alone add up to many times the purchase price of these quality instruments.

Vibration measurements extend well into the ultrasonic range with Massa Accelerometers because of their high resonant frequencies . . . dynamic range is from 0.001 g to as high as 3500 g. For maximum sensitivity the sensing element within the accelerometer is oriented along a single axis. Cross axis sensitivity is only 1% (40 db below) that of the main axis. Various Massa accelerometer models are available for hundreds of applications.

MASSA
A DIVISION OF
COHU
ELECTRONICS, INC.

280 LINCOLN ST. • HINGHAM, MASSACHUSETTS • 02043

Write for Technical Bulletin
"Accelerometers"

New Materials

Thermosetting coating resists solvents

An acrylic-base thermosetting coating, HumiSeal type 1F30, is a single-component system requiring oven cure at 250°F. Type 1F30 offers excellent resistance to chemical solvents. The manufacturer recommends it for use in high-temperature service on electronic components or assemblies on printed circuit boards. Maximum temperature rating for continuous service is 320°F. It withstands 360°F on an intermittent basis.

Columbia Technical Corp., 24-30 Brooklyn-Queens Expressway W., Woodside 77, N.Y. [411]

Silicone elastomer for semiconductors

Introduction of SES, a silicone elastomer designed for use in semiconductors to protect surfaces and p-n junctions, is announced. It is applicable to transistors, diodes, rectifiers and integrated circuits. Advantages include: -40° C to +250° C operation; high voltage capability of greater than 1,000 v; electrical stabilization with surface effects controlled and low-level leakage current insured; protection against weld flash and contamination; mechanical stabilization against shock, vibration and acceleration; and it is simple to use. Transene Corp., 121 Conant St., Danvers, Mass. [412]

Colorless agent removes rosin flux

Alpha 563 removes flux residues in printed-circuit dip soldering. It may also be used for room temperature immersion cleaning, vapor phase or ultrasonics cleaning of most materials. It is a blend of organic solvents developed as a quick, efficient removal agent. The colorless liquid has no flash point, and boiling point is 245° F. It is considerably less toxic than carbon tetrachloride, although slightly more toxic than

Plant Site Report

Forecast of the '70's in Industrial Colorado

COLORADO NO. 1 LABOR CHOICE

Scientists form a higher percentage of Colorado's population than in other states. Colorado: .20%; New Jersey: .17%; California: .14%. Recent survey of college graduates shows Denver one of three preferred U. S. cities. Colorado's Pleasant Living draws skilled labor at rate of 27,000 annually.

RESEARCH FACILITIES

Outstanding, due to interplay of private and government researchers. 12 colleges and universities, Air Force Academy Aerodynamics Laboratory, Denver Research Institute, National Center for Atmospheric Research, National Bureau of Standards Laboratories, Ball Brothers Research Corp., Marathon Oil Co. Research Center just a few tapped by manufacturers.

SUPPLY SOURCES

Almost every space-age mineral and metal mined or processed in Colorado.

Martin and Sundstrand, already on scene, term sub-contractor situation "excellent."

TRANSPORTATION

Central location is asset. Most of U. S. within two truck-line days. 7 airlines with 269 flights daily. 7 Class I railroads.

COMPLETE INFORMATION AVAILABLE

All new 1964 Executive Portfolio, Special Reports available. Inquiries confidential. Write:

COLORADO

DIVISION OF COMMERCE AND DEVELOPMENT

65 State Services Building
Denver, Colorado, 80203

Circle 207 on reader service card

alcohol. It can be distilled without decomposition and should be used in a well-ventilated room. Rosin flux remover is available in 54 gallon, 5 gallon and 1 gallon containers.

Alpha Metals, Inc., 56 Water St., Jersey City, N.J. [413]

Epoxy resin system withstands thermal shock

An epoxy resin system, made to withstand strong thermal shock, has high insulating resistance, low moisture absorption, good adhesive properties and minimum shrinkage on curing. A-Q epoxy No. 4060 meets conditions of MIL-T-27A Class H, and the thermal-shock requirements of MIL-I-16923 from -100° to $+180^{\circ}\text{C}$. It is recommended as an encapsulant for motors and transformers.

Chemical/Compounds division, Acme Wire Co., P.O. Box 4186, New Haven, Conn. [414]

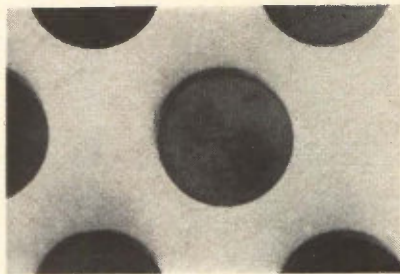

Garnet material aids component design

A new garnet material whose saturation magnetization can be accurately controlled is available, permitting mass-production manufacture of electronic and microwave devices. The garnet, MCL-290TG, can be typically held within 15 gauss at levels of 290 gauss, allowing component designs at uhf frequencies below 900 Mc. Operating below resonance, the material is ideal for use in switches, circulators, isolators, phase shifters, frequency doublers, solid-state amplifiers and power limiters. Dielectric constant is 13.4; loss tangent at 4.4 Gc is less than 0.0005 and linewidth is 40 oersteds.

Microwave Chemicals Laboratory, Inc., 282 Seventh Ave., New York, N.Y. 10001. [415]

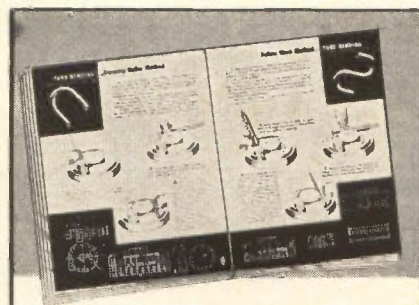

How to form it by **BENDING...**

Free Manual shows techniques of forming round, square, or hex bar stock... tubing...channel... angle... flat and other materials.

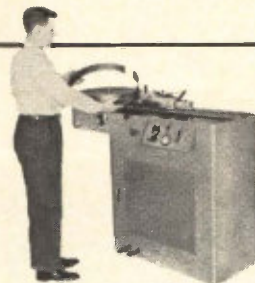
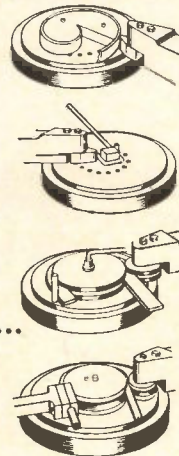

Di-Acro Hydra Power Bender

It's easy to bend a wide variety of material when you know how—profitable too because bending can simplify product design—make one curved piece do the job of two or more. Bending can improve product appearance and lower your production costs!

This 32-page illustrated manual shows how to make center eye and off center bends, circles, zero radius bends, scrolls, squares, springs and coils, loops and spirals—all with *one versatile machine*. Booklet also tells how to tool for tubular, channel, angles and other special bending needs.

ORDER YOUR FREE COPY TODAY. SEE YOUR NEAREST DIACRO DISTRIBUTOR OR WRITE US.



DI-ACRO CORPORATION
435 Eighth Avenue, Lake City, Minnesota

Circle 135 on reader service card 135

1/4%
ACCURACY
UNIVERSAL
BRIDGE

***HI-RESOLUTION**
5000 DIVS/RANGE

\$590

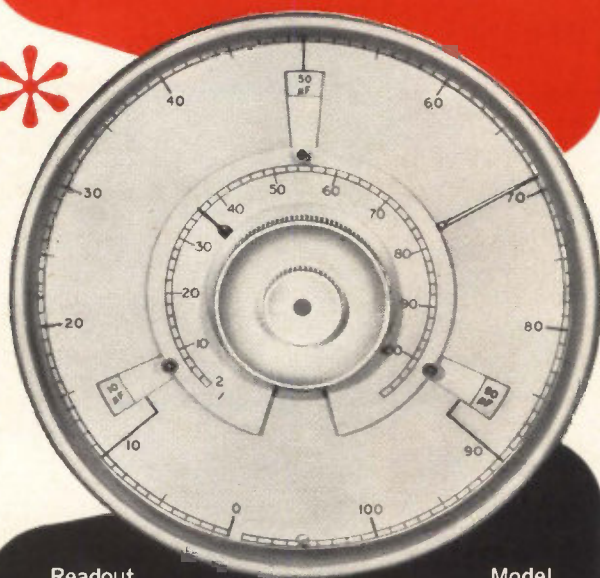

Readout
System

Model
1313

MEASURES

- INDUCTANCE** $1\mu\text{H}$ to 100H
- CAPACITANCE** 1pF to $110\mu\text{F}$
- RESISTANCE** 0.01Ω to $110\text{M}\Omega$
- DIRECT READOUT** **NO FACTORS**
- BUILT-IN 1kc and 10kc OSCILLATORS**
- 100 cps to 20kc WITH EXT. OSCILLATOR**

*** Reads**
 $69.36\mu\text{F}$

Write
for detailed
catalog sheet.

MARCONI
INSTRUMENTS

DIVISION OF ENGLISH ELECTRIC CORPORATION
111 CEDAR LANE • ENGLEWOOD, NEW JERSEY
Main Plant: St. Albans, England

Get
constant
1000 megohms
input impedance.

Worth \$1,000 more
than its price.



The new Hughes Model 5100 Digital Voltmeter is an integrating 5 digit, all solid state instrument priced at \$2695.

We can bring you this new voltmeter, equal or superior to devices costing \$4000 or more, at a low price because of an entirely new concept in circuitry design.

The Hughes 5100 Digital Voltmeter incorporates a new and unique voltage to frequency converter* as the heart of the machine. This device practically eliminates the use of critical or trouble-making components. The result is a voltmeter offering remarkable reliability, accuracy, ease of maintenance, and high noise rejection.

The Model 5100 can be used with the Model 1100 AC-DC Converter. Precise measurements of AC voltages from 30 cycles to 10 KC can be made simply, with 10 megohms input impedance on all ranges.

We would like to demonstrate the Hughes 5100 Digital Voltmeter and prove to you that it is the best value on the market. For full information, write or call HUGHES INSTRUMENTS, 2020 Ocean-side Boulevard, Oceanside, California. For export information write Hughes International, Culver City, California. *Patent Pending



New Literature

Design enclosures Pneumafil Corp., 2516 Wilkinson Blvd., Charlotte, N.C. 28208, offers a brochure illustrating and describing the 200 series heavy-duty electronic equipment enclosures which are adaptable to individual needs through the use of specially designed accessory components.

Circle 451 on reader service card

Servomechanisms Ling-Temco-Vought, Inc., P.O. Box 5003, Dallas, Texas, has published a 66-page booklet entitled "Testing & Evaluation of Servomechanisms." [452]

Bilateral switching diode Transatron Electronic Corp., Wakefield, Mass., has published a brochure on silicon power BiSwitches designed for use in a-c phase control applications which require blocking capability of 200 v and load currents up to 20 amperes rms. [453]

Micro inductors Collins Radio Co., 19700 San Joaquin Road, Newport Beach, Calif. A catalog sheet describes transistor-size micro inductors with Q's exceeding 30 at 20 kc and 120 at 200 kc. [454]

Semiconductor converter Linear Systems Inc., 605 University Ave., Los Gatos 2, Calif. Bulletin P100-1263 covers details of the Century model semiconductor converter that provides a variety of high, low, and bias voltages from an input of 12 to 15 v d-c. [455]

T-Y recorder Houston Instrument Corp., 4950 Terminal Ave., Bellaire 101, Texas. A four-page brochure describes the T-Y recorder, a new concept in recording a variable as a function of time. [456]

Magnetic latching relays Sigma Instruments, Inc., 170 Pearl St., Braintree 85, Mass., offers a booklet entitled "How Magnetic Latching Relays Operate." [457]

Industrial relays Potter & Brumfield, Princeton, Ind. Catalog 64 describes in 20 pages a complete line of electromagnetic relays. [458]

Frequency multipliers Applied Research Inc., 76 South Bayles Ave., Port Washington, N.Y. Broadband passive frequency multipliers are covered in a single-sheet brochure. [459]

Ultra small relay Couch Ordnance, Inc., 3 Arlington St., North Quincy 71, Mass. Data sheet No. 9 describes the type 2X rotary relay designed primarily for signal switching. [460]

Programmed current pulse generators Computer Test Corp., Route 38 & Longwood Ave., Cherry Hill, N.J., has published a bulletin on programmed current pulse generators. [461]

Strain-gage supply Elcor, 1225 W. Broad St., Falls Church, Va. 22046, has released a data sheet on the A4QP highly-isolated all-silicon Isopoly series designed for use in strain gage or transducer circuits. [462]

Servomechanism design Vernitron Corp., 52 Gazza Blvd., Farmingdale, N. Y., has available a 6-page technical bulletin entitled "Practical Factors in Servomechanism Design." [463]

Beam power tube Tung-Sol Electric Inc., One Summer Ave., Newark 4, N.J. Two-page product bulletin provides information on an r-f beam power transmitting tube operating at frequencies up to 600 Mc. [464]

Ionization gage control Vacuum-Electronic Corp., Plainview, L.I., N.Y. Bulletin discusses the RGLL-6 solid-state gage control which provides both logarithmic type and linear pressure readouts. [465]

Resistors Ferroxcube Corp. of America, Saugerties, N.Y. Bulletins NTC 8-14 contain latest application data on the company's negative temperature coefficient resistors. [466]

Data transmission system Lenkurt Electric Co., Inc., 1105 County Road, San Carlos, Calif. A 4-page brochure describes the 27A high-speed data transmission system for utilization over h-f radio. [467]

Transistor reliability Honeywell Semiconductor Products, 2747 Fourth Ave. South, Minneapolis, Minn. 55408. Four new reliability reports on 5-through 65-amp germanium power transistors are available. [468]

High-speed decade divider Janus Control Corp., Hunt St., Boston, Mass. Illustrated bulletin B100-10 describes a versatile, high-speed, decade divider card module. [469]

Micrologic elements Fairchild Semiconductor, 545 Whisman Road, Mountain View Calif. A specification brochure covers planar epitaxial micrologic elements. [470]

Wirewound resistors California Resistor Corp., 1631 Colorado Ave., Santa Monica, Calif., has published a specifications brochure for Cal-R precision wirewound resistors. [471]

Surface preparation Geoscience Instruments Corp., 110 Beekman St., New York, N.Y. 10038, has begun publishing a monthly bulletin, "Surface Preparation News", which will specialize in articles on preparation of critical surfaces—the machining, lapping and polishing of materials. [472]

Electromagnetic indicators Patwin Electronics, Waterbury 20, Conn., has

LASER GASES

MIXED TO ANY SPECIFICATION XENON • NEON HELIUM • ARGON OXYGEN

- Scientifically blended and tested mixtures for critical needs.
- Guaranteed ultra-high purity.
- Fast nationwide delivery in bulbs or cylinders.
- Quality based on more than 50 years of rare gas know-how.
- Complete technical service.

SEND FOR NEW 24-PAGE ONE-SOURCE RARE GAS BOOKLET

First
comprehensive
price and
specification
list for most
gases and
mixtures.

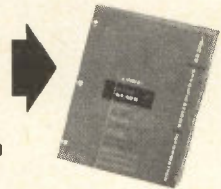

CLIP COUPON ATTACH TO
BUSINESS LETTERHEAD

Union Carbide Corporation
Linde Division, Dept. PTY-4
270 Park Avenue, N. Y., N. Y. 10017

- Please send a copy of your booklet listing prices, specifications, and information on LINDE Atmospheric Gases.
- Have a representative contact me.

**UNION
CARBIDE**

**LINDE
DIVISION**

"Linde" and "Union Carbide" are registered trade marks of Union Carbide Corporation.

DURANT

ELECTRIC COUNTERS
provide accurate, high speed
COUNTING by
REMOTE CONTROL

**WILL NOT
BURN OUT
when
ACTIVATING
CURRENT IS
LEFT ON**

When the electric impulse sent to advance the counter remains on as a steady flow of current, Durant Electric will not burn out nor lose the count. When the cause is corrected, continued operation is assured.

Durant Electric are used as standard equipment on machines and for instrumentation by thousands of satisfied OEM users. This is because of all-around dependability, long life, accuracy, better readability, variations of mounting, and many stock models. Durant engineering service is available close to you to help you in design requirements. Popular standard models are UL and CSA approved.

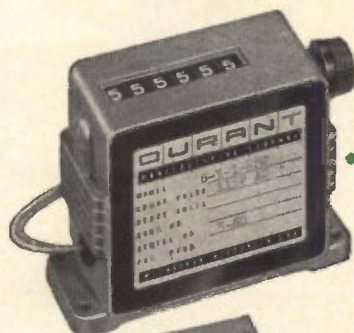

"Y" Electric Series
(Model 6-Y-1-MF)
1000 CPM

"CS" Electric Series
(larger size —
larger figures)



Ideal for PANEL MOUNT
(placed and mounted from front)
on machine or at control center



Tumbler Lock Key Reset
for "tamper control"

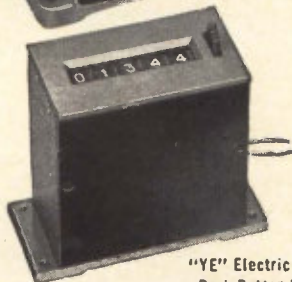

"YE" Electric Series
Push Button Reset
(Model 5-YE-8947-Q)
1500 CPM

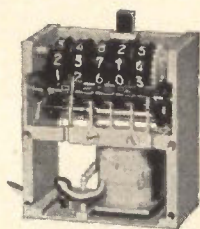

"Y" Electric Series
Push Button Reset
(Model 5-Y-11479)
No external case

STANDARD MODELS FOR YOUR OEM, MACHINE, INSTRUMENT or SYSTEM

"Y" Electric — Small, compact, AC counters with integral rectifier for high speed and long life. Four, six or seven figures.

"CS" Electric — Larger case size and figures for rugged, heavy-duty applications.

"YE" Electric — Electric or finger-flick instant reset. Hermetically sealed model available.

"Y" Special Electric — Extremely compact for built-in applications — no external case.

Send for Electric Counter Catalog
DURANT MANUFACTURING CO.
612 N. Cass Street, Milwaukee, Wis. 53201

DURANT®

COUNTING INSTRUMENTS

Accurately Count Everything . . . EVERYWHERE



"YE" SERIES
HERMETICALLY
SEALED FOR
MILITARY



MODEL 3-3-5-Y
ELECTRIC
COUNTERS
ONE FRAME



MODEL 6-Y
ELECTRIC
PREDETERMINING
COUNTER



PUSH BUTTON
RESET ELECTRIC
FOR MILITARY
APPLICATION



4 FIGURE
"Y" ELECTRIC
PANEL
MOUNT



"SP-MF"
ELECTRIC
PREDETERMINED
COUNTER

published a bulletin illustrating and describing the Magneline electromagnetic indicators. [473]

Integrated circuits Motorola Semiconductor Products Inc., Box 955, Phoenix, Ariz. 85001. Brochure describes a new approach to custom-built diode-transistor logic integrated circuits. [474]

Inductor design data Ferroxcube Corp. of America, Saugerties, N.Y. Bulletin 120 contains extensive information and formula for the design of inductive components utilizing ferrite materials in pot core configurations. [475]

Cylindrical connector Methode Electronics, Inc., 7447 W. Wilson Ave., Chicago, Ill., 60631, offers a two-page bulletin on its miniature water-sealed cylindrical connector. [476]

Reed relays Coto-Coil Co., Inc., 65 Pavilion Ave., Providence, R.I. 02905. A 4-page catalog outlines a complete selection of basic reed relays and coils for reeds, including all specifications and prices. [477]

A-C power supplies CML, Inc., 350 Leland Ave., Plainfield, N.J. Catalog No. 300 describes static d-c to a-c inverters and static frequency converters rated at 6 to 15,000 v-a. [478]

Microminiature connectors Elco Corp., Willow Grove, Pa. 19107. A 28-page report covers the design, function and application of Microcon contacts and connectors. [479]

R-f measurements Bird Electronic Corp., 30303 Aurora Road, Cleveland 39, O., is publishing a periodical that includes helpful hints on r-f measurements, practical solutions to r-f problems, and novel applications of the company's instruments. [480]

Circuit breakers Metals & Controls Inc., a corporate div. of Texas Instruments Inc., 34 Forest St., Attleboro, Mass. Bulletin CIRB-1 describes Klixon magnetic, thermal, and thermal-magnetic circuit breakers. [481]

Test and measurement instruments John Fluke Mfg. Co., Inc., Box 7428, Seattle, Wash. 98133. Catalog digest 64A covers 41 models of differential voltmeters, power supplies and other precision instruments. [482]

Integrated circuitry Centralab, P.O. Box 591, Milwaukee, Wisc. 53201. A 16-page brochure on PEC integrated circuitry is now being made available to electronic engineers. [483]

Paper tape readers Royal McBee Corp., 150 New Park Ave., Hartford, Conn. 06106, offers a catalog sheet on the series 500 desk and panel mounted tape readers. [484]

Pulse generators Orbitran Co., Inc., 5839 Mission Gorge Road, San Diego, Calif. 92120., has released four pages of technical data and specifications on a new line of marker pulse and pulse delay generators. [485]

New Books

Delay lines

Ultrasonic Delay Lines, by C. F. Brockelsby, J. S. Palfreeman and R. W. Gibson, Iliffe Books, London, 297 pp., 65 s net.

This volume from overseas will appeal to a wide range of specialists, from the technician and purchasing agent to the theoretical physicist and project engineer. It is the first book written entirely on this topic.

It presents, in one concise volume, an integrated review of a rapidly developing area in ultrasonics and electronics that, until now, has been treated in depth only in scattered journal articles. While the presentation often differs from previous works—as in the discussion of the mechanical and electrical relations of a loaded transducer—the treatment is correct and simple. Some mathematical background, including partial differential equations, is needed.

Flaws appear mainly when the authors attempt to deal with the historical development of delay lines, where there may be considerable differences of opinion on opposite sides of the Atlantic. The authors entered the field only in 1952, when the major problems had already been worked out. The earliest work was done under wartime security, and later developments were confined to commercial organizations whose policies were even more restrictive.

It is unfortunate that, while the British were the first to suggest the use of ultrasonic delay lines, their activity has been negligible compared with that in the United States. It is therefore all the more intriguing that this book, which may prove to be definitive, should be written from the British—or rather Mullard, Ltd.—point of view.

There is often little correlation between the references and the text. In chapter 5, p. 105, J. S. Palfreeman is cited as having given an improved technique for making an indium bond, but no complete reference appears. In other instances the citations are misleading—as the assignment of credit

to H. J. McSkimin for the discovery of both the polygonal shapes and the wedge symmetry, whereas he is only responsible for the latter. On p. 86, it is stated that the ripples in the bandpass due to frequency increment were not observed by the Mullard research group, whereas in fact they have been observed and discussed by many others.

Performance figures are taken mainly from products of the Mullard laboratory, and do not achieve values that are obtainable elsewhere.

David L. Arenberg, President
Arenberg Ultrasonic Laboratory, Inc.
Jamaica Plain, Mass.

Cybernetics and all that

Brains, Machines, and Mathematics, by Michael A. Arbib; McGraw-Hill Book Co., New York, 1964, 152 pp., \$6.95.

Such fashionable topics as cybernetics, information theory and Goedel's theorem are explored in this book for the nonspecialist reader. The aim is to establish a common mathematical ground for the theories of neural nets, communication and computation machines and general cybernetics. Though this is not a highly technical book, a calculus background is needed.

The author takes a brief look at the various model networks that have been proposed to explain the operation of the brain, and also reviews the experimental evidence.

The final chapter deals with Goedel's theorem of incompleteness, and offers a simple proof of its thesis: that any adequate consistent arithmetical logic must necessarily be incomplete. This has a direct bearing on the question of whether a machine can think.

In the epilogue, the author expresses hope that cybernetics as an interdisciplinary effort may yet succeed, in spite of the many exaggerated claims made for it in the past, and makes the point that scientists with a new degree of competence will be needed to accomplish this.

George V. Novotny

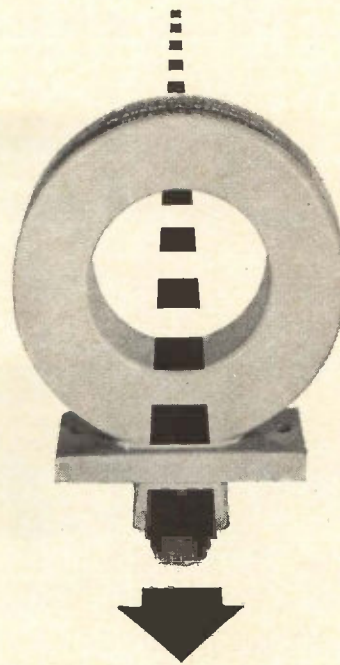

Wide Band, Precision

CURRENT MONITOR

With a Pearson current monitor and an oscilloscope, you can precisely measure ac and pulse currents from milliamps to thousands of amperes, in any conductor or beam of charged particles, at any voltage level up to a million volts, at frequencies up to 35 mc or down to 1 cps.

The monitor is completely isolated, physically and electrically, from the circuit. It is a current transformer capable of highly precise measurement of both amplitude and waveshape. The one shown above, for example, offers high accuracy in output amplitude (+1%, -0%), 1 cps to 35 mc bandwidth, fast rise time (20 nanoseconds), and low droop (0.5% per millisecond).

Whether you want to install a Pearson current monitor around a conductor or a klystron, or measure the beam current in a particle accelerator, it's likely that one of our off-the-shelf models (ranging from ½" to 10¾" in ID) will do the job. If not, we'll make one that does. Send us your name and you'll have data sheets in a few days.

PEARSON ELECTRONICS INC
4007 Transport St., Palo Alto, California

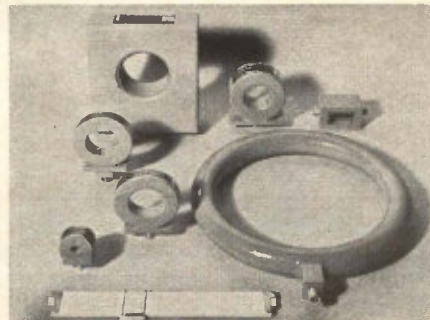

DATA CONVERSION?

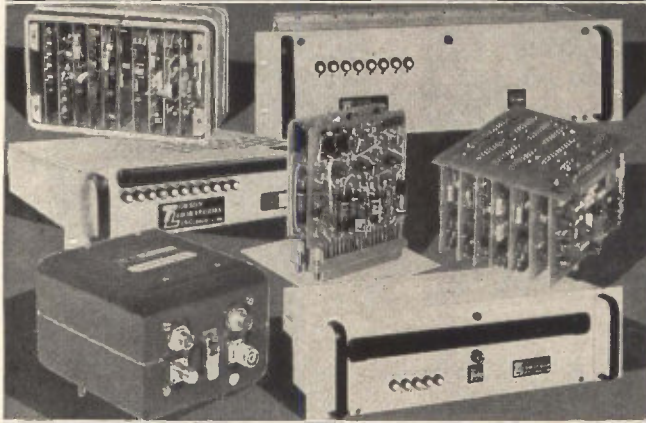

TRY THE **TZ** VERSION!

ALL UNITS FULLY TRANSISTORIZED

CAPCODER ANALOG-TO-DIGITAL CONVERTERS

OC 1001/1002

Airborne, PCM Telemetry Unit
10 bits; 23,000 encodings/sec., serial binary data output
Military
100 cubic inches

OC 1005/1006

Similar to above except parallel binary data output (OC 1006 has thermal housing)

OC 1501

Airborne
10 bits; 23,000 encodings/sec., serial or parallel binary data output
Small size unit with extended temperature range

OC 2010A, B, C

General purpose
8 bits; 185,000 encodings/sec., serial or parallel binary output
Special models available for inverted serial readout or absolute value encoding of negative quantities

OC 3100

Economical Remote Data Converter
For industrial application
8 bits; 2000-10,000 bits/sec., serial binary data output
High reliability; 114 circuit components
Small size, two plug-in boards
Low power, 0.65 watt total
Compatible with telephone line transmission

OC 4000A

Multi-purpose
11 bits; 50,000 encodings/sec., serial or parallel binary data output
Optional high input impedance or operational amplifier models

OC 5000

True logarithmic encoder (no approximations)
Dynamic range to 60 db
Resolution to 9 binary digits

OM 2000

Caplexer Capacitive Sampling Multiplexer
Sample and hold multiplexer
Sampling apertures 0.25 to 5 microseconds
Sampling rates of 100 KC to over 1 MC
Low and high level inputs
Addressable or sequential programming

SPECIAL ITEMS OR TECHNIQUES

- Multiplexed Synchro Encoder
- Video Multiplexer
- Very Low Power Capcoder
- Remote Multiplexer

Visit our display at the National Telemetering Conference—
Booth 29—June 2-4 Los Angeles, Calif.



Designers and manufacturers of CAPCODER and
CAPLEXER Capacitive Charge devices

TOWSON LABORATORIES, INC.

3500 PARKDALE AVE. • BALTIMORE, MD. 21211
AREA CODE 301-367-4001

THE DECI-CAP

New Subminiature Ceramic Capacitor—0.100" Diameter by
0.250" Molded Envelope—to 27,000 pf

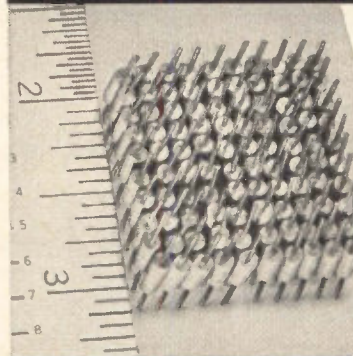

10 PER LINEAR INCH,
100 PER SQUARE INCH

5 pf to 27,000 pf in 39 values
200 WVDC to 470 pf
100 WVDC to 27,000 pf

Epoxy molded. Capacitance
change is less than 7½%
from 5 pf to 470 pf and
less than 15% from
560 pf to 27,000 pf
at -55°C to +125°C

FEATURES:

Standardized size
for high density
cordwood packaging

Designed to meet
all the require-
ments of MIL-C-11015

The DECI-CAP is the latest addition to Nytronics' DECI Series—a series that does consist of inductors, capacitors and resistors in a uniform envelope to facilitate point-to-point assembly in cordwood, printed circuit and other high density module assemblies.

For complete engineering data, write Dept. WL-34, or phone 201-464-9300.

NYTRONICS, INC.

550 Springfield Ave., Berkeley Heights, N. J.

Design Leaders STANDARD components to meet CUSTOM requirements

Circle 209 on reader service card

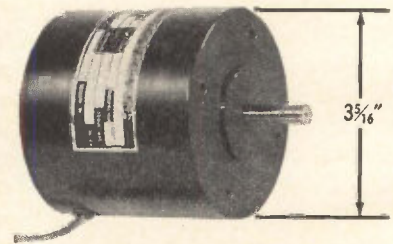

NEW SMALL A.C. MOTORS

10 to 20 oz. in. torque

Here's big torque from a small, light weight MIL spec unit; hysteresis synchronous motors produce 10 oz. in. maximum sync torque, up to 20 oz. in. from induction types. Globe LC motors weigh only 3 lbs. 5 oz., are 3 3/8" dia. x 3 3/8" long (shorter or longer, depending on performance desired). Where space and weight are critical these motors permit extremely small package designs for blowers, servo systems, actuators, etc. Available with a variety of windings for voltages up to 208 v.a.c., 2, 4, or 6 poles, 1 or 2 phase, 60 or 400 cycles, special or variable frequency. Motors can be furnished with integral brakes and special gear reducers. Write for Bulletin LC from Globe Industries, Inc., 1784 Stanley Ave., Dayton 4, Ohio.

GLOBE

GLOBE
INDUSTRIES,
INC.

Technical Abstracts

Synchro converters

Solid-state synchro conversion devices, John Brinkman, Kearfott Division, General Precision, Inc, Little Falls, N. J.

Rapid, accurate and reliable angle encoding and decoding are particularly critical in weapons control, guidance and data systems, where there is a need for a link between various types of analog sensors and the central digital computer. Two all solid-state converters, a synchro-to-digital and a digital-to-synchro type, have been designed to function as such a link between typical synchros in a system and an associated digital computer.

The synchro-to-digital converter is, in effect, an all-electronic servo-mechanism. It derives a digital output through a series of internally programmed steps. At each step the output successively approximates the value of θ , the analog input signal.

Heart of the converter is a unique circuit, the tan X network. This network consists of an array of resistors and semiconductor switches. It is used as a variable attenuator which operates on one of the input signals $\cos \theta$ to produce a signal proportional to $\tan X \cos \theta$. Timing circuits control of the output storage register to perform a bit-by-bit comparison between the $\sin \theta$ input and the $\tan X \cos \theta$ input to a comparator amplifier. Output of this amplifier determines the relative amplitude of each bit as compared to the $\sin \theta$ input. Comparator output is also used to store the result in a storage register. By each bit comparison, the output of the tan X network is made to successively approximate the $\sin \theta$ input.

The digital-to-synchro converter is similar in operation to a simple digital-to-analog voltage converter, except that it is comprised of two such converters, and the reference is 400-cps voltage. The two inputs are each a binary digital number, one proportional to $\sin \theta$, and the other to $\cos \theta$. The outputs of the two channels are proportional to $\sin \theta$ and $\cos \theta$ respectively.

Both converters can be implemented with all-solid state and mi-

croelectronic devices. Several packaging schemes have evolved which can optimize one or more of the following requirements: cost, maintainability and size and weight.

Paper presented at the Symposium on rotating and static precision components, April 21-22, Washington, D.C.

Machinable masks

Graphite masks for thin film deposition. Guy Robert Stutzman, Chief, Advanced Manufacturing Techniques Branch, U.S. Naval Avionics Facility, Indianapolis, Ind.

The urgent need for thin-film circuits in military and space applications requires manufacturing techniques designed to take the circuit from design concept to finished hardware in as short a time as possible. Mask-making has long been the bottleneck. High-purity, high-density graphite now provides a new material for masks that can be turned out on automatic high-speed tape-controlled milling machines. The cost of the graphite mask, including the preparation of the punched tape, is \$20 whereas the cost per mask by use of previous techniques ranged from \$500 to \$1000.

Graphite maintains its flatness during temperature changes in the deposition cycle. This allows the circuit designer to use thin cantilever sections without danger of excessive distortion. The development of a new process for producing very high density graphite represents an important technological advance. The new material, originally designed for high temperature missile work, now lends itself to thin-film mask making at a slightly higher cost than the original high-density, high-purity graphite. Total impurities can be reduced to five parts per million, if necessary. Machinability is excellent, and the definition of the machined edge is knife-sharp with no broken lines. Line widths can be controlled to ± 0.0002 in. over the entire pattern. Thermal expansion is about one-fourth that of iron, which makes it compatible with most substrate materials.

In the future, circuit designs from the computer will extend the numerically-controlled automatic concept by eliminating layout drawings of the masks and going

ONE
OF THESE
OMEGA
WATCHES
IS
WAITING
TO GO ON
YOUR WRIST



IF YOU CAN
THINK OF
NEW
APPLICATIONS
FOR OUR
RESONANT
REEDS



mini-reed

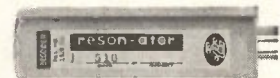

reson-ator

WRITE NOW FOR FULL CONTEST DETAILS!

All the rules and lots of technical data will come to you in a handsome executive portfolio—no obligation, of course. Enter only on this form; contest closes June 15.

**If you're a winner and you already own an Omega watch, we'll give you a lady's model for your wife or . . .*

S&G Electronics
Dept. E-5

Sargent & Greenleaf, Inc.
Rochester, N. Y. 14621

Please send me rules and details on your applications contest.

NAME

TITLE

FIRM

ADDRESS



ELECTRONICS

SARGENT & GREENLEAF, Inc.
(formerly Security Devices Laboratory)



Wives are important too—when you move key people!

Mayflower eases their moving problems,
when their husbands change locations

It's the way her move is handled that most concerns a wife. The help of our local Mayflower agent, and knowing exactly who will help her at the other end mean so much. So does the courteous, efficient manner of well trained Mayflower movers and the care they show her furnishings. She'll quickly tell you the biggest help is to let Mayflower move her... when you move him. Exclusive agents listed in phone book Yellow Pages in over 2700 localities.

AERO MAYFLOWER TRANSIT CO., Inc., INDIANAPOLIS

© AMTC 1964



America's Most Recommended Movers

directly to a tape for numerically-controlled automatic machining.

Presented at the annual microelectric symposium of the St. Louis section of the IEEE, April 13-15, 1964, St. Louis, Mo.

Automated radio programing

Radio automation Don W. Clark, Continental Electronics Division, Continental Electronics Manufacturing Co., Dallas

Prolog, a system that provides 24-hour, fully automatic radio programing, is discussed in this paper. This system is simple, flexible and reliable and can be operated economically.

The heart of the system is the station's daily log that controls taped programs and announcements. The desired broadcast schedule for 24 hours is typed onto the log, using an appropriate type-written symbol to represent the time an item is to be broadcast. When this symbol is read by a photoelectric head, it warns a tape machine containing the material that it will be used next. An inaudible tone, recorded after the material on the same tape, advances the log to the next item and activates a printer to record the time the item goes off the air.

The system can automatically handle all station breaks, taped introductions and commercials, and can also switch to a live announcer at a prearranged time. Thus the announcer is relieved of all logging and switching operations except for pushing a button when he is finished. An emergency button allows live operation without waiting for completion of an item being broadcast.

Last-minute changes or insertions are made by applying typed information into the appropriate location on the log.

Prolog systems are combined as required by the station's operations. They are made up of plug-in modules, so that minimum systems may be expanded as desired. This system is also used with low-priced IBM tabulating equipment to automatically provide such necessary accounting controls as sales journals, accounts receivable, cash receipts, affidavits and statements.

President at the 42nd annual meeting of the National Association of Broadcasters, April 5-8, Chicago, Ill.

HELPFUL McGRAW-HILL BOOKS



available by mail
for 10 days'
free examination

MODERN DIGITAL CIRCUITS

Just Out. Helps you solve design problems for digital-type circuits used in data processing, communications, telemetry, etc. Provides block diagrams, actual circuit schematics, procedures, and performance data. Thin film circuits, integrated circuits, tunnel-diode logic, field effect devices, and many other topics are treated. By S. Weber, *Electronics*. 368 pp., 426 illus., \$9.50

ION PROPULSION FOR SPACE FLIGHT

Just Out. Explains the properties and capabilities of ion propulsion systems. Basic theory, specific designs, and results of laboratory experiments on ion motors and other components are described. By E. Stuhlinger, *NASA*. 368 pp., 191 illus., \$17.50. Payable \$7.50 in 10 days, and \$10 in 1 month.

MASERS AND LASERS

How They Work, What They Do

Just out. Brings you the ABC's of masers and lasers—how they were developed, the key ideas and principles underlying their operation, and their value—both actual and potential—to science and technology. Focuses upon recent major breakthroughs. By M. Brotherton, *Bell Telephone Labs*. 165 pp., illus., \$8.50

METHODS FOR SOLVING ENGINEERING PROBLEMS

Just Out. Helps you in solving a wide range of engineering problems with analog computers. Guides you through every step involved in programming, including advanced techniques for statistical and noise problems. By L. Levine, *Hughes Aircraft Co.* 500 pp., illus., \$14.50. Payable \$7 in 10 days, \$7.50 in 1 month.

SEMICONDUCTOR CIRCUIT ANALYSIS

Just Out. From the fundamentals of semiconductor physics to the most advanced transistor applications—here are the vital techniques, facts, and data on circuit analysis of transistors and semiconductor devices. By P. Cutler, *North American Aviation*. 656 pp., 543 illus., \$10.00



10 DAYS' FREE EXAMINATION

Convenient Mail Service

Direct from McGRAW-HILL

McGraw-Hill Book Co., L-5-4
327 W. 41st St., N.Y.C. 10036

Send me book(s) checked below for 10 days' examination on approval. In 10 days I will remit for book(s) I keep plus few cents for delivery costs, and return unwanted book(s) postpaid. (If you remit with coupon, plus local tax, we pay delivery costs—full refund and return privilege.)

- Weber—Modern Digital Circuits, \$9.50
- Stuhlinger—Ion Prop. for Space Flt., \$17.50
- Brotherton—Masers & Lasers, \$8.50
- Levine—Methods for Solv. Eng. Prob., \$14.50
- Cutler—Semicond. Circ. Anlys., \$10.00
- Check here if you want to pay on terms

Name

Address

City State Zip Code

Company

Position

For price and terms outside U. S. write McGraw-Hill Intl., N. Y. 10036 L-5-4

EMPLOYMENT OPPORTUNITIES



The advertisements in this section include all employment opportunities—executive, management, technical, selling, office, skilled manual, etc.

Look in the forward section of the magazine for additional Employment Opportunities advertising.

— RATES —

DISPLAYED: The advertising rate is \$52.00 per inch for all advertising appearing on other than a contract basis. Contract rates quoted on request.

An advertising inch is measured $\frac{1}{8}$ " vertically on a column—3 columns—30 inches to a page.

Subject to Agency Commission.

UNDISPLAYED: \$2.70 per line, minimum 3 lines. To figure advance payment count 5 average words as a line.

Box numbers—count as 1 line.

Discount of 10% if full payment is made in advance for 4 consecutive insertions.

Not subject to Agency Commission.

New York • Los Angeles • St. Louis • Minneapolis • Atlanta

EE-MATH

**CONFIDENTIAL
SELECTIVE
FEE-PAID
ALL DEGREES**

SEND RESUME TO:



**AEROSPACE
PLACEMENT CORPORATION**
P.O. Box 2125 Philadelphia, Pa. 19103



E. E.'s
for FEE-PAID Positions
WRITE US FIRST!
Use our confidential application for professional, individualized service . . . a complete national technical employment agency.
ATOMIC PERSONNEL, INC.
Suite 1207L, 1518 Walnut St., Phila. 2, Pa.

ADDRESS BOX NO. REPLIES TO: Box No. Classified Adv. Div. of this publication. Send to office nearest you.
NEW YORK, N. Y. 10036: P. O. Box 12
CHICAGO, Ill. 60611: 645 N. Michigan Ave.
SAN FRANCISCO, Cal. 94111: 255 California St.

POSITION WANTED

Young Man, Graduate (BS. Electronic Technology) seeks engineering aide, or technician or repair of machines position with electronics firm. PW-4267, Electronics.

PROFESSIONAL SERVICES

GIBBS & HILL, Inc.
Consulting Engineers

Systems Engineering
Operations Research • Development
Field Studies • Design • Procurement
Power • Transportation • Communications
Water Supply • Waste Treatment
393 Seventh Avenue New York 1, N. Y.

Employment

Electronics

Opportunities

QUALIFICATION FORM FOR POSITIONS AVAILABLE

ATTENTION: Engineers, Scientists, Physicists

This Qualification Form is designed to help you advance in the electronics industry. It is unique and compact. Designed with the assistance of professional personnel management, it isolates specific experience in electronics and deals only in essential background information.

The advertisers listed here are seeking professional experience. Fill in the Qualification Form below.

Strictly Confidential

Your Qualification Form will be handled as "Strictly Confidential" by Electronics. Our processing system is such that your form will be forwarded within 24 hours to the proper executives in the companies you select. You will be contacted at your home by the interested companies.

What To Do

1. Review the positions in the advertisements.
2. Select those for which you qualify.
3. Notice the key numbers.
4. Circle the corresponding key number below the Qualification Form.
5. Fill out the form completely. Please print clearly.
6. Mail to: Classified Advertising Div., Electronics, Box 12, New York, N. Y. 10036.

COMPANY	SEE PAGE	KEY #
AEROSPACE PLACEMENT CORP. Phila., Pa.	143	1
ATOMIC PERSONNEL INC. Phila., Pa.	143	2
IBM CORP. Owego, New York	147*	3
MOTOROLA, INC. Scottsdale, Arizona	144	4
SPACE & INFORMATION SYSTEMS DIV. North American Aviation Inc. Downey, Calif.	135*	5

* These advertisements appeared in the April 20th issue.

(cut here) ----- (cut here)

Electronics Qualification Form For Positions Available

(Please type or print clearly. Necessary for reproduction.)

Personal Background

Name
Home Address
City Zone State

Education

Professional Degree(s)
Major(s)
University
Date(s)

Fields of Experience (Please Check)

5464

- | | | |
|--|--|---------------------------------------|
| <input type="checkbox"/> Aerospace | <input type="checkbox"/> Fire Control | <input type="checkbox"/> Radar |
| <input type="checkbox"/> Antennas | <input type="checkbox"/> Human Factors | <input type="checkbox"/> Radio—TV |
| <input type="checkbox"/> ASW | <input type="checkbox"/> Infrared | <input type="checkbox"/> Simulators |
| <input type="checkbox"/> Circuits | <input type="checkbox"/> Instrumentation | <input type="checkbox"/> Solid State |
| <input type="checkbox"/> Communications | <input type="checkbox"/> Medicine | <input type="checkbox"/> Telemetry |
| <input type="checkbox"/> Components | <input type="checkbox"/> Microwave | <input type="checkbox"/> Transformers |
| <input type="checkbox"/> Computers | <input type="checkbox"/> Navigation | <input type="checkbox"/> Other |
| <input type="checkbox"/> ECM | <input type="checkbox"/> Operations Research | |
| <input type="checkbox"/> Electron Tubes | <input type="checkbox"/> Optics | |
| <input type="checkbox"/> Engineering Writing | <input type="checkbox"/> Packaging | |

Category of Specialization

Please indicate number of months experience on proper lines.

	Technical Experience (Months)	Supervisory Experience (Months)
Research (pure, fundamental, basic)
Research (Applied)
Systems (New Concepts)
Development (Model)
Design (Product)
Manufacturing (Product)
Field (Service)
Sales (Proposals & Products)

Circle Key Numbers of Above Companies' Positions That Interest You

1 2 3 4 5 6 7 8 9 10 11 12 13 14 15

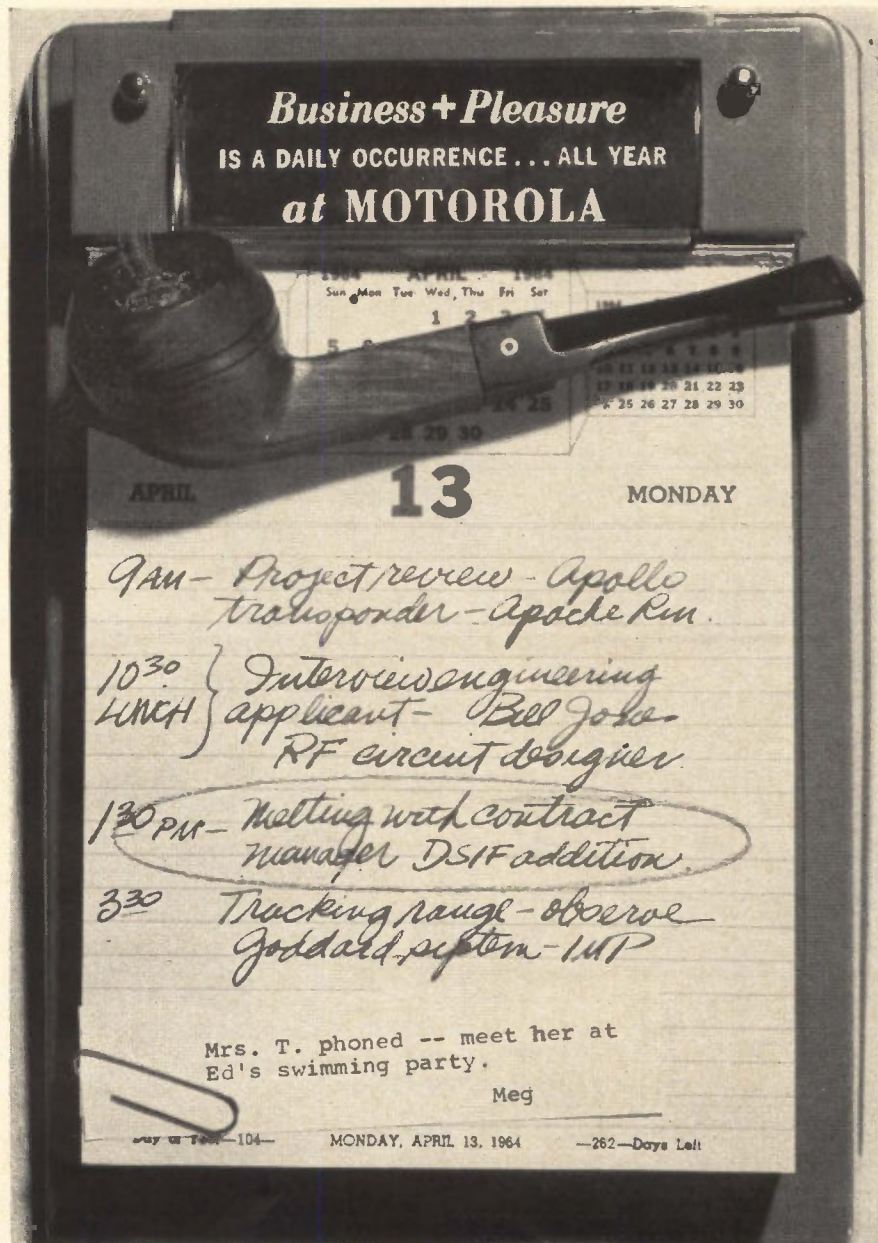

A CALENDAR JAM-PACKED WITH OPPORTUNITY for career fulfillment in aerospace electronics can be yours at Motorola in Phoenix. There's exciting, pace-setting work to be done on Gemini, Apollo and other equally advanced projects — interspersed with wonderful fun-in-the-sun weekends the year 'round, that add a zestful new dimension to living. Check these opportunities:

Antennas & Propagation
Solid State R. F.
Microwave Techniques
Missile & Space Instrumentation
Operational Support Equipment
Integrated Circuitry

Reliability Analysis
Parts Reliability
Reliability Program Coordination
Data Acquisition, Processing & Display
CW Transponders
Radar and Radar Transponders

Guidance & Navigation
Command & Control
Space Communications
Signal Processing
ECM, CCM & Surveillance
Tracking & Telemetry

Contact Phil Nienstedt, Manager of Recruitment, Department 655



Military Electronics Division • Western Center • P.O. Box 1417, Scottsdale, Arizona
MOTOROLA ALSO OFFERS OPPORTUNITIES AT CHICAGO, ILLINOIS — AN EQUAL OPPORTUNITY EMPLOYER

SEARCHLIGHT SECTION

(Classified Advertising)

BUSINESS OPPORTUNITIES
EQUIPMENT - USED or RESALE

DISPLAYED RATE
The advertising rate is \$27.25 per inch for all advertising appearing on other than a contract basis. Contract rates quoted on request. AN ADVERTISING INCH is measured 3/8 inch vertically on one column, 3 columns—30 inches—to a page. EQUIPMENT WANTED or FOR SALE ADVERTISEMENTS acceptable only in Displayed Style.

UNDISPLAYED RATE
\$2.70 a line, minimum 3 lines. To figure advance payment count 5 average words as a line.

PROPOSALS, \$2.70 a line an insertion.
BOX NUMBERS count as one line additional in undisplayed ads.
DISCOUNT OF 10% if full payment is made in advance for four consecutive insertions of undisplayed ads (not including proposals).

Why Do You Read So Slowly?

A noted publisher in Chicago reports there is a simple technique of rapid reading which should enable you to double your reading speed and yet retain much more. Most people do not realize how much they could increase their pleasure, success and income by reading faster and more accurately.

To acquaint the readers of this publication with the easy-to-follow rules for developing rapid reading skill, the company has printed full details of its interesting self-training method in a new book, "Adventures in Reading Improvement" mailed free to anyone who requests it. No obligation. Simply send your request to: Reading, 835 Diversey Pkwy., Dept. 1865, Chicago, Ill. 60614. A postcard will do.

CIRCLE 960 ON READER SERVICE CARD

V-I-S* SERVICE

FASTEST TO BOTH COASTS

FOR YOUR VERY IMPORTANT SHIPMENTS

2nd DAY between Chicago—Milwaukee and Eastern Terminals

4th DAY between Chicago—Milwaukee and West Coast

LIFSCHULTZ FAST FREIGHT

NEW YORK — CHICAGO — PHILADELPHIA — BOSTON
HOLYOKE — BALTIMORE — BLOOMFIELD, N. J.
NEW HAVEN — PROVIDENCE — MILWAUKEE
LOS ANGELES — SAN FRANCISCO

CIRCLE 961 ON READER SERVICE CARD

Color DIAL TELEPHONES \$10.95

Factory rebuilt Western Electric in white, beige, ivory, pink, green, or blue. If 4 prong plug is required add \$2.00. Fully guaranteed. Write for free list. All shipments FOB.

Complete

SURPLUS SAVING CENTER
Waymart Dept. MH-E 5464 Penna.

CIRCLE 962 ON READER SERVICE CARD

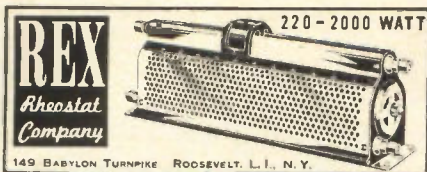

CIRCLE 969 ON READER SERVICE CARD

FOR SALE

Potter Magnetic Tape Handler

Model 902. 1/2" tape, 6 track heads. Make offer. H. Phillimore, 126 Oaks Rd., Millington, N. J.

CIRCLE 970 ON READER SERVICE CARD

OVER 2,000,000

RELAYS
IN STOCK!

Send for Catalog \$5
Universal RELAY CORP.

42 WHITE ST., N.Y. 13, N.Y. • Walker 5-6900

CIRCLE 971 ON READER SERVICE CARD

SMALL AD but BIG STOCK

of choice test equipment
and surplus electronics

Higher Quality—Lower Costs
Get our advice on your problem

ENGINEERING ASSOCIATES

434 Patterson Road — Dayton 19, Ohio

CIRCLE 972 ON READER SERVICE CARD

**BENEFIT YOURSELF BY
ADVERTISING IN THESE
SECTIONS**

EMPLOYMENT OPPORTUNITIES:

for all employment advertising
including Positions Vacant or
Wanted and Selling Opportuni-
ties Offered or Wanted.

SEARCHLIGHT SECTION:

A national medium for Surplus
New or Used Equipment and
other Business Opportunities.

PROFESSIONAL SERVICES:

A dignified method for Special-
ized consultant skills and services.

For Rates and Information Write:

Electronics

Classified Advertising Div.,
P.O. Box 12, New York, 10036

POLARAD Single Generator MSG-1,
950 To 2400 MC..... **850.00**

POLARAD Single Generator MSG-2A,
2000 To 4600 MC..... **850.00**

KAY ELECTRIC Ligna Sweep
Model SKV..... **575.00**

HEWLETT PACKARD Oscilloscope Model
150 A7 with Dual Trace Pre Amp Type
152 B..... **895.00**

HEWLETT PACKARD Transfer OSC,
540 A..... **495.00**

HEWLETT PACKARD VTVM,
410 B..... **150.00**

HEWLETT PACKARD VTVM,
400 H..... **225.00**

HEWLETT PACKARD Microwave Meter,
430-C..... **135.00**

HEWLETT PACKARD Power Supply
Model 715-A..... **150.00**

TEKTRONIX Oscilloscope,
Model 531 with 53/54..... **850.00**

TEKTRONIX Time-Mark Generator
Type RM 181..... **150.00**

HEWLETT PACKARD Signal Generator,
Model 616 A, 1800 to 4000 Mc..... **895.00**

JENNINGS VTVM,
Model J-1002..... **375.00**

HEWLETT PACKARD Power Supply
Model 710-B..... **65.00**

UNIVERSAL ELECTRONICS Power Supply
Model 520-A..... **175.00**

LFE Digital Recorder, Model 504
with Clary Printer..... **350.00**

All material in excellent condition. All prices
F.O.B., San Francisco, Cal., subject to prior sale.
Send for Listing and Flyers.

Marty's Mart

1236 Market St., San Francisco 3, California
Phone: UNDERhill 3-1215

CIRCLE 964 ON READER SERVICE CARD

FREE Catalog
OF THE WORLD'S FINEST
ELECTRONIC GOV'T
SURPLUS BARGAINS



**HUNDREDS OF TOP QUALITY
ITEMS — Receivers, Transmitters,
Microphones, Inverters, Power Sup-
plies, Meters, Phones, Antennas,
Indicators, Filters, Transformers,
Amplifiers, Headsets, Converters,
Control Boxes, Dynamotors, Test
Equipment, Motors, Blowers, Cable,
Keys, Chokes, Handsets, Switches,
etc., etc. Send for Free Catalog—
Dept. E-4.**

FAIR RADIO SALES
2133 ELIDA RD. • Box 1105 • LIMA, OHIO

CIRCLE 965 ON READER SERVICE CARD

ELECTRON TUBES

**KLYSTRONS • ATR & TR • MAGNETRONS
SUBMINIATURES • C.R.T. • T.W.T. • 5000-
6000 SERIES**

• SEND FOR NEW CATALOG A2 •

A & A ELECTRONICS CORP.

1063 PERRY ANNEX
WHITTIER, CALIF.
AN 92865 OR 696-7544

CIRCLE 966 ON READER SERVICE CARD

OPTICAL BENCHES
\$13. to \$13,000. New Catalog

THE Ealing CORP.

2250 Massachusetts Avenue, Cambridge, Mass., 02140

CIRCLE 967 ON READER SERVICE CARD

NEW DISC CAPACITORS

OVER 3 1/2 MILLION IN STOCK
ALL SIZES—BELOW FACTORY PRICES

Call or Write for Quotes

SAMUEL GLICK & SONS
313 Broadway, Dept. C New York 7, N. Y.
Phone: 212 WO 4-5162

CIRCLE 968 ON READER SERVICE CARD

AUTOTRACK ANTENNA MOUNT

360 degree azimuth, 210 degree elevation sweep
with better than 1 mil. accuracy. Missile velocity
acceleration and slewing rates. Amplidyne and servo
control. Will handle up to 20 ft. dish. Supplied
complete with control chassis. In stock—immediate
delivery. Used world over by NASA, USAF. TYPE
MP-61-B. SCR-584.

SCR 584 RADARS AUTOMATIC TRACKING
3 CM & 10 CM

Our 584s in like new condition, ready to go, and in
stock for immediate delivery. Ideal for telemetry
research and development, missile tracking, satellite
tracking, balloon tracking, weather forecasting, anti-
aircraft defense tactical air support. Used on At-
lantic Missile Range, Pacific Missile Range, N.A.S.A.,
Wallops Island, A.B.M.A. Write us. Fully Desc.
MIT Rad. Lab. Series, Vol. 1, pps. 207-210, 228,
284-286.

NIKE "AJAX" MOUNTS

Complete antenna mounts, as new, in stock for im-
mediate delivery.

PULSE MODULATORS

MIT MODEL 9 PULSER

1 MEGAWATT—HARD TUBE

Output 25 kv 40 amp. Duty cycle, .002. Pulse lengths
.25 to 2 microsec. Also .5 to 5 microsec. and .1 to .5
msec. Uses 6C21. Input 115v 60 cycle AC. Mfr. GE.
Complete with driver and high voltage power supply.
Ref: MIT Rad. Lab. Series, Vol. 5, pps. 152-160.

500KW THYRATRON PULSER

Output 22kv at 28 amp. Rep. rates: 2.25 microsec.
300 pps, 1.75 msec 550 pps, .4 msec 2500 pps. Uses
5C22 hydrogen thyatron. Complete with driver and
high voltage power supply. Input 115v 60 cy AC.

2 MEGAWATT PULSER

Output 30 kv at 70 amp. Duty cycle, .001. Rep rates:
1 microsec 600 pps, 1 or 2 msec 300 pps. Uses 5948
hydrogen thyatron. Input 120/208 VAC 60 cycle.
Mfr. GE. Complete with high voltage power supply.

15KW PULSER—DRIVER

Biased multivibrator type pulse generator using 3E29.
Output 8kv at 5 amp. Pulse lgths .5 to 5 microsec.
easily adj. to .1 to .5 msec. Input 115v 60 cy AC.
\$475. Ref: MIT Rad. Lab. Series, Vol. 5, pps. 137-
160.

MIT MODEL 3 PULSER

Output: 144 kw (12 kv at 12 amp.) Duty ratio: .001
max. Pulse duration: 5.1 and 2 microsec. Input:
115 v 400 to 2000 cps and 24 vdc. \$325 ea. Full
desc. Vol. 5, MIT Rad. Lab. series, pg. 140.

MICROWAVE SYSTEMS

C-BAND RADAR

250 KW output, C-band, PPI indicator, 5C22 thya-
tron modulator. Antenna large parabolic section.
Input 115 volts 60 cycle AC, complete \$2750.00

300 TO 2400MC RF PKG.

300 to 2400MC CW. Tuneable. Transmitter 10 to 30
Watts. Output. As new \$475.

X BAND DOPPLER SYSTEM

AN/APN-102 G.P.L. ANT/RCVR/XMTR PKG. 4
Beam Pulsed Janus Planar Array—New \$1,600 ea.

AN/TPS-ID RADAR

500 kw 1220-1359 mca. 160 nautical mile search range
P.P.I. and A Scopes. MTTI. thyatron mod. 5J26
magnetron. Complete system.

10 CM. WEATHER RADAR SYSTEM

Raytheon, 275 KW output S Band. Rotating yoke
P.P.I. Weather Band, 4, 20 and 80 mile range. 360
degree azimuth scan. Price \$975 complete.

AN/APS-15B 3 CM RADAR

Airborne radar. 40 kw output using 725A magnetron.
Model 3 pulser. 30-in. parabola stabilized antenna.
PPI scope. Complete system. \$1200 each. New.

10KW 3 CM. X BAND RADAR

Complete RF head including transmitter, receiver,
modulator. Uses 2J42 magnetron. Fully described in
MIT Rad. Lab. Series Vol. 1, pps 616-625 and Vol.
II, pps. 171-185. \$375. Complete System. \$750.

AN/APS-27 X BAND RADAR

Complete 100 kw output airborne system with AMTI,
5C22 thyr. mod. 4J52 magnetron, PPI. 360 deg az
sweep, 60 deg. elev. sweep, gyro stabilizer, hi-gain
revr. Complete with all plugs and cables \$2800.

M-33 AUTO-TRACK RADAR SYSTEM

X band with plotting board, automatic range track-
ing, etc. Complete with 1 megawatt acquisition
radar.

AN/APS-45 HEIGHT FINDER

Airborne system, 40,000 ft. altitude display on PPI
& RHI. 8375 mcs. 400kw output using QK-172
negatron, 5622 thyatron.

L BAND RF PKG.

20 KW peak 990 to 1040 MC. Pulse width .7 to 1.2
microsec. Rep rate 180 to 420 pps. Input 115 vac.
Incl. Receiver \$1200.



**Radio-Research
Instrument Co.**

550 5th Ave. New York 36, N. Y.
Tel. JUdeon 6-4691

CIRCLE 963 ON READER SERVICE CARD



<ul style="list-style-type: none"> ■ A M P Inc. 98 Garceau, Hargrave & McCullough Inc. Aero Mayflower Transit Co. Inc. 142 Caldwell, Larkin & Sidener-Van Riper Inc. Alco Electronic Products, Inc. 105 Marketronics Adv. American Electronic Laboratories, Inc. 112 Benn Associates Atlee Corporation 124 S. Gunnar Myrbeck & Company ■ Ballantine Labs. 111 Lang-Lawrence Adv. Inc. Barber-Colman Company 19, 20 Howard H. Monk & Associates, Inc. Bendix-Pacific 117 John B. Shaw Co. Inc. ■ Bliley Electric Co. 127 Barber & Drullard Inc. ■ Boonton Radio Company 2 George Homer Martin Associates ■ Bourns Inc., Trimpot Div. 33 Allen, Dorsey & Hatfield Inc. Brand, William Electronic Components Inc. 104 Max Berking Inc. ■ Clairex Corp. 131 S. Paul Sims Co. Colorado Div. of Commerce & Development 135 William Kosta & Associates, Inc. Communication Electronics Inc. 129 John E. Waterfield/Admasters Adv. Inc. Consolidated Electrodynamics Corp. 27 Hixson & Jorgensen, Inc. ■ Couch Ordnance, Inc. 132 Culver Advertising Inc. ■ Defense Electronics Inc. 115 Compton Jones Associates Di-Arco Corp. 135 Charles E. Brown Adv. DuPont de Nemours & Co. Inc. E.I. 24, 47 Batten, Barton, Durstine & Osborn Durant Manufacturing Co. 138 Keck Advertising Agency Edgerton, Germeshausen & Grier, Inc. 126 Reach, McClinton & Humphrey, Inc. Elgeet Optical Co., Inc. 105 Hutchins Adv. Co., Inc. Engelhard Industries, Inc. 118, 119 Keyes, Martin & Company Fairchild Semiconductor 14 Johnson & Lewis Inc. Fluke Mfg. Co. Inc., John 123 Pollock & Loth, Inc. Flying Tiger Line 12, 13 Hixson & Jorgensen, Inc. General Electric Company, Miniature Lamp Div. 128 Batten, Barton, Durstine & Osborn Inc. General Electric Company, Rectifier Components Div. 52 Ross Roy Inc. Advertising ■ Globe Industries Inc. 140 Odiorne Industrial Adv. Inc. ■ Hewlett-Packard Co. 1 L.C. Cole Company Inc. Hughes Aircraft Company 50, 136 Foote, Cone & Belding ITT-Royal Electric 112 West, Weir & Bartel Inc. International Rectifier Corp. 44 Communication Associates ■ Jennings Radio Mfg. Corp. 120 L.H. Waldron Kay Electric Company 23 Josephson, Cuffari & Co. ■ Keithley Instruments Inc. 114 Bayless-Kerr Company ■ Kepeco, Inc. 16 Weiss Advertising Kin Tel Div. of Cohu Electronics 3rd Cover Erwin Wasey Ruthrauff & Ryan ■ Klein & Sons, Mathias 21 The Buchen Co. Leach Corp. 37 Hixson & Jorgensen, Inc. ■ For more information on complete product line see advertisement in the latest Electronics Buyers' Guide 	<ul style="list-style-type: none"> Lear Siegler Inc./Laser Systems Center 133 Gustafson-Whitmer Adv. Design Lepel High Frequency Laboratories Inc. 130 Apex Graphic Company Levin & Son, Inc., Louis 105 M.R. Grossman Co. Licon, Div. of 25 Illinois Tool Works Inc. Linde Div. of 137 Union Carbide Corp. Ling-Temco-Vought 40, 41 J.M. Mathes Incorporated Wyatt, Allen & Ryan Inc. 8 Machlett Laboratories Inc., The 8 Fuller & Smith & Ross Inc. Marconi Instruments 136 Armand Richards Adv. Agency Markem Machine 96 Culver Adv. Inc. Massa Div. of 134 Cohu Electronics Inc. L.K. Frank Co. Inc. 142 ■ Micro Switch Div. of Honeywell 22 Batten, Barton, Durstine & Osborn Inc. Minnesota Mining & Mfg. Co. Mincom Div. 97 Reach, McClinton & Co., Inc. ■ Moseley, F.L. 121 L.C. Cole Company Inc. Motorola Semiconductor Products Inc. 42, 43 Lane and Bird Advertising Inc. ■ North Atlantic Industries, Inc. 110 Dunwoode Associates Inc. Nytronics Inc. 140 Groody Advertising Agency Inc. ■ Ohmite Mfg. Co. 51 The Fensholt Adv. Agency Ozalid A Div. of 26 General Aniline & Film Corp. Lennen & Newell Inc. 106, 107 Paktron, Div. of 106, 107 Illinois Tool Works Inc. Raymond E. Finn & Associates 139 Pearson Electronics 11 Hal Lawrence Inc. Pennsalt Chemicals 11 Aitkin-Kynnett Co., The ■ Philco A Sub., of Ford Motor Co. 38, 39 Maxwell Associates, Inc. Polaroid Corporation 95 Doyle, Dane, Bernbach Inc. Radiation Inc. 28 G.M. Basford Company Radio Corporation of America 4th Cover Al Paul Lefton Company ■ Sanborn Co., A Sub. of Hewlett-Packard 48, 49 Culver Adv. Inc. Sargent & Greenleaf, Inc. 141 Wolff Associates, Inc. Siemens America Incorporated 103 Max Berking Inc. Sperry Semiconductor 9 Div. of Sperry Rand Corp. Armand Richards Advertising Agency 5, 6, 10 Sprague Electric Co. 5, 6, 10 The Harry P. Bridge Company Struthers-Dunn, Inc. 125 The Harry P. Bridge Company ■ Superior Tube Co. 116 Gray & Rogers, Inc. Texas Instruments Incorporated 108, 109 Industrial Products Group Robinson-Gerrard, Inc. 140 Towson Laboratories Inc. 140 George C. Ruehl, Jr. Adv. ■ United Transformer Corp. 2nd Cover Bradley Rosen & Kaus Adv., Inc. Unitrode Transistor Products Inc. 7 Chirurg & Cairns Inc. Unitron Inc. 127, 129, 131 Wayne George Corp. 35 L.K. Frank Co. Inc. Welch Scientific Co., The 122 Armstrong Adv. Agcy. Inc.
---	---

Advertising sales staff

James T. Hauptli: [212] 971-2210
Advertising sales manager

Atlanta, Ga. 30309: Gus H. Krimsier, Michael H. Miller, 1375 Peachtree St. N.E., [404] TR 5-0523

Boston, Mass. 02116: William S. Hodgkinson, McGraw-Hill Building, Copley Square, [617] CO 2-1160

Chicago, Ill. 60611: Robert M. Denmead, Daniel E. Shea, Jr., 645 North Michigan Avenue, [312] MO 4-5800

Cleveland, Ohio 44113: Paul T. Fegley, 55 Public Square, [216] SU 1-7000

Dallas, Texas 75201: Frank Le Beau, The Vaughn Building, 1712 Commerce Street, [214] TR 9-9721

Denver, Colo. 80202: John W. Patten, David M. Watson, Tower Bldg., 1700 Broadway, [303] AL 5-2981

Houston, Texas 77025: Kenneth George, Prudential Bldg., Halcombe Blvd., [713] RI 8-1280

Los Angeles, Calif. 90017: Ashley P. Hartman, John G. Zisch, 1125 W. 6th St., [213] HU 2-5450

New York, N.Y. 10036: Donald R. Furth [212] 971-3616
Donald H. Miller [212] 971-3615
George F. Werner [212] 971-3617
500 Fifth Avenue

Philadelphia, Pa. 19103: William J. Boyle, Warren H. Gardner, 6 Penn Center Plaza, [215] LO 8-6161

San Francisco, Calif. 94111: Richard C. Alcorn, 255 California Street, [415] DO 2-4600

London W1: Edwin S. Murphy Jr., 34 Dover Street

Frankfurt/Main: Matthee Herfurth, 85 Westendstrasse Phone: 77 26 65 and 77 30 59

Geneva: Michael R. Zeynel, 2 Place du Port 244275

Paris VIII: Denis Jacob, 17 Avenue Matignon ALMA-0452

Tokyo: Shigeo Chiba, 1, Kotohiracho, Shiba, Minato-ku (502) 0656

Osaka: Kazutaka Miura, 163, Umegae-cho, Kita-ku [362] 8771

Nagoya: International Media Representatives, Yamagishi Bldg., 13-2-Chome, Oike-cho Naga-ku

R.S. Quint: [212] 971-2335
General manager
Electronics Buyers' Guide
David M. Tempest: [212] 971-3139
Promotion manager
Henry M. Shaw: [212] 971-3485
Market research manager
Richard J. Tomlinson: [212] 971-3191
Business manager
Theodore R. Gelpel: [212] 971-2044
Production manager

Classified advertising

F.J. Eberle, [212] 971-2557
Business Manager

Professional Services 143
Employment Opportunities 143-144
Equipment
(Used or Surplus New) 144-145
For Sale 144-145

Classified advertisers index

<ul style="list-style-type: none"> ■ A & A Electronics Corp. 145 Aerospace Placement Corp. 143 Atomic Personnel Inc. 143 Ealing Corp., The 145 ■ Engineering Associates 145 ■ Fair Radio Sales 145 Glick & Sons, Samuel 145 Lifschultz Fast Freight 144 Markus-Campbell Co. 144 Marty's Mart 145 Motorola Inc. 144 Phillimore, Horace R. 145 Surplus Saving Center 144 ■ Radio Research Instrument Co. 145 Rheostat Co., Rex 145 ■ Universal Relay Corp. 145
--

Executive, editorial, circulation and advertising offices: McGraw-Hill Building, 330 West 42nd Street, New York, N.Y., 10036. Telephone Area Code 212-971-3333. Teletype TWX N.Y. 212-640-4646. Cable McGrawhill, N.Y. Officers of the Publications Division: Shelton Fisher, President; Vice Presidents: Joseph H. Allen, Operations; John R. Callahan, Editorial; Ervin E. DeGraff, Circulation; Donald C. McGraw, Jr., Advertising Sales; Angelo R. Venezian, Marketing. Officers of the Corporation: Donald C. McGraw, President; Hugh J. Kelly, Harry L. Waddell, L. Keith Goodrich, Executive Vice Presidents; John L. McGraw, Treasurer; John J. Cooke, Vice President and Secretary. Title R registered U.S. Patent Office; © copyright 1964 by McGraw-Hill, Inc. All rights reserved, including the right to reproduce the contents of this publication, in whole or in part.

KIN TEL

**world's
largest
DC amplifier
manufacturer**

**has an
amplifier
to fit
your**

requirements



Solid state, non inverting amplifier

Model 121A/A. Response from DC to beyond 200 kc. Input impedance >10 megohms; output capability ± 15 volts, 100 ma; output impedance <0.2 ohm in series with 50 microhenries. Price: \$995.

Floating, differential amplifier

Model 114C. High common mode rejection, low effective input capacity. DC to 85 cps. Input impedance >40 megohms; output capability ± 10 volts, 10 ma; output impedance <0.25 ohm to 500 cps; <1 ohm to 2 kc. Price: \$995.

Floating, differential amplifier

Model 114A. Effective input capacity less than $1\mu\text{fd}$, high common mode rejection. 100 cycle bandwidth. Input impedance >5 megohms. Output capability ± 10 volts, 10 ma; output impedance <2 ohms, DC to 1 kc. Price: \$895.

Wideband amplifier

Model 112A. Four different plug-in attenuator units. DC to 40 kc. Input impedance 100 K ohms; output capability ± 35 volts, 40 ma; output impedance <1 ohm in series with 25 microhenries. Prices: \$575 to \$680.

Visit our Booth 1017 at WESCON, Sports Arena, Los Angeles, August 25-28

All KIN TEL DC data amplifiers: have drift less than $2\mu\text{v}$ • accuracy of 0.01% for any single gain step • fit six to a standard 19-inch rack • are available in portable cabinets • have an integral power supply • are chopper-stabilized • have exceptional linearity and low output impedance.

All prices FOB, San Diego, California. (Additional export charge.)
Write for detailed information. Representatives in all major cities.

5725 Kearny Villa Road
San Diego, California 92112
Phone (714) 277-6700

COHU
ELECTRONICS, INC.
KIN TEL DIVISION

Circle 901 on reader service card

For production-line testing...
 Equipment maintenance... Product quality checks...
 Laboratory measurements...



1

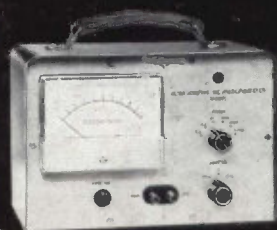

2



3



4



5



6



7



8

USE HIGH-QUALITY RCA TEST INSTRUMENTS

These rugged, high-quality test instruments offer you several important advantages in industrial testing:

- They give you excellent performance at moderate cost... enabling you to buy more test instruments within budget. This in turn expedites production line testing, product quality checks, and equipment maintenance work.
- They eliminate the need to tie up your high-cost instruments on routine tests and measurements—and increase the overall efficiency of your electronic maintenance department.

- 1 **RCA WT-100A MICROMHOMETER** Measures tube characteristics under actual operating-voltage conditions.
 Tests vacuum tubes, gas-filled tubes, semiconductor diodes.
 Measures: True transconductance (both control-grid-to-plate and suppressor-grid-to-plate) to an accuracy of better than 3%; Transconductance up to 100,000 micromhos in six ranges; DC plate, screen grid, and grid-No. 1 test voltages; Electrode currents from 3 μ a to 300 ma; Heater-cathode leakage currents; . . . and other important electron tube parameters. **\$989.00***
- 2 **WV-84C ULTRA-SENSITIVE DC MICROAMMETER** Battery-operated vacuum-tube microammeter measures down to 0.0002 microampere. Especially useful in measuring "dark currents" in vidicons and phototubes as well as minute currents in image orthicons. Can also be used as a high-impedance voltmeter and as an ohmmeter to measure extremely high resistances in the order of billions of ohms. **\$110.00***
- 3 **WO-91A RCA 5-INCH OSCILLOSCOPE** A high-performance, wide-band "scope"—serves as a display-type VTVM. Choice of wide band (4.5 Mc—0.053-volt rms/inch sensitivity) or narrow high-sensitivity band (1.5 Mc—0.018-volt rms/inch sensitivity). New 2-stage sync separator provides solid lock-in on composite TV signals. **\$249.50***

*Optional Distributor Resale Price

- 4 **WA-44C RCA AUDIO GENERATOR** Generates sine-wave and square-wave signals over range of 20 to 200,000 cps to test audio systems. Can be used to measure intermodulation distortion, frequency response, input and output impedances, speaker resonance, transient response, and phase shifts. Less than 0.25% total harmonic distortion over range of 30 to 15,000 cps. **\$98.50***
- 5 **RCA WV-76A HIGH-SENSITIVITY AC VTVM.** A combination voltmeter and preamplifier for audio applications. For signal tracing, audio-level and power-level measurements, gain measurements, amplifier balancing applications, and audio voltage measurements. Frequency response from 10 cps to 1.5 Mc with "direct" probe, 10 cps to 500 kc with "low-cap" probe. Measures decibels from -40 to +40 db in 9 overlapping ranges (up to 56 db with probe switch in "low-cap" position). As a pre-amplifier, provides up to 38 db maximum gain. **\$79.95***
- 6 **WV-98C NEW RCA SENIOR VOLT-OHM-MILLIAMMETER®** For direct reading of peak-to-peak voltages of complex waveforms, rms values of sine waves, DC voltages, and resistance. Accuracy: 3% full scale on both AC and DC, with less than 1% tracking error. Color-coded scales differentiate peak-to-peak from rms readings. New 0.5 volt full scale DC range for use in low-voltage transistor circuits. 6 $\frac{1}{2}$ " meter. **\$79.50***
- 7 **RCA WV-38A VOLT-OHM-MILLIAMMETER** One of the most versatile electronic test instruments. 0.25-volt and 1.0-volt DC ranges. Big easy-to-read 5 $\frac{1}{2}$ " meter. Non-breakable sealed plastic case. Jacks located below switches to keep leads out of the way. Spring clips on handle to hold leads. Attractive, scuff-resistant, rugged carrying case, only \$4.95* extra. **\$43.95***
- 8 **RCA WV-120A POWER LINE MONITOR.** Provides a constant check on incoming line voltage. Responds to voltage fluctuations. Highly accurate (\pm 2% at 120 volts). Gives true rms reading. 5" wide meter. **\$14.95***

SEE THEM ALL AT YOUR AUTHORIZED RCA TEST EQUIPMENT DISTRIBUTOR.

RCA ELECTRONIC COMPONENTS AND DEVICES, HARRISON, N. J.



The Most Trusted Name in Electronics