

electronics®

HIGH-FREQUENCY LENS New antenna may replace rhombics

ORBITING SPECTROMETER Circuits can count single photons

TV REMOTE CONTROLS Transistors replace stepping relay

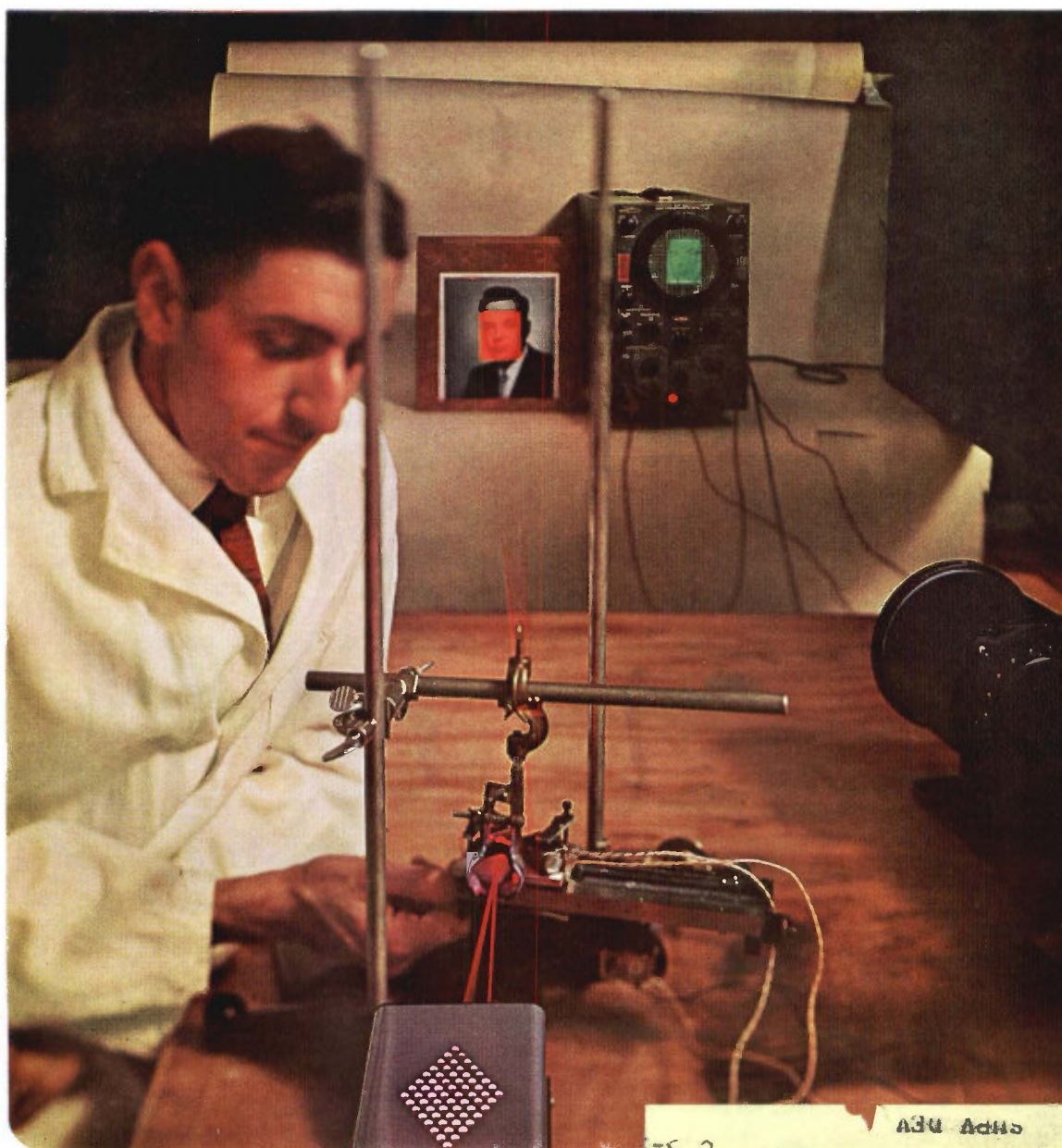

LASER RADAR provides azimuth and

R D SKINNER
 1020 COVINGTON RD
 LOS ALTOS CALIF
 C 3-1
 CHPV DEV

**SPECIAL
(CUSTOM BUILT)**



POWER TRANSFORMERS & INDUCTORS

TO YOUR SPECIFICATIONS

Exceptional quality and reliability is provided in all UTC designs. Over 30 years of engineering knowledge and experience backed by complete environmental testing and life testing facilities assure the highest standard in the industry. Full analysis and evaluation of materials are conducted in UTC's Material and Chemical Laboratories. Rigid quality control measures coordinated with exhaustive statistical findings and latest production procedures results in the industry's highest degree of reliability. Range covered in Power Transformers is from milliwatts to 100 KVA. Some typical applications include: Current Limiting, Filament, Isolation, Plate, Transistor Inverter, Transistor Supply.

**MILITARY AND COMMERCIAL TYPES FOR
EVERY PHASE OF THE ELECTRONICS ART**

POWER TRANSFORMERS • AUDIO TRANSFORMERS • INDUCTORS • PULSE TRANSFORMERS • ELECTRIC WAVE FILTERS • LUMPED CONSTANT DELAY LINES • HIGH Q COILS • MAGNETIC AMPLIFIERS • SATURABLE REACTORS • REFERENCE UNITS

Write for catalog of over
1,200 UTC HIGH RELIABILITY
STOCK ITEMS
IMMEDIATELY AVAILABLE
from your local distributor.



Low capacity current limiting filament transformer. Primary 118 V. 60 cycles to 6.3 V. at 3 A., 8 A. at short circuit. 25 MMFD capacity. 30 KV hipot and 200:1 capacity divider; 5 x 3 3/4 x 4 1/2", 9 lbs.



MIL-T-27B ultraminiature Scott connected power transformer, 5/16 Dia. x 13/32" H., 1/10 Oz. Primary 28 V. 400 — with taps @ 50% & 86.6%. Two units provide 28 V two phase from three phase source.



Molded Power Transformer 3 Phase. Input 200V, 380-420 cps. Electrostatic Shield, 8 output windings, 26 terminals. MIL-T-27B, Grade 2 Class S. Max. Alt. 50K Ft. Size 6 x 2 1/2 x 5", 8 lbs.



Commercial type molded power transformer. Primary 115/230 V., 50/420 cycles to 680 VCT.-0.15 A., 6.3 VCT.-1.2 A., 6.3 V.-.6A. Size: 2 1/2 x 3 x 2 7/8", weight: 1.6 lbs.

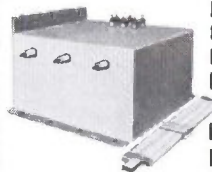

Three phase high voltage power transformer. Primary jumper hardware for easy conversion from delta to wye inputs. Made to MIL-T-27B specifications. Primary: 440 V 60 cycles delta or wye 3 phase input. Secondary: 2100 V line to line or 1215 V line to line @ 242 ma.



High current filament transformer. Primary 140/156 V., 47/63 cycles to 1.8 V.-1070 A. Current limiting through separate primary reactor, MIL-T-27B; 10 x 10 x 1 1/2", 150 lbs.

UNITED TRANSFORMER CORP.

150 VARICK STREET, NEW YORK 13, N. Y.

PACIFIC MFG. DIVISION: 3630 EASTHAM DRIVE, CULVER CITY, CALIF.
EXPORT DIVISION: 13 EAST 40th STREET, NEW YORK 16, N. Y. CABLE: "ARLAB"

CIRCLE 900 ON READER SERVICE CARD

LEWIS H. YOUNG, Editor
Dial Direct: (971-2645)
Area Code 212

FEBRUARY 28, 1964

J. M. CARROLL, Managing Editor (2293)

SENIOR EDITORS
Samuel Weber (2371)
George W. Sideris (3444)

SENIOR ASSOCIATE EDITORS
Michael F. Wolff (2467)
John F. Mason (2666)

ASSOCIATE EDITORS
Michael F. Tomaino (2071)
William P. O'Brien (2297)
George J. Flynn (2188)
George V. Novotny (3151)
Leon H. Dulberger (3446)
Alexander A. McKenzie (2685)

ASSISTANT EDITORS
Stephen B. Gray (2245)
Barry A. Briskman (2306)
Joel A. Strasser (2127)
Vincent S. Acunto (2592)
C. R. Whetstone (3495)
Louis S. Gomolak (2472)
G. G. Tirellis (2710)

REGIONAL EDITORS
Harold C. Hood,
1125 W. 6th St., Los Angeles 90017, Calif.
(213-482-5450)
Laurence D. Shergalls,
John Hancock Bldg., 255 California St.,
San Francisco 94111, Calif. (415-362-4600)
Thomas Magulre
McGraw-Hill Bldg., 607 Boylston St.,
Boston 02116, Mass. (617-262-1160)
Cletus M. Wiley,
Blair Bldg., 645 N. Michigan Ave.,
Chicago 60611, Ill. (312-664-5800)

ART DIRECTOR
Howard R. Berry (2430)

ASSISTANT ART DIRECTOR
John C. Wright, Jr. (3430)

EDITORIAL ASSISTANTS
Lorraine Rossi, Virginia T. Bastian,
Lynn Emery, Ann Meila, Lorraine Werner,
Alice M. Moyer, Sharon Parks,
Claire Benell, Kay Fontana,
Sandra A. Le Mond, Mary Jo Jadin

FOREIGN NEWS BUREAU
DIRECTOR, John Wilhelm, (2532);
Lawrence Mihlon (2997), Alyne Elias
(2998)
LONDON—John Shinn, Derek Barlow,
Nicholas Landon, 34 Dover St., London
W.1, England
BONN—Richard Mikton,
Silke McQueen, Mittelstrasse 39, Bad
Godesberg, Germany
BRUSSELS—Arthur Erikson, 27 Rue Ducarle,
Brussels, Belgium
PARIS—Robert Farrell, 17 Ave. Matignon,
3rd Fl., Paris 8, France
MILAN—Bruce Bendow, Via Manzoni
No. 12, Milan, Italy
MEXICO CITY—Wesley Perry, Jr.,
Lafragua 4-314, Mexico 1 D.F. Mexico
RIO DE JANEIRO—Leslie Warren, Rua
Mexico 3-S/1507 1509, Rio de Janeiro,
Brazil
MOSCOW—Donald Winston,
Kutuzovsky Prospekt 19, Apt. 28-29,
Moscow, USSR
TOKYO—Richard Halloran, Charles Cohen,
John Yamaguchi, Toranomon Sangyo
Bldg., 1 Kotohiracho Shiba, Minato-Ku,
Tokyo, Japan

CIRCULATION MANAGER
Hugh J. Quinn (2310)

C. C. RANDOLPH, Publisher (3996)

electronics

A MCGRAW-HILL PUBLICATION 75 CENTS

HELIUM-NEON LASER SCANS photograph (left) in azimuth and elevation as the beam of the cathode-ray oscilloscope (right) is similarly deflected. Light reflected from the photograph is received by a multiplier phototube and modulates the cro beam to produce a C-type radar display. *Applications could range from a laser microscope to radar sets and might include outdoor tv or motion-picture projection.* See p 44

COVER

OPTOELECTRONICS. Advances in optoelectronics seem harder to come by these days. The difficulty, it was indicated in panel discussions at the Solid-State Circuits Conference, lies in closing the gap between research and practical working systems. *Discussions reflected uncertainty about the ultimate role of light in computers and communications*

10

FAIL-SAFE. Elaborate fail-safe techniques have been built into launch controls for the Minuteman ICBM. The techniques, and the human factors involved in control design were tested in full-scale mockups. *Fifteen of the launch control centers will be installed for the newest Minuteman wing in North Dakota*

14

H-F LENS ANTENNA. Wire-grid lens antenna on the island of Molokai in Hawaii receives signals from Alaska, Japan, Australia and other Pacific points since its steerable beam provides full azimuthal coverage. *Rhombic antennas previously used needed 1,100 acres of land; the lens needs only 850 feet.*

By G. V. Rodgers, Federal Aviation Agency 25

ORBITING OBSERVATORY. Three Orbiting Astronomical Observatories to be launched by NASA will make stellar observations in the ultraviolet range. Part of the instrumentation of the third OAO is a unit sensitive enough to count single photons. *It uses a special multiplier phototube and tunnel-diode pulse-height circuit.*

By R. Cuikay and T. Callahan, Sylvania 28

TV REMOTE CONTROLS. Low-cost silicon transistors replace a ratchet-operated stepping relay now used to control volume remotely in tv receivers. Increased reliability and decreased cost result. *A unijunction transistor combines the functions of level detection and trigger pulse generation.*

By J. H. Phelps, General Electric 32

Contents continued

Published weekly, with Electronics Buyers' Guide as part of the subscription, by McGraw-Hill, Inc. Founder: James H. McGraw (1860-1948).

SUBSCRIPTIONS: Available only by paid subscription. Publisher reserves the right to refuse non-qualified subscriptions. Subscriptions to Electronics solicited only from those actively engaged in the field of the publication. Position and company connection must be indicated on subscription orders forwarded to address shown below. Subscription rates for individuals in the field of the publication: U. S. and possessions and Canada \$6 one year, \$9 two years, \$12 three years (single copies 75¢). All other countries \$20 one year (single copies \$1.50).

EXECUTIVE, EDITORIAL, CIRCULATION and ADVERTISING OFFICES: McGraw-Hill Building, 330 West 42nd Street, New York, N. Y., 10036. Telephone Area Code 212, 971-3333. Teletype TWX N. Y. 212-640-4646. Cable McGrawhill, N. Y. Printed in Albany, N. Y. Second class postage paid at Albany, N. Y. Title reg. ® in U. S. Patent Office. Copyright © 1964 by McGraw-Hill, Inc. All Rights Reserved. The contents of this publication may not be reproduced either in whole or in part without consent of copyright owner.

OFFICERS OF MCGRAW-HILL PUBLICATIONS: Shelton Fisher, President; Vice Presidents: Joseph H. Allen, Operations; John R. Callahan, Editorial; Ervin E. DeGraff, Circulation; Donald C. McGraw, Jr., Advertising Sales; Angelo R. Venezian, Marketing.

CORPORATION OFFICERS: Donald C. McGraw, President; L. Keith Goodrich, Hugh J. Kelly, Harry L. Waddell, Executive Vice Presidents; John J. Cooke, Vice President and Secretary; John L. McGraw, Treasurer.

UNCONDITIONAL GUARANTEE: The publisher, upon written request, agrees to refund the part of the subscription price applying to the remaining unfilled portion of the subscription if service is unsatisfactory.

SUBSCRIBERS: Please address all correspondence regarding subscriptions, change of address notices, and subscription orders to Fulfillment Manager, Electronics, P. O. Box 430 Hightstown, N. J., 08520. Change of address notices should be sent promptly; provide old as well as new address; include zip code or postal zone number if any. If possible, attach address label from recent issue. Please allow one month for change of address to become effective.

POSTMASTER: Please send Form 3579 to Fulfillment Manager, Electronics, P. O. Box 430, Hightstown, N. J., 08520.



Audit Bureau of Circulation



Associated Business Publications

PARAMP SYSTEM DESIGN. Parametric amplifiers offer low noise and high gain needed for satellite tracking but designing them into receiving systems raises new engineering problems. *Here's how they were solved in a five-channel feed-mounted system.*
By R. L. Slevin and R. J. Domchick,
Airborne Instruments Lab 34

TRIANGULAR-WAVE GENERATOR. A triangular waveform is useful in determining the dynamic linearity of an amplifier as a function of frequency and as a function input to analog computers. *This generator converts a sinusoid into a proportional d-c voltage; amplitude is constant from 20 to 100,000 cps.*
By D. E. Cottrell, Colorado State University 38

NAVY'S NEW AVIONICS PROGRAMS. Within the next few months, Navy will award a development contract for a computer-based helicopter system. In a few weeks, study contracts will be awarded for the integrated systems to be used by light attack planes. *And coming up next are studies of more advanced systems that would really push computer and display technology* 43

DEPARTMENTS

Crosstalk. DOD's Self Portrait	5
Comment. Optoelectronics. Packaging	6
Electronics Newsletter	17
Meetings Ahead. Military Electronics International Convention	18
Washington This Week. Senators Will Probably Approve Higher Patent Fees	20
Research and Development. Laser Camera Gives Bright Picture	44
Components and Materials. Practical 100-Kilogauss Superconducting Magnet	47
Production Techniques. Fixtures Form Semirigid Coax	48
New Products. Microcircuits Offer High Speed	50
Literature of the Week	55
People and Plants. Signetics Starts \$5-Million Expansion	57
Index to Advertisers	60

Look to Sprague!

volume availability of

**MAT...SBT...MADT...
ECDC...SPAT...SEPT**

switching and communications

TRANSISTORS

(ECDC and SEPT are trademarks of Sprague Electric Co.; MAT, SBT, MADT, and SPAT are trademarks of Philco Corp.)

2N128	2N794	2N1118	2N1742	2N1867	2N2170	2N2361	2N2791
2N231	2N795	2N1119	2N1743	2N1868	2N2185	2N2362	2N2792
2N240	2N796	2N1122	2N1744	2N2048	2N2187	2N2377	2N2795
2N344	2N846A	2N1122A	2N1745	2N2095	2N2217	2N2378	2N2796
2N345	2N858	2N1300	2N1746	2N2096	2N2218	2N2398	2N2797
2N346	2N859	2N1301	2N1747	2N2097	2N2219	2N2399	2N2798
2N393	2N860	2N1427	2N1748A	2N2098	2N2220	2N2400	2N2799
2N499	2N861	2N1429	2N1754	2N2099	2N2221	2N2401	2N2942
2N499A	2N862	2N1499A	2N1785	2N2100	2N2222	2N2402	2N2943
2N501	2N863	2N1499B	2N1786	2N2162	2N2274	2N2451	2N2962
2N501A	2N864	2N1500	2N1787	2N2163	2N2275	2N2487	2N2963
2N502	2N865	2N1676	2N1788	2N2164	2N2276	2N2488	2N2964
2N502A	2N979	2N1677	2N1789	2N2165	2N2277	2N2489	2N2965
2N502B	2N980	2N1683	2N1790	2N2166	2N2278	2N2787	2N2968
2N768	2N982	2N1726	2N1864	2N2167	2N2279	2N2788	2N2969
2N769	2N983	2N1727	2N1865	2N2168	2N2280	2N2789	2N2970
2N779A	2N984	2N1728	2N1866	2N2169	2N2360	2N2790	2N2971

These Transistor Types are all available in quantity from Sprague. Increased production capability assures you of a continuing **PROVEN SOURCE** for your high-performance transistor needs.

Sprague Transistors cover these applications: Ultra-high-speed switches; High-voltage, high-speed switches; Core drivers; Low-level UHF amplifiers; VHF power

amplifiers; Symmetrical high-speed silicon switches; High-speed choppers.

For complete information on the Sprague Transistor Types in which you are interested, write to Technical Literature Service, Sprague Electric Company, 35 Marshall Street, North Adams, Mass.

SPRAGUE COMPONENTS

TRANSISTORS
CAPACITORS
RESISTORS
MICROCIRCUITS
INTERFERENCE FILTERS
457-459-43

PULSE TRANSFORMERS
PIEZOELECTRIC CERAMICS
PULSE-FORMING NETWORKS
TOROIDAL INDUCTORS
ELECTRIC WAVE FILTERS

CERAMIC-BASE PRINTED NETWORKS
PACKAGED COMPONENT ASSEMBLIES
BOBBIN and TAPE WOUND MAGNETIC CORES
SILICON RECTIFIER GATE CONTROLS
FUNCTIONAL DIGITAL CIRCUITS

SPRAGUE®
THE MARK OF RELIABILITY

*Sprague and 'Q' are registered trademarks of the Sprague Electric Co.

World's first all-solid-state 10 KC to 15 MC Wave Analyzer

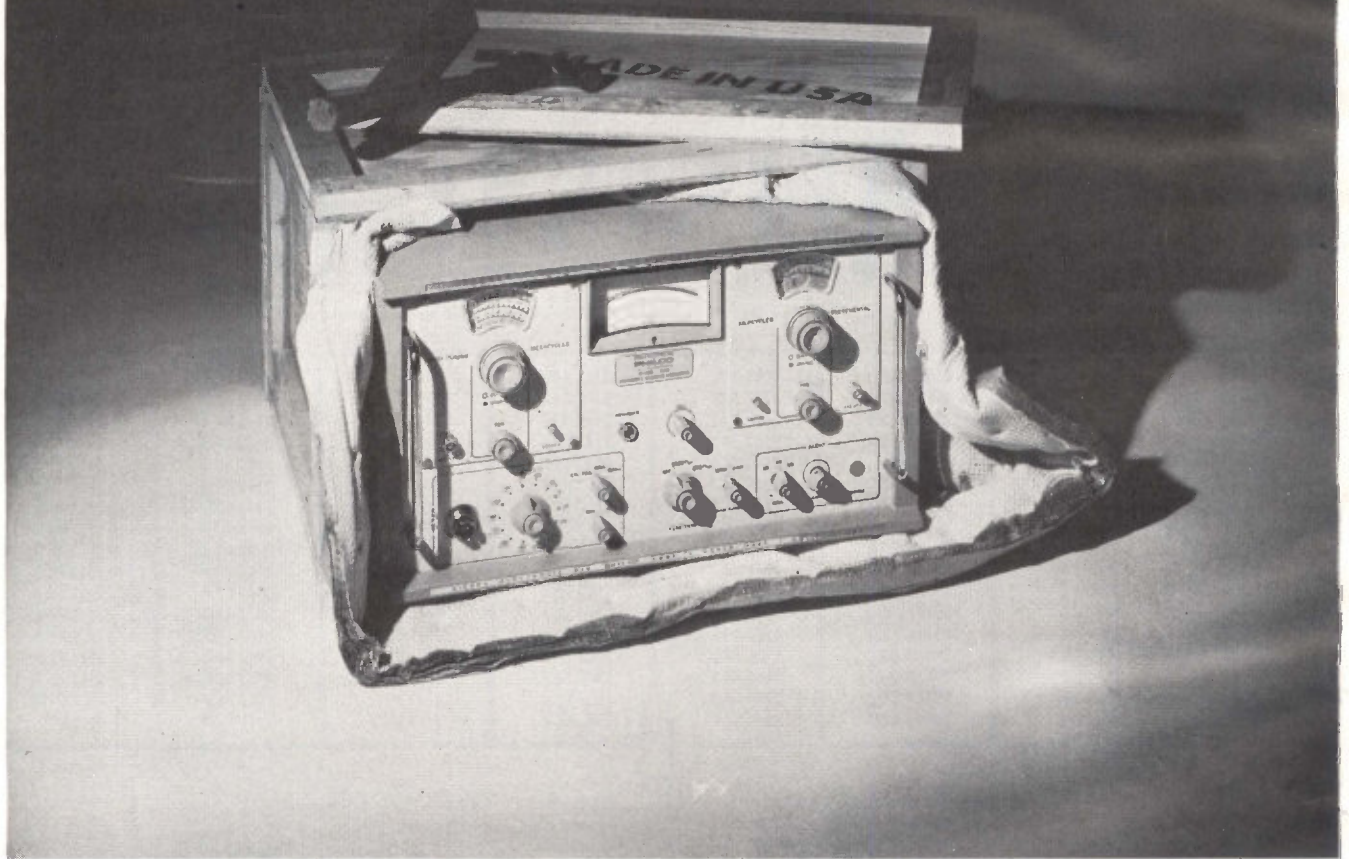

Up to now you had to look outside the U.S.A. for a wave analyzer to fit this billing. Except you'd never find an all-solid-state model. Because there weren't any until Sierra's new Model 128A Extended Range Wave Analyzer came along. □ Now you'll be seeing more and more Sierra Wave Analyzers at work in carrier communications terminals, in microwave repeater sta-

tions, and in R&D labs. That's because Model 128A's specs, taken as a view of total performance, exceed those of any other wave analyzer made in the world today. You'll find the specs in a newly published product bulletin, available now from Sierra. Or, a word

to your Sierra sales representative could produce both the bulletin and a date for a product demonstration.

SIERRA ELECTRONIC DIV.
OF
PHILCO
A SUBSIDIARY OF *Ford Motor Company*

SEE IT AT I.E.E.E. BOOTH 3031-3033

Sierra Electronic Division / 3875 Bohannon Drive / Menlo Park, California

DOD's Self Portrait

THE WORLD OF Robert McNamara is almost complete. His defense goals have been achieved; they are in the form of new hardware, development projects well on the way toward completion, zombie projects made to look alive for political reasons, and scuttled programs that can never be revived.

Not only has the defense secretary reshaped the present, he has fashioned an inevitable future. Since advanced weapon systems take ten years to create, the U. S. will have, in 1974, what McNamara is planning today. Our strategic force will consist almost entirely of ICBM's and Polaris missiles; we will have no bombers; and we will be maintaining a gigantic limited war force, partially created to help police a disarmed world.

Arranging all this was no small feat. McNamara and the Administration have fought strong opposition from the military, congress, and public opinion. They have ignored advice, refused to spend money appropriated for specified systems, and cancelled big projects before anyone knew what was taking place (Skybolt).

Now, with the big things accomplished, it is time to tie up loose ends. The image of the nation's defense posture must be kept bright. The next step is tight control of information.

The electronics industry, along with other elements in our society, will suffer from more restrictions on release of information. Although companies with a need-to-know status get detailed reports on specific DOD-approved projects, there will be less news of technological advances available to the entire industry. We believe this cross-fertilization is very important for our defense and for commerce.

Recent example of piece-meal control was the well-publicized way in which the discrepancy in missile reliability figures given by McNamara and then General Curtis LeMay before the House Committee on Armed Services was put under top secret wraps. Members of the committee were called after they got back to their offices and reminded that what they heard was "very top secret." General LeMay took responsibility for this move, but many believe it was prompted by McNamara.

Permanent control of information, guaranteed by organizational change, is just over the horizon. One plan calls for unification of public information offices now run by separate military services. This means that Army, Navy and Air Force information offices in the Pentagon that provide information to the press, tv and radio will be shut down. Some of the personnel will then be put in a DOD pool, headed by a representative of DOD, and all inquiries for information will be directed to this pool.

DOD says the move was prompted by the General Accounting Office to cut down on expenses by cutting down on personnel. You do save salary money by firing employees. You can also save on the electricity bill by cutting off all the lights. You won't however, see very well, and you might, in time, cause serious injury to your eyes.

Unification of the military information offices is going to cut down on dissemination of news because the new offices will be understaffed and won't be able to handle the work. Also, the quality of news will not be the same. No Army man can sit next to an Air Force pilot and report comfortably on Army's new air-assault division. An Air Force information officer cannot describe Air Force's reasons for wanting development of a manned bomber with a disapproving DOD representative nearby.

Lack of time and the collective quality of the unified centers will undoubtedly dull the military point of view. The representatives will soon learn to hide behind statements prepared by DOD or no statements at all. This condition in a nation in which public opinion is so important, even in our choice of weapons, could be a dangerous state of affairs.

The second step involves control of information on a very high level. It would enable McNamara to be the sole spokesman for military intelligence appraisals and estimates. This plan was reported in the *New York Times*, February 7. When DOD was asked about it, the answer was "no comment". The story was not, however, denied.

According to the *Times*, the military intelligence chiefs would be removed from the nation's intelligence board, leaving the recently established Defense Intelligence Agency—which answers to McNamara—as the sole military representative. The other members of the board include the Central Intelligence Agency, State Department, FBI, and Atomic Energy Commission. McNamara would be in complete control of providing the military point of view—a horrifying prospect for the experienced Air Force general who does not share McNamara's digitized faith in ICBM's. DOD has signed the order. It is now waiting for President Johnson's signature.

What motivates a man to want such control? There can only be one answer: he believes he, or his group, can save the world. This notion has motivated many leaders in world history. It always promotes the premise that concentration of power is in the best interests of the people, that control of news will work out well in the long run, and that the end justifies the means. Unfortunately, the result is always disaster.

President Johnson revealed this attitude in himself on February 11 at his meeting with the field officers of the Internal Revenue Service. He admonished the "alarmists" who disagree with his sanguine view of the world situation—despite the critical situations existing in Viet Nam, Cyprus, Africa and other areas of the world. He saw danger in those "who like to jump on their government, people who like to criticize, people who find it quite impossible to be affirmative and constructive . . . They will join with some of our opponents and they will be almost as much of a problem as some of our other enemies . . . The best way to treat them is just 'God forgive them, for they know what they do.'"

It is understood that all defense secrets and foreign policy can not be opened for public perusal. But we do believe that matters as grave as these should be handled by as many experts in the field as security will permit. The military should have more say in military matters, and the American citizen should be told a little more about what's in store for him.

NOW...

THE FAMOUS
JERROLD
900-B
SWEEP SIGNAL
GENERATOR



OFFERS CENTER
FREQUENCIES FROM
500 kc to 2,000 mc
without plug-ins

The versatile Jerrold Model 900-B Sweep Signal Generator now extends its useful frequency range all the way up to 2,000 mc, with sweep widths ranging from 10 kc to 800 mc. A diode frequency doubler, priced at only \$150, increases the usefulness of the 900-B without the need for plug-ins.

Frequency Doubler Specifications

Input Frequency ... 500-1000 mc
Output Frequency ... 1000-2000 mc
Conversion loss at
1 volt RMS less than 12 db
Output component, other
than harmonic
of input 20 db or more below
Maximum Input 1 volt RMS
Connectors 50 ohm, BNC

The diode frequency doubler can also be used with the economical Jerrold 900-A Sweep Generator.

Model 900-B \$1,980
Model 900-A \$1,260
Frequency Doubler \$ 150

Write for complete technical data.
Jerrold Electronics Corporation, 15th
& Lehigh Ave., Philadelphia 32, Pa.

JERROLD
ELECTRONICS

A subsidiary of THE JERROLD CORPORATION

COMMENT

OPTOELECTRONICS

In your *Crosstalk* item in the Jan. 24 issue (p 5), you briefly called for a shortened form of optoelectronic technology. It immediately came to mind that the most obvious word that covers the field would have to be—Optonics.

In the same issue, a letter in *Comment* (p 6) titled Data also caught my eye. In his letter, J. L. Coffell infers that your fine publication somehow is in error when acting in any casual manner toward certain usages. Let me refer Mr. Coffell, and any others so convinced, to a most interesting volume on English usage by Dr. Bergen Evans, titled "Comfortable Words" [Random House, 1962]. His comments on page 113 concerning "data" are of particular interest here.

Many thanks for a fine publication.

RICHARD F. MADDEN

Portsmouth, New Hampshire

• Quoting Dr. Evans: Data may be treated as a singular or a plural. Most Americans find the real singular of the word strange. . . . Social scientists commonly use *data* as a singular. . . . They talk about "much data" and "very little data." These are singular constructions and they are quite all right if they are not followed by a plural verb.

In the physical sciences, on the other hand, *data* is more often treated as a plural. This too is quite all right. But it must be consistent. It's not enough merely to use a plural verb. . . . He cannot use *much* or *little* with *data* and then use a plural verb. . . .

PACKAGING

On p 40 of the Feb. 7 article, Modern Electronics Packaging, you credit the Capehart Corp. for the design of a "multiple function test equipment."

The equipment illustrated in the top photo is the "Test, Set Radar, AN/UPM-98," developed by Admiral Corp., Chicago, Illinois, for the Bureau of Ships, Department of the Navy. This development was done in the years of 1958 and 1959, and when I left Admiral Corp. in 1960, the equipment was in production. Two of the modules from the upper chassis, nomenclatured "Test Set, Radar, TS-1253/UP," are missing from the photograph.

I can remember cutting the large notches in the front lip of the case with a rather dull file during the development of the first models.

GEORGE M. BOYD

Granada Hills, California

• While the original work was done by Admiral Corp., this particular unit—a redesign of the original—was built by Capehart.

The equipments all look alike because the Navy wants it that way. Changes resulting from redesign are not visible, but they include different delay lines, demodulator and r-f section.

THIN FILM INDUCTORS

In the Jan. 31 *Newsletter* item (p 19), Lab Reports Progress On Thin-Film Inductors, the three inductance figures are given in millihenries; they should be in microhenries.

FRANCIS R. GLEASON

Motorola, Inc.
Phoenix, Arizona

• The correct inductances are given in the full story on these thin-film inductors, in the Feb. 7 (p 84) *Production Techniques* article, Ferrites: Can They Be Deposited As Thin Films?

RESISTOR, NOT CAPACITOR

In the article, Direct-Reading Meter Gives Impedance and Phase Angle (p 57, Jan. 3) there is on p 59 a cut of a device called a "10-ohm variable capacitor."
Could you elaborate on this control, part of the Grutzmacher bridge?

DAVID ATKINS

Los Angeles, California

• It is a 10-ohm variable resistor.

**Why use a
Cyclic-to-natural
Code Converter
when it is no
longer necessary?**

**Now! Natural Code
Non-Ambiguous
Optical Encoders
Exclusive from
Wayne-George!**

**Typical
Cyclic (Gray)
Code Disk.
Output is
cyclic or in-
verted code
and must be
converted to
natural form for
computation.**



**Wayne-George
Natural Code
(Binary) Disk.
Output is non-
ambiguous,
natural code
produced direct
without
conversion from
cyclic code.**

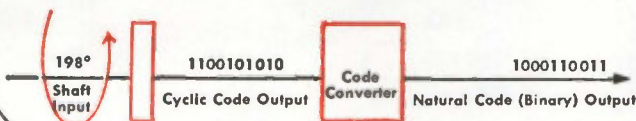

Only Wayne-George offers a complete line of optical shaft-angle encoders providing direct, non-ambiguous natural code outputs without code conversion. The new **DIGISEC®** and "N" Series **DIGISYN®** encoders completely obsolete encoders using inverted or cyclic (Gray) codes and their conversion equipment.

The **DIGISEC** and "N" Series **DIGISYN** encoders cover accuracies and resolutions (per turn) ranging from several minutes of arc to one second of arc. Natural binary, binary coded decimal or other natural codes are available. Outputs are DC levels in parallel form and are continuously available. There is no limit to interrogation rate. Integral code displays can be provided.

High reliability is attained through solid state circuits and long-life incandescent lamps using low voltages and low power.



WAYNE-GEORGE CORPORATION

322 Needham Street, Newton 64, Massachusetts (617) 969-7300

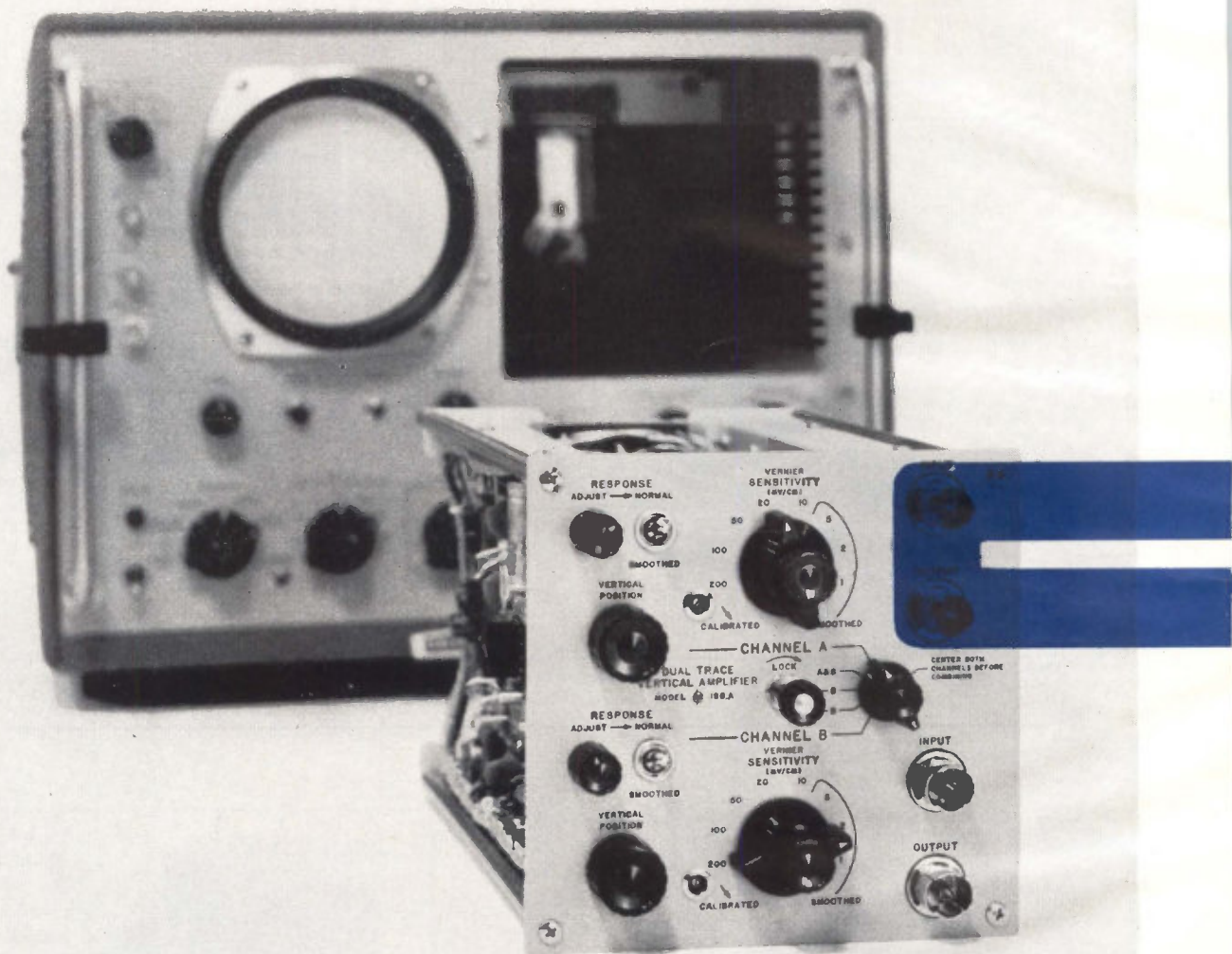

New plug-in for your hp 185 Sampling Oscilloscope with unique bridging sampler lets you monitor signals

- Without disturbing the signal
- With 90 picosecond rise time
- With 1 mv/cm sensitivity

hp 188A Dual Trace Vertical Amplifier Plug-in

Monitoring Fast Signals

The unique bridging sampler in the new 188A Plug-in lets you monitor fast signals in 50-ohm lines without attenuating or loading. An internal 50-ohm line couples the input connector with the output so signals are fed through unattenuated. A new high impedance sampler monitors the voltages on this line and avoids any test signal loading. Both channels in the 188A have the bridging sampler for simultaneous measurements of the input and output of transmission lines, semiconductors, or other devices. Either channel can be terminated in 50 ohms when desired by simply connecting an external 50-ohm load to the output connector.

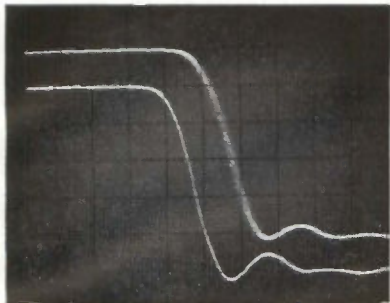

Upper trace shows step response with 100% sampling efficiency; lower with 20%. Rise times are 80 ps and 50 ps, respectively; sweep speed, 50 ps/cm.

Viewing Actual Response

The 90 picosecond rise time of the 188A allows you to view the actual response of extremely fast signals. An advanced design two-diode bridge permits far greater bandwidth than ever before. The 90 picosecond rise time is specified at 100% sampling efficiency, (amplitude reaches final value in one sample). Even faster rise time may be obtained by adjusting the front panel response control. Rise time as fast as 50 ps has been observed at lower sampling efficiencies, permitting full coverage to 7 gc.

WATCH 90 PICOSECOND

RISE TIME PULSES GO BY

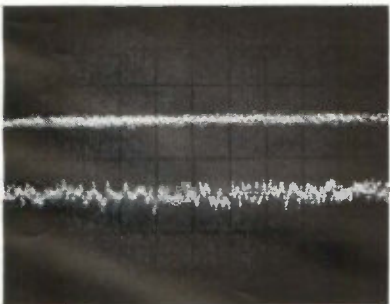

Upper trace shows noise of typical 188A at 10 mv/cm; lower at, 1 mv/cm.

Low Level Signals

A high sensitivity of 1 mv/cm allows critical measurements of low level signals such as those found in advanced switching devices. Smoothing is automatic on the lower three ranges, essentially reducing the noise level without degrading the bandwidth.

Other Plug-ins for the 185B

For applications requiring high input impedance for circuit probing, the hp 187B Dual Trace Amplifier Plug-in is available. It provides bandwidth greater than 1000 mc, with an input impedance of 100 K shunted by 2 picofarads. Probe adaptors are available and a special 50-ohm tee can be used to view signals on coax lines.

The flexibility of the 185B Oscilloscope is further extended by the hp 186A Switching Time Tester for visual display of transistor, diode, or tunnel diode switching characteristics, as well as the pulse response of circuit networks.

Complete technical information on characteristics and use of sampling oscilloscopes and accessories is available from your Hewlett-Packard field engineer.

188A SPECIFICATIONS

Input Impedance:	50 ohms, either terminated or feed-through; a 50-ohm load may be connected to the output jack to terminate the system under observation
Rise Time:	less than 90 psec
Overshoot:	less than 5%
Sensitivity:	calibrated ranges from 1 mv/cm to 200 mv/cm in a 1, 2, 5 sequence; vernier gives continuous attenuation between ranges and increases the sensitivity to 0.4 mv/cm
Dynamic Range:	± 1 volt
Noise:	less than 3 mv p-p, 10 mv/cm to 200 mv/cm; less than 0.8 mv p-p, 1 mv/cm (automatic smoothing); smoothed position of response control reduces noise by a factor of approx. two
Mode of Operation:	1, Channel A alone; 2, Channel B alone; 3, Channel A and Channel B; 4, Channel A and (-) Channel B; 5, Channel A minus Channel B (differential)
Price:	188A Dual Trace Vertical Plug-in, \$1500 hp 185B Oscilloscope, \$2000 hp 187B Dual Trace Amplifier, \$1000 hp 186A Switching Time Tester, \$1700

Data subject to change without notice. Prices f.o.b. factory.

**HEWLETT
PACKARD
COMPANY**



*An extra measure
of quality*

9035

1501 Page Mill Road, Palo Alto, Calif. 94304, (415) 326-7000.
Sales and service in all principal areas. Europe, Hewlett-Packard S.A., 54 Route des Acacias, Geneva, Switzerland; Canada, Hewlett-Packard (Canada) Ltd., 8270 Mayrand St., Montreal, Que.

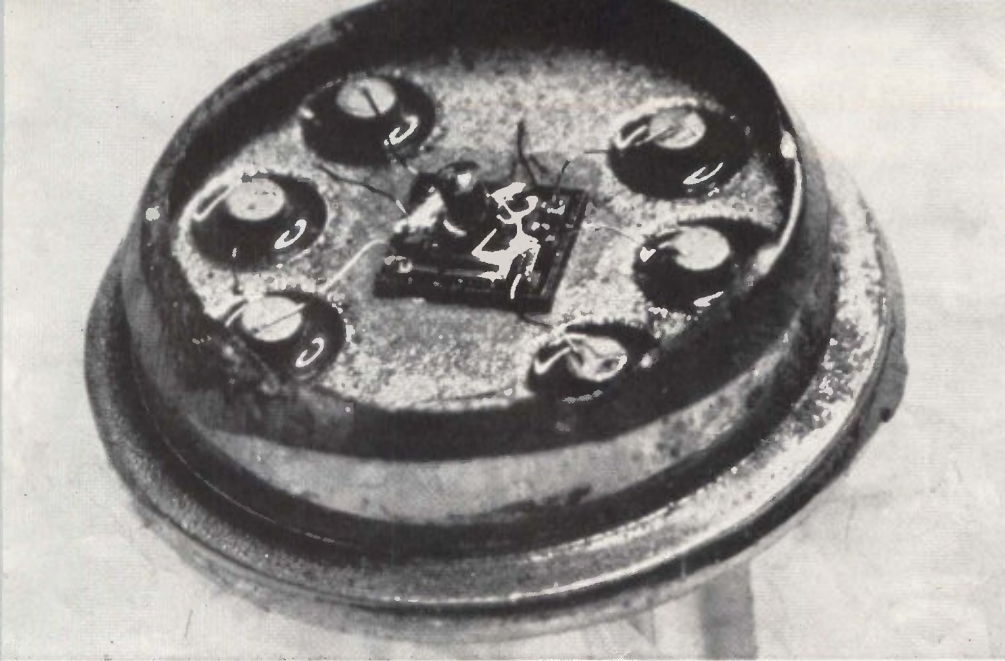

EXPERIMENTAL INTEGRATED sensing circuit constructed at Raytheon incorporates a piezo-junction accelerometer. Preliminary measurements indicate sensitivities of the order of 300 microvolts per g with a seismic mass of 0.1 gram. Work was described by W. Rindner, R. Wonson and G. Doering at the Solid-State Circuits Conference

Optoelectronics' Advance Slows Down

Solid-State conference reveals gaps between ideas and actual systems

By SAMUEL WEBER
Senior Editor

Philadelphia—Can electronics research into new phenomena and physical effects continue to pay off in new devices? That was the provocative question posed by H. B. G. Casimir, director of Philips Research Labs. of Eindhoven, to the 1,400 attendees at the Solid State Circuits Conference last week.

In effect, Dr. Casimir declared that electronics has reached the point of diminishing returns in the yield of breakthroughs in fundamental knowledge. He called for a consolidation of present technology, and greater exploitation of existing possibilities rather than a massive effort in trying to find new ones.

The tenor of the conference seemed to bear out Dr. Casimir's thesis. No new fundamental advances were announced, but solid engineering achievements were described in areas considered at the frontiers of knowledge only a year

or two ago.

Although the evening panel sessions reflected uncertainty about the ultimate role of light in computers and communication, two papers delivered at the formal sessions testified to advances in optical detection.

H. S. Sommers, Jr. and W. B. Teutsch, of RCA Research Labs., proposed a scheme for using a photoconductor mounted in microwave cavity as a broadband envelope detector for an optical communications receiver. Although no device has been built, the analysis shows that the scheme can result in superior gain and efficiency over the photodiode and multiplier phototube, opening the possibility of high performance in the infrared. The scheme is also described in the February *Proceedings of the IEEE*.

K. M. Johnson, of Texas Instruments, described experiments leading toward a solid-state version of the multiplier phototube. He exploited a well-known but little-utilized signal enhancement effect in both planar and mesa silicon photodiodes when they are reverse-biased to avalanche breakdown. The effect (believed to be similar to the multiplier phototube gain effect in that signal amplification results by collision-induced electron multiplication) has yielded a signal-to-noise ratio

improvement of 5 db at 1.25 Gc. The devices were not optimized for this application, but if they were, Johnson claims, the avalanche photodiode may be 20 db more sensitive than any other available detector.

Optical Computers—An evening panel discussion on the digital considerations of optical techniques failed to generate much controversy. Most panel members agreed that input-output isolation was the most attractive advantage of digital optoelectronic circuits, but some in the audience posed the thesis that the isolation was illusory, and caused by the low efficiency of presently available emitters and detectors.

I. Wunderman, of HP Associates, a staunch advocate of optical computers, cited other potential advantages: no charge buildup due to electrostatic potentials, circuit topological freedom allowing coupling in 3 dimensions more easily than with wires, visual compatibility allowing a more direct link with man. He conceded that optical devices have lower gain-bandwidth and speed but felt that the simpler logic possible, and the isolation outweigh these disadvantages.

R. J. Potter, of IBM, held little hope for a completely optical computer. He feels that optical devices

will be most useful in performing optical tasks, such as read-in and read-out, or in memories. The future data processing system will be a hybrid of optical and electronic devices, according to Potter.

J. R. Tippett, of the Department of Defense, said that present devices are not necessarily optimum for data processing, called for more cooperation between physical chemists and device and systems engineers to produce the necessary refinements.

Optical Communications—Another panel on optical communication reflected more technical progress, but equal uncertainty as to the best methods for wideband modulation and efficient, noise-free demodulation of lasers, key stumbling block to practical optical communications links. On the modulation side, only modest progress was reported in the growth of large strain-free crystals of cuprous chloride and hexamene by Fred Sterzer of RCA. However, an internal phase modulation scheme recently developed by Siemens and reported in the September 1963 *Physics Letters* (see also *ELECTRONICS*, p 15 and 16, March 1, 1963) may prove to be an effective answer.

L. Bloom described a new electro-optic light-beam deflector developed at General Telephone Labs. The device permits the rapid deflection of laser beams by purely electrical means, and is applicable to precision high-speed tracking systems. Bloom showed photos of Lissajous patterns obtained using the deflector, and said there was no reason why a microwave Lissajous pattern could not be obtained in this way.

Bloom predicted, on the basis of work he knows of in several laboratories, that practical schemes for modulation in the gigacycle range using synchronous methods would emerge within a year. How to control the problems of the effects of atmospheric perturbations on the light beam was another matter, he said.

The panel generally agreed that optical systems will not replace existing microwave links on a one-to-one basis, but would be utilized in special situations where their advantages were most useful.

Unique production techniques assure reliable ML-6696/6697... 50kw service

RF SEAL-IN techniques, used by Machlett since 1949, make possible closely spaced electrodes for low drive. Oxide-free closure of tube envelope maintains interior cleanliness essential to high vacuum. (Below)

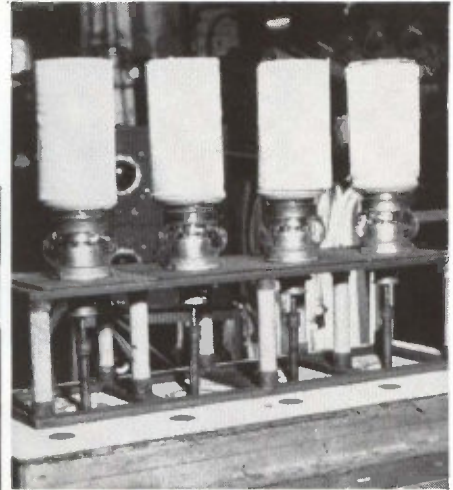
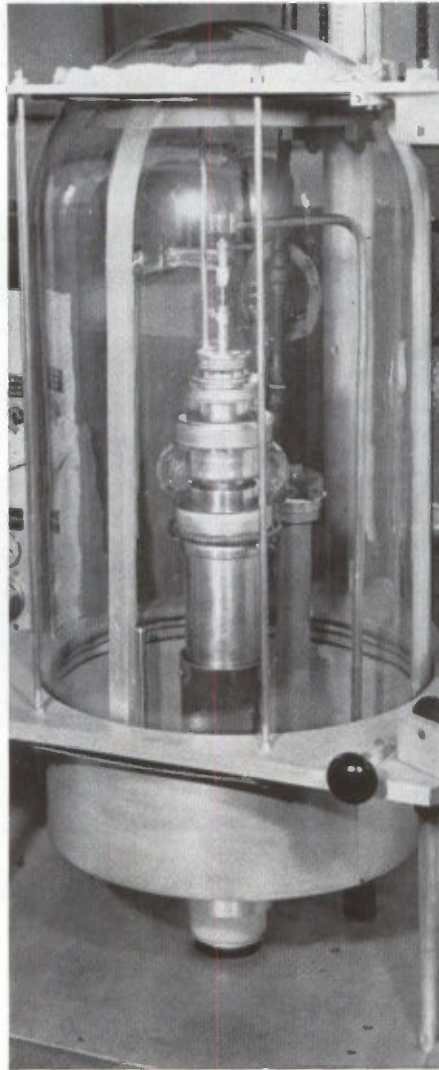

SPECIAL JACKETS are used for thorough anode outgassing during exhaust of ML-6697 (F.A.C.). Other unusual methods have been developed for oven baking, anode heating, grid outgassing, and cold cathode desparking.

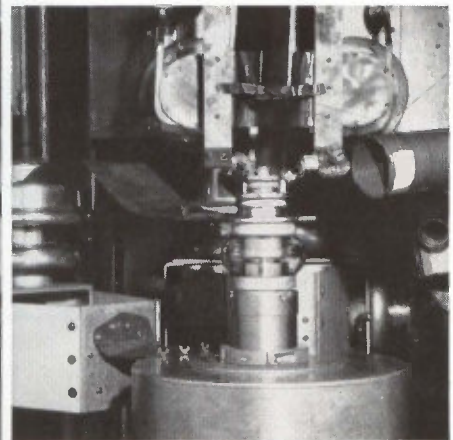

UNIQUE 1.2 MW TEST SET is used for high-power rf amplifier test of water-cooled ML-6696. Tests are programmed from remote control console.

For complete dependability in power tubes, depend on Machlett experience in design and production. For more information on Machlett ML-6696, ML-6697 and other large power tubes, write The Machlett Laboratories, Inc., Springdale, Connecticut. An affiliate of Raytheon Company.

MACHLETT

ELECTRON TUBE SPECIALIST

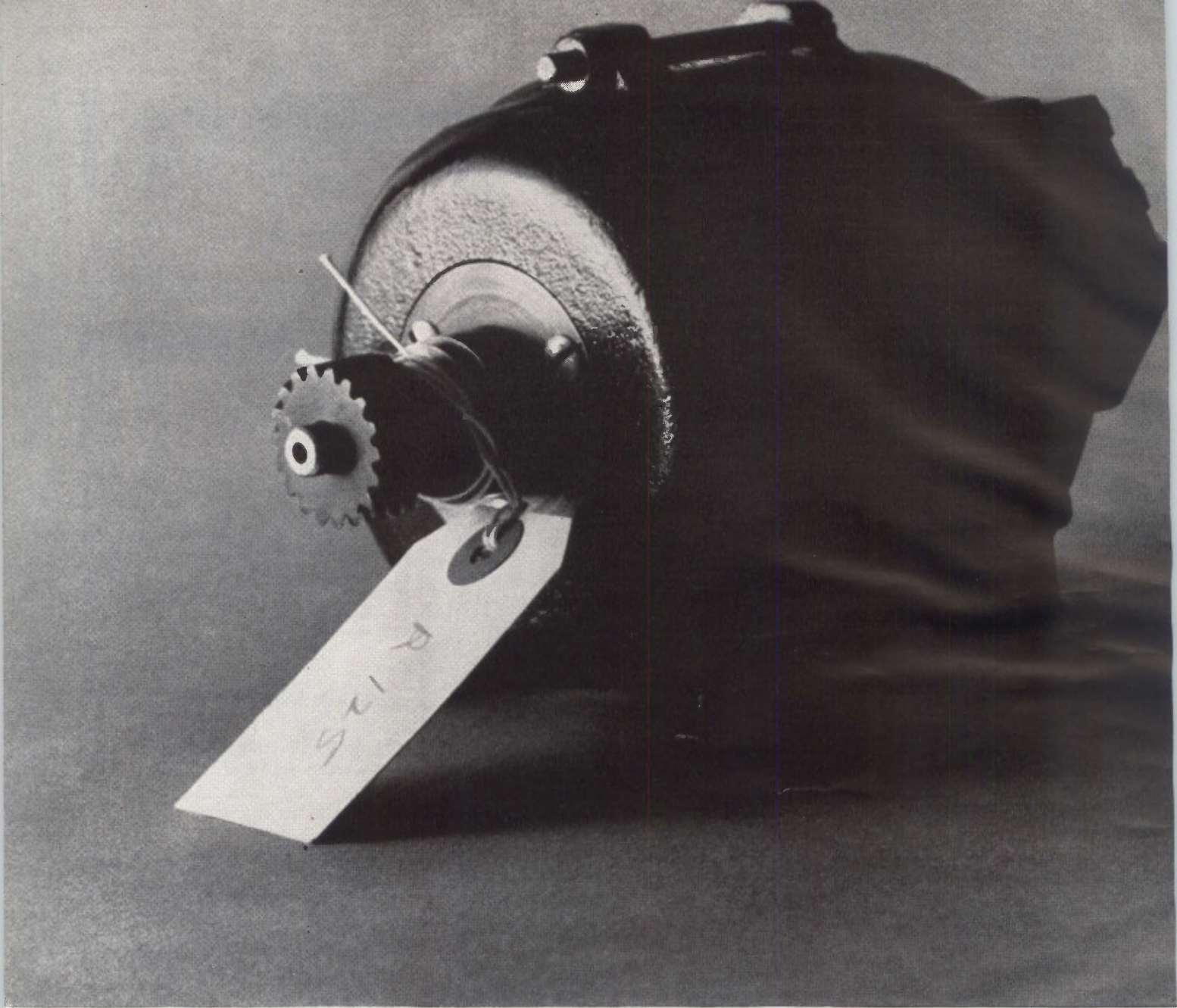

Custom designs—in minutes

With IBM's new Automated Design Engineering application, you can—in just minutes—modify standard designs to meet specific customer requirements.

When customer requirements are entered into the computer this new IBM approach enables you to select, compare and analyze all design elements and to produce specifications that meet order requirements.

Your computer automatically prints a list of standard parts and standard drawing numbers for each order. And, where necessary, it even lists non-standard part specifications and instructions for the preparation of new drawings.

With Automated Design Engineering you'll find you can respond to bid requests sooner, deliver finished orders sooner, too. Engineering lead times will go down, consistent design practices will go up.

Automated Design Engineering won't replace creative talent. But it will free that talent for creative engineering.

Call our branch office for details.

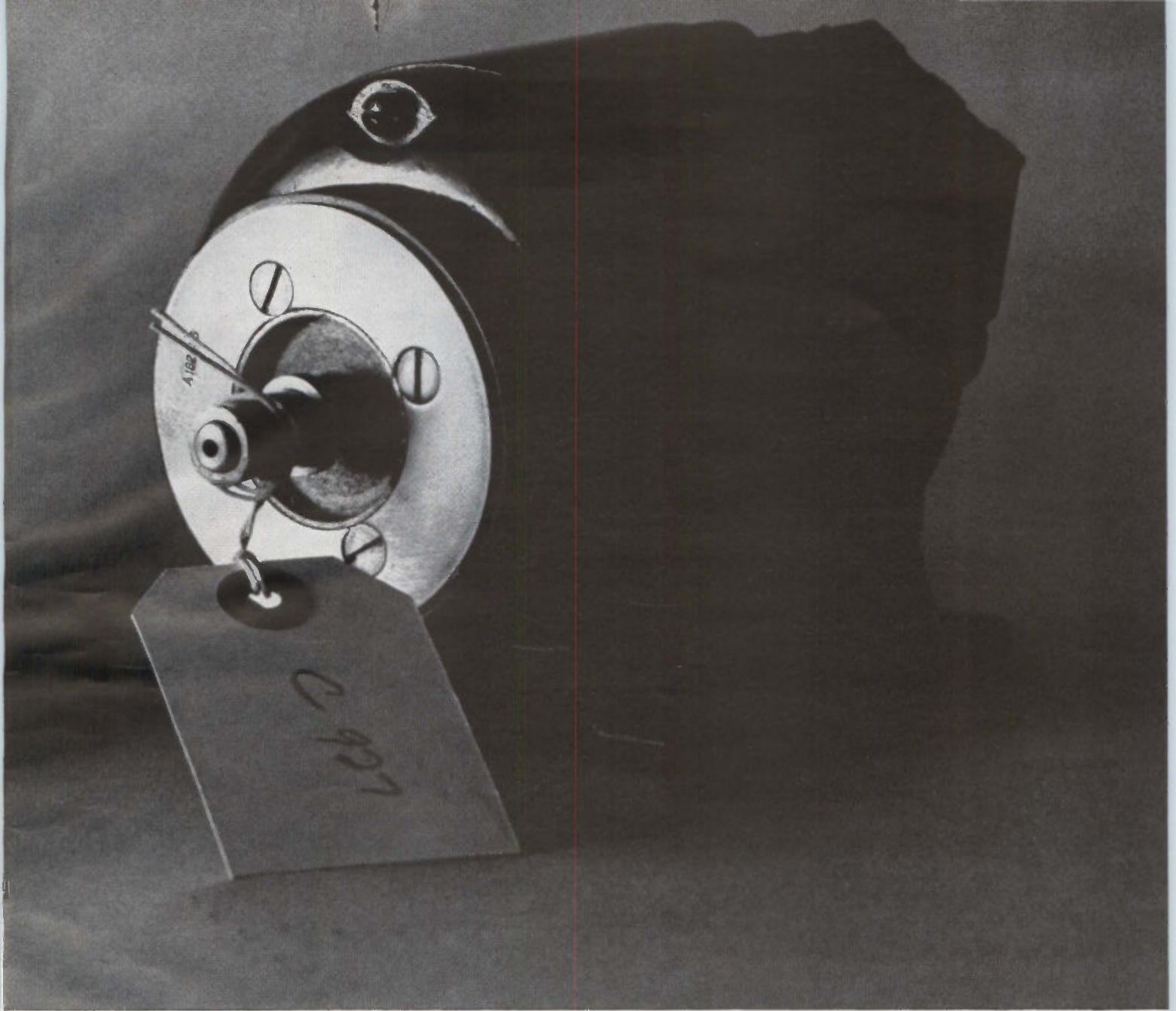

IBM's Automated Design Engineering application works for design engineers in all industries. It's adaptable to almost all IBM computers. The right system for you depends upon the complexity of the product, the customer's requirements and the number of orders you process a day.

IBM[®]
DATA PROCESSING

CIRCLE 13 ON READER SERVICE CARD



FULL-SCALE mockup of instrument panel for underground launch control center



DISTANCE from one console to the other is determined by the time it would take a human being to dash from one to the other. This, one of the human factors built into the control center design, is to insure simultaneous countdown by both SAC duty officers

Mockup Simulates Minuteman Controls

Fail-safe features of underground launch center tested in new simulator

By THOMAS MAGUIRE
Regional Editor, Boston

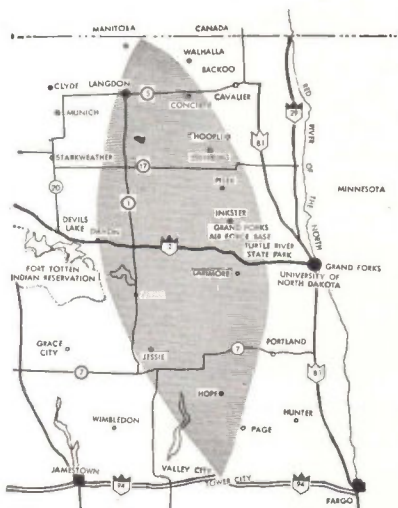

NORTH DAKOTA sites are spread over 7,500 square miles (shaded area), will require about 950 miles of hardened cable

WALTHAM, MASS.—While the fail-safe controls built into actual ICBM launch centers remain classified, Sylvania this week revealed a mockup that simulates the new control centers being built for the improved Minuteman missile and provides clues to their design.

Testing of fail-safe techniques and other human-factor elements was among the reasons for construction of a full-scale mockup of a Minuteman control center at Sylvania Electronic Systems here. Sylvania has a multimillion-dollar contract for the Minuteman ground electronic system. Announced funding to date totals \$18 million.

The control center mockup displays where and how equipment fits and also serves as a guide for the mechanical layout. Complete with control panels and banks of electronic equipment, the simulated center demonstrates the sequence of operations which readies, targets and launches the ICBM.

It Takes Two Buttons—Among the fail-safe techniques is the distance required between the two consoles in the underground control center.

Starting with the initial step of

inserting a firing key in the launch slot, both SAC (Strategic Air Command) duty officers in the real control center must actively take part in the countdown, otherwise the launch would be aborted. To prevent one man from, for example, attacking and disabling the other while he performed the countdown procedures alone, the countdown is designed so that no more than two seconds may elapse between any step performed by one man and the same step performed by the other. The distance between the consoles in the control center is large enough to insure that a man could not possibly get from one to the other in two seconds.

The approved Minuteman force at present is 950 missiles. Of these, 800 will be of the same type as those now in the operational force. The remaining 150 will cost 10 percent more per missile, but will have greatly increased performance. A bigger second stage, e.g., will give extra power—for greater range and accuracy in delivering a larger nuclear warhead, or to carry decoys and thus help penetrate enemy missile defenses. Since it will deliver a bigger payload with greater accu-



SIMULATED CAPSULE for remote control of Minuteman missiles. Low bridge tunnel, foreground, is protected—in the real nerve center—by an eight-ton blast-resistant steel and concrete door

racy, the improved Minuteman might be assigned to targets in groups of two missiles, instead of eight of the present weapon.

The first solid-propellant missile developed by the U. S., the three-stage Minuteman has a range of more than 6,300 miles.

Now Deployed: 300—At present, 300 armed and operational systems are in hardened, underground launch silos ready to blast off at a signal from the launch center. Each center controls 10 missiles, deployed at unmanned sites miles away. The launch control centers, built to be manned 24 hours a day by two SAC officers, are 50 feet below the surface and contain an equipment room mounted on shock absorbers to withstand pressures resulting from an atomic blast.

Sylvania is also installing a cable communication system to connect 165 new Minuteman sites (150 missiles, 15 launch control centers) in North Dakota, and producing equipment for a test site at Vandenberg AF Base.

The ground electronics system transmits firing orders and target information to the missile, provides continuous control of unmanned missile sites, and monitors the operational readiness of missiles and related equipment.

variations in lead dimensions?

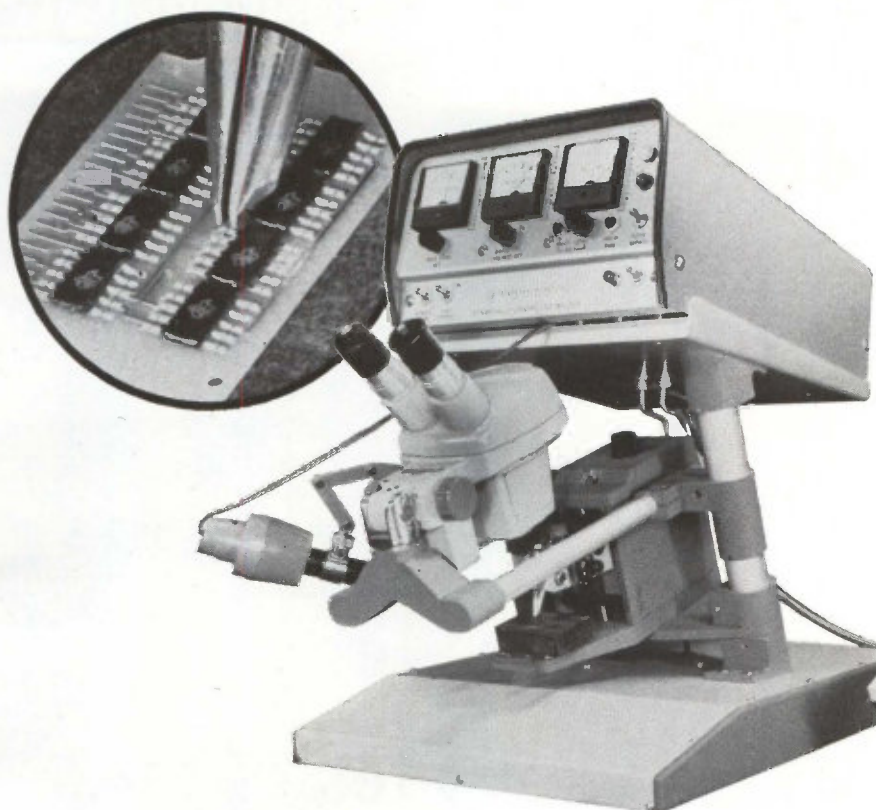

NO SCHEDULING REQUIRED with dynamically controlled welder

Faster, easier, more accurate welding of integrated circuit packages and other electronic components is obtained with Texas Instruments Dynamically Controlled Welder. Assembly line speeds are possible due to a unique control feature which dynamically controls the current throughout the weld pulse to compensate for lead resistance changes during the weld cycle. Continuous optical inspection with a stereo microscope is made on welds of rectangular leads up to 6 mils thick and 15 mils wide or leads up to 10 mils in diameter. It is easy to

determine the optimum weld pulse setting for the particular lead thickness of a test joint by optically inspecting each successive weld. With this optimum setting, additional welds can be made on all leads without resetting for normal lead variations. It is possible to safely reweld continuously on test leads without damage. The weld head features independently supported electrodes to ensure equal electrode pressure and a variable gap (0-40 mils, calibrated). Weld pressure is variable from 0 to 3 pounds (0 to 8 lbs optional).

Write for complete information.

INDUSTRIAL
PRODUCTS
GROUP



TEXAS INSTRUMENTS
INCORPORATED
P. O. BOX 66027 HOUSTON, TEXAS 77006

630



Product of the Month: MAGNETIC LATCH

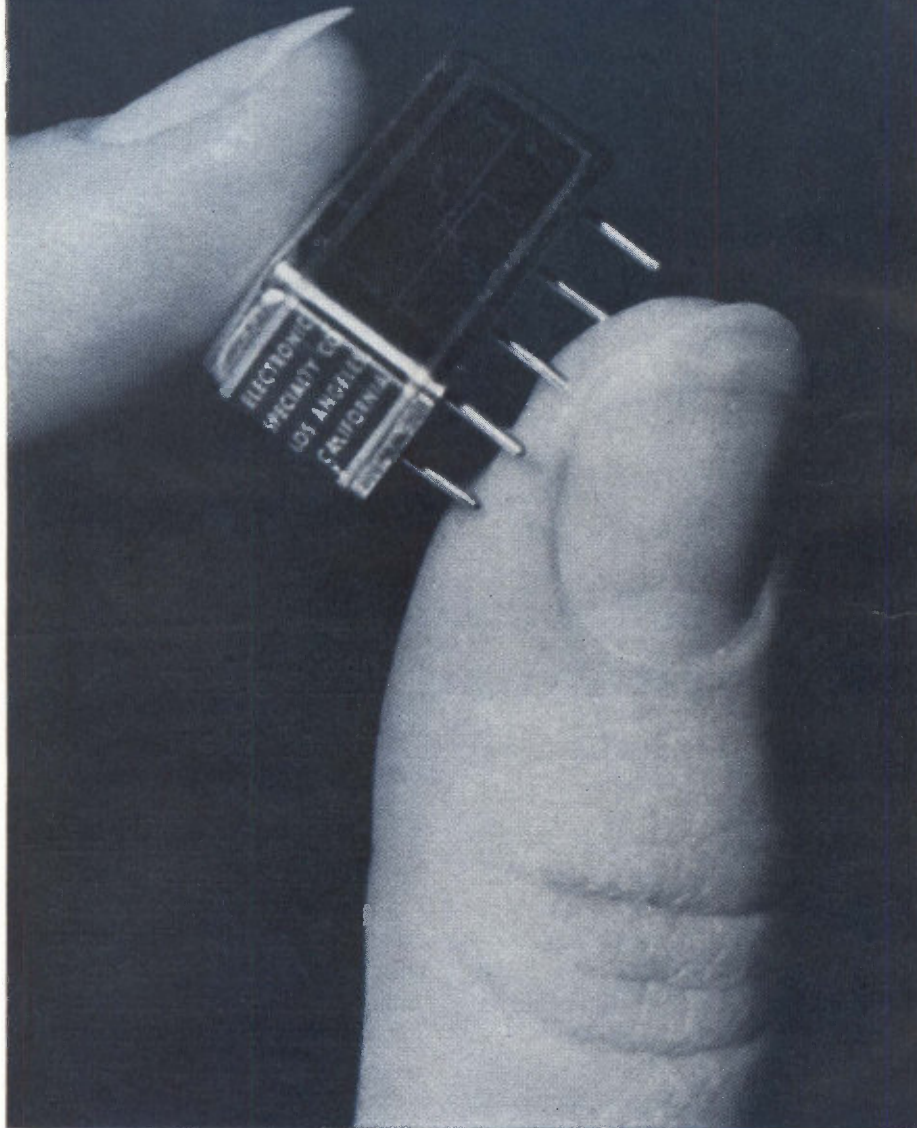

Increasingly complex advanced systems depend heavily on basic components for reliability, weight and space savings. Knowing this, Electronic Specialty developed a micro-micro-miniature magnetic latching relay that is ideally suited to sophisticated aerospace systems as well as technically advanced industrial applications. The new "pico" relay is a hermetically sealed, two pole double throw type that weighs only 0.35 ounce, with a contact rating from 10 microamperes to 2 amperes, and an operating life and reliability equal to that of relays twice the size and weight. □ For additional information on the "pico" relay, write to the Director of Marketing, address below.

ES is a diversified, dynamic, multi-divisional organization serving defense and industry over a broad range of vital areas with advanced systems, sub-systems, and state-of-the-art components. Major contributions are currently being made in the following:

ELECTRONIC AND ELECTROMECHANICAL CONTROLS:

gyroscopes, relays, static switching devices, sensors, flashers, regulators, converters, rotary and linear actuators; motors, generators, weapon and camera controls, electromechanical assemblies for aerospace applications.

COMMUNICATIONS:

antennas, flexible and rigid waveguides, coaxial switches, diplexers, power dividers, filter, radio telescopes, solar furnaces, matching networks, antenna drive motors and controls.

POWER:

precise power systems, dynamotors, computer power sources, motor - generators, actuators, starter generators, power conversion systems, transmission towers for public utilities.

SPACE CONDITIONING:

electronically programmed environmental controls and systems for industrial, commercial, and military applications.

SYSTEMS:

Systems Laboratories conduct research, development and study programs in reconnaissance, electronic countermeasures, interferometer phased array systems, and total energy packages; integrating divisional components, sub-systems, and specialized technical skills.

For information concerning the corporate systems capability, product line, or research and development programs, write to the Director of Marketing, address below.



ELECTRONIC SPECIALTY CO.

5121 San Fernando Road • Los Angeles 39, California

Spectrum Gap Almost Closed

LASER DESIGNERS have all but closed the spectrum gap between the highest frequencies obtained from r-f sources and the lowest frequency conventional infrared lasers provide.

In the U.S., scientists at Bell Telephone Laboratories revealed this week that they had obtained a wavelength of 87 microns from a neon laser. Earlier, Bell Labs had gotten up to 57.355 microns from neon lasers (p 19, Jan. 24).

Last week, a British team announced that they had achieved coherent radiation at nine wavelengths between 23.3 and 78.8 microns, from a 15-ft-long water-vapor laser. A spokesman said the water-vapor laser has been operated at wavelengths longer than 79 microns, but refused to give details.

A wavelength of 87 microns is the equivalent of 0.09 millimeters. This almost reaches the shortest wavelength—0.1 mm—considered feasible with carcinotrons. The French have developed 0.5-mm carcinotrons. Most conventional lasers operate at around 1 or 2 microns.

Because of the interest in mm-wave systems for such applications as transmitting through the space-vehicle plasma-sheath re-entry black-out, and because of the potentially greater bandwidth at near-optical frequencies, interest in sub-millimeter systems has been high.

As yet, however, U.S. laser experts see no practical use yet for the long-wavelength lasers, especially the bulky British laser. One, however, said that a 200-micron laser would be "interesting."

The British team, from the Services Electronics Research Lab, the Royal Radar Establishment and the National Physical Laboratory, filled their laser discharge tube with water vapor at pressure of 1 mm of mercury. Microsecond discharges are applied with electrodes sealed into the tube. Peak power outputs were reported at 15 watts at 23.3 microns, 40 w at 27.9 microns. Output then falls off to 0.2 w at 78.8 microns.

Radar Adds Beep to Home Sets

PITTSBURGH residents are complaining to Air Force that the new AN/FPS-24 long-range radar outside of town is causing audible beeps every 12 seconds on their tv, radio and hi-fi sets. And since Air Force, with FCC backing, blames the problem on set design, manufacturers can expect some customer complaints—and not just from Pittsburgh. Air Force is installing 24 of the big radars around the country, as part of an up-dated detection network.

Investigations have put the blame on home-equipment overload and audio-system detection of the powerful radar emission, rather than spurious signals from the radar. Air Force sends complainants mimeographed instructions on how to modify their sets and tells the set owners they must pay the cost—\$5 to \$25 a set. The modifications don't always work. Some die-hard audiophiles, according to one report, are even moving to locations shielded from the radar beam by natural obstacles.

FCC's Buffalo, N.Y., office, which is fielding the Pittsburgh complaints, says it isn't taking any specific action. It classes the beeps with interference from ham radios, citizen's band, industrial and other r-f equipment. The solution, FCC indicated, is better interference-prevention design in the sets, such as additional bypassing and shielding.

Verdict on the Cryotron: Industry Doesn't Want It

PHILADELPHIA—Has the cryotron come to the end of the road? Engineers at the Solid-State Circuits Conference last week were asking this question when they heard a paper on a cryotron multilevel logic and memory circuit by M. L. Cohen, of A. D. Little Inc.

The paper was a sort of final report on nearly a decade of work at the Cambridge, Mass., company. ADL is phasing out cryotron work because there is not enough interest in this superconductive computer component to attract R&D sponsorship. Industry still shows interest in continuous-sheet type superconductive memories, but the cryotron as a discrete component attracts little interest—or money—now because of the bulky equipment required to

create the cryogenic (temperatures near absolute zero) environment required.

It was on Christmas Day in 1955 when a young graduate student at MIT, the late Dudley A. Buck, operated a flip-flop built from small superconductive wires, and named it the cryotron. It is generally recognized as the first engineering application of superconductivity. ADL soon afterwards began R&D work on the cryotron.

New R-F Radar Will Use Optical Pulse Compressor

RADAR SYSTEM being developed for the Navy by Lockheed Electronics Co. will use optical—instead of electronic—pulse expansion—compression. The \$6.2-million radar system will control 5-inch guns and operate as a surface search and navigation

system. It employs advanced computer techniques in a digitally oriented system.

Pulse compression permits higher energy in a peak power limited radar. The optical pulse-compression method, Lockheed says, is the result of independent R&D.

Light obtained from a mercury-arc lamp is directed through a slit, collimated, and passed through an ultrasonic light modulator consisting of a liquid-filled tank with two driving crystals in its base. The signal to be expanded is applied to one crystal, producing waves in the liquid which divert the light beam to a second slit and thus to a phototube pickup. A transparent film replica placed in the ultrasonic modulator tank provides the required frequency coding operation. The phototube output at i-f is converted to the transmitter frequency of the radar and radiated as an r-f (not an optical) signal.

During reception, in the compression phase, the frequency-modulated signal is down-converted to the i-f frequency of the receiver. The signal is reversed in time and

applied to the other crystal in the tank, producing large fluctuations in light intensity when the waves in the liquid are in juxtaposition with the code on the replica. The phototube interprets these light fluctuations as received signals.

Navy Outlines its Plans for ASW R&D

WASHINGTON—Navy's antisubmarine warfare (ASW) R&D program was summarized for the House Armed Services Committee by Rear Admiral Edwin B. Hooper, ASW research-development director. Highlights of the report released last week include:

- Technical evaluation of the SOS-26 sonar shows that it will give our ships for the first time convergence zone and bottom bounce capabilities
- Development will start now on a new sonar system for future submarines
- Problems with DASH, the drone ASW helicopter, have been over-

come and it is now operating from destroyers

- Installation of the Artemis receiver array for long-range detection of enemy submarines has been completed

- Increased developmental effort is being given to variable-depth sonars to detect submarines at longer ranges. Operation should be easier and more reliable

- New fire-control techniques to be investigated and developed may use the additional information available from new types of sonars

- Studies show that ASROC can be modified to achieve a greater range. ASROC is a rocket fired from a surface ship toward the target; it becomes an acoustic-seeking torpedo when it is submerged

- Development will begin on a high performance ASW mobile target for training and weapon testing.

Peltier Cooling Getting A Rival: Thermomagnetic

BOSTON—Thermomagnetic cooling of electronic parts has moved a step closer to practical use. MIT researchers have obtained 100 degrees of cooling from room temperature using the Nernst-Ettinghausen (NE) effect. T. C. Harman and four co-workers at MIT's Lincoln Laboratory report they have constructed refrigerators of exponentially-shaped pure bismuth crystals in which temperatures of 200 deg K were achieved at the cold junction while maintaining the hot junction at room temperature (300 K).

The NE effect is a thermomagnetic effect in which a temperature difference appears in a direction perpendicular to a longitudinal electric current and an applied magnetic field (p 84, Sept. 6, 1963). In the experiment, the field is 110 kilogauss—too large for practical applications. But Harman feels that smaller fields—5 to 10-Kg—could produce cooling of 30 degrees below the liquid nitrogen temperature of 77K—much greater than the cooling obtained with the commercially available Peltier-effect devices. NE devices could cool injection lasers.

MEETINGS AHEAD

DATA PROCESSING CONFERENCE, American Management Association; Statler-Hilton Hotel, New York, N. Y., March 2-4.

ELECTRONIC INDUSTRIES ASSOCIATION SYMPOSIUM, EIA; Statler Hilton Hotel, Washington, D. C., March 9.

ADVANCES IN CONTROL SYSTEMS MEETING: DIGITAL METHODS, University of Wisconsin; Wisconsin Center Building, Madison, Wisc., March 9-10.

EXPLODING CONDUCTOR PHENOMENON CONFERENCE, AFCL; Boston, Mass., March 10-12.

IRON AND STEEL INDUSTRY INSTRUMENTATION CONFERENCE, ISA; Roosevelt Hotel, Pittsburgh, Pa. March 11-12.

COLD CATHODE TUBE INTERNATIONAL SYMPOSIUM, British Institution of Radio Engineers; Cavendish Laboratory, England, March 17-19.

NUMERICAL CONTROL SOCIETY MEETING, NCS; Hotel Commodore, New York, N. Y., March 19-20.

IEEE INTERNATIONAL CONVENTION, IEEE; Coliseum and New York Hilton Hotel, New York, N. Y., March 23-26.

RADIO TECHNICAL COMMISSION FOR MARINE SERVICES MEETING, RTCMS; Boston, Mass., March 31-April 2.

JOINT COMPUTER CONFERENCE, British Computer Society, IRE, IEE; Edinburgh, Scotland, March 31-April 3.

MINING INDUSTRY TECHNICAL CONFERENCE, IEEE; Wilson Lodge, Oglebay Park, Wheeling, W. Va., April 1.

SYMPOSIUM ON ENGINEERING ASPECTS OF MAGNETOHYDRODYNAMICS, IEEE, MIT; Massachusetts Institute of Technology, Cambridge, Mass., April 1-2.

NONLINEAR MAGNETICS INTERNATIONAL CONFERENCE, IEEE; Shoreham Hotel, Washington, D.C., April 6-8.

CLEVELAND ELECTRONICS CONFERENCE, IEEE, ISA, Cleveland Physics Society, Western Reserve University, Case Institute of Technology; Public Hall, Cleveland, Ohio, April 7-9.

MEASUREMENT AND CONTROL INSTRUMENTATION SYMPOSIUM, ISA; Hotel Floridian, Tampa, Fla., April 8-10.

ADVANCE REPORT

MILITARY ELECTRONICS INTERNATIONAL CONVENTION, IEEE; Shoreham Hotel, Washington, D. C., Sept. 14-16; May 1 is deadline for submitting 500-word abstracts and biographical sketches, in triplicate, to H. M. O'Bryan, Chairman, Technical Program Committee, Bendix Corporation, 1730 K Street, N.W., Washington, D. C. 20006. Some topics include microelectronics, communications, detection, instrumentation.

Integrated Circuits More Reliable

PHILADELPHIA—Integrated digital logic circuits seem to be living up to the rosy reliability forecast that was made at their inception. Litton Industries, a major user of integrated circuits, reports it has found them 6.6 times more reliable than discrete component versions of the same system.

Speaking at a panel discussion at the Solid-State Circuit Conference last week, D.L. Ort of Litton's data systems division presented reliability data gathered during checkout of an operating airborne early warning and control system. This is believed to be the first such report of microelectronics reliability information and, since it was gathered for circuits a few years old, the state of the art is presumably even more advanced.

The original Litton system contained shift register cards of 216 discrete components. Additional buffer elements had to be added when converting to microelectronics, resulting in cards with 485 components in 31 circuit packages. Data gathered over 72,000 card hours gave a card failure rate of 0.11 per thousand hours, or package failure rate of 0.0043 per thousand hours. This is 6.6 times the reliability of a discrete component version of the same system, Ort said, adding that entire integrated circuits are now approaching the reliability of a single discrete component.

Radiation resistance of integrated circuits is as limited as ever, however, according to a panel discussion at the conference. The discussion was restricted to damage caused by short bursts of ionizing radiation—like cosmic rays—because studies of other types of radiation damage are classified.

In general, the panel agreed that solid state components would be ineffective during an ionizing burst. That means the most promising remedy is clever circuit design that recognizes the possibility of the circuit going out of business and then recovering its function after the burst. A semiconductor component with a minimum junction area and

a minimum electron collector was thought to have the best resistance to this kind of radiation.

Bomber vs. Missile Fight; Bomber Wins First Round

WASHINGTON—Advocates of adding new manned aircraft to a military force dominated by missiles won an important first-round victory when the House overwhelmingly voted \$92 million (p 17, Feb. 14), to start design work on a new bomber and an interceptor aircraft. The projects opposed by Defense Secretary McNamara, but had been recommended by Air Force and the Joint Chiefs of Staff. The money is included in a bill authorizing \$10.6 billion for procurement of planes, missiles and ships and \$6.3 billion for research and development in fiscal year starting July 1. Procurement spending authority declines about \$1.3 billion, R&D funds go down about \$500 million.

Sony Says It Will Sell Lawrence-Tube Tv Here

SONY CORPORATION of Japan's two years of development work on the Lawrence color tv picture tube (p. 116, Jan. 4, 1963) has been rewarded by Paramount Pictures Corp. Paramount is licensing Sony to sell both the tubes and sets using the tube in the U.S., and is cutting the royalty rate.

Paul Raibourn, vice-president of Paramount, said last week that the license includes the smaller-size one-gun picture tubes for smaller sizes and three-gun tubes for 25-inch rectangular direct-view systems. Two U.S. firms are negotiating licenses, he said. Sony's license is not exclusive.

Sony says that because of its developments, it soon will be offering a color tv set that will be brighter, less bulky, more reliable and cost less than other color sets.

IN BRIEF

LASER-PUMPING technique using an electrodeless coaxial flash tube and a pinched-gas technique has been developed by Philco. Technique gives greater output powers and higher repetition rates—to about 100 per minute—with crystal lasers.

BUSHIPS will request bids for an integrated sonar system for Seahawk, the destroyer escort that is being designed from keel up as an integrated ASW weapon system.

NAVY plans to request bid proposals next month for a standardized surface-to-air missile to replace the defunct Typhon.

PILL-CONFIGURATION laser package has been developed at MIT Lincoln Laboratory for use in optical radar investigations for DOD and NASA. A gallium-arsenide laser and two semi-insulating gallium-arsenide spacers are alloyed between two 0.080-inch-diameter metallic disks.

RCA'S COLOR-TV picture tubes will be produced outside the U. S. for the first time, this year by RCA Victor, Ltd., of Canada.

NATIONAL VIDEO will reportedly spend \$4 million to expand facilities and step up production of the rectangular color-tv tube developed by Motorola.

TEAMSTERS UNION was set back last week in its efforts to organize the electronics industry. New York Telephone Company workers voted, 12,558 to 8,751, to stay in the Communication Workers of America.

TRW ELECTRONICS has operated an insulated-gate field-effect transistor to 500 Mc as an oscillator and to 100 Mc as a front-end amplifier. Amplifier gain was typically 20 db with a noise figure of 3 db.

NASA this week began studying GE's and Univac's range-range approach for an air-traffic-control and navigation satellite and Westinghouse's range-angle-angle approach. Westinghouse would use eight satellites at medium altitudes; the other proposal calls for 24 satellites 6,500 miles high.

JOHNS HOPKINS' Applied Physics Laboratory is testing another dumb-bell-type gravity-gradient satellite attitude stabilizer (p 16, Aug. 23, 1963), according to informed sources. APL will hold the lossy-spring damper for 30 days, giving the new satellite a chance to stabilize itself with only its hysteresis rods. Then the damper spring will be released to further stop the oscillations to maintain earth-orientation.

Senators Are Expected To Approve Higher Patent Fees

Opponents of high patent fees are likely to lose most of their battle. The Senate Committee holding hearings on the issue is expected to accept without major change the House-approved bill that would cost inventors an additional \$13 million a year by 1977.

Patent applications now cost \$30 to file and \$30 more if the patent issues, with an extra \$1 charged for each claim over 20. The legislation would raise the application cost to \$50, and charge \$2 for each claim over 10, \$10 for additional independent claims, \$10 for printing each page of specifications or description, and \$2 per drawing.

The new fee involves additional charges to be introduced during the 17-year life of the patent. A \$50 charge is proposed to keep the patent alive after its fifth anniversary, another \$100 on the ninth and finally \$150 on the 13th. These could be deferred, and all paid at once on the 13th anniversary, however.

Navy Plans New Polaris Bases In Spain, Guam

Rota, Spain has been selected as the forward support base for Polaris Submarine Squadron 16 that will operate in the Mediterranean. Primarily, Rota will serve as the basing point for a special submarine tender vessel just as Holy Loch, Scotland, serves Polaris Submarine Squadron 14, which operates in the Atlantic.

Three of the 10 Polaris submarines in Squadron 14 are temporarily operating in the Mediterranean. They will be replaced by Squadron 16 boats. The first, the *Lafayette*, will take station in March.

Late this year, too, the first Pacific operating Polaris submarines will be deployed with Guam serving as the forward support base. When the full 41 Polaris submarines are in service a year or so more hence, four squadrons will operate in the Atlantic and Mediterranean and one squadron in the Pacific.

Congress Forming Panels To Advise It on R&D Effort

Congress is seeking deeper understanding of the nation's \$15-billion research and development effort. Two new panels of scientists and scientific managers are being named advisers to congressional committees specializing in R&D matters. One panel, soon to be selected, will be a management advisory panel for the Science Subcommittee of the House Science and Astronautics Committee.

The other new advisory group will work with the House Select Committee on Government Research, empaneled last year to take the House's first overall look at science and technology without regard to jurisdictions of other committees. The special committee so far has held only preliminary hearings to familiarize itself with its field and fix the general areas it works on.

Pentagon Will Brief Industry On Procurement

Special briefing for electronics industry officials on Defense Department buying plans for the next five years is tentatively set for May 27. The idea is to tip off defense electronics contractors to probable shifts in procurement needs early enough to allow contractors to shift production programs as needed. Only top-level management will be allowed to attend, since classified information will be discussed. For more information, write to Capt. William W. Jones, Office of Naval Materiel (MAT 32), Room 2020, Main Navy Bldg., Washington, D. C.

A briefing on command and control developments is also being planned for late May or early June. Information will be available from Maj. John Delistraty, Office of the Director of Defense Research and Engineering, Plans and Policy, Room 3E1082, the Pentagon. Information on an aircraft briefing, May 25, and missiles, May 26, can be had from Col. Robert F. Todd, Office of the Deputy Chief of Staff (Plans), Air Force Systems Command, Andrews AFB, Md.

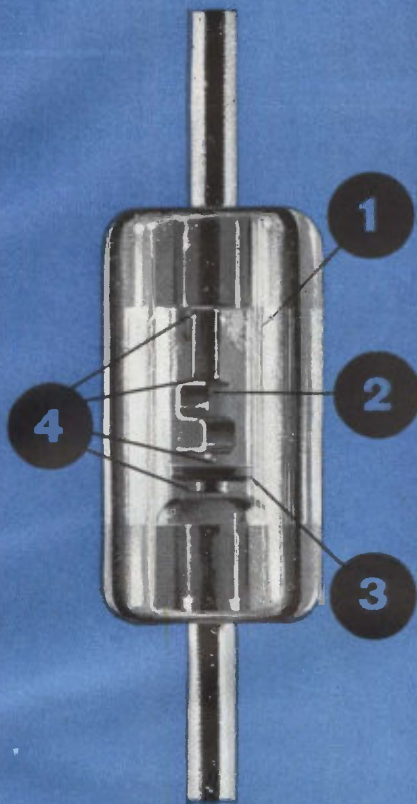

Ordinary diode
trouble spots



Unitrode
trouble spots

That's
reliability!

(1) Void in conventional diode becomes contaminated by trapped impurities, degrading diode characteristics. Unitrode® diodes have no void — the silicon dice is high-temperature bonded *directly* between the terminal pins, and hard glass is fused to all exposed silicon. Electrical performance is fixed, permanently. And because they're simpler, Unitrodes are smaller . . . in fact, this small: 

(2) Whisker can be burned out by surges, and contacts broken by vibration. Unitrodes have no whisker — their broad contact surfaces withstand continuous 10-watt power overloads, thermal shock and cycling from -195°C to $+300^{\circ}\text{C}$.

(3) Exposed silicon dice can easily be tipped, cracked or contaminated in assembly. The Unitrode dice — sandwiched between terminal pins and sealed in hard glass — is practically invulnerable.

(4) Delicate construction increases chances of faulty assembly — loose solder balls, double whiskers, flaking gold, defective glass seal, distorted elements. One-piece Unitrodes are so simplified, trouble-free and rugged that characteristic readings do not change through all MIL-S-19500 environmental testing . . . and performance will not deteriorate throughout a long service life.

This kind of reliability has to cost a little more — but it's essential for electronic packages that require all the performance possible in the smallest space. Allow our representative a few minutes to demonstrate the entire Unitrode line of diffused 3-ampere silicon diodes, fast switching rectifiers, 3-watt zeners, high voltage stacks and bridge assemblies, and ask him for the Unitrode Reliability Manual. Just write or call . . . UNITRODE TRANSISTOR PRODUCTS, INC., 214 Calvary Street, Waltham, Massachusetts 02154. Tel: (617) 899-8988, TWX: (617) 894-9876.

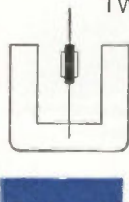

UNITRODE

Here's a new Tektronix Oscilloscope

...essentially 2 high-performance instruments

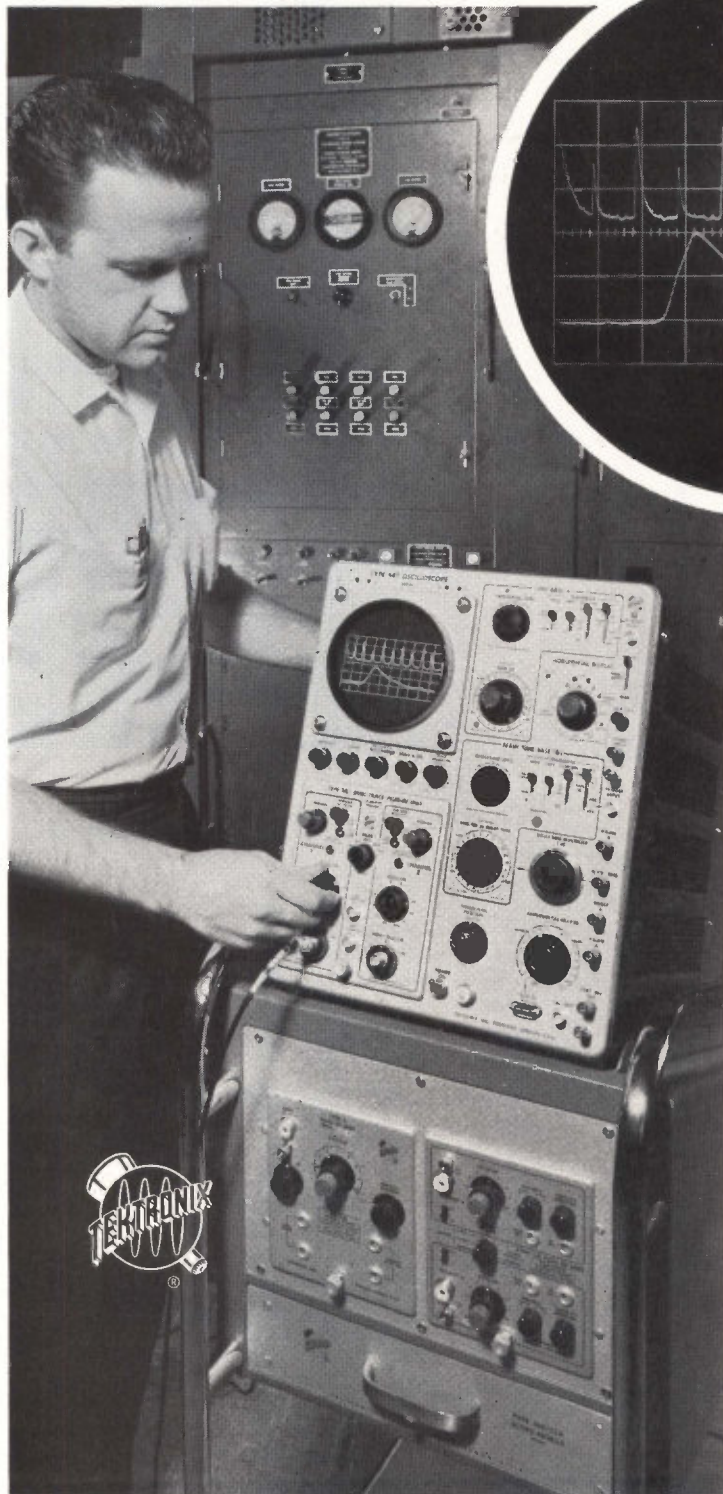

Dual-trace display shows the lower trace as an expanded presentation of the intensified portion of the upper trace. Note the bright display of small spot size and uniform focus over the full viewing area.

Automatic

DISPLAY SWITCHING

With a Type 547 Oscilloscope—and Type 1A1 Plug-In Unit—you can control either or both traces with either time-base generator. You can operate one time-base unit as a delay generator—hold off the start of any sweep generated by the other for a precise interval from one-tenth microsecond to 50 seconds—and observe both the original display and the delayed display.

Used with the normal sweep, this mode allows an alternate presentation of the same signal at different sweep rates—Channel 1 can be locked to Time Base A and Channel 2 can be locked to Time Base B. In many applications, this provides the equivalent of a dual-beam oscilloscope.

Used with the delayed sweep, as illustrated, this mode allows an alternate presentation of a waveform brightened over a selected portion, and the selected portion expanded to fill the full display area.

With its facility for displaying both time bases alternately or separately, the Type 547 provides high adaptability in displaying waveform phenomena not only in dc-to-50 Mc, 50 mv/cm applications, and in dc-to-28 Mc, 5 mv/cm applications, but also in other specialized applications, when using "letter-series" plug-in units.

for a demonstration, call your Tektronix Field Engineer.

with AUTOMATIC DISPLAY SWITCHING combined into one compact package

New Type 547 with 1A1 Unit
DC-TO-50 MC
DUAL-TRACE
50 MV/CM
DC-TO-28 MC, 5 MV/CM

*The Type 547 also uses
17 "letter-series" plug-in units*

With Automatic Display Switching, the Type 547 provides two independent oscilloscope systems in one cabinet, time-sharing a single-beam crt. This feature alone should speed up and simplify a wide range of oscilloscope applications. But this unique capability is only one of many technological advancements of the Type 547.

Using the new dual-trace unit, the Type 547 adds new convenience and performance characteristics to display and measurement of high-sensitivity, wide-band applications—even under difficult environments of temperature, shock, altitude, and vibration.

And for increased signal-handling versatility, the Type 547 can accept any of the established, up-to-30 Mc passband, "letter-series" units for a wide variety of special-purpose applications.

Some of the Type 547/1A1 Unit Features

No-Parallax Crt—which assures measurement accuracy over the full 6 cm by 10 cm display area.

2 Independent Triggering Systems—which simplify set-up procedures, provide stable displays over the full passband and to beyond 50 Mc, and include bright-line automatic modes for convenience.

2 Independent Sweep Systems—which provide 24 calibrated time-base rates from 5 sec/cm to 0.1 μ sec/cm and three magnified positions of 2X, 5X, and 10X, with the 10X magnifier increasing the maximum sweep rate to 10 nsec/cm. **Calibrated Sweep-Delay**—which extends continuously from 0.1 microsecond to 50 seconds, provides jitter-free operation for delayed-sweep presentations.

Single-Sweep Operation—which enables one-shot displays for photography of either normal or delayed sweeps.

Horizontal Display Modes—See Horizontal Display Switch, illustrated,

Type 547 Oscilloscope (without plug-in unit) . . . \$1875
Type 1A1 Dual-Trace Unit . . . \$ 600
Rack-Mount Model—Type RM547 will also be available

U.S. Sales Prices f.o.b. Beaverton, Oregon



HORIZONTAL DISPLAY

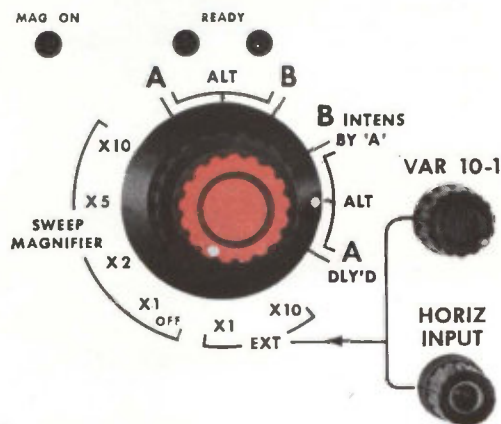

Tektronix, Inc.

P.O. BOX 500 • BEAVERTON, OREGON 97005 • Phone: (Area Code 503) Mitchell 4-0161 • Telex: 036-691
TWX: 503-291-6805 • Cable: TEKTRONIX • OVERSEAS DISTRIBUTORS IN 25 COUNTRIES
TEKTRONIX FIELD OFFICES in principal cities in United States. Consult Telephone Directory.
Tektronix Australia Pty., Ltd., Melbourne • Sydney • Tektronix Canada Ltd., Montreal • Toronto
Tektronix International A.G., Zug, Switzerland • Tektronix Ltd., Guernsey, C. I.
Tektronix U. K. Ltd., Harpenden, Herts

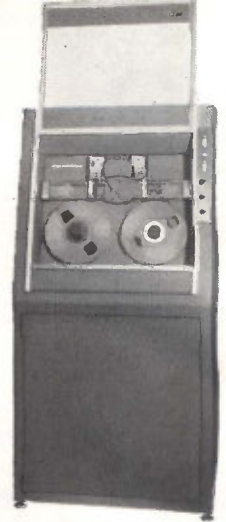
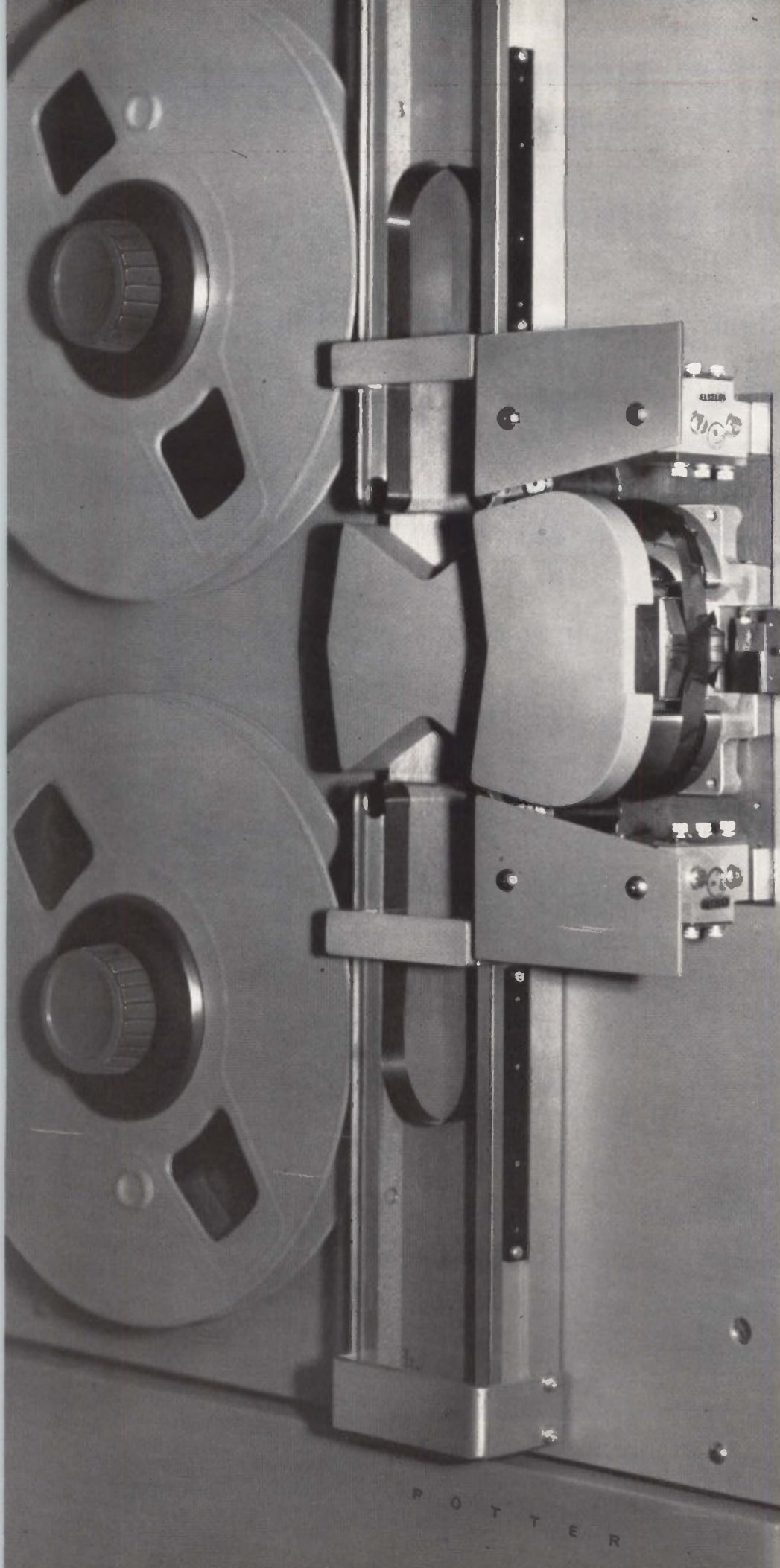

A very big transport in a 2-foot package

This is Potter's MT-24, a new vacuum column, digital magnetic tape transport which is already proving big in the field. Packed into its mere 24" height (or length if you prefer to mount it sideways) is all the dependability and performance of tape drives costing over twice as much. Here are the facts:

PERFORMANCE — Read/write tape speeds from 3 to 36 ips, data transfer to 28.8 kc, 200 commands per second. (50 ips and 40 kc performance available in the MT-36 companion unit at very little increase in price!)

RELIABILITY — Use of thoroughly field tested components in combination with new vacuum column construction has resulted in improved transport dependability. Reliability warranted 1 in 10^8 bits read.

COMPATIBILITY — The MT-24 is compatible with IBM's 7330, with packing densities of 200, 556, and 800 bpi. One inch tape and other computer formats are readily accommodated.

ECONOMY — MT-24 (and MT-36) costs less per effective bit transferred than any other transport on the market . . . and with greater operating dependability and data transfer reliability than tape drives costing more than twice as much.

Potter is shipping MT-24's NOW. Delivery within 4 weeks. Want details? Write — Sales Manager.

POTTER
INSTRUMENT CO., INC.
151 Sunnyside Boulevard, Plainview, New York



T.M.

CIRCLE 24 ON READER SERVICE CARD

COMPARISON of wire-grid antenna and part of the 1,100-acre antenna farm formerly required. Diamond patterns outlined by poles show individual rhombic antennas



Lens-Like Antenna: Low Noise, Less Space

Wire-grid array improves signal-to-noise ratio and gives excellent gain in any direction. Erection space only 850 feet in diameter reduces cost

By G. V. RODGERS, Chief, Data Transfer Section,
Federal Aviation Agency, Washington 25, D. C.

RADICAL departure from conventional antenna technology is demonstrated in the design of a high-frequency lens antenna that consists of two circular grids, suspended one over the other, and surrounded by a radial wire horn. Electromagnetic waves are intercepted by the horn, concentrated in a vertical direction, and transferred to the lens as depicted in Fig. 1A.

Refraction within the lens causes the wave front to bend and converge at a focal point on the diametrically-opposite side, where a transmission-line coupler is located. Up to thirty-six couplers may be installed in the lens to provide coverage in as many different directions. Outputs from the feeds can also be combined to provide a steerable beam for full azimuthal coverage.

Developed for the Federal Aviation Agency by R. L. Tanner of TRG-West, the wire-grid lens antenna is located at the International Flight Service Receiver Station on the island of Molokai, Hawaii. Signals transmitted from Anchorage,

San Francisco, Sidney, Tokyo, and other Pacific Ocean points are received and relayed to the FAA Air Traffic Control Center near Honolulu. Rhombics previously installed to receive these transmissions require about 1,100-acres of land, whereas the lens requires only 850 feet for simultaneous reception of signals over operational circuits from seven directions between 3 Mc and 30 Mc. Poles that hold some of the rhombics, and the wire-grid lens that is intended to replace them appear in the lead photo. The line from the lens to the buildings contains feedlines.

Design—Lens techniques, based upon optical theory developed by the late R. K. Luneburg¹ have been applied in the design of relatively small microwave and UHF antennas. In these antennas, wave focusing is generally accomplished with a dielectric foam material with a refractive index that is made to vary over the cross section in a prescribed fashion. The Luneburg lens may be constructed in spherical or disc form; the concept has not previously been extended to the lower frequencies due to the impracticability of using solid dielectric materials in large structures.

The wire-grid lens antenna² has properties which resemble the disc-type Luneburg lens. The solid dielectric is eliminated and the focusing properties of the lens are achieved by varying the spacing between a pair of wire grids in a systematic manner. Index of refraction is made to vary as a parabolic function across the lens aperture, and the velocity of propagation varies between the free space value at the circumference of the grids, to approximately 70% of the free-space value at the center of the grids. This variation in velocity of propagation of a wave entering the lens may be explained as follows.

Operation—At the edges of the lens

BIG BROTHER TO THE LUNEBURG LENS

The antenna described in this article uses lens techniques based upon optical theory developed by the late R. K. Luneburg. While the Luneburg lens has been used extensively at microwave frequencies, this array is the first to extend lens principals to the 3-Mc to 30-Mc range. Moreover, the antenna described does the job formerly assigned to 1,100 acres worth of rhombics, yet requires only a fraction of the geographical area necessary for rhombics with equivalent coverage

where the spacing between the grids is large relative to the mesh size, the grids simulate a pair of metal plates and the wave in this region propagates at nearly the speed of light. At the center of the lens, where the spacing between the grids is small compared to the mesh size, the grids act as a network of interconnected open-wire transmission lines and the wave in this region propagates at a slower rate, that has been shown² to be $1/\sqrt{2}$ times the velocity of light. The end result is that the plane wave front intercepted by the lens is transformed into a curved wave front, with rays converging at a focal point on the opposite side. The properties of the lens are independent of frequency, as long as the mesh size is small compared to a wavelength, at the highest operating frequency. Since the waves traveling between the grids have electric fields that are generally vertical, the antenna is essentially vertically polarized.

Radiation efficiency at lower frequencies is preserved by the electromagnetic horn attached to the grid. This horn provides proper impedance match between free space and the lens, and also increases vertical directivity.

Construction—The wires that comprise the grids are attached to rings fabricated from specially extruded aluminum sections. Both upper and lower grids are identical; each of the rings is 600 ft. in diameter with grid wires spaced to form squares 5 ft. on a side. The mesh is uniform from the center of the lens to a distance of $37\frac{1}{2}$ ft. from the outer edge, where satellite wires taper away from each of the major grid wires to form a mesh of $2\frac{1}{2}$ ft. squares at the periphery of the lens.

The two grid rings are attached together by diagonal-web members of impregnated hardwood to form a truss. The spacing between the upper and lower grids is 12 ft. at the rings and $6\frac{1}{2}$ inches at the center of the lens. Proper spacing between the grids is maintained by insulating spacers.

The horn is composed of wires which extend radially from the lens rings to bridle cables attached to the 24 outer poles, which average 94 ft. in height. There are 504 radial wires, 145 ft. long in the upper-horn curtain and an equal

number of wires, 130 ft. long in the lower curtain. Short lengths of wire are connected between the radial wires out to $1/5$ of their length from the lens rings. These wires are necessary to provide paths for circumferential currents produced by the higher order propagation modes which would otherwise be strongly excited, due to the discontinuity, and contribute to side and back lobe radiation.

The upper-horn curtain is attached to the outer poles at points which are a constant height above the plane of the lens. The lower-horn curtain is attached to the poles at points seven feet above the ground. The average angle between the horn curtains is 25 degrees.

Line Coupler—The device used to couple the signal from the lens to the receiver transmission line, is a modified ramp feed that evolved from a comprehensive series of experiments and calculations. In simplified form, the ramp feed consists essentially of one or more conductors extending diagonally between the lower and upper grids of the lens. Since the ramp has vertical current components along its slope, it may be considered as a series of vertical current elements which couple to the electric fields of the waves traveling between the grids. The array pattern is a cardioid with its null in the rearward direction.

The actual feeds extend 75 ft. into the lens as shown in Fig. 1B. Each feed consists of a pair of wires spread apart along their lengths to provide a constant impedance. Maximum coupling between the lens and the feed occurs when the phase velocity along the feed is slightly slower than that of the lens. This wave slowing was accomplished by the addition of capacitive loading in the form of aluminum plates connected across the wires of the ramp. The phase velocity along the feed is slowed from the free space velocity by the ratio of 1.2:1. Broad banding of the feed is accomplished with a constant-resistance network in which $R = \sqrt{L/C}$. The current in the end elements is fed in the proper phase relationship with respect to the ramp through phase-inverting transformers connected to each of the current elements.

The coupler is constructed with two identical feeds spaced 30-ft.

apart at the circumference of the lens. The pattern characteristics of the feed are such that less of the lens aperture is illuminated at the higher frequencies, making beamwidth essentially constant at frequencies above 10 Mc.

Performance—Results of preliminary tests indicate that the antenna is performing in accordance with design predictions. Impedance match to the transmission line surpassed expectations; the highest standing wave ratio measured for any of the couplers over the entire frequency band is less than 2:1 at the antenna coupler output. The beams are well defined with a minimum of side and back lobe radiation.

Throughout the development cycle, two valuable tools were employed to optimize design parameters. The first was a $1/40$ th scale model of the lens and horn structure, and the second, a high-speed digital computer equipped with an automatic pattern plotter. Analytical methods were used to derive the differential equations describing wave propagation in the lens and the feeds. These equations were solved directly by the computer, while the scale model was used for experimentation to improve the feed and coupling methods. A complete set of calculated patterns was produced by the computer. Example of calculated patterns for frequencies near both ends of the band are shown in the solid curves of Fig. 2.

As generally recognized, it is extremely difficult to obtain full-scale radiation patterns of antennas operating in the HF range. This being the case, the results of calculations or measurements using scale models, are usually accepted as final results. Since there is such widespread interest in application of the wire-grid lens to communications and other purposes, full-scale pattern measurements are mandatory. As an initial approach to this objective, a set of pattern measurements was made with a test transmitter and antenna mounted on a vehicle.

The receiver site on Molokai was surrounded by a network of roads, making it possible to define a path sufficiently distant from the antenna to be in the far field of radiation. A total of 43 test stations were

established along this path and their azimuthal directions from the antenna were defined with reasonable precision. By moving the vehicle from one test station to another, it was possible to define the main beam of one feed and the side and back lobe radiation from another. The results were pieced together to form fairly complete patterns. Examples of the actual patterns obtained by this method are shown in the broken curves of Fig. 2.

Irregularities in measured radiation patterns are attributable to two causes. First, the contours of the terrain on the island and the geography of the roads available for running the vehicle containing the test transmitter were such that it was impossible to obtain line-of-sight measurements. The patterns taken, therefore, represented signal fringing over the edge of hills between the antenna and the transmitter. Second, the antenna used as a reference was found to be far from omni-directional. Actually, two antennas were used for this purpose; a tuned whip with the grids of the lens acting as a counter poise, and a huge bi-conical composed of the upper and lower lens and horn segments. Neither of these reference antennas was omni-directional, but it appeared from the data that the bi-conical feed to the lens provided the most uniform reference. This antenna was used to plot the data shown in Fig. 2.

Preliminary operational tests of the lens antenna compared to the rhombics indicate that although the signal level received via the lens was lower than that received from the rhombics, the improved signal-to-noise ratio resulted in increased readability at lower signal levels.

The Federal Aviation Agency is preparing for a comprehensive evaluation of the wire-grid lens antenna with support from the U. S. Army Electronic Research and Development Laboratory at Fort Monmouth and the U. S. Navy. This program, will include flight-test measurements of the full-scale radiation patterns and operational tests to determine performance.

REFERENCES

- (1) R. K. Luneburg, *Mathematical Theory of Optics*, Brown University Graduate School Lecture Notes, pp 208-214, 1944.
- (2) R. L. Tanner, and M. G. Andreason, *A Wire-Grid Lens Antenna of Wide Application*, *Trans IRE, PGAP*, July, pp 408-429, 1962.

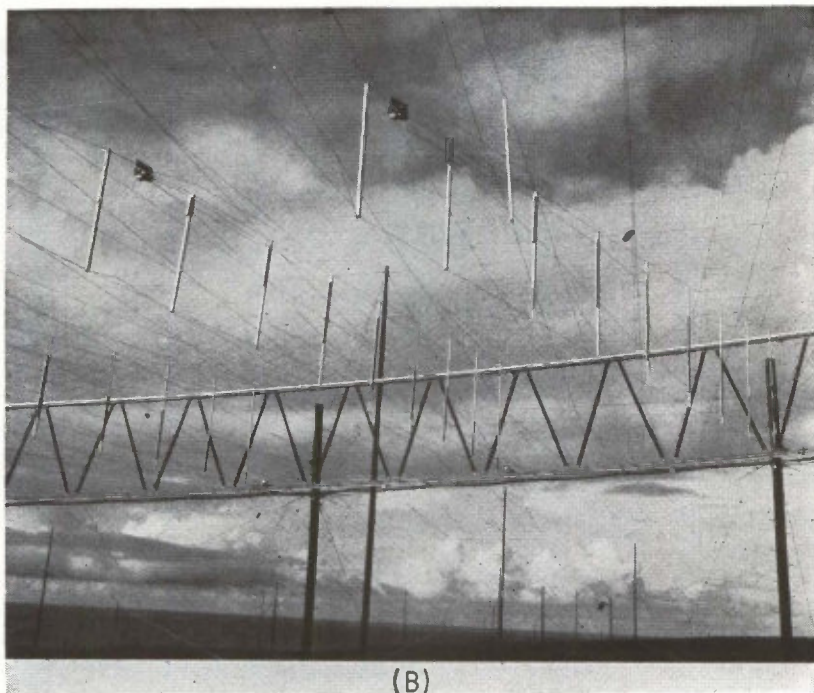
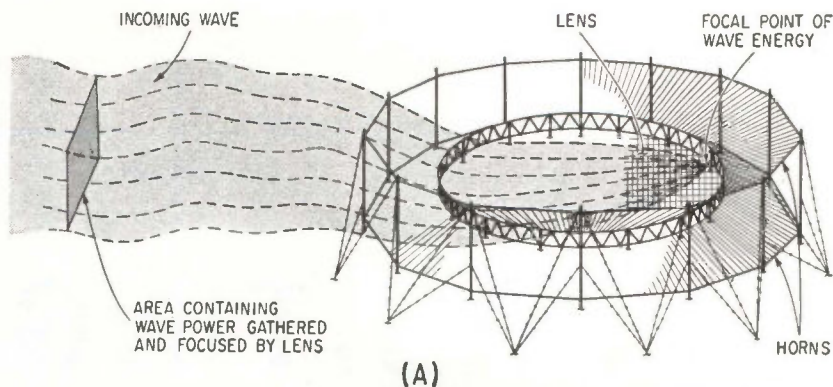

CONCENTRATION of wave energy by wire-grid lens shown in artist's drawing (A), and transmission-line coupler assembly installed in the lens (B)—Fig. 1

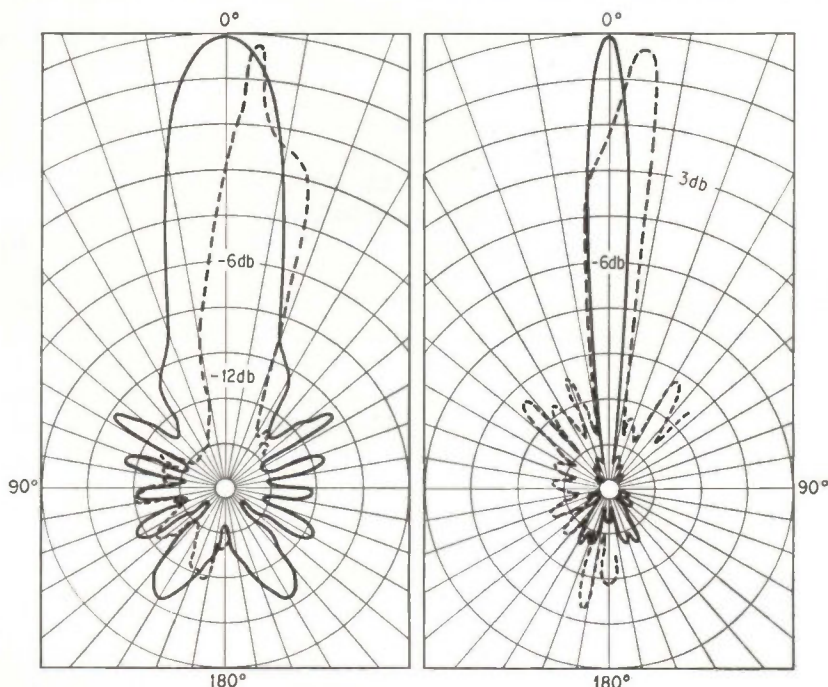

POLAR patterns showing calculated (solid) and measured (broken) plots of the array. Patterns were calculated for 4.0 Mc and 30 Mc, while measurements were taken at 3.8 Mc and 25 Mc—Fig. 2

ORBITING OBSERVATORY

To measure stars' dim light

Special multiplier phototube and tunnel diode pulse height circuit allow single photons from distant stars to be counted. Data are stored for later transmission to ground station

By **R. CUIKAY** and **T. CALLAHAN**, Sylvania Electronics Systems Div.,
Sylvania Electronics Products Inc., Needham, Mass.

SOME OF THE secrets of the birth and death of stars and solar systems are contained in the light reaching us from galaxies many light years away. But the light from many interesting stars is so dim it is almost entirely lost as the earth's atmosphere absorbs, scatters, reflects and bends these rays. The Orbiting Astronomical Observatory promises to unlock many new secrets for astronomy by putting delicate light gathering instruments above the atmosphere.

NASA's Goddard Space Flight Center has planned three satellite experiments to study ultraviolet emitted from stars. The third Orbiting Astronomical Observatory—the Princeton University experiment—will study how intergalactic gas clouds absorb ultraviolet light, hopefully to explain composition and physical state of the gas.

This satellite will carry a 32-inch telescope and a Paschen-Runge type spectrometer in the 800 to 3,200 Angstrom range. The equipment is the most sensitive of this type ever designed, so sensitive it can count single photon arrivals at selected wavelengths.

Part of project is to determine how sensitive a spectrometer can be built. But its great sensitivity will be a boon in spotting light from stars never before examined.

Photon Counting—Seven photon counting channels of the type shown in Fig. 1 will be used in the Princeton experiment. During normal operation incident photons excite the cathode of a special spectrometer photomultiplier tube and generate current pulses of about 10^{-11} amperes with a width of 1 to 3 microseconds. The preamplifier and amplifier-discriminator separate photon pulses from background noise by amplitude and pulse-duration discrimination and present normalized high level pulses to the gate circuit. Then the program circuit, as shown in Fig. 1, operates on the photon generated pulses to allow a pulse count, as follows.

- A reset pulse returns the counter to zero.
- The input gate opens for 15 seconds for pulse counts.
- The input gate closes and the output gate opens, and the count is transmitted to the spacecraft memory where it is held until transmitted to a ground station. The program then repeats.

The counter can operate at 400 kc and is conventional in design. But photon arrivals cannot exceed approximately 1,000 per second without exceeding counter capacity, and, since arrivals are random, photons closer than 2.5 μ s will not be counted

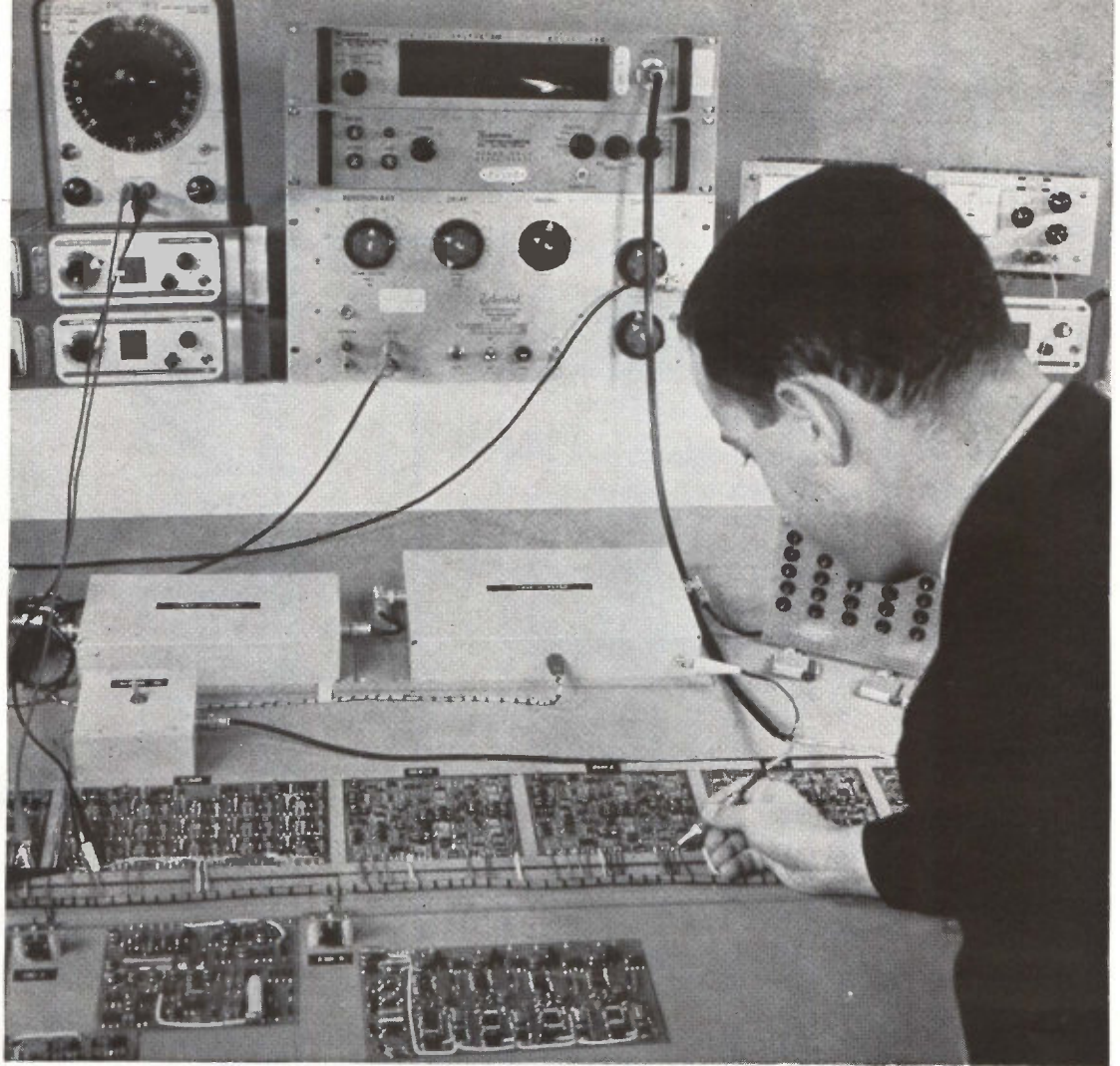

CIRCUITS FOR PHOTON counting equipment are checked out before assembly in package for orbiting observatory

separately. Since the time resolution of the counter is accurately known however, the data can be corrected for this effect.

Circuit requirements thus include amplification

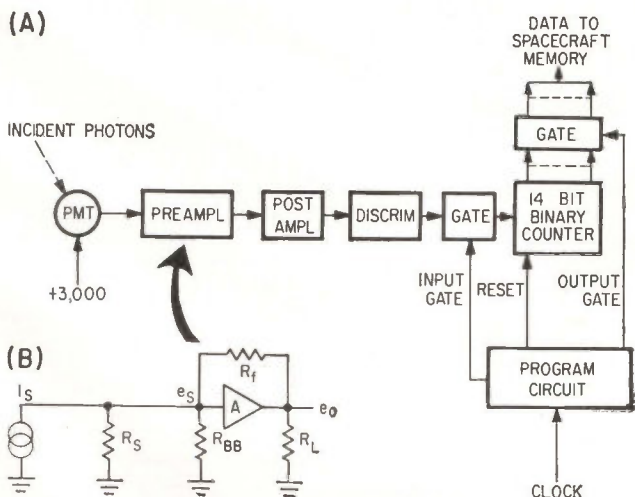

SPECIAL MULTIPLIER phototube (block diagram) can respond to single photon. To match multiplier phototube's high output impedance, preamplifier (B) is designed as current amplifier—Fig. 1

sufficient for pulse height discrimination, a photon detector capable of 4,000 random pulses per second (for one percent loss because of photon overlap or coincidence) and fast recovery from photon overloads up to 1,000 times threshold; the temperature range is from -55 to 125 C.

Photomultiplier—The spectrometer photomultiplier tube has a venetian blind structure for the electrostatic dynode system and an average gain of 10^6 at 3,000 volts; average dark current is 8×10^{-10} amperes at 25 C. The tube is treated as a constant current source of high internal impedance from which the output signal—taken from the collecting anode—is sent to a current sensing preamplifier. Designed to be sensitive to photons in the 1,500 to 3,000 Å range, the tube has a greater pulse rate detection than the counter rate of 4,000 pulses per sec.

Preamplifier—In the wideband preamplifier following the photomultiplier tube, a major design problem is matching the high impedance tube to the input stage. A transistor with low noise current cannot present a high enough impedance to the photomultiplier tube.

Usually, the transistor noise current of the first stage is optimized by transforming the source im-

pedance to match the impedance of the input stage. When a transformer is not feasible and the source impedance is fixed, first stage noise current can be optimized by adjusting emitter current with source impedance fixed. Design criteria for the first stage to operate at a minimum noise current is as follows.

- Transistor current transfer ratio should be large.
- Transistor cut-off frequency should be high.
- Transistor leakage current should be low.
- Emitter current should be adjusted for minimum noise current.
- Collector resistance r_c should be large.
- The time constant of collector-to-base capacitance C_{ob} times load resistance R_L should be small.

Since the photomultiplier tube is an equivalent current source, the preamplifier should ideally be a current amplifier. An equivalent of the circuit used is shown in the inset of Fig. 1.

Current at the summing node of the preamplifier, assuming $R_s \gg R_{BB}$, is

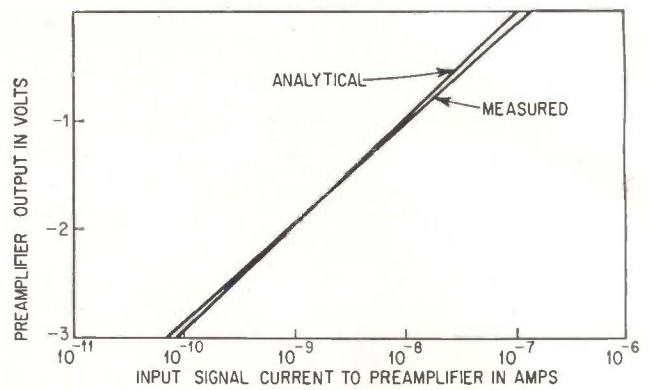

MEASURED and calculated transfer functions of preamplifier agree closely—Fig. 2

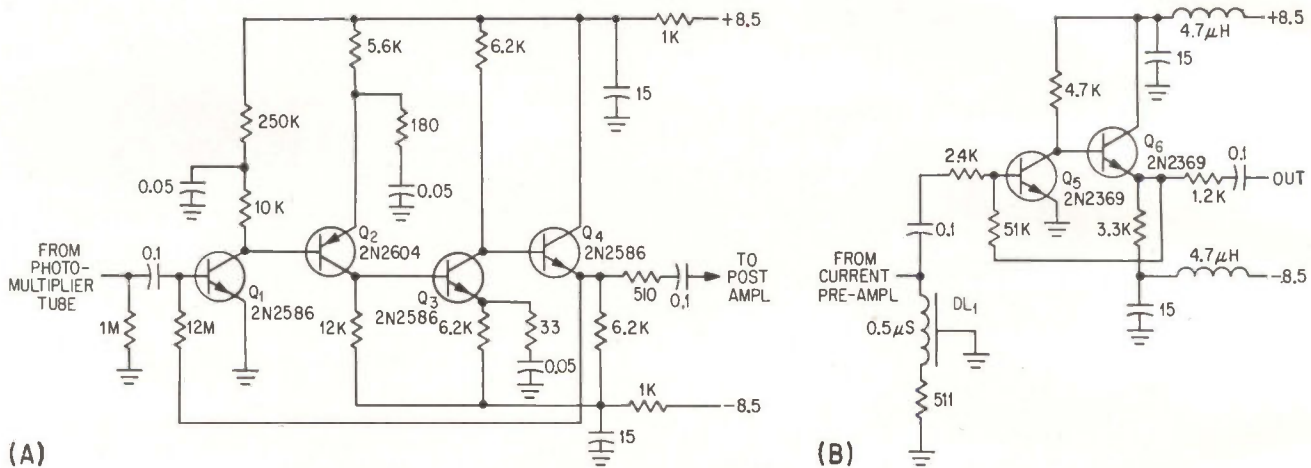

CURRENT PREAMPLIFIER (A) is a-c coupled from multiplier phototube and to following or post amplifier. Feedback holds gain change to ± 5 percent over temperature range. Post amplifier (B) uses delay line for pulse shaping—Fig. 3

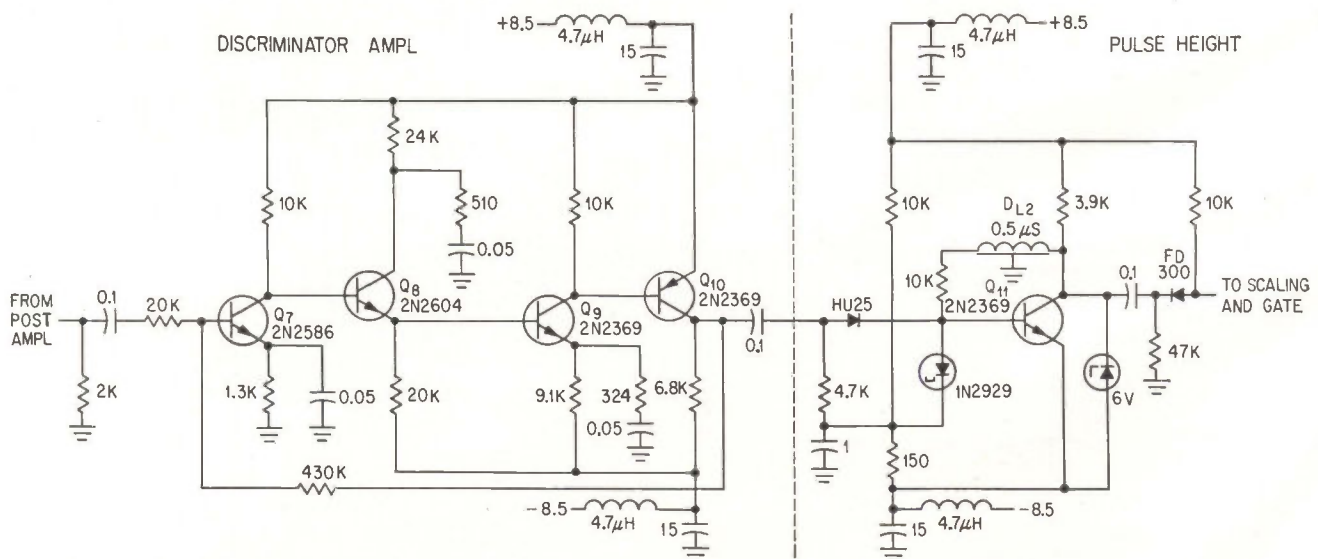

DISCRIMINATOR AMPLIFIER feeds pulse height circuit. Tunnel diode at input to pulse height circuit does not pass small pulses or low level noise—Fig. 4

$$i_s + \frac{e_0}{R_f} - \frac{e_s}{R_{BB}} - \frac{e_s}{R_f} = 0 \quad (1)$$

Since the circuit is a current preamplifier, the transfer function of the amplifier yields convenient results when solved in terms of output voltage to input current. To do this e_s should be eliminated from Eq. 1. This is accomplished by substituting the basic gain equation $e_o = e_s A$ into the equation. The transfer function of e_o to i_s for the current preamplifier after the necessary substitutions is

$$i_s + \frac{e_o}{R_f} - \frac{e_o}{AR_{BB}} - \frac{e_o}{AR_f} = 0 \quad (2)$$

$$i_s + e_o \left(\frac{1}{R_f} - \frac{1}{AR_{BB}} - \frac{1}{AR_f} \right) = 0 \quad (3)$$

$$i_s = e_o \left(\frac{R_f + R_{BB} - AR_{BB}}{AR_{BB} R_f} \right) \quad (4)$$

$$i_s = e_o \left(\frac{R_{BB}(1-A) + R_f}{AR_{BB} R_f} \right) \quad (5)$$

$$\frac{e_o}{i_s} = \frac{AR_{BB} R_f}{R_{BB}(1-A) + R_f} \quad (6)$$

$$\frac{e_o}{i_s} = \frac{AR_{BB}}{\frac{R_{BB}}{R_f}(1-A) + 1} \quad (7)$$

The transfer function is plotted in Fig. 2.

Next, the current sensitivity of the amplifier with a typical photomultiplier for no-signal is established. At 298 K and for a bandwidth of 1Mc. the uncorrelated noise currents associated with the input of the current preamplifier are

- Photomultiplier tube noise is 8×10^{-10} amperes.
- Equivalent source impedance noise is 1.2×10^{-10} amperes.
- Preamplifier noise with a 2N2586 in the first stage is 3.3×10^{-10} amperes.

Total noise current, the rms of the individual currents, establishes a minimum preamplifier sensitivity of 8.7×10^{-10} amperes.

Preamplifier Circuit—In the actual circuit of the current preamplifier, Fig. 3A, four direct coupled transistor stages provide a closed loop gain of 12, with an input dynamic current range from 3.3×10^{-10} to 5.6×10^{-7} amperes.

In accordance with the criteria for low noise operation, the collector current of the first stage (Q_1) is small. Apparent load resistance ($250k + 10k$) is large, which not only reduces collector current but lowers the break frequency of the stage and thereby its bandpass. In lieu of a lower supply voltage, the load resistor is separated into 2 sections and the largest section decoupled. The unbypassed resistance—the effective load resistance—now determines the gain and raises the break frequency. The next two common emitter stages provide voltage gain and the necessary phase shift for negative feedback. The final emitter follower stage provides buffering for circuits following and the feedback resistor. Gain changes from -55 to $125C$ was ± 5 percent; measured phase margin was 40 degrees.

Post Amplifier—The post amplifier, Fig. 3B, is a basic shunt-series feedback amplifier providing pulse

shaping and buffering for the voltage signal from the preamplifier.

Pulse shaping is obtained by a delay line at the amplifier input; the delay line is shorted at one end and terminated at the other in its characteristics impedance. This normalizes the input width to twice the characteristic delay of the line (delay is $0.5 \mu s$). The first stage—a common-emitter—provides an open loop gain of approximately 118. The second stage—an emitter-follower—is a low impedance drive for feedback and the following discriminator amplifier.

The post amplifier, with a phase margin of 60 degrees and a bandwidth of 1 Mc, operates from -55 to $125 C$ and maintains a loop gain of 17 ± 5 percent.

Discriminator Amplifier—The Discriminator Amplifier, Fig. 4, is a voltage amplifier with four direct-coupled transistor stages a-c coupled from the post amplifier and to the pulse height circuit. The three common emitter stages provide an open loop gain of approximately 6,300. The final emitter-follower provides a low impedance drive for the negative feedback resistor and pulse height circuit. The discriminator amplifier, with a phase margin of 50 degrees and a bandwidth of 1 Mc, operates from -55 to $125 C$ at a loop gain of 36 ± 5 percent.

Pulse Height—The pulse height circuit,¹ also shown in Fig. 4, uses a tunnel diode discriminator circuit to exclude noise and small pulses from the signals being counted. Signal pulses from the discriminator amplifier are a-c coupled to a tunnel diode (1N2929) pulse height sensor through a uni-diode (HU 25) for isolation.

The tunnel diode pulse height sensor, normally biased ON is directly coupled to a single transistor stage (Q_{11}) for amplification; feedback is through a delay line (DL_2) to obtain monostable operation of the pulse height circuit. Voltage threshold of the discriminator circuit is set slightly higher than the voltage noise level of the photon counting system. Voltage signals equal to or greater than the preset threshold level cause a negative output pulse to be sent to the scaling and gate circuits.

Results—At an ambient of $25 C$ and with photomultiplier voltage at 2.7 kv, a channel threshold level of 2.4×10^{-9} amperes gives a maximum background counting rate of 135 counts per second. Holding the threshold level constant and lowering the temperature of the photomultiplier and the current preamplifier to $-55 C$ lowers the background to 7 counts per second.

Minimum channel threshold level at $25 C$ is limited by photomultiplier dark current and the band limited noise of the current preamplifier. At $-55 C$, the minimum channel threshold, 1.1×10^{-10} amperes, is mainly determined by the band limited noise of the preamplifier. In each case, a compromise has to be made on threshold level and background count.

REFERENCE

- (1) Subcontract performed by the Bendix Corp., Research Div., for Princeton University Observatory under contract AF19(604)-4972.

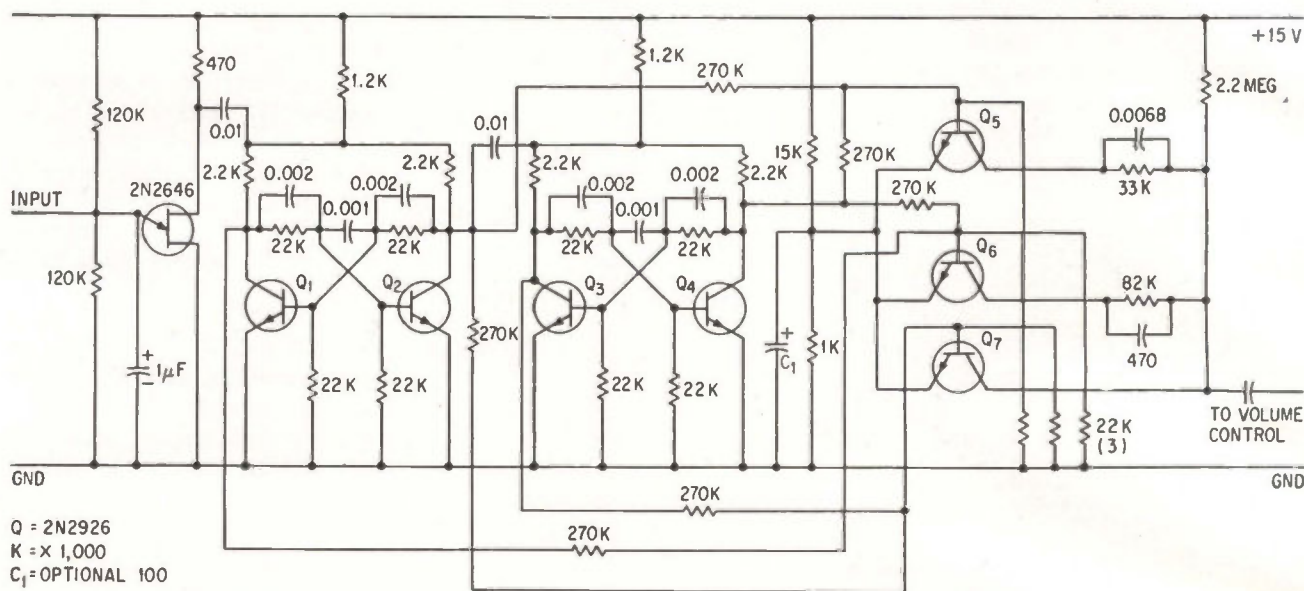

SOLID-STATE stepping switch performs all the functions of a conventional stepping relay using low-cost silicon transistors. The unijunction transistor threshold detector combines the two functions of level detection and trigger pulse generation

Transistors Instead of Relays Tune

Reliability increases and cost decreases when the mechanical stepping switch in tv sets is replaced by a solid-state design. A simple resistor/transistor logic scheme is used

By **JOHN H. PHELPS**

Manager, Application Engineering, Electronic Components Div., General Electric Co., Syracuse, N. Y.

LOW COST silicon transistors can replace, in television receivers, the ratchet-operated stepping relay currently used to remotely control volume. Peripheral components are compared in the photo. The upper set is required for the conventional stepping switch, the lower set for the solid-state switch. The reduction in completed cost between the two systems is approximately 13 percent.

Relay Operation—A spiral-shaped wiper arm in the stepping relay moves across selects printed lands, each of which selects a distinct volume level. The volume control sequence (mute, low, medium, high) an appropriate RC network, which is placed in shunt with the set's regular volume control. This network provides proper attenuation and frequency shaping to give distinct loudness levels. High and mute are

open and short-circuit shunts respectively.

The solenoid of the stepping switch is driven from a current amplifier. This unit provides a trigger pulse of current each time the receiver amplifier and detector recognize an ultrasonic burst from the hand-held transmitter.

Immunity to spurious noise is obtained principally by a steep and narrow amplifier frequency response at the command frequency.

Solid-State Design—The functions of the stepper are summarized and used to design a solid-state equivalent: (1) detection level; (2) triggering; (3) counting; (4) holding the count (memory); and (5) shunting the volume control.

Level Detection—This is an important design con-

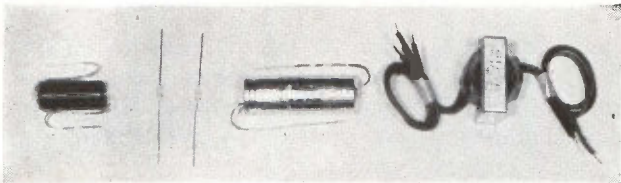
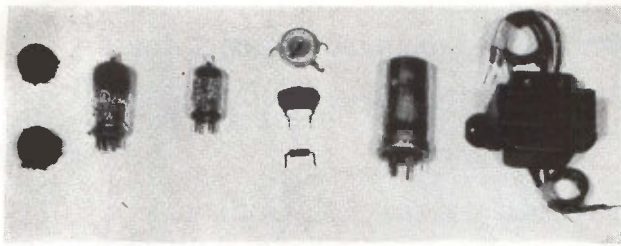

DRIVE COMPONENTS, for both power and signal, compared. The upper row is used in conventional designs, the bottom row is solid-state version

TV Volume

sideration since it provides an opportunity to increase false-trigger immunity by setting a threshold. This threshold, combined with the equivalent time delay set by the receiver passband and detector integrator, rules out false triggering by random noise.

Trigger—When the level detector calls a legitimate command pulse, the next function is that of generating a clean, repeatable trigger pulse to initiate count. The twin functions of level detection and trigger-pulse generation are implemented in the unijunction transistor threshold detector shown in the schematic. The 2N2646 is biased just below its peak firing voltage by the divider arm in the emitter circuit.

CONDITION TABLE

Conditions	Q ₁	Q ₂	Q ₃	Q ₄	Switch Closure
1	0	1	0	1	open
2	0	1	1	0	Q ₆
3	1	0	0	1	Q ₇
4	1	0	1	0	Q ₅

Since the threshold voltage V_p at which the unijunction fires is $V_p = \eta V_{bb} + V_D$, the divider-arm ratio must be set to provide immunity against false trigger pulse, caused by high line voltage. The divider ratio and η (the intrinsic standoff ratio of the unijunction transistor) set the noise or false-trigger threshold. In any case, the circuits driving the stepper must determine the divider ratio. With an η of 0.6 the voltage threshold against false trigger is 10 percent of the supply voltage for a 2:1 divider (1:1 arrangement).

Negative triggering is obtained at the base 2 end of the base 2 resistor. When the 1- μ f timing and integrating capacitor discharges, the modulation of R_{bb} pulls base 2 downward for a sharp, well defined, short-duration pulse (approximately 2- μ sec).

Count—The function is combined with memory by the use of two cascaded bistable dividers. Since each divider has two stable states, a table of conditions shows all possible count combinations (only four possible arrangements). Since four distinct conditions are needed, proper use of the divider condition table will yield the information needed to perform the last task—shunting the volume control.

Volume Control Shunting—This requires only three closures. The fourth function, high volume, is attained by the absence of any of the other three shunts. The shunt circuits then are formed by transistors which are either cut-off or saturated as dictated by the condition of transistors in the divider/counter. Cut-off is assured by elevating the emitters through the divider to a potential which assures back bias from emitter-to-base for the presence of any single input (one transistor in the counter on, and one off).

If both transistors feeding a switch turn off, the switch transistor saturates shunting the volume control with the network in its collector. The scheme is simple resistor/transistor logic and the divider condition table tells that a switch transistor, having its base connected through coupling resistors to Q_1 and Q_3 , will conduct only under condition 1.

Considering condition 1 (Q_1 and Q_3 OFF) then Q_6 functions as a two-input AND gate, being fed by a 270,000-ohm resistor from both Q_1 and Q_4 collector loads and their common load. Since the emitter of Q_6 is held at approximately 15 ($1/15 \cong 1$ -volt, and $V_{BE} \cong 0.7$ -v then a single AND input must never provide more than 1.3-v and an AND command must furnish more than 1.7-v. At the 15-v center shown, R must be greater than 250,000-ohm but less than 450,000. The value of 270,000 (shown) lies in this range and favors extra base drive.

Similarly, conditions 2 and 3 will distinctly address only one switch respectively. Condition 4 (Q_1 and Q_3 ON, Q_2 and Q_4 OFF) opens all switches and provides high volume. The large collector load causes no significant decrease in open volume.

PARAMP SYSTEM Achieves High

Used for satellite tracking in five-channel, feed-mounted systems, these amplifiers provide unusual channel-to-channel isolation

By R. L. SLEVEN and R. J. DOMCHICK

Department of Applied Electronics, Airborne Instruments Laboratory, Deer Park, L. I., N. Y.

STABLE low-noise receiving systems for satellite tracking and telemetry have become available through continual improvements in parametric amplifiers. Their frequency range is constantly being increased with units now extending through K band. Performance improvements include wide-tuning ranges, octave bandwidths and maser-like noise performance with cryogenic systems.

Several parametric amplifier systems recently completed here demonstrate that the parametric amplifier has graduated from laboratory status.

These systems, mounted on antenna feeds, combine low noise figure and extreme stability. System noise figures as low as 1.5 db are achieved with stable operation for any input impedance over a wide temperature range. The noise fig-

ures of the parametric amplifiers alone are less than 1 db. All noise figures are measured with the precise hot-cold body standard noise generator.

Success of the system depends upon solution of many subtle problems not obvious from the system specifications and not anticipated at the start of the program.

Two different tracking systems are considered, one at 400 Mc and

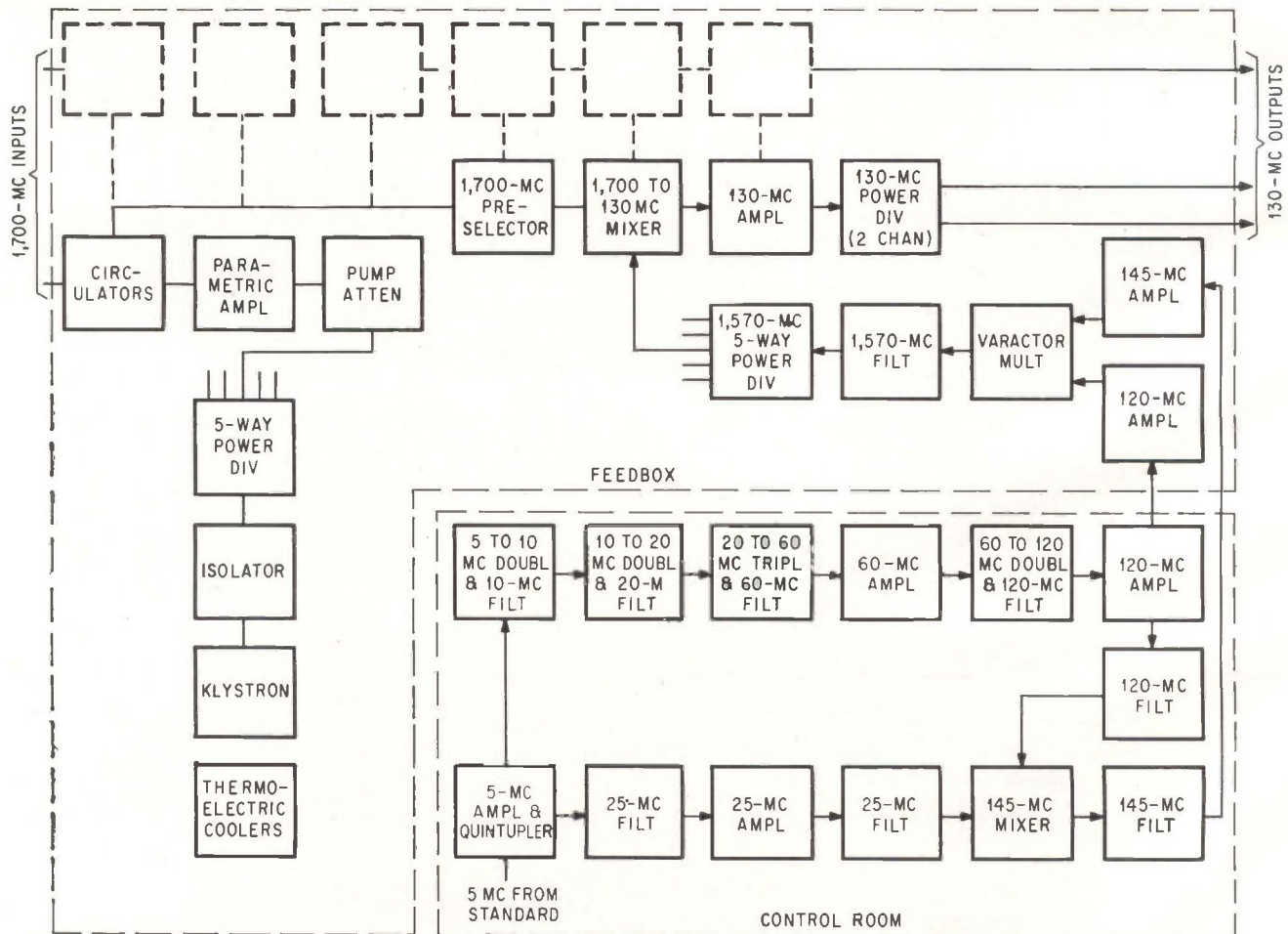

PARAMETRIC amplifier converter system for 1,700 Mc. The comparable system for 400 Mc is simpler as described in text

Stability

one at 1,700 Mc. Parametric amplifiers for these systems had demonstrated on the bench satisfactory performance with respect to gain, bandwidth, noise figure, dynamic range and stability. As used for satellite tracking in five-channel, feed-mounted systems requirements of channel-to-channel isolation, gain stability over a wide temperature range and, above all, reliability are important.

The block diagram shows one system and Table I lists typical performance data for the 400 and 1,700 Mc systems. The double conversion in the 400-Mc system is required to eliminate spurious responses that would otherwise be caused by the second harmonic of the local oscillator if a direct 400-to-130 Mc converter were used. The large number of stages in the local-oscillator synthesizers insures a large signal-to-noise ratio throughout the chain and with it extreme frequency stability.

Channel Isolation—When a single parametric amplifier channel had operated satisfactorily on the bench, the next step was to pump five channels with a common pump source. The X-band pump power is distributed to the amplifiers by a five-way waveguide power divider comprising a 7-db multihole coupler and three 3-db hybrid couplers. Broad-band couplers ensure isolation between channels at the idler ($f_{\text{pump}} - f_{\text{sig}}$), the pump (f_{pump}) and the sum ($f_{\text{pump}} + f_{\text{sig}}$) frequencies. The minimum isolation over this band of frequencies (7.1 to 7.9 Gc for the 400-Mc system and 7.8 to 11.2 Gc for the 1,700-Mc system) is 22 db. The system specification for signal isolation between channels is 50 db.

Coupling between channels through the pump network can occur when the signal frequency is converted in one varactor to idler or sum frequency. The resulting signal then propagates in the waveguide to a second channel and its frequency is converted back to the original frequency. The total channel-to-channel isolation of the system is therefore determined by three

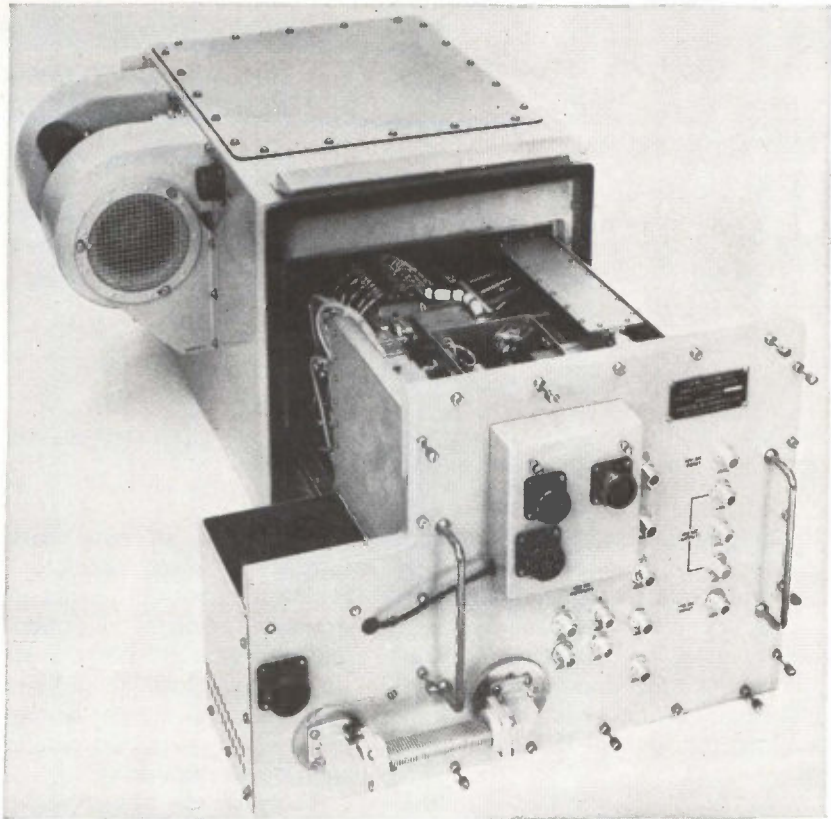

1,700-Mc feedbox equipment is shown above

MARRIAGE OF THE YEAR

Most of the literature on parametric amplifiers deals with the unit alone. This article shows that problems associated with incorporating them into systems have been solved. They are now ready for field service. The time is past, our authors claim, when one says, "oh yes, they're ok in the laboratory when tended by an engineer, but they're too tricky for the field"

TYPICAL PERFORMANCE—TABLE I

	400-Mc System	1,700-Mc System
Input center frequency.....	403 Mc	1,705 Mc
Output center frequency.....	133 Mc	133 Mc
Noise figure.....	1.75 db	2.0 db
Gain.....	30 db	27 db
Bandwidth (2-db points).....	6.5 Mc	16 Mc
Input swr.....	1.1	1.2
Dynamic range.....	Noise to -49 dbm	Noise to -36 dbm
Isolation between channels.....	52 db	50 db
Gain stability		
Absolute gain variation for 1 hour.....	0.3 db	0.4 db
Absolute gain variation for 12 hours.....	0.5 db	0.5 db
Relative gain variation for 12 hours.....	0.5 db	0.4 db
Absolute gain variation over environment.....	2.0 db	1.7 db
Relative gain variation over environment.....	1.0 db	0.6 db
Gain variation for 5-to-1 source swr variation.....	0.2 db	0.3 db
Gain variation for ± 10 percent line voltage variation.....	0.5 db	0.7 db
Differential phase stability for 12 hours.....	3 degrees	1.5 degree
Image rejection.....	>90 db	>90 db
Temperature		
Feedbox.....		0 to +130F
Electronic cage.....		-60 to +130F
Control room.....		+60 to +120F

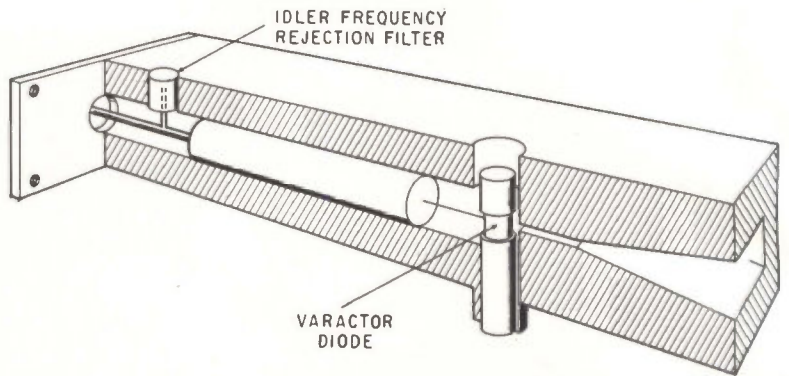
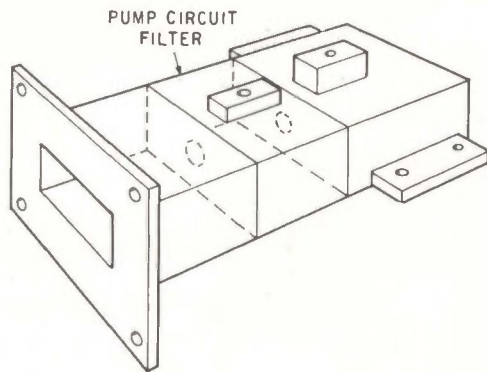

PUMP circuit with isolation filter (left) was necessary to provide isolation within the designed package. Signal circuit with idler rejection filter is shown at right

things: the isolation of the pump power distribution network at the idler and sum frequencies, the amplifier conversion efficiency of signal input to sum or idler output in the pump circuit, and the conversion efficiency of sum or idler power in the pump circuit to the signal output.

With 22 db of isolation in the pump network, the measured isolation between channels (signal going in one channel and out a second channel) is only 30 db.

After the component layout and the cabinet dimensions are established, the solution to even simple electrical problems becomes difficult. To meet the isolation specification an additional 20 db was required.

The optimum solution here was a filter at each pump port to pass the pump frequency with minimum loss and to provide at least 20 db of rejection at the idler and sum frequencies. As illustrated, the waveguide pump circuit of the parametric amplifier is slotted and inductive irises are inserted to form the required filter. The pump-frequency insertion loss of the filter is 0.2 db and the rejection of the unwanted signals greater than 24 db. Resulting minimum channel-to-channel isolation in the parametric amplifier portion of the system is greater than 60 db.

Circulator Impedance—When many items are being assembled, problems occur that are never observed with only one or two laboratory units. Several problems occurred when forty parametric amplifiers were mated with their circulators.

Although tests over the signal frequency band indicated that the char-

acteristics of all circulators were satisfactory, some circulator-amplifier combinations produced an unacceptable frequency response. One had a response with a 3 to 6 db ripple. By replacing the circulator with what appeared to be an identical unit, a perfect frequency response was obtained.

The problem was caused by differences in the circulator impedances at the idler frequency. Normally, circulator characteristics such as impedance, insertion loss and isolation are specified only over the signal-frequency band. For proper operation of the parametric amplifier, the varactor should see a purely reactive impedance. The resistive component of the circulator impedance at the idler frequency caused the problem.

A low-pass filter between the circulator and amplifier was one solution, but with cabinet dimensions fixed, the two or three inches necessary were not available. It was therefore necessary to provide the reactive termination somewhere inside the amplifier. An idler frequency rejection filter comprising a quarter-wave open-circuit coaxial stub (illustrated) was placed in the amplifier signal circuit. Its suscep-

tance at signal frequency is negligible.

Gain Stability—Specifications of ± 2 db absolute gain stability and 1-db relative gain stability between channels over the environmental temperature range presented a major problem. The parametric amplifier is housed in a room at the antenna feed where the temperature range is 0 to 130 F and the pump power supply is located behind the antenna where the temperature range is -60 to $+130$ F.

Major causes of gain variation are change in the amount of pump power delivered to the varactor and change in the circulator impedance with temperature. The pump-power variation can result from changes in the pump-power supply voltages or changes in the output of the pump source.

For 20 db of parametric amplifier gain, a change of 0.1 db in pump power will cause a gain change of 0.5 to 1.5 db, depending on the particular varactor characteristics. A 10 C change in the temperature of the amplifier-circulator combination will have about the same effect. To meet the relative gain stability specification of 1 db, the

TEMPERATURE STABILIZATION—TABLE II

Component	Ambient Temperature Range (deg F)	Temperature Stabilization (deg F)	Variation of Electrical characteristics
Klystron power supply	-60 to $+130$	130 to 150	Beam voltage: 1 volt (0.2 percent) Reflector voltage: 1 volt (0.3 percent)
Klystron	0 to 130	153 to 167	Pump frequency: 2.7 Mc
Parametric amplifier enclosure	0 to 130	86 to 93	Gain: 0.2 db

pump power delivered to the varactor must be held constant to better than 0.1 db and the amplifier temperature variation must be well below 10 C.

The pump source for the 1,700-Mc system is the Varian VA-242 klystron. The stability of this tube is specified as: reflector voltage modulation coefficient, 1.5 Mc per v and temperature coefficient, 150 kc per deg C. Although the value is not specified, there is also a change in output power owing to beam-voltage variations. The beam voltage-power output coefficient was measured to be 0.02 db per v.

One other factor that is significant in determining the system stability is the bandwidth of the pump circuit. The wider this bandwidth the less will be the change in gain with variations in pump frequency. With a filter in the pump circuit to reject sum and idler frequencies, the pump bandwidth is about 50 Mc.

Table II summarizes the temperature stabilization achieved and its effect on electrical performance. Over the full environmental temperature range, the average system gain stability is 2 db absolute and 1 db channel to channel.

SWR—The specifications for input standing-wave ratio and gain stability as a function of source impedance variations require a high degree of isolation at the parametric amplifier input.

A point easily overlooked is that the swr at the system input increases when the parametric amplifier is turned on. It increases because the parametric amplifier is a negative-resistance device that has a reflection coefficient much greater than 1. Most of the amplified signal is directed to the output port by the circulator. However, because of the finite isolation provided by the circulator, some of the signal appears at the input port and affects the input swr.

The system input swr is therefore a function of the circulator swr, the isolation and the parametric amplifier gain. With a circulator swr of 1.1 and parametric amplifier gain of 20 db, the isolation necessary for a 1.25-operating system swr is 44 db. To maintain a gain stability of ± 1 db for source swr variations from unity to five, the required input isolation is 35 db. The 44-db value

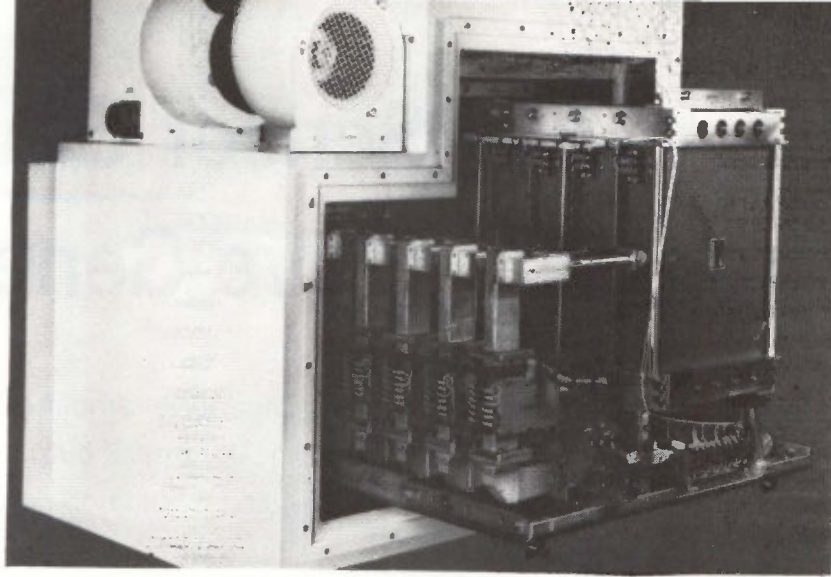

FEEDBOX equipment for operation at 400 Mc

therefore determines the isolation requirement for the input circulator.

Two circulators were cascaded at the input to provide about 50 db of isolation with a maximum of 0.4-db insertion loss. Since one circulator isolates the amplifier from the second stage, a total of three circulators is required for each channel. To minimize size and weight, the three circulators, d-c blocking capacitor and biasing circuits are all housed in one package.

Noise Figure—In any low-noise system, attaining the specified noise figure often presents a problem but the accurate measurement of noise figure is often more difficult.

For the systems discussed, the average noise figures are 1.75 db at 400 Mc and 2 db at 1,700 Mc. The noise figures of the parametric amplifier alone are less than 1 db.

The measurement problem involves the relative accuracies of an argon gas discharge noise source and the standard hot-cold body noise source.

With either, the calculation of an amplifier's noise figure requires measurement of the change in output level for a calibrated change in input noise. With the hot-cold body noise source, the calibrated change in input noise is obtained by switching from a matched input termination immersed in liquid nitrogen to one heated to 100 C. With the argon gas discharge noise source, the calibrated change in input noise is obtained by ionizing the argon and thereby changing from 290 K input temperature (room temperature) to about 11,000 K input temperature.

The actual ionized temperature ranges from 10,000 K to 11,800 K, depending on the particular tube.

Three factors can affect the accuracy of the noise-figure measurement: the accuracy to which the input temperatures are known, the change in swr when changing input temperature (from 77 to 370 K in one case and from 290 to 11,000 K in the other) and insertion loss in the measurement equipment.

Error—The noise-temperature calibration should result in a maximum measurement error of 0.05 db with the hot-cold noise source and 0.25 db with the gas-discharge noise source. At frequencies from 1 to 5 Gc, the effects of insertion loss and swr have a small effect and comparative measurements with both noise sources have been in agreement within 0.2 db. At frequencies near 400 Mc, the effect of swr and insertion loss is significant. It must be carefully compensated.

By neglecting these effects, the noise-figure values measured with the argon noise source at 400 Mc are about 0.7 db lower than those obtained with the hot-cold body noise source. This point must be considered when comparing noise figures of other equipments with those reported here. These were made with the more pessimistic, but presumably more accurate, hot-cold noise source.

The authors thank the personnel of the Applied Electronics Department for cooperation and especially A. Harvey, G. Hayes and A. Martling for contributions to system design.

Frequency Sensor Stabilizes Triangular-Wave Generator

Generator can determine the dynamic linearity of amplifier as a function of frequency over a range of 20 to 100,000 cps. Its peak-to-peak output voltage is constant despite frequency changes. Another use is providing a function generator for analog computers

By DON E. COTTRELL, Dept. of Electrical Engineering, Colorado State University, Fort Collins, Colorado

THIS SOLID-STATE instrument generates a triangular waveform of constant amplitude over the frequency range of 20 to 100,000 cps. It converts sinusoidal frequency changes into a proportional d-c voltage. This d-c voltage is fed into a pulse amplifier and integrator to compensate for any attempted change in integrator output voltage, so that the integrator output remains constant regardless of frequency.

A particular application of this generator is to determine the dynamic linearity of an amplifier as a function of frequency. Since the output of the amplifier is a linear triangular wave, the distortion, when monitored on an oscilloscope, is readily apparent, whereas if a sine wave were used, the output distortion would be more difficult to detect.

Functional diagram—Figure 1 illustrates the basic operation. A sine wave of constant amplitude, regardless of frequency, is coupled into a Schmitt trigger circuit that converts it into a square wave of constant amplitude. This square wave is a-c coupled into a pulse amplifier whose square-wave output voltage varies directly with frequency. The variable amplitude square wave then drives an integrator that produces a triangular waveform of constant amplitude over a frequency range of 20 to 100,000 cps.

The frequency-sensing circuit's purpose is to indicate any change in frequency by producing a d-c voltage directly proportional to frequency. This voltage acts as the d-c source for the pulse amplifier and as part of the d-c source for the integrator. Thus, any change in frequency causes a change in d-c voltage which reflects directly in the square-wave signal that drives the integrator. Thus the peak-to-peak voltage of the triangular wave is kept nearly constant.

Circuit—Fourteen transistors are used as illustrated in Fig. 2. A sinusoidal source of constant voltage (10 volts peak to peak) is connected to a Schmitt trigger circuit, which is biased so that the left 2N706A transistor is normally conducting and the right 2N706A transistor is cutoff. When the sine wave

goes 0.7 volt negative below its average value, this causes the left transistor to cutoff and in turn the right transistor will start to conduct. When the sine wave reaches 0.7 volt above its average value, the transistor's collector voltages are reversed to the original state and because of the rapid switching action, a square wave is produced. The 2N706A emitter follower is direct coupled from the Schmitt circuit and provides isolation between it and the pulse amplifier. This helps to preserve the rise and fall times of the square wave.

Frequency sensing circuit—This is nothing more than a RC series network. If the capacitive reactance at the low end of each frequency range is made approximately 10 times larger than 2,200 ohms, then the a-c voltage across the 2,200-ohm resistor is directly proportional to frequency. This a-c voltage is then rectified and filtered to give a d-c voltage directly proportional to frequency. The d-c output voltage of the frequency sensor varies from 0.1 to 1.0 volt. It is necessary to amplify this output by a d-c amplifier with an overall voltage gain of 10. To provide a low output impedance, a 2N526 emitter follower is used and its output then acts as the d-c source voltage for the pulse amplifier and the emitter circuit of the integrator.

The d-c amplifier output versus frequency range is given in Fig. 3. The d-c output is linear in frequency except at the upper frequency end, where the exponential characteristic of the frequency sensor appears.

The 2N966 *pnp* pulse amplifier will saturate whenever the square-wave input goes negative about its average value, and will be cutoff when the square wave goes positive. Thus, the pulse amplifier output is also a square wave—flat on the top and bottom with rise and fall times of 0.05 microsecond. The square-wave signal output is always dependent upon the negative d-c source voltage and will therefore vary directly with changes in frequency. It is necessary that this voltage vary directly with frequency, since the output signal of the integrator would other-

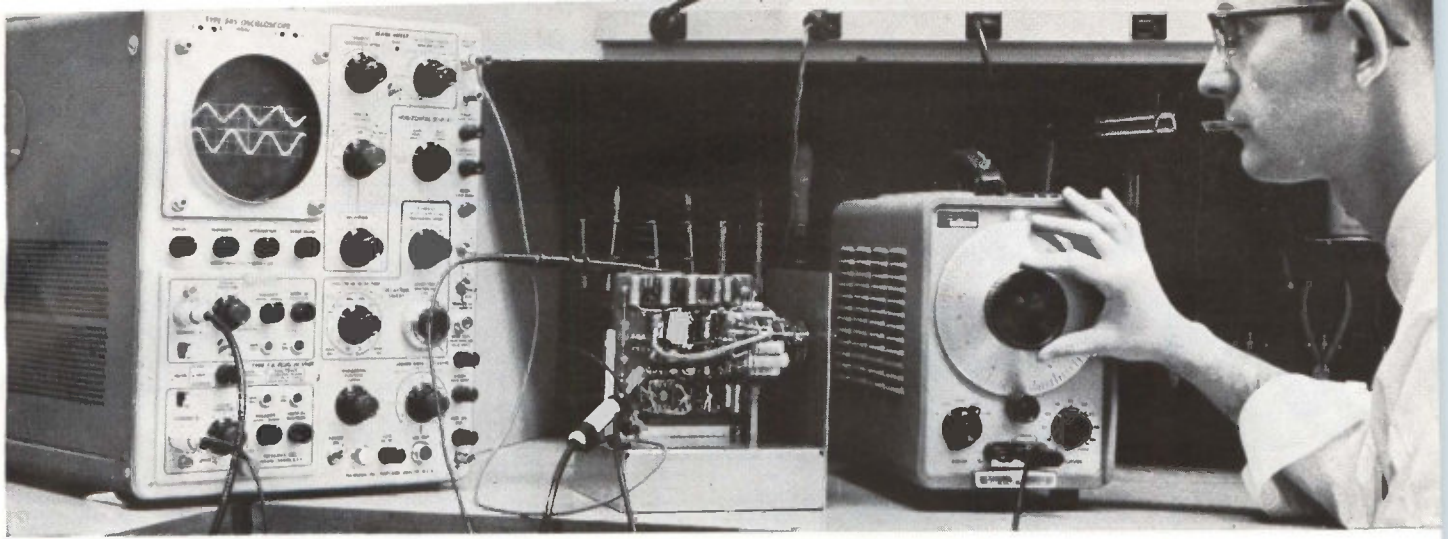

AUTHOR adjusts the sine-wave generator

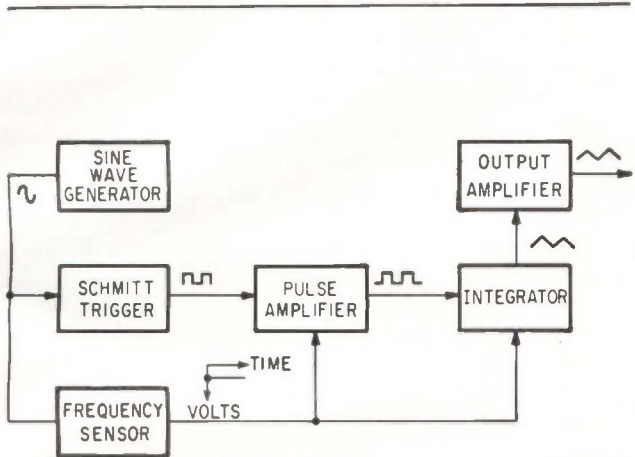

TRIANGULAR-WAVE generator uses a frequency sensing circuit to keep amplitude constant—Fig. 1

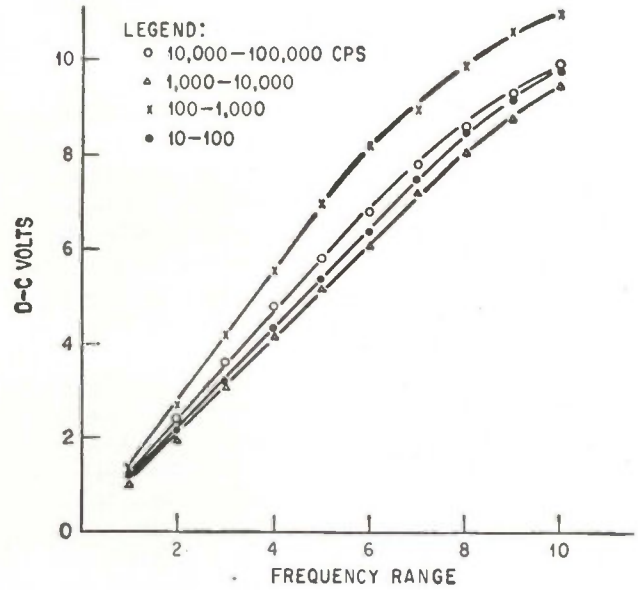

OUTPUT VOLTAGE of the frequency sensor is linear, except at the upper frequency range—Fig. 3

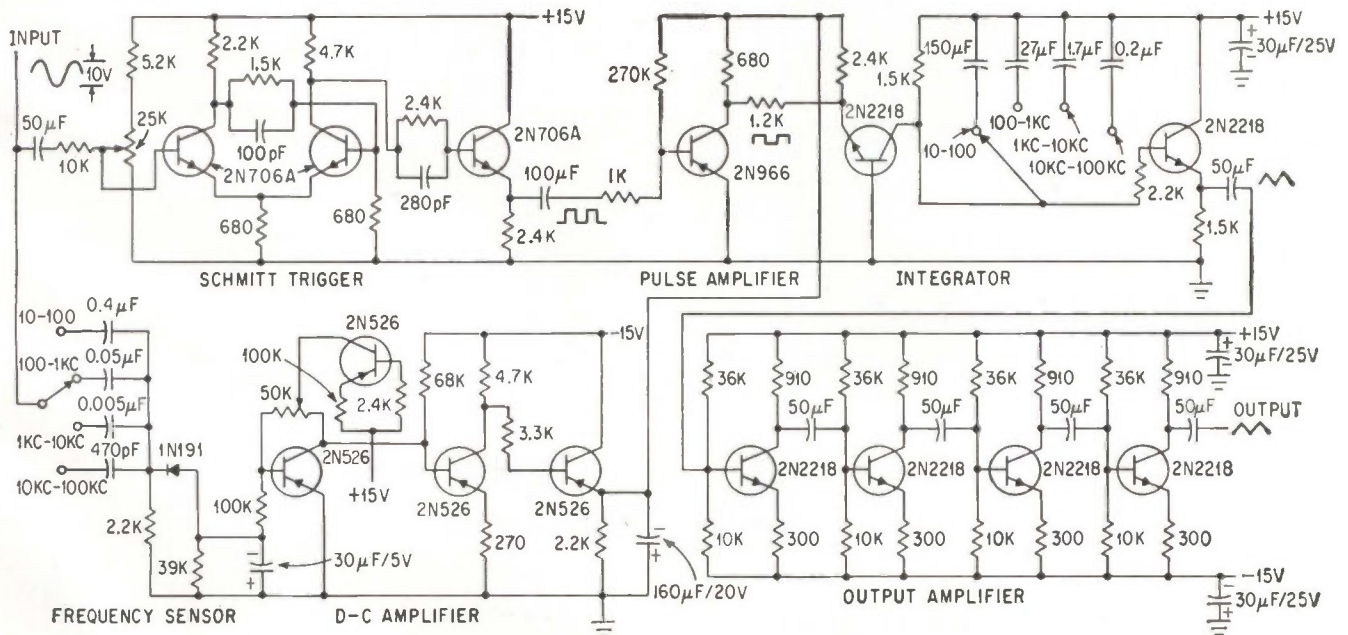

CIRCUIT of the triangular-wave generator uses 14 transistors—Fig. 2

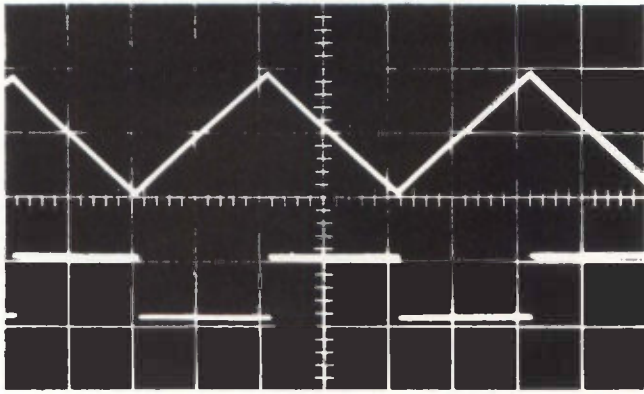

WAVEFORM is measured at the output of the amplifier for 500 cps. Scale is: vertical—5 v per cm and horizontal—500 μ s per cm—Fig. 4

wise decrease as the sinusoidal input frequency increases. The pulse amplifier compensates for this, since the square-wave signal voltage will rise linearly with increased frequency.

Integrator—The biasing of the emitter of the 2N2218 integrator transistor that is connected to the negative d-c source, varies the emitter d-c current to change the d-c operating point of the integrator. Hence, there is less emitter and collector d-c current at low frequencies than at high frequencies, which tends to also compensate for the larger output signal that would otherwise result at low frequencies.

The 2N2218 integrator is a simple grounded-base circuit with the integrating capacitor across the 1,500-ohm load resistor. The grounded-base circuit has excellent constant-current characteristics and hence makes a good linear integrator. When the input signal to the integrator goes negative, the transistor will conduct and the voltage across the capacitor discharges toward ground potential through the collector-to-base circuit of the transistor. When the input to the integrator becomes positive, the transistor ceases to conduct and is essentially an open circuit so that the capacitor will charge towards the +15 volts supply through the 1,500-ohm load resistor. In either the discharge or charge case, the capacitor is allowed to operate on only a small portion of the charge or discharge exponential curves to give a linear output. An RC time constant of approximately 5 times the period of the lowest operating frequency for a given frequency range is chosen to make this possible. The output triangular wave is 0.08 volt peak to peak at the output of the 2N2218 emitter follower that is needed to isolate the integrator.

The signal from the integrator is amplified 100 times in the four-stage 2N2218 output amplifier to produce reasonable signal levels of around 8 volts peak to peak for all frequency ranges. Each stage of the output amplifier has an emitter resistor without any bypassing. This permits negative feedback and hence improved amplifier linearity. The a-c voltage gain of this amplifier was designed to stay constant over the desired frequency range.

Triangular waveforms—These were measured at the output of the amplifier for four different frequencies,

50,000, 5,000, 500, and 50 cps. All waveforms were the same and very linear. Also shown in Fig. 4 is the square-wave input to the pulse amplifier. It is desirable to have as idealized a square wave as possible, to obtain the best integrated waveform.

The amplitude characteristics as a function of frequency were measured at the output of the four-stage amplifier. The peak-to-peak voltage of the triangular wave stays nearly constant, regardless of frequency, except at the low and high end of each frequency range. The output does not drop below the half-power point in any case.

Nonlinearity—The nonlinearity¹ of the triangular waveform was measured and found to be never worse than 3.5 percent at 1,000 cps, but this rapidly improved with increasing frequency so that the nonlinearity could not be measured accurately on the oscilloscope at 3,000 cps. The nonlinearity for most frequencies was determined to be less than 1 percent, except at the low end of each frequency range. This was due to the relatively short RC time constant of the integrator with respect to the period at these frequencies. The nonlinearity could easily be improved merely by increasing the value of the integrating capacitance.

One particular area that requires careful design is the d-c amplifier. It should have a linear voltage output between approximately 0.5 volt to 13 volts. Otherwise the amplitude of the triangular waveform will be affected. This effect is observed at the high-frequency end for each scale in Fig. 3 where the output amplitude begins to drop off. This can be caused also by the slightly exponential characteristic of the frequency sensor, and is not altogether a nonlinearity of the d-c amplifier. Larger supply voltages for the d-c amplifier could be used to help eliminate any nonlinearity.

It was found that nonpolarized capacitors gave the best linear triangular waveform. It was noted experimentally that nonlinearities were produced at the top and bottom of the triangular wave when polarized capacitors were used, even though the d-c potential across the capacitors was not reversed or exceeded.

This same instrument could easily be made into a variable frequency sawtooth generator, if the Schmitt trigger circuit were replaced by a monostable circuit. The monostable circuit would provide a narrow, rectangular pulse. This signal would drive the pulse amplifier and the output would be a sawtooth wave of constant amplitude. The output may be used as a source to generate a linear sweep signal for a cathode-ray tube.

The author acknowledges the assistance of John Dean, George Mosher, Aram Budak and John Morgan of Colorado State University, and William Bensema of the National Bureau of Standards at Boulder, Colorado. The main portion of the funds was made available by a Colorado State University faculty research grant.

REFERENCES

- (1) L. Straus, "Wave Generation and Shaping," McGraw-Hill, Inc. New York, p 154, 1960.

NEW—LOW PRICED

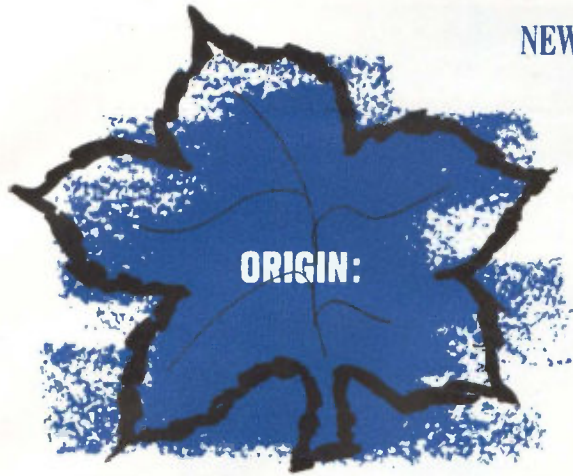

SILICON TRANSISTOR CORPORATION

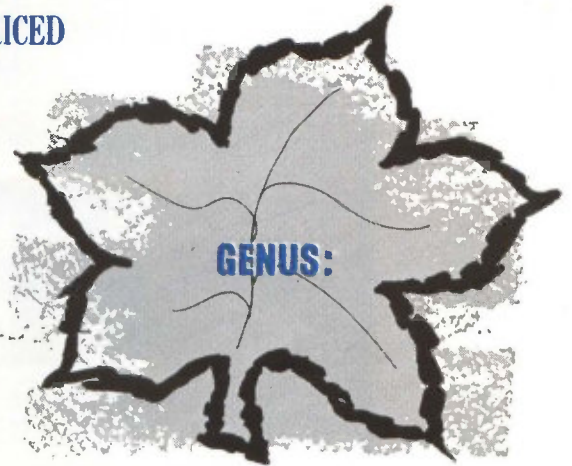

INDUSTRIAL POWER TRANSISTORS



SILICON

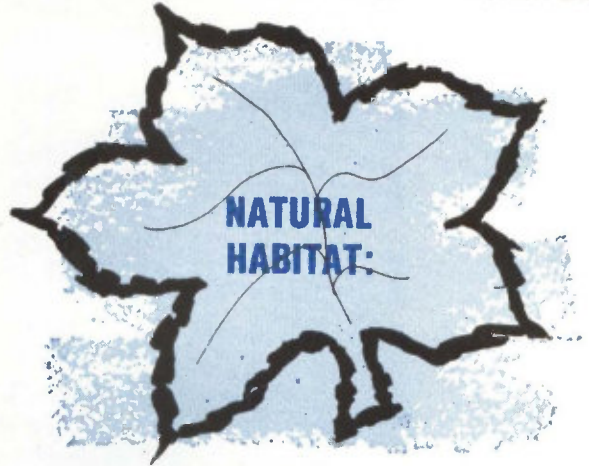

REGULATED POWER SUPPLIES,
CONVERTERS, INVERTERS,
SWITCHING REGULATORS
AND GENERAL PURPOSE



New, low-cost, industrial silicon power transistors from Silicon Transistor Corporation. Maximum junction temperature of 200°C for high power, high temperature operation. Manufactured by the all-diffused process, these transistors are not "fall-offs" from our military line but are designed specifically for the industrial market. Rugged enough to prevent second breakdown with peak switched power ratings at approximately 20 times the D.C. rating. These transistors have power capabilities from 95 to 200 watts, maximum current capabilities from 7.5 to 20 amps and maximum breakdown voltages from 60 to 160 volts. The 2N3232 through 2N3240 series are designed for use in regulated power supplies and amplifiers, transistorized auto ignition systems, converters, inverters and switching regulators and are excellent general purpose transistors for industrial power applications. All are in the TO-3 package. All are comparably priced and are far superior to their germanium counterparts. They are now available from stock and from your local STC distributor. For complete specifications and applications information, contact:



SILICON TRANSISTOR CORPORATION



CARLE PLACE, L. I., NEW YORK 516-Pioneer 2-4100

DISTRICT OFFICES: LONG BEACH 2, CALIF., 217 ELM AVE. (213) 437-2788. TWX 213-549-1972. DAYTON 19, OHIO, 49 PARK AVE. (513) 298-9913. TWX 513-944-0372. WALTHAM, MASS., 751 MAIN ST. (617) 899-3470. HUNTSVILLE, ALA., POST OFFICE BOX 1467. (205) 881-4793

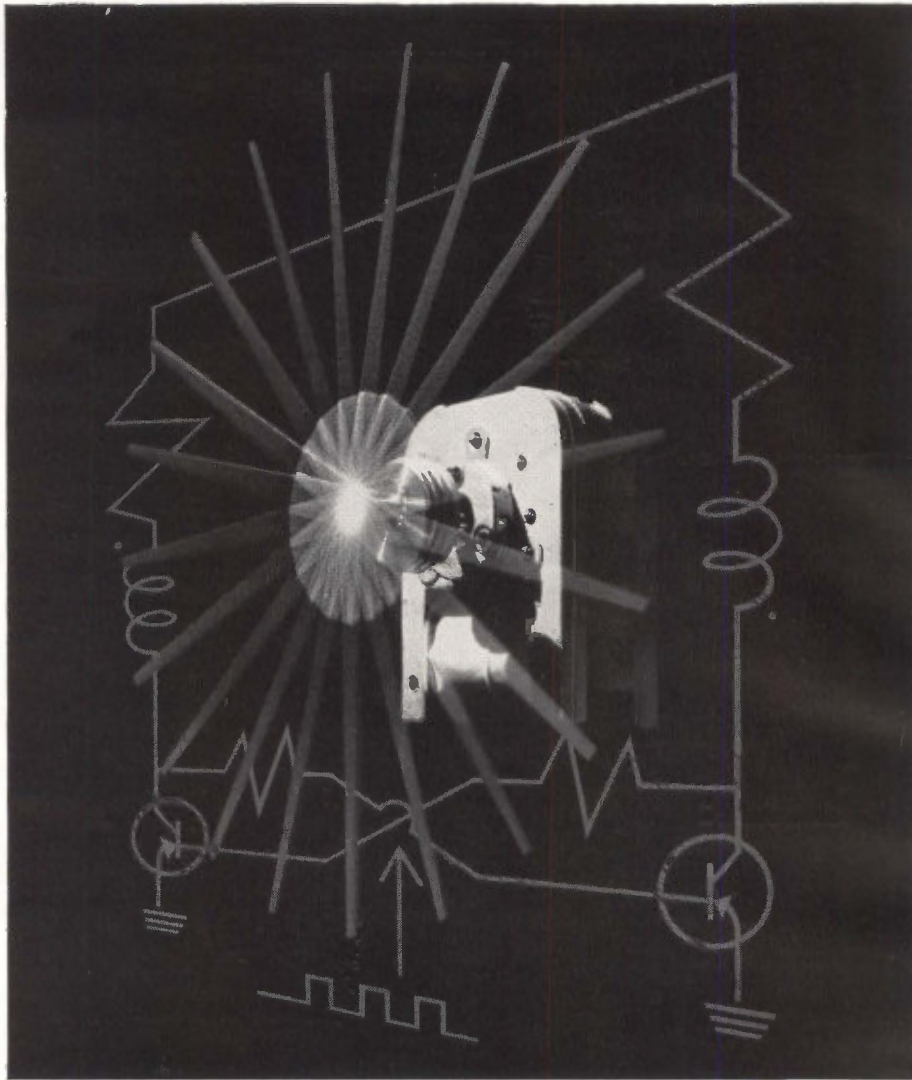

Sigma Cyclonome® Stepping Motor

Even a simple flip-flop can drive it

This is a typical Sigma Cyclonome drive circuit. Uncomplicated. Economical. Reliable. It requires no special input sequencing or phase shifting, thus bypassing the complicated and costly drive sources usually required by other stepping motors. In fact, the motor will operate from any source that provides current reversals or successive pulses—60 cps line, variable frequency oscillators, flip-flop circuits, relay drive, manual switching, commutating.

With any of these unusually simple and reliable drive sources, the Cyclonome Stepping Motor:

- *Delivers* precise 18° steps—at a rate of up to 1,000 steps per second.
 - *Provides* up to 5 inch-ounces of torque.
 - *Maintains* higher holding torque without standby power.
 - *Occupies* as little as 1 cubic inch of space.
- Cyclonome Stepping Motors are at work in

a wide variety of applications... chart and tape drives, analog-digital converting, impulse counting, step servos, remote positioning, timing, synchronizing.

A Sigma Application Engineer will be glad to help you put the Cyclonome Stepping Motor and its drive circuitry to work in your particular application. Or perhaps you would first prefer to read more about it. If so, send for a copy of the Cyclonome Drive Circuit Bulletin. Write to Box 32.

SIGMA DIVISION  **SIGMA INSTRUMENTS INC**
Assured Reliability With Advanced Design/Braintree 85, Mass.

Sigma's Cyclonome Stepping Motor is reliable because it's simple: only one part moves.

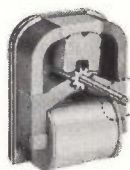

This cutaway view of the Cyclonome Stepping Motor reveals its unique simplicity. Its only moving part is a rotor without windings, without brushes. The precise, incremental rotation of the rotor is due solely to magnetic force. For a

complete description of the Cyclonome Stepping Motor's design, construction, operating sequence and application possibilities, send for your copy of Cyclonome Stepping Motor Basic Bulletin. Write to Box 32A.

Next for Navy: Integrated Avionics

Computers will integrate all sensors, so pilots can operate all aircraft gear

By JOHN F. MASON
Senior Associate Editor

WASHINGTON — Navy's Bureau of Weapons is ready to move on three big avionics projects, each of which will eventually represent multimillion-dollar contracts. One system, for helicopters, and another for light attack planes will be considered for use by all three services.

Common denominator to all three is integration of all the avionics equipment by feeding their acquired data into a computer, thus allowing the pilot and copilot to operate the whole system.

Helicopter System—Farthest along is the Integrated Helicopter Avionics System (IHAS). Its project definition phase finishes up this week. After proposals are studied, in about two months, Navy will probably award a development contract. Competitors are Texas Instruments, Nortronics and Tele-Dyne Systems, Inc.

Sensors that will feed into the computer are communications, navigation, IFF, terrain-following radar, and station-keeping (equipment to enable pilots to maintain relative position to each other in a formation). The pilot and copilot will operate the entire system with a control console. Displays will be both audio and visual.

First completed IHSA will go into the Marines' attack/transport helicopter, CH-53A. The most difficult to develop equipment promises to be the terrain-following radar and the station-keeping system for helicopters. At present there is no such gear.

Light Attack Planes—A much more complex system is the Integrated

Light Attack Avionics System (ILAAS). It will have more sensors than IHSA (ILAAS includes bomb-Nav radar), and will use more advanced components. Planned for the future, ILAAS could go into VAL, Navy's new light-attack aircraft (ELECTRONICS p 17, Feb 21), if ILAAS is finished in time. It will certainly be used in VAX, the planned follow-on to VAL in the early 1970's.

Since ILAAS will be such a big project, and cost so much, Navy is giving the contractual arrangements very special treatment. Eleven companies have submitted bid proposals. Within two weeks, Navy will give two or more project-definition-phase contracts for studies lasting about nine months.

Advanced Projects—Most advanced project of the three is the Integrated Advanced Avionics for Aircraft system (IAAA). New technology will be studied to determine whether it should be applied to the phased integration program.

For example, will it pay to substantially improve computer technology? Computer access rates are now about a microsecond. Is it worth the cost to go for nanosecond rates? Will larger computer memories stand up to a cost/effectiveness scrutiny? Plans for IAAA call for 1/2-million to 1-million bit memories and are such large memories feasible? They would expand storage capacity and correlation techniques, and permit cryptology.

Another area is display techniques. Is it possible to get an optical display directly from the computer memory without a cathode ray tube? At least one company says it is.

Navy will request bid proposals in about a month for studies to outline the problem. If industry reports that implementation of the project would result in major advances in technology, and Navy agrees, a project-definition-phase contract would then be awarded.

Pulse Network Problems Solved by Experienced Systems Engineers

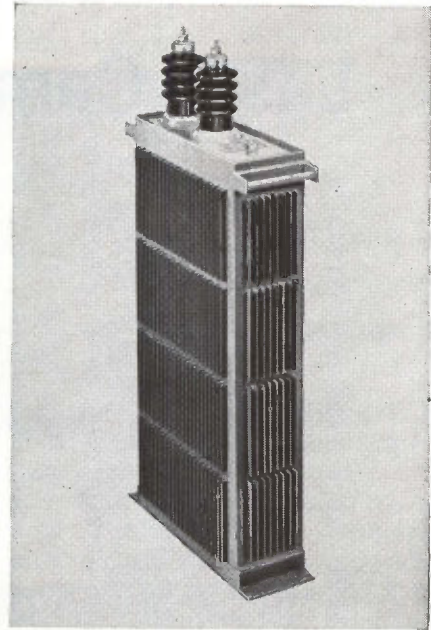

Typical Large Pulse-Forming Network designed by Sprague to meet a specific customer need.

Prompt cooperation on customers' pulse network problems is readily available from Sprague Electric Company's Pulse Capacitor and Network Section.

Sprague has much to offer to designers of radar systems, laser systems, tube testing systems, and other specialized systems. A highly-technical special engineering section devoted exclusively to pulse capacitors and networks includes systems as well as pulse network engineers. *Sprague can help you with your problems because Sprague fully understands your problems!*

But Sprague service does not end here. Following up the design aspect, these specialists can quickly and efficiently estimate pulse network sizes and prices for bidding purposes. They are also equipped to give quick reaction capabilities for your breadboard and prototype units.

A pioneer in pulse networks, Sprague is a major supplier of custom units from less than 1 KV up to 500 KV over a broad range of power levels.

For application engineering assistance, or additional information, write to Pulse Network Section, Sprague Electric Company, 35 Marshall St., North Adams, Massachusetts.

48PN-104-63

Laser Camera Takes Bright Picture

Experimental system shows possibilities for laser use in display

COMBINING a gas laser light source with a scanning principle used in the early days of television, researchers at General Precision's Aerospace Group in Pleasantville, N.Y. have come up with a laser radar system that can scan targets angularly and produce a C-type oscilloscope display, resembling a television image.

Dubbed a "laser camera", the experimental system (shown on the cover) has a helium-neon laser. The beam is reflected successively by two rotating mirrors which give it a scanning ability in the x and y directions, and focussed onto the target.

The reflected light is picked up from the target by an EMI multiplier phototube, amplified and displayed on a cathode-ray oscilloscope. Two oscillators provide the x and y scanning signals for both the rotating mirrors and for the cro display.

The transmitter laser was an unmodulated Spectra-Physics 115 He-Ne laser radiating at 6,238 Å, providing a cw output of under one milliwatt. The beam was taken from a small circular spot on the plane mirror of the laser (operating in the hemispherical configuration), and focused by a lens to converge on the target. The beam diameter at the lens was 1 mm, narrow enough to be completely intercepted by the small beam-deflecting mirrors which measured 3×4.5 mm. Spot size at the target was about 2 mm.

Each mirror was mounted on a galvanometer element, giving an angular displacement of ± 1 deg at 500 cps. The two mirrors were oriented so that the laser beam scanned horizontally due to motion of mirror M_x and vertically due to motion of

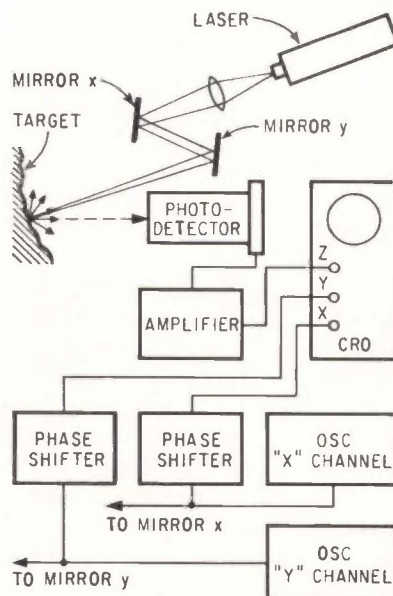

EXPERIMENTAL setup of laser camera system. (A) shows the path of the laser beam, (B) the receiver and display electronics

mirror M_y . Each mirror was driven by its own sine-wave generator; consequently the beam traced out on the target a Lissajou figure appropriate to the two movements.

The deflected beam was bounced off a variety of targets, including a photograph and an electric motor, at a distance about 2 m, giving a target area of 50 cm².

TARGET of laser beam was photographed at left, the final display on the cro is shown at right



After reflection from the target, the beam was filtered by a 6,238 Å interference filter to suppress ambient light. The horizontal and vertical sweeps for the cro display were supplied by the same oscillators used for deflecting the mirrors, with a phase shifter in each line to compensate for mechanical lag of each galvanometer movement.

As the laser beam scanned the target, the backscattered light became intensity modulated depending on the average reflectivity of the particular target spot. After collection and amplification this signal was used to intensity-modulate the cro's z-axis.

Both oscillators ran at about 500 cps, but, because their outputs were sinusoidal rather than linear, provided non-uniform illumination of the target. Range of contrast was limited by multiplier phototube saturation and possibly by nonlinear response of the cro's P20 phosphor to variations in beam intensity.

The primary advantage of a laser light source over conventional incoherent sources is the higher resolution, together with higher energy density available at the target. The narrow optical bandwidth enables suppression of ambient light, thus improving the noise level.

Possible applications of the laser

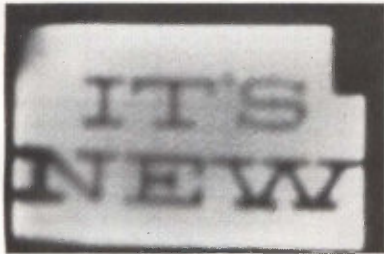

PRINTED TYPE target remains legible after display; target is shown on top, final display on bottom

camera technique range from a "laser microscope" requiring resolution of the order of microns over a small target area to a "volumetric scan" for a laser radar of lower resolution but illuminating a much greater target area.

A laser could also be used to produce a bright display for outdoor TV or motion picture projection, using a reverse arrangement in which the laser beam is scanned in a raster pattern, and intensity-modulated to generate the image.

How to Cut Tv Bandwidth —Study the Human Eye

BEDFORD, MASS.—Air Force Cambridge Research Labs is investigating the human visual system for suggestions on how to reduce the bandwidth required for black and white tv transmission. Designers of color tv took advantage of physiological processes, getting the human eye-brain mechanism to do part of the work of color intensification, and AFCRL researchers in the Data Sciences Group claim this approach has not been adequately exploited for black and white tv.

The studies are concerned with image-area properties, the way in which the picture divides itself into areas of equal brightness—black, white and gray. So far, indications are that the time and space properties of the human receiver can be more effectively utilized.

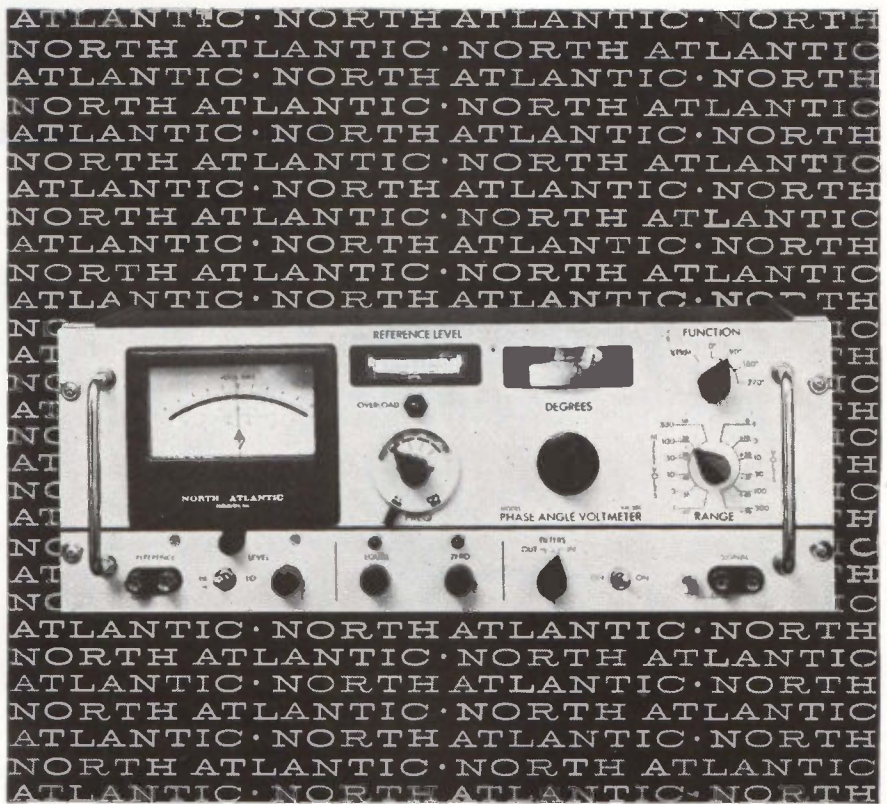

how to measure in-phase, quadrature and angle while sweeping frequency to 100 kc

North Atlantic's latest addition to the PAV line of Phase Angle Voltmeters* enables you to make measurements while frequency is varying over half-decades without recalibration. The VM-301 Broadband Phase Angle Voltmeter* provides complete coverage from 10 cps to 100 kc, and incorporates plug-in filters to reduce the effects of harmonics in the range of 50 cps to 10 kc with only 16 sets of filters. Vibration analysis and servo analysis are only two of the many applications for this unit. Abridged specifications are listed below:

Voltage Range.....	1 mv to 300 volts full scale
Voltage Accuracy.....	2% full scale
Phase Dial Range.....	0° to 90° with 0.1° resolution (plus 4 quadrants)
Phase Accuracy.....	0.25°
Input Impedance.....	10 megohms, 30μf for all ranges (signal and reference inputs)
Reference Level Range.....	0.15 to 130 volts
Harmonic Rejection.....	50 db
Nulling Sensitivity.....	less than 2 microvolts
Size.....	19" x 7" x 10" deep
Price.....	\$1990.00 plus \$160.00 per set of filters

North Atlantic's sales representative in your area can tell you all about this unit as well as other Phase Angle Voltmeters* for both production test and ground support applications. Send for our data sheet today.

*Trademark



NORTH ATLANTIC industries, inc.
TERMINAL DRIVE, PLAINVIEW, L. I., NEW YORK • Overbrook 1-8600

first major breakthrough in trimmer design in 10 years!

MIDGI-TRIM



ALL NEW FROM THE INSIDE OUT... DESIGNED TO ELIMINATE THE PROBLEMS OF CONVENTIONAL SQUARE TRIMMERS

And here's how: With Conelco's unitized design that eliminates five parts common to conventional trimmers, A revolutionary new cog wheel serves as the mechanical actuator... electrical wiper... slip ring... spring preload... slip clutch action... and positive rotating stop.

Because of its unparalleled simplicity, Midgi-Trim is the most reliable $\frac{3}{8}$ " square trimming potentiometer available... easily meets and greatly exceeds the requirements of MIL-R-27208.

Midgi-Trim is the only really new design since the first square trimming potentiometer — a perfectly sealed unit that withstands humidity, has conventional 2-hole mounting, offers highest insulation resistance and dielectric strength.

Evaluation samples available immediately. Phone your local Conelco Components stocking representative today or write for specifications and data file 2502-1.

PATENT APPLIED FOR

CONELCO COMPONENTS

465 WEST FIFTH STREET, SAN BERNARDINO, CALIFORNIA 92401

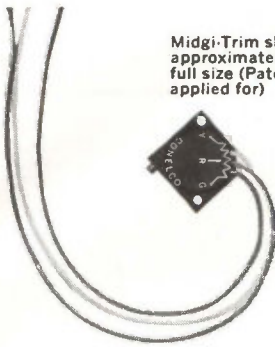

Midgi-Trim shown approximately full size (Patent applied for)

MIDGI-TRIM SQUARE TRIMMING POTENTIOMETERS AVAILABLE NOW!

Order TODAY from the following stocking reps.

MICHAEL WOLFE
136-52 71st Road
Flushing 67, Long Island, N.Y.
212-803-1413
CARLSON ELECTRONIC SALES
7448 N. Harlem Avenue
Chicago 48, Illinois
312-774-0277, 774-4812, 774-4813
TWX 312-265-1412
E. C. ELECTRONIC SALES
10108 Abbott Ave., S.
Minneapolis, Minn. 55431
612-888-0102
TWX 612-292-4195
DAYTON ASSOCIATES
1731 Philadelphia Dr.
Dayton 6, Ohio
513-223-9621

8211 Avery Rd.
Cleveland 4, Ohio
216-526-3990
14746 Richfield
Livonia, Michigan
313-453-8414
HOUSER ASSOCIATES
188 Water Street
Perth Amboy, New Jersey 08861
201-442-3159

A-F SALES ENGRG., INC.
94 S. Los Robles Ave.
Pasadena, Calif. 91101
213-681-5631 & 695-7081
TWX 213-449-3454
DEERE ELECTRONICS, INC.
853 Bauer Drive
San Carlos, Calif.
415 Lytell 1-9461
TWX 415-594-8802
THE GORDON V. PECK CO.
210 Casa Linda Plaza
P. O. Box 18627
Dallas, Texas 75218
214 Davis 8-3511
TWX 214-899-8470

P. O. Box 15671
Tulsa, Okla. 74115
918-939-3047
4007 Bellaire Blvd.
Houston, Texas 77025
713-664-1435

HYER ELECTRONICS CO.
3385 S. Bannock St.
Englewood, Colorado
303-761-0754
TWX 303-789-1943

1st National Bank Bldg. E.
Central & San Mateo, NE
Albuquerque, New Mexico
505-268-6744
TWX 505-243-8331
3550 N. Central Ave.
Phoenix, Arizona
602-266-5017
TWX 602-255-0507
1415 S. Main Street
Salt Lake City, Utah
801-486-0951
TWX 801-521-2331

R. V. DALLIS & ASSOCIATES
P. O. Box 6
Decatur, Georgia
404-373-0635

P. O. Box 951
Coral Gables, Florida
WALLY B. SWANK, INC.
2310 Bellevue Avenue
Syracuse 4, New York
315 Granite 8-2141
JOHN E. BOEING CO., INC.
1779 Massachusetts Ave.
P. O. Box 235
Lexington, Mass. 02173
617-862-2500
TWX 617-862-3295
225 Montowese St.
P. O. Box 151
Branford, Conn. 06406
203-488-8301
TWX 203-488-4597

CONELCO COMPONENTS

465 W. 5TH ST., SAN BERNARDINO, CALIF.

CIRCLE 47 ON READER SERVICE CARD

← CIRCLE 46 ON READER SERVICE CARD

— COMPONENTS AND MATERIALS —

Supercooled Magnet Yields Repeatable 100 Kilogauss

Niobium-titanium alloy permits cycling without damage

NEW YORK—The first superconductive solenoid known to achieve a repeatable magnetic field has been announced here as a major advance in the creation of extremely intense magnetic fields. The development was reported Feb. 18 by W. T. Reynolds of Westinghouse, at the annual meeting of the American Institute of Mining, Metallurgical, and Petroleum Engineers.

The new superconducting material that makes possible the superstrength solenoid is a niobium-titanium alloy developed by Westinghouse. An earlier solenoid, constructed from niobium-tin was reported to achieve 100,000 gauss once, but then seriously damaged itself upon normalization and had to be scrapped. The Westinghouse solenoid has been excited many times in the range between 90,000 and 100,000 gauss without damage.

Construction—The solenoid produces fields of up to 100,000 gauss at 4.2 deg K. It consists of an outer section wound from niobium-zirconium wire and an inner section wound from niobium-titanium wire. Copper plate of one mil thickness is used to protect the windings from high voltage damage. The solenoid is approximately 7 inches outside diameter, 4 inches long and has an access hole of 0.125-inch diameter. All together the magnet contains more than 20 miles of superconducting wire about the thickness of a sewing thread. One reason for the three-part construction is that superconducting

materials differ in their ability to remain superconducting under the intense magnetic field they themselves create.

The niobium-titanium alloy is similar in ductility and workability to niobium-zirconium, but is capable of carrying high-density electric currents in magnetic fields of more than 100,000 gauss. It is not an intermetallic substance, such as niobium-tin, which has excellent magnetic properties, but is very brittle and hard to handle (ELECTRONICS, Oct. 25, 1963, p 52).

The outside layer of the new solenoid experiences the lowest magnetic field and is the largest single section of the new magnet. The niobium-zirconium alloy of which it is wound has been used in most of the superconductive magnets in service today.

Importance—Value of a practical 100-kilogauss superconducting magnet can be appreciated when it is realized that there are no more than four magnet installations of this strength in continuous operation anywhere in the world. None of these are superconducting magnets. Each of them require something like one million watts of electric power for its operation and thousands of gallons of cooling water or oil per minute. Each installation is a multimillion-dollar investment. In contrast, the new 100-kilogauss superconducting magnet operates from an automobile battery, which is disconnected entirely once the supercurrents of electricity are set into motion in the magnet coils.

The entire magnet and its power supply weighs hundreds of pounds instead of hundreds of tons. The space requirement is a corner of a laboratory, and the dollars involved are measured in thousands.

Fixtures Form Semirigid Coax

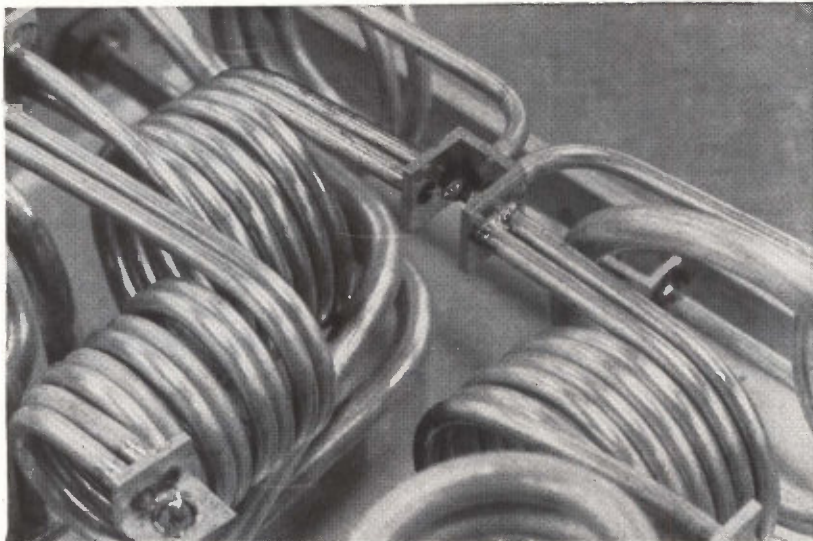

SHIELDS ARE SOLDERED to interconnect bracket, and inner conductors are soldered inside the bracket, in this phase comparator assembly

Close tolerances and tight specs maintain electrical characteristics

DEER PARK, N. Y.—Production employees used to working with readily switch to fabricating assemblies of the relatively new semirigid coaxial cable—if suitable forming fixtures are used and if cable specifications are chosen to avoid production problems.

Methods must be worked out carefully because even seemingly insignificant liberties in manufacturing and design can introduce marked changes in vswr, impedance match and other electrical characteristics, according to manufacturing engineers at Airborne Instruments Laboratory, a division of Cutler-Hammer.

AIL uses semirigid coaxial cable for crossover hybrids, phase comparators and similar devices because of its excellent shielding qualities and the ease with which precise electrical length can be obtained. In assembly fabrication, mechanical length tolerances of ± 0.005 inch are standard and ± 0.002 inch can be held. Bend radii of $\frac{5}{16}$ inch are repeatedly achieved, without damage to the cable or change in electrical characteristics.

Forming the Cable—To form the cable, AIL developed fixtures designed to eliminate as much as possible the kinks, score marks, burrs and other defects that would change the electrical characteristics.

When a large run of similar parts is required, a special-purpose fix-

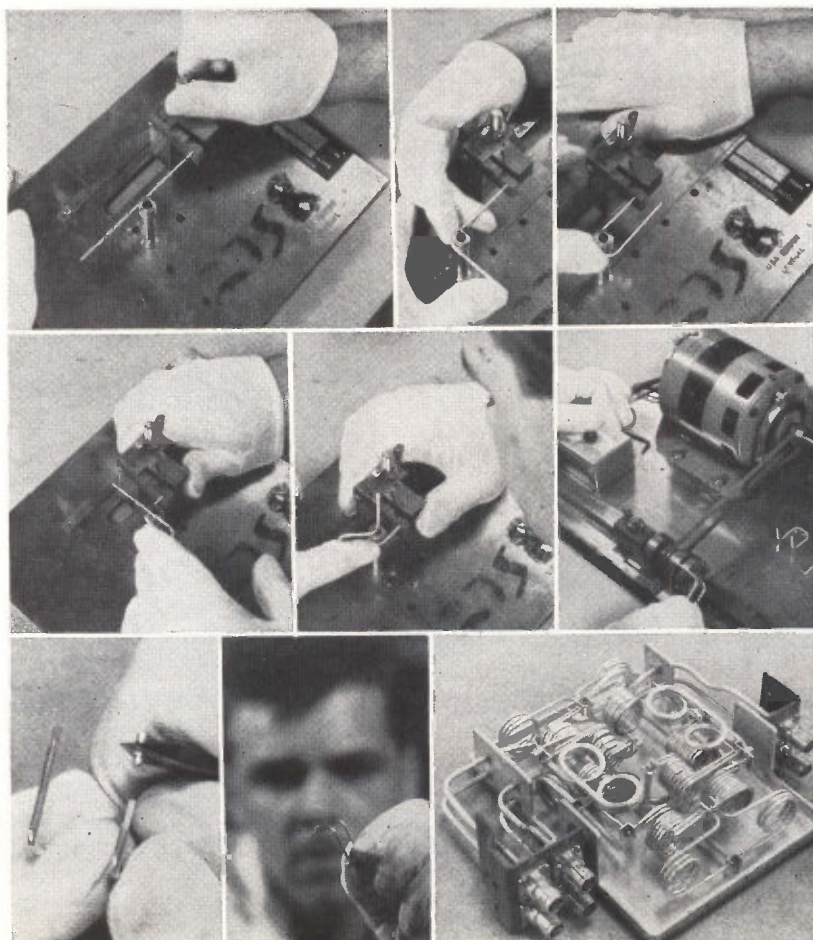

FORMING METHOD employed with adjustable fixture is shown by first five photos (see text for details). Shield is trimmed and removed. Parts are then assembled.

ture is generally best. For short runs, AIL uses adjustable fixtures like the one shown in the series of photographs. This fixture has removable bending mandrels, a vernier scale for positioning the cable, and a holding device.

Operations illustrated include: (1) clamping the cable in the fixture; (2) bending the cable 90 degrees around the post; (3) repositioning the cable and bending again to form a U; (4) making another 90-degree bend; (5) shifting the post to another position so the cable end will swing over the top of the fixture.

Trimming the Shield—In the next photo, the metal shield is cut by a motorized trimmer. The machine is set to cut only the shield, to an accuracy of 0.0001 inch. The cut end of the shield is removed with pliers, leaving the Teflon dielectric to protect the inner conductor.

The original blank measured 4.700 ± 0.002 inches; 0.750 ± 0.001 inch was trimmed from each end; the finished part measures 3.200 ± 0.004 inches. Parts such as this are used to assemble intricate devices, such as the phase comparator seen in the last photo.

Soldering Interconnections — Precisely dimensioned interconnect brackets make assembly easier and prevent impedance mismatches and excessive vswr. The cut ends of the shielding are soldered to the outside of the bracket, in the assembly shown, while the inner conductors are soldered together inside the bracket.

One of the soldering problems is that the heat of soldering causes the Teflon to extrude from the joint. Trimming the Teflon back to the joint allows the remaining Teflon to spring back inside the outer shield. In both cases, electrical characteristics are changed. This must be accounted for in the design.

Some manufacturing problems can be solved by careful attention to cable procurement. Sliding or relative motion between the center conductor and outer shield (caused by Teflon's low friction) was eliminated by compressing the dielectric within the shield. Wrinkling and cracking of the shield during bending was avoided by specifying a minimum elongation.

NEW! HIGH SENSITIVITY

GENERAL PURPOSE 247A

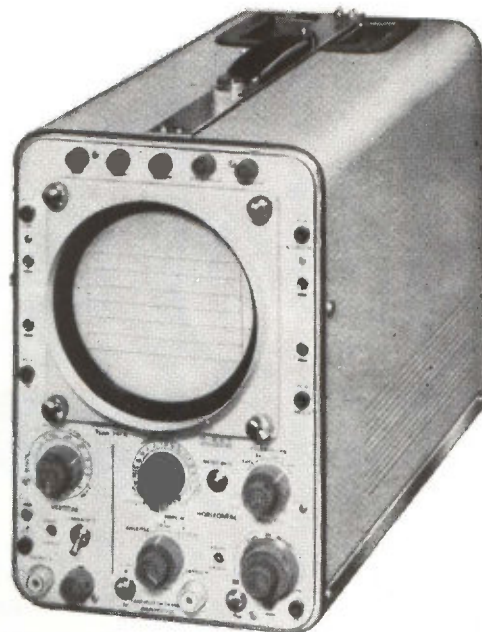

The type 247-A oscilloscope fully qualifies as a universal instrument because its performances and the size (13 cm (5") dia.) of its C.R. Tube authorize accurate measurements and tests in all fields of low-frequency instrumentation. Also, because of its simplicity of operation, the 247-A is ideally suited for practical laboratory work of an educational nature.

TECHNICAL SPECIFICATIONS

Vertical amplifier

1 channel; Frequency range: DC to 1 Mc/s (-3 dB)
Sensitivity: 50 mV/cm
AC: 10 c/s sinewave or 50 c/s square-wave to 100 Kc/s (-3 dB)
Sensitivity: 5 mV/cm
Calibrated attenuator: step-adjustable from 5 mV to 20 V/cm in 12 positions
Sequence: 1 - 2 - 5 - 10 etc...

Attenuator vernier ratio 1/3
Constant input impedance: 1 M Ω 47 pF

Sweep

Free-running - triggered - single sweep
Duration: 1 s/cm to 0.5 μs/cm in 20 calibrated positions
Vernier: 1: 3 ratio -
x 5 magnification expanding
sweep durations from 3 s/cm to 0.1 μs/cm

Sync

5 positions: single-sweep, HF, LF, TV-line, TV-frame
Polarity: + or - internal or external
selection of triggering level

Horizontal Amplifier

Frequency range: 0 to 500 Kc/s (-3 dB)

Sensitivity: 1 V/cm or 10 V/cm (switch-selected)
Vernier: 0 to 1
Constant input impedance: 1 M Ω and 47 pF

Cathode-ray Tube

5 ADP 2 or equivalent type
Screen: 13 cm (5") dia.
deflection factors:
X: 30 V/cm (approx.)
Y: 20 V/cm (approx.)

Direct drive of H and V plates
Acceleration voltage: 3 Kv

MECHANICAL FEATURES

Light-alloy chassis, readily-detachable panel for easy access to circuits.

1) Tube complement

9/ECF80 - 2 NM2L or equivalent types

2) Power supply

105 - 115 - 127 - 220 - 240 V - 50 or 60 c/s

3) Dimensions

Width: 20.5 cm - (8")
Depth: 38.5 cm - (15")
Height: 31 cm - (12")
Weight: 14 kg - (30 lbs)

OTHER INSTRUMENTS

Oscilloscopes

204 A - High speed and fast rise oscilloscope
241 A - 242 A - 243 A, Multi-function osc. with plug-in preamplifiers.
255 B - Portable oscilloscope
245 A - High performance portable oscilloscope
246 A - High sensitivity low-frequency oscilloscope
248 A - Maintenance oscilloscope.

Sweep frequency Generators

411 A - Laboratory sweep frequency generator
410 B - TV - FM sweep frequency generator
476 A - Radio sweep frequency generator

Signal Generators

405 A - Low frequency RC signal gen. (30 c/s-300 Kc/s)

428 A - HF constant amplitude signal generator (100 Kc/s-30M c/s)
458 - Pulse generator (5 c/s - 50 Kc/s).

TV pattern generators

465 C - Portable electronic pattern generator
464 A - Test - pattern generator

Regulated power supplies

117 A - Transistorised regulated power supply
114 A - Regulated power supply

Cameras

1000 A - oscilloscope camera with Polaroid
1001 B - oscilloscope recorder

INTER-PLANS

RIBET-DESJARDINS

MEASURE & CONTROL DEPARTMENT, 13-17, rue Périer MONTROUGE/PARIS TEL: ALESIA 24-40
CANADIAN BRANCH: RIBET-DESJARDINS (CANADA) Room 114, 5757 Decelles Avenue - MONTREAL.

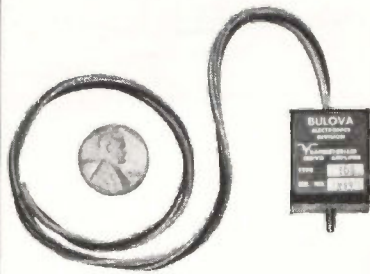

New
BULOVA
 ¼ cubic inch
 3.5 watt
SERVO
AMPLIFIER

Measuring approximately ¼ cubic inch, the new Servo Amplifier is stable to 125°C. Bulova type 165 AMP operates at a nominal frequency of 400 cps, and provides a power output of 3.5 watts into an effective resistance of 450 ohms (size 11 motor). The unit has a direct push-pull output stage, with an output impedance of 100 ohms (maximum) resistive. Its input impedance is 10,000 ohms resistive constant; its voltage gain is 5000 (± 3 db) under all environmental conditions and independent of load. The small servo has an operating ambient temperature of -55°C to +125°C maximum, with a storage temperature of -65°C to +150°C. The 165 AMP meets pertinent requirements of MIL-E-5272C.

Price: \$150 for quantities under 10.

The full line of Bulova amplifiers assures superior performance in extreme environments, greater flexibility in system design, maximum savings in volume and weight. Every critical component is manufactured "in-house", maintaining Bulova quality standards, engineering, production and delivery schedules. For detailed specification sheets, write Bulova Electronics, Woodside 77, New York.

INDUSTRIAL/DEFENSE GROUP

BULOVA
 ELECTRONICS DIVISION

NEW PRODUCTS

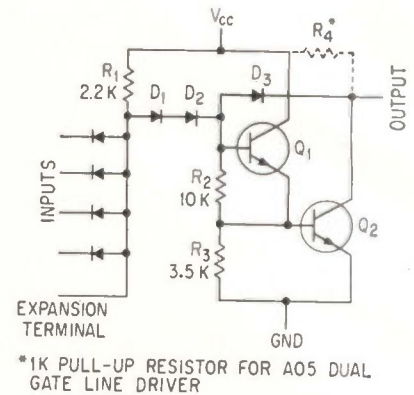
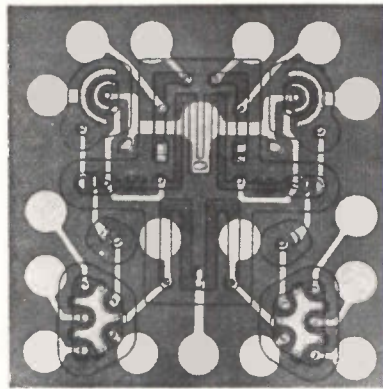

Microcircuits Offer High Speed

Series features more circuitry per package, reduces systems cost

AVAILABILITY of a new family of seven high-speed clamped DTL (diode transistor logic) integrated circuits is announced. Designed for fast reliable computer performance with a minimum number of circuits, the A series offers single power-supply operation, 18-nsec propagation delay, binary counting rates up to 10 Mc and low 7-mw power drain per gate. A01A through A07A in the modified TO-5 and A01F through A07F in a solid alumina-glass FlatPac are designed around the basic NAND gate circuit shown. Photograph illustrates the 35-mil square NAND/NOR gates. Each circuit is an epitaxial-diffused and passivated monolithic chip. The combination of low propagation delay and low power dissipation with a single power supply results from two circuit design modifications of conventional DTL circuitry: (1) the addition of emitter-follower Q_1 to relax gain restrictions and (2) the use of clamping diode D_3 to prevent inverter saturation and thereby minimize propagation delay. Avoiding the use of capacitors results in higher operating speed because of smaller active chip areas and attendant reduction in circuit time constants. Operation is guaranteed from -55 to +125 C.

Typical d-c stability margins for all A series networks vary from 1.2

v at -55 C to 0.5 v at +125 C under combined worst-case conditions of input and output loading. All circuits in this series are d-c coupled and have the same logic levels.

Prices are the same for each type in quantities from 1 through 999. Modified TO-5 packaged circuit prices are: A01A single 4-input NAND/NOR power gate (fan-out=15), \$14; A02A dual 4-input NAND/NOR power gate (fan-out=15), \$21; A03A counter, shift register circuit, \$29; A04A diode array, \$7; A05A dual gate line driver, \$21; A06A single 4-input NAND/NOR gate (fan-out=5), \$18. The A01A and A06A are fan-in expandable with A04A.

Because the DTL series offers more circuitry per package, lower cost and higher reliability, systems are assured with a minimum number of circuits. Siliconix Inc., 1140 W. Evelyn Ave., Sunnyvale, Calif. CIRCLE 301, READER SERVICE CARD

Light Pen Provides Accurate Detection

A FAST LIGHT PEN for use with crt displays with rapid plotting rates has been developed. Type 370 utilizes a fiber optic light pipe and photomultiplier system for accurate detection and modification of displayed computer information. Increased sensitivity and high reliability are obtained by photomultiplication of light signals from the crt. Type 370

has a turn-on time approximately five times faster than present photodiode systems. This increase in speed permits a greater degree of accuracy in point detection under minimum light intensity levels.

The flexible fiber optic light pipe eliminates electrical noise problems inherent in photodiode systems. Since all active electrical components are stored inside the dis-

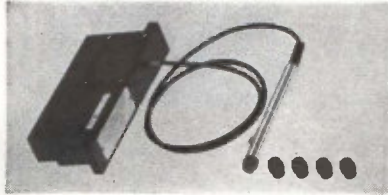

play housing, noise caused by sudden shock or dropping of the pen holder is eliminated.

Type 370 consists of a photomultiplier tube, h-v supply, amplifier, and flexible light pipe with pen holder. Photomultiplier tube and power supply are integrated into a single potted modular unit mounted inside the crt housing of the display. Power supply input is — 15 v at 700 ma. Rise and fall times of the output signal are dependent upon the rise and decay times of the crt phosphor. Amplitude of the output signal ranges from 0 to approximately — 6 v. Price of unit is \$1,625. Digital Equipment Corp., Maynard, Mass. (302)

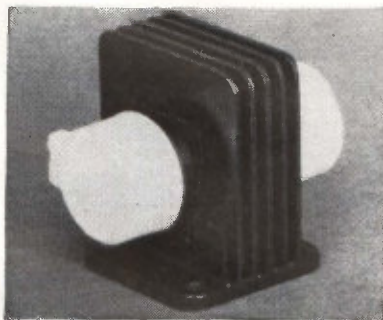

Reflex Klystrons Operate in Ku Band

SERIES of Ku-band reflex klystron tubes offer output power of up to 2 w at beam voltage of only 800 v d-c. At the 800 v d-c level, X1149



MAKE VHF BRIDGE MEASUREMENTS

with

AUDIO EASE

(and accuracy)



... not that audio measurements are always smooth sailing, mind you, but it's the region from 1-100 MC that separates the men from the boys.

With the B-801—our peerless VHF Bridge, you can make two terminal, balanced or unbalanced, and three-terminal measurements, from 1-100 MC, with $\pm 2\%$ accuracy and split-hair resolution, just as easily as you "crank up" the value of a capacitor or resistor on a 1 KC component bridge.

You'll find the B-801 impressively flexible, too. It's perfect for checking transistor parameters, cables parameters, VSWR, amplifier admittance, and truly informative component measurements... including the shunt capacitance of coils, among many other examples. Hundreds swear by it. No-one, to our knowledge, swears at it.

Speaking of ease, our gallant field force informs us that the B-801 "sells on sight" ... all right, then—have a look!

SPECIFICATIONS

G: 0-100 millimhos
(10 Ω to 10,000 Ω , 3-digit readout)

C/L: 0 to plus 230 pf and
0 to minus 230 pf, with
vernier resolution of 0.2 pf!

1-100 MC, $\pm 2\%$ accuracy

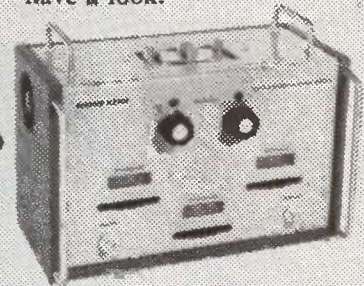

Now for the "clinch"—the price of this irresistible instrument is only \$940! Buy one! (After which we'll wave a few seductive accessories under your nose: a low-priced source and detector; precise R, L, and C standards; and a free and handy re-order blank.)

How soon may we show you the B-801 ... so that you may begin a life of ease?



WAYNE KERR

CORPORATION

1633 RACE STREET, PHILADELPHIA 3, PA. LOCUST 8-6820

INNOVATIONS in INSTRUMENTATION

series tubes have outputs of 1.2 to 2 w in the 12 to 15 Gc frequency range and 1.0 to 1.5 w in the 15 to 18-Gc band. Mechanical tuning range is available up to ± 200 Mc. Among applications of the new tube are Doppler navigators, radar altimeter, multiple paramp pumps, communications systems, and terrain avoidance radar. Eitel-McCullough, Inc., 301 Industrial Way, San Carlos, Calif.

CIRCLE 303, READER SERVICE CARD



Meter Shows Noise and Field Intensity

THE SIMULTANEOUS measurement (broad band) of the entire 20 cps to 250-kc range as well as precise narrow-band measurement from 20 cps to 15 kc are possible with the NF-315 Empire noise and field in-

tensity meter. For narrow-band operation, two bandwidths (7 and 70 cps) permit faster measurements, more precise identification of signals and optimum sensitivity. Instrument is portable, solid state, and has a built-in rechargeable battery. It measures to MIL-I-1691 (Ships), GM-07-59-2617, and D2-2444-1 (both Minuteman).

Input overload is minimized by an input low pass filter and a unique calibration procedure. A wide range of input impedance enhances operation. Highly stabilized circuits eliminate the need for recalibration when tuning to a new frequency, and frequency is indicated by a digital read-out. Several detector functions, including average, rms, and peak reading, are provided. Price is \$3,500. The Singer Co., Metrics Division, Bridgeport, Conn. (304)

Digital Transducer Uses Optical Scanning

OPTICAL-SCANNING transducer provides the pick-off or sensor for other transducers such as compass heading, inclination, and pressure. Basic principle is the rotation of a light

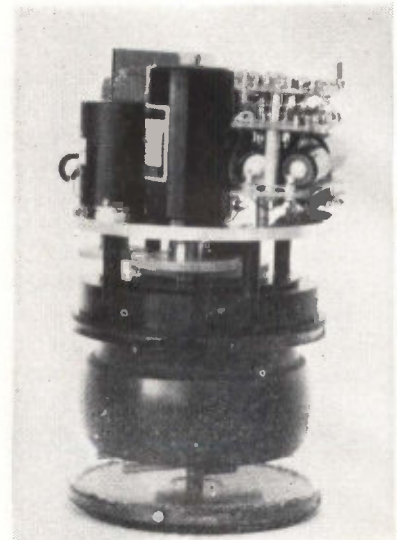

beam (through fiber optics) and the sensing of reflected light (also through fiber optics) at a reference position and at a position which is a function of the input. The scanner and frequency generator are directly coupled and motor driven. The frequency is sampled from the reference position to the variable position, yielding a number of pulses or count proportional to the input. The design is primarily directed for oceanographic use. White Avionics Corp., Terminal Road, Plainview, L. I., N. Y. (305)

only **4** basic materials...
 ...a new capacitor construction
 concept to give high performance
 and low cost. Filmatic® by Paktron

1...mylar*

Servo Indicator Offers High Accuracy

MODEL CS109 indicator is a versatile servo system indicator with built-in power supply and high-gain solid-state amplifier. The only power required is the 115-v 60-cps or 400-cps line. For high readout accuracy it has a dual-speed dial. Accuracy of the overall system is 0.05 percent. System exhibits this accuracy under both static conditions and also during slewing at rates up to 65 deg per sec. The accuracy is achieved by the all-transistor amplifier with a low output impedance coupled to the motor which drives the indicator through a low-friction, high-accuracy gear train incorporating anti-backlash gearing. System can be furnished for command signals derived from

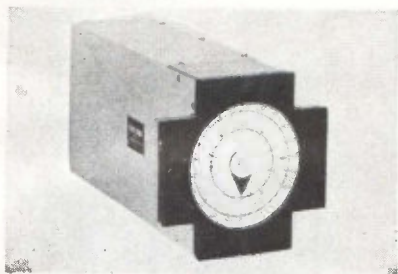

single-speed or dual-speed synchros or a-c and d-c excited potentiometers. Control Technology Co., Inc., 41-16 29th St., Long Island City, 1, N. Y. (306)

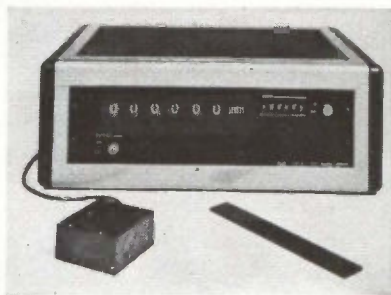

Linear Digitizer Gives Accurate Measurement

LONG-TRAVEL linear digitizer for extremely accurate measurement or positioning applications has been introduced. Called DIG, the instrument provides a digital least count of 0.000050 in. or one micron. Measurements are displayed in decimal form with optional BCD readout. The DIG system consists of three elements: a reading head, precisely calibrated glass scale and a display console. The reading head

contains a rotating optical scanner and a new pulse-train generator which provides a digital count proportional to the displacement of the scan from the measuring axis. Detection of a scale graduation by the scanner gates the pulse train, giving an exact digital interpolation of the distance to the graduation. At the same time, the reference scale graduation is digitally identified by an internally mounted coarse encoder. Complete measurement is electronically processed and displayed decimally. General Measurement Research, Inc., 1786 Shattuck Ave., Berkeley 9, Calif. (307)

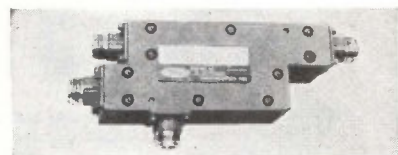

Triplexers Have 5.5-Db Crossover Levels

LINE of triplexers for use in conjunction with wideband r-f antennas and systems is announced. Typical of these is the FNM-305, which covers the frequency range of 300

2
...foil...

3
...leads...

4
...impregnant

This unique combination provides a rugged self-case, high lead strength, excellent moisture resistance, improved life, high volumetric efficiency . . . all at a considerable savings in cost.

Available in three case sizes:

Range:	.001 mfd. through .5 mfd.
Voltage:	50-100-200-400-600 WVDC
Tolerance:	± 10% & ± 20%
*DuPont	

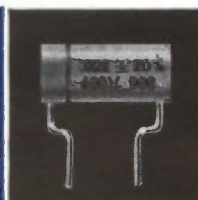

ACTUAL SIZE

Filmatic®
Capacitors
with
RIPPLEWELD™



PAKTRON
DIVISION ILLINOIS TOOL WORKS INC.
1321 LESLIE AVENUE • ALEXANDRIA, VIRGINIA

specify the new Microdot Products
contact Avnet for best service

AVNET

on-time delivery of Microdot
Connectors and cable

Multipin connectors with up to 61
power or 19 coaxial contacts in
1 1/8" o.d. plug; microminiature coax
connectors in 50, 70, 90 ohm types;
coax, twinax, triaxial cables (RG
types approved to MIL-C-17C).

many other Microdot Products are
available immediately from Avnet

MICRODOT

call your local Avnet Headquarters
The Avnet System, coast to coast



Westbury, L. I.; Chicago; Phoenix;
Burlington, Mass.; Syracuse, N. Y.;

LOCAL

Salt Lake City; Bellevue, Wash.;
San Diego, L. A., Sunnyvale, Cal.

CIRCLE 202 ON READER SERVICE CARD

MICO

(KING SIZE ENGRAVER)



FEATURES

- Seven reduction ratios available. From 1.5:1 to 8:1.
- Spindle has integral micrometer depth control of 1/2".
- Twenty-four inch line of two-inch characters can be engraved in a single set-up.
- Uses 1/4" diameter shank cutters. Adaptor available for 1/8" diameter shanks.
- Standard Mico master type available—1/4" to 3" high.
- Copy carriers available in four widths and two lengths; can be spaced separately.
- Constant-depth attachment supplied; for uniform depth of engraving over large areas.

Send for illustrated Catalog

MICO INSTRUMENT CO.

77 Trowbridge St.

Cambridge 38, Mass.

54 CIRCLE 54 ON READER SERVICE CARD

to 7,300 Mc with three outputs
covering 300 to 2,450, 2,450 to
4,375, and 4,375 to 7,300 Mc.
Typical passband insertion losses
are 1.5 db. Off-band rejection is
better than 30 db at ± 10 percent
of the crossover frequencies. Cross-
over levels are 5.5 db. Size is 3.2
in. by 6.5 in. by 2 in. Price is \$1,250.
American Electronic Laboratories,
Inc., Richardson Road, Colmar, Pa.
CIRCLE 308, READER SERVICE CARD

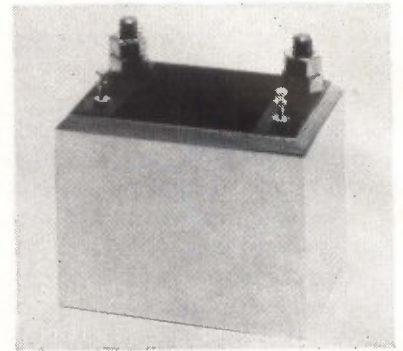

sistors designed for forced air or
liquid cooling can be supplied at
extra cost. Feature of the shunts is
their temperature stability. Change
is less than 10 parts per million per
deg C over normal ambient tem-
perature range. Laboratory curves
for change in resistance vs tempera-
ture are supplied. Quantum Elec-
tronics Co., 3086 Claremont Ave.,
Berkeley 5, Calif. (310)

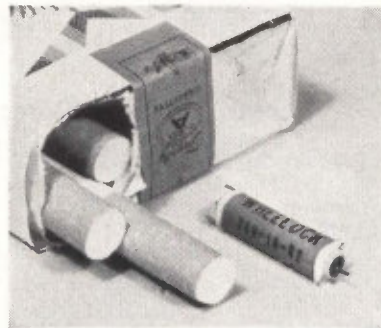

Glass Reed Relay Is One Inch Long

SERIES 269 glass reed relay
measures 0.23 in. in diameter and 1
in. long (1.1 in. including leads).
It is a single pole, normally open
relay (1 Form A) with 10-w con-
tact capacity. Coils up to 24 v d-c
require 100-mw operate power.
Designed as a component of a
welded module for airborne equip-
ment, the relay will withstand 30-g
vibration: 10-2,000 cps. It incor-
porates the "cradle" feature: shock
mounting the reed in a resilient
bobbin with epoxy end seals. Be-
cause the reed is "floated", the
relay can be used within an encap-
sulated module without any trans-
fer of deforming stresses. Wheelock
Signals, Inc., 273 Branchport Ave.,
Long Branch, N. J. (309)

Custom-Made Shunts Are Temperature Stable

SERIES of custom-made shunts
rated from 10^{-3} to 1/2 ohm has been
designed for use in high-amperage
circuits. Nominal tolerance of these
precision resistors is ± 1 percent
The standard resistors are designed
for conductive cooling. Special re-



Half-Wave Diode Tube Handles High Voltage

INDIRECTLY-HEATED, hydrogen-filled
half-wave diode tube is said to
possess greater voltage and current-
surge safety factors than those
characteristic of semiconductor
stacks. Type 7793 handles higher
voltages than comparable xenon
tubes, and functions in a wider
range of ambient temperatures than
comparable mercury vapor devices.
Maximum peak inverse anode volt-
ages for shunt diode and rectifier
services are 30,000 and 25,000 v
respectively, with maximum cathode
current in the same services of 1,500
and 16 amperes respectively. Tung-
Sol Electric Inc., One Summer Ave.,
Newark 4, N. J. (311)

February 28, 1964 electronics

LITERATURE OF THE WEEK

CERAMIC-METAL SEALS Varian Associates, 611 Hansen Way, Palo Alto, Calif. A new 16-page brochure describes the company's research, development and manufacturing service on ceramic-metal seals. (361)

SELECTOR SWITCHES CTS Corp., 1142 W. Beardsley Ave., Elkhart, Ind. Catalog 4000 covers a line of military and industrial selector switches. (362)

ELASTOMERIC MOUNTS Vibrashock division, Robinson Technical Products, Inc., Teterboro, N.J. Bulletin 5000 covers Duro-Flex elastomeric mounts for shock, vibration, and noise control. (363)

ELECTRONIC COOLING McLean Engineering Laboratories, Princeton, N.J., offers an 8-page engineering guide on cooling electronic circuitry. (364)

POTENTIOMETER SELECTION Fairchild Controls, 225 Park Ave., Hicksville, L.I., N.Y. Data sheets on the Faircon line of potentiometers recently released to the industrial market utilize a new method of selecting linearity and resistance for the design engineer. (365)

INSTRUMENT CHOPPERS James Electronics, Inc., 4050 N. Rockwell St., Chicago, Ill. 60618. Bulletin F-5186 features high-speed, solid-state instrument choppers. (366)

TEFLON TERMINALS Sealectro Corp., 225 Hoyt St., Mamaroneck, N. Y. Catalog covers a complete line of Press-Fit Teflon insulated terminals and includes comprehensive guides for selection and installation. (367)

RESISTANCE DEVIATION BRIDGE Industrial Instruments Inc., 89 Commerce Road, Cedar Grove, N. J., has made available a data sheet describing its model DB-1 resistance deviation bridge. (368)

REED SWITCH APPLICATION SELECTOR Hamlin Inc., Lake Mills, Wisc., 53551, announces a practical and easy-to-use application guide for reed switch and reed relay users. (369)

TEST INSTRUMENTS Associated Research, Inc., 3777 W. Belmont Ave., Chicago, Ill. 60618. Bulletin 10-13 details a line of instruments for measuring high voltage breakdown, dielectric strength, insulation resistance, ground resistance and earth resistivity. (370)

SERVO SYSTEM ANALYZER Servo Corporation of America, 111 New South Road, Hicksville, L. I., N. Y. Data sheet covers the model 1980 Servomatic analyzer for fast, accurate testing and analysis of d-c control systems and components. (371)

DISPLACEMENT INSTRUMENTATION Wayne Kerr Corp., 1633 Race St., Philadelphia 3, Pa., has published a technical bulletin on two distance and vibration measuring instruments, the DM-100 distance meter and the B-731A vibration meter. (372)

WANT TO DO BUSINESS WITH THE GOVERNMENT

??????????????

Then check the Military and Government Procurement Guide in the orange section of your **ELECTRONICS BUYERS' GUIDE.**

!!!!!!!!!!!!!!!!!!!!

specify the new circuit breakers by Mechanical Products, Inc.

AVNET

contact The Avnet System for best service & on-time delivery

the line includes breakers with both standard commercial and Mil Spec part nos. Mechanical Products' circuit breakers meet requirements of MIL C-5809 and MIL C-7079.

for MP circuit breakers

MECHANICAL PRODUCTS

call your Local Avnet Headquarters

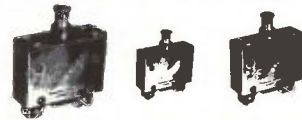

Westbury, L. I.; Chicago; Phoenix; Burlington, Mass.; Syracuse, N. Y.;

LOCAL

Salt Lake City; Bellevue, Wash.; San Diego, L. A.; Sunnyvale, Cal.

CIRCLE 203 ON READER SERVICE CARD

Magneline[®]
THE INDICATOR WITH INHERENT MEMORY

NEW DIGITAL INDICATORS FOR DIFFICULT SYSTEMS

SERIES 14000—FOR SOLID STATE LOGIC

Character Size $\frac{3}{32}'' \times \frac{1}{4}''$
No. of Characters Up to 11
Leads 11 plus a common
Watts 2.4

SERIES 15000—FOR RELAY LOGIC

Character Size $\frac{5}{16}'' \times \frac{1}{4}''$
No. of Characters Up to 10
Leads 5 plus a common
Watts 1.0 - 1.7

RUGGED

UNITS MEET OR EXCEED MIL E 5272. HAVE BEEN LIFE TESTED AT 28 MILLION CYCLES. NEED NO MAINTENANCE.

COMPACT

UNITS REQUIRE ONLY 1.12 CUBIC INCHES, WEIGH ONLY 1.5 OUNCES.

READABLE

DISTINCT WHITE CHARACTERS STAND OUT AGAINST DULLED BLACK BACKGROUND IN NORMAL ROOM LIGHTING. ILLUMINATED MODELS AVAILABLE.

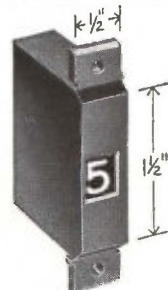

External appearance of 14000 or 15000 series

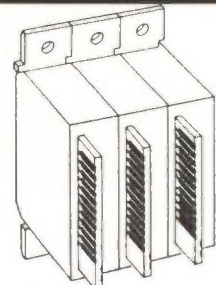

Rear view of units showing stacking and plug-in connectors

VISIT US AT
BOOTH 3050
IEEE SHOW

PATWIN[®] ELECTRONICS

A DIVISION OF THE PATENT BUTTON COMPANY
WATERBURY, CONNECTICUT • 06720

DATA CONVERSION?

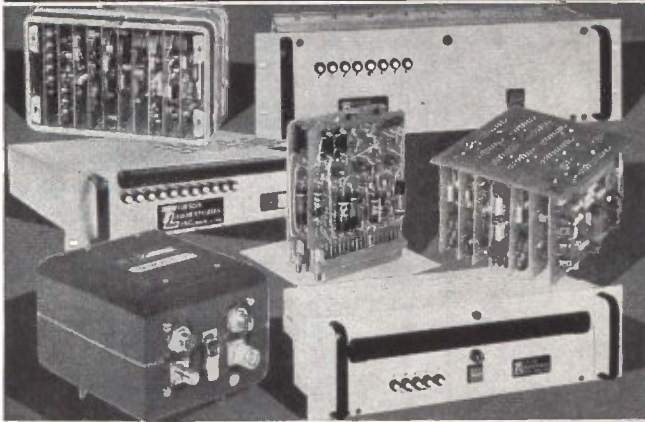

TRY THE VERSION!

ALL UNITS FULLY TRANSISTORIZED

CAPCODER ANALOG-TO-DIGITAL CONVERTERS

OC 1001/1002

Airborne, PCM Telemetry Unit.
10 bits; 23,000 encodings/sec., serial binary data output
Militaryized
100 cubic inches

OC 1005/1006

Similar to above except parallel binary data output (OC 1006 has thermal housing)

OC 1501

Airborne
10 bits; 23,000 encodings/sec., serial or parallel binary data output
Small size unit with extended temperature range

OC 2010A, B, C

General purpose
8 bits; 185,000 encodings/sec., serial or parallel binary output
Special models available for inverted serial readout or absolute value encoding of negative quantities

OC 3100

Economical Remote Data Converter
For industrial application
8 bits; 2000-10,000 bits/sec., serial binary data output
High reliability; 114 circuit components
Small size, two plug-in boards
Low power, 0.65 watt total
Compatible with telephone line transmission

OC 4000A

Multi-purpose
11 bits; 50,000 encodings/sec., serial or parallel binary data output
Optional high input impedance or operational amplifier models

OC 5000

True logarithmic encoder (no approximations)
Dynamic range to 60 db
Resolution to 9 binary digits

OM 2000

Caplexer Capacitive Sampling Multiplexer
Sample and hold multiplexer
Sampling apertures 0.25 to 5 microseconds
Sampling rates of 100 KC to over 1 MC
Low and high level inputs
Addressable or sequential programming

SPECIAL ITEMS OR TECHNIQUES

- Multiplexed Synchro Encoder
- Video Multiplexer
- Very Low Power Capcoder
- Remote Multiplexer

Visit our Booth No. 3003 at the IEEE Show,
New York City Coliseum March 23-26



Designers and manufacturers of CAPCODER and
CAPLEXER Capacitive Charge devices

TOWSON LABORATORIES, INC.

3500 PARKDALE AVE. • BALTIMORE, MD. 21211
AREA CODE 301 - 367-4001

DIRECT FROM STOCK

brushless D. C.
Torque Motors

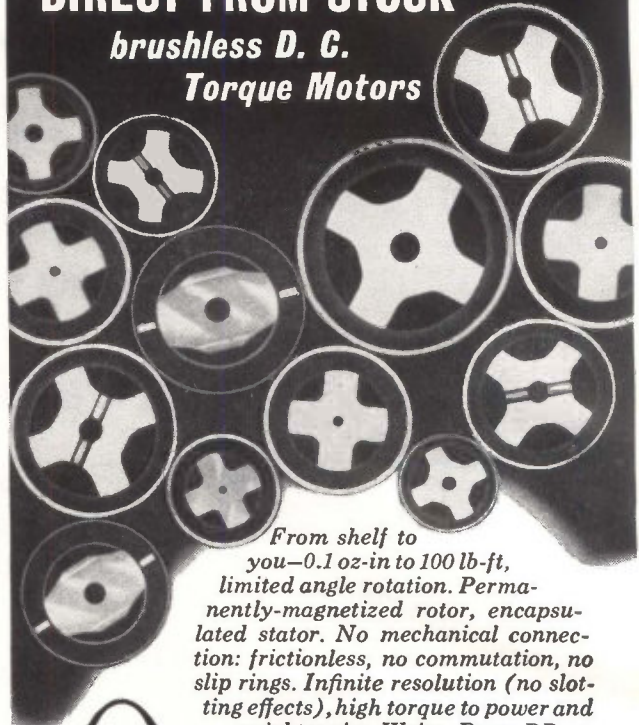

From shelf to you—0.1 oz-in to 100 lb-ft, limited angle rotation. Permanently-magnetized rotor, encapsulated stator. No mechanical connection: frictionless, no commutation, no slip rings. Infinite resolution (no slotting effects), high torque to power and weight ratios. Write Dept. RB-46 for full technical information.



AEROFLEX LABORATORIES
INCORPORATED
South Service Road, Plainview, L. I., New York
(516) MYrtle 4-6700

CIRCLE 204 ON READER SERVICE CARD

TO ORDER REPRINTS

Fill in, cut out coupon below
insert in envelope and mail to:

electronics

Reprint Dept.

330 W. 42nd Street, New York, N. Y. 10036

REPRINT ORDER FORM

(To help expedite mailing of your reprints please send cash, check or money order with your order.)

For Listing of Reprints Available see the Reader Service Card.

For Reprints of the latest Special Report:
Modern Electronic Packaging

Send me.....Reprints of Key No. R-48 at 50¢ ea.

For Reprints of previous Special Reports or Feature Articles fill in below:

Send me.....Reprints of Key No.(s).....@.....¢ each.
(For prices, see Reader Service Card.)

*For orders of Bulk Reprints of other editorial articles in this issue or past issues:

Send me.....Reprints of page No.(s).....of issue date....

of article entitled.....

*Minimum bulk order 100 copies. You will be advised of costs by return mail.

Name

Number of Street

City, Zone No., State.....



Signetics Starts \$5-Million Complex

SIGNETICS CORPORATION has begun construction of what a company spokesman said would be the largest facility devoted exclusively to the development and manufacture of high-performance semiconductor integrated circuits.

F. J. Van Poppelen, Jr., executive vice president of Signetics, said that completion of the first phase of the building program would result in a 10-fold increase in the firm's production capacity. "Our production orders rose sharply through 1963," he said, "and in the month of December alone we received orders in excess of \$1 million."

Signetics, which now has about 325 employees in three plants in Sunnyvale and neighboring Mountain View, Calif., is expected to double employment by the time the first 100,000-sq-ft building is completed this November.

The new \$5-million, 250-sq-ft complex of buildings, to be situated on a 16-acre tract near the International Science Center and the projected University of California Extension Center in Sunnyvale, will be completed in three years.



Hausman Receives New Executive Assignment

ARTHUR H. HAUSMAN, former vice president, research and advanced technology for Ampex Corporation, has been appointed to the newly created post of vice president-operations.

In his new position, Hausman assumes responsibility for two Ampex divisions—research and advanced technology (headquartered in Red-

wood City, Calif.) and the computer products division (Culver City, Calif.)

Ampex Corporation develops and manufactures electronic recorders, data storage equipment and magnetic tape for a wide range of markets.

AMI Acquires Another Subsidiary

TO EXPAND its product offerings to the electronic and electrical industries, B. M. Austin, president of Affiliated Manufacturers Inc., Whitehouse, N.J., has announced the acquisition of Automation Equipment Inc. of Wallingford, Conn., manufacturer and designer of precision screen printing machines for component circuitry.

Automation Equipment will be continued as a totally owned subsidiary of Affiliated Manufacturers

Inc. with manufacturing being carried out in existing facilities and new facilities provided by another newcomer to the AMI group, Acme Industries of Farmingdale, Long Island, N.Y.



Litton Industries Elevates Connolly

PROMOTION of John J. Connolly to president of the Data Systems division of Litton Industries, Canoga Park, Calif., has been announced.

Connolly, who formerly was division vice president, will continue as general manager of the division. He has been with Litton Industries in management positions since 1955, and has been associated with the Data Systems division since its inception in 1961.



Cameron Moves Up at Varian Associates

IN A MOVE designed to accelerate the company's diversification and growth programs, Emmet G. Cameron has been named vice president, engineering, for Varian Associates, Palo Alto, Calif.

In his new position, Cameron will investigate technical areas of poten-



MEMO

Merlin:

Here's the list of "rare birds" we need to complete the staff of Advanced Technical Planning.

I know these guys are hard to find and hard to move. Tell them about our new pay scale and remind them about the good Florida life, too.

If we can shake a few more loose to work with us, perhaps we can all take a little more time to enjoy it.

Do what you can, but remember, we need only the best!

Operations/Missions Analysts

NAVIGATION SYSTEMS ANALYST — BS, MS, PhD in Physics, Math, EE or AE. Several years experience in the systems analysis of space navigation systems, exploration, reconnaissance, surveillance and space weapons applications. Should possess working knowledge and experience in stabilization, guidance, computer and environmental control systems.

OPERATIONS ANALYST — BS, MS (or equivalent) in Physics, Math, EE or AE. Several years experience in weapons systems analysis, synthesis, evaluation, war gaming and advanced engineering planning studies. Some experience in planning and supervising activities in systems requirements, cost effectiveness and systems integration studies.

SYSTEMS ANALYST — MS in Math, Physics or equivalent. Five or more years of experience in advanced analytical studies applying mathematical disciplines to physical problems. Knowledge and experience in classical mechanics, space mechanics involving analysis of trajectories and the control of motion and orientation of vehicles. Knowledge and association with navigation, guidance and control systems required.

ALSO NEEDED: Weapons Systems Analysts and Cost Effectiveness Analysts experienced in the Operations/Missions Analysis field.

The best of the "Rare Birds" are urged to contact us at once. A brief note, describing your education, experience and specific area of work interest, addressed to M. L. Keese, Honeywell, 13350 U. S. Highway 19, St. Petersburg, Florida, will bring a prompt confidential reply and probably an invitation to visit our facilities, meet our people and discover for yourself the many added advantages of working and living here on Florida's West Coast.

Honeywell

An Equal Opportunity Employer



To investigate professional openings in other Honeywell facilities, send resume to F. F. Laing, Honeywell, Minneapolis 8, Minnesota.

tial interest to Varian. He will direct market, engineering and cost studies, and will be responsible for the integration of new product activities into Varian's operations. He is also charged with investigating acquisition possibilities and joint ventures. The scope of his activities include the Palo Alto headquarters, other domestic operations in the U.S. and in Canada, and overseas facilities in Italy, Switzerland and France.

Cameron was formerly vice president of Varian's Microwave Tube Group. Functions formerly reporting to him now report to Edward Ginzton, chairman of the board and chief executive officer.

PEOPLE IN BRIEF

B. D. Pritchard moves up to v-p and director of engineering at The Technical Materiel Corp. **Ray B. Oxman** advances to director of engineering liaison in Europe for the Components Group of Litton Industries. **Roy G. Neville**, formerly with Aerospace Corp., appointed director of research at Epoxylite Corp. **David E. Hartig**, previously with General Precision, Inc., named military systems mgr. of the engineering department at the Western div. of Computer Control Co., Inc. **Watts S. Humphrey Jr.** promoted to director of systems and application engineering of IBM Corp. **Don Hersh** raised to div. mgr. of the Transonic div. of Jamieson Industries, Inc. **Herbert I. Chambers**, from director of engineering to asst. g-m of the Data Recorders div., Consolidated Electrodynamics Corp. **Stewart L. Smith** and **H. Vincent Nelson** elevated to v-p's, engineering and marketing, respectively, at Precision Instrument Co. **Raymond W. Peirce**, former new products mgr., named mgr., Far Eastern Operations for Oak Mfg. Co. **Ronald W. Koehler**, ex-Potter Co., appointed director of engineering of Hopkins Engineering Co. **J. Frank Leach**, v-p, Amphenol-Borg Electronics Corp., takes post of group executive-electronics. **John B. Cowen** leaves Aerojet-International to join Space-General Corp., a subsidiary of Aerojet-General, as v-p of marketing. **Ned S. Underhill**, previously with Radio Industries, Inc., elected v-p, mfg, of the parent firm, The Hallicrafters Co.

HOW TO USE YOUR ELECTRONICS BUYERS' GUIDE

Advertising Product Sections

Advertisements in the ELECTRONICS BUYERS' GUIDE are grouped together according to the kind of product advertised. All Power Supply advertisements, for example, will be found in the same section of the book. Thus it is made convenient for you to "shop" through the specifications presented to you by advertisers, without having to flip pages back and forth constantly. Keep your ELECTRONICS BUYERS' GUIDE close to your work area at all times.

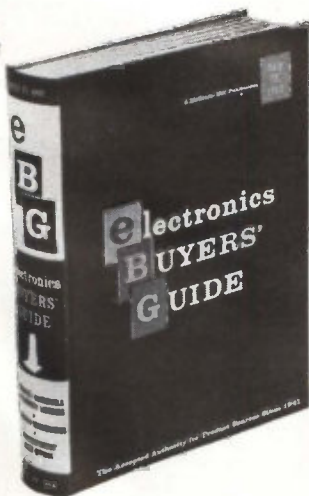

EMPLOYMENT OPPORTUNITIES



The advertisements in this section include all employment opportunities—executive, management, technical, selling, office, skilled, manual, etc.

Look in the forward section of the magazine for additional Employment Opportunities advertising.

— RATES —

DISPLAYED: The advertising rate is \$52.00 per inch for all advertising appearing on other than a contract basis. Contract rates quoted on request.

An advertising inch is measured 1/4" vertically on a column—3 columns—30 inches to a page.

Subject to Agency Commission.

UNDISPLAYED: \$2.70 per line, minimum 3 lines. To figure advance payment count 5 average words as a line.

Box numbers—count as 1 line.

Discount of 10% if full payment is made in advance for 4 consecutive insertions.

Not subject to Agency Commission.



E. E.'s
for FEE-PAID Positions
WRITE US FIRST!

Use our confidential application for professional, individualized service . . . a complete national technical employment agency.

ATOMIC PERSONNEL, INC.
Suite 1207L, 1518 Walnut St., Phila. 2, Pa.

ADDRESS BOX NO. REPLIES TO: Box No.
Classified Adv. Div. of this publication.
Send to office nearest you.
NEW YORK, N. Y. 10036: P. O. Box 12
CHICAGO, Ill. 60611: 645 N. Michigan Ave.
SAN FRANCISCO, Cal. 94111: 255 California St.

POSITION WANTED

Circuit Design—Transistors, SCR's, tubes, relays—B.S.E.E.—19 years experience—salary from \$8,000/year—will relocate.
Arthur Bertram Moulton, P.E. P.O. Box 24
Livermore, California.

*"Put Yourself in the Other
Fellow's Place"*

TO EMPLOYERS

TO EMPLOYEES

Letters written offering Employment or applying for same are written with the hope of satisfying a current need. An answer, regardless of whether it is favorable or not, is usually expected.

MR. EMPLOYER, won't you remove the mystery about the status of an employee's application by acknowledging all applicants and not just the promising candidates.

MR. EMPLOYEE you, too, can help by acknowledging applications and job offers. This would encourage more companies to answer position wanted ads in this section. We make this suggestion in a spirit of helpful cooperation between employers and employees.

This section will be the more useful to all as a result of this consideration.

Classified Advertising Division

McGraw-Hill Publishing Co., Inc.
330 West 42nd St., New York, N. Y. 10036

SEARCHLIGHT SECTION

(Classified Advertising)

BUSINESS OPPORTUNITIES

EQUIPMENT - USED for RESALE

DISPLAYED RATE

The advertising rate is \$27.25 per inch for all advertising appearing on other than a contract basis. Contract rates quoted on request. AN ADVERTISING INCH is measured 1/4 inch vertically on one column, 3 columns—30 inches—to a page. EQUIPMENT WANTED or FOR SALE ADVERTISEMENTS acceptable only in Displayed Style.

UNDISPLAYED RATE

\$2.70 a line, minimum 3 lines. To figure advance payment count 5 average words as a line.

PROPOSALS, \$2.70 a line an insertion.

BOX NUMBERS count as one line additional in undisplayed ads.

DISCOUNT OF 10% if full payment is made in advance for four consecutive insertions of undisplayed ads (not including proposals).

OPTICAL BENCHES \$13. to \$13,000. New Catalog

THE Ealing CORP.

2250 Massachusetts Avenue, Cambridge, Mass., 02140

CIRCLE 950 ON READER SERVICE CARD

WRITE FOR NEW KEYSTONE free catalog

We are the leading producers of BATTERY HOLDERS, TERMINALS, TERMINAL BOARDS & ELECTRONIC HARDWARE.

KEYSTONE ELECTRONICS CORP 49 BLEEKER ST NEW YORK 12 N Y

CIRCLE 951 ON READER SERVICE CARD

(1) Used U.H.F. Impulse Generator

Model 1G-102, Serial #218

Manufacturer—Empire Products Corp.

Late Model—Excellent Condition

Contact

THE EQUITABLE EQUIPMENT CO.

1201 Champlain Street Toledo, Ohio 43601

CIRCLE 952 ON READER SERVICE CARD

RADAR AUTO-TRACK & TELEMETRY ANTENNA PEDESTALS 3 & 10 CM. SCR 584 AUTOTRACK RADARS. M-33 RADAR TPS-1D SEARCH. APS-45 TPS-10D HT. FINDERS. WX RADARS. FPN-32GCA. APS-10 APS-15B APS-27 (AMTI) SEARCH. ■ ■ APN-102 DOPPLER. DOZENS MORE CARCINOTRONS PPKS. 25-S-1-2-3-6 MEGAWATT PULSE MODULATORS. CAVITIES. PULSE TRANSFORMERS. IF STRIPS. WAVEGUIDE. BENDS 200 MC. 1 KMC. 3 KMC. 6 KMC. 9 KMC. 24 KMC. RF PKGS.

RADIO RESEARCH INSTRUMENT CO.

550 5TH AVE., NEW YORK 36, N. Y.

JU 6-4691

CIRCLE 953 ON READER SERVICE CARD

OFFICIAL PROPOSALS

Bids: May 1, 1964

THE PORT OF NEW YORK AUTHORITY

LINCOLN TUNNEL
SOUTH TUBE

CLOSED CIRCUIT TELEVISION

SURVEILLANCE SYSTEM

CONTRACT O & M 888

Sealed proposals for the Supplying of Closed Circuit Television Surveillance System in the South Tube of the Lincoln Tunnel will be received at the office of the Department of Purchase and Administrative Services of The Port of New York Authority, Room 900, 111 Eighth Avenue, New York 11, New York, until 11:00 A.M., Friday, May 1, 1964, at which time and place said proposals will be opened and read.

Contract documents may be seen at the office of the Department of Purchase and Administration Services, Room 900, and copies will be furnished upon request.

THE PORT OF NEW YORK AUTHORITY
S. Sloan Colt, Chairman

New York, February 28, 1964

INDEX TO ADVERTISERS

Aeroflex Laboratories Inc.	56
• Avnet Electronics Corp.	54, 55
• Bulova, Electronics Div.	50
Conelco Components	46, 47
Electronic Specialty Co.	16
• Hewlett-Packard Company ...	8, 9
Honeywell	58
IBM Data Processing	12, 13
• ITT Cannon Electric Inc. ...	3rd cover
Jerrold Electronics Corp.	6
Kerr Corp., Wayne	51
Machlett Laboratories, Inc., The	11
Mico Instrument Co.	54
• North Atlantic Industries, Inc. ...	45

Paktron, Div. of Illinois Tool Works	52, 53
Patwin Electronics	55
Potter Instrument Co., Inc.	24
Radio Corporation of America	4th cover
• Ribet-Desjardins	49
Sierra Electronics, Div. of Philco	4
• Sigma Instruments, Inc.	42
Silicon Transistor Corp.	41
Sprague Electric Co.	3, 43
• Tektronix, Inc.	22, 23
Texas Instruments Incorporated Industrial Products Group	15
Towson Laboratories, Inc.	56
• United Transformer Corp. 2nd cover	
Unitrode Transistor Products, Inc.	21
Wayne-George Corp.	7

CLASSIFIED ADVERTISING	
F. J. Eberle, Business Mgr. (2557)	
EMPLOYMENT OPPORTUNITIES ..	59
EQUIPMENT	
(Used or Surplus New)	
For Sale	59
CLASSIFIED ADVERTISERS INDEX	
Atomic Personnel Inc.	59
Ealing Corp., The	59
Equitable Equipment Co., The	59
Keystone Electronics Corp.	59
• Radio Research Instrument Co.	59

• See advertisement in the July 25, 1963 issue of electronics Buyers' Guide for complete line of products or services.

This Index and our Reader Service Numbers are published as a service. Every precaution is taken to make them accurate, but electronics assumes no responsibility for errors or omissions.

electronics



Audit Bureau of Circulation



Associated Business Publications

AUDITED PAID CIRCULATION

JAMES T. HAUPTLI (2210)
Advertising Sales Manager
HENRY M. SHAW (3485)
Market Research Manager
DAVID M. TEMPEST (3139)
Promotion Manager

electronics Buyers' Guide

R. S. QUINT (2335)
General Manager

RICHARD J. TOMLINSON (3191)
Business Manager

THEODORE R. GEIPEL (2044)
Production Manager

NEW YORK TELEPHONE: Dial Direct:
971 plus number in parenthesis,
Area Code 212

ADVERTISING REPRESENTATIVES

ATLANTA, GA. 30309
G. Krimsier, Michael H. Miller
1375 Peachtree St. N.E.,
Trinity 5-0523 (area code 404)

BOSTON, MASS. 02116
William S. Hodgkinson
McGraw-Hill Building, Copley Square,
Congress 2-1160 (area code 617)

CHICAGO, ILL. 60611
Robert M. Denmead
Harvey W. Wernecke,
645 North Michigan Avenue,
Mohawk 4-5800 (area code 312)

CLEVELAND, OHIO 44113
Paul T. Fegley
55 Public Square, Superior 1-7000
(area code 216)

DALLAS, TEXAS 75201
Frank Le Beau
The Vaughn Bldg.,
1712 Commerce St.
Riverside 7-9721 (area code 214)

DENVER, COLO. 80202
David M. Watson
Tower Bldg., 1700 Broadway,
Alpine 5-2981 (area code 303)

HOUSTON, TEXAS 77025
Kenneth George
Prudential Bldg., Halcombe Blvd.,
Riverside 8-1280 (area code 713)

LOS ANGELES, CALIF. 90017
Ashley P. Hartman, John G. Zisch,
1125 W. 6th St., Huntley 2-5450
(area code 213)

NEW YORK, N. Y. 10036
Donald R. Furth (212) 971 3616
Donald H. Miller (212) 971 3615
George F. Werner (212) 971 3617
500 Fifth Avenue

PHILADELPHIA, PA. 19103
William J. Boyle, Warren H. Gardner
6 Penn Center Plaza,
LOcust 8-6161 (area code 215)

SAN FRANCISCO, CALIF. 94111
Richard C. Alcorn
255 California Street,
Douglas 2-4600 (area code 415)

LONDON W1:
Edwin S. Murphy Jr.
34 Dover St.

FRANKFURT/Main:
Matthee Herfurth
85 Westendstrasse

GENEVA:
Michael R. Zeynel
2 Place du Port

TOKYO:
Shigeo Chiba,
1, Kotohiracho, Shiba, Minato-ku

ANOTHER EXAMPLE OF "TOTAL VALUE" ASSURANCE...

CANNON

HAS A PLUG FOR EVERY KNOWN ENVIRONMENT

Cannon has plugs built to withstand the various conditions of temperature, moisture, altitude and other environmental hazards encountered in high-performance applications, whether your environmental need is earthbound or in outer space.

Over the past four decades, CANNON® Plugs have provided reliable operation for both military and

industrial users in more than 56,000 designs. If your application or environment requires the most exacting demands, look to Cannon, the world's largest and most experienced manufacturer of electrical connectors. For information, write to ITT Cannon Electric Inc., 3208 Humboldt Street, Los Angeles 31, California.



Our 50th Year



CANNON ELECTRIC INC.

3208 Humboldt Street, Los Angeles 31, California

A SUBSIDIARY OF INTERNATIONAL TELEPHONE AND TELEGRAPH CORPORATION

® "CANNON" IS A TRADEMARK REGISTERED IN U. S. PAT. OFF. AND IN FOREIGN COUNTRIES BY ITT CANNON ELECTRIC INC. ©1964 ITT CANNON ELECTRIC INC.



CIRCLE 901 ON READER SERVICE CARD

Now... 200°C Silicon in Production Quantities For as Low as 30¢ an AMPERE*

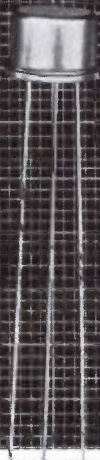

2N3053—5 watts at 25°C
 f_T — 100 Mc min.
 DC Beta — 50 to 250
 @ 150 ma
 V_{CEX} — 60 volts
 P_D 2.8 watts @ 100°C
 I_C (max) 0.7 amps



2N3054—25 watts at 25°C
 f_T — 700 KC typical
 DC Beta — 25 to 100
 @ 0.5 amp
 V_{CEX} — 90 volts
 15 watts @ 100°C
 I_C (max) 4.0 amps



*** 2N3055—115 watts at 25°C**
 f_T — 500 KC typical
 DC Beta — 20 to 70
 @ 4.0 amps
 V_{CEX} — 100 volt
 67 watts @ 100°C
 I_C (max) 15 amps

Three Great New RCA Silicon Transistors to Cut Costs and Step Up Performance

Now—you no longer need to sacrifice performance in price-limited designs! RCA now offers, in volume, three economy priced transistors with true industrial-quality silicon performance.

Built on a long background in military and industrial silicon types, these are the silicon transistors you've been waiting for—at real economy prices. 2N3053 is ideal for low-level to driver applications and medium power switching. RCA 2N3054 and 2N3055 offer high-current and high-voltage in the intermediate and high power areas.

For more information on how RCA-2N3053, 2N3054 and 2N3055 can be applied to your designs for power supplies, voltage regulators, converters, inverters, automotive ignition, speed control, and high fidelity audio systems, see your RCA Representative. For technical data, write: Commercial Engineering, Section I-N-2-4, RCA Electronic Components and Devices, Harrison, N. J.

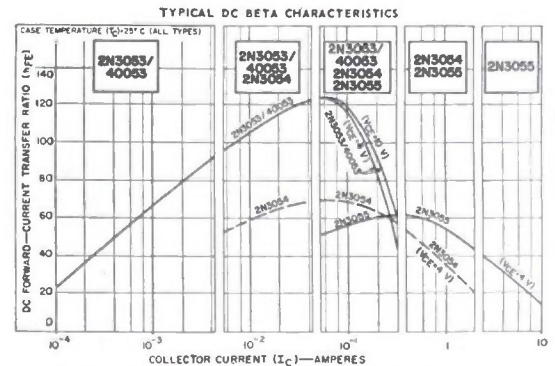

AVAILABLE THROUGH YOUR RCA DISTRIBUTOR



The Most Trusted Name in Electronics

CIRCLE 902 ON READER SERVICE CARD