

electronics

ADAPTIVE TELEMETRY

Conserving stored energy in spacecraft

AMPLIFIER FOR MONOPULSE RADAR

Switching 160 stages each with 1/2-db gain

MOON BASE IN 1972?

Lunar communications will use earth-relay

INTERNATIONAL SATELLITE. Joint U.S.-U.K. craft has a 130-ft dipole to receive galactic noise

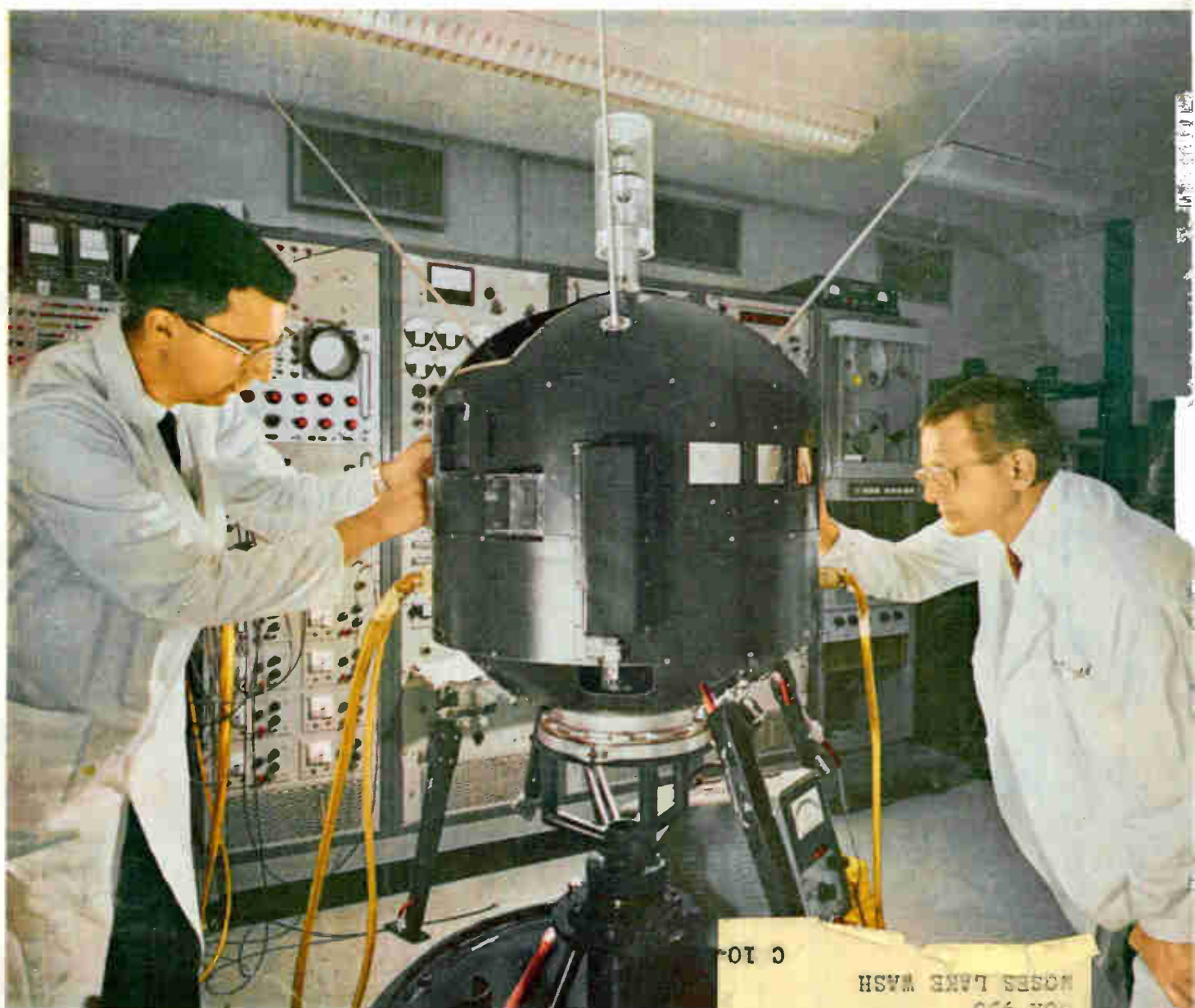

C 10
 MOSES LAKE WASH
 BOX 956
 L 11
 ROLAND KISSLER

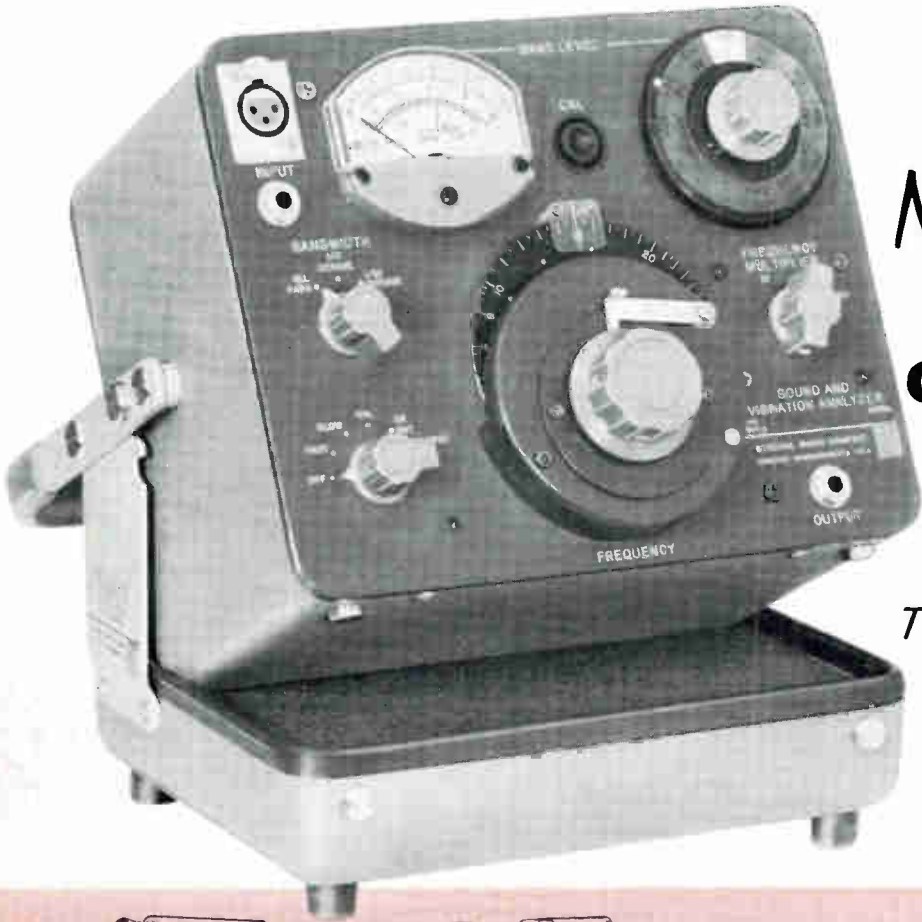

New
**1/3 and 1/10-
 Octave-Band
 Analyzer**

*Doubles as a
 Tunable Audio Voltmeter*

**Type 1564-A
 Sound and Vibration Analyzer...**
 Available in both portable
 and relay-rack adapted models
\$1150 in U.S.A.

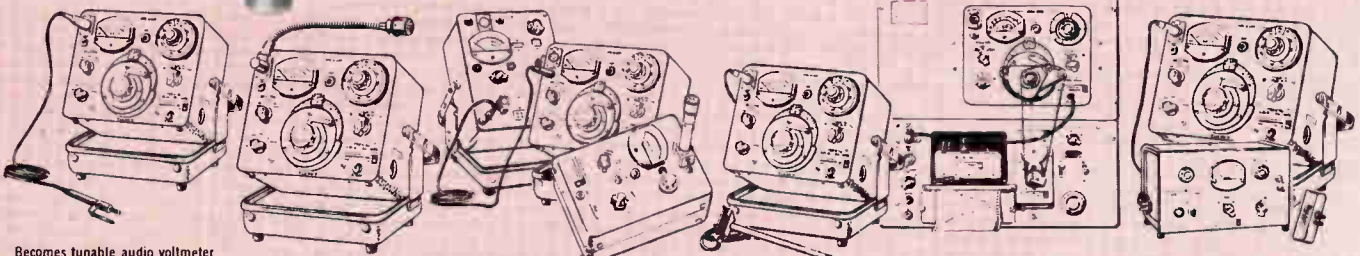

Becomes tunable audio voltmeter, with accessory Type 1564-P41 Audio-Frequency Probe (\$45). Probe, a 10:1 RC divider, is supplied with variety of tips.

Measures component levels above 44 db with Type 1560-P4 Microphone (\$80).

Ideal analyzer for use with Type 1551-C Sound-Level Meter and Type 1553-A Vibration Meter.

Measures acceleration above 0.0007g with accessory Type 1560-P52 Vibration Pickup (\$100).

Designed for use with Type 1521-A Graphic Level Recorder for continuous recording of spectra.

Useful with Type 1390-B Random-Noise Generator and Type 1390-P2 Pink-Noise Filter for producing bands of noise.

The 1564-A is completely new constant-percentage bandwidth analyzer that has both 1/3- and 1/10-octave bandwidths. Useful as a sound analyzer, vibration analyzer, or as a tunable voltmeter . . . the 1564 has ten sound-level ranges covering 44 to 150 db (re 0.0002 μ bar), an acceleration range of from 0.0007g to 100g, and eleven voltage ranges from 50 μ v to 30v. Its high, 25-megohm input impedance permits the direct use of piezoelectric transducers.

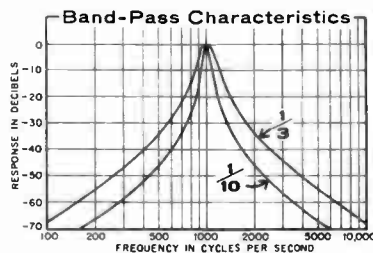

- ★ Direct reading in either volts or, when used with a microphone, in db re 0.0002 μ bar.
- ★ High sensitivity . . . 300 μ v full scale.
- ★ Wide 2.5 cps to 25 kc range . . . logarithmic frequency scale accuracy \approx 2% of setting.
- ★ Ideal for use with 1521-A Graphic Level Recorder . . . Continuous unattended tuning from 25 cps to 25 kc.
- ★ Detents at ASA preferred 1/3-octave center frequencies to simplify manual operation.
- ★ High 25-megohm input impedance.
- ★ Has internal amplitude calibrating system.
- ★ Quasi-rms detector has three averaging times.
- ★ Completely transistorized . . . operates from either power line or rechargeable battery.

Write for Complete Information

GENERAL RADIO COMPANY
 WEST CONCORD, MASSACHUSETTS

IN CANADA: Toronto 247-2171, Montreal (Mt. Royal) 737-3673
 IN EUROPE: General Radio Overseas, Zurich, Switzerland

NEW YORK, N. Y., 964-2722 CHICAGO PHILADELPHIA, 424-7419 WASHINGTON, D. C. SYRACUSE DALLAS SAN FRANCISCO LOS ANGELES ORLANDO, FLA. CLEVELAND
 (Ridgefield, N. J.) 943-3140 (Oak Park) 848-9400 (Abington) 887-8486 (Rockville, Md.) 946-1600 454-9323 FL 7-4031 (Los Altos) 948-8233 469-6201 425-4671 886-0150

CIRCLE 900 ON READER SERVICE CARD

electronics

A MCGRAW-HILL WEEKLY 75 CENTS

W. W. MacDONALD, Editor
Telephone Area Code 212 (971-2645)

J. M. CARROLL, Managing Editor (2293)

SENIOR EDITORS

Samuel Weber (2371)
George W. Sideris (3444)

SENIOR ASSOCIATE EDITORS

Michael F. Wolff (2600)
John F. Mason (2666)

ASSOCIATE EDITORS

Michael F. Tomaino (2071)
William P. O'Brien (2297)
George J. Flynn (2188)
George V. Novotny (3151)
Leon H. Oulberger (3446)
Alexander A. McKenzie (2685)

ASSISTANT EDITORS

Stephen B. Gray (2245)
Barry A. Briskman (2306)
Dan Smith (2467)
Joel A. Strasser (2127)

REGIONAL EDITORS

Harold C. Hood,
1125 W. 6th St., Los Angeles 90017, Calif.
(213-482-5450)
Laurence D. Shergalis,
John Hancock Bldg., 255 California St.,
San Francisco 94111, Calif. (415-362-4600)
Thomas Maguire
McGraw-Hill Bldg., 607 Boylston St.,
Boston 02116, Mass. (617-262-1160)
Cletus M. Wiley,
Blair Bldg., 645 N. Michigan Ave.,
Chicago 60611, Ill. (312-664-5800)

ART DIRECTOR

Howard R. Berry (2430)

ASSISTANT ART DIRECTOR

John C. Wright, Jr. (3430)

EDITORIAL ASSISTANTS

Lorraine Rossi, Virginia T. Bastian,
Lynn Emery, Ann Mella, Lorraine Werner,
Alice M. O'Brien, Sharon Parks,
Claire Benell, Kay Fontana

FOREIGN NEWS BUREAU

DIRECTOR, John Wilhelm, (2532);
Lawrence Mihlon (2997), Alyne Elias
(2998)
LONDON—John Shinn, Derek Barlow,
Nicholas Landon, 34 Dover St., London
W.1, England
FRANKFURT—Bruce Bendow, Richard Mikton,
Mike McQueen, Mittelstrasse 39, Bad
Nauheim, Germany
BRUSSELS—27 Rue Ducarle, Brussels,
Belgium
PARIS—Robert Farrell, Arthur Erikson,
Jean-Louis Matignon, 3rd Fl., Paris 8,
France
MILAN—Marc A. Messina, Via Manzoni
12, Milan, Italy
MEXICO CITY—Wesley Perry, Jr.,
P.O. Box 4-314, Mexico 1 D.F., Mexico
RIO DE JANEIRO—Leslie Warren, Rua
S. Francisco 1507 1509, Rio de Janeiro,
Brazil

NEW YORK—Edward Ramsey,
Prospekt 19, Apt. 28-29,
Prospect Park, New York 10017
PHOENIX—Halloran, Charles Cohen,
1001 N. Central Expressway,
Phoenix, Arizona 85012
TOKYO—Toranomon Sangyo
Shinsha, 1-10-1 Toranomon, Chiyoda-ku,
Tokyo 100, Japan

MANAGER

John Fisher (2016)

INTERNATIONAL SATELLITE. The S-52, second of three scientific satellites built under a cooperative U. S.-U. K. program will go into orbit later this year. Built by Westinghouse Electric, it will measure galactic noise, high-altitude atmospheric ozone, size and number of micrometeoroids in the ionosphere. A unique 130-ft dipole wire antenna and two ferrite rods will receive noise signals. *Centrifugal force will pull two 65-ft wires out of booms on either side of the satellite after separation from the fourth stage of the launch vehicle*

COVER

LOW-COST LOCALIZER. FAA is developing a low-cost aircraft landing aid that small airports can afford. Part of the project is a directional array of antenna loops that may also be used in all-weather systems. *It would mask out false courses on either side of a big all-weather-landing waveguide array*

10

TRANSISTORS CONTROL TRAINS. In Europe, trolleys also have digital controls for their electric traction motors. *These systems are two more examples of how Europeans are rapidly putting electronics to work in a wide variety of industries*

10

MODULAR TEST SET. National Bureau of Standards wants the military to adopt concept that would permit rapid "good-bad" testing of complex equipment. *The catch: equipment tested would require built-in networks to accommodate tests*

11

MOON BASE. By November 15, NASA will receive study of communications and other needs for lunar base. Tentative plans are to link widespread lunar facilities with an earth relay. *NASA will decide on the project by 1965, may set 1972 as a target date*

14

ADAPTIVE AEROSPACE TELEMETRY. More efficient use of stored energy aboard space probes and satellites can greatly increase the usefulness of space missions. Varying the data rate and hence the bandwidth depending upon information to be sent and varying transmitter power in accordance with trajectory may be an answer. *Control can be either internally programmed or sent over a command link.*

By A. Hauptschein and R. C. Sommer, New York University

23

PHONING DIGITAL DATA. A major university makes one large central computer to do the work of several with a simple circuit that sends 40,000 bits per second over telephone lines. *It comprises a line driver and wave shaper, and a line receiver and pulse slicer—four transistors in all.*

By R. M. Lee, University of California

30

Contents continued

Published weekly, with Electronics Buyers' Guide as part of the subscription, by McGraw-Hill Publishing Company, Inc. Founder: James H. McGraw (1860-1948).

Title ® registered U.S. Patent Office; © copyright 1963 by McGraw-Hill Publishing Co., Inc. All rights reserved, including the right to reproduce the contents of this publication, in whole or in part.

Executive, editorial, circulation and advertising offices: McGraw-Hill Building, 330 West 42nd Street, New York, N. Y., 10036. Telephone Area Code 212 971-3333. Teletype TWX N. Y. 212-640-4646. Cable McGrawhill, N. Y. PRINTED IN ALBANY, N. Y.; second class postage paid at Albany, N. Y.

OFFICERS OF THE PUBLICATIONS DIVISION: Shelton Fisher, President; Vice Presidents: Joseph H. Allen, Operations; John R. Callahan, Editorial; Ervin E. DeGraff, Circulation; Donald C. McGraw, Jr., Advertising Sales; Angelo R. Venezian, Marketing.

OFFICERS OF THE CORPORATION: Donald C. McGraw, President; Hugh J. Kelly, Harry L. Waddell, L. Keith Goodrich, Executive Vice Presidents; John L. McGraw, Treasurer; John J. Cooke, Vice President and Secretary.

Subscriptions are solicited only from those actively engaged in the field of the publication. Position and company connection must be indicated on orders. Subscription rates: United States and Possessions and Canada, \$6.00 one year, \$9.00 two years, \$12.00 three years. All other countries \$20.00 one year. Single copies, United States and Possessions and Canada 75¢. Single copies all other countries \$1.50.

THE PUBLISHER, UPON WRITTEN REQUEST TO OUR NEW YORK OFFICE FROM ANY SUBSCRIBER, AGREES TO REFUND THAT PART OF THE SUBSCRIPTION PRICE APPLYING TO COPIES NOT YET MAILED.

Subscribers: Please send change of address notices, subscription orders or complaints to Fulfillment Manager, Electronics, at the address below. Change of address notices should provide old as well as new address, including postal zone number if any. If possible, attach address label from recent issue. Allow one month for change to become effective.

Postmaster: Please send Form 3579 to Fulfillment Manager, Electronics, P. O. Box 430, Hightstown, New Jersey, 08520.



Audited Paid Circulation

Contents continued

ONE-STAGE SCALER. This scale-of-*n* scaler is achieved in one stage by use of tunnel diodes. It comprises a monopulser to shape output amplitude and width, a bistable memory element and an AND gate. *It avoids the customary use of flipflops and feedback circuits.* By C. A. Budde, Electronic Specialty Co. 32

LOCKING MONOPULSE RADAR ON TARGET. Error signal developed between sum or reference channel and elevation or azimuth channels can furnish a control voltage to reorient the antenna, but the reference channel amplifier must hold output within less than 1 db of 10-v peak over an 80-db range. *Amplifier has 160 stages of 1/2 db each switched in or out as required by the input.* By W. W. Smith, Lincoln Laboratory, MIT 34

SPACE ROUND TRIPS. Their requirements are pushing electronics techniques. Example: X-band telemetry system for 100-g reentries. *For velocity measurement, one doppler system gains sensitivity by employing the Mossbauer effect of nuclear resonance* 40

DEPARTMENTS

Crosstalk. Value Engineering and Engineering Values 5

Comment. Fragmented Engineer. Transistor Symbol III 6

Electronics Newsletter. Apollo Computer Details Revealed 17

Meetings Ahead. Annual Symposium, Professional Technical Group on Human Factors in Electronic

Washington This Week. Billion-Dollar Cut in Defense Budget Forecast

Research and Development. Automatic Compensates Color

Components and Materials. Novel BWO Magnet

Production Techniques. Xerography Simulates Circuit Production

New Products. Solid-State Oscilloscope to Mc Passband

Literature of the Week

People and Plants. PBE Erecting Plant

Index to Advertisers

BO...
Go...
BRUS...
PARIS...
17 Av...
MILAN...
No. 12...
MEXICO C...
RIO DE J...
Brazil...
Mexico 3-S...
MOSCOW—St...
Kutuzovsky...
Moscow, USS...
KYO—Ri...
Yamaguch...
1 Kotohr...
Japan
MAN...
'310

Only from Sprague!



Improved Type 150D Solid-Electrolyte

TANTALEX® CAPACITORS

with **PERFORMANCE CHARACTERISTICS**

NEVER BEFORE POSSIBLE!

■ **DISSIPATION FACTOR CUT BY ½**—Not more than 3% at 20 VDC and up, permitting even higher a-c ripple currents!

■ **LOWER IMPEDANCE AT HIGH FREQUENCY**—With impedances in fractional ohmic values in the megacycle range, Type 150D admirably meets the stringent requirements of high-speed computers.

■ **LOWER LEAKAGE CURRENTS**—Previous limits have been dramatically reduced; in some instances by as much as a factor of three.

■ **INCREASED CAPACITANCE STABILITY**—Capacitance change with temperature is now less than ½ the previous guaranteed values. Capacitance change with life is almost insignificant.

■ **NEW HIGHER VOLTAGE RATINGS**—50, 60, 75 and 100 volt ratings are now available, with associated surge voltages higher than any presently offered in the industry.

NEW ULTRA-MINIATURE TYPE 172D

New end-seal design makes possible two tiny sizes (.085" dia. x .250" long, and .127" dia. x .375" long) for "cordwood" packaging to supplement standard-sized Type 150D ratings in case size "A".

For complete technical data on Type 150D and 172D Tantalex Capacitors, write for Engineering Bulletins 3520E and 3523, respectively, to Technical Literature Service, Sprague Electric Company, 35 Marshall Street, North Adams, Massachusetts.

Popular ratings of Type 150D Capacitors are available for fast delivery from your Sprague Industrial Distributor

SPRAGUE COMPONENTS

CAPACITORS
TRANSISTORS
RESISTORS
MICROCIRCUITS
INTERFERENCE FILTERS

PULSE TRANSFORMERS
PIEZOELECTRIC CERAMICS
PULSE-FORMING NETWORKS
TOROIDAL INDUCTORS
ELECTRIC WAVE FILTERS

CERAMIC-BASE PRINTED NETWORKS
PACKAGED COMPONENT ASSEMBLIES
BOBBIN and TAPE WOUND MAGNETIC CORES
SILICON RECTIFIER GATE CONTROLS
FUNCTIONAL DIGITAL CIRCUITS

SPRAGUE®
THE MARK OF RELIABILITY

'Sprague' and '®' are registered trademarks of the Sprague Electric Co.

MULTIMETER CONVENIENCE

with
LABORATORY
PRECISION!



Look what you can measure with the hp 410C Electronic Voltmeter:

1. dc voltage, 1.5 mv to 1500 v; no zero set
2. dc current, 0.15 nanoamps to 150 ma; no zero set
3. ac voltage, 50 mv to 300 v; to 700 mc
4. resistance, 0.2 ohm to 500 megohms; no zero or ∞ set

Never in electronic measurement has so small an instrument done so much so well! Ideal for use in the lab or service department or on the production line. A unique hybrid circuit eliminates drift (and the need for a zero set) and provides such features as 100 megohms dc voltmeter input impedance; low resistance recorder output, 1.5 v dc at full scale; dc voltage accuracy of $\pm 2\%$ of full scale, current accuracy of $\pm 3\%$ of full scale, floating input for measurement to 400 v above chassis ground. The 410C also incorporates a rugged individually calibrated taut band meter movement. Get all the facts from the specifications below. Then get a demonstration from your Hewlett-Packard field engineer.

Data subject to change without notice. Prices f.o.b. factory.

**HEWLETT
PACKARD
COMPANY**



1501 Page Mill Road, Palo Alto, Calif. 94304, (415) 326-7000. Sales and service in all principal areas. Europe, Hewlett-Packard S.A., 54 Route des Acacias, Geneva, Switzerland; Canada, Hewlett-Packard (Canada) Ltd., 8270 Mayrand St., Montreal, Que.

8690

DC VOLTMETER

Range: ± 15 mv to ± 1500 v full scale
Accuracy: $\pm 2\%$ of full scale, any range
Input resistance: 100 megohms $\pm 1\%$ on 500 mv range and above; 10 megohms $\pm 1\%$ on 15 mv, 50 mv and 150 mv ranges

DC AMMETER

Ranges: ± 1.5 μ a to ± 150 ma full scale
Accuracy: $\pm 3\%$ of full scale, any range
Input resistance: decreasing from 9 k ohms on 1.5 μ a scale to approx. 0.3 ohm on 150 ma scale
Special current ranges: ± 1.5 , ± 5 , and ± 15 nanoamps to $\pm 5\%$ on the 15, 50 and 150 mv ranges using voltmeter probe

OHMMETER

Range: 10 ohms to 10 megohms, center scale
Accuracy: $\pm 5\%$ of reading at mid-scale

AMPLIFIER

Voltage gain: 100 maximum
Output: proportional to meter indication; 1.5 v dc at full scale; maximum current 1 ma; impedance less than 3 ohms at dc

AC rejection: 3 db at $\frac{1}{2}$ cps; approx. 66 db at 50 cps and higher frequencies for signals less than 1600 v peak or 30 times full scale, whichever is smaller

Noise: less than 0.5% of full scale on any range (p-p)
DC drift: less than 0.5% of full scale/year at constant temperature; less than 0.02% of full scale/ $^{\circ}$ C

Recovery: recovers from 100:1 overload in less than 3 sec

AC VOLTMETER (hp 11036A AC Probe required)

Ranges: 0.5 v to 300 v full scale, 7 ranges
Accuracy: $\pm 3\%$ of full scale at 400 cps for sinusoidal voltages from 0.5 to 300 v rms; ac probe responds to the positive peak-above-average value of applied signal
Frequency response: $-3\% \pm 2\%$ at 100 mc; $\pm 10\%$ from 20 cps to 700 mc (400 cps reference); indications to 3000 mc
Frequency range: 20 cps to 700 mc
Input impedance: input capacity 1.5 pf, input resistance greater than 10 megohms at low frequencies; at high frequencies impedance drops because of dielectric loss

Meter: calibrated in rms volts for sine wave input

GENERAL

Maximum input: dc-100 v on 15, 50 and 150 mv ranges; 500 v on 0.5 to 15 v ranges; 1600 v on higher ranges; ac-100 times full scale or 450 v peak, whichever is less

Power: 115 or 230 volts $\pm 10\%$, 50 to 100 cps; 13 watts (20 watts with hp 11036A probe)

Dimensions: 6-17/32" high, 5-1/8" wide, 11" deep behind panel
Price: hp 410C, \$300

Option 01: hp 11036A Probe calibrated with instrument, add \$50 to price of 410C; 11036A, \$60 when ordered separately

Value Engineering and Engineering Values

"An engineer is a person educated in the principles of mathematics and the physical sciences who applies this knowledge to direct and control the materials and forces of nature for the safe economic use and convenience of man."

WE LIKE the above definition of an engineer, and don't balk too much at a shorter definition: "An engineer is a person who can do for a dollar what any fool can do for five."

The scientist is interested primarily in pushing forward the frontiers of knowledge. His obligation is to all mankind, even to generations yet unborn. To the applied scientist, the result is what counts.

The engineer uses scientific knowledge to provide goods and services that deliver a prescribed level of performance at reasonable cost. His function is not to engineer a product to death by designing in everything that comes down the pike to achieve the last elusive ultimate of performance. This is how to make unreliable equipment, bankrupt an employer or raise everybody's taxes.

Even Uncle Sam is tired of this kind of engineering. The Defense Department is now requiring that value

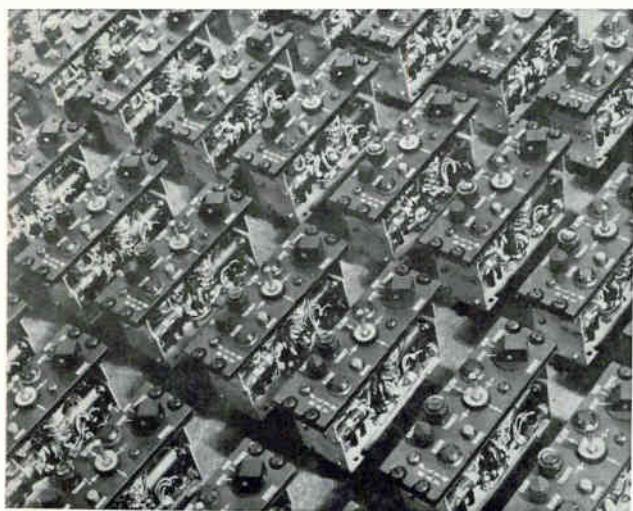

VALUE ENGINEERING simply means achieving a desired equipment function at least cost, particularly in mass production. (Photo is plotting-board control units produced by Maxson for Navy ASW systems)

engineering be employed on all major contracts.

We maintain that value engineering is just good engineering and, conversely, that every good engineer is, or should be, a value engineer.

Engineering economy should not be just part of a budding professional engineer's examination. It is, or should be, a way of life. Every engineer should, among other things, be a value engineer.

Appreciation of cost, both initial and ultimate, as well as safety and convenience, will become even more necessary if the atomic test ban treaty proves to be a harbinger of better international relations.

Only through application of the principles of engineering economy as well as the achievement of other engineering objectives will we develop, for industry and the consumer, new and saleable items to broaden the base of our largely munitions-oriented industry. Such a base is essential. It could give the whole economy a lift while guaranteeing our jobs.

GOVERNMENTAL TELECOMMUNICATIONS. Industry has been puzzled by creation of the post of Special Assistant to the President for Telecommunications (ELECTRONICS, p 19, Sept. 13).

Since the Defense Communications Agency is already coordinating government communications, why does the President need a new official to oversee coordination and development of telecommunications into a national system? Jerome Wiesner, the man who is temporarily filling the post, is the President's Special Assistant for Science and Technology and has, in other areas, been knitting government-agency programs into national programs.

The White House department-of-fuller-explanation has now dissipated some of the mystery. Execution of whatever programs come out of national system planning will still be in the hands of the Defense Communications Agency. The new assistant will give plans and policy guidance for knitting nonmilitary as well as military government communications into a national system. Each of the government's various operating agencies will probably retain its own system, but participate in an interagency board to work out common problems.

In the beginning, changes will most likely be administrative. Changes in hardware and consolidation of duplicate communications channels will presumably come later.

Since the government is today the largest user of communications, leasing many of its facilities from common carriers, any moves it makes toward a single national system bears close watching. As now proposed, further coordination of government systems seems a reasonable step. But in other countries, national systems have wound up being nationalized.

now
available
for
immediate
delivery:

**JERROLD
RF SWEEP
EQUIPMENT
...the industry's
finest!**



**Model 900B
Super Sweep Generator**

Wide plus narrow band in one versatile instrument. Handles all IF, VHF, UHF sweep requirements. Sweep widths from 10kc to 400mc. Frequency range from 500kc to 1,200mc. Built-in crystal-controlled harmonic markers, dc or ac scope preamplifier, precision attenuator. **\$1,980.00**



**Model LA-5100
rf Log Amplifier**

Accurate within ± 1 db over 80db dynamic range. Frequency range 500kc to 100mc. Lets you make exact measurements of attenuation in networks, filters, amplifiers with dynamic ranges down to 85 db. Total rf response displayed in precise log ratio on standard dc-coupled scope. **\$795.00**

Model 900A Wide-Band Sweeper

Sweep widths from 100kc to 400mc. Frequency range from 500kc to 1,200mc. **\$1,260.00**

Model 707 Ultra-Flat Sweeper

Flatness of ± 0.05 db in highest single octave. Plug-in oscillator heads. **\$840.00**

All for immediate delivery. Prices f.o.b. Philadelphia. Write for complete technical data on these and other Jerrold rf test instruments.



Industrial Products
Division,
Philadelphia 32, Pa.

A subsidiary of THE JERROLD CORPORATION

COMMENT

FRAGMENTED ENGINEER

What sort of guff are you handing out in your editorial of July 19 (p 3)—“The Fragmented Engineer”? I particularly resent your implication that the engineer should stick to the last and keep out of public life.

I doubt very much that there are superfluous committees. In fact, I recently read an article to the effect that the USA had *not* sent adequate personnel to an International Standards Committee meeting—and thus several international standards had been put forward which were against US interests.

If the engineer will not serve on committees, or join professional societies, who will? If he will not assist his government in technical proposals—should he leave it to nontechnical politicians?

Let's get back to the fundamental concept that an engineer is one who can handle materials, manpower and money. And one who can handle *materials* only is an applied scientist—not an engineer.

HARRY H. SCHWARTZ

Montreal, Quebec, Canada

• As we said in reply to a similar letter in the Sept. 13 *Comment* (p 6): “We did not mean that the engineer should keep to his work exclusively and stay out of public life. We are mainly pointing out that many times the demands of public life remove the competent engineer completely from his work at the most productive point of his career.”

TRANSISTOR SYMBOL III

I read in the July 12 issue (p 3) an article, Defeat in Venice?, concerning the symbolic representation of transistors, and I think that the Swedish proposal is not a giant step backwards because:

(1) It is not proved that the U.S. symbol is better than the Swedish symbol, and many thousands of transistors are also used in Europe.

(2) You say that the U.S. symbol can be used without the circle. I answer that the French-Swedish symbol can also be used without the circle. But, in the diagrams of *ELECTRONICS* the circles are always used for transistors!

(3) If we use miniaturized circuits in France, plans are large for drawing circles.

At last, the Swedish proposition has the advantage of being less difficult to draw than the U.S. proposition.

Another question—about “negative resistance”—is it not possible to talk of “contre réaction négative”?

R. PICOT

D.E.F.A.

St. Cloud (Seine et Oise), France

LOCALIZING HOT SPOTS

In the June 28 *Comment* (p 4), reader W. P. Czerwinski suggests the use of a liquid to localize hot spots in electronic devices. This interesting idea already has found an application, as you can read in the June 15, 1963, issue of *Nature*, pages 1051-1052, Heat Liberation in Alloy-Junction Silicon Diodes.

Prof. M. A. Melchy and E. A. Jarmoc describe a method to detect the junction thermal activity when a semiconductor diode is forward-biased. They submerge the diodes in methanol, and the liquid vaporizing at the points of higher temperature revealed where the heat was liberated. The diode was lapped down in a plane along the simple axis of symmetry, perpendicular to the junction, then polished and etched.

HEINZ DIECKMANN

Dusseldorf-Holthausen, Germany

LASER-BEAM DAMAGE

The *Newsletter* item entitled, Danger—Reflected Laser Beams (p 7, Aug. 9) should have been less alarmist. It should have read, “Gerard Groszof of TRG Inc., said these beams (pulsed ruby) *may* produce a dangerous energy density in the laboratory at virtually any angle.”

I indicated in my talk that it is quite possible, with today's generation of ruby lasers, to incur retinal damage when viewing the beam by diffuse reflection. As an example of one of these dangerous lasers, I chose a 40-joule burst illuminating a 1-cm diameter circular area on white cardboard, being viewed in a darkened laboratory. As an example of a safe situation, I chose a 1-joule laser irradiating a 1-cm diameter area on black matte paper in a brightly-lit laboratory.

GERARD M. GROSZOF

TRG Inc.

Syosett, New York



There are hundreds of possible magic squares of order four. Shown is the famous one from Durer's 1514 engraving *Melancholia*. All rows, columns and diagonals add to 34. This square has many unusual properties. The following all add up to 34: the numbers in the 4 squares in each corner; the numbers in the 2 squares top center plus

those in the 2 squares bottom center; the 2 squares found diagonally across each corner, plus their opposites; the individual squares in the 4 corners, etc. Other constant numbers, such as 748, may be found in like profusion.

HOW DOES THE NUMBERS GAME ADD UP?

It adds up in your favor, when you find the transistor you need "by the numbers" in the D.A.T.A. Transistor Characteristics Tabulation . . . or the semiconductor diode you need — again by the numbers — in the D.A.T.A. Semiconductor Diode Characteristics Tabulation.

D.A.T.A. is a "magic square" that helps you arrive at the right design decisions, starting from a known quantity or a key parameter you visualize. One compact volume covers every transistor currently offered in the world market. Another covers all semiconductor diodes.

By a unique new "three-easy-steps" method of referencing, you are guided instantly to specific characteristics, dimensions, type numbers, manufacturers, MIL Spec numbers, and qualified sources. What used to involve days of frustrating search now takes literally only seconds. And you will have the satisfaction of knowing that you have explored all possibilities.

Published semi-annually, D.A.T.A. Tabulations are subscribed to by more than 3000 key organizations — industrial, government and military — enthusiastically endorsed by thousands of engineers who wouldn't be without their personal copies. Write today for illustrated brochures: Derivation And Tabulation Associates, Inc., 43-17 South Day Street, Orange, N. J. 07050

D.A.T.A. TABULATIONS

TRANSISTORS • SEMICONDUCTOR DIODES • MICROWAVE TUBES



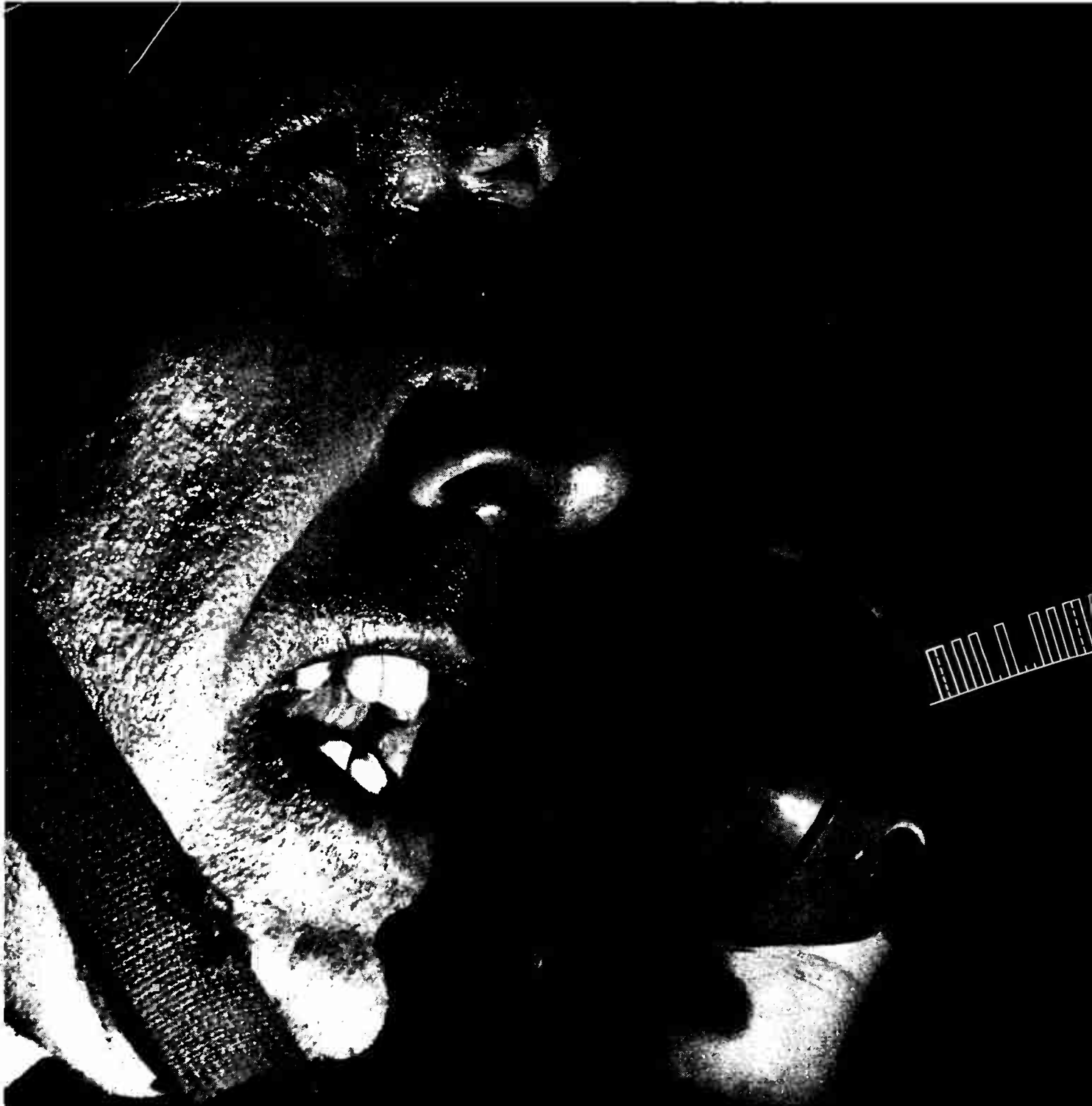

AT&T

**PRIVATE LINE TO ANYONE
...ANYWHERE...ANYTIME**

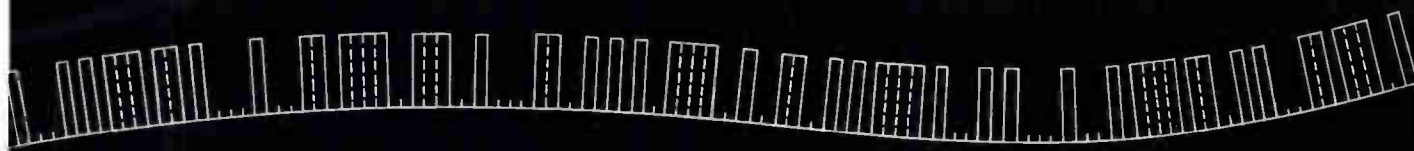

MOTOROLA'S RADEM* concepts, being applied to the most important recent advance in military communication systems... will carry many high-priority radio messages simultaneously in a single wideband frequency channel; maintain private-line direct dialing without central exchanges or fixed nets; do this without interference between concurrent messages transmitted from different locations within the system; and perform these tasks with designs that lend themselves to the application of advanced, integrated electronic circuitry.  RADEM is one of the many major military and space electronic programs in progress at Motorola. Scientists and engineers interested in joining the men who are making basic contributions to both research and applications in advanced electronics write today describing your background and experience in:

- Systems Design** • operational and functional systems analysis, economic analysis, optimum bandwidth utilization, digital, voice and data communications, secure communications.
 - Advanced Equipment Design** • solid state receivers, transmitters and repeaters, digital modems, digital data processing and display units, voice processing and reproduction equipment.
 - Familiarity with State-of-the-Art** • statistical theory of communications, spread-spectrum techniques, coding theory, integrated circuit applications, digital logic design, solid state RF circuit techniques, auto correlation and cross correlation techniques.
- are particularly interested in programs on which your experience was obtained and the extent of your technical responsibility. Please address this information to our Manager of Engineering at the location of your choice for immediate and confidential attention.

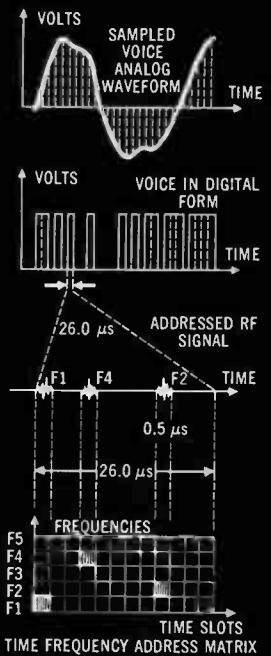

* **RADEM** (Random Access Delta Modulation) principle diagramed above is the result of 5 years of independent

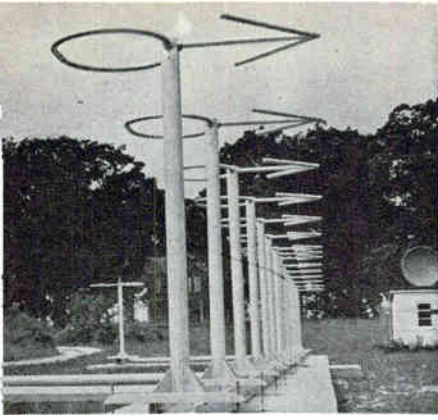

DIRECTIONAL ARRAY being tested by FAA could be used for low-cost ILS and may also improve all-weather landing systems

A LONG WAIT FOR MICROWAVE ILS?

ATLANTIC CITY, N. J.—The date when FAA may use instrument landing systems operating at microwave frequencies was left way up in the air at the Aviation R&D Symposium last week.

D. J. Sheftel, chief of the navigation branch in FAA's systems R&D service, said FAA's interest in such systems is purely experimental and that they would not replace present ILS. He did see some advantages over uhf/vhf, but forecast microwave only for special requirements like the supersonic transport.

A spokesman for Airborne Instrument Laboratories, developers of the 15-Gc Flaescan system (*Electronics*, p 24, Aug. 2), countered that microwave overcomes uhf/vhf limitations and may fill a definite need in 5 to 15 years. Foreign interests and the military, he said, are already interested

FAA Cutting Localizer Cost

Small airports could afford solid-state aircraft landing aid

ATLANTIC CITY, N. J.—FAA is developing a low-cost localizer for small airports. FAA spokesmen at the Second International Aviation R&D Symposium here last week said that the system will cut the cost of a localizer installation from over \$200,000 to about \$80,000. This would help small airports with low traffic densities afford instrument approach facilities.

Solid-state circuits, housed in two small boxes, feed the antenna array—the most expensive part of the system. FAA is planning a “hands-off” life test to determine maintenance requirements. The system would work with existing airborne ILS equipment.

New Array—A new clearance array, developed as part of the low-cost ILS project, has highly directional characteristics. The array employs 15 antennas (100 foot aperture), each a tubular loop fed across a single gap. The design, which includes a parasitic reflector, provides low radiation to the sides and rear.

Impedance compensation is included within the loop so that no external matching is required. Within the loop, a thermostat-controlled electric heating element provides automatic deicing.

The major lobe of the sideband

pattern reaches its maximum less than 5 degrees from the runway centerline and is down to one-fourth at less than 12 degrees. A back course and clearances are provided which are down approximately 11 db from the front-course hemisphere. Tests at NAFEC have been encouraging.

All-Weather Use—The new array, reported N. J. Proferes, of FAA's systems R&D service, may also be mounted above and to the rear of the primary waveguide array for an all-weather landing system (*ELECTRONICS*, p 46, Dec. 14, 1962).

In this application, the array provides clearance signals to mask out the false courses on either side of the course produced by the waveguide array. In case of failure of the pri-

mary waveguide array during an all-weather landing operation, lateral guidance is still provided to the aircraft.

Sensor — Smoother landings were made when an instantaneous vertical velocity (IVV) sensor was used in conjunction with glide slope information, according to an FAA spokesman. The IVV sensor is a device that processes barometric altitude and accelerometer data to determine instantaneous vertical velocity. In use, a pilot initially starts let down using the glide slope pointer. He then “flies” the IVV sensor, using the glide slope as a back-up. Test flights have shown a much closer adherence to the actual glide slope when using the IVV sensor.

Transistors Control Trains

In Europe, trolleys also have digital controls for motors

BASLE, SWITZERLAND—While the International Exhibition of Industrial Electronics (INEL) this month revealed few technological surprises, it did highlight the rapid penetration of electronics in Europe. Some 400 firms from 16 countries exhibited.

Traction Controls—Two firms, Secheron and Brown Boveri, use transistor logic to control tap settings on transformers for railroad traction motors. Both actuate tap changers. Secheron has installed on more than 20 French motor coaches a system that keeps speed to within 2 km an hour of the value set on a control knob.

Brown Boveri's system changes taps only if motor current is within permissible limits, if all currents are balanced and if drive wheels do not

Universal Test Set Urged

slip. If wheels slip, voltage is reduced. A Brown Boveri servo system for multiple-unit trains initiates tap changes by comparing phases of square waves generated from the desired and actual tap positions.

On Swiss trolleybuses, Brown Boveri uses digital counting. Binary coded controller position fed to a discriminator determines direction of tap change. A binary count representing deviation between desired and actual tap position is held in a reversible counter. As the count is reduced to zero by a 3-5-cps pulse generator, the counter output pulse steps the tap changer. Other circuits monitor acceleration and wheel slip.

Process Control—A CSF computer controls a superheated boiler in a 50-Mw experimental French power plant. The computer operates on an 80-kc carrier frequency and uses inductor-capacitor computing circuits. From fuel and boiler feed rates control valve settings are calculated by dynamic simulation of the plant. The computer operates in two modes, d-c for data transmission and h-f for algebraic operations.

A new instrument by Gardy Electronique Demieville, of Switzerland, views watch mechanisms and measures and records unevenness. A photocell and lens system produces a pulse train proportional to the escapement rate. Logic-circuit output indicates faulty gears.

The Swiss firm of Guttinger has a simple special-purpose computer that allows an unskilled person to set type. Input is from an IBM ball-head typewriter. The computer justifies lines and produces a punched tape for a typesetting machine. The system will select one of three type sizes; other type sizes can be programmed by a patchboard.

Statistical Evaluation—Techniques pioneered in Europe by Guttinger aroused much interest. Based on simple a-c circuits using multitapped transformers, a range of equipment is available to automatically calculate the mean value and standard deviation of up to 10 input classes. One central unit will time-sample up to 5 input units located throughout a plant, each unit classifying its inputs into 10 classes. Now under test is a system for continuously checking the statistical distribution of cigarette weights.

NBS wants military equipment fitted with built-in test points

WASHINGTON—National Bureau of Standards has big hopes for Fist (Fault Isolation by Semi-Automatic Techniques)—a simplified test system for modular electronic components—if Fist can get industry-wide application. Now, it is a tester with little, if anything, to test.

The problem, said one NBS spokesman: "You can't retrofit Fist. Prime equipment can't simply be modified to use Fist techniques—it requires complete redesign."

If the armed services adopt the Fist concept, NBS says, they could free qualified technicians for complex jobs by turning routine test chores over to those with only "bulb-changing" training. Fist is a "good-bad" device requiring no special skills.

Once convinced, services would specify it to industry. From what NBS gleaned at a seminar this month for key industry-services personnel, the reception is "encouraging." At least one service is studying upcoming contracts to see where Fist might fit in, NBS said.

Test Networks — The Fist Project tester, said NBS, compares two voltages for each test, such as amplifier module input and output. Set requires two components: tester itself (in use, a four cell device with four voltage comparators, logic circuitry, self-test receptacle, red and green lights, test plug on cord) and transformation network. Network, part of the prime equipment, converts amplifier input-output signals into voltages of comparable magnitude—if module is functioning within tolerances. Test set comparator determines this, and if so, green bulb is lit; if not, red bulb goes on. No light means requisite inputs are not present.

A simple one-cell test set would contain two input amplifiers. Except for one having a switch to select input from either end of the tolerance resistor, they'd be identical. One cell would also hold two peak-



NBS ENGINEER Owen Laug inserts probe of tester into self-test receptacle of fault-location test set

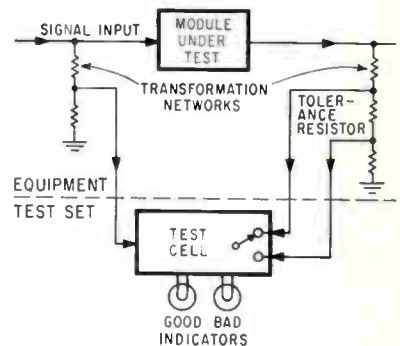

NETWORKS in equipment allow Fist test cell to test any equipment module

to-peak detectors to rectify signals and a differential d-c amplifier to compare them, a zero-crossing detector, and logic circuits. In operation, however, four cells in each test set permit simultaneous measurement of interacting module parameters.

Networks are cordwood assemblies of capacitors, resistors and "an occasional diode" mounted behind special prime-equipment test sockets. Design problems, and cost troubles, come here: socket must be accessible, close to the test module, and protected from damage.

Safari — Safari (Semi-Automatic Failure Anticipation Recording Instrumentation), another NBS project, is an extension of Fist. Safari anticipates breakdown, but requires human judgment.

Safari is a system to translate Fist's good-bad indications into a graphed record. The rate at which performance approaches the pre-established rejection level can be monitored and the module replaced before that level is reached.

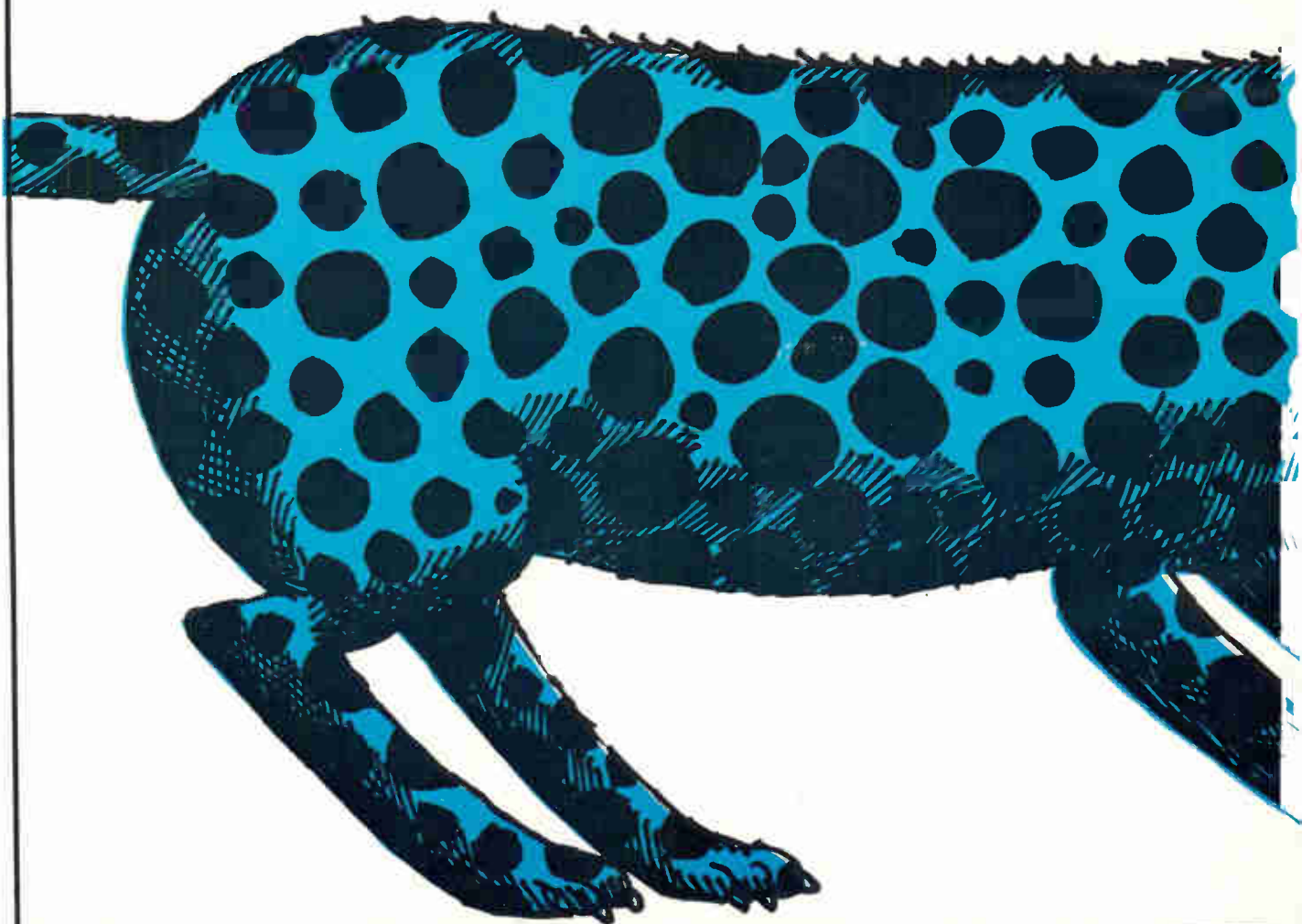

How spotty is your salesman's coverage?

Probably more spotty than you realize...and for very good reasons! Traveling, sales meetings, waiting-time, and paperwork all chew-up as much as 58% of an industrial salesman's time...leaving him a mere 42% for actual person-to-person selling. (Statistics show that industrial salesmen average only 61 minutes a year with each identified buying influence.) The constant employee shuffle in companies from hirings, firings, mergers and promotions frustrate his chance further by making even key customers hard to find...and puts tomorrow's big prospect virtually out-of-touch. Consider that the cost of the average industrial sales call has skyrocketed to \$30.35... and you see why so many successful companies back up their sales force with solid industrial advertising.

advertising reduces the cost of selling.

Advertising in McGraw-Hill Publications completes the important groundwork for the salesman. It pre-sells both his product and company. It frees him to make specific proposals and close orders. And it costs only a fraction of a penny a call to keep him Johnny-on-the-spot...with McGraw-Hill Publications. McGraw-Hill Publishing Co., Inc., 330 West 42nd St., New York 36.

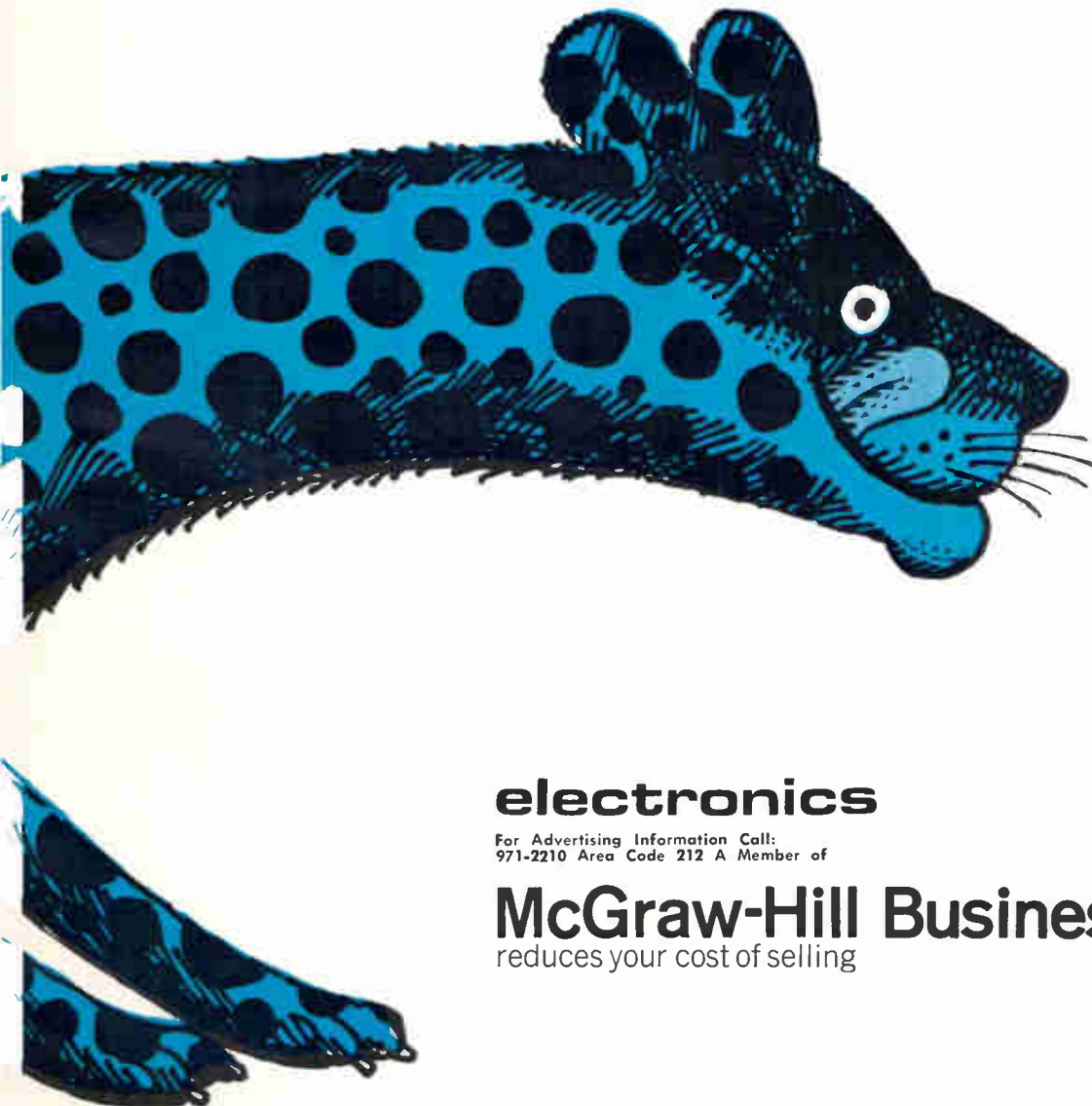

electronics

For Advertising Information Call:
971-2210 Area Code 212 A Member of

McGraw-Hill Business Press

reduces your cost of selling

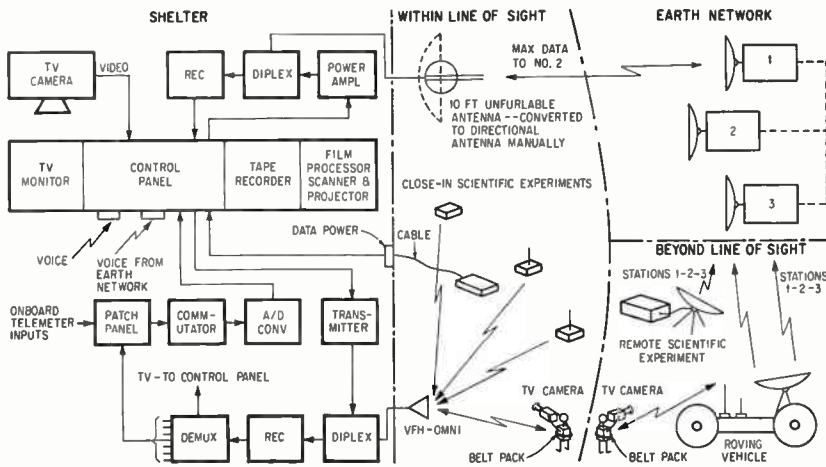

LUNAR BASE ELECTRONICS would include complete communications, control and telemetry facilities in upper compartment of base shelter. Base personnel could receive data on scientific experiments within line of sight directly or by earth-bounce from remote points beyond three-mile line of sight. Data from shelter and roving vehicle would be sent to earth network

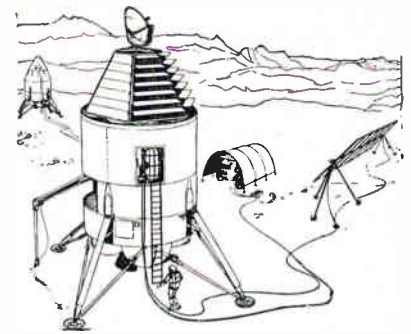

FOUR MEN—two astronauts and two scientists—would inhabit each two-story base shelter housing laboratory and living quarters. Garage for roving vehicle is at right

Target Date for Moon Base 1972?

Studies of communications and other needs will help NASA decide by 1965

By **JOEL STRASSER**
Assistant Editor

MAJOR STUDY of the requirements for the first manned lunar base, being performed by Boeing for NASA, will be completed by November 15, a company spokesman told **ELECTRONICS**.

The work includes communications, control and telemetry studies being performed by Bendix Radio under a subcontract.

In addition, NASA has begun awarding 15 conceptual feasibility study contracts for various portions of the base—Westinghouse has just gotten two, for the nuclear power plant and an engine-fuel regeneration system.

Next summer, according to Maj. Thomas C. Evans, NASA's assistant director for lunar studies, the preliminary study awards will be climaxed by a huge systems study contract.

By January, 1965, NASA should have enough information to give

the project a red or green light. An affirmative decision could produce a simple base by 1972, a complete facility by 1975.

Communications—Major communications problems seen by NASA are the earth-moon and long-range lunar links, and an earth communications network compatible with present systems. Deep Space Instrumentation Facility stations at Goldstone, Calif., and in Africa and Australia may be used, but other facilities will be weighed.

Also, monitoring and automating the base's nuclear power plant, roving vehicles and material and fuel regeneration facilities at the base becomes critical since mission costs will be \$100,000 a man-hour.

Communications systems being considered are:

- Modular communications facility to accommodate landing and roving vehicles, remote scientific stations, astronauts and other lunar bases.

- Automatic checkout of lunar base systems, monitored at earth stations by telemetry. Boeing is determining how much this would aid on-the-spot lunar base crew evaluations.

Communications equipment design would consider weight, antenna size, radiated power, primary power, operating frequency, r-f bandwidth, modulation and reliability. Earth and moon would be linked by a bandwidth of 1 Mc or more.

- Point-to-point communications between the lunar base and remote locations. A multipurpose antenna tower, several hundred feet high, would increase line-of-sight communications and provide a platform for optical and radar beacons. To erect the tower, however, might require too many men.

Maximum line-of-sight for point-to-point lunar communications is three nautical miles. Between widely separated stations, radio communications may require an earth relay. The moon has no ionosphere, but proton bombardment induces an electron layer that hovers just inches above the surface.

- Boeing is also comparing coaxial cable and radio for intersite and intrasite communications. Factors are transmission distances, power, weight and growth potential.

Boeing is also studying the effects of the lunar environment on electronics storage life and operation.

- Since communications equip-

UHF

ment in a single personnel shelter probably couldn't handle dense traffic, a separate communications module may be landed. The module may be combined with an operations and command control center to provide navigation information, map and chart layouts, control consoles, displays and film-scanning equipment.

- Portable radar will probably be used extensively to survey the moon. The mapping system would include a communications relay network to provide beacon "moonmarks."

Television — Because commercial-quality tv may be needed at the base, Boeing is studying picture resolution and frame rates for transmission of television and film data. Portable tv cameras may significantly aid lunar exploratory and scientific expeditions.

Roving Vehicle—A surface vehicle, operated manually or by remote control, is also planned for the lunar base. Cruising at a speed of from 0.25 to 10 mph, the vehicle could transport men to different points on the lunar surface or automatically conduct lunar measurements. Different types are planned for different purposes. General Motors, Chrysler, Bendix, Northrop and Westinghouse Electric have examined different concepts, according to Evans. An AMF version with a range of 250 miles would be powered by four electric motors—one for each flexible wheel—with energy supplied by a fuel cell.

Pakistan Wants Japanese Rocket and Radar Gear

TOKYO — Pakistan has offered Japan \$2.8 million for two Kappa rockets, plus radar tracking equipment, launchers and rocket know-how. While the Kappa series are sounding rockets used by Japan for meteorological research, they probably can be adapted for military use, it was reported. Japan sold five of the rockets to Yugoslavia in 1961.



NEW

Approximate Power Output CW
ML-8403 vs ML-7289

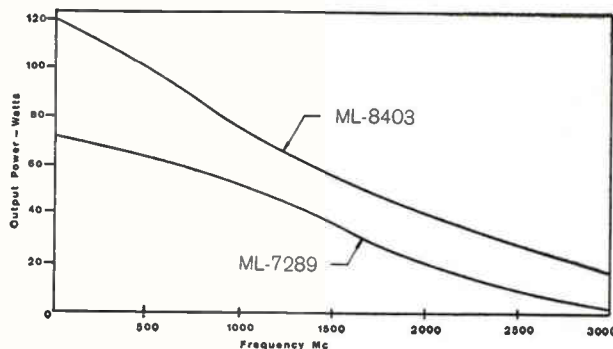

50% more cathode current... & Frequency stable performance

50% more cathode current (190 vs 125 ma) from the Phormat (matrix) cathode of the new ML-8403 planar triode allows higher powered performance—to nearly 120 watts CW—at normal plate voltages. A frequency stable anode permits variable duty cycle without noticeable shift in frequency. For ML-8403 ratings write The Machlett Laboratories, Inc., Springdale, Conn. An affiliate of Raytheon Company.



*This is your opportunity to obtain
a valuable edition of these newly published thrillers. You'll want to see them.*

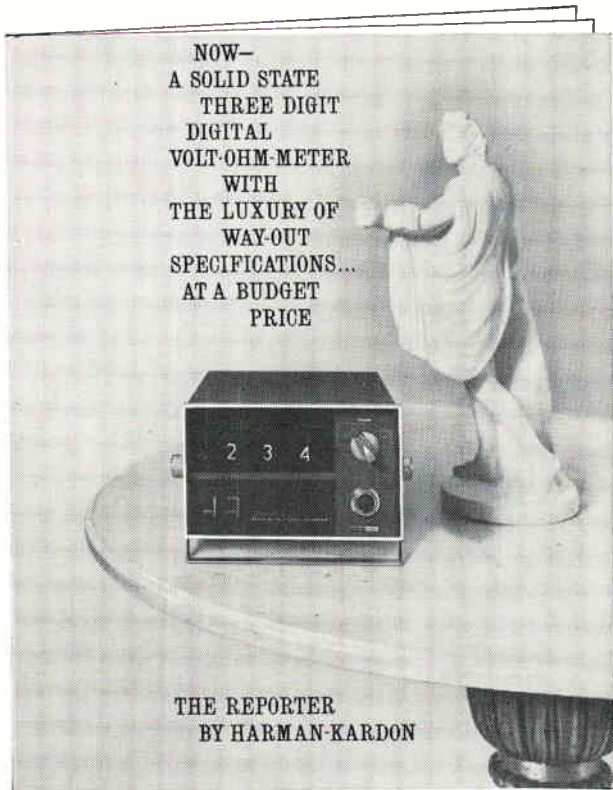

**THE REPORTER
SOLID STATE
DIGITAL VOLT-OHM-METER**

\$495

rush this coupon off today.

HARMAN-KARDON DATA SYSTEMS DIVISION
55 Ames Court, Plainview, Long Island, N.Y.

Gentlemen:

Rush me the brochure on the Harman-Kardon DVOM

Brochure—yes! Better yet—I'd like a demonstration soon

Name _____

Company _____ Phone _____

Address _____

City _____ Zone _____ State _____

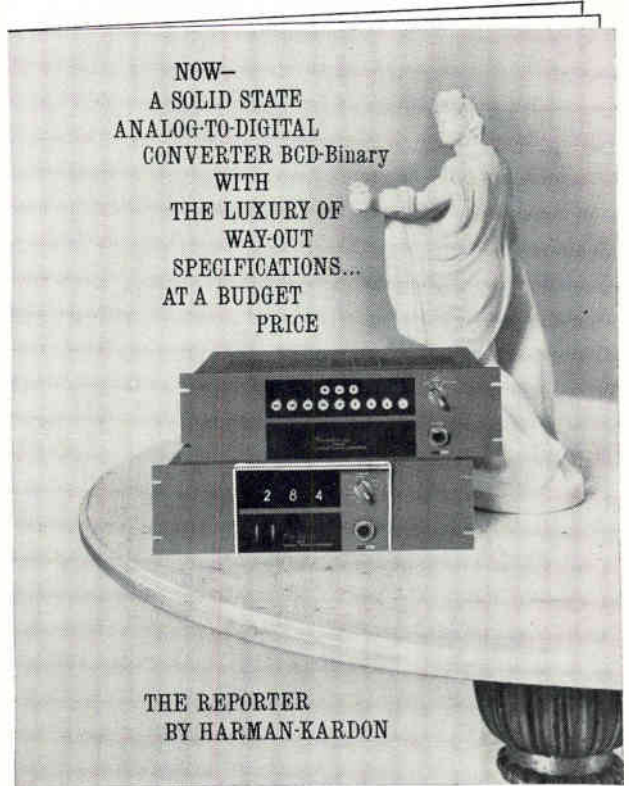

**THE REPORTER
SOLID STATE ANALOG-TO-DIGITAL
CONVERTER BCD-Binary**

\$695

rush this coupon off today.

HARMAN-KARDON DATA SYSTEMS DIVISION
55 Ames Court, Plainview, Long Island, N.Y.

Gentlemen:

Rush me the brochure on the Harman-Kardon Converter

Brochure—yes! Better yet—I'd like a demonstration soon

Name _____

Company _____ Phone _____

Address _____

City _____ Zone _____ State _____

harman kardon

A subsidiary of THE JERROLO CORPORATION

NASA Unveils Apollo Computer

End of Space Race?

WASHINGTON—If the Soviet Union picks up President Kennedy's invitation for a joint conquest of the moon by 1970, the U. S. will probably retain a 75-percent share of the work load, a key NASA official told ELECTRONICS this week. Net effect of the President's proposal would be to eliminate the space race and slow down NASA's lunar landing program by about 2½ years.

The trip would be made by a joint team of U. S. and Soviet astronauts in an American-built booster-spacecraft combination with little change in overall cost to the U. S. Interchanging boosters and spacecraft has been ruled out—there are too many technical and security problems.

The Soviet Union, in turn, would be asked to take over whole chunks of the program. These would include performing the required lunar surface studies, radiation measurements, and perfecting rendezvous techniques. Other cooperation would probably be in telemetry and tracking.

CAMBRIDGE, MASS.—Integrated micrologic circuitry and a core-rope memory help provide a unique computer for the Apollo spacecraft. First details of the Apollo guidance-navigation system were disclosed this week by NASA at the MIT Instrumentation Laboratory. Working with MIT are Raytheon, Sperry Gyroscope, A. C. Spark Plug and Kollsman.

The Raytheon-built modular computer occupies less than one cubic foot and weighs under 60 pounds. Via a pushbutton console, the astronaut can query the computer on position and course, command it to navigate in various modes and change course in accordance with automatically fed data from inertial and optical systems. For certain high-speed tasks, the astronaut can let it operate on its own.

It is the first general-purpose, operational, parallel computer produced specifically for deep-space navigation and guidance. Its memory cycle is 11.7 μ sec. Single addition time is 23.4 μ sec. Basic word length in parallel operations is 15

bits with an added bit for parity check.

Logic sticks are modules the size of a candy bar. Each has 120 NOR gates, and each NOR gate has three transistors and four rope resistors on a silicon chip. Each rope-memory module, about the same size, contains 500 magnetic cores. Memory density is 1,550 bits per cubic inch.

Radio Astronomy Gains Frequencies

WASHINGTON—Three new bands have been assigned by FCC expanding national radio astronomy allocations. One band, 38 to 38.16 Mc, replaces 40.66 to 40.70 Mc, which will no longer be available to this service. The two additional bands are: 1,664.4 to 1,668.4 and 88,000 to 90,000 Mc. An existing band from 404 to 406 Mc will be retained although initially slated for change to lower frequencies. Still under study is the proposal to reassign uhf-tv channel 37 for radio astronomy. Other moves to streng-

FLOATING DRILL Gets On-the-Spot Help

LOS ANGELES—Radar, sonar and a computer will keep the anchorless Mohole drilling platform centered above a particular spot on the ocean floor for three years in all kinds of whether. The system will control propellers, compensating for wind and current, as the Mohole's drill attempts to bore through the earth's crust into the unknown mantle below. No site has yet been chosen for the project, but it is likely the platform will be stationed in deep water, where the crust is thinnest. The platform can operate in depths up to 18,000 feet.

Honeywell, which is designing the positioning system under a \$185,000 contract from the National Science Foundations, says three independent sets of signals will feed into the computer. Two will come from underwater sonar systems similar to the Navy's shipboard submarine detectors. These will generate sound waves that will echo from four transponders spotted on the ocean bottom near the hole and from four tight-line buoys anchored 150 feet beneath the surface. The third will come from a surface radar system ranging off 4 buoys anchored around the platform.

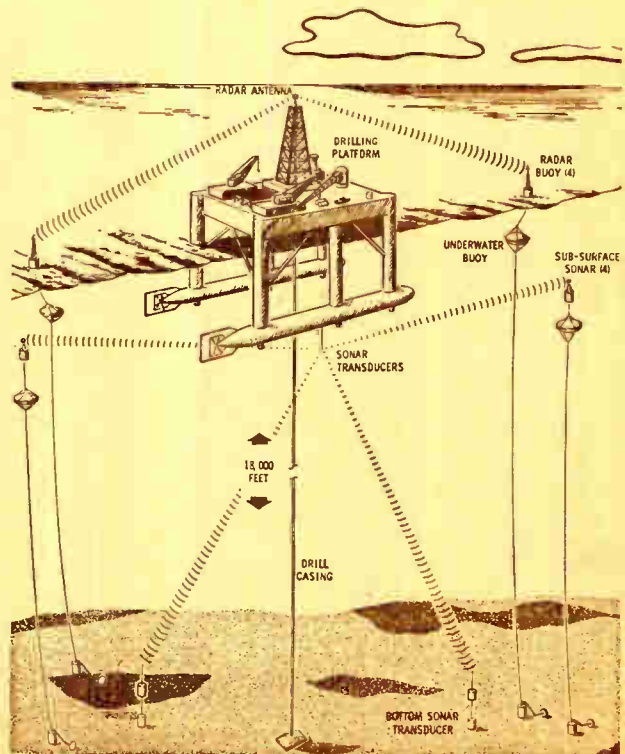

then the position of research include assignment of guard zones reducing interference to radio astronomy installations at Green Bank and Sugar Grove, W. Va., and at Danville, Ill. Changes proposed by FCC to the ITU include new frequencies for high-altitude balloons used in astronomical observations.

European Warehouses Buying Automated System

LONDON—German and Austrian grocery wholesalers have ordered \$1 million worth of computer-controlled warehouse automation from ITT's London subsidiary, Standard Telephones and Cables Ltd. Each \$90,000 installation, using a simplified Zebra computer, combines stock control, accounting-invoicing, and warehouse floor order selection.

During an 18-month test, one Austrian pilot plant said it achieved 50 percent savings in stock turn-around time. First unit will be installed at Nurnberg, Germany.

France Cuts Space Budget; Satellite Still Going Up

PARIS—Cutbacks amounting to one-third of next year's proposed \$70-million civil space budget will not affect plans to launch France's first satellite next October from Point Mugu, Calif., using a NASA Scout booster.

CNES, France's coordinating agency for civil space programs, said the government-imposed cuts are to help curb inflation but will slow France's over-all space effort. Largest loss, \$16-million, was in funds to join Europe-wide projects.

The curtailment also hinders 1965 launch plans from the Sahara in that only two of four tracking stations will be operational.

The first government contract for equipping these two stations has been awarded to Compagnie Generale de Telegraphie Sans Fil and Thomson-Houston. The electronic division of Snecma, a state-owned engine company, also is involved. The CNES budget for 1964 contains \$4 million for tracking stations.

UHF System Transmits Through Ion Sheath

CAPE CANAVERAL—Breakthrough in reentry vehicle telemetry transmission was successfully accomplished during the Asset flight last week.

In addition to the standard vhf telemetry transmitter, the reentry research craft carried a uhf transmitter. During the 22-minute flight, vhf telemetry was interrupted for about 100 seconds. This was the beginning of reentry and attributed to the ion sheath. The X-band telemetry, however, sent clear signals throughout the entire flight.

MEETINGS AHEAD

ENGINEERING PROBLEMS OF MANNED INTERPLANETARY EXPLORATION MEETING, AIAA; Cabana Motor Hotel, Palo Alto, Calif., Sept. 30-Oct. 1.

CANADIAN ELECTRONICS CONFERENCE, IEE REGION 7; Automotive Bldg., Toronto, Ont., Canada, Sept. 30-Oct. 2.

SPACE ELECTRONICS NATIONAL SYMPOSIUM, IEEE-PTG-SET; Fontainebleu Hotel, Miami Beach, Fla., Oct. 1-3.

SECOND NATIONAL SYMPOSIUM, Society for Information Display; Barbizon Plaza Hotel, N. Y., Oct. 3-4.

ELECTROMAGNETIC RELAYS INTERNATIONAL CONFERENCE, IEEE, ICER, IEE, Tohoku University, Science Council of Japan; Sendai, Japan, Oct. 8-11.

ELECTRICAL - ELECTRONICS CONFERENCE, Aerospace Electrical Society; Pan Pacific Auditorium, Los Angeles, Calif., Oct. 9-11.

NATIONAL AEROSPACE CONFERENCE, National Society of Professional Engineers; Lafayette Hotel, Long Beach, Calif., Oct. 10-11.

SOCIETY OF MOTION PICTURE-TELEVISION ENGINEERS CONVENTION, SMPTE; Somerset Hotel, Boston, Mass., Oct. 13-18.

AUDIO ENGINEERING SOCIETY FALL CONVENTION—EXHIBIT, AES; Barbizon-Plaza Hotel, New York, Oct. 14-18.

EAST COAST CONFERENCE ON AEROSPACE-NAVIGATIONAL ELECTRONICS, PTG-ANE; Emerson Hotel, Baltimore, Md., Oct. 21-23.

NATIONAL ELECTRICAL MANUFACTURERS ASSOCIATION ANNUAL MEETING, NEMA; Edgewater Beach Hotel, Chicago, Ill., Oct. 21-24.

NATIONAL ELECTRONICS CONFERENCE, IEEE, ITT, Northwestern University, University of Illinois; McCormick Place, Chicago, Ill., Oct. 28-30.

ELECTRON DEVICES MEETING, IEEE; Sheraton Park Hotel, Washington, D. C., Oct. 31-Nov. 1.

17TH NORTHEAST ELECTRONICS RESEARCH-ENGINEERING MEETING, New England Sections IEEE; Commonwealth Armory and Somerset Hotel, Boston, Mass., Nov. 4-6.

RADIO FALL MEETING, IEEE-EIA; Hotel Manger, Rochester, N. Y., Nov. 11-13.

MAGNETISM-MAGNETIC MATERIALS ANNUAL CONFERENCE, PTG-MTT-IEEE-AIP; Chalfonte-Haddon Hall, Atlantic City, N. J., Nov. 12-15.

ADVANCE REPORT

ANNUAL SYMPOSIUM, PROFESSIONAL TECHNICAL GROUP ON HUMAN FACTORS IN ELECTRONICS, IEEE; San Diego, Calif., May 5-6, 1964; Oct. 30 is deadline for submitting 500-word abstracts to Dr. Mel Freitag, Program Chairman, Ryan Aeronautical Company, Electronics Division, 5650 Kearny Mesa Road, San Diego 12, Calif. Topics include human factors in electronics equipment design-manufacture, man-machine interaction-simulation and models, biological-behavioral instrumentation, bionics and artificial intelligence, professional-technical trends in human factors engineering.

Satellites Will Handle ATC, Navigation at Sea

BALTIMORE—A world-wide air/sea navigation system using six to eight satellites at altitudes of 4,000 miles is under study at the Westinghouse Electronics division. The six-month study contract is sponsored by NASA, and should be completed by January, 1964. It amounts to \$225,000.

Ground stations throughout the world would command any satellite in line-of-sight to interrogate ships and aircraft in line-of-sight with the satellite. Coded signals would trigger each transponder-equipped addressee to respond. The system would reveal range and bearing.

Westinghouse initially believes a fix might be taken in 0.1 sec, and that the satellite system could handle 36,000 users

McNamara Is Calling the Shots

BOSTON—Defense procurement of the future will bear the stamp of Defense Secretary Robert McNamara's management philosophy—and the three services and industry better learn to live with it.

This is the advice of the Assistant Chief of Naval Material.

"The shift of the center of power from the services to OSD is a fait accompli," Capt. John B. Cline told a Navy League seminar on Defense Procurement For the Seventies. He added:

"Today, the crucial decisions on Navy's future procurement are being made by SecDef, not in-house."

These predictions, by both military and industry experts, emerged from the seminar:

- There will be more, not less, government scrutiny of contractors and their costing practices (p 5, Sept. 13)
- Virtual abolition of the cost-plus-fixed-fee contract and emphasis on fixed price and various incentive features
- Standardized procurement for the three services and centralized contract administration
- More make-or-buy decisions by the government, not the prime.

Crystals Studied As Data-Storage Banks

WAYS TO MAKE crystals vast data storage banks will be studied by Carson Laboratories, Bristol, Conn. The investigation, under a grant by the Council on Library Resources, involves feasibility of the "crystal color center" phenomenon—the tendency of certain crystals to change color under visible radiation.

Colors in such centers can be bleached and restored by light of the right wavelength and intensity. The centers are about the same size as the controlling light wavelength (one micron), and could carry in "bits" as much data as is held in 125,000 books.

Laser At Room Temperature Produces Ultraviolet Rays

PALO ALTO, CALIF.—A nitrogen gas laser operating at room temperature has produced ultraviolet radiation in the visible spectrum, it was reported last week by Energy Systems Inc., formerly Radiation at Stanford (see p 7, Aug. 23).

It could be useful in medicine, physical electronics, and communications with its ability to use standard multiplier phototubes. Other lasers have operated only at

temperatures of liquid nitrogen and helium, the firm said, and there are few good infrared detectors.

The borosilicate glass, multiple-light device produces strong lines in the visible range at 3,400 Å and at 3,374 Å in the invisible range. Pulse width is 10 to 20 nsec. Peak-power input, pulsed by a cold-cathode discharge, is 10 to 100 mw and peak power output runs between 10 to 100 w.

DOD and Microelectronics: R&D Aide Predicts Boom

GARDEN CITY, N. Y.—DOD's scientific and technical information program may have a considerable impact on microelectronics. Speaking at a microelectronics symposium here last week, W. L. Doxey, acting technical director of U. S. Army Electronics R&D Lab, foresaw the need for a "tremendous" use of digital integrated circuits in the nationwide information storage and retrieval system (see p. 20).

In another talk, D. S. Elders of USAERDL said more than 700 digital and communications circuits have been reduced to micromodules and more than 100-million hours of life tests accumulated. On the basis of this, estimated mttf is now 766,000 hours at 60 percent confidence for a 10-element module.

BRITAIN'S Fylingdale's radar station opened last week, the last of three links in the \$1-billion Bmews system. Twin dish antennas join others at Thule and Clear, Alaska, coordinated by NORAD.

ITT enters the ground-shipboard radar field with plans, firmed up "in principle," to acquire the 50-year-old Gilfillan Corp.

WHIRLPOOL'S solid-state controlled washer (p 14, Sept. 13) will get a consumer display next month at the Texas State Fair.

FIRST three-continent phone conversation—a 20-minute experimental transmission between Africa and South America via North America—was conducted last week by NASA's Relay I and Syncom satellites. Officials called quality "good."

THE ARMY and Sandia Corp. awarded Electro-Mechanical Research Inc. two contracts for telemetry instrumentation and subsystems hardened against nuclear radiation.

MEXICAN auto makers must use electrical parts made in Mexico instead of importing them and assemble all car radios within the country, the government has ordered.

GARRETT Corp. will build environmental control systems for Gemini and Apollo under a \$41-million contract.

RCA and GE have been awarded contracts totaling \$417,000 by Goddard Space Flight Center for work on the advanced Nimbus weather satellite. GE's \$252,000 pact covers control center operations; RCA received \$165,000 for solar cell modules.

INSTRUMENTS adapted from space flight research will aid studies of learning in brain damaged children. Northwestern University will investigate brain patterns for five years under a \$30,000 grant by the Easter Seal Research Foundation.

MOTOROLA says its sales of high-frequency Mesa germanium transistors rose more than 100 per cent from January to July.

NATIONWIDE sales of radio and tv sets totaled 4,633,713 and 3,405,249 respectively during the first six months of this year, compared with 5,721,663 and 3,173,566 in the same period last year.

RADAR FENCE will eliminate four guard towers at the Washington Correction Center, opening next fall at Shelton, Wash.

Billion-Dollar Drop in Defense Budget Forecast

Congressional cut of over \$1 billion in military funds for fiscal 1964 is certain.

First, Congress trimmed \$408.1 million from Department of Defense's \$49-billion request for new authorizational authority.

Cuts will be made in appropriations of actual funds, too. The Senate Appropriations Committee approved \$47.4 billion, some \$289 million more than approved by the House. After House-Senate conferees iron out differences between the two bills, final reduction will be more than \$1 billion. Major differences to be worked out are:

- In procurement, the Senate committee approved \$15.8 billion, nearly a billion below the administration's request and \$129 million over that voted by the House. Senate approved more for aircraft.

- In research, development, test and evaluation the Senate committee approved \$7 billion, a cut of \$278 million but \$95 million more than the House voted. The Senators voted \$103.1 million for the mobile mid-range ballistic missile, some \$60 million more than the House. The Senators also voted \$96.7 million for development of a military communications satellite system, compared to \$73.7 million approved by the House, and \$120.6 million sought by the Pentagon.

Final appropriations are expected to be about \$47.5 billion, compared to \$48.3 billion last year.

Engineers May Lose Premium Pay Incentive

Government engineers and scientists will lose their "extra" pay incentive if the new federal pay scales proposed by the President go through. Last year they won higher pay than other types of employees in the same Civil Service grade because of the shortage of technical people. The administration says engineers' salaries are now high enough. The proposed pay increases would raise other salaries at least 4 percent, bringing them up to the level of engineers. Engineering groups are urging Congress to maintain a differential for scientists and engineers.

Army Planning National Net For Tech Data

Army Office of Technical Information has been given responsibility by the Defense Department and the White House Federal Council on Science and Technology to develop a nationwide technical data storage and retrieval net. Prototype will be a system now being pushed for the chemical field that was sparked by development of a typewriter adapted to chemical formulas and symbols.

Army plans to hook such a typewriter through a data transmitter to a central storage computer. As presently conceived, the net can be tied together by telephone lines so anyone with terminal equipment can feed new developments into the computer, or query it, simply by operating his tape-producing typewriter. Contracts have already gone to Mergenthaler Linotype for typewriter prototypes. Other hardware is still in the planning and consideration stage.

NASA Pushing Reliability

NASA's new reliability specifications for million-dollar contracts will require testing throughout the hardware development cycle. NASA hopes to catch design weaknesses early in development.

Reliability of components has been a weak point throughout the space program. In 1958, two out of three space payloads failed. Since 1962, the ratio has shifted to two successful shots to every failure or partial success.

NEW PSI DISC-PACKAGE...NEW VHF POWER PERFORMANCE!



PSI-DESIGNED BERYLLIUM POWER PACKAGE

5 WATT - 250 MC* POWER TRANSISTOR

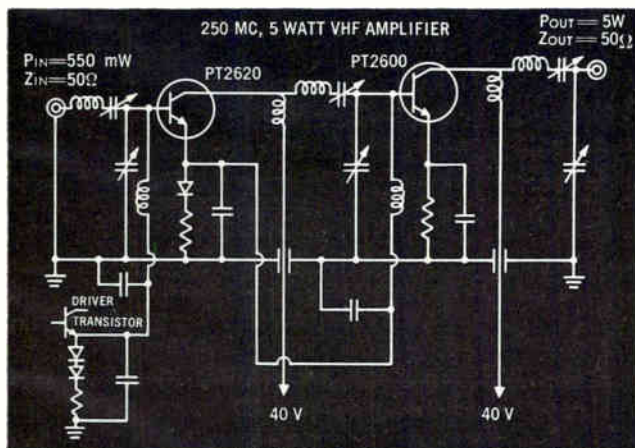

PT2600 *5 db POWER GAIN @ 40 VOLTS

This new PSI device represents state-of-the-art in the field of high-power VHF silicon transistors, and is made possible by the use of the PSI designed beryllium disc packaging. Designed for use at the communications and telemetry frequencies, this device can be paired with the PSI PT2620 which serves as an excellent Driver Amplifier. The PT2620 in a high dissipation TO-5 package provides 2 watts of RF power @ 250 mc. Both the PT2600 and the PT2620 are available directly from distributor stocks. Data sheets available on both devices.

TRW
electronics / *Pacific*
Semiconductors

THOMPSON RAMO WOOLDRIDGE INC.
14520 AVIATION BOULEVARD, LAWDALE, CALIFORNIA

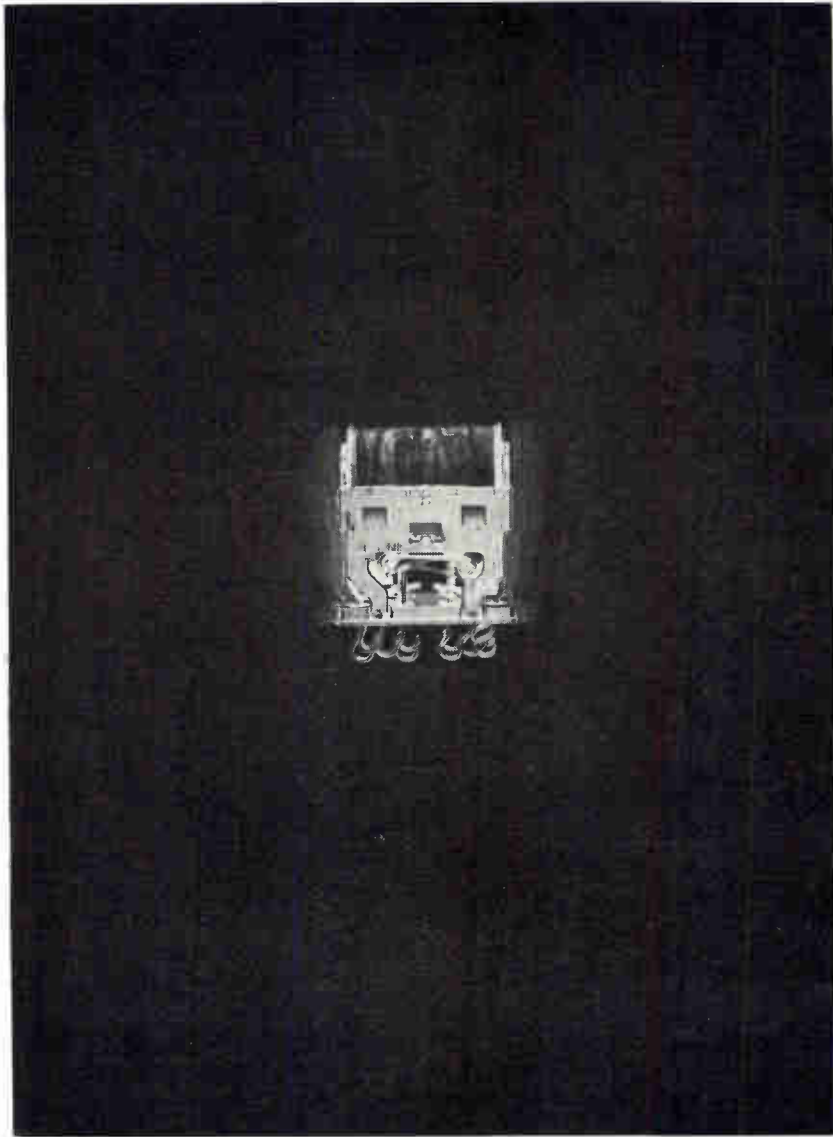

This Relay Obeys A 50-mw Signal...Even at 30 g's

The Sigma Series 32 contacts don't chatter during vibration of 30 g's to 5,000 cycles, or shock of 100 g's. The unique cross-leaf contact structure and magnetic circuit with horizontal coil also result in the 32's ability to switch reliably up to 2 amps, with an input signal as small as 50-mw—pulsed, sustained or gradually changing.

The Series 32 is a polarized, subminiature DC magnetic latching relay. Its con-

tacts are held magnetically in the position last energized—without continuous coil signal.

The relay is rugged, compact and operates at temperature extremes of -65°C to $+125^{\circ}\text{C}$. So reliable, the Series 32 helps shoot missiles, orbit satellites—and keeps computers and office equipment humming.

To help you take advantage of the outstanding capabilities of this relay, we'd

like to send you our Design Bulletin describing nearly 1,000 standard variations of the Series 32. Write to Department #32... or ask our application engineers to help you select the right switching control for your particular need.

You can choose from more than 100,000 different standard Sigma relays—both latching and non-latching, electromagnetic and solid state.

SIGMA DIVISION  SIGMA INSTRUMENTS INC
Assured Reliability With Advanced Design/Braintree 85, Mass.

Is your circuit power limited?

Magnetic latching relays can conserve power when used in a circuit like this. For example, the Sigma Series 32 requires only 950 micro-joules with a matching RC constant of 450 microseconds. Single pulse operation of relays is covered more completely in Sigma technical paper APN 2.3. Write Department 196 for a copy.

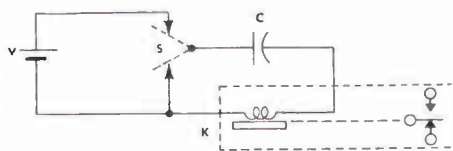

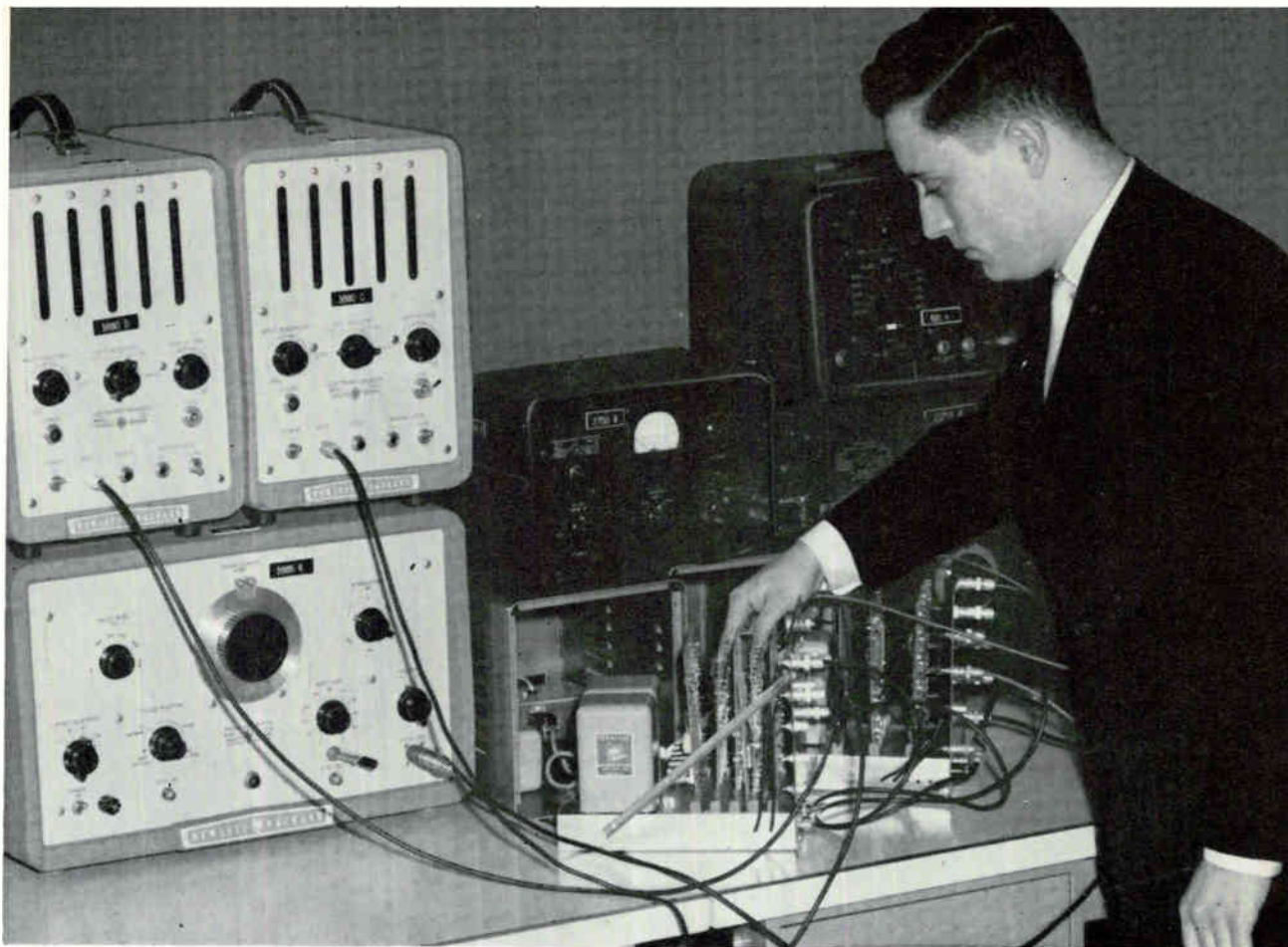

DISCRIMINATOR-DECODER breadboard for adaptive telemetry system

GETTING THE MOST OUT OF

AEROSPACE TELEMETRY

Comparison of adaptive transmission systems capable of varying power or bandwidth or both, to fight changing environmental conditions and to increase efficiency

By **A. HAUPTSCHHEIN**
R. C. SOMMER*

Laboratory for
Electroscience Research,
College of Engineering,
New York University,
New York, N. Y.

AS REQUIREMENTS on telemetry ranges expand and the amount of reliable information transferred between a space vehicle and its ground station increases, more stringent demands will be made of space systems. Unconventional techniques will be needed for these systems to perform satisfactorily. One promising approach is to include some adaptive capability in the system to combat changing environmental conditions, either deterministic or probabilistic, as well as

for increased efficiency of operation. An ideal design will be approached as a space telemetry system incorporates an increasing number of these concepts:

(1) Efficient use of stored energy—an adaptive system capable of varying power or bandwidth.

(2) Transmission of essential information only—sending at the information rate inherent in the measured data.

(3) The use of controlled redundancy (coding) to achieve re-

* Now with RCA Surface Communications Div., New York, N. Y.

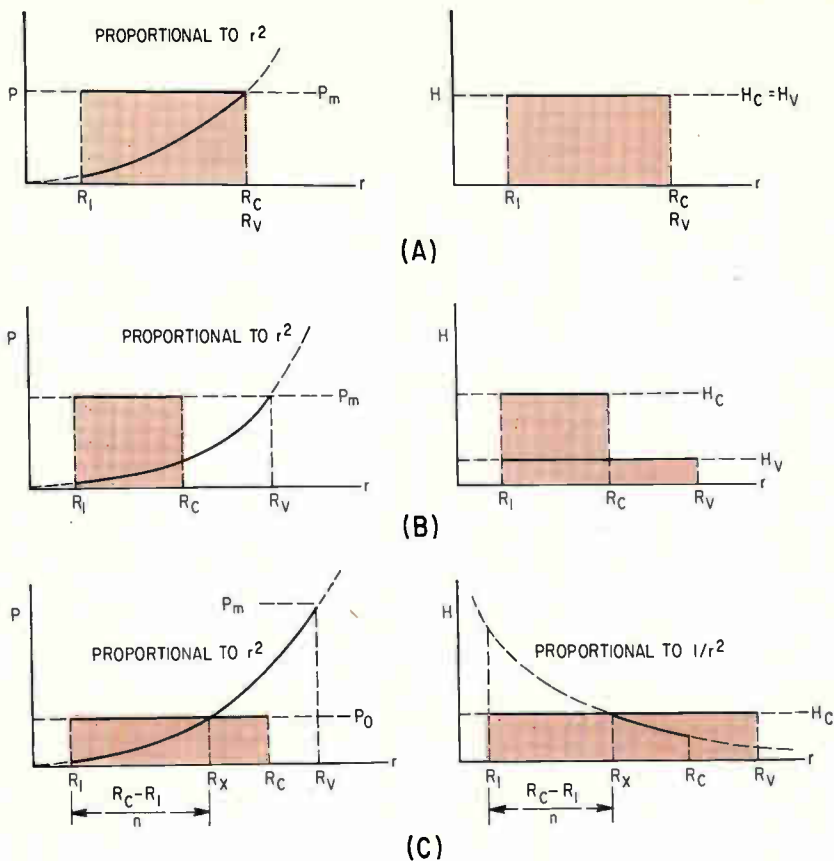

SYSTEM operating comparisons: a continuously variable power, constant-bandwidth system and a constant-power, constant-bandwidth system (A); a variable-power and a constant-power system, with equal consumed energy and constant bandwidths (B); a constant-power, variable-bandwidth system and a variable-power, constant-bandwidth system (C)—Fig. 1

GLOSSARY

- E_r = Relative energy consumption of a variable power system compared to a constant power system.
- h = Satellite altitude
- H_c = Information rate of constant power system
- H_v = Information rate of variable power system
- H_r = Ratio of total information capacities of variable power system to constant power system
- k = Received noise power/unit bandwidth
- K = Total number of allowable power levels
- n^{-1} = Fraction of total range that the variable bandwidth system uses maximum information rate.
- P_e = Error probability
- P_m = Maximum transmitted power of variable power system
- P_o = Constant transmitted power of constant power system
- P_r = Ratio of maximum to minimum allowable power levels
- r, R = Range
- R_e = Radius of earth
- R_1 = Range at which systems are turned on
- R_c = Maximum range of constant power system
- R_v = Maximum range of variable power system
- R_x = Range at which variable bandwidth system must initially decrease information rate
- δ = Fraction of total range that the systems are in use (Duty Factor)
- ϕ = Angle subtended at the center of earth by the ground receiving site and the satellite
- ϕ_m = Maximum value of ϕ

liable data transfer.

(4) Utilization of efficient methods of modulation, demodulation, and filtering, with emphasis given to threshold performance.

(5) The use of improved decision mechanisms of an adaptive nature; for example, null-zone detection, feedback, and coded feedback.¹⁻³

(6) Extension of range and coverage by relay stations.

Discussion is limited here to item 1 and is based on work performed for the National Aeronautics and Space Administration.

The efficient use of stored energy is significant because the amount of energy available determines the usefulness of space missions. While the nonpropulsive power required for most satellites and space probes launched to date has been in tens of watts, it is expected that power needs for future missions will grow about a thousandfold by the early 1970's.⁴

Adaptive Modes—Many systems are equivalent on the basis of performance; however, some of them use more total energy than others. This may be due either to requirements of auxiliary equipment, or to an inefficient mode of operation. An example of the latter is a constant-power transmitter sending at a constant information rate on a space-probe mission. Since at the final range, the received power must be at an acceptable level, then at lesser ranges the received power will be greater than needed.

There are several methods of eliminating or reducing this energy waste. Consider a Venus probe using a telemetry system that stores information for some length of time and then transmits it at an increased rate. For a typical situation, 2,400 watt-hours of energy are required to transmit at a long-term average data range of 5 bits per second, with 60 watts on-the-air power consumption at a fixed rate of 500 bits per second and a duty cycle of one percent. Alternatively, an equal amount of energy is consumed for the same mission when a 0.60-watt transmitter is used with a data rate of 5 bits/sec and continuous transmission. These two modes of operation are equivalent since the average information rates, total consumed signal energies and total informa-

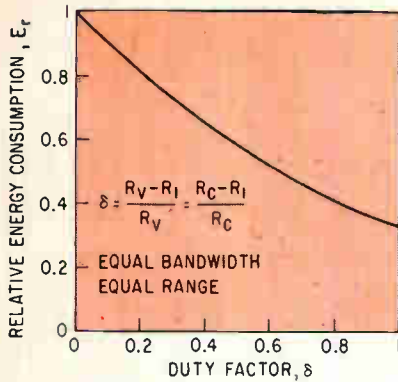

RELATIVE TOTAL ENERGY consumption versus transmitted duty factor —Fig. 2

tion gathering capacities are equal.

Consider next changing to an adaptive mode of operation in each of these systems. In the first system, the data rate may be varied by factors of two while simultaneously varying the length of each transmission burst (varying the duty cycle) to maintain a long-term average data rate of 5 bits/sec. The same 60 watts on-the-air power consumption is assumed. With ten levels of data rate and maximum and minimum data rates of 256,000 and 500 bits/sec, respectively, the energy consumed throughout the mission is reduced to 1,087.7 watt-hours.

In the second system, the information is still transmitted continuously, but the system can vary its power output by factors of two up to a maximum allowable power of 0.60 watt. If ten discrete power levels are used, the consumed energy also is reduced to 1,087.7 watt-hours. Thus, significant energy savings (45.3 percent reduction) are achieved by either of these schemes. Moreover, both systems remain identical in long-term average data rates, total information gathering capacities, and total signal energy consumption. In this comparison, the signal-to-noise ratios at the receiver are such that the maximum acceptable error probabilities for each system are equal.

From practical considerations, continuous transmission has numerous advantages over burst-type transmission. The need for storage in the latter system is a disadvantage in that increased size, weight, and power consumption requirements are imposed, as well as a means of changing the readout rate

by a factor of 100 compared to the storage rate. (For the variable data rate system this factor is 51,200. Moreover, the bandwidth of the receiving equipment must be synchronized to the data rate.)

Also, since the data rates differ by a factor of 100, the first system (500 bits/sec) requires 100 times the bandwidth of the second system. This not only means higher transmitted powers, but is a disadvantage in spectrum conservation. Finally, transistors could be used in the 0.60-watt transmitter, with their inherent advantages in size, weight, ruggedness, and reduction of consumed energy because of the elimination of filaments, while a vacuum tube is needed in the output stage of the 60-watt transmitter. A further consequence of using the burst-type system is that it must be turned on and off ten times during the mission, while the other system operates continuously. This on-off operation reduces component life expectancy and represents a possible cause for system failure.

Performance—The comparisons of the system are divided into two main groups. In the first group are idealized adaptive systems capable of continuously varying their controllable parameters for energy conservation. In the second group, discrete systems approximating the continuous systems are analyzed. Hence, the latter results indicate how closely the ultimate performance of the former systems may be matched in actual missions. Sketches of the operating characteristics of various schemes are given in Fig. 1. For the system model chosen: (1) operation is above threshold and the

ADAPTIVE COMMUNICATIONS

NASA is devoting much effort to redesigning solar cells and storage batteries to increase their efficiency. An alternative to this approach is to use adaptive operating modes in telemetry or communication systems.

With adaptation, the changing conditions of environment, such as variations in range or noise density, may be matched by varying the transmission parameters to maintain a specified detection reliability.

The use of adaptive operating modes is examined here, and several adaptive and conventional or nonadaptive systems are compared in terms of energy savings, total information capacity, error probability and practical system requirements. Bidirectional systems or feedback systems are suggested

error probability is sufficiently small to consider the information rate, H , to be proportional to channel bandwidth only, (2) the free-space radio-range equation is applicable, (for a given received signal power, the transmitted power is proportional to the square of the range), (3) the received signal-to-noise ratio is greater than or equal to some minimum value for all ranges to assure a maximum acceptable error probability, (4) the channel noise is white and gaussian with spectral density k , (for a given s/n ratio, bandwidth and received signal power are proportional), (5) the space vehicle has a constant velocity with respect to the ground station, and (6) the transmitted power is proportional to the energy consumed by the output stage of an r-f cascade.

Continuous Systems—For space probes, the comparison of a continuously variable power, constant-bandwidth system with a constant-power, constant-bandwidth system (Fig. 1A) shows that the ratio of total consumed energies is

$$E_r = 1 - \delta + \frac{1}{3} \delta^2 \quad (1)$$

and is plotted in Fig. 2. If the system is turned on throughout the entire flight ($R_1 = 0$), the duty factor δ approaches unity, and E_r approaches $1/3$, the maximum improvement possible. As the duty factor approaches zero (a single short-burst transmission) the relative energy consumption approaches unity. This result is explained by noting that the variable power system always is producing a constant received signal that yields a constant acceptable error probability,

P_e . For this error probability throughout the entire mission, the transmitted power and hence the consumed energy is always at the minimum possible. Thus, the variable power system is 100-percent efficient. Alternatively, the system with constant operating parameters is 33.3-percent efficient.

Since an equivalence exists between a variable-bandwidth, vari-

able-duty cycle system and a variable-power system, it is reasonable to assume that for a given total information capacity and a given maximum range requirement, an energy saving of a factor of 3 cannot be exceeded. In addition, to realize the full advantage from variable-bandwidth operation, the bandwidth must be allowed to approach infinity at small ranges and the receiver

bandwidth must continuously track the transmitted information rate.

Moreover, since energy conservation is particularly important in long range missions, there is less advantage in using variable-bandwidth techniques for energy conservation because the data rate and the total information received is greater at closer ranges. This is undesirable because it is likely that the data of greatest importance would be obtained at the final range. However, the variable power system would transmit at a constant rate throughout the mission and the receiving equipment would be conventional. Actually, the problems of receiving would be simplified because the signal level would remain constant at the receiver.

Next consider a comparison between a variable-power and a constant-power system for equal consumed energy and constant (unequal) bandwidths (Fig. 1B). If the peak power of the variable-power system is equal to the constant power of the latter a direct trade-off exists between range and total information capacity. Asymptotically as $R_1 \rightarrow 0$, $R_v \rightarrow 3R_c$ and $H_r \rightarrow 1/3$. One special case is that for which the information capacity is maximized. If information is desired during only 30 percent of the mission; that is, from R_1 to $1.42R_1$, for a given amount of stored energy the variable-power system delivers 16 percent more total information, increases the final range by 9 percent, and requires an information rate, and hence a bandwidth, 18 percent less than a constant-power system.

The comparison of a constant-power, variable-power, constant-bandwidth system, for the same total consumed energy, yields the results shown in Fig. 3. Sketches of the system characteristics are given in Fig. 1C. A maximum bandwidth restriction is imposed at the arbitrary range R_x . Moreover, the bandwidth of the constant power system at range R_x is chosen as the constant bandwidth of the variable power system.

For $n = 1$ or $R_x = R_c$, if $R_1 \ll R_v$, an increase in both maximum range and total information gathering capability of about 44 percent is obtained for the variable power system. This advantage is to be expected since the variable band-

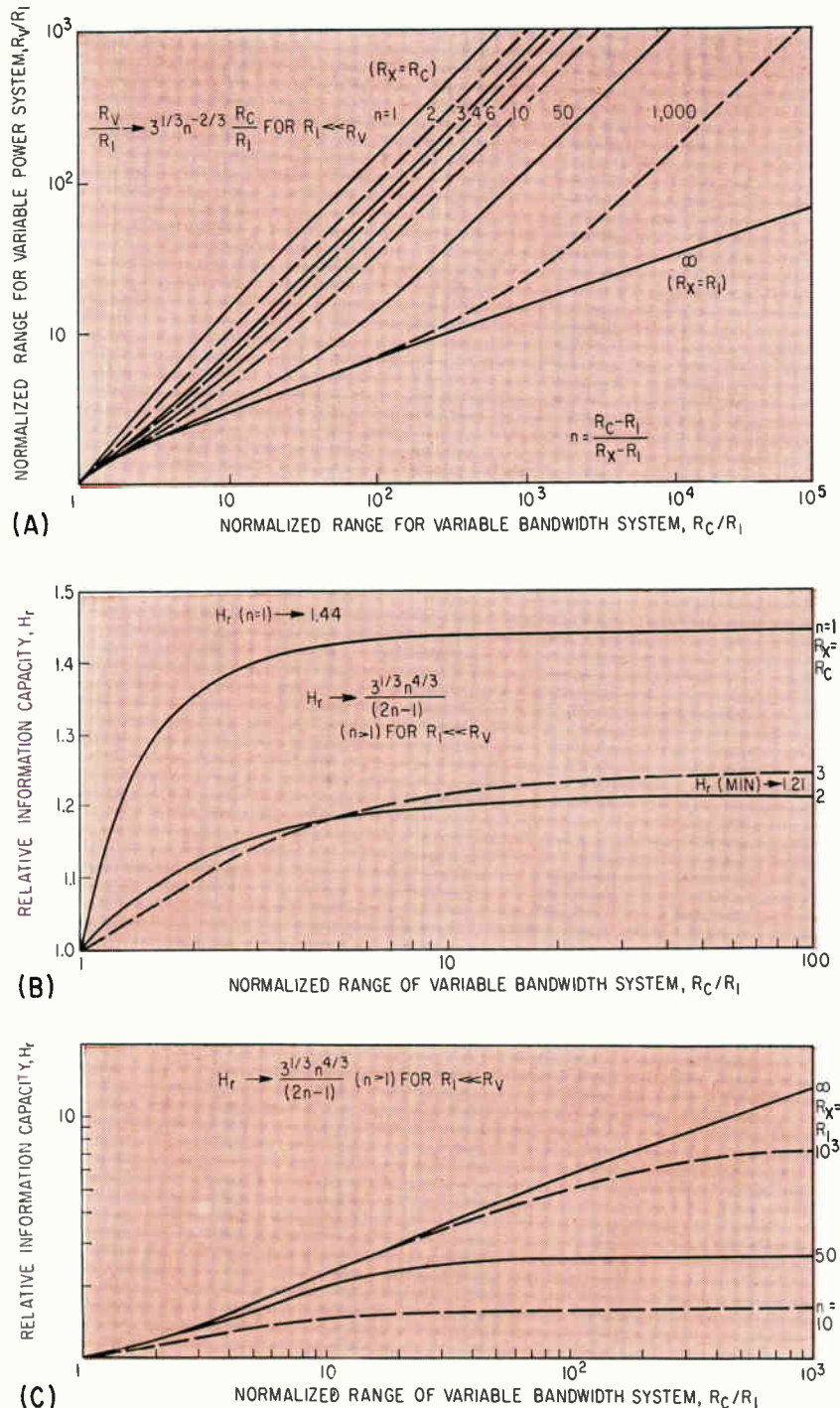

RANGE COMPARISON between variable-power and variable-bandwidth systems for equal total energy consumption (A); relative information capacity gain of variable-power system over variable-bandwidth system for equal energy consumption and n small (B) and n large (C)—Fig. 3

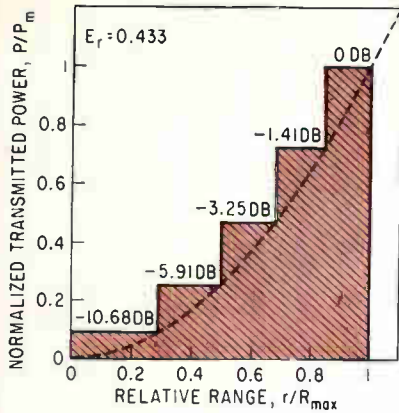

OPTIMIZED transmitter design for five power levels—Fig. 4

width system operates at its maximum bandwidth for the entire mission. The maximum bandwidth operation suggests the use of the term "saturated." Since, in this example ($n = 1$) the variable bandwidth system remains saturated, it is a constant bandwidth system.

For $n = 2$, a minimum ratio of total information capacities exists and the variable-power system is capable of sending 21 percent more total information at a sacrifice of 9.2 percent in maximum range in comparison with a variable-bandwidth system. With $n = 2$, the variable-bandwidth system remains saturated for half of its life. Once again the variable-bandwidth system delivers more information at the closer ranges, a feature that may be disadvantageous.

As n increases, the variable-power system sacrifices range and increases its total information capacity capabilities compared to the variable-bandwidth system. (As $n \rightarrow \infty$, the variable-bandwidth system is never saturated.)

Similar analyses can be applied to an orbiting satellite. However, only variable-power transmission will be considered. It is assumed that the receiving site is located at a pole and that the satellite is in a circular polar orbit. The assumption of a circular polar orbit is made since it has similar properties to inclined orbits, and it enables the satellite to pass over, and possibly observe, every point on earth. The polar location for the receiver is assumed because the percentage of the orbital period available for communication increases with the latitude of the receiving site, and

thus, it is generally desirable to locate receiving sites at the higher latitudes. Moreover, the results obtained with these assumptions are approximately valid for receiving sites located at the higher latitudes, or any receiving site location provided the satellite telemetry system is activated only on those orbital passes when the satellite passes near the zenith. Hence, the results are valid for most cases of practical importance.

For these assumptions, the maximum possible energy saving with continuously variable power transmission is

$$E_r = \frac{1 - \left[\frac{A}{1+A} \right] \frac{\sin \phi_m}{\phi_m}}{1 - \left[\frac{A}{1+A} \right] \cos \phi_m} \quad (2)$$

where $A = 2R_e(R_e + h)/h^2$. The savings attainable decrease with satellite altitude and the maximum possible saving corresponds to an $E_r = 0.333$ as shown in Fig. 7B, which is also the limiting value for a space probe.

Discrete Systems—For space probes, at the present state of the art, continuously variable-power transmission is not feasible. Therefore, approximating systems using discrete multilevel power schemes have been devised. The system model

chosen assumes a finite number of levels K , a maximum transmitted power level P_m , and a minimum received power requirement proportional to the square of the range. An optimized design for space probes in which the minimum amount of energy is consumed is given by

$$\begin{aligned} 3r_1^2 &= r_2^2 \\ 3r_2^2 &= 2r_1r_2 + r_3^2 \\ &\vdots \\ 3r_{k-1}^2 &= 2r_{k-2}r_{k-1} + r_k^2 \end{aligned} \quad (3)$$

$$\begin{aligned} 3r_{K-2}^2 &= 2r_{K-3}r_{K-2} + r_{K-1}^2 \\ 3r_{K-1}^2 &= 2r_{K-2}r_{K-1} + R_{max}^2 \end{aligned}$$

In these equations, r_i , $i = 1, 2, \dots, K-1$, are the ranges at which the power level should change to an adjacent power level.

For the practical cases of small K , these equations are not difficult to solve. The solution for $K = 5$ is given in Fig. 4, which shows that the energy saving compared with a constant power scheme is given by $E_r = 0.433$. Also, for $K = 2$, $E_r = 0.615$, for $K = 3$, $E_r = 0.516$ and for $K = 4$, $E_r = 0.469$. The ideal savings with continuous power variation is $E_r = 0.333$. Thus, the use of only five discrete power levels, encompassing a power range of about 10 db, achieves about 85 percent of the maximum

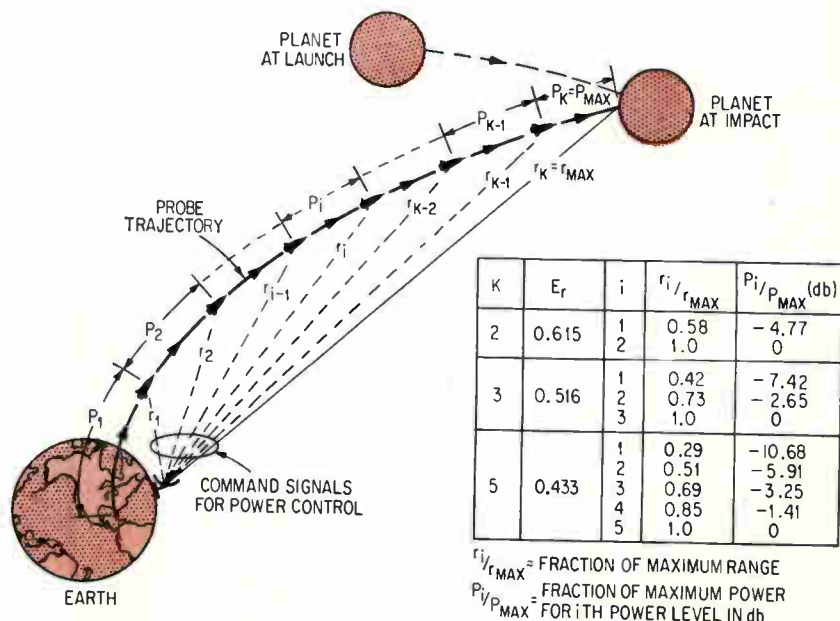

ADAPTIVE power control for space probe, with a new transmitter switched on at each r . The last column shows how much the transmitter power level should be changed along the path, and r_i/r_{max} are the optimum points at which power should be changed—Fig. 5

savings possible. The pictorial (Fig. 5) also gives the optimum design parameters for a discrete level system.

The optimization of the transition levels not only reduces the consumed energy, but also minimizes the required number of transitions between minimum and maximum power levels and hence the equipment complexity, for a given energy savings. Small changes of level (a few db) might be efficiently obtained by varying the voltages applied to the transmitter output stage. Larger variations of output may be obtained by switching successive stages in an r-f cascade to the antenna, while removing supply voltages from all following stages.

For satellites, multilevel, discrete-power systems may be designed in an analogous fashion to that for space probes. For example, a two-level power system has been analyzed and its performance determined. The transition point for switching from the low to the high-power level is found from

$$\phi_1 \sin \phi_1 - \cos \phi_1 + \frac{R}{R+h} = 0 \quad (4)$$

where ϕ_1 is the angle at which the transition should occur and is defined as the angle subtended at the center of the earth by the ground receiving site and the satellite.

The optimum ratio of the two power levels is determined by squaring the ratio of maximum range to the range at ϕ_1 , and is

$$P_r = \frac{(1+A) - A \cos \phi_m}{(1+A) - A \cos \phi_1} \quad (5)$$

This result is shown in Fig. 6 as a curve of optimum power ratio in db versus satellite altitude.

The relative energy consumption of an optimized dual-level transmitter system, compared with a single transmitter system, is

$$E_r = 1 - \frac{\phi_1}{\phi_m} \left[\frac{P_r - 1}{P_r} \right] \quad (6)$$

Figure 6 also shows the variations of Eq. 2 and 6 with satellite altitude. With both dual and continuous systems the relative energy consumption for orbiting satellites increases with satellite altitude.

Error Probability—Another significant performance characteristic for space telemetry systems is that of error probability. Space probe and satellite systems can be

compared with respect to this criterion by transforming the savings in required power into an equivalent gain in error probability. A coherent, uncoded, binary psk telemetry system is assumed.

The characteristics of multipower space-probe transmission systems are shown in Fig. 7A. It gives the reduction in peak error probability as a function of the number of available power levels K , for various error probabilities of a single-transmitter system, P_{e1} , on an equivalent energy basis. Significant reductions in peak error probability are seen for all $K \geq 2$ and all $P_{e1} \leq 10^{-2}$. Greater improvements are achieved by increasing the number of power levels. Lower bounds on peak error probability, corresponding to the performance of a continuously variable power system, are also shown.

The variation of error probability with range is such that a range crossover point exists above which the error probability is always less than the corresponding values for a single-transmitter system. Below this point the reverse is true. This feature is desirable if the maximum error probability is acceptable, because with space probes, the information from large ranges is usually more important. Error probability performance curves for orbiting satellites, similar to those in Fig. 7A for space probes, are given in Fig. 7B for optimized dual-transmitter systems as a function of satellite altitude. Significant reduction in P_e is noted again and the variations with range are similar to that for space probes. For example, at an altitude of 1,000 miles, the energy required to operate a single-transmitter system at an error probability of 10^{-3} when the satellite appears at the horizon (maximum range), would be sufficient to operate an optimized dual-transmitter system at a maximum error probability of 4.8×10^{-5} .

Adaptive Control—If an adaptive system is operated without a control or feedback command link, the transmitter must be programmed from knowledge of the planned trajectory to change power levels at the proper times. This form of control is not satisfactory. For example, consider a space probe. Failure to maintain sufficiently strong received

signals can result if the actual velocity of the probe is greater than the assumed velocity. But, if the actual velocity is less than that assumed, the received signals would be consistently stronger than planned, and the on-board stored energy would be depleted before the maximum desired range were reached.

These difficulties can be overcome by using feedback. If the received signal is monitored, and a threshold is set corresponding to the expected received signal strength from the maximum range (a signal strength sufficient for an acceptable error probability), the receiver has the capability for deciding when the power levels should change. When the received signal falls below the threshold, a command signal can be sent to increase the transmitted power to the next highest level. In this case, independent of the actual probe velocity, the successively higher power transmitters would be activated at the proper ranges.

Similar control is possible for an orbiting satellite. Consider the possible performance gains, and a means for implementing the adaptive control, for a satellite at an altitude of 300 miles that uses a dual-power transmitter. Assume that a transmitted power of 10 watts is needed to obtain the required signal-to-noise ratio at the maximum range (about 1,570 miles). Figure 6 shows that the energy consumption with two transmitters can be reduced to about 63 percent of that required for a single transmitter. This savings can be exploited in a dual-transmitter system to increase reliability, for example, with the higher power transmitter increased to 10/0.63 or 15.9 watts. From Fig. 6 the required low transmitter output is found to be 4.46 db below 15.9 watts, or 5.7 watts. At the maximum range, the 15.9-watt transmitter produces received signals about 2 db higher than the original 10-watt transmitter. Correspondingly, the digit error probability (assuming uncoded, coherent, binary transmission) is reduced from 10^{-2} to about 2.5×10^{-3} , as shown in Fig. 7B.

The ranges at which the transmitters should be switched can be determined by setting two decision thresholds at the receiver. After the satellite has achieved orbit, the high-powered transmitter (15.9

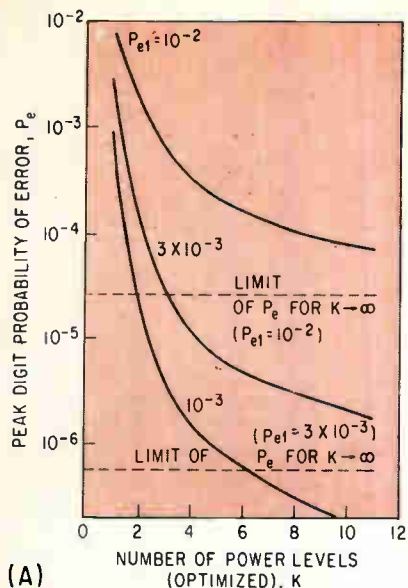

(A)

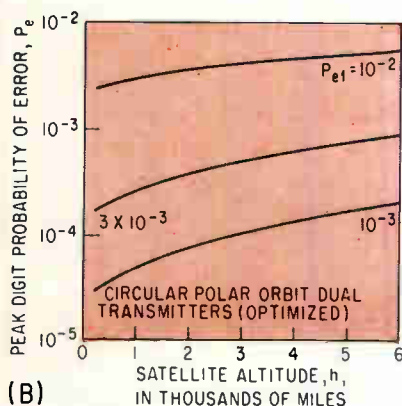

(B)

PEAK DIGIT ERROR probability versus number of optimized power levels (A) and versus satellite altitude (B) for space-probe binary telemetry systems with various single transmitter maximum error probabilities—Fig. 7

watts) is turned on and a threshold T_1 is set corresponding to satisfactory operation when the satellite is at the horizon (maximum range). A second threshold T_2 is then set 4.46 db above T_1 . As the range varies during the satellite orbit, either decreasing or increasing, a feedback command signal can be sent which activates the low-power transmitter (5.7 watts) when the received signal exceeds T_2 and activates the 15.9-watt transmitter when the received signal falls below T_1 . This feedback system helps combat the detrimental effects caused by the inability of directional ground antennas to track the satellite exactly. Moreover, the increased reliability should also simplify data reduction at the ground stations.

Figure 8 shows a block diagram of an adaptive space telemetry system

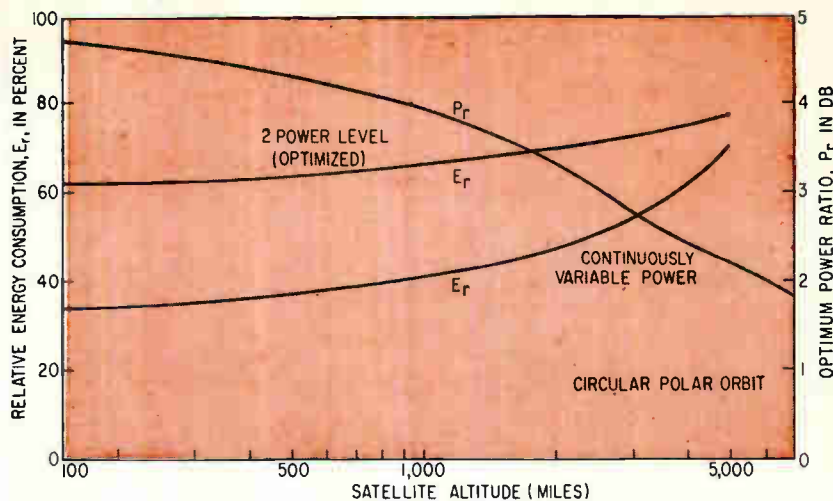

RELATIVE ENERGY CONSUMPTION and optimum power ratio versus satellite altitude—Fig. 6

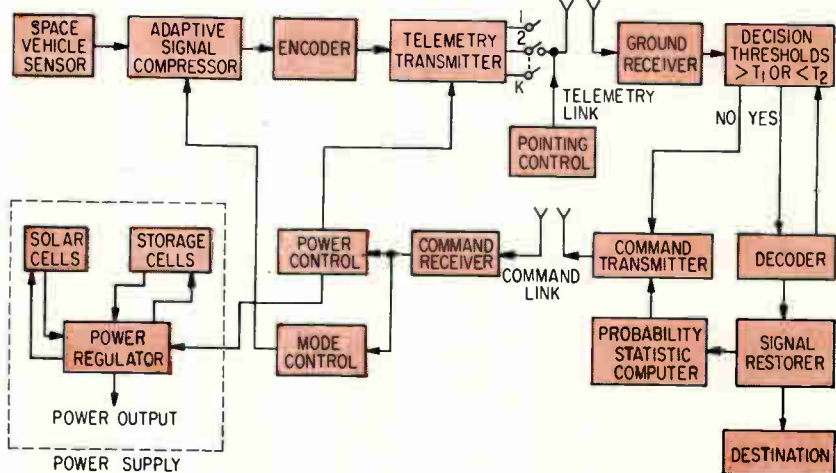

ADAPTIVE telemetry system—Fig. 8

tem capable of varying transmitted power. The photo shows a breadboard discriminator—decoder that is planned for future pulse-frequency-modulated (pfm/pm) telemetry systems with operation in a synchronous mode.⁵ Having a lower signal threshold than the asynchronous type used in present satellite missions it can use the received energy more efficiently. Thus it is capable of improving the reliability of detecting tone-burst signals of varying frequency, or alternatively, for a given reliability, the improved decoder action can extend telemetry range or decrease the energy drain from the space vehicle.

The research reported in this paper was performed at New York University and was sponsored by the National Aeronautics and Space Administration, Goddard Space Flight Center, Greenbelt, Maryland,

under Contract No. NAS 5-408 monitored by Cyrus J. Creveling. The authors are grateful to B. Harris, D. Hoffman and A. Thumim for their permission to use the photograph of the breadboard discriminator now under construction.

REFERENCES

- (1) F. J. Bloom, S. S. L. Chang, B. Harris, A. Hauptschein, and K. C. Morgan, Improvement of Binary Transmission by Null-Zone Reception, *Proc. IRE*, p 963, Vol. 45, 1957.
- (2) B. Harris, A. Hauptschein, K. C. Morgan, and L. S. Schwartz, Binary Communication Feedback Systems, *AIEE Trans., Communication and Electronics*, p 980, Vol. 40, 1959.
- (3) J. J. Metzner, and K. C. Morgan, Reliable Fail-Safe Binary Communication, 1960 *IRE WESCON Convention Record*, Part 5.
- (4) N. D. Sanders et al, "Power for Spacecraft," NASA SP-21, Office of Scientific and Technical Information, Washington, D. C., Dec. 1962.
- (5) B. Harris, A. Hauptschein, R. C. Sommer, and S. Wenglin, An Accurate Discriminator for Demodulating Noisy PFM Telemetry Signals, 1962 Record of National Symposium on Space Electronics and Telemetry, Oct. 2-4, 1962, Miami Beach, Fla.

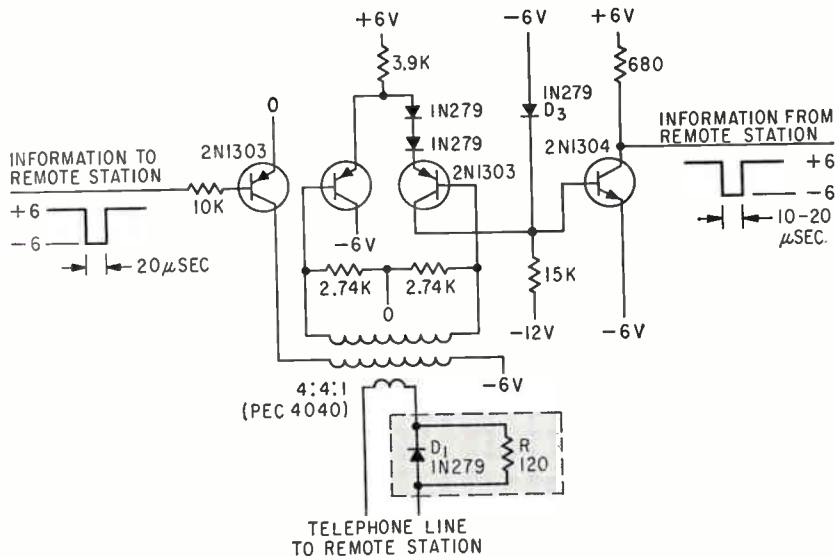

LINE DRIVER-RECEIVER package for sending high-speed digital information over standard voice telephone lines—Fig. 1

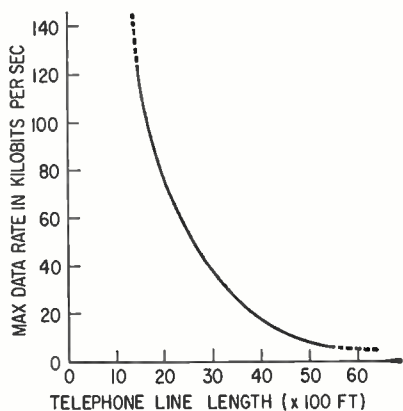

MAXIMUM DATA RATE versus telephone line length—Fig. 2

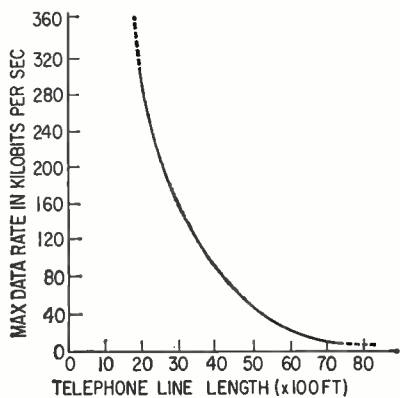

MAXIMUM DATA RATE versus telephone line length possible with high-gain receiver and more accurate wave slicer than shown in the circuit—Fig. 3

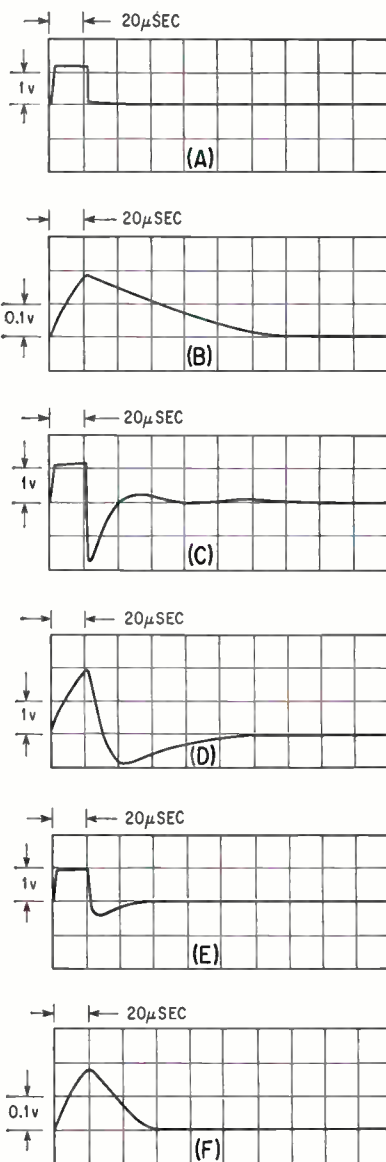

INPUT AND OUTPUT waveforms. Square input pulse (A) and corresponding output pulse (B). Overshoot applied (C) and output resulting (D). Adding diode and resistor gives input (E) output (F)—Fig. 4

By **ROBERT M. LEE**
 Research Engineer, Computer Center
 University of California
 Berkeley, California

SPEEDING

THE RATE at which digital data can be transmitted over standard voice grade telephone lines is limited to a maximum of 2,400 bits per second if standard on-off encoding techniques are used. Recently developed, more complex encoding schemes making use of both the frequency and amplitude bandpass characteristics of telephone lines allow data to be sent at 4,800 bps.

These limitations hold for distances greater than a few miles or through multichannel carrier equipment. For shorter distances and over standard voice grade cable pairs these limitations do not hold. For example, the simple circuit shown in Fig. 1 permits transmission of information at 40,000 bits per second over a distance of a half mile. A slightly more complex circuit, using the same mode of transmission would make it possible to double the distance.

This circuit was designed to connect a large central computer to satellite computers located nearby. It comprises a one-transistor line driver and wave-shaper and a three-transistor line receiver and pulse slicer. These circuits permit sending data one way over a pair of wires but not in both directions at once. The curve in Fig. 2 shows the relationship between maximum data rate and line lengths for this circuit.

Longer Distance— Provided the three-transistor line receiver and wave slicer of Fig. 1 were replaced by a higher gain line receiver and a more accurate wave slicer, only as complex as magnetic core memory circuits, information could be transmitted either at higher rates

COMPUTER ECONOMICS

Continuous use, shared use and interconnection with satellite computers are necessary trends in view of big-computer costs. The University of California has found a way to spread its investment by connecting the Center equipment to satellites located at various points on the Berkeley campus. The wiring is considerably more sophisticated than that involved in hooking up another electric light, but not really difficult, as shown by the inexpensive equipment described in the article

DIGITAL DATA Over Phone Lines

An extremely simple circuit permits transmission of as many as 40,000 bits per second over distances up to a half mile. With slightly greater circuit complexity similar information could be sent a mile.

or over longer distances. Figure 3 shows maximum data rate versus line length for such a circuit.

The simplicity of these circuits depends upon the fact that telephone lines of this length have input and output impedances that are composed primarily of capacitive reactance and pure resistance. If a short square pulse, as shown in Fig. 4A is applied to the input of the line the output from the line a half mile away will appear as shown in Fig. 4B.

Pulse Rise—The rate at which this signal rises is a function of line capacitance, line resistance, driver impedance and input signal amplitude. The rate of rise of the signal could be made higher by increasing the amplitude of the input signal except that input signal amplitude is limited by the telephone company to a maximum of 0 dbm on voice grade telephone circuits. The rate at which the received signal falls is a function of line capacitance, line resistance, driver impedance and receiver impedance. It is much slower than the rise time, for the conditions under which the measurements were made. Because of this long fall time the rate at which the square pulses of Fig. 4A can be transmitted over this line is limited to about 5 Kc.

If, following the pulse of Fig. 4A, a short pulse were to be trans-

mitted in the opposite direction it would have the effect of reducing the fall time of the signal. One way of doing this is to drive the line with a transformer and let the normal overshoot perform this function. With overshoot applied the input to the line will appear as shown in Fig. 4C and the resulting output will be as shown in Fig. 4D.

Compromise Circuit—A cursory comparison of this pulse with that in Fig. 4B shows that there is some improvement but the overshoot of the transformer more than com-

pensates for the input pulse and the line must now recover from the negative direction rather than from the positive direction. A compromise between these two situations is accomplished in the circuit of Fig. 1 by first disconnecting the overshoot of the transformer from the line by means of diode D_1 and then shunting this diode with a resistor R that couples part of the transformer overshoot into the line. When the proper value of resistance is selected the input to the line will appear as shown in Fig. 4E and resultant output as shown in Fig. 4F.

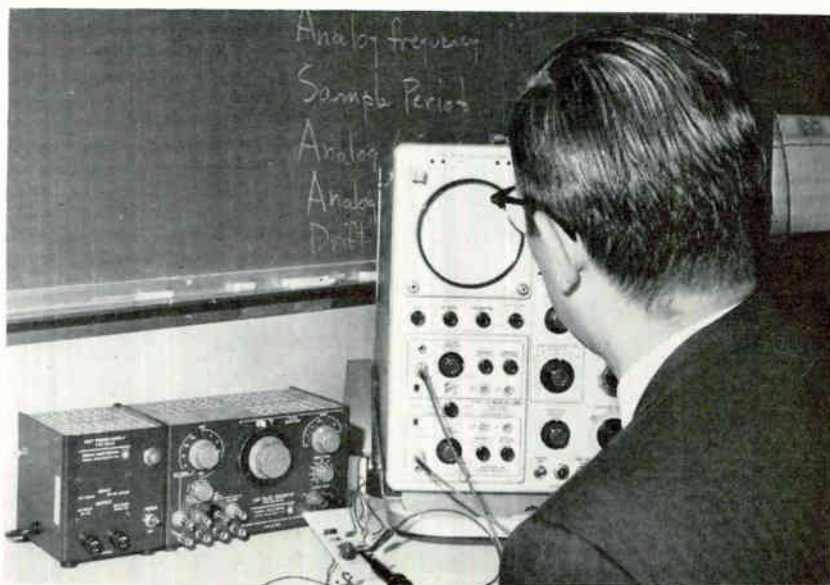

AUTHOR CHECKS OUT line-compensation device (circuit board to left)

ONE-STAGE SCALER NEEDS

By C. A. BUDE, Member Technical Staff, Systems Laboratories, Electronic Specialty Co., Los Angeles, Calif.

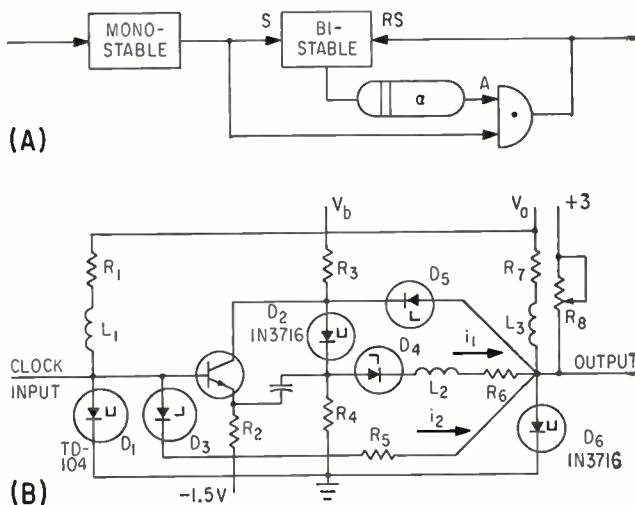

SIMPLICITY of concept is apparent in block representation (A) as well as in detailed circuit diagram (B)—Fig. 1

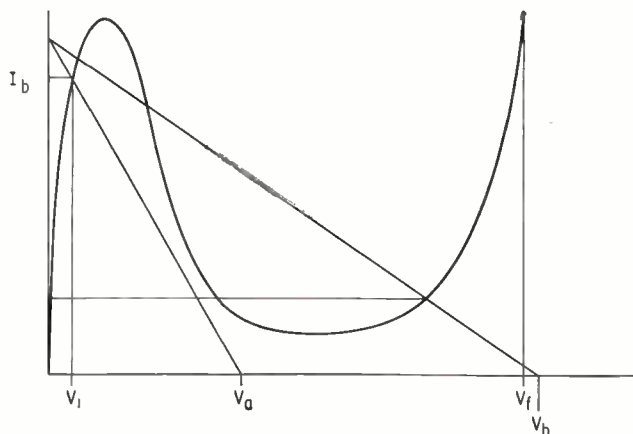

TUNNEL DIODE curves with parameter designations are used to clarify design equations in text—Fig. 2

DEVELOPMENT of a scaler whose base number is something other than 2, 4, 8, etc., generally requires the use of flip-flops and employs special feedback circuitry.

A scale of n has now been achieved in one stage with tunnel diodes. The circuit, shown in Fig. 1 comprises a monopulser to shape the input to the desired amplitude and width, a bistable serving as a memory element and an AND gate that produces an output when the sum of the currents at its input exceeds a certain level.

Operation is simple as explained below. When power is first applied, the bistable stage is in the set state. It can be assumed that the current is maximum at point A in Fig. 1A. The clock triggers the monopulser, which delivers a current pulse to the bistable and the AND gate. The sum of the currents at the input to the AND gate is now high enough to develop an output that is used to reset the bistable, causing the current at A to collapse.

The next clock pulse sets the bistable, which in turn delivers a current to A after being delayed by $N/f_o - 0.5/f_o$ seconds, where f_o is the clock frequency and N is the number by which it is to be divided. The pulse output of the AND gate, should be somewhat longer than the output of the monopulser and in the circuit described is 100 nanoseconds. The common-collector transistor is used as a buffer to relax the load imposed on the monopulser. The circuit shown was operated as a scale of 5 to 10 Mc ± 1 Mc from -55 to $+100$ C.

Scale Change—The scale factor is easily changed within practical limits by different values of L_2 . These limitations are a function of ambient temperature variation, stability of input pulse repetition rate and the percentage of total AND gate input current contributed by i_1 . The maximum limit on N was found empirically to be 8, at 10 Mc ± 0.1 percent, although calculations indicate a value of 10. The maximum limit can be left to the discretion of the designer. It is worth noting that while this technique is applicable to other input rates, with direct consideration given

NO COMPLEX FEEDBACK

Conventional flip-flop plus feedback can now be bypassed

the delay that governs N , it is most useful at high input rates where power consumption and loop delays become appreciable. The minimum value of N is 2. Two or more scalars may be coupled together to increase the scale factor.

Scaling Increase—Under this condition the monopulser may be omitted from subsequent stages since the output of the AND gate is a single pulse and can substitute for the monopulser. Presently a scale of 2 at 200 Mc is being undertaken. However, no data are yet available.

The design figures for the monopulser shown below refer to designations both in Fig. 1 and 2.

$R_8 = V_1/I_b = 5(10^{-1})/8(10^{-3}) = 6.25$ ohms;
 $R_1 = V_a/I_b - R_8 = 18.75$ ohms where $V_a = 200$ (10^{-3}) volts and V_1 is the quiescent voltage across the tunnel diode D_1 .

Let the output pulse be less than $0.5/f_o$ which at 10 Mc = 50 nsec therefore

let T_a equal 40 nsec. Then, $L_1 = 18.75 [4(10^{-8})] = 0.75(10^{-6})$ h

The bistable stage parameters are outlined. $R_2 = 0.4 V_b/i_1 = 266.4$ ohms

where, V_o is the 100-millivolt forward drop of the tunnel rectifier and V_b is 500 millivolts, letting $I_b = 3.8$ ma, $R_4 = 0.4 V_b/(I_b - i_1) = 65.6$ ohms and i_1 is the input to the AND gate.

$$R_t = R_8 R_4 / (R_8 + R_4) = 54.4 \text{ ohms}$$

$$R_3 = \frac{V_b - (0.4V_b + V_1)}{I_b} = 68.5 \text{ ohms}$$

Checking, $I_b = (V_b - V_1)/(R_t + R_3) = 3.78$ ma

AND Gate Design—Because a ± 10 percent peak-current tunnel diode is used here, underbiasing and current trimming compensates for large variation in I_p from unit to unit.

A GE 1N3716 is used here as well as in the bistable (I_p min = 4.2 ma I_p max = 4.7 ma). The bias is set at 3 ma with each fan-in supplying an additional 750 microampres.

THE VERSATILE TUNNEL DIODE

The tunnel diode finds another use in the scale-of- n device that replaces more conventional combinations of flip-flops with special feedback circuits. The circuit described in the article has been operated up to 10 Mc at a scale of 5. Scale factor can be changed within practical limits by substituting one inductor. Moreover, operation is possible from -55 to $+100$ C with power supply variations of ± 10 percent

$$\begin{aligned} R_8 &= V_1/I_b = 16.6 \text{ ohms} \\ R_7 &= V_a/I_b - R_8 = 50 \text{ ohms} \\ L_3 &= R_7 T_2 = 50(10^{-7}) \text{ h} \\ R_6 &= (0.4V_b - V_o)/7.5(10^{-4}) = 133.3 \text{ ohms} \\ R_5 &= (V_f - V_o)/7.5(10^{-4}) = 467 \text{ ohms} \end{aligned}$$

Current trimming is supplied by R_8 in conjunction with $+3$ volts.

Delay—A linear rate of rise is assumed for the current in the inductor, which proves to be satisfactory for this application, since current trimming is used. The amount of delay is given by $(N/f_o) - (0.5/f_o)$ sec where N is the scaling number and for this example is taken to be 5 while f_o is 10 Mc. The delay is therefore 450 nsec

$$L_2 = 4.5(10^{-7}) 133.3 = 60(10^{-6}) \text{ h}$$

The value of C is given by

$$C = \frac{[(0.4V_b/R_4) 0.5T_1]}{V_f} = 0.89(10^{-10}) \text{ farad}$$

Since the calculated values were not available, nearest values were used and proper consideration given to bias changes.

The R_2C time constant should be less than $1/f_o$. Therefore, R_2 is 1,125 ohms.

$$\begin{aligned} R_1 &= 18 \text{ ohms} & D_3, D_4, D_5 &= BD - 4 (GE) \\ R_2 &= 1.1K & L_1 &= 0.68 \mu\text{h} \\ R_3 &= 68 \text{ ohms} & L_2 &= 62 \mu\text{h} \\ R_4 &= 68 \text{ ohms} & L_3 &= 56 \mu\text{h} \\ R_5 &= 470 \text{ ohms} & V_a &= 200 \text{ mv} \pm 10 \text{ percent} \\ R_6 &= 130 \text{ ohms} & V_b &= 500 \text{ mv} \pm 20 \text{ percent} \\ R_7 &= 51 \text{ ohms} & C &= 82 \text{ pf} \\ R_8 &= 10K & & \end{aligned}$$

Fast AGC Amplifier

Locks Monopulse Radar on

There are numerous ways to keep a radar antenna locked on a moving target. Here is one method that uses monopulse-normalizing amplifier control voltages for antenna reorientation

By **W. W. SMITH**
Lincoln Laboratory*,
Massachusetts Institute of Technology
Lexington, Mass.

THIS MONOPULSE amplifier is part of a monopulse radar system. Attack time of agc is fast enough to permit the radar signal to be processed pulse by pulse and d-c coupling of control voltages allows the unit to be used for c-w signals. A signal applied to one channel produces binary information to the gain of other channels so that they have identical gain. The amplifier has 80 db of agc and will accept signals that vary between 1 millivolt and 10 volts, peak to peak and provide an output that is always constant within $\frac{1}{2}$ db of 10 volts.

Three signals are fed to the amplifier from the antenna and receiver front ends. After frequency conversion, they enter the normalizing amplifier channels at 200 kc. One of these channels is the sum or reference channel; when the antenna is pointed directly at the target, the signal is strong here and weak or nonexistent in the elevation and azimuth error channels. As the target moves from the center of the beam, the reference signal slowly drops. At the same time, the signal in the elevation and/or azimuth channels rapidly rises. The ratio between the error and reference channels is nearly proportional to the angular error and can be used to

develop a control voltage to reorient the antenna.

If the output of the reference channel is always held constant, and same amount of amplification is applied to the other two channels, the elevation and azimuth-error channel outputs are the desired ratios. Thus, the reference-channel amplifier has been designed to hold the output to within less than one db of 10 volts peak to peak although the input may vary over 80 db. This wide range prevents overloading the amplifiers under all operating conditions.

An initial survey of literature suggested a promising point of departure for the design of the amplifiers. Methods were described for combining silicon and germanium diodes with resistors so that agc currents can control circuit resistance with reasonable linearity. The addition of series resistance yields an electrically variable attenuator that can control the input of a fixed-gain semiconductor amplifier. An analog system based on this principle yielded encouraging results. However, two shortcomings caused consideration to be given to a digital solution of the problem. The diode combinations had to be carefully tailored, and the necessity for relatively heavy filtering of the agc current caused sluggish controlling action.

Operation—Consideration of digital techniques seemed to indicate that a digital solution was too cumbersome to be practical, and a novel adapta-

tion of the principle eliminated this objection.

In an amplifier consisting of 160 cascaded stages, each stage can be switched so it has a gain of either half a db or unity. A slicer that measures the amplitude of the signal and produces a gate if a predetermined reference level is exceeded, precedes each stage. This gate switches the stage from an amplifying condition to a condition where the signal passes through unchanged. The minimum signal (in this case 1 mv) will produce no gates but will be amplified in turn by each of the 160 stages. Thus, it will have the full 80-db gain of the amplifier applied to it, producing an output of 10 volts. If the input signal were already at the desired output value (10 volts) however, the first and all following slicers will produce gates and cause the signal to proceed through the chain without amplification. Again, the output will have the desired value (10 volts). For a signal between the two extremes, amplification will begin with the first stage and continue until the signal arrives at a slicer that produces a gate. At this point, since the signal has the desired amplitude, it will not be amplified by the following stage. All following slicers and amplifiers will behave similarly, so no further amplification is applied to the signal.

The amount of amplification required is determined as the signal enters the amplifier. This eliminates any tendency towards oscilla-

* Operated with support from the U. S. Army, Navy and Air Force.

Target

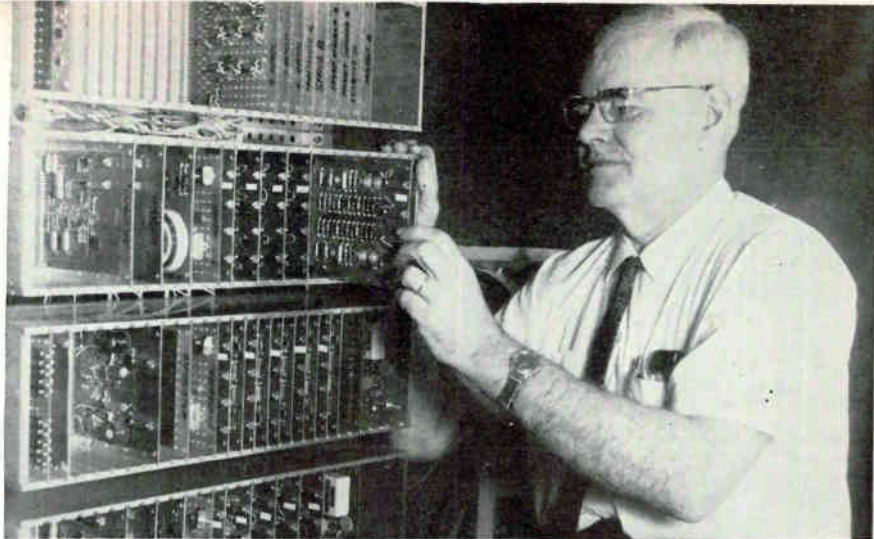

AUTHOR places an amplifier card in the assembly

tion encountered when a control signal is fed back from the output.

Actually, nine stages can be used to do the same job. Instead of 160 half-db stages, we can use four 16-db stages in cascade, followed by an 8-db, 4-db, 2-db, 1-db, and 1/2-db stage. Each stage can be gated to yield nominal gain or to pass the signal through unamplified at unity gain. Thus, large increments of amplification are added at the beginning if needed, and smaller amounts are added later. The signal passes on until sufficient amplification has been applied to bring the output to the desired amplitude. This process differs from the action in the 160-stage amplification in that production of a gate in an early stage does not necessarily mean that gates will be produced in all the following stages. For example, the signal might produce a gate in the fourth 16-db stage (taking 16 db out of the chain) and then be amplified by the remaining 15 1/2 db of amplification. The output would then be 1/2 db below the desired value, which is within the desired tolerance.

Tolerance can be narrowed by the addition of 1/4-db, or even 1/8-db or 1/16-db stages. The 1/2-db stage was tested in this case to demonstrate the validity of the principle, only.

Binary Division—Binary division of the amplification (16, 8, 4, 2, 1, etc.) was chosen so that the gates can furnish amplification data in the form of binary information to a computer. The basic

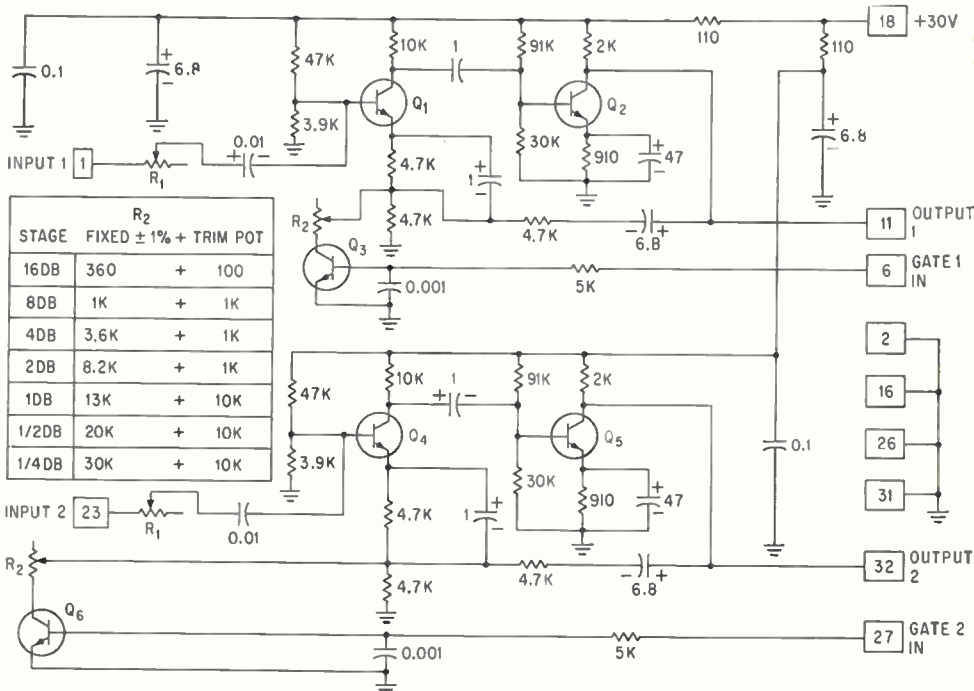

TYPICAL card contains two amplifiers. The table shows how gain may be varied as related to R_2 —Fig. 1

MEASURING AMPLIFIER BANDWIDTH

Measuring the frequency response in order to determine the bandwidth offers some interesting problems. The usual method of applying a variable frequency of constant amplitude to the input and measuring the output breaks down. If the amplitude of the signal should drop due to frequency distortion as it passes through the amplifier, the last stages will promptly generate the appropriate gates to restore the output to its initial level. Consequently, a special set of criteria was devised to get meaningful readings.

A signal of one volt peak-to-peak was applied to the input of the amplifier and the outputs of the first and second 16-db stages were measured. At this level, the first stage is amplifying and the second is passing the signal through with unity gain and one interstage coupling network is included. The second stage is loaded in the normal manner as it is followed by the rest of the chain.

This test showed that the gain is flat within 0.1 db from 43 kc to 300 kc, for either one or two stages. Below 43 kc, the slicing circuits have time to become aware that the signal input is low as it crosses the zero axis between cycles and spikes are added in the amplifier's effort to keep the output constant

amplifier stage uses two transistors and a large amount of negative feedback. This is desirable in any transistor amplifier, to make the gain of the amplifier substantially independent of the gain of the individual transistors. The gain is changed by applying a gate to a third transistor that acts as a switch and shorts out part of the feedback circuit resistance.

Example—The schematic diagram of a typical amplifier card is shown in Fig. 1. There are two stages shown on the card and the output of the first stage (11) is connected externally to the input of the second (23). In considering the first stage only, in the absence of a positive gate, Q_3 is open circuited and can be ignored. The gain of the amplifier is determined by the two unbypassed 4,700-ohm resistors, giving the amplifier an internal gain of 6 db, but the voltage divider comprised of R_1 and the input circuit to Q_1 attenuates the signal by 6 db; thus the stage has an external (from (1) to (11)) gain of unity. This may seem confusing, but is necessary because 100 percent feedback, that will produce unity gain without the attenuator, causes amplifier instability. However, since neither the input (1) nor the output (11) is aware of this subterfuge, the amplifier still has the necessary gain requirements.

When a positive gate is applied to terminal (6), Q_3 conducts to the point where it becomes saturated. This shunts R_2 in parallel with one of the 4,700-ohm resistors and decreases the feedback applied to Q_1 . As the table shows, R_2 can be adjusted to obtain the desired gain. Internally, the 16-db stage will have a gain of $16 + 22$ db.

The slicers are shown in Fig. 2. Again, two stages are built into one card. Considering only the first stage, the input (1) is tied externally to the input of the first amplifier. Thus, both cards receive the signal simultaneously. Q_1 is an emitter-follower that isolates the slicer and prevents loading of the signal circuit. The base of Q_3 is grounded, and Q_2 is prevented from conducting by the negative-reference voltage (9) that is applied through the clamping resistor and diode. When the peak-to-peak value of the input signal exceeds the reference voltage, Q_2 will conduct and apply a change to the base of Q_4 . The amplified signal is applied to a Schmitt trigger Q_5 and Q_6 which squares up the signal and applies it to Q_7 . Q_7 then delivers a gate to (6) and thence to the amplifier card. This gate not only swings to about 5 volts positive, but, in the absence of a large input signal, becomes negative with respect to ground by about 5 volts, assuring that the switching transistor in the amplifier

will be left in a nonconducting state. Input (23) of the second stage is connected externally to input (23) of the second amplifier stage. All slicers (control cards) are identical except for applied reference voltages. Application of the appropriate reference voltage will yield any desired slicing level.

Tests show that the amplifier can be used with either pulsed or c-w signals. Moreover, the input can vary from 1 millivolt peak-to-peak to 10 volts while the output is held constant at 10 volts peak-to-peak $\pm 1/2$ db. A change in the signal level that switches only one stage will be corrected within 15μ sec. If a change happens to switch a 16-db stage and several other stages as well, the correction process may take as long as 80μ sec. The phase shift from channel to channel is less than 3 degrees. Measurement of the entire amplifier's bandwidth poses special problems, but with two cascaded stages where one amplifies and the other passes the signal through with unity gain, the output is flat within 0.1 db from 100 to 300 kc. Input impedance is approximately 2,700 ohms, and output impedance about 65 ohms.

The writer wishes to express his appreciation for the many helpful suggestions from his colleagues at Lincoln Laboratory, and particularly to Ernst Gehrels, Gerald Hyde and Leon Kraft.

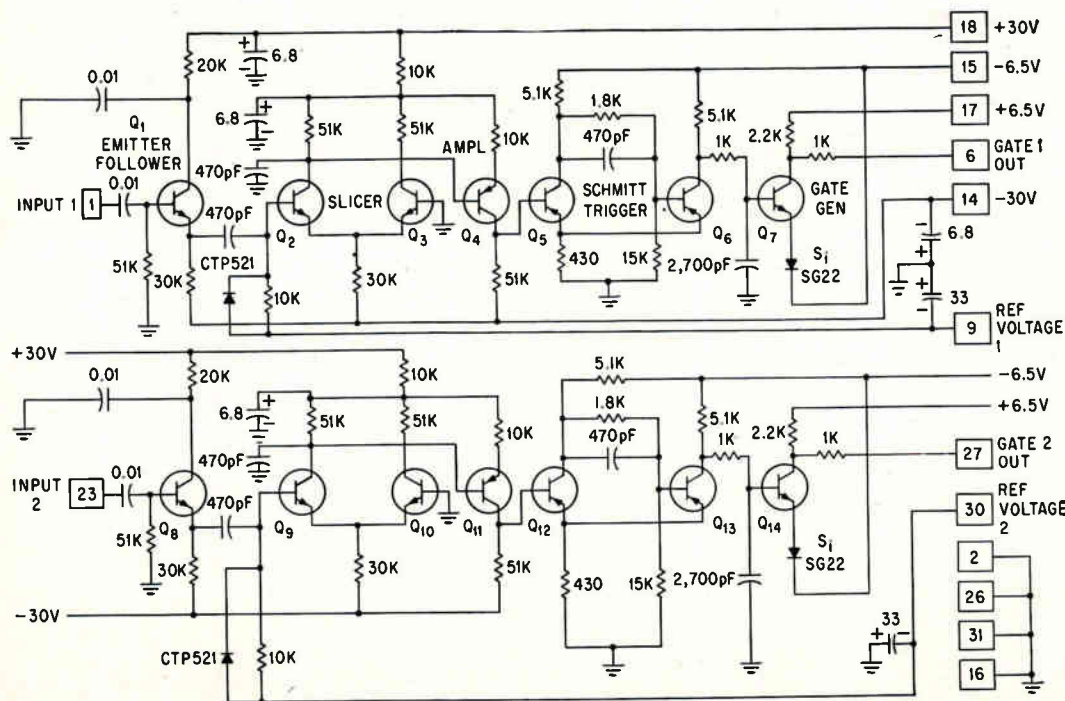

SLICERS are contained in two stages. Reference voltage will determine slicing level—Fig. 2

TO SEE WHAT AIR CAN DO SEE GARDNER-DENVER

In the sixties alone we have added hundreds of new and improved products to our lines of compressors, rock drills, air tools, drilling rigs. So before you invest in new air equipment, find out—from Gardner-Denver—how air can serve you better.

AUTOMATIC *Wire-Wrap*[®] MACHINE CUTS PANEL WIRING COSTS UP TO 93%

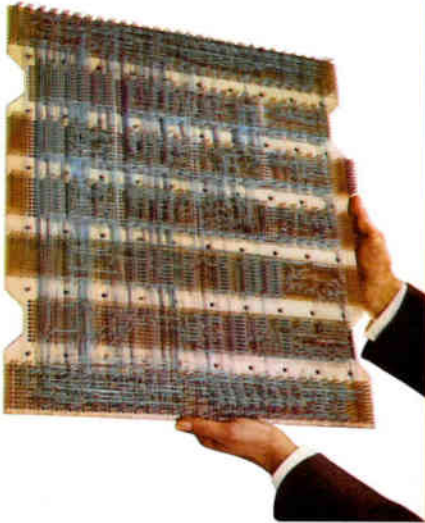

It costs only \$29 to make all connections on a typical 2000-wire panel—using a Gardner-Denver automatic “Wire-Wrap” machine. Old-fashioned hand wiring would cost \$1,000.

You make these solderless wrapped connections at the rate of five seconds per wire. Touch a button. Rotating wrapping bits swiftly make neat, permanent, solderless connections over a circuit pattern automatically controlled from punched cards or tape.



For sure, low-cost automatic electrical and electronic connections, use “Wire-Wrap” machines. They make 'em fast—and they make 'em last. Terminals connected the Gardner-Denver way are paired for keeps. These permanent, solderless connections resist corrosion and vibration for trouble-free circuitry. Proof? More than 15 billion connections without a reported electrical failure. It will pay you to investigate the Gardner-Denver way—with “Wire-Wrap” tools.



KEEP UP-TO-DATE WITH
GARDNER - DENVER
Gardner-Denver Company, Quincy, Illinois

MORE ABOUT
Wire-Wrap

TO SEE WHAT AIR CAN DO SEE GARDNER-DENVER

In the sixties alone we have added hundreds of new and improved products to our lines of compressors, rock drills, air tools, drilling rigs. So before you invest in new air equipment, find out—from Gardner-Denver—how air can serve you better.

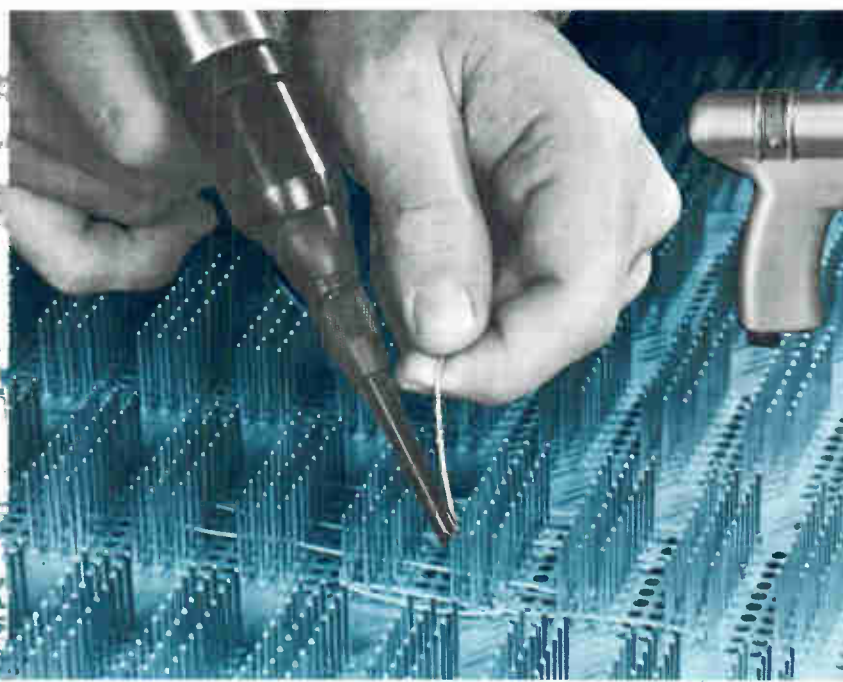

“WIRE-WRAP” TOOLS MAKE CONNECTIONS IN A HURRY—KEPT FREE FROM WORRY

“Wire-Wrap” tools wrap connections in only three seconds (actual wrapping time .3 seconds). That’s speed that means dollar savings to you—in production assembly, in the wiring of communications equipment, computers or electrical or electronic assemblies where dependability is equally as important as economy. Because, with “Wire-Wrap” tools, when the connection’s made, the connection stays.



BATTERY-POWERED “WIRE-WRAP” TOOL CARRIES ITS OWN POWER SUPPLY

No power outlets needed. This battery-powered tool brings new convenience to the production line—new freedom to the serviceman. Battery works through a full day’s schedule—recharges overnight. Tool makes the same tight connections as other “Wire-Wrap” tools.



For convenient servicing or making occasional connections with all the assurances and advantages of connections made with powered “Wire-Wrap” tools.

Hand-squeeze “Wire-Wrap” tool



Manual wrapping and unwrapping tools

Get full details. Simply write for Bulletins 14-1, 14-3, 14-121. We’ll also be glad to send you a compilation of articles describing methods of terminal connections made with Gardner-Denver “Wire-Wrap” tools.



KEEP UP-TO-DATE WITH
GARDNER - DENVER
 Gardner-Denver Company, Quincy, Illinois

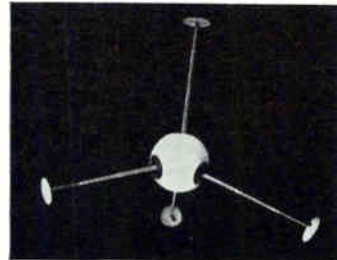
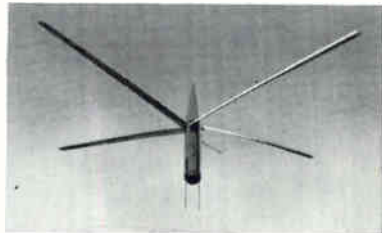
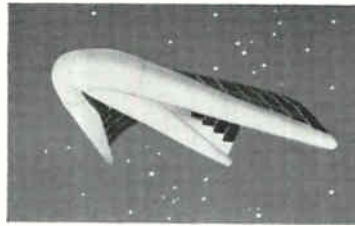

The value of diversity

The men at Space-General are deeply involved in every major area of space technology, from the development of electronic communication systems to complete space vehicles. ■ To the engineer or scientist of above average ability and ambition, this broad front of aerospace endeavor means a special kind of career opportunity. The chance to sink your teeth into a variety of challenging assignments...to gain the diversity of experience increasingly required of aerospace management. ■ *Among Current Projects:* Upper stages and research rocket systems for major space missions...re-entry paragliders for scientific experiments and space recovery... lunar payloads for observation and test... search systems to locate and identify downed objects...space telemetry ... ground communication systems for survival ... bacteriological detection systems...advanced guidance and thrust vector control systems.

There are many outstanding career opportunities at Space-General for engineers and scientists with a B.S. degree or higher and at least two years of experience in any of the following fields:

Hydraulic-Pneumatic Controls Development • Structural Test Analysis • Space Vehicle Design • Guidance and Control Analysis • Heat Transfer-Thermodynamics Analysis • Stress Analysis • Trajectory Analysis and Aerodynamics • Advanced Sensor Research • Bio-Sensor Research • Microwave Research • Nuclear Test Instrumentation • Communication Systems Analysis • Circuit Design ■ Your resume will receive immediate confidential attention. *Send to:* Donald L. Craig, Employment Mgr., Space-General Corp., Dept. No. NP-14, 9200 E. Flair Drive, El Monte, California.

An equal opportunity employer.



SPACE-GENERAL CORPORATION

El Monte, California

A subsidiary of Aerojet-General Corporation

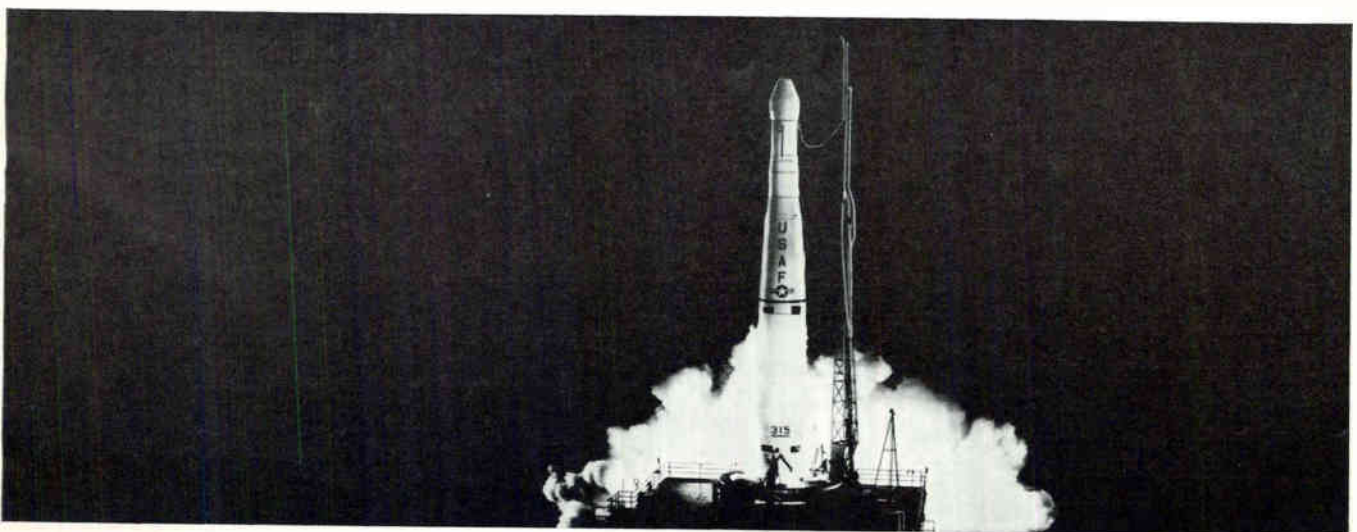

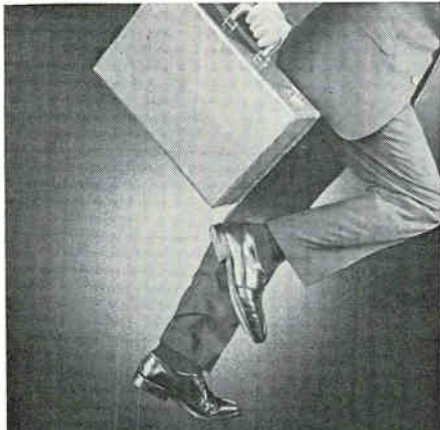

updating in electronics for busy engineers

CREI Extension Programs
fit any schedule

Are irregular hours, travel and family obligations keeping you from attending classes—even though you are fully aware of the danger of technical obsolescence? Check into CREI Special Programs for Engineers. They offer you the opportunity to catch up with new developments in electronics through home study at your own pace, your own schedule. Our free brochure gives full information, details on technical material covered. For your copy, use coupon or write:

CREI, Dept. 3909-A1,
3224 Sixteenth St., N. W.
Washington 10, D. C.



FREE BOOK

The Capitol Radio Engineering Institute



Founded 1927 Accredited Member of
the National Home Study Council
Dept 3909-A1, 3224 Sixteenth St.,
N. W. Washington 10, D. C.

Please send me free brochure describing CREI Special
Program in Electronics for Engineers.

Name _____ Age _____

Address _____

City _____ Zone _____ State _____

Company _____

Title _____

SP-41

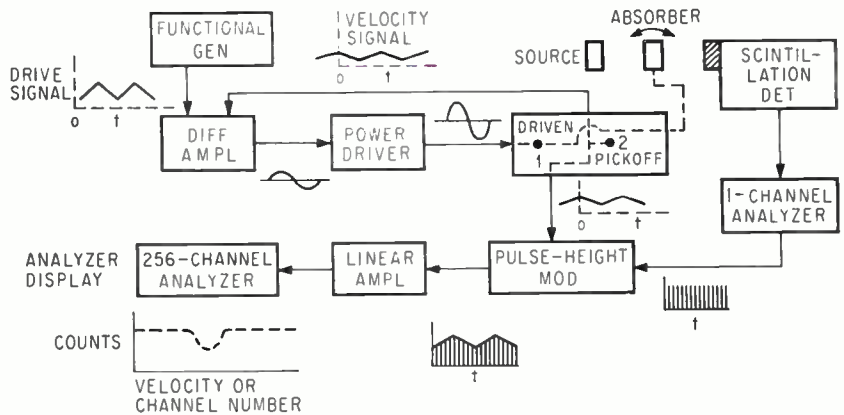

VELOCITY measurement based on Mossbauer effect. This is basic configuration of Martin device that can detect doppler shifts with high sensitivity

Space Round Trips Push

Example: X-band system
that telemeters data
during 100-g reentries

By **ALEXANDER A. MCKENZIE**
Associate Editor

REACHING for the moon in a session titled "Electronics for Apollo," receiving real-time signals through reentry blackout and exploiting vlf as a deep-space communication medium will all be studied next week at Miami Beach during a four-day symposium of IEEE's Professional Technical Group on Space Electronics and Telemetry.

Reentry Telemetry—NASA engineers R. F. Harrington, E. A. Brummer and W. A. Southall, of Goddard Space Flight Center, have attacked the problem in their design of an X-band telemetry system. It functions satisfactorily at 100 g or higher with a rate of 900 samples a second during reentry blackout at speeds up to 25,000 feet a second. The transmitter, using an MXM-16 magnetron, operates at 1-kw peak for 1 μ sec. Pulse rate is 1,800 a second. Its three pound weight makes it suitable for vehicles accommodating 10-pound payloads.

Lockheed California's F. R. Zboril describes Drift (diversity receiving instrumentation for telemetry) that employs f-m/f-m on 4,997, 5,000 and 5,003 Mc. It uses

13 standard IRIG channels from 1.7 through 70 kc, for a total of 39 subcarriers.

Other papers describe Sandia's high-resolution, radiation-proof rocket telemetry at 6 Gc, used in the Dominic nuclear high-altitude tests. Improvements have been engineered by NASA to provide better on-board data storage eliminating wow and flutter that constituted the limiting signal-noise ratio of 27 db. The new system, employing digitizing before recording, has cut the limit to 40 db. Recording rate is 200 bps, nrz, with each bit 5 ms. Playback is at 5,200 bps.

R. E. Leslie, of Airborne Instruments Lab, describes the unique circuit that permits thin-film modular fabrication of a 60-Mc log amplifier operating on a successive-detection principle. A differential arrangement eliminates transformers and tuning inductors.

Airborne Data—Improvement in data resolution, real-time deconvolution, automation of data handling (solved in one case with a core-memory for program storage) are concerns of one session. Improvements are attested by the fact that time-base stability on rotating head recorders has been pushed to ± 10 nanoseconds. General Electric's M. Berkowitz will report on an adaptive data sampling approach that tests for change in signal level from one sample to the next against *a priori* preprogrammed criteria so

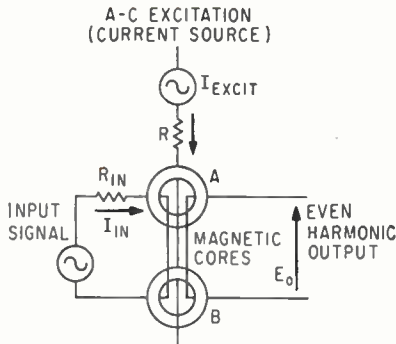

BASIC magnetic-core modulator multiplexer described by M. C. Kidd and A. G. Atwood, of RCA Aerospace. Switching speed is independent of input-circuit time constant

Techniques

as to limit transmission only to changed data.

Mossbauer Effect—This phenomenon has been employed by R. B. Matthews and J. G. Henderson, of the Baltimore division of Martin, as a velocity-measurement device. The basic configuration is illustrated and depends upon applying the Mossbauer effect of nuclear resonance at gamma frequencies. Doppler systems operating at r-f are adversely affected by attenuation problems at gamma-ray frequencies (10^{10}). Until recently, doppler shifts at gamma frequencies were unmeasurable, but the Mossbauer approach permits detecting shifts to one part in 10^{12} .

Collins Radio engineers S. E. Watson and W. S. Pope will detail the complex Apollo telecommunications system that must change parameters as it gains distance from earth. Within a few thousand miles vhf using f-m will carry data down and a C-band transponder will aid in radar tracking. Other equipment includes intercom, signal conditioner, pcm telemeter and data storage. At more than a few thousand miles all communications will be by phase-coherent unified S-band transponder. Additional equipments are h-f ssb transceiver and a vhf recovery beacon.

Evidence is mounting that attenuation bands centered in the very low frequencies (10 to 30 kc) exist

LAPP ANTENNA INSULATORS

...in all these standard sizes to save you time and money

RECTANGULAR STRAIN INSULATORS

Porcelain or steatite, in standard "P" dimensions of 4, 6, 8, 10, and 12 in.—other spacings available.

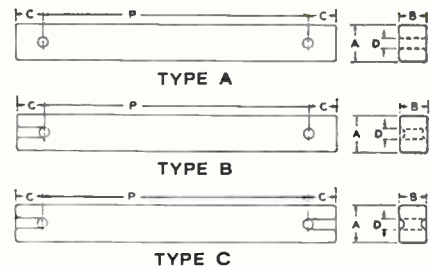

DIMENSIONS IN INCHES

Catalog Number	Material	Type	A	B	C	D	Strength Lbs.
9178	Porcelain	A	1½	1	⅞	1⅜	1500
25381	Steatite	A	1½	1	⅞	1⅜	1800
23959	Porcelain	B	1½	1	1	⅞	1500
25380	Steatite	B	1½	1	1	⅞	1800
26766	Porcelain	C	1½	1	1	⅞	1500
25374	Steatite	C	1½	1	1	⅞	1800

ROUND STRAINS



Porcelain units available in "P" dimensions of 12, 16 and 20 inches. Steatite, in "P" dimensions of 12 and 16 inches.

DIMENSIONS IN INCHES

Catalog Number	Material	A	B	C	D	Strength Lbs.
9175	Porcelain	1⅞	1⅞	⅞	1½	2000
26239	Steatite	1⅞	1⅞	⅞	1½	2300

SPREADERS

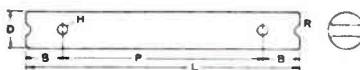

No. 26036 and No. 26223 available in lengths of 4, 6, 8, 10 and 12 inches. No. 9181 and No. 24811 available in lengths of 6, 10 and 12 inches. Other lengths available on special order.

DIMENSIONS IN INCHES

Catalog Number	Material	B	D	H	R
26036	Porcelain	¾	¾	⅞	⅞
26223	Steatite	¾	¾	⅞	⅞
9181	Porcelain	1	1	⅞	⅞
24811	Steatite	1	1	⅞	⅞

SHAPED ANTENNA INSULATORS

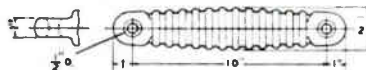

No. 5993, porcelain, 1750 lb. strength; radio rating 25 kv eff.; 60 ω wet flash-over 65 kv eff.

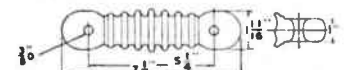

No. 23800, porcelain, 1250 lb. strength; radio rating 18 kv eff.; 60 ω wet flash-over 52 kv eff.

RATINGS FOR RECTANGULAR, ROUND AND SPREADER INSULATORS

"P" Inches	WET FLASHOVER 60 ω kv eff.	RADIO RATING kv eff.	
		Porcelain	Steatite
4	26	18	36
6	36	22	44
8	45	24	48
10	55	25	50
16	80	25	50
30	125	25	50

Lapp

WRITE for Bulletin 301-R
Lapp Insulator Co., Inc.,
209 Sumner Street, LeRoy, N. Y.

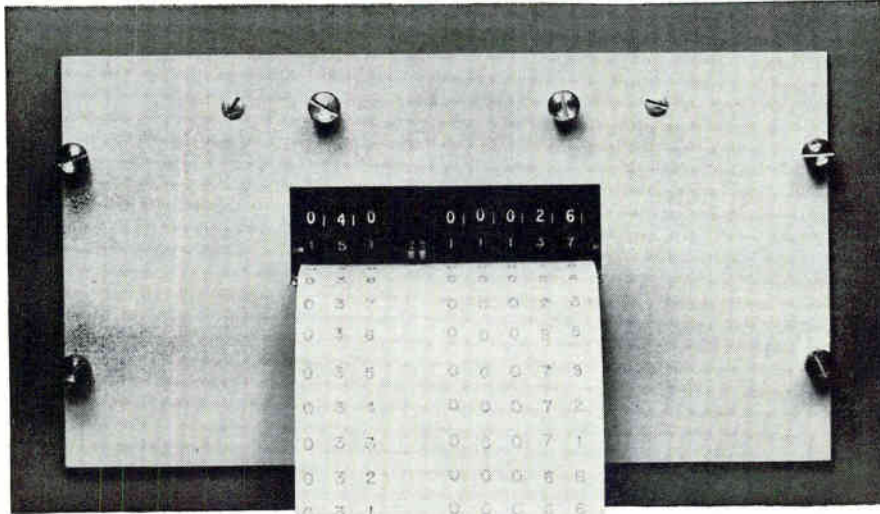

A Digital Printer for as little as \$258

Designed for custom use, the Texas Instruments Count Printer is a simple, low cost instrument capable of accumulating sequential input pulses at 600/minute. The accumulated total can be printed up to 60 times/minute on ordinary 3-inch adding machine tape . . . both dial total and last printed total are immediately vis-

ible. Compactly assembled on a 4 $\frac{3}{16}$ " by 7 $\frac{1}{16}$ " panel, the Count Printer is less than 7" deep and weighs only 3 $\frac{1}{2}$ pounds. It is available with either one or two in-line count channels for a-c or d-c operation. Each channel has independent count and reset functions. Prices start at \$258 list. Write for full information.

INDUSTRIAL
PRODUCTS
GROUP



TEXAS INSTRUMENTS
INCORPORATED
P. O. BOX 66027 HOUSTON 6, TEXAS

SENSING • RECORDING • TESTING • DIGITIZING INSTRUMENTS
THE INSTRUMENTS OF TEXAS INSTRUMENTS

564

CIRCLE 42 ON READER SERVICE CARD

**WANT TO
DO BUSINESS
WITH THE
GOVERNMENT ????????**

Then check the Military and Government Procurement Guide in the orange section of your **ELECTRONICS BUYERS' GUIDE**.

around the planets and the sun. If vlf communications can be exploited, communication over vast ranges of space might be achieved with great reliability and elimination of antenna problems. These exciting possibilities will be discussed by J. Z. Farber and G. Biernson, of Sylvania Electronic Systems.

Lunar Landing—One scheme for a high resolution system to be used in lunar and planetary landing-site selection is the product of Bendix Research Labs. J. C. Dawson and W. N. Gamber conceive a high-resolution radar with a special processor operating on the signals from parallel narrow-band receivers over an area 500 feet square at 1,000 feet in 30 seconds hover time.

Japan Weighs Tax Break As Spur to Research

TOKYO — The Science and Technology Agency wants the government to give industry a tax break on funds spent for R & D. It wants a 10-percent exemption on R&D expenditures, a depletion rate of 100 percent on research equipment, and extension for another three years of exemptions on income from technical exports and consulting fees.

Gathering Sea Data



ASWEPS (ASW environmental prediction system) equipment developed by Bisset-Berman Corp. for Navy includes automatic winch that lowers transducer housing into water, ocean depth, salinity, temperature and sound velocity transducer package, and ship-deck shelter containing data processing gear. System will enable all-weather gathering of oceanographic data. Photo shows winch in action during test



The Defense Dollar: Who spends it? Who gets it?

The obvious answer to the first question is government, of course. In the next fiscal year, over 23 billion defense dollars will be spent by the government on contracts for the goods and services of U.S. companies.

But government is not the only customer for the defense marketer. Industry itself is the other important customer. And, for many thousands of companies, industry is the *more important* customer.

Consider these facts. Only 100 U.S. firms—the leading defense contractors—account for three-fourths of the dollar value of all *prime* defense contracts. But half the dollar value of prime contracts is *sub-contracted*—more than \$11 billion in 1961. It is

conservatively estimated that over 100,000 firms compete for the many billions of dollars of sub-contracts.

In this complex field, how can you reach *both* buying influences—government and industry—most efficiently? In **BUSINESS WEEK**, the magazine that reaches the greatest concentration of management decision-makers.

BUSINESS WEEK reaches 8,389 high-level government subscribers every week. (Your **BUSINESS WEEK** District Manager will be glad to show you a list of their names.) **BUSINESS WEEK** also reaches management executives in every one of the top 100 companies doing defense business with the government. 36,266 subscribers—an average of 363 **BUSINESS**

WEEK subscribers per company!

Not only can your advertising in **BUSINESS WEEK** tell leading defense contractors about your capabilities, it can also promote—to all industry—the future commercial applications of your products and services to help you diversify and grow.

If you bid for the defense dollar—and want the most effectiveness for your *advertising dollar*—your message belongs in...

BUSINESSWEEK
A McGraw-Hill Magazine



Automatic Computer Identifies Color

Calculates exact color in two minutes; sensitivity exceeds human eye

COMBINING a recording precision spectrophotometer with a digital computer, a new unit developed by Toshiba's Central Research Laboratory, called the CC-1 Color Computer, automatically draws a spectral curve of an object's color, and then automatically computes and prints out the results in five-digit numbers on tape.

Intended for identifying, selecting and controlling exact color shades, the new instrument is said to be capable of distinguishing 100 million different colors, among them over 8 million different shades of red. Toshiba says the instrument is the first that has a color discriminating ability exceeding that of the human eye, and is many times faster and more efficient than previous colorimetric methods.

Standard Output—In addition to an automatically plotted spectral curve, color information is printed out in the standard tristimulus value numbers, obtained by a modified selected-wavelength method. Under standard conditions of illumination, the spectral relative reflectance (or transmittance) of a color sample is measured for a large number (885) of selected wavelengths, using a recording spectrophotometer with a range of 380 to 760 millimicrons, with an electrical control for constant spectral bandwidth of 2 to 5 millimicrons for each line. Values of selected wavelengths are then taken from the resulting curve, and converted by an analog-to-digital converter circuit into series of digital pulses, allowing 500 pulses for a full-scale value.

The pulse trains are then fed into the fully transistorized computer, and a summation is carried out to



COLOR COMPUTER comprises four major units: electronic tristimulus integrator with digital tube display, extreme left; voltage stabilizer and output printer, center, optical portion of recording spectrophotometer, top right, and electronic portion of recording spectrophotometer, bottom right

obtain the standard tristimulus values X, Y, Z that describe color in terms of human vision. The three numbers are displayed on digital display tubes, as well as printed out on paper tape.

Matching Colors—Color matching is performed by matching the three tristimulus values, or, for very criti-

cal cases, by comparing the photometric values for each wavelength. This can be done by comparing the two spectral curves.

The determination of color by the color computer is said to be accurate to within 0.2 percent, while the discriminating ability of the human eye is 0.3 percent, in terms of spectrophotometric value.

Martin Develops New Cosmic Ray Device

TWO additional cosmic-ray experiments are being prepared for Air Force satellite launching by Martin Company's Research Institute for Advanced Studies in Baltimore.

The experiments will measure a neutron field forming the "albedo" — those neutrons, found in a region relatively close to the earth, which are produced by interactions between primary cosmic rays and the earth's upper atmosphere. Scien-

tists believe this field may be the source of the Van Allen radiation belts.

Each experiment carries two neutron counters, designed to make independent measurements of fast neutrons and the total neutron density in the orbital path.

"The decay of the neutrons apparently supplies charged particles that eventually become trapped in the magnetic field around the earth

to form the Van Allen radiation belt," said J. P. Martin of the Martin Research Institute. "We can check the data from consecutive orbits to find short-term variations in the albedo flux, and compare records from different satellites to see long-term variations. By studying the interrelationship of information from all the experiments, we hope to get a clearer picture of the albedo as a source of the radiation belts."

Fuel Cell Will Orbit In Air Force Satellite

HYDROGEN-OXYGEN fuel cell system, designed and built by Allis-Chalmers, will soon orbit the earth, according to the Air Force.

Marking the first time a functioning electrical power source of this type is rocketed into space, the 50-watt fuel cell, said P. A. Joyner of Allis-Chalmers research division, is a logical step in finding a more compact and reliable source of space power. Up to now, batteries and solar cells have been predominating.

The self-contained unit is designed to operate at the 50-watt level for the duration of a 50-hour flight. It is equipped with automatic temperature control. A prototype has passed extensive zero-gravity tests aboard a KC-135 jet at Air Force's Aeronautical Systems Division in Dayton. The system has also undergone vibration, acceleration and thermal vacuum tests.



FUEL CELL system by Allis-Chalmers for space applications, exhibited for the first time at Air Force Association's annual Aerospace Panorama in Washington

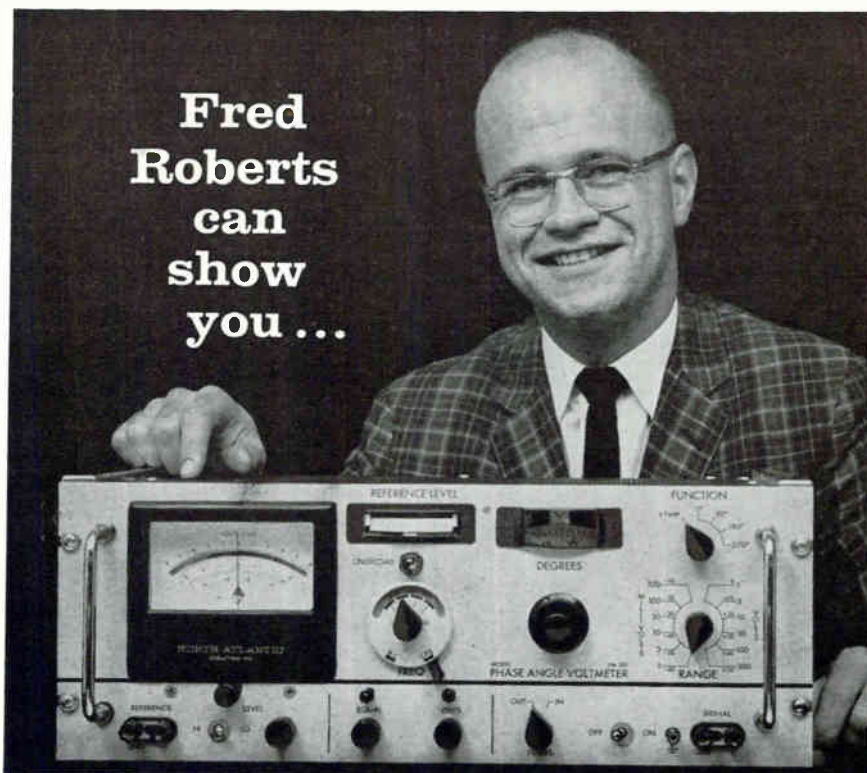

**Fred
Roberts
can
show
you ...**

Director of Marketing, North Atlantic Industries

how to measure in-phase, quadrature and angle while sweeping frequency to 100 kc

North Atlantic's latest addition to the PAV line of Phase Angle Voltmeters* enables you to make measurements while frequency is varying over half-decades without recalibration. The VM-301 Broadband Phase Angle Voltmeter* provides complete coverage from 10 cps to 100 kc, and incorporates plug-in filters to reduce the effects of harmonics in the range of 50 cps to 10 kc with only 16 sets of filters. Vibration analysis and servo analysis are only two of the many applications for this unit. Abridged specifications are listed below:

Voltage Range	1 mv to 300 volts full scale
Voltage Accuracy	2% full scale
Phase Dial Range	0° to 90° with 0.1° resolution (plus 4 quadrants)
Phase Accuracy	0.3°
Input Impedance	10 megohms, 30μf for all ranges (signal and reference inputs)
Reference Level Range	0.15 to 130 volts
Harmonic Rejection	50 db
Nulling Sensitivity	less than 2 microvolts
Size	19" x 7" x 10" deep
Price	\$1750.00 plus \$120.00 per set of filters

North Atlantic's sales representative in your area can tell you all about this unit as well as other Phase Angle Voltmeters* for both production test and ground support applications. Send for our data sheet today.

**Trademark*



NORTH ATLANTIC industries, inc.
TERMINAL DRIVE, PLAINVIEW, L. I., NEW YORK • OVERbrook 1-8600

New FILM-THIN Copper-clad Laminates for space-saver or multi- layer printed circuits



Synthane copper-clad laminates are now being produced with a base laminate of only .0035" and up—with 1 or 2 oz. cladding available on one or both sides. A pre-impregnated glass cloth with epoxy resin filler is also available for bonding multi-layer circuits. These new materials are produced under clean room conditions. Property values are comparable to military specs for the same materials in standard thicknesses. Write for folder of Synthane metal-clad laminates.

SYNTHANE

CORPORATION **S** OAKS, PENNA.

Glendale 2-2211 (Area Code 215) TWX 215-666-0589
Synthane-Pacific, 818 W. Garfield Ave., Glendale 4, Calif. TWX GDL 4417U

Synthane Corporation, 36 River Rd., Oaks, Pa.
Gentlemen:
Please send me Synthane metal-clad laminates folder.

Name _____

Address _____

City _____ Zone _____ State _____

0.25% ACCURACY
BURN-OUT PROOF
SHOCKPROOF



NEW SOLID STATE DC VOLTMETER

K-mag 800 is the first burn-out proof and shockproof precision DC voltmeter with $\pm 0.25\%$ accuracy on all ranges. Measurements are in nine ranges from 0-0.1 to 0-1000 volts, with overload insensitivity on all ranges. The instrument uses a special second-harmonic magnetic amplifier that has extreme linearity and gain stability, and no zero drift. High input impedance allows the K-mag 800 to be used without a transfer standard. Taut-band meter with mirror scale plate and 100 graduations assures fast, accurate reading without interpolation. Magnetic amplifier, taut-band meter, and solid state circuits make the K-mag 800 the most rugged DC voltmeter—and the most rugged is the most versatile. Request Bulletin 800 from Keinath Instrument Company, 1313 Chesapeake Avenue, Columbus 12, Ohio.

KEINATH INSTRUMENT COMPANY
SUBSIDIARY OF AMERICAN BRAKE SHOE COMPANY



CIRCLE 201 ON READER SERVICE CARD

DAVERS INFRARED

EARLY WARNING
MISSILE GUIDANCE
SEARCH TRACK
THERMAL MAPPING
RECOGNITION

Mosaic arrays and single element photovoltaic indium antimonide infrared detectors are now available with unequalled sensitivities. Take advantage of our custom detector capabilities and diversified experience—let Davers quote on your requirements.

DAVERS

Corporation □ Horsham, Penna.

THE SOURCE FOR INFRARED DETECTORS

CIRCLE 202 ON READER SERVICE CARD
SEPTEMBER 27, 1963 • electronics

Novel BWO Doesn't Use Magnet

By R. H. OHTOMO, Varian Associates, Palo Alto, California

Electrostatic focusing leads to lighter weight in x-band device

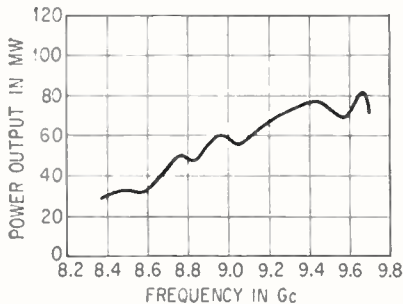

POWER OUTPUT versus frequency curve for a V-180A bwo—Fig. 1

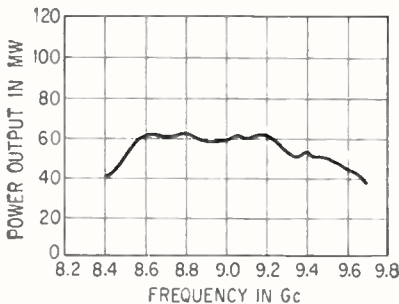

POWER OUTPUT versus frequency curve for a V-180B bwo—Fig. 2

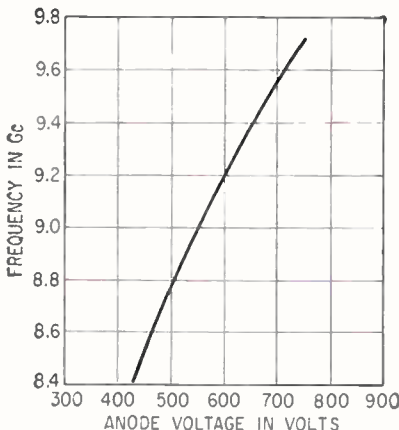

TYPICAL ANODE voltage versus frequency curve for V-180A bwo—Fig. 3

ELECTROSTATICALLY focused backward-wave oscillator (bwo) with characteristics competitive with the reflex klystron has been developed at Varian Associates. The model VA-180A bwo has two coaxial outputs each delivering a minimum of 20 mw over the frequency range of 8.5 to 9.6 Gc. Another model, the VA-180B, has a single waveguide output, and has delivered a minimum of 40 mw over the same frequency range.

One of the fundamental limitations of a reflex klystron is its narrow electronic tuning range and the rather cumbersome mechanical tuning required for wide frequency coverage. Modern systems requiring frequency diversity are continually demanding larger electronic tuning ranges. The backward-wave oscillator could provide broad electronic tuning range with extremely rapid tuning rates, but the permanent magnet or solenoid required for beam focusing has been a drawback. In addition, the intense magnetic field required that the tube be

shielded from other magnetic materials in the immediate vicinity.

It has been demonstrated that an electron beam suitable for use in a bwo could be focused by a periodic electrostatic lens system such as a bifilar helix, and that the desired r-f field could be supported on the same structure. The bifilar helix thus simultaneously serves as the r-f structure and the focusing structure. The magnet, which constituted most of the bulk and weight of the package, can thereby be eliminated. The shielding problem has also been eliminated by making the tube body from a material which protects the beam from any stray magnetic fields. In addition to the small size and light weight, the VA-180's have demonstrated that other desirable features such as low voltage, smooth power output, low noise, and low spurious outputs can be achieved in an electrostatically-focused bwo.

Electrostatic Focus — A hollow electron beam is used in the VA-180. A control grid determines

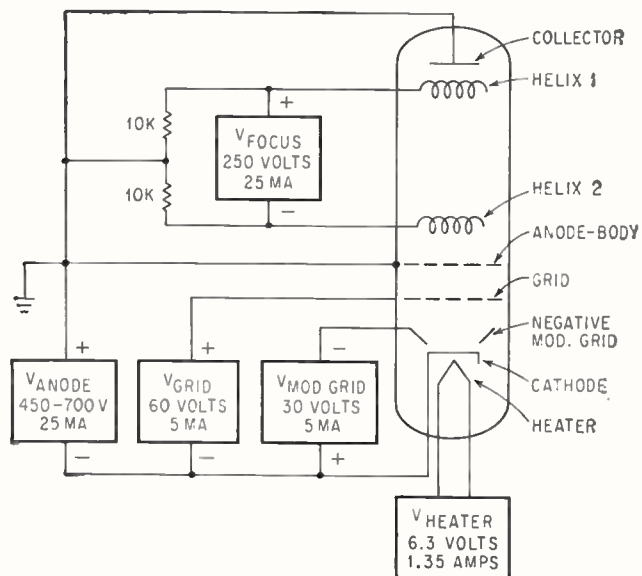

TYPICAL POWER connections for operation of electrostatically focused bwo—Fig. 4

COMINCO

HIGH PURITY METALS
AVAILABLE FORMS

clip and save

Product	ALUMINUM	ANTIMONY	ARSENIC	BISMUTH	CADMIUM	GOLD	INDIUM	LEAD	SILVER	TIN	ZINC
BARS	✓	✓	✓	✓	✓	✓	✓	✓	✓	✓	✓
SHEETS	✓					✓	✓	✓	✓	✓	✓
WIRE	✓					✓	✓	✓	✓	✓	✓
POWDER		✓	✓	✓	✓	✓	✓	✓	✓	✓	✓
SHOT		✓		✓	✓	✓	✓	✓	✓	✓	✓
ROD	✓			✓	✓	✓	✓	✓	✓	✓	✓
RIBBON							✓	✓			
PRE-FORMS	✓					✓	✓	✓	✓	✓	✓
SALTS					✓		✓				

COMINCO PRODUCTS, INC.

electronic materials division

933 West Third Avenue, Spokane 4, Washington
Phone Area Code 509 RI 7-7103 • TWX 509 328-1207

3602

CIRCLE 203 ON READER SERVICE CARD



VARIAN V-180B electrostatically focused bwo—Fig. 5

the current level, and an anode establishes the proper electron velocity. Frequency is tuned by varying the cathode to anode voltage; typically 450 to 700 volts for 8.5 to 9.6 Gc tuning. Focusing is achieved by maintaining a d-c potential difference, typically 250 volts, between the helices. The inward force due to the electrostatic lenses set up by the focusing voltage then balances the outward space-charge force of the electron beam. The focusing voltage is constant for operation in the 8.5 to 9.6 Gc range. Wider tuning range can be obtained by programming the focusing voltage such that it varies linearly with the tuning voltage.

In the case of the VA-180A, power from the bifilar helix is taken out separately in two N-type coaxial outputs. The two outputs are 180° out of phase since the bifilar helix is operating in the antisymmetric mode. This phase relationship could be useful in driving balanced systems. In the VA-180B, the two outputs are combined in a single waveguide output. Power output curves for the VA-180A and VA-180B are shown in Figures 1 and 2 respectively. Both tube types have the same tuning curve. Figure 3 shows a typical curve for the VA-180A.

Power Supply — A typical power supply arrangement together with a schematic diagram of the tube is shown in Figure 4. The focusing voltage is kept constant and the center tap of the bleeder resistor is connected to ground to establish the positive and negative voltages on the helices with respect to ground. There is secondary emis-

OPTICAL BENCHES AND ACCESSORIES



SECOND HARMONIC GENERATOR CONVERTS RED LASER LIGHT TO BLUE.

COVER PICTURE FROM ELECTRONICS MAY 10, 1963

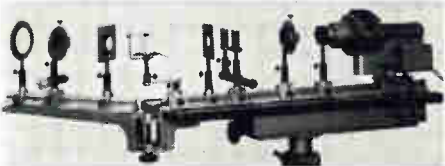

STRAIGHTNESS TO 0.1 mm

FOR A DESCRIPTION OF THIS EQUIPMENT ASK FOR OUR FREE CATALOG NO. 80E.

KLINGER SCIENTIFIC APPARATUS
83-45 Parsons Blvd., Jamaica 32, N. Y.
Tel: 212 OLYmpia 7-0335

new concept in HIGH VACUUM MOTORS



Remarkably different design! No rotary feed-through! No contamination, no leakage! Ready now... a dramatically different AC motor designed to provide mechanical motion and carry on manufacturing processes within an ultra-high vacuum system. No coils, electrical leads nor terminals inside the vacuum. No rotary feed-throughs. Will not contaminate the system. Easily degassable, easily cleaned, needs no lubricants. Offers a wide variety of advantageous applications, including sources and mask-changing apparatus in thin-film applications, crystal growing, food processing, and metallurgy. Features interchangeable, stainless steel, non-magnetic gear boxes. Available in several speeds and torques, with choice of Viton, Indium or gold gasket.

For complete descriptive bulletin with specifications and prices, write:
PHOTONICS CORPORATION
Dept. HVM-103
Walker Valley, New York



The Fujitsu 'Aloxcon', A New Electrolytic Capacitor:

sion from the negative to the positive helix and a 20K bleeder resistor is required to maintain the helix voltages under varying conditions. The anode voltage is variable and tunes the frequency. The grid voltage which establishes the current level is constant. The tube has another high impedance negative modulating grid which can be used to modulate the tube. For c-w operation grid is at cathode potential.

Local Oscillator—Experiments have been performed on receiver sensitivity using the VA-180A as a local oscillator. The measurement gives an indication of the noise generated by the oscillator in a 2 mc bandwidth, 30 mc above and below the carrier, which indicates a sensitivity of better than -95 dbm over the entire frequency range. Spurious oscillations were, found to be extremely low, of the order of -70 dbm. Measurements were made using a signal generator as a local oscillator in a receiver setup and comparing the spurious responses to a signal of known amplitude.

Characteristics—A photograph of the VA-180B is shown in Figure 5. Its dimensions are $3\frac{1}{4} \times 2 \times 1\frac{3}{4}$ " and it weighs 8 oz. The VA-180's have shown many characteristics desirable for a practical device suitable for many systems applications where wide electronic tuning range is an important requirement.

Fluid Analog Costs Less Than Electronic Twin

FLUID AMPLIFIER systems—representing a combination of pneumatic and electronic technologies—can have widespread applications in process control and calculating fields, according to a Corning Glass Works spokesman. Evaluation samples of discrete fluid flip-flops and proportional amplifiers are being sold by Corning—off the shelf—for \$10 to \$100 each. Lower prices are envisioned for large-quantity orders. The evaluation samples were designed to show compatibility of fluid amplifiers with photosensitive glass. More complex devices have been made to customer design—most of which are proprietary—the spokesman said.

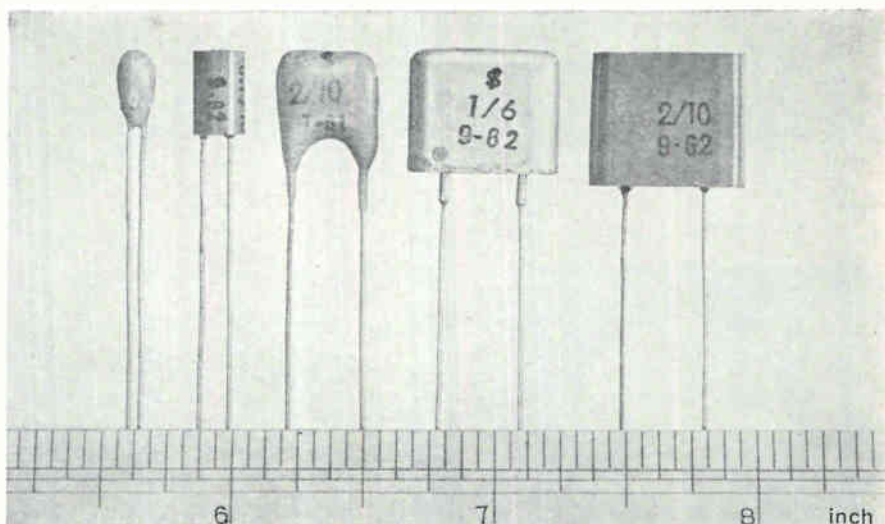

The high quality of tantalum at the low cost of aluminum

Designed for use in printed and transistorized circuits, Fujitsu's newly developed aluminum solid electrolytic capacitor 'Aloxcon' functions effectively at temperatures ranging from -60°C to $+80^{\circ}\text{C}$ and frequencies up to 100 kc or more. A semiconductor layer replaces the usual type of electrolytic and so the capacitance of an 'Aloxcon' is less affected by temperature and frequency than other types. 'Aloxcon' capacitors are highly resistant to moisture, and have low leakage current and extremely high life expectancy. They are ideal for transistor circuits requiring low impedance and miniaturization. Detailed specifications and application data available from our representatives.

Type	Voltage/ Capacitance	Working Voltage (V)		Surge Voltage (V)		Capacitance (mf)					
		6	10	12	30	0.01	0.02	0.05	0.1	0.2	0.5
AZ (Dipped)		6	10	8	12			0.05	0.1	0.2	0.5
GZ (Encased)		25	30	30	30	0.01	0.02	0.05	0.1		
AR (Dipped)		6	10	8	12			0.5	1	2	5
GR (Encased)		25	30	30	30	0.1	0.2	0.5	1	2	5
HR (Hermetically Sealed)		6	10	8	12			0.5	1	2	5
		25	30	30	30	0.1	0.2	0.5	1	2	5



FUJITSU LIMITED

Communications and Electronics

Tokyo, Japan

Represented by: U.S.A. HAR-WELL ASSOCIATES, INC. Southbury, Connecticut, Phone: 264-8222 THE NISSHO PACIFIC CORP. 120 Montgomery St., San Francisco 4, California, Phone: YUkon 2-7901, 7906 Canada: NISSHO (CANADA) LTD. 100 University Avenue, Toronto, Phone: EMpire 2-4794 United Kingdom: WALMORE ELECTRONICS LIMITED 11-15 Betterton Street, Drury Lane, London W.C. 2, Phone: TEMplebar 0201-5 Germany: NEUMÜLLER & CO. GMBH 8 München 13, Schraudolphstr, 2a, Phone: 29 97-24

CIRCLE 49 ON READER SERVICE CARD

**HELP YOUR POST OFFICE
TO SERVE YOU BETTER
BY
MAILING EARLY IN THE DAY
NATIONWIDE IMPROVED MAIL SERVICE
PROGRAM**

Xerography Simplifies P-C Production

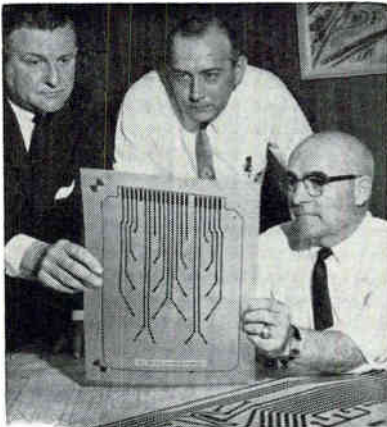

MYLAR MASTER replaces three drawings formerly required to photo etch boards



DRY IMAGE of circuit is transferred from paper to copper in processor to produce chemical resist pattern



DRILLING TEMPLATE made by same master on aluminum or steel provides accurate positioning of required holes for components

Duplicating machine provides chemical resist, reduces artwork

XEROGRAPHY has enabled General Signal Company, Rochester, N. Y., to reduce time needed to produce printed circuit boards from over six weeks to about two days, says Fred Isley, of Xerox Corporation.

This technique developed by W. F. Harman, chief draftsman, and George Alexander, supervising draftsman, of General Signal Company completes required art work in 12 hours. Circuit boards, engineering drawings and templates all stem directly from one master.

Standard Xerox equipment is used to affix chemical-resist images on copper. A copper-clad laminate can be prepared for etching in about 15 minutes.

Except for etching, the process is completely dry, requiring neither liquid chemicals nor darkroom facilities. Xerography's inherent black-powder image is transferred electrostatically to the copper side of the circuit to become an exact photo-resist pattern of the original drawing.

Artwork—This operation formerly required three separate pieces of art work: A detail drawing showing all circuits and holes, a circuit-board assembly, and an accurately-scaled, four-times size 12 x 18-inch circuit art work drawing on which circuit areas were filled in with black ink. The large scale was necessary for photographic reduction purposes. Now, the artist makes only one twice-size scale drawing on a dimensionally-stable Mylar sheet pre-printed with the outline of General Signal's standard board.

Circuit paths may be inked or made of pressure sensitive tape.

Tape circles for terminal pad points are commercially available. The company name is preprinted in reverse and a part number is placed on the reverse side of the Mylar sheet.

Circuit boards and documents can be produced by xerography from this one drawing. No dimensions are needed, checking is eliminated.

Board Processing—The circuit board can be processed before needed engineering drawings are completed. Art work is mounted on camera easel, reversed, and reduced 50 percent to bring the copy to exact board size. Next the reverse image is developed in a tone tray for best reproduction of solid areas, transferred to paper, but not fused.

The circuit board is placed in a special xerographic holder plate, which has the selenium removed and steel locators added, to be properly positioned for transfer. One corner of the board is placed under a small grounding clip. Then the paper with an unfused image is placed on the board's copper-clad surface. The tray is slid into a plateholder aperture in a processor and a negative charge is applied. This transfers the image downward to the circuit board. The right-read image is then fused to the copper-plated surface in a vapor fuser.

Retouching can be accomplished at four different times during this sequence: on the xerographic plate; on the unfused paper copy; on the unfused image on the board; or, after fusing, paint may be added to fill any pin-point deletions. A bubble-etching process accelerates and provides better regulation of the etching operation.

Boards are hung four at a time in a ferric chloride etching tank. Copper areas covered by the toner are protected from the etching solution and remain on the board. All unprotected areas are removed by the solution in about 20 minutes.

Finally, the boards are rinsed in water, drilled and trimmed to size. Toner is removed by scrubbing with Flo-Set fluid. Boards are then ready for mounting and soldering.

Drawings—Engineering drawings are produced with equal ease and efficiency. The detail drawing is produced by mounting the twice-size layout in the camera case so it is right reading.

Reduced 50 percent, the layout is reproduced on a standard 10½ x 15-inch vellum form. The tone tray is used to get the best reproduction of solid areas. The draftsman completes the title block and adds specifications and overall dimensions.

Circuit board assembly drawings display both the circuit and component sides of the board in one view. These are right-reading reproductions reduced 50 percent, on a 10½ x 15-inch vellum drawing form.

A 50-percent white dot pattern Craftint screen (about 25 dots per inch) is placed over the layout. Then the tone tray is used to obtain a screened, full-size copy of the artwork on the reverse side of the pre-printed drawing form. The artwork appears to be reverse reading when viewed from the front.

When a draftsman draws in the components, the face of the drawing is completed. He visually positions these from the terminal pad locations on the drawing's reverse side. Diazo prints from these tracings show the detail of each mounted component superimposed on the screen's image of the circuit.

Drill Template—Drill templates are also made with this process on ⅛ to ¼-inch aluminum plates. Holes follow the pattern of the circuit board terminals. Locator pins ensure accurate template positioning on the board. Transfer of the artwork image to the transfer paper is done in the same manner as circuit board preparation. The unfused image is transferred from the paper to the aluminum plate in a Xerox processor and the right-reading image is fused in the vapor fuser. Each template hole is center punched and drilled. Accuracy within $\pm \frac{1}{64}$ inch is sufficient to mount and attach components in the board assembly operation. Templates for large-quantity runs, can be made of steel and heat treated.

NOW from DEI

**High Performance...Very Low Noise...
Modular**

VHF/UHF Satellite Telemetry Receiver

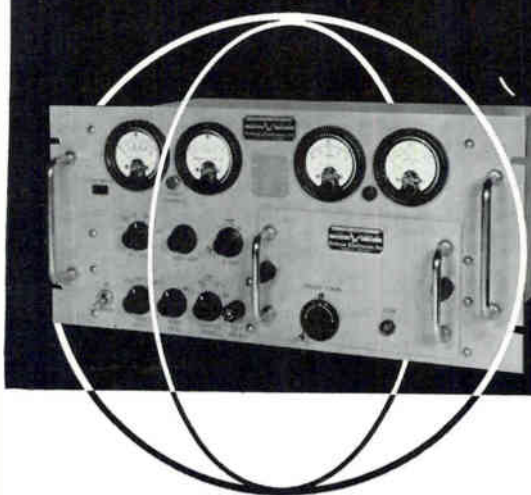

- Crystal controlled RF heads from 50 MC to 1000 MC
- IF bandwidths from 10 KC to 500 KC
- FM, AM, Phase-lock and Phase demodulators
- Plug-in pre-detection recording converters

Already used in more than a dozen unmanned earth orbit satellite programs, the Model TMR-6 telemetry receiver from Defense Electronics, Inc. has no true equivalent in its field.

The completely-modular unit has been specially-designed by DEI to accept inexpensive plug-in sub-assemblies . . . seven RF tuning heads . . . nine IF amplifiers and four demodulators . . . to cover all presently-assigned frequencies in the VHF/UHF spectrum.

The TMR-6 features crystal control of both oscillators, extremely low noise figures and can be adapted for use in PM systems by means of a phase-locked loop around the entire receiver. It is capable of tracking any frequency change introduced by Doppler shift, transmission and reception instabilities up to 0.007 per cent of the received frequency.

This versatile, low-cost receiver also accepts plug-in modules for pre-detection recording of either AM or FM with existing stationary head video tape recorders.

For real time data recovery at its finest, write for DEI bulletin TMR-6 . . . or call:



DEI *Defense Electronics, Inc.*

SERVING
GOVERNMENT
AND INDUSTRY

Rockville, Maryland

TXW: 301-949-6788 Phone: 301-946-2600

Sherman Oaks, California, Phone: 873-4322

Solid-State Scope Has Wide Passband

Compact unit features ceramic crt and swing-away heat sink



COMPACT oscilloscope, type 647, features d-c to 50 Mc passband, rear-panel swing-away heat sink, convection cooling and electronic regulation of d-c supplies. Unit is environmentalized to withstand extreme operating and storage conditions and can be used aloft to 15,000 ft. under 20 g shock conditions.

Type 647 also has a ceramic crt with parallel-ground faceplate, 14-kv accelerating potential and parallax-free internal graticule accurately ruled in cm squares with variable edge lighting. The instrument also includes a trace finder to attenuate both horizontal and vertical voltages, thus aiding in positioning of waveforms. Unblinking, d-c coupled to the crt grid, assures uniform bias on the crt for all sweep speeds and repetition rates at any setting of the scope's intensity control.

A 1-kc calibrator affords 18 square-wave voltages from 0.2 mv to 100 v in 1-2-5 sequence; calibrator also provides 100-v d-c output. Square-wave symmetry and frequency is accurate with $\pm 0.1\%$ and rise and falltimes are approximately 2 μ sec.

The solid-state amplifier, type

10A2, has a risetime of less than 7 nsec. Sensitivity is between 10 mv/cm and 20 v/cm in 11 calibrated steps with accuracy to within $\pm 2\%$ from -30 C to $+65\text{ C}$. Two identical channels can be added algebraically, operated singly with either polarity or dual trace, and with either alternate or chopped switching.

In the time-base unit, a trigger mode selects free-running, normal, automatic or single-sweep operation. Automatic triggering insures a bright reference trace regardless of

sweep speed, either without an input signal or when the input signal repetition rate drops below 20 cps. Above 20 cps, the time base is triggered at the repetition rate of the incoming trigger signal and will provide jitter-free displays to beyond 50 Mc.

The sweep delay portion of the time-base unit contains a calibrated delay that is continuously variable from 1 μ sec to 50 sec. Price: \$2,795 with two probes. Tektronix, Inc., P.O. Box 500, Beaverton, Ore.

CIRCLE 301, READER SERVICE CARD

Pulse Transformer Gives High-Voltage Trigger



TRANSIENT voltages as high as 400,000 volts can be safely handled by pulse transformer designed to provide a high-voltage trigger for a spark gap or crowbar assembly for military radars. Unit will operate in temperatures between 52 C and -29 C and at altitudes up to 12,000 feet. The transformers dimensions are 17 \times 24 \times 39-inches including high-voltage terminal and

its mounting extension. Both primary terminals are adequately insulated to permit polarity reversal and the low-voltage secondary terminal is insulated for 30 kv. Electrical characteristics include input voltage of 15,500 v peak, pulse width of 1 μ sec, pulse repetition rate of 100 pps, output voltage of 200,000 v peak and turns ratio of 1:13. Sperry Gyroscope Company, Div. of Sperry Rand Corp., Great Neck, N. Y. (302).

Compact Video Recorder Operates For 5 Hours

MODEL VR-660 videotape recorder is designed for mobile and studio work by network, commercial and educational broadcasters. According to the manufacturer, this unit is the only recorder of comparable size that may be used on the air with no



additional equipment other than that presently available in most tv stations. Using only transistors, the VR-660 has the same basic design as the company's VR-1500 closed-circuit tv recorder but has new circuit features that enable it to produce tv pictures that meet FCC standards for broadcast.

Recorder is available in both 50 and 60-cycle models permitting its use on a world wide basis. Moreover, the 60-cycle version has the lowest tape consumption of any broadcast recorder presently available. It operates at a tape speed of 3.7 inches per second and can record for up to 5 hours continuously on a single 12½-inch reel of standard 2-inch tape. Price: \$14,500. Ampex Corporation, 401 Broadway, Redwood City, California. 303.

Spirals Produce Nearly Constant Patterns

CAVITY-BACKED double Archimedes spiral antennas models ASN-111A

NEW! HIGH SENSITIVITY

GENERAL PURPOSE 247A

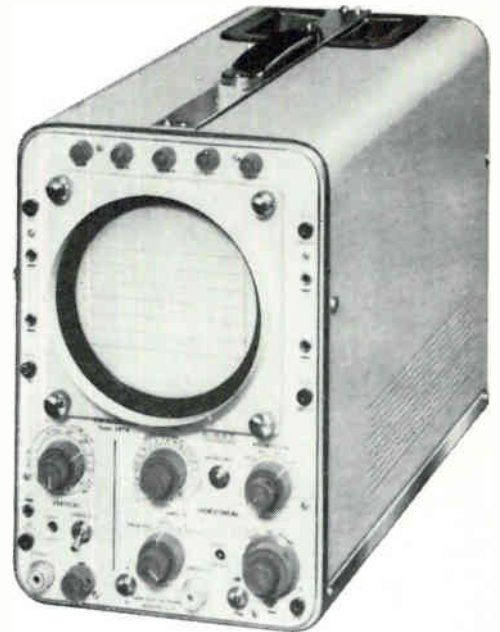

The type 247-A oscilloscope fully qualifies as a universal instrument because its performances and the size (13 cm (5") dia.) of its C.R. Tube authorize accurate measurements and tests in all fields of low-frequency instrumentation. Also, because of its simplicity of operation, the 247-A is ideally suited for practical laboratory work of an educational nature.

TECHNICAL SPECIFICATIONS

Vertical amplifier

1 channel; Frequency range: DC to 1 Mc/s (-3 dB)
Sensitivity: 50 mV/cm

AC: 10 c/s sine wave or 50 c/s square-wave to 100 Kc/s (-3 dB)
Sensitivity: 5 mV/cm

Calibrated attenuator: step-adjustable from 5 mV to 20 V/cm in 12 positions

Sequence: 1 - 2 - 5 - 10 etc...

Attenuator vernier ratio 1/3
Constant input impedance: 1 M Ω \pm 47 pF

Sweep

Free-running - triggered - single sweep
Duration: 1 s/cm to 0.5 μ s/cm in 20 calibrated positions
Vernier: 1:3 ratio -
x 5 magnification expanding
sweep durations from 3 s/cm to 0.1 μ s/cm

Sync

5 positions: single-sweep, HF, LF, TV line, TV-frame
Polarity: - or - internal or external
selection of triggering level

Horizontal Amplifier

Frequency range: 0 to 500 Kc/s (-3 dB)

Sensitivity: 1 V/cm or 10 V/cm (switch selected)
Vernier: 0 to 1
Constant input impedance: 1 M Ω and 47 pF

Cathode-ray Tube

5 ADP 2 or equivalent type
Screen: 13 cm (5") dia.
Magnification factors:
X: 30 V/cm (approx.)
Y: 20 V/cm (approx.)

Direct drive of H and V plates
Acceleration voltage: 3 Kv

MECHANICAL FEATURES

Light-alloy chassis, readily-detachable panel for easy access to circuits.

1) Tube complement

9/ECF80 - 2 NM2L or equivalent types

2) Power supply

105 115 - 127 - 220 - 240 V - 50 or 60 c/s

3) Dimensions

Width: 20.5 cm - (8")
Depth: 38.5 cm - (15")
Height: 31 cm - (12")
Weight: 14 kg - (30 lbs)

OTHER INSTRUMENTS

Oscilloscopes

204 A - High speed and fast rise oscilloscope
241 A - 242 A - 243 A, Multi-function osc. with plug-in preamplifiers.
255 B - Portable oscilloscope
245 A - High performance portable oscilloscope
246 A - High sensitivity low-frequency oscilloscope
248 A - Maintenance oscilloscope.

Sweep frequency Generators

411 A - Laboratory sweep frequency generator
410 B - TV - FM sweep frequency generator
476 A - Radio sweep frequency generator

Signal Generators

405 A - Low frequency RC signal gen. (30 c/s-300 Kc/s)

428 A - HF constant amplitude signal generator (100 Kc/s-30M c/s)
458 - Pulse generator (5 c/s - 50 Kc/s).

TV pattern generators

465 C - Portable electronic pattern generator
464 A - Test - pattern generator

Regulated power supplies

117 A - Transistorised regulated power supply
114 A - Regulated power supply

Cameras

1000 A - oscilloscope camera with Polaroid
1001 B - oscilloscope recorder

INTER-PLANS

RIBET-DESJARDINS

MEASURE & CONTROL DEPARTMENT, 13-17, rue Périer MONTROUGE / PARIS TEL : ALESIA 24-40
CANADIAN BRANCH : RIBET-DESJARDINS (CANADA) Room 114, 5757 Decelles Avenue - MONTREAL.

for your silicon power transistor

AVNET

requirements specify STC

over 150 2N type nos. in 12 package sizes in power ratings from 5 to 300 watts. 21 MIL approvals; features major breakthrough in miniaturized power without heat sink; isolated collector in 75-85 watts; PNP transistor with NPN complements.

contact Avnet for on-time delivery

S.T.C.

of STC silicon power transistors



call your nearest Avnet office

AVNET

10 Local Headquarters, coast to coast

CIRCLE 204 ON READER SERVICE CARD

free... information on the world's happiest hobby!



ELECTRONIC ORGAN KITS

for home, school, church, clubs.

The Original "Build-it-Yourself" Organ sounds like a glorious pipe organ

SAVE 70% up to



Anyone Can Do It! Here's What You Get



Manuals & Couplers, Tone Generator, Tone Changers, Pedal Keyboards, Consoles

Mail coupon below, and receive . . . absolutely FREE . . . complete information on Artisan's new 1963 Organ-Building Kit! Illustrated instructions lead you through every step of this happy hobby, as you assemble-at-home a magnificent custom Artisan electronic organ — the best in tone and styling! No technical skill required, and you save up to 70% of comparable ready-built organ costs by skipping dealer profits and factory labor! You can play as you build and pay as you build. From \$1750 to \$7500. Write today!

ARTISAN ORGANS 2476-X N. Lake Ave., Altadena, Calif.

NAME _____
 ADDRESS _____
 CITY _____ ZONE _____ STATE _____

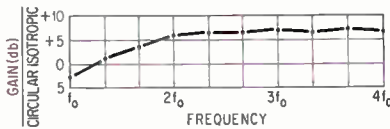
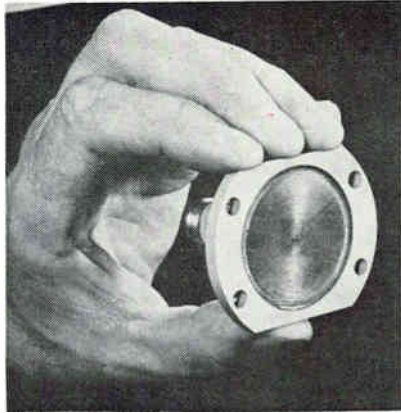

thru 114A maintain essentially constant impedance and pattern performance over better than 4:1 frequency bands. Gains of 7 to 8 db over an isotropic can be achieved over a 2:1 bandwidth as shown in the figure.

Circularly-polarized antennas are designed for broadbeam, broadband applications and provide compact, lightweight units that can easily be flush mounted. Successfully employed in systems for surveillance, telemetry, direction finding and command control, these units are available in overlapping bands between 0.5 Gc and 12 Gc. Antennas have axial ratios of 3 db, half-power beamwidths of 75 degrees and vswr of 2:1. American Electronic Laboratories, Inc., P. O. Box 552, Lansdale, Pa.

CIRCLE 304, READER SERVICE CARD

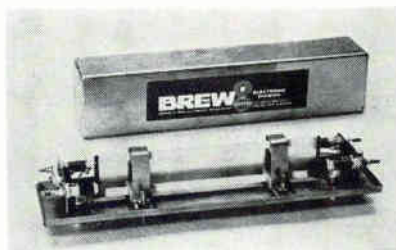

Delay Line Enhances Radar Resolution

DISPERSIVE lines have delay vs. frequency characteristics that closely approximate the linear curve required for pulse compression techniques. Unit design emphasizes a small number of components, rugged construction and compact size.

Save time with these tested transistor design circuits

Here's a ready source of quick, time-saving answers to your transistor circuit problems . . . practical guidance on essential phases of today's semiconductor developments. Because these three volumes bring you the successful work of practicing engineers, every topic has permanent reference value and contributes to the Library's usefulness in your work.

You'll have at your fingertips hundreds of *proved* transistor circuits — with all the necessary design information and component values required to utilize them in your own designs — and save valuable man-hours of time and effort.

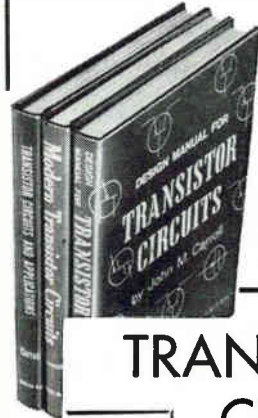

TRANSISTOR CIRCUITS LIBRARY

Edited by John M. Carroll, Managing Editor, *Electronics*

3 vols. 932 pp., 1735 illus. and tables, \$24.95 — payable \$8.95 in 10 days, \$8.00 monthly

Praise by experts . . .

" . . . a valuable reference to the circuit designer and engineer." —*Electronics*

" . . . useful to those who are entering the field of semiconductor circuit design." —*Control*

" . . . a convenient and comprehensive source of transistor information." —*Radio-Electronics*

These three big manuals supply hundreds and hundreds of transistor circuits ready to be adapted to your specific needs . . . give valuable material on transistor characteristics, structures, and techniques. Articles, photographs, design charts, nomographs, and ready-to-use circuits cover a vast range of applications . . . from simple one-transistor "push-pull" amplifiers . . . to complex computer switching circuits with high-power transistors. You get data and circuits for home-entertainment and broadcast equipment . . . computer and servomechanism circuits . . . missile, aircraft, and satellite equipment . . . industrial, scientific, and medical devices . . . and many more.

Library includes . . . *Transistor Circuits and Applications*, *Modern Transistor Circuits*, *Design Manual for Transistor Circuits*

Save \$4.55. Bought separately, these books would cost you \$29.50. But under this special Library offer, they come to you at a \$4.55 saving—and you pay in small, convenient installments if you desire.

SEE THIS LIBRARY 10 DAYS FREE Direct From Publisher

McGraw-Hill Book Co., Dept. L-9-27
 327 W. 41st St., N. Y. C. 10036

Send me the Transistor Circuit Library. In 10 days I will (check one) remit full price of \$24.95; or only \$8.95 in 10 days and \$8.00 monthly. Otherwise I will return books postpaid.

PRINT
 Name _____
 Address _____
 City _____ State _____ Code _____
 Company _____
 Position _____
 For price and terms outside U. S. write McGraw-Hill Int'l., N. Y. C. 10036 L-9-27

Trapped by

PW Assembly Cost Factors?



Then **DYNASERT** component inserting machine may be your way out. This is automated, high-speed inserting at its best: up to 10 times faster than costly hand methods. And savings add up and up: users find that their savings in direct labor costs and production time easily pay for a Dynasert installation in less than a year. Dynasert delivers product uniformity. Greater efficiency. Superior quality. It automatically feeds, cuts and bends leads, inserts and clinches all types of axial lead components. Virtually no operator training required. Changes made from one board or component type in seconds. Interested? Send for a free copy of: Dynasert — Production Equipment for Electronics. Dynasert Dept., United Shoe Machinery Corporation, Boston, Massachusetts.



United Shoe Machinery
BOSTON, MASSACHUSETTS

CIRCLE 205 ON READER SERVICE CARD
electronics • SEPTEMBER 27, 1963

According to the manufacturer, this component, with suitable weighting networks, represents a complete design package that can enhance the resolution and range of future radars, as well as retrofit of those now extant. Typical specifications include pulse compression ratios from 50 to 500; center frequencies up to 6 Mc; linear delay curve over 45 percent of center frequency; delay change over the band up to 100 percent of center frequency; center frequency delay up to 4,000 μ sec; insertion loss of less than 20 db for most applications and spurious and triple travel greater than 25 db down from output pulse over the frequency band. Units are operable under MIL specifications. Richard D. Brew & Co., Concord, New Hampshire. (305)

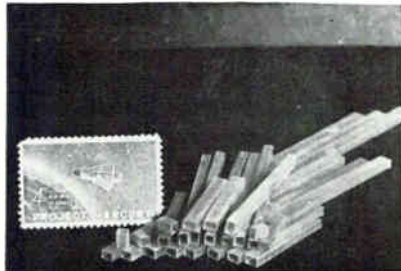

Microminiature Tubing Aids Coil-Form Design

COIL-FORM tubing with wall thickness of 0.005 in. and cross sections of $\frac{1}{8}$ in. square or less are now being produced. Multi-ply laminates of 0.001-in.-thick fiber-glass cloth and epoxy resin are wrapped on precision mandrels in lengths up to 4 in. Finished tubes exhibit good strength characteristics and compatibility with encapsulants. Sharp 90 deg corners insure a snug fit over the core. Tubing is rated for Class F temperature applications. Stevens Tubing Corp., 86-88 Main St., East Orange, N. J. (306)

Resin Coating Penetrates Metal

NEWLY developed TFE resin coating penetrates metal, resists abrasion and takes high loads at high speeds. The new product, called FluoroSpar Deep-coat, has been subjected to stern tests of 2500 psi up to 500 rpm. Sparta Mfg. Co., Dover, O. (307)

specify the new U.S. Sencor Products

AVNET

contact Avnet for best service



on-time delivery of

SEMCOR

diodes and capacitors

5 watt miniature Zener Diodes, high voltage temperature compensated Reference Elements, non-polar solid and hermetically sealed wet Tantalum Capacitors, 400MW Glass Zeners Mil Types USN 1N 962BM —USN 1N 984BM

call your local Avnet Headquarters

AVNET

The Avnet System, coast to coast

CIRCLE 206 ON READER SERVICE CARD



Coils for Contact Capsules

1 to 5 Reeds
.095 — .215 dia.
6 to 48 V.D.C.
Lead or Pin Term.
Also Available with Reeds.

Write for Bulletin and Prices

ELECTRICAL COIL WINDINGS

Wire sizes #6 to #56, Classes A, B, F and H. Complete engineering service available.

Coto-Coils

**COTO-COIL
COMPANY
INC.**

65 Pavilion Avenue, Providence 5, R. I.

CIRCLE 55 ON READER SERVICE CARD 55

This announcement is neither an offer to sell nor a solicitation of an offer to buy these securities. The offer is made only by the Prospectus.

540,000 Shares*
TEKTRONIX, INC.

Common Shares
(without par value)

Price \$19.75 per Share

*50,000 of these shares are being offered by the Underwriters to employees of the Company at \$19.25 per share.

Copies of the Prospectus may be obtained in any State only from such of the several Underwriters, including the undersigned, as may lawfully offer these securities in such State.

Lehman Brothers

Blyth & Co., Inc.	The First Boston Corporation
Eastman Dillon, Union Securities & Co.	Goldman, Sachs & Co.
Kidder, Peabody & Co. <small>Incorporated</small>	Lazard Frères & Co.
Carl M. Loeb, Rhoades & Co.	Smith, Barney & Co. <small>Incorporated</small>
White, Weld & Co. <small>Incorporated</small>	Dean Witter & Co. Paribas Corporation

September 12, 1963.

**WANT TO
DO BUSINESS
WITH THE
GOVERNMENT ????????**

Then check the Military and Government Procurement Guide in the orange section of your **ELECTRONICS BUYERS' GUIDE**.

LITERATURE OF

TINY CAPACITORS Aerovox Corp., New Bedford, Mass. Bulletin NPJ-124 contains complete specifications on type CRE ultraminiature 85 C electrolytic capacitors.

CIRCLE 308, READER SERVICE CARD

AUTOMATIC TAPE SEARCH Astrodata, Inc., 240 E. Palais Road, Anaheim, Calif. A 4-page technical bulletin describes model 6222 universal automatic tape search system. (309)

CROSS-CONNECT MATRIX Sylvania Electric Products Inc., 100 First Ave., Waltham 54, Mass. Bulletin describes a high density matrix that provides random access interconnection and is particularly suited for missile checkout and data logging equipment. (310)

HOT SPOT TESTING Shallander Development Co., 19709 Ventura Blvd., Woodland Hills, Calif. Brochure discusses Heatmap, a technique combining the use of fluorescent paint with motion pictures taken under uv floodlights for studying heat-effects of components under load. (311)

PHASE SHIFTERS Microwave Development Laboratories, Inc., 87 Crescent Road, Needham Heights 94, Mass. Bulletin PE-1 describes low-loss dielectric phase shifters. (312)

TOROIDAL COMPONENTS Sangamo Electric Co., Box 359, Springfield, Ill., has released a 16-page bulletin describing a new line of encapsulated toroidal components. (313)

PULSE CURRENT GENERATORS Computer Control Co., Inc., Framingham, Mass., has published catalog PCG-1 on positive and negative pulse current generators. (314)

MERCURY-WETTED RELAYS Potter & Brumfield, Princeton, Ind. A 16-page catalog covers three new types of mercury-wetted contact relays. (315)

READOUT DISPLAY Industrial Electronic Engineers, Inc., 5528 Vineland Ave., North Hollywood, Calif. A handy "Readout Display Selector Guide" is now available. (316)

H-F COMMUNICATIONS TRANSMITTER Continental Electronics, P. O. Box 5024, Dallas 22, Texas, has issued a brochure describing type 617A linear amplifier 50-kw shortwave communications transmitter. (317)

NARROW-BAND ANALYZER B&K Instruments, Inc., 3044 West 106th St., Cleveland 11, O., announces an 8-page technical brochure on the model 2107 narrow-band analyzer. (318)

ACCELEROMETER Endevco Corp., 801 South Arroyo Parkway, Pasadena, Calif. A 2-page bulletin describes model 2220 microminiature center mounting hole accelerometer. (319)

DIGITAL VOLTMETERS Houston Instrument Corp., 4950 Terminal Ave., Bellaire 101, Texas. A two-page bulletin describes the 2640 series digital voltmeters that utilize reed relays and all solid-state logic. (320)

SEPTEMBER 27, 1963 • electronics

THE WEEK

DIRECT-READING OHMMETER Millivac Instruments, Box 997, Schenectady, N.Y., has published a bulletin describing type MV-279 C linear precision ohmmeter. (321)

DELAY LINES Pulse Control, a division of Jamieson Industries, 7900 Haskell Ave., Van Nuys, Calif. Bulletin PC-301 covers a line of lumped constant delay lines in the nanosec to millisecc range. (322)

PROGRAMMING SWITCH Scaelectro Corp., 139 Hoyt St., Mamaroneck, N.Y. A 32-pole, double-throw, series AP programming switch is described in bulletin AP-2. (323)

POWER MODULES Electronic Research Associates, Inc., 67 Factory Place, Cedar Grove, N.J. Catalog supplement No. 129 covers a line of Transpac solid state power modules. (324)

TRAVELING-WAVE TUBES Raytheon Co., Foundry Ave., Waltham 54, Mass., offers an information bulletin on low- and medium-power twt's for radar applications and missile and space environments. (325)

CRT DISPLAY Digital Equipment Corp., 146 Main St., Maynard, Mass. A 4-page brochure describes type 31 cathode-ray-tube display designed for high degrees of accuracy, stability, and resolution. (326)

MAGNETICS INSTRUMENTATION Radio Frequency Laboratories, Inc., Powerville Road, Boonton, N.J. A complete system approach to permanent-magnet charging, measuring and stabilizing is described in a 4-page technical bulletin. (327)

MIL-TYPE RELAYS Hi-G Inc., Spring St. & Route 75, Windsor Locks, Conn. Complete technical data on miniature and microminiature hermetically-sealed Mil-type relays is available on request. (328)

DIGITAL INPUT DEVICE DASA Co., Inc., 235 Bear Hill Road, Waltham 54, Mass. A 4-page report gives a technical description of a low cost, highly reliable, magnetic tape digital computer input and query device. (329)

TRANSISTOR CHOPPERS Airpax Electronics Inc., Cambridge, Md. Bulletin C-117 provides information on the parameters of 13 different transistor chopper designs now available. (330)

MAGNETIC SHIELDS Magnetic Shield Division Perfection Mica Co., 1322 No. Elston Ave., Chicago 22, Ill., offers a data sheet on magnetic shields for subminiature electromagnetic devices. (331)

TRIMMER POTENTIOMETER CTS of Berne, Inc., Berne, Ind. Advance data sheet 5500 deals with series 350 1/2 in. diameter, single-turn wirewound trimmer potentiometer. (332)

WELDED CIRCUIT MODULES Marshall Laboratories, 3530 Torrance Blvd., Torrance, Calif., offers a brochure on welded circuit modules for space applications. (333)

20 to 200 D.P.

Send your prints
for quotations

- SPURS
- HELICALS
- WORM AND WORM GEARS
- STRAIGHT BEVELS
- LEAD SCREWS
- RATCHETS
- CLUSTER GEARS
- RACKS
- INTERNALS
- ODD SHAPES

We make gears like these for a wide variety of gages, meters, indicators, controllers, etc. Tell us your needs.

FOR AUTOMATIC
CONTROLS

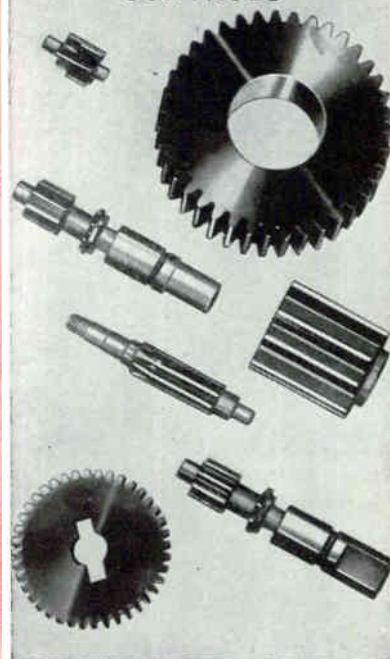

THE *Finest* IN GEARS

Beaver Gear Works Inc.

1021 PARMELE STREET, ROCKFORD, ILLINOIS



CIRCLE 207 ON READER SERVICE CARD

0.000,000,001 WATT DC RELAY

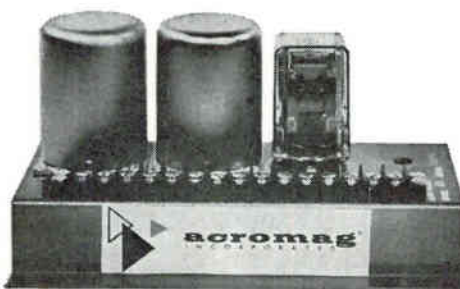

Model 301 Acro-Relay

**OPERATES
ON DC INPUT
OF ONLY
ONE Microampere
or
ONE Millivolt!**

Any DC signal of 1 microampere, 1 millivolt operates the DPDT output relay. Controls up to 1800 watts directly. Uses ultra-reliable magnetic amplifier and transistors. Ideal for temperature, vacuum and nuclear systems, liquid level, photocells, current and voltage monitors. Immediate delivery. List price: \$98.75.

Request Technical Bulletin No. 30

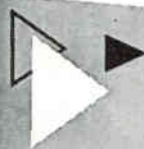

acromag[®]
INCORPORATED

15360 TELEGRAPH RD.

DETROIT*39, MICH.

Phone: 538-4242, Area Code 313

TELETYPE:
313-
538-4536



PBE Erecting Plant

CONSTRUCTION has begun in Santa Ana, Calif., on a new 75,000-square foot headquarters facility for the Computer division of Packard Bell Electronics.

The building will house research and engineering, manufacturing, marketing and administrative operations.

Representing an investment of more than \$1 million, the new structure is scheduled for completion in December, 1963, and will consolidate the division's headquarters operations and more than 400 employees who are now occupying leased facilities in Santa Ana, Anaheim and West Los Angeles.

Besides engineering and office areas, the facility will provide special computer demonstration areas, engineering laboratories and complete electronic equipment and systems manufacturing, including environmental testing.

The Computer division designs and builds the PB250 and PB440 general purpose computers, silicon and germanium digital modules, digital accessory equipment, and data processing systems and equipment for the military, commercial and aerospace markets.



Nytronics Subsidiary Promotes Kalfus

NEWLY appointed vice president of Essex Electronics of Canada, Ltd., a wholly-owned subsidiary of Nytronics, Inc., is J. Erik Kalfus.

With the Ontario firm since 1961, Kalfus served originally as chief engineer and more recently as general manager.

Announce Formation of Welch Relay Company

WELCH RELAY Company, No. Hollywood, Calif., has been organized to design, develop and manufacture electronic relay devices for the aerospace industry, it was reported by T. Ross Welch, founder.

Welch has long been identified

as a consultant and as a founder of previous firms. Most recently he was consultant to Cannon Electric's Magnetics division.



Volkert Stampings Elects President

JACK KLEINODER, chairman of the board of Volkert Stampings, Inc., Queens Village, N. Y., has been elected president of the company by the board of directors. He succeeds John Volkert, who has retired.

Kleinoder also is president and chairman of the board of two Volkert subsidiaries—Vidmar, Inc., of Williamsport, Pa., and Pennsylvania Tool & Mfg. Co., of York, Pa.

Volkert Stampings produces miniature precision stampings for the electronics and electrical industries.

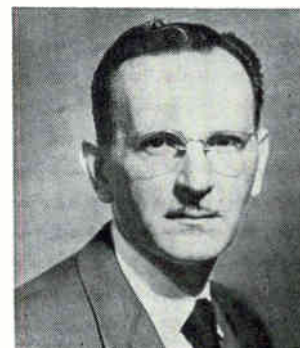

Bronson Moves Up At Silicon Transistor

ELECTION of Randolph Bronson to the post of president and chief executive officer has been announced by Silicon Transistor Corp., Carle Place, N. Y.

Bronson, one of the founders, a director and a vice president of the semiconductor manufacturing firm, has been executive vice president for the past year.

Machlett Laboratories Appoints Randmer

JACOB A. RANDMER has joined Machlett Laboratories, Springdale, Conn., as chief engineer for the firm's large power tube operation. He will be responsible for develop-

New! MINIATURE AXIAL FANS

with
up to 4 times
greater cooling efficiency!



FULLY GUARANTEED FOR 10,000 HRS. UNDER NORMAL OPERATING CONDITIONS

Characteristic	PAMOTOR Model 1000	Conventional Fan
Type of Motor	induction (capacitor-type squirrel cage)	shaded-pole
Housing	die cast warp-free Zymec	plastic
Output @ 60 cps (0 back pressure)	125 cfm	100 cfm
(.25" back pressure)	75 cfm	20 cfm
(.3" back pressure)	50 cfm	0
Output @ 50 cps (0 back pressure)	100 cfm	75 cfm
(.25" back pressure)	62.5 cfm	5 cfm
Operating Temp. Range	-55°C to +85°C	-18°C to +44°C

The PAMOTOR Model 1000 Miniature Fan is completely interchangeable with conventional units now in use (4 1/8" center-to-center mounting holes). But the similarity ends there.

check this comparison chart!

Model 1000 meets MIL-T-5422E (Class 2), and MIL-STD-202 Environmental specs. Inside-outside rotating motor design gives fly-wheel effect, resulting in constant, quiet fan speed. Large surface sleeve bearings mean minimum maintenance, maximum reliability.

For complete specifications and name of nearest stocking distributor, write to:

PAMOTOR, Inc.
312 Seventh Street • San Francisco 3, Calif.

CIRCLE 208 ON READER SERVICE CARD

EM-7548 HEXODE

by



SOLVES CIRCUIT PROBLEMS NO OTHER TUBE CAN!



★ PERFORMANCE FACTS: Ultra-fast rise time of 3ns. Amplitude of 1 amp., or repetition rate to 300 kc. Gain bandwidth product of 350. Transconductance: 26,000 umohs. Output cap: 3.4 uuf. Dynode makes possible single tube, free running, or triggered, ultra-fast pulse generator.

★ The EM-7548 secondary emission hexode amplifies with or without phase inversion.

★ Exceptional for distributed amplifiers and cathode followers. Anode and dynode may be combined in push-pull to double output voltage of pulse amplifiers and pulse modulator drivers.

★ Time-mark Generator 'pips' may be obtained directly from dynode output without extra clipping and differentiating stages.

★ Immediate delivery from stock. Write for complete tube characteristics and circuit applications manual.

ELECTRO-MITE ★ DIVISION OF
YORK RESEARCH
Stamford, Conn., U.S.A.

CIRCLE 59 ON READER SERVICE CARD

HOW TO USE YOUR ELECTRONICS BUYERS' GUIDE

The Two-Way Product Locator

Most products advertised in the ELECTRONICS BUYERS' GUIDE are listed twice for your convenience. After the Product Heading, advertising page numbers appear where appropriate (when advertisements of one kind are grouped together in the book). Next to the individual product listing, the page number of associated advertising material is cited. Thus you can locate all of the advertisements for a particular product category, or any specific advertisement, quickly, accurately, and conveniently. Keep your ELECTRONICS BUYERS' GUIDE close to your work area at all times.

ELECTRONICS BUYERS' GUIDE

A MCGRAW-HILL PUBLICATION



NEW PUSH-BUTTON SPOTTER

RANDOM ACCESS MAGNETIC
TAPE SEARCH LOCATES
UP TO 198 SPOTS ON
ONE 7-INCH REEL!



\$2650⁰⁰

THE NEW CROWN SPOTTER is completely unique...there is nothing else like it! Make your push-button selection and go immediately to any one of 99 different pre-programed positions per track. Each spot is cued to within 1/4-inch of play. Touch the "play" switch, and that's all there is to it. At the end of the selection, tape automatically returns to start position...ready for your next command. Braking is electromagnetic...never needs adjusting. Field tested in radio station use for a full year with **not one error in spot location!**

MANY APPLICATIONS

Broadcast Stations
Business Records
Information Centers
Educational Systems
Exhibitions
Sales Training

**OTHER MODELS
AND CUSTOM FEATURES
TO MEET YOUR
SPECIFIC NEED —**

WRITE DEPT. EL-09



ment and production engineering of the firm's high power tubes whose outputs range up to 400 kw and higher.

Prior to joining Machlett, Randmer was engineering director of the Systems I division of Sperry Rand's Univac division in Norwalk, Conn.



Aldrich Elected DASA Vice President

ELECTION of T. R. Aldrich, Jr. as vice president of marketing of DASA Co., Inc., a subsidiary of Perini Electronic Corp., Waltham, Mass., is announced. He was formerly with Itek Corp.

DASA is a newly-created company engaged in the data processing field.

Universal Circuits Elects Bice

DON C. BICE has been elected president of Universal Circuits, Inc., St. Louis Park, Minn. James H. Callan, former president, has been named chairman of the board of directors.

Bice joined Universal Circuits in March, 1963, as general manager. The year-old firm supplies printed-circuit board assemblies to manufacturers of computers and other electronic equipment.

Electra Acquires Microlectron

ELECTRA MANUFACTURING CO., Independence, Kansas, has announced the acquisition of Microlectron, Inc., Santa Monica, Calif., producer of precision resistive components and packaged networks, in an all-cash transaction.

EMPLOYMENT OPPORTUNITIES



The advertisements in this section include all employment opportunities—executive, management, technical, selling, office, skilled, manual, etc.

Look in the forward section of the magazine for additional Employment Opportunities advertising.

Electronic Instrument Technicians

The Oak Ridge National Laboratory
operated by

UNION CARBIDE NUCLEAR COMPANY

at
Oak Ridge, Tennessee

Has Openings for

Highly skilled electronic instrument technicians to work with electronic engineers in the development, installation and maintenance of electronic systems. Digital data handling, transistorized pulse height analyzers, analog and digital computer systems are only a few examples.

Minimum high school education, with additional training in electronics and at least three years' experience in installation and maintenance of complex electronic systems. Entrance rate \$3.19 per hour; \$3.25 per hour after six months. Reasonable interview and relocation expenses paid by Company.

Excellent Working Conditions
and

Employee Benefit Plans

An Equal Opportunity Employer

Send detailed resume to:

Central Employment Office

UNION CARBIDE NUCLEAR COMPANY

A Division of Union Carbide Corporation
Post Office Box M Oak Ridge, Tennessee

EMPLOYMENT SERVICES

Electrical Engineers for Mid-West positions.
Baker Emp. Ag'cy, Danville, Ill.

SELLING OPPORTUNITY WANTED

Foreign Sales Representation — Established electronics manufacturer expanding European sales office. Looking to represent additional products. Write RA-3017, Electronics, Classified Adv. Div., PO Box 12, New York, N. Y. 10036.

SEARCHLIGHT SECTION

RADIO RESEARCH INSTRUMENT CO.

AUTO-TRACK & TELEMETRY ANTENNA PEDESTALS
2 & 10 CM. SCR. 584 AUTOTRACK RADARS
AN/TPS-10 SEARCH. AN/APS-10 HT. FINDERS
AN/FPN-32CCA. AN/APS-10 NAVIC. & WEATHER
AN/APS-15B PRECISION. AN/APQ-35B PRECISION.
AN/APS-31A SEARCH. DOZENS MORE
5-12 MEGAWATT HIGH POWER PULSERS.

RADIO RESEARCH INSTRUMENT CO.
550 Fifth Ave., New York Judson 6-4691

RADAR SYSTEMS & COMPONENTS/ IMMEDIATE DELIVERY

CIRCLE 951 ON READER SERVICE CARD

Antique

TELEPHONES

As is complete, decorative purpose \$17.50. Working order, intercom \$19.50 Ext. on dial \$24.50, talking circuit only. Write for complete list. All shipments FOB, Simpson, Pa.

TELEPHONE ENGINEERING CO.
Dept. E-9273, Simpson, Pa.



CIRCLE 952 ON READER SERVICE CARD

OVER 2,000,000

RELAYS IN STOCK!

Send for Catalog 55
Universal RELAY CORP.
42 WHITE ST., N.Y. 13, N.Y. • Walker 5-6900

CIRCLE 953 ON READER SERVICE CARD

OPTICAL BENCHES \$13. to \$13,000. New Catalog

THE Ealing CORP.

2250 Massachusetts Avenue, Cambridge, Mass., 02140

CIRCLE 954 ON READER SERVICE CARD

George D. Butler, Electra president, termed the acquisition "the initial step in a broad and carefully planned program of vertical expansion."

Electra, with nearly 200,000 square feet of research and manufacturing facilities in two Independence locations, produces precision metal film and carbon resistors and integrated circuits. Its annual sales volume is in excess of \$10 million.

Microelectron will be operated as an Electra subsidiary, and essentially under its present management.

PEOPLE IN BRIEF

William F. Ruck promoted to product mgr., magnetics and anti-submarine warfare, of Dalmo Victor Co. **Robert August** moves up to plant mgr. of Fairchild Controls. **Leonard V. Waytenick** advances to mgr. of corporate data processing at Eric Resistor Corp. **Cliff L. Funk**, formerly with Motorola, Inc., named product engineering mgr. at The Singer Co. Metrics div. **Franklin B. Bossler**, previously with Bell Aerosystems Co., appointed director of spacecraft systems for Raytheon's Space and Information Systems div. **Joseph R. Mazzola** elevated to mfg. mgr. for DuMont Electronics div. of Fairchild Camera and Instrument Corp. Two promotions within Hughes Aircraft microwave tube div.: **William M. Mueller** to mgr. of mfg., and **Bruce A. Highstrete** to mgr. of R&D. **Frank Candela**, formerly with Pearce-Simpson, Inc., named v-p and g-m of Simpson Electronics, Inc. International Electronic Research Corp. ups **Walter R. England** to head of operations engineering. **Domenic Bitondo**, ex-Aerospace Corp., appointed technical director at Bendix Systems div. **Kenneth W. Gaddis**, from Thiokol Chemical Corp. to Tenney Engineering, Inc. as plant superintendent. **Stephen Kutosh** promoted to mgr.-mfg. for GE's Insulating Materials dept. **Arnold Pollack**, g-m of Aerotest Laboratories, Inc. elected a v-p. **George J. Vlay** advances to product mgr. of long distance strategic communications for the central operation of Sylvania Electronic Systems.

To Order Reprints

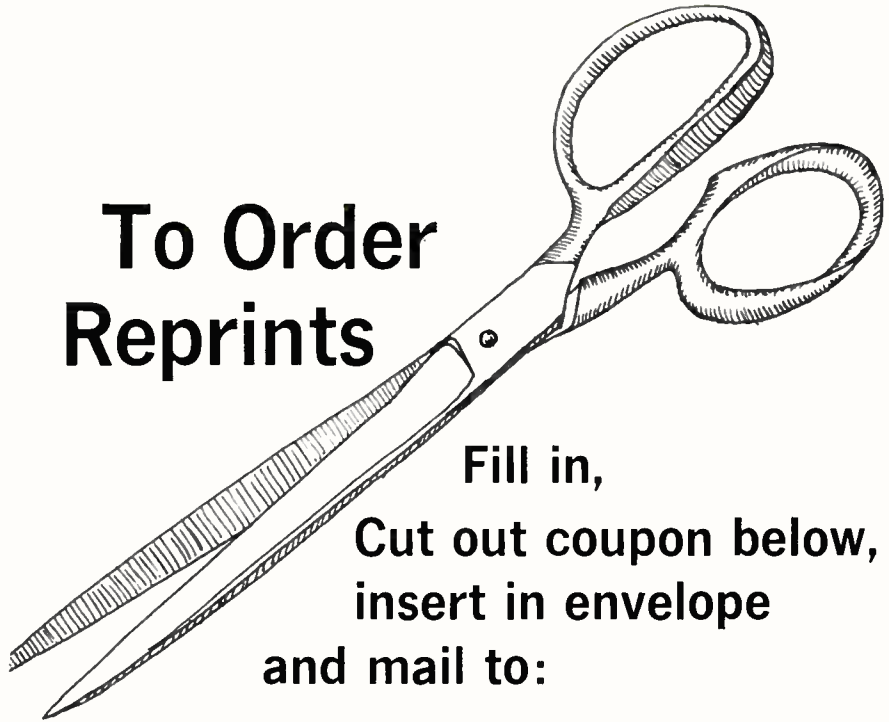

Fill in,
Cut out coupon below,
insert in envelope
and mail to:

electronics Reprint Dept.
330 West 42nd Street,
New York, N. Y.—10036

REPRINT ORDER FORM

For Listing of Reprints Available See Reader Service Card

(To help expedite mailing of your reprints please send cash, check or money order with your order.)

For Reprints of the latest Special Report:

Radio Frequency Interference

Send me Reprints of Key No. R-39. I—10 copies 75¢ each, II—24 copies 60¢ each, 25 or more 50¢ each.

For Reprints of previous Special Reports or Feature Articles fill in below:

Send me Reprints of Key No.(s) @ ¢ each.

(For prices, see Reader Service Card.)

*For orders of Bulk Reprints of other editorial articles in this issue or past issues:

Send me Reprints of page no.(s) of issue date

of article entitled

*Minimum bulk order 100 copies. You will be advised of costs by return mail.

Name

Number and Street

City, Zone No., State

INDEX TO ADVERTISERS

Acromag Inc.	57	Jerrold Electronics Corp.	6	• United Shoe Machinery Corp..	55
Artisan Organs	54				
• Avnet Electronics Corp.	54, 55	• Keinath Instrument Co.	46		
		Klinger Scientific Apparatus...	48		
Beaver Gear Works, Inc.	57				
Brush Instruments		• Lapp Insulator Co., Inc.	41		
Div. of Clevite Corp.	3rd cover	Lehman Bros.	56		
Business Week	43				
		Machlett Laboratories Inc., The	15		
Capitol Radio Engineering		McGraw-Hill Book Co.	54		
Institute, The	40	Motorola			
• Cominco Products, Inc.	48	Military Electronics Div. ...	8, 9		
Coto-Coil Co., Inc.	55				
Crown International	60	• North Atlantic Industries, Inc..	45		
Davers Corp.	46	Pamotor Inc.	59		
Defense Electronics, Inc.	51	Photonetics Corp.	48		
Derivation and Tabulation					
Associates, Inc.	7	Radio Corporation of America			
		4th cover			
Electro-Mite	59	• Ribet-Desjardins	53		
• Fujitsu Ltd.	49	• Sigma Instruments, Inc.	22		
		Space-General Corp.	39		
Gardner-Denver Company . . .	37, 38	Sprague Electric Co.	3		
General Radio Co.	2nd cover	• Synthane Corp.	46		
Harman Kardon Inc.	16	TRW Electronics			
• Hewlett-Packard Company . . .	4	Pacific Semiconductors	21		
		Texas Instruments Incorporated			
		Industrial Products Group	42		

CLASSIFIED ADVERTISING
F. J. Eberle, Business Manager (2557)

EMPLOYMENT OPPORTUNITIES . . . 62

EQUIPMENT
(Used or Surplus New)
For Sale 62

CLASSIFIED ADVERTISERS INDEX

Ealing Corporation	62
• Radio Research Instrument Co.	62
Telephone Engineering Co. . . .	62
Union Carbide Nuclear Company	62
• Universal Relay Corp.	62

• See advertisement in the July 25, 1963 issue of electronics Buyers' Guide for complete line of products or services.

This Index and our Reader Service Numbers are published as a service. Every precaution is taken to make them accurate, but electronics assumes no responsibilities for errors or omissions.

electronics



Audit Bureau of Circulation



Associated Business Publications

AUDITED PAID CIRCULATION

JAMES T. HAUPTLI (2210)
Advertising Sales Manager

DAVID CUNIFF (3139)
Promotion Manager

HENRY M. SHAW (3485)
Market Research Manager

electronics Buyers' Guide

R. S. QUINT (2335)
General Manager

RICHARD J. TOMLINSON (3191)
Business Manager

THEODORE R. GEIPEL (2044)
Production Manager

NEW YORK TELEPHONE: Dial Direct:
971 plus number in parenthesis,
Area Code 212

ADVERTISING REPRESENTATIVES

ATLANTA, GA. 30009
Michael H. Miller, Robert C. Johnson
1375 Peachtree St. N.E.,
Trinity 5-0523 (area code 404)

BOSTON, MASS. 02116
William S. Hodgkinson
McGraw-Hill Building, Copley Square,
Congress 2-1160 (area code 617)

CHICAGO, ILL. 60611
Harvey W. Wernecke,
Robert M. Denmead
645 North Michigan Avenue,
Mohawk 4-5800 (area code 312)

CLEVELAND, OHIO 44113
Paul T. Fegley
55 Public Square, Superior 1-7000
(area code 216)

DALLAS, TEXAS 75201
Frank Le Beau
The Vaughn Bldg.,
1712 Commerce St.
Riverside 7-9721 (area code 214)

DENVER, COLO. 80202
John W. Patten
Tower Bldg., 1700 Broadway,
Alpine 5-2981 (area code 303)

HOUSTON, TEXAS 77025
Kenneth George
Prudential Bldg., Halcombe Blvd.,
Riverside 8-1280 (area code 713)

LOS ANGELES, CALIF. 90017
Ashley P. Hartman, John G. Zisch,
1125 W. 6th St., Huntley 2-5450
(area code 213)

NEW YORK, N. Y. 10036
Donald H. Miller (212) 971 3615
George F. Werner (212) 971 3617
Donald R. Furth (212) 971 3616
500 Fifth Avenue

PHILADELPHIA, PA. 19103
Warren H. Gardner, William J. Boyle
6 Penn Center Plaza,
LOcust 8-4330 (area code 215)

SAN FRANCISCO, CALIF. 94111
Richard C. Alcorn
255 California Street,
Douglas 2-4600 (area code 415)

LONDON W1:
Edwin S. Murphy Jr.
34 Dover St.

FRANKFURT/Main:
Matthee Herfurth
85 Westendstrasse

GENEVA:
Michael R. Zeynel
2 Place du Port

TOKYO:
George Olcott,
1, Kotohiracho, Shiba, Minato-ku

Signal on
conventional channel
width
40mm

Identical signal
on Mark 280 channel
width
80mm



New! Brush records 35 cps full scale on 80mm

The new portable Mark 280 doubles resolution of traces without sacrificing frequency response! And . . . you get instantaneous rectilinear ink records of unparalleled accuracy and clarity. Forced fluid writing presents traces, at frequencies to 35 cps full scale, on low cost chart paper. Dual channels each have 50 divisions in an 80 mm width, with trace width constant at one-tenth of a chart division. So now, you can easily detect minute signal variations and take *full* advantage of a $\frac{1}{2}\%$ system accuracy. Matched solid-state amplifiers provide a sensitivity of 0.5 millivolts/div. Operating controls include attenuator, pen-position, variable gain and 12 push-button chart speeds. No other recorder can match the total capability of the Mark 280. Write for details.

brush INSTRUMENTS

DIVISION OF CLEVITE 37TH AND PERKINS, CLEVELAND 14, OHIO

CIRCLE 901 ON READER SERVICE CARD

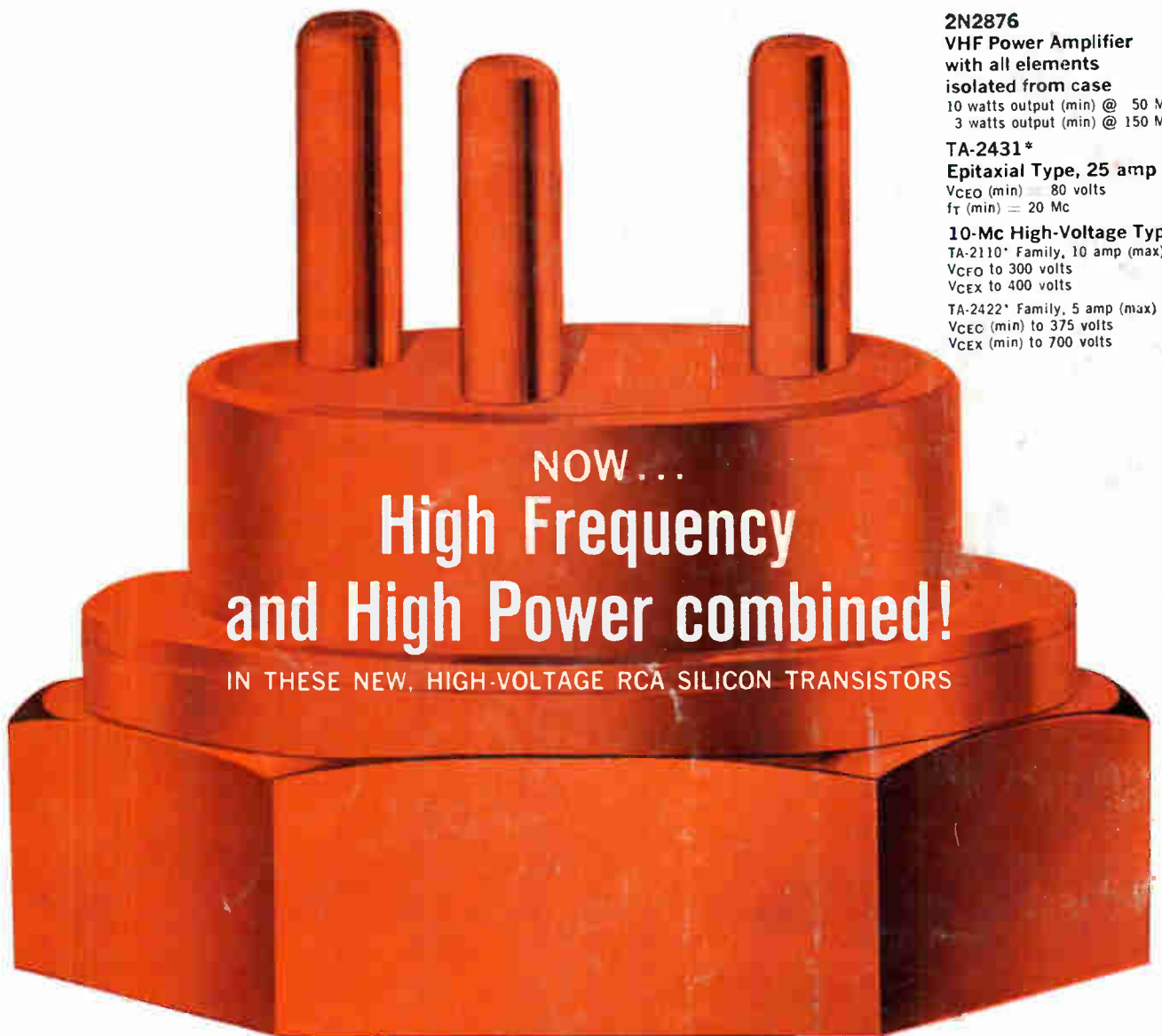

NOW ...
**High Frequency
 and High Power combined!**
 IN THESE NEW, HIGH-VOLTAGE RCA SILICON TRANSISTORS

2N2876
VHF Power Amplifier
 with all elements
 isolated from case
 10 watts output (min) @ 50 Mc
 3 watts output (min) @ 150 Mc

TA-2431*
Epitaxial Type, 25 amp (max)
 V_{CE0} (min) = 80 volts
 f_T (min) = 20 Mc

10-Mc High-Voltage Types
 TA-2110* Family, 10 amp (max)
 V_{CFO} to 300 volts
 V_{CEx} to 400 volts

TA-2422* Family, 5 amp (max)
 V_{CE0} (min) to 375 volts
 V_{CEx} (min) to 700 volts

RCA opens a new area of power applications to high-frequency transistors through high-efficiency packaging design and new advances in silicon technology.

RCA announces important advances in semiconductor design that bring new power performance to high-frequency transistors.

The interdigitated electrode structures of these silicon devices provide a long emitter periphery which accounts for their superior current-handling capability and excellent gain. New, advanced double- and triple-diffusion techniques, and epitaxial technology, provide an extra degree of uniformity in characteristics and performance.

These new types are packaged for power in specially designed double-ended stud packages. Hermetically sealed packages and heavy copper-alloy studs offer high mechanical reliability, high torquing capability, and low thermal resistance. An example of advanced case design is the RCA 2N2876 featuring ceramic seal in the feed-through terminals, isolated collector, low-silhouette for packaging flexibility, and low inductance for top RF performance.



All finished units are subjected to stringent conditioning tests, including a 100 per cent helium leak check and temperature cycling.

Call your RCA Representative today for full price and delivery information.

	RATINGS			PERFORMANCE
	I_C max. (amp)	V_{CEV} (volts)	V_{CE0} (volts)	Minimum Power Output (watts)
VHF Power Amplifier 2N2876	2.5	80	60	10 @ 50 Mc 3 @ 150 Mc

**RCA DEVELOPMENTAL TYPES
 TENTATIVE RATINGS AND CHARACTERISTICS**

	I_C † (amp)	V_{CEx} (volts)	V_{CE0} (volts)	h_{FE} @ I_C (amp)
20-amp, 20-Mc Epitaxial Power Switch TA-2431	20	120	80	22-80 @ 15
10-Mc High-Voltage Types 10-amp TA-2110 Family TA-2110 TA-2314	10 10	400 300	300 250	40-120 @ 5 35-130 @ 5
3-amp TA-2422 Family TA-2416 TA-2417 TA-2422	3 3 3	250 450 700	200 300 375	12-40 @ 2 12-40 @ 2 20-60 @ 1

† Suggested Operating Current * Developmental Type

All these types are rated and tested for safe operation (without second breakdown)

For a detailed study of design considerations to avoid second breakdown, ask for Application Note SMA-21. Write: Commercial Engineering, Section IN9, RCA Electronic Components and Devices, Harrison, New Jersey.



The Most Trusted Name in Electronics

CIRCLE 902 ON READER SERVICE CARD