

electronics®

NEW STANDARD FOR COLOR TV?

*Europe investigates
German system, p 22*

MICROELECTRONICS AROUND THE WORLD

*Japanese and Europeans are emphasizing
early use in commercial equipment, p 37*

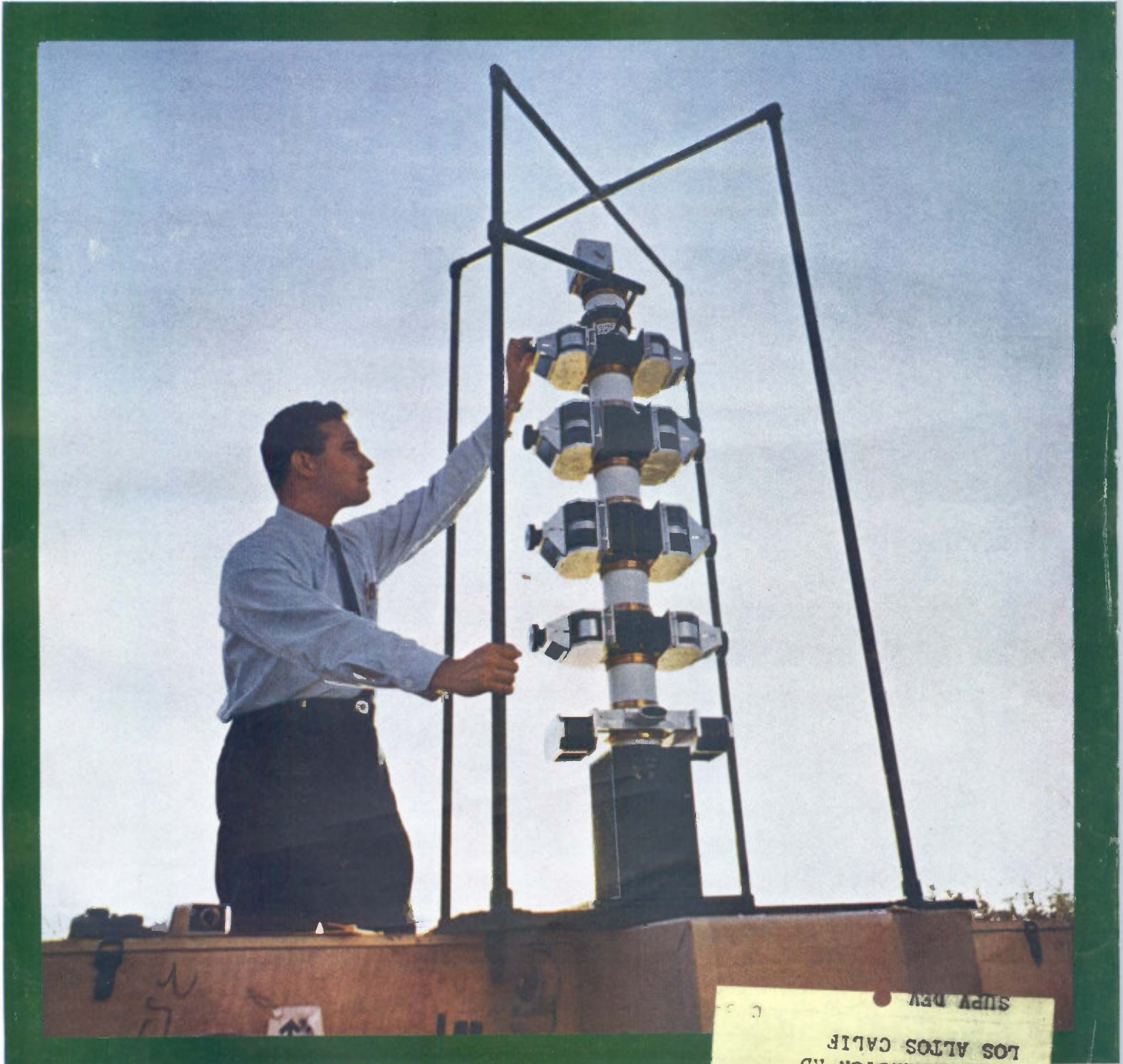

NEW POWER KLYSTRON tube is ready for all-channel tv switchover, p 61

R D SKINNER
1020 COVINGTON RD
LOS ALTOS CALIF
SUPPLY DEPT

New Megohmmeter

2,000,000-Megohm Direct-Reading



- ★ **TWO TEST VOLTAGES** 100v — EIA standard voltage for measurements of resistors above 100 kilohms
500v — For the measurement of insulation resistance
- ★ **SAFE . . .** Toggle switch on top of instrument lets you remove voltage without disturbing range-switch setting. In addition, a warning light indicates when voltage is on the terminals

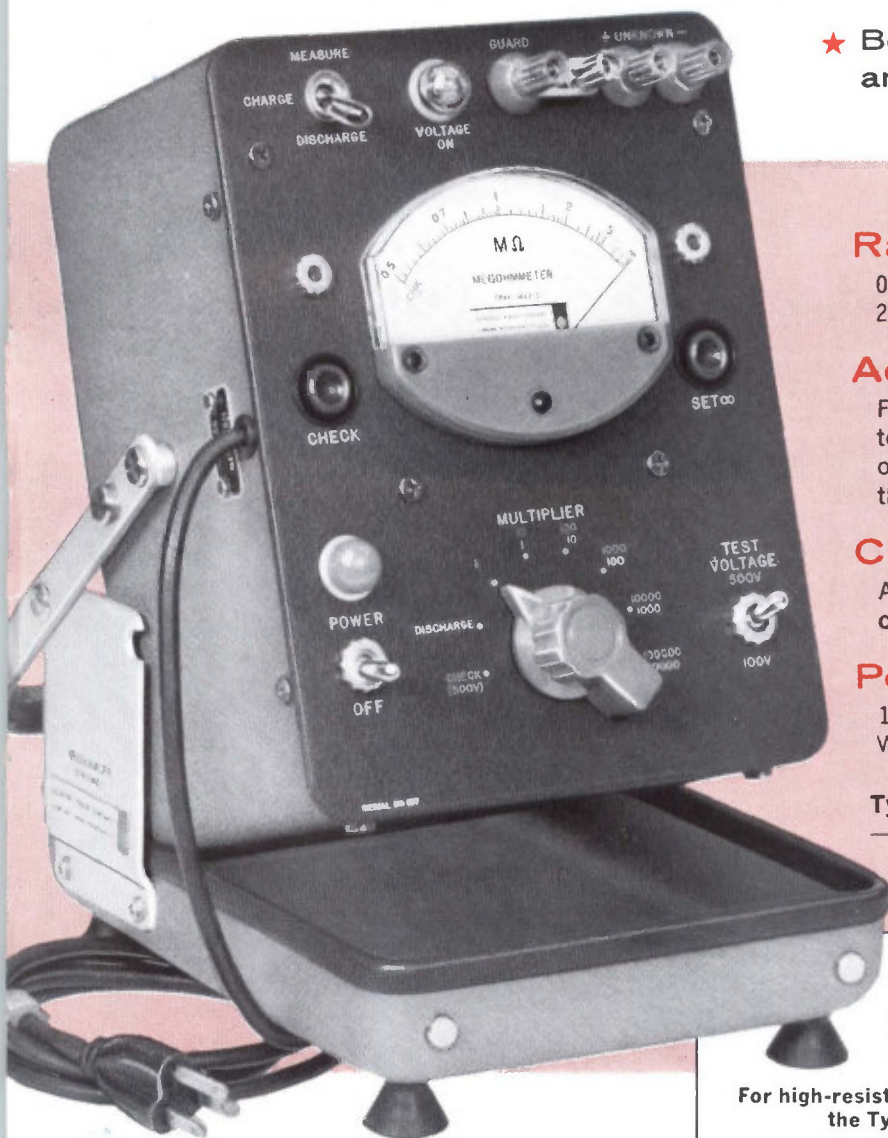

- ★ **Both Guard and Ground Terminals are Provided**

Range:

0.5 to 200,000 megohms at 100 volts and to 2,000,000 megohms at 500 volts.

Accuracy:

From $\pm 3\%$ at low-resistance end of each decade to $\pm 12\%$ at high resistance end, up to 50,000 megohms. There can be an additional $\pm 2\%$ error at the top decade.

Calibration:

Adjustment is provided for standardizing the calibration at 500 volts.

Power Requirements:

105-125 (or 210-250) volts, 40-60 cycles, 25 watts. Will operate on frequencies up to 400 cycles.

Type 1862-C Megohmmeter, \$310 (in U.S.A.)
— rack model also available at same price.

This instrument is useful for the measurement of insulation resistance of rotating machinery, transformers, cables, capacitors, appliances, and other electrical equipment.

For high-resistance measurements to 10^{13} ohms at lower voltages, the Type 1230-A Electrometer is available at \$460.

Write for Complete Information

GENERAL RADIO COMPANY
WEST CONCORD, MASSACHUSETTS

In EUROPE
General Radio
Overseas
Zurich, Switzerland

NEW YORK, N. Y., 964-2722
Ridgefield, N. J., 943-3140

CHICAGO
(Oak Park) 848-9400

PHILADELPHIA, 424-7419
Abington, 887-8486

WASHINGTON, D. C.
(Rockville, Md.) 946-1600

SYRACUSE
454-9323

DALLAS
FL 7-4031

SAN FRANCISCO
(Los Altos) 948-8233

LOS ANGELES
469-6201

ORLANDO, FLA.
425-1671

IN CANADA
(Toronto) 247-2171

CIRCLE 900 ON READER SERVICE CARD

electronics

A McGraw-Hill Weekly 75 Cents

W. W. MacDONALD, Editor (2645)

J. M. CARROLL, Managing Editor (2293)

SENIOR EDITORSSamuel Weber (2371)
George W. Sideris (3444)**SENIOR ASSOCIATE EDITORS**Michael F. Wolff (2600)
John F. Mason (2666)**ASSOCIATE EDITORS**Michael F. Tomaino (2071)
William P. O'Brien (2297)
Sy Vogel (2467)
George J. Flynn (2188)
George V. Novotny (3151)
Leon H. Dulberger (3446)
Alexander A. McKenzie (2685)**ASSISTANT EDITORS**Stanley Froud (2710)
Stephen B. Gray (2245)
Barry A. Briskman (2306)
Dan Smith (2472)
Joel A. Strasser (2127)**REGIONAL EDITORS**Harold C. Hood
(Pacific Coast, Los Angeles)
Laurence D. Shergalis
(Pacific Coast, San Francisco)
Thomas Maguire
(New England, Boston)
Cletus M. Wiley
(Midwest, Chicago)**ART DIRECTOR**

Howard R. Berry (2430)

ASSISTANT ART DIRECTOR

John C. Wright, Jr. (3430)

EDITORIAL ASSISTANTSLorraine Rossi, Virginia T. Bastian,
Lynn Emery, Ann Mella, Lorraine
Werner, Alice M. O'Brien, Sharon
Parks, Patricia Mitchell, Claire
Benell, Kay Fontana**FOREIGN NEWS BUREAU**DIRECTOR, John Wilhelm;
Laurence Mihlon, Alyne Elias
LONDON—John Shinn, Derek
Barlow, Nicholas London
BONN—Bruce Bendow,
Richard Mikton, Silke McQueen
BRUSSELS—Peter Forbath
PARIS—Robert Farrell,
Arthur Erikson
MILAN—Marc A. Messina
MEXICO CITY—Wesley Perry, Jr
RIO DE JANEIRO—Leslie Warren
MOSCOW—Stewart Ramsey
TOKYO—Richard Halloran,
Charles Cohen, John Yamaguchi**CIRCULATION MANAGER**

Hugh J. Quinn (2310)

W. W. GAREY, Publisher (2016)

NEW YORK TELEPHONE:
Diol Direct: 971 plus extensions
shown above in parenthesis. Area
Code 212

AIR-COOLED power klystron by Amperex mounts directly on a uhf-tv transmitter tower. This arrangement solves coupling problems from transmitter to antenna. High-power gain of 30 db enables design engineer to simplify transmitter circuits. *The tube's 11-Kw output was designed for uhf television broadcasting and tropo scatter. See p 61*

COVER

ATOMIC TEST BAN: What Does It Mean to the Electronics Industry? The atmospheric, oceanic and space test ban initialed in Moscow last week can have far-reaching consequences for the industry if its proclaimed aim of disarmament acquires any meaning. *But for now, government and industry officials see slight impact on weapons systems and defense sales*

18

EUROPE'S COLOR-TV Competition Gets a New Entry from West Germany. Phase alternation line system claims freedom from path distortion and other advantages over the SECAM and NTSC system. *BBC will test the new system soon*

22

ILS ANTENNA Driven by Tuning Fork. All-weather landing system uses torsion bars for scanning. *Developers say it cuts the number of data channels from three to one*

24

FRENCH CODE Gains in Europe. CMC 7 magnetic character reading system applications are snowballing. *One major attraction is that only a single head is needed to read the printing on checks and other documents*

28

FLYING RELAY for Television. Helicopter system transmits remote pickups to ground base. *Slaving airborne and ground antennas helps raise range to 80 kilometers*

32

MICROELECTRONICS AROUND THE WORLD. Heavy emphasis on applying microcircuits to industrial automation is reported from abroad. In fact, the first large-scale appearance of microelectronics on the commercial scene may come first in Europe and Japan, according to on-the-scene reports from six nations. Even some consumer products are under development. *This could mean a breakthrough in prices within the next few years*

37

SEQUENCE PULSE GENERATOR Conserves Transistors. Control systems often require a multiplicity of independent sequential timing and gating pulses. This circuit can develop as many as 10 output pulses from a single input, for programming and complex wave shaping. *Accuracy and stability are identical with individual pulse formers.*

By A. S. Ottenstein and R. L. Paul, Seaboard Electronic 44

Contents Continued

Published weekly, with Electronics Buyers' Guide as part of the subscription, by McGraw-Hill Publishing Company, Inc. Founder: James H. McGraw (1860-1948).

Title ® registered U.S. Patent Office; © copyright 1963 by McGraw-Hill Publishing Co., Inc. All rights reserved, including the right to reproduce the contents of this publication, in whole or in part.

Executive, editorial, circulation and advertising offices: McGraw-Hill Building, 330 West 42nd Street, New York, N. Y., 10036. Telephone Area Code 212 971-3333. Teletype TWX N. Y. 212-640-4646. Cable McGrawhill, N. Y. PRINTED IN ALBANY, N. Y.; second class postage paid at Albany, N. Y.

OFFICERS OF THE PUBLICATIONS DIVISION: Shelton Fisher, President; Vice Presidents: Joseph H. Allen, Operations; John R. Callahan, Editorial; Ervin E. DeGraff, Circulation; Donald C. McGraw, Jr., Advertising Sales; Angelo R. Venezian, Marketing.

OFFICERS OF THE CORPORATION: Donald C. McGraw, President; Hugh J. Kelly, Harry L. Waddell, L. Keith Goodrich, Executive Vice Presidents; John L. McGraw, Treasurer; John J. Cooke, Vice President and Secretary.

Subscriptions are solicited only from those actively engaged in the field of the publication. Position and company connection must be indicated on orders. Subscription rates: United States and Possessions and Canada, \$6.00 one year, \$9.00 two years, \$12.00 three years. All other countries \$20.00 one year. Single copies, United States and Possessions and Canada 75¢. Single copies all other countries \$1.50.

THE PUBLISHER, UPON WRITTEN REQUEST TO OUR NEW YORK OFFICE FROM ANY SUBSCRIBER AGREES TO REFUND THAT PART OF THE SUBSCRIPTION PRICE APPLYING TO COPIES NOT YET MAILED.

Subscribers: Please send change of address notices, subscription orders or complaints to Fulfillment Manager, Electronics, at the address below. Change of address notices should provide old as well as new address, including postal zone number if any. If possible, attach address label from recent issue. Allow one month for change to become effective.

Postmaster: Please send Form 3579 to Fulfillment Manager, Electronics, P. O. Box 430, Hightstown, New Jersey, 08520.



Audited Paid Circulation

CONTENTS continued

- LOW NOISE INPUT CIRCUITS:** How to Design Them. Circuit designers must attack the amplifier noise problem from three fronts—internal noise, source noise and noise bandwidth. This analysis shows how to get the lowest possible noise by component selection and impedance level adjustment. *Field effect transistors excel at high source impedance levels.*
By J. J. Rado, Precision Instrument Co. 46
- DELTA-MODULATED TV** For Long Distance Transmission. When transmitting a high-quality television signal over waveguide, where the distance between repeaters is 25 Km or more, distortion due to dispersion of the signal may result. *This tunnel-diode circuit permits 100-Mc clock rates, eliminates distortion and lowers quantizing noise.*
By C. Kramer and J. C. Balder, Philips Research Laboratories 50

DEPARTMENTS

- Crosstalk. *Microelectronics Abroad* 3
- Comment. *Hi Fi* 4
- Electronics Newsletter. *Japan Firms Setting Minimum Tv Prices* 7
- Washington This Week. *Communications Satellite Corporation Wants Satellite In Orbit by 1965* 12
- Meetings Ahead. *The 1964 Electronic Components Conference* 34
- Research and Development. *Infrared Mine Detector a Reality* 54
- Components and Materials. *New Klystron Helps UHF Transmitter Operate by Remote Control* 61
- Production Techniques. *Tool Speeds Solderless Termination* 68
- New Products. *L-Band Shifter Switches States in 10 nsec* 73
- Literature of the Week 80
- People and Plants. *Motorola Names Three Managers* 82
- Index to Advertisers 88

Microelectronics Abroad

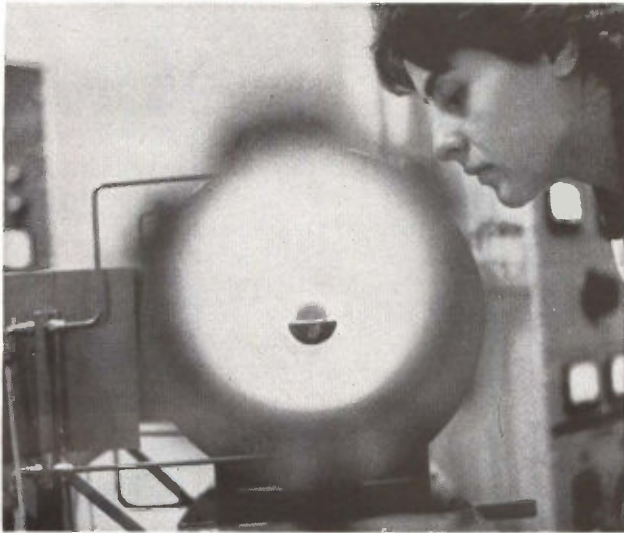

SILICON diffusion and oxidation furnace at Italian plant of *Societa Generale Semiconduttori*

THIS WEEK'S report of microelectronics activities in six distant countries (p 37) is an eye-opener. It should prove especially interesting to those U.S. electronics firms who feel microelectronics is still "blue sky" and are waiting for developments to settle down before they offer such equipment for sale.

Manufacturers in Western Europe and in Japan appear to be pushing microcircuits for commercial, industrial and consumer equipment harder than we are. American suppliers of microcircuits are already aware of the high overseas interest and are, in fact, capitalizing on it through foreign affiliates. It is largely the U.S. end-equipment manufacturer who has not yet clearly heard the message.

As we reported three months ago (p 22, May 10), U.S. manufacturers of civilian electronics products do not seem to be in any hurry to use microcircuits or to push their large-scale application in major equipments. Europeans apparently are not so hesitant. Their economic need for automated industrial controls, for example, is forcing them to push ahead and some prototypes are already in the works. The Japanese are using more microcircuits in computers and other industrial electronics products. Signifi-

cantly, they are also planning microcircuit consumer products.

We have seen enough microelectronics to recognize that it constitutes a coming wave of progress. The U.S. right now leads the world in microcircuit development. The military, who have underwritten much of the R&D cost and most of the initial production, and component developers and suppliers, have done their part. But we can lose our lead if we do not more rapidly put microcircuits to work.

WINTER SET. Two weeks ago, Assistant Editor Strasser walked into Canada's Defense Research Northern Laboratory—aptly named since it is located at Fort Churchill, on Hudson's Bay, 500 miles south of the Arctic Circle—and there on the magazine rack was the current issue of *ELECTRONICS*.

That's nice, thought Strasser. But he really felt at home when the librarian took him in tow and showed him a bound collection of *ELECTRONICS* dating back to 1930, the year we were founded. The 33-year set is part of a reference collection used by technical personnel in the far north.

You might expect the library to be used most during the winter, when the sun goes down for six months, temperatures drop to 70 below and the snow reaches the rooftops. But there is little or no nightlife in the summer, either—the sun never sets, the frozen wastes turn into swamps and there are deer flies $1\frac{1}{2}$ inches long. Strasser got the bites to prove it, though his hosts passed out insect repellent.

Strasser was one of several editors and reporters selected to fly aboard former President Eisenhower's plane, *Columbine III*, to Fort Churchill to witness the NASA and Air Force sounding rocket firings during the solar eclipse (*ELECTRONICS*, p 8 and p 37, July 26).

GONE WEST. Our well-traveled associate Larry Shergalis, once labelled "farthest-flung" editor in these columns, is now Regional Editor, Pacific Coast, based in San Francisco. That's being flung pretty far.

Larry drove his family across continent last month, following the tracks of the wagon trains and sometimes in them. His only mishap was an electrical failure, something the pioneers did not worry about.

Larry will cover the important electronics activities in the Bay area and the Pacific Northwest.

now
available
for
immediate
delivery:

**JERROLD
RF SWEEP
EQUIPMENT
...the industry's
finest!**



**Model 900B
Super Sweep Generator**

Wide plus narrow band in one versatile instrument. Handles all IF, VHF, UHF sweep requirements. Sweep widths from 10kc to 400mc. Frequency range from 500kc to 1,200mc. Built-in crystal-controlled harmonic markers, dc or ac scope preamplifier, precision attenuator. **\$1,980.00**



**Model LA-5100
rf Log Amplifier**

Accurate within ± 1 db over 80db dynamic range. Frequency range 500kc to 100mc. Lets you make exact measurements of attenuation in networks, filters, amplifiers with dynamic ranges down to 85 db. Total rf response displayed in precise log ratio on standard dc-coupled scope. **\$795.00**

Model 900A Wide-Band Sweeper

Sweep widths from 100kc to 400mc. Frequency range from 500kc to 1,200mc. **\$1,260.00**

Model 707 Ultra-Flat Sweeper
Flatness of ± 0.05 db in highest single octave. Plug-in oscillator heads. **\$840.00**

All for immediate delivery. Prices f.o.b. Philadelphia. Write for complete technical data on these and other Jerrold rf test instruments.



Industrial Products
Division,
Philadelphia 32, Pa.



A subsidiary of THE JERROLD CORPORATION

COMMENT

Hi Fi

I was both surprised and disturbed when I read the article, How Hi is Fi? (p 33, June 14), by Senior Associate Editor Wolff and Dr. Goldmark.

I have always looked upon the recording and reproduction of sound as a science rather than an art. The job of the recording and reproducing equipment is to record sound as faithfully as possible as it is received at the microphones. The reproducing apparatus must then reproduce the original at the speaker. If the recording director wishes to place the listener in the audience, he places the microphones there. The long-haired enthusiast may then wear earphones for an exact reproduction, and those of us who don't mind a bit of home flavor listen to speakers and tolerate the added effect of the reproducing room acoustics.

Dr. Goldmark places the listener in the position of a do-it-yourself chef who is provided a partial recipe and is expected to mix a special dish which, when sampled, cannot be distinguished from the real thing.

Let's have some live recordings made by placing microphones in the listener position during a live concert. It's just possible that if you start out with a genuine product, it can be preserved in recording and reproduced somewhere near the original without requiring special talents for gimmicks and gadgets on the part of the listener.

CURTIS W. FRITZE

St. Paul, Minnesota

Goldmark's Reply

The purpose of a good sound system in the home should be to create the same effect on the listener as intended by the composer. Proper microphone placement in the auditorium is important, of course, but insufficient to give maximum realism in the home where the listener's ears are usually exposed to a pair of loudspeakers placed at relatively close distance. To obtain an illusion of realism, the effect of space found in the concert hall has

to be simulated in the home as well. This was the purpose of my statements made during the interview referred to.

PETER C. GOLDMARK

CBS Laboratories
Stamford, Conn.

Tunnel Diode Errata

We request that an errata be published for the third article in the Gottlieb-Giorgis series on tunnel diodes (June 28, 1963, p 60), as follows:

On p 61, the first sentence of the last paragraph is inaccurate; it should read: "Converter Design—to start the autodyne converter design, one is given the operating r-f and i-f frequencies."

On p 62, the next to last paragraph in the third column, one half sentence is missing. It should read: "It is best to start from the low gain conditions and work towards increased gain to avoid frustrations caused by circuit instabilities."

On p 63, in the first column, a half sentence is omitted in the second paragraph's second sentence. It should read: "In the range of 100 to 135 mv bias, the gain is less than unity, but since the sensitivity of car radios is generally high, this conversion loss is of little consequence."

In the editorial box of p 64, the last two sentences should be: "Owing to their lower peak currents, back diodes would have much smaller junction areas and could be more fragile than tunnel diodes. Therefore, lower-current-concentration material is generally used to make back diode junctions larger and hence mechanically strong."

On p 65 in the first column, a portion of a sentence in the middle of the second paragraph has been deleted, obscuring the meaning. The sentence should read: "The relative merits of a tunnel diode converter versus a tunnel diode amplifier followed by a standard converter require investigation."

On p 66, in the fourth paragraph, the item between parentheses should read "(30 Mc i-f)".

R. W. SOLLINGER, JR.
General Electric Co.
Semiconductor Products Dept.
Syracuse, N. Y.

NEED A POWER SUPPLY TO MEET SPECIAL REQUIREMENTS?

See how LAMBDA modifies standard models at low cost

VISIT
LAMBDA
AT
WESCON SHOW
BOOTHS 2810—2811

Enlargements show some typical modifications made to a standard Lambda LA Series Power Supply.

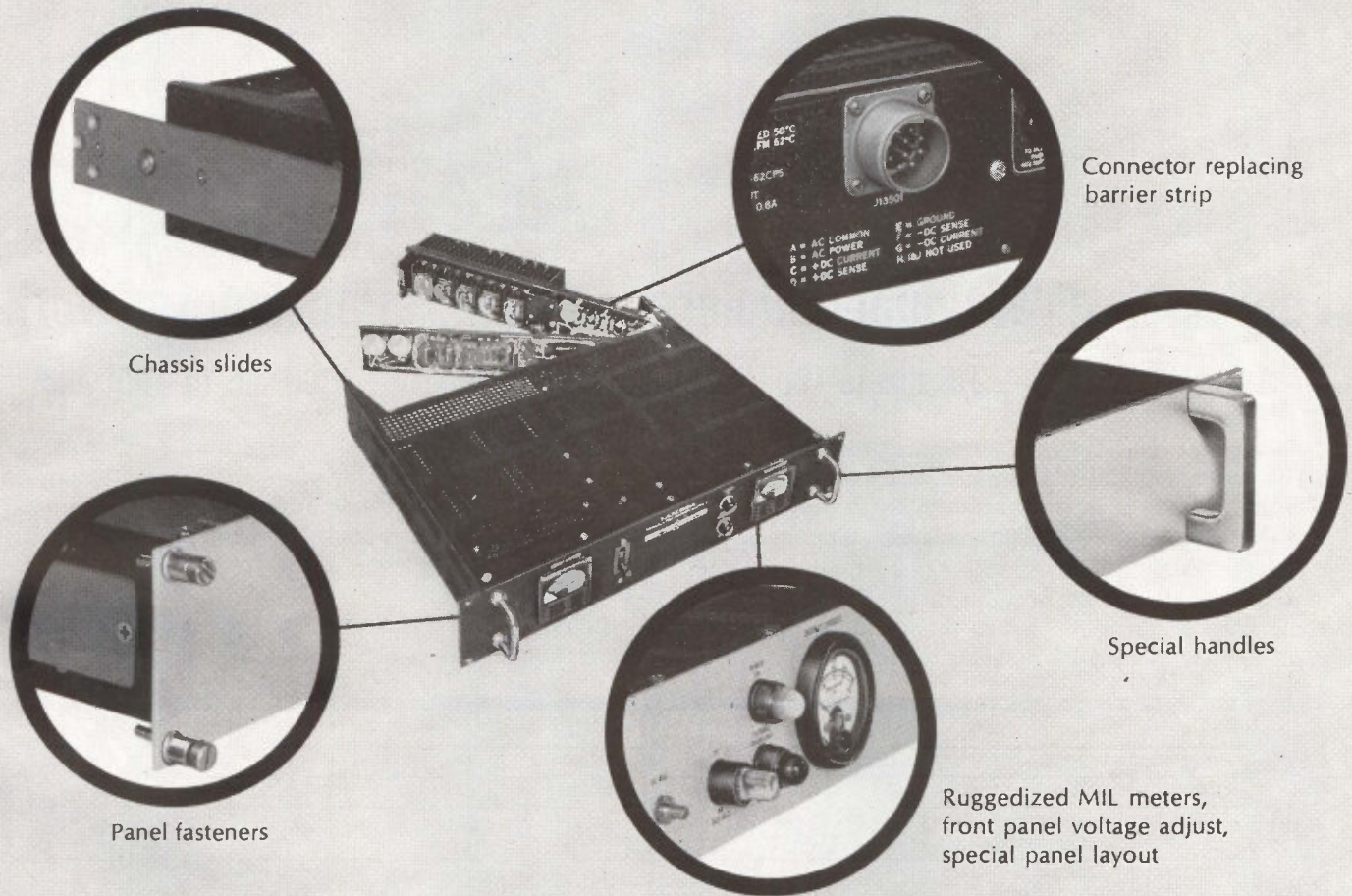

Now you can have Lambda power supply quality and reliability even if you must have a unit tailored to your needs. In most cases, Lambda can meet your special requirements by making simple, fast, low-cost electrical and mechanical modifications to any of its transistorized and tube regulated power supplies. Illustrated are just a few of the many modifications that Lambda makes

to a standard LA Series transistorized power supply.

Lambda's 5-Year Guarantee of performance applies to all modified units, as well as standard models. Write for bulletin listing typical modifications that can be made to Lambda's LE, LA, LT and Com-Pak® Series power supplies.

SEND FOR COMPLETE LAMBDA CATALOG.



LAMBDA ELECTRONICS CORP.

515 BROAD HOLLOW ROAD • MELVILLE, L. I., NEW YORK • 516 MYRTLE 4-4200

CIRCLE 5 ON READER SERVICE CARD

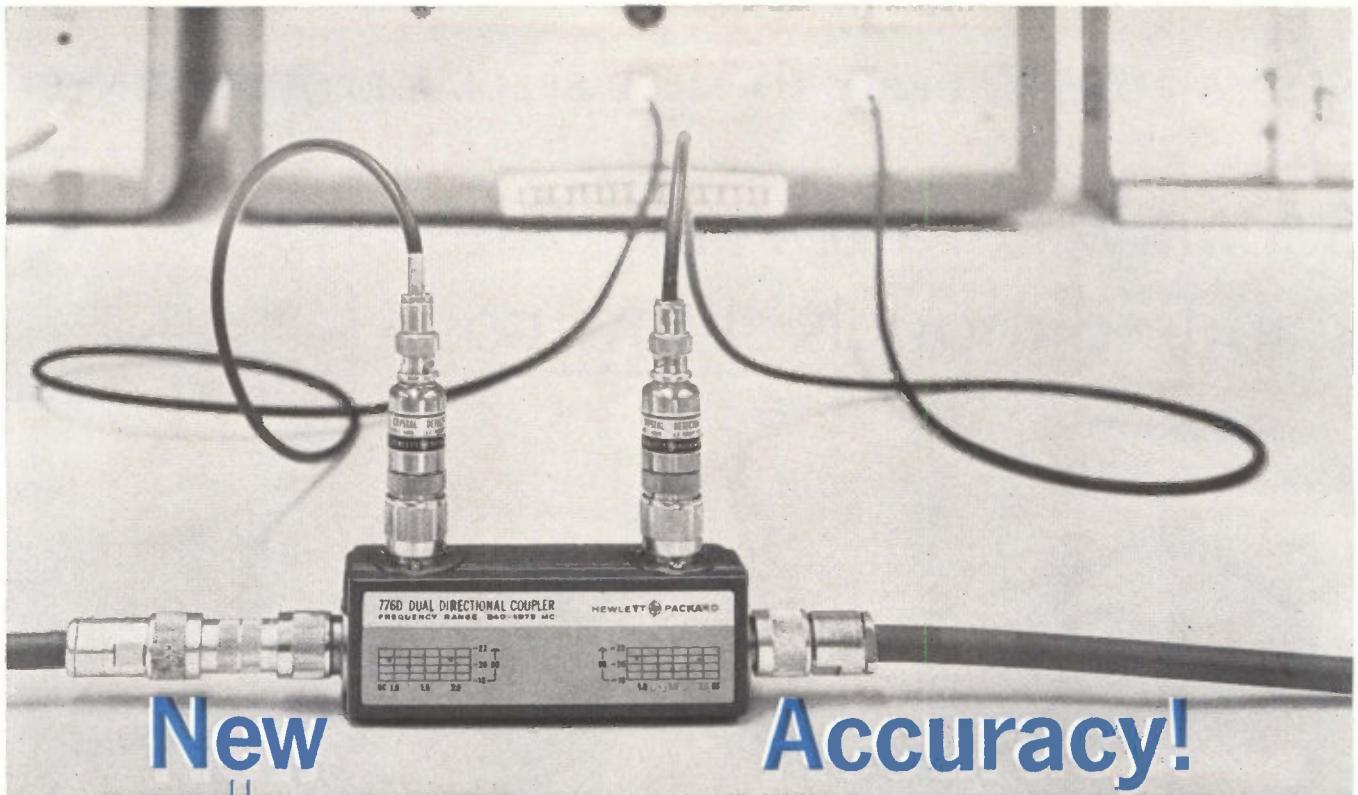

Four dual directional couplers for coax reflectometer work

40 db directivity — 215 mc to 1900 mc

30 db directivity — 1900 mc to 4000 mc

Coaxial swept reflectometer technique, time-saver in the design and manufacture of broadband apparatus, is simplified and made more accurate with these new dual directional couplers offering extremely high directivity.

The 40 db directivity is equivalent to a residual swr error of only 1.02 and provides accuracy in swept frequency reflectometer applications better than that of laborious point-by-point slotted line measurements.

Each of these couplers covers a frequency spread of more than two-to-one, with coverage centered on one of the important vhf-uhf bands. Together they cover from 215 to 4000 mc. Their high power handling capacity and low insertion loss make them useful for permanent installation in coax lines for power monitoring.

Call your nearest Hewlett-Packard field office for a demonstration on your bench.

SPECIFICATIONS	Model	774D	775D	776D	777D
	Frequency range:	215 to 450 mc	450 to 940 mc	940 to 1900 mc	1900 to 4000 mc
	Minimum directivity:	40 db	40 db	40 db	30 db
	Coupling attenuation: (each secondary arm)	20 db	20 db	20 db	20 db
	Accuracy of coupling: (each secondary arm)	Mean coupling level within 0.5 db of specified values			
	Coupling variation:	Less than ± 1 db over frequency ranges			
	Max. primary line swr: (50-ohm terminations)	1.15	1.15	1.15	1.25
	Max. secondary line swr: (50-ohm terminations)	1.20	1.20	1.20	1.50
	Power handling capacity:	50 watts cw 10 kw peak	50 watts cw 10 kw peak	50 watts cw 10 kw peak	50 watts cw 10 kw peak
	Primary line insertion loss:	Approx. 0.15 db	Approx. 0.20 db	Approx. 0.25 db	Approx. 0.35 db
Price:	\$200	\$200	\$200	\$200	

Data subject to change without notice. Prices f. o. b. factory.



**HEWLETT
PACKARD
COMPANY**

1501 Page Mill Road, Palo Alto, California, (415) 326-7000. Sales and service in all principal areas. Europe, Hewlett-Packard S.A., 54 Route des Acacias, Geneva, Switzerland; Canada, Hewlett-Packard (Canada) Ltd., 8270 Mayrand St., Montreal, Quebec.

Japan Firms Setting Minimum Tv Prices

TOKYO—Seventeen of Japan's major tv manufacturers are nearing agreement on minimum prices to charge exporters for tv sets destined for the U. S. market. The actual export prices cannot be set because of Japan's antitrust laws.

The minimum prices will apply to four classifications of sets: 19-inch, 16-inch, 5 and 6-inch and smaller than 5-inch sets. Exempt are color and closed-circuit sets.

The agreement covers the bulk of tv production by EIA-J members and is being made "to maintain orderly marketing." If everything proceeds smoothly, it should be ratified and in effect by October, EIA-J says. Similar agreements now cover dry cells and binoculars.

Topsy-Turvy Processing Reduces Diode Leakage

UPSIDE-DOWN processing can cut reverse leakage current of diodes 1,000 times, while boosting forward current 100 times, according to Yuan Feng Chang and H. W. Thompson, Jr., of Purdue University. Superiority of the resulting abrupt junction strongly suggests that most alloyed junctions should be made with impurity balls on the high temperature side of semiconductor wafers.

Substitution of thick base contacts for ohmic or soldered contacts can also reduce reverse leakage currents of $p+nn$ and $p+pn$ diodes almost two orders of magnitude, Thompson reported, making thick base contact germanium diodes comparable to silicon diodes. Thick base contact diodes also deliver greater forward conduction at high current densities, he said.

Abrupt junctions were developed by placing antimony balls under p -type germanium wafers, and then controlling the temperature gradient to prevent diffusion. The "first truly abrupt junction" in silicon,

using n -type silicon wafers over aluminum balls, exhibited one single slope for six decades of current.

Strike Command Testing Systems Coordination

U.S. STRIKE COMMAND is finishing up the second week of a four-week joint exercise in a 7,500-square-mile area in the Carolinas and Georgia. More than 75,000 soldiers and airmen are participating in diversified air and ground operations.

One result of the "battle" will be more clearly defined requirements for making Army and Air Force electronic systems more compatible, and coordinating command and control equipment and procedures. Big contracts will eventually be awarded to make the USSTRICOM team a smoothly-operating force.

Telstar II: It's Either Power Supply or Antenna

MURRAY HILL, N. J.—Bell Telephone Laboratories engineers have narrowed down the reasons for Telstar II's failure to either a faulty power supply regulator or loss of the vhf helical antenna, according to Robert H. Shennum, head of BTL's satellite design department.

Satellite Stabilizer

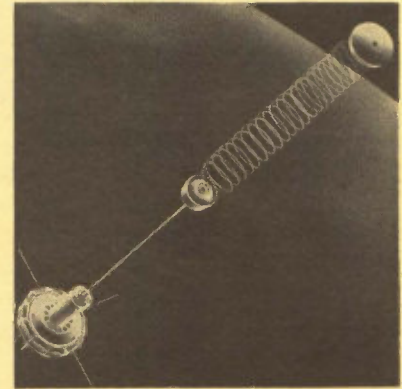

GRAVITATIONAL stabilization system developed by Johns Hopkins' Applied Physics Laboratory is successfully keeping a new Navy satellite oriented toward the earth. System did not work properly when first used aboard the Traac satellite in November, 1961

BTL has tried all the trick commands used with Telstar I to bypass various single elements of the decoder circuit. None of these has worked, strongly suggesting that the decoder is not involved. On Telstar II, the 136-Mc beacon would stay on even if the command structure didn't function.

Visual sightings made with a telescope at Holmdel, N. J. on July 23 and 24 proved that the satellite's spin rate, orbit and axis have not changed.

BTL has 20 to 30 men working full time on Telstar II experiments.

The Cold War, Tv-Wise

CHICAGO—A late-model Russian tv set displayed here last week is hardly a threat to U.S. manufacturers. Here are a few of the reasons: a 17-inch picture tube 23½-inches long—twice the length of the U.S. counterpart; a weight of 65 pounds—14 pounds heavier than U.S. models, and brightness levels 30 percent below U.S. sets. The Russian set, shown in the Westinghouse booth at the National Association of Music Merchants convention, was reminiscent of the U.S. state of the art 10 years ago. It would cost a Russian worker 324 rubles (\$359.65)

Two more flyable Telstars exist, and although no decision has yet been made, launching of a third Telstar has not been ruled out.

Mueller Succeeds Holmes of NASA

NASA HAS named George E. Mueller to head the manned spaceflight program, succeeding D. Brainerd Holmes, who has resigned (p 22, June 21). Mueller, vice president for research and development at Space Technology Laboratories, will assume his new duties Sept. 1. Previously, Mueller had been engaged in the Atlas, Titan, Minuteman, Thor, Pioneer, and Explorer programs.

8-mm Maser Will Update Radiometer System

BEDFORD, MASS.—One of the first 8-mm masers ever built is expected to be delivered here within the next two months by RCA for a new radiometer system under development by the Air Force Cambridge Research Laboratories. The existing station atop Prospect Hill in Waltham, Mass., will be updated for radio and radar astronomy studies at 15-17 Gc and 35 Gc (8 mm).

New equipment will also include a computer-controlled precision antenna system.

Syncom II A Success, Drifting to Rendezvous

WASHINGTON—Syncom II is functioning well, according to reports early this week. It is drifting 4.5 degrees westward and in two weeks should reach a previously selected position at 55 degrees west longitude over northern Brazil. Temperature of the spacecraft was 10 degrees cooler than normal, but officials said this would be corrected.

Operating at a 22,800-mile apogee and 22,110-mile perigee, the satellite successfully completed demonstrations with music and

voice communications, teletype and facsimile test patterns. During the week, experiments were planned between Lakehurst, N. J. and the USNS Kingsport in Lagos Harbor, Nigeria. The satellite should be visible to both the U. S. and Europe sometime today.

Uhf Ruling May Spur Localized Vhf Production

CHICAGO—The prospect for localized vhf-only tv-receiver production was seen by FCC Commissioner Robert E. Lee last week, following a National Association of Music Merchants clinic on all-channel broadcasting during NAMM's convention and show here. Vhf-only sets could enjoy a \$20 to \$30 price advantage in this highly competitive market, since the \$6 extra cost of the uhf tuner at the manufacturers level is accelerated by markups all along its route to the consumer.

Miniaturized 3-D Radar Is Air-Transportable

LIGHTWEIGHT three - dimensional radar that can be transported by helicopter and quickly put into operation in remote areas has been developed by Hughes. The radar provides long-range, simultaneous, 3-D data (range, height, and bearing) on airborne targets, can be set up by six men in 30 minutes and operates unmanned.

Lightness is achieved by miniaturized circuitry, an efficient transmitter, planar (billboard type) array antenna concepts and compact packaging techniques. The radar will use frequency scanning techniques previously developed by Hughes. It will be compatible with existing weapon systems and adaptable to many air defense and air traffic control functions.

Hughes said the radar's narrow pencil beam reduces ground clutter and provides low-altitude detection capabilities at long range, even in electronic countermeasure environments.

In Brief . . .

COSMAT CORP. will award the multiple-access system contract in early August. The six bidders are ITT, RCA and Bell Labs (for the medium altitude system); GT&E and Hughes (for the synchronous system) and Philco (for the time delay modulation).

ARCO is supplying the Air Force with one of the most powerful industrial x-ray machines ever built. The unit will be used to check solid-fuel elements—primarily Minutemen missiles—for voids or other imperfections.

MAGNAFLUX has introduced a microwave, corona, gamma-backscatter and eddy-current system for testing glass-epoxy missile motor cases.

ELECTRICAL ENGINEER ranks have grown faster than any other major engineering branch, a National Science Foundation study shows. There were 50,000 EE's in 1940, an estimated 220,000 this year and there probably will be 325,000 by the decade's end, NSF said.

AEROJET GENERAL has successfully fired the transtage of Titan III. The transtage is the last stage of the Titan III launch system.

CARL ZEISS has developed electronic instruments to check camera lenses automatically. The device may reduce camera costs, as well as increase lens quality.

SANSEI, a Japanese firm, is establishing a plant in California to assemble radios.

CZECHS have built their country's first gallium-arsenide diode laser.

LOCKHEED has installed a data-gathering system, based on two RCA 301 computers and 206 RCA EDGE (electronic data gathering equipment) units, that provides management with production line data from as far away as 400 miles.

SCIENTISTS at Sydney University in Australia have developed an electronic device that automatically keeps track of the egg-laying habits of a flock of hens.

SPRAGUE LOGIC TRANSISTORS GIVE SUPERIOR LATCH-UP PROTECTION!

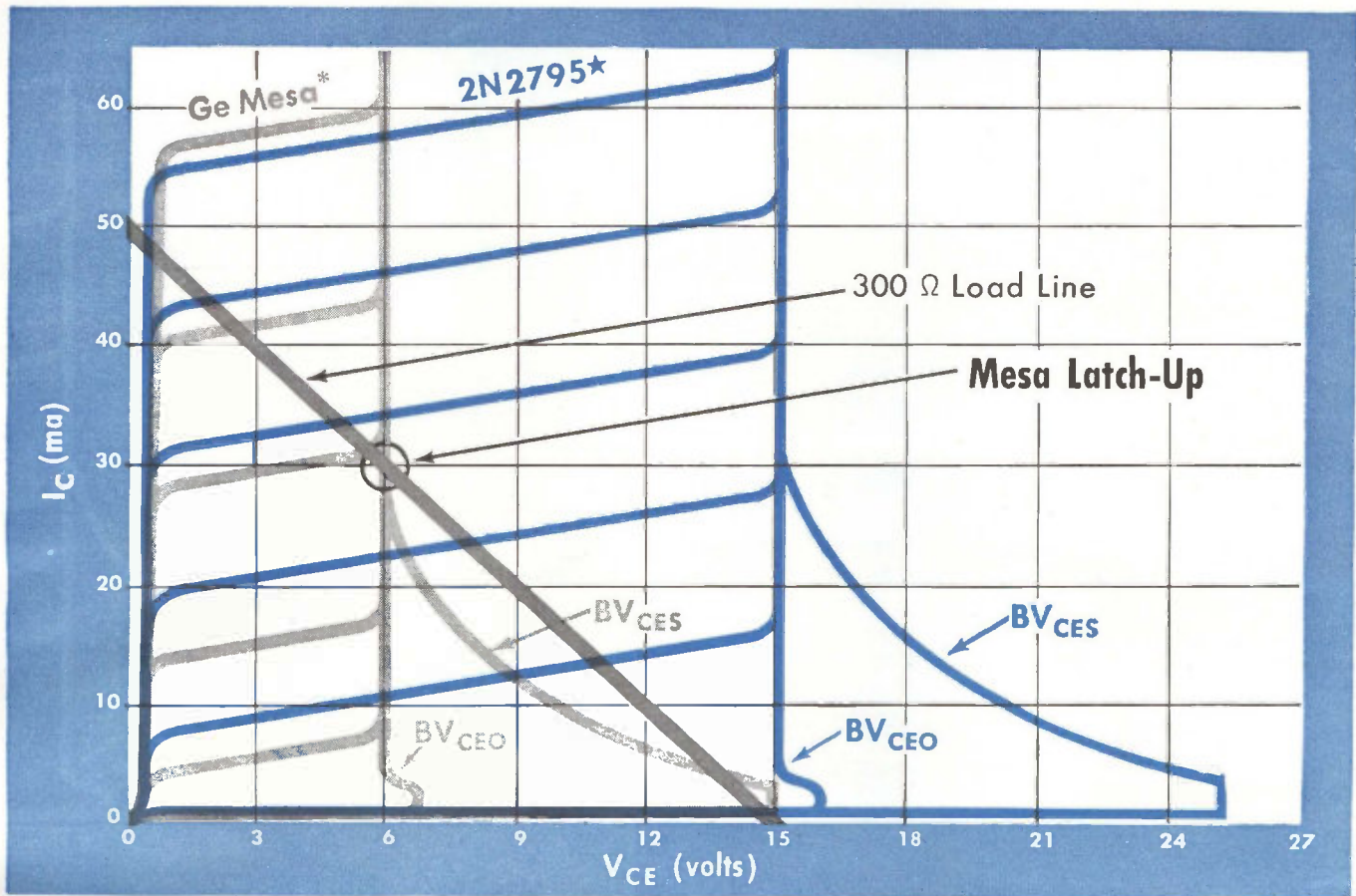

*ratings for most prime germanium mesa types. ★based on guaranteed ratings!

For Guaranteed High Voltage Operation at High Speeds, Investigate Sprague ECDC[®] and MADT[®] Transistors

Type No.	f _t (typical)	BV _{CES} (minimum)	BV _{CEO} (minimum)
2N2795	450 mc	25 volts	15 volts
2N2796	450 mc	20 volts	12 volts
2N984	350 mc	15 volts	10 volts
2N979	150 mc	20 volts	15 volts
2N980	150 mc	20 volts	12 volts
2N2048†	250 mc	20 volts	15 volts

(†TO-9 Case)

● For additional information on Sprague High Voltage Logic Transistors, write to the Technical Literature Service, Sprague Electric Company, 35 Marshall Street, North Adams, Massachusetts.

© Trademark, Philco Corp.

SPRAGUE COMPONENTS

TRANSISTORS
CAPACITORS
RESISTORS
MICROCIRCUITS
INTERFERENCE FILTERS

PULSE TRANSFORMERS
PIEZOELECTRIC CERAMICS
PULSE-FORMING NETWORKS
TOROIDAL INDUCTORS
ELECTRIC WAVE FILTERS

CERAMIC-BASE PRINTED NETWORKS
PACKAGED COMPONENT ASSEMBLIES
BOBBIN and TAPE WOUND MAGNETIC CORES
SILICON RECTIFIER GATE CONTROLS
FUNCTIONAL DIGITAL CIRCUITS



'Sprague' and '©' are registered trademarks of the Sprague Electric Co.

Get the Full Story at WESCON Booth 1818-22

How much do you know about today's high-frequency scopes?

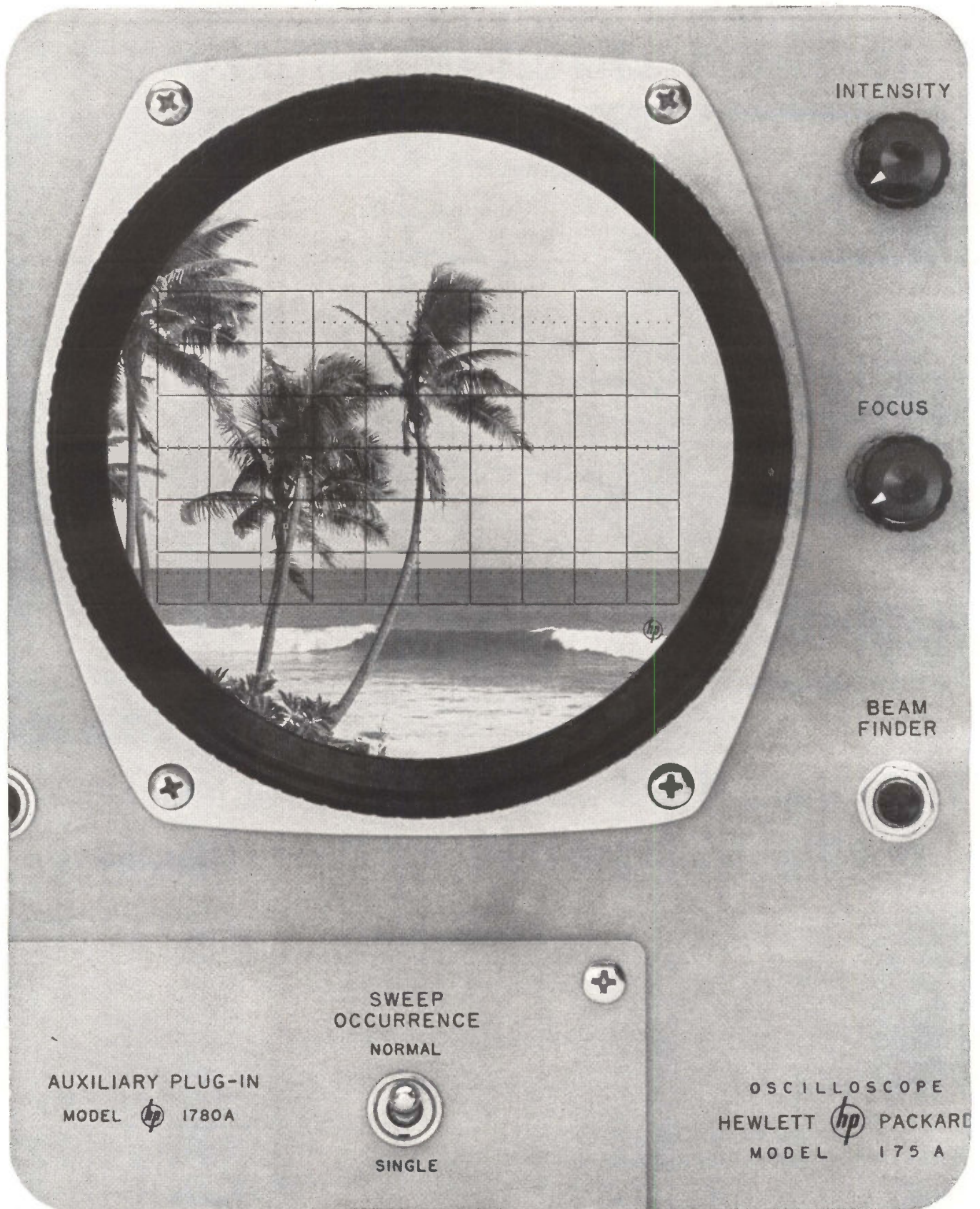

Why not?

Why not?

More pictures than you'd guess

You'll be amazed how many things you can see on the extraordinary 175A. Credit plug-in versatility.

You can tailor the 175A to your exact measuring task with an inexpensive plug-in . . . one designed specifically for the 175A. Consider these plug-ins available for the 175A 50 MC Oscilloscope:

On the vertical side of the ledger, the 175A has about the same plug-in versatility as the scope you've been using . . . except that we can let you do more with fewer plug-ins and, consequently, at lower cost. Once you've got the basic scope—with its big 6x10 cm picture free from parallax error and glare, its easy operation and simple maintenance features—you can go where you want, measure what you want from there.

Our vertical plug-ins include these (and we invite comparison with plug-ins for your present high-frequency scope): A versatile dual trace vertical amplifier which provides sensitivity of 0.05 v/cm to 20 v/cm to 40 mc, \$285.

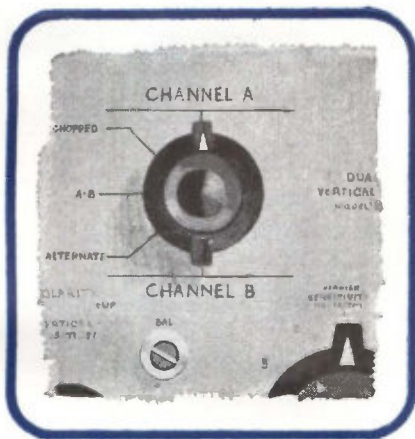

A single channel 50 mc amplifier which offers 50 mv/cm sensitivity, \$160. A high gain vertical amplifier which increases scope sensitivity to 5 mv/cm, \$225. A four channel vertical amplifier which permits big picture viewing of four traces at one time, to 40 mc, \$595.

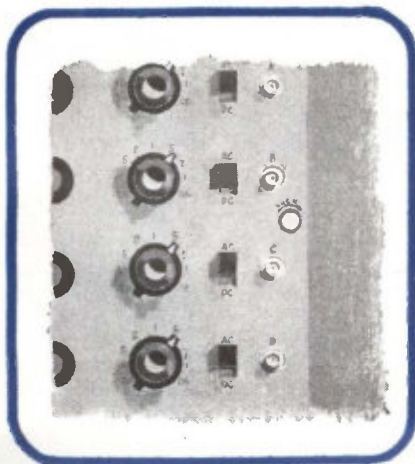

Unique with our 175A is the fact that it accepts horizontal plug-ins, too—the only high-frequency scope of its type offering this extra versatility. Our sweep delay generator is a plug-in, and you can add it whenever you need the capability, \$375. Then there's the exclusive display scanner which permits making high-resolution x-y plots of traces appearing on the 175A crt, \$425. A time mark generator plug-in is useful for measuring rise time and pulse duration, and its markers are also useful for photography, \$130. The auxiliary horizontal plug-in allows the 175A scope to perform all its standard functions, \$25.

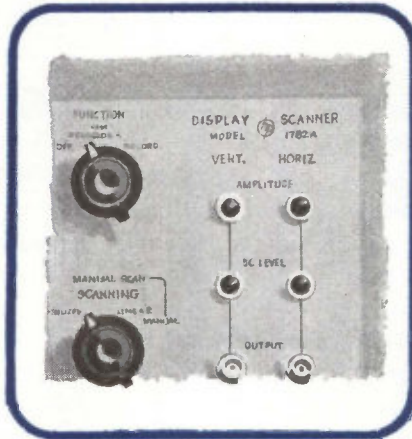

Because our 175A plug-ins are wide range and offer full sensitivity, you can do more . . . go farther . . . with fewer plug-ins. A money-saving item that lets you tailor your high frequency scope to meet your exact needs, adding plug-ins when, but not unless you need them.

Beyond this remarkable plug-in versatility, the 175A is a scope that'll introduce new accuracy through large-screen viewing and elimination of parallax error. It's also so easy to operate . . . color-coded controls so logically arranged that even a novice can learn to use it in half the time it takes to learn conventional scopes. The 175A has fewer controls, too. It offers positive pre-set syncing over the entire bandwidth, the easiest triggering and the most dependable triggering you can find in a high-frequency scope.

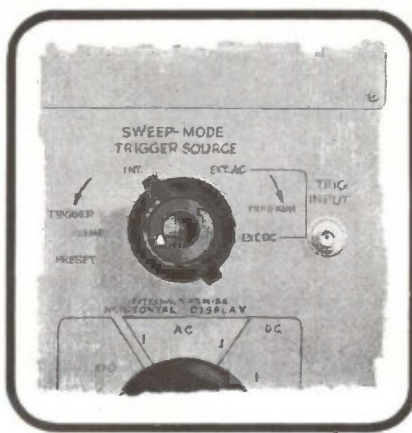

The maintenance story, too, is unprecedented. The sensitive 12 kv crt developed for the 175A permitted us to simplify driving circuitry . . . no distributed amplifiers, for example, with their attendant critical adjustment and alignment; and we've incorporated a new cable delay line that eliminates still more adjustments. We use only 7 tube types and 5 transistor types in the 175A . . . and none of them "selected." Think what that does to your parts inventory and how much it simplifies component replacement.

The 175A won't plan a trip for you, but it will get you where you want to go, measurement-wise, with a plug-in that's just the ticket. We're glad we don't have to charge you for more scope than you need, capabilities you don't really care about. You can *choose* the capabilities you *do* care about.

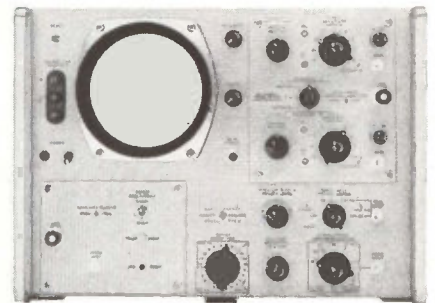

You can prove all this to your own satisfaction by setting the 175A alongside your present high-frequency scope and checking it out point by point. If you have anything at all to do with scopes, you owe it to yourself to take a look at the 175A. Same as we owed the 175A to you. hp 175A, \$1325 (plug-ins optional at extra cost).

Data subject to change without notice. Price f.o.b. factory.

HEWLETT PACKARD COMPANY



1501 Page Mill Rd., Palo Alto, Calif., (415) 326-7000.
Sales and service representatives in principal areas.
Europe, Hewlett-Packard S.A., 54 Route des Acacias,
Geneva, Switzerland; Canada, Hewlett-Packard
(Canada) Ltd., 8270 Mayrand St., Montreal, Quebec.

WASHINGTON THIS WEEK

COMSAT WANTS SATELLITE IN ORBIT BY 1965

TARGET DATES for the Communications Satellite Corporation are: freeze on system design by mid-1964; fly prototype satellites by mid-1965 and have a full system in operation by 1967. The corporation's technical priorities are to develop a multiple-access system, improve traveling-wave tube efficiencies and perfect attitude stabilization.

Government agencies are sufficiently advanced in stabilization work, so the corporation doesn't plan to buy research in this field. The corporation's first satellite system will use solar power. To conserve power usage, better tube efficiencies are wanted. The corporation is asking 15 American and six foreign companies if they can improve the efficiency of traveling-wave tubes.

A controversy may be brewing between the corporation and FCC. As it approved a \$600,000 loan request, FCC blasted the corporation for dragging its feet in getting a public stock offering out. FCC contended the temporary board of directors is dealing in basic decisions for the satellite system that a permanent board should make. The corporation counters that such decisions are necessary to a meaningful stock offering and that FCC has no authority over the initial stock offering. Earlier, FCC proposed a rule that the corporation notify FCC in advance of any contract that would exceed \$2,500. The corporation is certain to seek a higher ceiling. September 10 is set for replies to the proposed procurement regulation.

NASA'S BOSTON CENTER FUNDS FACE THE AX

FATE of the space agency's proposed \$50-million Boston electronics center hangs in fine balance. NASA sought \$5 million from Congress this year to get the new center started. The House Committee on Science and Astronautics cut NASA's request back to \$3.9 million. The Senate Aeronautical and Space Sciences Committee tentatively voted, 6 to 5, to cut all funds for the project. The vote came in executive session, however, with four members absent and all votes subject to change. Final outcome could go either way, say congressional sources.

POLITICS AND TECHNICIANS

A POLITICAL VISE also holds the administration's proposed program to train more skilled technicians. The Vocational Education Act, with \$180 million in matching funds for state programs, has been halted at the House Rules Committee. Chairman Howard W. Smith (D-Va.) reportedly intends to hold it up there as an extra item for horse-trading on more controversial administration legislation.

POST OFFICE ACCELERATES AUTOMATION

POST OFFICE is pushing up by several years the anticipated readiness of reading machines for rounding out the postal mechanization program, (*ELECTRONICS*, p 26, July 12). As many as 30 companies are testifying to the reality of the new time estimate—field trails in two years—by competing for a contract containing that deadline. Award of a \$3-million to \$5-million research and development contract is expected by mid-August.

The devices will be limited to the recognition of five-digit numbers, used in the ZIP code program. If mass mailers number-code their mail, digit-readers and existing machinery can virtually remove the human touch from many mail-handling operations. Postmaster General Day says that three years after field tests, the readers should be in scores of major post offices.

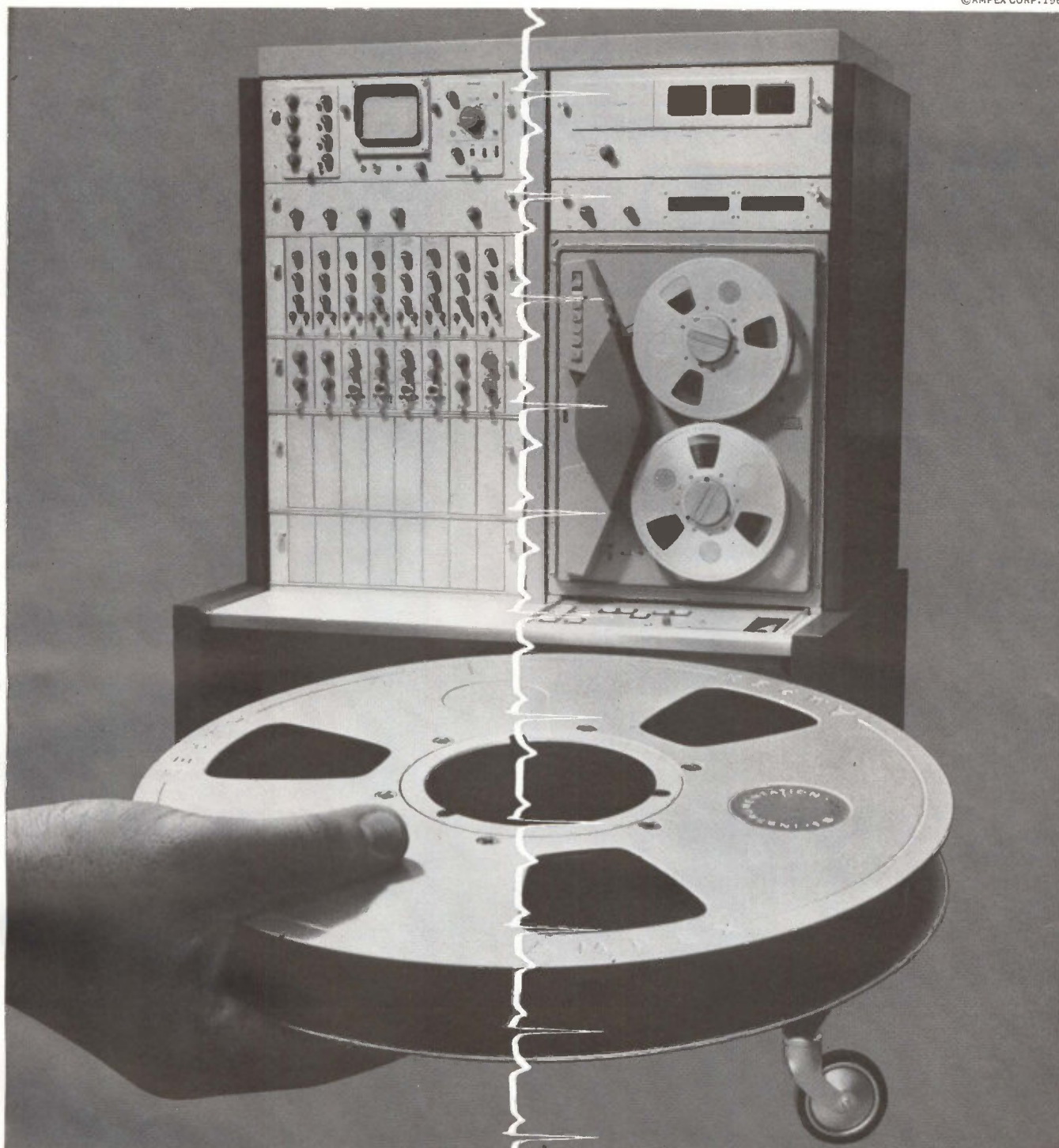

What new data acquisition system provides data ready for processing? AMPEX DAS-100

Introducing: the new DAS-100 from Ampex. It's the first complete magnetic tape data acquisition system. And it's designed to permit easy editing, precision retrieving and rapid searching. So you can have your data ready for processing far sooner and have your answers far faster than ever before. The DAS-100 can accept data from transducers or electrodes, recording the events simultaneously with a continuous time code. It provides its own signal conditioning with a choice of preamplifiers depending on input. It locates



data rapidly and automatically to a resolution of one millisecond, feeds analog data to a graphic recorder and permits visual monitoring during and after the experiment. The system includes a 7- or 14-track FR-1300 recorder/reproducer, preamplifiers and their associated input couplers, a time code generator, an oscilloscope monitor, a level indicator and a master control panel for ease of operation. For more data about the new DAS-100 write Ampex Corporation, Redwood City, Calif. Worldwide sales, service.

SEE THE DAS-100 AT WESCON — AUGUST 20-23, SAN FRANCISCO

PCM TELEMETRY



PCM Bit Synchronizer
and Signal Conditioner



Tunable Notch Filter



Airborne Time Code Generator

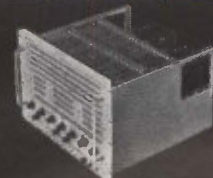

PCM Signal Simulator

Now...from Bendix-Pacific

Bendix-Pacific, pioneer in FM/FM telemetry since 1946, now proudly offers Pulse Code Modulation. Through an exclusive agreement, Bendix-Pacific has secured manufacturing and world-wide sales rights to the PCM telemetry products of the Correlated Data Systems Corporation.

This important consolidation now provides telemetry users with a single source for advanced FM/FM and

PCM systems, subsystems and components. Complete FM/FM/PCM ground equipments are available and other PCM items supplementing Bendix-Pacific's present line of FM/FM components and systems are soon to be introduced.

We welcome the opportunity to propose on your telemetry requirement. Write Bendix-Pacific, 11600 Sherman Way, North Hollywood, California.

Bendix-Pacific Division



nothing but talk...talk...talk...

LEACH SATELLITE RECORDER/REPRODUCERS are now in orbit storing lots and lots and lots of data . . . playing back when and where needed.

The unit shown here records on ¼-inch Mylar-base magnetic tape up to 210 minutes at 1.8 ips . . . transmits back to earth in 8:07 minutes. As it transmits, it erases itself and records all over again.

Seven pounds light and seven inches narrow, this Leach Satellite Recorder/Reproducer has taken the rockiest launch

in stride, works in temperatures from -30°F to 130°F with an average power consumption of only 4 watts.

If you're in the satellite making business, you should make it your business to know more about this recorder/reproducer and how it can be adapted to your needs. You can know, too. Just send a line to Leach. You will get complete specs on this specially engineered recorder as well as other high environmental tape recorders—in the return mail.



LEACH
CORPORATION
CONTROLS DIVISION
717 North Coney Ave. • Azusa, Calif.
Export: Leach International S. A.

Kodak reports on:

5 little advances . . . mail-order infrared optics . . . crystal growers' silver nitrate . . . film for over and over and over again

About paper for direct-writing oscillographs

Always order as "KODAK LINAGRAPH Direct Print Paper." The name has been around for a while, but what it covers is always subject to improvement. Today's KODAK LINAGRAPH Direct Print Paper permits the same high writing speed as hitherto. The trace pops up quicker, however. It's darker on a lighter background. It keeps longer before treatment for permanence. It looks better after the treatment.

Why not have the benefit of little advances like that as soon as they come out? Keep in touch with Eastman Kodak Company, Photo-recording Methods Division, Rochester 4, N. Y.

IRTRAN menisci

KODAK IRTRAN 2 $f/1$ lenses for 1-14 μ seem to be permeating infrared technology, probably for their thermal, mechanical, and chemical ruggedness. There is no chance of getting a poorly annealed one because they simply don't require annealing. If you can use any shown below, just send the purchase order to Eastman Kodak Company, Apparatus and Optical Division, Rochester 4, N. Y. We can probably ship in a week. If you need more data or more special lenses, phone 716-562-6000, Ext. 5166.

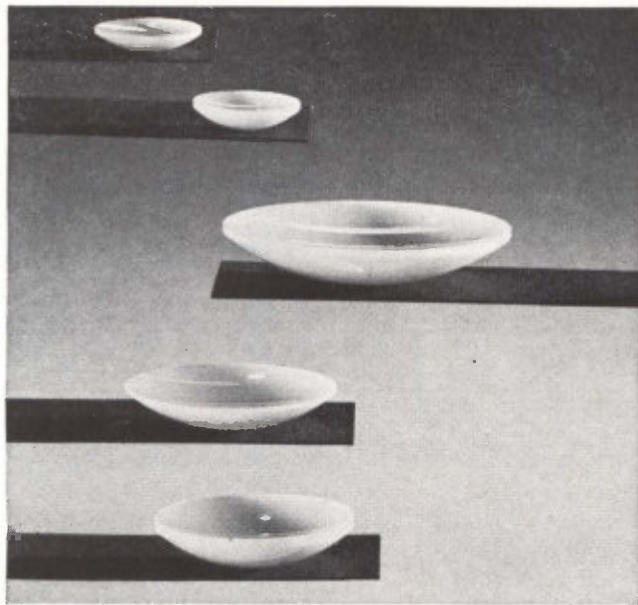

	EQUIVALENT FOCAL LENGTH (mm.)	MEASURED BLUR CIRCLE ^a (mm.)	**
1. IR-100	25.2 computed at 1.5 μ 26.4 computed at 10 μ	0.36	\$ 77
2. IR-101	25.4 computed at 3 μ 26.7 computed at 10 μ	0.15	\$235
3. IR-301	76.2 computed at 4.26 μ 79.5 computed at 10 μ	0.38	\$395
4. IR-200	50.6 computed at 1.5 μ 53.8 computed at 10 μ	0.61	\$168
5. IR-201	48.8 computed at 4.26 μ 50.9 computed at 10 μ	0.20	\$325

^adiameter of axial image of point source at which measured intensity drops to 5% of center peak intensity, for 2-4.5 μ range.

**net price each in 1-10 quantities, subject to change without notice.

The fraternity of purity

We have an abiding interest in the physics of the solid state and need all the company we can get in the pursuit of that interest.

More than 50 years ago, well before "solid state" became a label for a discipline, the founder of our house was persuaded that to go on any longer than necessary treating photographic emulsion-making as an art form would prove folly. As a result of both long-range and short-range thinking, he created an atmosphere around the place that had the effect, years after his departure, of making the silver halide crystal one of the more readily prepared objects of study for those who feel deep curiosity about the nature of purity just short enough of perfection to be interesting. That's how come much solid-state literature continues to deal with silver chloride.

The experimenter acquires the purest AgNO₃ he believes in, reacts it with HCl, melts the AgCl powder, and from the melt grows crystals many centimeters in diameter. Nowadays he usually also zone-refines. If he chooses to place his faith in our *Specially Selected Silver Nitrate* (EASTMAN X-491, \$38 for 500 grams), he has our assertion that it contains less than 5 parts per billion of Hg and in parts per million, less than the following limits of spectrographic measurement: Cu, 0.1; Fe, 0.1; Pb, 0.3; Ni, 0.2; Sn, 0.1; Bi, 0.1; Pd, 3.0; Zn, 10.0; Cr, 0.2; Mn, 1.0; Cl⁻, 4.0; SO₄²⁻, 6.0. The \$6.20 premium he pays over the price of 500 grams of plain *Silver Nitrate* (EASTMAN 491) seems a modest share of the cost of the technology that supports the assertion. And we do *not* assert that plain EASTMAN 491 does *not* meet the above-quoted specification.

Orders should be placed with Distillation Products Industries, Eastman Organic Chemicals Department, Rochester 3, N. Y. (Division of Eastman Kodak Company). For reprints of two of our publications on the preparation of high-purity silver halide crystals or to engage in brotherly banter on subjects like optical absorption edges and interstitial ions, address Eastman Kodak Company Research Laboratories, Physics Division, Rochester 4, N. Y.

Inside TV

Though you probably won't buy any yourself and though we hope you won't have to have any bought for you, you may find it useful in business to know that we now offer a product called KODAK Special TV Cinefluorographic Film, Type SO-210. This indicates the substantial presence and present health of a growing market based on electronic gear that fills an absolutely genuine, quite unpolitical, but sometimes unfortunate need. More and more radiological examinations being done in the hospitals today are dynamic instead of frozen. Doctors are looking at how blood and internal organs move. To keep down the radiation exposure to patients and themselves, they amplify the x-ray image with photoelectron-focusing intensifiers.

Presentation is often done today through TV circuits. Even if they watch the focused-electron picture direct, they need a photographic record. They have to watch the action over and over again to understand it. Therefore a button is now usually provided that starts a camera at the right moment so that the film can be projected over and over again instead of exposing the patient over and over again.

Our new addition to the line is intended for this work. It is fine-grain, blue-sensitive, suitable in speed and contrast, 16mm, perforated on both edges, wound emulsion in, on camera spool, Spec 449. If you want to be an actual customer, a convenient x-ray dealer will have to order no less than \$100 worth, which comes to some 40 100-ft rolls, delivered in about six weeks.

Prices subject to change without notice.

This is another advertisement where Eastman Kodak Company probes at random for mutual interests and occasionally a little revenue from those whose work has something to do with science

**Exclusive
Nesting
Feature
Permits
Maximum
Connections
in Minimum
Space**

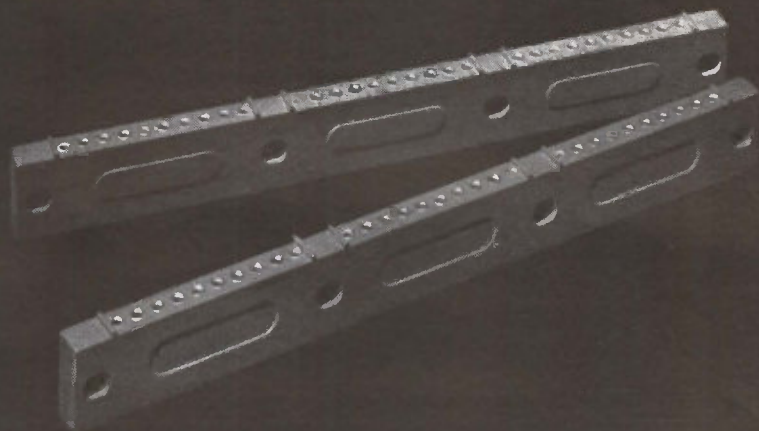
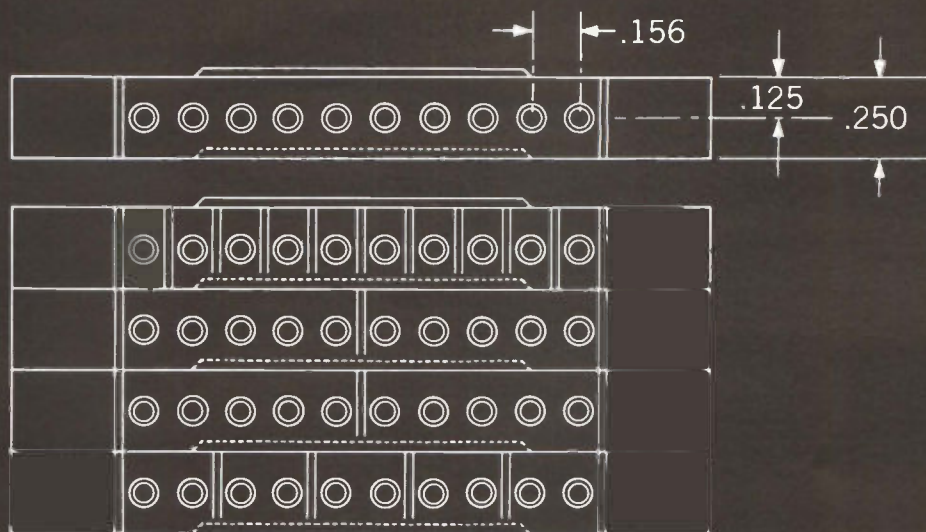

Gen-Pro *Single and Multiple Connection* Taper Pin Terminal Boards

Wherever multiple electrical connections must be made in limited space—whenever maximum flexibility in commoning is required—Gen-Pro taper pin terminal boards are your best answer. Designed to nest together for stacking, they offer from a single to 30 clearly numbered feed-through common connections—accept all standard taper pins. Barriers on board faces segregate common connections and increase creepage path. Mounting holes are elongated for easier installation and adjustment. Gen-Pro offers the widest range of molding compounds—phenolic, diallyl phthalate, or glass-filled alkyd. Taper pin sockets are available in commercial and military plating. Gen-Pro taper pin terminal boards meet MIL-S-901B.

Write today for descriptive literature



GENERAL PRODUCTS CORPORATION

UNION SPRINGS, N. Y.

Phone: (area code 315) TT 9-7367 • TWX: 315-999-1455

ATOMIC TEST BAN

What Does It Mean to Our Industry?

Officials see slight impact unless it starts a trend to disarmament

By RICHARD SMITH
McGraw-Hill World News

WASHINGTON — After eight years of false starts and frustrations, the USSR, the U.S. and Great Britain reached a nuclear test ban agreement last week. Only an unexpected renege by the Soviets, or a refusal by the U.S. Senate to ratify a treaty, can block it.

The agreement sidesteps the inspection issue (ELECTRONICS, p 26, Jan. 4, 1963) that blocked agreement in the past, by excluding underground testing from the ban.

The real significance could be more symbolic than anything else:

it could point toward more significant moves in East-West relations.

Within this broad framework, the agreement promises little immediate impact on the electronics and other defense industries, but it holds the seeds of major future change.

INDUSTRY CALM—No industry source informally canvassed by ELECTRONICS believes the ban will immediately effect much business. Most see it as an initial step toward more peaceful relations with Russia that would have to extend to general disarmament agreements and weaponry dismantlement before impact on defense business would be significant.

Administration officials, nonetheless, are sensitive to business opposition that might lessen the treaty's chances of ratification.

A joint government-industry meeting has already been set for August 13 under sponsorship of the Scientific Apparatus Manufacturers Association to discuss a ban's impact on atomic test instrumentation purchases.

One DOD official claims that a ban will put more emphasis than ever on detection capability and that radiation instrument sales could increase.

Of the industry's projected sales of \$11.8 billion in 1963, about \$50 million is directly tied to atmospheric test operations. Since government and industry sales are rising an average 10 percent a year, most officials conclude business lost as a result of the ban will be more than absorbed by the increasing sales rate.

WILL TREATY PASS?—It is still hard to tell whether the President can muster the necessary Senate votes. Some opposition is lining up in both houses of Congress.

Rep. Craig Hosmer argued last week that the ban is no ban at all, that the Russians could and would test in outer space and underground to perfect small tactical weapons and antimissile defenses.

Hosmer said that the Russians could break the treaty when they

Data Processing May Rise

BOSTON—Reaction of New England electronic companies to the nuclear test-ban proposal revolved in general around the themes that:

- Possibility of such a ban has been anticipated, has entered into their long-range planning

- Inspection and monitoring will provide alternative programs

- Treaty itself may even generate a new and massive program for exhaustive analysis of data from pre-treaty test shots

- It may also give a valuable preview of what problems might be

Raytheon, for one, has already invested heavily in information sciences R&D, inspection and monitoring, and has several arms-control study contacts.

An official of another electronics company said that data processing represents a much larger dollar expenditure than data acquisition in the area of nuclear tests. Point-

ing out that processing of data from previous tests is continuing at the present time, he suggested that the partial ban might even generate a massive program of data analysis to glean useful information from earlier shots.

EFFECT ON SATELLITES

BEDFORD, MASS.—High-altitude nuclear explosions and the resulting increase in radioactivity in space have damaged satellites in orbit (ELECTRONICS, p 22, Dec. 14, 1962). An atmospheric test ban would curtail this problem.

It would also eliminate the necessity for satellites to probe effects of atomic explosions on the atmosphere, according to Brig. Gen. B. G. Holzman, commander of Air Force Cambridge Research Laboratories. AFCRL has instrumented two such satellites to study the effects of the July 9 test in the Pacific. The second, which went up June 27, was revealed last week.

Holzman says, however, that AFCRL will continue to conduct research bearing on future Air Force communications, missile detection, command and control, navigation and guidance

CAN THEY CHEAT?

SANTA BARBARA, CALIF.—Clandestine nuclear tests could conceivably be made beyond the moon, according to Edward Tschupp, of General Electric's Tempo. The moon would hide the blast's light and the distance would make other detection techniques useless. Logistics for such a test would be formidable. To relay data back to earth would require a carefully placed satellite in the vicinity—close enough to measure the effects and far enough away to avoid being destroyed.

Space tests this side of the moon would light up the sky brighter than the sun. Vela satellites will be equipped with light sensors to detect sudden light of this magnitude.

Underwater cheating could be detected by seismic sensors, sonar, and tidal wave effect. The suspicious area could be tested for proof days or weeks later—such tests would almost certainly be in deep international waters.

Atmospheric tests could be detected by seismic reactions, blast wave pulse, and ionization. Aircraft can sample ionization up to 50,000 feet, balloons to 100,000 feet, and rockets to 100 miles

were ready for atmospheric tests of weapons that might give them a decisive lead in nuclear arms. The possibility of the U.S. losing its nuclear superiority is too great a risk to take, he concluded.

Administration replies are:

- U.S. will also continue underground testing and weapons production.

- Russian deep-space tests would be costly, not produce useful military results and be easily detected

- Antimissile defense systems are hard to develop (**ELECTRONICS**, p 16, May 10; p 24, March 8, 1963). The U.S. conducted experiments in the last test series and will continue theoretical investigations. There is no reason to believe that the Soviets are ahead and would benefit from a ban.

Senate supporters of the ban claim they have the necessary 67 votes for ratification. Advocates see it as a solution to the fallout buildup problem and a better chance for lasting peace.

NO WEAPONS CUTS—Since the administration intends to be ready to resume testing on 120 days notice indefinitely in case the treaty is abrogated, the effect on weapons programs is moot. Actual weapons fabrication presumably will continue at pre-ban rates. AEC spending on weapons is just under \$1 billion a year. No personnel cutbacks are slated and more underground shots are being planned. AEC says

its field budget may not be decreased at all.

DOD is responsible for the storage, deliverability and carrying out detection and identification programs of nuclear weapons tests. Again, the ban is not expected to cut back production of missile and manned-aircraft weapon delivery systems. There would have to be broader disarmament agreements before production of weapon systems and warheads were reduced or existing systems dismantled.

VELA PROJECT — DOD's Advanced Research Projects Agency (ARPA) is responsible for Project Vela, the national program for improving U.S. capability in detecting nuclear tests. A total of \$101.6 million has been appropriated for Vela program since fiscal 1960. This year's \$41 million goes toward upgrading seismological observatories world-wide, monitoring U.S. underground explosions, developing on-site inspection techniques, prototype electronic components, and so on. The fiscal 1964 request of \$20 million will not be reduced as a result of the ban and will be spent to continue existing programs.

The first budget item that may be pinched by a test ban is DOD's civil defense program and its plans for 235 million shelter spaces outfitted with radiation survey meter kits. But civil defense officials are standing by their budget requests for fiscal 1964.

THE POTTER MT-36

digital magnetic tape transport

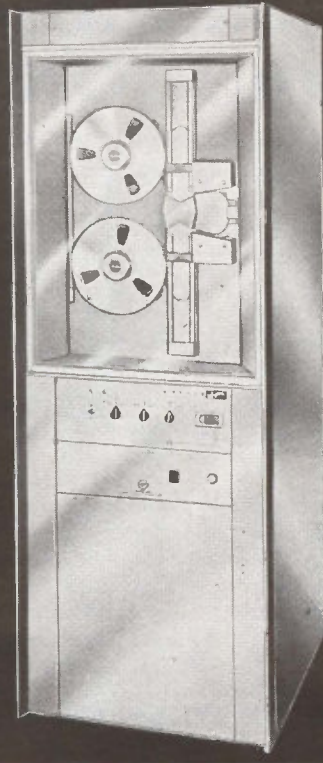

MT-36: THE MOST RELIABLE TRANSPORT in its price range

The Potter MT-36 Digital Magnetic Tape Transport offers maximum reliability for computer systems requiring an economical transport. The Potter MT-36 features:

- **NO PROGRAM RESTRICTIONS...** up to 200 commands per second at 36 ips.
- **SOLID STATE CIRCUITRY...** photo electric sensing minimizes the need for switches and relays.
- **VACUUM TROUGH GUIDES...** provide smooth tape stops.
- **IMPROVED PINCH-ROLLER CIRCUITS...** offer fast tape starts and stops.
- **EASE OF MAINTENANCE...** drive electronics and fully regulated power supply are mounted on individual plug-in boards.
- **RAPID TAPE THREADING...** Just 15 seconds for complete threading.
- **BUILT IN TAPE CLEANER...** vacuum on trough guide removes all loose oxide and dust.

For full information and specifications on the MT-36 Digital Magnetic Tape Transport, write today.



POTTER INSTRUMENT CO., INC.

TAPE TRANSPORT DIVISION
151 Sunnyside Boulevard • Plainview, New York



goes to WESCON

Booths 3220-21, South Hall

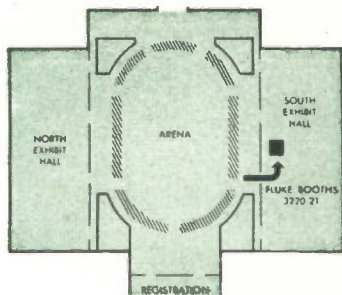

All types of Fluke precision test and measurement instruments are being displayed at WESCON, Aug. 20-23. Eight models, new since last year's show, offer advanced capabilities of special interest. See and operate them yourself at the Fluke exhibit.

NEW INSTRUMENTS ON DISPLAY

- Model 823A differential voltmeter
- Model 803D differential voltmeter
- Model 831A microvolt potentiometer
- Model 840A null detector
- Model 710B universal impedance bridge
- Model 413C high voltage power supply
- Model 430A high voltage power supply
- Model 313A solid state DC calibrator

NEW COMPONENTS ON DISPLAY

- New militarized decade potentiometers and rheostats, demonstrated under extreme environmental conditions.
- Improved commercial models of Fluke decade potentiometers, decade rheostats and vernier potentiometers.

There to greet and welcome you; this contingent from the Fluke factory:

- John Fluke, *president*
- Everts L. Johns, *executive v.p.*
- John W. Zevenbergen, *v.p., sales*
- Alton Knoke, *mfg. mgr.*
- Orlien Becker, *engineering mgr.*
- Don Hall, *ass't. sales mgr., instruments*

If precision measurement can help you achieve your research, development or production goals, make it a point to visit the Fluke exhibit—WESCON, 1963!

Best news in decades

New design
New models
Better accuracy
Better reliability

in the
NEW FLUKE

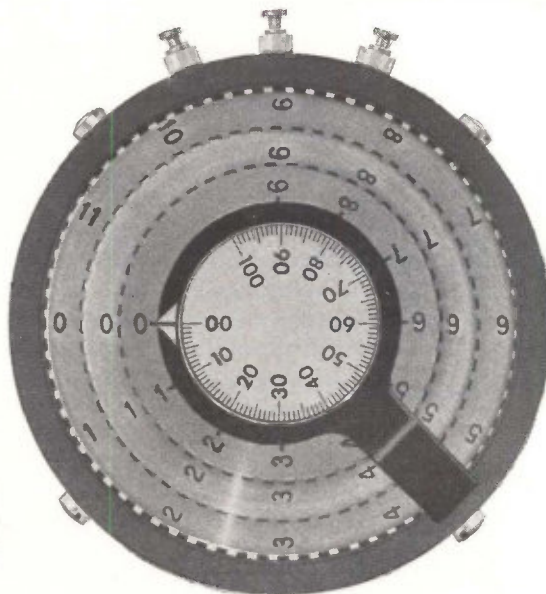
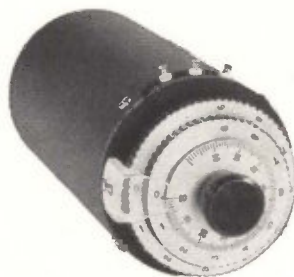

MILITARIZED and COMMERCIAL
precision decade

POTENTIOMETERS and RHEOSTATS

Improvements resulting from the development of militarized units have now been incorporated into the design and production of new commercial Fluke decade potentiometers and rheostats. Accuracy has been improved as much as two to one. Models are available in a range of accuracies to meet your most exacting requirements, with linearities to $\pm 0.0025\%$ and resistance accuracy to $\pm (0.025\% + \text{one dial div.})$. Prices involve no premium for added capabilities and reliability.

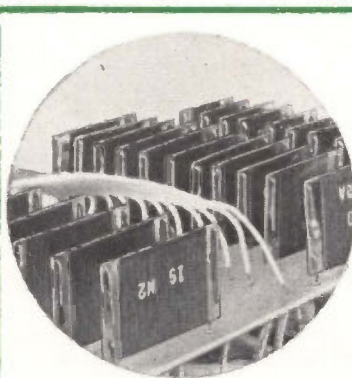

The same Fluke-manufactured, precision wirewound resistors, aged and matched, that make possible the high order accuracies of Fluke voltmeters and calibration standards are utilized in Fluke decade potentiometers and rheostats.

Complete technical data, new militarized models, and new commercial models will be unveiled at Wescon. See the Fluke exhibit, Booths 3220-21.

John Fluke Mfg. Co., Inc.
Box 7428, Seattle 33, Wash.



PR 6-1171

TWX, 206-879-1864

TLX, 852

Cable, FLUKE

at WESCON FLUKE

offers the most complete line of differential voltmeters on the market

Features common to all models are infinite input resistance at null; in-line readout with automatic lighted decimal; front panel DC polarity switch; standard cell reference (zener diode optional); taut band suspension meter and flow-soldered glass epoxy printed circuit boards.



Choose the degree of accuracy that meets your need...

	0.05%	0.02%	0.01%	0.05% 0.2%	0.1% 0.01% 0.1%	
DC ACCURACY ±% of input voltage	0.05%	0.02%	0.01%	0.05%	0.1%	
AC ACCURACY ±% of input voltage				0.2%	0.01%	0.1%
Models	801B	825A	821A	803B	803D	823A
INPUT RANGE	0-500V	0-500V	0-500V	0-500V	0-500V	0-500V
FREQUENCY RANGE	20 cps-10 kc	5 cps-100 kc	5 cps-100 kc
MAXIMUM FULL SCALE SENSITIVITY	10 mv	1 mv	1 mv	10 mv DC 1 mv AC	1 mv	1 mv
MAXIMUM METER RESOLUTION	50 uv	5 uv	5 uv	50 uv DC 5 uv AC	5 uv	5 uv
REFERENCE	Std. cell (zener diode optional)	Std. cell (zener diode optional)	Standard cell	Std. cell (zener diode optional)	Std. cell (zener diode optional)	Standard cell
PRICE Cabinet model	\$485.00	\$590.00	\$795.00	\$875.00	\$1,100.00	\$1,300.00
Rack model	\$505.00	\$610.00	\$815.00	\$895.00	\$1,120.00	\$1,320.00

Prices and data subject to change without notice. Prices f.o.b. factory.

MILITARIZED - DC DIFF. VOLTMETER

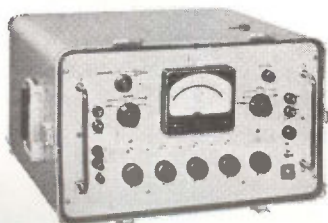

Meets all environmental requirements of Mil-T-945A. Provides accurate voltage measurements (0 to 500V) under adverse environmental conditions.

MODEL 8011A
PRICE: \$1745.00
Complete technical data on all FLUKE voltmeters available upon request

PARTIAL 8011A SPECIFICATIONS

ACCURACY: ±0.05% of input from 0.1 to 500V
±0.1% of input or 0.5 mv, whichever is greater, below 0.1V
NULL RANGES: ±10, ±1, ±0.1, ±0.01V
INPUT IMPEDANCE: Infinite at null from 0 to 500V
MAXIMUM METER RESOLUTION: 50 uv
REFERENCE: Temperature controlled Zener diode

John Fluke Mfg.
Co., Inc., Box 7428
Seattle 33, Wash.

FLUKE

INSTRUMENTS

PR 6-1171 TWX 206-879-1864 TLX 852 Cable: FLUKE

Europe's Color-Tv

Gets a New Entry from Germany

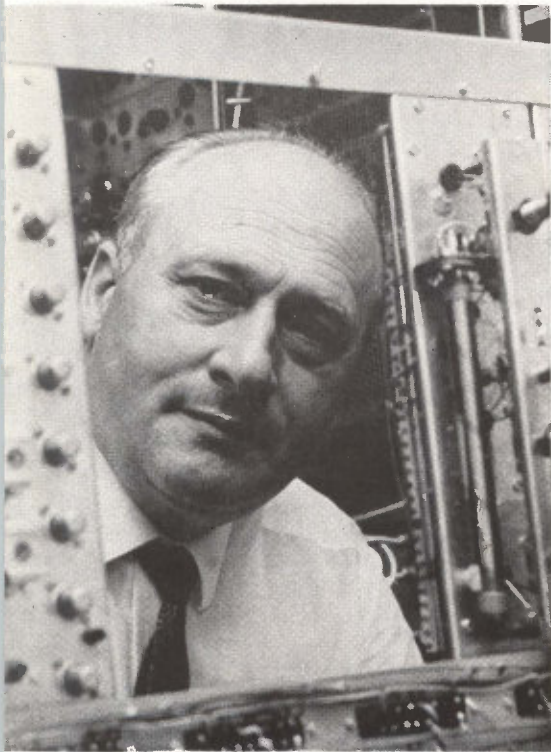

WALTER BRUCH, who developed the PAL color tv system in the Hanover, Germany, research laboratories of Telefunken GmbH, peers through a unit of the experimental equipment now undergoing tests

Phase alternation line system claims freedom from phase distortion

BONN—A strong new contestant in Europe's search for a color-tv standard system is Telefunken's PAL (phase alternation line). Already demonstrated before a working committee of the European Broadcasting Union (EBU), the concept has more hurdles ahead, including a forthcoming test by BBC.

It is one of three systems EBU is evaluating. The other two are the U.S.'s NTSC system and the French SECAM (sequential with memory)—for details, see *ELECTRONICS*, p

57, May 6, 1960).

The West German approach claims several advantages—

- Combines the best features of NTSC with a new freedom from phase distortion caused by the typical transmission path (SECAM's primary advantage lies here, too)

- Surpasses both SECAM and NTSC by transmitting both color signals completely and exploiting four signals, two each for one line, to provide the color information

- Insensitive to band limitation, such as single-sideband distortion

- Hue is faultlessly transmitted, making receiver readjustment from one station to another unnecessary (NTSC could be weak here)

- Reproduction of color pictures recorded on tape is improved over NTSC

- Compatible with existing monochrome and with Europe's 625-line system

- Reception on a simplified version of the PAL receiver attains most of the important system merits.

HOW IT WORKS—Color hue and saturation information is superimposed upon a carrier and mixed with the luminance signal—the signal important for monochrome-set reception.

In the NTSC system, hue and saturation information are superimposed upon the color carrier in quadrature modulation. The a-c signal is phase and amplitude modulated. Phase position determines hue and the amplitude the color saturation at the receiver. Telefunken claims that hue variations result from phase variations in transmitter, receiver or along the transmission path and also from one station to another.

In the PAL system the phase of one of the two modulations, composing its quadrature modulation, is switched over at the transmitter by 180 degrees from line to line.

At the receiver, Telefunken says,

New Camera Ready for Color Decision



COLORFUL young lady in multicolor dress is used by Marconi during London demonstration of new separate-luminance color-tv camera. Marconi says camera is suitable for NTSC, SECAM and PAL systems. It uses three $\frac{1}{2}$ -inch image orthicons, for luminance, red and blue signals. Green is derived from these three signals

Competition

By RICHARD MIKTON
McGraw-Hill World News

its demodulation method recovers color information without transmission path distortion. Color information transmitted during a line is delayed by the time required for the line, then combined in equal phase with the information of the following line. Carrier frequency summation in correct phase of the two different line data separates one signal uninfluenced by phase distortion and subtraction separates the other signal.

A delay line, similar to that used in the SECAM receiver, feeds the delayed signal into a Wheatstone bridge where it is added to or subtracted from the undelayed signal. A glass rod fitted with ceramic transducers delays the 4.43-Mc color signal ultrasonically about 64 microseconds.

The two superimposed signals shifted by 90 degrees in one line can be considered complex quantities and are reshaped in the transmitter in the subsequent line such that the conjugated complex quantity arrives at the receiver. The addition of two such quantities gives double the real component and subtraction provides double the imaginary component.

The transmitter switching device requires a receiver modification, a simple diode circuit to repole one of the two signals from line to line in synchronism with the transmitter.

COMPATIBILITY — The three European monochrome systems differ in video band widths. PAL proponents claim it can trim program signals to proper width without introducing single-sideband distortion.

When phase distortions over the transmission path are not too great, the demodulator delay line can be omitted. Besides claiming interference-suppression and noise figures comparable to NTSC, Telefunken says that a PAL receiver can receive NTSC signals by operating a simple switch requiring no accessories.

UHF



NEW

Approximate Power Output CW
ML-8403 vs ML-7289

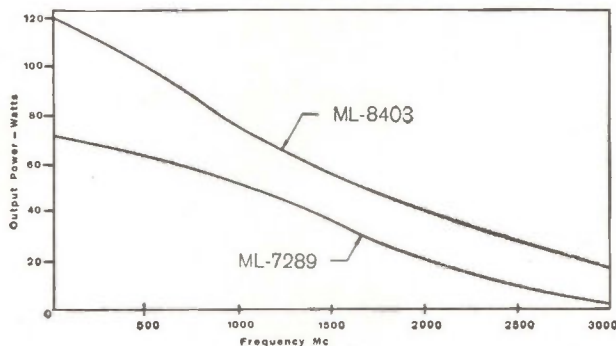

50% more cathode current... & Frequency stable performance

50% more cathode current (190 vs 125 ma) from the Phormat (matrix) cathode of the new ML-8403 planar triode allows higher powered performance—to nearly 120 watts CW—at normal plate voltages. A frequency stable anode permits variable duty cycle without noticeable shift in frequency. For ML-8403 ratings write The Machlett Laboratories, Inc., Springdale, Conn. An affiliate of Raytheon Company.



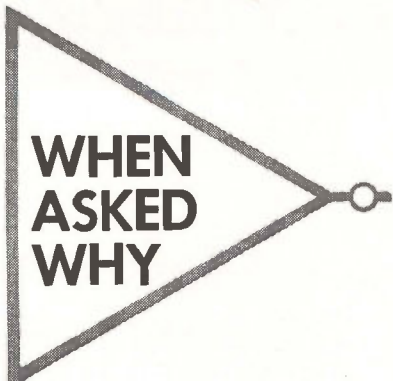

WHEN ASKED WHY

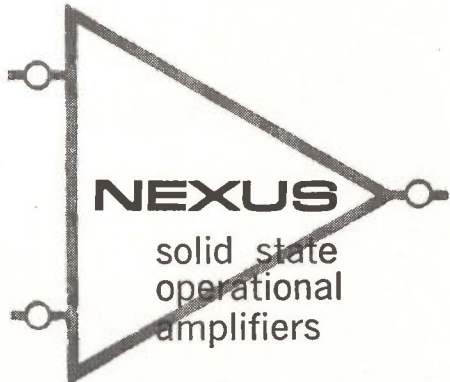

NEXUS
solid state
operational
amplifiers



WE SAY

"monolithic ruggedness"
"tight control of gain,
stability, and
offset current"
"20 models to choose
from starting @ \$40."
"fast delivery, try us"*

*but you have to tell us whether you want compact, miniature, or subminiature.
Write for literature.

NEXUS

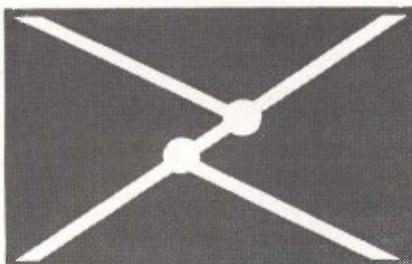

RESEARCH LABORATORY, INC.
19 Needham Street, Dedham, Massachusetts
(617) 326-8414

Fork Drives ILS Antenna

All-weather landing system uses torsion bars for scanning

TORSIONAL tuning fork is used as the antenna drive system for an all-weather instrument landing system now under development for the FAA by the Airborne Instruments Laboratory Division of Cutler-Hammer.

It is one of several all-weather systems the FAA is evaluating at the National Aviation Facilities Experimental Center (NAFEC), Atlantic City. The AIL system, being developed under a \$1-million contract, is expected to be placed in operation at NAFEC within the next two years.

The antenna drive system (see figure) operates much the same as a tuning fork, with rotation about a central axis rather than lateral motion. A fairly large antenna can

Laser Reflectors

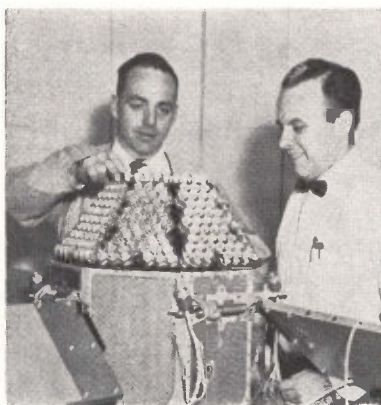

FUSED SILICA PRISMS on S-66 ionospheric satellite to be launched after August 15, possibly in September, will reflect laser beam striking spacecraft array from any angle back to its source, to provide range data (*ELECTRONICS*, p 20, Sept. 7, 1962; p 14, Nov. 23, 1962)

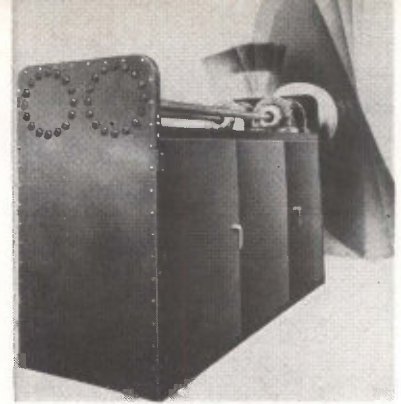

ANTENNA drive mounted on cabinet of glide-slope radar

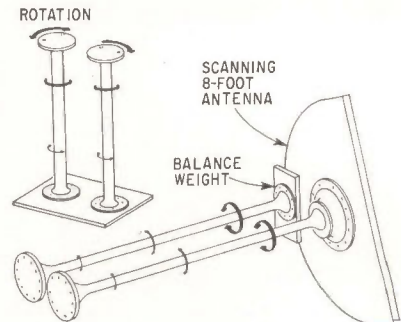

BASIC torsional tuning fork (top) is modified for resonant torsion-bar antenna system (bottom)

be scanned through 10 degrees of arc using a relatively small amount of electrical energy to maintain oscillations. The AIL system is designed to oscillate at approximately 5 cps, and two or more antennas can be operated synchronously.

Angular position data is pulse-coded into the 15-Gc beam by the AIL system, and, through the use of time-sharing techniques, only a single frequency channel is required for glide-slope, glide-path, and distance data. Present systems use separate frequencies for each type of data, AIL says.

BRITONS UNITE

LONDON—Nine trade associations and eighteen major electronics companies have jointly formed a Conference of the Electronics Industry. The conference will provide a forum for discussion of common problems within the industry and act as a central body for the industry in industry-government discussions



This Tiger flies to SCHPLNDBSCP B

If you want to ship to SCHPLNDBSCP B, however, you won't find it on the map. That's short for some of the major points we serve: San Francisco, Chicago, Hartford, Philadelphia, Los Angeles, New York, Detroit, Boston, Seattle, Cleveland, Portland, and Binghamton. In fact, you can get Tigers' overnight freight service to

most of the major markets in the country.

In addition, Skyroad, Tigers' combination air-truck service takes you into almost 2000 cities. That's why you're better off shipping with Flying Tigers. We can deliver the goods. After all, we're the nation's largest and most experienced all-cargo airline.

first in airfreight with airfreight first **FLYING TIGER LINE**



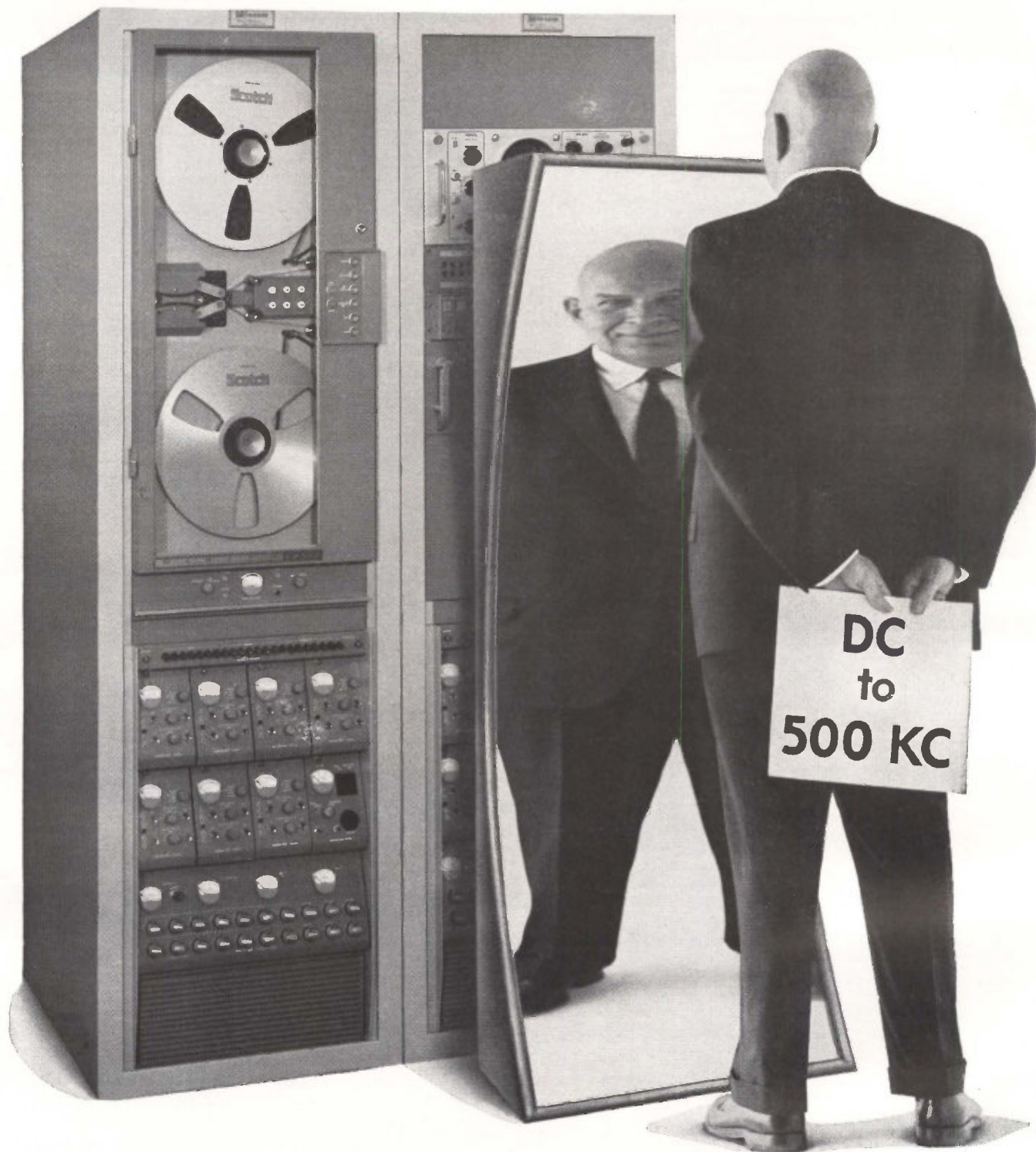

WIDEBAND FM recording, using 1.5-megacycle analog techniques to attain an improved frequency response of DC-500 kc, is Mincom's latest telemetry development. Heart of the new system is the standard Mincom 1.5-mc CM-114 Recorder/Reproducer. The extended FM responses enable telemetry facilities to record simultaneously the most complex narrow-band and wideband signals in PCM, PCM/FM, PDM, and FM/FM modulation. More advantages: Extended low frequency response, excellent linearity, seven or fourteen recording tracks, versatility without modification, greater dynamic range, dropout reduction virtually to zero. Write today for details and complete specifications.

Mincom Division **3M**
COMPANY

2049 South Barrington Avenue, Los Angeles 25
425 13th Street N. W., Washington 4, D. C.

when every millivolt counts...

Use Motorola's New 50-Amp 2N2728 Transistor With Only 0.075V Typical Saturation Voltage

When your equipment is used in a remote location and it must depend on a solar battery, fuel cell or other low voltage source, you can't afford to waste voltage on a semiconductor device with high saturation resistance.

With this in mind, Motorola scientists and engineers have developed a high-current power transistor for high-speed switching applications which will enable you to get the highest possible efficiency, and make every precious millivolt count.

Designated 2N2728, this new Motorola device features an extremely low saturation resistance of only 0.0015 ohms... *less than that of one foot of 12-gauge copper wire*... resulting in a 0.075 Vdc typical saturation voltage at 50 amperes collector current. This characteristic, plus its fast switching time, makes this device ideal for power converters using solar cells, fuel cells, thermoelectric generators, sea cells, or 1.5 volt batteries.

Power loss in this transistor in the saturated condition is *less than half* that of power transistors previously available for similar applications.

The rugged design of the Motorola 2N2728 (in the proven TO-36 package), permits its use in the roughest of applications such as air-dropped sonobuoys, military field vehicle equipment, or in missiles and satellites. If your circuit design calls for an extremely low voltage power supply, *don't waste a millivolt!* Specify the Motorola 2N2728 germanium power transistor.

LOOK AT THESE PERFORMANCE RATINGS!

Characteristic	Symbol	Min	Typ	Max	Unit
DC Current Transfer Ratio $I_c = 20 \text{ A}, V_{CE} = 2 \text{ V}$	h_{FE}	40	—	130	—
Collector-Emitter Saturation Voltage $I_c = 50 \text{ A}, I_b = 5 \text{ A}$	$V_{CE(sat)}$	—	.075	0.1	Vdc
Base-Emitter Voltage $I_c = 50 \text{ A}, I_b = 5 \text{ A}$	$V_{BE(sat)}$	—	0.85	1.0	Vdc
Common Emitter Cutoff Frequency $I_c = 20 \text{ A}, V_{CE} = 2 \text{ V}$	f_{α}	3	4.5	—	kc

This new device is immediately available from your local Motorola Semiconductor Distributor or District Office. For complete information on the 2N2728, write: Technical Information Center, Motorola Semiconductor Products Inc., P.O. Box 955, Phoenix 1, Arizona.



"your most complete power transistor source"

MOTOROLA Semiconductor Products Inc.

BOX 955 • PHOENIX 1, ARIZONA • A SUBSIDIARY OF MOTOROLA INC.

S-63-040

CIRCLE 27 ON READER SERVICE CARD



NUMBERS, service symbols and letters are made up of seven vertical strokes of magnetic ink

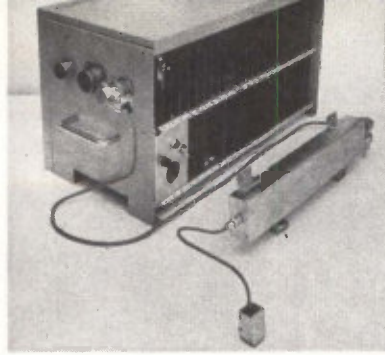

BASIC READOUT equipment is reading head (foreground), preamplifier and recognition circuits



French Find 7 Lucky Number

Sales of CMC 7 magnetic character reading systems snowballing in Europe

By ARTHUR ERIKSON
McGraw-Hill World News

PARIS—After breaking into the majority of European banks this year, Compagnie des Machines Bull has started to move into other fields with its CMC 7 magnetic character.

Already in the works or in sight are applications in the French and German postal check systems, Austrian telephone system billing, the Norwegian lottery and several French government departments.

Bull is selling a check-sorting machine based on the CMC 7 character plus peripheral equipment to feed check data into a Gamma 30 electronic bookkeeping system.

Bull has put its basic patent on the character into the public domain and is now offering to other data-handling equipment makers the basic readout hardware.

AMERICAN OUT—The banks decided to use CMC 7, not the American E 13 B character, after both were compared at the French Post Office Department's Centre National d'Etudes des Telecommunications. CNET gave the CMC 7 the edge mainly for its more simple readout circuitry. The magnetic head has a single reading element compared to 30 for one E 13 B system.

CNET also saw these advantages for the CMC 7:

- Badly printed characters can't be read, so won't be read wrongly
- A full 26-letter alphabet, 10 digits and 5 service symbols
- Characters look like ordinary printing

CMC 7 symbols, all 1/8-inch high as for the E 13 B, are made up of seven vertical strokes of magnetic ink that establish a combination of six short and long (0.3 and 0.5 mm) intervals. An extra-long interval (> 0.67 mm) separates characters.

CODE READER—The reading head senses flux changes as ink strokes pass under it. Intervals between stroke passages are measured by voltage comparison to switch to 0 or 1 binary state six corresponding flip-flops.

Because vertical stroke heights differ making signal amplitudes vary, the head output signal is differentiated. Input to the comparison circuits depends on times of positive and negative pulse maximums as leading and trailing edges of the stroke pass the head. An amplitude threshold blocks spurious signals.

To reduce rejects, there are two independent logic channels, one sensitive and one attenuated. The sensitive channel, with a differentiated signal threshold of 0.14 v is normally used. But if parasite signals make the result incoherent, the attenuated channel (0.5 v threshold) is analyzed and read out if it contains a coherent code.

To check on readout correctness, both leading-edge and trailing-edge pulses are treated separately in each channel and the two sets of intervals compared.

Standard reading speed is 1.2 or 3.81 m/sec, but equipment can be adapted to between 0.7 and 14 m/sec. Magnetic density of the ink can vary from 1/2 to 2 times standard.

CODE 2/6							CODES 1/6 AND 3/6													
1	2	3	4	5	6		1	2	3	4	5	6		1	2	3	4	5	6	
1	1	0	0	0	0	7	0	1	0	0	0	0	A	0	1	1	1	0	0	N
1	0	1	0	0	0	3	1	0	1	0	1	0	B	1	0	0	0	0	0	O
1	0	0	1	0	0	4	0	0	0	1	1	1	C	0	1	0	1	1	0	P
1	0	0	0	1	0	1	1	0	0	1	1	0	D	1	1	1	0	0	0	Q
1	0	0	0	0	1	SI	1	0	1	1	0	0	E	1	0	1	0	0	1	R
0	1	1	0	0	0	2	0	0	1	0	1	1	F	1	0	0	1	0	1	S
0	1	0	1	0	0	9	1	0	0	0	1	1	G	0	1	0	0	1	1	T
0	1	0	0	1	0	8	0	0	0	1	0	0	H	1	1	0	1	0	0	U
0	1	0	0	0	1	SII	0	0	0	0	0	1	I	1	1	0	0	0	1	V
0	0	1	1	0	0	0	0	0	1	0	0	0	J	0	1	0	1	0	1	W
0	0	1	0	1	0	6	0	1	1	0	1	0	K	1	1	0	0	1	0	X
0	0	1	0	0	1	SIII	0	0	0	0	1	0	L	0	1	1	0	0	1	Y
0	0	0	1	1	0	5	0	0	0	0	1	0	M	0	0	1	1	0	1	Z
0	0	0	1	0	1	SIV														
0	0	0	0	1	1	SV														

CODES FOR CMC 7 characters. Digits and symbols have two long intervals, letters have either one or three long intervals

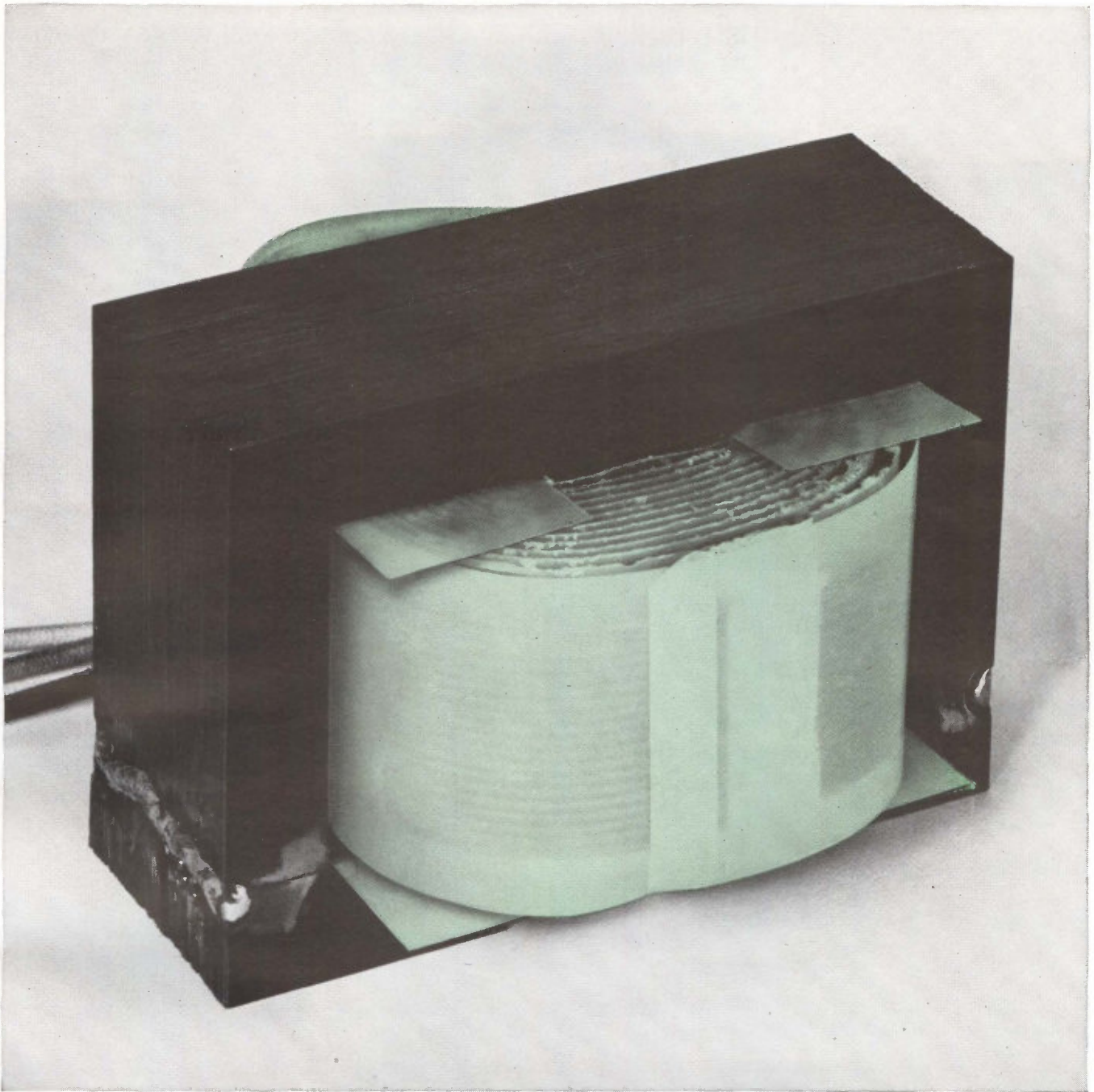

MYLAR[®] tripled the guarantee on this ballast transformer!

It's Wide-Lite Corporation's new 1,000-watt ballast transformer. It offers an exclusive 3-year guarantee against failure, compared with the usual 1-year guarantee! Wide-Lite was able to do this by using insulation of "Mylar"* polyester film on the windings. "Mylar" is far more heat-resistant than conventional insulation, and it retains its extremely high dielectric strength even when damp. These properties also gave the ballast an official approval for Class B temperature conditions (130°C).

With longer guarantees and Class B approval possible, think what insulation of "Mylar"

could do in your own designs! Besides its thermal, dielectric and moisture-resistant properties, insulation of "Mylar" is strong and durable. Also, "Mylar" is of high-volume resistivity, resistant to solvents and easy to work with, compared with other insulation materials.

Find out the full story by writing Du Pont Company, Film Dept., Box 22F—Rm. N10452, Wilmington 98, Delaware. *Du Pont's registered trademark.



Better Things for Better Living
...through Chemistry

SEE US IN BOOTH #912-913 AT WESCON

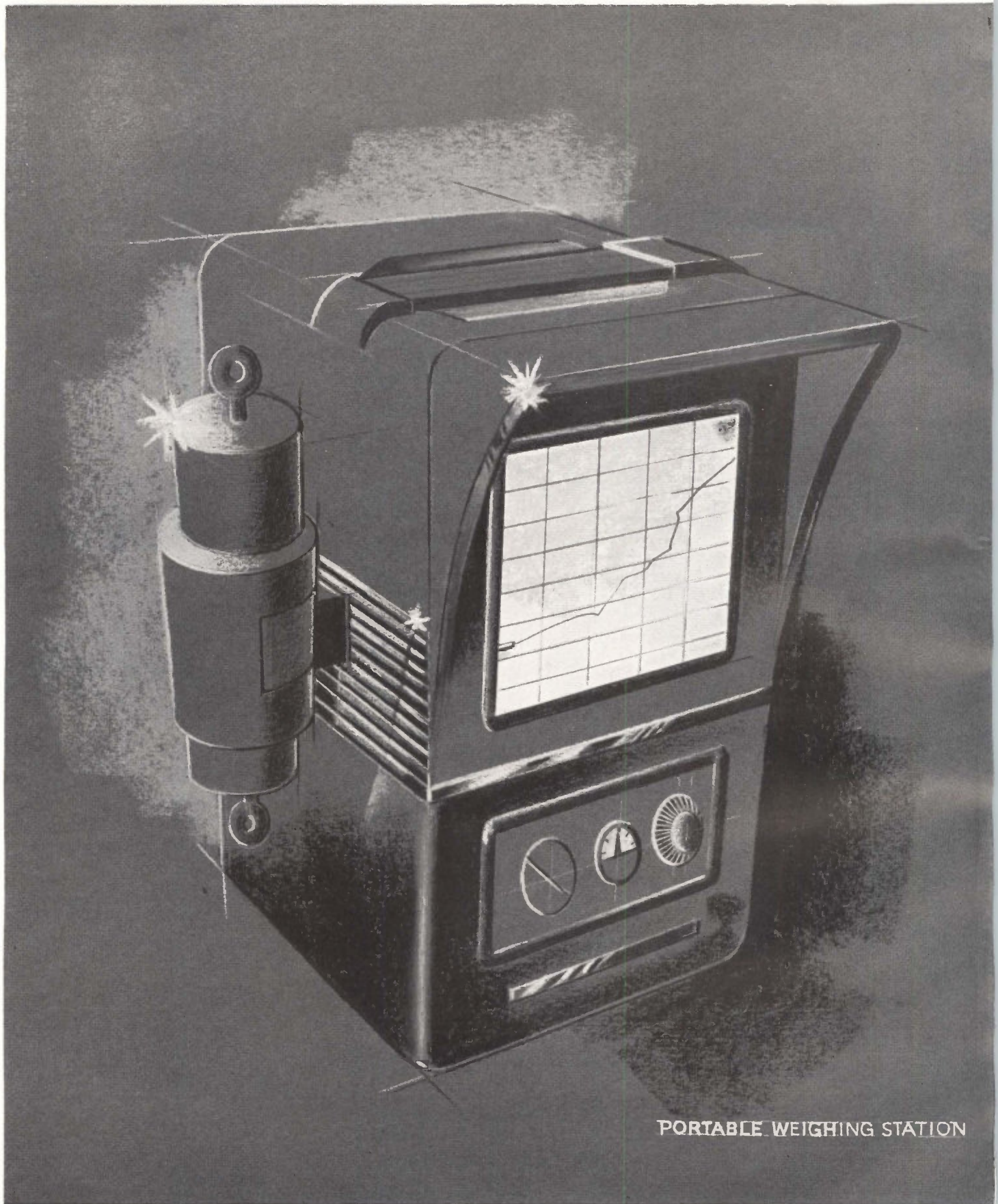

PORTABLE WEIGHING STATION

When *your* design calls

Mallory—best source for answers to battery problems for more than 20 years.

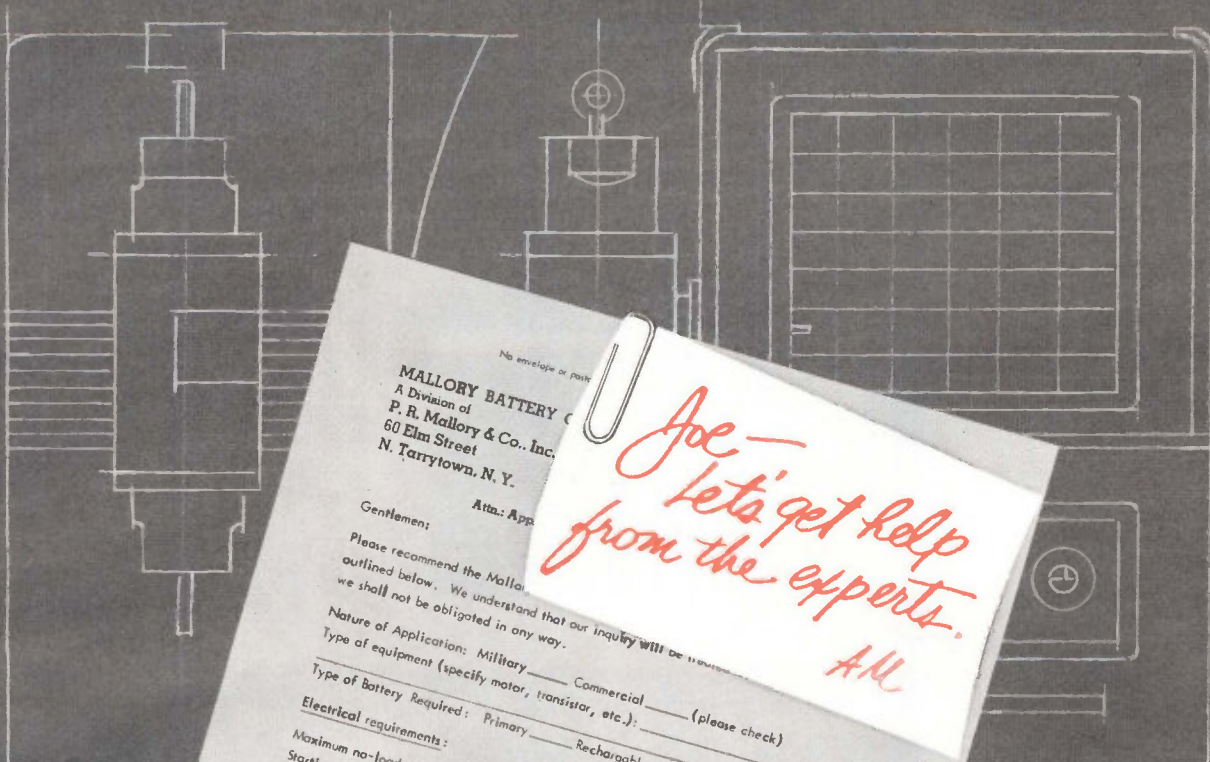

No envelope or post

MALLORY BATTERY COMPANY
 A Division of
P. R. Mallory & Co., Inc.
 60 Elm Street
 N. Tarrytown, N. Y.

Attn: App
 Gentlemen:

Please recommend the Mallory battery outlined below. We understand that our inquiry will be treated as confidential and we shall not be obligated in any way.

Nature of Application: Military _____ Commercial _____ (please check)
 Type of equipment (specify motor, transistor, etc.): _____

Type of Battery Required: Primary _____ Rechargeable _____

Electrical requirements:

Maximum no-load voltage _____ V
 Starting voltage under load _____ V
 Minimum or cut-off voltage _____ V
 Resistance of load _____ V
 Current drain (average) _____ OHMS
 Peak current (if any) _____ MA
 Duration of peak current _____ SEC.
 Is battery operation continuous? _____ If intermittent, time on _____ time off _____

Desired total battery operating service life _____ hrs.
 Physical and environmental requirements:
 Overall battery size limitations:
 Length _____ Width _____ Height _____ or Diameter _____ Height _____

Type terminals _____ Locations of Terminals _____
 If battery has more than one section, are negative terminals common? _____
 Operating temperature range from _____ to _____ of.
 Storage temperature range from _____ to _____ of.
 Vibration or shock conditions (describe): _____
 Other unusual conditions: _____

Name _____ Position _____
 Company _____
 Street Address _____
 City _____ Zone _____ State _____

Battery Application Data

1-404 2/63

*Joe -
 Let's get help
 from the experts.
 AM*

CHAMBERLAIN	BAR BATTORUTO
ALBERT	DELM 2/2/63
SUPERM...	...
...	...
BATLIA	...
...	...
...	...

for battery power . . . call

Mallory Battery Company, Tarrytown, New York — a division of P. R. Mallory & Co. Inc.



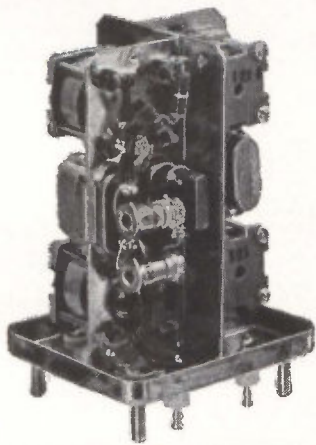

BULOVA PRECISION CRYSTAL FILTERS

Bulova experience with prototype and production quantities of precision filters guarantees maximum sensitivity, stability — in "isolating" any frequency. These examples indicate Bulova mastery of difficult problems in high performance filter engineering.

BAND PASS FILTERS — In a band of 30 filters, Insertion loss variation between filters, and over the temperature range 25°C to 75°C, held to .3db between highest and lowest.

Part #69-A-RP-13-2N (1 thru 30).

SINGLE SIDE BAND FILTERS — Band ripple held to $\pm 1/2$ db, both 1 and 3db points defined, over the temperature range 0°C to 85°C, and 300 to 3000 cps vibration at 30G level

Part #117B-FC-22-4WU.

DISCRIMINATOR — Center frequency held to within 10 cps, frequencies equally spaced from center, held to 5.4v peak $\pm 5\%$. Part #186C-TN-22A-

WD. BAND SUPPRESSION FILTERS — 2kc wide band attenuated 60db, right next to it a pass band held flat to $\pm 1/4$ db for 150kc.

Part #158-TF15-6R.

Contact Bulova engineering specialists to help you choose the right filters — when you have tough filtering problems, need additional information, or practical application assistance. Write Dept. 2702, Bulova Electronics, Woodside 77, N. Y.



INDUSTRIAL/DEFENSE GROUP

BULOVA

ELECTRONICS DIVISION

TRANSMITTING antenna below
helicopter transmits tv signals
while camera peers out window

RECEIVING antenna on roof of
NHK Technical Laboratories



For Tv — A

*Slaving airborne and
ground antennas helps
raise range to 80 Km*

By CHARLES COHEN

McGraw-Hill World News

TOKYO—Range of helicopter relay stations for remote-pickup tv programs is greatly increased by a directional antenna system demonstrated here last month by NHK, the government broadcasting system.

NHK expects the new system will be especially useful for covering the forthcoming Olympic games in Tokyo. The airborne antenna keeps pointing at the ground station while the helicopter follows the event being relayed. The helicopter can relay signals from widely scattered pickup trucks—whose signals might otherwise be blocked by hills or buildings—or can carry a camera for direct pickup.

In an earlier system, lower power and use of a nondirectional antenna limited range to about 4 Km. Range of the directional system is 80 Km (see table).

ANTENNA CONTROL—The base station operator points the receive-

ing antenna at the helicopter and manually adjusts azimuth and elevation. Common reference bearing is the earth's magnetic field. Control frequency is 3.18 to 3.5 Kc.

The receiving antenna's azimuth angle θ_r is transmitted to the helicopter as the command signal. The transmitting antenna hanging from the helicopter rotates until its azimuth θ_t matches and it points at the receiver.

For transmission and comparison, θ_r and θ_t are converted to audio frequencies f_r and f_t . The transducers are variable resistors whose rotors are coupled to the rotating antenna axes. In the helicopter, the stator is coupled to a flux valve by a servomotor, so it always points in the same direction regardless of helicopter motion. A voltage proportional to the differ-

RELAY SYSTEMS COMPARED

	OLD	NEW
Transmitter output	2 w	5 w
Max. freq. dev.	± 1 Mc	± 2 Mc
Transmitter antenna gain	0	11 db
Rec. antenna gain	18 db	20 db
Rec. noise figure	13 db	7.3 db
Effective range	4 Km	80 Km

BASE STATION operator keeps receiving antenna pointing at helicopter



Flying Relay

ence between f_r and f_c controls the d-c servomotor that rotates the transmitting antenna. Error is ± 3 deg stationary, ± 10 deg while in rotation.

SOUND AND PICTURE — Command signal is transmitted to the helicopter by a 25-w transmitter. A voice communications channel is multiplexed on the command link.

From the helicopter, voice communications with the base station are by pulse-amplitude modulation of the tv signal sync pulses. The helicopter transmits a 775-Mc f-m picture signal.

One-Pound Laser Sends Messages One Mile

RAYTHEON has developed a portable, one-pound laser, capable of transmitting voice signals up to one mile. The device will be able to send more messages, or tv signals, over longer distances when more sophisticated infrared detectors are developed. Wider bandwidths would also permit the laser to be used as a computer link, Raytheon said.

Operating on a 3.5-micron wavelength, the laser signals travel through the atmosphere with relative ease. Battery power is used.

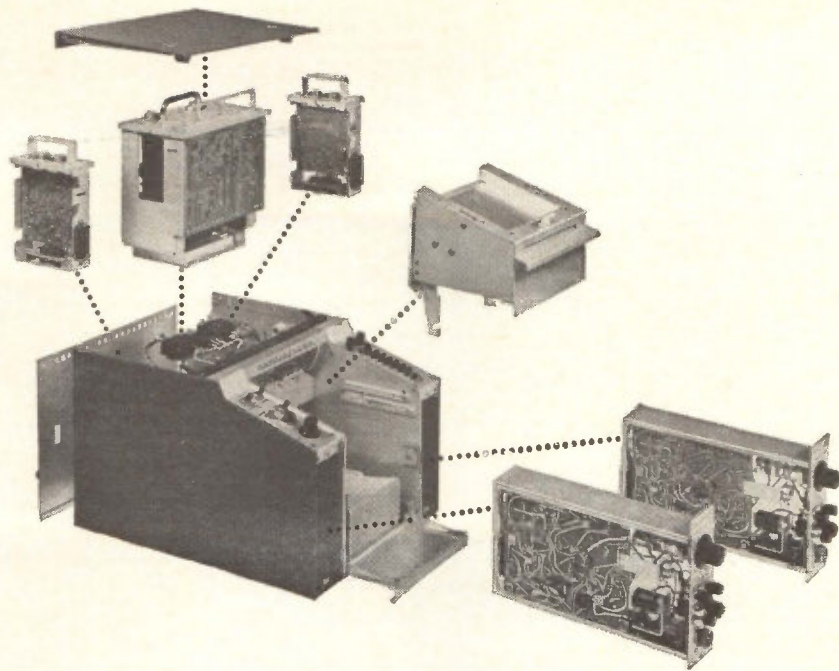

All the features you want in a medium frequency recorder

The *oscillo/riter** recorder incorporates all the features you want for top performance, convenience and reliability. Modular construction and all transistorized electronics provide complete accessibility and maximum reliability; interchangeable

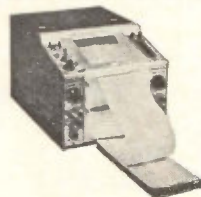

able amplifiers handle more recording jobs; extended frequency response; top panel push buttons select 8 chart speeds from 1 mm/sec to 250 mm/sec; choice of roll or Z-fold chart paper, interchangeable ink or heat writing with Texas Instruments exclusive rectilinear recording system. Write for full information.

*A trademark of Texas Instruments Incorporated.

INDUSTRIAL
PRODUCTS
GROUP



TEXAS INSTRUMENTS
INCORPORATED
P. O. BOX 66027 HOUSTON 6, TEXAS

SENSING • RECORDING • TESTING • DIGITIZING INSTRUMENTS
THE INSTRUMENTS OF TEXAS INSTRUMENTS

566

CIRCLE 33 ON READER SERVICE CARD



Your **electronics BUYERS' GUIDE** should be kept in your office at all times—as accessible as your telephone book.

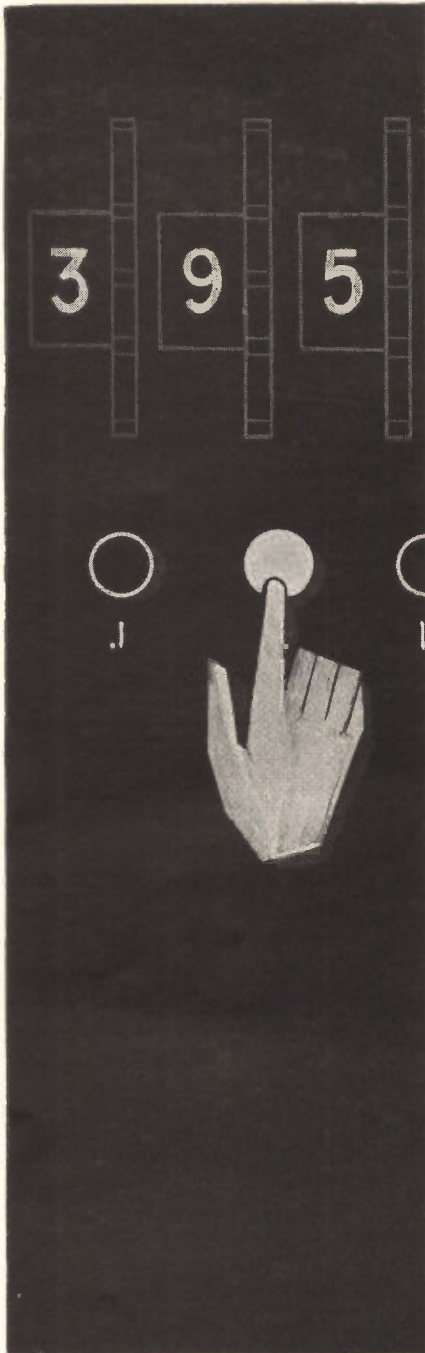

NEW from DEI PUSH-BUTTON PCM SYNCHRONIZER

- Exceptional Stability and Calibration Accuracy
- Correlating Bit Detection
- All Digital Loop Filter
- Wide Dynamic Input Range

NOW—for the first time, push-button bit rate selection is possible!

From Defense Electronics, Inc. comes the latest in a line of PCM Digital Products.

The solid state BRS-1 Bit Synchronizer/Conditioner has been designed for PCM telemetry applications and features accurate setting (within 0.1 per cent) for a known bit rate prior to actual signal reception.

This exceptionally stable and highly accurate synchronizer accepts a serial PCM signal at rates up to 1 mc, automatically conditions the incoming data and generates a stable clock signal.

Automatic circuitry adjusts to input signals over a 40 db dynamic range. The unit incorporates a unique digital loop filter that maintains bandwidth proportional to bit rate at all frequencies. Output of the synchronizer is a reshaped, noise-free, serial PCM signal and a set of clock signals phase coherent with the output data.

The BRS-1—which can be remotely controlled—performs the functions of data regeneration, format conversion and serves as the “front-end” for any digital telemetry system.

Write for DEI bulletin BRS-1 . . . or call

Defense Electronics, Inc.

Main Office:

5455 Randolph Rd. Phone: WH 62600
Rockville, Md. TWX: 301-949-6788

Regional Office: Sherman Oaks, Calif. Phone: 873-4322



DEI
SERVING
GOVERNMENT
AND INDUSTRY

AEROSPACE SUPPORT INTERNATIONAL CONFERENCE & EXHIBIT, IEEE, ASME; Sheraton-Park Hotel, Washington, D. C., Aug. 4-9.

INTERNATIONAL ELECTRONICS CIRCUIT PACKAGING SYMPOSIUM, University of Colorado, et al; at the University, Boulder, Colo., Aug. 14-16.

WESTERN ELECTRONICS SHOW AND CONFERENCE, WEMA, IEEE; Cow Palace San Francisco, Calif., August 20-23.

DATA PROCESSING NATIONAL CONFERENCE & EXHIBITION, Association for Computing Machinery; Denver Hilton Hotel, Denver, Colo., Aug. 27-30.

AUTOMATIC CONTROL INTERNATIONAL CONGRESS, International Federation of Automatic Control; Basle, Switzerland, Aug. 27-Sept. 4.

MILITARY ELECTRONICS NATIONAL CONFERENCE, IEEE-PTGMIL; Shoreham Hotel, Washington, D. C., Sept. 9-11.

ELECTRICAL INSULATION CONFERENCE, IEEE, NEMA; Conrad-Hilton Hotel, Chicago, Sept. 10-14.

JOINT ENGINEERING MANAGEMENT CONFERENCE, IEEE, ASME, et al; Biltmore Hotel, Los Angeles, Sept. 12-13.

INTERNATIONAL ASSOCIATION FOR ANALOG COMPUTING, AICA; Brighton College of Technology, Lewes Rd., Brighton, England, Sept. 14-18.

INDUSTRIAL ELECTRONICS ANNUAL CONFERENCE, IEEE, ISA; Michigan State University, East Lansing, Mich., Sept. 18-19.

NATIONAL POWER CONFERENCE, IEEE, ASME; Netherland-Hilton Hotel, Cincinnati, Ohio, Sept. 22-25.

INTERNATIONAL TELEMETERING CONFERENCE, IEEE, ISA, et al; London, England, Sept. 24-27.

PHYSICS OF FAILURE IN ELECTRONICS SYMPOSIUM, Armour Research Foundation and Rome Air Development Center, Illinois Institute of Technology, Chicago, Sept. 25-26.

ELECTROCHEMICAL SOCIETY FALL MEETING, ECS; New Yorker Hotel, New York, Sept. 29-Oct. 3.

ADVANCE REPORT

THE 1964 ELECTRONIC COMPONENTS CONFERENCE, EIA, IEEE, ASQC: Washington, D. C., May 5, 6, 7, 1964. Nov. 15 is deadline for submitting 3 copies of 500 word abstracts to Dr. John J. Bohrer, technical program chairman, International Resistance Co., 401 N. Broad St., Philadelphia 8, Pa. Papers to be presented in the fields of capacitors, resistors, wiring and cabling, interconnections and connectors, reliability, thin film devices, and materials.

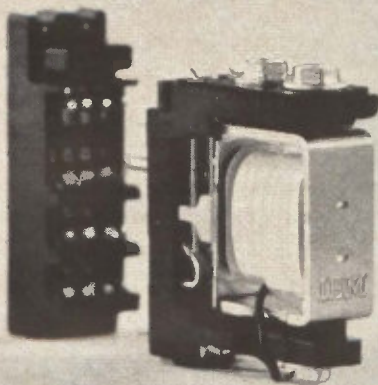

New low price is a big reason to use IBM Wire Contact Relays

Compare IBM relay price/performance with the relay you are now using. Four PDT IBM relays start at a new low of \$2.90, 12 PDT start as low as \$5.40. And IBM latch relays start at \$8.45. Add all this to the performance shown above and they can't be beat.

Delivery is un-beatable, too. Production shipments within 24 hours if requested.

Design-in or plug-in an IBM relay. Here's what you get:
Life: Up to 200 million operations.

Operate Speed: As fast as 4 ms.

Release: 5 ms.

Contact Arrangement: 4, 6, and 12 PDT Form C, 4, and 6 PDT latch.

Contact Rating: Vary with life requirements (see chart).

Reliability: 1 error per over 400 million contact closures

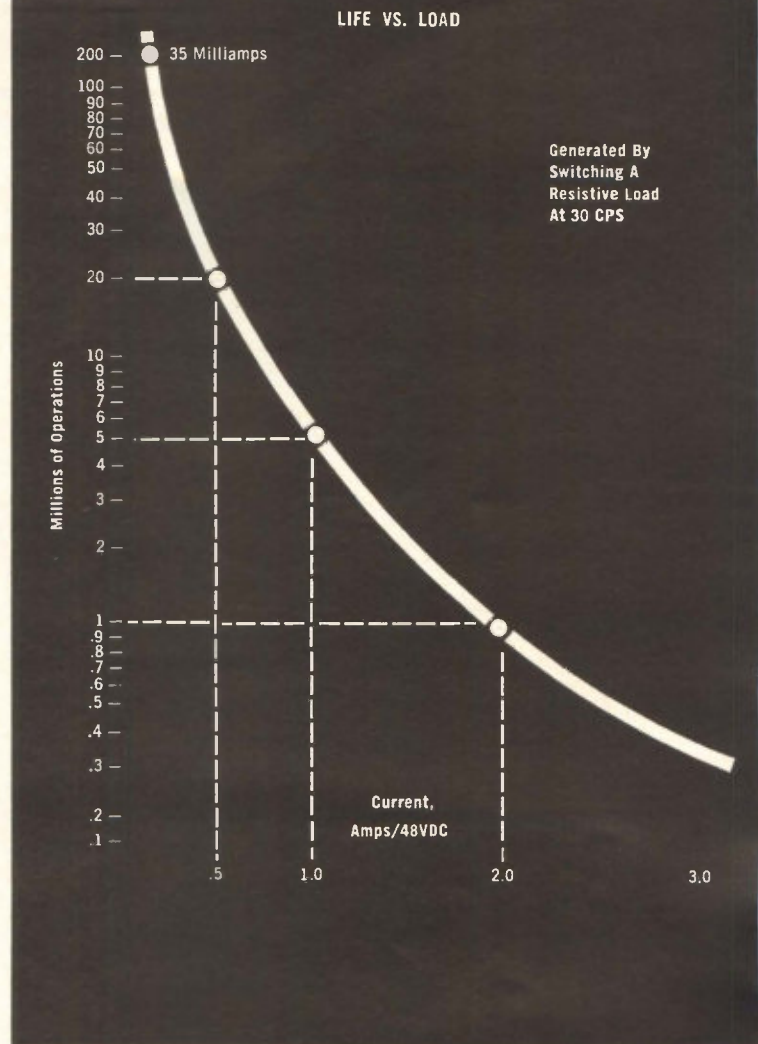

Performance is an even bigger reason to use IBM Wire Contact Relays

at 48 VDC attainable with these relays.

Coil Voltages: Up to 100 VDC.

Integrated Package: Solderless connections, multiple coils, compactness and standardized mountings give you *manufacturing savings and lower product costs.*

Applications. Wire contact relays are ideal for counting, logic switching, shift registers, flip-flop and timing circuits in numerical control, communications, test equipment, process control, data processing, supervisory control systems, and many other applications.

Send for Catalog that tells you the relay story—performance data, electrical characteristics, mounting hardware, prices. You get all you need for a price/performance ratio. Write direct to: IBM Corporation, Commercial Sales, Relays, Essex Junction, Vermont.



If this is such a great capacitor, where's its IBM card?

Feed these characteristics into the computer on top of your shoulders and you'll understand why the CORNING® CYFM Capacitor needs no card.

Sizes and values—four case sizes cover pf ranges from 0.5 to 10,000, exceed all requirements of MIL-C-11272B.

Voltages—300v and 500v from -55 to +125°C.—no derating.

TC retrace—within 5ppm of the curve at any temperature; drift less than 0.1% or 0.1 pf.

Tolerances—±5% or ±0.25 pf is standard; also available in ±1%, ±2%, and ±10%.

I.R.—tops 500 ohm farads at 125°C., high over entire temperature range.

Losses—low over entire range,

D.F. is less than 0.001 at 1 kc and 25°C.

Life—less than .5% capacitance change after 2000 hours at 1 mc or 1 kc at 125°C. and 150% of full rated voltage; D.F. at 125°C. is less than 0.007 and I.R. is greater than 10¹⁰ ohms.

Moisture resistance—exceeds all requirements of the MIL spec and Mil-Std-202 Method 106 tests.

Radiation resistance—no significant change in properties after exposure to 10¹⁸ NVTth.

Applications—yours, In coupling, decoupling, filtering, timing, switching, or computer circuits.

Price—up to 60% less than you'd pay for the only other comparable capacitor—and that's our high-relia-

bility CYFR.

We make the CYFM the same way we make the CYFR, but the CYFM costs you less because we don't wring every one out—and punch an IBM card—and guarantee a reliability of at least 99.9994%/1000 hours at 60% confidence as we do with the CYFR.

Call your CORNING distributor for complete data sheets on the CYFM or for fast delivery on all case sizes and values. Your circuits won't know there's no IBM card.

CORNING ELECTRONICS

A DIVISION OF CORNING GLASS WORKS
3901 ELECTRONICS DR., RALEIGH, N. C.

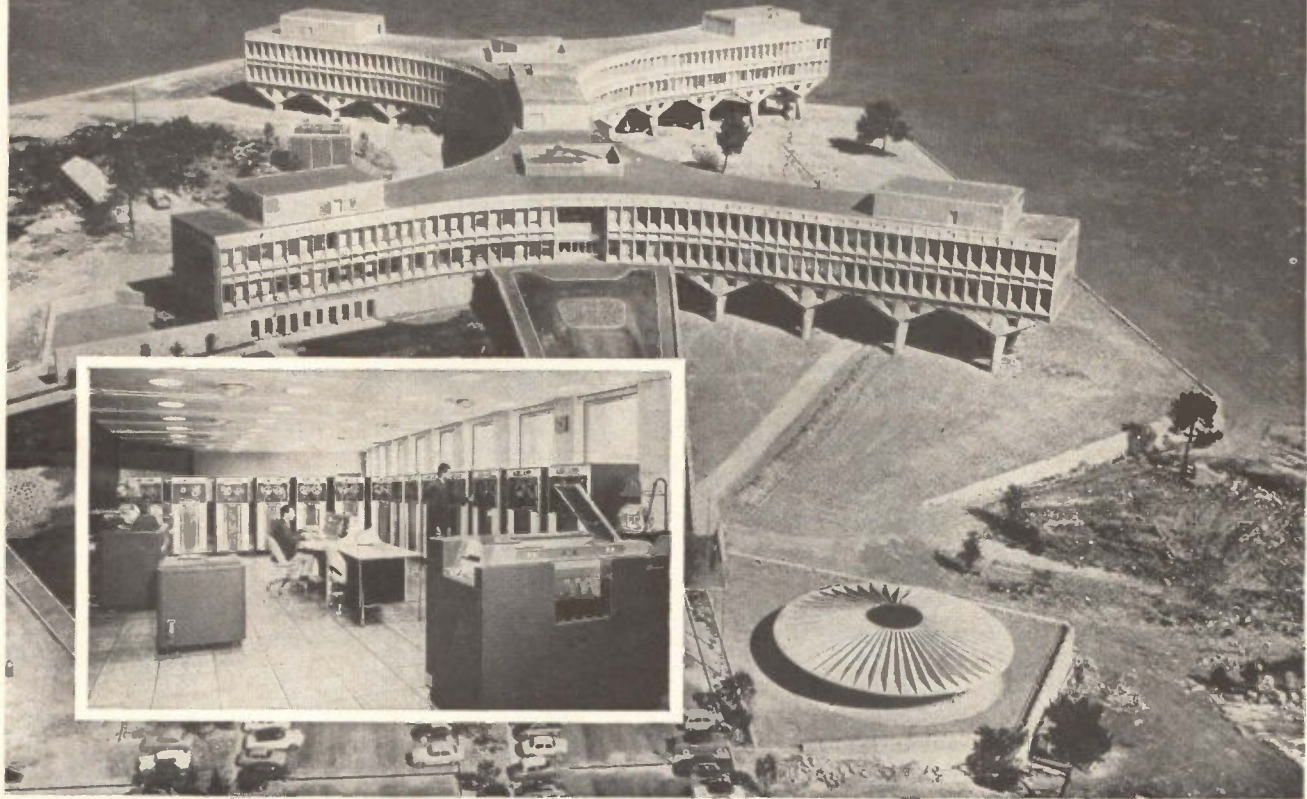

LONG-RANGE DATA transmission is one of the key research areas at IBM's recently dedicated La Gaude Laboratory near Nice, France. Circuit costs may be cut with thin-film logic elements that are under development

MICROELECTRONICS AROUND THE WORLD

European and Japanese manufacturers are looking to integrated circuits for industrial computers, process control systems and—in a few cases—consumer items

An ELECTRONICS Staff Report

LARGE-SCALE APPEARANCE of microelectronics on the commercial scene may come first in Europe and Japan. Major companies there are taking a hard look at integrated circuits for industrial electronics applications. This could bring about the volume requirements that U. S. manufacturers predict will reduce integrated circuit prices below that of conventional components.

An on-the-spot check by McGraw-Hill World News correspondents confirms reports of "tremendous" in-

terest in applying integrated circuits to commercial computers and process control systems (ELECTRONICS, p 22, May 10). This interest is spurred, especially in Europe, by the newness of their facilities and the strong push to automation arising from the shortage of skilled labor and climbing wage scales.

While actual applications are limited at present, some prototype equipment is being developed and most electronics companies expect significant applications to appear within the next five years. How-

ever, they are reticent to reveal details on specific equipment or techniques.

Like their U. S. counterparts, European and Japanese firms cite expectations of reduced cost, increased reliability and small volume as the main reasons for their interest in microelectronics. There is also general agreement that substantial consumer usage is further off. However, some Japanese firms are already fabricating prototype microelectronic items for the consumer market.

Here are the highlights of reports from six countries:

GREAT BRITAIN

Multimillion-dollar industrial electronics market predicted for microcircuits

LONDON—Silicon integrated circuits are on the verge of large-scale acceptance by British equipment makers. Strangely enough, first applications are likely to be more prolific in professional equipment than in military systems. But at present no one is saying what these commercial applications will be or even which firms are actively experimenting with integrated circuit designs.

The same close-mouthed attitude covers thin-film circuit applications. Only one manufacturer, Elliott-Automation Ltd., has announced any production uses for these techniques. In their new 503 computer, thin-film circuits will be used experimentally in the computer peripheral equipment. Another application is the switchover to thin-film RCTL sub-units for Elliott's Minilog package logic system. Third application revealed by Elliott uses thin-film units in a gyro stabilizer system.

In the integrated circuit area, the only announced applications come from Government research establishments. At the Royal Armament Research and Development Establishment, integrated circuits are being used in a high-speed tape comparator, Fig. 1, to locate and display differences between two 5-digit tapes. The Royal Radar Establishment has a tunable solid-state filter operating between 15 and 90 Mc. The filter makes use of the distributed capacitance associated with a diffused silicon resistor to form a twin-T network whose center frequency is shifted by altering the voltage on the voltage-dependent $p-n$ capacitance.

But while few applications have been disclosed, there is plenty going on under the surface with five major companies, Standard Telephones and Cables Ltd. (an ITT subsidiary), Ferranti, Plessey, Texas Instruments and SGS-Fairchild offering silicon integrated circuits. Well advanced commercially is Texas Instruments with prototype applications already under test on industrial digital servos, commercial computer designs, airborne radar units, aircraft surface control systems and navigation computers. Plessey is finalizing a fast logic application for a 30-Mc counter and developing multi-emitter logic with good noise rejection capabilities.

THE MARKET—All five suppliers assess today's integrated circuit potential as lying firmly within

ON THE SCENE

Electronics is an international business and its coverage requires international footwork. This point is demonstrated by the accompanying story which resulted from the efforts of McGraw-Hill World News correspondents in six nations who contacted 50 electronics companies and filed 7,000 words of copy—all within a few weeks. The reporters: Derek Barlow (London), Charles Cohen (Tokyo), Arthur Erikson (Paris), Marc Messina (Milan), Richard Mikton (Bonn), and Robert Skole (Stockholm). Their copy was coordinated in New York by Senior Associate Editor Michael F. Wolff

the professional equipment rather than military systems. Confirming this view are current studies on integrated circuit applications for electronic telephone exchanges. One manufacturer says that compared to commercial applications of integrated circuits in the U. S., the U. K. commercial market will appear faster and be broader based.

British circuit suppliers are confidently talking about a multimillion dollar market in the U. K. Guesses as to when the upsurge will start vary from manufacturer to manufacturer. One company, Semiconductors Ltd., (a subsidiary of the Plessey group) anticipates its turnover in 1967 in integrated circuit sales will top \$3 million. Other firms, like Texas Instruments, see a more rapid growth with the major boom occurring in 1964-5. Growth rate of the market is not expected to follow the normal smooth exponential rise but will be a step function when after this 1963-4 assessment period involving quantities of a few hundred integrated circuits, the production phase from 1965 on will call for thousands, a fact that has production men worried.

Paradoxically it is the lack of a heavy military program in the U. K. that has caused this ready acceptance of commercial integrated circuit applications. With little call for the microminiaturization afforded by the circuits, reliability and economic advantages are considered their chief selling points. This emphasis is causing changes as manufacturers seek ways to recoup their development costs. In place of the original thrust on logic circuits, British designers are switching to linear circuits and hybrid systems.

LINEAR CIRCUITS—Highest priority is on linear circuit development as offering the widest market potential. All manufacturers currently offer amplifiers with gains adjustable by feedback resistor variation, solid-state demodulators, phase splitters, and emitter followers. Typical of these circuits are Plessey's single chip amplifiers (gain of 25, 6-7 Mc bandwidth).

Main applications of linear circuits are foreseen in instrumentation and sections of communications equipment. At first, hybrid configurations are an-

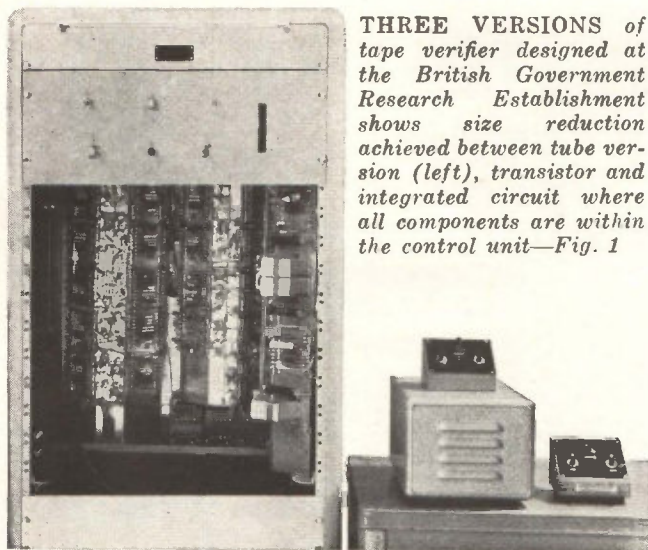

THREE VERSIONS of tape verifier designed at the British Government Research Establishment shows size reduction achieved between tube version (left), transistor and integrated circuit where all components are within the control unit—Fig. 1

icipated using both integrated circuit elements and conventional components. But this imposes economic problems on the manufacturer since cost of linear circuit elements must be comparable to the component assembly it replaces. Cost is currently the main sales feature because integrated circuits form only a part of the overall equipment and, therefore, the increased reliability stemming from their use is limited. Solid-state costs in the U. K. are expected to be comparable with conventional techniques by 1964-5.

An alternative approach finding favor with many users is a hybrid circuit where a thin-film substrate acts as a mechanical base for the silicon integrated circuits. The economics of this approach look promising as thin-film costs are expected to be equivalent to conventional techniques by next year. With heavy Government backing British thin-film production is growing rapidly; by the end of the year it is estimated that Mullard Ltd., Welwyn Electric Co., and STC will have a joint production capacity of 30,000 thin films per week. But none of the manufacturers is saying just what the demand will be.

Solid-state logic elements—initially thought to have an immediate sales outlet—are not expected to get to full production for 2 or 3 years. Around 1967-8 the full production of electronic telephone systems, increased military applications and the commercial computer usage will push integrated circuit logic. But for the next couple of years the

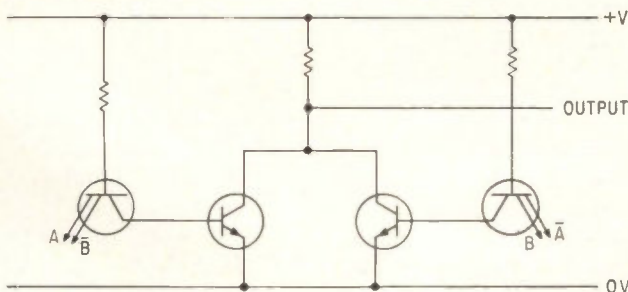

EXCLUSIVE-OR integrated circuit developed at Plessey uses multiple-emitter transistors—Fig. 2

majority of clock rates for computers in production will be in the kilocycle rather than megacycle range and suppliers will find it tough going to offer solid logic with its megacycle capability at prices competitive with conventional components. In the next computer generation now on the drawing board, solid logic elements will be used. Manufacturers claim this will be within 2 or 3 years.

Another factor slowing down acceptance of solid logic is the multiplicity of logic configurations currently available on the U. K. market: DTL (Ferranti), DCTL (Texas Instruments), RCTL (Welwyn and Elliott) together with multi-emitter logic. Most likely long-term solution seems to be the multi-emitter system. One manufacturer, Plessey Ltd., is already in pilot production of a single-chip multi-emitter transistor configuration providing two-level logic. The circuit, Fig. 2, performs AND operations on the multiple-emitter transistors and an OR-INVERT in the amplifiers. Propagation time for a 40-stage parallel adder is 1 microsec.

Consumer applications in the U. K. of integrated circuits for domestic radio and tv look far out. Reasons quoted by manufacturers range from excessive costs of integrated circuits to lack of requirements for the increased reliability. Only investigation reported underway, and this rather desultorily, is the application to hearing aids.

ITALY

Semiconductor microcircuits planned for commercial computers, are already in some prototype office equipment

MILAN—Italy's electronics industry—both home grown and foreign affiliated—shares the opinion that a "tremendous interest" exists throughout Western Europe in applying integrated circuits to commercial computers and process control systems. But the consensus is that actual commercial application of integrated circuits in these fields in Europe—and particularly Italy (excluding some specific NATO military contracts)—is still extremely limited—particularly so when compared to integrated-circuit progress in the United States.

Major electronics firms using or studying the use of semiconductor or thin-film integrated circuits in Italy include Olivetti, IBM Italia, Cea-Perego (electronics affiliate of the giant Edison company) and the Compagnia Generale di Eletticit  (CGE), Italian affiliate of the American General Electric Co.

Giorgio Sacerdotti, director of Olivetti's electronic research laboratories in Rho says Olivetti has no intention of introducing integrated circuits in its existing machines as it would not be economically sound. However, the company is studying both semiconductor and thin-film integrated circuits for commercial computers and office equipment now in development. Several prototype commercial calculators use the new systems, but he said Olivetti could not release details at the present time.

Semiconductor integrated systems rather than thin-film systems are being favored in Olivetti's planning because of the former's more widespread

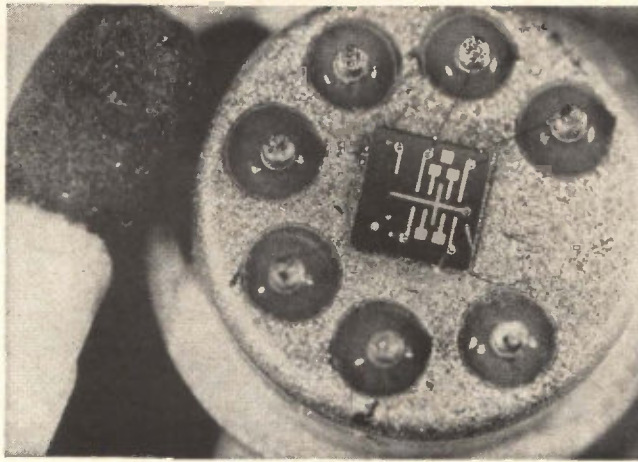

(A)

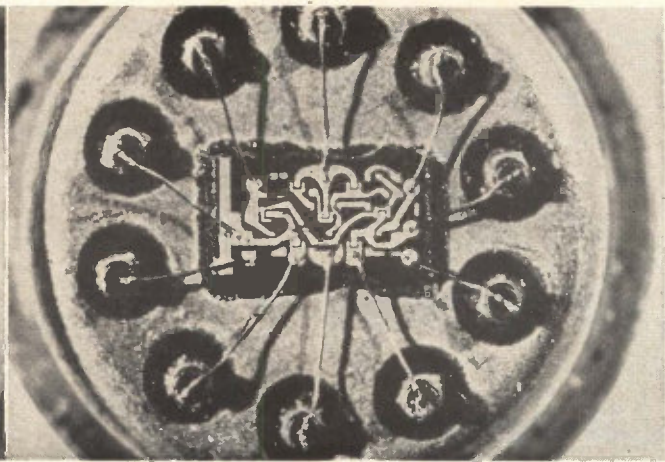

(B)

MICROCIRCUITS from Siemens (A) and Telefunken (B)

use and consequent proven experience.

Industry sources suspect Olivetti will introduce its new semiconductor integrated circuit computers only when the company feels it can sell them at a profit. This may range from one to five years.

OTHER MANUFACTURERS—Cea-Perego's electronic computer expert Giorgio Quazza says his company is working on semiconductor integrated circuits for prototype computers it has under development. The firm also feels integrated circuits will have an important place in other process control devices it is developing.

Quazza says it will be one or two years before Cea Perego would consider using thin-film integrated circuits, which are still in the initial stages of development.

Enrico Chiesa, chief engineer for CGE, reports his firm is developing semiconductor circuits for eventual use in the computer and process control systems it manufactures as GE's Italian affiliate. He feels that since this type of integrated circuit has undergone more proven experience than that based on thin films, it will hold the lead over thin-film systems for at least the next few years.

Italy's largest semiconductor manufacturer, Societa Generale Semiconduttori, is currently marketing Fairchild's integrated circuits. But according to SGS sales manager Donald Rogers, Fairchild plans to build its Micrologic systems in Europe by 1964 utilizing SGS's Agrate facility and another plant in London. Rogers expects dollar volume of Fairchild affiliate sales in the U. K. and Western Europe this year to run from \$1.5 million to \$2 million. He says SGS is working with about eight large computer manufacturers in Europe.

SGS plans to do some thin-film work, and Rogers feels the future of integrated circuits will be in hybrid systems utilizing a combination of semiconductor and thin-film devices.

Although SGS plans to do some work in radio circuits, Rogers believes it will be "quite some time" before component manufacturers can slash the price of their product to the low price necessary to meet the "cheap cost" demands of the radio and tv manu-

facturers. The manufacturers of these "low cost" consumer products will accept only very low-cost electronic components for their products, he says.

Among advantages cited by Rogers are lower cost resulting from less design time required to plan integrated circuit systems, fewer parts, smaller boards, and so forth. SGS estimates semiconductor integrated circuits, although they may be more expensive per individual unit, will cut costs as much as 25 percent in setting up overall electronics systems.

Siemens Elettra SpA, Italian affiliate of the West German Siemens Group, imports semiconductors from Germany where the company has been building commercial computers and process control systems since 1956, and where they are now applying semiconductor integrated circuits to these products.

Engineer Arnaldo Moruzzi says Siemens is working with semiconductors rather than thin-films, feels thin films are still "too costly, too sophisticated, too refined" to be accepted by the average Italian company.

Siemens is counting on something like \$10 million in computer sales for fiscal 1963-64 but Moruzzi emphasizes the company is still in the groundwork stage. He feels integrated circuits are an "absolute necessity" to meet the needs of advanced electronics systems. The cost is "still rather high priced," but microelectronic systems are "fulfilling high-priced functions." He adds that the cost of integrated circuits is still "far too high" for consumer items.

WEST GERMANY

Integrated circuits are under development for both industrial and consumer applications

BONN—Leading West German electronics companies are of the opinion that progress here in solid-state and thin-film integrated circuits is presently at a stage that was reached in the U.S. some two years ago. However, all of the large firms — including Siemens, Telefunken, Standard Elektrik Lorenz and Grundig—report substantial laboratory development work on integrated circuits for applications varying from computers through aerospace equipment to industrial electronics and consumer goods. Siemens

expects to use integrated circuits in the model 3003 commercial computer it is now building but will not change over its present 2002 model.

Telefunken says its offering three months ago of seven solid-state circuits for computer applications has met with gratifying success. Telefunken's progress in this sector is typical of a cautious but hopeful policy by German electronics manufacturers of developing components and finding applications in order to be prepared when the first really substantial demand occurs in three to five years' time. DCTL and ECTL circuits are out of the laboratory stage at Telefunken and available as samples for computer, data-processing, aerospace, instrumentation and military applications, where their small size and high order of dependability argue against their relatively high cost. The company says a small but technically important market already exists in Europe in the military and satellite fields.

CONSUMER APPLICATIONS—Widespread consumer goods applications cannot be expected for another five years, in the opinion of several companies whose plans include immediate market penetration in those sectors where the circuits' advantages overshadow their higher cost. Standard Elektrik Lorenz reports it is well along with laboratory testing of thin-film circuits employing tantalum (among other materials), concentrating on amplifiers, power supplies and passive circuits. The company expects to make its first deliveries in 1964, having already discussed a range of possible uses with various equipment manufacturers.

First area of application should be in data processing equipment, although SEL says it is concentrating just as heavily on tv, radio and tape recorders. Although it is still too early to give even an approximate estimate of the market for such circuits, SEL engineers feel acceptance will be rapid once the first deliveries are on the market in consumer goods. Primary advantages for integrated circuits, in their opinion, is cost-cutting of mass-produced goods and increased dependability.

Grundig says its research labs are actively pursuing integrated circuit applications in both consumer goods as well as industrial equipment. The company's primary interest lies in items such as integrating apparatus, closed circuit tv cameras—where the present tendency is to smaller dimensions—and various types of office equipment (Grundig owns the Olympia company, one of West Germany's largest office machine manufacturers).

Grundig reports that all its development work at present is intended for application in its current product line (radios, tv sets, tape recorders). Management emphasizes they are only in a research phase and that application of developments is still far off. Circuits in development are not being discussed.

JAPAN

Microcircuits planned for telephone switching equipment and several consumer products

TOKYO—All Japanese semiconductor companies are studying integrated circuits, but most seem to be

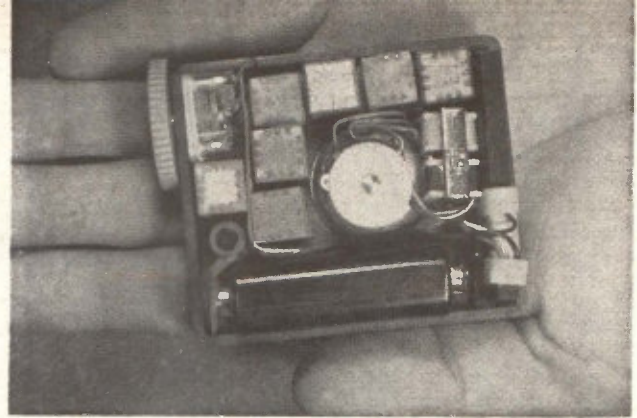

(A)

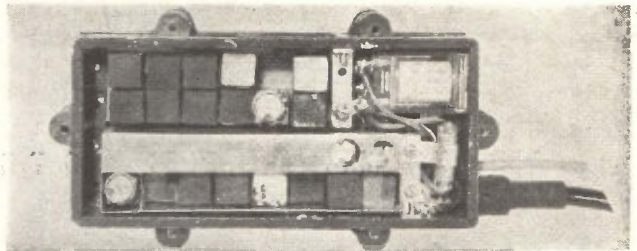

(B)

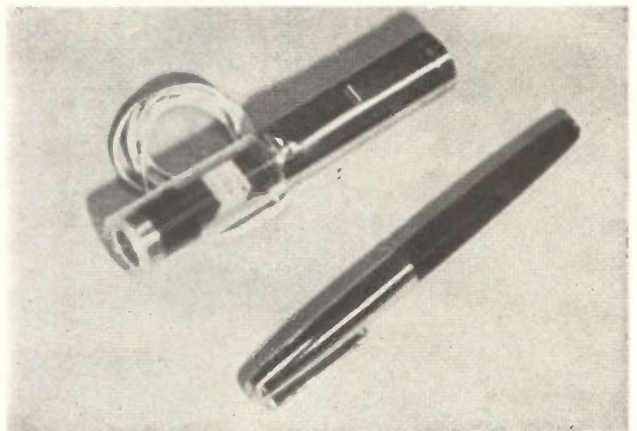

(C)

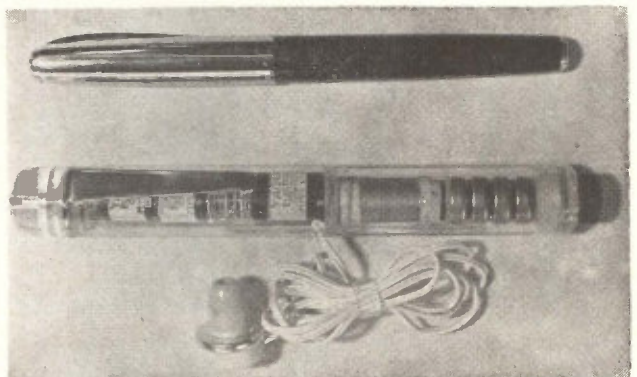

(D)

PROTOTYPES OF consumer items in which Yaou Electric plans to use integrated circuits are pocket radio (A), transceiver (B), radio microphone (C) and pencil radio (D)

waiting to see what types of circuits the Americans use for what, and their success, before committing themselves. With cost still a big stumbling block most people feel use of integrated circuits in any but the most specialized products is at least three to five years away. Nevertheless, some companies are pushing ahead on prototype development.

Middlesized Yaou Electric plans to develop several consumer items such as a pocket radio, pencil radio, transceiver, car radio, radio microphone, and radio page. The company also plans to use integrated circuits for industrial items such as tv cameras and tv broadcasting equipment including camera, auxiliary amplifier and synchronizing signal generator. The consumer items will probably use silicon circuits, while thin films look most suitable for the industrial products.

Sony's chief engineer says his company is starting to think about using integrated circuits in consumer equipment but has not yet made any definite plans.

TELEPHONE EQUIPMENT—Oki Electric Industry Co. is interested in using integrated circuits in computers and telephone exchanges. It considers speed one of the greatest advantages of applying integrated circuits to computers and is therefore looking toward all-thin-film integrated circuits for this application. On the other hand, semiconductor integrated circuits are expected to provide the increased reliability and small size considered important for telephone exchanges. Electronic telephone exchanges are expected

to greatly reduce present need for expensive secondary facilities.

Although it is difficult at present to foresee the size of the market, Oki is convinced the economic feasibility of producing its integrated circuits will depend on demands for its computers and telephone exchanges. At present, trial production of semiconductor circuits is underway and thin-film circuits are being researched. Future plans include developing active thin-film elements, and trial manufacture of thin-film memories.

Nippon Electric plans to apply semiconductor integrated circuits to computers, telephone exchanges, carrier terminal equipment and others. It anticipates that by 1970 half the semiconductor devices for such equipments will be replaced by integrated circuits. Silicon circuits look most likely to be used because of their reliability.

Other companies studying integrated circuits for computers include Hayakawa Electric, Matsushita Electric Industrial Co. and Mitsubishi Electric. Matsushita is researching the introduction of thin-film circuits into some commercial computers that are presently all-transistorized. Thin films are expected to appear shortly in switching circuits, later in other portions. The company reports similar plans for consumer items like transceivers and tape recorders.

Mitsubishi is experimenting with various types of circuits but considers details company secret. Hayakawa is researching thin films primarily for small computers at this time because of the present high cost.

SWEDEN

Integrated circuits under close scrutiny for industrial computers

STOCKHOLM — Standard Radio & Telefon AB, Bromma, is planning to use semiconductor integrated circuits in military and industrial type computers for series production starting 1967-68. Extensive use of integrated circuits is considered dependent on the reduction of present prices that is foreseen in the near future. The requirement for the individual circuit element is fairly moderate in logic circuits and will thus promote a good yield of the production of integrated circuits in these applications, the company feels.

Svenska Aeroplan Aktiebolaget (SAAB) reports that for the past couple of years it has been working on an integrated circuit technique in designing an airborne digital computer. SAAB, most famous for its jet fighter planes and rally-winning automobiles, has an electronics division that produces computers for civil and military use.

Viggo Wentzel, head of the computer department, says that as a result of this integrated circuit work "we have gained a lot of experience and we also feel that we have been successful in using integrated circuits for that particular project. Having this background it is quite natural that we are now studying the integrated circuit technology in order to find out if, and when, we can use this technology in our future commercial computers. From the same point of view, we are also interested in thin-film

INTEGRATED CIRCUITS IN U. S. TELEPHONE SYSTEMS?

When informed of Japanese intentions to use integrated circuits in telephone switching equipment, two U. S. firms told **ELECTRONICS** they had no similar plans at this time but were actively studying the possibility.

Electronic switching system No. 1 being installed by Bell Telephone Labs at Succasunna, N. J., is using discrete components because present cost of integrated circuits is too high, according to R. W. Ketchledge, director of Bell's electronic switching lab. However, he foresees the need for integrated circuits in the future when machines must work faster and consequently be made much smaller to reduce delay times. Integrated circuits look promising for such applications and an exploratory development program is underway in which several basic types are being evaluated, he said.

Automatic Electric Company, a subsidiary of General Telephone & Electronics, is studying the use of silicon integrated circuits in telephone switching equipment, and believes that such usage will someday be feasible. With extreme compactness not so important in commercial telephone equipment, emphasis of the study will be on the expectations of greater reliability and (ultimately) lower cost than existing circuits using discrete components

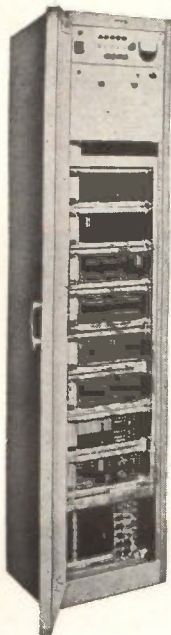

CENTRAL DIGITAL COMPUTER and system control desk is type of equipment in which Sweden's Standard Radio & Telefon plans to use integrated circuits

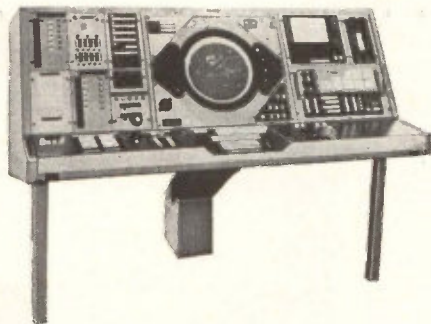

circuits or possibly in hybrids. The latter may be a more optimum technique at this time. As a consequence of our interest in this circuit technology, we have now started suitable evaluation work on the matter."

Wentzel adds that the basic advantage SAAB foresees for integrated circuits in commercial digital computer applications lies in increased reliability. He also says that during SAAB's early work with integrated circuits, they found that the assembly cost will be considerably reduced when the prices of integrated circuits "come down to a reasonable level."

"We have also found that layout and draft work was eased because the integrated technique allowed a more standardized logical symbolism," Wentzel says.

Speaking for L. M. Ericsson Co., the telecommunications firm, Percy Broomé says that his company has not introduced integrated circuits into any equipment manufactured by the firm "and we have no decisive plan to do so." He adds, however that the company is keeping abreast of developments in this field and has discussed the possibilities of using integrated circuits in certain control units in airborne equipment. This would be the first step in a coming chain of introducing integrated circuits in airborne and later on in ground equipment, both for military and civil purposes, Broomé says.

FRANCE

Major market is still military

PARIS—France seems to be an exception to the foregoing industrial electronics picture. Although all the heavyweights of the French electronics industry see high promise for integrated circuits, no one is far enough along with them to talk specifics about the potential commercial market.

True, by the end of the year the semiconductor manufacturing subsidiaries of CSF, Thomson-Hous-

ton and Philips all will have pilot production lines started up, or just about ready to start, but for the next two or three years only military applications seem likely. In fact, French Air Force research funds have financed the bulk of integrated-circuit R&D done so far.

The computer makers, too, are taking a hard look at these circuits. Bull, for example, says it's cooperating closely with component manufacturers to develop planar silicon circuits, and is working on superconducting thin films in its own laboratories. A top research engineer at Bull predicts a mass entry of integrated circuits in the computer field within the next five years, but refuses to be more specific than that.

At IBM-France, integrated circuits rate as just one of several avant-garde techniques that may one day cut down the cost of computers. At its La Gaude research center, for example, thin-film parametric cells are under development. They have relatively slow switching times but exceptional cost-cutting potential. However, IBM-France's research chief flatly states there's no prototype computer in the works for the moment.

SILICON DOMINATES—A look at the pilot-production units slated to go on the market next year shows the silicon integrated circuit dominating. CSF's subsidiary COSEM is setting up a line to produce logic circuits by the planar technique. And CSF has developed an experimental NOR circuit with four field-effect transistors plus passive components diffused into a silicon slab 1 mm by 1.5 mm. Still, a CSF engineer working on integrated-circuit research thinks that for the long haul the hybrid circuit shows the greatest promise because you can't get very high resistance and capacitance values in a silicon slab.

At SESCO (Societe Europeenne des Semi-conducteurs), the Thomson-Houston semiconductor subsidiary, silicon integrated circuits will start coming off a pilot production line early in 1964. The circuits and the technique used to produce them are very similar to General Electric's—SESCO will begin production using GE masks.

Still a third company, the Philips group subsidiary COPRIM (Compagnie des Produits Elementaires pour Industries Modernes) recently put on the market preproduction prototypes of hybrid integrated logic circuits using oxide films on a glass base for the passive elements. Like CSF and SESCO, COPRIM sees only military applications—notably airborne computers—in sight for the moment.

With military computer applications the only imminent potential market, French integrated-circuit manufacturers generally cite reliability first and component density second when talking about the advantages of integrated circuits. And all three agree that computers look far and away the most likely commercial application, but not until the price is right.

As far as consumer items go, the French feel that integrated circuits won't start to find their way into radio and tv sets until they're cheaper than conventional circuits. Right now, that seems several years off.

Sequence Pulse Generator

Simplified generator produces many outputs from one input without objectionable interaction. Only one power supply is required

By A. S. OTTENSTEIN and R. L. PAUL, Seaboard Electronic Corp., New York, N. Y.

THIS CIRCUIT provides five independent gating outputs when triggered by a single pulse. It is useful in many digital control systems that require sequential timing and gating pulses. It uses about half the number of transistors in a conventional monostable configuration and can be designed to provide as many as ten outputs.

The circuit has been used successfully in several digital systems. Accuracy and stability were identical to individual pulse-forming circuits in the range -55°C to 71°C .

OPERATION—In Fig. 1A, switching transistor Q_6 is normally in the OFF state while output transistors Q_1 through Q_5 are ON. Application of a positive trigger pulse to the input turns OFF Q_6 and turns ON Q_1 through feedback network R_{11} and C_{11} . The resulting positive-step voltage is applied to output transistors Q_1 through Q_5 . Each of these transistors has an independent network connected to its base to determine the OFF time; thus, the pulse width of each output is determined by these time constants. No interdependence exists except in the network formed by R_5 and C_5 , which must be used to produce the output gate of maximum width.

DESIGN—The equations developed in reference 1

are used in the design. It is assumed that similar transistors with equal base and collector currents are used so that all base resistors are equal and all collector resistors are of the same value.

For Q_1 through Q_5 ,

$$I_C = \frac{V_1 - V_{CE(\text{sat})}}{R_C} \quad (1)$$

To insure saturation

$$I_B(\text{min}) \geq \frac{I_C}{h_{FE}(\text{min})} \quad (2)$$

To insure temperature stability

$$I_B(\text{min}) \geq 8 I_{CBO}(\text{max}) \quad (3)$$

To insure proper base drive

$$R \leq \frac{V_1 - V_{BE(\text{sat})}}{I_B(\text{min})} \quad (4)$$

If $V_{BE(\text{sat})}$ is small with respect to V_1 , the output pulse width is

$$T = 0.69 RC$$

from which

$$C = \frac{T}{0.69 R} \quad (5)$$

To insure that the capacitors fully charge during the circuit recovery time ($t - T_5$), the following restriction is placed on R_{12} .

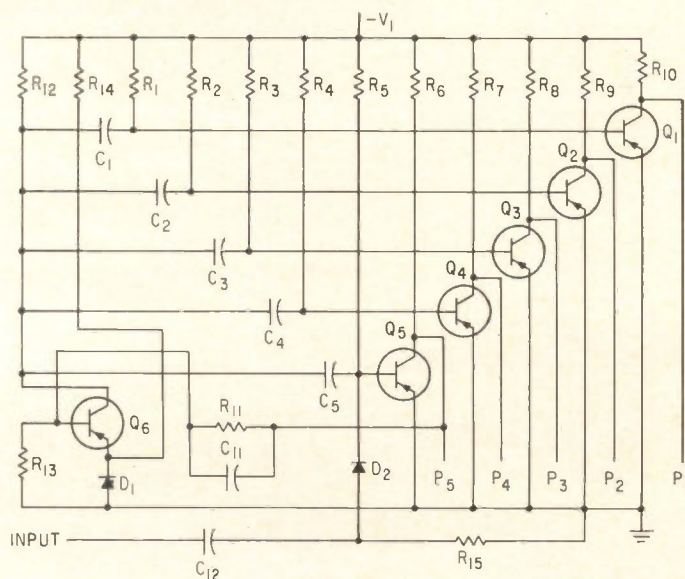

$$R_1 = R_2 = R_3 = R_4 = R_5 = R \quad R_6 = R_7 = R_8 = R_9 = R_{10} = R_C$$

(A)

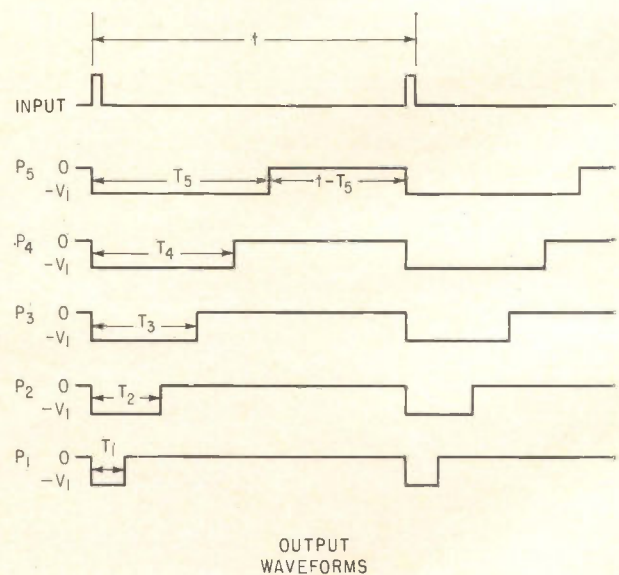

PULSE generator has five outputs, but more can be obtained (A). Time constants in base circuits determine T_1 to T_5 . Last stage must have longest duration (B)—Fig. 1

Saves Transistors

$$\text{where } 5 R_{12} [C_1 + C_2 + C_3 + C_4 + C_5] \leq (t - T_5)$$

$$T_5 = R_5 C_5$$

$$\text{or } R_{12} \leq \frac{(t - T_5)}{5 C_{\text{total}}} \quad (6)$$

The peak collector current of Q_6 is,

$$I_{C6(\text{peak})} = \frac{V_1 - (V_{CE6} + V_{E6})}{R_{12}} + \frac{2V_1 - (V_{BE(\text{sat})} + V_{E6} + V_{CE6})}{\frac{1}{5} R} \quad (7)$$

To insure saturation of Q_6 a base current must be supplied which is,

$$I_{B6(\text{min})} \geq \frac{I_{C6(\text{peak})}}{h_{FE6(\text{min})}} \quad (8)$$

Virtually independent outputs are achieved only when a low impedance is present at the collector of Q_6 when it is ON. This low impedance is assured only if Q_6 remains saturated.

The OFF bias is provided at the emitter of Q_6 through the combined action of resistor R_{11} and diode D_1 . High conductance diodes must be employed if I_{C6} peak is large.

DESIGN EXAMPLE—Transistors Q_1 through Q_5

Type	— 2N404
I_C	= 10 ma, $h_{FE(\text{min})} = 15$
$V_{CE(\text{sat})}$	= 0.1 v
$V_{BE(\text{sat})}$	= 0.15 v
$I_{CBO(\text{max})}$	= 0.1 ma

Let $T_1 = 20$ ms, $T_2 = 40$ ms, $T_3 = 60$ ms, $T_4 = 80$ ms, $T_5 = 100$ ms Input rep rate = 6 cps. (Fig. 1B).

Transistor $Q_6 = 2N1187$

$h_{FE(\text{min})}$	= 40
$V_{CE(\text{sat})}$	= 0.2 v
$V_{BE(\text{sat})}$	= 0.5 v
$I_{CBO(\text{max})}$	= 0.120 ma
V_{E6}	= 0.6 v
V_1	= 12 v

From Eq. 1

$$R_C = \frac{12 - 0.1}{1 \times 10^{-3}} = 1,190 \text{ ohms} \quad \text{Use } R_C = 1,200 \text{ ohms}$$

From Eq. 2 and 3

$$I_B \geq \frac{10 \times 10^{-3}}{15} = 0.66 \text{ ma}$$

$$I_B \geq 8 (0.1 \times 10^{-3}) = 0.8 \text{ ma}$$

$$\text{From Eq. 4 } R \leq \frac{12 - 0.15}{0.8 \times 10^{-3}} = 15,000 \text{ ohms}$$

$$\text{From Eq. 5 } C_5 = \frac{100 \times 10^{-3}}{0.69 (15 \times 10^{+3})} = 10 \mu\text{f}$$

Solving for the other capacitor values

$$C_1 = 2 \mu\text{f}, C_2 = 4 \mu\text{f}, C_3 = 6 \mu\text{f}, C_4 = 8 \mu\text{f}$$

$$\text{From Eq. 6 } R_{12} \leq \frac{50 \times 10^{-3}}{150 \times 10^{-6}} = 330 \text{ ohms}$$

$$\text{From Eq. 7 } I_{C6(\text{peak})} = \frac{12 - (0.2 + 0.6)}{330} + \frac{24 - (0.15 + 0.6 + 0.2)}{3 \times 10^3}$$

$$= 41.6 \text{ ma}$$

$$\text{From Eq. 8 and 3 } I_{B5} \geq \frac{41.6 \times 10^{-3}}{40} = 1.04 \text{ ma}$$

$$I_{B6} \geq 8 (120 \times 10^{-6}) = 0.96 \text{ ma}$$

use $I_{B6} = 1.04$ ma

For good temperature stability I_{R13} is made equal to $3 I_{CBO(\text{max})}$ during the ON state of

$$R_{13} = \frac{V_{BE6(\text{sat})} + V_E}{3 I_{CBO6}} = \frac{0.5 + 0.6}{360 \times 10^{-6}} = 3,050 \text{ ohms}$$

use $R_{13} = 3,000$ ohms

To insure adequate base drive when Q_6 turns ON, the current through R_{11} is made equal to I_B (I_{R13}). Therefore

$$R_{11} + R_6 = \frac{V_1 - (V_{BE(\text{sat})} + V_E)}{I_{B5} + 3 I_{CBO6}}$$

$$= \frac{12 - (0.5 + 0.6)}{(1.04 + 0.36) \times 10^{-3}} = 7,800 \text{ ohms}$$

However, since $R_6 = 1,200$ ohms, $R_{11} = 6,600$ ohms. Use $R_{11} = 6,200$ ohms.

In the OFF state, the voltage at the base of Q_6 is 0.3 volt with 0.120 of leakage. This, in conjunction with the 0.6 volt developed across D_1 , provides an OFF bias of 0.3 volt at 71 C.

APPLICATIONS—One application is a multiple-channel temperature alarm system. This system consists of a 5-shot sequence generator with two fixed outputs, one to accomplish operation *T logic* and one to establish a time reference *T ref*, an external clock. The three remaining channel-timing resistors can be replaced by thermistors. These temperature-sensing elements will be mounted so as to monitor three critical temperature points in a system. To accomplish system sampling, a clock with known frequencies triggers the generator. The outputs of T_1 , T_2 and T_3 are fed to three a-c gates that will sample the positive-going trailing edges of the monitoring channels. The gates are open only during the period of *T ref*. During a nonalarm condition, the period of each monitoring channel is selected to be greater than *T ref* but shorter than *T logic*. If the temperature on any one channel or on all channels increases to an alarm condition, the period of time generated by that channel will decrease until its trailing edge falls within the period of *T ref*. The pulse will pass through the gate, be integrated and trigger the alarm circuit.

Since the system clock rate is fixed and the period of each monitoring channel is a function of temperature, these may be individually sampled with a dwell meter calibrated to indicate temperature. After receiving an alarm condition, the operator is able to sample the temperature of the individual channels and determine the exact point in the system where fault occurred.

REFERENCE

(1) R. L. Paul and A. Ottenstein, Eliminating the First Stage Of A Monostable Multivibrator, *ELECTRONICS*, Sept. 7, 1962.

Designing Input Circuits

Getting lowest possible noise means juggling input transistor types, source and impedance levels, and other factors. Field-effect transistors, for example, come into their own when source impedance levels are high

By JOHN J. RADO, Precision Instrument Co., Palo Alto, California

SYMBOLS FOR THE EQUATIONS — TABLE I

Symbols for the Equations — Table I

V_{CE}	— Collector to emitter voltage
I_c	— Collector current
R_g	— Generator or source resistance
NF	— Noise Figure
$S_{P\ in}$	— Signal power input
$S_{P\ out}$	— Signal power output
$N_{P\ in}$	— Noise power input
$N_{P\ out}$	— Noise power output
$S_{V\ in}$	— Signal voltage input
$S_{V\ out}$	— Signal voltage output
$N_{V\ in}$	— Noise voltage input
$N_{V\ out}$	— Noise voltage output
N_{VD}	— Noise voltage of input device (transistor)
A	— Open loop gain
Δf	— Bandwidth
f	— Frequency
$f\alpha$	— Cutoff frequency
h_{FE}	— Current Gain
B	— Feedback ratio
e_{out}	— Output voltage (amplifier)
e_{in}	— Input voltage (amplifier)
R_E	— Emitter resistance
$Z'_{in\ ol}$	— Open loop input impedance (without bias network)
$Z'_{in\ cl}$	— Closed loop input impedance (without bias network)
$Z_{in\ cl}$	— Closed loop input (with bias network)
$Z_{cl\ out}$	— Closed loop output

ART IN ENGINEERING

Until all amplifier design is completely analyzed and computer programmed, the circuit designer will have to do some blind flying. Call it the art of engineering. Rules like keeping source impedance low to minimize noise and pickup are vital, but sometimes basic rules have exceptions. Even if amplifier design could be done by computer, there would still be times when it might be simpler to do it yourself

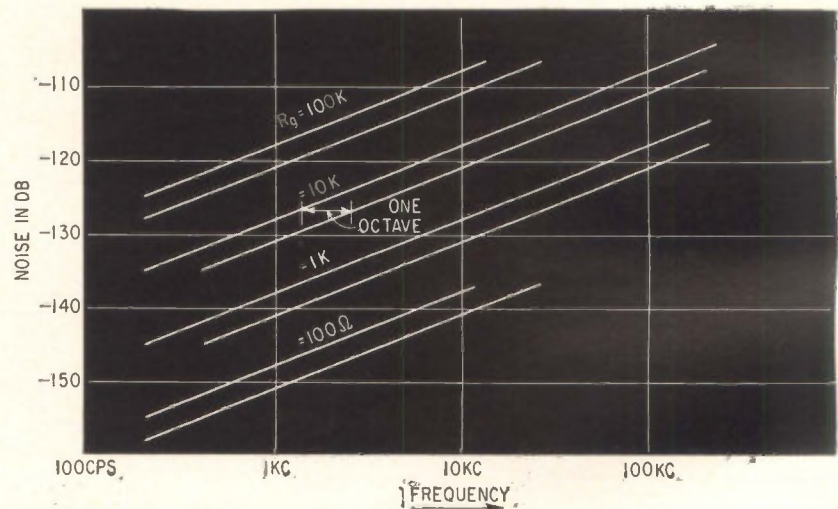

PARALLEL LINES define one-octave bandwidths for various source impedances. Increasing bandwidth increases noise by 3 db for each octave—Fig. 1

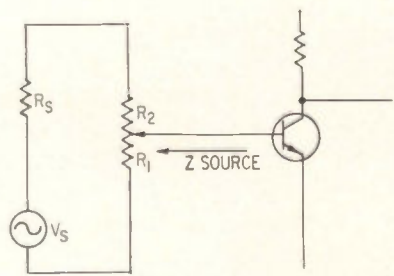

(A)

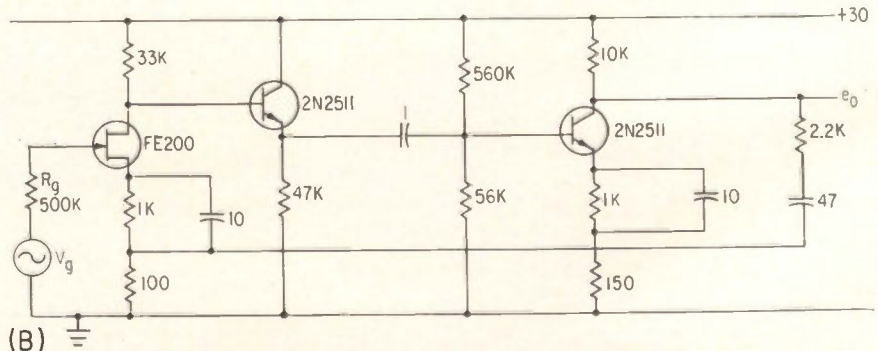

(B)

LOWEST INPUT impedance is not always optimum for lowest noise operation (A). The field-effect input transistor (B) will give lower noise than the more usual types when source impedance is high—Fig. 2

With Lowest Possible Noise

NOISE in transistor amplifiers originates from three basic factors: internal noise generated by the components of the amplifier; noise generated by the source; and the bandwidth of the amplifier and its relation to the bandwidth of the noise.

The designer has at least a limited control in selecting components with low-noise characteristics and in setting circuit parameters to enhance operation. Source and the amplifier bandwidth are usually either given or implied in the specification and therefore can seldom be altered to improve the noise figure of the amplifier.

INPUT TRANSISTOR NOISE—

The equivalent input noise of any amplifier cannot be less than the noise contributed by the input stage. Noise generated by subsequent stages will be, in essence, reduced by the gain preceding them. The manufacturer's data sheet for the 2N930, a popular unit for low-level low-noise applications, shows, for example, a noise figure (*NF*) of 4 db max for $V_{CE} = 5$ v, $I_c = 10$ μ a, and $R_s = 10,000$ ohms for a bandwidth from 10 cps to 10 Kc. (See Table I for symbols.)

What is the best performance possible with this type of transistor? Will it be possible, for example, to recover a 10 μ v signal with less than 1 μ v noise superimposed?

Noise figure is defined as

$$NF = 10 \log \left(\frac{S_{P_{in}}/N_{P_{in}}}{S_{P_{out}}/N_{P_{out}}} \right)$$

Since both signal and noise voltages look into the same generator resistance

$$S_{P_{in}} = S^2_{V_{in}}/R_s \quad \text{and} \quad N_{P_{in}} = N^2_{V_{in}}/R_s$$

$$NF = 10 \log \left(\frac{S_{V_{in}}/N_{V_{in}}}{S_{V_{out}}/N_{V_{out}}} \right)^2$$

$$= 20 \log \left(\frac{S_{V_{in}}/N_{V_{in}}}{S_{V_{out}}/N_{V_{out}}} \right) \quad (1)$$

If the amplifier voltage gain is *A*, then

$$S_{V_{in}}/S_{V_{out}} = 1/A \quad (2)$$

$$\text{and} \quad N_{V_{out}} = A(N_{V_{in}} + N_{VD}) \quad (3)$$

where N_{VD} is the noise voltage of



WIDEBAND AMPLIFIER is optimized for low noise with respect to both source impedance and input transistor

the input device. Rearranging Eq. 1 and substituting Eq. 2 and 3

$$NF = 20 \log \frac{S_{V_{in}}/N_{V_{in}}}{S_{V_{out}}/N_{V_{out}}}$$

$$= 20 \log \frac{S_{V_{in}} \cdot N_{V_{out}}}{S_{V_{out}} \cdot N_{V_{in}}}$$

$$= 20 \log \frac{S_{V_{in}}}{S_{V_{out}}} \cdot \frac{A(N_{V_{in}} + N_{VD})}{N_{V_{in}}}$$

$$= 20 \log \frac{1}{A} \cdot \frac{A(N_{V_{in}} + N_{VD})}{N_{V_{in}}}$$

$$NF = 20 \log \left(1 + \frac{N_{VD}}{N_{V_{in}}} \right) \quad (4)$$

Assuming input noise $N_{V_{in}}$ is entirely thermal noise generated in source resistance R_s

$$N^2_{V_{in}} = 4 \cdot K \cdot T \cdot \Delta f \cdot R_s \quad (5)$$

where *K* = Boltzmann's constant.

For $\Delta f = 10$ Kc, $R_s = 10,000$ ohms (both as specified in the 2N930 data sheet), and $T = 273 + 20 = 293$, input noise $N_{V_{in}}$ is ($K = 1.38 \times 10^{-23}$ joule/deg K) easily calculated as 1.27 microvolts, which is the noise generated by the generator resistance alone.

Substituting this value into Eq. 4 and solving for N_{VD} for $NF = 4$ db (as specified for the 2N930)

$$\frac{4}{20} = \log \left(\frac{1.27 \times 10^{-6} + N_{VD}}{1.27 \times 10^{-6}} \right)$$

$$N_{VD} = 0.74 \mu v$$

Thus, thermal noise from the source and noise generated by the input transistor amounts to 2.01 μ v, of which 0.74 μ v is contributed by the transistor. This is the minimum noise at the input for the conditions given.

Noise factors are summarized in Fig. 1 and Table II.

SOURCE IMPEDANCE—Contrary to intuition, lower source imped-

NOISE FOR A BANDWIDTH FROM 100 CPS TO 200 KC FOR VARIOUS SOURCE IMPEDANCES—TABLE II

R_s , in ohms	Noise in db
10,000	-105
1,000	-115
100	-125
10	-135
1	-145

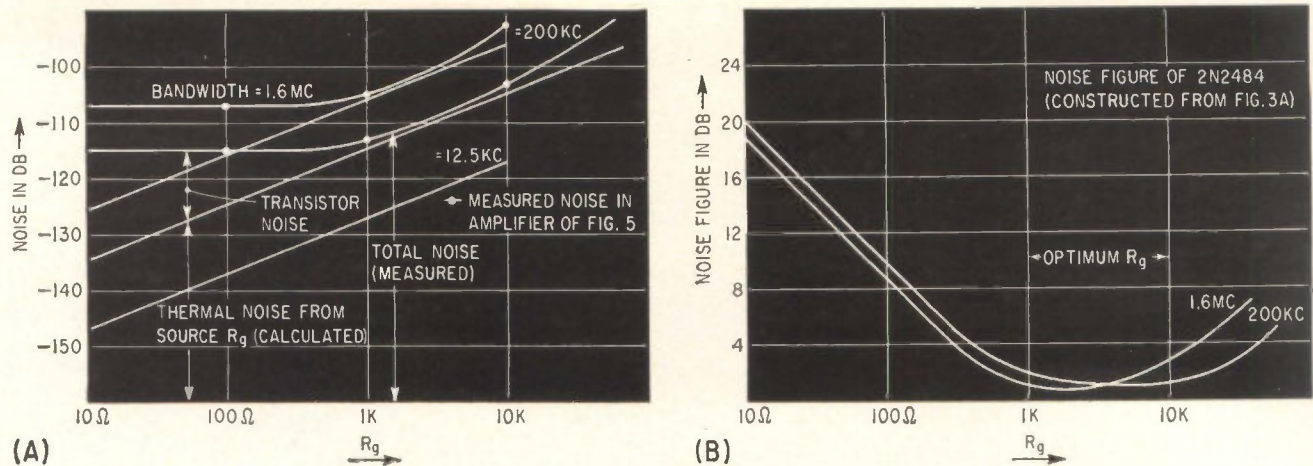

WIDEBAND NOISE as a function of source impedance (A) and optimum source impedance (B)—Fig. 3

ance does not necessarily mean lower transistor noise figure. To verify this, assume the hypothetical case represented in Fig. 2A.

The circuit is a good analogy for transducer inputs such as the reproduce head of a tape recorder or the pick-off windings of a differential transformer. Since both of these devices operate by electromagnetic induction, their output voltage will, to a first approximation, follow the $e = N d\phi/dt$ relationship. In other words, the output voltage will increase with the number of turns but so will the source impedance to the input transistor.

Thus there is a source impedance that will yield maximum output voltage and minimum transistor noise figure. In other words, a compromise has to be worked out between transducer output impedance, output voltage and transistor noise figure.

For applications where the pre-amplifier is to operate from a source impedance of several hundred kilohms, field-effect transistors may provide the best overall signal-to-noise ratio. The extremely high input impedance (several megohms and thus minimum loading effect on the source) and minimum noise figure for a source impedance from 100,000 ohms to 1 megohm for field-effect devices produces this result.

The FET 200 field-effect transistor used as input device in the amplifier of Fig. 2B has a noise figure of about 1 db, or an order of magnitude better than any of the low-noise transistors (2N930,

2N2484) for the same source impedance.

For most transistors, optimum noise figure will occur if the generator resistance is between 1,000 and 10,000 ohms. For source impedances from 500,000 ohms to 1 megohm, field-effect transistors will show better performance.

Figure 3A shows noise figures for the 2N2484 as a function of source impedance for two bandwidths; Fig. 3B shows optimum source impedance.

COLLECTOR CURRENT AND BANDWIDTH—In the preceding analysis of the effect of source impedance on the noise figure of a transistor, collector current was assumed constant and both measurements and calculations were made at a few exclusive frequencies and bandwidths.

But the noise figure also depends on collector current and bandwidth; these also effect one another and their combination further effects the optimum source impedance. Despite this combination of variables some relatively simple rules

indicate the general trend caused by each variable individually and can aid optimization. Noise figure as a function of frequency is plotted in Fig. 4. At low frequency is the $1/f$ or flicker noise region, which reaches a minimum at around 1 Kc.

Noise figure remains constant until the second breakover point occurs at $f = f_c/\sqrt{1 + h_{FE}}$, after which it increases at 6 db per octave.

Since the high-frequency performance of a transistor improves with increasing collector current, the second breakover point also occurs at higher frequencies. In general, increased collector current moves the curve in Fig. 4 up and to the right; the optimum source impedance is inversely proportional to bandwidth (Fig. 3B). In addition, higher collector current requires lower source impedance to obtain the same noise figure.

The noise figure of field-effect transistors, however, does not change with drain current (corresponding to I_c) and the first breakover point, the end of the $1/f$ region, occurs about one magnitude lower than that indicated in Fig. 4, which makes them particularly suitable for low-noise high-input impedance applications from dc to 1 Kc.

WIDEBAND AMPLIFIER—A low-level, low-noise wideband amplifier was designed along the lines set forth above.

The Fairchild 2N2484 double-diffused silicon planar transistor was selected for the amplifier. Its noise figure is shown in Fig. 3. The

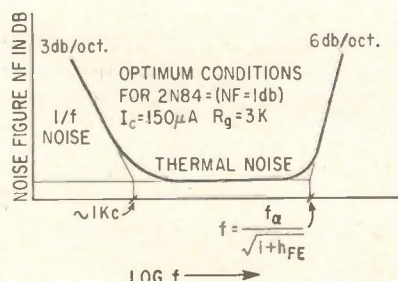

TRANSISTOR noise has two break points—Fig. 4

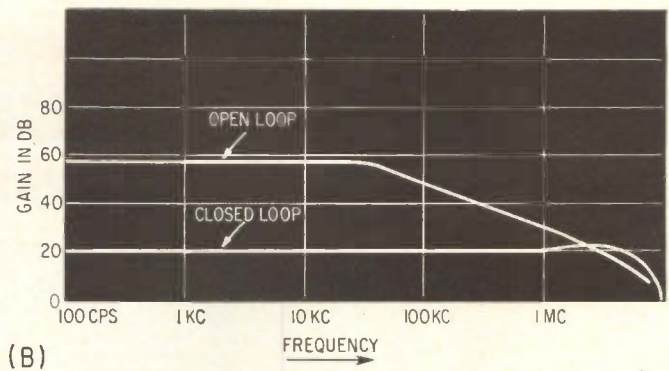
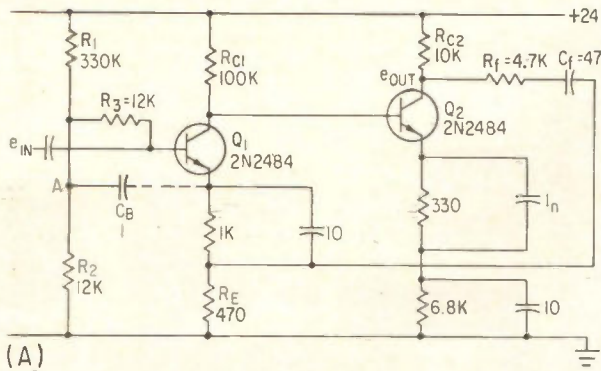

LOW-NOISE, wideband amplifier (A), designed for tape recorder, and its responses (B)—Fig. 5

Amelco 2N2511 transistor was found to have identical characteristics and is, therefore, interchangeable with the 2N2484.

The completed circuit is given in Fig. 5A. Since the amplifier is used as head preamp in the reproduce circuit of a tape recorder, the actual effective source impedance varies from 1,000 to 6,000 ohms with frequency. As indicated in Fig. 4, optimum collector current is $I_c = 150 \mu\text{a}$ for this range of source impedance.

Since the gain of the first stage is in excess of 12 to 15 db throughout the bandwidth of interest, a 10,000 ohm collector resistor was permissible. Although this 10,000 ohms also appears as source impedance for the second stage, which from the standpoint of noise is not ideal, its effect on overall noise is negligible due to the gain preceding it. It further permits direct coupling between stages. Overall open-loop and closed loop gains are shown in Fig. 5B.

The feedback used increases the open-loop input impedance and decreases the open-loop output impedance in proportion to the available excess gain. A good approximation for low frequencies can be developed by starting with the expression for a feedback amplifier

$$\frac{e_{out}}{e_{in}} = \frac{A}{1 + A \cdot B} \quad (6)$$

Product $A \cdot B$ is sometimes called the excess gain. In the amplifier of Fig. 5A, $A \cdot B$ amounts to approximately 36 db or a factor of 63. Open loop input impedance is

$$Z'_{inol} \cong R_e \cdot h_{FE} \quad (7)$$

after closing the loop it is

$$Z'_{inol} \cong R_e \cdot h_{FE} \cdot A \cdot B \quad (8)$$

This impedance, however, is fur-

ther reduced by the bias network R_1 , R_2 , and R_3

$$R_{bias} = \frac{R_1 R_2}{R_1 + R_2} + R_3 \quad (9)$$

Then

$$Z'_{incl} = \frac{\frac{R_1 \cdot R_2}{R_1 + R_2} + R_3 \cdot R_E \cdot h_{FE} \cdot A \cdot B}{\frac{R_1 \cdot R_2}{R_1 + R_2} + R_3 + R_E \cdot h_{FE} \cdot A \cdot B} \quad (10)$$

Considering the circuit values used in Fig. 5, the conclusion is, that since Z'_{incl} is at least two magnitudes larger than R_{bias} , maximum input impedance at best will be of the order of R_{bias} .

Since the source impedance (the reproduce head) feeding the amplifier increases with frequency, the loading effect also becomes more and more significant. Using the parameters shown in Fig. 5, and considering a source impedance of 6,000 ohms, perhaps 20 percent of the available signal (6,000 ohms looking into 24,000 ohms) is lost.

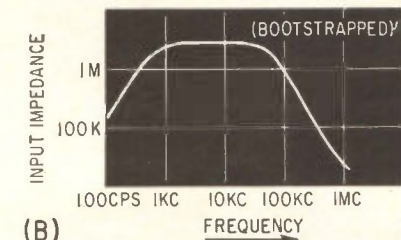
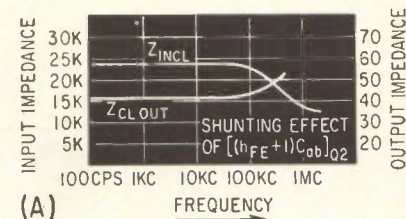

INPUT and output impedance (A) of amplifier shown in Fig. 5 and the effects of bootstrapping (B)—Fig. 6

To avoid such loading effect, bootstrapping was considered. By returning point A with capacitor C_n to the emitter of Q_1 , the shunting effect of R_{bias} is, in essence, swamped out and the source, with increasing frequency sees $Z'_{incl} = R_e \cdot h_{FE} \cdot A \cdot B$.

But as the frequency goes above 10 Kc, the approximation of Eq. 10 loses validity. The effect of the collector capacitance (thus far neglected) will become significant, appearing as a shunt across Z'_{incl} . This, in addition to the fact that both h_{FE} and A decrease with increasing frequency, is responsible for the shape of impedance curves of Fig. 6A and 6B.

OUTPUT IMPEDANCE—Output impedance of the amplifier of Fig. 5 can be calculated as follows. The open loop output impedance is R_{out} in parallel with $R_f + j\omega C_f$. Closed loop output impedance is

$$Z_{clout} \cong \frac{R_{c2}(R_f + j\omega C_f + R_E)}{R_{c2} + R_f + j\omega C_f + R_E} \cdot \frac{1}{A \cdot B} \quad (11)$$

The wideband noise of the amplifier is shown in Fig. 3A. The noise in octaves within a 200 Kc bandwidth is given in Fig. 6C.

No attempt has been made here to cover all theoretical aspects of noise or to follow a bona fide analysis of the equivalent circuits of the amplifier of Fig. 5. The general standpoint has been practical. The concept was to provide some general rules and approximations that will help improve circuit performance.

BIBLIOGRAPHY

- Nielsen, Behavior of Noise Figure in Junction Transistors, *Proc IRE* July, 1957.
- L. Blaser, The Design of Low Noise High Input Impedance Amplifiers, Fairchild Application Note APP-36.
- Hunter, "Handbook of Semiconductor Electronics," McGraw-Hill Book Co., 1956.

Delta Modulator Codes

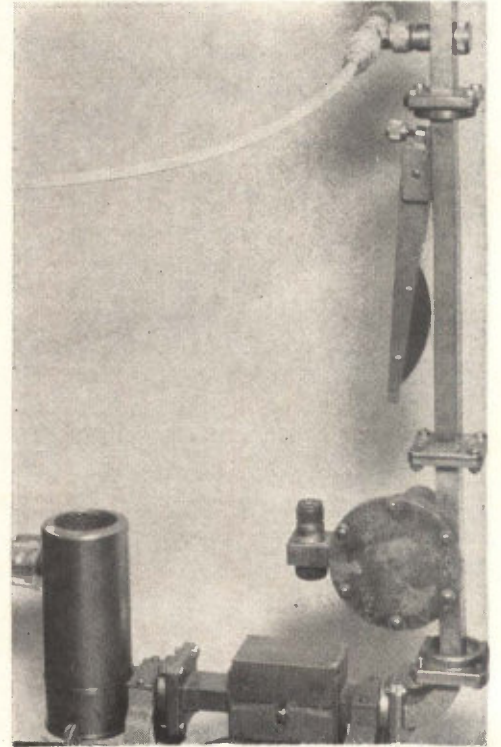
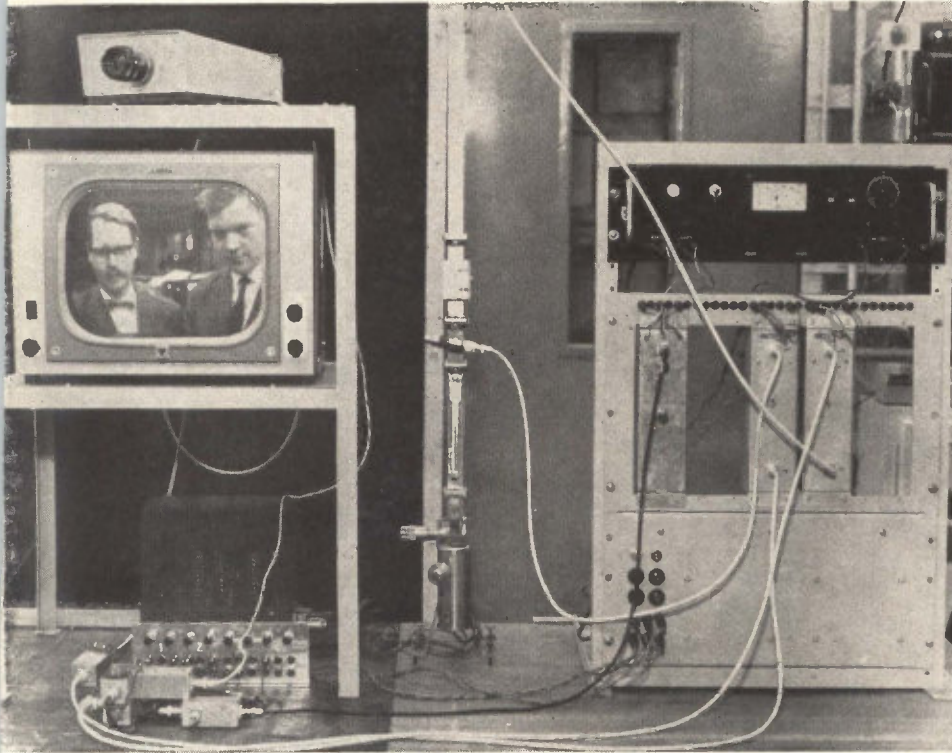

AUTHORS' pictures are transmitted over the closed circuit (left). Detail of crystal modulator (insert at right) showing crystal diode crossing waveguide to increase bandwidth above that available with crystal in shunt arm

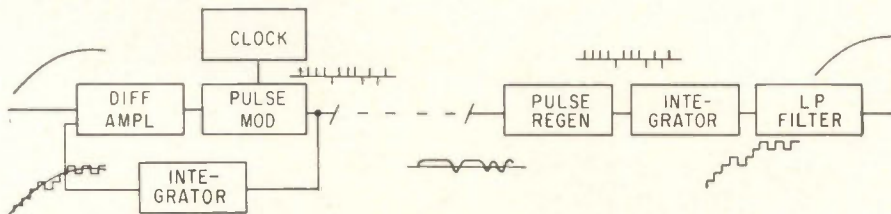

DELTA modulator uses feedback, quantized in amplitude and time, to obtain a faithful replica of the transmitted signal—Fig. 1

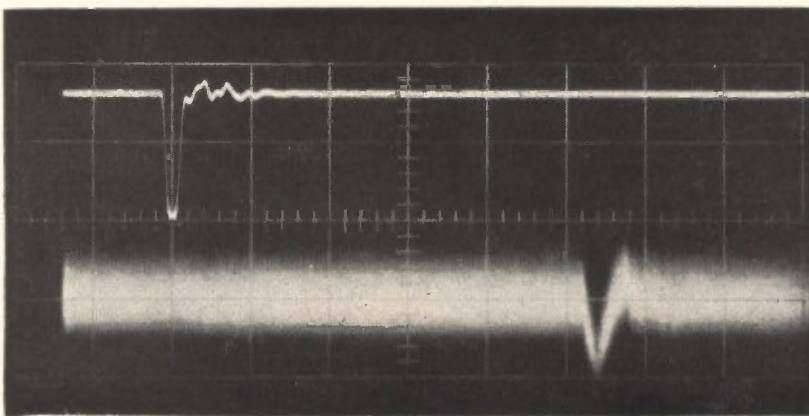

FIVE-NANOSECOND pulse before and after transmission through 3-cm waveguide circuit showing delay and distortion in waveguide

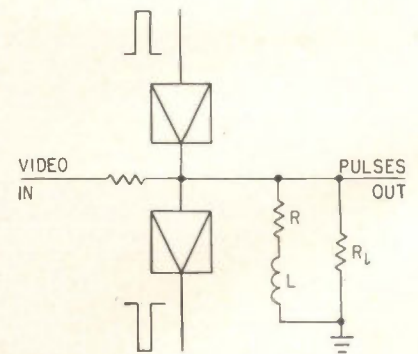

TUNNEL-diode Goto pair achieves high speed in simple delta-modulator—Fig. 2

Television Waveguide Link

Clock rate of 100 Mc is the key to high-quality transmission over simulated 25 Km waveguide with a simple tunnel-diode Goto pair

By C. KRAMER and J. C. BALDER Philips Research Laboratories
N. V. Philips' Gloelampenfabrieken Eindhoven, Netherlands

WHY IS IT BETTER?

The trick here is to provide a simple system suitable for long-distance transmission of a high-quality television picture over waveguide. The design considers a signal of 5-Mc bandwidth to be sent 25 kilometers. Delta modulation, a form of pulse code modulation, is chosen. Tunnel diodes operating at clock rates of 100 Mc make for simple hardware while also keeping the ratio of signal-to-quantizing noise—this noise decreases as a function of clock frequency—to about 40 db

DELTA-MODULATION^{1, 2} converts a continuous signal into a binary pulse pattern for transmission through low-quality channels. The conversion is effected by quantized feedback, as shown in Fig. 1.

The pulse modulator produces a positive or a negative pulse, depending on the polarity of the difference between the input signal and a reconstructed signal obtained by integrating the pulses. The reconstructed signal is thus made to approximate the original signal as closely as possible. At the receiver the pulses must be integrated to obtain the same reconstructed signal, after which the high-frequency components are removed by a low-pass filter. The difference between the input signal and the filtered reconstructed signal gives rise to quantizing noise, which decreases

with increasing clock frequency.

To transmit a tv signal of 5-Mc bandwidth with a signal-to-quantizing noise ratio of 40 db, a clock rate of 100 Mc is required. An extremely simple delta-modulator³ that operates at these high clock rates can be constructed by using tunnel diodes, Fig. 2.

This circuit can be shown equivalent to the encoder in Fig. 1. The difference of the original video signal current and the reconstructed signal current flows either into or out of the node between the tunnel diodes and gives rise to either a positive or a negative voltage pulse. The reconstructed signal is obtained by integrating the output voltage pulses in the network comprising inductance L and series resistance R . The current steps built-up in the integrator counteract the signal

current. In this way the reconstructed signal follows the original signal closely with a difference of one step or less. As the delta-modulator differentiates the input signal, the video signal has to be integrated first, or fed in series with the inductance and resistance of the integrating network.

SINE WAVES — Shifted sine waves can be used instead of rectangular supply pulses. The output signal of the delta-modulator then consists of positive and negative half-sine wave pulses about 5 nsec wide.

It must now be determined whether these pulses can be transmitted through a H_{01} -mode waveguide circuit where the distance between repeaters is 25 Km. A principal cause of distortion in waveguide circuits is dispersion,

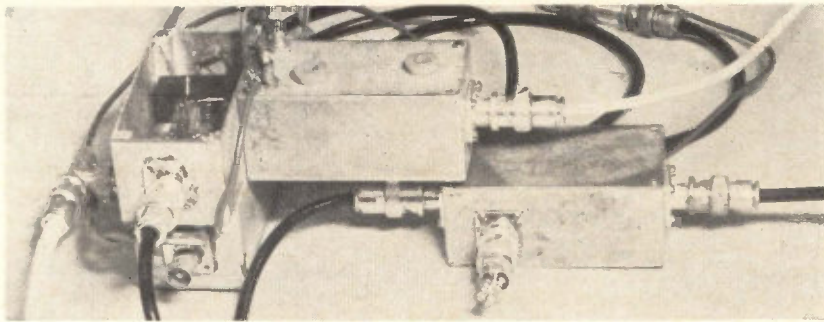

UNDER the transparent lid at left is the delta-modulator consisting of tunnel diodes and coil. Modulator circuits are contained in the four boxes

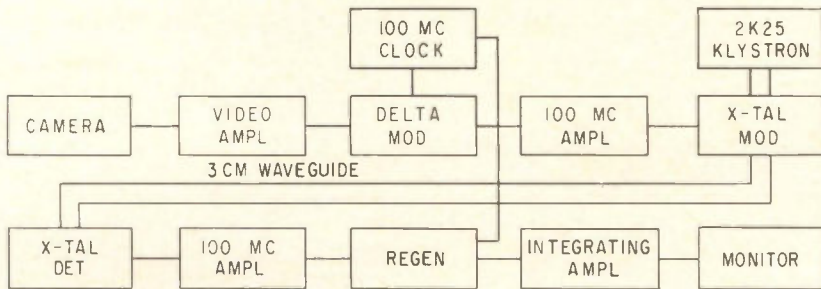

SIMULATED long-distance waveguide transmission link shown also in the photograph—Fig. 3

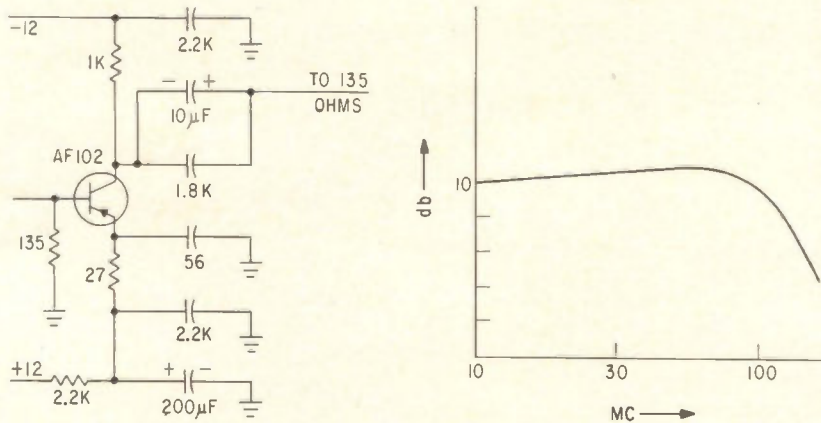

LARGE bandwidth (right) is obtained in 100-Mc amplifier stage using emitter feedback peaking—Fig. 4

which causes different sidebands of the same signal to arrive at different times. This dispersion can be calculated by

$$\lambda_g = \lambda_0 / \sqrt{1 - \lambda_0^2 / \lambda_c^2}$$

where λ_0 = free space wavelength
 λ_g = guide wavelength
 λ_c = cut-off wavelength of the guide
 l = length of waveguide

By $\tau = l/v - l/f\lambda_g$ this can be written as $\tau = \tau_0 \sqrt{1 - f_0^2/f^2}$ where τ_0 = transmission delay in free space

f = carrier frequency
 f_0 = guide cut-off frequency

By differentiation

$$\frac{\Delta\tau}{\tau_0} = \frac{f_0^2/f^2}{\sqrt{1 - f_0^2/f^2}} \frac{\Delta f}{f}$$

Considering a circular waveguide with $d = 5$ cm ($f_0 = 7,320$ Mc for the H_{01} mode), $\lambda_0 = 4$ mm and $l = 25$ Km, then $\Delta\tau = 4.16$ nsec for a signal with a bandwidth $\Delta f = 200$ Mc. This means that 5 nsec pulses are widened by the dispersion to about 9 nsec. Since the distance between two succes-

sive pulses is 10 nsec, this distortion does not make the pulses unrecognizable.

Because it is not practicable to use 25 Km of circular waveguide for the experiment, the circuit was simulated by using rectangular 3 cm waveguide. Here the dispersion per unit length is much larger because f_0/f is large. With $f_0 = 6,560$ Mc, $f = 9,200$ Mc and again $\Delta f = 200$ Mc the value of $\Delta\tau/\tau_0 = 0.0155$. If $\Delta\tau$ should again be 4.16 nsec, τ_0 has to be 269 nsec, so $l = 80.5$ m. This is a reasonable length of waveguide to use in the laboratory. As shown in the oscillograms, $\Delta\tau$ is indeed about 4 nsec.

SYSTEM—The transmission circuit is shown in Fig. 3. The signal output of the camera is amplified and supplied to the delta-modulator. The pulse output of the delta modulator is amplified by a four-stage 100-Mc bandwidth amplifier, one stage of which is shown in Fig. 4. After amplification, the pulses amplitude-modulate a 3 cm carrier by means of a wideband crystal modulator.

At the receiving end the pulses are detected by a 3 cm crystal detector and again amplified in a four-stage 100 Mc amplifier. The amplifier pulses control a tunnel diode pair, which is fed by a 100 Mc shifted sine wave in such phase that the start of a 100 Mc supply pulse coincides with the peak of a signal pulse. The signal pulses are thereby restored to their original shape and the distortion and noise are removed. The regenerated pulses are then integrated to obtain the original tv signal. The picture on the monitor shows that the signal suffers little degradation during this series of modulating and demodulating processes.

The authors thank R. Muller and E. de Boer for assistance in constructing and aligning the equipment.

REFERENCES

- (1) J. F. Schouten, F. de Jager and J. A. Greefkes Delta-modulation, a new modulation system for telecommunication, *Philips Tech. Rev.* 13, p 237-245, March 1952.
- (2) A. Lender and M. Kozuch, Single-bit Delta Modulation Systems, *ELECTRONICS*, 34, 46, p 125-129, Nov. 17, 1961.
- (3) J. C. Balder and C. Kramer, Video Transmission by Delta Modulation using Tunnel Diodes, *PIRE*, 50, 4, p 428-431, Apr. 1962.

You can take your work to the HONEYWELL 8100 TAPE RECORDER

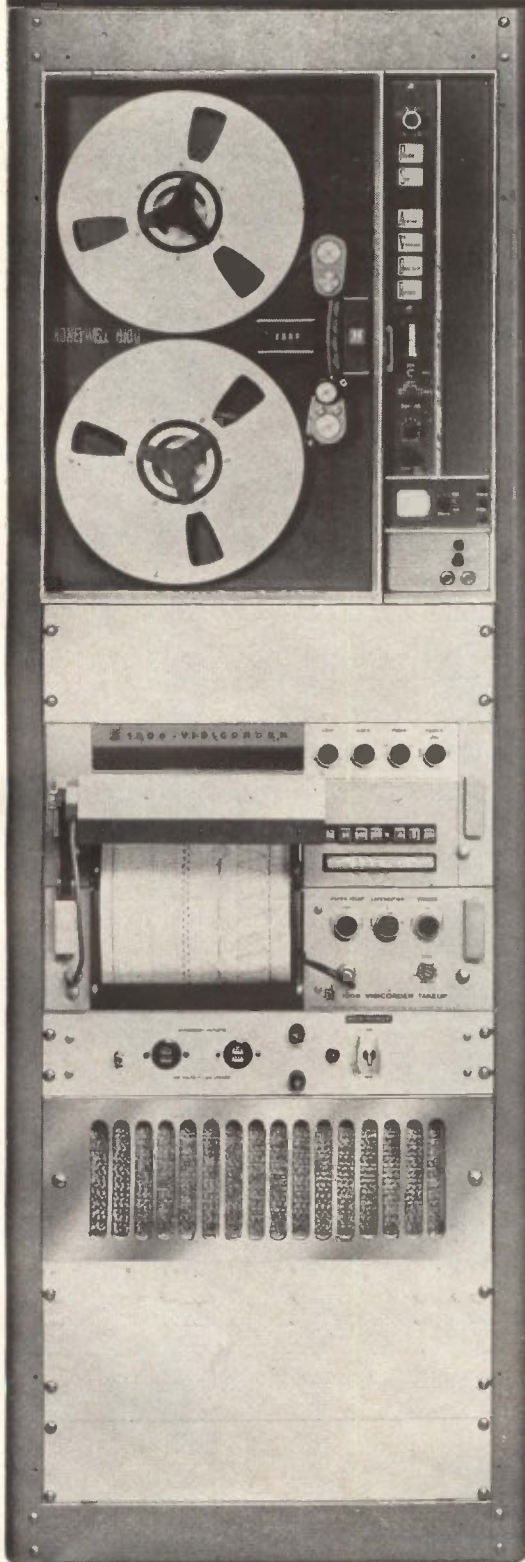

or
you can
take
the
8100
to
your
work!



Completely portable, completely self-contained, the new Honeywell 8100 recorder/reproducer offers instrumentation quality in a package you can carry from test to test with one hand. Or you can rack-mount the 8100, as shown at left with a Honeywell Model 1508 Visicorder Oscillograph. The 8100 contains all its own electronics, plus such convenience features as a built-in calibration panel and automatic switching of center frequencies. You can record analog data from DC to 10,000 cps on up to 8 data channels. And there's an optional built-in scope for monitoring data while you record. Available with either $\frac{1}{4}$ or $\frac{1}{2}$ inch tape. Weight only 85 pounds. Price from \$5900 to \$11,300. Write for brochure #2038 to Honeywell, Denver Division, Denver 10, Colorado.

Honeywell

Infrared Mine Detector a Reality

Basic experiment shows infrared mine detection technique feasibility

By W. E. OSBORNE
Whittier, California

INFRARED detection techniques developed in the past ten years have made it possible for an infrared receiver to detect differences, at close range, of less than 0.001 deg F. Such sensitivity has suggested interesting new applications.

One such application is the detection of explosive mines buried in soil. To investigate the possibilities for such detection, experiments were run with a simulated mine at different depths, and showed that this is a promising field for further research.

All materials and objects emit and absorb radiation as a function of their temperature. While the emitted radiation results from the acceleration of electrical charges within the material, and is therefore electromagnetic in nature, radiative behavior is usually explained in terms of thermodynamics. In the case of mine detection by infrared, the system depends on determining any significant temperature differences in the ir radiation of different small sections of a given area. Parameters such as emissivity and spectral radiant power are secondary in this instance, as the main concern is detection of radiant intensity differences in terms of watts/steradian, along a strip of ground about 10 ft. wide.

Theoretically, a mine, or any other buried object, should reach an equilibrium temperature equal to that of the surrounding soil, after a certain period of time, provided the material in each case is the same. Kirchoff's law for such conditions shows that the absorp-



SIMULATED MINE was plastic bucket containing metal objects, fabric and fertilizer. Infrared detector, amplifier and readout meter shown at right—Fig. 1

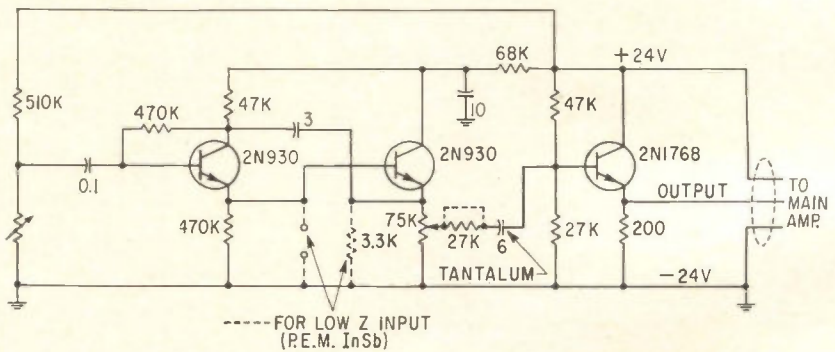

DETECTOR HEAD preamplifier carries signal from lead telluride detector cell over a 200-ohm output to main amplifier—Fig. 2

tance of the mine then equals its emissivity, or reradiation efficiency factor. However, a marked difference exists between the material composition of the mine and its surroundings. The radiant emissivity, absorptance and reflectance are therefore considerably different, irrespective of whether the weapon is plastic or metal, and it is detectable as either a warmer or a colder object than the surrounding soil.

A parallel is provided by a packet of frozen food in an almost empty freezer. It may be immediately located by an infrared detector

inside the freezer even though the food has been frozen for weeks.

PROCEDURE—Experiments were conducted with a receiver using a lead telluride cell, responding at 6 microns, and cooled with dry ice. Although the amount of incident radiant energy receivable by this cell was only about four percent of maximum (at 55 deg F, a receiver peaking at 10 microns would be preferable), a very usable signal was obtained with the target buried at 18 inches (see Fig. 1).

One week later more checks were

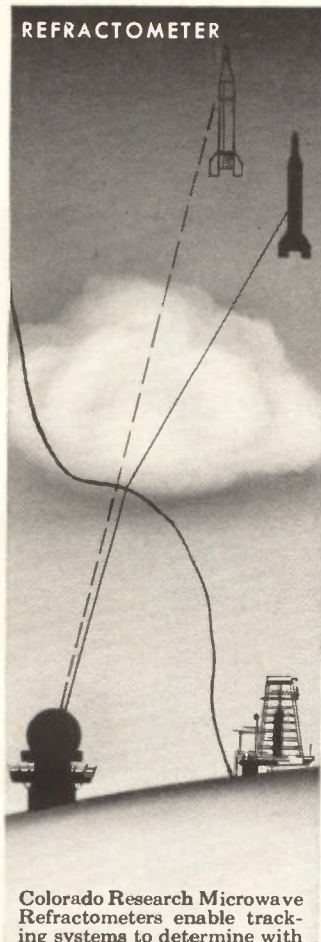

Colorado Research Microwave Refractometers enable tracking systems to determine with new accuracy variances of radar wave velocity caused by variances in refractive properties of the atmosphere.



Measurement of shaft position with high precision has been made possible by the Colorado Research Microgon Shaft Angle Encoder System. Measurements with an accuracy of 1 part in 2^{21} make the system invaluable in the encoding of azimuth and elevation shaft angles of tracking systems.

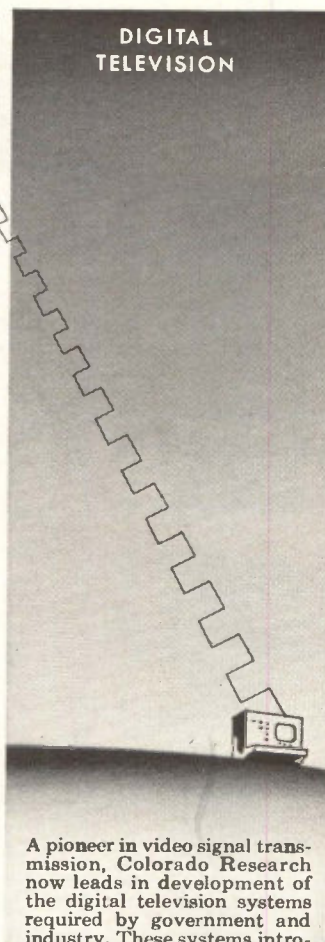

A pioneer in video signal transmission, Colorado Research now leads in development of the digital television systems required by government and industry. These systems introduced the "delta" technique, which requires less bandwidth, and improves signal-to-noise performance.

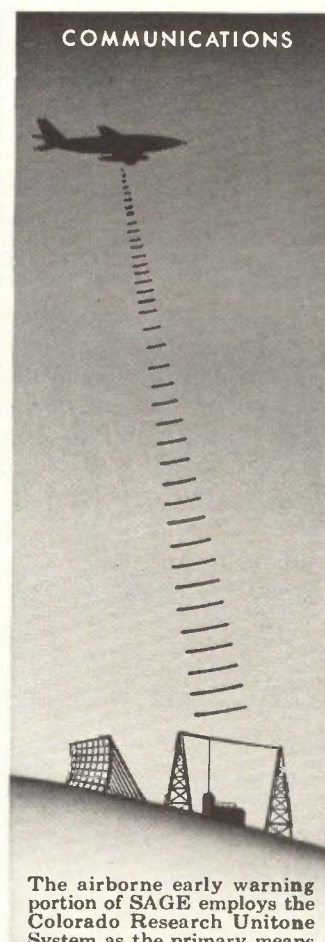

The airborne early warning portion of SAGE employs the Colorado Research Unitone System as the primary means for air-to-ground communication over difficult circuits considered unusable or marginal for other encoding techniques.

4 steps ahead in scientific problem solving

► Everything new about the four systems represented here has expanded the capabilities of science, defense establishments and industry, or opened new fields for scientific exploration.

► For example, the CRC Refractometer has given scientists a new yardstick for measuring refractive index... with direct application in the tracking of missiles and satellites, aircraft detection and the study of weather. The CRC Digital TV System allows further video signal processing for special transmission requirements.

► These accomplishments are typical of the creative intelligence with which Colorado Research is approaching a variety of related problems. Work now in progress covers methods of transmitting information at higher speeds, subminiature television camera systems, new techniques for pre-composing messages, new rotary and linear displacement sensing techniques and basic instrumentation research.

► For information on how these capabilities can contribute to your project's success, address Manager of Marketing, Colorado Research Company, Broomfield, Colorado.

STAFF POSITIONS ARE OPEN FOR MEN WHO WANT TO STAY AHEAD IN SCIENTIFIC PROBLEM SOLVING.

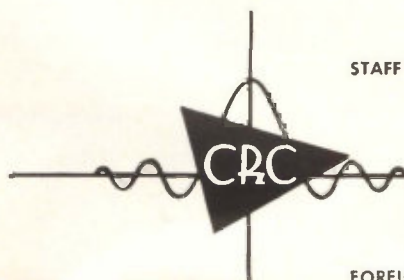

COLORADO RESEARCH Company

BROOMFIELD, COLORADO

The Electronics Division of Bell & Gossett Company

FOREIGN REPRESENTATION BY HENLEY & CO., INC., 202 E. 44TH ST., N. Y. 17, N. Y.

Automatic Control without Contacts or Signal Drain

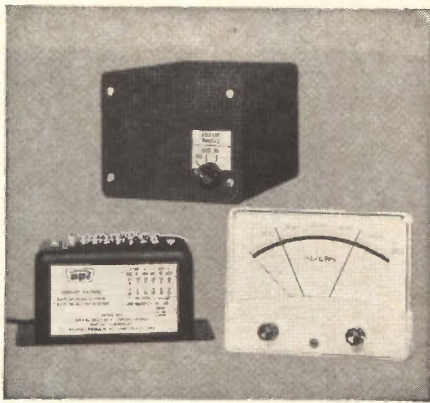

A panel-mounting electronic voltmeter with an Optical Meter-Relay

Until now, you just couldn't get such a control combination.

The newly-invented optical meter-relay, by Assembly Products, lets you use the simplest possible circuitry for automatic control. You can have the circuitry in a module (shown), ready for mounting anywhere. You also get

Instantaneous action at set point

Adjustable set points—as close as 2% of full scale

Continuous signal indication, either side of set points

The Metronix electronic network (in large unit shown) gives you **High Input Impedance and Floating Input**.

Result: critical measuring ability that requires very little signal current. You also save space with the panel-mounting Metronix design. Units are always connected and ready to use.

Read Remote Signals

One additional Metronix advantage is the ability to read low-level signals, from practically any variable, over great distances. For example, temperature may be measured and controlled as far away as two miles.

Ask for literature describing the full line of Metronix PMEVS—in single or multiple ranges, with either meter-relays or conventional indicating meters.

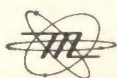

METRONIX

The Electronic Instrument Division
of Assembly Products, Inc.
Chesterland, Ohio

Telephone: HAmilton 3-4440

made, to evaluate the effects of time and weather. Even with no rain, the signal strength had fallen by about 18 percent, but the "mine" could still be easily found with a temperature difference signal of about 1.5 deg F, which was then attenuated by the covering soil.

The target was then retrieved and buried in another spot, where the readings almost duplicated the previous measurements. When the soil was thoroughly watered, the

signal dropped almost to noise level. About 3 inches of soil were removed, leaving 15 inches of damp soil as the detection threshold.

INFRARED RECEIVER—The test receiver contained an elementary reticle driven by an a-c motor. A preamplifier (Fig. 2) was mounted in the gun-like cell-chopper housing, kept at a measured distance of 2 feet from the ground during tests. Chopping frequency was 200

LEM'S Five-Way Communications

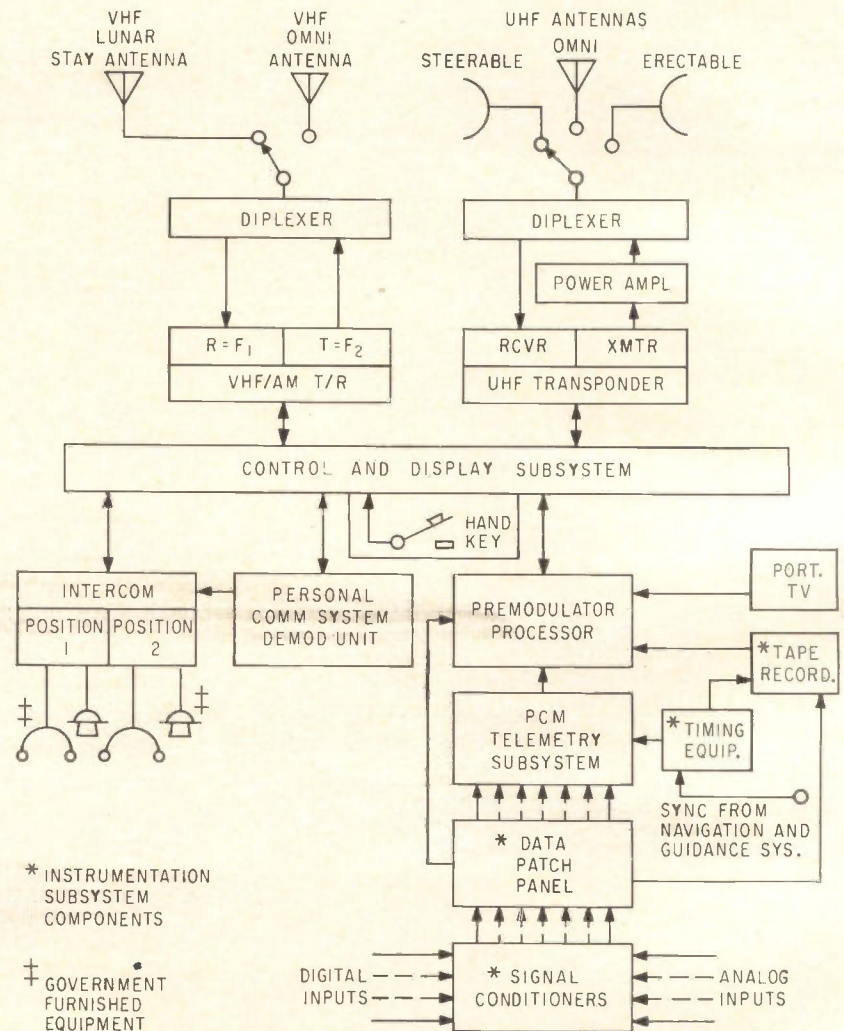

LUNAR EXCURSION MODULE for the Apollo manned moon flight (*ELECTRONICS*, p 22, July 19) will carry a communications system like this, say NASA sources. Equipment will be used for communication from (1) astronaut to astronaut in LEM, (2) astronaut to astronaut on the lunar surface, (3) astronaut in the command module orbiting the moon to LEM, (4) LEM on the lunar surface to the command module and (5) LEM to earth, both radio and tv links. One on-board camera will provide real-time video information for transmission to earth-based receiving station while LEM is moon-based

Report from

**BELL
LABORATORIES**

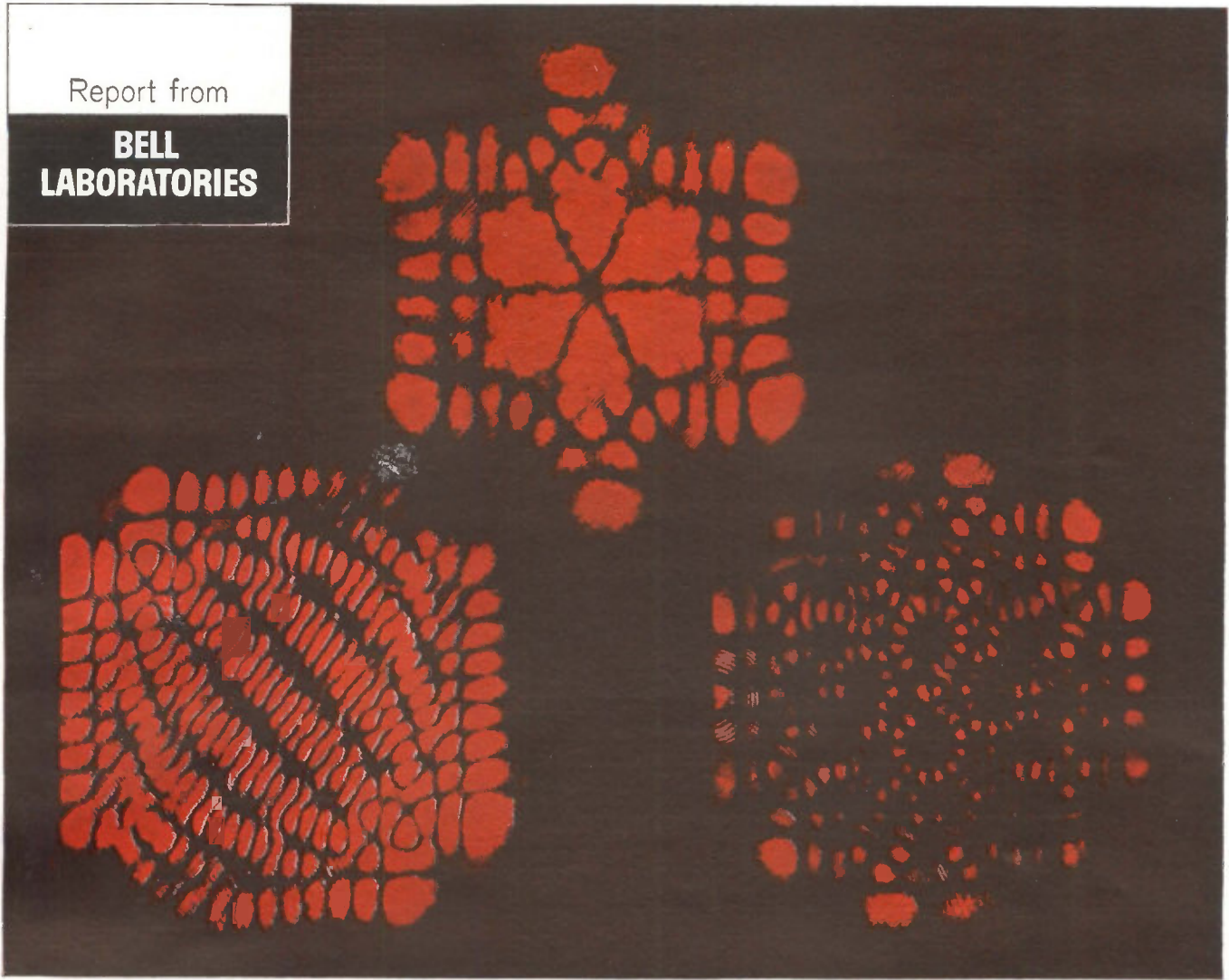

To produce these mode patterns, the normal operation of a helium-neon optical maser is perturbed by placing a pair of wire cross hairs in the cavity. These wires interact with the mode structure of the unperturbed cavity, suppressing some modes and, in certain cases, coupling others together. By changing the angle between the cross hairs, this interaction can be altered and different mode patterns, as shown, can be produced.

A STEADILY GROWING FAMILY OF OPTICAL MASERS

Scientists at Bell Telephone Laboratories are continuing extensive research programs to gain increased knowledge about optical maser (laser) action. The immediate goal of these investigations is more complete understanding of the phenomenon itself. In the long run, however, this knowledge will help us to evaluate better the communications applications.

One aspect of optical maser research is the study of the mode structures in laser cavities. The modes excited in a particular experiment can be identified by mode patterns, shown above, produced by directing the emergent beam onto a photographic plate.

Optical maser research at Bell Laboratories has resulted in a broad new field of radiation science. For instance, discovery of gas lasers also provided the first continuously operating laser. The active medium in this device is a mixture of helium and neon; its

operation depends on the excitation of neon atoms by collision with excited helium atoms. Originally, this system emitted infrared light, but recently it has been made to produce visible red and yellow light.

More recently, in another significant advance, our scientists have discovered two other new mechanisms for creating maser action in gases. One depends on the dissociation of oxygen molecules in mixtures of oxygen and neon or argon. The other takes place in pure noble gases—helium, neon, argon, krypton and xenon—and depends on a direct transfer of energy from accelerated free electrons to the gas atoms.

With these mechanisms and various gases or gas mixtures, we have achieved maser action at approximately 150 different wavelengths extending from 0.594 microns in the yellow region of the spectrum to 34.5 microns in the far infrared—and more are in prospect.



BELL TELEPHONE LABORATORIES

World center of communications research and development

**Brian
Clare
can
show
you...**



Sales Engineer, North Atlantic Industries

how to measure in-phase and quadrature with **0.1% accuracy—in milliseconds**

Previously unobtainable accuracy and millisecond response are only two of the reasons why NAI's Phase Sensitive AC-to-DC Converters meet the most critical requirements in computer, recording, automatic test and digital display systems.

Unlike conventional converters, these all solid state modules measure not only total signal—but quadrature, in-phase and fundamental components as well. DC output is proportional to selected input component, yet unaffected by harmonics. A wide range of manual and relay-actuated models permits selection and programming of function, range and frequency to suit test or system requirements.

Specifications of relay-programmed models PSC-410 and -411, and manually switched models PSC-415 and -416 are given in the table.

Voltage Range	PSC-410, PSC-415 PSC-411, PSC-416	1 volt to 300 volts f.s., 4 ranges 10 millivolts to 300 volts f.s., 6 ranges
Functions	Total, Fundamental, In-Phase Quadrature	
Frequency Range Total mode & response*	60 cps to 10kc 0.5 sec. 350 cps to 10kc 0.1 sec. Phase Sensitive Single frequency from 60 cps to 2kc.	
Input Impedance	1 megohm	
Output	-10 to +10 vdc into 10k load	
Linearity	0.1% f.s. (10 mv dc)	

**dependent upon output filter*

The North Atlantic man in your area can quickly show you how the PSC models simplify automatic AC measurements. Call today for his name and request Bulletins.



NORTH ATLANTIC industries, inc.
TERMINAL DRIVE, PLAINVIEW, L. I., NEW YORK • OVERBROOK 1-8600

SEE US AT WESCON—BOOTHS 4217 AND 4218

cps. The detector head contains a short collimator, a reticle wheel housing with motor container, and an insulated lead telluride cell container. Preamp output at 200 ohms from an emitter follower is carried to an R-C tuned main amplifier at 200 cps. The output was synchronously gated to reduce noise, and the display was a standard bench meter.

Hypoxia Warning Systems Developed by Beckman

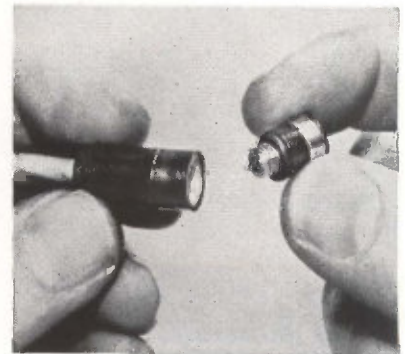

OXYGEN SENSOR is an inch in length, less than 1/2 inch diameter, operates electrochemically independent of gravity pull and acceleration forces

PROTOTYPE hypoxia warning units, consisting of miniature oxygen sensors and lightweight amplifiers, have been developed by Beckman Instruments, Inc., Fullerton, Calif. for the Aerospace Medical Laboratory.

Hypoxia is the physiological impairment caused by lack of oxygen; it begins by mental slowdown similar to the effects of alcohol. The new warning systems will alert pilots when oxygen level falls below normal, by means of a warning light or audible alarm.

The \$159,250 contract calls for delivery of 33 such systems to the U.S. Air Force, for incorporation in the seat packs of F-106 and F-101B operational squadrons.

The hypoxia sensor uses a replaceable electrode cell to measure the partial pressure of oxygen, can withstand accelerations of 50 g's, as well as severe vibration.

A special amplifier for the warning system is drift-free, includes meter readout and an alarm circuit that can be preset to any partial pressure.

ELECTRONICS...

**STATE OF THE ART
IN JAPAN**

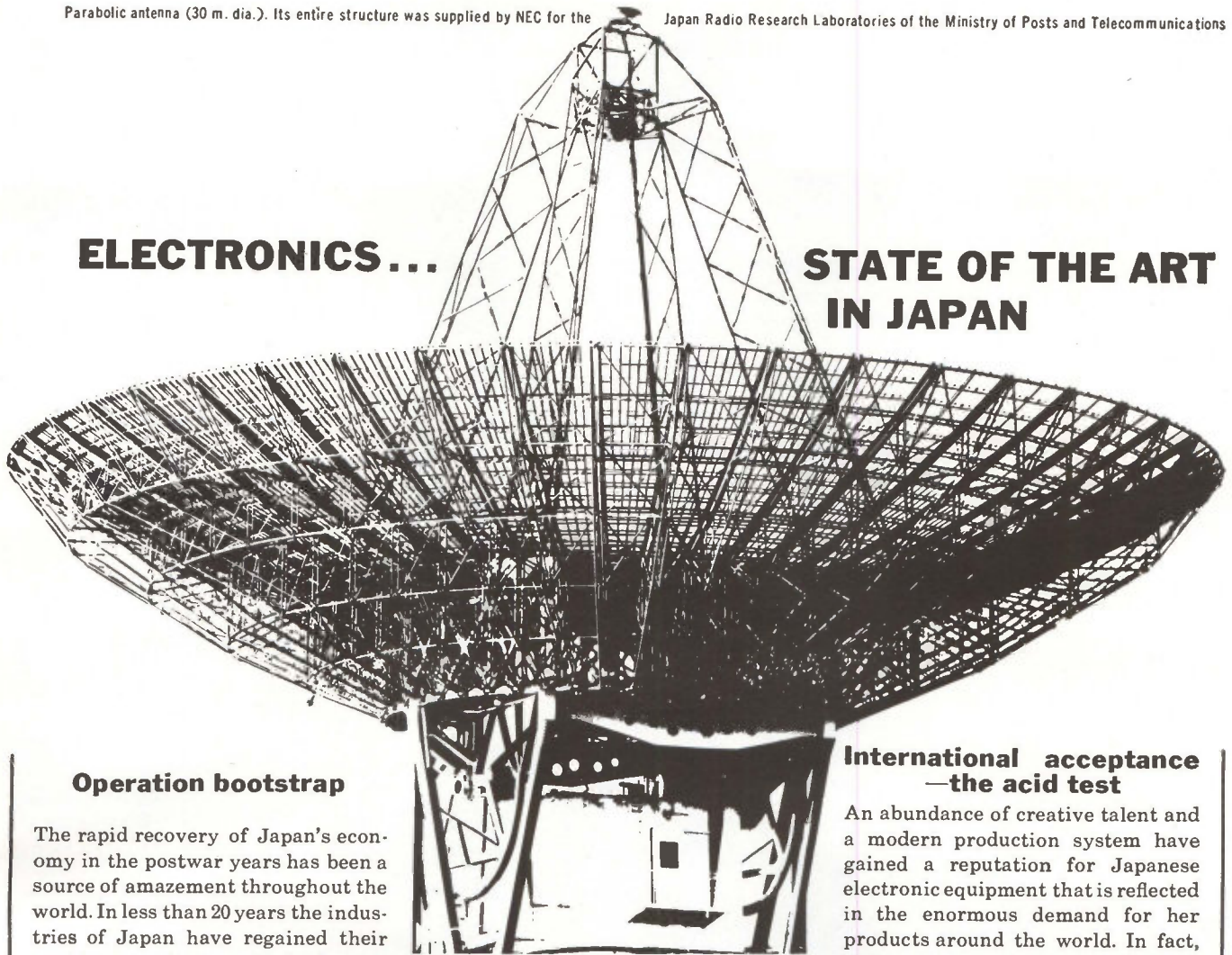

Operation bootstrap

The rapid recovery of Japan's economy in the postwar years has been a source of amazement throughout the world. In less than 20 years the industries of Japan have regained their positions among world leaders in their respective fields. In particular, is this true of the electronics industry.

In the past 6 years the annual value of Japanese electronic equipment has increased 7 times to almost \$2 billion—more than half of which is devoted to a multitude of consumer products: radio, TV, tape recorder, stereo, etc.

To serve her people Japan has constructed a microwave communication network for long-distance relay of telephone and television which extends to more than 2 million channel-miles—is second in size only to that of the U.S. She boasts 325 modern television stations and satellite stations, giving her the highest coverage density in the world. It has been NEC's privilege to supply over 96% of this microwave system and 60% of these TV stations. The result is that, today, the Japanese people enjoy the fruits of an electronic technology the equal of most great nations of the world.

Research & diversification —industry wonderdrug

But this is only one side of the coin. Japan's electronics industry has made great strides toward diversification, and at present research and production cover a wide range of industrial, technical and scientific activities.

Such recent developments as transistorized microwave equipment, a 2,700 channel super multiplex carrier telephone system, electronic telephone switchboard, and the gigantic parabolic antenna for space communication pictured above—all, incidentally, products of NEC—are typical of the variety of highly complex systems coming from Japan's laboratories. (The 98 ft. diameter antenna is Japan's contribution to the new worldwide TV relay network and, pending successful satellite launchings, will afford you a good chance of seeing Tokyo's 1964 Olympics.)

International acceptance —the acid test

An abundance of creative talent and a modern production system have gained a reputation for Japanese electronic equipment that is reflected in the enormous demand for her products around the world. In fact, 20% of her productive effort in this field now finds its way to overseas users. NEC's own export record—the largest in the field—reflects the international confidence placed in its equipment. For instance, the U.S. now imports NEC microwave technology; Spain takes broadcasting systems; the Philippines, a nationwide communication network; India and Pakistan, nationwide coaxial-cable carrier telephone networks; Australia, TV equipment; Thailand, new international shortwave telecommunication network. In fact NEC's overseas activities would more than fill this entire page.

The future—Japan, electronics and NEC

The future of Japan's electronics industry is no longer limited by technology—only by the heights to which the imagination of man can soar in finding new, useful and peaceful applications for it. It is NEC's intention to continue making a major contribution to these efforts.

Nippon Electric Company Limited

P.O. Box 1, Takanawa, Tokyo, Japan

NEC

Nippon Electric New York Inc.

Pan American Bldg., 200 Park Ave., New York 17 Tel: MO 1—3420

Affiliate of
ITT



traveling under ice in the Arctic?

yes

Only a submarine can reach the North Pole by sea — with continuous Sonar operation to determine distances from sea bottom, ice ceiling and other hazards. In critical applications like this, where extreme accuracy in sending and receiving signals is required, Gamewell Precision Rotary Switches have proved completely dependable. Characteristics include: tolerance of $\pm 0.5^\circ$ for any segment width over 1° ; phasing to $\pm 0.25\%$; torque less than 1 oz. in. with sleeve bearings at room temperature; high resistance to shock, vibration, temperature and acceleration. For special switches to meet your circuit sampling, sequencing, programming or similar applications, take advantage of Gamewell's YES service — ***your e**ngineered **s**pecials service. Send us details.

GAMEWELL
ELECTRONICS DIVISION



THE GAMEWELL COMPANY, 1607 CHESTNUT ST., NEWTON 64, MASS. A SUBSIDIARY OF E. W. BLISS COMPANY

UHF Transmitter Operates by Remote Control

New klystron meets FCC requirements for ultra-high-frequency television

A NEW KLYSTRON, now available for ultrahigh frequency broadcasting, seems to have anticipated the latest Federal Communications Commission's recommendation that will allow uhf transmitters to be operated by remote control.

In the spring, the FCC said that "while it is realized that presently available uhf transmitters require direct supervision by qualified technical personnel, the Commission feels that refinements can be made which will make remote control feasible".

Responding to the latest FCC stimulus, the Springfield Television Broadcasting Corporation of Springfield, Mass. applied for a construction permit for a uhf-tv station in Toledo, Ohio. They will operate a klystron transmitter by remote control. The broadcasting company intends to place the final amplifier on top of the antenna tower.

According to William L. Putnam, the company's president, the plan is to mount a klystron ampli-



AIR-COOLED power klystron is assembled by Amperex's John Nielsen. Transmitter will be installed in zig-zag antenna, at new uhf-tv site

fier with its accessories in a weatherproof steel drum, and ride the unit up the tower.

ON THE AIR—Positioning on top of the tower will be controlled by a pushbutton. A motor control will raise or lower the drum. When the klystron reaches a point at the top of the tower, the drum will automatically trip a switch and put the station on the air.

Power supplies and driver amplifier may be located on the ground, since piping and small signal r-f impose no difficulties.

The klystron has been made available by the Amperex Electronic Corporation of Hicksville, N. Y. The tube, designated type YK1001, is said to be the first fully air-cooled power klystron at the 10 Kw level which utilizes lightweight magnets for beam focusing. Magnet fields are readily adjustable by magnetic shunts.

At ultrahigh frequencies, the four-cavity klystron can produce 10 Kw of output power with only 10 to 50 watts drive. This depends upon the required band width.

For the same output, a typical tetrode would require 1 Kw or more of power drive.

Extension of the tetrodes first into vhf and then into uhf has been accompanied by a decrease in both efficiency and operating life, according to engineers. To overcome the effects of transit time and maintain the gain bandwidth product, high-frequency tetrodes must be made with extremely short electrode systems and close interelectrode spacings. The result is that the cathode surface area must be small and there is little room for reserve emission capability. In many cases, the grid, because of its inability to cope with high temperatures which result from the interception of part of the electron stream, becomes the bottleneck in tetrode design and can limit tube life. Moreover, as frequency increases, reactive currents go up, generating still more heat, Amperex says.

NO ANTIFREEZE — Until recently, only water systems were used for cooling uhf high power klystrons. Cumbersome pumps were required, antifreeze was needed for outdoor environments, and corrosion problems plagued the equipment. Another disadvantage of previous klystrons was the need to provide a stabilized power supply for the operation of the beam focusing magnets. These

SYSTEMS GO FOR ALL-CHANNEL CHANGEOVER

The latest FCC recommendations on uhf-tv include changing the ratio of video to audio transmitter power from 2 to 1, to 10 to 1. In addition FCC grants permission to operate uhf-tv transmitters by remote control.

These moves can add up to substantial savings for broadcasting station equipment, and operating expenses. Economies may offer opportunities for new explorations into broadcasting.

The uhf-tv klystron, described in this article, was made available almost immediately after the latest FCC reports that will open up all-channel television throughout the country

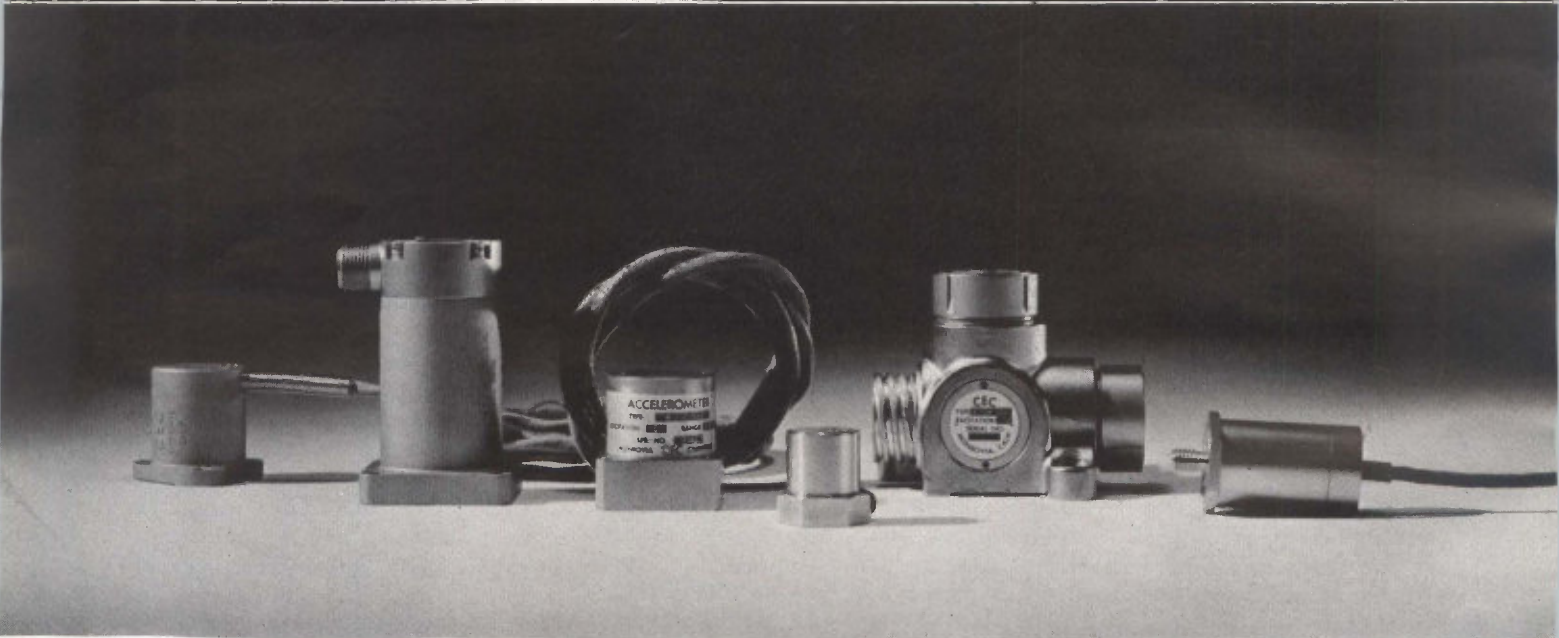
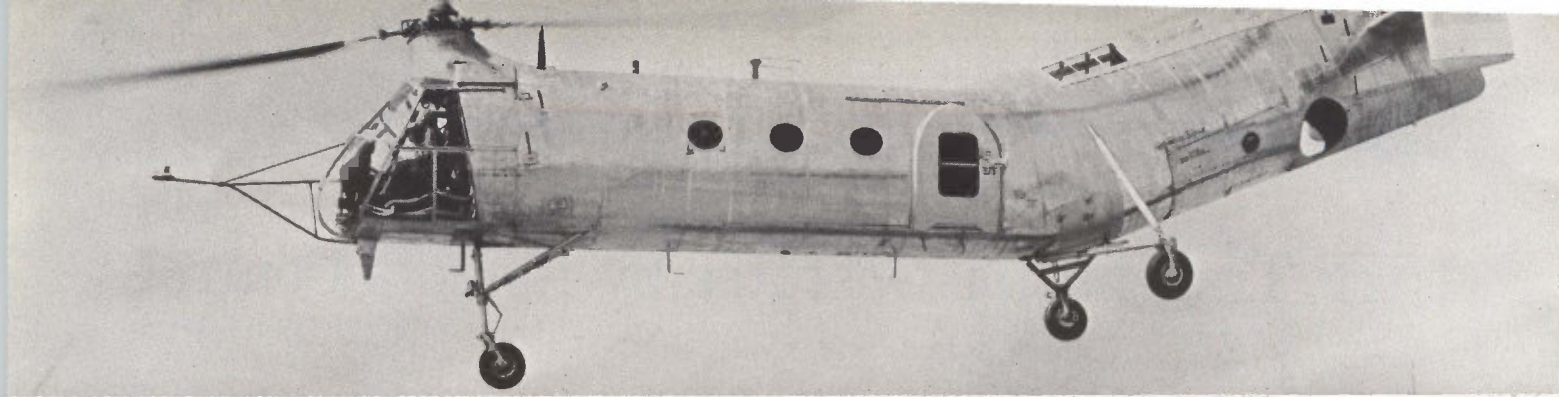

We second the motion

Any motion

Whether it's vibration, shock or acceleration, CEC's trio of motion measuring lines cover just about any move you can make. For sophisticated shock and dynamic acceleration problems (into high g and wide frequency ranges), CEC's piezoelectric accelerometers are outstanding. The unique 4-280 features output impedance less than 100 ohms, voltage sensitivity of 20 mv (peak)/g (peak) and electrical case isolation operating to 250 g (peak) from 6 to 6000 cps over temperatures that range from -65°F to $+200^{\circ}\text{F}$.

CIRCLE 62 ON READER SERVICE CARD

In traditional vibration problems, you've other reliable friends: CEC's vibration transducers. A newcomer to the family, the 4-126 is especially effective above 45 cps and between -65°F and $+700^{\circ}\text{F}$. Use it with any a-c voltage measuring device presenting a 10,000 ohm resistive load impedance.

Measuring both static and dynamic acceleration from d-c to medium frequencies? Try CEC's unbonded strain gage accelerometers. The 4-204 is tri-axis, bi-directional, measures from ± 5 g to ± 500 g, operating

temperature range is 70°F to 300°F .

For displacement or velocity readout, team them up with CEC's compatible 1-117 Vibration Meter. And, for an analytical system, the 1-117 may be coupled with CEC's 1-159 Variable Filter. Further data? Call or write your CEC office for Bulletins in Kit 3470-XI.

CEC
Transducer Division

CONSOLIDATED ELECTRODYNAMICS

A Subsidiary of Bell & Howell • Pasadena, Calif. 91109

ANALYZE

vibration
efficiently
with



CEC's 1-117 Vibration Meter and



1-159 Variable Frequency Bandpass Filter

Teamed, CEC's 1-117 Vibration Meter and 1-159 Variable Frequency Bandpass Filter make an unbeatable vibration analyzer system... in field, lab, or production lines. CEC's 1-159 offers narrow-band frequency selection from 8-2500 cps. Lightweight, portable and all solid state, it is available for AC or DC operation. Dial accuracy? Within 1% of frequency reading.

CEC's 1-117 meters vibration velocity and peak-to-peak displacement at selected frequency. Features: 4 input channels; 4-stage single channel amplifier stabilized for extreme reliability. More information? Call or write for Bulletins CEC 1117-X2 and 1159-X5.

CEC

Transducer Division

CONSOLIDATED ELECTRODYNAMICS

A Subsidiary of Bell & Howell • Pasadena, Calif.

CIRCLE 63 ON READER SERVICE CARD
electronics • August 2, 1963

magnets confine the electron beam and control the beam in the drift spaces between the cavities.

The new klystron solves both air cooling and beam focusing. Permanent-magnet beam focusing will be important in a tower installation. A dispenser cathode makes possible a tube with a life warranty of 5,000 hours.

The cathode is basically a porous tungsten sponge. This is processed with a monoatomic layer of barium which is resistant to emission poisoning, to high-voltage electrostatic fields, and to high-speed gas ions.

ION PUMP—A continuously-operating ion pump is employed with the YK1001 to maintain an extremely low level of gas, and provide continuous monitoring of the vacuum. This ion system is a vacuum-like device that uses electrical and chemical means to maintain vacuums in excess of 10^{-9} mm.

The ion getter pump is an integral part of the klystron circuit. It works when the tube operates, allowing continuous monitoring and check of the vacuum in the tube. Previously, klystrons have used flash getters of indeterminate efficiency, there being no means of directly checking the vacuum.

The new klystron is capable of efficient depressed collector operation. Flexibility of the tube is enhanced by a system of interchangeable cavities. One set is available for the high band (770-960 Mc), and another for the low band (470-790 Mc).

The high power gain of the tube enables the designer to simplify the earlier circuit stages for a more reliable transmitter. Typically, the YK1001 requires a driving power of 10 watts for an output power of 11 kilowatts. The power gain is 30 db.

Creating a Modern Drugstore for Materials

SIGNIFICANCE of a \$400,000 award to Materials Research Corporation by Advanced Research Project Agency is not in its size, but in the

fact that it is one of ten programs comprising a \$5 million dollar effort initiated by ARPA.

General framework of ARPA program centers around crystal growth techniques, the acquisition of precisely-defined crystals, and the characterization and analysis of crystals. MRC will contribute to area of high-temperature metal and ceramic materials.

Sheldon Weinig, MRC president, says impact of whole program will be great in area of solid state development. "We have been inspired by the idea of creating a modern drugstore for materials", says Weinig. "The researcher sends in his prescription and we produce the crystal to his order. With this ARPA grant, we will be able to expand our services and increase the efficiency of research."

The first of MRC's materials breakthroughs, and one that encouraged the company to establish their Advanced Materials Laboratory, was the production of extremely high purity refractory metal crystals on company's own electron beam zone refiner. The first products were single crystals of tantalum, molybdenum, tungsten and columbium with aggregate interstitial impurities of less than 25 parts per million. The crystals were offered to researchers with the request that they specify purity levels and orientation. Thus the materials drugstore was born.

Navy Report Defines Microcircuit Functions

A REPORT on the work that Battelle has done for the Navy, defining circuit functions for microminiature equipment, has been issued by ASTIA (now the Defense Documentation Center for Scientific and Technical Information).¹

These functions are not being proposed as standards at this time. However suggestions are given with a view of presenting over-all functional characteristics of silicon block circuits.

The circuits need not be specified in terms of individually recognizable component parts. Aim is to specify a device by describing the

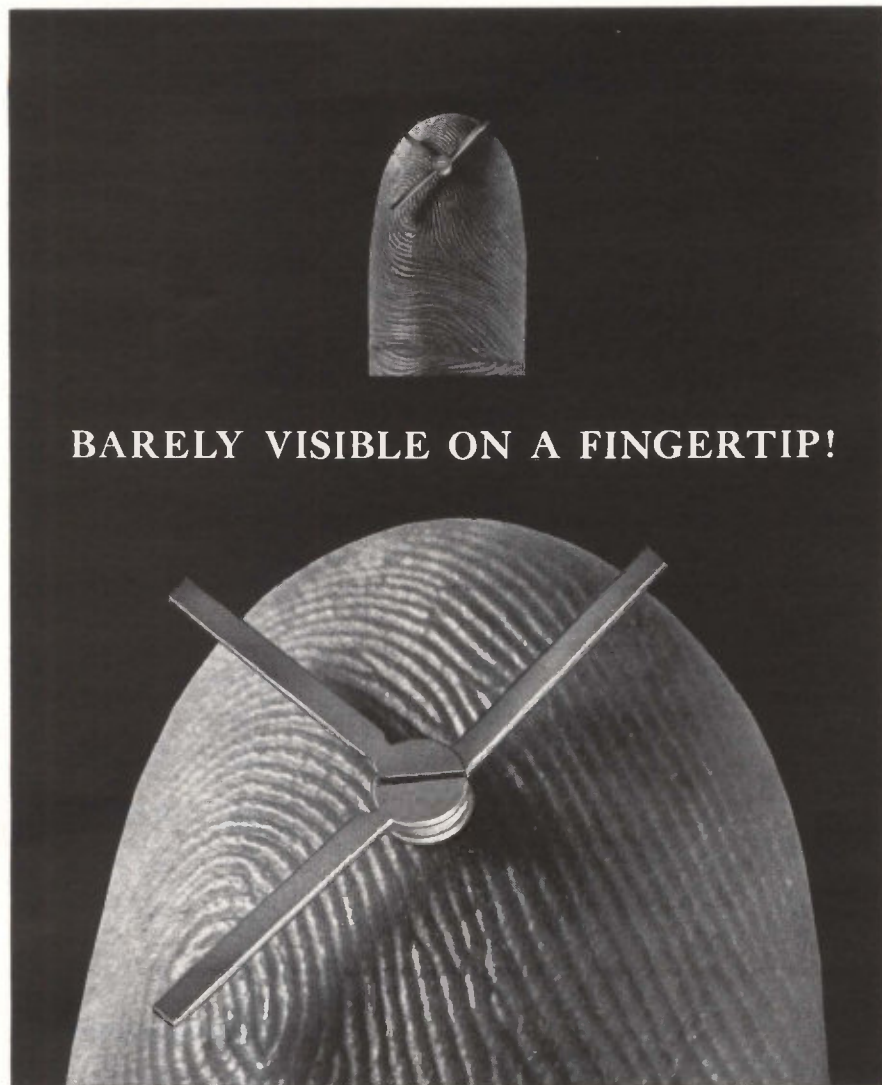

BARELY VISIBLE ON A FINGERTIP!

STEREOZOOM® HELPS PRECISION-MANUFACTURE THE MICROMINIATURE AT HUGHES AIRCRAFT...

The Semiconductor Division of HUGHES AIRCRAFT Company, Newport Beach, California, fabricates MICROSEAL* transistors and diodes. The MICROSEAL configuration is a small, ceramic cylinder, .062 inches in diameter. Total thickness is .030 inches. Metal and ceramic are brazed together to form a hermetically tight container.

The Bausch & Lomb StereoZoom microscopes permit seeing these microminiature parts in enlarged, natural, three-dimensional detail. The long (up to 7"), unobstructed working distance of the StereoZoom allows intricate assembly operations without damage to delicate parts. A turning of the zoom dial gives continuously variable magnification without altering working distance.

A wide choice of 24 models assures you of obtaining just the right one for *your* inspection and assembly needs. For an on-the-job demonstration of the B&L StereoZoom microscope, call our nearest office, your dealer, or write Bausch & Lomb Incorporated, 61444 Bausch Street, Rochester 2, N. Y.

*Trademark Hughes Aircraft Company



BAUSCH & LOMB



In Canada, write Bausch & Lomb Optical Co., Ltd., Department 614, Scientific Instrument Division, 16 Grosvenor St., Toronto 5, Canada

output, input and transfer characteristics and its variations. Prototype circuits are included for reference purposes, and are not considered restrictive as to design approach. Guides are given to basic function performance ranges.

Navy spokesmen say that no substantially new functions have been created recently.

The report on Information on Microelectronics for Navy Avionics Equipment was issued by the U. S. Naval Air Development Center in Johnsville, Pennsylvania. Evaluation of Navy microcircuits is now being transferred to the Naval Ammunition Depot, Crane, Indiana. The Crane facility will evaluate commercially-available modules and functional blocks and will issue reports on findings.

Work at Johnsville will now be confined to the application of microelectronics to Navy equipment.

The Johnsville facility is now working on a one-way data link for an automatic carrier landing system. An all solid-state digital system, designed at Johnsville, will record the plane's position. This information will be transferred from carrier to aircraft.

The receiver in the data link system will be miniaturized, but will not use silicon block circuits.

REFERENCE

(1) Information on Microelectronics for Navy Avionics Equipment, Report NADC-EL-6319, Micronotes No. 3, 5 June, 1963 (Micronote No. 1 was issued 26 July, 1962; Micronote No. 2 was issued 26 Nov., 1962), Defense Documentation Center, Alexandria, Va.

Reed Relay Encased In Phenolic Tube

A LOW-COST, long-life dry reed relay has its coil assembly encapsulated in molded plastic. Unit was designed by Grigsby Company, Inc., Arlington, Illinois, for direct mounting on printed circuit board.

Design permits automatic assembly and easy reed replacement.

The reed is cradled in the bore of the bobbin, and therefore easily replaceable. Operating temperature range covers -55 C to 130 C. The coil subassemblies in standard voltage ranges are carried in stock and a wide range of reed switches con-



What you can do with General Electric's RTV silicone compounds

to insulate, seal and mold from -150°F to 500°F

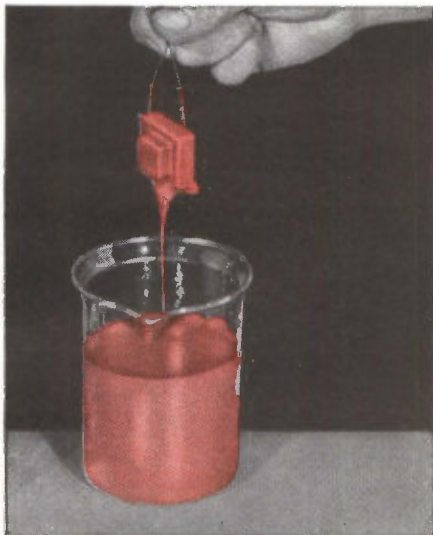

Encapsulate it. Fluid RTV silicone rubber penetrates deep into transformer coils. RTV has excellent dielectric strength and practically no shrinkage. Cure time at room temperature can be varied from minutes to hours.

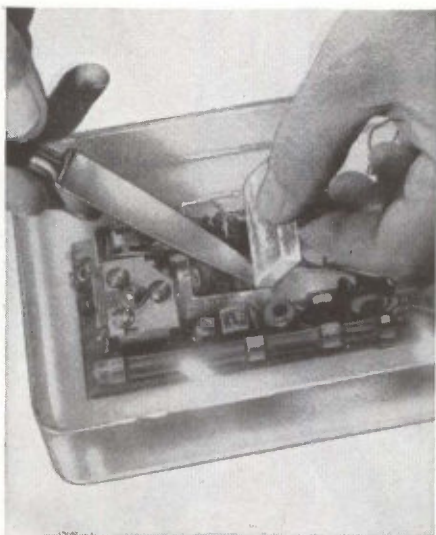

Pot it. Transparent or opaque, G-E silicones provide a resilient protection against moisture, ozone, thermal and mechanical shock. Flows freely around complicated parts, can be cut away to replace internal components.

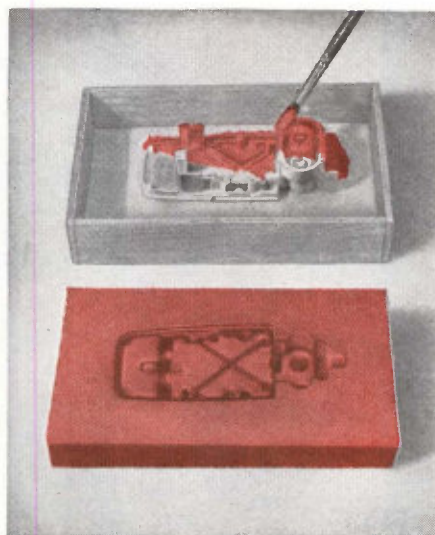

Duplicate it. Flexible RTV is often used to make molds for prototypes and short run production. This part requires deep undercutting, but duplicate parts flex free easily. RTV's tensile strength is as high as 850 psi.

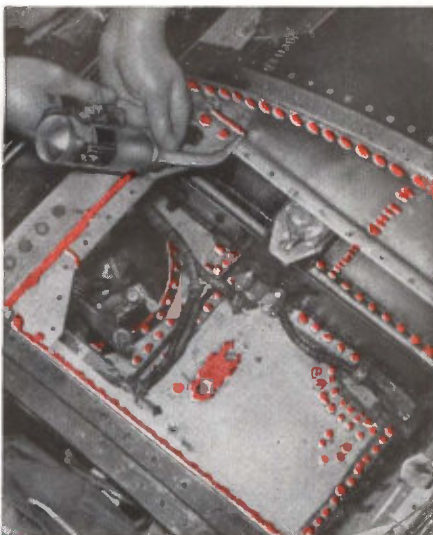

Seal it. Bondable RTV (when surface is properly primed) seals against moisture and vibration, ozone and chemicals. Can be used for sheet metal fabrication, shock mounts, gasketing. Viscosities range from pourable to paste.



Insulate it. Adhesive/sealant RTV-102 requires no mixing of catalyst, can be used to insulate open wiring, for on-the-spot caulking, gluing and soldering. RTVs are virtually ageless, will not stress-crack or weather.



Manufacture it. RTV adhesive/sealants are fast working assembly tools, eliminate prefabricated parts or more costly, time consuming techniques. Here an RTV adhesive laminates flexible mica strips to form cylindrical ducts.

If you would like a free sample of one of the nine General Electric RTV silicones for evaluation, write on your letterhead, describing your application. For additional information, check reader service card. Section N895, Silicone Products Dept., General Electric Company, Waterford, New York.

GENERAL  ELECTRIC

U T I C A[®]

UTICA

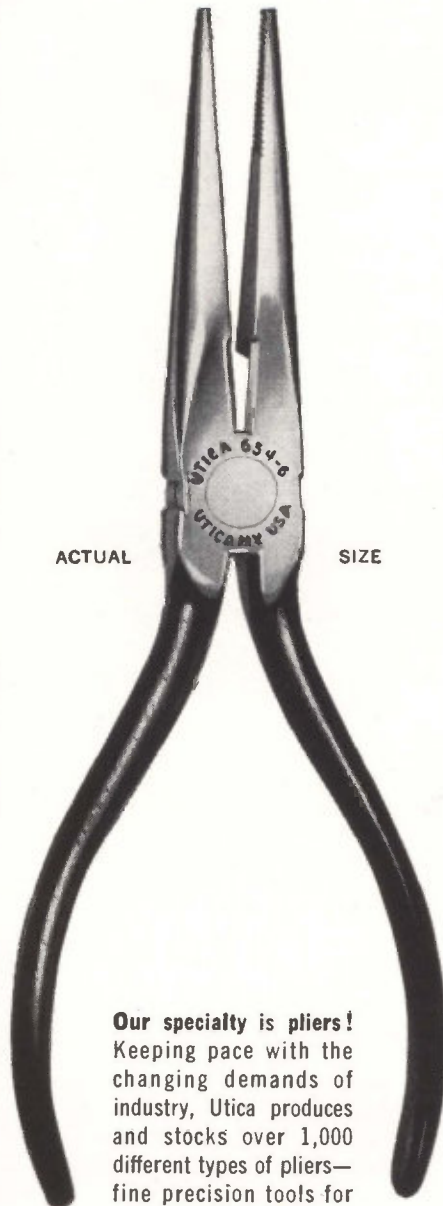

ACTUAL

SIZE

Our specialty is pliers! Keeping pace with the changing demands of industry, Utica produces and stocks over 1,000 different types of pliers—fine precision tools for every conceivable use. Because of the job we have been able to do in many of the country's largest and most specialized plants, we believe that Utica tools can help you, too—either reduce your costs or improve your products. Contact your Utica distributor, today.

Utica Deep Forge & Herbrand Tool Division, Kelsey-Hayes Company, Orangeburg, S. C.

tools the experts use!

tact systems are available for multicircuit applications. Unit measures 1½-in. long by 0.425-in. dia. Voltages are 6-v d-c, 12-v d-c and 24-v d-c at 250 milliwatts. Special coil impedances are available.

Applications for the encapsulated reed include use in instrumentation, transistorized drives and computers.

New TWT Developed For Satellites

A NEW TRAVELING wave tube amplifier will be developed for the Air Force by Eitel-McCullough. The new tube, power converter, telemetry and control circuits will be combined in a single package designed to have a useful life of 50,000 hours.

The project will take 30 months and will be carried out in Eimac's Microwave Tube Division Engineering Laboratories, San Carlos.

Advance Claimed for High-Resolution Display

A NEW and original method has been developed for preparing electrophoretic screens directly on glass surfaces. The new process is said to have important advantages over fine settled screens and over electrophoretic screens deposited on ECG coated glass.

The two latter types represent the present state-of-the-art for phosphor screens. CBS says that their new developments, made under an Air Force program are, therefore, advances in the state-of-the-art of high-resolution screens.

Microwave Tubes Will Use Tunnel Cathodes

A THIN-FILM capacitor cathode will be developed for microwave tubes. Stanford Research Institute has been working on tunnel cathodes for the Air Force. Evaporated cadmium sulfide films and other dielectric layers have been investigated. Present work indicates that better techniques must be found for depositing thin uniform films of the dielectric.

Don't Be Half Safe...

Use LEL Multipliers To Be Sure

No need to sweat over multiplying frequencies any more...LEL's doublers, triplers and integrated multiplier assemblies are factory tuned to exact specifications...give proven product performance. There is a low-cost, LEL Varactor Frequency Multiplier for every frequency requirement from 300MC to 10 GC.

Send for 72-page catalog '63 today.

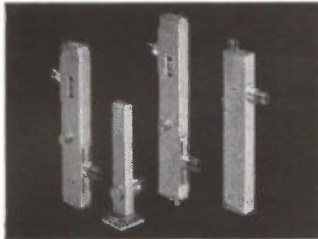

LEL Varactor Multipliers for High or Low Power Applications.

See us at WESCON Booth 4708



75 AKRON STREET,
COPIAGUE, L. I., N. Y.

(516) PYramid 9-8200

(516) AMityville 4-2200

CIRCLE 201 ON READER SERVICE CARD

100% Financing! Lowest monthly cost!

BRAND NEW ONE STORY PLANT \$560 built for you 5 Sq. Ft.



in the East's finest industrial location
THE PHILADELPHIA INDUSTRIAL PARK

651 Acres surrounding the North Philadelphia Airport. Suburban environment with all metropolitan utilities, services, conveniences.

Developer: **TISHMAN INDUSTRIAL PARKS, INC.**

Exclusive Agent:

BINSWANGER

CORPORATION • INDUSTRIAL LOCATION SPECIALISTS

1420 Walnut St., Phila. 2, Pa. • PEnnypacker 5-0202

CIRCLE 202 ON READER SERVICE CARD

electronics • August 2, 1963

UNDERSTANDING SWITCHING TECHNIQUES THROUGH KNOWLEDGE

Janco's understanding of switches lies in the knowledge gained from its experience in making switches that function properly under conditions beyond the normal electrical, mechanical, or environmental standards. This experience provides a comprehensive knowledge of switching techniques. This means that proven performance is inherent in every Janco switch. ■ Janco's continuing research and development programs are dedicated toward meeting tomorrow's requirements today. Years of service with high performance military aircraft and missile systems is conclusive evidence of Janco's superior knowledge and experience.

JANCO

CORPORATION

3111 WINONA AVENUE • BURBANK, CALIFORNIA

CIRCLE 67 ON READER SERVICE CARD

Tool Speeds Solderless Terminations

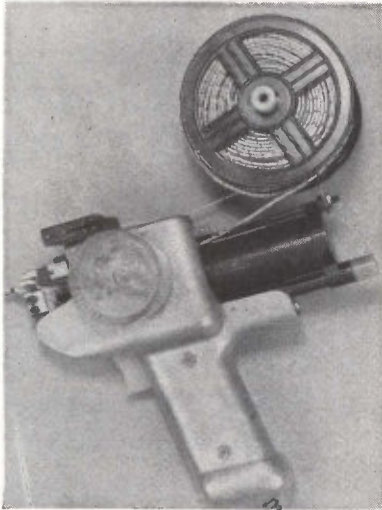

REEL feeds wire and strip connection terminals into small-nosed pneumatic tool that strips wire, affixes terminals into wire and slips terminals onto connection posts

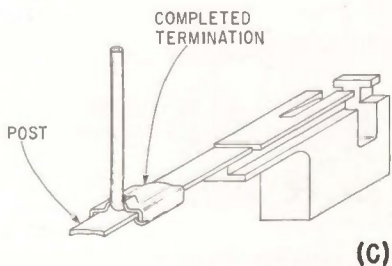
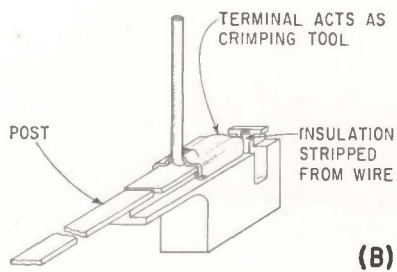
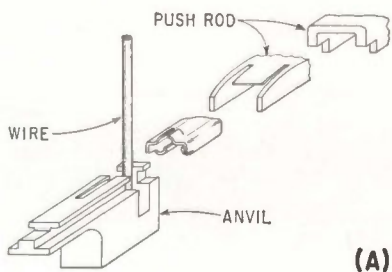

Automatically strips wire and makes post connections

NEW DEVELOPMENT in solderless termination that permits high-speed connection of solid, stranded, printed, enamel and tinsel wires, has been announced by AMP, Inc. of Harrisburg, Pa. Strip-type terminals are used to make post-connections. Reportedly, the technique has a number of advantages over other solderless joining methods. These include increased density of connections and easier serviceability. Increased density is said to result from the combined use of the thin, metal terminals and a small-nosed pneumatic fastening tool. The company says the equipment is thus especially qualified for use on computers, switchboards, data processing equipment. Serviceability is enhanced with a hand extraction tool which can remove any one of a multiple number of connections in any position on the connection post without electrically disturbing the other terminations. Reconnection to post with pneumatic tool is made using a new strip-type terminal and the same wire.

OPERATION—Wire from a reel is loaded into an accessible funnel loading device on the pneumatic tool. The operator then trips the tool's trigger to initiate stripping of wire, affixing of connecting terminal into wire and slipping of terminal onto post with a wipe-clean action. Reel feeds both wire and terminals into tool which has an integral cutting device for cut-

OPERATION SEQUENCE: wire inserted into anvil of gun and push rod pushes terminal into wire (A and B); push rod then pushes terminal and wire into post (C)

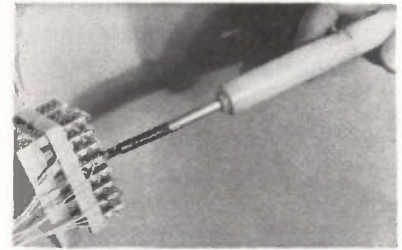

NON-DESTRUCTIVE residual-force test tool includes indicator in handle that registers tensile value of pull on connection



MICROSECTION shows wire being held onto post by spring action of terminal

ting wire to desired length. A wide range of wire sizes can be handled without changing tool or terminal, AMP reports.

HIGH PRODUCTION—Same connection technique is performed by a floor-mounted electro-mechanical machine for high-production operations. Guided by programmed instructions, the machine automatically makes connections point-to-point in horizontal, vertical and oblique directions.

RESIDUAL FORCE — Residual force in connections is claimed to be above normal-conductivity requirements and to be great enough to create a gas-tight connection between contact surfaces of wire and post. This is checked by a non-destructive terminal checking tool applied at the edge of the terminal. A slow-steady pull is exerted on the

MORE

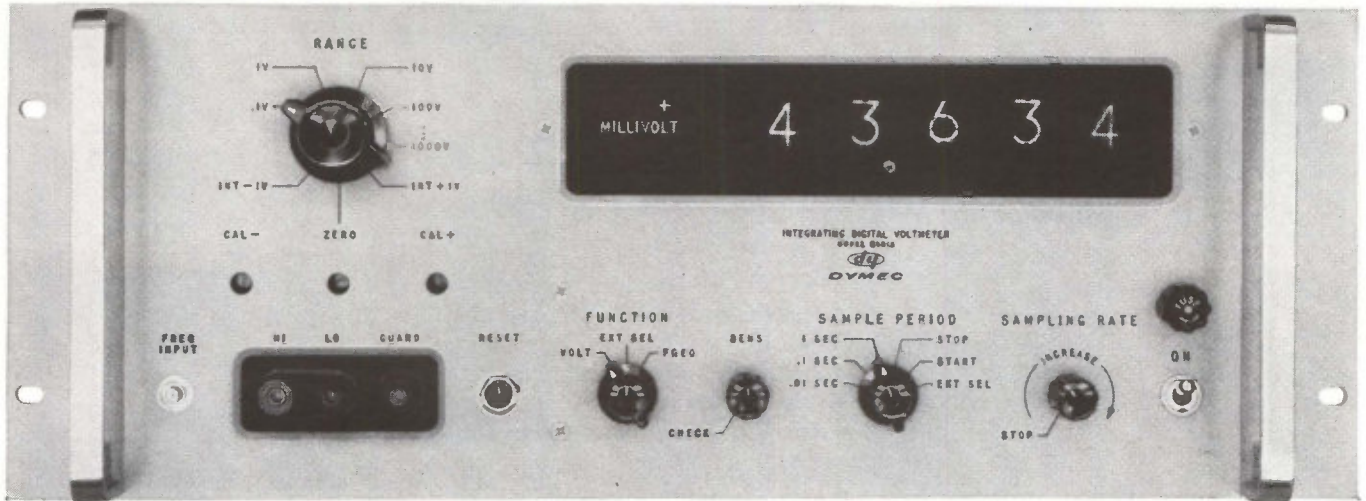

measurements

LOW LEVEL DC and FREQUENCY with the DY-2401A Integrating Digital Voltmeter

Standard features of the DY-2401A include full scale 5 digit ranges of 1 volt and 100 millivolts with 300% overranging! Flip a switch and your DY-2401A becomes a 300 kc frequency counter, with period measurements available as a standard option. Floated and guarded input circuitry permits extreme measurement flexibility. All functions and ranges are programmable of course. These are a few of the reasons why the industry's first integrating digital voltmeter is the most useful.

The DY-2401A offers a broader measuring capability than any other digital voltmeter available today. And its guarded input and integrat-

ing operation permits measuring of the smallest signals . . . even in the presence of high common mode noise. Ten volts of common mode on the signal results in a mere one microvolt error, an unparalleled capability.

Accessory instruments include the DY-2411A Guarded Data Amplifier, which adds a 10 mv full scale range (again, with 300% overranging) while preserving the noise rejecting features. Input resistance is 10,000 megohms. The DY-2410A AC/Ohms Converter provides floated and guarded, broadband ac voltage and resistance measurements. Like the DY-2401A Integrating Digital Voltmeter, both accessory instruments are programmable by simple contact closures to ground.

Call your hp/Dymec field engineer today for complete data and for a demonstration in your plant.

DY-2401A	\$3950
DY-2410A	\$2250
DY-2411A	\$1150

Data subject to change without notice. Prices f.o.b. factory.

Don't miss seeing the Dymec Integrating Digital Voltmeter in operation at WESCON, Booths 2722-2723.

DYMEC

A DIVISION OF HEWLETT-PACKARD COMPANY

DEPT. Y-7, 395 PAGE MILL ROAD, PALO ALTO, CALIF.



8634

● PHONE (415) 326-1755 TWX 415-492-9363

POROSITY?

If you machine into a flaw in a Morris Bean casting, we'll replace the casting and pay you for lost machining time



BEAN

request free Resources and Capabilities booklet
MORRIS BEAN & COMPANY, YELLOW SPRINGS 8, OHIO
aluminum and ductile iron foundries

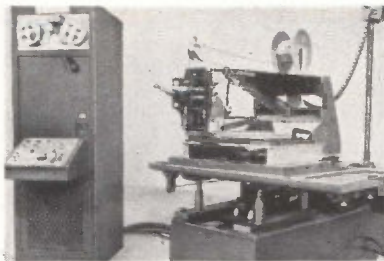

FLOOR-MOUNTED machine for high-production operations uses programmed instructions

tool handle until an indicator contained therein registers sufficient tensile strength.

ECONOMIES—Economies resulting from use of technique are attributed to:

- Speed and ease of application
- Use of bulk wire
- Absence of requirement for pre-stripped lead inventory
- Liberal post requirements: posts need not have sharp corners to form satisfactory contact.

Cooler for In-Line Testing

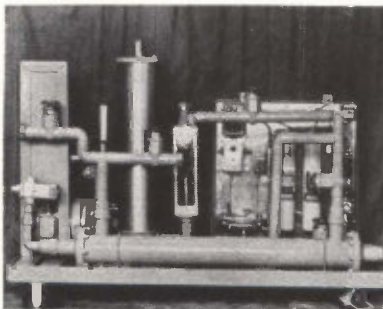

WATER-TO-WATER heat exchanger used to cool high-power radar assemblies is portable

ROLL-ABOUT COOLING system facilitates in-line testing of high-power electronic equipment. Cooling components mounted on three portable dollies now used by Raytheon's Wayland, Mass. plant, provide convenient flexibility.

Rolled to the equipment in test and connected by rubber hoses, the system is capable of dissipating a total 204,000 BTU's per hour. Included are a water-to-water heat exchanger, a Holstead and Mitchell closed circuit evaporative type water cooler, and a 5 h-p pumping

system. Able to be used with brackish or contaminated water supplies for the outer jackets, only distilled water in a closed circuit loop runs through the test fixture.

Designed by Harris Refrigeration Inc., Cambridge, Mass., this system eliminates the high cost of refrigeration units or the bulkiness of an air-cooled system.

Welding Press Floats on Air

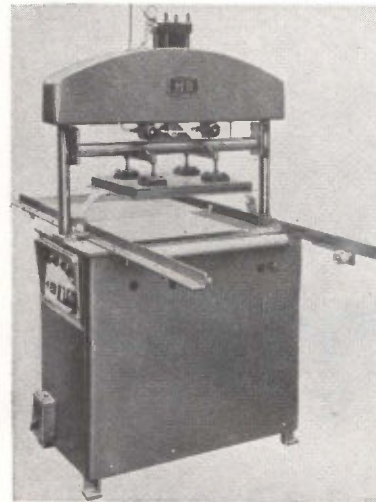

OPEN-SPAN welding press uses electrical and pneumatic circuits for positioning weld material

MEDIUM-SIZED, high frequency open-span welding press is being introduced that has a sliding tray system using a flotation-on-air principle. Built by Stanelco Industrial Services, Ltd. of London, England, the welding press thus reduces operator effort. Also, air-flotation feature simplifies and economizes jig construction and permits upward facing electrodes. Air consumption has been cut to a minimum by adjustable stroke-limiting facilities for production use: a full 6 inches for setting up but 1/2 inch for running. Material to be heated is accurately positioned in the h-f field immediately under the welding electrode through use of dual weld/dwell electrical and pneumatic circuits. Welding-time cycle and applied pressure can be adjusted independently of dwell time and pressure. Thus, pressure can be low during heat but can then become higher than normally permissible, increasing production rate.

MITSUBISHI MICROWAVE ANTENNAS FOR TELECOMMUNICATIONS



Japan today has the second largest microwave network in the world. Mitsubishi Electric, with the longest microwave antenna experience in Japan, has supplied 90% of the antennas used in the trunk lines of this extensive network. Mitsubishi antenna systems include parabolic, scatter, horn reflector and radar types, as well as a complete line of waveguide components and accessories. Frequencies from 900 Mc. to 24 KMc. are covered. The IU-61, shown above and specified at the right, is typical of the outstanding performance of Mitsubishi microwave antennas. Full technical information on any of these types of antennas is available at your request.

IU-61 6000 Mc. Band Parabolic Antenna

Diameter : 4 meters
 Frequency Range : 5925~6175 Mc/s or 6175~6425 Mc/s
 Feed System : Dual circularly polarized wave
 Gain : 45 db
 Beam Width : 0.98 degrees (half power)
 First Side Lobe : -23 db
 Wide Angle Radiation : -60 db
 (over 60 degrees)
 Front-to-Back Ratio : 65~70 db
 VSWR : 1.02
 Ellipticity Ratio : 1.1 (power axial ratio)
 Discrimination of anti-
 circularly polarized wave : -30 db
 Coupling of Both Arms : -35 db
 Guaranteed for
 Wind Velocity of : 60 meters/second
 Weight : 800 kilograms



MITSUBISHI ELECTRIC CORPORATION

Head Office: Mitsubishi Denki Bldg., Marunouchi, Tokyo. Cable Address: MELCO TOKYO

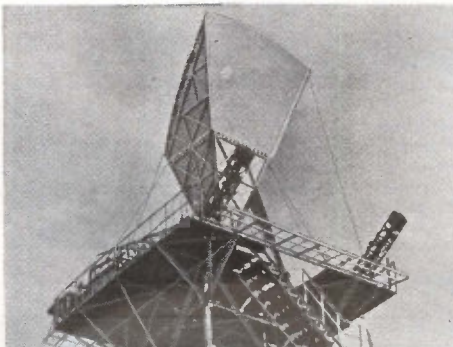

■ Horn reflector antenna



■ Air inflated parabolic antenna

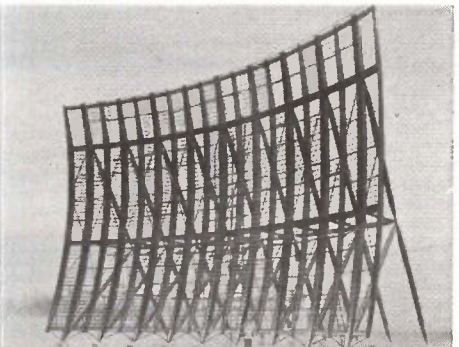

■ 25×16 meter scatter antenna

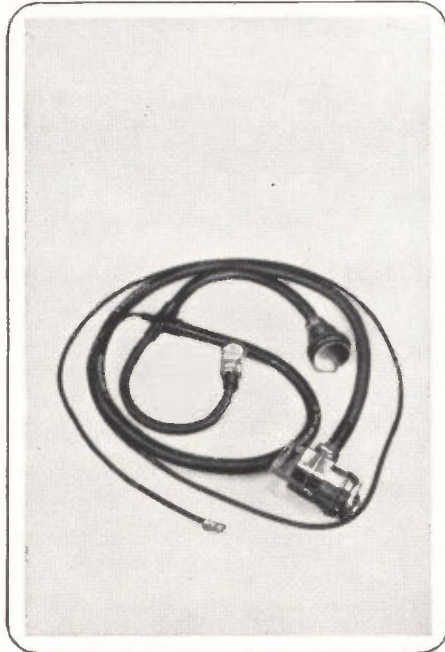
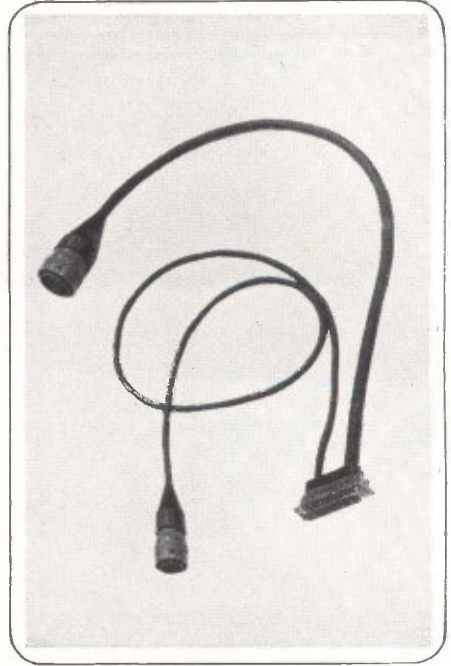
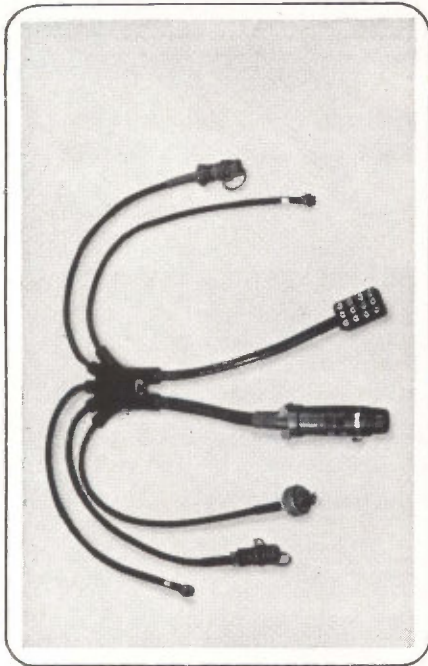

**Now
let us
solve
your
cable
problem
!**

You'll probably never need any of these five cables. But somebody did. And the same versatility and reliability-control which fit these special cables to special needs are now available to solve your cable problems. These are products of Rome's Special Products Facility, where unique cable constructions are everyday products. Cables like these can't afford to fail—there often isn't a second chance. So Rome insures reliability with a quality control program second to none. It tests each cable construction continuously throughout construction and inspection.

The program has been so successful that we recently won the first aerospace reliability contract ever awarded to a cable manufacturer. Its goal is to prevent cable assembly malfunctions in the Minuteman missile. Other cable constructions from Rome's Special Products Facility have proved themselves reliable on such projects as Hound Dog, Atlas, Mercury, and Sergeant. Our Special Products Facility brochure explains how you can fit Rome's unique experience, skills and equipment to your specific problems. Just send the coupon.



Special Products Facility
Rome Cable Division of Alcoa
2937 South Tanager Avenue
Los Angeles 22, California

Please send my copy of your brochure describing how I can benefit from Rome's Special Products Facility.

NAME _____
COMPANY _____
ADDRESS _____
CITY _____ ZONE _____ STATE _____

L-Band Shifter Switches States in 10 nsec

*Two-port device
uses varactors and
requires low drive*

RECENTLY announced by Microwave Associates, Inc., Burlington, Mass., model MA-8352-2LIT is an L-band, two-port transmission device that will provide continuous analog phase modulation by means of an applied bias voltage. Control is accomplished with varactors that require very low drive of less than 0.01 watt. The unit is capable of fast modulation rates including sinusoidal modulation signals to 30 Mc or switching between two particular phase states in 10 nsec.

According to the manufacturer, model MA-8352-2LIT has an r-f power rating (cw) of 100 mw, but may be used at higher levels if phase shift sensitivity with r-f power level is not objectionable. This device finds use in countermeasure applications where a signal may be phase modulated with random or deceptive information

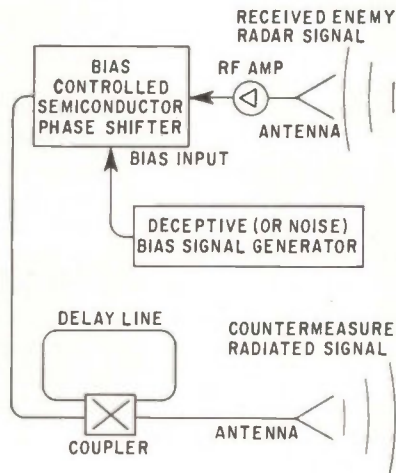

and re-transmitted to its original source. In this way, accurate target velocity determination by interpretation of returned signal frequency deviation or phase change can be inhibited. Other applications include use in automatic impedance measuring bridges, production of a known phase increment, control of driver stages in parallel chain and use in high-power amplifiers. One application of the device in radar countermeasures is shown in the diagram along with a graph of

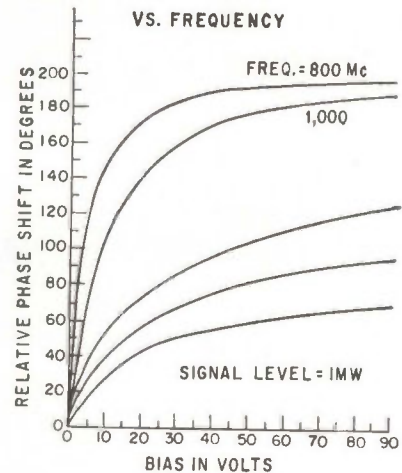

phase shift plotted against bias.

The L-band phase shifter conforms to the following characteristics: freq. range—800 to 2,000 Mc; power level—100 mw continuous; insertion loss—2.0 db max; minimum phase shift—800 to 1,600 Mc between 0 and 90 degrees; input and output impedance—50 ohms; bias range—0 to 90 volts at less than 100 μ a and vswr less than 2 to 1. The unit weighs only 1 pound.

CIRCLE 301, READER SERVICE CARD

TWT Amplifier Has Modular Construction



MODEL 304D S-band twt Amplifier, soon to be introduced by Huggins Laboratories, Inc., 999 East Arques Avenue, Sunnyvale, Calif., operates between 2.0 and 4.0 Gc with 35 db of small signal gain, 1 watt saturation power output, 20 db maximum noise figure and spurious modulation at least 40 db below the signal. The unit has an a-m bandpass between d-c and 100 Kc and a minimum change in r-f output of 20 db with a grid voltage of 30 v. Connectors for r-f input and output as well as a grid-modulation jack are located on the front panel and servicing is facilitated by

ELECTRONIC DRAWER PULL-OUT CABLES...

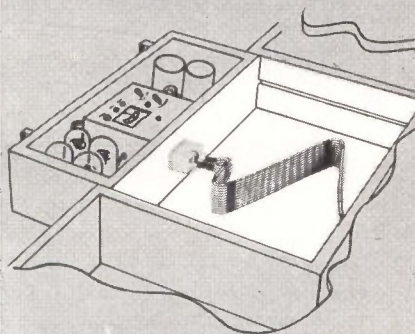

SPECTRA-FLEX CABLES®

Spectra-Flex Cables are efficiently neat, flexible, compact and easily handled. Comes in all sizes from #10 to #30 AWG. Made to your specifications, any wire with a vinyl jacket.

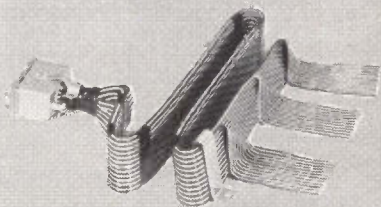

Write for information regarding extensible, retractable harness.



P.O. BOX 415, Tel.: 714 537-4530
TWX 714 530-0313
GARDEN GROVE, CALIF.

modular plug-in construction.

According to the company's engineers, adequate protection of the power supply and twt is ensured by fusing the main power line, high-voltage primary and filament circuit, and by incorporating a 3 minute filament warmup and helix-overload circuit. Excellent r-f stability is achieved with high-voltage regulation of 0.01%; a-c filament regulation of 2% and high-voltage ripple of better than 20 mv peak to peak.

Model 304D can be used to amplify the low output power of backward-wave oscillators and klystron signal generators, as an electronically controlled attenuator, for doppler radar simulation or shift generation and as an extremely stable oscillator to produce oscillations with stability on the order of 1 part in 10⁹. The device operates on 110 vac, consumes 1,000 watts maximum and weighs 37 lb. It costs \$2,250.

CIRCLE 302, READER SERVICE CARD

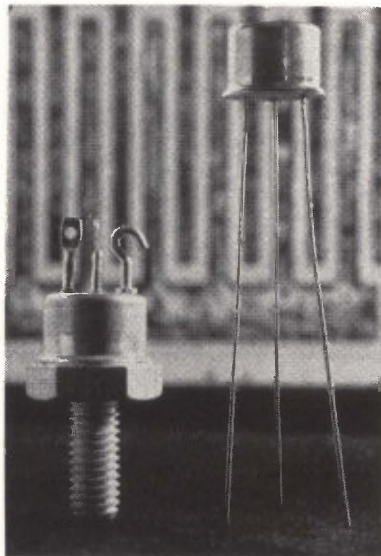

NPN Device Has 20-Watt Dissipation

PLANAR epitaxial power transistor recently announced by Fairchild Semiconductor, Div. of Fairchild Camera and Instrument, Syosset, New York, features 20 watts of d-c power dissipation at 100 C case temperature. Called the 2N2893, the transistor is packaged in a $\frac{1}{8}$ -inch hexagon configuration and has a guaranteed beta range between 50 and 150 at 2 amp.

The company says that the high

performance of this silicon unit is made possible by its interdigitated geometry that provides a maximum emitter area to collector base area ratio. Moreover, they state that the interdigitated, epitaxial construction lends itself to precise manufacturing process control, resulting in lower collector resistance and capacitance and thus increasing device speed. A similar unit, the 2N2892 has a beta of 30 to 90 at 2 amp and two others of the series, the 2N2891 (beta = 50 to 150 at 2 amp) and 2N2890 (beta = 30 to 90 at 2 amp) are available in JEDEC TO-5 packages.

These transistors are useful in audio power applications up to vhf frequencies, power converters, video drivers and other high-reliability circuits. They cost between \$35 and \$55 in lots of 100. (303)

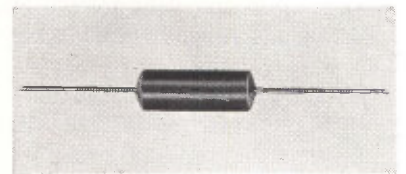

Encapsulated Resistor With Axial Leads

RESISTOR, type 7044, measuring $\frac{1}{2}$ -in. diameter by $\frac{1}{2}$ -in. long, offers 1 megohm, maximum resistance (utilizing 0.001 wire), 0.5 w maximum, 400 maximum volts. Wattage is rated at 25 C through 125 C. Type 7044 is non-inductive wound. RCL Electronics, Inc., One New Jersey Ave., Riverside, N. J. (304)



VOM Features High Accuracy

MODEL 261 volt-ohm-milliammeter offers accuracies of $\pm 1\frac{1}{2}$ percent

d-c, ± 3 percent a-c. It also features self-shielded annular meter movement (not influenced by outside magnetic fields; spring backed jewels (withstands more abuse due to shock and vibration without increasing frictional error); mirror scale—knife-edge pointer; diode overload protection (prevents movement burnout even on 200,000 percent overload). Price of model 261 is \$59.95; model 261RT (roll top), \$65.95. Simpson Electric Co., 5205 West Kinzie St., Chicago 44, Ill. (305)

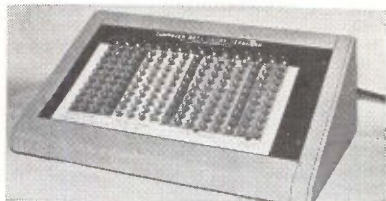

Data-Entry Keyboard Used With Computers

A MORE ACCURATE and convenient method of entering large quantities of data into digital computers directly at the source has been introduced. The computer data-entry keyboard can be equipped with as many as 18 decades of lighted keys upon which an entire field of numeric data may be entered. The keys are electrically interlocked by decades and store the data field for visual verification prior to recording on punched paper tape. The self-contained desk-top key board employs highly reliable, solid-state electronic components to scan the fixed format data field and also provides automatic entry of certain prewired computer instructions, such as end of field and end of record codes. Colorado Instruments, Inc., Garden Office Center, Broomfield, Colo. (306)

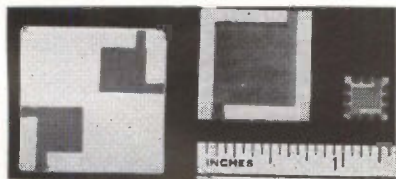

Film Capacitor Has High Reliability

THIN-FILM screened capacitor, the Cerafer, has a capacitance range up to 8,000 pf per single layer per $\frac{1}{2}$ -in. square maximum size. Capacitance

NEW SATELLITE HEART LIVES LONGER IN SPACE

World's First TRUE Brushless DC Motor Has Highest Efficiency/Weight Ratio



■ The new Sperry Farragut self-starting brushless direct current servomotor* offers highest efficiency/weight ratios, longest life and dependable static-free operation. It is the only TRUE brushless direct current motor made for battery operation. Others require inversion units. This solid-state commutator motor lives longer in space because there are no brushes to wear out . . . gone are the friction, arcing and wear of switching commutation necessary for conventional D.C. motors.

*Patent Pending

Characteristics of Model Being Made for NASA'S Goddard Space Flight Center
Efficiency — 50%
Torque — .67 in.-oz. @ 3,000 rpm
Weight — 7.8 oz.

FREE TECHNICAL REPORT

TECHNICAL BULLETIN SPERRY-FARRAGUT



SERVOMOTOR BRUSHLESS DC

Another Space-Age First From



DIVISION OF SPERRY RAND CORPORATION
BRISTOL, TENNESSEE

Write today to Dept. E-82

To Order Reprints

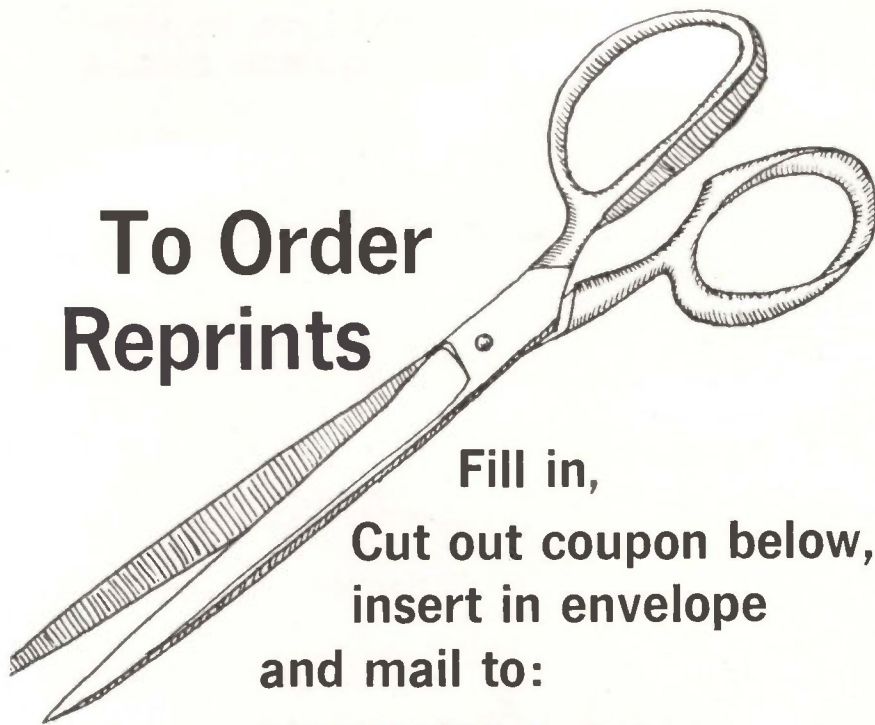

Fill in,
Cut out coupon below,
insert in envelope
and mail to:

electronics Reprint Dept.
330 West 42nd Street,
New York, N. Y.—10036

REPRINT ORDER FORM

For Listing of Reprints Available See Reader Service Card

(To help expedite mailing of your reprints please send cash, check or money order with your order.)

For Reprints of the latest Special Report:

Radio Frequency Interference

Send me..... Reprints of Key No. R-39. I—10 copies 75¢ each, II—24 copies 60¢ each, 25 or more 50¢ each.

For Reprints of previous Special Reports or Feature Articles fill in below:

Send me..... Reprints of Key No.(s)..... @..... ¢ each.

(For prices, see Reader Service Card.)

*For orders of Bulk Reprints of other editorial articles in this issue or past issues:

Send me..... Reprints of page no.(s)..... of issue date.....

of article entitled.....

*Minimum bulk order 100 copies. You will be advised of costs by return mail.

Name

Number and Street.....

City, Zone No., State.....

and Q remain constant throughout life and throughout processing temperatures up to 500 C for 15 minutes. Rating is 75 v d-c working and insulation resistance exceeds 100,000 megohms at 50 v d-c over -65 C to +125 C temperature range. Standard tolerances are ± 10 percent over 25 pf and ± 25 percent under 25 pf with special tolerances of ± 2 percent and ± 5 percent available at 50 pf and over. Cerafer capacitors are designed for applications involving micro or thin circuitry on flat alumina substrates. CTS Corp., Elkhart, Ind.

CIRCLE 307, READER SERVICE CARD



Resistor Tester Needs No Adjustment

AUTOMATIC resistor test instrument, model R105, tests nominal resistance value from 10 ohms to 11.999 megohms to an absolute accuracy of 0.1 percent, yet never needs adjustment. With simple dial-knob settings for the resistance and the desired tolerances, the R105 is handled by non-technical personnel after a few minutes orientation. Plus and minus tolerances are separately programmed from 0 to 10.9 percent in 0.1-percent steps. A "guard band" safety factor is introduced by a convenient plug-in module. Testing rate is approximately 80 millisecc per resistor. Manual handling is accomplished with a fast-loading clip which assures a sound four-probe contact for all resistors. Teradyne, Inc., 87 Summer St., Boston 10, Mass. (308)

Recorder/Reproducer Has Six Speeds

ADVANCED r-f/predetection video recorder/reproducer, model L-4000, is announced. Tape speeds are 7½, 15, 30, 60, 120 and 180 ips. Wow and flutter: less than 0.2 percent peak-to-peak measuring components

I Dreamed I Heard From Venus With My LEL Amplifier

No matter what your needs... spacial or terrestrial... LEL catalogs more than 200 amplifiers of all shapes and sizes including miniature or subminiature tube, transistor and nuvistor types to meet all your receiver requirements. Quick reaction capability plus proven product performance makes LEL the first source to figure on for RF and Micro-wave receiving equipment.

Send for 72-page catalog 63 today.

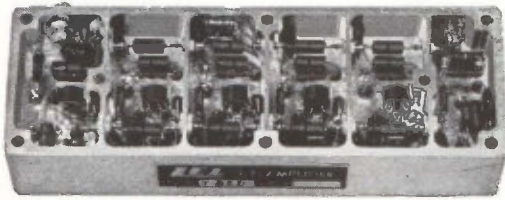

LEL Series 82
Transistorized Missile Amplifier

See us at WESCON Booth 4708

LEL INC.

75 AKRON STREET,
COPIAGUE, L. I., N. Y.

(516) PYramid 9-8200

(516) AMityville 4-2200

CIRCLE 203 ON READER SERVICE CARD

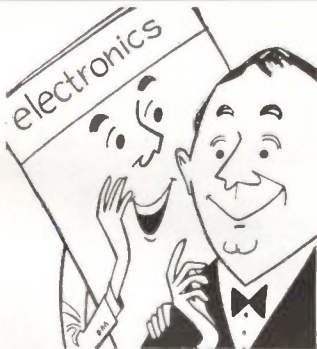

electronics
IS EDITED
TO KEEP YOU
FULLY INFORMED
— a "well-rounded"
engineer

What's your *present* job in electronics? Do you work on computers? (electronics ran 158 articles on computers between July, 1961 and June, 1962!) Are you in semi-conductors? (For the same period, electronics had 99 articles, not including transistors, solid-state physics, diodes, crystals, etc.) Are you in military electronics? (electronics had 179 articles, not including those on aircraft, missiles, radar, etc.)

In all, electronics' 28-man editorial staff provided more than 3,000 editorial pages to keep you abreast of all the technical developments in the industry. No matter where you work today or in which job function(s), electronics will keep you fully informed. Subscribe today via the Reader Service Card in this issue. Only 7½ cents a copy at the 3 year rate.

electronics

electronics • August 2, 1963

A major event
in the history of our profession



RADIO AND
TELEVISION
INTERNATIONAL
SHOW

For the 1st time
at Paris
(Porte de Versailles)
from September 5-15
1963

The RADIO & TELEVISION INTERNATIONAL SHOW will present for the first time the complete ranges produced by the leading international manufacturers of Radio Redifusion, Television, Recording and Reproduction equipment.

For the first time in France TV programs will be continuously transmitted on BOTH CHANNELS—in order to enable the general public to evaluate the reception qualities of both the 819 and the 625 line transmission systems.

The RTF (Radio & Television of France) will contribute to the success of this Show by continuous transmissions—over both radio & TV—programming, in specially equipped studios, gala events featuring those international artists having most public acceptance.



Show open from 10:00 to 19:00 hours

INFORMATION FROM: S.D.S.A. — 23 RUE DE LUBECK, PARIS 16
PHONE: PASSY 0116

CIRCLE 77 ON READER SERVICE CARD 77

for your silicon power transistor

AVNET

requirements specify STC

over 150 2N type nos. in 12 package sizes in power ratings from 5 to 300 watts. 21 MIL approvals; features major breakthrough in miniaturized power without heat sink; isolated collector in 75-85 watts; PNP transistor with NPN complements.

contact Avnet for on-time delivery

S.T.C.

of STC silicon power transistors



call your nearest Avnet office

AVNET

10 Local Headquarters, coast to coast

CIRCLE 204 ON READER SERVICE CARD

Telrex

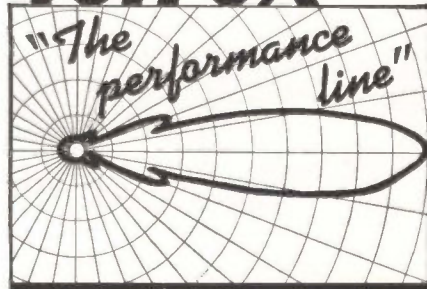

"— with a MATERIAL DIFFERENCE!"

The Choice of the Discriminating Communication Engineer... the Man who Never Settles for Anything Less than THE-VERY-BEST!

telrex "BEAMED-POWER" ANTENNAS and ANTENNA SYSTEMS

Provide optimum performance and reliability per element, per dollar. Antennas from 500 Kc to 1500 Mc. Free PL88 condensed data and pricing catalog, describes military and commercial antennas, systems, accessories, Towers, Masts, Rotators, "Baluns" and transmission line data.

ANTENNAS

SINCE 1921

telrex

LABORATORIES

Asbury Park 41, New Jersey, U.S.A.

Communication and TV Antennas

from d-c to 10 Kc at 60 ips. Absolute time displacement error: ± 0.2 μ sec reference to a 100 Kc control tone at 60 ips. Reel and tape sizes: 10½ in. to 15 in. NAB reels, ½-in. or 1-in. wide tape. Frequency response: 800 cps to 2.225 Mc ± 3 db at 180 ips; 300 cps to 93.5 Kc ± 3 db at 7½ ips. Rise time: 0.22 μ sec at 180 ips; 5.28 μ sec at 7½ ips. Winston Research Corp., 6711 S. Sepulveda Blvd., Los Angeles 45, Calif.

CIRCLE 309, READER SERVICE CARD

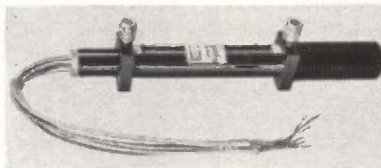

Traveling Wave Tube Offers Compactness

COMPACT traveling wave tube that boosts energy output for missile and airborne use has been developed. Only 3 lb in weight and 12½ in. long, the rugged metal ceramic type QKW 1023 tube delivers a minimum 10 w continuous wave power output. It operates in the 4 to 8-Gc frequency range. Tube features ppm focusing. This helps reduce tube size and weight as well as magnetic field interference problems. It also eliminates the need for external mounts. Raytheon Co., Microwave and Power Tube division, Foundry Ave., Waltham 54, Mass. (310)



Component Oven Operates at 75 C \pm 2 C

COMPONENT oven V1077 has a capacity sufficient for one 1½- by 3½-in. circuit board. Dimensions are 1¾ by 1½ by 4 in., excluding studs and header. Operating temperature is 75 C \pm 2 C. Stability is ± 4 C over an ambient temperature range of

MICO

DESK AND DOOR PLATE ENGRAVER

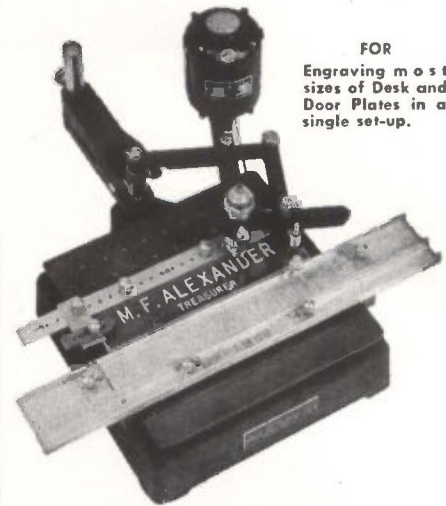

FOR Engraving most sizes of Desk and Door Plates in a single set-up.

FEATURES

1. Six pantograph ratios—from 1.5:1 to 4:1.
2. Spindle has integral micrometer depth control of .250"
3. Uses standard tapered-shank engraving cutters.
4. New 19" Copy carriers hold 17" of master copy; Permits engraving about 11" line of characters in one set-up at the 1.5:1 ratio.
5. Three sizes of copy carriers available. Each positioned separately.
6. Work-holding fence speeds set-up and engraving time.

Send for illustrated Catalog

MICO INSTRUMENT CO.

77 Trowbridge St.

Cambridge 38, Mass.

CIRCLE 205 ON READER SERVICE CARD

STUCK FOR

MAGNETS?



CALL

PERMAG

We stock all sizes, all shapes, all grades, for all uses... all ready for 24-HOUR DELIVERY. Also magnets engineered and fabricated to your needs.

PERMAG PACIFIC CORP. 6178 W. Jefferson Blvd. Los Angeles 16, Calif. / Phone: Area Code 213 VERmont 7-4479 / TWX: 213 836-0445

PERMAG CENTRAL CORP. 5301 D Otto Ave. Rosemont, Des Plaines, Illinois / Phone: Area Code 312 678-1120

PERMAG CORP. 88-06 Van Wyck Expressway Jamaica 18, New York / Phone: Area Code 212 OLYmpia 7-1818 / TWX: 212 479-3654

-55 C to 65 C. Power requirements: 20 watts at 110 volts a-c. Specifications may be modified to suit user's requirements. Reeves-Hoffman Division of Dynamics Corp. of America, Cherry and North Streets, Carlisle, Pa. (311)

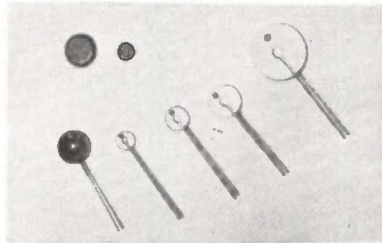

Silicon Varistors Are Low Voltage Type

SERIES of low voltage varistors are made of silicon carbide mixed with ceramic binders, molded and fired at high temperatures. Classified in 10 current ranges at voltages of 12, 24 and 48 volts, the varistors are available in $\frac{1}{4}$, $\frac{1}{2}$, 1 and 3 watt sizes as flat disks with metal sprayed faces or with tinned leads and dip coated. The Carbone Corp., P. O. Box 89, Boonton 2, N. J. (312)

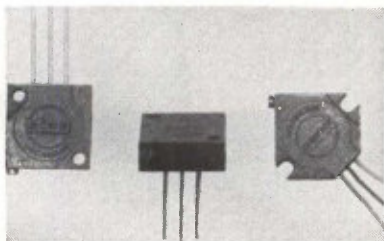

Trimming Pots Are Wirewound

NEW $\frac{3}{8}$ in. and $\frac{1}{2}$ in. square wirewound trimming potentiometers which are humidity-proof, dust-proof, and shock-proof to 100 g, have been developed. They operate from -65 C to +175 C. Resistance ranges from 10 to 100,000 ohms with ± 5 percent standard tolerance for the $\frac{1}{2}$ -in. model and 10 to 50,000 ohms, ± 5 percent standard tolerance for the $\frac{3}{8}$ -in. trimmer. The $\frac{1}{2}$ -in. power rating is 1 w at 70 C, and the $\frac{3}{8}$ in. is 1 w at 50 C—both are derated to 0 w at 175 C. Resolution of adjustment is 1.0 percent to 0.084 percent; mechanical adjustment—25 turns nominal. Temperature coefficient is 50 ppm/deg C

nominal. Borg Equipment, a division of Amphenol-Borg Electronics Corp., Janesville, Wisc. (313)

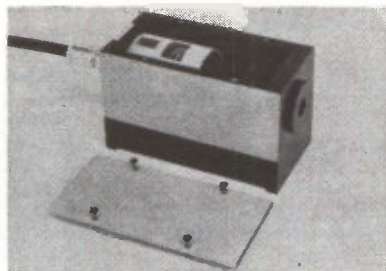

Laser Detector Is Power Sensitive

MODEL K-D1 detector is a power-sensitive photon radiation transducer for measuring and monitoring laser output and the output of other light sources. Device has a rise time of 0.3 nsec. Absolute power measurements from 1 w to 10^{10} w, and energy measurements from 10^{-3} to 10^3 joules are typical. Unit is available with either an S-20, S-4 or S-1 photo-surface; these three different surfaces provide a spectral response range from 3,000 to 11,500 angstroms. Korad Corp., 2520 Colorado Ave., Santa Monica, Calif. (314)



Miniature Amplifier Features Low Noise

GENERAL-PURPOSE low noise amplifier, model 206, provides selection of three fixed gain settings of 10, 100 and 1000 at bandwidths of 1 Mc, 650 Kc and 500 Kc respectively. Max output is rated at 3 v rms and distortion is less than 1 percent at max rated output. Equivalent input noise for full bandwidth (input shorted) is less than 10, 7 and 6 μ v for gains of 10, 100 and 1,000, respectively. Typical narrowband noise voltage is 5×10^{-9} v per root cycle, and noise current 3×10^{-12} amperes per root cycle above 1 Kc. Instrument is packaged in a cabinet measuring 4 in. by 7 in. by 6 in. including all controls. Quan-Tech Laboratories, Inc., Boonton, New Jersey. (315)

specify the new Bendix* Products

AVNET

contact Avnet for best service

Pygmy* types PT, SP; Pygmy crimp types PTCE, PTSE; MS, MS-E, MS-R, QWLD, SR rack and panel

on-time delivery of emergency

BENDIX

and prototype connector needs

Reg. T.M. Bendix Corp.



call your Local Avnet Headquarters

AVNET

The Avnet System, coast to coast

CIRCLE 207 ON READER SERVICE CARD

Coils for Contact Capsules

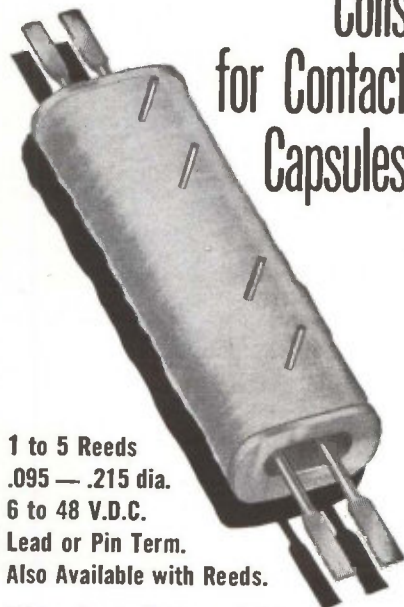

1 to 5 Reeds
.095 — .215 dia.
6 to 48 V.D.C.
Lead or Pin Term.
Also Available with Reeds.

Write for Bulletin and Prices

ELECTRICAL COIL WINDINGS

Wire sizes #6 to #56, Classes A, B, F and H. Complete engineering service available.

Coto-Coils

COTO-COIL COMPANY INC.

65 Pavilion Avenue, Providence 5, R. I.

Origin

Silicon Controlled Rectifier

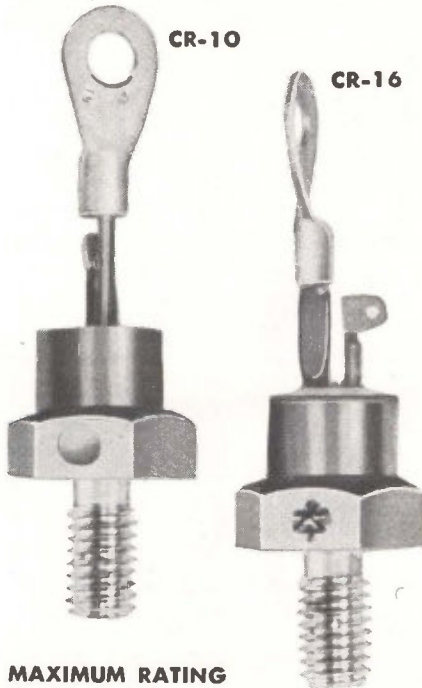

MAXIMUM RATING
CR-10 CR-16

TYPE Specification	CR-16A CR-10A	CR-16H CR-10H	Units
Peak Voltage (Reverse biased)	25	~ 400	V
Peak Blocking Forward Voltage	25	~ 400	V
A.C. Input Voltage	17.5	~ 280	VRMS
Average Forward Current	(CR-10) 10	(CR-16) 16 (Ta = +20°C)	A
Surge Current	(CR-10) 100	(CR-16) 130	A
Peak Gate Power	5		W
Average Gate Power	0.5		W
Peak Gate Current	2		A
Peak Gate Voltage (Forward)	10		V
Peak Gate Voltage (Reverse)	5		V
Junction Temperature	100		°C
Storage Temperature	-40 ~ +125		°C

Main Products:

Semi-conductors, condenser type spot welder, synthetic enamel and miniature ball bearing.

ORIGIN ELECTRIC COMPANY LTD.

1-195 Takadaminami-cho, Toshima-ku,
Tokyo, Japan
Cable Address: "ORIGINELE TOKYO"

Literature of the Week

DRUM MEMORIES Vermont Research Corp., P.O. Box 498, Springfield, Vt. Brochure describes two series of magnetic drum memories with data on information storage and retrieval.

CIRCLE 316, READER SERVICE CARD

CENTER BONDED MOUNTINGS Lord Mfg. Co., Erie, Pa. Bulletin 712 describes design, performance features and typical applications for center bonded mountings. (317)

D-C POWER MODULES Valor Instruments, Inc., 13214 Crenshaw Blvd., Gardena, Calif. Bulletin PS363 describes ResisTran high current d-c power modules. (318)

OPTICAL METER RELAY Assembly Products, Inc., Chesterland, O. Bulletin 33-A covers an optical meter relay that features contactless control with continuous indication through fiber optics and solid-state electronics. (319)

RELAY ASSEMBLIES C. P. Clare & Co., 3101 West Pratt Blvd., Chicago 45, Ill. Data sheet 551 contains a description of two sizes of type J DP direct plug-in telephone-type relay assemblies. (320)

THERMISTORS FOR FLOW MEASUREMENT Victory Engineering Corp., 122-48 Springfield Ave., Springfield, N. J. Publication V-1136 gives complete background and application information on flow metering with thermistors. (321)

POWER KLYSTRONS Varian Associates, 611 Hansen Way, Palo Alto, Calif., is offering a booklet written for engineers and technicians who operate and maintain equipment using power klystrons. (322)

PORTABLE INDICATING INSTRUMENTS Westinghouse Scientific Equipment Department, P.O. Box 868, Pittsburgh 30, Pa. Bulletin 99-352 describes a line of portable indicating instruments with taut-band suspension. (323)

AUTOMATIC TEST INSTRUMENTS Tera-dyne, Inc., 87 Summer St., Boston 10, Mass. Brochure describes the characteristics of a broad range of easily programmed automatic test instruments for electronic components. (324)

PACKAGED BLOWERS McLean Engineering Laboratories, P.O. Box 228, Princeton, N. J. A broadly expanded line of Mil-Spec packaged blowers for electronic rack cooling is presented in an eight-page catalog. (325)

CONNECTORS AND HEADERS Statham Instruments, Inc., 12401 W. Olympic Blvd., Los Angeles 64, Calif. Bulletin describes hermetically sealed connectors and headers designed for maximum resistance to radiation, high temperature, thermal shock, and corrosive environments. (326)

ELECTRONIC MEDICAL SYSTEMS Honeywell Electronic Medical Systems, 4800 E. Dry Creek Road, Denver 10, Colo. A condensed catalog contains information on various types of electronic medical systems. (327)

NICKEL CADMIUM BATTERIES Sylvania Electric Products Inc., 1100 Main St., Buffalo 9, N. Y., offers a brochure on its nickel cadmium rechargeable batteries. (328)

MICROWAVE ANTENNAS Lenkurt Electric Co., Inc., San Carlos, Calif. Volume 12, No. 5 of the *Demodulator* contains Part One of a series of articles on antenna systems for microwave. (329)

MICROWAVE COMPONENTS Airtron, 200 E. Hanover Ave., Morris Plains, N. J. The first 12 data sheets for what will be a complete catalog of microwave components are now available. (330)

STANDARD QUARTZ & PYREX ACCESSORIES General Technology Corp., 3510 Torrance Blvd., Torrance, Calif. Bulletin 7100 describes standard quartz and pyrex accessories employed by the semiconductor industry in diffusion, doping and heat treating operations. (331)

PULSE GENERATOR Texas Instruments Incorporated, 3609 Buffalo Speedway, Houston, Texas. Bulletin D602 describes ten pulse shaping modules including specifications and oscilloscope photographs of output waveforms. (332)

MICROWAVE DIODES Alpha Microwave, Inc., 381 Elliot St., Newton Upper Falls 64, Mass., offers literature describing its line of ceramic cartridge and subminiature glass microwave mixer and video detector diodes. (333)

COMPLEX TRANSFORMATION RATIO DETERMINATION North Atlantic Industries, Inc., Terminal Drive, Plainview, N. Y. Technical bulletin TB-105 now available describes the measurement of complex transformation ratios by phase sensitive nulling techniques. (334)

DIFFUSION FURNACES Electroglas, Inc., 841 Warrington Ave., Redwood City, Calif., has available literature describing capacity, performance and full operating specifications on diffusion furnaces for semiconductor processing. (335)

PRECISION RESISTORS Marstan Electronics Corp., 204 Babylon Turnpike, Roosevelt, N. Y., has available a new edition of the precision resistor catalog referencing changes in the new Mil spec. (336)

BEAM POWER PENTODE TUBE Tung-Sol Electric Inc., One Summer Ave., Newark 4, N. J., announces publication of a 4-page product bulletin on the type 8149 beam power vhf pentode tube. (337)



**Are you a
COMPLETELY INFORMED
electronics engineer?**

Today you may be working in microwaves. But on what project will you be working tomorrow? You *could* have read **electronics** this past year and kept abreast of, say, microwave technology. *There were 96 individual microwave articles between July, 1961 and June, 1962!*

But suppose tomorrow you work in some area of standard electronic components, in semiconductors, in systems? Would you be up-to-date in these technologies? Did you read the more than 3,000 editorial pages that **electronics'** 28-man editorial staff prepared last year?

electronics is edited to keep you current *wherever* you work in the industry, *whatever* your job function(s). If you do not have your own copy of **electronics**, subscribe today via the Reader Service Card in this issue. Only 7½ cents a copy at the 3 year rate.

electronics

NASA STANDARD

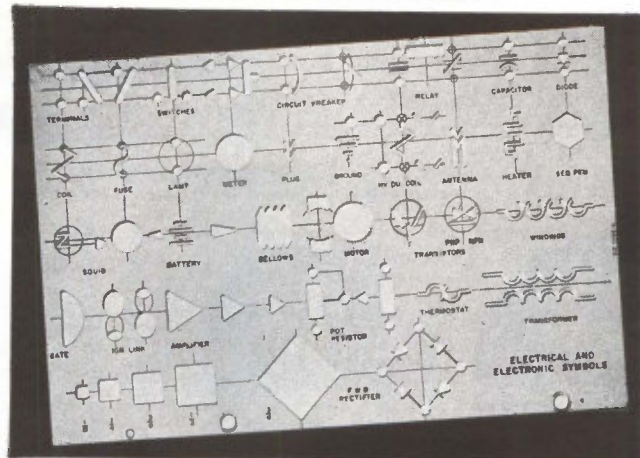

**RD6102A ELECTRICAL
DRAFTING TEMPLATE**

"Required on all electrical documentation performed for quality assurance division."

MEMO. NO. M-QUAL-OE 62.27

PRICE \$5.00

There are more than 100 RAPIDESIGN TEMPLATES—all of which are better made—more useful.

Catalogue No. 70 available upon request

RAPIDESIGN INC.

P. O. BOX 429 • BURBANK, CALIFORNIA
CIRCLE 208 ON READER SERVICE CARD

Counting knob

**Zivy
Z 1003**



for mounting on precision multiturn potentiometers, controls of precision instruments, machine tools, etc.

Read to 1/500 of a turn

Estimate 1/1000th

Write to:

Victor George Herman
49 West 96th Street
New York 25, N.Y.

Motorola Names Three Managers



R. Peth



J. F. Mitchell



D. R. Jones

MOTOROLA'S Communications division in Chicago has named Robert Peth, John F. Mitchell and Donald R. Jones to new positions.

According to vice-president William J. Weisz, each man has full responsibility for the design, development, production, marketing and sale of the products assigned to him.

Peth has been appointed manager of mobile communications products, and is assigned mobile two-way radio communications equipment, including mobile units, base, stations, and control equipment. He was most recently manager of engineering for mobile and portable communications products.

Mitchell has been named manager of portable communications products in charge of portable two-way radio products. He was formerly chief engineer of mobile and portable communications products.

Jones has been appointed manager of signalling products. Before his promotion, he was manager of marketing for mobile and portable communications products.

Hughes Aircraft Appoints White

C. E. WHITE has been appointed manager, administration and material of the Hughes Aircraft Company's ground systems group in Fullerton, Calif.

White's responsibilities will in-

clude supervision of the following departments: industrial relations and services, management operations, information media, and material services staff. He will also direct the operations of the material organizations which service engineering, manufacturing, and communications.

Prior to his current appointment, White was manager for administration at ground systems group.



Indiana General Appoints Smith

APPOINTMENT of Gerald Smith as general manager of the newly created Memory Systems division of Indiana General Corp., Valparaiso, Ind., has been announced. Until now the engineering, manufacture and sale of Indiana General Corporation's memory systems have been part of the company's Electronics division.

Before joining Indiana General,

Smith was director of research and development of the Military Electronics division of Daystrom, Inc.

Von Harz Accepts IRC Position

JAMES L. VON HARZ has joined International Resistance Co. as general manager of the Burlington (Iowa) division.

Von Harz was administrative vice president at Oak Mfg. Co. when he terminated his affiliation with that firm after 21 years of service. Immediately prior to joining IRC, he was vice president of Waller Corp.



Honeywell Promotes Edward Lund

APPOINTMENT of Edward C. Lund as vice president and general manager of Honeywell's Ordnance division has been announced. In this position he is responsible for Ordnance division plants in Hopkins and New Brighton, Minn., employing some 5,200 persons, and plants in West Covina, Calif., and Seattle, Wash., with a total of approximately 1,000 employees.

Lund was formerly general manager in charge of Minneapolis Ordnance operations.

Raybuck Advances to Vice President

CHARLES B. RAYBUCK has been made vice president for engineering at Melpar, Inc., Falls Church, Va. He joined Melpar in 1951 as assistant

THIS TAPE RECORDER SELDOM SPINS ITS REELS

Instead of keeping its reels in motion, this new digital recorder operates incrementally. It stands still awaiting the arrival of each character, records it, then moves the tape a uniform distance to await the next. Though digital characters may

a r r i v e l i k e t h i s

The PI incremental recorder assembles them, bit by bit,

like this

on the tape, ready for computer entry. The format is fully compatible with IBM, CDC, and other computer input requirements.

Whether characters arrive irregularly or synchronously, once a month or 150 times a second — from such sources as a teletypewriter or analog-to-digital converter — they are now recorded in a proper, uniform packing density of 200 BPI (556 optional). Punched cards, paper tape, or other forms of intermediate data storage are eliminated.

To tell you more, we've assembled some 86,000 bits of information on the RSL-150 incremental recorder. They space out nicely into a 6-page brochure, a copy of which is yours for the asking. Address us at **Stanford Industrial Park, Palo Alto 20, California.**

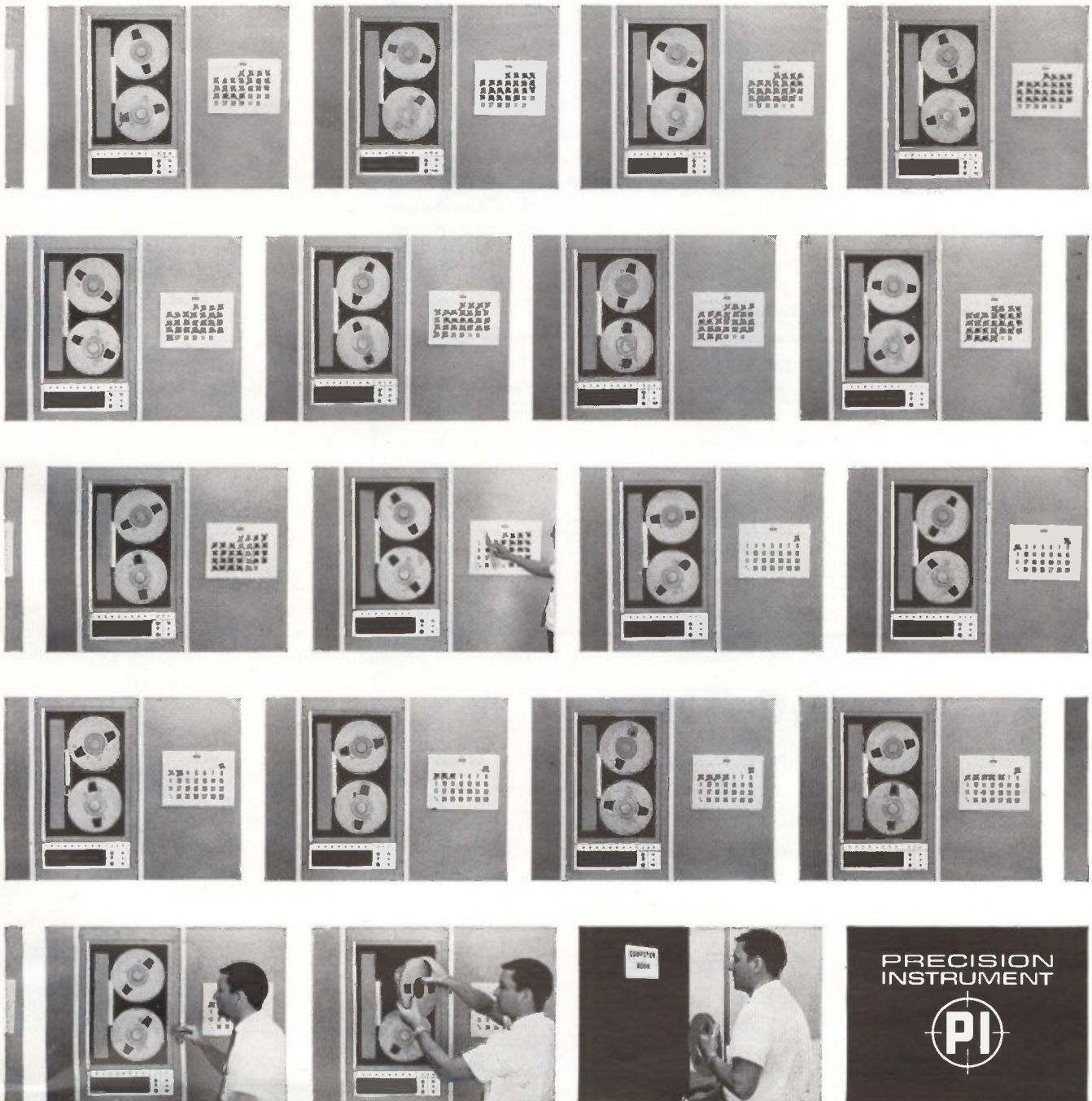

NEW MINIATURE DELAY LINES

¼ CU. INCH PER μ SEC.

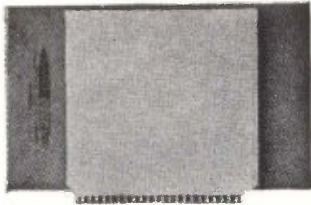

Total delay of 24.65 μ sec. in a 4½" x 4" package



- Total weight: 8½ oz.
- Total delay accuracy better than ½ of 1%
- Total delay to rise time ratio better than 40:1
- Distortion under 4%
- Temp. coefficient: 50 ppm \pm 20 ppm/°C

WRITE FOR DETAILS

Opening exists for a Delay Line Design Engineer

ADMIRAL PALO ALTO

Palo Alto Division of Admiral Corporation
Stanford Industrial Park, Palo Alto, California

CIRCLE 84 ON READER SERVICE CARD

WHEATSTONE BRIDGE



**$\pm 0.1\%$
ACCURACY**

Model L-3C

Range:	.001 Ω to 11.11M Ω
Rheostat Arm:	1 Ω x10+10 Ω x10+100 Ω x10+1000 Ω x10 (4 dials)
Ratio Arm:	x0.001, x0.01, x0.1, x1 x10, x100, x1000
Overall Accuracy:	100 Ω to 100k Ω $\pm 0.1\%$ 1 Ω to 1M Ω $\pm 0.3\%$ 1 Ω to 10M Ω $\pm 0.6\%$

Accurate resistance measurement achieved with a single unit. No accessories, no power source required. Operates on three type D, 1.5V dry cells, YEW's new, rugged galvanometer, Model G-2(B) incorporated. All 5 dials make no-rubbing contact and are dust-proofed, housed in individual plastic case. The L-3C has elastic mold unbreakable housing. Size: 7¼" x 9" x 5" Weight: 5 lbs. Shipping weight: 10 lbs. Available for immediate delivery.

Cat No. 52402 \$156.00

CONFIDENCE BEGINS WITH

YEW

YOKOGAWA ELECTRIC WORKS, INC.

40 WORTH STREET NEW YORK 13, N. Y.
Area Code 212 Telephone: 8Eekman 3-6720

CIRCLE 209 ON READER SERVICE CARD

chief engineer. He was elected an officer of the corporation in 1954 and until recently was in charge of contract management.

In his new position Raybuck has charge of four major organizational elements in the company: the electronics division, the Aerospace division, the Special Products division, and the Field Service department, as well as the necessary supporting activities.

PEOPLE IN BRIEF

Walter G. Wadey, formerly with Bowles Engineering Corp., appointed chief scientist of Washington Technological Associates. Geoffrey C. Winkler promoted to director of mfg. for Huggins Laboratories, Inc. James M. McCarty advances to mgr. of engineering, West Coast operations, of the Perkin-Elmer Corp. Warren R. Barton leaves Consolidated Vacuum Corp. to join Bendix-Balzars Vacuum Inc. as director of mfg. Martin H. Bloom, previously associated with Brooklyn Polytech, named technical asst. to the president of General Applied Science Laboratories, Inc. William J. Hammond moves up at Claud S. Gordon Co. to asst. g-m and marketing mgr. L. A. Caldwell promoted to g-m of Admiral Corp.-San Diego div. Northrup ups James M. Ricketts to operations mgr. at the Nortronics systems support dept. Henry H. Eichel, USAF Ret., joins Space Technology Laboratories in program management capacity. Dalmo Victor Co. upgrades Roy A. Hundley to mgr., mechanical and servo engineering dept. Robert N. Palmer advances to applications engineering mgr., R&D, of the Tube div. of Varian Associates. A. J. Critchlow leaves GE to rejoin IBM as mgr. of innovation products technology. Robert W. Jennings moves up at Ampex Corp. to mfg. mgr. of the video and instrumentation div. Arthur A. Turner, g-m of The Carborundum Co. Refractories and Electronics div., elected a v-p of the company.

EMPLOYMENT OPPORTUNITIES



The Advertisements in this section include all employment opportunities—executive, management, technical, selling, office, skilled, manual, etc. Look in the forward section of the magazine for additional Employment Opportunities advertising.

Positions Vacant
Positions Wanted
Part Time Work

Civil Service Opportunities
Selling Opportunities Wanted
Selling Opportunities Offered

Employment Agencies
Employment Services
Labor Bureaus

DISPLAYED

The advertising rate is \$40.17 per inch for all advertising appearing in other than a contract basis. Contract rates quoted on request.

An advertising inch is measured ¾" vertically on a column—3 columns—30 inches to a page.

Subject to Agency Commission.

Send NEW ADS to CLASSIFIED ADV. DIV. of ELECTRONICS, P.O. Box 12, N. Y. 36, N. Y.

RATES

\$2.70 per line, minimum 3 lines. To figure advance payment count 5 average words as a line.

Box Numbers—counts as 1 line.

Discount of 10% if full payment is made in advance for 4 consecutive insertions.

Not subject to Agency Commission.

UNDISPLAYED

MAGNETIC THIN-FILMS

A metropolitan university is seeking an electronics engineer (M.S. preferred) with three years experience in magnetic thin-films and a good knowledge of circuits, to work in one of its Research Laboratories on a long-term computer-oriented applications program. Individual should be capable of working independently, and directing small group.

New York City Location

University Benefits

Write:

P-2595, Electronics

Classified Adv. Div., P.O. Box 12, New York, N. Y. 10036

electronics

WEEKLY QUALIFICATION FORM FOR POSITIONS AVAILABLE

ATTENTION: ENGINEERS, SCIENTISTS, PHYSICISTS

This Qualification Form is designed to help you advance in the electronics industry. It is unique and compact. Designed with the assistance of professional personnel management, it isolates specific experience in electronics and deals only in essential background information.

The advertisers listed here are seeking professional experience. Fill in the Qualification Form below.

STRICTLY CONFIDENTIAL

Your Qualification form will be handled as "Strictly Confidential" by ELECTRONICS. Our processing system is such that your form will be forwarded within 24 hours to the proper executives in the companies you select. You will be contacted at your home by the interested companies.

WHAT TO DO

1. Review the positions in the advertisements.
2. Select those for which you qualify.
3. Notice the key numbers.
4. Circle the corresponding key number below the Qualification Form.
5. Fill out the form completely. Please print clearly.
6. Mail to: Classified Advertising Div., ELECTRONICS, Box 12, New York 36, N. Y. (No charge, of course).

COMPANY	SEE PAGE	KEY #
ATOMIC PERSONNEL INC. Philadelphia, Pa.	79*	1
BELL AEROSYSTEMS CO. Div. of Bell Aerospace Corporation A Textron Company Buffalo, New York	86	2
GENERAL DYNAMICS/ELECTRONICS Military Products Div. San Diego, California	87	3
HEWLETT-PACKARD CO. 1501 Page Mill Rd. Palo Alto, California	77*	4
INDUSTRIAL DEVICES INC. Edgewater 8, N. J.	86	5
LOCKHEED MISSILES & SPACE CO. Div. of Lockheed Aircraft Corp. Sunnyvale, California	75*	6
PAN AMERICAN WORLD AIRWAYS INC. Guided Missiles Range Div. Patrick AFB, Fla.	79*	7
U.S.A.F AIR FORCE LOGISTICS COMMAND Joint Professional Placement Office New York, N. Y.	71*	8
P 2595	84	9

* These advertisements appeared in the July 26, issue.

(cut here)

electronics WEEKLY QUALIFICATION FORM FOR POSITIONS AVAILABLE

(cut here)

(Please type or print clearly. Necessary for reproduction.)

Personal Background

NAME

HOME ADDRESS

CITYZONE.....STATE.....

HOME TELEPHONE

Education

PROFESSIONAL DEGREE(S)

MAJOR(S)

UNIVERSITY

DATE(S)

FIELDS OF EXPERIENCE (Please Check)

8263

- | | | |
|--|--|---------------------------------------|
| <input type="checkbox"/> Aerospace | <input type="checkbox"/> Fire Control | <input type="checkbox"/> Radar |
| <input type="checkbox"/> Antennas | <input type="checkbox"/> Human Factors | <input type="checkbox"/> Radio-TV |
| <input type="checkbox"/> ASW | <input type="checkbox"/> Infrared | <input type="checkbox"/> Simulators |
| <input type="checkbox"/> Circuits | <input type="checkbox"/> Instrumentation | <input type="checkbox"/> Solid State |
| <input type="checkbox"/> Communications | <input type="checkbox"/> Medicine | <input type="checkbox"/> Telemetry |
| <input type="checkbox"/> Components | <input type="checkbox"/> Microwave | <input type="checkbox"/> Transformers |
| <input type="checkbox"/> Computers | <input type="checkbox"/> Navigation | <input type="checkbox"/> Other |
| <input type="checkbox"/> ECM | <input type="checkbox"/> Operations Research | <input type="checkbox"/> |
| <input type="checkbox"/> Electron Tubes | <input type="checkbox"/> Optics | <input type="checkbox"/> |
| <input type="checkbox"/> Engineering Writing | <input type="checkbox"/> Packaging | <input type="checkbox"/> |

CATEGORY OF SPECIALIZATION

Please indicate number of months experience on proper lines.

	Technical Experience (Months)	Supervisory Experience (Months)
RESEARCH (pure, fundamental, basic)
RESEARCH (Applied)
SYSTEMS (New Concepts)
DEVELOPMENT (Model)
DESIGN (Product)
MANUFACTURING (Product)
FIELD (Service)
SALES (Proposals & Products)

CIRCLE KEY NUMBERS OF ABOVE COMPANIES' POSITIONS THAT INTEREST YOU

1 2 3 4 5 6 7 8 9 10 11 12 13 14 15

ENGINEERS...PHYSICISTS...

Can Your Professional Growth Keep Pace with Bell's Growth in Electronics?

Avionics Division Shows 600% Sales Increase in Past 5 Years

If you are not certain how far your present position can take you, you may wish to consider a position with the Avionics Division of Bell Aerosystems Company.

This division is growing—and expects to continue—as a result of trail-breaking engineering concepts and performance in inertial guidance (a Bell digital velocity meter triggered the Mariner mid-course correction), and automatic landing systems (Bell's all-weather, automatic aircraft landing system can touch down 2 planes a minute even in dense fog).

Current contractual work involves controls for a lunar landing research vehicle, digital-to-voice converters, digital tie-in equipment and computers, sighting devices, exotic instruments, battlefield air traffic controls, learning machines, high precision gyroscopes and accelerometers, target locator systems, navigation systems, mapping systems and automatic landing systems.

To assure Bell's continuing progress and expansion in the electronics area, a few senior positions are available for experienced men interested in making significant contributions in the following areas:

ADVANCED SYSTEMS ANALYSIS

Responsibility for analytical investigations associated with modern weapon systems involving problems in areas of fire control, guidance, radar, and communication systems using digital and analog computing facilities when required. Advanced degree in physics, engineering or math with minimum 8 years related experience required, of which 4 must be in one of the above specific areas. Salary to \$18,000.

ADVANCED SYSTEMS DESIGN

Responsibility for analytical and preliminary design studies of command and control systems for terrestrial and orbital vehicles. Specific areas of investigation include position determination, vehicle control, data processing and transmission, and information display. Advanced degree in physics or EE with minimum 8 years related experience required, plus knowledge of military system design requirements. Salary to \$18,000.

AIR TRAFFIC CONTROL SYSTEMS

Perform studies of advanced air traffic control problems, define system requirements, investigate various approaches to problem solution, perform analytical work to support system feasibility, optimize system performance, suggest means for reduction to practice, act as consultant in the fabrication of feasibility hardware. Advanced degree in EE or physics with minimum 5 years related experience in one or more of the following: radar systems engineering, closed loop control, aerospace vehicle dynamics, operation analysis. Salary to \$18,000.

ADVANCED RESEARCH & DEVELOPMENT

Responsibility for determination of fruitful areas of research for advancing the state of the art, conducting original studies (both analytical and experimental), and acting as consultant in other communication and radar problems. An advanced degree in physics or EE with a communications specialty is required, plus the analytical ability to recognize problem areas, and the conceptual ability to determine solutions. Salary to \$18,000.

SOLID STATE PHYSICS

Form and head up group to perform research and development in solid state to further basic physical solid state phenomena towards practical application in avionics systems. MS or PhD in physics required with experience in one or more of the following: stimulated emission of radiation, semiconductor devices, solid state devices for information storage and retrieval. Salary to \$18,000.

INERTIAL SYSTEMS

Responsibility for inertial systems synthesis and analysis, including application to existing government requirements; and to establish new requirements, analyze existing systems and develop and apply new ideas in the field, including analysis of hybrid systems. Advanced degree in EE, physics or math with minimum 10 years related experience, 5 years of which must have been in inertial navigation. Salary to \$18,000.



Resumes are invited from qualified men.
Please address Mr. Thomas Fritschi, Dept. G-24.

BELL AEROSYSTEMS CO.

DIVISION OF BELL AEROSPACE CORPORATION—A **Textron** COMPANY

An Equal Opportunity Employer P.O. Box #1, Buffalo 5, New York

ENGINEERS

An Unusual Opportunity in Northern N. J.

For the creative engineer, with E.E. degree or equivalent, able to work with minimum supervision on the development of new electro-mechanical products—an opportunity to enjoy design freedom and complete responsibility, and to determine the future unhampered by the inertia of a large organization.

We manufacture indicator lights, switches, and molded plastic components for the electronic and electrical industries, and have enjoyed steady rapid growth based on solid industrial business—relatively unaffected by the "boom or bust" military pattern.

We are prepared to offer immediate status within our organization and rewards commensurate with results. The future is dependent only upon performance.

Send your resume today to Nathan Schnoll, President

INDUSTRIAL DEVICES, INC.

Edgewater 8, New Jersey

SELLING OPPORTUNITY AVAILABLE

"ALFA" V.O.M.'s Made in Belgium. We should like to appoint Distributors in USA for the famous ALFA V.O.M.'s, competitive in the international market-beautiful and precise instruments. For conditions and quotations please write to: Societe Industrielle Alfa, S.A., 80, rue de la Senne, Brussels-Belgium. Tel.: 12-67-30 (5 lines). Telex: 2-21844.

(Additional Employment Opportunity
Advertisement on page 84)

SEARCHLIGHT SECTION

(Classified Advertising)

BUSINESS OPPORTUNITIES

EQUIPMENT - USED or RESALE

DISPLAYED RATE

The advertising rate is \$27.25 per inch for all advertising appearing on other than a contract basis. Contract rates quoted on request. AN ADVERTISING INCH is measured 3/4 inch vertically on one column, 3 columns—30 inches—to a page. EQUIPMENT WANTED or FOR SALE ADVERTISEMENTS acceptable only in Displayed Style.

UNDISPLAYED RATE

\$2.70 a line, minimum 3 lines. To figure advance payment count 5 average words as a line.

PROPOSALS, \$2.70 a line an insertion.

BOX NUMBERS count as one line additional in undisplayed ads.

DISCOUNT OF 10% if full payment is made in advance for four consecutive insertions of undisplayed ads (not including proposals).

RADIO RESEARCH INSTRUMENT CO.

AUTO-TRACK & TELEMETRY ANTENNA PEDESTALS
3 & 10 CM. SCR. 584 AUTOTRACK RADARS
AN/TPS-10 SEARCH, AN/TPS-10 MT. FINDERS
AN/FM-32GCA, AN/APS-10 NAVIG. & WEATHER
AN/APS-15B PRECISION, AN/APQ-35B PRECISION
AN/APS-31A SEARCH, DOZENS MORE
5-12 MEGAWATT HIGH POWER PULSERS.

RADIO RESEARCH INSTRUMENT CO.
550 Fifth Ave., New York Judson 6-4691

RADAR SYSTEMS & COMPONENTS/ IMMEDIATE DELIVERY

CIRCLE 950 ON READER SERVICE CARD

LOOKING FOR USED/SURPLUS ELECTRONIC EQUIPMENT/COMPONENTS?

For an up-to-date listing of such equipment see Searchlight Section of July 12th issue.

BREAKING THE TIME BARRIER

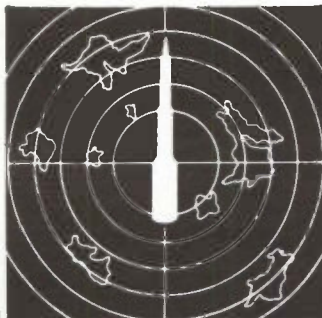

Although Rome wasn't built in a day, much less 137 days, the General Dynamics/Electronics SC-760 was. In fact, this highly versatile two-way doppler tracking system was "idea-ed" and delivered within this astonishingly short span of time.

A four and a half month wonder when you consider that our engineers and scientists produced it from scratch and that it is now gathering highly accurate rate information—in digital data form—on cooperative missiles launched from the Pacific Missile Range. Its exceptionally reliable, solid-state phase-lock receiver is highly sensitive—operating at signal levels as low as -151 dbm.

This tracking colossus is just one example of the work being done at General Dynamics/Electronics. Whatever the phase of electronic and communication systems or however complex, our engineers and scientists are busily pushing aside many grey areas in pattern recognition studies, speech analysis, bandwidth compression, single sideband communications, underwater detection systems and in digital communications. Above all, they are creating technology on the move. And...their careers move, too.

Right now an interdisciplinary team is designing and building the equipment to test the most sophisticated electronic equipment for the most advanced tactical aircraft under development today. Each man on the team is becoming thoroughly familiar with a wide sampling

of commercial hardware designed by leaders in their respective fields.

There are openings on this team for graduate EE's with design experience in space communications, RF circuitry, tracking equipment, advanced pulse circuitry, mobile communication sets, doppler systems, navigation aids, reconnaissance/countermeasures, USW/ASW equipment, aerospace ground equipment, IFF equipment and telemetry receivers and transducers.

Additional positions are available in the Space Electronics & Navigation Laboratory where the SC-760 was created. In-house contracts can provide assignments for RF circuit design engineers on TACAN navigation systems (both airborne and ground equipment), advanced telemetry and tracking receiver design, and Doppler and monopulse tracking systems.

While the nature of the work is a star attraction at General Dynamics/Electronics, the Company location provides another source of satisfaction. Rochester, New York has the largest percentage of professional people in the nation for a city in the 500,000 population class...is noted for its cultural and educational advantages, and its proximity to the recreational and vacation areas on Lake Ontario, the Finger Lakes and the Adirondack Mountains.

If you would like to join this professional community within a professional community, send a resume to R. W. Holmes, registered engineer, Dept. 22.

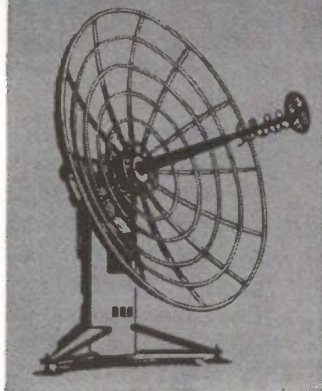

GENERAL DYNAMICS | ELECTRONICS

An Equal Opportunity Employer

1400 N. GOODMAN ST., ROCHESTER 1, N. Y.

INDEX TO ADVERTISERS

Admiral Corp.	84	IBM Corp.	35	● Utica Drop Forge & Herbrand Tool Division, Kelsey-Hayes Co.	66
Alcoa, Rome Cable Div.	72	International Radio & Television Show	77	Yokogawa Electric Works, Inc.	84
Ampex Corp.	13	Janco Corp.	67	Zivy	81
● Avnet Electronics Corp.	78, 79	Jerrold Electronics Corp.	4		
Bausch & Lomb, Inc.	64	● Lambda Electronics Corp.	5		
Bean & Co., Morris.	70	Leach Corporation	15		
Bell Telephone Laboratories.	57	● LEL, Inc.	67, 77		
Bendix Corporation		Machlett Laboratories, The.	23		
Bendix Pacific Division.	14	Mallory and Co., Inc., P. R.	30, 31		
Binswanger Corp.	67	Metronix, Inc.	56		
Brush Instruments		Mico Instrument Co.	78		
Div. of Clevite Corp.	3rd cover	Minnesota Mining & Mfg. Co.			
● Bulova Electronics Div.	32	Mincorn Division	26		
Colorado Research Co.	55	Mitsubishi Electric Corp.	71		
Consolidated Electrodynamics Corp.	62, 63	Motorola Semiconductor Products Inc.	27		
Corning Electronics		Nexus Research Laboratory, Inc. ..	24		
Div. of Corning Glass Works.	36	● Nippon Electric Co., Ltd.	59		
Coto-Coil Co., Inc.	79	● North Atlantic Industries, Inc.	58		
● Defense Electronics, Inc.	34	● Origin Electric Co., Ltd.	80		
du Pont de Nemours & Co., Inc., E. I.	29	Permag Corp.	78		
● Dymec, A Division of Hewlett Packard Co.	69	Potter Instrument Co., Inc.	19		
Eastman Kodak Co.	16	Precision Instrument Co.	83		
Fluke Mfg. Co., Inc., John.	20, 21	Radio Corporation of America. 4th cover			
Flying Tiger Line.	25	Rapidesign, Inc.	81		
Gamewell Co., The	60	Spectra Strip Wire & Cable Corp. ..	74		
General Electric Co.		Sperry Farragut Co.			
Silicone Products Dept.	65	Div. of Sperry Rand Corp.	75		
● General Products Corp.	17	Sprague Electric Co.	9		
General Radio Co.	2nd cover	Telrex Laboratories	78		
● Hewlett-Packard Company. .6, 10, 11		Texas Instruments Incorporated			
Honeywell		Industrial Products Group	33		
Denver Division	53				

CLASSIFIED ADVERTISING

F. J. Eberle, Business Mgr. (2557)

EMPLOYMENT OPPORTUNITIES ..84, 86, 87

EQUIPMENT

(Used or Surplus New)

For Sale

86

CLASSIFIED ADVERTISERS INDEX

Bell Aerosystems Co. a Div. of
Bell Aerospace Corp. A Textron
Co. 86
General Dynamic/Electronics 87
Industrial Devices Inc. 86
● Radio Research Instrument Co. 86

● See advertisement in the July 25, 1963 issue of Electronics Buyers' Guide for complete line of products or services.

This Index and our Reader Service Numbers are published as a service. Every precaution is taken to make them accurate, but electronics assumes no responsibilities for errors or omissions.

electronics



Audit Bureau
of Circulation



Associated Business
Publications

Audited Paid Circulation

JAMES T. HAUPTLI (2210)

Advertising Sales Manager

DAVID CUNNIFF (3139)

Promotion Manager

HENRY M. SHAW (3485)

Market Research Manager

Electronics Buyers' Guide

R. S. QUINT (2335)

General Manager

RICHARD J. TOMLINSON (3191)

Business Manager

THEODORE R. GEIPEL (2044)

Production Manager

NEW YORK TELEPHONE: Dial Direct:
971 plus number in parenthesis, Area Code 212

ADVERTISING REPRESENTATIVES

ATLANTA, GA. 30009

Michael H. Miller, Robert C. Johnson
1375 Peachtree St. N.E., Trinity 5-0523
(area code 404)

BOSTON, MASS. 02116

William S. Hodgkinson
McGraw-Hill Building, Copley Square,
Congress 2-1160 (area code 617)

CHICAGO, ILL. 60611

Harvey W. Wernecke, Robert M. Denmead
645 North Michigan Avenue, Mohawk 4-5800
(area code 312)

CLEVELAND, OHIO 44113

Paul T. Fegley
55 Public Square, Superior 1-7000
(area code 216)

DALLAS, TEXAS 75201

Frank Le Beau
The Vaughn Bldg., 1712 Commerce St.
Riverside 7-9721 (area code 214)

DENVER, COLO. 80202

John W. Patten
Tower Bldg., 1700 Broadway,
Alpine 5-2981 (area code 303)

HOUSTON, TEXAS 77025

Kenneth George
Prudential Bldg., Halcombe Blvd.,
Riverside 8-1280 (area code 713)

LOS ANGELES, CALIF. 90017

Ashley P. Hartman, John G. Zisch,
William C. Gries
1125 W. 6th St., Huntley 2-5450
(area code 213)

NEW YORK, N. Y. 10036

Donald H. Miller (212) 971 3615
George F. Werner (212) 971 3617
Donald R. Furth (212) 971 3616
500 Fifth Avenue

PHILADELPHIA, PA. 19103

Warren H. Gardner, William J. Boyle
6 Penn Center Plaza, LOcust 8-4330
(area code 215)

SAN FRANCISCO, CALIF. 94111

Richard C. Alcorn
255 California Street, Douglas 2-4600
(area code 415)

LONDON W1:

Edwin S. Murphy Jr.
34 Dover St.

FRANKFURT/Main:

Matthae Herfurth
85 Westendstrasse

GENEVA:

Michael R. Zeynel
2 Place du Port

TOKYO:

George Olcott,
1, Kotohiracho, Shiba, Minato-ku



COPYRIGHT 1961

BRUSH INSTRUMENTS

DIVISION OF CLEVITE CORPORATION

CLEVELAND OHIO

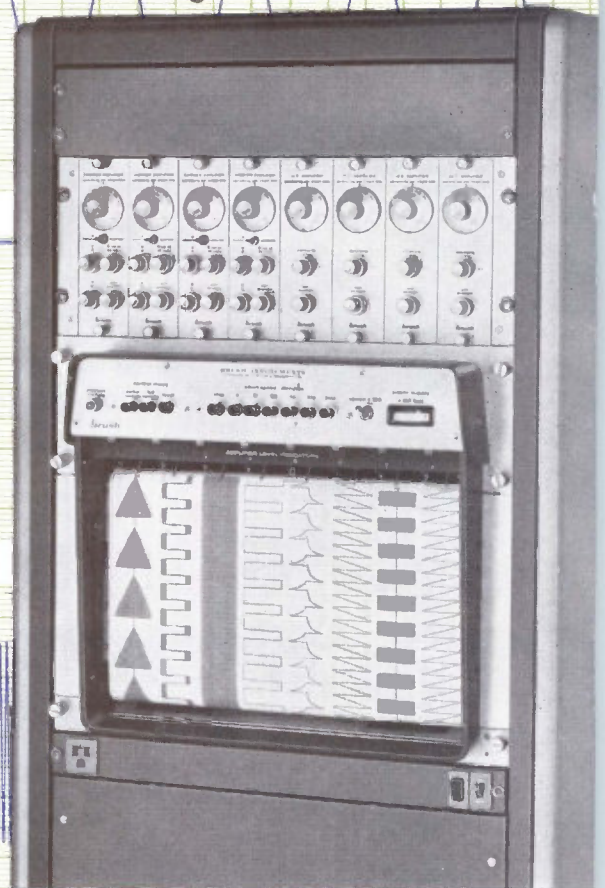
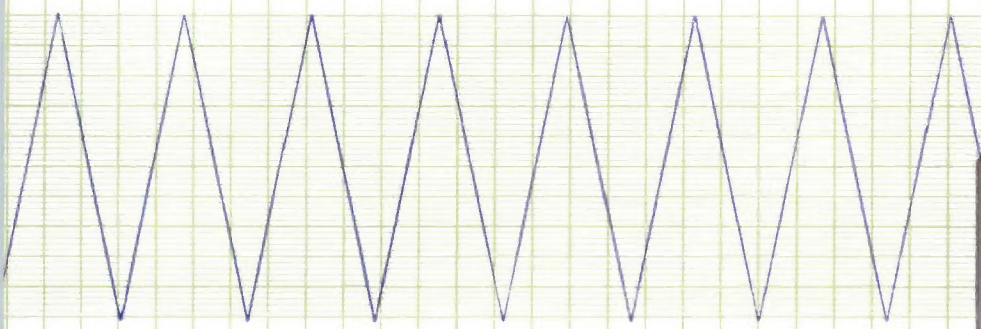
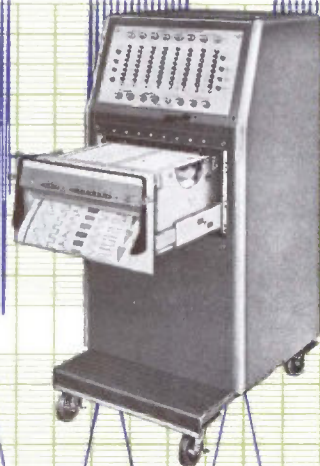
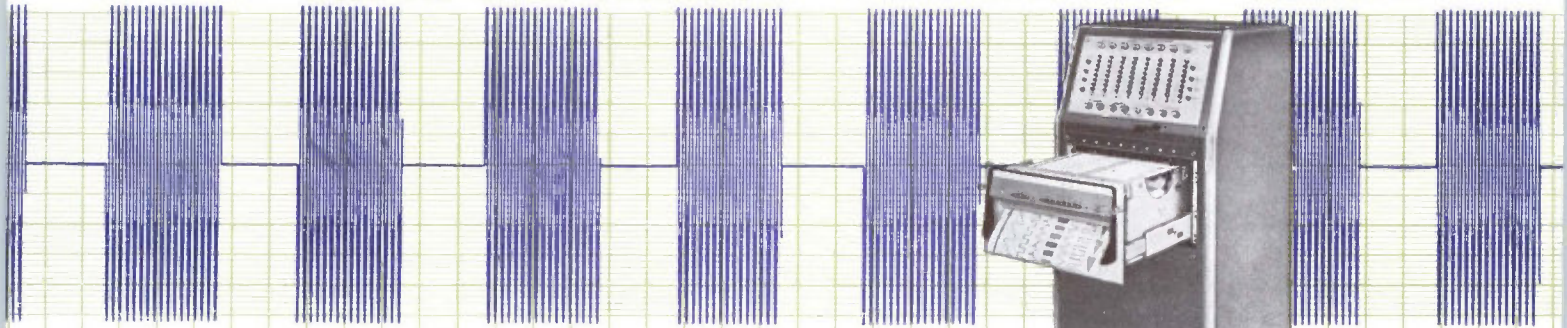

**precision and
clarity never
before achieved...**

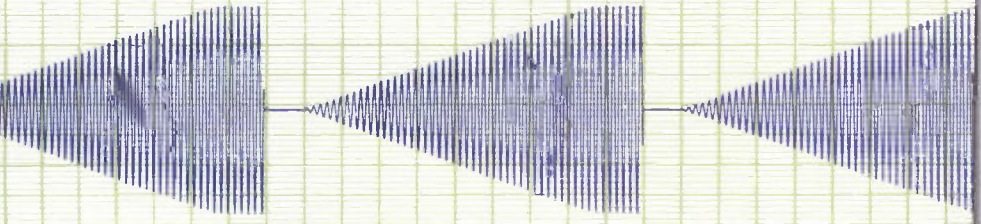

The new Brush Recorder Mark 200 made these incredibly crisp tracings. No other recorder in existence can match them. Note the line width. It never varies . . . regardless of writing velocity, regardless of chart speed. The writing mechanism is electrically signaled by the position-seeking "Metrisite" transducer . . . no parts to wear, infinite resolution, verifiable dynamic $\frac{1}{2}\%$ accuracy. Traces are permanent, high-contrast, reproducible . . . on low cost chart paper. The Mark 200 has but three standard controls . . . attenuator, pen position, chart speed. Such fidelity, simplicity and economy are possible with no other direct writing recorder. Available in both vertical and horizontal models with interchangeable plug-in preamplifiers or signal conditioning push-button controls. Write for details . . . they'll speak for themselves.

brush INSTRUMENTS
DIVISION OF CLEVITE 37TH AND PERKINS, CLEVELAND 14, OHIO

CIRCLE 901 ON READER SERVICE CARD

Why Wurlitzer chose
the RCA-7868 NOVAR Power Pentode
 for its Electronic Pianos



**“High Power Sensitivity, High Power Output Capabilities
 and Low Cost”...**

THE WURLITZER COMPANY

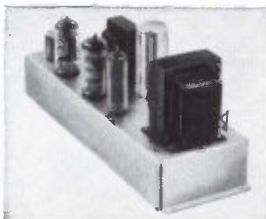

This is the power amplifier stage of the new Wurlitzer Console Electronic Piano, *first mass-produced instrument of its kind on the market.* The two power pentodes are RCA-7868 novar types. Why did Wurlitzer engineers choose novar tubes?

Because:

- “The RCA-7868 offers high power sensitivity, high power output capabilities and low cost.”
- “Comparative tests were run on other tubes with equal results from the standpoint of distortion at power outputs of 20 and 30 watts, but the novar tube provided the desired performance at reduced cost.”
- “In addition to supplying the required power at lower cost than other types, the novar 7868 also permitted us to ship the instruments with the tubes in their sockets without special mounting clamps or packing materials.”
- “The compactness of the tube permitted us to install it in amplifiers where vertical clearance is limited.”
- “Novar construction permits more efficient heat conduc-

tion through the base pins to the sockets and the chassis, thus transferring heat from the tube bulb to a greater cooling area.”

The RCA-7868 supplies 25 and 35 watts of audio power in Wurlitzer Model 4100 and 4430 electronic organs respectively, and 15 watts of audio power in the Wurlitzer console electronic piano.

The unique design features that made these novar types a wise choice for Wurlitzer may also be the answer to *your* circuit design problem. For more information on novar tube types, see your RCA Field Representative or write Commercial Engineering, Section H-19-DE-1, RCA Electronic Components and Devices, Harrison, N. J.

RCA Field Offices—EAST: 32-36 Green Street, Newark 2, N. J., (201) 485-3900.
 MIDWEST: Suite 1154, Merchandise Mart Plaza, Chicago 54, Ill., (312) 527-2900 • WEST: 6801 E Washington Blvd., Los Angeles 22, Calif., (213) RAYmond 3-8361 • 1838 El Camino Real, Burlingame, Calif., (415) 697-1620.



THE MOST TRUSTED NAME IN ELECTRONICS