

electronics®

THE BIG CODE CHANGE

*New tape will handle
most data chores, p 22*

NEW LIGHT ON AIR TRAFFIC

*Bright display tube
with alphanumerics, p 42*

TRANSISTOR CHECKING

*Reducing incoming
inspection woes, p 47*

LAST WEEK'S SOLAR ECLIPSE was a unique chance to study the ionosphere. Scientists made the most of it. p 37



SPECIFICATIONS

Source Impedance:	50 ohms on 50 v range and below
Pulse Shape:	RISE AND FALL TIME—Less than 13 nsec on 50 v range and below; typically less than 10 nsec for maximum vernier attenuation; typically 15 nsec on 100 v range PULSE AMPLITUDE—100 v into 50 ohms; calibrated attenuator to 0.2 v plus vernier POLARITY—Positive or negative LEADING AND TRAILING EDGE OVERSHOOT—Less than 5% PULSE TOP VARIATIONS—Less than 4% PULSE DROOP—Less than 5% PRESHOOT—Less than 2%
Rep Rate Trigger and Timing:	PULSE WIDTH—0.05 μ sec to 10 msec, continuously adjustable INTERNAL—Repetition Rate: 10 cps to 1 mc, continuously adjustable; pushbutton for single pulse EXTERNAL—Repetition Rate: dc to 1 mc, controls allow selection of level and slope; sensitivity: greater than 1 v TRIGGER OUTPUT PULSE—Continuously adjustable 0 to 10 msec in advance or delay of output pulse; amplitude, 10 v into 1000 ohms; jitter less than 0.05%
Power:	115 or 230 v \pm 10%, 50 to 60 cps, 325 watts
Dimensions:	16 $\frac{3}{4}$ " wide, 7 $\frac{1}{4}$ " high, 18 $\frac{3}{8}$ " deep; hardware furnished for quick conversion to 7" x 19" rack mount, 16 $\frac{3}{8}$ " deep behind panel
Weight:	Net 35 lbs.
Price:	\$875

Data subject to change without notice. Price f.o.b. factory.

PULSE POWER (100 v, 2 a into 50 ohms)

- 50-ohm source impedance
- Less than 15 nsec rise and fall times
- Positive and negative pulses, dc coupled
- Double pulse feature
- Pulse burst capability

This new Hewlett-Packard pulse generator delivers positive or negative 100 volt 2 amp pulses into 50 ohms with rise times of 10 to 15 nanoseconds. What's more, it offers controlled pulse shape, external trigger slope and level selection and a 50-ohm source impedance for elimination of errors arising from reflections.

The high power output of the 214A is four times the power available from previous pulse generators. At output levels below 50 volts, the 214A has a matched source impedance of 50 ohms, eliminating error-producing reflections. Reflections from the circuit under test are absorbed in the 50-ohm source impedance, and the output pulse is always clean, even though the impedance of the circuit under test may be complex. At reduced output levels the duty cycle may be as high as 50%, ideal for square wave testing.

Pulse repetition rate is continuously adjustable to 1 mc, and pulse charac-

teristics are carefully controlled. Pulse rate, width and delay jitter are kept to a minimum to assure accurate, dependable test results.

The 214A offers an extremely wide range of trigger syncing for triggering on external signals. It will trigger on external signals as small as 1 volt peak, either polarity, and slope and level may be selected so that triggering occurs at a given point on the trigger waveform. The instrument also provides a trigger output for use in synchronizing external equipment.

The pulse generator may be gated on, to provide bursts of pulses, and a double pulse feature is provided for pulse resolution tests of amplifiers and memory cores.

Ask your Hewlett-Packard representative for a demonstration on your bench.

8437

**HEWLETT
PACKARD
COMPANY**



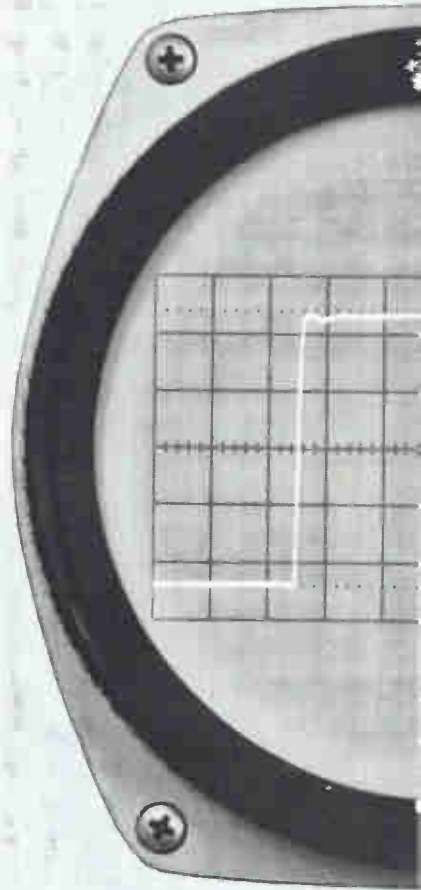

1501 Page Mill Rd., Palo Alto, Calif., (415) 326-7000. Sales and service representatives in principal areas. Europe, Hewlett-Packard S.A., 54 Route des Acacias, Geneva, Switzerland; Canada, Hewlett-Packard (Canada) Ltd., 8270 Mayrand Street, Montreal, Quebec.

POWER PACKED PULSES 200 WATT

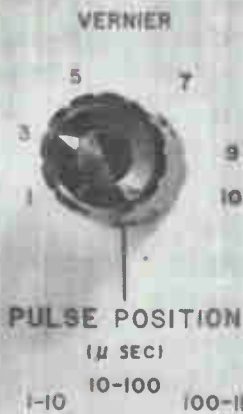

PULSE POWER from the new *hp* 214A!



PULSE GENERATOR
HEWLETT  PACKARD
MODEL 214 A

hp 214A
PULSE
GENERATOR
DELIVERS
200 WATTS

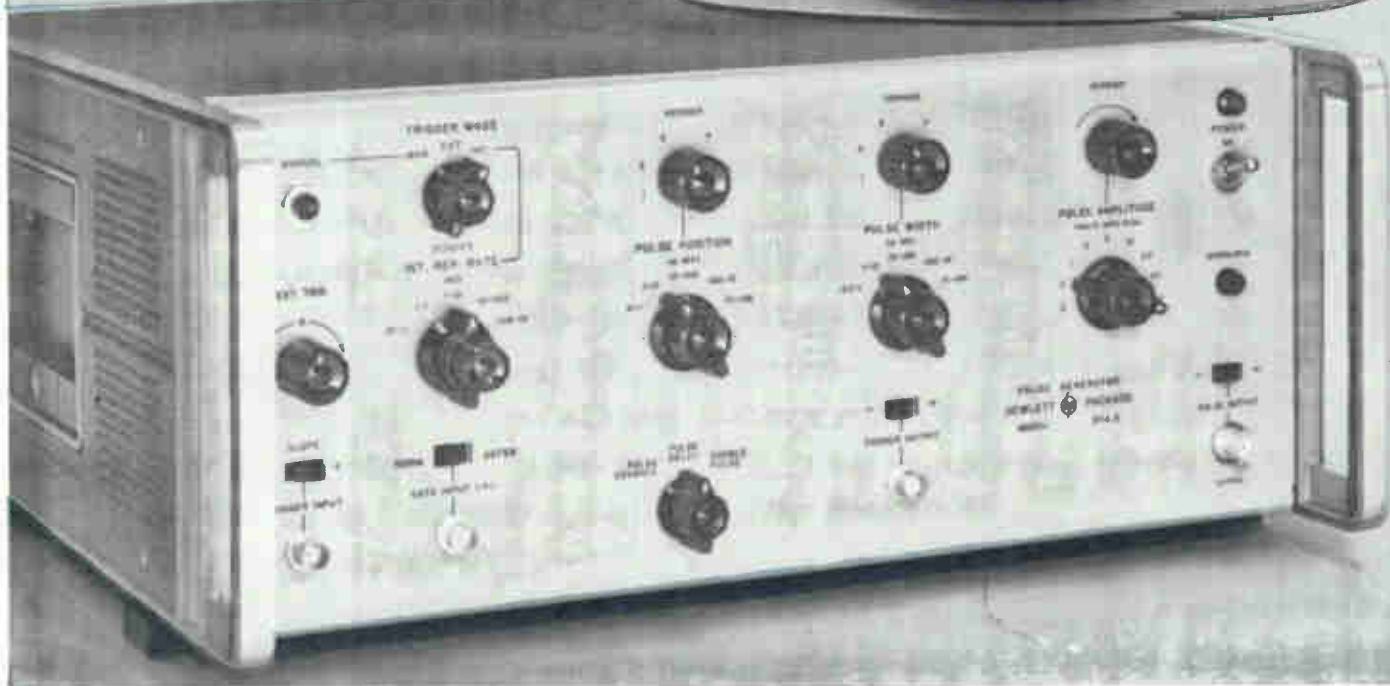
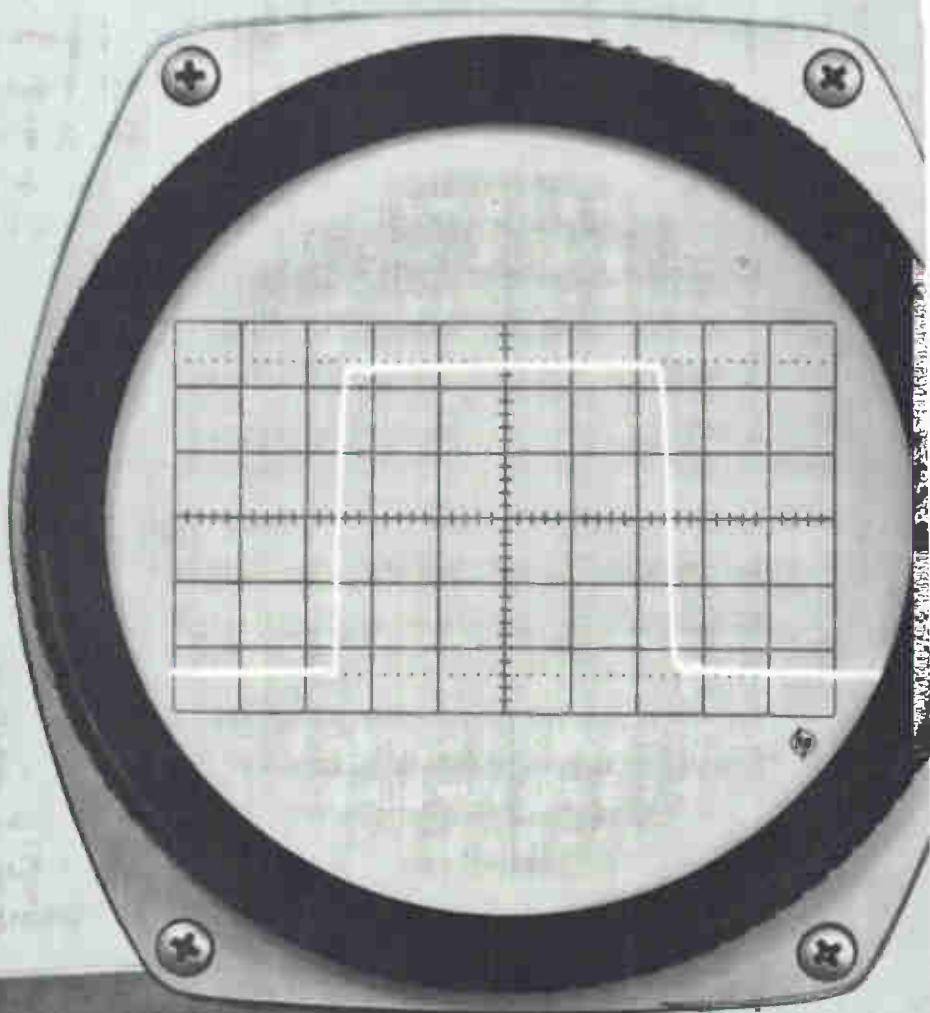

W. W. MacDONALD, Editor (2645)

electronics

A McGraw-Hill Weekly 75 Cents

J. M. CARROLL, Managing Editor (2293)

SENIOR EDITORSSamuel Weber (2371)
George W. Sideris (3444)**SENIOR ASSOCIATE EDITORS**Michael F. Wolff (2600)
John F. Mason (2666)**ASSOCIATE EDITORS**Michael F. Tompino (2071)
William P. O'Brien (2297)
Sy Vogel (2467)
George J. Flynn (2188)
George V. Novotny (3151)
Leon H. Dulberger (3446)
Alexander A. McKenzie (2685)**ASSISTANT EDITORS**Stanley Froud (2710)
Stephen B. Gray (2245)
Roy J. Bruun (3495)
Barry A. Briskman (2306)
Dan Smith (2472)
Joel A. Strasser (2127)**REGIONAL EDITORS**Harold C. Hood
(Pacific Coast, Los Angeles)
Laurence D. Shergalis
(Pacific Coast, San Francisco)
Thomas Maguire
(New England, Boston)
Cletus M. Wiley
(Midwest, Chicago)**ART DIRECTOR**

Howard R. Berry (2430)

ASSISTANT ART DIRECTOR

John C. Wright, Jr. (3430)

EDITORIAL ASSISTANTSLorraine Rossi, Virginia T. Bastian,
Lynn Emyer, Ann Mello, Lorraine
Werner, Alice M. O'Brien, Sharon
Parks, Patricia Mitchell, Claire
Benell, Kay Fontana**FOREIGN NEWS BUREAU**DIRECTOR, John Wilhelm;
Laurence Mihlon, Alyne Elias
LONDON—John Shinn, Derek
Barlow, Nicholas London
BONN—Bruce Bendow,
Richard Mikton, Silke McQueen
BRUSSELS—Peter Forboth
PARIS—Robert Farrell,
Arthur Erikson
MILAN—Marc A. Messina
MEXICO CITY—Wesley Perry, Jr
RIO DE JANEIRO—Leslie Warren
MOSCOW—Stewart Ramsey
TOKYO—Richard Halloran,
Charles Cohen, John Yamaguchi**CIRCULATION MANAGER**

Hugh J. Quinn (2310)

W. W. GAREY, Publisher (2016)

NEW YORK TELEPHONE:Dial Direct: 971 plus extensions
shown above in parenthesis. Area
Code 212

SOLAR ECLIPSE last week drew a 70-second band of darkness in varying degrees across most of North America. It was the most photographed and electronically-probed eclipse in history. The cover is an earlier eclipse photographed by the Navy in Khartoum in 1953. *See p 37 for the complete story on how electronics helped study the latest eclipse and what the findings may mean to communicators*

COVER

NEED WEATHER DATA? You can buy a satellite ground station for less than \$50,000, receive cloud pictures from U.S. weather satellites. *The U.S. is installing 42 to receive Tiros pictures*

20

NEW CODE STANDARD. Information interchange code for punched tape is already in use here, international adoption may be next. *The code will simplify future digital communications*

22

THIN FILMS Solution Sprayed. Developers say aqueous spray process is adaptable to mass production of a wide range of large-area devices. *Vacuum equipment is not needed*

24

SPACE BOOSTER Passes Major Test. Strap-on booster for Titan III worked so well last Saturday that Air Force may speed up program. *Vehicle will be workhorse for manned and unmanned missions*

26

RUSSIAN METROLOGY Matches American. U. S. experts rate USSR measurement techniques on a par with the U.S. *This indicates Soviet state of the art is in step in other fields, too*

27

DO-IT-YOURSELF COMPUTER for Life Sciences. Biomedical researchers will build their own at new computer technology center. *The model selected is a new, versatile, lab computer*

28

SKIP RADIO Replaces Alaskan Cable. Telephone company installs two-hop troposcatter system. *Reasons: more commercial business, need for reliable military circuits*

30

RACING THE SOLAR ECLIPSE. Last week's total eclipse of the sun gave scientists 70 seconds to observe recombination of electrons in the ionosphere and study regions above the F layer. Never has an eclipse been so exhaustively studied. Scientists used rockets, satellites, tv cameras, ionosphere sounding transmitters and transmitters bouncing signals off the moon. *Others chased the moon's shadow in jet planes.*

By T. Maguire, J. Strasser and H. Brown 37

LATEST WRINKLE IN THE SCHMITT TRIGGER. The conventional Schmitt isn't very good for driving low-impedance loads such as coaxial cables. Usually an emitter follower is added but this d-c trigger circuit incorporates the emitter follower into the original Schmitt circuit. *Advantages are lower output impedance and fewer basic components. The output transistor conducts continuously.* By G. Klein, Standard Instrument Corp.

40

Contents Continued

Published weekly, with Electronics Buyers' Guide as part of the subscription, by McGraw-Hill Publishing Company, Inc. Founder: James H. McGraw (1860-1948).

Title © registered U.S. Patent Office; © copyright 1963 by McGraw-Hill Publishing Co., Inc. All rights reserved, including the right to reproduce the contents of this publication, in whole or in part.

Executive, editorial, circulation and advertising offices: McGraw-Hill Building, 330 West 42nd Street, New York, N. Y., 10036. Telephone Area Code 212 971-3333. Teletype TWX N. Y. 212-640-4646. Cable McGrawhill, N. Y. PRINTED IN ALBANY, N. Y.; second class postage paid at Albany, N. Y.

OFFICERS OF THE PUBLICATIONS DIVISION: Shelton Fisher, President; Vice Presidents: Joseph H. Allen, Operations; John R. Callahan, Editorial; Ervin E. DeGraff, Circulation; Donald C. McGraw, Jr., Advertising Sales; Angelo R. Venezian, Marketing.

OFFICERS OF THE CORPORATION: Donald C. McGraw, President; Hugh J. Kelly, Harry L. Waddell, L. Keith Goodrich, Executive Vice Presidents; John L. McGraw, Treasurer; John J. Cooke, Vice President and Secretary.

Subscriptions are solicited only from those actively engaged in the field of the publication. Position and company connection must be indicated on orders. Subscription rates: United States and Possessions and Canada, \$6.00 one year, \$9.00 two years, \$12.00 three years. All other countries \$20.00 one year. Single copies, United States and Possessions and Canada 75¢. Single copies all other countries \$1.50.

THE PUBLISHER, UPON WRITTEN REQUEST TO OUR NEW YORK OFFICE FROM ANY SUBSCRIBER AGREES TO REFUND THAT PART OF THE SUBSCRIPTION PRICE APPLYING TO COPIES NOT YET MAILED.

Subscribers: Please send change of address notices, subscription orders or complaints to Fulfillment Manager, Electronics, at the address below. Change of address notices should provide old as well as new address, including postal zone number if any. If possible, attach address label from recent issue. Allow one month for change to become effective.

Postmaster: Please send Form 3579 to Fulfillment Manager, Electronics, P. O. Box 430, Hightstown, New Jersey, 08520.



Audited Paid Circulation

CONTENTS continued

- NEW LIGHT ON AIR TRAFFIC:** Bright Plan Display With Alphanumerics. Aircraft location and identity should be available for viewing by controllers at any instant—not once per antenna scan or when shrimp boats are moved to update the display. This plan-position data display system accomplishes these objectives. *It is a time-shared, direct-view storage-tube system and works with a track-while-scan processing unit.*
By T. Vagt, General Precision, Inc. 42
- MEASURING TRANSISTOR BETA:** A Fresh Approach. Transistor beta, more properly called h_{FE} , is usually guaranteed as being between some maximum and minimum for a given combination of collector and emitter voltage. This point may be far from the desired operating point. *This article describes several ways to measure beta that may be useful in incoming inspection.* By R. M. Mann, Texas Instruments Incorporated 47
- USING A NEW COMPONENT:** The NRE as a Free-Running Multi. When the negative-resistance element (NRE), a composite device, is used as an astable multivibrator, its entire d-c characteristic is utilized. *The circuit uses an inductor for energy storage.* By C. D. Todd, Hughes Aircraft 50

DEPARTMENTS

- Crosstalk. *The Space Race* 3
- Comment. *Gauss or Gausses? Batteries* 4
- Electronics Newsletter. *West Ford Dipole Belt Performing as Planned* 7
- Washington This Week. *Next Defense Budget About \$51 Billion. Air Force Puts Screws on Test Gear* 12
- Meetings Ahead. *International Conference on Electromagnetic Relays. Fifth Joint Automatic Control Conference* 32
- Research and Development. *Thermoplastic Video Tape Ready Soon* 54
- Components and Materials. *Foils Get Thinner, More Versatile* 60
- Production Techniques. *Epoxy Pellets Improve Diode Production* 64
- New Products. *Picoammeter Has 30 Millisecond Rise Time* 69
- Literature of the Week 72
- People and Plants. *GE Realigns Computer Department* 74
- Index to Advertisers 80

THE SPACE RACE

WE HAD HOPED that as the manned spaceflight program gathered momentum more people would become accustomed to the idea and criticism would subside. Unfortunately this has not happened.

To a small but hard core of professional scientists who have criticized the program from its inception have been added various statesmen, congressmen and newspaper columnists. Recently, British author-scientist C. P. Snow joined the chorus. Snow, who has convinced many people he is an expert on social and scientific problems, criticizes the magnitude of our effort and feels we have overreacted to Soviet space feats. He thinks the program should proceed at a "natural" pace. We wonder what he considers the natural pace of a program that didn't exist three years ago.

Congressional criticism has been largely based on fear that large expenditures for manned spaceflight are creating an imbalance in the nation's scientific and economic efforts. Some legislators object on the grounds that too many scientists will soon be working for the government and that too few will be left for private companies. Some feel that money would be better spent on housing or education.

SO FAR President Kennedy has been firm in his support of Project Apollo. He has pointed out that even if the space program were cut, the

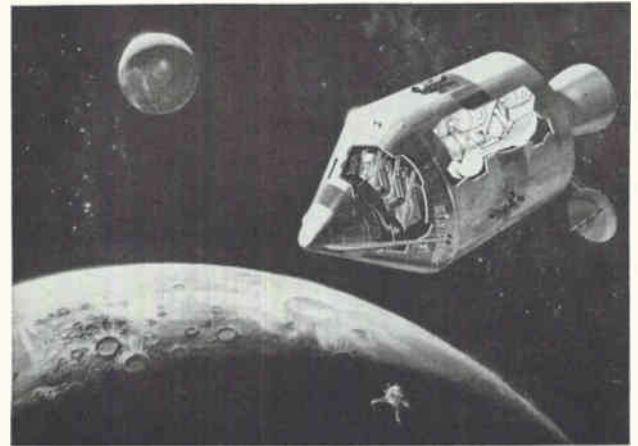

resulting funds would not then necessarily be voted for, say, education. He has consistently implied that man in space is of vital political importance both in terms of the present world power struggle and in terms of future development of our national strength.

The danger is, of course, that increasing opposition will force a change in position. Far too many people lately seem to be echoing Senator Fulbright, who finds it "strange" that the best minds of both the Western and Communist worlds should want to land on the moon "where no solutions to our problems await us." Widespread agreement with this view could be difficult for the administration to resist.

IN OUR OPINION the program is a vital one and the pace is sound. Here are some of the reasons we feel this way:

MILITARY—Probably the most urgent issue in the world today is to halt the expansion of Communism. A maximum space effort is an important defense against such an eventuality. For, regardless of the truth of the matter, people everywhere link the space program to military capability. And if indeed there is a military role in space (which we believe there is), one can be sure the Russians will use it.

ECONOMIC—There are broad economic reasons for supporting a consistent space program. Initiating action on our own or reacting to Soviet

achievements, then cooling off and canceling or slowing down projects, is costly and wasteful. We have a long, expensive record of such lack of consistency in purpose.

SCIENTIFIC—One frontier of exploration is space and we must be there. Possible discoveries include the origin of the solar system and even of life itself. Instruments alone will not insure that some unexpected phenomenon is not being overlooked. Men must go there. This does not mean that other frontiers such as molecular biology, oceanography and geology should be neglected. And they need

not be—last year Americans spent more on cigarettes and horse racing than on space.

IN SUMMARY, we have to spend what we must but see that it is spent wisely and that what we learn along the way is plowed back into the economy in the form of technological advances. There is no doubt that NASA's budget should be carefully scrutinized to eliminate any waste and costly frills. But there can also be no doubt that to cripple the man-in-space effort would be to cripple our national effort for years to come. Possibly forever.

TOUGH



... AS A TURTLE'S BACK

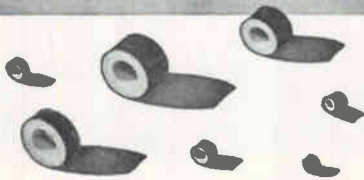

**ARMAG*-PROTECTED
DYNACOR®
BOBBIN CORES**

AT NO EXTRA COST!

Tough-as-tortoise-shell Armag armor is an exclusive Sprague development. It is a thin, non-metallic laminated jacket for bobbin cores that replaces the defects of nylon materials and polyester tape with very definite advantages—and, you pay no premium for Armag extra protection.

Tough Armag is suitable for use with normal encapsulation techniques on both ceramic and stainless steel bobbins. It withstands 180°C without deterioration—is completely compatible with poured potted compounds—has no abrasive effect on copper wire during winding—fabricates easily to close-tolerance dimensions—inner layer is compressible to assure tight fit on bobbin—does not shrink, age or discolor.

For complete data covering the wide range of Dynacor standard and custom Bobbin Cores, write for Engineering Bulletins to Technical Literature Service, Sprague Electric Company, 35 Marshall Street, North Adams, Mass.

TRADEMARK

SPRAGUE®

THE MARK OF RELIABILITY

4S-512-R1

COMMENT

Gauss or Gaussses?

Ten thousand cross cast their shadows across the field at Vimy Ridge, more than 50,000 dress per month are manufactured along Seventh Avenue, and now, by the June 7 *ELECTRONICS Newsletter* headline (p 7), a "Superconductor Hits 101,000 Gauss."

Let others fail to use the plural spelling (99 percent of authors do) but please, not the authoritative dean of American electronics publications.

Why have practically all authors perpetuated this omission of the plural ending? Webster's Second International Dictionary, and logic too, indicate "gausses" to be the plural of "gauss." How about it—will you join us in a quiet, unheralded guiding of our electronics brethren into giving a plural its due?

E. S. SEABURY

Radio Frequency Laboratories, Inc.
Boonton, New Jersey

Our working dictionary is the 1960 issue of "Electronics and Nucleonics Dictionary," by Cooke and Markus (McGraw-Hill, of course), who define gauss as: "Gauss (plural gauss) The cgs electromagnetic unit . . ."

Batteries

We read with interest your comments on the need for better power sources for the foot soldier, in the June 7 *Newsletter* (p 7).

However, the statements that follow require further clarification: ". . . cadmium-class batteries aren't efficient enough and it is often two to three seconds before power is available. In a recent radio design, the Army went back to its old standby, the carbon-zinc battery."

We believe that the carbon-zinc battery would not be capable of providing a solution unless an oversize pack was selected for the application indicated. Further, we don't know of any cadmium-type battery that would perform so poorly.

In the area of communications

where voltage requirements are not excessive, the power delay would be reduced to a fraction of a second with the use of rechargeable batteries. Either a silver-cadmium or a nickel-cadmium battery, both of which are noted for low internal resistance, could provide the answer to this power need.

ALBERT HIMY

Yardney Electric Corporation
New York, New York

GaAs Lamp

The article on optoelectronic tape readers, Diode Lamp Makes Tape Readers Faster (p 44, May 17) by Broom and Hilsum, was of considerable interest to us.

However, a serious omission has apparently been made! The relevant properties of the gallium arsenide semiconductor lamp, which presumably makes this improved tape reader possible, are not "summarized in the box" as the author says.

R. COLMAN

Photolume Corporation
New York, New York

The box was inadvertently omitted, but the references to it were not deleted. Here is what was in the box:

The conventional photoelectric tape reader uses a tungsten lamp for a light source. Lamps of this type have relatively low efficiency and short life, and create an optical alignment problem because of filament sag.

Use of gallium arsenide diodes as a source of infrared illumination increases reliability. Moreover, these devices have greatly extended life and cause no alignment problems.

Characteristics of gallium-arsenide lamp: Dimension and shape: pill-shaped, 4 mm diameter, 2 mm deep. Source: 1-mm circle. Voltage: about 1.4 volts at 1 ampere. Rating: 500 ma mean current, 100 amperes in short pulses. Emission: 9,000 Å with a half-width of 200 Å. Efficiency: 1 to 2 percent during pulses over 10 amp, less at lower currents. Modulation speed: up to 100 Mc. Life: Greater than 1,000 hours at 500 ma mean current.



TUNG-SOL COMPACTRON DESIGNED FOR TV PRODUCTION ECONOMY

TUNG-SOL 6BA11 TRIODE-TWIN PENTODE

Here's a new compactron from Tung-Sol, the 6BA11 triode-twin pentode. A major manufacturer has already specified it for a color TV application. The medium- μ triode section serves as a vertical deflection oscillator, while the twin pentode section does double duty in sync-agc circuitry. Packaged in a T-9 bulb, 12-pin, button-base, Tung-Sol's 6BA11 mounts in any position on chassis or circuit board.

In black and white or color TV, this Tung-Sol compactron provides a reliable multi-function advantage. Assembly costs, hardware requirements, cooling and packaging problems will be reduced. Cost per circuit function and set size will shrink. Tung-Sol may have a compactron answer to your design problem. May we talk about it? Tung-Sol Electric Inc., Newark 4, N. J. TWX: 201-621-7977.

OPERATING CHARACTERISTICS

Average Characteristics

	TRIODE	PENTODE				
		Each Section ^A Separately		Both Sections ^C Operating		
Plate Voltage	250	100	100	100	100	Volts
Grid 2 Voltage	---	67.5	67.5	67.5	67.5	Volts
Grid 3 Voltage	0	0	0	-10	0	Volts
Grid 1 Voltage	-11	0	B	B	B	Volts
Plate Current	5.0	---	2.5	0	2.5	MA.
Grid 2 Current	---	---	---	7.0	4.4	MA.
Grid 1 Transconductance	1800	1700	---	---	---	μ MHOS
Amplification Factor	18	---	---	---	---	
Grid 3 Transconductance	---	---	450	---	---	μ MHOS
Grid 1 Voltage (Approx.) For 1b = 100 μ A.	-18	2.3	---	---	---	Volts
Grid 3 Voltage (Approx.) For 1b = 100 μ A.	---	---	-3.2	---	---	Volts

A. Plate and Grid 3 of opposite section grounded.
B. Grid 1 voltage adjusted so that $i_{c1} = 100 \mu$ A DC.
C. Voltages and plate current apply to each section.

MAXIMUM RATINGS

Plate Voltage	
Triode	300 volts
Pentode	300 volts
Plate Dissipation (each plate)	
Triode	1.5 watts
Pentode	1.1 watts

HEATER RATINGS

Average	
Voltage	6.3 volts
Current	600 MA.
Warm-up	11 sec.
Limits	
Voltage	6.3 ± 0.6 volts
Current	600 ± 40 MA.



TUNG-SOL



COPY
CAT

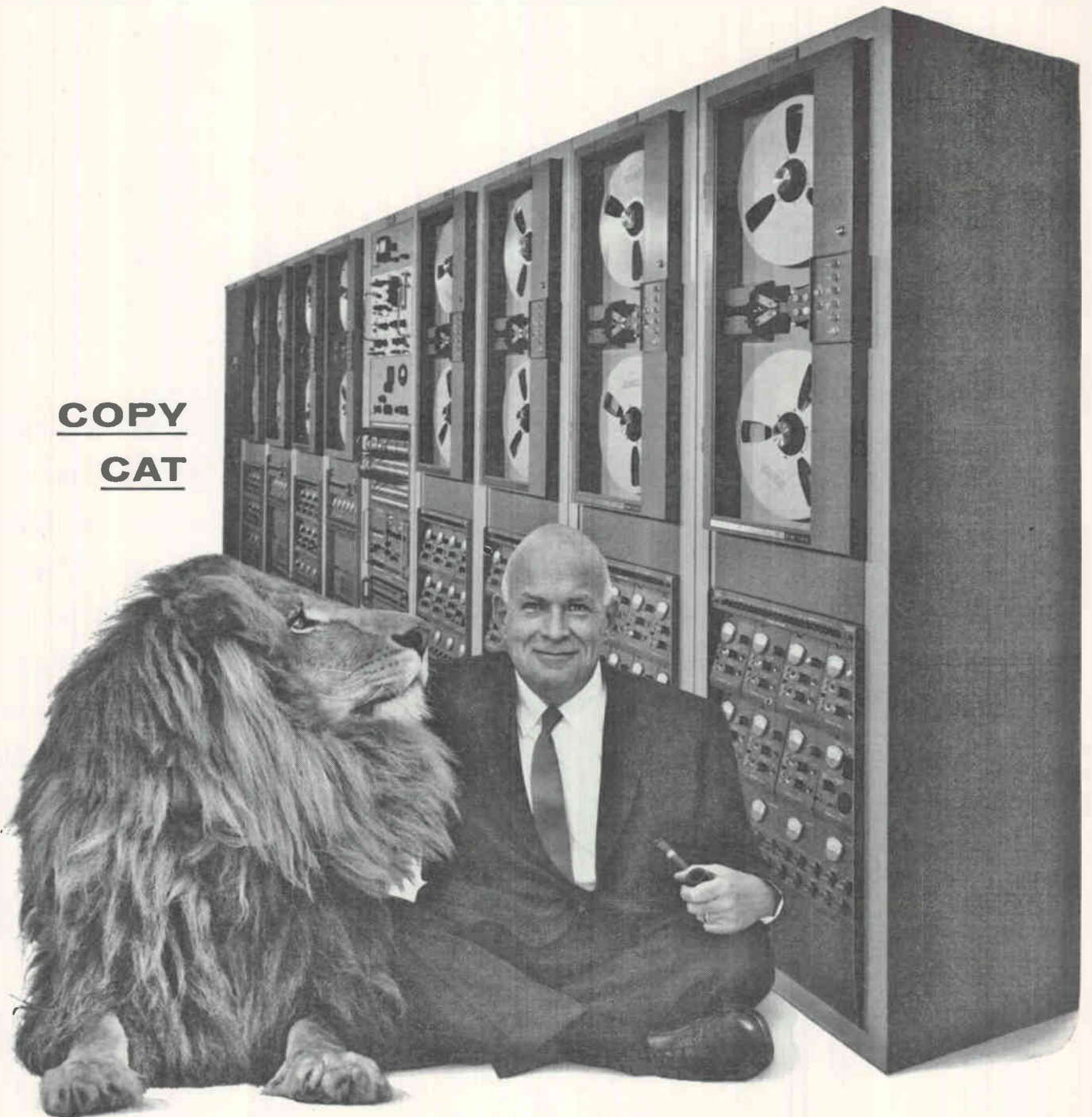

TAPE COPY STATION FOR ATLANTIC MISSILE RANGE

Six 1.5-mc Mincom CM-100 Recorder/Reproducers form the backbone of an extremely complex tape copy station recently delivered to the Atlantic Missile Range, through Defense Electronics, Inc., Rockville, Maryland. Set up at AMR last March, the station makes possible for the first time as many as five first-generation copies of prime data tapes in one operation. In addition to the six CM-100's, it also includes two 600-kc Mincom G-100's, two degaussers, and an advanced monitor alarm system policing forty-two 1.5-mc channels. The station is the result of Mincom's long experience with frequency responses of better than 1 mc—an outstanding reliability record since 1955.

Mincom Division **3M**
COMPANY
2049 South Barrington Avenue, Los Angeles 25
425 13th Street N. W., Washington 4, D. C.

West Ford Dipoles Diffusing as Planned

BOSTON—As the Project West Ford belt of dipoles continued to diffuse this week, the brightness of the tiny wires against the sky diminished as predicted, and the likelihood of naked-eye or photographic observation also diminished. Prof. William Liller, Harvard astronomer and coordinator for optical observations of the belt, said photoelectric sightings are being made regularly by about eight major U. S. observatories.

According to Prof. Liller, the brightness level has followed closely what was predicted by the committee of scientists which studied Project West Ford proposals. "Those optical astronomers who took the time to study the facts," says Liller, "knew that optical observations would not be damaged by 50 pounds of copper wires." He added: "500 pounds would be a different matter."

The U. S. has pledged to the world scientific community that no other belts of dipoles will be launched until all the facts are in and analyzed concerning the experimental belt. Liller expects that the reports on the optical and radio effects will be completed by the end of the summer. After the reports are analyzed, a top-level U. S. decision will be made whether to launch an operational belt or belts.

Hardened Sage Center Nearly Completed

SAGE COMBAT CENTER now being completed in North Bay, Ontario, Canada, will be the only hardened Sage center on the North American continent. The underground site for the Ottawa sector will guard eastern and midwestern Canada against attack by aircraft. The center will also be specially equipped as backup for NORAD (North American Air Defense) headquarters in Colorado.

The Ottawa sector was in the

planning stages when U. S. was debating construction of hardened super-Sages instead of vulnerable, above-ground sites. It was decided to go ahead with above-ground Sage centers and back them up with Buic weapons control centers (p 28, April 20, 1962), but to build the Ottawa center as a special underground, hardened site.

The center is expected to become operational this fall. The question of how hard is hard remains a moot one. There is little agreement on what type of attack the site could withstand. This is clear however: being underground, it is less vulnerable than the 21 other Sage centers.

FAA Awards Contract For Blind-Landing Systems

WASHINGTON—FAA has reportedly awarded the Airborne Instruments

Laboratory Division of Cutler Hammer a \$1-million contract to develop an all-weather instrument landing system. A time-sharing technique is used to provide glide-slope, glide-path, and DME information all on one frequency channel. At present, a separate frequency is used for each type of information. A test version of the system should be ready within two years.

Learning Machine Built for Air Force

A **PATTERN RECOGNITION** system, called Conflex I, has been constructed for the Air Force by Scope, Inc. The system is capable of recognizing previously learned visual patterns, including pictorial displays, letters, numbers, and geometric designs, with a 99.6-percent accuracy. The machine learns in a

Brain Watcher



HELMET worn by scientist (right) at the University of California, Los Angeles, could take electroencephalogram readings from U. S. astronauts during extended space flights, UCLA says. Key element in the headgear is a microminiaturized preamplifier. Data is analyzed by an IBM 7094/1410 in UCLA's new computer center

FALLOUT SERVICE

A computer will tell any New York resident or business owner how safe his home or establishment is from atomic fallout. The New York State Civil Defense Commission is providing the service free. The property owner simply fills out a form, which is sent to the GE Information Processing Center, Schenectady, where it is processed in one minute. Previously, the task required a man to work nearly four hours

random fashion, and its intelligence can be increased by adding memory units. With different sensors, the technique may be extended to recognize speech and other audio patterns.

Conflex I extracts a large quantity of general data from pictorial information. The unknown data are compared to stored reference data. A choice is then made as to which class of stored data correlates highest with the unknown data. The machine can recognize 100 different units of a class.

Rockets a Partial Success During the Total Eclipse

FORT CHURCHILL, CANADA — Six Nike-Apaches were launched here during the total eclipse Saturday but only four confirmed existing D-region ionospheric theories (main story on p 37). Telemetry signals stopped after first-stage burning on the first rocket launched by Geophysics Corp. for NASA-Goddard. On the second rocket, the second stage failed to ignite and separate.

On the Aerobee 150A, sodium radiation data were successfully obtained from the photometer, but the ultraviolet spectrometer did not reach its assigned altitude. The solid-fuel booster burned out after two seconds—a half-second too soon. Fifty miles above the range, telemetry failed after 50 seconds.

Canada's Black Brant II was apparently successful. Project per-

sonnel said the rocket performed well. Early reports indicated that instruments for the five experiments worked properly.

Meanwhile, NASA spokesmen said that the Aerobee 150A fired from Wallops Island provided good data. There was some indication that a pointing device on the Aerobee 300A at White Sands, N. M., may have malfunctioned.

At the Stanford Research Institute in Palo Alto, Calif., an experiment conducted with a 150-foot diameter steerable dish telescope showed a decrease of 25 percent in the number of ionized particles in the ionosphere during the 23 percent partial eclipse in the area.

On board the Project APEQS flight, representatives of all 13 parties involved in the experiment were highly pleased. The flight caught the maximum shadow for the greatest period of observation.

Submarine Testing Radiometric Sextant

A RADIOMETRIC sextant made by Northrop is now being tested aboard a submarine at sea. The device is designed to provide all-weather celestial tracking even when the submarine is submerged. The sextant is accurate to within a few seconds of arc, Northrop says.

The system is enclosed in a plastic radome which is carried in a storage locker capable of withstanding the maximum depth pressures of the submarine. For operation, the locker is flooded and opened so the tracking head can be elevated to a position above the surface of the water.

Second Tv Channel Planned by BBC in 1964

LONDON—Britain's second non-commercial tv program run by the BBC will open in London in April, 1964. This service will be the first to operate on 625 lines. Eight other 625-line stations will open during 1965 with another nine opening in 1966 to provide a 75 percent population coverage. Expansion of the earlier 405-line system is also underway.

In Brief . . .

U.S. AND CANADA announced agreement to make "certain adjustments" in radar equipment that would permit closing 28 Distant Early Warning (DEW) line stations. The announcement said that the 48 remaining stations would "still provide acceptable early warning."

RAYTHEON will produce a multi-channel ssb transmitter for use with synchronous orbit communications satellites at 22,300-mile altitudes.

MARCONI has developed a separate-luminance tv system. One image orthicon tube provides the luminance signals while two others produce the red and green signals. The green component is derived from these three signals.

SATELLITE Communications Conference concluded in London on July 18 after establishing a committee to study organizational, technical and financial aspects of a communications satellite program.

WESTINGHOUSE is using a superconducting magnet with a 70-Gc traveling-wave maser. The magnet provides the high field uniformity necessary for maser operation at high gain, broad bandwidth, high frequency and high sensitivity.

BRITISH Government and 13 major British electronics companies are launching a \$4-million research program for computer design.

BHARAT ELECTRONICS of New Delhi, a government-owned, defense-electronic equipment manufacturer, plans to double output next year. The company is the only such manufacturer in India.

A FULL-COLOR visual simulator developed by Redifon, Ltd., that uses a three-dimensional color model of an airport has been ordered by NASA for use in supersonic transport investigations. The simulator will cost \$280,000.

Only from Sprague!

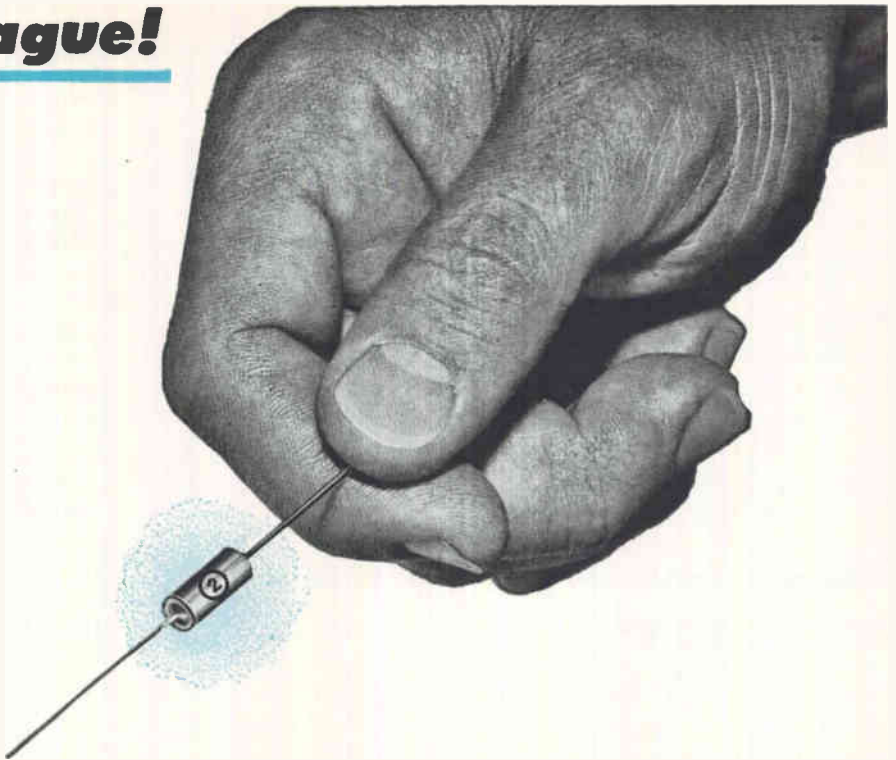

Improved Type 150D Solid-Electrolyte TANTALEX[®] CAPACITORS

with **PERFORMANCE CHARACTERISTICS
NEVER BEFORE POSSIBLE!**

■ **DISSIPATION FACTOR CUT BY ½**—Not more than 3% at 20 VDC and up, permitting even higher a-c ripple currents!

■ **LOWER IMPEDANCE AT HIGH FREQUENCY**—With impedances in fractional ohmic values in the megacycle range, Type 150D admirably meets the stringent requirements of high-speed computers.

■ **LOWER LEAKAGE CURRENTS**—Previous limits have been dramatically reduced; in some instances by as much as a factor of three.

■ **INCREASED CAPACITANCE STABILITY**—Capacitance change with temperature is now less than ½ the previous guaranteed values. Capacitance change with life is almost insignificant.

■ **NEW HIGHER VOLTAGE RATINGS**—50, 60, 75 and 100 volt ratings are now available, with associated surge voltages higher than any presently offered in the industry.

■ **NEW ULTRA-MINIATURE TYPE 172D**—New end-seal design makes possible two tiny sizes (.085" dia. x .250" long, and .127" dia. x .375" long) for "cordwood" packaging to supplement the standard-sized Type 150D ratings in case size "A".

For complete technical data on Type 150D and 172D Tantalex Capacitors, write for Engineering Bulletins 3520E and 3523, respectively, to Technical Literature Service, Sprague Electric Company, 35 Marshall Street, North Adams, Massachusetts.

Popular ratings of Type 150D Capacitors are available for fast delivery from your Sprague Industrial Distributor

SPRAGUE COMPONENTS

CAPACITORS
TRANSISTORS
RESISTORS
MICROCIRCUITS
INTERFERENCE FILTERS

PULSE TRANSFORMERS
PIEZOELECTRIC CERAMICS
PULSE-FORMING NETWORKS
TOROIDAL INDUCTORS
ELECTRIC WAVE FILTERS

CERAMIC-BASE PRINTED NETWORKS
PACKAGED COMPONENT ASSEMBLIES
BOBBIN and TAPE WOUND MAGNETIC CORES
SILICON RECTIFIER GATE CONTROLS
FUNCTIONAL DIGITAL CIRCUITS



Sprague[®] and 'Q' are registered trademarks of the Sprague Electric Co.

A.C. Corona Level Unimpregnated Wound Capacitors "Mylar" Polyester Film

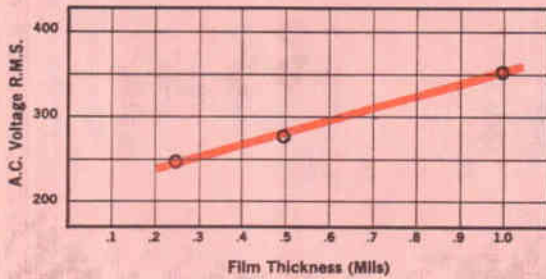

Unimpregnated Single Layer 25 Gauge Capacitors of "Mylar"

D.C. Bias (Volts)	0	100	300
A.C. Volts R.M.S. necessary to produce corona at 25°C	290	290	290
at 125°C	285	285	280

Unimpregnated Single Layer 50 Gauge Capacitors of "Mylar"

D.C. Bias (Volts)	0	200	400
A.C. Volts R.M.S. necessary to produce corona at 25°C	345	350	350
at 125°C	315	320	310

AC CORONA LEVEL

Corona levels for various gauges of "Mylar"* in capacitors were determined in life tests and are shown above. AC corona level is defined as the r.m.s. voltage below which corona does not exist.

AC/DC CORONA LEVEL

Corona is a function of AC voltage only. Table shows full AC voltage must be applied before corona can exist, whatever the DC bias may be.

AC/DC Capacitor study... New tests show compatible in

Now designers can apply the high reliability and low cost of capacitors of "Mylar" to AC and AC/DC circuits. Capacitors with "Mylar"* polyester film as the dielectric are completely compatible in these circuits in home entertainment equipment and similar circuits in other equipment. Data proving compatibility was developed in Du Pont's test at the Film Department Sales-Service Laboratory and at Inland Testing Laboratory.

Briefly, the tests showed that for a capacitor with a dielectric of dry "Mylar" it does not matter whether the voltage is DC, or AC, or combinations

of these voltages. There are only two limitations: (1) the AC voltage or AC component in an AC/DC situation should not exceed the corona level, and (2) the total of the DC voltage plus the r.m.s. AC should not exceed the rated DC working voltage.

Now that it's assured that these capacitors are completely functional in such circuits, designers can utilize the other advantages of "Mylar"—over-all reliability, high IR, small size, moisture resistance, capacitance stability. Remember, too—capacitors of "Mylar" cost about the same as paper.

*Du Pont's registered trademark for its polyester film.

TO APPLY THESE IMPORTANT FINDINGS TO YOUR DESIGN, CLIP AND MAIL THIS COUPON: 

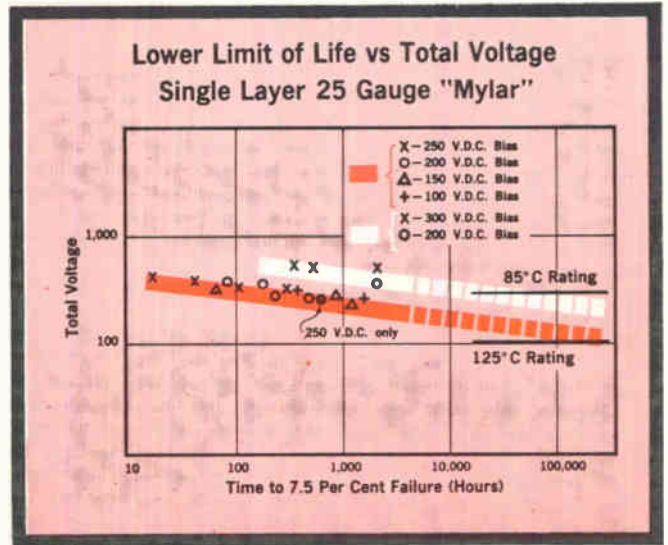
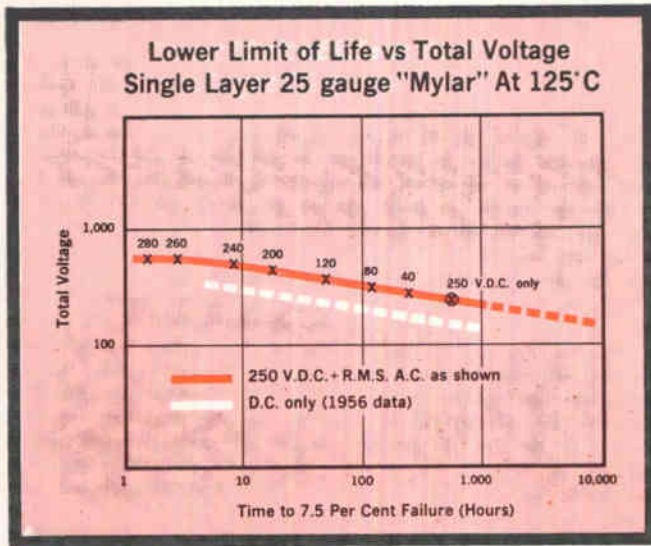

AC/DC LIFE

Below AC corona level, life is a function of total voltage. AC/DC total voltage life performance is identical to DC life performance.

Regardless of AC/DC combinations, the basic voltage-life law is maintained, and the law applies to various operating temperatures as shown.

capacitors of **MYLAR**[®] AC/DC circuits

E. I. DU PONT DE NEMOURS & COMPANY (INC.)

FILM DEPARTMENT

BOX 22B-RM. N10452 WILMINGTON 98, DELAWARE

Rush me your *Pocket Report* on "Mylar" polyester film as a capacitor dielectric for AC and AC/DC voltages.

NAME _____ TITLE _____

FIRM _____ EQUIPMENT _____

ADDRESS _____

CITY _____ STATE _____



REG. U.S. PAT. OFF.

BETTER THINGS FOR BETTER LIVING
... THROUGH CHEMISTRY

only DU PONT makes

MYLAR[®]
POLYESTER FILM

WASHINGTON THIS WEEK

NEXT DEFENSE BUDGET ABOUT \$51 BILLION

AS PREPARATION of next year's defense budget goes into high gear, here's how the outlook for military spending now shapes up:

The Pentagon expects to request about \$51 billion for fiscal 1965—pretty close to this year's appropriation. So the burgeoning trend in the Kennedy administration defense budgets will be reversed for the first time.

The services are coming in with whopping new budget proposals: the Army wants lots more aircraft, the Navy would like to build more carriers and expand its fleet-modernization program, and Air Force is plumping for an accelerated space program. As usual, requests will be severely trimmed back, though the administration has not clamped a formal ceiling on the budget.

ECONOMY DRIVE IS ALREADY ON

LEVELING-OFF in defense spending will be quicker than the administration planned. The House has whacked \$1.9 billion out of the Pentagon's appropriation request—mostly for procurement and R&D.

Traditionally, the Senate restores funds trimmed by the House, but Senate sentiment has changed. For example, in the weapons authorization bill, already passed by both houses, the Senate cut \$200 million out of the \$15.4-billion Pentagon proposal after the House had tacked on some \$700 million. The compromise authorization bill totaled \$15.3 billion, pretty close to the Senate's version.

On the expenditure side—or cash outlays—no matter what Congress does to the new appropriation, outlays will still add up to at least \$51 billion this year, as scheduled. This is \$2.7 billion more than last year. But if the appropriation cuts stick in the Senate, spending will be up only about \$1 billion in fiscal 1965. In military spending, this is virtually a levelling-off.

AIR FORCE PUTS SCREWS ON TEST GEAR

AIR FORCE is clamping new controls on purchases of electronic test equipment (such as oscilloscopes, oscillographs and related components) and special tooling by its contractors and procurement agencies. The Pentagon is concerned that Air Force inventory controls have been inadequate and that it doesn't assure re-use of equipment after a production or development project is completed.

Air Force is surveying 1,465 prime and subcontractor plants to identify and classify special test equipment, tooling and components, to determine what equipment can be used subsequently as general-purpose test apparatus or in other test systems. New procedures being set up will require revalidation of purchase requirements, and will standardize recording and classification.

TEST BAN WILL HAMPER STUDY OF "BLACKOUT"

MANY MILITARY leaders privately object to the administration's push for a nuclear test ban agreement with the Soviet Union. They doubt Soviet intentions and scoff at the administration's belief that a test ban would limit the proliferation of nuclear weapons. A primary reason military men want to resume atmospheric testing is to continue studies of the "blackout" effect of nuclear detonations on radar, communications, and electronic guidance systems. Last year's Pacific tests produced considerable data, but experts argue that there is still lots more to learn about blackout.

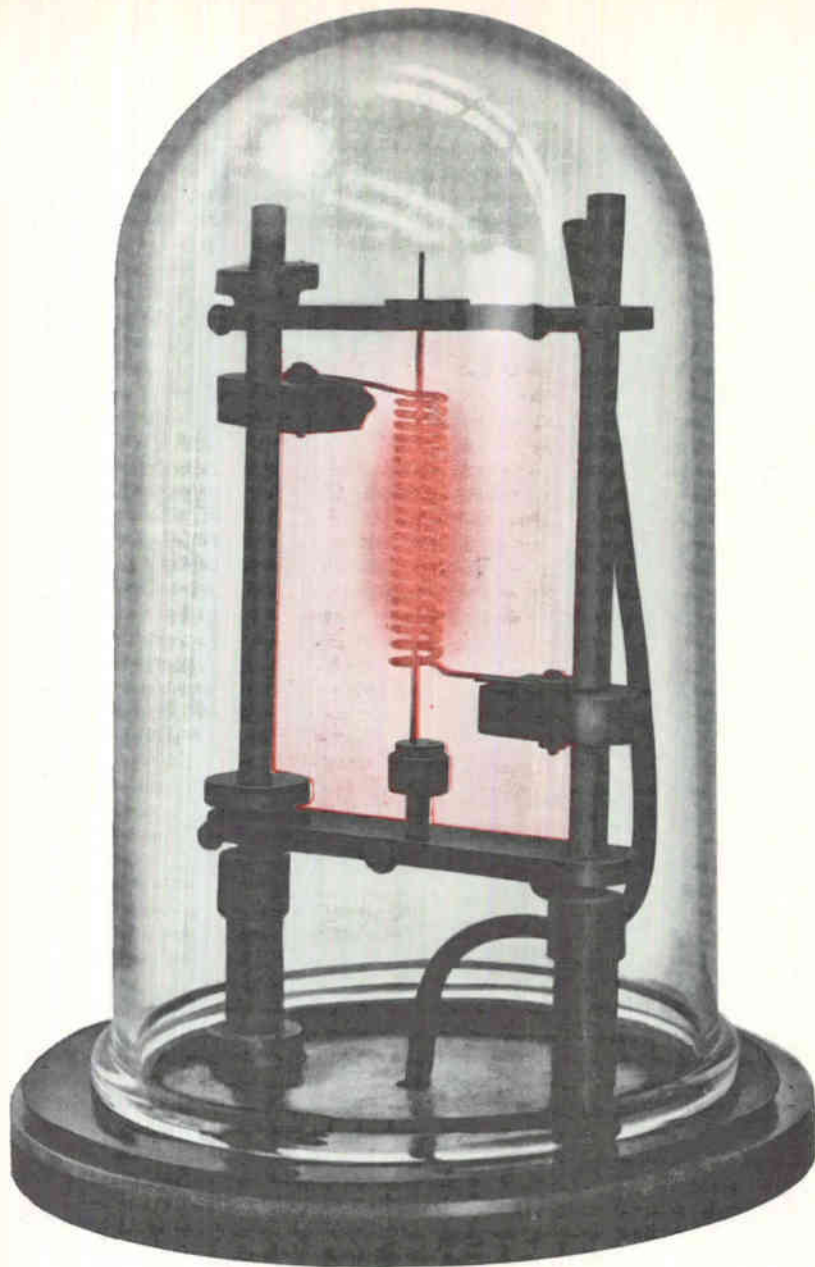

To optimize a TWT . . . use a crystal ball



STC-278, 50 watt pulsed C band TWT, provides superior electrical performance as a driver in radar transmitters, rf amplifiers, and other wide band applications.

"Pyrolytic deposition" is the fancy name for it. In simpler terms, it's Sperry's method of using heat and a controlled atmosphere to put attenuation on TWT support rods in a very precise manner. Result: higher gain and improved efficiency for Sperry traveling wave tubes.

This is only part of the Sperry effort to optimize the electrical parameters of TWT's. Attenuators are important . . . beam focusing, amplitude fine structure, and gun design get their share of attention too. All these programs are devoted to a single objective . . . the production of TWT's with a near-perfect mix of electrical characteristics.

Many of these efforts are already bearing fruit in the form of operational hardware. Production tubes like the STL-405 and STS-101 (200 W performance over octave bandwidth at L and S bands) and the STC-278 (exceptional fine structure and phase linearity characteristics) vouch for Sperry's success.

A NEW TECHNICAL PAPER gives full engineering and scientific details of the considerations involved in electrically optimizing traveling wave tubes. For your copy, write Sperry, Gainesville, Florida, or contact your Cain & Co. representative. In Europe, contact Sperry Europe Continental, Paris.



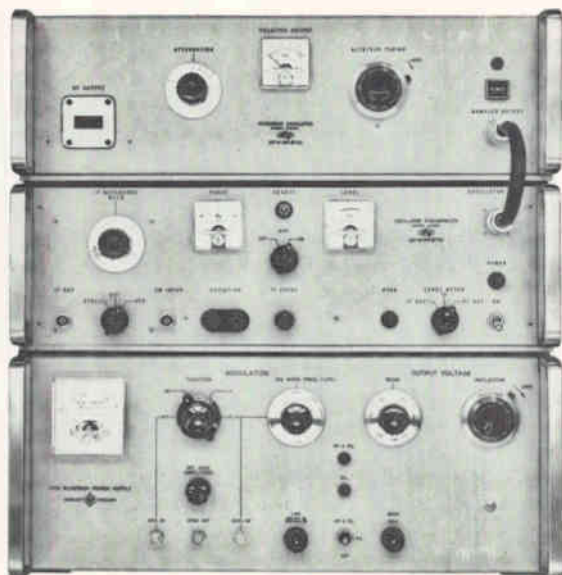

DY-2041A X-Band Stabilized Oscillator System

XTAL STABILITY AT X-BAND

An oscillator system for accurate signals 8.2 to 12.4 gc

Phase-locking techniques, introduced with the DY-2650A Oscillator Synchronizer, are combined with a precision klystron oscillator and a precisely regulated klystron power supply to provide, in the DY-2041A X-Band Stabilized Oscillator System, an accurate, stable signal 8.2 to 12.4 gc.

Use the system for:

Doppler, microwave spectroscopy,
radar cross-section measurements

Radio astronomy

Maser and parametric amplifier pumping
applications

Benefit from these features:

Frequency modulation and control with
deviations up to 500 kc at rates to 50 kc

Manual control, 2 mc range, of the
klystron frequency



DY-2650A Oscillator Synchronizer

Or buy the DY-2650A Oscillator Synchronizer separately, for phase-locked stabilization of klystron oscillators, 1 to 12.4 gc. Price, \$1450. Other versions are available to operate at frequencies to 40 gc.

The Dymec X-band oscillator system supplies a series of frequencies specified to within $\pm 0.001\%$. The technique of phase-locking a klystron oscillator to an internal crystal reference achieves a short-term stability of 1 part in 10^8 (averaged over 1 second) and a long-term stability of 1 part in 10^6 per week. Temperature stability is 1 part in 10^8 , 0 to 50°C. In addition to the DY-2650A, the system incorporates the DY-2655A Microwave Oscillator and hp 716A Klystron Power Supply.

The system is offered with a variety of basic options providing various individual frequency ranges, 8.2 to 12.4 gc, and minimum power output specifications, 30 mw to 500 mw. It is offered in stackable modular cabinets, with hardware provided for convenient rack mounting. System price, from \$4155, depending on options.

Call or write your hp/Dymec field engineer today for all the information on the oscillator system and the separately available oscillator synchronizer.

**See the system at Wescon 1963,
Booths 2722-2723**

Data subject to change without notice. Prices f.o.b. factory.

8662

DYMEC

A DIVISION OF HEWLETT-PACKARD COMPANY

DEPT. E-7, 395 PAGE MILL ROAD, PALO ALTO, CALIF. ● PHONE (415) 326-1755 TWX 415-492-9363



Simplex Electronic Cables...

Float at Sea

Eliminate Hosing Problems

Link Rockets to Ground Control

Many inner space projects require cable that will not sink to the ocean floor. To meet such requirements, Simplex has designed and produced special cables with built-in flotation. If desired, cables can be designed with plastic tubes to be used as gas, pneumatic or hydraulic lines.



For the growing number of installations where hosing of water through a cable could cause serious trouble, Simplex offers a "non-hosing" cable construction. Cables with this construction contain a special filler compound which eliminates wicking action even if the cable jacket is damaged.



Umbilical cables manufactured by Simplex are used to connect rockets to their sites before firing. Essential characteristics of these cables include flexibility, exceptional reliability, resistance to mechanical damage and chemical attack by exotic fuels.

There's a Simplex electronic cable to meet virtually every existing application involving the transmission of power, control and communications. And Simplex has unique capabilities for solving any problems you may encounter in these areas. For further information, write Department 365, Simplex Wire & Cable Co., Cambridge, Mass.



Simplex
WIRE & CABLE CO.

EXECUTIVE OFFICES: Cambridge, Mass.

Plants at Cambridge, Mass., Portsmouth, N.H.,

Westbury, L.I., Monrovia, Calif.

CIRCLE 15 ON READER SERVICE CARD

To Order Reprints

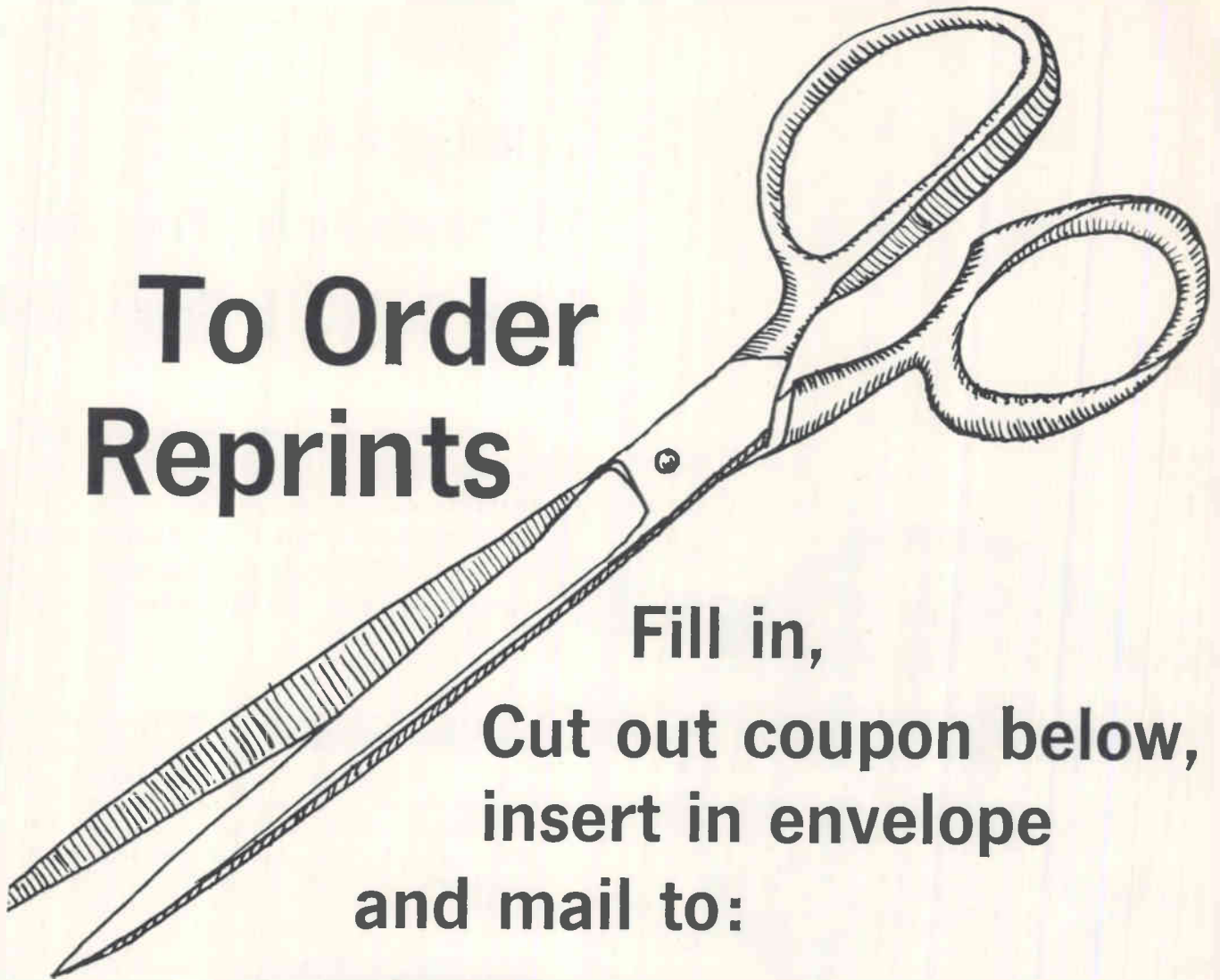

Fill in,
Cut out coupon below,
insert in envelope
and mail to:

electronics Reprint Dept.
330 West 42nd Street,
New York, N. Y.—10036

REPRINT ORDER FORM

For Listing of Reprints Available See Reader Service Card

(To help expedite mailing of your reprints please send cash, check or money order with your order.)

For Reprints of the latest Special Report:

Radio Frequency Interference

Send me Reprints of Key No. R-39

1-10 copies 75¢ each, 11-24 copies 60¢ each, 25 or more 50¢ each.

For Reprints of previous Special Reports or Feature Articles fill in below:

Send me Reprints of Key No.(s) @ ¢ each. (For prices, see chart above.)

*For orders of Bulk Reprints of other editorial articles in this issue or past issues:

Send me Reprints of page (no.(s)) of issue
of article entitled

*Minimum bulk order 100 copies. You will be advised of costs by return mail.

Name

Number and Street

City, Zone No., State



ACTUAL
SIZE

Electronic technology that works...

CERAMIC FILM CAPACITORS SAVE SPACE ABOARD IMPROVED MINUTEMAN

An exciting breakthrough in technical ceramics . . . a ceramic film so thin that you can read through it . . . is being used *now* in space-saving, miniaturized Erie film capacitors on the Air Force's new, improved Minuteman missile.

Replacing bulkier capacitors, these new high performance, high volumetric efficiency parts save valuable space and withstand flight environmental conditions in the circuitry of this vital missile.

These smaller, better, shockproof, Erie ceramic film capacitors are another example of the new advanced research and production technologies now at work at Erie . . . where reliability goals are assured.

Tell us your ideas and needs for electronic components and assemblies to be resolved by Erie technological experience and staff.

ERIE RESISTOR CORPORATION



644 West 12th Street
Erie, Pennsylvania

DESIGNER, PRODUCER AND MARKETER OF TECHNOLOGICAL PRODUCTS

CIRCLE 17 ON READER SERVICE CARD

Sigma's Cyclonome® Stepping Motor—

An Uncomplicated Approach to Accurate Positioning, Counting, Converting

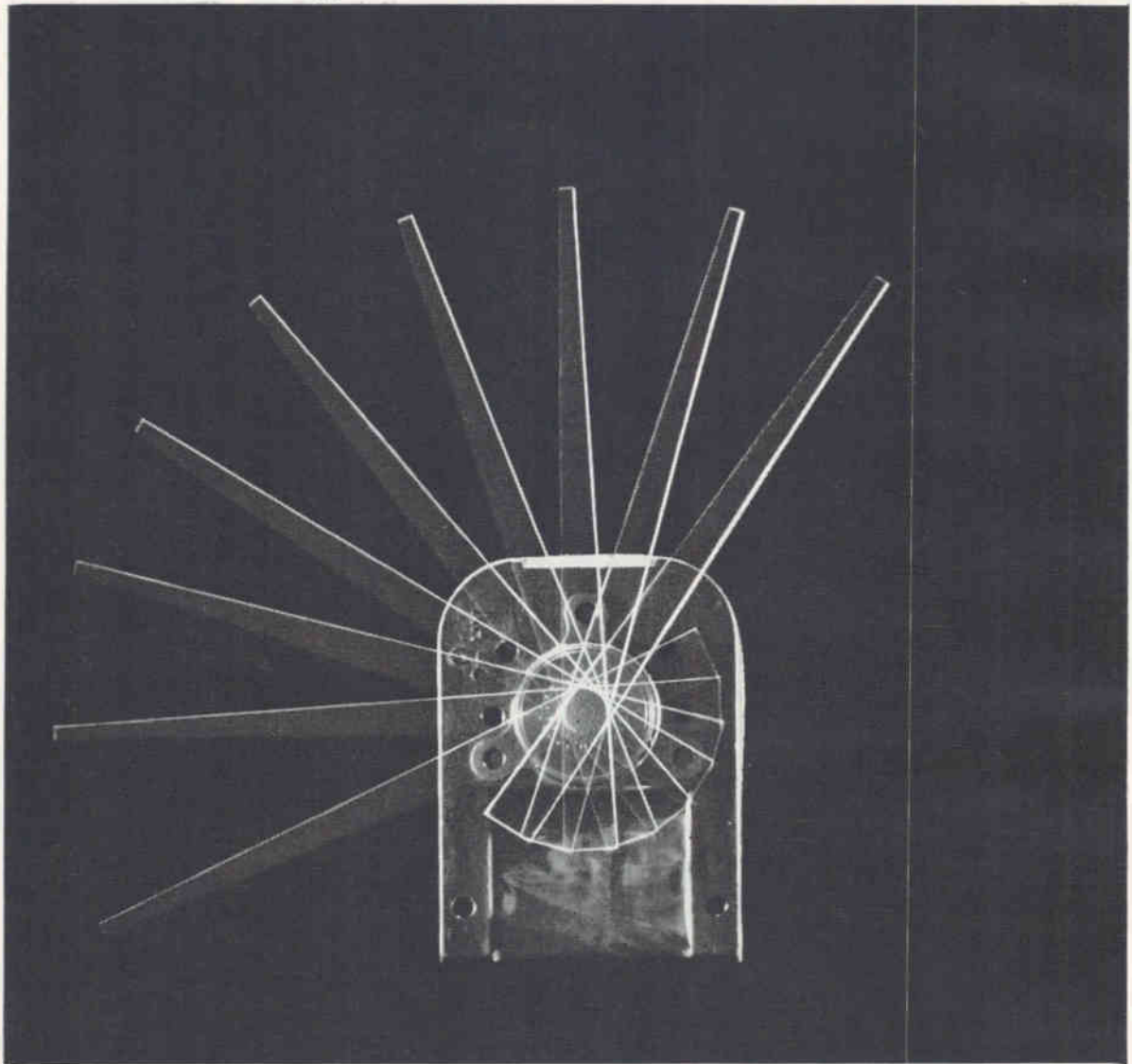

From Sigma comes an electromagnetic drive that delivers torque in precise 18° steps . . .
... up to 1,000 steps per second
... up to 5 inch-ounces of torque
... with no standby power to maintain high holding torque
... with only one moving part (no catches, ratchets, escapements)
... with size as small as 1 cu. in.
And requiring only the simplest input circuitry.

Engineers are already applying the Cyclonome stepping motor in chart and tape drives, in analog-digital converting, in impulse counting, in step servos, in remote positioning, in timing.

If you position, count or convert, the Cyclonome stepping motor can benefit you. Our application engineers will be glad to work with you. Or perhaps you would first prefer to read more about the Sigma Cyclonome. If so, send for a copy of The Cyclonome Technical Bulletin. Write to Dept. 11.

See the Cyclonome stepping motor demonstrated at Wescon. Booth 3621-3622.

SIGMA DIVISION  SIGMA INSTRUMENTS INC
Assured Reliability With Advanced Design/Braintree 85, Mass.

What is a Stepping Motor?

A stepping motor is like a synchronous motor in principle, except that its rotor does not revolve smoothly and continuously when

the motor is energized. Instead, on command from the input, the rotor travels an incremental step, stops instantly and locks magnetically in position. When a signal

of opposite polarity is applied, the rotor advances another precise step, delivering torque in exact proportion to and at the same rate as the input.



Hughes assures dependability of its Videosonic Systems with Allen-Bradley Hot Molded Resistors

■ Getting production started on complex assembly jobs produces endless problems incidental to the training to get the job started . . . the requirements for quality control . . . the time lost in retraining when production changes . . . etc. But, that's all over now, because of Hughes' new Videosonic System of colored slides synchronized with magnetic taped instructions that can guide even the unskilled assembler to surprising quality production output.

A variety of Allen-Bradley electronic components find application in this Videosonic apparatus. Allen-Bradley Type TR 1/10 watt hot molded resistors are used in quantity, because these hot molded resistors are an assurance of the high quality and dependability that the Hughes Aircraft Company demands. As a result of many years

of experience, Hughes is another one of our valued customers who has learned that only A-B hot molded resistors can give their products the reliability that top quality demands, and the uniformity that the most critical operating conditions must have. With A-B hot molded resistors, there's never been a catastrophic failure.

If you are not already a consistent user of A-B hot molded resistors, you'll want more detailed information about them, and also about other Allen-Bradley quality electronic components. So, please write for Publication 6024: Allen-Bradley Co., 110 West Greenfield Avenue, Milwaukee 4, Wisconsin.

In Canada: Allen-Bradley Canada Ltd., Galt, Ontario.

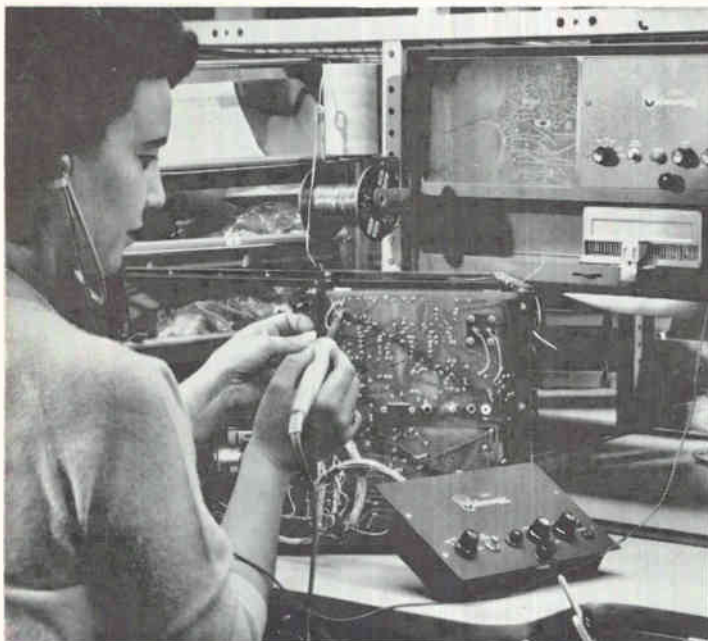

Hughes Videosonic System is installed at eye level, directly in front of the assembler. Color slides appear on screen at right, while corresponding taped instructions are delivered simultaneously through earphones (as shown in photograph above) or with loud speaker.

TYPE TR 1/10 WATT		MIL TYPE RC 06
TYPE CB 1/4 WATT		MIL TYPE RC 07
TYPE EB 1/2 WATT		MIL TYPE RC 20
TYPE GB 1 WATT		MIL TYPE RC 32
TYPE HB 2 WATTS		MIL TYPE RC 42

HOT MOLDED FIXED RESISTORS are available in all standard EIA and MIL-R-11 resistance values and tolerances.

ALLEN-BRADLEY

QUALITY ELECTRONIC COMPONENTS

Need Weather Data? —BUY A

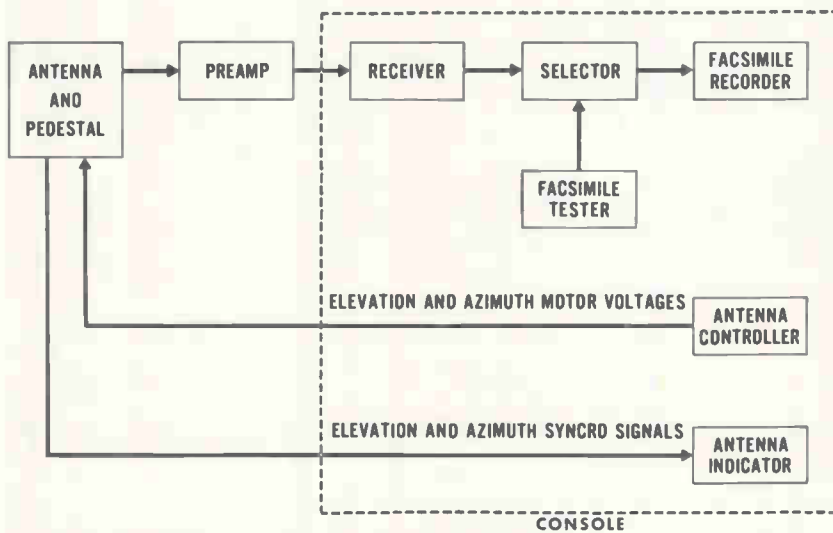

GROUND STATION consists basically of a receiving antenna, preamplifier, f-m receiver and facsimile recording equipment. Auxiliary equipment includes a test signal source and a facsimile test set. The latter provides start tones, phasing pulses, resolution patterns and gray shades

Nimbus ground stations cost less than \$50,000; give direct APT readout

By **JOEL STRASSER**
Assistant Editor

WYANDANCH, L. I.—Delivery of forty-two meteorological satellite ground stations to sites around the world was completed this month by Electronic Systems div. of Fairchild-Stratos. The stations are designed to read out weather pictures directly from the Automatic Picture Transmission (APT) subsystems on future Nimbus satellites. Four have gone to NASA, one to Army, 19 to Air Force, six to Navy and 12 to Weather Bureau. All are expected to be ready for the scheduled September launch of Tiros 8, which will carry an experimental APT subsystem.

The stations will give at least one 8 by 8-in. facsimile cloud picture daily of the 1,000-mile-square area around the ground station as the satellite passes overhead. Cost is less than \$50,000 per station.

Conceivably, this will pave the way for rich, progressive Farmer Jones to go out and buy himself a space station that will help him cut down the heavy losses caused by weather damage to his crops. The comparatively low-cost stations may also be a boon to others who need immediate advance weather information, including airlines, shipping companies, foreign governments and television weather forecasters.

APT CAMERA SYSTEM—Nimbus' APT is designed to transmit weather pictures in an automatic readout mode to small ground stations in any part of the world on a real-time basis. The slow-scan tv picture is scanned automatically in 200 seconds. These signals are transmitted directly to the earth below where they are reproduced in visual form on the

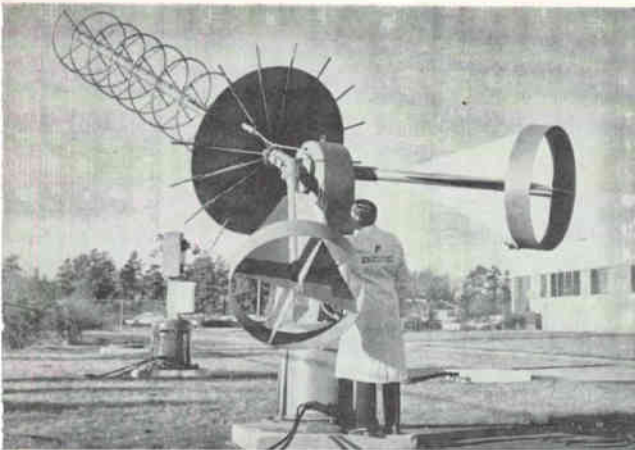

HELICAL ANTENNA is 14 ft long and 27 inches in diameter with a ground plane 72 inches in diameter. It can rotate 720 degrees in azimuth and 180 degrees in elevation

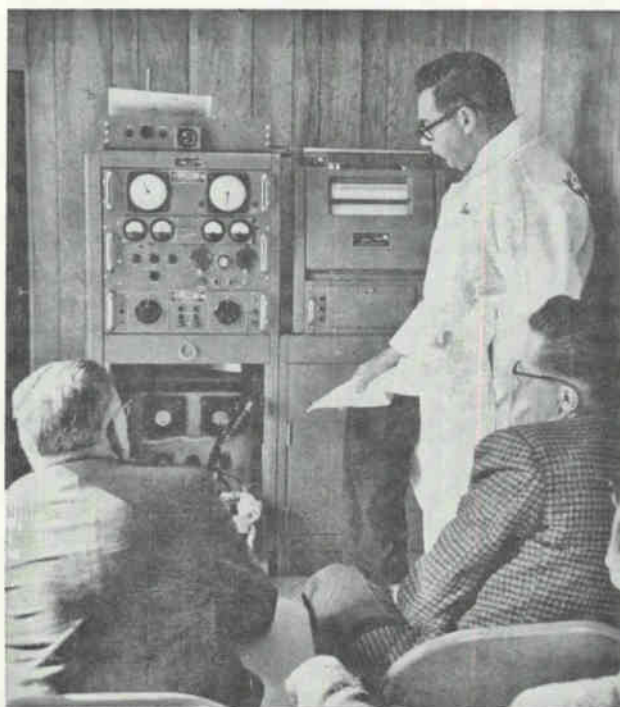

TWO - WEEK TRAINING course with ground station covers operation, picture location and interpretation, and specific methods of integrating satellite data into operational forecasts

SATELLITE GROUND STATION

ground station's facsimile machine. When the scanning has been completed, the camera in the satellite resets itself, exposes the next picture, and again stores the information for automatic scanning. The total cycle takes 208 seconds.

The system was one of several developed for Nimbus by RCA. Others include an advanced vidicon camera system (AVCS) which takes and stores weather pictures for later readout by larger stations, and a high resolution ir radiometer.

RCA is supplying a ground station at Fairbanks, Alaska for APT, AVCS and ir readouts. A similar, backup data acquisition station is planned for Inogmish, Nova Scotia, later this year. These stations, however, are considerably beyond the price range of Farmer Jones. RCA is also supplying "laboratory version" APT ground station equipment at Valley Forge, Pa., where General Electric is assembling Nimbus, as well as a laboratory-type APT ground station for the Pacific Missile Range.

APT GROUND STATION—Developed by Fairchild-Stratos for government as well as commercial and foreign use, APT consists of a manually-positioned directional antenna, for receiving satellite-transmitted signals, and automatic data recording and display units.

As the satellite rises over the horizon within 1,700 miles of the station, the operator points the antenna toward it to receive the signal. When reception begins, the operator hears a signal indicating that the facsimile recorder has begun automatically recording the cloud picture. He follows the satellite's orbit by monitoring its signal strength and tracing its orbit with pre-distributed overlays and graphs. While the slow-scan tv image is scanned in the satellite, the ground station facsimile recorder retraces the lines to reconstitute the weather picture. A built-in test set keeps constant tabs on the sta-

tion's performance.

The ground stations will operate with the experimental APT subsystem aboard Tiros 8 this fall, and with later meteorological satellites including Nimbus and Aeros—a synchronous orbit vehicle planned for the distant future. With one Nimbus satellite in orbit in late 1963, cloud coverage will be available each noon. Coverage will increase as additional satellites are launched.

HARDWARE—The ground station includes an 8-turn helical antenna made by TACO with a beamwidth of 34 degrees at the half-power points and a 13-db gain. The pedestal, built by Scientific-Atlanta, has position-motor drives, gearing, position-synchro transmitter, and limit switches. It can rotate 720 degrees in azimuth and 180 degrees in elevation.

The preamplifier is a Nems-Clarke PR203A 2-stage r-f amplifier with a 5-Mc passband and 22-db gain. The f-m receiver is a Nems-Clarke model 1440-2, crystal-controlled unit from 130 to 140 Mc to pick up the satellite's 136.950-Mc signals. A second oscillator vernier control allows tuning across 150 Kc on either side of the operating frequency. The receiver has a selectable bandwidth of 50 or 100 Kc.

The facsimile recorder, a Fairchild Camera and Instrument "Scan-a-fax," operates at 240 rpm with a 100-line-per-in resolution. The helix and writing-blade-type machine, using electrosensitive (wet) paper, forms the image by ion deposition. The unit starts and phases automatically on receipt of a 300-cps start tone and five seconds of phasing pulses from the satellite equipment. The recorder can also be started and phased manually.

The ground station operates at altitudes up to 10,000 ft above sea level, at temperatures from -65 to 160 F unsheltered, or 32 to 125 F sheltered.

"Few things are impossible to diligence and skill."



These are the trademarks of some of our customers—each an important contributor to a dramatically growing industry. We at Potter pledge our diligence and skills to this growth through a constantly expanding program of research and development.

the **POTTER**™



MT-120
eliminates
program
restrictions

The new Potter MT-120 Magnetic Tape Transport features high performance in a COMPLETELY STANDARD, LOW COST PACKAGE. An evolutionary development of the reliable M906II tape deck, the MT-120 incorporates a patented tape handling system* that eliminates program restrictions. This unique engineering achievement permits Start/Stop, Reverse/Stop or Forward/Reverse operation at up to 200 commands per second and at tape speeds to 120 ips without external program delays.

The MT-120 delivers extremely high data transfer rates. Using the Potter Contiguous Double Transition** High Density recording technique, rates of 1.6×10^6 information bits per second are obtained. And with standard 7-channel format, 556 bits per inch are provided at speeds of 120 ips.

To learn more about the MT-120 and its unprecedented 1-year warranty of reliability, write to our Director of Marketing today...



*Potter Patent No. 3,016,207
**Potter Patent No. 2,853,357
and other patents pending

POTTER INSTRUMENT CO., INC.
151 Sunnyside Boulevard • Plainview, New York

New Code Standard in U.S.— INTERNATIONAL ADOPTION NEXT?

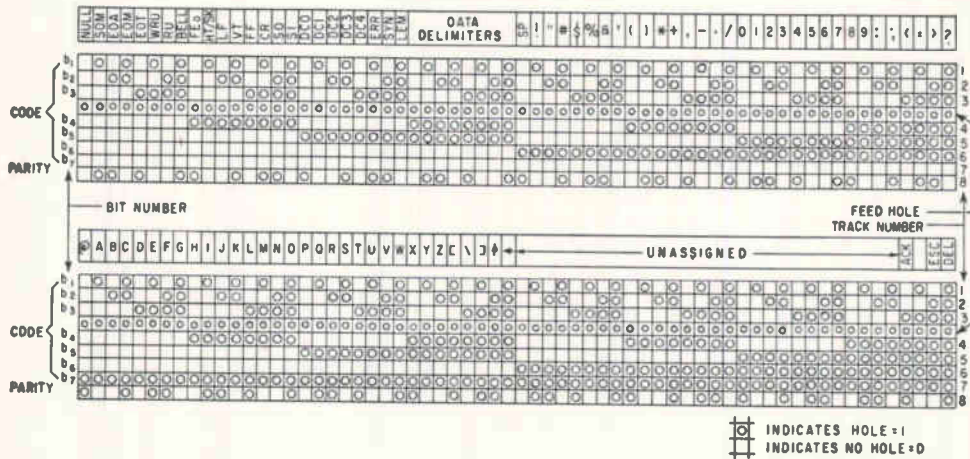

NEW STANDARD CODE applied to Bell System 100-wpm nationwide teleprinter network that will go into full operation next December. Eighth bit is error check

Information interchange code for punched tape is already in use here

By **ALEXANDER A. MCKENZIE**
Associate Editor

APPROVAL THIS MONTH of the American Standard Code for Information Exchange (X3.4-1963 of the American Standards Association) will simplify future interconnection of digital output devices, communications circuits and computers. The code, sponsored by Business Equipment Manufacturers Association (BEMA), provides 128 binary combinations, 28 of which are as yet unassigned, but available for future growth.

While BEMA's data processing group estimates that the four-year effort to develop the new standard represents an investment of \$3 million, the new common language will save many times that amount. Without the code, connection of one system to another requires the use of expensive interface devices and techniques. Even where interface equipment is still necessary, the amount and complexity will be reduced.

INTERNATIONAL CODE—

Through no accident, the new standard code is also under study at the international level in CCITT (French abbreviation for International Telegraph and Telephone Consultative Committee). If adopted, this 7-unit code would supplement and eventually replace the existing CCITT No. 2 alphabet, which uses five units. However soon world agreement comes, many communications services will find it difficult or unnecessary to make a quick switch from existing codes. Telex, for example, the international teleprinter service operated by RCA, will probably continue using its present standards although its cable and radio circuits can easily connect two printers or data exchange devices using the new code.

SOME ANGLES—The new standard was developed by an ASA committee that included representative users far beyond the membership of the sponsoring BEMA group. Experts from the air transport, banking, management and insurance fields had a hand. Government, telephone, gas, electric and oil interest were represented. Fourteen broad areas of need were postulated and the code form provides graphics, device controls, unique meaning for each character, error control and

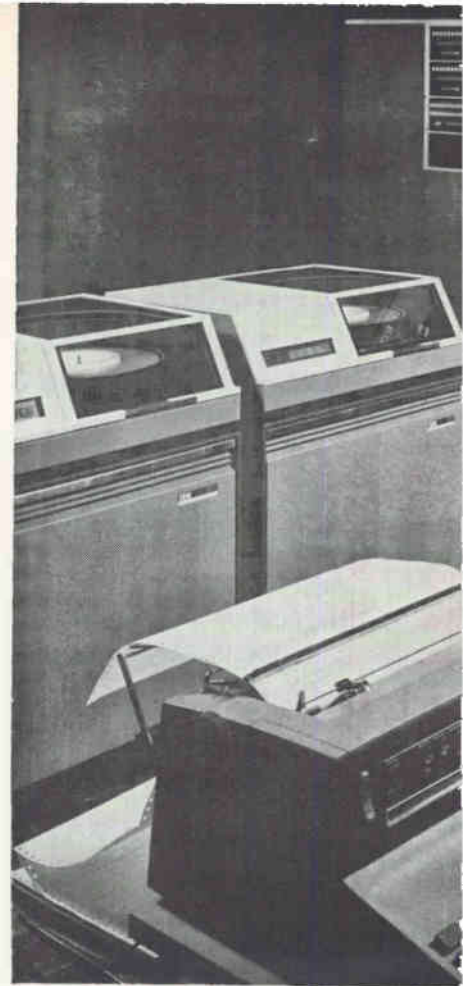

OPERATOR CONSOLE (foreground) control system. Controlled by a program (left) the equipment handles a wide variety of the newly adopted American standard

international usage. Logical, historical and conventional approaches have all been used; in other words, the human element has not been overlooked.

It was found that a 7-bit set, generating 128 possible characters, was needed although the brevity of a 6-bit and the added spaciousness of an 8-bit set were considered.

RUSSIANS CAN PLAY — Even when specific symbols are not designated, the code has been grouped into sets that can be employed with special keyboards. For example, the English alphabet (26 characters) is grouped with a symbol preceding A and five symbols following Z. The whole Cyrillic alphabet (32 characters) can be substituted in this contiguous block for Russian-language use. The special letters of other languages, such as accented French, German umlaut and the Scandinavian symbols can easily be accommodated when the code is used for communication rather than data interchange.

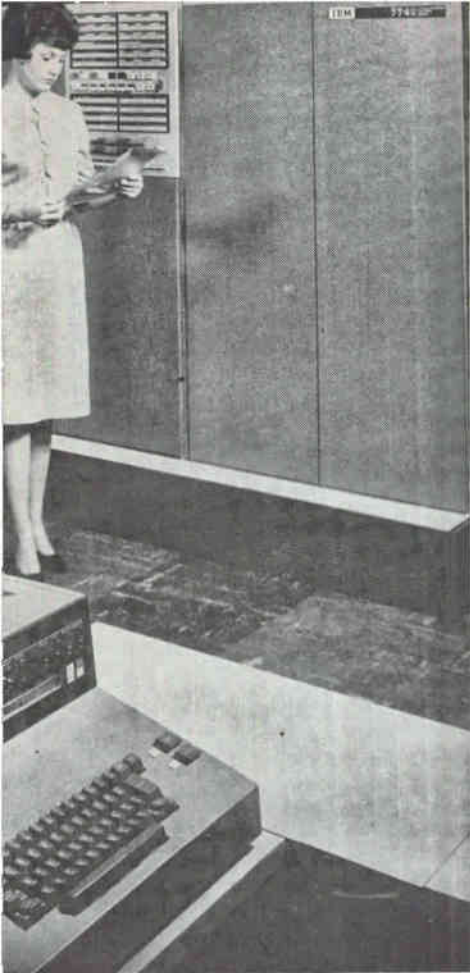

monitors the IBM 7740 communication stored in its own magnetic core storage variety of communications codes, including

**the WHOLE HISTORY
OF YOUR RESEARCH,
permanently recorded
with the HIGHEST
available ACCURACY.**

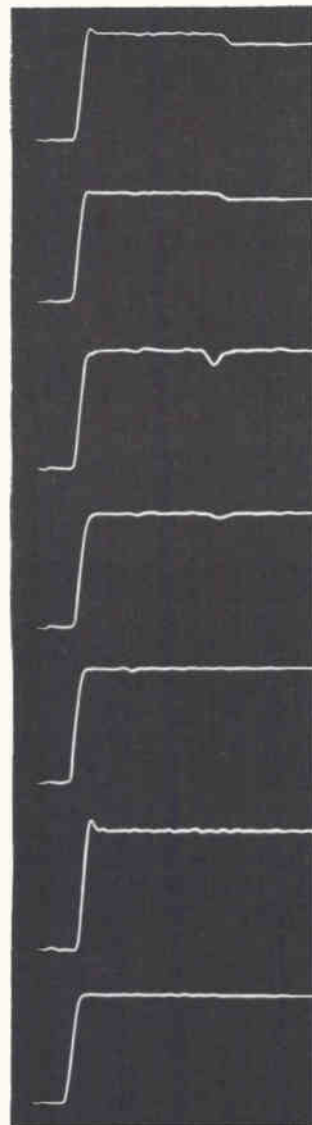
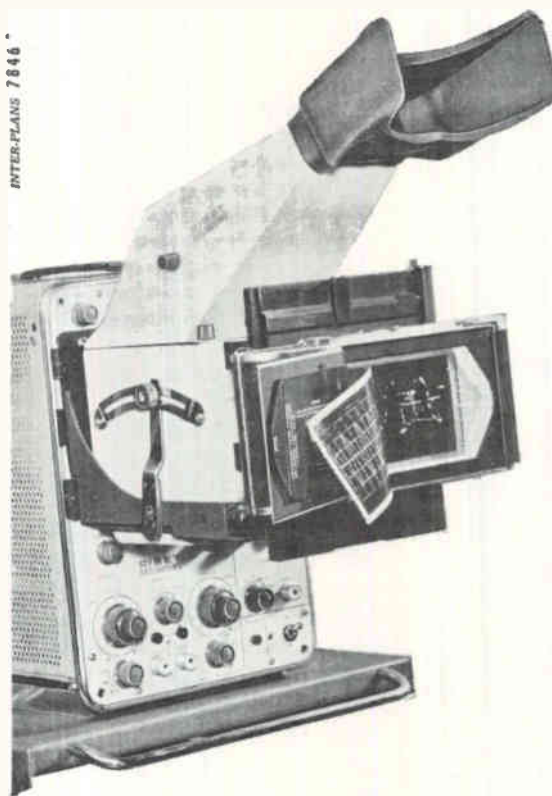

BINARY NUMBERS—The logic of assigning to numbers the proper binary codes has been followed. As an example, the first four digits in the new code for the number 5 are thus 0101. Because graphics have been assigned the spaces immediately following the digit 9 it is possible to employ digits 10 and 11 for applications requiring use of the sterling monetary system or duodecimal arithmetic.

Although the 28 unassigned characters can be used in any convenient fashion by individual users, ASA cautions that until symbols are approved this constitutes a deviation from standard. The study continues and will later include punched cards and magnetic tape.

TELETYPE USE—One practical application of the new code is for teleprinter message service in the United States. Having cut over all TWX — subscriber interconnected Teletype service—to automatic dial in September 1962, the Bell System introduced a supplementary

CAMERA POLAROÏD 1000 A

Spécial polaroid camera for oscilloscopes adaptable to the oscilloscopes of all the major manufacturers.

TECHNICAL ASSISTANCE IS, AS USUAL, PROVIDED.

RIBET-DESJARDINS

INSTRUMENT DIVISION - 13-17, rue Périer
MONTROUGE, PARIS - TÉL. : ALÉSIA 24-40

CANADIAN BRANCH : RIBET-DESJARDINS (CANADA) LTD.
ROOM 114, 5757 DECELIES AVENUE - MONTREAL.

A list of our sales representatives will be mailed on request.

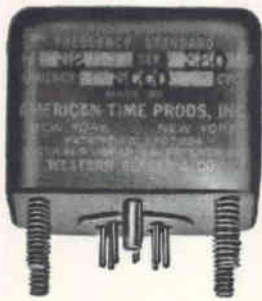

**AMERICAN
TIME
PRODUCTS
240 to
20,000 cps
FREQUENCY
STANDARD**

Whatever the frequency, 240 to 20,000 cps, the type 32 American Time Products standard assures an uncompromising balance between stability and reliability.

A compact, lightweight and highly reliable audio range unit, the 32 employs a temperature compensated tuning fork and its associated oscillator circuit. Hermetically sealed, this all silicon semi-conductor oscillator provides stability up to $\pm 0.02\%$ from -65°C to $+125^{\circ}\text{C}$. In narrower temperature ranges, such as 15°C to 35°C , $\pm 0.002\%$ is possible.

Other specifications include: Power — 28v at approx. 6 m.a. or calibrated for any other available voltage; Output — 5v r.m.s.; Wave — limited Sine; Loading — up to 20K; Mounting — 4 studs; Termination — 7 pin header.

For more information on American Time Products' type 32 standard, line of fork standards or oscillators, filters, inverters, power supplies, timers or light choppers, write Bulova, American Time Products, 61-20 Woodside Avenue, Woodside 77, New York. Area Code 212 NE 9-5700.

INDUSTRIAL/DEFENSE GROUP

BULOVA

AMERICAN TIME PRODUCTS

100-word-per-minute service early in 1963. Some time after December 1 this year, Bell will open up an automatic dial service between 100-wpm stations and interconnecting 100-wpm sets with standard 60-wpm stations. A special dialing code will be used so that to reach a point in New England, for instance, the number 710 will first be dialed.

For Teletype use, Bell has actually added another digit, making the standard 7-unit code an 8-digit code. However, the added unit is merely included by the sending equipment and used at the re-

ceiving end. The purpose is to provide an error-checking mechanism called even parity check. In other words, the eighth digit appears only when the sum of the signaling digits adds up to an odd number.

In actual transmission, the basic code is almost always modified. The present standard 5-unit teleprinter code turns out to be an 8-bit code since an additional bit is used as a start signal and 2 bits signal a stop. Thus, in practice, the new Teletype code will be an 11-bit code; 7 bits for the signal, one bit for parity, one bit to start and two bits for stop.

Solution Process Sprays Thin Films on Substrates

*Developers say method
can be used for mass
production of devices*

NEW PROCESS for depositing inorganic thin films was reported this week by National Cash Register. The company indicates the process—based on a solution-spraying technique—may be used for mass production of a variety of devices from a wide range of materials.

Vacuum equipment is not required. The process is suited to large-area film deposition and to continuous deposition on belt-type substrates. Deposition can be on rigid substrates such as glass, ceramics and mica, or on flexible substrates, NCR says.

MATERIALS—The range of materials that lend themselves to film formation by aqueous spraying has been extended beyond the simple sulfides and selenides originally under investigation, NCR says. Electroluminescent, photoluminescent, photoconductive, cathodoluminescent and photovoltaic phenomena have been demonstrated in deposited films.

In cathodoluminescence, NCR says it has demonstrated control

over the films' emitted color and graininess. Surface texture control—from glossy and transparent, to frosty and translucent (similar to settled phosphors)—is expected to provide optimum brightness resolution for specific applications.

NCR reports adhesion of films to substrates is excellent, that films on non-rigid substrates have been flexed many times without significant deterioration of either physical or semiconductor properties. The flexible structure is attractive for satellite solar cells.

PHOTOCONDUCTORS — The process is considered particularly applicable to photoconductors.

In photoconductors, according to NCR, the spray process results in large-area deposition, higher yields, greater reproducibility of characteristics, high dark-resistance-to-light-resistance ratios with rise and fall times in the millisecond range, and improved spectral response characteristics. Spectral response tends to follow the absorption curve for pure materials.

Photoconductor cells can be used for control and metering, but NCR says their characteristics merit special consideration for automatic camera shutters, automatic light control and data processing equipment.

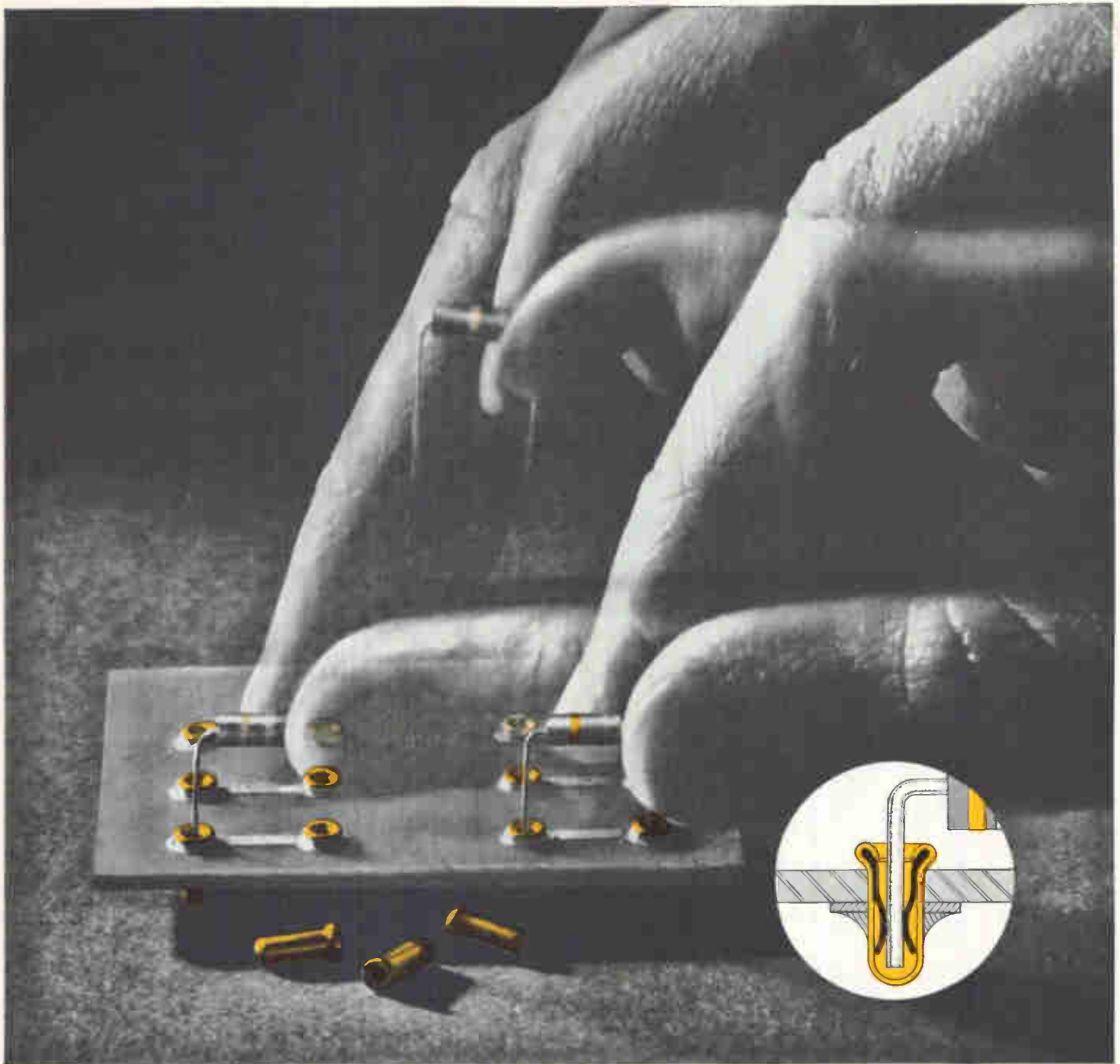

Put 'em in . . . take 'em out . . . "burn-in" test again and again!

Here's a new A-MP* reusable component jack to make "burn-in" testing of printed circuit components easy and economical. Easy, because it provides for quick, by-hand insertion and extraction of diodes, resistors, capacitors, transistors and all types of components. Economical, because it not only accommodates a wide variety of component wire lead sizes (.018 to .040), but also because it does away with costly soldering and unsoldering and expensive test fixture replacement. And *that's* important when you consider the loss of expensive components through heat damage and rough handling that occurs with present methods.

Just add up the advantages—quicker test set-up, no solder problems, no "good" component loss and reuseability that goes on and on . . . test after test! Here's a product that does a big job but is small enough to warrant sending you a sample.

Write today for yours.

*Trademark of AMP INCORPORATED



AMP products and engineering assistance are available through subsidiary companies in: Australia • Canada • England • France • Holland • Italy • Japan • Mexico • West Germany

Air Force Successfully

*Titan III will give
USAF a workhorse
booster for space*

By ED ADDEO
McGraw-Hill World News



SYSTEMS PROGRAM director for Titan III, Col. J. S. Bleymaier, and model

COYOTE, CALIF.—Last Saturday afternoon, an important and noisy spectacle took place in this usually peaceful area some 65 miles south of San Francisco. Orange-white flames shot hundreds of feet into the air and a deafening roar spread over the rolling California hills for miles around.

The strap-on, solid-fuel booster for the Titan III C had been successfully static fired, producing 1.3 million pounds of thrust, and the Air Force was one step closer to having a standardized space launch system that will be capable of putting a variety of manned and unmanned missions into space (ELECTRONICS, p 8, July 19).

One high-ranking official said he "wouldn't be surprised if a complete Titan III-C package was launched next summer, instead of the planned target date of spring, 1965."

Besides Dynasoar, Titan III may be used for communications satellites, later Gemini flights, and a manned orbital space station. It will be used by both the Defense Department and NASA.

CONTRACTORS—The firing site was United Aircraft's Development and Test Center, one of the six associate contractors for the Air Force Space System's Division project. The other contractors are: Aerospace Corp. for systems engineering and technical supervision; United Aircraft's United Technology Center, responsible for entire first stage of Titan III-C, including the strap-on motors; Martin Co., airframe, assembly, test, and system integration; Aerojet-General, liquid propulsion; AC Spark Plug, inertial guidance; Ralph M. Parsons, architectural engineering and design of the integrate-transfer-launch (ITL) complex at Cape Canaveral.

Subcontractors for the static firing instrumentation and booster guidance systems under United Technology Center development are: Temco Electronics, pitch/yaw controls; Hamilton-Standard, guidance controls; Data Technology, countdown sequencers, programmers, and test equipment; Interstate Electronics, support instrumentation; Exact Electronics, ground support equipment; and Vidar Corp., f-m data acquisition equipment. This equipment is separate from the AC Spark Plug gear which only takes over after the strap-on boosters fall away.

Basic static test instrumentation—almost all solid-state—is being supplied by Wiancko Engineering.

UTC president, Barney Adelman, said after the 113-second-long firing that there had been some diffi-



FIVE-SEGMENT, 120-inch-diameter, solid-propellant rockets lift Titan III-C from pad then fall away after burnout

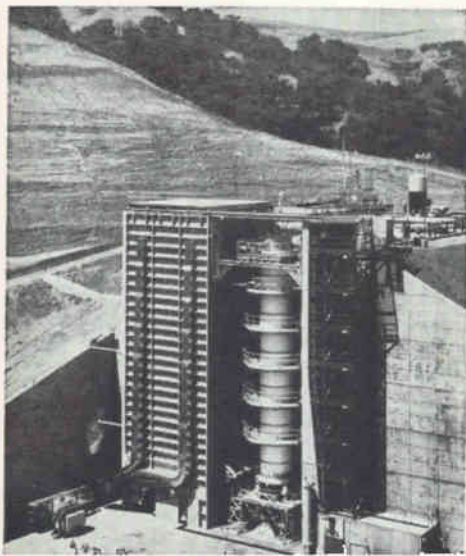

VERTICAL TEST bay—the biggest of its kind in the nation—was used in the static test-firing

Tests New Space Booster

culty with airborne power and ground-based electronic and hydraulic systems. Adelman suggested that while all 274 channels of instrumentation, mostly narrow-band f-m, functioned properly before T-minus-O, not every channel was operative at cut-off. Also, Adelman said, "we had to switch to airborne hydraulic just before the test," instead of going with airborne electronic as planned.

A vibration system consisting of a sine control console, a random control console, a power amplifier and an exciter will be installed at the test site's massive ST-9 test stand next month. The \$150,000 system will test the capability of flight-weight hardware to withstand vibrations to which individual components will be subjected during flight, and is being

supplied by Ling Electronics.

STILL SECRET—One of the most closely guarded and exotic secrets of the Titan III C's boosters is the technique for controlling direction through thrust vector control (TVC). This system uses a reactive fluid injected into the exhaust stream, creating an oblique shock wave which deflects exhaust gases and changes the direction of thrust vectors. United Technology Center's TVC system uses nitrogen tetroxide as the main fluid; other TVC systems in latter stages of the rocket use Freon.

The TVC controls are activated by ground control electronics, Polaris and Minuteman use similar TVC steering systems.

RUSSIAN Metrology — It Looks as Good as Ours

WASHINGTON—The Soviets are well advanced in measurement techniques, it was reported last week by three returning members of a seven-man team of metrology experts who made a month-long tour of USSR measurement laboratories and instrument factories.

Generally, the team rates the USSR on a par with the U.S. in metrology—even ahead in some electronic techniques—indicating parallel progress in allied fields. The visit was the U.S.'s first really good look at Soviet capabilities in metrology, though the team was not given access to information on USSR military and space prowess.

TEAM MEMBERS—Last week's report was given by D. P. Johnson, a National Bureau of Standards specialist in vacuum and pressure measurements; H. W. Lance, an NBS r-f measurement specialist, and George Toumanoff, of Airborne Instrument Laboratory. Other team members are William A. Wildhack, Les Guildner, F. K. Harris and A. G. McNish, all of NBS.

The visit was arranged by the Soviet Committee on Standards, Measures and Measuring Instruments—a highly rated government organization. The tour, starting

in Moscow June 2, included 10 institutes and 2 instrument plants.

The Soviets will make a return visit to the U.S. in the fall.

WHO'S AHEAD? — Johnson, Lance and Toumanoff made these general observations on Soviet metrology:

- **Electronics:** Soviets can accurately measure a wider frequency range than the U. S. and have gone further in radio noise measurement. This is important to nuclear explosion detection, as well as space telemetry, radio astronomy and such. In microwave power measurement, particularly impressive was a microcalorimeter that uses principles the U. S. knows but has not applied.

- **Time:** Russia is trying to leapfrog the U. S. by working on the hydrogen-beam technique. If they are successful, the USSR would be temporarily ahead of the U. S. The team saw work on ammonia clocks, but was told no effort is being put into cesium-beam clocks.

- **Pressure:** There is a surprising similarity between the technical problems and solutions of the U. S. and USSR.

- **Optics:** The U. S. team was surprised by the amount of effort



REPORTERS take notes as D. P. Johnson, George Toumanoff, A. V. Astin and H. W. Lance (left to right, rear) discuss trip. Astin is NBS director

devoted to this, but were unable to learn the reason for the emphasis. Interest in lasers is high, but no Soviet lasers were seen. The team impression was the U. S. is ahead in lasers.

INSTRUMENT PRODUCTION—The Soviets are far ahead of the U. S. in using the taut-band suspension technique for pointer-type electrical instruments. They are producing such meters in great numbers.

Assembly work is comparable to that in the U. S. The team was impressed by the care taken, especially in calibration and to insure stability, with very high precision instruments being made in a Kiev factory.

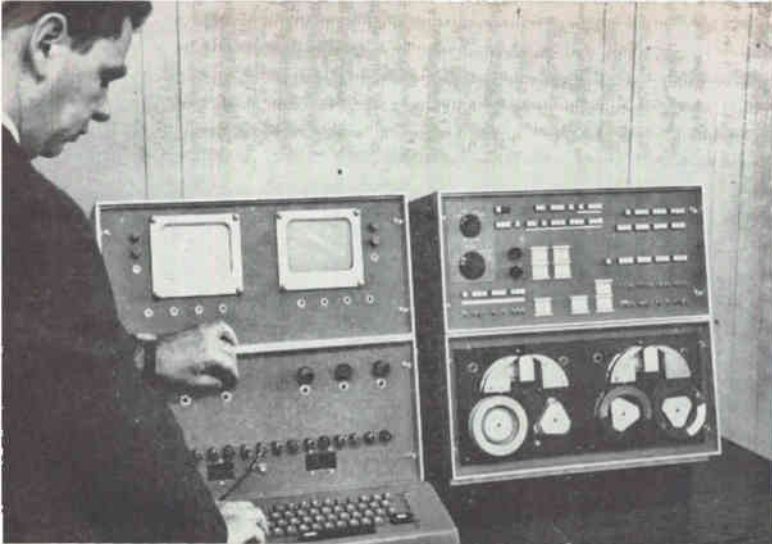

INFORMATION typed on keyboard and displayed on scope is simultaneously stored in central memory. From there it may be transferred to magnetic tape

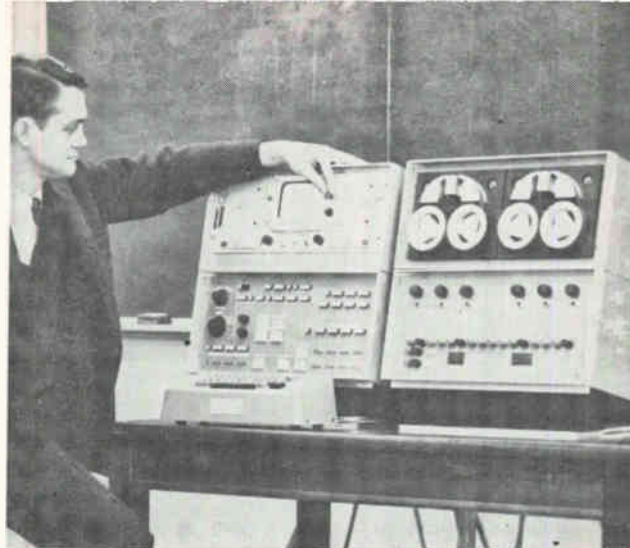

DESIGNER Wesley A. Clark, Jr., with LINC, which comprises four console modules connected by separate cables to a remote cabinet containing the electronics

FOR LIFE SCIENCES:

A Do-It-Yourself Computer

*Biomedical researchers
will build their own
at new MIT center*

By THOMAS MAGUIRE
New England Editor

CAMBRIDGE, MASS.—A giant step is being taken at MIT this summer in the attempt to place the enormous capabilities of digital computer technology more fully at the service of biophysics and related life sciences.

Focal point of the effort is the center for computer technology in the biomedical sciences, established under sponsorship of the National Institutes of Health (NIH) and NASA (ELECTRONICS, p 12, April 5).

NIH announced this month a grant of \$2.8 million for first-year support of the center. With NIH and NASA sharing the costs, government support of the center was pledged for a period of seven years. The center has been in operation for several months in rented quarters near MIT.

A total of 12 New England aca-

demic and medical institutions will participate in the work of the regional center. In addition to organization of the regional center, immediate goal is evaluation of the Linc laboratory instrument computer (ELECTRONICS, p 8, Jan. 18).

COMPUTER MAKERS—A dozen biomedical researchers from throughout the country are spending a month each at MIT this summer to learn the basics of digital technology, put together their own Linc's and return to their labs prepared to program, operate and maintain their Linc's like any other

laboratory tool.

The "computation center" setup has helped to introduce the modern biomedical researcher to a powerful tool—the digital computer.

LINC COMPUTER—Linc is an on-line laboratory instrument that enables a researcher to observe results and then modify, repeat or reorient his experiment while it is in progress. For real-time research on data from complex sources, the machine is tied into the experiment itself, sometimes even coupled to the data source.

Among problems successfully

When You Think of It, It's Easy

LASER STABILITY is improved significantly by standing it on end and mounting the mirror on quartz rods, report Professor Chihiro Kikuchi (left) and Don Gillespie, University of Michigan. Gravity-induced curvature and strain in the tube are reduced. Seismic movements of a micron could be detected. Lear Siegler loaned the helium-neon laser and Argus the optics



now

3

5

10

or

TURN PRECISION
POTENTIOMETERS
FOR AS LITTLE AS

\$5

EACH



The multi-turn precision potentiometer that has rocked the industry—now available in *any number of turns up to 10!*

Best of all, the same high degree of electrical precision and the same low price still hold. Now, no need to settle for higher-priced pots for those 3 or 5 or other number of turn requirements in industrial and instrument applications—specify Series 62 for top performance at lowest cost.

Write for complete details . . .

FEATURES

- Absolute Linearity: $\pm 0.25\%$ *
- Resistance Tolerance: $\pm 5\%$
- Power Rating: 2 watts @ 25°C*
- Dielectric Strength: 1000 V. rms for 1 minute at atmospheric pressure.

*BASED ON 10-TURN MODEL

PRECISION POTENTIOMETER DIVISION



 CLAROSTAT

CLAROSTAT MFG. CO., INC. DOVER, NEW HAMPSHIRE

SPECIFY HANDSETS

by
Stromberg-Carlson



... for mobile radio, dictating systems, carrier, microwave and other applications.

Illustrated are lightweight models No. 33 and No. 35. Both incorporate push-to-talk switches and high-gain receivers and transmitters. These Stromberg-Carlson handsets meet a great variety of needs in a broad range of industrial applications.

No. 33 lightweight handset is furnished with a rocker bar switch.

No. 35 comes with a button switch, or with both the button and rocker bar switches.

Get technical data on these and other handsets from our Industrial Sales Department.

STROMBERG-CARLSON
A DIVISION OF GENERAL DYNAMICS
114 CARLSON ROAD • ROCHESTER 3, N. Y.

tackled so far by Linc is processing of single-unit data from the nervous system of animals. Programs were written to determine, from micro-electrode recordings, the times at which single neurons fired, and to calculate the distribution of intervals between successive firings of neurons.

Other applications of Linc are seen in communications, nuclear physics research, and pattern and speech recognition.

DESIGN—In designing the Linc, principal objective has been to maximize the degree of control over the instrument by the individual researchers. The machine is fast enough to process data "on line" during the experiment, and logically powerful enough to permit

later, more complex calculations if required. It can be interconnected with a variety of lab apparatus, both analog and digital. And it includes design features to facilitate training of persons unfamiliar with digital computers. The Linc uses transistor circuitry and a random-access ferrite-core memory.

Computer speed is fixed by the time required to read information from or store information into one of the 1,024 (expandable to 2,048) 12-bit memory locations. Most of the Linc's instructions require from 1 to 4 memory-cycle times of 8 μ sec each for execution.

The Linc consists of four independent console modules, one housing most of the controls, a second containing terminals to connect Linc to other lab equipment and

SKIP RADIO

REPLACES ALASKAN CABLE

*Two-hop scatter system
now connects Alaska
with British Columbia*

COMMERCIAL TROPOSCATTER system now links Alaska to the other states. In two hops, it connects Ketchikan, Alaska, to Vancouver, British Columbia. An existing 6-Gc microwave chain connects Vancouver and other points south and east.

Growth of its commercial business and need for reliable military circuits spurred General Telephone & Electronics into the \$5-million communications investment. Circuits leased to the military help make the venture attractive.

The 240 channels now available essentially replace a combination of submarine cable—subject to damage from seaquakes—and 24-channel 140-Mc radio relay.

GT&E installed the system through its subsidiaries, British Columbia Telephone and Alaska Telephone. Two other subsidiaries, Lenkurt Electric, of San Carlos, Calif., and Lenkurt of Canada, were prime contractors. Radio Engineering Laboratories supplied r-f hardware, except for antennas.

The northern hop is from Annette Island in the northwest to Trutch Island 154 miles south. Then a 190-mile hop connects Trutch with Port Hardy on Vancouver Island.

At the Port Hardy and Annette Island terminals there are two 10-Kw transmitters and four receivers tied into a pair of antennas. Four transmitters, eight receivers and two pairs of antennas pointing in opposite directions serve the Trutch Island relay station. These circuits handle voice and data communications.

The tropospheric forward-scatter technique, which has a present practical limitation of about 200 miles, is in use throughout the Arc-

the two that house two display oscilloscopes and a pair of magnetic tape transports for storing programs, data and results.

There are 16 analog input channels. Internal analog-to-digital conversion translates input voltages to an 8-bit binary number.

Converted data can be displayed on the oscilloscope.

Linc results from several years of collaboration between the Digital Computer Group of MIT Lincoln Laboratory and the Communications Biophysics Group of the MIT Research Laboratory of Electronics. The prototype models were built at Lincoln Laboratory with the aid of AF Cambridge Research Laboratories. Wesley A. Clark, Jr. and AF Lt. Charles E. Molnar directed the development effort.

...and I want
to know
why it's...

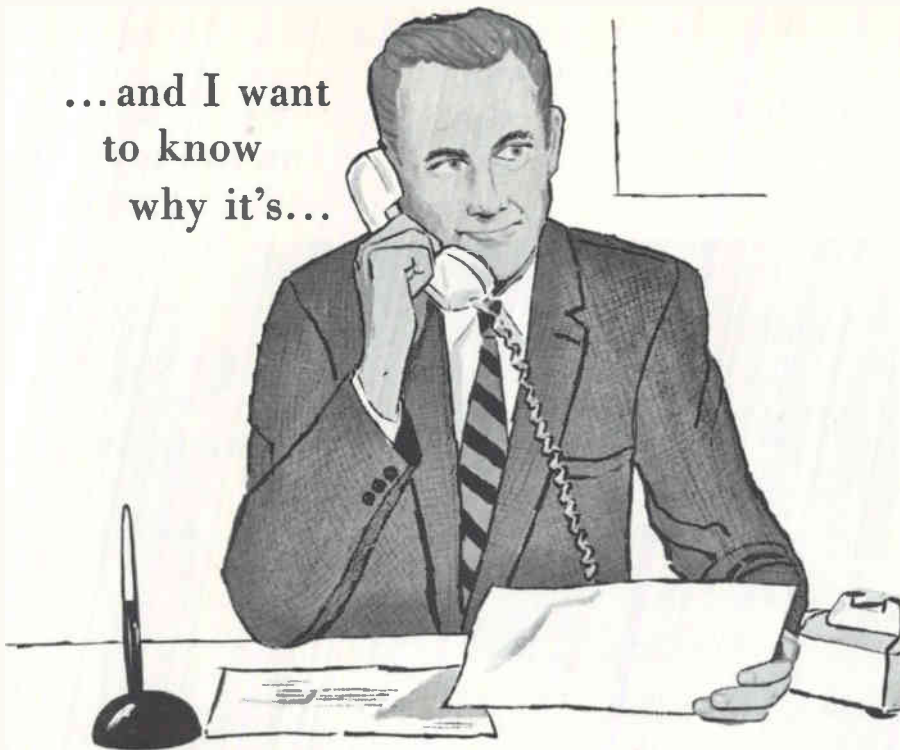

Florida's newest metropolitan industrial area

The complete story on Daytona Beach . . . STRATEGIC GEOGRAPHIC LOCATION; EXPANDING FLORIDA MARKET; LOW-COST INDUSTRIAL SITES; FAVORABLE TAXES; AMPLE POWER, FUEL, AND WATER; AVAILABLE MANPOWER POOL; MINIMUM ABSENTEEISM, THANKS TO A MILD YEAR-ROUND CLIMATE AND CLEAN OCEAN AIR WITH A POLLEN COUNT OF LESS THAN ONE . . . is now available to you by writing to the:

DAYTONA BEACH INDUSTRIAL AREAS

THRESHOLD OF THE RACE TO SPACE

Ormond Beach • Holly Hill • Daytona Beach • South Daytona • Daytona Beach Shores • Port Orange

THE DAYTONA BEACH AREA COMMITTEE OF 100 pledges its complete cooperation in helping you find a profitable industrial site. Direct your inquiry to J. Saxton Lloyd, Chairman, who will hold all such inquiries in his personal file in the very strictest confidence.

TRUTCH ISLAND relay station. High-gain, 60-ft-square, 70-ton antennas are built to withstand the weight of an inch of ice and 120-mile winds

tic where conventional communications frequently black out and microwave relay stations would prove impractical because of their relatively close spacing of about 25 miles.

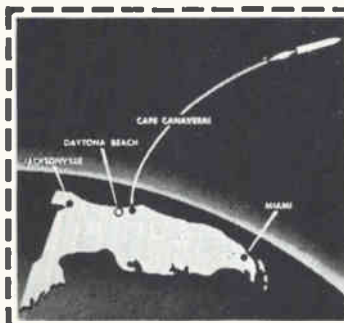

Mr. J. Saxton Lloyd, Chairman
Committee of 100
Daytona Beach Industrial Areas
Dept. D-12 — Daytona Beach, Fla.

Please send detailed information on the
Daytona Beach Industrial Areas.

NAME.....TITLE.....
COMPANY.....
ADDRESS.....
CITY.....ZONE.....STATE.....

All inquiries held in strict confidence

Giant klystrons, which are providing megawatts of peak power for space radar systems, are part of the extensive line of Litton microwave tubes and display devices. San Carlos, California. In Europe, Box 110, Zurich 50, Switzerland.

LITTON INDUSTRIES
ELECTRON TUBE DIVISION

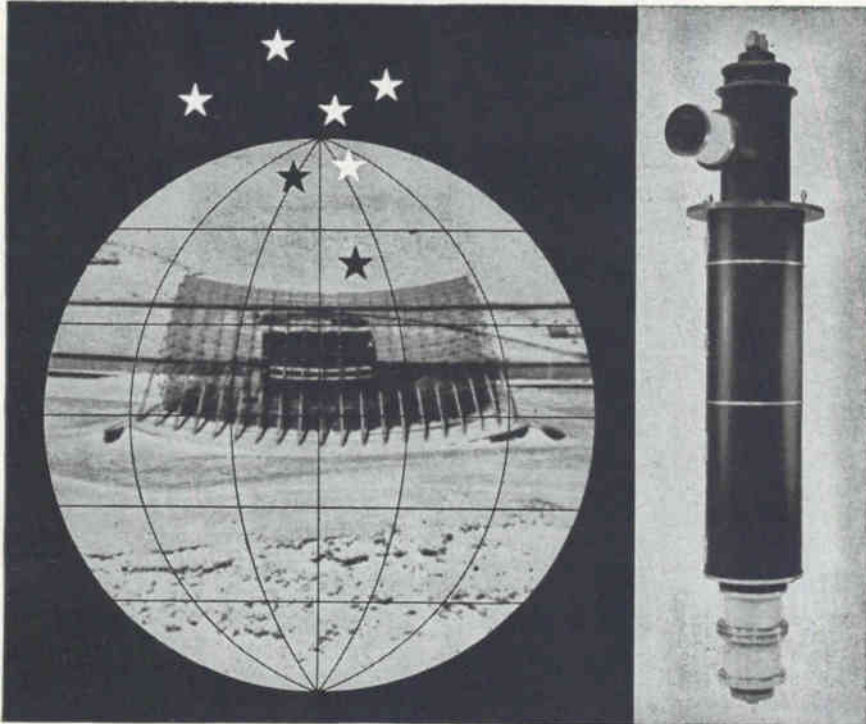

CIRCLE 201 ON READER SERVICE CARD

MEETINGS AHEAD

AEROSPACE SUPPORT INTERNATIONAL CONFERENCE & EXHIBIT, IEEE, ASME; Sheraton-Park Hotel, Washington, D. C., Aug. 4-9.

INTERNATIONAL ELECTRONICS CIRCUIT PACKAGING SYMPOSIUM, University of Colorado, et al; at the University, Boulder, Colo., Aug. 14-16.

WESTERN ELECTRONICS SHOW AND CONFERENCE, WEMA, IEEE; Cow Palace San Francisco, Calif., August 20-23.

DATA PROCESSING NATIONAL CONFERENCE & EXHIBITION, Association for Computing Machinery; Denver Hilton Hotel, Denver, Colo., Aug. 27-30.

AUTOMATIC CONTROL INTERNATIONAL CONGRESS, International Federation of Automatic Control; Basle, Switzerland, Aug. 27-Sept. 4.

MILITARY ELECTRONICS NATIONAL CONFERENCE, IEEE-PTGMIL; Shoreham Hotel, Washington, D. C., Sept. 9-11.

ELECTRICAL INSULATION CONFERENCE, IEEE, NEMA; Conrad-Hilton Hotel, Chicago, Sept. 10-14.

JOINT ENGINEERING MANAGEMENT CONFERENCE, IEEE, ASME, et al; Biltmore Hotel, Los Angeles, Sept. 12-13.

INTERNATIONAL ASSOCIATION FOR ANALOG COMPUTING, AICA; Brighton College of Technology, Lewes Rd., Brighton, England, Sept. 14-18.

INDUSTRIAL ELECTRONICS ANNUAL CONFERENCE, IEEE, ISA; Michigan State University, East Lansing, Mich., Sept. 18-19.

NATIONAL POWER CONFERENCE, IEEE, ASME; Netherland-Hilton Hotel, Cincinnati, Ohio, Sept. 22-25.

INTERNATIONAL TELEMETERING CONFERENCE, IEEE, ISA, et al; London, England, Sept. 24-27.

PHYSICS OF FAILURE IN ELECTRONICS SYMPOSIUM, Armour Research Foundation and Rome Air Development Center, Illinois Institute of Technology, Chicago, Sept. 25-26.

ADVANCE REPORT

INTERNATIONAL CONFERENCE ON ELECTROMAGNETIC RELAYS, International Conference on Electromagnetic Relays Committee and Japanese Ministry of Education; Sendai, Japan, Oct. 8-11. Indicate interest by contacting or sending paper as soon as possible to: Charles F. Cameron, Professor, School of Electrical Engineering, Oklahoma State University, Stillwater, Okla.

FIFTH JOINT AUTOMATIC CONTROL CONFERENCE, IEEE, ISA, et al; Stanford University, Stanford, Calif., June 19-21, 1964. Sept. 30 is the deadline for submitting 100-word abstract to: IEEE Headquarters, 1964 JACC, Box A, Lenox Hill Station, New York 21, N. Y.

COMINCO

clip and save

HIGH PURITY METALS
AVAILABLE FORMS

Product	ALUMINUM	ANTIMONY	ARSENIC	BISMUTH	CADMIUM	GOLD	INDIUM	LEAD	SILVER	TIN	ZINC
BARS	✓	✓	✓	✓	✓	✓	✓	✓	✓	✓	✓
SHEETS	✓				✓	✓	✓	✓	✓	✓	✓
WIRE	✓				✓		✓	✓		✓	✓
POWDER		✓	✓	✓	✓	✓	✓	✓	✓	✓	✓
SHOT		✓		✓	✓	✓	✓	✓	✓	✓	✓
ROD	✓			✓	✓		✓	✓	✓	✓	✓
RIBBON							✓	✓			
PRE-FORMS	✓				✓	✓	✓	✓	✓	✓	✓
SALTS					✓		✓				

COMINCO PRODUCTS, INC.

electronic materials division

933 West Third Avenue, Spokane 4, Washington
Phone Area Code 509 RI 7-7103 • TWX 509 328-1207

USE AEROCOM'S AMPLIFIER FOR MORE COMMUNICATION POWER!

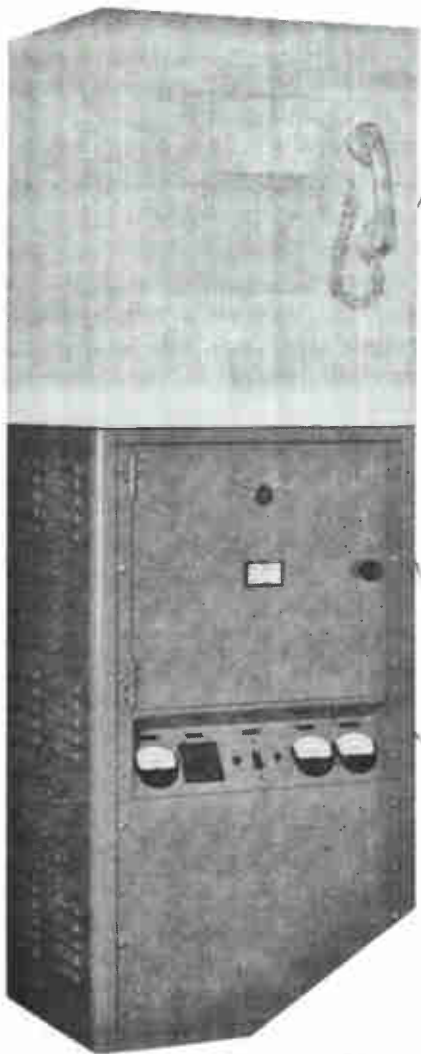

AEROCOM'S Linear Amplifier used with conventional low power SSB transceivers for excitation, provides power output of 1000 watts PEP, continuous service. The SSB exciter should have at least an output of 65 watts PEP to maximum output of the amplifier.

The Model 10LA amplifier is housed in a cabinet (22" W x 14 3/4" D x 36 3/4" H) and may be used as a base for conventional SSB exciter, or amplifier may be placed at a distance away from the associated exciter, if necessary for

Frequency
in 6 b
chr

Common to all four channels, or 4 output coaxial receptacles (one for each channel) are available; each channel normally requiring its own antenna. For multi-channel operation with 1 antenna it is recommended that a Model ATU-410 antenna coupler be used.

A directional coupler provides monitoring of forward power and SWR. Grid current, plate current, and high voltage are metered.

Attenuation: second harmonic and higher harmonics are at a level 40 db below 1000 cycles. Intermodulation products, in two-tone tests, depending on character-

Aerocom equipment, is available for trouble-free service. For more data on request.

Amphenol-Borg Electronics Corporation
Connector Division

MATING CYCLES (PAIRABILITY)
500 400 300
400 300 200
300 200 100
200 100 0
1000 800 600 400 200 0
with electrodeless gold over nickel plating. Each pair was subjected to 1000 mating cycles.
Male contacts were Amphenol cat. number 22-892, formed from gold-plated, nickel.
The females (cat. number 220-502 short) are copper bodies.

Help yourself

You have probably become conditioned to sacrificing one feature to gain another in your selection of micro-miniature connectors. The part that's small enough may be relatively unreliable or nearly impossible to work with. Often you must choose between size, electrical characteristics, or performance reliability.

Not so with the Amphenol Wire-Form Group.

NO COMPROMISE

The Wire-Form Contact is an interconnection device that combines small size with easy handling in assembly . . . high reliability with low cost. Most important of all, though, is the application versatility of the Wire-Form.

The Wire-Form Group conforms effortlessly to your packaging requirements, whatever they may be. From single contacts on component leads through Strip Connectors or Tiny Tim[®] Connectors on modules to Micro-Rac[®] or Mighty-Mite[®] Connectors for system input-output lines . . . the Wire-Form family can provide the best answer to your design needs. No more "round hole-square peg" problems!

FOR EXAMPLE

The Wire-Form Contact is extremely small, permitting high-density packaging. Depending on the connector insert used, you can have contact centers on 0.100", 0.085", or even down to 0.075". Yet connectors are easy to assemble . . . because you terminate *before* contacts are inserted, while there's still room to maneuver. Later, if you want to change circuitry or replace a component, contacts can be removed, repositioned, or replaced without discarding the connector.

Wire-Form Contacts can be termi-

nated by crimping, soldering, welding, or wire-wrapping. For single-contact terminations we have eyelet type female contacts that can be potted in modules or soldered into circuit boards.

PRICED RIGHT

The Wire-Form family will help keep costs down. High volume manufacturing methods let Amphenol market Wire-Forms at unusually low purchase prices. For example, our circular Wire-Form Connector (the Mighty-Mite) meets or exceeds the performance characteristics of other micro-miniature connectors selling for ten times its price. But initial cost is only half the battle . . . What about installed cost? Well, it's rock-bottom too. The Poke-Home feature means that most all of the assembly can be done out in the open, with plenty of room, and no fiddling with tweezers or magnifying glass. In short, it can be done quickly. And quickly means inexpensively, as labor costs go.

Wire-Forms give top reliability. Equalized, multi-point contact pressure results in exceptionally stable and low contact resistance. Contact resistance

varies less than half a milliohm through a thousand cycles of engagement-disengagement. (See chart below.)

FAMILY PLAN

One of the more important things to remember about the Wire-Form Group is the way it works as a team. No matter what kind of challenge comes up, at least one member of the Wire-Form team can handle it. This means you only need to stock one basic component, the Wire-Form Contact, to meet virtually all your micro-miniature connection needs. The savings in inventory investment, in stock control, and in uniform manufacturing methods can be substantial.

FACTS AND FIGURES

The new 24-page catalog on Amphenol Micro-Miniature Connectors (Catalog MM-1) has the facts, figures, drawings, and detailed performance characteristics you'll need to "help yourself." You can get a copy by contacting your local Amphenol Sales Engineer or by writing to Dick Hall, Vice President, Marketing, Amphenol Connector Division, 1830 S. 54th Avenue, Chicago 50, Illinois.

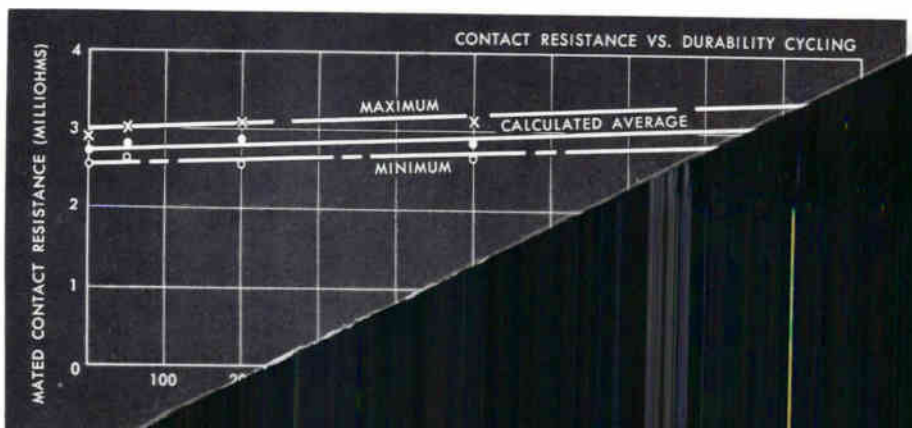

Tested
in

AMPHENOL

USE AEROCOM'S AMPLIFIER FOR MORE COMMUNICATION POWER!

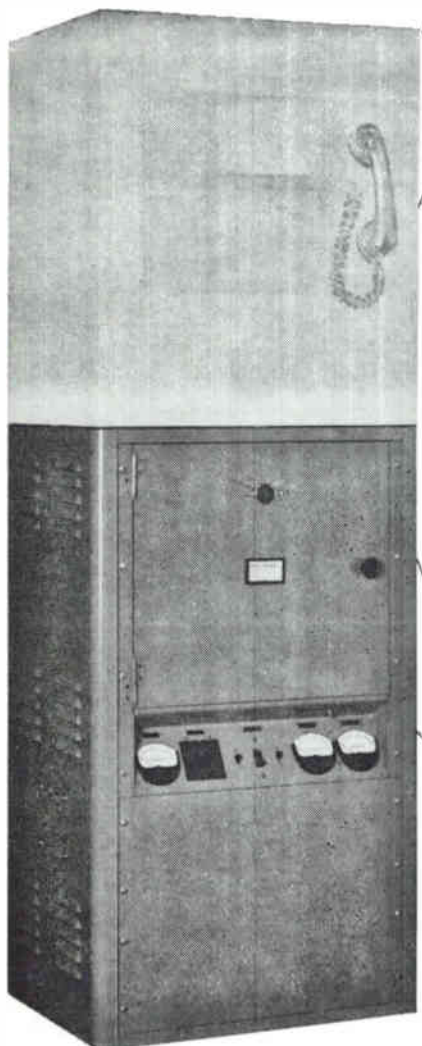

AEROCOM'S Linear Amplifier used with conventional low power SSB transceivers for excitation, provides power output of 1000 watts PEP, continuous service. The SSB exciter should have at least an output of 65 watts PEP to obtain maximum output of the amplifier.

The Model 10LA amplifier is housed in a cabinet (22" Wx14 $\frac{3}{4}$ " Dx36 $\frac{3}{4}$ " H) which can serve as a base for conventional SSB exciter, or amplifier may be placed a short distance away from the associated exciter, if necessary for convenience.

Frequency range of 10LA is from 2 to 20mc, covered in 6 bands. Up to 4 independent non-simultaneous channels are provided. These four channels are selected externally by exciter channel control. One tuning unit is provided for each frequency specified up to maximum of four.

The 10LA amplifier is designed to work into a 50 ohm coaxial feed line. One output coaxial receptacle,

common to all four channels, or 4 output coaxial receptacles (one for each channel) are available; each channel normally requiring its own antenna. For multi-channel operation with 1 antenna it is recommended that Aerocom Model ATU-410 antenna coupler be used.

A built-in directional coupler provides monitoring of output power and SWR. Grid current, plate current, filament voltage and high voltage are metered.

Harmonic output attenuation: second harmonic is at least 55 db down and higher harmonics are at least 70 db down. Noise level is 40 db below 1000 watts PEP output. Distortion products, in two-tone test, are at least 35 db down, depending on characteristics of exciter.

This linear amplifier, like all Aerocom equipment, is ruggedly constructed to give long trouble-free service. Additional information and technical data on request.



3090 S. W. 37th Avenue — Miami 33, Florida

Help yourself

You have probably become conditioned to sacrificing one feature to gain another in your selection of micro-miniature connectors. The part that's small enough may be relatively unreliable or nearly impossible to work with. Often you must choose between size, electrical characteristics, or performance reliability.

Not so with the Amphenol Wire-Form Group.

NO COMPROMISE

The Wire-Form Contact is an interconnection device that combines small size with easy handling in assembly . . . high reliability with low cost. Most important of all, though, is the application versatility of the Wire-Form.

The Wire-Form Group conforms effortlessly to your packaging requirements, whatever they may be. From single contacts on component leads through Strip Connectors or Tiny Tim[®] Connectors on modules to Micro-Rac[®] or Mighty-Mite[®] Connectors for system input-output lines . . . the Wire-Form family can provide the best answer to your design needs. No more "round hole-square peg" problems!

FOR EXAMPLE

The Wire-Form Contact is extremely small, permitting high-density packaging. Depending on the connector insert used, you can have contact centers on 0.100", 0.085", or even down to 0.075". Yet connectors are easy to assemble . . . because you terminate *before* contacts are inserted, while there's still room to maneuver. Later, if you want to change circuitry or replace a component, contacts can be removed, repositioned, or replaced without discarding the connector.

Wire-Form Contacts can be termi-

nated by crimping, soldering, welding, or wire-wrapping. For single-contact terminations we have eyelet type female contacts that can be potted in modules or soldered into circuit boards.

PRICED RIGHT

The Wire-Form family will help keep costs down. High volume manufacturing methods let Amphenol market Wire-Forms at unusually low purchase prices. For example, our circular Wire-Form Connector (the Mighty-Mite) meets or exceeds the performance characteristics of other micro-miniature connectors selling for ten times its price. But initial cost is only half the battle . . . What about installed cost? Well, it's rock-bottom too. The Poke-Home feature means that most all of the assembly can be done out in the open, with plenty of room, and no fiddling with tweezers or magnifying glass. In short, it can be done quickly. And quickly means inexpensively, as labor costs go.

Wire-Forms give top reliability. Equalized, multi-point contact pressure results in exceptionally stable and low contact resistance. Contact resistance

varies less than half a milliohm through a thousand cycles of engagement-disengagement. (See chart below.)

FAMILY PLAN

One of the more important things to remember about the Wire-Form Group is the way it works as a team. No matter what kind of challenge comes up, at least one member of the Wire-Form team can handle it. This means you only need to stock one basic component, the Wire-Form Contact, to meet virtually all your micro-miniature connection needs. The savings in inventory investment, in stock control, and in uniform manufacturing methods can be substantial.

FACTS AND FIGURES

The new 24-page catalog on Amphenol Micro-Miniature Connectors (Catalog MM-1) has the facts, figures, drawings, and detailed performance characteristics you'll need to "help yourself." You can get a copy by contacting your local Amphenol Sales Engineer or by writing to Dick Hall, Vice President, Marketing, Amphenol Connector Division, 1830 S. 54th Avenue, Chicago 50, Illinois.

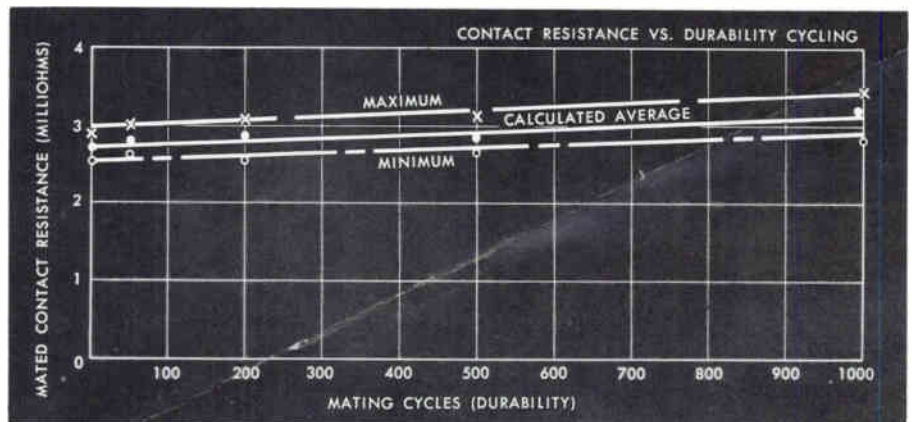

Tested male contacts were Amphenol cat. number 22-692, formed from gold-clad, nickel-interlined beryllium copper wire. The females (cat. number 220-502 short) are copper bodies with electroless gold over nickel plating. Each pair was subjected to 1000 mating cycles.



Connector Division / Amphenol-Borg Electronics Corporation



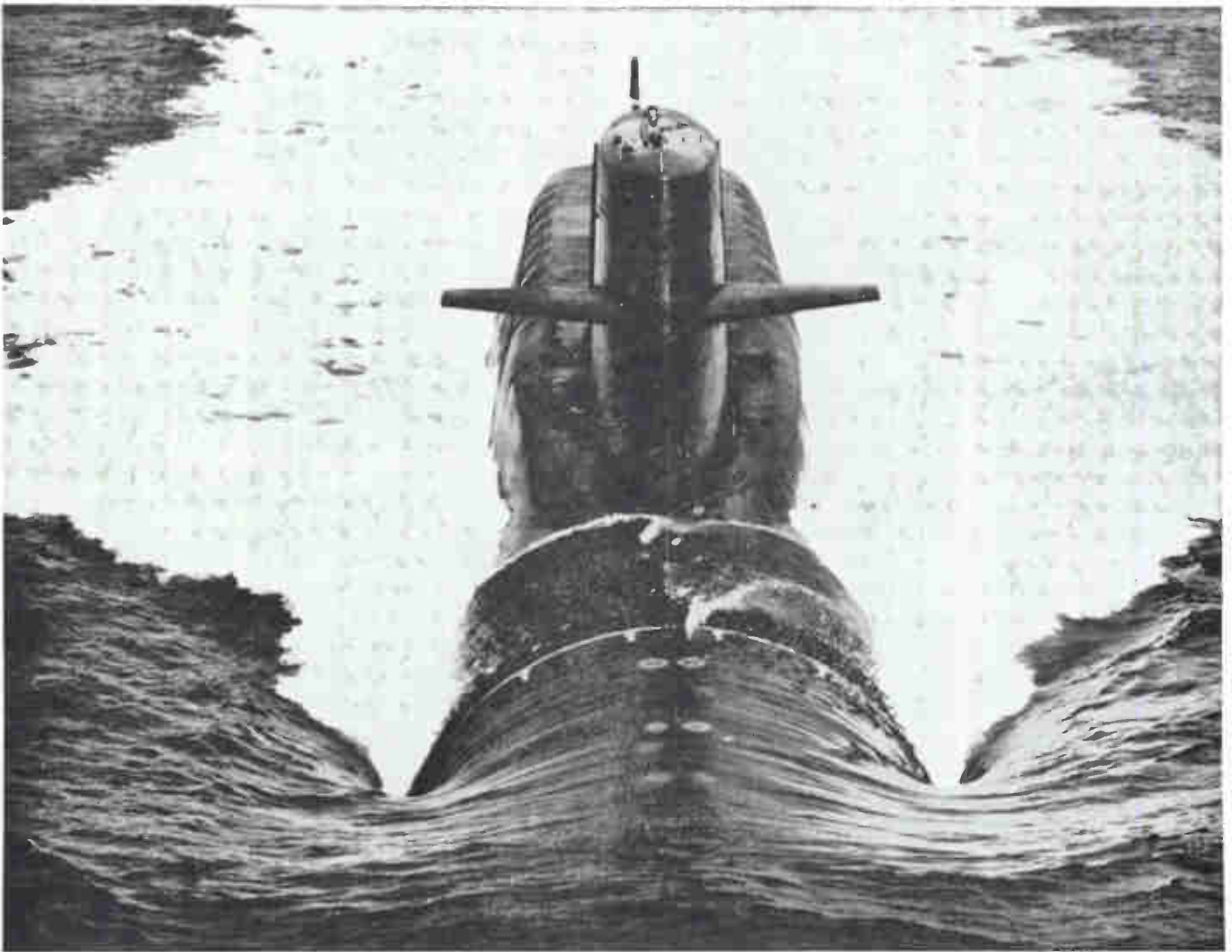

Official U.S. Navy Photograph

CUBIC digital voltmeters check out Polaris weapons system

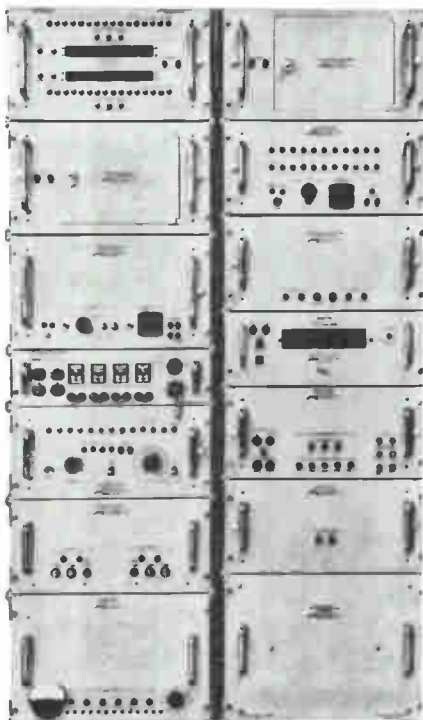

Cubic Corporation is proud to have had the opportunity to develop three distinct types of specialized digital voltmeters for use in the Polaris program. The instruments were developed by Cubic and supplied for three specialized applications for check-out functions in the Polaris Fleet Ballistic Missile Weapons System—a key element in the defense of the free world.

One of the major uses of Cubic digital voltmeters in the Polaris program is in the digital data acquisition system built by Interstate Electronics Corporation, Anaheim, California. This system is used in the submarines to acquire data regarding the weapon system performance. It is part of the calibration equipment whose purpose is to insure satisfactory operation of the Polaris missiles. The Cubic instrument is indicated by arrow at left.

The Cubic militarized digital voltmeter features all solid-state plug-in circuitry and lifetime reed relays used for bridge switching. Operating components are compact, rugged and lightweight. A special snap-out replacement readout is available to insure minimum downtime, should maintenance be required. Absolute accuracy of .01% of reading, ± 1 digit is provided. Sensitivity is 1 mv. MIL-STD's 16B, 167, 202B are met. For additional information, write to Department B-167.



LEADER IN INDUSTRIAL, GEODETIC AND AEROSPACE ELECTRONICS

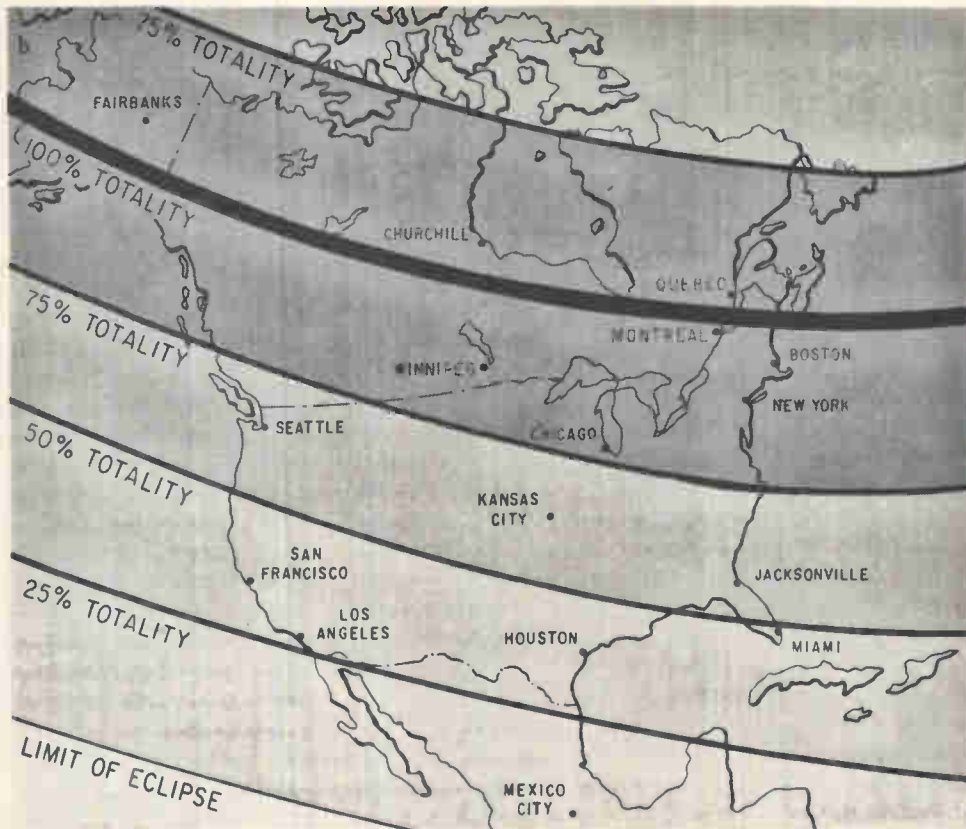

ECLIPSE MAP shows degree of totality over the North American continent

RACING THE SOLAR ECLIPSE

Quiet sun sets stage for radio observations of ionosphere, visual sightings closing gap on solar knowledge

By **JOEL STRASSER**
Assistant Editor

THOMAS MAGUIRE
New England Editor

HENRY J. BROWN
McGraw-Hill World News

RADIO AND VISUAL observation of last week's solar eclipse was more extensive and more detailed than during any previous eclipse in the history of our planet.

For radio observation particularly, an eclipse sets the stage for effectively probing the earth's ionosphere in a period of relatively quiet solar activity.

The structure and workings of the ionosphere are crucial in space defense activities: in earth-to-

earth and earth-space communications, in navigation and guidance of space vehicles, in manned space flight, in space "intelligence"—surveillance, detection and tracking.

Radio observations can furnish important clues to the dynamic processes at work in the ionosphere, which is largely a product of the interaction of solar energy with air molecules in the earth's atmosphere. By observing iono-

spheric conditions before, during and after an eclipse, it is possible to derive new insights into ionospheric processes.

Visual observations during the eclipse permitted examination of phenomena, particularly the sun's corona and chromosphere, normally masked by the sun's dominance. Clues were obtained for the mechanism behind the development of solar flares, and the chromosphere's structure—the unstable region above the photosphere where temperatures rise from about 10,000 F, to 2,000,000 F in the corona. Because some theorize that the sun's corona fills all interplanetary space, this region received considerable attention.

Last week's eclipse takes on added significance because of the approach of the International Year of the Quiet Sun (ELECTRONICS, p 20, Sept. 14, 1962). The Year starts officially in January, 1964 and continues through 1965, but the sun has already quieted down to some extent. Reports persist that the Soviet Union will attempt a manned lunar landing by 1965. Their astronomers have been citing the dangers for manned space flight during the 1966-1970 period of increased solar activity.

MILITARY PLANS—Special emphasis was given to radio observations by the Air Force Cambridge Research Laboratories for measuring the effects of the eclipse on the

ionosphere. The 150-foot radio telescope at Hamilton, Mass. was used to measure variations in signal strength from the radio star Cassiopeia (ELECTRONICS, p 26, July 19). This signal strength varied with changes in the ionosphere. Signals reflected from the moon, transmitted by the Army's Fort Monmouth, N. J., laboratories were received by the other 84-foot radio telescope at Hamilton. Following analysis of the Faraday rotation of these lunar-reflected signals, it is hoped that AF will learn of any changes in the electron density of the earth's atmosphere caused by the eclipse.

The broad-band riometers (relative ionosphere opacity meters) were listening to the general cosmic background noise. If the ionospheric density was reduced by the normal recombination of electrons and positive ions without the corresponding creation of these charged particles by the sun's action, it was detected by the riometers. Very little final data was available at press time.

Riometers in Maine measured changes in the D-layer. By noting changes in phase and amplitude of the signals, changes in the height and reflectivity of the D-layer resulting from the eclipse were measured.

In another Air Force sponsored experiment, AFCRL fired a Canadian-built Black Brant rocket with instrumentation for measuring

variations in the D- and E-layers during the eclipse. At Fort Churchill, Canada, where the Black Brant was fired. NASA also conducted firings of Nike-Apache and Aerobee sounding rockets.

AFCRL also had an KC-135 in the air, instrumented to measure the effects of the D-layer. The planes met the eclipse at Fort Churchill, and followed the path to permit observation of the total eclipse for as long as four minutes.

Two F-104's from Kirtland AFB, Albuquerque, N. M., flew scientists from Ottawa, Canada. One carried a Brown University scientist northwest, intercepted the eclipse, and returned to Ottawa. The other carried a scientist from Technical Operations Corp. from Ottawa southeastward to Dow AFB, Maine. Planes were used to take the observers further out of the earth's atmosphere.

PROJECT APEQS—One of the largest non-government expeditions to observe the eclipse also made use of a plane, a specially-adapted Delta Air Lines DC-8 flying at 42,000 feet. National Geographic Society and Douglas Aircraft Co. conducted Project APEQS—Aerial Photography of the Eclipse of the Quiet Sun.

Seats along the right side of the plane were removed, and a special floor was installed for mounting spectrographs, telescopes, cameras and other bulky astronomical in-

AT AFCRL's Sagamore Hill Radio Observatory in Hamilton, Mass, only 225 miles from the path of totality, the new 150-foot dish in foreground took scintillation measurements of signals from the radio star Cassiopeia during the eclipse. The 84-foot dish in the background caught moon-reflected transmissions in an experiment to determine the effects of a changing ionosphere on radio signals

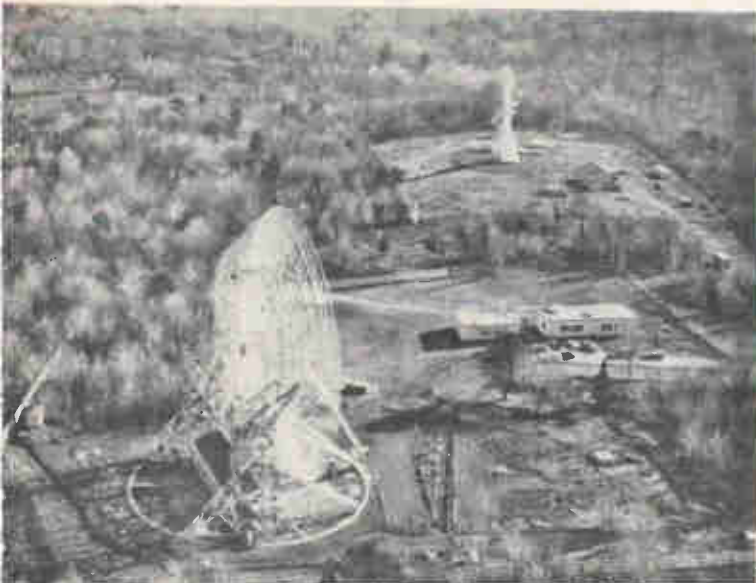

GERMANIUM WINDOW that visible light cannot penetrate was installed in the DC-8 jet flying eclipse observatory. Instruments recorded for infrared radiation band in sun's corona during eclipse. Germanium is opaque to visible light, transparent to ir rays



struments. Some of the windows were replaced with glass lenses, ground optically flat, in flush, recessed or gimbaled mounts.

Douglas engineers installed an inverter in the plane providing 110-v, 60-cps current for operating many of the observing instruments. An advanced SP-30 autopilot, developed by Douglas and Sperry-Phoenix, kept the plane stable to 0.5 degree of arc. The plane carried a special flight recorder to reconstruct the location, altitude and attitude history of the flight and to correlate all astronomical observations with Greenwich Time.

On the plane, Rand Corp. scientists conducted photographic photometry of the outer corona (zodiacal light) in two colors, to judge the color of light reflected and diffracted by interplanetary particles. One of Rand Corp.'s cameras had a 20-in. lens to obtain data within a few degrees of the sun. The other camera had a 6-in. lens to obtain data to 20 or 30 degrees were the coronal brightness was below that of the sky.

Naval Ordnance Test Station performed photographic and photoelectric photometry and radiometry. Two multilens K-24 aerial cameras were mounted on rigid tripods and guided manually by operators looking through auxiliary telescopes.

Other experiments employed a zodiacal photometer with internal baffles, silicon photodiodes and interference filters. A 28-v d-c motor drove the assembly. Data were dis-

EVERYBODY HAS HIS PROBLEMS

AS THE TOTAL solar eclipse neared its sweep across the state of Maine, thousands of tourists and scientists started to converge on that state. The annual convention of the Astronomical League of the United States alone brought about 1,000 delegates to the University of Maine at Orono.

In fact, things were getting so hectic at one point that the Skowhegan (Me.) Chamber of Commerce got a telephone call from a motel owner demanding to know why the eclipse had been scheduled for that particular Saturday. It's the busiest weekend of the season, he continued, "so why can't you get it postponed until later?"

He'll have time to prepare for the next one. A solar eclipse will be visible in Aroostock County in 2106

played on an eight-channel chart recorder. Time reference and instrumentation orientation data were also recorded. Other equipment included an airglow photometer, and an eclipse radiometer that measured the sun's radiation.

Pacific Missile Range, Point Mugu, Calif., was represented on board by one scientist who took pictures of Bailey's Beads. (The first beads of light radiating out from between the moon's craters and other physical irregularities.)

Douglas Aircraft Co. performed a variety of experiments. A two-prism spectrograph, loaned by Mt. Wilson Observatory for the flight, was used in conjunction with a 6-in. aperture reflecting telescope to photograph the coronal spectrum.

Recent advances in far ir sen-

sors made it possible to study the solar corona with minimum background radiation. Measurements were performed in the 2-to-14 micron wavelength region of the spectrum.

Polarization studies of the total eclipse were also made in Project APEQS. An intervalometer pulsed shutters enabling cameras to be operated at desired exposure times. All films were sensitometrically controlled. In this way, the contrast, film speed and density-exposure characteristic curves will be known when the film is ultimately processed and photometrically analyzed.

Selected pictures will be scanned with a microdensitometer.

A research physicist from Aerospace Research Laboratories at

FLASH SPECTRA of the sun's corona were photographed during eclipse with this camera aboard the DC-8 by John Waddell of Douglas Aircraft



AIRBORNE TELESCOPE is attached to stellar spectrograph in preparation for use on National Geographic Society-Douglas Aircraft Co. eclipse flight

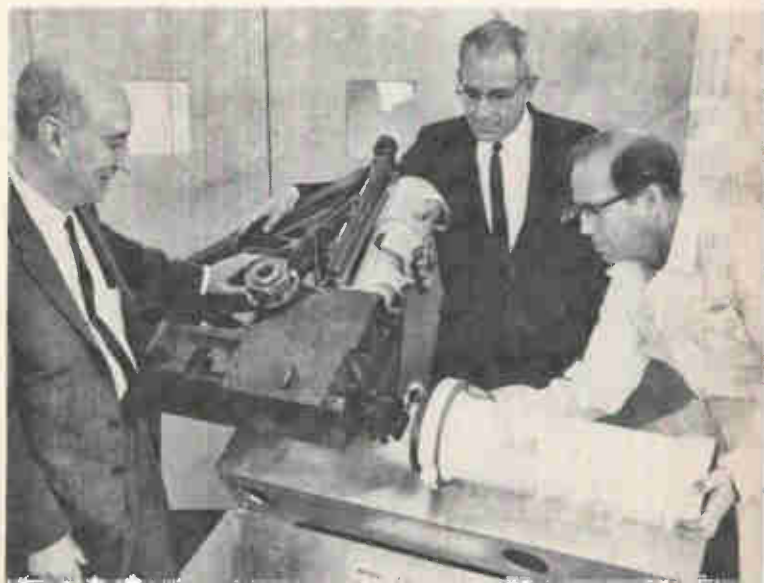

Wright-Patterson AFB, Ohio, obtained flash spectra of the solar chromosphere in the infrared.

Lockheed scientists on board photographed the outer solar corona in time exposures using a modified K-24 aerial camera with guiding telescope in a special swivel window, and a 16-mm motion picture camera.

A photometer of the University of Pittsburgh and the Service D'Aeronomie, Verrieres, France, scanned the spectrum of light in the partial illumination of the penumbra to obtain information on the altitude and excitation mechanism of the sodium airglow.

Johns Hopkins University used a spectrophotometer to investigate the creation of four sodium airglow emission bands.

National Bureau of Standards, Boulder, Colo., studied the airglow with hand-held photometers and a spectroscopy from both sides of the DC-8 to record the auroral emission during the eclipse.

OTHER FLIGHTS—Flying at 32,000 feet above Great Slave Lake in Canada, an Aero Service Corp. B-17 permitted scientists from the Geophysical Institute of University of Alaska to study daytime aurora, dayglow and the total eclipse.

Extremely sensitive photometers studied various emissions in the dayglow. Sky brightness was also studied during the experiment. Intensity of various wave-length regions was measured with a photoelectric photometer and spectrograms were taken.

An American Airlines 990 jet flying northeasterly over Maine also took to the air at an altitude of 35,000 feet. It carried scien-

tists from New York's Hayden Planetarium and Boston's Smithsonian Astrophysical Observatory, along with other observers.

INDUSTRY GROUPS—In addition to participating in the DC-8 flight, Lockheed also sent a team to Sourdough, Alaska, to take time-lapse and color motion pictures of the corona during the eclipse, and of the darkening rim of the sun just before and after. The team operated two complete optical systems (cameras and reflecting mirrors), stop motion camera, and a heliostate telescope camera.

Bell Telephone Laboratories measured solar noise during the eclipse with their horn antenna at Andover, Maine.

Geophysics Corp. of America conducted ionospheric sounding with rockets immediately before, and during the solar eclipse for NASA. They provided the first simultaneous measurement of electron density, uv and x-ray radiation in the ionosphere under varying conditions of solar radiation.

NASA EXPERIMENTS—In the area of sounding rockets, NASA supervised the firing of six Nike-Apaches and one Aerobee-150A from Fort Churchill during the eclipse, an Aerobee-150A from White Sands, N. M., and an Aerobee-300A three-stage vehicle from Wallops Island, Va.

Six Nike-Apache vehicles were fired in sequence periodically in less than two hours during the eclipse. These were designed to measure electron density and electron temperature, using Langmuir probes, and to measure solar radiation in the uv and x-ray regions

of the spectrum. These tests were instrumented to tell whether electrons are destroyed by recombination with positive ions or by attachment to neutral molecules or atoms. The eclipse provided an opportunity to determine the value of the coefficient of destruction and recombination. Each rocket carried an f-m/f-m, 2-w telemetry transmitter and 22-, 40- and 70-Kc sub-carrier oscillators.

The Aerobee-150A fired from Fort Churchill was designed to measure spectral emission lines in the upper atmosphere as well as to provide a measurement of sodium concentration. Line intensity is measured as a function of altitude, thus determining the distribution of molecular and atomic species.

Telemetry was f-m/f-m at 234 Mc modulated by 12 subcarrier frequencies from 1.7 to 70 Kc. Transponder was a DPM-41 receiver-transmitter beacon. All data was returned to Goddard Space Flight Center. Experimenters included scientists from Johns Hopkins University, University of Paris, and University of Pittsburgh.

NASA's Aerobee-150A fired from White Sands, N. M., was designed to give data on flight, performance and calibration of the solar uv spectrophotometer optics for the S-17 satellite. The rocket was also designed to photograph the extended solar corona, and the solar disc in the Lyman-Alpha light. Instrumentation included a uv spectrophotometer, a wide-angle solar coronagraph, a Lyman-Alpha spectroheliograph, and a solar pointing control that sent signals from a photodetector to two independent servo systems (azimuth and elevation).

The three-stage Aerobee-300A sent aloft from Wallops Island, was designed to simultaneously measure electron and neutral particle temperatures from 120 to 360 Km. A secondary objective was to measure ion and neutral particle density in the same altitude interval during the eclipse. Telemetry transmitter for this vehicle was a five-channel f-m/f-m unit. Goddard was in charge of most of these experiments.

Besides the rocket launchings,

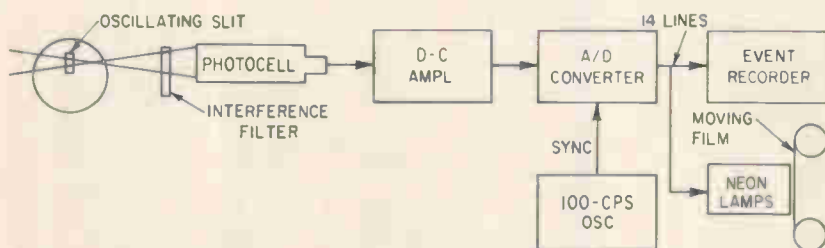

KITT PEAK OBSERVATORY photometer used two recording systems for output. Each of the 14 bits is fed to a separate channel of an event recorder. Also, each bit operates a neon lamp, and light from the lamps passes through a glass light pipe that is in contact with moving 35-mm film

NASA had Astronaut Scott Carpenter and Jocelyn Gill, an astronomer from Goddard Space Flight center, aboard the Douglas-National Geographic Society DC-8 to observe solar phenomena and receive briefings.

Tiros 6, was in position to take photos during the eclipse. NASA wanted to see the effects of an eclipse on cloud cover pictures from the meteorological satellite.

A six-man team from Goddard was at Pleasant Pond, Me., in the line of totality to search for faint comets near the sun.

NBS PARTICIPATION—At Palmer, Alaska, National Bureau of Standards had an experiment to measure the change in absorption during the eclipse using multi-frequency dual-polarization riometers. NBS hopes to be able to work out height profiles to study electron density changes in the D-region during the eclipse. Recordings of the ordinary and extraordinary components of cosmic noise were made at 10 and 15 Mc.

In another experiment, NBS tried to determine the role of the ionosphere in causing variations in 1-cps micropulsations. Using two stations 250 Km apart, NBS also studied variations in the auroral current stream in the ionosphere in conjunction with the magneto-

graph at College, Alaska.

NBS also operated a photometer at Orono, Maine, to measure absolute brightness in the sky before, during and after the eclipse. The photometer has a 5-degree field and about a 50-angstrom bandwidth in the blue-green part of the spectrum (5,300 Å). Purpose was to pin down the effect of the eclipse on total sky brightness in this frequency range.

In a final experiment, signals from a U. S. Navy vlf transmitter at Cutler, Me. (14.7 Kc) arrived at the receiver at one reflection from the D-region at a point where the D-region underwent total eclipse. Phase and amplitude of these and other vlf and l-f signals from Ottawa and Annapolis, Md., which pass through areas of partial eclipse, were recorded. The experiment provided information on ionization and recombination processes in the D-region.

OTHER INSTITUTIONS — Kitt Peak National Observatory in Arizona used a specially-designed photometer together with a coelostat to track the sun. The experiment was designed to measure accurately the decrease of the sun's intensity toward the limb. In the photometer (see figure), a slit oscillated back and forth across the thin crescent of sunlight existing be-

fore and after totality. A cam, shaped to provide constant scanning rate, moves the slit. The light passes through the slit and through an interference filter centered at 6,043 Å whose spectral width is about 15 Å. Light measuring chain consists of a photomultiplier cell, d-c amplifier and an analog-to-digital converter that can make one hundred 14-bit conversions a second. Two independent systems recorded the output.

At Laurentian University in Ontario, a portable vertical incidence ionosonde built by University of Illinois was beamed 200 miles up to get electron density profiles above the F region. Stanford University and University of Illinois operated similar experiments at other locations.

A team from the radiophysics division of MIT Lincoln Laboratory, working in Bingham, Me., operated a four-frequency mm-wave radiometer, looking for radiation from the solar corona at 4, 8, 13 and 22 mm.

At James Bay, Ontario, Dearborn Observatory researchers from Northwestern University recorded signals from the corona during totality. A three-transistor pulse control has been specially-developed to regulate exposure times of a Signal Corps image orthicon from 1/30 to one frame per second.

INSTRUMENT PACKAGE for Nike-Apache solar eclipse rocket is adjusted by Leslie G. Smith, project director. Blockhouse control panel is shown in rear



CAMERA-MIRROR SYSTEM was used by Lockheed California Co. scientists to photograph eclipse last week at Sourdough, Alaska.

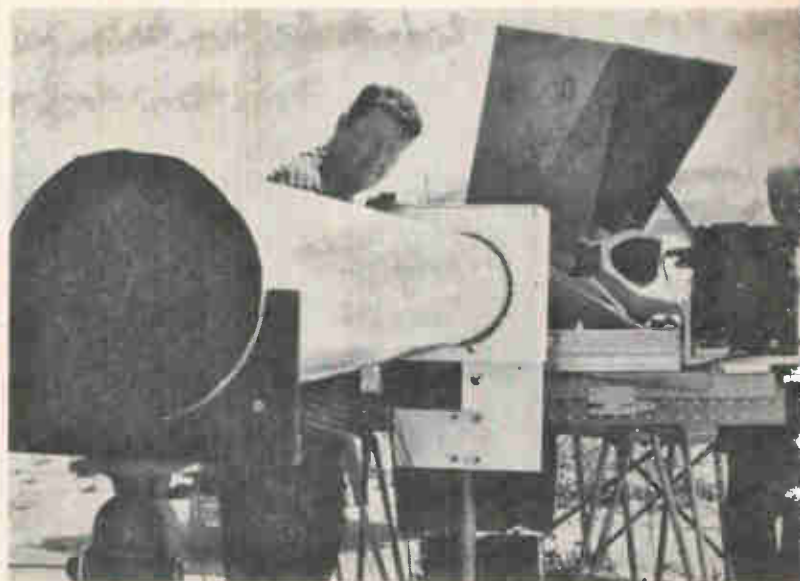

New Light on Air Traffic: Bright

Bright display console combines alphanumeric characters and track-while-scan

AIR TRAFFIC control centers near airports and in other heavy traffic areas have several controllers viewing displays that cover the entire area or sectors of the area depending upon the controller's responsibility. These displays are usually derived from one or two prime radars.

Two important pieces of data are aircraft location (ppi echoes) and identity or tracking data associated with the echoes. These two classes of data for every aircraft in each controller's area should be available for viewing at any instant, not once every radar antenna scan or when the displays are updated by

moving markers to follow the radar echoes.

Viewing in a normally lighted room reduces eye strain as the controller refers from display to tabular data. Meeting these specifications requires electronic time sharing of the system input data in conjunction with an advanced method of storage tube erase control. To enhance operational flexibility in a small console, maximum use of remote processing functions is made.

PP DATA DISPLAY—The plan position data display is a time-shared, direct-view storage-tube

system. Each system contains a maximum of up to five displays and is normally associated with a track-while-scan processing unit, although the display could be used as a conventional ppi indicator.

Each display console uses an extruded beam writing technique for alphanumeric as well as spot writing techniques for radar data. The processing equipment associated with each console uses time sharing techniques to combine several data inputs. Flexibility for transfer of responsibility between displays in the same group or overall monitoring is provided by designing each console with identical and yet universal capabilities in de-centering, range, sector and video selection controls.

The equipments that comprise the system are: The PPDD console containing the direct view storage tube and operator controls; the unit processor rack required for each display containing the power supplies, video, analog and logic circuits for the display console (this unit may be remoted from the display console by as much as 300 feet); and the group processor rack required for each display system and containing functions common to all the display consoles.

SYSTEM OPERATION — The PPDD System is designed to operate from several different signal sources available in a combined radar and beacon track-while-scan system with altitude gating and alphanumeric data capability. Prime signal sources are:

(1) Analog track-while-scan system (video trackers) providing the resolved ppi sweeps and display time gates for both search and beacon radars, and target video for the search radar and data for the alphanumeric displays.

(2) Altitude processing equipment, to be added in the future will take processed target data (mixed and range gated) from each dis-

WE NEED THIS ONE

Any new technique that will keep our airplane away from other airplanes is welcomed. This system, developed for FAA, has a number of new features to help do just that. Two of the most important are the provision for showing altitude and aircraft identification along with the target blip. Presently, this system is undergoing engineering and operational evaluation at NAFEC at Atlantic City, N. J.

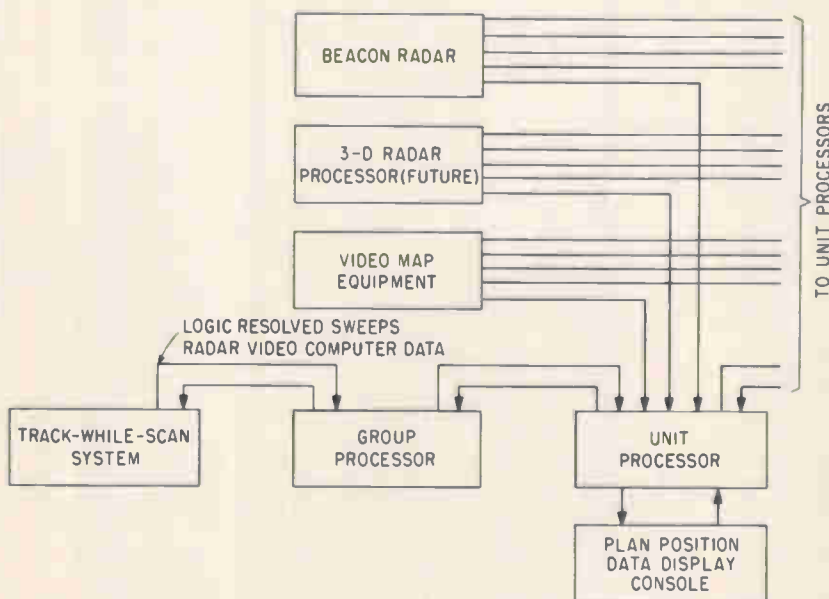

SYSTEM INPUTS are combined in each unit processor. As many additional display consoles as necessary may be added—Fig. 1

Plan Display With Alphanumerics

information on a storage tube

By T. VAGT, General Precision, Inc., Pleasantville, N. Y.

play and provide altitude discrimination.

(3) Video mapping equipment to provide area maps to each display that is synchronized with the search radar antenna.

(4) Beacon decoding equipment to provide display pretriggers and processed beacon radar target data.

PPDD system interrelations are shown in Fig. 1. With the varied data inputs a logical sequence of displaying this information is necessary. The most urgent data (characters, beacon) must be displayed as soon as available at the system input.

Time sharing the inputs with specific priorities for certain information satisfies these requirements. The priorities assigned are computer data (available once every 3 seconds), beacon radar, search radar and slew/strobe data for visual indication of operator assignment and control of trackers.

The sequence used in the PPDD system for this priority governed time sharing is: blank the storage tube writing beam; switch the deflection system to the new data coordinate; unblank the writing beam and display the new data; blank the writing beam again; return the deflection system to the next lower priority data coordinate; then

unblank the beam and display the next lower priority data.

This sequence is repeated to form the composite display. For very slow moving targets with tracking gate computer data or for areas reserved solely for computer data, illegibility must be avoided. Incorporating two modes of erasing the storage tube eliminates this problem. Mode 1 is a long-storage mode that provides four or five radar echoes while Mode 2 is a complete erasure before update and is used where computer data clarity is most important.

To blank the beam of the display tube before changing deflection coordinates, preknowledge is required from the next higher priority data. This is provided by a pretrigger in the case of beacon and logic gates for computer and slew/strobe data.

Processing functions are assigned to each equipment in the display in accordance with system or console criteria. System functions are performed in the group processor. Individual display processing functions including the time-sharing circuits are part of the unit processor. In addition, all circuits that can be remoted from the display are in the unit processor. The display console contains only the circuits associated with the storage

tube and the operating controls.

GROUP PROCESSOR—The group processor (Fig. 1) contains a generator for range marks with 2, 5 and 10 mile range outputs. It normalizes the incoming video and intensity signals at a standard level of one-half volt. It also provides buffering for feedback signals to the tracking system as well as logic control for the rate of computer data printing in the display system. This rate is variable from a complete data print every 6 seconds to a print every 24 seconds. The choice of character display rate would be dependent on the range of the system using the displays, once every 21 or 24 seconds for the long range radar of the transition area and once every 9 to 15 seconds for the shorter ranges used in the terminal area.

UNIT PROCESSOR—This is the heart of the time sharing and processing required for the PPDD system. It uses transistors throughout and its functions, Fig. 2, can be divided into logic, video/intensity and analog/deflection.

The inputs bridge common lines from the group processor which are fed to the next unit processor of the display group. The time shar-

AIRCRAFT identification, altitude and destination information travels along with the target blip to aid traffic control. Typical display, left, and console



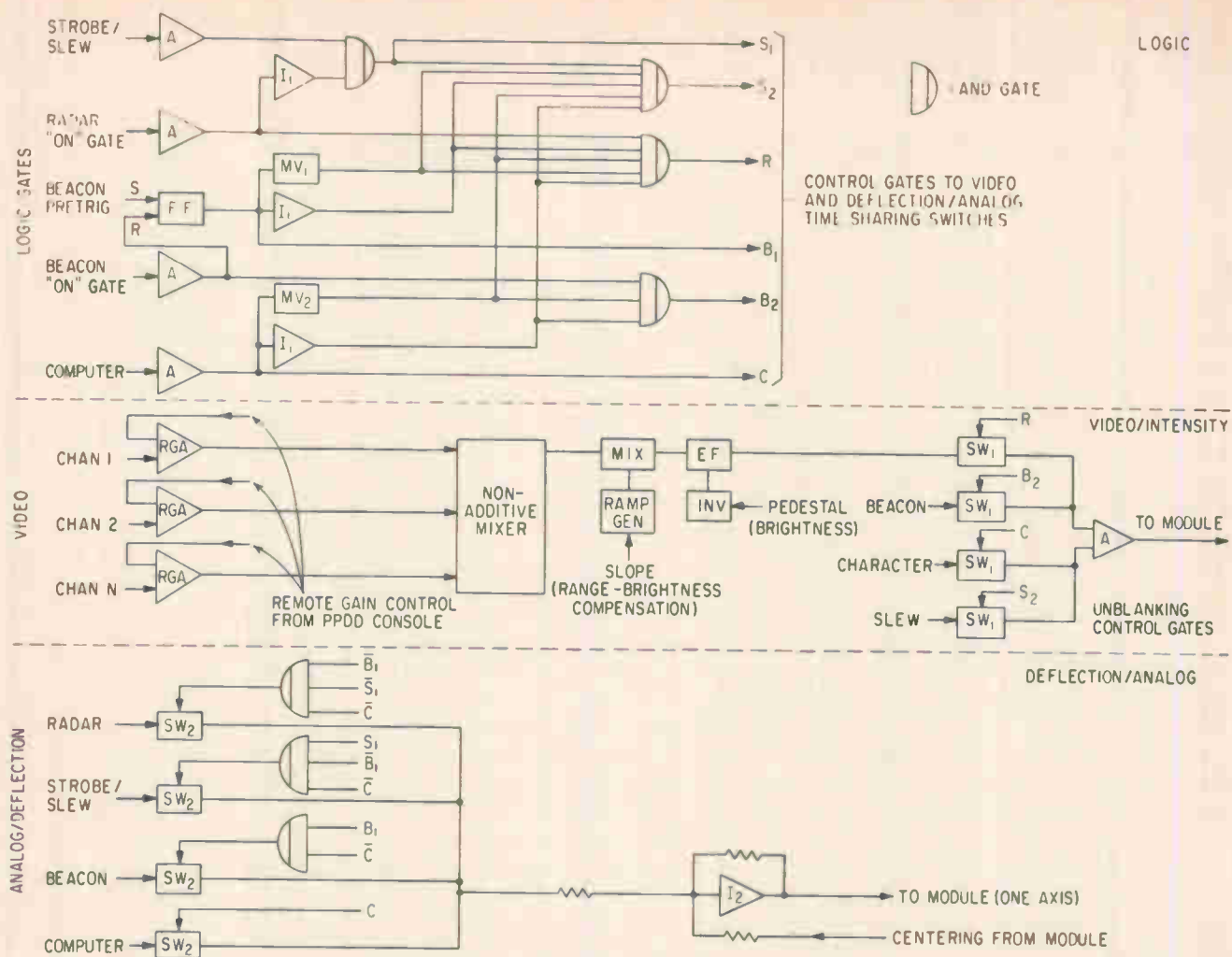

UNIT PROCESSOR controls the time sharing function—Fig. 2

ing is built around the use of diode switches in the analog and video channels; three diode types for video/intensity signals (SW_1) and 6 diode types for analog/deflection signals (SW_2). Logic circuits control these switches in sequence starting from the lowest order priority data (search radar) to higher priority data as logic commands are received.

The S , B and C inhibiting control gates to video switches (SW_1) are FALSE and the deflection channel is switched to the radar deflection buses by the six-diode switch (SW_2) bridging the incoming radar deflection data. When the radar on-gate goes TRUE, the R control gate closes the three diode switch associated with the radar video channel and the mixed radar video is transmitted to the console for display.

When a beacon pretrigger or computer-logic gate goes TRUE during radar display time, the radar video is interrupted by the R gate being inhibited by the beacon or

computer logic gate. The deflection system is then switched to the beacon deflection bus or the computer data coordinate. Next, the beacon or computer video channel is switched on for the length of time that their control gates are TRUE.

Finally, the deflection system is returned to the radar deflection bus while the video is held off by the multivibrators (MV_1 or MV_2). These are triggered by the trailing edges of the logic gates (beacon and computer) and hold the R and B_1 AND-gate outputs in the FALSE state for approximately 50 microseconds until the deflection channel has had time to settle back to the next lower priority data coordinate. For example, after a beacon ON gate, multivibrator (MV_1) in the beacon channel holds the radar video three-diode switch open until the deflection system, which was switched to the radar deflection bus at the end of the beacon ON gate, has settled back to the position of the radar data.

VIDEO—The combination of Fig. 3 and switch SW_1 of Fig. 2 forms the video switching and pedestal background control for the video/intensity circuits. The three-diode switch operates in the conventional manner by the application of a logic gate between a positive and negative voltage on the input to D_1 . This diverts the current from resistor R , through diode D_1 (switch open) or through diodes D_2 and D_3 (switch closed). With the switch closed and no video signal, diodes D_2 and D_3 are biased with approximately 3 ma in D_2 and one ma in D_3 . This is done to prevent D_2 from being cut off on high peak signals. Resistor R , provides a return path for the bias current in D_1 to insure the output base remaining at zero. The output of several of these switches can be connected together with no base line shift regardless of the state of the switches and the pedestal setting in each switching circuit.

Clamp diode D_1 insures that the

base line of the switch output will always be positive. The pedestal or bias level when the switch is on, (when D_2 and D_3 are closed) is established by the voltage on the emitter follower. This is remotely controlled from the PPDD console. The inverter was inserted in this control line so that bias on the emitter follower and the pedestal level of the video signal being fed to the emitter follower would never go the full white if the pedestal control line from the PPDD console were broken. This protects the storage tube from damage should the pedestal go towards full white and cause serious blooming. Outputs of four of these circuits are paralleled and fed to the display console as the composite video signal.

The remote gain amplifier (RGA) of Fig. 4 was designed to eliminate all but the final video amplifier at the PPDD console while providing the controller with on/off and gain control facilities for all types of video signals.

The circuit, Fig. 4, is composed of a diode gain-control circuit, an emitter follower, two stages of amplification and an output emitter follower to drive the subsequent mixers. The gain-control operation is obtained by a divider network composed of R_1 and D_1 . As the current through D_1 is varied from the PPDD console, its resistance changes and so does the video level at the input to the emitter follower.

High frequency compensation is provided by C_1 and the first emitter follower provides isolation between the gain control diode and the remaining sections of the amplifier. To obtain the required range of gain control (30 to 1), a relatively low level signal appears across diode D_1 . This requires the two additional stages of amplification (shown symbolically) to restore the signal to a level suitable for mixing with the other video signals. Isolation and low output impedance is provided by the last emitter follower. Video circuitry of the PPDD system provides better than 2.5 Mc response.

ANALOG DEFLECTION — Analog/deflection data inputs to the PPDD system are x and y coordinate data (resolved ppi sweeps, computer coordinate, etc.). Scale

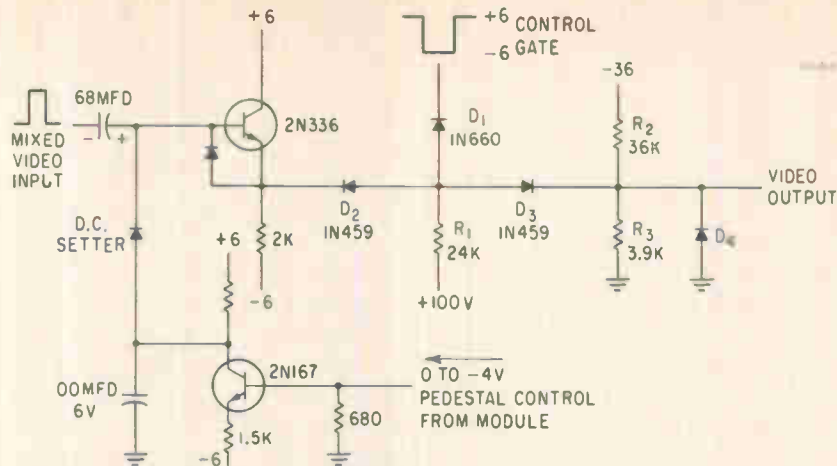

VIDEO TIME SHARING is accomplished by a three-diode switch operated by applying a control gate to D_1 .—Fig. 3

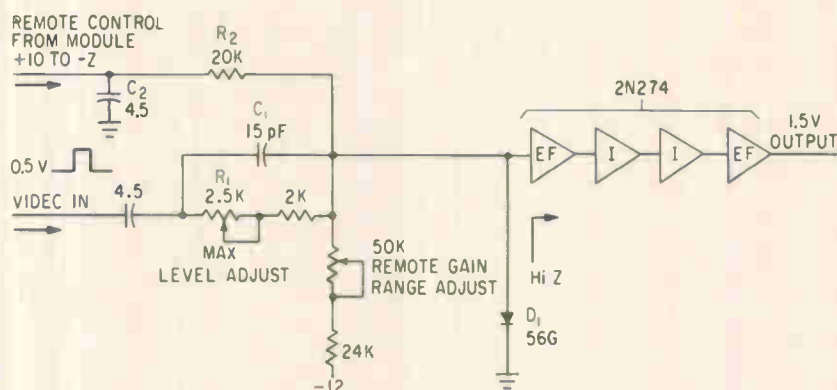

REMOTE GAIN amplifier provides the controller with gain control of video signals—Fig. 4

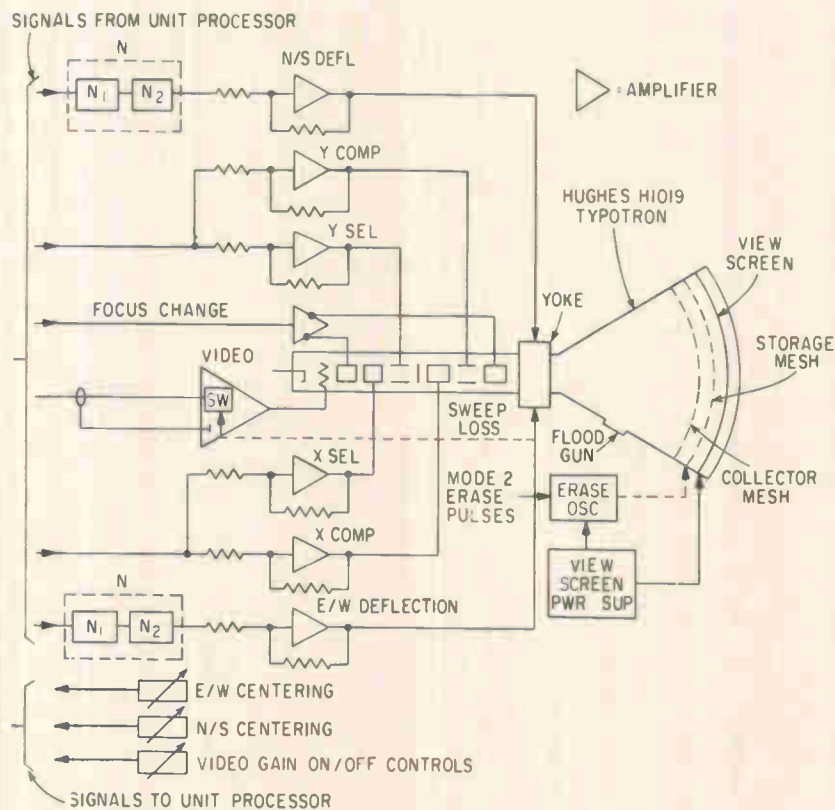

PPDD CONSOLE with connections to unit processor—Fig. 5

factor is 5 miles/volt for data associated with radar targets at ranges up to 100 miles. Provision has been made for an inches/volt scale factor channel so that characters associated with targets will have the same size independent of range.

The six-diode switch is the best method for switching these high level signals. However, signal current capabilities of these switches and the signal sources in the tracking system are limited. Inverter *I*₁ of Fig. 2 overcomes these difficulties. It also provides for addition of decentering voltage from the PPDD console which has the same scale factor as the deflection data.

The inverters are actually summing amplifiers consisting of three direct-coupled sections.

CONSOLE—The PPDD console is designed around the Hughes H1019 Typotron 21-inch, direct-view storage tube Fig. 5.

Incoming signals from the unit processor and therefore the functions in the display console are basically video and analog deflection performed in the unit processor. Outputs from the console to the unit processor consist of the control lines from remote video gain, centering, and range gating.

Video processing is in the final video amplifier that controls the intensity of the Typotron writing gun. It consists of a two-stage amplifier with a differential input section. The differential input is used to suppress low-frequency noise pickup on the 300 feet of coaxial cable between the console and unit processor. A video switch is also included in the input to turn off the Typotron write gun in the event of sweep (deflection circuits) failure.

The analog/deflection circuit provides the choice between spot writing or character printing, selection of the individual character during character printing and the final position of the spot or character Typotron screen.

Section and compensation amplifiers are designed to meet the requirements of the Hughes H1019. They are class-A push-pull types consisting of two stages of amplification with cathode follower output driving the electrostatic deflections plates of the Typotron selection and compensation system.

Overall voltage feedback is provided so that accuracy requirements of character registration (0.25 percent) can be met. The output stage of these amplifiers is capable of a dynamic swing of over 200 volts.

The deflection channels consist of the final deflection amplifier and the range/sector selector, and are fed by 300 feet of coaxial cable from the unit processor and subject to low-frequency noise that may be 10 percent of the signal for full-scale deflection. Suppression of this signal by at least 50 to 1 is required to eliminate noise as a source of location errors on the Typotron screen. The location errors on the Typotron are less than 2 percent and are mainly a function of tube geometry and deflection yoke design.

To suppress this noise, the input stage of the final deflection amplifier is differentially connected between the shield and the center conductor of the coaxial cable from the unit processor. The succeeding two stages are class-A push-pull with 0.1 percent linearity maintained by overall current feedback. To obtain the 50 to 1 noise suppression (high common mode rejection), the feedback network as well as the input to both halves of the differential amplifier must be balanced to 10 percent. The range/sector selector is part of this input feedback circuit and maintains this balance. The common mode rejection achieved was approximately 60 db from d-c to 1,000 cps.

The erase oscillator is part of a special method of controlling the erase characteristics of the Typotron. The usual technique of storage tube erasure consists of pulsing the storage mesh periodically with a pulse train whose amplitude and duty cycle are sufficient to prevent buildup and maintain the background level at or near black. This erasing, however, was previously accomplished in the presence

of the full view screen potential (9 Kv). The field caused by the view screen around the storage mesh maintains a small amount of the charge on the storage mesh resulting from previous scans of the writing beam. Under this condition, it is impossible to erase previous data below the 5 to 10 percent brightness level without decreasing the useful storage time by a factor of 5 to 10. This is illustrated by the curves of Fig. 6.

This problem can be eliminated by removing the effects of the view screen field during the erase pulse time by gating the 9 Kv power supply to a negative voltage during that time. Results approaching the ideal curve of Fig. 6 have been obtained using this technique. Within the limits imposed by ion buildup, varying the erase pulse duty cycle results in a nearly linear decay that is variable from 20 to 120 seconds or more.

In applications where computer data updates fall in the same locations as previous data, complete erasing of the viewing area is desirable. This is accomplished by continuing a single erase pulse condition for sufficient time to completely clear the storage mesh of prior data. The time required in the present tube is about ½ second.

RESOLUTION ENHANCEMENT

—In using the Hughes H1019, the image plane for the viewing screen is normally the character matrix. This type of operation produces best character clarity, but not the highest resolution for spot writing. The thickness of the lines forming each character are normally about 0.030 inch, which is twice the value that represents the limit of the storage mesh/collector mesh assembly. Two focus electrodes in the Typotron control the beam size at the matrix and the focus at the view screen. Voltages on these electrodes can be gated between the optimum for character printing and spot writing.

Video on/off and gain controls are available at the panel for all signals displayed. Analog/deflection controls that vary the display range among 25, 50 and 100 mile centered and decentered ranges are provided. There are also three pre-set sectors, with full scale decentering at 25, 50 and 100 mile ranges.

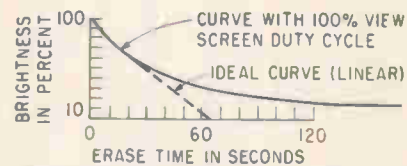

ERASE CHARACTERISTIC of storage tube (solid line) when a residual charge remains on the storage mesh. Negative pulsing results in near ideal curve—Fig. 6

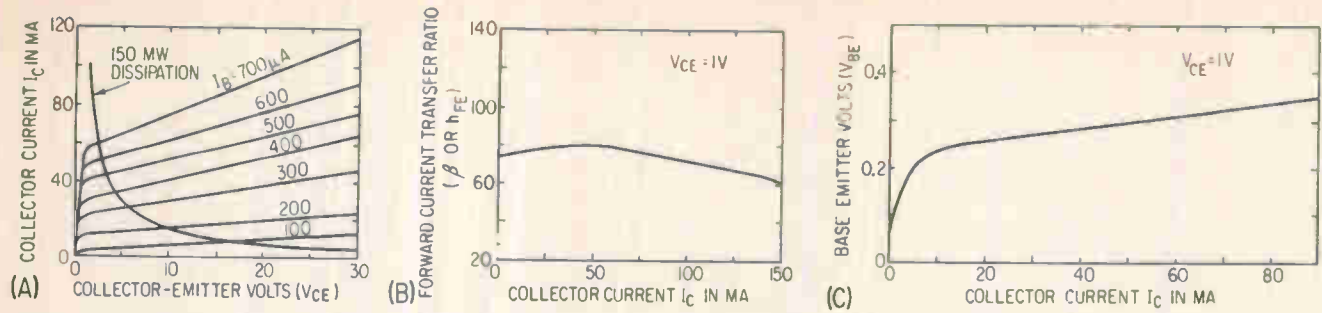

COMMON emitter characteristics (A), beta curve for one condition (B), and base-emitter voltage as a function of collector current (C), for TI pnp alloy types 2N1370 and 2N1371—Fig. 1

FRESH APPROACH TO

Measuring Transistor Beta

For circuit design, incoming inspection and production control, the major beta-measuring methods are pulsing, using a curve tracer, and steady-state techniques. Here's how to choose the best one for the job

By RONALD M. MANN, Texas Instruments Incorporated, Dallas, Texas

TRANSISTOR manufacturers and users continually encounter problems in correlating d-c beta test results. Much of the difficulty is caused by different measuring techniques and can be overcome by careful attention to the characteristics of the tests.

First, beta itself is more properly referred to as h_{FE} . The small h designates a small-signal h parameter, the capital F d-c forward transfer, and the capital E common or grounded emitter. Beta or h_{FE} , then, is the forward common emitter transfer ratio or gain with collector to emitter voltage constant

$$h_{FE} = \left. \frac{I_C}{I_B} \right|_{V_{CE} = \text{constant}}$$

The variation of beta for a typical transistor is shown in Fig. 1. Even though a guaranteed beta may be specified for each type transistor, this beta is

FROM WORSE TO BETA

The trouble with the constant known as beta (or h_{FE} by up-to-date engineers) is that it varies too much. Variable constants may be useful in engineering school but they have been causing engineers trouble for a long time and there is still no hope in sight. What to do? Sometimes feedback works in an actual circuit, but what about incoming inspection? One solution is to measure beta accurately for actual transistor operating conditions. Trouble again. There's more than one way

between some minimum and maximum, and is given for some fixed collector and emitter voltage. In many circuits this point is far from the desired operating point or the desired operating temperature, or both.

BETA MEASUREMENT—There are at present three main ways to measure beta.

- **Pulse measurement**—This method is useful when dissipation is severe. Collector and base drives are furnished in synchronized pulses and the device under test sees a short duty cycle. This allows an accurate measurement of beta with no drift problems, since junction heating does not occur.

- **Curve tracer**—This method uses a Tektronix curve tracer and displays the transistor characteristic with a load line. Beta is read by counting the steps.

- **Steady state**—This includes a number of general methods, all characterized by holding certain conditions constant.

- **Limit condition**—This steady-state method, Fig. 2A, is used primarily in automatic test equipment and for incoming inspection. Fixed collector and base currents are applied and transistor V_{CE} is measured. If V_{CE} is less than specified, beta is above the limit; if V_{CE} is greater than specified, beta is below the limit.

- **Switching measurement**—Usually associated with transistors to be used in switching applications, this method, Fig. 2B, holds base current and V_{CE} constant. Collector current depends on the beta of the transistor and can be large if beta is high.

- **Common base condition**—This is the simplest method. The base is grounded and metered, Fig. 3A, and a constant voltage is applied to the collector and a

constant current to the emitter.

Common Emitter Condition—Although this is the most complex of the steady-state methods, it is also the most desirable. A constant collector current is forced into the collector, Fig. 3B, the emitter is grounded, and a variable base drive is applied to bias the transistor to some fixed V_{CE} .

The table lists the advantages and disadvantages of each of the above techniques for measuring beta.

The preferred method, Fig. 3B, gives a true, active, common emitter beta measurement. The tricky part of the circuit is the feedback system from collector to base, which is completed by the transistor under test. Although this system is the hardest to build

and adjust, it thereafter gives little trouble. Since it is a closed loop system, oscillations are possible under some conditions. The collector is fed by a constant current source, such as shown in the circuit of Fig. 4, or else through a resistive source. Base current is adjusted to bias the transistor so that the collector maintains the desired V_{CE} . Bias adjustment can be accomplished by an active feedback loop, as shown in Fig. 4, or manually, with the operator adjusting the base current.

The wide-range d-c beta test set shown in Fig. 4 will test both *npn* and *pnP* transistors, and can be designed to cover almost any current and V_{CE} range. The collector of the transistor under test is fed

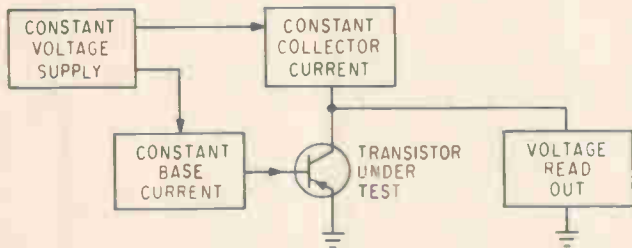

(A) LIMIT CONDITION OR CROSSOVER METHOD

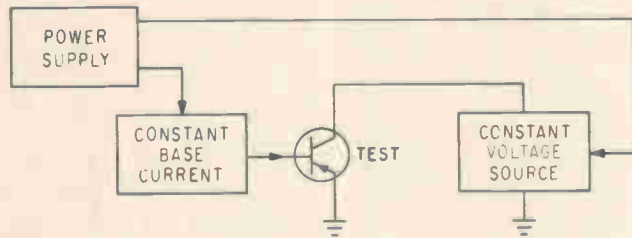

(B) I_B, V_{CE} METHOD

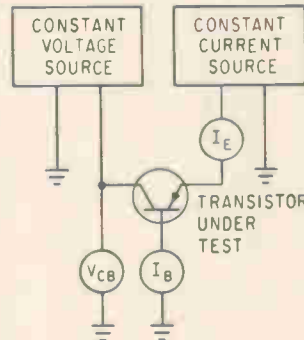

(A) COMMON BASE METHOD

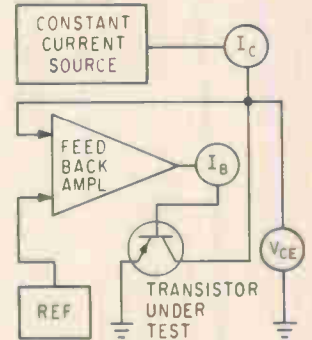

(B) COMMON EMITTER APPROACH

COMMON-BASE method (A) is simplest of all techniques; common-emitter with feedback (B) is most complex but usually the most desirable—Fig. 3

VOLTAGE READOUT circuit (A) is often used in automatic checkout equipment. Collector current measurement (B) is useful for measuring switching transistors—Fig. 2

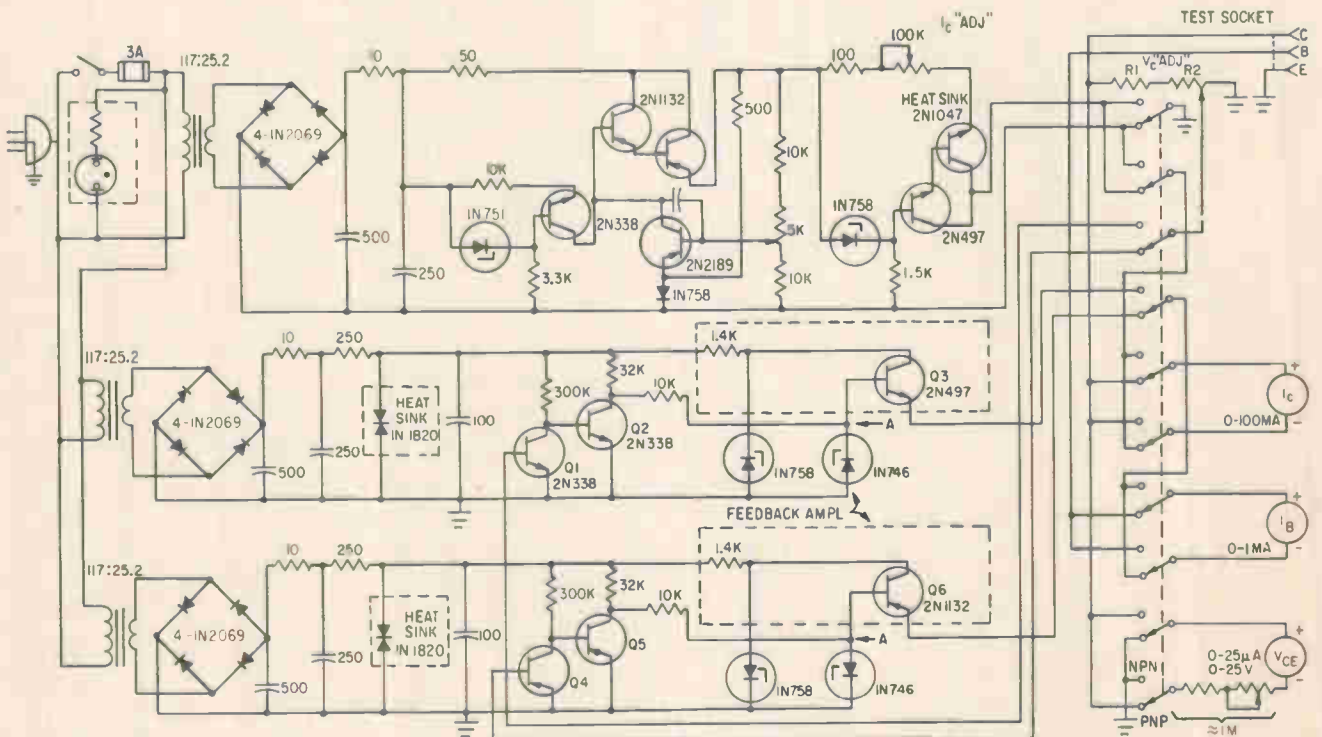

WIDE RANGE, active, common-emitter beta test set uses two feedback amplifiers, measures both *npn* and *pnP* transistors to 1 to 7 percent error—Fig. 4

MAJOR CHARACTERISTICS OF THE THREE MAIN WAYS OF MEASURING BETA

METHODS	MEASURE	HELD CONSTANT	ERROR SOURCES	ERROR IN %	ADVERSE EFFECTS	USE	EASE OF USE	EASE OF CONST.
Curve Tracer	Beta	V_{CE} and I_C	Parallax; width of trace; no calibration between steps	10 to 15	None	General lab use	For technically trained person only	Purchased
Steady State 1. Limit	Beta V_{CE}	I_B and I_C	Accurate only at cross over Accuracy of meters Regulation of I_B and I_C	0.5 to 20	None if current sources clamped so break-down voltages are not exceeded	Limit testing as in incoming inspection or automatic testing	Unskilled labor can use	Excellent
2. Switching	I_C	V_{CE} and I_B	Meters and parallax	3 to 7	At large V_{CE} and high β , collector current can be excessive	Production, incoming inspection for switching transistors	Semiskilled labor; must convert to beta	Fair
3. Common Base	I_B	V_{CE} and I_E	Meters and parallax effects of V_{BE} on low voltage operating point. I_C in error by amount of base current	3 to 20	None if clamped to prevent exceeding breakdown voltages	General lab use	Semiskilled; must convert to beta	Fair
4. Common Emitter	I_B	V_{CE} and I_C	Meters and parallax	1 to 7	None, if clamped to prevent exceeding break-down voltages	Production, incoming insp. lab use for all types of transistors	Semiskilled; must convert to beta	Complex; only higher skilled personnel
Pulse	Beta	(In general, this technique has the same characteristics as are listed under Steady State.)						

through the *pnp/npn* switch by an adjustable constant current¹ source with a range from approximately 100 microamp to 100 milliamp. Maximum open circuit voltage is set high enough for most requirements, and the constant current source is supplied by a "stiff" constant voltage regulator of conventional design. This current source has a stiff reference and remains extremely constant over a wide range of currents. The same collector circuit could be used with power transistors by increasing the current and power capabilities of the voltage regulator and current source. The collector also has a voltmeter circuit for monitoring the V_{CE} . For *npn*, the whole collector supply system is reversed and the other side becomes common to the emitter. This is not so easily done for the feedback system, and therefore two are used, one of each polarity.

The feedback system is the key to the operation of this method. Collector voltage is set by R_1 and R_2 , setting a bias on Q_1 or Q_2 in comparison to their V_{BE} . This causes conduction in Q_1 or Q_2 , and causes a V_{CE} to be set; V_{CE} biases Q_1 or Q_2 in comparison to their V_{BE} , causing a bias on the base of Q_1 or Q_2 . This allows Q_1 or Q_2 to conduct, furnishing base current to the test transistor, thus biasing it ON until the desired V_{CE} is obtained. Once the V_{CE} is set it remains constant from transistor to transistor. When a new transistor is plugged in, V_{CE} will momentarily tend

to be different. If V_{CE} is slightly higher, Q_1 increases conduction, decreasing the bias on Q_2 ; Q_2 decreases conduction, thereby increasing its V_{CE} and Q_1 bias. This furnishes more base current and causes the transistor under test to conduct more, decreasing its V_{CE} .

Herein lies the problem with this type of positive feedback. A chance of oscillation exists if this change is not properly damped. In most cases, a 1- μ f capacitor at the socket between collector and base furnishes enough negative a-c feedback; another solution is to place resistance in series with the base of the transistor under test to increase the time constant. For high beta transistors tested at low collector current, biasing difficulty is experienced because Q_1 or Q_2 do not allow the base current to reverse, where I_{CBO} is greater than that required to saturate the device under test. A switch can be used to disconnect Q_1 or Q_2 and connect the I_B meter directly to point A, thereby allowing the base bias to go below the V_{BE} of the unit under test.

(Portions of this article will appear in the author's forthcoming book "Transistor Performance Engineering," to be published by McGraw-Hill.)

REFERENCES

- (1) Ronald M. Mann, Constant Current Modules use one Basic Board *Electronic Design*, p 87, June 21, 1962.
- (2) Ronald M. Mann, Rapid Constant Current Design Using Nomograms *Electrical Design News*, April, 1963.

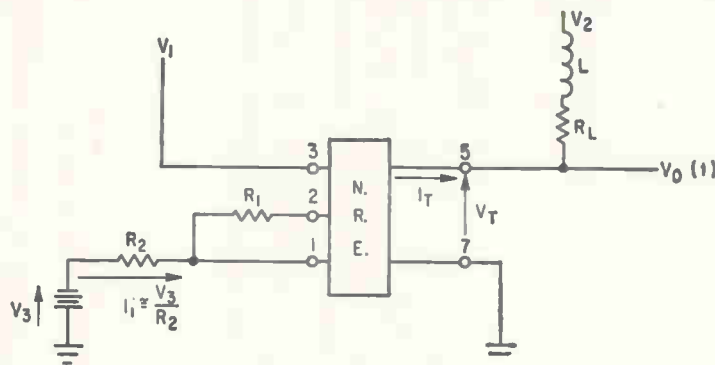

(A)

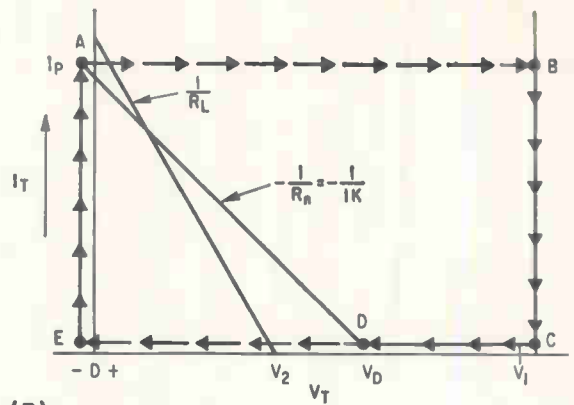

(B)

A STABLE MULTI using the NRE (A), its operating characteristics (B), instantaneous equivalent circuit when voltage

Using a New Component: The NRE

Design based on negative resistance element requires few components

By **CARL DAVID TODD**, Modular Circuits Department
Hughes Electronic Products Division
Hughes Aircraft Co., Newport Beach, California

NEGATIVE RESISTANCE elements are voltage stable or S-type negative resistance devices and require an inductor for energy storage in the relaxation or astable mode of operation. A typical circuit, Fig. 1A, includes all of the biasing arrangements needed.

Operating characteristics for the NRE under the conditions of the circuit given are illustrated in Fig. 1B. For astable operation it is necessary that d-c

load line, determined by the resistance of R_L , intersect the negative resistance portion of the characteristic curve without intersecting either of the positive resistance regions.

Several conditions must be met in order that the load line pass through only the negative resistance portion of the characteristic curve. First, the value of the load resistor, R_L , must be less than R_n , the magnitude of the negative resistance of the NRE used. In addition, the supply voltage, V_s , must be made between $I_p R_L$ and a voltage, V_D , corresponding to point D in Fig. 1B. V_D may be computed from the value of the bias current, I_b , and the value of R_n by $V_D \cong -I_b R_n$.

OPERATION—The intersection of the load line and the negative resistance portion of the NRE is not a stable point of operation and hence the operating point must slide either down the curve to point D or up the characteristic curve to point A.

Suppose the operating point is momentarily at point A. Conditions are such that the terminal current through the NRE under a stable state must exceed I_p when the terminal voltage is equal to V_A corresponding to point A. As the current attempts to exceed I_p , a switching action takes place. The current through the NRE is momentarily held equal to I_p by inductor, L , whose current may not change instantaneously, and the terminal voltage across the NRE increases to V_b corresponding to point B on the characteristic curve.

With the terminal voltage equal to V_b , however,

MORE ON THE NRE

This is the third article we have published by the same author on the NRE and its uses. On p 21, May 31, 1963, he discussed basic operation and general characteristics, and on p 32, July 12, designing d-c switches

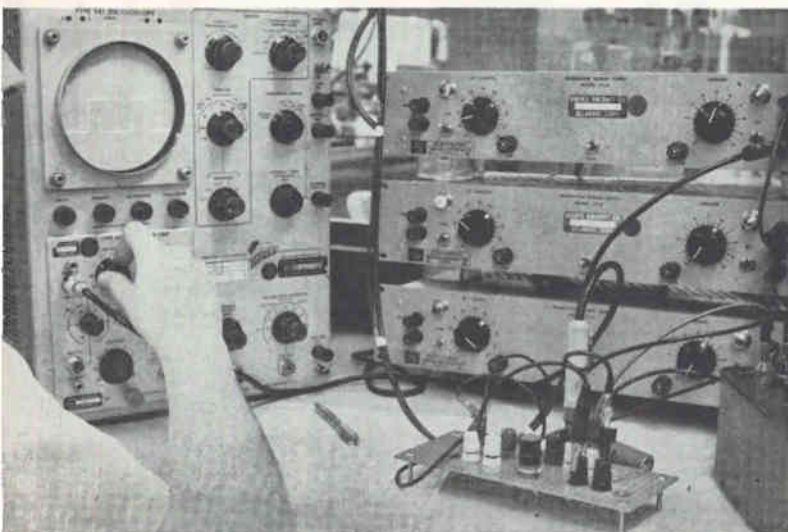

STABLE LINEAR output is a feature of the NRE multi-vibrator

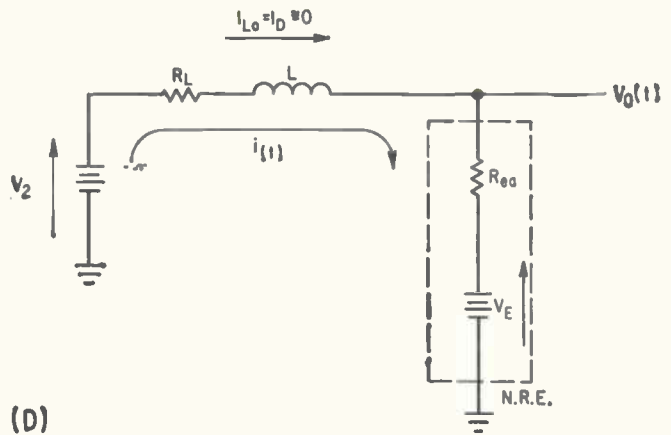
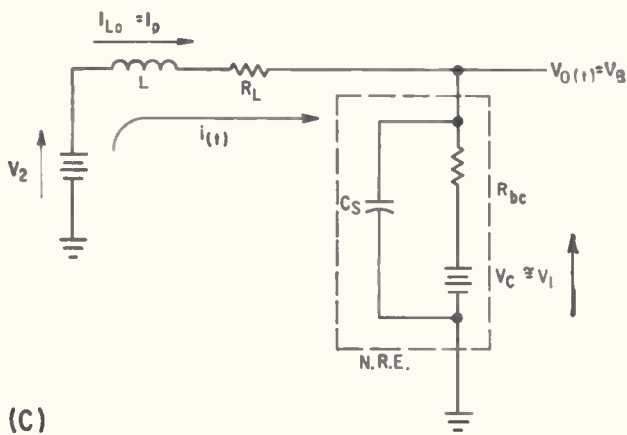

reaches point B of the operating characteristic (C), and equivalent circuit with operating point at E (D)—Fig. 1

as a Free-Running Multivibrator

conditions are not such that the supply voltage, V_2 , may provide the energy necessary to sustain a current through the NRE equal to I_P . The instantaneous equivalent circuit at the instant that point B is reached is shown in Fig. 1C.

The NRE has been represented by a voltage source which is very nearly equal to V_C , corresponding to point C; a series resistance, R_{bc} , which is equal to the inverse of the slope from point B to point C on the characteristic curve; and an equivalent shunt capacitance, C_s .

For a medium or low speed circuit, the effect of the shunt capacitance, C_s , may be neglected. Making this assumption, the transient equation for the circuit of Fig. 1C may be written from which an expression for the time, t_1 , to traverse the characteristic curve from B to C may be derived.

$$t_1 = \frac{L}{R_L + R_{bc}} \ln \left[\frac{\frac{V_1 - V_2}{R_L + R_{bc}} + I_P}{\frac{V_1 - V_2}{R_L + R_{bc}} + I_C} \right] \quad (1)$$

Since I_C is usually small

$$t_1 \cong \frac{L}{R_L + R_{bc}} \ln \left(1 + \frac{I_P (R_L + R_{bc})}{V_1 - V_2} \right) \quad (2)$$

Time, t_2 , required for the operating point to move from point C to point D will be much shorter than t_1 and may be assumed negligible because the device resistance, represented by the inverse slope of the line from C to D, is large, typically from 50 to 300,000 ohms for the unloaded multivibrator depending on the source resistance of the supply providing I_1 . Where t_2 may not be ignored

$$t_2 = \frac{L}{R_L + R_{cd}} \ln \left[\frac{\frac{V_2}{R_L + R_{cd}} - I_C}{\frac{V_2}{R_L + R_{cd}} - I_D} \right] \quad (3)$$

where R_{cd} represents the dynamic resistance represented by the slope from point C to point D.

As point D is reached and the current attempts to fall to a lower value than I_D , a switching action must occur and the operating point jumps to point E. Figure 1D illustrates the instantaneous equivalent circuit at the instant point E is reached.

Using the equivalent circuit of Fig. 1D, the tran-

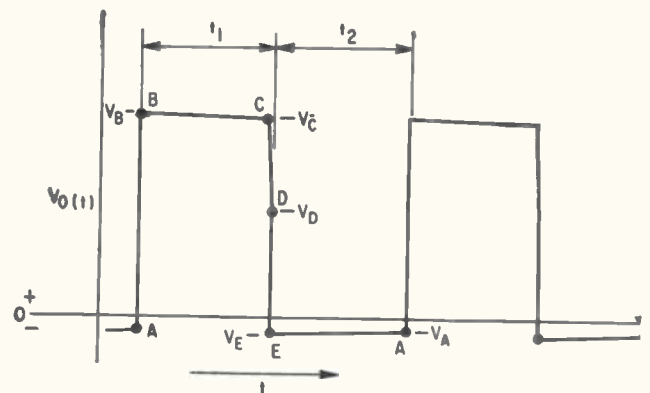

OUTPUT WAVEFORM for astable multivibrator of Fig 1A—Fin. 2

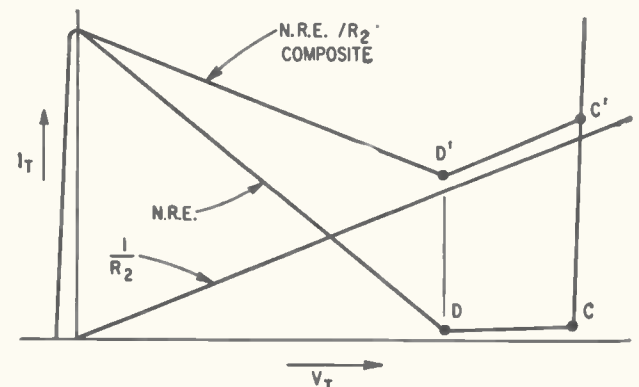

ADDING the external load resistor modifies the terminal characteristic—Fig. 3

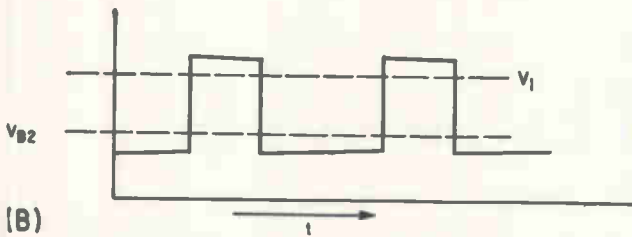
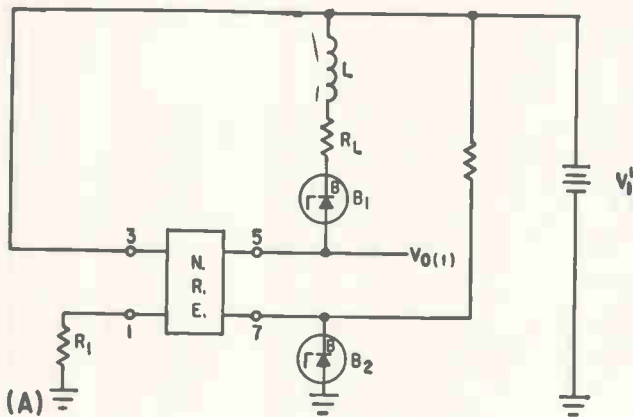

(A) SINGLE SUPPLY astable multivibrator (A) and its operating characteristics (B)—Fig. 4

sient equation governing the current in the loop is

$$i_{(t)} = \frac{V_2 - V_E}{R_L + R_{ee}} \left(1 - \exp - \frac{(R_L + R_{ee})t}{L} \right) + I_D \exp - \frac{(R_L + R_{ee})t}{L} \quad (4)$$

A period time, t_2 , will be required for the operating point to move from point E to the original point A where the switching action will again occur. The value of t_2 may be found by setting the value of $i_{(t)}$ in Eq. 4 to the value of the current at point A which is equal to I_P . The initial current in L will be equal to I_D

$$t_2 = \frac{L}{R_L + R_{ee}} \ln \left[\frac{\frac{V_2 - V_E}{R_L + R_{ee}} - I_D}{\frac{V_2 - V_E}{R_L + R_{ee}} - I_P} \right] \quad (5)$$

If I_D may be assumed zero, as for the normal unloaded multivibrator, Eq. 5 simplifies to

$$t_2 \cong \frac{L}{R_L + R_{ee}} \ln \left(\frac{1}{1 - \frac{I_P (R_L + R_{ee})}{V_2 - V_E}} \right) \quad (6)$$

If R_L is made large with respect to the dynamic resistances R_{ee} and R_{cc} , which are typically less than 50 ohms each, then Eq. 2 and 6 may be simplified

$$t_2 \cong \frac{L}{R_L} \ln \left(1 + \frac{I_P R_L}{V_2 - V_E} \right) \quad (7)$$

$$t_2 \cong \frac{L}{R_L} \ln \left(\frac{1}{1 - \frac{I_P R_L}{V_2 - V_E}} \right) \quad (8)$$

WAVEFORM—The output waveform (Fig. 2) is nearly flat on both top and bottom because of the self limiting action of the characteristic curve. In the high voltage state, as the operating point moves from B to C the output voltage changes only a few

tenths of a volt. In like manner, the output voltage remains nearly constant as the operating point moves from E to A.

Except for the area represented by the line C-D, the rise and fall times are short and depend only upon the various shunt capacitances and the frequency response of the transistors used in the NRE. If it is desirable to eliminate this slower transition, then the circuit biases are changed such that V_1 is made equal to the valley voltage, V_v , which is equal to the product of I_P and R_{ee} . The peak voltage amplitude in the high voltage state is almost entirely dependent upon the value of the voltage supply, V_1 .

LOADING—It has been assumed that the multivibrator has no external load connected to its output.

The easiest method of analyzing the effect of load R_L is to consider the manner in which it modifies the equivalent NRE terminal characteristic. Since the NRE and R_L are in parallel, the currents may be added graphically, Fig. 3.

For the example shown, output current is about one half the peak current. Points C and D are modified to C' and D', otherwise Eq. 1, 3 and 5 may be used as before.

PRACTICAL CIRCUITS—The circuit of Fig. 1A requires two positive supply voltages and one negative supply voltage from which I_1 may be derived. For the opposite polarity NRE family, V_1 and V_2 must be negative and V_3 should be positive. There are some variations in the circuit that require fewer supplies for biasing the NRE.

In a two-supply circuit, V_2 is always less than V_1 , and it is possible to derive V_2 from V_1 by a normal resistive voltage divider if adequate power available. This may be done and the output resistance of the voltage divider may be used for R_L . Should this be impractical, V_2 may be developed by using a voltage regulator diode in series with V_1 . Current flows at all times, so no bleeder resistor is necessary.

The bias current I_1 is obtained from a voltage supply opposite in polarity to V_1 by means of a series limiting resistor R_1 .

The voltage output will switch between a minimum voltage which will be a few tenths of a volt negative for the positive voltage NRE as shown in Fig. 1A, or positive for the negative voltage types of NRE, and a maximum voltage nearly equal to V_1 .

By using the arrangement shown in Fig. 4A, it is possible to use only one voltage supply for the NRE astable multivibrator. Bias current, I_1 , is developed by voltage regulator diode B_2 and resistor R_1 . Voltage regulator diode B_1 provides the proper voltage for V_2 . Note that this approach for obtaining V_2 always gives a constant value for $V_1 - V_2$, even if V_1 should change from time to time. This is helpful in giving immunity to supply voltage variation on the time t_1 , as seen by Eq. 1.

Switching levels for the output voltage will be changed from that given by the other circuits. The minimum voltage level will be fixed by the value of the breakdown voltage of B_1 . The upper voltage level will still be limited by the value of V_1 . The value of V_1 in Eq. 1 will be equal to $V_1' - V_{ee}$.

NEW **E-I** HERMETICALLY SEALED RELAY HEADERS

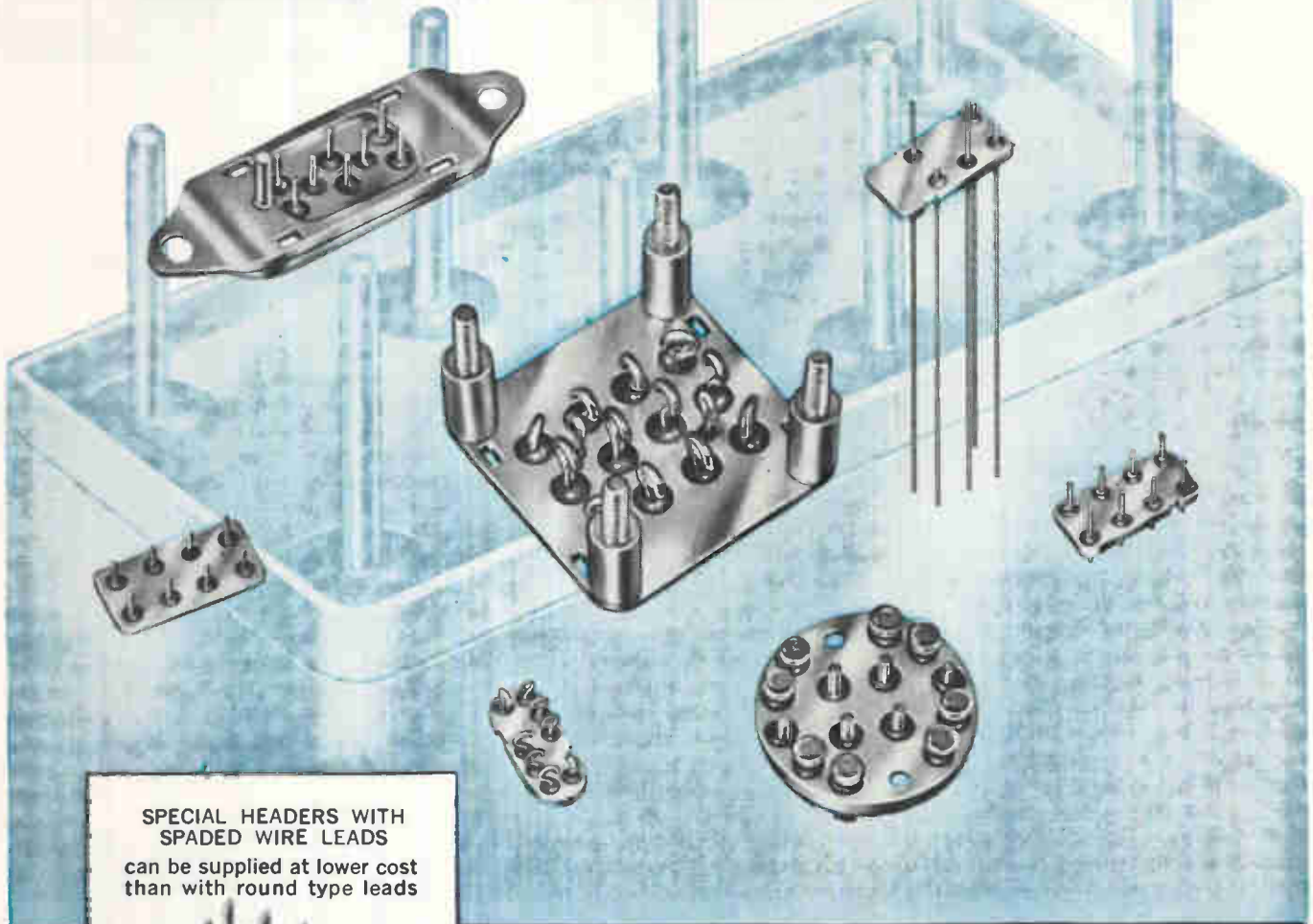

SPECIAL HEADERS WITH
SPADED WIRE LEADS
can be supplied at lower cost
than with round type leads



MODULAR TYPE HEADER
SUITABLE FOR
HELI-ARC WELDING



- Available in a Wide Range of Configurations
- Header Thicknesses down to .050 Inches
- Increased Torque Resistant Wire Available

E-I headers, featuring ruggedized compression seals, can be produced to your exact specifications to meet practically any type of relay application. In many cases, standard E-I tooling can be utilized at a considerable saving. Brazed contacts are available if required. Standard finishes available include hot solder dipped, electro-tin, nickel and gold. Special plating on order. Call or write E-I for quotations on your specific requirements!



ELECTRICAL INDUSTRIES

691 CENTRAL AVENUE, MURRAY HILL, NEW JERSEY

Division of Philips Electronics & Pharmaceutical Industries Corp.

PATENTED IN CANADA, NO. 523,390; IN UNITED KINGDOM, NO. 734,583; LICENSED IN U. S. UNDER NO. 256462

THERMOPLASTIC recording unit shown with its inventor, William E. Glenn, may soon replace video magnetic tape recording systems

Other research projects include adaptive filters, lasers, EL diodes

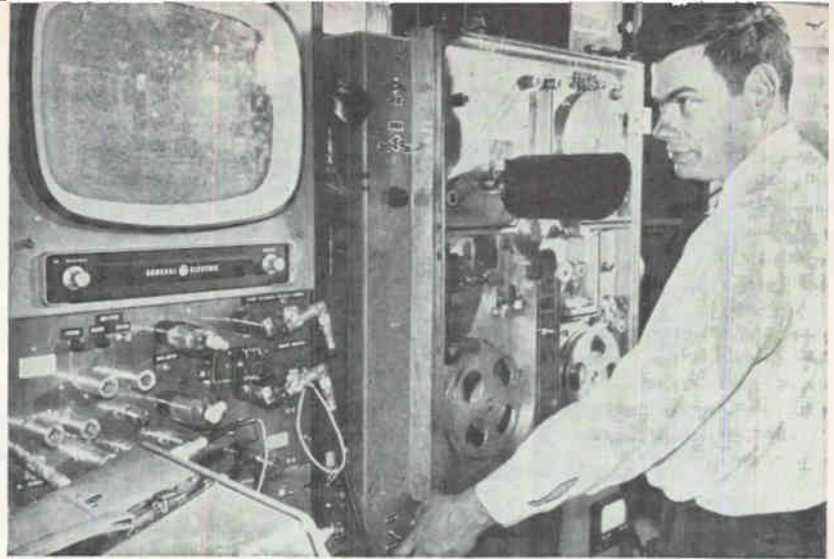

Thermoplastic Video Tape Ready Soon

By **GEORGE V. NOVOTNY**
Associate Editor

SCHENECTADY, N. Y. — Continuing work on thermoplastic television film, directed by inventor William Glenn in GE's Research Laboratory here, is nearing the point where the system will be ready for market. It uses an electron beam to inscribe an image on a soft thermoplastic polymer film, which can then be projected in any ordinary film projector with a Schlieren device. Us-

ing diffraction gratings, Glenn has succeeded in recording color movies in a similar fashion. The film needs no developing, can be reused any number of times, has an optical resolution in black and white of 200 lines/mm (silver halide film resolutions are of the order of 70). Both in material and equipment, thermoplastic recording will be cheaper than present-day magnetic tape video recording, and lends itself to compact portable units. Among the applications foreseen are commercial video recording,

medical fluoroscopy recording, and disaster monitoring using a continuous loop that stores the last two minutes before the mechanism is stopped. The recording is done at 10^{-4} Torr, uses inexpensive hairpin type tungsten electron guns.

LASERS—From another corner of GE's Research Laboratory, the announcement last month of a continuous $1\frac{1}{2}$ -watt junction laser was a significant step in that field (**ELECTRONICS** June 21, p. 24). Scientists Robert N. Hall and Jerry

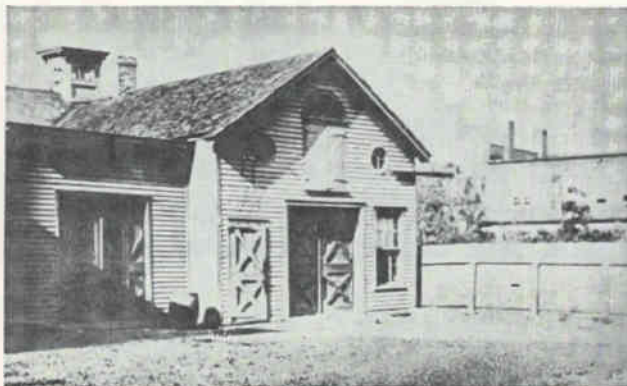

From a barn in a backyard in 1900, General Electric's Research Laboratory, Schenectady, N. Y., has developed into one of the country's largest industrial laboratories devoted exclusively to basic research; today it is a 220-acre complex of specialized buildings, employing over 1,200 people.

The laboratory's success over its long history can probably be ascribed to its policy of maintaining an "appro-



prate balance between research that is mainly science oriented and that which is directed toward advancing technology".

The keyword is versatility: the laboratory is active in all the major areas in which electronics research is most promising. This includes cryogenics, thin-film devices and plasma studies, to mention a few, in addition to the developments reported above

NEW!

MODE INDICATORS FOR VOLTAGE/CURRENT REGULATED POWER SUPPLIES

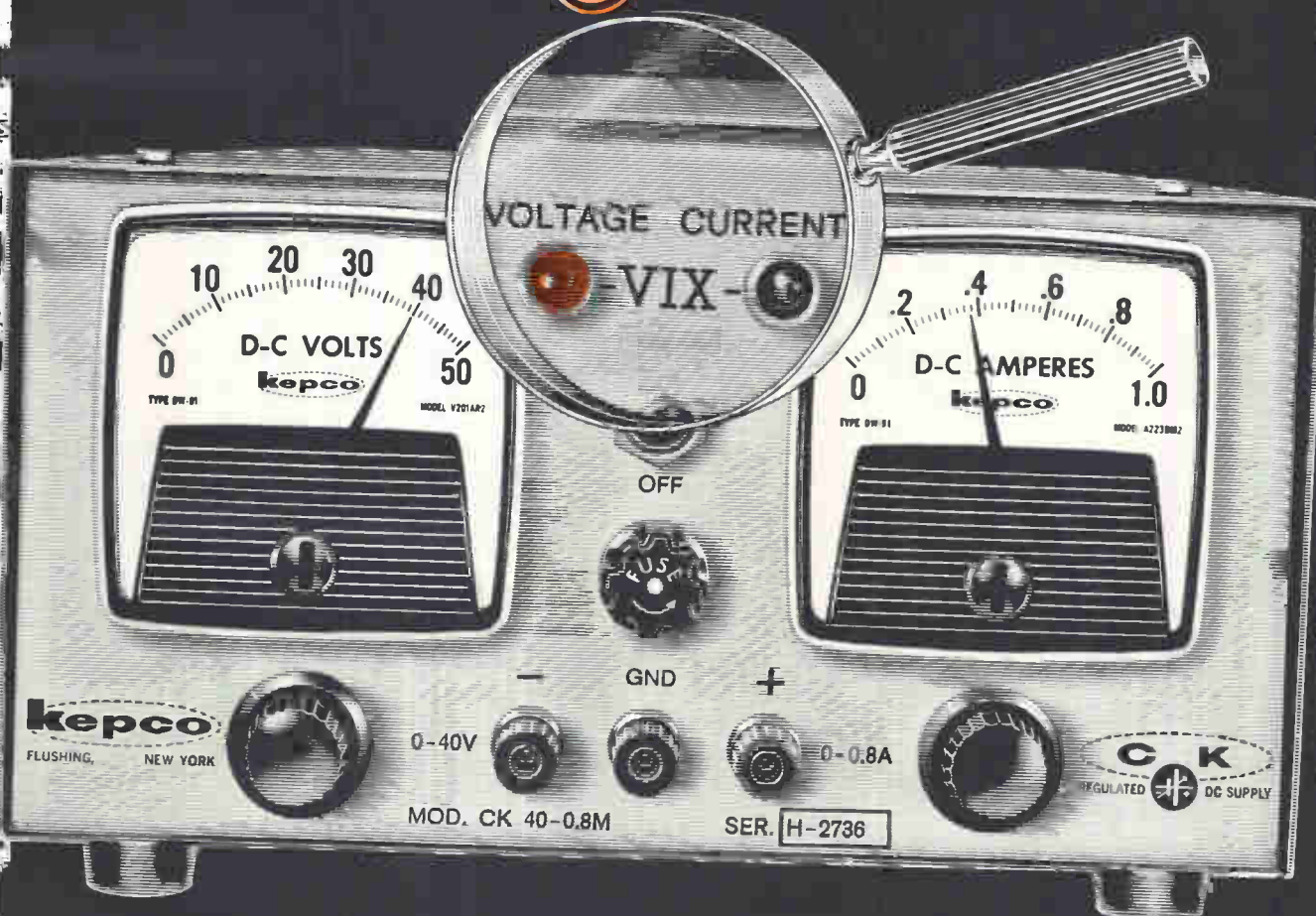

KEPCO TIME-**VIX*** INDICATORS

Kepco voltage/current regulated power supplies in the CK series come equipped with voltage/current mode indicators called "VIX".* Time saving and added utility are provided by these indicators which show at a glance whether the power supply is in its voltage regulating mode or its current regulating mode. This indication is especially useful in the Kepco CK Models since they have extremely sharp cross-over characteristics.

VOLTAGE/CURRENT CROSSOVER INDICATORS

NEW CK SERIES
REGULATED DC SUPPLY

0.01% REGULATION and STABILITY

DC OUTPUT RANGE		MODEL	PRICE
VOLTS	AMPS		
0-2	0-8	CK 2-8M	\$330.00
0-8	0-5	CK 8-5M	330.00
0-18	0-3	CK 18-3M	290.00
0-36	0-1.5	CK 36-1.5M	290.00
0-40	0-0.8	CK 40-0.8M	255.00
0-60	0-0.5	CK 60-0.5M	290.00

Send for complete data on
Kepco CK Models
featuring NEW "VIX" Indicators.



131-38 SANFORD AVE. • FLUSHING 52, N.Y.
(212) IN 1-7000 • TWX# 212 539-6623

True Torque Control

NO MORE
SCRATCHED
FIXTURES

ELECTRONIC
COMPONENT
MANUFACTURER USES
CLECOMATIC*
BECAUSE . . .

(1) Fragile cabinets were being marred by old fastening methods. The Model 10RSA-10 CLECOMATIC with the automatic start/stop feature has eliminated damaged screw heads, scratched cabinets and cracked surfaces.

(2) Air tool operates only while driving the fastener. Wasted air is eliminated. Parts wear drastically reduced.

If you have a trouble spot on your production line, call your nearest CLECO Representative. He can help you.

*Fully warranted for one year by the GOLDEN CIRCLE guarantee



A DIVISION OF
REED ROLLER BIT COMPANY

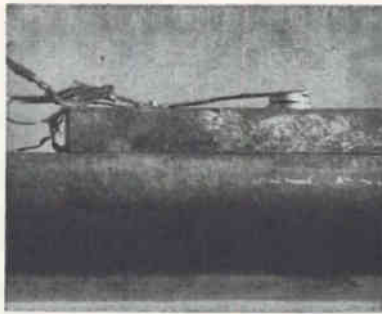

CLOSEUP of the Engeler-Garfinkel junction laser that achieved high power output, (A); and an exploded view, (B)

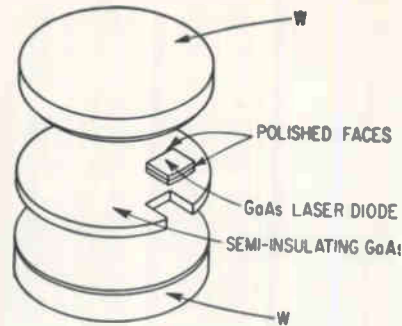

Tieman, connected with the development, continue exploration of the laser diode's properties and foresee a future for the device, which lends itself to a variety of modulating techniques, both internal (input current modulation) and external (operating on the emitted beam).

ADAPTIVE FILTERS — General Electric's group on adaptive filters had previously announced success in retrieving evenly spaced pulses out of high-level Gaussian noise (ELECTRONICS, Feb. 17, 1961, p. 117). Work has now progressed to the point where random spaced pulses are retrieved from noise by a special computer program, and classified by their waveshape. This makes it unnecessary to synchronize transmitter and receiver signals (as in space telemetry). The group is under the direction of C. V. Jakowatz.

ELECTROLUMINESCENCE—The laboratory's Dom Cusano foresees advances in electroluminescence, specifically in the field of 2-6 phosphor compounds, where the energy gaps are greater than in the heretofore investigated 3-5 compounds.

Another approach for achieving higher efficiency and more desirable properties in electroluminescent systems is by replacing the powdered EL materials with junctions of solid material.

The same group is searching for new materials to replace the single-crystal silicon solar cells used in space today, which are heavy and tend to be degraded by micrometeorite bombardment. Possibilities are tough, thin, flexible films. Some of the experimental materials are cadmium sulphide and cadmium telluride; today however their efficiency is only about 7 percent

From the same group of 2-6 materials are also expected to come new materials for junction laser

LIVING POWER—From a different part of General Electric, the Valley Forge, Pa., Space Science Laboratory, comes a report that useable electric power can be drawn directly from living animals.

J. J. Konikoff, Manager of the Physical Biology Operation, says researchers have powered a specially built radio transmitter by placing electrodes in different parts of an animal's body. This means that small electronic devices can be permanently implanted in the body, either to report its reactions or even to regulate the body's own functions, without the use of batteries or other power supplies, and without need for skin openings for wiring.

General Electric's work on biogenesis, a modern descendant of Galvani's eighteenth-century work on frogs' legs, grew directly out of an attempt to build a biological fuel cell using yeast and glucose.

TRANSMITTER OPERATION

In the present program, a 500-mw transmitter was implanted in a rat and powered by its own electricity derived from two implanted electrodes. Top power of 155 microwatts was observed in a load of 50 ohms at 0.23 volts. Open-circuit voltage was measured as 0.68 volts.

The transmitter operated continuously for eight hours, but the researchers believe it could operate for the animal's entire lifetime. No harmful effects or disturbances of body functions were measured. In another experiment, electrodes drew voltage from a living rat body for six months, without an

NOW...ON-LINE!

New Correlation Computer System permits on-line auto- and crosscorrelation studies



MNEOTRON's Correlation Computer System (CC-1) consists of the COR-256 combined with the Computer of Average Transients (CAT 400B). This system performs real time auto- and crosscorrelation computations, thereby permitting the study of statistical properties of repetitive signals buried in random noise.

The Correlation Computer generates up to 256 points of the auto- or crosscorrelation functions. On-line

operation eliminates the need for time consuming and costly data analysis. Results computed by the system are immediately available as an oscilloscope pattern. Accessory units make results available as an analog plot or a printed or punched digital readout.



Executive Sales Offices: 202 Mamaroneck Ave., White Plains, N. Y.
CIRCLE 202 ON READER SERVICE CARD

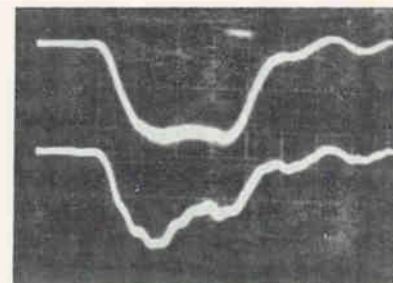

PHOTOMULTIPLIER output, taken through monochromator, shows quenching: upper trace shows current pulse applied to one laser only, lower trace shows quenching effect of second current pulse applied to quenched laser 50 nanosec later—Fig. 2

the two lasers were radiating in the same mode.

The quenching action is demonstrated by the oscillograms of Fig. 2. The top trace is a 100-nanosecond pulse passed through one laser only; the lower trace shows that when the quenching laser is pulsed 50 ns. after the start of the first pulse, the output is quenched.

A. B. Fowler said that although present quenching ratios are low (0.07-0.008), improvement in the techniques for increasing the light gathering efficiency should greatly increase the quenching ratios.

Computer Figures Out Ionospheric Wave Field

LONDON—A new method of calculation has been developed at the Government Radio Research Station, Slough, that determines the distribution of the wave field inside the ionosphere for a wave incident at any angle and at any frequency below 200 Kc. From knowledge of the arbitrary distribution of electrons and collision frequency in the atmosphere, a computer program not only deduces the wave field but also determines the amplitude, phase and polarization of the reflected wave.

The station has also developed an ionosonde that will measure ionosphere virtual heights to an accuracy of one percent—five times better than had been previously achieved. A 20-Kw transmitter using a 50-microsecond pulse width sweeps the frequency band 1-20 Mc within 60 or 15 seconds. Transistor receiver detects return pulse.

GENERAL PURPOSE CAPCODER CAPACITIVE CHARGE TRANSFER ANALOG-DIGITAL CONVERTER



MODEL OC-2010A (MODEL OC-2010B)

- 8 bits, serial or parallel output
- 0 to 185,000 encodings per second, faster units on special order
- Operational amplifier input ranges to ± 0.5 ma (1000 ohms per volt)
- Fully transistorized
- Minimum of 5.4 microseconds between encodings
- Effective sampling aperture approximately 100 nanoseconds; 50 nanoseconds on special order

- Encodes upon command
- Standard rack mounting with self-contained power supplies. Front access to all plug-ins
- Approximately 25 watts input power



Visit our display at the WESCON Convention—Booth 4446—August 20-23, San Francisco, Calif., and ISA Show—Booth 830—Sept. 9-12, Chicago, Ill.



Designers and manufacturers of CAPCODER and CAPLEXER Capacitive Charge devices
TOWSON LABORATORIES, INC.
200 E. JOPPA RD. BALTIMORE 4, MD. AREA CODE 301-825-6361

FOUR NEW *Preformed*
GRID WIRE CONNECTORS...

AND... TWO HANDS



T-CONNECTORS*— Designed for terminating a wire at a cross-wire or catenary, they prevent premature fatigue damage often caused by high-stress fittings... Available in both standard and reducing configurations.

CROSS-TIES*— Interlock design holds grid wires securely yet permits adjustment to various angles. Available in standard or reducing configurations, as well as spacer types, which join intersecting but noncontacting wires.



L-CONNECTORS*— An excellent electrical and mechanical connector; made of compatible materials... available in standard or reducing types, for wires of equal or different diameters.



Nothing more needed to make connections on Grid Type Arrays

PREFORMED helically-formed Grid-Wire Connectors are wrapped on by hand; no tools are needed. They provide safe, uniform holding; prevent stress points.

No parts can loosen to create noise. High mechanical strength and electrical conductivity are assured

Preformed **DEAD-ENDS**** are used to terminate all grid wires. These dead-ends hold securely, eliminate clamping devices, bolts, and socketed fittings. They are applied without tools.



PREFORMED LINE PRODUCTS COMPANY

5349 St. Clair Avenue • Cleveland 3, Ohio • UT 1-4900 (DDD 216)
600 Hansen Way • Palo Alto, California • 327-0170 (DDD 415)

Use the reader service card to request complete information, or write for Bulletin SP-2041.

*Made in accordance with U. S. Patent No. 2,691,865.

**Made in accordance with or for use under U. S. Patents 2,691,865 and 2,761,273.

CIRCLE 59 ON READER SERVICE CARD



Are you a COMPLETELY INFORMED electronics engineer?

Today you may be working in microwaves. But on what project will you be working tomorrow? You *could* have read electronics this past year

and kept abreast of, say, microwave technology. *There were 96 individual microwave articles between July, 1961 and June, 1962!*

But suppose tomorrow you work in some area of standard electronic components, in semiconductors, in systems? Would you be up-to-date in these technologies? Did you read the more than 3,000 editorial pages that electronics' 28-man editorial staff prepared last year?

electronics is edited to keep you current *wherever* you work in the industry, *whatever* your job function(s). If you do not have your own copy of electronics, subscribe today via the Reader Service Card in this issue. Only 7½ cents a copy at the 3 year rate.

electronics

Planning to change your address?

Use the form below to indicate a change of address. Because our issues are addressed in advance, please try to allow at least 5 weeks for change of address to become effective. Attach the address label from your most recent issue in the space provided below.

(Please print the following information for proper service)

Title or position.....

Name

Chief Job Responsibility.....

Distributor
Manufacturer

Company and Div.....

Product or Service Approx. No. of Employees

Address

City Zone State or Prov.

Mail to home address below:

Address

City Zone State or Prov.

Mail to: Fulfillment Manager, electronics
330 West 42nd Street, New York City 36, N. Y.

***Paste present mailing label or address from wrapper or envelope here.**

Foils Get Thinner, More Versatile

Here's a guide to the latest thin-gage alloys for microminiaturization

By LEON HURWITZ

General Manager
Precision Metals Division,
Hamilton Watch Company,
Lancaster, Pa.

MORE EXOTIC alloys, thinner-gage metal foils and new manufacturing techniques will open up additional uses for tissue-thin metals in microminiature systems.

Advances in rolling techniques and precision have now narrowed the definition of metal foil to ma-

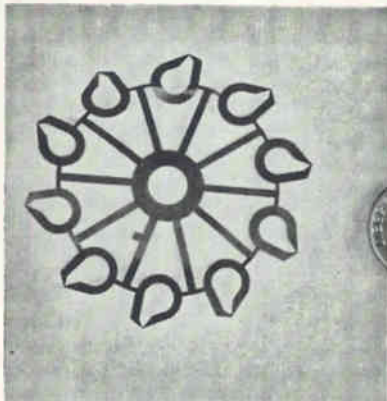

BERYLLIUM-copper module, used in circuit breaker, is 0.002-in. thick. The metal has been rolled to 0.000080-in.

terial 0.001-in. thick and less. Now virtually any commercially-available alloy can be supplied in production quantities at a thickness of 0.0001-in. to 0.0002-in. ± 5 percent in widths from $\frac{1}{2}$ -in. to 4-in.

Some alloys are available in thinner gages. Beryllium copper has been rolled as thin as 0.000080 in. Pure hafnium was rolled for the first time to 0.0005 in.

These thin foils perform success-

SOME APPLICATIONS FOR ULTRATHIN METAL SHEETS

Metal Foil	Thickness* in in.	Some end uses
Beryllium copper.....	0.000080	spacers and shims
Columbium.....	0.000500	shielding
Karma.....	0.00010 to 0.00020	strain gages
Permalloys.....	0.000100, 0.000125 0.000250, 0.000500	bobbin cores, tape wound cores
Stainless steels.....	0.00010 to 0.00020	windows in neutron sources, diaphragms
Titanium.....	0.000300	diaphragms
Zirconium.....	0.000800	flash bulbs

* Not necessarily minimum thickness to which materials can be rolled. Standard thickness tolerance is 5 percent

ALLOYS THAT CAN BE ROLLED TO FOIL

Atmos. reactive....	columbium, hafnium, tantalum, titanium, zircalloy, zirconium
Ferrous alloys.....	SAE and AISI Grades, maraging steels
High-temp alloys..	Hastelloys, Havar, Inconel, Inconel X, molybdenum, Rene 41
Low-expansion....	Invar, Kovar
Low-temp. coeff. . .	Elinvar Extra, Isoelastic
Magnetic alloys....	Audioloy, iron, nickel, Permalloys
Nonferrous alloys..	beryllium-copper, brass, bronze, copper, Monel, silver
Resistance alloys...	Advance, Balco, Constantan, Cupron, Elinvar Extra, Isoelastic, Karma, Nichrome
Stainless steels.....	300 and 400 series, 17-7 PH, 15-7 MO

fully in memory and logic systems, shift registers, transformers, magnetic amplifiers, saturable reactors, and other electronic applications, see tables.

CONDUCTION—In such thin sections eddy-current losses are less than in thicker cross sections. Squareness ratio is better than that of the same material in other forms. Wide ranges of physical and mechanical properties are available as a result of the varieties of compositions offered.

For example, Havar contains 42.5 percent cobalt, 20 percent chromium, and 13 percent nickel, with smaller amounts of molybdenum, beryllium, manganese and tungsten. This formulation combines

corrosion resistance with strength and fatigue endurance. As a foil, Havar has been used as a protective tape over computer-sensing heads. Maximum thickness is 0.00025-in. for this application.

Nonmagnetic and hard, Havar gives the abrasion protection required without sacrificing head sensitivity. Attempts are now being made to roll Havar to less than 0.000091-in. thin.

The Permalloys are among the most commonly used foils. One type contains 79-percent nickel, 4-percent molybdenum, and lesser amounts of manganese and silicon. This type possess very high initial permeability at low magnetizing forces, with minimum hysteresis loss. This foil is being used ex-

NEW!

usefulness,
with simplicity

Model 135C, new member of the Moseley 135 series X-Y recorder family gives wide usefulness, at low cost. Standard size graph paper (7" x 10" writing area), solid state for ruggedness, floating inputs, transformer isolated, 10 fixed input ranges from 0.5 mv/in to 10 v/in each axis, and stepless range control. Rack or table model, \$1190.

(Versatile Model 135, offers 16 ranges, Zener reference, built-in time sweep, high accuracy, \$1650.)

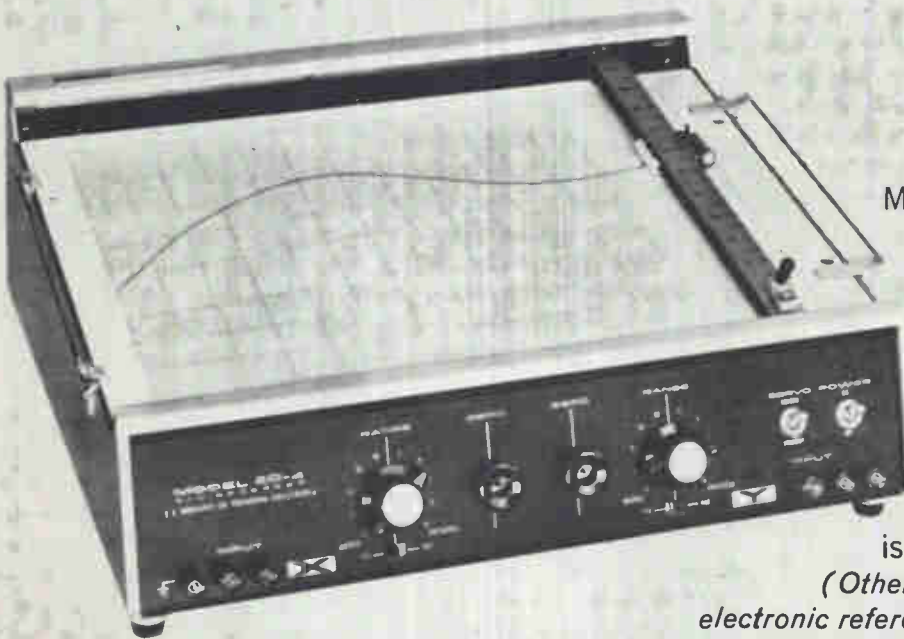
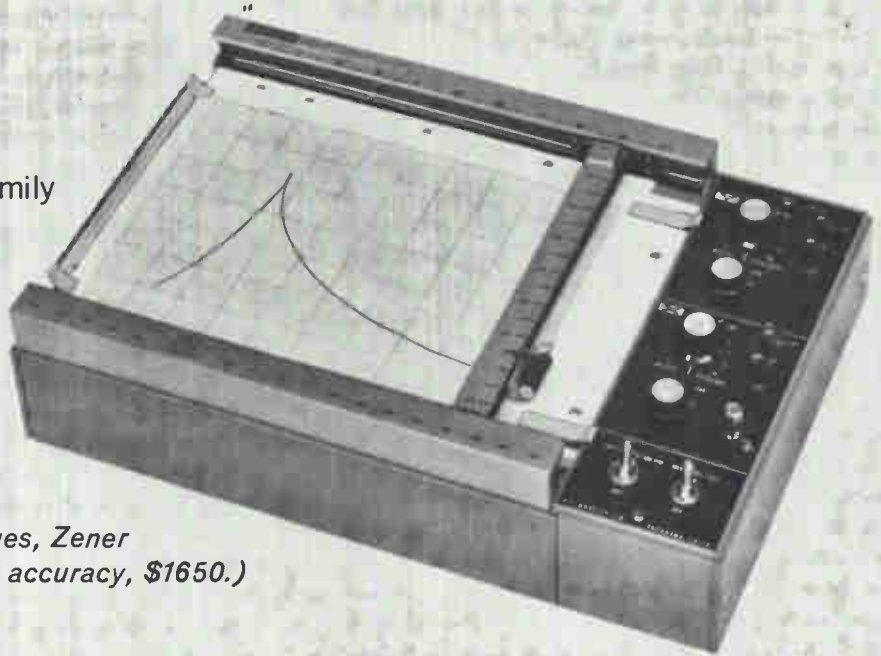

companion model
for larger paper

Model 2D-4 is the newest addition to the Moseley 2D series of precision X-Y recorders. Uses standard graph paper with 10" x 15" writing area. Electrical specs similar to 135C above. Input accessories include log converter, two channel ac-dc converter, waveform translator for high frequency repetitive signals. Variable speed, roll chart is optional. Rack or table model, \$1490.

(Other 2D series models provide more ranges, electronic reference, built-in time sweep, high accuracy, operation with curve follower, digital-to-analog translators, delay simulation, etc.)

See your Moseley Rep or write us today for data

F. L. MOSELEY CO. 409 N. Fair Oaks Ave., Pasadena, California

an affiliate of Hewlett-Packard Company

6372

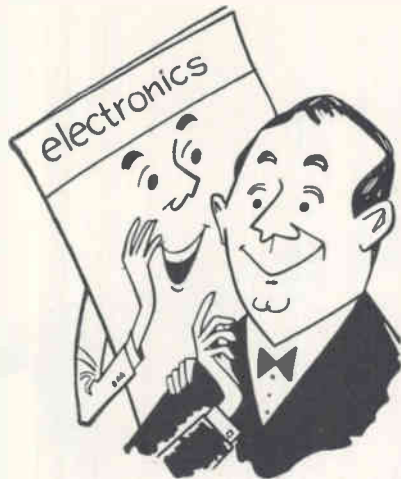

**electronics IS EDITED
TO KEEP YOU FULLY INFORMED**
— a “well-rounded” engineer

What's your *present* job in electronics? Do you work on computers? (**electronics** ran 158 articles on computers between July, 1961 and June, 1962!) Are you in semiconductors? (For the same period, **electronics** had 99 articles, not including transistors, solid-state physics, diodes, crystals, etc.) Are you in military electronics? (**electronics** had 179 articles, not including those on aircraft, missiles, radar, etc.)

In all, **electronics'** 28-man editorial staff provided more than 3,000 editorial pages to keep you abreast of all the technical developments in the industry. No matter where you work today or in which job function(s), **electronics** will keep you fully informed. Subscribe today via the Reader Service Card in this issue. Only 7½ cents a copy at the 3 year rate.

electronics

**TYPICAL PHOTOFORMING
CAPABILITIES FOR FOILS**

Normal Tolerances*

Aluminum and Al alloys. ± 0.0005 in.

Copper and Cu alloys... ± 0.0003 in.

Special alloys

Havar..... ± 0.0005 in.

HyMu-80..... ± 0.0005 in.

Molybdenum..... ± 0.0004 in.

Nickel..... ± 0.0004 in.

Stainless steel

300 series..... ± 0.0004 in.

400 series..... ± 0.0004 in.

Titanium..... ± 0.0005 in.

* For thicknesses 0.001 in. and below. Tolerances on other metals will vary similarly according to type and thickness. Normal thickness tolerances on metals will be ± 5 percent. Maximum part size: 4 in. \times 6 in. or 4-in. diam

tensively as bobbin core tape. Common thickness in this application are 0.000100 in. and 0.000125 in., with tolerances held to a total of 6 millionths to prevent flux buildup.

The high-purity Vapalloys were developed for use as evaporants or source metal for vacuum deposition of thin magnetic films. The thin deposits serve as memory sites in random-access computer memories. Thin films switch primarily by a spin-rotational mechanism rather than domain-wall movement, and thus permit extremely rapid access to memory data.

Switching time of thin films is measured in nanoseconds, and cycle times of $\frac{1}{2}$ microsecond or less are possible. By careful control of raw materials and alloy composition, elements in binary alloys can be held to ± 0.15 percent of specified amounts. Actual tolerance is usually within ± 0.100 percent of the nominal specified.

Flat precision parts can be produced from foils by photoforming, a process that combines photographic and chemical techniques. This technique affords flexibility in designing parts that would be impractical or impossible to make by conventional mechanical metal-



COMPOSITE *electronic unit is made of 0.0005-in. thin Havar*

working methods.

Major advantages of the photo-forming process include the infinite variety of complex shapes possible, and simplification of complicated production techniques.

New Solid State Concepts For Microwave Devices

TWO DEVICES show promise for application in the low microwave region: a transit-time delay diode for direct power from a d-c source, and the *pin* charge-storage diode for harmonic generation from an r-f source of lower frequency.

Clevite is now working on both of these devices for the government. This program will extend the application of solid-state devices in the microwave region. First efforts will be directed to explore the transit-time delay diode for its theoretical and practical capability.

ASTIA Is Now DDC

THE ARMED Services Technical Information Agency has been redesignated the Defense Documentation Center for Scientific and Technical Information.

In its present capacity, DDC is authorized to receive all Department of Defense scientific documents except Top Secret, cryptographic, registered documents and special categories of intelligence in which there is little research, development, testing or evaluation.

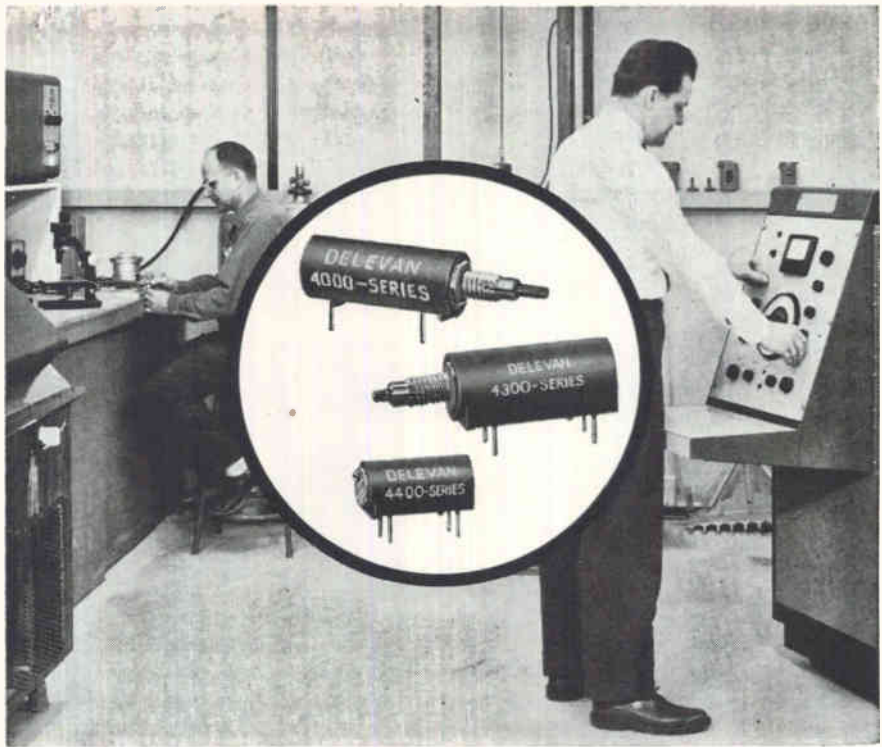

First to Bring You Repeated Dependability in Molded Tunable COILS AND TRANSFORMERS

Final evaluation of every product is its repeated dependability throughout its intended service. Delevan has made an outstanding break-through in producing a production line series of molded tunable coils and transformers that definitely contribute to the advancement of the "State-of-the-Art" in consistent environmental dependability at economical prices. Extensive product testing in Delevan's certified environmental test laboratory assures repeated dependability and conformance to Grade 1 Class B MIL-C-15305. Write for Delevan's Molded Tunable Coil and Transformer "State-of-the-Art" Catalog #S-186. *Delevan Electronics Corporation, 270 Quaker Road, East Aurora, New York.*

Kit 1 — 15 dependable Series 4000 molded tunable coils with powdered iron cores. Value ranges of your choice from 31 standard values.



Kit 2 — All the necessary components to design your own tunable coils and transformers. Coils wound on these forms can be molded at Delevan.



Delevan Electronics Corporation

A SUBSIDIARY OF AMERICAN PRECISION INDUSTRIES INC.

CIRCLE 63 ON READER SERVICE CARD



Your electronics BUYERS' GUIDE should be kept in your office at all times—as accessible as your telephone book.

Epoxy Pellets Improve Diode Production

Economies and smaller products are gained with molding process

By VINCENT SUSSMAN

Epoxy Products, Inc.
Irvington, N. J.

RALPH CARRUTH

Sylvania Electric Products, Inc.
Hillsboro, New Hampshire

EPOXY cases and epoxy pellets in commercially-available forms have greatly economized encapsulation of low-power *pn* alloyed junction rectifiers at the Hillsboro, New Hampshire plant of Sylvania Electric Products, Inc. Technique can also be applied to high-power rectifiers.

The Sylvania process makes use of the E-Pak case and pellet forms manufactured by Epoxy Products. Correctly applied the material passes the moisture-test requirements of Method 106 MIL-STD-202B.

The technique eliminates electric

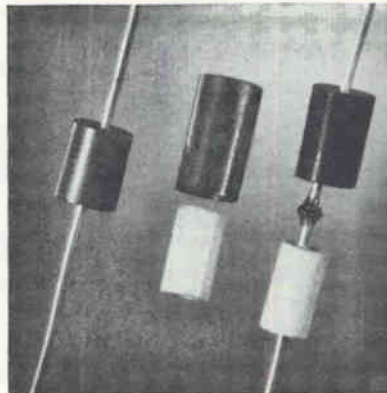

CASE AND PELLET encapsulation of a rectifier junction: case (left), pellet and rectifier junction (center), encapsulated unit is shown above unencapsulated junction (right)

potential on rectifier cases. This, in turn, eliminates use of insulation between rectifier and chassis and, also, the restrictions on rectifiers touching each other; this together with smaller resultant size enables greater component density.

SETTING-UP — A special manufacturing process has been developed by Sylvania to accommodate case-pellet encapsulation. After alloying junctions on rectifiers, the cathode leads are attached in a batch soldering operation in a conveyor furnace. Fig. 1 shows exit end of furnace. As shown holding fixture B has just been removed from furnace A. The upright wires are the cathode leads. Fixture B is inverted on fixture C and bottom

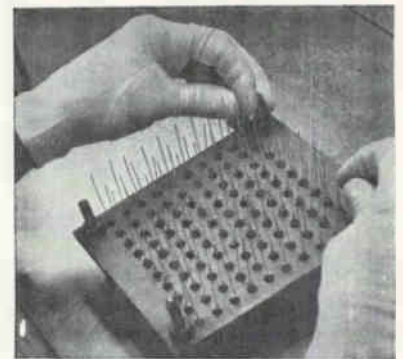

ONE HUNDRED cases and pellets are placed into the encapsulating tray and then a rectifier unit is loaded into each case-and-pellet unit—Fig. 2

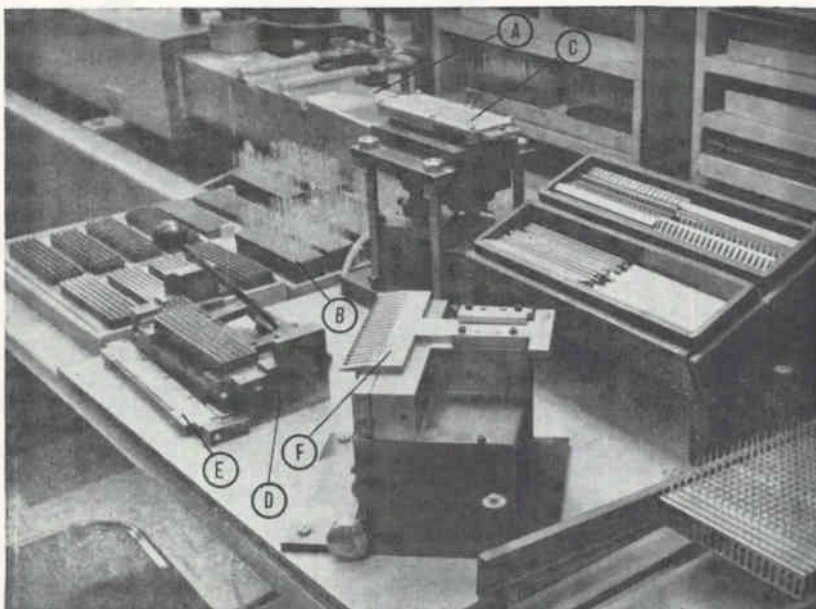

RECTIFIER JUNCTIONS after they leave the conveyor furnace are racked in 20-position trays and then etched, washed, dried, baked, silicone varnished and the anode leads welded—Fig. 1

plate of B is removed. Rectifiers are thus positioned so that the dice are sticking up. Now rectifiers are transferred to fixture D so that just wires are in holes of fixture. Lowering the handle on fixture D raises the leads so that fixture E can pick up a row of components and transfer them to fixture F which contains a 20-position tray. The tray is set into rack on the right where components are held prior to being etched, washed, dried, baked, silicone varnished, baked again and their anode leads welded.

After undergoing above processes, components are properly finished and positioned for encapsulation. The encapsulating tray shown in Fig. 2 is loaded with 100 sets of E-Pak cases and pellets. (Counter-bored holes are used in

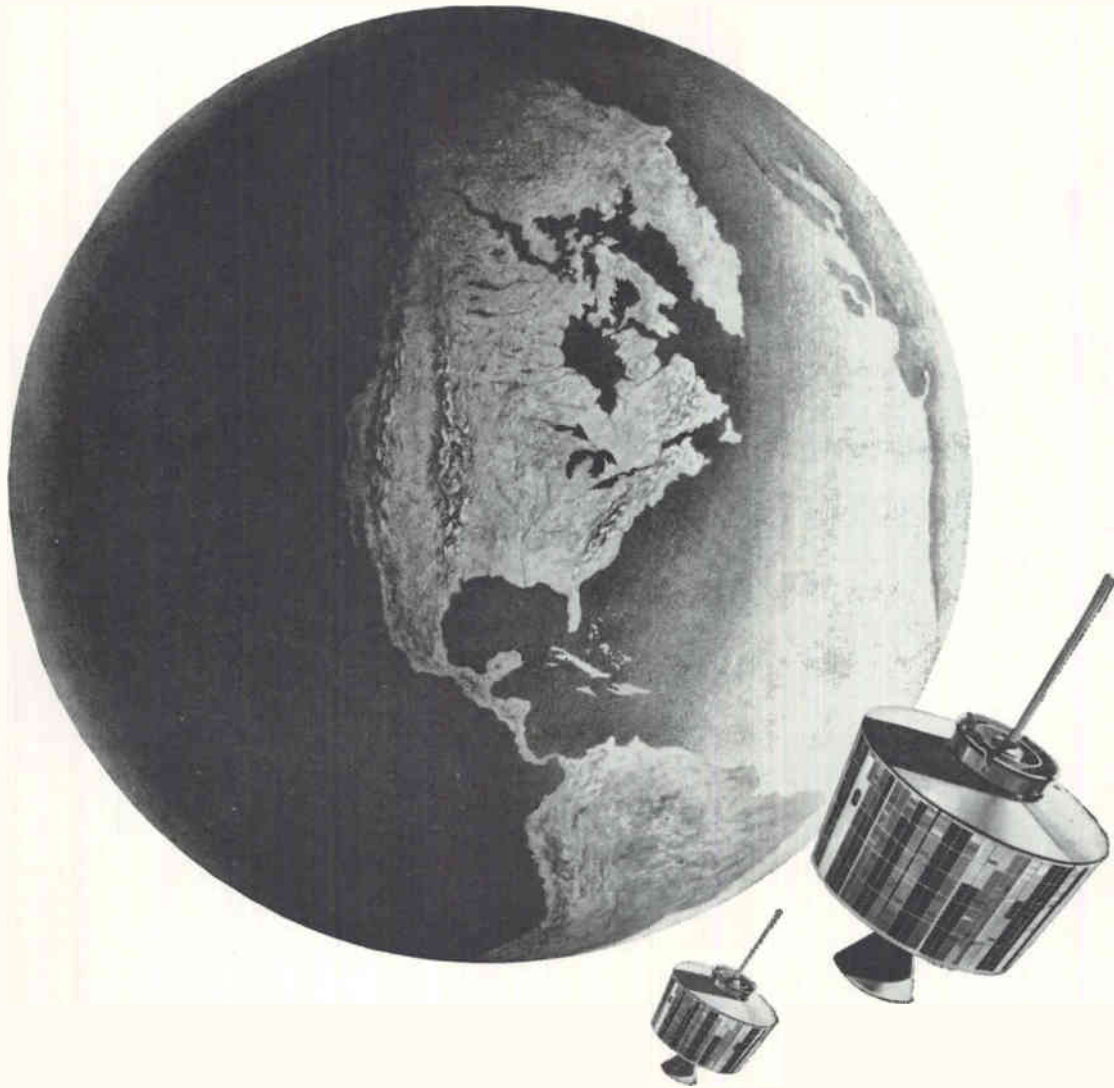

circuit designers...is your appointment in space with Hughes?

Today, Hughes is one of the nation's most active space/electronics firms. Projects include: MMRBM Integration, Assembly & Checkout, F-111B PHOENIX Missile System, VATE, TOW Anti-Tank Missile, SURVEYOR, SYNCOM, ARPAT, POLARIS and others.

This vigor promises the qualified engineer or scientist more and bigger opportunities for both professional and personal growth.

Many immediate openings exist. The engineers selected for these positions will be assigned to the following design tasks: the development of high power airborne radar transmitters, the design of which involves use

of the most advanced components; the design of low noise radar receivers using parametric amplifiers; solid state masers and other advanced microwave components; radar data processing circuit design, including range and speed trackers, crystal filter circuitry and a variety of display circuits; high efficiency power supplies for airborne and space electronic systems; telemetering and command circuits for space vehicles, timing, control and display circuits for the Hughes COLIDAR* (Coherent Light Detection and Ranging).

If you are interested and believe that you can contribute, make your appointment today.

Please airmail your resume to:
Mr. Robert A. Martin
Head of Employment
Hughes Aerospace Divisions
11940 W. Jefferson Blvd.
Culver City 68, California

We promise you a reply within one week.

Creating a new world with electronics

HUGHES

HUGHES AIRCRAFT COMPANY
AEROSPACE DIVISIONS

An equal opportunity employer.

Helps you to . . . Achieve top reliability in electronic circuits

Here is practical handbook help for the selection and use of component parts in the design of electronic equipment of maximum, practical reliability. For each component part, the set gives a description of types available, recom-



Your guide to proper choice of such components as:

Volume 1
RESISTORS • RELAYS
• CAPACITORS
• SWITCHES

Volume 2
POWER SOURCES and
CONVERTERS • FUSES
and CIRCUIT BREAKERS
• ELECTRICAL INDICATING INSTRUMENTS • PRINTED WIRING BOARDS • SOLDER and FLUXES • CHOPPERS • BLOWERS • RF TRANSMISSION LINES

Volume 3
TRANSFORMERS and
INDUCTORS • CONDUCTORS • WIRE AND CABLE TERMINALS • TUBE SHIELD • HARDWARE

mended applications, and environmental cautions that must be observed. Primary emphasis is given to component parts having a coordinated tri-service military specification—parts that can be safely used without getting special permission. In addition, this set covers component types for which single-service specifications or industry standards and specifications are described in detail.

ELECTRONIC COMPONENTS HANDBOOK LIBRARY

Editors

KEITH HENNEY and
CRAIG WALSH and
HARRY MILEAF
(vol. 3)

Technical Writing
Service, McGraw-Hill
Book Co., Inc.

3 vol. 783 pp., 8½ x 11,
523 illus., 225 tables

\$36.00

EASY TERMS: Pay \$9
in 10 days; then \$9
monthly

Here, for designers of electronic equipment, are data on a variety of component parts to enable them to use these components so that maximum reliability is attained in the completed unit.

For each component the library offers a general description of the kinds available. This includes information on their advantages and disadvantages under various conditions, where they should and should not be used, and effects on each of unfavorable environment—heat, humidity, altitude, pressure, shock, vibration, etc. Extensive information appears in the form of charts, tables, and diagrams that cover characteristics, tolerances, dimension, and mechanical construction.

10 DAYS' FREE EXAMINATION— DIRECT FROM PUBLISHER

McGraw-Hill Book Co., Dept. L-7-26
327 W. 41st St. New York 36

Send me the ELECTRONIC COMPONENTS HANDBOOK LIBRARY for 10 days' examination on approval. In 10 days I will (check one) send you the full price of \$36. or \$9. then \$9 a month until the full price is paid. Otherwise I will return the Library postpaid.

Name

Address

City..... Zone..... State.....

Company

Position

For price and terms outside U. S.
write McGraw-Hill Int'l. New York 36 L-7-26

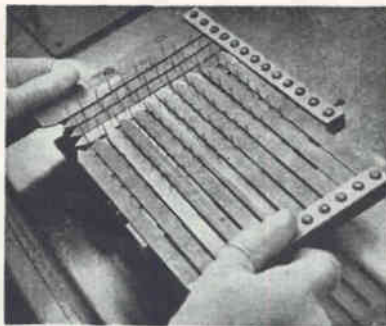

COMBS are used to align the cathode leads—Fig. 3

the tray to prevent the cases from falling through.)

The rectifiers are transferred two at a time from the 20-position tray and loaded into the cases and pellets. (Pellets inside cases have holes for accepting rectifier dice.) This operation is done in a dry box filled with nitrogen to prevent any moisture from getting at the exposed junction.

Fig. 3 shows cathode leads of rectifiers (in case and pellet units) being combed so that a top plate can be slipped over wires to align them. (When the two combs slide together carefully-positioned guide holes are created for positioning wires.) As shown in Fig. 4, a top plate similar to tray's bottom plate is now placed over leads and over the 4 corner posts of the encapsulating tray. Top plate differs from bottom plate only in having small holes for leads instead of large holes for the shells. Thus, lead concentricity is assured—an important requirement since the majority of the rectifiers are packed and shipped on tape reels.

MELTING & CURING—The loaded encapsulating-tray fixture is now put into an oven set at 150 degrees C to melt and cure the epoxy pellets—not the epoxy cases which differ somewhat in material content—so that they fuse to cases. After the epoxy melts the rectifiers



TOP PLATE positioned over the units insures that all leads are perfectly concentric—Fig. 4

are gently pushed into the molten epoxy to cure. After curing units are removed and electrically tested.

Pellets are pre-shaped charges of a one-component epoxy resin-hardener system. They are formulated so that when properly heated, they will flow and completely surround the diode without leaking through the bottom hole in the case. Upon continued heating, they gel and cure to a tough infusible mass.

Glassivation Forms Hermetic Seal

GLASS PASSIVATION process called "Glassivation" forms a hermetic seal at the chip of multiple diodes at Sylvania Electric Product's Semiconductor Division. Thomas A. Longo, Director of Research and Engineering, says process was pioneered by Sylvania to fuse a thin glass layer to an oxide-protected silicon junction. Therefore, says Longo, it is not necessary for the diode package to provide the hermetic seal but only to provide mechanical protection and convenient, reliable electrical termination. He says that arrays as complex as a 12-diode matrix can be made.

Soldering and Welding, Neither Are Knaves

SPECIAL REPORT for the Aerospace Electrical Institute shows that both soldering and welding can contribute to reliable miniaturized electronic equipment, but that this requires a thorough understanding of both process and their differences. Written by Bernard Matisoff, a mechanical as well as an electronics engineer, of Douglas Aircraft, the report urges the circuit-packaging engineer to base his choice between soft soldering and electronic resistance welding on specific needs of his project: For example, soldering is preferable with closely-spaced configurations difficult to reach mechanically. (Important in soldering is a solder material composition that has a coefficient of expansion compatible with base material.) On the other hand, Matisoff cites weight reduction and mechanical strength increases as principal advantages of resistance welding over soldering.

Frequency Standards

Model 14-31



Model 901

Model 18-10

Northeastern offers three frequency standards to meet your requirements.

Model 18-10:

Clock Standard of high stability producing both 1mc and 100kc frequencies.

Output.....
1 volt rms (phase locked)

Stability.....
± 7 parts in 10⁹ per day

Price.....\$295

Model 14-31:

A rackmount of the basic Model 18-10 clock standard having independent fixed output voltages of 1 volt into 50 ohms with less than 1% distortion for 100kc and 1mc frequencies.

Price.....\$600

Model 901:

A proportional oven ultra-stable standard with outputs of 5 mc, 1 mc and 100kc simultaneously.

Output.....
Nominal 1 volt rms across
100 ohm unbalanced

Stability.....
± 2 parts in 10¹⁰ per day

Price.....\$1495

NORTHEASTERN
ENGINEERING INCORPORATED
MANCHESTER 4, NEW HAMPSHIRE
AFFILIATE OF ATLANTIC RESEARCH CORP.
VISIT US AT WESCON
BOOTHS 4602-4603

Printed circuits that STAY STUCK

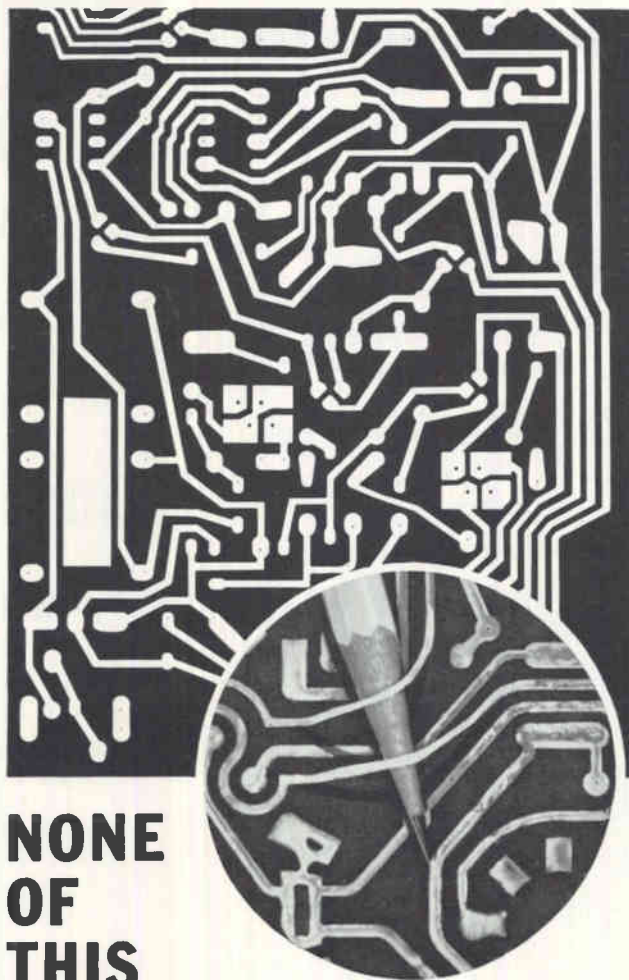

NONE OF THIS

Printed circuits may pull away from the laminate during the soldering operation. To reduce this possibility—to practically eliminate it—Synthane produces a special glass epoxy base grade of copper clad—G-10R—with high HOT PEEL STRENGTH (2 to 4 lbs. per inch of width after immersion for 15 secs. at 500°F* as compared with the usual 0.1 to 0.2 lbs. per inch of width). G-10R also meets or exceeds NEMA and MIL specs for Room Temperature Peel Strength. Write for folder of all Synthane metal-clad grades.

*Tests made on 1/4" and 1/2" wires.

SYNTHANE

CORPORATION **S** OAKS, PENNA.

Glendale 2-2211 (Area Code 215) TWX 215-666-0589
Synthane-Pacific, 818 W. Garfield Ave., Glendale 4, Calif. TWX 213-240-2104U

Synthane Corporation, 36 River Rd., Oaks, Pa.
Gentlemen:
Please send me your latest folder on Synthane G-10R and other Synthane copper-clad laminates.

Name _____

Address _____

City _____ Zone _____ State _____

CIRCLE 203 ON READER SERVICE CARD

CIRCLE 67 ON READER SERVICE CARD

FEATURING LATE RELEASES FROM TEXAS INSTRUMENTS

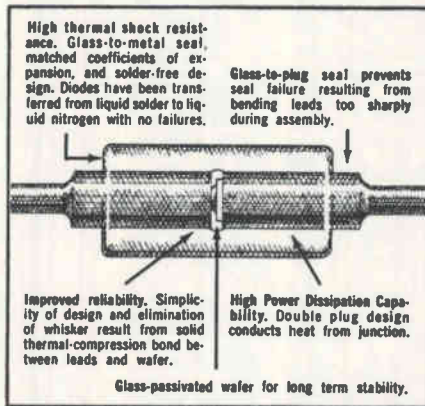

New *UNI/G** diodes feature rugged construction

Computer designers can now select from a series of TI silicon diodes which offer a new high in reliability, power-handling capacity, and stability.

An entirely new concept in diode construction makes it possible for *UNI/G* diodes to meet extreme reliability requirements in military computer applications. Recently five different types of *UNI/G* diodes were tested according to the requirements of MIL-S-19500/116, /114, /118, /265A (EL). There were *no failures of any parameter of any unit.*

UNI/G diodes are presently available in the following types: 1N251; 1N659; 1N660; 1N662; 1N663; 1N914; 1N914A; 1N914B; 1N915; 1N916; 1N916A; 1N916B; 1N917; JAN 1N251; UNS 1N914; USN 1N3064; U/G 625, 626, 627 (electrically identical to 1N625, 1N626, 1N627); U/G 3064 (electrically identical to the 1N3064); and TI71-75.



New power transistors dissipate 150 watts

TI's new 2N1539 series of germanium-alloy power transistors offers guaranteed power-dissipation capability of 150-watts — highest available in the TO-3 diamond package.

This high power capability assures lower junction temperatures and thus greater reliability. It also permits operation at higher ambient temperatures without temperature compensation.

A tight 2-to-1 h_{FE} ratio (50 to 100 at three amps) makes these devices particularly useful for power-amplifier applications requiring critical stability. Major equipment applications include power supplies, power regulators, servo and power amplifiers, and peripheral computer gear.

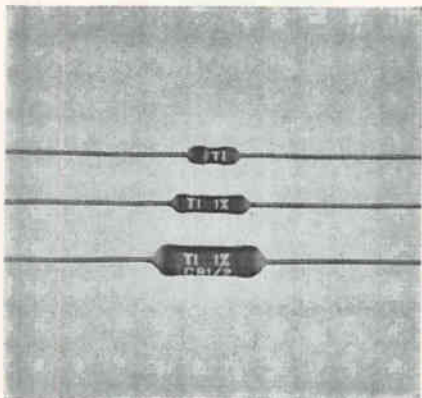

*epoxy.plus** carbon-film resistors meet military requirements at low cost

These new TI precision resistors are ideal for military and commercial applications calling for the most inexpensive RN55D, RN60D and RN65D package sizes.

Epoxy-plus resistors are coated with a new double-tough synthetic sealant by an exclusive TI process that assures extremely high moisture resistance over the entire operating temperature range.

These new TI units surpass the doubled requirements of characteristic D, MIL-R-10509 D — handling full load rating at 125°C and double-wattage rating at 70°C. *Epoxy-plus* resistors are now immediately available in a wide range of resistance values.

*Trademarks of Texas Instruments Incorporated.

NEWARK

ELECTRONICS CORPORATION

AUTHORIZED DISTRIBUTOR

CHICAGO 6, ILLINOIS,
Newark Electronics Corporation,
Main Office and Warehouse,
223 West Madison Street,
Area Code: 213, Phone: ST 2-2944

LOS ANGELES AREA,
Newark Electronics Co., Inc.,
4747 W. Century Blvd.,
Inglewood, Calif.
Area Code: 213, Phone: OR 8-0441

DENVER 22, COLORADO,
Newark-Denver Electronic
Supply Corporation,
2170 South Grape,
Area Code: 303, Phone: SK 7-3351

DETROIT 37, MICHIGAN
Newark-Ferguson Electronics, Inc.,
20700 Hubbell Avenue,
Area Code: 313, Phone: JOrdan 4-5490

GRAND RAPIDS, MICHIGAN,
Newark-Industrial Electronics Corp.,
2114 S. Division Ave.,
Area Code: 616, Phone: GL 2-1411

CINCINNATI 10, OHIO,
Newark-Herrlinger Electronics Corp.,
112 East Liberty Street,
Area Code: 513, Phone: GA 1-5282

NEW YORK 10, NEW YORK,
Newark-Electronics Center, Inc.
(TI resistors only) 160 Fifth Avenue,
Area Code: 212, Phone: AL 5-4600

BRAND NEW! 1964
NEWARK INDUSTRIAL
ELECTRONICS
CATALOG NO. 75

- 596 descriptive, fully illustrated pages!
- Over 70,000 items. Backed up by over \$6,000,000 Industrial Electronic Inventory!
- Write for your FREE copy!

See these and other new Texas Instruments Products at WESCON, booths 3303-3308

21-63-09

Picoammeter Has 30 Millisecond Rise Time

Unit provides tenfold increase in response speed

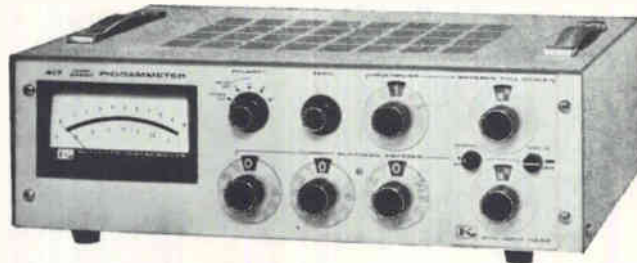

MODEL 417 picoammeter manufactured by Keithley Instruments, Inc., 12415 Euclid Avenue, Cleveland 6, Ohio is ten times faster than most conventional instruments and features wide range and sensitivity from 10^{-18} ampere full scale to 3×10^{-5} ampere. Having completely solid-state circuits except for one electrometer tube, the unit has zero drift of less than 1 percent per day and calibrated current suppression is up to 1,000 times full scale. Also, accuracy is within 3 percent and power consumption less than 20 watts. A 3 volt, 1 mil output for recorders is available for full-scale signals on any range.

Unique plug-in design of the Model 417 permits the amplifier to be located at distances as great as 100 feet from the instrument chassis, assuring high-speed meas-

urements. A full complement of accessories is available to facilitate remote operations.

When fast response is unnecessary, the rise time may be adjusted with a front panel damping control. Moreover, the current suppression ability of the unit, permits full-scale display of 0.1 percent variations in signals as small as 10^{-10} amperes.

According to the manufacturer, the combination of fast response, high sensitivity and calibrated current suppression make the model 417 ideal for use with photomultipliers, ion chambers, mass spectrometers and flame and beta-ray ionization detectors. The unit is applicable to experiments such as noise studies, gas chromato-

graphy, flash-filament testing, plasma physics and vacuum studies.

The 417 picoammeter derives its ultra-fast response from a high-gain d-c amplifier and a critically-damped feedback network. Stability is due to a well regulated supply and suppression originates from a calibrated current source. The d-c amplifier is designed for an overall gain of better than 10,000; three transistor amplifier stages are used in conjunction with an electrometer tube input and emitter-follower output.

Price of the model 417 is \$850. The unit requires 105 to 125 or 210 to 250 volts, 50-1,000 cps for primary power.

CIRCLE 301, READER SERVICE CARD

Solid-State Preamps Provide Low Noise

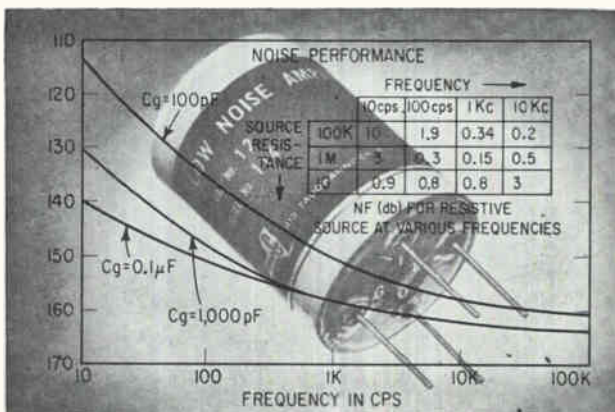

MARKETED by Ithaco, Inc., 413 Taughannock Blvd, Ithaca, N. Y., model 114 high input impedance amplifier has excellent noise figure and linearity. Operable equally well from capacitive or resistive signal sources, these amplifiers provide very high input impedance and low input capacitance and are suitable for use as preamps for piezoelectric transducers, capacitor microphones, high resistance ir detectors, bio-medical sensors and lab amplifiers.

The unit is completely solid-

state and has a voltage gain of 10 (20 db non-inverting), frequency response between 0.5 cps and 200 Kc ± 1 db, input resistance exceeding 1,000 megohms at 25 C, input capacitance less than 15 pf and maximum noise (for 1 cps, 1,000 pf at 25 C) 160 db below 1 volt at 10 Kc. The model 114 requires -12 to 25 vdc, 3 to 6.5 ma and weighs only 2.75 ounces. It conforms to the characteristic curves shown in the diagram and has an output impedance of 35 ohms maximum.

According to the manufacturer, model 114 preamplifiers offer a typical 55 db attenuation to power supply ripple and transients within the amplifier passband and are tested to specifications with a 2,000-ohm power supply impedance. Since the amplifier is non-inverting, it is readily applicable to signal sources where capacity neutralization is desirable.

CIRCLE 302, READER SERVICE CARD

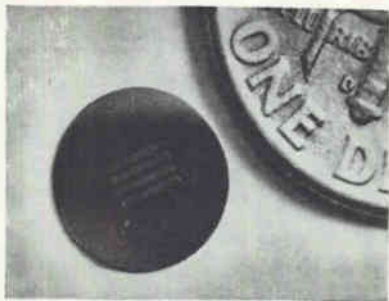

Si Detectors Extend Spectral Response

THREE basic types of silicon optical detectors now available from Electro-Nuclear Laboratories, Inc., 2443 Leghorn St., Mountain View, Calif., offer controlled and extended spectral responses from 5,000 to 9,000 Angstroms. Series 9,000 detectors provide normal silicon spectral response peaking at 9,000 A, while Series 5,500 and 5-9,000 offer optical peaking at 5,500 A and a broader, less peaked response between 5,000 and 9,000 A, respectively.

Directivity ranges between 10^{10} and 10^{12} , response is in the Mc range with higher frequency responses available on special order. Sensitive areas are defined with optical precision, typically ± 0.00005 inch.

Diffused p-n junction detectors

are provided in numerous configurations including mosaics, arrays, x-y plotters, concentric circles, radial patterns and hemispherical caps and in sizes from 0.1 mm² to over 2 cm diameter. Surface barrier detectors are also available. (303)



D-C Amplifier Covers Wide Band

WIDEBAND d-c amplifier, model 3104B features light weight and extreme portability, with high performance electrical characteristics. It will produce full output of ± 15 v at ± 100 ma to 10 Kc—enough to drive the highest frequency galvanometers directly. Noise is $5 \mu\text{v}$ d-c to 10 Kc, and drift is only $2 \mu\text{v}$ in 100 hr. Unit pictured, complete with a P3PB attenuator having gains of 10, 20, 50, 100, 200, 500 and 1000 with a 6 db vernier, sells for \$765. California Instruments Corp., 3511 Midway Drive, San Diego 10, California. (304)

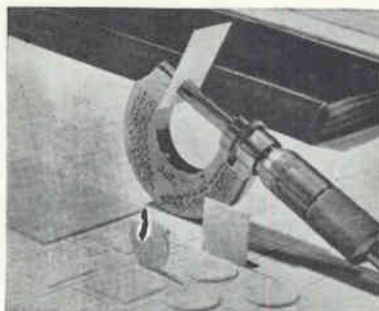

Flat Alumina Plates Used As P-C Bases

DEVELOPMENT of flat alumina plates used as printed circuit bases for assembly into electronic components is announced. The plates, made from high-purity 96 percent alumina, are available in sizes up to 3 in. square in thicknesses down to 0.008 in. with tolerances to ± 0.0005

in. All pieces have polished or lapped faces and are made parallel within 0.0005 in. The alumina plates provide high physical strength and good electrical properties, as well as high resistance to softening. Saxonburg Ceramics, Inc., Saxonburg, Pa. (305)

High-Speed Flux For Printed Circuits

DESIGNATED No. 183, this new flux is completely homogeneous, non-corrosive, non-conductive and conforms to military specifications. It is highly concentrated in its ratio of solids contents to liquid and has outstanding wetting and capillary properties. The flux is available in one quart, one and 5 gallon glass or plastic containers and 54 gallon drums. Alloys Unlimited Solder, 21-01 43rd Ave., Long Island City 1, N. Y. (306)

Digital Computer Has High Reliability

LOW COST digital computer, the PDP-5, is designed for use as an independent information handling system or as the control element in larger systems. It is a single address, fixed word, stored program computer operating on 12-bit, 2's complement binary numbers. It has a 6- μsec memory cycle time and fully parallel processing providing a computation rate of 55,555 additions per sec. Digital Equipment Corp., Maynard, Mass. (307)

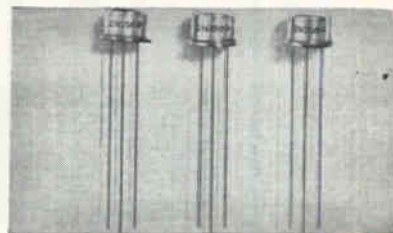

Low-Level Choppers Give High Performance

SILICON low level choppers, the 2N-2569 and 2N2570, feature low offset voltage and low cost. The 2N2569 has an offset voltage of 250 μv (max) and is priced at \$10.60 in quantities of 100; the 2N2570

Requirement: Complete utilization of resources and talents... toward aerospace mastery

The heart of the problem lies here: "To accomplish the rapid advancement of aerospace technology and its adaptation into aerospace systems." Simply stated, that is the mission assigned to the Air Force Systems Command.

The Air Force Systems Command civilian-military team has been given responsibility for the research, development, production, procurement and check-out actions required to place a complete aerospace system in operation. To fulfill this responsibility, with all its interrelated areas of theory and practice, calls for engineers, scientists, people of dozens of different disciplines, with the training, experience and ability to cope with problems of the most advanced and sophisticated nature. To utilize every individual's talent to its ultimate limit is an urgent requirement if AFSC is to accomplish its mission.

In research, development, testing and contract management facilities throughout the country, challenging and vital aerospace programs are being managed . . . the problems are myriad, complex and of compelling importance.

AFSC employment benefits include patent protection for inventions, opportunity for advanced study, authorship credit on scientific papers, honorary, academic and cash awards, promotion based on merit, health and retirement benefit programs, low cost life insurance, paid vacations and sick leave, plus all the benefits of civil service.

AFSC is now staffing the specific positions listed below. If your qualifications are appropriate, we would be interested in discussing further with you the unique and rewarding career opportunities AFSC has to offer.

AIR FORCE SYSTEMS COMMAND

has immediate openings for engineers and scientists in these areas.

INSTRUMENTATION ENGINEER—Evaluates range contractor instrumentation proposals to meet test requirements by using telemetering means which include HF, VHF, UHF transmission and receiving equipment, complex antenna systems, recording systems.

AEROSPACE ENGINEER—Accomplish, promote and sponsor basic research in the areas of Air Force interest in the field of fluid motion, emphasizing, but not limited to hypersonic phenomena. Analyze and evaluate fluid dynamic research proposals.

OPERATIONS RESEARCH ANALYST—Develop, through research, advanced techniques and methods for assuring the effectiveness of the management of military systems development and acquisition and to develop solutions to complex management problems.

MATHEMATICIAN—Analyze and evaluate inertial guidance data, environmental data, biological and space radiation data. Conducts vibration analysis studies. Follows up on collection and evaluation methods used and determines accuracy of the end product.

HEALTH PHYSICIST—Provide expert health physics consultant and staff services in dealing with research, hazards evaluation and monitoring of environmental factors as applies to nuclear and radiological problems of the Air Force. These programs include nuclear weapons systems and facilities, reactors and reactor facilities and other systems and facilities utilizing nuclear energy.

ELECTRONICS ENGINEER—Strong background in development, fabrication, installation, maintenance and experimental operation of large radar sites. Should possess ability to recognize deficiencies and incompatibilities in plans.

Scientists and engineers interested in joining the staff of AFSC are invited to send their resume or Application for Federal Employment (SF-57) with geographical preference and salary requirement to:

United States Air Force
AFSC-AFLC Joint Professional Placement Office
527 Madison Avenue, Dept. F, New York 22, N. Y.
An Equal Opportunity Employer

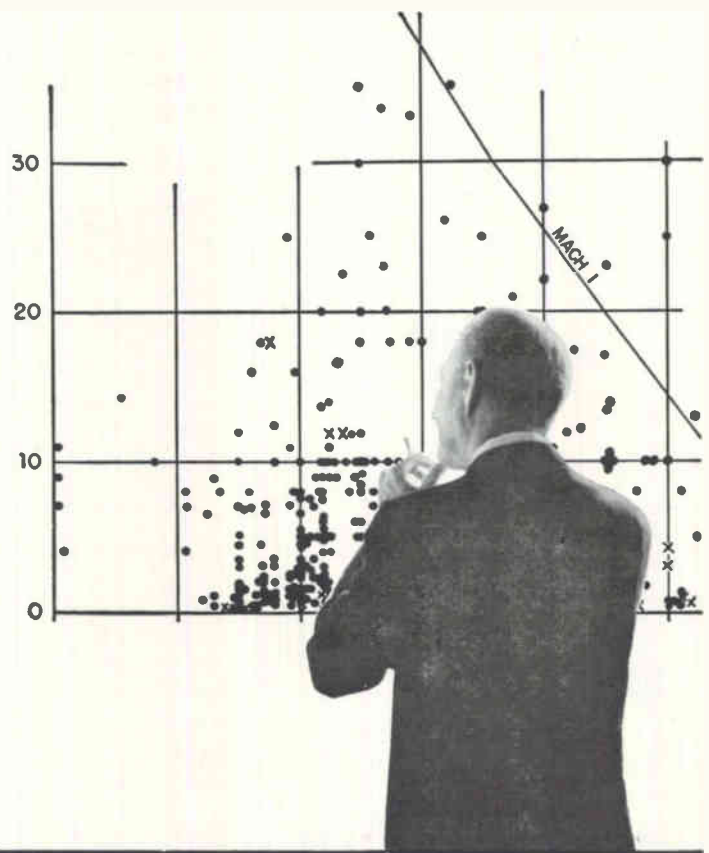

Acoustical Components of Superior Quality

JAPAN PIEZO supplies 80% of Japan's crystal product requirements.

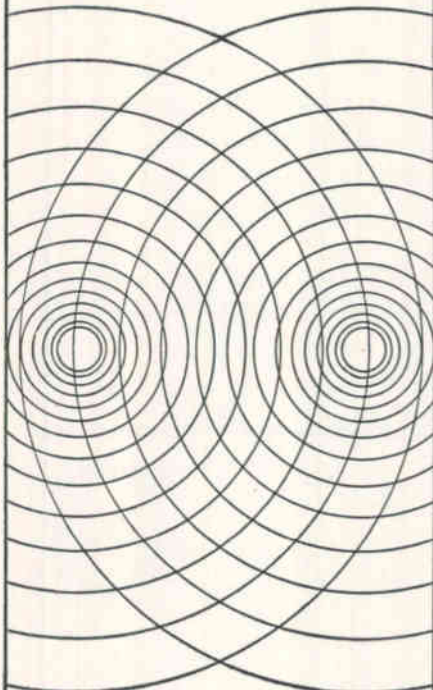

STEREO CARTRIDGE

Crystal — "PIEZO" Y-130

X'TAL STEREO CARTRIDGE

At 20°C, response: 50 to 10,000 c/s with a separation of 16.5 db. 0.6 V output at 50 mm/sec. Tracking force: 6 ± 1 gm. Compliance: 1.5×10^{-6} cm/dyne. Termination: $1M\Omega + 150$ pF.

Write for detailed catalog on our complete line of acoustical products including pickups, microphones, record players, phonograph motors and many associated products.



**JAPAN PIEZO
ELECTRIC CO., LTD.**

Kami-renjaku, Mitaka, Tokyo, Japan

has an offset voltage of 500 μ V (max) and is priced at \$8 in similar quantities. Emitter cutoff current is less than 2 nanoamperes. Noise transients are low. The two types have use in such applications as low level voltage measurements, d-c amplifier stabilization, analog to digital conversion, telemetering and wherever ultra-precise switching is needed. Amperex Electronic Corp., 230 Duffy Ave., Hicksville, N. Y.

CIRCLE 308, READER SERVICE CARD

Reference Diodes Have High Stability

NOW AVAILABLE are USN 1N935B, 1N937B, and 1N938B temperature compensated zener reference diodes which meet military specification MIL-S-19500/156A (Navy). Offering a guaranteed stability between 0.004 and 0.006 v over 1,000 hours, these units have been tested in an advanced new integrated facility capable of carrying out parameter measurements, temperature stability and life testing simultaneously. Motorola Semiconductor Products Inc., 5005 East McDowell Road, Phoenix 8, Ariz. (309)

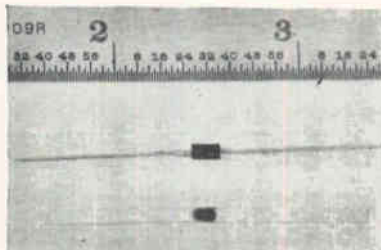

Micro Diodes Offer Fast Recovery

LINE of micro diodes are capable of handling in excess of 1 amp average rectified current and recovering in less than 100 nsec. Light weight airborne converters and inverters are made possible due to usage of lighter transformer cores, along with smaller micro diodes. Units may be obtained with ribbon or round leads. Sizes are 0.150 in. by 0.075 in. ribbon leads; 0.160 in. by 0.085 in. round leads. Devices will meet applicable specifications of MIL-S-19500C testing. Micro Semiconductor Corp., 11250 Playa Court, Culver City, Calif. (310)

Literature of the Week

RIBBON CABLE Hitemp Wires Co., Westbury, L. I., N. Y., has prepared an 8-page technical bulletin, No. 100, on high temperature flat ribbon cable. (311)

MANNED SPACE SYSTEMS General Electric Co., Valley Forge Space Center, Philadelphia 1, Pa., has issued a 24-page illustrated brochure describing its manned space systems laboratory equipment and programming available. (312)

TOOLS & ACCESSORIES Techni-Tool, Inc., 1216 Arch St., Philadelphia 7, Pa. Catalog No. 10 covers a line of special pliers and tweezers for exacting aerospace requirements, and includes a selection of clean-room hand coverings and white-room accessories. (313)

CROSSBAR LOGIC & DRIVE CIRCUITRY James Cunningham, Son & Co., Inc., P.O. Box 516, Rochester 2, N. Y. Engineering bulletin No. 60-302 describes various manual and electrical driving circuits and logic networks for controlling and programming crossbar switching operations. (314)

SHOCKPROOF RESISTORS. Ohmite Mfg. Co., 3671 Howard St., Skokie, Ill. Bulletin 104 announces a line of wire-wound, vitreous enameled resistors designed to meet MIL-R-15109B. (315)

MAGNETIC TAPE Ampex Corp., 934 Charter St., Redwood City, Calif., has released a 12-page catalog on magnetic tape for instrumentation applications. (316)

X-Y RECORDER Houston Instrument Corp., 4950 Terminal Ave., Bellaire 101, Texas. A 4-page brochure describes the HR-96, 8-in. by 11-in. X-Y recorder. (317)

DIGITAL EVENT RECORDERS Packard Bell Computer, 1905 Armacost Ave., Los Angeles 25, Calif. Bulletin SP-152A details operation and specifications of the DER-600 and the DER-2000 digital event recorders. (318)

PRECISION POTENTIOMETERS Markite Corp., 155 Waverly Place, New York, N. Y. Bulletin NL is entitled "Non-Linear Conductive Plastic Precision Potentiometers." (319)

MAGNETIC HEADS Potter Instrument Co., Inc., 151 Sunnyside Blvd., Plainview, L. I., N. Y. Product data brochure No. 1-311 describes the firm's line of magnetic record/playback heads. (320)

MICROCIRCUIT ASSEMBLY MACHINE Kullicke and Soffa Mfg. Co. Inc., 135 Commerce Drive, Fort Washington, Pa. Product bulletin describes model 410 microcircuit assembly machine and accessory devices that account for its versatility. (321)



**Are you a
COMPLETELY INFORMED
electronics engineer?**

Today you may be working in microwaves. But on what project will you be working tomorrow? You *could* have read **electronics** this past year and kept abreast of, say, microwave technology. *There were 96 individual microwave articles between July, 1961 and June, 1962!*

But suppose tomorrow you work in some area of standard electronic components, in semiconductors, in systems? Would you be up-to-date in these technologies? Did you read the more than 3,000 editorial pages that **electronics'** 28-man editorial staff prepared last year?

electronics is edited to keep you current *wherever* you work in the industry, *whatever* your job function(s). If you do not have your own copy of **electronics**, subscribe today via the Reader Service Card in this issue. Only 7½ cents a copy at the 3 year rate.

electronics

Now
**SYSTEMS & SUBSYSTEMS
COMPONENTS for
INPUT-OUTPUT
EQUIPMENT**

INVAC Corporation announces for the first time its completely solid state on-line and off-line equipment for special punched paper tape applications.

This off-the-shelf equipment provides for system flexibility . . . military applications — low RFI — uses photoelectric principle to eliminate electrical contacts..

Fast delivery assured — large or small quantities. For additional information write or call: Area Code 617 899-2380.

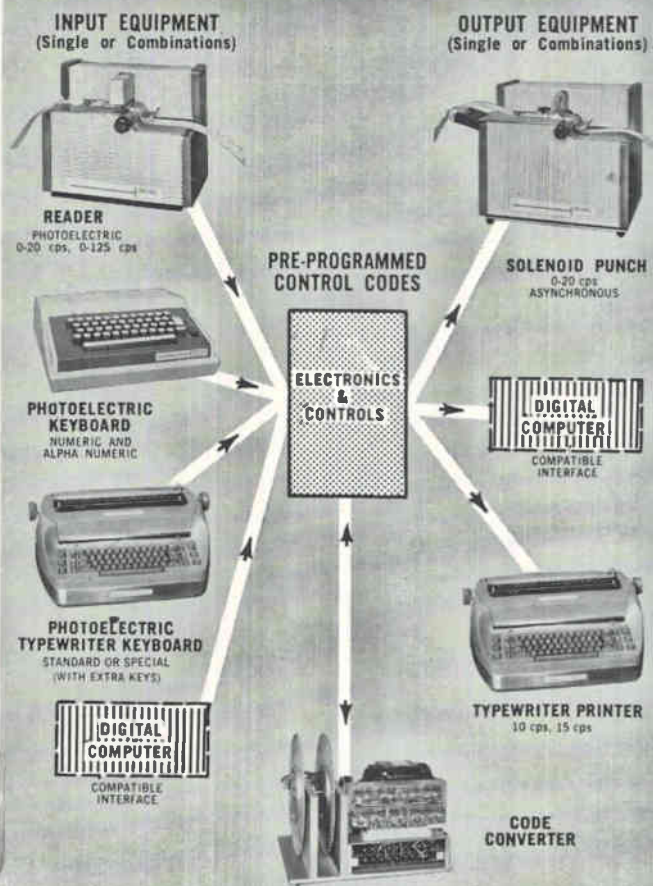

INVAC
CORPORATION

26 FOX ROAD • WALTHAM 54, MASS. Area Code 617 - 899-2380

GE Realigns Computer Department



R. R. Johnson



J. O. Paivinen



B. R. White

ESTABLISHMENT of two new product organizations, and three top managerial appointments in General Electric Company's Computer Department, Phoenix, Ariz., have been announced by Harrison Van Aken, department general manager.

New product organizations are the Advanced Products Operation and the Peripheral Equipment Business. According to Van Aken, the new Operation and new Business are established "in recognition of the growth opportunities ahead."

Named to manager of the Advanced Products Operation is Robert R. Johnson, formerly manager of engineering for the department. He is succeeded by John O. Paivinen, formerly assistant to the president of International Electric Corp., Paramus, N. J.

Bill R. White is appointed general manager of the new Peripheral Equipment Business. He was formerly manager of manufacturing for the company's Communication Products department, Lynchburg, Va.

In his new position, Johnson is

National Research Elects Gardner

ELECTION of James H. Gardner as executive vice president and a di-

rector of development of advanced products and bringing them to production status. He is also responsible for the Computer Laboratory at Sunnyvale, Calif., and for design and systems engineering, packaging design, circuits and machine-oriented programming for the advanced products.

Paivinen will handle GE's 200 computer line, custom products and data communications equipment. He will also provide engineering support to the Advanced Products Operation and the Peripheral Equipment Business.

White is responsible for developing a fully-integrated peripheral equipment business to support Computer Department needs, including both mechanical and electronic portions of the peripherals. This includes electro-mechanical design, electronic equipment design circuits, and data accumulation products.

The Computer Department develops, manufactures and markets business and scientific data processors, a full line of peripheral equipment, factory-monitoring, data accumulation and data communications systems.

rector of National Research Corp., Cambridge, Mass., has been announced.

Gardner, a former vice president of the company, has been on a two-

year leave-of-absence while serving as Deputy Director of Defense Research and Engineering, Department of Defense. NRC is a wholly-owned subsidiary of Norton Company.

Announce Formation of New Company

N-H MICROWAVE, INC., Red Bank, N. J., is a new company organized to specialize in the design, development and manufacture of ferrite and other microwave devices. The company was formed by Lennart H. Nilson and H. W. Hurd who were formerly in the ferrite effort at Bendix Corp., Red Bank division.

Nilson serves as president of the new firm, and Hurd, vice president.



Meyer Advances at Lincoln Laboratory

JAMES W. MEYER, a pioneer in solid-state maser work, has been named head of the Radio Physics division of MIT Lincoln Laboratory, Lexington, Mass.

He succeeds John V. Harrington, who will direct MIT's new Center for Space Research. Meyer had been associate head of the Solid-State Division of Lincoln Laboratory since July of 1962.

A Missouri native and graduate of the University of Wisconsin, he joined the staff of Lincoln Laboratory in 1952 and worked on modification of the TPS-1D radar for the DEW line. He later turned to low-temperature instrumentation for microwave measurements on solid-state materials, and developed high-



Here, at Lockheed Missiles & Space Company's Space Communications Laboratory, scientists are re-investigating the possibility of using the moon to facilitate earth communications. Possibilities for the use of the moon as a relay station for earth-to-earth communications have been largely neglected because the moon's shape and rugged surface greatly distorted a return signal. But Lockheed research into the extension of communications on difficult communication channels, using techniques applicable to dispersive time variant channels, is making significant inroads into this problem.

Another area receiving intense study at Lockheed is satellite tracking of deep space probes. Since tracking accuracy

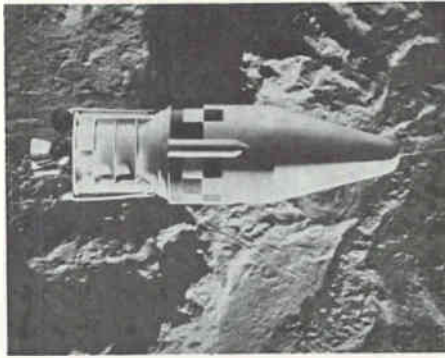

depends greatly on stations being as far from each other as possible, while retaining line-of-sight communications, Lockheed is studying the use of two earth-orbiting satellite tracking stations, 8000 miles apart. Not only would great accuracy be gained by the separation, but it would be further enhanced by the positioning of the stations above the earth's atmosphere, thus eliminating atmospheric distortion.

Examples of other research projects being pursued by Lockheed in the communications area include: Random multiplexing, satellite readout techniques, scatter communications, radar mapping, submarine tracking, modulation of optical energy, communications over multipath channels, and learning systems.

LOOK AT LOCKHEED... AS A CAREER

Consider Lockheed's leadership in space technology. Evaluate its accomplishments—such as the Polaris missile and the Agena vehicle's superb record of space missions. Examine its outstanding advantages—location, advancement policies, creative climate, opportunity for individual recognition.

Then write for a brochure that gives you a more complete Look at Lockheed. Address: Research & Development Staff, Dept. M-43E, P.O. Box 504, Sunnyvale, California. Lockheed is an equal opportunity employer.

SCIENTISTS & ENGINEERS: In addition to positions in the research and development of communications and optics, other important openings include: Inertial guidance • Orbit thermodynamics • Electromagnetics • Mission & trajectory analysis • Gas dynamics • Chemical and nuclear propulsion • Systems engineering

LOCKHEED

MISSILES & SPACE COMPANY

A GROUP DIVISION OF LOCKHEED AIRCRAFT CORPORATION

Sunnyvale, Palo Alto, Van Nuys, Santa Cruz, Santa Maria, California • Cape Canaveral, Florida • Huntsville, Alabama • Hawaii

LOOK AT LOCKHEED IN SPACE COMMUNICATIONS:

Where outstanding successes have created aerospace leadership

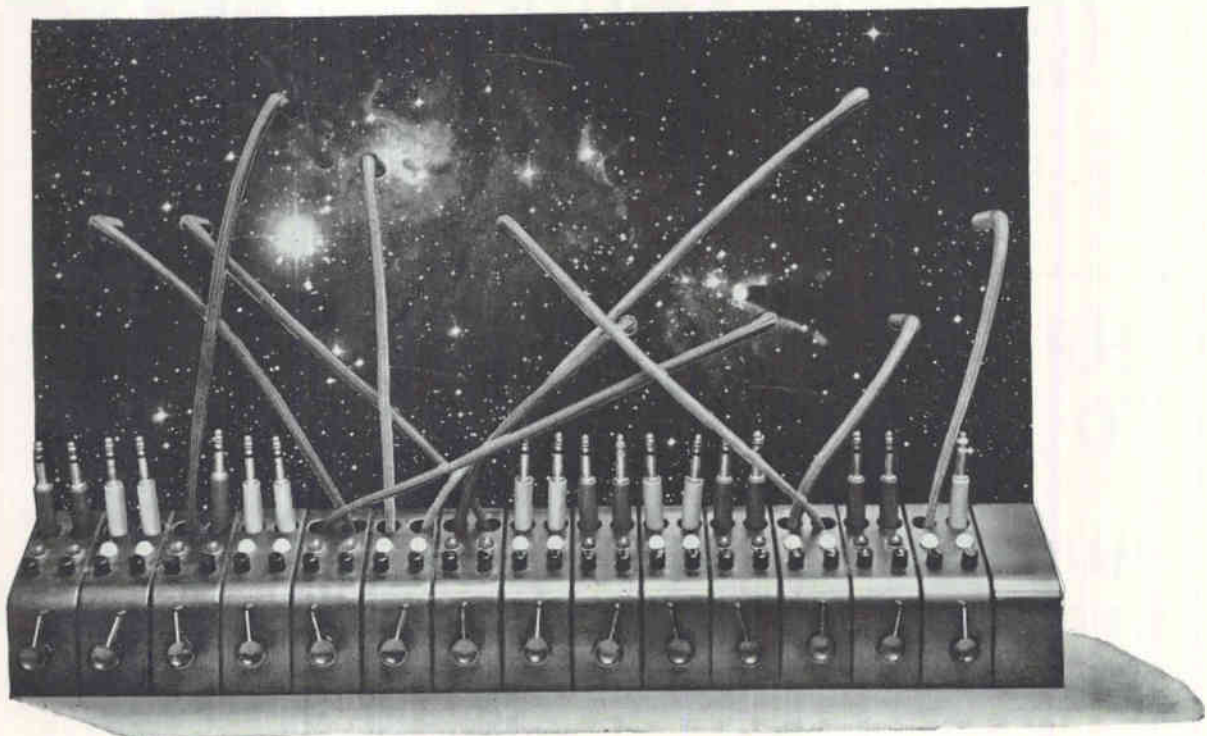

The Fujitsu 'Aloxcon', A New Electrolytic Capacitor:

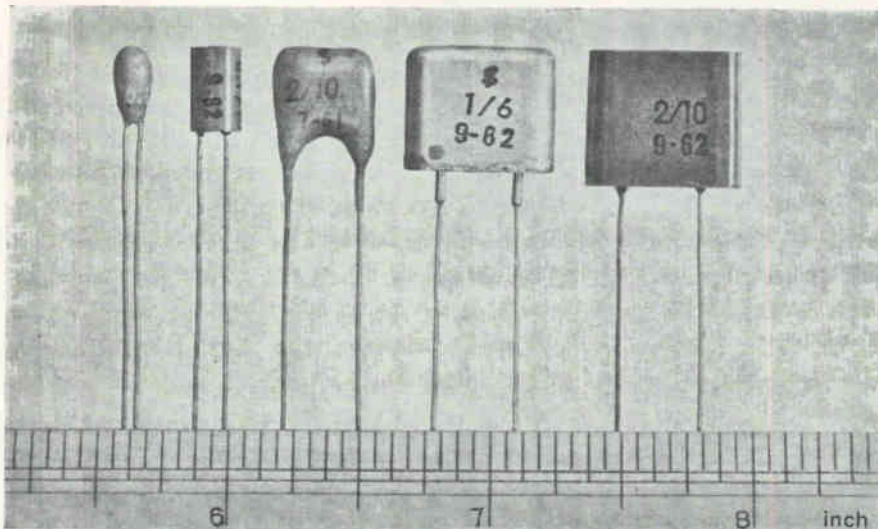

The high quality of tantalum at the low cost of aluminum

Designed for use in printed and transistorized circuits, Fujitsu's newly developed aluminum solid electrolytic capacitor 'Aloxcon' functions effectively at temperatures ranging from -60°C to $+80^{\circ}\text{C}$ and frequencies up to 100 kc or more. A semiconductor layer replaces the usual type of electrolytic and so the capacitance of an 'Aloxcon' is less affected by temperature and frequency than other types. 'Aloxcon' capacitors are highly resistant to moisture, and have low leakage current and extremely high life expectancy. They are ideal for transistor circuits requiring low impedance and miniaturization. Detailed specifications and application data available from our representatives.

Type	Voltage/Capacitance	Working Voltage (V)	Surge Voltage (V)	Capacitance (mf)				
AZ (Dipped)	6	6	8			0.1	0.2	0.5
	10	10	12			0.05	0.1	0.2
	25	25	30	0.01	0.02	0.05	0.1	
AR (Dipped)	6	6	8			1	2	5
	10	10	12			1	2	5
	25	25	30	0.1	0.2	0.5	1	2
GR (Encased)	6	6	8			1	2	5
	10	10	12			1	2	5
	25	25	30	0.1	0.2	0.5	1	2
HR (Hermetically Sealed)	6	6	8			1	2	5
	10	10	12			1	2	5
	25	25	30	0.1	0.2	0.5	1	2



FUJITSU LIMITED

Communications and Electronics

Tokyo, Japan

Represented by: U.S.A. HAR-WELL ASSOCIATES, INC. Southbury, Connecticut, Phone: 264-8222 THE NISSHO PACIFIC CORP. 120 Montgomery St., San Francisco 4, California, Phone: YUkon 2-7901, 7906 Canada: NISSHO (CANADA) LTD. 100 University Avenue, Toronto, Phone: EMpire 2-4794 United Kingdom: WALMORE ELECTRONICS LIMITED 11-15 Betterton Street, Drury Lane, London W.C. 2, Phone: TEMplebar 0201-5 Germany: NEUMÜLLER & CO. GMBH 8 München 13, Schraudolphstr. 2a, Phone: 29 97-24

CIRCLE 76 ON READER SERVICE CARD

**HELP YOUR POST OFFICE
TO SERVE YOU BETTER
BY
MAILING EARLY IN THE DAY
NATIONWIDE IMPROVED MAIL SERVICE
PROGRAM**

power duplexers for the FPS-17 radar.

Experimental work for his doctoral thesis on microwave properties of paramagnetic materials put the laboratory in a good position to exploit the solid-state maser, emerging at about that time. In 1956, Meyer and Alan McWhorter developed the first solid-state maser to function as an amplifier.

In March of 1959, Meyer became associate head of the Radar Division and a member of the Lincoln Laboratory Steering Committee. As associate head of the Solid-State division prior to his current post, Meyer worked on application of the new semiconductor lasers to communications and radar.

The 43-year-old scientist is a member of the Scientific Advisory Board to the Air Force Chief of Staff and a special advisor to the AF Electronic Systems Division.



**Ampex Appoints
H. L. Brown**

HERBERT L. BROWN, former vice president and general manager of Ampex Corporation's audio division in Sunnyvale, Calif., has been appointed vice president, Ampex International-manufacturing and engineering.

Brown joined Ampex in 1955 and has been a vice president of the corporation since 1959.

Bream Heads Up Stellarmetrics

HUGH C. BREAM is the new president and chief executive officer of Stellarmetrics Inc., Santa Barbara, Calif., research and development firm. He joins the company directly

from the Lear-Siegler Astronics division, Santa Monica, where he was vice president.

Primary activities at Stellar-metrics include development of telemetry systems, electronic systems, multiplexers, commutators and electromechanical switching devices, data reduction systems, audio sound systems and f-m high-sensitivity, low-noise receivers.

PEOPLE IN BRIEF

Frederick M. Brose leaves Dutex Corp. to join Coleman Electronic Systems as product mgr. Morton Antler, formerly with IBM's Engineering Laboratory, named deputy director of research at Burndy Corp. Arthur B. Sperry promoted to mgr. of mfg. engineering for the eastern operation of Sylvania Electronic Systems. William C. Purple, Jr. moves up to v-p and g-m of Melpar, Inc. Nytronics, Inc., advances William H. Bowman to materials and production control mgr. Albert A. Gerlach, with Cook Electric since 1953, appointed asst. director of the Research Laboratories dept. of the Cook Technological Center div. GE ups A. P. Taylor to mgr. of mfg. of the Communication Products dept. Ian H. McLaren, previously with Bendix Corp., named mgr. of Emerson Electric's Electronic Systems dept. He succeeds Warren Helberg who becomes mgr. of the Space div.'s Engineering Administration dept. Algeron S. Badger, ex-Dresser Industries, appointed technical director of Test Equipment Corp. Robinson Technical Products, Inc., elevates James H. Hollyer to exec v-p. Thomas Beling advances to mgr. of instrumentation engineering of Acton Laboratories, Inc. Jefferson R. Wilkerson, from Sylvania Electronic Products to Melabs as system design specialist. Frank V. Wagner moves up to v-p, plans and programs, Informatics Inc. Maurice J. Raffensperger, formerly with Philco Corp., now director of engineering at Northrop Nortronics' Systems Support dept.



EMPLOYMENT OPPORTUNITIES

The Advertisements in this section include all employment opportunities—executive, management, technical, selling, office, skilled, manual, etc. Look in the forward section of the magazine for additional Employment Opportunities advertising.

Positions Vacant
Positions Wanted
Part Time Work

Civil Service Opportunities
Selling Opportunities Wanted
Selling Opportunities Offered

Employment Agencies
Employment Services
Labor Bureaus

ELECTRONIC MARKETING MANAGER—FRANCE

French manager wanted to assume complete responsibility of new Hewlett-Packard sales office in Paris. Applicant must be French National who desires to live permanently in Paris. Technical background in electronics, plus sales engineering or sales management experience essential. Salary & benefits commensurate with French industry. Starting salary between N.F. 50,000 and 60,000. Growth opportunity unlimited. Write in confidence to: Mr. N. O. Williams, Professional Employment Supervisor.

Hewlett-Packard Company

1501 Page Mill Road, Palo Alto, California

An equal opportunity employer.

ADDITIONAL
EMPLOYMENT ADVERTISING
ON PAGE 79

POSITION WANTED

Electronics Engineer, non-graduate, age 28, 11 years experience including circuit design (tube & semiconductor), instrumentation; some communications and audio. Experienced in aircraft sub-systems. FW-2626, Electronics, Classified Adv. Div., PO Box 12, New York N. Y., 10036.

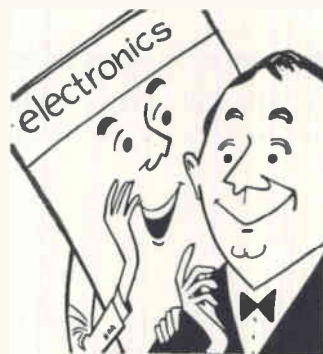

electronics
IS EDITED
TO KEEP YOU
FULLY INFORMED
— a "well-rounded" engineer

What's your *present* job in electronics? Do you work on computers? (**electronics** ran 158 articles on computers between July, 1961 and June, 1962!) Are you in semiconductors? (For the same period, **electronics** had 99 articles, not including transistors, solid-state physics, diodes, crystals, etc.) Are you in military electronics? (**electronics** had 179 articles, not including those on aircraft, missiles, radar, etc.)

In all, **electronics'** 28-man editorial staff provided more than 3,000 editorial pages to keep you abreast of all the technical developments in the industry. No matter where you work today or in which job function(s), **electronics** will keep you fully informed. Subscribe today via the Reader Service Card in this issue. Only 7½ cents a copy at the 3 year rate.

electronics

electronics

WEEKLY QUALIFICATION FORM FOR POSITIONS AVAILABLE

ATTENTION: ENGINEERS, SCIENTISTS, PHYSICISTS

This Qualification Form is designed to help you advance in the electronics industry. It is unique and compact. Designed with the assistance of professional personnel management, it isolates specific experience in electronics and deals only in essential background information.

The advertisers listed here are seeking professional experience. Fill in the Qualification Form below.

STRICTLY CONFIDENTIAL

Your Qualification form will be handled as "Strictly Confidential" by ELECTRONICS. Our processing system is such that your form will be forwarded within 24 hours to the proper executives in the companies you select. You will be contacted at your home by the interested companies.

WHAT TO DO

1. Review the positions in the advertisements.
2. Select those for which you qualify.
3. Notice the key numbers.
4. Circle the corresponding key number below the Qualification Form.
5. Fill out the form completely. Please print clearly.
6. Mail to: Classified Advertising Div., ELECTRONICS, Box 12, New York 36, N. Y. (No charge, of course).

COMPANY	SEE PAGE	KEY #
ATOMIC PERSONNEL INC. Philadelphia, Pa.	79	1
5th NAVAL DISTRICT Dept. of Navy Portsmouth, Virginia	113*	2
HEWLETT-PACKARD CO. 1501 Page Mill Rd. Palo Alto, Calif.	77	3
LOCKHEED MISSILES & SPACE CO. Div. of Lockheed Aircraft Corp. Sunnyvale, Calif.	75	4
PAN AMERICAN WORLD AIRWAYS INC. Guided Missiles Range Div. Patrick AFB, Fla.	79	5
SPACE TECHNOLOGY LABORATORIES, INC. Sub. of Thompson Ramo Wooldridge Inc. Redondo Beach, Calif.	13*	6
UNITED AIRLINES San Francisco 28, Calif.	128*	7
U.S.A.F. AIR FORCE LOGISTICS COMMAND Joint Professional Placement Office New York, N. Y.	71	8

* These advertisements appeared in the July 19 issue.

(cut here)

electronics WEEKLY QUALIFICATION FORM FOR POSITIONS AVAILABLE

(cut here)

(Please type or print clearly. Necessary for reproduction.)

Personal Background

Education

NAME

HOME ADDRESS

CITY ZONE STATE

HOME TELEPHONE

PROFESSIONAL DEGREE(S)

MAJOR(S)

UNIVERSITY

DATE(S)

FIELDS OF EXPERIENCE (Please Check)

72663

- | | | |
|--|--|---------------------------------------|
| <input type="checkbox"/> Aerospace | <input type="checkbox"/> Fire Control | <input type="checkbox"/> Radar |
| <input type="checkbox"/> Antennas | <input type="checkbox"/> Human Factors | <input type="checkbox"/> Radio-TV |
| <input type="checkbox"/> ASW | <input type="checkbox"/> Infrared | <input type="checkbox"/> Simulators |
| <input type="checkbox"/> Circuits | <input type="checkbox"/> Instrumentation | <input type="checkbox"/> Solid State |
| <input type="checkbox"/> Communications | <input type="checkbox"/> Medicine | <input type="checkbox"/> Telemetry |
| <input type="checkbox"/> Components | <input type="checkbox"/> Microwave | <input type="checkbox"/> Transformers |
| <input type="checkbox"/> Computers | <input type="checkbox"/> Navigation | <input type="checkbox"/> Other |
| <input type="checkbox"/> ECM | <input type="checkbox"/> Operations Research | <input type="checkbox"/> |
| <input type="checkbox"/> Electron Tubes | <input type="checkbox"/> Optics | <input type="checkbox"/> |
| <input type="checkbox"/> Engineering Writing | <input type="checkbox"/> Packaging | <input type="checkbox"/> |

CATEGORY OF SPECIALIZATION

Please indicate number of months experience on proper lines.

	Technical Experience (Months)	Supervisory Experience (Months)
RESEARCH (pure, fundamental, basic)
RESEARCH (Applied)
SYSTEMS (New Concepts)
DEVELOPMENT (Model)
DESIGN (Product)
MANUFACTURING (Product)
FIELD (Service)
SALES (Proposals & Products)

CIRCLE KEY NUMBERS OF ABOVE COMPANIES' POSITIONS THAT INTEREST YOU

1 2 3 4 5 6 7 8 9 10 11 12 13 14 15



E. E.'s
for FEE-PAID Positions
WRITE US FIRST!
Use our confidential application for professional, individualized service . . . a complete national technical employment agency.
ATOMIC PERSONNEL, INC.
Suite 1207L, 1518 Walnut St., Phila. 2, Pa.

SEARCHLIGHT SECTION
(Classified Advertising)

BUSINESS OPPORTUNITIES
EQUIPMENT - USED or RESALE

DISPLAYED RATE

The advertising rate is \$27.25 per inch for all advertising appearing on other than a contract basis. Contract rates quoted on request. AN ADVERTISING INCH is measured 1/8 inch vertically on one column, 3 columns—30 inches—to a page. EQUIPMENT WANTED or FOR SALE ADVERTISEMENTS acceptable only in Displayed Style.

UNDISPLAYED RATE

\$2.70 a line, minimum 3 lines. To figure advance payment count 5 average words as a line.

PROPOSALS, \$2.70 a line an insertion.

BOX NUMBERS count as one line additional in undisplayed ads.

DISCOUNT OF 10% if full payment is made in advance for four consecutive insertions of undisplayed ads (not including proposals).

OVER 2,000,000

RELAYS
IN STOCK!

Send for Catalog 55
Universal RELAY CORP.
42 WHITE ST., N.Y. 43, N.Y. • WAlker 5-6900

CIRCLE 952 ON READER SERVICE CARD

RADIO RESEARCH INSTRUMENT CO.

AUTO-TRACK & TELEMETRY ANTENNA PEDESTALS
3 & 10 CM. SCR. SR. AUTO-TRACK RADARS
AN/TPS-10 SEARCH, AN/TPS-10 HT. FINDERS
AN/FPN-32GCA, AN/APS-10 NAVIG. & WEATHER
AN/APS-15B PRECISION, AN/APS-35B PRECISION
AN/APS-31A SEARCH, DOZENS MORE
3-1-2 MEGAWATT HIGH POWER PULSERS.

RADIO RESEARCH INSTRUMENT CO.
550 Fifth Ave., New York Judson 6-4691

RADAR SYSTEMS & COMPONENTS/ IMMEDIATE DELIVERY

CIRCLE 953 ON READER SERVICE CARD

LOOKING FOR
USED/SURPLUS ELECTRONIC
EQUIPMENT/COMPONENTS?

For an up-to-date listing of such equip-
see Searchlight Section of July 12th Issue.

PROFESSIONAL SERVICES

GIBBS & HILL, Inc.
Consulting Engineers

Systems Engineering
Operations Research • Development
Field Studies • Design • Procurement
Power • Transportation • Communications
Water Supply • Waste Treatment
398 Seventh Avenue New York 1. N. Y.

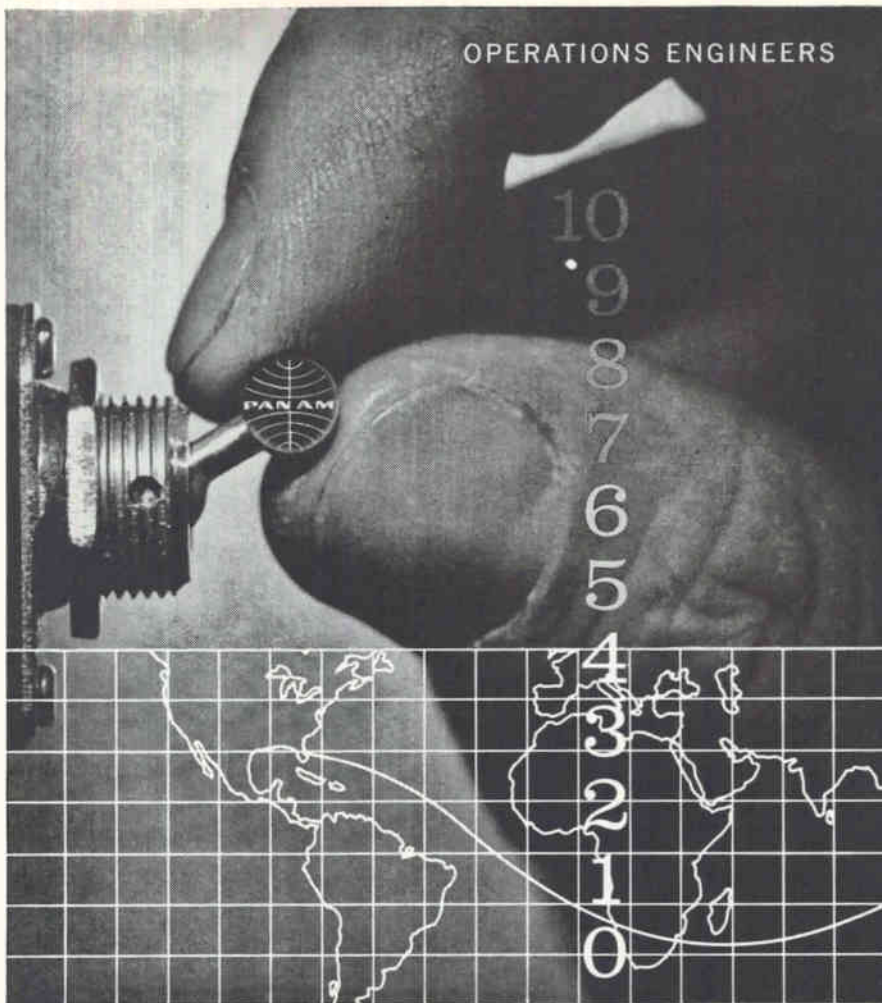

OPERATIONS ENGINEERS

ON THE FIRING LINE

of the Big Birds at the Atlantic Missile Range

All the knowledge and experience of the Operations Engineers with Pan Am's Guided Missiles Range Division at Cape Canaveral come into play in the vital decision which starts at countdown—the decision to launch.

Whether ballistic missile, manned space vehicle, satellite or space probe, these Engineers coordinate all of the range instrumentation systems from countdown through to impact. This responsibility encompasses real-time monitoring of the vehicle's performance in flight . . . an exacting responsibility shared by Pan Am Operations Engineers at down-range tracking stations and on the fleet of advanced range instrumentation ships.

For engineers who can make significant decisions while under pressure, and who have 3-5 years experience in instrumentation systems employing radar, telemetry, optics, infrared, and supporting data handling equipment, these important positions are open at Pan Am: Superintendents of Range Operations (at Cape Canaveral) / Base Operations Managers (at down-range stations) / Ship Operations Managers (on board tracking vessels).

For further information, write in confidence to Dr. Charles Carroll, Dept. 28G-4



GUIDED MISSILES RANGE DIVISION

PAN AMERICAN WORLD AIRWAYS, INC.
P. O. BOX 4465, PATRICK AIR FORCE BASE, FLORIDA,
An equal opportunity employer

INDEX TO ADVERTISERS

● AMP Incorporated	25	Japan Piezo Electric Co., Ltd.....	72	Sprague Electric Co.....	4, 9
Aerocom	33	● Kepco, Inc.	55	Stromberg-Carlson	
Air Force Systems Command ...	71	Kin Tel		Div. of General Dynamics	30
Allen-Bradley Co.	19	A Division of Cohu Electronics		● Synthane Corp.	67
● American Time Products Div. of		Inc.	3rd Cover		
Bulova Watch Company, Inc....	24			Towson Laboratories, Inc.....	58
● Amphenol-Borg Electronics Corp.				● Tung-Sol Electric, Inc.....	5
Connector Division	34, 35				
● Clarostat Mfg. Co., Inc.....	29	● Litton Industries			
Cleco		Electron Tube Division.....	32		
Division of Reed Roller Bit Co..	56	Lockheed Missiles & Space Co..	75		
● Cominco Products, Inc.....	32				
Cubic Corp.	36				
Daytona Beach Chamber of Com-		McGraw-Hill Book Co.....	66		
merce	31	Minnesota Mining & Mfg. Co.			
Delevan Electronics Corp.....	63	Mincom Division	6		
duPont de Nemours & Co., Inc.,		Mnemetron Corp.	58		
E. I.	10, 11	● Moseley Co., F. L.....	61		
● Dymec					
A Division of Hewlett-Packard		Newark Electronics Corp.....	68		
Co.	14	● North Atlantic Industries, Inc....	57		
		Northeastern Engineering, Inc....	67		
Electrical Industries	53	Potter Instrument Co., Inc.....	21		
● Erie Resistor Corp.....	17	Preformed Line Products Co.....	59		
● Fujitsu Ltd	76				
		Radio Corporation of America. 4th cover			
● Hewlett-Packard Company.....	inside front cover	● Ribet-Desjardins	23		
Hughes Aircraft Co.					
Aerospace Divisions	65				
Invac Corp.	73				
		● Sigma Instruments, Inc.	18		
		Simplex Wire & Cable Co.....	15		
		Sperry Electronic Tube			
		Div. Sperry Rand Corp.....	13		

PROFESSIONAL SERVICES

CLASSIFIED ADVERTISING

F. J. Eberle, Business Mgr. (2557)

EMPLOYMENT OPPORTUNITIES

EQUIPMENT

(Used or Surplus New)

Far Sale

CLASSIFIED ADVERTISERS INDEX

Atomic Personnel Inc.....	79
Hewlett-Packard Co.....	77
Pan American World Airways...	79
● Rodio Research Instrument Co...	79
● Universal Relay Corp.....	79

● See advertisement in the July 25, 1963 issue of Electronics Buyers' Guide for complete line of products or services.

This index and our Reader Service Numbers are published as a service. Every precaution is taken to make them accurate, but electronics assumes no responsibility for errors or omissions.

electronics



Audit Bureau of Circulation



Associated Business Publications

Audited Paid Circulation

JAMES T. HAUPTLI (2210)

Advertising Sales Manager

DAVID CUNNIFF (3139)

Promotion Manager

HENRY M. SHAW (3485)

Market Research Manager

Electronics Buyers' Guide

R. S. QUINT (2335)

General Manager

RICHARD J. TOMLINSON (3191)

Business Manager

THEODORE R. GEIPEL (2044)

Production Manager

NEW YORK TELEPHONE: Dial Direct:
971 plus number in parenthesis, Area Code 212

ADVERTISING REPRESENTATIVES

ATLANTA, GA. 30009

Michael H. Miller, Robert C. Johnson
1375 Peachtree St. N.E., Trinity 5-0523
(area code 404)

BOSTON, MASS. 02116

William S. Hodgkinson
McGraw-Hill Building, Copley Square,
Congress 2-1160 (area code 617)

CHICAGO, ILL. 60611

Harvey W. Wernecke, Robert M. Denmead
645 North Michigan Avenue, Mahawk 4-5800
(area code 312)

CLEVELAND, OHIO 44113

Paul T. Fegley
55 Public Square, Superior 1-7000
(area code 216)

DALLAS, TEXAS 75201

Frank Le Beau
The Vaughn Bldg., 1712 Commerce St.
Riverside 7-9721 (area code 214)

DENVER, COLO. 80202

John W. Patten
Tower Bldg., 1700 Broadway,
Alpine 5-2981 (area code 303)

HOUSTON, TEXAS 77025

Kenneth George
Prudential Bldg., Halcombe Blvd.,
Riverside 8-1280 (area code 713)

LOS ANGELES, CALIF. 90017

Ashley P. Hartman, John G. Zisch,
William C. Gries
1125 W. 6th St., Huntley 2-5450
(area code 213)

NEW YORK, N. Y. 10036

Donald H. Miller (212) 971 3615
George F. Werner (212) 971 3617
Donald R. Furth (212) 971 3616
500 Fifth Avenue

PHILADELPHIA, PA. 19103

Warren H. Gardner, William J. Boyle
6 Penn Center Plaza, LOcust 8-4330
(area code 215)

SAN FRANCISCO, CALIF. 94111

Richard C. Alcam
235 California Street, Douglas 2-4600
(area code 415)

LONDON W1:

Edwin S. Murphy Jr.
34 Dover St.

FRANKFURT/Main:

Matthee Herfurth
85 Westendstrasse

GENEVA:

Michael R. Zeynel
2 Place du Port

TOKYO:

George Olcott,
1, Kotohiracho, Shiba, Minato-ku

KIN TEL

**world's
largest
DC amplifier
manufacturer**

**has an
amplifier
to fit
your**

requirements



Solid state, non inverting amplifier

Model 121A/A. Response from DC to beyond 200 kc. Input impedance greater

than 10 megohms; output capability ± 15 volts, 100 ma; output impedance < 0.2 ohm in series with 50 microhenries. Price \$1000.



Narrow band, 3 terminal amplifier

Model 118. Signal terminals isolated from chassis ground. DC to 85 cps.

Input impedance greater than 40 megohms; output capability ± 10 volts, 10 ma; output impedance < 0.25 ohm to 500 cps; < 1 ohm to 2 kc. Price \$795.



Floating, differential amplifier

Model 114C. High common mode rejection, low effective input capacity.

DC to 85 cps. Input impedance greater than 40 megohms; output capability ± 10 volts, 10 ma; output impedance < 0.25 ohm to 500 cps; < 1 ohm to 2 kc. Price: \$995.



Wideband amplifier

Model 112A. Four different plug-in attenuator units. DC to 40 kc. Input impedance 100 K ohms; output capability ± 35 volts, 40 ma; output impedance < 1 ohm in series with 25 microhenries. Prices: \$575 to \$685.

VISIT OUR BOOTHS 1926-1927 AT WESCON, SAN FRANCISCO, AUGUST 20-23

All KIN TEL DC data amplifiers: have drift less than $2\mu\text{v}$ • accuracy of 0.01% for any single gain step • fit six to a standard 19-inch rack • are available in portable cabinets • have an integral power supply • are chopper-stabilized • have exceptional linearity and low output impedance.

All prices FOB, San Diego, California. (Additional export charge.)
Write for detailed information. Representatives in all major cities.

5725 Kearny Villa Road
San Diego 12, California
Phone 277-6700
(Area Code 714)



CIRCLE 901 ON READER SERVICE CARD

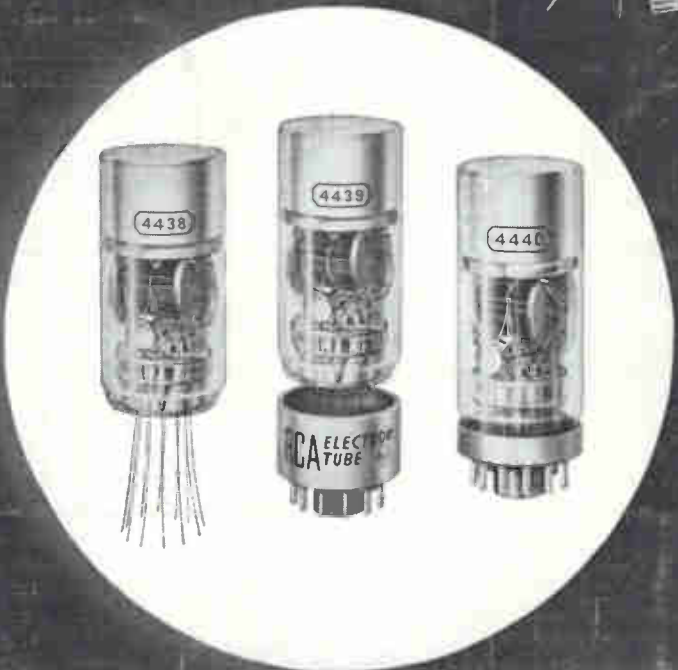
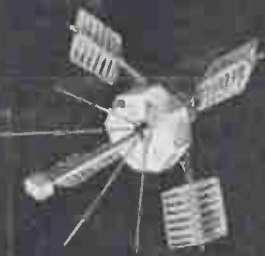

Ruggedized RCA PHOTOMULTIPLIERS

help scientists study energetic particles in space

Ruggedized RCA Photomultiplier types RCA-4438, -4439, and -4440, originally known as developmental type C7151, have been of significant value to scientists studying the nature of the energetic particles in space and the nature of the Earth's magnetic field. Used in Explorer satellite experiments, these tubes were found to be extremely effective and reliable. They have now been made available commercially. In addition, as a result of this prototype performance, RCA subsequently extended the application of this family with types RCA-4441 and RCA-C70114.

Developed especially for space study, this tube family, operating in NASA-developed circuitry for Explorer XII, has helped scientists learn:

- The Van Allen Radiation Belt is a trapping region with particles having various characteristics.
- The density of electrons with energies above 40 KEV in the outer zone was about 10^8 particles per cm^2 per second.
- A large population of trapped protons having energies of a few hundred KEV exists in the region from 4,000 miles above the surface of the Earth to the outer edge of the trapping region. Maximum intensity is about 3×10^8 protons per cm^2 per second.
- There are a larger number of solar-proton events emanating from the sun than previously thought.

Since the Explorer experiments began in 1958, RCA has worked closely with NASA's Fields and Particles Branch at the Goddard Space Flight Center, as well as with Dr. James Van Allen's group at the State University of Iowa.

For information on the RCA family of Photomultipliers, see your RCA Industrial Tube Representative or write: Commercial Engineering, Section G-19-Q-4, RCA Electronic Components and Devices, Harrison, N. J.



RCA-4441. Developed as a result of the performance of prototypes in space, this 1½-inch diameter, 10-stage, head-on Photomultiplier has an S-11 spectral response. It features reduced over-all length for even greater ruggedness, and a photocathode connection which assures continuous cathode contact under rough environmental conditions. Similar to the RCA-4441 is type C70114 which uses copper-beryllium dynodes for greater stability of tube gain over long periods of operation.

FIELD OFFICES

OEM SALES: Newark 2, N. J., 32-36 Green St., (201) 485-3900 • Chicago 54, Ill., Suite 1154, Merchandise Mart Plaza, (312) 527-2900 • Los Angeles 22, Calif., 6801 E. Washington Blvd., (213) RA 3-8361 • GOVERNMENT SALES: Harrison, N. J., 415 South Fifth St., (201) 485-3900 • Dayton 2, Ohio, 224 N. Wilkinson St., (513) BA 6-2366 • Washington 6, D. C., 1725 "K" St., N.W., (202) FE 7-8500 • INTERNATIONAL SALES: RCA International Div., Clark, N. J., (201) 382-1000

ALSO AVAILABLE FROM YOUR AUTHORIZED RCA INDUSTRIAL TUBE DISTRIBUTOR



The Most Trusted Name in Electronics