

# electronics

## LASER IN A WINE CELLAR

*Javan and Townes to check Einstein, p 74*

*(photo below)*

## COMPONENTS THAT LEARN

*Four of five devices are magnetic, p 49*

## HOW SIDEVIEW RADAR WORKS

*Electronic eye for Mach 3 planes, p 22*

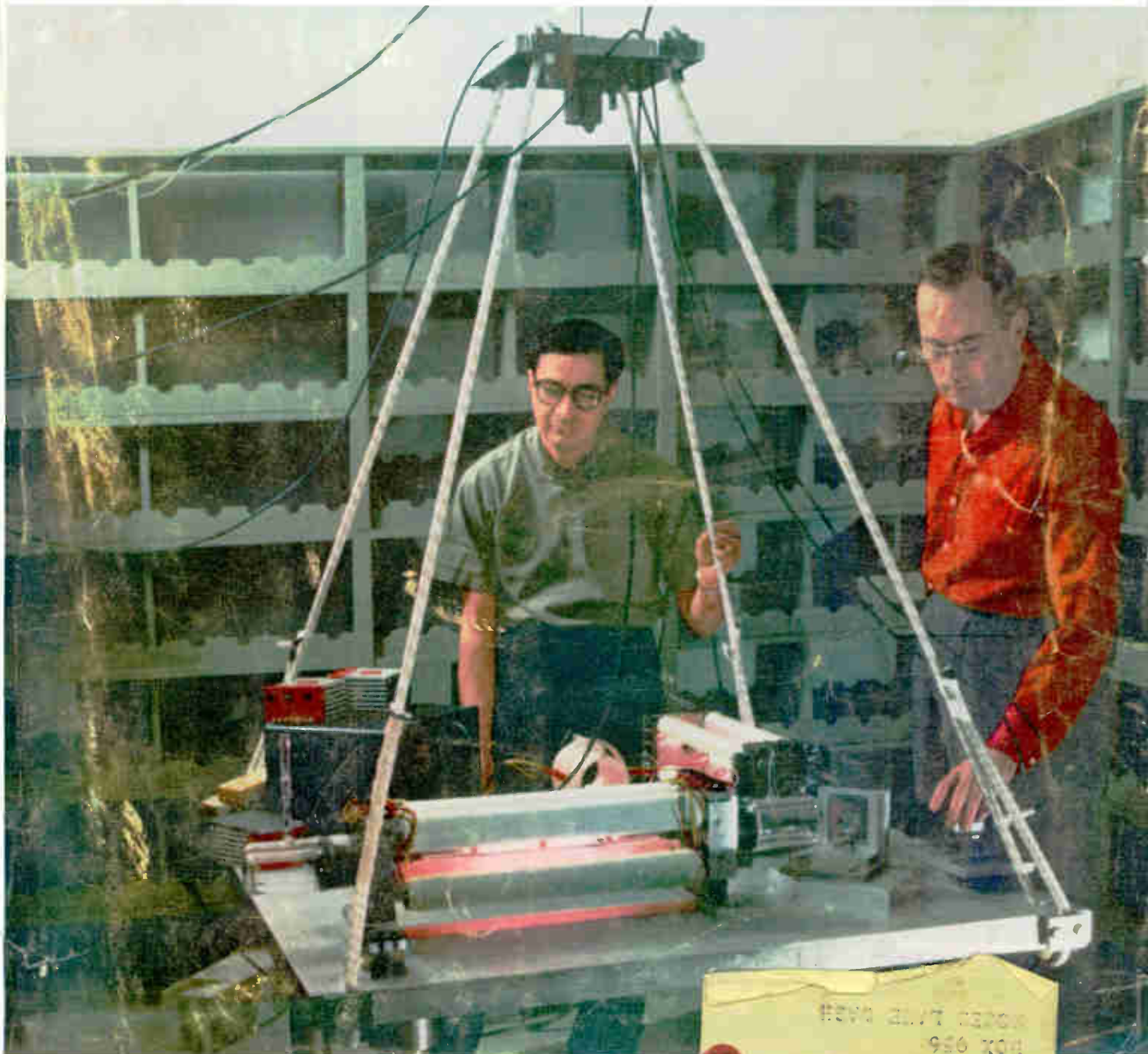

ROLAND KISSLER  
BOX 956  
MORRISVILLE, N.C. 27560

# MEASURE MILLIVOLTS at 1000 MC

hp 411A RF Millivoltmeter now available. Measure low level radio frequency, radio frequency and intermediate frequency stage gain, and radio frequency in coaxial lines from 500 kc to 1000 mc, 10 mv to 10 volts. Measuring is simple, resolution is high, and thermal drift errors are virtually eliminated with the 411A Voltmeter. This remarkable instrument has true linear operation (no correcting networks) and readings are presented on a large, mirror-backed linear meter. Temperature stability is such that there is virtually no change from 10° to 40° C.

Specifications alongside indicate basic features of this important new, time-saving instrument. Other special features include: matched diodes protected against burnout; probe temperature compensated for low drift; amplifier photochopper eliminating contact noise, guaranteeing high sensitivity and zero-drift freedom; extra probe tips available including a 500 kc to 250 mc UHF tip, 100:1 Capacity Divider tip for measurements up to 1000 v peak, and Type N Tee tip for coax use to 1000 mc. Get a new 411A into action on your bench now!



**HEWLETT  
PACKARD  
COMPANY**

1501 Page Mill Rd., Palo Alto, California, Area Code 415, DA 6-7000. Sales and service representatives in all principal areas, Europe, Hewlett-Packard S.A., 54 Route des Acacias, Geneva; Canada, Hewlett-Packard (Canada) Ltd., 8270 Mayrand Street, Montreal

## SPECIFICATIONS

### Voltage Range:

10 mv rms full scale to 10 v rms full scale in seven ranges; full scale readings of 0.01, 0.03, 0.1, 0.3, 1, 3 and 10 v rms

### Frequency Range:

500 kc to 1 gc with accessory probe tips; usable indications to 4 gc

### Accuracy:

500 kc to 50 mc,  $\pm 3\%$  of full scale; 50 mc to 150 mc,  $\pm 6\%$  of full scale; 150 mc to 1 gc,  $\pm 1$  db using appropriate probe tips

### Meter Scales:

Two linear voltage scales, 0 to 1 and 0 to 3, calibrated in the rms value of a sine wave; db scale, calibrated from +3 to -12 db; 0 db=1 mw in 50 ohms

### Probe Tip Furnished:

411A-21E BNC open circuit tip, 500 kc to 500 mc; shunt capacity less than 5 pf; max. input 200 v dc; input resistance at 10 mc typically 80K ohms

### Galvanometer Recorder Output:

Proportional to meter deflection, 1 ma into 1000 ohms at full scale deflection

### Power:

115 or 230 v  $\pm 10\%$ , 50 to 60 cps, 35 watts

### Dimensions:

Cabinet Mount: 11 $\frac{3}{4}$ " high, 7 $\frac{1}{2}$ " wide, 12" deep  
Rack Mount: 6 - 31/32" high, 19" wide, 10 $\frac{3}{8}$ " deep behind panel

### Price:

- ⊕ 411A, (cabinet) \$450
- ⊕ 411AR (rack mount) \$455

*Data subject to change without notice.  
Price f.o.b. factory.*



# electronics

A McGraw-Hill Weekly 75 Cents



**W. W. MacDonald, Editor**

**J. M. CARROLL**, Managing Editor

**SENIOR EDITORS**

Samuel Weber, George W. Sideris

**SENIOR ASSOCIATE EDITORS**

Michael F. Wolff, John F. Mason

**ASSOCIATE EDITORS**

Michael F. Tomaino, Sylvester P. Carter, William P. O'Brien, Sy Vogel, Leslie Solomon, George J. Flynn, Laurence D. Shergalis, George V. Novotny, Leon H. Dulberger

**ASSISTANT EDITORS**

Nilo Lindgren, Stanley Froud, Stephen B. Gray, Roy J. Bruun, Barry A. Briskman

**REGIONAL EDITORS**

Harold C. Hood (Pacific Coast, Los Angeles), Thomas Maguire (New England, Boston), Cletus M. Wiley (Midwest, Chicago)

**ART DIRECTOR**

Howard R. Berry

**ASSISTANT ART DIRECTOR**

John C. Wright, Jr

**EDITORIAL ASSISTANTS**

Lorraine Rossi, Virginia T. Bastian, Lynn Emery, Ann Mella, Lorraine Werner, Alice M. O'Brien

**FOREIGN NEWS BUREAU**

DIRECTOR, John Wilhelm;  
Alyne Elias, Charles Obertance

LONDON—John Shinn, Derek Barlow, Nicholas Landon

BONN—Bruce Bendow,  
Richard Mikton, Silke McQueen

BRUSSELS—Peter Forbath

PARIS—Robert Farrell,  
Arthur Erikson

MILAN—Marc A. Messina

MEXICO CITY—Wesley Perry, Jr

RIO DE JANEIRO—Leslie Warren

MOSCOW—Stewart Ramsey

TOKYO—Richard Hallaran,  
Charles Cahen, John Yamaguchi

**CIRCULATION MANAGER**

Hugh J. Quinn

**W. W. GAREY, Publisher**

**LASER IN A WINE CELLAR.** Charles H. Townes, inventor of the maser, and Ali Javan, who developed the c-w gas laser, set up low-powered helium-neon lasers to update the classical Michelson-Morley experiment. They will look for the Lorentz-Fitzgerald contraction—a modification of length due to the earth's orbital velocity, and one support for Einstein's special theory of relativity. *Working at bedrock level in the wine vault almost eliminates acoustic vibrations. See p 74* **COVER**

**MERCURY FLIGHT to Carry New Experiments.** Astronaut Cooper will carry a tv camera into orbit. Camera will share a dual transmitter with telemetry. *For the first time, an astronaut can isolate himself from ground control* **18**

**ELECTRON BEAM Builds Microcircuits.** Filmed pattern, scanned by a flying spot, determines beam position in this fully automatic system. *Pattern machined is monitored by tv* **18**

**SIDE-LOOKING RADAR Makes Maps in Flight.** Airborne radar for complex target intelligence rivals cameras in resolution. *Brute force methods employed in early systems have given way to synthetic aperture techniques in advanced systems* **22**

**NEW EDP SYSTEM Totes Track Odds.** Data-collecting and processing system uses two computers. *It will figure odds on the trotters next June* **26**

**COMMAND AND CONTROL.** Air Force plans a network of command and control systems that stress survivability after nuclear attack and flexibility of response. *Here is a rundown on the systems being built—and why* **28**

**RELAY TRANSMITTING AGAIN.** During four days, while ground crews strived to get Relay going again, the U.S. had no working communications satellites. *Telstar and Syncom were still off the air last week* **32**

**COMPONENTS THAT CAN LEARN and How to Use Them.** Adaptive electronic systems can be trained to perform specific tasks as a human can. The system is shown sample problems and their solutions. Afterwards it can solve similar problems on its own. *Adaptive components include memistors, multiple-aperture, magnetostrictive devices, magnetic integrators and second-harmonic magnetic elements.*  
By H. S. Crafts, Stanford Research Institute **49**

**TRANSISTOR-TRANSISTOR LOGIC CIRCUITS: First Design Details.** Logic circuit configurations are multiplying rapidly. Last week we described LCTDL (load-compensated transistor-diode logic). This week it is TTL. There seem to be endless ways to implement the basic Boolean operations of union, intersection and inversion. *This system can operate at widely varying power levels retaining high fan-in and fan-out.*  
By H. W. Ruegg, Fairchild Semiconductor **54**



Published weekly, with Electronics Buyers' Guide as part of the subscription, by McGraw-Hill Publishing Company, Inc. Founder: James H. McGraw (1860-1948).

Title ® registered U.S. Patent Office; © copyright 1963 by McGraw-Hill Publishing Co., Inc. All rights reserved, including the right to reproduce the contents of this publication, in whole or in part.

Executive, editorial, circulation and advertising offices: McGraw-Hill Building, 330 West 42nd Street, New York 36, N. Y. Telephone Longacre 4-3000. Teletype TWX N.Y. 212-640-4646. Cable McGrawhill, N. Y. PRINTED IN ALBANY, N. Y.; second class postage paid at Albany, N. Y.

OFFICERS OF THE PUBLICATIONS DIVISION: Shelton Fisher, President; Vice Presidents: Joseph H. Allen, Operations; John R. Callahan, Editorial; Ervin E. DeGraff, Circulation; Donald C. McGraw, Jr., Advertising Sales; Angelo R. Venezian, Marketing.

OFFICERS OF THE CORPORATION: Donald C. McGraw, President; Hugh J. Kelly, Harry L. Waddell, Executive Vice Presidents; L. Keith Goodrich, Executive Vice President and Treasurer; John J. Cooke, Vice President and Secretary.

Subscriptions are solicited only from those actively engaged in the field of the publication. Position and company connection must be indicated on orders. Subscription rates: United States and Possessions, \$6.00 one year, \$9.00 two years, \$12.00 three years. Canada: \$10.00 one year. All other countries \$20.00 one year. Single copies, United States and Possessions and Canada 75¢. Single copies all other countries \$1.50.

THE PUBLISHER, UPON WRITTEN REQUEST FROM ANY SUBSCRIBER TO OUR NEW YORK OFFICE AGREES TO REFUND THAT PART OF THE SUBSCRIPTION PRICE APPLYING TO COPIES NOT YET MAILED.

Subscribers: Please address change of address notices, subscription orders or complaints to Fulfillment Manager, Electronics, at above address. Change of address notices should provide old as well as new address, including postal zone number if any. If possible, attach address label from recent issue. Allow one month for change to become effective.

Postmaster: Please send Form 3579 to Fulfillment Manager, Electronics, 330 West 42nd Street, New York 36, New York.



Audited Paid Circulation

CONTENTS continued

**CHARTING PROGRESS OF RADIO PILLS.** Use of tiny radio transmitters called endoradiosondes has become well known in physiological studies. The pills telemeter useful data such as pressure, temperature and chemical effects. But from what part of the long gastrointestinal tract? *In this instrument a servo system follows the pill, records its position on chart.*  
By B. Jacobson and B. Lindberg, Karolinska Institutet, Stockholm, Sweden 58

**FASTER DIGITAL COMMUNICATIONS** With Duobinary Techniques. Process compresses bandwidth of a train of binary digits by a factor of two while retaining the decoding simplicity of the conventional binary system. *Transmission speeds as high as 3,200 wpm have been achieved.*  
By A. Lender, Lenkurt Electric 61

**HOW DIRECT COUPLING SHRINKS AMPLIFIERS,** Saves Size and Cost. The conventional way to design a high-gain wide-band amplifier is to stabilize each stage for d-c operating point and capacitor-couple the stages. *In this amplifier, feedback from final to initial stage sets bias level. Technique is compatible with microcircuit layouts.*  
By P. Laakmann, American District Telegraph 66

DEPARTMENTS

Crosstalk. <i>Impact of Microelectronics</i>	3
Comment. <i>Microminiaturization</i>	4
Electronics Newsletter. <i>67 Firms Vie for Space Station Study</i>	7
Washington This Week. <i>Bigger Issue Underlies RS-70 Debate in Congress</i>	12
Meetings Ahead. <i>National Symposium on Reliability and Quality Control</i>	38
Research and Development. <i>Laser Used to Confirm Physical Standards</i>	74
Components and Materials. <i>Optical Coupling: Key to Design Freedom</i>	82
Production Techniques. <i>Optical Soldering Promotes Automated Packaging</i>	90
New Products. <i>Counter Simplifies Quantity Measurement</i>	98
Literature of the Week	112
People and Plants. <i>Babcock Sets Up Florida Division</i>	114
Index to Advertisers	124



# Impact of Microelectronics

ON JUNE 26 and 27 in Chicago, *ELECTRONICS* will co-sponsor with the Armour Research Foundation of the Illinois Institute of Technology a conference on the theme "The Impact of Microelectronics."

Much information about the technical side of microelectronics has been published. *ELECTRONICS* itself has given full coverage to this aspect of the subject, and will continue to do so as new developments occur. However, we feel that our responsibility to the industry does not end there. We share with thoughtful people at Armour and elsewhere a deep interest in the changes being wrought in electronic products, and consequent changes in the traditional structure of the industry. It is in this spirit that this conference was conceived.

It is anticipated that prominent and knowledgeable industrial, government and educational leaders will participate in the program, which is being designed to present a forum for the discussion of such vital subjects as the changing structure of the electronic components industry, changes in the vendor-user relationship, management of research and engineering for microelectronic systems, product status and forecasts of future trends. Time will also be allotted for presentation of brief reports on the latest technical advances.

*ELECTRONICS* and Armour believe the forthcoming conference will prove valuable to many people in the industry who will be involved in making the difficult decisions that will be required to reap the potential rewards of microelectronics. These decisions will affect many things in the future—from the direction of corporate policies to the courses of individual careers.

More details on the conference will appear in next week's issue.

**LEARNING MACHINES.** An article such as our lead feature this week (p 49) on adaptive or "trainable" system components would have been impossible to write a dozen years ago—not only because the components themselves had not yet been developed but because the underlying interdisciplinary approach had not yet evolved.

It was only a dozen years ago that a handful of researchers gathered in Boston to discuss how scientists could pool their knowledge and break down the barriers between such diverse fields as physics, chemistry, psychology, mathematics, statistics and electrical engineering. All of these fields play an

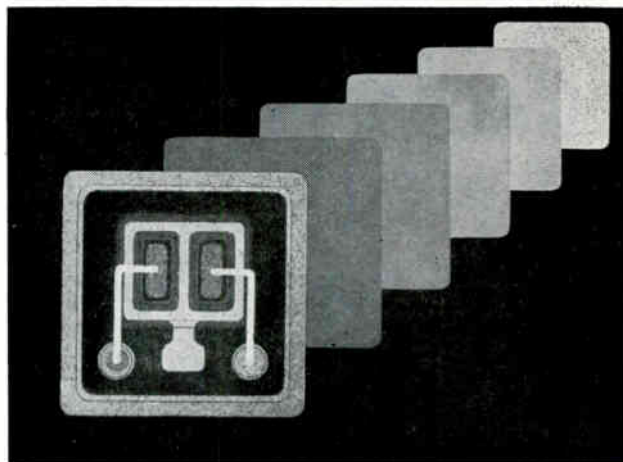

important part in development of trainable systems.

An example of how the interdisciplinary approach is gaining adherents and momentum is the turnout anticipated for the Bionics Symposium this week. Some 2,500 scientists and engineers are expected to gather at Dayton to hear reports on information processing by living organisms and machines.

While the five different variable-gain components discussed this week by Harold S. Crafts, of Stanford Research Institute, are not strictly speaking bionics devices, they represent developments complementary to bionics. For example, one can envision systems composed of variable-resistance memory elements interconnected in immense learning networks. Low-resistance paths would form in the networks as the machine gained experience—as it got smarter.

The probability that millions of such components will be used in the future should appeal to front-office personnel as well as researchers. The market for such components today is understandably small, since they cost about a dollar each. But a decade ago, they sold for \$10. The day may come when they cost only a dime and are best-sellers.

## Coming In Our March 29 Issue

**ANTENNA SCANNING.** Next week, we start off with a description of an electronic antenna scanning method that does not use phase shifters. Instead, a line of microwave receiving antennas are switched at high speed. Other upcoming features include:

- Automatic thin-film deposition control
- Overload protectors that do not rob power
- Using avalanche scr's in power supplies
- Magnetically coupled precision multivibrators
- Power and vswr monitor for h-f and vhf.

**new!**

# NANOSECOND PULSE TRANSFORMERS IN TO-5 TRANSISTOR CASES!

Sprague Type 45Z Subminiature Pulse Transformers are especially designed for use in low-power, ultra-high-speed computer circuitry.

Their TO-5 transistor cases offer several distinct advantages:



1. Another step forward in minification
2. Welded hermetic seal on high-density package
3. Increased uniformity and reliability
4. Comparability with transistor mounting techniques

In order to suit various installation and packaging techniques, Type 45Z Pulse Transformers are available with standard length wire leads. Weldable or solderable leads can be furnished. Short pin-type leads for use with subminiature sockets are also available.

For complete technical information on Type 45Z Pulse Transformers, write for Engineering Data Sheet 40210 to Technical Literature Service, Sprague Electric Company, 35 Marshall Street, North Adams, Massachusetts.



43-441 GET THE FULL STORY AT IEEE BOOTH 2424

4 CIRCLE 4 ON READER SERVICE CARD

## COMMENT

### Microminiaturization

Just read your story on Advances in Microminiaturization (p 45, Feb. 15). It's great! And I can appreciate the time you must have spent on so comprehensive an article.

HAL GETTINGS

Dynatronics, Inc.  
Orlando, Florida

### Eyeglass TV?

I noticed in your Jan. 11 issue, in the article on New Tubes and Circuits (p 47), a box entitled "Eyeglass TV?"

Enclosed is a copy of the Oct. 1936 issue of *Shortwave Craft*. I believe I was the first to publicize this idea in 1936, when of course there was no regular television.

HUGO GERNSBACK  
Gernsback Publications, Inc.  
New York, New York

The editorial by reader Gernsback forecasts, in part:

You will use a tiny television receiver placed right on your very nose—a device which I term "television eyeglasses." These will be regulation eyeglasses, but instead of having the normal lenses, they will have a small projection of one or two inches which will house the entire television receiver. There will be two such receivers working in unison, giving you thereby a stereoptical television view.

### Reentry Plasma Heating

I am presently engaged in applying lasers to plasma diagnostics, and am most interested by the short article, Reentry Plasma Heating Studied by Laser Technique, in your January 18 issue (p 59).

The technique described for measuring electron density and temperature is identical to that I am applying. I would very much like to contact those "Texas A&M College scientists" who have apparently beaten me to it.

Wishing you continued success in producing what I find to be a

very stimulating and up-to-date magazine.

C. M. H. SHARP  
Marchwood Engineering Laboratories,  
Marchwood, Hampshire,  
England

The project is headed by Dr. Melvin Eisner, research physicist, at Texas A&M College, College Station Texas. The NASA grant also assists six graduate students who are in Dr. Eisner's group.

### Handwired TV

I noted on p 60 in the review of the consumer goods electronics market for 1963 (Jan. 4), a paragraph reporting that "hand wiring in construction of television sets has been reinstated by several manufacturers reportedly as a means of gaining reliability and reducing service problems."

I should like to take exception to the implication in this paragraph that hand wiring in any way gains reliability or reduces service problems. The public controversy over the relative merits of printed circuitry and hand wiring is one purely of advertising, sales promotion and emotionalism. Any objective survey of the two systems shows no fundamental difference in reliability for well-designed products of either system, although I do believe there is better control over product uniformity with printed circuits. As to serviceability, a glance at modern printed circuit designs, with schematic diagrams printed right on the board, indicates that they are probably easier to service than hand-wired receivers.

It would be unfair of me to end this note of criticism without observing that I find your magazine consistently of great interest and stimulation and I look forward to its appearance on my desk every week.

DAVID SILLMAN  
Manager of Engineering  
Television-Radio Division  
Westinghouse Electric Corp.  
Metuchen, New Jersey

The implication is not ours, but that of several manufacturers who have returned to conventional wiring, and who told us why they did so.

For confidential information, write Robert J. George, BALTIMORE GAS AND ELECTRIC COMPANY, Baltimore 3, Maryland. Or call him at 301-539-8000.

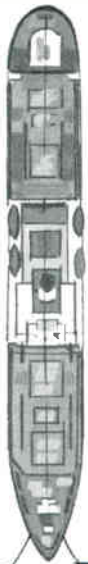
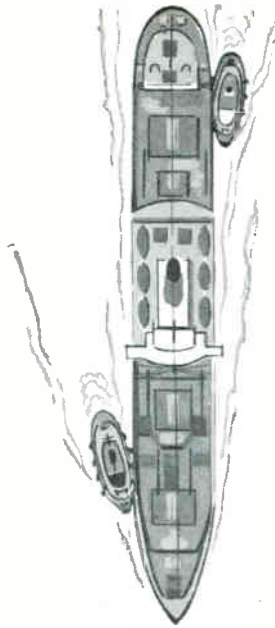

**PUT YOUR  
PLANT IN**

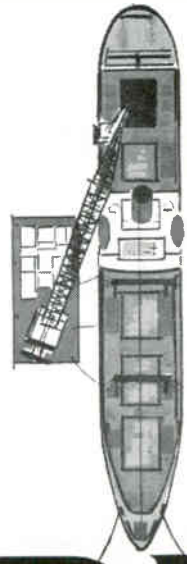

# BALTIMORE

**WHERE YOUR SHIP COMES IN DAY AFTER DAY**

There's nothing like a port city to put you right next door to the world. And Baltimore is one of America's bustling and busy top ports . . . millions of tons per year move into or out of the holds of better than 5,000 ships. Nearer the Midwest, decidedly, than any other Eastern harbor, Baltimore gives you a vital edge in freight rates and speed.

Inland transportation, too, is equal to the port's demands . . . and yours. Trunk railroads, truck lines, and airlines make the Baltimore area a prime shipping hub for half the nation. All sorts of manufactured goods, all kinds of skilled labor are here. So are plant sites aplenty . . . including 2,500 zoned acres in 30 industrial parks. When you want to think big, think BALTIMORE.



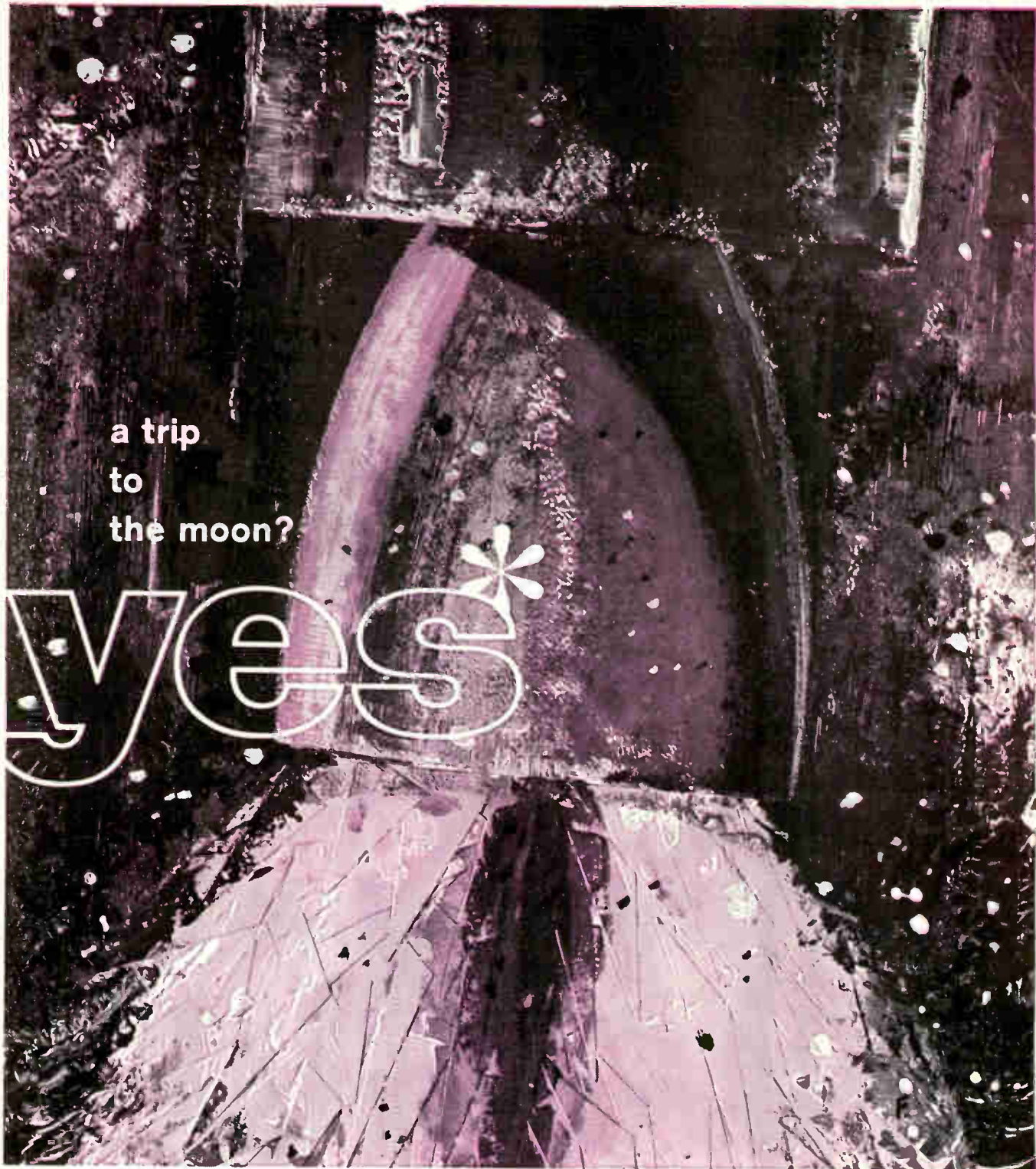

a trip  
to  
the moon?

yes

Gamewell made a Master Pot with these characteristics: resistance, 31,500 ohms (nominal); total angle, 359.5°; resolution, .000055 (or approximately 1 minute of arc); linearity,  $\pm .01^\circ$  zero based; cam corrected; O.D., 8"; thickness, 2"; shaft, 1/4"; alignment boss, 1" x 1/16"; and an anodized aluminum finish. This extremely accurate precision potentiometer demonstrates our ability to manufacture pots to meet the most demanding specifications — such as might be necessary on a trip to the moon. Write and tell us about your *special* pot problems. Chances are they can be solved by Gamewell's YES service — **\*your e**ngineered **S**pecials service. Your answer is YES.

**GAMEWELL**  
ELECTRONICS DIVISION



THE GAMEWELL COMPANY, 1602 CHESTNUT ST., NEWTON 64, MASS. A SUBSIDIARY OF E. W. BLISS COMPANY

## 67 Firms Vie for Space Station Study

NASA'S MANNED Spacecraft Center (MSC) has received 67 proposals for a contract soon to be awarded for operations and logistic study of a manned orbital space station (MOSS). The study will establish preliminary design requirements for Moss and for a resupply spacecraft.

Twenty-two proposals have been received for a contract to study the electrical power systems for Moss. The study will encompass power generation, energy storage and power distribution for both Moss and the resupply spacecraft. MSC has also requested proposals for the environmental control and life support system for a large Moss.

Four Moss studies that MSC has not sent out yet are for definition of the configuration, preliminary design and program definition of (1) a manned rotating space station; (2) zero gravity manned space station; (3) a 5 to 6 man modified Apollo resupply spacecraft for space station support; and (4) a lifting body resupply spacecraft for space station support.

Proposals will be sent out by the Manned Space Flight Center (MSFC) for a study contract on the integration of orbital systems.

### Super Laser Forerunner Of Anti-ICBM Device?

SPECULATION ON THE USE of super-power lasers for military radiation weapons has been aroused by the development of a 500-joule optically pumped laser by Radiation at Stanford (p 38, March 15). Reports say ARPA or AF may study the device in hopes of developing an anti-ICBM laser.

Laboratory experiments over very short distances have reportedly shown that Radiation's laser, using external focusing devices, can burn through a 1/4-inch steel plate. The laser, cooled by liquid nitrogen, has an array of eight flash lamps. These irradiate a 12-inch long, 5/8-inch diameter ruby rod.

Neodymium-doped glass rods can be used in place of the ruby crystal. Another version of the system using a 16-inch ruby rod is planned. A Kerr cell modulation system is employed to control pulse repetition rate. In one version of the instrument, this is one every four minutes.

### Army Picks Developer For Anti-ICBM Missile

SELECTION of Martin-Marietta as development contractor for the Sprint missile, a major component of the Army's Nike X anti-missile system (p 24, March 8), was approved this week.

Amount of the initial subcontract will be about \$5 million. Martin will be subcontractor to Bell Telephone Labs, system developer. Western Electric is prime contractor.

Sprint will use a solid-fuel rocket. It will be shorter, lighter and accelerate faster than the 48-foot-long Nike Zeus. Sprint's primary radar

is Mar (formerly Zmar, being developed by Sylvania). Other radar will be needed.

### Navy Fighter Getting Down-Looking Radar

WASHINGTON—The Navy is starting an "equipment improvement program" for the McDonnell F4H (now called the F4B) fighter plane, which the Air Force is also buying in quantity. Purpose is to give the plane what one admiral describes as "a downward radar look capability to pick up enemy aircraft at low altitudes." Raytheon is contractor for the new radar.

### Electronic Tape Device Reads, Writes Maps

LONDON—Electronics map-making system will be developed by Dobbie McInnes of Glasgow under a \$180,-

### Computer Makes Room for Human Intuition

TECHNIQUES THAT BRING the basic research scientist and the electronics computer closer together have been developed by Thompson Ramo Wooldridge. Their purpose is to allow the scientist to make greater use of his intuition.

Direct two-way communication between scientist and computer is made possible by a console that has a tv-like screen and push-button controls labeled in scientific terminology. From the console, the scientist can command the computer to make mathematical calculations for him. Answers are displayed on the screen. Much use is made of mathematical curves because they are familiar and because they convey information rapidly and efficiently.

In essence, the user is his own programmer. The user can string together any number of preprogrammed functions to create a new expression or formula to fit his problem. In demonstrations, the new console has been used with the TRW-400 'polymorphic' computer.

Another firm has obtained a similar console for an advanced information-retrieval system in which the user furnishes clues to the machine based on his partial recall and the machine hopefully can then answer his query. The console would be hooked to a large-capacity storage device such as a photostore and to a computer such as the IBM 7090



000 joint government-industrial contract. The system will read data from manuscript maps onto magnetic tape, and write from the tape directly onto the photographic negatives used for map printing.

Maps of any area, scale and color can be made automatically from the tape. Place names are inserted automatically in their correct position and size. The machine, due for completion by mid-1964, will produce shading patterns and fine line structures down to 0.0021 inch thick.

## Limited-War Transceiver Demonstrated by Air Force

AIR FORCE was to demonstrate yesterday a two-channel four-transceiver unit weighing 37 lbs. It was developed by Sylvania in 120 days, for paratroop, antiguerrilla air and troop control service in South Vietnam. First public showing will be at the IEEE Show.

System is composed of two vhf transceivers, uhf and h-f transceivers. The h-f transceiver has 7-w voice and 5-w cw outputs and a range up to 500 miles. It can be used as a homing beacon for aircraft, as well as communications. The vhf and uhf units have 1 to 3-w voice outputs.

## Contact Analog Displays Will Guide Submarines

CONTACT ANALOG DISPLAY systems for the automatic control of many of the piloting maneuvers of submerged submarines are now being

---

### New Conductance Unit?

INTERNATIONAL Electrotechnical Commission's Technical Committee 25 on Letter Symbols and Signs has circulated a draft for the fourth edition of its publication 27 "International Letter Symbols Used in Connection With Electricity."

A new unit appears for the quantities: conductance, admittance and susceptance. It is the siemens (S)—that's all there is, there isn't any mho

---

produced by United Aircraft under a \$1,126,000 Navy contract.

As the submarine moves submerged, the commander or diving officer feeds into a display generator information on the desired course, speed and depth. A synthetic picture on a 19-inch tv screen provides the pilot with a "roadway" with a floor and ceiling that mark the proper course and the bottom and the surface of the ocean.

## New Bionics Hardware Exhibited at Dayton

DAYTON, OHIO—Three new bionics systems were on display this week during the Air Force-sponsored bionics symposium, attended by some 2,500 scientists.

In addition to the frog's eye model (p 18, March 8), there was a system called Lannet (Large Artificial Nerve Network) developed by Melpar, and an electrical cochlea built by the Bio-Acoustics Lab.

Lannet, a high-speed self-organizing system, contains 1,024 statistical switches (or 250 Artrons—see p 18, June 1, 1962).

A mathematical theory for such equipment as phonetic typewriters was also presented. One is being developed at the Air Force Aerospace Research Labs here.

## Use in Spectroscopy Seen for Hydrogen Maser

BOSTON—The hydrogen maser may turn out to have important applications in spectroscopy and chemical analysis as well as being a basic research tool and an extremely sensitive magnetometer.

In an IEEE lecture last week, Asst. Prof. Daniel Kleppner of Harvard told of experiments now underway in which a foreign gas is introduced into the maser cavity and interacts with the hydrogen, giving researchers a direct look at molecular reactions in the gas state.

A tantalizing idea, said Kleppner, is the multiplication of the hydrogen maser frequency up to optical bands and use of it to stabilize a gaseous laser to a definite and precise frequency.

## In Brief . . .

INFERMETER using a helium-gas neon laser has detected motion to an accuracy of 1/24,000 of a wave length of light, says North American. Device can also measure distances as small as the 'gap' between two atoms, 10<sup>-9</sup> inch, the firm said.

NASA MAY LAUNCH Scout rockets carrying French instrumented payloads to study very low frequency electromagnetic waves at 46 to 62-mile altitudes.

LIGHTWEIGHT AIRBORNE multiplex system has been developed by Electronic Communications Inc. Firm says unit is one-half the size and one-third the weight of other systems.

TWT AMPLIFIER for use in a military communications satellite system will be developed by Watkins-Johnson for the Army.

ARMY WILL SPEND \$31 million in 1964 on Redhead and Roadrunner target missiles. North American is prime contractor.

RECORD for long-distance space communication has been claimed by Russia. Tass said telemetric data was received last week from the Mars-1 interplanetary rocket while it was 61.095 million miles away.

LASER system which doubles the efficiency of data transfer by light beam has been developed, says Sylvania.

JOINT PROPOSAL will be submitted by Hughes, Douglas and FMC Corp. on AADS-70, Army Air Defense System—1970.

SALES OF FIRMS recently reported include: Hull Instruments to Century Geophysical; Granite State Machine to Shieldtron; H. O. Boehme to Pakco; Advanced Scientific Instruments, Inc. to Electro-Mechanical Research, Inc.; A&M Instrument to Loral; Kar-Trol Signal to Tamar, partner company of Electro-Science Investors, Inc.

NASA GAVE Textron \$1.5-million contract to make Satan (Satellite Automatic Tracking ANtenna) systems.



# A modest proposal

In selecting a microwave signal generator, we urge you to ignore the "specification race". Give or take a split hair, each manufacturer's performance specification is conspicuous only by its similarity to the others. We say this despite the fact that many of our signal generators have led the pack in this frantic race for years.

**The numbers game** is fun to play, particularly when one is so often ahead, but we cannot, in good conscience, urge you to choose a Polarad Generator merely because it has a few megacycles more range, a wider choice of prfs, more linear frequency modulation, or even an intriguing and exclusive operational feature or two.

**We propose**, instead, that you go beyond the specification and ask: "How is this performance achieved? . . . How long will this instrument continue to perform within specification? . . . How much will it cost to maintain in perfect working order? . . . What percentage of the time will it be out of service for repair and recalibration?" Isn't each of these criteria at least as important as the performance specification? Of course it is. You want and need to buy the instrument that is very well designed and very well built . . . not just very well specified.

**We say this:** look beyond the specification, at the instrument itself. Examine the

panel critically — but then take off the cover, and look inside. In a Polarad Generator, you will see:

- The highest quality components, generously derated. (You may be surprised at the distinguished labels that flunk this simple test!)
- The meticulous craftsmanship that is uniquely essential to precision and stability in microwave instrumentation (you'll find no "baling-wire" mechanics here!).
- Non-contacting-short cavity tuning, for complete freedom from noise, wear, and frequency skip or drift.
- Clean, modular layout, rugged construction, and an advanced thermo-mechanical design, ensuring rock-solid stability despite hard usage and repeated environmental stress. (Polarad Generators are the "work-horses" of the industry.)

**It is no accident** that Polarad is consistently selected to furnish microwave signal generators for the toughest, most reliability-conscious programs. We design them and build them so that the finished instrument is as impressive as the specification.

**Call your Polarad Field Engineer today.** Ask him to show you the quality of our instruments.



**MODEL MSG-34**  
4.2 — 11.0 KMC.  
Accurately calibrated absolute power-level. Adjustable from 0 to -127 dbm from 1 MW.

MODEL	FREQUENCY KMC	CALIBRATED POWER OUTPUT	INTERNAL MODULATION
PMR	0.5 - 1.0	0.5 MW (-3 dbm) to -127 dbm	Ultra-linear FM modulation standard sq-wave, 25-10,000 pps; with optional pulse, 10-10,000 pps; in pulse modulator
PMX	4.45 - 11.0 (2 plug-ins)	1 MW (0 dbm) to -127 dbm	All instruments in this group: pulse modulation: 10-10,000 pps. *pulse width: 0.2-10 μsec. pulse delay: 2-2,000 μsec. square-wave modulation: 10-10,000 pps. FM deviation: ±2.5 MC min.
MSG-34 (Ultra Broadband)	4.2 - 11.0 digital freq. indicator	1 MW (0 dbm) to -127 dbm	
MSG-1R	0.95 - 2.40	1 MW (0 dbm) to -127 dbm	
MSG-2R	2.0 - 4.60	1 MW (0 dbm) to -127 dbm	
KSS (Signal Source)	1.05 - 11.0 (4 plug-ins)	Uncalibrated Power Output: 14-400 MW, depending on freq.	*0.3-10 μsec. in MSG-1R and 2R. sq-wave, 10-10,000 pps (external pulse, sq-wave FM)

**POLARAD**

**HAVE YOU MADE RESERVATIONS YET?**



Polarad's new "Project Mohammed" is now bringing the "Mountain" (our new Mobile Microwave Calibration Laboratory) to "Mohammed" (your microwave instruments). Be sure to take advantage of this opportunity to have your gear checked — at your doorstep. Save weeks of delay and needless expense. Call your Polarad field engineer for details and schedules!

**Polarad Electronic Instruments**  
A Division of Polarad Electronics Corporation  
**World Leader in Microwave Instrumentation**  
34-02 N. Queens Blvd.  
Long Island City 1, New York

# Embed, pot, encapsulate

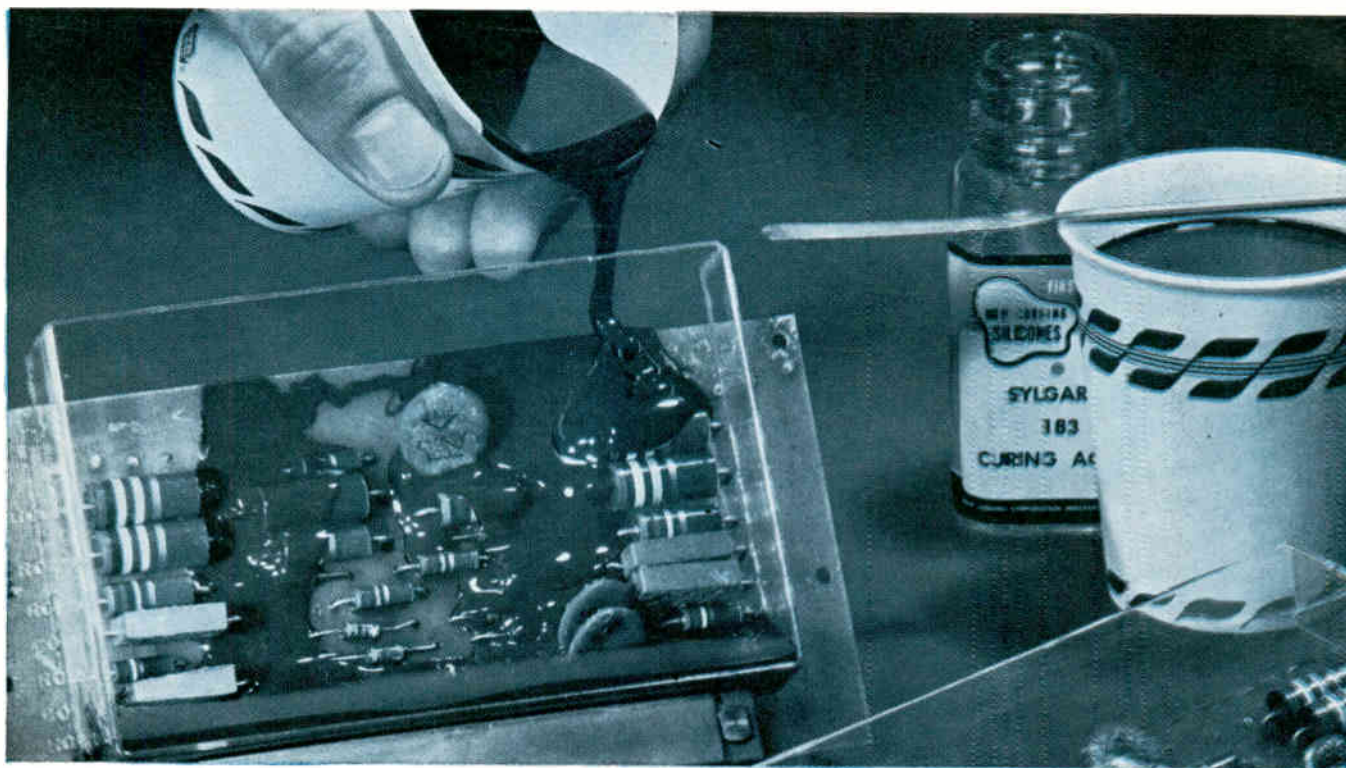

## Cut encapsulating costs with tough, flexible, easy-to-use Sylgard® 183

This new, opaque, solventless silicone resin protects intricate components against heat, moisture, shock, vibration, ozone, voltage stress and thermal cycling. Combining toughness with flexibility, Sylgard 183 offers long pot life, deep section cure, and requires no post cure.

**Fast, easy to use.** Supplied as a low viscosity black fluid, Sylgard 183 flows freely and smoothly into place after blending with a curing agent. When heat is applied, the material sets up without exotherm to form a tough-but-flexible dielectric material. Recommended curing schedule: four hours at 65 C (150 F); can be varied from 15 minutes at 150 C (300 F) to 24 hours at 40 C (100 F). Sylgard 183 cures in sections of unlimited thickness even when completely sealed; is usable at temperatures from -65 to 250 C (-85 to 500 F) immediately after curing.

Repair of sealed components is simple: sections of the resin are cut out, repairs made, new Sylgard 183 poured in place. The new resin bonds tightly to the original embedment. Sylgard 183 is compatible with a wide range of materials including metals, plastics, glass, asbestos, natural and synthetic fibers, and ceramics.

**Physically, dielectrically tough.** When cured, Sylgard 183 retains its properties over a wide range of temperature, frequency and humidity;

is effective from -65 to 250 C; shows no significant change in physical or electrical properties after 1,000 hours of continuous aging at 250 C; has tensile strength in the range of 800 to 1,000 psi.

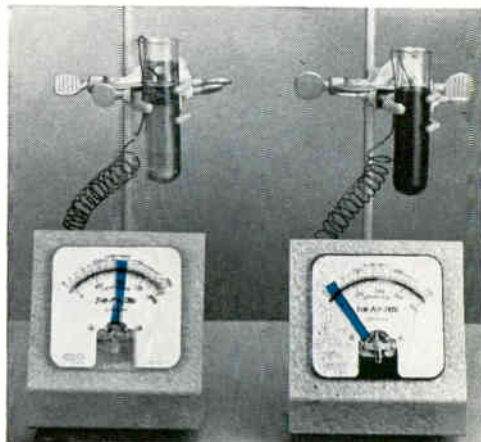

Test shows absence of exothermic heat. Sylgard 183 (right) holds room temperature throughout cure; organic material (left) generates temperatures of more than 400 F.

CIRCLE 289 ON READER-SERVICE CARD

Dow Corning is your best source for a broad line of silicone fluids, gels, elastomers and rigid forms for potting, filling, embedding and encapsulating.



# Dow Corning



# - with these silicones

## See-through embedding

Supplied as an almost colorless liquid, Sylgard 182 solvent-less silicone resin pours easily in place; forms a tough transparent mass that provides maximum protection and complete visual inspection of components. Sylgard 182 features a cure schedule similar to that of Sylgard 183; offers equal curability in thick sections, and in confined spaces; has good dielectric properties and moisture resistance. Long service life from  $-65$  to  $200$  C.

Elongation is in the range of 100%; tensile strength from 800 to 1,000 psi. Repair of embedded parts follows same procedure as for Sylgard 183.

CIRCLE 290 ON READER-SERVICE CARD



## Resilient encapsulating

Silastic® RTV silicone rubber cures without heat to form a tough, rubbery dielectric mass. Available in several colors and grades, it is easily applied by caulking gun or by pouring. Though higher in viscosity than Sylgard 183, it flows smoothly around delicate components without stress or pressure; forms a solid rubber jacket that protects from  $-55$  C to about  $250$  C ( $-67$  F to about  $182$  F); resists weathering, moisture, ozone, corona, shock and vibration. Repair of encapsulated circuits or components is easy, using a procedure similar to that detailed for Sylgard 183.

CIRCLE 291 ON READER-SERVICE CARD

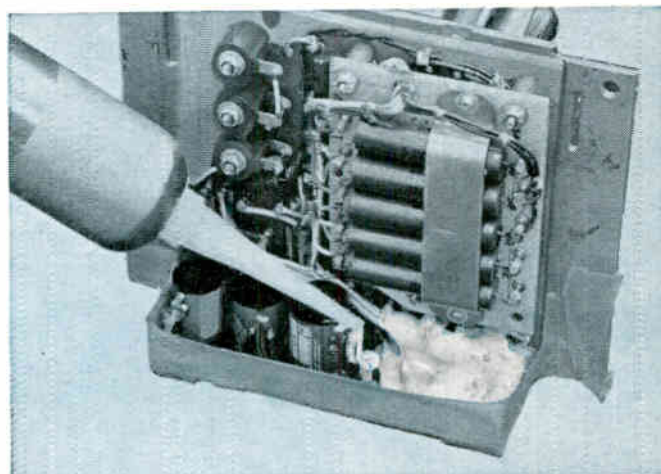

## Self-healing protection

This clear potting compound pours easily into assemblies; fills all voids; exerts negligible stress on components; cures to a jelly-like, transparent, resilient mass without exotherm. Curing time can be varied from 30 minutes to 48 hours; curing temperatures from  $40$  to  $150$  C. Potted parts can be quickly checked, either visually or by instrument probe. When probe is removed, Dielectric Gel reseals itself with no alteration of properties. Fully cured, it is self-healing from  $-60$  to  $200$  C (usable to  $-100$  C) has exceptionally stable dielectric properties; resists moisture; will not revert to fluid. Repair procedure is similar to that previously described.

CIRCLE 292 ON READER-SERVICE CARD

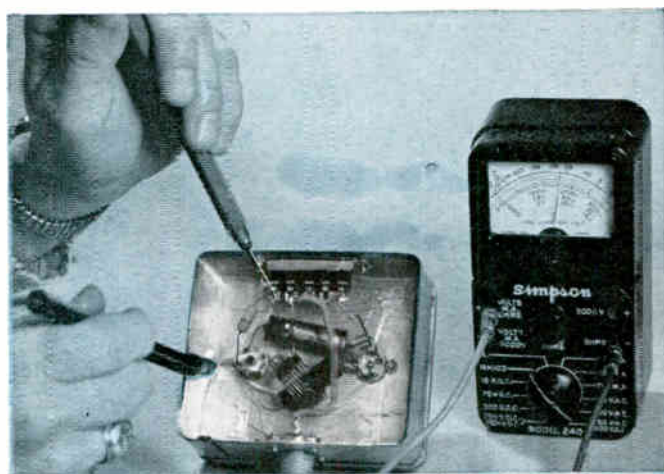

Free 12-page manual, "Silicones for the Electronic Engineer". Write Dept. 3915, Electronic Products Division, Dow Corning Corporation, Midland, Michigan.



# WASHINGTON THIS WEEK

## BIGGER ISSUE UNDERLIES RS-70 DEBATE IN CONGRESS

DEFENSE SECRETARY McNamara underwent a scorching Congressional attack last week, reflecting growing antagonism to his policies. At issue, specifically, are his refusal to push RS-70 development and his reversal of a military recommendation on the TFX contract award (ELECTRONICS, p 12, March 8, and p 12, March 15).

Behind these specifics, however, is a broader issue: who should dominate defense policies? McNamara dominates the military as none of his seven predecessors were ever able to—or probably even wanted to. In doing this, he has substantially reduced the influence of military professionals and of Congress itself. McNamara was denounced by a ranking Republican (Rep. Arends of Ill.) as a “dictator” and “monarch” and was castigated by a Democrat (Rep. Hebert of La.) for disregarding “military judgments.”

The House again backed the Air Force on the RS-70 issue, voting a \$15.9-billion weapons authorization bill that includes an extra \$363.7 million for two planes equipped as complete weapons systems. But there is little doubt that McNamara will again refuse to expand the program. He may even get support from the Appropriations Committees, which have yet to act on next year's defense budget.

## DEPARTMENT OF SCIENCE PUSH RENEWED

INFORMATION HANDLING problems in science and technology—source of growing government concern—is becoming a lever for Congressional pressure to reorganize the government's entire science and technology structure. Organization of information retrieval and distribution took up a major portion of a report by the Senate Government Operations Committee recommending establishment of a Hoover-type commission to study government science organization.

The Senate passed the study bill that is now under consideration in the House—with better chance of passage than in previous years. The commission bill, its supporters hope, could lead to the creation of a federal department of science at the Cabinet level.

## GEMINI FAVORED OVER DYNA-SOAR

CANCELLATION of Air Force's manned space project Dyna-Soar is expected soon. McNamara has told Congress that it makes little sense to spend around \$800 million to develop the single-man Dyna-Soar vehicle with first manned flight set for 1965 while NASA is spending a like amount to develop the two-man Gemini spacecraft with first manned flights due in 1964. While Dyna-Soar has more maneuverability, McNamara contends it may be better to modify Gemini and cut out Dyna-Soar, on which \$200 million has been spent.

## SEA HAWK TO SAIL IN 1965

NAVY HAS SET 1968 as the target date for operational deployment of its first Sea Hawk advanced antisubmarine-warfare vessel (ELECTRONICS, p 12, Feb. 15). First prototype ship will be built not later than fiscal year 1965. Meantime, development of active and passive sonar components and navigation, command, and control systems is being accelerated. In the upcoming year, prototype tests of an integrated sonar system and other asw components will be conducted aboard an experimental escort ship (AGDE-1).

1963 SAAB . . . built so well that it has a 24,000-mile/24-month written warranty\*

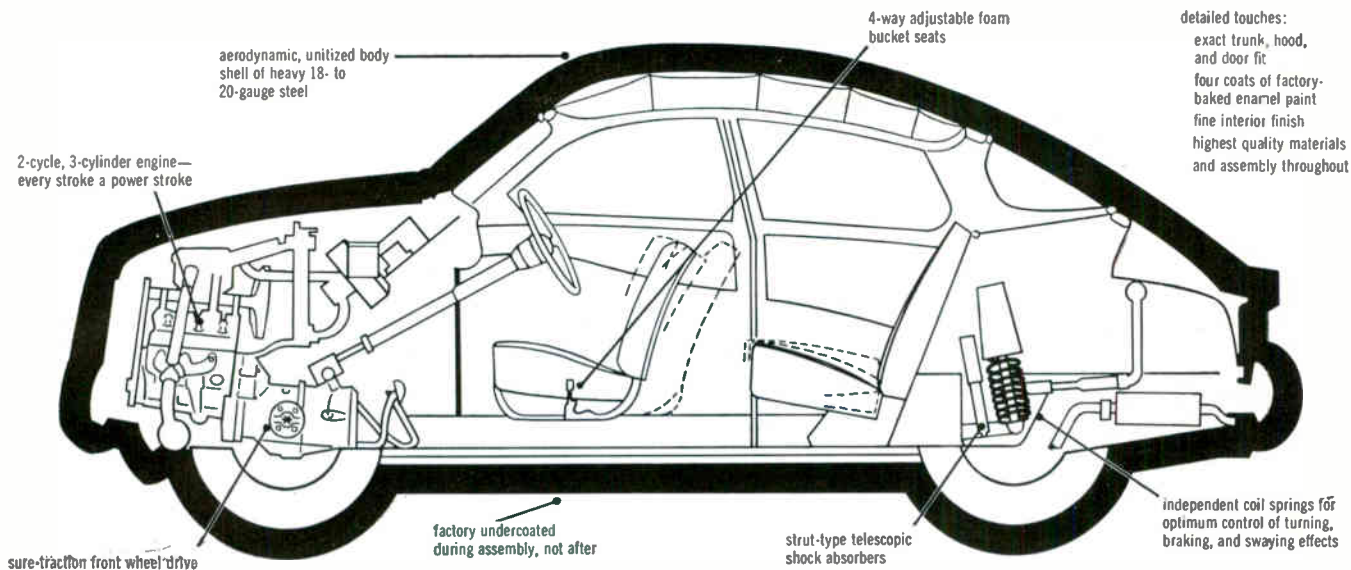

## Take a critical look at SAAB engineering . . .

Aircraft reliability and performance standards are blended with an entirely new approach to over-all automotive design in the Swedish SAAB 96. This car was built to be better, not different . . . built by one of Europe's leading aircraft manufacturers . . .

built for those who enjoy mechanical excellence, technical uniqueness, and extraordinary craftsmanship.

A critical look at all the facts and specifications will prove that SAAB is unquestionably one of the world's best engineered cars.

\*Engine, transmission (3- or 4-speed gear box available), and differential have a written warranty for 2 years or 24,000 miles.

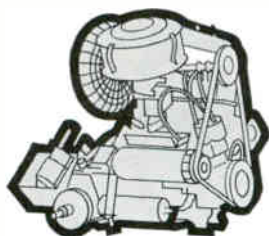

**SAAB ENGINE**, an economical, quiet three-cylinder, two-stroke valveless unit, employs Schnürle principle of charging through the crankcase. Simple, efficient design produces all the power of 6 cylinders with only 7 basic moving parts, eliminates 103 points of friction, wear, potential trouble. Engine proved in world-wide competition driving victories, and by the many SAABs which have delivered low maintenance performance past the 100,000-mile mark.

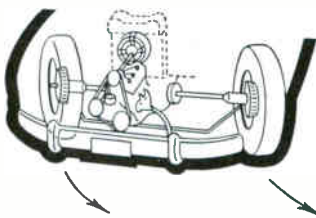

**SAAB FRONT WHEEL DRIVE** transmits engine torque directly to front wheels. The result is extraordinary directional stability and handling ease under all road conditions, plus outstanding traction around corners, over icy, wet, or muddy patches, and snow. Front wheel drive and carefully calculated understeering provide best possible high speed roadability and safety. Other advantages: more comfort (because there is no driveshaft hump) and more trunk and interior space.



**SAAB BODY SHELL** is designed and wind tunnel tested for best possible aerodynamic efficiency. Full belly pan further reduces wind resistance and subdues road noise. Result: increased economy, better performance, excellent stability—even in cross-winds of gale force. Moreover, the SAAB body shell is virtually uncrushable, combining 18- to 20-gauge steel (thicker than most American cars) and rigid unitized construction for optimum safety.



1ST OVERALL WINNER—MONTE CARLO RALLY 1962-1963

Arrange a test drive at your nearest SAAB dealer. Or write for more information—and the SAAB North American Road Atlas, a 64-page comprehensive travel guide valued at \$1.00, but yours for only 25¢ to cover postage and handling. SAAB Motors, Inc., Dept. 303, 405 Park Avenue, New York, New York.

\$1895 P.O.E. (little enough for one of the world's best engineered cars)



SAAB MOTORS, INC.—NEW YORK • NEW HAVEN • JACKSONVILLE • ST. LOUIS

FOR INFORMATION OTHER THAN ROAD ATLAS CIRCLE NO. 299 ON READERS SERVICE CARD



# NEW

# RIBBON CABLE!



## Teflon Insulated Wires Woven Together With Unsintered Teflon Tape

Here's a valuable new find in your endless quest for significant design advantages — Hitemp's "TWR" Ribbon Cable. Lighter than round conductor cable, "TWR" separation of individual conductors is controlled to 15-20 mils spacing, with its flat configuration offering unlimited design possibilities in terms of the number of conductors, types and sizes of wires and cables, and color coding, among other specifications.

In such difficult applications, for example, as situations where lateral movement is unavoidable, "TWR" Ribbon Cable has exceptional durability because the unsintered Teflon tape covers 90% or more of the outer surface — reducing wear to an absolute minimum.

And Hitemp also makes other ribbon cables with Teflon insulated wires — one where individual insulated conductors are heat bonded together, Type "ER", another where individual insulated conductors are woven with either Dacron, Rayon, Nylon, or Teflon yarn, Type "TR". TWR, ER, and TR ribbon configurations are perfectly suited to miniaturized components, restricted packaging, and point-to-point contact for

hook-up of control, signal, and power circuits.

So, now you can relax whenever size, weight, abrasion resistance, flexibility, *and* reliability are critical — because Hitemp's Teflon insulated Ribbon Cables provide *the* safe, sound solution.

SEND FOR NEW BULLETIN No. 100 for the full details on HITEMP Ribbon Cables. Or, send along a piece of what you're currently using — we'll evaluate it carefully and advise you of any savings you might be able to achieve with Hitemp's Teflon insulated Ribbon Cables. Take advantage of either or both offers right now.

### HITEMP WIRES CO.

a Division of Simplex Wire & Cable Co.

1200 SHAMES DRIVE, WESTBURY, NEW YORK  
1532 S. CALIFORNIA AVE., MONROVIA, CALIF.



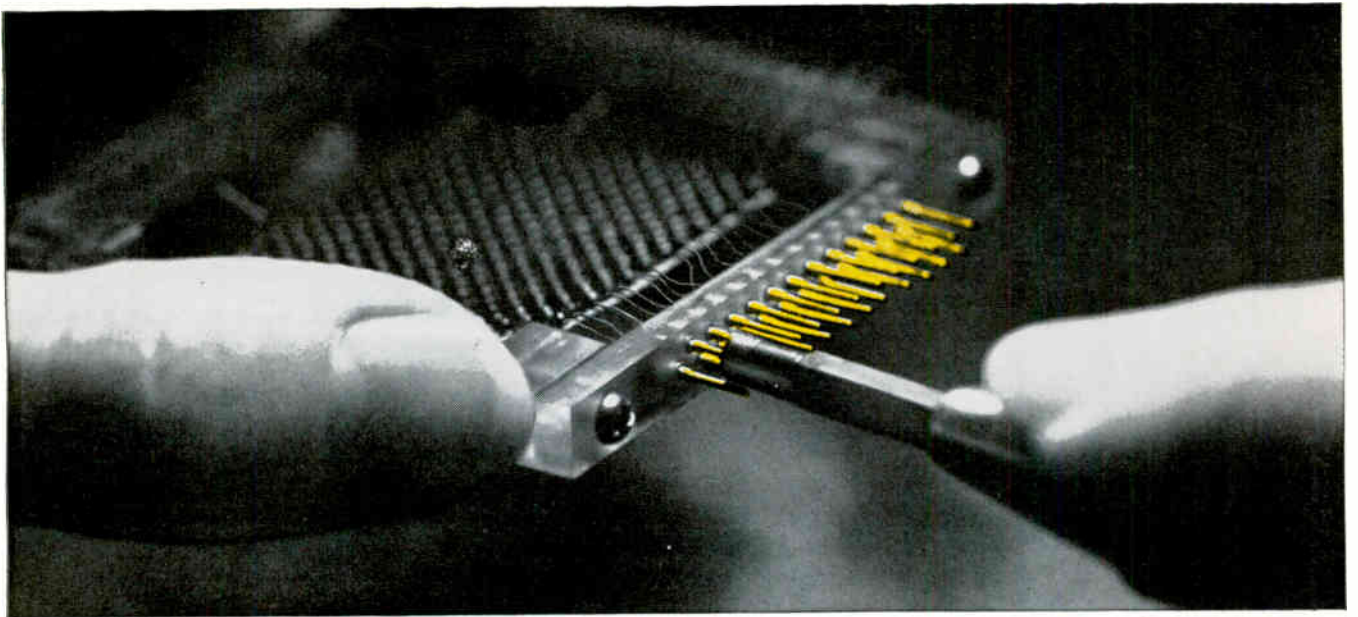

## Fine wire finesse!

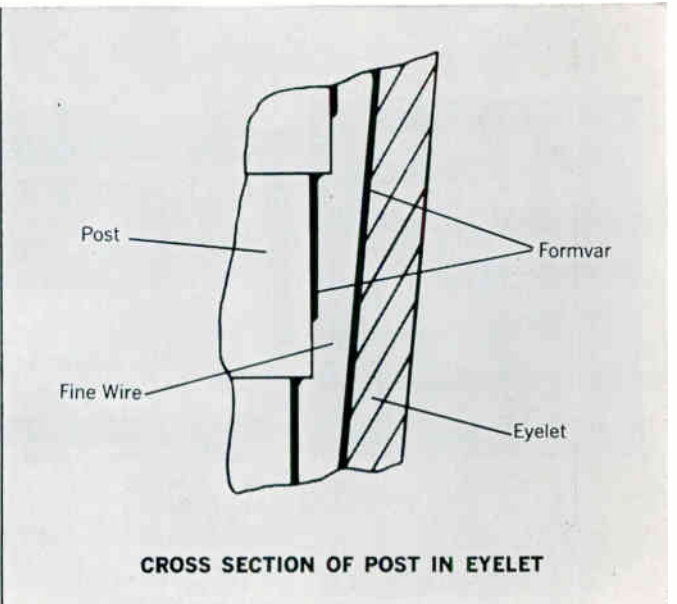
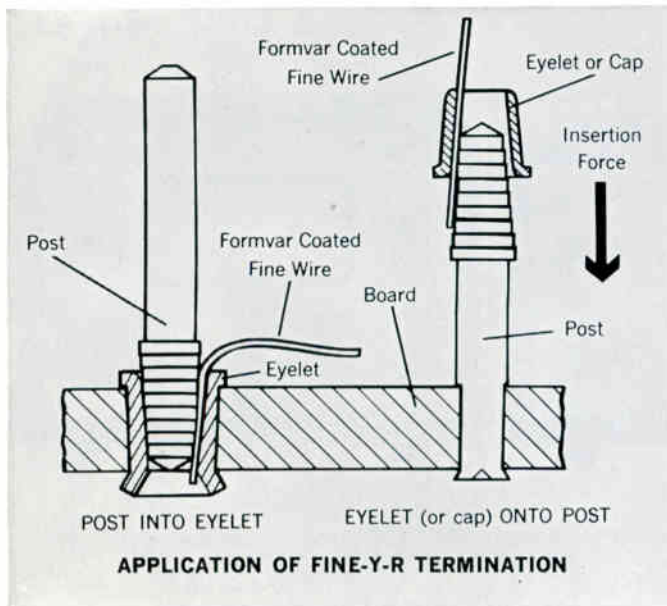

Visit us at the IEEE Show  
Booths 2527-31 and 2837  
March 25-28, 1963

The AMP FINE-Y-R\* Termination's wedge fit does away with time consuming and costly insulation stripping. Makes possible the handling of fine wire, in wire range size #26 through #56 AWG, without burnt insulation, cold solder joints, embrittled conductors and oxide contaminations! You get a reliable, virtually gas-tight connection whose parts can be used again and again... removed and reused up to 5 times, if necessary!

A precision-tapered post evenly spaced with concentric serrations, a matching capping sleeve or eyelet and a specially calibrated application tool... that's all that's needed. When these elements go to work, the bared wire molds snugly over the points of serration and produces an

electrical connection as good as the wire itself.

If you're using fine wire in any type application, you can now make quicker connections and at a fraction of your present cost with AMP FINE-Y-R Terminations.

Put finesse in your fine wire applications by sending for complete details today!

\*Trademark of AMP Incorporated



AMP products and engineering assistance are available through subsidiary companies in: Australia • Canada • England • France • Holland • Italy • Japan • Mexico • West Germany



# an ample choice of Philips electronic voltmeters

available  
**now**

Philips voltmeters cover every practical need for accurate measurements in the DC-LF-HF and UHF ranges.

**AMPLIFIER  
mV-METERS**

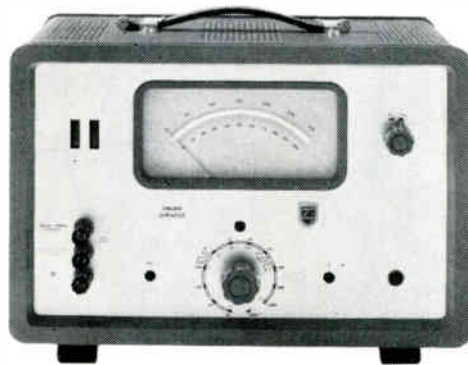

**D.C.  
GM 6020**  
Range (fsd) 100  $\mu$ V - 1000 V  
Input impedance  
Input I 1 M $\Omega$   
Input II 100 M $\Omega$   
Accuracy 3%  
Predeflection < 5  $\mu$ V  
Automatic polarity indication  
DC current measurements  
(10  $\mu$ A - 10  $\mu$ A); with UHF probe  
for AC measurements up to 800 Mc/s,  
as an indicator up to 4000 Mc/s.

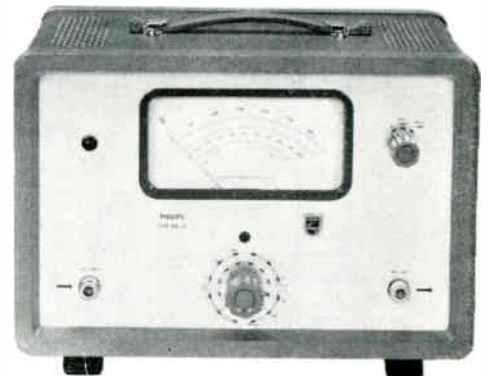

**L.F. 2 c/s - 1 Mc/s  
GM 6012**  
Range (fsd) 1 mV - 300 V  
-80 dB to +52 dB  
Input impedance  
(1 mV - 3 V) 4 M $\Omega$  // 20 pF  
(10V-300V) 10 M $\Omega$  // 10 pF  
Accuracy  
(5 c/s - 100 kc/s) 2.5%  
(2 c/s - 1 Mc/s) 5%  
Calibration voltage 30 mV and 10 V  
Amplifier output 50 x

# PHILIPS *electronic measuring*

Sold and serviced by Philips Organizations all over the world

Further information will gladly be supplied by:

**N.V. Philips' Gloeilampenfabrieken, EMA-Department, Eindhoven, the Netherlands**  
For Canada: Philips Electronic Equipment Ltd., 116 Vanderhoof Ave., Toronto 17, Ont.



**GM 6001**

**DC Range (fsd) 300 mV - 1000 V**  
with EHT probe up to 30 kV  
Input impedance 10 M $\Omega$  - 100 M $\Omega$   
Accuracy 2.5%

**AC 20 c/s - 1000 Mc/s**  
Range (fsd) 1 V - 300 V  
Input capacitance 3.5 pF  
Accuracy 3%

**Resistances**  
Range 1  $\Omega$  - 1000 M $\Omega$  (centre scale values 10  $\Omega$  - 100 M $\Omega$ )

**Special features**  
Floating input. Centre scale facility.  
Calibration voltage incorporated.  
Special heater stabilisation.



**GM 6000**

**DC Range (fsd) 1 V - 1000 V**  
Input impedance 10 M $\Omega$   
(with probe GM 6070: 1000 M $\Omega$ )  
Accuracy  $\pm$  3% of full scale

**AC (20 c/s - 100 Mc/s)**  
Range (fsd) 1 V - 300 V  
Input impedance at 1 Mc/s  
1.2 M $\Omega$  // 8 pF  
Accuracy  $\pm$  3% of full scale

**Resistances**  
Range 10  $\Omega$  - 5 M $\Omega$   
Floating input.  
Calibration possibility incorporated.

**UNIVERSAL  
VOLT-  
OHM-METERS**



**H.F. 1 kc/s - 30 Mc/s  
GM 6014**

Range (fsd) 1 mV - 30 V  
-80 dB to +32 dB  
Input impedance  
without attenuator  
1 M $\Omega$  - 50 k $\Omega$  // 7 pF  
with attenuator  
50 M $\Omega$  - 2 M $\Omega$  // 2 pF  
Accuracy 3%  
Calibration voltages 30 mV and 3 V



**U.H.F. 0.1 Mc/s - 800 Mc/s  
GM 6025**

Range (fsd) 10 mV - 10 V  
-60 dB to +22 dB  
Input impedance at 200 Mc/s  
35 k $\Omega$  // 1 pF  
Accuracy 5%  
Calibration voltages for each range  
Probe-diode quickly exchangeable  
T-piece for measurements on 50  $\Omega$ -  
coaxial lines available

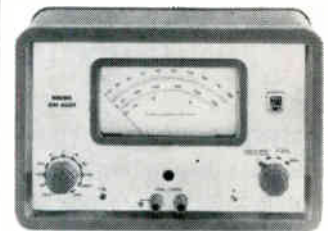

**Simple L.F. millivoltmeter  
GM 6023**

Frequency range 10 c/s - 1 Mc/s  
Measuring range 10 mV (fsd) - 300 V  
-60 dB to +52 dB  
Overall accuracy 5% (from 20 c/s -  
200 kc/s); 8% (from 10 c/s - 20 c/s  
and 200 kc/s - 1 Mc/s)  
Input impedance 1.5 M $\Omega$  // 25 pF  
(10 mV - 1 V); 1.5 M $\Omega$  // 15 pF  
(3 V - 300 V)  
Pre-deflection < 300  $\mu$ V  
Calibration voltage incorporated

**instruments: quality tools for industry and research**





# Mercury To Carry New Experiments

*Capsule will carry tv, more power, and make radiation measurements*

By JOHN W. WASIK  
McGraw-Hill World News

**CAPE CANAVERAL**—Astronaut Leroy Gordon Cooper, Jr., is expected to carry his own television camera into orbit with him on the next Mercury orbital flight, scheduled for May 14 at the earliest.

The tv camera is one of several experiments slated for Spacecraft 20 that have not been tried before.

The tv camera, produced by Lear-Siegler, will monitor the astronaut's well-being, obtain back-up readings of the instrument panel and observe tests and external phenomena through the spacecraft window.

Though the tv experiment is planned for the flight, it is not yet a definite part. Some system re-

quirements were still to be met. The 10-lb camera will consume 56 watts during operation.

The tv transmitter serves a dual purpose. It will transmit the tv output directly to the ground over the higher of the two Mercury telemetry frequencies and, in emergency, will back up telemetry.

The emergency telemetry signals sent over this unit will be picked up by all ground stations, but the tv signal can be picked up only at Cape Canaveral and two other stations. Special equipment will reconstruct the picture transmitted at 0.5 frame/sec. Slow scan is used because of on-board size and weight restrictions.

**OTHER EXPERIMENTS**—Radiation measurements at spacecraft altitudes will be made on Cooper's flight with Geiger-Muller counters. Scientists hope to learn more about fission electrons trapped in the

earth's magnetic field, gain additional data on the decay of the artificial radiation belt, and the preferential direction of radiation at the spacecraft. One G-M tube, sensitive to electrons of 2.5 to 10 Mev, will survey the heat shield region where external radiation is most likely to reach the pilot. Another tube, sensitive to electrons of 0.25 to 10 Mev, will register incoming radiation along the Z axis.

With associated counting circuits, both tubes will measure rates as high as  $2 \times 10^7$  counts/sec. A high-voltage power supply will maintain an operating plateau of approximately 550 volts across each tube.

Electrical changes in the spacecraft were made primarily in the power supply and communications systems.

**MORE POWER**—Stand-by battery supply has been increased and a second battery has been added to

## Electron Beam Builds Microcircuits

**STAMFORD, CONN.**—CBS Laboratories has begun building a fully automated electron-beam microcircuit processor under a contract from U. S. Naval Avionics Facility,

Indianapolis. The processor could be used for welding, etching, alloying, polymerization or dissociation and surface conditioning of microcircuit substrates. Theoretically

transistors as small as  $2 \times 2$  microns can be fabricated according to W. W. Gaertner, vice president of the solid-state physics dept. In addition, electronic programming of the beam makes masking the sample unnecessary, he said.

After initial alignment in the vacuum chamber (see illustration), the electron beam is positioned on the substrate by a flying-spot scanner that views a 35-mm photographic slide. The beam traces over the substrate at the same rate and relative position as the flying spot working on the substrate only where the scanner views a transparent portion of the slide.

Transparency and substrate are scanned with a 2,000-line tv raster that may be varied from  $1\frac{1}{2}$  by 2 inches down to  $\frac{3}{8}$  by  $\frac{1}{2}$  inch. Total exposure time may be varied from 50 milliseconds to 50 seconds.

The electron gun has produced 2 megawatts per sq inch, enough to etch through tungsten foil over  $\frac{3}{8}$  by  $\frac{1}{2}$  inch in half a second.

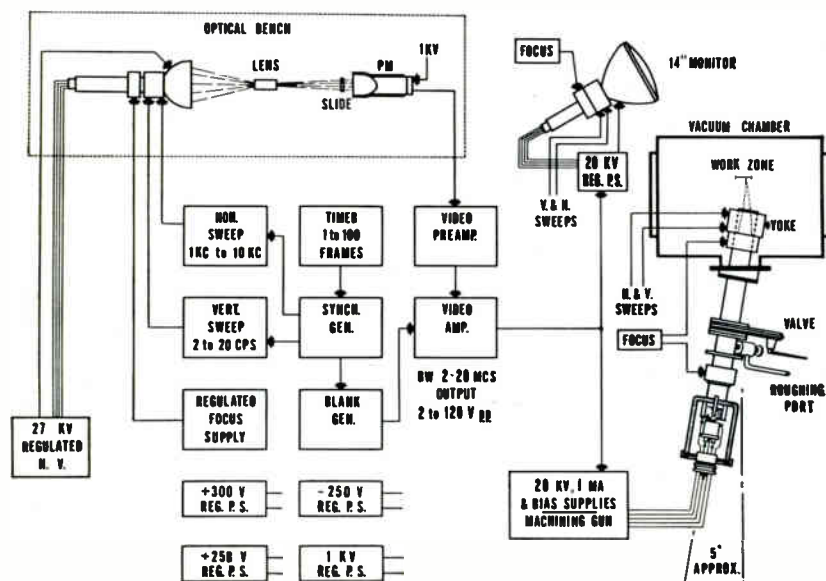

TELEVISION MONITOR displays pattern being machined

# And Slow-Scan Tv

the sequential circuit to insure proper indication of all critical events on the astronaut's control panels.

To conserve power, the telemetry transmitters will not operate continuously throughout the mission. The astronaut, or ground control, will be able to switch the transmitters on and off. This will be the first time an astronaut will be able to isolate himself completely from ground control.

To conserve weight in the craft and because of past reliable performance of the main uhf voice

transmitter/receiver, the backup unit has been deleted from Spacecraft 20. To preserve the remaining unit, the flight plan calls for disabling the unit during descent from 10,000 feet to impact.

The whip antenna has been modified also. Previously, this antenna would deploy automatically upon impact. Communications problems in previous flights may have been because the antenna deployed underwater.

Cooper will deploy the antenna after he is certain the spacecraft is upright in the water.

## Tv Eases German Auto Jams

*Six West German cities are using television to monitor traffic*

**BONN, GERMANY** — Six West German cities have installed automatic traffic control systems in the past three years, and five others are currently running extensive tests on them.

Systems now in use include these features:

- Closed-circuit tv, usually with both stationary and rotating cameras.
- Cameras with both wide-angle

and telescopic viewing capabilities and automatic light meters.

- Coaxial cable transmission of tv signals over short distances, reliance on 7 Gc directional beams over longer distances.

- Manual control automatic systems in case of special traffic situations.

- Temporary installations for trade fairs.

The six cities with the control systems are West Berlin, Munich, Frankfurt/Main, Stuttgart, Hamburg and Hanover. Grundig and Siemens, whose systems are being tested in other cities, will not name the cities involved.

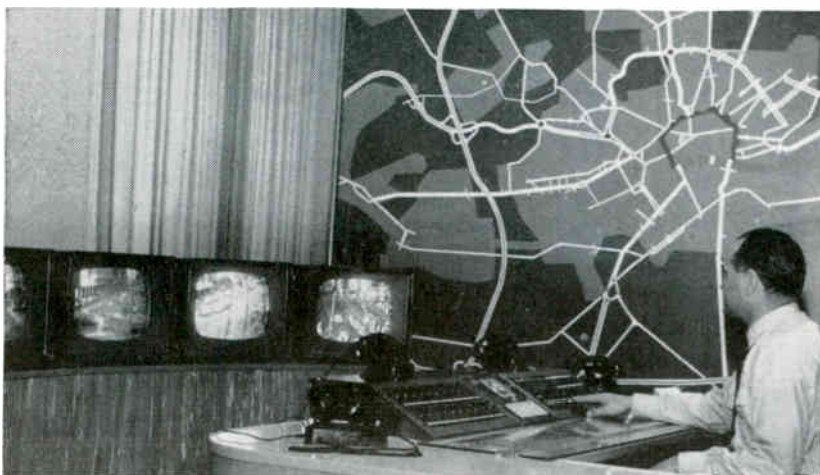

**TRAFFIC CONTROLLER** watches closed-circuit tv receivers at Frankfurt/Main police headquarters. Map shows city's main thoroughfares

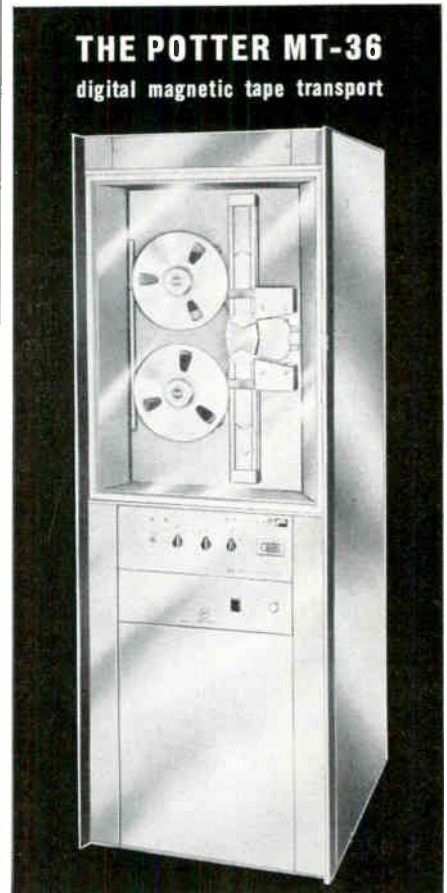

## MT-36: THE MOST RELIABLE TRANSPORT in its price range

The Potter MT-36 Digital Magnetic Tape Transport offers maximum reliability for computer systems requiring an economical transport. The Potter MT-36 features:

- **NO PROGRAM RESTRICTIONS...** up to 200 commands per second at 36 ips.
- **SOLID STATE CIRCUITRY...** photo electric sensing minimizes the need for switches and relays.
- **VACUUM TROUGH GUIDES...** provide smooth tape stops.
- **IMPROVED PINCH-ROLLER CIRCUITS...** offer fast tape starts and stops.
- **EASE OF MAINTENANCE...** drive electronics and fully regulated power supply are mounted on individual plug-in boards.
- **RAPID TAPE THREADING...** Just 15 seconds for complete threading.
- **BUILT IN TAPE CLEANER...** vacuum on trough guide removes all loose oxide and dust.

For full information and specifications on the MT-36 Digital Magnetic Tape Transport, write today.



**POTTER INSTRUMENT CO., INC.**

**TAPE TRANSPORT DIVISION**  
151 Sunnyside Boulevard • Plainview, New York



# Side-Looking Radar Makes Maps In Flight

*High-resolution airborne radar for complex target intelligence rivals cameras*

By **LEON H. DULBERGER**  
Associate Editor

**AIRBORNE RADAR** for military use has undergone a quiet revolution during the last half decade. Presently, side-looking airborne radar (slar) using synthetic aperture antennas, provides high-resolution strip maps with photographic-like detail.

Early interest in side-looking techniques fostered development of radar systems allowing surveillance missions to be performed from the

air without overflying unfriendly territory. Instead, aircraft fly along the edge of terrain of interest and direct a beam at right angles to the direction of flight.

The side-looking orientation of the antenna and forward motion of the aircraft, permitted evolution of techniques leading to extremely high-resolution radars. Special signal processing techniques produce radar maps with a resolution of 20 feet in 100 miles, obtained with aircraft traveling at altitudes up to 70,000 feet. Modern slar systems,

with antennas looking left and right, are used on overfly as well as flyby missions when superior resolution is required.

**ANTISUBMARINE USES**—These same signal processing techniques readily provide a display which differentiates submarine snorkels from background sea clutter—valuable in antisubmarine applications.

The use of a single-sweep mode in some side-looking airborne radars makes enemy jamming dif-

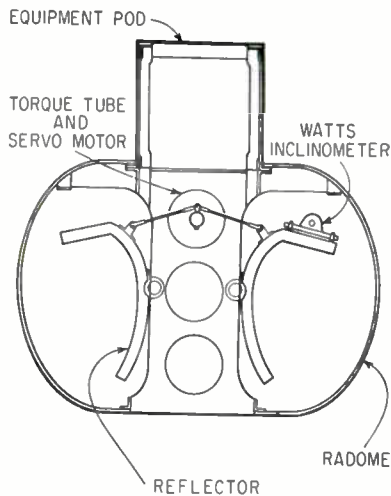

**AIRCRAFT ROLL servo system** is used to correct antenna angle. Roll stabilization of  $\pm 4.5$  degrees is achieved with transistor-magnetic amplifier servo systems, using aircraft's stable platform as reference

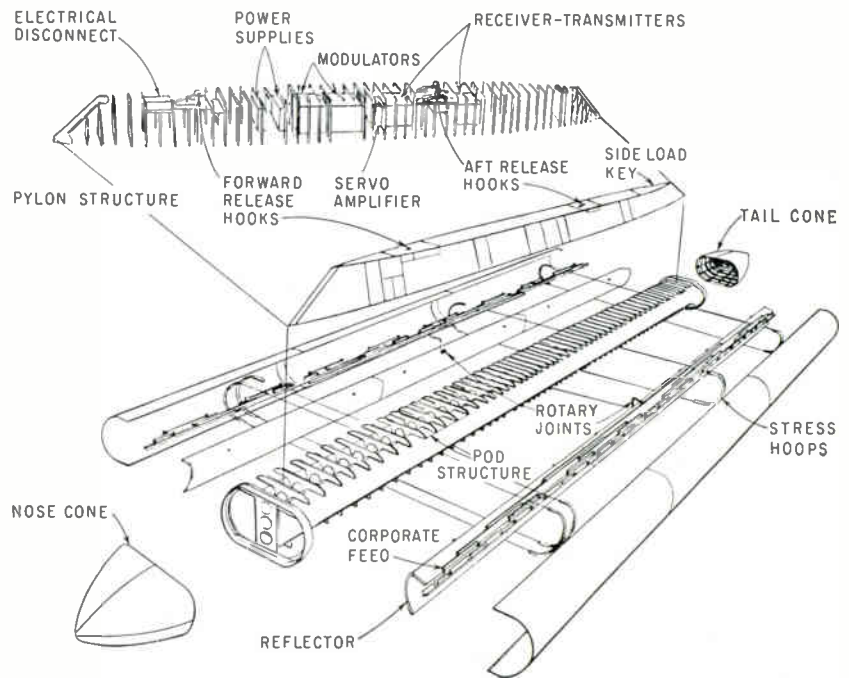

**ANTENNA POD and electronics pylon of side-looking airborne radar, in exploded view.** A series of 32 slotted-waveguide arrays are used as a line source feed for each of the two roll-stabilized antennas. Air Force system operates at X-band, with 240-Kw peak power



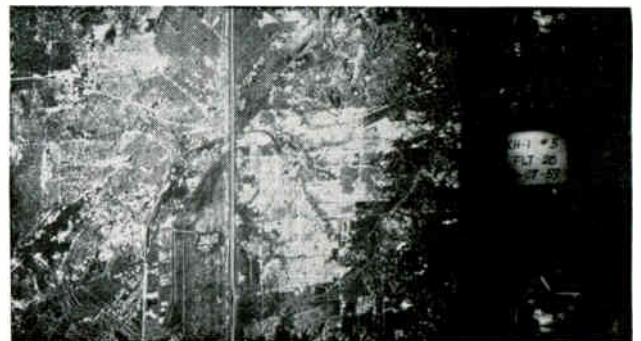

## SIDE-LOOKING RADAR FOR RS-70

Engineers experienced in side-looking airborne radar say that the present state-of-the-art is adequate to design and produce radar required for Air Force's RS-70, Mach-3 aircraft (p 18, Feb. 1). They point out that all of the techniques needed to meet Air Force specifications have been demonstrated. But, they claim, the Department of Defense is requesting greater resolution than Air Force says it needs



**STRIP MAP** obtained with side-looking radar illustrates high resolution. Map is made with antennas looking left and right, seam indicates aircraft line of flight

# Yours in this **STANDING WAVE INDICATOR**



-  Pinpoint resolution for precise attenuation measurements
-  Scale expansion with no "blind spots" no resetting
-  Built-in bolometer protection
-  AC or battery operation
-  All solid state design



Model 415D Standing Wave Indicator is a high-gain, low-noise solid state amplifier and voltmeter calibrated for square-law detectors to read directly in SWR or db. The amplifier is tunable, 980 to 1,020 cps, for matching source modulator or for optimizing several instruments in one system. Variable bandwidth (15 to 100 cps) permits both high sensitivity testing and swept-frequency work.

For highest resolution on precise attenuation measurements, you can expand to full scale each 2.5 db portion of any 10 db range with no "blind spots," and the reference is maintained automatically! This expansion gives you 24 calibrated ranges, 0 to 60 db, in 2.5 db steps. The 415D also reads directly in SWR; it is ideal for measuring reflection coefficient and extremely useful as a null indicator for audio-frequency bridges.

Two peak-limited bias currents, readable on the front-panel meter and adjustable  $\pm 10\%$ , prevent accidental bolometer burnout. Other inputs permit operation with crystals and as a null detector.

The 415D has both an ac output for use as a high-gain tuned amplifier and a dc recorder output. High stability with line changes makes the instrument ideal for long-term monitoring. An internal battery pack (optional) makes the 415D completely portable. It is housed in the new  modular cabinet, which can mount in half of a rack 7" high, combining conveniently in a single rack width with such companion instruments as  431 Power Meter.

## SPECIFICATIONS

<b>Frequency:</b>	1,000 cps variable 5%, other frequencies between 400 and 1,500 cps available
<b>Sensitivity:</b>	0.1 $\mu$ v rms at 30 cps bandwidth (lower sensitivity at 0° C)
<b>Noise:</b>	5 db below full scale with 0.1 $\mu$ v rms sensitivity and minimum bandwidth
<b>Range:</b>	70 db in 10 and 2.5 db steps
<b>Meter Scales:</b>	SWR: 1-4; 3-10; EXPAND 1-1.3. DB: 0-10; EXPAND 0-2.5 Bolo Bias: 4.3 and 8.7 ma indicated.
<b>Accuracy:</b>	$\pm 0.1$ db/10 db step, maximum cumulative $\pm 0.2$ db; $\pm 0.1$ db switching from any 10 db step (NORM) to any 2.5 db step (EXPAND) except $\pm 0.05$ db switching to 0.0 (EXPAND); $\pm 0.02$ db linearity on EXPAND scales
<b>Input:</b>	Bolo: 200 ohms, bias 8.7 or 4.3 ma; Crystal: 200 ohms, 200 K
<b>Output: (one side grounded)</b>	DC: 1 ma into 1,500 ohms maximum AC: 1 v rms in EXPAND, 0.5 v rms in NORM (across 10 K minimum)
<b>Power:</b>	115 or 230 v $\pm 10\%$ , 50 to 1,000 cps, 2 watts
<b>Dimensions:</b>	7½" x 6½" x 12½"; 8 lbs., 11 lbs. with battery
<b>Price:</b>	\$325.00; \$425.00 with battery

*Data subject to change without notice. Prices f.o.b. factory*

## HEWLETT-PACKARD COMPANY

1501 Page Mill Road, Palo Alto, California, Area Code 415, DA 6-7000. Sales and service representatives in all principal areas; Europe, Hewlett-Packard S. A., 54 Route des Acacias, Geneva; Canada, Hewlett-Packard (Canada) Ltd., 8270 Mayrand Street, Montreal.

8261



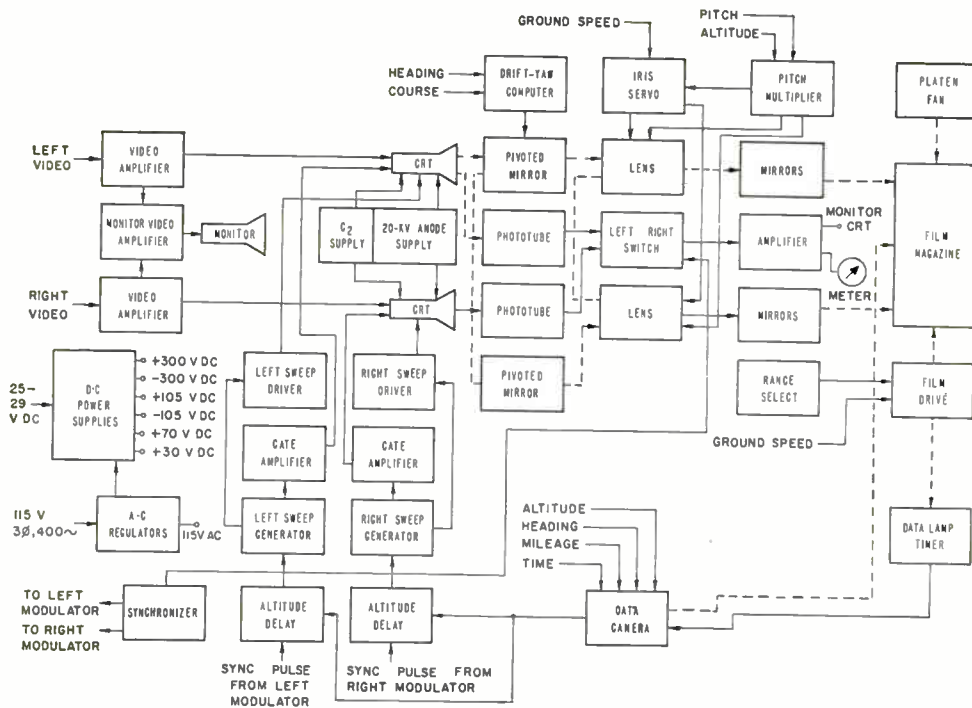

**STRIP MAP RECORDER** for side-looking airborne radar, produces continuous photographic record on 9½-in. film. Air Force system also records aircraft heading, course altitude, time and other data

difficult. The radar beam sweeps the terrain only once, making it difficult for countermeasures equipment to lock on to transmitter output.

Modern side-looking airborne radar usually employs two antennas, looking left and right of the aircraft line of flight. A complete transmitter and receiver system is provided for each antenna. The display and recording system is timed to the radar repetition rate, and also incorporates aircraft flight co-

ordinates in the final map. Antenna angle relative to the ground is adjustable.

Antennas, and transmit-receive equipment, plus servo control systems for antenna angle, are often mounted in a pod and pylon assembly below the aircraft.

**TWO GENERIC TYPES** Side-looking airborne radar is of two generic types, dubbed "brute force" and synthetic aperture.

The brute force technique involves turning the antenna 90 degrees from the usual position of looking ahead and down in relation to the line of flight, to that of looking to the side and down.

This allows the construction of an antenna of larger aperture than may be obtained in the usual bomb-ay radar format, by providing a longer surface on the fuselage. Large aperture antennas are able to focus the radar beam to a higher degree, producing a narrow bandwidth. A tighter beam provides higher target definition for a given operating frequency and pulse width. Some side-looking radars have antennas 50 feet long, to permit large-aperture designs.

Synthetic aperture techniques take advantage of the antennas' longer physical size and also use special signal processing techniques. This permits reducing the actual physical size of the antenna and at the same time permits synthesizing antennas that are effectively hundreds of feet long.

This is achieved with memory techniques that process aircraft ground speed, course, heading, altitude and other data, and in effect create a series of antennas set end to end, as the aircraft progresses.

Forward motion of the aircraft is used to achieve terrain scanning,

## Single-Chip Dual NAND Gate

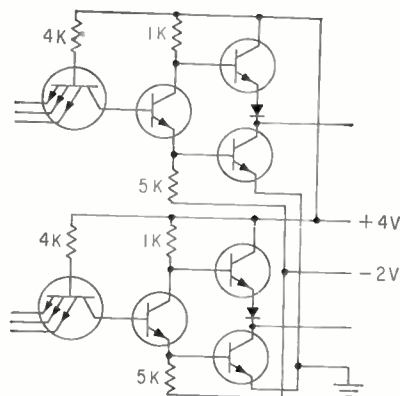
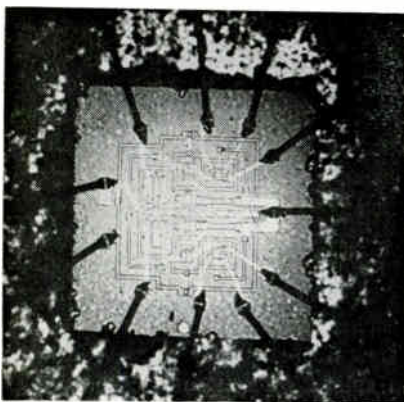

**TYPICAL** of the family of modified transistor-transistor integrated logic blocks introduced last week by Sylvania (see p 8, March 15) is this dual NAND gate. Propagation delays are 8 or 11 nsec depending on whether dissipation per stage is 15 or 7 mv. The block shown uses a Darlington-type circuit to increase fan-out to 25 and cascode connection at output to drive 50-pf capacitive loads

while slant range and target direction are obtained in conventional manner.

The signal handling methods used remove all distortion except that of standard radar shadowing, usually obtained with normal physical antennas as well. The resulting strip map that is produced has a seam down the middle, indicating the aircraft's flight path when the mission is carried out by overflying the terrain. Any advanced side-looking radar is of the synthetic array type.



ARMY'S MOHAWK observation plane, outfitted with side-looking airborne radar (long pod below fuselage) for reconnaissance missions

**PROCESSED IN FLIGHT** — One Air Force star system that processes the signal while in flight produces a 9½-inch-wide map. It has 240-Kw transmitters, with a pulse length of 0.1 microsecond and is tunable in the X-band range.

Receivers for this system are linear-log type, using afc and manual tuning. The antennas used in this star are roll-stabilized by an electronic servo system to correct for aircraft movement.

Much of the original development work on side-looking radar was done at the University of Michigan, and grew out of Project Michigan carried out there. A side-looking radar was developed by them for the (then) U.S. Army Signal Corps. That system processed the signal on the ground, after the flight was completed (ELECTRONICS, p 40, Nov. 18, 1960). Some of the companies involved now or at one time in the development or production of side-looking radar equipment include: Hughes Aircraft, IBM, General Dynamics, Texas Instruments Incorporated, Raytheon, Goodyear Aircraft, RCA, GE, Bendix, Conduccion Corp. and Sperry Gyroscope.

# our stock answer is YES!



ALL UNITS ACTUAL SIZE

## ALL AXIAL LEAD BLUE JACKET RESISTORS

*in 1, 2, 3, 5, 7 and 10-watt power ratings are carried in  
factory stock for immediate delivery.*

*Place your order now with your  
nearest Sprague District Office or Sales Representative.*

*Key Sprague Industrial Distributors  
carry most popular ratings in local stocks.*

*For application engineering assistance write:  
Marketing Dept., Resistor Division, Sprague Electric Co., Nashua, New Hampshire.*

### SPRAGUE COMPONENTS

RESISTORS  
CAPACITORS  
TRANSISTORS  
INTERFERENCE FILTERS  
PIEZOELECTRIC CERAMICS  
PULSE-FORMING NETWORKS  
45R-107-62

PACKAGED COMPONENT ASSEMBLIES  
FUNCTIONAL DIGITAL CIRCUITS  
MAGNETIC COMPONENTS  
PULSE TRANSFORMERS  
CERAMIC-BASE PRINTED NETWORKS  
HIGH TEMPERATURE MAGNET WIRE



GET THE FULL STORY AT IEEE BOOTH 2424



**For production line testing,  
quality control,  
trouble shooting...**

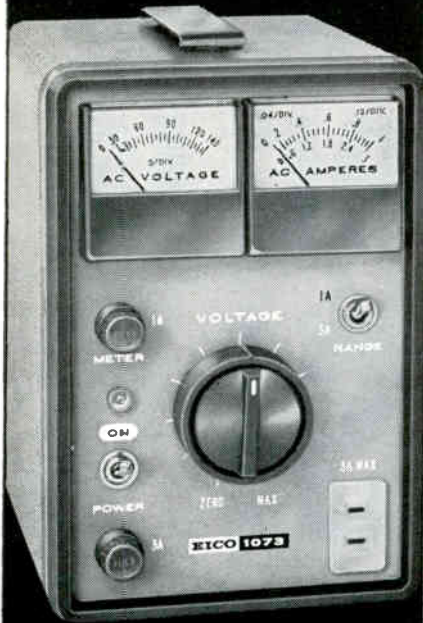

**EICO® NEW METERED  
VARIABLE AUTO-  
TRANSFORMER  
AC BENCH  
SUPPLIES**

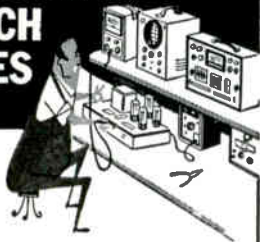

- Deliver any voltage up to 140 VAC
- Linear variation of output throughout entire range
- Smooth rotary brush-tap controlled by dial on panel
- Highly efficient variable auto-transformer of toroidal core design
- No waveform distortion or voltage drop from no-load to full-load
- Separate output ammeter and output voltmeter
- Dual range ammeter: Switching permitted under load
- Rugged, compact, professional appearance

Study the performance of electric or electronic components under varying line conditions . . . expose intermittent components by inducing failure with over-voltage . . . check power consumption . . . compensate for power line voltage variations.

Model 1073 (3 amp. rating)  
Kit \$35.95    Wired \$47.95  
Model 1078 (7½ amp. rating)  
Kit \$42.95    Wired \$54.95  
(Add 5% in the West)

See the 41 additional test instruments . . . helpful for your lab and production work. Write for free Catalog & name of Distributor.

EICO Electronic Instrument Co., Inc.  
Dept. E-3B, 3300 N. Blvd., L. I. C. 1, N. Y.  
Export Dept: Roburn Agencies, Inc.  
431 Greenwich St., New York 13, N. Y.

## New EDP System Totes Odds

*Track calculations are  
speeded by electronic  
data-processing system*

WESTBURY, N. Y. — When the trotters race next June at Roosevelt Raceway here, track odds will be figured and posted by an electronic totalizing system. While electronic computers are now used at some tracks to compute odds, this track will have an all-electronic data collecting and processing system.

The solid-state, digital system was developed by Digitronics; racing savvy was supplied by Roosevelt Raceway. A joint venture by the two firms, named Westbury Electronic Corp., will manufacture and sell the system.

At demonstrations for representatives of tracks from the U.S. and seven other countries, the system was programmed to handle all racing situations, including such an unlikely event as a 15-horse dead heat. Daily-double bets can be accepted up to post time, giving late-arriving fans an extra 10 minutes to get in on the action.

As many as 1,024 ticket selling windows—more than twice what the largest U.S. track now needs—can feed data into the calculating and processing equipment. Each window has a built-in magnetic tape recorder, and each sale is reviewed and certified by the computer in 250 microseconds before the ticket is issued. When a race is over, all accounting is completed in 51 seconds.



CONSOLE provides operating controls and selected readout

Data-processing equipment includes two general purpose magnetic-core-memory computers and two electronic aggregators for adding up the bets on each horse in each race; readout equipment consists of high-speed printers, punched paper tape, and magnetic tape. System error rate is estimated at 1 in 10<sup>14</sup> calculations.

## Commerce Department Sees New Industry Highs

ALL-TIME records for output, employment and foreign trade in the electronics industry have been predicted for 1963 by the Dept. of Commerce. Factory shipments are expected to reach \$8.65 billion in 1963 for combined military and space, commercial and industrial, and consumer products. This would be an increase of 12 percent from the \$7.7 billion production of 1962.

Research, development, test and evaluation (RDT&E) is expected to reach \$3.2 billion for military and space projects, up from \$2.8 billion. This places the total value of production and RDT&E at \$11.85 billion, against the \$10.5 billion figure issued for 1962. The predicted increase is almost 13 percent.

Exports of U. S. electronic products may reach \$975 million during 1963, up from an estimated \$765 million in 1962, an increase of over 25 percent. Imports may jump from \$275 million to over \$340 million in 1963.

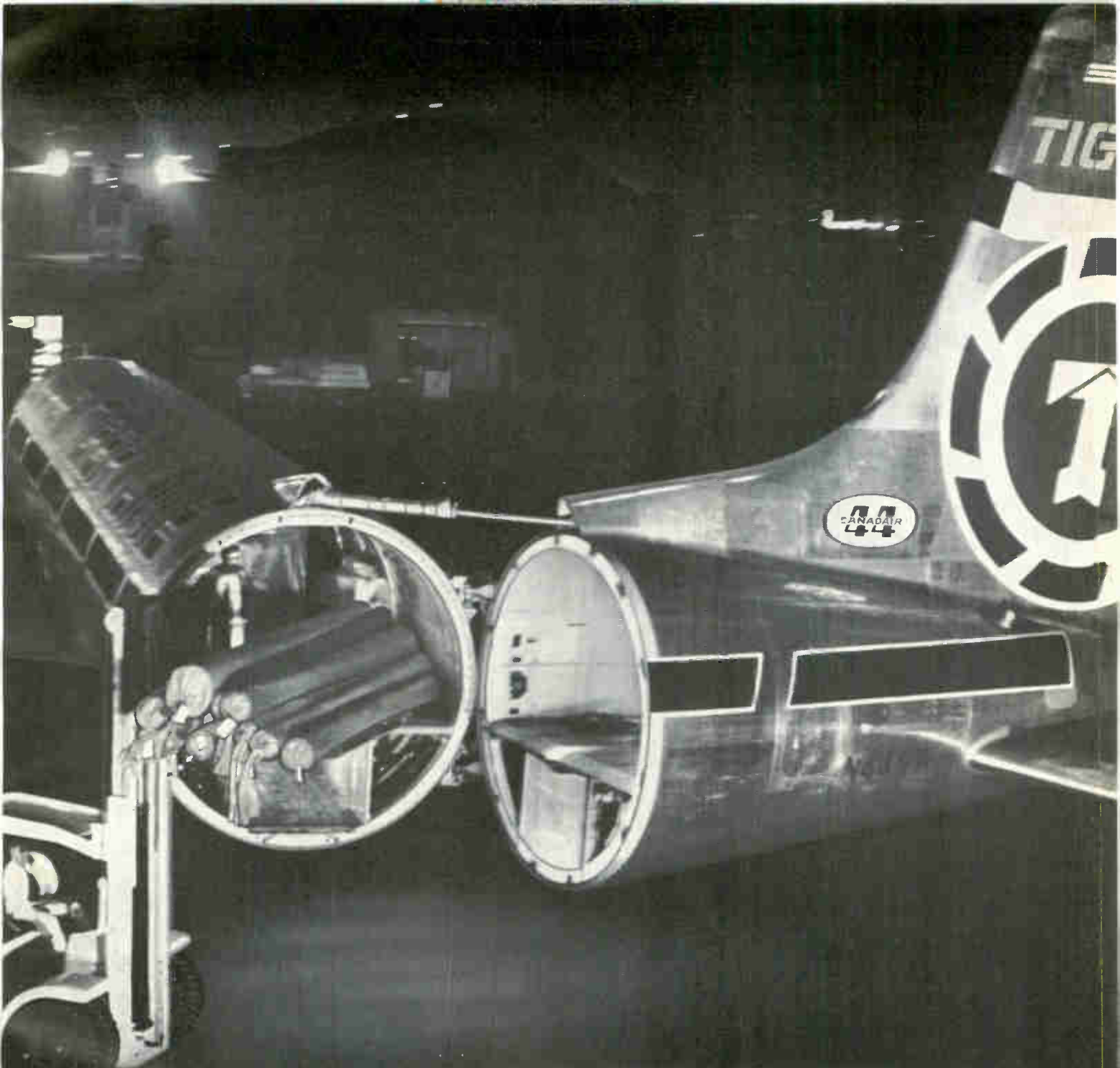

## Flying carpets? Flying Tigers!

Why does the country's largest manufacturer of special-order custom carpeting regularly ship by air? And why via Flying Tigers?

Because with the Tigers' Swingtail-44's, orders received today can be delivered tomorrow. It sure beats having warehouses all over the country.

Tigers' expanded fleet of Swingtail-44's means improved schedules, later cut-off times, faster service. The Swingtail-44's

open wide, carry a big load—66,000 lbs. That's a lot of cargo space. No chance of your shipment getting left behind. And as for dimensions, whatever the shape, whatever the size, if Tigers' Swingtail-44 can't handle it, nobody can.

Why Flying Tigers for flying carpets? Because they have the greatest all-cargo air lift in the country today. They're fast, they're dependable. They're the Airfreight Specialists.

*first in airfreight with airfreight first* **FLYING TIGER LINE**





# Air Force Plans Net to Survive Nuclear Attack

*Here's how generals will communicate if the H-bombs hit*

By THOMAS MAGUIRE  
New England Editor

**HANSCOM AFB, MASS.**—A triple mandate implicit in the cold war is reshaping the direction and pace of development in military command and control (C&C) systems.

Emerging and future C&C systems must be:

- Survivable
- Flexible
- Evolutionary

"It must survive under all conditions," says AF Maj. Gen. John B. Bestic, speaking of the first-generation National Military Command System now being designed under Defense Communications Agency direction to assure continuity of command at the presidential and Joint Chiefs of Staff level.

**SURVIVABILITY**—Other systems now under design or implementation by the Air Force also stress survivability: Pail (Post-Attack Intercontinental Link), in the study stage at Mitre Corp.; 481L Paces (Post-Attack Command and Control System) for SAC; 416L Buic (Backup Interceptor Control) for Sage (ELECTRONICS, p 28, Apr. 20, 1962); 425L NORAD COC (Combat Operations Center), a hard-core center in the Cheyenne Mountains, Colo.; 477L Nudets (Nuclear Detection and Reporting System), whose sensors, though not survivable, would report nuclear attack data before being destroyed; and Spacecom (USAF Aerospace Communications Complex), whose overall goal is communications between any two command posts in the world by at least two geographically and technically separate routes.

Under study are space-based C&C systems, which "may offer a significant increase in survivability," according to Lt. Gen. James Ferguson, AF deputy chief of staff for research and technology.

One example of the emphasis on survivability is the creation of Buic—a survivable backup system for the vulnerable Sage. In the continuing development of "Baby Sage," the 412L system tagged "Quickdraw," two versions of this overseas-theater tactical air weapons control and warning system are being built, embodying two of the approaches to survivability. The air-transportable version, undergoing tests in North and South Carolina, will be movable when its site becomes vulnerable. It will probably be assigned to Hawaii for Pacific defense against air-breathing threats. The second type is being put into concrete—at hard-core centers in West Germany.

In the proposal stage is Nage (NATO Ground Environment), a Europe-wide air defense system similar to Sage but more sophisticated and presumably less vulnerable. Mitre Corp., the engineering systems advisor for the AF Electronic Systems Division, has an office in Paris for preliminary studies.

**FLEXIBILITY**—The Administration is giving increased attention to flexibility in C&C systems due to the emphasis on conventional war.

One of the newest C&C systems, tagged 492L, is a special communications net for Strikecom, the AF-Army joint task force for fighting brushfire wars.

Concurrent with the emphasis on flexibility of response is decreased emphasis on automation.

"There never was any question of a machine being in a position to 'push the button,'" says an Electronic Systems Division official, "but the automation aspect had

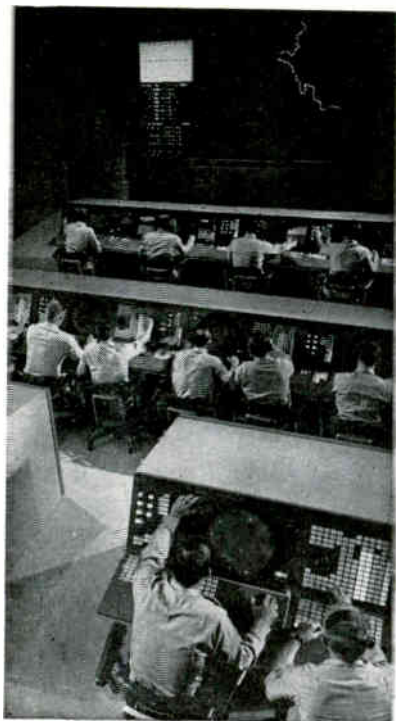

**AIR-SPACE DETECTION** and tracking data flows automatically to combat operations center like this for the Air Force's 412L Air Weapons Control System, a coordinated network of data acquisition stations, data processing and display centers and weapons bases

**MOBILE TACTICAL radar** used for height measuring, searchlighting targets and locating jamming sources (the AN/MPS-16 nodding-beam) is part of the 412L system

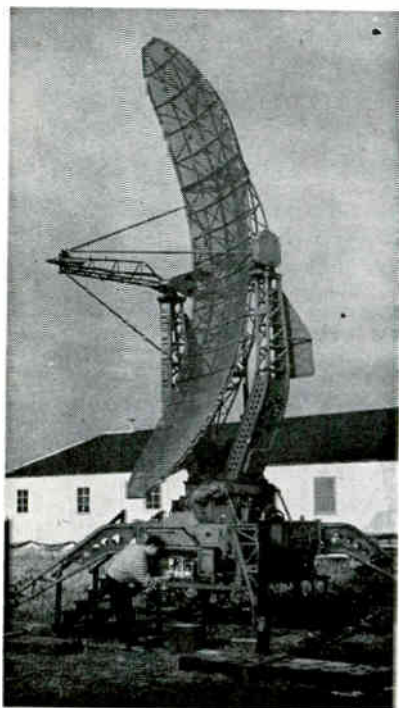

been overstressed and it has become necessary to de-emphasize it in order to correct some false notions."

C&C planners agree that the "software" problem — vital for flexibility of response—is more difficult than design or acquisition of C&C hardware. This was a principal thesis at the First Congress on the Information System Sciences, held late last year in Hot Springs, Va. "Software" includes data interpretation techniques; computer programming; extraction of information for sensor data and of intelligence from the information; and design analysis to insure that the system will do what it is supposed to do—permit the commander to make decisions based on the realities of the situation.

**EVOLUTIONARY**—Both the flexible and the evolutionary requirements of C&C systems are pointed up by the establishment of the Systems Design Laboratory at AF Electronic Systems Division (ESD), where a billion dollars a year is spent on L systems. The Systems Design Laboratory (SDL) now under construction, will be connected to the Sage development sector center at Hanscom Field and will use some of the Sage computer facilities. A Stretch computer, however, will be the heart of the facility.

SDL will simulate, model and test C&C system designs for the future. It is expected to play the major role in system design technology, and will focus the research and experimentation being done by other labs, such as those at System Development Corp., GE, Tempo, SRI and others.

Just as Sage—precursor, pioneer and test bed of modern C&C—taught the dangers of vulnerability and the necessity for survivability provisions, so Sage also taught the need for evolutionary development of C&C systems: 'Do not try to optimize a system, but fix it so you can change it quickly.'

"We have to make sure the user's capability grows with the system," it was pointed out recently by C. A. Zraket of the Mitre Corp. and ESD's Harold Wright. Instead of being built in isolation, a system

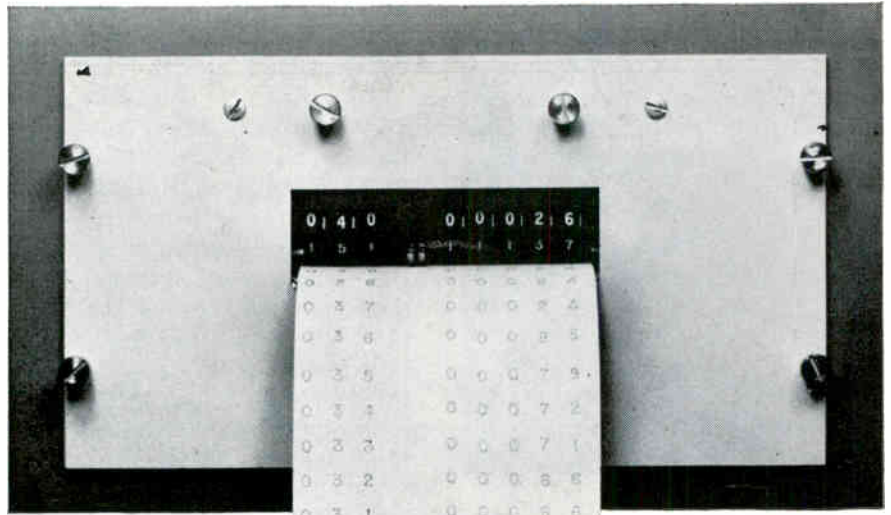

## A Digital Printer for as little as \$258

Designed for custom use, the Texas Instruments Count Printer is a simple, low cost instrument capable of accumulating sequential input pulses at 600/minute. The accumulated total can be printed up to 60 times/minute on ordinary 3-inch adding machine tape . . . both dial total and last printed total are immediately vis-

ible. Compactly assembled on a 4 $\frac{3}{8}$ " by 7 $\frac{1}{8}$ " panel, the Count Printer is less than 7" deep and weighs only 3 $\frac{1}{2}$  pounds. It is available with either one or two in-line count channels for a-c or d-c operation. Each channel has independent count and reset functions. Prices start at \$258 list. Write for full information.

INDUSTRIAL  
PRODUCTS  
GROUP



**TEXAS INSTRUMENTS**  
INCORPORATED  
P. O. BOX 66027 HOUSTON 6, TEXAS

SENSING . RECORDING . TESTING . DIGITIZING INSTRUMENTS  
THE INSTRUMENTS OF TEXAS INSTRUMENTS

564

CIRCLE 29 ON READER SERVICE CARD

**HELP YOUR POST OFFICE  
TO SERVE YOU BETTER  
BY  
MAILING EARLY IN THE DAY  
NATIONWIDE IMPROVED MAIL SERVICE  
PROGRAM**



## LAYOUT SHEETS TWICE AS FAST

with  
New Di-Acro  
Lokator Layout  
Machine



Here's a fast low cost method for laying out sheets and plates without individual use of squares, scribes, scales, punches and hammers. New sliding secondary scales on the primary transverse and longitudinal scales permit direct reading of all locations whether dimensioned from material edges or from each other.

Any bench mechanic can make layouts to  $\pm .005$ " accuracy on the new Di-Acro Lokator Layout Machine—in half the time it takes by hand.

Permanent magnets hold the work sheet to the layout machine base under calibrated sliding scales. A sheet up to 18" x 24" x 1" can be handled in one layout. By re-locating, sheets up to 36" wide by any length can be processed. Etched and plated satin finish steel scales read through magnifiers for maximum accuracy. Choose any of three models: calibrated in increments of  $1/64$ " from 0 at base line on left side and bottom,  $1/64$ " from 0 at center of sheet and  $.001$ " from 0 at base line on left side and bottom.

Satin finish hard chrome plating for non-rust, non-glare surface on all parts—punch point hardened to 60-62 Rockwell C. Slides are precision ground to maintain parallel surfaces. All bearings are bronze, adjustable for wear and squareness.

For complete details consult the yellow pages of your phone book under Machinery/Machine Tools for the name of your nearest Di-Acro distributor or use coupon below.



DI-ACRO  
CORPORATION

433-W EIGHTH AVENUE, LAKE CITY, MINN.

Please send information on the following:

- Di-Acro Lokator Layout Machine     Punch Presses  
 Press Brakes     Punches and Dies

Name \_\_\_\_\_

Address \_\_\_\_\_

City \_\_\_\_\_ State \_\_\_\_\_

would ideally evolve with the capabilities of the user—making sure he is prepared to use the system when it is ready.

**TOP LEVEL C&C**—The Systems Design Laboratory at Hanscom Field will be the principal instrumentality for assuring this evolutionary development. It will simulate and model systems before they are built, testing their compatibility with other systems and integrating them into the C&C pyramid whose apex is the White House-level National Military Command System (Nmcs).

Today's Nmcs is both manned and vulnerable. "We have achieved a high degree of survivability in our major weapons systems, which we do not enjoy in our command and control structure," Gen. Bestic recently told a National Security Industrial Association meeting at Hanscom Field.

Bestic is deputy director of the Defense Communications Agency, to which DOD has assigned the job of designing the first-generation Nmcs. Hopefully, it will be operational in 1966. Various facets have been assigned to the three services by DCA.

Meanwhile, the existing system is being improved through redundancy and mobility. The heavy cruiser USS Northampton has been equipped with special communications, data processing and display equipment required to make it function as a command center. To provide alternate centers aloft, KC-135 Turbojet tankers have been similarly equipped and are in service.

"Other quick-fix improvements will be pursued even as we develop the design for what we call the first-generation Nmcs," says Bestic. Advances in data processing, and display, data transmission and human engineering will figure prominently in the design.

Responsibility of the Nmcs is comprehensive. It must provide complete and current status of U.S. and allied forces; complete and current status of neutral, potentially hostile and hostile forces; complete and current status of U.S. weapons; accurate and current evaluations of worldwide politico-military situations as they influence, or may influence, U.S. response," Bestic said.

And finally: "It must survive under all conditions."

## \$4-Million Worth of Computer

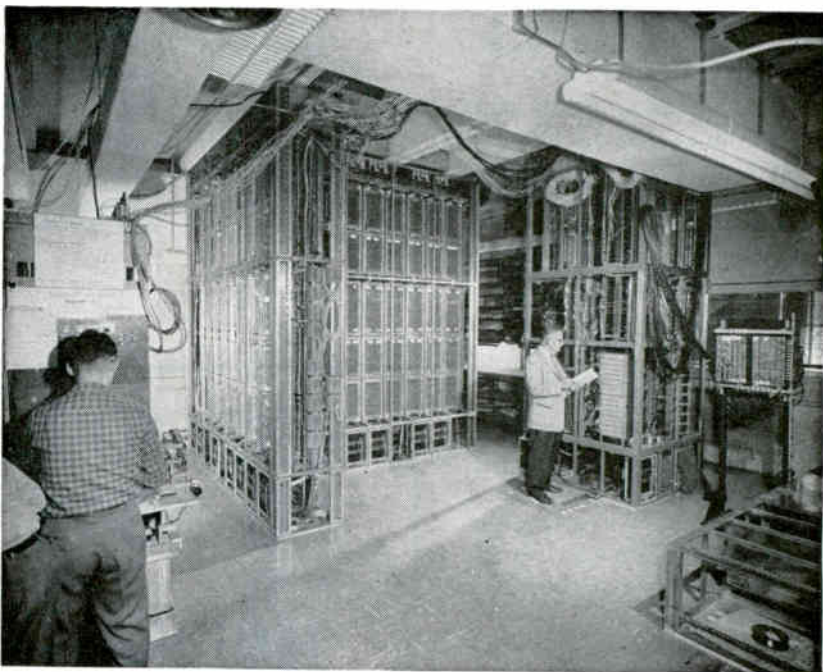





ILLIAC II, successor to the University of Illinois' recently retired Illiac computer is expected to go into general use in June. University says that it competes with Stretch in speed. Part of the \$4-million cost was provided by AEC, Navy and IBM. Under construction since 1958, computer will contain 40,000 transistors and 60,000 diodes

# what's so special about GRC's tiny zinc die castings and thermoplastic moldings?

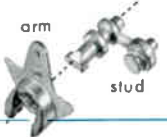
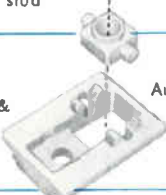
You get benefits no other method can match through GRC's single cavity technique. In one automatic, high speed operation, GRC's exclusive special die casting and molding machines turn out precision intricate die cast and molded parts, completely trimmed... with an unequaled degree of uniformity and preciseness. *They give you wider design latitude...* GRC's special techniques provide shortcuts to economy and quality that permit original design, or redesign, of small parts for greater value improvement. *They lower your end-use cost...* GRC's exclusive HIGHER VALUE methods deliver parts with a high part-to-part uniformity which reduces assembly costs, helps make automated assembly possible. **HERE ARE A FEW EXAMPLES:**

# THIS!

GRC customer	part description (plus end product use)	material & processes used	how GRC provides <b>HIGHER VALUE</b>
<b>STEWART WARNER</b>	Coil Carrier for Electric Speedometer 	Automatically molded in Nylon	Precise, intricate 1-pc. molding 1) retains coil, dynamic balance pin, pivot shaft, 2) provides mount for counter-balance weight, <b>assures uniform multi-function part, simpler assembly.</b>
<b>CLAROSTAT</b>	Mated Rocker Arm & Stud for Volume Control 	Automatically die cast in Zinc Alloy	Pre-GRC: 2 screw machine parts + stamped arm + forming operation. GRC die casts 2 studs as 1 part; integral lug of stud mates with locking slot in arm. <b>Lowers assembly cost and inventory, improves product performance.</b>
<b>RONSON</b>	Mated Inner Cutter Bearing & Trunion for Electric Razor 	Automatically molded in Delrin	Precise snap-fit of trunion & inner cutter bearing—fit held to 0.001"—assures bind-free rotation during 14,400 cpm reciprocating motion of bearing (cutter bar attached to it). Design allows replacement of worn cutter head only, not entire shaving head. <b>Makes competitive product advantage possible.</b>
<b>DICTAPHONE</b>	Taper Pin Receptacles for Dictating Machine 	Automatically die cast in Zinc Alloy	Quickly, efficiently establishes electrical contact, eliminates soldering assembly step, provides easy connect and disconnect. <b>Simplifies field service, speeds assembly.</b>
<b>LIONEL</b>	Coupler for Model Railroad Train 	Automatically molded in Delrin	Pre-GRC: spring + casting + assembly. GRC molding with integral leaf spring design costs less, eliminates extra assembly, simplifies major coupling problem. <b>Reduces parts, assembly, inventory costs, improves performance.</b>
<b>IBM</b>	Plug Nose for Data Processing Machine 	Automatically die cast in Zinc Alloy	Design with GRC plug nose makes patch cord removal from program board easy, yet resists accidental pull-out; allows automatic assembly of patch cord (former stamped part did not). <b>Automates assembly, improves in-use reliability.</b>

Parts shown actual size

Find out about GRC's unusual and complete services, and write for several significant guides to help you in designing simple and intricate small parts.

Be sure to see us at the IEEE—Booth #4054

**G R I E S R E P R O D U C E R C O R P .**

world's foremost producer of small die castings & plastic moldings

151 Beechwood Ave., New Rochelle, N. Y.

(914) NEw Rochelle 3-8600

electronics • March 22, 1963

CIRCLE 31 ON READER SERVICE CARD

31

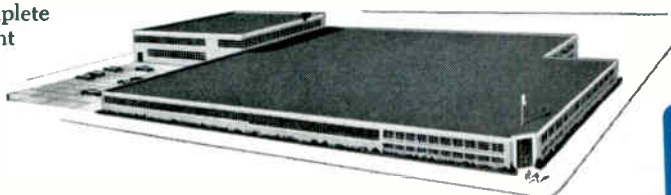

Maximum sizes:  
zinc alloy: 2" long; 1/2 oz.  
plastics: 1 1/4" long; 05 oz.  
no minimum

**GRIES** 



BEFORE RELAY I failed, Associated Press used the satellite to transmit this news photograph of a woman flyer simultaneously to London, Paris and Rome



## Relay Transmitting Again

*One satellite is cured but Telstar and Syncom still are not operating*

**ALTHOUGH THE U.S.** has three active communications satellites in orbit, none of them were operating early last week. The previously reported failures of Telstar and Syncom left only Relay working, and that went off the air from March 9 to 13.

An abnormal power drain resulted when a transistor switch in Relay's No. 1 transponder could not be turned off. To prevent damage from overheating, the satellite

was deactivated. After the batteries recharged, the switch was closed. This permitted the use of transponder No. 2, which has been used for more than 500 communications experiments.

Telemetry data began coming in again from the satellite at 10 p.m. March 13.

**TELSTAR** — Experiments continued last week at Bell Telephone Laboratories to try to get AT&T's Telstar satellite functioning again. Scientists are transmitting various coded command signals in attempt to reactivate Telstar, according to Bell Labs. Transistor damage from high radiation levels reportedly

caused Telstar to misinterpret one of the coded signals and command the satellite to stop transmitting.

**SYNCOM**—Hope that Syncom may yet be put into operating order still exists. Cause of the failure has, thus far, been attributed to a malfunction in the main power supply.

Although the orbit was better than expected, NASA believes that Syncom may not have achieved correct attitude preventing the vehicle from acting on ground commands. Syncom is now drifting at a 2.8-degree eastward rate and attempts are being made to command the satellite.

Syncom is providing the first flight test for Goddard Space Flight Center's range and range rate tracking method. The system enables ground stations to predict the satellite's position, so it can be optically located and photographed. The system will probably be used for all satellites in the orbiting observatory series and it is likely all NASA ground stations will be modified for it.

## Microwaves Study Weather

MILLION-DOLLAR microwave investigation of earth's lower atmosphere will begin this spring as a joint project by University of Wisconsin meteorologists and Collins electrical engineers.

One-degree microwave beams will be pulsed simultaneously from 30-foot radar-type antennas at Arlington Farms and Collins at Cedar Rapids—about 140 miles away.

Scattered signals from their "common volume" intersection—picked up by antennas in pauses between pulses—will total about one ten-billionth of the transmitted signal, according to Verner Suomi, Wisconsin meteorology professor. He said transmission frequency and height of the "common volume" can be varied.

Characteristics of the scattered microwaves related to moisture distribution, thermal and turbulence phenomena and other atmospheric

properties will be recorded and analyzed over two years of investigations.

Probing the atmosphere electronically to provide basic meteorologic and electronic data could ultimately have far-reaching practical applications, Suomi said.

Airports of the future could use such a setup for continuous monitoring flight conditions over their fields. Flicker and fade-out of tv and radio signals might be avoided by automatically adjusting the transmitting frequency according to atmospheric conditions reported by scatter information, said William Birkemeier, Wisconsin associate professor of electrical engineering.

The National Science Foundation granted Wisconsin the first part of an expected \$250,000 for the project last month. Collins is providing additional equipment valued at \$750,000.

## King-Sized Radome

RADOME weighing 102 tons is built around 125-ft-long antenna of FPS-35 continental air defense radar in Oregon. Object, says Sperry Gyroscope, is to permit radar to keep operating in 150-mph winds, which it cannot now do





**But you can  
still make the sale**

## **Because Air Express delivers overnight...anywhere in the USA**

Why freeze money in inventory, when smaller stocks will do just as well? And they will...when you take planned advantage of Air Express.

Here's how easy it is to get fast stock replacement by Air Express: Phone your order to suppliers, specifying delivery by Air Express. We pick up your shipment from your supplier, wherever he may be...put it on the first flight out...and our trucks deliver it to you the next day.

Air Express alone can offer this service, because Air Express shipments have official priority with all 38 scheduled airlines—first cargo aboard after air mail. The cost is less than you think. For example, 10 lbs. travels 1,500 miles for only \$6.66.

You can switch to this fast-growing, cost-cutting modern practice of "stock when you need it"...simply by specifying Air Express. And for prompt service when you ship, call your REA Express office for Air Express service.

**AIR EXPRESS**

DIVISION



**CIRCLE 33 ON READER SERVICE CARD**

**CIRCLE 34 ON READER SERVICE CARD →**



# Be fussy

Two things determine whether or not a particular printed circuit connector is "right" for your application:

1. How the printed circuit board mates with the connector, and
2. How the connector connects to the rest of the system.

Take mating, for example. Besides having the correct number of contacts, a printed circuit connector must hold the board securely whether the board happens to fall at the high or low end of thickness tolerances.

#### IT TAKES THREE

These considerations convinced Amphenol engineers that no single contact design could satisfy the requirements of a wide range of applications. So they designed three contacts that will.

One, used in Prin-Cir\* connectors, looks a lot like a tuning fork with lips. The circle lip design makes contact overstressing or "setting" impossible—even after repeated insertions. The contact's long spring base also enables it to accommodate boards that range in thickness from .055" to .073", while doing an excellent "wiping" job.

#### EASY DOES IT

But not every application requires the Prin-Cir "bite." For this reason, Amphenol engineers designed connectors with ribbon contacts that mate with a gradual wedge-like force. In

blind mating applications, gradual mating makes the feeling of *correct* mating unmistakable. (Just the thing when your equipment may eventually be maintained by less-skilled and less-concerned personnel.) Ribbon contact wedge action also makes it possible for connectors using these contacts to accept the same wide range (.055" to .073") of board thicknesses as do Prin-Cir connectors.

Finally, advances in micro-miniaturization (like Amphenol-Borg's Intercon® pre-fabricated circuitry) meant that tinier-than-ever-before connectors were needed. Amphenol's answer was the Micro-Min® receptacle and printed circuit board adapter. Micro-Min contacts are actually tiny springs of beryllium copper wire, formed in a precisely designed arc to assure firm circuit board retention. This unique design makes it possible to space contacts on .050" centers and crowd 19 connections into a little more than an inch of space.

#### TERMINATIONS COUNT, TOO

"How to connect connectors to the rest of the system" also merits a good deal of consideration. In some cases, hand soldered terminations will do just fine. In others, higher volume requirements call for high production rate methods like dip soldering and wire-wrapping. Some engineers prefer taper pin terminations.

Our printed circuit connectors are available with contact tails designed for each of these termination methods. In addition, adapters are available for use in connecting printed circuit boards at right angles to each other or in modular arrangements. We make printed circuit connectors with hermetically sealed contacts — still others with coaxial contacts.

Take your choice.

Any Amphenol Sales Engineer or authorized Amphenol Industrial Distributor will be happy to discuss printed circuit connectors (ours) with you. Or, if you prefer, write directly to Dick Hall, Vice President, Marketing, Amphenol Connector Division, 1830 S. 54th Avenue, Chicago 50, Illinois.

\*T.M. Amphenol-Borg Electronics Corp.

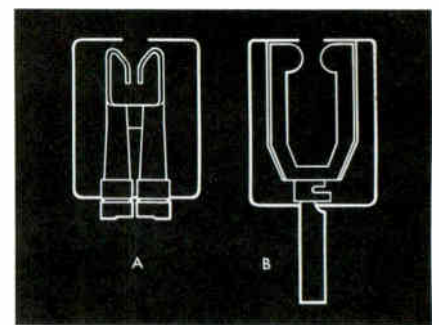

Wedging action of Amphenol ribbon-type (A) and long spring base of Amphenol Prin-Cir connectors (B) assure firm printed circuit board retention, whether board happens to fall at low (.055") or high (.073") end of thickness tolerance.



Connector Division / Amphenol-Borg Electronics Corporation

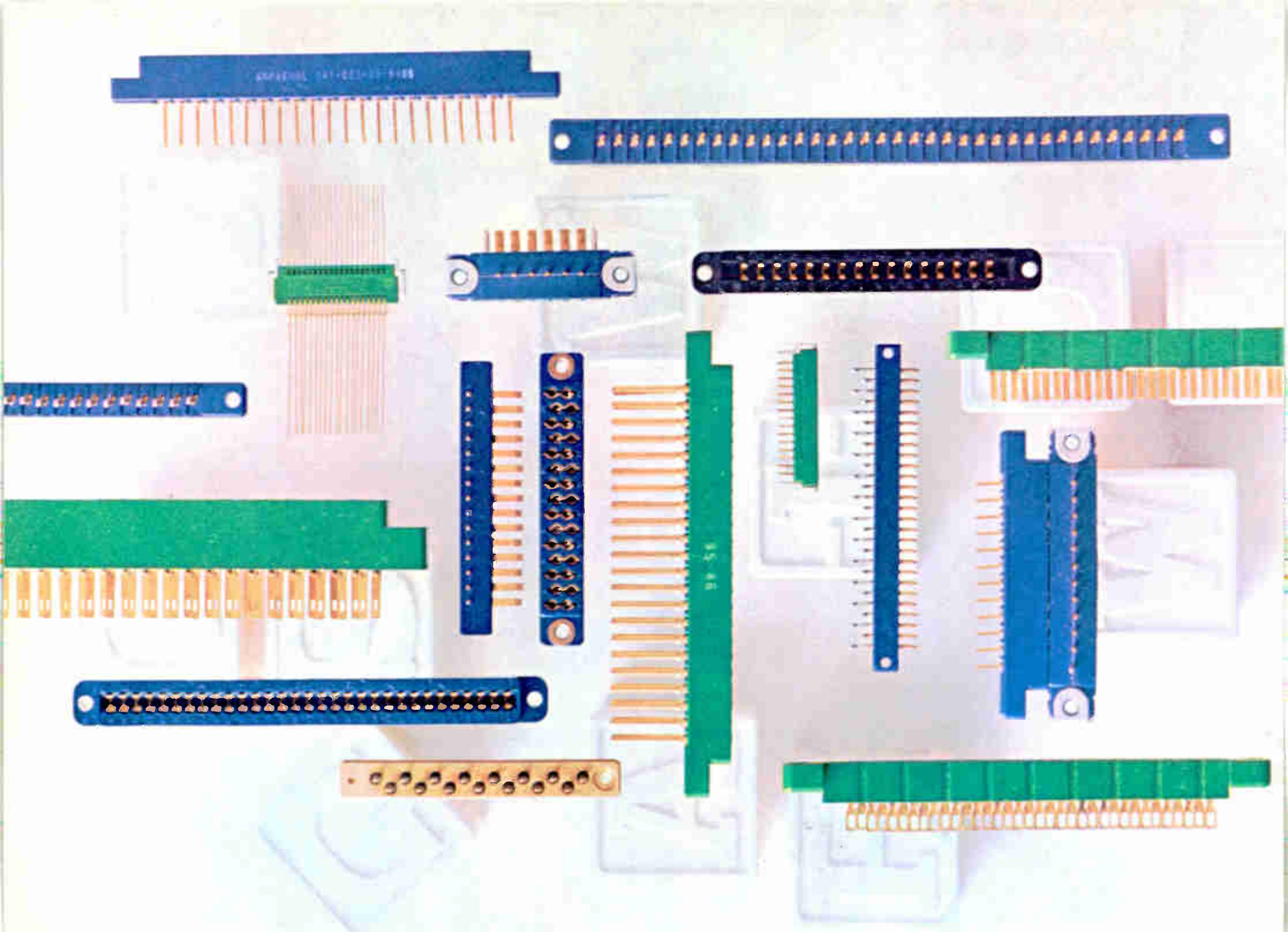



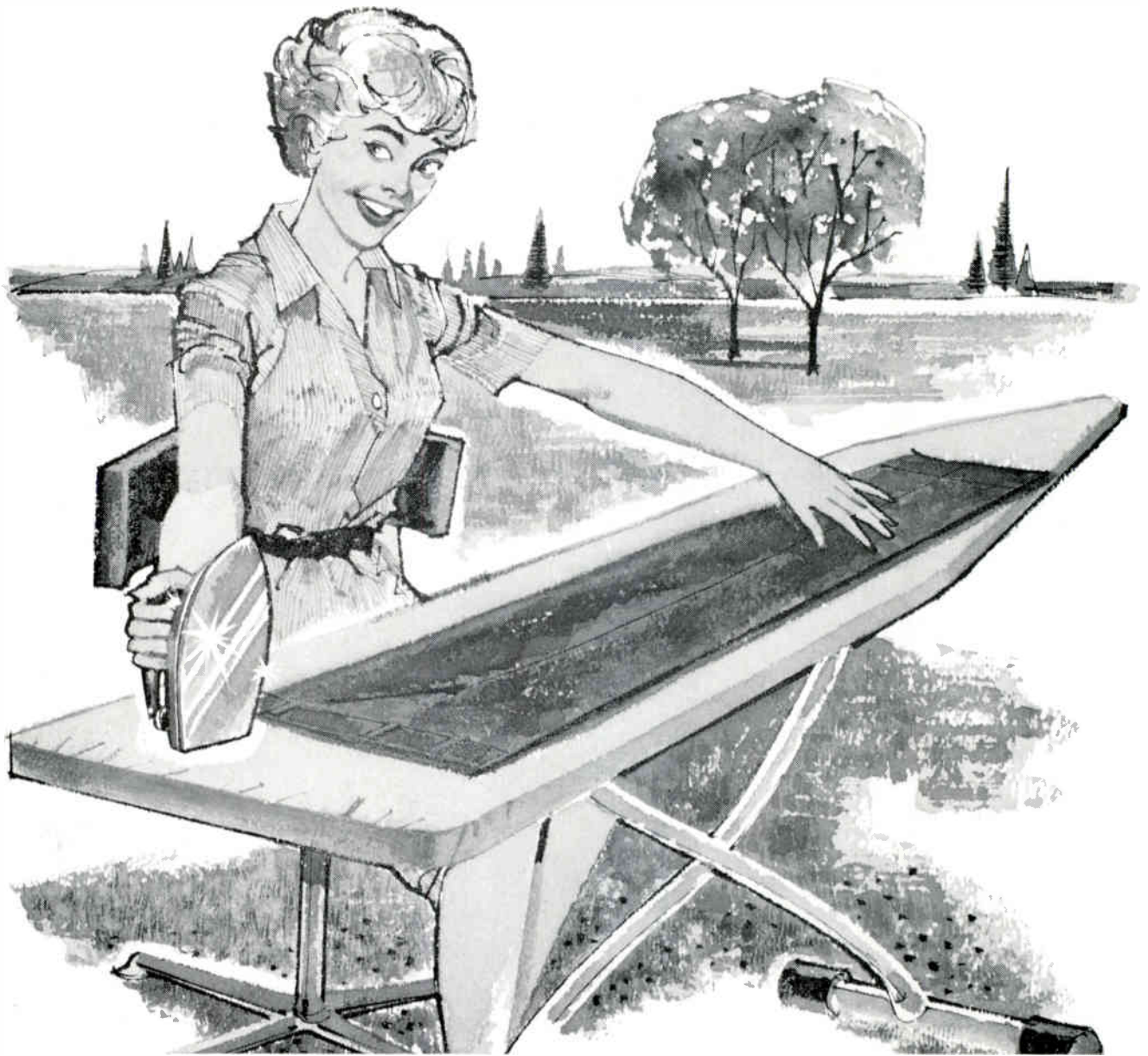

## What won't you think of next?

Maybe the picture of Mom ironing Dad's trousers while sunning herself may be a bit far-fetched. A portable iron (battery-powered?) may be even more so. Probably impractical.

Our point is this—your present design problem may seem just as impractical, just as the drill, shaver, mixer and other cordless products did a few years ago. But Gould-National research engineers developed a package of concentrated power using NICAD® Hermetically Sealed Rechargeable Cells that helped to make these products a reality

*Have a design problem that could be solved with Nicad portable power? Write us, we may be able to help you solve your problem.*



**NICAD BATTERY DIVISION**

GOULD-NATIONAL BATTERIES, INC. / St. Paul 1, Minnesota

*For radiography—it's Ansco best by definition*

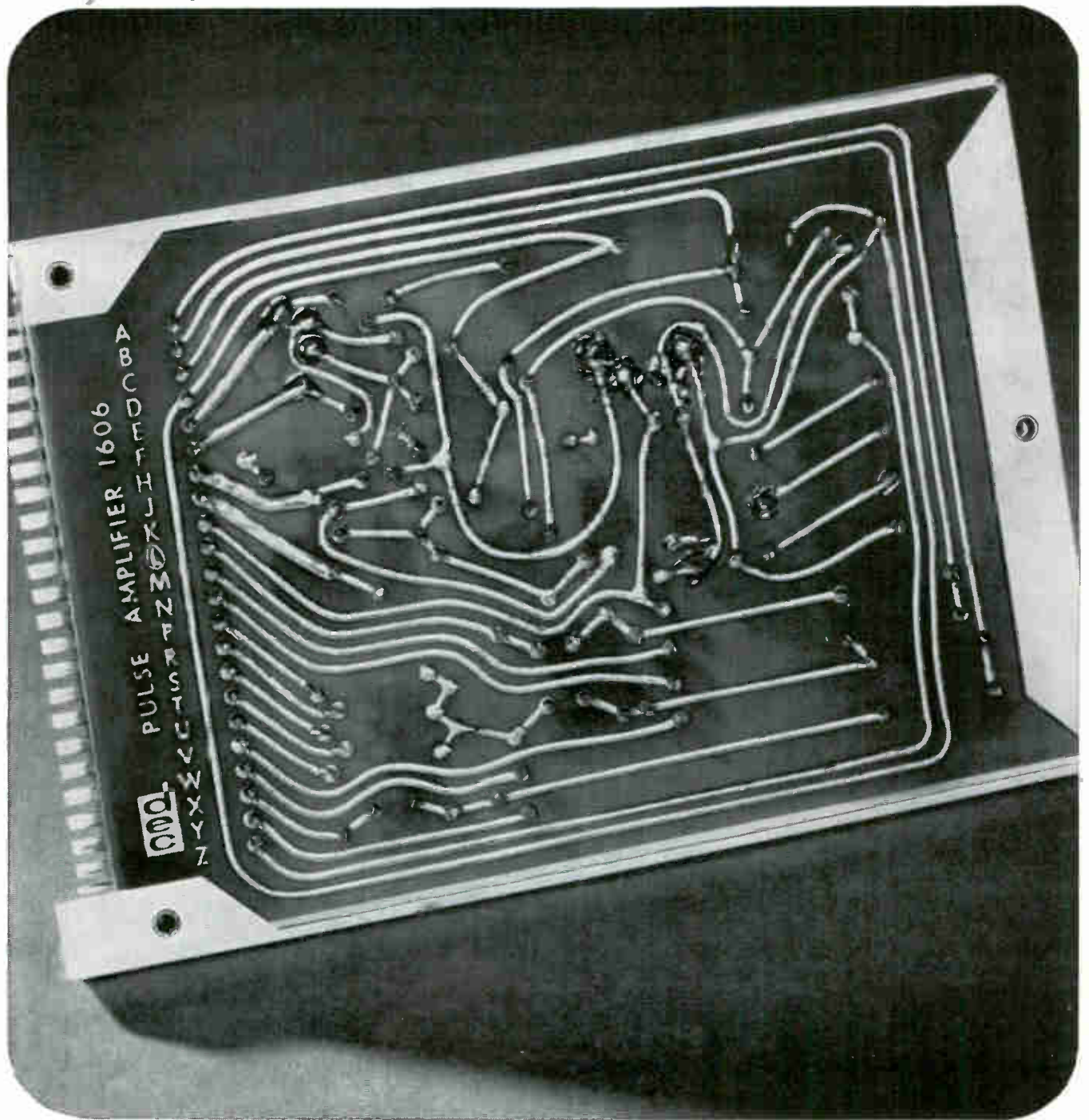

## *Checking your components in braille?*

While other methods of non-destructive testing may indicate discontinuity or tiny imperfections, nothing brings proof to your eyes like a radiograph on Ansco Superay 'H-D' Industrial X-ray Film.

This ultra fine grain Class I film makes you Ansco-sure of sending only faultless components to cus-

tomers. Get very high contrast throughout the widest range of X-radiation used today.

For the ultimate in image sharpness use Ansco Superay® 'H-D', available in economical bulk packaging. Ask your Ansco Representative for technical literature, or write X-ray Department, Ansco, Binghamton, N. Y.

*America's first manufacturer of photographic materials... since 1842.*





# Precision Quality Assurance Problems ?



HERE'S HELP FROM  
BAUSCH & LOMB IN:

- Tool Design
- Inspection
- Fabrication
- Measuring
- Testing

## ZOOM MACROSCOPE

Measure direct to 0.001"—at any magnification from 10X to 30X—with constant focus throughout.



## 10" BENCH PROJECTOR

Magnifies silhouette of production part on high-contrast, wide-angle screen for measurement or comparison with template. Optional micrometer stage reads to 0.0001".



## SCRATCH DEPTH GAGE

With this simple hand-held instrument you can measure the depth of any scratch from 0.0002" to 0.016" in a width range of 0" to 0.015".



## DIE-WEAR MICROSCOPE

See readily if die needs sharpening, and exactly how much metal must be removed. Direct, easy-to-read measurement of die wear up to 0.020" ... least reading—0.001".



## DR-25B & DR-25C OPTICAL GAGES

Fastest, easiest way to measure depth, thickness, height, diameter, taper. Read direct to 0.0001" on bright, magnified scale. A shop instrument with gage room accuracy.



## TOOLMAKERS' MICROSCOPE

Wide field of view, bright shadow-free light and wide reticle lines for fast, easy linear measurements to 0.0001"; angular, to 1 minute of arc.



## STEREOZOOM® MICROSCOPES

Big, bright 3-D views of tiny parts. Zoom to any magnifications you need for assembly, inspection. Dust-proof, shockproof—can be mounted right on machines.



**BAUSCH & LOMB** 

Please send literature on optical production aids checked below:

- D-285—DR-25B and DR-25C Optical Gages  D-282—Toolmakers' Microscope  D-15—StereoZoom Microscopes  D-2018—Zoom Macroscope  D-2029—10" Bench Projector  D-2012—Scratch Depth Gage  D-2015—Die-Wear Microscope

NAME..... TITLE.....  
COMPANY..... ADDRESS.....  
CITY..... ZONE..... STATE.....

**BAUSCH & LOMB  
INCORPORATED**  
61439 Bausch St.  
Rochester 2, N. Y.

## MEETINGS AHEAD

EUROPEAN ELECTRONICS MARKET, EIA; Statler Hilton, Washington, D. C. March 19-22.

INSTITUTE OF PRINTED CIRCUITS MEETING, IPC; Barbizon-Plaza Hotel, New York City, March 25-27.

IEEE INTERNATIONAL CONVENTION, Institute of Electrical and Electronics Engineers; Coliseum and Waldorf-Astoria Hotel, New York, N. Y. March 25-28.

ELECTRON BEAM SYMPOSIUM, Alloyd Electronics Corp.; Somerset Hotel, Boston, Mass. March 28-29.

BROADCAST ENGINEERING CONFERENCE, National Association of Broadcasters; Conrad Hilton Hotel, Chicago, March 31-April 3.

RADIOISOTOPE CONFERENCE, Oak Ridge National Laboratory, et al; Gatlinburg, Tenn., April 1-3.

PROTECTIVE RELAY ENGINEERS CONFERENCE, A & M College of Texas; at Texas A & M, College Station, Texas, April 8-10.

ENGINEERING ASPECTS OF MAGNETO-HYDRODYNAMICS SYMPOSIUM, IEEE, IAS, University of California; at UC, Berkeley, Calif., April 10-11.

OHIO VALLEY INSTRUMENT-AUTOMATION SYMPOSIUM, ISA, et al; Cincinnati Gardens, Cincinnati, Ohio, April 16-17.

CLEVELAND ELECTRONICS CONFERENCE, IEEE, Case Institute, Western Reserve University, ISA; Hotel Sheraton, Cleveland, O., April 16-18.

OPTICAL MASERS SYMPOSIUM, IEEE, American Optical Society, Armed Services, et al; Waldorf Astoria Hotel, New York City, April 16-18.

INTERNATIONAL NONLINEAR MAGNETICS CONFERENCE, IEEE; Shoreham Hotel, Washington, D. C., April 17-19.

SOUTHWESTERN IEEE CONFERENCE & ELECTRONICS SHOW, IEEE (Region 5); Dallas Memorial Auditorium, Dallas, Texas, April 17-19.

BIO-MEDICAL ENGINEERING SYMPOSIUM, IEEE, et al; Del Webb's Ocean House, San Diego, Calif., April 22-24.

NATIONAL ELECTROMAGNETIC RELAY CONFERENCE; Oklahoma State University; OSU, Stillwater, Okla., April 23-25.

## ADVANCE REPORT

RELIABILITY & QUALITY CONTROL NATIONAL SYMPOSIUM, IEEE-PTG; Statler Hilton Hotel, Washington, D. C., Jan. 7-9, 1964. May 15 is deadline for submitting 10 copies of 800-word abstract and brief biographies to: Dr. L. S. Gephart, Lockheed Missiles and Space Co., Department 64-01, Building 104, Sunnyvale, California. Papers must not have been presented at other national society meetings. However, papers given at local meetings are acceptable.

# Now — 3/8"-Square Potentiometers In Wirewound or RESISTON® Carbon Models

NUMBER 27—NEW PRODUCT SERIES

Measuring just 3/8" x 3/8" x 1/4", these TRIMPOT® potentiometers embody the performance and features of units occupying twice the volume. The unique central mounting hole makes this improvement possible—in both wirewound and RESISTON carbon versions. It permits the same size resistance elements as those used in 1/2"-square potentiometers and the same high power ratings—1W @ 70°C for wirewound and 0.50W @ 50°C for RESISTON carbon. Both models offer 25-turn screwdriver adjustment with positive end-stops. A special clutch feature eliminates the possibility of damage from forced adjustment.

The infinite-resolution RESISTON carbon models extend the resistance range of Bourns 3/8"-square potentiometers to 1 megohm, and offer a maximum temperature coefficient of just ±0.03%/°C from -65° to +150°C.

Both models are the same size; you can mount 14 wirewound

or 14 carbon units in one square inch of circuit-board space. The procedure is simple and sure. Stacking tabs on the cases ensure proper alignment and prevent rotation. A sealed case contributes to the reliability of these units, which meet or exceed applicable Mil Specs.

	MODEL 3280 (wirewound)	MODEL 3281 (RESISTON® carbon)
Max. Oper. Temp.:	175°C	150°C
Power Rating:	1W @ 70°C; 0.5W @ 125°C	0.50 @ 50°C; 0.25W @ 100°C
Resistances:	100Ω to 50K	20K to 1 Meg.
Humidity:	MIL-STD-202B, Meth 106 (cycling)	



ACTUAL SIZE

Units are available immediately with printed circuit pins (from either narrow or flat side of case) or flexible leads. Write for complete data.

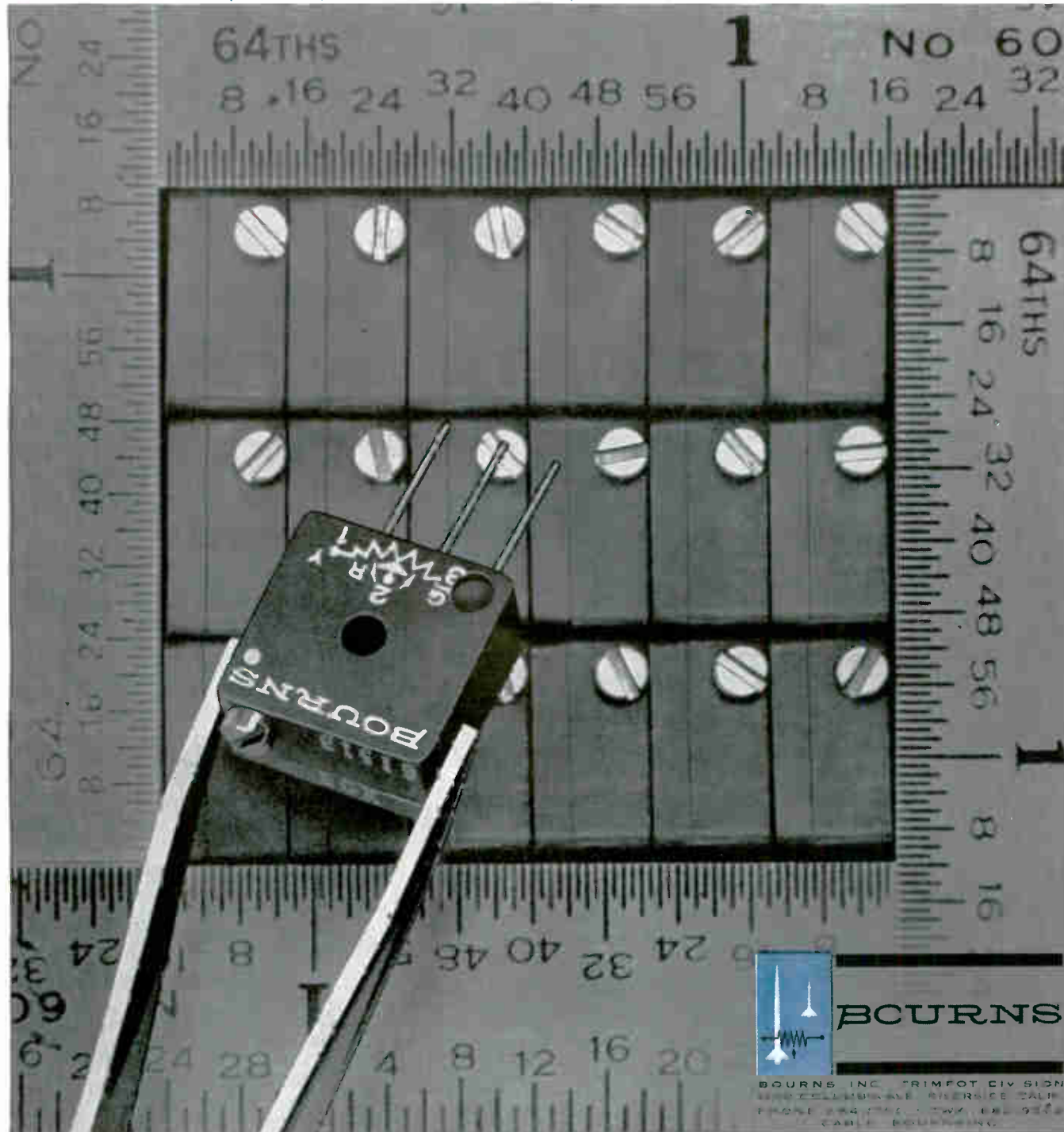

**BOURNS**

BOURNS INC. TRIMPOT DIVISION  
3800 COLLETT AVENUE RIVERSIDE CALIF.  
PHONE 949-938-1100 TWX 910-950-9500  
CABLE BOURNSINC

Manufacturer: TRIMPOT® potentiometers; transducers for position, pressure, acceleration. Plants: Riverside, Calif.; Ames, Iowa; and Toronto, Canada

SEE BOURNS PRODUCTS IN BOOTHS 1429-1431 AT THE IEEE SHOW





**WE USE BOTH ENDS OF THE PENCIL...**

*to solve advanced systems research problems*



Out beyond the State-of-the-Art, original solutions to the formidable new problems of today's advanced electronic systems depend on the effective application of three important tools...the pencil, the eraser and man's brain. At Motorola, these factors have been successfully applied to the design and development of such major electronic systems as the NASA/Goddard Range & Range Rate Satellite Tracking System...the Air Force data acquisition and relaying system at the Edwards AFB high speed flight corridor... and the RADAS random access, discrete address system.

If you are interested in participating in these stimulating areas of systems research, write today describing your background and training in:

**Applied Systems Research** • conceptual design and equipment development, communications theory, coding theory, logic systems design, systems and analysis, and operations research as applied to both military and non-military systems.

**Systems and Sub-Systems Design** • antenna and microwave design, integrated circuit applications, stress analysis and heat transfer, digital and voice communications, command and control, telemetry and tracking systems design, data processing and display, ultrareliability design techniques, radar and guidance equipment.

We are particularly interested in programs on which this experience was obtained, and the extent of your technical responsibility. Address information to our Manager of Engineering at the location of your choice for immediate attention.

**MOTOROLA**  
*An equal opportunity employer*



**Military Electronics Division**

CHICAGO 51 Illinois, 1450 N. Cicero Ave./SCOTTSDALE, Arizona, 8201 E. McDowell Rd./RIVERSIDE, California, 8330 Indiana Ave.





W5/1G and P.P.M. mount 495-LVA-105B with all-mechanical focus adjustment.

# PROGRESS IN MICROWAVE COMMUNICATIONS

Advances in components design have brought far-reaching changes in circuit techniques employed in microwave link repeaters but, for broadband response, the travelling wave tube amplifier maintains its position supreme. This does not imply complacency on the part of the tube manufacturer. On the contrary, continuous efforts are made to produce tubes of better and better performance—improved gain, lower noise factor, higher synchronous saturated output level and reduced phase modulation distortion. During the last decade, STC have maintained a leading position in this field.

The travelling wave tube cannot be considered in isolation. Its correct performance is very much dependent upon its mount which contains a magnetic focusing arrangement

(including devices for trimming the focus of individual tubes) as well as arrangements for coupling the input and output signal to and from the tube helix together with the requisite matching contrivance.

Whilst the mode of operation of the travelling wave tube does not permit much change in the overall length of the mount, economy has been achieved by replacing power consuming solenoids by periodically reversed permanent magnets; forced air systems by convector coolers, and focus-trim deflector coils by mechanical fine adjusting screws.

STC designs are based on a vast experience of manufacturing components for microwave equipment in use in major communication systems installed in 19 countries of the world.

STC  
TRAVELLING  
WAVE  
TUBES

Announcing another NEW Type

## abridged data

Tube Type	Mount Type	RF Connexion (W.G. Flange)	Frequency Range (Gc/s)	Sync. Sat. Output (W)	Gain (dB)	Noise Factor (dB)
W5/1G	495-LVA-105B	UG344/U	5·85 to 7·2	8 to 11	35 to 39	26
	495-LVA-105C	CMR137				
	495-LVA-105D	UG344/U				
W5/2G	495-LVA-107B	UG344/U	5·8 to 6·6	16	37 to 41	27
	W7/3G	495-LVA-104	12A*	8 to 10	28	27
W7/4G	495-LVA-101A	12A*	3·6 to 4·2	10	42	27

\*Transition pieces to WR229 available

Write for brochure MS/113 "STC Microwave Tubes"



**Standard Telephones and Cables Limited**

VALVE DIVISION · BRIXHAM ROAD · PAIGNTON · DEVON · ENGLAND

USA enquiries for price and delivery to ITT COMPONENTS DIVISION · P.O. BOX 412, CLIFTON N.J.



63/1MS

I NEED **50 KW** CW POWER  
AT **X-BAND** BUT I ALSO  
NEED **TUBE STABILITY!**

ANY IDEAS ??

SURE!  
USE A...

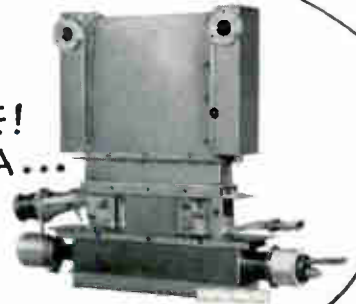

A  
**WHAT?**

AN **MBK!** IT'S GENERAL ELECTRIC'S  
**MULTIPLE BEAM KLYSTRON,**  
TYPE ZM-6601. THIS NEW TUBE'S conservatively  
designed individual beams, multiplied in a phase-locked multiple-beam structure,  
provide high RF power output at low thermal densities. And G.E. is now offering  
60 day delivery!

Electrical and thermal stability of the ZM-6601 is typical of tubes operating  
at **one-tenth the power level.** The MBK requires only 12.8 KV beam voltage, eliminating  
extra size and weight encountered in paralleling conventional "high power" klystron  
tubes. It's unique among factory-built klystrons.

Here are some of its vital statistics . . .

Frequency . . . . .	8.3-8.5 Gc
Tuning Range . . . . .	80 mc
Power Output . . . . .	50 KW CW
Typical Voltage . . . . .	12.8 KV
Nominal Gain . . . . .	45 db
Efficiency . . . . .	35%

Tubes sold in pairs are priced substantially below \$1000 per kilowatt. And  
design is flexible, so ask about other frequency and power capability or pulse  
service design. Call any G-E Power Tube district sales office for full information.

**GET THE PICTURE ?**

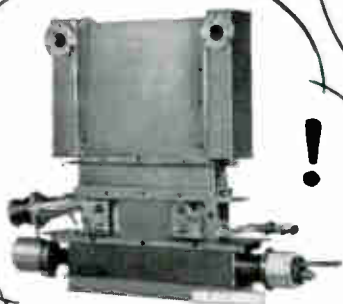

**GE ELECTRONICS**  
PROGRESS IN MICRO WAVE TECHNOLOGY

INCLUDING IGNITRONS, HYDROGEN  
THYRATRONS, VOLTAGE-TUNABLE  
MAGNETRONS, METAL-CERAMIC  
TRANSMITTING TUBES, MICROWAVE POWER FILTERS, HIGH/SUPERPOWER KLY-  
STRONS. FOR INFORMATION ON THESE PRODUCTS, WRITE SECTION 265-25, POWER  
TUBE DEPT., GENERAL ELECTRIC CO., SCHENECTADY 5, N. Y. OR TELEPHONE

**GENERAL ELECTRIC**

POWER TUBE DEPARTMENT

265-25

TODAY: SCHENECTADY, N. Y. FRanklin 4-2211 (Ext. 5-3433) • WASHINGTON, D. C. Executive 3-3600 • DAYTON, OHIO Baldwin 3-7151 • LOS ANGELES, CALIF. BRadshaw 2-8566  
SYRACUSE, N. Y. 652-5102 • CHICAGO, ILL. SPring 7-1600 • CLIFTON, N. J. GRegory 2-8100 • NEW YORK, N. Y. Wisconsin 7-4065 • ORLANDO, FLA. GArden 4-6280



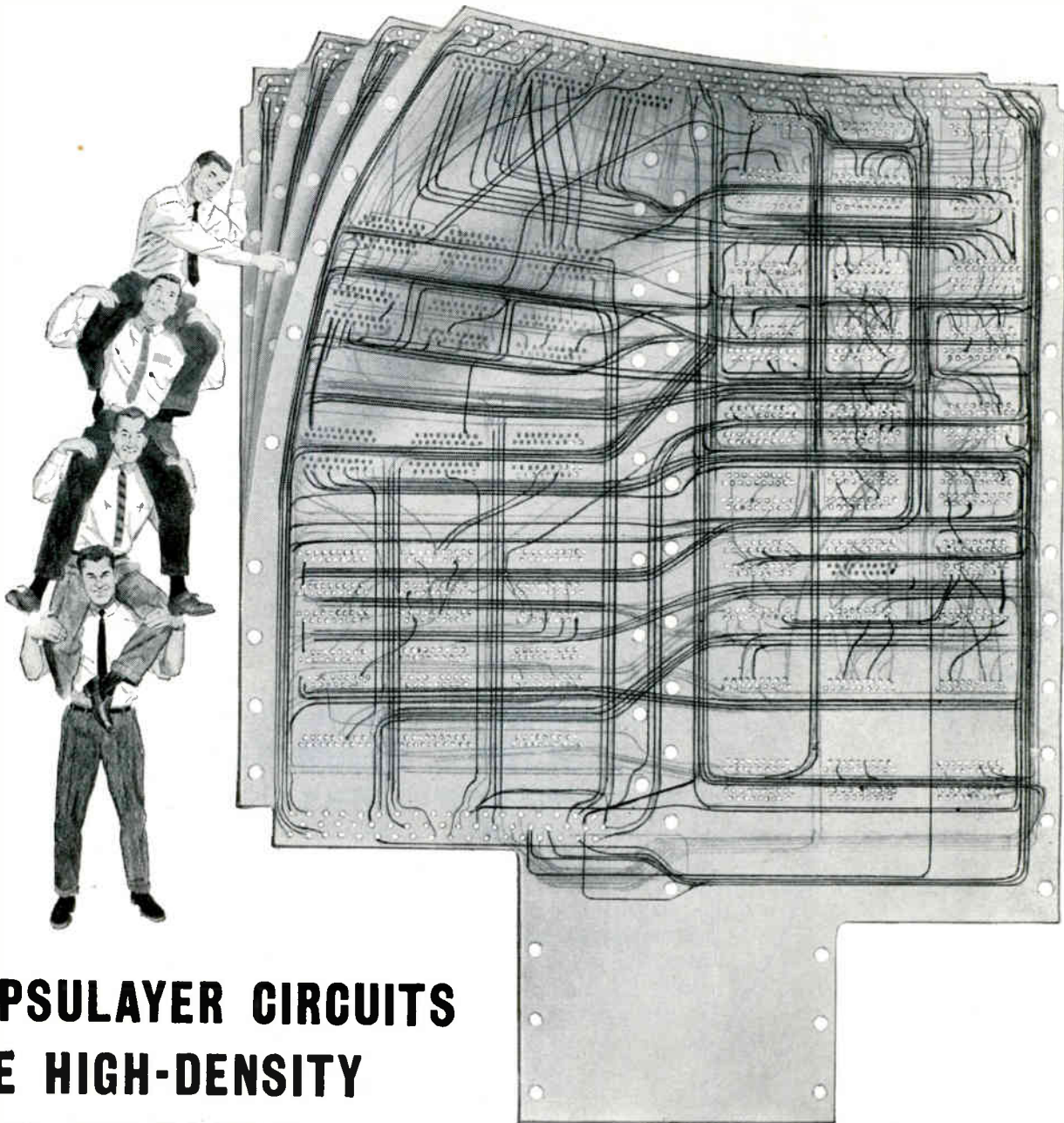

## ENCAPSULAYER CIRCUITS SOLVE HIGH-DENSITY DESIGN PROBLEMS

"Encapsulayer" is Photocircuits' multilayer printed circuit—an advanced new technique embodying great technical advantages. Thin printed circuit layers are stacked over each other—laminated together in registry to make one integral board. Plated-through holes provide interconnections between layers, interlinking all layers' circuitry with each other and board surface. Some advantages?

- Problems of conductor cross-over, spacing, and routing are sharply minimized—space required for component or module interconnection circuitry is reduced.
- Expanded printed circuit design freedom—much more than possible with conventional circuits. Encapsulayer circuits are dip-solderable and are able to meet severe environmental requirements.

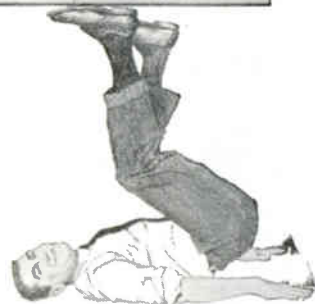

- Hole spacing on .050" centers is possible; shielding or ground layers can be put directly into board; and the number of layers is virtually unlimited.

Simplifying wiring of complex sub-assemblies at reasonable cost—Encapsulayer provides maximum reliability in the smallest space—another Photocircuits value engineering first.



# Photocircuits

C O R P O R A T I O N

Glen Cove, New York

Anaheim, California

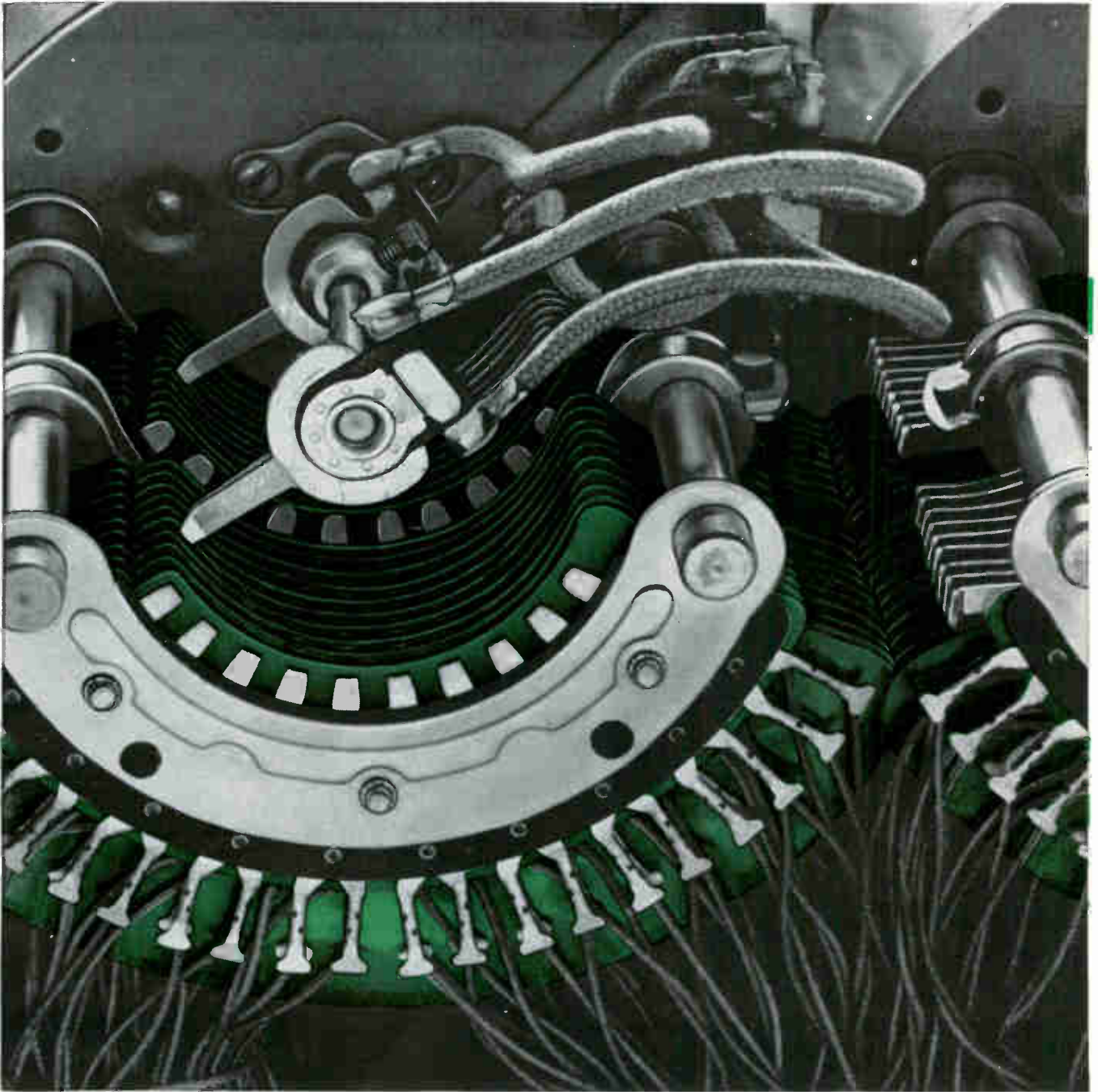

The insulation of "Mylar" is shown in green.

## HOW MYLAR® CUT STEP-SWITCH COSTS FOR WESTERN ELECTRIC

This step-by-step switch handles 300 trunk calls a day. A hundred thousand times a year the central contact wiper flashes between the tough spacers of Du Pont "Mylar" polyester film.

Western Electric Co. picked "Mylar" to replace stiff phenolic fiber. It reduced manufacturing costs, since separate insulators could be punched out automatically at high speeds from rolls of "Mylar". Phenolic fiber was available only in sheets, not adaptable to full automation. "Mylar" was tougher and more durable: resisted cracking when flexed or bent. It had a higher dielectric rating, allowing valuable space reductions.

"Mylar" today is the standard insulation in a wide variety of electrical/electronic applications. In motors, capacitors, switches and wiring, its superb dielectric,

chemical and thermal properties guarantee years of trouble-free performance. The high performance of "Mylar" in thinner gauges frequently gives substantial savings—since you use less "Mylar" than conventional materials.

Additional cost reductions can come from design modifications and manufacturing economies. Why not investigate its unique properties in your application? Save time and money now by writing to: Du Pont Company, Film Dept., Wilmington 98, Delaware.

only DU PONT makes

**MYLAR®**  
POLYESTER FILM



BETTER THINGS FOR BETTER LIVING  
... THROUGH CHEMISTRY



add this new  
**Visicorder Oscillograph**  
 to your  
 data system

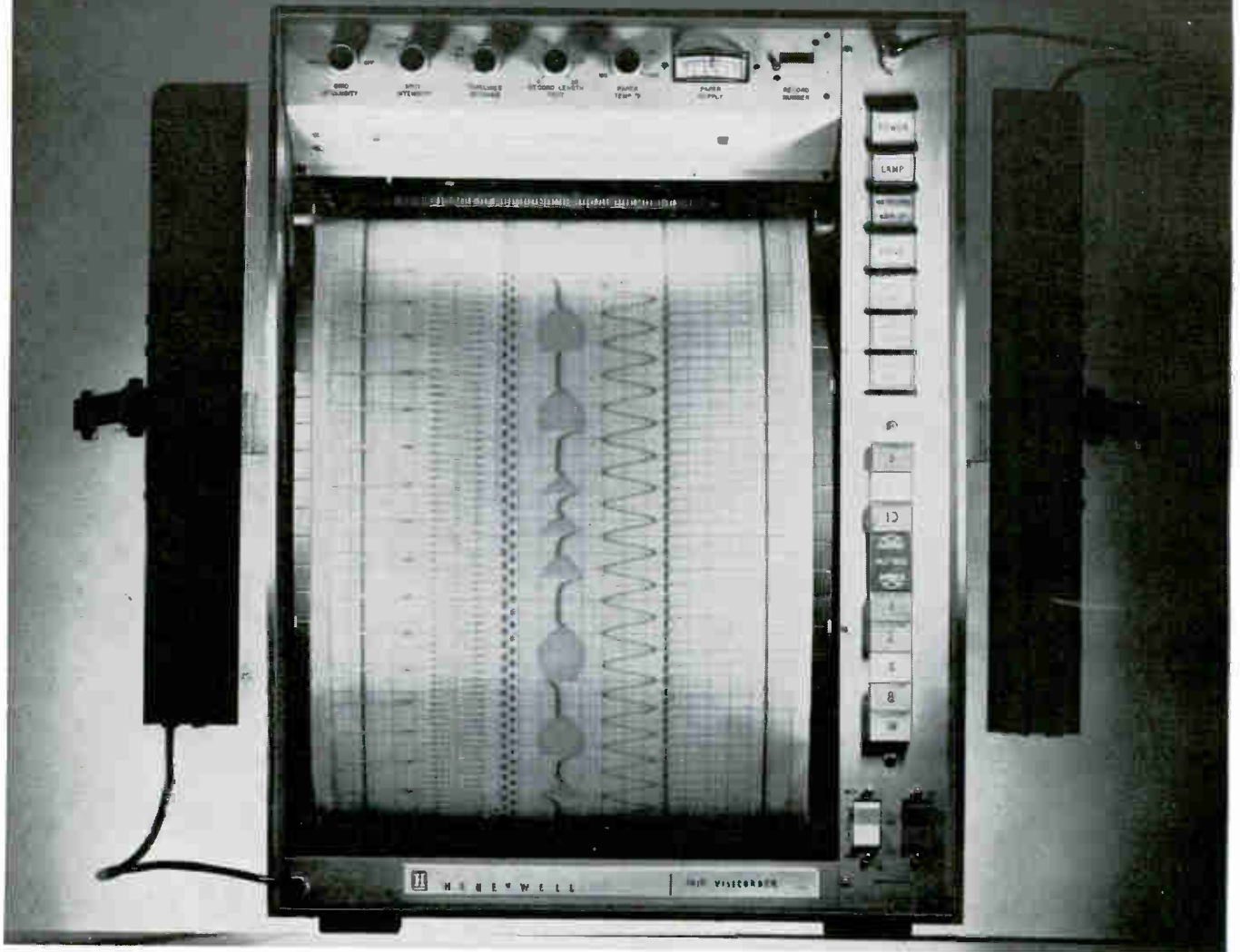

The Honeywell 1612 Visicorder Oscillograph is a completely new 36-channel instrument. It was designed from the base up for systems use. Features such as a built-in heated platen, modular electronics, and push-button controls make it the most versatile oscillograph ever built by Honeywell, pioneer in direct writing oscillography using light beam galvanometers.

The built-in heated platen, a factory-installed option, serves as a standard platen until heat is desired, at which time the operator

simply pushes a button. Platen heat improves the quality of the record and gives better contrast. In conjunction with the two latensifier lamps, it provides immediate read-out of records at speeds up to 16 inches per second.

Other examples of the 1612's functional design are:

15 forward recording speeds (from 0.1 to 160/ips) and 10 reverse speeds—all pushbutton controlled.

All controls on front surface.

Paper loading accomplished in seconds.

**HONEYWELL INTERNATIONAL SALES AND SERVICE OFFICES IN ALL PRINCIPAL CITIES OF THE WORLD.**

Instrument may be operated in the rack, pulled out on slides, or bench-mounted. Uses Type M miniature galvanometers, interchangeable among other Honeywell oscillographs.

*For full details on all Visicorder Oscillographs, tape systems, and signal conditioning equipment, write to Honeywell, Denver Division, Denver, 10, Colo., or phone 303-794-4311.*

**DATA HANDLING SYSTEMS**

**Honeywell**

*Complex? No!*

*BELDEN designs cables smaller...less complicated*

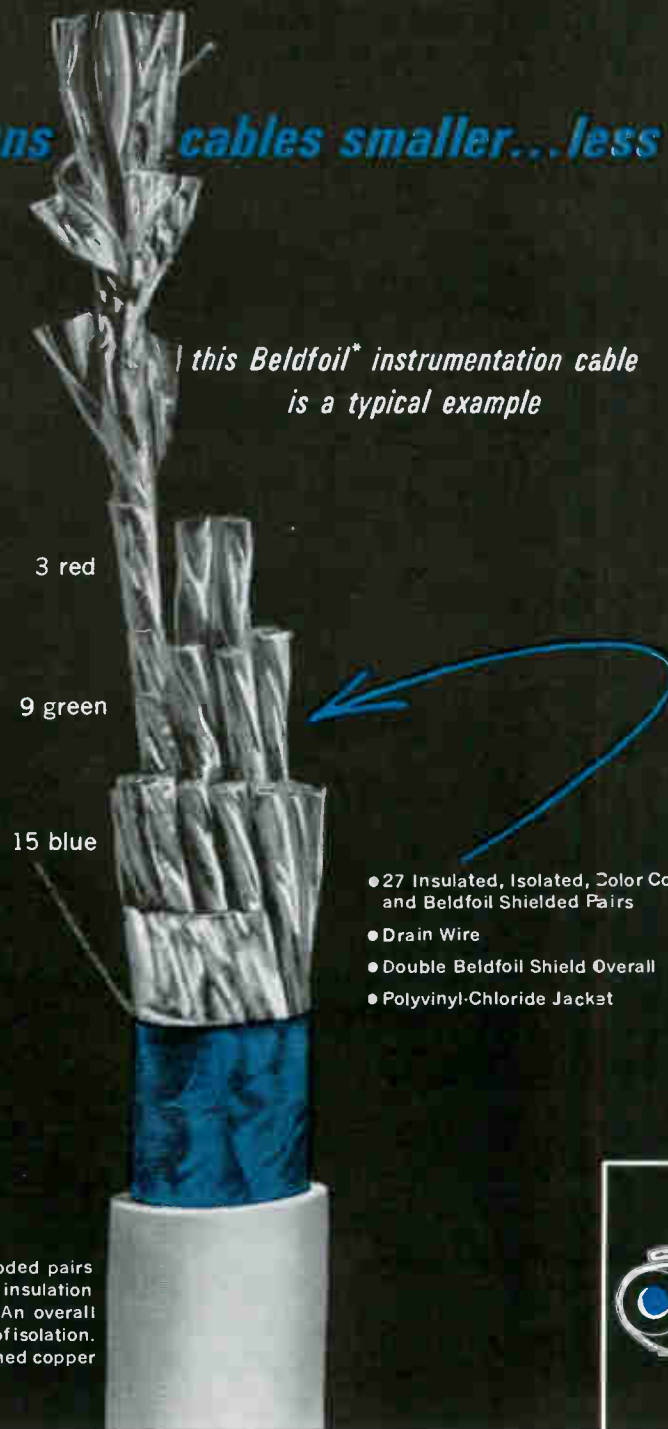

*this Beldfoil® instrumentation cable is a typical example*

3 red

9 green

15 blue

- 27 Insulated, Isolated, Color Coded, and Beldfoil Shielded Pairs
- Drain Wire
- Double Beldfoil Shield Overall
- Polyvinyl-Chloride Jacket

Individually insulated and color coded pairs are protected by a Mylar\*\* tape insulation under a wrapped Beldfoil shield. An overall Mylar tape adds the final measure of isolation. Each pair has its own stranded tinned copper drain wire for shield grounding.

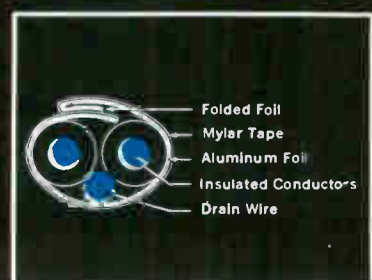

*Belden engineers have designed thousands of Beldfoil shielded cables similar to this one..special instrumentation, strain gauge, and control cables. They can and will design a smaller cable to reduce the size of your product..a less complicated cable that will do the same job better..or perhaps a single cable to do the job of two or more different cables. Many well-known manufacturers of specialized electronic products depend on Belden for special cable design. If a smaller, less complicated cable will improve your product..call on Belden.*

\*BELDFOIL shielding is a lamination of aluminum foil with Mylar which provides a high dielectric strength insulation that is lighter in weight, requires less space, and is usually lower in cost. For multiple-paired cables with each pair separately shielded, the Mylar is applied outside with an inward folded edge. This gives 100% isolation between shields and adjacent pairs.

Write Belden Manufacturing Company, 415 South Kilpatrick Avenue, Chicago 80, for data sheet on Beldfoil shielding.



®Belden Trademark Reg. U.S. Pat. Off. \*\*du Pont Trademark

8-6-2





## "ALLEN-BRADLEY RESISTORS ... ARE THE MOST RELIABLE WE HAVE BEEN ABLE TO PURCHASE"

A compliment such as this must be earned through years of reliable performance. Allen-Bradley fixed and variable resistors have delivered that kind of performance for nearly thirty years. In fact, it's almost "standard" for Allen-Bradley resistors to be used in test equipment of the highest quality and precision—equipment such as Ballantine Laboratories' sensitive wide band voltmeter.

And here are the reasons: Allen-Bradley fixed resistors—made by an *exclusive* hot molding process—have such uniform and stable characteristics that performance can be predicted over long periods of time, and they have never experienced catastrophic failure in service.

A-B variable resistors have an *exclusive* solid hot

molded resistance element that assures exceptionally long life and smooth control. There are never any abrupt changes in resistance during adjustment. And, while the "noise" factor is exceptionally low initially, it actually decreases with use.

Then there are A-B's ceramic feed-thru capacitors that provide unusually effective filtering at VHF and UHF frequencies. Their unique discoidal design eliminates all parallel resonance effects at frequencies up to 1000 mc.

You can obtain this same reliability and superior performance only when you specify Allen-Bradley quality electronic components. Please write for Publication 6024, today.

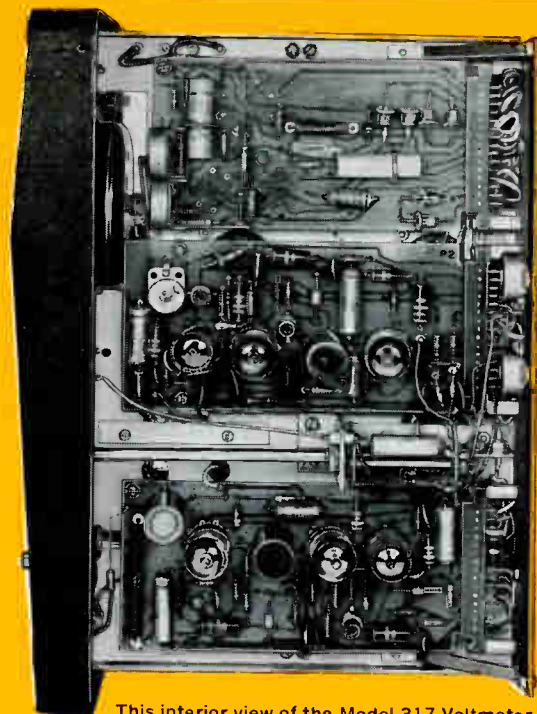

This interior view of the Model 317 Voltmeter shows the use of Allen-Bradley hot molded fixed resistors, Type J potentiometers, and discoidal feed-thru capacitors.



**BALLANTINE Model 317**  
Sensitive Wide Band Voltmeter features a voltage range from 300  $\mu$  v to 300 v over the frequency from 10 cps to 11 mc.

Here are the Allen-Bradley components that provide the accurate and precision measurements of voltage that characterize the Ballantine line.

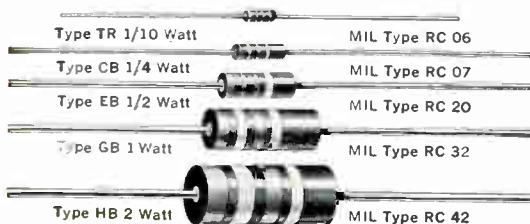

**HOT MOLDED FIXED RESISTORS** are available in all standard EIA and MIL-R-11 resistance values and tolerances.



**TYPE J POTENTIOMETERS** Rated 2.25 watts at 70°C. Available in standard tapers and in standard resistance values to 5 megohms, as well as special tapers and resistance values. Resistances up to 1000 megs available on special order.



**FEED-THRU CAPACITORS** Available in standard values of 470 mmf  $\pm$ 20% and 1000 mmf G.M.V. Special values from 6.8 to 1000 mmf. Rated to 500 v DC max.

ALLEN-BRADLEY CO., 110 W. GREENFIELD AVE., MILWAUKEE 4, WIS.

IN CANADA: ALLEN-BRADLEY CANADA LTD., GALT, ONT.

# ALLEN-BRADLEY

QUALITY  
ELECTRONIC  
COMPONENTS

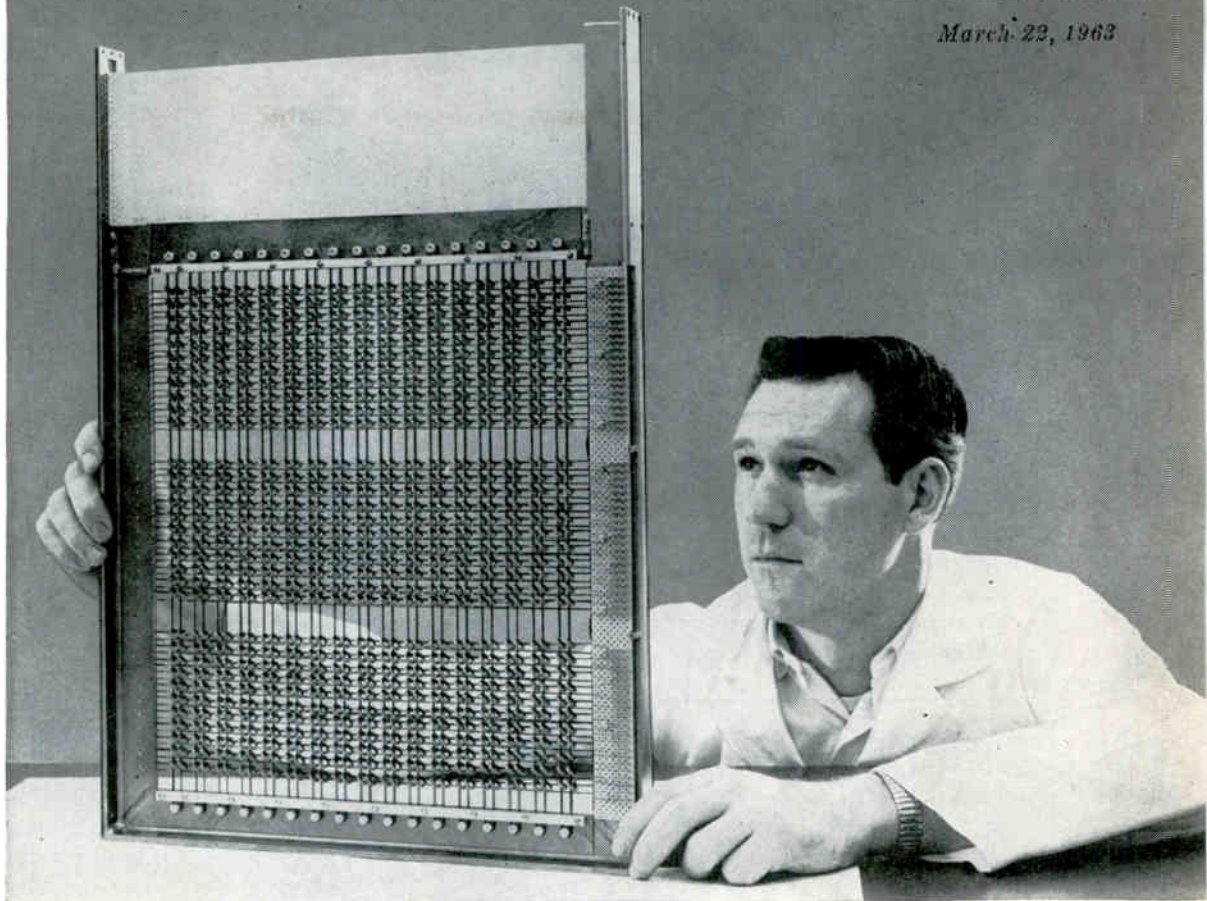

ANALOG MEMORY plane with 561 second-harmonic magnetic weights

# COMPONENTS THAT LEARN AND HOW TO USE THEM

By HAROLD S. CRAFTS, Research Engineer, Stanford Research Institute, Menlo Park, California

*Five components suitable for use in adaptive systems are detailed along with their application to complete adaptive systems*

ADAPTIVE SYSTEMS can be trained to perform specific tasks by being shown sample problems and solutions. In addition, such systems can generalize on limited training experiences in solving related, but previously unseen, problems. The ability of adaptive systems to tolerate either malfunctioning components or input noise makes them suited to solve problems such as pattern recognition.

These properties have stimulated the search for suitable adaptive

components. Many phenomena offer the potential of variable gain with memory. At present, however, the required long-term gain stability limits consideration to phenomena involving atomic translation or rotation. Purely electronic phenomena, with the possible exception of cryogenic devices, are excluded.

Five components providing variable gain with memory are discussed in this article, together with applications of these components. The memory mechanism used in the



## SYSTEMS THAT LEARN BY DOING

Adaptive or learning systems modify their own structure to get a certain performance based upon past experience. If the output of the system agrees with the desired output, the values of the variable gains are not changed. If the output does not agree, the variable gains are altered so that it does. In adaptive terminology, these gains are called weights, and they may have positive or negative values. The weight setting determines how much effect that input will have upon the output.

One application of an adaptive system is in high-speed aircraft control systems where the control response time varies over a wide range depending upon altitude. Outside the field of adaptive systems, variable gain components may find use in the analog storage of information. But adaptive systems remain the principal use for these components, since no other component can perform this function at a price that can be afforded. Presently, weights cost about a dollar as compared to 10 dollars a year ago. At the rate that adaptive systems are being pushed, prices of weights will have to be reduced at least another order of magnitude

first of these devices is the translation of atoms in an electrolytic plating system; the remaining four devices exploit magnetic phenomena.

**MEMISTOR** — The nonmagnetic component considered here is called the memistor (for resistor with memory).<sup>1</sup> It consists of a resistive substrate immersed in an electrolyte. A d-c adapt signal removes copper from an anode and deposits it by electroplating upon the substrate, thus lowering the resistance of the substrate. Reversal of the adapt current removes the copper from the substrate and returns it to the anode, raising the resistance of the substrate to its original value. The basic structure is shown in Fig. 1A. Resistance of the substrate is sensed with a small alternating current, the voltage drop being proportional to the resistance. The sensing current must be small enough so that the a-c output voltage does not interfere with the plating reaction. This limits the output to about 100 millivolts, but low impedance levels contribute to a good signal-to-noise ratio. Components whose resistance is continuously adjustable over 100:1 range with a drift in gain stability of less than 1 percent per day have been made. An adapt current of 10.2 milliamperes will change the resistance of the substrate through its dynamic range in about ten seconds.

There are two basic types of magnetic variable gain components. In both types, the gain is in proportion to the net remanent flux in the cores. The difference arises in the method of sensing this flux.

**MULTIAPERTURE - DEVICE** — The diagram of a multiaperture device (MAD) variable gain adaptive component is shown in Fig. 1B.<sup>2</sup> In this device, flux can be switched around the small apertures without disturbing the flux around the main aperture. Thus, the output may be sensed by al-

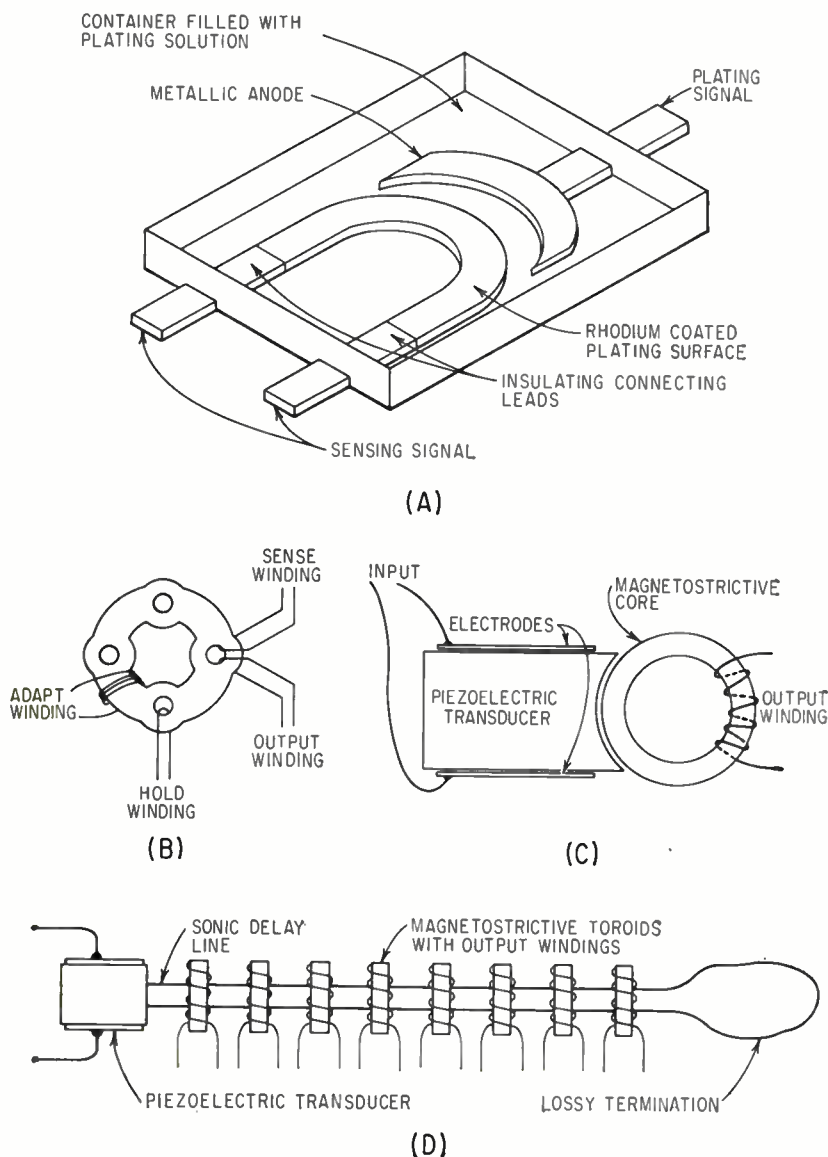

VARIABLE GAIN components include a nonmagnetic component, the memistor (A), a multiple aperture device (MAD) variable gain component (B), a magnetostrictive device (C), and a magnetostrictive device using a sonic delay line (D)—Fig. 1

ternately switching the flux around one of the small apertures. However, the amount of flux being switched by the sense current is dependent upon the amount of flux that has been switched around the main aperture. By pulsing the adapt winding, flux is switched in small increments around the main aperture. This changes the amount of flux that can be switched around the small aperture by the sense current, and hence changes the output voltage.

The sense winding on the multi-aperture device switches flux irreversibly, producing high output levels but requires high drive power. A core is said to be switched reversibly if the remanent state is not affected by the switching current. If the current level is raised until the remanent state is disturbed, the switching becomes irreversible. Although the switching is irreversible, the sensing is nondestructive, since the amount of flux switched is controlled by the main aperture magnetic condition. In other magnetic variable-gain components, the sensing current switches flux reversibly, reducing the required drive power and the output level.

**MAGNETOSTRICTION** — The direction of the net remanent flux in a magnetostrictive core can be sensed if the core is excited mechanically. If the scheme shown in Fig. 1C, a magnetostrictive core is driven from an electromechanical transducer. The vibrations in the core produce an alternating change in the remanent flux that induces a voltage in the output winding; the phase of the output voltage depends upon the relative direction of the remanent flux in the core. The level of the remanent flux can be changed in either direction by pulsing the output winding. The drive level is adjusted so that the core is not demagnetized by the mechanical vibrations. The gain memory is excellent, but these devices have a large drive power requirement.

A better engineering solution has been obtained by coupling an ultrasonic delay line to the transducer. Magnetostrictive toroids are then placed on the line at in-

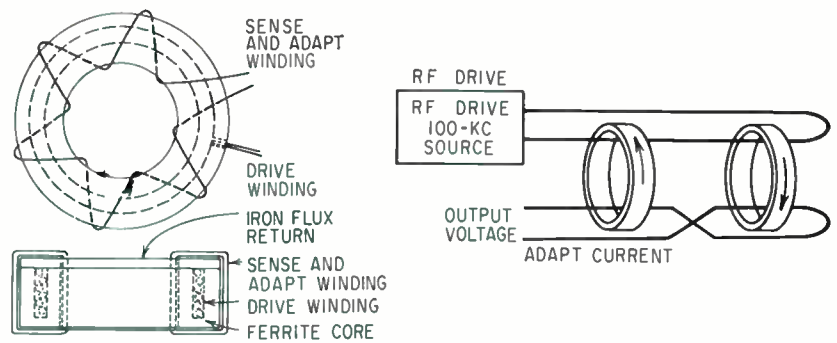

(A)

(B)

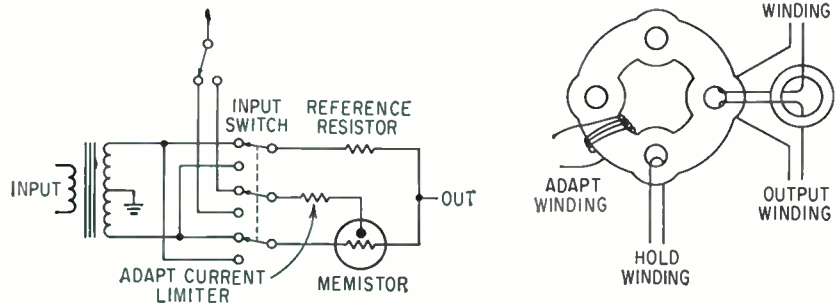

(C)

**TWO FORMS of magnetic integrators.** In (A), the flux level is altered by pulsing the output winding. In the second harmonic generator (B), the flux level is altered by passing d-c through the output winding. Bridge arrangements (C) for operation of the memistor or MAD—Fig. 2

tervals of one-half wavelength. The delay line mechanically excite several toroids which in turn produce an output voltage on the order of 100 mv. Figure 1D<sup>a</sup> shows the arrangement of the toroids.

Nondestructive readout may also be obtained by driving a magnetic core electrically. By reducing the drive to a sufficiently low value, the remanent state of a core made of square-loop material may be sensed in either of two modes. Since magnetic cores are, in general, nonlinear, the output voltage can contain harmonics of the drive current. In particular, the even harmonic voltages produced by the nonlinearities in the core are found to be proportional to the net remanent flux, so the remanent flux level can be detected by sensing the second-harmonic voltage. If the drive current is a pulse, rather than a simple sinusoid, the output voltage will likewise be a pulse of either polarity depending on the remanent state of the cores, independent of the polarity of the drive current

pulse. Hence these devices may be operated with either a sinusoid or a pulse drive, and sensed accordingly.

**MAGNETIC INTEGRATOR**—The structure of a magnetic integrator, Fig. 2A, shows that the drive and sense windings are mutually orthogonal.<sup>4</sup> This reduces the direct coupling between these windings. Coupling must be kept small if the input pulse is not to appear directly in the output. The flux level in the core is altered by pulsing the output winding; the flux level is then sensed with pulses applied to the drive winding. The output pulses will be either positive or negative depending upon the direction of the remanent flux, with an amplitude proportional to this flux.

**SECOND-HARMONICS**—Another form of the magnetic integrator, Fig. 2B, is a second-harmonic generator consisting of a pair of tape-wound cores driven from an r-f sinusoidal power source.<sup>5</sup> The out-



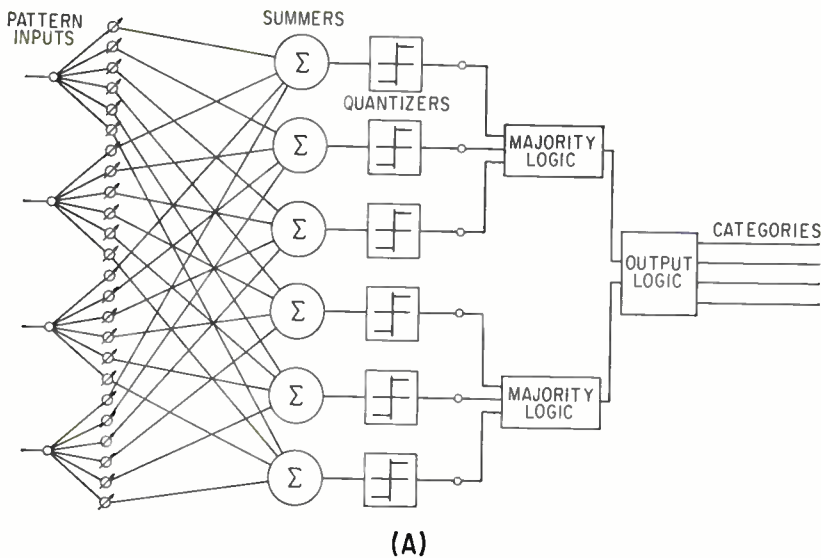

(A)

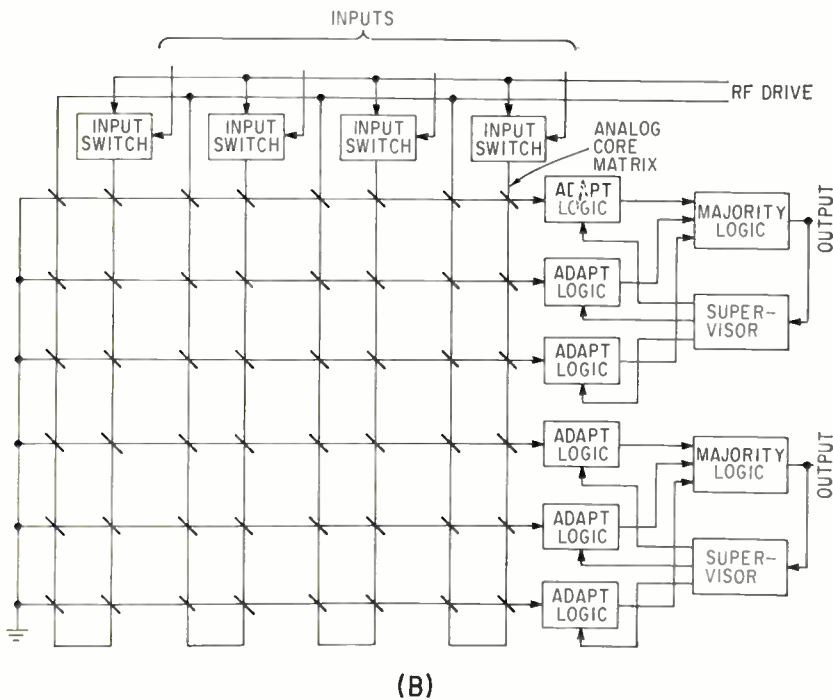

(B)

ADAPTIVE SYSTEM that classifies 4-bit patterns into four categories (A), and the manner in which the cores can be arranged in a matrix (B)  
—Fig. 3

ated in a bridge arrangement (Fig. 2C) to obtain negative weight values. The other components produce either positive or negative weight values without extra circuits.

**MATRIX WIRING**—A simple matrix scheme has been developed for wiring the cores used in second-harmonic magnetic variable gain components. In this scheme, the magnetomotive force required to adapt the second-harmonic components is much less than the coercive force of the cores. Because of this reduced threshold, the applied adapt current affects only those cores being driven by the r-f signal. Only those weights with an input of one can be adapted. This condition exactly fits the requirements of the system that has inputs of one and zero. With some additional logic, the system that has inputs plus one and minus one can also be accommodated.

The cores required for a simple adaptive system that can classify 4-bit patterns into four categories, Fig. 3A, are arranged in the matrix shown in Fig. 3B. The pattern is applied to the four inputs at the top of the figure. The inputs from the pattern operate the drive switches. Since two cores are required for each weight, the drive line is threaded down one column of cores and back up the next. The adapt lines are threaded through each row of cores. The summed output signal is taken from each of the adapt lines. Each pair of columns corresponds to an input to the system; each row corresponds to the output of an adaptive element.

Each input switch turns on a corresponding weight in each of the adaptive elements of the system. If the output of the element is wrong, an adapt signal, whose sign is determined by the sign of the summed output, is applied to the adapt line. This signal changes the gain of those variable gain components that have inputs of one, but does not alter the gain of the components that have an input of zero. The system is adapted by presenting input patterns in sequence and adapting the element when the output is incorrect. This

put winding is arranged so that the induced fundamental component of the drive voltage cancels out, leaving a second-harmonic distortion voltage proportional to the remanent flux in the cores (indicated by the arrows). The remanent flux level can be altered by passing a direct current through the output winding. Due to an interaction between the d-c adapt current and the r-f drive current, the rate of change of the remanent flux with respect to the adapt current is con-

stant and reversible. Tape-wound cores are preferable to ferrite cores in this application by virtue of considerably superior performance and, because of a higher permeability, require fewer turns.

The variable gain components have all reached a stage of development where they can be used in the implementation of adaptive logic circuits. Any of the variable gain components may be used for weights. The memistor and the MAD component are usually oper-

procedure is repeated until all patterns are classified correctly.

The requirement for any matrix scheme is a coincidence logic circuit that will allow the adaption of only those weights with binary one input. Magnetostrictive gain components using MAD cores or magnetostrictive toroids are adapted with short rise-time pulses of constant volt-time product. These adapt pulses are generated with a gate core, which can be incorporated into the coincidence logic scheme required for the matrix. Here, the gate cores are arranged in the matrix, and coupled to the weight cores as shown in Fig. 4. Signals on the x-drive lines corresponding to the inputs to the system and signals on the y-drive lines corresponding to incorrect outputs from the system cause the gate cores threaded by both these lines to adapt the associated variable gain components.

**LOGIC**—Returning to Fig. 3B, the logic required to perform adaptations according to the rule of systems with inputs of binary one and zero is shown in Fig. 5. Here the output signal from the adapt line in the analog core matrix is demodulated, quantized, and compared with the desired output signal, which is sent into the system along with the pattern. If the quantized output differs from the desired output, an adaptation can take place where the adapt current will have the same sign as the quantized output signal.

If more than one adaptive element is to be incorporated into a system, which is the case if the

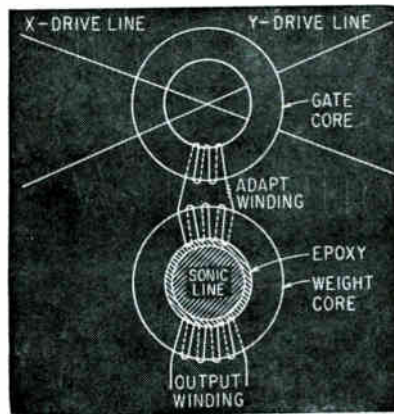

COUPLING of a magnetostrictive component to its gate core—Fig. 4

matrix scheme is to be useful, some sort of supervisor is required to control the overall operation of the system. In Fig. 3B, majority logic could be used between the output of the six adaptive elements and the two output lines of the system. The output lines would then contain a binary one if at least two of the three adaptive elements feeding that line have an output of one. If this is not the case, the supervisor would cause the adaptive element that is least wrong to adapt until its output agrees with the desired output. The supervisor compares the analog outputs of each of the adaptive elements to determine which is the least wrong.

Of the various types of variable gain components, the second-harmonic magnetic variable gain component is the least expensive for systems with on the order of  $10^4$  weights. The extra cost of the tape-wound cores is compensated by the lower fabrication costs. This

type of weight is still undergoing development, and may result in a further decrease in cost.

This simple class of adaptive systems, with a single layer of adaptive weights coupled with a subsequent layer of fixed threshold logic units, may be extended to include a layer of fixed threshold logic ahead of the adaptive layer. However, this is the present state of the art. New adaptive system theory is needed to allow formulation of rules by which a multilayer adaptive system is to be trained, and guarantee convergence of the sequence when two or more cascaded layers are being trained.

The Memistor was developed at Stanford University by M. E. Hoff and B. Widrow. A. E. Brain developed the MAD at Stanford Research Institute and the magnetostrictive components were developed at SRI by C. A. Rosen and G. E. Forsen.

#### REFERENCES

- (1) B. Widrow, "An Adaptive 'ADALINE' Neuron Using Chemical 'Memistors'," TR No. 1553-2, Stanford Electronics Laboratories, Stanford, California, October 17, 1960.
- (2) A. E. Brain, "The Simulation of Neural Elements by Electrical Networks Based on Multiaperture Magnetic Cores," *Proc IRE*, pp. 49-52, January 1961.
- (3) A. E. Brain and G. E. Forsen, "Graphical Data Processing Research and Experimental Investigation," Quarterly Progress Report 7, Project 3192, Stanford Research Institute, Menlo Park, California, March 1962. Prepared for the U. S. Army Signal Research and Development Laboratory, Fort Monmouth, New Jersey.
- (4) J. K. Hawkins and C. J. Munsey, "A Magnetic Integrator for the Perceptron Program," Annual Summary Report, Publication No. U-603, Aeronutronic, Newport Beach, California, July 30, 1960.
- (5) H. S. Crafts, "A Magnetic Variable-Gain Component for Adaptive Networks," SEL-62-147, Technical Report 1851-2, Stanford Electronics Laboratories, December 1962.

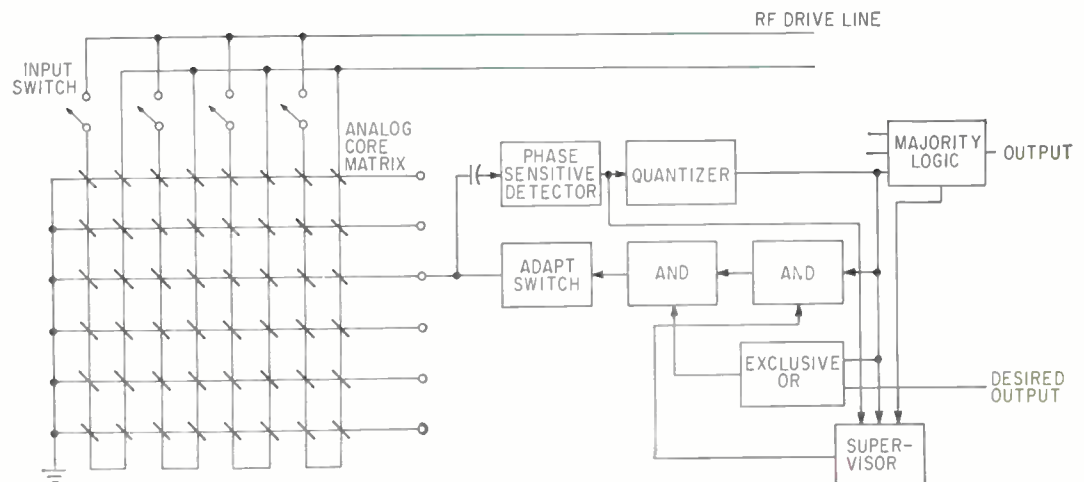

ADAPT LOGIC required to perform adaptations with inputs of one and zero—Fig. 5



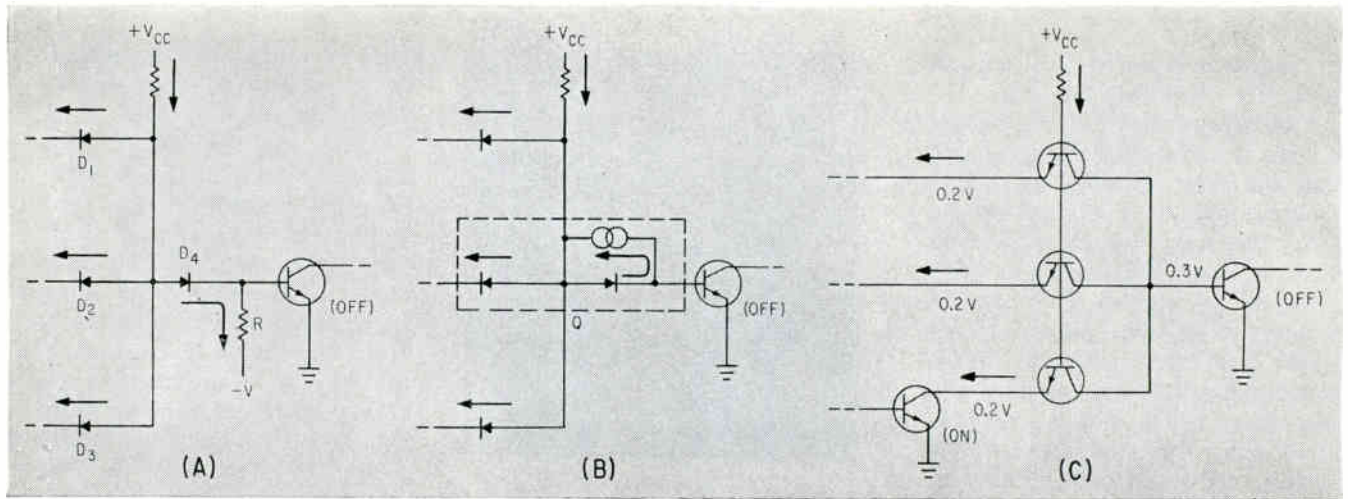

LOW LEVEL diode-transistor-logic (DTL) NAND gate (A) and a possible ideal solution (B). Development of TTL is shown (C)—Fig. 1

# FIRST DESIGN DETAILS Transistor-

*Analysis of transistor-transistor logic circuits and their advantages over other types of logic*

By H. W. RUEGG, Fairchild Semiconductor, Mountain View, California

**TRANSISTOR-TRANSISTOR** logic (TTL) offers a saturated-transistor logic that is simple, compact, and has a high degree of design flexibility. High speed operation of very low power circuits is an additional feature.

Simplicity and compactness is achieved by employing a single supply voltage and a minimum of components. Design flexibility is increased because operating power level can be changed over a wide range by varying the node current while simultaneously retaining high fan-in and fan-out over this range.

**EVOLUTION OF TTL**—A well-known form of low level diode-transistor logic is shown in Fig. 1A. The gate gives the positive NOT AND or NAND function. If at least one input line connects to the collector of a transistor which is on, node current flows to the left and leaves the right transistor off. The current sink,  $-V/R$ , assures that current always flows through diode  $D_4$ , causing a drop that compensates for forward drops across diodes  $D_1$ ,  $D_2$  and  $D_3$ . This configuration has disadvantages of requiring a second supply voltage with an additional resistor each stage, and of reducing available drive current by draining away part of the node current.

An ideal solution would replace the current sink with a current generator, Fig. 1B. This not only removes the disadvantages, but also provides compensation for the diode voltage drops over a wide



LOGIC CIRCUIT being tested in its completed form

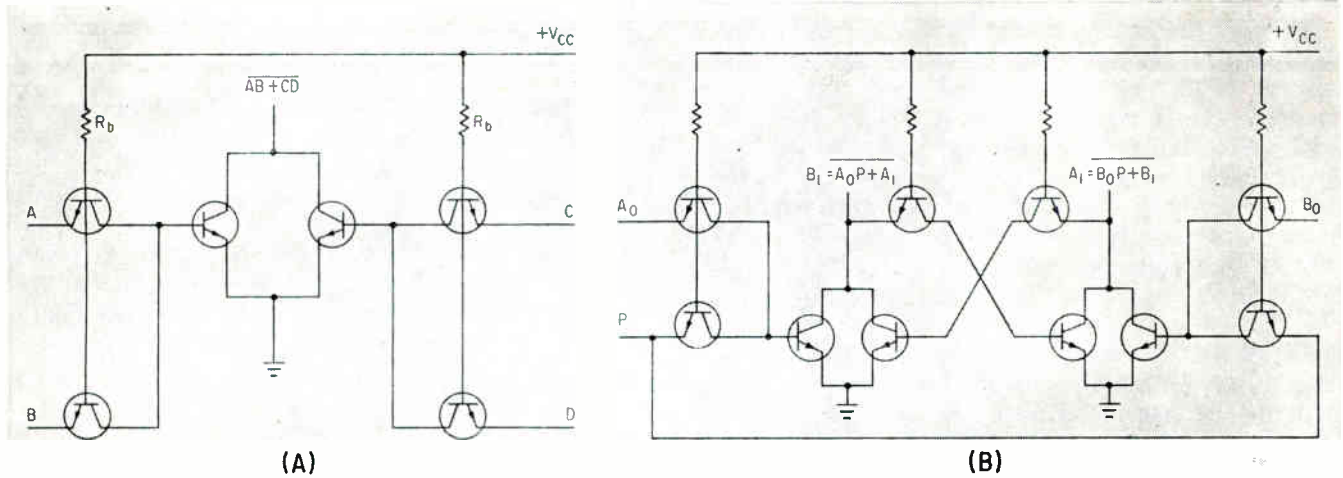

COMBINED TTL and DCTL (direct-coupled transistor logic) parallel gates leads to NOT-AND-OR circuit (A). TTL gated flip-flop (B) is designed for minimum logic delay—Fig. 2

# Transistor Logic Circuits

current range as available current is rerouted through the level shifter diode.

The diode pair and generator combination (broken lines) is equivalent to a transistor. Thus the ideal case can be approximated with a gating transistor substituted for the combination. The resulting configuration, Fig. 1C, is called transistor-transistor logic (TTL or T<sup>2</sup>L).<sup>1</sup>

Logic operation is identical to the original DTL-NAND gate, Fig. 1A. If one or more input lines are connected to the collector of an ON transistor, node current will flow to the left. The base voltage of the inverter transistor to the right equals the collector saturation voltage of the preceding inverter, augmented by the offset voltage of the intermediate gating transistor. Values indicated in Fig. 1C are typical for silicon devices. The transistor to the right is kept off as required by the logic. But if all input lines are connected to off transistors, node current will flow into the base of the following inverter transistor.

TTL can be combined with DCTL type parallel gates. Combination NOT-AND-OR circuits, Fig. 2A, can be obtained. The TTL gated flip-flop, Fig. 2B, is an example of a design having minimum logic delay.

**PROPAGATION DELAY**—TTL is a low-level saturating logic similar to DCTL. It might be expected that the addition of gating transistors would reduce speed to considerably less than that of pure DCTL. Experiments show, however, that the propagation delay attributable to the gating transistors is less

## WHAT IS T<sup>2</sup>L?

Transistor-transistor logic uses transistor gates with the inverter transistor. The technique is new and it has the advantage of using only transistors and resistors. This makes it adaptable to integrated circuit manufacture

than 1 nanosecond and that this delay is nearly independent of their switching performance.

The reason is that a gating transistor is highly saturated in both states of operation. Voltages across the base-emitter and base-collector junctions change by about 50 mv during switching, so negligible delay arises from charging the junction capacitances. Experiments show no measurable difference in propagation delay between a circuit using gating transistors of small area and junction capacitances of 1-3 pf, and one using gating transistors with 10 times larger junction capacitances.

Minority carrier concentrations also remain nearly unchanged during switching. They are high in the base and collector regions and low in the emitter region for double-diffused structures. Thus large minority carrier lifetimes in the gating transistors will not materially affect switching time. In fact no reduction of propagation delay is observed when the lifetime of minority carriers in the gating transistors is decreased. Consequently the propagation delay of a TTL stage is primarily contributed by the



switching speed of the inverter transistors.

In Fig. 3, experimental values for propagation delay of TTL and of the corresponding direct-coupled scheme (TTL less gating transistors) are plotted against current level. Propagation delay decreases with increasing fan-out values at current levels below the minimum delay point, because of higher collector current. Propagation delay stays approximately constant from -55 to 25 C and increases slightly with temperatures above 25 C. In Fig. 3,  $N_{in} = 1$ ,  $N_{out} = 1$ ,  $V_{cc} = 3$ ,  $T = 25$  C.

**FAN-IN AND FAN-OUT**—If TTL circuits are to be used as digital building blocks, the values of fan-in and fan-out insuring correct operation under worst case conditions must be known. In TTL each inverter transistor is associated with a gating block (Fig. 1C). Hence it has a potential base current equal to the node current  $I_n'$ , where

$$I_n' = (V_{CC} - V_{BE(on)} - V_{BC(sat)})/R_b \quad (1)$$

Symbols are illustrated in Fig. 4A.

Collector current ideally is limited to node current  $I_n''$  multiplied by the fan-out, where

$$I_n'' = (V_{CC} - V_{CE(sat)} - V_{BE(sat)})/R_b \quad (2)$$

Under worst case conditions, however, base current available to an inverter transistor which should be on will be less than  $I_n'$ . A worst case circuit configuration is shown in Fig. 4B, where part of the node current of one inverter transistor is drained away through the emitters of the gating transistors. This is due to differences in the base on-voltages of the inverter transistors of the same fan-out family. Such unbalances can be caused by a difference in transistor parameters and/or by a large difference in collector currents. The additional current  $I^*$  flowing into the inverter transistors with a low value of base on voltage, is limited to

$$I^* \leq \bar{\beta}_i I_n' \quad (3)$$

as  $I^*$  must flow through the associated gating transistor in the inverse direction.  $\bar{\beta}_i$  is the maximum direct-current gain of the gating transistors for inverted operation.

Also under worst case conditions the inverter transistors preceding the critical one will have the maximum allowed base voltage for the off-stage,  $V_{BE(off)max}$ , which is the voltage at which the transistor conducts maximum allowed off-current  $\bar{I}_o$ . This leads to an additional drive current loss through each gating transistor with an upper limit of  $M\bar{I}_o$ , if  $M$  is the maximum number of inverter transistors with joined collectors (DCTL-type parallel gates). Thus from Fig. 4B the worst case (minimum) base current  $I_b$  of the critical transistor is

$$\begin{aligned} I_b &= I_n' - \bar{N}_{in}(\bar{N}_{out} - 1)I^* - M\bar{N}_{in}\bar{I}_o \\ &= I_n'[1 - \bar{N}_{in}(\bar{N}_{out} - 1)\bar{\beta}_i] - M\bar{N}_{in}\bar{I}_o \end{aligned} \quad (4)$$

The circuit configuration of Fig. 4C illustrates the second type of loss mechanism in TTL. The difference between the base on-voltage of  $Q_2$  and the collector saturation voltage of  $Q_1$  causes current  $I^{**}$  to flow through two gating transistors. The drive current of the critical inverter  $Q_2$  is therefore reduced

by the same multitude of the basic loss current as in Fig. 4B. Calculation shows  $I^{**}$  to be limited to

$$I^{**} = I^*/2 \approx (\bar{\beta}_i I_n'')/2 \quad (5)$$

Measurements on double-diffused transistors support the validity of this at low current levels and yield lower values for  $I^{**}$  at high current levels.

From the standpoint of base current reduction, the circuit configuration illustrated in Fig. 4B therefore represents the worst case. But as  $I^{**}$  is added to the basic collector current of an inverter transistor, the circuit configuration shown in Fig. 4C leads to a worst case (maximum) collector current of

$$\begin{aligned} \bar{I}_C &= \bar{N}_{out}(I_n'' + I^{**}) \\ &= \bar{N}_{out}I_n''(1 + \bar{\beta}_i/2) \end{aligned} \quad (6)$$

To insure saturation of an inverter transistor, which by the logic is required to be on, the worst case ratio of collector current to base current must be  $\beta_c < \beta_N$ , where  $\beta_N$  is the minimum normal current gain of the inverter transistors at the current level of interest. Thus,

$$\bar{I}_C/\bar{I}_b = \beta_c < \beta_N \quad (7)$$

The degree of saturation  $\beta_N/\beta_c$  to be specified depends upon the desired noise margin. From Eq. 4 and 6 an expression relating fan-in and fan-out  $\beta_c$  and minimum inverse current gain of the inverter transistors can be obtained by

$$\beta_c = \bar{N}_{out}I_n''(1 + \bar{\beta}_i/2) / \{I_n'[1 - \bar{N}_{in}(\bar{N}_{out} - 1)\bar{\beta}_i] - M\bar{N}_{in}\bar{I}_o\} \quad (8)$$

$$\text{or } \bar{N}_{out} = \beta_c \{ (I_n'/I_n'')(1 + \bar{N}_{in}\bar{\beta}_i) - M\bar{N}_{in}(\bar{I}_o/I_n'') \} / [ (1 + \bar{\beta}_i/2) + (I_n'/I_n'')\beta_c\bar{\beta}_i\bar{N}_{in} ] \quad (9)$$

Loci of constant fan-in and fan-out in a  $\beta_c$ - $\beta_i$  plane can be plotted, using Eq. 8 and 9, and are valid for a fixed temperature. As both the normal current gain (and thus the allowed  $\beta_c < \beta_N$ ) and the inverse cur-

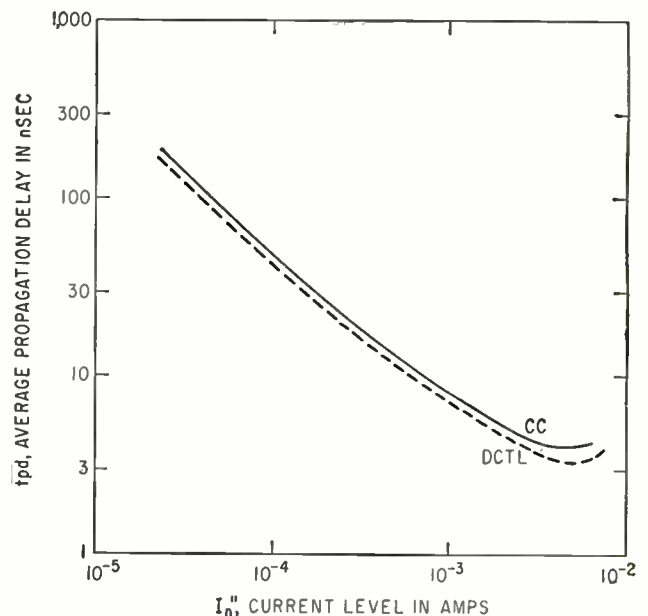

PROPAGATION DELAY of TTL-NAND with current level. Type 2N709 transistors were used as inverters and for gating—Fig. 3

rent gain will change with temperature, however, the maximum allowed fan-in and fan-out values also vary over the temperature range.

Fan-in and fan-out values over a whole temperature range are important. As both current gains increase with temperature, fan-out calculated from Eq. 9 is assured over the whole temperature range, if  $\beta_N$  is measured at the low end and  $\beta_I$  at the high end of this range. This procedure is unnecessarily restrictive, however, because for a double-diffused silicon transistor (such as 2N709) the normal current gain increases two or three times faster with temperature than does the inverse current gain. Thus it is usually sufficient to insure a certain fan-in and fan-out at the low end of the temperature range.

**NOISE MARGIN**—Like DCTL, TTL is a low impedance, low level scheme, and is susceptible to ground plane noise. This can be minimized (and must be minimized for TTL) by using low resistance, low inductance ground conductors.<sup>2</sup> Referring back to Fig. 4A, the voltage at the base of an inverter transistor which is required to be off is

$$V_{BE(off)3} = V_{CE(sat)1} \left| \frac{I_c}{I_b} + V_{offset} \right. \quad (10)$$

Offset voltage of the gating transistor  $Q_2$  is<sup>3</sup>

$$V_{offset} = V_{CE} \Big|_{I_c=0} = (kT/q) \ln [(1 + \beta_I)/\beta_I] \quad (11)$$

This agrees with values measured for planar double diffused devices.

If the noise margin  $\Delta V_n$  is defined as the difference between voltage  $V_{BE(off)3}$  and the maximum allowed base voltage of an inverter transistor which should be off,  $V_{BE(off)max}$ , the worst case expression is

$$\Delta V_n = \frac{V_{BE(off)max} - V_{CE(sat)}}{\beta_c - (kT/q) \ln [(1 + \beta_I)/\beta_I]} \quad (12)$$

This indicates that, to achieve a high noise margin, the degree of saturation of the inverter transistors should be high ( $\beta_c \ll \beta_N$ ), and gating transistors with a high inverse current gain should be chosen. Unfortunately, large fan-in and fan-out values require exactly the opposite. There is a tradeoff between fan-in, fan-out and noise margin.

The terms of Eq. 12 can be plotted against temperature. Because of two opposing tendencies (increasing  $\beta_I$  with increasing temperature and increasing  $kT/q$ ), offset voltage varies only slightly over the temperature range. Temperature variation of the noise margin therefore is given mainly by variations of  $V_{BE(off)max}$  and  $V_{CE(sat)}$  of the inverter transistors.

The author acknowledges contributions of R. Shultz and D. Farina.

#### REFERENCES

- (1) H. W. Ruegg and R. H. Beeson, "New Forms of All Transistor Logic", Solid State Circuits Conference, Philadelphia, February, 1962.
- (2) R. L. Foglesong, "The Design of High Speed All Transistor Logic Circuits", Fairchild Semiconductor Application Note APP-49, December, 1962.
- (3) J. J. Ebers and J. L. Moll, "Large-Signal Behavior of Junction Transistors", Proceedings of the IRE, Vol. 42, pp 1761-1772, December, 1954.

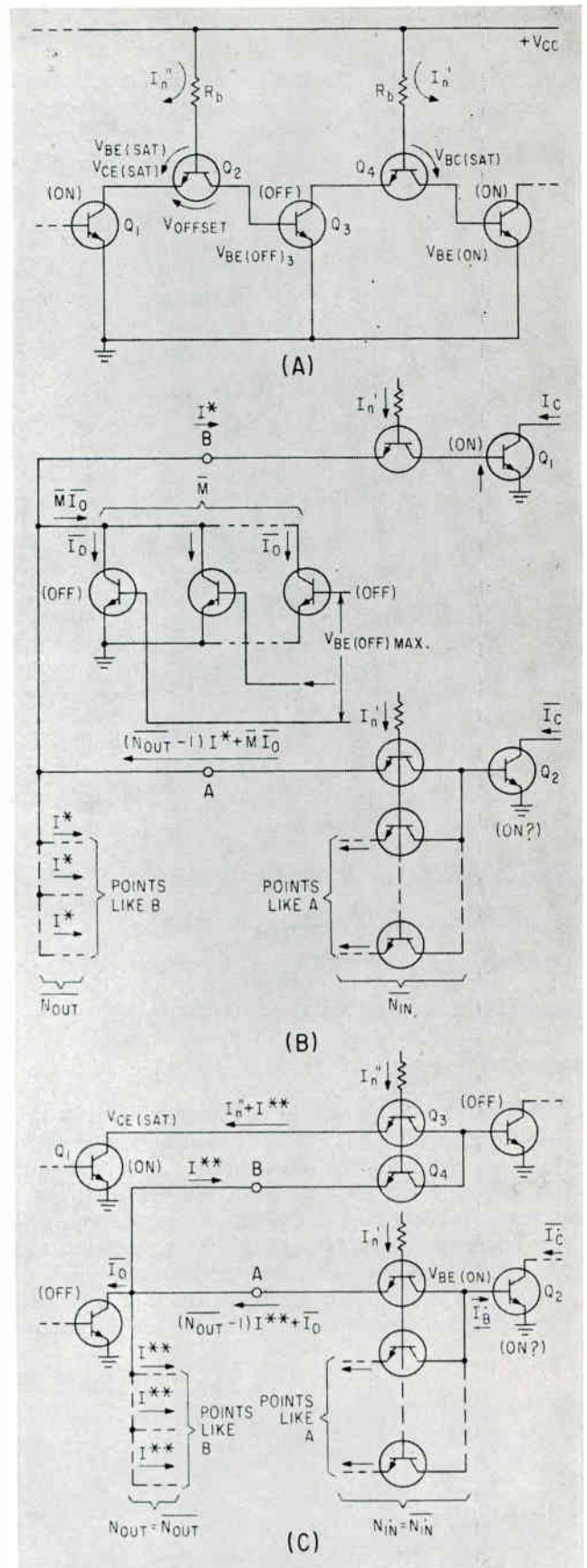

TWO TTL stages (A) with symbols used in the fan-out equations. Worst case circuit (B) where drive current is drained from  $Q_1$  because of base voltage differences of inverter transistors of the same fan-out family. Base current of  $Q_1$  adds to collector current of  $Q_2$ . Question mark indicates that under worst case conditions,  $Q_2$  may not actually be on—Fig. 4

## PAINLESS PROBE

Medical research has scrutinized the heart, lungs and kidneys for many decades until now these organs are pretty well charted and understood. But not so with the gastrointestinal tract.

Advent of the radio pill, which can telemeter information about temperature, pressure, oxygen concentration, acidity, and other variables, now changes the picture. At long last medical researchers have a tool which they can use to advance their rather primitive knowledge about the gut to a level of understanding comparable with that of the more accessible organs. In telling where the pill is sending its data from, this servo tracker adds immeasurably to the usefulness of the radio-pill technique

# SERVO TRACKS PILL IN HUMAN BODY

By B. JACOBSON and B. LINDBERG

Department of Medical Electronics, Karolinska Institutet, Stockholm, Sweden

*Radio pill telemeters f-m data about intestinal conditions; rotating antenna charts pill's journey by seeking position of constant signal*

**TELEMETRY** from within the human body by tiny radio transmitters has become a routine procedure in studying physiological phenomena. Such transmitters, called endoradiosondes or radio pills, have a volume often less than one tenth of a cubic inch; they can telemeter such data as pressure, temperature, pH, enzyme activity and oxygen concentration.<sup>1</sup>

Pressure telemetering by radio pills is of particular interest since conventional methods for measuring

pressures employing tubes or wires disturb the normal physiological conditions. They also tend to be painful, or at least, uncomfortable. The radio pills used in this study employ frequency modulation in the range 300-400 Kc, with frequency deviation 30 Kc or less. The variable inductance transducer consists of a rubber membrane acting on a ferrite rod moving in a coil. The oscillator circuit is a one-transistor Hartley with a power consumption of about 80  $\mu$ w, giving a battery life of 3 weeks with an RM 312 mercury cell. The transmitting range is about one foot.

**SQUARE MEAL**—Because of their small size the radio pills can be swallowed and passed freely through the alimentary canal. Their mobility is a great advantage since they can pass along with the food during the digestion procedure, thus permitting observations that cannot be obtained in any other way. However, although the pill's mobility is very convenient, it does produce problems. As it is of limited interest to record data if their site of origin is unknown, it is necessary to follow the movements of a radio pill accurately. Moreover, the pill movement in itself is an important piece of information in studying gastrointestinal activity. Since the movements cannot be continuously followed by X-rays due to radiation hazards, a servoed antenna tracker has been designed.

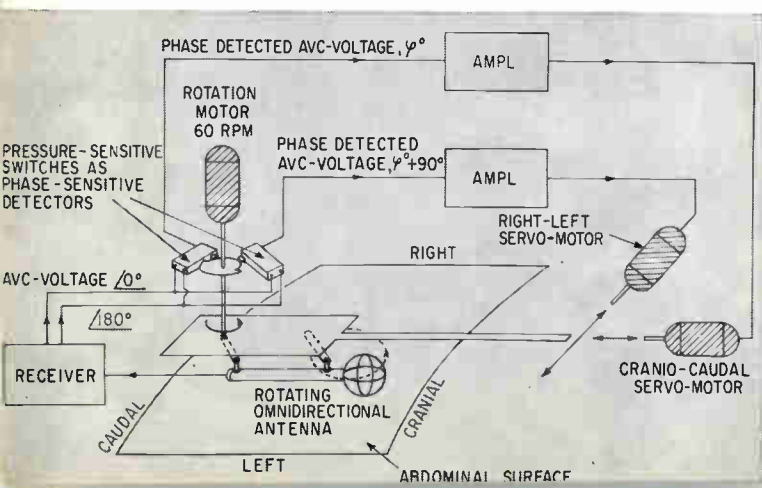

**SERVO SYSTEM** sends control signals to drive-motors, which then position antenna rotation axis to coincide with pill location—Fig. 1



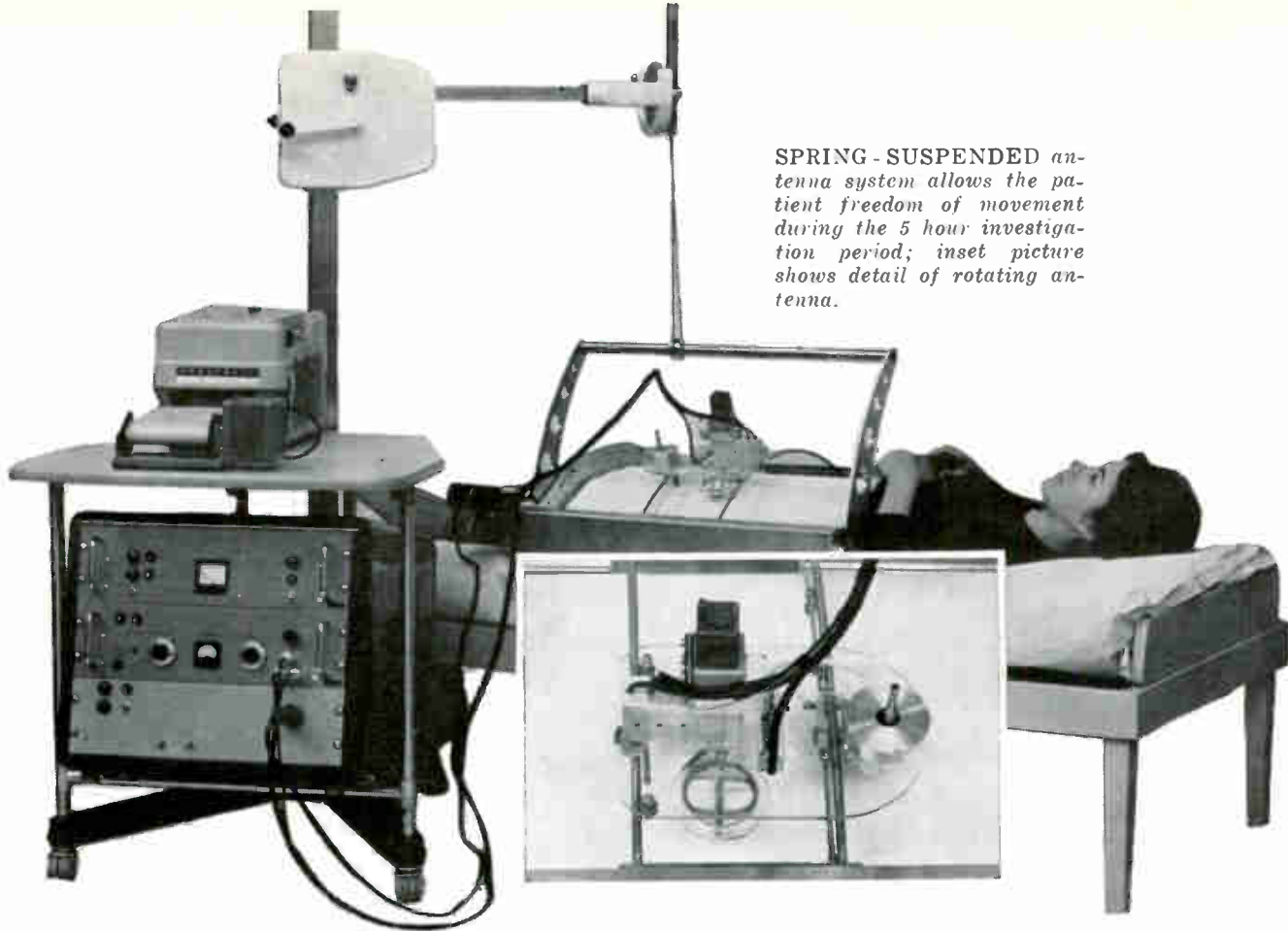

SPRING-SUSPENDED antenna system allows the patient freedom of movement during the 5 hour investigation period; inset picture shows detail of rotating antenna.

Tracking is accomplished by a rotating omnidirectional antenna mounted on a carriage, Fig. 1. The rotation occurs in a plane parallel to the abdominal surface. The resulting variation in the field strength, owing to the varying distance to the pill, generates an error signal in the antenna. This signal is detected by the receiving system, which controls two servomotors acting in perpendicular directions upon the antenna carriage to make the carriage to follow the movements of the radio pill. The carriage automatically seeks a position where the field strength is constant during the antenna rotation. This occurs when the rotation axis passes through or near the radio pill.

**RECEIVER**—Tracking relies upon the omnidirectional sensitivity of the rotating antenna. Signals from three mutually perpendicular loops are connected in turn to the r-f stage of the receiver. Signals from the three coils are switched sequentially by diode gates driven from a ring counter. The switching occurs at 25 cps, thus averaging the signal fed to the receiver each 0.12 sec. Averaging provides omnidirectional sensitivity.

The receiver has excellent frequency stability, with drift less than 20 cps per day. The receiver is a modified superheterodyne circuit with electronic tuning and is scanned at a 25 cps rate over the 30 Kc f-m channel sandwiched somewhere in the 300 to

400 Kc range. This scanning is accomplished by a sawtooth voltage applied to the tank circuit of the local oscillator, r-f and mixer stages. When the sawtooth voltage has the right instantaneous amplitude to tune the receiver to the frequency of the radio pill, a gating pulse is obtained from the detector. This pulse opens a gate for sampling the instantaneous value of sawtooth voltage, producing an output whose amplitude is a linear function of the frequency-deviation of the transmitted f-m signal. By storing the amplitude until the next scan occurs, a d-c signal is obtained, whose amplitude is proportional to the entity under study.

**PHASE DETECTION**—The error signal in the antenna during its rotation results in receiver avc voltage variations of the same frequency as that of the antenna rotation, 1 cps. The phase of the voltage

INTEGRATOR charges capacitor C at rate proportional to signal from rate-generators; Schmitt output-pulses provide distance markers—Fig. 2

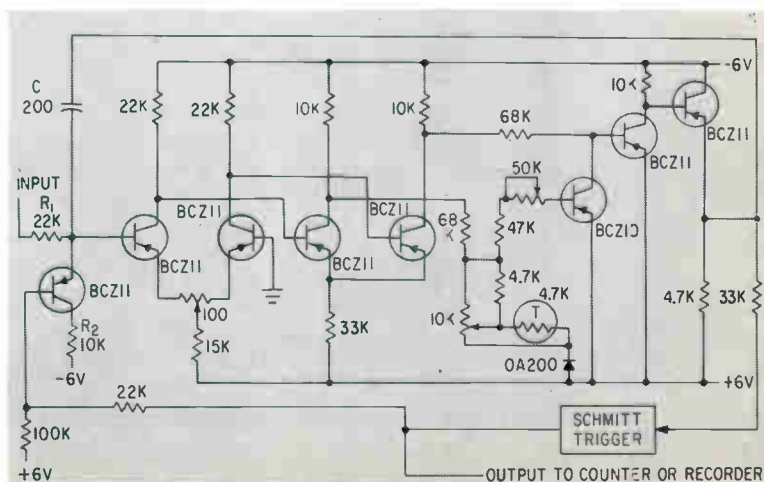

variations depend upon the relative positions of radio pill and antenna. To control the servo-motors a phase sensitive detection is made by two pressure actuated switches operated by a cam on the antenna shaft. By feeding the switches with two avc voltages 180 degrees out of phase, full wave rectification is obtained. The phase detected voltages from the two microswitches are 90 degrees out of phase, corresponding to the orientation of the two servo-motors that move the antenna carriage in the right-left and the cranio-caudal (up-down) direction respectively. Thus, the two switches deliver phase detected voltages that are proportional to the position unbalance in the two directions.

The avc voltages are obtained by rectifying the signal from the last m-f transformer. To obtain two 180-degree phase-shifted voltages, two similar rectifier circuits are used with the diodes turned in opposite directions. The 1 cps components of the avc voltages are amplified in two identical 90 db amplifiers before phase detection in the switches.

**CHARTING**—Radio pill movements are charted by

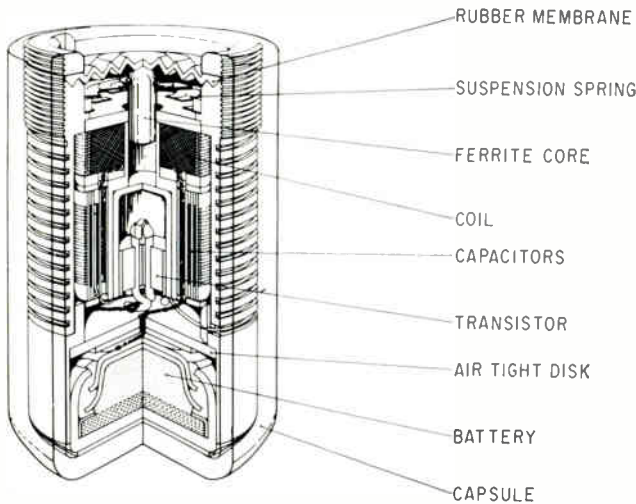

**RADIO-PILL** is slightly larger than the rubber eraser on an ordinary pencil

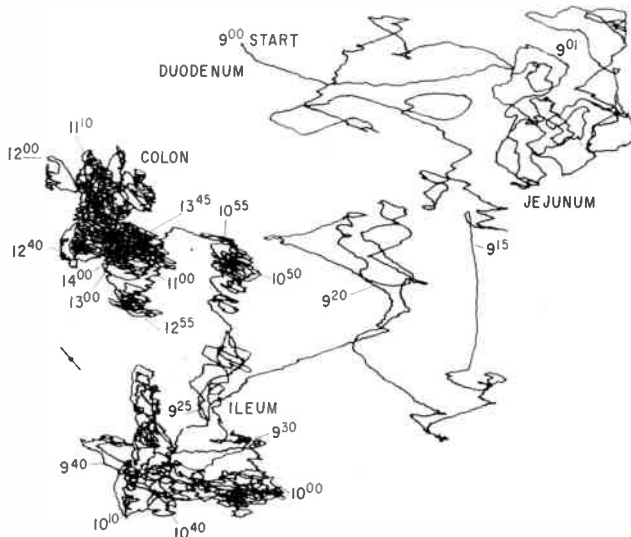

**FIVE hour journey of pill through patient's gastrointestinal tract is chartered on this maze. Pill travels about 9 feet—Fig. 3**

an ink pen on a piece of paper supported by a curved Plexiglass plate resting on the abdomen. The pen is attached to the antenna carriage. Noise in the circuit results in a charting uncertainty of less than a quarter of an inch. This noise decreases with decreasing distance between the radio pill and the antenna.

**INTERPRETATION**—To interpret the results of intestinal studies it is necessary to determine the track length of the radio pill. The servo-motors are equipped with rate generators that deliver a-c voltages proportional to the momentary speed of movement in the right-left and cranio-caudal directions. The two voltages are added 90 degrees phase shifted, thus giving a voltage proportional to the speed of movement in the plane of the abdominal surface. This voltage is rectified and recorded.

The speed d-c voltage is integrated in a quantizing circuit to deliver a number of pulses proportional to the track length projected on the abdominal surface, Fig. 2. The transistor differential amplifier with an open loop voltage gain of 60 db is a conventional integrator that charges capacitor  $C$ , with constant  $R_1C$ . A Schmitt trigger controls the discharge of the capacitor through  $R_2$ . The frequency of the Schmitt trigger pulses is proportional to the input voltage in the range 2 to 200 mv within  $\pm 1$  percent. Temperature stabilization is achieved by the diode and thermistor; the 10,000-ohm potentiometer adjusts the amplifier to minimum drift.

The equipment does not allow accurate measurement of pill-movement in the direction perpendicular (depth) to the abdominal surface. However a semi-quantitative recording can be made from the d-c level of the avc voltage. This voltage is a function of the distance, limited in accuracy by r-f absorption in the body tissues.

**APPLICATIONS**—Figure 3 shows the result of a five hour continuous tracking of a radio pill through the small intestine. The passage was unusually fast in this experiment influenced by the drug Prostigmine that enhances intestinal activity. As is seen in the figure, different parts of the intestine give track patterns of characteristic appearance. Thus, by observing the track pattern, it is usually possible to determine in what part of the alimentary canal the radio pill is located.

The intraluminal pressure waves for the different parts of the alimentary canal are of different types. The function of these waves is not quite clear. For instance, there are nonrhythmic pressure waves in the small intestine that have been assumed to have a propulsive action on the intestinal content. Detailed investigations with the servoed tracker have not confirmed this hypothesis.

**ACKNOWLEDGMENT**—This project was supported by a research grant A-2338 from the National Institute of Arthritis and Metabolic Diseases, U. S. Public Health Service.

#### REFERENCE

(1) B. Jacobson, Endoradiosonde Techniques, Medical Electronics and Biological Engineering, 1, 2, 1963.



# Faster Digital Communications With Duobinary Techniques

*These arrangements permit speeds equal to those of quaternary systems but keep equipment simplicity on a par with binary methods. Here is a way to get transmission speeds as high as 3,200 wpm with these new techniques*

By ADAM LENDER

Lenkurt Electric Co., San Carlos, Calif.

SEVERAL data transmission systems now available use a binary method of operation. However, these systems have restricted speed capabilities, and are limited in the number of information bits they can transmit in a specified period. This restriction is due to the bandwidth limitation of the associated data communication channel and results in an apparent limit of the

number of times (per second) one binary state can be switched to another.

Techniques have been developed to increase the transmission rates of data systems over band-limited channels. Of these, the quaternary method results in a transmission rate that is double that of a binary system. While this method increases the operating speed, however, it also increases equipment complexity. In the quaternary method, a serial train of binary data digits is converted into two

separate pulse sequences, each at one-half the speed of the original data pulses. Then, by superimposing one of the sequences on the other, a composite signal is formed. This signal has four possible states as compared with two for a binary system, and each quaternary state represents two binary digits, one from each of the two pulse sequences. In the presence of transmission impairments, the decoding process of the quaternary signal is more difficult than for a binary signal, since four states must be detected, rather than two.

The duobinary technique permits doubling the number of times per second one binary state can be switched to the other while preserving the binary form of the original signal. By compressing the bandwidth of a train of binary digits by a factor of two, duobinary coding allows a given data channel to accommodate twice as many duobinary digits as binary digits.

Bandwidth compression is accomplished by converting a random sequence of binary digits into a correlated train of digits according to duobinary coding rules, where, binary ZERO (0 or SPACE) remains a ZERO; binary ONE (1 or MARK) can assume either a positive (+) polarity or a negative (-) polarity, each of equal magnitude, depending on the number of intervening ZEROS between the ONES; the polarity of the first ONE in the digit train is arbitrary; the polarity of the next ONE is the same as the polarity of the preceding ONE if the number of intervening ZEROS is even; the polarity of the

AUTHOR (left) and Gregor McGibbon adjust data transmission equipment in the laboratory

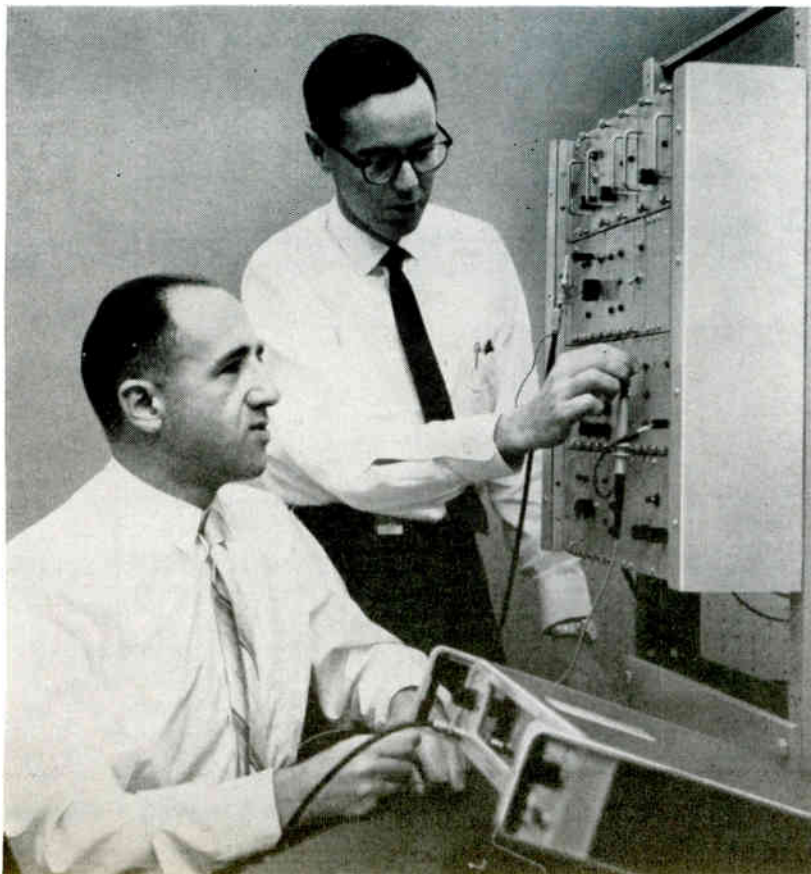



next ONE is opposite to the polarity of the preceding ONE if the number of intervening ZEROS is odd; and the polarity of the next ONE is the same as the polarity of the preceding ONE if there are no intervening ZEROS.

For example, *B* is the original binary data pattern and *D* is the resulting duobinary-coded train of data digits, as shown in Fig 1A. Sequence *B* is completely random in that the occurrence of ONE or ZERO in each time slot bears no relationship to the binary digits in the previous time slots. In sequence *D*, however, the polarity of each ONE depends upon the number of prior ZEROS as well as the polarity of the preceding ONE. Also, each digit in sequence *D* still represents either ONE or ZERO.

The net result of the binary-to-duobinary transformation is that the spectral density of the original binary sequence *B* is compressed by a factor of two. Theoretical proof of this, based on statistics of *B* and *D*, has been demonstrated,<sup>1</sup> and the experimental verification is shown in Fig. 1B. The spectral densities of a random binary sequence and a resulting duobinary sequence at a rate of 2,400 bits per second are shown in Fig. 1. In both sequences, nonreturn to ZERO (NRZ) pulses with no shaping were used. Both spectra have identical form and shape, except that the binary spectrum has minimums occurring at multiples of the data bit rate, (2,400 cps, 4,800 cps, etc.); the

B : 1 1 0 0 0 1 1 1 0 0 1 0 1 0 1 1 1 1 1 0 0 0 0 1 1  
 D : - 1 - 0 0 0 + 1 + + 0 0 + 0 - 1 0 + + + 1 0 0 0 0 +

(A)

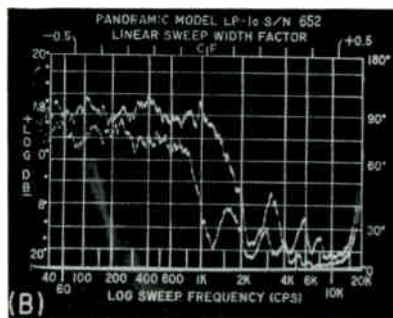

DUOBINARY-CODED train of data digits (A) and spectral densities of binary and duobinary sequences at 2,400 bits-per-second (B) —Fig. 1

duobinary spectrum has minimums occurring at multiples of one-half the data bit rate, (1,200 cps, 2,400 cps, etc.). The main lobe of the binary sequence contains 90-percent of the spectral energy, and extends from d-c to 2,400 cps; the corresponding lobe for the duobinary sequence extends to only 1,200 cps.

To illustrate the compression property of duobinary coding, suppose that a binary sequence consists of alternate ONES and ZEROS, such as: 1 0 1 0 1 0 1 0 1 0. The fundamental frequency of this periodic sequence equals one-half the data bit rate, and under ideal conditions, a transmission bandwidth equal to the fundamental frequency is sufficient to recover the

data. When the binary pattern is converted to its corresponding duobinary sequence, + 0 - 0 + 0 - 0 + 0 - 0, the period of the sequence is twice that of the original binary pattern. Consequently, the fundamental frequency of the duobinary sequence is one-half that of the binary sequence.

**BASIC SYSTEM** — A basic data transmission system employing the duobinary technique is shown in Fig. 2A. Conversion from a binary to a duobinary form that is suitable for transmission over a band-limited channel is accomplished between points A and D. Input binary data pulses are gated into bistable multivibrator 1, and only input ZEROS cause a change in the state of the multivibrator. Bistable multivibrator 2 serves as a one-bit delay device. Its input (point B) and output are summed in the arithmetic adder to produce duobinary data pulses at point C. In some applications, such as in fsk data systems, bistable multivibrator 2 and the arithmetic adder may be omitted. In this case, the design requirements of the low-pass filter are more stringent. In either case, the low-pass filter has a half-amplitude point at  $f_1$  cycles per second and can accommodate only  $2 f_1$  binary digits per second. In the duobinary system, the rate at points A and B is  $4 f_1$  binary digits per second. Therefore, the output wave at point D is band-limited by the filter, and is duobinary in form

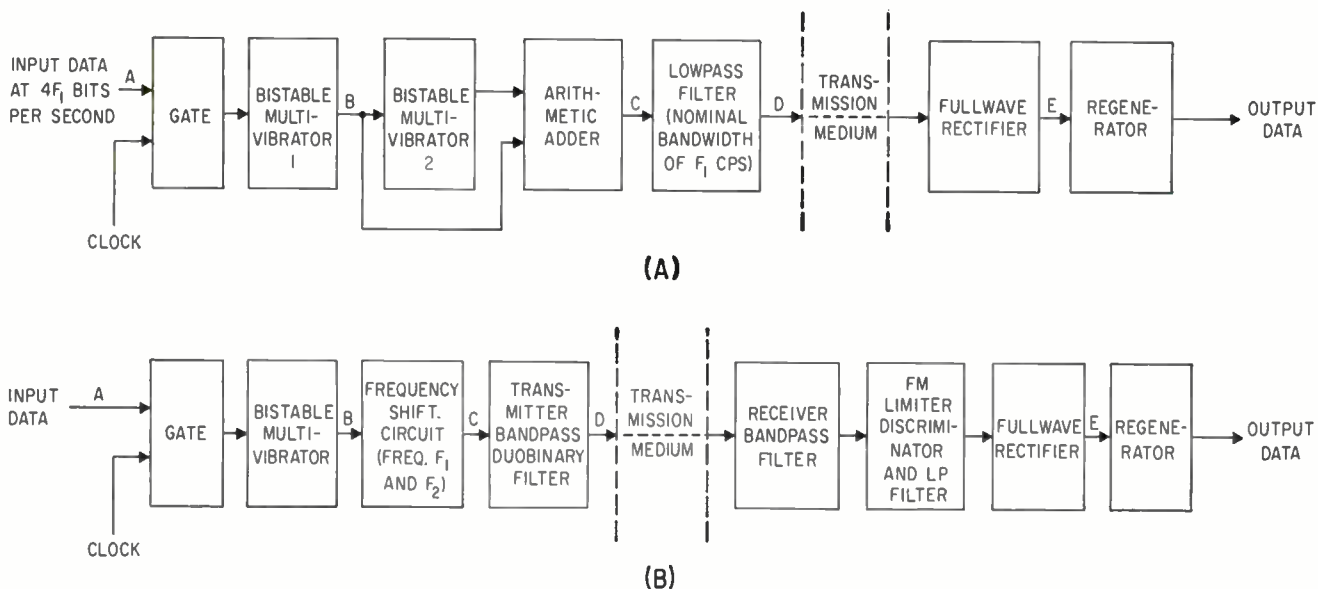

ELEMENTARY duobinary data system (A) and block diagram of an f-m system (B)—Fig. 2

with ZEROS being represented by a center voltage level, and ONES by either an upper or a lower voltage level, according to duobinary-coding rules. The duobinary wave is reconverted to binary form at the receiving end after passing through a full-wave rectifier that changes all ONES to the same polarity. In the last step, a regenerator changes the analog form of the binary wave appearing at point *E* into a two-state replica of the original data. The regenerator accomplishes this by a quantizing process that detects ONES above and ZEROS below a predetermined slicing level. Retiming of the regenerated data is entirely optional.

The waveforms shown in Fig. 3 illustrate the pertinent duobinary processes during transmission of a 16-bit data pattern such as 1 1 0 0 1 0 0 1 0 0 0 1 1 0 1 1. Each waveform depicts an occurrence at a lettered point in Fig. 2A. For example, waveform 3B shows the pattern, 1 1 0 1 1 0 1 1 0 1 0 0 0 1 1 1, at point *B* of Fig. 2; and waveform 3C shows the digital duobinary form, + + 0 0 + 0 0 + 0 0 0 - - 0 + +, at point *C* of Fig. 2A. A data bit speed of 2,400 bits per second, which is equivalent to 3,200 words per minute was used, and the bandwidth of the transmitting low-pass filter at the half-amplitude point was 600 cycles per second.

Any modulation method such as a-m, vestigial, f-m, or phase-shift keying can be used in a duobinary system. Since the most likely transmission media for digital-data transmission systems are voice-band telephone lines and high-frequency radio, f-m is suitable. Unlike a-m, vestigial, or suppressed-carrier phase-shift keying systems, no agc is required with f-m, and a large dynamic range can be achieved to assure a low sensitivity to line level changes. Also, analysis of high-frequency radio circuits shows that f-m is more resistant to fading and phase instabilities than other modulation techniques. An actual implementation of a duobinary f-m system is shown in Fig. 2B.

In Fig. 2B, the input binary data (point *A*) is converted to a new binary form (point *B*) in exactly the same manner as in Fig. 2A. Two frequencies,  $f_1$  and  $f_2$ , are keyed in a strictly binary manner

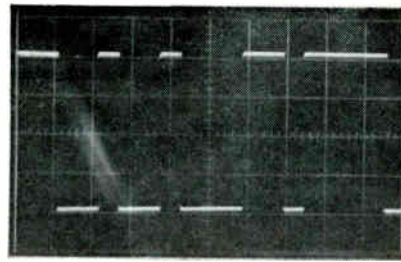

(A) 16-BIT BINARY PATTERN

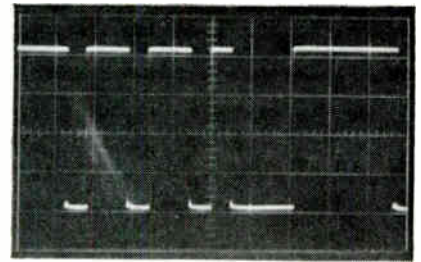

(B) DIFFERENTIAL 16-BIT BINARY PATTERN

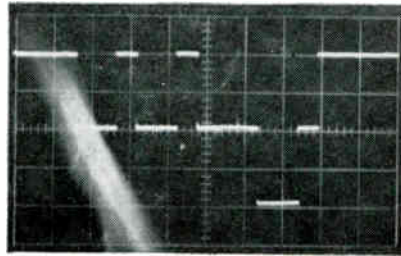

(C) DIGITAL DUOBINARY PATTERN

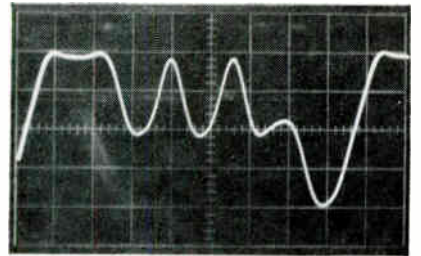

(D) SHAPED DUOBINARY PATTERN

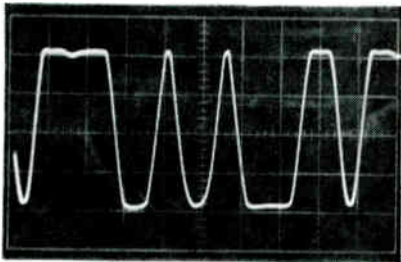

(E) RECTIFIED DUOBINARY PATTERN

BINARY pattern of 16 bits (A), differential binary 16 bit pattern (B), digital duobinary pattern (C), shaped duobinary pattern (D) and rectified duobinary pattern (E) oscilloscope waveforms—Fig. 3

### 3,200-WPM DATA TRANSMISSION SYSTEM

Conventional data transmission systems depend mainly on binary methods. This limits the amount of information they can transmit in a given amount of time because data channel bandwidth limitations slow switching from one binary state to another.

Here are details on the duobinary technique that doubles switching speed while retaining the binary form of the original signal

between points *B* and *C*. The separation between these frequencies (in cycles per second) is numerically equal to one-half the input data rate at points *A* and *B*. At point *C*, the signal wave is still in binary form, with ZEROS being represented by changes from  $f_1$  to  $f_2$ , or from  $f_2$  to  $f_1$ , and ONES being represented by no change. The function of the transmitting band-pass filter is to convert the modulated wave to duobinary form, shape the duobinary wave, and limit the frequency band of the signal so that it can be accommodated by the transmission medium. Since the band-pass filter passes

only signal frequencies between and including  $f_1$  and  $f_2$  during, for example, a steady ZERO condition, all sidebands are virtually eliminated. A frequency that is an average of  $f_1$  and  $f_2$ , termed the carrier frequency, will appear at point *D*. A ONE condition at point *D* is represented by either  $f_1$  or  $f_2$ , depending upon the frequency of the last ONE in the sequence and the number of intervening ZEROS. Thus, the waveform at point *D* is duobinary f-m, although only two frequencies are actually generated in the equipment.

At the receiving end, standard f-m demodulation techniques are

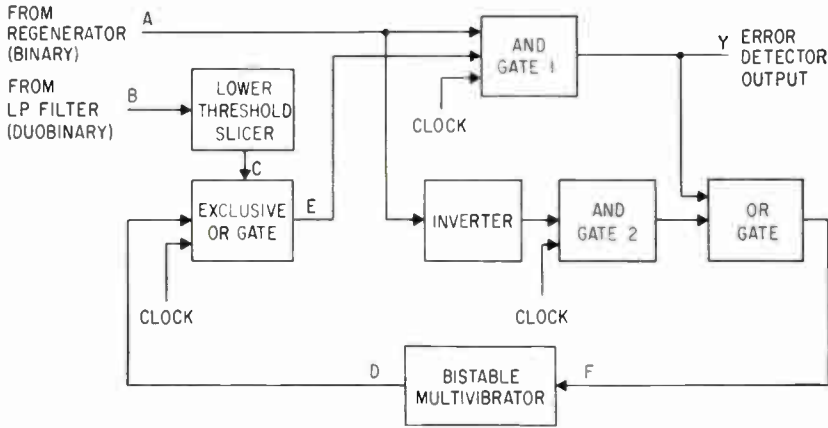

NEW techniques are suitable for error detectors such as this—Fig. 4

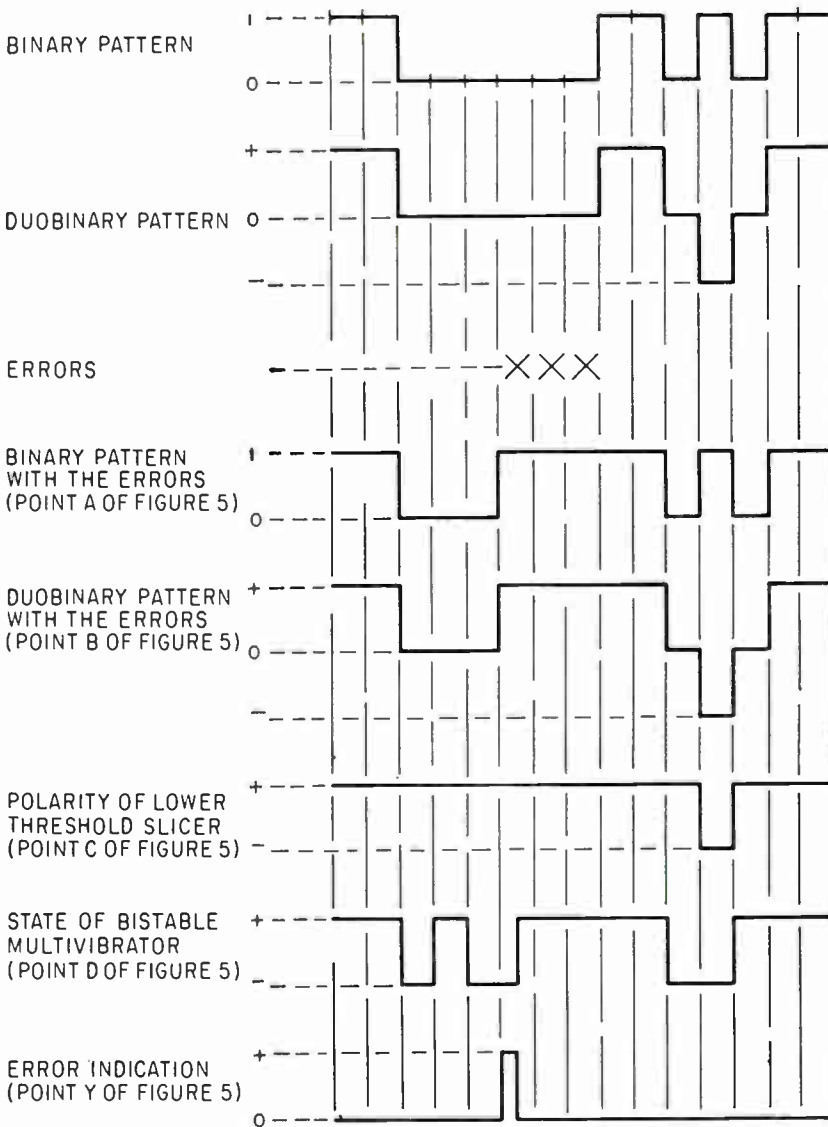

ERROR detection process during the occurrence of a triple error—Fig. 5

used. However, the bandwidth of the low-pass filter following the f-m discriminator can accommodate only a duobinary wave, since its nominal pass-band is one-fourth the data bit rate. Recovery of the two-state binary signals from the duobinary wave follows the same procedure indicated for Fig. 2A.

**ERROR DETECTION**—A unique feature of the duobinary technique in data transmission applications is the error detection that can be accomplished without introducing redundancy into the original data. In most binary or quaternary data transmission systems, the original random input data is also represented by random variations of carrier parameters, such as, amplitude, phase or frequency. In the duobinary technique, the random input data digits are converted to a correlated train of pulses following predetermined rules. This property of the duobinary technique is used to a great advantage in detecting errors. Odd-numbered errors can be easily detected as well as those even-numbered errors which violate duobinary principles. For example, odd numbered errors in a ZERO condition will result in an even number of ZEROS between ONES of opposite polarity, or in an odd number of ZEROS between ONES of identical polarity.

A block diagram of an error detector that consists of a bistable multivibrator, diode gates, and inverter, and a level slicer appears in Fig. 4. The function of the multivibrator is to remember the positive or negative state of the last ONE in the sequence, to count the number of ZEROS between ONES, and to predict the polarity of the first ONE (or ONES) following one or more ZEROS. In effect, the bistable multivibrator follows the duobinary pattern and violation of the duobinary-coding rules results in error indication.

In Fig. 4, the input at point A is supplied by the regenerator, and the input at point B is furnished by the low-pass filter. Both circuits are of course located at the receiving end. The output at point C is strictly binary, and is negative whenever a negative ONE is present; during a ZERO or a positive ONE condition, point C is positive. Also, the output at point



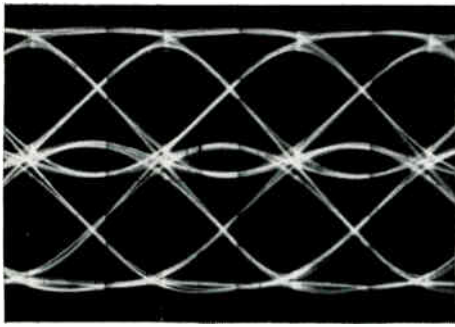

(A)

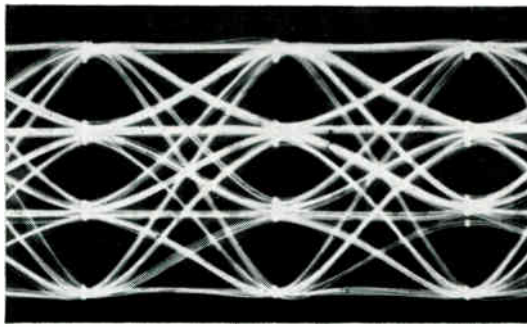

(B)

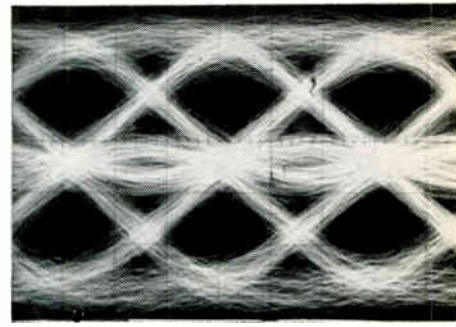

(C)

EYE PATTERNS of the duobinary system (A), Quaternary system (B) and the duobinary system with white noise added (C)—Fig. 6

$D$  is positive and negative, respectively, during the positive and negative ONE conditions. As long as points  $C$  and  $D$  have identical polarities, there is no output at point  $E$ . But when points  $C$  and  $D$  have opposite polarities, an output at point  $E$  will occur during a ONE condition, if a violation of the duobinary pattern is detected. To assure that an output at point  $Y$  will occur only during a ONE condition, the error indicator supply line to a display (point  $Y$ ) will be energized only when a ONE condition (positive voltage) is present at point  $A$ . In the event of an error indication, the bistable multivibrator is immediately restored to the proper polarity, since the error-indicating signal (point  $Y$ ) will provide the appropriate change-of-state signal (point  $F$ ) to the input of the multivibrator through an OR gate. Each ZERO (negative voltage at point  $A$ ) is counted by the bistable multivibrator through an inverter, AND gate 2, and an OR gate. As a result, the multivibrator always has the same polarity as the last ONE, and counts the ZEROS. When the last ZERO appears, a prediction is made by the multivibrator on the correct polarity of the next ONE. An example illustrating the operation of the error detector during the occurrence of a triple error is shown in Fig. 5.

**WAVESHAPES** — Although the waveshapes resulting from the duobinary process may assume three amplitude levels, the technique has no relationship to a ternary technique. In a ternary system, all three voltage levels are equally probable, and a transition from any one level to any other level is possible. At any instant of time, the multi-level

wave represents a ternary rather than a binary state, whereas a duobinary wave at any instant of time, represents a strictly binary ONE or ZERO. In the duobinary case, a transition from a positive to a negative ONE, or from a negative to a positive ONE is impossible, since two successive ONES always have identical polarities. Furthermore, a duobinary system has the same bit information capacity as a quaternary system and twice that of a binary system. This, however, is not true for a ternary system.

**EYE PATTERNS**—Data transmission systems can be compared by their eye patterns. These patterns not only provide an excellent measure of intersymbol interference, but also serve as a good criterion for analyzing the transmission qualities of data systems. The eye pattern is a superposition of many data patterns from a source like a random binary-digit generator, and is observed on an oscilloscope that is externally synchronized with the data bit rate. The eye is the clear area that exists between the amplitude levels; the larger the eye opening, the more margin there is for noise and other impairments. The pattern of a duobinary system has an upper and a lower eye. A quaternary system has three eyes and four distinct voltage levels and the transition from one level to any other level is equally probable. Consequently, there is a considerable amount of inter-pulse interference between successive quaternary symbols. Figures 6A and 6B show eye patterns of both systems, with each operating at 160 bits-per-second over the same bandwidth. To evaluate the noise margin of the two systems, the same amount of white

noise was continuously added. At the point where the eye pattern of the quaternary system was almost obliterated due to the noise, the duobinary pattern maintained a fairly good noise margin as shown in Fig. 6C, and had an error rate of one error-bit per million transmitted bits.

Another interesting comparison between duobinary and other data transmission systems is the degree of equipment complexity required. With the single exception of a rectifying stage at the receiving end, a duobinary f-m system has the same amount of circuitry as a straight binary f-m system. However, the duobinary system has twice the speed capability. When compared to an efficiently implemented differentially coherent four-phase modulation system, a duobinary f-m system is far less complex and, only requires about one-half the circuitry.

The last factor to be considered in the assessment of the duobinary technique is performance. The measured values of the normalized signal-to-noise ratio (signal power-per-bit divided by white noise power-per-cycle-per-second) at various operating speeds indicate that only a 3 db difference exists between a duobinary and a binary system. A typical normalized signal-to-noise ratio for a duobinary system is 16.5 db with a resulting error rate of one error bit per one million transmitted bits. If wire telephone lines are used as the medium, the 16.5 db figure allows more than adequate margin.

#### REFERENCE

- (1)—A. Lender, "The Duobinary Technique for High Speed Data Transmission," paper 63-283, *IEEE* Winter General Meeting, Feb. 1, 1963

# DIRECT COUPLING SHRINKS

*Feedback from final to first stage sets the bias level of multistage amplifier, eliminates bulky capacitors and makes circuit compatible with microelectronic fabrication techniques*

By PETER LAAKMANN, American District Telegraph, 155 Sixth Avenue, New York

**THE USUAL TECHNIQUE** in designing high-gain wide-band a-c amplifiers is to stabilize each stage for d-c operating point and then capacitor-couple the individual stages. This usually calls for a number of large electrolytic capacitors to shunt the emitter stabilizing resistor, plus a coupling capacitor for each stage. Minimum size of the finished amplifier is then limited by the size of the electrolytics.

A more economical approach may be to couple all stages directly and apply output-to-input a-c and d-c feedback to the circuit. To achieve stability of a multistage amplifier it is necessary only that the d-c output current of the last stage can be controlled by a d-c input current to the first stage under all circumstances. Then any degree of d-c output current stability can be obtained by providing an output current sensing circuit which controls the

input d-c current in a degenerative mode. Therefore, a-c gain is obtained by shunting the control loop with a capacitor and gain stability by negative feedback across all stages.

**STABILITY**—Current derived stabilization produces the simplest direct coupled a-c amplifier that can be built, Fig. 1A, using only one capacitor. Gain stability can be made reasonably good by choosing resistor  $R_1$  to give sufficient negative feedback. However, output current stability is poor and output current is highly dependent on the common emitter current gain of the first transistor. Output voltage swing is limited to a fraction of the supply voltage since the normal d-c operating point of the last stage has to be chosen for a collector voltages of about 20 percent of the supply voltage.

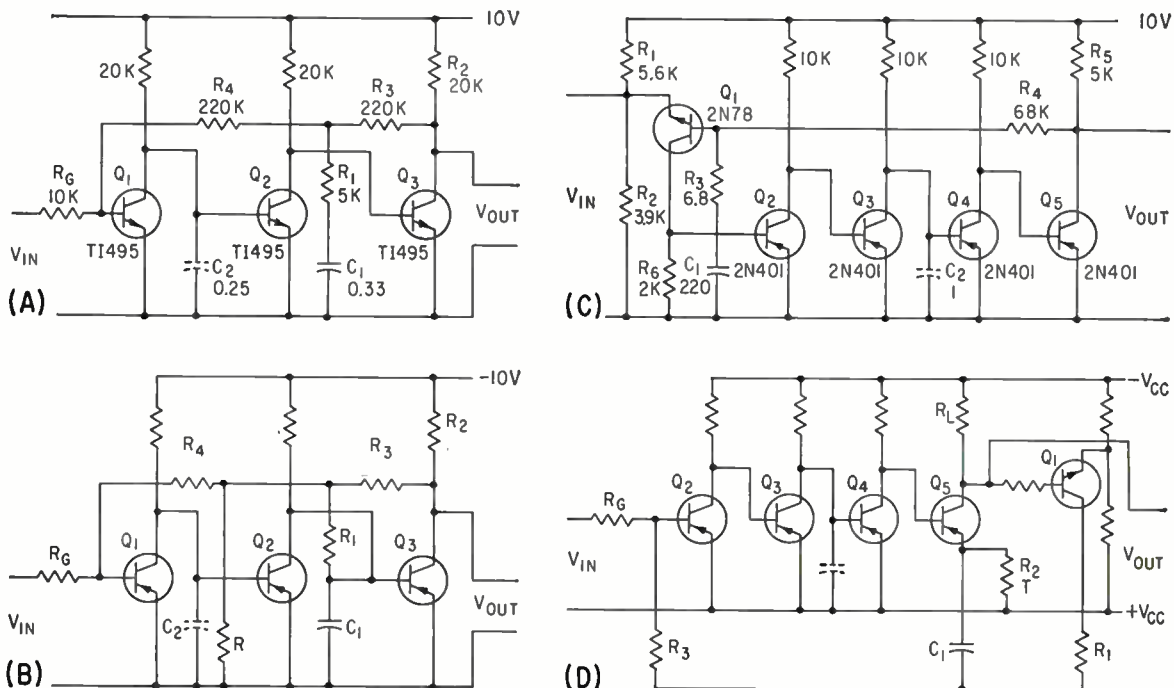

**CURRENT DERIVED** stabilization (A), Shunted-base current-derived stabilization (B). Circuit with bridge derived stabilization (C) has component values worked out in text, alternative version of bridge stabilized circuit (D)—Fig. 1

# AMPLIFIER SIZE AND COST

THREE - STAGE shunted-base amplifier with current derived stabilization is highlighted at right hand tip of circuit card



The transistors should have good current gain at zero collector to base voltage, as this is the operating point for all but the last stage. Most silicon transistors, and a number of germanium transistor types do. Germanium mesa transistors are especially useful but they suffer from poor noise figure. Current gain of germanium alloy switching transistors at zero  $V_{CB}$  is a function of temperature, decreasing with increasing temperature. More negative feedback is therefore required to stabilize gain over a given temperature range than if silicon transistor or mesa transistors are used.

Common emitter current gain cut off frequencies for transistors in the amplifier have to be at least an order of magnitude above the upper cut off frequency for which the amplifier is designed, if negative feedback is to be provided from  $R_1$ . Feedback is applied over at least three stages, which can result in a phase shift at some high frequency equaling 180 degrees. If the beta cut off frequency is chosen too low, the amplifier would tend to oscillate at a frequency not much higher than the upper cut off frequency. Adding  $C_2$  (shown dotted in Fig. 1A) can reduce the gain for higher frequencies and eliminate instability, but the cut off frequency would then be too low. For example, to design a 10-Kc cut off amplifier using transistors with a beta 50 would take a beta cut off frequency in excess of 100 Kc, even if only a moderate amount of feedback is used. An alpha cut off frequency of 5 Mc is therefore the absolute minimum.

Lower cut off frequency of the amplifier is given by

$$f_L = 1/2\pi R_1 C_1 \quad (1)$$

provided the closed loop gain is controlling the amplifier gain. Closed loop voltage gain under this condition is

$$A_b = R_3 R_4 / R_1 R_G \quad R_2 \ll R_3 \quad (2)$$

If the generator impedance is not resistive, a series resistor may be required to avoid additional phase shift. Also, capacitive loading at the output can cause instability under some circumstances.

**DESIGN PROCEDURE**—Assume that transistors with a total beta range of 50 to 200 (initial, tem-

perature and aging) are to be used. Lower cut off frequency is 100 cps and the supply voltage is 10 v. Generator impedance is 10,000 ohms and voltage gain is to be 60 db. Transistors are silicon so that  $I_{CBO}$  is no problem. Collector current should be 0.5 ma per transistor.

At 0.5 ma all load resistances are 20,000 ohms. Gain of 60 db can be handled by a three-stage amplifier since current gain per stage is at least 50.

Base current for a 0.5-ma collector current is 10  $\mu$ a at minimum beta. The input transistor will need 10  $\mu$ a and this current will be supplied from the output. The output voltage can only be 10 v and at that the current would have to be zero. A maximum voltage of 5 v should be allowed. For silicon,  $V_{BE}$  is approximately 0.5 v, so that 4.5 v are available across  $R_1$  and  $R_3$ . Thus  $R_1 + R_3 = 4.5/10^{-5} = 450,000$  ohms. Resistors  $R_3$  and  $R_1$  should be equal so that their product is highest, resulting in highest value of  $R_1$  for a given voltage gain, Eq. 2. This will minimize  $C_1$ . If  $R_1 = R_3 = 225K$  (220,000 ohms),  $R_1$  is then 5,000 ohm, Eq. 2. For  $f_L = 100$  cps,  $C_1$  becomes 0.32  $\mu$ g.

At maximum beta of 200, input current would be

## ACCENTUATE THE POSITIVE

Here is a direct coupled amplifier that combines many distinct advantages into one circuit

- Overall output-to-input feedback can be applied, using a simple stability criterion.
- Performance of basic amplifier can be tailored to individual applications with a feedback network that governs closed-loop characteristics.
- Direct coupling permits low frequency operation down to near d-c values.
- Absence of several bulky electrolytics reduces amplifier volume, prunes cost and simplifies assembly.
- Amplifier operates at zero collector-base volts, a condition for minimum noise.
- Amplifier is direct coupled throughout suggesting microelectronics manufacturing techniques, with the whole amplifier built in a single chip of silicon, feedback and dampng network being added externally







**ELECTRONICS**  
PROGRESS IN SEMICONDUCTORS



## The hard way

(up to 9 unnecessary components)

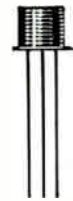

## The unijunction

(one little transistor)

# REDUCE OVERALL CIRCUIT COST...SIMPLIFY CIRCUITRY... IMPROVE STABILITY OVER A WIDE TEMPERATURE RANGE

Consider the cost savings. Example: in a typical time delay circuit, one unijunction transistor can save you up to \$13.11 by replacing three silicon transistors, one diode, one capacitor and four resistors. Another example: in a typical voltage threshold detector, one unijunction can save you up to \$7.40 by replacing two silicon transistors, one capacitor and three resistors. Our Application Engineers can give you many more examples, all reflecting similar cost savings with improved stability in your timing circuits.

**2N489** series. TO-5 case. Military and industrial applications (a military version is used on MINUTEMAN) G-E Fixed-Bed construction.

**2N2417** series. TO-18 case. Direct electrical replacement for 2N489. G-E Fixed-Bed construction.

**2N1617** series. TO-5 case. For general purpose industrial applications with economy and stability.

**2N2647** series. TO-18 case. For triggering intermediate and high power SCR's, and for long timing applications; 6V minimum  $V_{ob1}$  guaranteed; 0.2 uamps leakage current.

For detailed Application Notes on the unijunction, on the new 5C28 series, and on unijunction temperature compensation, see your G-E District Sales Manager. Or write Sect. 16C136-R, Semiconductor Products Department, General Electric Company, Electronics Park, Syracuse, New York. In Canada: Canadian General Electric, 189 Dufferin St., Toronto, Ont. Export: International General Electric, 159 Madison Avenue, New York 16, N. Y.

AVAILABLE THROUGH YOUR G-E SEMICONDUCTOR DISTRIBUTOR

**GENERAL**  **ELECTRIC**

## DROPOUT PROTECTION



### **MINCOM SERIES CM-100 RECORDER / REPRODUCER**

Data loss from dropouts is practically eliminated in the CM-100, due to this unique system's predetection recording capability. In ordinary post-recording, a dropout more than 6 db down is generally considered a data loss; the CM-100's operational predetection performance retains such signals through superior phase characteristics and extended bandwidth. Mincom's **CM-100 Recorder/Reproducer**, performing longitudinal recording with fixed heads up to 1.5 mc at 120 ips, also offers 7 or 14 tracks, trouble-free dynamic braking, complete modular plug-in assembly, built-in calibration, instant push-button selection of six speeds. Versatile, reliable, a model of simple maintenance and operation, the CM-100 is tops in its field. Write today for detailed specifications.

**Mincom Division** **3M**  
COMPANY  
2049 South Barrington Avenue, Los Angeles 25  
425 13th Street N. W., Washington 4, D. C.



# HIGH-POWER LOW-FREQUENCY DUPLEXERS

## 1 Mw to 25 Mw

Bomac presents a state-of-the-art advancement in high-power, low-frequency duplexers. Applications include a wide variety of radar services and systems.

These duplexers are available in both waveguide and coaxial line configurations. Peak power ratings: 1 Mw to 25 Mw. Frequency range: 450 to 9600 Mc. Life expectancy: greater than 2000 hours.

Improved window design provides increased radar capability. Arc loss: much less than 0.1 db. Recovery time at high power is the fastest of any gas switching duplexer on the market. With increased power; recovery time increase is negligible.

Write for additional information, including power level and frequency desired.

Frequency (Mc)	Duplexer Type	Power		Max. Recovery Time @ 3 db ( $\mu$ sec)	Arc Loss (db)	Transmitter to Receiver Isolation (db)
		Peak (Mw)	Average (kW)			
400-450	Branched Duplexer	2.5	300		< 0.1	74
400-450	Balanced Duplexer	5	40*	100	< 0.1	73
570-630	Balanced Duplexer	3	25	50	< 0.1	68
1250-1400	Balanced Duplexer	25	50	75	< 0.1	94
2700-3100	Balanced Pre-TR	10	25	100	< 0.1	50
5250-5750	Balanced Pre-TR	1	6.5	25	< 0.1	53
8400-9600	Balanced Duplexer	2	6	20	< 0.1	80

HIGH POWER WAVEGUIDE DUPLEXER LENGTH APPROX. 5'

\*Short term tests have been successfully completed at 95 Mw peak, 150 kW average

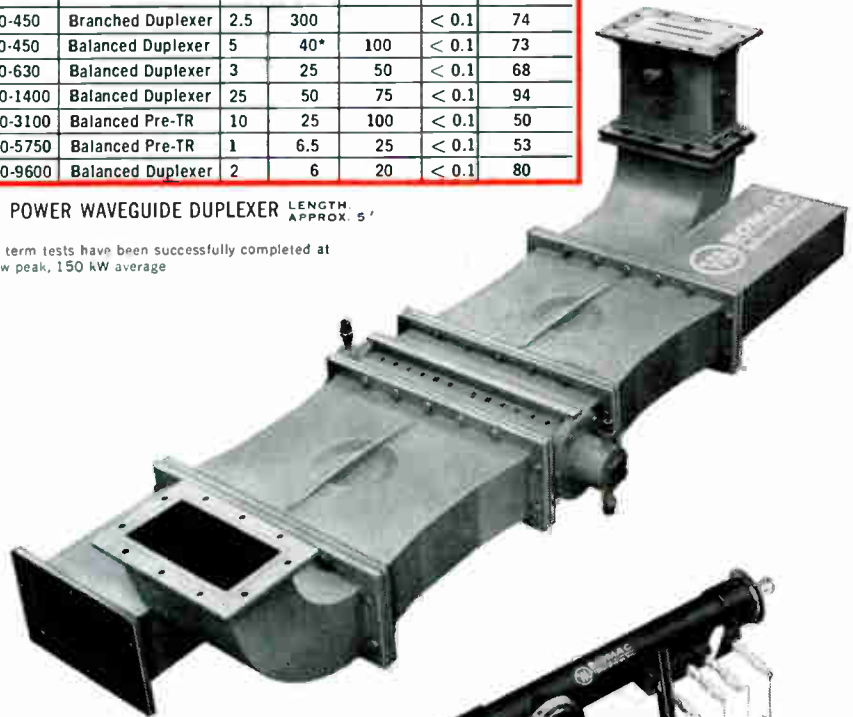

HIGH POWER COAXIAL LINE DUPLEXER LENGTH APPROX. 3'

Frequency (Mc)	Duplexer Type	Power		Max. Recovery Time @ 3 db ( $\mu$ sec)	Arc Loss (db)	Transmitter to Receiver Isolation (db)
		Peak (Mw)	Average (kW)			
400-450	Balanced Duplexer	3	15	120	< 0.1	70
400-450	Branched Duplexer	3	5	100	< 0.1	60
850-950	Balanced Duplexer	2	15	100	< 0.1	70

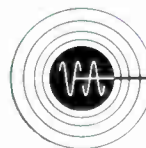
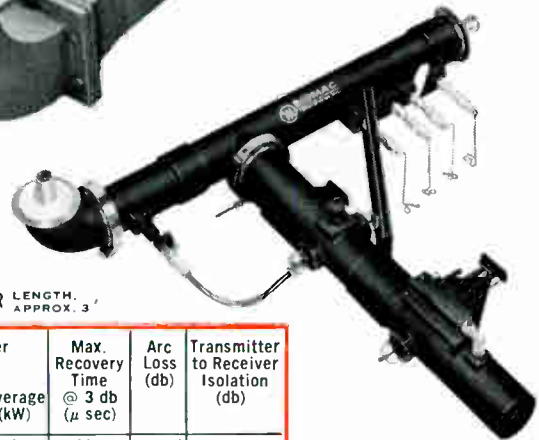

**VARIAN** associates

BOMAC DIVISION, Beverly, 1, Mass.

MICROWAVE TUBE GROUP:

PALO ALTO TUBE DIVISION

BOMAC DIVISION

S-F-D LABORATORIES, INC.

VARIAN ASSOCIATES OF CANADA, LTD.

SEMICON ASSOCIATES, INC.

SEMICON OF CALIFORNIA, INC.

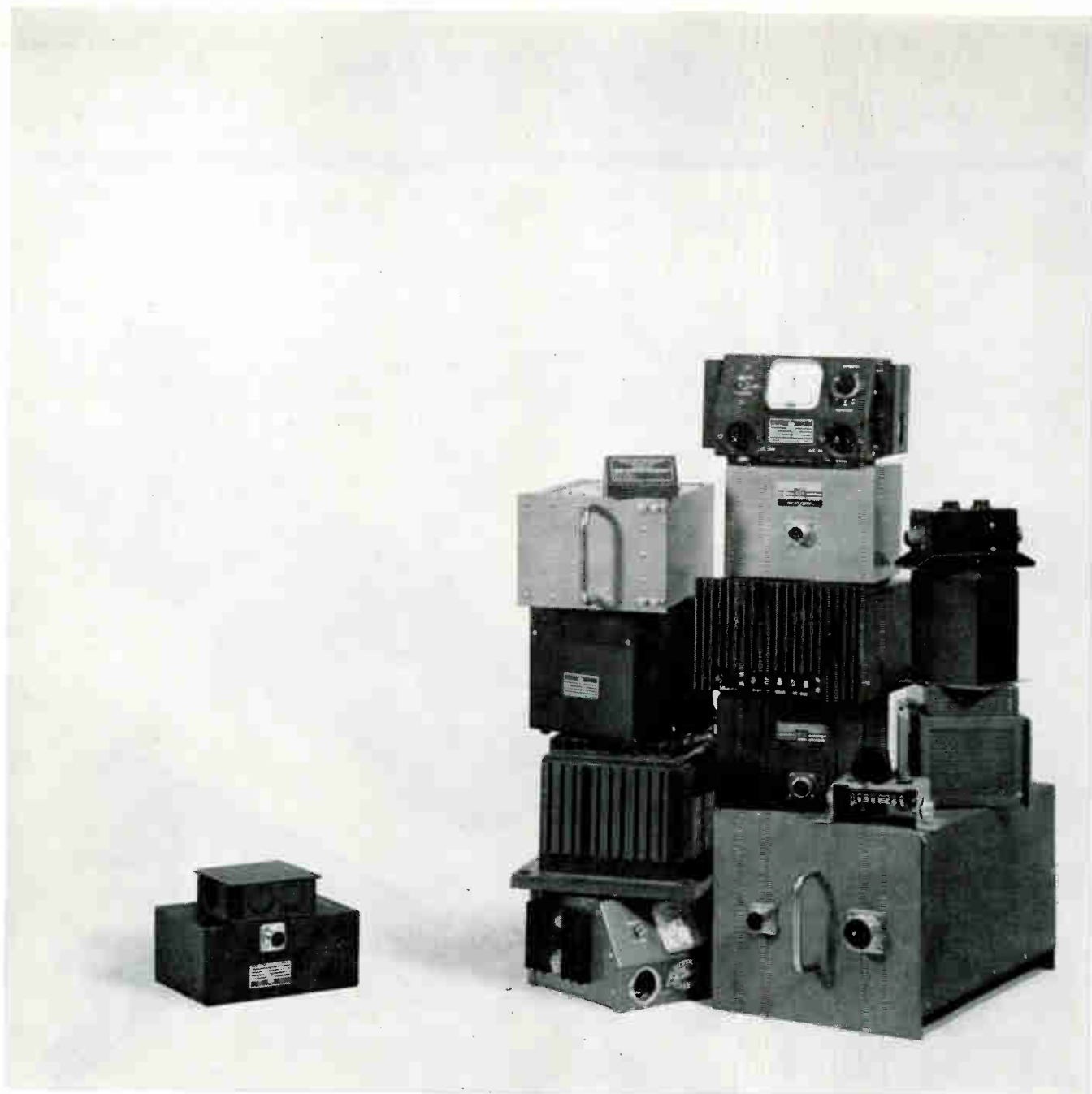

When you make a good inverter . . .

it's hard to stop.

If you're looking for one of the most complete lines of static inverters for military and industrial applications, you'll find it at Hamilton Standard.

From models in production, you can mix a limitless combination of characteristics to match your application—perfectly.

The variables: output rating (from 25 va to 10 Kva), number of phases, wave form, conversion

efficiency, operating temperature range ( $-55^{\circ}\text{C}$  to  $+125^{\circ}\text{C}$ ), size, weight, design life, vibration (10 to 5,000 cps at 30 Gs), overload protection, operating shock performance (10 to 400 Gs).

We'd be glad to send a representative list (complete with specifications) of our static power conversion equipment. Write: Electronics Department, Hamilton Standard, Broad Brook, Connecticut.

See us at IEEE, Booth 2128 and the Italy Room on the Mezzanine

**Hamilton Standard** DIVISION OF UNITED AIRCRAFT CORPORATION  
ELECTRONICS DEPARTMENT  
BROAD BROOK, CONNECTICUT

**U  
A**

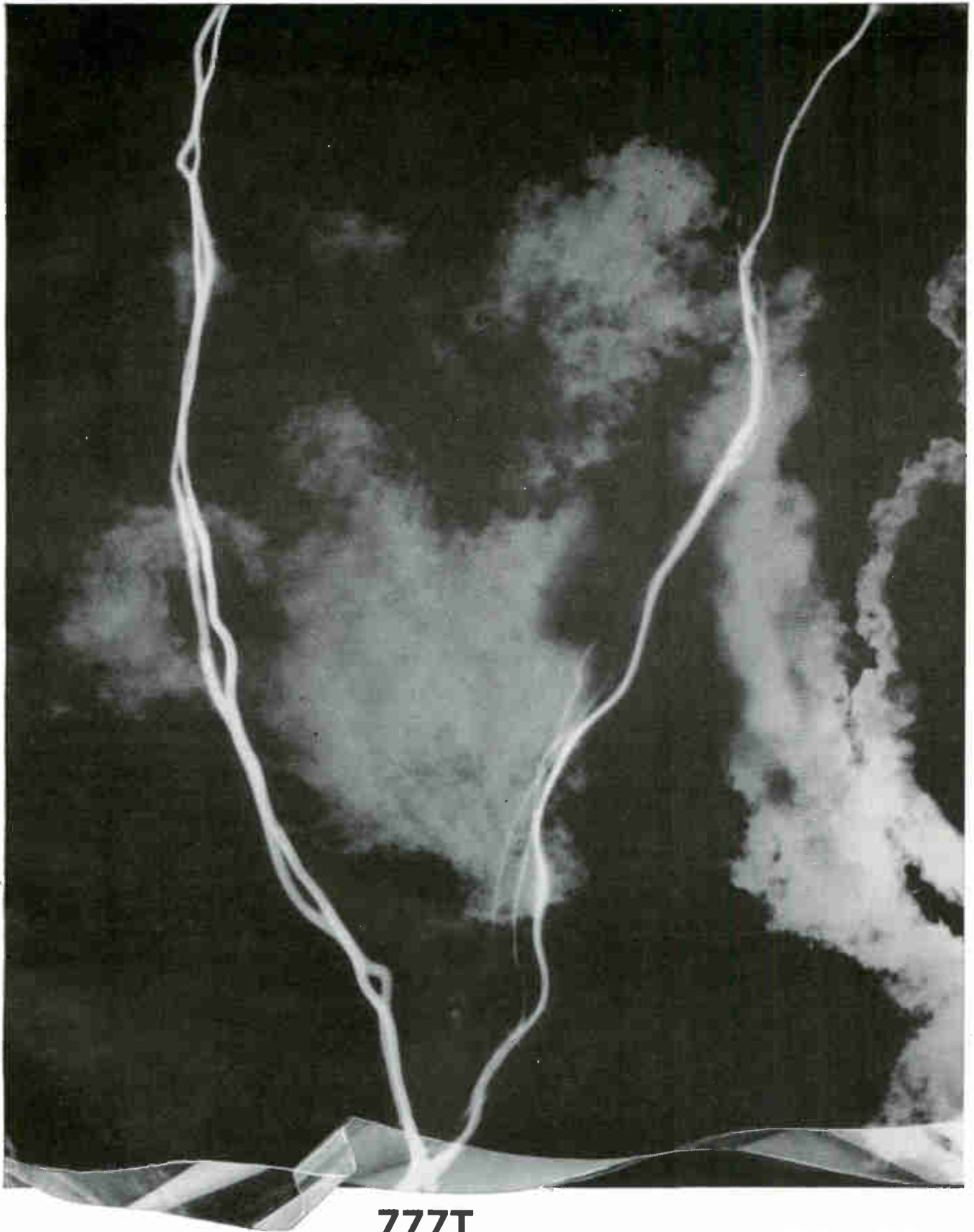

**ZZZT** Put 10,000 volts to this

ribbon of glass and its properties won't break down. This is the proven dielectric that goes into all Corning capacitors. Its dissipation factor is less than .001. Its TC holds within 10ppm with absolute retrace. Its *radiation resistance* withstands  $10^{18}$  NVTth. Put it to work for you in axial or radial lead capacitors wherever superior stability and reliability are considerations. Call your Corning distributor or write us for technical data sheets.

**CORNING  
ELECTRONICS**

A DIVISION OF CORNING GLASS WORKS  
3901 ELECTRONICS DRIVE, RALEIGH, N. C.



# Laser Used to Confirm Physical Standards

*Michelson-Morley experiment to be up-dated with laser*

By **THOMAS MAGUIRE**  
New England Editor

IN A WINE VAULT in a South Dartmouth, Mass., mansion, a team of MIT researchers headed by Charles H. Townes is preparing to explore the potentialities of the laser as a fundamental scientific tool of great precision and delicacy, and the wavelength of light as possibly the ultimate standard of length and time.

Prof. Townes will conduct the equivalent of an updated Michelson-Morley experiment with low-powered He-Ne lasers operating in the 1-micron range. Working with him are Associate Prof. Ali Javan, T. S. Jaseja, and John Murray. The laser work is associated with the MIT Research Laboratory of Electronics, which also sponsored the project which recently illuminated the moon by a laser beam.

The experiment is one of a

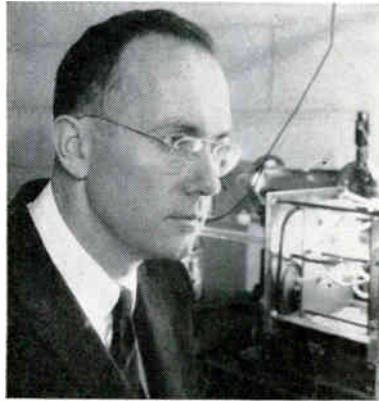

PROFESSOR *Charles F. Townes* heads the MIT research group that investigates the utilization of lasers for physical experiments and measurements

series of three proposed by Townes to help examine fundamental relations concerning length and time predicted by relativity theory. These experiments and others being carried out by the group at MIT will help determine achievable limits of precision of the optical maser, and could open the way to more precise standards of length and time.

Back in 1958, Townes, then at Columbia, used two ammonia-beam

masers to do a refined version of Michelson's ether-drift experiment. The 1958 experiment, which gave further clear-cut support to special relativity over the ether theory, involved a comparison of the rate of oscillation, or the time scale, of two maser oscillators to an accuracy of one part in  $10^{12}$ .

The one now under preparation at Round Hill would search for modifications in length resulting from the earth's orbital velocity, rather than changes in time as in the 1958 test. The third experiment proposed by Townes—one which he has no present plans to implement—would measure the ratio of changes in time to changes in length, by comparing the frequencies of two optical masers with mirrors of different reflectivities.

**LASERS COMPARED**—In the Round Hill experiment, see illustration on the cover, two optical masers—oscillating independently—are placed at right angles, with a half-silvered mirror at the junction of their outputs. Half of the beam output from one laser goes through to the photocell beyond,

## Large Particle Accelerators to Universities

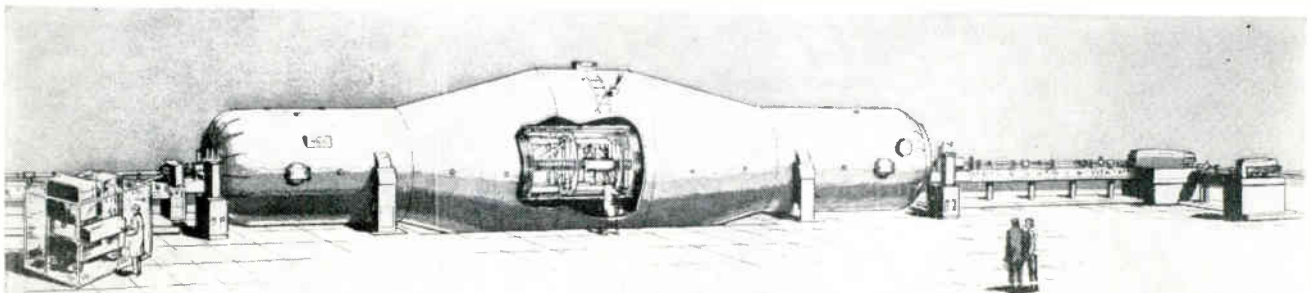

**HIGH VOLTAGE** *Engineering Corporation's \$3-million 20-Mev tandem Van de Graaff accelerator, purchased during the last two months by the National Science Foundation and AEC for nuclear structure research at Rochester, Minnesota and Yale Universities, will produce stabilized and homogeneous accelerated ion beams at currents up to 25 microamperes, weighs 187 tons*

# can you use the advantages of Kepco's STATIC MAGNETIC VOLTAGE STABILIZER

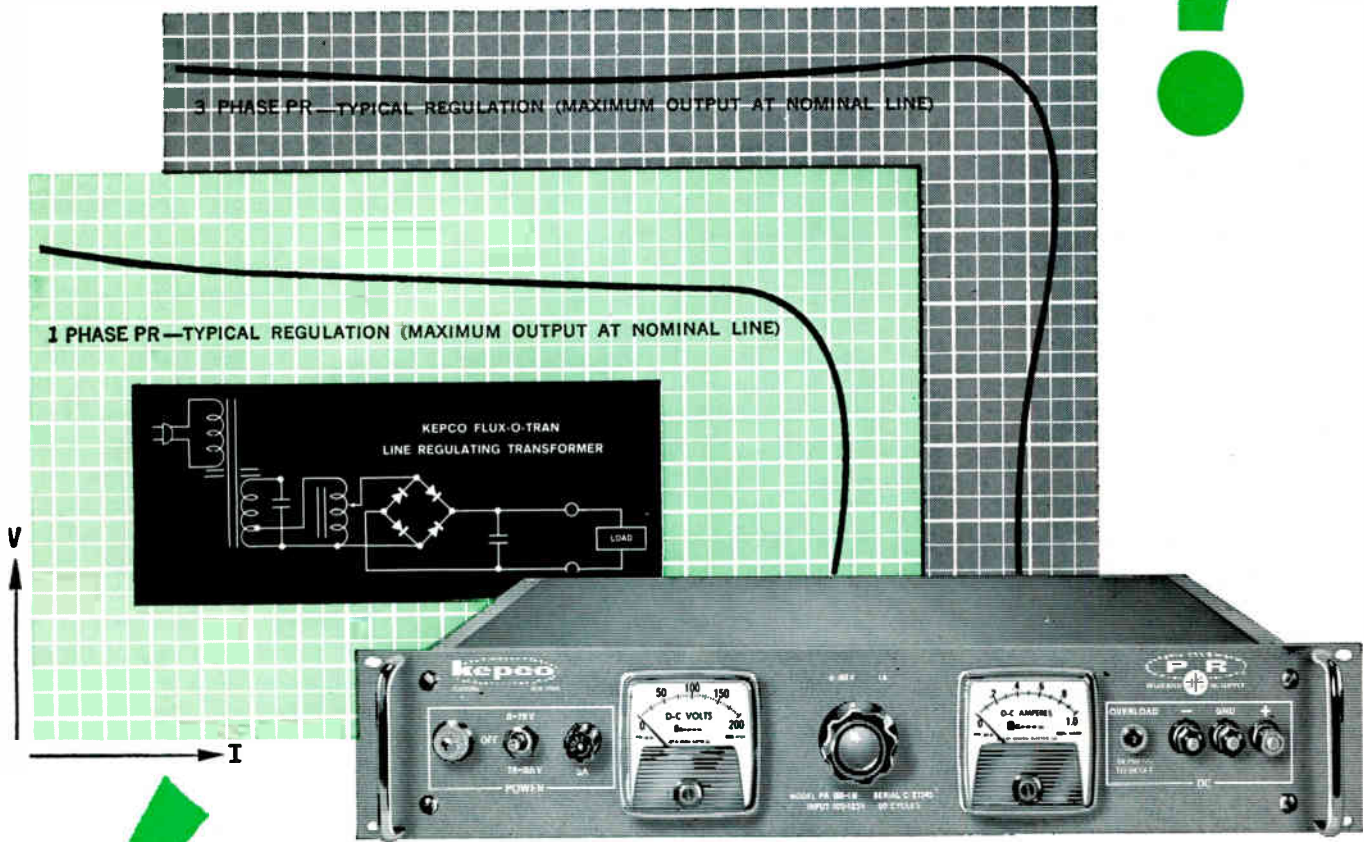

## KEPCO POWER SUPPLIES

Kepco's **FLUX-O-TRAN** is a ferro-resonant static magnetic voltage stabilizer. Its design characteristics feature:

- output essentially free of line voltage variations
- isolation of line transients
- current limiting protection from current overloads and external short-circuit

The **FLUX-O-TRAN** is the heart of Kepco's PR GROUP of DC Power Supplies. By delivering a squared-waveform to the rectifier, the **FLUX-O-TRAN** increases rectifier utilization and improves the loading characteristics of the filter capacitors. This characteristic

provides a relatively low intrinsic source impedance, improving load regulation and affording a low ripple content. The result is a simple FOOL-PROOF, high efficiency source of regulated DC power in *minimum space* and at *minimum cost*.

The PR GROUP offers a wide choice of *adjustable* output voltage and output ratings with:

- typical ripple values 0.5 to 3%
- overcurrent protection
- no voltage overshoot
- power efficiency typically 50-70%
- reliable, efficient silicon full-wave rectification

± 1% LINE REGULATION — 105-125 V AC, 60 CPS ± 5% — 1 PHASE											± 2% LINE REGULATION 208/230 V AC ± 10% 60 CPS ± 5% — 3 PHASE		
VOLTS	0-7.5-15	0-15	0-19-38	0-38	0-40-80	0-80	0-78-155	0-155	0-165-310	0-310	0-20	0-40	0-50
AMPS	0-10	0-30	0-5	0-15	0-2.5	0-8	0-1	0-4	0-0.6	0-2	0-100	0-50	0-40
MODEL	PR 15-10M	PR 15-30M	PR 38-5M	PR 38-15M	PR 80-2.5M	PR 80-8M	PR 155-1M	PR 155-4M	PR 310-0.6M	PR 310-2M	PR 20-100M	PR 40-50M	PR 50-40
PRICE	\$345	\$495	\$325	\$475	\$325	\$450	\$325	\$430	\$345	\$430	\$1,125	\$950	\$950

for complete specifications on more than 250 standard models, write for NEW Catalog B-631

See our Catalog in  Sec. 4000



131-38 SANFORD AVENUE • FLUSHING 52, N.Y., U.S.A.  
Phone (212) IN 1-7000 • TWX# (212) 539-6623  
Cable Address: KEPCOPOWER, NEWYORK

VISIT US AT IEEE BOOTH NOS. 2636-2638



# SWITCH PROBLEMS?



NORTH ATLANTIC

## Sealed Switch Assemblies & Modules

Designed for application where reliability and high performance specifications prohibit printed circuit switch wafers. All modules are sealed to insure long-term performance in severe environments, and can be supplied in any assembly configuration. Features include:

- Silver alloy contacts break 2 amps resistive load
- Long life—low contact resistance
- Decimal outputs per module: to 4 poles 6 positions, or 2 poles 12 positions
- Coded output 1248 (with or without complement)
- In-line readout for any number of digits
- Only 11/16" panel space per module

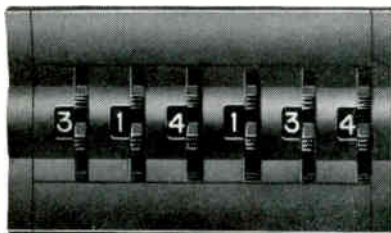

Sealed switches available as bezel-mounted assemblies, with or without panel seal, or as individual modules for prototype work. Your North Atlantic representative has complete data. Or write for Bulletin SM-400.



**NORTH ATLANTIC**  
industries, inc.

TERMINAL DRIVE, PLAINVIEW, L.I., NEW YORK  
Telephone: OVerbrook 1-8600

See us at IEEE—Booth 3939

## FIRST PRACTICAL APPLICATION?

Although many strange and wonderful uses have been proposed for the laser, today it still is mainly an experimental device. One of the first fields where it may find a practical application is in checking and confirming physical standards of measurement (see also *ELECTRONICS*, Feb. 15, p. 84). The MIT team will use the laser's high precision to confirm Einstein's theory of relativity

and the other half is reflected off the mirror and dispersed in the surrounding air. Of the output from the other laser, half the beam is reflected into the photocell and half goes through the mirror and is dispersed in the air. Light from the two lasers is mixed in the photocell and the difference frequency is accurately determined by standard electronic techniques. After the frequencies are beat together and measured, the table will be rotated 90 degrees changing the orientation of the light paths with respect to the earth's orbital velocity, the difference frequency measured again, and any change in the effective optical path for the two can be detected. From this a precise determination can be made of the upper limit of "ether drift".

The Lorentz-FitzGerald contraction associated with the earth's orbital velocity is about  $10^{-8}$  of the plate separation. Hence a frequency comparison of the two optical masers to a fractional precision  $\epsilon = 10^{-15}$  would determine this contraction to one part on  $10^7$ , about four orders of magnitude more accurately than previous techniques. Whether a precision as high as  $10^{-15}$  can be obtained in practice is uncertain because of the effects of temperature variations, acoustic vibrations and other problems. However, it seems very likely that presently available precision can be markedly improved by use of optical masers.

Working at bedrock level in the Round Hill wine vault, the experimenters are trying to eliminate any acoustic vibrations that could cause variations of the optical maser frequencies. The experimenters hope to keep one laser mirror steady with relation to the other to the extent that they could detect a change in the length of the optical path amounting to

0.001 the diameter of an atom, or  $10^{-11}$  cm.

"That means," says Prof. Townes, "being able to detect the ground shaking, or measuring the waves that rise when someone walks over the ground. Detection of a change of  $10^{-11}$  cm. would give us an optical oscillator which would be constant to three parts in  $10^{13}$ . We expect to be able to compare optical paths to that precision, which would give us an accuracy of one part in  $3 \times 10^4$  in examination of the Lorentz-FitzGerald contraction, about two orders of magnitude more accurate than previous measurements. Without rotation, and over brief periods of time, the lasers do show that accuracy. We hope that, with rotation, the same accuracy will be obtainable."

To minimize temperature variations from excess heating, the

## How Noisy Are Stars?

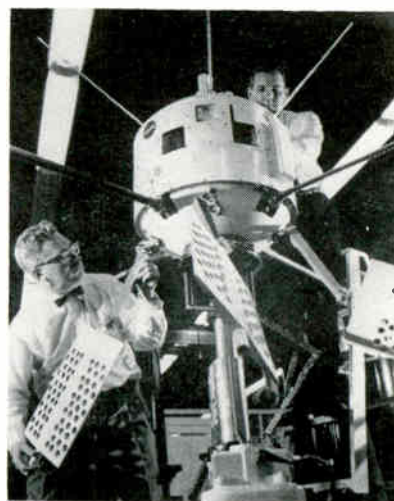

**ENGINEERS EXAMINE** test model of the S-52 satellite, a joint U. S.-United Kingdom project to measure galactic noise, ozone distribution and micrometeoroids. Westinghouse Electric is building it for NASA; British scientists will provide instrumentation



# NEW... FOAMED TEFLON® FEP

- DIELECTRIC CONSTANT: LOW! ■ FOR REDUCED SIZE AND WEIGHT IN COAXIAL CABLE ■ RATED FOR CONTINUOUS USE AT 400°F.
- NONFLAMMABLE, CHEMICALLY INERT

To meet the increasing need for less attenuation and further reductions of size and weight in coaxial cables, a Du Pont TEFLON FEP-fluorocarbon resin is now available in foamed constructions.

You can take advantage of this material's low dielectric constant (nominally 1.6) in two ways:

For a given conductor size, the outside diameter and cable weight can be significantly reduced; or, for a given outside diameter, the conductor can be made larger for added mechanical strength and lower electrical losses.

In either case, foamed FEP constructions offer you the unmatched insulating reliability of TEFLON resins—the high use temperatures (400°F. continuous), the

nonflammability, the chemical inertness under all operating conditions. In addition, outgassing losses in vacuum environments are held to a minimum.

Why not find out more about this new development in coaxial cable insulation and the new tailored performance and reliability it makes available to you. Write to: E. I. du Pont de Nemours & Co. (Inc.), Div. E-322 63TE, Room 2526 Nemours Bldg., Wilmington 98, Delaware. *In Canada:* Du Pont of Canada Limited, P.O. Box 660, Montreal, Quebec.

**TEFLON**<sup>®</sup>  
FLUOROCARBON RESINS

TEFLON is Du Pont's registered trademark for its family of fluorocarbon resins, fibers and films, including TFE (tetrafluoroethylene) resins and FEP (fluorinated ethylene propylene) resins.



BETTER THINGS FOR BETTER LIVING . . . THROUGH CHEMISTRY

NEW  
FROM WESTON



## Portable Standard replaces eleven other standards

New Weston Portalab® is an ac-dc portable laboratory voltammeter with unusual features. It combines  $\pm 0.05\%$  accuracy of indication, plus light, rugged construction for field and production testing. Truly portable, it performs the measurements of eleven precision instruments, permitting lab accuracy on location.

Direct readout and a movable, lighted decimal point eliminate interpolation, make reading easy. A highly-stable Zener reference source is contained in a temperature controlled oven. The Portalab is designed for use from  $-10$  to  $+40\text{C}$ , ambient. Fuses and instrument relays protect measuring circuit against overload, and a diode network guards thermo elements against damage.

Range, dc: 0.01 to 1,500v; 100  $\mu\text{a}$  to 1.5 amperes. True RMS response is provided in ac measurements: 1 to 1,200v; and 0.01 to 12 amperes. Frequency span: dc and 50 to 2,500cps (5,000cps to 120v). Input power: 105/130v, 50/440cps. Write for details on Model 1572 Portalab.

**WESTON**  
**Instruments & Electronics**



Division of  
Daystrom,  
Incorporated

614 FRELINGHUYSEN AVENUE, NEWARK 14, NEW JERSEY

lasers are run at low power, and emit only a fraction of a milliwatt.

They are placed on a heavy block of aluminum, which is suspended from its four corners by aircraft shock cords. These meet in a metal plate which can be rotated around a rigid rod connected to ceiling beams. The aluminum table—effectively isolated from ambient vibrations—can be rotated when a small motor is actuated and tugs on it gently with thin rubber bands.

## Government Underwrites New Biomedical Center

CHICAGO—U.S. Public Health Service is financing its first biomedical engineering research center at Northwestern University, with a \$1.3-million grant extending over the next five years. Part of the funds will expand labs for physiological control systems, transducers and biomedical instrumentation, and also help accelerate computer applications to medical research. PHS has indicated it may also establish similar centers at other universities. About 10 schools have biomedical engineering programs.

## Human Fly



**UPSIDE-DOWN MAN** demonstrates possible space use for ceramic magnets that can have their poles reversed by switching circuit. Shoes can be used by astronauts during weightlessness in space. Magnets, developed by Westinghouse Electric, are being evaluated also for remote control, relay, memory and other applications

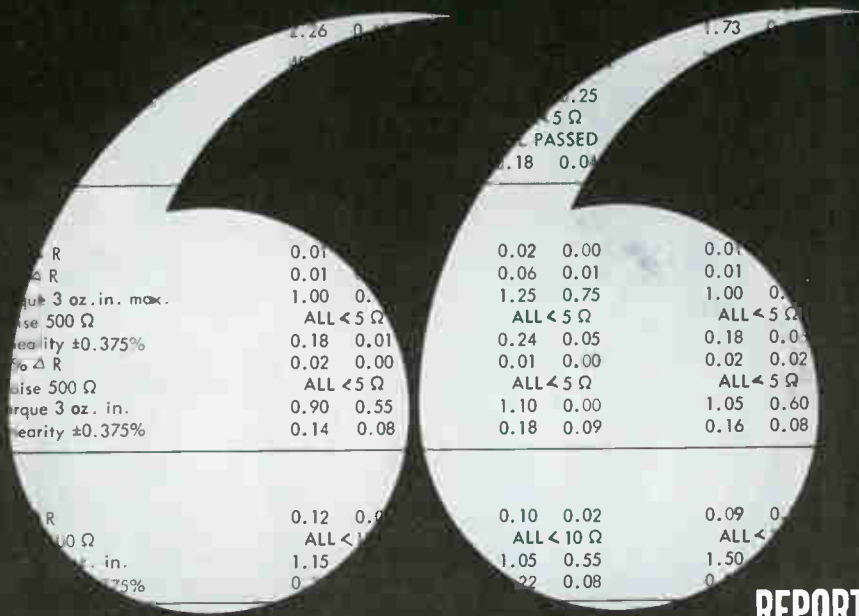

## REPORT TO THE INDUSTRY

At introduction a year ago, the industry's reaction was — "It's impossible at that price!" Now, the outstanding performance, reliability and value of the Series 62 potentiometer is an historical fact, backed by extensive in-field and laboratory evaluations.

Leading manufacturers are employing this remarkable ten-turn precision potentiometer in industrial equipment of all types. We've doubled and tripled our production capacities — and still the demand increases! Have you taken advantage of this potentiometer in your equipment? A precision ten-turn potentiometer of absolute linearity  $\pm 0.25\%$  for \$5.00 (production quantities). Start thinking Series 62 today. ☺☺

**WRITE** for your free copy of a complete engineering test data report for your personal evaluation.



# CLAROSTAT

MFG. CO. INC., DOVER, NEW HAMPSHIRE







## WORLD'S FIRST TRULY PORTABLE, SELF-POWERED DATA RECORDER—FROM LOCKHEED

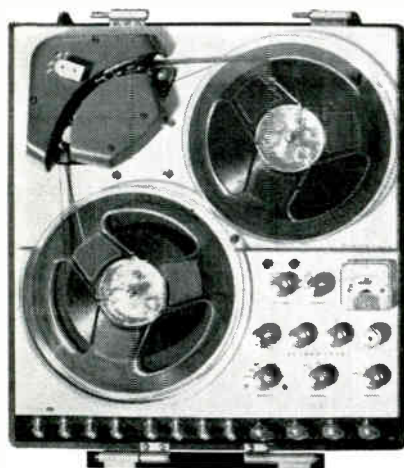

WEIGHS ONLY 25 POUNDS!

Now you can carry a portable precision recorder and record data in remote or difficult locations without the need for external power. The new Lockheed 411 Instrumentation Tape Recorder/Reproducer weighs only 25 pounds, is completely battery-powered yet has precision features and performance characteristics of console instruments.

It can record 4 tracks, FM or direct, at 3 switchable speeds on standard 7-inch reels. Ideal for recording all kinds of precision data: shock, vibration, temperature, pressure, voltage, torque, acceleration, flow, acoustics and shaft rotation, etc.

MAIL COUPON TODAY for full information. Lockheed Electronics Company, Industrial Technology Group, Metuchen, N. J., a Division of Lockheed Aircraft Corporation.

Lockheed Electronics Company  
Instrumentation Sales, Dept. E-3,  
Metuchen, N. J.

Mr. Bernard Mayer: Send me free product  
specification folders on the Lockheed 411  
Instrumentation Recorder/Reproducer.

NAME \_\_\_\_\_  
TITLE \_\_\_\_\_  
COMPANY \_\_\_\_\_  
ADDRESS \_\_\_\_\_  
CITY \_\_\_\_\_ STATE \_\_\_\_\_

## What's in it for you?

Just this. This Leach Balanced Armature Relay withstands 2000 foot lbs. of shock loading and 30 G's to 2000 cps vibration to meet Mil-S-901B for equipment-mounted components. How? First, the standard relay has a dynamically balanced armature that provides equalization of the mass to stabilize the contact structure. Next, exclusive buffer blades are added to provide additional stability to the stationary contacts. Finally, the internal mechanism is tied down tight to the enclosure.

But shock and vibration resistance may not be your main aim. Maybe you're looking for minimum voltage spike generation, or radiation resistance, or extended life at maximum rated current, or other special features. This Leach Balanced Armature Relay or one like it will end your search. So stop looking. Start asking Leach for the answers.

# LEACH

 CORPORATION

18435 Susana Road, Compton, California • Export: Leach International S. A.

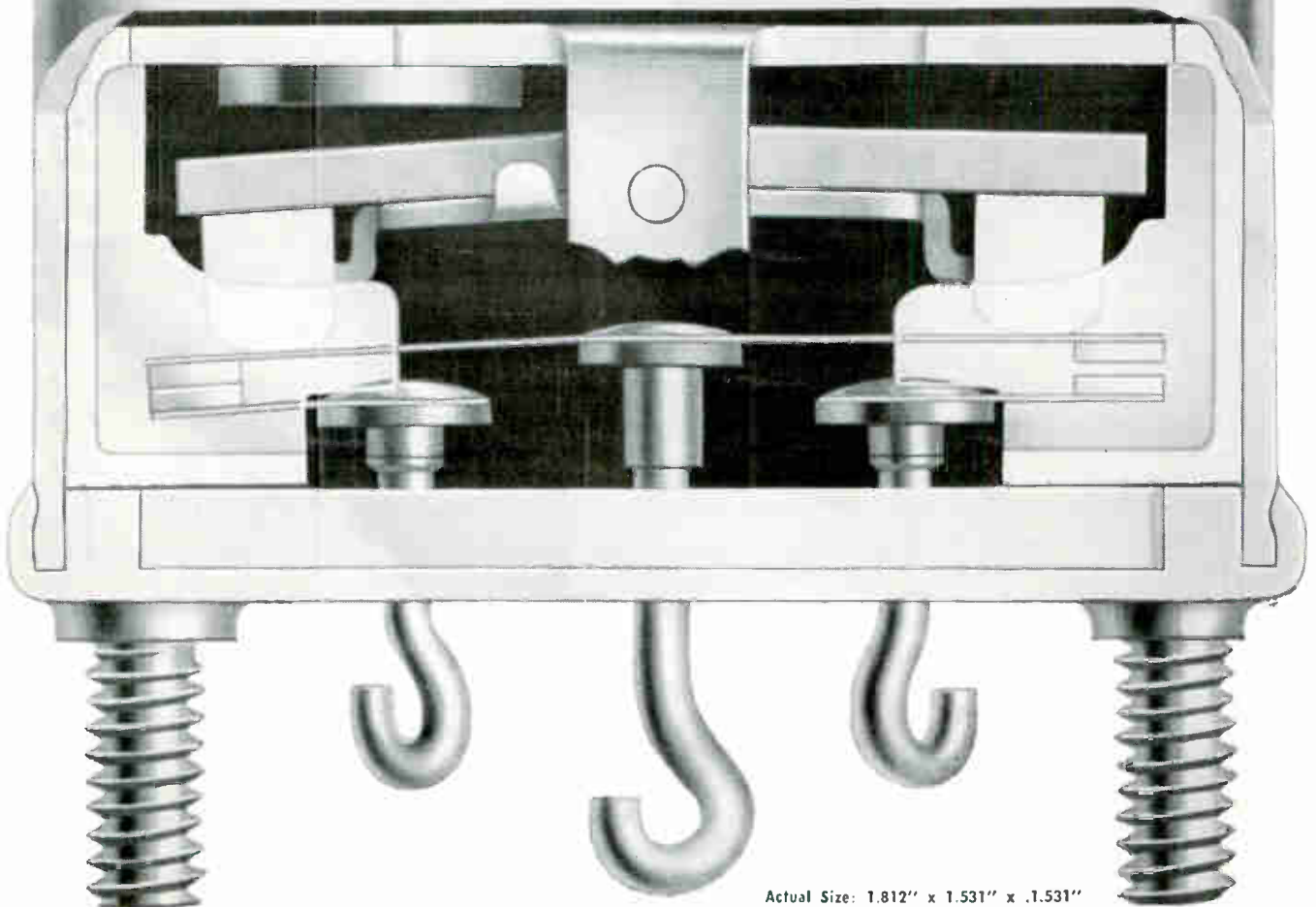

Actual Size: 1.812" x 1.531" x .1531"

# Optical Coupling: Key to Design Freedom

*Photons hold answer as signal carrier in three important areas*

DETAILS of IBM's experimental gallium arsenide transistor, which uses optical coupling between diffused  $p-n$  junctions, was recently reported by company's R. F. Rutz (*ELECTRONICS*, Mar. 8, p 7).

Schematic drawing of the device is given in diagram, along with common base current voltage characteristics. Rutz says wider base region can be used in this type of configuration, which means lower base resistance.

Primary disadvantage right now is low current gain. But Rutz says improvements are possible by removing the highly light absorbing, heavily doped surfaces of the  $P$ -regions and adding reflecting coatings.<sup>1</sup>

Several three-layer  $pnp$  structures were fabricated by diffusing zinc at 850 C to a depth of approximately 2 mils into a 6-mil thick wafer of  $n$ -type gallium arsenide, tellurium doped, with a room temperature net impurity concentration of approximately  $3 \times 10^{17}$  atoms/cm.<sup>2</sup>

From the wafer, small square chips of 10 mils to a side were cut and ohmic contacts were alloyed to the three regions. Width of the base region is about 2 mils.

The optically-coupling transistor may be useful as a fast inverter in the common connection, and as an impedance transformer. Devices were fabricated by R. McGibbon, and unit has been operated as a one megacycle oscillator by C. Lanza.

Greater band gap and potentially greater mobility of gallium arsenide over silicon and germanium has been generally known for some time. During the past few years, gallium arsenide compounds have been examined for potential use in

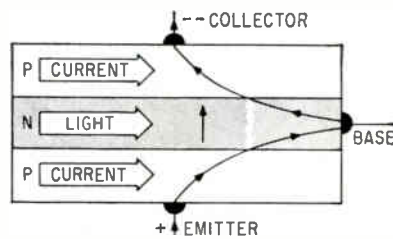
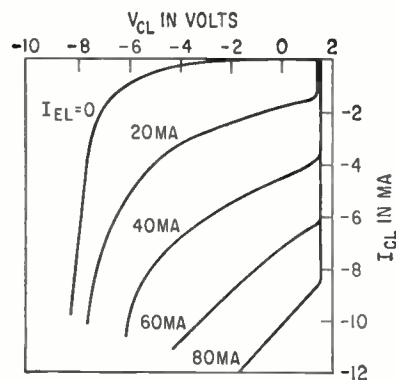

EXPERIMENTAL optical-coupling transistor structure is examined by IBM's R. F. Rutz (standing) and R. C. McGibbon. Configuration uses light energy to create electron-hole combinations as photons are absorbed near junction between base and collector. Graph shows current-voltage characteristics of three-layer device

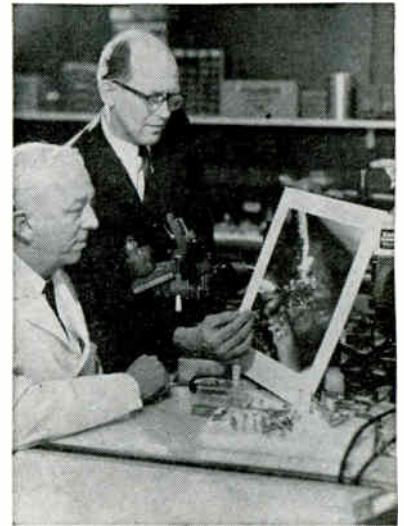

high-frequency and high-temperature devices.<sup>2</sup>

**PHOTONS**—Key to new freedom in transistor design is fact that gallium arsenide differs from semiconductors like germanium and silicon in that light (photon) energy is produced in former, charged current carriers are produced in latter two.

Not only do gallium arsenide

compounds offer possibility of supplying a light source<sup>3</sup>, photon injection mechanism can be used as the transport between input and output junctions of solid-state devices, and gallium arsenide compounds have potential in the laser area.

Light, used to carry signals, can open up new horizons for diodes and transistors<sup>4, 5, 6</sup>, integrated solid-state networks<sup>7</sup>, optoelectronic

## REFERENCES

- (1) R. F. Rutz, Transistor-Like Device-Using Optical Coupling Between Diffused  $p-n$  Junctions in GaAs, *Proc of IEEE*, Mar., 1963.
- (2) M. F. Tomaino, What Lies Ahead for Gallium Arsenide?, *ELECTRONICS*, Feb. 17, 1961, p 144.
- (3) Will Gallium Arsenide Provide New Electronic Light Source?, *ELECTRONICS*, Dec. 28, 1962, p 52.
- (4) L. K. Anderson, The  $p-n$  Junction Photodiode as a Detector of Light Modulated at Microwave Frequencies, Bell Telephone Labs, Murray Hill, N. J. (1963 Solid-State Circuits Conf, IEEE).
- (5) R. V. Bez, Switching Light With Light: Absorption Edge Modulation, Syl-

- vanla Electric, Needham Heights, Mass (1963 Solid-State Circuits Conf, IEEE).
- (6) J. R. Biard et al, GaAs Infrared Source for Optoelectronic Applications, Texas Instruments, Dallas, Texas (1963 Solid-State Circuits Conf, IEEE).
- (7) M. F. Wolff, Advances in Micro-miniaturization, Special Report, *ELECTRONICS*, Feb 15, 1963, p 57, 59.
- (8) F. H. Dill, Jr., Gallium Arsenide Injection Laser, Thomas J. Watson Research Center, IBM Corp, Yorktown Heights, N. Y.
- (9) N. Holonyak Jr., Active Region in Visible-Light Diode Laser, GE Semiconductor Products, Syracuse, N. Y., *ELECTRONICS*, Mar 1, 1963, p 35.



# Clifton Precision announces **4** major improvements in Servo Motor performance

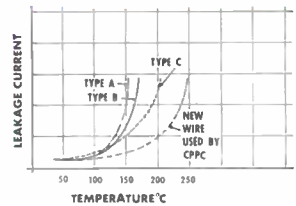
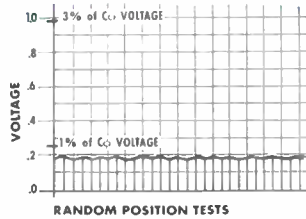
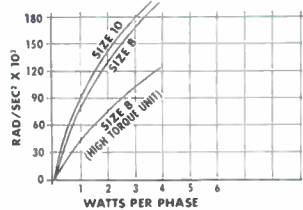
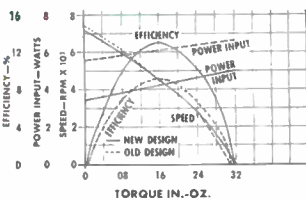
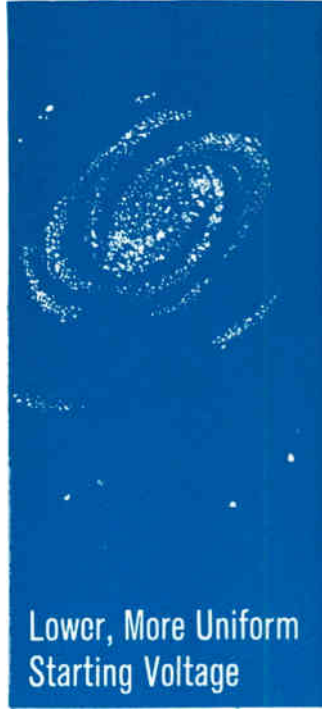

These motors provide more torque for considerably less power input. This results in a more efficient motor as well as a cooler running motor.

In addition, single phasing considerations have not been sacrificed.

Acceleration is increased to 160,000 rad/sec<sup>2</sup> at between 2 and 3 watts/phase. Up to 200,000 rad/sec<sup>2</sup> is possible under certain conditions.

This is such an improvement that in certain motor-generator requirements, a new CPCC servo motor will now suffice.

Whereas starting voltages have been specified at 3% of control phase voltage, we can now guarantee 1% and a great deal more uniformity.

Furthermore, starting voltage of these motors has been exhaustively tested so that all starting characteristics can be accurately predicted.

New slot and magnet wire insulation allows much less current leakage at high temperatures.

In addition, new lubricants and new impregnation enable these motors to withstand 200°C plus. Solderless (all welded) connections are now incorporated in our servo motor line.

For full information: Sales Dept., 5050 State Rd., Drexel Hill, Pa., 215 MA 2-1000, TWX 215 623-6068—or our Representatives. See and discuss these motors in our suite, Barbizon-Plaza Hotel during the IEEE Convention, New York City, March 25-28.

**CLIFTON PRECISION PRODUCTS, INC.** • Clifton Heights, Pa. • Colorado Springs, Colo.

# RELIABLE MODULES ARE POTTED IN

## TIMONIUM

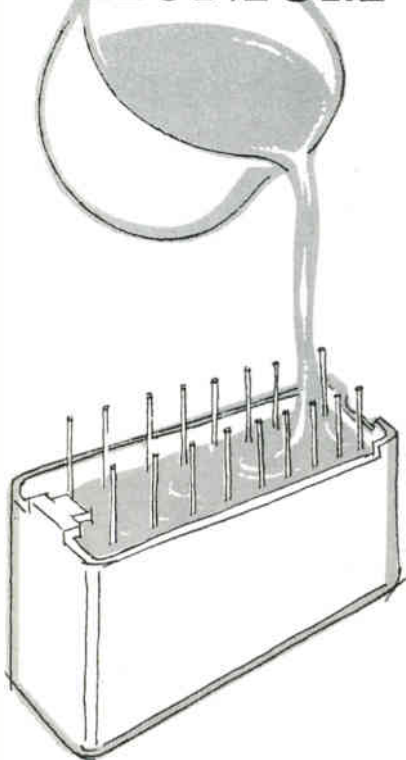

### EMC

**ELECTRONIC  
MODULES  
CORPORATION**

1949 GREENSPRING DRIVE • TIMONIUM, MD.  
Clearbrook 2-2900

DIGITAL LOGIC MODULES • DIGITAL  
EQUIPMENT AND CUSTOM PACKAGING

circuits, and laser action at higher pulsed current<sup>6</sup>.

Mechanism of photon emission from gallium arsenide structures is still not clearly understood. But phenomenon is being explored at many laboratories, including General Electric, RCA, MIT Lincoln Labs, Texas Instruments, Sperry Rand, and Hewlett-Packard Associates.

An exciting possibility for photon injection is foreseen in integrated circuit blocks. The photon mechanism could solve knotty interconnection problems that now seem to be the bane of microelectronics.

## Capacitor Wafers Now in Production

TWO TYPES of single-layer ceramic capacitor microelements for micro-modules, recently announced by Cornell-Dubilier are their temperature-compensating capacitor, Type MMC, and general purpose Type MMG. Each has a capacitor element made from a notched ceramic wafer 0.310-in. sq and 0.010-in. thick with fired silver terminations.

Micromodule circuit is formed by stacking capacitor wafer with resistor, inductor, transistor and semiconductor microelements in square frame of 12 wires, 3 to a side. Encapsulated module forms a unit 0.36-in. sq, height depends on number of stacked microelements.

Temperature-compensated capacitor element is rated at 100 v d-c working, and has capacitance range of 4.7 to 400 pf. Tolerances are either  $\pm 5$ ,  $\pm 10$ , or  $\pm 20$  percent. The Q factor or ratio of pure reactance to effective resistance is 1,500 minimum up to 100 pf. The Q value decreases linearly above 100 pf to minimum of 1,000 at 400 pf.

The general-purpose wafer also is rated at 100 v d-c working, has capacitance range of 300 to 5,000 pf. Unit has maximum dissipation factor of 2 percent.

## Engineers Will Study Laser at IEEE

LASER, developed by General Telephone & Electronics Laboratories, will be displayed at IEEE show. Long-life, sealed gas laser



is now available to commercial and military customers through Microwave Device Division of Sylvania.

Single laser, as a communication source, may some day carry as much information as all communications channels now in existence. Scientists are now investigating laser uses for precision drilling and welding. Source of heat is as high as 100 million watts per square centimeter.

## Power Amplifier Meets Satellite Requirements

IN TRAVELING-WAVE tubes, bulk of overall weight is usually contained in magnet structure which focuses the electron beam along the length of the tube. Cathode design is a critical factor that can affect tube life. These two considerations were carefully evaluated in designing the key power-amplifying device of Project Relay Communications Satellite, RCA Type A1245.

The twt developed for NASA solved the weight problem by incorporating platinum-cobalt ring magnets for the magnet focusing structure and overcame problems of cathode-current emission density and low operating temperatures. Relay's twt employs a helical slow-wave circuit and a periodic permanent-magnet focusing system.

Tube produces a minimum r-f output of 11 watts at a gain of 33 db over its 4,050 to 4,250 megacycle frequency band. Overall efficiency of the tube is 21 percent, according to company. High efficiency is achieved in the tube by operating



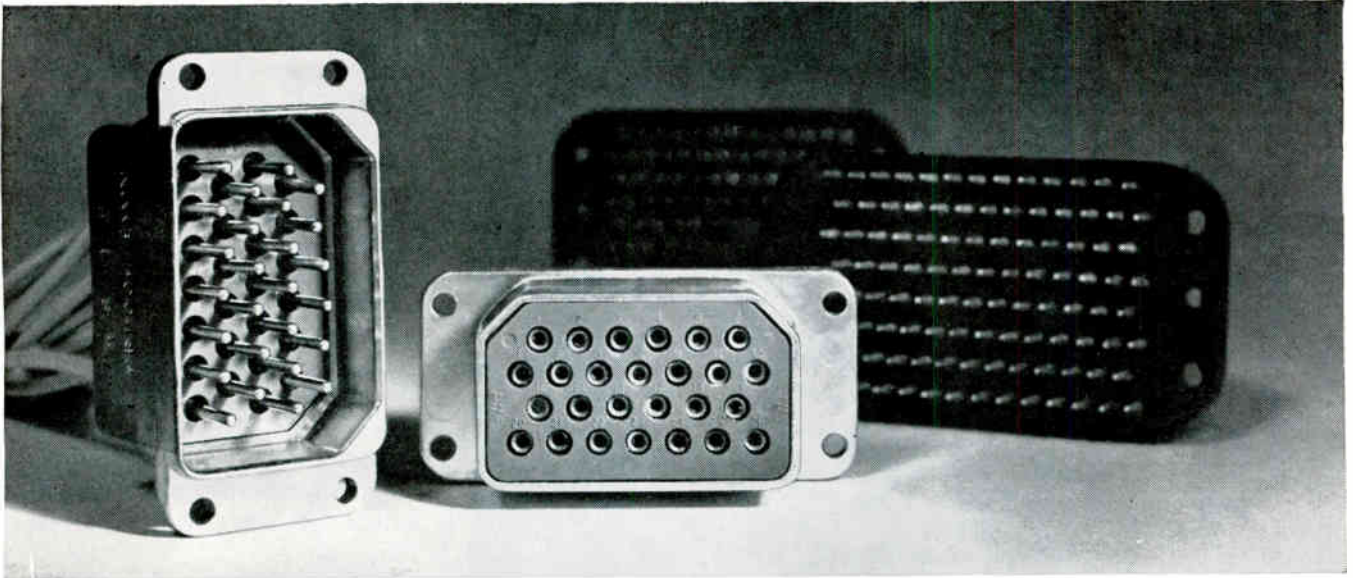

## What's unique about these connectors?

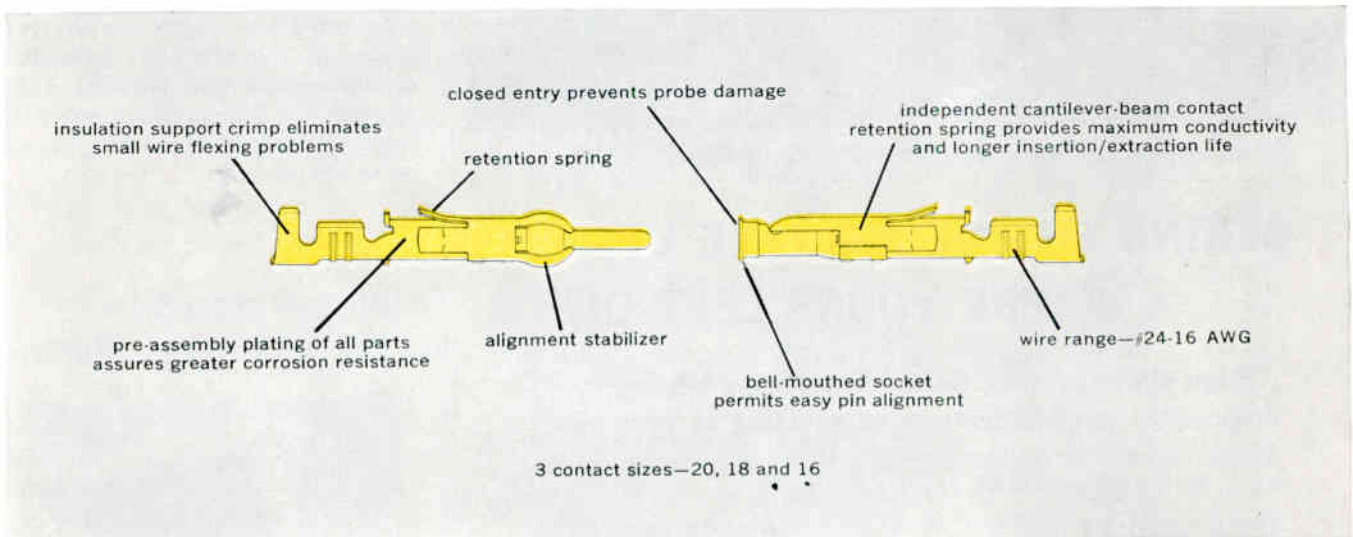

## This stamped and formed contact!

This is the AMPin-cert\* TYPE III pin and socket contact—an exclusive development of AMP Incorporated. With it, you can now get reliable connector performance at a much lower initial cost . . . at the lowest applied costs in the industry. Consider these facts:

- performance characteristics conform to all dimensional and mechanical requirements of MIL-C-8384A.
- contacts are crimp, snap-in type

for assured uniformity and quick, easy connector assembly.

- strip-mounted, reel-fed termination with our automatic crimping machine provides rates of 1,600 uniformly crimped contacts per hour.
- contacts are available for a wide range of housing block types and configurations—including AMPin-cert "M" (MIL-C-8384), "D" and "D-D" and "W" Series Connectors.
- Standard AMP Contact Plating:

.00003" non-porous gold over .00003" nickel, special platings available on request.

Put an end to solder-pot uncertainties, hit-or-miss connections, production slow-ups due to time-consuming inspection steps. Get consistently reliable connectors and at the lowest applied costs in the industry. Specify AMPin-cert TYPE III contacts. There is no equivalent! Write today for more information.

Visit us at the IEEE Show  
Booths 2527-31 and 2837  
March 25-28, 1963



**AMP**  
INCORPORATED  
Harrisburg, Pennsylvania

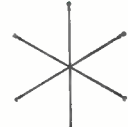

AMP products and engineering assistance are available through subsidiary companies in: Australia • Canada • England • France • Holland • Italy • Japan • Mexico • West Germany

\*Trademark of AMP INCORPORATED





*To move your delicate equipment faster, better...*

## BEKINS ENGINEERS TAKE UP WHERE YOURS LEFT OFF!

**From start to finish, Bekins Electronics Moving is engineered to specifications as exacting as your own**

When it comes to the moving of delicate electronics equipment, Bekins starts with *the man*.

There's good reason, too. We'd be the first to admit that many of our competitors have vans as good as ours. But we just don't believe that anyone in the world can teach a van how to do the job.

That's why we teach our men. They're the real key. And we teach them thoroughly. Only after they're Certified in our special electronics school are they ready to serve you.

No wonder Bekins Certified Electronics Moving is your best bet. You get skilled specialists *at both origin and destination*. And knowledgeable supervisors, too.

It might be worth remembering that Bekins is the largest moving and storage organization in the world. We've been in business since 1891.

Think about it! Isn't that the kind of experience *your* delicate equipment deserves?

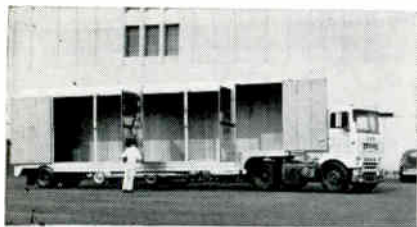

CERTIFIED SERVICE WITH BEKINS WORLDWIDE MOVING AND STORAGE

the collector at a voltage depressed considerably below helix voltage. Company says forced air cooling requirements are eliminated by conducting the heat from the collector to a heat sink.

Use of the RCA-developed dark heater further reduces the operating temperatures of the heater to less than 1,000 C, a value well within limits required for long life and good reliability. Extensive cycling tests of heater-cathode assemblies determine effects of repeated on-off cycling. Company reports no changes after an accumulated 100,000 cycles which is equivalent to 100 years of satellite operation.

Douglas Smith, vice president and general manager of RCA Electron Tube Division, said the 3.5-pound traveling wave tube used in Relay is the key power-amplifying device of the satellite's wideband communication transmitters. Tube measures 18.5 inches long and 2.25 inches in diameter, and is cylindrical in shape.

### Rugged Little Solar Power Converter Works

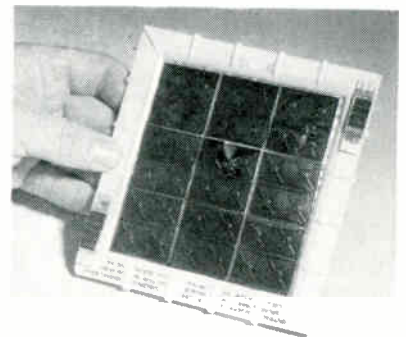

EXPERIMENTAL solar converter was successfully tested under actual space conditions

AIR FORCE announced recently that it has successfully test-flown in a satellite a radiation-resistant thermoelectric converter. Such converters, it was reported, will probably be cheaper and lighter than silicon solar cells.

The experimental model consists of 36 elements sandwiched between 2 thin metal plates. One plate collects energy, the other dissipates waste heat. Elements, measuring

# THE RESISTOR WITH A 3 YEAR HEADSTART ON

# MIL-R-55182

NEW RELIABILITY SPECIFICATION

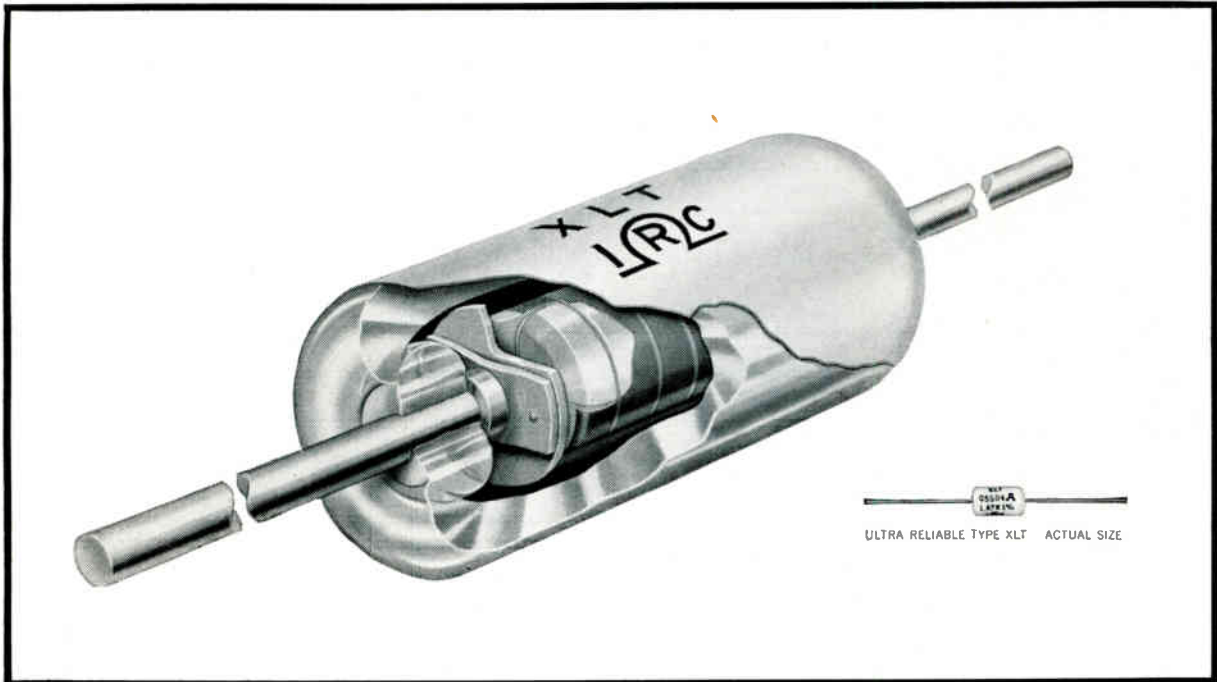

This is the resistor that pioneered Documented Reliability . . . forerunner of the MIL-R-55182 concept of component reliability. It was designed to meet the most stringent reliability standard ever set forth, the standard adopted by the Military in 1958 for critical missiles.

## MISSILE RELIABILITY

To date, the ultra-reliable XLT resistor has been tested for more than 260,000,000 unit hours (65,000 units for 4,000 hours), demonstrating a failure rate of 0.00036%/1,000 hours (1/16W., 25°C, proved to 60% confidence, failure defined as  $\Delta R > 0.5\%$ ).

## HIGH STRESS RELIABILITY

Under higher stress conditions, IRC has accumulated 35,100,000 unit hours, demonstrating a failure rate of 0.0027%/1,000 hours (1/8W., 100°C, proved to 60% confidence, failure defined as  $\Delta R > 2\%$ ).

## MIL-R-55182 RELIABILITY

MIL-R-55182 reliability levels are established at 1%, .1%, .01% and .001% at  $\Delta R > 2\%$ . Testing to this specification, IRC has already accumulated 6,200,000 unit hours WITH NO FAILURES . . . and is still going, demonstrating a failure rate of 0.015%/1,000 hours (1/8W., 125°C, proved to 60% confidence).

IRC's experience with the ultra-reliable XLT is now being applied to other types of IRC precision film resistors. If you want a headstart on MIL-R-55182, write: International Resistance Co., Philadelphia 8, Pa.





# In RF VOLTAGE MEASUREMENTS

Voltmeters from Boonton Electronics give you

- Accuracy up to 3%
- Voltage readings: 300  $\mu$ v to 300 v
- Frequency range: 10 Kc to 1200 Mc
- VSWR better than 1.2 up to 1200 Mc
- True RMS response up to 3 v
- Temperature stability inherent in probe design

See condensed specification chart below. For complete data contact Boonton Electronics Corporation or our local representative.

VOLTMETER MODEL NO.	VOLTAGE RANGE	FREQUENCY RANGE	ACCURACY	INCLUDED ACCESSORIES	PRICE
91D	300 $\mu$ v to 300 v	10 Kc to 1200 Mc	50 Kc - 50 Mc $\pm$ 3% 25 Kc - 200 Mc $\pm$ 5% 10 Kc - 1200 Mc $\pm$ 10%	RF Probe "TEE" Adapter 50 $\Omega$ Termination Voltage Divider "N" Adapter	\$750
91CA	300 $\mu$ v to 3 v	10 Kc to 600 Mc	25 Kc - 200 Mc $\pm$ 5% 10 Kc - 600 Mc $\pm$ 10%	RF Probe 50 $\Omega$ Adapter	\$550
91C	1 mv to 3 v	10 Kc to 600 Mc	25 Kc - 200 Mc $\pm$ 5% 10 Kc - 600 Mc $\pm$ 10%	RF Probe 50 $\Omega$ Adapter	\$450

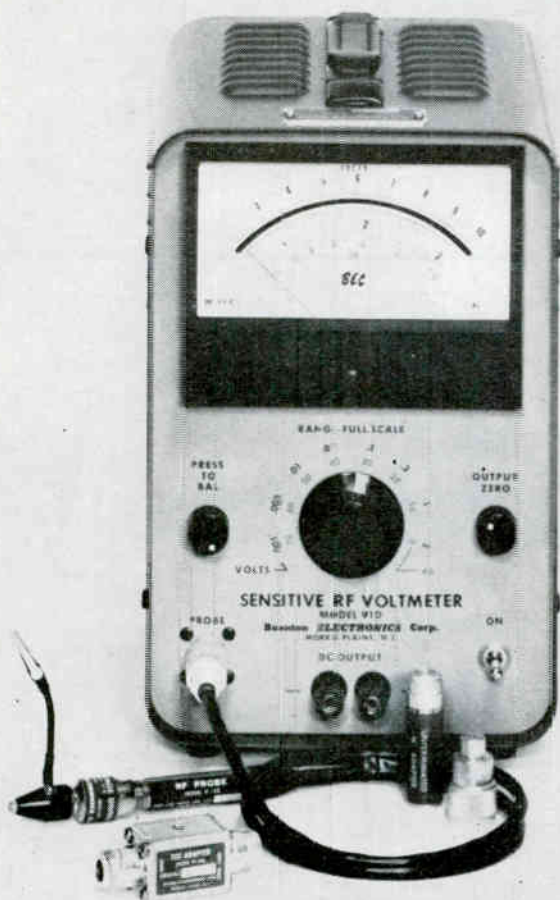

**BOONTON  
ELECTRONICS**  
CORPORATION

RF VOLTMETERS • CAPACITANCE  
BRIDGES • INDUCTANCE BRIDGES  
RF ADMITTANCE BRIDGES • DC  
METERS • RF DISTORTION METERS  
MORRIS PLAINS, N. J.

See us at the I. E. E. E. Show Booths #3114-3116

0.04  $\times$  0.04  $\times$  0.1 inch, are made of *p*-type zinc antimonide and *n*-type lead telluride. The converter was developed by General Dynamics.

## Air Force Reviews Materials Programs

STUDIES in materials, ranging from the development of new metal alloys for aerospace applications to investigations of high-temperature fabrics for re-entry parachutes, are described in publications just released to science and industry.

Reviews cover reports on materials programs conducted during the period from July 1959 to June 1960, and during the period from July 1960 to June 1961.

### REFERENCES

- (1) D. J. Tate, A Review of the Air Force Materials R & D Program, 193 p, June, 1961, AD 270267 OTS, U. S. Dept of Comm, Wash, 25, D. C., \$3.
- (2) J. J. Banks and D. J. Tate, A Review of the Air Force Materials R & D Program, 210 p, Mar, 1962, AD 276 709 OTS, U. S. Dept of Comm, Wash, 25, D. C., \$3.50.

## High-Purity Iron Prepared for Study

RODS of super pure alpha iron single crystals, up to several inches in length, have been pulled for advanced materials research. Resistivity values for these crystals, a function of their purity, are claimed to be the highest ever reported, according to Materials Research Corp., Orangeburg, New York.

The iron crystals will be used to obtain more precise information about the electronic structure of the material, radiation susceptibility, corrosion behavior, and investigation of the mechanical properties of iron.

Rods are made by purification of starting material in the MRC electron beam zone refiner. Iron is converted to single-crystal form by straining and heat treatment.

Major objective of this materials program includes further development of techniques for preparation of crystals having reproducibly good structure and properties. Program is sponsored by Atomic Energy Commission.



# COM



# PARE!

Measure microvolt signals accurately... in the presence of high common mode noise!

The bench-proved and system-proved DY-2401A Integrating Digital Voltmeter from Dymec is today's most accurate instrument of its kind for measuring low-level signals in the presence of high common mode noise. It's today's best digital voltmeter buy!

Ten volts of common mode noise on the signal results in a mere one microvolt error. No other digital voltmeter can match that performance. Dymec accomplishes this remarkable performance in the DY-2401A with two techniques: Guarding of the entire measuring circuit, which physically breaks the ground loop currents that circulate in systems with more than one ground; and true averaging of the signal over the sample period, which solves the problem of noise superimposed on the signal. Averaging alone provides virtually infinite rejection of 60 cps and 400 cps noise. The DY-2401A is not dependent on passive input filtering responsible for slower measuring speed.

**Low-level measurement . . .** High sensitivity of the DY-2401A, even in the presence of noise, offers a 5-digit range of 100 mv full scale. Add the DY-2411A Guarded Data Amplifier and you have an unequalled  $\pm 10$  mv full scale 5-digit range. Compare this with any other digital voltmeter . . . and consider your applications in measuring the outputs of thermocouples, strain gage bridge transducers or other millivolt level dc voltages.



**For 10 mv full scale sensitivity** DY-2411A Guarded Data Amplifier adds the  $\pm 10$  mv full scale 5-digit range to the DY-2401A Voltmeter,

with overranging to 30 millivolts and constant 10,000 megohm input resistance. It preserves the guarded measurement features of the 2401A, providing 134 db effective CMR. Gain settings of +1, +10 and bypass are programmed by simple ground closures, with no effect on common mode rejection.

**DY-2410A AC/Ohms Converter . . .** provides floated and guarded broadband ac voltage and resistance measurements, with full programmability. AC measurements 50 cps to 100 kc, five ranges including 0.1 v rms full scale, 300% overranging on four most sensitive ranges, 110 db common mode rejection at 60 cps when used with the 2401A. Resistance measurement, 100 ohms to 10 megohms full scale in six ranges, with 300% overranging.\*

**COMPARE:** DY-2401A, \$3950  
DY-2411A, \$1150  
DY-2410A, \$2250\*

*Data subject to change without notice. Prices f.o.b. factory.*

\* Available also in ac-only, ohms-only models.

See these instruments at the New York IEEE Show, on Easy Street, Booths 3414 - 3416.

## DYMEC

A Division of Hewlett-Packard Company



8362

Dept. D-315, 395 Page Mill Road, Palo Alto, Calif. Phone: (415) 326-1755 TWX: 415-492-9363





# How Potter & Brumfield precision-cleans relay relays for top reliability!

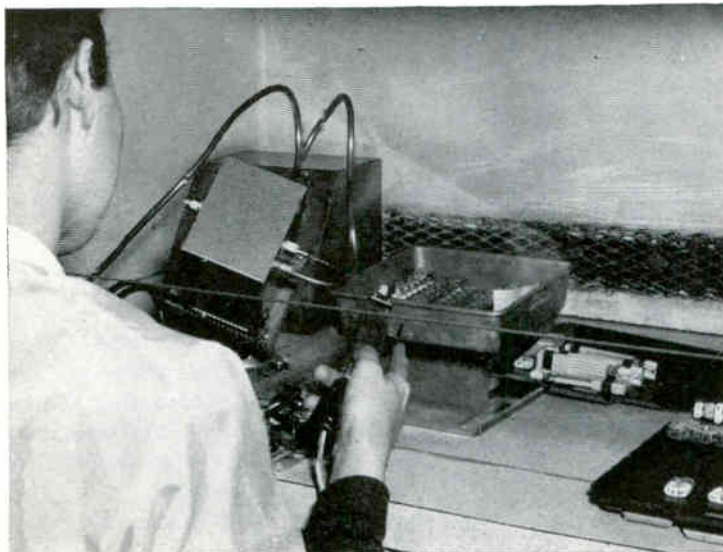
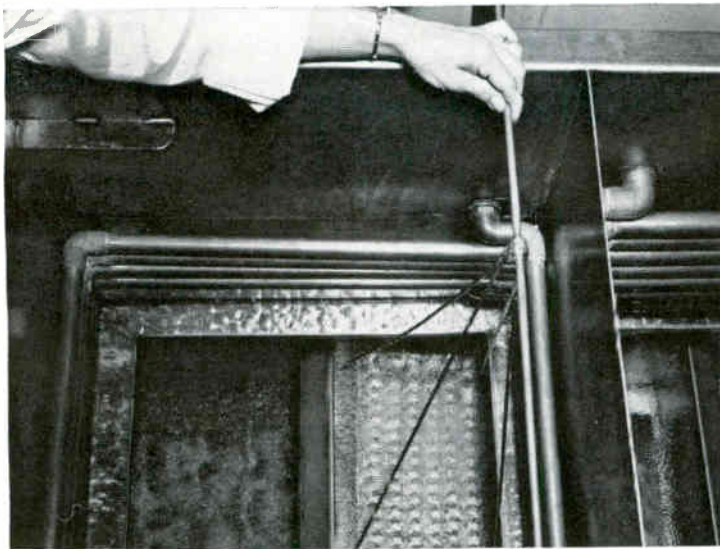
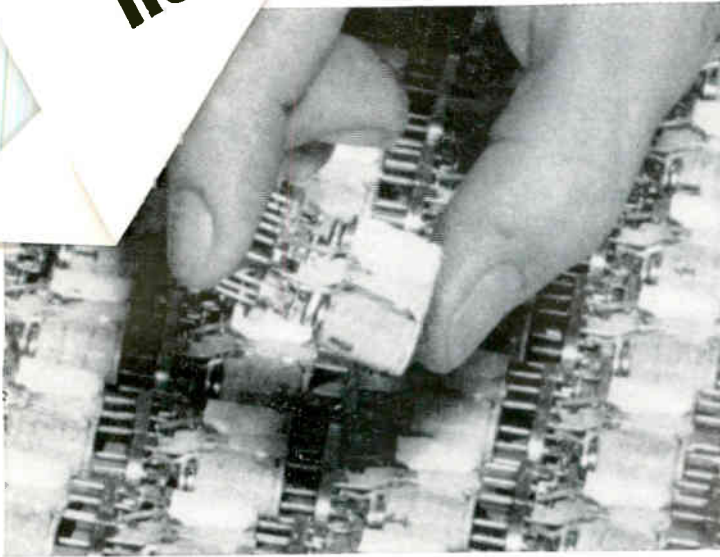

**PROBLEM:** How to reduce an unacceptably high reject rate on critical "crystal-case" electrical relays (first photo) at Potter & Brumfield, Division of American Machine & Foundry Company... eliminate employee problems of headaches and nausea due to solvent vapors.

**SOLUTION:** A new cleaning system using "Freon" fluorinated solvents. "Freon" is an excellent selective cleaning agent. It removes solder flux, dust, lint and other contaminants, yet doesn't harm delicate relay parts. Also, "Freon" is virtually non-toxic, thus eliminating complaints about vapors.

In the cleaning process, a basket of relays is first given a 15-second ultrasonic bath in "Freon" TMC, then an ultrasonic bath in "Freon" TF for 15 seconds (second photo), and a 15-second rinse in TF vapor. Because of its low surface tension, "Freon" quickly penetrates the tiny spaces in the relays, allowing precision cleaning of delicate parts.

As a final cleaning step, the relay contacts are washed in a spray of "Freon" TF, while being electrically actuated (third photo). This assures that no particles are entrapped between the contacts. Only the high dielectric strength of "Freon" makes this operation possible.

According to Potter & Brumfield, the adoption of "Freon" solvent cleaning has upgraded product quality, meeting their critically high standards, equivalent to a 17% increase in production capacity while at the same time decreasing labor costs. They point out that "Freon" dries quickly and leaves no residue, and that its non-flammability and low toxicity let them operate without expensive ventilating equipment. They've found "Freon" solvents economical to use because they can be recovered in simple equipment for reuse...over and over again. Most important, "Freon" solvents have eliminated employee complaints on nausea and headaches.

• • • •  
We'll be glad to give you help in selecting "Freon" solvents for use in your own cleaning operation. Just write on your letterhead to Du Pont, 2420E-3B Nemours Bldg., Wilmington 98, Delaware.

**FREON**<sup>®</sup>  
solvents



BETTER THINGS FOR BETTER LIVING . . . THROUGH CHEMISTRY



# NEW LOW PRICED

BEATTIE-COLEMAN  
OSCILLOTRON



## POLAROID® PRINTS IN 10 SECONDS

It's new! It's efficient! It's versatile! It's the Beattie-Coleman K5 Oscilloscope Camera.

- Direct view while recording.
- Single traces at 1:0.9 ratio or 13 traces at 1:0.7 on one frame of Polaroid Land film.
- Choice of Polaroid roll film back or 4x5 back for Polaroid or regular cut film holders.
- Uses Polaroid Land 10,000 speed film.
- f/1.9 Oscillo-Raptar lens.

**\$395 complete**

### ACCESSORIES:

- Electric shutter actuator.
- Data recording chamber.

Circle number on card for info. on full Oscilloscope line.

"Polaroid"® by Polaroid Corp.



1004 N. Olive St., Anaheim, Calif. • PR 4-4503

wires and with soldering provides the tight fitting required for a rigid assembly.

**FABRICATION**—A module is fabricated as follows (Fig. 2):

- Circuit elements are connected to "bottom" circuit board with lead wires pushed into countersunk holes tightly enough to support elements
- "Top" multi-layered circuit board is placed in position to receive element "top" wires that are tightly inserted
- Assembly is placed in a board-holder jig
- Solder preforms are placed around wires using tweezers in top board and each row of holes is fluxed using a hypodermic needle with a low-viscosity, high temperature flux

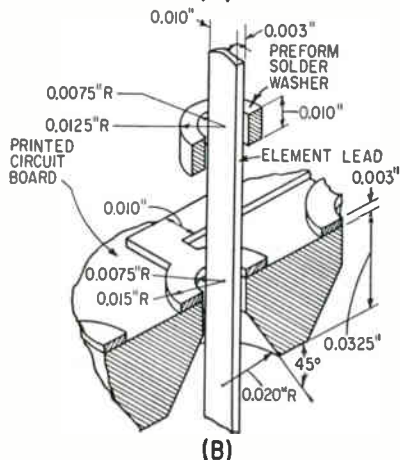
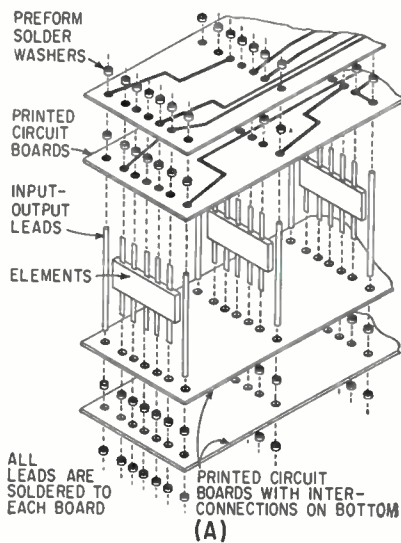

**EXPLODED VIEW** of module shows assembly details (A). Close-up of soldered joint assembly shows how needed rigidity is supplied by countersink configuration that provides conical shape of solder mass (B)—Fig. 2

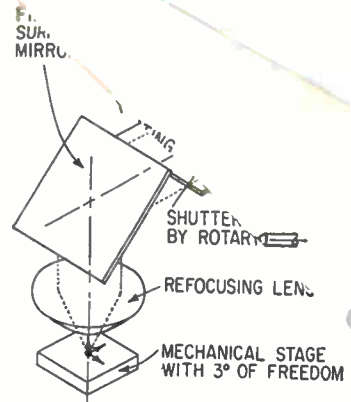

**HOT-ENERGY SPOT** is generated by optical soldering system and selectively applied to portions of joint soldered—Fig. 3

- Heat is applied with the optical soldering system to each joint in top board
- Module is inverted and procedure repeated for bottom board.

**OPTICAL SOLDERING**—Module fabrication is ultimately dependent on the optical soldering technique shown schematically in Fig. 3. The technique was developed to provide a controlled heat source requiring no physical contact with the solder joint. As shown, the system consists of:

- A carbon-arc heat energy source
- Collimating and refocusing lenses for beaming heat energy onto solder joints
- Shutter and shutter control equipment for on-off control of heat-energy beam
- Mechanical stage with jigs for module positioning
- Optical aids for inspection and monitoring of soldering operation.

The module-positioning jig provides height of board needed to have system's hot spot pass through each solder joint. A filter is used with the optical viewing equipment to allow visually monitoring of each joint as it passes through the hot spot; jig is used to move module through hot spot.

**AUTOMATION**—A high degree of automation is foreseen for this process. The present "hand" operations—hole drilling, solder-perform placement, etc.—supporting the optical technique are too time consuming for other than the present laboratory procedure.

Features promoting an auto-

# PACKAGING WITH COORS CERAMIC

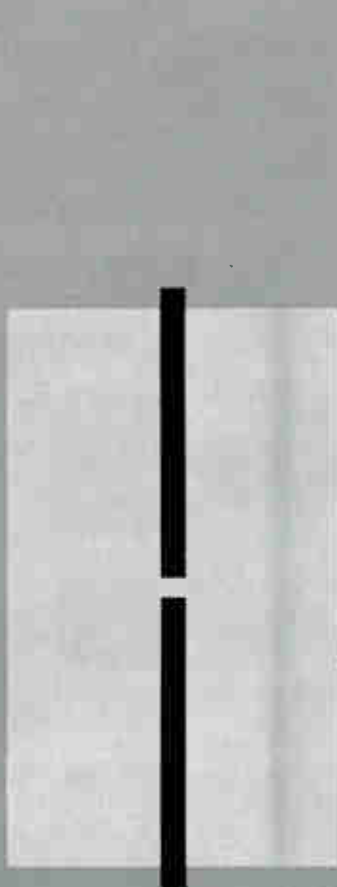

VACUUM SWITCHES

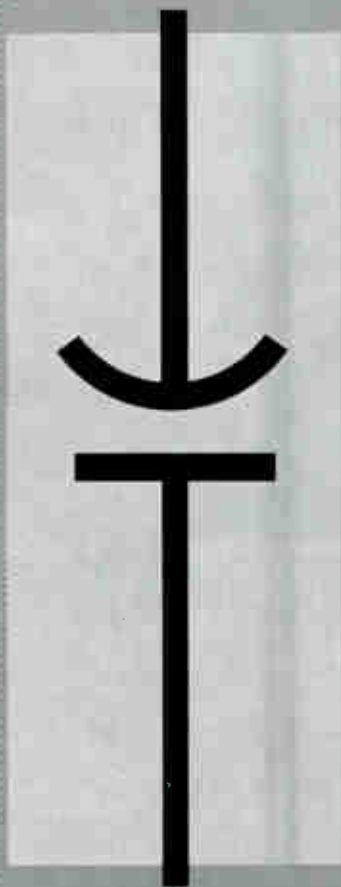

VACUUM CAPACITORS

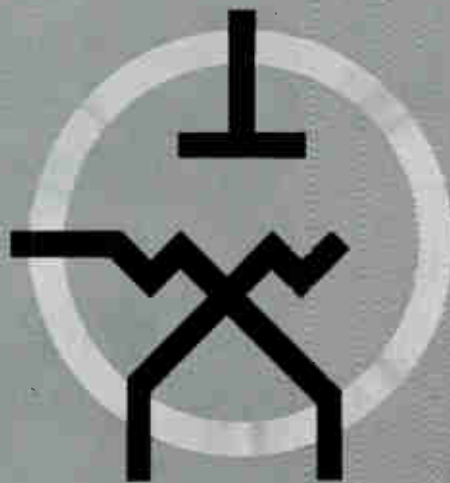

VACUUM TUBES

When your packaging application demands high strength and reliability — envelopes for vacuum switches, vacuum capacitors, vacuum tubes — use Coors high alumina ceramics. Outstanding properties include high dielectric characteristics at high frequencies, and high mechanical strength even at high temperatures. These materials can be metallized and subsequently brazed with bond strengths up to 15,000 psi. Coors has facilities for forming, for metallizing and for precision inspection of mass production quantities of dimensionally uniform envelopes. Small parts are dry-pressed... larger ones are isostatically formed. Write for "Ceramic Envelopes for Electronic Packaging," Data Sheet No. 7003, or call your nearest Coors regional sales manager: WEST COAST, Kenneth Lord, 536-8556, Huntington Beach, Calif.; MIDWEST, John E. Marozek, 529-2510, Roselle, Ill.; CENTRAL, Donald Dobbins, GL 4-9636, Canton, Ohio; EAST COAST, John J. McManus, MA 7-3996, Manhattan, N. Y.; NEW ENGLAND, Warren G. McDonald, FP 4-0653, Schenectady, N. Y.; SOUTHWEST, Kenneth R. Lundy, DA 7-5716, Dallas, Texas; SOUTHWEST, William H. Ramsey, UN 4-6369, Houston, Texas.

# Coors

## ALUMINA CERAMICS

Coors Porcelain Co., Golden, Colo.

CIRCLE 93 ON READER SERVICE CARD



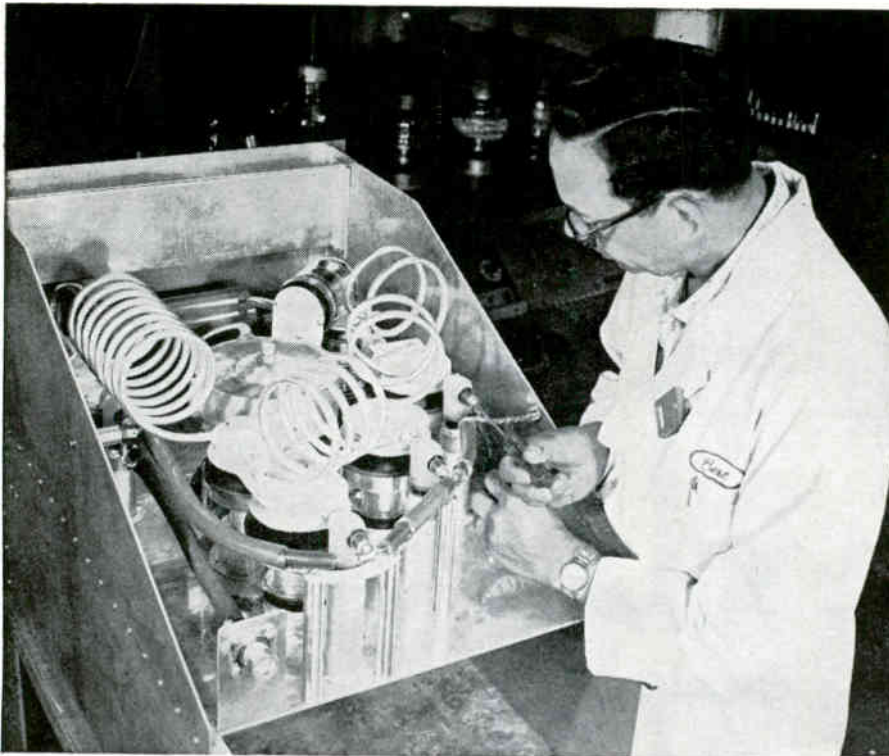

## EXCEPTIONAL DESIGNS START WITH JENNINGS VACUUM CAPACITORS

This electronics engineer is just completing a 17.5 kw, all band, continuous tuning power amplifier to be used for test purposes. It has a range of 2 megacycles through 34 megacycles yet only occupies 2' x 2' x 3' of space!

Can you imagine this amplifier being designed or even dreamed of with anything but vacuum capacitors? Every circuit design presents different problems but this application illustrates the range of design possibilities available with Jennings vacuum capacitors. Here are some of the exclusive advantages of these capacitors that make it possible to extend your range of design ideas:

**WIDE FREQUENCY RANGE . . .** Jennings vacuum capacitors offer the widest capacity change ratio available anywhere. Some capacitors have ratios as high as 150 to 1.

**RELIABILITY . . .** Sealed plates never become contaminated.

**EFFICIENCY . . .** Vacuum dielectric results in very low dielectric losses.

**COMPACTNESS . . .** High strength vacuum dielectric results in much smaller capacitor with the additional advantage of lower inductive losses.

**WIDE SELECTION . . .** Jennings offers over 400 types of fixed and variable vacuum capacitors to meet your circuit requirements.

Write today for more detailed information about Jennings complete line of vacuum fixed and variable capacitors.

RELIABILITY MEANS VACUUM / VACUUM MEANS *Jennings*<sup>®</sup>

JENNINGS RADIO MFG. CORP., 970 McLAUGHLIN AVE., SAN JOSE 8, CALIF., PHONE CYpress 2-4025

mated process include:

- Standardized hole matrix permits automatic drilling or molding of boards to eliminate drilling
- Hot-solder dipping of boards could leave enough solder material on copper lands surrounding board holes so as to eliminate individual solder preform placement. Along with this, continuous fluxing could be mechanized or a reducing atmosphere used
- Optical soldering technique could be servo-drive controlled.

### Jigless Boring Helps Small-Lot Production

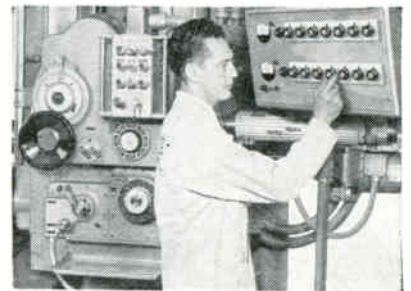

ROTARY dial switches on spindle-head-mounted console control precise boring operations

TWO SETS of direct-reading dials for preselecting horizontal and vertical movements permit fast set-up of boring operations for small-lot production jobs and eliminates the necessity for positioning jigs in assuring positioning accuracy. Used as part of the control system on the "Spirmatic Jigmils" produced by DeVlieg Machine Company, the rotary dial switches permit dialing-in of dimension settings in increments of 0.0001 inch, or if metric system measurement is being used, in increments of 0.001 mm. This is translated to horizontal movement of machine's table and vertical movement of machine's spindle head when operator depresses a pushbutton. While machine completes one operation, operator dials next move to duplicate blueprint dimensions on workpiece. Control system is entirely electronic using transistor circuits. A full zero offset is provided to permit operator to set zero or datum point at any point within control system's positioning range. Provision is made to switch to mechanical programming for automatic work.





**BFD2  
BINARY DIVIDERS**  
(division by 2, 4, 8, 16, 32)

## PRECISION FREQUENCY

From 1 CPS—to 20 KC

Model FG-F and FG-E oscillators available with solid state dividers, multipliers, and shaping stages, providing a variety of output levels and wave shapes.



**FG-F (FLAT CAN SERIES)**  
MJQ FORK—solid state  
circuitry—for card mounting



**MG OR  
MGQ RESONATOR**  
 $\pm .005\%$  from  $-20^{\circ}\text{C.}$  to  $+85^{\circ}\text{C.}$   
 $\pm .002\%$  or  $\pm .001\%$  from  $0^{\circ}\text{C.}$   
to  $+75^{\circ}\text{C.}$  960 cps to 2500 cps

## PHILAMON<sup>®</sup> TUNING FORK RESONATORS

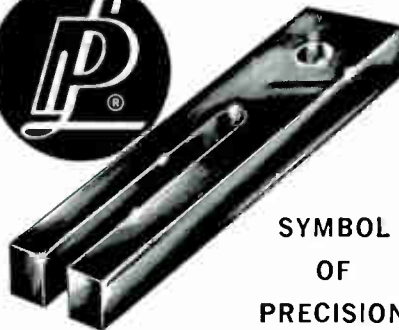

SYMBOL  
OF  
PRECISION



**MJQ-4 FORK RESONATOR**  
MJQ RESONATOR for  
vibration isolated mounting



**MGFO OSCILLATOR**  
contains MG fork and  
vacuum tube circuitry

**PHILAMON PRODUCTS** are known for their conservative ratings, reliability, and uncompromising quality. If you have a special frequency problem, or simply desire detailed technical data, please write or phone:

**PHILAMON LABORATORIES INC.**  
90 HOPPER ST. • WESTBURY, LONG ISLAND, N.Y.  
AREA CODE: 516 EDGWOOD 3-1700  
TWX: 516 333 5037



**MJFO OSCILLATOR**  
contains MJ fork and  
vacuum tube circuitry



**MJ OR MJQ RESONATOR**  
 $\pm .05\%$ ,  $\pm .02\%$   $\pm .01\%$   
from  $-55^{\circ}\text{C.}$  to  $+85^{\circ}\text{C.}$   
reduced accuracy to  $+125^{\circ}\text{C.}$   
360 to 5000 cps

## FORK FILTERS

Effective Q ranging from 1400 to 10000, having frequency range and center frequency stability. Comparable to models MJ, MJQ, MG, and MGQ resonators.



**FG-E (E CAN SERIES)**  
MJQ FORK—solid state  
circuitry—for chassis mounting

William J. Kennedy  
Sales Manager  
shown 1/25 actual size  
Model 9200  
Coaxial Termination  
shown actual size.



## 50-OHM COAXIAL TERMINATIONS

■ "Model 9200 50-Ohm Coaxial Termination is one of eight models in our SAGE-LINE of terminations. It provides a maximum VSWR of 1.15 over the entire range from DC-5000 MC. Its peak power capability is 1 KW; average power, 1 watt. ■ The 9200 connector is type N male. The dimensions are  $2\frac{7}{8}$ " in diameter and  $1\frac{1}{2}$ " in length. Weight is 2 ounces. All materials and finishes are to government specifications. ■ The price of the 9200 is \$12.50, FOB Natick. Quantity discounts are available. Delivery is from stock for quantities up to 100. ■ If you have a question or would like to place an order, I hope you will call the number shown below. We'll look forward to talking with you." ■

William J. Kennedy / Sales Manager



**SAGE LABORATORIES, INC.**  
3 HURON DRIVE • NATICK, MASS. • Tel: 617-653-0844  
TWX: 617-653-6193 • Cable: SAGELABS-NATICK

CIRCLE 200 ON READER SERVICE CARD

## THE DECI-CAP

New Subminiature Ceramic Capacitor—0.100" Diameter by  
0.250" Molded Envelope—24 Hour Delivery

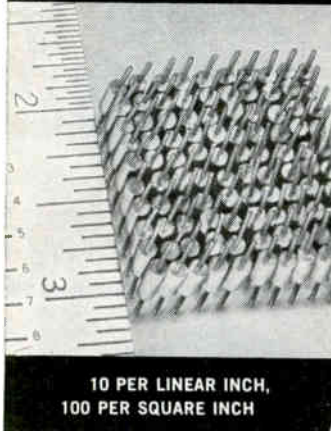

5 pf to 470 pf in 19  
values, 200 WVDC

Epoxy molded for high-  
est reliability and perform-  
ance—less than 7½%  
capacitance change from  
-55°C to +125°C

### FEATURES:

Standardized size  
for high density  
cordwood packaging

Designed to meet  
all the require-  
ments of MIL-C-11015

10 PER LINEAR INCH,  
100 PER SQUARE INCH

The DECI-CAP is the latest addition to Nytronics' DECI Series—a series that does consist of inductors, capacitors and resistors in a uniform envelope to facilitate point-to-point assembly in cordwood, printed circuit and other high density module assemblies.

For complete engineering data, write Dept. WL-59, or phone 201-464-9300.

**NYTRONICS, INC.**

550 Springfield Ave., Berkeley Heights, N. J.

Design Leaders STANDARD components to meet CUSTOM requirements

96 CIRCLE 96 ON READER SERVICE CARD



Are you a

**COMPLETELY INFORMED**

**electronics engineer?**

Today you may be working in microwaves. But on what project will you be working tomorrow? You *could* have read **electronics** this past year and kept abreast of, say, microwave technology. *There were 96 individual microwave articles between July, 1961 and June, 1962!*

But suppose tomorrow you work in some area of standard electronic components, in semiconductors, in systems? Would you be up-to-date in these technologies? Did you read the more than 3,000 editorial pages that **electronics'** 28-man editorial staff prepared last year?

**electronics** is edited to keep you current *wherever* you work in the industry, *whatever* your job function(s). If you do not have your own copy of **electronics**, subscribe today via the Reader Service Card in this issue. Only 7½ cents a copy at the 3 year rate.

**electronics**

CIRCLE 97 ON READER SERVICE CARD →

Mullard tubes for Audio

# ECL86

## 6GW8

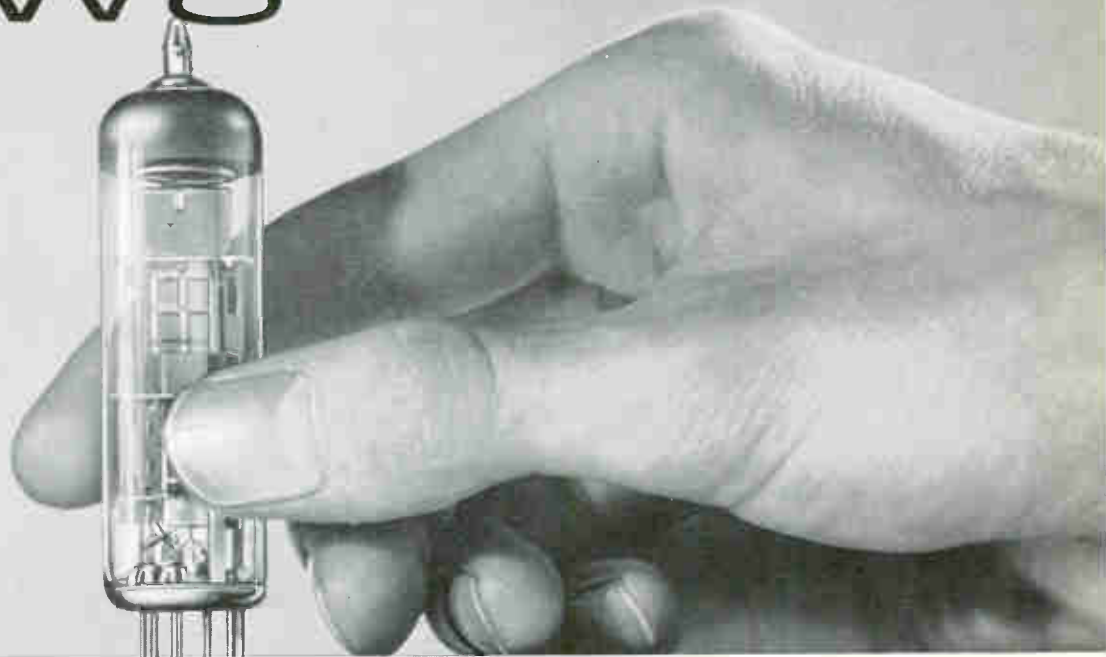

### COMBINED HIGH MU TRIODE AND 9 WATT PENTODE

High sensitivity, coupled with high output power make the ECL86 the ideal tube for audio amplifiers. The high sensitivity of this tube stems from a triode amplification factor of 100 combined with a pentode slope of 10 mA/V. A single ECL86 will give an audio output of 4W ( $B+ = 250V$ ), and two in push-pull will provide 14.3W ( $B+ = 300V$ ).

### CHARACTERISTICS

#### Pentode Section

$g_m$	10	mA/V
$P_p$	9	W
$r_p$	48	k $\Omega$
$E_b$	250	V
$E_{c2}$	250	V
$E_{c1}$	-7.0	V
$I_{b1}$	36	mA
$I_{c2}$	6.0	mA

#### Triode Section

$\mu$	100	.
$g_m$	1.6	mA/V
$r_p$	62	k $\Omega$
$E_b$	250	V
$E_c$	-1.9	V
$I_b$	1.2	mA

Full details on the Mullard range of tubes for stereo, high-fidelity and television available from:

**INTERNATIONAL ELECTRONICS CORPORATION,**

81 SPRING STREET, NEW YORK 12, N.Y.

Worth 6-0790



# Mullard

ELECTRONIC TUBES

MULLARD OVERSEAS LIMITED · LONDON · ENGLAND

\*Mullard' is the trade mark of Mullard Limited



## Counter Simplifies Quantity Measurement

*Translates one function of time into another and displays it*

RECENTLY announced by Computer Measurements Co., 12970 Bradley Ave., San Fernando, California, model 702A variable time base frequency counter provides direct readout of unknown quantities by translating one function of time into another function of time. Frequency range is 1 cps to 300 Kc, sensitivity is 5 mv rms from 10 cps to 30 Kc and 100 mv rms from 1 cps to 300 Kc, input impedance is 100,000 ohms shunted by 50 pf and readout is 5-decade (vertical columns of incandescent lamps). Remote programming is available as

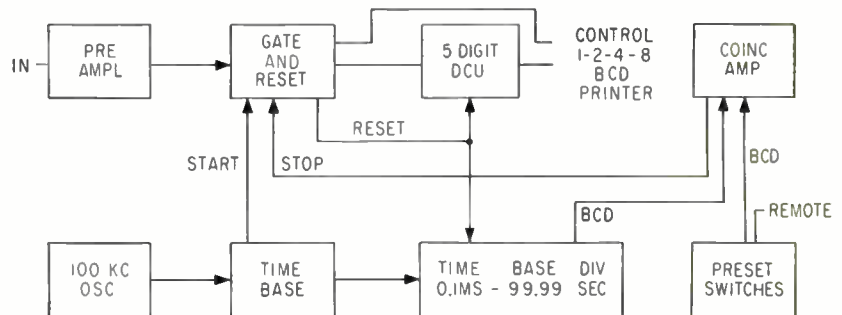

well as a 1-2-4-8 BCD 5-digit printer output. One example of use is determining fluid flow rate. If a transducer provides 250 pulses per gallon of flow, and  $n$  equals gallons per minute, then  $250n$  could be displayed if the counter is gated for 60 seconds. Therefore,  $n$  could be displayed directly if the counter is gated for 60/250 seconds, or 0.24 second. Better resolution could be

obtained by using a 2.4 or 24 second gate and shifting the decimal point. Operation is shown in sketch. The input signal is fed to the pre-amplifier and shaped. The signal gate is controlled by start and stop signals from preset time base. When started, input frequency is counted by decade counting units (DCU) until stop pulse arrives.

CIRCLE 301, READER SERVICE CARD

## Electronic Gage Measures to 0.000001 Inch

MANUFACTURED by Brown and Sharpe Mfg. Co., 235 Promenade St., Providence 1, Rhode Island, are a series of transistorized electronic gages, the model 961 low magnification, model 962 high magnification and the model 964 differential. Range of low-magnification model is  $\pm 0.003$ , 0.001 and 0.003-in. with corresponding readout in increments of 0.0001, 0.000050 and 0.00010-inches. The high magnifica-

tion is  $\pm 0.0003$ , 0.0001 and 0.00003-in. with corresponding readout in increments of 0.000010, 0.000005 and 0.000001-inch. Zero position on each amplifier remains unchanged with range switching. The differential amplifier has a continuously-variable range adjustment between  $\pm 0.003$  and 0.0003-in. with readings from 0.0001 to 0.00010 inch. This unit may be used for absolute or comparative measurements with a single gage head or for reading sum or difference measurements by two gage heads. As shown in the sketch, the gage head consists of two coils with a sintered iron core centered between them. The core is attached to the gage spindle and moves axially. Its position relative to the coils affects coil impedance. The coils and transformer form a bridge and when the core rests equally between the coils the bridge is balanced and out-

put signal is zero. When core is displaced, coil impedance is changed. A signal proportional to amount of displacement is generated, amplified, rectified and displayed on a d-c meter. (302)

## Analog Computer Has Wide Dynamic Range

ANNOUNCED by Computer Systems, Inc., Industrial Park, Ft. Washington, Pennsylvania, the Dystac SS-100 solid-state analog computer has a computing range of +100 v to -100 v and features extreme precision at computing speeds from real time to iterative rates in excess of 1,000 solutions per second, modular construction, adaptable to linkage with digital computers in hybrid installations, and compatibility with current precision analog

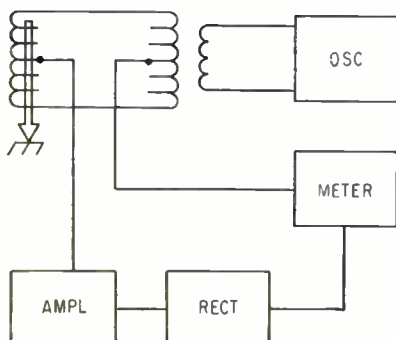

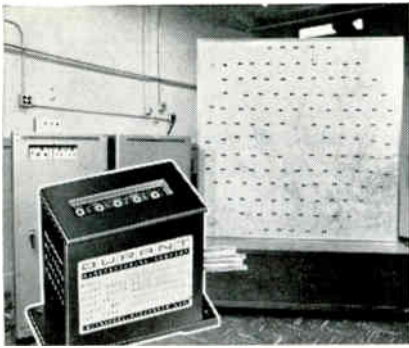

## Precipitation Integrator Reveals "Nature's Secrets"

DURANT COUNTERS furnish instant, radar-calculated rainfall measurement from a widespread area to feed a computer in the preparation of river and flood forecasts.

This new system was developed by Stanford Research Institute for the Weather Bureau, U. S. Dept. of Commerce, currently on test in Oklahoma. Existing radar installations are read electronically and this information is transmitted to the River Forecast Center. Precipitation is registered cumulatively in tenths of inches by Model "YE" Durant Electric Counters set in a display map of a river basin (basin illustrated has 150 counters). Counters are instantly reset electrically.

Durant "YE" Counters are ideal where important numerical data from many distant points is desired at a strategic control center . . . for visual observation or to be fed into a computer.



## Timeter Translates Time Into Dollars

DURANT MANUFACTURING CO., Milwaukee, provides the counter for accurate records of chargeable production time. Money figures (cost or selling), or total work time, is read directly from Durant 4-Y-9434-T Counter. Total production time of worker, machine, operation or function is also recorded. To operate, the employee flips the switch at the start and, when finished, the reading is noted on the job record. If necessary to leave, the Timeter is turned off until employee restarts it.

Durant's easy-to-read figures, compactness and positive electric actuation provide dependable numerical data in applications where four figures are sufficient.



*above and beyond...*

. . . the accepted norm is the pursuit of achievement which dictates the research and development program behind DURANT COUNTERS . . . each model is precision engineered to perform above and beyond its specified requirements. To accomplish its purpose, a DURANT COUNTER must provide: **actuation**—somehow, somewhere, by mechanical, electrical or electronic means, the counter must be actuated. Durant Counters . . . Stroke, Revolution, or Electric . . . respond to every known method of recording the sequence of numbers. **accumulation**—as actuation occurs, the internal mechanism must accumulate the impulses without fail. Durant Counters do this with a minimum of working parts, operating in simple movements for long life and dependable readings. **accuracy**—numbers mean nothing unless they are accurate. There can be no slip-up, no missed impulses, no stuck numbers. When a Durant Counter indicates a number — it is accurate and the human eye can see it in the most readable presentation. ♦ **When numbers are important** — for basic control, visual readout, computing, recording or integration of quantitative data to a complete system . . . there's a Durant Counter for the job . . . call on a Durant man and let him prove it. Durant Manufacturing Co., 1929 North Buffum Street, Milwaukee 1, Wisconsin. Write for company booklet.

**DURANT**  
**PRECISION COUNTERS**



REPRESENTATIVES IN ALL PRINCIPAL CITIES

**Acme Electric**  
**Has The Solution To Your POWER SUPPLY PROBLEM**



Acme Electric has the experience and "know-how" in developing and building Power Supplies to help you determine the practical operating parameters essential to the application.

Acme Electric engineers have developed and produced more than 1000 different Power Supply designs, ranging in capacities from 1/8 watt to 600 KW; 5 ma to 4800 amps; with voltages from 0.7 to 27000 DC. More than 43,000 complete Power Supplies were shipped from our plants in a recent 12 month period.

Custom Power Supplies are designed with regard to regulation, frequency, response, recovery time, transient disturbances, ripple noise level, isolation, temperature drift, stability and the most practical physical size consistent with the component and circuitry requirements.

If you have a power supply problem and need experienced assistance, send your specs to Acme Electric.

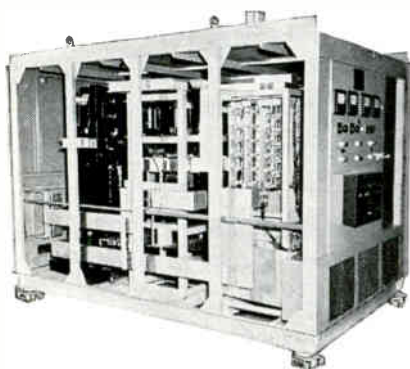

Typical construction of 600 KW, 250 volt dc power supplies designed by Acme Electric for use at Brookhaven National Laboratory. Similar units furnish the reliable power for other nuclear research installations at Cambridge, Argonne, Oak Ridge.

**ACME ELECTRIC CORPORATION**  
 313 WATER ST. SAA 3650/2087 CUBA, N.Y.  
 In Canada: Acme Electric Corp., Ltd., 50 Northline Rd., Toronto, Ont.

**Acme Electric**

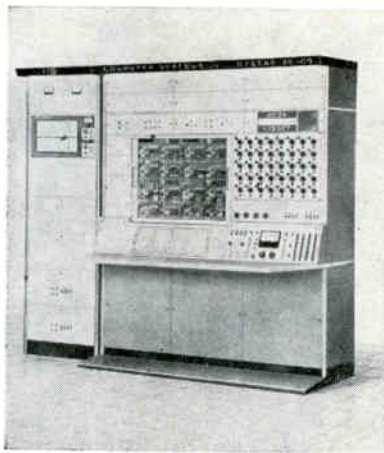

computing equipment. The 100-v level makes possible a dynamic range of 10,000 to 1 with computing accuracies of 0.01 percent at the lower range of the time scale. Although high packing density reduces parasitic capacitances and allows high computing frequencies, the highest range of computing frequencies requires operation at very-low impedance and voltage levels.

CIRCLE 303, READER SERVICE CARD

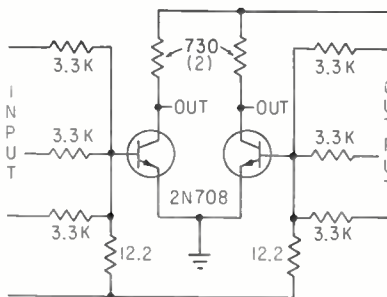

### Double NOR Gate for Dense Packaging

INTRODUCED by Intellux, Inc., 30 S. Salsipuedes, Santa Barbara, California, the types GG700 and GG1050 double NOR gates are a combination of thin-film techniques and semiconductor devices. Supply voltage is 7 v and dissipation is 30 mw at 6 v for the GG700 and 10.5 v and 60 mw at 9 v for the GG1050. Pulse repetition rate is 1 Mc, propagation delay is 70 ns per stage, fan in is 3 and fan out up to 6. Each microcircuit is  $\frac{3}{8} \times \frac{3}{8} \times \frac{1}{2}$  inch, weighs less than 2 grams and is terminated with 13 pins suitable for insertion and dip soldering into a multilayer board. The sketch shows internal circuit of the GG700 double NOR gate. Semiconductors are nested in molded preform to provide additional heat sink. (304)

### Determining Inductance Variation with D-C Current

INTRODUCED by Arnold Magnetics Corp., 6050 W. Jefferson Blvd., Los Angeles 16, California, the Digibox decade inductor enables simplified means of determining in-

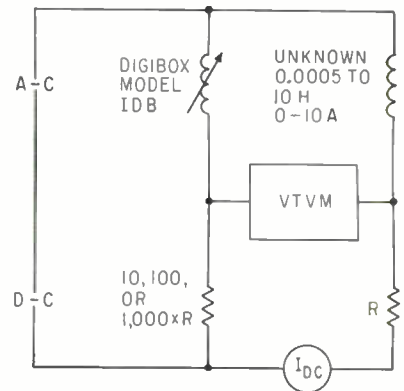

ductance variation with d-c current. The sketch shows how any inductance between 0.0005 and 10 H can be determined. This sketch shows a choke, with d-c superimposed and requires only a vtvm, a 25-w a-c amplifier, a low-ripple 1 to 10 ampere d-c supply and the Digibox unit. (305)

### Metal Stampings

BRAUN TOOL AND INSTRUMENT CO., INC., Hawthorne, N. J. Custom and standard beryllium copper precision metal stampings include component clips, contact strips and rings, printed circuit contacts, tube socket clips, diode clips, tube shields, crystal holders, etc. (306)

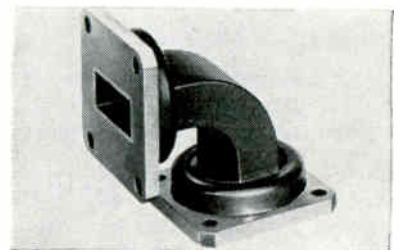

### H and E-Plane Bends For X-Band

FXR DIV., Amphenol-Borg Electronics Corp., 33 E. Franklin St., Danbury, Conn., has developed a standard line of 90 deg H and E-plane bends at X-band for production runs of commercial and military



# NEWS



## Varistor helps cut picture interference on latest

### Zenith TV—automatically

A development of the patented "Fringe Lock" circuit incorporated in Zenith TV receivers now automatically cuts annoying picture disturbances, whether made by nearby electrical machines or external influences such as passing automobiles.

Function of the circuit is to cut off the twin pentode 6HS8 (see below) when external noise is introduced. Plates of the pentode are connected respectively to the AGC and Sync circuits. Two of the grids are fed by composite video signals. Automatic bias setting, varying with signal level

fluctuations and always safely above the Sync tips, is provided by the voltage-sensitive resistance characteristics of the type BNR-331 Carborundum varistor.

The varistor replaces a potentiometer that required adjustment for maximum noise protection, particularly in fringe areas. The varistor not only provides automatic control and positive, instantaneous cut out, but also costs one-third less than the potentiometer previously used.

## New Technical data on varistors points way to wider applications and production savings

Carborundum offers a new bulletin and technical literature to aid

in the selection and application of silicon carbide non-linear, voltage-sensitive resistors.

A variety of body types and sizes is available, with electrical characteristics suitable for applications requiring microamperes at one volt up to kiloamperes at kilovolts. Typical applications are lightning arrestors; contact arc suppression for relay coils and solenoids; protection for silicon rectifiers, capacitors and other electronic components against high peak inverse voltage; and voltage regulation and control.

The bulletin lists standard stock varistors with pertinent design information. Individual technical sheets provide E/I characteristic curves and specifications on over 100 stock varistors.

For your copies, write Dept. EL-3, Electronics Division, Carborundum Company, Niagara Falls, New York. Inquiries regarding application to specific problems are invited.

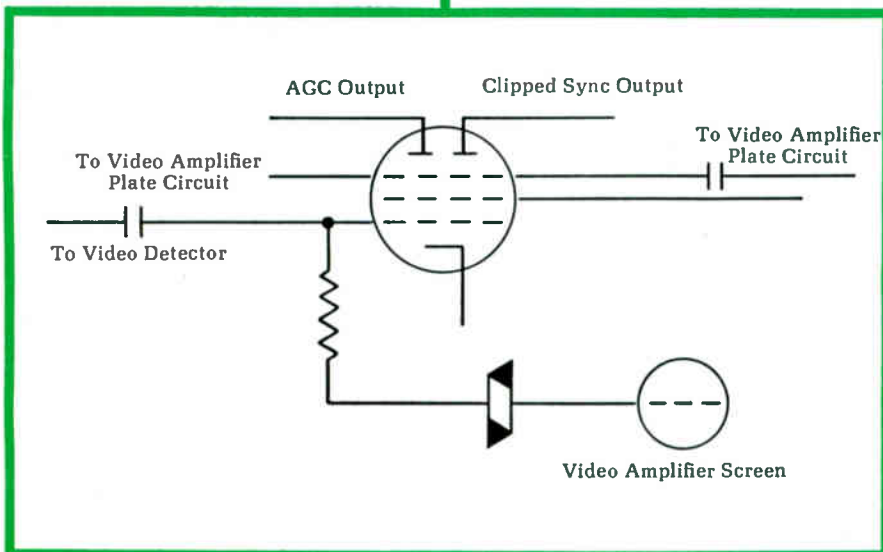

**CARBORUNDUM®**

Be sure to visit our booth at the IEEE Show.

# BRISTOL'S LOW-NOISE CHOPPERS

for unmatched **RELIABILITY**  
in low-level instrumentation



MINIATURE BRISTOL SYNCROVERTER CHOPPERS

Low-Noise Syncroverter\* choppers are used in the finest and most accurate d-c amplifiers, microvolt-ameters and null-balance systems where only the best is required. Write for complete specifications:

**The Bristol Company, Aircraft Equipment Division, 150 Bristol Road, Waterbury 20, Conn.**

A Subsidiary of American Chain & Cable Company, Inc.



**BRISTOL**

\*T.M. Reg. U.S. Pat. Off. 1.3

... engineers for precision, builds for reliability

Come visit us at Booth 1719 at the IEEE Show

systems. Units are offered in a choice of both brass and aluminum, and  $\frac{1}{2}$  in. and  $2\frac{1}{2}$  in. radii. Max vswr is 1.05 over the frequency range of 8.2-12.4 Gc. All units are painted light grey in accordance with MIL-E-15090, Type II, Class II. Aluminum bends are chemically treated per MIL-5541 before painting.

CIRCLE 307, READER SERVICE CARD



## All-Crimp Connectors Meet MIL-C-26482 C

BURNDY CORP., Norwalk, Conn., has developed a line of Smooth Bantam all crimp connectors which conform to MIL-C-26482C (Navy). Company supplies not only connector and contacts, but also provides crimping tools, both hand and automatic as a complete package. Other advantages: insert design which supports contacts to assure pin alignment and proper mating of plug and receptacle; closed entry socket with completely enclosed internal spring to prevent tearing or damaging of resilient insert or grommet. (308)

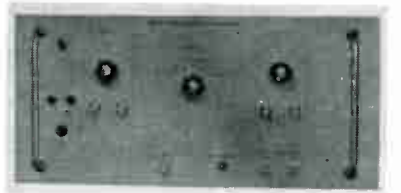

## Modulator-Demodulator For Measurement Uses

WAYNE KERR CORP., 1633 Race St., Philadelphia 3, Pa. The SA 400 broadens use of the SA 100 transducer function computer. Unit is applied to carrier systems of between 50 and 2400 cps. (309)

## Transistor Testers Offered in Two Types

BAIRD-ATOMIC, INC., 33 University Road, Cambridge 38, Mass. Model

OT-1 high-frequency transistor test set measures gain ( $h_{re}$ ) at 20, 100, and 200 Mc by means of individual plug-in units. Measurement range is 1-10. Collector voltage is 0-30, and emitter current 0-100 ma. Accuracy is  $\pm 3$  percent. Model PB-1 automatic transistor test set measures breakdown voltages and leakage currents up to 300 v. It also measures gain and saturation voltages up to 30 v and 500 ma. (310)

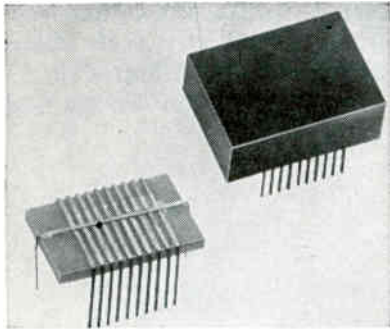

### Micro Package Has Ten Transistors

BURROUGHS CORP., P.O. Box 1226, Plainfield, N. J. Multi-element micro package consists of a strip of 10 npn diffused silicon transistors simultaneously fabricated and connected in a common emitter configuration. The transistors have high collector-emitter breakdown voltage which make them ideal for operation of gas discharge devices such as Nixie indicator tubes from low level signals. Current gains are typically 15. (311)

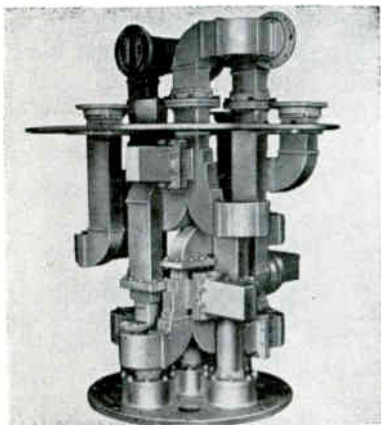

### Signal Comparator For C-Band

GOMBOS MICROWAVE INC., Clifton, N.J. C-band signal comparator is



# A Brand New STRIP TYPE!

**LEL-LINE** strip type components are real traffic stoppers. What's more they're the most available you'll find. How do we deliver LEL strip type components so fast? Easy... we make your time our business by delivering the goods — on the line... LEL-LINE that is. LEL-LINE is potted... gives superb environmental reliability under severe stress conditions... adapts to special packaging requirements without sacrificing electrical performance. LEL-LINE components are inexpensive, compact, light... have broad bandwidth. Normally fitted with standard TYPE-N connectors, they can be furnished with special connectors as required to achieve total compatibility with any type of system. A complete range of LEL-LINE Strip Type components, designed for breadboard or in-system uses, is manufactured in our own plant and can be speedily delivered.

**LEL-LINE** products include:



FSB-1-2000  
Bandpass Filter

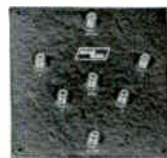

CSM-1-2000  
Monopulse Comparator



DSB-1-5402  
Low Frequency Binary Power Divider  
(3 octave coverage; 2, 4, 8 or 16 outputs)



HSD-1-2650  
High Isolation Hybrid

- SSB Suppressed Carrier Modulators
- High Frequency Binary Power Dividers
- Broadband High Isolation Mixers
- Fixed-Tuned Preselectors and Low Pass Filters

FOR A DETAILED LEL-LINE BROCHURE WRITE:



75 AKRON STREET, COPIAGUE, L. I., N. Y.  
(516) AMityville 4-2200 • (516) PYramid 9-8200



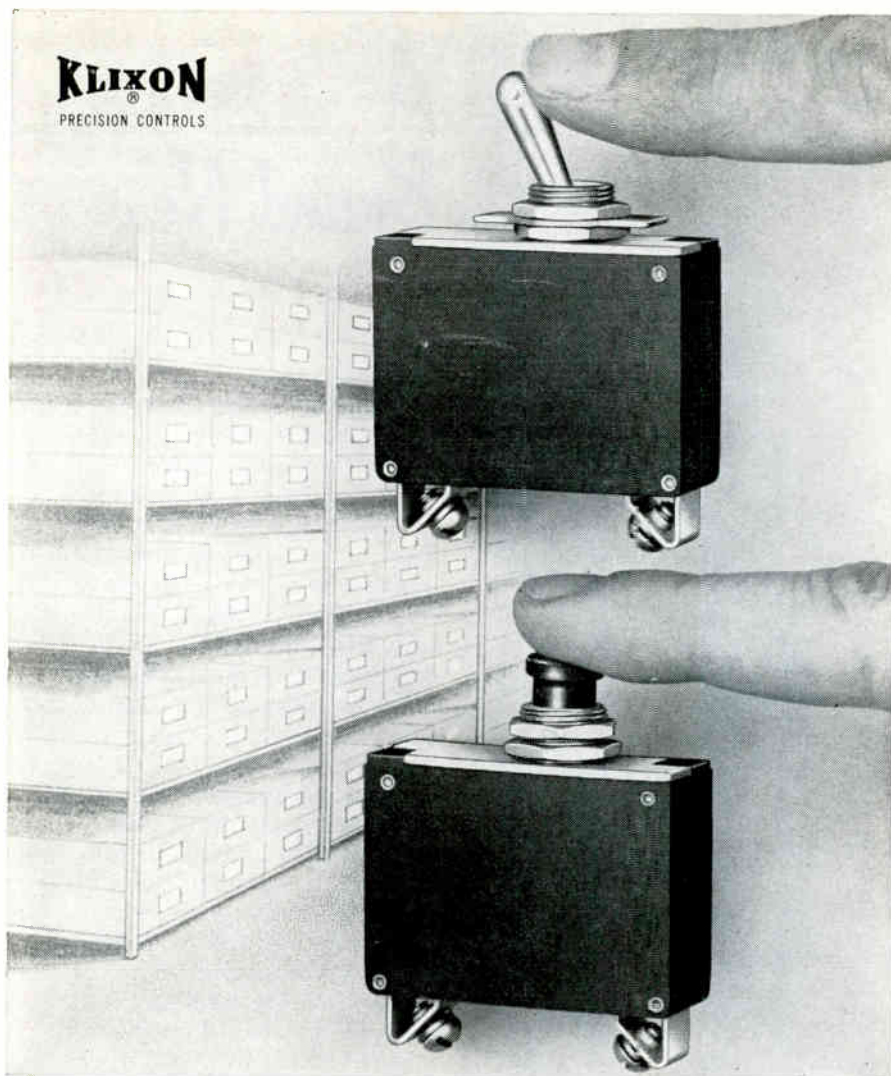

## NOW...you can choose magnetic circuit breakers...from stock!

New KLIXON miniature units . . . push-pull and toggle . . . are stocked at 8 convenient locations.

Freedom from design limitations and delivery delays are two reasons why leading companies are specifying KLIXON 2MC and 3MC Series Magnetic Circuit Breakers.

**Design options** provide freedom of choice in two areas: actuators and terminals. 2MC units feature toggle actuation; 3MC, push-button actuation. Both types provide visual warning of an overload condition — either by the position of the toggle or the exposed white band on the push button. You also have a choice of quick-connect, solder or screw-type terminals.

**Other desirable features** include: ratings from .050 to 15 amp at either 32 v-dc or 120 v-ac, 60 cycle; trip-free protection of circuits and equipment; trip response of 5 to 15 MS at 200% rating and endurance cycling of 10,000 operations at 100% rating.

**Eight-point warehousing** promises off-the-shelf delivery to all users of KLIXON Magnetic Circuit Breakers.

**Bulletin DD-CIRB-28** gives complete specifications, design options and performance characteristics. Write for it and the name of the distributor nearest you today.



**METALS & CONTROLS INC.**

5003 FOREST ST., ATTLEBORO, MASS.  
A CORPORATE DIVISION OF

**TEXAS INSTRUMENTS**  
INCORPORATED

the feed system which forms an integral component of a high-power monopulse radar system. It provides the proper phases and amplitude characteristics for the transmitted and received signals, so that optimum tracking accuracy in both elevation and azimuth planes is achieved. Comparator is housed in a tapered cylinder closed at each end by a plate, and occupying about four cu ft. During target tracking by the radar system, the received pulse energy from the target enters the comparator channels at the circular ports joined to the antenna feed horns.

CIRCLE 312, READER SERVICE CARD

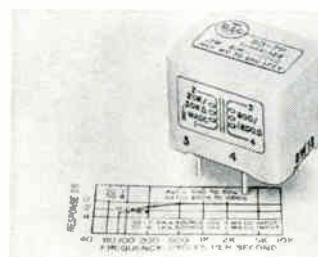

## Audio Transformers Are Vacuum Molded

UNITED TRANSFORMER CORP., 150 Varick St., New York 13, N.Y. Miniature audio transformers are vacuum molded to MIL Grade 5, Class R, Life X specifications. They employ 40 mil deeply anchored pin terminals ideally suited for p-c designs. Terminals are strong enough to support the light weight (approximately 0.4 oz) units. Physical design employs moisture barrier offset construction. Power levels range from 5 to 250 mw. Impedances range from 200,000 to 3.2 ohms. (313)

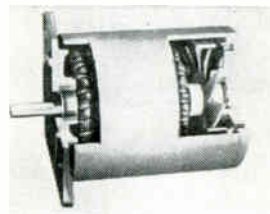

## Fractional H-P Motors Come in 25 Models

MCLEAN SYNTORQUE CORP., West Hurley, N. Y., offers a line of fractional h-p motors guaranteed for 20,000 hours of continuous duty.

**With Hart Series W:  
More Relay**



**... 25 amps!**

**CONTACT RATINGS**

- 25 A resistive  
120 V a-c or 240 V a-c

---

- 25 A inductive  
(75% power factor) 120 V a-c

---

- 12½ A inductive  
(75% power factor) 240 V a-c

---

- 1 HP  
120 V a-c (96A locked rotor)

---

- 2 HP  
240 V a-c (72A locked rotor)

---

- 25 A resistive  
24 V d-c

**Low Cost, Easy to Mount**



For more information on these compact, dependable, general-purpose relays, write for Bulletin WU-09 which gives complete data, specifications, applications and illustrations.

**HART**  
MANUFACTURING CO.  
202 BARTHOLOMEW AVENUE  
HARTFORD 1, CONNECTICUT  
Telephone: Area Code 203: 525-3491  
A SUBSIDIARY OF OAK MANUFACTURING CO.

Twenty-five models are available with 1/50 h-p to ½ h-p ratings in induction or hysteresis synchronous types, 60 cycle a-c. They operate from -30 C to 60 C. Ball bearings are cartridge type with long-life Mil-Spec lubricants. Rotors are dynamically balanced to 40 microinch excursions or better. Windings are class F high temperature polyester wound and impregnated. (314)



**Modular Connector Has Color Coded Housing**

AMP INC., Harrisburg, Pa., offers the 187 Fastin-Faston modular connector. A self interlocking housing device permits addition of modules without use of locking hardware. The 105C Nylon housing is color coded in a variety of nine colors and white and has a three rib design located over the number one contact for positive orientation and identification. Egg crate construction completely shields contacts and meets UL requirements in construction and material. Modular connector can be built in any combination of three circuits. Connector can be used with standard tabs and takes a wire size 20-16 Awg. Current capacity is 15 amp. (315)

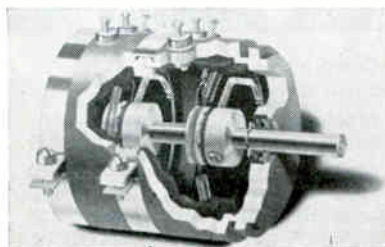

**Wirewound Pots Are Single-Turn Devices**

DALE ELECTRONICS, INC., P. O. Box 488, Columbus, Neb. Line of precision pots will be supplied in eight physical sizes from ¼ in. to 3 in. in diameter. All sizes meet require-

**aerospace  
component  
engineers  
&  
chemists**

Development contracts for VATE, MMRBM (Integration, Assembly & Checkout), TFX(N) Electronics, SURVEYOR, SYNCOM, POLARIS guidance . . . and others, have created growth opportunities at Hughes in Southern California for Chemical, Mechanical and Electronics Specialists in the following fields:

**COMPONENT PARTS ENGINEERS** Familiar with semiconductor, electromechanical, mechanical and passive components. Experience required in application, design and/or development of component parts.

**TESTING/TEST EQUIPMENT ENGINEERS** Experience required in electrical test methods, environmental equipment, test equipment design and testing of component parts.

**LUBRICATION ENGINEER** Knowledge of bearing and lubricant materials technology is required, with experience involving oils, greases and other lubricants (fluid through solid) as applied to rotating components and sliding bearings. Vacuum testing experience is desirable.

**CERAMICS ENGINEER** Experience is desired in aerospace ceramics applications plus ability in oral and written communications and in the development of consultant relationships.

Basic requirements include an appropriate degree from an accredited university, U. S. Citizenship and several years of directly related work in aerospace applications. For complete information, please airmail your resume to:

**MR. ROBERT A. MARTIN**  
Head of Employment

*Creating a new world with electronics*

**HUGHES**

**HUGHES AIRCRAFT COMPANY  
AEROSPACE DIVISIONS  
11940 W. JEFFERSON BLVD.  
CULVER CITY 18, CALIFORNIA  
An equal opportunity employer.**





# IRIG TIME CODE GENERATOR COSTS 10-15% LESS!

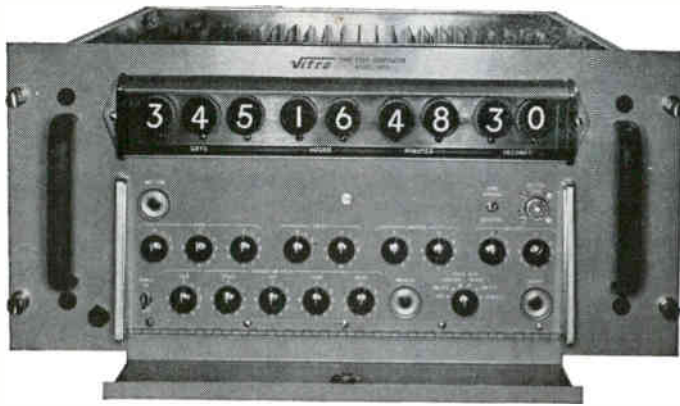

The VITRO 1900 Time Code Generator was researched and developed for one of the world's newest test ranges. It not only meets IRIG standards, BUT it gives you six great, new engineering features . . .

# FREE!

- |  |  |
|--|--|
| <ol style="list-style-type: none"> <li>1. Easily adaptable to NASA code, AMR code, or any other code by a switch of cards.</li> <li>2. Quickly synchronized to external time standards.</li> </ol> | <ol style="list-style-type: none"> <li>3. Operates up to 60° C.</li> <li>4. Light weight.</li> <li>5. Mechanically more rugged.</li> <li>6. Simultaneous outputs to within 1/4 microsecond.</li> </ol> |
|--|--|

We will be glad to send you the data sheets on this new equipment. Write or call New Projects Manager, Vitro Laboratories, 200 Pleasant Valley Way, West Orange, New Jersey (Area Code 201) REdwood 1-3400.



*Vitro Laboratories is a Division of Vitro Corporation of America*



ments of MIL-R-12934B and NAS-710. Single or ganged units will be available and special mechanical configurations, electrical angles and functions will be supplied to specification.

CIRCLE 316, READER SERVICE CARD

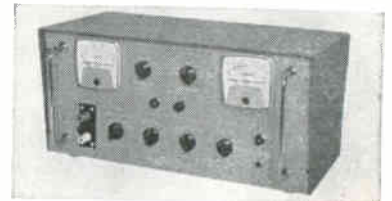

## SCR Test Set Uses Pulse Techniques

ELECTRONIC RESEARCH ASSOCIATES, INC., 67 Factory Place, Cedar Grove, N. J. Model SCR100 measures forward breakover voltage, peak reverse voltage, forward voltage drop, gate voltage and current characteristics, and other parameters. Forward voltage drop may be measured for currents from 1 ma up to 100 amp without use of external heat sinks. Breakdown voltage range is 0 to 1,000 v. All parameters can be measured either on the direct reading meter scales or via oscilloscope connections which are provided. (317)

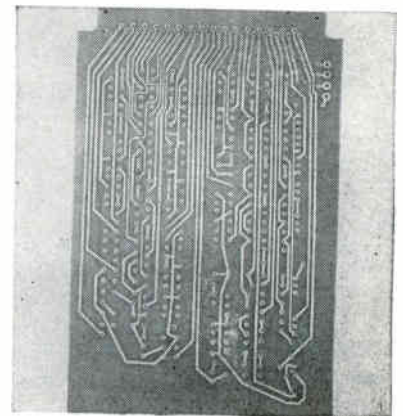

## Printed Circuits Meet MIL-P-55110

PHOTOCIRCUITS CORP., Glen Cove, N. Y. "Standard Circuits", a new type of printed circuit, reduce the cost of printed wiring boards by 40-60 percent, cut delivery time in half and eliminate most of the red tape and paperwork involved in the purchase of printed circuits. They meet the requirements of all military specifications relating to



**Helpful new book  
tools for your  
professional library**

**1. TRANSISTOR CIRCUIT DESIGN**

**Just Out.** Helps ease your transistor circuit design work. Reflects combined knowledge and experience of 32 expert circuit design engineers, bringing you design procedures and circuits most often requested from Texas Instruments Inc. Prepared by Eng. Staff of Texas Instru. Inc. Ed. by J. Walston and J. Miller. 523 pp., 526 illus., \$15.00.

**2. ENGINEERING CIRCUIT ANALYSIS**

**Just Out.** Clearly explains the basic concepts and techniques of circuit analysis. Covers resistive circuits, transient analysis, sinusoidal steady-state analysis, the complex frequency concept, and goes through Fourier analysis. By W. H. Hayt, Jr., and J. E. Kemmerly. 640 pp., \$10.95

**3. AN INTRODUCTION TO WAVES, RAYS, AND RADIATION IN PLASMA MEDIA**

**Just Out.** Presents a unified treatment of various facets affecting propagation of waves, rays, and radiation in anisotropic plasma media. Covers both macroscopic and microscopic description of such media, and explains principles and methods. By J. Brandstatter. 704 pp., illus., \$15.00

**4. NONLINEAR AUTOMATIC CONTROL**

**Just Out.** Provides a thorough and comprehensive treatment of the analysis and design of nonlinear automatic control systems. Covers linear continuous systems, statistical design principles, sampled data systems, analytical techniques used in nonlinear control, and more. By J. Gibson. 608 pp., illus., \$16.50

**OTHER BOOKS OF INTEREST**

- 5. **Microwave Circuit Theory and Analysis.** By R. Ghose. \$12.00
- 6. **Principles of the Statistical Theory of Communication.** By W. Hartman. \$10.50
- 7. **Models of Transistors and Diodes.** By J. Linvill. \$7.95
- 8. **Introduction to Radar Systems.** By M. Skolnik. \$14.50
- 9. **Delay Tables.** By A. Descloux. \$15.00
- 10. **Mathematics Manual.** By F. Merritt. \$9.50
- 11. **Integrals of Bessel Functions.** By H. Luke. \$12.50

**10 DAYS' FREE EXAMINATION  
DIRECT FROM PUBLISHER**

McGraw-Hill Book Co., Dept. E-3-22  
327 W. 41st St., New York 36, N. Y.

Send me book(s) circled below for 10 days' examination on approval. In 10 days I will remit for book(s) I keep plus few cents for delivery costs, and return unwanted book(s) postpaid. (We pay delivery costs if you remit with this coupon—same return privilege.)

1 2 3 4 5 6  
7 8 9 10 11

Name .....

Address .....

City..... Zone., State.....

Company .....

Position .....

For price and terms outside U.S., write McGraw-Hill Intl., N.Y.C. 36 E-3-22

p-c boards and the acceptance criteria of MIL-P-55110. (318)

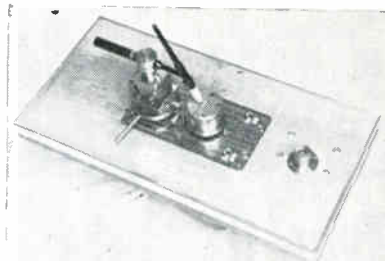

**Welding Fixture Tracks  
Symmetrical Shapes**

VAN ALLEN-ANDREWS, INC., 31 Holland Ave., Bridgeport 5, Conn. Model SF200 is a versatile welding fixture for moving a symmetrically shaped assembly in a precise path under an arc welding torch. It is ideal for welding hermetically sealed switches, relays, or any enclosed unit where flux removal is difficult. Operator merely places an assembled unit in a nest, places the nest in a fixture, flips a switch, and the unit is automatically welded while the operator is loading a second nest. A typical 0.400 in. by 0.800 in. crystal can relay like the one shown in the picture can be welded in only 8 sec. (319)



**Shielded Room  
Is Prefabricated**

FILTRON CO., INC., 131-15 Fowler Ave., Flushing 55, N. Y. New prefabricated shielded room features a fastening device which completely eliminates piercing the shield of the room. In addition, a new type of corner construction positively prevents any chance of r-f leakage. Filtron has also standardized its single door construction with a 36 in. width (clear opening) flush mounted. Erection and testing of the finished enclosures are made by Filtron's rfi specialists and are



**CONTROL SYSTEMS  
ANALYSTS FOR DEEP  
SPACE SYSTEMS  
STUDIES**

**Important opportunities** now exist at Hughes for specialists in many diverse areas ranging from complex precision systems of established types to studies on systems which will be based on entirely new concepts.

Work will cover preliminary design studies, analysis of systems requirements, performance trade off decisions and configuration planning.

Activities will include servo analyses, computer simulations, error analyses, parametric studies and similar functions.

Three to fifteen years' experience in the same or allied field is desirable. Advanced degree from an accredited university is preferred.

*For immediate consideration,  
please airmail your resume to:*

**MR. ROBERT A. MARTIN**  
Head of Employment  
Hughes Aerospace Divisions  
11340 W. Jefferson Blvd.  
Culver City 29, California

*Creating a new world with electronics*

**HUGHES**

HUGHES AIRCRAFT COMPANY  
AEROSPACE DIVISIONS

An equal opportunity employer.



# DESIGN WITH ARNOLD

## "Square-Permalloy" Tape Cores... YOU CAN GET THEM FROM STOCK IN THE RUGGED Type 6T CASE

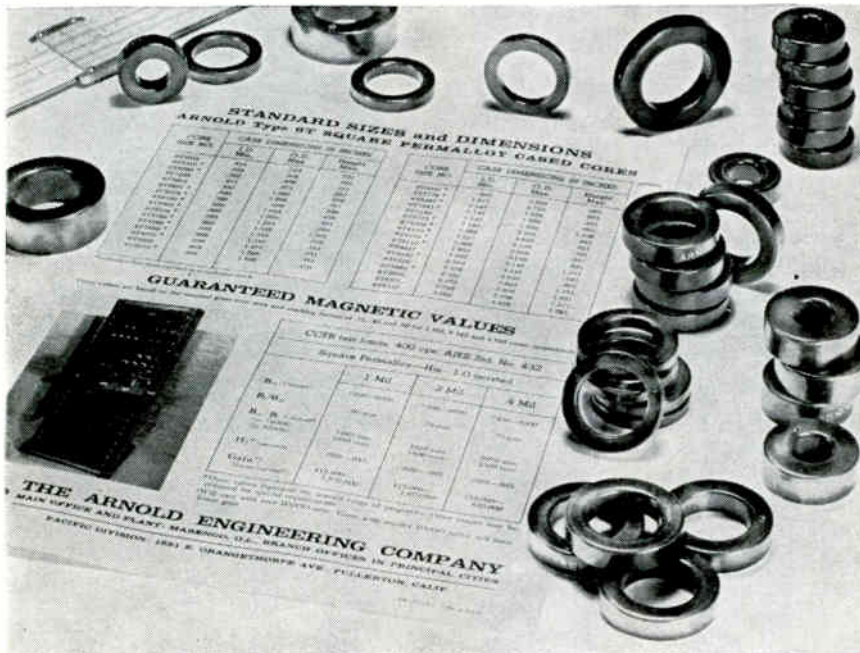

Use Arnold Square Permalloy Tape Cores in your designs for low level mag amps, high frequency mag amps, magnetic modulators, converters, pulse transformers, etc.

They offer you a number of desirable magnetic characteristics, with the assurance of high uniformity from lot to lot that is available only from a completely integrated producer such as Arnold. These properties include low coercive force, low excitation to saturate, high gain and a hysteresis loop of good squareness—along with high maximum permeability and relatively stable performance under ambient tem-

peratures in the broad range from  $-55^{\circ}$  to  $+200^{\circ}\text{C}$ .

Arnold Square Permalloy Cores are produced in all standard AIEE sizes (AIEE No. 430) in 1, 2 and 4-mil tape thicknesses. Most of these sizes are available for immediate shipment from stock in the Arnold Type 6T case (aluminum cased, oil filled, hermetically sealed and epoxy coated). Square Permalloy cores are also available in non-standard sizes in 1, 2 and 4-mil tape thicknesses. In addition, they're available in heavier gauges than 4-mil, and in ultra-thin gauges (less than 1-mil).

• For more data, write for Supplement 4, Bulletin TC-101A.

ADDRESS DEPT. E-3

4322R1A



# ARNOLD

SPECIALISTS in MAGNETIC MATERIALS

THE ARNOLD ENGINEERING COMPANY, Main Office: MARENGO, ILL.  
BRANCH OFFICES and REPRESENTATIVES in PRINCIPAL CITIES

guaranteed to meet or exceed MIL-E-4957A and MIL-STD-285 requirements.

CIRCLE 320, READER SERVICE CARD

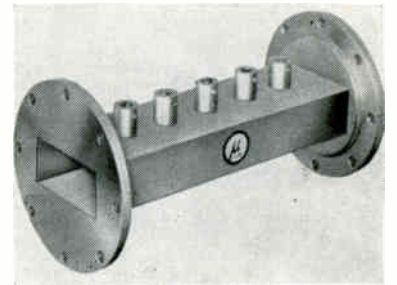

### Waveguide Filters in Six Frequency Bands

MICROLAB, 570 West Mt. Pleasant Ave., Livingston, N. J. The VA and VB series narrow band preselectors cover the frequency range from 4 to 12 Gc in six bands. The filters utilize iris coupled  $TE_{101}$  mode resonators, and provide an optimum response shape over a wide tuning range. Minimum bandwidth at 3 db is 20 Mc. Max bandwidth at 30 db is 200 Mc for two section type, 115 Mc for the three section type, and 85 Mc for the four section type. Max vswr is 1.5 for all types. Peak power rating is 10 Kw. (321)

### Coils

WABASH MAGNETICS, INC., First & Webster Streets, Wabash, Ind., has available a line of epoxy molded coils for all temperature ranges (Class A to Class H), and miniature ultra-fine wire coils. (322)

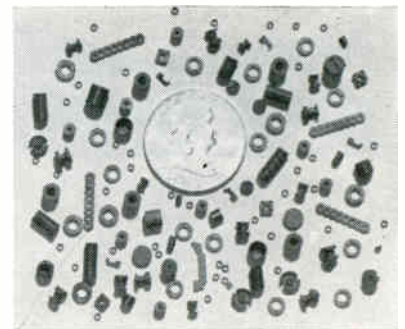

### Ferrite Parts Are Microminiaturized

INDIANA GENERAL CORP., Electronics Division, Keasbey, N.J., introduces a broad line of microminiature ferrite parts such as toroids with an



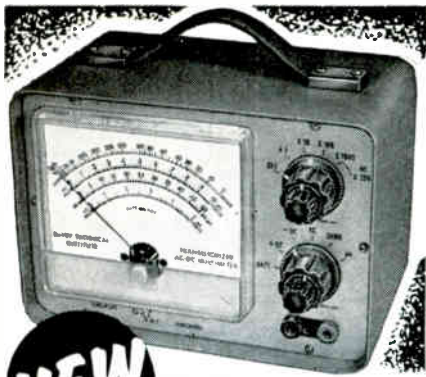

**NEW** DeVry  
TECHNICAL INSTITUTE'S

## TRANSISTORIZED METER

PORTABLE  
LOW-PRICED

**\$89<sup>50</sup>**

Combines the advantages of a vacuum tube voltmeter and a sensitive microammeter plus full protection for the meter movement! High input impedance, temperature stability, silicon semiconductors, 1% attenuator resistors, wide frequency response. Order direct (not sold through distributors). Satisfaction guaranteed.

**SPECIFICATIONS:** DC Current 0-50/0-500 $\mu$ a. 0-5/0-50 ma. DC Voltage 0-1/0-10/0-100/0-1000. AC Voltage 0-5/0-500/0-1000. Resistance to 0-10 Megohms in four ranges. Battery powered.



Product Research Division - Dept. RD-6  
**DeVry Technical Institute**  
4141 Belmont Ave., Chicago 41, Ill.

CIRCLE 202 ON READER SERVICE CARD

## WHEATSTONE BRIDGE



**±0.1%**

ACCURACY

Model L-3C

**Range:** .001 $\Omega$  to 11.11M $\Omega$   
**Rheostat Arm:** 1 $\Omega$ x10+10 $\Omega$ x10+100 $\Omega$   
x10+1000 $\Omega$ x10 (4 dials)  
**Ratio Arm:** x0.001, x0.01, x0.1, x1  
x10, x100, x1000  
**Overall Accuracy:** 100 $\Omega$  to 100k $\Omega$  ±0.1%  
1 $\Omega$  to 1M $\Omega$  ±0.3%  
1 $\Omega$  to 10M $\Omega$  ±0.6%

Accurate resistance measurement achieved with a single unit. No accessories, no power source required. Operates on three type D, 1.5V dry cells, YEW's new, rugged galvanometer, Model G-2(B) incorporated. All 5 dials make no-rubbing contact and are dust-proofed, housed in individual plastic case. The L-3C has elastic mold unbreakable housing. Size: 7 $\frac{1}{4}$ " x 9" x 5" Weight: 5 lbs. shipping weight: 10 lbs. Available for immediate delivery. Cat No. 52402 \$156.00

CONFIDENCE BEGINS WITH **YEW**

**YOKOGAWA ELECTRIC WORKS, INC.**  
40 WORTH STREET NEW YORK 13, N. Y.  
Area Code 212 Telephone: BEEKMAN 3-6720  
See YEW-IEEE Show-Booth 3844

CIRCLE 203 ON READER SERVICE CARD

o-d of 0.018 in.; cup cores with an o-d of 0.230 in.; bobbins and sleeves of 0.118 in. in length; and other parts as thin as 0.005 in. Applications range from i-f transformers, as used in the micromodule program, r-f and pulse transformers, delay lines, recording heads, to miniature inductors for filter applications. (323)

### High Power Loads

DE MORNAY-BONARDI CORP., 780 S. Arroyo Parkway, Pasadena, Calif. Two series of high power loads (air cooled and water cooled) feature high temperature, high heat conductivity, good thermal shock and virtually no cycling effects. (324)

### Relays

BRANSON CORP., Whippany, N. J., announces a complete line of time delay relays, transistor size relays, crystal can and  $\frac{1}{2}$  crystal can relays, two- and four-pole, plus a line of sockets designed specifically for relays. (325)



### Pulse Modulator for High Output Radar

CALVERT ELECTRONICS, INC., 220 E. 23rd St., New York 10, N. Y., announces the English Electric C1148 radial beam pulse tetrode for use as the modulator in radar equipments having peak power outputs in the range 10 to 25 Kw. Although the heater consumption is only 31 w, peak output powers of 150 Kw are attainable. Tube has a short grid base, thus permitting rela-

# RELIABILITY

for  
the  
"birds"



\*"Birds," such as the Advanced POLARIS (we build the guidance system); the "birds" for anti-missile defense (we have boost-intercept, mid-course and terminal studies under way); the orbiting "birds" like SYNCOM (our synchronous communications satellite); the soft lunar landing "birds" like SURVEYOR—plus others like MMRBM (Integration, Assembly & Check-out) and TFX(N) Electronics.

At Hughes in Southern California, a scientific, organized approach to total reliability makes the Reliability Engineer a key man in every phase of every program—from proposal to production.

A few of our current openings for qualified Reliability Engineers include:

#### SYSTEM RELIABILITY ANALYSTS

To determine reliability requirements and make reliability forecasts for weapon systems under development.

#### QUALITY ASSURANCE ENGINEERS

Experienced in quality control management, quality testing, electronic test instrumentation, processing of performance data and development of corrective programs.

#### COMPONENT RELIABILITY SPECIALISTS

With experience in reliability and failure analysis of components, testing methods, test equipment design and environmental testing.

#### RELIABILITY ENGINEERS

Familiar with organizing reliability programs, circuit analysis, maintenance analysis, test planning, missile system test and failure analysis, parts standardization and selection, documentation, qualification and Mil Specs.

If you feel that you are qualified by interest, training and experience—and hold a degree from an accredited university and U.S. Citizenship, we would like to talk with you.

Please airmail your resume, in confidence, to:

**MR. ROBERT A. MARTIN**  
Head of Employment

Creating a new world with electronics

**HUGHES**

HUGHES AIRCRAFT COMPANY  
AEROSPACE DIVISIONS  
11940 W. Jefferson Blvd.  
Culver City 19, California  
An equal opportunity employer



# Forget Wire!

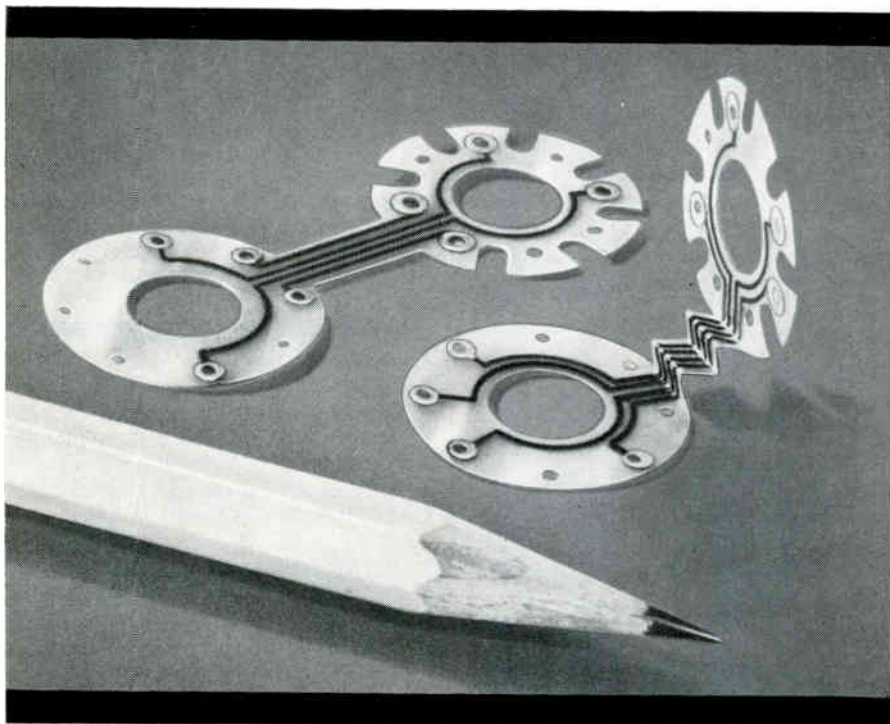

Photo Courtesy International Resistance Company

## SPECIFY Schjel-Clad\*

### Replace expensive hand wiring with low-cost continuous processing of Schjel-Clad

This unique combination of flexibility and dimensional stability in Schjeldahl's metal-to-plastic electrical laminate, Schjel-Clad, can really cut costs. It permits reliable, continuous in-line processing to produce flexible wiring harnesses, computer memories and other flexible printed wiring.

Schjel-Clad is available in a variety of materials: Copper, Aluminum or Nickel bonded to Polypropylene, Mylar or Teflon. Each laminate is available in a wide variety of thicknesses and widths. Write or call for data sheets and samples in the sizes you need. Phone: Area Code 507, NI 5-5635.

\*G. T. Schjeldahl Co., T.M. Reg. U.S. Pat. Off. 1duPont trademarks for its polyester film; fluorocarbon resins

Putting Materials Together Through Chemistry and Mechanical Design

PRODUCTS



SERVICES

## G.T. Schjeldahl Co.

SAY "SHELL-DOLL" • NORTHFIELD, MINNESOTA

tively low grid drive requirements to provide full output power. Vacuum envelope is entirely of glass, incorporating a standard B5F base, and natural free air circulation gives adequate cooling in most environments.

CIRCLE 326, READER SERVICE CARD

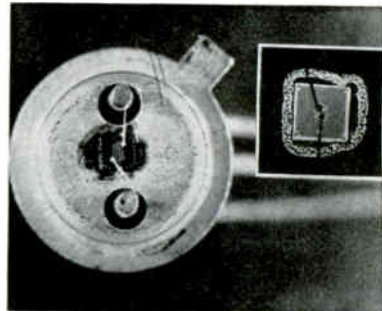

### Planar Transistors For Industrial Use

SILICONIX INC., 1140 W. Evelyn Ave., Sunnyvale, Calif., announces two new P-channel planar diffused silicon UNIFETs (unipolar field-effect transistors) priced for industrial applications. The U-110 and U-112, in the TO-18 package, have two different geometries with a 1.1 to 1 ratio of  $g_m$  to  $I_{DSS}$  and 6 v max pinch-off on each device. 100 unit prices are \$9.50 for the U-110 and \$11.50 for the U-112. Storage temperature range is  $-65$  to  $+200$  C. Max gate-drain breakdown voltage is 20 v at  $I_o = 1 \mu a$ . (327)

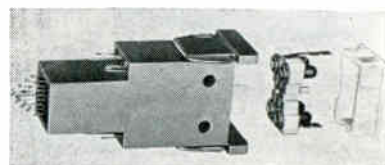

### Display Switch Rated 1 Amp at 24 V

TELEX, INC., 3054 Excelsior Blvd., Minneapolis 16, Minn. Pushbutton display switch features high contact density per panel area. With an electrical rating of 1 amp at 24 v for over 500,000 operations, the wirebridge type switch is said to have no measurable contact bounce. Switch is well suited for dry circuit applications. Four-bulb indicator design provides greater reliability and multiple indication. It is constructed of heat resistant materials to provide for continuous four-

bulb operation if desired. Switch is available in momentary or alternate (push-on, push-off) actions. A light operating force of only 20 oz is required for the 8-pole switch. (328)

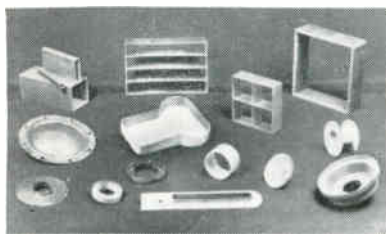

### Laminated Insulators In Variety of Sizes

STEVENS PRODUCTS INC., 86 Main St., East Orange, N. J., offers specially molded glass laminated insulation components. Glass silicone, epoxy, polyester, and melamine coil form tubes in over 800 standard sizes are available. Company has facilities for specially molded small motor insulation, slot wedges, end insulators, shaft collar, and acoustic diaphragms. (329)



### D-C Amplifier Is Electrostatic Type

B.K. SWEENEY MFG. CO., 6300 E. 44th Ave., Denver 16, Colo. Miniature electrostatic d-c amplifier provides  $10^{12}$  ohms input resistance and 5 pf capacity. Model SWE-1120A is simple, stable and requires only a zero adjustment. It is easily coupled into read-out devices of conventional impedance levels and is especially useful when signal loading must be kept at an absolute minimum. Amplifier drives an external output of 100,000 ohms minimum with a power gain of 50 db minimum. Frequency response is d-c to 100 Kc within 3 db. (330)

**SHRINKS DOWN  $\frac{1}{2}$**

**7 SECONDS TO YOUR JACKETED CABLE**

**WITH ALPHLEX®**



Alphlex FIT-105 Tubing with "controlled shrinkage" is an economical, easy-to-use, irradiated PVC tubing that provides a snug, extremely flexible cable covering.

Cable cores may be pulled through FIT-105 Tubing with ease and shrunk down to form a jacket with all the qualities of the finest extruded plastic jackets. The tubing is supplied in expanded form and in continuous lengths and shrinks 50% upon application of heat (325°F). Heat may be applied through the use of the Alpha Heat Gun, or other heat sources. FIT-105 conforms to MIL-I-631C (105°C).

FIT-105 Tubing is available at your local electronics distributor in 14 sizes ranging from 3/64" to 4" I.D. before shrinking.

Write for your FREE Alphlex Catalog AT-63 describing the industry's most complete tubing line.



### ALPHA WIRE CORPORATION

Subsidiary of LORAL Electronics Corporation  
200 Varick Street, New York 14, N. Y.  
PACIFIC DIVISION:  
11844 Mississippi Ave., Los Angeles 25, Calif.





## What's round, rugged and reliable?

**Roller contacts**, that's what! The same proven roller contacts that make United Control the quality leader in motorized **Power Transfer Switches** for aerospace and industrial application. The efficient roller contacts that assure you fast, dependable power transfer whenever you need it. The roller contacts that get the job done long after cyclic life requirements have been passed—a sound engineering bonus that costs you nothing.

**Why roller contacts?** Simple. They give you remarkable freedom from detrimental arcing and high pressure contact erosion. The positive rolling action on the contact segment provides an extremely effective type of surface cleaning. High mechanical loading of the free-floating, self-aligning rollers yields high contact pressure and low contact resistance, superior vibration characteristics, and contact ratings in excess of 300 amps. And check all these features—

- Compact, hermetically-sealed packaging
- Low power requirements
- Multiple circuits with contact redundancy
- Make-before-break or break-before-make operation
- Various silver alloys available for rollers and contact segments
- Normal operation under vibration levels above 20 g's at 2,000 cps
- Life in excess of 10,000 cycles

For more information on United Control **Power Transfer Switches**, or the complete line of flight, propulsion, temperature and environmental controls, and accessory systems and components, write or call United Control today!



### UNITED CONTROL CORPORATION

Overlake Industrial Park, Redmond, Washington  
 Dial: 206-885-3711 TWX: 206-999-1874  
 United Data Control Corporation and Palomar Scientific Corporation Subsidiaries

## Literature of the Week

**TRANSFORMER-RECTIFIERS** Tung-Sol Electric, Inc., One Summer Ave., Newark 4, N. J. Short form catalog lists specifications on 22 different models of transformer-rectifiers for airborne power conversion. **CIRCLE 331, READER SERVICE CARD**

**AEROSPACE INSTRUMENTATION** Beckman Instruments, Inc., 2500 Harbor Blvd., Fullerton, Calif., has published an illustrated brochure describing its capabilities in the field of aerospace instrumentation. **(332)**

**FACILITIES BROCHURE** Litton Industries, Electron Tube Division, 960 Industrial Road, San Carlos, Calif. A 36-page illustrated 1963 summary of products and review of capabilities is available. **(333)**

**COMPUTER TIME CLOCKS** Electronic Engineering Co. of California, Box 58, Santa Ana, Calif. Data sheet describes the EECO 790 and 791 Datachron time clocks for computers and data processing systems. **(334)**

**POTENTIOMETERS** Spectrol Electronics Corp., 1704 South DelMar Ave., San Gabriel, Calif. A 10-page short form catalog describes a line of precision potentiometers, turn-counting dials and trimming potentiometers. **(335)**

**ELECTRONIC HARDWARE** Microdot Inc., 220 Pasadena Ave., South Pasadena, Calif., offers the 1963 edition of a 32-page catalog on the Lerco line of electronic hardware. **(336)**

**RANDOM-NOISE GENERATOR** General Microwave Corp., 155 Marine St., Farmingdale, L. I., N. Y. Model 503 broadband random-noise generator is illustrated and described in a catalog sheet. **(337)**

**LEVEL MEASUREMENT** Magnetic Instruments Co., Inc., Thornwood, N. Y. Data bulletin 6.0 discusses level measurement and control applications utilizing capacitance-type level device. **(338)**

**ELECTRONIC CHOPPER** Solid State Electronics Co., 15321 Rayen St., Sepulveda, Calif. Single-sheet bulletin describes the model 70 silicon transistor electronic chopper with operating temperature from  $-55^{\circ}\text{C}$  to  $+130^{\circ}\text{C}$ . **(339)**

**MAGNETOMETERS** Varian Associates, 611 Hansen Way, Palo Alto, Calif. Data sheet illustrates and describes the V-4931 series marine/station magnetometers. **(340)**

**SILICON EPITAXIAL MESA TRANSISTORS** Sylvania Electric Products Inc., 1100 Main St., Buffalo 9, N. Y. Brochure outlines types TO-5 and TO-46 *npn* large signal silicon epitaxial mesa transistors. **(341)**

**RESISTORS** Electra Mfg. Co., Independence, Kansas, has available two



new catalogs outlining its complete lines of precision carbon film and metal film resistors. (342)

**WROUGHT ALLOYS** Special Metals, Inc., New Hartford, N. Y., offers a wall chart featuring 16 micrographs of two vacuum induction melted super-alloys — Udimet 700 and Udimet N-115. (343)

**TAPES, GASKETS & COILS** Garlock Inc., Palmyra, N. Y., has released a bulletin describing five styles of gasketing tapes, seven styles of folded asbestos gaskets and eight styles of gasketing coil. (344)

**MONOPULSE TRACKING RECEIVER** Defense Electronics, Inc., 5455 Randolph Rd., Rockville, Md. Bulletin covers the TTR-2, a complete sum and difference monopulse tracking receiver. (345)

**MASS FLOWMETER** Technology Inc., 3090 Richfield Center, Dayton 30, O. Linear gas mass flowmeter, MFM-150-1, is described in a recent bulletin. (346)

**CIRCULAR WAVEGUIDE** Andrew Corp., P.O. Box 807, Chicago 42, Ill. Bulletin 8495 covers the WC530D circular waveguide that features low attenuation. (347)

**STANDARDIZED BATTERY HOLDERS** Keystone Electronics Corp., 49 Bleecker St., New York 12, N. Y., has released an 8-page catalog of battery holders and battery holder accessories. (348)

**COAXIAL CABLE ASSEMBLIES** Paraplegics Mfg. Co., Inc., 304 North York Road, Bensenville, Ill. Catalog announces a complete line of coaxial cable assemblies for every requirement. (349)

**PULSE GENERATORS** Intercontinental Instruments Inc., 123 Gazza Blvd., Farmingdale, L. I., N. Y. A six-page brochure on the TPG series of pulse generators provides data on both single pulse and double or delayed pulse instruments. (350)

**MEASURING RECEIVER** Rohde & Schwarz, 111 Lexington Ave., Passaic, N. J. The Selektomat measuring receiver with an electronically-tuned local oscillator is described in a technical information bulletin. (351)

**CUSTOM CABLE CONSTRUCTIONS** Chester Cable Corp., Chester, N. Y. A 12-page folder shows how custom cable constructions are designed and manufactured. (352)

**SILICON PLANAR TRANSISTORS** Sperry Semiconductor, Division of Sperry Rand Corp., Norwalk, Conn. A 32-page illustrated brochure presents a compilation of information gathered from seminars on complementary silicon planar transistors. Request copy on company letterhead.

**CLOSED-CIRCUIT TELEVISION** Cohu Electronics, Inc., Kin Tel Division, Box 623, San Diego 12, Calif. Data sheet 8-40 lists more than 75 examples of applications for closed-circuit television. (353)

# BALLANTINE Wide-Band VTVM

## Measures 300 $\mu$ V to 300 V at frequencies 10 cps to 11 Mc

Logarithmic scales with high precision and constant accuracy at any point

Usable as 100  $\mu$ V null detector, or as wide-band amplifier to 20 Mc

Binding post, or coaxial input to reduce ground current error

Cathode follower probe has high input impedance of 10 M $\Omega$ —7 pF



model 317  
Price: \$495. with probe

A stable, multi-loop feedback amplifier with as much as 50 db feedback, and 10,000 hour frame grid instrument tubes operated conservatively, aid in keeping the Model 317 within the specified accuracy limits over a long life. Its uses extend from simple audio frequency measurements to accurate RF measurements made directly in the circuit using the low-loading cathode-follower probe. Individually calibrated logarithmic scales provide uniformly high accuracy over their entire length. Accuracy is 2%, 20 cps to 2 Mc; 4%, 2 Mc to 4 Mc; 6%, 4 Mc to 11 Mc.

Write for brochure giving many more details



— Since 1932 —

**BALLANTINE LABORATORIES INC.**

Boonton, New Jersey

CHECK WITH BALLANTINE FIRST FOR LABORATORY AC VACUUM TUBE VOLTMETERS, REGARDLESS OF YOUR REQUIREMENTS FOR AMPLITUDE, FREQUENCY, OR WAVEFORM. WE HAVE A LARGE LINE, WITH ADDITIONS EACH YEAR. ALSO AC/DC AND DC/AC INVERTERS, CALIBRATORS, CALIBRATED WIDE BAND AF AMPLIFIER, DIRECT-READING CAPACITANCE METER, OTHER ACCESSORIES.

See us at the IEEE Show—Booth 3502-3504

## Babcock Sets Up Florida Division



**BABCOCK ELECTRONICS** Corp. recently dedicated a new 20,000-square foot plant in Orlando, Fla. Cost of the entire complex is in excess of \$300,000.

The Orlando division is the first major out-of-state facility of Babcock Electronics, Costa Mesa, Calif. It will manufacture electromechanical systems for use in such areas as guidance, communications, countermeasures, sub-systems and special support equipment. Two other divisions, the Aero Space division and the Relays division, are located in plants in Costa Mesa.

The Florida manufacturing complex was the result of a major expansion program undertaken by the California company early last year. Reasons for locating in Florida include the nearness of Cape Canaveral and the Atlantic Missile Range, and the proximity of other prime missile contractors, to whom it could offer sub-contracting.

The Orlando division will not engage in any R&D programs—only the assembly and manufacture of these systems. Company says as many as 100 persons may be employed there within the next six months. Of the total plant area 15,000 square feet will be used for production. The remaining space will house administrative offices. The building, on a 20 acre site, is designed on the modular concept, thus allowing future expansion to total more than 200,000 square feet.

Babcock Electronics Corp. was formed in 1948. It does business with the military, either direct or through other prime contractors, as

well as various industrial concerns. The Aero Space division develops and produces advanced systems for the command control and guidance of ballistic missiles, high speed targets, remote controlled anti-submarine helicopters and vehicles used in nuclear experiments. The Relay division makes subminiature precision relays for aircraft, missiles and industrial applications.

General manager of the Orlando division is Fred A. Cullman. Other executives include Carroll S. Miller, management consultant; Guy L. Cole, engineering manager; Charles J. Filko, manager of production; Robert McClintock, Jr., quality assurance manager; and R. A. Zimorski, material manager.



**Sanders Associates Appoints Peyser**

**SANDERS ASSOCIATES, INC.**, Nashua, N.H., has announced the appointment of William P. Peyser to the position of general manager for the company's Microwave division. He will have overall responsibility for the division's engineering,

manufacturing and marketing efforts.

Prior to joining Sanders, Peyser was section head and project director at Airborne Instruments Laboratory, Aerospace Systems department.

## Honeywell EDP Opens Another Building

**HONEYWELL** Electronic Data Processing recently opened its third administration building in as many years at its Wellesley Hills, Mass., headquarters. This brings to eight the number of engineering, research, manufacturing and administrative facilities maintained by the firm in the Greater Boston area.

The company, manufacturer of high-speed digital computers, has more than 3,000 employees in plants at Brighton, Lowell, Needham, Newton and Wellesley Hills.

The new 32,000-sq ft facility will house the programming systems division.



**Sperry Rand Univac Elevates Horrell**

**APPOINTMENT** of Maurice W. Horrell as vice president-engineering and manufacturing for the Univac division, Sperry Rand Corp., is announced.

Horrell, who joined Univac as director of engineering and manufacturing in 1962, is responsible for all divisional engineering and manufacturing programs. Univac manufacturing facilities are located in Philadelphia; St. Paul; Dallas; Ilion-Utica, N.Y.; Genoa, Ill.; and



## DYNAPLEX CORPORATION

— INTRODUCES —

ITS NEW HIGH PERFORMANCE

# TYPE 035

AIRBORNE  
AMPLIFIER

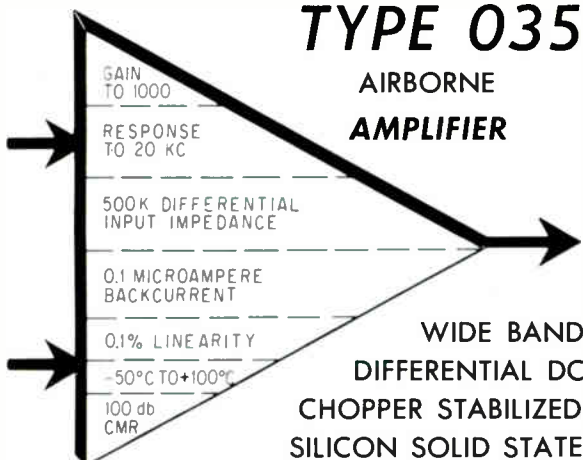

DESIGNERS AND MANUFACTURERS OF

- SOLID STATE MULTIPLEXING SWITCHES
- PAM, PDM, PPM MULTICODING SYSTEMS
- PULSE CODE AND DIGITAL SYSTEMS
- SIGNAL CONDITIONING EQUIPMENT

## DYNAPLEX

CORPORATION

P. O. BOX 341, PRINCETON, N. J.

CIRCLE 204 ON READER SERVICE CARD



## What Can You Do With a SIRKIT<sup>TM</sup> WAFER?



ACTUAL SIZE

*\*The First Successfully Mass  
Produced Micro-Miniature  
Integrated Circuits.*

Looking for an integrated, thin film micro-miniature circuit that meets your specific requirement? Just name your application . . . DIGITAL LOGIC CIRCUITRY . . . LINEAR AMPLIFIERS . . . ANALOG PROJECTS . . . MATCHED NETWORKS . . . RC NETWORKS . . . IF STRIPS. Hand us your specifications and National does the rest . . . on a SirKit wafer. Quantities? You name them too . . . we can deliver up to 12,000 per day.

"Utterly Fantastic!" you say? True, but there's no magic involved here . . . just the use of National's patented thin film techniques for producing passive componentry . . . combine with proven semi-conductor devices . . . add strict standardization of formulation, atmospherics and time. The result . . . reliable, lottery-free integrated circuits. National's exclusive design, tooling and processing assures quantity deliveries of SirKit wafers within five weeks from receipt of an order . . . savings in cost are worthy of note too.

Send today for the Utterly Fantastic story of SirKit wafers, supported by Applications Sheets and Test Data Results.

Don't forget to attend the symposium on Integrated Circuits at the SirKit Suite, Plaza Hotel, during the IEEE (IRE) Show . . . Send for free reservation on company letterhead.

## New TWO-WAY



\*available to 2.5 mc

## Counter\*

- AC line for lab operations
- Battery-powered for field use

# \$875<sup>00</sup>

Here is the newest solid state Counter-Timer available . . . Accurate Instrument's Model 5A35 . . . 5½" wide and only 17 lbs., including batteries! This bright, easy-to-read counter has internal, rechargeable batteries for field work on shipboard, flightlines, etc.—a truly portable counter. The unit is AC powered for accurate lab use. Remotely programmable, the Accurate Counter offers these measurement functions: frequency (.1, 1 and 10 second time base), period (X1, X10, X100 and X1000) and ratio. Compact for inclusion in systems work, too.

**SPECIFICATIONS:** Frequency and Period Measurement: DC to 300KC ■ Display: five 10-digit, brightly illuminated columns ■ Input Sensitivity: 0.1 volt ■ Input Power: 115 volts at 15 watts, 50 to 70 cps or 8 internal size D nickle cadmium batteries ■ Size: 7" H x 5½" W x 12¼" L ■ Remotely programmable ■ No Operating Adjustments.



Write for Catalog Information  
**ACCURATE INSTRUMENT CO.**

Phone JA 6-4946 (713) P. O. Box 66373  
Houston, Texas

CIRCLE 205 ON READER SERVICE CARD

**National ResisTronics INC.**  
56 WALTER STREET, PEARL RIVER, NEW YORK



# Do You Know

How much HEAT SINK  
this 100 WATT  
static inverter  
requires at  
100°C ambient?

# None

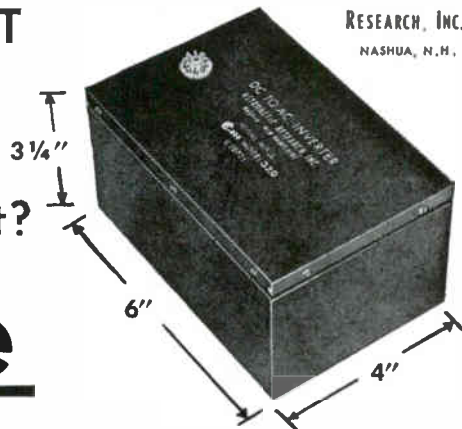

ASTRONETIC  
RESEARCH, INC.  
NASHUA, N.H.

**Specifications: Model ARI 320 STATIC INVERTER**

1. Voltage input 24-32 VDC.
2. Efficiency 80% all conditions.
3. 400 cps sine wave/ $\pm 0.5\%$  stability.
4. Weight 4 1/2 pounds.
5. No heat sink up to 10,000 feet.  
(Special provision for space applications).

Also 90% efficient DC-DC converters also available.

**ASTRONETIC RESEARCH, INC.**  
BOX 397 NASHUA, NEW HAMPSHIRE

CIRCLE 206 ON READER SERVICE CARD

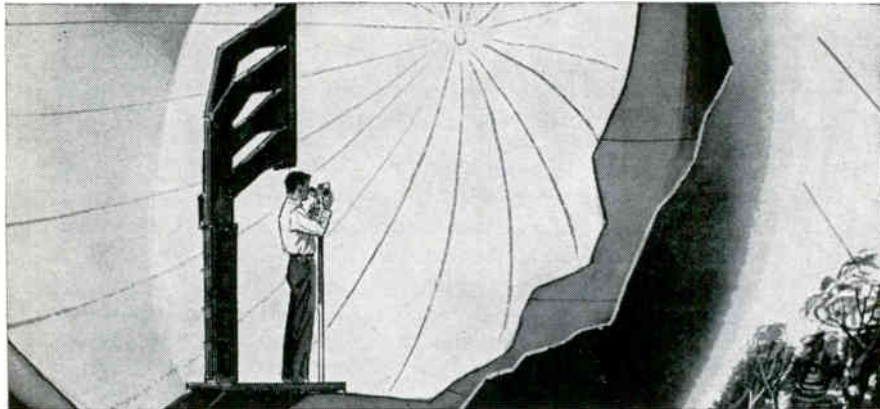

## Fastest check for radar dish contour

Barr & Stroud Rangefinder gives 1/8-inch accuracy at 22-foot range!

In the application shown, a B. S. 8-inch rangefinder measures the distance of key targets. A simple mount with azimuth and elevation scales simplifies the observation of range measurements.

**Easy to operate!** No training required. Just sight through eyepiece... turn knob until two images of object coincide... read range directly in feet or yards. No triangulation or computing!

**Barr & Stroud Rangefinders**, of various base lengths and magnifications, are widely used in surveying, engineering, construction and marine applications. Sold and serviced exclusively in the U. S. by Kollmorgen Corporation. Write for facts today to Kollmorgen Corporation, 347 King St., Northampton, Mass.



116 CIRCLE 116 ON READER SERVICE CARD

Holyoke, Mass. The company maintains engineering centers at Whip-pain Township, Pa.; Dallas, Texas; and St. Paul, Minn.

## Electron Heating Appoints Ingalls

W. BRADFORD INGALLS, formerly with Alloyd Electronics Corp., has been appointed executive vice president at Electron Heating Corp., Medford, Mass. In this position, he will be responsible for the direction, planning and execution of the overall company operation.

Electron Heating Corp. is an affiliate of the General Vacuum Corp., manufacturer of vacuum systems.



## Littelfuse Names H. A. Cornelius

HERBERT A. CORNELIUS has been appointed to the newly created position of vice president in charge of manufacturing at Littelfuse, Inc., Des Plaines, Ill. He was formerly vice president in charge of manufacturing sales.

Littelfuse produces circuit protection and control devices.

## Hancock Telecontrol Sets Up New Division

HANCOCK TELECONTROL CORP., New York City, has announced the establishment of its Datametric division which will specialize in the development, manufacture, and marketing of instruments and other devices for use in the control of industrial operations by management.

The new division will be under the direction of George V. Mohn, vice president, marketing. Datametric products will be engineered

March 22, 1963 • electronics



**electronics IS EDITED  
TO KEEP YOU  
FULLY INFORMED—  
a "well-rounded" engineer**

What's your *present* job in electronics? Do you work on computers? (*electronics* ran 158 articles on computers between July, 1961 and June, 1962!) Are you in semi-conductors? (For the same period, *electronics* had 99 articles, not including transistors, solid-state physics, diodes, crystals, etc.) Are you in military electronics? (*electronics* had 179 articles, not including those on aircraft, missiles, radar, etc.)

In all, *electronics'* 28-man editorial staff provided more than 3,000 editorial pages to keep you abreast of all the technical developments in the industry. No matter where you work today or in which job function(s), *electronics* will keep you fully informed. Subscribe today via the Reader Service Card in this issue. Only 7½ cents a copy at the 3 year rate.

**electronics**

electronics • March 22, 1963

**NEW**

## HIGH VOLTAGE POWER SUPPLIES



PSR Series, pictured above offer these important features: Range 5 to 30 KV, 2 to 30 MA • Regulation  $\pm .05\%$  • Ripple .1% RMS • Completely Solid State Circuitry • Light Weight • Rack Height 8¾" maximum • Dry Insulation • Overload Protection • Reversible Polarity • Simplified Controls; coarse and fine voltage, ON-OFF meter reversing switch • Triple-Range Kilovoltmeter and Milliammeter. Write for New 1963 High Voltage Bulletin.



**ELECTRONICS DIVISION**

RESEARCH-COTTRELL, INC., BOUND BROOK, NEW JERSEY

CIRCLE 207 ON READER SERVICE CARD

**HERE IS THE WORLD'S SMALLEST MOTOR  
YET IT'S SO POWERFUL . . .**

**MITSUMI MICRO MOTOR**



MODEL MI-100

Less than 20mm in diameter, the new Mitsumi Micromotor provides a startling efficiency of over 50%, the barrier which miniature motors are not allowed to pass.

A novel construction principle helped to make this accomplishment possible. The form is more simplified by setting all the terminals at one position. Because the entire mechanism is given full protection against irregular revolution and above all, electrical noise is entirely eliminated, you may call this the most perfect micromotor yet devised. Please write for complete information on Mitsumi Micromotor, and we will send you specifications and data.



**MITSUMI PARTS**  
**MITSUMI ELECTRIC CO., LTD.**  
TOKYO • OSAKA • NEW YORK

CIRCLE 117 ON READER SERVICE CARD 117

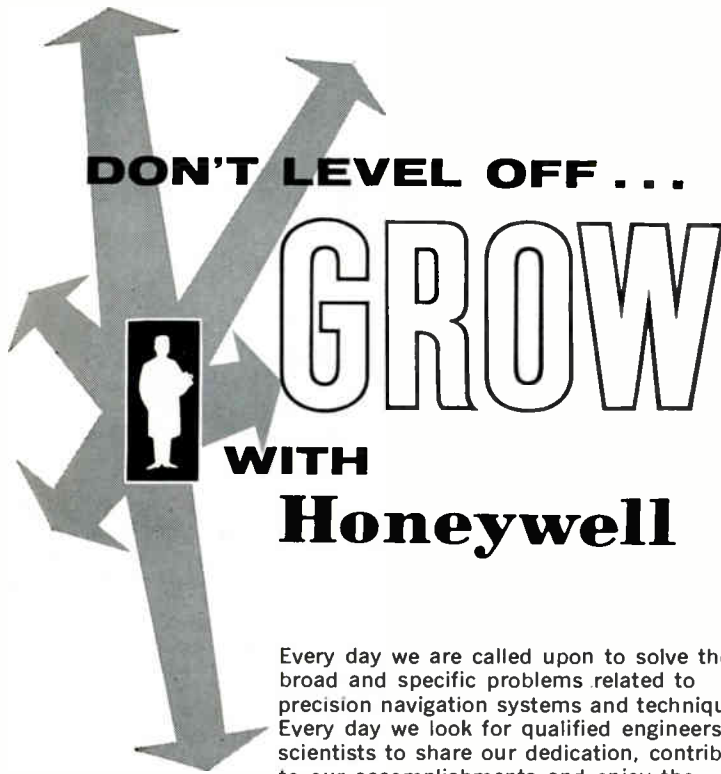

**DON'T LEVEL OFF . . .**

**GROW**

**WITH**

**Honeywell**

Every day we are called upon to solve the broad and specific problems related to precision navigation systems and techniques. Every day we look for qualified engineers and scientists to share our dedication, contribute to our accomplishments and enjoy the personal and professional rewards of achievement. Such projects as Gemini, Dyna-Soar and Centaur indicate the important space projects with which we are concerned.

If your capabilities and ambitions are guidance oriented, we invite your immediate inquiry. As the following list of requirement areas indicates, long-range opportunities exist at all levels.

**Systems Engineers/Circuit Designers/Logic Designers/Systems Analysts/Programmers/Packaging Engineers/Rotary Component Designers/Systems Test Engineers/Materials & Component Engineers/Test Equipment Designers/Manufacturing Prototype Development Engineers/Reliability Engineers/Quality Control System Engineers.**

And remember, *you and your family* will enjoy Florida's Suncoast living. To learn more about how YOUR career can GROW at Honeywell, write, in confidence, to Mr. L. D. Ericson, Honeywell, 13350 U. S. Highway 19, St. Petersburg, Florida. We'll reply promptly.

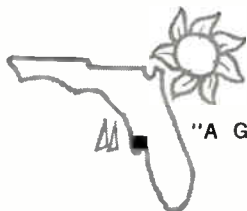

**Honeywell**

AN EQUAL OPPORTUNITY EMPLOYER

"A Good Place to Live . . . A Good Place to Work"

To investigate professional openings in other Honeywell facilities, send your resume to H. F. Eckstrom, Honeywell, Minneapolis 8, Minnesota

**HONEYWELL ENGINEERS ARE DOING THINGS IN FLORIDA**

and manufactured at the company's plant in Old Greenwich, Conn. Additional personnel are being hired for the purpose.



**Babits Assumes  
New Post**

VICTOR A. BABITS has advanced from chief to manager of research at General Dynamics/Astronautics in San Diego, Calif. He assumes overall responsibility for the Applied Research Laboratories' scientific program, including laser and optoelectronic research.

Before joining GD/Astronautics, Babits was professor of electrical engineering at Rensselaer Polytechnic Institute.

**Schneider Joins  
Electra Manufacturing**

JACK B. SCHNEIDER has been appointed to the new post of vice president of operations at Electra Mfg. Co., Independence, Kansas. Electra manufactures resistors, capacitors, micromodules, and integrated circuits.

Schneider was previously division manager of the Bay City, Michigan, division of Electric Autolite Co.

**Announce Formation of  
New Company**

SIX former Varian Associates employees have left the firm to form their own company, Mitek Corp., Menlo Park, Calif. The new firm's president is Maurice W. St. Clair, former director of Melabs, Inc., also of Menlo Park.

Mitek will specialize in stable frequency sources and parametric devices, with their initial efforts including development and manufac-



ture of high-Q cavities for stabilizing reflex klystrons, filter applications and harmonic generators.

### Arnold Magnetics Appoints Quinn

THOMAS B. QUINN has been named general manager of Arnold Magnetics Corp., Los Angeles, Calif. He will report directly to Forrest M. Arnold, company president.

Quinn joined the firm as operations manager in late 1961.



### Reeves Soundcraft Names Kane

JOHN S. KANE has been named vice president of Reeves Soundcraft Corp., New York City. He will be general manager of Soundcraft's magnetic tape division in Danbury, Conn.

Prior to joining Reeves Soundcraft, Kane was assistant director of operations for International Resistance Co. of Philadelphia.



### Marble Moves Up at Systron-Donner

FRANK G. MARBLE has been appointed a vice president of Systron-Donner Corp., Concord, Calif. Marble, who has served the company as

## Fast and accurate pressure calibration

*REC's new  
MODEL 802B  
Reference  
Pressure  
Cell  
and  
MODEL 545A  
Reference  
Pressure  
Indicator*

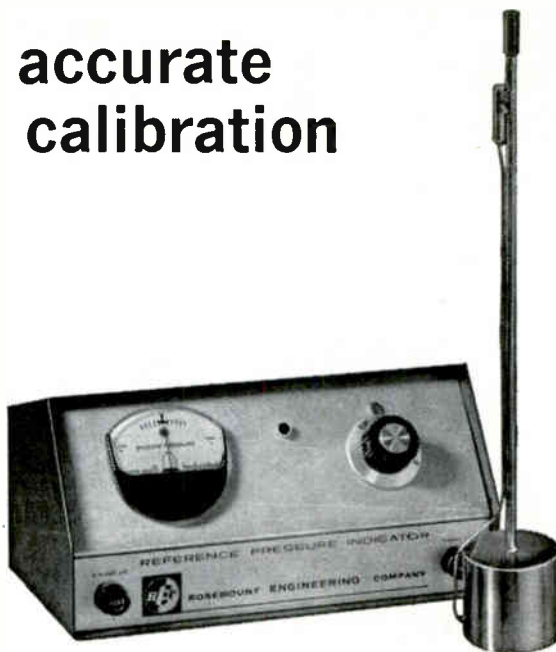

This new precision system offers 0.1 second response, stability of better than .002 psi and resolution of .00005 psi. The operating range is from 0.1 to 200 psia.

The REC system is designed for calibration of pressure gages, absolute and differential pressure transducers, altimeters and other precision pressure instruments. Compared to mercury manometers, it is much faster in response, requires relatively little service or operator training, and is much more portable.

The REC Model 802 Pressure Calibration System has one or more Model 802B Reference Pressure Cells and a Model 545A Reference Pressure Indicator. Each cell acts as a pressure "gage block" to give a precise pressure point. The indicator provides the necessary electrical circuit and visual indication of when the system being calibrated is at the reference point.

The reference pressure cell is made of stainless steel to withstand 200 psia system pressure. The indicator operates on either 115 volt 60 cycle ac or 22½ volts dc. A standard Model 545A indicator will accommodate five Model 802B cells.

For more details on the REC Pressure Calibration System, write for Bulletin 9623.

### A complete precision line

Rosemount Engineering Company designs and manufactures high quality precision equipment in these lines:

- |  |  |
|--|--|
| <b>Air data sensors</b>                                    | <b>Surface temperature sensors</b>                   |
| <b>Total temperature</b>                                   | <b>Pressure sensors</b>                              |
| <b>Pitot-static tubes (de-iced)</b>                        | <b>Accessory equipment and aeronautical research</b> |
| <b>Immersion temperature sensors (including cryogenic)</b> |  |

For more information please write for the REC catalog. Specific questions on any temperature or pressure problems are welcomed.

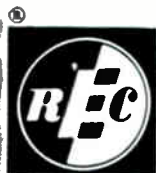

**ROSEMOUNT  
ENGINEERING  
COMPANY**

4900 West 78th Street • Minneapolis 24, Minn.

**SPECIALISTS IN TEMPERATURE & PRESSURE MEASUREMENT**

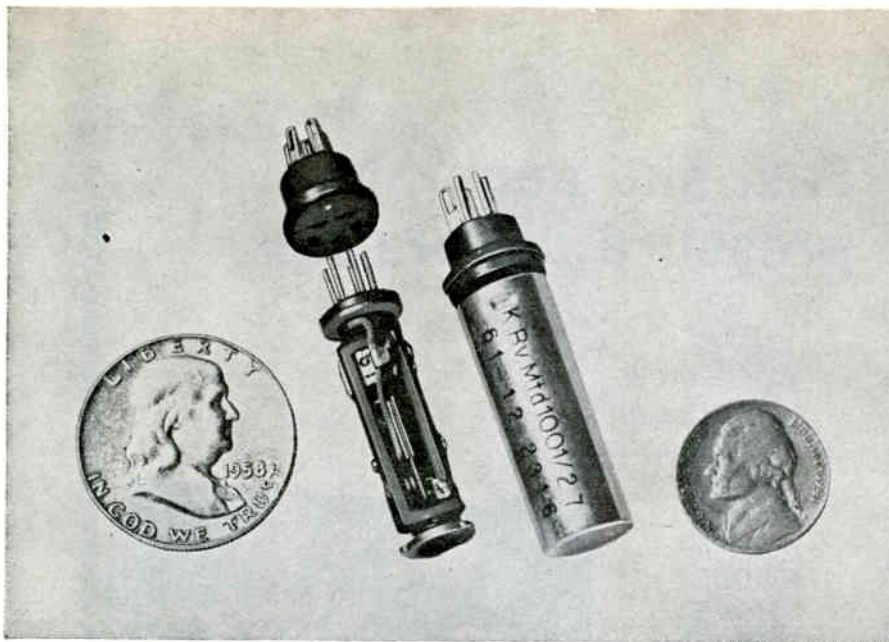

## MINIATURE FREQUENCY-ACTUATED REMOTE SELECTOR SWITCHES

These miniaturized resonant reed selectors are designed for remote signaling and control in multiplex telemetry, mobile communications and similar applications. Each selector will respond to one of 40 audio frequencies spaced at 15 cps intervals from 262.5 to 847.5 cps, and actuate signals, counters, controls or other devices. Normal drive current is 2.5 ma. and driving power needed is only 1.8 mW. Selectivity is  $\pm 1.5$  cps of calibrated frequency and stability is within  $\pm 0.5$  cps of calibrated frequency from  $-10$  to  $+50^\circ\text{C}$ . Fujitsu resonant reed selectors are particularly useful where space and weight are at a premium. A new electro-mechanical design permits both the reed and driving coil to be sealed in a case only 36mm long and 12.6mm in diameter. For detailed specifications and applications information contact our nearest representative.



**FUJITSU LIMITED**

*Communications and Electronics*

Tokyo, Japan

Represented by: U.S.A. HAR-WELL ASSOCIATES, INC. Southbury, Connecticut, Phone: 264-8222 THE NISSHO PACIFIC CORP. 120 Montgomery St., San Francisco 4, California, Phone: YUKON 2-7901, 7906 Canada: NISSHO (CANADA) LTD. 100 University Avenue, Toronto, Phone: EMpire 2-4794 United Kingdom: WALMORE ELECTRONICS LIMITED 11-15 Betterton Street, Drury Lane, London W.C. 2, Phone: TEMplebar 0201-5 Germany: NEUMÜLLER & CO. GMBH. 8 München 13, Schraudolphstr 2a, Phone: 29 97 24

CIRCLE 120 ON READER SERVICE CARD

**HELP YOUR POST OFFICE  
TO SERVE YOU BETTER  
BY  
MAILING EARLY IN THE DAY  
NATIONWIDE IMPROVED MAIL SERVICE  
PROGRAM**

assistant to the president and marketing manager, has held senior management positions with Boonton Radio Corp., Philco Corp. and Kay Electric Co.

Systron-Donner is engaged in the development and manufacture of transducers, flight control devices, test and measuring instruments, analog computers and accelerometers.

### PEOPLE IN BRIEF

**Gottfried R. Rosendahl** leaves GE to join ITT Federal as senior scientist. **Bernard Friedland**, formerly with Melpar, Inc., appointed principal staff scientist in control at General Precision's Aerospace Research Center. **Jerome L. Herold**, ex-Fairbanks, Morse & Co., named director of materiel and procurement for the Space Systems div. of the Martin Co. **Howard Courter**, previously with Riddle Airlines, Inc., joins Aerospace Electronics, Inc., as mgr. of quality control. **Fred T. Sinnott**, from GD/Astronautics to Kinetics Corp. as chief electronics engineer. **Frank Waldhorst**, recently with Transnuclear Corp. and Pitometer Log Corp., now production mgr. at M. Ten Bosch, Inc. **John Spanos** promoted to asst. director of mfg. at the Semiconductor div. of Hoffman Electronics Corp. **Daniel Shevelenko** leaves Cook Electric Co. to become director of engineering at Hathaway Instruments, Inc. **George A. Bronson** moves up to director, engineering & operations, of General Technology Corp. **George W. Pratt** advances to mgr., overseas operations for Philco's Lansdale div. **George Merker**, ex-ElectroTec, now managing director of newly formed Gyrex, Inc. **Edward D. Sherman**, formerly with California Technical Industries, appointed plant production mgr. at Eldorado Electronics. **James W. Otis** promoted to mgr. of mfg. operations for the Eagle Signal div. of E. W. Bliss Co. He succeeds **W. P. Juckem** who was named asst. to the president for the Bliss Co. Fairchild Defense Products ups **George M. Walsh** to inspection and test mgr. at its headquarters facility.

# electronics

## WEEKLY QUALIFICATION FORM FOR POSITIONS AVAILABLE

### ATTENTION: ENGINEERS, SCIENTISTS, PHYSICISTS

This Qualification Form is designed to help you advance in the electronics industry. It is unique and compact. Designed with the assistance of professional personnel management, it isolates specific experience in electronics and deals only in essential background information.

The advertisers listed here are seeking professional experience. Fill in the Qualification Form below.

#### STRICTLY CONFIDENTIAL

Your Qualification form will be handled as "Strictly Confidential" by ELECTRONICS. Our processing system is such that your form will be forwarded within 24 hours to the proper executives in the companies you select. You will be contacted at your home by the interested companies.

#### WHAT TO DO

1. Review the positions in the advertisements.
2. Select those for which you qualify.
3. Notice the key numbers.
4. Circle the corresponding key number below the Qualification Form.
5. Fill out the form completely. Please print clearly.
6. Mail to: Classified Advertising Div., ELECTRONICS, Box 12, New York 36, N. Y. (No charge, of course).

COMPANY	SEE PAGE	KEY #
ACF INDUSTRIES INC Albuquerque Division Albuquerque, New Mexico	223*	1
AEROSPACE PLACEMENT CORP. Phila. 3, Penna.	222*	2
AFSC-AFLC Joint Professional Placement Office New York, N. Y.	221*	3
ATOMIC PERSONNEL INC. Philadelphia, Penna.	122	4
BELL AEROSYSTEMS CO. Div. of Bell Aerospace Corporation A Textron Company Buffalo, New York	223*	5
BENDIX CORPORATION Kansas City Division Kansas City, Missouri	220*	6
BOOZ, ALLEN APPLIED RESEARCH INC. Bethesda, Md.	222*	7
BRISTOL COMPANY Waterbury, Conn.	122	8
BROOKHAVEN NATIONAL LABORATORY Upton, New York	215*	9
ELECTRO INTERNATIONAL INC. Annapolis, Md.	122	10
GENERAL DYNAMICS, ELECTRIC BOAT Groton, Conn.	123	11
GENERAL DYNAMICS/ELECTRONICS Rochester 1, N. Y.	217*	12
HONEYWELL St. Petersburg, Fla.	118	13
NORDEN Div. of United Aircraft Corp. Norwalk, Conn.	219*	14
PAN AMERICAN WORLD AIRWAYS INC Guided Missiles Range Div. Patrick AFB Fla.	218*	15
PERSPECTIVE Needham Heights, Mass.	222*	16

(Continued on page 122)

(cut here)

### electronics WEEKLY QUALIFICATION FORM FOR POSITIONS AVAILABLE

(cut here)

(Please type or print clearly. Necessary for reproduction.)

#### Personal Background

NAME .....

HOME ADDRESS .....

CITY ..... ZONE ..... STATE .....

HOME TELEPHONE .....

#### Education

PROFESSIONAL DEGREE(S) .....

MAJOR(S) .....

UNIVERSITY .....

DATE(S) .....

#### FIELDS OF EXPERIENCE (Please Check)

32263

- |  |  |                                       |
|--|--|---------------------------------------|
| <input type="checkbox"/> Aerospace           | <input type="checkbox"/> Fire Control        | <input type="checkbox"/> Radar        |
| <input type="checkbox"/> Antennas            | <input type="checkbox"/> Human Factors       | <input type="checkbox"/> Radio-TV     |
| <input type="checkbox"/> ASW                 | <input type="checkbox"/> Infrared            | <input type="checkbox"/> Simulators   |
| <input type="checkbox"/> Circuits            | <input type="checkbox"/> Instrumentation     | <input type="checkbox"/> Solid State  |
| <input type="checkbox"/> Communications      | <input type="checkbox"/> Medicine            | <input type="checkbox"/> Telemetry    |
| <input type="checkbox"/> Components          | <input type="checkbox"/> Microwave           | <input type="checkbox"/> Transformers |
| <input type="checkbox"/> Computers           | <input type="checkbox"/> Navigation          | <input type="checkbox"/> Other .....  |
| <input type="checkbox"/> ECM                 | <input type="checkbox"/> Operations Research | <input type="checkbox"/> .....        |
| <input type="checkbox"/> Electron Tubes      | <input type="checkbox"/> Optics              | <input type="checkbox"/> .....        |
| <input type="checkbox"/> Engineering Writing | <input type="checkbox"/> Packaging           | <input type="checkbox"/> .....        |

#### CATEGORY OF SPECIALIZATION

Please indicate number of months experience on proper lines.

	Technical Experience (Months)	Supervisory Experience (Months)
RESEARCH (pure, fundamental, basic)	.....	.....
RESEARCH (Applied)	.....	.....
SYSTEMS (New Concepts)	.....	.....
DEVELOPMENT (Model)	.....	.....
DESIGN (Product)	.....	.....
MANUFACTURING (Product)	.....	.....
FIELD (Service)	.....	.....
SALES (Proposals & Products)	.....	.....

CIRCLE KEY NUMBERS OF ABOVE COMPANIES' POSITIONS THAT INTEREST YOU

1 2 3 4 5 6 7 8 9 10 11 12 13 14 15 16 17 18 19 20 21 22 23 24 25



# ENGINEERS

## JOIN THE LEADER IN THE HIGHLY SPECIALIZED FIELD OF RADIO FREQUENCY INTERFERENCE

ELECTRO-INTERNATIONAL, is a medium sized growth company offering unusual benefits, PLUS unequalled professional and remunerative advancement in a healthy year-round community living environment for men with the following qualifications:

### CIRCUIT DESIGN (All Levels)

B.S. E.E. or M.S. E.E. min 3 years experience with project and/or supervisory experience desired. Systems or equipment design, evaluation and test engineering experience essential, as applied to military & commercial hardware involving broad Radar & Communication techniques.

### EQUIPMENT IMPROVEMENT

B.S. E.E. or M.S. E.E. with strong practical systems background. Ability to re-work, re-design, modify and improve hardware for both military and commercial application. Must be able to generate ideas towards concepts breakthrough.

**New York Interviews** During IEEE convention **CO 5-2974**  
Call Mr. C. Scott Lewis

If unable to apply, send resume



### ELECTRO-INTERNATIONAL INC.

A subsidiary of Electro Instrument  
Greenwood Acres, Annapolis, Md.

An Equal Opportunity Employer

## TO ENGINEERS WHO ARE LOOKING FOR THE ROUTE TO THE TOP:

Enter the sales field and benefit directly and rapidly from the effort you put forth. In sales engineering, you solve the industrial problems and make the recommendations for the technical equipment or services to produce the needed result; you gain the added benefit and satisfaction of applying your engineering and technical knowledge for the customer. Success in selling (and sales engineering is no exception) inevitably leads to greater responsibility for you, and to proportionately higher income. You are challenged to develop a stronger capability for getting along well with others, for exercising judgment, and for building the kind of background that is today most highly valued in business enterprises. These are the vital qualities which lead to the top! Sales engineering should interest you! Send us your resume. We design, develop, and manufacture instruments and control systems to be marketed nationally by our own sales team. You can be an important part of that team. Successful applicants are given a comprehensive three-months course at headquarters, with regular salary and expenses from start of employment. All replies will be held in complete confidence, and every inquiry will be answered.

Write: Charles F. Johnson, Manager of Sales Training  
**The Bristol Company Waterbury 20, Conn.**  
(An equal opportunity employer)



# electronics

## WEEKLY QUALIFICATIONS FORM FOR POSITIONS AVAILABLE

(Continued from page 121)

SPACE TECHNOLOGY LABORATORIES INC.	13*	17
Sub. of Thompson Ramo Wooldridge Inc. Redondo Beach, California		
SVERDRUP & PARCEL AND ASSOCIATES INC.	222*	18
St. Louis, Mo.		
TELEVISION ASSOCIATES OF INDIANA, INC.	222*	19
Michigan City, Indiana		
U. S. DEPT. OF COMMERCE	222*	20
National Bureau of Standards Boulder Labs. Boulder, Colorado		
VEZAN—WEST & COMPANY	222*	21
W. Hartford 7, Conn.		

\* These advertisements appeared in the March 15th issue.



**E. E.'s**  
for FEE-PAID Positions  
**WRITE US FIRST!**  
Use our confidential application for professional, individualized service . . . a complete national technical employment agency.  
**ATOMIC PERSONNEL, INC.**  
Suite 1207L, 1518 Walnut St., Phila. 2, Pa.

### EMPLOYMENT OPPORTUNITIES

The advertisements in this section include all employment opportunities—executive, management, technical, selling, office, skilled, manual, etc. Look in the forward section of the magazine for additional Employment Opportunities advertising.

#### — RATES —

**DISPLAYED:** The advertising rate is \$40.17 per inch for all advertising appearing on other than a contract basis. Contract rates quoted on request. An advertising inch is measured 3/8" vertically on a column—3 columns—30 inches to a page. Subject to Agency Commission.

**UNDISPLAYED:** \$2.70 per line, minimum 3 lines. To figure advance payment count 5 average words as a line. Box numbers—count as 1 line.

Discount of 10% if full payment is made in advance for 4 consecutive insertions. Not subject to Agency Commission.



## Are you a COMPLETELY INFORMED electronics engineer?

Today you may be working in microwaves. But on what project will you be working tomorrow? You *could* have read **electronics** this past year and kept abreast of, say, microwave technology. *There were 96 individual microwave articles between July, 1961 and June, 1962!*

But suppose tomorrow you work in some area of standard electronic components, in semiconductors, in systems? Would you be up-to-date in these technologies? Did you read the more than 3,000 editorial pages that **electronics'** 28-man editorial staff prepared last year?

**electronics** is edited to keep you current *wherever* you work in the industry, *whatever* your job function(s). If you do not have your own copy of **electronics**, subscribe today via the Reader Service Card in this issue. Only 7½ cents a copy at the 3 year rate.

# electronics

## SEARCHLIGHT SECTION

(Classified Advertising)

BUSINESS OPPORTUNITIES

EQUIPMENT - USED or RESALE

### DISPLAYED RATE

The advertising rate is \$27.25 per inch for all advertising appearing on other than a contract basis. Contract rates quoted on request. AN ADVERTISING INCH is measured 1/8 inch vertically on one column, 3 columns—30 inches—to a page. EQUIPMENT WANTED or FOR SALE ADVERTISEMENTS acceptable only in Displayed Style.

### UNDISPLAYED RATE

\$2.70 a line, minimum 3 lines. To figure advance payment count 5 average words as a line. PROPOSALS, \$2.70 a line an insertion. BOX NUMBERS count as one line additional in undisplayed ads. DISCOUNT OF 10% if full payment is made in advance for four consecutive insertions of undisplayed ads (not including proposals).

## SAVE! BIG MONEY on GENERATOR SETS



### MOTOR-GENERATOR, AC TO DC

Motor: 5 H.P. 3510 RPM, 220/440 volts, 60 cycles, 3 phase. Type O-1X, Frame 225, Class G, Form B. Generator: 28 volts, 100 amperes

D.C. Model No. 60. Made by MotoResearch Co. Equipped with motor starter box and generator control panel. Complete assembly mounted in tubular frame for portability. Shpg. wt. 250 lbs. F.O.B. Chicago No. AS-G764. . . . . ONLY . . . . . \$175.00

### 50 KW, 400 CYCLE MOTOR GENERATOR SET

Ideal Type F-1. Rated 62.5 KVA, 50 KW, 120/208 volts, 3 phase, 400 cycles, 0.8 P.F. Powered by 60 cycle, 3 phase, 220/440 volt motor. Complete with instrument and control panel. Overall dimensions: 85" L, 34" W, 41" H. Shpg. wt. 2100 lbs. F.O.B. Chicago. No. AS-G964. . . . . ONLY . . . . . \$1,250.00



## FREE CATALOG!

Write today for Groban's NEW 72 page Equipment Catalog and Hydraulic Reference Manual. Tremendous Savings on hundreds of items.



### GROBAN SUPPLY COMPANY, INC.

1139 So. Wabash Ave., Dept. AS-3, Chicago 5, Ill. WEBster 9-3793 • Cable: GROBANCO — CHICAGO

CIRCLE 950 ON READER SERVICE CARD

### RADIO RESEARCH INSTRUMENT CO.

AUTO-TRACK & TELEMETRY ANTENNA PEDESTALS 3 & 10 CM. SCR. 584 AUTO-TRACK RADARS. AN/TSP-10 SEARCH, AN/TSP-10 MT. FINDERS. AN/FRN-322CA, AN/APS-10 NAVIG. & WEATHER. AN/APS-15B PRECISION, AN/APQ-35B PRECISION. AN/APS-31A SEARCH. DOZENS MORE. 5-12 MEGAWATT HIGH POWER PULSERS.

RADIO RESEARCH INSTRUMENT CO. 550 Fifth Ave., New York Judson 6-4691

### RADAR SYSTEMS & COMPONENTS/ IMMEDIATE DELIVERY

CIRCLE 951 ON READER SERVICE CARD

OVER 2,000,000

## RELAYS IN STOCK!

Send for Catalog SS

Universal RELAY CORP. 42 WHITE ST., N.Y. 13, N.Y. • WALKer 5-6900

CIRCLE 952 ON READER SERVICE CARD

# Look what EE's are doing

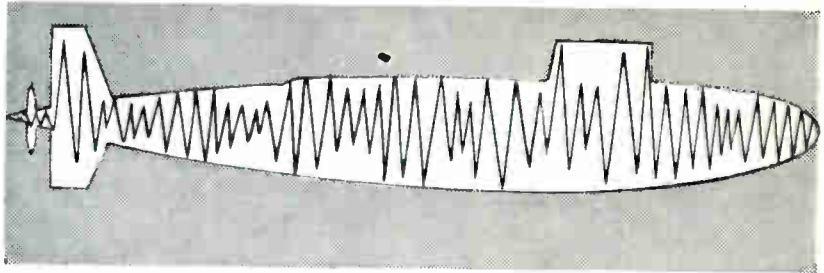

## at ELECTRIC BOAT

- Design of Special Instrumentation for Measurement of Acoustic & Vibration Data
- Design & Installation of Interior Communication Systems, Navigation Systems, Ship Control Systems, Depth Control Systems, Steering & Diving Devices
- Application and Systems Engineering of Radio, Radar, Sonar & Countermeasures Systems & Components
- Design and Installation of Electric Power Plants & Distribution Systems
- Quality/Reliability Control & Assurance
- Nuclear Power Plant Systems Schematics Review
- Advanced Circuit Design
- Electronic Systems Engineering
- Missile Fire Control, Guidance and Checkout Systems & Equipment
- Installation and Test of Reactor Plant Auxiliary Power Supplies
- Integration of Control and Instrumentation Systems
- Navigation Systems and Equipment
- Procurement • Signal Systems Analysis
- Vendor Product Application Design
- Electrical Power & Control Systems & Component Design
- Test Development & Instrumentation Design
- Vendor Performance Analysis
- Process Control Engineering & Instrumentation
- Sound, Shock & Vibration Analysis

As a world of technology in miniature—incorporating missile launching systems, a nuclear propulsion plant, and life support systems—the nuclear submarine is an engineering challenge of the highest order. The Electrical and Electronic Engineer working at Electric Boat has a unique opportunity for professional development, not only in his own specialty but through broad knowledge gained in the unity of all technologies.

Your resumes are invited. Please address Mr. Peter Carpenter.

# GENERAL DYNAMICS

## ELECTRIC BOAT

Groton, Connecticut

AN EQUAL OPPORTUNITY EMPLOYER

# INDEX TO ADVERTISERS

• AMP Incorporated .....15,	85	Hamilton Standard Div. of United Aircraft Corp. ....	72	Tektronix, Inc. ....	20, 21
• Accurate Instrument Co. ....	115	• Hart Manufacturing Co. ....	105	Texas Instruments Incorporated Industrial Products Group.....	29
• Acme Electric Corp. ....	100	• Hewlett-Packard Company..2nd Cover	23	Texas Instruments Incorporated Metals & Controls Division.....	104
Air Express .....	33	Hltemp Wires Inc. ....	14	United Control Corp. ....	112
Allen-Bradley Co. ....	48	Honeywell .....	118	Varian Associates Bomac Div. ....	71
• Alpha Wire Corp. ....	111	Honeywell, Denver Div. ....	46	Vitro Laboratories .....	106
• Amphenol-Borg Electronics Corp. Connector Division .....	34, 35	Hughes Aircraft Co. Aerospace Divisions .....	105, 107, 109	Weston Instruments & Electronics A Division of Daystrom Inc.....	73
Anasco .....	37	International Resistance Co. ....	87	Yokogawa Electric Works, Inc. ....	109
Arnold Engineering Co., The .....	108	• Jennings Radio Manufacturing Corp..	94		
Astronetic Research Inc. ....	116	• Kepco, Inc. ....	75		
• Ballantine Laboratories, Inc. ....	113	Kollmorgen Northampton Div. of Kollmorgen Corp. ....	116		
Baltimore Gas & Electric Co. ....	5	Leach Corporation .....	81		
Bausch & Lomb, Inc. ....	38	• LEL, Inc. ....	103		
Beattie-Coleman Inc. ....	92	Lockheed Electronics Co.....	80		
Bekins Van Line .....	86	McGraw-Hill Book Co. ....	107		
Belden Manufacturing Co. ....	47	Minneapolis-Honeywell Denver Div. ....	46		
Boonton Electronics Corp. ....	88	Minnesota Mining & Mfg. Co. Mincom Division .....	70		
Bourns Inc. ....	39	Mitsumi Electric Co., Ltd. ....	117		
Bristol Company, The .....	102	Motorola Military Electronics Div. 40,	41		
Carborundum Company, The .....	101	• Mullard Ltd. ....	97		
• Clarostat Mfg. Co., Inc. ....	79	National Resistronics, Inc. ....	115		
• Clifton Precision Products Co., Inc...	83	• North Atlantic Industries, Inc. ....	76		
Coors Porcelain Co. ....	93	Nytronics Inc. ....	96		
• Corning Electronics Div. of Corning Glass Works.....	73	• Philamon Laboratories, Inc. ....	95		
DeVry Technical Institute .....	109	Photocircuits Corp. ....	44		
Di Aero Corp. ....	30	Philips Gloeilampenfabrieken, N.V..16,	17		
Dow Corning Corp. ....	10, 11	• Polarad Electronic Instruments, A Div. of Polarad Electronics Corp..	9		
duPont de Nemours & Co., Inc., E. I. ....	45, 77, 91	• Potter Instrument Co., Inc. ....	19		
• Durant Manufacturing Co. ....	99	• Radio Corporation of America ..4th cover Research-Cottrell, Inc. Electronics Div. ....	117		
Dymec A Division of Hewlett Packard Co...	89	• Rosemount Engineering Co. ....	119		
Dynaplex Corp. ....	115	SAAB Motors Inc. ....	13		
• Electronic Instrument Co., Inc. (EICO)	26	Sage Laboratories Inc. ....	96		
Electronic Modules Corp. ....	84	• Schjeldahl Co., G. T. ....	110		
Flying Tiger Line .....	27	Sperry Electronic Tube Div. Sperry Rand Corp.....3rd cover	4, 25		
Fujitsu Ltd. ....	120	Sprague Electric Co. ....	4, 25		
Gamewell Co., The .....	6	Standard Telephones & Cables, Ltd...	42		
General Electric Co. Power Tube Dept. ....	43				
Semiconductor Products Dept. ....	69				
• Gould National Batteries Inc. ....	36				
Gries Reproducer Corp. ....	31				

## CLASSIFIED ADVERTISING

F. J. Eberle, Business Mgr.

EMPLOYMENT  
OPPORTUNITIES .....122, 123

EQUIPMENT  
(Used or Surplus New)  
For Sales ..... 123

## INDEX TO CLASSIFIED ADVERTISERS

Atomic Personnel Inc. .... 122  
Bristol Company ..... 122  
Electro International Inc. .... 122  
General Dynamics/Electric Boat .... 123  
• Groban Supply Co., Inc. .... 123  
• Radio Research Instrument Co. .... 123  
• Universal Relay Corp. .... 123

• See advertisement in the July 25, 1962 issue of Electronics Buyers' Guide for complete line of products or services.

This Index and our Reader Service Numbers are published as a service. Every precaution is taken to make them accurate, but electronics assumes no responsibilities for errors or omissions.

## electronics



Audit Bureau  
of Circulation



Associated Business  
Publications

Audited Paid Circulation

### JAMES T. HAUPTLI

Advertising Sales Manager

### BEN ANELLO

Market Services Manager

### DAVID CUNNIFF

Promotion Manager

### RICHARD J. TOMLINSON

Business Manager

### Electronics Buyers' Guide

R. S. QUINT  
General Manager

## ADVERTISING REPRESENTATIVES

### ATLANTA (9):

Michael H. Miller, Robert C. Johnson  
1375 Peachtree St. N.E., Trinity 5-0523  
(area code 404)

### BOSTON (16):

William S. Hodgkinson, Donald R. Furth  
McGraw-Hill Building, Copley Square,  
Congress 2-1160 (area code 617)

### CHICAGO (11):

Harvey W. Wernecke, Robert M. Denmead  
645 North Michigan Avenue, Mohawk 4-5800  
(area code 312)

### CLEVELAND (13):

Paul T. Fegley  
55 Public Square, Superior 1-7000  
(area code 216)

### DALLAS (1):

Frank Le Beau  
The Vaughn Bldg., 1712 Commerce St.  
Riverside 7-9721 (area code 214)

### DENVER (2):

John W. Patten  
Tower Bldg., 1700 Broadway,  
Alpine 5-2981 (area code 303)

### HOUSTON (25):

Joseph C. Page, Jr.  
Prudential Bldg., Halcombe Blvd.,  
Riverside 8-1280 (area code 713)

### LOS ANGELES (17):

Ashley P. Hartman, John G. Zisch,  
William C. Gries  
1125 W. 6th St., Huntley 2-5450  
(area code 213)

### NEW YORK (36):

Donald H. Miller, Henry M. Shaw,  
George F. Werner  
500 Fifth Avenue, LO-4-3000  
(area code 212)

### PHILADELPHIA (3):

Warren H. Gardner, William J. Boyle  
6 Penn Center Plaza, LOcust 8-4330  
(area code 215)

### SAN FRANCISCO (11):

Richard C. Alcorn  
255 California Street, Douglas 2-4600  
(area code 415)

### LONDON W1:

Edwin S. Murphy Jr.  
34 Dover St.

### FRANKFURT/Main:

Matthée Herfurth  
85 Westendstrasse

### GENEVA:

Michael R. Zeynel  
2 Place du Port

### TOKYO:

George Olcott,  
1, Kotohiracho, Shiba, Minato-ku



# SPERRY PHASE-LOCKS BWO'S BY SIGNAL INJECTION

**IN:** Microwatts from the most stable frequency source you can find

Local oscillator output frequency control by injection phase-locking, heretofore unavailable in the millimeter region, is now available with two new Sperry BWO's.

Sperry Electronic Tube Division is offering two new BWO's — the SBM-421, voltage tunable from 48 to 63 Gc, and the SBE-402, voltage tunable from 65 to 86 Gc.

Because of Sperry's precision design and manufacturing techniques, the addition of an optional input waveguide to these two tubes simplifies frequency stabilization of their outputs. The input waveguide is used to introduce a very low-power (as little as 1 microwatt) signal from an unusually stable frequency source. The 10 to 30 mW output of the BWO is then slaved to the frequency stability of the input source.

Use of this technique can greatly simplify the task of millimeter wave system designers who require precision frequency control. Injection phase-locking eliminates complicated electronic stabilization loops. This development is also expected to improve the accuracy of doppler radar systems and to open many new application possibilities in the millimeter region of the spectrum.



**OUT:** 10-30 mW power at 48 to 86 Gc, and just as stable

**A FREE TECHNICAL BOOKLET** gives full details on new Sperry BWO's and their optional injection phase-locking feature. For your copy, write to Sperry Electronic Tube Division, Sperry Rand Corporation, Gainesville, Florida.

Also described in the booklet are other system-simplifying features of the Sperry BWO's. These include permanent magnet focusing, a gridded triode gun, and photo-etched slow-wave structures.

For specific information or quotation, contact the appropriate Sperry Sales Representative: in the U.S.A., the nearest office of Cain & Co.; in Europe, Sperry Europe Continental, Paris.

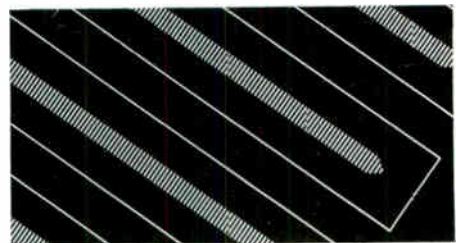
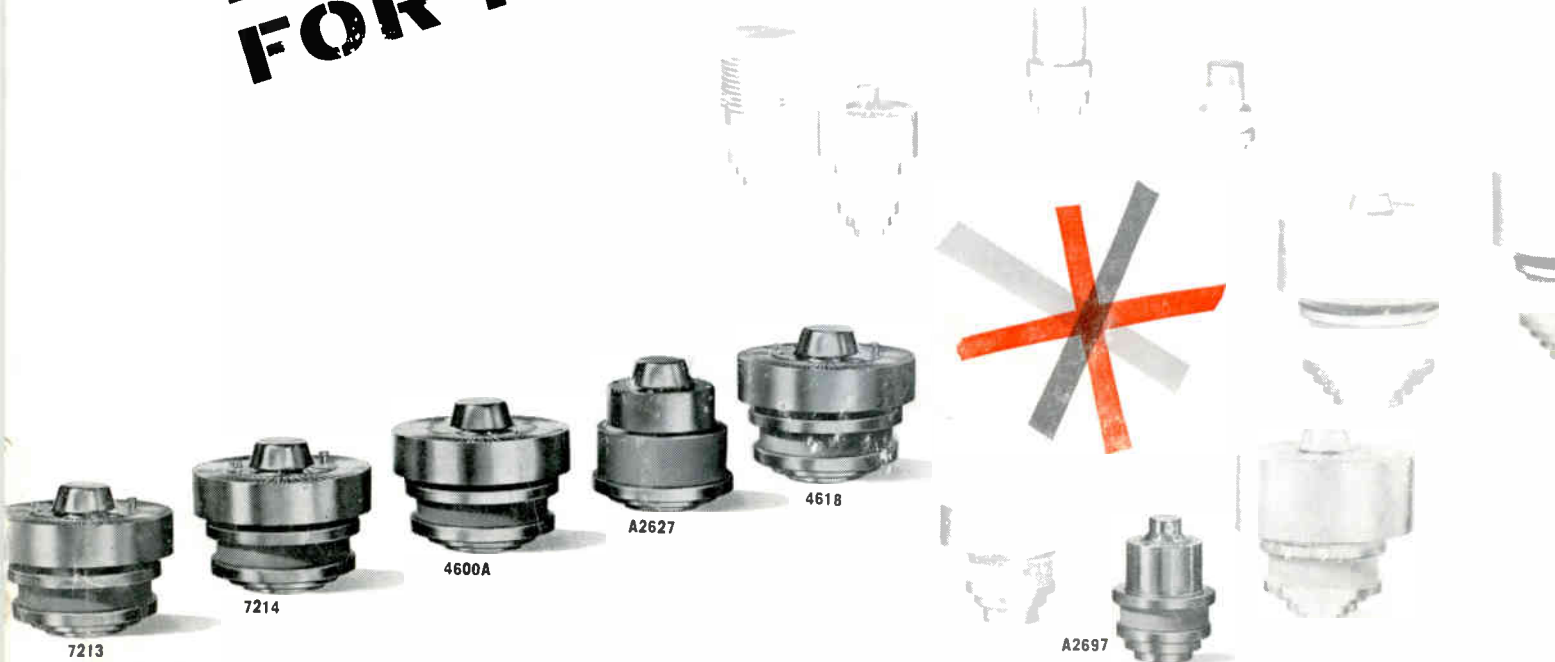

**PHOTO-ETCHING** of slow-wave structures from negatives like this (shown greatly enlarged) gives significantly superior performance to Sperry BWO's.



SPERRY RAND CORPORATION  
GAINESVILLE, FLA. / GREAT NECK, N. Y.

# PATTERN FOR POWER



# RCA CERMOLUX FAMILY

Just five years ago RCA introduced the first members of the CERMOLUX "family," a new concept in power tubes incorporating precision-aligned grids, and ceramic-metal construction. Today, "second generation" types are emerging and forming individual "type-families." Highlighted here are just two of these "type-families:" RCA-7650 and RCA-7213. These rugged beam power designs provide the power required for virtually every type of electronic application. They are easily tailored to a variety of air-cooled or conduction-cooled techniques for communications, control, radar, UHF-TV, phased array, and distributed amplifier applications. CERMOLUX design is adaptable in power and size from watts to megawatts, and in frequency from kilocycles to gigacycles.

For technical information and assistance, consult your RCA Industrial Tube Representative or for technical data on specific tube types write: Section: C-19-Q-3. Commercial Engineering, RCA Electron Tube Division, Harrison, N. J.

Tube Type	Capabilities	Applications	Cooling
7650	800 watts power output	CW Amplifier	Forced-Air
7651	39,000 watts peak power output	RF-Pulse Amplifier	Forced-Air
4614	2,500 max. plate volts 0.5 max. plate amperes	Voltage Regulator	Forced-Air
A2697	3,000 max. plate volts 1.25 min. peak plate amperes at zero bias	Hard-Tube Modulator	Conduction
7213	1,350 watts power output	CW Amplifier	Forced-Air
7214	65,000 watts peak power output	RF-Pulse Amplifier	Forced-Air
4600A	3,500 max. plate volts 1.0 max. plate amperes	Voltage Regulator	Forced-Air
A2627	15,000 max. plate volts 20 max. peak plate amperes	Hard-Tube Modulator	Conduction
4618	1,350 watts power output	CW Amplifier	Forced-Air



The Most Trusted Name in Electronics

INDUSTRIAL TUBE PRODUCTS FIELD OFFICES—OEM SALES:  
Newark 2, N. J., 32-36 Green St., (201) 485-3900. Chicago 54, Ill.,  
Suite 1154, Merchandise Mart Plaza, (312) 527-2900. Los Angeles, 22,  
Calif., 6801 E. Washington Blvd., (213) RA 3-8361. **GOVERNMENT**  
SALES: Harrison, N. J., 415 South Fifth St., (201) 485-3000. Dayton  
2, Ohio, 224 N. Wilkinson St., (513) BA 6-2366. Washington 5, D. C.,  
1725 "K" St., N.W., (202) FE 7-8500. INTERNATIONAL SALES: RCA  
International Div., Clark, N. J., (201) 382-1000.