

# electronics®

## NOT A GIANT HAIRDRIER

*It's a Blue Scout  
nose cone with a  
new antenna, p 64*

*(photo right)*

---

## WHY USE A RING COUNTER?

*Here's breakeven data  
on ring vs binary, p 44*

---

## NEW EM FIELD MAPPING SCHEME

*Light modulation means  
no leads to probe, p 39*

---

## PICK THE BEST CONNECTION

*Big table rates  
eighteen methods, p 50*



# 3 oscillators in 1

with the turn of a switch

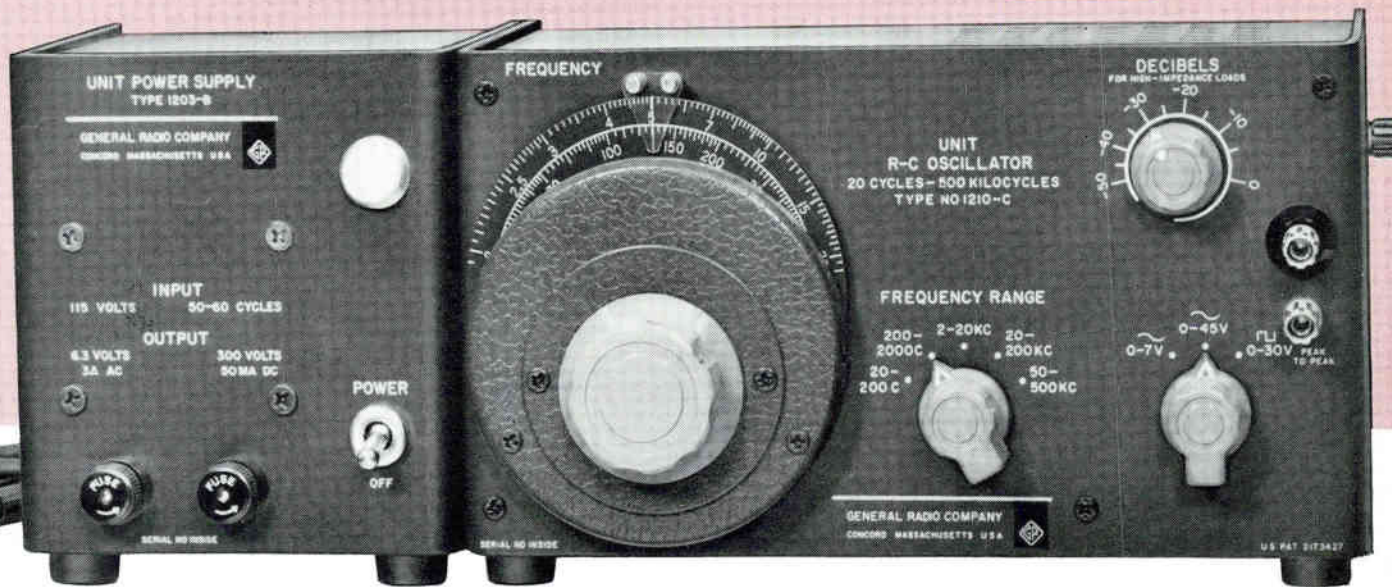

Type 1203-B Unit Power Supply, \$50.

Type 1210-C Unit R-C Oscillator, \$180.

## With this versatile R-C oscillator you have a choice of three outputs:

**SINE WAVE, Low-Impedance** — for loads of 500 ohms and higher. Maximum open-circuit output is 7v. Output constant within  $\pm 1$  db to 200 kc; distortion less than 1.5% over entire range; hum down 60 db.

**SINE WAVE, High-Impedance** — for loads of 10,000 ohms and higher. Maximum open-circuit output is 45v. Output constant within  $\pm 1$  db from 200c to 150 kc; distortion less than 5% from 200c to 200 kc; hum down 60 db.

**SQUARE WAVES** — 0 to 30v peak-to-peak; rise time about  $\frac{1}{3}$   $\mu$ sec; overshoot approximately 1%; hum down 60 db.

### Other Features

- Very wide frequency range — 20 cps to 500 kc in 5 ranges.
- Calibrated output control (0-50 db).
- Fast-responding AVC system holds amplitude of oscillations constant.
- Sweeping of any frequency range using optional dial drive.
- Small, compact, lightweight and rugged.
- Low in cost — high in value.

Write for complete information



Type 1210-C can be converted to a sweep oscillator by adding a G-R Synchronous Dial Drive. Type 908-P1 Drive sweeps one frequency decade in 70 seconds. \$35.



Type 1210-C Unit R-C Oscillator and Type 1203-B Unit Power Supply shown relay-rack mounted using Type 480-P4U3 Relay Rack Panel (\$12.00).

**GENERAL RADIO COMPANY**  
WEST CONCORD, MASSACHUSETTS

In EUROPE  
General Radio  
Overseas  
Zurich, Switzerland

NEW YORK, N. Y., 964-2722  
Ridgefield, N. J., 943-3140

CHICAGO  
(Oak Park) 848-9400

PHILADELPHIA, 424-7419  
Abington, 887-8486

WASHINGTON, D.C.  
(Rockville, Md.) 946-1600

SYRACUSE  
454-9323

DALLAS  
FL 7-4031

SAN FRANCISCO  
(Los Altos) 948-8233

LOS ANGELES  
469-6201

ORLANDO, FLA.  
425-4671

IN CANADA  
(Toronto) 247-2171

CIRCLE 900 ON READER SERVICE CARD

# electronics

A McGraw-Hill Publication 75 Cents



W. W. MacDONALD, Editor

J. M. CARROLL, Managing Editor  
 SENIOR EDITORS: Samuel Weber, George W. Sideris. SENIOR ASSOCIATE EDITORS: Michael F. Wolff, John F. Mason. ASSOCIATE EDITORS: Michael F. Tomaino, Sylvester P. Carter, William P. O'Brien, Sy Vogel, Leslie Solomon, George J. Flynn, Lawrence D. Shergalis, George V. Novotny, Leon H. Dulberger. ASSISTANT EDITORS: Nilo Lindgren, Stanley Froud, Stephen B. Gray, Roy J. Bruun, Barry A. Briskman. REGIONAL EDITORS: Harold C. Hood (Pacific Coast, Los Angeles), Thomas Maguire (New England, Boston), Cletus M. Wiley (Midwest, Chicago). ART DIRECTOR: Howard R. Berry. ASSISTANT ART DIRECTOR: John C. Wright, Jr. EDITORIAL ASSISTANTS: Lorraine Rossi, Virginia T. Bastian, Lynn Emery, Ann Mella, Lorraine Werner, Alice M. O'Brien. FOREIGN NEWS BUREAU: Director, John Wilhelm; Alyne Elias, Betsy Wilson. LONDON—John Shinn, Derek Barlow, Nicholas Landon. BONN —Bruce Bendow, Richard Mikton, Silke McQueen. BRUSSELS — Peter Forbath. PARIS—Robert Farrell, Arthur Erikson. MILAN—Marc A. Messina. MEXICO CITY—Wesley Perry, Jr. RIO DE JANEIRO—Leslie Warren. MOSCOW—Stewart Ramsey. TOKYO—Richard Haloran, Charles Cohen, John Yamaguchi.

W. W. GAREY, Publisher

BLUE SCOUT nose cone at Armour Research Foundation has two 2,000 to 4,000-Mc log-periodic antennas. Each one provides 180-deg coverage. *A flush-mounted achimedian spiral may operate up to 17 Gc* COVER

MILITARY AND SPACE BUDGETS. Department of Defense last week asked Congress for \$52.2 billion in fiscal year 1964. And NASA has put in a bid for \$5.7 billion. *Here's an analysis of these budgets, pointing up contracting shifts and opportunities for electronics firms* 18

LARGE DISPLAYS: Military Market Now, Civilian Next. A multimillion-dollar military market is expected to be followed by applications in education and business, perhaps even on-the-wall tv. *Three approaches to building displays for rapidly changing data are outlined* 24

MICROWAVE CENTER for Space Research Is Upgraded by Air Force. Integration of new components into the Millstone-Haystack complex greatly increases its utility. *Among the additions are monopulse radar and a little brother of the huge facility at Arecibo* 28

RADAR PROBE sees Flatlands on Venus. Experiments indicate that the planet is smoother than the moon. *Evidence that Venus is lifeless is building up* 30

EM FIELD MEASUREMENTS: New Technique Simplifies Them. Mechanical and electrical connections to probes used in measuring antenna near-field patterns can significantly disturb the measurements. Here, the field is measured by the modulated signal reflected from a small dipole. *The dipole is loaded with a photocell that is illuminated by a chopped light beam.* By K. Iizuka, Harvard University 39

WHY A RING COUNTER—Why Not a Binary? Pulse-circuit designers can often do a job equally well with a ring counter or a binary. Ring counters save power, handle large outputs conveniently and resist false triggering. *But they can suffer from high-frequency limitations, complications in clocking and double pulsing.* By J. Durio, Collins Radio 44

SIMPLE MEDICAL TELEMETER: How to Design It. If you can do an instrumentation job without multiplexing, here is a simple 80-mw telemetering transmitter and modulator. *Use of pulse-rate modulation reduces circuit complexity.* By A. G. Potter and J. D. McMechan, Iowa State Univ. 47



Published weekly, with Electronics Buyers' Guide as part of the subscription, by McGraw-Hill Publishing Company, Inc. Founder: James H. McGraw (1860-1948).

Title ® registered U.S. Patent Office; © copyright 1963 by McGraw-Hill Publishing Co., Inc. All rights reserved, including the right to reproduce the contents of this publication, in whole or in part.

Executive, editorial, circulation and advertising offices: McGraw-Hill Building, 330 West 42nd Street, New York 36, N. Y. Telephone Langacre 4-3000. Teletype TWX N.Y. 212-640-4646. Cable McGrawhill, N. Y. PRINTED IN ALBANY, N. Y.; second class postage paid at Albany, N. Y.

OFFICERS OF THE PUBLICATIONS DIVISION: Shelton Fisher, President; Vice Presidents: Joseph H. Allen, Operations; John R. Callahan, Editorial; Ervin E. DeGraff, Circulation; Donald C. McGraw, Jr., Advertising Sales; Angela R. Venezian, Marketing.

OFFICERS OF THE CORPORATION: Donald C. McGraw, President; Hugh J. Kelly, Harry L. Waddell, Executive Vice Presidents; L. Keith Goodrich, Executive Vice President and Treasurer; John J. Cooke, Vice President and Secretary.

Subscriptions are solicited only from those actively engaged in the field of the publication. Position and company connection must be indicated on orders. Subscription rates: United States and Possessions, \$6.00 one year, \$9.00 two years, \$12.00 three years. Canada: \$10.00 one year. All other countries \$20.00 one year. Single Copies, United States and Possessions and Canada 75¢. Single copies all other countries \$1.50.

THE PUBLISHER, UPON WRITTEN REQUEST FROM ANY SUBSCRIBER TO OUR NEW YORK OFFICE, AGREES TO REFUND THAT PART OF THE SUBSCRIPTION PRICE APPLYING TO COPIES NOT YET MAILED.

Subscribers: Please address change of address notices, subscription orders or complaints to Fulfillment Manager, Electronics, at above address. Change of address notices should provide old as well as new address, including postal zone number if any. If possible, attach address label from recent issue. Allow one month for change to become effective.

Postmaster: Please send Form 3579 to Fulfillment Manager, Electronics, 330 West 42nd Street, New York 36, New York.



Audited Paid Circulation

CONTENTS continued

**PERMANENT ELECTRICAL CONNECTIONS:** Choosing the Right One. Some people say electronics is like ward politics: you have to pull the right wires, make the right connections and get along with the coppers. *This article covers the second operation and compares 18 different mechanical, chemical and thermal ways to make permanent electrical connections.*

By J. H. Whitley, AMP Inc. 50

**NEW MODULATION TECHNIQUE** Simplifies Circuits. Many engineers feel delta modulation results in the simplest pcm circuits, but integration of transient disturbances at the output can cause loss of d-c level. *The delta-sigma modulation system introduces an integration process in the delta modulator to generate pulses carrying amplitude information.*

By H. Inose, Y. Yasuda, J. Murakami and H. Fujita, University of Tokyo 52

**REDUCING WINTER SKIDS** With a Transistor Warning Circuit. A thin film of ice on the road has caused many a fatal accident for the unwary driver. Here a simple transistor circuit mounted in front of the vehicle 2 feet above ground enables a driver to assess likelihood of ice formation. *In Britain, over a thousand cars already use it.*

By J. A. Irvine, Findlay, Irvine Ltd. 56

DEPARTMENTS

Crosstalk. <i>How to Unspecialize</i>	3
Comment. <i>On Behalf of Lab Courses</i>	4
Electronics Newsletter. <i>Boston Gets Two Space Centers</i>	7
Washington Outlook. <i>Supersonic Airliner Needs Automatic Landing System</i>	12
Meetings Ahead. <i>Medical Electronics International Conference</i>	32
Research and Development. <i>Magnetic Field Rotates Ultrasonic Waves</i>	64
Components and Materials. <i>How Diodes Keep Current to Constant Value</i>	74
Production Techniques. <i>Serrations Solve Wire-Termination Problem</i>	86
New Products. <i>Generating 0.5-Nanosecond Rise-time Pulses</i>	98
Literature of the Week	108
New Books. <i>Basic Theory and Application of Tunnel Diodes</i>	110
People and Plants. <i>Lear Siegler Dedicates Aerospace Center</i>	116
Index to Advertisers	126



# CROSSTALK

**HOW TO UNSPECIALIZE.** When Associate Editor Shergalis returned a few days ago from a trip to Florida that included the IRE Millimeter and Submillimeter Conference, in Orlando, he groused about the weather—too cold for swimming after the day's work—but he had warm words for the conference.

Shergalis has been to many conferences (he's one of our farthest-flung editors) and, frankly, some of them were dogs. But the millimeter meeting, he says, was a pleasure: lots of news, and a feeling among the participants that they are in a lively, interesting and expanding field.

Some of these impressions spilled into the report on the conference that we published last week. But to make the deadline, the report had to be rushed through—by air express, telegraph and, at the last minute, tied together by Shergalis in Florida and the editor in New York with a phone call. So there wasn't much chance for discussing the more personal aspects of the conference.

Nobody at the conference complained to Shergalis of being in a rut. That engineers have to specialize has been the complaint of many technical people in the electronics industry. Engineers that specialize can become limited in their views and often they can't appreciate the worth of technical advances in allied fields. They could even miss the boat on possible applications of new developments, seemingly divorced from their speciality.

But one of the things that keeps millimeter and submillimeter researchers hopping is that it is hard to specialize. This field has one of the broadest technical bases. Almost every physical phenomenon must be investigated for possible application to the problems of generating, detecting and transmitting coherent energy at millimeter frequencies.

The broad scope of his work, says the ultramicrowave engineer, is both a challenge and a frustration, but it is not boring. He must be a jack of all trades in applied physics.

The ultramicrowave engineer must understand the theory, be able to convert it into something practical, know where he can buy the best components and equipment at the best prices, and be a diplomat in order to argue his views with fellow ultramicrowave engineers.

Typical of the subject areas that must be investigated are classical electronics, quantum

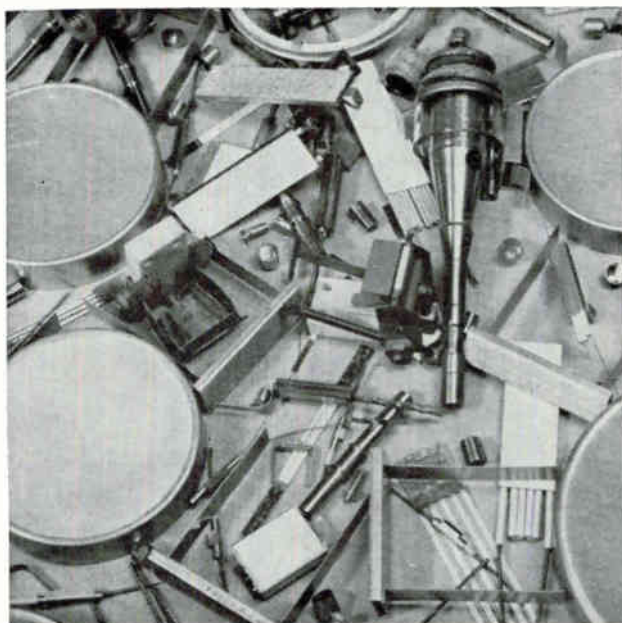

electronics, solid-state devices, ferrites, superconductors, optics, electromagnetism, acoustics, relativistic physics, plasma, spectroscopy, and precision metalworking methods.

And most of all, he must be able to communicate his ideas on any one of these things to engineers with interests as broad as his own.

**REDUCING THE ERRORS.** Werner Heisenberg's celebrated "uncertainty principle" states that it is impossible to obtain accurate measurements of, say, position and velocity, because the very process of taking measurements changes these values. For example, we can't watch an electron in orbit, because the reflected light we would need to see it would disturb the orbit.

This same sort of situation arises in taking field-pattern measurements for high-frequency antennas. The probe disturbs the field pattern being measured. Even if the probe is minute, its leads are usually long enough to counteract all the care taken in shrinking the probe. Obviously the best method is to use no probe—that would solve the lead problem, too.

As yet nobody has put this ideal solution to practice. However, Keigo Iizuka, of Harvard, has gone a long way in the right direction. He uses a probe, but dispenses with all connecting leads. The basic idea, detailed in our lead technical feature this week on p 39, is to use a tiny probe and detect its re-radiated energy.

# new!

## NANOSECOND PULSE TRANSFORMERS IN TO-5 TRANSISTOR CASES!

Sprague Type 45Z Subminiature Pulse Transformers are especially designed for use in low-power, ultra-high-speed computer circuitry.

Their TO-5 transistor cases offer several distinct advantages:



1. Another step forward in minification
2. Welded hermetic seal on high-density package
3. Increased uniformity and reliability
4. Compatibility with transistor mounting techniques

In order to suit various installation and packaging techniques, Type 45Z Pulse Transformers are available with standard length wire leads. Weldable or solderable leads can be furnished. Short pin-type leads for use with subminiature sockets are also available.

For complete technical information on Type 45Z Pulse Transformers, write for Engineering Data Sheet 40210 to Technical Literature Service, Sprague Electric Company, 35 Marshall Street, North Adams, Massachusetts.

**SPRAGUE**  
THE MARK OF RELIABILITY

45-441

4 CIRCLE 4 ON READER SERVICE CARD

## COMMENT

### Reliability

We wish to express our sincere appreciation for providing us with thirty copies of the article, Reliability: 1962, by John M. Carroll (p 53, Nov. 30, 1962).

Because of the excellent content of the article, we wished to give it the widest possible circulation among our engineering and quality control personnel, as expeditiously as possible, which we accomplished due to your prompt response to our request.

NICHOLAS J. MIGLIACCIO  
Quality Control Division  
Newark, N. J., Air Force Contract  
Management District  
Air Force Systems Command

### On Behalf of Lab Courses

I tend to disagree with your editorial of Dec. 14, 1962 (p 3). Based on my own experiences here at Rensselaer, I feel labs serve a very good purpose. First, let me make the qualifying statement that all E.E. labs, with the exception of special reports, are performed and written up during the time allotted for lab work. This does mean no endless evenings spent on reports, which I agree is wasted time.

I found it very helpful to have basic theory enhanced by lab work. I have plotted plate characteristics of a pentode, and torque curves of a series motor. That old adage, "seeing is believing," is very applicable when a student first confronts and is confronted with basic theory, particularly when more time is devoted to performance of the experiment.

Upperclass labs are even more helpful. Depending on the amount of theory a student has mastered, he is free to do whatever he wants in a certain area. (Example: Experiment on Logic—EE Lab III. Some students built and tested AND, OR and NOR gates. Others built and investigated complete logic circuits, utilizing flip-flops and any other number of basic circuits. Grades were given on the basis of originality and performance of work attempted.) Thus these labs can

provide an excellent aid to the mastering of basic theory.

PAUL CHERECWICH, JR.  
Rensselaer Polytechnic Institute  
Troy, New York

### Pulse Transformer Design

I've just read the article, Recently Derived Graphs Simplify Pulse Transformer Design, by Dan M. Bowers, in your Nov. 2 issue (p 52), and I must point out that the equation for calculating the impedance  $Z_i = e_r R / (e_r - e_i)$ , is in error.

Since the circuit contains both resistive and reactive components, the voltages in question cannot be subtracted arithmetically. Instead of the term  $(e_r - e_i)$ , another term has to be substituted:  $e_r$ , the voltage across the resistor.

CYRILLE POUCH  
Freed Transformer Company  
Brooklyn, New York

### Author Bowers replies:

On a theoretical basis, reader Pouch's point is well taken; that is, due to the reactive nature of the circuit,  $e_r - e_i = e_r$ , is not a true statement. As a practical matter, however, the maximum phase shift over the frequency range of interest is a little more than 3 degrees, and the error introduced thereby is less than 0.4 percent.

Considering that the method described in the article is graphical in nature, and that the error resulting is of such a magnitude as to be nearly imperceptible in a slide-rule calculation, I must conclude that the equation used in the article is not, in the practical sense, erroneous. (These calculations are based on  $R = 5K$ ; they obviously increase nearly five times in significance if the  $R = 1K$  graph is used. The phase-shift effect may be seen in the graphs, in the article, as the divergence of the lines for  $R = 1K$  and  $R = 5K$ .)

It may be of interest to note that the equation in question was adopted because, as a practical matter, the values  $e_r$  and  $e_i$  are more easily measured with an oscilloscope than is  $e_r$ .

DAN M. BOWERS  
Computer Control Company  
Framingham, Massachusetts

CIRCLE 5 ON READER SERVICE CARD→



# NEW GENERATION AUTOMATIC **CIRCUIT** ANALYZER

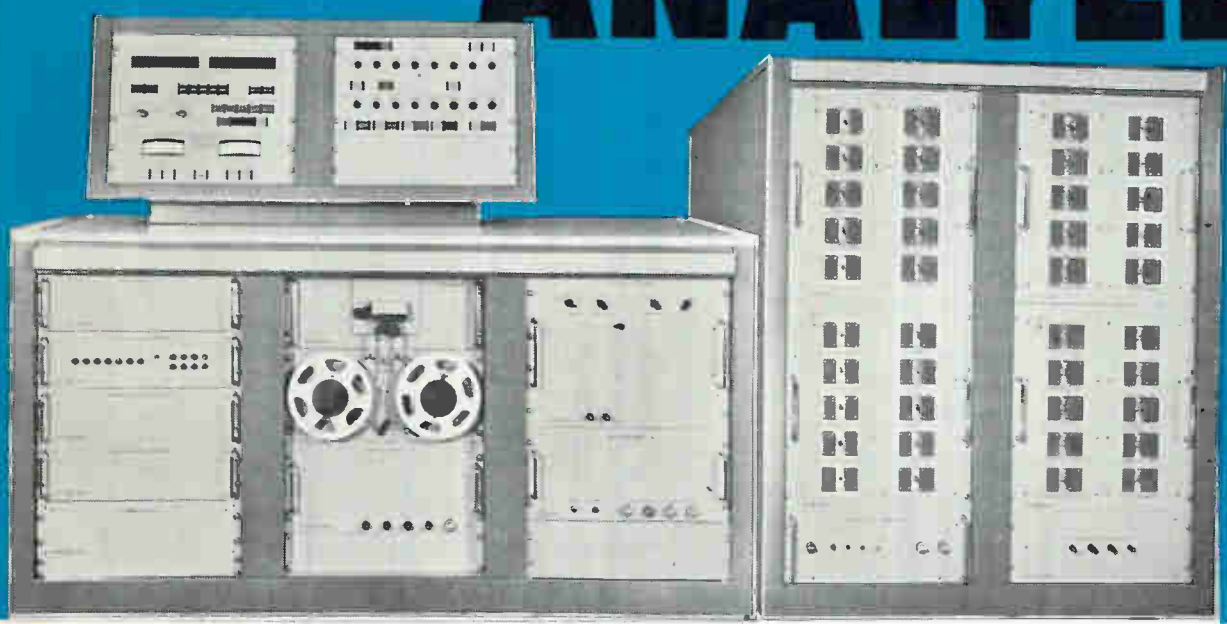

**SOLID STATE DIT-MCO MODEL 610A** features customer-selected programming, output medium, test capacity ...

### PROGRAMMABLE TEST PARAMETERS

HIGH VOLTAGE	100-1500 VDC (7 levels)
LEAKAGE RESISTANCE	200 K ohms - 1000 Megohms (36 levels)
CONTINUITY RESISTANCE	1 ohm - 1 Megohm (55 levels)
CONTINUITY CURRENT	0.1-2.5 amps (6 levels)
DWELL TIME	100 millsec. - 300 sec. (30 values)

### INPUT OPTIONS

- Punched Tape
- Punched Cards
- Computer

### OUTPUT OPTIONS

- Printed (electric typewriter or digital printer)
- Punched Tape
- Computer Codes

**TEST CAPACITY:** Up to 100,000 terminations, in 1000 termination modules.

For the first time, the compactness, reliability and maintenance advantages of solid state switching and control circuitry have been combined with the rugged and reliable performance of electro-mechanical devices required for switching test voltages and currents in automatic circuit analyzers. This new generation DIT-MCO development assures consistent, trouble-free and reliable automatic testing of wiring harness and electrical cabling in production, quality control, final assembly, maintenance and overhaul. Self-programming, external energization and packaging are only a few of the many options available, making possible a "customized" random access Analyzer to meet your specific requirements.

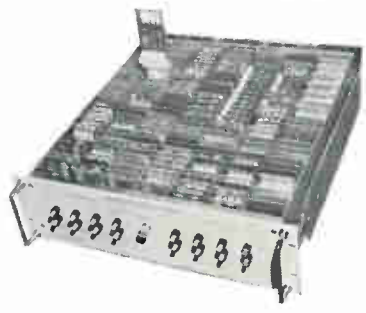

DIT-MCO also manufactures the Model 720A Automatic Logic Circuit Tester and a complete line of Automatic Circuit Analyzers, proven in use by leading aircraft and missile manufacturers.

*Write today for complete information on the Model 610A or other DIT-MCO equipment.*





# A modest proposal

In selecting a microwave signal generator, we urge you to ignore the "specification race". Give or take a split hair, each manufacturer's performance specification is conspicuous only by its similarity to the others. We say this despite the fact that many of our signal generators have led the pack in this frantic race for years.

The numbers game is fun to play, particularly when one is so often ahead, but we cannot, in good conscience, urge you to choose a Polarad Generator merely because it has a few megacycles more range, a wider choice of prfs, more linear frequency modulation, or even an intriguing and exclusive operational feature or two.

We propose, instead, that you go beyond the specification and ask: "How is this performance achieved? . . . How long will this instrument continue to perform within specification? . . . How much will it cost to maintain in perfect working order? . . . What percentage of the time will it be out of service for repair and recalibration?" Isn't each of these criteria at least as important as the performance specification? Of course it is. You want and need to buy the instrument that is very well designed and very well built . . . not just very well specified.

We say this: look beyond the specification, at the instrument itself. Examine the

panel critically — but then take off the cover, and look inside. In a Polarad Generator, you will see:

- The highest quality components, generously derated. (You may be surprised at the distinguished labels that flunk this simple test!)
- The meticulous craftsmanship that is uniquely essential to precision and stability in microwave instrumentation (you'll find no "bailing-wire" mechanics here!).
- Non-contacting-short cavity tuning, for complete freedom from noise, wear, and frequency skip or drift.
- Clean, modular layout, rugged construction, and an advanced thermo-mechanical design, ensuring rock-solid stability despite hard usage and repeated environmental stress. (Polarad Generators are the "work-horses" of the industry.)

It is no accident that Polarad is consistently selected to furnish microwave signal generators for the toughest, most reliability-conscious programs. We design them and build them so that the finished instrument is as impressive as the specification.

Call your Polarad Field Engineer today. Ask him to show you the quality of our instruments.

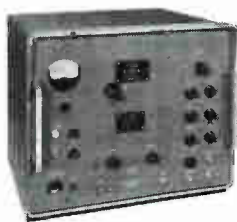

**MODEL MSG-34**  
4.2 — 11.0 KMC.  
Accurately calibrated absolute power-level. Adjustable from 0 to -127 dbm from 1 MW.

MODEL	FREQUENCY KMC	CALIBRATED POWER OUTPUT	INTERNAL MODULATION
PMR	0.5 - 1.0	0.5 MW (-3 dbm) to -127 dbm	Ultra-linear FM modulation standard sq-wave, 25-10,000 pps} with optional plug-pulse, 10-10,000 pps} in pulse modulator
PMX	4.45 - 11.0 (2 plug-ins)	1 MW (0 dbm) to -127 dbm	All instruments in this group: pulse modulation: 10-10,000 pps. *pulse width: 0.2-10 μsec. pulse delay: 2-2,000 μsec. square-wave modulation: 10-10,000 pps. FM deviation: ±2.5 MC min.
MSG-34 (Ultra Broadband)	4.2 - 11.0 digital freq. indicator	1 MW (0 dbm) to -127 dbm	
MSG-1R	0.95 - 2.40	1 MW (0 dbm) to -127 dbm	
MSG-2R	2.0 - 4.60	1 MW (0 dbm) to -127 dbm	
KSS (Signal Source)	1.05 - 11.0 (4 plug-ins)	Uncalibrated Power Output: 14-400 MW, depending on freq.	

HAVE YOU MADE RESERVATIONS YET?



Polarad's new "Project Mohammed" is now bringing the "Mountain" (our new Mobile Microwave Calibration Laboratory) to "Mohammed" (your microwave instruments). Be sure to take advantage of this opportunity to have your gear checked — at your doorstep. Save weeks of delay and needless expense. Call your Polarad field engineer for details and schedules!

**POLARAD**

**Polarad Electronics Corporation**

World Leader in  
Microwave Instrumentation

43-20V 34th Street  
Long Island City 1, New York

# NASA Center Boosts Boston's Space Aims

BOSTON—Boston area's drive to become a center of space research (p 24, Nov. 2, 1962) will get a major push if Congress approves a \$5-million appropriation in the proposed NASA budget (see p 18). The money is to start an electronics research center that would make this area the center of electronic component development for space.

Franklyn W. Phillips, director of NASA's North East Office, announced the center would be on equal level with Goddard, Lewis, Ames and other NASA centers. It would be the 15th such center.

Plans are to buy a 1,000-acre site, house the staff in temporary quarters until the center is operational. By 1967, there would be a staff of 2,000 in a \$50-million facility. They would concentrate on developing components, allied physical sciences and, probably, auxiliary power sources. Emphasis will be on in-house research, although some contracts will be let.

The center will be located near the Boston-Cambridge university community to tap electronics research talent in that area.

MIT is planning to build a \$4-million interdisciplinary center for space research, with NASA supplying \$3 million of the cost. Phillips said the two centers would act independently, but would complement each other.

Meanwhile, Boston civic and industrial leaders are still making plans for a company to seek large NASA prime contracts for the area.

## Japan Acts to Control Its Rising Tv Exports

TOKYO—The Japan Machinery Exporters Association (JMEA) set up a tv-export committee last week to maintain orderly exports. Misao Matsuda, business manager, said that exports to the U.S. increased so rapidly last year that the committee was organized to prevent a

repetition of problems encountered in transistor radio exports.

Matsuda said that Japan exported \$12.5 million worth of tv sets between January and October 1962, more than triple the exports in the corresponding period of 1961. But exports to the U.S. alone soared more than 400 percent.

JMEA is an official organization that handles most machinery exports from Japan, including radio and tv sets. In 1961, JMEA handled \$1.1 billion, a 22-percent increase over 1961.

## Radar Computer Maps Storm Height and Size

WEATHER RADAR data processor that automatically and almost immediately produces digital maps showing intensity and height of storms was described this week at the American Meteorological Society meeting by David Atlas, of Air Force Cambridge Research Laboratories. Called Stradap (Storm Radar Data Processor), the system enables maximum radar intensity and echo height to be displayed within five-mile squares.

Atlas reported that, in its first test in severe storm conditions late

last year, Stradap detected and displayed a storm that produced a tornado in Charlton, Mass. Atlas said a network of 100 long-range radars and Stradap units could provide automatic storm-mapping for the entire country. Built by Budd Electronics, and based on Atlas' idea, the computer is tied to conventional weather radar.

## Laser Radar Sweeps Can Indicate Size of Target

BEAM-SWEEPING technique being developed by Sperry Rand may enable long-range laser radar to make precision measurements of target size and to discriminate between targets and clutter.

Each 500-microsecond pulse of the laser beam is to be deflected through a known angle, alternately horizontal and vertical. Duration of the returns reflected from the target will provide angular width and angular length of the target. Angular presentations, multiplied by target range in a computing circuit, would give numerical readout of target size.

The deflector presently in development is a series of 1/4-inch-long bar-shaped optical prisms made up

## Japanese Mission to Moscow: Sell Instruments

TOKYO—Japan International Trade Promotion Association will sponsor an instrument show in Moscow from July 22 through August 5. Displays worth about \$2 million from about 100 Japanese firms will be shown. Approximately 60 to 70 Japanese technicians and businessmen will accompany the exhibition to Russia.

The Association is hoping that the USSR will buy one-third of its instrument requirements from Japan. A spokesman said that some of the participating companies might bring their instruments back to Japan rather than sell them in Russia. Fear of being copied is one reason given.

Instruments for measuring, communication, controlling, and medical purposes will be displayed. Most will be units developed using Japanese technology exclusively; very few or no units made under technical agreements with other countries will be sent, it was reported



of wedge-shaped sections of potassium dihydrogen phosphate. Varying a voltage applied to a prism varies its refractive index and the exit angle of the laser output beam passing through the prism.

The technique was revealed yesterday in Sperry's quarterly *Engineering Review*, by Robert D. Kroeger. It is expected to find application in earth-to-space, space-to-space and high-altitude airborne laser radars.

## Mach-3 Jetliner Demands New Electronic Gear

FAA HAS ALREADY set up a committee to study what electronic equipment a proposed supersonic air transport (see p 12) would require. Led by the FAA's Joseph K. Power, the committee hopes to complete its initial report sometime this year.

Power told **ELECTRONICS** that existing military equipment will be examined for clues as to what is wanted. For instance, the B-58's flight management system has "certain parts we like very much," Power said, although there are other parts that would be of no use to a commercial airliner.

Other items for study are a fully automatic landing system and the longer range radar needed for such a high-speed airplane. Cost estimates will not be possible until the committee nears the specifications stage, Power said.

## France Plans to Build \$100-Million Tv Net

PARIS—Government-owned broadcasting organization, Radiodiffusion Television Francaise (RTF), plans to spend \$100 million over the next four years to equip a second nation-wide television network.

Although the existing network will continue broadcasting on the French 819-line standard, for its new network RTF will shift to the European 625-line standard. That opens the door to eventual color broadcasts, which RTF plans to start in the late sixties. For color, the European countries have agreed to adopt a common 625-line

system, but have not yet decided whether to use the French SECAM or the American NTSC systems.

The new French network, industry observers generally feel, will add new kick to already brisk tv sales. Last year, tv set production in France hit 1 million units, up nearly 22 percent over 1961. Also, some 3.5 million existing sets would need adapters for 625-line reception.

## Short-Range Cloud-Height Sets Sought by Air Force

BEDFORD, MASS.—Technical proposals are due February 18 on 65 cloud-height sets (AN/TMQ-14) to be purchased by Air Force Electronic Systems Division, Hanscom Field, for the 433-L weather system. Air and truck transportable systems will be for tactical operations. The basic sensor is optical, but information will be processed electronically and displayed by crt. Optical triangulation method will be used to detect cloud height at maximum range of 2,000 feet.

## French Jets Will Use New Low-Ceiling ILS

SANTA MONICA—An initial order for 20 automatic landing systems has been received by Lear Seigler for use in Sud-Aviation's French Caravelle jetliners. Delivery is scheduled for October.

The new device—recently tested in France by FAA and its French counterpart—allows jets to land automatically under weather conditions of 100-foot ceiling and  $\frac{1}{4}$  mile visibility. Presently, landing minimums are 200-foot ceiling and  $\frac{1}{2}$  mile visibility in Europe and 300-foot ceiling and  $\frac{3}{4}$ -mile visibility in U. S.

Although the system is now used only with LSI flight control systems it can be used with others. One feature is an instantaneous vertical velocity sensor that links ground control signals with the autopilot. There are also lateral and longitudinal couplers and a throttle control. During the final few seconds of flight, a radio altimeter regulates rate of descent.

## In Brief . . .

**ADVANCED NUCLEAR GYRO** contract has been awarded to American Bosch Arma by Air Force (p 48, Dec. 28, 1962).

**FURTHER DEVELOPMENTS** in display technology (see p 24), particularly small area techniques, are expected from Navy R & D pact to be let February 12. G E, Sylvania and Lear are rumored to be among the bidders.

**INERTIAL GUIDANCE** system for the X-20A Dyna-Soar underwent its first test flight recently at Eglin AFB, Fla. Equipment was carried in the nose of a jet 'Voodoo' aircraft.

**HUGE, AUTOMATIC** data communications switching center (Mar. 2, 1962, p 26) has gone into operation at Tinker AFB, Okla. It is the third of five such centers to be activated.

**AVNET HAS PURCHASED** controlling interest in Production Technologies, Inc., Jamaica, N. Y.

**GENERAL INSTRUMENTS** will build a thermoelectric generator for the AEC. It will produce electricity directly from the unrefined waste of nuclear reactors.

**COMMUNICATIONS SUBSYSTEM** for the AF's mobile, mid-range ballistic missile is being designed by Sylvania, as part of Martin's overall command and control system design.

**PHILCO** has an \$8-million Air Force contract to build data processing and display system to provide semiautomatic compilation and output of surveillance and tactical data at Alaskan long-range radar sites and automatic processing, display and re-transmission of data at four NORAD control centers and NORAD's Alaskan region combat center.

**NASA WILL HOLD** its second Industry Program Plans Conference February 11 and 12. Advance registration forms are available from room 50058, NASA headquarters, 400 Maryland Avenue, SW, Washington, D. C. No mail requests for forms will be honored.



# QUICK, SLICK WAY TO PROTECT PRODUCTS



MADE OF TOUGH, FLEXIBLE POLYETHYLENE  
WON'T CHIP, BREAK, SHRED OR COLLAPSE  
SAFEGUARD PRODUCTS IN PROCESS, STORAGE  
AND TRANSIT  
OVER 700 SIZES IN NUMEROUS STYLES AND  
COLORS NOW IN STOCK

# Caplugs

GET FREE SAMPLE KIT IN EXCHANGE FOR THIS COUPON

**CAPPLUGS DIVISION  
PROTECTIVE CLOSURES CO., INC.**  
2205-11 ELMWOOD AVE., BUFFALO 23, N. Y.  
**MAIL** a free assortment of Caplugs, literature and  
prices to us, without obligation.

name \_\_\_\_\_  
title \_\_\_\_\_  
firm \_\_\_\_\_  
address \_\_\_\_\_  
city \_\_\_\_\_ zone \_\_\_\_\_ state \_\_\_\_\_



# Now 1~ to 14gc low-noise

## 10 DECADES OF LOW-NOISE DEVICE

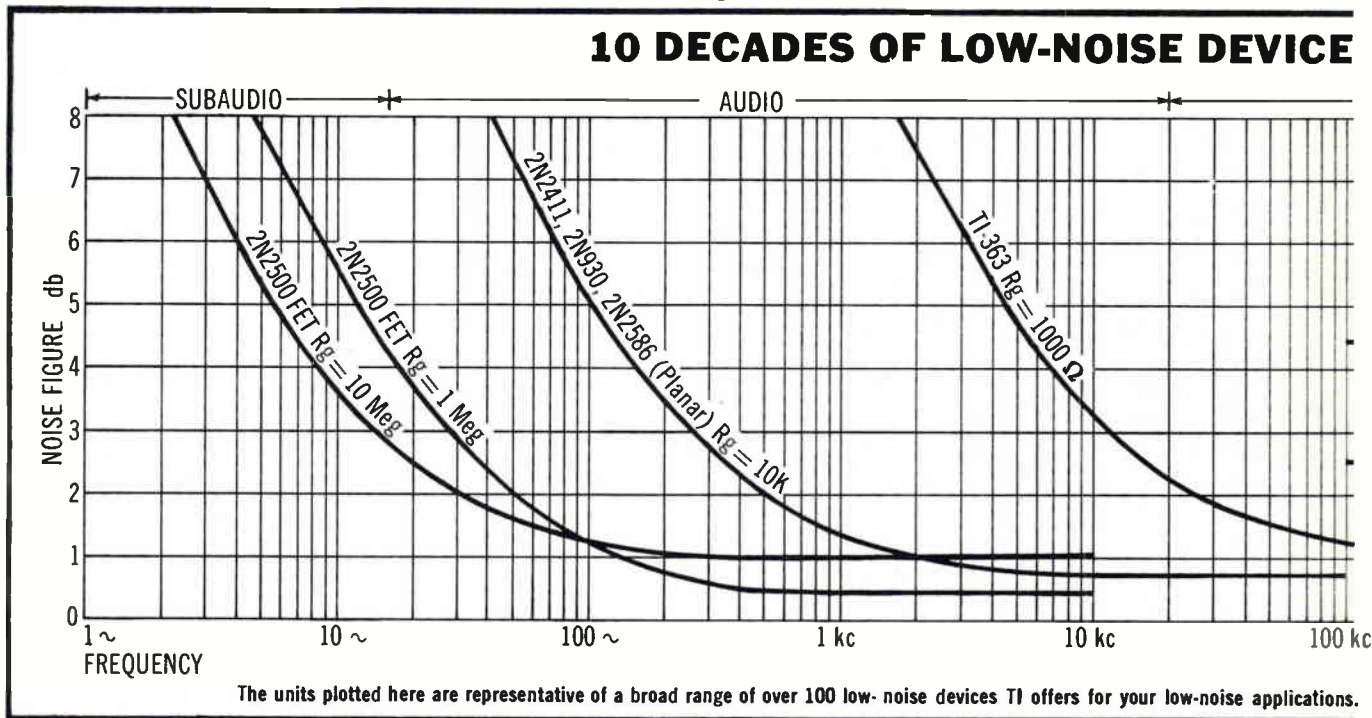

### Low-noise devices for your SUBAUDIO CIRCUITS

Texas Instruments 2N2497-2500 series field-effect transistors give the design engineer extremely low-noise characteristics — as low as 5 db at 10 cycles. They are ideal for such low-frequency equipment as null-detection apparatus, medical research equipment, oscillographic and magnetic tape recorders, oscilloscopes and all types of low-level transducers. ■ The circuit below illustrates how Texas Instruments 2N2500 silicon field-effect transistors are used to achieve low-noise, low-frequency operation.

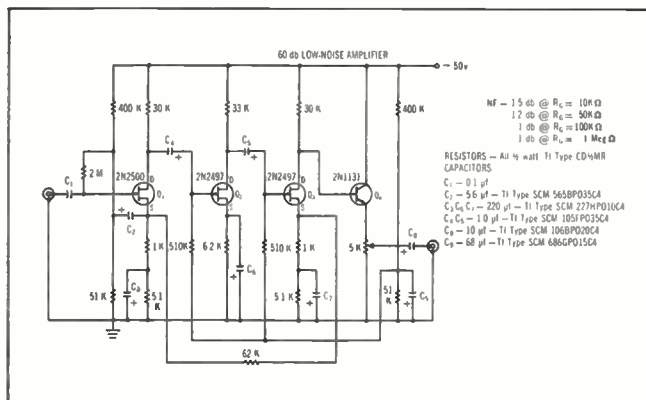

This circuit gives you a maximum voltage gain of 60 db  $\pm 0.5$  db from  $-55^\circ\text{C}$  to  $125^\circ\text{C}$  with built-in gain adjustment. You also get good low-frequency response and stable circuit operation. ■ Write for your technical information file on low-noise TI devices for your subaudio applications.

TI cannot assume any responsibility for any circuits shown or represent that they are free from patent infringement.

### Low-noise devices for your AUDIO CIRCUITS

Now you can design the low-level, high-gain amplifier shown below with typical noise figure as low as 1 db. Advanced low-level planar technology of Texas Instruments 2N929 and 2N2586 transistors makes possible high gain at low current levels, plus the extremely low leakage currents necessary for true low-noise performance.

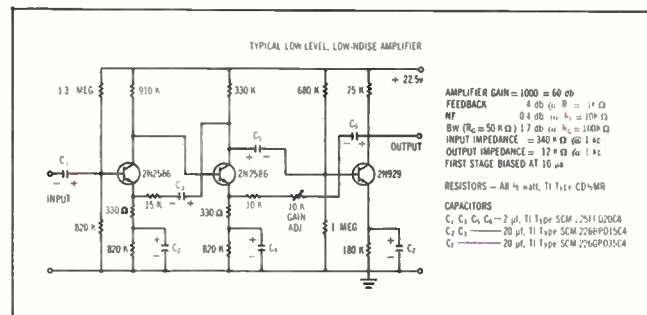

For high-impedance transducer applications, TI 2N930 and 2N2586 devices permit typical 1 db noise figure at emitter currents below 1 microampere, and generator resistances over 1 megohm. These special characteristics allow direct coupling of low-level, high-impedance sources...advantages previously available only with vacuum tubes and field-effect transistors. High gain at low levels plus very thin regions in these units combine to offer low power consumption and high radiation resistance to make the 2N930 and 2N2586 ideal for space applications. ■ A technical information file on almost 50 TI low-noise devices for audio circuits is yours upon request.

SEMICONDUCTOR-COMPONENTS  
DIVISION

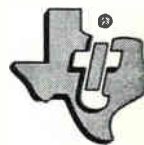

# solid-state amplification

## FROM TEXAS INSTRUMENTS

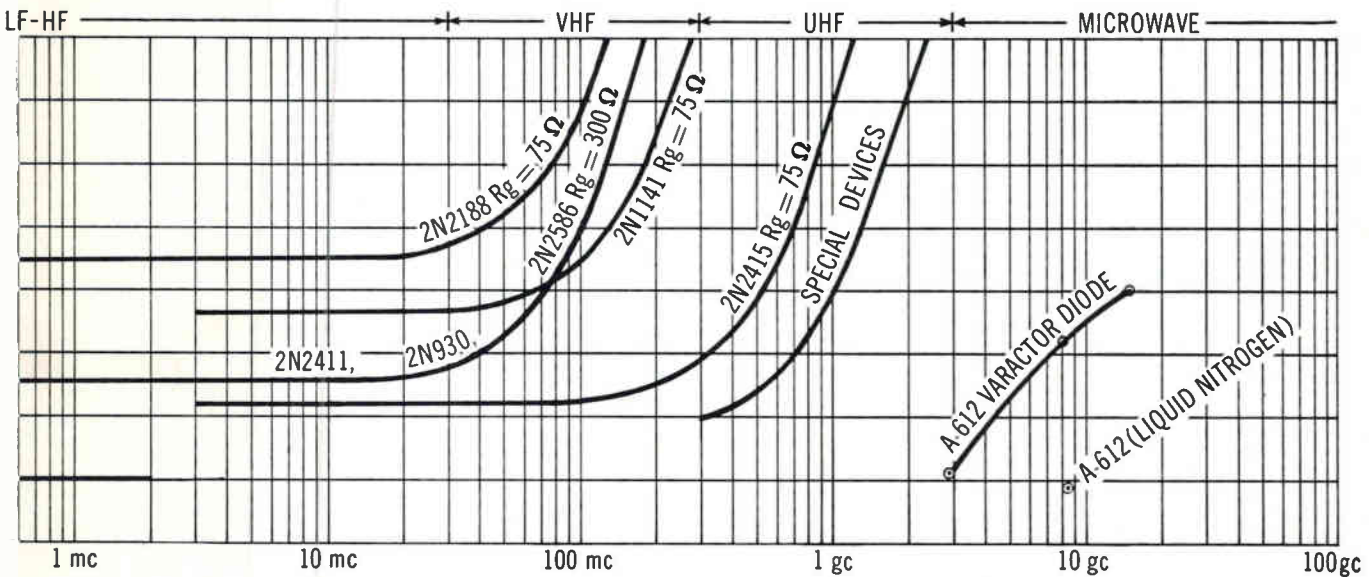

Figures shown are not theoretical; all are achieved measurements from actual circuit operation.

### Low-noise devices for your LF-UHF CIRCUITS

For your low-noise, high-frequency receiver and preamplifier applications, TI 2N2415 germanium mesa transistors give you a typical noise figure of 2.4 db at 200 mc, maximum available gain of 15.5 db at 500 mc with a  $f_{MAX}$  of 3 gc. ■ In the following circuit, HRB-Singer, Inc. utilizes 2N2415 transistors and "multiple feedback" techniques to achieve a uniform low noise figure, nominally 6 db, over the entire frequency range of 300 to 1000 mc with an average gain of 35 db. Unique design provides stable operation over a temperature range of  $-30^{\circ}$  to  $+70^{\circ}$ C and eliminates the need for RF tuning capacitors.

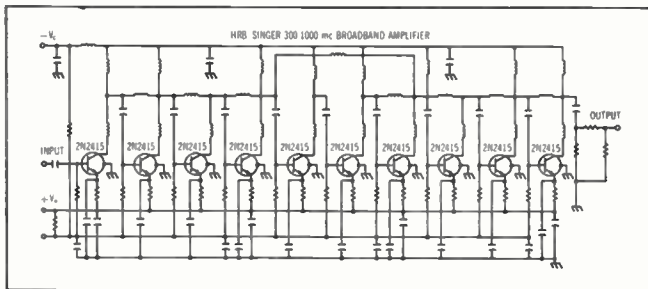

Another line of TI low-noise communications devices is the Dalmesa 2N2188 and TI363 series of germanium alloy diffused mesa transistors. These advanced units offer you ultra-high performance from dc to 100 mc, typical mid-frequency noise figures of less than 2 db, and increased high-frequency stability through guaranteed maximum output capacitance of 2.8 pf at 9 volts. ■ Investigate TI's wide selection of low-noise transistors for LF-UHF circuits by writing for a free fact file on these devices.

### Low-noise devices for your MICROWAVE CIRCUITS

Now you can design microwave circuits for highest frequencies at lowest noise with the new GaAs Pill Varactor Diode from Texas Instruments. These new subminiature devices offer you minimum cutoff frequency of 90 gc to 150 gc at  $-2$  volts with low junction capacitance  $-C_j$  @ 0 bias from 0.15 to 0.75 pf. Your production-line requirements for identical plug-in units are met through tight control of junction and package characteristics. ■ These features offer you the lowest package capacitance and inductance in industry today—backed up with TI varactor manufacturing capacity to meet your tightest production schedules. ■ TI GaAs Pill Varactor Diodes are particularly applicable to low-noise parametric amplifiers, harmonic generators, microwave switches, sub-harmonic oscillators, phase shifters and parametric limiters.

#### FOR FULL INFORMATION...

... write for a fact-filled file of technical data on low-noise TI devices designed for application in your frequency range. Please address your card or letter to Department 605 and specify which of these four information files you desire.

1. SUBAUDIO
2. AUDIO
3. LF-UHF
4. MICROWAVE



**TEXAS INSTRUMENTS**  
INCORPORATED  
13500 N. CENTRAL EXPRESSWAY  
P. O. BOX 5012 • DALLAS 22, TEXAS

Ask your authorized TI distributor about "Transistor Circuit Design," an informative new hardbound book for circuit designers authored by 32 TI engineers and published by McGraw-Hill.



# WASHINGTON OUTLOOK

## SUPERSONIC AIRLINER NEEDS AUTOMATIC LANDING SYSTEM

DEVELOPMENT of a fully automatic landing system is a prerequisite to U.S. entry into the supersonic airliner field, it was brought out in an advisory group report to Federal Aviation Administrator Najeeb E. Halaby. The report urges the U.S. to enter the supersonic airliner race quickly. The government would recoup the estimated \$1 billion development costs through royalty charges to the airlines.

An administration go-ahead is expected this summer, although Halaby asked the advisors to provide more details. An unresolved problem is the need for fully automatic landing at zero-zero weather conditions. The planes would be so fast (mach 2.3 to 3.5) that one leaving New York would need simultaneous landing clearance in Los Angeles, and weather must not prevent its landing.

## \$150 MILLION IN FAA BUDGET FOR ELECTRONICS

FEDERAL AVIATION AGENCY is requesting \$99.8 million for fiscal 1964 to buy and install new air navigation and air traffic management equipment. This includes radars, radar beacons, towers, approach lights and radio range transmitters. The current appropriation for this program is \$113 million. FAA is also requesting \$50 million in new R&D funds, including \$37.6 million for work on traffic control and navigation.

## A-M STATIONS FACE NEW CURBS

TOUGHER ENGINEERING and financial standards are on the way to curb the proliferation of uneconomic a-m radio stations. The National Association of Broadcasters and the Federal Communications Commission are concerned about the problem of more stations getting a smaller share of some \$400 million in radio revenue. In 1961, a third of the licensees reported losses.

NAB wants FCC to raise financial standards and prod weak stations to merge. In addition, industry wants tighter engineering standards, including higher power to improve service, instead of new stations, and an end to the 10-percent rule that entitles an applicant to a station license if no more than 10 percent of his projected signal contour will receive objectional interference.

## SATELLITE COMPANY NEARS INCORPORATION

SPACE COMMUNICATIONS CORPORATION is expected to file articles of incorporation by February 1. The 13-man team of incorporators, appointed last October, are ready to present their final draft of the articles to President Kennedy for his approval. The communications industry and government agencies were briefed last week. After the filing, the incorporators will become temporary board members until stocks are sold and the stockholders elect a permanent board of directors. This may take six months to a year.

## TAX COLLECTOR EXPLAINS CREDIT

GOVERNMENT TAX EXPERTS are going on the road to sell industry on plant modernization. In the first session next month in Philadelphia, Stanley S. Surrey, Assistant Secretary of the Treasury, and Internal Revenue Service Commissioner Mortimer Caplin, will try to combat skepticism and confusion about the investment tax credit voted last year by Congress. Commerce Department's Business and Defense Services Administration and local industry are sponsoring the meeting.



*Solid State Radar | The Catcher in the Sky*

A new solid state radar system built by STL engineers and scientists can send out and receive signals at X-band frequencies to help man rendezvous and dock vehicles in space. STELATRAC is its name. It is the first solid state system of its kind. The X-band transmitter is shown above. It has successfully passed temperature and vibration tests. STELATRAC can also be used as a command link between vehicles in flight. By altering its module design, the flexible radar system operates as an altimeter and doppler velocity sensor to guide spacecraft safely to the surface of the moon and planets. Today STL is busy on many such projects as STELATRAC. STL is also prime contractor for NASA's OGO and a new series of classified spacecraft for Air Force-ARPA. And STL continues Systems Management for the

Air Force's Atlas, Titan and Minuteman programs. These activities create immediate openings in Theoretical Physics • Systems Engineering • Radar Systems • Experimental Physics • Applied Mathematics • Space Communications • Antennas and Microwaves • Inertial Guidance • Analog Computers • Solid State Physics • Computer Design • Telecommunications • Space Physics • Digital Computers • Guidance & Navigation • Electromechanical Devices • Engineering Mechanics • Aerodynamics • Propulsion Systems. For Southern California or Cape Canaveral positions, write Dr. R. C. Potter, Department CG-2. One Space Park, Redondo Beach, California, or Box 4277, Patrick AFB, Florida. Your inquiry will receive a prompt reply. STL is an equal opportunity employer.



**SPACE TECHNOLOGY LABORATORIES, INC.**  
*a subsidiary of Thompson Ramo Wooldridge Inc.*



measuring down to 300 mV DC, up to 1000 Mc/s AC,  
and 1-1000 M $\Omega$  with ONE instrument only,

## the Electronic

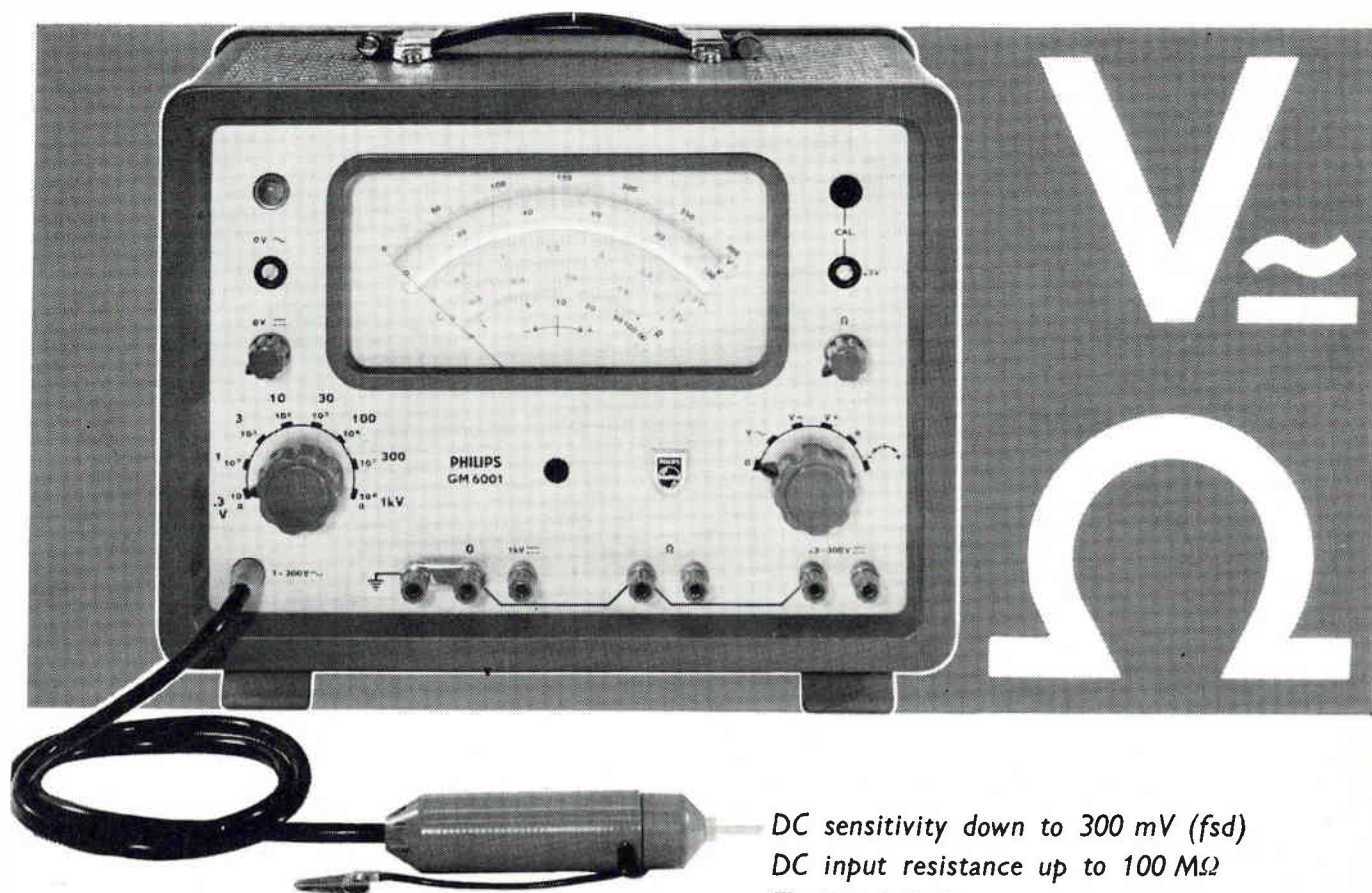

DC sensitivity down to 300 mV (fsd)  
DC input resistance up to 100 M $\Omega$   
Floating input  
AC frequency range 25 c/s up to 1000 Mc/s  
Very low input capacity  
High accuracy  
Resistance range 10  $\Omega$  - 100 M $\Omega$  (centre scale values)  
Stabilized HT and heating current

# PHILIPS *electronic measuring*

Sold and serviced by Philips Organizations all over the world

Further information will gladly be supplied by:

**N.V. Philips' Gloeilampenfabrieken, EMA-Department, Eindhoven, the Netherlands**

For Canada: Philips Electronic Equipment Ltd., 116 Vanderhoof Ave., Toronto 17, Ont.



# Volt-ohm-meter, type GM 6001

## Specification

### DC Voltages

Measuring ranges : 300 mV (f.s.d.) - 1000 V  
: by means of EHT probe  
up to 30 kV

Accuracy : 2.5%

Input impedance : range 300 mV: 10 M $\Omega$   
range 1 V: 30 M $\Omega$   
other ranges: 100 M $\Omega$

Floating input

Special centre-zero facility

### AC Voltages

Measuring ranges : 1 V (f.s.d.) - 300 V

Frequency range : 25 c/s - 1000 Mc/s

Accuracy : 3%

Input impedance : 3 M $\Omega$  at 1 Mc/s  
0.4 M $\Omega$  at 10 Mc/s  
0.07 M $\Omega$  at 40 Mc/s

Input capacity : 3.5 pF

### Resistances

Measuring range : 10 $\Omega$  - 100 M $\Omega$  (centre scale values)

Accuracy : 8%  
range 100 M $\Omega$  : 10%

Mains supply : 110 ... 245 V, 40-100 c/s

### Optional accessories

EHT probe GM 6071

Attenuation : 100 x

Maximum

input voltage : 30 kV

Coaxial T-piece

PM 9250

for measurements on

coaxial lines

Impedance : 50 $\Omega$

Frequency range : 0.1 ... 1000 Mc/s

V.S.W.R. : 1.1 up to 800 Mc/s

1.2 for 800 ... 1000 Mc/s

### Internal calibration

It should be noted that all Philips electronic voltmeters contain calibration standards which enable the user easily and rapidly to check, and, if necessary, to recalibrate his voltmeter at any time without the use of additional instruments.

**new**  
and available  
**now**

**instruments:** quality *tools* for industry and research



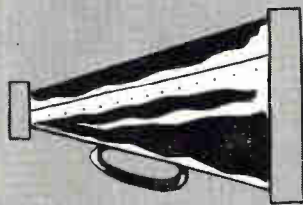

ANNOUNCING FOR 1963  
a tremendous  
electronics BUYERS' GUIDE Issue



NEW LOW CATALOG RATES ALLOW SUFFICIENT SPACE FOR YOU TO PROVIDE COMPLETE BUYING INFORMATION ON YOUR ENTIRE PRODUCT LINE



Take complete advantage of marketing's  
**MAGIC COMBINATION**

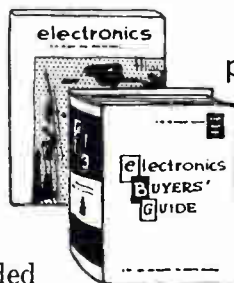

**electronics** every Friday – to create preference for your products...

The 1963 BUYERS' GUIDE to make product preference pay off in buying action

For 22 years of sales-minded

effectively and economically than ever before. Your electronics representative has full information on how this can be accomplished. Look at these new eBG catalog rates:

this combination has worked magic for thousands companies. It will work for you in 1963 more

**CATALOG ADVERTISING RATES PER PAGE:**

Without "EARLY BIRD" Discounts

Space Used	Rates	Space Used	Rates
1 page .....	\$900	12-15 pages .....	\$545 per page
2-3 pages .....	740 per page	16-19 pages .....	495 per page
4-5 pages .....	670 per page	20-23 pages .....	465 per page
6-7 pages .....	630 per page	24 or more .....	440 per page
8-11 pages .....	590 per page		

**FOR THE SAME PRICE AS 1962, FROM 33% TO 60% MORE SPACE!**

Rates with "EARLY BIRD" Discounts

1 page .....	\$837.00	12-15 pages .....	\$506.85
2-3 pages .....	688.20	16-19 pages .....	460.15
4-5 pages .....	623.10	20-23 pages .....	433.45
6-7 pages .....	585.90	24 or more .....	409.20
8-11 pages .....	548.70		

"EARLY BIRD" Closing Dates (For Discounts)

Reservations for space Feb. 15th / Copy to set April 16th / Complete plates April 25th

ACT NOW!



For Complete Information, Contact Local Sales Offices Listed on the Last Page of This Issue

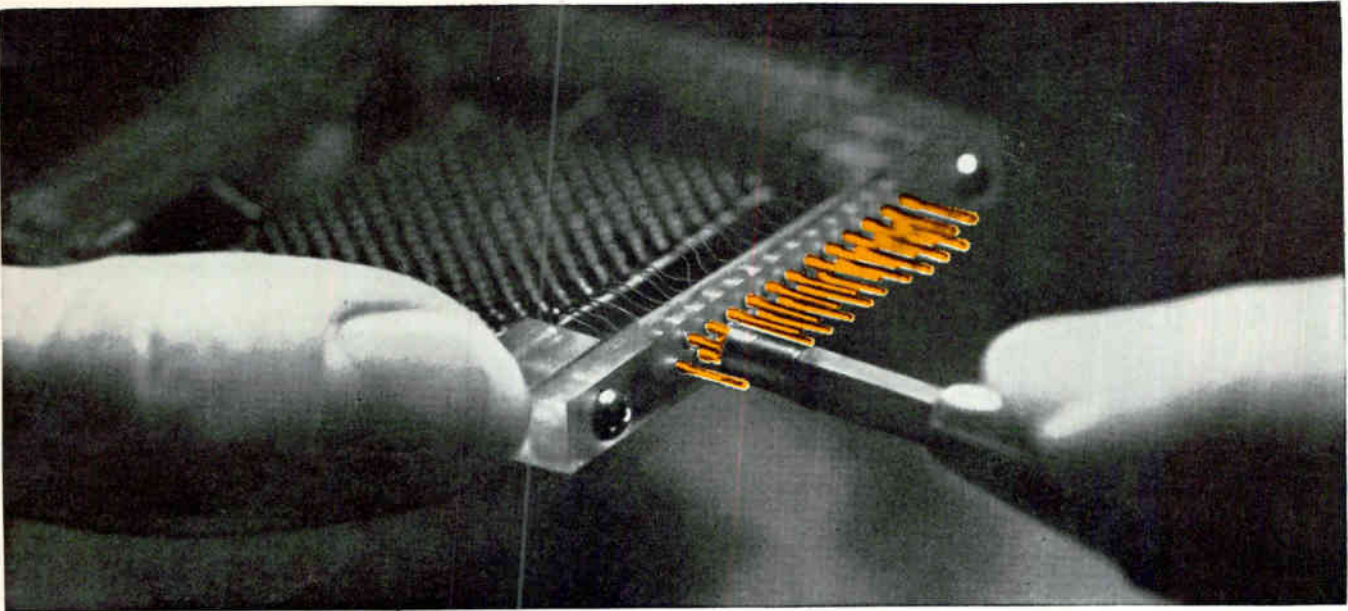

## Fine wire finesse!

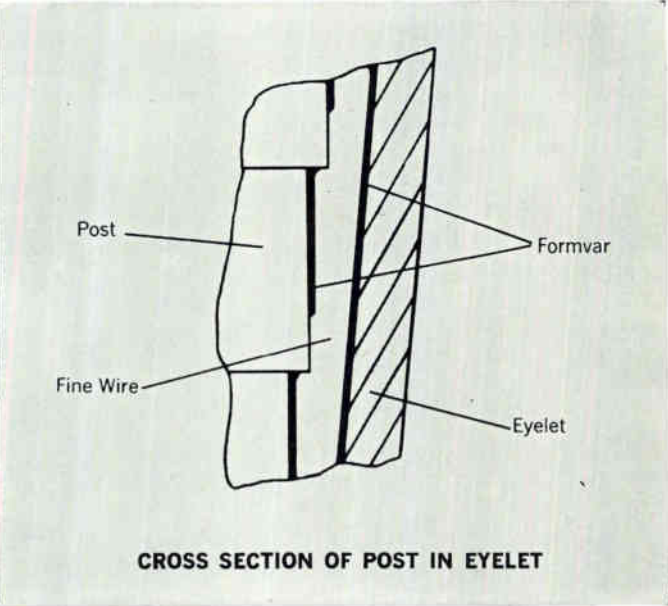
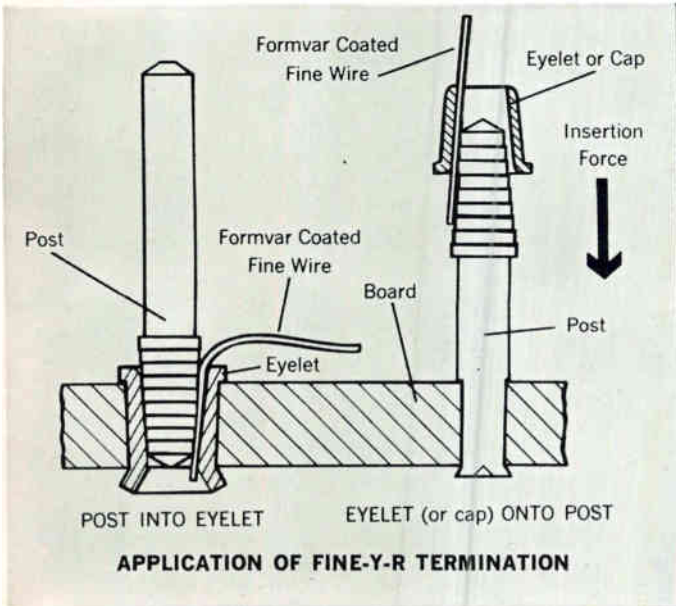

The AMP FINE-Y-R\* Termination's wedge fit does away with time consuming and costly insulation stripping. Makes possible the handling of fine wire, in wire range size #26 through #56 AWG, without burnt insulation, cold solder joints, embrittled conductors and oxide contaminations! You get a reliable, virtually gas-tight connection whose parts can be used again and again...removed and reused up to 5 times, if necessary!

A precision-tapered post evenly spaced with concentric serrations, a matching capping sleeve or eyelet and a specially calibrated application tool...that's all that's needed. When these elements go to work, the bared wire molds snugly over the points of serration and produces an

electrical connection as good as the wire itself.

If you're using fine wire in any type application, you can now make quicker connections and at a fraction of your present cost with AMP FINE-Y-R Terminations.

Put finesse in your fine wire applications by sending for complete details today!

\*Trademark of AMP Incorporated



AMP products and engineering assistance are available through subsidiary companies in: Australia • Canada • England • France • Holland • Italy • Japan • Mexico • West Germany



# Military Electronics Will Level Off in Fiscal 1964

*But slack will be taken up by a big rise in space budget*

WASHINGTON — More than \$9 billion for new electronics production, research, development, test and evaluation spending is included in the defense and space budgets for fiscal year 1964 that the Administration submitted to Congress last week.

While the total military budget sets a new peacetime record (see table), there will be a virtual leveling-off in new military electronics contracts. The estimate for such contracts is about \$6.6 billion.

Space spending by all government agencies adds up to about \$3.1 billion for satellite electronics and supporting electronics equipment. Of this total, about \$800 million is for military space electronics and the remainder—about \$2.3 billion—is for nonmilitary projects. NASA

is asking for large increases in its major programs (see table).

**MILITARY ELECTRONICS** — Total new orders for military electronics production are estimated at about \$4.4 billion in fiscal year 1964, starting next July 1—less than \$100 million over this year's rate.

Electronic contracts for Research, Development, Test, and Evaluation (RDT&E) will amount to some \$2.2 billion for the new year, a slight boost over this year.

These figures are based on unofficial but authoritative estimates that about 25 percent of aircraft procurement (see table) is devoted to electronics, that electronics' share of the missile dollar amounts to about 35 percent, and that electronics accounts for about 30 percent of military RDT&E.

The only electronics figure specifically identified in the Pentagon budget covers what officials call "pure electronics"—electronics and

communications equipment not associated with aircraft and missile systems. Total orders in this category will increase to \$1.5 billion from this year's \$1.4 billion.

**PROGRAM BUILDUPS** — Increased Army contracting will cover FM series vehicular and portable communications sets; improved airborne terrain-surveillance and reconnaissance equipment and air-to-ground equipment to increase the air mobility of tactical forces; global strategic command and control systems equipment; cryptographic and countermeasures equipment and devices; and "modification improvements" for fire-control and direction radar.

The Navy's procurement program will stress antisubmarine devices and information display and tactical command and control equipment. The Navy will also begin production of the Walleye "guided bomb"; accelerate output of the Goodyear Aircraft-Kearfott Subroc antisubmarine missile; Texas Instruments' Shrike air-launched, radar-homing missile (the Air Force will make its first buy of Shrike next year); and the Martin-Maxson Bullpup air-to-surface missile.

**CUTBACKS** — Reduction in Air Force electronics procurement reflects scheduled completion of installation of the Bmevs system and the SAC control system.

In the RDT&D field, the Air Force will continue development of "reconnaissance strike components" for the RS-70 and "for possible application to various aircraft." But Defense Secretary McNamara is sticking by his controversial decision not to begin production of the aircraft.

Similarly, production of the Army's Nike Zeus anti-ICBM system is once again turned down.

**NEW ANTI-ICBM'S**—The budget, however, earmarks over \$325 mil-

## Mauler Will Be Highly Mobile



RADAR-GUIDED Mauler missiles will be used by Army to protect forward battle positions against bombing and strafing aircraft and short-range ballistic missiles and rockets. Maulers will be fired from moving vehicles. Photo shows engineering mockup of system, being developed by General Dynamics/Pomona; \$16.6 million was just added to R & D contract.

DEFENSE BUDGETS, FISCAL YEARS 1963 AND 1964

	FY 1963 (Billions of Dollars)	FY 1964 (Billions of Dollars)
<b>Total Defense Budget</b>		
New Appropriations.....	50	52.2
Expenditures.....	48.3	51
<b>Total Military Procurement</b>		
New Appropriations.....	16.6	16.7
Expenditures (essentially deliveries).....	15.5	16.3
New Contracts.....	17	17.3
Aircraft.....	6.2	6.2
Missiles.....	4	3.9
Ships.....	2.7	2.5
Other Procurement.....	4.1	4.6
Army Electronics & Communications.....	0.3156	0.365
Air Force Electronics & Communications.....	0.6268	0.564
Navy Electronics & Communications.....	0.368	0.556
<b>Total Research, Development, Test &amp; Evaluation</b>		
New Appropriations.....	7	7.3
Expenditures.....	6.6	7.1
New Contracts.....	7.2	7.4

NASA'S PROPOSED BUDGET FOR SPACE PROGRAMS

	FY 1963 (Millions of Dollars)	FY 1964 (Millions of Dollars)
<b>Total NASA Budget</b>		
New Appropriations.....	3,673	5,712
Expenditures.....	2,358	4,151
<b>Major Programs</b>		
Manned Space Flight.....	1,707	3,193
Meteorology.....	64.3	73.1
Communications.....	49	55.8
Earth Satellites.....	174.2	232.6
Lunar & Planetary Exploration.....	226.4	331.3
Launch Vehicle Development (other than manned flight)	121.5	149.5
Space Vehicle Systems.....	89.7	111.4
Electronic Systems.....	44.9	59.3
Propulsion and Space Power.....	193.7	268.8
Aircraft Technology.....	14	45.1
Tracking & Data Acquisition.....	159.8	261.6
Other Research Programs.....	75.8	129.8
Construction of Facilities.....	737.4	800
<b>Total</b> .....	<b>3,673</b>	<b>5,712</b>

lion to the Army for development of an improved, redesigned Zeus system—dubbed “Nike X” and including the Sprint project—and more than \$100 million for other anti-ICBM research efforts. Test firings of Nike Zeus will continue.

**AIR FORCE R&D**—Work on a ballistic missile reentry system to improve penetration of enemy defense systems is included in Air Force R&D. Space R&D will be increased slightly with work devoted to the Dyna-Soar; navigation satellites; a communications satellite system; satellite tracking, identification, and intercept systems; and guidance and navigation components.

Defense Department communications satellite development will concentrate on a low-altitude system, while NASA stresses work on a

high-altitude synchronous system.

**SPACE BUDGET**—NASA is stepping up development of the Nimbus meteorological satellite to \$43.8 million in fiscal 1964, compared to \$30.3 million this year. Part of the increase stems from problems in perfecting the satellite so that it will remain earth-oriented. Nimbus's cameras are to point toward the earth constantly. The Tiros weather satellites point toward earth only part of the time.

The space agency is budgeting \$55.8 million for communication satellites. Of this, \$40 million is earmarked for developing an advanced Syncom satellite to be placed in a synchronous orbit. From now on, NASA will concentrate its satellite communications efforts on synchronous orbits.

*"Few things are impossible to diligence and skill."*

These are the trademarks of some of our customers—each an important contributor to a dramatically growing industry. We at Potter pledge our diligence and skills to this growth through a constantly expanding program of research and development.

**the POTTER**™



**MT-120**  
eliminates  
program  
restrictions

The new Potter MT-120 Magnetic Tape Transport features high performance in a COMPLETELY STANDARD, LOW COST PACKAGE. An evolutionary development of the reliable M906II tape deck, the MT-120 incorporates a patented tape handling system\* that eliminates program restrictions. This unique engineering achievement permits Start/Stop, Reverse/Stop or Forward/Reverse operation at up to 200 commands per second and at tape speeds to 120 ips without external program delays.

The MT-120 delivers extremely high data transfer rates. Using the Potter Contiguous Double Transition\*\* High Density recording technique, rates of 1.6 x 10<sup>6</sup> information bits per second are obtained. And with standard 7-channel format, 556 bits per inch are provided at speeds of 120 ips.

To learn more about the MT-120 and its unprecedented 1-year warranty of reliability, write to our Director of Marketing today...

**POTTER INSTRUMENT CO., INC.**  
151 Sunnyside Boulevard • Plainview, New York

\*Potter Patent No. 3,016,207  
\*\*Potter Patent No. 2,853,357  
and other patents pending



# THE INSIDE STORY... on an important advance in zener diodes

The technique of integrally sealing the surface of silicon semiconductor junctions—so successfully applied in the Motorola Star Planar Transistor—has now been modified to meet the requirements of a new type of zener diode.

In the new Motorola zener diode, the silicon surface is oxidized at a relative low temperature to form an integral layer of protective glass that is essentially impervious to the penetration of moisture and other contaminants. This unique glass-passivating technique was developed as part of a military contract program sponsored by the Manufacturing Technology Laboratory of the Air Force Aeronautical Systems Division at Wright-Patterson Air Force Base. The resulting glass surface, whose thickness is measured in Angstrom units, is as impervious to moisture penetration as conventional hermetic sealed packages, and is conservatively 10,000 times less permeable than typical "paint-on" and epoxy coatings.

**SURFACE PASSIVATION TEST RESULTS**—These surface passivated dice, with leads attached and no further protection, passed all standard mil high temperature-humidity storage.

With the hermetic seal now an integral part of the dice, the main requirement of a package is provision for the necessary mechanical strength without degradation.

Various epoxy plastics were investigated but found lacking in both mechanical and dielectric strength at temperatures above 150°C.

Turning to silicone polymers, which are known for their high temperature capabilities, Motorola scientists worked with the supplier — Dow Corning — through several changes in the composition of the silicone plastic, finally developing one compound that met all requirements. Devices of this type have passed 1,000 hour operating tests at 200°C and storage in air at 400°C . . . far beyond the limits of conventional encapsulated devices.

Of special interest in military applications, is the fact that, unlike most epoxy plastics, the Motorola silicone zener diode will not "flame." This can be demonstrated by holding a match (700-800°C) to the package. The Motorola silicone zener not only refuses to ignite, but its reverse electrical characteristics will return to normal after the flame is removed.

**NEW PACKAGING PROCESS** — Most epoxy packages are merely cast. Consequently, they contain voids that permit the penetration and collection of moisture. With Motorola's special, high-pressure molding process, the silicone is void free, eliminating a source of moisture and corona problems.

The final product, which we call the "SURMETIC"\* zener diode, has been subjected to all standard military tests. It not only passed these, but also met such special tests as: 20,000 g acceleration; 1,500 g shock; 175°C continuous power operation and high temperature lead-pull tests.

This is the first zener diode available with a true inorganic glass surface passivation, a silicone plastic package, and conservative ¼ watt and 175°C ratings in a package that is no larger in volume than the conventional 400 mw glass package. It is being introduced in the more popular 11 to 51 volts range. The price for this ¼ watt unit is competitive with 250 and 400 mw units. We invite you to investigate the capabilities of this new development for your applications.

For more information write or call your local Motorola Semiconductor representative.

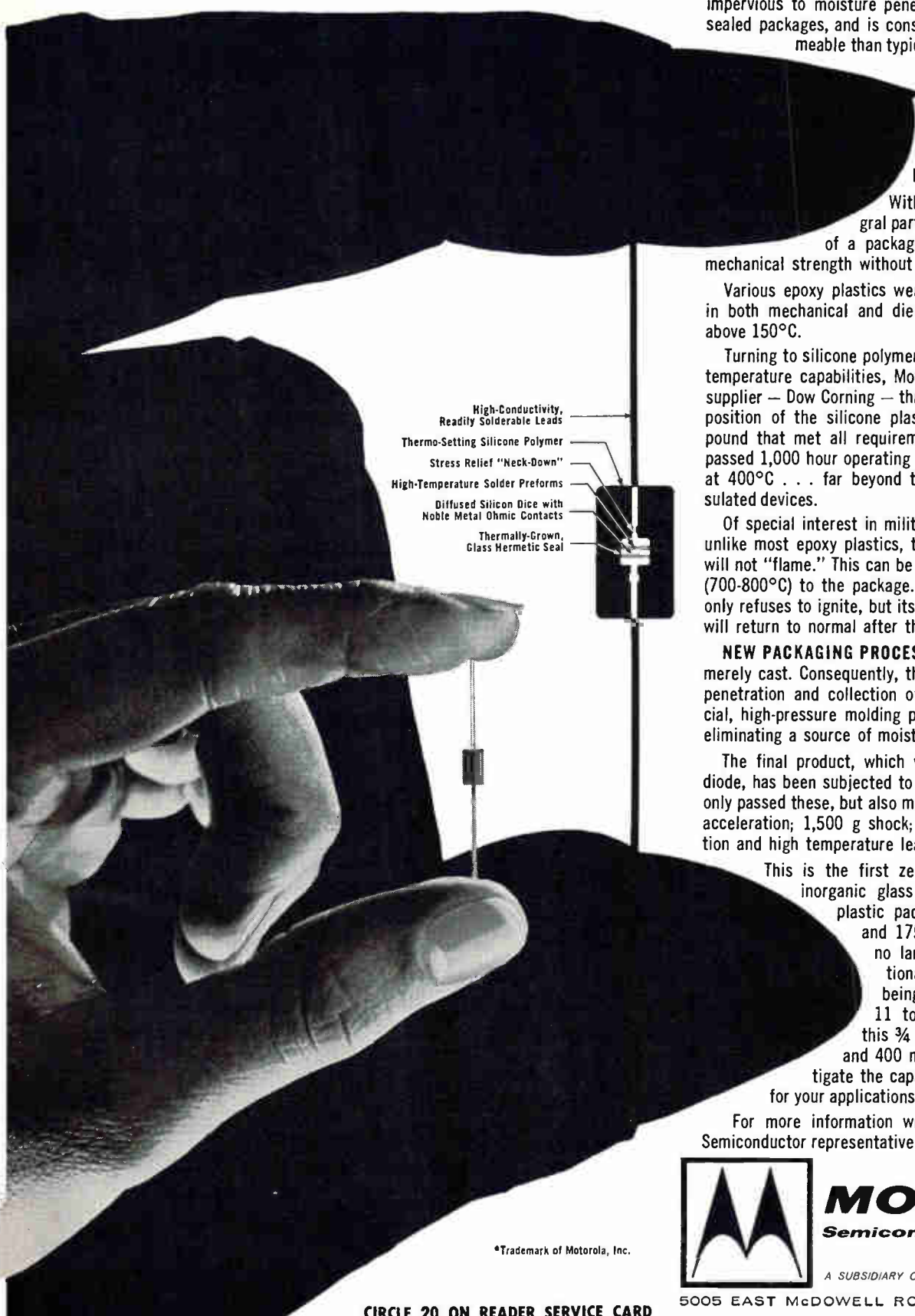

High-Conductivity, Readily Solderable Leads  
Thermo-Setting Silicone Polymer  
Stress Relief "Neck-Down"  
High-Temperature Solder Preforms  
Diffused Silicon Dice with Noble Metal Ohmic Contacts  
Thermally-Grown, Glass Hermetic Seal

\*Trademark of Motorola, Inc.

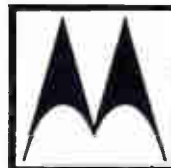

**MOTOROLA**  
Semiconductor Products Inc.

A SUBSIDIARY OF MOTOROLA, INC.

D-13-012

CIRCLE 20 ON READER SERVICE CARD

5005 EAST McDOWELL ROAD • PHOENIX 8, ARIZONA



# HERE'S WHY FLUKE DC DIFFERENTIAL VOLTMETERS CHALLENGE COMPARISON

★ ACCURACY

±0.01%

0-500V DC

★ DURABILITY

★ LOW COST

\$895<sup>00</sup> FOB SEATTLE



**FLUKE MODEL 821A** Now—for the first time—it is possible to obtain ±0.01% accuracy with a differential voltmeter over a 0-500V DC range *regardless of source impedance!* Built-in rugged construction, plus the use of highest quality components and latest manufacturing techniques guarantee long, trouble-free operation. Through simplified circuitry and conservative design, factory selection of components is virtually eliminated insuring ease-of-maintenance . . . minimum down-time. Fluke instruments cover many applications such as: calibrating, testing, and stability measurements of regulated power supplies, DC voltmeter calibration, AC voltmeter calibration and precise AC voltage or current measurements when used with an AC/DC transfer standard. The John Fluke Mfg. Co. is the most experienced manufacturer of differential voltmeters—with over 18,000 in use today! Buy with confidence from the company that developed the *differential voltmeter!*

## PARTIAL SPECIFICATIONS:

**ABSOLUTE ACCURACY:** ±0.01% of input voltage from 0.5 to 500V. ±0.01% of input voltage plus 10 microvolts below 0.5V.

**INPUT RESISTANCE:** Infinite at null from 0 to 500V

**METER RESOLUTION:** 5uv maximum; 1 MV full scale.

**CALIBRATION:** 500V working reference supply calibrated against built-in standard cell.

**STANDARD CELL STABILITY:** 0.003% per year.

**INPUT POWER:** 115/230V AC ±10%, 50-400 cps, 60 watts.

## FEATURES:

- Infinite resistance at null over entire 0-500V range
- Polarity switch
- Taut-band suspension meter
- Standard cell reference
- Recorder output
- In line readout with automatic lighted decimal
- No zero controls

The complete FLUKE line of differential voltmeters offers a variety of test/measuring instruments to meet every application at minimum cost. Ask for a demonstration or write for detailed information.

John Fluke Mfg.  
Company, Inc.  
Seattle 33, Wash.

**FLUKE**

**INSTRUMENTS**

Box 7428 PR 6-1171 TWX—Halls Lake TLX—852

All prices FOB Seattle. Prices and data subject to change without notice.

# To meet tough-spot specs

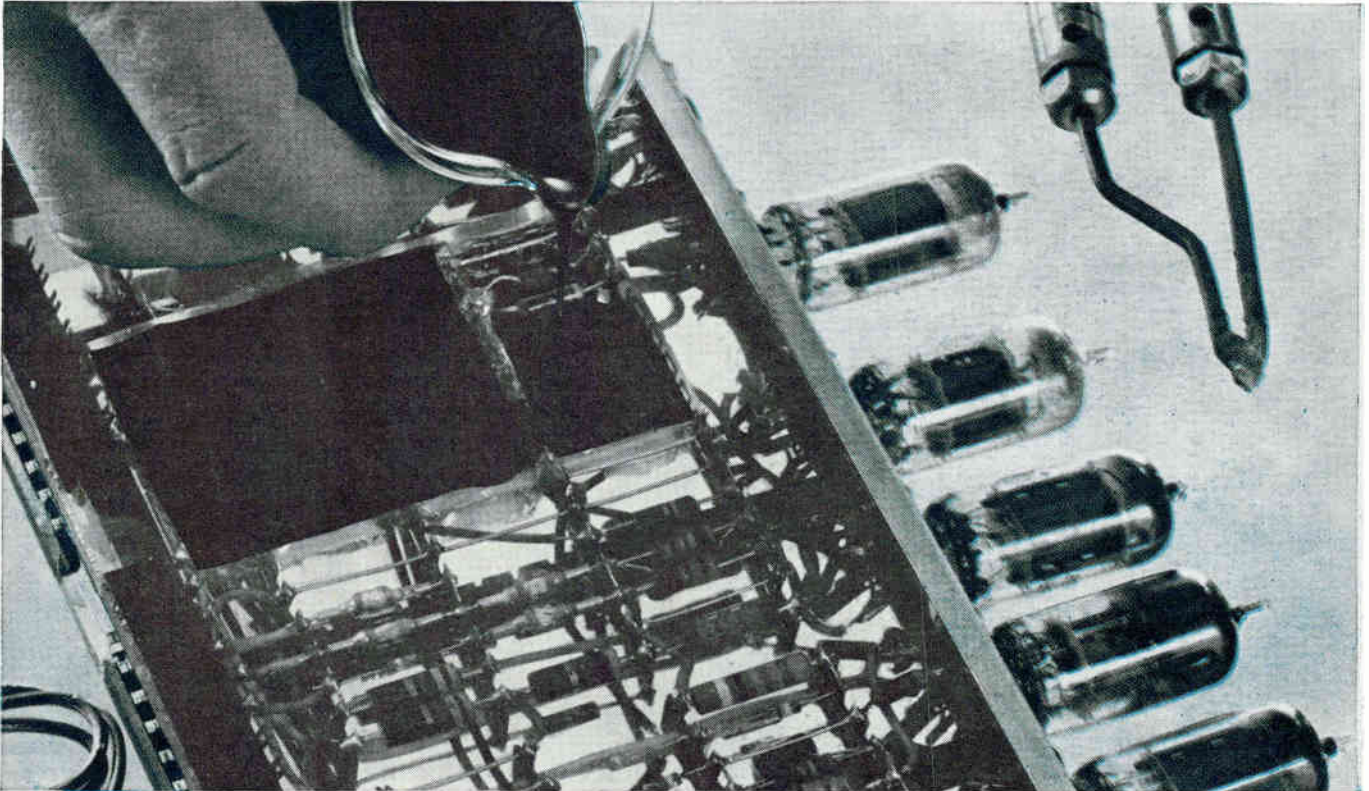

## For resilient protection, specify easy-processing Sylgard® 183

Specify Sylgard 183, the new opaque solventless silicone resin, for embedding, potting, or encapsulating circuits or impregnating components. It is resilient . . . has excellent dielectric properties, heat stability and mechanical strength.

**Processing is simple** with Sylgard 183. Blend it with a curing agent and pour it in place . . . it cures without exothermic heat to a tough, flexible, impervious jacket. Because of its low viscosity . . . about the same as No. 40 engine oil . . . Sylgard 183 flows rapidly around the most intricate shapes. It cures in sections of unlimited thickness, and even in completely sealed assemblies. Curing time can be varied from four hours at 65 C (150 F) to only 15 minutes at 150 C (300 F). After curing, the material can be used immediately at temperatures from -65 to 250 C (-85 to 500 F). No post cure is required.

**Protection is assured** because fully cured Sylgard 183 withstands heat, moisture, shock, vibration, ozone, voltage stress and thermal cycling over a wide range of temperature, frequency and humidity. This new Dow Corning resin is compatible with metals, plastics, glass, asbestos, ceramics, natural and synthetic fibers, and also with Dow Corning's transparent solventless casting resin, Sylgard 182, as shown above. When sealed components must be repaired or replaced, Sylgard 183 can be cut

away, repairs made, and new Sylgard 183 poured in place. It bonds tightly to the original embedment. To cut application costs . . . and to assure recoverability of costly components . . . specify Sylgard 183.

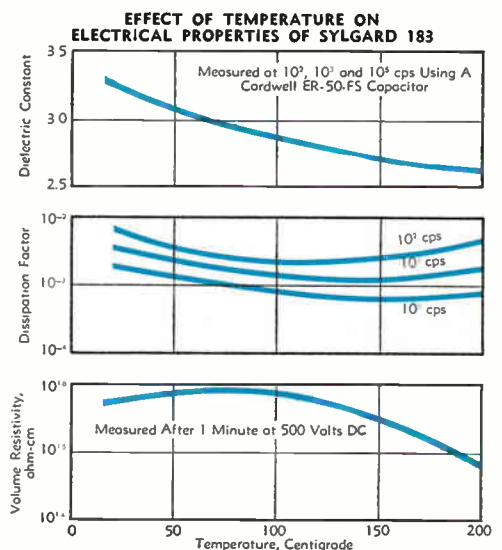

CIRCLE 289 ON READER SERVICE CARD

Dow Corning is your best source for a broad line of silicone fluids, gels, elastomers and rigid forms for potting, filling, embedding and encapsulating



# Dow Corning



# - specify these silicones

## To package silicon diodes

Mechanical strength and good dielectric properties at temperatures to 175 C minimum were requirements for the protective package needed by Motorola Semiconductor Products, Inc., for their new glass surface-passivated "Surmetic"\* zener diode. The material specified is a Dow Corning Molding Compound developed for this application. It molds easily and quickly at temperatures and pressures that will not damage the semiconductor junctions . . . produces a void-free package that eliminates moisture and corona problems . . . doesn't soften when device leads are soldered . . . has withstood storage in air at 400 C and operating tests of 1000 hours at 200 C . . . is a big contributing factor to the high 175 C operating junction temperature rating of these Motorola "Surmetic" devices. A plus in military application: the Dow Corning Silicone Molding Compound will not flame.

\*"Surmetic" — a trademark of Motorola, Inc.

CIRCLE 290 ON READER SERVICE CARD



## Silastic spurns corona

Corona discharge can cause rapid insulation failure, but not when wire and cable are insulated with Silastic®, the Dow Corning silicone rubber. Samples subjected to over 12,000 hours of this test, which creates a high concentration of ozone, show no signs of cracking or checking when flexed. Other important Silastic properties: flexibility and stability from -130 to 500 F; consistently high dielectric strength under adverse conditions; inertness to oxygen, many chemicals: resistant to water, vapor, steam, weathering: minimum deterioration due to age, thermal cycling, or exposure to radiation.

CIRCLE 291 ON READER SERVICE CARD

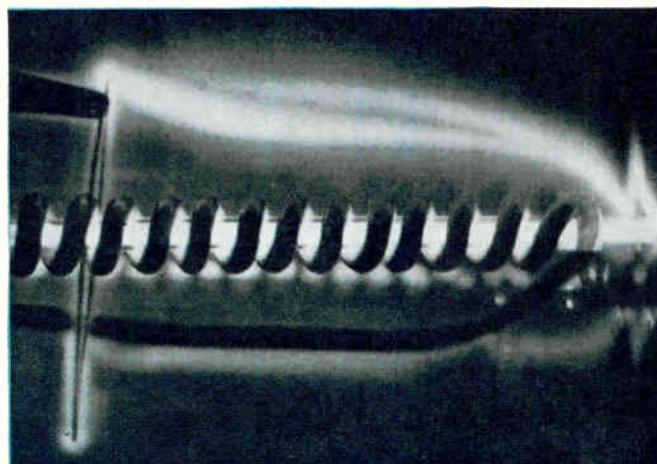

## Laminates resist solder heat

The heat needed to melt solder won't loosen terminals from silicone-glass laminates, even where complex wiring requires repeated soldering in small, confined areas. Long-term heat resistance is also exceptional . . . up to 250 C continuous for years . . . much higher for short periods. In addition, silicone-glass laminates retain excellent dielectric properties despite moisture, storage, environmental aging, changing ambients, and shock. They offer low loss factor, low moisture absorption, good resistance to arcing, corona, corrosion. Weight-strength ratios are high, and machinability, even in thin sections, is exceptional.

CIRCLE 292 ON READER SERVICE CARD

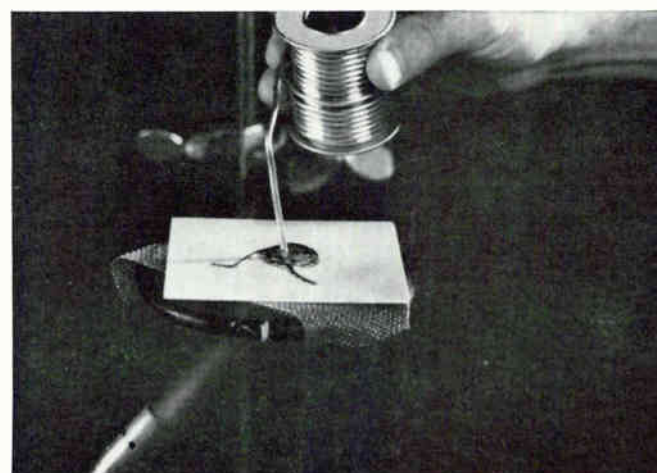

For detailed data on these silicones, contact  
Dow Corning Corporation, Dept. 3913, Midland, Michigan



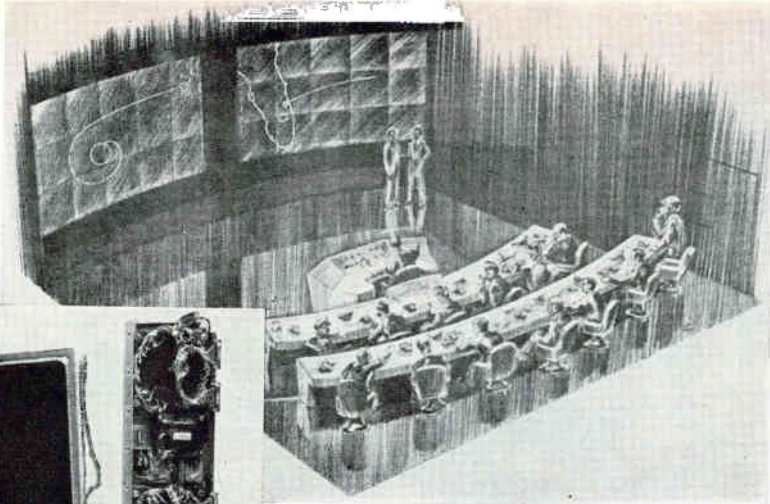

DISPLAY PANEL prototype (photo) developed by Lear Siegler can be built up into wall-sized position maps as indicated in sketch

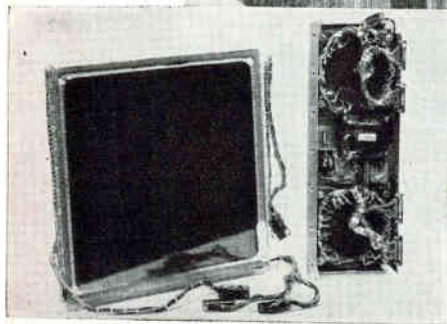

# LARGE DISPLAYS: Military Market Now, Civilian Next

*Here are three ways data can be quickly shown on a big wall*

By HAROLD C. HOOD  
Pacific Coast Editor

LOS ANGELES—Three totally different approaches to the problem of displaying increasingly complex military intelligence will be aired next week at the IRE Winter Convention on Military Electronics.

Systems described will include:

- Flat-sandwich, gas-discharge

panel, developed by Lear Siegler

- Electroluminescent display with an element density of 256 per square inch, from Westinghouse Electric

- Multicolor, back-lighted system using magnetically operated shutters, reported by Electro Nuclear Systems.

All three developers believe, as do other companies in the field such as General Electric and General Telephone, that large military displays will soon be a multimillion-dollar business, and that many non-military markets, educational and business displays, for example, will quickly develop.

All feel that such displays will

facilitate decision-making which cannot be performed by computers. Picture-on-the-wall tv is also a possibility.

**GAS-DISCHARGE TUBE** — Lear Siegler, which adopted the gas-discharge-tube principle to maximize brilliance for a cockpit display developed for the Navy, sandwiches a 0.06-inch layer of photoceramic material (Fotoceram) between two plates of 1/4-inch soft glass in one of its prototype displays.

Cathode grids (see diagram) consist of evaporated Nichrome plus copper with an electroplated topping of Permalloy. Anode strips, deposited on the glass plate facing

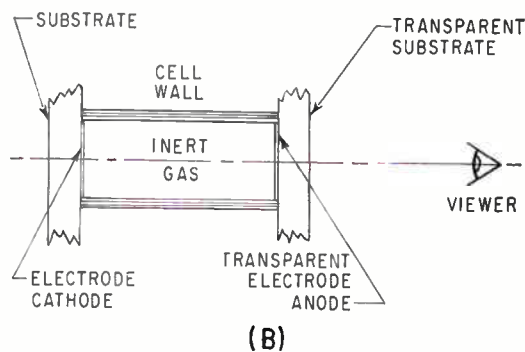
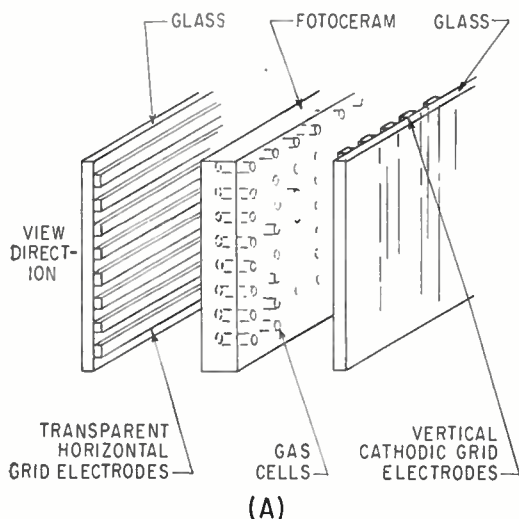

ELEMENTS of Lear Siegler display consist of glass-ceramic sandwiches (A). Each hole in ceramic is a gas cell (B) fired through a geometric grid of conductors

the viewer, are of transparent indium oxide. At each intersection of anode and cathode strips is a 0.05-inch-diameter cylindrical hole etched in the ceramic and filled with neon.

The 10-inch-square display consists essentially of 10,000 tiny neon gas cells which are individually lighted when a current is impressed across their X and Y electrodes.

Contact with the system's electronics is made through conducting strips led to the edge of display plates. Typical cells have a 250-v firing voltage and 125-v extinction voltage. A holding voltage of 200-v will keep cells ON or OFF, providing memory capability.

The prototype's spot brightness is 300 foot lamberts. Cell rise time is 50  $\mu$ s and decay time is 80  $\mu$ s. Predicted lifetime is over 2,000 hours.

Display components can be made inexpensively with mass-production techniques, the company says. Densities of 2,500 cells an inch are possible with present methods. A random-hole approach might provide up to 250,000 cells per square inch.

One of the more promising solutions to the expense of having a transistor switching circuit for each cell, according to David Moore, of Lear Siegler, is to terminate the anode and cathode strips in two cathode-ray switching tubes. The beam could be swept across the desired contacts.

**ELECTROLUMINESCENT**—Westinghouse thinks 10 to 12-foot-lamberts brightness per element is sufficient for most military displays. It uses a basic 4-inch-square building block of 4,096 elements. Each module is made up of 32 sandwich structures containing bridge capacitors, indirect storage capacitors, suppressor resistors and ionic switches. Electroluminescent screen layers are sprayed on the module's front surface and overlaid with a transparent deposition of gold for the common electrode.

Two ferroelectric capacitors associated with each electroluminescent phosphor cell store the d-c potential for control of light output. Control is by a nonlinear ferroelectric bridge and depends for operation upon its nonlinear variation of capacitance with voltage. When an

# Get ~~QUICK~~ Cooperation from SPRAGUE

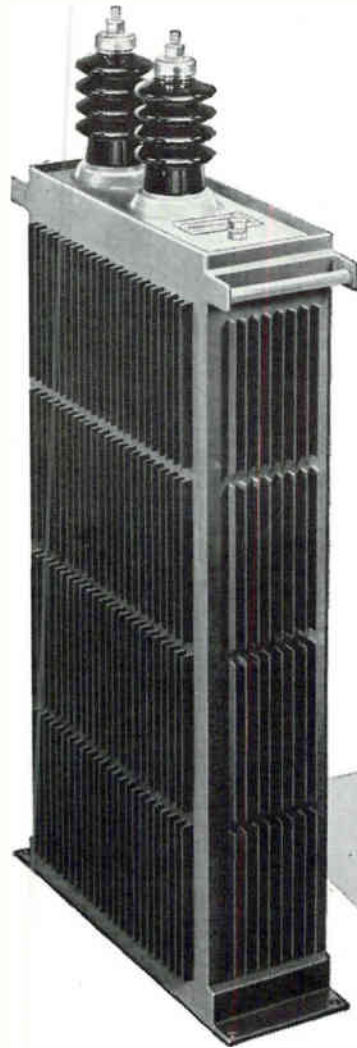

## on your PULSE NETWORK PROBLEMS

Experienced Systems Engineers At Your Service!

Sprague has much to offer to designers of radar systems, laser systems, tube testing systems, and other specialized systems. A highly-technical special engineering section devoted exclusively to pulse capacitors and networks includes *systems* as well as pulse network engineers. We can help you with your problems because we fully understand your problems!

But Sprague service does not end here. Following up the design aspect, we can quickly and efficiently estimate pulse network sizes and prices for bidding pur-

poses. We're also equipped to give quick reaction capabilities for your breadboard and prototype units.

A pioneer in pulse networks, Sprague is a major supplier of custom units from less than 1 KV up to 500 KV over a broad range of power levels.

For application engineering assistance, or additional information, write to Pulse Network Section, Sprague Electric Company, 35 Marshall Street, North Adams, Massachusetts.

### SPRAGUE COMPONENTS

PULSE-FORMING NETWORKS	PACKAGED COMPONENT ASSEMBLIES
CAPACITORS	FUNCTIONAL DIGITAL CIRCUITS
RESISTORS	MAGNETIC COMPONENTS
TRANSISTORS	PULSE TRANSFORMERS
INTERFERENCE FILTERS	CERAMIC-BASE PRINTED NETWORKS
PIEZOELECTRIC CERAMICS	HIGH TEMPERATURE MAGNET WIRE



45PN-475



# SDL reson-ator

RESONANT REED RELAY  
Patent No. 3029326



**FREQUENCY SENSITIVE SWITCH**



**HAS NARROW BANDWIDTH**



**... HIGH SELECTIVITY**



**... RUGGED DEPENDABILITY**



**... AND COSTS ONLY \$12.50\***

\*in lots of 50-99

ALSO COMPANION RESONANT REED OSCILLATOR UNITS

**SDL SECURITY DEVICES LABORATORY**  
ELECTRONICS DIVISION OF SARGENT & GREENLEAF, INC.  
17 Seneca Ave.  
ROCHESTER 21, N.Y.

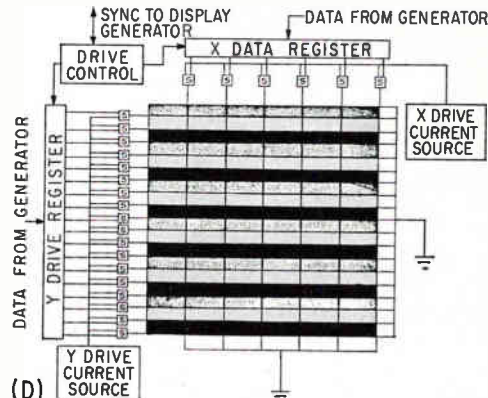
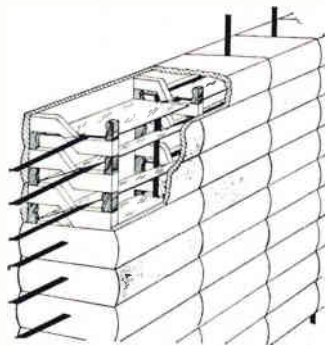
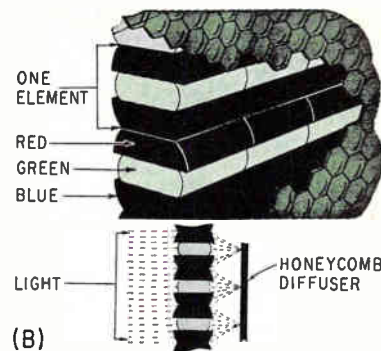
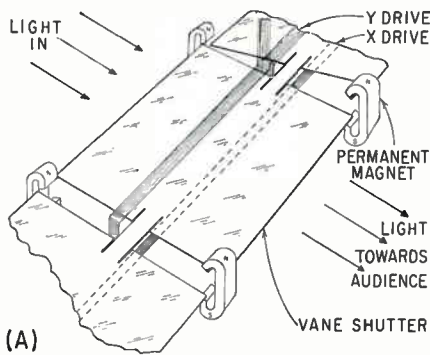

(C)

(D)

MULTICOLOR DISPLAY is achieved by Electro Nuclear Systems with back-lighting and magnetically operated shutters (A). Other sketches are lens arrangements (B), segment of a panel module (C) and drive and control hookup (D)

initial charge of 200 v on the indirect storage capacitor drops to zero, the bridge becomes unbalanced and the a-c voltage across the electroluminescent capacitor results in light output.

Palladium ionic switches, or spark gaps, provide information storage and element isolation in the matrix selector system. These are fabricated in steatite strips of 16 each, with electrode gaps of 6 to 8 microns. They are fired by 320 to 360 v, well above the amplifier logic level of 200 v. Surrounded by an argon-nitrogen-oxygen environment, these switches last well over 1,000 hours.

Peripheral circuitry consists of X-column and Y-row drivers. The X amplifiers use *pnpn* switches that will block 200 v in the OFF position and can be triggered to ON by a relatively low-power pulse. Two of the same type of switches are used back-to-back in the Y-row commutator that controls passage of the ionic switch firing voltage.

MULTICOLOR DISPLAY—Brilliance of its display, reports Electro Nuclear Systems, is unlimited and depends upon the number and in-

tensity of conventional fluorescent lamps used. Each of the ¼-inch-square elements has a seven-color capability, transmitting any one or combination of three primary colors introduced by the plastic lenses (see diagram above). Each has three individually controlled magnetic vanes.

Vane operating speed is about 1 ms. Microsecond response is expected in future models. Small permanent magnets lock the vanes in either the open or closed position. Each X and Y-drive line carries slightly more than half the current required to force a vane away from its detent, so simultaneous pulses through both wires are needed to change vane position. The panel can be driven by high current switching devices such as transistors, SCR's or relays as needed for each X and Y-drive line. The entire system—display generator, data distribution network and display panel—is reportedly compatible with existing command and control information processing systems and can accept information from such sources as computers, communication circuits, digital stores and tv systems.



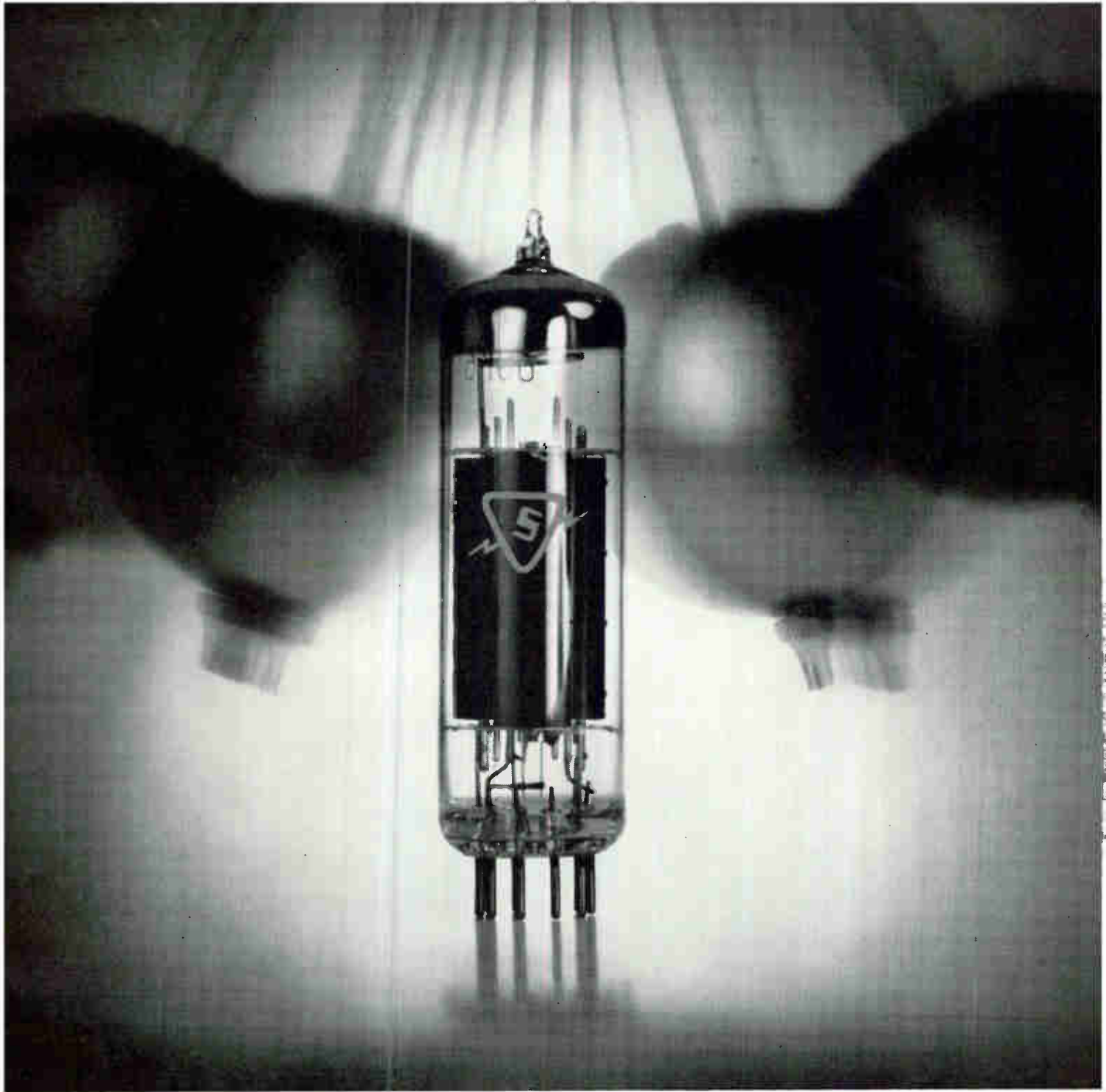

## How Sylvania's LIFE-BOOST\* Cathode puts more time in receiving tubes

Early death for a receiving tube can come from unwanted elements in the cathode material. Copper, for instance, can vaporize and settle as troublesome leakage paths between tube parts. Sulfur harms electron emission by "poisoning" the cathode coating.

Sylvania metallurgists found a way to achieve alloy purity far greater than is possible with melting, the usual method.

Powdered ingredients, purer to begin with, are blended and immediately cold-rolled into thin-gauge strip. No more hot melt, with its tendency to draw impurities from anything it touches.

Results? Sylvania tubes with the new cathode (90 types already have it) show significant improvement in life, stability throughout life, tube-to-tube uniformity, and cathode strength. In short, the cathode

we've named LIFE-Boost is a real achievement in terms of greater value for tube users.

Isn't a company with broad capabilities—from powder metallurgy to electron optics—more likely to have the answer to your problems?

Electronic Tubes Division, Sylvania Electric Products Inc., 1100 Main Street, Buffalo 9, New York.

\*Trademark

# SYLVANIA

SUBSIDIARY OF

**GENERAL TELEPHONE & ELECTRONICS**



NEW CAPABILITIES IN: ELECTRONIC TUBES • SEMICONDUCTORS • MICROWAVE DEVICES • SPECIAL COMPONENTS • DISPLAY DEVICES

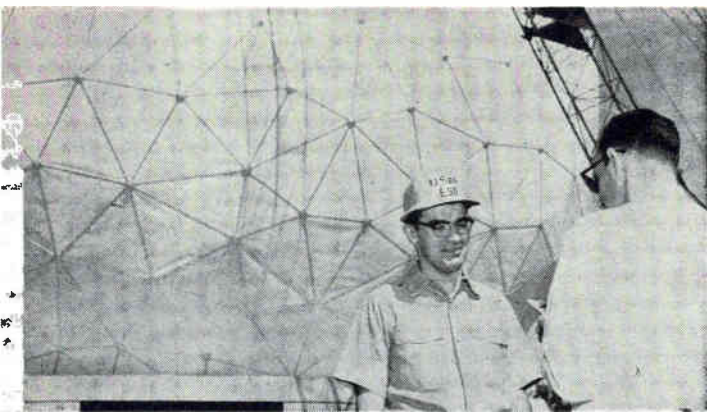

PLASTIC TRIANGLES, measuring up to 15 feet on a side and installed in a random pattern to avoid interference, make up 134-foot-high radome for Haystack facility. The 120-foot antenna is to be completed late this year

## Air Force Upgrades Space Research Microwave Center

*Monopulse radar and "baby Arecibo" are added at Millstone*

By THOMAS MAGUIRE  
New England Editor

BOSTON—An S-band monopulse radar antenna system is the latest in a series of Air Force-MIT Lincoln Laboratory projects that have made the Millstone-Haystack complex in northeastern Massachusetts a multi-million-dollar center of radar and communications research.

The S-band parabola is the proto-

type of an antenna which will be built at Arbutle Neck, Va., a Lincoln Lab site for reentry studies.

The military research center, carved out of wooded areas in Westford and Tyngsboro, Mass., just south of the New Hampshire line, also includes the Millstone Hill radar upgraded this year, a 220-foot ground-mounted paraboloid for ionospheric backscatter studies at uhf, the 60-foot parabola for Project West Ford, and the Project Haystack 120-foot antenna facility still under construction (ELECTRONICS, p 34, May 5, 1961, and p 49, Nov. 9, 1962).

**SPACE RESEARCH**—The original Millstone Hill antenna system, built for missile defense research, was quickly adapted for satellite tracking when the first Sputnik went up.

Until last March, Air Force had a crew at Millstone Hill for routine satellite tracking. The station was shut down then for modifications. It is no longer used for routine satellite tracking, but its tasks in space physics research do include tracking experiments.

A Cassegrain reflector has been installed on the 84-foot dish, and a lobe-comparison tracking feed at L-band. New transmitter components include two X-780 klystrons.

Frequency was changed from 440 Mc to 1,300 Mc. With improved

low-noise receivers and slightly higher peak transmitter power, this has improved net detection sensitivity by about 15 db. Thus, it can better detect echoes from Venus and brings the planet Mars within radar reach. Long signal integration may enable the system to detect Mercury.

Millstone Hill made the first radar contact with Venus in 1958. According to John V. Harrington, Radio Physics division head at Lincoln Lab, the new system should yield more reliable information on the Venusian surface and more about the planet's rotation rate. Major emphasis in recent experiments was on pulse and doppler-broadening experiments.

**BABY ARECIBO** — Transmitting and receiving equipment from the original system will be used with a 220-foot paraboloid mounted on the ground nearby and pointing toward its zenith.

This open-mesh antenna, a sort of junior Arecibo (ELECTRONICS, p 20, Jan. 27, 1961), permits continuation of the electron density studies of the original Millstone Hill dish. Experimenters are using noncoherent scatter techniques, observing very weak signals scattered back from the individual electrons in the ionosphere when illuminated by high powers at frequencies well above the plasma or critical fre-

### Chinese Hearing Aid



STATE-OF-THE-ART in Communist China is indicated by transistor hearing aid made by Shanghai Medical Apparatus Bureau. This is reportedly an improved model with better tone quality and more volume than earlier types

quency. Electron density and temperature profiles well into the exosphere can be obtained.

**WEST FORD**—At the foot of Millstone Hill is the 60-foot parabolic antenna built—along with a twin at Camp Parks, Calif.—for Project West Ford, the experimental scatter communications system that will use an orbiting belt of tuned dipoles.

In the absence of an orbiting belt, the antenna systems on the East and West coasts have been used for lunar relay, radiometric measurements of the atmosphere and satellite tracking. At both terminals, a uhf feed system was installed to permit reception of telemetry signals. Also, voice channel terminal equipment has been added. The antenna will soon be enclosed in a radome.

Coast-to-coast transmission of high-quality voice signals and high-speed data have been achieved at these terminals using the moon as a passive reflector of 8-Gc signals. Previous work on lunar scattering at this range of frequencies made it possible for Lincoln Lab researchers to use a "tailor-made" modulation technique.

## Nimbus Station To Be Built in Nova Scotia

UNITED STATES and Canada will build a command and data acquisition station for the Nimbus meteorological satellite system, at Ingomish, Nova Scotia, during 1963. The station will supplement the station being completed at Fairbanks, Alaska.

Now under development by NASA and the Weather Bureau, Nimbus will be the successor to the Tiros weather satellite program. Nimbus will circle the earth in a near-polar orbit "seeing" the whole world every 24 hours. Tiros sees only about 20 percent of the earth daily. Within a few years it is expected that there will be at least one Nimbus in orbit at all times to support weather analysis.

The Ingomish station will be manned by Canadians with some U.S. personnel.

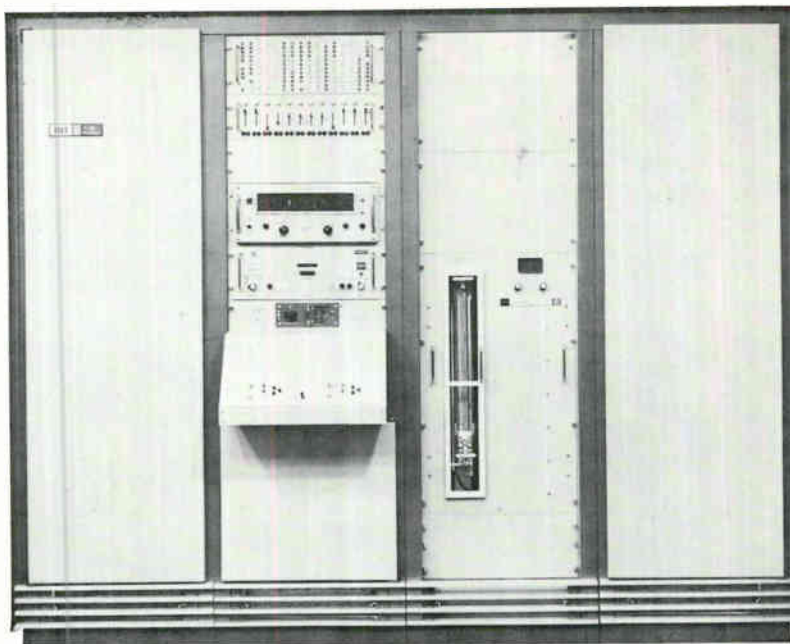

## State of the Art

**tact**, Texas Instruments Transistor

And Component Tester . . . keeps pace with testing requirements

A universally applicable transistor and component tester, TACT has been proved on every major missile program to date . . . is keeping pace with the newest testing concepts. The TACT system design incorporates anti-obsolescence features that provide unlimited testing flexibility for future expansion and component development.

Versatile, expandable TACT now offers: duty cycle pulse testing to 500 volts or 25 amperes; switching time measurements from 1 nanosecond to 1 microsecond; low current measurements from 1 picoampere automatic ranging — all in one system. Additional plug-in module capacity and system accessories such as environmental chambers and scanners for various component mounting boards are available.

The basic TACT system provides sequentially controlled reliability testing of transistors, diodes, capacitors, resistors, relays and other components. Digital control of analog functions with punched card pre-programming on each device assures absolute repeatability — eliminates operator variation.

Only TACT can fulfill both your present and future testing requirements. Write for information.



INDUSTRIAL  
PRODUCTS  
GROUP



**TEXAS INSTRUMENTS**  
INCORPORATED  
P O BOX 66027 HOUSTON 6, TEXAS

SENSING • RECORDING • TESTING • DIGITIZING INSTRUMENTS  
THE INSTRUMENTS OF TEXAS INSTRUMENTS

571



# WITH THIS



**YOU CAN SET  
3000 CONTACTS  
LIKE THESE IN  
JUST ONE HOUR**



THIS is the new Black & Webster Model FSTC Contact Setter. It can set 3000 contacts per hour. (Compare that figure with your present production.) Highly reliable. And easy operating. Contacts are oriented automatically in bowl, fed swiftly down raceway to staking nest. Operator places blade over contact and trips foot switch — that's it! Production climbs, costs tumble. Equipment can be readily tailored to your specific needs.

For complete facts, write: Dept. E  
**BLACK & WEBSTER, INC.**  
570 Pleasant Street, Watertown 72, Mass.  
617-WALnut 6-0100

## Venus: Plains and Desert?

*Radar probe finds  
evidence of huge  
flats on planet*

WASHINGTON — Evidence that Venus is even smoother than the moon (which in turn is smoother than the earth according to other radar experiments) has been turned up by the National Bureau of Standards' scatter radar installation at Jicamarca, Peru, reports Kenneth L. Bowles, observatory director. NBS scientists recorded echoes of 0.5-millisecond pulses from the specular point—the point on Venus nearest the earth.

Bowles believes the reflected "glints" from Venus, in the 0.5-ms and in 3-ms bursts, unlike echoes from any other planetary radar probes, are caused by the focusing of echoes by individual large flat areas hundreds or thousands of acres in extent. He also suggests that examination of the data may well end the controversy over the

length of the Venusian day.

The Jicamarca installation, designed as an ionosphere depth probe is credited with first published discovery of the artificial radiation belt spawned by the high energy nuclear test in the Pacific last July. It took a stab at Venus on learning that Venus would both be closest to the earth (45 million kilometers) and directly over Jicamarca's 22-acre fixed antenna, late last year.

Other recent radar probes of Venus by Naval Research Laboratory and Jet Propulsion Laboratory scientists disclosed that Venus echoes are blank in the 1.35-cm water vapor line. Their conclusions that the planet is a windswept desert compares favorably with Jicamarca's results so far.

## Free World's Industrial Output Rising 5% in '63

NEW YORK — The gross national product (GNP) in the free industrial world will increase by about 5 percent in 1963. In the U.S., the gain should be nearly 3 percent.

For most industrialized nations, the outlook for 1963 is a bit less bright than it was for 1962, according to a survey compiled by the McGraw - Hill Publishing Company's Department of Economics.

Wages are going up much more in 22 of the industrialized nations than in the U.S. The gap between U.S. industrial costs and those of foreign countries is narrowing slightly. At present, the U.S. does not face a build up of the inflationary pressures that are plaguing other countries.

Estimates of the increase in percent of the gross national products in leading industrial nations include: Canada, 6 percent; Belgium 5 percent; West Germany, 8 percent; France, 6 percent; Italy, 7 percent; The Netherlands, 7 percent; United Kingdom, 5 percent; Japan, 7 percent.

## Thin-Film Computer



AEROSPACE computer introduced last week by Univac is built with 1,248 integrated circuits and a 74,000-bit thin-film memory. It weighs less than 17 pounds and dissipates 53 watts

# ONLY WITH THE 175A:

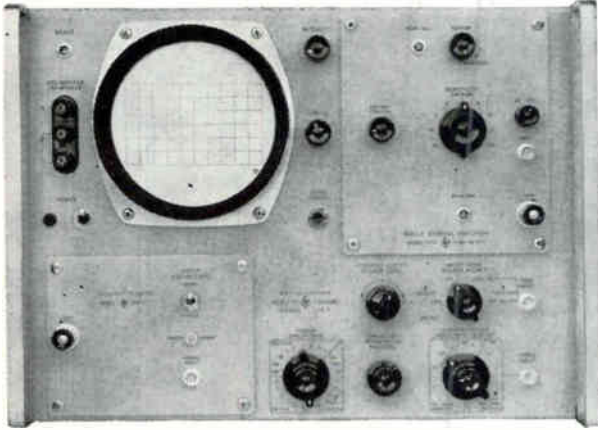

175A Universal Oscilloscope and 1751A Fast Rise Vertical Amplifier

*Less than 7 nsec  
rise time!  
Full  
6x10 cm display!*

The 175A Universal Oscilloscope challenges comparison! Rise times of less than 7 nsec at all sensitivities (50 mc bandwidth) even at the input probe and a sharp, full 6 x 10 cm no-parallax display make this the greatest scope value available today. Sweep speeds to 10 nsec/cm for measuring fast rise times. Both vertical and time axis

plug-ins for maximum versatility. Simplified circuitry with no distributed amplifiers speeds maintenance and insures stability. Only 7 tube types and 5 transistor types are used. Check the specs of the 175A and plug-ins, then check with your Hewlett-Packard representative for a close-up, convincing demonstration in your own lab.

## SPECIFICATIONS, 175A OSCILLOSCOPE

<b>SWEEP GENERATOR</b>	
Internal Sweep:	0.1 $\mu$ sec/cm to 5 sec/cm, $\pm$ 3%; vernier extends slowest speed to 12.5 sec/cm
Magnification:	x10; extends fastest sweep to 10 nsec/cm, $\pm$ 5%
Triggering:	Internal, from vertical input signal causing 2 mm or more vertical deflection, or from power line; external, from signal 0.25 v p-p or more
Triggering Point:	Controls allow selection of level and slope
<b>HORIZONTAL AMPLIFIER</b>	
Bandpass:	DC to 500 kc
Sensitivity:	2 ranges, 0.1 and 1 volts/cm; vernier provides continuous adjustment to 10 volts/cm
<b>VERTICAL AMPLIFIER</b>	
Rise Time:	Less than 7 nsec
<b>GENERAL</b>	
Power Requirements:	115 or 230 v ac $\pm$ 10%, 50 to 60 cps; maximum of 425 watts, depending on plug-ins used
Weight:	Maximum of 70 lbs., depending on plug-ins used
Price:	\$1325

Data subject to change without notice. Prices f.o.b. factory

## SPECIFICATIONS, 175A PLUG-INS

### VERTICAL PLUG-INS

**1750A 40 MC Dual Channel Amplifier:** Permits viewing of two phenomena simultaneously, bandpass dc to 40 mc, rise time 9 nsec, sensitivity 50 mv/cm to 20 v/cm; differential input for common mode rejection, \$285

**1751A Fast Rise Vertical Amplifier:** Rise time, < 7 nsec, dc to 50 mc; sensitivity, 50 mv/cm to 20 v/cm; vernier extends sensitivity to 50 v/cm, \$160

**1752A High Gain Amplifier:** Provides 5 mv/cm sensitivity dc to 18 mc with differential input for high common mode rejection, \$225

### HORIZONTAL PLUG-INS

**1780A Auxiliary Plug-in:** Normal and single sweep, \$25

**1781A Sweep Delay Generator:** For detailed examination of complex signals or pulse trains; permits viewing expanded waveform segment while still retaining presentation of earlier portions of the waveform; delay time 1  $\mu$ sec to 10 sec.; delaying sweep, 2  $\mu$ sec/cm to 1 sec/cm, \$375

**1782A Display Scanner:** Provides output to duplicate on X-Y recorder any repetitive wave appearing on scope; resolution with permanent records higher than CRT photograph, \$425

**1783A Time Mark Generator:** Permits easy time measurements by providing intensity modulated time markers on scope trace; range, 10  $\mu$ sec, 1  $\mu$ sec and 0.1  $\mu$ sec intervals,  $\pm$  0.5%, \$130

**HEWLETT  
PACKARD  
COMPANY**

1501 Page Mill Road, Palo Alto, Calif., Area Code 415, DA 6-7000  
Sales and service representatives in all principal areas; Europe,  
Hewlett-Packard S. A., 54 Route des Acacias, Geneva; Canada,  
Hewlett-Packard (Canada) Ltd., 8270 Mayrand Street, Montreal



8241



"CLAIREXCOR NYC — TELEGRAM

"AT 1201 PST TODAY DEC 14 1962 THE MARINER 11 SPACECRAFT MADE ITS CLOSEST APPROACH TO THE PLANET VENUS WITHIN THE PLANNED MISS CORRIDOR THIS INTERPLANETARY FLIGHT HAS SET MANY WORLD RECORDS INCLUDING COMMUNICATIONS DISTANCE QUANTITY AND SIGNIFICANCE OF DATA RECEIVED THREE AXIS ATTITUDE CONTROL AND INTERPLANETARY SPACE MANEUVER.

"WE ARE PLEASED TO REPORT THAT YOUR CADMIUM SULFIDE PHOTOCONDUCTOR DETECTORS USED IN THE MARINER 11 SUN SENSORS AND SUN ATE HAVE OPERATED SUCCESSFULLY THROUGHOUT THE COMPLETE 109 DAY FLIGHT YOUR DETECTORS HAVE PLAYED A KEY PART IN THE SUCCESS OF THIS HIGHLY SUCCESSFUL MISSION.  
JET PROP LAB G W MEISENHOLDER SCHMIDT R G FONEY J M WHALEN"

# THE EYES OF A MODERN MARINER



CLAIREX PHOTOCONDUCTIVE CELLS recently served as the detectors in the sun-sensing "eyes" of Mariner II, our Venus space vehicle, controlling reference attitude prior to the critical mid-course correction maneuver which reduced the "miss" from 233,000 to 21,000 miles! The sun sensors also served as panel-orientors throughout the flight for maximum power output of the solar cell panels, signalling position errors to the pitch and yaw stabilization jets.

The Clairex cells in Mariner II were the standard CL-605 type now in use in hundreds of other more earth-bound applications. Special single-crystal Clairex components, however, have been utilized in Ranger and other space probe projects as radiation detectors.

## MID-COURSE CORRECTION AFFECTS FLIGHT PATH

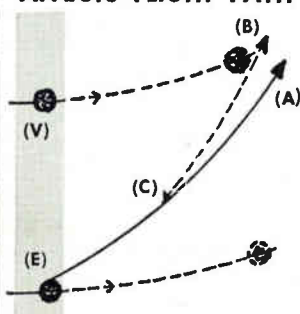

Redirecting vehicle from destination (A) to (B) in vicinity of Venus required flight correction at point (C) by applied jet propulsion of short duration. The vehicle's maneuvers prior to corrective propulsion were based on initial proper sun reference via the photoconductive sun sensors.

## SUN SENSING ARRAY ON MARINER VEHICLE

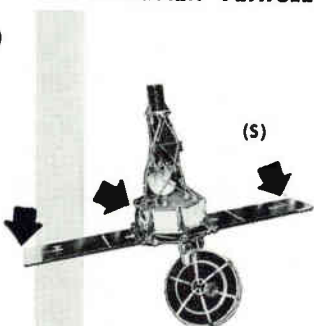

Throughout the life of the craft, prior and subsequent to mid-course correction, the sun sensors (S) signalled error-correcting commands to the stabilization jets for pitch and yaw control, thus keeping the solar cell banks properly oriented for maximum power output.

## PHOTOCONDUCTIVE CELL COMPONENTS

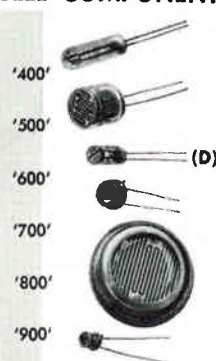

Six Standard Series of photoconductive cells, including the Mariner II type, (D), are manufactured by Clairex Corporation. Illustrated are units of both Cadmium Sulfide and Cadmium Selenide, in glass or metal containers, offering a wide range of response characteristics.

Technical design data available on request.

"The light touch in automation and control"

# CLAIREX CORPORATION

8 West 30th Street, New York 1, New York

THE OLDEST MANUFACTURER OF CADMIUM SULPHIDE AND CADMIUM SELENIDE PHOTOCONDUCTIVE CELLS

## MEETINGS AHEAD

INSTITUTE OF ELECTRICAL & ELECTRONICS ENGINEERS WINTER GENERAL MEETING & EXPOSITION, IEEE; Statler and New Yorker Hotels, New York City, Jan. 27-Feb. 1.

ELECTRICAL ENGINEERING EXPOSITION, IEEE; New York Coliseum, New York City, Jan. 28-31.

MILITARY ELECTRONICS WINTER CONVENTION, IRE-PGMIL; Ambassador Hotel, Los Angeles, Calif., Jan. 30-Feb. 1.

QUANTUM ELECTRONICS INTERNATIONAL SYMPOSIUM, IRE, SFER, ONR; Unesco Building and Parc de Exposition, Paris, France, Feb. 11-15.

INFORMATION STORAGE AND RETRIEVAL SYMPOSIUM, American University; International Inn., Washington, D. C., Feb. 11-15.

ELECTRICAL & ELECTRONIC EQUIPMENT EXHIBIT, ERA, ERC; Denver Hilton Hotel, Denver, Colo., Feb. 18-19.

SOLID STATE CIRCUITS INTERNATIONAL CONFERENCE, IRE-PGCT, AIEE, University of Pennsylvania; Sheraton Hotel and U. of P., Philadelphia, Pa., Feb. 20-22.

PACIFIC COMPUTER CONFERENCE, AIEE; California Institute of Technology, Pasadena, Calif., March 15-16.

BIONICS SYMPOSIUM, United States Air Force; Biltmore Hotel, Dayton, Ohio, March 18-21.

IEEE INTERNATIONAL CONVENTION, Institute of Electrical and Electronics Engineers; Coliseum and Waldorf-Astoria Hotel, New York, N. Y., March 25-28.

ENGINEERING ASPECTS OF MAGNETO-HYDRODYNAMICS SYMPOSIUM, IRE-PGNS, AIEE, IAS, University of California; UCLA, Beverly, Calif., April 10-11.

OHIO VALLEY INSTRUMENT-AUTOMATION SYMPOSIUM, ISA, et al; Cincinnati Gardens, Cincinnati, Ohio, April 16-17.

CLEVELAND ELECTRONICS CONFERENCE, IRE, AIEE, Case Institute, Western Reserve University, ISA; Hotel Sheraton, Cleveland, April 16-18.

INTERNATIONAL NON-LINEAR MAGNETICS CONFERENCE, IRE-PGEC, PGIE, AIEE; Shorcham Hotel, Washington, D. C., April 17-19.

## ADVANCE REPORT

MEDICAL ELECTRONICS INTERNATIONAL CONFERENCE, International Federation of Medical Electronics, University of Liege; Centre Européen des Grands Congrès, Esplanade de l'Europe, Liege, Belgium. March 1 is the deadline for submitting two copies of paper to: D. H. Peckering, Institute of Medical Physics, 45 Da Costakade, Utrecht, The Netherlands. Main topic of the conference will be the physical transducer. Papers on devices for measuring various parameters of living systems are encouraged; examples include: plethysmograph, accelerometer, pressure transducer (e.g. electromanometer, pneumotachograph, spirometer, flow meter, tocograph, tonometer, microphone, strain gauge, ergometer, photoresistor, thermoresistor, pH electrode, microelectrode, ultrasonic detector, azimeter. Sessions on other topics will also be organized.





# 106 kW CW AT X-BAND! FROM VARIAN

Varian now offers the VA-873 SBK\* amplifier klystron, providing the world's highest CW power at X-band. More than 106 kilowatts was obtained from a single tube during extensive evaluation tests in the laboratory. Production tubes will be conservatively rated at 50 kW CW. \*Single Beam Klystron

 **VARIAN ASSOCIATES**  
TUBE DIVISION  
Palo Alto 1, Calif.

MICROWAVE TUBE GROUP: PALO ALTO TUBE DIVISION • BOMAC  
DIVISION • S-F-D LABORATORIES, INC. • SEMICON OF CALIFORNIA, INC.  
VARIAN ASSOCIATES OF CANADA, INC. • SEMICON ASSOCIATES, INC.

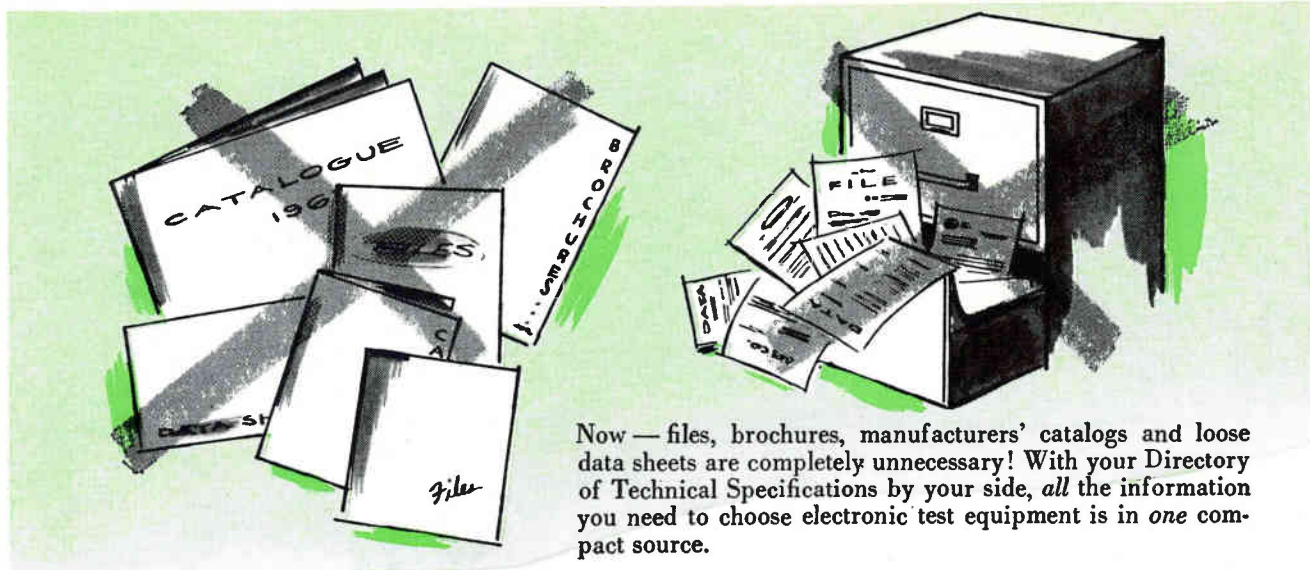

Now — files, brochures, manufacturers' catalogs and loose data sheets are completely unnecessary! With your Directory of Technical Specifications by your side, *all* the information you need to choose electronic test equipment is in *one* compact source.

## HERE'S WHAT YOU GET

**Over 40 individual sections** — a separate section for each type of instrument listed below! And each section contains all the specs on all models of that type of equipment sold in the United States!

AC Amplifiers • DC Amplifiers • Microwave Amplifiers • High Current DC Power Supplies • Laboratory Type DC Power Supplies (Parts I & II) • DC High Voltage Power Supplies • Special Purpose DC Power Supplies • AC Power Supplies • Signal Generators • Oscillators • Pulse Generators • Sweep Generators • Noise Generators • Square-wave & Function Generators • Fixed Attenuators • Variable Attenuators • Phase Shifters • Variable Filters • Receivers • Time Delay Units • Shorts • Mismatches • Fixed Loads • Variable Loads • Waveguide Directional Couplers • Coaxial Directional Couplers • Isolators • Lab Type Voltmeters • Multimeters • VTVM's • Digital Voltmeters • Ohmmeters • Wattmeters • Phase Meters • Waveguide Frequency Meters • Low Frequency & Coax Frequency Meters • Frequency Counters • Field Strength Meters • SWR Meters • Oscilloscopes • Spectrum Analyzers • Wave Analyzers & Distortion Meters • Slotted Lines

**In short —**

**ALL THE DATA YOU NEED** — complete specs on every available electronic test instrument!

**UP-TO-DATE INFORMATION — ALL THE TIME** — One revised section, containing all the latest data, changes and additions on one type of instrument, is sent to you every week, for 12 months! The entire Directory is thus revised in less than a year.

**LARGE DETAILED PICTURES** — full-page illustrations, 7½" x 9½" — so that you can see the design, controls, and other features of the instruments you want!

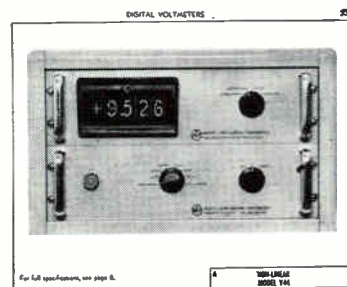

**Everything is complete, logical and concise!**

**Here's how the data appears in the Directory:**

DIGITAL VOLTMETERS

Photo See Page	MANUFACTURER	MODEL	No. of Ranges	VOLTAGE			Acc. %	Read-out Polarity	Read-ing Type	Speed Rds /sec	Input Imp. Ohms	AC Freq.	OUTPUT		RATIO MEAS.		Ref.
				Min.	Max.								Type	Printer	Min.	Max.	
33	CUBIC (A)	V-70 J	3 manual	.001	999.9	0.01 +1 digit	manual	d	manual	*	10M @ balance	con-verter a	* BCD or dec	*	-	-	-40db @60cps filter
	CIMRON (A)	6100 J v	3 manual	.001	999.9	0.01 +1 digit	manual	f	auto-matic	*	10G @ balance	30cps -10kc	none	none	.0001	99.99	up to 100v 50kΩ
	NON-LINEAR SYSTEMS (A)	V44 J	3 manual	.001	999.9	0.01 fs +1 dig	auto-matic	d	auto manual remote	200 const-ant	10M	30cps -10kc	BCD & dec-imal	l m n o p g	-	-	-

(This is just one portion of two typical facing pages in the Directory.)

## HOW TO ORDER

Here's all you do: just fill in the coupon on the next page to give us your authorization to start your subscription. We'll bill you later. Your complete Directory, with a free set of six handsome binders, will be mailed to you immediately, postpaid. You'll also get revisions, as they are released, for 12 months. (If you prefer, enclose a check, or purchase order.)

## WANT A FREE SAMPLE SECTION?

We'll be happy to send you a free sample section from the Directory. It will be outdated — and our subscribers have received the most recent revision — but it will give you a good picture of the Directory's format. Use the coupon in this ad or this publication's Reader Service Card to request your free sample.

**MAIL COUPON TODAY!**



**TECHNICAL INFORMATION CORPORATION**

Dept. E-27-2., 260 Glen Head Road, Glen Head, New York  
Area Code 516 ORiole 1-6565



# NOW! You can stop "clerking" and have more time for engineering!

## Subscribe to the DIRECTORY OF TECHNICAL SPECIFICATIONS!

When you need a new piece of test equipment, do you spend hours searching through files, catalogs, brochures, etc., trying to decide which instrument would meet your needs best? Do you spend valuable time "clerking", which could better be devoted to engineering?

The Directory of Technical Specifications can end all of this for you. It lists over 40 different categories of instruments, and gives complete specifications of *all* models from *all* manufacturers selling in the United States (over 500). You can make model-to-model comparisons, quickly, since *all* important parameters are shown, in columns. Even prices are included! And to make the Directory especially easy to use, all instruments are arranged according to the parameter most important to you in making your selection!

Different models from the same company are *not* listed consecutively (unless the parameter so dictates) but *are* listed wherever they fit in relation to other manufacturers' equipment.

The Directory contains one complete, individually bound

**Six handsome binders for your Directory of Technical Specifications — free, with your first year's subscription!**

section for each of over 40 different categories of equipment. In other words, there are more than 40 self-contained sections in the Directory, each covering a different type of instrument. A different section is completely revised every week, and your subscription entitles you to all revisions for one year. As you receive each revised section, you simply throw out the existing, out-dated section, and replace it with the new, up-to-date section. What's more, as new sections are issued, covering other instrumentation not currently in your Directory, you will receive them automatically.

All this, for just \$300 per year! And, with your first subscription, you receive six handsome binders absolutely free. We're so sure you'll find the Directory everything we say it is — and more — we make this offer: Use it for 30 days. If for any reason you're not satisfied, return it to us and we will refund your full subscription price!



### SPECIAL TRIAL OFFER FOR NEW SUBSCRIBERS

Try the Directory of Technical Specifications for 6 months for just \$200. Use it and see for yourself how valuable it is. You will receive the complete Directory immediately, and all revisions and new sections as they are issued over the next 6 months. At the end of that time, you will be entitled to renew at the annual rate of \$300. And — if you act fast — we'll also include the complete set of six binders at no extra cost. They'll be sent postpaid upon receipt of your order for a trial subscription. Use the handy coupon to order.

DIGITAL VOLTMETERS

Type	MECHANICAL				Price Dollars	NOTES	FOOTNOTES
	Width Inches	Height Inches	Depth Inches	Wt. Pounds			
R	19	5 1/4	14	28	1580.00	4. Absolute, rms sum of systems tolerances. 8. Balance time: 500ms average, 750ms maximum. 10. See AC digital voltmeter sec. 11. 12. BCD or 10 line decimal to drive printer special. 8. Bal rate: 30 steps/sec, typical bal time 1sec. 9. On 9.999V; 11MG on 99.99 & 999.9V rngs. 10. See AC digital voltmeter sec. Front panel plug-in permits add. of AC, preamp & ohms conv. 10. See AC digital voltmeter sect. Millivolt ranges with model 140 preamp. 11. Outputs provided for parallel decimal & parallel binary coded decimal. 5ms balance time.	l. Flexowriter. m. Electric Typewriter. n. Card Punch. o. Tape. p. Digital Recorder v. Ratiometer also.
C	17	5 1/4	14	26	1330.00		
R	19	10 1/2	15 1/4	65	6185.00 FOB dest.		

(This is just one portion of two typical facing pages in the Directory.)

Use your Directory for 30 days — your money back if not satisfied!

#### TECHNICAL INFORMATION CORPORATION

Dept. E-27-2.  
260 Glen Head Road, Glen Head, L. I., New York

- Please enter our subscription for  12 months  6 months  
 Our check is enclosed  Please send bill  
 Our P.O. #.....  
 Please send sample section

NAME.....TITLE.....

COMPANY.....

ADDRESS.....

CITY.....ZONE.....STATE.....

Mail coupon today to order your Directory; to enter a trial subscription; or to request a free sample section. Or, for your free sample, you can circle number 35 on this publication's Reader Service Card.





**NEW**

# Soniline Magnetostrictive Delay Lines

## 4 TO 20,000 MICROSECONDS

### STANDARD SONILINE MODELS

3C Soniline Model	S-33A	S-33A-1	S-44A	S-66A	S-66B	S-77B	S-88A	S-88B	S-99A	S-99B	S-99C	S-99D
Delay Range (μsec)	4-14	4-14	Max. 1000	Max. 1500	Max. 2000	Max. 2200	Max. 3500	Max. 6500	Max. 4500	Max. 9000	Max. 15,000	Max. 20,000
Case Size L x W x H (Inches)	5 x 1 x 7/16	5 x 1 x 7/16	3 1/4 x 3 1/4 x 7/16	4 1/4 x 4 7/8 x 7/16	4 1/4 x 4 7/8 x 3/4	4 1/2 x 5 1/2 x 3/4	6 x 7 x 3/4	6 x 7 x 3/4	9 1/2 x 10 1/2 x 7/16	9 1/2 x 10 1/2 x 3/4	9 1/2 x 10 1/2 x 1	9 1/2 x 10 1/2 x 1 1/2
Maximum Storage Capacity RZ (Binary Bits)	28	28	1000	1500	2000	2200	3500	5000	4500	9000	10,000	10,000
Bit Rate RZ (Megacycles)	0-2	0-2	0-1	0-1	0-1	0-1	0-1	0-0.8	0-1	0-1	0-0.7	0-0.5
<b>INPUT</b>												
V-in. (Volts)	15	15	15	15	15	15	15	15	15	15	25	25
I-in. (MA)	50	50	50	50	50	50	50	50	50	50	80	80
Z-in. (Ω)	300	300	300	300	300	300	300	300	300	300	300	300
L-in (μH)	15	15	30	30	30	30	30	30	30	30	60	60
Pulse Width (μsec)	0.20	0.20	0.4	0.4	0.4	0.4	0.4	0.4	0.4	0.4	0.8	0.8
Rise & Fall Time (μsec)	0.05	0.05	0.1	0.1	0.1	0.1	0.1	0.1	0.1	0.1	0.2	0.2
<b>OUTPUT</b>												
V-out (MV)	70	20	20	20	10	10	10	10	10	5	5	2
Z-out (Ω)	1500	1500	1500	1500	1500	1500	4000	4000	4000	4000	4000	4000
L-out (μH)	80	80	150	150	150	150	150	150	150	150	300	300
(RZ) Pulse Width (μsec)	0.5 ± 0.05	0.5 ± 0.05	1.0 ± 0.1	1.0 ± 0.1	1.0 ± 0.1	1.0 ± 0.1	1.0 ± 0.15	1.25 ± 0.15	1.0 ± 0.15	1.0 ± 0.2	2.0 ± 0.2	2.0 ± 0.2
Signal to Spurious Noise (Static)	10:1	10:1	10:1	10:1	10:1	10:1	10:1	10:1	10:1	10:1	8:1	6:1
Signal to Spurious Noise (Dynamic)	5:1	5:1	5:1	5:1	5:1	5:1	4:1	4:1	5:1	4:1	4:1	3:1
<b>MECHANICAL</b>												
Volume (Cu. In.)	2.2	2.2	5.5	9.4	15.6	18.6	18.4	31.5	43.5	75	100	150
Weight (lbs.)	0.2	0.2	0.4	0.6	1.0	1.2	1.1	1.25	2.7	3.0	3.1	3.4
Mounts*	TS	TS	TBI	TBI	TBI	TBI	TBI	TBI	EMTI	EMTI	EMTI	EMTI
<b>ENVIRONMENTAL</b>												
Opt. Temp. Range (°C)	0-80	0-80	0-55	0-55	0-55	0-55	0-55	0-55	0-55	+10 to +40	+10 to +40	+10 to +40
Max. Delay Change Due to Temperature (μsec)	±0.04	±.005	±0.1	±0.1	±0.1	±0.1	±0.1	±0.15	±0.1	±0.1	±0.2	±0.3
(Non-operating) Shock	50 g, 11 ms	50 g, 11 ms	50 g, 11 ms	50 g, 11 ms	50 g, 11 ms	50 g, 11 ms	50 g, 11 ms	50 g, 11 ms	50 g, 11 ms	Normal Handling	Normal Handling	Normal Handling
Vibration (Non-operating)	20 g, 5-2000 cps	20 g, 5-2000 cps	20 g, 5-2000 cps	20 g, 5-2000 cps	20 g, 5-2000 cps	20 g, 5-2000 cps	20 g, 5-2000 cps	20 g, 5-2000 cps	20 g, 5-2000 cps	20 g, 5-2000 cps	Normal Handling	Normal Handling

\* TBI — Threaded Blind Inserts

\* TS — Threaded Studs

\* EMTI — Edge Mounted Threaded Inserts

Delivery on standard models in 3 to 4 weeks

### ON REQUEST — LIBRARY OF INFORMATION ON DELAY LINES

**HOW TO USE** — An extensive collection of technical notes describes a variety of typical digital applications for magnetostrictive delay lines including storage, sequential buffering, cross-and auto-correlation, signal compression and expansion, and video signal analysis  **HOW TO SPECIFY** — 20-Page technical booklet discusses specification of magnetostrictive delay lines for digital applications. Details include: capabilities and limitations, principles of operation, modulation techniques, test patterns and effects of temperature  **HOW TO ORDER** — 3C Catalog MDL-1 details complete line of standard Soniline models. Order form included.



**COMPUTER CONTROL COMPANY, INC.**

OLD CONNECTICUT PATH, FRAMINGHAM, MASS. • 2251 BARRY AVENUE, LOS ANGELES 64, CALIF.

# ONLY

In Mincom's CM-100 instrumentation recorder/reproducer, the series elements before data

## THE MINCOM CM-100

storage have been reduced to receiver and mixer, only one step from the antenna. With the

## IS NOW PERFORMING

CM-100's 1.2-megacycle response and linear phase equalization at all speeds, an original

## OPERATIONAL

IF signal thus can be heterodyned so that the carrier swing and its sidebands fall within the

## PREDETECTION RECORDING

Mincom CM-100's frequency range—in FM, FM/FM modulation, PCM and PCM/FM.

...and actually doing it at defense facilities as you read this page.

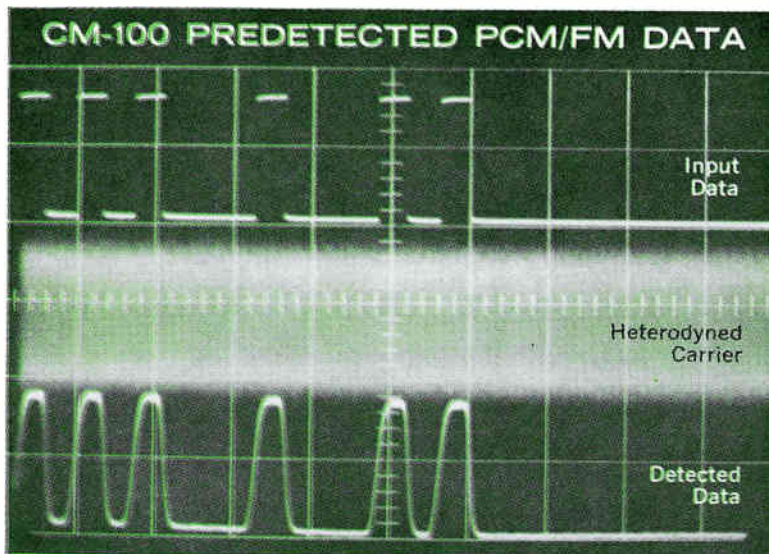

5.0-mc IF carrier heterodyned down to 750 kc. Random-spaced pulses, 20  $\mu$ s on-20  $\mu$ s off-type information. Sweep rate: 50  $\mu$ s/cm.

Write for brochure.



Mincom Division **3M**  
COMPANY

2049 South Barrington Avenue, Los Angeles 25,  
425 13th Street N. W., Washington 4, D. C.



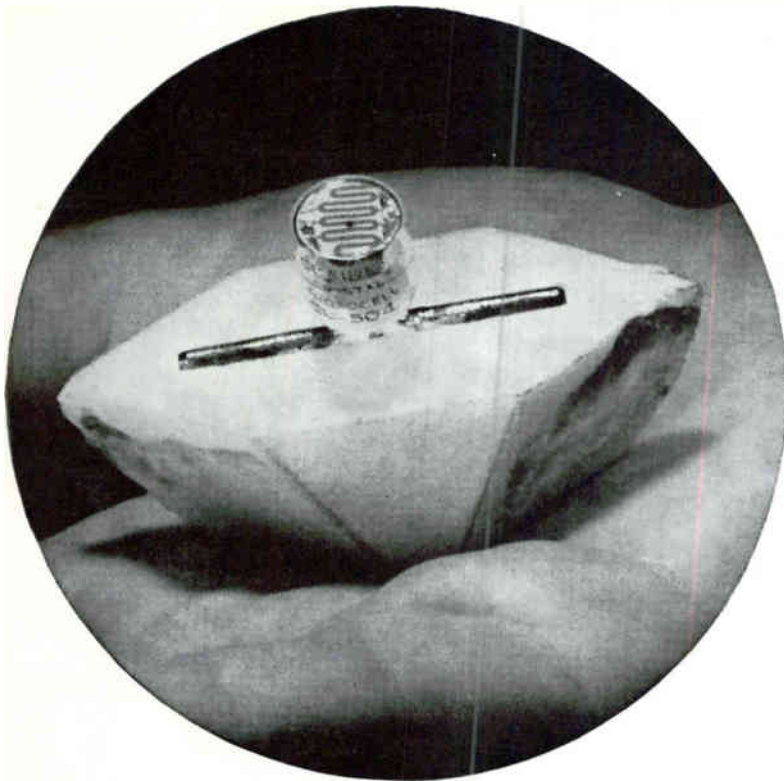

E-FIELDS can be measured with dipole probe loaded with light-modulated photoconductor

*Light-modulated probes with no connections to detection system remove disturbing effects of leads on antenna E and H-field measurements. Current distribution along an antenna can also be measured without restrictions on antenna shape or size*

## HOW TO MEASURE FIELD PATTERNS WITH PHOTONSENSITIVE PROBES

By KEIGO IIZUKA  
Gordon McKay Laboratory  
Harvard University  
Cambridge, Massachusetts

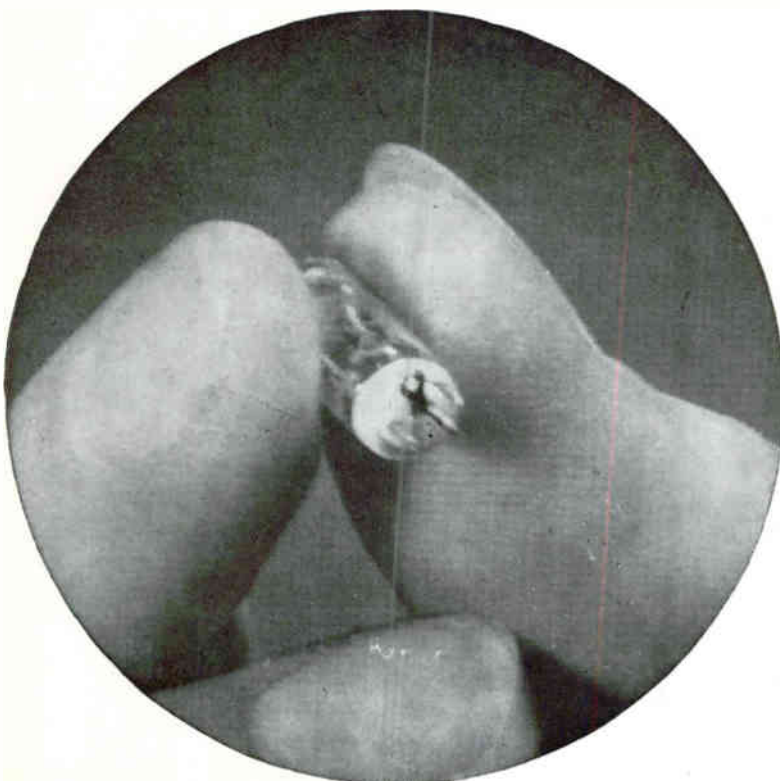

H-FIELDS as well as current distribution along an antenna can be measured by shield-loop probe

**NEAR-FIELD PATTERNS** of half-wave dipoles and current distribution along antennas can be measured without restrictions on antenna size and shape. All mechanical and electrical connections between the probe and the detection system are eliminated along with their disturbing effects on measurements. The concept used in this new measurement technique might also be extended to display instantaneous field patterns on an oscilloscope.

Distribution of an E field (or H field) is determined by measuring

## INSTANT FIELD PATTERNS

Making measurements, particularly those associated with antennas, is often a chore. However, dependable quantitative information is needed at least as much in this as in other areas of electronics. Both the tediousness and the uncertainty in antenna field measurements are reduced by the conceptually simple approach investigated by the author. He even describes a system that might provide instantaneous field pattern displays.

the modulated signal reflected from a small dipole (shielded loop). The dipole is loaded with a photocell that is illuminated by a chopped light beam. Current distribution is measured by sliding along the antenna a small shielded-loop probe that is center-loaded with a photocell. Both the near-field pattern and current distribution measured by these probes have been found to be in general agreement with those theoretically determined.

The size of the probes generally used to measure electromagnetic field intensity can usually be reduced so that their disturbing effects on the field to be measured can be ignored. However, the disturbing effects of lead wires between the probe and the detection system are often difficult to reduce to negligible proportions. These effects are eliminated by the photo-modulated probe, which is particularly important close to the antenna where any small disturbances can affect results.

**OPERATING PRINCIPLE**—To measure an electromagnetic field, a small dipole is placed in the field. The signal reflected from the dipole is proportional to the component of the E field that is parallel to the dipole axis. Hence, the E field at the position of the dipole is indicated by the intensity of the signal reflected by the dipole probe.

In practice, it is often difficult to separate the small dipole-reflected signal from the incident wave, from an unwanted signal reflected from the structure supporting the probe or from any other disturbances. To overcome this difficulty, the scattered signal from the probe is modulated by periodically varying the impedance of the photocell load. The amplitude-modulated reflected wave can then be easily separated

from the unmodulated incident wave or other disturbances.

The entire arrangement used in experiments to measure the field pattern of a dipole (or monopole over an image plane) using the photo probe is shown in Fig. 1. A 600-Mc signal is fed to the hybrid junction. One arm of the junction is connected to the antenna under test and the other arm is connected to an adjustable dummy load. The hybrid junction is balanced in the absence of the probe by adjusting the dummy load so that the detecting system is completely decoupled from the oscillator. The dipole probe loaded by the photocell is then introduced into the field. The scattered signal reflected from the probe is received by the same antenna and is fed through the junction to the detection system.

Input to the detecting system is proportional to the square of the field-intensity distribution function of the antenna under test at the position of the probe. The basis for this relationship is that current induced in the probe by the monopole field is proportional to the field-intensity distribution function (field factor) at the position of the probe, and the reradiated signal resulting from this current and received by the monopole is also proportional to the field distribution function.<sup>1, 2</sup>

**LIGHT MODULATION**—Impedance of the photocell is varied periodically by illuminating it with a chopped light beam. Thus current in the dipole and the scattered signal produced by it are amplitude modulated.

In the test structure in Fig. 2, the wooden frame was built in front of a vertical aluminum image plane. A half-wave, 600-Mc monopole was mounted horizontally on the plane. The horizontal polyfoam

( $\epsilon_r = 1$ ) table in front of the image plane provides support for the probes. Absorbing materials were arranged around the edges of the image plane to reduce reflections.

The thin dipole shown in the first photograph was secured on the boat-shaped piece of polyfoam and was center-loaded with a CL 504 photocell with its sensitive surface upwards. A sharp polystyrene needle was installed at the bottom center of the piece of polyfoam. This assembly is inserted into the polyfoam table, on which elliptic and hyperbolic coordinates are drawn. Height of the assembly is fixed so that the dipole probe is at the same level as the source of the image plane.

Light to the photocell was provided by a 300-watt zirconium arc lamp. The light beam was square-wave modulated by a chopper made from a thin Pyrex glass disk. The chopper disk, half of which was painted with carbon black, was driven by an 1,800-rpm (30-cps) synchronous motor. Light flux was adjusted by an iris and focused uniformly over the entire photocell surface by a lens. The part of the spectrum near the infrared is filtered out by a heat trap placed between the lamp and the lens.

The entire light assembly was housed in an aluminum casing with forced-air ventilation. The casing was suspended from four wheels that roll on two cylindrical rods. The rods, in turn, roll on a horizontal wooden rack. The light assembly is thus movable in a plane so that a constant distance can be maintained between the light source and the probe.

**REFERENCE CELL**—A reference photocell exposed to the same chopped light beam was installed in series with a 47-ohm resistor and a 6-volt battery inside the casing. The potential across this resistor is amplified and fed to the reference terminal of the lock-in amplifier in Fig. 1.

As modulating frequency is increased, the low-frequency noise that is associated with the surface and barriers of the photocell is decreased. However, the ratio of light-to-dark impedance is also decreased because the light is switched on and off more rapidly than photocell conductivity can



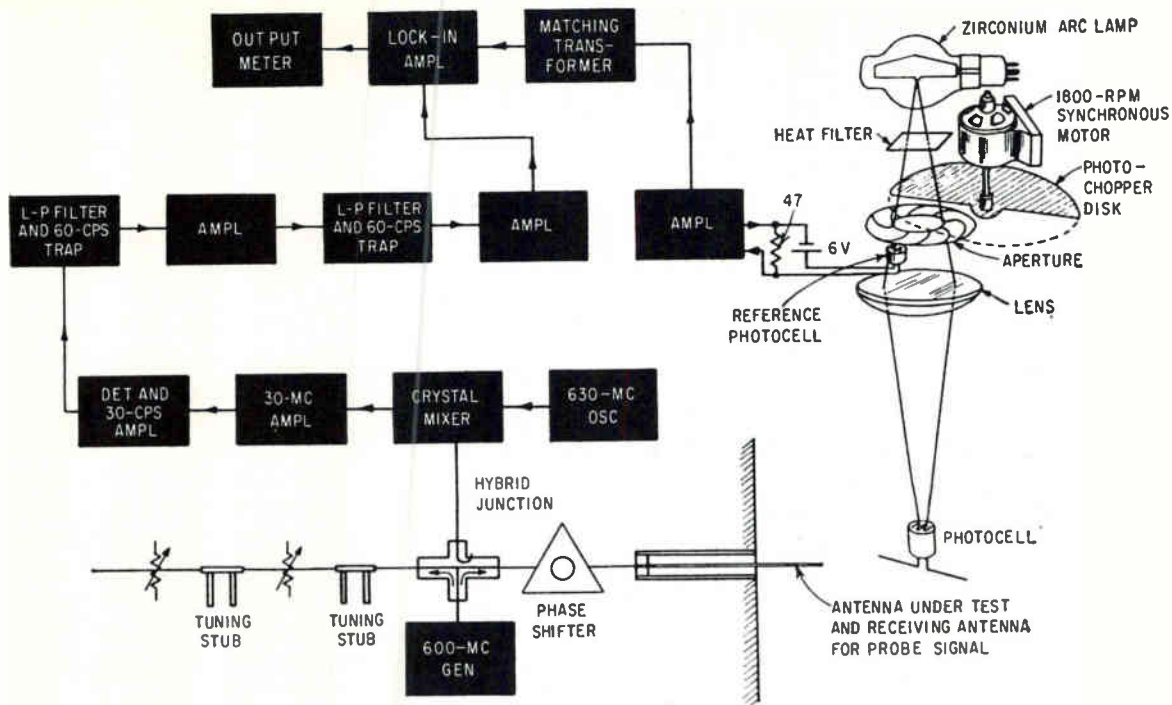

EXPERIMENTAL arrangement was used to measure electromagnetic fields by a light-modulated scattering probe—Fig. 1

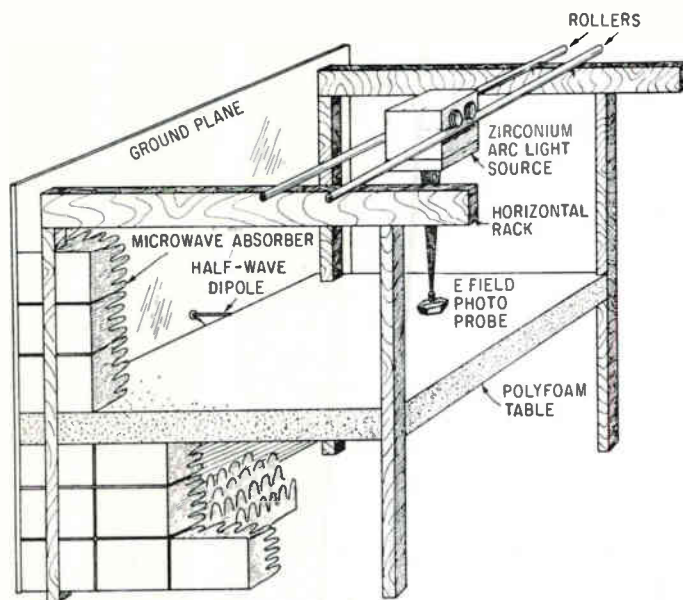

STRUCTURE provided support for the probe and the modulated light source—Fig. 2

DYNAMIC impedance is shown for photocell used at 600 Mc—Fig. 3

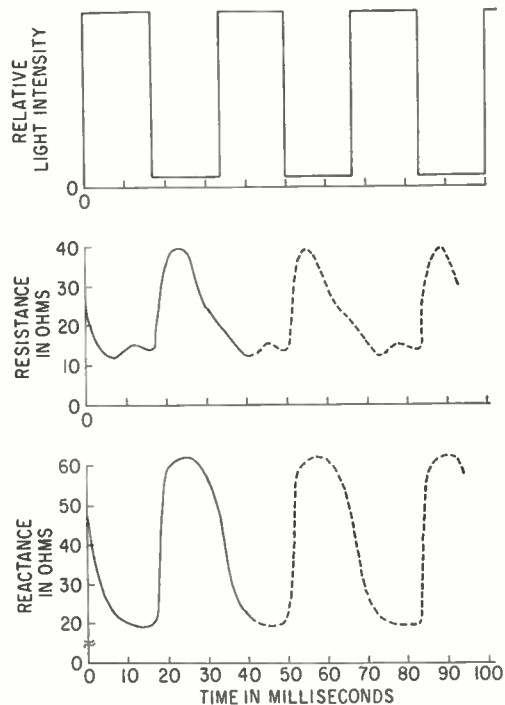

reach its maximum and minimum values. This fact was considered in choosing the 30-cps modulating frequency, as well as the problems of 60-cps pickup, mechanical vibration and stability of the light chopper.

Commercially available cadmium-selenide photocells were used as photoconductive loads for the probes. Clairex Corp. type CL 504 photocells  $\frac{1}{2}$  inch in diameter and  $\frac{1}{2}$

inch high were used for the E-field probe and CL 604 photocells  $\frac{1}{4}$  inch in diameter and  $\frac{1}{2}$  inch high were used for both H-field and current probes.

The dynamic ratio of light-to-dark impedance was measured. Not only is no information available about this ratio at frequencies as high as 600 Mc but rise and decay times depend greatly on light levels,

ranging from seconds to milliseconds. The dynamic ratio should also be measured at the light level of the arc lamp actually used.

Measured dynamic resistance and reactance of the CL 504 photocell at 600 Mc is plotted in Fig. 3. A previously reported technique was used to measure this nonstationary load impedance.<sup>3</sup>

From the measured difference be-

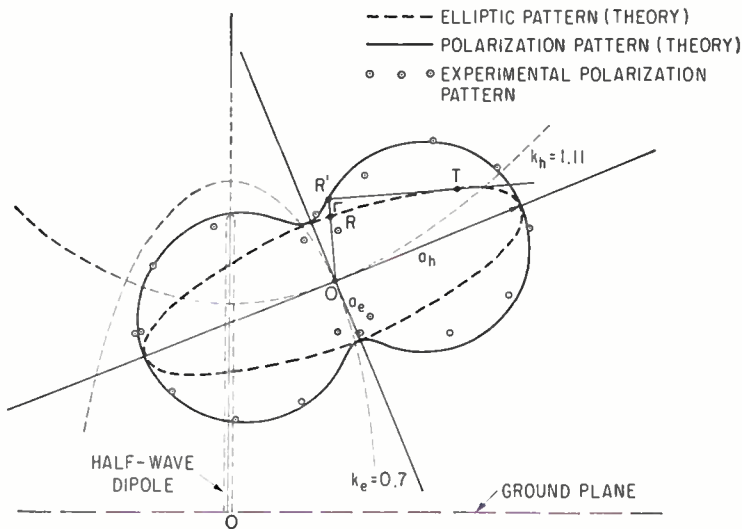
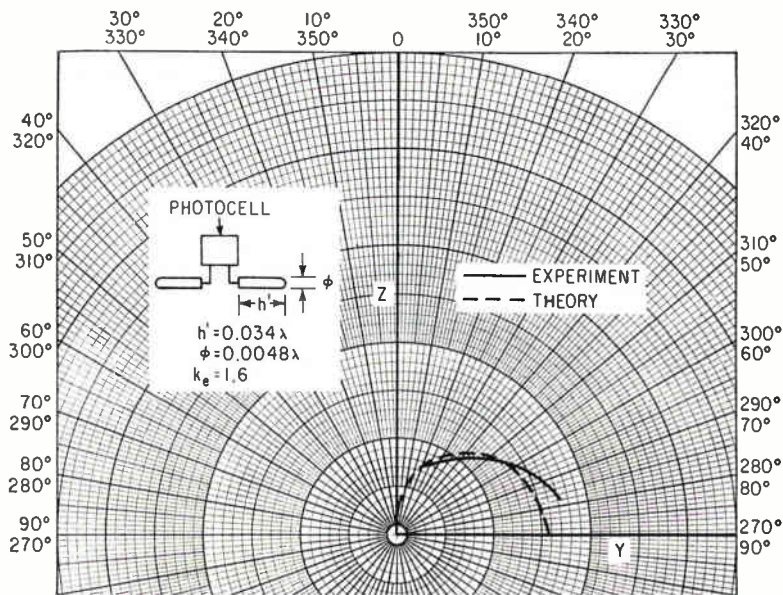

RADIATION pattern in upper graph and polarization pattern beneath it show close agreement with theoretical curves—Fig. 4

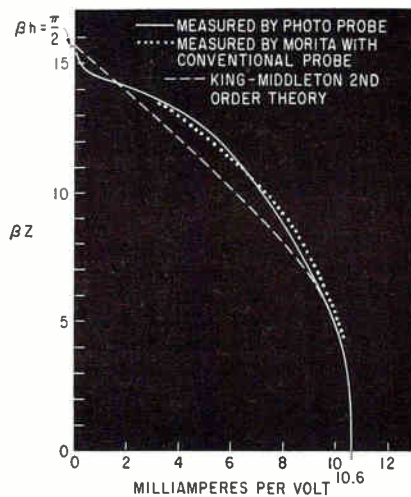
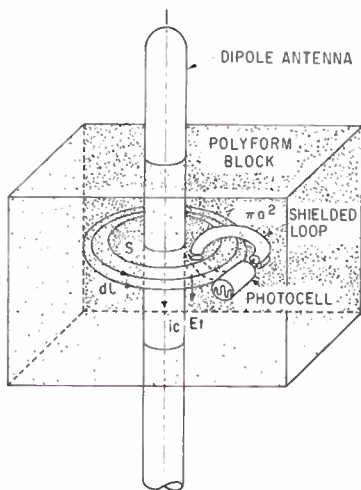

CURRENT distribution along an antenna measured with shielded-loop probe at left agrees with conventionally measured and theoretical curves at right—Fig. 5

tween the light and dark impedances, modulation factor of the scattered signal from the dipole loaded with a photocell can be determined.<sup>1</sup> The modulation factor was 1.2 percent for a probe having a length and diameter, respectively, of 0.034 and 0.004 wavelength at 600 Mc. This small value proved to be sufficient. The modulated signal can easily be separated from noise fluctuations by the lock-in amplifier.

**MEASURING E FIELDS**—Actual measurements using the photo-modulated scattering probe are shown in the radiation pattern in Fig. 4 top along with the theoretical curve. These measurements correspond to one quarter of the familiar doughnut-shaped pattern. The dipole has its center at  $Z = 0$  and its end at  $Z = \pm h$ . The confocal coordinates  $k_r$  and  $k_h$  are the reciprocal eccentricities  $1/e_r$  and  $1/e_h$  of a family of ellipsoids and a family of hyperboloids with foci at  $Z = \pm h$ . The field component  $E_r$ , which is tangential to the ellipsoid, was measured along the circumference  $k_r = 1.6$ .

Another example of the kind of measurements that can be made with this apparatus is shown in Fig. 4 bottom. It is the near-field polarization pattern of a quarter-wave monopole over an image plane drawn in correct proportion at the position of  $k_r = 0.7$ ,  $k_h = 1.11$ . The dipole measures a so-called polarization pattern when it is rotated 360 degrees around the point  $O$  but not the polarization ellipse. When the dipole is placed in the direction  $OR$ , probe response is proportional to the greatest dimension of the ellipse measured normally to  $OR$ , which is  $OR'$ .

Agreement between the measured and theoretical values is good. Measuring field intensity so close to the antenna would be difficult using any other means, since the results would be affected by any small disturbance.

**MEASURING H FIELDS**—The analogy between electric and magnetic dipoles indicates that if a small loop instead of a dipole were loaded with a photocell, it would receive and scatter a signal proportional to the H field that links with

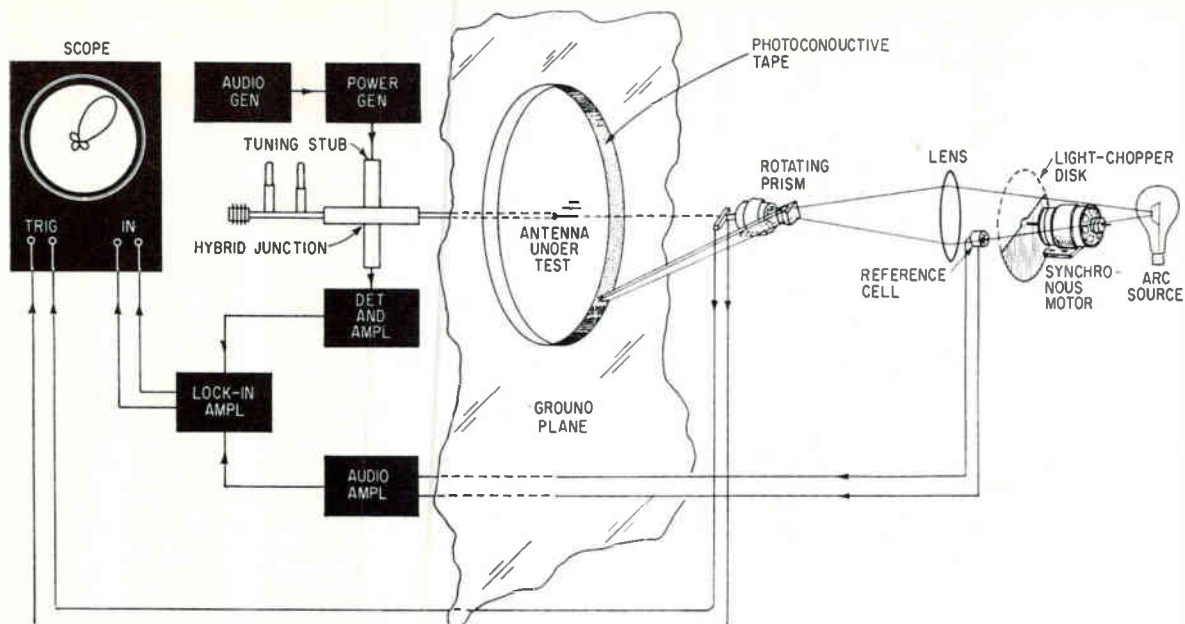

OSCILLOSCOPE field pattern displays may be possible with an arrangement like this—Fig. 6

the loop. Such an H-field probe is shown in the second photograph. The loop is covered by a shield that has a gap at the center to reduce the effect of the E field, which is parallel to the connecting line between the gap and the center of the loop.<sup>1</sup>

The shielded-loop photo probe was made of a special thin copper coaxial cable 22 mils in diameter and a CL 604 photocell. Outer diameter of the loop is 67 mils or 0.0014 wavelength at 600 Mc. The probe was constructed under a microscope and may be the smallest probe for measuring the H field in existence.

#### CURRENT DISTRIBUTION —

This versatile technique permits current distribution along an antenna to be measured, since the magnetic flux that encircles the antenna is nearly proportional to antenna current. Hence current distribution along the antenna can be measured by sliding the probe along the antenna at a constant small distance from it.

The current probe was mounted in a straight hole in a polyfoam block of relatively high density. It was mounted so that the gap in the shield faced the hole (antenna), as shown in Fig. 5 left. Current distribution is measured by sliding the probe and polyfoam casing along the antenna. The distance between the probe and the antenna was

0.003 wavelength.

Current distribution along a half-wave dipole measured using this probe is shown in Fig. 5 right. For comparison, results obtained by T. Morita using a conventional shielded-loop probe moved along a slot in the antenna and a theoretical curve by R. W. P. King are included. The three curves are in good agreement except near the tip, which has been discussed in a previous report.<sup>1</sup>

During these experiments with photomodulated scattering probes, it was observed that probe sensitivity was unchanged or increased when the photoconductive cell was replaced with a photovoltaic cell. This observation may be explained by the fact that the change in internal resistance of the photovoltaic cell is about as large as that in a photoconductive cell.

#### PATTERN DISPLAYS—

In work associated with this project, it was found that a strip of cadmium selenide evaporated on a thin piece of ceramic material behaves like a small strip dipole antenna. The surface of this device could also be used as a probe, but its sensitivity is somewhat lower than a dipole loaded with a photocell. This principle might be used to display an instantaneous field pattern on an oscilloscope using an arrangement like that shown in Fig. 6. A photoconductive tape with the sensitive

side facing in is placed around the circumference of a circle centered at the antenna under test. A revolving prism positioned at the center of the antenna away from the ground plane rotates a light beam shaped like a narrow strip.

As the light beam rotates around the conductive tape, the source antenna receives a scattered signal that is proportional to the square of field intensity distribution on the circumference. If the received scattered signal is amplified and fed to an oscilloscope that is swept at prism rotation speed, the radiation pattern can be displayed on the oscilloscope.

Since this technique does not require rotation of either the transmitter or antenna being investigated, it is particularly useful for measuring the field patterns of electronically scanned antenna arrays.

This research was supported by the Office of Naval Research. The author acknowledges the support of R. W. P. King and his suggestions about the manuscript and the assistance of D. MacMillan in constructing the experimental apparatus.

#### REFERENCES

- (1) K. Iizuka, A Photoconductive Probe for Measuring Electromagnetic Fields, *Cruft Laboratory Tech Report 374*, Harvard University, July 25, 1962.
- (2) K. Iizuka, A New Technique for Measuring an Electromagnetic Field by Coil Spring, *Cruft Laboratory Tech 365*, Harvard University, June 1962.
- (3) K. Iizuka, A Method of Measuring the Time-Dependent Impedance of the Load, *Microwave Journal*, November, 1962.



# Why A RING COUNTER—Why

*Although a binary counter usually has fewer components not always the best circuit for the job. This article*

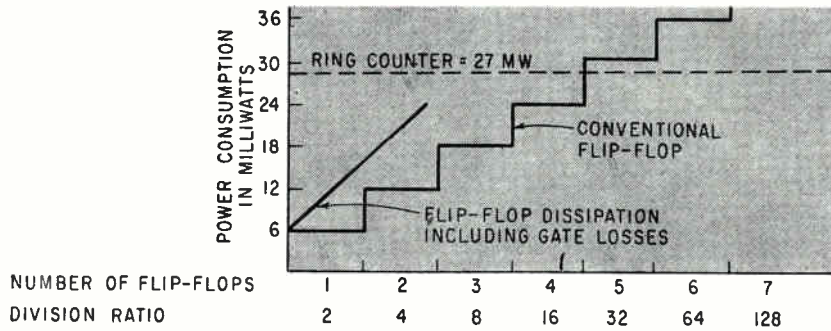

RING COUNTER power consumption is almost constant regardless of number of stages, binary counter absorbs increased power for every added flip-flop—Fig. 1

**ADVANTAGE** of the ring counter over the conventional flip-flop counter is that, regardless of the number of stages in the ring, only one stage is on and consuming power at any time. But binary counters always have one transistor conducting in every stage regardless of count.

Figure 1 shows the relative power consumptions and break-even point for binary and ring-counter circuits. Basic assumptions are 10 milliwatts consumption for the ring counter conducting stage plus 17 milliwatts for its clock circuit, while each flip-flop in the binary counter is assumed to take 6 milliwatts.

Two factors are not accounted for in Fig. 1. First, the ring counter stages do consume some power when off, generally 1 to 10 percent of these values. Second, the gating losses in conventional flip-flop combinations are not negligible. A third factor relating to readout is that if all digital combinations are to be gated out, diodes and resistors required for gating can make the component count of a binary counter much greater than a ring counter.

Another advantage to the ring counter is that when large power outputs are required, one transistor in each stage can be a high-dissipation unit while the other need be capable only of supplying base current to the output transistor.

**COUNTING ERRORS**—Since the ring counter transfers its count consecutively from stage-to-stage, noise-generated miscounts affect the least significant digit; however, if noise triggers a conventional shift register the whole count can be lost.

The ring counter flip-flop consists of an npn-pnp pair of transistors, with one transistor the output stage and the other transistor its base-

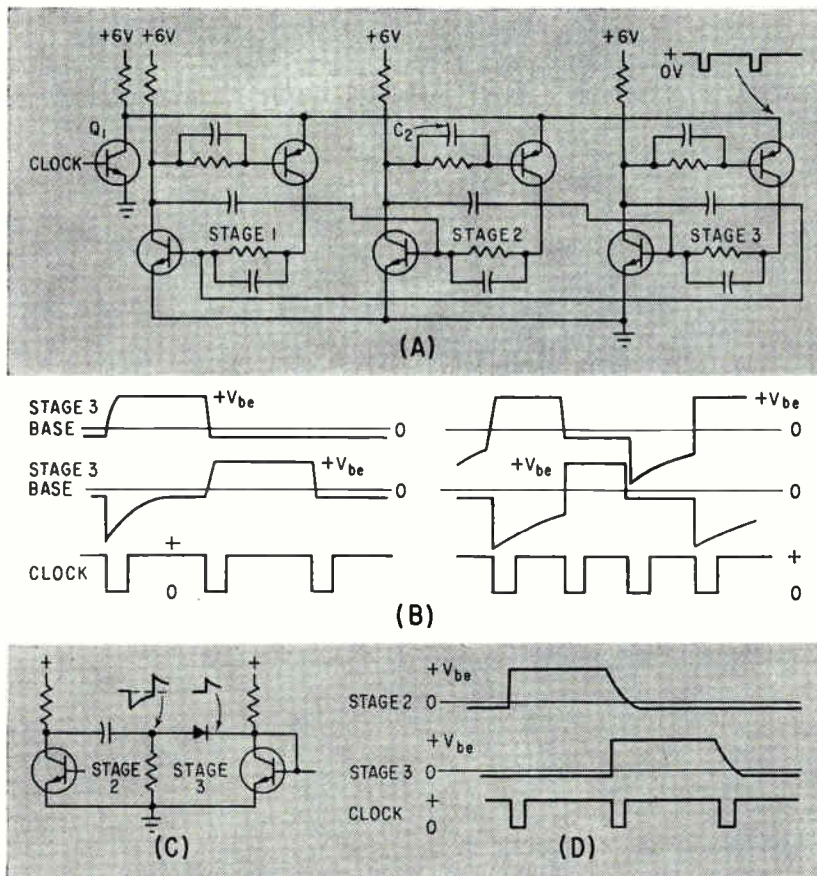

COUNT is advanced in simple ring-counter by grounding pnp transistor emitters (A), critical pulsing occurs during turn-on (B), series diode improves interstage coupling (C), slows base-turnoff characteristics (D)—Fig. 2

# Not A BINARY?

By JOHN DURIO, Systems Development Department,  
Collins Radio Company, Newport Beach, Calif.

*for a given count, it is  
gives some reasons why*

current supply switch. Figure 2A shows such a circuit. There are actually two sources of base current for the *npn* output transistor. One base supply is a steady-state source; the other is a transient source. To explain this transient source, first assume that stage 2 in Fig. 2A is on, where it will remain indefinitely unless a clock pulse is introduced.

One method for turning a stage on is simply to momentarily ground the collector of the output stage, thereby grounding the *pnp* base resistor as well. This places the *pnp* base at a negative potential relative to its emitter, turning the *pnp* transistor on. A base current supply is now provided for the *npn* transistor, so that it turns on too. When the ground is removed, the *npn* collector remains near ground, with the stage left in the on state.

When a clock pulse occurs, the collector of the clock transistor goes to ground. This grounds emitters of all *pnp* transistors and turns off the conducting *pnp* transistor of stage 2. Stage 2 is then turned off. Now the *npn* collector goes from ground to +6 v and provides a forward bias path from the +6 v supply, through the collector resistor and through  $C_2$  to the base of the stage 3 *npn* transistor. The stage 3 *npn* transistor goes on and the clock is removed before the R-C discharge is dissipated. With the removal of the clock pulse the emitters of all the *pnp* transistors now have a positive voltage appearing on them. Since the stage 3 *npn* collector is at ground because of the R-C discharge, the stage 3 *pnp* transistor turns on and supplies the steady-state forward bias for the *npn* transistor, thereby holding stage 3 on.

**PROBLEMS**—Transfer of a count

## CONSERVING THE POWER

If power supply is limited, as in a space satellite, then economizing on power consumption is a major design problem. The ring counter serves well here, since only one stage conducts for any count. Although binary circuits are fashionable, ring counters should be scrutinized for other advantages too—they provide decimal readout with the utmost simplicity, can deliver high power outputs without auxiliary transistors, and don't suffer from serious counting errors when noise spikes add a few false triggers

is caused by turning off a preceding stage. However, one high-frequency-limiting factor is created by turning on a stage. The turn-on waveform is transferred to the following *npn* base as a large negative spike which may even exceed the  $BV_{EBO}$  of the transistor. The timing of the negative spike is exactly wrong, Fig. 2B, because as the spacing of the clock pulses decreases, this negative charge actually opposes the turn-on positive transient that is due to occur with the next clock pulse.

A simple method for overcoming this problem is to place a diode in series with the capacitor as shown in Fig. 2C. This diode blocks the transfer of the negative spike across the capacitor and onto the base of the next stage's *npn* transistor.

At still higher frequencies another problem occurs as seen by the base circuit waveshapes shown in Fig. 2D. Even with speed-up capacitors the trailing edge of the base waveshapes show that as frequency is increased the base of the transis-

tors will still be significantly positive just when the negative turn-on pulse arrives. This leads to erratic triggering and double pulsing.

To eliminate this problem another diode R-C network is introduced, which uses the large negative spike that was previously inhibited from the base of the following transistor. The new R-C network routes the negative spike to the base of the preceding stage to speed up its negative excursion.

Now a clean base waveshape with a definite negative spike is observed in Fig. 3A. This negative spike can be controlled by adjusting the value of the capacitor so that the  $BV_{EBO}$  is not exceeded. This adjustment is not possible with the simple capacitor coupling of Fig. 2A.

**CLOCKING**—Another problem is the many turn-on and turn-off actions that happen sequentially. In transferring a count it is necessary to ground the clock lines, thus the delay and rise of clock transistor potential is first in the sequence of switching actions. This is followed by the on stage *pnp* transistor storage and fall times and later by the storage and fall time of the complementary *npn* transistor. All of these actions are followed by the turn-on sequence of the succeeding stage, where the *npn* delay and rise times are followed by *pnp* delay and rise times. Thus 10 transients are involved, the first few of which are in series while the last vary with transistor, capacitor and resistor tolerances and temperatures.

However, it is necessary to insure that the R-C time constant provides enough base current to keep the turning-on *npn* transistor in conduction long enough for its associated *pnp* transistor to turn on sufficiently to provide steady-state current. Thus the clock period must be long enough for the turning-on *pnp* transistor to conduct in worst-case conditions and short enough to prevent the *npn* transistor's tran-



sient phase current dropping to an insufficient value.

Another method of clocking that eliminates some of the numerous small transients is shown in Fig. 3B. Here the clock goes to the *npn* transistor's base through a diode and first turns off the *npn* transistor then the *pnp* transistor. Thus, the *pnp* storage and fall times are eliminated from the sequence of events, and the *pnp* turn-off parallels some of the other small transients.

This method of clocking allows for operation at frequencies where the *pnp* actually fails to function. At such frequencies the R-C turn-on current lasts for the entire clock period and the *pnp* is not needed. This region of operation can be marginal since external loading dictates how much base current is required. Breadboard operation has been achieved in the 2.5 to 5.0-Mc range using this technique. A frequency increase of one order of magnitude should be simple to accomplish.

All this implies that for operation at various frequencies, the driver is a one shot followed by an inverter, or inverters, the last stage of which is a clock transistor.

**DOUBLE COUNTING**—A further problem is that of double counting. This is, unfortunately, a natural phenomenon in ring counters.

When specifications call for a wide temperature range, large de-rating factors and large fan out, double counts are inevitable. If for example, it is necessary to derate a typical transistor beta from 50 to 10 because of worst-case low-temperature considerations, and yet accommodate a nontypical high-temperature beta of 200, even though the clock resistor limits the amount of available drive, this same resistor must provide enough drive for the  $\beta = 10$  case. Thus at high temperatures numerous transistors can conduct if they are prone to do so because of noise, sloppy turn-off and so on. Also a large fan out multiplies the problem. One way of

eliminating the fan-out problem is to permanently load each stage with one inverter only. This in addition to a temperature sensitive resistor in the place of the normal clock resistor, can almost completely eliminate the problem of double pulses.

Another method that can be used is that of the common *npn* line resistor shown in Fig. 3C.

The resistor can be returned to a negative source to prevent the collector going too far positive. This resistor provides degenerative feedback during normal operating, and if more than one stage attempts to go on, positive voltage increase at the emitters tends to turn all stages off. The stage that is receiving the R-C transient will come back on when the other interfering stages have been turned off. This method is extremely effective and can be improved if the negative source is a forward biased diode or diodes. The diode drops decrease with increase in temperature and this causes the *npn* emitters to become more positive, thus counteracting the increased beta.

Another improvement is to replace the feedback resistor with a device that increases its resistance with temperature. This also makes the feedback greater at high temperatures. A saturated transistor could be used in place of the feedback resistor since the collector-to-emitter drop increases with temperature.

A current-limiting device can eliminate double pulsing if the feedback resistor is replaced by a limiter of the proper current capability.

For example, if the collector resistor draws one milliamper and the stage can drive up to two loads of 0.5 milliamper each, the current limiter should have a 2.0-ma rating. Each ring-counter flip-flop should be loaded fully either by actual or dummy loads. With this configuration, the circuit is no longer beta sensitive because now only one stage will come on at a time, there being no collector current available for an additional stage. Also if the fan out is not too great, and if the collector load resistor is made much lower than the external loads, the necessity of fully loading each stage can be eliminated.

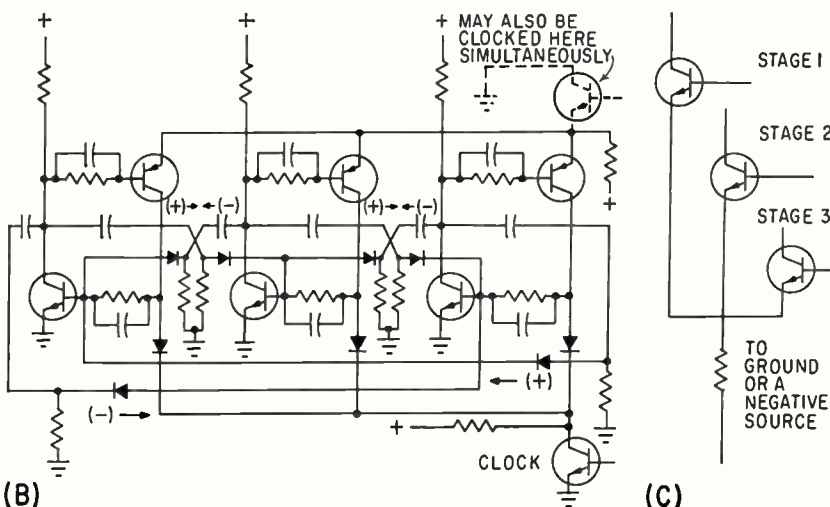
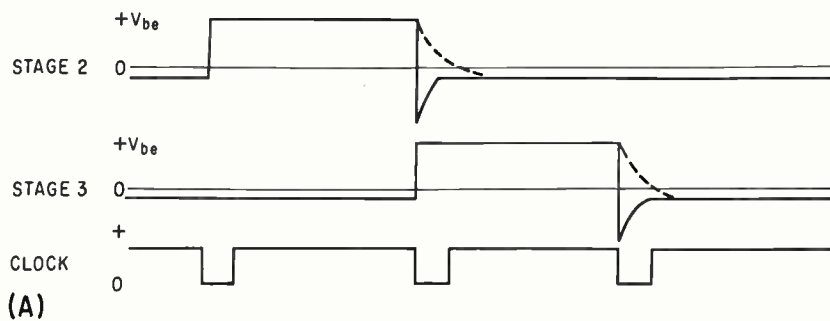

ADDING A DIODE R-C circuit sharpens negative trigger (A), Negative spikes are deliberately fed back in this base-triggered circuit (B), common feedback resistor in *pnp* emitters prevents double counting (C)—Fig. 3



---

## PULSE RATE FOR PULSE RATES

Medical researchers can't be bothered fooling with complicated electronic gear. Thus, this equipment was designed to overcome some of the limitations of biomedical telemetry systems using phase or amplitude modulation. Key to the simplicity and reliability of the system is the pulse-rate modulator. The design can be applied to many other measurement problems

---

# Designing a Simple Telemeter for Medical Research

*Pulse-rate modulation technique cuts complexity, provides stable, compact single-channel medical research system*

By A. G. POTTER and J. D. McMECHAN

Department of Electrical Engineering, Iowa State University, Ames, Iowa

SINGLE-CHANNEL telemetry systems for biomedical measurements should be simple, stable and have low power drain. To meet these requirements, a system using pulse-rate modulation (prm) was designed. Pulse-rate modulation turns the r-f carrier on in ac-

cordance with a pulse train whose pulse rate contains the base-band information. The system consists of a relaxation oscillator, or an astable multivibrator that samples the amplitude of the modulating signal. Its output is a pulse train whose frequency is linearly

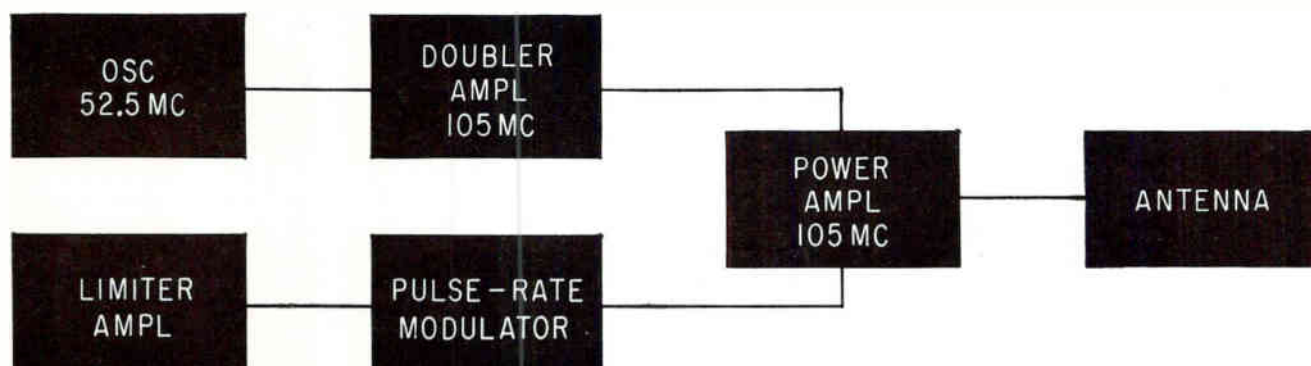

TELEMETRY transmitter has a power output of 80 milliwatts into a 50-ohm dipole antenna—Fig. 1

related to the amplitude of the modulating signal.

Although prm does not lend itself to multiplexing, either pulse-position or pulse-duration modulation could have been used if multichannel operation had been desired. However, equipment size, complexity and power consumption would have been increased.

Although the apparent increase in d-c to r-f efficiency derived from using prm is lost in generation of sidebands, this modulation technique was chosen because (1) the transmitter unit is reliable and simple, (2) the modulation information is not contained in the frequency of the r-f carrier, (3) the r-f signals can be demodulated by either an f-m or an a-m detector, and (4) there is considerable improvement in noise figure over a pulse-amplitude modulated system.

The transmitter, Fig. 1, was designed as a belt-mounted unit with a companion eeg amplifier for human telemetry. This was done to facilitate system testing and modification. The crystal-controlled oscillator operates at 52.5 Mc and drives a doubler amplifier with a gain of 3 to 6 db. Input to the doubler is an adjustable L-matching network, whereas the output circuit uses a conventional pi matching network. The final power amplifier consists of a pair of transistors connected in parallel running grounded base, class C, and matched through a pi network to a 50-ohm antenna load.

When running under steady r-f carrier conditions, the transmitter delivers 80 mw into a 50-ohm load. Under these conditions it draws 47 ma at a supply voltage of 9 volts. When using the pulse-rate modulator with a duty cycle of 2.5 percent, the unit draws 8 ma at 9 volts.

Under these conditions the doubler and final r-f amplifiers, which use 40 ma when operating continuously, draw an average current of 1 ma with the remaining circuits taking 7 ma. It is possible to decrease the average d-c drain to r-f peak power output

ratio by reducing the current drain of the nonpulsed circuits.

**RATE MODULATOR**—The unijunction relaxation oscillator and limiter amplifier circuit, Fig. 2, generate output pulses  $e_o(t)$  that turn on the doubler and final r-f amplifier for a fixed period of time at a rate dependent upon  $e_i(t)$ .

In designing the modulator circuit let average pulse repetition rate  $f_o = 2500$  cps, pulse duration  $d = 10 \mu\text{sec}$ , and maximum frequency deviation  $\Delta f_{\text{max}} = 250$  cps. Modulating voltage ( $e_i$ ) and the pulse-rate ( $f$ ) are related by

$$V_1 + V_{E_{\text{min}}} + V_D = e_i + V_1 + V_{E_{\text{min}}} - e_i \epsilon^{-t_4/t} \quad (1)$$

where  $V_1 = -7$  v,  $V_{E_{\text{min}}} = 2$  v,  $V_D = 0.6$  v, and  $t_4 = 1/R_4 C_4$ . Rearranging and substituting the given numerical values into Eq. 1

$$f = \frac{f_4}{\ln(5 + e_i) - \ln(1.4 + e_i)} \text{ cps} \quad (2)$$

A plot of Eq. 2 in  $\lambda$  and  $e_i$ , where  $\lambda = R_4 C_4 f$ , is shown in Fig. 3A. The best linear approximation to this curve is a straight line having the equation

$$\lambda = 1.7 e_i + 7.87 \text{ volts}; e_i \leq 0 \text{ or} \quad (3)$$

$$f = \frac{1.7}{R_4 C_4} e_i + \frac{7.87}{R_4 C_4} \text{ cps}; e_i \leq 0 \quad (4)$$

Let  $e_i = e_m + V_n$ , where  $V_n$  is the d-c component of  $e_i(t)$ , then calculate  $V_n$  and  $R_4 C_4$  to fit the conditions: (a)  $e_i = 0$ ,  $f = f_n = f_o + \Delta f_{\text{max}}$ ; (b)  $e_i = V_n$ ,  $f = f_o$ ; and (c)  $e_i = 2V_n$ ,  $f = f_i = f_o - \Delta f_{\text{max}}$ .

These conditions are imposed because the limiter must operate with one of its voltage limits equal to zero volts. The other condition equation needed to solve for  $R_4 C_4$  and  $V_n$  is

$$\Delta f_{\text{max}} = \frac{-1.7 V_n}{R_4 C_4} \text{ cps} \quad (5)$$

Solutions of Eq. 4 and 5 give  $V_n = -0.425$  v and  $R_4 C_4 = 2,860 \mu\text{sec}$ . The limiter amplifier is then designed

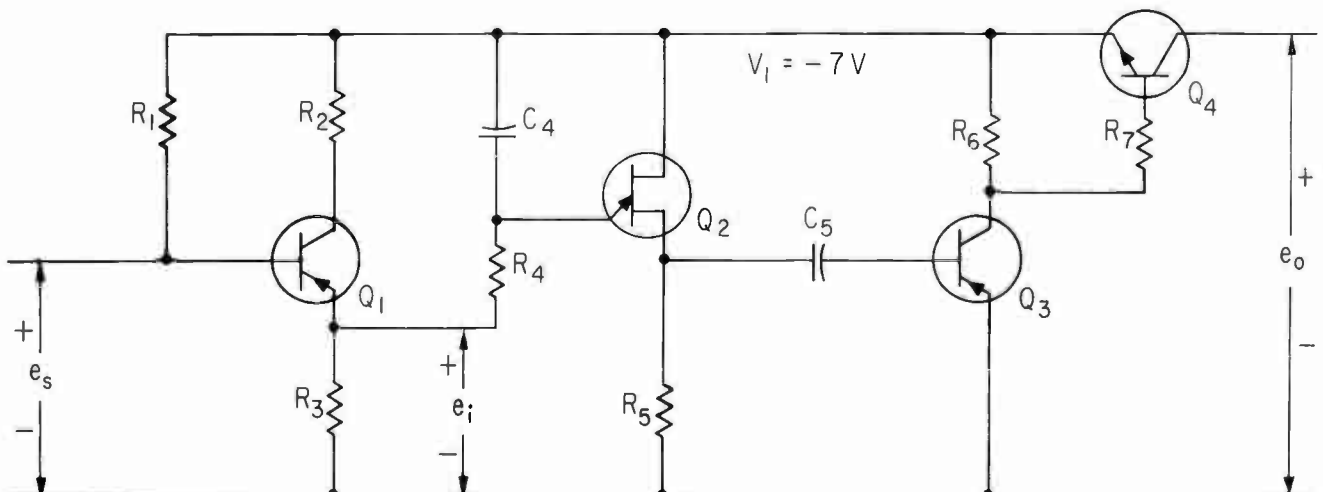

UNIUNCTION transistor relaxation oscillator and limiter amplifier comprise the rate modulator—Fig. 2

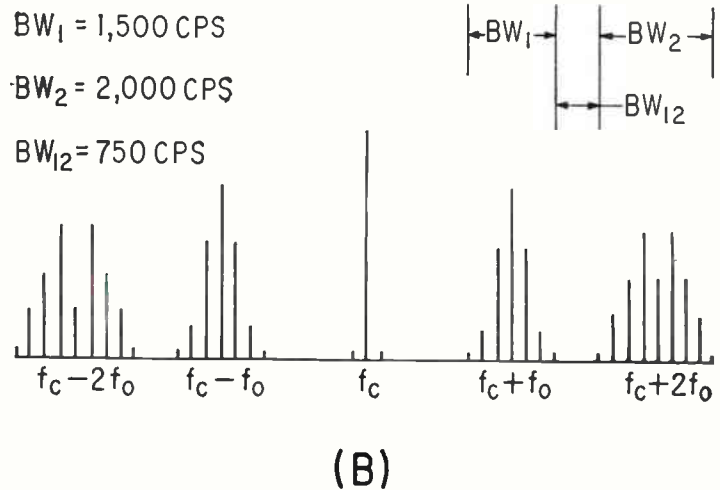
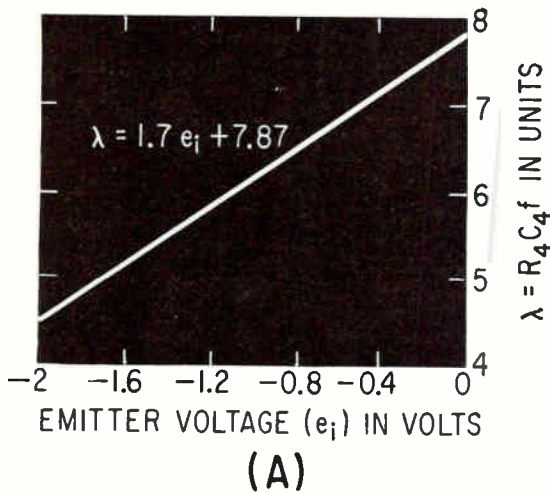

TRANSFER CURVE for pulse-rate modulator shows a linear relation between pulse rate and modulating voltage (A). Spectrum of modulator output with two sideband groups (B)—Fig. 3

so that limiting occurs at  $e_i = 0$ , and  $e_i \leq -0.85$  v. If an overall sensitivity of 500 cycles per volt is desired, the gain of the limiter amplifier must be 0.84.

For good temperature stability of the unijunction relaxation oscillator the value of  $R_s$  is

$$R_s \cong \frac{0.7R_{BB}}{\eta V} \cong 1,200 \text{ ohms} \quad (6)$$

where  $\eta$  is the standoff ratio (0.5) and  $R_{BB}$  is the interbase resistance (6,000 ohms). The value of  $C_4$  may be approximated by

$$C_4 \cong \frac{d - 4V_{E_{min}}}{10V_{E_{min}}} \cong 0.1 \mu\text{f.} \quad (7)$$

where  $d$  is pulse duration in microseconds and  $V_{E_{min}}$  minimum emitter voltage in volts. Using the product  $R_s C_4 = 2,860 \mu\text{sec}$  and the results of Eq. 7,  $R_s = 28,600$  ohms. The oscillator has a linearity of better than  $\pm 1$  percent, a temperature coefficient of frequency of less than 0.01 percent per degree C, and a frequency variation with supply voltage no greater than 0.4 percent per volt.

**TRANSMITTING ANTENNA**—Belt-mounted, the antenna is a shunt feed dipole 0.65 meter long. The antenna is matched to a 50-ohm line by tapping through a 5 to 30-pf. capacitor to a point 10 cm from the center of the dipole. The antenna pattern is omnidirectional to within 3 db, when measured with a horizontal dipole 2 meters above the ground plane at a distance of 100 meters. During this measurement the dipole was worn by a person having a radius

of 15 cm and was positioned approximately 1.2 meters above the ground plane.

**SIGNAL DETECTION**—A line spectrum diagram of the modulator output signal, Fig. 3B, shows the first two sideband groups for  $\Delta f_{max} = 250$  cps and  $f_{mmax} = 250$  cps. The condition is the worst with regard to bandwidth, that is, the largest bandwidth is required for each sideband group.

Two methods were considered for receiving and demodulating this signal. First, a wide-band a-m receiver with circuits to restore the original pulse shape was proposed. The receiver would frequency demodulate the prm signal and filter out all frequencies above 250 cps. The second proposal was to use a relatively narrow-band a-m receiver to receive most of the r-f power in the signal, then after i-f amplification to use a narrow-band filter to retain only the carrier and the  $n = 1$  sidebands. The receiver would frequency demodulate the prm signal and filter out all frequencies above 250 cps.

The second method was used. The receiver system is made up of three sections: a converter, tunable i-f receiver and frequency demodulator. The converter i-f is 26 to 30 Mc with a flat response over 104-108 Mc. The frequency demodulator consists of a transformer, clipper, Schmitt trigger and one-shot multivibrator followed by a 250-cps low-pass filter.

The receiving antenna now being used for outside monitoring is a stationary, 12-element, colinear type possessing about 6 to 8 db gain with broad beam width and wide frequency range.

## REFERENCES

- (1) D. W. Douglas, H. R. Seal, Internal Animal Telemetry System, Electronic Considerations, Aerospace Medical Association Meeting, Chicago, Ill., April 24-27, 1961.
- (2) W. N. Cooper, M. S. Beaupre, Internalized Animal Tele-

metry System Engineering Considerations, Aerospace Medical Association Meeting, Chicago, Ill., April 24-27, 1961.

- (3) M. Schwartz, "Information Transmission Modulation and Noise", McGraw-Hill Book Company, Inc., New York, N. Y., 1959.

- (4) G. M. Russell, "Modulation and Coding in Information Systems", Prentice Hall, Englewood Cliffs, N. J., 1962.



# WHICH PERMANENT SHOULD YOU USE?

*There are 18 different methods to choose from and a whole host of ways in which these methods can be applied. This table guides the user to an optimum choice of jointing technique*

**FOR PERMANENT CONNECTIONS** alone, not counting disconnectable types, there are 18 different mechanical, chemical and thermal methods of joining conductors. In the table, a rating value from zero to 10 is assigned to each connector type for every performance category. A rating of 10 means that the connection method (top of table) is suitable in the category considered. Lower assigned values are considered less suitable, but values as low as 5 are sometimes acceptable. A zero value implies that the connection method is a poor choice, while a dash means it is not applicable.

PERFORMANCE AND COMPATIBILITY		THERMAL				CHEMICAL		
		Solder	Braze	Gas or Arc	Spot	Plating	Conductive Adhesive	Amalgam
ELECTRICAL PROPERTIES	Low Resistance	9	10	10	10	8	3	8
	Resistance							
	Stability	10	10	10	10	8	7	9
	Low Voltage	9	10	10	10	8	5	8
MECHANICAL PROPERTIES	High Currents	8	10	10	9	1	1	3
	Pull-off Force	9	10	10	10	1	1	
	Low Creep	9	10	10	10	5	5	
APPLICABILITY TO THESE CONDUCTORS	Strength	9	10	10	7	3	4	4
	Solid Wire	10	10	10	10	10	10	
	Stranded Wire	9	9	8	0	10	9	
	Insulated Wire	6	2	2	8	9	9	9
	Aluminum Wire	5	2	1	0	2	2	0
	Tinsel Wire	5	0	1	1	5	5	5
JOINING WIRE TO:	Bus Bars and Structures	8	8	8	9	6	6	
	Wire	10	10	9	8	—	8	
	Component	10	8	5	9	4	5	
WIRE INSULATED CONNECTIONS	Separable Connector	9	8	1	8	8	5	
	Pre-Insulation	0	0	0	1	1	8	9
RESISTANCE TO ENVIRONMENTS	Post-Insulation	8	8	8	8	8	8	10
	Hi-Temp	5	9	10	10	6	1	7
	Low-Temp	9	10	10	10	9	5	8
	Thermal Shock	8	9	10	10	7	7	7
	Vibration	6	7	10	9	2	1	7
	Salty and Humid Air	9	10	10	10	5	5	8
	Aging	9	10	10	10	8	5	8
	Hermetic	10	10	10	1	9	9	10
	Nuclear Radiation	9	10	10	10	9	1	5
	COST ECONOMY	Tooling	7	4	3	4	5	9
Connector		9	8	8	9	5	8	5
Process		6	5	5	5	4	8	8
ACCESSIBILITY IN ASSEMBLY	Method Needs							
	Little Space	8	5	4	8	5	8	8
	Ease of Repair	8	6	5	9	7	9	7

EIGHTEEN headings list a wide range of connection methods, left-hand column

# ELECTRICAL CONNECTION

By JAMES H. WHITLEY, AMP Inc., Harrisburg, Pennsylvania

MECHANICAL										
	Wire- Wrap	Metal Powder	Cold Weld	Ultra- sonic Weld	Rivets	Eyelets	Screws Wire	Terminal	Twisted Wires	Wire Nuts
9	9	10	10	10	9	8	9	9	9	9
9	9	10	10	10	9	5	7	9	5	8
9	9	10	10	10	10	5	8	9	5	8
9	8	9	10	10	9	5	9	9	8	9
9	8	9	10	9	9	7	3	10	2	8
9	7	9	10	10	9	8	3	8	2	8
9	7	9	10	9	10	9	5	9	1	8
0	10	9	10	10	5	5	10	—	9	10
0	0	9	1	1	2	5	2	—	9	10
0	9	9	9	9	9	9	9	—	9	9
8	1	5	8	8	4	1	4	—	1	6
8	0	5	0	5	6	6	4	—	0	0
7	—	—	8	8	10	10	—	10	—	—
8	—	9	9	7	3	3	4	—	10	10
8	8	7	7	7	8	8	10	10	10	10
6	9	7	3	3	6	8	10	10	—	—
0	0	7	4	5	1	5	10	10	0	10
0	7	10	7	8	8	8	8	7	9	10
0	8	9	9	9	4	3	7	8	5	7
0	8	9	9	9	5	5	8	8	7	7
3	7	8	9	9	4	3	2	8	2	8
0	3	8	9	9	5	5	2	9	1	7
0	6	9	10	10	8	7	7	9	4	8
0	8	9	10	10	8	7	7	8	7	8
0	1	9	10	10	8	1	1	—	1	1
0	9	9	10	10	9	9	9	9	9	9
0	7	2	4	1	7	8	9	10	10	10
0	9	7	8	7	9	9	10	9	10	9
0	8	5	5	1	8	8	10	10	10	10
0	8	7	7	7	8	9	9	9	10	8
0	7	6	6	6	7	7	10	10	10	9

For example, a twisted-wire terminal has a rating of 10 under each of three cost categories, meaning it is economical, but a twisted wire terminal rates 1 for applicability to aluminum wire because troublesome oxides form quickly making it unsuitable for that application.

A 100-percent consistency in ratings is impossible in any chart because a given connection method may vary widely in workmanship. A low-rated connection, expertly made, will work better than a high-rated, poorly made one. For convenience in using the table, it is assumed that all connections are equally well made in ordinary production facilities by a good manufacturer.

## PROS AND CONS

Here are many characteristics of different materials and joining techniques, brought together into one comprehensive table for quick comparison. Cross-checking guides the engineer to the best technique for a particular job

shows how they are applied





# SIMPLIFIES CIRCUITS

*Delta-sigma modulation technique permits digital communications systems to transmit signals having a d-c component. Cumulative errors in the demodulated signal resulting from transmission disturbances are avoided, and signal-to-noise ratio is independent of signal frequency*

By HIROSHI INOSE, YASUHIKO YASUDA, JUNZO MURAKAMI\* and HIROSHI FUJITA\*

Faculty of Engineering, University of Tokyo, Tokyo, Japan

**THIS MODULATION** technique for digital communications systems reduces circuit complexity. Called delta-sigma modulation, it offers d-c transmission capability, stable performance and independence of signal-to-noise ratio from signal frequency. The required bandwidth for the new type modulator is less than for the pulse-number modulation.

Delta modulation has been noted for its circuit simplicity. However, its use has been confined to signals not having a d-c component because of the differentiation and subsequent integration inherent in this modulation. Transmission disturb-

ances result in a cumulative error in the demodulated signal.

**PRINCIPLE** — The delta-sigma modulation technique was designed to overcome this limitation. Integration takes place in the modulator, so that output pulses carry information corresponding to input signal amplitude.

The delta-sigma modulator is shown at the top of Fig. 1. Output pulse  $p$  is fed back to the input and subtracted from input signal  $s$ . Difference signal  $d = s - p$  is integrated, and integrated difference signal  $\epsilon(t) = \int d(t) dt$  is compared in amplitude with a predetermined reference. If the integrated difference signal is positive and larger than the reference, the sampling

pulse generator feeds a pulse to the output. This negative feedback always keeps the integrated difference signal near the reference. Thus, output pulses carry data corresponding to input amplitude.

Demodulation requires only reshaping of the pulses and passing them through a low-pass filter. No integration is involved, so that no cumulative error resulting from transmission disturbances occurs.

**NOISE PERFORMANCE** — Theoretical calculations<sup>1</sup> reveal that signal-to-quantizing-noise ratio of the delta-sigma modulation system with single integration is

$$S/N \propto (f_r/f_c)^3 \quad (1)$$

where  $f_r$  is sampling pulse repetition frequency and  $f_c$  is cutoff fre-

\* Now with Tokyo Shibaura Electric Company, Kawasaki, Japan.

DELTA-SIGMA modulation technique is tested at Tokyo University by author Inose

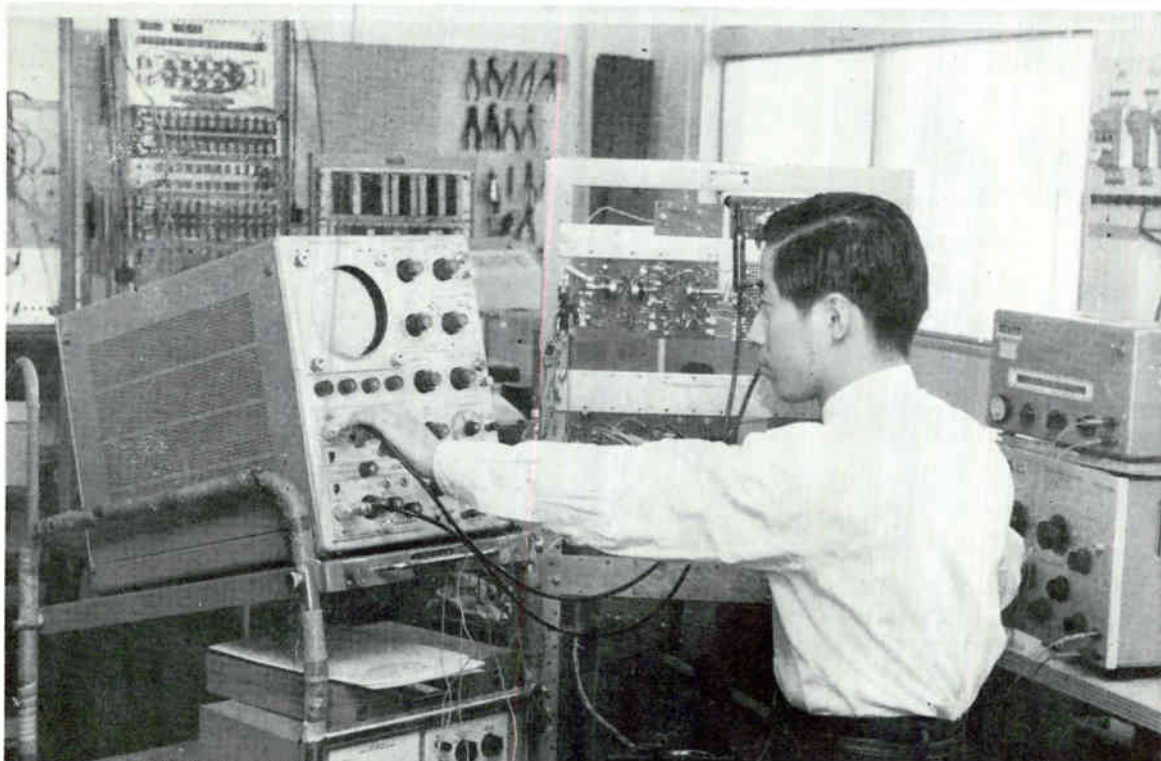

## DELTA VERSUS DELTA SIGMA

The lukewarm acceptance of delta modulation is at least partly explained by its performance limitations. Some of these objections may be overcome by this modified delta modulator. The integrator has been removed from the demodulator so that the effect of transmission disturbances on the demodulated signal is not cumulative

frequency of the demodulator low-pass filter. Signal quantizing noise ratio the delta modulation system is

$$S/N \propto f_r^{3/2} / f_c^{1/2} f_s \quad (2)$$

where  $f_s$  is signal frequency. Eq. 1 and 2 show that the same relationship to the pulse repetition frequency exists for both systems but signal frequency has no relation to signal-to-quantizing-noise ratio in the delta-sigma modulator.

Signal-to-noise ratio of pulse-number modulation is

$$S/N \propto f_r / f_c^{1/2} f_s^{1/2} \quad (3)$$

where  $f$  is sampling frequency. Eq. 1, 2 and 3 indicate that delta and

delta-sigma modulation have an advantage over pulse-number modulation in the degree of improvement in noise performance in relation to pulse repetition frequency.

With double integration  $\epsilon(t) = \iint f d(t) dt dt$ , calculated signal-to-quantizing-noise ratio<sup>3</sup> is proportional to  $(f_r)^{5/2}$ . For  $k$  integrations, signal-to-quantizing-noise ratio is proportional to  $(f_r)^{\exp(2k+1)/2}$ . Thus, more improvement in signal-to-quantizing-noise ratio is expected with more integration stages.

**STABILITY**—With signals having a d-c component, drift of the refer-

ence level is generally a serious problem. Assuming that the reference level has drifted  $\epsilon'$  volts, the equivalent variation<sup>1</sup> at the input of the signal integrator is

$$d' \doteq \epsilon' / A \quad (4)$$

where  $A$  is integrator gain. Eq. 4 indicates that  $d'$  can be reduced by increasing integrator gain. Thus, drift of the reference has only a slight affect on performance.

**TEST MODULATOR**—The experimental telemetering modulator at the bottom of Fig. 1 was constructed to demonstrate feasibility. Key waveforms are shown in Fig. 2.

The sampling pulse generator supplies 5-microsecond pulses,  $c$ , at repetition frequencies from 1 to 3 Kc. Pulse  $c$  is gated by Schmitt trigger output  $g$  and  $-g$ . The gated pulses become set input  $p$  and reset input  $-p$  of the flip-flop, which reshapes the gated pulse to the width of one sampling period. Reset output  $-g$  from the flip-flop is fed back to the input, added to input signal  $s$  and fed to the Miller integrator. Integrator output is fed directly to the Schmitt trigger.

When the integrated difference signal fires the Schmitt trigger, the trigger circuit provides positive output  $g$ , which opens the gate and passes pulse  $c$  to set the flip-flop. When the integrated difference signal is smaller than trigger level, phase inverter output  $-g$  becomes positive and resets the flip-flop. Thus, integrator output is kept near the trigger level of the Schmitt trigger. Reset input  $-p$  of the flip-flop is fed to the transmitter.

**MODULATOR CIRCUIT** — The circuit is shown in Fig. 3. The transmitter has been omitted, and the set output of the flip-flop is fed directly to an emitter follower and demodulated by an active low-pass filter with a cutoff of 50 cps.

The relationship between a d-c input to the modulator and output from the demodulating low-pass filter is shown in Fig. 4A for a frequency of 3 Kc and an integrator time constant of 100 milliseconds. This result and repeated counts of the output pulses indicate the satisfactory linearity of the equipment.

Frequency characteristics of the system are shown in Fig. 4B. Since equipment characteristics are iden-

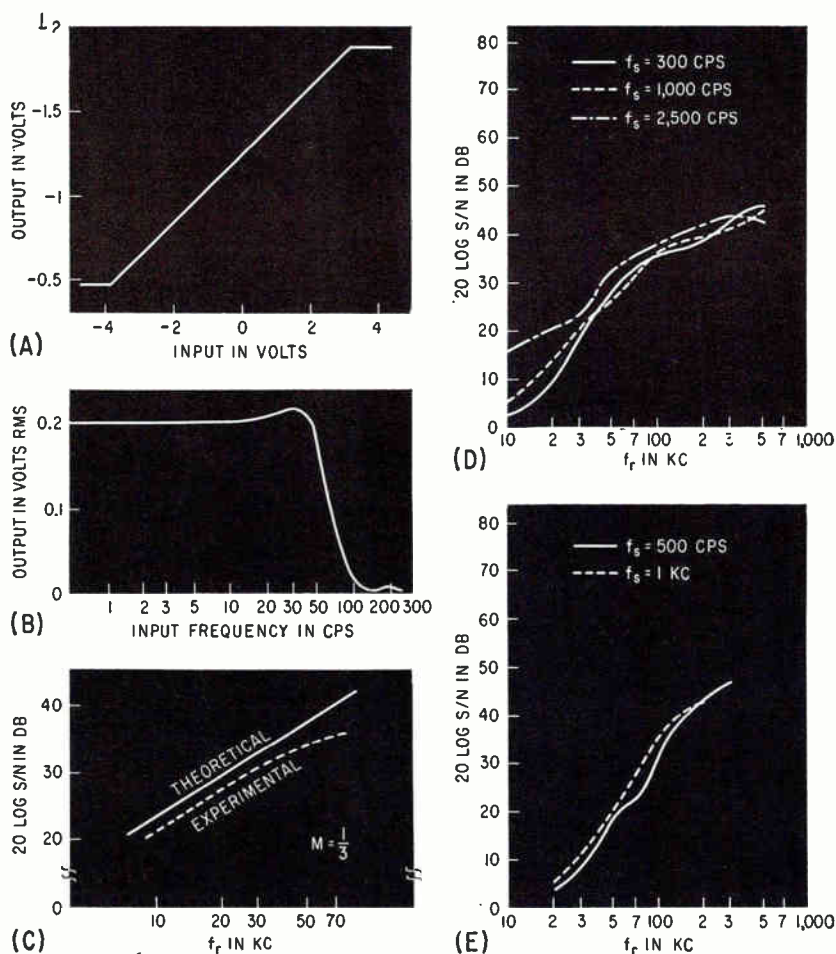

RELATIONSHIP between d-c input and filter output (A) and between frequency and output (B). S/N was measured for 30-cps signal (C) and in another equipment for single (D) and double (E) integration—Fig. 4

tical to frequency characteristics of the filter, the system has constant characteristics throughout the signal frequency range. Some examples of the input and output waveforms are shown in Fig. 5. The signal-to-noise ratio shown in Fig. 4C was measured at a signal frequency of 30 cps at several repetition frequencies.

Another equipment was designed for a signal frequency range from d-c to 4 Kc and repetition frequencies up to 500 Kc. Measured signal-to-noise ratio with single integration is shown in Fig. 4D and double integration in Fig. 4E. Signal-to-noise ratio is improved about 9 db per octave for single integration and 15 db per octave for double, which conforms with Eq. 1 and 4. Results show that S/N is constant over signal frequency range.

**SYNCHRONIZATION**—The frame synchronization pattern generally used in digital communications systems is successive ONE's. However, this pattern in the delta-sigma modulation system is vulnerable because the same pattern appears stationary in the signal channel at the edge of the input dynamic range. Similarly, patterns with six or nine bits may appear stationary. Thus a 12-bit pattern was sought that occurs least frequently either stationary or statistically. The pattern is 11001100 . . . , and the equipment in Fig. 6, left, was constructed. Nine channels are for signal and one for synchronization. Frame frequency is 1 Kc.

The frame pulse generator divides the 10-Kc bit pulse by ten to generate the 1-Kc frame pulse. The channel extractor consists of a monostable multivibrator and an AND gate. It extracts one channel out of ten and feeds it to the shift register, which stores three successive bits from the extracted channel. When the required pattern occurs, the shift register stores one of the patterns 110, 100, 001 or 011. Regardless of which pattern is stored set output of the first register and reset output of the third register are identical.

If this relationship is assumed to exist for a stationary pattern of . . .  $p_j, p_{j+1}, p_{j+2}, p_{j+3} \dots$ , the relationships  $p_j = p_{j+2}, p_{j+1} = p_{j+3}, p_{j+2} = p_{j+4} \dots$  are satisfied. When  $p_j$  and

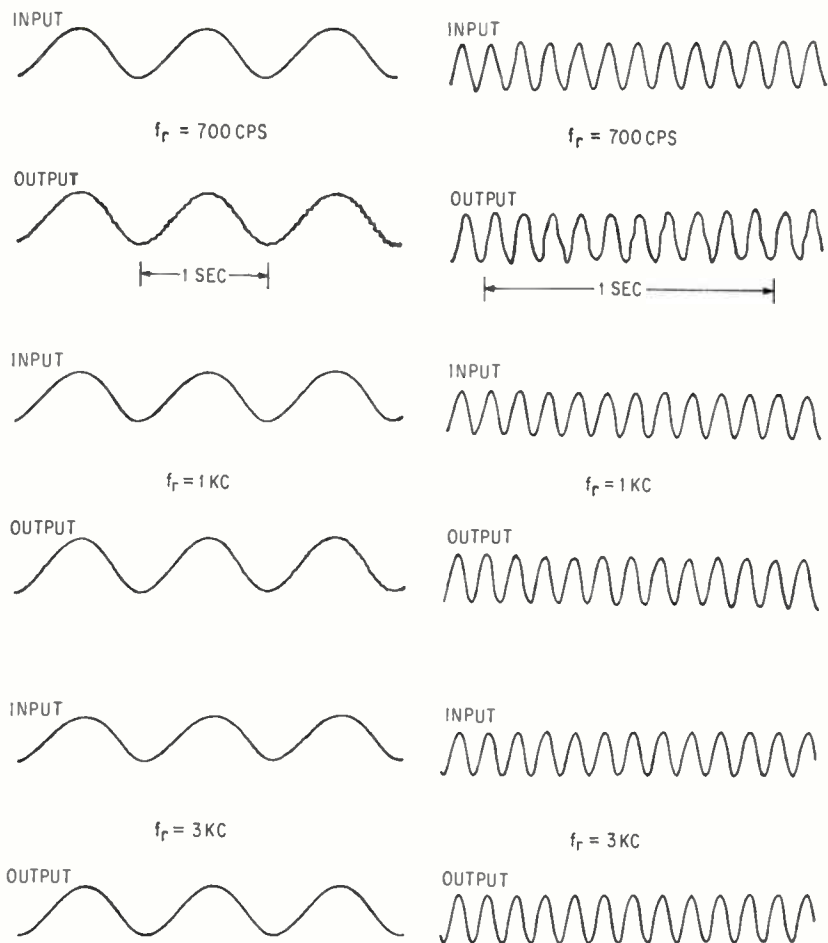

INPUT and demodulated output are shown at different signal and repetition frequencies—Fig. 5

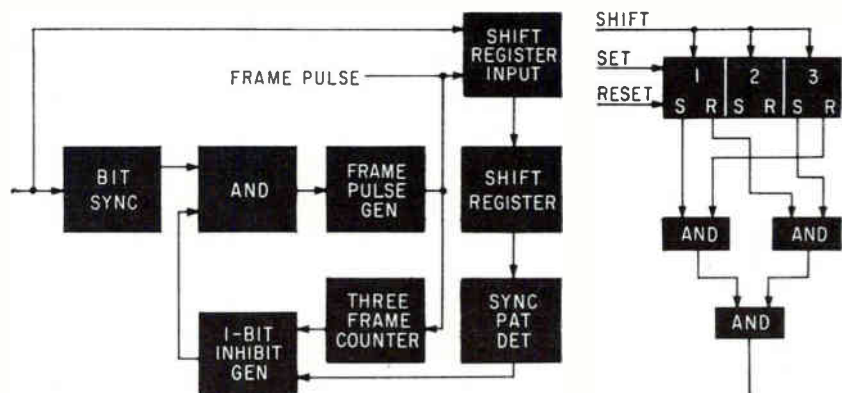

SYNCHRONIZATION equipment is shown at left of synchronization pattern detector—Fig. 6

$p_{j-1}$  are determined by these relationships, the pattern becomes unique. Thus, for all combinations of  $p_j$  and  $p_{j-1}$  (11, 10, 01 and 00, the pattern is uniquely determined to be 11001100. Therefore, the circuit is sufficient to detect the pattern.

The three-frame counter and one-bit inhibit generator detect whether output of the synchronization director is present three frames after operation. If not, a pulse is extracted and the frame pulse is shifted one channel.

**REFERENCES**

(1) H. Inose, Y. Yasuda and J. Murakami, A Telemetry System by Code Modulation— $\Delta$ - $\Sigma$  Modulation, *IRE Trans PGNET*, 8, p 204, Sept. 1962.  
 (2) F. de Jager, Delta Modulation—A Method of PCM Transmission Using One Unit Code, *Philips Res Rep*, 7, p 442.

(3) Y. Yasuda, J. Murakami and H. Inose, Signal to Noise Ratio in  $\Delta$ - $\Sigma$  Modulation System, to be published in 1962 *Joint Convention Record of Electrical Institutes, Japan*.  
 (4) Y. Yasuda, H. Fujita and H. Inose, Synchronization in  $\Delta$ - $\Sigma$  Modulation, 1962 *National Convention Record of Institute of Electrical Communications Engineers of Japan*.



There has been considerable interest in the use of electronic gear in automobiles during the past few years. In practice, however, automotive electronic equipment is still largely limited to the R part of the ever-present optional extras—R & H. Here is a transistor circuit that is actually being used in a few thousand motor vehicles in Britain

# REDUCING WINTER SKIDS

## With a Transistor Warning Circuit

*Analysis of skidding accidents and study of road icing has led to a warning device for motor vehicles. Temperature sensor determines icing conditions.*

*Simple transistor circuit responds linearly to temperature changes*

By J. A. IRVINE, Director, Findlay, Irvine Ltd. Penicuik, England

**TEMPERATURE** sensor with fast thermal response could cut motor vehicle accidents during winter. Operation is based on a linear temperature-dependent characteristic that occurs in both germanium and silicon transistors. The stable temperature-sensing circuit is used in Icelert, an alarm system to warn drivers of conditions under which ice can form on roads. The sensors, several thousand of which are now in use on British roads, could also be adapted to other applications.

Accidents resulting from skidding are notorious in Britain, where temperatures oscillate about the freezing point for several months

during the year. Analysis of motor-vehicle accidents during winter indicated that a high percentage are caused by skidding on roads that the driver did not know were icy.

**ROAD ICING**—In general, the two conditions that make roads hazardous are a moist road surface accompanied by a temperature drop to or below 0 degrees C and the presence of snow or sleet. Much of the uncertainty about the existence of ice would be removed if the driver were constantly informed of road surface temperature. However, it has been found impractical to measure road surface temperature

from a moving vehicle.

Analysis of a large number of air-temperature measurements recorded at varying heights above the road during all types of weather indicated a practical solution. If the sky is clear and there is no wind, ice can form on a road when air temperature 2 feet above the surface is 2 degrees C, as indicated at the left of Fig. 1. In some European countries, a freezing road surface is possible at air temperatures of 3 deg. C. This phenomenon results from rapid cooling of the road by radiation and the poor thermal conductivity of air. When it is cloudy and windy, ice forms only when air temperature drops to 0 degrees C. Thus, a temperature-indicating system mounted at the front of the vehicle 2 feet above the ground can enable a driver to assess the likelihood of ice formation.

The system indicates that air temperature has dropped to the

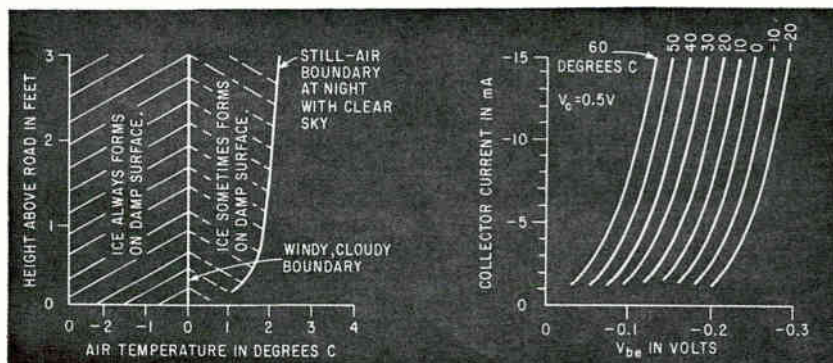

WEATHER conditions determine air temperature at which ice forms (left). Temperature is measured by its effect on  $I_c$ - $V_{be}$  characteristic shown for typical germanium transistor (right)—Fig. 1

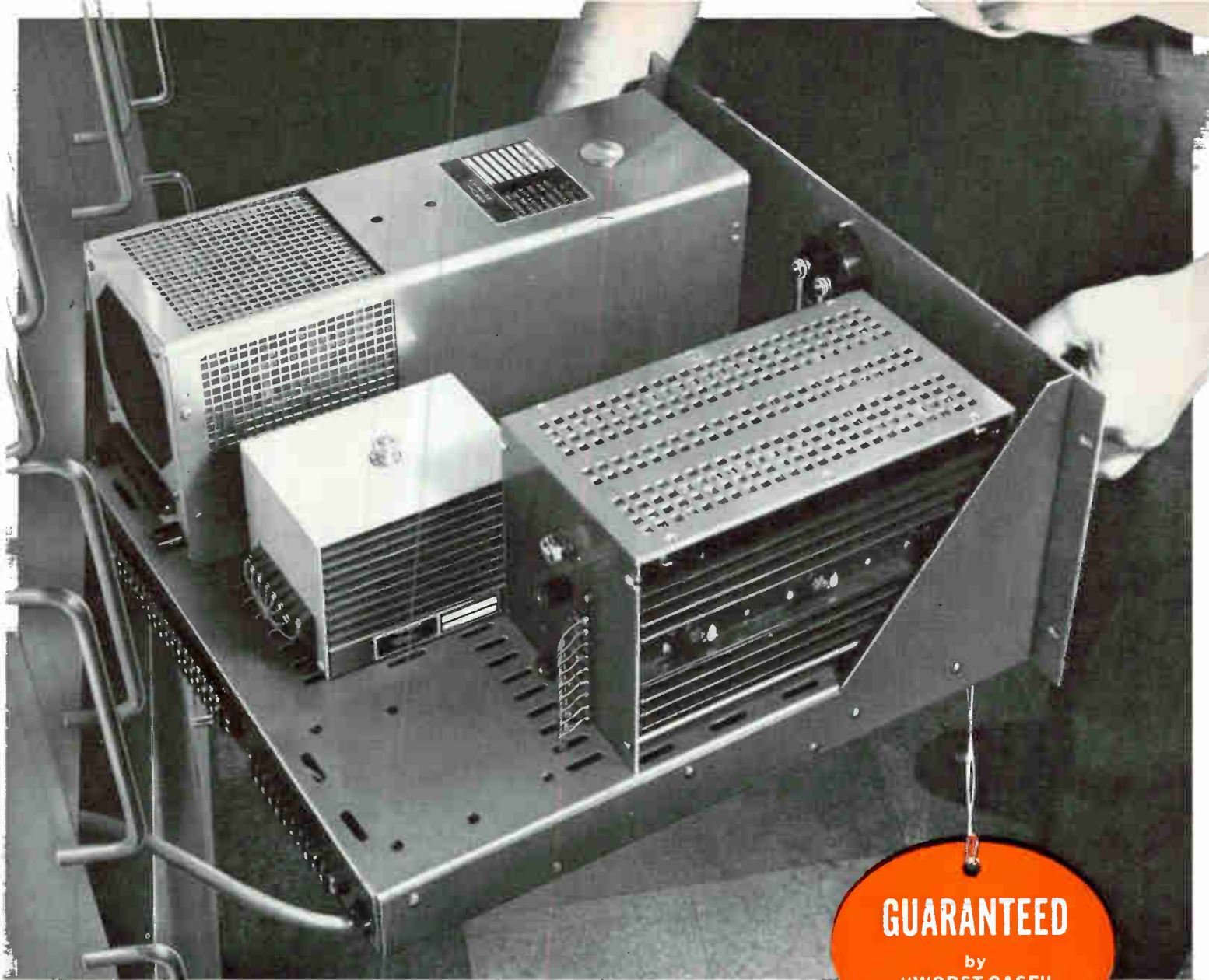

**GUARANTEED**  
by  
"WORST CASE"  
ANALYSIS

# Chances are you'll "plug-in" this power supply only once!

Forget all your old ideas about how long a precision power supply will last . . . how much abuse it can take and still stay accurate.

Once installed, you'll probably never ever touch a Con Avionics transistorized power supply again during the life of the equipment it operates.

Many of these power supplies have survived 20,000 hours under the worst possible conditions without the slightest sign of failure.

The reason? Con Avionics unique design principle "Worst Case" Analysis.

It eliminates 90% of the causes for power supply failure. Increases the accurate life of a power supply substantially. Assures virtually failure-proof performance.

Learn how Con Avionics transistorized power supplies can give you extra protection against costly shutdowns, and substantially reduce your supply cost per operating hour. Write for bulletin on Con Avionics complete line of Transistorized Power Supplies. Or call your local Con Avionics representative.



New LR and XR MODULES for applications to 14 amps. 0.05% or 10 mv Regulation. Ripple: 2 mv. Stability: 0.1% for 8 hours. Operating temp: 45°C as specified, derated to 70°C. Send for bulletins 103 and 104 for details.

**CONSOLIDATED AVIONICS CORPORATION**

800 SHAMES DRIVE, WESTBURY, L. I., NEW YORK

CIRCLE 57 ON READER SERVICE CARD





danger zone by flashing a light within the zone of peripheral vision. Flash frequency is about 2 cps and the mark-to-space ratio changes from 0 to 1 as temperature drops from 2 to 0 degrees C.

**SENSING TEMPERATURE**—By connecting the junction of a transistor to the case, the transistor becomes an inexpensive and stable temperature sensor with fast thermal response. Most transistor-type temperature-sensitive circuits use the change in collector current with temperature. However, this characteristic has been shown to be unstable with time. A stable temperature-sensing circuit can be based on the fact that base-emitter voltage in both silicon and germanium transistors must be reduced about 2 millivolts per degree C rise in junction temperature to maintain constant collector current.

The  $I_c$ - $V_{be}$  characteristic of a typical germanium transistor is shown at the right in Fig. 1. When  $V_{be}$  is supplied from a low-impedance source, voltage-temperature characteristic is stable and linear.

**OPERATION**—Power for the circuit in Fig. 2 is supplied by the vehicle battery. Resistor  $R_1$  and zener diode  $D_1$  provide regulated voltage for the voltage-sensitive

part of the circuit.

The temperature-sensing transistor is  $Q_1$ , and constant base-emitter potential is provided by the stabilized supply through  $R_2$ ,  $R_3$  and  $R_4$ . Although there is no direct American equivalent to the transistors used, the 2N 466 should be suitable. The effect of temperature on the voltage at the collector of  $Q_1$ , which is  $|\partial I_{c1} / \partial T| R_6$  volts per degree C, is practically independent of current gain. Any voltage change at the collector of  $Q_1$  is transferred by emitter follower  $Q_2$  to the base of  $Q_3$ . Thus collector current in  $Q_3$  changes

$$\beta_3 \left| \frac{\partial I_{c1}}{\partial T} \right| R_6 / (R_{in} + R_7) \text{ amperes per degree C} \quad (1)$$

where  $\beta_3$  is common-emitter current gain of  $Q_3$  and  $R_{in}$  is input resistance of  $Q_3$ .

The indicating lamp is rated at 6 volts and 40 milliamperes. Resistor  $R_5$  is chosen so that  $Q_3$  is saturated by 40 milliamperes of collector current. Because of the non-linear voltage-current characteristic of the lamp, the saturating current is nearly constant over the range of battery voltage.

To prevent vehicle speed from affecting calibration, the temperature rise of  $Q_1$  from self-heating is restricted to 0.1 degree C by keeping collector current below 400, micro-

amperes. With a zener voltage of 6.5 volts, required collector load is 15,000 ohms. Using this value for  $R_6$ , the voltage-temperature relationship at the collector of  $Q_1$  is 0.5 volt per degree C.

Using a GET 535 transistor for  $Q_3$ , current gain is typically 40 and input resistance is about 200 ohms. Substituting these values into Eq. 1 indicates that  $R_7$  should be 800 ohms for current in  $Q_3$  to change 20 milliamperes per degree C. Variations in current gain and input resistance can be corrected by using  $R_7$ . With  $Q_1$  in heat sink at 0 deg C,  $R_5$  is adjusted so the lamp is lit but on the verge of flashing. At 2 deg C,  $R_7$  is adjusted so the lamp is out but on the verge of flashing.

Positive feedback from the collector of  $Q_3$  to the base of  $Q_1$  makes the circuit regenerative. However, loop gain is less than unity and no oscillation occurs if  $Q_3$  is either cutoff (junction temperature of  $Q_1$  greater than 2 degrees C) or saturated (junction temperature of  $Q_1$  less than 0 deg C). At temperatures between 2 and 0 deg C, the changes in junction temperature of  $Q_1$  can be regarded as changes in base-emitter voltage with a change of 1 deg C equivalent to 2 millivolts. The variation in  $V_{be1}$  with time is shown in Fig. 3A when the junction of  $Q_1$  has reached 2 deg C and  $R_1$  is 10 ohms,  $C_1$  is 20 microfarads and  $R_6$  is 6,800 ohms.

At 2 deg C,  $Q_3$  begins to conduct, and regeneration rapidly causes it to saturate. The positive voltage step that appears at the base of  $Q_1$  is equal to battery voltage  $V(R_4/R_3) = 20$  millivolts. Capacitor  $C_1$  then begins to discharge with time constant  $R_7 C_1$  toward a potential of -144 millivolts. However, at -140 millivolts, current in  $Q_3$  begins decreasing and regeneration causes  $Q_3$  to be cutoff. The lamp is switched on for time  $t_1$  and off for time  $t_2$ .

The variation in  $V_{be1}$  with time at 1 deg C is shown in Fig. 3B. Flash duration  $t_1$  has increased because the potential towards which  $C_1$  discharges is -142 millivolts. Duration of the flash increases as temperature approaches 0 deg C, after which the lamp remains on.

The housing must be waterproof and the components protected from vibration by encapsulating the circuit in a foaming polyurethane.

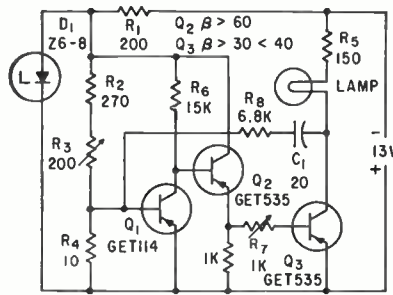

SENSOR mounted on vehicle (left) uses transistor circuit (right) to warn drivers of temperatures in the danger zone—Fig. 2

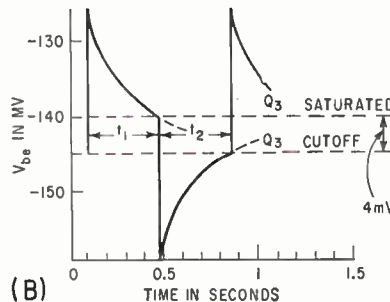
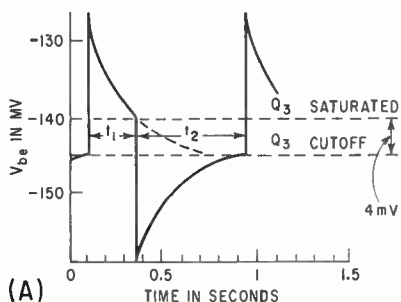

DURATION of flash increases as temperature is reduced from 2 to 0 degrees C at height of 2 feet above road surface—Fig. 3



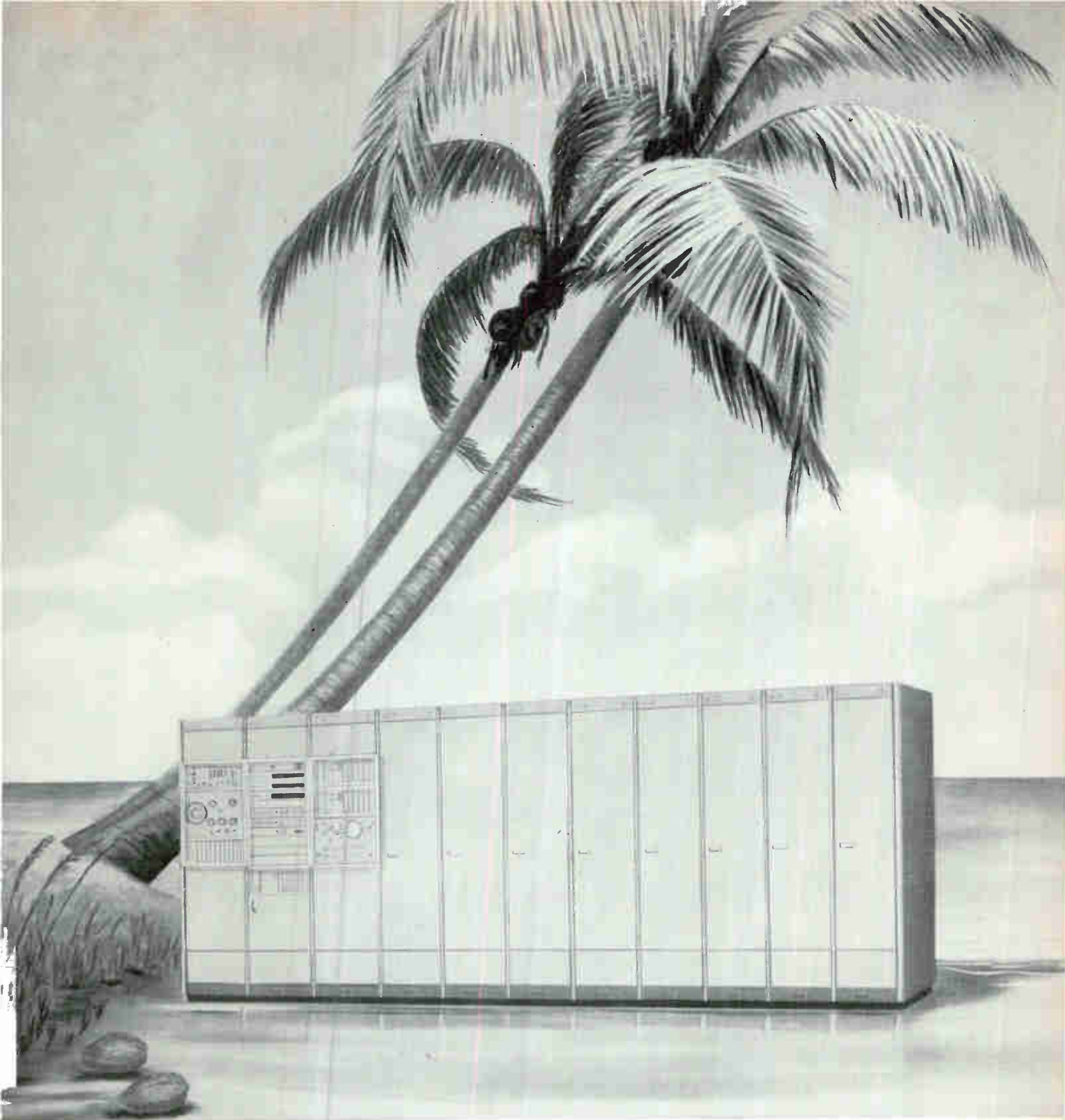

## For real-time PCM telemetry in far away places . . . NASA picks EMR

At stations in NASA's manned space flight world-wide tracking network, MSFTP-1 equipment by EMR will handle the real-time PCM telemetry. Why did NASA choose EMR? Because this EMR equipment offers unusual flexibility, operational simplicity, and adaptability to varying mission formats. And EMR data processors have a complete assortment of distribution functions and outputs.

Now you can apply similar flexibility, simplicity and adaptability to your PCM telemetry needs by specifying EMR's standard Model 285 system. Find out how the 285 can put you years ahead in PCM data handling capability . . . write Sec. 108, Electro-Mechanical Research, Inc., Sarasota, Florida.



**ELECTRO-MECHANICAL  
RESEARCH, INC.**

Sarasota Products Division  
Sarasota, Florida



## What won't you think of next?

Brew a perfect pot of coffee . . . even in the middle of a lake? Impossible? Of course not, but a portable coffee pot (battery-powered) may be somewhat impractical.

Our point is this—your present design problem may seem impractical, just as the drill, shaver, mixer and other cordless products did a few years ago. But Gould-National research engineers developed a package of concentrated power using NICAD® Hermetically Sealed Rechargeable Cells that helped to make these products a reality.

*Have a design problem that could be solved with Nicad portable power? Write us, We may be able to help you solve your problem.*



**NICAD BATTERY DIVISION**

GOULD-NATIONAL BATTERIES, INC. / St. Paul 1, Minnesota

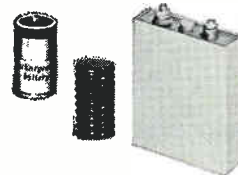



# The Honeywell Visicorder watches a bolt do the twist

When measuring the dynamic effects of torque and load on a bolt fastener, Lamson and Sessions found that fast rise-time was the most essential characteristic of the measuring instrument.

The high frequency response of the Visicorder Oscillograph (DC to 5000 cps) thus made it the choice for measuring these sudden loads applied by an impact wrench.

The Lamson and Sessions studies have charted the complex relationships of joint components under load. Some of these relationships are: fastener strength; relaxation properties; optimum clamping load for a given size and strength of fastener; bearing areas adequate to prevent embedding; the number, size, and strength of fasteners consistent with the greatest strength, lightest weight, and lowest cost; and proper assembly techniques. Visicorder recordings have provided the knowledge of these factors necessary to point the way to new fastener specifications and designs.

There are six models of the Honeywell Visicorder Oscillograph. You'll find at least one of them designed to meet your specific test program requirements. Visicorders offer recording capacity of up to 36 data channels. Paper speeds vary from .1 inch per hour to 160 inches per second, depending upon the model you select. Thus, a Visicorder can be chosen which will present your data on the time base most meaningful to your test.

**H** For full specifications on all Visicorder Oscillographs, write Minneapolis-Honeywell, Heiland Division, Denver 10, Colorado. Or phone 303-794-4311.

**DATA HANDLING SYSTEMS**

# Honeywell

HONEYWELL INTERNATIONAL Sales and Service offices in all principal cities of the world. Manufacturing in United States, United Kingdom, Canada, Netherlands, Germany, France, Japan.

CIRCLE 61 ON READER SERVICE CARD

61

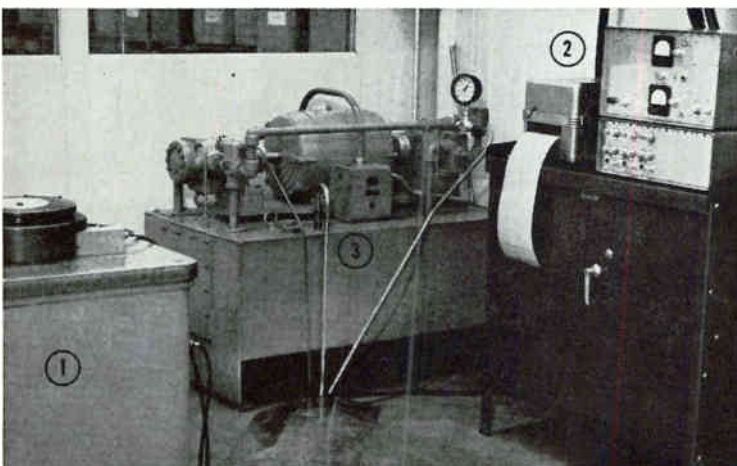
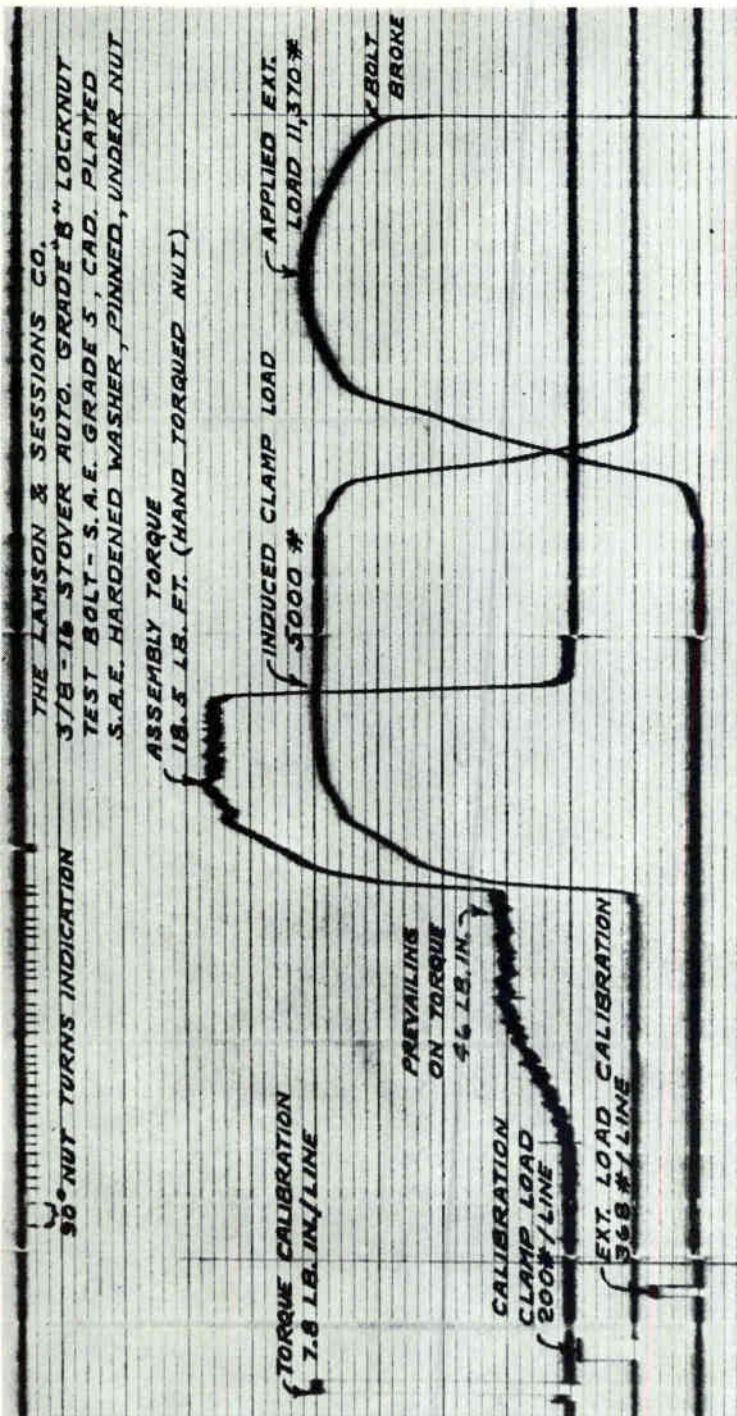

The Lamson and Sessions Load Analyzer: (1) Test block with load cell included, (2) Honeywell Model 906 Visicorder and 119 Amplifier, (3) Hydraulic pump unit.

January 25, 1963





# Tempo means aerospace programmer flexibility

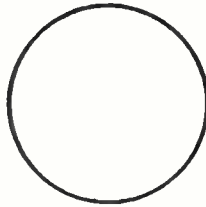
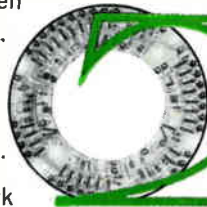
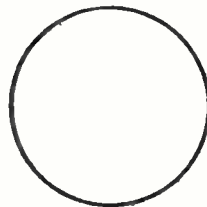
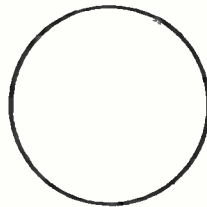
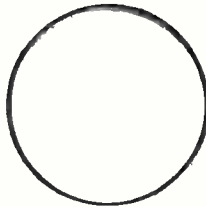
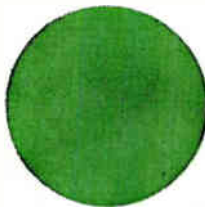
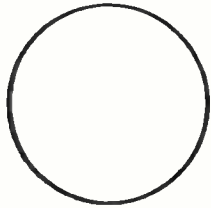
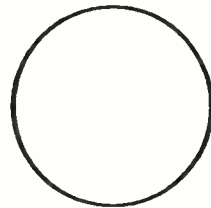
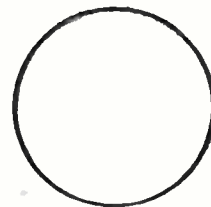

From microseconds to months or years—with an infinite number of stops between—**Tempo Programmers** automatically trigger a series of events in precisely-timed, pre-determined sequence. Modular construction provides flexibility to meet last minute changes in program requirements—a necessity for Quick-Reaction Projects. Count on—and receive—solid-state timing accuracy and reliability in your next project.

**TEMPO INSTRUMENT INCORPORATED**

Plainview, L. I., New York

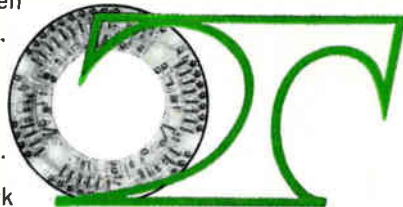

# Magnetic Field Rotates Ultrasonic Waves

*New family of devices may be possible, based on recent development*

A NEW FAMILY of ultrasonic devices, such as circulators and isolators, now appears possible with a new development announced by Bell Telephone Laboratories. Herbert Matthews and R. Conway Le-Craw succeeded in rotating the direction of polarization of a transverse ultrasonic wave, traveling in a crystal, by subjecting it to a d-c magnetic field. The rotation is nonreciprocal, that is, the rotated wave is reflected by the wall of the crystal and returns to its source without returning to its original direction of polarization.

A quartz disk is bonded to one

end of a cylinder made of a single crystal of yttrium iron garnet (see the figure), and a d-c magnetic field is applied parallel to the cylinder's axis, thus aligning the magnetic moments of the iron atoms in the garnet in a direction parallel to the field.

Pulsed r-f is applied to the quartz crystal, generating by the piezoelectric effect a 500-Mc ultrasonic wave pulse, polarized parallel to the (100) axis of the quartz crystal. This ultrasonic pulse, travelling down the garnet cylinder, strains the crystal lattice so that the iron atoms are alternately pulled apart from each other and pushed together in a direction perpendicular to the magnetic field.

Straining the atoms creates a second r-f magnetic field, also at the pulse frequency, but perpen-

dicular to the applied d-c magnetic field. A component of the r-f field interacts with the aligned iron atoms and changes the direction of their magnetization. This process is the reverse of magnetostriction, in which ferromagnetic materials such as iron are elongated in the direction of a d-c magnetic field and contract in a direction perpendicular to it.

The change in the direction of the magnetic moments of the iron atoms affects the direction in which they move as the ultrasonic pulse strains the crystal lattice. (The motion of the iron atoms is linearly polarized in a plane perpendicular to the wave's direction of travel). The initial group of iron atoms moves up and down in this plane. The next group of atoms moves at an angle to the previous group in the perpendicular plane. This rotation is caused by the interaction of the r-f field and the lined-up iron atoms, and is analogous to the Faraday rotation of electromagnetic waves in ferrites. Each group of atoms is strained at an angle to the previous strain, and thus the direction of motion rotates continuously.

**PERMANENT ROTATION**—When the wave is reflected at the end of the YIG cylinder, rotation of the strain polarization continues in the original direction, since interaction between strain and the aligned iron atoms is independent of the direction in which the wave travels. The amount of rotation depends on the strength of the d-c field and on the distance the wave travels through it.

Yttrium iron garnet is particularly suitable for this application, because of its extremely high acoustic Q and resulting low loss, and its unique magnetic properties. The high Q enables the ultrasonic wave to make many back-and-forth trips through the crystal and thus undergo considerable rotation before being completely attenuated.

When the pulse reaches the input

## Log-Periodic Spiral Antenna for Space

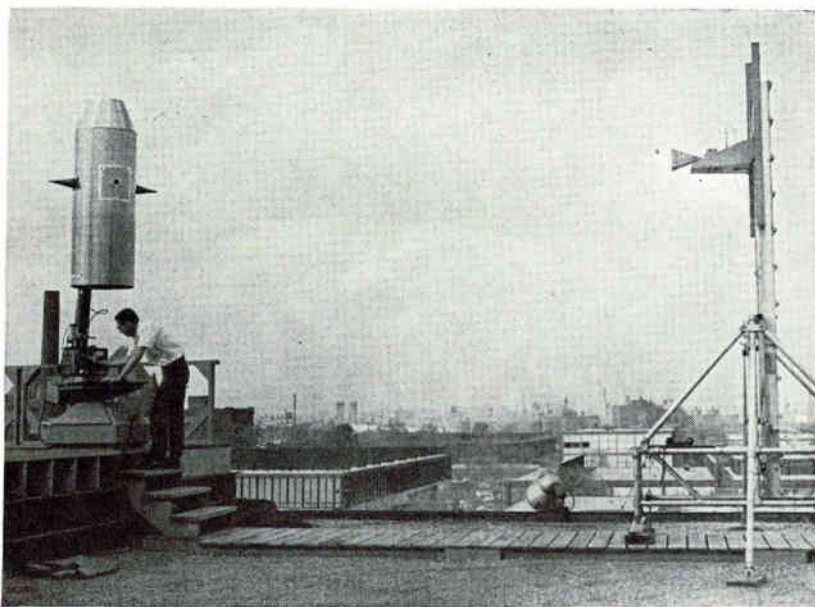

OMNIDIRECTIONAL COVERAGE and a 2- to 4-Gc frequency range are among the advantages of a new type log-periodic antenna (also see cover) developed by Armour Research Foundation, Chicago, for the Air Force Systems Command's Aeronautical Systems Division. Shown above is a radiation pattern test arrangement, where two antenna elements protrude from a Blue Scout payload nose cone. This series of antennas was developed for measuring electromagnetic radiations in space



can you use the advantages of Kepco's  
**AUTOMATIC VOLTAGE-CURRENT CROSSOVER**

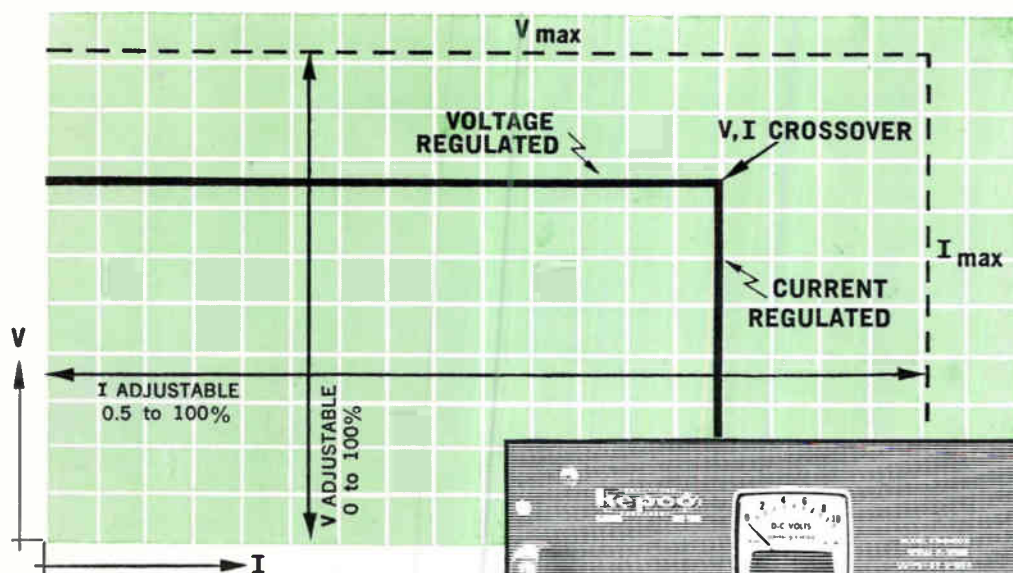

**KEPCO**  **POWER SUPPLIES**

Automatic Voltage-Current Crossover is the characteristic of a power supply that automatically changes the method of regulation from *constant-voltage* to *constant-current* (or vice-versa), as dictated by varying load conditions. The constant-voltage and constant-current levels can be independently adjusted within their specified voltage and current limits. The intersection of the constant-voltage and constant-current lines is called the crossover point (V,I, as shown in the graph above), and may be located anywhere within the volt-ampere range.

Kepco's KS Group of HIGH-POWER, highly regulated DC power supplies provides two panel control

knobs that allow *automatic crossover* to be set from less than 0.5% to 100% of rated current and 0 to 100% of rated voltage.

- Programming of output voltage
- Programming of output current
- Remote error signal sensing
- High resolution adjustment
- No voltage overshoot

0.01% REGULATION and STABILITY	MODEL	DC OUTPUT RANGE		PRICE
		VOLTS	AMPS	
	KS 8—100M	0—8	100	\$1,395
	KS 18—50M	0—18	50	\$1,295
KS 36—30M	0—36	30	\$1,195	
KS 60—20M	0—60	20	\$1,295	

for complete specifications on more than 250 standard models, write for NEW Catalog B-631



131-38 SANFORD AVENUE • FLUSHING 52, N.Y., U.S.A.  
 N.Y. Phone (212) IN 1-7000 • TWX# (212) 539-6623  
 Cable Address: KEPCOPOWER NEWYORK

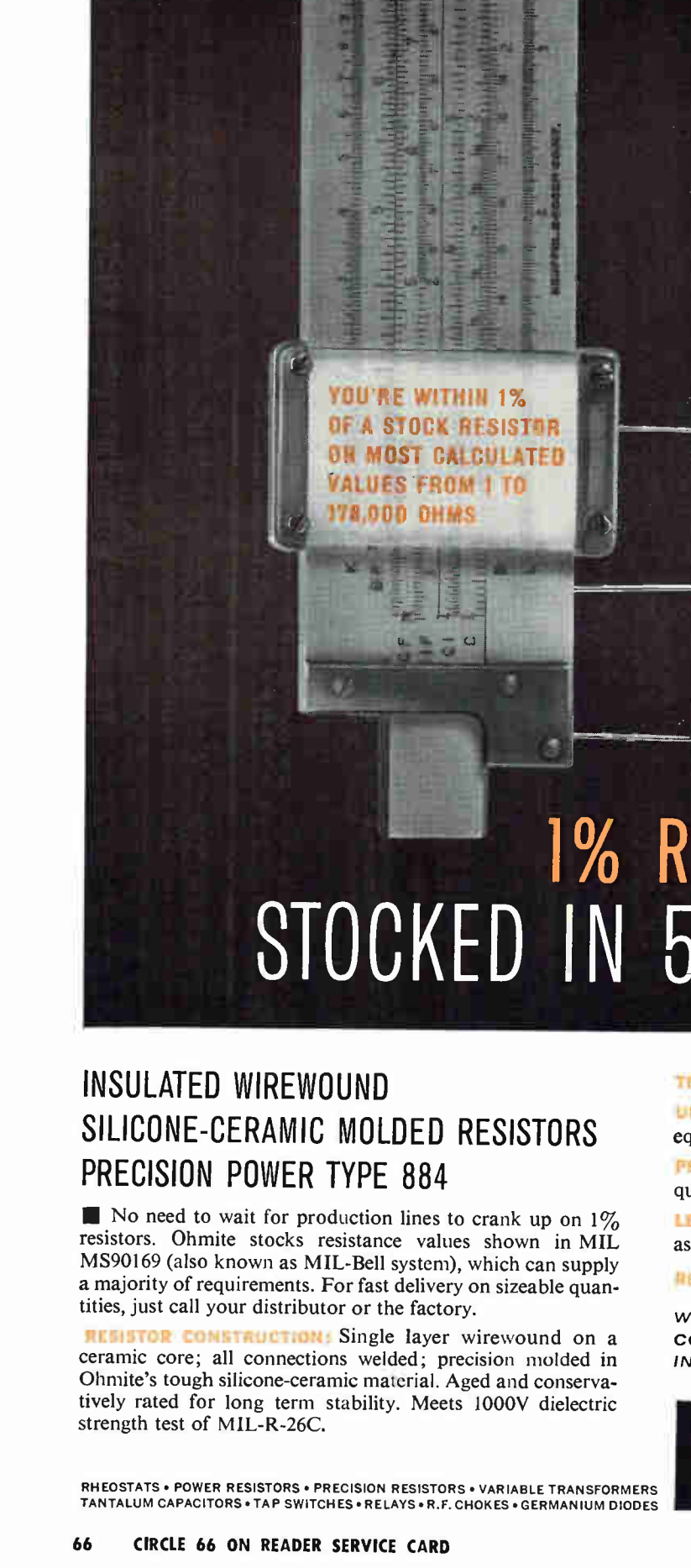

YOU'RE WITHIN 1%  
OF A STOCK RESISTOR  
ON MOST CALCULATED  
VALUES FROM 1 TO  
178,000 OHMS

OHMITE  
3-watt

OHMITE  
5-watt

OHMITE  
10-watt

# 1% RESISTORS STOCKED IN 505 VALUES

## INSULATED WIREWOUND SILICONE-CERAMIC MOLDED RESISTORS PRECISION POWER TYPE 884

■ No need to wait for production lines to crank up on 1% resistors. Ohmite stocks resistance values shown in MIL MS90169 (also known as MIL-Bell system), which can supply a majority of requirements. For fast delivery on sizeable quantities, just call your distributor or the factory.

**RESISTOR CONSTRUCTION:** Single layer wirewound on a ceramic core; all connections welded; precision molded in Ohmite's tough silicone-ceramic material. Aged and conservatively rated for long term stability. Meets 1000V dielectric strength test of MIL-R-26C.

**TEMPERATURE COEFFICIENT:** Only 20 ppm/°C.

**UNIFORM PHYSICAL SIZE:** Trouble free in automated assembly equipment.

**PERMANENT MARKINGS:** Meet many solvent resistance requirements for printed circuit board applications.

**LEADS:** Tinned nickel stocked. Bare nickel (weldable), as well as other special leads also available.

**RELIABILITY DATA:** Supplied on request.

WRITE FOR BULLETIN 153 . . .

COVERING ALL OHMITE MOLDED RESISTORS  
INCLUDING MILITARY AND COMMERCIAL

RHEOSTATS • POWER RESISTORS • PRECISION RESISTORS • VARIABLE TRANSFORMERS  
TANTALUM CAPACITORS • TAP SWITCHES • RELAYS • R.F. CHOKES • GERMANIUM DIODES



**OHMITE**  
MANUFACTURING COMPANY  
3610 Howard Street, Skokie, Illinois



# OHMITE DIODES

Germanium, Gold Bonded



Standard Glass Envelope (Enlarged)



Quad in 1/2" submin. case



Quad in 3/4" submin. case



In 6H6 tube shell and base

**One of industry's largest off-the-shelf selections; 90% of orders shipped same day.**

**IS YOUR DIODE DATA UP-TO-DATE?**



Catalog 801

Stock Price List, SR819

Interchangeability Tables, 803

# OHMITE

MANUFACTURING COMPANY

3610 Howard Street, Skokie, Illinois

CIRCLE 67 ON READER SERVICE CARD

January 25, 1963

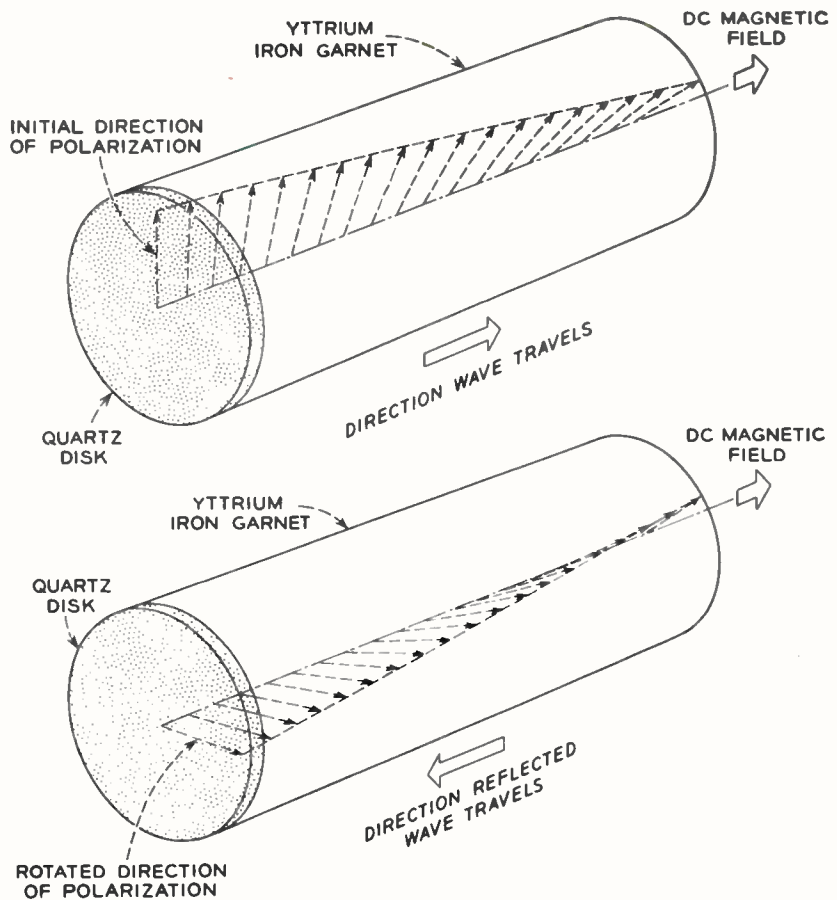

ULTRASONIC WAVE pulse is launched by quartz transducer, top; as pulse travels down yttrium iron garnet cylinder it interacts with magnetic field and is rotated. Reflected wave pulse, bottom, is further rotated so that wave returns to quartz transducer rotated by a total of 90 degrees

end of the cylinder, after reflection from the far end, the quartz disk detects only the component of strain along the (100) axis of the crystal; hence the detected amplitude varies as the cosine of the rotation angle. The amount of rotation of polarization is then calculated from the change in amplitude.

Discovery of this effect makes it theoretically possible to build an ultrasonic isolator, which would be used in ultrasonic delay lines to suppress reflections that occur when a wave encounters a discontinuity in a system. Applied to the input of an ultrasonic device, the isolator would rotate the direction of polarization of the wave by 45 degrees when travelling forward, and by another 45 degrees when returning after being reflected. An absorbing device would absorb the energy of waves polarized at 90 degrees, and thus would prevent a reflected wave from reaching the input of a system. At present, however, fabrica-

tion is not practical because a suitable absorbing material has not been developed, Bell Telephone Labs said.

## Dopplometer Will Measure Ionospheric Absorption

A NEW INSTRUMENT called a dopplometer will be added to the Douglas Geophysical Station at McMurdo Sound, Antarctica. It will be used in conjunction with existing riometers to provide reliable data from the south polar region regarding polar cap absorption events (events caused by the influx of solar flare protons into the polar ionosphere).

The geophysical station now consists of two riometers, operating at 10 Mc and 30 Mc respectively, and a spherics receiver operating at 27 Kc. The riometers measure the absorption of cosmic rays in the





*To move your delicate equipment faster, better...*

## BEKINS ENGINEERS TAKE UP WHERE YOURS LEFT OFF!

From start to finish, Bekins Electronics Moving is engineered to specifications as exacting as your own. When it comes to the moving of delicate electronics equipment, Bekins starts with *the man*.

There's good reason, too. We'd be the first to admit that many of our competitors have vans as good as ours. But we just don't believe that anyone in the world can teach a van how to do the job.

That's why we teach our men. They're the real key. And we teach them thoroughly. Only after they're Certified in our special electronics school are they ready to serve you.

No wonder Bekins Certified Electronics Moving is your best bet. You get skilled specialists *at both origin and destination*. And knowledgeable supervisors, too.

It might be worth remembering that Bekins is the largest moving and storage organization in the world. We've been in business since 1891.

Think about it! Isn't that the kind of experience *your* delicate equipment deserves?

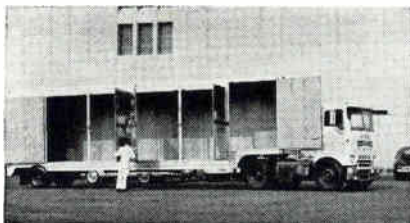

CERTIFIED SERVICE WITH BEKINS WORLDWIDE MOVING AND STORAGE

ionosphere, which depends on both electron density and collision frequency at the ionospheric height involved; the new dopplometer will measure frequency changes, which depend on electron density only. From simultaneous observations with both instruments it will be possible to determine the collision frequency, the height at which maximum absorption occurs, and the recombination coefficients.

Measuring the ionospheric absorption of high-frequency extraterrestrial radio noise is a useful method for detecting the influx of low-energy solar cosmic rays. The ionization produced by solar protons increases the electron density, so that radio waves passing through the ionosphere are significantly absorbed. Most of this absorption is due to protons with energies of 100 million electron volts or less, which are stopped at heights of 30 kilometers and up. Due to the earth's magnetic field, particles in this energy range reach the earth only in polar regions.

**RIOMETER OPERATION**—The riometer output, which is a measure of radio-frequency signal strength at a given frequency, is therefore related to the flux of particles that bombard the earth's atmosphere. The riometer measures the low-level signals by using an electronic servo system to adjust a calibrated and metered voltage-controlled reference to an output voltage equal to the signal voltage that appears at the antenna. This antenna signal measurement is independent of the receiver-generated noise.

**RIOMETER ANTENNAS**—The antenna complex for the present 10-Mc and 30-Mc riometers consists of broad-side arrays, each having two dipole elements side by side with reflectors. The angle of acceptance of each antenna is 60 degrees.

Due to man-made noise in the McMurdo Sound area, the 10-Mc riometer has not produced any useful data; it will therefore be converted to 50-Mc operation.

The geophysical station, operated by Douglas in cooperation with the National Science Foundation, is designed to determine the nature and

properties of solar flare corpuscular radiation, the effects of the radiation on the earth's atmosphere and the frequency of occurrence of polar cap ionospheric absorption events.

### Semiconductor Materials Available for Research

SINGLE-CRYSTAL indium arsenide and single-crystal indium antimonide, produced by the Czochralski method, have been made commercially available as part of Monsanto Chemical's line of III-V intermetallic semiconductor materials.

Indium arsenide is used in Hall generators and photovoltaic cells, and is being tried for possible use in thermistors and magnetoresistance devices. Indium antimonide

### Liquid Metal Flywheel

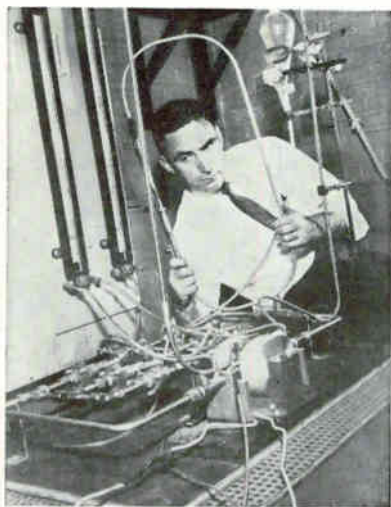

MERCURY, circulated through stainless steel tube loops by an electromagnetic pump, may help stabilize the attitude of space vehicles. The experimental unit, developed by GE's Advanced Technology Services, is said to have 60 times faster response to directional changes than conventional flywheels, and to be more practical than attitude-stabilizing fuel jets, since it does not require a large fuel supply. The electromagnetic pump used is said to have an efficiency of 30 percent, compared to 1 to 3 percent for conventional magnetic pumps; it uses a lightweight permanent magnet and a low-power flow controller.

**Phil Greenstein can show you...**



*Instrumentation Sales Manager, North Atlantic Industries Inc.*

## how to measure in-phase, quadrature and angle while sweeping frequency to 100 kc

North Atlantic's latest addition to the PAV line of Phase Angle Voltmeters\* enables you to make measurements while frequency is varying over half-decades without recalibration. The VM-301 Broadband Phase Angle Voltmeter\* provides complete coverage from 10 cps to 100 kc, and incorporates plug-in filters to reduce the effects of harmonics in the range of 50 cps to 10 kc with only 16 sets of filters. Vibration analysis and servo analysis are only two of the many applications for this unit. Abridged specifications are listed below:

Voltage Range	1 mv to 300 volts full scale
Voltage Accuracy	2% full scale
Phase Dial Range	0° to 90° with 0.1° resolution (plus 4 quadrants)
Phase Accuracy	0.3°
Input Impedance	10 megohms, 30μf for all ranges (signal and reference inputs)
Reference Level Range	0.15 to 130 volts
Harmonic Rejection	50 db
Nulling Sensitivity	less than 2 microvolts
Size	19" x 7" x 10" deep
Price	\$1750.00 plus \$120.00 per set of filters

North Atlantic's sales representative in your area can tell you all about this unit as well as other Phase Angle Voltmeters\* for both production test and ground support applications. Send for our data sheet today.

*\*Trademark*



**NORTH ATLANTIC industries, inc.**  
TERMINAL DRIVE, PLAINVIEW, L. I., NEW YORK • Overbrook 1-8600



# They HAVE to breathe!



## StereoZoom® makes SURE they breathe!

Precision is so vital in Dacor Underwater Demand Breathing Regulators that "the Bausch & Lomb 3-D microscope has proved the most effective way to inspect the many tiny parts. It's an invaluable time-saving and foolproof inspection tool." So says S. M. Davison, Jr., Vice-president, Dacor Corporation, Evanston, Ill.—manufacturer of diving equipment.

And you'll agree. B&L 3-D StereoZoom Microscopes give you today's fastest, easiest focusing . . . over today's widest range of magnification . . . from 3.5X to 120X! Design and manufacture makes them the most trouble-free, punishment-proof scopes you can buy for hard industrial use. See for yourself.

**BAUSCH & LOMB**



**BAUSCH & LOMB  
INCORPORATED**  
61437 Bausch Street  
Rochester 2, N. Y.

- Schedule a demonstration at my convenience.  
 Send me StereoZoom Catalog D-15.

Name .....

Company .....

Address .....

City ..... Zone ..... State .....

has a primary application as an infrared detector, and its potential applications are in photodiodes and in injection lasers, Monsanto said.

Both materials can be manufactured either undoped or doped.

### Subsonic Storm Warning

AN INSTRUMENT that gives warning of the approach of a storm 12 to 15 hours before it begins has been developed at the University of Moscow, according to a Russian newspaper.

It has been noted that gulls, dolphins and jellyfish take shelter long before the approach of a storm; they detect the sounds of the storm that arise from the friction of waves against the air. These signals have frequencies of 8 cps to 13 cps. This is detected by the new instrument: a pickup on the deck of a vessel detects the subsonic oscillations and transmits them to an amplifier. The resulting records are said to warn of the approach of a storm and also to indicate its intensity.

### Light UV Spectrometer



ULTRAVIOLET spectrometer undergoing final adjustments before delivery to Princeton University. The 110-lb instrument, built by Perkin-Elmer in Norwalk, will be mounted in Aerobee-Hi nose cone, right, to measure ultraviolet energy emitted by stars



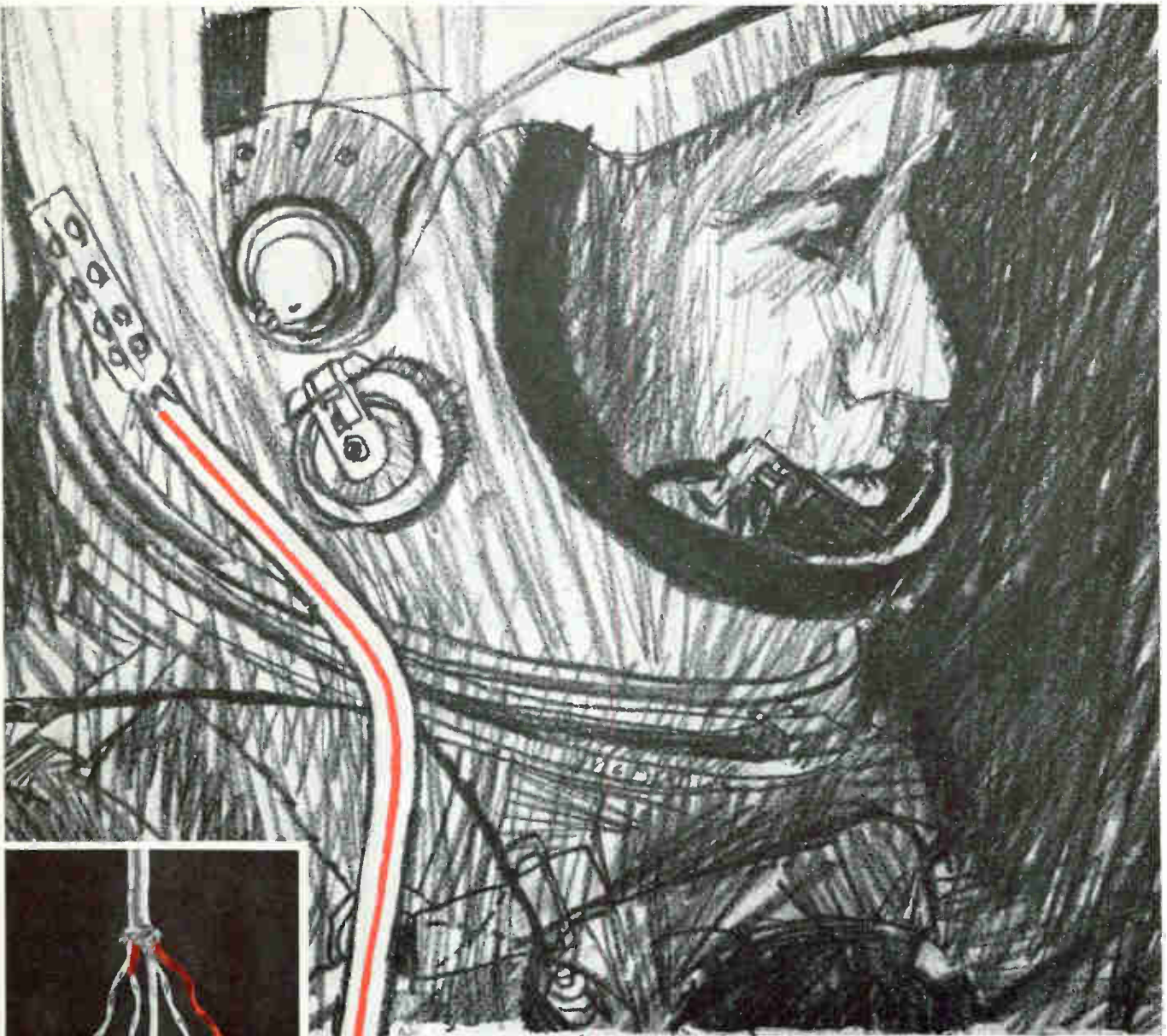

## Ultra-reliable voice link between astronauts and ground: 15" cable insulated with **TEFLON**<sup>®</sup>

In all Project Mercury flights, oral communication between the astronaut and ground tracking stations depends among other things on a fifteen-inch-long, highly flexible multi-conductor cable linking the helmet with the spacecraft's communications system. The reliability of this cable depends to a large extent on the electrical and mechanical properties of primary insulation and tape jacket of Du Pont **TEFLON** TFE-fluorocarbon resins. Ten mils of TFE primary insulation are used on each conductor, and TFE tape is used over the shields of two of the twisted pairs. (See photo at left, above.)

Electrically, the superior insulating properties of **TEFLON** are essential to minimum cross-talk and power loss. Me-

chanically, the very low coefficient of friction of **TEFLON**, coupled with good abrasion resistance and miniaturization potential, help provide extreme flexibility—a must for this application. The high-temperature resistance of the primary insulation also makes possible the use of an extremely pliant sheath of silicone rubber, which requires high curing temperatures.

If operational reliability is important in *your* wire and cable applications—and isn't it always?—consider the advantages of **TEFLON** for insulation. Write to: E. I. du Pont de Nemours & Co. (Inc.), Div. E-1-25-63TE, Room 2526, Nemours Bldg., Wilmington 98, Delaware. *In Canada:* Du Pont of Canada Ltd., P.O. Box 660, Montreal, Quebec.



**TEFLON**<sup>®</sup>  
FLUOROCARBON RESINS

*TEFLON is Du Pont's registered trademark for its family of fluorocarbon resins, fibers and films, including TFE (tetrafluoroethylene) resins and FEP (fluorinated ethylene propylene) resins.*

BETTER THINGS FOR BETTER LIVING ... THROUGH CHEMISTRY

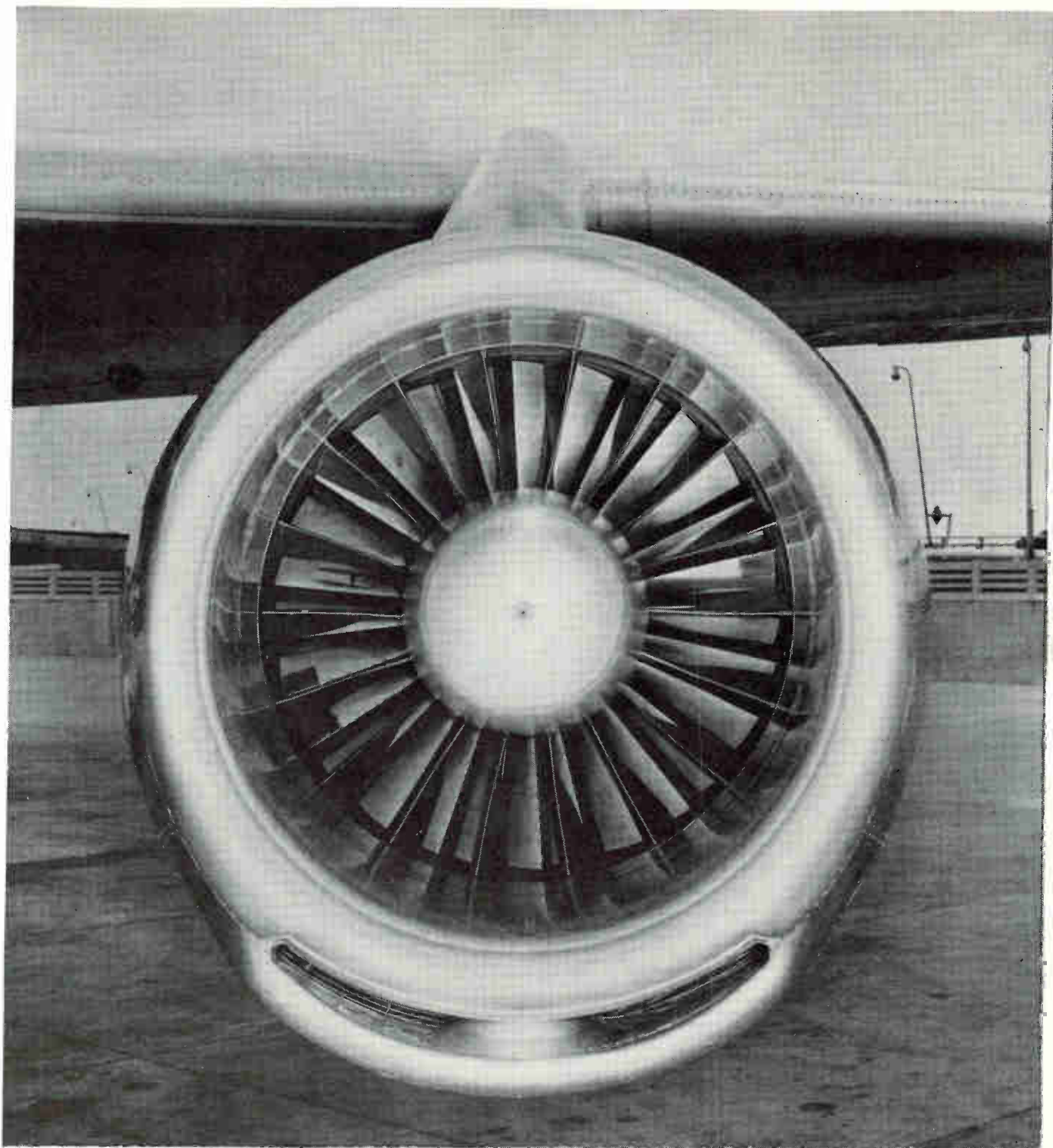

## Say, "Ahhhh!"

**Be "Anso-sure" . . . Aircraft radiography demands Anso Superay H-D®** — the first, ultra-fine-grain American X-ray film for pinpointing the smallest manufacturing defects or stress fatigue. Besides its critical definition, this film's high contrast records more minute details—which would only show up marginally on conventional films.

*For radiography—it's Anso best by definition*

Anso—America's first manufacturer of photographic materials . . . since 1842

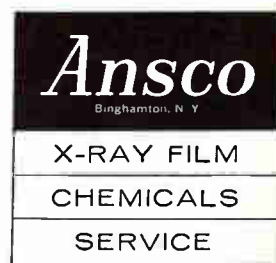



## What's in it for you?

Just this. This Leach Balanced Armature Relay withstands 2000 foot lbs. of shock loading and 30 G's to 2000 cps vibration to meet Mil-S-901B for equipment-mounted components. How? First, the standard relay has a dynamically balanced armature that provides equalization of the mass to stabilize the contact structure. Next, exclusive buffer blades are added to provide additional stability to the stationary contacts. Finally, the internal mechanism is tied down tight to the enclosure.

But shock and vibration resistance may not be your main aim. Maybe you're looking for minimum voltage spike generation, or radiation resistance, or extended life at maximum rated current, or other special features. This Leach Balanced Armature Relay or one like it will end your search. So stop looking. Start asking Leach for the answers.

# LEACH

 CORPORATION

18435 Susana Road, Compton, California • Export: Leach International S. A.

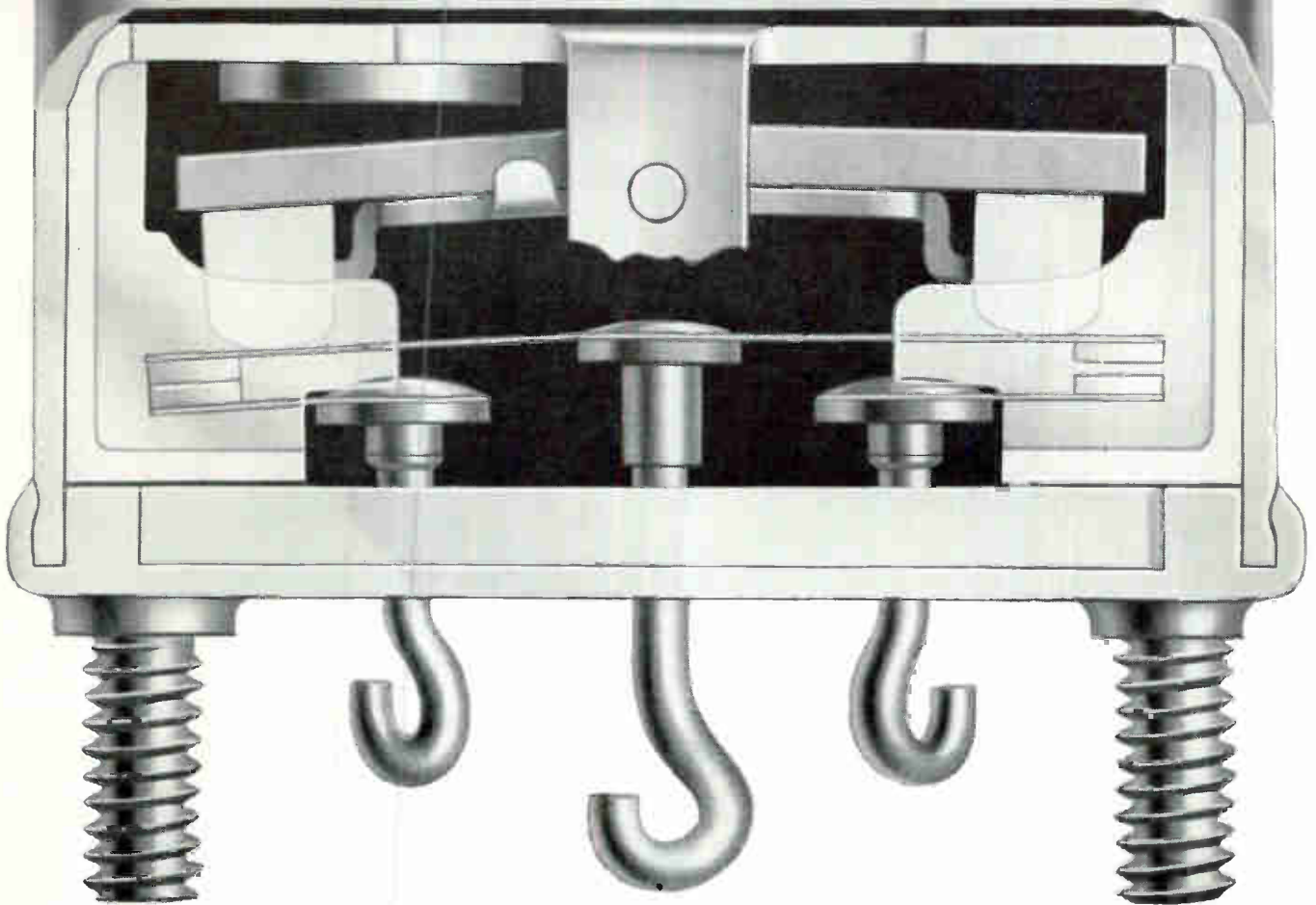



# How Diodes Keep Current to Constant Value

*Family of current regulators can simplify a variety of circuits*

By **NEIL WELSH**  
 Chief Engineer  
 CircuitDyne Corporation  
 Laguna Beach, California

**CONSTANT-CURRENT** diodes, called **Correctors**, are two-terminal solid-state devices that limit current. Current-limiting action of these units is comparable to the voltage-limiting action of zener diodes.

Departure from theoretical behavior of presently available types of Correctors is negligible for most applications. And designers now find their use can effect improvements for power supplies, linear amplifiers, multivibrators, and wave-shaping circuits.

**CHARACTERISTICS** — Typical first-quadrant characteristic of a polar constant-current diode of this type is shown in Fig. 1A. The operating region, that portion of the curve over which current is essentially independent of voltage, is bounded on its lower side

by an abrupt change in slope. A more gradual slope change marks the upper boundary of the operating region.

Nonpolar types Fig. 1B, have nearly identical forward and reverse characteristics. Deviations from exact symmetry are slight, and are confined to the extremes of the operating voltage range.

The linear equivalent circuit, Fig. 2, is appropriate to the operating regions of both polar and nonpolar types.

Shunt capacitance,  $C_c$ , has a voltage dependence similar to that of reverse-biased  $pn$  junctions. Magnitude of this shunt capacitance presently limits usefulness of these devices to frequencies below a few hundred kilocycles.

Shunt conductance is also a function of voltage. The peak absolute magnitude of the shunt conductance is held, in most cases, to one micromho per milliampere. However, conductance is negative over much of the operating range, reducing the average value to about one-tenth of the peak. This fact is significant for applications which involve operation over wide voltage spans.

Such an application is the circuit

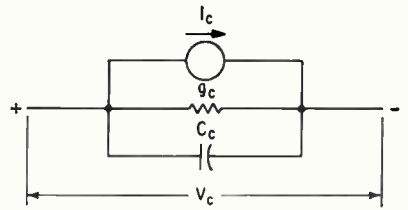

**EQUIVALENT** circuit is applicable to both types of constant-current diodes—Fig. 2

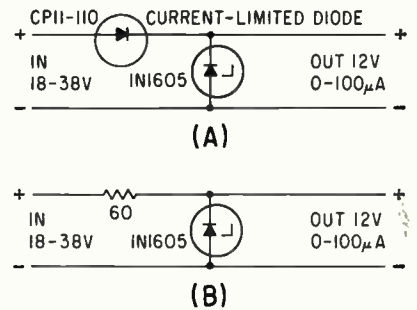

**CURRENT-LIMITED** shunt-voltage regulator circuits utilizing Corrector-zener diode (A) and resistor-zener (B)—Fig. 3

shown in Fig. 3A. This circuit supplies 0-100 ma of load current at a nominal output voltage of 12-v d-c, from a  $28 \pm 10$ -v d-c source. Corrector selected has a current rating 10 percent higher than the maximum normal load current, and functions over extremes of input voltage for both normal and shorted loads. The isolation of output voltage from changes of input voltage varies less than  $\pm 4$  mv for 16 to 40-v d-c inputs. Short-circuit current is similarly independent of input voltage, being  $10 \pm 2$  ma over the full input-voltage span.

**MERITS**—Unusual features of this design approach are illustrated by comparison with conventional resistor-zener voltage regulator shown in Fig. 3B.

Largest series resistance that can be used in this circuit is 60 ohms. Output voltage variation, for the rated input-voltage change, is  $\pm 425$  mv—more than 100 times that of the Corrector-zener cir-

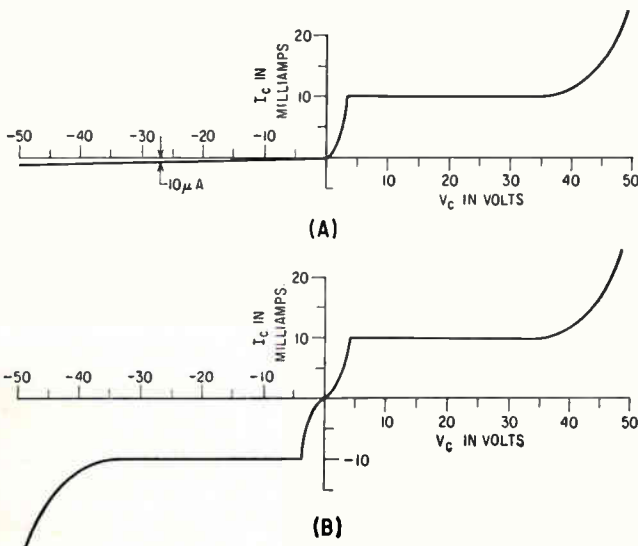

**TYPICAL** diode characteristics are given for two types of diodes used to regulate current. Curves are shown for polar (A) and nonpolar (B) types—Fig. 1

# Clifton Precision announces 4 major improvements in Servo Motor performance



**Greater  
EFFICIENCY**

These motors provide more torque for considerably less power input. This results in a more efficient motor as well as a cooler running motor.

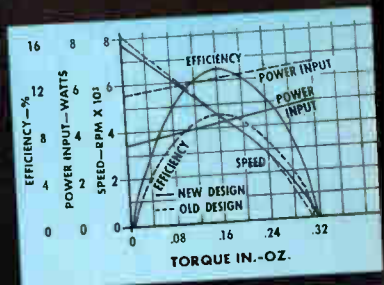

**Higher  
TORQUE/INERTIA  
RATIO**

Acceleration is increased to 160,000 rad/sec<sup>2</sup> at between 2 and 3 watts/phase. Up to 200,000 rad/sec<sup>2</sup> is possible under certain conditions.

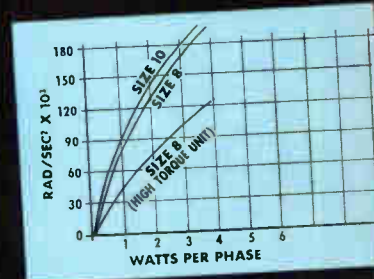

This is such an improvement that in certain motor-generator requirements, a new CPPC servo motor will now suffice.

**Lower  
STARTING  
VOLTAGE**

Whereas starting voltages have been specified at 3% of control phase voltage, we can now guarantee 1% and a great deal more uniformity.

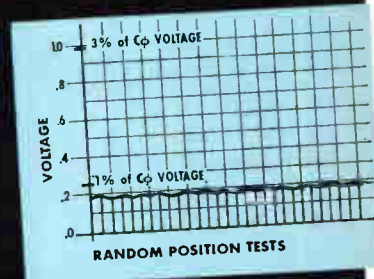

Furthermore, starting voltage of these motors has been exhaustively tested so that all starting characteristics can be accurately predicted.

**Less heat  
vulnerable  
MATERIALS**

New slot and magnet wire insulation allow much less current leakage at high temperatures. In addition, new lubricants and new impregnation enable these motors to withstand 200°C plus. Solderless connections are now incorporated in our servo motor line (all connections are welded).

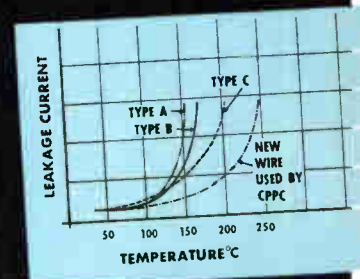

For full information: Sales Dept. 5050 State Rd., Drexel Hill, Pa. MADison 2-1000, TWX 215 623-6068—or our Representatives.

Be sure to see and discuss these motors in our suite, Barbizon-Plaza Hotel at the IEEE Convention, New York City, March 25-28.



Clifton Heights, Pa.  
Colorado Springs, Colo.

CLIFTON PRECISION PRODUCTS CO., INC.



**IMMEDIATE DELIVERY**  
**from the TRU-OHM STOCKING DISTRIBUTOR**  
**in your area**

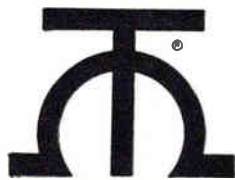

**POWER RHEOSTATS**

from  
**12½ watt**  
 to  
**300 watt**

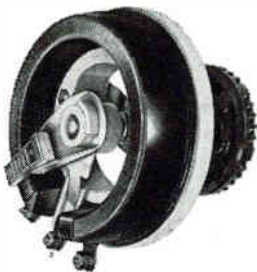

There is a TRU-OHM POWER RHEOSTAT for any and every application . . . with the custom variations for your particular needs. Your Tru-Ohm distributor has stock . . . your Tru-Ohm representative in your area is ready to answer your problems . . . your inquiry is invited.

Write for our latest complete catalog.



**TRU-OHM PRODUCTS**

Div. of Model Engineering & Mfg., Inc.  
 3426 West Diversey Blvd.  
 Chicago 47, Illinois  
 Factory: Huntington Indiana

cuit. For normal load conditions, input current varies from 265 ma, at 28-v input, to 435 ma at 38-v input. Maximum zener-diode power dissipation is, therefore, almost four times as high as in the circuit of Fig. 3A. The output impedance of the resistor-zener circuit is about 20 percent lower than that of the Currector-zener circuit, because of the shunting effect of the 60-ohm resistor, and the lowering of the zener-diode impedance due to the higher zener current. Most impedance reduction is due to the latter cause, and so is expensive in terms of efficiency, power dissipation, short circuit-current and input-output isolation. The performance of the Currector-zener circuit compares favorably with more complex regulator circuits.

**TEMPERATURE** — Configuration of Fig. 3A, though generally valuable as a zener-drive circuit, has merit for use with temperature-compensated reference diodes, since their high impedance requires that they be driven with a constant current. This circuit is useful also in decoupling applications, for it provides excellent isolation even with a low voltage drop. Also, circuit does not introduce instability caused by the inherent phase shift of r-c decoupling networks.

The Currector in Fig. 4 isolates the output of the single-stage amplifier from changes in supply voltage, and acts as a collector-load impedance. Bias resistor establishes collector voltage at a quiescent value of  $-10v$ . With no signal input, collector voltage remains substantially constant for supply voltages between  $-12$  and  $-35v$  d-c. Decoupling, as measured by superimposing 1vrms on a supply of  $-25v$  d-c is 30 db or greater for frequencies below 50 Kc, indicating that a stage of this configuration is unusually immune to power supply ripple and power supply-coupled feedback.

The voltage gain of this circuit is unusually high. Voltage gain in a common emitter amplifier stage approaches  $r_o/r_i$ , (expressed in T-equivalent parameters) as load admittance approaches zero.

In Fig. 4, the effective load con-

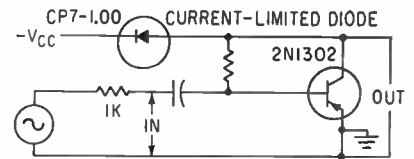

CONSTANT-CURRENT diode used as a collector load—Fig. 4

sists of the parallel combination of the Currector shunt admittance and the bias resistance, and is nearly equivalent to the bias resistor alone. Several transistors with betas ranging from 20 to 100, were tried in the circuit. In each case, appropriate bias resistors establish quiescent collector voltage at  $-10v$  d-c. Bias resistor values ranged from 200 kilohms to 1 megohm. Mid-frequency voltage gains for the single stage varied from 57 to 66 db, and upper 3 db cutoff frequencies from 50 to 100 Kc. Low frequency response was limited by the input r-c circuit alone.

As a consequence of the high gain attained by using a Currector as a collector-load impedance, quiescent collector-voltage level must, for linear operation, be defined by feedback. This was the reason for selecting the biasing method used in Fig. 4. Without stabilization of the collector voltage by either internal or external feedback, linear amplification would be impossible. This presents no problem, of course, if operation in the switching mode is desired.

**LINEARITY** — A simple linear ramp generator utilizes a Currector for linearization. This circuit achieves performance ordinarily obtained only through the use of bootstrap techniques.

When the incoming gate signal turns off the transistor of the generator, Currector current is diverted into charging the capacitor. Rate of change of the capacitor voltage, remains constant until  $e_c$  reaches a level such that the voltage drop across the Currector is less than its minimum operating voltage. Thus the lower limit on the supply voltage is defined. Voltage must exceed the desired ramp magnitude by at least the knee voltage of the diode. Also, since the supply voltage is impressed directly across the current limiter when the transistor is gated on, supply volt-



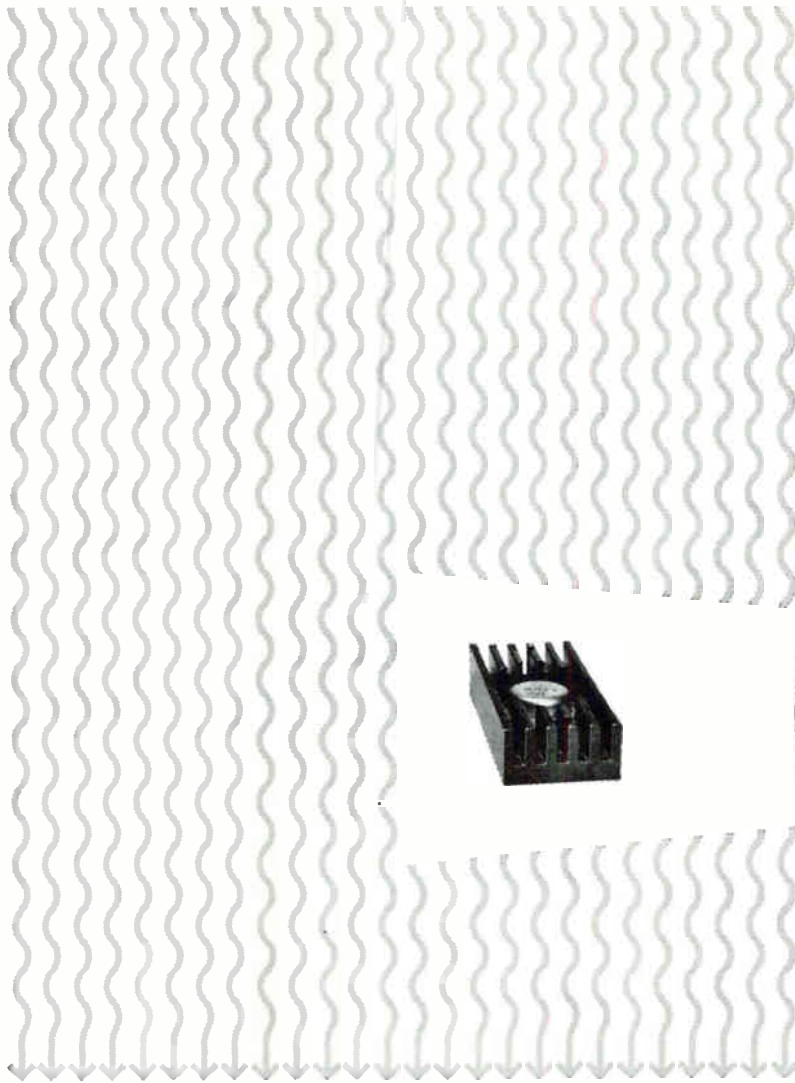

1 1/8" dia. x 1 3/4" long  
weight 1.4 ounces

## NEW MINIATURE A. C. BLOWER COOLS CIRCUIT HOT SPOTS

When heat sink techniques won't cool a critical hot spot in your circuit, telephone Globe. New VAX-1-AC blower moves 9 cfm of air against .75" H<sub>2</sub>O backpressure. We'll be happy to ship one to you right now. VAX-1 blowers combine the utmost compactness with optimum useful performance and good life. If you don't have a.c. available in your circuit, request the d.c. version, also stocked for 24-hour delivery.

VAX-1 blowers are the smallest of Globe's complete line of cooling blowers for electronic applications. Request Bulletin VAX-1 from Globe Industries, Inc., 1784 Stanley Ave., Dayton 4, Ohio, Phone 222-3741.

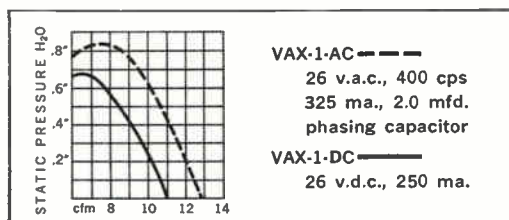

VAX-1-AC — — —  
26 v.a.c., 400 cps  
325 ma., 2.0 mfd.  
phasing capacitor  
VAX-1-DC — — —  
26 v.d.c., 250 ma.



GLOBE INDUSTRIES, INC.

PRECISION MINIATURE MOTORS, GEARMOTORS, TIMERS, ACTUATORS, CLUTCHES, BLOWERS, MOTORIZED DEVICES

# ARNOLD: WIDEST SELECTION OF MO-PERMALLOY POWDER CORES FOR YOUR REQUIREMENTS

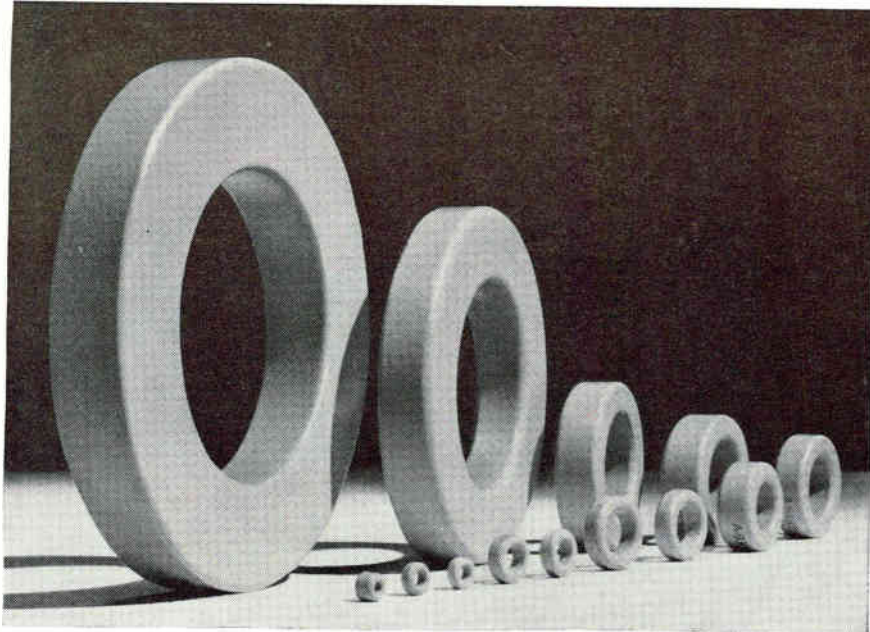

For greater design flexibility, Arnold leads the way in offering you a full range of Molybdenum Permalloy powder cores . . . 25 different sizes, from the smallest to the largest on the market, from 0.260" to 5.218" OD. Standard permeabilities are 14, 26, 60 and 125 Mu, and the high permeability range includes cores of 147, 173 and 205 Mu.

In addition to pioneering the development of the cheerio-size cores, Arnold is the exclusive producer of the largest 125 Mu core commercially available. A huge 2000-ton press is required for its manufacture, and insures its uniform physical and magnetic properties. This big core is also available in 14, 26 and 60 Mu.

High-permeability cores up to 205 Mu are now available in most sizes. These cores are specifically designed for low-frequency applications where

the use of 125 Mu cores does not result in sufficient Q or inductance per turn. They are primarily intended for applications at frequencies below 2000 cps.

Most sizes of Arnold M-PP cores can be furnished with a controlled temperature coefficient of inductance in the range of 30 to 130° F. Many can be supplied temperature stabilized over the MIL-T-27 wide-range specification of -55 to +85°C . . . another special Arnold feature.

Graded cores are available upon special request. All popular sizes of Arnold M-PP cores are produced to a standard inductance tolerance of + or - 8%, and many of these sizes are available for immediate delivery from strategically located warehouses.

Let us supply *your* requirements for Mo-Permalloy powder cores (*Bulletin PC-104C*) and other Arnold products.

age must not exceed the maximum rated voltage of the Currector. Within these limits, supply voltage has no influence on the ramp output, which is both linear and stable.

A number of familiar circuits can be improved substantially by substituting a constant-current diode for a resistor. However, application of the diode is not restricted to the modification of conventional circuits.

In a triangular-wave-shaping circuit, a non-polar constant-current diode limits the magnitude of a capacitor-charging current whenever the instantaneous generator voltage is such that the voltage drop across the diode exceeds its knee voltage. This simple circuit produces an output that is largely independent of input waveform characteristics.

Small truncations visible on the output waveform of the wave-shaping circuit are the result of the combination of low rate-of-change of the driving waveform near its points of polarity reversal, and the diode knee voltage. Truncation error can be reduced by increasing the magnitude of the drive voltage, or using a drive waveform which reverses polarity rapidly, such as a square wave. Similar circuits are easily adapted to the demodulation of pulse frequency, pulse wave and pulse repetition.

## High-Temperature Alloy May Fit Microcircuit Needs

A MIDWESTERN copper mill has announced a new coppermetal alloy which possesses moderately high electrical conductivity and is reportedly stronger than copper. The alloy contains 2.3 percent iron and 0.3 percent phosphorus, with the balance copper.

Tensile strength of the alloy in annealed form is 35 percent greater than that of electrolytic copper. Electrical conductivity is 65 percent, compared with electrolytic copper's 100 percent (International Annealed Copper Standard), and this compares with only 28 percent for yellow brass, it is reported.

According to spokesman for



ADDRESS DEPT. E-1  
**ARNOLD**  
SPECIALISTS in MAGNETIC MATERIALS

THE ARNOLD ENGINEERING COMPANY, Main Office: MARENGO, ILL.  
BRANCH OFFICES and REPRESENTATIVES in PRINCIPAL CITIES

1187R1D



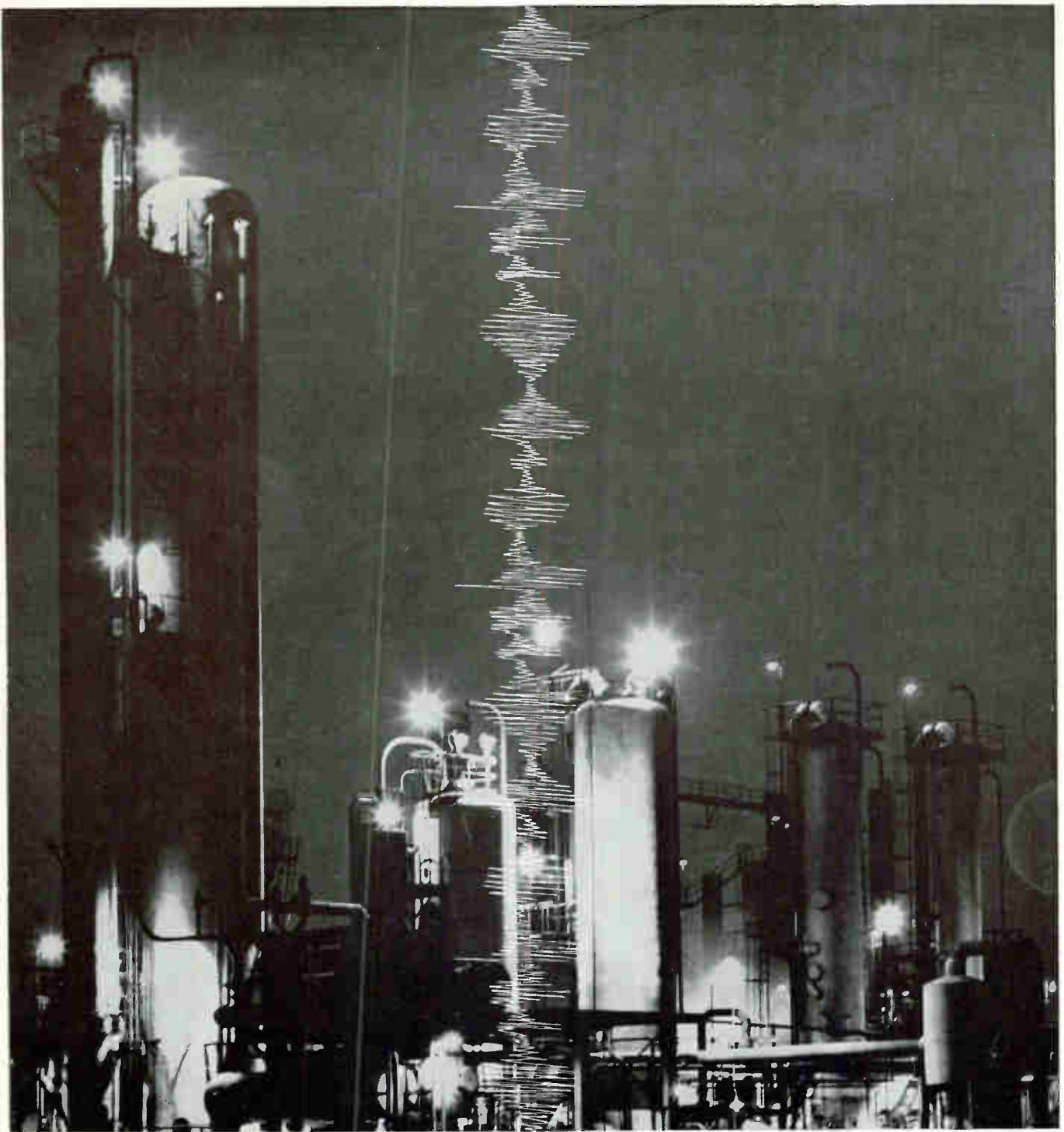

Where can they get a true instrumentation recorder for under \$5,000? **AMPEX**

Now: Ampex offers industry and research true instrumentation performance in a low-cost portable package — the Ampex SP-300. No other recorder on the market does so much for so little cost. The SP-300 gives you four speeds, with electrical switching of both transport and electronics by a single control. It has four channels. Records both FM and Direct. Comes with built-in calibration and erase. And it uses the most thoroughly proved and reliable of all professional tape transports—specifically adapted for precise

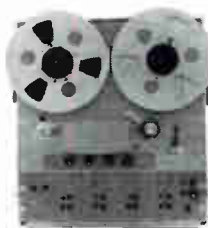

instrumentation applications. The price fits the most modest budget: Less than \$5,000. And it's economical to operate—uses ¼-inch tape. That's why you'll find the SP-300 perfect for data acquisition needs of medical, industrial and research applications. For more information write the only company providing recorders, tapes and memory devices for every application: Ampex Corporation, 934 Charter Street, Redwood City, California. Sales and service engineers throughout the world.

**AMPEX**

# AIRPAX Electronic Tachometer

Converts signal information frequency  
into a directly proportional DC output

## TYPICAL SIGNAL SOURCES

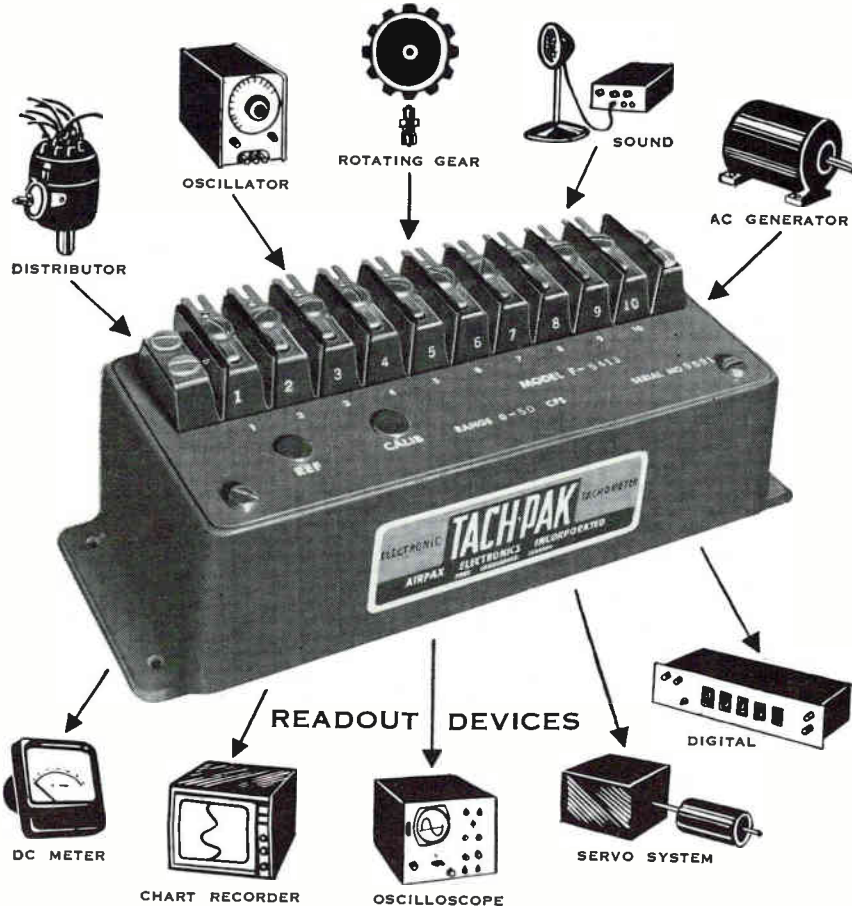

The Airpax Tach-Pak solid state electronic tachometer employs a combination of transistor and magnetic circuits to produce a device of exceptional accuracy and versatility. Other than its common use as a speed indicator, present applications include: ★ Propeller shaft rotation indicator on atomic submarines ★ Starter cut-off on jet aircraft engines ★ Turbine overspeed warning system ★ Speed recorder on railway rolling stock ★ Impact tool frequency recorder. The Tach-Pak is available in a hermetically sealed case, explosion proof housing or cast aluminum or NEMA enclosure with barrier strip or plug connectors.

Write, wire or phone for descriptive literature

TWX: 305-587-1000

AIRPAX  
ELECTRONICS

Phone 587-1100 (305)

SEMINOLE DIVISION

FT. LAUDERDALE, FLA.

Metals Division of Olin Mathieson Chemical Corp, company who developed the new copper base alloy, the Olin 605 HSM copper provides both strength and moderately high conductivity. Also, because of its thermal and electrical conductivity, alloy should solve many problems of excessive heat rise.

Olin Brass has started producing the new alloy in sheet and strip form, and prices quoted are at generally the same level as for company's electrolytic copper sheet and strip.

High-temperature alloy may solve miniaturization problem: maintaining strength and still achieve enough conductivity for small electrical and electronic components.

## Current-Carrying Spring Made of Composite Material

MULTITEMPERED composite spring material provides current carrying parts with locking properties at one end and sufficient malleability at the other end for crimping and forming. It is designed for use in

## Reliability at 20,000 G's



TRANSISTORS, spinning inside these bins at Raytheon's semiconductor plant, take stresses of 20,000 G's. Units that pass, head for service in Minuteman missile. Normally weighing no more than an ordinary paper clip, a transistor weighs 52 pounds while being tested





**NEW**

# FM STEREO MODULATOR

**TYPE 219-A**



## SPECIFICATIONS:

- Direct (L) & (R) Inputs
- SCA Input
- Internal Preemphasis
- Internal 1 KC Modulating Oscillator
- Peak Reading Output Meter
- Self-Checking Switchable Matrix

### INPUT CHARACTERISTICS

LEFT (L) & RIGHT (R) INPUTS

Frequency Range: 50 cps — 15 KC

Level:  $1.7 \pm 0.3$  volts rms\*

\*For 45% peak multiplex output; simultaneous (L) and (R) inputs yield 90% peak multiplex output

Preemphasis: 75  $\mu$ sec preemphasis switchable in or out of circuit

SUBSIDIARY COMMUNICATIONS (SCA) INPUT

Frequency range: 20 — 75 KC

Level: 1.0 volt rms\*

\*For approx. 10% peak multiplex output

### MODULATING OSCILLATOR CHARACTERISTICS

Osc Frequency: 1 KC

Osc Output: Switchable into either (L) or (R) input

The FM Stereo Modulator Type 219-A is designed to provide a multiplex output signal in accordance with FCC Docket 13506 when fed with Left (L) and Right (R) audio stereo channel inputs and/or subsidiary communications FM sub-carriers (SCA). The output of the modulator may be switched to provide either (L + R), (L - R), 19 KC pilot carrier, 38 KC residual carrier or the complete multiplex signal which can then be used to modulate a suitable FM Signal Generator. When used with the BRC Type 202-E, no external audio oscillator or other equipment is required.

A peak reading metering system, calibrated in % of system deviation, is provided for setting and monitoring the levels of the individual sub-carriers. The internal matrix may be switched from the normal condition to provide either (L + R) or (L - R) null for checking the matrix in the receiver under test. The modulator is completely self-contained and housed in a single cabinet which may be adapted for standard rack mounting.

## BOONTON RADIO COMPANY

A Division of Hewlett-Packard Company



GREEN POND ROAD, ROCKAWAY, NEW JERSEY

Tel. 627-6400 (Area Code 201) TWX: 201-627-3912 Cable Address: Boonraco

### OUTPUT CHARACTERISTICS

Level: 0 — 7.5 volts peak\*

\*Multiplex output

Residual Hum & Noise: > 60 db below 100% output

Crosstalk: > 40 db below 100% output

\*Output

\*(L - R) into (L + R)

### METERING

Range: 0 — 10%\* (19 KC and 38 KC only); 0 — 100%\*

\*Multiplex output; output adjustable 0 — 7.5 volts peak for 100%

Output Modes: Switchable for (L + R), (L - R), 19 KC pilot carrier, 38 KC residual carrier, or multiplex signal

### PILOT CARRIER

Frequency: 19 KC

Accuracy:  $\pm 0.01\%$

### MONAURAL (L + R)

Fidelity: 50 cps — 15 KC  $\pm 1$  db\*

\* $\pm 0.2$  db and  $\pm 1.5^\circ$  relative to (L - R)

### DOUBLE SIDEBAND SUPPRESSED CARRIER (L - R)

Frequency: 38 KC

Fidelity: 50 cps — 15 KC  $\pm 1$  db\*

\* $\pm 0.2$  db and  $\pm 1.5^\circ$  relative to (L + R)

### SUBSIDIARY COMMUNICATIONS (SCA)

Fidelity: 20 — 75 KC  $\pm 0.5$  db

### OSCILLOSCOPE SYNC SIGNAL

Frequency: 19 KC

Output Level: 0.5 volts rms

Price: \$915.00 F.O.B. Rockaway, N. J.

# TICKET TO THE TOP

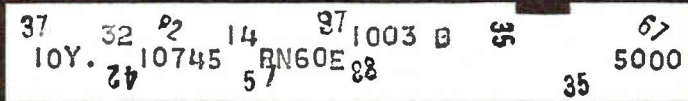

# IN RESISTOR QUALITY

Every resistor going through the new Ward Leonard plant at Hagerstown, Md. rides a quality control ticket... and every resistor produced in this unique, air-conditioned, humidity-controlled plant is a METAL FILM PRECISION Resistor.

When the trip is over, the ticket looks like this—loaded with imprints. The completed ticket records the identity and integrity of each technician and engineer who performed each operation—and made every inspection. The ticket will have the history of 18 manufacturing stages, 7 inspections, 8 quality-control checks, and another 7 tests for conformance to MIL-R-10509D.

The new Ward Leonard plant for Metal Film Precision Resistors produces just one line of resistors (1/10 to 1/2 watt) and that's the *top quality*. WARD LEONARD METOHM® and other metal film precision resistors are built to be the Best Resistor for Demanding Applications. They unvaryingly exceed all specifications, and hold well within the permitted tolerances... otherwise, they never leave the Hagerstown plant.

Demand this top-performance quality for your own resistor requirements. Ask for new Catalog 50A on METOHM Metal Film Precision Resistors—and the entire line of Ward Leonard resistors stocked by leading Authorized Industrial Distributors. Please write or call—Ward Leonard Electric Co., Metal Film Division, 30 South Street, Mount Vernon, N. Y.

8-27



METAL FILM DIVISION  
**WARD LEONARD**  
**ELECTRIC CO.** MOUNT VERNON  
NEW YORK  
RESISTORS • RHEOSTATS • RELAYS • CONTROLS • DIMMERS

connectors, clips, springs and terminals.

The composite material consists of a layer of carbon spring steel clad on both sides with copper—material ratio of 5/90/5 or 10/80/10. Metals are metallurgically bonded into one material. Bond is reportedly undamaged by shearing, bending, etc. Supposedly, the composite material provides the high conductivity and low contact resistance of copper with the high elasticity and mechanical strength of spring steel.

Developed by Metals & Controls, Inc., a division of Texas Instruments, it is being marketed under TI's trademark, Conflex. Material is supplied in coils having 4½, 8 or 16 inches inside diameters with strip thicknesses from 0.004 to 0.040 inch and widths ranging from ½ to 2½ inches.

## Etchant Established For Tin-Nickel Circuit Boards

GOLD has been used for plating a protective metal over the copper circuit to provide an etch resist when the final circuit pattern is etched out. Recently, a new low-cost plating bath, which plates out an alloy of 65 percent tin and 35 percent nickel by weight, is said to give excellent results when used for a protective overplate.

High reliability, low cost tin-nickel plated circuit boards are etched with ammonium persulfate, according to J. R. Hopkins technical service manager of FMC Corporation's Inorganic Chemical Division. Hopkins told *ELECTRONICS* that Hewlett-Packard has evaluated several etchants in the developmental stage, and found ammonium persulfate was the best available for the new boards. R. J. Dietz, Hewlett-Packard's printed circuit process engineer, said that the quality of the new boards stems directly from pattern-plating techniques used during their fabrication. Characteristics claimed for tin-nickel plating include improved solderability and lower production costs than gold, as well as excellent wearability, abrasion and corrosion resistance.



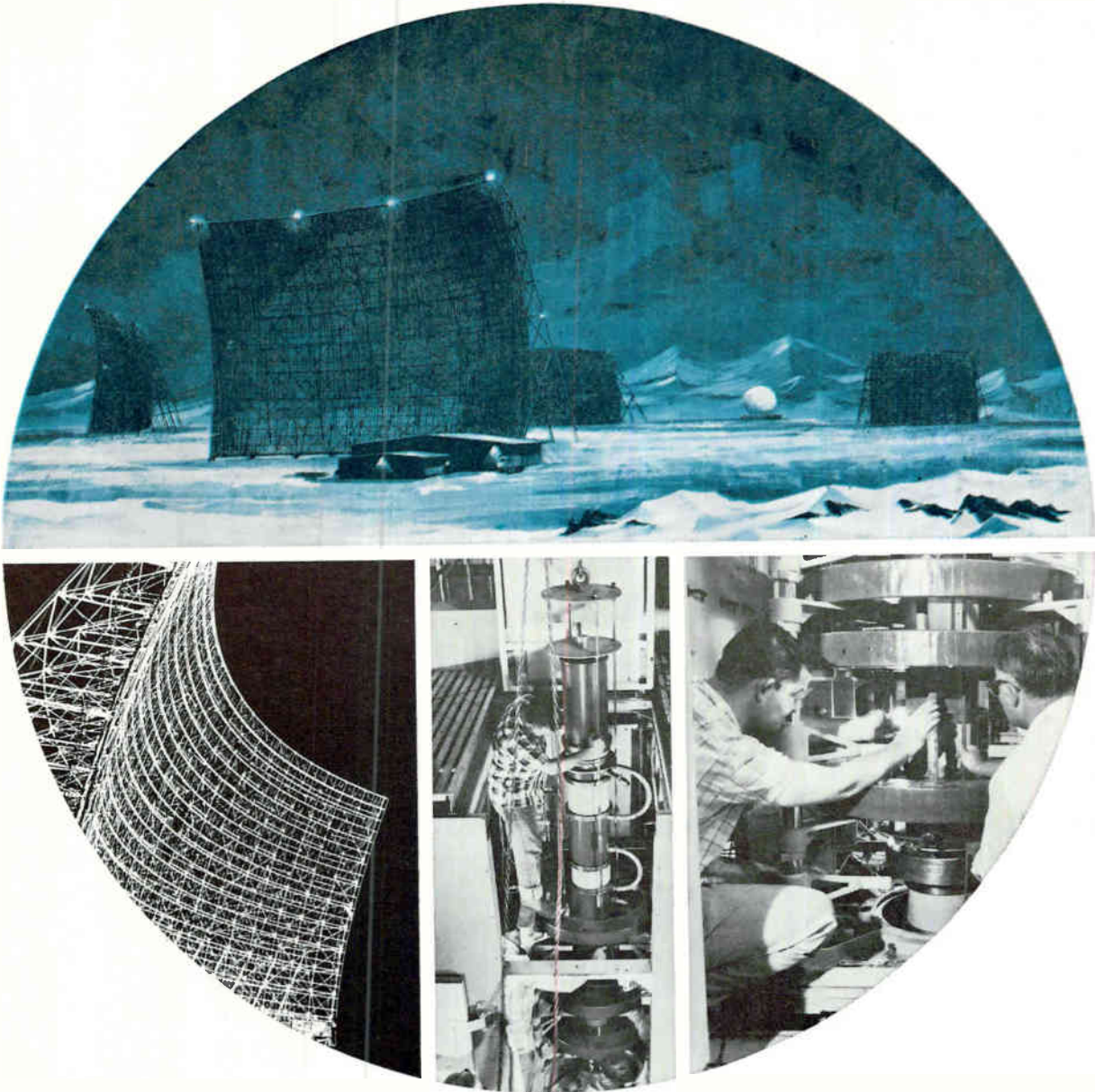

## **SUPER POWER RADAR TRANSMITTERS FOR BMEWS**

Continuously scanning the northern approaches to England and North America from installations at Fylingdales Moor, England, Thule, Greenland, and Clear, Alaska, the U. S. Air Force's Ballistic Missile Early Warning System is the free world's first warning of enemy ICBM attack. Continental Electronics has delivered all of the transmitters for surveillance and tracking radars at the three BMEWS installations. ■ Provided under subcontract to General Electric and R.C.A., Continental's AN/FPT-7 super power transmitters use specially-developed klystron tubes to produce multi-megawatt radar signals. Serving what is described by the Air Force as, "the world's most powerful operational radar", the BMEWS transmitters were designed by the specialists in super power transmitting equipment.

**Continental Electronics**

MANUFACTURING COMPANY • MAILING ADDRESS: BOX 17040 • DALLAS 17, TEXAS  
4212 S. BUCKNER BLVD. • EV 1-7161 • LTV SUBSIDIARY OF LING-TEMCO-VOUGHT, INC.

*Designers and Builders of the World's Most Powerful Radio Transmitters*



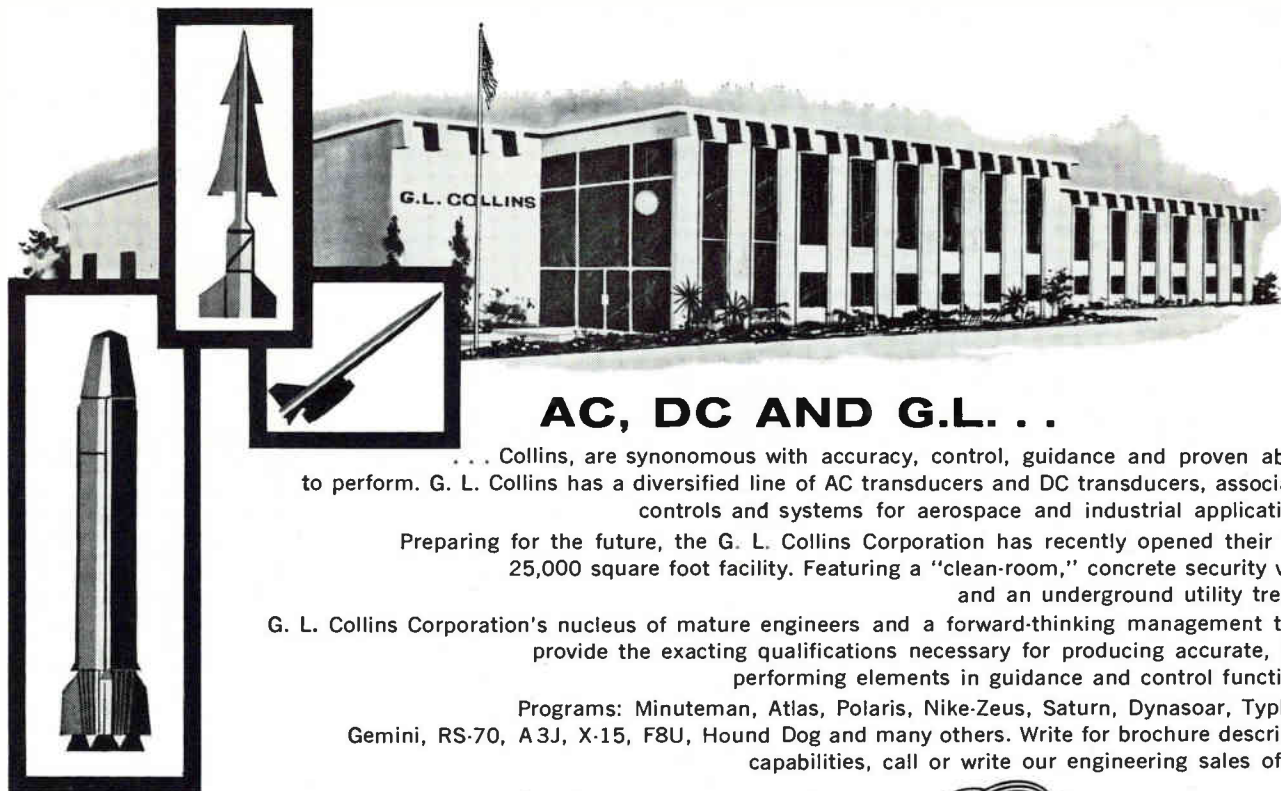

## AC, DC AND G.L. . .

. . . Collins, are synonymous with accuracy, control, guidance and proven ability to perform. G. L. Collins has a diversified line of AC transducers and DC transducers, associated controls and systems for aerospace and industrial applications.

Preparing for the future, the G. L. Collins Corporation has recently opened their new 25,000 square foot facility. Featuring a "clean-room," concrete security vault and an underground utility trench.

G. L. Collins Corporation's nucleus of mature engineers and a forward-thinking management team provide the exacting qualifications necessary for producing accurate, high performing elements in guidance and control functions.

Programs: Minuteman, Atlas, Polaris, Nike-Zeus, Saturn, Dynasoar, Typhon, Gemini, RS-70, A3J, X-15, F8U, Hound Dog and many others. Write for brochure describing capabilities, call or write our engineering sales office.

## G. L. COLLINS CORPORATION



2820 Hullett Street, Long Beach 5, California

(213) NEVada 6-8141 • (213) MEtcalF 0-3121 • TWX: 634-4095

CIRCLE 201 ON READER SERVICE CARD

## COMBINED VIBRATION & SHOCK CONTROL!!

Available through many unique cable isolator configurations for specific environments either in



individual isolators or complete isolation systems.

Write for information on how we can solve your vibration and shock problems.

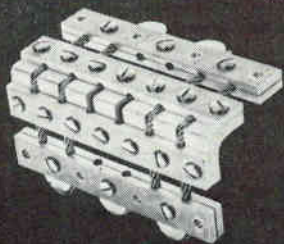

## AEROFLEX LABORATORIES INCORPORATED

Dept. JL-91 • 48-25 36TH STREET • LONG ISLAND CITY 1, N. Y.

# IEEE

## MEET

THE BEST BRAINS,  
THE BEST PRODUCTS  
IN THE INDUSTRY  
at

## I-TRIPLE-E's

International Convention  
and Exhibition in New York

**MARCH 25, 26, 27, 28**

The COLISEUM at Columbus Circle  
& The WALDORF ASTORIA HOTEL

admission: MEMBERS \$1.00; NON-MEMBERS \$3.00  
MINIMUM AGE: 18

# SHOW

(formerly the IRE Show)



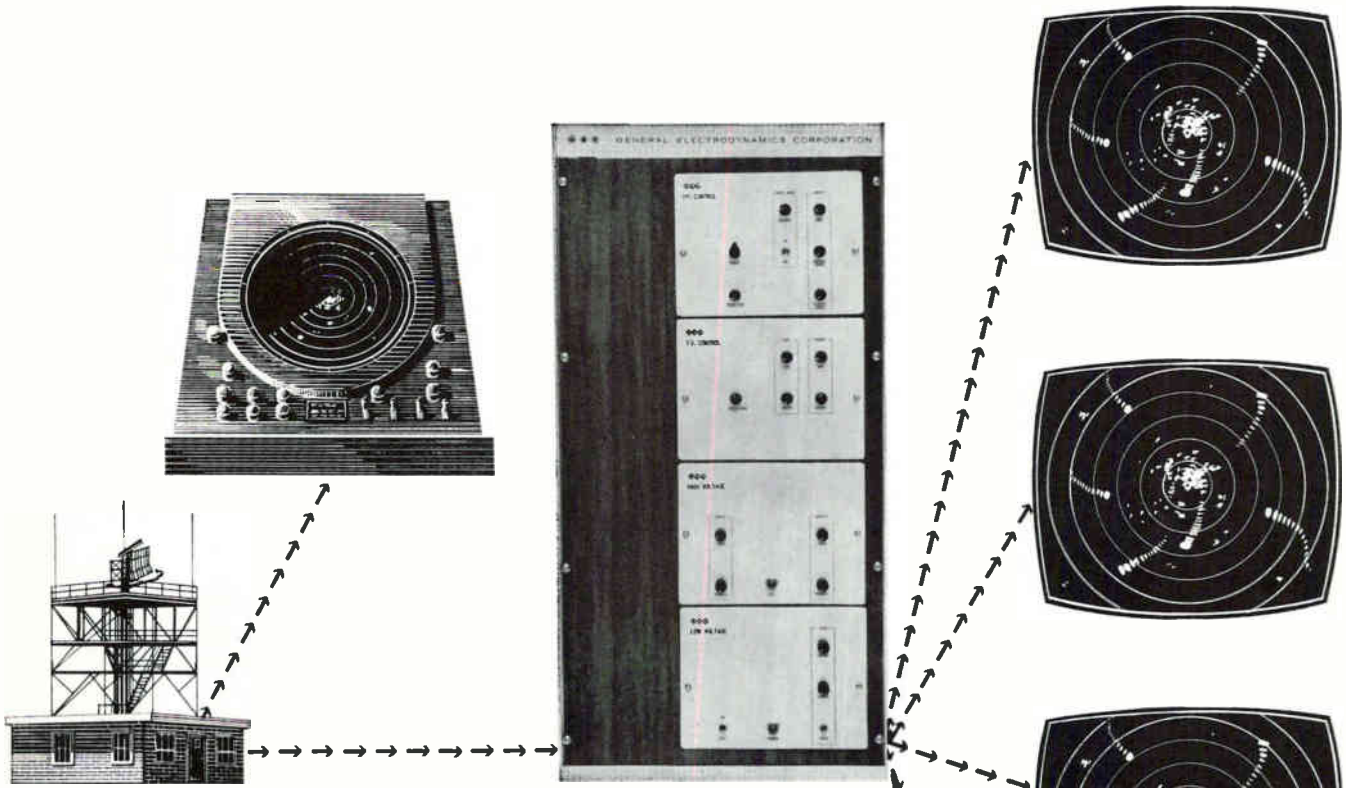

## Now Multiple PPI Displays Under High Ambient Light Conditions... With G E C Scan Converter

With GEC's *transistorized* 6021 Scan Converter, it is no longer necessary to look at rapidly decaying PPI displays in dark surroundings. Any number of inexpensive TV monitors can be operated from one PPI source with controlled image storage time affording more reliable evaluation of displayed information.

Readily tailored to your specific requirements through its plug-in functional modules, the 6021 Scan Converter is capable of:

- ◆◆◆TRANSLATION of video information from one scanning mode to any other.
- ◆◆◆STORAGE and INTEGRATION of video information.
- ◆◆◆TIME-COORDINATE TRANSFORMATION for expansion or reduction of bandwidth.

Contact GEC for more information about conversion of radar PPI to TV, TV standards conversion or conversion of slow scan narrow band TV to standard TV or vice versa.

Qualified electronic engineers are needed for work in the field of Scan Conversion. Address inquiries to Professional Placement Manager. An equal opportunity employer.

. . . advanced electronics at work



**GENERAL ELECTRODYNAMICS CORPORATION**

4430 FOREST LANE • GARLAND, TEXAS • BROADWAY 6-1161

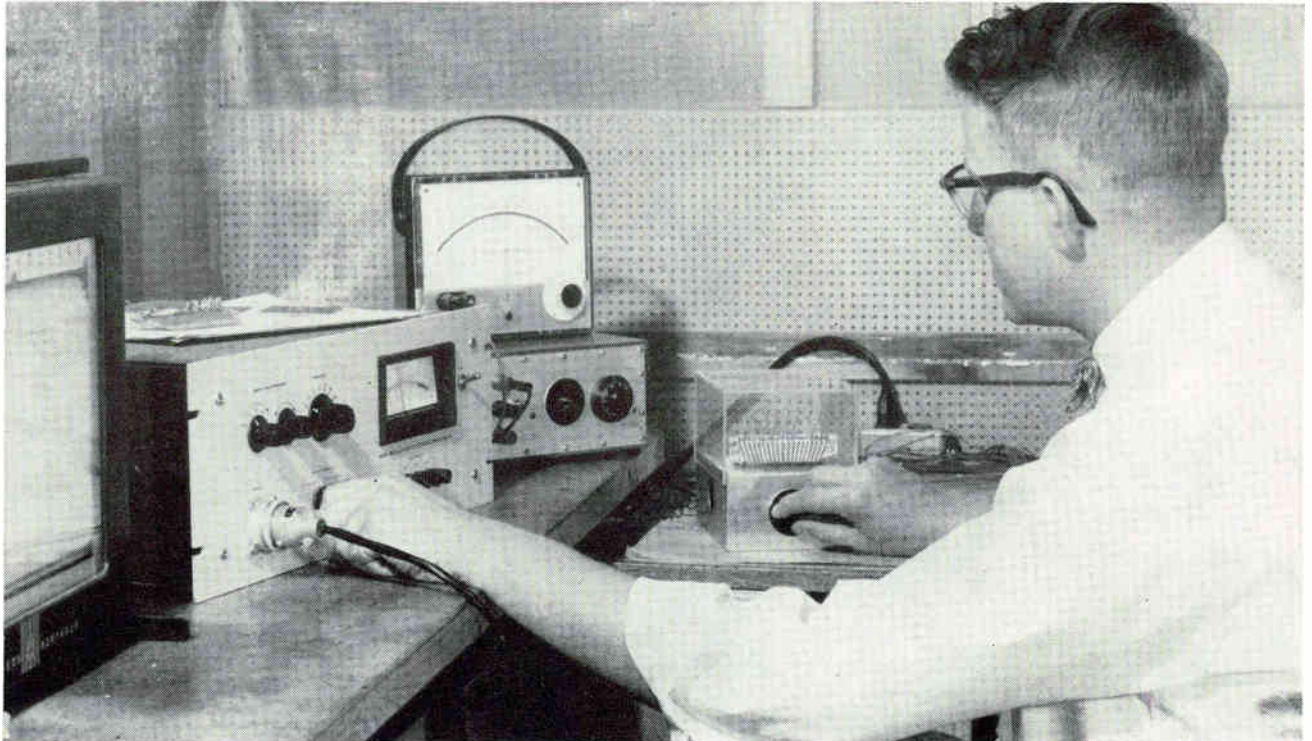

CONTACT RESISTANCE of serrated connections tested to below 50 micro-ohms

## Serrations Solve Wire-Termination Problem

*Permanent, gas-tight, reusable connections made in one step*

By MALCOLM N. BROWN  
CARL F. VIESER  
AMP, Inc.  
Harrisburg, Pennsylvania

REMOVAL of the various types of insulation used with fine wire to obtain bare-wire contact is difficult

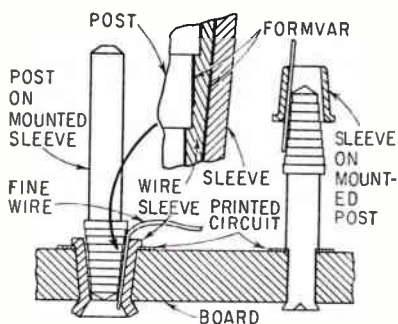

RADIAL FORCES acting on wire in terminal configuration maintain longitudinal, gas-tight, multiple electrical contact in all serrations and adjacent areas—Fig. 1

and time consuming. Mechanical stripping calls for extreme care and operator skill. Chemical stripping demands constant alertness. Solder-bath removal has definite difficulties and shortcomings.

**SERRATION TECHNIQUES**—At AMP, a one-step termination method not requiring removal of insulation has been developed (Fig. 1). As illustrated, a section of Formvar-coated wire is terminated on a fine-wire post. A series of evenly spaced concentric serrations, carefully depth-controlled, are machined into the post at a precisely tapered angle. The sleeve has a precisely matched tapered angle so that when it is placed over the post, the insulated fine wire is securely trapped between. A calibrated tool is inserted over the post to drive it carefully into position (or the sleeve may be inserted on a mounted post). The resulting radial forces cause elongation of the wire to produce and maintain longitudinal contact

in all serrations and adjacent areas, producing a gas-tight, multiple, electrical contact.

Thus, in a fraction of a second, a fine-wire electrical termination is made that is permanent and gas-tight, but can still be removed and reused, if necessary, up to 5 times. Besides stripping, problems of cold soldered joints, corrosion due to ex-

### FINE TERMINATING OF FINE WIRE

Fine-wire terminations in today's miniature and complex circuitry should be: strong as the wire itself, solderless and installed at low cost. Increasing use of fine wire has expanded its categories in a few years from the single No. 28 AWG to No. 26 through No. 56. The technique discussed here has been used with No. 32 through No. 56.



# How General Dynamics/Electric Boat precision-cleans missile launching-tube components for Polaris subs!

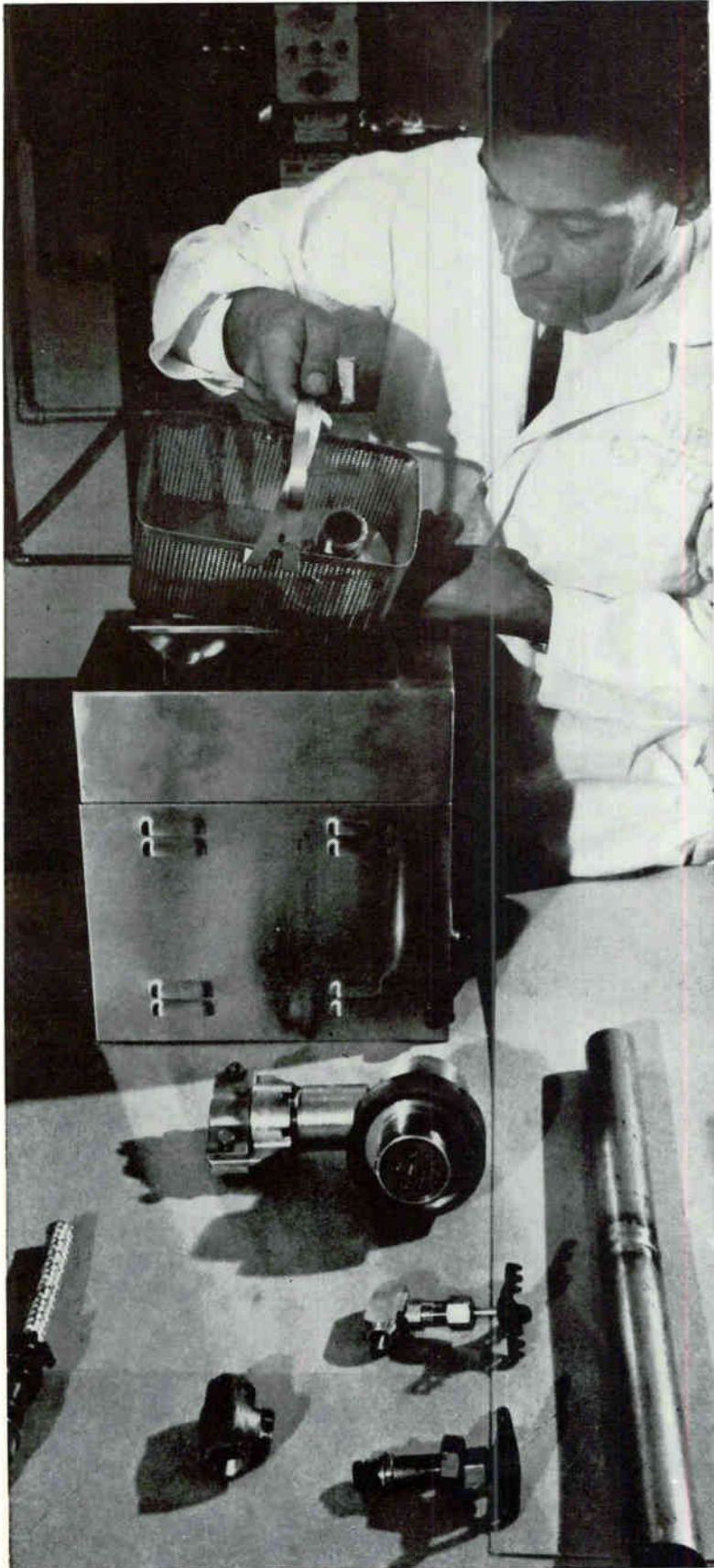

**PROBLEM:** Pneumatic launching-tube systems for the Polaris, involving miles of pipes, tees, valves, unions, etc., must be kept scrupulously clean at all times, according to Electric Boat. In an environment of high air pressure, the most minute organic contaminants could support a dangerous explosion. The previous cleaner was rated only 83 to 88% effective in removing a known hydrocarbon contaminant; also it had to be heated to 160°F. before use.

**SOLUTION:** All launching system components are now cleaned in an ultrasonic bath of FREON fluorocarbon solvent, both initially and during subsequent maintenance. FREON scores 100% every time on the hydrocarbon contaminant test, and works perfectly at ambient temperature.

Electric Boat continues, "Besides cleaning effectiveness, FREON has high purity, extremely low toxicity, nonflammability and ease of handling. Then, it's noncorrosive to metals and generally inert to plastics and elastomers—so FREON is ideal for cleaning when many different materials of construction are involved. Also, Du Pont supplied us with plenty of research data, which saved us time because we didn't have to run extensive analyses ourselves."

We'd be happy to show you how FREON can improve your own cleaning operation. First send the coupon or Reader Service Card for our new booklet on cleaning!

**FREON®**

solvents

BETTER THINGS FOR BETTER LIVING . . . THROUGH CHEMISTRY



REG. U.S. PAT. OFF.

**MAIL COUPON FOR NEW  
BOOKLET ON CLEANING**

E. I. du Pont de Nemours & Co. (Inc.)  
FREON Products Division  
N-2420E-1, Wilmington 98, Delaware

Name \_\_\_\_\_ Title \_\_\_\_\_

Company \_\_\_\_\_

Address \_\_\_\_\_

Please send new booklet on FREON solvents for precision cleaning.

I am interested in cleaning \_\_\_\_\_

I would like Du Pont to send a cleaning specialist.

# Compact View of Hart Relays



## SERIES R&S Miniature, Hermetically Sealed.

4PDT. Contact ratings from micro-amperes to 10 amps. Meet or exceed MIL-R-5757D. A-c coil version available.



## SERIES P High Speed Polarized.

SPDT. Operating response to 200 microseconds. No contact bounce.

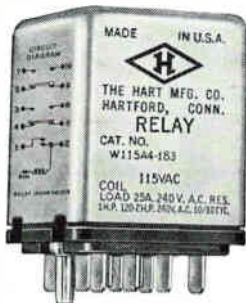

## SERIES W General Purpose.

DPDT, double break, a-c, d-c relays. Plug-in type or quick-disconnect terminals. Rated up to 25 amps, yet more compact than most 10 amp relays. Holding contact available.

For complete information write to:



**HART**  
MANUFACTURING CO.  
202 BARTHOLOMEW AVENUE  
HARTFORD 1, CONNECTICUT  
Telephone: Area Code 203. 525-3491

A SUBSIDIARY OF OAK MANUFACTURING CO.

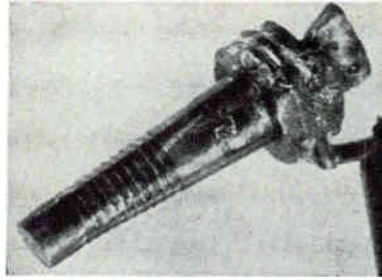

**BRIGHT STREAK** on terminal post (top) gives evidence of desired cold-welding. Wire (bottom) shows mating streak and multiple areas scrubbed of insulation by serrations—Fig. 2

cessive fluxing and other soldering problems have been eliminated.

The geometry need not be circular. Experimental fine wire terminations have been formed into square and rectangular configurations and in a variety of other configurations.

**OXIDE REMOVAL**—The combination of extrusion, longitudinal motion and serrations thoroughly scrubs away oxides as well as insulation from the conductor to impale the bare conductor on the serration crest. This produces a gas-tight, multiple electrical contact having a high residual holding

force. Friction, plus this residual force, lock sleeve and post together with a force of about 8 to 10 pounds.

**CONTACT RESISTANCE**—The actual contact resistance on all samples tested was well under 1 milliohm, with the contact area ranging from 200 to 400 percent of the cross section area of the wire. Contact resistance of many samples with carefully controlled serrations ranged in the neighborhood of 50 microohms or below. Actual cold welding was found to occur during termination process, as shown in Fig. 2. These photographs show a standard Series 53 post and number 32 AWG wire after subjection to a hydrogen sulphide test, disassembly of the sleeve from the post, and peeling of the wire from the post.

Cold welding is indicative of intimate molecular contact and synonymous with the best electrical contact.

**PRODUCT TESTING**—These terminations were thoroughly tested by the gauntlet of available and applicable military tests, plus several others devised by our engineering department to determine superior capabilities.

The usual Mil-W Specs were followed for thermal shock, vibration,

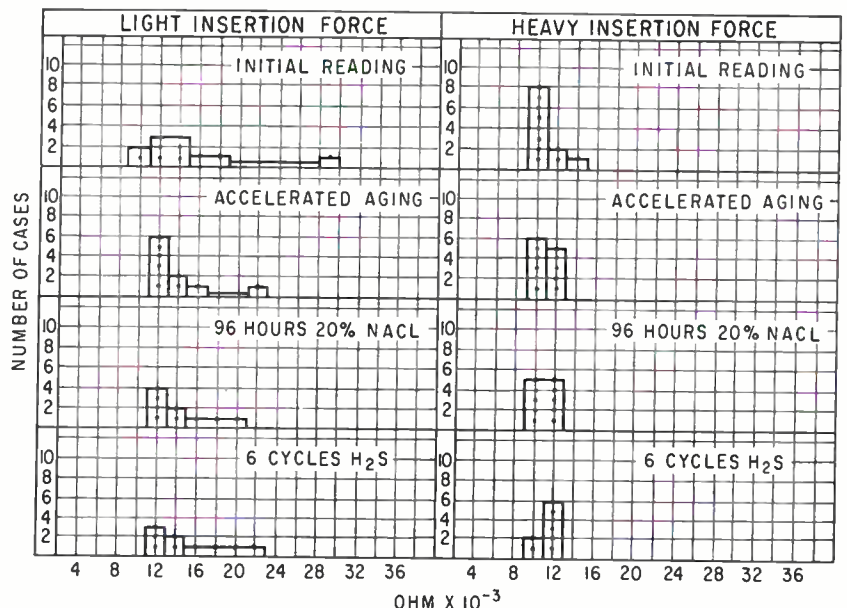

**CONTACT RESISTANCE** of copper wire-to-amalgam terminations for various environmental tests—Fig. 3



# DELAY EQUALIZER

Some are extremely simple, others extremely complex. Collins provides both kinds.

Correcting for envelope delay or delay distortion is becoming more of a problem every day with increased use, complexity and speed of communication and data transmission systems. At today's data transmission speeds, even a very small delay distortion can result in loss of information. □ Developing a network with a precisely controlled phase shift at various frequencies — and without attenuating the signal significantly — requires complex and extensive calculations. This means experience, skill and interest, and on all three counts, Collins is exceptionally well-qualified to develop delay lines, phase equalizers and other complex many-sectioned networks. □ From its own communication systems and from hundreds of government, military and industrial applications, Collins can inject years of experience in network and component design and manufacture into every assignment. Other innovations such as extensive application of computers to network design provides Collins with capabilities far beyond the ordinary. □ Along with this capability to handle the unusual is a broad line of standard toroids, LC filters and other magnetic components. For magnetic components — simple, complex or even not yet developed — Call Collins. □ COLLINS RADIO COMPANY • Components Division • 19700 San Joaquin Road, Newport Beach, California • Phone: KImberly 9-2911 • International Division, Dallas, Texas.

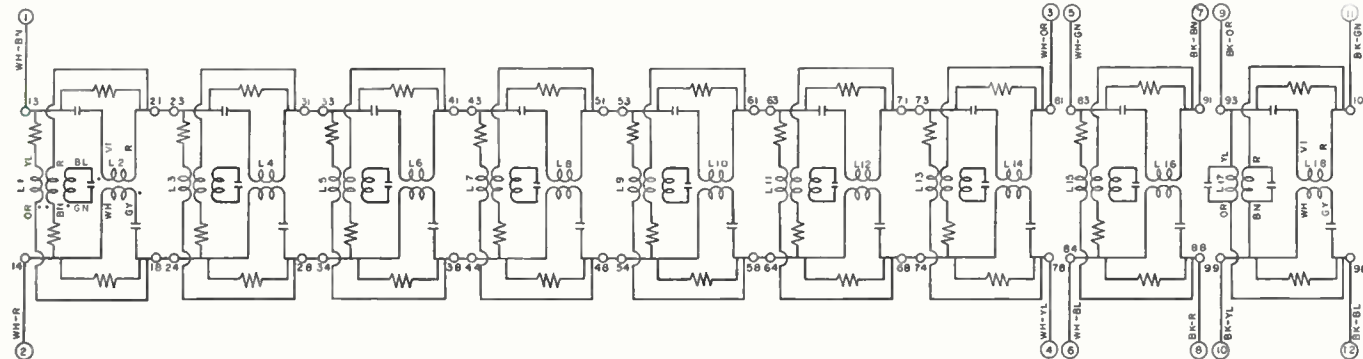

This phase equalizer for a microwave communication system is typical of the unusually complex networks which can be supplied by Collins Components Division. This particular unit contained nine sections plus two adjustment sections and provided an envelope delay of  $\pm 150$  microseconds from 400 to 3000 cps, with a frequency response of .5 db from 200 cps to 4000 cps and a maximum insertion loss of 13 db.

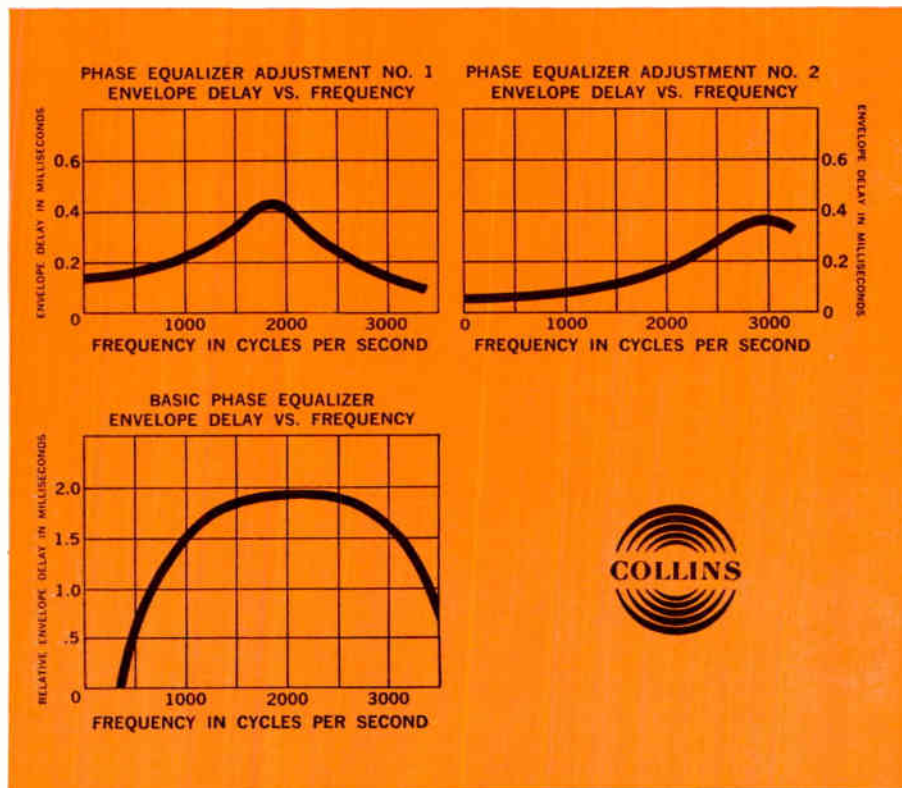

# BALLANTINE SENSITIVE ELECTRONIC VTVM

model  
300-G  
Price: \$315

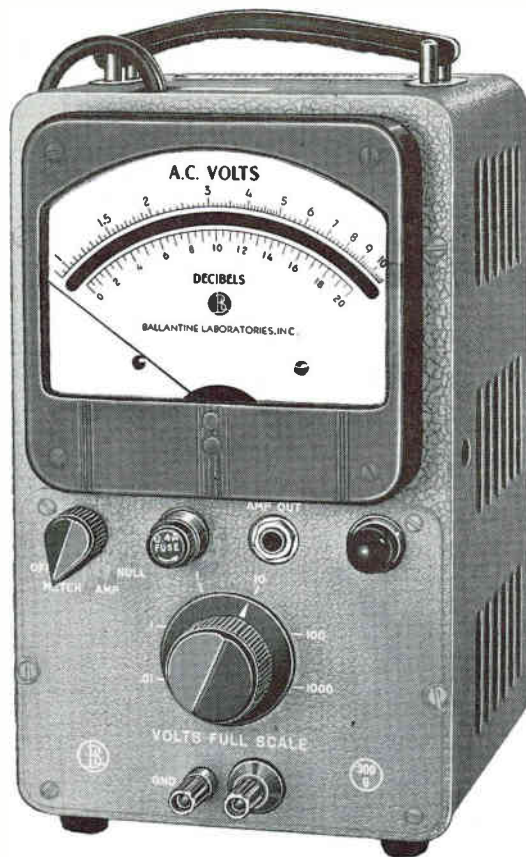

**GIVES  
YOU  
1%  
ACCURACY  
OVER ENTIRE METER SCALE**

1 mV-250 V, 20 cps-20 kc

Ballantine's hand-calibrated logarithmic voltage scale makes it possible to read voltages to the same high accuracy at the bottom as at the top of the scale. You use the full 5 inches of mirror-backed scale. This instrument incorporates the best of the features developed in 25 years experience designing and building laboratory-quality vtvm's. Conservative operation of long life instrument tubes and high multiple path feedback over the frequency range result in a unit which is insensitive to tube deterioration or tube changes. There is less than 1/2% change in indicated voltage for a change in power supply voltage of 115 ±10%.

Every Model 300G is given a 50-hour "aging" at full power line voltage during a period of several days prior to its calibration. After calibration, each instrument is "aged" again for 3 to 4 hours and then cross-checked by a second operator at a second test console before final acceptance. This is not an occasional test but applies to every Ballantine instrument. Of course components such as indicating meters receive extensive testing prior to assembly into a vtvm.

You can be assured of more than 3000 hours use within specifications, without servicing or recalibration. The 300G is an excellent instrument for use as a reference standard in any electronics laboratory.

Frequency Range: 10 cps to 250 kc  
Accuracy in % of reading anywhere on the scale: 1%, 1 mV to 250 V, 20 cps to 20 kc;

2%, 1 mV to 1000 V, 10 cps to 250 kc  
Available in 19 inch relay rack version as Model 300G-S/2 at \$320

Write for brochure



— Since 1932 —

**BALLANTINE LABORATORIES INC.**

Boonton, New Jersey

CHECK WITH BALLANTINE FIRST FOR LABORATORY AC VACUUM TUBE VOLTMETERS, REGARDLESS OF YOUR REQUIREMENTS FOR AMPLITUDE, FREQUENCY, OR WAVEFORM. WE HAVE A LARGE LINE, WITH ADDITIONS EACH YEAR. ALSO AC/DC AND DC/AC INVERTERS, CALIBRATORS, CALIBRATED WIDE BAND AF AMPLIFIER, DIRECT-READING CAPACITANCE METER, OTHER ACCESSORIES.

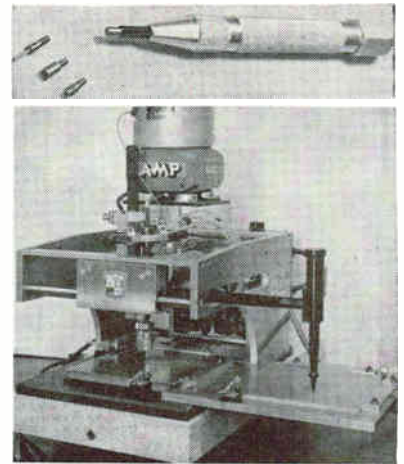

CONNECTIONS are made with manual (top) or semi-automated (bottom) tooling. Spring-loading of hand tool provides calibrated driving force needed for proper mating. Automatic operation is preceded by lining-up machine head over post or eyelet with guiding mechanism (right). Foot switch initiates automatic connection

96-hour salt spray, accelerated aging, and humidity, with excellent results. Fig. 3 shows terminal resistance of No. 38 AWG Formvar wire to amalgam plating for the various types of conditions.

T-W Tubes Really Clean,  
Increasing Reliability, Life



TECHNICIANS assemble traveling-wave tubes in GE clean room, claimed to be largest in country devoted to exclusive t-w production

TRAVELING-WAVE tube production at GE's Palo Alto, California plant is performed in a surgically clean "snow-white" area having an absolute filtering system. Dust and moisture which could cause early failure of tube's anode or cathode are eliminated by the filtering system that reportedly provides a 99.97



# 20-YEAR HITCH IN DAVY JONES' LOCKER

*(Mycalex components are built to work on over 4,000 miles of ocean floor until at least 1983)*

These amplifiers will be spaced at 20-mile intervals along a single cable on the ocean floor to help the Bell System handle the growing number of inter-continental telephone calls—well over 4,000,000 last year alone.

In designing these new amplifiers the Bell System engineers aimed at developing a device that would stand up for at least 20 years under the extreme pressure. For failure of any of the complex components could interrupt vital transoceanic circuits.

They looked to Mycalex Corporation of America for 11 key parts—resistors, inductors and transformers—because Western Electric knows from over 20 years of materials testing and experience that our SUPRAMICA® 555 ceramoplastic is one of the most nearly perfect insulating materials. It can be precision molded for reliable operation. It is extremely stable. It has a thermal expansion coefficient close to that of stainless steel. It permits easy soldering of imbedded inserts.

SUPRAMICA (we make three kinds, 555, 560, and 620 "BB") is only one of the products we produce as the world's leading specialists in high-temperature, high-reliability ceramic insulation materials and components. If you'd like a sample of SUPRAMICA 555 plus our newest literature on this amazingly versatile engineering material, please fill out the coupon below.

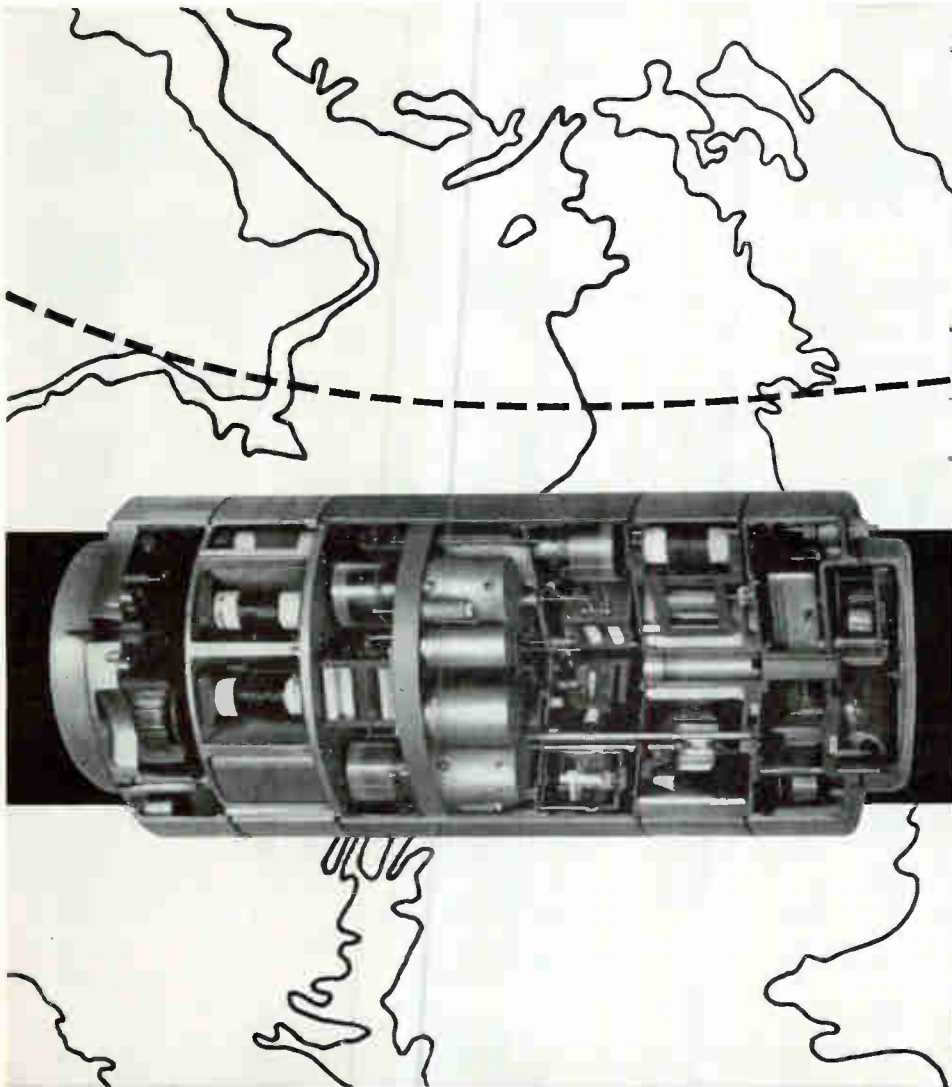

## MYCALEX

World's largest manufacturer of ceramoplastics, glass-bonded mica and synthetic mica products.

Mycalex Corporation of America  
Dept. E, Clifton Blvd.  
Clifton, New Jersey

Please send me information on SUPRAMICA 555 ceramoplastic and other Mycalex products. My specific

interest is \_\_\_\_\_

Name \_\_\_\_\_

Title \_\_\_\_\_

Company \_\_\_\_\_

City \_\_\_\_\_ State \_\_\_\_\_

**KLIXON**  
PRECISION CONTROLS

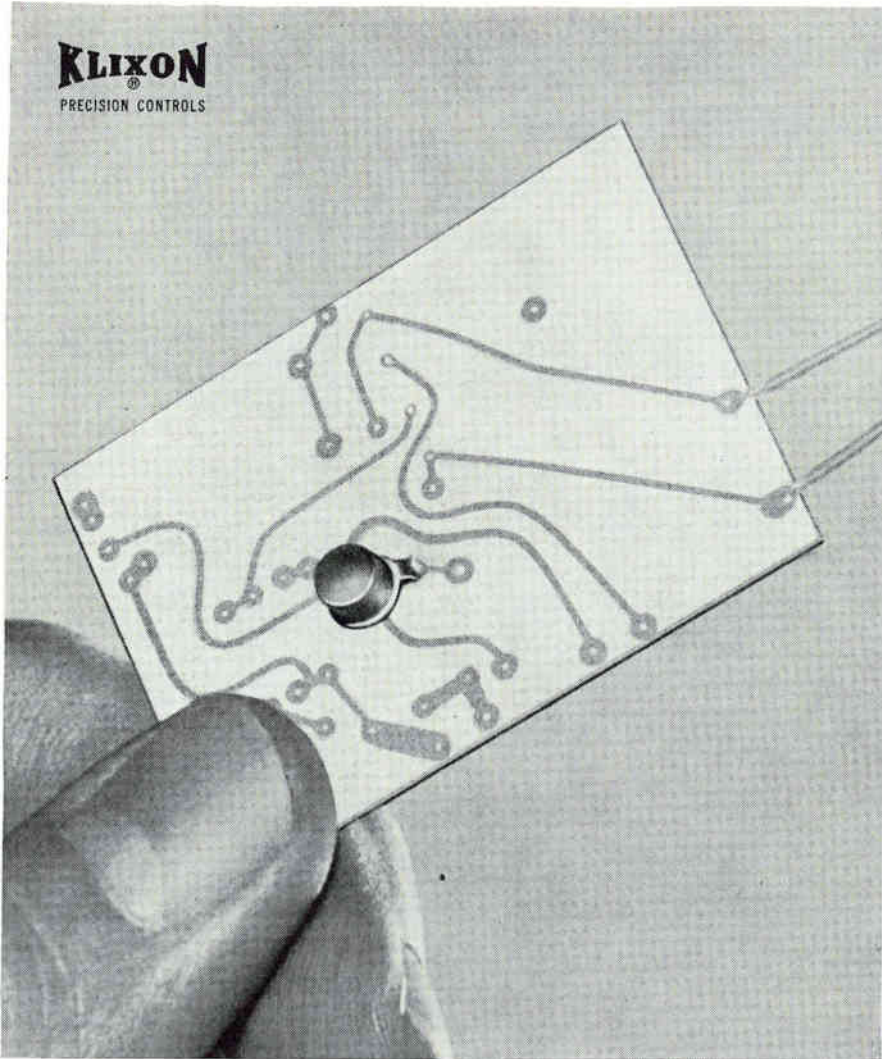

## The smallest — lightest — fastest — snap-acting thermostat ever made!

KLIXON® 3BT transistor-size thermostat offers a new dimension in temperature control — weighs 80% less . . . responds five times faster than comparable thermostats!

**Weighs only 0.4 gram!** Low thermal mass explains why the KLIXON 3BT Series hermetically-sealed, snap-acting thermostat responds so much faster than its nearest equivalent.

**Evaluate the specs!** This SPST "Tiny-Stat\*" temperature limiter is rated up to ½ amp, 115 V-ac/30 V-dc for 5,000 cycles. Temperature range is 0° to 350°F, open or close on temperature rise. Vibration resistance is 5-2000 cps at 25G. Welded seal guards against hostile environments. Pin terminals speed assembly.

**Consider these applications!** . . . as temperature limiters and/or monitors in printed circuit boards, computers, thermal batteries, heat sinks, solid propellant applications, etc.

**Write today** for bulletin DD-PRET-12. Application kit including two operating samples set at 185°F (85°C) plus one thermocouple sample available at \$15.00.

\*Pat. Pending

KLIXON 3BT "Tiny-Stat" Series  
(actual size)



**METALS & CONTROLS INC.**

5001 FOREST ST., ATTLEBORO, MASS.  
A CORPORATE DIVISION OF

**TEXAS INSTRUMENTS**  
INCORPORATED

percent pure atmosphere. Facilities include: electrostatic floor mat as well as suction vacuum blowers; specially-designed vacuum stations for atmosphere brazing and high-vacuum exhaust of tubes in production; special storage provisions such as vacuum containers for cathodes. GE's Power Tube Department built the facility to increase reliability, life and performance of t-w tubes used in airborne radars and electronic counter-measures systems. It is claimed to exceed conditions specified by the U.S. Air Force for clean rooms. Temperature is held at 72-degrees F  $\pm 1$  degree and humidity at 40-45 percent. Particles of 0.3 micron in diameter are removed from incoming air.

## Custom Hybrid Ring Gives High Signal Isolation

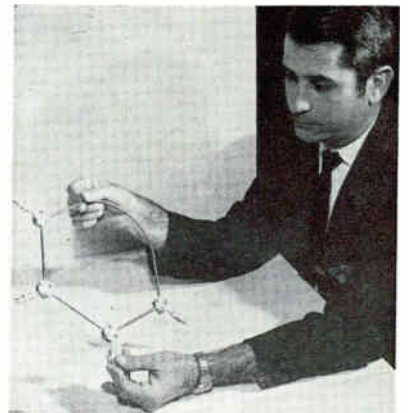

R-F AMPLIFIER with low power output requirements for Martin's missile systems has its voltage standing wave ratio measured with this special hybrid ring held by its designer, Karl Mitchell

SIGNAL ISOLATION as high as 50 db is attainable with a hybrid ring designed by Karl Mitchell a foreman at Martin's Orlando Division's Special Program activity. Commercial sources reportedly had said that practical pitfalls prevented realistic production of such rings: (1) costly—\$300 per ring; (2) rings with a 40 db isolation must be produced on a cost-plus-fixed fee basis because of the predictability risk. Mitchell built 6 rings initially that, in addition to 50 db isolation, produced a standing wave ratio of 1.1 at tolerances held as closely as  $\pm 0.005$ . Cost was \$200 each. Mar-



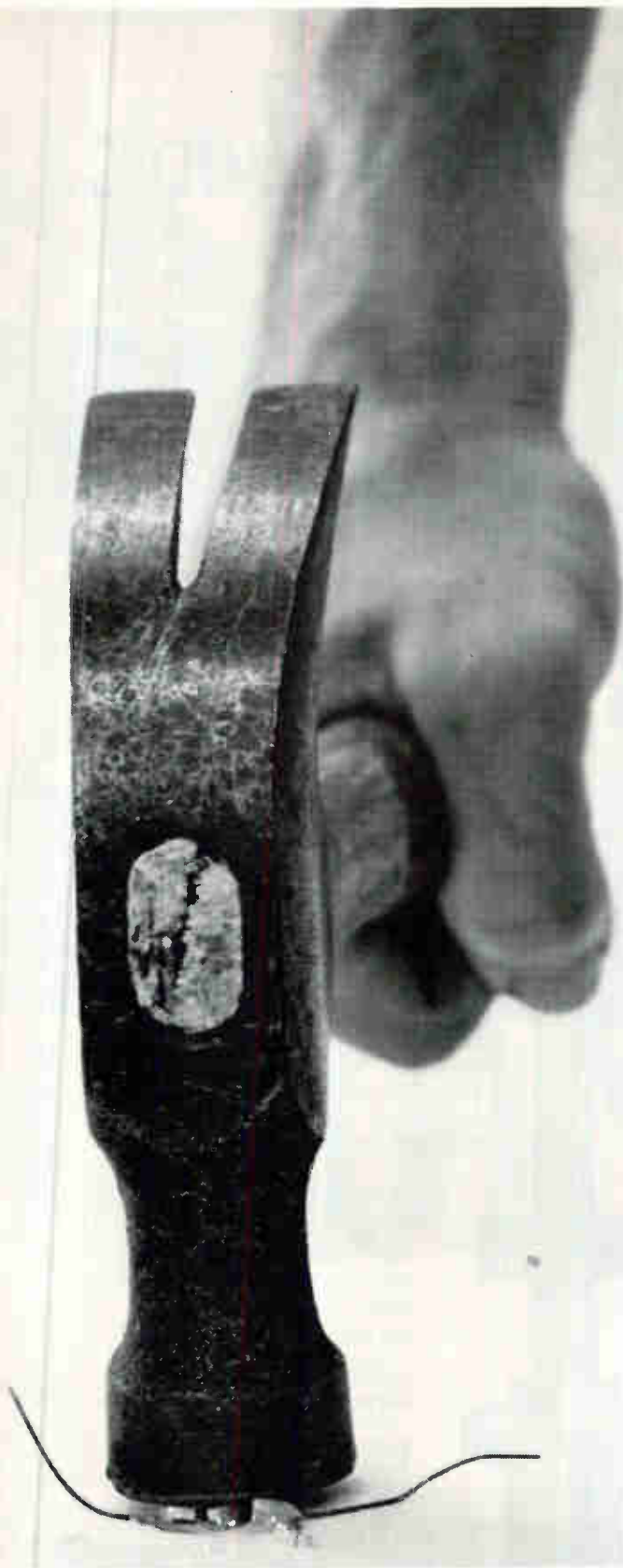

## CRUNCH!

Some of our customers complain they have trouble establishing a statistical failure rate for Corning capacitors. They hardly ever fail. Stack layers of glass and foil, add sealing beads and leads, then *fuse* them all with heat and pressure into a monolithic unit and you naturally wind up with a capacitor that you have to smash to destroy. If you'll take our word on stability and reliability, we have data that goes back years. It's all valid, because we haven't changed the materials or the process. Ask your Corning distributor, or write us, for product data sheets.

## CORNING ELECTRONICS

A DIVISION OF CORNING GLASS WORKS  
3901 ELECTRONICS DRIVE, RALEIGH, N. C.

January 25, 1963

CIRCLE 93 ON READER SERVICE CARD 93

JANUARY 25, 1963

CIRCLE 95 ON READER SERVICE CARD 95

SO HERSHEIMER  
COMES IN AND  
I TELL HIM  
I'M QUITTING!



AND HE SAYS  
**WHY?** YOU'RE  
GETTING AS MUCH  
AS SIEFRIED  
AND LUCAS!



SO I SAID: MONEY!  
WHAT'S MONEY? YOU  
BUSINESSMEN JUST  
DON'T UNDERSTAND  
THE MIND  
OF AN  
ENGINEER!

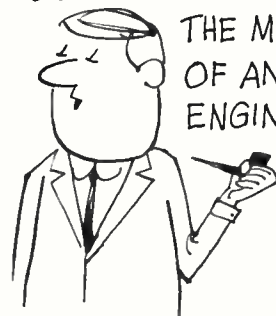

I'M AN ENGINEER  
AND I OUGHT  
TO KNOW  
WHAT AN  
ENGINEER  
WANTS!

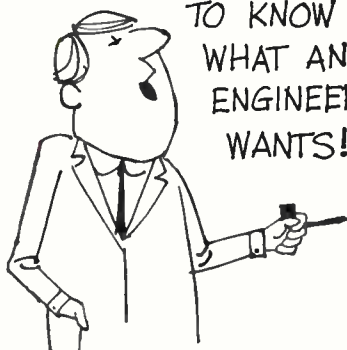

I WANT **FULLFILLMENT**  
I WANT TO WORK ON  
THE **SURVEYOR**  
AT HUGHES!



JUST THINK!  
SOMEDAY THERE'LL  
BE A LITTLE  
PIECE OF **ME**  
ON THE  
MOON!



NO MORE ELECTRONIC  
EGG-TIMERS! I'LL  
BE **CONTRIBUTING!**  
I'LL BE DOING  
SOMETHING **SIGNIFICANT!**  
SOMETHING **INTER-PLANETARY!**



BESIDES—  
HUGHES  
IS CLOSER  
TO THE  
BEACH.



**Hughes is hiring!** Numerous opportunities now exist in a variety of advanced projects and studies. Examples include: The MMRBM—Mobile Mid-Range Ballistic Missile (Integration, Assembly & Checkout), TFX(N) Electronics, SURVEYOR—soft-landing lunar spacecraft, SYNCOM—synchronous-orbit communications satellite, VATE—automatic test equipment, BAMBI—anti-missile defense, and others. Positions are open at all levels for specialists with degrees from accredited universities.

**CONTROLS ENGINEERS.** Concerns airborne computers and other controls related areas for: missiles and space vehicles, satellites, radar tracking, control circuitry, control systems, control techniques, transistorized equalization networks and control servomechanisms.

**CIRCUIT DESIGNERS.** Involves analysis and synthesis of systems for: telemetering and command circuits for space vehicles, high efficiency power supplies for airborne and space electronic systems, space command, space television, guidance and control systems, and many others.

**INFRARED SPECIALISTS.** To perform systems analysis and preliminary design in infrared activities for satellite detection and identification, air-to-air missiles AICBM, infrared range measurement, air-to-air detection search sets, optical systems, detection cryogenics and others.

**SYSTEMS ANALYSTS.** To consider such basic problems as: requirements of manned space flight; automatic target recognition requirements for unmanned satellites or high speed strike reconnaissance systems; IR systems requirements for ballistic missile defense.



Please airmail  
your resume to:

**Mr. Robert A. Martin**  
Head of Employment  
Hughes Aerospace Divisions  
11940 W. Jefferson Blvd.  
Culver City 16, California

Creating a new world with Electronics

**HUGHES**

HUGHES AIRCRAFT COMPANY  
AEROSPACE DIVISIONS

An equal opportunity employer.



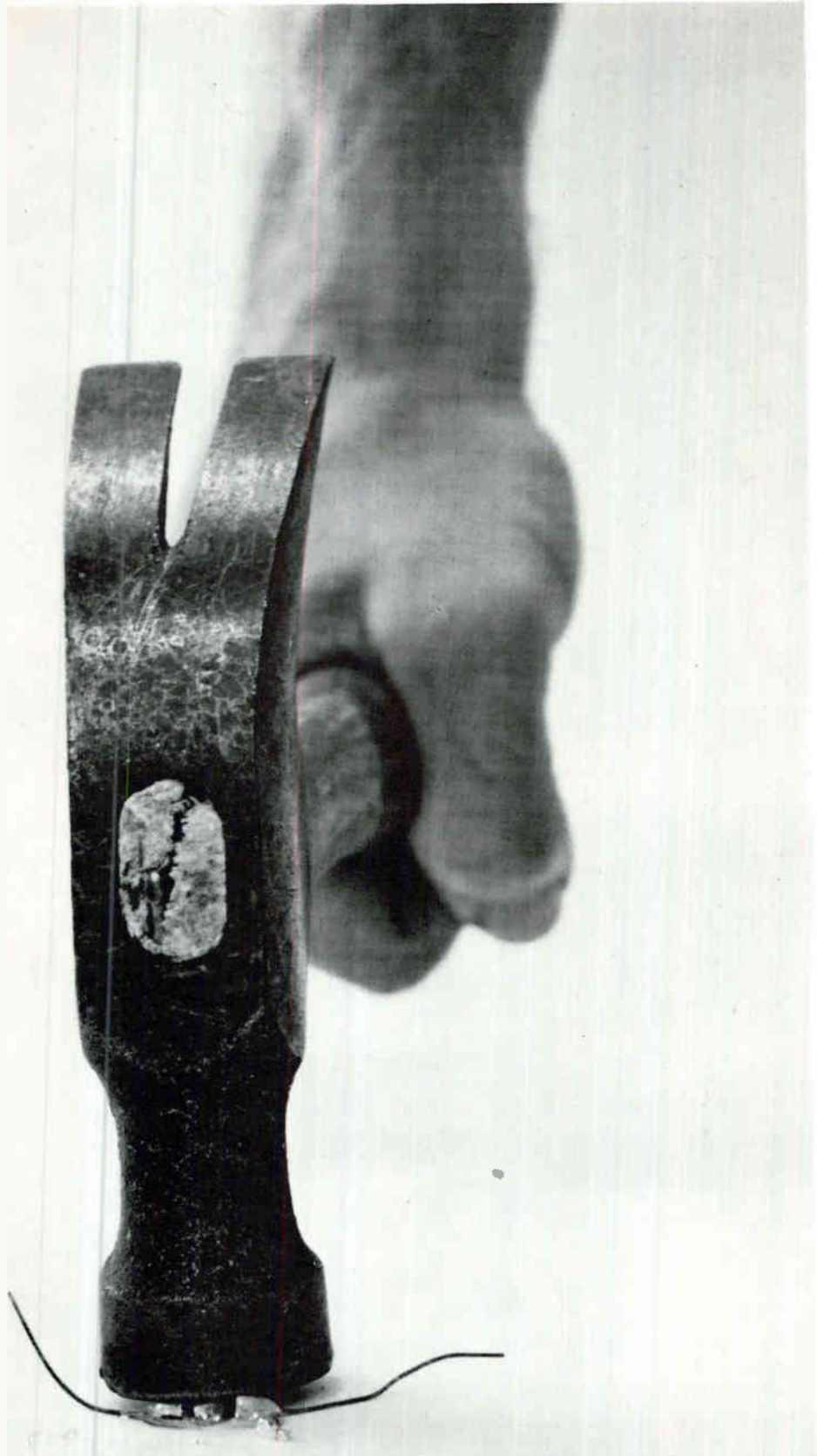

## CRUNCH!

Some of our customers complain they have trouble establishing a statistical failure rate for Corning capacitors. They hardly ever fail. Stack layers of glass and foil, add sealing beads and leads, then *fuse* them all with heat and pressure into a monolithic unit and you naturally wind up with a capacitor that you have to smash to destroy. If you'll take our word on stability and reliability, we have data that goes back years. It's all valid, because we haven't changed the materials or the process. Ask your Corning distributor, or write us, for product data sheets.

## CORNING ELECTRONICS

A DIVISION OF CORNING GLASS WORKS  
3901 ELECTRONICS DRIVE, RALEIGH, N. C.

# Accurate sensing -260° to +1000°C.

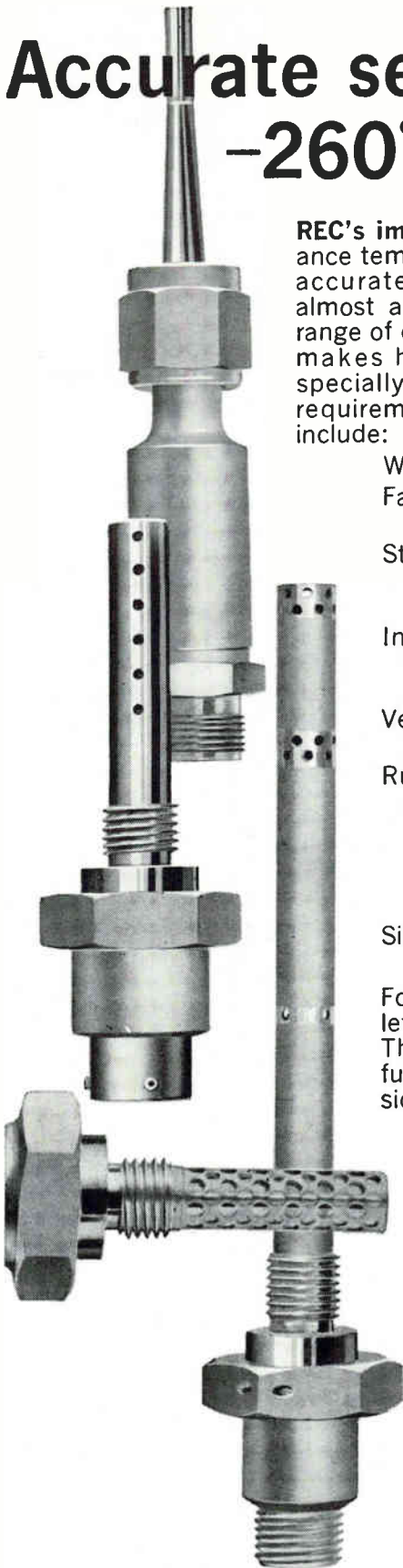

REC's immersion-type platinum resistance temperature sensors provide fast, accurate sensing of temperature in almost any liquid or gas over a wide range of environmental conditions. REC makes hundreds of models, many specially developed to meet specific requirements. General characteristics include:

Wide range: -260° to +1000° C.

Fast response: Time constants as low as 0.1 second.

Stability: To within  $\pm 0.05\%$  of temperature span to which sensor has been exposed.

Interchangeability: All sensors of a type to within  $\pm 0.25^\circ$  C. in selected operating range.

Versatility: Choice of immersion lengths and mountings.

Ruggedness: Withstand pressure to 12,000 psig, vibration to 60G (sine and high-level random) or more. Corrosion-resistant and radiation-resistant models available.

Size: Down to 0.05" dia., 0.5" length.

For further details write for Bulletin 9612 on immersion sensors. This 52-page bulletin includes fundamental engineering discussion of platinum thermometry.

## A complete precision line

Rosemount designs and manufactures high quality precision equipment in these lines:

### Air data sensors

- Total temperature
- Pitot-static tubes (de-iced)

### Immersion temperature sensors (including cryogenic)

### Surface temperature sensors

### Pressure sensors

### Accessory equipment and aeronautical research

For more information please write for the REC catalog. Specific questions welcomed.

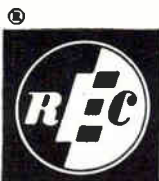

**ROSEMOUNT  
ENGINEERING  
COMPANY**

4900 West 78th Street • Minneapolis 24, Minn.

**SPECIALISTS IN TEMPERATURE & PRESSURE MEASUREMENT**

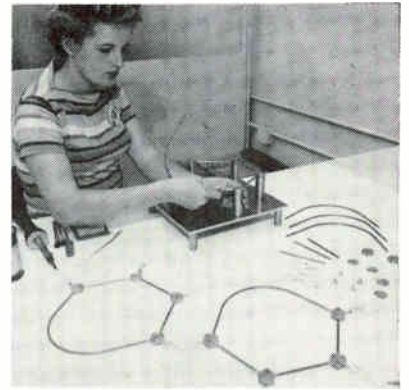

*SPECIAL JIG is used to assemble rings shown in various fabrication stages*

tin is now mass producing rings at lower cost for use as test tools for missile systems. Ring is made of rigid coaxial cable precision cut on a lathe. Special jig used to fit and assemble ring provides the close assembly controls needed.

## Plastic Mold Process For Panel Production



*BACK-DRAFTED contours were attained by new process for this 8-inch epoxy-reinforced fiberglass cover for a document-processing system*

CUSTOM MOLDING and reinforced plastic laminations have found increased utility in back-drafted contours in new technique by Plastics Div. of Basic Industries, Inc. Process uses epoxy resin rather than polyester. Reportedly this provides advantages: eliminates distortion and telegraphing of reinforcement onto the part face; shape maintained by reducing shrinkage; thickness closely held; no extra reinforcing required; material is self-extinguishing; parts can be color impregnated to restore appearance if damaged; surface can be textured.



# DECISIONS!



# DECISIONS!

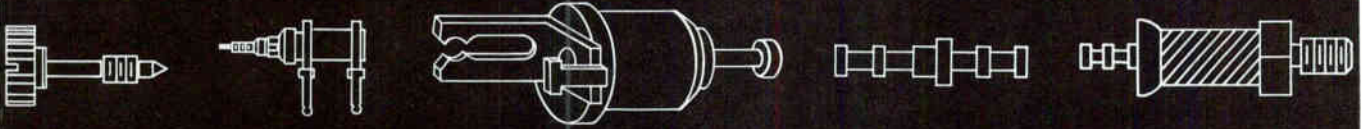

# DECISIONS!

## ***More easily made with Cambion<sup>®</sup>***

There are more than 15,000 *standard* electronic components in the CAMBION line, including terminals, terminal boards, insulated terminals, coil forms, coils, capacitors, connectors, chokes, computer components and hardware. They are immediately available from stock and so reliable, they are unconditionally guaranteed in any quantity. When it's time to decide, choose CAMBION. You can't go wrong. *Write for our new full-line Catalog.* Cambridge Thermionic Corporation, 437 Concord Ave., Cambridge 38, Mass.

# **CAMBION**

STANDARDIZE ON CAMBION...THE GUARANTEED ELECTRONIC COMPONENTS

SO HERSHEIMER  
COMES IN AND  
I TELL HIM  
I'M QUITTING!



AND HE SAYS  
**WHY?** YOU'RE  
GETTING AS MUCH  
AS SIEFRIED  
AND LUCAS!



SO I SAID: MONEY!  
WHAT'S MONEY? YOU  
BUSINESSMEN JUST  
DON'T UNDERSTAND  
THE MIND  
OF AN  
ENGINEER!

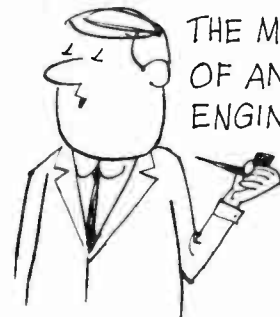

I'M AN ENGINEER  
AND I OUGHT  
TO KNOW  
WHAT AN  
ENGINEER  
WANTS!

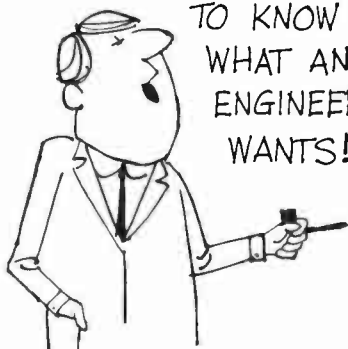

I WANT **FULLILLMENT**  
I WANT TO WORK ON  
THE **SURVEYOR**  
AT HUGHES!



JUST THINK!  
SOMEDAY THERE'LL  
BE A LITTLE  
PIECE OF **ME**  
ON THE  
MOON!



NO MORE ELECTRONIC  
EGG-TIMERS! I'LL  
BE **CONTRIBUTING!**  
I'LL BE DOING  
SOMETHING **SIGNIFICANT!**  
SOMETHING **INTER-PLANETARY!**

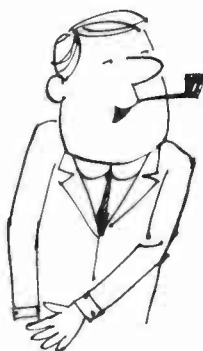

BESIDES—  
HUGHES  
IS CLOSER  
TO THE  
BEACH.

**Hughes is hiring!** Numerous opportunities now exist in a variety of advanced projects and studies. Examples include: The MMRBM—Mobile Mid-Range Ballistic Missile (Integration, Assembly & Checkout), TFX(N) Electronics, SURVEYOR—soft-landing lunar spacecraft, SYNCOM—synchronous-orbit communications satellite, VATE—automatic test equipment, BAMBI—anti-missile defense, and others. Positions are open at all levels for specialists with degrees from accredited universities.

Please airmail  
your resume to:

**Mr. Robert A. Martin**  
**Head of Employment**  
**Hughes Aerospace Divisions**  
**11940 W. Jefferson Blvd.**  
**Culver City 16, California**

**CONTROLS ENGINEERS.** Concerns airborne computers and other controls related areas for: missiles and space vehicles, satellites, radar tracking, control circuitry, control systems, control techniques, transistorized equalization networks and control servomechanisms.

**CIRCUIT DESIGNERS.** Involves analysis and synthesis of systems for: telemetering and command circuits for space vehicles, high efficiency power supplies for airborne and space electronic systems, space command, space television, guidance and control systems, and many others.

**INFRARED SPECIALISTS.** To perform systems analysis and preliminary design in infrared activities for satellite detection and identification, air-to-air missiles AICBM, infrared range measurement, air-to-air detection search sets, optical systems, detection cryogenics and others.

**SYSTEMS ANALYSTS.** To consider such basic problems as: requirements of manned space flight; automatic target recognition requirements for unmanned satellites or high speed strike reconnaissance systems; IR systems requirements for ballistic missile defense.



Creating a new world with Electronics

**HUGHES**

HUGHES AIRCRAFT COMPANY  
**AEROSPACE DIVISIONS**

An equal opportunity employer.



**HIGH GAIN I.F. PENTODES**

When improved i.f. performance is required, the first choice of television designers is the EF183, EF184 combination.

In i.f. amplifier circuits the frame-grid construction of these two tubes gives outstanding advantages of reduced microphonics, uniformity, better controlled characteristics and high gain—twice the slope of conventional tubes.

Both tubes are available with 6.3V, 0.45A or 0.6A heater ratings.

For full technical data on the EF183 and EF184, write to the address below.

**CHARACTERISTICS**

**EF183**

$g_m$	14	12.5	10.6	mA/V
$E_b$	170	200	230	V
$E_{c2}$	90	90	90	V
$I_b$	14	12	10.5	mA
$E_{c1}$	-1.8	-2.0	-2.1	V

**EF184**

$g_m$	15.6	15	mA/V
$E_b$	170	200	V
$E_{c2}$	170	200	V
$I_b$	10	10	mA
$E_{c1}$	-2.0	-2.5	V

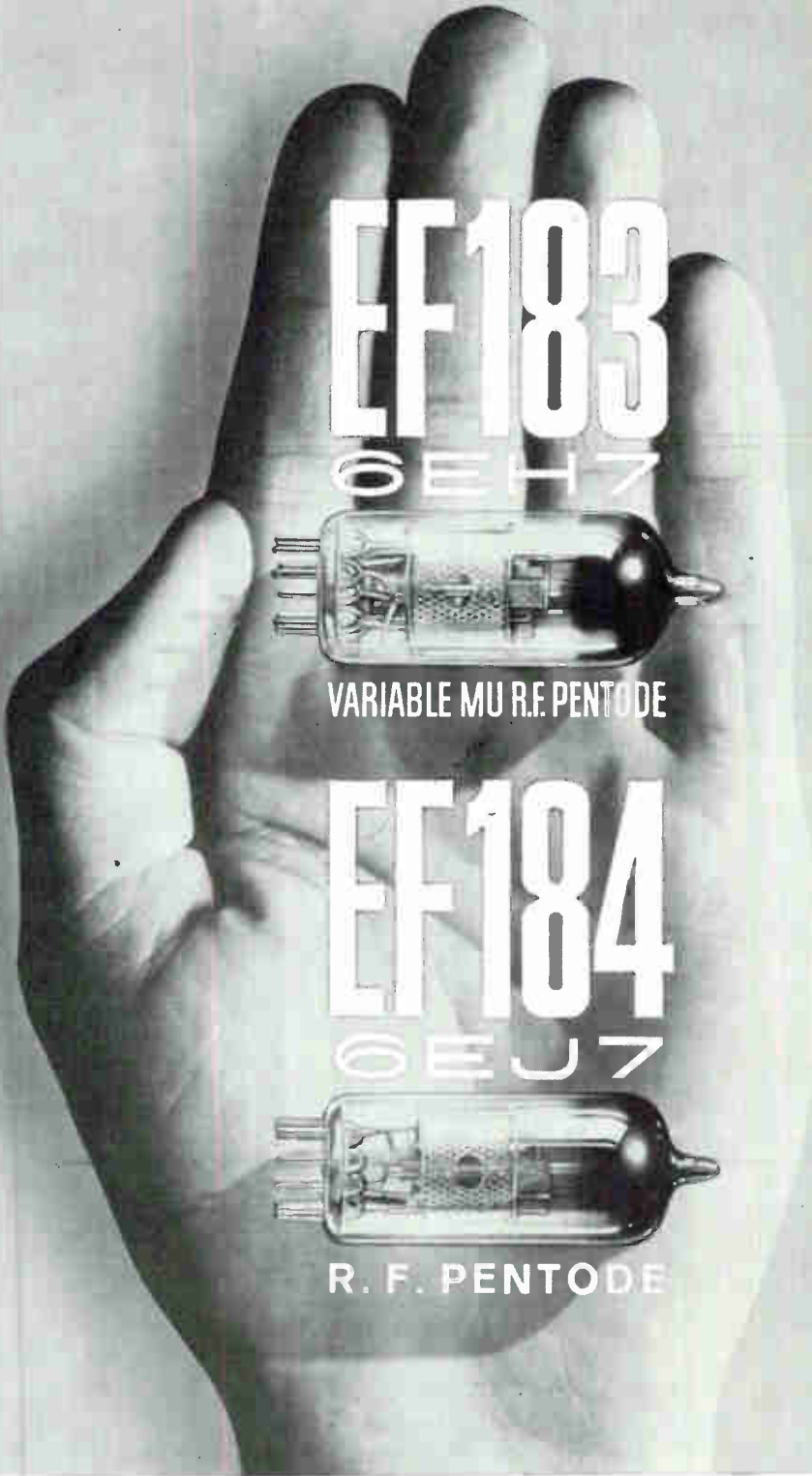

Full details on the Mullard range of tubes for television, stereo and high-fidelity available from:

INTERNATIONAL ELECTRONICS CORPORATION,   
 81 SPRING STREET, NEW YORK 12, N.Y.  
 Worth 6-0790

**Mullard**  
 ELECTRONIC TUBES

MULLARD OVERSEAS LTD • MULLARD HOUSE  
 TORRINGTON PLACE • LONDON • ENGLAND

\*Mullard\* is the trade mark of Mullard Limited

## Generating 0.5-ns Risetime Pulses

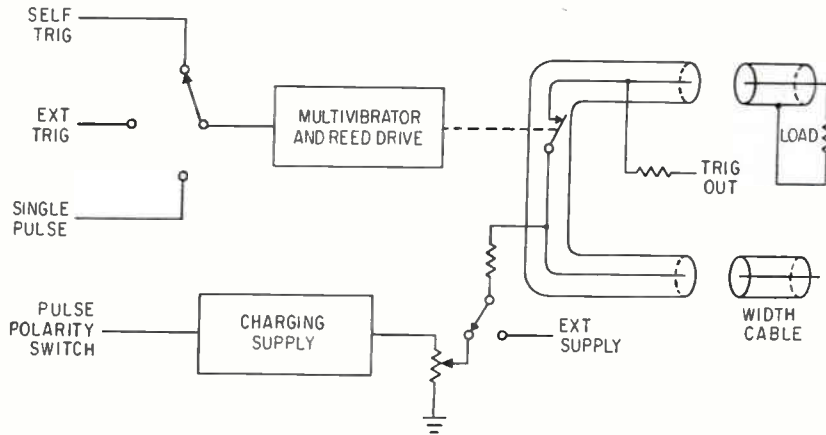

*Coaxial-cable shaper produces variable width and amplitude ns pulses*

RECENTLY introduced by Spencer-Kennedy Laboratories, Inc., 1320 Soldiers Field Road, Boston 35, Massachusetts, the model 503A fast-rise pulse generator is designed to test transient response of wide-band systems used in radar, communications and nuclear research. The variable repetition rate is from 50 to 120 pulses per second which can be extended to 0 to 120 pps with an external source. Rise time is less than 0.5

nanosecond, amplitude is variable from 0 to 150 v, or up to 1 Kv with external supply, and the device has six built-in pulse widths of 1, 2, 10, 25, 50 and 100 nanoseconds. An external delay line can be added to provide unrestricted maximum width. An output trigger, occurring simultaneously with the main pulse, is available on the front panel. As shown in the sketch, the pulse is generated when the energy stored in a section of coaxial cable, charged to a selected potential, is discharged into the load. When the relay is open, the 50-ohm width cable is charged through a resistor whose value is large compared to cable

characteristic impedance. When the relay closes, a voltage step appears at the output. Simultaneously, a voltage step of opposite polarity but equal amplitude travels down the width cable from the switch. Because cable is unterminated, the step is reflected without amplitude or polarity change and cancels the pulse at the output thus creating the pulse trailing edge. Pulse width is determined by length of width cable. The switch is a mercury wetted contact relay.

CIRCLE 301 READER SERVICE CARD



## Oscillator Is Powered by Input Trigger

NEW from RHG Electronics Laboratory, Inc., 94 Milbar Boulevard, Farmingdale, New York, the TD series of tunnel-diode oscillators use the input video signal to provide the necessary power to generate r-f pulses at preset frequencies

between 10 and 100 Mc. Standby power is zero. Trigger signal is 30 v and output is greater than -30 dbm into a 50-ohm load. Risetime is 2 r-f cycles nominal while a built-in zener regulator prevents frequency and amplitude variations during the pulse period. Output only occurs with trigger application and ringing and overshoot are undetectable. Output frequency can be trimmed when desired. Applications include testing of i-f and logarithmic amplifiers, simulation of fast system pulses, checking transient response

of filters and in programmed oscillator applications. Besides individual frequencies, packages containing up to 10 frequencies are available. The photograph shows a typical output waveform. (302)

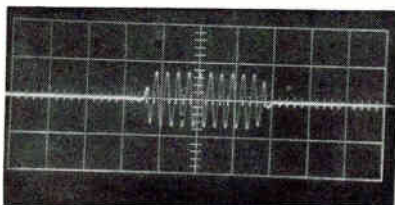

## Microwave Bandpass Filter Is Electronically Tuned

ANNOUNCED by Watkins-Johnson Co., 3333 Hillview Avenue,





## Any resemblance to 12 other power transistors is purely economical

Delco Radio's 2N1970 is a high-amp., low-gain, high-voltage, low-cost power transistor that you can substitute for any of 12 other higher priced power transistors.

The 2N1970 can directly replace the 2N442, 2N443, 2N2077, or 2N2490—at a cost savings!

With minor circuit modifications, the 2N1970 can also replace the 2N2075, 2N2076, 2N2080, 2N2081, 2N173, 2N174, 2N278, or 2N2491—at a cost savings!

Reduce production cost without sacrificing product quality. Place your order for Delco's 2N1970 at one of our Sales Offices listed below. Or phone your nearby Delco Radio Semiconductor Distributor.

Ic (MAX.)	Vcbo (MAX.)	Vebo (MAX.)	Vceo (MAX.)	Sat. Voltage @ Ic (MAX.)	Gain Min./Max. @ Ic	Thermal Resistance (MAX.)
15A	100V	40V	50V	1.0V @ 12A	17/40 @ 5A	.5° C/watt

#### Sales Offices

Union, New Jersey  
324 Chestnut Street  
MURdock 7-3770  
AREA CODE 201

Detroit, Michigan  
57 Harper Avenue  
TRinity 3-6560  
AREA CODE 313

Santa Monica, California  
726 Santa Monica Blvd.  
UPton 0-8807  
AREA CODE 213

Syracuse, New York  
1054 James Street  
GRanite 2-2668  
AREA CODE 315

Chicago, Illinois  
5151 N. Harlem Ave.  
775-5411  
AREA CODE 312

General Sales Office: 700 E. Firmin, Kokomo, Ind.. Gladstone 2-8211—Ext. 500 • Area Code 317

Division of General Motors • Kokomo, Indiana



## PLOT HIGH SPEED REPETITIVE WAVEFORMS



### Unique Moseley Type 101 Waveform Translator

Now you can produce an accurate, permanent inked record of high speed repetitive function displayed on an oscilloscope. It's as simple as connecting scope deflection plate voltage to input terminals of the Moseley Type 101 and applying 101 output to respective axes of the Autograf X-Y Recorder.

Type 101 Waveform Translator provides automatic or manual sweep of the scope trace, by a sampling technique, and a bright spot on the CRT trace shows the point being traced. The trace also may be "blanked" by the waveform translator, which likewise may be operated directly from the test device without an intermediate oscilloscope. Inked records may be produced to any scale and positioned anywhere on the recorder graph paper.

Typical functions that can be translated by the Type 101 include magnetic hysteresis loops, volt-ampere characteristics and Lissajous figures. Particularly suitable applications for the Type 101 include interconnecting dc analog simulation equipment with analog equipment operating at high frequencies, or recording actual operating characteristics of a production item.

The solid-state Waveform Translator permits front-panel switch selection of direct dc or capacitive ac coupling. Input impedance is greater than 100,000 ohms. Recording scan rate is 2 to 60 sec. for full scale, or manual. Modular construction permits simple bench or rack mount use, with all controls on the front panel. \$575.00

Write or call today for complete information.

**AUTOGRAF** recorders

**F. L. MOSELEY CO.**  
409 N. Fair Oaks Ave., Pasadena, California  
an affiliate of Hewlett-Packard

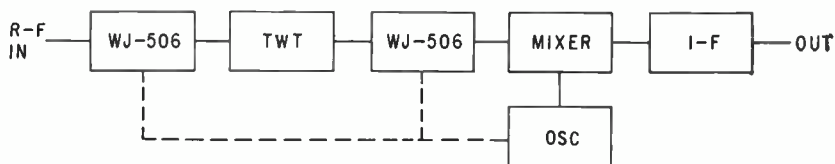

Stanford Industrial Park, Palo Alto, California, the WJ-506 electronically-tuned bandpass filter covers the entire range of WR-90 waveguide. Frequency range is 8.2 to 12.4 Gc, insertion loss at resonance is less than 2 db, 3 db bandwidth is 30 Mc, skirt selectivity is 12 db per octave, and vswr on and off resonance is less than 2. Off-resonance isolation in the band is greater than 50 db, spurious level is -30 db or better, directivity is greater than 25 db and d-c power for  $\pm 2$  Gc tuning is 3 watts. The device is non-reciprocal and a bandpass transmission characteristic of low-insertion loss is present only in one direction through the filter. Energy traveling in the other direction is greatly attenuated. This allows use of internal resistive terminations which results in matched in-

put and output impedances both on and off resonance without increase in filter insertion loss. Thus the device is equivalent to a bandpass filter with an isolator before it and a second isolator following it. It incorporates a permanent magnet which simultaneously biases two yttrium-iron garnet (YIG) spheres to resonance to obtain a synchronously-tuned bandpass response centered at approximately 10.2 Gc. The filter is tuned by application of current to tuning coils. A second set of tuning coils allows detuning the resonator without changing center frequency. It can be used as a pre-selector in a microwave receiver to provide selectivity and image rejection. Tracking is simplified by the linear tuning characteristic of the device.

CIRCLE 303 READER SERVICE CARD

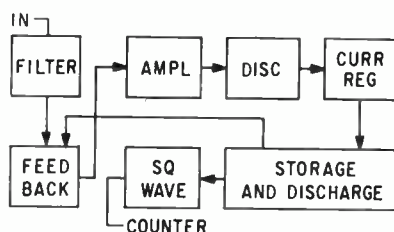

### Electronic Integrator Operates on Millivolts

MANUFACTURED by Royson Engineering Co., 100 North Penn St., Hatboro, Pennsylvania, the electronic integrator operates directly from millivolt-level signals and has either dry-contact (2 amperes at 115 v) closure output with counting rate of 1,000 counts per minute indicated on front-panel counter or pulse-type output, negative 50-v spikes at 10  $\mu$ sec duration. The latter model can be provided with output rates of 1,000, 2,400, or 10,000 counts per minute. Input ranges from 0 to 50 mv at 0 and 50 ma in three steps. As shown in the sketch, difference between input and feedback is impressed on a high-gain, chopper-type amplifier operating

into a discriminator and filter. This d-c voltage controls the value of d-c current output of a current regulator operating through the feedback resistor and into a storage capacitor in parallel with a discharge device. On discharge, the pulse operates a second current controller arranged to operate a relay or provide a pulse for high-counting rates. Being a null balance instrument, it has inherent stability. Normal variations in line voltage or room temperature does not cause inaccuracies, zero shift or span change. Error is always less than 1-percent full scale. (304)

### Extending Piezoelectric Gage L-F Response

ON THE MARKET from Endeveco Corp., 161 East California Boulevard, Pasadena, California, the model 2614B input amplifier provides an input resistance of 1,000 megohms and gains of 1, 3 or 10 into an output load of 2,500 ohms



Complex? No!

**BELDEN designs cables smaller...less complicated**

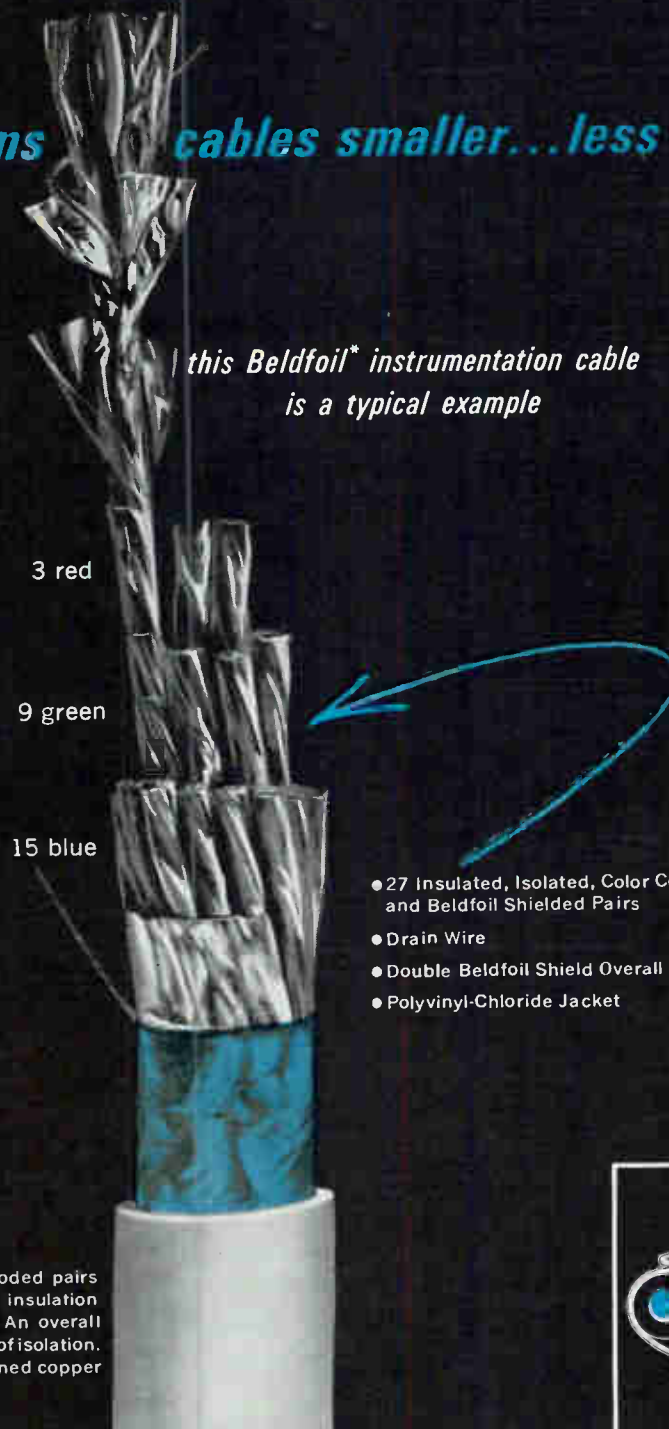

*this Beldfoil\* instrumentation cable is a typical example*

3 red

9 green

15 blue

- 27 Insulated, Isolated, Color Coded, and Beldfoil Shielded Pairs
- Drain Wire
- Double Beldfoil Shield Overall
- Polyvinyl-Chloride Jacket

Individually insulated and color coded pairs are protected by a Mylar\*\* tape insulation under a wrapped Beldfoil shield. An overall Mylar tape adds the final measure of isolation. Each pair has its own stranded tinned copper drain wire for shield grounding.

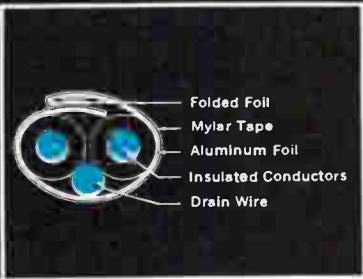

*Belden engineers have designed thousands of Beldfoil shielded cables similar to this one...special instrumentation, strain gauge, and control cables. They can and will design a smaller cable to reduce the size of your product...a less complicated cable that will do the same job better...or perhaps a single cable to do the job of two or more different cables. Many well-known manufacturers of specialized electronic products depend on Belden for special cable design. If a smaller, less complicated cable will improve your product...call on Belden.*

\*BELDFOIL shielding is a lamination of aluminum foil with Mylar which provides a high dielectric strength insulation that is lighter in weight, requires less space, and is usually lower in cost. For multiple-paired cables with each pair separately shielded, the Mylar is applied outside with an inward folded edge. This gives 100% isolation between shields and adjacent pairs.

Write Belden Manufacturing Company, 415 South Kilpatrick Avenue, Chicago 80, for data sheet on Beldfoil shielding.

\*Belden Trademark Reg. U.S. Pat. Off. \*\*du Pont Trademark



# IEEE

## SEE

THE NEW  
ELECTRONIC  
WIZARDRY

at

### I-TRIPLE-E's

International Convention  
and Exhibition in New York

## MARCH 25, 26, 27, 28

The COLISEUM at Columbus Circle  
& The WALDORF ASTORIA HOTEL

admission: MEMBERS \$1.00; NON-MEMBERS \$3.00  
MINIMUM AGE: 18

# SHOW

(formerly the IRE Show)



Are you a  
**COMPLETELY  
INFORMED  
electronics  
engineer?**

Today you may be working in microwaves. But on what project will you be working tomorrow? You could have read electronics this past year and kept abreast of, say, microwave technology. *There were 96 individual microwave articles between July, 1961 and June, 1962!*

But suppose tomorrow you work in some area of standard electronic components, in semiconductors, in systems? Would you be up-to-date in these technologies? Did you read the more than 3,000 editorial pages that electronics' 28-man editorial staff prepared last year?

electronics is edited to keep you current *wherever* you work in the industry, *whatever* your job function(s). If you do not have your own copy of electronics, subscribe today via the Reader Service Card in this issue. Only 7½ cents a copy at the 3 year rate.

# electronics

## CURTISS-WRIGHT ELECTRONICS...

*adding a new dimension to the capability of man*

C-BAND RADAR is equipped with plan position, range-height and azimuth range scope indicators. Sweep ranges for the plan position indicator are 30, 60, 120 and 200 nautical miles. Sweep ranges for the range-height indicator are 15, 30, 60 and 120 nautical miles with height scales of 0 to 40,000 ft. in 5,000 ft. intervals and 0 to 80,000 ft. in 10,000 ft. intervals. The receiver-transmitter-modulator unit can be housed with the antenna assembly or remote up to 100 feet.

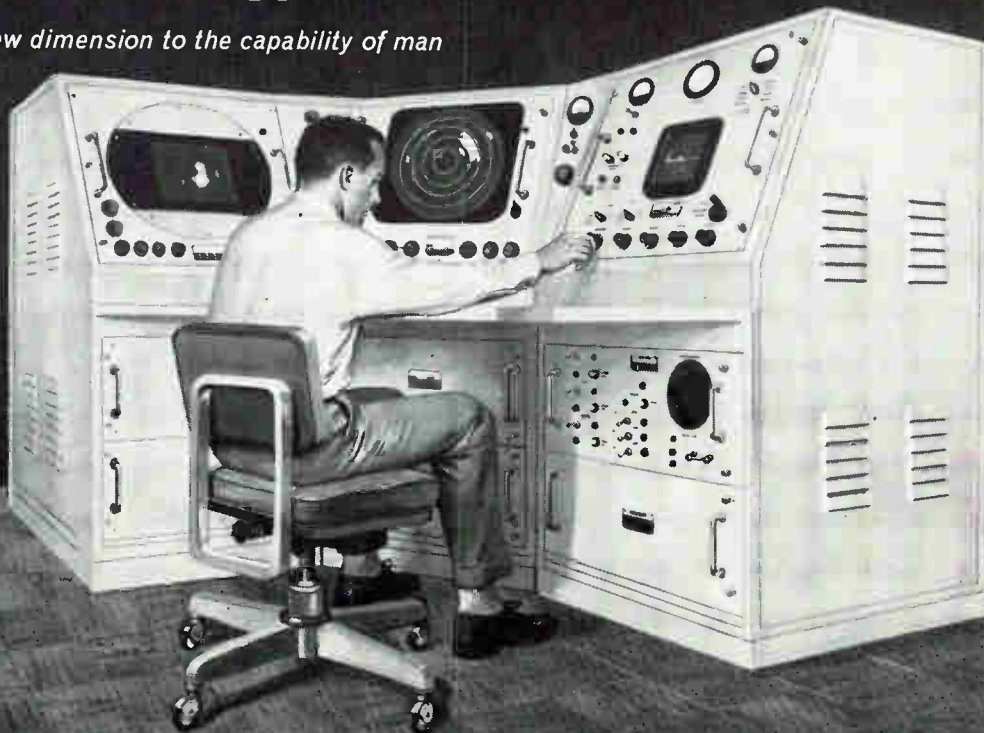



or more. This high input resistance, with or without d-c isolation, can extend low-frequency response of piezoelectric gages well below 2 cps. A 3-decade input switch allows selection of shunt capacitance in 10 pf steps from 10 to 9,990 pf to trim sensitivity of piezoelectric gages to a standard value without affecting

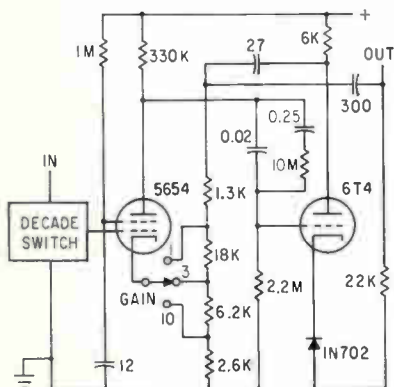

h-f response. Output impedance is 75 ohms resistive in series with 300  $\mu$ f, output voltage is 5 v rms maximum into 2,500 ohms or 10 v into 25,000 ohms and up. Maximum

linear current is 2 ma rms. Frequency response is 2 cps to 20 Kc  $\pm$ 3 percent and amplitude linearity is  $\pm$ 1 percent maximum deviation from a straight line between zero and full scale. Total harmonic distortion is 5-percent maximum. The output can drive galvanometers or any load above 2,500 ohms and an external transformer allows for loads as low as 28 ohms. As shown in the sketch, the input couples through a decade capacitance switch to the amplifier. After amplification, the signal is low-frequency compensated and passes to the triode stage. Amount of negative feedback is controlled by the amplifier gain switch.

CIRCLE 305 READER SERVICE CARD

### Time Delay Module Uses Semiconductors

SOLID STATE ELECTRONICS CO., 15321 Rayen St., Sepulveda, Calif. Model 2825-50200 time delay module is of completely solid state design uti-

lizing silicon semiconductors. Unit was designed to overcome many of the inherent deficiencies of mechanical time delay relays. For example, the solid state relay is an inertialess device capable of over one million operations. Actuation time is 1  $\mu$ sec. Use of silicon semiconductors provides for reliable operation over a wide temperature range of - 55 C to + 100 C. (306)

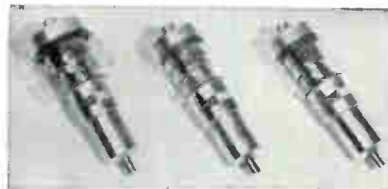

### Vacuum Capacitors For H-V R-F Circuits

CALVERT ELECTRONICS INC., 220 E. 23rd St., New York 10, N. Y. Series of compact vacuum variable capacitors have maximum r-f voltages up to 20 Kv and are rated at 40 amp r-f current up to 27 Mc. Range of capacitance available is 5 to 750

## PRODUCT IN POINT:

### C-BAND METEOROLOGICAL RADAR

... sets new standards for weather analysis!

At Curtiss-Wright, new applications of science and technology develop products which become integral parts of military and industrial programs.

**Product in Point:** C-Band Meteorological Radar—this precision, land-based system obtains more accurate weather data than can now be acquired by any standard radar unit. It provides greatly increased cloud penetration yielding new and vital information for the detection and analysis of storms, tornadoes and other weather phenomena.

This equipment is but one example of the challenging radar projects being carried out by Curtiss-Wright engi-

neers. Others include the RMT-100 radar maintenance trainer now in wide service throughout the world; Model 57-9 six-target radar simulator currently training air traffic control personnel; plus the more elaborate Model 58-2 two-target, three-dimensional radar target simulator.

These and other advanced activities have created immediate opportunities for systems engineers and circuit designers with RF and video experience.

For complete information, write Mr. G. Gene Kelly, Manager of Professional Placement, Electronics Division. An equal opportunity employer.



ELECTRONICS DIVISION  
**CURTISS-WRIGHT CORPORATION**

35 MARKET STREET, EAST PATERSON, N. J.

WHY SETTLE FOR LESS?

**0.01%**

**ACCURATE**

SIZE 23 RESOLVER



Type 23RV4al

**Here's a top rated resolver that's priced surprisingly low. So why settle for less than Ford Instrument's highly accurate Size 23 Resolver...the resolver that exceeds MIL-E-5272A.**

**SPECIFICATIONS:**

- Maximum Functional Error (over 360° of shaft rotation)...0.01% of input voltage at maximum coupling
  - Maximum Total Null Voltage... 1 mv/volt input maximum
  - Maximum Interaxis Error (rotor) ... 1.5 minutes
  - Maximum Interaxis Error (stator) ... 1.5 minutes
  - Maximum Variation of Transformation Ratio (with input voltage from 6-18 volts with 12 volts input as reference) ... 0.03%
  - Maximum Variation of Transformation Ratio (with input voltage from 0.3 to 6 volts) ... 0.02% of 6 volts
- 0.025% accuracy available in size 15  
Bulletin FR 62-1 gives full specifications. It's yours for the asking. Write:

**FORD INSTRUMENT CO.**

Division of Sperry Rand Corporation  
31-10 Thomson Ave., Long Island City 1, N. Y.

pf. These capacitors are suited for use in a wide variety of high voltage r-f circuits in broadcasting, commercial and industrial equipments.

CIRCLE 307, READER SERVICE CARD

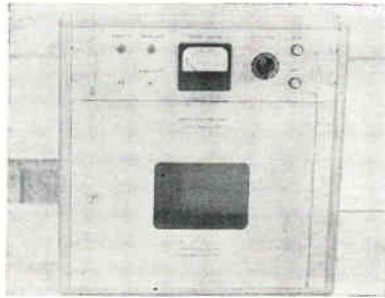

**High Voltage Tester Offers Portability**

AMULEX ELECTRONICS, INC., 467 Connecticut Ave., South Norwalk, Conn., announces model HP-10 portable a-c Hipot tester. Input line is 120 v  $\pm$  10 percent, 60 cycles, single phase. Output voltage is 0 to 8 Kv rms, continuously variable. Output current is limited to a non-destructive value of 1 to 2 ma under short circuit conditions. Test chamber is 17 in. wide by 14 in. high by 18 in. deep with "High Voltage Interlocked" door. Overall size is 22 in. high by 21 in. wide by 18 in. deep. (308)

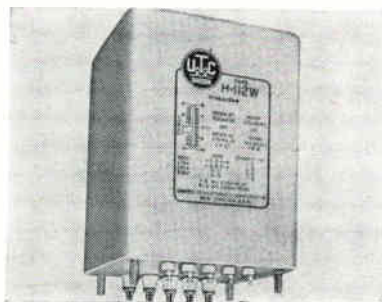

**Plate Transformers Sealed in MIL Cases**

UNITED TRANSFORMER CORP., 150 Varick St., New York 13, N.Y. Units in the W series of plate transformers are designed to be used for both full wave center tap and full wave bridge rectifier applications. The design incorporates a fully insulated center tap in addition to special insulation throughout the construction. This permits the center tap to be disconnected from ground for full wave bridge

application. Units are rated for inductor input filtering. Secondary a-c high voltages range from 1,050 v to 1,900 v center tap. D-C voltages range from 730 v to 1,580 v. Current ranges are from 190 ma to 420 ma. (309)

**Telemetry Power Supply**

SONEX, INC., Tele-datatx Division, 20 E. Herman St., Philadelphia 44, Pa. The TEX-3605, an all solid state high environmental power supply developed for aircraft and missile applications where reliability, size and weight are of prime consideration, provides a floating regulated output voltage for use as transducer excitation at loads up to 125 ma. (310)

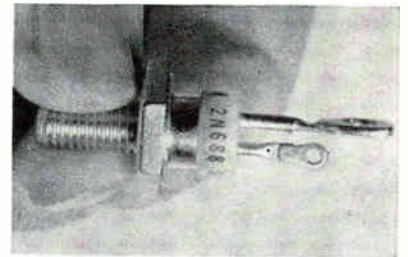

**Controlled Rectifiers Come in 18 Types**

MALLORY SEMICONDUCTOR CO., Indianapolis 6, Ind., has available 18 types of silicon controlled rectifiers. Featuring blocking voltages to 500 v and current handling capacities up to 25 amperes, the devices are designated by EIA numbers 2N681 through 2N689 (high current) and 2N1842 through 2N1850 (medium current). (311)

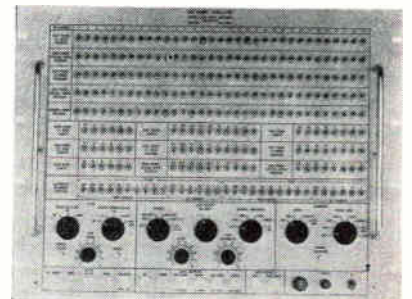

**PCM Signal Simulator Speeds Ground Checkout**

CORRELATED DATA SYSTEMS CORP., 1007 Air Way, Glendale, Calif., has





By **DICK HAHN**  
Syracuse, N. Y.  
District Office  
Non-Linear Systems, Inc.

## Solving special temperature measurement problems with a digital voltmeter...

How standard instrumentation and standard methods were utilized by General Electric Company could be of interest to anyone involved in temperature measurement.

### THE BASIC PROBLEM

These were the requirements faced by GE and NLS engineers:

- Measure 300 temperatures quickly, approximately 2 seconds per measurement.
- Maintain a resolution of  $\pm 10$  microvolts, which is  $\pm 0.02\%$  of full scale, and an accuracy of  $\pm (0.05\%$  of reading  $\pm 10$  microvolts) for thermocouple voltage measurement, up to  $\pm 55.00$  millivolts.
- Provide instantly available data in printed form.
- Measure several voltages as great as 300 volts.
- Provide operating simplicity in instrumentation.
- Separate operator's control portion of the system from the area where measurements are generated.

These requirements were met by a remote control data system formed primarily of standard instruments, including an NLS digital voltmeter for voltage measurements and a precision DC preamplifier for millivolt measurement.

### FEATURES REMOTE CONTROL

Basically, the system is a two-unit setup connected by a 30-conductor cable 150 feet long. Installed in a cabinet in a hazardous area near the thermocouples are the preamplifier, the switching section of a crossbar scanner, and the temperature-controlled thermocouple reference junctions ( $\pm 0.1^\circ\text{F}$ ). In the operator's console are an NLS V34 Transistorized Digital Voltmeter, an NLS 155 Transistorized Data Printer, and the control section of the crossbar scanner.

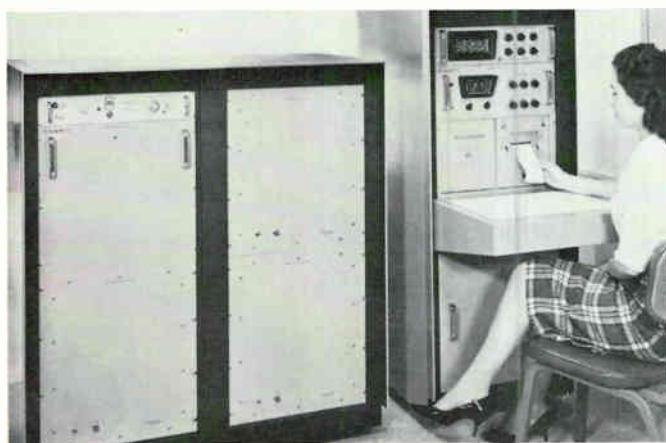

This data system, incorporating a digital voltmeter and other standard instruments, measures and records up to 300 widely varying temperatures.

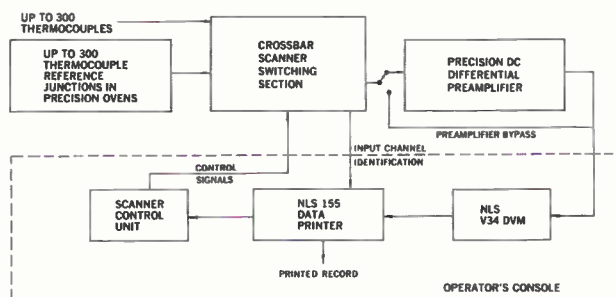

Simplified functional chart of the system.

Without this remote control feature, it would have been necessary to run 600 relatively expensive thermocouple wires 150 feet.

One of the major advantages of the system for this type of application is related to the resolution of the digital voltmeter. Input voltage changes of 0.02% of full scale are instantly recognizable. This means that the numerical display of the DVM will change to a new number for an input voltage change of 10 microvolts. Unlike a strip chart recorder or moving pointer meter, a digital voltmeter eliminates any doubt concerning small input changes. Also, the digital display of a DVM can be read instantly, from close up or 30 feet away.

### SYSTEM VERSATILITY

System control is extremely versatile. The input scanner can be set to sample any group of consecutive input channels continuously; stop after one sampling cycle; or sample any single input channel once or continuously upon command. Also, the system can, while monitoring one input channel continuously, record data only when the input voltage changes.

Similar systems are available with a wide variety of options, including more or fewer input channels... strain gage measurements... higher speed voltmeters and recorders... electric typewriters, tape or card punches, magnetic tape recorders... digital clocks for time data... digital comparators for warning or go/no-go tests... AC/DC converters for precise AC measurements... resistance measurements.

For additional information or competent advice on digital measurements, please circle the reader's service number or contact one of the 19 NLS factory offices located throughout the U.S., or write Non-Linear Systems, Inc., Del Mar, Calif.



**non-linear systems, inc.**  
Originator of the Digital Voltmeter



## new low cost precision

### THERMISTORS

match standard curves  
-40° to 150° C.

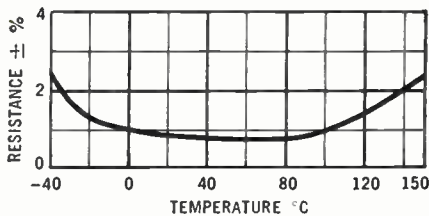

Resistance Tolerance  
30K thermistor No. 44008

■ YSI precision thermistors can now be stocked by the thousands, used interchangeably. The high cost problems of matching, padding, auxiliary resistances or individual calibration have been eliminated.

■ Stock base resistances at 25° C. of:  
100 Ω            1K            10K  
300 Ω            3K            30K  
   100K

■ For 5 years YSI has manufactured precise, interchangeable thermistors for laboratory instrumentation.

■ Now we offer as components a family of precision thermistors which match the same Resistance-Temperature curves to within  $\pm 1\%$  over a wide temperature range.

■ \$4.90 each, with substantial discounts on quantity orders.

■ Quantities under 100 available from stock at Newark Electronics Corporation and its branches.

For complete specifications and details write:



developed model SS-1000 pcm telemetering signal simulator to bring problems of satellite, missile and space vehicle ground check out closer to complete solution. It provides a wide variety of patterns covering bit, word, sub-frame and frame groups as found in contemporary pcm telemetering systems. Approximately 50 p-c cards utilizing all solid state circuitry and fully transistorized modular construction are employed to simulate operating characteristics of satellites using pcm telemetering techniques.

CIRCLE 312 READER SERVICE CARD

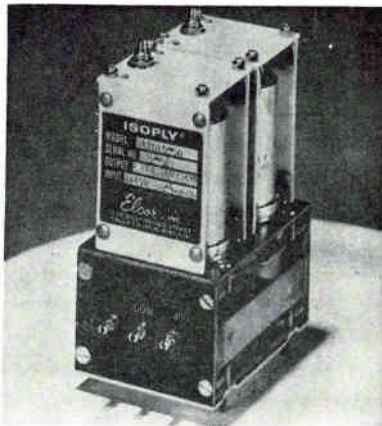

### Isolated Power Supply Has Dual Output

ELCOR, INC., 1225 W. Broad St., Falls Church, Va. Suitable for small transistor amplifiers, the A4TD Isoplys offer very low shunt capacitance (25 pf) and a high leakage resistance (in excess of 100,000 megohms) at the output. Ideal for many other applications, they can be used for instance to power an operational amplifier connected for potentiometric (very high input impedance use). (313)

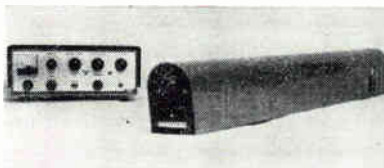

### Gas C-W Laser Has Adjustable Mirrors

OPTICS TECHNOLOGY, INC., 248 Harbor Blvd., Belmont, Calif. Model 150 gas c-w laser is a versatile source of continuous coherent light.

Standard instrument produces intense beam of visible light at 6328 Angstroms; accessory mirrors available for infrared output at 1.153 microns. The extremely narrow-band output is ideal as a source for modulation, long path interferometer experiments, a variety of demonstrations in classical optics, and various systems applications. The precision mirrors are readily adjustable to produce various optical mode patterns. (314)

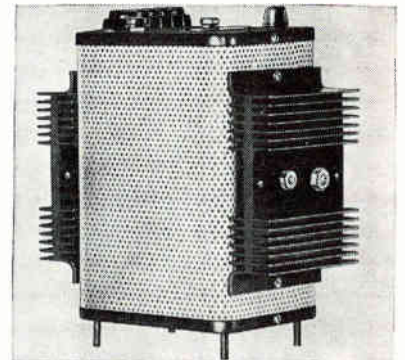

### Power Supplies Fit Small Space

ACOPIAN TECHNICAL CO., 927 Spruce St., Easton, Pa. The JS series transistorized power supplies are narrow enough to be mounted into a 3½ in. rack. Short circuit protection is provided. The series handle current of 1.5 and 2.0 amperes with output voltage ratings ranging from 6 to 25 v. Line regulation is  $\pm 0.5$  percent. Load regulation is 0.5 percent. Ripple is 5 mv rms. Internal voltage adjustment of  $\pm 0.5$  v is provided. (315)

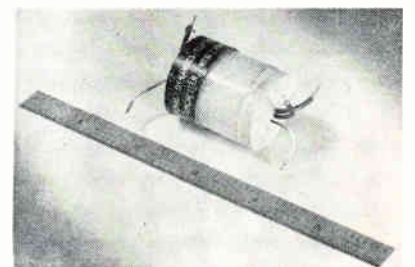

### Rugged Preamplifier Provides 20 Db Gain

GENERAL DYNAMICS/ELECTRONICS, 1400 N. Goodman St., Rochester 3, N. Y. Model Q-4 preamplifier, designed for use with deep-submergence hydrophones and high impedance strain gages, is also suit-



able for many other applications because of its compact size, light weight, and very low noise figure. Providing a 20 db gain, the unit has a response from 5 cps to 100 Kc, with a power requirement of 0.5 ma at 8.4 v. Component derating insures high reliability and long life. Epoxy encapsulation produces a rugged assembly and virtually eliminates microphonic and acoustic coupling. (316)

### Subcarrier Oscillator

SOLID STATE ELECTRONICS CO., 15321 Rayen St., Sepulveda, Calif. Model V-510 all solid state voltage controlled oscillator, designed for accurate conversion or varying analog d-c voltage to a linearly proportional sine wave frequency, has application within f-m/f-m telemetering systems and as an analog-to-digital converter. (317)

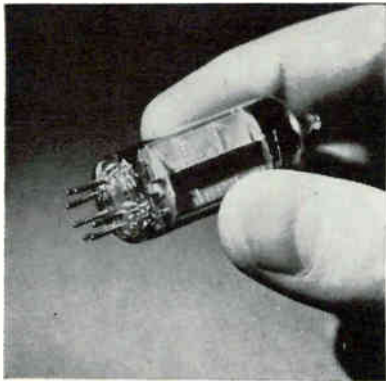

### Miniature Thyratron Is Xenon-Filled

RAYTHEON CO., 55 Chapel St., Newton 58, Mass., announces a miniature thyratron designed as a pulse modulator or a switching tube in a relay, magnetic clutch, or grid-controlled rectifier. Capable of many thousand cycles of intermittent operation, the CK5727/2D21W is built to withstand the 750-g shock of a  $\frac{1}{4}$ -millisecond impact acceleration test and a 2.5-g vibrational acceleration of a 96-hr fatigue test under 25 to 60 cps. In pulse modulator service, features include a forward peak anode voltage of 500 v, peak cathode current of 10 amp and a peak positive control grid current of 20 ma. (318)

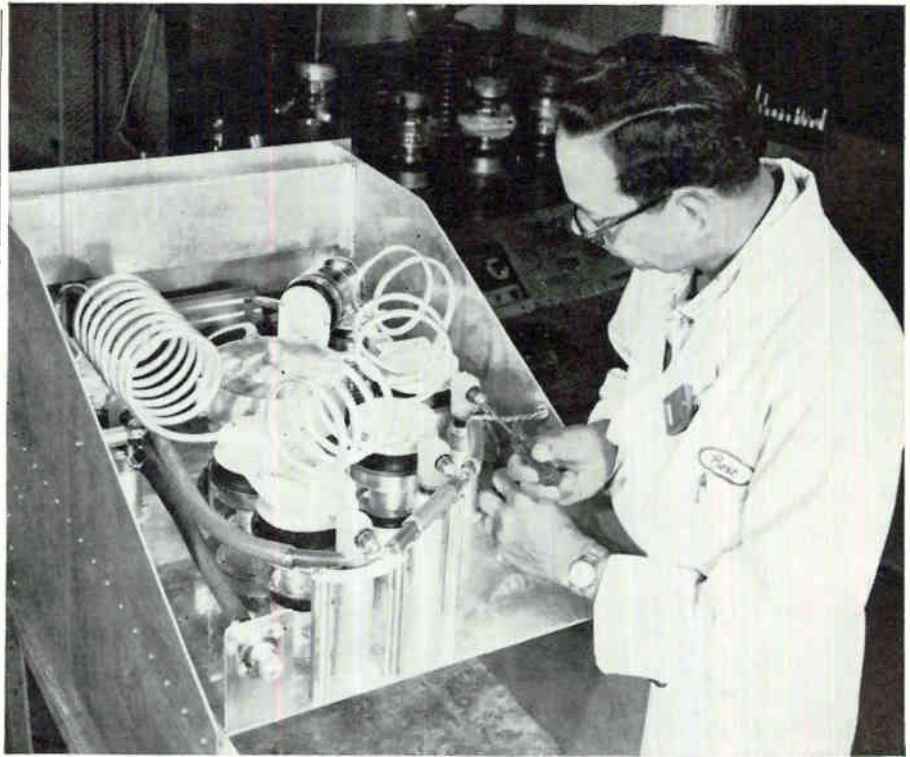

## EXCEPTIONAL DESIGNS START WITH JENNINGS VACUUM CAPACITORS

This electronics engineer is just completing a 17.5 kw, all band, continuous tuning power amplifier to be used for test purposes. It has a range of 2 megacycles through 34 megacycles yet only occupies 2' x 2' x 3' of space!

Can you imagine this amplifier being designed or even dreamed of with anything but vacuum capacitors? Every circuit design presents different problems but this application illustrates the range of design possibilities available with Jennings vacuum capacitors. Here are some of the exclusive advantages of these capacitors that make it possible to extend your range of design ideas:

**WIDE FREQUENCY RANGE . . .** Jennings vacuum capacitors offer the widest capacity change ratio available anywhere. Some capacitors have ratios as high as 150 to 1.

**RELIABILITY . . .** Sealed plates never become contaminated.

**EFFICIENCY . . .** Vacuum dielectric results in very low dielectric losses.

**COMPACTNESS . . .** High strength vacuum dielectric results in much smaller capacitor with the additional advantage of lower inductive losses.

**WIDE SELECTION . . .** Jennings offers over 400 types of fixed and variable vacuum capacitors to meet your circuit requirements.

Write today for more detailed information about Jennings complete line of vacuum fixed and variable capacitors.

RELIABILITY MEANS VACUUM / VACUUM MEANS *Jennings*<sup>®</sup>

JENNINGS RADIO MFG. CORP., 970 McLAUGHLIN AVE., SAN JOSE 8, CALIF., PHONE CYpress 2-4025

## WHAT'S NEW FROM GARLOCK

### Electronic Products

**Free-Flex\* Circuitry.** Pure, bright copper conductors . . . no oxide, no contamination. Completely encapsulated in FEP . . . unmatched for its electrical, physical and thermal properties . . . provides maximum line-to-line and line-to-ground protection . . . eliminates short circuits. Lighter, more flexible . . . reduces package size and weight. Can be soldered by conventional or infrared automatic methods . . . saves installation time and money. Write for AD-195. \*Garlock Trademark

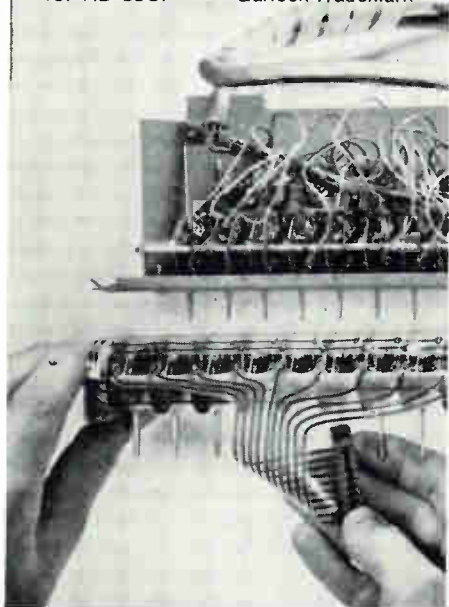

**TFE Transistor Sockets** exhibit the lowest dielectric loss ever achieved at high frequencies. Silver-plated, gold-flashed Beryllium copper contacts for outstanding pin retention, long life and top protection against vibration. They are the finest TFE transistor sockets on the market . . . and include the only socket of any kind for JEDEC TO-8 type cases (new RF power amplifier transistors). Available from local stock. Write for AD-169.



For full information, contact your Garlock Electronic Products distributor or representative. Or, write GARLOCK ELECTRONIC PRODUCTS, GARLOCK INC., Camden, New Jersey.

# GARLOCK

## Literature of the Week

**GYRO COMPONENTS** Vernitron Corp., 600 Old Country Road, Garden City, N. Y. Valuable engineering data for gyro systems designers is contained in a brochure giving specifications for 29 gyro components. CIRCLE 319 READER SERVICE CARD

**TRIMMER POTENTIOMETERS** CTS Corp., Elkhart, Ind. Three single turn subminiature trimmer pots are described in catalog 2500. (320)

**LINE VOLTAGE REGULATOR** Basic Products Corp., Elk Grove Village, Ill., has published a brochure on the theory of design and operation of the Solatron electronic-magnetic type line voltage regulator. (321)

**FERRITE LIMITERS** Watkins-Johnson Co., 3333 Hillview Ave., Palo Alto, Calif. Technical bulletin covers the WJ-519 low-power ferrite limiters for operation in C band. (322)

**PRESSURE TRANSDUCER SYSTEMS** Consolidated Controls Corp., Bethel, Conn. Bulletin describes pressure transducer systems for monitoring gaseous and liquid media in severe environments. (322)

**DECODERS & DECIMAL COUNTERS** Burroughs Corp., Plainfield, N. J., has available five bulletins describing the new Bipco module decoders and decimal counters. (324)

**ROTARY SWITCHES** Micro Switch, Freeport, Ill. Data sheet 202 describes the IRM series multipole rotary switches with high power handling capacity. (325)

**TRANSISTOR REGULATOR** The Leece-Neville Co., 1374 E. 51st St., Cleveland 3, O. Bulletin TR-5003 describes a new full-semiconductor transistor regulator. (326)

**PLOTTING BROCHURE** California Computer Products, Inc., 305 Muller Ave., Anaheim, Calif., offers a four-page brochure entitled "Digital Plotting with the IBM 1401". (327)

**ATTENUATION CALIBRATOR** Weinschel Engineering, Gaithersburg, Md. Catalog sheet covers model BA-5 attenuation calibrator which can be used to make direct attenuation measurements to 35 db in either the single or dual channel measuring systems. (328)

**ELECTRICAL CONNECTORS** The Deutsch Co., Municipal Airport, Banning, Calif., has prepared a chart containing detailed data on six different lines of cylindrical-miniature, electrical connectors. (329)

**LINEAR ACCELERATOR** High Voltage Engineering Corp., Burlington, Mass. Bulletin describes an 8 Mev microwave linear accelerator for radiation therapy. (330)

**TERMINAL BOARDS** General Electric Co., Schenectady 5, N. Y., offers 16-page



bulletin GEA-7317A covering a complete line of sectional and one-piece terminal boards. (331)

**BASEBAND REGULATOR ASSEMBLY** Lenkurt Electric Co., Inc., 1105 County Road, San Carlos, Calif. Four-page pamphlet describes type 940A1 baseband regulator assembly which is used to improve baseband stability on multi-hop microwave radio systems. (332)

**MICROWAVE TEST EQUIPMENT** Budd Stanley Co., Inc., 175 Eileen Way, Syosset, L. I., N. Y. Six-page folder illustrates and describes a line of microwave test instruments and components. (333)

**SILICON RECTIFIERS** Tung-Sol Electric Inc., One Summer Ave., Newark 4, N. J. Technical data sheet gives comparative ratings on top hat silicon rectifiers. (334)

**RECEIVING TUBES** Raytheon Co., 55 Chapel St., Newton 58, Mass. New receiving tubes designed to reduce space requirements and entertainment equipment costs are described in a 19-page loose-leaf folder published for design engineers. (335)

**H-F STANDARDS RECEIVER** Gertsch Products, Inc., 3211 S. LaCienega Blvd., Los Angeles 16, Calif. Brochure offers information on model RHF-1 all-transistorized high-frequency standards receiver. (336)

**THIN LAMINATES** The Mica Corp., 4031 Elenda St., Culver City, Calif. A brochure details the Micaply thin glass/epoxy laminates for use in multilayer circuitry. (337)

**COIL BOBBINS** Gries Reproducer Corp., 400 Beechwood Ave., New Rochelle, N. Y., has issued the third edition of GRC standard specifications for molded nylon coil bobbins. (338)

**POWER TRANSISTORS** AMF Semiconductors, Vandalia, O. Four specification data sheets describe physical and electrical characteristics of *n-p-n* silicon mesa high power transistors. (339)

**PRINTED CIRCUITRY** Electralab Electronics Corp., P.O. Box 548, Encinitas, Calif. The 14 basic steps in producing circuit boards are pictorially illustrated and explained in a four-page folder. (340)

**NEON LAMPS** Signalite Inc., Neptune, N. J. Neon glow lamps for use in electronic circuits such as computer and memory circuits are described in technical bulletin 110B. (341)

**MICROWAVE COMPONENTS** Microlab, 570 W. Mt. Pleasant Ave., Livingston, N. J. A 16-page illustrated catalog outlines the significant specifications of the company's complete line of microwave components. (342)

**PRINTED CIRCUITS** Martin Electronics Mfg. Corp., 3750 E. 10th Court, Hialeah, Fla., has available an illustrated brochure describing its facilities for the manufacture of printed and flush circuits, electronic assemblies, p-c switches and terminal boards. Request on company letterhead.

  
**SIEMENS**

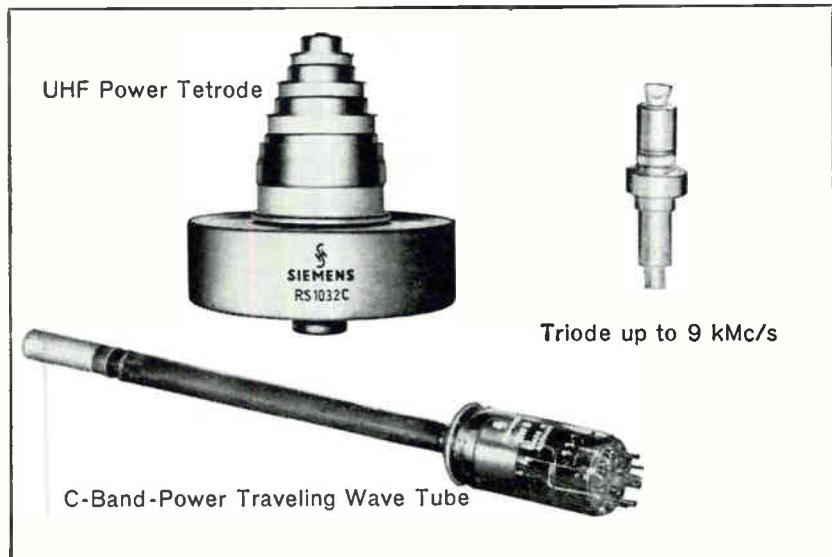

## Electron Tubes

Siemens offers a wide range of power and special purpose tubes to meet the requirements of your design:

### POWER GRID TUBES

for AM and FM radio broadcasting, VHF and UHF television, transmitting, communication and industrial applications. External glass-metal or ceramic-metal types cooled by forced air, water or vapor up to 1000 Mc/s and plate dissipation ratings to 180 kWatts. Internal anode radiation cooled glass types up to 600 Mc/s and plate dissipation ratings to 1.2 kWatts.

### SPECIAL QUALITY TUBES

with frame grid construction, especially designed for use in critical industrial and military applications, in which service reliability is of primary importance.

### DISC SEAL TRIODES

in ceramic-metal construction up to 9 kMc/s.

### REFLEX KLYSTRONS

for communication service in the frequency range from 3.6 to 5.9 kMc/s.

### TRAVELING WAVE TUBES

for broadband radio links in the frequency range from 0.5 to 7.3 kMc/s.

### BACKWARD WAVE OSCILLATORS

in the frequency range from 26.5 to 90 kMc/s.

■  
SIEMENS & HALSKE AKTIENGESELLSCHAFT · GERMANY

For further information and application engineering assistance write to our representatives in USA

### SIEMENS AMERICA INCORPORATED

350 Fifth Avenue, New York 1, N.Y. · Tel: LOngacre 4-7674. Telex 01-2070, Cable: siemens

in Canada:

### SIEMENS HALSKE SIEMENS SCHUCKERT (CANADA) LTD.

407, McGill Street, Montreal 1, P.Q. · Tel: 849-5783. Telex 012800, Cable: siemenscan

# MAKING ROOM AT THE TOP



*EICO creates a new, professional lab quality test instrument series at moderate prices.*

**EICO®**

**AC VTVM & AMPLIFIER #250**

Kit \$49.95, Wired \$79.95

**VTVM:** 12 ranges from 1mv to 300v rms; response absolutely flat from 10 cps to 600 kc; input impedance 10M $\Omega$  shunted by 15 $\mu$ f; accuracy  $\pm$ 3% of full scale.

**Note:** Average responding meter calibrated in rms. Linear 0-1, 0-3 scales. Decibel scales based on 0db=1mw in 600  $\Omega$  with 10db interval between ranges.

**AMPLIFIER:** 60db gain on 1mv range; response +0, -3db from 8cps to 800kc; output to 5V rms undistorted, variable down to zero by attenuator control at output; input impedance 10M $\Omega$ , output impedance 5K $\Omega$ ; hum & noise -40db for signal inputs above 2mv.

**DESIGN QUALITY:** All frame-grid tubes; 60db frequency-compensated input attenuator ahead of cathode follower with 10db/step attenuator following; two-stage R-C coupled amplifier and full-bridge meter circuit in one overall feedback loop; no response adjustment required in amplifier circuit; single sensitivity adjustment; voltage-regulated power supply. 50/60 cycle operation.

**EICO MODEL 255 AC VTVM** identical to Model 250 described above, but less amplifier facility. 50/60 cycle operation. Kit \$44.95      Wired \$72.95

Add 5% in the West.

See the 41 additional EICO instruments helpful for your lab and line work. Write for free catalog and name of neighborhood distributor.

**EICO®**

Dept. E-1B  
3300 N. Blvd., L.I.C. 1, N. Y.  
Export Dept.: Roburn Agencies, Inc.  
431 Greenwich St., N. Y. 13, N. Y.

CIRCLE 202 ON READER SERVICE CARD

## NEW BOOKS



### Basic Theory and Application of Tunnel Diodes

By SYLVESTER P. GENTILE  
*D. Van Nostrand Company, Inc., Princeton, N. J., 1962, 295 p, \$9.*

ONE of the first books dealing exclusively with tunnel diodes, this text presents their basic principles in a simplified form, without relying on the reader's knowledge of transistor physics.

After covering basic semiconductor theory, energy level considerations, negative resistance and tunneling, the author describes tunnel-diode circuits including series and parallel amplifiers and oscillators, cascading tunnel-diode amplifiers matched to transmission lines, isolators, gyrators, pulse and switching circuits, modulators, detectors, and semiconductor circuits where tunnel diodes are combined with transistors and diodes.

The descriptions use a minimum of mathematics and draw on a large number of practical contemporary tunnel-diode circuits.—G.V.N.

### Fundamentals of Electricity and Magnetism

By ARTHUR F. KIP  
*McGraw-Hill Book Company, Inc., New York, 1962, 395 p, \$7.95.*

A TEXT in classical electric and magnetic theory, this book ranges in subject matter from fundamental electrostatics to electric and magnetic quantum effects. The treat-

# INDUSTRIAL COLORADO



## PRIME SITE FOR ELECTRONIC INDUSTRIES!

Locate in the middle of the great new industrial west...right between the giant west coast and expanding midwest markets...Locate in Colorado, the transportation hub west of the Mississippi. Many of the nation's leading electronic companies have Colorado addresses... enjoy Colorado's year 'round Pleasant Living bonus. Discover the advantages for your company in Colorado.

### WRITE TODAY FOR FREE EXECUTIVE PORTFOLIO... "INDUSTRIAL COLORADO"

9-booklet portfolio containing the latest data on Colorado's industrial assets, sites, markets, labor and of course... Pleasant Living. All inquiries are strictly confidential.

**COLORADO DEPARTMENT OF DEVELOPMENT**

11 STATE CAPITOL DENVER 2, COLORADO





ment is on an engineering student level, and presupposes the knowledge of elementary calculus; more advanced mathematical concepts are developed as needed. Some essential concepts of solid-state physics are included, as are some of the phenomena that illustrate the impact of quantum mechanics on classical electricity and magnetism. There are ample problems and examples in each chapter.

### Principles of Self-Organization

Editors: HEINZ VON FOERSTER and GEORGE W. ZOPF, Jr., University of Illinois

Pergamon Press, New York, 1962, 560 p., \$15.

THESE papers, presented at a symposium on self-organizing systems held at the University of Illinois last June, represent five major areas of interest: theoretical and experimental foundations of self-organization; theories of the behavior of complex systems; immunology of self-organizing systems (i.e. how complex systems can be made immune against errors); preorganization in cognitive systems; and componentry. Although only two of the 23 papers deal with specific componentry that will be of importance in the development of highly intelligent, self-organizing machines, electrical engineers should find all these papers fascinating for the light they throw on future computer developments. The recorded discussions by the symposium participants are especially interesting, for they reveal as much as anything the difficulties in breaking into new interdisciplinary ground and in finding a common language in which diverse specialists can talk with one another.—N.L.

### Industrial Electronics

By ALLAN LYTEL

McGraw-Hill Book Company, Inc., New York, 1962, 456 p., \$10.

THIS text covers important industrial applications of electronics not

# NEW DESIGN

ADDITIONAL WARRANTY  
(Components : 18 months)

# OSCILLOSCOPES

WITH PLUG-IN UNITS

## 241A/242A/243A

Inter-Plans 6255

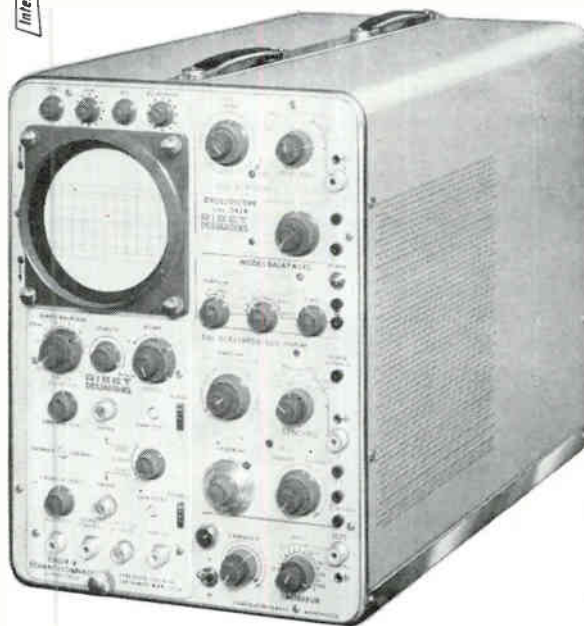

- 241 A : DC - 30 MHz  
Double sweep system  
Selection of triggering level  
Direct reading calibration on both axis

- 242 A : DC - 15 MHz  
Double sweep system  
Other specifications same as type 241 A

- 243 A : DC - 15 MHz  
Single sweep system  
Other specifications same as type 242 A

#### Plug-in preamplifiers :

- T 130 : 1 trace 30 MHz  
Sensitivity : 50 mv/cm DC 5 mv/cm AC

- T 230 : Dual trace 30 MHz  
Sensitivity : 50 mv/cm DC and AC
- T D 1 : Differential preamplifier  
Sensitivity : 1 mv/cm

- T 120 : 1 trace - 20 MHz  
Sensitivity : 5 mv/cm DC and AC

- T 2700 : Pulse-sampling system - 700 MHz

# RIBET-DESJARDINS

TECHNICAL ASSISTANCE IS, AS USUAL, PROVIDED.

MEASURE & CONTROL DEPARTMENT : 13-17, rue Périer MONTROUGE (Seine)  
FRANCE Tél. ALEsia 24-40 + Cable Address: PILACELECT - MONTROUGE

Agencies throughout the world:

NORTH AMERICA (Canada): ELECTROLINE TELEVISION EQUIPMENT INC.  
Room 114,5757 Decelles Avenue - MONTREAL

Other areas : addresses sent on request.

International Exhibition of Electronic Components Paris—Stand 129—Hall 61 Allee Blanche



**NOW!** HIGH FREQUENCY PERFORMANCE  
UP TO 100 Mc.



WITH MECHATROL'S  
NON-WIREWOUND **MECHATRIMS**

**1/2" SQUARE TRIMMER POTENTIOMETERS**

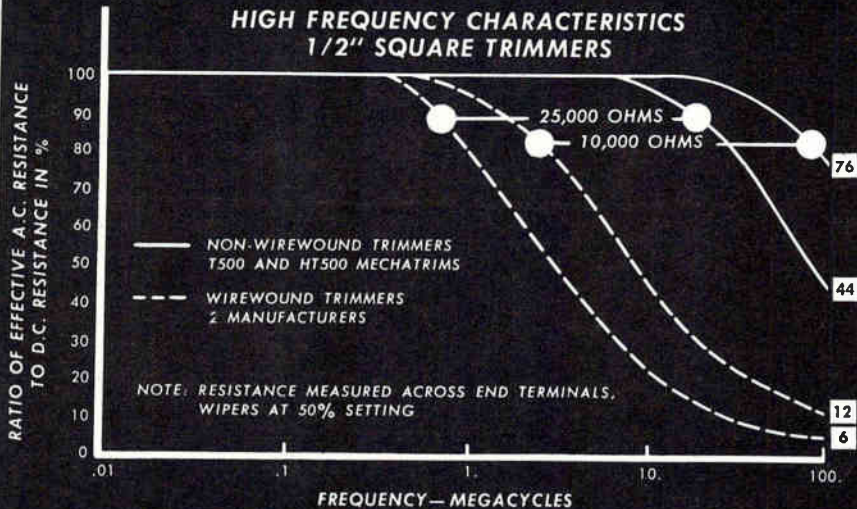

**SERVOMECHANISMS/INC.**  
**MECHATROL DIVISION**

WESTBURY, LONG ISLAND, NEW YORK

EL SEGUNDO, CALIFORNIA

CIRCLE 203 ON READER SERVICE CARD

## ORIGIN SILICON DIODE

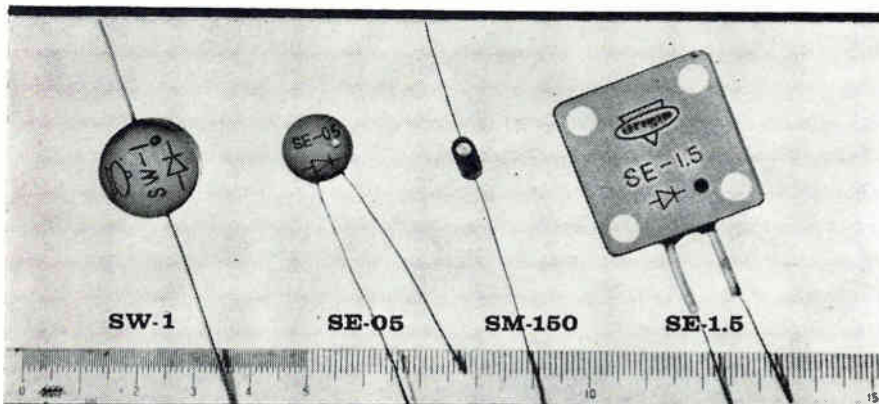

Origin diodes shown, are available in 4 models for PIV of 400, 600, 800 and 1000 volts.

Max. AC input voltages (RMS) of 280, 420, 560 and 700 volts.

Max. reverse current (at PIV, 25°C ambient) is less than 10 $\mu$ A, only 50 $\mu$ A for SW-1.

### Main Products:

Semi-conductors, condenser type spot welder, synthetic enamel and miniature ball bearing.

Max. average rectified current (single phase, half-wave) is 150m A for SM-150, 500m A for SE-05, 1 A for SW-1, and 1.5 A for SE-1.5.

Surge current (for 1=one cycle) is respectively 10 A, 16 A, 30 A and 20 A. Ambient temperature operating range is -55 to +13°C for each diode.



**ORIGIN ELECTRIC COMPANY LTD.**

1-195 Takadaminami-cho, Toshima-ku, Tokyo, Japan  
Cable Address "ORIGINELE TOKYO"

including broadcast or tv equipment. It is intended primarily for use by students at the technical institute level that have had basic electronics, vacuum tubes and other general supporting subjects.

The book is treated with a minimum of mathematics, but does feature some graphs and charts to show interrelationships between variables. Emphasis is given to broad techniques which have wide applicability to a variety of industrial equipment. Particular attention is placed on understanding basic devices and circuits.—B.A.B.

**THE INTERNATIONAL SERIES OF MONOGRAPHS ON SEMI-CONDUCTORS**, edited by H. K. Heinisch, University of Reading, published by Pergamon Press, New York, present specialized accounts of various aspects of semi-conductors, written by outstanding authorities. There are five volumes; the fifth, Electroluminescence, by H. K. Heinisch, was reviewed in *ELECTRONICS* on Sept. 7, 1962. The other four volumes are described below.

### Semiconducting III-V Compounds (Volume 1)

By C. HILSUM and R. C. ROSE-INNES

Pergamon Press, 240 p, \$10.

WITH the fundamental and technical importance of III-V semiconducting materials, physical processes unique to them are discussed concisely yet comprehensively. Band structure, crystal structure, technique of preparation, transport processes, optical, photoelectric and galvanomagnetic properties as well as device applications are presented.

### Photo and Thermoelectric Effects in Semiconductors (Volume 2)

By J. TAUC

Pergamon Press, 1962, 248 p, \$10.

THE physical laws that govern the generation of electromotive forces in semiconductors are given; and a unified treatment of photovoltaic, thermoelectric, photomagnetic and thermomagnetic effects is pre-



# WHO makes the BEST POWER SUPPLIES?

Our customers say — we do. And they should know because the power supplies we furnish must be equal to the critical performance standards of laboratory testing and evaluation.

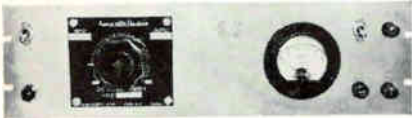

**PS-1-6757** Input: 95/130 volts, 60 cps. Filtered, direct current output 0/45 volts, 0/2.5 amperes. Continuously adjustable and stabilized  $\pm 1\%$  at any setting regardless of line change. Voltage regulation 5%.

## PORTABLE MODEL

### PS-6757

Input: 95/130 volts, 60 cps. Filtered, direct current output 0/45 volts, 0/2.5 amperes. Continuously adjustable and stabilized  $\pm 1\%$  at any setting regardless of line change. Voltage regulation 5%.



**PS-39600** Input: 120 volts  $\pm 15\%$ , 60 cps. Filtered, direct current output 0/50 volts, 0/5 amperes. Ripple voltage RMS less than 1%. Line regulation  $\pm 1\%$ . Load, 3% from 50% to 100% of capacity.

## DC VOLTAGE REFERENCE SUPPLY

### PS-39590

A really unique and useful laboratory instrument. Input regulation of  $\pm 0.005\%$  for  $\pm 15\%$  line change. Output voltage adjustable from 0 to 52 volts dc and stabilized at any setting. Fine adjustment to 2 mv. Ripple .002% peak to peak. Output voltage stability  $\pm 0.015\%$ .



Every good laboratory should have this precise instrument. Details in catalog 17.

## ACME ELECTRIC CORPORATION

311 WATER ST. SAA 3645/2001 CUBA, N.Y.  
In Canada: Acme Electric Corp. Ltd., 50 Northline Rd., Toronto, Ont.



sented. Special attention is given to the effect of illumination, the presence of temperature gradients or magnetic fields, and variations of impurity content.

## Semiconductor Statistics (Volume 3)

By J. BLAKEMORE

Pergamon Press, 1962, 374 p, \$12.50.

THE SCOPE of this book is confined to the basic properties of semiconductor materials. Part I provides an introduction to the electron theory of solids and then provides a comprehensive discussion of charge carriers for semiconductors in thermal equilibrium (or rather a low-current-density quasi-equilibrium condition). Part II considers non-equilibrium situations, for semiconductors with excess carrier densities. The various recombination mechanisms are considered and steady-state and transient conditions studied.

## Thermal Conduction in Semiconductors (Volume 4)

By J. R. DRABBLE and  
H. J. GOLDSMID

Pergamon Press, 236 p, \$10.

INCREASING interest in and importance of thermoelectric devices have created a need for fundamental understanding of thermal conditions in solids. Since the book is restricted mainly to thermal conductivity in semiconductors, readers with a practical interest in elemental and compound semiconductors will find particularly useful material. Conduction properties of a large number of semiconductors are analyzed on the basis of heat transport by electrons and by phonons—R. Colman

## Lines, Waves and Antennas

By ROBERT G. BROWN,  
ROBERT A. SHARPE and  
WILLIAM L. HUGHES

The Ronald Press Company, New York, N. Y., 297 p, \$10.

AN introductory text on electric energy propagation that presup-

# 10 Megohms

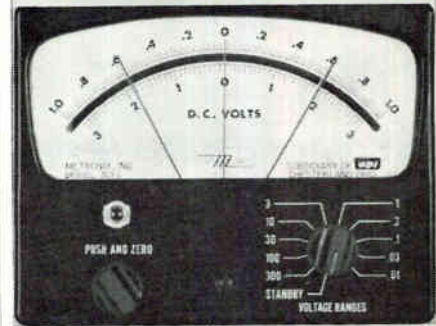

## PLUS Control

## An electronic voltmeter with a meter-relay

This happy combination makes an extremely versatile and acute instrument.

It has critical measuring ability that goes with high input impedance, in space-saving panel-mounting style.

It also has the reliable, simple control of a locking contact meter-relay, with adjustable set points.

Many difficult functions can be easily controlled: conductivity cells, life testing of components or systems, production testing and sorting, automatic Go-No Go of missile circuits.

## Ready When Needed

Metronix DC instruments such as Model 301-C-CMR (illustrated) have input resistances up to 10 megohms. AC input impedances go as high as 5 megohms. Like all Metronix panel-mounting electronic voltmeters (PMEV's), they are always connected—immediately available for continuous monitoring of critical parameters.

Send for data sheets describing Metronix PMEV's in single or multiple ranges, DC or AC, with either meter-relays or conventional indicating meters.



## METRONIX

The Electronic Instrument Division  
of Assembly Products, Inc.  
Chesterland, Ohio

Telephone: HAmilton 3-4440



the most  
reliable  
**EDGEWISE  
METERS**  
on earth...  
or in space!



Rugged, accurate, super-reliable miniature panel meters in a wide variety of ranges and sizes, with horizontal or vertical scales, zero at center, left or right. Also special scales, ranges, sensitivities, resistances, cases and other modifications to your exact requirements. Available as DCUA, DCMA, DCA, DCMV, DCV, ACV, VU, Db.

ACCURACY equal to finest conventional meters.

SAVE SPACE —  $\frac{2}{3}$  less panel area than round or square.

SUPERIOR READABILITY — fast, accurate, readout, minimum parallax. IDEAL FOR STACKING — for speedier, more accurate comparative readings.

CLEAN DESIGN — display only the essential pointer-scale relationship. INTERNALLY ILLUMINATED (some models).

SPEEDY ACTION ON PROTOTYPES OR SERVICE — conveniently located modification centers in your area.



WRITE FOR ENGINEERING DATA SHEETS.

**international instruments inc.**

88 Marsh Hill Road, Orange, Connecticut, Cable: "INTERINST"

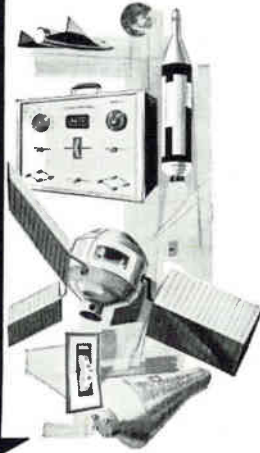

CIRCLE 205 ON READER SERVICE CARD



**Good  
parts  
work  
best!**

Intermediate  
Frequency  
Transformer  
IFT



The high standards of MITSUMI electronic components are insured by a fully-automated assembly system, and double-checked by rigid quality controls. Mitsumi Electric Company is Japan's largest manufacturer of components for radio, television and communications equipment.

POLYVARICON  
Variable  
Capacitor



**MITSUMI PARTS**

**MITSUMI ELECTRIC CO., LTD.**

Tokyo, Osaka, New York



poses a thorough background in static field theory and circuit analysis. For complete comprehension, the reader should have a basic understanding of differential equations and vector analysis.

Some of the topics covered are transmission line analysis, field equations, radiation of electromagnetic waves, wave-guides and lossless line analysis. An excellent appendix with a well-rounded collection of data closes the book. —B.A.B.

## Aspects of the Theory of Artificial Intelligence

(The Proceedings of the First International Symposium on Biosimulation, Locarno, June 29-July 5, 1960)

Edited by C. A. MUSES

Plenum Press, New York, Dec. 1962, 290 p, \$10.

THE thinking of most of the gentlemen included in this volume—McCulloch, Ashby, von Foerster, MacKay, Pask, Schutzenberger—is by now well-known to readers in this field: it is distinguished by its serious philosophical level, by its articulate imaginativeness and by a speculativeness that is nevertheless grounded in deep scientific knowledge and experience. In the words of Charles Muses, the editor, this "Locarno Conference of 1960 is interesting from the viewpoint of the history of science because it was the first symposium ever held on the general problem of what might be termed 'robotics' or the electromechanical . . . simulation of man by man." This is not a volume for the practical bench engineer; it is for the man who likes to sit by his fireplace late at night meditating on the nature of intelligence and of life with the serious intention of attempting to make working models of it. The volume is far better than most symposium collections.

The odd man in the show might be considered to be K. R. Shoulders, "On Microelectronic Components, Interconnections, and System Fabrication", except for his ambitious program of aiming at fabricating  $10^{11}$  active microelectronic components in a cubic inch, to build the intelligent machines others are dreaming up.—N.L.



Of interest to engineers and scientists

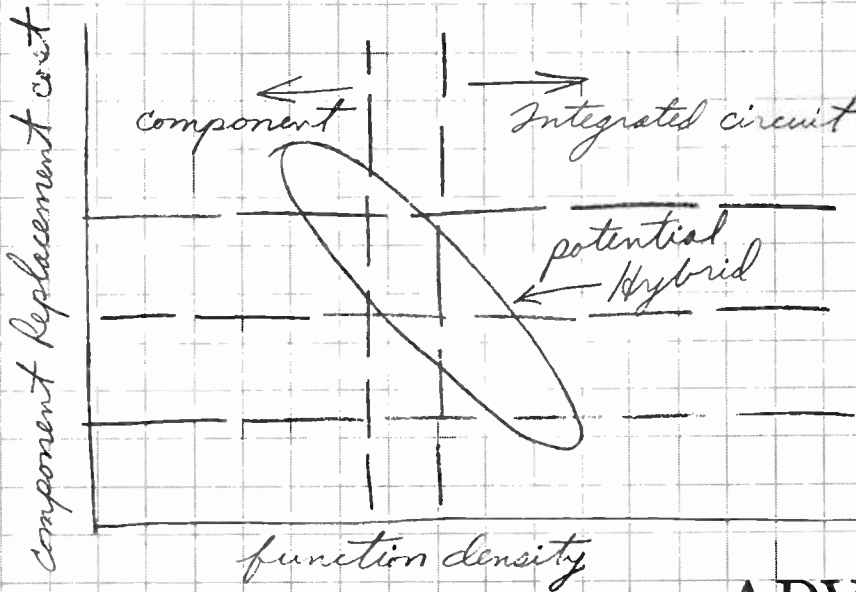

## ADVANCED ELECTRONICS PACKAGING

...one of more than 500 R&D programs under way at Douglas

Douglas is studying new design techniques related to miniature electronic systems that must function under conditions more severe than any previously encountered.

These electronic packages must operate perfectly at sound levels up to 168 decibels; at accelerations up to 120G; and in vacuum environments of less than  $10^{-10}$  Torr. They must be impervious to shock loading of hundreds of G's.

Considerable progress has been made toward these goals. Great promise is being shown by hybrid systems which combine discrete components with integrated circuits.

### Of career interest to engineers and scientists

Electronics has become a major factor in almost every aspect of Douglas missile and space programs. Assignments include some of the most interesting and advanced work in the communi-

cations, control and computer fields. By accepting a position at Douglas, you can be assured of the rapid professional advancement your ability warrants.

This applies not only to those qualified in electronics, but also to engineers and scientists in many of the wide variety of disciplines related to aerospace and defense programs.

Send us your resume or fill out and mail the coupon. Within 15 days from the receipt of your letter, we will send you specific information on opportunities in your field at Douglas.



**MISSILE & SPACE SYSTEMS DIVISION**

An equal opportunity employer

Mr. F. V. Edmonds  
Missile and Space Systems Division  
Douglas Aircraft Company  
3000 Ocean Park Boulevard  
Santa Monica, California

J-151

Please send me full information on professional opportunities in my field at Douglas.

Name \_\_\_\_\_

Engineering or scientific field \_\_\_\_\_

Address \_\_\_\_\_

City \_\_\_\_\_

State \_\_\_\_\_

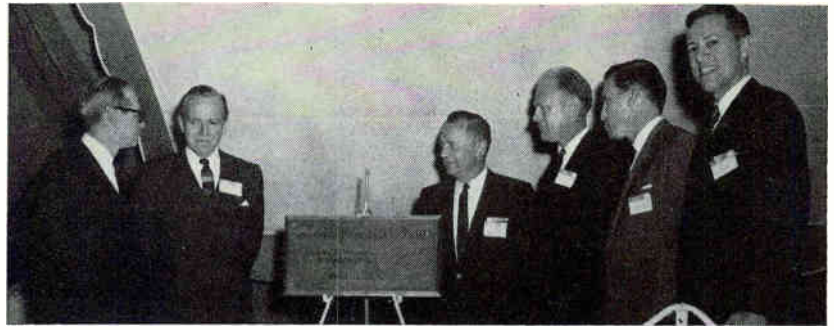

FEATURED in the ceremonies were left to right, Joseph M. Walsh, Instrument division's president; Roswell L. Gilpatric, Deputy Secretary of Defense; John G. Brooks, chairman of the board of Lear Siegler, Inc.; Gerald R. Ford, Jr., U. S. Congressman; Albert G. Handschumacher, president of Lear Siegler, Inc.; and James V. Bitner, Instrument division vice president

## Lear Siegler

# Dedicates Aerospace Center

LASER BEAM, triggered by Roswell L. Gilpatric, Deputy Secretary of Defense, was recently used to unveil the dedication plaque at the Aerospace Development Center, new 80,000 square foot engineering and research facility of the Instrument division of Lear Siegler, Inc., in Grand Rapids, Mich.

Joseph M. Walsh, Instrument division president, said the new center represents one of the most advanced engineering facilities of its kind in the nation today. "It provides added impetus to our capa-

bility to anticipate and fulfill requirements essential to the security and progress of our country," he said.

Designed specifically for aerospace research and engineering, the \$1.8 million center houses the latest in precision equipment used in the development of aerospace systems and components. In addition to 8,000 square feet of clean rooms, the building has 12 laboratories. Among these are a solid state laboratory, a systems laboratory, a gyro and platform laboratory, an elec-

tronics laboratory, and an environmental laboratory.

The environmental laboratory is one of the best-equipped company-owned testing facilities in the world, according to Lear Siegler officials. One of its features is a space chamber, which simulates the "nothing" conditions and extreme temperatures encountered at orbiting altitudes.

The computer laboratory includes company-owned analog computers, leased digital computers, and additional equipment is on order.

## ECI Expands Engineering Facility

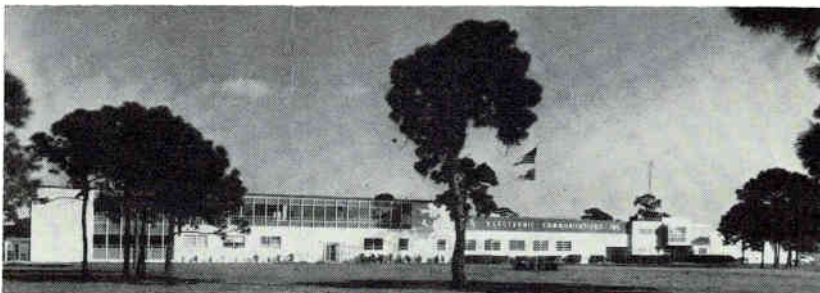

AN EXPANDED engineering facility, more than doubling the size of the former building, is to be dedicated on Monday by Electronic Communications, Inc., St. Petersburg, Fla.

Major General Charles H. Terhune, Jr., Commander, Electronic Systems division, Air Force Systems Command, is the principal dedication speaker.

Some 75,000 square feet have been added to the firm's engineering building with the addition of a second floor, a 50-foot extension shown to the left, and a 70-foot extension in the rear. Designed to provide space for an overall expansion of engineering activity, the building in particular incorporates enlarged and improved facilities for the systems management function

and for research and development programs.

The 125,000-square foot engineering facility combines with a 150,000-square foot manufacturing building to give ECI a 275,000-square foot plant.

With headquarters in St. Petersburg, Electronic Communications, Inc., is prime contractor and systems integrator for the Strategic Air Command's Airborne Command Post and is handling the communication and data link phase of the SAGE Airborne Long Range Input program.

## Girdwood Named To New Mallory Post

JAMES GIRDWOOD has joined P. R. Mallory & Co. Inc. as special assistant to the president. Formerly pub-



# Capacitors of MYLAR® often cost no more than paper—sometimes cost less

## AT LOW PRICES

This graph is an analysis of capacitor prices using capacitance range versus typical unit costs as ordinates. The graph was plotted by using average capacitor prices of a variety of representative capacitor manufacturers.

Analysis of this graph demonstrates that for a wide range of capacitance values, from approximately .001 to 1 mfd., capacitors using "Mylar" polyester film are lower in cost than paper capacitors. In addition, capacitors of "Mylar" are comparable in price to paper units throughout the entire capacitance range. In fact, for the sizes and voltage ratings found in typical electronic gear, the average price for a group of capacitors of "Mylar" would be little different than comparable paper types.

Improved size and weight factors, circuit and packaging simplification often brings the total performance cost below other types of capacitors.

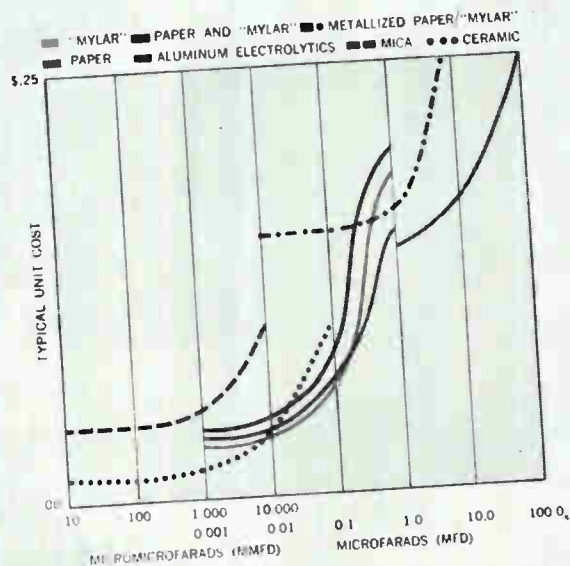

**As shown  
by an analysis of industry prices**

A recent industry survey made by Du Pont showed that most design engineers did not consider capacitors of "Mylar"® in the same low price range as paper. Yet a study of manufacturers' average prices, as reported in our capacitor booklet, points out THAT OVER A RANGE OF SIMILAR CAPACITANCES AND RATINGS—UNITS MADE WITH "MYLAR" COMPARE CLOSELY IN PRICE WITH THOSE OF PAPER.

This means, at no greater cost, you get the extra

reliability of "Mylar"—superior dielectric strength, moisture resistance, and thermal stability over a wide range of temperatures. And you can design more compact components with the reduced capacitor size permitted by "Mylar".

Write for this industry study and price chart. Evaluate the full advantages and properties of "Mylar" before specifying your choice of capacitors. Du Pont Co., Film Dept., Wilmington 98, Del.

®"Mylar" is Du Pont's registered trademark for its polyester film.



BETTER THINGS FOR BETTER LIVING... THROUGH CHEMISTRY

January 25, 1963

only DU PONT makes

**MYLAR®**  
POLYESTER FILM

CIRCLE 117 ON READER SERVICE CARD 117

# SARATOGA INDUSTRIES REPORT

A Precision Ratio Transformer  
for Military Applications —  
SI-011-R

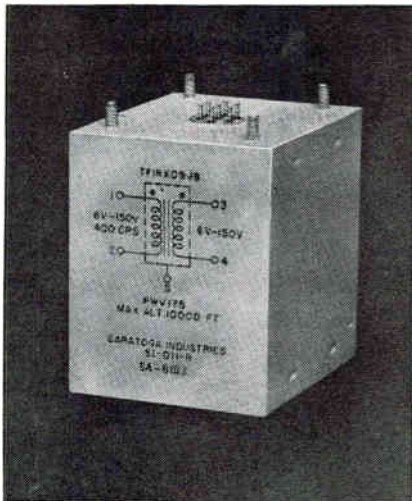

Custom designed and manufactured to meet the rigorous requirements of electronic checkout systems.

**FEATURES**—low phase shift—high transformation accuracy—high input impedance—hermetically sealed to meet requirements of MIL-T-27A, grade I, class R.

**SPECIFICATIONS** —

Input Voltage: 150 V RMS  
400 cps  $\pm 2$  cps

Input Impedance: 6-30 V 1 meg min.  
30-60 V 1.5 meg min.  
60-120 V 2.0 meg min.

Input Current: 6 ua max. @ 6 V 400 cps  
20 ua max. @ 30 V 400 cps  
30 ua max. @ 60 V 400 cps

Load Impedance: 10 meg min.

Phase Shift: primary to secondary  $\pm .15$  milliradians

Turns Ratio: primary to secondary  
max. 1.00006  
min. .99994

For full information about Saratoga Industries complete design, engineering and production facilities, write —



**SARATOGA INDUSTRIES**

A Division of Espey Mfg. & Electronics Corp.  
Saratoga Springs, N. Y. • Telephone 4100

lisher of **ELECTRONICS** magazine and, at an earlier date, "Nucleonics", he had been with the McGraw-Hill Publishing Company since 1948.

Girdwood served as a Marine Corps officer. A graduate of the University of Maine, he studied electronics at the Graduate Schools

of Engineering of Harvard University and Massachusetts Institute of Technology.

G. Barron Mallory, president of Mallory, said that Girdwood's position includes responsibility for market research, planning and product distribution policies. He will be based at Indianapolis.

## Grand Tour for Sales

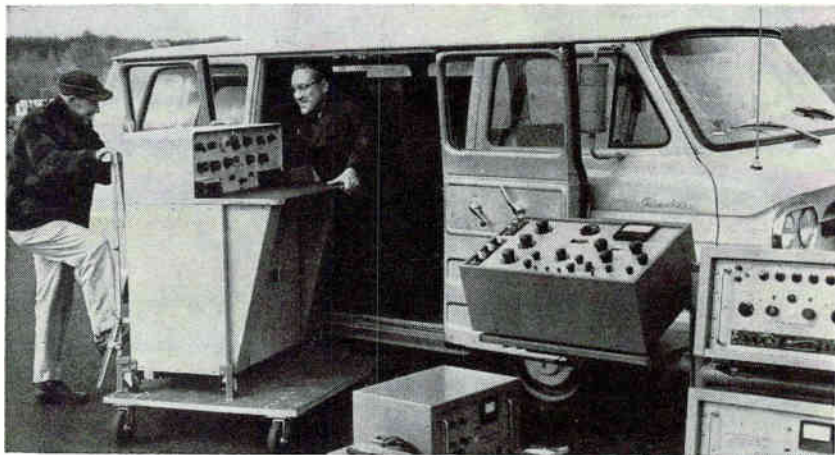

**EQUIPMENT** and panel wagon that are being taken on 20,000 mile trip through Europe to demonstrate RFL equipment in actual operation

A 27-YEAR-OLD electrical engineer at Radio Frequency Laboratories just began seeing Europe without really trying—or paying.

Anthony Faiola, a bachelor, will spend the rest of this year touring France, Italy, Switzerland, West Germany, Belgium, Holland, Norway, Sweden and the United Kingdom. It will all be part of his job.

Purpose of his travels will be to demonstrate RFL equipment under actual working conditions in European plants, a program that has done much to increase sales of RFL products in the United States in the last few years, according to Edwin S. Seabury, RFL executive vice president.

RFL makes precision calibration standards, power supplies, magnetics equipment and crystal impedance meters. Faiola will have \$31,000 worth of these instruments aboard an American panel wagon he will pilot from country to country.

"At the plants we will bring the equipment into the calibration or testing area, or in larger plants into their special demonstration rooms," Seabury said.

"Here the engineers can get their hands on it and our man will work with them and others of the management team to explain cost and time-saving advantages, and how our equipment can speed up the testing of preliminary designs and finished products."

James F. Lavarity, of the U.S. Commerce Dept., calls the RFL program "one which offers great possibilities for American firms manufacturing a variety of goods, electronic or otherwise."

RFL has agreed to furnish the Commerce Dept. with periodic reports of the tour. It said it will also give this information to any American firm requesting it.

### Magnavox Building \$5-Million Plant

CONSTRUCTION of a \$5 million facility in Greeneville, Tenn., for production of color television and black and white instruments plus stereo-tv combinations has been announced by The Magnavox Co.

The new plant will be completely automated and is scheduled for com-



The Best Miniature Soldering Iron In The World . . .

**ANTEX-Precision**  
MINIATURE SOLDERING IRON

Low Wattage . . . 110-120 volts . . . no transformer!

Weights 1 ounce

- Life of element and ease of handling are superior to any other miniature iron.
- Sealed element maintains constant temperature around 626 F.
- Ultra-flexible 3-wire cord — grounded — 50 megohms between element and tip protects components and operator.
- Bright "safety" yellow handle stands more than 1000 F . . . stays cool.
- Easy slide-on tips stay hot under production speeds . . . made of tungsten-copper alloy; nickel or iron plated; diameter from 3/64" to 3/16"; spade or chisel ends.

Irons furnished less plugs; heavy duty 2 or 3 pronged plugs available.



JUST 6 1/2 INCHES LONG

Model C115

**\$4.35**  
EACH  
in lots of 6  
Tips extra

**M. M. NEWMAN CORPORATION**

Dept. 5 — 79 Clifton Avenue, Marblehead, Massachusetts

CIRCLE 206 ON READER SERVICE CARD

**IEEE**

**SPEAK**

TO OUTSTANDING  
ELECTRONICS ENGINEERS,  
SCIENTISTS, PHYSICISTS  
at

**I-TRIPLE-E's**

International Convention  
and Exhibition in New York

**MARCH 25, 26, 27, 28**

The COLISEUM at Columbus Circle  
& The WALDORF ASTORIA HOTEL

admission: MEMBERS \$1.00; NON-MEMBERS \$3.00  
MINIMUM AGE: 18

**SHOW**

(formerly the IRE Show)



**Thru-Connected**  
Printed Wiring Boards

**HIGH** { *Reliability!*  
*Re-usability!*

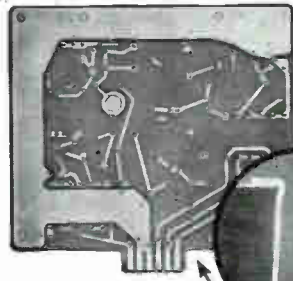

**Fused In Place Eyelets**

Solder flowed under flanges by high current electrode set dies using latest equipment improvements — fast, flexible, economical. Special Methode techniques now permit the mounting of .016" semi-conductor leads into eyelets which can be supplied with a .021" ± .003" inside diameter.

**Plated Thru Holes**

Using copper reduction techniques for sensitizing in conjunction with preclad laminates — compact, reliable, excellent component soldering and high component density.

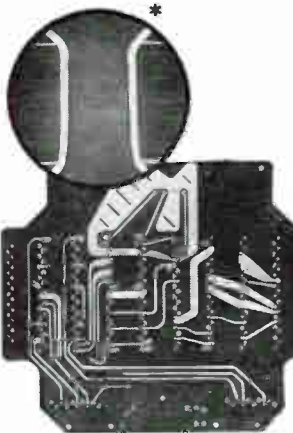
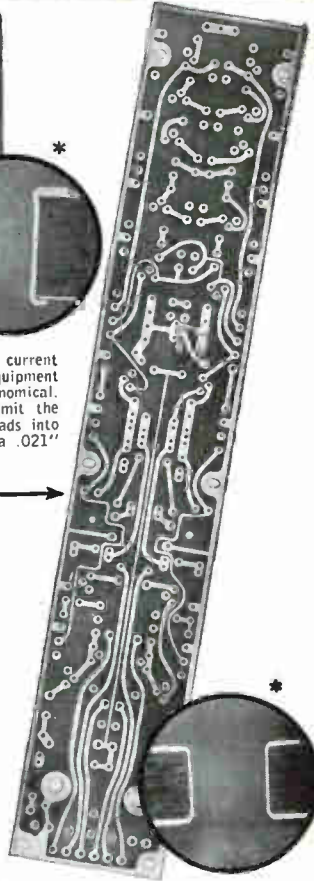

**Funnel Tubelets**

Funnel shaped tubelets—permit easy component insertion, repeated removal and re-mounting without damage to board or adhesion — maximum re-usability.

**New Three-Dee Sealed Harness**

Methode's new fully encapsulated multi-layer circuitry—permits unlimited cross-overs and taps, flexible, conformal light and tough for interconnecting individual circuit cards or black boxes.

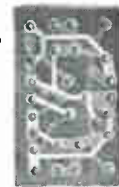

37 to one micro photographic cross-section view

Use the Best Prefabricated Wiring Technique for Your Requirement . . .

ALL ARE AVAILABLE FROM:



**Methode Electronics, Inc.**

7447 West Wilson Avenue

Chicago 31, Illinois





## MEASURED STABILITY

The Paktron Mylar\* MR 330 Capacitor has a change less than 2.5%, 25°C — 85°C. Temperature range from —55°C to 125°C derating above 85°C to 50% at 125°C. Other features are low dissipation factor, excellent dielectric strength, good insulation and moisture resistance and low cost. For additional information write.

**i t PAKTRON**  
**w** PACKAGED ELECTRONICS  
 DIVISION OF ILLINOIS TOOL WORKS, INC.  
 1321 LESLIE AVENUE • ALEXANDRIA, VIRGINIA

AREA CODE 703 King 8-4400

\* \* DUPONT

pletion in June 1963. Situated on a 90-acre tract of land northeast of the company's present facilities, it will have more than 500,000 square feet of manufacturing area and has been designed to allow for future expansion. The existing tv facility will be placed on a stand-by basis when the new plant becomes operative.

### Texas Instruments Appoints Teal

GORDON K. TEAL, assistant vice president—Corporate Research & Engineering at Texas Instruments Incorporated, has been appointed technical director of TI's International division.

Teal is known as the inventor of methods to prepare single crystal semiconductor material for transistors, and as co-inventor of the grown junction transistor. After 22 years on the scientific staff of Bell Telephone Laboratories he joined TI in 1953 to establish the Central Research Laboratories.

In his new assignment, Teal will relocate in Europe with his major objective to create and maximize the flow of technology between TI's international and U. S. operations.



### Ishikawa Joins Consultant Group

SAN FRANCISCO, CALIF.—A new engineering link between the U.S.A., Europe and Japan, designed to aid small electronics firms, was recently announced here by Electronic Engineers International.

H. M. Ishikawa, a consulting engineer in Tokyo, has joined EEI and will operate throughout Japan.

EEI is an association of consulting engineers with its colleagues living and working in the U.S.,



## ELECTRONIC PRODUCTS NEWS BY CARBORUNDUM

# NEWS

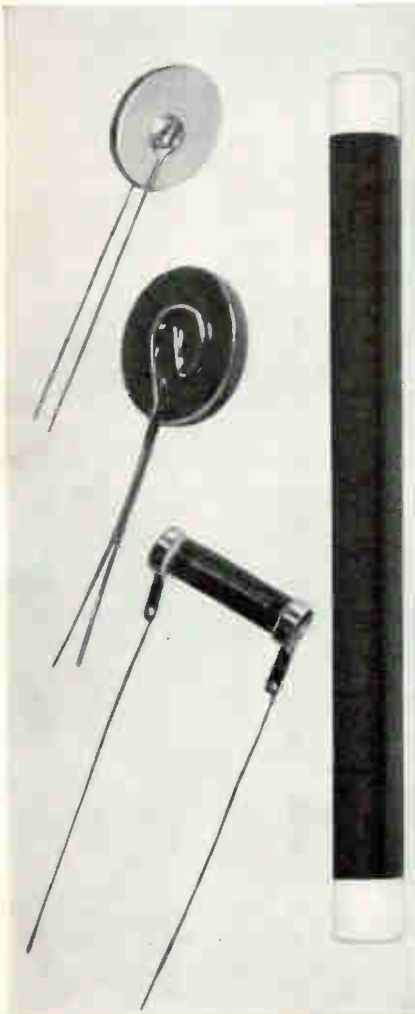

### New \$1½ million electronic facility marks spectacular Carborundum development program

Almost doubling the size of the original plant, a new addition to Carborundum's electronic product manufacturing facilities is now in operation at Niagara Falls.

The new facility provides for greatly increased production of the line of non-metallic resistors, thermistors and varistors. It will also allow for greater diversification resulting from new products

developed out of Carborundum's extensive research in solid-state materials, particularly for high temperature applications. Several significant developments in this field are expected to be announced shortly.

Modern manufacturing facilities provide for improved quality control, aimed at precise reproducibility of physical and electrical characteristics of all electronic products. Expanded technical services will be available to assist in the solution of industry problems.

If your product could benefit from application of symmetrical varistors, positive or negative temperature coefficient thermistors, or high temperature ceramic resistors, write for technical data to Dept. ED-12G, Electronics Division, Carborundum Company, P. O. Box 339, Niagara Falls, New York. For evaluation or quotations covering your particular application, please include the necessary particulars.

### Heavy duty glass-to-metal seals pass stringent tests . . . 2½ million without rejects!

The heavy duty seal illustrated is one of hundreds of types manufactured by Carborundum's Latrobe Plant, for use in electrical and electronic components. This particular example is a refrigerator seal. It must withstand wide

swings in temperature and seal against refrigerant leakage.

Quality control checks include cyclic testing for thermal shock resistance from freezing to 500F., resistance to gas leakage at 350 psi and a flash-over test at 2500 volts. Despite these requirements, 2½ million have been supplied to the refrigerator industry without a single reject. Automated production equipment keeps costs of these seals exceptionally low.

Typical of other critical hermetic sealing applications solved with Carborundum's metal-bonded ceramic-to-metal assemblies and metal-bonded ceramics are those involving space capsules and guided missiles, pressure vessels, canned nuclear pumps, thermopile lead-thrus, nuclear reactors, and housings for silicon and germanium rectifiers.

Carborundum's Latrobe plant specializes in all types of glass-to-

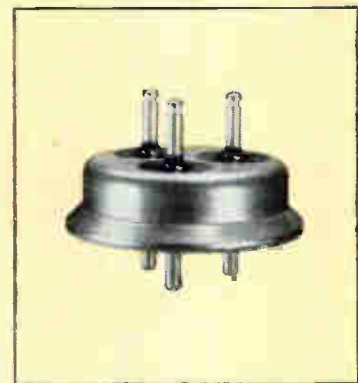

metal and ceramic-to-metal seals. For helpful suggestions in solving a variety of difficult sealing problems, contact Dept. ED-12S, Electronics Division, Latrobe Plant, The Carborundum Company, Latrobe, Pennsylvania.

## CARBORUNDUM®

# VERNITRON 3-MINUTE CONTROL SYNCHROS DELIVERED ON REGULAR PRODUCTION BASIS

60 & 400 Cycle

ALL SIZES—11 through 23

ALL TYPES—Transformers, Transmitters, Differential Transmitters—Thru-Bore and Standard

ALL ENGINEERED & MANUFACTURED TO: MIL-S-2335, MIL-S-16892, FXS-1066, MIL-S-12472, MIL-S-20708A

ALL AVAILABLE WITH MAXIMUM ELECTRICAL ERROR OF  $\pm 3$  MINUTES! A major break-through, made possible by VERNITRON specialization in precision synchro component design and manufacture.

WRITE, WIRE, PHONE NOW for complete price, delivery and specification data, ask for new Vernitron Catalog

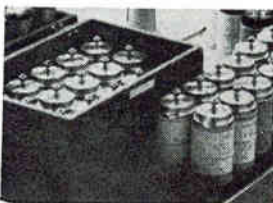
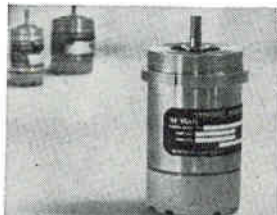

THE QUALITY NAME IN PRECISION SERVO COMPONENTS

606 Old Country Rd., Garden City, N. Y. • Pioneer 1-4130 • TWX: 516-248-9525  
West Coast Plant: 1742 So. Crenshaw Blvd., Torrance, Cal. FAirfax 8-2504 • TWX: 213-328-1802

England, and Common Market countries. Through an international liaison network they offer services designed to help electronics companies establish themselves in overseas markets.

Ishikawa's work will be to help smaller firms in the U.S. and Japan to exchange knowledge in the fields of electronics and applied physics, and form marketing and manufacturing partnerships.

## PEOPLE IN BRIEF

Janis Galejs promoted to a senior scientist at Sylvania's Applied Research Laboratory. **Harvey Riggs**, president of International Electronic Research Corp., elected chairman of the board. **Alvan J. Lynn**, formerly with Daystrom-Transicoil, Inc., appointed senior systems engineer for Kollsman Motor Corp. **Robert P. Scott** advances to coordinator of subsidiary operations at CTS Corp. **Burton Yale** leaves Ramo Wooldridge div. of TRW to join Computer Control Co. as staff engineer. **Paul Kisliuk** moves up to head of the Quantum Electronics dept. at Aerospace Corp. Honeywell Research Center ups **James J. Renier** to asst. director. **David Goldgewert**, ex-PRD Electronics, Inc., now microwave engineer at General Microwave Corp. **Grady B. Hall**, with Lockheed Aircraft since 1950, named director of reliability engineering at Lockheed Propulsion Co. **Paul D. Ross** moves up at GE to g-m of the Specialty Control dept. **HRB-Singer, Inc.**, promotes **Robert Laughlin** to head its new Electro-Optical Laboratory. **Lawrence M. Limbach**, from GD/Astronautics to Ryan Aeronautical Co. as v-p, manufacturing. **Louis J. Metevier**, **Robert W. Jorgensen**, and **William H. Shaw**, previously division g-m's, elected v-p's for aerospace, commercial products and commercial contracts, respectively, at The Hallcrafters Co. **Robert F. Halligan**, Hallcrafters president, given the additional responsibilities of chief executive officer.

CIRCLE 207 ON READER SERVICE CARD

Peter A. York, P. Eng.  
Ontario Dept. of Economics & Development  
454 University Avenue,  
Toronto 2, Ontario, Canada

Please send me your information packet.

Name .....

Title .....

Company .....

Address .....

Product Line .....

### IN 30 SECONDS BEGIN TO INCREASE YOUR CANADIAN ELECTRONICS PROFITS WITHOUT INITIAL INVESTMENT!

**HOW:** By entering into a manufacturing agreement with one of 1800 going Ontario companies, or, more simply, by filling in the coupon at the top of this advertisement (average time: half-a-minute).

**WHY:** With recent devaluation of the Canadian dollar and other developments, it is tougher to break into and stay in the Canadian market. Through a manufacturing arrangement in Ontario, you:

1. Overcome these barriers, eliminate freight costs, import duties on finished goods.
2. Take advantage of brand acceptance, marketing outlets built up by successful Canadian companies.
3. Earn a faster, bigger, more continuous profit return through royalties and licensing fees.

**PROVE IT:** Here are the three materials we'll send you—a full outline of the manufacturing arrangements program, a sample descriptive listing of Ontario Companies ready to make Electronic products like yours under license, an M.A. inquiry form that will help us find with you a "best bet" licensing partner.

Remember Canada is a \$39 billion market. Isn't it time you got your share?

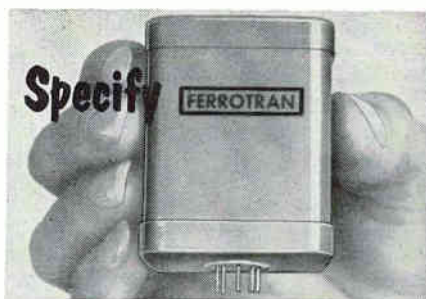

## AUDIOTRAN TRANSISTORIZED AUDIO AMPLIFIERS

High gain, self-contained, low distortion, completely transistorized Audio Amplifier modules.

**FEATURES:** Plugs into 7- or 8-pin socket; hermetically sealed; rugged military construction; cool-running; high stability; driver plus P-P output transformer; negative or positive 15 V., DC operation.

MODEL	POWER OUTPUT	INPUT RES. ohms	OUTPUT RES. ohms	POWER GAIN	DIST.	PRICE
AA-1	150 mw	600	6	57 db.	2%	\$75
AA-2L	135 mw	4700	600	44 db.	1.5%	75
AA-3-3	2 W	600	3.2	38 db.	3%	85
AA-3-8	2 W	600	8.0	36 db.	4%	85
AA-4-3	2 W	600	3.2	64 db.	2.0%	125
AA-4-8	2 W	800	8.0	66 db.	2.3%	125
AA-4L	3 W	800	250	68 db.	4.3%	125
AA-5	2 W	800	3.2	63 db.	3.0%	125
AA-5H	2 W	2.3 K	3.2	58 db.	2.3%	125
AA-6-3	4 W	600	3.2	61 db.	4.6%	130

CASE SIZES: AA-1, AA-2L—2K, "x2"x2½"; AA-3 thru AA-6—3"x2½"x4¼". IMPEDANCES OPTIONAL. FOR COMPLETE LINE SEE EEM PGS. 624-625.

**FERROTRAN ELECTRONICS CO.**  
693 BROADWAY • N. Y. 12, N. Y. • AL 4-5810  
Makers of A-F and I-F Amplifiers • Transistor Power Supplies and Miniature Transformers

CIRCLE 204 ON READER SERVICE CARD



# electronics

## WEEKLY QUALIFICATION FORM FOR POSITIONS AVAILABLE

### ATTENTION: ENGINEERS, SCIENTISTS, PHYSICISTS

This Qualification Form is designed to help you advance in the electronics industry. It is unique and compact. Designed with the assistance of professional personnel management, it isolates specific experience in electronics and deals only in essential background information.

The advertisers listed here are seeking professional experience. Fill in the Qualification Form below.

#### STRICTLY CONFIDENTIAL

Your Qualification form will be handled as "Strictly Confidential" by ELECTRONICS. Our processing system is such that your form will be forwarded within 24 hours to the proper executives in the companies you select. You will be contacted at your home by the interested companies.

#### WHAT TO DO

1. Review the positions in the advertisements.
2. Select those for which you qualify.
3. Notice the key numbers.
4. Circle the corresponding key number below the Qualification Form.
5. Fill out the form completely. Please print clearly.
6. Mail to: Classified Advertising Div., ELECTRONICS, Box 12, New York 36, N. Y. (No charge, of course).

COMPANY	SEE PAGE	KEY #
ATOMIC PERSONNEL INC. Philadelphia, Penna.	124	1
BELL AEROSYSTEMS CO. Division of Bell Aerospace Corporation A Textron Company, Buffalo 5, N. Y.	93*	2
DAYSTROM INC. Electric Division Poughkeepsie, N. Y.	93*	3
DOUGLAS AIRCRAFT CO. Missiles & Space Systems Division Santa Monica, California	115	4
GENERAL DYNAMICS/ELECTRONICS Rochester 1, N. Y.	124	5
GRUMMAN AIRCRAFT ENGINEERING CORP. Bethpage, L. I., New York	91, 92*	6
JET PROPULSION LABORATORY Pasadena, Calif.	125	7
LOCKHEED MISSILES & SPACE COMPANY Sunnyvale, California	77*	8
ROME AIR MATERIEL AREA (AFLC) Griffiss Air Force Base, Rome, N. Y.	94*	9
SPACE TECHNOLOGY LABORATORIES, INC. Sub. of Thompson Ramo Wooldridge Inc. Redondo Beach, California	13	10
SPERRY MICROWAVE ELECTRONICS CO. Clearwater, Florida Div. of Sperry Rand Corp.	126	11

\* These advertisements appeared in the Jan. 18th. issue.

(cut here)

### electronics WEEKLY QUALIFICATION FORM FOR POSITIONS AVAILABLE

(cut here)

(Please type or print clearly. Necessary for reproduction.)

#### Personal Background

NAME .....

HOME ADDRESS .....

CITY ..... ZONE ..... STATE .....

HOME TELEPHONE .....

#### Education

PROFESSIONAL DEGREE(S) .....

MAJOR(S) .....

UNIVERSITY .....

DATE(S) .....

#### FIELDS OF EXPERIENCE (Please Check)

12563

- |  |  |                                       |
|--|--|---------------------------------------|
| <input type="checkbox"/> Aerospace           | <input type="checkbox"/> Fire Control        | <input type="checkbox"/> Radar        |
| <input type="checkbox"/> Antennas            | <input type="checkbox"/> Human Factors       | <input type="checkbox"/> Radio-TV     |
| <input type="checkbox"/> ASW                 | <input type="checkbox"/> Infrared            | <input type="checkbox"/> Simulators   |
| <input type="checkbox"/> Circuits            | <input type="checkbox"/> Instrumentation     | <input type="checkbox"/> Solid State  |
| <input type="checkbox"/> Communications      | <input type="checkbox"/> Medicine            | <input type="checkbox"/> Telemetry    |
| <input type="checkbox"/> Components          | <input type="checkbox"/> Microwave           | <input type="checkbox"/> Transformers |
| <input type="checkbox"/> Computers           | <input type="checkbox"/> Navigation          | <input type="checkbox"/> Other .....  |
| <input type="checkbox"/> ECM                 | <input type="checkbox"/> Operations Research | <input type="checkbox"/> .....        |
| <input type="checkbox"/> Electron Tubes      | <input type="checkbox"/> Optics              | <input type="checkbox"/> .....        |
| <input type="checkbox"/> Engineering Writing | <input type="checkbox"/> Packaging           | <input type="checkbox"/> .....        |

#### CATEGORY OF SPECIALIZATION

Please indicate number of months experience on proper lines.

	Technical Experience (Months)	Supervisory Experience (Months)
RESEARCH (pure, fundamental, basic)	.....	.....
RESEARCH (Applied)	.....	.....
SYSTEMS (New Concepts)	.....	.....
DEVELOPMENT (Model)	.....	.....
DESIGN (Product)	.....	.....
MANUFACTURING (Product)	.....	.....
FIELD (Service)	.....	.....
SALES (Proposals & Products)	.....	.....

CIRCLE KEY NUMBERS OF ABOVE COMPANIES' POSITIONS THAT INTEREST YOU

1 2 3 4 5 6 7 8 9 10 11 12 13 14 15 16 17 18 19 20 21 22 23 24 25

# LET'S TALK About the New Field of AEROSPACE GROUND ELECTRONICS!

The rapidity with which we are reaching further and further into outer space . . . the many new and as yet completely unexplored related technologies . . . are giving birth to a vital new field—Aerospace Ground Electronics.

To be sure, ground support equipment, test equipment design and the like are involved. But the enormity of the tasks which lie ahead require different approaches than before and can only be described in new terms, and by the creation of a new master-field.

General Dynamics/Electronics is very active in Aerospace Ground Electronics and expects to become even more heavily involved. Our preliminary ideas in the field evolve from the disciplines listed below. If you have the required background, we would like to explore the possibilities of AGE with you.

## SYSTEMS ENGINEERING

Broad knowledge of Aerospace Ground Electronics design. Will analyze aerospace electronic sub-systems for test requirements and determine test equipment needs. Experience in Air Force Shop or Naval Carrier Installations desirable, with emphasis on equipment layout, intercabling, work flow analysis, operational and calibration procedures.

## PROJECT ENGINEERING

Project Engineers to supervise design and integration of test equipments and test stations. Should be familiar with all types of testing equipment and techniques in one or more of the following areas.

- Flight Control Systems
- Radar
- HF-UHF Navigation & Communication Equipment
- Microwave Equipment
- Antenna Systems
- Electronic Countermeasures

## DESIGN ENGINEERING

**MICROWAVE**—Engineers experienced in the design of signal generators and receivers in the following frequency bands: L, S, C, T, Ku, Ka. Should also know techniques for remote control of frequency and signal amplitude.

**LOW FREQUENCY**—Experience in the design of audio and sweep signal generators and servo systems test equipment. Knowledge of remote control of audio generator frequency and output using digital techniques is desirable, or in cathode ray tube sweep circuits.

**HF-UHF**—Engineers with experience in the design of HF and UHF signal generators, using both transistorized and vacuum tube circuitry. Knowledge of techniques for digital selection of frequency, such as frequency synthesis, and remote control of signal amplitude required.

## CIRCUIT DESIGN

Digital and Pulse engineers with experience in the design of transistorized logic circuits, pulse generators and other digitally controlled circuits such as numerical indicators.

Assignments Immediately Available in:

RELIABILITY SPACE NAVIGATION  
ADVANCED DEVELOPMENT & ENGINEERING DESIGN  
OF DATA & RADIO COMMUNICATIONS

Send us your qualifications now. A discussion can be arranged.  
Address Mr. R. W. Holmes, Dept. 22.

**GENERAL DYNAMICS | ELECTRONICS**  
AN EQUAL OPPORTUNITY EMPLOYER  
**ROCHESTER**

1400 N. Goodman St., Rochester 1, New York



**E. E.'s**  
for FEE-PAID Positions  
**WRITE US FIRST!**  
Use our confidential application for professional, individualized service . . . a complete national technical employment agency.  
**ATOMIC PERSONNEL, INC.**  
Suite 1207L, 1518 Walnut St., Phila. 2, Pa.

## POSITION VACANT

**Test Engineer:** Nationally known company in transportation equipment field has opportunity in Research & Development in Chicago area for Test Engr. to immediately assume responsibility for testing program. Require B.S.M.E., B.S.E.E. or M.S.E.E. degree with a minimum of five years' experience in development and application of electronic and electro-mechanical instrumentation. Must have strong background in dynamics. Responsibilities include supervising top grade electronic technicians, developing instrumentation, instrumentation techniques and automation experiments. Position vacant due to promotion. Above average benefit program including tuition reimbursement. Please send resume detailing educational background, employment history, and salary requirements. All replies held confidential. P-1387, Electronics, Classified Adv. Div., 645 North Michigan Ave., Chicago 11, Ill.

## EMPLOYMENT OPPORTUNITIES

The advertisements in this section include all employment opportunities—executive, management, technical, selling, office, skilled, manual, etc. Look in the forward section of the magazine for additional Employment Opportunities advertising.

### — RATES —

**DISPLAYED:** The advertising rate is \$40.17 per inch for all advertising appearing on other than a contract basis. Contract rates quoted on request.

An advertising inch is measured 1/8" vertically on a column—3 columns—30 inches to a page. Subject to Agency Commission.

**UNDISPLAYED:** \$2.70 per line, minimum 3 lines. To figure advance payment count 5 average words as a line. Box numbers—count as 1 line.

Discount of 10% if full payment is made in advance for 4 consecutive insertions. Not subject to Agency Commission.

## SEARCHLIGHT SECTION

(Classified Advertising)

### BUSINESS OPPORTUNITIES

EQUIPMENT - USED or RESALE

### DISPLAYED RATE

The advertising rate is \$27.75 per inch for all advertising appearing on other than a contract basis. Contract rates quoted on request. AN ADVERTISING INCH is measured 1/8" vertically on one column, 3 columns—30 inches—to a page. EQUIPMENT WANTED or FOR SALE ADVERTISEMENTS acceptable only in Displayed Style.

### UNDISPLAYED RATE

\$2.70 a line, minimum 3 lines. To figure advance payment count 5 average words as a line. BOX NUMBERS count as one line additional in undisplayed ads.

## FOR RESEARCH — DEVELOPMENT & EXPERIMENTAL WORK

Over 10,000 different electronic parts: waveguide, radar components and parts, test sets, pulsed, antennas, pulse xmtrs, magnetrons, IF and pulse amplifiers, dynamotors, 400 cycle xmtrs, 584 ant. pedestals, etc.  
**PRICES AT A FRACTION OF ORIGINAL COST! COMMUNICATIONS EQUIP CO!**  
343 CANAL ST., N. Y. 13, WD 6-4045  
CHAS. ROSEN (Formerly at 131 Liberty St.)

CIRCLE 950 ON READER SERVICE CARD

## RADIO RESEARCH INSTRUMENT CO.

AUTO-TRACK & TELEMETRY ANTENNA PEDESTALS  
3 & 10 CM. SCR. 584 AUTOTRACK RADARS  
AN/TPS-10 SEARCH, AN/TPS-10 HT. FINDERS  
AN/SPN-20CA, AN/APS-10 NAVIG. & WEATHER  
AN/APS-15B PRECISION, AN/APQ-35B PRECISION  
AN/APS-31A SEARCH, DOZENS MORE  
.5-12 MEGAWATT HIGH POWER PULSERS.

RADIO RESEARCH INSTRUMENT CO.  
550 Fifth Ave., New York      Judson 6-4691

RADAR SYSTEMS & COMPONENTS/ IMMEDIATE DELIVERY

CIRCLE 952 ON READER SERVICE CARD

electronics





# AFTER VENUS, WHAT?

Sure we at JPL are elated with the success of our Mariner 2. But Venus is just one important way station on the long journey through space. There are lots more things to be done:

Soft moon-landings. Landings on Mars. Jupiter fly-bys. Electronic probes of other planets. And more Venus trips.

Yes, there's much left to do out there. Much of it will continue to be done by the scientists and engineers at

Caltech's Jet Propulsion Laboratory. They think for a living. If you do, think of yourself as part of JPL's exciting world of other-world exploration. A resume to JPL could make you a part of it.



## **JET PROPULSION LABORATORY**

4814 Oak Grove Drive, Pasadena, California  
Attention: Personnel Department

"An equal opportunity employer." Jet Propulsion Laboratory is operated by the California Institute of Technology for the National Aeronautics and Space Administration.



# ENGINEERS SCIENTISTS

## SPERRY MICROWAVE ELECTRONICS CO.

seeks the creative engineer and scientist to become a vital part of a rapidly expanding Engineering Department probing the vast and challenging region of microwave theory and technique. Openings exist for those men who have the imagination, resourcefulness and sufficient background in the following areas.

### CIRCUIT DESIGN ENGINEERS

E.E. or Physics grad. with 4 or more yrs. exp. in design of electronic circuits and sub-systems. Background in transistorized pulse, grating or I.F. circuit development is required.

### SENIOR SYSTEMS ENGINEERS

To contribute to advanced techniques in the field of electronic instrumentation. Should have at least 6 yrs. exp. including recent work in system analysis, synthesis, and integration. An advanced degree in E.E. is desired.

### SENIOR

#### APPLICATIONS ENGINEER

B.S.E.E.—5 yrs. exp. in ferrites—solid state or related microwave fields. Must have experience in commercial and military sales, sales objective forecasts, microwave components. Must be capable of developing sales contacts, establishing sales objectives and meeting forecasts.

#### APPLICATIONS ENGINEER

B.S.E.E. or equivalent in experience. Minimum 5 yrs. exp. in sales covering military and commercial contacts. Must be familiar with system instrumentation such as automatic check-out equipment for beacons, telemetry, etc., and spectrum surveillance instrumentation. Must be responsible for establishing sales objectives and meeting forecasts.

### SENIOR

#### RELIABILITY ENGINEER

Career opportunity. Head up all engineering aspects of reliability and coordinate other departments' activities in this area. Perform reliability analysis and MTBF predictions. Conduct design reviews, analyze parts, failure reports and prepare technical reports. 3 yrs. reliability engineering experience on full-fledged reliability programs plus minimum of 2 years in circuit design, derating and redundancy techniques, etc. Must have B.S.E.E. with suitable academic background in mathematics.

### RESEARCH

A few unusually challenging openings are available for individuals with Ph.D. or equivalent backgrounds.

Master of Engineering degree (University of Florida) may be obtained locally under company-paid program.



Contact: Mr. R. C. Carroll,  
Employment Supervisor

## SPERRY MICROWAVE ELECTRONICS CO.

Division of Sperry Rand Corp.

**CLEARWATER, FLA.**

Phone 855-3311 (Tampa)  
An equal opportunity employer

# INDEX TO ADVERTISERS



## Audited Paid Circulation

• AMP Incorporated .....	17	Ferrotran Electronics Co. ....	129
• Acme Electric Corp. ....	113	Fluke Mfg. Co., Inc., John. ....	21
Aeroflex Laboratories Inc. ....	84	Ford Instrument Co. Div. of Sperry Rand Corp. ....	104
Air Express .....	36		
Airpax Electronics, Inc. ....	80		
Ampex Corporation .....	79		
ANSCO .....	72		
Arnold Engineering Co., The. ....	78		
		• Garlock Electronics Products Inc. ....	103
		• General Electrodynamics Corporation. ....	85
		General Radio Co. ....2nd cover	
		Globe Industries, Inc. ....	77
		• Gould National Batteries, Inc. ....	60
• Ballantine Laboratories, Inc. ....	90		
Bausch & Lomb, Inc. ....	70		
Beattie-Coleman Inc. ....	127		
Bekins Van & Storage Co. ....	68		
Belden Manufacturing Co. ....	101		
• Black & Webster, Inc. ....	30		
• Boonton Radio Corp. Div. of Hewlett Packard Co. ....	81	• Hart Manufacturing Co. ....	88
		Heiland Division, Minneapolis-Honeywell ....	61
		• Hewlett-Packard Company .....	31
		Hughes Aircraft Co. Aerospace Divisions .....	96
Cambridge Thermionic Corp. ....	95		
Carborundum Company, The .....	121		
• Clairex Corp. ....	32		
• Clifton Precision Products Co., Inc. ....	75	I-Triple-E Show .....	62, 84, 102, 119
Collins Corp., G. L. ....	84	• International Instruments, Inc. ....	114
Collins Radio Co. ....	89		
Colorado Dept. of Development. ....	110		
Computer Control Co., Inc. ....	37		
Consolidated Avionics Corp. ....	57		
Continental Electronics Mfg. Co. ....	83		
• Corning Electronics Div. of Corning Glass Works. ....	93	• Jennings Radio Manufacturing Corp. ....	107
• Curtiss-Wright Corp. ....	102, 103		
Delco Radio .....	99	• Kepco Inc. ....	67
Dit-Mco, Inc., Electronics Div. ....	5		
Douglas Aircraft Co. ....	115		
Dow Corning Corp. ....	22, 23		
duPont de Nemours & Co., Inc. E. I. ....	71, 87, 117	Leach Corporation .....	7
Electro Mechanical Research, Inc. ....	59		
• Electronic Instrument Co., Inc. (EICO) .....	110	McGraw-Hill Book Co. ....	123
		• Methode Electronics, Inc. ....	119





Now—TEXAS  
INSTRUMENTS  
ENGINEERS  
help you . . .

**Solve  
circuit  
design  
problems  
quicker**



Just  
Published

Here's a practical reference that can ease your transistor circuit design work. It brings you a wealth of data and facts prepared by the engineering staff of Texas Instruments, Inc. Reflecting the combined knowledge and experience of 32 expert circuit design engineers, this book makes conveniently available the actual design procedures and circuits most often requested from Texas Instruments.

# TRANSISTOR CIRCUIT DESIGN

Prepared by the Engineering Staff of Texas Instruments Incorporated

Edit. by J. A. WALSTON  
Transistor Applications Mgr.

and J. R. MILLER  
Technical Publications Mgr.

523 pp., 526 illus., \$15.00  
Terms: Pay only \$5 in 10 days,  
and \$5 monthly

Organized to provide a single outstanding manual of transistor circuitry, this big volume provides complete coverage of all topics—from interpretation of data sheets and measurement of transistor parameters, to design procedures for VHF power stages and discussions of the effects of complex thermal impedances on circuit stability. It translates the most frequently used elements of transistor theory into practical solutions, giving you a large number of circuit examples with easy-to-follow design procedures. With this book and a slide rule on hand, you can design an appropriate circuit quickly and accurately by following the simple directions given.

Check these  
partial contents

Transistor Specifications • Measurement of Electrical Quantities and Parameters • Transistor Biasing • Direct-Coupled Amplifiers • Voltage Regulators • Chopper Amplifiers • AGC of Audio Circuits • Operational Amplifiers • Servo Amplifiers • Wideband or Video Amplifiers • Noise • RF Harmonic Oscillators • Frequency Heterodyning and Multiplication • VHF Power Amplifiers • Remote Control System • Switching Design Considerations • Digital Circuits • Logic Circuits • Transistorized Timers • High-Level Switching • Light Flashers • Blocking Oscillators • D.C. Converters • Inverters • Voltage Regulator • Switching-mode Motor Control • Switching-mode Servo Amplifier • and more

## 10 DAYS' FREE EXAMINATION

Direct From Publisher

McGraw-Hill Book Co., Dept. L-1-25  
327 W. 41st St., New York 36, N. Y.

Send me Texas Instrument's Transistor Circuit Design for 10 days' examination on approval. In 10 days, I will (check one)  send you the full price of \$15.00 or  \$5.00, then send \$5.00 a month until the full price is paid. Otherwise, I will return book postpaid. (We pay delivery costs if you remit with this coupon; same return privilege.)

### PRINT

Name .....

Address .....

City ..... Zone ..... State.....

Company .....

Position .....

For price and terms outside U.S.,  
write McGraw-Hill Int'l., N.Y.C.

L-1-25

electronics



Audit Bureau  
of Circulations



Associated Business  
Publications

Audited Paid Circulation

JAMES T. HAUPTLI

Advertising Sales Manager

R. S. QUINT:  
Assistant Publisher Buyers'  
Guide and Business Manager  
FRED STEWART:  
Promotion Manager  
B. ANELLO:  
Market Services Manager

RICHARD J. TOMLINSON:  
Production Manager  
GEORGE E. POMEROY:  
Classified Manager  
HUGH J. QUINN:  
Circulation Manager

### ADVERTISING REPRESENTATIVES

#### ATLANTA (9):

Michael H. Miller, Robert C. Johnson  
1375 Peachtree St. N.E., Trinity 5-0523  
(area code 404)

#### BOSTON (16):

William S. Hodgkinson, Donald R. Furth  
McGraw-Hill Building, Copley Square,  
Congress 2-1160 (area code 617)

#### CHICAGO (11):

Harvey W. Wernecke, Robert M. Denmead  
645 North Michigan Avenue, Mohawk 4-5800  
(area code 312)

#### CLEVELAND (13):

Paul T. Fegley  
55 Public Square, Superior 1-7000  
(area code 216)

#### DALLAS (1):

Frank Le Beau  
The Vaughn Bldg., 1712 Commerce St.  
Riverside 7-9721 (area code 214)

#### DENVER (2):

J. W. Patten  
Tower Bldg., 1700 Broadway,  
Alpine 5-2981 (area code 303)

#### HOUSTON (25):

Joseph C. Page, Jr.  
Prudential Bldg., Halcombe Blvd.,  
Riverside 8-1280 (area code 713)

#### LOS ANGELES (17):

Peter S. Carberry, Ashley P. Hartman,  
W. C. Gries  
1125 W. 6th St., Huntley 2-5450  
(area code 213)

#### NEW YORK (36):

Donald H. Miller, Henry M. Shaw,  
George F. Werner  
500 Fifth Avenue, LO-4-3000  
(area code 212)

#### PHILADELPHIA (3):

Warren H. Gardner, William J. Boyle  
6 Penn Center Plaza, LOcust 8-4330  
(area code 215)

#### SAN FRANCISCO (11):

R. C. Alcorn  
255 California Street, Douglas 2-4600  
(area code 415)

#### LONDON W1:

Edwin S. Murphy Jr.  
34 Dover St.

#### FRANKFURT/Main:

Matthée Herfurth  
85 Westendstrasse

#### GENEVA:

Michael R. Zeynel  
2 Place du Port

"Headquarters for Business Information"

## McGraw-Hill Technical and Business Publications

American Machinist/Metal-  
working Manufacturing  
Aviation Week and Space  
Technology  
Business Week  
Chemical Engineering  
Chemical Week  
Coal Age  
Construction Methods and  
Equipment  
Construction Daily  
Control Engineering  
Electrical Construction  
and Maintenance  
Electrical Merchandising Week  
Electrical Newsletter  
Electrical West

Electrical Wholesaling  
Electrical World  
Electronics  
Engineering Digest  
Engineering and Mining Journal  
E & MJ Metal and Mineral  
Markets  
Engineering News-Record  
Factory  
Fleet Owner  
Industrial Distribution  
National Petroleum News  
Nucleonics  
Nucleonics Week  
Platt's Oilgram News  
Platt's Oilgram Price Service  
Power

Product Engineering  
Purchasing Week  
Science Week  
Textile World

Overseas only:  
Automobile International  
(English, Spanish)  
Ingenieria Internacional  
Construccion (Spanish)  
International Management  
(English, Spanish  
Portuguese editions)  
Metalworking Production  
(Great Britain)

Available by subscription only—to qualified persons actively engaged in the field of the publication. For subscription rates and information describing the editorial coverage of any of the above publications, write to: Subscription Manager, Circulation Department, McGraw-Hill Publishing Company, 330 West 42nd Street, New York 36, N. Y.



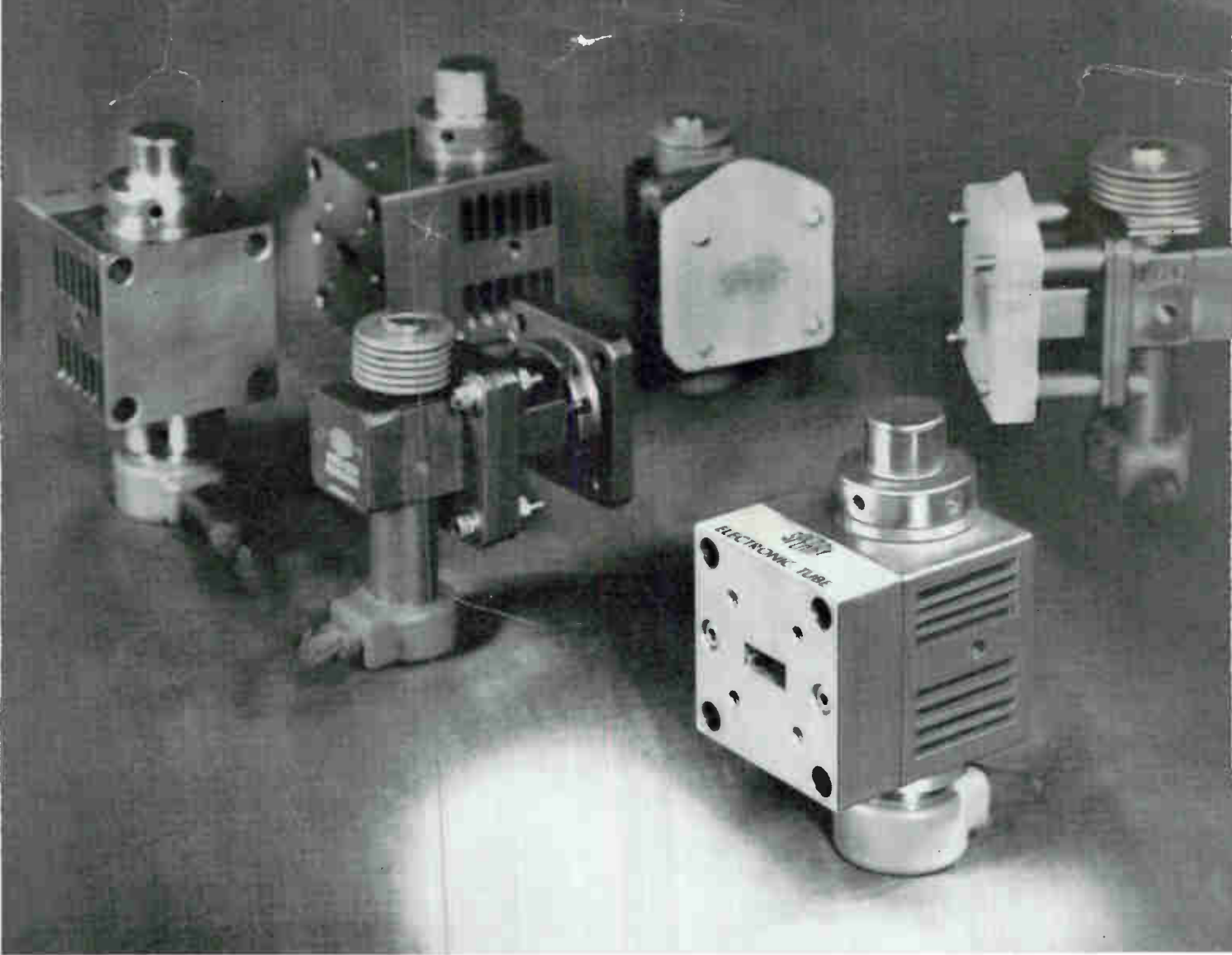

**New SOV-2200** pumps paramps and masers at 35 Gc and delivers 500 mW of power. Operation at any frequency from 31 to 40 Gc is possible with this new oscillator family. Although miniaturized these Sperry oscillators have the frequency, high power, and stability of heavy-weight tubes.

## New miniature, high-power oscillators push range to 40 Gc for paramp pumping

A new family of V band two-cavity klystron oscillators provides high power levels for parametric amplifier and maser pumping, doppler systems, and FM communications systems. These tubes cover the frequencies from 31 to 40 Gc. You now get off-shelf to 60-day delivery of two-cavity oscillators from Sperry Electronic Tube Division at any frequency from 12.5 to 40 Gc.

The unique combination of 500 mW power output at frequencies up to 40 Gc, exceptional AM stability, and small size is found only in Sperry's two-cavity design.

These Sperry miniaturized pump tubes weigh just 12 ounces — yet offer the performance formerly found only in much larger, heavier tubes.

The flat-topped "output power vs. beam voltage" mode shape results in outstanding amplitude stability, since variations in beam voltage and temperature produce only negligible variations in output power.

Sperry's two-cavity oscillators deliver power outputs ranging from .5 to 2 watts. Typical output at U band is 2 watts and at V band, 500 mW.

Use of two-cavity klystrons also permits considerable

system simplification, since equipment such as reflector power supply, automatic power leveler, and — in most applications — automatic frequency control can be eliminated.

For applications where outputs up to 300 mW and wide tuning ranges are required, ask about Sperry's tunable, low-voltage reflex klystron pumps.

A free technical booklet describing the entire Sperry line of paramp pump tubes — both two-cavity and reflex — is now available. For your copy, write Sperry, Sec. 182, Gainesville, Florida, or contact Cain & Co., Sperry's national representatives.



SPERRY RAND CORPORATION  
GAINESVILLE, FLA. / GREAT NECK, N.Y.

CIRCLE 901 ON READER SERVICE CARD

# UNIFORMITY...

one more  
proven benefit of  
RCA NUVISTORS

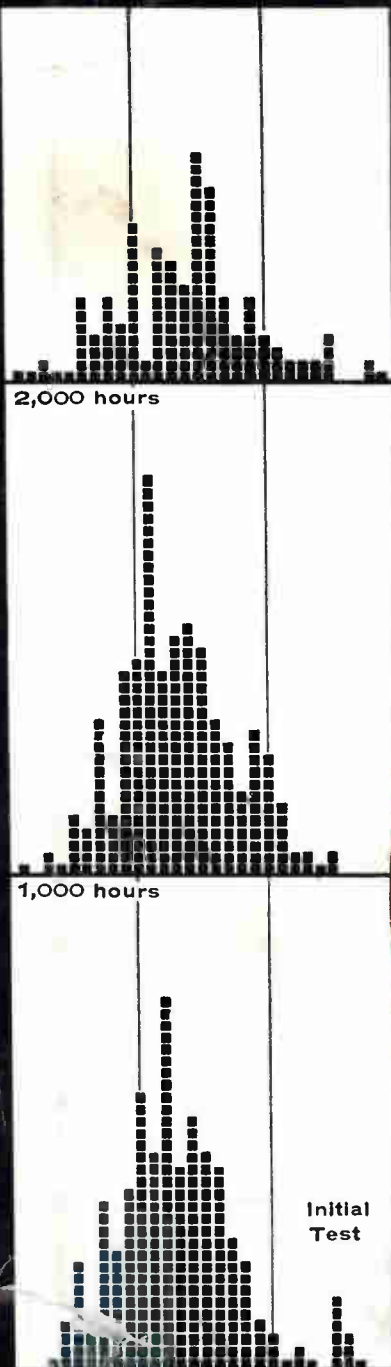

13,000 12,000 11,000 10,000  
Max. Limit Min. Limit

TRANSCONDUCTANCE VALUES (gm)  
FOR RCA-7586 NUVISTOR  
Plate dissipation 0.75 Watt

Each  represents one tube in randomly-selected sample of 243 tubes.



The chart above provides a graphic demonstration of one of the many benefits you receive by using RCA's nuvistors in your circuits—outstanding uniformity of characteristics from tube to tube and throughout life.

Note the distribution of transconductance values on initial test and the fact that this distribution remains relatively unchanged within the extremely tight limits after 1,000 and 2,000 hours of life tests.

The data compiled in this chart covers a test of 243 randomly-selected RCA-7586 nuvistors. It is typical of the performance you can expect from all nuvistors—as indicated by these transconductance range values of industrial nuvistors:

Nuvistor No.	TRANSCONDUCTANCE RANGE VALUES* (micromhos)		Plate Volts (dc)	Cathode Resistor (ohms)	Cathode-Bypass Capacitor (microfarads)
	Max.	Min.			
RCA-7586	13,000	10,000	75	130	1,000
RCA-7895	10,900	7,900	110	150	1,000
RCA-7587**	12,200	9,000	125	68	1,000
RCA-8056	8,500	6,500	24	100	1,000
RCA-8058	14,800	10,000	110	47	1,000

\*with 6.3 volts ac or dc on heater

\*\*tetrode, dc grid #2 volts = 50

Nuvistors offer you the opportunity to design to new concepts of size and dependability. Take advantage of their other benefits—small size and light weight; exceptional reliability; low heater drain; low noise factor; rugged construction; extremely low interelectrode leakage; high sensitivity and stability, and the fact that they are in the class of active electronic circuit components least susceptible to catastrophic failure from nuclear radiation.

For more information on nuvistors call your nearest RCA Field Technical Serviceman or write Commercial Engineering, Section A-19-DE-4, RCA Electron Tube Division, Harrison, N. J.

#### RCA ELECTRON TUBE DIVISION FIELD OFFICES

EAST: 714 Broad Street, Newark 2, New Jersey, HUmboldt 5-3900  
MIDWEST: Suite 1154, Merchandise Mart Plaza, Chicago 54, Illinois.

S. F. Washington Blvd., Los Angeles 22, Cal., RAymond 3-8361;  
Reol, Burlingame, Calif., OXFord 7-1620



The Most Trusted Name in Electronics