

electronics.

SPECIAL REPORT

SPECIAL REPORT WHAT THE FUTURE HOLDS

SPECIAL REPORT ELECTRONICS MARKETS 1963
WHAT THE FUTURE HOLDS

SPECIAL REPORT MARKET HOLDS

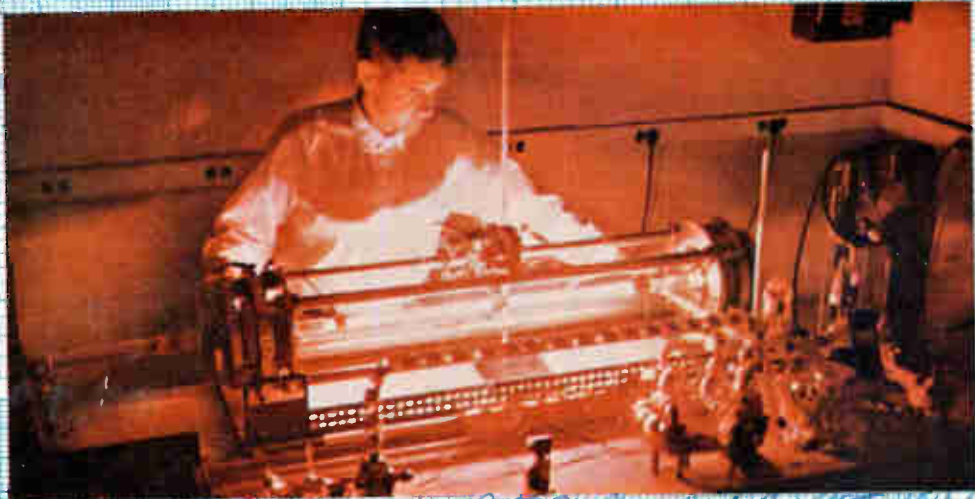

SPECIAL REPORT MARKET HOLDS
SPECIAL REPORT MARKET HOLDS



SPECIAL REPORT



CONSUMER MARKET

CONSUMER MARKET

CONSUMER MARKETS

CONSUMER MARKETS

COMPONENTS MARKETS

COMPONENTS MARKETS

INTERNATIONAL MARKETS

INTERNATIONAL

MARKET INDUSTRIAL MARKETS

AL MARKETS

956 956
NO 956 LINE WASH
NO 956
ROLAND KIBLER
NO 956



DO-T & DI-T

Transistor TRANSFORMERS & INDUCTORS

HERMETICALLY SEALED TO MIL-T-27A

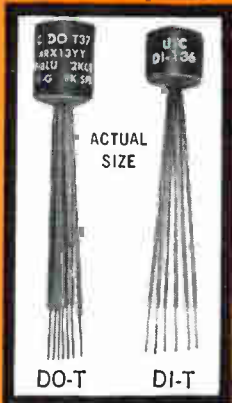

There is no transformer even twice the size of the DO-T and DI-T series which has as much as 1/10th the power handling ability . . . which can equal the efficiency . . . or equal the response range. And none to approach the reliability of the DO-T and DI-T units (proved to, but exceeding MIL-T-27A grade 4).

IMMEDIATE DELIVERY FROM STOCK

- High Power Rating up to 10 times greater
- Excellent Response twice as good at low end
- Low Distortion reduced 80%
- High Efficiency up to 30% better . . . compare DCR
- Moisture Proof hermetically sealed to MIL-T-27A
- Rugged Grade 4, completely metal cased
- Anchored Leads will withstand 10 pound pull test
- Printed Circuit Use (solder melting) nylon insulated leads
- Suited to Clip Mounting use Augat #6009-8A clip

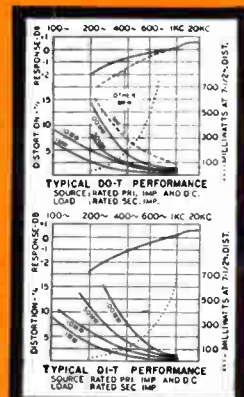

TRANSFORMERS PICTURED DO-T: $\frac{3}{8}$ " Dia. x $\frac{1}{2}$ "_l, 1/10 Oz.; DI-T: $\frac{3}{8}$ " Dia. x $\frac{1}{4}$ "_l, 1/15 Oz.

TRANSFORMERS

DO-T No.	Pri. Imp.	D.C. Ma.† in Pri.	Sec. Imp.	Pri. Res. DO-T	Pri. Res. DI-T	Mw Level	DI-T No.
DO-T44	80 CT	12	32 split	9.8	11.5	500	DI-T44*
	100 CT	10	40 split				
DO-T29	120 CT	10	3.2	10		500	
	150 CT	10	4				
DO-T12	150 CT	10	12	11		500	
	200 CT	10	16				
DO-T13	300 CT	7	12	20		500	
	400 CT	7	16				
DO-T19	300 CT	7	600	19	20	500	DI-T19
DO-T30	320 CT	7	3.2	20		500	
	400 CT	7	4				
DO-T43	400 CT	8	40 split	46	50	500	DI-T43*
	500 CT	6	50 split				
DO-T42	400 CT	8	120 split	46		500	
	500 CT	6	150 split				
DO-T41	400 CT	8	400 split	46	50	500	DI-T41*
	500 CT	6	500 split				
DO-T2	500	3	50	60	65	100	DI-T2
	600	3	60				
DO-T20	500 CT	5.5	600	31	32	500	DI-T20
DO-T4	600	3	3.2	60		100	
DO-T14	600 CT	5	12	43		500	
	800 CT	5	16				
DO-T31	640 CT	5	3.2	43		500	
	800 CT	5	4				
DO-T15	800 CT	4	12	51		500	
	1070 CT	4	16				
DO-T32	800 CT	4	3.2	51		500	
	1000 CT	4	4				
DO-T21	900 CT	4	600	53	53	500	DI-T21
DO-T3	1000	3	50	115	110	100	DI-T3
	1200	3	60				
*DO-T45	1000 CT	3.5	16,000 split	120		100	
	1250 CT	3.5	20,000 split				
DO-T16	1000 CT	3.5	12	71		500	
	1330 CT	3.5	16				
DO-T33	1060 CT	3.5	3.2	71		500	
	1330 CT	3.5	4				
DO-T5	1200	2	3.2	105	110	100	DI-T5
DO-T17	1500 CT	3	12	108		500	
	2000 CT	3	16				
DO-T22	1500 CT	3	600	86	87	500	DI-T22
DO-T34	1600 CT	3	3.2	109		500	
	2000 CT	3	4				
DO-T37	2000 CT	3	8000 split	195	180	100	DI-T37*
	2500 CT	3	10,000 split				
DO-T18	7500 CT	1	12	505		100	
	10,000 CT	1	16				
DO-T35	8000 CT	1	3.2	505		100	
	10,000 CT	1	4				

DO-T No.	Pri. Imp.	D.C. Ma.† in Pri.	Sec. Imp.	Pri. Res. DO-T	Pri. Res. DI-T	Mw Level	DI-T No.
*DO-T48	8.000 CT	1	1200 CT	640		100	
	10.000 CT	1	1500 CT				
*DO-T47	9.000 CT	1	9000 CT	850		100	
	10.000 CT	1	10,000 CT				
DO-T6	10.000	1	3.2	790		100	
DO-T9	10.000	1	500 CT	780	870	100	DI-T9
	12.000	1	600 CT				
DO-T10	10.000	1	1200 CT	780	870	100	DI-T10
	12.500	1	1500 CT				
DO-T25	10.000 CT	1	1500 CT	780	870	100	DI-T25
	12.000 CT	1	1800 CT				
DO-T38	10.000 CT	1	2000 split	560	620	100	DI-T38*
	12.000 CT	1	2400 split				
DO-T11	10.000	1	2000 CT	780	870	100	DI-T11
	12.500	1	2500 CT				
DO-T36	10.000 CT	1	10,000 CT	975	970	100	DI-T36
	12.000 CT	1	12,000 CT				
DO-T1	20.000	.5	800	830	815	50	DI-T1
	30.000	.5	1200				
DO-T23	20.000 CT	.5	800 CT	830	815	100	DI-T23
	30.000 CT	.5	1200 CT				
DO-T39	20.000 CT	.5	1000 split	800		100	
	30.000 CT	.5	1500 split				
DO-T40	40.000 CT	.25	400 split	1700		50	
	50.000 CT	.25	500 split				
*DO-T46	100.000 CT	0	500 CT	7900		25	
DO-T7	200.000	0	1000	8500		25	
DO-T24	200.000 CT	0	1000 CT	8500		25	
DO-T500	Power DO-T, Pri 28V 380-1000 cycles, sec 6.3V @ 60 ma						

INDUCTORS

*DO-T50	\$.075 Hy / 10 ma, .06 Hy 30 ma	10.5	
(2 wdgs.)	\$.018 Hy / 20 ma, .015 Hy 60 ma	2.6	
DO-T28	.3 Hy / 4 ma, .15 Hy / 20 ma	25	
	.1 Hy / 4 ma, .08 Hy / 10 ma		25 DI-T28
DO-T27	1.25 Hys / 2 ma, .5 Hy / 11 ma	100	
	.9 Hy / 2 ma, .5 Hy / 6 ma		105 DI-T27
DO-T8	3.5 Hys / 2 ma, 1 Hy / 5 ma	560	
	2.5 Hys / 2 ma, .9 Hy / 4 ma		630 DI-T8
DO-T26	6 Hys / 2 ma, 1.5 Hys / 5 ma	2100	
	4.5 Hys / 2 ma, 1.2 Hys / 4 ma		2300 DI-T26
*DO-T49	\$.20 Hys / 1 ma, 8 Hys / 3 ma	5100	
(2 wdgs.)	\$.85 Hys / 2 ma, 2 Hys / 6 ma	1275	

DO-TSH Drawn Hipermalloy shield and cover 20/30 db DI-TSH
 †DCMA shown is for single ended usage (under 5% distortion—100MW—1KC) . . . for push pull, DCMA can be any balanced value taken by .5W transistors (under 5% distortion—500MW—1KC) DO-T & DI-T units designed for transistor use only. Pats. Pend.
 §Series connected; §§Parallel connected → *Units newly added to series

Write for catalog of over 1,000 STOCK ITEMS with UTC High Reliability IMMEDIATELY AVAILABLE from YOUR Local Distributor



AND CUSTOM BUILT SPECIAL UNITS TO YOUR SPECIFICATIONS

UNITED TRANSFORMER CORP.

150 VARICK STREET, NEW YORK 13, N.Y.

PACIFIC MFG. DIVISION: 3630 EASTHAM DRIVE, CULVER CITY, CALIF.
 EXPORT DIVISION: 13 EAST 40th STREET, NEW YORK 16, N. Y. CABLES: "ARLAB"

electronics

A McGraw-Hill Publication 75 Cents



W. W. MacDONALD, Editor

J. M. CARROLL, Managing Editor
 SENIOR EDITORS: Samuel Weber, George W. Sideris. SENIOR ASSOCIATE EDITORS: Michael F. Wolff, John F. Mason. ASSOCIATE EDITORS: Michael F. Tomaino, Sylvester P. Carter, William P. O'Brien, Sy Vogel, Leslie Salomon, George J. Flynn, Lawrence D. Shergalis, George V. Navotny, Leon H. Dulberger. ASSISTANT EDITORS: Nilo Lindgren, Stanley Froud, Stephen B. Gray, Roy J. Bruun, Barry A. Briskman. REGIONAL EDITORS: Harold C. Hood (Pacific Coast, Los Angeles), Thomas Maguire (New England, Boston), Cletus M. Wiley (Midwest, Chicago). ART DIRECTOR: Howard R. Berry. ASSISTANT ART DIRECTOR: John C. Wright, Jr. EDITORIAL ASSISTANTS: Gloria Lorraine Rossi, Virginia Lynn Emery, Werner, Ali NEWS

DIRECTIONS IN ELECTRONICS. Symbolic of the many branches of our industry in 1963 are a plasma-focusing electron gun in bell jar at GE, Hawk missile under environmental test at Raytheon, color picture tube degaussing at RCA, etch pits on CdS crystals viewed with microscope at Philips' in the Netherlands, ground-station antennas for Tiros satellite, by RCA, and a helium-neon gas laser at Avco. *For our annual market report see p 43*

COVER

DOWN UNDER—Suddenly Mecca for Radio Men. Australia is breaking out in a rash of U.S. facilities—satellite tracking stations, a big Navy vlf station and radio research stations. *Major attractions are the country's geographic location and relative freedom from radio interference*

20

BLACK BOX BLAST DETECTION—Hope or Hoax? Will untended seismic detection stations be able to police a nuclear test ban? Even if such stations are reliable, can clandestine tests be moved into space? *Here is an authoritative summary of the engineering problems that make the black box a political hot potato*

26

DRONE HELICOPTER Is Tested by Navy. In two recent tests, controls maneuvered the 'copter at distances to six 'manned helicopters could be used for reconnaissance over antisubmarine weapons

32

WHAT THE FUTURE HOLDS—Our pre-electronics industry in 1963 and beyond is con- or all segments of the electronics industry, but v selective basis. Space exploration, military arial automation and consumer demand will sales. *Major challenges are international ercapacity and increasing selectivity in ontracts.*

By L. H. Dulberger and B. Anello 43

MINI-LINES: Micromodules Make it as a complete digital computer for h's only 90 lb. *The computer uses can operate from widely varying*

By A. S. Rettig, RCA 77

OPTICAL LASER LIGHT. A semi-signals, converting them to fies the demodulated signal. *actions in a dual role.*

T. Kimura and Y. Uno, University of Tokyo 82

Contents Continued

96
 116 Color-TV
 124
 129
 132
 142
 144
 154
 electronics
 Index to Advertisers
 People and Plants
 of the Week
 WEMA Board Elects Officers
 Infrared-Resolution Steps
 Base Figure Measure-
 154

Published weekly, with Electronics Buyers' Guide and Reference Issue as part of the subscription, by McGraw-Hill Publishing Company, Inc. Founder: James H. McGraw (1860-1948).

Title ® registered U.S. Patent Office; © copyright 1963 by McGraw-Hill Publishing Co., Inc. All rights reserved, including the right to reproduce the contents of this publication, in whole or in part.

Executive, editorial, circulation and advertising offices: McGraw-Hill Building, 330 West 42nd Street, New York 36, N. Y. Telephone Longacre 4-3000. Teletype TWX N.Y. 212-640-4646. Cable McGrawhill, N. Y. PRINTED IN ALBANY, N. Y.; second class postage paid at Albany, N. Y.

OFFICERS OF THE PUBLICATIONS DIVISION: Shelton Fisher, President; John R. Callahan, Vice President and Editorial Director; Joseph H. Allen, Vice President and Director of Advertising Sales; A. R. Venezian, Vice President and Circulation Coordinator; Daniel F. Crowley, Vice President and Controller.

OFFICERS OF THE CORPORATION: Donald C. McGraw, President; Hugh J. Kelly, Harry L. Waddell, Executive Vice Presidents; L. Keith Goodrich, Executive Vice President and Treasurer; John J. Cooke, Vice President and Secretary.

Subscriptions are solicited only from those actively engaged in the field of the publication. Position and company connection must be indicated on orders. Subscription rates: United States and Possessions, \$6.00 one year, \$9.00 two years, \$12.00 three years. Canada: \$10.00 one year. All other countries \$20.00 one year. Single Copies, United States and Possessions and Canada 75¢. Single copies all other countries \$1.50.

THE PUBLISHER, UPON WRITTEN REQUEST FROM ANY SUBSCRIBER TO OUR NEW YORK OFFICE, AGREES TO REFUND THAT PART OF THE SUBSCRIPTION PRICE APPLYING TO COPIES NOT YET MAILED.

Subscribers: Please address change of address notices, subscription orders or complaints to Fulfillment Manager, Electronics, at above address. Change of address notices should provide old as well as new address, including postal zone number if any. If possible, attach address label from recent issue. Allow one month for change to become effective.

Postmaster: Please send Form 3579 to Fulfillment Manager, Electronics, 330 West 42nd Street, New York 36, New York.



Audited Paid Circulation

CONTENTS continued

MULTITONE OSCILLATORS—Source of Simultaneous Frequencies. Simple, two-transistor circuit is designed to oscillate simultaneously at any of five selected frequencies with no mutual mixing. *It is the basis of a five-bit parallel data encoder for telemetry.* By R. Stapelfeldt, Westinghouse Air Brake 86

FAIL-SAFE SQUELCH CIRCUIT Adapts to Changing Noise Levels. It has a smooth, noiseless transition between on and off states, is ideal for use in remote unattended receivers, in aircraft or vehicles. *Circuit includes an a-m detector, noise amplifier, noise detector and modified Schmitt to key the receiver output.* By H. G. Michael, Collins 88

AIR TRAFFIC CONTROL—Communication and Weather Networks Planned. Last of three articles on ATC. Plans are to reduce plane-to-ground radio contacts and make better use of available frequencies. Weather system will include 1,000 observing stations. *Processing and presentation are major features of plan.* By J. F. Mason 92

DEPARTMENTS

Crosstalk. <i>Market Analysis</i>	3
Comment. <i>Air Traffic Control</i>	4
Electronics Newsletter. <i>Megawatt Space Power Source Planned</i>	7
Washington Outlook. <i>Military Procurement to Level Off Next Year</i>	12
Meetings Ahead. <i>National Symposium on Radio-Frequency Interference</i>	34
Research and Development. <i>New Approaches to Electronic Self-Repair</i>	
Components and Materials. <i>Bright Picture Tube</i>	
Production Techniques. <i>New Instrument Standardized</i>	
Design and Application. <i>Developing Motor</i>	
Literature	
Product	

CROSSTALK

"THERE ARE TWO TIMES in a man's life when he should not speculate," Mark Twain said, "when he can't afford it, and when he can."

Perhaps Twain said this after he lost a fortune by misguided investment of huge sums in a typesetting machine. Twain needed a penetrating market survey and technical counsel before he jumped in with his hard-won money.

In spite of Twain's epigram, the needs of commerce demand intelligent speculation or profits grind to a halt.

Each year that we research the electronics marketplace, it becomes clearer to us what the role of the long-range planner and marketing expert is to his firm.

Many of the decisions made, in effect, by marketing men today, were once reserved for the company president and the board of directors. With the high level of technical knowledge needed for intelligent judgments in electronic marketing, judging has become a full profession.

Recommendations by market analysts have become near flats on the direction a company should take in research, product development, production effort, sales approach, new investments and diversification.

Business planning today must acknowledge such complications as the growing international character of electronics. Competition is no longer a simple domestic affair—rather it includes what businessmen in European, Eastern and indirectly, Soviet-block nations are doing.

Further affecting decisions is the increasing dominance of research and development in the already complex electronics industry. With the aerospace industry, electronics accounts for the greatest share of money spent on research and development in this country. The military indulges in nearly as much Research, Development, Test and Evaluation projects as it does procurement, in electronics.

Thus, marketing men must include a high scientific and engineering competence in their battery of investigative tools. Deep involvement in a given segment of the electronics industry is needed to understand completely the segment's potential and problems. The marketing



INTERNATIONAL FLAVOR of the electronics industry is reflected in this view of transmitting towers at the Vatican's high-power broadcasting site, erected by Telefunken, near Rome. The statue is the Archangel Gabriel

analyst may also be called on to help make a decision on his firm's activity in an area about which little is known either to himself or to his company.

The tools of marketing men vary, and the demonstrable results as well. Much is gained by a well ordered study of the other guy's experience, and the collection of blue sky expectations by knowledgeable persons.

Statistical market data help, by supplying a base of past sales for the building projections. Government predictions, and industry association statistics enter the mix.

Accuracy depends chiefly on tailoring the quest, for answers to a clearly defined range of questions.

But in the end, a marketing survey is of value chiefly because blended and weighted sets of views are produced by persons devoting full-time to the job.

In the ELECTRONICS marketing report this week, we endeavor to add to the knowledge of persons interested in all aspects of the market. Specific recommendations are limited—general trends are accurately indicated. The tone and health of the industry, what the experts are saying, and why they say it, are organized and clarified as the opinions of those "in the know." Read our report—and join them.



JERROLD'S® versatile

900A SWEEP GENERATOR covers the range of three regular instruments!

The most economical wide-band Sweep Generator in the electronics industry... covers all your needs from 1/2 mc to 1200 mc, for IF's, radar, video, telemetering, communications!

Two ranges—0.5 mc to 400 mc and 275 mc to 1200 mc. Supplies sweep signal with center from 500 kc to 1000 mc and with sweep widths as broad as 400 mc and as narrow as 100 kc. RF output, carefully monitored by matched crystal diodes feeding two-stage, push-pull AGC amplifier, is flat within ± 0.5 db at full sweep width up to 800 mc and ± 1.5 db from 800 mc to 1200 mc. When using sweep widths as narrow as 20 mc, flatness at any center frequency is approximately ± 0.15 db.

\$1260.00

Now... full production
assures fast delivery.

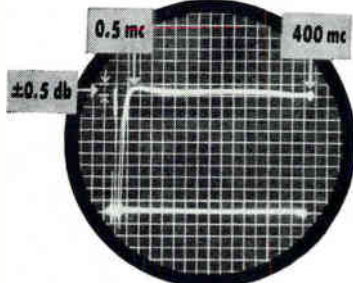

• HIGH OUTPUT!

.25 volt RMS on VHF, .5 volt RMS on UHF!

• WIDE SWEEP WIDTHS!

VHF—100 kc to 400 mc
UHF—100 kc to 40% or more of C.F.

• FLAT OUTPUT!

Flat to ± 0.5 db on widest sweep width!

Write for on-the-spot demonstration.

JERROLD

ELECTRONICS CORPORATION

A subsidiary of The Jerrold Corporation
Dept. ITE-168, Philadelphia 32, Pa.

COMMENT

Air Traffic Control

Saw the first of what I am sure will be three excellent articles on air traffic control. Naturally, the article was of extreme interest to many people here and they are looking forward to the next two.

J. C. FORBES

The Mitre Corporation
Bedford, Massachusetts

The first article, by Senior Associate Editor John Mason, appeared on p 37, Dec. 7, and the second on p 46, Dec. 14. The third and last appears in this issue, on p 92.

Those Lab Courses

I most heartily concur with your views in the editorial, Five Years? Or a Better Four? in the December 14 issue (p 3), 1962.

I started working for a B.S. in E.E. at the age of 34 last summer, and have been constantly hearing warnings from upperclassmen about how I will be slaughtered by labs in the years ahead. There have been repeated recommendations to switch to physics because it's more modern, there are fewer labs, the point requirements for a degree are lower, and the degree commands as good a price as the E.E. does. All excellent reasons!

And I may make the change after my freshman program is completed. Time is a precious commodity to me now, and when one works during the day and goes to school at night, there is no room for lost motion. I refuse to waste one minute on the "old discipline" labs that persist today to prolong archaic academic traditions. If labs take up so much time and are so "necessary," why don't they carry more credit?

I even suspect many graduate courses could be included in the undergraduate curriculum, if the latter were modernized by getting rid of a lot of chaff. But then I suppose we mustn't overlook the fact that engineering schools are trying to secure their financial stake in the "education business"

by prolonging their program, a distasteful but plausible explanation.

Anyway, industry can count on one less engineer in 1968. He will be me, as I refuse to become a victim of the system.

ROBERT D. FREED

New York, New York

SiC Junctions For Lasers?

For all the recent attention on the light emission *p-n* junction, I fail to find any mention of silicon-carbide junctions in which the light emission effect in the visible region has been known for years. The material may be valuable for current-pumped lasers.

G. A. MAY

National Research Council
Ottawa, Canada

Five years ago, researchers were interested in silicon carbide, but they found its efficiency too low. Gallium arsenide, on the other hand, is highly efficient in the conversion of electricity to light. For more information on diode lasers, see p 24, Nov. 16, and p 14, Nov. 23, 1962.

Equation Errors

Your Nov. 30, 1962, issue contains an article entitled Reliability: 1962. On p 63 is a section on Sequential Testing which contains several errors. The *y*-intercept numbers in the equations for the accept and reject lines are numerically wrong in that the intercept in each case should be approximately 590 (slide-rule accuracy).

Further, on p 64, the statement that "The test would have to continue at least 1,800 hours..." is not correct, and is not justified or explained in the text.

D. H. WYTHE, JR.

Sunnyvale, California

The correct equation for the accept line is $y = 138.62x + 588.8$, while the equation for the reject line should be $y = 138.62x - 588.8$.

The statement on p 64 should read 600 hours, which is three times contract MTBF.

Signetics offers three ways to planar integrated circuits:

STANDARD

DTL
logic
circuits



off-the-shelf

We can give you immediate delivery on any of our standard circuits. Our standard line includes: NAND/NOR Gate, Buffer, Multi-Purpose Flip-Flop, Diode Array, and Exclusive-OR Network. Each of these circuits provides a maximum noise rejection and the highest speed possible on low power consumption. And each is a product of the most refined degree of planar technology today. Your choice of TO-5 can or flat modular packaging. Write for complete details: 680 West Maude Avenue, Sunnyvale, California.

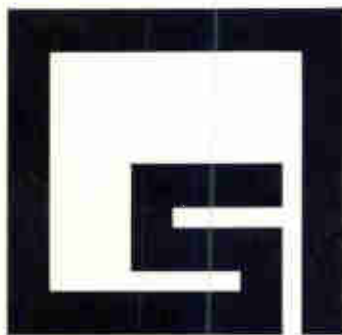

SIGNETICS INTEGRATED CIRCUITS

variFEBS[®]

customized
digital or
linear circuits

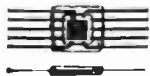

3 weeks

This is the quickest and most economical way to get integrated circuits made to meet your requirements. Here's how it works. Take any of our standard circuits. (They all have 500 MC transistors, 3 nsec diodes, 60 pf capacitors, and resistors up to 20 K.) And redesign the interconnection patterns. Then we'll integrate your interconnection patterns onto the silicon chip. Your choice of TO-5 can or flat modular packaging. Write for complete details to: 680 West Maude Avenue, Sunnyvale, California.

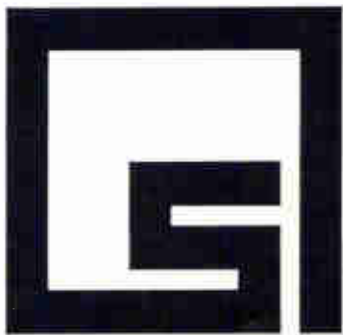

SIGNETICS INTEGRATED CIRCUITS

preFEBS[®]

custom digital
or linear
circuits



8 weeks

Here's the newest concept in integrated circuits. You design your own linear or digital circuit. Breadboard it with individually packaged transistors, resistors, diodes and capacitors from our stock. (These components have their associated parasitic capacitance and will duplicate the performance in the final integrated circuit.) Then return the circuit to us. And we'll integrate it. Your choice of TO-5 can or flat modular packaging. Write for complete details: 680 West Maude Avenue, Sunnyvale, California.

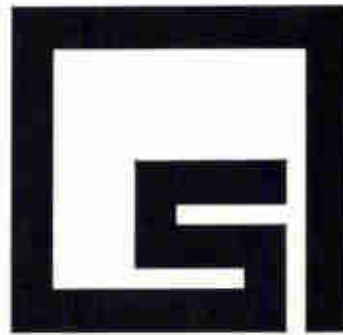

SIGNETICS INTEGRATED CIRCUITS



"made-to-measure precision"

Tests Transistor Beta in-the-circuit

TRANSISTOR TESTER — Portable, Battery Operated

- Reads Beta directly in-the-circuit (1-4, 3-12, 10-40, 30-120); no need to unsolder leads
- Measures I_{co} , (0-50, 0-500 μa) & Beta out-of-circuit
- Packaged for portability in $\frac{1}{3}$ of a cubic foot; weighs 12 $\frac{1}{4}$ lbs.
- Carries its own battery power supply
- Price: \$335; delivery immediately from stock

For a free demonstration, more information about the 219B Transistor Tester, or the complete Sierra Quick Reference Catalog, contact your Sierra representative, or write to address below:

SIERRA ELECTRONIC DIV.

OF
PHILCO

A SUBSIDIARY OF *Ford Motor Company*

Sierra Electronic Division / 3885 Bohannon Drive / Menlo Park 1, California

Megawatt Space Power Source Planned

WASHINGTON—AEC, the Defense Department, and NASA have set up a joint program to develop a nuclear space power unit capable of producing from 300 Kw to 1 Mw of electrical power. The unit, designated Snap-50/Spur, would be used as a power source for communications satellites and other space vehicles requiring large amounts of power.

AEC will manage the program, expected to cost about \$250 million over the next 6 to 10 years. The new program brings together bits and pieces of development work by AEC and Department of Defense on nuclear space power sources. The reorganization indicates a more concerted government effort to produce an operational system.

Air Force officials envisage future needs for a source that would provide sustained power for life support systems to keep up to 20 men in orbit, for communications and other electronics systems and for maneuvering a large vehicle in space. A vehicle capable of all these missions would require at least 300 Kw. However, Air Force says that it now has no precise requirement for a unit producing so much power.

Navy Seeks Contractors For Underwater Range

WASHINGTON—Next week, Navy is scheduled to receive preliminary management proposals for prime contracts for the in-air and underwater tracking systems for Project Autec (Atlantic Undersea Test and Evaluation Center).

Funds for the underwater test range at Andros Island in the Bahamas were provided in the fiscal 1963 budget. But construction has been held up because of diplomatic snags in reaching an agreement with the British for use of the area.

Navy, however, plans to enlarge the facility beyond the original concept. This was outlined recently at a meeting with prospective contrac-

tors at Newport, Rhode Island. The range is expected to require radar, underwater and optical tracking, telemetry, microwave and communications, computing and data processing equipment.

Airborne Optical System Gathers Missile Data

BOSTON—Airborne system designed to detect and measure characteristic optical radiations from U. S. missiles is now being flight-tested. Called Skyscraper, it's part of Project Press (Pacific Range Electromagnetic Signature Studies).

The instrumentation will measure infrared, visible and ultraviolet radiation at altitudes above 30,000 feet, where atmospheric attenuation is low.

A computer is fed information on aircraft position, missile launch time and predicted trajectory. The computer directs an optical tracker. When the target is acquired, the tracker locks on and controls the aircraft and the line-of-sight optical system. A multiple spectrometer continually samples the radiation and tapes the data for later analysis.

Skyscraper was designed by Air Force Cambridge Research Laboratories and built aboard a KC-135 aircraft. It has been turned over to MIT Lincoln Laboratory, scien-

tific director for Project Press, for evaluation flights.

Infrared Communications Headset Is Developed

DALLAS—Texas Instrument's Apparatus division will be announcing soon that it has developed a battery-powered infrared communication set using gallium-arsenide light sources.

The two-way communication set is contained in two ordinary headsets. The set carries voice over an infrared link between two operators facing each other. Successful conversations have been held over distances in excess of 100 feet.

The demonstration unit uses TI's gallium-arsenide light sources (similar to the SNX100) for the transmitter. Output is amplitude modulated. The resultant voice signal "has good high-fidelity quality at short ranges." Receiver consists of a focusing lens, and a TI silicon photo-voltaic detector (type M7003).

Information capacity of the infrared carrier wave is high. For example, tv broadcasts were transmitted over a similar link, using only a small fraction of available bandwidth.

Set's optics provide a 30-degree beam width for both transmitter and receiver. TI says that for other

Sugar Grove Won't Be a Total Loss

WASHINGTON—Navy has decided to move part of its communications facility from Cheltenham, Md., to Sugar Grove, W. Va. The Navy has been looking for a substitute use for Sugar Grove since it cancelled last year the trouble-ridden project to build a 600-foot radio telescope there.

One reason has been strong pressure by West Virginia congressmen. Another is Navy's bid to temper criticism of the ill-fated telescope project by making some use of the money spent on the project. The area was made virtually free of background disturbances, including construction of an underground lab.

Initially, the Navy plans to move its receivers from Cheltenham to Sugar Grove. That will take a year or more. Money for the move is being included in the fiscal 1964 budget

applications, it will be "a simple matter" to come up with "an exceedingly narrow beam, requiring more precise alignment, but allowing long-distance transmission."

Average output of the gallium arsenide light source is 0.5 mw at wavelength of 0.897 angstroms. Efficiency (light power output over electrical power input) is now about 0.1 percent.

Venus Probing Upsetting Solar System Theories

STANFORD, CALIF. Findings from NASA's two-pronged probing of Venusian secrets may upset long held theories about that planet and the origin of the solar system, attendees at the American Geophysical Society meeting were told last week.

JPL's Venus radar bounce experiment indicates that Venus's rotational direction may be opposite to that of earth and all other planets in the solar system except Uranus, baffling proponents of the theory that the planets originally coalesced from swirling gas masses all turning in the same direction. Rotational direction of Venus was determined by analyzing the spread of the return 2,388-Mc radar signal. Further, it appears that Venus rotates only once every 250 earth days.

Mariner's December 14 fly-by has established the mass of Venus at 0.81485 that of earth's—indicated by a two-way doppler measurement. Mariner was slowed 3,000 mph by the gravitational field of Venus.

Initial reduction of data from the probe's 3-axis fluxgate magnetometer gives no evidence of a Venusian magnetic field, but scientists cautioned that solar winds could confine a weak field to inside Mariner's 21,500 mile vantage point. The finding is consistent with theory that planetary fields are partially a function of rotational speeds.

Ranger Launch Scrubbed For Reliability Tests

INSTEAD of being launched early this year, as originally scheduled by NASA, Ranger VI will undergo

an autopsy to find out what ailed the first five Rangers.

NASA said that Ranger VI will be "subjected to an exhaustive test program" and design review. Resulting reliability improvements are to be incorporated in Rangers VII through IX.

None of the first five Rangers fulfilled their lunar missions.

Mariner, which evolved from Ranger, had a better batting average. Mariner got to Venus after one launch failure.

Reading System Recognizes 20 Different Type Styles

SYLVANIA REPORTS development of a multifont print reader that can handle 20 different type styles. Rate of conversion from print to punched cards or tape is 700 characters a second. Speeds up to 20,000 characters a second are feasible, the company says.

Material to be read is scanned by a flying spot. Reflections are converted to signals that are compared with coded reference characters. Information provided to the recognition unit is a pattern of 320 elements representing light and dark areas in the character being read. These elements are tested simultaneously for the best match against stored representations of 2,000 characters.

The system is insensitive to type size, automatically compensates for variations in paper and type registration, and scanning is digitally controlled so reading can be programmed.

Flash Detector to Help Guard Eyes from A-Blasts

SPECIAL GOGGLES that will darken an instant after an atomic explosion are to be developed by National Cash Register under a \$234,000 Air Force contract. The goggles are to protect aircrew members from blinding light. NCR plans to make the goggles of photochromic materials that darken only when exposed to ultraviolet light. Ultraviolet light will be provided by a source triggered by an electronic flash detector. The goggles are to darken within 75 microseconds.

In Brief . . .

NASA HAS AWARDED graduate training grants for the academic year 1963-64 to 88 colleges and universities. Grants will go to some 800 predoctoral trainees who have chosen a graduate study research program that is space oriented.

RUSSIA'S 12th satellite in its Cosmos geophysical research series is now circling the earth once every 90½ minutes. This is the first shot in the program since October. The project is designed to study radiation belts, their effect on radiowave propagation and the structural elements of spaceships.

GOODYEAR will develop a high-resolution radar system for the Air Force's new RF-4C photo-reconnaissance aircraft, a modified version of the Navy's Phantom II. Radomes will be made of reinforced fiber glass.

GE'S THIN ROUTE tropo radio-tele-type writer communications system is now being used by the Air Force at overseas installations. GE says the system substantially reduces transmission costs for point-to-point communication.

INSTRUMENTATION and control systems for Project Nerva (p 24, Rec. 28, 1962), will be developed by Edgerton, Germeshausen & Grier under a \$5.5 million contract with the Space Nuclear Propulsion Office.

VOCALINE will quality test Sonobuoys furnished under BuWeps contracts for the Navy.

IBM WILL DESIGN an advanced data center for the NASA-Marshall Space Flight Center in Huntsville, Ala., that will allow scientists to keep track of the thousands of deadlines associated with manned lunar explorations.

AUSTRIA'S Air Force plans to construct three long-range radar stations that will put the whole of Austrian territory under radar surveillance. First is being built at Koloman Mountain near Mondsee.

New from Sprague!

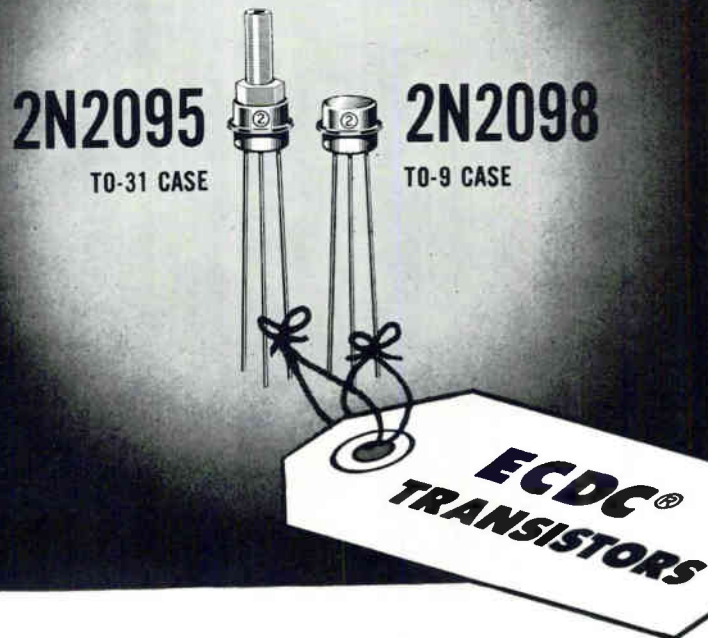

Investigate these Power Amplifiers for your VHF Communications Needs!

CHECK THESE KEY PARAMETERS:

$P_d @ 25^\circ\text{C case}$	1 W
BV_{CBO}	30 V
BV_{CEO}	15 V
f_T	1 Kmc
PG @ 160 Mc	7 db
C_{ob}	8 pF
$r_b^1 C_c$	60 nsec

Sprague's ECDC technology, proven in the 2N2100 nanosecond film memory driver, has been extended to amplifier or oscillator transistors covering a wide range of VHF communications applications. The ECDC process combines the benefits of electrochemical and diffusion technology to provide today's best combination of electrical characteristics for maximum circuit efficiency.



For complete engineering data, write for Engineering Bulletins 30,409 and 30,414 to Technical Literature Service, Sprague Electric Company, 35 Marshall Street, North Adams, Massachusetts.

SPRAGUE COMPONENTS

TRANSISTORS
CAPACITORS
MAGNETIC COMPONENTS
RESISTORS
MICRO-CIRCUITS

INTERFERENCE FILTERS
PULSE TRANSFORMERS
PIEZOELECTRIC CERAMICS
PULSE-FORMING NETWORKS
TOROIDAL INDUCTORS

HIGH TEMPERATURE MAGNET WIRE
CERAMIC-BASE PRINTED NETWORKS
PACKAGED COMPONENT ASSEMBLIES
FUNCTIONAL DIGITAL CIRCUITS
ELECTRIC WAVE FILTERS



'Sprague' and '®' are registered trademarks of the Sprague Electric Co.

48T-478

January 4, 1963

CIRCLE 9 ON READER SERVICE CARD 9

Measure Switching Time of Fast Diodes, Transistors

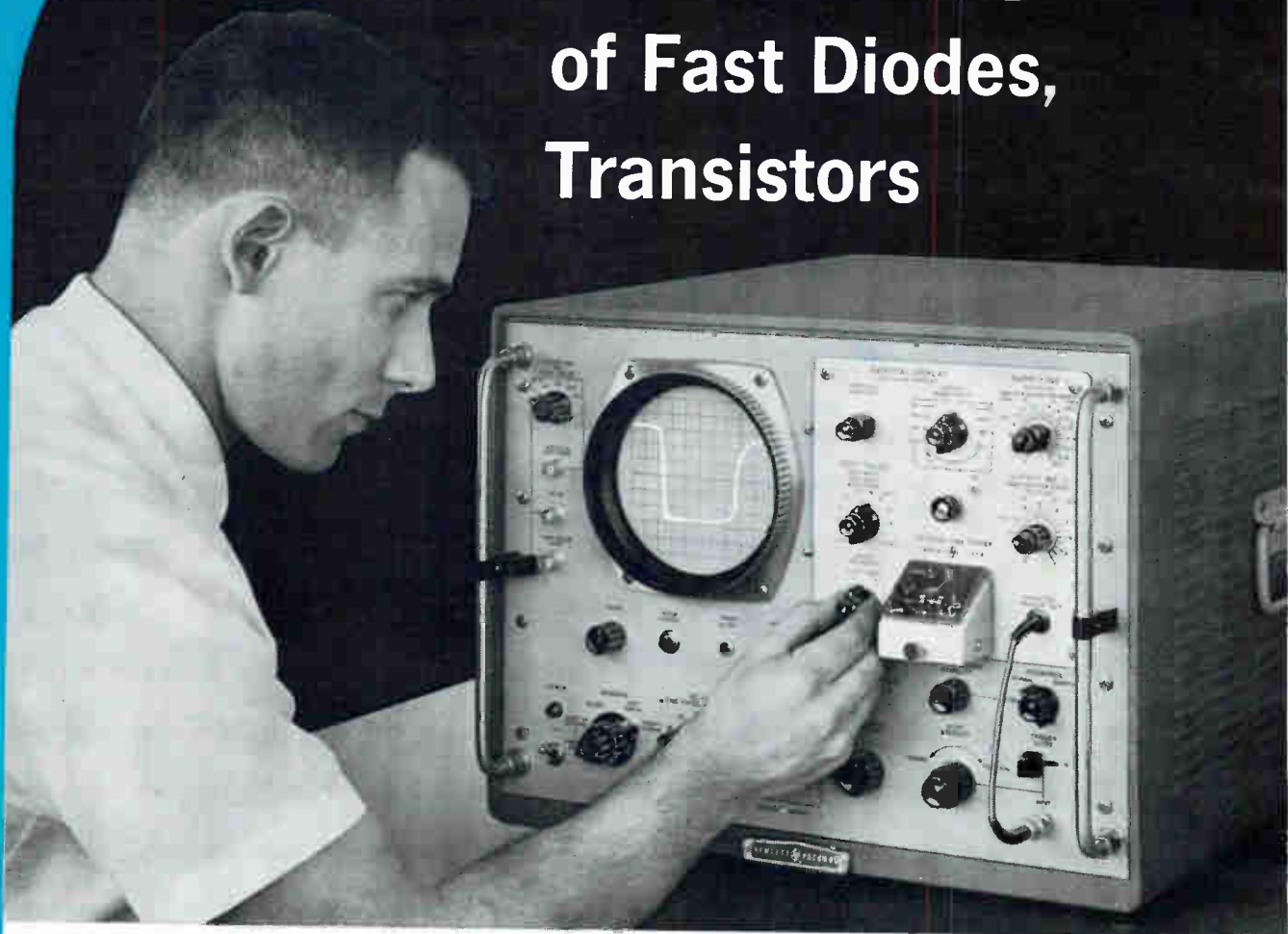

1 nsec resolution with new plug-in test set for **hp** 185 1,000 MC scope

A new "state-of-the-art" plug-in for your **hp** 185 Oscilloscope measures transistor and diode switching time with nanosecond resolution! Just plug in the **hp** 186A Switching Time Tester . . . and all the versatility of the 185 1,000 MC scope is yours for making switching time tests on transistors, diodes and tunnel diodes, or testing pulse response of active and passive networks. The 185 displays switching characteristics of test elements powered and pulsed by the 186A plug-in. And what's more . . . you can use the X-Y output of the scope for making permanent records with a Moseley AUTO-GRAF® or other standard X-Y recorder.

The 186A includes all instrumentation

needed for fast pulse testing. It provides a test pulse generator, vertical amplifier for the oscilloscope, and two bias supplies for the device under test. Pulses with less than 1 nsec rise time and up to 20 v output are available for many types of switching tests. Component and network testing is easy with a series of quick-change test adapters that plug into the front panel of the 186A.

Because the vertical amplifier in the 186A provides a rise time of less than 0.5 nanoseconds, you retain the remarkable versatility of the basic 185 scope. Test measurements are displayed on the 10 by 10 cm scope screen, and the high rep-rate pulse generator in the 186A insures clear, continuous, flicker-free display.

Specifications 186A

(when plugged into  185A or 185B Sampling Oscilloscope)

PULSE GENERATOR

Amplitude: 0.1, 0.2, 0.5, 1, 2, 5, 10 and 20 volts peak, either polarity
Rise Time: Less than 1 nsec
Width: 1 μ sec or 0.2 μ sec
Fall Time: Less than 3 nsec
Repetition Rate: Approximately 5 KC to 100 KC, continuously variable

VERTICAL CHANNEL

Sensitivity: 10 mv/cm to 10 v/cm
Bandwidth: Greater than 800 MC (0.45 nsec rise time)
Noise: Less than 3 mv
Input Impedance: 50 ohms

BIAS SUPPLIES

Supply #1 (Collector): 0 to \pm 30 volts 50 ma maximum (0.5 amp with 10% duty cycle)
Supply #2 (Base): 0 to \pm 10 volts, referable either to ground or supply #1 (20 ma maximum)

TRIGGER OUT

Triggers  185A or 185B Oscilloscopes

TEST BOARDS (supplied with 186A)

Transistor Test Board
Diode Test Board
Tunnel Diode Test Board
Universal Adapter for circuit tests (optional)

Price



 186A Switching Time Tester, \$1,500.00

And Look at the Scope Itself: Hundreds of Different Measurements, DC to 1,000 MC!

Look what you can do with the  185B Oscilloscope: Sync on any signal rep rate, look at rf sine waves to 1,000 MC. See clear, bright pictures, 10 cm full scale width, of a single event as long as 100 microseconds, as short as 0.5 nanoseconds. Sync on signals as small as 10 mv. Effectively see any portion of 600,000 sq. cm. display, with a sharp, steady trace!

Besides performing the measurement work of lower frequency scopes, the  185B is ideal for analyzing rf carrier signals by viewing rf directly; measuring phase angle on signals to 1,000 MC by dual channel viewing with the 187B Dual Trace Amplifier plug-in; analyzing

coaxial connectors, cables, attenuators and other devices by observing reflections of fast pulses. It's the first practical, commercially available answer to the need for measuring and viewing nanosecond pulses . . . and broad sweep speed capability and extreme sensitivity increase its usefulness for viewing all types of repetitive waveforms.

 experience, know-how, quality manufacturing techniques and careful testing procedures assure performance according to specs, long life and exceptional instrument value. Check the specifications on these pages, then call your  rep for a demonstration on your bench.

Specifications 185B with 187B Dual Trace Amplifier

VERTICAL (Dual Channel)

Bandwidth: Greater than 800 MC, usable to 1,000 MC; less than 0.5 nsec rise time for any input signal.
Sensitivity: Calibrated ranges, 10 to 200 mv/cm. Vernier increases sensitivity to 4 mv/cm. Attenuator accuracy, \pm 3%.
Voltage Calibrator: 20 to 1,000 mv, \pm 3% accuracy.
Input Impedance: 100 K ohms shunted by 2 pf.

HORIZONTAL



Sweep Speeds: 10 ranges, 10 nsec/cm to 10 μ sec/cm, calibrated within \pm 5%. Vernier increases fastest speed to 4 nsec/cm, provides continuous adjustment between ranges.
Time Scale Magnifier: 7 calibrated ranges x1, x2, x5, x10, x20, x50, x100. Increases maximum calibrated speed to 0.1 nsec/cm, vernier to 0.04 nsec/cm.
Jitter: Less than 0.03 nsec or 2 mm with x100 expansion, whichever is greater.
Variable Delay Range: Any portion of the trace may be viewed in detail using the Time Scale Magnifier and the time delay.
Trigger Functions: (Normal) External trigger 150 mv for 5 nsec or longer, 50 cps to 100 MC.
(Sensitive) External trigger 15 mv for 5 nsec or longer, 50 cps to 100 MC.
(High Frequency) External trigger 200 mv p-p, 50 MC to 1,000 MC.

Minimum Delay: Less than 120 nsec, 100 nsec/cm sweep and faster.
Sampling Rep Rate: 100 KC maximum.

SYNC OUTPUT

Amplitude: Positive, at least 1.5 volts into 50 ohms.
Rise Time: Less than 2 nsec.
Width: Approx. 7 μ sec.
Recurrence: One pulse per sample.

GENERAL

X-Y Recorder Output: Available for making pen recordings of waveforms in MANUAL, RECORD and EXTERNAL scanning modes.
Beam Finder: Facilitates location of beam that is off-scale vertically or horizontally.
Accessories Furnished: 187A-76A BNC Adapter (2); 187A-76F accessory adapter (2); 185B-21A Sync Probe.
Prices:  185B Oscilloscope, \$2,300.00;
 187B Dual Trace Amplifier, \$1,000.00.

Data subject to change. Prices f.o.b. factory.

HEWLETT-PACKARD COMPANY

1501 Page Mill Road, Palo Alto, California, Area Code 415, DA 6-7000; Sales and service representatives in all principal areas; Europe, Hewlett-Packard S. A., 54-54bis Route des Acacias, Geneva; Canada, Hewlett-Packard (Canada) Ltd., 8270 Mayrand Street, Montreal.

7568

WASHINGTON OUTLOOK

PROCUREMENT TO LEVEL OFF NEXT YEAR

MILITARY PROCUREMENT is expected to level off under the Pentagon's fiscal 1964 budget that goes to Congress later this month.

New production orders should run about \$18 billion and R&D contracting around \$7.1 billion, roughly the same as this year. However, electronics orders will probably rise slightly from this year's \$4.5 billion for production and \$2.1 billion for R&D.

The budget totals some \$48.3 billion, up about \$2.5 billion from fiscal 1963. But this does not mean more new defense business. The rise reflects major boosts in new orders during the past two years, resulting in more production shipments and completion of R&D projects.

MORE FOR LIMITED- WAR GEAR

LOOK FOR A MAJOR SHIFT in defense contracting emphasis—reflecting recent policy decisions—in the Pentagon's fiscal 1964 budget. The proportionate share of contracts for conventional, nonnuclear arms and equipment will rise substantially over 1963, while the share for strategic weapons systems will drop sharply. Funds for another 150 Minuteman ICBMs are anticipated, but there will be no new money for bombers, except for minor amounts to continue R&D on the RS-70 airplane.

AND MORE FOR MILITARY SATELLITES

DEFENSE COMMUNICATIONS AGENCY is expected to get enough money in the new budget to expand work on military communications satellites. Funds to begin the projects are in the 1963 budget, requests for proposals are about to be issued and contractors will be selected within six months. For a start, a small active repeater will be orbited at an altitude of at least 5,000 miles. Later, a larger, synchronous satellite will be developed.

NASA WANTS \$6 BILLION

NASA'S FISCAL 1964 BUDGET request to Congress is expected to tally close to \$6 billion, compared to the \$3.7 billion it got for 1963. More than 70 percent of the new budget is reportedly earmarked for manned space flight projects, including Saturn, Apollo and Gemini. Expectations are that many scientific space programs will be stretched out due to a dollar shortage.

SUCCESSFUL TEST DOESN'T SAVE SKYBOLT

SKYBOLT MISSILE PROJECT is dead, despite the successful test firing last week. Technical factors never really were the prime consideration in Skybolt's demise. The missile's low rating in Pentagon "cost-effectiveness" studies was the major reason.

In the test late last month over the Atlantic near Cape Canveral, the missile was air-launched from a B-52 flying at 40,000 feet. The missile reportedly hit its target 900 miles away. Air Force said it was the first time a ballistic missile was launched from an aircraft to fly a full mission under its own power and guidance.

The Nassau agreement to sell Britain Polaris in place of Skybolt still stands, however. Polaris production will be stepped up, though the number to be sold Britain has yet to be decided.

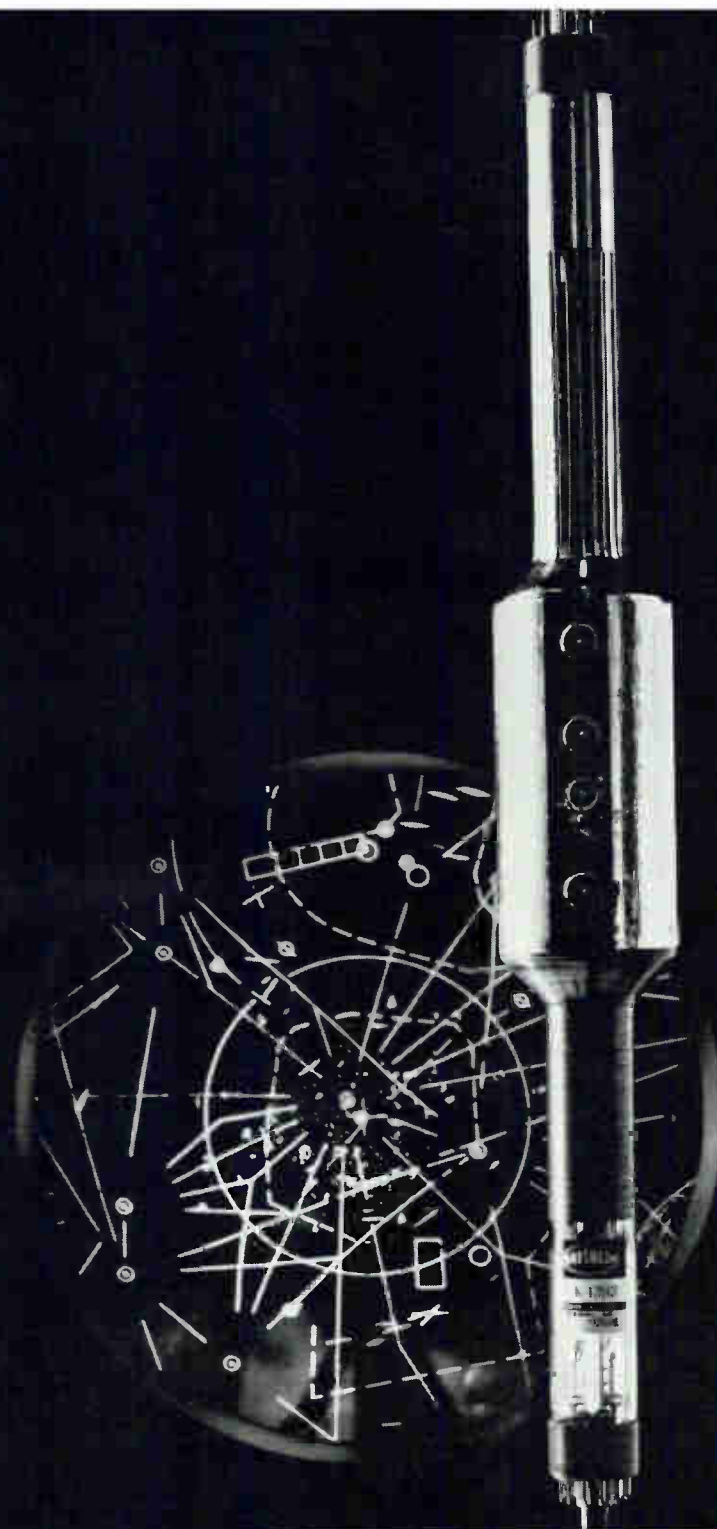

Raytheon storage tubes help FAA control air traffic more effectively, improve flight safety

Fifty-one Raytheon "bright display" electronic systems featuring Raytheon CK1383 two-gun storage tubes are being produced for the air traffic controllers of the Federal Aviation Agency. The CK1383 stores radar blips and presents them on a Raytheon CRT CK1381 display tube (Radar/PPI television-type presentation). This way, a continuous picture of a plane's flight path is available. The video can be seen in many areas at the same time, making the controllers' tasks faster and easier. Panoramic displays can depict instantaneously the status of all aircraft in a selected area. In addition, the display itself is bright enough to be seen in a normally lighted room.

Raytheon Storage Tubes are available for many other types of scan conversion and for such applications as stop motion, integration for signal-to-noise improvement, information storage for data processing systems, slow-down video, time delay, and phase shift.

Whatever your storage tube requirements, Raytheon can meet them best. Unmatched capabilities and more than a decade of experience are at your command. For complete details on Raytheon storage tubes and display devices, please write: Raytheon, Industrial Components Division, 55 Chapel St., Newton 58, Mass.

RAYTHEON

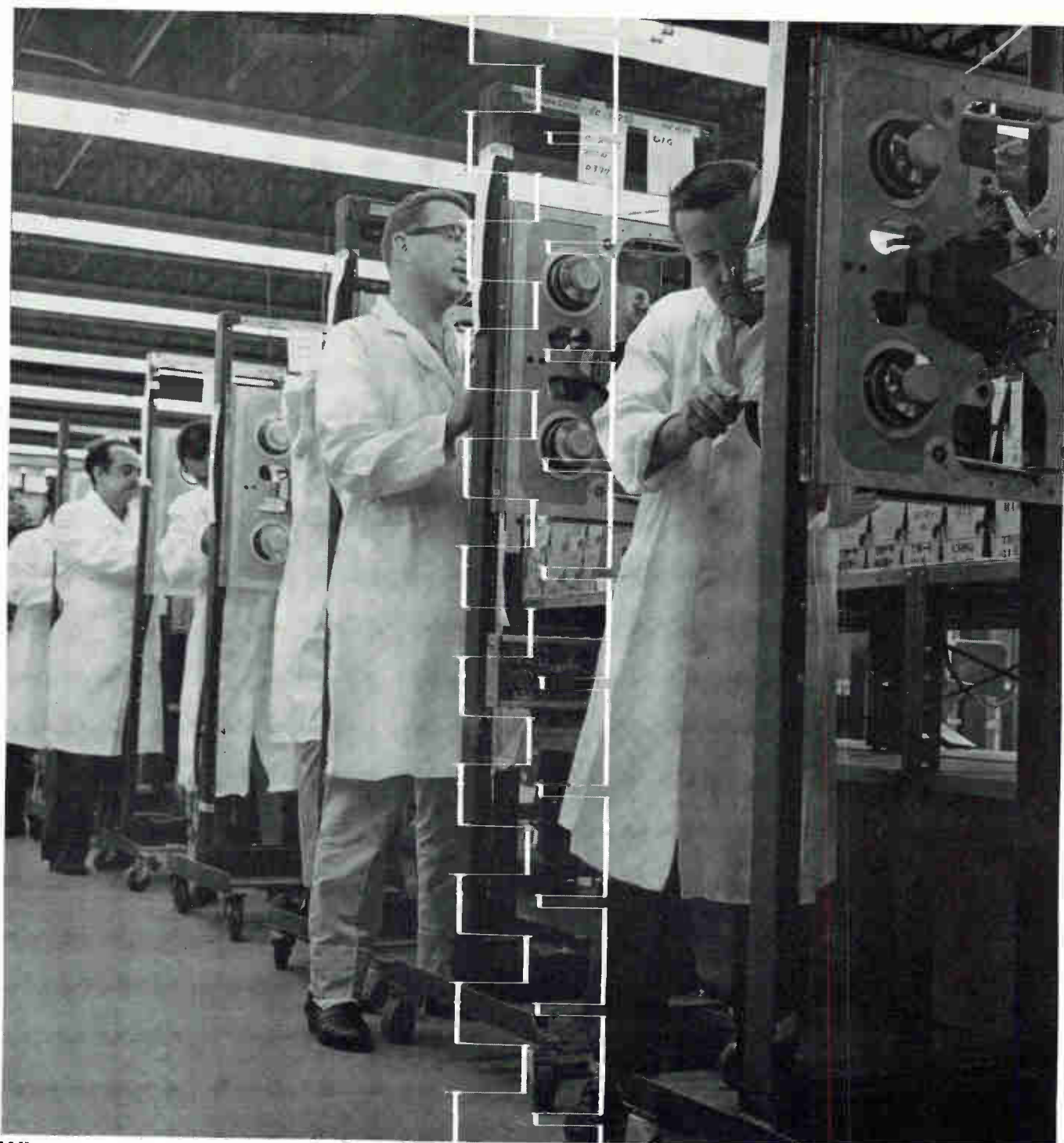

Who says you can get fast delivery on advanced tape memory systems? **AMPEX**

We took the world's most advanced high speed and medium speed tape units and added solid state electronics. Result: the Ampex TM-2100 and TM-4100 tape memory systems. We can deliver them to you practically off the production line. Performance? The TM-2100 operates at speeds up to 150 ips; the TM-4100 at speeds up to 75 ips. Both systems read, write and check digital data. They're compatible with most computer formats at 200, 556 and 800 bpi. And you can have either system in a 19" rack



mount, a tri-sectional cabinet, or any way you want it packaged. Or you can get either tape transport by itself. (As many as ten transports can operate on one set of electronics.) Ampex Computer Products Co., Culver City, California. A division of the only company providing recorders, tapes and core memory devices for every application: Ampex Corporation, 934 Charter Street, Redwood City, California. Term financing and leasing available. Sales, service engineers the world over.



If you record data, you'll appreciate these outstanding features:

Total Accessibility — in operation!



The tape transport pivots 180° in the same way as the cut-out panel at right, thereby exposing transport mechanisms on the rear. Rotated 90°, it permits the power supply or servo-control unit to be rolled forward during operation.



The chassis containing record and reproduce circuits rolls forward, and the card cage rotates downward to permit insertion or removal of plug-in solid-state electronic modules.



Seven tape speeds — both directions: 1 7/8 through 120 ips, precisely controlled in forward and reverse, all electrically selectable.

Can't spill tape. Pushbutton-actuated logic circuits "think ahead" to provide error-proof sequencing between any two operating modes.

Remote and Automatic Control. Recorder may be operated or programmed from a distance, actuated by low-level, low-impedance signals.

Extreme speed accuracy. Capstan speed is phase-locked to 0.01% crystal-controlled standard.

Flutter reduced at the source. Capstan mounts directly on shaft of new-type motor, thereby eliminating flutter produced by mechanical transmission links.

Servo-controlled tape tension. Sensitive electronic system keeps constant tension on tape as it enters and leaves the closed loop.

Simple, reliable mechanics. No pulleys, belts or gears. Dynamic brake and holdback tensions are provided by

over



FIRST
CLASS
PERMIT
NO. 489
Palo Alto,
California

BUSINESS REPLY MAIL

Precision Instrument Company
Stanford Industrial Park
Palo Alto, California

400 PI

combines the convenience,
flexibility and performance
that best meet today's
recording needs



400 PI

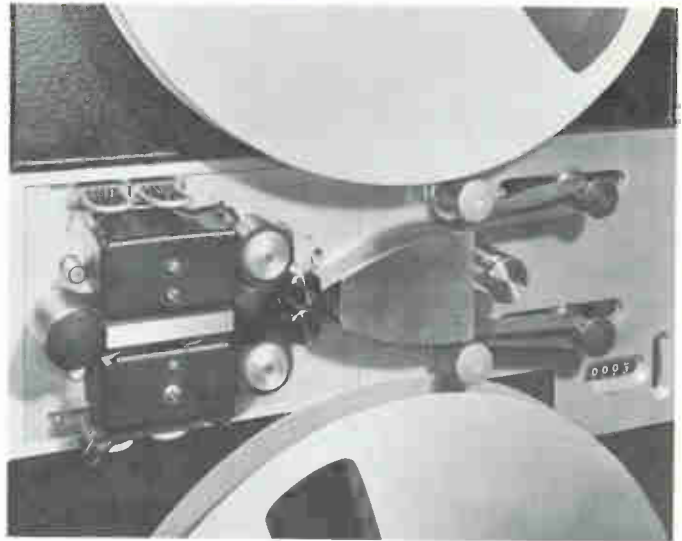

Close-up of PI-400 tape guiding mechanism. The tape chute reduces transverse vibration and positions the edges of the tape accurately to minimize skew. The bilateral symmetry permits the tape to be transported in either direction with equal control.

reel motor torque; mechanical brakes function only on power failure.

Gentlest tape handling. Tape and capstan motion are synchronized in starting and stopping; no rubbing of an idling capstan against stationary tape.

Expanded signal-handling capacity. The PI-400 transport lends itself admirably to a wide variety of encoding and decoding techniques. Presently available are record and reproduce electronic systems using standard techniques, as well as many quasi-standard modifications. Special requirements will be given prompt attention by our staff of experienced applications engineers. For information on how the PI-400 will meet your recording problem, fill out the postcard below and mail it now.

FRONT VIEW
of an exciting new
magnetic tape data recorder
from

**PRECISION
INSTRUMENT**



I would like technical data concerning the performance of the PI-400 in the following application:

To record, to reproduce or both?.....

Recording or reproducing time per reel:.....

Type of data:.....

Data bandwidth required:.....

Send me general brochure #71 on the PI-400, including specifications.

Have your representative phone. My number is.....

Name.....

Title.....

Organization.....

Address.....

.....

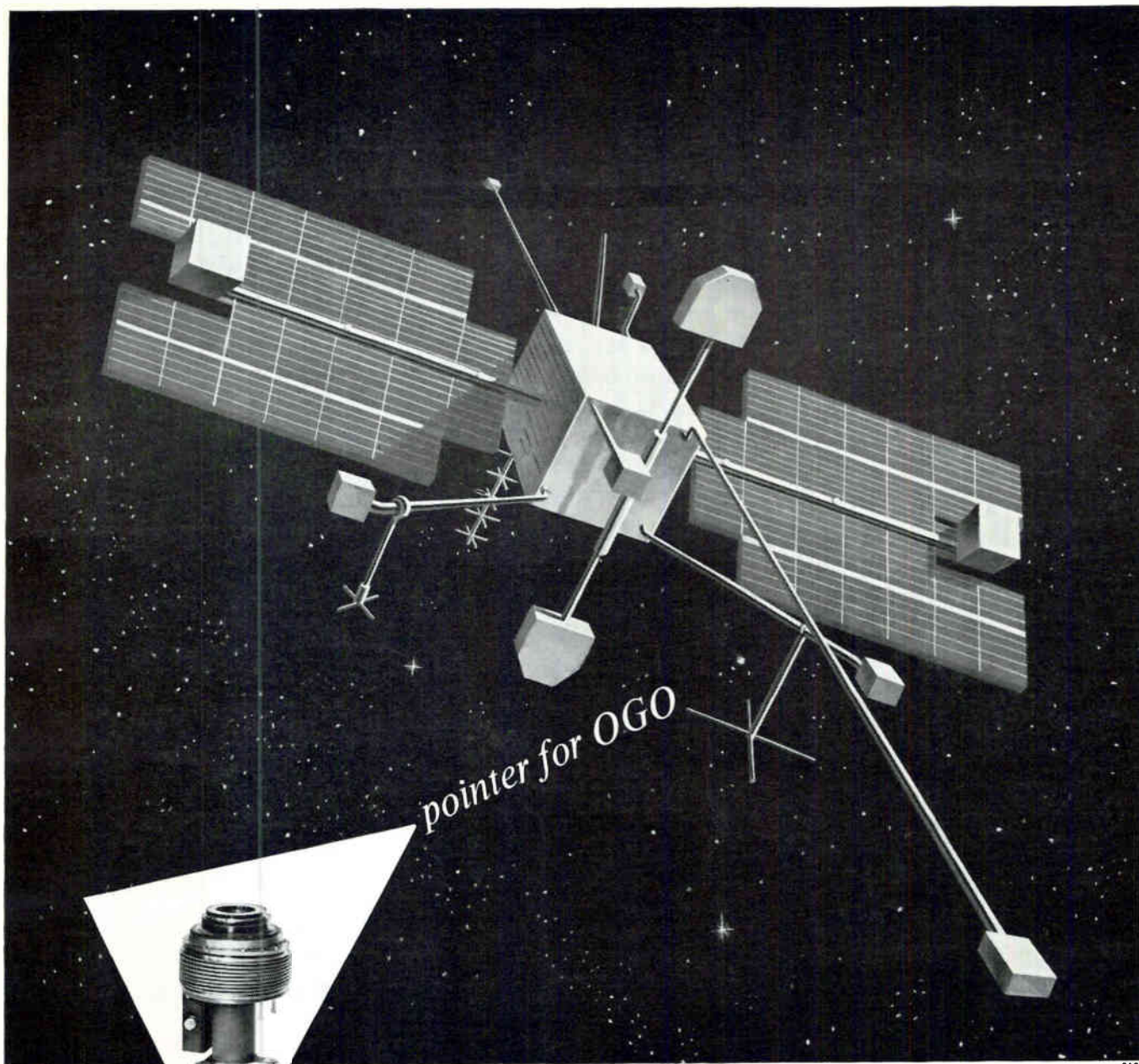

Once in orbit, OGO (NASA's Orbiting Geophysical Observatory) must orient scientific equipment in three directions. Some of its experimental packages must line up perpendicular to the sun's rays. Other experiments must turn to face the earth. Another group must seek a line parallel to OGO's own orbital plane. STL engineers and scientists have produced a hermetically sealed drive mechanism to help solve these orientation requirements. Two mechanisms are used in OGO's attitude control system. One rotates solar arrays in continuous orientation with the sun; a second keeps experiment packages fixed in desired position with respect to the orbital plane. The drive mechanism (shown above) is hermetically sealed to permit use of a conventional high-speed servo-motor without the usual problems of gear lubrication. It does its work by wobble or twist motion at a rate

of one degree per second with a final gear reduction of about 24,000 to 1. STL's many projects include building OGO spacecraft for NASA's Goddard Space Flight Center, building spacecraft for Air Force-ARPA, and continuing Systems Management for the Air Force's Atlas, Titan and Minuteman programs. These activities create immediate openings in fields such as: Space Physics, Radar Systems, Applied Mathematics, Space Communications, Antennas and Microwaves, Analog Computers, Computer Design, Digital Computers, Guidance and Navigation, Electromechanical Devices, Engineering Mechanics, Propulsion Systems, Materials Research. For Southern California or Cape Canaveral positions, write Dr. R. C. Potter, One Space Park, Dept. G-1, Redondo Beach, California or P. O. Box 4277, Patrick AFB, Florida. STL is an equal opportunity employer.



SPACE TECHNOLOGY LABORATORIES, INC.
a subsidiary of Thompson Ramo Wooldridge Inc.

Los Angeles • Vandenberg AFB • Norton AFB, San Bernardino • Cape Canaveral • Washington, D. C. • Boston • Huntsville • Dayton
VISITING LOS ANGELES JAN. 14-FEB. 1? SEE "ART IN SCIENCE" EXHIBIT AT STL'S SPACE TECHNOLOGY CENTER.

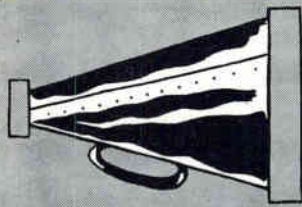

ANNOUNCING FOR 1963
 a tremendous
electronics BUYERS' GUIDE Issue



NEW LOW CATALOG RATES ALLOW SUFFICIENT SPACE FOR YOU TO PROVIDE COMPLETE BUYING INFORMATION ON YOUR ENTIRE PRODUCT LINE



Take complete advantage of marketing's
MAGIC COMBINATION

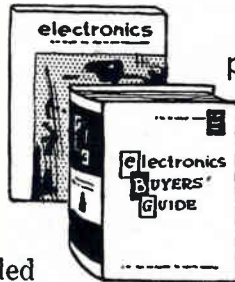

electronics every Friday – to create preference for your products...

The 1963 **BUYERS' GUIDE** to make product preference pay off in buying action

For 22 years of sales-minded

this combination has worked magic for thousands of companies. It will work for you in 1963 more effectively and economically than ever before. Your electronics representative has full information on how this can be accomplished. Look at these new eBG catalog rates:

CATALOG ADVERTISING RATES PER PAGE:

Without "EARLY BIRD" Discounts

Space Used	Rates	Space Used	Rates
1 page	\$900	12-15 pages	\$545 per page
2-3 pages	740 per page	16-19 pages	495 per page
4-5 pages	670 per page	20-23 pages	465 per page
6-7 pages	630 per page	24 or more	440 per page
8-11 pages	590 per page		

FOR THE SAME PRICE AS 1962, FROM 33% TO 60% MORE SPACE!

Rates with "EARLY BIRD" Discounts

1 page	\$837.00	12-15 pages	\$506.85
2-3 pages	688.20	16-19 pages	460.15
4-5 pages	623.10	20-23 pages	433.45
6-7 pages	585.90	24 or more	409.20
8-11 pages	548.70		

"EARLY BIRD" Closing Dates (For Discounts)

Reservations for space Feb. 15th / Copy to set April 16th / Complete plates April 25th

For Complete Information, Contact Local Sales Offices Listed on the Last Page of This Issue

ACT NOW!

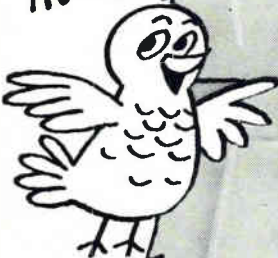

MITSUBISHI MICROWAVE ANTENNAS FOR TELECOMMUNICATIONS



Japan today has the second largest microwave network in the world. Mitsubishi Electric, with the longest microwave antenna experience in Japan, has supplied 90% of the antennas used in the trunk lines of this extensive network. Mitsubishi antenna systems include parabolic, scatter, horn reflector and radar types, as well as a complete line of waveguide components and accessories. Frequencies from 900 Mc. to 24 KMc. are covered. The IU-61, shown above and specified at the right, is typical of the outstanding performance of Mitsubishi microwave antennas. Full technical information on any of these types of antennas is available at your request.

IU-61 6000 Mc. Band Parabolic Antenna

Diameter : 4 meters
 Frequency Range : 5925~6175 Mc/s or 6175~6425 Mc/s
 Feed System : Dual circularly polarized wave
 Gain : 45 db
 Beam Width : 0.98 degrees (half power)
 First Side Lobe : -23 db
 Wide Angle Radiation : -60 db
 (over 60 degrees)
 Front-to-Back Ratio : 65~70 db
 VSWR : 1.02
 Ellipticity Ratio : 1.1 (power axial ratio)
 Discrimination of anti-circularly polarized wave : -30 db
 Coupling of Both Arms : -35 db
 Guaranteed for
 Wind Velocity of : 60 meters/second
 Weight : 800 kilograms



MITSUBISHI ELECTRIC MANUFACTURING COMPANY
 Head Office : Tokyo Building, Marunouchi, Tokyo Cable Address : MELCO TOKYO



■ Horn reflector antenna



■ Air inflated parabolic antenna

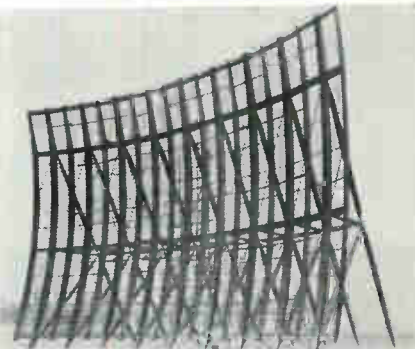

■ 25×16 meter scatter antenna



DRILLING RIG probes shimmering white limestone salt flat, to insure there will be no caverns under tower foundations at Navy's vlf station

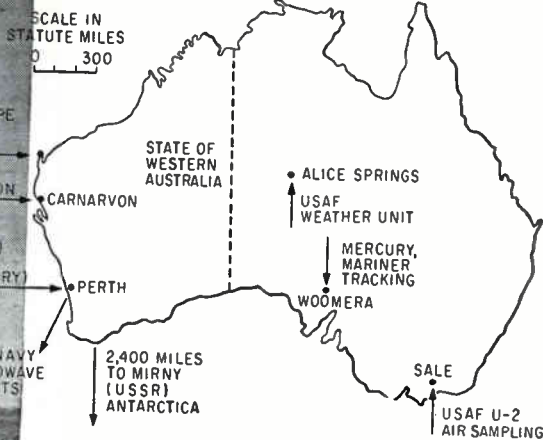

MOST U. S. RADIO sites in Australia are strung along the west coast

Down Under — Suddenly

Australia is breaking out in a rash of U. S. electronics facilities

By **LLOYD MARSHALL**

McGraw-Hill World News

PERTH, AUSTRALIA—Two factors have combined to make little-known Western Australia suddenly a focal area for U.S. electronic activity. Australia's west coast is almost opposite, on the globe, to the U.S. east coast, and it is relatively free from man-made interference.

In quick succession Australia's west coast has attracted stations for Mercury and Apollo tracking, vlf communications, communications research and l-f basic research.

VLF STATION—The Navy vlf station, similar to one at Cutler, Maine (**ELECTRONICS**, p 34, July 15,

1960), will cost about \$80 million.

The antenna array on the tip of the North-West Cape peninsula (see map) will have inner and outer rings of 13 towers with a central tower reaching up to 1,294 ft.

Near the vlf transmitter are sites for an h-f receiver and an h-f transmitter.

Construction will begin in 1963 and should end late in 1965. The station is to be fully operative with a staff of 300 to 500 men by 1966.

The station will be the first permanent U.S. defense base on Australian mainland soil.

MUCHEA TRACKER — A command tracking station built in 1960 at Muchea (pronounce it M'you-shay) was the first U.S. electronic interest in Western Australia. Strategically situated on the flat, sandy coastal plain 34 miles from Perth, Muchea can cover the first 3 orbits of a Mercury mission,

and the last 7 of an 18-orbiter.

It has all the regular features of a Mercury command station. The station is managed and staffed by officers of the Weapons Research Establishment of the Department of Supply. During missions, the staff is 30 Australians, plus American specialists. Expansion of the station is considered inevitable in view of future NASA commitments of Gemini and possibly Centaur.

AIR FORCE RESEARCH—Seven miles from Muchea, the U.S. Air Force has a radio communications research station at the Royal Australian Air Force station at Pearce. Considerable security surrounds the establishment.

The base, so far, is manned by 14 men. When put on a permanent footing it would have up to 50 men.

The reasons for putting the station at Pearce are the certainty of good weather, calm atmospheric conditions, and relative freedom from tv and radio interference.

The research team is studying space phenomena. Information will be useful in communications satellite programs and is also being



DEBRIEFING after a Mercury flight. Man with the white shoes is Gordon Cooper, who is to make the next Mercury flight



ROUGHING IT at Muchea. This is the telemetry and control facility at the Mercury tracking station

Mecca for Radio Men

made available to the RAAF.

U.S. Air Force also has a weather observation unit operating from Alice Springs. U-2 upper-air-sampling aircraft are permanently based at Laverton, near Melbourne.

ENTER STANFORD—Latest U.S. entry in W.A. is a l-f radio propagation research station established by Stanford Research Institute in the Gngangara pine plantation about 12 miles north of Perth. The University of W.A. is providing graduate assistance and servicing.

SRI researchers say the installation has nothing to do with the Navy's vlf station. L-f signals are used over long distances and Perth is about as far away as one can get from the U.S. on land.

This trailer-mounted, semiautomated unit has four antenna structures about 400 feet apart and about 20 feet above the ground. They are directional loop antennas, triangular in shape and 20 ft high, and directional capacitor screen type antennas 36 by 16 ft.

Received signals are taped then airfreighted to a similar station in California for comparison.

PROJECT APOLLO—Six hundred miles north of Perth is the small port of Carnarvon, chosen for a

Project Apollo tracking station. The final site has not been announced. Negotiations between governments are not ended.

Considerable surveying, soil and interference tests have been carried out on a high, red sandhill at Brown Range, 3½ miles east of Carnarvon. The site gives an unimpeded radar scan to west and to east.

It is likely Carnarvon will have a TPQ-18 tracker (p 26, Dec. 15, 1961). The station will need about 40 staff.

AND A MYSTERY—In February, 1962, a U.S. Navy research aircraft bristling with antennas appeared at Perth Airport to engage in microwave research.

Simultaneously, one of America's very latest guided missile destroyers, *USS Coontz*, berthed nearby at Fremantle, the port of Perth, on a "goodwill" visit.

The aircraft flew a number of times towards Antarctica, ostensibly investigating atmospheric ducts—the phenomena that act like giant coaxial cables.

It was not explained why the aircraft left two men to operate a transmitter from the disused Caversham airstrip, 11 miles from Perth. The men were later embarked on the *Coontz*.

"Nothing is impossible to diligence and skill"

Samuel Johnson



These are the trademarks of some of our customers—each an important contributor to a dramatically growing industry. We at Potter pledge our diligence and skills to this growth through a constantly expanding program of research and development.

POTTER

M906 II Tape Transport

**couples
high-performance
and reliability . . .**

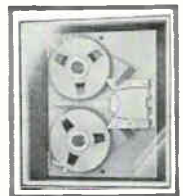

with the lowest price in the industry. The unique design of this versatile transport provides compatibility for a variety of applications in digital data processing and computer systems.

Five tape widths up to 1¼" may be accommodated at speeds up to 120 IPS. In addition, data transfer rates of 62,500 BCD digits per second are readily obtained using conventional recording techniques. When used in high-density recording applications, transfer rates of over 450,000 BCD digits per second with drop-outs fewer than 1 bit in 100,000,000 are provided.

Complete specifications for this highly reliable system are available on request.



Manufacturers of:

- Digital Magnetic Tape Systems
- Perforated Tape Readers
- High Speed Printers
- Data Storage Systems

POTTER INSTRUMENT CO., INC.
Sunnyside Boulevard • Plainview, New York



**TOPS
'em
ALL!**

paradynamics

10 WATT Microwave Swept Sources

1.0-18.0 Gc/s

The pinnacle of power levels, at the highest standard of reliability, is now easily within reach via the Paradynamics Series 858B Swept Signal Sources. Flexibility is a key factor here, too, since these highly versatile units incorporate all of the features of the Paradynamics standard milli-watt, 1, 2 and 5 watt instruments.

With the 858B Series, Paradynamics makes available for the first time standard production 10-watt instruments capable of operating either as stable CW Signal Generators or as Sweeping Oscillators. Maximum reliability with a minimum of heat, space and weight is assured in these units through the use of permanent magnet focused wave tubes for both the BWO and TWT.

Unique features such as remote programming of RF frequency, power and modulation make the 858B Series a natural selection for use in automatic check-out systems, antenna range setups and other similar applications.

- Power Output Leveling ± 0.75 db
- May Be Pulse Modulated
- May Be Remote Programmed
- Panel Height 17 $\frac{1}{4}$ "
- Weight—95 lb

Catalog available on request



paradynamics
INCORPORATED

10 Stepar Place / Huntington Station, L. I., N. Y. / 516 HA 7-7961

New DIFFUSION FURNACE with Kanthal A-1 elements



Many design features utilized in the new Despatch K-36 combustion and diffusion furnace combine to give it broader applications and new dependability for laboratory and production work.

The Kanthal 3-zone A-1 elements are divided into end and center zone heats. The silicon control rectifier and transformer assembly with proper instrumentation provides accurate $\pm 1^\circ$ F. heat uniformity current control. The all ceramic exterior tubes and the efficient new type insulation, alumina-silica fibers in multiple layers, combine to maintain a cool shell even when the furnace is operated at capacity heat.

The new Despatch K-36 features are well suited to analytical work of semi-conductor deposits, for diffusion involving vapor growth, for combustion carbon determination.

MODEL K-36

Tube Furnace tube I.D. 2 $\frac{1}{2}$ "
end zones 29 $\frac{1}{2}$ "
center zone 11"

For complete information write for bulletin 206-61F.

**DESPATCH
OVEN
CO.**

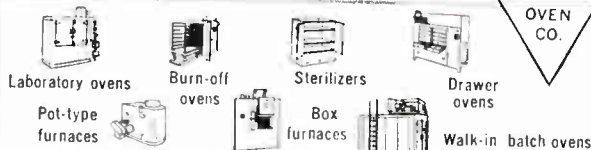

DESPATCH OVEN CO. 619 S.E. 8th St., Minneapolis 14, Minn.

CIRCLE 200 ON READER SERVICE CARD

BEST MINIATURIZED INDICATOR

RADIATOR



V-403



SB-305



R-201



R-101

R-101	Tuning indicator and Battery residual capacity indicator
F-102	FM tuning indicator
V-103	Audio level indicator
A-104	AM tuning indicator
SB-105	Stereo balancing indicator
B-106	Battery indicator
R-201	Smaller type tuning and battery indicator
V-203	Smaller type level indicator
B-206	Smaller type battery indicator
R-301	Larger type tuning and battery indicator
V-303	Larger type level indicator
SB-305	Larger type stereo balancing indicator
V-403	VU meter
V-403B	Audio level indicator
SB-405	Null indication stereo balancing indicator

ACCEPTABLE SPECIAL DIAL UPON YOUR REQUEST

D I S T R I B U T O R

ATAKA NEW YORK, INC.
633 THIRD AVENUE
16TH FLOOR
NEW YORK 17, N.Y., U.S.A.
PHONE: OXFORD 7-7480

ATAKA & CO., LTD.
OHTEMACHI BLDG.
1-CHOME, OHTEMACHI
CHIYODA-KU, TOKYO
PHONE: 201-6411

M A K E R

TOYO MUSEN CO., LTD.
75, WAKABAYASHI-CHO, SETAGAYA-KU, TOKYO



**MAKE
IT
BIG**

Coors produces the largest isostatically formed ceramic parts now available to industry. Complete homogeneity of ceramic is assured because of this unique Coors process used in forming large parts. Homogeneity is essential in high-frequency, high-power applications—radomes, envelopes and windows—because hot spots and punctures created by voids and air pockets are virtually eliminated by Coors. Complete uniformity also means reliable, uniform strength properties. In addition to fabricating large precision ceramics, Coors can metalize such king-size ceramic parts as shown here. Write for Data Sheet 3001, "New Ceramic Design Freedom With Coors Forming Methods," or call your nearest Coors Regional Sales Manager: WEST COAST, William S. Smith, Jr., EM 6-8129, Redwood City, Calif.; MIDWEST, John E. Marozeck, 529-2510, Roselle, Ill.; CENTRAL, Donald Dobbins, GL 4-9638, Canton, Ohio; EAST COAST, John J. McManus, MA 7-3996, Manhusset, N. Y.; NEW ENGLAND, WARREN G. McDONALD, FR 4-0663, Schenectady, N. Y.; SOUTHWEST, Kenneth R. Lundy, DA 7-5716, Dallas; SOUTHWEST, William H. Ramsey, UN 4-6369, Houston.

Coors

ALUMINA CERAMICS

Coors Porcelain Co., Golden, Colo.

CIRCLE 23 ON READER SERVICE CARD



NEW COAX!



flexible

MINIATURE THIN WALL 100% SHIELDED TEFLON COAXIAL CABLE

Inner-space, outer-space, or lack of space — wherever size, weight, and shielding of coax is a criteria, Hitemp's new cables provide design advantages not previously available!

Engineering, production, and Q.C. techniques advanced by Hitemp make it possible to hold shielding to a wall thickness of 1.5 mils, or less. For example, on a RG-196A/U teflon insulated coax cable, Hitemp holds the O.D. to .040" or half the O.D. of conventional wire braid construction (.080"). Subsequently, there's a weight savings of 21%. And this miniaturized cable can be wrapped around a $\frac{3}{8}$ " mandrel.

Naturally, the 100% shielded construction improves attenuation characteristics, reduces cross-talk to a minimum, stabilizes capacitance, and lowers VSWR.

100% shielding offers you assembly economies, too. It eliminates many termination problems associated with braided shields, and increases the reliability of the terminations, themselves.

Wherever your circuitry requires lower attenuation, improved VSWR, and so forth — wherever shielding, weight, size, flexibility, and reliability are critical, that's where it will pay you to use Hitemp's new miniature 100% shielded.

SEND FOR A SAMPLE if you'd like to run some checks on it yourself. Or, send us a piece of what you're currently using. We'll evaluate it and advise you of the savings you can make with Hitemp's new miniature coax. Why not take advantage of *either* offer today!

HITEMP WIRES CO.

a Division of Simplex Wire & Cable Co.

1200 SHAMES DRIVE, WESTBURY, NEW YORK
1532 S. CALIFORNIA AVE., MONROVIA, CALIF.





TYPICAL PARAMETRIC AMPLIFIER SPECIFICATIONS: *Tuning Range 5.4 - 5.9 Gc; Gain-Bandwidth Product 150 mc minimum; Single Sideband Noise Figure (including Circulator) Uncooled Mode (290°K) 2.3 - 2.7 db; Cooled Mode (80°K) 1.3 - 1.6 db; Pump Frequency 17.5 Gc; Pump Power Requirements 100 mw maximum.*

20/20 TRACKING VISION

Let's look at it this way. In space exploration 20/20 vision of instrumentation and tracking radar is a must. Advanced parametric amplifiers developed by Sperry will reduce minimum discernible target size and up the range of radar systems.

In tests conducted in major military radars, Sperry-designed solid state parametric amplifier systems produced excellent stability and optimum system performance far beyond normal... and at reasonable cost. Furthermore, Sperry has solved cryogenic cooling problems to achieve ultra low noise figures.

The Sperry Model D61C1 is a non-degenerate C-band parametric amplifier designed to meet military specifications. A temperature-controlled model of this amplifier was recently incorporated into a military radar system requiring extreme stability and low noise figure—gain changes of less than 0.5 db

per day for temperature changes from -20° to +150°F. were realized.

When incorporated as a complete subsystem, with ferrite circulators to divert the signal path when desired, amplifiers provide an effective, practical technique for improving system performance at economics heretofore unobtainable... and with fail-safe reliability features.

Optimum radar system operations can be achieved in single as well as multi-channel amplifier configurations as a result of extensive research and development at Sperry over the past five years.

Why not investigate improvements attainable in your radar using Sperry's extremely low noise, high reliability parametric amplifiers?

Write or call for complete information on integrated packaging for your radar application.

SPERRY

DIVISION OF SPERRY RAND CORPORATION **SPERRY MICROWAVE ELECTRONICS COMPANY** CLEARWATER, FLORIDA
Solid State Devices and Materials • Microwave Subsystems • Microwave Components and Antennas • Microline • Radar Test Sets • Systems Instrumentation

January 4, 1963

CIRCLE 25 ON READER SERVICE CARD 25



HIGH RESOLUTION, motorized film viewers for seismic analysis program compare two seismic signals. Digital and analog computers are also used in analysis



SEISMOMETERS for earth measurements can be 10 miles away from data-recording station

BLACK BOX

BLAST DETECTION — HOPE OR HOAX?

Will unattended nuclear detection stations be able to police test ban?

By **GEORGE J. FLYNN**
Associate Editor

FOR FOUR YEARS U.S. and Soviet representatives have been deadlocked over a proposed ban on nuclear weapons testing.

The U. S. has been insisting on an inspection procedure to make sure the ban is not violated clandestinely; we want inspection teams on the spot in the USSR.

The Soviets at first insisted that their word alone be taken that they would comply with a ban. Lately they have proposed policing a ban by unmanned instrument packages — "black boxes."

The U. S. is not buying this proposal.

What can the black box do, and what can't it do? Is the truth somewhere between these two conflicting viewpoints?

Last week, William C. Foster, director of the U. S. Arms Control and Disarmament Agency, told 400 scientists on the University of Michigan campus that "at present scientific instruments and techniques cannot reduce the area of ambiguity and risk to tolerable limits. This is why we have con-

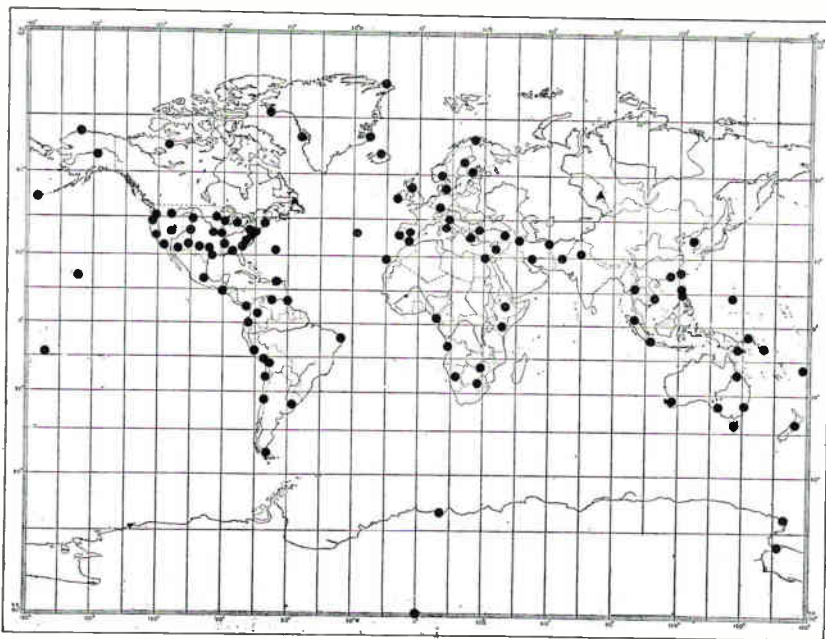

TENTATIVE LOCATIONS of standard seismograph stations furnished by U. S. Coast and Geodetic Survey to universities and research institutions to assist Project Vela-Uniform in earthquake studies and help establish criteria for underground blast detection

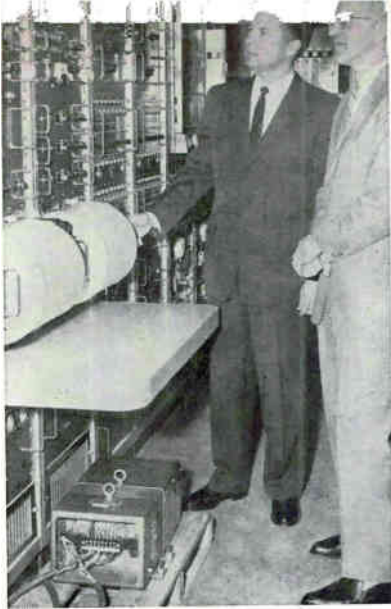

VELA-UNIFORM station built by Texas Instruments and Geotechnical Corp.

tinued to include provisions for on-site inspection in a system of checks and balances."

Robert E. Matteson, advisor to the agency, told the same group "nothing U. S. scientists have seen or read leads them to believe that automatic stations can be used to replace a system of manned control posts with suitable arrays of seismic instruments or to significantly reduce the number of necessary, obligatory on-site inspections required to identify seismic events."

He added that 100 black boxes would not eliminate the need for on-site inspection although they would be a helpful adjunct. Even with manned stations having the best instruments, there would still be need for a communications network with standard reporting forms for central data collection, processing and analysis.

Even 100 black boxes probably wouldn't be enough. Another analysis—of the problem of detecting small explosions—shows that it would take 400 to police the USSR's huge land mass. That's a far cry from the Soviet offer of three unmanned stations, an offer rejected recently by the U. S. test-ban negotiators.

STATE OF THE ART—Too little is known about how to tell a nuclear blast from an earthquake. And the simple seismometers of black



15 Mw Modulator Power
3.0 Mw R-F Power
ML-7560
Ceramic Triode

Coaxial terminal, thoriated-tungsten cathode ML-7560 provides:

15 Mw Pulsed Modulator Power Capability at 1% duty . . .

DC Plate Voltage Max 50 kv

Pulse Cathode Current Max 550 amps

3.0 Mw R-F Pulsed Power capability at 5% duty . . .

Peak Plate Pulse Supply Voltage Max 40kv

Pulse Cathode Current, Max 550 amps

Send for 74 page brochure, "Hard Pulse Modulator Tubes", containing useful information for Radar Design Engineers and others.



An Affiliate of Raytheon Company

THE MACHLETT LABORATORIES, INC.

SPRINGDALE, CONNECTICUT



LARGE VALUES OF CAPACITANCE

IN SMALL PHYSICAL SIZE!

Sprague offers two series of "block-buster" electrolytic capacitors for use in digital power supplies and allied applications requiring extremely large values of capacitance.

Type 36D Powerlytic® Capacitors pack the highest capacitance values available in their case sizes. Intended for operation at temperatures to 65 C, maximum capacitance values range from 150,000 μF at 3 volts to 1000 μF at 450 volts.

Where 85 C operation is a factor, Sprague offers the Type 32D Compulytic® Series, the ultimate in reliable long-life electrolytics for digital service. These remarkably trouble-free units have maximum capacitance values ranging from 130,000 μF at 2.5 volts to 630 μF at 450 volts.

Both 32D and 36D Capacitors have low equivalent series resistance and low leakage currents, as well as excellent shelf life and high ripple current capability.

If you'd like complete technical data on Type 36D units, write for Engineering Bulletin 3431. For the full story on the "blue ribbon" Type 32D Series, write for Engineering Bulletin 3441B to the Technical Literature Section, Sprague Electric Company, 35 Marshall Street, North Adams, Massachusetts.



49-362RS

28 CIRCLE 28 ON READER SERVICE CARD

Black Box . . . Easy to Spoof

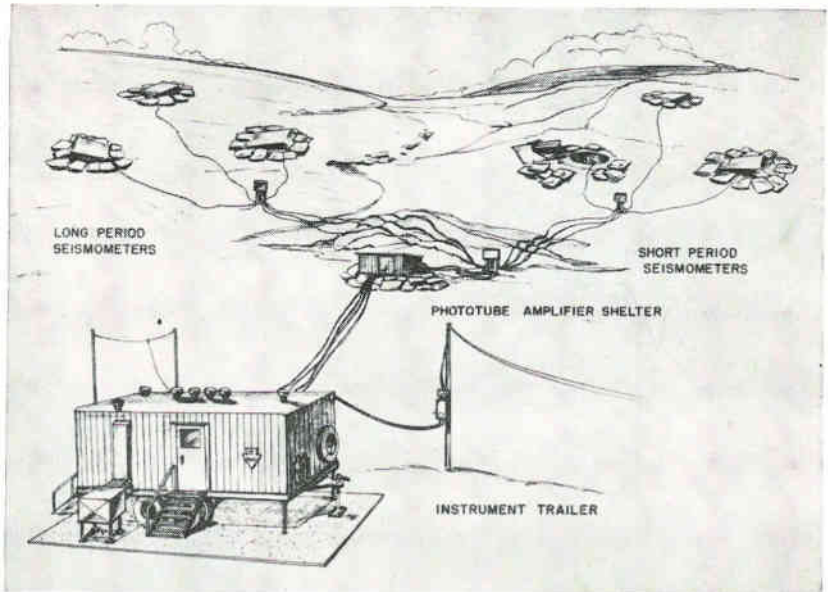

MOBILE seismograph stations of this type built by Geotechnical Corp. are being used in long range seismic measurements program

boxes can be spoofed—simply by driving a tractor around the box when a blast goes off. Seismic effects of a blast can be reduced to low levels by setting it off in a salt mine or under the polar ice cap.

Even on-site teams will have trouble. Suppose a detection network could pinpoint suspicious events to within 500 ft. Then the probability of finding radioactive evidence of an underground 20-kiloton blast by drilling five holes is only 26 percent. Digging enough holes to be sure would cost tens of millions a year—and there are 500 seismic disturbances in the USSR each year that might bear looking into.

Nuclear blasts in outer space have characteristics that will probably allow them to be detected unless exceptional shielding methods are used. Even blasts on the far side of the moon could be detected since by the time such testing would be practical inspection or spy satellites of various types will be available.

QUAKE OR TEST? — Detecting underground blasts and distinguishing between them and natural earthquakes is primarily a problem in seismic analysis, although all nuclear explosions also generate an electromagnetic signal. The direct electromagnetic signal is attenu-

ated rapidly by the earth, but signals below 10 Kc may be detectable'.

Seismic waves traveling through the earth's crust generate a second electromagnetic signal that precedes the shock wave. Neither the direct nor the seismically induced electromagnetic signal can presently be used for detection except at short range, but both have sufficient worth to justify further research.

UNDERGROUND BLASTS — The major problem with seismic signals at present is that they are noisy.

Noise in the seismic signal results from multiple reflections within the earth (ghosting), local earth movements at the seismometer site (called microseisms), and noise from trucks, trains, factories, wind, and ocean and earth tides.

Only the so-called first motion is known to help in identification. For an explosion, this motion is always a compression signal radiated in all directions from the blast.

First motions of earthquakes sometimes have the same pattern and sometimes have a rarefaction pattern. Thus, the most that can be proved with seismic signals alone is that an event is an earthquake and not an explosion.

Neither Western nor Eastern

CIRCLE 29 ON READER SERVICE CARD→

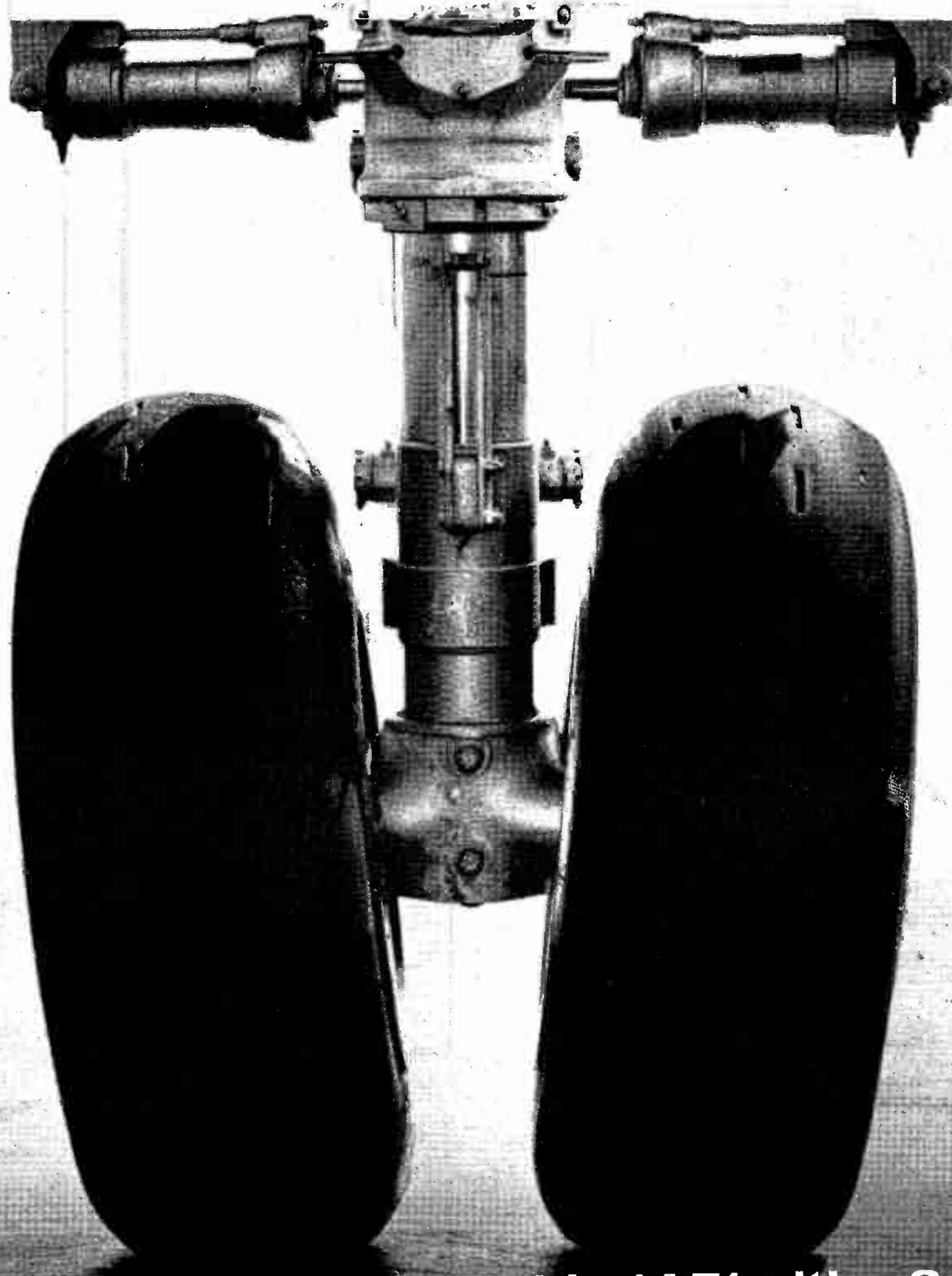

Who's the big wheel in 1451 cities?

We are. If you think that's bold, you should see our new Skyroad transportation system. Skyroad is an integrated network of trucks, trains and Flying Tigers' airfreight combined to give you door-to-door airfreight service in 1451 cities and towns.

With Skyroad, you can forget your worries about delays in loading and unloading shipments. Freight is never held up

because we have a nationwide teletype system that keeps tabs on your shipment from initial pickup to final delivery.

Skyroad simplifies your shipping too. You pay only one flat rate. And you receive only one bill for this combined service. You'll be amazed at how low Skyroad rates are. We never play big wheel with other people's money. See for yourself. Call for details.

first in airfreight with airfreight first **FLYING TIGER LINE**





SEISMOMETER for use in holes or wells as deep as 10,000 ft improves signal-to-noise ratio as much as 10:1 over surface types

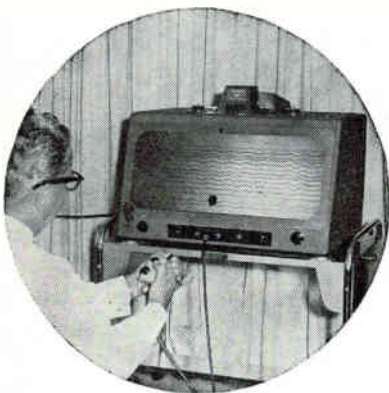

FILM READER scans data on 16-mm film. Seismologists can quickly locate events of interest but do not always agree on the interpretation of weak signals

scientists at the 1958 Geneva Conference of Experts were able to show how shallow underground nuclear explosions could be positively identified, and no method suggested since then has been verified.

With the seismic equipment available today, seismologists can reliably identify a first compression motion if the signal-to-noise ratio is 7:1 or better (s/n of 5:1 may be acceptable). But a radial compression pattern cannot be positively determined from only a few scattered seismic stations—clean first-motion signals from a network of stations are necessary.

The signal-to-noise ratio is thus a major stumbling block of any unattended inspection system. Since tactical weapons with powers of 5 Kt or less are of interest, signal power is relatively low. Simple decoupling techniques can reduce it by a factor of ten or more. Hanging the bomb in a cage within a cavern can reduce the seismic effect by as much as 300. There is evidence that small explosions deep in arctic snow are completely muffled.

BLACK BOXES — Simple and rugged seismometers able to operate unattended for a month or more can reliably detect the first motion of a 5-Kt blast 100 to 200 miles away. A network to cover the Soviet Union would need 400 or more stations.

The manned seismic stations first proposed at the Geneva Conference are more sensitive and complicated instruments than unattended ones can be and have a range of about 1,000 miles. The Soviet Union now has over 100 seismic observatories of the most modern type.

Seismic stations cannot just be placed on the ground and turned on. A quiet area is needed and the equipment must be directly connected to bed rock. Spoofing is relatively easy. Driving a tractor around a site could bury blast signals in noise.

SPACE BLASTS — At least five different types of ground-based equipment to detect blasts in space appear feasible at this time. Detection methods would be based on

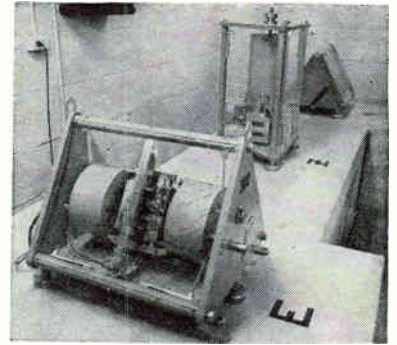

SEISMIC STATION requires at least three seismometers, power supply, recording system and timing signals with 0.1-second absolute accuracy

the visible flash, the electromagnetic signal, and soft or long-wavelength thermal x-rays.

Los Alamos estimates that 10^{-6} of the total energy of a 1-megaton blast is given off as visible light over a 30-microsecond period. If the same energy proportion holds for smaller explosions, a 10-kiloton blast would give off 4×10^7 joules as light.

With an optical system having a 0.2-radian field of view, and phototube with a sensitivity of 0.04 amp per watt, a peak photocurrent pulse of 0.08 microamp would be obtained from a 10-Kt blast 10^5 Km away. This can be used to obtain a signal-to-noise ratio of 10 to 1, with a false-alarm probability of 1 in 10^{30} seconds.

But if the light pulse is only 0.9 times as much as assumed, the false-alarm probability is 3×10^7 or about 1 per year. An acceptable false-alarm rate has generally been estimated at 1 per century.

RADIO ENERGY — Electromagnetic energy from the nuclear blast is concentrated in the 10 to 100-Mc band and is relatively insensitive to the size of the blast. The signal from a blast 10^5 Km away is about 3×10^{-10} watt/m². Cosmic noise in the same band is approximately 6×10^{-12} watts/m², giving a signal to noise ratio of 100:1. But nonstatistical variations in cosmic noise could occasionally give a spike 100 times the rms level, thereby giving a false alarm.

The x-ray pulse from a nuclear blast lasts from 0.1 to 1 microsecond; thermal x-rays reaching the ionosphere and upper atmosphere from a space blast would cause a nearly instantaneous increase in ionization in these regions. Time for the suddenly increased ionization to dissipate is a function of altitude, initial electron density and time of day. It ranges from hundreds to thousands of seconds.

VLF PHASE SHIFT—The sudden increase in electron density causes an effective lowering of the D layer and a consequent phase shift in vlf signals that travel in the duct formed by the layer and the earth.

A 10-Kt blast 10⁶ Km away could cause a phase shift in a 20-Kc signal of 480 degrees in 1 microsecond. This is a much larger rate of phase change than the 0.5-degree-per-second rate for a solar flare and the 0.03-degree rate for sunset and sunrise. The U.S. Navy is now evaluating vlf phase-shift detection methods (ELECTRONICS, p 28, Oct. 19, 1962).

Two other ways of detecting space blasts appear feasible. Lowering of the D layer increases absorption of cosmic noise, and a 10-Kt blast at 10⁶ Km is estimated to change the 15-Mc cosmic signal by about 0.1 db. Although the magnitude of change is small, the rate of change is much higher than any caused by natural events, so detection with a fast-acting riometer should be possible.

The other method is based on detecting the air fluorescence that occurs when thermal x-rays excite nitrogen molecules. Approximately 0.25 percent of the absorbed energy is emitted as blue light at 3914 Å. An air-fluorescence detector has been operated by Los Alamos Laboratory for 2½ years, and a detection range of 10⁶ Km for a 1-Kt blast is believed possible.

REFERENCES

- (1) S. D. Abercrombie, Ground Based Detection of Atomic Weapons, Paper presented at 9th IRE-Professional Group Nuclear Science, 1962.
 - (2) Carl Romney, Commentary on "The Detection of Underground Explosions" (An article by L. Don Leet, Scientific American, June, 1962), Vestac Bulletin, U. of Michigan, Ann Arbor, Mich.
 - (3) Cabell A. Pearse, Ground Based High Altitude Detection Systems, Paper presented at 9th IRE-Professional Group Nuclear Science, 1962.
- All illustrations accompanying this article were furnished by The Geotechnical Corp., Garland, Texas.

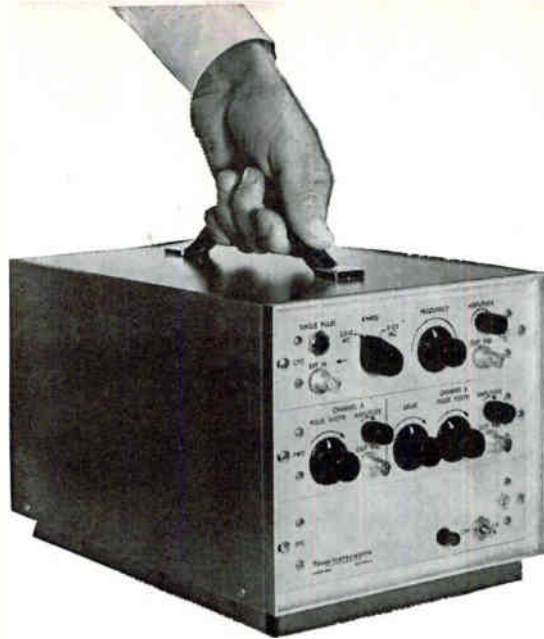

TI has what you need in pulse programming!

Versatility — Custom combination of modules for any desired performance characteristics. **Portability** — Compact, lightweight, easy to carry. **High Rep Rate** — Repetition rates of 100 cycles to 100 megacycles.

Texas Instruments Series 6000 Pulse Generators are the smallest instruments available with the advantages of modular construction plus a wide range of operating features which include variable width and delay, variable rise and fall times, plus and minus outputs, pulse mixing, programmed and random word generation.

TI Pulse Generators combine dependable performance with a high degree of versatility and convenience. Circuitry is all solid state with compact controls. Write for complete information.

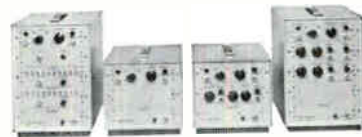

INDUSTRIAL
PRODUCTS
GROUP



TEXAS INSTRUMENTS
INCORPORATED
P. O. BOX 66027 HOUSTON 6, TEXAS

SENSING . RECORDING . TESTING . DIGITIZING INSTRUMENTS
THE INSTRUMENTS OF TEXAS INSTRUMENTS

572

CIRCLE 31 ON READER SERVICE CARD

electronics

Editorial Opportunity

IT DOESN'T HAPPEN OFTEN, but **electronics**, "bible of the industry" and a McGraw-Hill publication, has an opening for an Assistant Editor.

Ideally, the man we are looking for and to whom a post on our New York staff could be a long-term challenge, would have an electrical engineering degree or technical equivalent, practical experience in our field and a demonstrated aptitude for editing, writing, reporting. He probably lives somewhere in the metropolitan area and therefore would have no relocation problem.

Write **The Editor, electronics, 330 W. 42nd St., New York 36**, stating experience, aspirations and past earnings. Mark the envelope "Confidential" and it will be kept that way.

HOW TO BEND BARS and TUBING



HOW TO BEND . . . OFF CENTER EYES

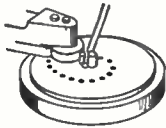

1
Insert bar stock between Locking Pin and Radius Pin of desired size.

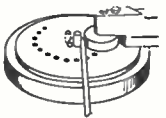

2
Set Forming Roller against material and advance Operating Arm.



3
Complete operation with one steady movement.

HOW TO BEND . . .

TUBING



1
Clamp tube. Insert Follow Block between material and Forming Roller.

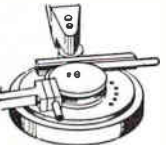

2
Advance Operating Arm until it strikes Angle Stop.

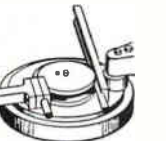

3
Remove Follow Block, release clamp and remove tube.

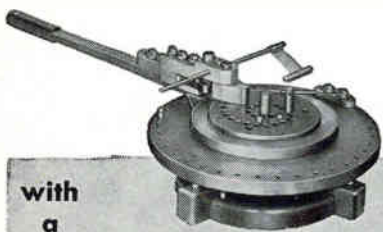

with
a

DI-ACRO BENDER

Complete details on forming rods and tubing with standard accessories as well as tips and technical data on angle, channel and other materials will be found in "It's Easy to Bend", a 32 page summary of Di-Acro Benders and bending. A copy is yours free of charge.

Consult the yellow pages of your phone book for the name of your nearest Di-Acro distributor or write:

pronounced die-ack-ro



DI-ACRO CORPORATION

431-W 8th Ave., Lake City, Minn.



GROUND CONTROLS bring unmanned helicopter in for landing

Navy Tests Drone 'Copter

Unmanned helicopters could spy on enemy and deliver undersea weapons

DALLAS—Bell Helicopter has successfully demonstrated the capability of a remote-control helicopter drone system, in two unmanned flights at the Naval Ordnance Test Station, China Lake, Calif. Bell believes the system could expand the use of helicopters on hazardous military missions, such as:

- Using drones as decoys to probe and expose enemy firepower.
- Providing radar or tv spying platform above a battlefield. Held stationary at 7,000 to 8,000 feet, such a helicopter could broadcast a continuing picture of enemy troop and equipment positions and movements. In Navy use, drones could safely scout shorelines and ship movements.

• Flying into contaminated areas with radiation detectors to measure the effect of nuclear explosions.

• Reducing the hazard of delivering antisubmarine underwater missiles and depth charges.

The present system can stabilize on four axes. This unit activates servomechanisms that control pitch, roll, yaw and collective axes by hydraulic manipulation of a dual control system.

Control signals are telemetered from a 17-by-13-inch ground-con-

trol panel to the autopilot through a pulse-amplitude-modulation data-link system. An encoder mixes multi-channel control commands for single-channel broadcast to the helicopter by an f-m transmitter. A decoder in the craft converts the telemetered commands into channel signals acceptable to the autopilot. Lag time between command and reaction is measured in microseconds.

The recent tests at China Lake involved an 11-year-old Army OH-13E helicopter. It was flown 72 minutes over a prescribed course. After the first flight, it was refueled, checked and reflight on a second 48-minute unmanned flight. Flight altitudes ranged up to 2,000 feet, maximum speed was 70 knots, and maneuvering distance 6 miles.

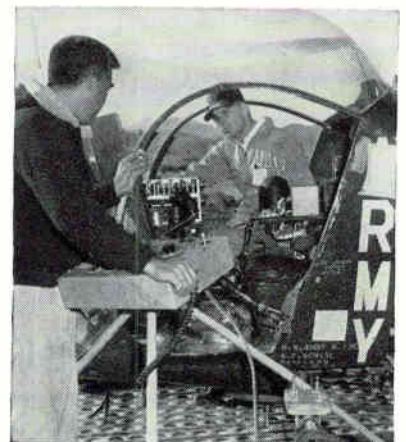

TRIPOD-MOUNTED ground control panel is checked out

KNOW OF A
SMALL, RUGGED
METAL-CERAMIC TRIODE
WITH **HIGH P_o**
THROUGH 1600 MCS?

HAVEN'T YOU
HEARD?—



COME ON. YOU CAN'T **HEAR**
PICTURES

**THIS ONE IS WORTH
LISTENING TO. IT'S GENERAL ELECTRIC'S
NEW**

ZP-1026, a triode amplifier with the highest known power-handling capability of any tube its size through 1600 mc. Its peak power capabilities include 2 KW at 0.02 duty, and 750 watts at 0.03 duty.

This G-E triode was designed for use in applications such as TACAN, IFF, steerable arrays, Doppler radar and altimeters, and is only one of a complete line of metal-ceramic tubes General Electric has for a variety of military applications. Its features include long pulse and high duty capabilities, long life, small size and heat-sink cooling.

HERE ARE SOME CHARACTERISTICS OF OTHER TYPICAL G-E TUBES...

	ZP-1030 METAL-CERAMIC TETRODE	ZP-1016B METAL-CERAMIC TRIODE	ZP-1029 METAL-CERAMIC DIODE
TYPICAL APPLICATION	AM and CW Communications, SSB, Satellite Communications, Tropo-Scatter	Series Regulator	RF Switching
BRIEF DESCRIPTION	100 W carrier linear amplifier @ 225-400 mc; 300 W CW @ 225-400 mc; 200 W CW @ 900 mc.	$E_b = 10$ KVdc; $\mu = 10$; $P_p = 300$ W.	Heat-sink cooled; $I_b = 0.300$ Adc; PIV = 5500 v.

SOUNDS LIKE
A PICTURE
WORTH HEARING
ABOUT



ELECTRONICS

INCLUDING IGNITRONS, HYDROGEN THYRATRONS, MAGNETRONS, METAL-CERAMIC TETRODES, TWT's, HIGH-POWER DUPLEXERS, HIGH-POWER WAVEGUIDE FILTERS, KLYSTRONS AND THERMIONIC CONVERTERS. FOR INFORMATION ON THESE PRODUCTS, WRITE SECT. 265-23, POWER TUBE DEPT., GENERAL ELECTRIC CO., SCHENECTADY, N. Y. OR TELEPHONE TODAY: SCHENECTADY, N. Y. FRanklin 4-2211 (Ext. 5-3433) • WASHINGTON, D. C. EXECutive 3-3600 • DAYTON, OHIO Baldwin 3-7151 • LOS ANGELES, CALIF. BRadshaw 2-8566 SYRACUSE, N. Y. 652-5102 • CHICAGO, ILL. SPRing 7-1600 • CLIFTON, N. J. GRegory 3-6387 • NEW YORK, N. Y. Wisconsin 7-4065 • ORLANDO, FLA. GArden 4-6280

GENERAL ELECTRIC

POWER TUBE DEPARTMENT

265-23

HOW WE TOOK THE SLIP OUT OF TEFLON*

Why Gudebrod's Common Sense Approach to Lacing Problems Pays Dividends For Customers!

Motor manufacturers came to us some time ago with a problem. They required a flat-braided lacing tape that would meet temperature requirements of -100°F to 500°F . A teflon lacing tape would meet the temperature requirements but teflon is slippery... knots were hard to tie... harnesses worked loose after installation. Valuable production time would be lost!

Gudebrod's answer to this problem was to coat teflon with a special synthetic rubber finish that was non-flaking and fungistatic. We then flat-braided it—we originated the flat braiding process! The result was TEMP-LACE® H, a teflon lacing tape that met the temperature requirements of motor manufacturers and assured them that knots would not slip, harnesses would stay tied and assemblies would remain firm long after installation.

Taking the slip out of teflon is but one of many ways in which Gudebrod's common sense approach to problems pays dividends for customers. Whatever your lacing needs—nylon, glass, dacron†, fungus proofing, color coding, special finishes, Gudebrod has the answer because:

1. *Gudebrod lacing tape increases production!*
2. *Gudebrod lacing tape reduces labor costs!*
3. *Gudebrod lacing tape means minimal maintenance after installation!*
4. *Gudebrod is quality—our standards for lacing tape are more exacting than those required for compliance with MIL-T!*

Write today for our Technical Products Data Book which explains the many advantages of Gudebrod lacing tape for both civilian and military use. Address inquiry and your lacing tape problems to Electronics Division.

*DuPont registered trademark for its TFE-fluorocarbon fiber.

†DuPont trade name for its polyester fiber.



GUDEBROD BROS. SILK CO., INC.

FOUNDED IN 1870

Electronics Division

225 WEST 34th STREET, NEW YORK 1, NEW YORK

MEETINGS AHEAD

MILLIMETER AND SUBMILLIMETER CONFERENCE, IRE-Orlando Section; Cherry Plaza Hotel, Orlando, Florida, Jan. 7-10.

RELIABILITY & QUALITY CONTROL SYMPOSIUM, IRE-PGRQC, AIEE, ASQC, EIA; Sheraton Palace Hotel, San Francisco, Calif., Jan. 21-24.

INSTITUTE OF ELECTRICAL & ELECTRONICS ENGINEERS WINTER GENERAL MEETING & EXPOSITION, IEEE; Statler and New Yorker Hotels, New York City, Jan. 27-Feb. 1.

MILITARY ELECTRONICS WINTER CONVENTION, IRE-PGMIL; Ambassador Hotel, Los Angeles, Calif., Jan. 30-Feb. 1.

QUANTUM ELECTRONICS INTERNATIONAL SYMPOSIUM, IRE, SFER, ONR; Unesco Building and Parc de Exposition, Paris, France, Feb. 11-15.

INFORMATION STORAGE AND RETRIEVAL SYMPOSIUM, American University; International Inn, Washington, D. C., Feb. 11-15.

ELECTRICAL & ELECTRONIC EQUIPMENT EXHIBIT, ERA, ERC; Denver Hilton Hotel, Denver, Colo., Feb. 18-19.

SOLID STATE CIRCUITS INTERNATIONAL CONFERENCE, IRE-PGCT, AIEE, University of Pennsylvania; Sheraton Hotel and U. of P., Philadelphia, Pa., Feb. 20-22.

PACIFIC COMPUTER CONFERENCE, AIEE; California Institute of Technology, Pasadena, Calif., March 15-16.

BIONICS SYMPOSIUM, United States Air Force; Biltmore Hotel, Dayton, Ohio, Mar. 18-21.

IEEE INTERNATIONAL CONVENTION, Institute of Electrical and Electronics Engineers; Coliseum and Waldorf-Astoria Hotel, New York, N. Y., March 25-28.

ENGINEERING ASPECTS OF MAGNETO-HYDRODYNAMICS SYMPOSIUM, IRE-PGNS, AIEE, IAS, University of California; UCLA, Beverly, Calif., April 10-11.

OHIO VALLEY INSTRUMENT-AUTOMATION SYMPOSIUM, ISA, et al; Cincinnati Gardens, Cincinnati, Ohio, April 16-17.

INTERNATIONAL NON-LINEAR MAGNETICS CONFERENCE, IRE-PGEC, PGIE, AIEE; Shoreham Hotel, Washington, D. C., April 17-19.

ADVANCE REPORT

RADIO FREQUENCY INTERFERENCE NATIONAL SYMPOSIUM, IRE-PGRFI; Bellevue Stratford Hotel, Philadelphia, Pa., June 4-5, 1963. March 1 is the deadline for submitting a 250-word abstract to: Albert R. Kall, Technical Program Chairman, c/o Ark Electronics Corp., 62; Davisville Road, Willow Grove, Pennsylvania. Symposium theme is "new dimensions in rfi." Papers in the following rfi areas are specifically invited: instrumentation, suppression; system compatibility analysis; communications; special problems above 10 kmc; measurement problems in the vrf range. After selection of papers, authors will be requested to submit a 1,000-5,000 word summary for publication in the PGRFI Symposium Transactions.



SOLID STATE

IN

Electronics

Men of vision thrive here. And it takes men of vision to cope with today's electronics and space problems. Space in more ways than just up. Space problems of a different nature plague the manufacturer who must expand, but hasn't the land to expand on.

Here in Florida we have the space, the climate, the work force. Florida has more to offer electronics firms than any other area on earth. Men think better where life is pleasant, where off hours can be devoted to just plain *living*—and to just plain *thinking*.

Yes, Florida is a Solid State in Electronics. Already the sun, Mother of Life, shines on over sixty thriving electronics firms in our busy state.

Cape Canaveral is here, too, with its massive, awesome missiles blasting off to make space history. Electronics makes possible every thrust into the universe. Every hope of getting to the moon depends upon electronics—and the first American to the moon will definitely soar to history from Florida.

Engineers and their families dream of living here in Florida. Give them this dream by moving your plant here. Nurture the brains that will give your business a greater and greater stature in this, the Electronics Age.

For complete details of the many advantages Florida offers the Electronics Industry, write us. Let us tell you why some of the greatest names in electronics have impressive plants here in Florida.

FLORIDA'S ASSURANCE POLICY

"You have my personal assurance of a sunny business climate here in Florida. You have positive assurance of every aid and assistance possible from our Florida Development Commission and from the overwhelming majority of our businessmen, industrialists, and financiers. We have everything to make your large or small enterprise healthy and successful. Write, wire, or phone us TODAY. The only thing better than a FLORIDA vacation is having your plant here."



FARRIS BRYANT
Governor

Investigate

Florida

...A 10 BILLION DOLLAR MARKET

Ask about free film "Profile of Progress" FLORIDA FOR CONVENTIONS— Write for free information on Florida's wonderful facilities for your group meeting.



Mr. Wendell Jarrard, Chairman
FLORIDA DEVELOPMENT COMMISSION
Box 4247D, Tallahassee, Florida

Please send me brochure, "Why Your New Plant Should Be Located In Florida," containing the facts about FLORIDA's opportunities for New Industry, the 10 BILLION DOLLAR CONSUMER MARKET, Labor, Climate, Schools, Natural Resources, Favorable Tax Structure.

Name.....

Firm Name.....

Address.....

City..... Zone..... State.....

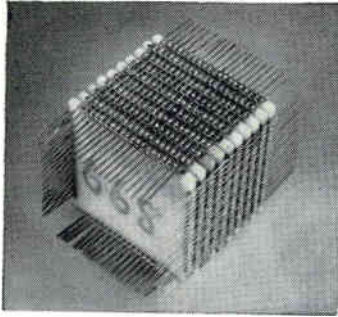

Micro assemblies of 0.030-inch thick alumina wafers with riser wire interconnections welded by a new Hamilton Standard electron beam technique.

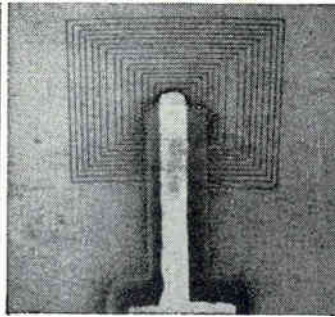

Thin film inductor, consisting of titanium film on an aluminum oxide wafer, scribed by high-power density Hamilton-Zeiss cutting equipment.

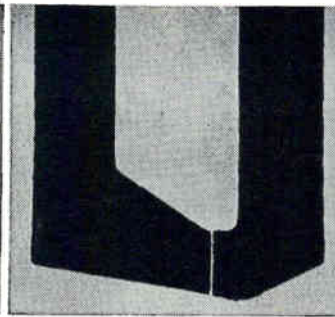

Ferrite memory core, 0.005-inch thick, with slots cut by electron beam. Slot widths: 0.0005- to 0.001-inch.

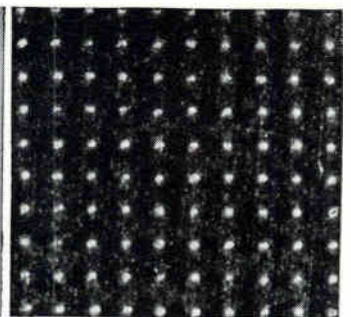

Grid screen of .003" diameter holes on .010" centers drilled in .020" stainless steel sheet.

NOW — THE FIRST COMPLETE MICROMINIATURE PRODUCTION TOOL

The new Hamilton-Zeiss Electron Beam CW-1 Cuts, Welds, Drills, Scribes

The new Model CW-1 Electron Beam Cutter-Welder is the most advanced machine yet developed for work in microminiaturization. With CW-1 equipment, you can fabricate complete microminiature assemblies, cut, scribe and drill thin film and solid state components. You can also weld necessary leads without distorting the workpiece. And the vacuum chamber provides a contamination-free environment with a bonus in "free" vacuum for hermetic encapsulation operations. Almost all metallic elements and many nonmetallics including aluminum oxide, quartz, and ceramics, can be processed by the CW-1.

The new CW-1 can cut and drill shapes of practically unlimited geometries for fabrication of micro-storage devices. All materials that are chemically and metallurgically compatible may be welded without distortion or contamination, and heat-affected zone is for all practical purposes eliminated. For the first time, you can fabricate thin film resistors and capacitors to extreme accuracies by "in-process" monitoring and corrective feed-back, thus eliminating high reject rates and selective assembly techniques.

Heart of the CW-1 is a highly developed electron gun and electron optical system providing a focused spot diameter of .0005" or less. The system operates at a maximum accelerating voltage of 150 KV and provides currents to 15 Ma during pulsed operation

providing nearly 10,000 megawatts per square inch at the workpiece. Such extremely high power densities permit the cutting of any material known today.

UNIQUE FEATURES OF THE MODEL CW-1

- A *Zoom Type Binocular Optical Viewing System* (14X to 40X) provides stereo-effect microscopic examination of the workpiece at all times permitting precise positioning and eliminating the need for removal of the workpiece for inspection. Fabrication and inspection can be combined in one operation.
- A *Precision Beam Deflection System* permits programming of the beam (workpiece stationary) over the workpiece in any pre-selected pattern using electronic programming* and simple external control knob adjustments.
- A *Precision Work Table* with all backlash eliminated provides positioning accuracies to .0002".
- *Polished Stainless Steel* is utilized on the inside of the work chamber and on all apparatus exposed to the work chamber, thus providing an extremely clean workpiece environment free from corrosion, outgassing and extraneous contamination.
- *Tape Controlled Programming.** Operation of the CW-1 can be fully automated. Beam deflection and table position can be programmed on tape using conventional industrial numerical controls.

*With optional equipment at extra cost.

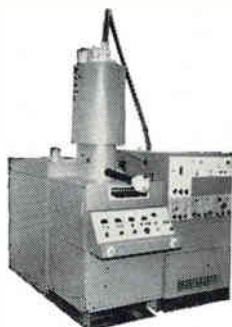

For complete information on the Model CW-1, contact: Sales Manager, Electron Beam Machines, Hamilton Standard, Windsor Locks, Conn.

Hamilton Standard DIVISION OF UNITED AIRCRAFT CORPORATION



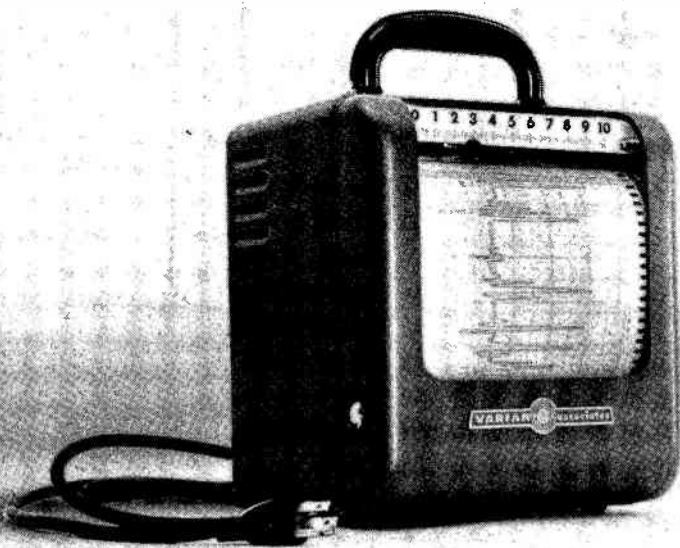

It's just like buying a custom-built recorder!

With so many standard options from which to choose, it takes a bit of extra effort to buy a Varian G-11A recorder. But most of our customers don't seem to mind at all. After all, where else could they buy a compact, reliable potentiometer recorder custom-built to their exact specifications at such a reasonable price?

Here are just a few of the many options which the G-11A offers: you have a choice of input circuits for measuring voltage, current or temperature; a choice of one, two or four chart speeds from $1/8$ " /hr up to 60"/min; a choice of voltage spans from 10mv to 100v — temperature spans from -200°C to $+1500^{\circ}\text{C}$; a choice of reference voltage — mercury cell or zener diode; and a choice of many other options including

ink or inkless writing, event markers, zero center scale, field span adjust, and rack mounting.

Best of all, no matter which options you select for your G-11A, you still have a light-weight, reliable recorder with 1% limit of error and a pen speed of 1 second full scale.

Wouldn't you like to have your next recorder custom-built? For complete information on prices and all available options, see your Varian Recorder Representative or write the INSTRUMENT DIVISION.

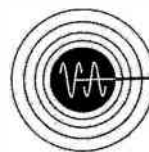

VARIAN associates

PALO ALTO 1, CALIFORNIA

PUMPS • VALVES • BAFFLES • GAUGES VACUUM COMPONENTS

DIFFUSION PUMPS



Only NRC offers a full line of high-speed diffusion pumps with all these important advantages:

- No super-heating... minimizes pump fluid decomposition.
- Fractionating jet assembly... constantly purifies pump fluid... lower pressures can be held longer.
- Patented Cold Cap*... an NRC exclusive... cuts back-streaming 98%.

Available now in 4", 6", 10", 16" and 32" sizes for all your high vacuum testing and production applications, where performance and reliability really count.

*Licensed exclusively from Edwards High Vacuum Limited. U. S. Patent No. 2919061.

SLIDE VALVES



New NRC Slide Valves (HC Series) are very-high and ultra-high vacuum valves at conventional prices. Pressures of 10^{-8} to 10^{-10} torr range have been produced... without baking... in vacuum systems using these valves. 100% clear opening and low height provide highest conductance. Double-pumped stem seal cuts gas bursts 99%. They're available in 4" and 6" sizes, either hand or air operated.

CRYO AND MOLECULAR BAFFLES



Now, your high vacuum system can be operated at lowest pressures for extended periods of time with no detectable trace of hydrocarbons reaching the chamber! The reason: NRC's Circular Chevron Cryo Baffle and the all-new NRC Molecular Sorbent Baffle (which utilizes three full trays of zeolite) virtually eliminate back-migration of pump fluid vapors. Yet, they provide exceptionally high conductance for maximum useful pumping speed.

VACUUM GAUGES

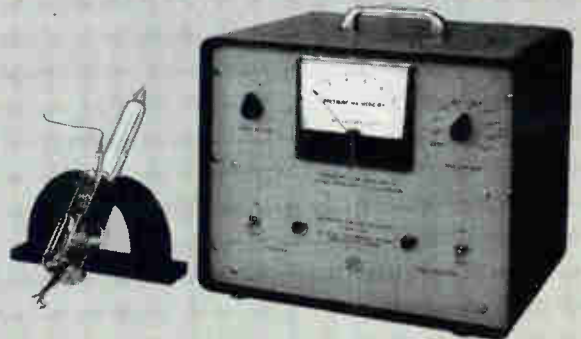

Get accurate, reproducible direct-readings to 10^{-13} torr with the new NRC Model 752 Red-head Magnetron Gauge! The only really satisfactory gauge commercially available for measurements below 1×10^{-9} torr. Increased current readings provide 50 times the sensitivity of hot-wire ionization gauges. Because there's no hot filament, it's magnitudes less "gassy", can't become contaminated by vaporizing of gauge elements. And the 752 Gauge is not X-ray limited.

NRC's full line of vacuum gauges and controls also includes an improved Bayard-Alpert type gauge, Model 751, for accurate, reliable measurement in the 1×10^{-3} to 10^{-10} torr range.



A Subsidiary of National Research Corporation

160 Charlemont St.
Newton 61, Massachusetts
Area Code 617, DEcatur 2-5800

All of the above components are stock items. Write today for product data sheets. Let us show you how NRC components can improve the performance of your high vacuum system.

MANUFACTURING PLANTS IN NEWTON, MASSACHUSETTS AND PALO ALTO, CALIFORNIA

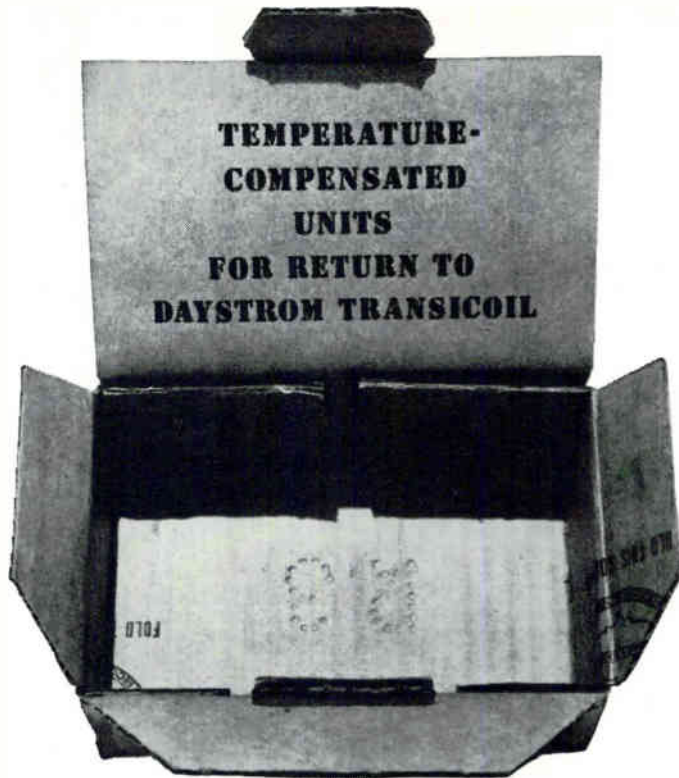

A Month's Rejects

Transicoil delivers highest volume with lowest reject rate on precision temperature-compensated motor tachometers.

Daystrom Transicoil's claims to lowest reject rate rest squarely where such claims are proven: at the customer's incoming inspection. Coupled with this reliability, moreover, is our ability to deliver on schedule in volume. In fact, Daystrom Transicoil is the largest known producer of temperature-compensated motor tachometers.

In recent months, systems requirements have become increasingly stringent for component reliability. Our Size 11's have successfully met this challenge in such systems as the F-104, A3J, Pershing, Hound Dog, Mirage, and a number of other systems as yet not even officially designated by name. Most delivery promises have been met . . . and even bettered. Why don't you check the specs at right, then find out for yourself how our temperature-compensated motor tachometers can meet your own requirements?



DAYSTROM, INCORPORATED
TRANSICOIL DIVISION
 WORCESTER, PENNSYLVANIA
 TELEPHONE 215-584-2421

SIZE 11 TEMPERATURE-COMPENSATED TACHOMETER ELECTRICAL CHARACTERISTICS	
INPUT VOLTAGE (V)	115
INPUT POWER (W)	5.5
INPUT IMPEDANCE (OHMS)	1500
INPUT CURRENT (A)	0.077
OUTPUT IMPEDANCE (OHMS)	5000
OUTPUT VOLTAGE (V/1000RPM)	2.75
MAX. NULL RMS (VOLTS)	0.020
LINEARITY (%)	0.07
SIGNAL TO NOISE	140
PHASE SHIFT AT 25°C (DEG.)	0±0.5°
SCALE FACTOR VAR. W/TEMP.	±0.5%
PHASE SHIFT VAR. W/TEMP.	±0.5°
	-55°C to +100°C

NEW SELF-DECODING NUMERICAL READOUT AND PULSE COUNTER

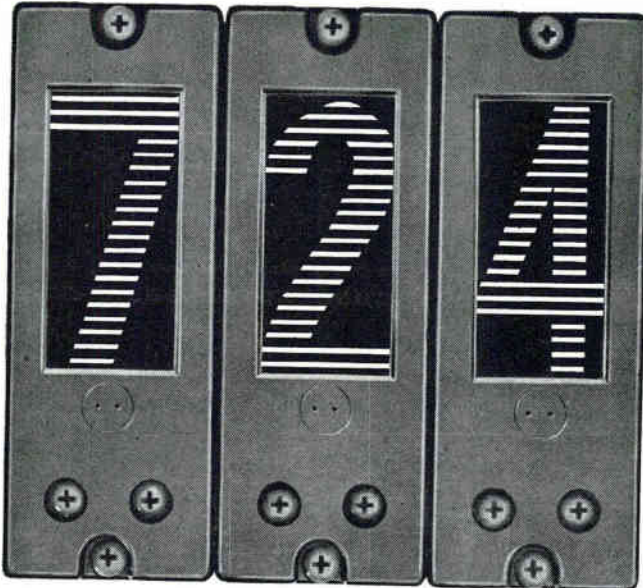

QUANTITY PRICES FROM \$40.00 EACH

■ The new Kauke readout is a simple, rugged, visual display unit that converts 1-2-4-8 code, parallel input, into numerical characters. ■ It is electro-mechanically operated, with enclosed construction, and features single or grouped front panel mounting with exceptionally wide-angle viewing. ■ Simple and inexpensive accessories broaden its use to provide a wide variety of applications and special conditions.

DESIGN

Character is changed by simple stepping motor . . . can be used as decoder or counter (up to 50 steps per sec.)

MEMORY

Once the displayed character corresponds to input code, the character is retained indefinitely.

POWER

Low drive power, only 200 ma at 24v. No drive power is used while character is being displayed.

APPLICATION FLEXIBILITY

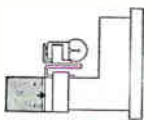

Plug-In Adapter
Allows for 4-line parallel input from low level logic.

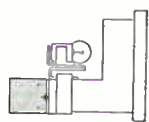

Count Module
Provides carry pulse, simultaneous zero-set, and verification.

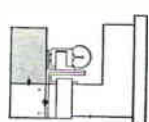

Buffer Storage
Accepts microsecond logic input while previous input appears.

■ Write today for complete detailed specifications.

KAUKE and COMPANY, INC.
E-M Products Division
1632 Euclid Street • Santa Monica, California

BUDELMAN

POINT-TO-POINT
Economical • Reliable • Effective

2KMC

Type 14C Microwave Radio Terminals

provide needed communication and data transmission for railroads, telephone companies, public utilities, public safety services and the armed forces. Whether for a "thin-route" gap filler or a 48-channel multi-hop system, Budelman Type 14C, 1700-2300 MC Microwave and Speech Multiplex equipment "proves in" where others cannot.

Write for Spec-sheets, Engineering Analysis or Systems Proposals...
without obligation.

BUDELMAN ELECTRONICS CORP.

A Subsidiary of General Railway Signal Co.

375 Fairfield Ave., Stamford, Conn. • 203 FI 8-9231

CIRCLE 202 ON READER SERVICE CARD

DRG-DTH

HAMLIN
magnetic reed
SWITCHES

the largest selection
ever offered . . .

The use of magnetic reed switches has been increasing by leaps and bounds, and Hamlin engineers have set the pace with the greatest selection. All standard varieties, of course, plus . . .

- DRM-001 High Voltages (up to 5000 v)
- DRG-DTH Double Throw (Form C)
- DRR-5 Heavy Duty (up to 50 v amp.)
- DRS-5 Heavy Thrust (in-rush to 15 amp.)
- HRC-1 No-Bounce (Mercury wetted)

and many more designed for special requirements . . . YOUR specifications. Send for literature.

SEE IT! HEAR IT!

FREE CARD
with magnet
and switch

HAMLIN

Dept. EL • LAKE AND GROVE STREETS • LAKE MILLS, WISCONSIN

CIRCLE 203 ON READER SERVICE CARD
CIRCLE 41 ON READER SERVICE CARD →

THE REAL DIFFERENCE IS INSIDE



■ That's right — we cut the can away . . .

You are looking at the most critical area of Motorola's PNP germanium epitaxial mesa transistor — the die itself. Magnified over 50 times, this unretouched photograph enables you to see clearly the emitter and base stripes and their lead wires.

Most engineers have never seen the inside of a Motorola transistor. Clean, isn't it? Critical controls must be maintained in order to produce such units . . . controls that have a significant effect on the ultimate reliability of a transistor.

Notice the sharp, uniform metallic deposition of stripes . . . the precise control of stripe area, definition, and spacing. Motorola controls these dimensions to within one ten-thousandths of an inch. This care and skill is indicative of that taken throughout all phases of Motorola mesa transistor production, from the growth of epitaxial layers controlled to millionths of an inch to literally controlling the number of molecules of surface moisture necessary for optimum transistor performance.

Such precision may not be required to build a transistor that merely meets minimum performance standards. However, it is essential for the production of devices that will provide the continued reliable operation that has become synonymous with the name Motorola Mesa.

But, don't take our word for it . . . the next time your Motorola representative calls, have him open one of these mesa devices for you. Compare its obvious mechanical perfection with that of any other transistor on the market today.

You'll discover for yourself why Motorola high-frequency germanium mesa transistors were chosen to meet the highest reliability level of any transistor used in the critical Minuteman missile program . . . and are currently specified in applications demanding the most stringent reliability and performance requirements to date.

Compare it with others . . .
THE REAL DIFFERENCE IS INSIDE!



MOTOROLA

Semiconductor Products Inc.

A SUBSIDIARY OF MOTOROLA INC.

5005 EAST McDOWELL ROAD • PHOENIX 8, ARIZONA

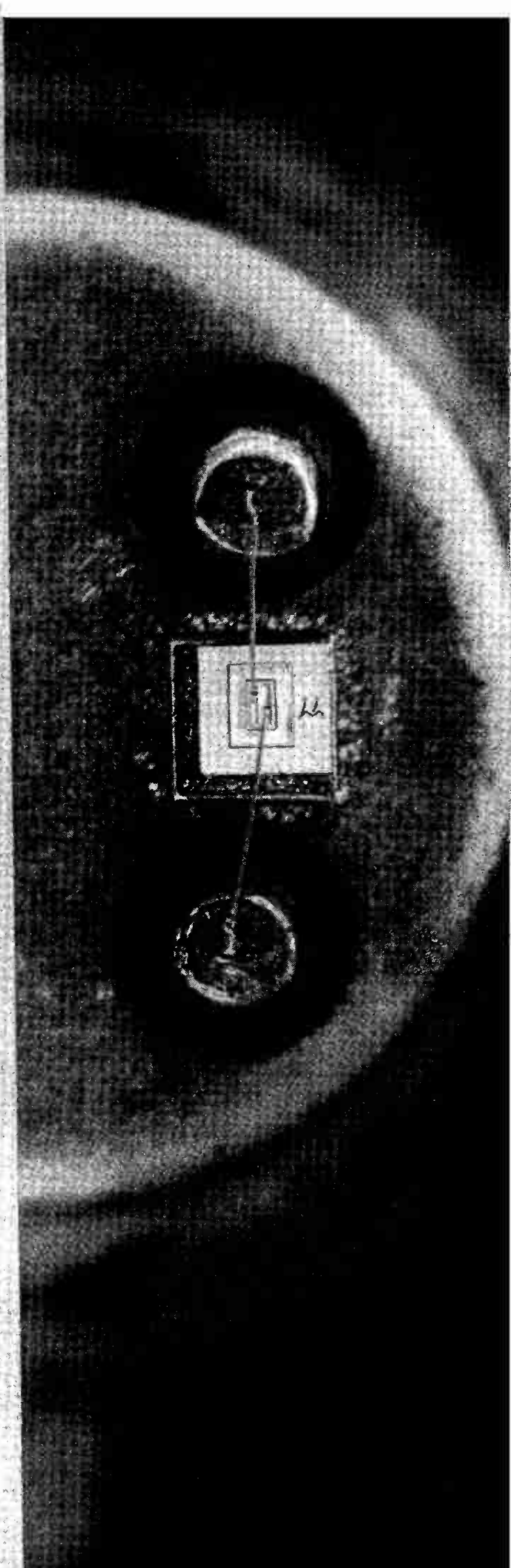

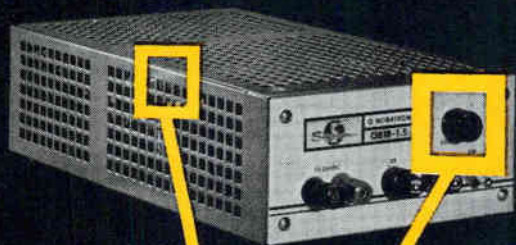

WHEN



GREAT NAMES GET TOGETHER...

... something good is bound to happen ... like the introduction of Sorensen's QB Series transistorized low-voltage dc power supplies.

This great-name firm wanted to deliver the best. They used the best: Clarostat Series 43 2-watt wire-wound potentiometers.

Clarostat Series 43 pot was a natural selection. Long a favorite of industrial equipment manufacturers, the Series 43 offers a wide variety of mounts, terminals and shaft configurations. Available in resistance tolerances of $\pm 10\%$ or closer from 1 to 50K ohms, the Series 43 is designed to do its job ... and then some! It is an obvious choice of great-name manufacturers who **will not compromise with quality.**

Sorensen, a unit of Raytheon Company, wanted — and got — the finest ... Clarostat. If you're a great name (or would like to be one) contact Clarostat ... today.

CLAROSTAT

CLAROSTAT MFG. CO., INC. DOVER, NEW HAMPSHIRE

ELECTRONICS MARKETS 1963

WHAT THE FUTURE HOLDS

By LEON H. DULBERGER Associate Editor • BEN ANELLO Mgr., Market Service Dept.

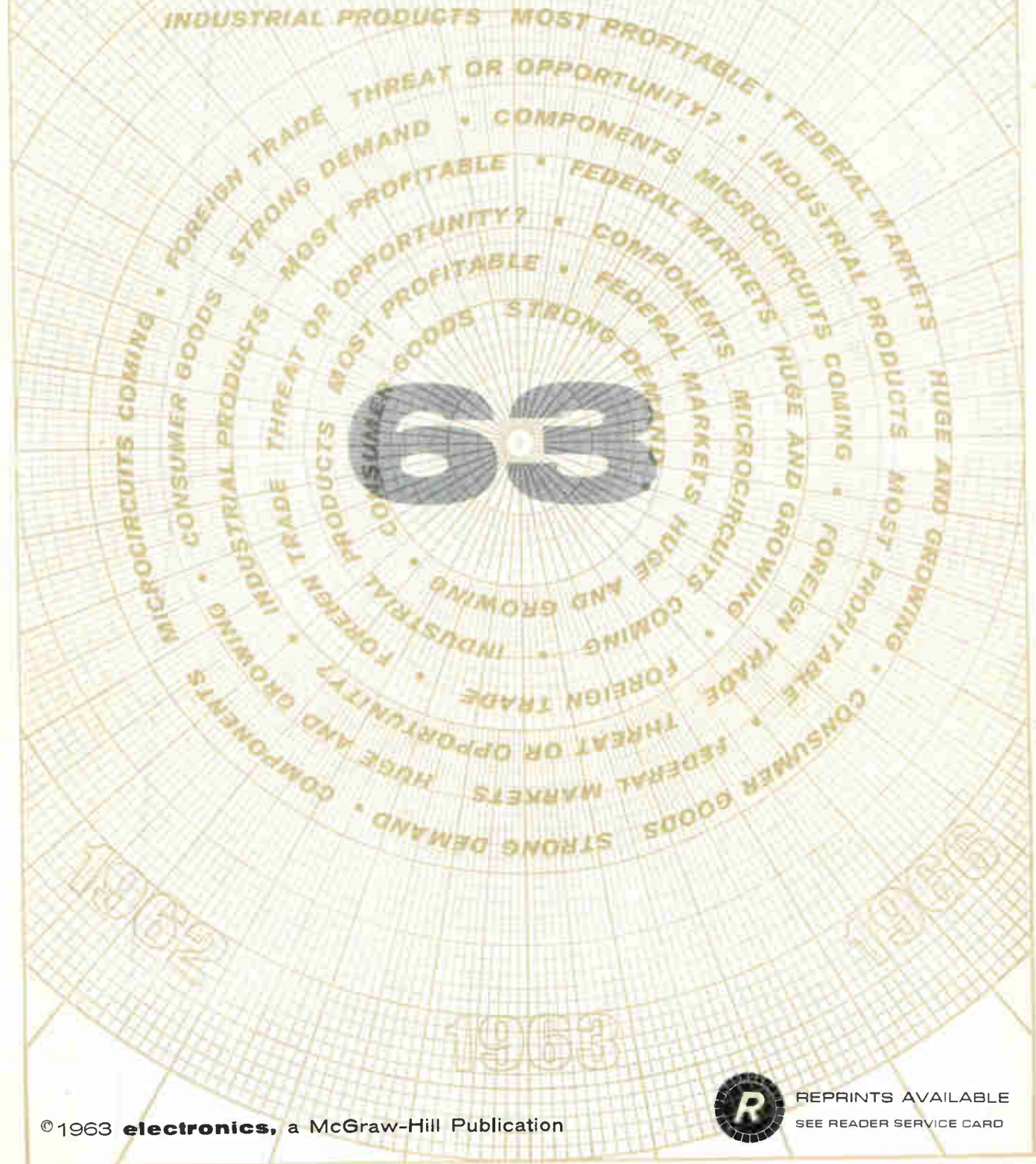

IN A NUTSHELL: • Industrial products lead profit parade. Data communications and reduction, industrial controls and computers show strength • More color-television programming boosts consumer interest in sets • Key points in military buying: big command and control systems, equipment for limited war • Microminiature techniques sweep into components industry • Foreign competition grows, so do opportunities for sales abroad

ELECTRONICS MARKETS 1963

INTRODUCTION

THE FUTURE HOLDS CONTINUED GROWTH for all segments of the electronics industry, on an increasingly selective basis. The combined impetus of space exploration, industrial needs, increasing military preparedness and consumer product demand, will produce increasing sales. International markets and competition are growing factors in electronics. Government contracts are being awarded with care, and overcapacity is besetting some segments of the industry, notably components.

INDUSTRIAL ELECTRONICS APPLICATIONS are burgeoning in industrial control, data processing and data communication. Jobs once done mechanically are now done increasingly with electronics. Test, measurement and control instruments are being used in new industries. High-volume communications systems are multiplying. Ultrasonics, cryogenics, lasers and teaching machines are opening new markets. New navigation systems for aircraft and ships are under development.

SPACE RESEARCH is creating markets for ground tracking gear, telemetering systems, guidance and check-out equipment. Research to achieve space goals is creating a host of new components and technologies that find use on earth too.

MILITARY SPENDING is aimed at increasing limited-war capability, creating command and control systems for hardened missile sites and portable operations. More communications facilities are a must, and procurement for missiles, surveillance equipment, tactical aircraft and phased-array radar is increasing. Antimissile and anti-submarine research is continuing, and reliability and electromagnetic compatibility of equipment is receiving greater attention.

Air-traffic-control spending is up, and nuclear reactor control and instrumentation devices are selling faster.

CONSUMER ELECTRONICS is receiving a boost with increased demand for color television, and more firms building color tubes and sets. Stereo f-m is growing, as well as high-fidelity sales. All-channel tv—providing vhf and uhf coverage—will improve future b&w receiver sales.

COMPONENTS are phasing into microminiature production techniques, with military R&D leading the way. Integrated circuits, thin films and molecular electronics are receiving attention. Transistor unit sales are up, and military and industrial uses of vacuum tubes continue level. The military is trending toward greater use of transistors, and planning more microelectronic circuits in future projects. Overcapacity in the component industry is causing some concern.

INTERNATIONAL SALES by American electronic firms to all parts of the world is rising; but foreign competition is viewed as an increasing problem by many U. S. firms. Imports of consumer electronic products, from Japan and other countries remains high. Exports of U. S. industrial and military equipment will go up, especially, computer and data processing systems.

MORE EFFICIENT MANAGEMENT of electronic firms, particularly those dealing with the military, must evolve in the next seven years. Because of growing competition, profit margins are shrinking in government contracts. It will be the job of management to cut costs, to realize a full allowable profit. Observers believe that profits in the future can actually be higher than in the past.

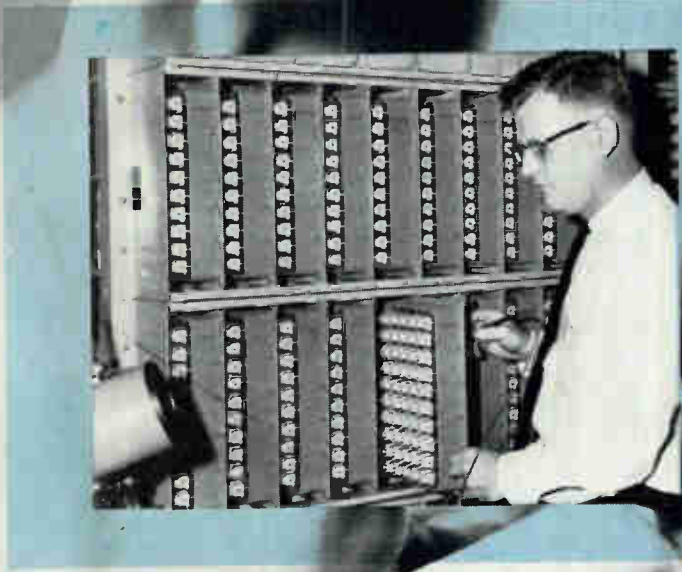

ELECTRONIC TELEPHONE EXCHANGE (inset), developed by Automatic Electric Co., a subsidiary of GT&E, is compatible with electro-mechanical switching equipment. Magnetic switches in hermetically sealed capsules (above) are used in switching matrix

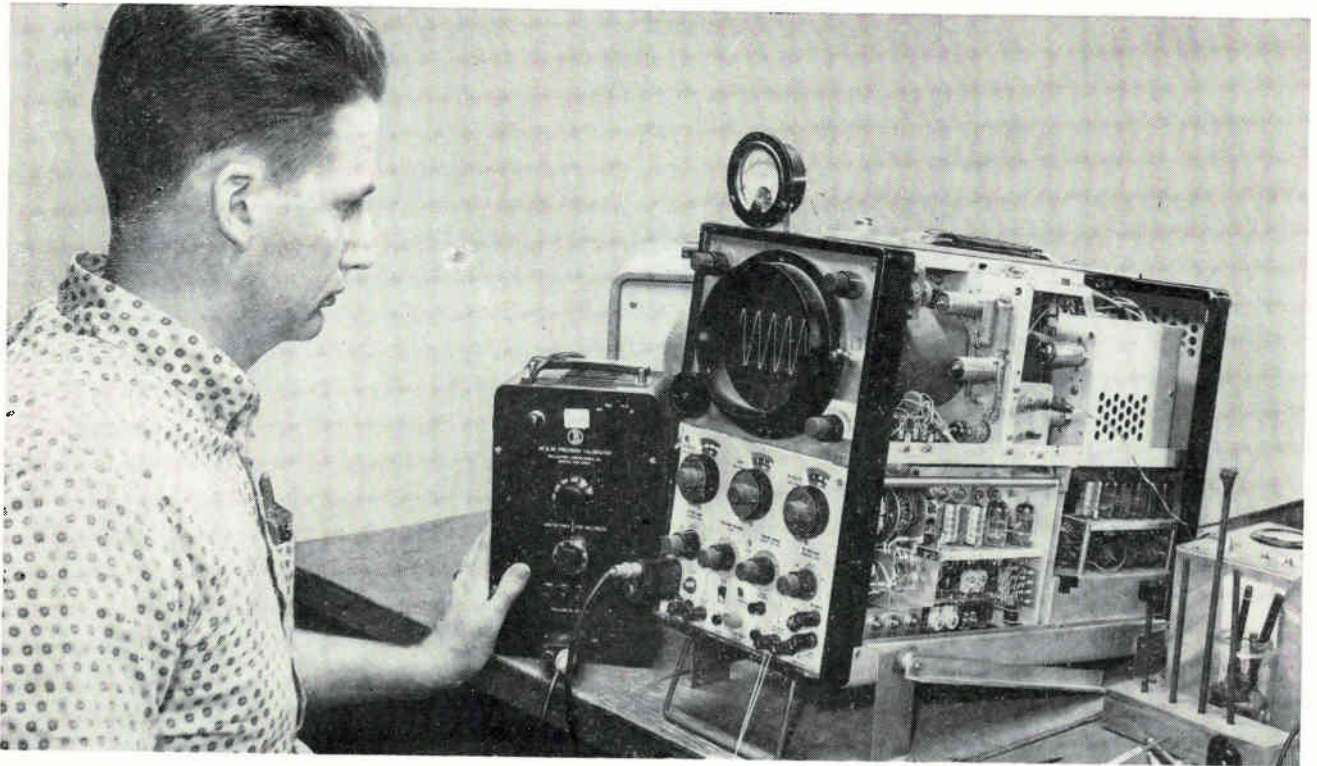

PRECISION D-C and A-C VOLTAGES are generated by Ballantine Laboratories calibrator (left) shown providing stable reference standard in oscilloscope calibration. Standards instruments and devices represent a maturing market

INDUSTRIAL PRODUCTS

TEST INSTRUMENTS—Sales of test instruments for measuring electrical parameters are burgeoning. The market for instruments for industrial and scientific use is also growing rapidly.

The cornerstone for achieving market penetration is designing increased measurement precision, accuracy and repeatability into new instruments. Contemporary instrumentation and system requirements, for both industry and the military, demand better measurement performance than previously acknowledged. Frequency heads the list of parameters that must be measured more accurately. In industrial and scientific instruments temperature and pressure measurements are desired with improved precision and repeatability.

TEST STANDARDS—A new and active market is developing for instruments and components designed to perform calibration checks to maintain the increased accuracies of new measuring instruments. While still only a fraction of the dollar volume of the test instru-

ment business itself, test standards show promise of being a profitable area for new sales efforts.

These test standards range from accurately measured capacitors and inductors to accurate frequency and voltage-generating devices.

Standards labs are springing up across the U. S., contracting to maintain the accuracy of a plant's entire complement of test equipment. These firms perform periodic checks and recalibration of instruments, based on historical knowledge of when to service each instrument. A standards lab may earn several hundred thousand dollars a year from a single account.

Digital readout for instruments is enjoying rising popularity. Advantages cited include greater facility of use by semitechnical personnel, nonambiguous display; and in printed readout devices, records of each reading.

Among the digital readout methods, the largest number of instruments employ numerical glow tubes, followed by electromechanical devices, and electroluminescent (solid-state) devices. There is rising interest in



LASER WELDING promises to be one of the most fruitful applications of this new device. A Hughes Aircraft Company scientist prepares to fire a forced-air-cooled, ruby laser in a welding experiment



LORAN NAVIGATION equipment is favored by maritime operators. Position coordinates of ship at sea are obtained by officer using Sperry Gyroscope Co. receiver and world-wide loran network. Commercial loran C receivers are predicted

MOST PROFITABLE

electroluminescent digital readout and General Telephone and Electronics Laboratories Inc. predicts extensive instrument applications of el devices during the coming year.

While several transistor operated test instruments have appeared during the last few years, general opinion seems to reflect moderate enthusiasm for such instruments unless portable operation, small size and low primary power drain are important requirements. Vacuum tubes lend themselves directly to the solution of most instrument design problems without specialized design techniques and environmental qualifications demanded by transistors—some instrument designers declare.

One of the greatest opportunities for profitable introduction of a new instrument line lies in industrial and scientific instruments. An example is the nuclear scintillation counter. It may be used to measure energy level of a radiation tracer introduced into a material for evaluation of wear; as in tire studies. The instrument

uses electronics for its operation, but measures a non-electronic variable.

MEDICAL ELECTRONICS—The big money maker in medical electronics is still x-ray equipment, both for diagnostic and therapeutic applications.

The growth of other aspects of the medical electronics market is healthy, but industry observers no longer speak of immediate spectacular sales gains. Attempts to achieve volume markets for patient monitoring systems still await acceptance by medical leaders, and further R & D. One industry spokesman points out that psychological resistance by patients, already sick and often old, against being instrumented physically with necessary sensors, is a problem. Also, the varying sizes of human organs require that sensors be developed to comfortably fit all variations encountered.

The possibility of using remote pickup techniques, such as infrared devices to measure a patient's temperature, remote sonic systems for breathing rate, or mattress

sensors, have been suggested as a promising avenue of research.

The concept of instrumenting a patient while he is being operated on, and the information obtained is vastly important, has the charm that the patient is not conscious and objecting to this instrumentation. Equipment for this use is expected to find great application.

Computer analysis of electrical recordings of heart and brain-wave patterns as well as x-ray negatives, will come into greater use in the future.

Remote diagnosis based on such records will be done by computer analysis at medical centers, and may in time lead to development of a medical tape history of all children from birth, which will be kept up to date and referred to when illness develops. This is a long way off, however.

A small market will develop for specialized medical electronic devices, for both diagnostic and therapeutic tasks. One possibility is equipment to take an infrared profile of the human body as a means of detecting tumors, which would show up as a hot spot. More use of fiber optic devices to allow inspection through body openings is expected. Ultrasonics for therapeutic use is receiving more attention, and lasers for eye surgery will become more common.

Remote manipulators for x-ray systems will see wider application, as a means of reducing radiation hazards to medical personnel, in many new medical x-ray installations. Also, much work is being done on faster x-ray films, for greater safety and picture definition.

Electronic industry experts believe that marketing men must consult with medical experts in the field before developing instruments for them. It has been cited that the electronic stethoscope does not serve a real need, as doctors do not use the traditional acoustic type to gain acoustic sensitivity. Rather it is an esthetically more acceptable technique to their patients than the ear-to-the-chest-method, and prevents the spread of disease. Thus, electronic stethoscopes serve no real need, many doctors claim, and therefore have not found major acceptance.

INDUSTRIAL CONTROL—Applications of industrial control electronics are expanding rapidly, and this field represents one of the brightest areas for profitable growth in the entire industry.

Telemetry and control systems for oil and gas pipelines are still being perfected, though there are several installations, and growth is expected at an increasing rate.

Numerical control for machine tools is receiving greater attention, and those aspects of industrial control generally thought of as automation are becoming more prevalent.

However, firms using industrial control systems are becoming more realistic about their purchasing standards. There is no longer a desire to prefer electronic solutions to problems, rather than mechanical or electromechanical ones, unless the electronic equipment does the job better. Reliability of systems must be demonstrated in advance, and some observers feel this places companies with a healthy history of performance in industrial electronic control in the best position for future business.

Buyers insist that a firm be able to get behind the systems they sell, and maintain them efficiently.

Several industrial experts agree that automation and

industrial control techniques have often been applied, in the past, where a human might have actually done the job more efficiently, or at lower cost. This has led to a more careful look at the jobs within plants, and a tendency to employ controls selectively, without going overboard. It is predicted that in the long run, this will engender greater use of electronics, and cause increased acceptance among those still enamored of using mechanical or pneumatic techniques to do the job; because automation projects using electronics will have established a record of success.

However, when a man can do the job best, planners will be more receptive to his use over any kind of control system. This will not retard the growth of industrial controls, rather assure that they will be applied where they are really needed.

DATA PROCESSING—Strong growth is predicted in the data processing field, including greater use of data communications. It is expected that major emphasis will be on information storage and retrieval, with a variety of new methods offered for storage of bulk material.

Most observers feel that data processing represents one of the best areas of profitable operations in electronics, for those firms with the requisite experience. A drop out is believed to be probable for some firms now engaged in marginal operations in this field. One type of marginal operation might be the attempt to sell to industry designs originally conceived and marketed to the military, such as a special-purpose computer, unsuited for industrial applications without extensive redesign. Often the firm promoting such a product lacks the large engineering staff required for redesign.

Oversell in data processing systems, has given rise to the phrase "garbage-in, garbage-out" to denote the cases where extensive data-reduction systems have been bought by industry (and the military) to do jobs that might better be handled with simpler manual operations. A greater sophistication in selection of data processing in the future is certain, with the customer demanding solid experience and the ability of the manufacturer to recommend optimum equipment for a job.

DIGITAL COMMUNICATIONS—Most electronics planners feel that one of the strongest areas of future growth lies in the digital communications field. One estimate places the number of business data machines of all types now transmitting over circuits at 6,000; with over ten times that number expected in similar service in four years.

Data communications may well be the largest single market in the 1960's.

COMPUTERS—Increased use of thin-film memories, and new and higher speed ferrite memories will be employed in new computers. For high-density applications, techniques such as thermoplastic recording will receive attention.

Computer applications abound, many of them linked with industrial process-control.

Several banks have installed on-line computers to handle savings accounts. Important advantages to the customer include being able to deposit or withdraw at any branch of the bank. Waiting time at a teller's window has been cut to a minimum, and the customer can go to any teller, instead of having to go to a certain group of

windows. Advantages to the bank include time saved in balancing cash at the end of the banking day.

COMMUNICATIONS—Both radio and wire communications will continue to grow in volume throughout the world. The desire to achieve practical satellite communications will see increased effort by major firms and the government to produce high-volume, 24-hour-a-day, systems.

Right now some 500 circuits are available to carry voice by cable or high-frequency radio from the U. S. to overseas points.

By 1970, General Telephone and Electronics Corp. estimates, 3,000 circuits will be needed to satisfy the demands of voice, data, and image traffic, not including international television.

Data communications will be one of the fastest growing areas of the electronics industry. It will be a common thing for computers and other business machines to "talk to each other."

Millimeter wavelengths will see development exploiting untouched areas of the radio spectrum and handling specialized applications such as plasma sheath penetration in space operations.

Microwave communications will expand, with foreign markets opening rapidly for systems operating in this frequency range.

Optical communications techniques will see active research and systems development, with the great bandwidth capabilities of this medium attracting planners with high information density requirements. Among others, General Electric is exploring this field, with a closed-loop optical television link possessing a five-mile range.

ULTRASONICS—The applications of ultrasonic techniques in industry are expanding rapidly, and assure specialists in this field an excellent market.

New research is being carried out in various techniques from microdeburring of microminiature components to control of solid rocket propellant burning rates. In the electronics industry itself, ultrasonic cleaning is now firmly entrenched, according to R. L. Jeffery, president of National Ultrasonic Corp. He explains that white-room concepts now prevail in the industry, and final cleaning of components, subassemblies and micromodules by ultrasonics, is prevalent.

Jeffery indicates that cold welding using ultrasonics is of growing importance to avoid damage to sensitive components, and that ultrasonic plating to achieve a fine deposition of precious metals, and also for printed circuit work, is getting attention. Ultrasonic removal of dust, dirt and oxides from magnetic tape helps to eliminate much of the costly information "drop out" problem.

Liquid-level sensing; thickness testing; drilling of easily damaged parts; defoaming in liquid flow or filling operations; drying of granulated, porous or fibrous materials; are other areas of research or growing application.

Ultrasonics is finding application in counting of objects, such as automobiles entering or leaving parking lots, where nonambiguous counting is a must. Medical use of ultrasonics is also growing.

OCEANOGRAPHY—The present interest in oceanographic research by physical scientists and antisubmarine warfare researchers will produce a fallout of techniques

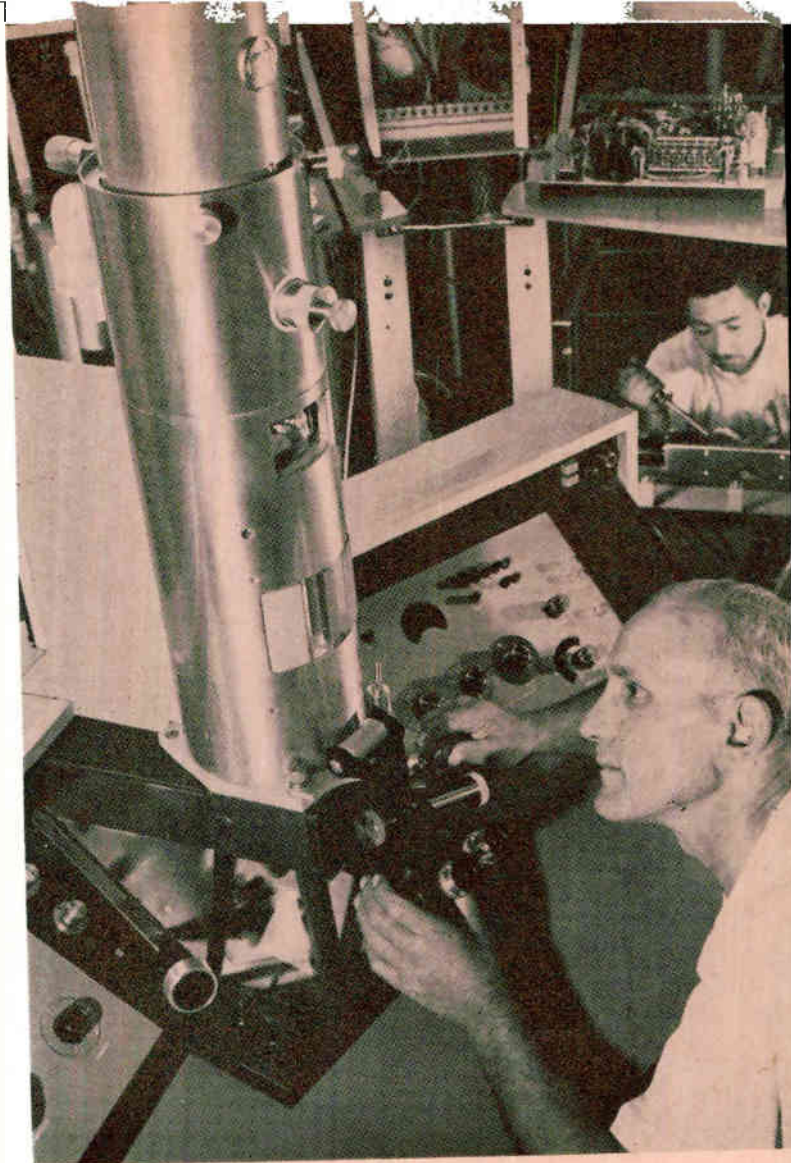

ELECTRON MICROSCOPE under final assembly at RCA. The instrument is widely used in medical and scientific research. It employs 50 vacuum tubes, allows photographing objects one million times thinner than a human hair.

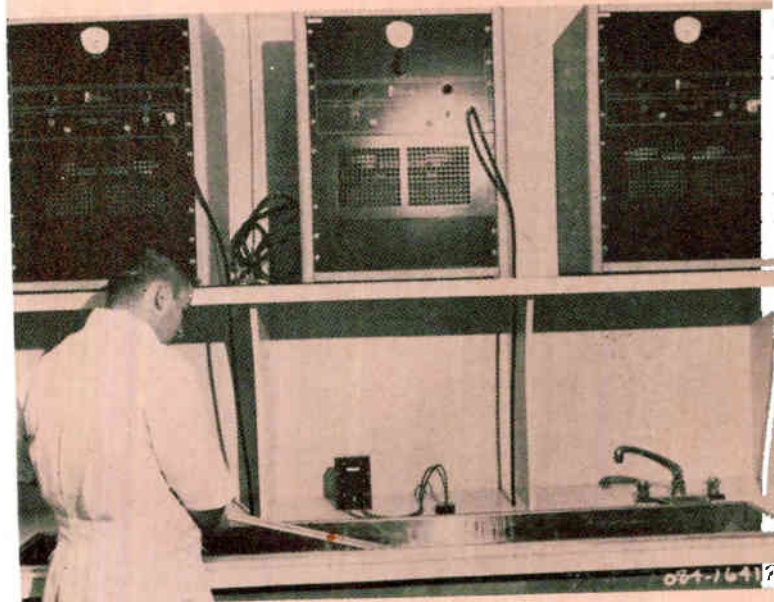

ULTRASONIC CLEANING equipment installed in white room, shown in use on missile components. These 500-watt generators by National Ultrasonic Corp. drive barium-titanate transducers at Martin-Marrieta Corp. installation

and equipment designs that will spark strong industrial activity undersea.

We are engaged in a general age of ocean explorations, leading to an understanding of this environment; and finally to increased commercial operations in the medium, using electronics. Right now, some \$15 million is spent each year in commercial electronic oceanography.

The studies now being conducted of ocean currents and the development of instruments to measure them, will find use in ship salvage operations. There are many wrecks on the ocean bottom, containing still valuable cargo.

Salvage operations will be effected in the future with the help of undersea handling equipment, positioned with sonar and optical sensors, including tv.

Exploitation of undersea mineral and food supplies in the future will lead to a mining and perhaps farming industry carried on beneath the surface. A general knowledge of the character of the ocean, gained with the aid of oceanographic instruments will increase yield, a spokesman for Loral Electronics Corp., states.

Loral expects that their line of undersea one and two man craft, heavily instrumented with electronic sensors, will find application in this field.

Underwater equipment maintenance of offshore oil rigs and dock facilities will foster development of salinity and corrosion measuring instruments.

The growing problem of nuclear waste disposal will require development of oceanographic techniques, using electronic devices, to monitor ocean currents and radioactive leakage.

NAVIGATION SYSTEMS—Commercial application of navigation systems will probably see its largest increase in airborne systems. Jim McSweeney of Sperry Gyroscope Co. predicts development of inertial navigation systems for use by commercial airlines in time to meet the requirements of supersonic airliners now being developed. This may occur by 1968. He points out that inertial navigation with its inherent high accuracy will be needed to obtain maximum utilization of airspace. It will give instantaneous readout of position, important at speeds in excess of Mach one.

These systems will use an inertial platform, gyros, accelerometers and computers. They will obviate the need to shoot the stars and make radio contact to get a d-f fix. No ground-support equipment is required for an inertial navigation system. About two to three more years of military experience with such systems is required to allow development of a suitably inexpensive equipment for commercial use to begin.

Maritime use of inertial navigation systems is not apt to come about, Mr. McSweeney believes, as shipping firms do not have the time saving requirement faced in the air. Instead, loran coverage of shipping lanes will increase, and commercial loran C receivers will be developed. These receivers will read out directly in latitude and longitude, but must be inexpensive to find acceptance.

NASA is talking about a commercial navigation satellite of lower accuracy than Transit for use by both aircraft and ships. However the price of a receiver for use with such a satellite may prove to be too high for commercial use.

An upsurge of radar applications for harbor control seems certain, to avoid the present high accident rate



ANALOG COMPUTER in use to simulate a complete metal rolling metal in the mill, drives, regulators and control system on large

normally associated with operations in ports. A ship identification system, similar in concept to iff, but much simpler will be used as part of increased collision avoidance operations in harbor control.

Land navigation systems are apt to prove expensive, and find no civilian market demand, Mr. McSweeney feels. The military has a land navigation requirement for tank and troop carrier operations beyond established roads. Such systems cost \$40 to \$50 thousand dollars each, which prohibits civilian land vehicle use.

TEACHING MACHINES—A spokesman for Loral Electronics Corp. predicts a steady growth for the teaching-machine industry, but cautions that only a small portion of the actual material and equipment sold is electronic. One estimate of the total market's size by 1967 is \$100 million including softgoods, with about \$20 million worth of electronics tucked inside that figure. Much of the development required before teaching machines become prevalent as a technique, is the development of good programming material, which is a slow job. In the strictest sense, a programmed textbook with a graphite pencil scoring system is a teaching machine. In a more sophisticated system, employing programming logic, switching and relay equipment, slide display and perhaps audio devices, the entire aid may cost \$1,200, exclusive of the programming softgoods.

The student is taught a bit at a time, and his knowledge reinforced by questions and exercises programmed according to his grasp of the subject.

An outstanding advantage of teaching machines is that they enable a single exceptional instructor to reach many

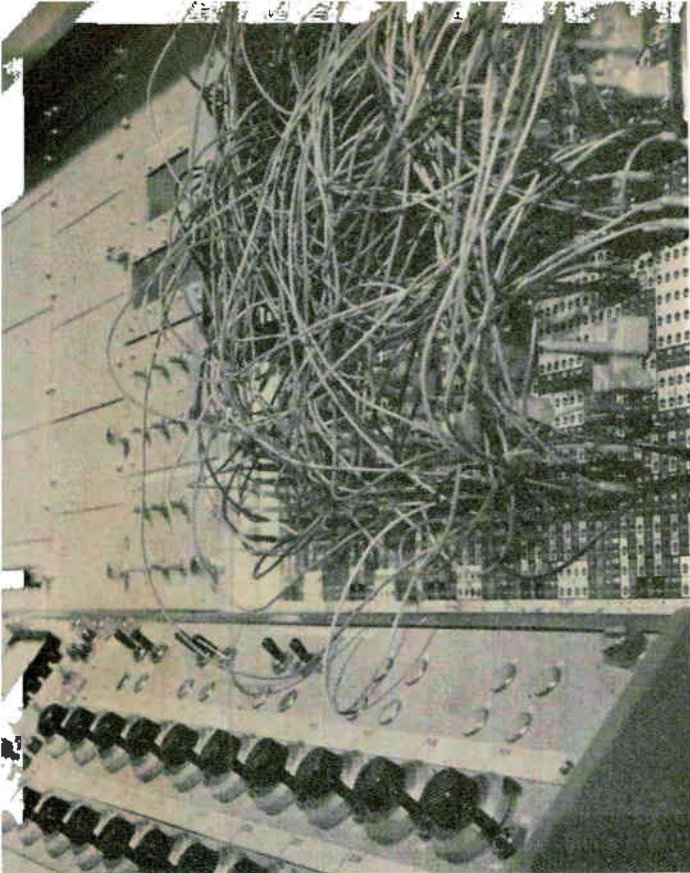

process. General Electric personnel simulate the rolling mill, scale computer

students. Certain subjects lend themselves naturally to audio teaching machine systems, such as the study of language. Experts feel, however, that any subject at all may be taught better with a teaching machine than by the conventional personal student-instructor relationship.

Acceptance by educators is expected to be slow, and some observers feel that this relatively new concept will be best advanced by introducing it into teaching schools, to provide new teachers with knowledge of its potential. It is recommended by market planners that electronics firms team up with publishing companies to be in the best position to profit from a teaching-machine venture.

LASERS—Among the markets receiving major attention by industry planners, and much research and development effort, are lasers. With the recent introduction of a class of gallium-arsenide diode lasers, which require only d-c pulses as a pumping source, the future form of this research effort may be altered.

The diode laser pumped by d-c, is a much simpler device to instrument, than a light-pumped solid-state laser, or a light or r-f pumped gas laser. It should also prove easier to modulate.

LASER WELDING AND CUTTING—Informed observers feel that it is in the area of welding and cutting metal that the laser will find its widest and most profitable industrial application.

Welding with the laser does not require a vacuum chamber for carrying out the operation as an electron-beam welder does. Many firms are actively researching these applications, including Hughes Aircraft Company.

This firm expects to see metal welding, cutting and melting techniques revolutionize metal processing within five years. Most laser experts agree that this is possible.

COMMUNICATIONS—Communications between cities, using laser transmitters and receivers, in a form that will compete with microwave and wire facilities is in the future. However, it has been pointed out by many long-term planners, that until there is a direct traffic need for such installations, they will not come into being. They are microwave and wire links that now serve the nation's needs, and until these become written off as investments, or outmoded in information-handling capacity, they will be kept in service. But wide bandwidth of laser communication systems, and advances in modulation techniques by many researchers, probably mean tests with complete experimental systems will take place during the next few years.

SENSORY ELECTRONICS—Future developments will allow eventual electronic duplication of all five of the human senses with great facility. This includes work in visual (character recognition) and audio (speech recognition) techniques, which are moving ahead rapidly.

Industry observers predict that a practical voice-operated typewriter could result from this research in the near future. However, a machine that can handle the entire vocabulary used in business correspondence may need a decade of development, other critics feel. Ability to process speech in different languages, and extensive use of electronic translating machines, is also in the future.

Character recognition has received great impetus in systems designed to process bank forms; with rapid gains expected in other character-reading systems, such as devices to read books to the blind.

CRYOGENICS—Experimental use of cryogenic materials will find employment in new areas ranging from computers to particle accelerators. Devices such as lasers promise to bring cryogenic techniques out of the laboratory and into use for field application. However, this view is held by only an optimistic portion of industry observers.

Most feel that cryogenics directly applied to the electronics industry's field operations, will not achieve a volume dollar level sufficient to qualify it as an important market. They cite activity in many laboratory applications, but point out that field-operated or airborne systems pose problems not readily solved. These include reliability considerations encountered with the relatively unstable techniques, even in computer memories.

However, the use of liquified gases in space shoots, steel processing, food storage, and similar industries should cause a sharp increase in cryogenic applications.

AUTOMOTIVE—The development of transistor ignition systems is receiving much attention, and some predict a large market for this field when customer demand will allow the inclusion of these systems in most new vehicles.

City traffic control electronics is experiencing an upsurge, with New York City alone planning a \$10 million dollar project to install computer regulated signal light systems, throughout the metropolis.

ELECTRONICS MARKETS 1963

FEDERAL MARKETS

HUGE AND GROWING

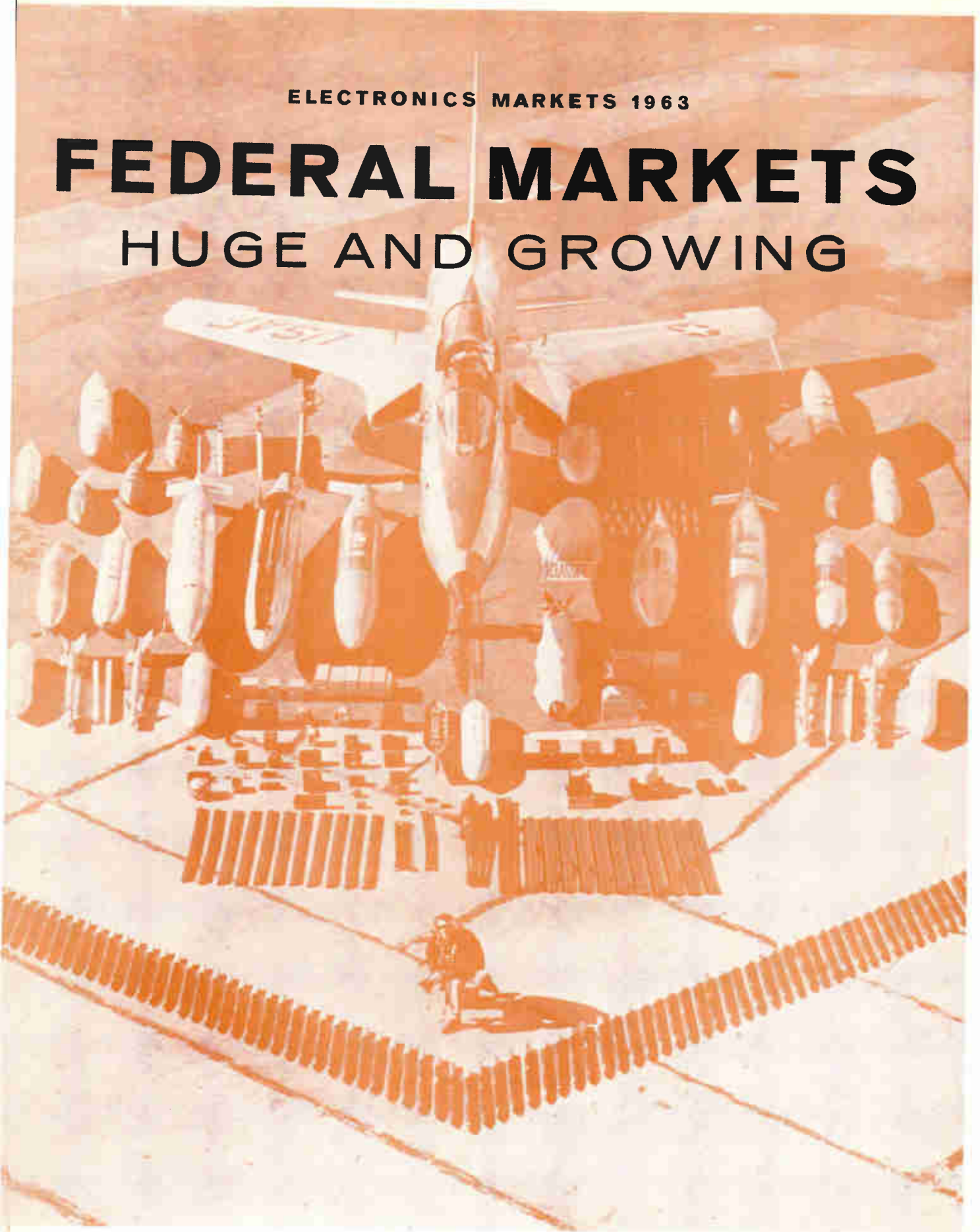

FIGHTER-BOMBER F-105D built by Republic Aviation Corp., with armament display. Mach-2-plus aircraft uses Sidewinder air-to-air and Bullpup air-to-ground missiles. Electronic content in dollars of missiles is 65 percent



TRACKING ANTENNA designed for Air Force by Radiation, Inc., with receiving bandwidth of 100-2,300 Mc, is part of a \$1.5-million contract. Antenna systems will be installed at both the Atlantic and Pacific missile ranges



TRANSMITTER-RECEIVER undergoing field tests by U. S. Army. Built to provide dependable 300-mile range, the Sylvania Electric Products set has 10-watt power output, can be strapped to infantryman's back

THE FEDERAL GOVERNMENT is responsible for the overwhelming share of sales in the electronics market. Federal expenditures in space and military electronics continues to rise, as it has for the last several years.

An increasing portion of sales to these markets is essentially research and development—rather than production—contracts. What is being sold is essentially a service. It demands demonstrated ability to conceive and carry out ideas, against the older standard of performing on tangible criteria, as in hardware production.

MARKETING ABILITIES—A company selling to this market requires strong technical competence within its marketing staff to sell the firm's R&D capability. Scientific, engineering and management components of a company must be of high caliber. And some private investment in company facilities is required to be able to perform on these R&D contracts adequately.

OVERCAPACITY SCORED—Profit margins on government contracting are shrinking, due partly to overcapacity, and thus fierce competition, within the electronics industry. Firms often bid for research, development or production contracts knowing that a reasonable profit is not possible at their bid price. Reasons for this bid pattern are varied, including a desire to maintain volume operations, gain government confidence, retain a full technical staff, and desire to obtain additional experience in a given area. The result has been to force strongly competitive bidding by electronics manufacturers.

NATURE OF CONTRACTS—Sales to the government are facing more penetrating scrutiny by federal officials. Government middle and high-level planners and military personnel in decision making positions are highly trained, more intelligent, and display greater ability than in the past.

Contractors dealing with the federal government will be selling equipment and services to astute persons who demand proof of a project's worth on a high technical level, before a contract is let.

There will be a trend to larger, but fewer, prime contracts in the future. Examples are Apollo, Minuteman, Polaris and the "L" systems. It is expected that the marketing efforts of many firms will shift away from military and NASA procurement agencies and move toward the larger potential prime contractors.

MILITARY SALES—Any attempt to forecast the military electronics market must allow for constantly varying geopolitical conditions throughout the world. Ultimately our nation's defense posture, and thus military electronics appropriations, are determined by geopolitical factors. An enemy's actions and goals in a hot or cold war, and the battlefronts selected or forced upon us, produce overriding determinants.

Several strong market demands have been stated by military observers to be evident. These include: electronic equipment for limited-warfare; command and control systems for the three services and the government itself; development of military space capability; surveillance equipment of varied nature; research systems to provide antimissile and antisubmarine capabilities.

Military marketing experts place the future command

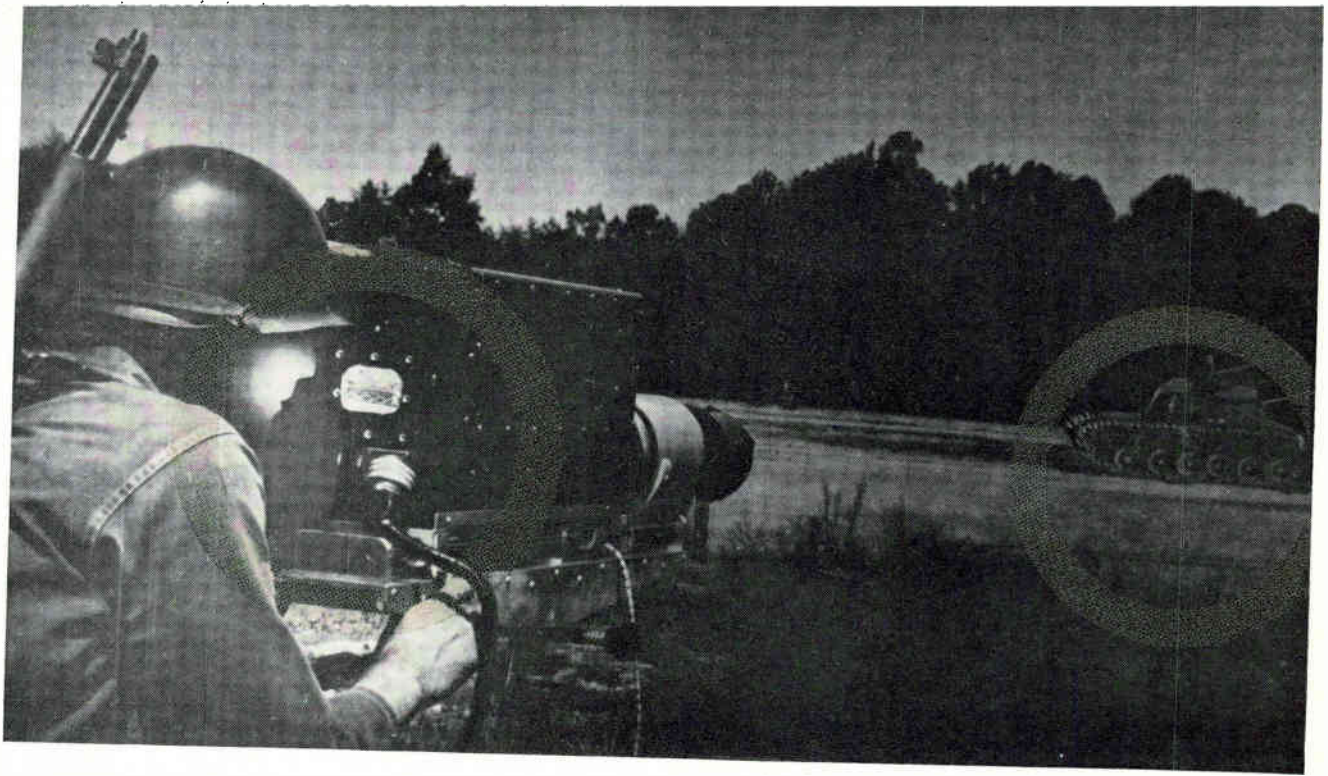

AMBIENT LIGHT SURVEILLANCE system for Army allows tv camera to view tank in the dark. Image intensifier at pick up requires only starlight, moonlight and skyglow

end control market in the front rank for sales through 1970.

MILITARY BUSINESS CLIMATE—Next year's Department of Defense (fiscal 1963) RDT&E budget is expected to equal that of last year's. For the following fiscal year, 1964, it may go down a slight amount. This is due to the phasing out of large systems now reaching the end of their construction phase; and the beginning research on new projects.

FORM OF CONTRACTS—Much of today's military contracting is in research, development, test, evaluation, and to a lesser extent, operations and maintenance. The nature of modern warfare has shifted procurement quantities of electronic systems from thousands or hundreds; to tens, or even one of a kind, in weapons or support systems.

EFFECTS OF CUBAN CRISES—The Cuban situation has focused sudden interest on the needs of military service leaders requesting more limited and general war capability for U. S. fighting forces. Not yet resolved are requests that would boost the budgets of all three services. The Army wants more close support aircraft and antimissile capability. Navy desires increased attention on ASW developments; and fast surface craft for support operations. Air Force seeks more missiles and aircraft, greater emphasis on the RS-70, and a beef up of their air reconnaissance ability; proven so important for detecting offensive weapons build up by the overfly and oblique photos of Cuba.

Estimates run to as high as an extra \$4.5 billion on top of the present \$48 billion defense budget for fiscal 1963 and 1964. Some feel \$2 billion is more likely.

COMMAND AND CONTROL—The front-running military market through 1970, will be command-and-control systems. They impose severe technical demands on the electronics industry. The most capable scientific, engineering and management minds will be enlisted to meet the challenge. Solutions will employ computers, data reduction, communications, and display techniques.

Command and control for military use includes input sensors such as surveillance radar, communications nets using tropospheric and ionospheric scatter equipment, and digital-computer data-processing equipment. Also required are display techniques, including digital and analog readout systems.

Reliable and fast command and control between government and national military command centers is needed to allow international and local control of aircraft dispatch, submarine direction, and missile-launch commands. Portable command and control systems are needed for tactical operations in all three services by local commanders.

An important problem is command of the huge retaliatory missile force this country is building up. Command ability is required to order strikes from hardened and soft sites, as well as roving launchers, such as Polaris submarines. The command and control systems must be hardened, technically fool proof, spook proof (impervious to sabotage), and fast acting.

The systems must be designed with ability to determine by radar and computers within brief moments which retaliatory missiles would be hit first in an attack so that these may be fired first. Such systems demand a high order of sophistication in information handling, using extensive electronics.

LIMITED WARFARE—Activity in electronics for lim-

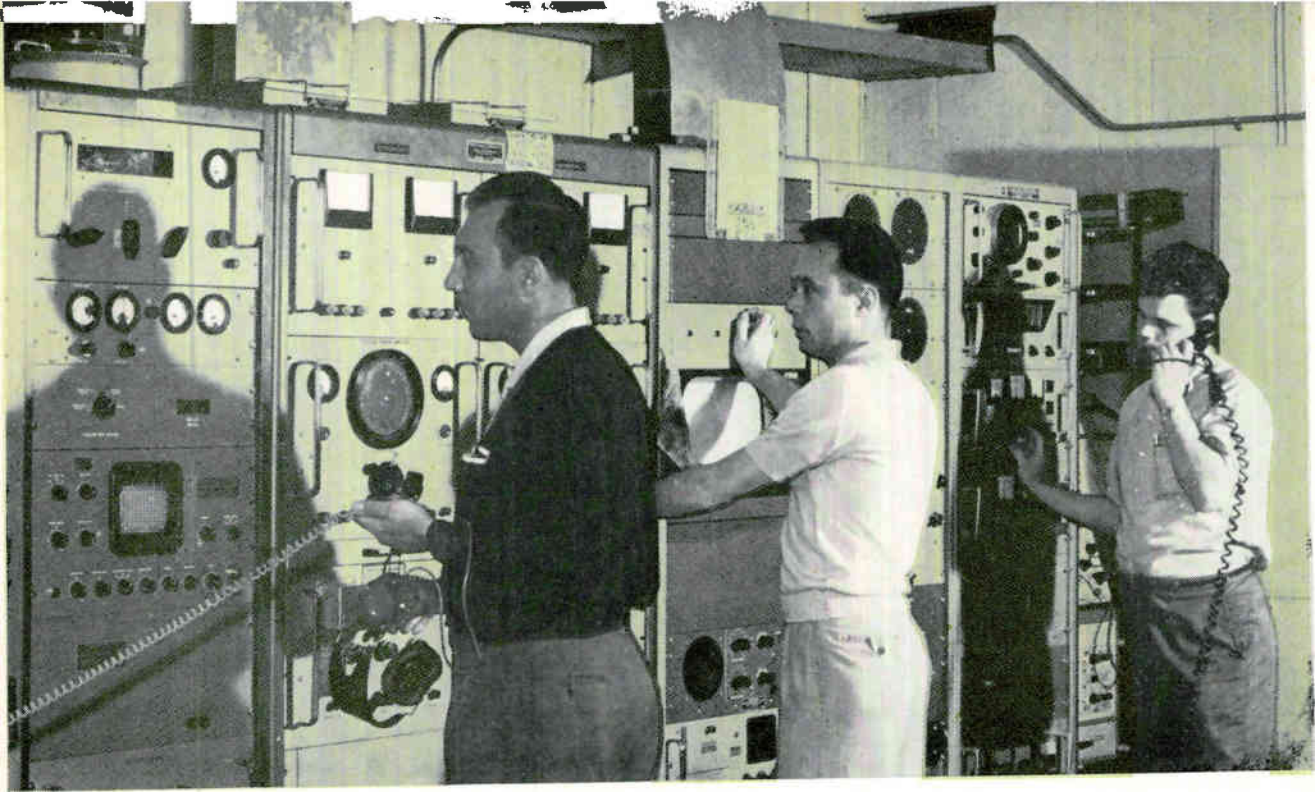

TRACKING WEATHER SATELLITE at receiving station operated by NASA. Tiras satellite may be tracked when within 1,500 miles of antennas operated by cansale equipment

ited warfare will be high during the coming years. It has recently received much greater priority by the DOD.

The procurement picture for walkie-talkies, surveillance equipment such as ir devices, and also equipment modification contracts, is on the upswing. This last includes such projects as conversion of radar equipment from fixed to rapid tuning, to achieve anti-jamming capability.

According to Sylvania Electronic Systems, a unit of GT & E, limited warfare electronic sales will burgeon as equipment bought in the early 1960's and built with standard electronic techniques is gradually replaced with equipment using microelectronics, by 1970.

Engineering talent and industrial efforts applied to the design of limited-war electronics has not always been of the highest order, the government says. The DOD points out that an important market awaits electronics firms catering to limited-war needs. Suggested as an example; a firm developing an efficient, tiny, hand-held radar for battlefield use, by independent research or government contract; would find themselves in a position to cash in on a high volume procurement market.

One industry expert notes that the limited-warfare market is the most talked about and the least performed on in the field of electronics. He feels however, that it is with good reason, for the best scientific management and engineering minds, as well as most of the money, is required for development of strategic weapons systems such as command and control of retaliatory forces.

COMMUNICATIONS—During the last year, Department of Defense expenditures for communications rose, at the expense of radar procurement. Within the broad category of military communications lies the greatest single area of future electronics expenditures. This is

a market trend that is unassailable. Military communications are an integral part of command and control, and are discussed elsewhere in that context.

There is a firm trend toward increasing use of single sideband for military communications. Jonas Shapiro, vice president of communications engineering at Manson Laboratories, Inc., a subsidiary of Hallicrafters, Co., underlines this, and says it will replace standard techniques in the next ten years as traffic density increases. Single sideband will also move up into uhf communications.

RADAR—Many military electronics observers feel that phased-array radar will be an increasingly important part of the future radar market. They hold that search and tracking functions can be easily combined using this technique. Wherever movement of a physically large antenna would be required, phased-array radar offers advantages.

However, government planners doubt that phased-array radar will ever achieve the stature of a large market. Instead they expect a year of peak sales in the future with completion of projects now planned, but do not feel it will represent a constant high sales area.

Radar is much in demand for varied surveillance tasks, including satellite tracking and antimissile defense activities. Actually, system radar is an input sensor for modern command-and-control systems, and is increasingly discussed in that context by planners.

MILITARY SPACE APPLICATIONS—One of the first big military space applications will be development of communication systems using space satellites. It represents one of the real needs of the military. This capability is certain to be achieved as part of the military

command-and-control network now being developed.

OTHER SATELLITES—Air Force purchases of satellites similar to Midas early warning units which detect ICBM infrared radiation, and Samos reconnaissance satellites, will achieve volume proportions in the future. Emphasis will be on reliability, as space replacement is an expensive chore. Estimated rate of failure techniques will be used to determine replacement time of equipment orbiting in space.

Bambi, a space-based system for boost-phase intercept of enemy missiles will receive attention, but will probably be preceded by a ground-based intercept system first.

Weather satellites are a needed military facility, and will see increased attention. Navigation satellites for use by aircraft, ships, and perhaps land vehicles are receiving research and development attention. This work will lead to operational systems.

ADDITIONAL SPACE MISSIONS—However, beyond this point, space operations for the military are not firmed up. The DOD believes that it must first be made clear what is needed in space for the military. They ask what advantages there are in military space operational ability, what the nature of the threat they will be called on to counter really is; and feel that it is not clear at this time.

Certainly knocking down each others surveillance satellites will be in order, but what else? The day when dogfights in space are a reality, seems a long way off.

NASA AND MILITARY—The trade off of information and research activities between the Department of Defense and NASA is extensive. Some DOD laboratories are used by NASA regularly in their work; and the Air Force mans many of the space tracking stations that NASA uses in scientific shoots.

There is close liaison between administrators of DOD and NASA, at all levels.

AIR FORCE'S VIEW—The Air Force feels a vested interest in space, and while it accepts the fact that cooperation between themselves and NASA is a real and useful operation, look beyond the present to develop their own view of the military role in space.

Air Force holds that this is a reasonable strategic anticipation of the direction the arms race will take, and they want to be ready for it in advance.

ADDITIONAL FUNDS—The Air Force is asking for additional funds to develop space weapons, and to make rapid steps toward a manned maneuverable space craft. This craft would begin with R&D on the two-man Gemini capsule, and lead to a craft which can take off from earth. It would accomplish a mission in space such as neutralizing an enemy satellite or space craft, and return to earth; all under control of a space pilot.

In discussing beam-directed energy weapons which may some day be used in space, an Air Force official points out that such weapons could obsolete the ICBM. Fast acting weapons aboard an enemy maneuverable space craft could give them ability to pull the teeth out

of our ICBM nuclear deterrent. Only an equal space military ability would prevent an imbalance of power, he states.

The Air Force is currently investigating their anti-satellite ability, by testing various existing missiles in an effort to produce a working missile system for this application, using missiles in existence.

ANTIMISSILE WEAPONS—Right now the nation is without an effective antimissile system in operation. The Nike-Zeus ground-to-air missile, not yet in production and with no firm plans to implement production, is the only demonstrated hardware we have. At best it is considered a half-way measure by military experts, though perhaps worth effecting in lieu of nothing.

Much attention and many dollars—the amounts classified—are now focused on radiation weapons as a possible means of defense against missiles. The Air Force and Navy are known to be exploring the possibility of such weapons carefully.

One possible type of radiation weapon would take advantage of the intense energy contained in a focused, high-power laser beam; or a bank of lasers operating in phase. It is known that metal can be vaporized at long distances in a vacuum, using these devices. Space laser operation provides vacuum operation, without the attenuating effects of the atmosphere. Additionally, high-power electron beams, artificial lightning, gamma and other energy beams are under consideration. But it is the laser, able to operate from infrared through ultraviolet (the last a recent development) that is the prime contender for the antimissile role, many technical persons hold. Others argue that even allowing for the ability to punch a hole in the skin of a nose cone, there is no assurance that effective damage to the warhead, or ability to explode it harmlessly, will be achieved.

MISSILES—Military procurement of missiles is continuing at a high level of interest with controversial effort on Air Force's Skybolt air-launched ballistic missile; Navy's third generation of the Polaris, and Minuteman. Guidance and control of an IRBM or an ICBM is roughly forty percent of total cost. Estimates of the electronic content of guided missiles are sixty-five percent for short-range missiles.

ANTISUBMARINE WARFARE—A sharp rise in anti-submarine warfare equipment procurement awaits a technical breakthrough. Traditional sonar techniques are now aided by magnetic anomaly detection methods, but both leave much to be desired. A submarine can still effectively hide beneath the surface if sea conditions are propitious, experts say.

Right now Navy buys sonar equipment, data processing gear, guidance and gun-laying electronics for attack weapons, magnetic-anomaly detectors; and spends heavily on R&D for new weapons.

Much research is being conducted on the ocean environment to facilitate prediction of sea state, bending of sound rays, other variables.

The sea is transparent, under most conditions, to sound. This accounts for continued applications of sonar to ASW. Sonar systems today are complex, include target

discrimination equipment. However, temperature, pressure and other ocean variables cause bending and attenuation of sound. Submarines can hide beneath thermoclines caused by these anomalies. Dunk sonar, where a hydrophone is lowered by cable beneath the thermocline, helps to ferret them out. High-power sonar offers advantages, still suffers from range limitations.

Sensitive dunk sonar from ships and helicopters and magnetic anomaly readings from aircraft are used extensively.

The possible use of light undersea, perhaps from a laser; chemical evaluations of the sea, and other advanced concepts are being explored in hopes of achieving the desired breakthrough.

SPACE PROGRAM ACCENTED—This nation is committed to a vast space program to achieve uncontested leadership in the field. Markets are being created for a host of new electronic components and systems.

Since NASA's electronic facilities are greatly augmented by the use of military facilities and equipment, it is important to judge space activities as a joint civilian-military venture.

At present it is roughly true that 90 percent of NASA's money goes to industry; and 50 percent of this is spent for electronics. For unmanned space craft, some 70 percent of the cost is for electronics, not including the launch vehicle.

The electronic portion of a launch vehicle, in dollars, is estimated at 50 to 60 percent.

APOLLO PROGRAM—It is on the Apollo program to land men on the moon, that NASA will use the greatest amount of electronics out through 1967 to 1968. Selection of the lunar orbit rendezvous technique indicates areas where electronics will be applied.

The LOR (Lunar Orbit Rendezvous) program will carry three men into orbit around the moon, and land two on its surface. Finally, all three men will be returned to earth. A transfer craft will carry the two men from the command module in lunar orbit, to the moon's surface. Both space craft will employ rendezvous and docking radar systems, transponder systems and optical devices.

The entire project calls for communications gear, guidance control systems and scientific instrumentation for lunar investigations. Guidance techniques include space sextant, inertial guidance, and radio command from earth.

In addition to the man in space programs, which will account for the major electronic expenditures in the future, NASA is engaged in a wide range of other activities that employ electronics.

Communications satellite developments are being carried forward, with interest in both active and passive systems. Projects include Syncom 24-hour orbit narrow-band active system, being developed with DOD, and Relay wide-band active repeater satellites.

Meteorology research is continuing with Nimbus weather satellites using infrared scanners and tv cameras, with increased effort on the project slated for 1963. The eventual development of a global meteorological



HAWK GUIDED MISSILES on mobile loader which carries missiles to launching site. Army's Hawk is built under Raytheon Company prime contract, is designed for surface-to-air-use

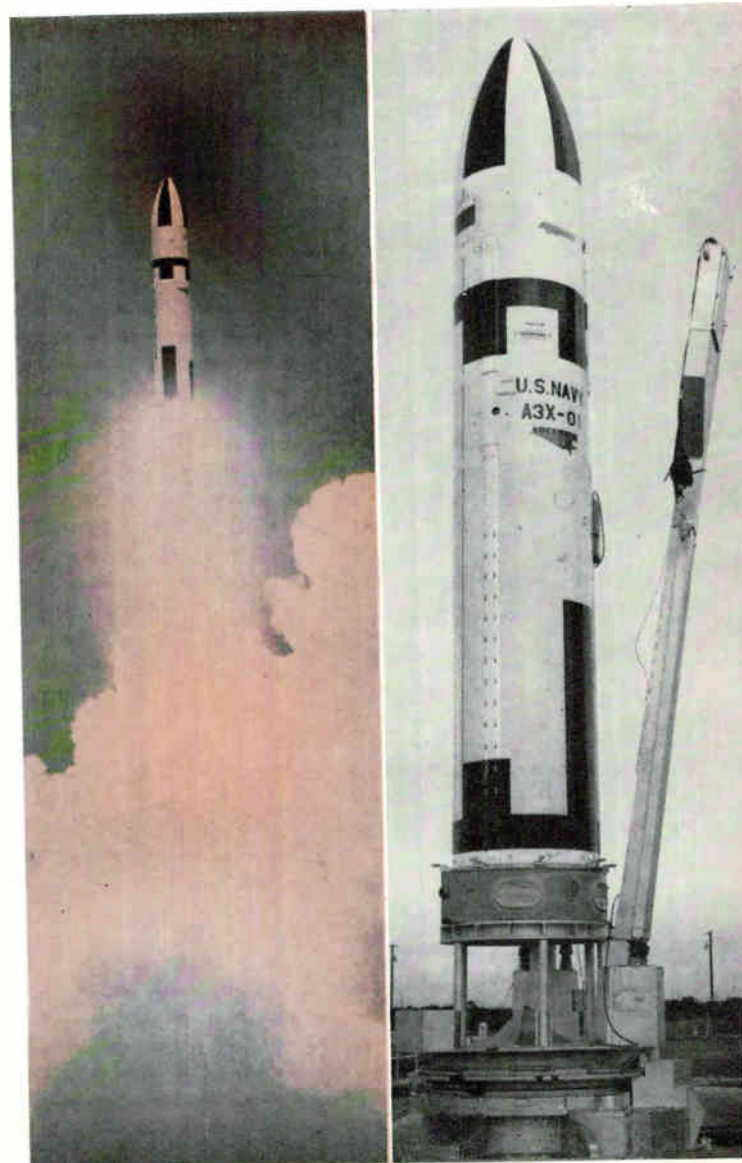

NAVY'S POLARIS A-3 missile in test shot. Third-generation missile has 2,500 nautical mile range, is designed for launching from submerged submarine. Will be operational in 1964

weather system is predicted, employing these satellites. The U. S. Weather Bureau will fund the service through NASA.

COHERENT LIGHT IN SPACE—Coherent light techniques for communications appear promising for future space applications, NASA states. From 1967 and beyond, it is expected that these techniques will receive strong attention and refinement. The laser is a ready source of coherent light, but other devices may be developed by 1970 for generation of such light, it is suggested. Above about 35,000 feet there is no attenuation due to clouds. A microwave relay system might be employed to relay signals from earth to a point in space where optical communications would take over.

Radar-like systems, using lasers are being developed for space ranging and tracking tasks. RCA plans to develop a 10-megawatt laser radar, using a 20-inch diameter receiving antenna, for tracking of the S-66 satellite at an altitude of 600 miles.

ELECTRIC PROPULSION — Research into electric space propulsion techniques will receive greater funding in the future. These systems will be used for a variety of space missions during the period from 1967 to 1975.

Included are vernier corrections of satellite orbits and space vehicle trajectories, transportation of heavy payloads to planets within the solar system. Under study are various types of electric propulsion such as arc-jet, ion-jet and magnetohydrodynamic (MHD) jet.

TRACKING NETWORK UPDATED—The growing complexity of future spacecraft will lead to increased spending to update tracking facilities. More complex

orbiting observatories require ability to handle larger amounts of data. Additional command and control equipment for satellites, as well as, data-reduction gear including analog and digital computers will be procured. New support equipment needed for the manned space flight program will be purchased.

Masers are to be added to existing equipment, and automatic checkout gear to reduce flight preparation time is sought. Various standards equipment such as microwave and time standards will be installed; and to handle the increased flow of data between ground stations, additional communications including video systems are needed.

FLIGHT CONTROL—The Federal Aviation Agency will spent \$1½ billion by 1975 to build an airspace control system to keep pace with the growing civil and military air traffic. The new National Airspace Utilization System will evolve from the \$1-billion system we are now using. The major overhaul will occur in wide scale automation and new electronic displays. Aircraft position will be determined by ground radar—new long-range radar is needed—and secondary radar (beacon transponders). The beacon system will also transmit automatically the plane's altitude and identity. One problem not yet solved is economical production of small light-weight altitude-transmission equipment (SLATE) for general aviation planes. 3-D radar is still being tested but without too much enthusiasm.

The weather portion of the new system will be extensive. It calls for new sensor gear, data processing, displays, and communications.

Voice communications will continue to be the principle technique for control.



PLAN-POSITION DATA DISPLAY console built by General Precision Inc. is part of FAA's engineering model for testing new system design for air-traffic control. Direct-view storage tube is by Hughes Aircraft Co.

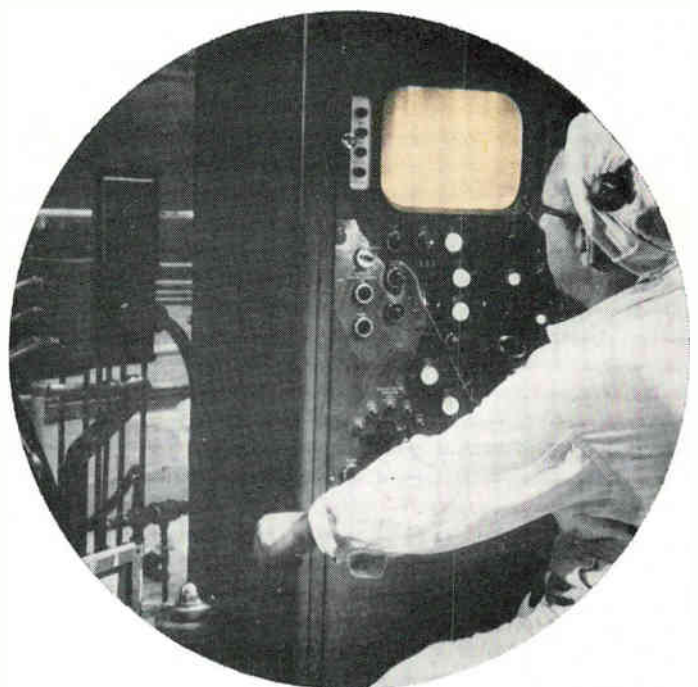

NUCLEAR REACTOR FOR GENERATION OF COMMERCIAL POWER is loaded by technician with aid of television cameras submerged in 25 feet of water. System, built by RCA, monitors loading of 120 fuel elements into reactor core

AEC PROJECTS—Most of the projects being advanced by the Atomic Energy Commission make extensive use of electronic controls and instrumentation. The AEC is also developing a series of compact nuclear power supplies to generate electric power for space and other applications.

The SNAP series of radioisotope and compact reactor electric generators will supply power for satellites and spacecraft, as well as remote electronic operated gear such as automatic weather stations located in the Arctic. Radioisotope versions of SNAP have already been used to supply part of the power for Navy's Transit navigational satellites, along with solar batteries. SNAP units for space applications are being developed with electric generating ability ranging from a few watts to a megawatt or more.

The higher power units will be suitable for powering

communications, television and radar satellites, and to supply energy for ion or electric propulsion of space vehicles.

Research in high-energy physics by the AEC is producing a market for electronic equipment at a rapid rate. Projects such as Stanford University's linear accelerator are an example.

Growing use of nuclear reactors to generate commercial electric power is apparent, with electronic equipment used for monitoring, control and safety devices.

Materials study by AEC is being advanced and commercial manufacturing processes using nuclear tracer techniques are standard in many industries, largely through AEC's efforts.

Research programs in mathematical and computer sciences are under way at AEC, will employ extensive computer and data-processing facilities.

ELECTRONICS MARKETS 1963

CONSUMER GOODS STRONG DEMAND

A **STRONG DEMAND** for consumer electronic products is expected during the coming year, with much impetus expected from color tv, stereo f-m, educational tv, and a beginning rise in uhf tv set production.

COLOR TELEVISION—Color television may see up to a two-fold increase in sales during the coming year some observers feel, with an increase in color programming by major networks a strong factor. The current rate of unit production, roughly four hundred thousand sets in 1962, resulted in a stock pile of unsold receivers. About half that number of sets found their way into customer's homes, with price given as the major deterrent to sales.

Many broadcasters expect black-and-white television broadcasting to be merely a vestigial service, by 1975. Increasing competition promises to force the retail price of color receivers down, which will result in increased customer acceptance.

Opinion is varied on the possibility of the single-gun color picture tube being able to aid this price decrease. Some industry leaders are convinced that a one-gun tube would lead to simpler circuitry within the receiver, as well as effect a saving on the tube itself.

The so-called two-color system of achieving a three-color picture, using two monochromatic (standard b&w) picture tubes, is not expected to produce any impact as a

commercial system, though there has been some interest in the approach overseas.

Another strongly voiced opinion holds that the three-gun tube has been sufficiently refined to allow economical production of the tube itself, and that much catching up in mass production technology would be required to make the single-gun tube competitive. However, observers note that the single-gun tube provides greatly increased brightness, but they doubt that it is an important factor at this time. Reducing the cost of the three-gun tube, is considered the direction to head, and most agree, the direction the industry seems to be taking, with at least three new manufacturers expected to start production of the tubes this year.

It is expected that 90-degree, 21-inch, color tv tubes could be prominent in 1963, with some manufacturers showing rectangular color tubes by 1965, including 25 inch types.

Receiver circuitry simplification, and thus cost reduction, can be achieved by engineering refinement without deserting the three-gun tube, some feel. Unless a major breakthrough in receiver engineering is achieved, the color tv market during the next few years—perhaps five, one expert feels—will be roughly twenty percent of the total tv receiver market.

A strong push by advertisers for color tv programming

as a means of displaying their products in color, is reported, and may have been responsible for the increased programming now scheduled.

ALL-CHANNEL TELEVISION—Recent passage of the government's all-channel television legislation, which calls for complete vhf and uhf coverage in all tv receivers to be manufactured in the future, promises to spark b&w sales over the coming years. A three-year grace period will pass before the government enforces the ruling, but manufacturers are expected to begin some production of these receivers immediately.

The time lag is provided to permit design of new tuners, and tooling for their production. It will take 2 to 3 years for uhf television to become an important market.

About a \$30 increase in receiver price to the customer is predicted initially with a drop until it is completely absorbed in the price, as volume production gets under way. Greatest impact of sales of the receivers is expected in rural areas, where vhf coverage is slight. There is talk of a court test of the legislation's legality, but most feel the law will hold.

Many believe that the new uhf ruling will spur educational television across the country. Several industry leaders and educators, however, note that the proposed 2,500-Mc bands for educational tv use now under consideration by the FCC, will prove best for interschool applications.

BLACK AND WHITE TELEVISION — Volume production of truly portable tv sets will be realized in the future, industry observers feel. The availability of

planar and epitaxial transistor types will help boost this market. Instant warm-up, low drain cathode ray tubes will be in demand.

Full transistor compliment tv receivers for home use awaits less expensive transistors. It is looked upon as a way to achieve longer life sets, through reduction of heat which affects other components, as well as the intrinsic long life advantage of semiconductors.

The use of hand wiring in construction of television sets has been reinstated by several manufacturers reportedly as a means of gaining reliability and reducing service problems.

A television market that will grow out of the needs of businessmen will be telephone with closed-circuit television. Possibly using laser communication links, with their wide bandwidth capability, and small-screen tv at each office telephone, businessmen will be able to show each other documents, including letters and graphs, while speaking of commercial matters. The market here should develop by 1970.

STEREO F-M—Continued strong market growth is expected in stereo f-m, and an increase in broadcasting services in this mode is predicted.

The Federal Communications Commission anticipates that roughly 25 percent of operating f-m broadcasters will be transmitting f-m stereo at the beginning of 1963, or a total of 250 stations. Harold L. Kassens of the FCC says that 300 stations could be registered for this service when another year is out. He feels that the extensive monaural record library found in large existing stations, impedes conversion. However, new stations not faced with this problem are apt to be stereo.

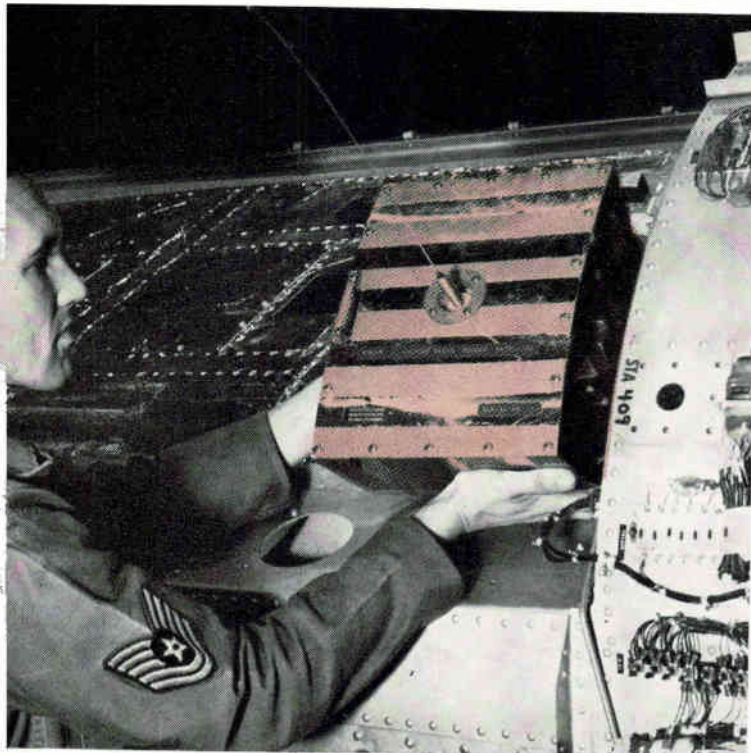

AMATEUR RADIO BEACON installed in Discoverer satellite provided ham radio operators with a chance to study propagation phenomena. The amateur constructed, 144 Mc package was launched into orbit from Vandenberg Air Force Base



TRANSISTOR PIANO operates from a-c or battery pack. Wurlitzer instrument uses steel reeds in polarized field to generate tones, varistors to modulate vibrato system. Fast response time of instrument is for jazz.

HIGH FIDELITY—Sales of high-fidelity reproducing instruments are being fostered at a growing rate by interest in stereo. Prerecorded tapes have come down in price, with tape machine sales climbing rapidly. The phonograph business, including renditions not truly high fidelity, is essentially all stereo today. In teen-age record sales, manufacturers make monaural disks, which are played on stereo instruments.

Single instruments with the speaker in the cabinet are preferred to separate components in quality home instrument sales. There is still a good market for simple phonographs, although it has been shrinking with the preference for high-fidelity equipment.

TRANSISTOR RECEIVERS—Radio receiver sales draw heavily on imported sets in the small transistor receiver class of instruments. However, in the case of high quality a-m transistor receivers, American manufacturers are doing well. To date the cost of f-m transistor receivers has been too high to encourage domestic manufacturers to enter this field heavily.

Foreign competition is continuing to grow in the transistor receiver field with most American manufacturers apparently content to relegate the market to overseas firms, based on a labor cost difference in their favor. Some American firms have set up overseas subsidiaries, or have stock in foreign firms, gaining some profit through this measure.

HOME ELECTRONICS—The home will see more use of electronics during the next ten years, with many of the more fanciful present speculations turning into realities. Data communications and data processing is considered

almost certain to lead to consumer store purchasing systems where the housewife never leaves her home. She would order over a telephone system using an electronically coded charge plate and make her item selection aided by closed circuit television, to the store or supermarket.

A drop in prices for such systems equipment will probably come about due to increased competition, and the fact that much of the needed engineering will have been done on similar industrial and military systems.

Radar ranges will be installed in many new homes, and are certain to become an important facet in restaurant operations. The advantage in the latter service are avoidance of food spoilage by allowing restaurant owners to keep food frozen until orders come into the kitchen. Frozen fare can be cooked in moments, precluding the need to carefully predict peak ordering loads on the kitchen.

AMATEUR RADIO—Activity in amateur radio is high, and is now reaching into space. Recently a radio package dubbed Oscar, weighing ten pounds and operating in the two meter band was included in a satellite and placed into orbit.

Radio operators will check antenna efficiency, signal propagation and Heaviside layer effects, at worldwide locations, using this satellite package.

Estimates of money spent last year by amateur radio enthusiasts run to slightly over \$38 million not including citizens' band equipment. This is based on an average expenditure of \$155 per year by each ham, for equipment and components. There are now roughly 240,000 hams in the U. S.



STEREO CARTRIDGE is examined under magnifying glass to assure correct seating of stylus, and positioning of diamond point in Motorola high fidelity instrument

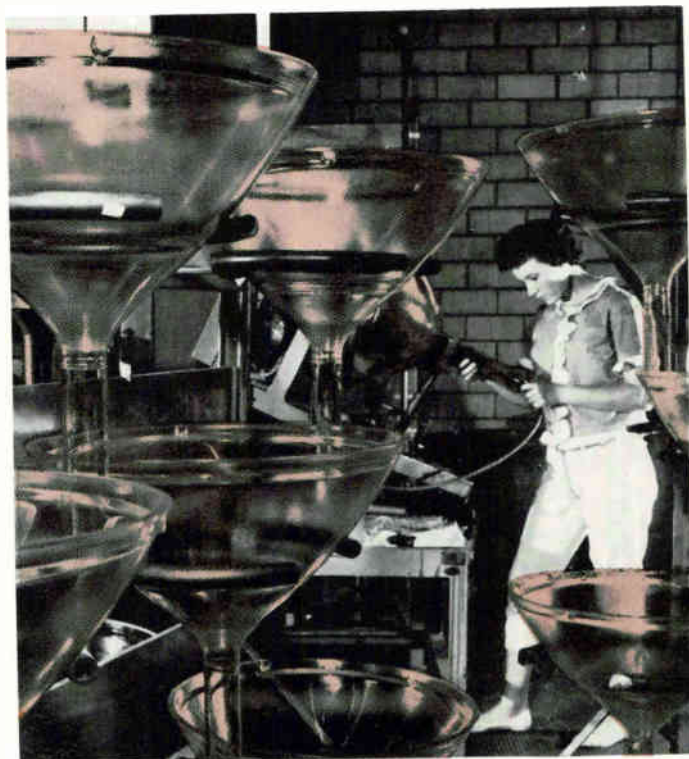

COLOR TV PICTURE TUBES on 24-hour-a-day production schedule at RCA's second factory for manufacturing color tubes. Black coating is applied in neck during this initial production step

COMPONENTS

MICROCIRCUITS COMING

CONSUMER PRODUCT USE is the design goal of this new low-cost silicon controlled rectifier developed by General Electric. Applications include household, automotive and light industrial use

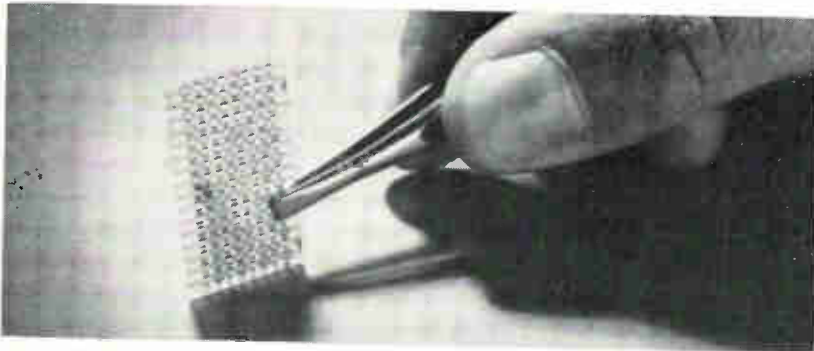

THIN-FILM TECHNIQUES are receiving much attention. Diode logic matrix of 64 diodes by General Electric is designed for use in telemetry system

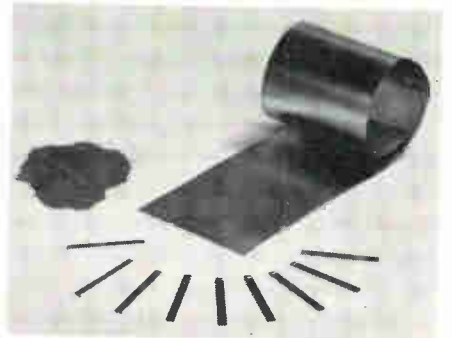

VACUUM TUBE RELIABILITY and performance are improved by powder-metal strip cathode. Sylvania Electric Products rolls carbonyl nickel powder and additives into thin strip for cathode sleeves



DIODE BURN-IN to improve semiconductor reliability at Sperry Rand Corp. Units are subjected to many hours of electrical stress. Diodes will be used in Polaris missile

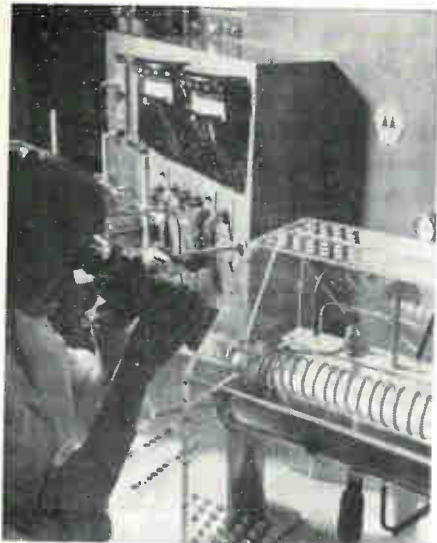

SILICON WAFERS are checked with optical pyrometer for exact temperature during growth of epitaxial layers, Motorola



SLOW-SCAN VIDICON TUBE developed by Westinghouse Electric for use in tv systems operating at a rate of one picture every eight seconds. High resistivity photoconductive target is used

MANUFACTURERS of components are stepping up efforts to apply microelectronics in production runs of military, industrial and consumer equipment. Most components men hold that the future for their segment of the industry lies in this activity.

Techniques ranging from micromodules and thin films, through integrated and molecular circuits are receiving attention.

Both growing domestic competition and increasing foreign component imports, are leading to profit pressure. Industry pulse watchers note that there is overcapacity in the components industry, perhaps to a greater extent than in other segments of the electronics industry. Some observers expect a shake out of manufacturers during the coming year.

Microelectronic techniques, in particular thin films, are expected to give American component manufacturers an advantage in competing with foreign competition. These techniques will lead to automatic production, and reduce the advantage of less expensive labor enjoyed by foreign manufacturers, such as Japan.

On the other hand, several international business men state that it would only be a matter of time before foreign competitors achieved the same microelectronic capability, due in part to royalty and licensing arrangements with American firms. Also it has been noted that British, German and Japanese scientists are following the microelectronic field carefully, will be ready to function in this area readily. Also the Dutch based Philips companies are known to be actively engaged in their own development work in this field.

All experts agree however, that it is imperative that American industry gain an early lead in microelectronics, and strive to maintain it. Unless this is done, problems of international competition are apt to be even more severe.

However, most observers agree that in order for microelectronic techniques to become a commercial reality in the U. S., extensive military application is needed. All agree that the three military services and NASA will be first to fully exploit the technology of thin films and molecular circuits.

The form that microelectronics circuits will take is open to speculation, but most experts believe it will be a combination of thin films and semiconductor techniques. Integrated circuits, using thin films deposited on semiconductor substrates, and also semiconductor circuits will be strong in the 1960's. In 1965, ten percent of the components market will be molecular, experts state.

However, it will require initiative on the part of industry to bring microelectronics to commercial fruition, in addition to the advances wrought by the military.

The ultimate of reliability and financial saving will be realized when single material—functional (molecular) circuit—techniques are worked out, a leading scientist says. He points out that the hybrid form (integrated circuits) of microelectronics will not be the final form. The day will come when a chemical mixing beaker will contain the compound that ultimately constitutes a complete circuit, it is predicted.

Increasingly, equipment manufacturers are becoming producers of components. This trend will find its apex in the concerted effort of equipment makers to develop in-house capability in microelectronic technologies. It

will reach a point where firms that make only equipment may be nonexistent. Another trend that is clear is the growing ability of component manufacturers to produce complete equipment and systems. The present delimitation between component and equipment makers is likely to disappear completely, with both types of firms able to perform in all areas of electronic development and production.

Another reason for equipment manufacturers entering into component production, will be to protect the proprietary nature of their design from other manufacturers.

One of the requirements in developing microelectronic circuits is the selection of materials with inherent stability. General Telephone and Electronics is carefully choosing materials which avoid temperature, frequency and voltage instability.

An advantage of molecular electronics is the ease with which redundancy in circuits can be achieved.

MILITARY COMPONENTS—There is a strong requirement for military command systems with twenty-year reliability. So called "mummified" command and control facilities for hardened sites, where the total environment is impervious to massive attack.

It is expected that Russia will continue with efforts to perfect the big-blast nuclear bomb of 30-40 Mt and improve still further her guidance system accuracies. This poses a threat to hardened sites that do not really fulfill the letter of their name.

Toward this end, modern components must afford radiation and shock resistance.

Robert J. Brown, General Manager, Defense Programs Operation of General Electric Company, suggests that firms develop radiation resistant components for use in potential military environments with both steady and transient radiation levels, thus also achieve a line of space compatible electronic components and circuits while doing military R&D. They will then be ready to compete with the mechanical and chemical components now used in space when they are called on for space operations in the future. Brown states that military radiation resistant electronic components are a must; the fact that they are also useful in space operations is a bonus.

Techniques for applying thin films to military electronics are progressing rapidly. The Navy is putting on a big push for microelectronics, with the Air Force and the Army following.

TRANSISTORS FOR THE MILITARY — Transistors will take over many military applications now performed by vacuum tubes. This has already been the pattern, but is now expected to occur on a greater volume basis. The exception will be in high-power and special-purpose applications where the vacuum tube will remain the primary device. By 1970, transistors will constitute roughly 90 per cent of the units, and 70 percent of the dollars, in filling sockets in the manufacture of military equipment.

Unit sales of transistors are climbing, but profits are smaller. Transistors are finding greater application in hi-fi equipment, partly on what is called "snob appeal." However in television, vacuum tubes are still favored for price, and design factors. It has been pointed out that

in the tv sockets where the most trouble occurs, high voltage, damper, horizontal deflection; the semiconductor device is at present no better suited.

NEW APPLICATIONS—A wide range of new applications for semiconductor components are being found. Home appliances now include semiconductors as the control element in timing cycles, where bimetal strips and similar electromechanical devices were used.

General Electric Company has just introduced a series of consumer priced silicon controlled rectifiers for use in automatic clothes dryers, and automobile alternators.

Ignition systems now employ transistors, and some automobile experts expect commercial trucking will soon standardize on transistor systems. Reduced maintenance and easier cold weather starting are obtained.

Miniature portable transistor tv sets, such as Sony's eight pound receiver which can operate from battery pack or an auto battery, through the cigar lighter socket, are receiving attention. It is expected that an increasing number of American firms will begin marketing similar tv receivers, based on the Japanese firm's success.

The development of a transistor operated piano by the Wurlitzer Co. marks another home-instrument victory for the transistor. The eighty-pound piano is able to operate from a-c and battery pack, has a 64-note keyboard. Steel reeds vibrate in a polarized electric field to produce the tone, with pickup plates, amplifier and loudspeaker.

Bulova's transistor operated wrist watch, employing a tiny tuning fork to achieve accuracy, provides another example of semiconductors invading a new field.

VACUUM TUBES—Receiving-tube sales are trending down, based on industry unit counts. Military tube sales have held up, over the past three years, and less use of tubes by consumer and industrial electronic manufacturers is responsible for the down trend in sales. This is due to the longer life of vacuum tubes today, and the use of multipurpose tubes—several in one envelope. Also new circuit developments permit doing a job with

fewer tubes. This has come about through development of better tube types. Transistor sales are increasing, and are a factor in the drop off of tube sales.

Total receiving tube sales will drop some ten percent in the next five years.

Tubes have not yet reached their ultimate in reliability, and a factor of two improvement is predicted. Improvement in filaments are being made. Methods of using nickel in fabricating cathodes are leading to lower and more predictable cathode interface levels.

ELECTROLUMINESCENT DEVICES—The greatest use of electroluminescent devices in the electronics industry during the next year will be in digital readout.

Use of nonlinear resistive devices for switching and display will be developed. The equipment will translate digital information to analog information for electroluminescent display. It will employ electroluminescent and photoconductive devices.

General Telephone And Electronics hopes to develop a flat black-and-white tv display. They hold that a color picture tube is possible. Within the next three years, specialized crt's for lower definition display will be using electroluminescent cross grid techniques.

It is possible that a flat, wall type picture tube may develop out of work on electroluminescent tubes. The techniques would employ a piezoelectrical material, such as the Yando device, developed at General Telephone and Electronics.

STANDARDIZATION—Industry experts state that our competitive international position would be improved if standardization were brought to the many varieties of components now being manufactured, quantities would go up, costs down. An example are tv receiver tubes. There are now 100 to 120 types, which might be replaced by 10 without impairing performance.

Trade associations are not considered effective enough in bringing this standardization about. Fear of government antitrust laws are weakening some efforts at standardizing.

FOREIGN TRADE

DURING the first six months of 1962, United States electronic exports spurted up 32 percent over the previous year, reaching \$370 million, the Department of Commerce reports.

Our government's efforts to foster foreign-trade expansion is aimed at a further increase in exports during the coming year. The electronics industry will share in the gain, if it occurs. In spite of the slowing economy of western Europe, the coming year is expected to at least equal the present level of electronic exports.

EUROPEAN MARKET—A downturn in the European

economy has been noted, but is not thought to affect U. S. export trade to these countries, by present indicators.

Technology advances in the world electronics market are expected to come mainly from the U. S. over the near term. However, European (and Japanese) firms are expected to develop advanced research and development capabilities in the future, to maintain commercial leadership within their specialties. In components, the U. S. will always maintain a lead, due to advanced R&D work in areas funded by DOD.

Europe enjoys a technical lead in the area of lower microwave band, communications equipment. One huge



MOBILE RADIOS will be supplied to London motorcycle patrolmen and other United Kingdom police forces by Cossor Communications Co., Ltd. a subsidiary of Raytheon Co.



TELEVISION TRANSMITTER in Austria will radiate German language programs to four and a half million tv screens. Telefunken engineers erected equipment, Austrian, Swiss and German engineers will operate it



TRANSISTOR TV CAMERA built by Tokyo Shibaura Electric Co., Ltd. is designed for field or studio use. Instrument provides 525 line, 30 frame, scanning



FLIGHT INFORMATION SYSTEM employing transistor operated control network is built in Switzerland. Tele-Norm Autophon equipment is shown at New York International Airport; similar systems are installed in European stock exchanges, industrial plants and banks



COMPUTERS FOR FRENCH AND ENGLISH firms, built by RCA, undergoing final test before overseas shipment. RCA has multimillion dollar agreements to sell data-processing systems to European companies

THREAT OR OPPORTUNITY?

European firm has developed a kit of transistors suitable for use in home television, which may prove technically superior to U. S. types designed for tv service.

AUTOMATION IN EUROPE—There is strong stimulus for automation applications in Europe, due to shortage of skilled help and climbing labor rates. Steel mills and similar factories are trending toward automation rapidly. U. S. manufacturers of electronic automation equipment, including computers, will find a ready market throughout most of Europe during the next five years.

NATO nations, and to a lesser extent SEATO nations,

will provide international military electronics in the future to aid in the huge job of achieving military preparedness for treaty organization members. This will increase competition for U. S. military suppliers. Small guided missile production in France is rising, and the country is exporting to the U. S. and NATO countries at increasing rates.

The requirements of America's military and space efforts have produced test equipment of advanced and specialized design which finds a ready foreign market. Both Germany and England export sophisticated test equipment to the U. S., but both countries, plus the rest of the international market place, are part of the growing

market for U. S. built test equipment. Most European countries do not have volume requirements for specialized test equipment and measuring instruments, thus have not developed extensive manufacturing capacity for such equipment.

Production of radio and television sets are responsible for much of the electronics sales in Germany, with industrial electronics, including data reduction and process control becoming increasingly important.

JAPAN—Already assured of a strong consumer electronics product capability, Japan is now seeking to develop industrial, space, and to some extent, military equipment capability.

Sales of consumer electronics are approaching saturation for the local market, with 60 percent of Japanese families owning tv sets; practically all have radios. A general downtrend of electronic sales is partly due to a slowing down of the entire Japanese economy, which some feel expanded too fast.

By switching to the production of transistor radios with six or more transistors, and to high-fidelity units, Japan has succeeded in raising her export level to the U. S.

The nation is expected to become a future leader in international color tv production, largely because of a strong demand developing within their own country.

Several industry observers expect electronic toys to become a big market in the future, and when it does they look to Japan to become the leader in this field.

The nation is well on its way to developing an extensive industrial electronic capability, but that growth too, is slowing down. Industrial sales are a small portion of the electronic industry.

Computer development is receiving strong attention from Japanese industrial firms. Additionally, a Japanese government subsidy of \$278 million has been allocated for research to develop large electronic computers. Right now, Japan is a large importer of U. S. built machines, both analog and digital. Japanese companies are forming joint effort groups for rapid computer development. They are aided by large numbers of engineers being trained on government subsidies. In time they will be less dependent on licensing arrangements with the U. S. in building computers, as these engineers create original equipment. Local use, as well as export volume is expected for the Japanese-built computers.

Japanese scientists are interested in microelectronic techniques, attend U. S. professional conferences devoted to this subject regularly, and are engaged in their own R&D. Wage levels are rising in Japan, and automation techniques plus microelectronics will undoubtedly help the country offset these in the future. However, because Japan does not have a large military electronics effort, microcircuits are not expected to achieve commercial applications soon.

The Japanese are doing advanced research on translating machines, speech operated typewriters, thermoelectric devices, and communications techniques. They have instituted a space research program, firing sounding rockets with instrument packages into the upper atmosphere and space. Some of the ground tracking equipment, instrumentation and rockets are being exported.

The nation is also cooperating with the U. S. in communications satellite developments, has signed an agree-

ment with NASA to construct a ground station for handling satellite signals.

Medical electronic equipment is expected to become a growth area for Japan, with small precision equipment, and perhaps electron microscopes among the products.

Because of little local need for military electronics, Japan has developed few sophisticated systems of this type.

Strict quality control of electronic exports is a feature of the nation's trade operations, and has contributed to their international success.

Japan is striking out for the Latin American market strongly, expects to be a major supplier to countries south of our border. Additionally she seeks to capture India, Burma and Pakistan as markets.

LATIN AMERICA—Future development of the Alliance For Progress Program will strengthen the economy of Latin America, and hence the electronics market in these countries.

At present Latin America has a relatively low income per capita level, and thus consumer purchasing power is limited. However, the citizens of these countries exhibit a strong desire for radio and television receivers plus a need for communications equipment of all types. Microwave systems to accommodate mountainous terrain are much in demand.

Much of the Latin American electronic equipment now in service is of World War Two vintage, and there is a brisk trade in supplying replacement components to maintain this gear.

The Latin American Free Trade Area which is an affiliation of countries below the border, is apt to figure strongly in the future of their electronics industry. Major aims include enlargement of marketing ability of member countries, and encouragement of trade between them. A tariff reduction between LAFTA countries, and a complementation of manufacturing resources to flesh out the product lines of LAFTA as a whole is contemplated. Some American observers are fearful that this might lock out some electronic equipment now sold to LAFTA members, because of future tariff levels.

Mexico is achieving some sufficiency in supplying itself with electronics, and relative to the rest of Latin America, is experiencing a healthy growth in electronic manufacturing capability. Many foreign companies, such as Siemens, are setting up production facilities in Mexico. Both Brazil and Argentina have healthy beginnings on electronic operations.

European and Japanese firms are striving for a greater share of the Latin American electronics market, and many feel that their sales techniques are in some ways superior to those of Americans in dealing with Latin American customs and mores.

Political unrest in Latin American countries has to some extent put a damper on plans by some American firms to invest or set up facilities below the border.

CANADA—The future of the Canadian electronics market will depend heavily on the ability of Canadian firms to produce more original equipment for the export market. The nation is strong in manufacture of communications and navigation equipment, but must branch into other sophisticated areas of electronics for healthy growth.

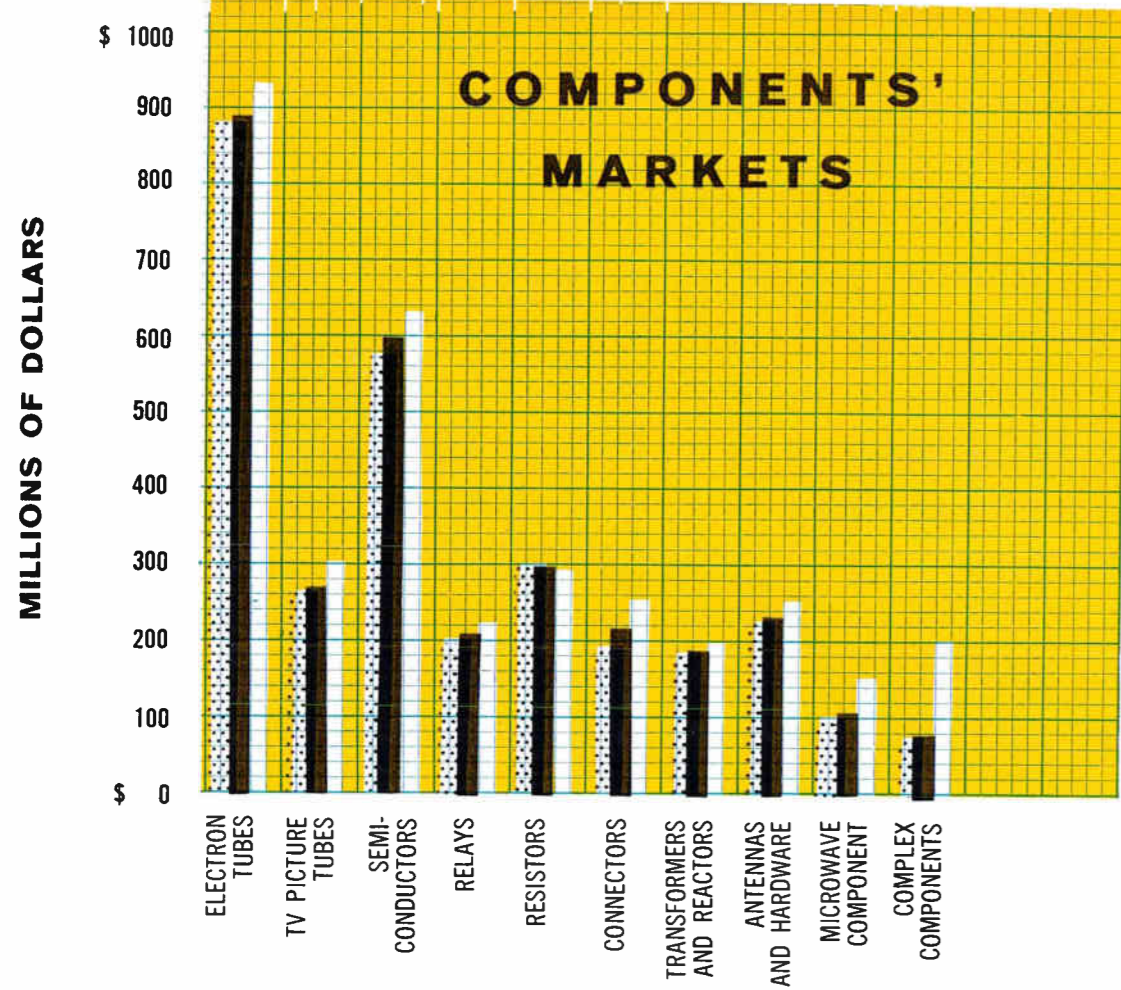

LEGEND: 1962 1963 1966

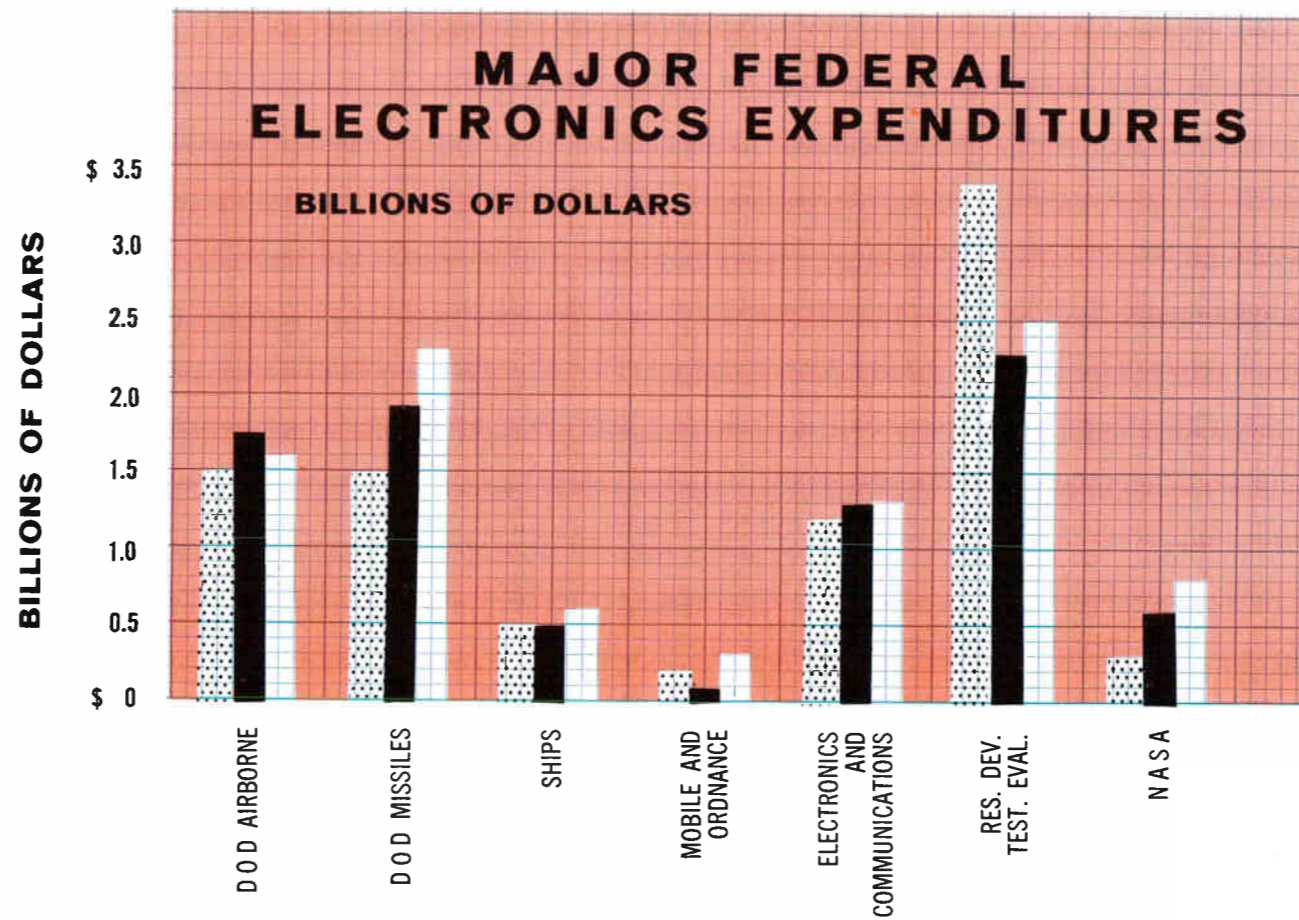

ELECTRONICS MARKETS

1962 1963 1966

© 1963 electronics a McGraw-Hill Publication

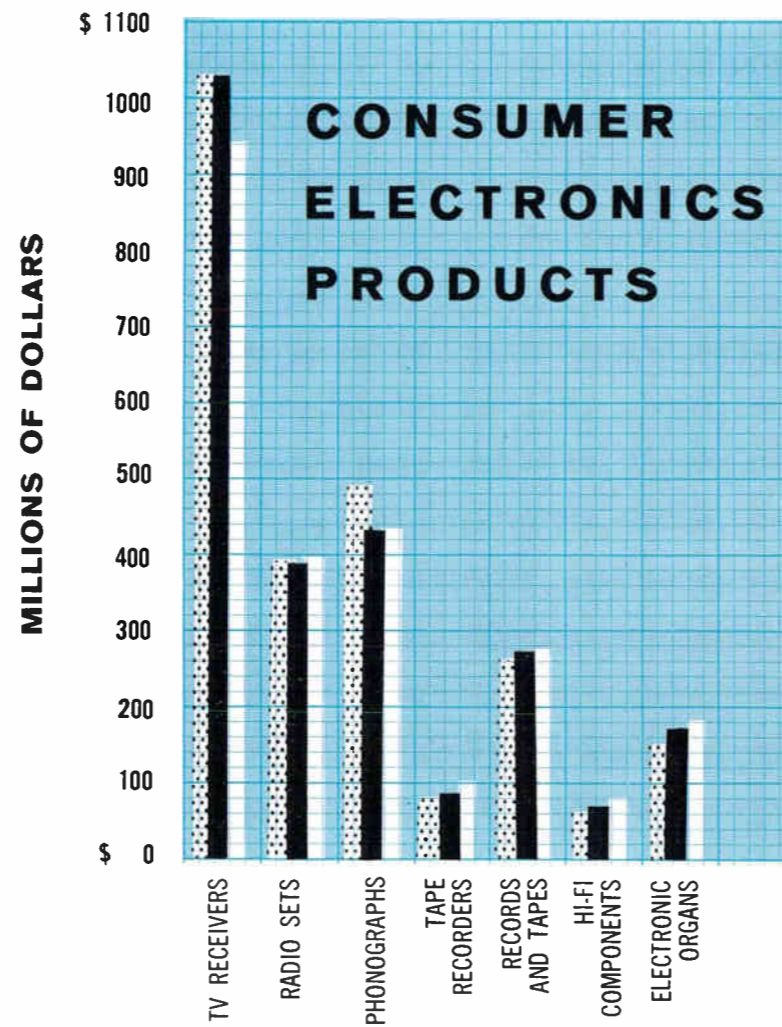
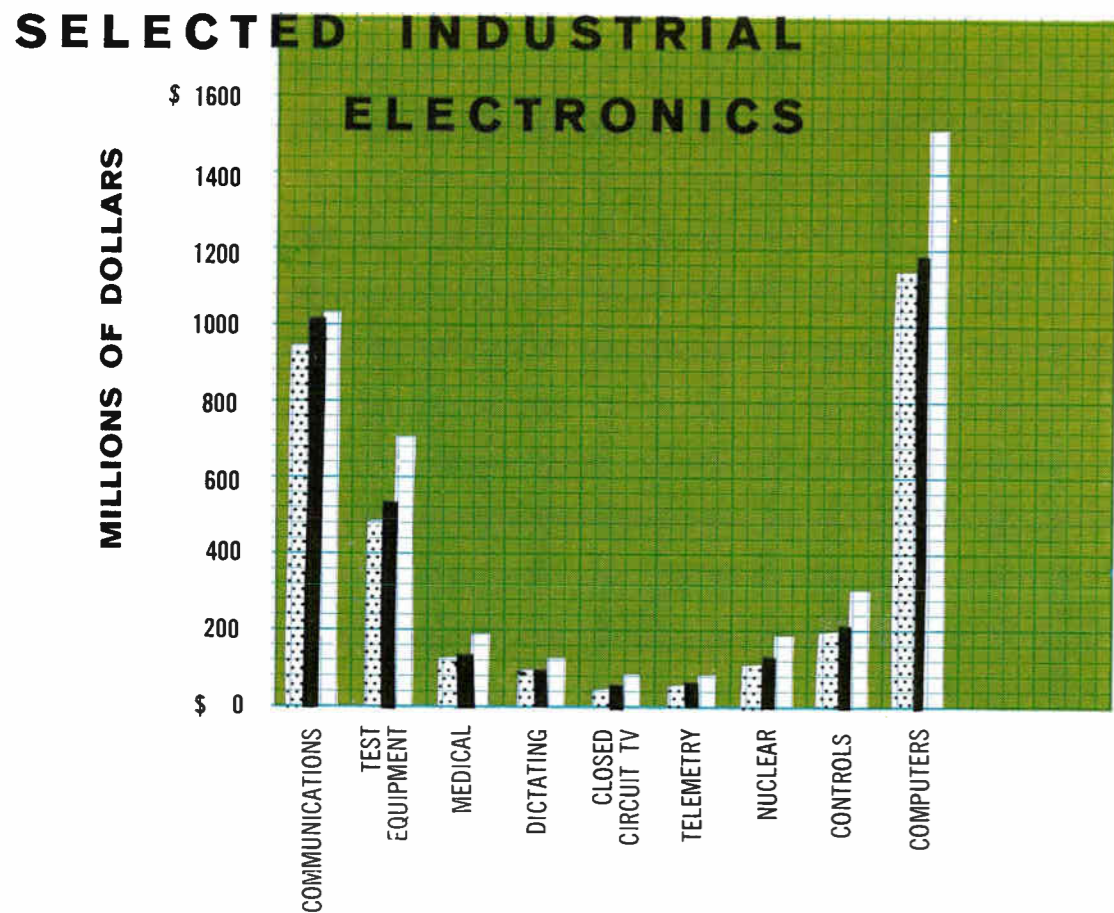

LEGEND:

1962 1963 1966

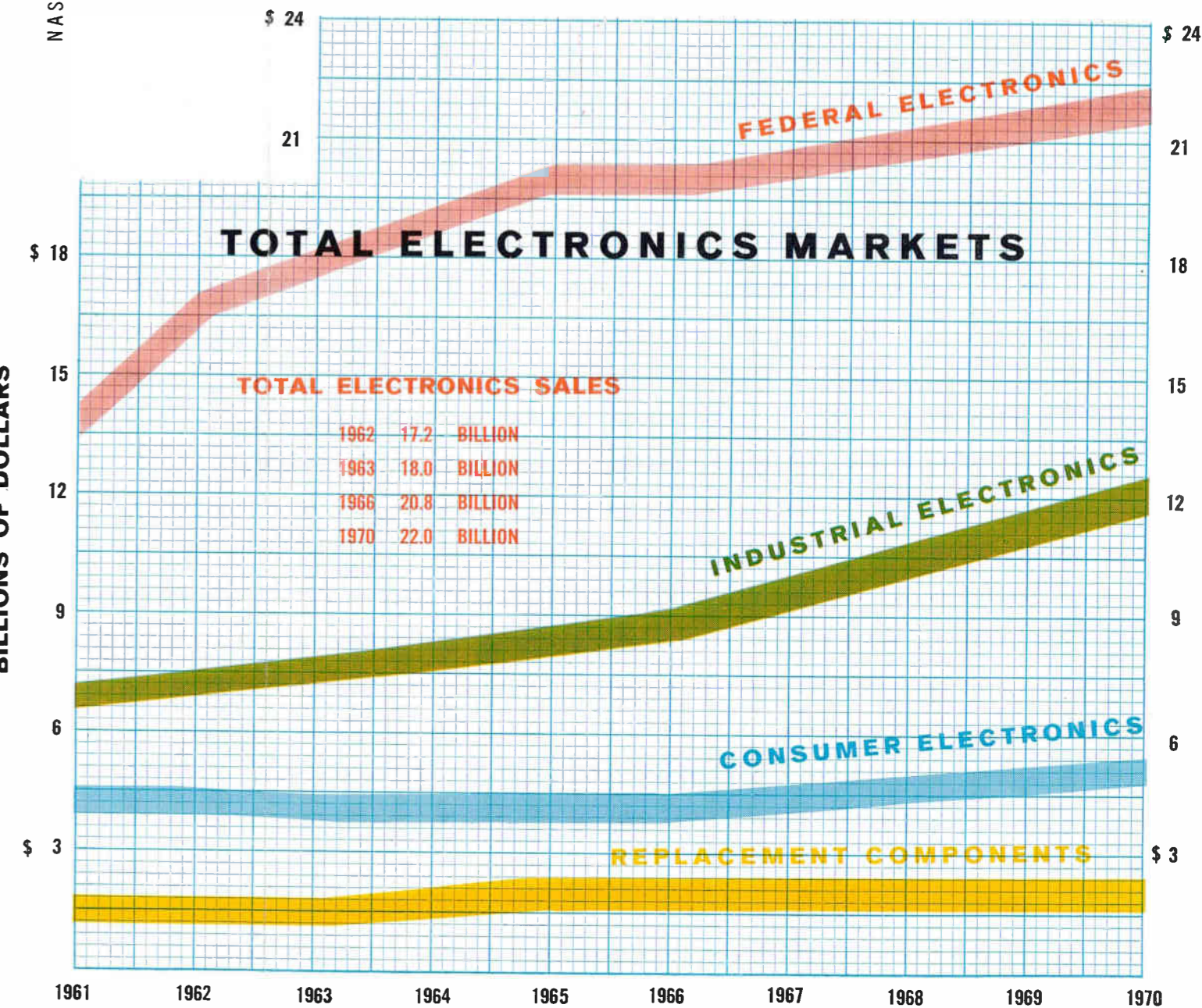

THE MARTIN COMPANY HAD A PROBLEM ■

How to condition and calibrate 100 variable missile signals simultaneously, select any circuit from 1 to 100, and monitor the calibration voltage on the transducer output voltage during test.

ANSWER ■ THE AIRTRONICS AUTOMATIC CALIBRATION CONSOLE REDUCES TEST & CALIBRATION TIME BY 75%

The Airtronics Calibration console provides an accurate and efficient means to condition and calibrate up to 100 AC and DC transducer signal channels. The input and output signals are conditioned to the voltage level and impedances required by the recording equipment and transducers. An accurate .1% step calibration is provided to each recording channel. The following operational efficiencies are attained in a test program:

1. A sound electrical and orderly termination point for signal input and recorder cables.
2. Signal output sensitivities may be adjusted for each channel.
3. Conditioning networks may be selected for each channel.
4. Calibration signals may be selected manually or automatically for one or all channels.
5. Individual channel input signals may be switch-selected for evaluation on the oscilloscope or for measurement on an auxiliary voltmeter.
6. Excitation voltage is available for each transducer as required.

Thus the time required to set up and perform a test program is materially less than that required for the breadboard and patch panel type of test preparation.

The Martin Company has used the Airtronics Calibration Console in Pershing missile test operations for NASA since 1961. The performance time of these test programs has been reduced as much as 75%!

■ **AIRTRONICS** ...is proud to have designed, engineered, and built an automatic calibration console which has met the rigid requirements specified by the Martin Company.

DETAILED SPECIFICATIONS GLADLY FURNISHED ON REQUEST

another product first by

AIRTRONICS INTERNATIONAL CORPORATION

P. O. BOX 8429
FORT LAUDERDALE, FLORIDA



Time Tested IBM Wire Contact Relays

Prices start at \$3.40 for a single relay. And there's one low price regardless of quantity. Standard 4, 6, and 12 pole relays range from \$3.40 to \$6.15. Latching relays with 4 and 6 poles range from \$8.45 to \$9.35. All prices are f.o.b. Essex Junction, Vermont. Shipments of production relays can be made *within 24 hours of receipt of order when requested.*

Time Tested Performance

Life: 50 to 200 million minimum

Operate Speed: 4 to 8 ms including bounce

Release: 5 ms maximum including bounce

Contact Rating: Vary with life requirements (See Chart)

Reliability: 1 error per over 400 million contact closures at 48 VDC

Coil Voltages: Up to 100 VDC

Integrated Package. Solderless connections and multiple coil designs coupled with compactness, standardized mounting hardware and racks offer *manufacturing savings and lower product costs.*

Applications. Wire contact relays are ideal for counting, logic switching, shift registers, flip-flop and timing circuits for such applications as numerical control, communications, test equipment, process control, data processing, supervisory control systems, and many others.

New Catalog. Get the complete story of the wire contact relay—applications, circuits, 15 years of field performance data, electrical characteristics, mounting hardware, and, of course, prices. Here's everything you need to determine a price/performance ratio.

Write direct to: IBM, Commercial Sales, Relays, Essex Junction, Vermont.

IBM®

General Products Division

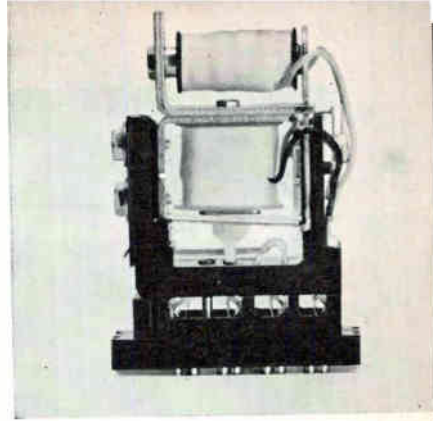

The mechanical latch type wire contact relay for low cost memory

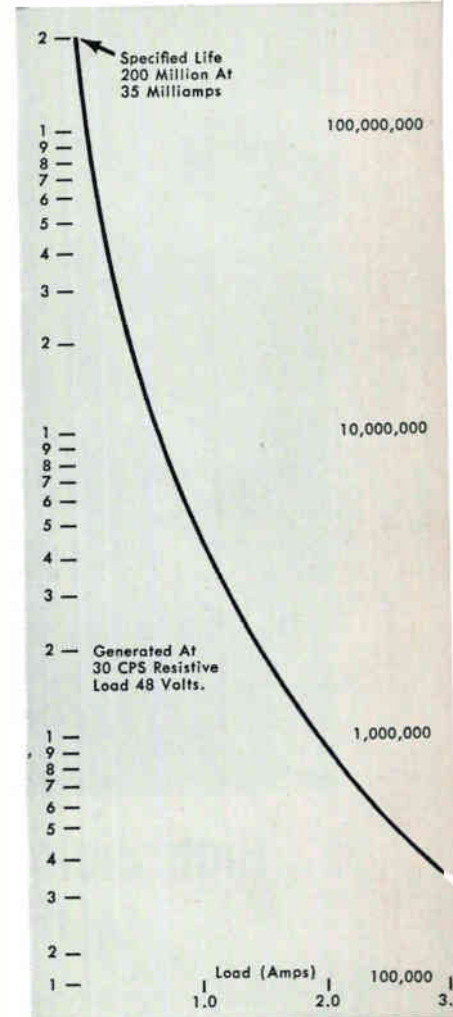

Life vs Load

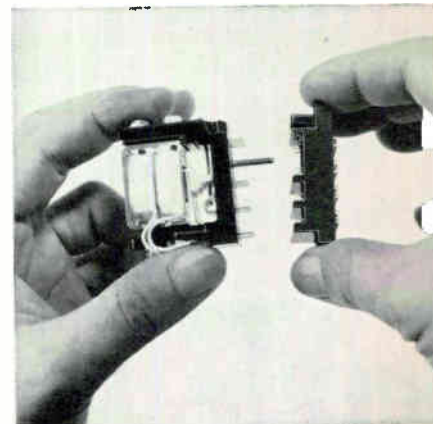

Pluggability simplifies installation, reduces inventory cycle

SOLVING INSULATION PROBLEMS WITH "MYLAR"®

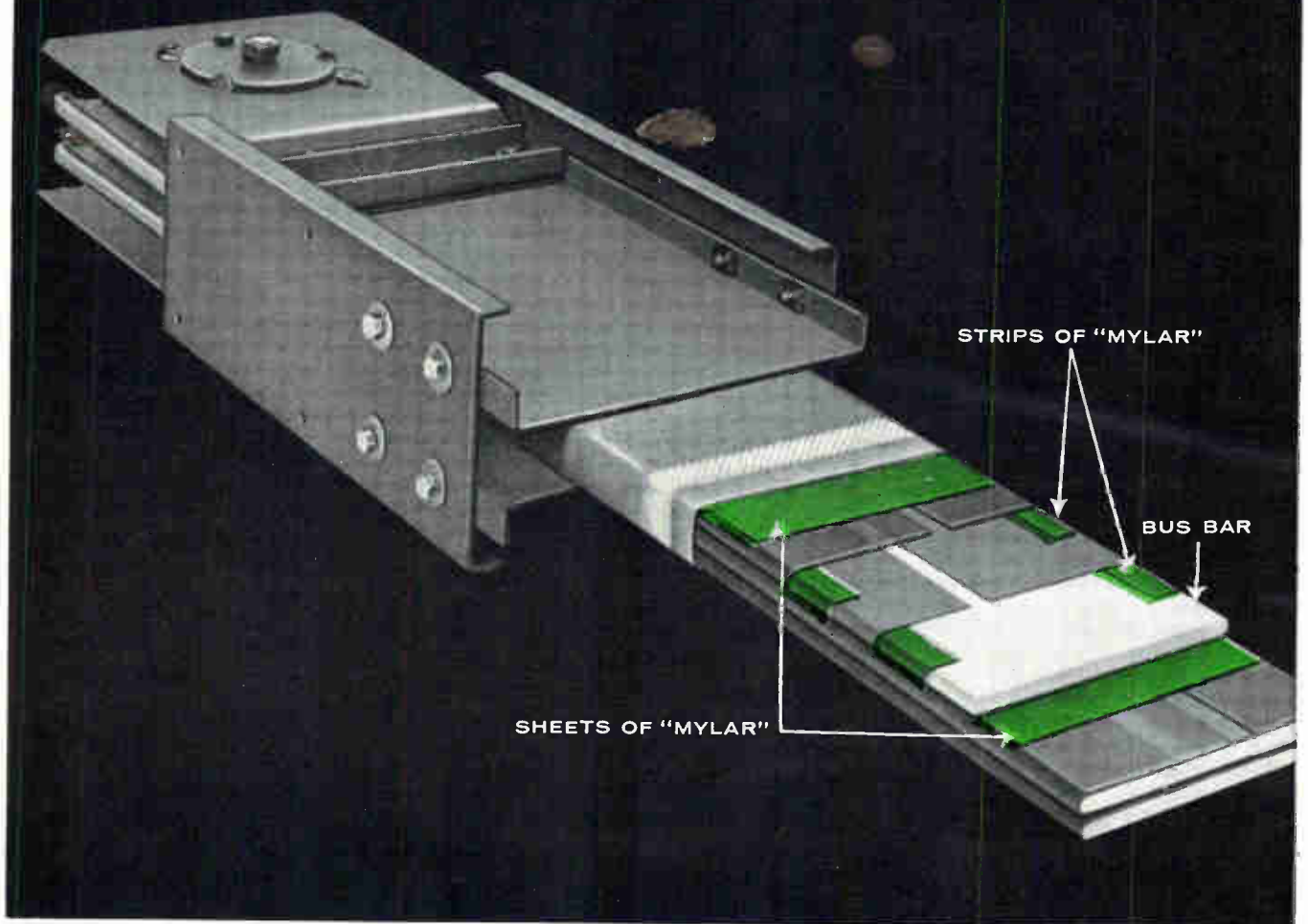

THE INSULATION OF "MYLAR" IS SHOWN IN GREEN

High dielectric and thermal properties of "Mylar" make busway smaller...at lower cost

The outstanding performance of "Mylar" polyester film in thin gauges allowed the Square D Company to design a more compact busway at lower cost. "Mylar" provided an insulation material that was both strong and durable, with higher dielectric and thermal properties that eliminated the air space needed for cooling between the bars. Unlike many conventional insulating materials, heat can be dissipated directly through the "Mylar" without causing any breakdown of the insulating value.

While the Square D busway operates within Class A temperature limits, the unit was subjected to a Class B test (130°C.). "Mylar" withstood this test, giving a 25° safety factor—and an expected insulation life of four times Class A insulation.

The combination of properties of "Mylar" offers

you added benefits that can lead to product improvement. "Mylar" is resistant to solvents, easy to work with as compared with other insulation materials. "Mylar" has excellent volume resistivity even at elevated temperatures. It has low moisture permeability.

You may be able to reduce your costs through design modifications and manufacturing economies, using "Mylar" to replace your present insulating material. Why not investigate its unique combination of properties in your applications? Save time and money now by writing to Du Pont Company, Film Dept., Wilmington 98, Delaware.



Better Things for Better Living
...through Chemistry



MICROPAC weighs in at only 90 pounds, but is a complete digital computer for tactical applications

Computers in the Front Lines: Micromodules Make it Possible

Development of micromodules has significantly reduced the size and weight of electronic equipment. This computer has a wide range of uses. It takes advantage of micromodular construction

By A. S. RETTIG, Surface Communications Div.,
Defense Electronics Products,
Radio Corporation of America, Camden, N. J.

THIS GENERAL-PURPOSE military digital computer will be used in tactical applications where high reliability, small size and weight and low power requirements are primary considerations. The computer uses micromodular construction, providing high packaging density, excellent reliability and a predicted failure rate of 0.04-percent per 1,000 hours per two-circuit micromodule. The computer, as a whole, has a mean-time-before-fail-

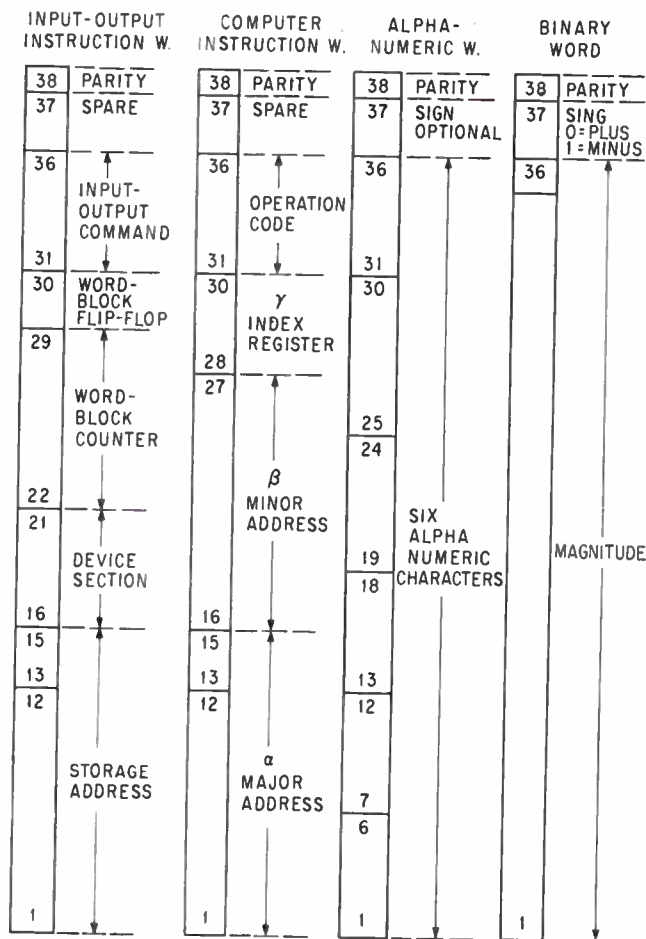

FORMAT of computer words conforming to Fieldata—Fig. 1

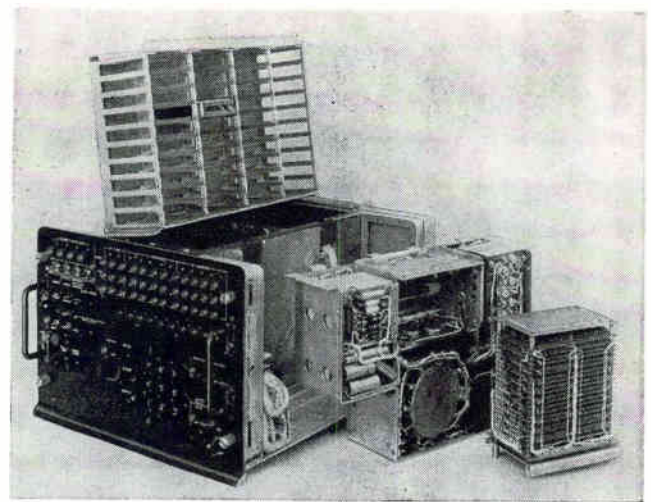

LOGIC RACK (top), power supply and memory stack (right) of computer

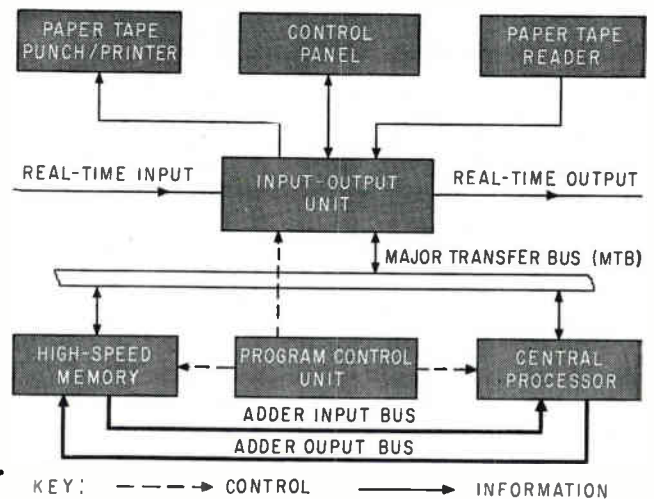

THE COMPUTER is divided into five major subsections, all of which have micromodular features—Fig. 2

ure of over 1,000 hours at a 60-per-cent confidence level.

Much of the equipment in the computer is time-shared to further reduce the required circuits. Developed under the Signal Corps micromodule program, its name MICRO-PAC, which stands for Micromodule Data Processor and Computer, was designed to be compatible with the U. S. Army's Fieldata automatic data-processing equipment.

The high packaging density gained with micromodules (about 150,000 components per cubic foot in the circuit section) permits the effective use of a single-case design of 2.7 cu ft that weighs 90 pounds. It requires 250 watts d-c power and 270 v-a generator power.

SYSTEM ORGANIZATION — The computer accommodates a wide variety of problems and has 21 mechanized instructions as shown in the table. It also has register provisions and is a binary synchro-

nous computer operating in a completely serial mode at a clock frequency of 1.6 Mc, permitting a reasonably short execution time per instruction.

The clock pulses drive a timing-level generator producing a sequence of gate levels of varying lengths within a 63-clock pulse period. This 63-clock pulse period of about 40 μsec is called a minor cycle, and is abbreviated during certain instructions to decrease operation time. An instruction is executed in one or more minor cycles plus a minor cycle for instruction access.

The various 38-bit word formats are provided. Figure 1 shows the format of a binary word, an alphanumeric word, a computer instruction word or an input-output instruction word. The basic random-access ferrite core memory of 2,048 word capacity is expandable in multiples of 2,048 to a maximum of 8,192 words.

The computer is divided into five major subsections as shown in Fig. 2. These include: high-speed memory, central processor, program control, input-output and major transfer bus.

HIGH-SPEED MEMORY — The high-speed memory unit contains the core-memory and registers for data storage, controls for reading, writing and word selection. The memory operates with coincident-current selection (destructive read-out with regeneration) having a duty cycle of 40 μsec between read interrogations.

The memory array consists of 20 double planes, each containing two 64 × 32 core matrices; also included in the stack are a diode board, heater assembly and header board containing plugs for external connection. This section appears in the lower right-hand corner of the photo. The 20 double planes provide two spare bits per word. These

spares can be utilized by connecting the sense winding output to any input circuit and completing a circuit between the digit winding to the digit drive of the corresponding regenerative loop. The memory module bank is a completely self-contained plug-in unit. Four banks may be used with the computer.

A 13-bit address generated by the central processor determines which one of four memory banks and which of 8,192 words will be selected and sent to the two memory output registers. Register 1 is a temporary buffer for parallel data flow to and from the memory; register 2 is both a buffer effecting parallel-to-serial conversion of data and an operand register for several instructions.

CENTRAL PROCESSOR — The central processor performs internal data-processing functions. It has a one-bit adder, various shift registers that, among other functions are used with the adder to form the arithmetic unit, gates to transfer data between registers and adder, and control timing and logic.

All arithmetic operations are done in binary-serial form using a one-bit adder. Subtraction is accomplished by two's-complement addition. Multiplication is performed by successive addition of partial products, and division is executed by a nonrestoring algorithm. Computer operands are fixed-point, signed magnitude.

The accumulator, instruction and program-counter registers are contained within this section. The accumulator contains first the operand and then the result of the arithmetic instructions. In divide, the remainder is stored in the accumulator and the quotient in the Q-register (a register simulated in high-speed memory). In multiply, the high-order result is stored in the accumulator while the low-order result is in the Q-register. The instruction register holds the instruction during execution in the computer. The program counter stores the address of the next instruction to be executed in the program sequence. Other registers required for the central processing function are simulated in the memory.

PROGRAM CONTROL UNIT — The program control unit generates

the various controls required by the high-speed memory, central processor and input-output sections. It comprises the decoders, signal generators, and control flip-flops.

INPUT-OUTPUT DEVICES—The input-output section controls data exchange between the central processor and control panel, a paper-tape reader and printer-punch plus a real-time channel. The standard Fieldata intercommunication conventions, 8-bit characters, ready-busy line and strobe line, are used for all input-output operations. On-line insertion of information may be accomplished at 300-characters-per-second by a paper-tape reader or by a programmed instruction requesting operator input at the console. In the latter mode, the computer waits until a specified quantity of information has been inserted and then automatically continues program execution.

Similarly, on-line output of information may also be performed by a paper-tape punch-printer at 30 characters-per-second or through the control panel. In the last case, the computer waits until the operator has requested the display of the instruction-specified number of words and then automatically continues program execution.

The computer can communicate with other computers with real-time input and output channels on a computer-interrupt basis at a maximum rate of 300 characters-per-second.

The computer may concurrently perform real-time input, real-time output, and data-processing func-

HOW COMPACT CAN A COMPUTER GET?

This computer won't fit in a man's pocket, but it represents an achievement in size and weight reduction.

It is possible because of micromodules that permit a good deal of circuit to occupy a minimum of physical space. Groups of these tiny circuits make possible a design of high packaging density, excellent reliability and low power needs

INSTRUCTIONS AND TIMING

Instruction	Approximate Time μsec (including IAC)
Arithmetic:	
1 Add	80
2 Subtract	80
3 Multiply Fast (18 bits)	32%
4 Multiply	1035
5 Divide	1075
Transfer:	
6 Transfer Unconditional	40
7 Transfer and Load Pcs.	120
8 Transfer on Negative	40
9 Transfer on Zero	40
10 Transfer on Index	200
Logical	
11 Shift Right	280, max.
12 Shift Left	280, max.
13 Store	80
14 Logical Multiply	80
15 Load	120
16 Halt	40
Sense	
17 Sense	40
18 Sense and Set	40
19 Sense and Reset	40
Input-Output	
20 Read Alphanumeric	variable
21 Write Alphanumeric	variable

tions. When a character has been received from the real-time input unit or when the real-time output unit signifies that it is ready to accept a character, the computer temporarily interrupts its data-processing function, services the character and then resumes data processing from the point of interruption. One to seven-character storage or retrieval operations are implemented by computer interrupts until a complete data word or a single control character has been stored or retrieved. A program interrupt will then transfer the completed word to the message storage section of the high-speed memory, or retrieve a complete word from the message-storage section for output.

MAJOR TRANSFER BUS—Most transfers are accomplished by a major transfer bus; some transfers to and from the adder that occur concurrently with transfers of data through the major bus are executed by minor transfer buses.

CIRCUIT DESCRIPTION — Requirements of +90 C maximum internal ambient temperature to permit reliable circuit performance within the high-density micro-module packaging, made silicon semiconductor components mandatory. For the bulk of the micro-module logic circuits, the 2N914

switching transistor was selected for its relatively high-speed switching and good reliability record.

The basic circuit is the standard logic gate of Fig. 3A with the following characteristics: fan in—20 maximum; fan out—4; power dissipation—75 mw average; pair delay—60 nsec nominal, and rise time—30 nsec nominal.

This standard gate is the most frequently used micromodule in the computer. Low-power gates are provided when the speed and power capabilities of these standard gates are not required. Several micromodule configurations of the standard and low-power gates were designed. Gates are packaged two to a micromodule. Several gate micromodules were designed with different input-diode arrangements so that the module's 12 standard outputs could accommodate the input-terminal requirements of a number of different logical configurations. Diode-cluster micromodules are provided to handle unusual cases.

Although the gates make up the bulk of micromodules in the computer, many other special-purpose circuits are required. Figure 3B shows a shift register capable of shifting at a 1.6-Mc clock rate with an output drive of two standard gates and one steering resistor of another shift register stage.

A starting point for the design of the shift register was the standard gate. Two standard gates were interconnected in a flip-flop arrangement and capacitor-resistor-diode gates tied to the bases for the trigger input. This was satisfactory except for a worst-case condition at 125 C which had a turn-off time of 0.15 μ sec instead of 0.13 μ sec. The worst-case test included a maximum load of four standard gates and the steering resistor input of the shift register. The maximum output load was reduced to two standard gates, and the steering input and base drive loads were also reduced slightly. These modifications that permitted operation under worst-case temperature conditions were satisfactory and therefore consequently adopted.

The studies were continued to determine the requirements for even better operation. Inductors added in series with the steering input resistors permitted a sub-

stantial increase in operation speed and a reduction in trigger power.

The addition of the two inductors decouples the collector from the following trigger steering network during the time of the trigger pulse. After the trigger pulse, there is over 0.5 μ sec for the capacitor to assume its new voltage state.

This circuit would be the most desirable one to use from an electrical viewpoint; however, the addition of the two inductors would require more than one micromodule for a shift-register stage and, in the interests of economy of volume, the design without the inductors was chosen.

All logic micromods are compatible and use common supply voltages and signal-voltage characteristics. Line receivers and drivers are provided for the transition from computer signal voltage to Fieldata operation.

All electronic components are operated well below rating to assure maximum reliability. Resistors are operated at a maximum of 20-percent of rating. Silicon transistors are junction-temperature limited to 100 C in operation, although circuits were designed and tested for 125 C operating temperatures.

POWER SUPPLY — The power supply is operationally typical of digital computers in that it furnishes a large number of well-regulated output voltages with low source impedance. However, it differs from most computer supplies in two major respects that complicate the design: the requirement for small overall size and poor regulation of the primary power source. A block diagram of this supply is shown in Fig. 4.

The input voltage source for the computer may range from a poorly regulated field-type to a well regulated commercial power line. The d-c power supply has been designed for the following input power conditions: voltage—120 v, 10 percent single phase; frequency—50 to 60 cps, 10 percent; transient voltage range—(5 sec) 31 to 86 cps.

The required d-c output of the supply with two memory packages (4,096 word capacity) is 250 watts, consisting of 13 different voltages. The wide range of input voltage and frequency coupled with the require-

ment of minimum size and weight, made unsatisfactory the conventional design approach using a power transformer with individual rectifiers and regulators for each voltage. Instead, a power supply incorporating the following features was designed: (1) controlled bridge rectifiers operating directly from the a-c line, to achieve rough regulation in the order of 15-percent; (2) single-section L-C-filter to reduce ripple to less than 10-percent after 60-cycle line input rectification; (3) Morgan regulator circuit, using a silicon-controlled rectifier and a square-loop core to achieve regulation in the order of 2-percent; (4) single-section L-C-filter to reduce ripple to less than 1-percent after high-frequency regulation; (5) silicon-controlled rectifier parallel inverter operating at 1,000 cycles, using a power transformer with separate windings for individual supplies; and (6) individual rectifiers and regulators for each output voltage, where required.

In the bridge rectifier and filter, silicon-controlled rectifiers are used as the primary type of rectification to provide lossless voltage regulation to the Morgan circuit. The regulation required is relatively crude with a large ripple voltage inasmuch as the Morgan circuit can operate with pure or pulsating dc-inputs. Severe voltage and frequency variations of the primary power source make the exclusive use of a Morgan circuit or controlled bridge awkward. If only a controlled bridge is used, the filter choke required is large and heavy, although the capacitor is reasonable. If a Morgan circuit is used exclusively with a conventional full-wave bridge input, the filter capacitor required on the bridge must have a high voltage rating, which represents height, weight, and volume, since physical size increases with voltage rating. In addition, the nearly 2:1 voltage variations from the bridge would make acceptable regulation difficult. The use of a combination of two circuits allows much smaller chokes and capacitors to achieve the same regulation and transient load response for the input to the inverter.

The Morgan regulator and filter circuit provides lossless, tighter regulation for the inverter input.

The circuit generates pulses of approximately constant width to the load, by virtue of the silicon-controlled rectifier acting as a switch in series with the load. The repetition rate of these pulses is controlled by a voltage-sensing feedback network that regulates average potential. The repetition rate ranges from 500 to 2,000 cps; thus, the filter choke and capacitor may be much smaller and lighter than those required if the controlled bridge were used to operate the inverter. The Morgan circuit regulation response is inherently faster than the controlled bridge since its repetition rate is so high. This is an advantage for transient load changes, because the controlled bridge response is always at least a half-cycle behind at line frequencies.

The parallel silicon inverter uses two silicon-controlled rectifiers in a parallel inverter to convert 50 volts d-c to 1,000 cycles a-c. Two additional silicon rectifiers are used for 400 cycles a-c. The scr requirements are 5 amperes average current and about 150 volts peak-inverse voltage to allow for switching transients. These are reasonable ratings, well within the range of available scr's. The rectifiers are triggered 180-degrees out of phase by a binary counter to insure symmetry of the applied square wave to the transformer.

Insuring symmetry of the 1,000-cycle square wave minimizes the 1,000-cycle ripple in the rectified outputs of the individual supplies and reduces the amount of regulation required.

The power transformer has eight output windings for the various voltage supplies. Bridge rectifiers are used on the higher-voltage windings to minimize winding space, while full-wave center-tapped windings are used for low voltage to minimize diode drops. Where voltages are close in value, or load currents are small, one winding is used for several voltage outputs.

The 128-v and 26-v fan-motor supplies are derived from taps on the primary winding of the 400-cycle auto-transformer.

The individual output regulators are of the series and shunt types. The series regulators are used for high-current supplies, with shunt

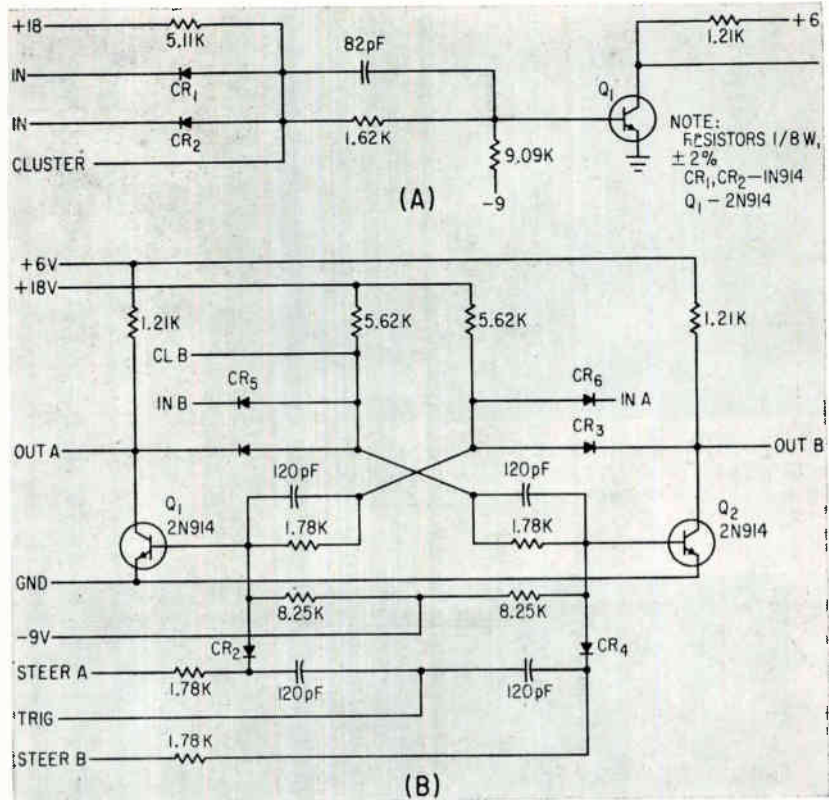

STANDARD GATE circuit is the most frequently used micromodule in the computer (A); shift register operates at a 1.6-Mc clock rate (B)—Fig. 3

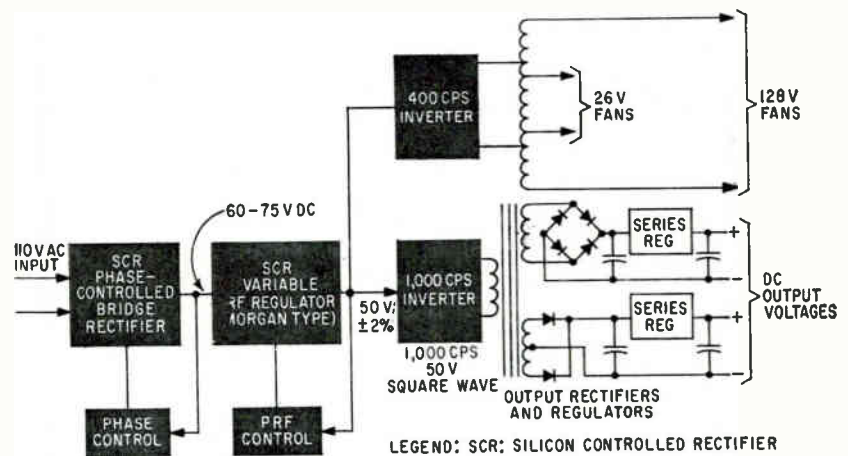

POWER SUPPLY for the computer uses several modern techniques to achieve high regulation from a widely varying power source—Fig. 4

zener-diode regulators for low-current supplies. These regulators are standard. Little regulation is required to compensate for input changes, because of good regulation preceding the inverter; hence, a minimum of power is wasted in series regulators, and power-supply efficiency and cooling are not problems.

CONTROL PANEL—The control panel provides for manual insertion of information into the computer and for monitoring and selecting

the various operational modes.

Information may be entered manually by the keyboard on the control panel. Input or output data may be displayed in digital and binary forms by 10 Nixie tubes and 38 neons, respectively.

This work was a joint effort by the Tactical Data Processing activity of the Digital Data Communications Department of RCA Defense Electronic Products. The author thanks A. Coleman, E. Schlain, R. Torrey, W. Miller and H. Sauer for their work.

THE VERSATILE How It Detects

By S. SAITO, K. KUROKAWA,
Y. FUJII T. KIMURA and Y. UNO
Institute of Industrial Science,
University of Tokyo, Tokyo, Japan

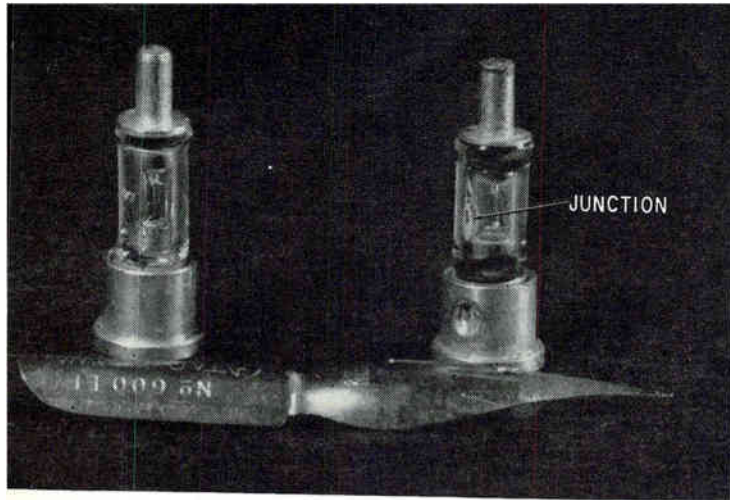

PARAMETRIC DIODES. Two kinds of silver-bonded, point-contact diodes (Ge and Si) have been tested. Shown here are Ge diodes, type GSB1B—Fig. 1

SEVERAL methods of demodulating laser signals into microwave have been tested and it has been found that the semiconductor diode has a high quantum efficiency. Further, the diode, which can be used in the infrared region, allows parametric amplification of the demodulated signal. Experiments show that parametric diodes can demodulate and amplify the signal from a ruby laser.

PRINCIPLES—For frequency conversion, especially demodulation of laser light, nonlinear devices are necessary. A. T. Forrester¹ demonstrated the square-law characteristics and microwave response of a photocathode, and B. J. McMurtry and A. E. Siegman² succeeded in detecting and amplifying the beat components in laser light. They used the external photoelectric effect, or photoelectric emission, in which the electrons are carried away from the cathode material by photon energy. There is another photoelectric effect, the so-called internal photoelectric effect (a general term for photoconductivity, photovoltaic effect, etc.) that uses the same principle — electrons are taken away from the filled band to the conduction band by acquisition of photon energy.

To discuss the applicability of these photoelectric effects to a laser detector, consider quantum efficiency. The signal-to-noise ratio of optical superheterodyne reception is proportional to the quantum efficiency η , as

$$S/N = \eta P_{in} / h\nu B$$

where P_{in} is input light power, h is Planck's constant, ν is light frequency and B is receiver band-

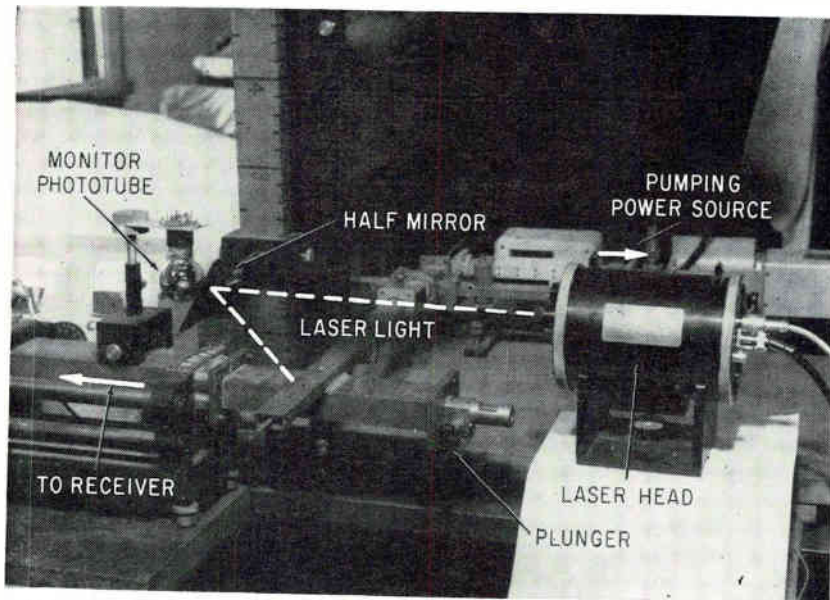

DOTTED WHITE LINE shows path of laser beam in experimental setup—Fig. 2

AUTHORS Shigebumi Saito (right) and Kaneyuki Kurokawa (left) demonstrate the experimental setup used in demodulating and amplifying laser signals

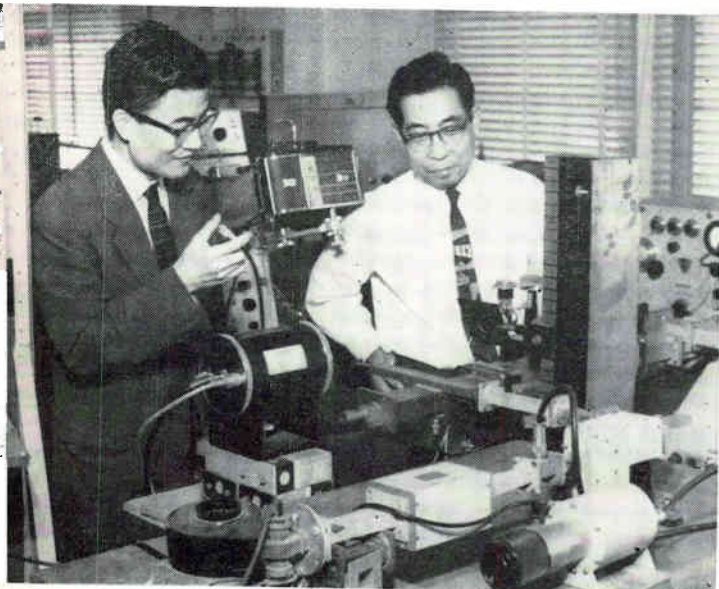

POINT-CONTACT DIODE and Amplifies Laser Light

Laser signals are demodulated and converted into microwave by a semiconductor diode that also parametrically amplifies the demodulated signal

width. The quantum efficiency of the usual photocathode material is poor. To 6,943 Å light from the ruby laser, for example, $\eta = 10^{-2}$ to 10^{-3} for a Ag Cs photocathode and $\eta = 10^{-5}$ to 10^{-6} for an oxide cathode. By contrast, the internal photoelectric effect of the semiconductor has a quantum efficiency of nearly 100 percent. Thus it can be an efficient detector. This detector also has the possibility of infrared light detection. The infrared limit of the photoemission is about 1.2 microns in wavelength obtained from a Ag Cs photocathode. For semiconductors, however, the limit is determined by the energy-band gap between the filled band and the conduction band. Many semiconductors have a low energy gap; for example, an intermetallic compound semiconductor InSb has an extremely narrow band gap, 0.17 eV, which means that light of 10 microns wavelength is still detectable.

H. Inaba and A. E. Siegman³ and L. U. Kibler⁴ first reported the detection of the laser light by a *pin* silicon diode and a germanium diode, respectively. We have detected the laser light by a point-contact diode and parametrically amplified the microwave signals.

POINT CONTACT DIODE—Since the excitation of electrons by incident light may take place without any appreciable time delay, the frequency response of the detecting device is restricted chiefly by the velocity of holes or electrons, recombination, and the additional resistance or capacitance. Since the semiconductor point-contact diode is conventionally used for microwave detection, it has sufficiently fast response.

Because these diodes are made for parametric amplification, both detection and amplification can be obtained by the parametric principle. This device gives high gain, low noise figure and a wide bandwidth. It may be an excellent and sensitive laser detector.

LASER—The laser used is a Raytheon model LH-1. The crystal is 0.05 percent trivalent chromium ion doped ruby, 2.5 inches long and 0.25 inch in diameter. The pumping xenon flash tube is a EG&G type FX-38. The crystal and xenon flash tube are placed at the two foci of an elliptical mirror. This laser is usually pumped to a level of 300 joules in the experiment. Threshold is about 150 joules. Output power of the laser light is several watts at the peak. The beat frequency f_b of two adjacent longitudinal modes is generally given by $f_b = c/2Ln$, where L is the ruby rod length, n is the refractive index of ruby, c is the light velocity in vacuum; (see Fig. 3A). The third harmonic of beat frequency should be 4,026 Mc. 3,960 Mc is obtained experimentally with both photodiode and photocathode.

LASER COMMUNICATION

If, as seems possible, photodiodes can be used for down conversion and amplification of laser light, these semiconductor devices could play an important role in laser communication systems of the future. These experiments show that the photodiode is indeed a promising device

Two kinds of silver-bonded, point-contact parametric diodes were tested. They are germanium and silicon (Fig. 1), manufactured by Nippon Electric Co. The germanium diode is a GSB1B; the silicon diode is a test specimen. These diodes are all glass-sealed, and the junction is visible (Fig. 1). The crystals are about 1 mm square, with *n*-type doping; the point-contact is made by Ag-Ga wire 0.05 mm in diameter. Junction capacitance is 0.1 to 0.3 pf.

EXPERIMENTAL SETUP—The experimental equipment for diode-type detection is shown in Fig. 3B. (See also Fig. 2 and photo). The diode is placed in the 4,000 Mc waveguide cavity. Laser light from the ruby is reflected by a partially transparent mirror (96 percent reflectance) used to adjust the position of incident spot. Neither collimation nor a focusing system is employed. The laser light is projected obliquely to the junction of the diode through a hole drilled on the cavity wall. Behind the mirror, a phototube monitors the laser output power. The 8,000-Mc pumping-power waveguide is placed across the 4,000-Mc waveguide. Pumping power is coupled to the 4,000-Mc cavity by a stub in a hole. A dual beam oscilloscope displays any two of these three: receiver output, diode current or monitor phototube output.

An equivalent circuit of the photodiode including the detector is shown in Fig. 3C. When no pumping power is applied, the negative conductance should be excluded. The signal source is a current generator at the junction excited by photon energy. The isolator de-

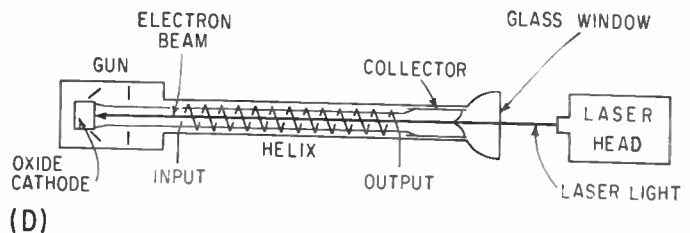
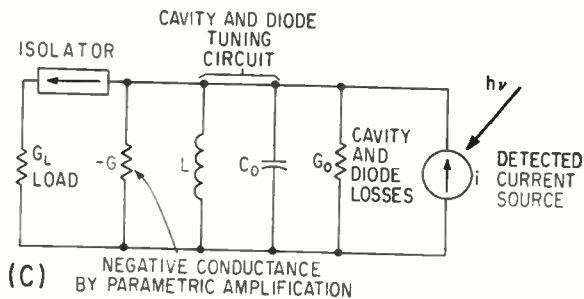
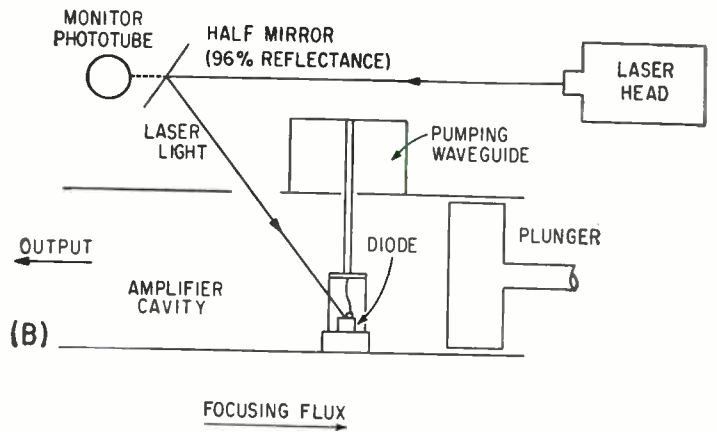
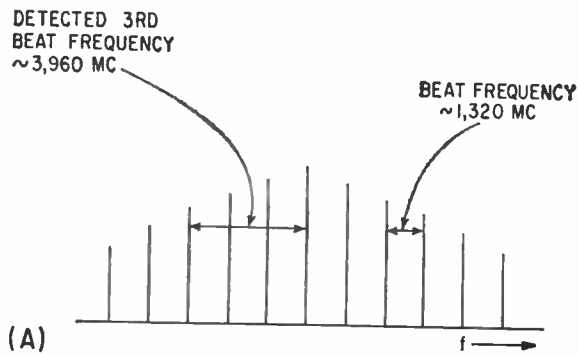

SPECTRUM of laser light (A); diode detector-amplifier system (B); equivalent circuit of detector system (C); and twt photodetector (D)—Fig. 3

couples the detector from the receiver and stabilize the parametric amplifier.

A similar detection experiment was done with a phototube twt. The experimental equipment for a phototube twt is almost identical with that for the diode. Instead of

the junction of the diode as shown in Fig. 3B, a traveling-wave tube with oxide-coated cathode plays a main role. See Fig. 3D. The laser light is projected to the cathode through a transparent glass window and cylindrical collector. The emitted photoelectrons form an electron

beam that amplifies the detected signal contained in the electron beam in a conventional way. Twt output is fed to the receiver.

RESULTS—The output of the photodiode detector not parametrically amplified is shown in Fig. 4B. The spectrum of the detector outputs is shown in Fig. 5A. The half width of the spectrum is about 10 Mc. This photodiode spectrum is almost identical with that of the phototube twt. The output of the phototube twt is shown in Fig 4A. The peak emitted current is about $500 \mu\text{a}$ and the net amplifier gain at this level of beam current is 0 db. Since the receiver bandwidth is about 10 Mc, the details of the spectrum cannot be found from these data. The equivalent input power of the detected beat component is about -60 dbm for both types of the detectors. The equivalent input power is the input power that could produce the same output as the detected signal of the laser light. Considering the extremely small area of the junction, the diode detectors are much more sensitive than the oxide cathode twt. This is also clear from considerations of the quantum efficiency.

The waveform of the ruby laser output has many irregular spikes. The coincidences of the spikes between the three waveforms of the

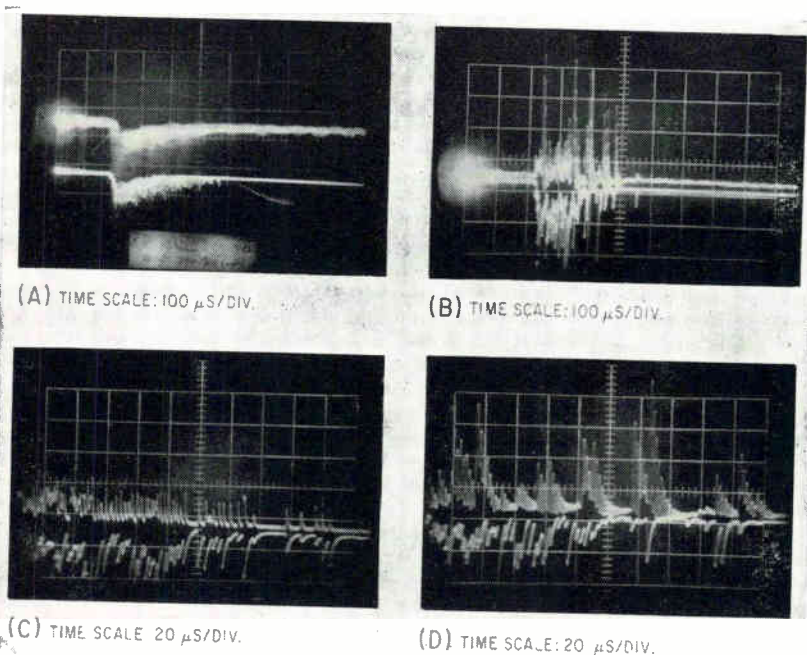

DETECTED OUTPUT of phototube twt (A) is upper trace; lower trace is beam current ($500 \mu\text{a}/\text{div}$). Detected output of Ge diode (B) is upper trace; lower trace is diode current ($100 \mu\text{a}/\text{div}$). Coincidence between laser output and diode current (C) shows monitor phototube current in upper trace and diode current ($100 \mu\text{a}/\text{div}$) in lower trace. Coincidence between diode current (lower trace, $100 \mu\text{a}/\text{div}$) and detected output (upper trace) of Ge diode is shown in (D)—Fig. 4

monitor phototube output, diode current and detected output are important. The coincidence between the phototube output and the diode current is nearly perfect (Fig. 4C); the coincidence between the diode current and the microwave output is less perfect (Fig. 4D). Figure 5B shows the changes of the photodiode current and the detected output. The negative bias voltage increases the detector output because the increase of junction impedance makes the junction capacitance smaller. Thus the available output power may be increased.

With pumping power, the diode detector system operates as a parametric amplifier. The detected current through the junction is amplified, increasing linearly with the parametric amplifier gain as shown in Fig. 5C. The change of diode impedance, probably the increase of the d-c capacitance C_0 in Fig. 3C, is observed during illumination. This could be explained by the increase of capacitance due to decrease of bias voltage induced by photovoltaic emf. This conclusion is supported in that the gain of the parametric amplifier increases during laser illumination if the cavity is detuned by reducing L in Fig. 3C (moving the plunger toward the diode). But gain decreases (Fig. 6A) if the cavity is detuned by increasing L (moving the plunger away from the diode). This change of gain corresponds to the junction voltage. When the diode bias is open-circuited, the photovoltaic emf. appears with the incidence of the light beam and cannot decay. The gain changes suddenly with incidence of light (Fig. 6B). The change of impedance is also observed in direct impedance

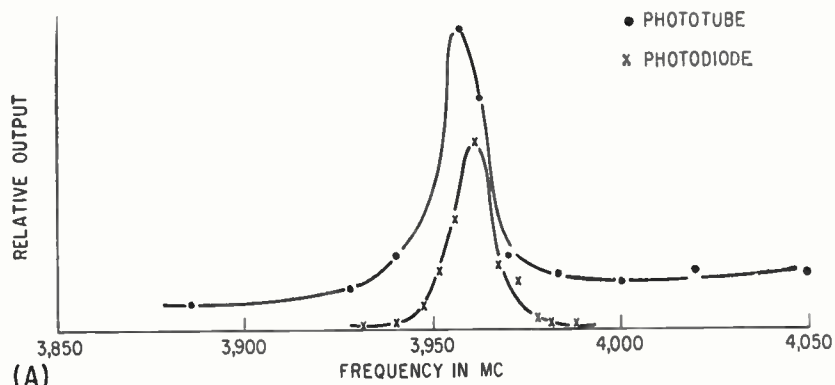

(A)

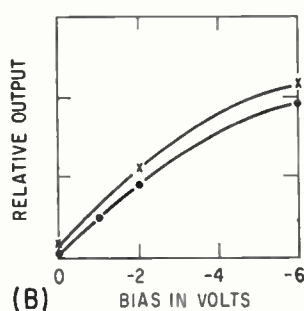

(B)

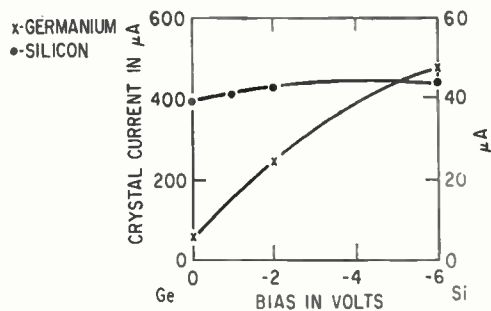

SPECTRUM of phototube output and photodiode output (A); bias-voltage characteristics of the detector diode (B); parametric amplifier gain of the detected signal (C)—Fig. 5

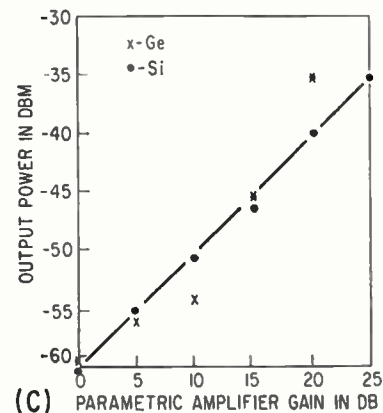

(C)

measurements by the standing-wave detector during illumination. Figure 6C shows an example of

the output of the standing-wave detector. The standing-wave ratio changes with laser light.

REFERENCES

- (1) A. T. Forrester, et. al., *Phys Rev* 99, p 1,691, 1955.
- (2) B. J. McMurtry and A. E. Siegman,

- Appl Opt*, 1, p 51, 1962.
- (3) H. Inaba and A. E. Siegman, *Proc IRE*, 50, p 1,823, 1962.
- (4) L. U. Kibler, *Proc IRE*, 50, p 1,835, 1962.

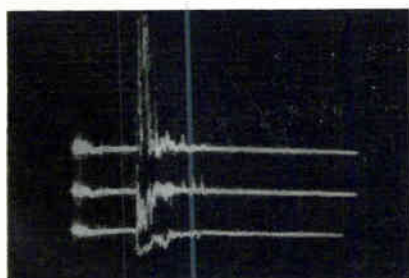

(A) TIME SCALE: 100 μS/DIV.

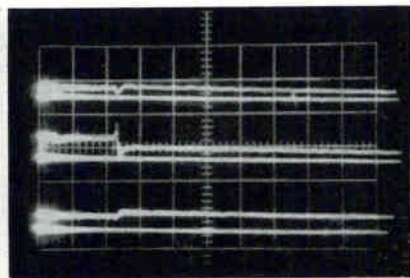

(B) TIME SCALE: 100 μS/DIV.

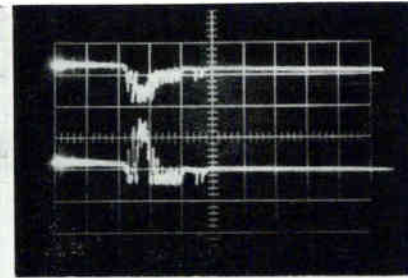

(C) TIME SCALE: 100 μS/DIV.

CHANGE of parametric amplifier gain for Ge diode (A)—upper trace is for reduced L , middle trace for tuned L , and lower trace for increased L . Gain change when Si diode circuit is open-circuited (B)—upper trace is for large L , middle trace for tuned L , and lower trace for small L . Standing-wave detector output for Ge diode (C) is shown in lower trace and diode current is in upper trace—Fig. 6

MULTITONE OSCILLATORS-*New*

Transferring the amplitude stabilizing elements to individual tank circuits permits sinusoidal oscillation at several frequencies with no mutual mixing

PICK A FREQUENCY

Here's how to design five oscillators, all tuned to different frequencies, using only two transistors. The multitone circuit can operate at any of the five frequencies, or in any frequency combination.

The circuit forms the basis of a five-bit parallel data encoder for telemetry use

THE SIMPLE two-transistor circuit, Fig. 1, represents a large class of multitone oscillator circuits that can be designed for simultaneous oscillations at many independent frequencies. There is negligible interaction between the frequency determining tank circuits, and output has low harmonic distortion. The circuits use noncritical components

The key to multitone oscillator design is the amplitude stabilization process in an ordinary oscillator. Fig. 2A depicts the starting transient of a series-tank oscillator. If the switch is closed at $t = 0$ there will be a buildup of an oscillation at a frequency $\omega_0 \cong 1/\sqrt{LC}$

with oscillation envelope amplitude increasing exponentially proportionally to $t (|R_n| - R)/2L$.

In any practical circuit this exponential buildup is eventually limited by nonlinearities in the circuit—usually in the negative-resistance device itself. The amplitude of oscillation stabilizes at a steady state value where energy added by the negative resistance source equals the energy lost in the tank. This steady-state amplitude of oscillation permits the average negative resistance of the source to equal the equivalent positive resistance R of the series tank circuit.

The terminal characteristics of the negative-resistance source are modified by the steady-state oscillation. Not only is there a sinusoidal oscillation at the tank frequency ω_0 , but terminal characteristics of the source at frequencies other than ω_0 have been seriously affected by the periodic clipping or saturation of the source, which is necessary to maintain the steady-state amplitude of oscillation. Any attempt to use the negative-resistance source simultaneously at a frequency other than ω_0 will consequently introduce mixing and am-

plitude-modulation effects.

NONLINEAR TANK—If, instead, the equivalent series resistance of the tank circuit can be made to adjust itself upward to equal the negative resistance of the source, steady-state oscillations can be achieved without ever driving the negative resistance source into its nonlinear region (see curves, Fig. 2B and 2C).

In conventional oscillator operation (Fig. 2B), the envelope amplitude increases exponentially until the nonlinear portion of the negative-resistance source curve is reached and equilibrium $R = |R_n|$ established. This equilibrium lies in the nonlinear region and will be maintained by the periodic clipping or saturation of the transistor, tube or tunnel diode used as the negative-resistance source.

In the tank-stabilized oscillator, Fig. 2C, the envelope amplitude increases exponentially, but is limited by the increasing positive series resistance of the nonlinear tank circuit; $R = |R_n|$ in the steady state, but now the equilibrium of positive and negative resistances occurs in the linear region of the negative-resistance source. The source can be used simultaneously at other frequencies without mixing occurring, if the instantaneous sum of all oscillation voltages never drives the source into its nonlinear region.

Nonlinear series tank circuits can be achieved in many different ways (see Fig. 2D). The basic requirement is that the effective series resistance of the tank circuit at resonance must increase with rms current amplitude. The V/I nonlinearity of the added circuit element in each tank causes the equivalent positive series resistance of the tank to increase above the low-level equivalent value $R_{e0} = \omega L/Q = 1/Q\omega C$ of the simple series L-C tank circuit, Fig. 2A. The parallel nonlinear elements cause a nonlinear

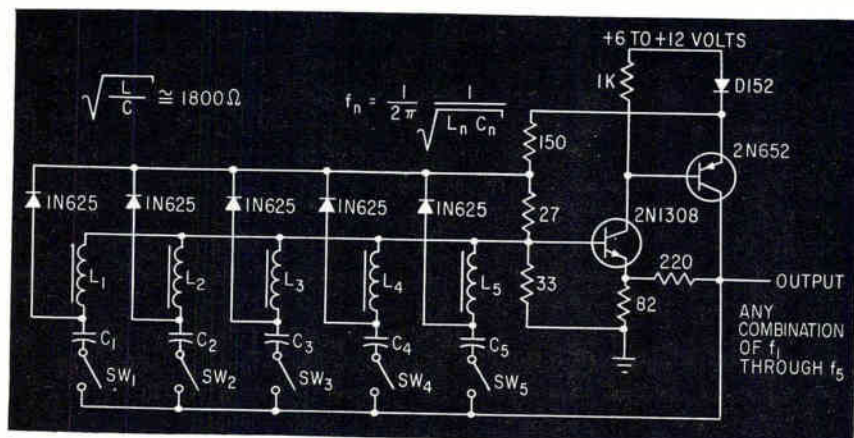

DIFFERENT PERMUTATIONS of one through five tones are generated by this circuit, enabling it to operate as a five-bit parallel encoder for industrial telemetry—Fig. 1

Source of Simultaneous Frequencies

By ROELIF STAPELFELDT

Research Department, Union Switch & Signal Div.,
Westinghouse Air Brake Company, Pittsburgh, Pa.

change in the effective Q of the reactive element being shunted and thus affect the equivalent series resistance of the tank circuit. The nonlinear device can be placed in parallel with either the tank capacitor or the tank inductor, depending on d-c bias requirements.

AMPLIFIER CHARACTERISTICS

—Many linear negative-resistance sources can be used when designing multitone oscillator circuits. The source's negative resistance must be in excess of the low-level equivalent series resistances of the tanks to be driven by it. But if there is too much excess negative resistance, the operating Q of the tank circuits may be reduced to the point where undesired loading effects and harmonic distortion become appreciable.

APPLICATION—An extension of the multitone oscillator principle is used in the vehicle identification beacon shown in Fig. 3. This circuit achieves amplitude modulation by using an unstabilized r-f tank circuit (a BaTi Transfilter) in parallel with the stabilized a-f tanks. The restriction that the negative-resistance source always must be operating in its linear range is not mandatory if only a single r-f tank is present and its resonant frequency is much greater than the highest a-f frequency tank. Then the r-f is amplitude-limited by saturation or clipping in the negative-resistance source but at such a rapid rate that the effective negative resistance at the lower frequencies remains virtually constant. Moreover the r-f oscillations will be a-m modulated by the much lower audio frequencies and will be suitable for transmission by conventional r-f techniques. The loopstick transmitting antenna and the bypassed 160-ohm resistor comprise a collector load of enough impedance at all frequencies present to allow the transistor amplifier to develop adequate open loop gain at the audio frequencies while effectively driving the loopstick at 456 Kc.

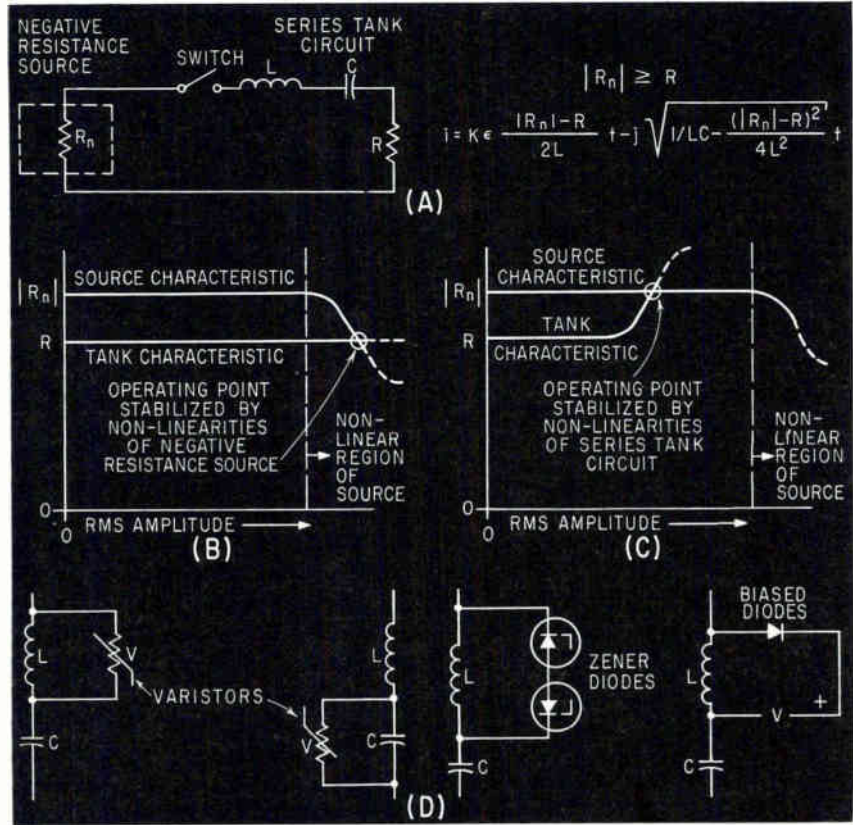

STARTING TRANSIENT in a simple series-tank oscillator (A). Conventional oscillator is stabilized by adjusting equivalent resistance of negative-resistance source (B); multitone oscillator uses nonlinearities to adjust tank circuit equivalent resistance (C); methods for using nonlinear elements in tank-circuit stabilization (D)—Fig. 2

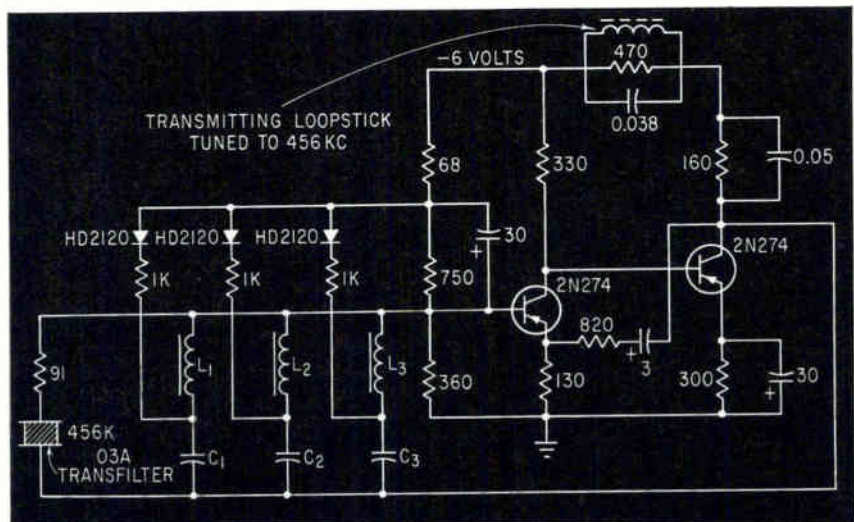

LOOPSTICK of vehicle identification beacon broadcasts 465-Kc carrier amplitude-modulated by sum of a-f signals generated by three plug-in tank circuits—Fig. 3

Here is a squelch circuit designed for point-to-point vhf and uhf receivers. It is self-adaptive to changing noise levels and receiver gain. It has smooth, noiseless, on-off transition ideal for use in remote unattended receivers, in aircraft, or in mobile communications

FAIL-SAFE SQUELCH CIRCUIT

By H. G. MICHAEL*

Collins Radio Company
Cedar Rapids, Iowa

RECEIVERS for point-to-point communication in vhf and uhf bands have a squelch scheme that suppresses the noise output of the receiver when no carrier is present.

Previous squelch schemes had several drawbacks; they required either adjustment of a manual threshold control, or could be turned on accidentally by high ambient noise, or the squelch threshold level would vary with varying receiver gain.

* Presently at Space Craft, Incorporated, 8620 South Memorial Parkway, Huntsville, Alabama.

This squelch overcomes these drawbacks; it has fast attack and release times; it self adjusts to changing noise levels; and it is fail-safe, that is, the squelch opens and remains opened when the receiver gain is below the threshold level.

The squelch does not require external controls, and may not be accidentally turned on by high ambient noise; moreover, it will not permit simultaneous reception of two channels if their frequency difference is greater than the upper cutoff frequency of the receiver audio system.

The system is based on the fact that the carrier-to-noise ratio at the i-f output of the receiver depends on the noise bandwidth of

the i-f stage; therefore, the minimum squelch threshold is also related to the i-f bandwidth. The self-adjusting squelch is obtained using the relationship between carrier-to-noise ratio and bandwidths.

THEORY OF OPERATION—The carrier-to-noise ratio at the i-f output of a receiver is

$$\frac{C}{N} = \frac{C_{in}G}{(KTBF + N_a)G} = \frac{C_{in}}{KTBF + N_a}$$

where C/N = carrier-to-noise power ratio at the i-f output, C_{in} = carrier power at receiver input terminals, G = overall gain, K = Boltzman's constant, T = equivalent noise temperature of antenna in degrees Kelvin, B = receiver i-f bandwidth, N_a = noise power due to ambient noise at receiver input terminals, and F = receiver noise figure expressed as a power ratio.

Thus, assuming that the receiver has sufficient gain to produce a measurable power, the carrier-to-noise ratio at the i-f output is independent of receiver gain. For a given modulation percentage, the signal-to-noise ratio of the detector output, and the carrier-to-noise ratio at the i-f output are proportional; therefore, satisfactory squelch is obtained by actuating it at a fixed carrier-to-noise ratio at the i-f output.

The squelch threshold must be low enough to operate on signals that produce approximately 1-db

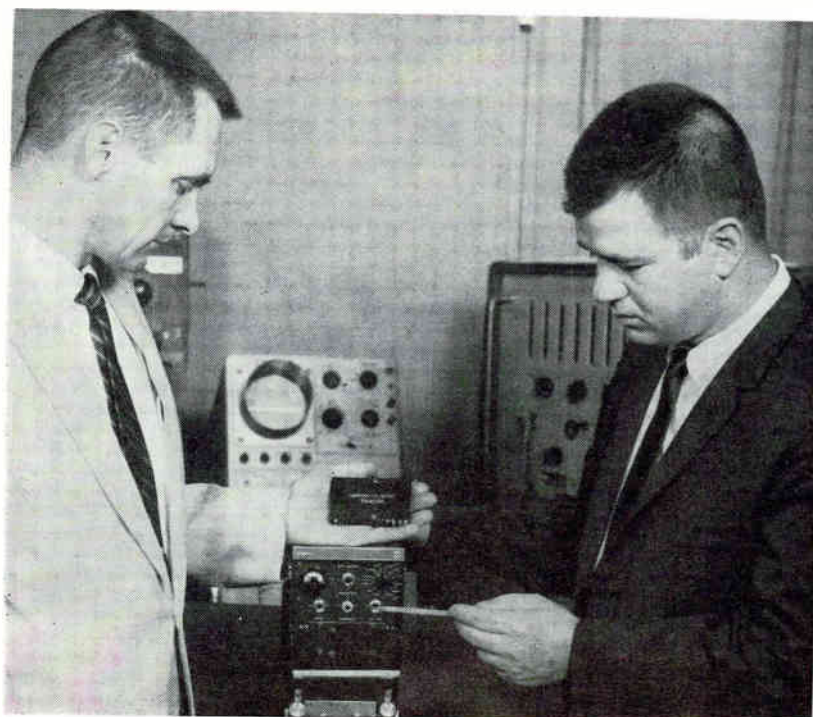

AUTHOR, H. G. Michael (left) and C. P. Womack discuss first working model of carrier-to-noise squelch incorporated to a transistor vhf transceiver

SQUELCH CIRCUITS: HOW GOOD ARE THEY?

Squelch circuits are designed to quiet a receiver when desired signals are not present. While the object of the squelch action is to eliminate unwanted noise, not all squelch circuits achieve the goal successfully, or conveniently. For example, some squelches are triggered by ignition or other peak signals; others require frequent adjustment of the threshold control; still others introduce clicks and noises when keyed

Adapts To Changing Noise Levels

signal-to-noise ratio at the audio output terminals when the carrier is modulated 30 percent. Since a linear a-m detector changes the signal-to-noise ratio, it is necessary to find a relationship between the output signal-to-noise ratio and the carrier-to-noise ratio at the detector input. This relationship is discussed in the literature^{5, 6, 7} and curves are available for receivers with a high ratio of i-f to audio bandwidth. A new curve has been plotted and is shown in Fig. 1A for a typical vhf receiver with a 40-Kc i-f bandwidth and a 4-Kc audio bandwidth. At 30 percent modulation an output signal-to-noise ratio of 1 db occur for approximately 7 db carrier-to-noise ratio at the detector input. It is of interest to determine the signal level required at the receiver antenna terminals to produce a 7-db carrier-to-noise ratio at the i-f output. For a receiver with a 40 Kc i-f bandwidth and a 10-db noise figure, the noise power referred to the receiver input terminals in the absence of external ambient noise is

$$N = KTBF = 1.65 \times 10^{-15} \text{ watt}$$

For a 50-ohm antenna impedance R , the rms noise voltage referred to the antenna terminals is

$$E_n = \sqrt{NR} = 0.29 \mu\text{v}$$

Therefore, the r-f carrier voltage at the receiver antenna terminals is 0.62 μv for a 7-db carrier-to-noise ratio. This corresponds to 1.24 μv open circuit. Thus, a minimum squelch threshold at a 7-db carrier-to-noise ratio is adequate to obtain squelch action at the lowest usable signal level.

One method of operating the re-

ceiver squelch at a given carrier-to-noise ratio uses the noise suppression properties of a band-pass limiter and provides nearly ideal squelch performance. Another method uses the noise reduction properties of a conventional receiver agc system and performs nearly as well as the limiter method but with considerable circuit simplification.

NOISE SUPPRESSION — The noise suppression characteristics of a band-pass limiter may be used to provide an output voltage proportional to the carrier-to-noise ratio at the receiver i-f output. To illustrate the limiter properties that make this possible consider a perfect limiter with band-pass filters. The power output P_o is constant for any given input level above zero. The noise power output with no carrier at the input (N_{nc}) and carrier P_{nc} . The carrier power output with no noise at the input (C_{nn}) is also equal to P_o . Noise power output with carrier is N_o and carrier power output with noise present is C_o . When noise and carrier are both present at the input, the output ($C_o + N_o$) is still equal to P_o . Thus

$$P_o = N_{nc} = C_{nn} = C_o + N_o = \text{constant}$$

The noise suppression characteristics of the limiter as a function of the carrier-to-noise power ratio at the limiter output may be determined by

$$\beta^2 = \frac{N_o}{N_{nc}} = \frac{N_o}{N_o + C_o} = \frac{1}{1 + C_o/N_o}$$

The term β denotes the ratio of rms noise voltage at the limiter output in the presence of a carrier to the noise voltage when no carrier is

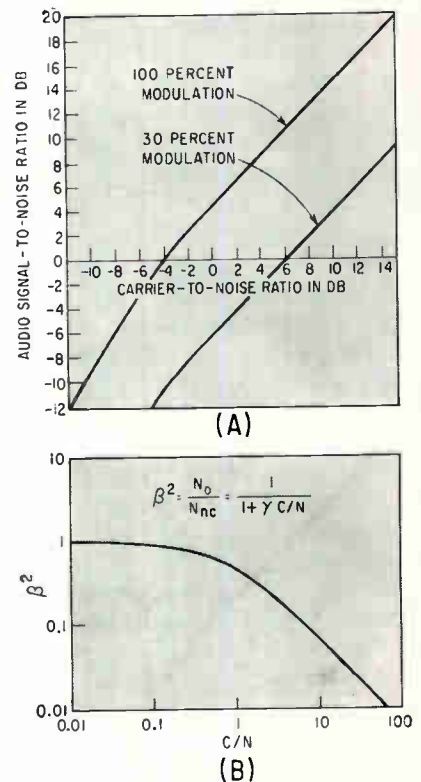

SIGNAL-TO-NOISE ratio at output of linear a-m detector plotted against carrier-to-noise ratio for 40-Kc i-f bandwidth, and 4-Kc audio bandwidth (A); ideal band-pass limiter noise-suppression characteristic (B)—Fig. 1

present. Thus, β^2 is the noise power suppression factor of the limiter when noise and carrier are both present at the limiter input. Davenport⁴ has shown that the carrier-to-noise ratio at the limiter output is related to the carrier-to-noise ratio at the limiter input by

$$\frac{C_o}{N_o} = \gamma \frac{C}{N}$$

where γ is a function of the carrier-

to-noise ratio at the limiter input. Thus, the noise power suppression factor in terms of carrier-to-noise ratio at the limiter input is

$$\beta^2 = \frac{1}{1 + \gamma \frac{C}{N}}$$

A plot of β^2 for various C/N ratios is shown in Fig. 1B. Sufficient change in noise power is available at the limiter output to operate a squelch circuit at a carrier-to-noise ratio of about 6 db at the limiter input. Therefore, the band-pass limiter is an ideal sensing device for operating a squelch system at a fixed carrier-to-noise ratio.

DESIGN CONSIDERATIONS —

A limiter is followed by circuits that operate a squelch gate at a predetermined carrier-to-noise ratio. The squelch circuit includes an a-m detector, noise amplifier, noise detector, and modified Schmitt trigger (Fig. 2).

The limiter provides noise suppression; ideally, it should provide at least 20 db of amplitude limiting. The series diode limiter, selected because of its symmetry, has a flat output amplitude characteristic, and a controllable output amplitude. However, it requires a high input level. Therefore, a 500-Kc amplifier stage was necessary between the receiver i-f and the limiter.

The a-m detector converts the noise in the i-f passband to noise in the audio frequency spectrum. Whatever carrier component may be present is removed from the low-

frequency noise at the detector output by a band-rejection filter. The low-frequency noise power at the output of a linear a-m detector when no carrier is present is approximately⁶

$$N_o = \frac{\pi}{8} N_{i-f}$$

where N_o is the low frequency noise power and N_{i-f} is the noise power in the i-f passband. This equation applies when the audio bandwidth is at least twice the i-f bandwidth so that the noise-noise beats near the i-f band edge are included. When a modulated carrier is present at the detector input, the low-frequency noise power for C/N_{i-f} greater than unity is approximately⁷

$$N_o = N_{i-f} \left[\frac{1 + \frac{M^2}{2} + \frac{N_{i-f}}{2C}}{1 + \frac{N_{i-f}}{C}} \right]$$

Thus, the low-frequency noise power at the a-m detector output increases in the presence of a carrier. For example, at a 6-db carrier-to-noise power ratio, the low-frequency noise power is increased by approximately 3.5 db.

The noise amplifier increases the noise power from a-m detector to a level sufficient to operate the noise detector. The frequency response of the noise amplifier extends from the upper end of the audio range to at least one-half the i-f bandwidth. This insures that most of the noise power will be amplified and that any modulation components not removed by the

limiter will be attenuated.

A noise detector converts the amplified noise to d-c voltage that operates the squelch control circuit. The d-c output from the noise detector varies with the noise power. A transistor for the noise detector and its d-c gain enhances the voltage change associated with a given change in noise power. In addition, the transistor detector can be arranged so that a decrease in noise power at the input produces an increase in d-c voltage at the output (see Fig. 3A). It is easy to actuate a trigger circuit at a d-c output level from the noise detector.

A trigger circuit assures fast snap-action turn-on and turn-off of the receiver audio output at predetermined carrier-to-noise ratios. The snap-action eliminates intermittent or distorted audio output on threshold-level signals. The trigger circuit accurately controls the hysteresis (range between turn-on and turn-off voltages) for optimum performance of the squelch in the presence of weak signals that may have a changing level due to fading. The hysteresis effect is also useful in minimizing the effects of carrier shift or modulation components that may show up on heavily-modulated signals. Therefore, the trigger circuit can be adjusted to turn on at a selected d-c voltage and turn off at a lower d-c voltage. The hysteresis range can be varied to suit applications. The modified Schmitt trigger has all of these desirable characteristics

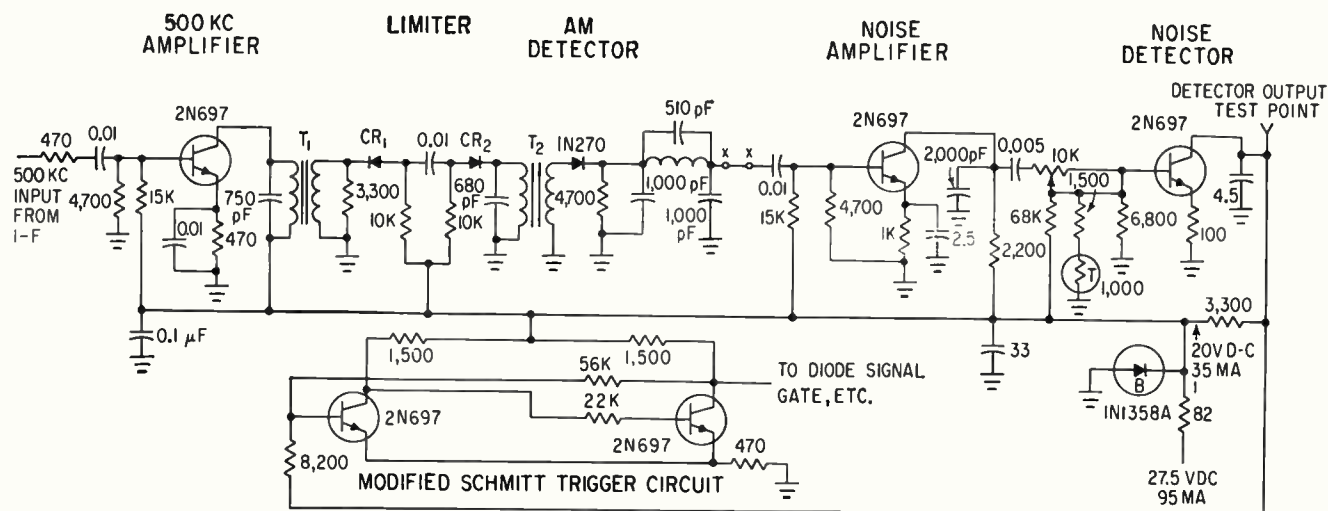

EVALUATION circuit diagram of the carrier-to-noise squelch system; modified Schmitt is triggered by output of noise detector—Fig. 2

and is fail-safe; that is, failure of any stage ahead of the trigger input causes the squelch gate to remain in the state that allows the receiver audio output to be heard.

The squelch gate either passes or blocks the audio signal according to whether the Schmitt trigger is on or off; a diode gate is used. When the trigger is on the diode, which is forward biased, lets the audio signal pass to the output circuits. When the trigger is off the diode, which is now reverse biased, blocks the audio signal.

The turn-on threshold of the carrier-to-noise squelch is a function of the i-f bandwidth preceding the limiter input, noise amplifier gain, noise detector gain and operating point, and Schmitt trigger turn-on voltage. The noise amplifier gain is easiest to control. Tests were run to determine the range of control. The curves (Fig. 3B) show that the threshold can be varied from about 3 μV to over 100 μV by varying the noise amplifier gain.

CIRCUIT PERFORMANCE—The threshold control resistor (Fig. 2) was adjusted to minimum resistance to find the maximum turn-on threshold with the given circuit. The upper limit was approximately 2 μV open circuit. Reliable operation can be obtained at r-f input levels as low as 0.5 μV from the generator by increasing the control resistor. The threshold was adjusted to 1.0 μV (open circuit) and the variation in carrier level re-

quired for turn-on was checked over the entire frequency range of the receiver (108.95 Mc to 135.95 Mc). The turn-on threshold was never less than 1.0 μV nor greater than 1.2 μV for any of the channels checked. The threshold control resistor had to be placed at the input to the noise detector rather than the more desirable position across the points marked X-X. Therefore, the upper limit of adjustment was limited to 2 μV .

The threshold control was set to turn on the squelch at 0.7 μV . The r-f generator was modulated 30 percent with a 1,000-cps signal; the output $(S + N)/N$ ratio was 1.5 db. The noise generator fed the receiver i-f strip just ahead of the 40-Kc band-pass filter. The turn-on threshold was 300 μV and the output $(S + N)/N$ ratio still was 1.5 db. Thus, the squelch circuit is a true carrier-to-noise device with external white noise. An additional test, using the noise output from the brushes of a 28-volt d-c motor was run; the noise, fed into the receiver antenna terminals through a small capacitor, was observed on a scope, and contained many variable-amplitude pulses and spikes. The motor noise raised the turn-on threshold to 100 μV and changed the output $(S + N)/N$ ratio to 1.0 db. Thus, the performance was still essentially determined by the carrier-to-noise ratio.

With the receiver tuned to 118.7 Mc through an attenuator, the squelch performed well at all signal levels. The squelch threshold was

set so low that the received signal could not be understood; the operation of the squelch was reliable and consistent. The threshold was also set so high as to give a readable signal with an estimated 15-db $(S + N)/N$ ratio; the operation of the squelch was also excellent. The turn-on and turn-off times were fast and operation was smooth. No undesirable characteristics were observed during several days of listening at periodic intervals. Ignition noise from cars in a nearby parking lot, observed on a scope at the receiver i-f output, raised, at some times, the noise level by several db; its effect was to raise the turn-on threshold of the squelch. Listening tests, showed that the optimum value of hysteresis is from 4 to 6 db.

The squelch unit was mounted on the front panel of the test receiver. This model has been flown in several two-engine aircraft; circuit performance was excellent.

BIBLIOGRAPHY

- (1) W. G. Klehfoth, Squelch System Controlled by Signal-to-Noise Ratio, Collins Tech. Rep. CTR-137, May 10, 1955.
- (2) J. M. Tewksbury, A Carrier Operated Squelch System Using Double Superheterodyne Reflex Techniques, Eighth Annual East Coast Conference on Aerospace and Navigational Electronics, October 23, 1961, pp 2.1.2-1 to 2.1.2-5.
- (3) J. M. Tewksbury, Receiver Squelch Control Uses Double Superheterodyne, ELECTRONICS, Jan. 19, 1962, pp 44-46.
- (4) W. B. Davenport, Jr., Signal-to-Noise Ratios in Bandpass Limiters, *Jour. of Applied Physics*, June 1953, pp 720-727.
- (5) E. G. Fubini and D. C. Johnson, Signal-to-Noise Ratio in AM Receivers, *Proc. IRE*, Dec. 1948, pp 1461-1466.
- (6) W. R. Bennett, Response of a Linear Rectifier to Signal and Noise, B. S. T. J., Jan. 1944, pp 97-113.
- (7) J. R. Ragazzini, The Effect of Fluctuation Voltages on the Linear Detector, *Proc. IRE*, June 1942, pp 277-288

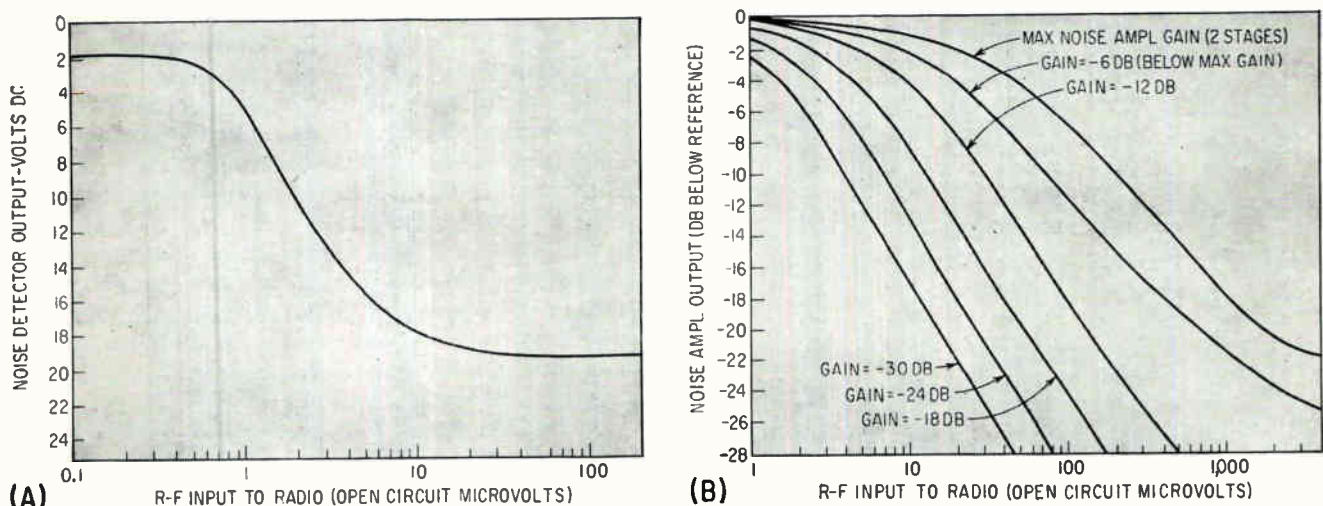

(A) NOISE DETECTOR d-c output plotted against r-f input of the test receiver (A) and noise-quieting characteristics of various noise amplifier gains (B)—Fig. 3

IMPROVED Air Traffic Communication

Communications network will be improved in a number of ways now under study. Weather network will undergo comprehensive long-range buildup

By JOHN F. MASON, Senior Associate Editor

THE PILOT of a six-hour jet flight from New York to San Francisco talks to air traffic control men on the ground approximately fifty times. On a one-hour flight from New York to Washington, he uses his voice communications gear eleven times. He averages, on the long flight, one voice contact with the ground every seven minutes; on the short flight, one every five minutes.

The result of all this loquacity is that the pilot and controller are often talking when they need to be doing something else; the available frequencies are loaded; and the entire air traffic control system slows

WSR-57 WEATHER radar at FAA's experimental station can detect precipitation at ranges up to 200 miles



down. The situation is bad today, and will undoubtedly get worse, since by 1975, the number of hours flown per year will increase by one third.

Solution to the problem will not be sought by advanced data link—although such equipment will be developed for the future; nor will additional frequency allocations be requested. Instead, the need for voice communications will be reduced.

The pilot who now makes fifty voice reports on a transcontinental flight will make approximately 16 in the future. He can dispense with the remaining 34 since his beacon transponder will automatically tell the controller his altitude and identity; ground radar will reveal his position; and his computer-processed flight plan will be transmitted from center to center and presented to controllers on electronic displays (ELECTRONICS, p 37, Dec. 7). Point-to-point data link will also relieve the pilot of much time-consuming conversation with other ground facilities.

In view of the lightened load on voice communication, vhf-uhf will continue to be the basic means of control through 1975. The system will, nevertheless, be improved.

VOICE - SYSTEM IMPROVEMENTS — Six techniques are being considered for increasing the capability of uhf-vhf radio.

- Minor improvements of the current system—Vhf will be changed from 100-Kc channel selectivity to 50 Kc by 1966. (Uhf will continue to operate with 100 Kc separation.) This will increase the number of available channels from 185 to 253. More channels would become available if it were possible to assign vhf transmitters and receivers on adjacent 50 Kc frequencies at the same ground site. To do this, a new generation of ground receivers and transmitters with more exacting specifications than present gear would have to be built, and sharply-tuned antenna coupling devices would have to be developed. Such gear is now being tested at FAA's National Aviation Facilities Experimental Center (NAFEC), near Atlantic City, N. J.

Other minor improvements under study include the possibility of using directional antenna patterns to reduce the number of required frequencies; and the possible benefit of separately operating the vhf/uhf switches of each paired assignment.

- Increase sector size and capacity—Larger sectors would reduce the number of channels needed, by putting more planes on the same channel. It is hoped that with computers, displays and data link, one controller can increase his sector capacity from seven to 20 aircraft.

and Weather Nets Planned

WHAT THE INITIALS MEAN

A/G —Air/Ground	RAPCON —Radar Approach Control Facility (USAF)
AMIS —Air Movements Information Service	RATCC —Radar Air Traffic Control Center (U. S. Navy)
ASR —Airport Surveillance Radar	RCAG —Remote Control Air to Ground
ARSR —Air Route Surveillance Radar	RCO —Radio Communication Outlet
ARTCC —Air Route Traffic Control Center	SAGE —Semi-Automatic Ground Environment (of the air defense system)
ATC —Air Traffic Control	SVC —Service
ATCRB —Air Traffic Control Radar Beacon	T —Transmitter
CARF —Central Altitude Reservation Facility	TVOR —Terminal VHF Omnidirectional Range
DME —Distance Measuring Equipment	UHF —Ultra High Frequency
FSS —FAA Flight Service Station	VHF —Very High Frequency
ILS —Instrument Landing System	VOR —VHF Omnidirectional Range
L/MF —Low and Medium Frequency	VORTAC —VHF Omnidirectional Range Collocated with TACAN
LRCO —Limited Radio Communication Outlet	Wx —Weather Station
NDB —Nondirectional	
R —Receiver	



REMOTE SITES pick up voice messages (vhf and uhf) from pilots and relay them by land line to distant centers below the horizon

In some cases, radio coverage will have to expand beyond line-of-sight. Two methods for doing this are site-switching and the offset carrier (or multiple site transmission) method. The former requires no equipment modification in the aircraft. The ground implementation, however, includes transmitters and receivers and a switching capability appropriate to the way each service is being provided.

The offset carrier method is used in Great Britain and the U.S. (but not by FAA). With a few exceptions, existing 50-Kc airborne receivers have sufficient frequency stability to accommodate the off-set carrier method. One slight modification required for receivers not already equipped would be the addition of a 3 Kc filter.

- Radio trunking on a center-wide basis—This method requires a greater number of transmitters and receivers at each site than exist at present. Also, automatic switching directed from the ground would be necessary. Main consideration is cost.

- One channel per aircraft—Feasibility of assigning each plane a frequency for the entire trip, or even the entire lifetime of the plane will be studied. Cost and complexity of ground gear would be high.

- Wide band voice—Digital techniques can be used to accommodate in a discrete manner a large number of voice messages at the same time, in the same wide band channel. Many examples of this technique have been developed for the Defense Department. Given the proper parameters and utilizing both audio frequency and time multiplexing, this technique would distribute the communications workload over an entire ARTC center. It would also eliminate frequency switching within the center area and provide a multichannel service where the use of adjacent 50-Kc channels is now prevented. Cost of scuttling all airborne and ground equipment and putting in wide band gear would, of course, be very high. The concept will, nevertheless, be studied.

- Data link—FAA does not plan to use air/ground data link in the national system before 1975. The controller will acquire position reports by radar and beacons, and voice will be used for control. Pos-

sible future applications for vhf/uhf data link include: confirmation of identity; confirmation of frequency change (for example, after radar hand-off), printing routine weather information, and printing departure clearances. Although no need for such equipment is foreseen in the near future, FAA is supporting the development of components to a limited extent.

REMOVING RADAR DATA—The need for radar remoting stems from two design decisions: (1) that primary radar and beacon, or beacon alone, will be the primary means of monitoring aircraft position and identity; and (2) within each large en route control area a centralized control facility will acquire, process and display the radar data to controllers.

Techniques for remoting radar data include coaxial cable, microwave, and narrow band wire line. Coaxial cable is used for distances up to two miles.

For longer distances, FAA has initiated a study—results of which will soon be released—for determining costs and feasibility of six configurations for processing and remoting radar data: (1) microwave remoting of decoded beacon data to a control center where the data are displayed by one electron gun of 945-line tv display; (2) microwave remoting of both decoded beacon data and radar video data to the same display; (3) microwave remoting of beacon video data (without decoding) to the control center; (4) microwave remoting of beacon video (without decoding) and radar video data to the control center; (5) analog to digital conversion of decoded beacon data at the radar site and remoting of this data by wire line to a control center; (6) analog to digital conversion of decoded beacon and radar video data at the radar site and remoting by wire line to a center.

WEATHER—On a recent flight from New York to Washington, an FAA official was surprised to see the stewardess busily hauling out trays to serve lunch. He could see the small cups of what the airlines believe is soup, the boiled chicken resting in a white fluid, the fruit compote piled high with whipped

cream, and the cups for the scalding water later.

Although forbidding under the best of conditions, the menu was particularly formidable because of what was going to take place in fifteen minutes. The stewardess had apparently not been told that the thunderstorm ahead would put every tray and every delicacy on it into a quick state of weightlessness, followed, just as suddenly, by at least two g's. The official knew this because he had visited friends in the airport weather station before boarding the plane. The pilot, he learned later, had not had time between flights to check the weather.

To avoid perils of travel such as this one, and others that are far worse, FAA is developing the Common Aviation Weather System (CAWS). "The objective of the system is to communicate weather data to the airspace user," FAA's W. Eggert, head of research for CAWS, said. "The CAWS is actually an engineering problem. We are not trying to improve the science of meteorology."

The system is being coordinated with the Weather Bureau, the Defense Department, and other government agencies. When operative, it will service all airspace users, both civil and military, in the United States through the 1975 period. FAA has taken over the Air Force's 433-L Weather Observation and Forecasting System in the U.S., the Air Force will handle it for its operations overseas.

The CAWS will consist of four subsystems: observing, processing, presenting, and communicating.

OBSERVING—By 1975, there will be 1,000 surface observing stations—600 will be automatic stations at terminals and generate observations on a five-minute cycling time; 200 will be manual stations at terminals, and 200 will be automatic remote stations—all 400 providing hourly observations.

There will be 100 upper-air radiosonde/rocketsonde stations at hub terminals; 100 pilot-to-forecaster service stations at hub terminals; and 100 longrange radar stations at hub terminals and gap filling radars as dictated by topography. Implementation of this equipment will begin in 1964 and be finished in 1970.

PROCESSING—The CAWS design includes a single

national processing center, four regional processing centers, and 100 local centers at hub terminals. Processing subsystem design and implementation is dependent upon the availability of adequate forecasting techniques—many of which do not exist today. Implementation of the subsystem will begin in 1965, and finish in 1975.

PRESENTING—Displays must be numerous, standard and readily understandable. There are five display situations in the CAWS: pilot ground briefing, which will use direct display, tv, telephone and radio; airborne pilot briefing—radio; ATC towers, ATC centers and processing centers will all use direct displays and tv.

The design provides for up to 750 ground briefing stations, 100 continuous weather broadcasting stations and 100 pilot-to-forecaster stations. It anticipates a total of up to 750 tower displays and 20 to 30 center installations.

COMMUNICATING—The CAWS design includes an evolutionary transition from the present multiple civil and military communication circuits to a configuration that uses only two primary circuits—both transmitting alphanumeric and graphic messages. One of these circuits is used by aviation meteorologists, civil and military, for collecting observations and exchanging intra-processing products. The other circuit transmits only operational products to CAWS users—pilots, dispatchers, and the ATC system. Both circuits use the normal telephone line bandwidth.

Telephone links with automatic telephone briefing equipment will be used for pilot ground briefings. Radio links (L/MF, vhf, uhf) will be used for pilot-to-forecaster, continuous weather broadcast and advanced planning transmissions.

Around-the-base circuits, ATC tower and center displays and local processing centers will use tv, mainly to present local weather radar data.

LAST IN A SERIES OF THREE ARTICLES.
First appeared on Dec. 7, second on Dec. 14

FAA WANTS to simplify this complex communications network in the new system

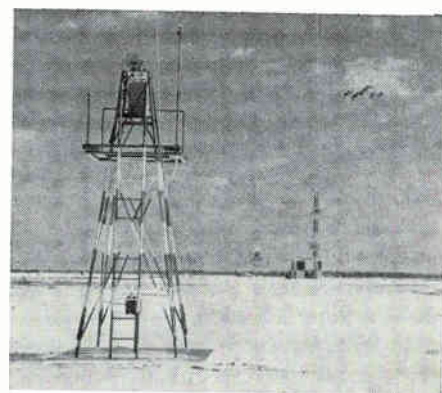
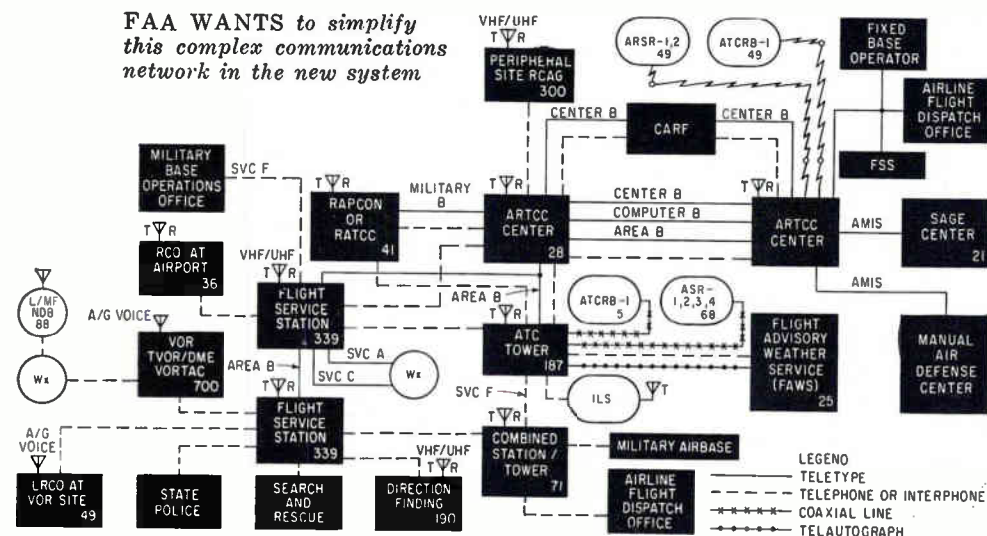

TRANSMISSOMETER receiver (foreground) measures strength of light from transmissometer transmitter (background) to determine visibility

Top Performance at Lower Cost!

RMC TYPE B DISCAPS

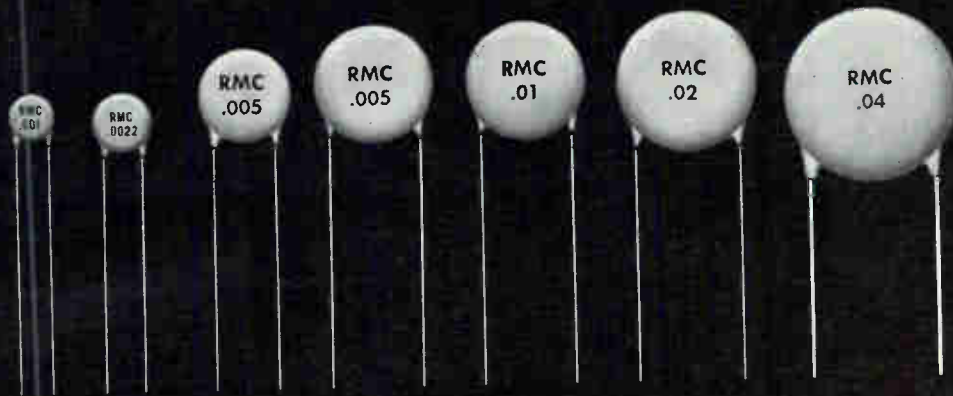

150	680	.0015	.0033	.0047	.0068	.01	.02
220	750	.0018	.0039	.005	.0082	.02*	+80%—20%
330	800	.002	.0047*	2x.002	.01*	+80%—20%	.04*
470	820	.0022	.005*	.01*	.02*	2x.004	+80%—20%
500	.001	2 x 800	2x.0015	±20%		2x.005	
560	.0012	2 x .001	2x.002*	.02*			
				+80%—20%			

*Rated 500 V.D.C.W. Flash test 1250 V.D.C.

Life test per EIA RS-198

Disc sizes under 1/2" diameter have lead spacing of .250. Discs 1/2" diameter and over have .375 spacing.

SPECIFICATIONS:

POWER FACTOR: 1.5% Max. @ 1 KC (initial)

POWER FACTOR: 2.5% Max. @ 1 KC (after humidity)

WORKING VOLTAGE: 1000 V.D.C.

TEST VOLTAGE (FLASH): 2000 V.D.C.

LEADS: No. 22 tinned copper (.026 dia.)

INSULATION: Durez phenolic—vacuum waxed

INITIAL LEAKAGE RESISTANCE: Guaranteed higher than 7500 megohms

AFTER HUMIDITY LEAKAGE RESISTANCE: Guaranteed higher than 1000 megohms

Type B DISCAPS are rated at 1000 working volts yet cost no more than ordinary lighter constructed units. Designed for by-passing, coupling or filtering, applications, Type B DISCAPS are available in capacities between .00015 and .04 MFD. They meet or exceed all EIA RS-165 specifications for Z5U ceramic capacitors and show a minimum capacity change between +10° C and +85° C.

Type BTM values to meet MIL C 11015B available on special order.

DISCAP
CERAMIC
CAPACITORS



RADIO MATERIALS COMPANY

A DIVISION OF P. R. MALLORY & CO., INC.
GENERAL OFFICE: 4242 W. Bryn Mawr Ave., Chicago 46, Ill.
Two RMC Plants Devoted Exclusively to Ceramic Capacitors
FACTORIES AT CHICAGO, ILL. AND ATTICA, IND.

New Approaches to Electronic Self-Repair

Natural physical phenomena may increase electronic reliability

AS MILITARY and space requirements necessitate the construction of more and more complex systems, the contemporary philosophies of reliability and maintainability will become inadequate for successful performance of mission objectives. Most severely affected will be the systems on which maintenance cannot be performed, such as satellite-borne systems, and strategic military systems where the luxury of even a small downtime cannot be afforded.

A paper investigating various models of self-repair presented at the Aerospace Science and Engineering Symposium at Brooks AFB by Jerome Klion, of the Rome Air Development Center, Griffiss AFB, included the following:

Practical self-repair consists of sensing failure, discarding the failed component, and replacing it with a working one. The comparable requirements in redundant systems have been met with relays, solenoids, and other complex devices. However, dependence on these devices has been the major drawback to satisfactory redundant configurations.

An alternate approach is the use of natural phenomena to effect switching, sensing and interconnection. These may be more reliable and more easily implemented than conventional methods.

One phenomenon that could be used to sense failure is the Peltier effect. Electronic component failure is generally followed or immediately preceded by a change in temperature; by using thermocouples, this temperature change reflected in terms of a voltage outside a preset range can activate replacement. It appears there are more means of reliably implementing replacement and discard than of sensing failure.

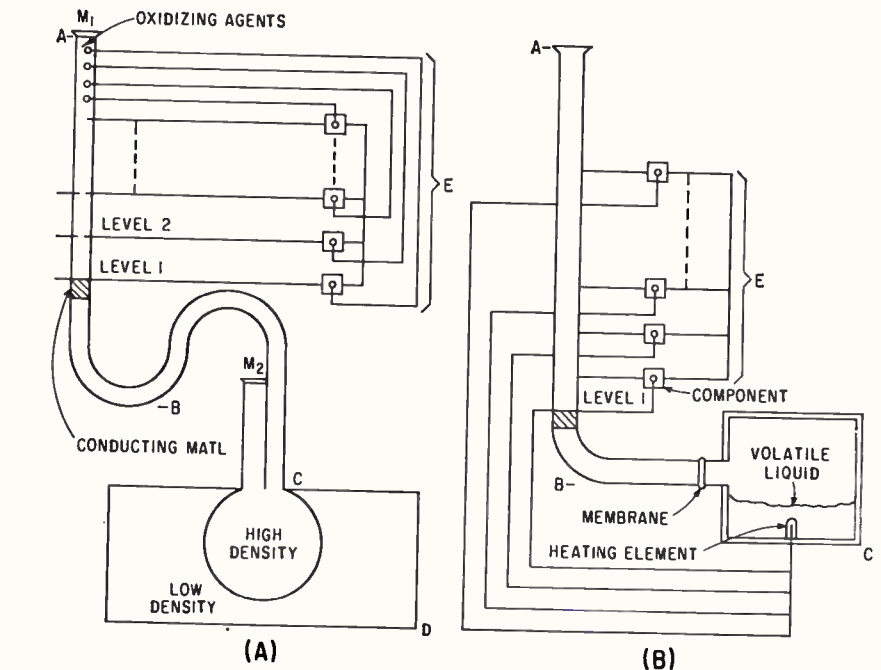

OSMOSIS SELF-REPAIR uses oxidation and osmosis for interconnecting electronic components, (A); diffusion self-repair depends on vaporizing measured amounts of volatile liquid, (B)—Fig. 1

Replacement or discard might be accomplished by an efficient and reliable phenomenon such as osmosis, gaseous diffusion, tropisms, gravity, induction, or anisotropy.

OSMOSIS SELF-REPAIR—In osmosis self-repair, automatic switching is accomplished by an air pressure differential caused by failure of an on-line electronic component. If the pressure differential fails to occur, a process of osmosis working independently of the pressure differential provides a backup to restore operation.

In Fig. 1A, section AB is a cylindrical tube with a pressure-sensitive semipermeable membrane, valve or one-way diaphragm M_1 , N equally spaced paths along the length of the section, each connected to a separate electronic component in section E, a column of mercury or other conducting material, and N oxidizing agents each connected electrically to a failure-sensing device in each component.

Section CD contains solutions of

high and low densities separated by a semipermeable membrane. Section BC contains a gaseous medium, a pressure-sensitive semipermeable membrane, valve, or one-way diaphragm M_2 , and the current level of osmosis.

Initially the column of conducting material is at level 1, providing a conductive path for the necessary power to operate component 1. No power is being provided to the remaining components. If an active component fails, the failure sensor for that component activates its respective oxidizing agent. The ensuing oxidation consumes a prescribed portion of the environmental medium in section AB, decreasing the environmental pressure between the column of conducting material and the upper end of section AB. The pressure loss causes conducting material to rise to level 2 and complete the upper electrical circuit. At the same time, the failed component is disconnected, stopping the oxidation process.

If the oxidizing agent fails, os-

D I G I T A L R E A D O U T

of pulse amplitudes
as small as
2 millivolts
peak-to-peak.

of pulse risetimes
as fast as
0.4 nanosecond.

of time differences
as small as
50 picoseconds up to
100 microseconds.

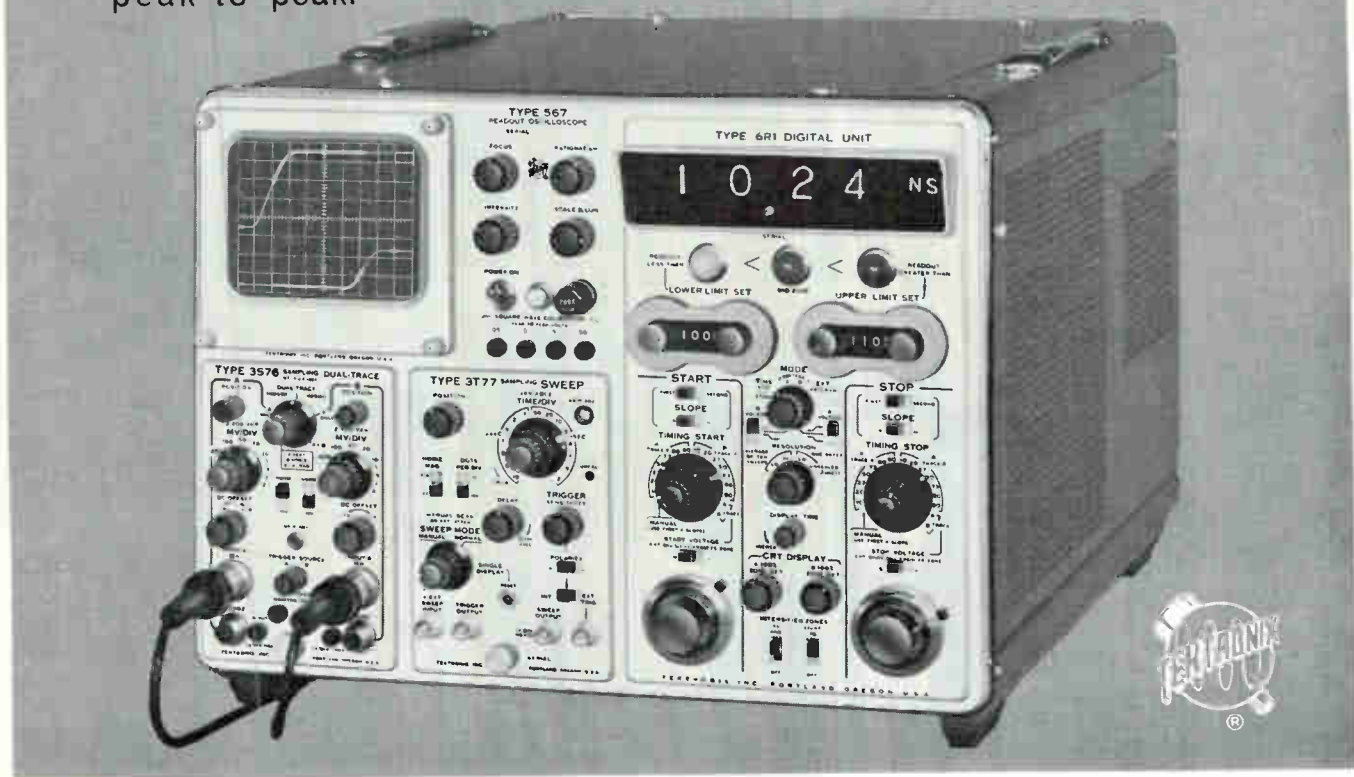

TEKTRONIX READOUT OSCILLOSCOPE *with Dual-Trace Sampling*

With this new Tektronix Readout Oscilloscope you can measure pulse amplitudes and time increments faster and easier. For, after selecting measurement points on the displayed waveform *once* for all successive similar measurements, you make the tests and read the digital data directly. Indicators light to designate the readout status—whether *in* the preset-limit range, *below* it, or *above* it.

In a typical test application, such as measuring transistor switching times, you can read directly such characteristics as the delay, rise, storage, and fall times; the total turn-on and turn-off times; the width of pulse A and pulse B; and time and amplitude between two selected points on either waveform. You know immediately by the digital presentation and indicator lights whether or not the item tested has met specifications.

Also, the Tektronix Readout Oscilloscope—with digital and sampling plug-in units—can be externally programmed for automatic sequential operation.

On a production line, in a laboratory, or for sustained testing programs, the digital convenience of this Tektronix Readout Oscilloscope can speed up and simplify your measurement applications.

- Type 567 Readout Oscilloscope (without plug-ins) \$ 700
- Plug-In Units include:
- Type 6R1 Digital Unit \$2500
- Type 3S76 Sampling Dual-Trace Unit . . \$1100
- Type 3T77 Sampling Sweep Unit \$ 650

U.S. Sales Prices f.o.b. Beaverton, Oregon

**FOR A DEMONSTRATION—
PLEASE CALL YOUR
TEKTRONIX FIELD ENGINEER**

Soon Available—2 new plug-in units to extend digital readout of signal information to low and medium frequency applications.

Tektronix, Inc. / P. O. BOX 500 • BEAVERTON, OREGON / Mitchell 4-0161 • TWX-503-291-6805 • Cable: TEKTRONIX.
OVERSEAS DISTRIBUTORS IN 27 COUNTRIES AND HONOLULU, HAWAII.

Tektronix Field Offices are located in principal cities throughout the United States. Please consult your Telephone Directory.
Tektronix Canada Ltd: Montreal, Quebec • Toronto (Willowdale) Ontario • Tektronix International A. G., Terrassenweg 1A, Zug, Switzerland.

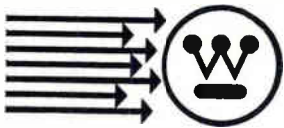

For Your Needs . . . One Source

WE RECTIFY ANYTHING!
(except broken romances)

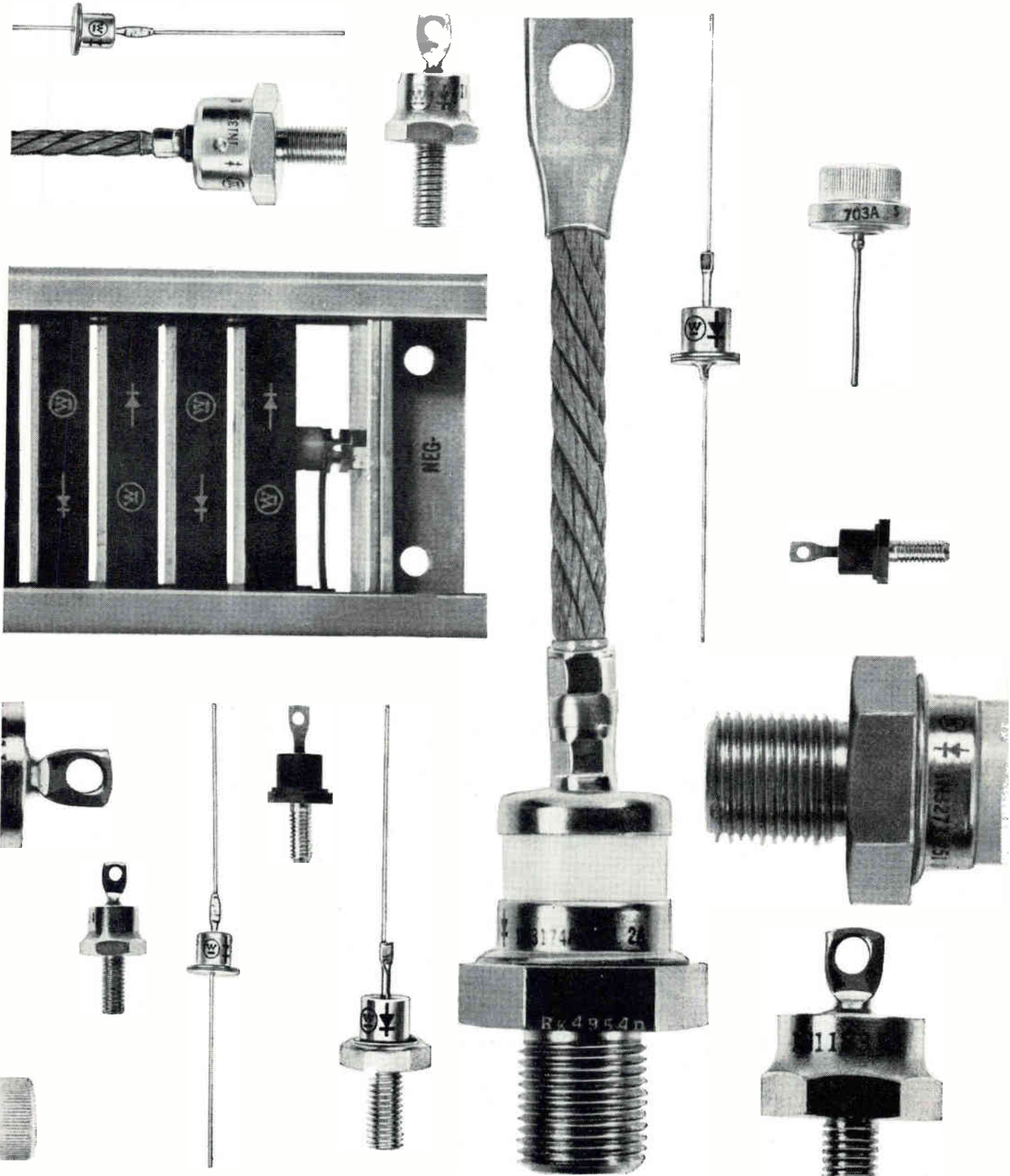

A choice of performance, reliability and price

Westinghouse offers three families of silicon rectifiers designed to satisfy a wide range of current requirements. With this freedom of choice, you'll never "overbuy." You can get the reliability and performance you need, at the price you want. Important, too, these rectifiers are available locally for immediate off-the-shelf delivery.

OEM line

Low-cost line offers top performance for commercial equipment where pennies count. Current ratings of 5, 10 and 15 amperes with voltages to 600 volts are available. Units feature hermetic sealed cases, hard-soldered junctions and minimum size.

Industrial line

Field proven, dependable rectifiers for industry. They have a reliability unmatched by anyone. Exclusive power testing assures top performance. Ratings from .25 amp (1N536 series) to 240 amp (1N3161 series). Voltages to 1000 volts in most ratings.

Military rectifiers

Military rectifiers are available for those applications where strict conformance to military specifications is required. Ratings include the 12 amp USAF 1N1200-1N1206 (MIL-E-1/1108), the 20 amp USA 1N249B-1N250B-1N2135A (MIL-S-19500/134), the 35 amp USAF 1N1184-1N1188 (MIL-E-1/1135) and the 120 amp USA 1N3263-1N3267 (MIL-S-19500/212).

The line grows longer

New rectifiers for an even wider selection! Molded, modular high-voltage assemblies in half wave, doubler, bridge and special configurations . . . 6 and 12 amp avalanche type rectifiers with forward and reverse polarities . . . 6 and 12 amp rectifiers through 1000 volts (1200 V transient) in forward and reverse polarities . . . 160 amp rectifiers with continuous PRV ratings through 1600 volts.

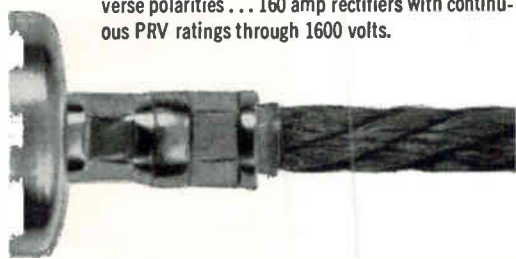

Free rectifier selector

Use it to select the one rectifier that's just right for you . . . from the many rectifiers in the Westinghouse line. The front of this 6" rule is scaled in inches and centimeters. The other side has a handy rectifier selection guide. Send for it now. Write: Westinghouse Semiconductor Division, Youngwood, Penna.

You can be sure . . . if it's

SC-1086

Westinghouse

CIRCLE 99 ON READER SERVICE CARD
January 4, 1963

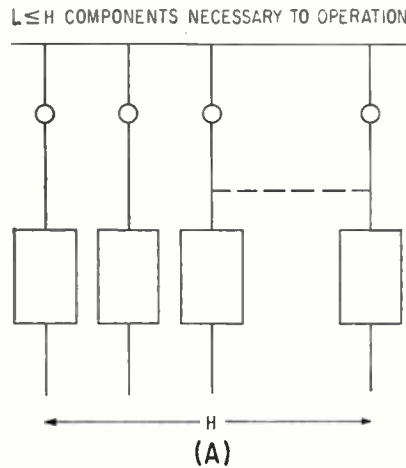

PINBALL PRINCIPLE of circuit interconnection, (A), is implemented by steel balls held in receptacles by individual magnetic fields, (B)—Fig. 2

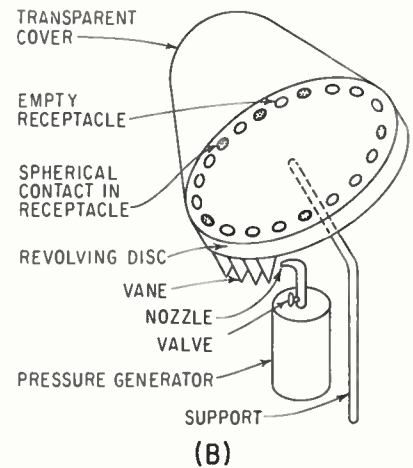

mosis continues at a prescribed rate, which disconnects the failed component and activates the next.

DIFFUSION SELF-REPAIR—As in osmosis self-repair, automatic switching is accomplished by a pressure differential caused by failure of an on-line electronic component. If the pressure differential fails to occur, a process of diffusion provides the necessary pressure differential and restores operation.

In Fig. 1B, cylindrical section *AB* is open at the upper end and bounded at the lower end by a membrane. Electronic paths equally spaced along the tube connect to separate electronic components in section *E*. The tube also contains a column of mercury or other conducting material of length equal to the distance separating any two adjacent electronic paths. Section *BC* is sealed at its far end and contains a reservoir of a volatile substance that partly vaporizes with a relatively small amount of heat. A heating element in the reservoir is activated by a pulse from a failure sensor.

Initially the column of conducting material is at level 1 providing a conduction path for component 1, and no power is provided to the remaining components. On failure of component 1, an electrical impulse is conveyed to the heating element in the reservoir. Vapor pressure in section *BC* increases and diffusion through the membrane increases. The conducting material rises, activating the upper circuit, disconnecting the failed component and deactivating the heating element.

If the heating element fails, dif-

fusion, which continues at a modest rate without heat, ultimately disconnects the failed component and activates the next component.

PINBALL SELF-REPAIR—A possible model of a simple "pinball" binomial self-repair is shown in the system in Fig. 2A. The system is composed of *H* components but only *L* components are needed for operation. The remaining components are inactive.

In the possible design of Fig. 2B, replacement is accomplished by a pinball concept in conjunction with an electromagnetic field. The system is arranged in the disk-like platform in accordance with the configuration of Fig. 2. A circular aperture along the conduction path of each component breaks electrical contact to each component. Magnets are placed in each aperture. A sphere is placed on the discs, having satisfactory conductive and magnetic characteristics. The disc is positioned at an angle to the horizontal plane, and the disk revolves on an axis. The underside of the disk contains an arrangement of vanes. An air nozzle is positioned so that a jet of air introduced through it to the vanes would cause the disk to revolve. The air nozzle and its corresponding valve are constructed so that if air enters the valve at a given rate, it is expelled through the nozzle only after a definite internal air pressure is reached. The result of such a design is that given a constant input of air, the valve expels air in individual bursts of a given force equally spaced in time.

The system is composed of *L*

**John
Brogan
can
show
you...**

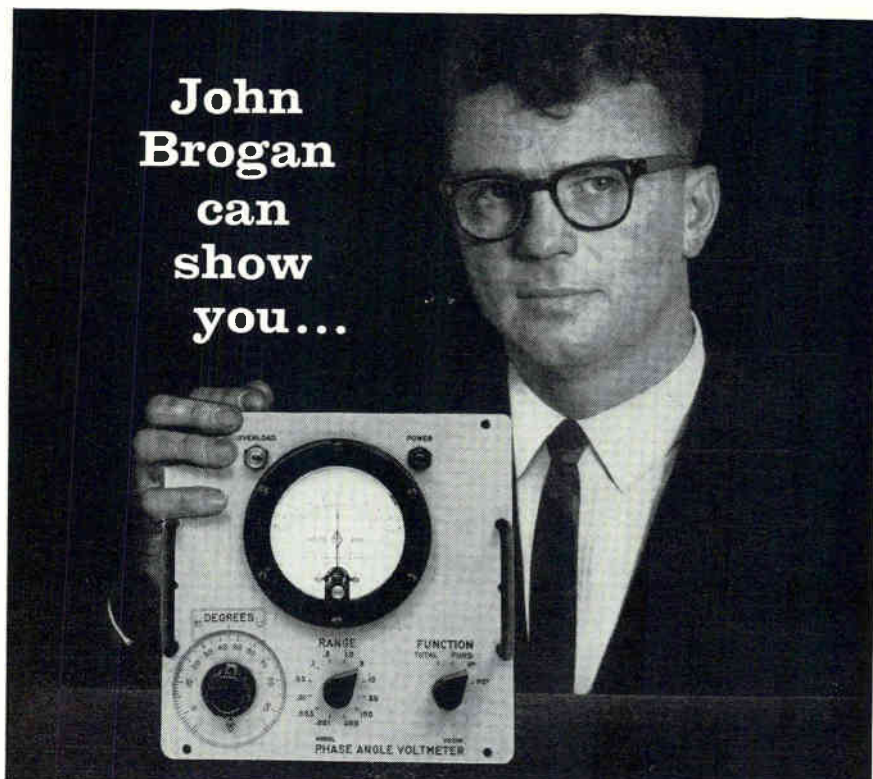

Brogan Associates, Inc.

how to match a PAV to tough GSE specs

From its all solid state circuitry to its MIL-type hermetically sealed meter and plug-in amplifiers, every design feature of the Model VM-235 Phase Angle Voltmeter has been selected for rigorous service in Aerospace Ground Equipment.

Your North Atlantic man can quickly demonstrate how this rugged, miniaturized version of North Atlantic's famous PAV provides direct, accurate reading of phase angle, nulls, total, fundamental, quadrature and in-phase voltages—even under the roughest of military field conditions.

The VM-235's ability to meet tough system specs is demonstrated daily in operational and support equipment for USAF and Navy aircraft and missile programs. Its capabilities for complex measurements are shown in the abridged specifications below:

Voltage Range.....	1 mv to 300 v f.s., 12 ranges
Voltage Accuracy.....	±2% f.s.
Phase Accuracy.....	dial: ±1°; meter: ±3% of F.S. degrees
Signal Frequency.....	400 cps
Input Impedance.....	1 megohm
Reference Input.....	26 v or 115 v
Meter scale.....	3-0-3, 10-0-10 linear
Phase Angle Dial.....	2 scales, 90° (elec.) apart
Nulling Sensitivity.....	2 microvolts (phase sensitive)
Harmonic Rejection.....	55db (with filters)
Dimensions.....	8 ¹ / ₁₆ " h. x 8 ¹ / ₂ " w. x 6 ¹ / ₂ " d.

North Atlantic's field engineering representative in your area has full data on the VM-235, as well as modified versions for specific systems requirements. For his name, call or write today, or request Bulletin VM-235.



NORTH ATLANTIC industries, inc.
TERMINAL DRIVE, PLAINVIEW, L. I., NEW YORK • Overbrook 1-8600

spherical contacts, seated in receptacles around the circumference of the disk, and acting as conducting paths that activate *L* components. An independent magnetic field in each receptacle holds its respective sphere firmly in position. When a component fails, the failure sensor reverses the magnetic field of its receptacle and also supplies air to revolve the disk. On reaching its apex with no applied magnetic field (or at any point if the reversed magnetic field is enough to expel the receptacle), the affected sphere drops out and seeks another receptacle with a favorable magnetic field. At this time, the disk stops and system operation is restored.

BIOLOGICAL SELF-REPAIR — The best-known self-repairing device, and in spite of its shortcomings the most reliable to date, is the human body. On the system level, a remarkable example of an expanding, never-dying system is the human race.

The human body has an average life of 70 years. During this time, the skin appears almost constant and continues to perform its function, yet the mean time to wear-out or replacement of each surface cell is measured in months. Moreover, in the event of a cut, built-in failure sensors immediately begin removal of damaged cells and replacement with working cells.

It is not outside the realm of possibility to consider an electronic system having similar characteristics. The system could be a matrix arrangement of organic semiconductor blocks that could function successfully if enough blocks were operative. In the event of a random, wearout or incipient failure of one or more blocks, a built-in sensing system inherent to the makeup of the material would initiate formation of a new block. Wearout or incipient failures could be predicted or sensed in advance and an automatic replacement rate chemically adjusted and maintained.

One straight-forward approach to self-repair involves a flux and an atmosphere, where the flux could be contained within a given element not unlike that within hollow-core solder and released by breakage of the element. This approach is analogous to blood glucose and air facili-

WHAT IS THE "HH" SERIES?

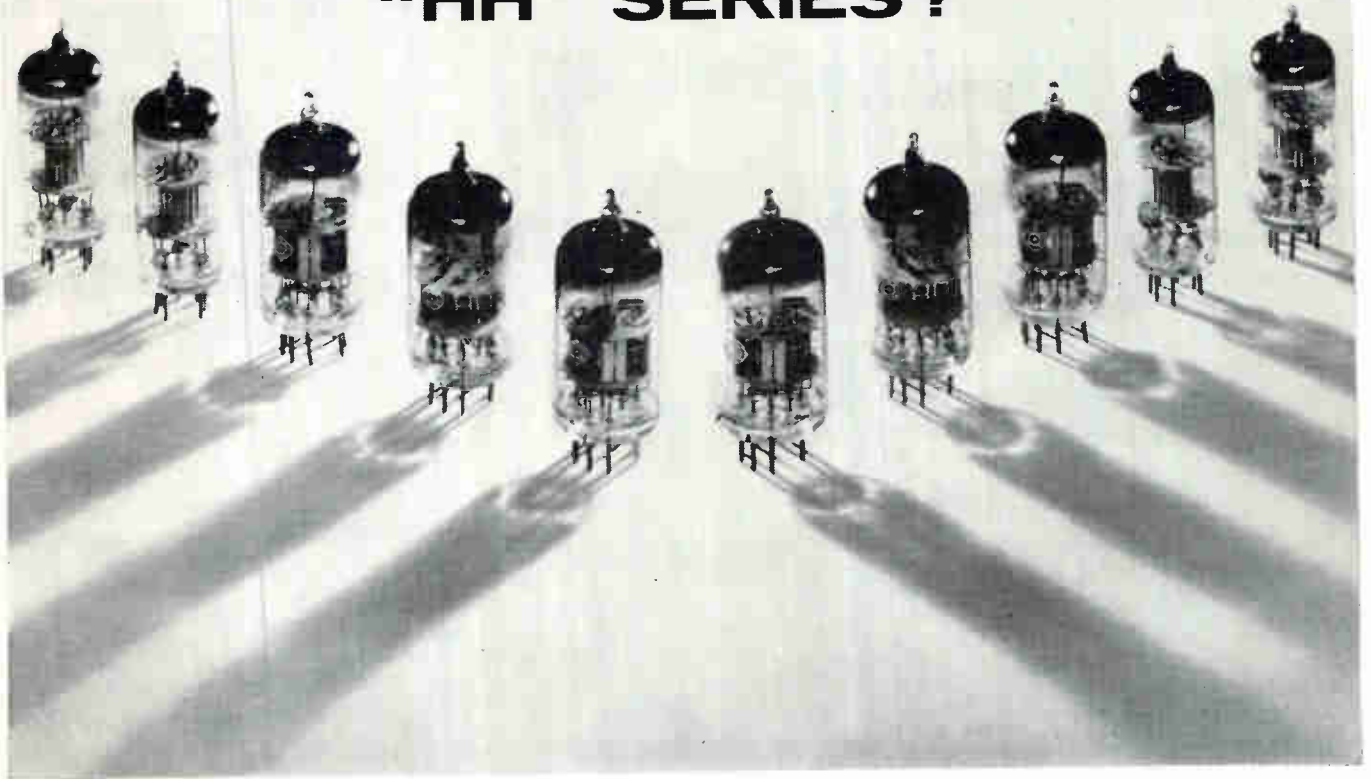

The "HH" series is Hitachi's new superior line of television receiver tubes, the ultimate in far-reaching reception of television waves.

For RF amplifier of VHF television tuners, specify the 4R-HH2 and 6R-HH2 which feature very high transconductance, high sensitivity and low noise. These twin triode tubes replace the 4BQ7A and 6BQ7A without change of circuit.

For frequency convertor and local oscillator of VHF television tuners, specify 5M-HH3 and 6M-HH3 twin triodes which replace the 5J6 and 6J6 without change of circuit.

The "HH" series is another fine quality line from Hitachi, one of the most completely integrated electrical manufacturers in the world.

INTERNATIONAL IMPORTER INC.

2242 South Western Avenue,
Chicago 8, Illinois, U.S.A.

 **Hitachi Ltd.**
Tokyo Japan

WE'VE HELPED OUR CUSTOMERS*

Daylight Switches
Automatic Door Controls
Burglar Alarms
Counting - Sorting Devices
Medical Pulse Counters

SHED A LITTLE LIGHT**

Oil Burner Flame Detector
Conveyor Routing Controls
Analogue - Digital Converters
Furnace Temperature Controllers
Camera Automatic Exposure Controls
TV Receiver Automatic Brightness - Contrast Controls
Reading Machines for Blind
Space Vehicle Sun Sensors for Attitude Control and Telemetry
Metal Working Automatic Line Followers
Boat Automatic Pilots
Computer Punched Tape - Card Readers

ON LOTS OF PROBLEMS***

*Clairex Photoconductive Cells, in their capacity as reliable, light-controlled variable resistors, have assisted thousands of systems design engineers; (most of the leading electronics manufacturers have depended on Clairex for years as a key source of supply).

**Clairex Photoconductive Cells don't require much!

***Clairex Photoconductive Cells are now operating as essential components in hundreds of applications, both simple and complex, (the list at left is just a sample).

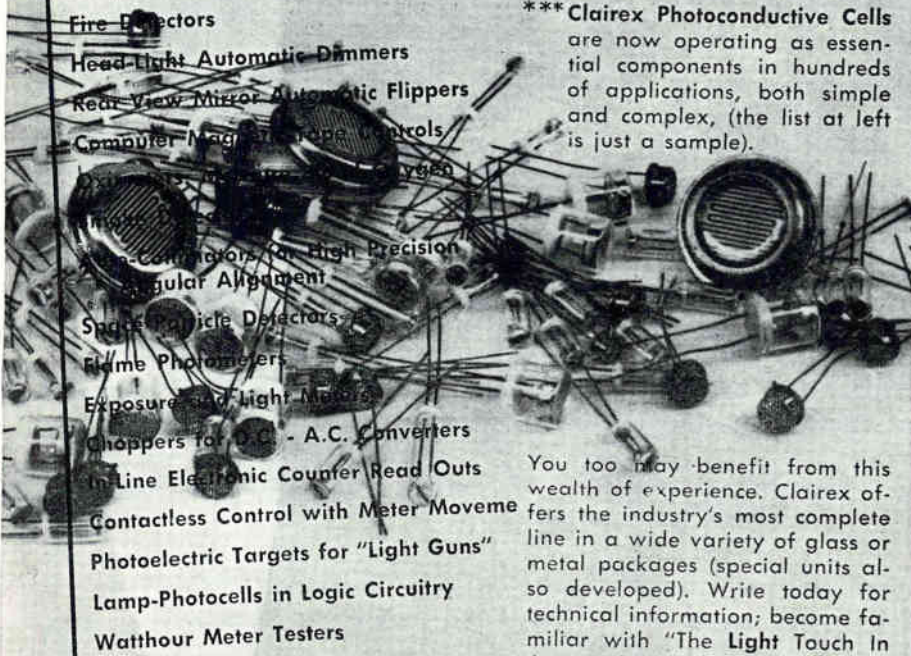

You too may benefit from this wealth of experience. Clairex offers the industry's most complete line in a wide variety of glass or metal packages (special units also developed). Write today for technical information; become familiar with "The Light Touch In Automation And Control."

CLAIREX CORPORATION 8 West 30th Street, N. Y. 1, N. Y.

tating the repair of tissue. Many flux-atmosphere combinations are possible: liquid solders, dental silver, suspended metals. In most cases air could act as atmosphere, resulting in a hardening of bond between the otherwise fluid metal and the element.

A particularly promising approach to self-repair of components involves crystalline anisotropy. It is known that metallic whiskers form on capacitor plates and produce short circuits. It may be possible to turn this phenomenon to advantage; metallic whiskers are an example of crystalline anisotropy where the material has different properties in different directions. Conceivably, circuit elements could be made as single crystals with anisotropic properties, to facilitate repair of a given break.

High-Frequency Optical Phonon Masing Reported

By SY VOGEL
Associate Editor

NEW YORK—A recently observed phenomenon—stimulated emission of phonons with frequencies almost as high as light frequencies—might be used in a new light or acoustical generator or amplifier.

C. D. Becker of Precision Instrument Co. described this phenomenon at the Ultrasonics Symposium. Becker induced stimulated emission of phonons (defined as packets, or quanta, of elastic energy) with an alpha quartz tube filled with mercury vapor (illustration A). The mercury discharge provides ultraviolet (uv) energy that raises (pumps) the energy levels of the quartz molecules; the ultraviolet light spectra that go into the quartz ensuing are thereby affected by the phonon maser action within the quartz.

The spectrometer looks at one of these spectral lines and at the line spectra (Raman lines) whose frequencies are slightly above and below the frequency of the incident-light line; the differences between the spectral intensities observed at low (B) and high (C) values of ultraviolet pumping energies are due to, and indicate, optical-phonon maser action within the quartz.

When enough electrical power is

DROPOUT PROTECTION



MINCOM SERIES CM-100 RECORDER / REPRODUCER

Data loss from dropouts is practically eliminated in the CM-100, due to this unique system's predetection recording capability. In ordinary post-recording, a dropout more than 6 db down is generally considered a data loss; the CM-100's operational predetection performance retains such signals through superior phase characteristics and extended bandwidth. Mincom's **CM-100 Recorder/Reproducer**, performing longitudinal recording with fixed heads up to 1.5 mc at 120 ips, also offers 7 or 14 tracks, trouble-free dynamic braking, complete modular plug-in assembly, built-in calibration, instant push-button selection of six speeds. Versatile, reliable, a model of simple maintenance and operation, the CM-100 is tops in its field. Write today for detailed specifications.

Mincom Division **3M**
COMPANY
Los Angeles 25, California * Washington 4, D. C.

EIC MODEL H-1000 SERIES MAGNETIC HEADS

AM • FM • AM / FM combination



EIC magnetic recording head components are now available for any recording or playback system. Originally designed for use in EIC recording systems, these heads are now proved and offered as industrial electronic components. Their wide range of electrical and mechanical adaptability makes them your best buy for laboratory and industrial applications in recording, control, and data analysis.

Features:

- Vacuum impregnated and potted in epoxy resin.
- Mu-metal shielded.
- Precise mechanical tolerances.
- Available in single or multi-head blocks.
- Blocks available in permanently imbedded or individually replaceable heads.

Applications:

- Drum, reel, or disc recording.
- Sound or seismic recording.
- Process instrumentation and control computers.

Specifications

Type No.	Track Width (In.)	Gap Width (In.)	Over-All Width (In.)	Inductance (mh)	Resistance (Ohms)
A-12	0.012	0.00025	0.125	6.7	6.75
A-40	0.040	0.00025	0.125	600	215
A-50	0.050	0.00025	0.125	750	220
B-50	0.050	0.00025	0.125	65	30
C-50	0.050	0.0010	0.125	325	220
A-60	0.060	0.0010	0.207	3	200
A-90	0.090	0.00025	0.207	100	30
A-100	0.100	0.00025	0.187	1200	265
B-100	0.100	0.0010	0.187	500	265
C-100	0.100	0.00025	0.187	375	265
A-125	0.125	0.0020	0.207	29	34
B-125	0.125	0.0050	0.207	1.17	1.9
C-125	0.125	0.0050	0.207	0.224	0.7
A-140	0.140	0.0010	0.207	500	230
B-140	0.140	0.0010	0.207	7	10
C-140	0.140	0.0030	0.207	235	230
A-30-3	0.030	0.001	0.145	7.0	14.5

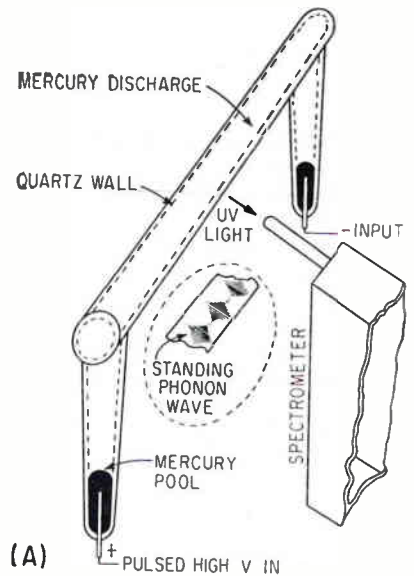

(A)

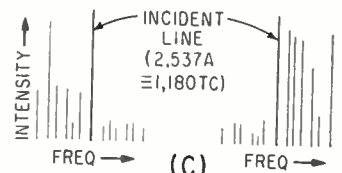

(B)

(C)

OPTICAL-PHONON MASER action is produced within quartz walls of tube (A). Spectral lines for low- (B) and high-intensity (C) inputs

applied, the ultraviolet radiation produced by the mercury discharge is increased enough to drive more than half the quartz molecules to higher energy levels. When the molecules drop to lower energy levels, they emit phonons. The phonons build up a field of elastic energy that stimulates further emission of phonons. (This might be described as "phaser action"—phonon amplification by stimulated emission of radiation.) The phonon field comprises several frequencies that are in the order of teracycles, the highest being 100 Tc (10^{11} cps).

When pumping energy is low, the spectrometer sees the normal distribution of spectral lines (B) produced by the scattering of the incident light by the quartz; the lines scattered to either side of the incident frequency are quanta that have either lost or gained energy from the quartz molecules (Raman effect). When pumping energy is increased above a critical level, stimulated emission of phonons occurs within the quartz and the phonon frequencies subtract and add to the incident frequency, thus producing spectral distribution in (C).



ELECTRODYNAMIC INSTRUMENT CORPORATION

SUBSIDIARY OF REED ROLLER BIT COMPANY

TXW 713-571-341 / RI 8-2760 1841 Old Spanish Trail — Houston 25, Texas

Cable: EICORP — Houston

EIC REPRESENTATIVES

CLYDE M. SALISBURY CO., San Francisco, 1453 Seventh Ave. — MO 4-0586 • REPCO SALES, Miami, 401 N.W. 71st Street — PL 7-2911 • ELECTRONIC SALES, INC., Denver 22, 2641 S. Ivy Street — SK 6-4148 • WALLACE AND WALLACE, Los Angeles 15, 1206 Maple Ave. — RI 7-0401 • BRANCH OFFICE: P. O. Box 30201, Dallas 30 — EM 1-0174.

CIRCLE 104 ON READER SERVICE CARD

**HELP YOUR POST OFFICE
TO SERVE YOU BETTER
BY
MAILING EARLY IN THE DAY
NATIONWIDE IMPROVED MAIL SERVICE
PROGRAM**

WHAT IS HAPPENING IN ELECTRONICS IN 1963 ?

See for yourself
by visiting the

6th international exhibition of electronic components

FROM 8th - 12th FEBRUARY 1963
IN PARIS PORTE DE VERSAILLES

The largest display
in the world
covering the field
of electronics

All components, valves
and semiconductors,
measuring, testing
and electro-acoustic equipments



Send now for full information
and literature :

FÉDÉRATION NATIONALE
DES INDUSTRIES ÉLECTRONIQUES
23, rue de Lübeck - PARIS 16^e PASsy 01-16

Under the patronage of the F.N.I.E.

3rd international congress of quantum electronics

organised by the French section
of the I.R.E. and by the S.F.E.R.

FROM 10th - 15th FEBRUARY 1963
FROM 10th - 15th FEBRUARY 1963

Unesco-House
Information : 7, rue de Madrid PARIS 8^e

28 years ago...

In 1933, the French National Association of Radio-Electrical Industries, which for ten years had been organizing the annual Wireless Show, decided to exhibit separately the receivers appealing to consumers and components used only by manufacturers and technicians. Thus was born, in January 1934 the first French components Exhibition. By 1957 its international character had already been well established, and since then the International Exhibition of Electronic Components, is reserved exclusively to manufacturers, and opens its doors every year to firms specialized in the field of Electronics.

Largest specialized display.

To-day, it is considered to be the world largest display in the field of components and electronic accessories. Its success grows year by year. Not only does it display, on a vast scale the world's production of electronic components, but it is also a privileged occasion for specialized constructors and technical elite of all countries to meet and to compare equipment and techniques, and also to build up together the trends of to-morrow's developments.

7 Times more foreign exhibitors in 5 years.

Year by year the international character of the Exhibition is increasing. Whereas in 1957 only about thirty foreign stands could be counted, to-day the Golden Book of foreign exhibitors enlists 250 Firms. As for foreign visitors, the high technical qualification of which was particularly noticeable last year, their number is increasing proportionately. In 1962 they accounted for 12 % of all visitors, coming from 30 different countries.

Products exhibited

In order to maintain the specific character of the Exhibition which is entirely devoted to the field of electronic components, the participation is reserved exclusively to Firms actually manufacturing the equipment listed underneath.

— Variable and adjustable capacitors — fixed capacitors — radiofrequency coils — coils and transformers for industrial and audio frequencies — resistors — terminal and wiring accessories — switching — safety devices — power supplies — racks and chassis — aerials — electro-acoustical material — tubes — semiconductors — meters — relays — equipment and materials for electronic purposes — miscellaneous.

25.000 m² • 800 exhibitors



6th INTERNATIONAL EXHIBITION
OF ELECTRONIC COMPONENTS
PARIS



CAMPAGNIE FRANCAISE THOMSON-HOUSTON

ELECTRON TUBES FOR
BROADCASTING
TELEVISION-RADARS
COMMUNICATIONS
INDUSTRY-MEDICINE
AND SPECIAL PURPOSES



VAPOTRONS

POWER GRID VAPOR COOLED TUBES

From 15 kW up to 300 kW
From 30 mc/s up to 1000 mc/s

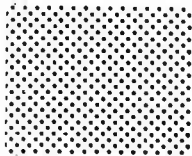

CERAMIC U.H.F. POWER TUBES

CW AND RF PULSE TRIODES AND TETRODES

From 20 W up to 25 kW CW
From 15 kW up to 2.5 MW (peak)
From 200 mc/s up to 3000 mc/s



Engineered to be the finest

TRAVELING WAVE TUBES

CW AND PULSED EM AND PPM FOCUSED

From 30 W up to 4 kW CW
From 100 mc/s up to 6000 mc/s

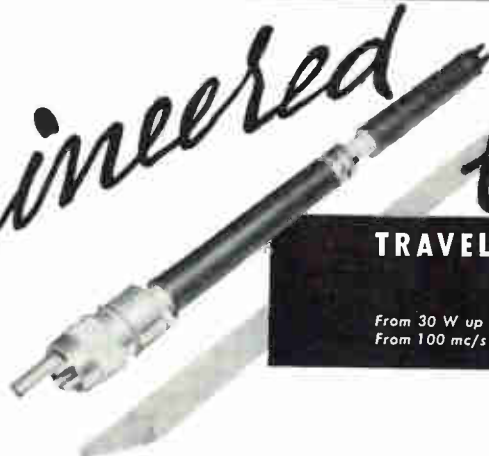

IMAGE TUBES

PICK-UP TUBES (VIDICONS - IMAGE-ORTHICON)
MONOSCOPES
X-RAYS IMAGE INTENSIFIERS
IMAGE CONVERTERS



SPECIAL PURPOSE TUBES

HARD TUBES MODULATOR
SPECIAL APPLICATIONS
GAS-TIGHT THROUGH TERMINALS FOR
HIGH TEMPERATURE AND ULTRA-HIGH VACUUM



THOMSON  HOUSTON

DIVISION TUBES ELECTRONIQUES • 6, RUE MARIO NIKIS-PARIS XV°-Tel.: SUFFren 91-00
U. S. REPRESENTATIVE: THOMSON ELECTRIC CO. • 50 ROCKEFELLER PLAZA, ROOM 916 • NEW YORK 20 (N. Y.), U. S. A.

GE/SPI

WHAT IS HAPPENING IN ELECTRONICS IN 1963 ?

See for yourself
by visiting the

6th international exhibition of electronic components

FROM 8th - 12th FEBRUARY 1963
IN PARIS PORTE DE VERSAILLES

The largest display
in the world
covering the field
of electronics

All components, valves
and semiconductors,
measuring, testing
and electro-acoustic equipments



Send now for full information
and literature :

FÉDÉRATION NATIONALE
DES INDUSTRIES ÉLECTRONIQUES
23, rue de Lübeck - PARIS 16^e PASsy 01-16

Under the patronage of the F.N.I.E.

3rd international congress of quantum electronics

organised by the French section
of the I.R.E. and by the S.F.E.R.

FROM 10th - 15th FEBRUARY 1963
FROM 10th - 15th FEBRUARY 1963

Unesco-House
Information : 7, rue de Madrid PARIS 8^e

28 years ago...

In 1933, the French National Association of Radio-Electrical Industries, which for ten years had been organizing the annual Wireless Show, decided to exhibit separately the receivers appealing to consumers and components used only by manufacturers and technicians. Thus was born, in January 1934 the first French components Exhibition. By 1957 its international character had already been well established, and since then the International Exhibition of Electronic Components, is reserved exclusively to manufacturers, and opens its doors every year to firms specialized in the field of Electronics.

Largest specialized display.

To-day, it is considered to be the world largest display in the field of components and electronic accessories. Its success grows year by year. Not only does it display, on a vast scale the world's production of electronic components, but it is also a privileged occasion for specialized constructors and technical elite of all countries to meet and to compare equipment and techniques, and also to build up together the trends of to-morrow's developments.

7 Times more foreign exhibitors in 5 years.

Year by year the international character of the Exhibition is increasing. Whereas in 1957 only about thirty foreign stands could be counted, to-day the Golden Book of foreign exhibitors enlists 250 Firms. As for foreign visitors, the high technical qualification of which was particularly noticeable last year, their number is increasing proportionately. In 1962 they accounted for 12 % of all visitors, coming from 30 different countries.

Products exhibited

In order to maintain the specific character of the Exhibition which is entirely devoted to the field of electronic components, the participation is reserved exclusively to Firms actually manufacturing the equipment listed underneath.

— Variable and adjustable capacitors — fixed capacitors — radiofrequency coils — coils and transformers for industrial and audio frequencies — resistors — terminal and wiring accessories — switching — safety devices — power supplies — racks and chassis — aerials — electro-acoustical material — tubes — semiconductors — meters — relays — equipment and materials for electronic purposes — miscellaneous.

25.000 m² • 800 exhibitors



6th INTERNATIONAL EXHIBITION OF ELECTRONIC COMPONENTS PARIS



CAMPAGNIE FRANCAISE THOMSON-HOUSTON

ELECTRON TUBES FOR
BROADCASTING
TELEVISION-RADARS
COMMUNICATIONS
INDUSTRY-MEDICINE
AND SPECIAL PURPOSES



VAPOTRONS

POWER GRID VAPOR COOLED TUBES

From 15 kW up to 300 kW
From 30 mc/s up to 1000 mc/s

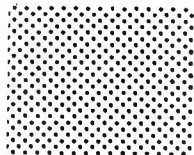

CERAMIC U.H.F. POWER TUBES

CW AND RF PULSE TRIODES AND TETRODES

From 20 W up to 25 kW CW
From 15 kW up to 2.5 MW (peak)
From 200 mc/s up to 3000 mc/s



Engineered to be the finest

TRAVELING WAVE TUBES

CW AND PULSED EM AND PPM FOCUSED

From 30 W up to 4 kW CW
From 100 mc/s up to 6000 mc/s

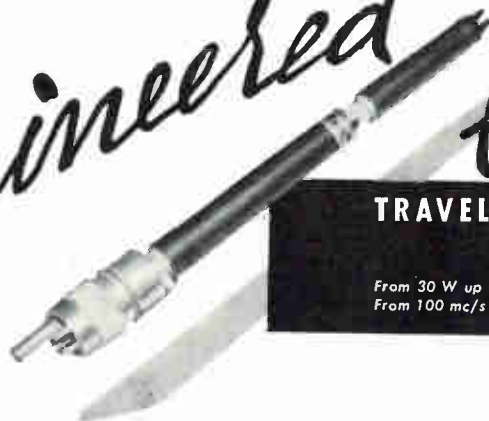

IMAGE TUBES

PICK-UP TUBES (VIDICONS — IMAGE-ORTHICON)
MONOSCOPES
X-RAYS IMAGE INTENSIFIERS
IMAGE CONVERTERS



SPECIAL PURPOSE TUBES

HARD TUBES MODULATOR
SPECIAL APPLICATIONS
GAS-TIGHT THROUGH TERMINALS FOR
HIGH TEMPERATURE AND ULTRA-HIGH VACUUM



THOMSON  HOUSTON

DIVISION TUBES ELECTRONIQUES • 6, RUE MARIO NIKIS-PARIS XV^e-Tel.: SUFFren 91-00
U. S. REPRESENTATIVE: THOMSON ELECTRIC CO. • 50 ROCKEFELLER PLAZA, ROOM 916 • NEW YORK 20 (N. Y.), U. S. A.

GE/S/D1



6th INTERNATIONAL EXHIBITION OF ELECTRONIC COMPONENTS PARIS



TUBES AND MICROWAVE COMPONENTS

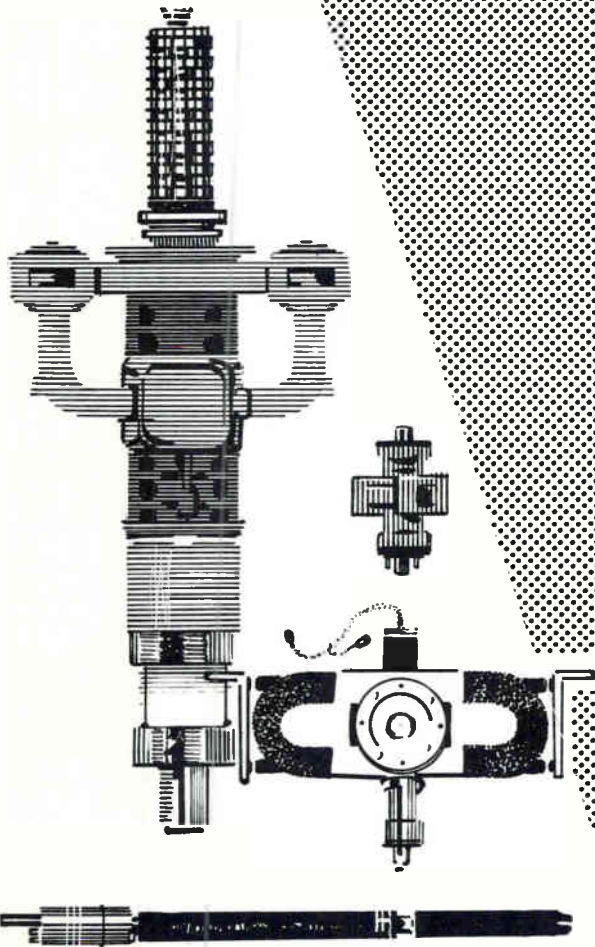

- ▶ AMPLIFIERS KLYSTRON
- ▶ REFLEX KLYSTRONS
- ▶ TRAVELING WAVE TUBES
- ▶ MAGNETRONS
- ▶ TR AND ATR TUBES

GE/SDI

THOMSON-VARIAN

6, RUE MARIO NIKIS-PARIS XV^e • Tel.: SUFFren 91-00

CIRCLE 204 ON READER SERVICE CARD

January 4, 1963

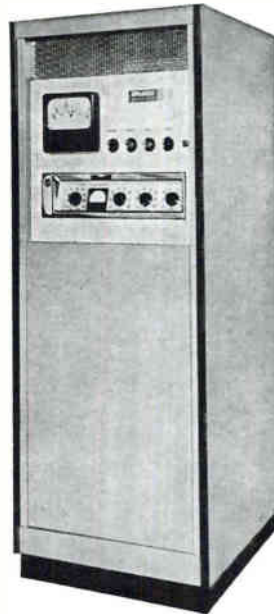

HIGH SPEED STATIC VOLTAGE REGULATORS

Input:

- Mains supply voltage fluctuation $\pm 15\%$
- Mains supply frequency 48-52 cycles
- Power factor of regulator at full load more than 0.86

Output:

- Regulation accuracy $\pm 0.2\%$
- Overall harmonic distortion Less than 3%
- Admissible load variation 5 to 100%
- Recovery time constant:
 - For 20% mains variation 0.04 sec.
 - For 95% load variation 0.03 sec.
- Efficiency at full load 96%
- Radiation free—Instantaneous start up
- 10 Standard ratings: 0.5—1-2-5-10-15-20-30-40-60 Kva
- Mains supply: 110-117-127 and 220 V.

SATURABLE REACTORS

- Power rating from 0.05 to 300 Kva (oven supply, motor control, etc.)

MAGNETIC AMPLIFIERS

- For proportional temperature regulation

STATIC CONSTANT-CURRENT SUPPLIES FOR ELECTROMAGNETS

Input:

- Single-phase or three-phase mains supply $\pm 10\%$

Output:

- Power rating 1 to 100 Kva
- Regulation accuracy: Drift less than 0.005% in 8 hours
- Set point adjustment to 100%
- Recovery time constant for 10% mains supply fluctuations, 3 millisecc.

Also: field stabilization with Hall effect and nuclear resonance-devices

STABILIZED POWER SUPPLIES

- For electron-beam furnaces

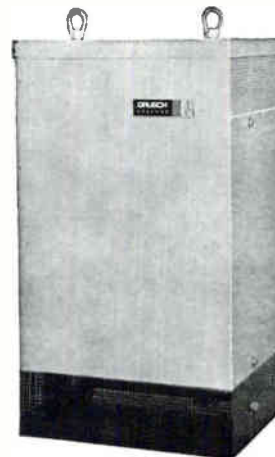

DRUSCH

V O L T R E G

138, RUE GALLIÉNI—PARIS/RUEIL-MALMAISON (S.-&O.)

Tel.: 967-11-33 et 967-20-54

RAPY

CIRCLE 109 ON READER SERVICE CARD

109



6th INTERNATIONAL EXHIBITION OF ELECTRONIC COMPONENTS PARIS



**LOUDSPEAKERS
AUDAX
FRANCE**

Société Anonyme au Capital de 6.000.000 NF
45, Avenue Pasteur
MONTREUIL (Seine) FRANCE
Téléphone : AVRon 50-90 +
Telegrams : OPARLAUDAX-PARIS

CIRCLE 205 ON READER SERVICE CARD

VIDEON



More than half of all television receivers manufactured in France use **VIDEON** components: the first French specialists in manufacture of UHF tuners, VHF rotary switches, intermediate-frequency coils, deflection coils, high-voltage transformers, chokes, etc.

VIDEON

95 rue d'Aguesseau, Paris/Boulogne-sur-Seine, France
Tel.: VAL 55-95
Plant in Monville near Rouen (Seine Maritime)

RAPY

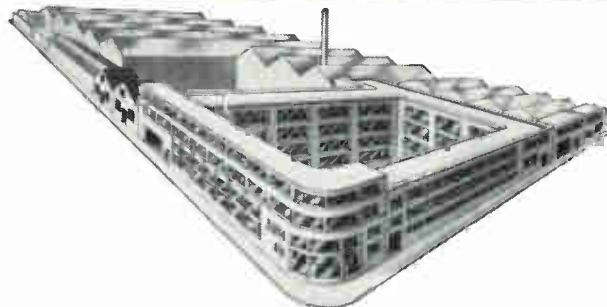

Société des Ateliers René Halftermeyer



Société Anonyme au Capital de N.F. 3.000.000.
Established in 1923, by Mr. R. Halftermeyer.

Head Office :
35, avenue Faidherbe,
MONTREUIL-PARIS
(Seine) FRANCE

Plants :
- at the Head-Office address
- St Aubin-les-Elbeuf
(Seine-Maritime) FRANCE

RADIO AND TELEVISION ELECTRONIC COMPONENTS

- Variable Condensers for Broadcasting
- Variable Condensers for professional use
- High Voltage Transformers and Deflection Yokes
- UHF Tuners
- Printed Circuits, etc...

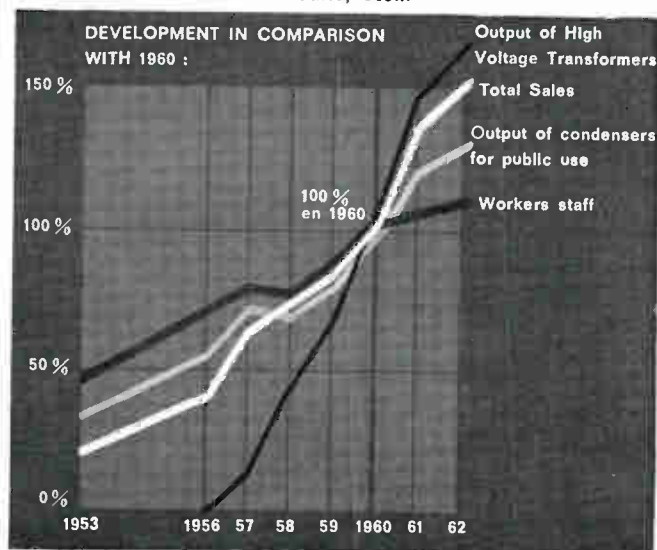

Ask for complete data.



CIRCLE 206 ON READER SERVICE CARD
electronics



6th INTERNATIONAL EXHIBITION OF ELECTRONIC COMPONENTS PARIS



In the electronic measurement field,
the component quality conditions
instrument
accuracy and reliability.

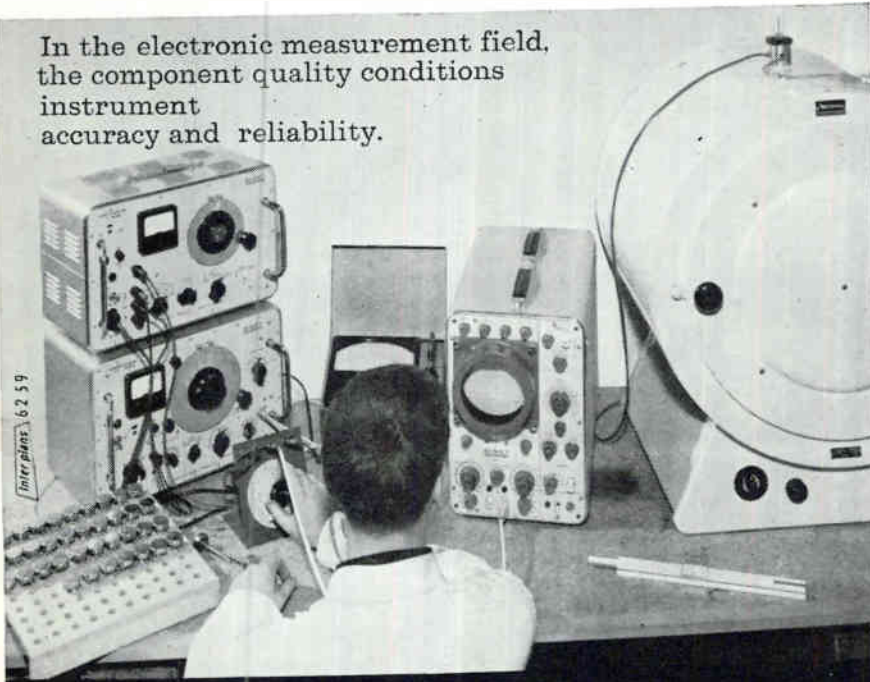

AT RIBET-DESJARDINS'S, OVER 5,000
COMPONENTS ARE STRICTLY SELECTED.
THEIR QUALITY IS SUBJECTED TO MANY TESTS.

FACTOR OF R.D. PRODUCTION IMPROVEMENT
TECHNOLOGICAL INVESTIGATION IS THE MAIN

RIBET-DESJARDINS

Based upon an unceasing study of research requirements and demands, the activity of R. D. Development Department deals altogether with the three basic features of the problems arising from scientific evolution and industry conditions :

- Investigation of French and Foreign markets in order to find the most reliable components.
- Testing of the selected samples according to much higher performances than requested in common use, these requirements lead from time to time to creating original components either by cooperation with manufacturers or by R.D. own manufacture.
- Systematic testing of every component in order to keep a constant quality.

From observation instrument the oscilloscope has come to measurement instrument. This underlines enough the importance of the reliability and accuracy of its components, taking into account specific conditions of use (change in temperature, humidity, peculiar ageing of each component...) for securing the constancy of performances in the future.

The permanent technological investigation performed by R.D. is the most obvious security of this constancy, more especially as it constitutes at the same time a continuous improvement in the operating reliability of the equipment.

MEASURE & CONTROL DEPARTMENT : 13-17, rue Périer MONTRouGE (Seine)
FRANCE Tél. : ALEsia 24-40 + Cable Address : PILACELECT · MONTRouGE
CANADIAN BRANCH : RIBET-DESJARDINS (Canada) L. t. d.
Room 114,5757 Decelles Avenue - MONTREAL
Agencies throughout the world: addresses sent on request.

CIRCLE 207 ON READER SERVICE CARD

SOURIAU ET CIE

ELECTRICAL
CONNECTORS

AERONAUTICS
NAVY
ELECTRONICS
RADIO

9 Rue Gallieni
BOULOGNE
BILLANCOURT
FRANCE

SOURIAU ELECTRIC
G. m. b. H. Dusseldorf
Rathausufer 17

SOURIAU ITALIANA
S. p. A. Milan
Piazza Velasca 5

SOCIETE ELECTRIQUE
BENELUX SOURIAU
Bruxelles
Rue Royale 163





6th INTERNATIONAL EXHIBITION OF ELECTRONIC COMPONENTS PARIS



French electronics group manufactures all components

Safety electronic tubes and special tubes — CSF. DIVISION TUBES ELECTRONIQUES 79, BOULEVARD HAUSSMANN, PARIS 8^e ■■■■ *Quartz - Quartz filter - Crystals controls - Ovens* — CSF. DEPARTEMENT DE PIEZO-ELECTRICITE 6, RUE A. LA LYRE, COURBEVOIE SEINE ■■■■ *Millimetric microwave components* — CSF. DIVISION INTERNATIONALE 79, BOULEVARD HAUSSMANN, PARIS 8^e ■■■■ *Special electric alloys - Sintered alloys - Very high capacity resistors - Relays Synchros - Motors - Transformers* — CSF. COMPOSANTS EXPORT 128, RUE DE PARIS, MONTREUIL-SOUS-BOIS SEINE ■■■■ *Any industrial or electronic ceramics - Thermistors - Metal-plated ceramics - Thermoelectric modules* — CICE. COMPAGNIE INDUSTRIELLE DES CERAMIQUES ELECTRONIQUES 63, RUE BEAUMARCHAIS, MONTREUIL-SOUS-BOIS SEINE ■■■■ *Ferrite cores for radio and TV - Ferrinox High grade pot cores for telecommunications - Memory and switching cores - Memory stacks - Ferrite Microwaves Devices* — COFELEC (joint venture with : BULL - CFTH and UGINE) ● *Semi-conductors* — COSEM (joint venture with : SACM and BELVU) ● *Ceramic, plastic film, mica, Tantalum capacitors - Delay lines - Fonctionnal modules* — LCC. STEAFIX ● *Carbon coated resistors - Metal Layer resistors* — EURISTA ● *Windings - Printed circuits - Magnetic circuits - Transformers-power supply (Manoury) - Transformers L.T.* — OREGA ● CSF. COMPOSANTS EXPORT 128, RUE DE PARIS, MONTREUIL-SOUS-BOIS SEINE ■■■■ *Connectors - Rotary switches - Microphones - Earphones* — SOCAPEX 9, RUE EDOUARD NIEUPORT, SURESNES SEINE ■■■■

ITALIAN AFFILIATED COMPANIES

Ceramic, plastic film, paper and electro-chemical capacitors - Variable capacitors — CIRCE - DUCATI - MICROFARAD ● *Semi-conductors* — MISTRAL ● DUCATI-ELETTROTECNICA - EXPORT CASELLA POSTALE 572 BOLOGNE ITALY — Distributor in FRANCE : LCC. STEAFIX ■■■■



CSF - COMPAGNIE GÉNÉRALE DE TÉLÉGRAPHIE SANS FIL

79 BOULEVARD HAUSSMANN / PARIS 8^e / ANJ. 84-60



6th INTERNATIONAL EXHIBITION OF ELECTRONIC COMPONENTS PARIS



and

WESTON

present

a complete line of
all solid-state
frequency
time-interval
period **COUNTERS**

basic instruments

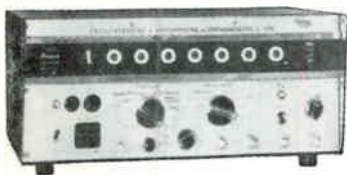

A 1149

Plug-in and accessories such as
TYPE A 1215: Aperiodic divider per-
mitting direct counting

up to >60 Mc

TYPE A 1212: Preset time-base
TYPE A 1170: Universal codeverter

and some other
extra features

A 1149

A 1213

A 1197

A 1211

Max Frequency	> 22 MC	> 2.2 MC	> 220 KC	> 220 KC
Count capacity	99,999,999	999,999	99,999	99,999
Counting time	0.1-1-10 Sec.	0.1-1-10 Sec.	0.1-1-10 Sec.	0.1-1-10 Sec.
Standard frequency	5 MC	1 MC	100 KC	100 KC
Standard stability (± 1 part in...)	10 ⁶ a week 10 ⁶ a week	10 ⁶ a week	10 ⁶ a week	10 ⁶ a week
Standard frequencies outputs	1c/s; 10 c/s;...10 MC	1c/s; 10 c/s;... 1MC	1c/s; 10 c/s;...100 KC	1c/s; 10 c/s;...100KC
Frequency measurements I ₁	50 mV to 100 Vrms Z=100 KΩ/50 μμF	50 mV to 100 Vrms Z=100KΩ/50 μμF	0.2V to 100 Vrms Z=500KΩ/30 μμF	d* A-1197
Input characteristics (2 frequency inputs) I ₂	200 mV to 100 Vrms Z=100 KΩ/30 μμF	200 mV to 100 Vrms Z=100 KΩ/30 μμF	1V to 10 Vrms Z = 10 KΩ	d* A-1197
Period measurements	1 or 10 periods	Period input: I ₁ (A-1149 and A-1213)	or I ₂ (A-1197 and A-1211)	
Time Interval measurements	Polarity: +; Sensitivity: 5 to 5V; Z=10 KΩ/100 μμF		Polarity + Sensitivity: 6 to 50V	+ and -polarity built in pulse shaper
Pulse duration and radio measurements	•	•	•	•

according to their very low consumption all
this instruments can easily be

DC powered.

ask for built-in battery power-pack models,
[8 hours duty] and DC to AC converters.

Rochar
ELECTRONIQUE

Distributed in U.S.A. and Canada by:
WESTON - Newark (N.J.)
for complete information on our line of products and address of
our agency in your country please apply to
**ROCHAR-ELECTRONIQUE, 51, rue Racine
MONTROUGE (Seine) FRANCE.**

Am

eBG

BRINGS BUYERS DIRECTLY TO YOU

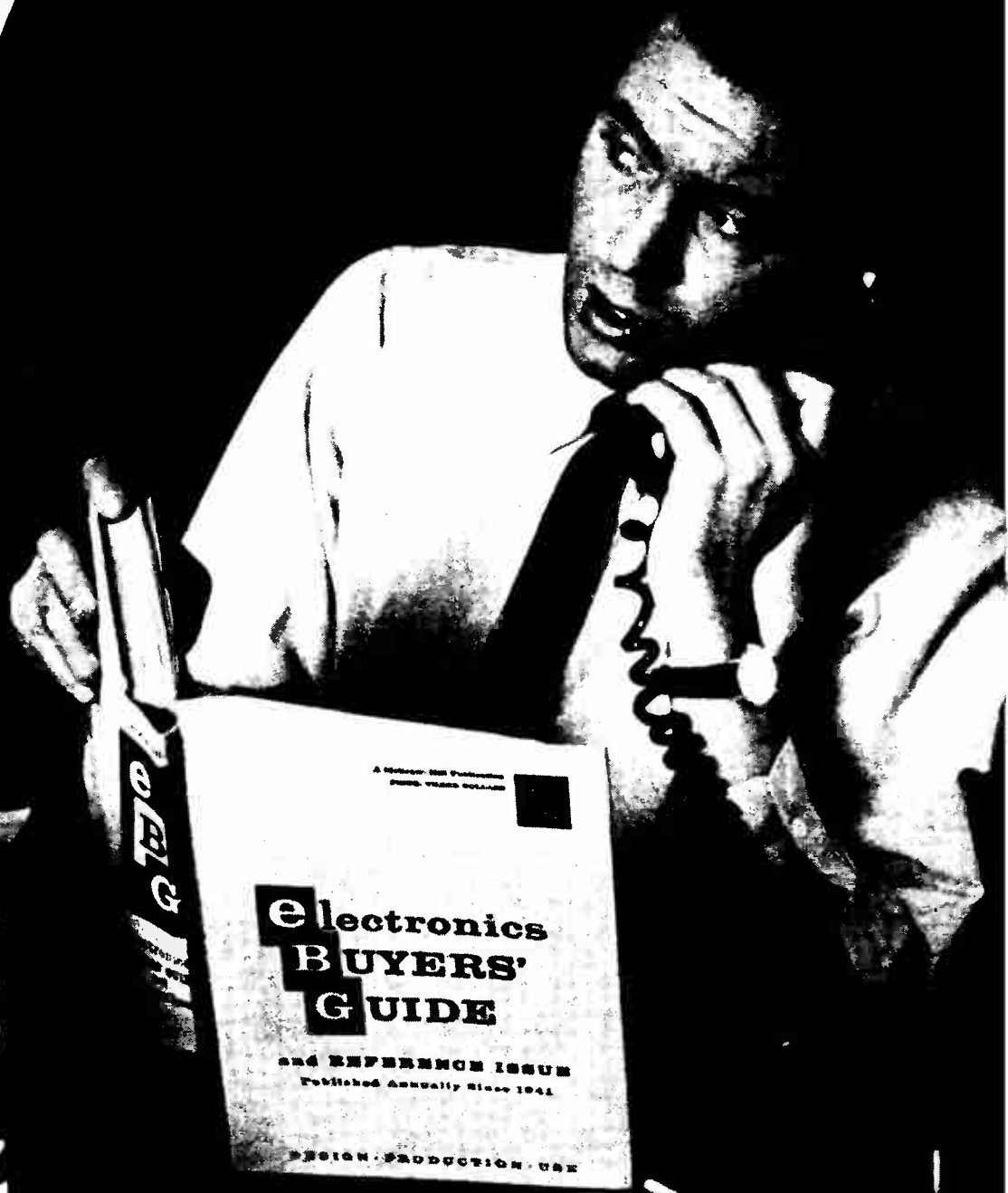

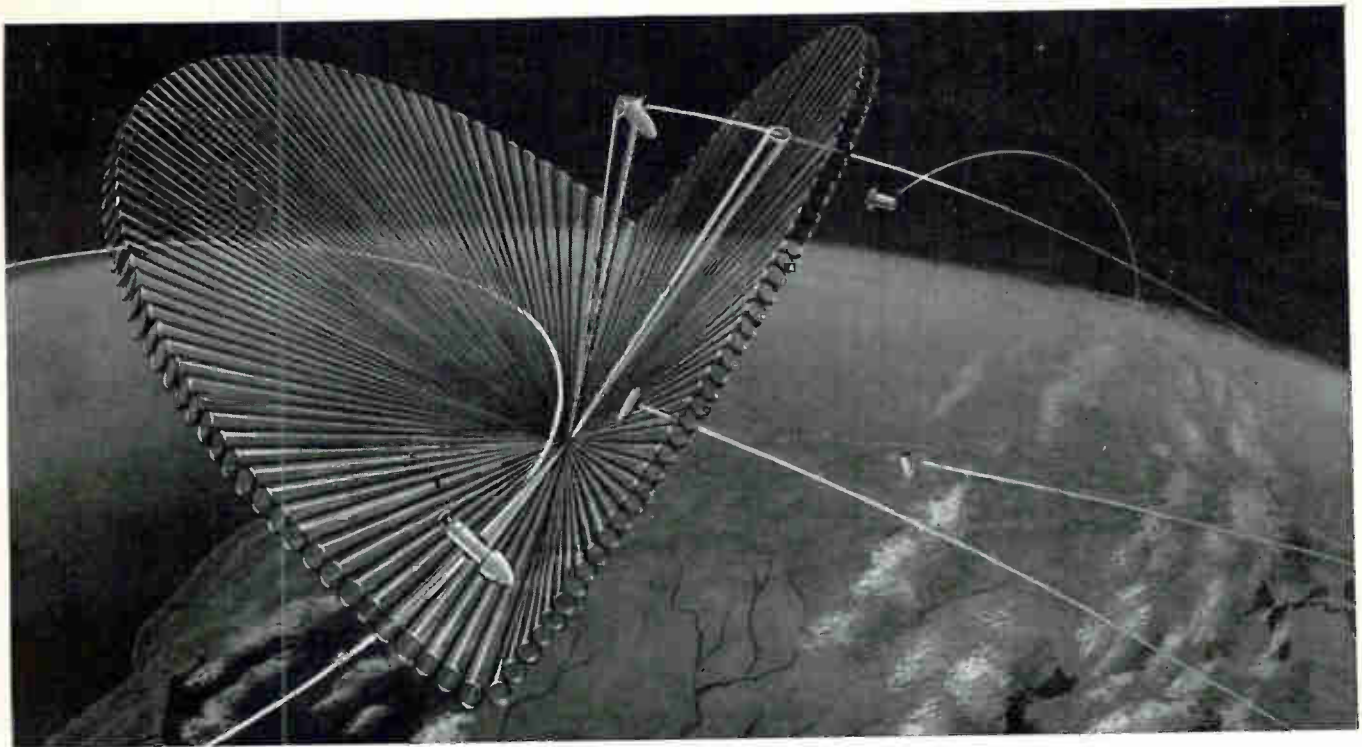

Radar Engineers

Major projects at Hughes-Fullerton in Southern California include multidimensional, electronically-scanned, array radars for defense and space systems and a variety of even more advanced R & D contracts and studies.

Rewarding professional assignments are available NOW for engineers qualified in:

- Waveform Coding
- LASER/MASER Applications
- Pulsed Doppler
- Pulse Compression
- Automatic Detection
- Pattern Recognition
- ECM/ECCM Studies
- Range Instrumentation

Opportunities also exist in RF Circuit Design, Antennas, Microwave Components, Signal Processing, Low-noise Circuits, Transmitter Design, Power Supplies, Receiver Circuitry and Packaging.

Located in Southern California's Orange County (the nation's fastest-growing electronics center), Hughes-Fullerton offers you a stimulating working and living environment, top-flight associates, unequalled facilities and long-term stability.

CALL COLLECT for full information: MR. J. E. TENNEY, Supervisor, Professional Staffing, TRojan 1-4080, Ext. 3741 or airmail resume to: HUGHES-FULLERTON R & D, P. O. Box 3310, Fullerton, Calif.
An equal opportunity employer.

HUGHES

HUGHES AIRCRAFT COMPANY

TOYO CONES



MANUFACTURERS
OF VARIOUS TYPES
OF SPEAKER CONES
ESPECIALLY
OF SPIDER TYPE



No. 2-37, Nakano-cho, Miyakojima-ku
Osaka, Japan
phone: Osaka (351) 7791
Tokyo Office:
No. 1-589, Totsuka-machi, Shinjuku-ku
Tokyo, Japan
phone: Tokyo (341) 3522

TOYO CONEPAPER CO., LTD.

CIRCLE 115 ON READER SERVICE CARD
January 4, 1963

any size panels

engraved in your own plant

Engrave 1-inch nameplates or
6-foot panels by unskilled
labor.

Spindle covers 18¼" x 6" in
one set-up — more than any
other machine of its kind.

Bench type model I-R—\$685.

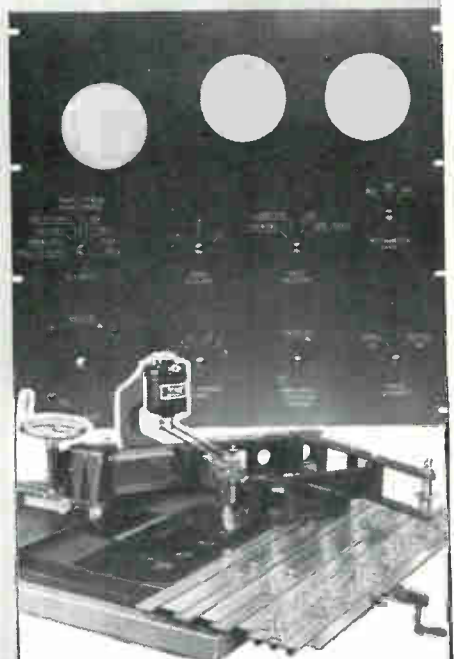

Send for complete catalog ZR-4
Write direct on your letterhead.

new hermes ENGRAVING MACHINE CORP.

154 WEST 14th STREET, NEW YORK 11, N. Y. IN CANADA: 359 St. James Street West, Montreal, P. Q.

Brighter Color Tv in Offing?

Proposed tv tube claims 300 foot-lamberts, is independent of ambient light

By **LESLIE SOLOMON**
Associate Editor

LATEST version of the Lawrence tube is a new three-gun Chromatron that uses conventional color tv circuits to process signals.

Prototype tube is a 25-inch, 90-degree direct-view color crt proposed primarily for home receivers, according to engineers of the Chromatic Division of Paramount Pictures Corp. Company claims multi-gun Chromatron can produce at least 300 foot-lambert highlight brightness.

Other picture qualities claimed

COLORFUL NEWS FROM ALL OVER

There was an international flurry of activity in color tv last year. From Britain came the banana-tube display (*ELECTRONICS*, Jan 26, p 44); from Bermuda, the Harries sunflower optics system (*ELECTRONICS*, Dec 14, p 44); and from Canada came news of a color tv set that claimed to operate using human body heat as a power source (*ELECTRONICS*, Nov 23, p 7).

Now from the U. S. A., we have taken a look at a proposed new version of the Lawrence tube. Designers of this tube claim that the highlight brightness makes it possible to view color tv in a well-lighted room. Unlike the original Lawrence tube that used one gun and horizontally-laid color phosphors, this new version uses three in-line guns and vertically-laid phosphors.

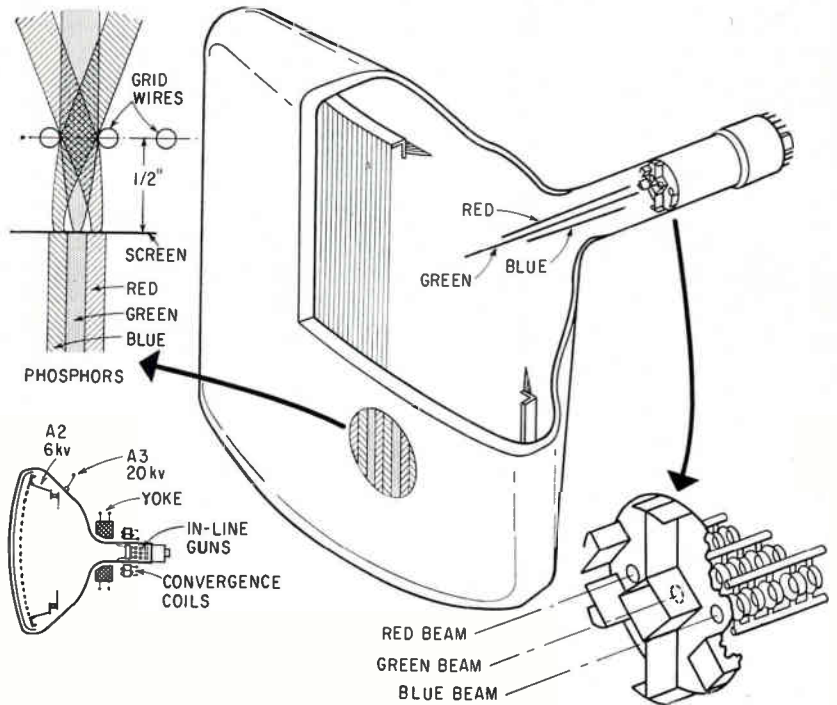

COLOR TUBE uses three electron guns, lower right, that focus on vertical array of color phosphors. Intense color image is produced after beams pass through relatively transparent second anode grid in front of phosphor array. Second anode is array of vertical grid wires

for new tube are usefulness in well-lighted rooms or outside in open, with no protection necessary either inside or outside. Sets developed using proposed tube could be portable, and small-area contrast ratios are excellent, according to company.

CONTRAST — Basic mechanical configuration of the new tube is shown above. Although the phosphors are shown as a continuing sequence of red-green-blue vertical stripes, a slender black stripe is laid between each color to improve contrast.

The vertical array of color phosphors lead to the choice of a horizontal three-in-line electron gun. In combination with the second anode grid located 1/2-inch in front of the phosphors, the beams from the three electron guns are electron-optically directed to their respective color phosphor stripes. The two

outer guns have a slight inward inclination so that the three beams converge on the phosphor screen as a unit.

During raster scan, the deflection yoke can distort the converged unity of the triple-beam array and a complex color image would lose the desired superposition of the red and blue picture areas (by the outside pair of electron guns) with the green (detailed by center gun).

In the horizontal plane, there will be directed displacement between the three beams in their transit through the deflection field. Vertical convergence errors are inherently small since in effect the beams have no relative vertical displacement. The small angular difference between the center and outer beams path length through the vertical deflection field may be compensated by a slight negative gradient from the desired uniform vertical field.

In the horizontal direction of de-

IN 45 SECONDS

45 DIFFERENT TESTS

150 TEST CONDITIONS!

BETTER
MEASURING
FROM



While originally designed as a system tester for Doppler Radar, the extreme versatility of the Electro Instruments Digital Multimeter permitted Raytheon to check the integrated circuit elements of the Apollo Spacecraft systems. The EI system performed 45 different tests under 150 test conditions in 45 seconds! These test operations formerly required 45 minutes of manual effort.

As demonstrated by this fully automatic system tester created for Raytheon, your key to greater speed, higher reliability, significant cost savings and lower investment lies in EI all solid state Digital Multimeters.

Your desires for similar savings, whether they be in connection with spacecraft, components or purely industrial processes, can be realized with digital measuring. Available to you in this regard are instruments for measuring DC volts, AC volts, DC ratios, resistance, capacitance, inductance and impedance. EI all solid state Digital Multimeters provide swift, accurate answers to your measurement and display problems. Put digital measuring to work for you now — the benefits will be worth your while.

For full details on EI's individual digital instruments, or our complete capabilities in the field of measurement, display and recording — write direct in care of Department MA-1.

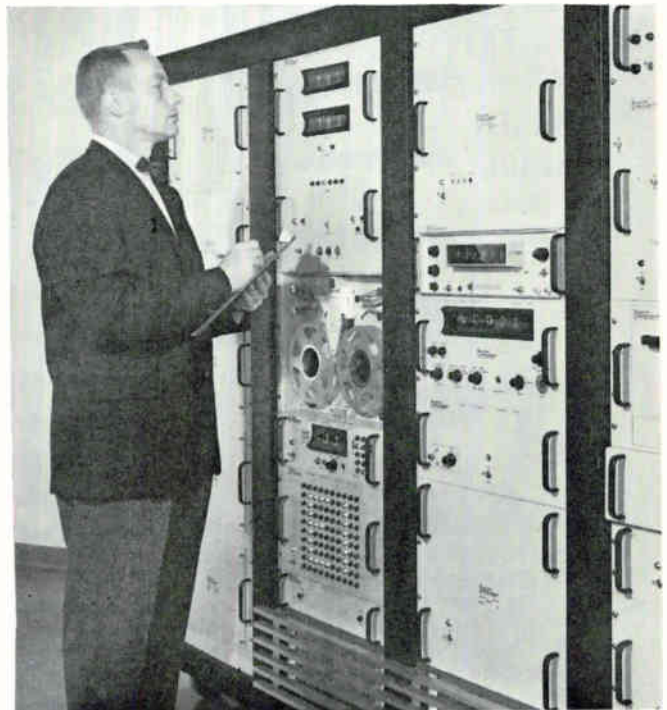

Versatile . . . cost cutting automatic system tester built for RAYTHEON by Electro Instruments.



Electro Instruments, Inc.
8611 Balboa Avenue, San Diego 12, California

Celco DEFLECTION

HIGH
Efficiency

MAXIMUM
Resolution

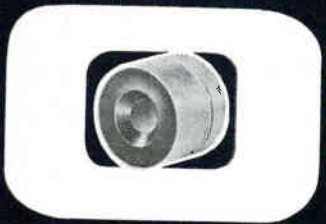

MINIMUM
Distortion
LOW
Residual

FASTEST
Spot Recovery
WIDE
RANGE
Inductances



Celco Precision Deflection Yokes are now available for neck diameters from 1/2" to 5" for all types of military and commercial CRT displays. For technical assistance or Celco's latest catalog, call or write:

Celco

**CONSTANTINE ENGINEERING
LABORATORIES COMPANY**

Mahwah, N. J.
Area Code: 201
Davis 7-1123
Ed Ryder

Miami, Fla.
Area Code: 305
Plaza 1-1132
Walt Faust

Upland, Cal.
Area Code: 714
Yukon 2-0215
Bob Reese

flection, a comparatively larger positive magnetic gradient (a saddle-shaped distribution of flux density) effectively maintains beam convergence along this axis.

STABILITY—Thus by a small change in winding distribution of a conventional deflection yoke, automatic dynamic convergence in the rectangular axes of the display is attained. Trapezoidal error, evident in diagonal corners, is corrected by a magnetically-driven convergence magnet assembly atop the outer electron guns. Corrections are electrically symmetrical and convergence stability is a high order since a major portion of the correcting function is tied directly to the deflection yoke which is the actual disturbance source.

The post-deflection focusing second-anode grid is an array of closely-spaced parallel taut wires, located 1/2-inch from the phosphors operating at a potential of 6 Kv. Approximately 20 Kv is applied to the final anode consisting of the Aquedag internal coating and the phosphor coating.

As the screen of the evacuated

bulb must withstand air pressure, it is designed with a convex arc arranged along the horizontal axis of view similar to a theatre stage. Since the electronic nature of this crt dictates that the phosphor screen surface be nearly co-planar with the second-anode grid, this determines a virtually flat panel section along the vertical axis. Thus, the second-anode grid is an arrangement of vertically strung wires arrayed in a smoothly-bowed curtain.

Component Makers Urged To Revamp Thinking

MORE manufacturers of electronic systems are acquiring the know-how to make component for their own systems, according to G. B. Mallory, President of P. R. Mallory and Co.

Company has evaluated a study of a group of the largest users of components in the country. Survey reveals that 21 percent of them already have component or module production capability, and 14 percent of firms that use components

Rectifiers Assembled in Nitrogen

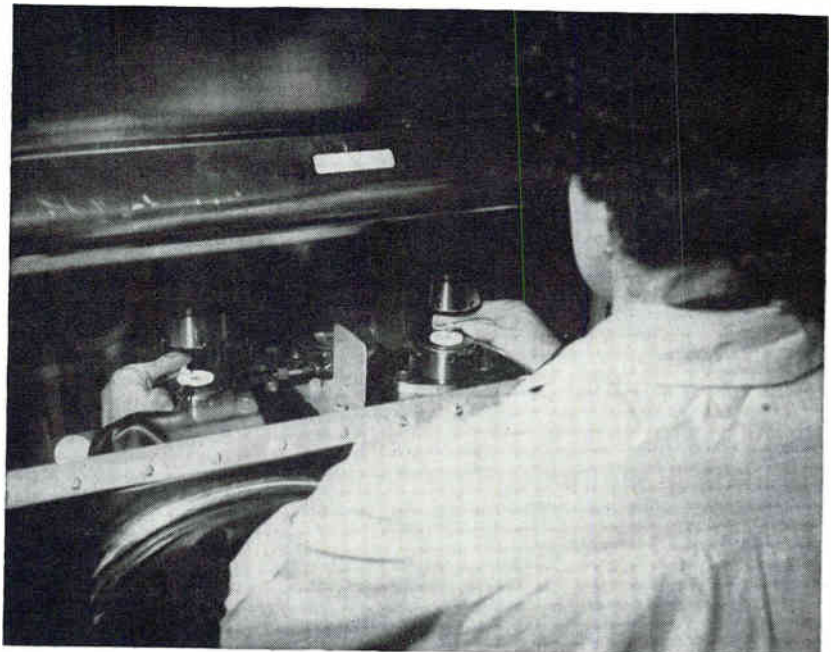

NITROGEN replaces air in specially built glassed-in boxes, used to weld pigtailed-mounted silicon rectifiers. Technique prevents oxygen contamination, keeps moisture down to one part in million or less, according to General Instrument. Station is part of new rectifier facility that costs quarter million dollars. Company says the facility produces super-reliable devices at cost of conventional units, due to high yield

IN THIS BIG TRIANGLE
OF SAFE OPERATION,
PHILCO MADT* SWITCHES

NEVER
AVALANCHE!

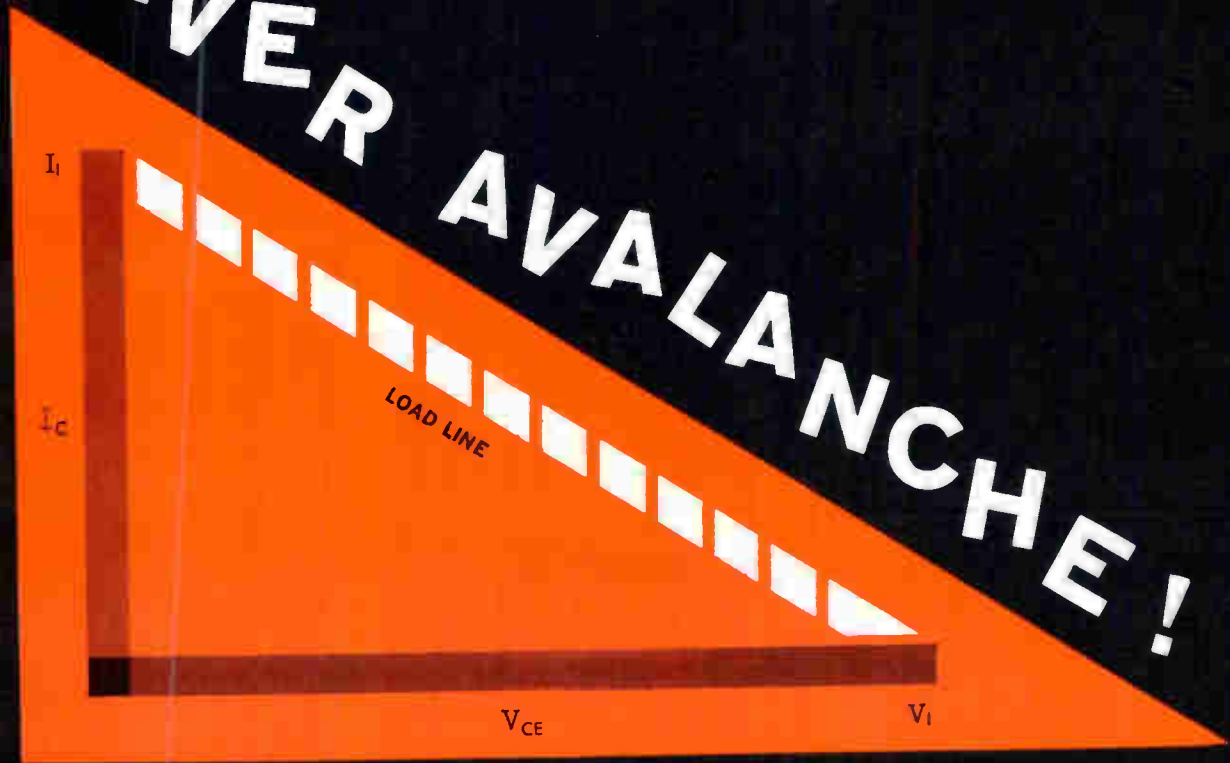

Philco triangle of safe operation includes all current-voltage conditions under which a Philco MADT is *guaranteed* against avalanche (and resultant latching).

TRIANGLE OF GUARANTEED
LATCH-FREE OPERATION

2N779A
2N1499A
2N2048
2N2401
2N2402

$I_1 = 50 \text{ ma}$



$V_1 = 15 \text{ v}$

Now you can forget about avalanche (and resultant latching) as a pitfall in circuit design. Philco Micro Alloy Diffused-base Transistors—inherently resistant to avalanche—now are *certified* avalanche-resistant with a Philco guarantee. Philco MADT switch specifications now include an I-V triangle of (guaranteed) safe operation—at no extra cost.

For more reliable switching at every clock-frequency, there's a Philco MADT. For complete data on specific types, write Dept. E1462.

*Micro Alloy Diffused-base Transistor

All Philco MADT types
are in stock at your Philco
Industrial Semiconductor Distributor.

PHILCO

A SUBSIDIARY OF *Ford Motor Company*
LANSDALE DIVISION • LANSDALE, PENNSYLVANIA



NEW FROM NSL



15 NEW TYPES OF CdS
PHOTOCONDUCTIVE
CELLS NOW AVAILABLE
IN RUGGED HERMETIC-
ALLY SEALED METAL EN-
CLOSURES

SAMPLES ON REQUEST

NATIONAL SEMICONDUCTORS LTD.
230 Authier St., Montreal 9, P.Q.
PHONE: 744-5507

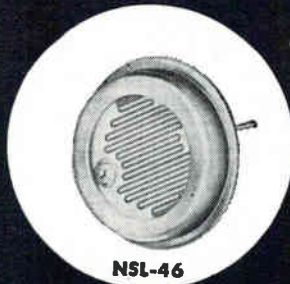

NSL-46



NSL-56



NSL-63

CIRCLE 208 ON READER SERVICE CARD

LOW-LEVEL DC PREAMPLIFIERS

IMPROVE RELIABILITY

A new series of low-level ACROSTAT DC Preamplifiers, epoxy potted, self-contained, operate from 115 V \pm 10% AC, 2 watts. Model 104 amplifies signals of 1 micro-microwatt with a power gain of 330,000 in a single stage from thermocouples, strain gages, Hall devices, and other low-level DC sources. Input, output and AC supply are isolated and floating. Null stability is better than 10 microvolts over moderate environments, and 50 microvolts over severe environments.



Price only \$139.00 each, 1-5 units; quantity discounts; immediate delivery. Request Technical Bulletin No. 10.

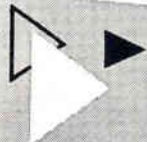

acromag[®]
INCORPORATED

15360 TELEGRAPH RD.

DETROIT 39, MICH.

Teletype:

DE 970

Phone: 538-4242, Area Code 313

have production capabilities for making discrete components. Over half of these large users of components are engaged in R & D activities in the components area. However every one of the companies included in this survey have their own component evaluation groups.

What does this mean for firms who just stick to components?

Some may fall by the wayside, says Mallory, unless they revamp their thinking to anticipate the future needs of the major users of electronic components. Research is a requirement for survival.

Mallory suggests needs for a basic scientific understanding in these areas: Fundamental electrochemical processes occurring in material systems, structure and physics of thin and bulk films, depth studies in solid-state phenomena centering around dielectric and semiconductor materials, and physical properties and important characteristics of metallurgical systems.

Company has made products in fields that were separable and distinct — metallurgical, electromechanical, electronic, electrochemical. These fields are now interrelated and, for Mallory interdependent.

Mallory's new Laboratory for Physical Sciences, recently opened in Burlington, Mass., has been established for basic research in these interrelated fields.

Do Radical Changes Lie Ahead for Components?

LACK of proper materials is major difficulty in development of most high-performance aerospace vehicles, according to Aerospace Industries Association. Aerospace Technical Forecast notes that temperature resistance of refractory metal alloys will increase about 1,000 F during the next ten years. Plastic materials will increase between 500 to 1,000 F for short term applications, according to report.

Report presents a broad outline of the technological capability industry is developing and technical problem areas to be solved to meet anticipated national aerospace re-

CHANNEL SEPARATION?

SPECIFY MIDLAND CRYSTAL FILTERS

Years ago, Midland knew of the impending high frequency spectrum "jam". Today it's here! The steep attenuation slope exhibited by a crystal filter is an important characteristic in design of H.F. communications systems for maximum channel separation. Crystal filters are small, reliable, rugged and stable over a wide temperature range. They are more in demand now than ever before. That's why Midland, through purchase, is integrating Itek's Electro-Products Division's production, test equipment and filter designs into Midland's already established 100,000 square foot facility—to further enhance the ability to serve the growing needs of the communications industry. Two typical Midland production filters are the EL-1B and DL-1B. Check the response, inband ripple and ultimate attenuation, with only 3 db insertion loss. Approx. size 2"x1"x3/4". Write for Engineering Bulletins NBS-104 and NBS-105 for complete technical information.



EL-1B

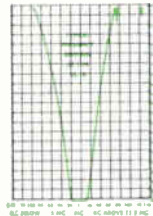
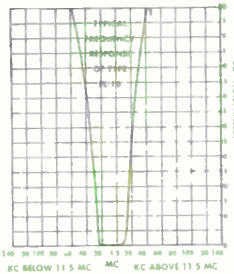

DL-1B



Midland
MANUFACTURING COMPANY
 3155 Fiberglas Road • Kansas City 15, Kansas

WORLD'S LARGEST PRODUCER OF QUARTZ CRYSTALS & CRYSTAL FILTERS • Division PACIFIC INDUSTRIES, INC.

CIRCLE 209 ON READER SERVICE CARD

the finest
precision
coaxial
connectors*

*TM®
(miniaturized TNC)

General RF Fittings, Inc.

702 BEACON STREET, BOSTON 15, MASSACHUSETTS
 Telephone: 617 267-5120

CIRCLE 210 ON READER SERVICE CARD

CHATILLON

FOR PRECISION MEASUREMENT OF PUSH AND PULL

Completely New Model DPP
MAGNETICALLY ACTIVATED CLUTCH
 ... holds maximum readings
VERSATILE ... hundreds of uses ...
 checking tension and compression in
 lab, factory or field
TESTS PUSH AND PULL FROM EITHER
END ... does the work of two gauges
ACCURATE ... within 1/2 of 1%
RANGE ... models in 1 to 50 pound
 capacities

As a hand-held instrument, the Chatillon DPP gives complete flexibility. It may be used in any position for checking tension or compression in an unlimited variety of applications. With the Chatillon LTC test stand, designed specifically for use with the DPP, it becomes a compact, low capacity laboratory tester.

SEND FOR DATA SHEETS.
 Full details on both the DPP Push/Pull gauge and the LTC Test Stand are yours for the asking. Write to John Chatillon & Sons, 85 Cliff Street, New York 38, N. Y.

CHATILLON ... the force in force measurement
 since 1835
 Manufacturers of scales, force measuring instruments and precision springs.

CIRCLE 121 ON READER SERVICE CARD

Rely on ROHN

for TOWERS, TOWER SYSTEMS, MICROWAVE PASSIVE REFLECTORS, LIGHTING EQUIPMENT and ACCESSORIES

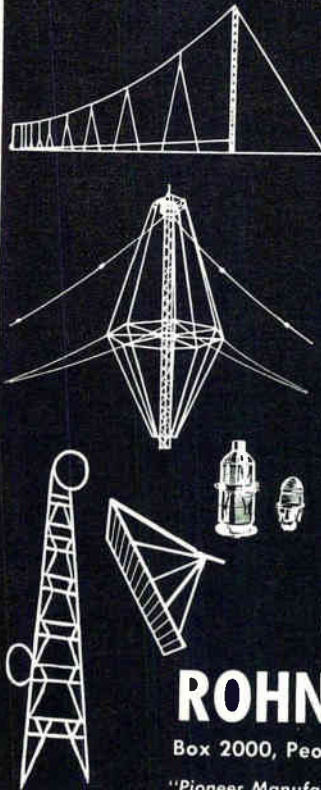

ROHN is the largest company of its kind exclusively manufacturing communication towers and allied equipment. They can supply a wide range of both guyed and self-supporting towers from all heights up to 800'. They have available engineering and manufacturing facilities for special tower systems and complete engineering and design services. Also ROHN makes microwave passive reflectors and complete tower lighting equipment. So whether it's a single tower or a complete communications system, contact ROHN for dependable and reliable equipment and service.

ROHN Manufacturing Company

Box 2000, Peoria, Illinois • Phone 309-637-8416

"Pioneer Manufacturers of towers of all kinds—Representatives world-wide"

CIRCLE 211 ON READER SERVICE CARD

ORIGIN SILICON DIODE

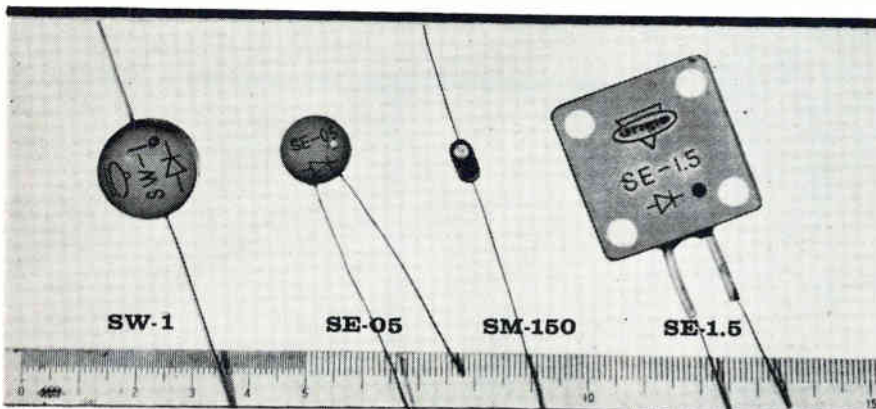

Origin diodes shown, are available in 4 models for PIV of 400, 600, 800 and 1000 volts.

Max. AC input voltages (RMS) of 280, 420, 560 and 700 volts.

Max. reverse current (at PIV, 25°C ambient) is less than 10 μ A, only 50 μ A for SW-1.

Main Products:

Semi-conductors, condenser type spot welder, synthetic enamel and miniature ball bearing.

Max. average rectified current (single phase, half-wave) is .150m A for SM-150, 500m A for SE-05, 1 A for SW-1, and 1.5 A for SE-1.5.

Surge current (for 1=one cycle) is respectively 10 A, 16 A, 30 A and 20 A. Ambient temperature operating range is -55 to +13°C for each diode.



ORIGIN ELECTRIC COMPANY LTD.

1-195 Takadaminami-cho, Toshima-ku, Tokyo, Japan
Cable Address "ORIGINELE TOKYO"

quirements in the next decade.¹

Tensile strength of glass fiber reinforced plastics will increase from 200,000 psi to 300,000 psi during the next ten years. Structural weight can be reduced by one-third in rocket motor casing.

Forecast sees more radical changes in components. Use of small parts and molecular electronics and thin films will increase by at least 20 percent and as high as 80 percent, according to report. Present densities, largely using printed wiring, are about 10,000 equivalent parts per square foot. Use of molecular techniques is expected to increase this density to one billion equivalent parts in the next ten years.

Report predicts improvement in reliability of electronic systems as much as 100 times greater than today. Aerospace industry also predicts that memory capacity of ground-based data processing equipment will increase about a million times. "An entirely new methodology must be developed to obtain the necessary reliability of space missions. It is virtually certain that redundant systems incorporating self-checking, fault-locating and indicating, self-organizing and adaptive features will have to be devised," forecast notes.

REFERENCE

(1) Aerospace Technical Forecast, Aerospace Industries Association, 1725 De Sales St., N. W., Washington 6, D. C. (\$3.00)

Motor Commutates With Transistor Flip-Flop

KEY to new brushless motor lies in use of simple oscillator circuit that commutates electronically. There are no brushes to wear out, and motor is said to last as long as the bearings. Cycle output is variable, and good starting torque is claimed. Ametek motor, named Komlectro, does not rely on sparking contacts for operation. Continuous rotation is achieved through switching action of the commutator which sequences the current in the rotor, thereby causing the d-c motor to operate on a-c.

Other advantages claimed for small fractional horsepower motor, packaged in small cube: reduction

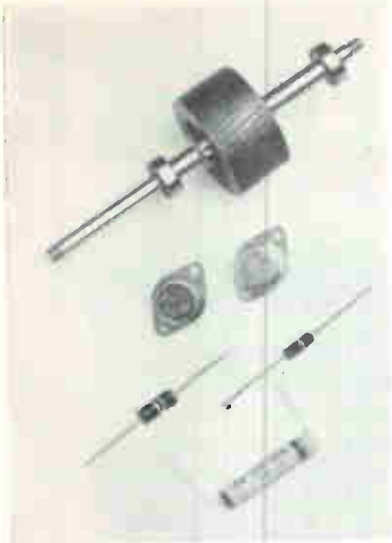

BRUSHLESS motor parts show squirrel-cage type rotor, two power transistors, two resistors, one capacitor

in both electrical noise and acoustical noise, reduced maintenance, wider variations of speed control characteristics.

Present designs are available for motors from 1/20 hp up to one hp. Limiting factor is the transistors' junction temperatures.

Wire Woven on Cloth Looms

METAL wire can be woven in cloth patterns using tantalum, columbium, molybdenum, and tungsten. With 0.6-mil wire, meshes up to 350 x 2,300 can be produced in some materials, says Fansteel.

Although cloth weaving technique was developed for ion emitters, refractory metal cloth could be used for directly heated dispenser cathodes, filters for high-temperature fluids and liquid metals, flame holders and catalysts.

Microfilament Wire

WIRE of pure tungsten is being drawn in 0.0002-in. to 0.029-in. diameters. Pure molybdenum is being drawn in the 0.0008-in. to 0.019-in. diameter range. Tolerances on diameters are 0.5 percent with a typical 0.0005-in. diam tungsten wire. A 0.5 percent tolerance provides an actual variation of 0.000001 inch. Thermionic Products reports applications other than in electronic devices in aerospace.

PROVED

in thousands
of
applications

AIRPAX

MICRO-MIDGET LOW-NOISE CHOPPERS



Model 30A
60 CPS



Model 40A
400 CPS

Introduced in mid-1960 after exhaustive laboratory and application tests, thousands of these tiny electromechanical choppers are performing to complete customer satisfaction in devices such as: RF and DC Voltmeters, ultra low-level DC Amplifiers, Servo Systems in complex aircraft-landing sequences and in similar critical areas. The 60 CPS series will operate at drive frequencies from 0 to 250 CPS; the 400 CPS series, from 0 to 1,000 CPS. Each series is obtainable in a variety of enclosures and header types.

CHARACTERISTICS

Drive: 6.3 volts
Contacts: SPDT BBM
Signal: to 10 volts DC; 2 MA max.
Noise: as low as 0.6 microvolts
Temperature: -65 to +100° C
Vibration: 15G to 2,500 CPS Shock: 100G
Volume: 0.15 cubic inches Weight: 9 grams

Available from Stock



TWX 301-228-3558 PHONE: 228-4600 (301)
AIRPAX ELECTRONICS • CAMBRIDGE DIVISION • CAMBRIDGE, MARYLAND
incorporated

Standardizing Noise-Figure Measurement

Long-sought r-f amplifier technique gives 95 percent repeatability

By THOMAS E. GAUSMAN
Electronic Tube Division
Sylvania Electric Products, Inc.
Emporium, Pa.

NOISE-FIGURE measuring technique having 95 percent repeatability was recently devised by the Noise Advisory Group of the Electronics Industry Association. This group, a subcommittee of EIA's Joint Electronic Devices Engineering Committee, (JEDC), will present complete specifications in a forthcoming JEDC publication.

BASIC EQUIPMENT—Measuring equipment consists of a noise source, a tube test jig circuit and a high-gain post amplifier.

A 50-ohm noise generator is needed to rapidly measure noise figure with a high degree of repeatability. An instrument like the Hewlett-Packard noise figure meter, Model 342A used with the Hewlett-Packard vhf noise source, Model 343A will continually monitor noise figure as the amplifier input is tuned for noise-matched conditions.

Basic requirements for the tube test jig circuit (Fig. 1) are:

- (1) 200-megacycle center frequency
- (2) A 3-db bandwidth of 10 ± 2 megacycles

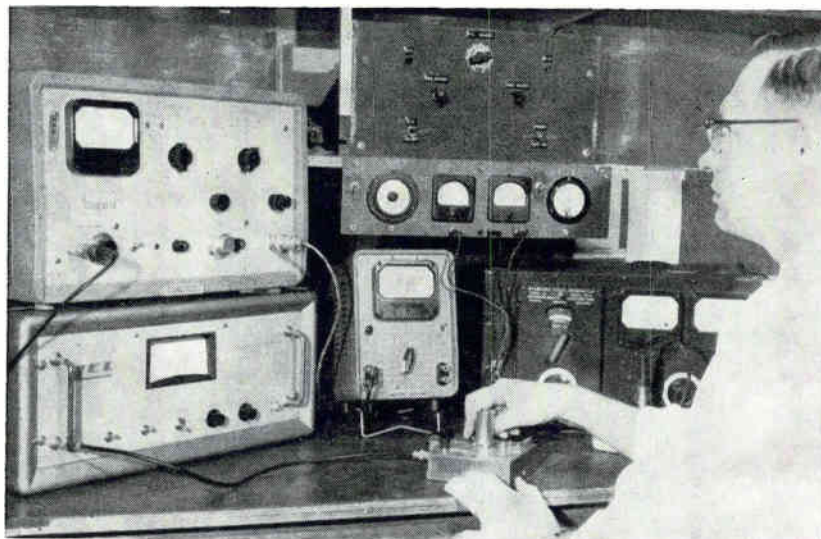

NOISE FIGURE of r-f amplifier in test jig (center) is measured using a meter that continually monitors noise figure and gives a direct noise-figure readout in db.

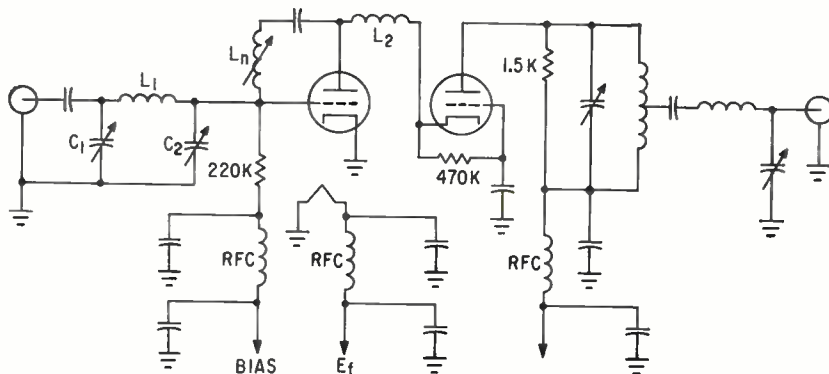

JIG CIRCUIT for cascode type tubes typifies jig requirements—Fig. 1

- (3) A pi input circuit adjustable to noise-matched conditions
- (4) A pi output circuit tunable to 50 ohms impedance

- (5) Single frequency neutralization for triodes, including the grounded cathode section of cascode tubes

- (6) Rated voltages applied to the tube

NOISE-FIGURE MEASUREMENT

Standardized method for measuring noise figure of r-f amplifiers has been a long-time industry goal. During 1955 and 1956, EIA conducted a series of round-robin tests on noise figure and input impedance of cascode r-f amplifiers. Poor correlation of findings stymied development of a noise-figure specification expressed directly as noise figure or indirectly by describing tube parameters. This prompted EIA to form the Noise Advisory Group, an engineering study task force. Company members are: Sylvania, RCA, GE, Westinghouse and Tung-Sol

The cascode-tube jig circuit shown here illustrates these specifications. C_1 , L_1 and C_2 form the input-pi section that matches the 50-ohm input to the tube input impedance. A 1,500-ohm 5-percent resistor loads the output section plate coil to approximately 10-megacycles bandwidth. The output-pi network is tapped to the center of the output coil and matches-down to the 50-ohm output. Peaking coil



WHAT'S \$1/turn?

Daystrom's new ten-turn precision 349 series pots...that's what.

Here's a new computer-grade Multipot® produced to provide *all* the precision and reliability you need...and priced at reasonable levels.

The series 349 Multipot® gives you ten quick turns with resistances to 1 full Megohm and with torques which never exceed 2.5 oz.-inches. Look at these specs...

MECHANICAL

Mechanical Rotation Refer to Schematic
 Starting Torque (Max.) 2.5 oz.-in.
 Running Torque (Max.) 2.5 oz.-in.

ELECTRICAL

Linearity $\pm 0.25\%$ 1K and above
 Total Resistance 1K to 1 Meg.
 Resistance Tolerance $\pm 5\%$
 Power Dissipation 2.5 W
 Electrical Angle $3600^{\circ} \pm 5^{\circ}$
 Insulation Resistance (500 VDC) 50 Meg. Minimum
 Dielectric Strength (1 Minute) 1000 VAC

Equivalent Noise Resistance (Max.) $.1\%$ or 100Ω
 Max. Continuous Working Voltage 500 VDC

ENVIRONMENTAL

Vibration 10-2000 CPS (MIL-STD-202 Method 204 Condition "B")
 Shock 50 G's (MIL-STD-202 Method 205)
 Operating Temperature -55°C to $+105^{\circ}\text{C}$

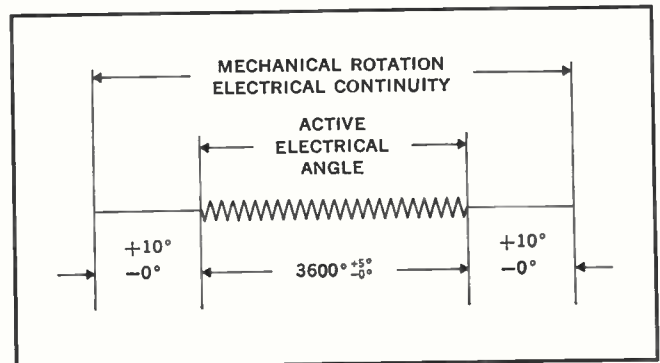

Contact your local Daystrom representative for technical assistance, volume prices, and deliveries. Or write:



ACTUAL SIZE

DAYSTROM, INCORPORATED
 POTENTIOMETER DIVISION
 ARCHBALD, PENNSYLVANIA • LOS ANGELES, CALIFORNIA

High CAPACITY VACUUM

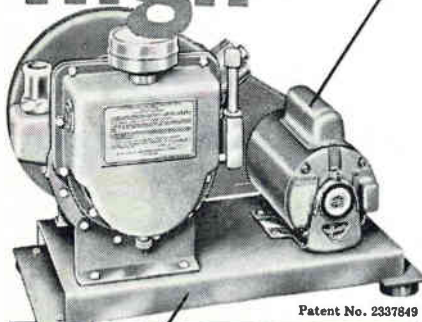

Patent No. 2337849

WELCH
DUO-SEAL VACUUM PUMP
WITH VENTED EXHAUST

Welch "Duo-Seal" No. 1397 is a two-stage, oil sealed, rotary vacuum pump with a free air capacity of 425 liters per minute and a guaranteed vacuum performance of 0.1 micron or better with the vented exhaust closed . . . 1.0 micron with vent open. The performance is uniformly high over a range of 1×10^{-4} mm Hg (Torr). It is especially suited for application to large systems involving substantial vapor removal.

The 1397's are equipped with vented exhausts to eliminate condensation of vapors which raise the vapor pressure of the sealing oil, contaminate and break down the oil, and corrode the metal parts.

IMPORTANT FEATURES:

- High pumping speed—425 liters per minute
- Low ultimate pressure— 1×10^{-4} mm Hg (Torr)
- Quiet, vibration-free operation
- Compact, rugged design
- Air-cooled
- Vented Exhaust—eliminates condensed vapors, oil filters and separators
- Belt guard
- Trouble-free, low maintenance

Over the years, Welch "Duo-Seal" Vacuum Pumps have gained a world-wide reputation for best performance, greatest reliability and quietest operation. They are available in a wide selection of capacities and ultimate vacuum characteristics, ranging in capacities from 21 to 1400 liters/minute and ultimates from 2×10^{-2} mm Hg (Torr) down to 1×10^{-4} mm Hg (Torr).

WHEN YOU USE A WELCH "DUO-SEAL" VACUUM PUMP, YOU'RE USING THE FINEST!

For complete descriptions, specifications and prices, write for Welch "Duo-Seal" catalog.

SINCE 1880 THE WELCH SCIENTIFIC COMPANY
Foremost manufacturers of scientific equipment
1507 N. Sedgwick Street, Chicago 10, Illinois

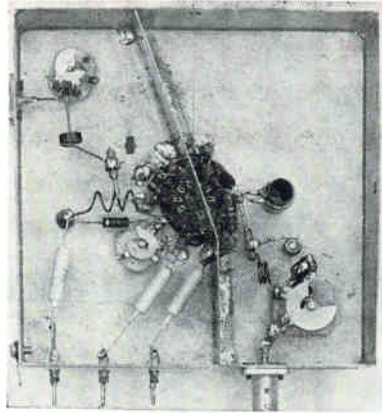

SHIELDING of test jig's input and output sections is shown in bottom view—Fig. 2

L_2 is adjusted for minimum noise figure with the first tube measured. Neutralizing coil L_n is resonated with the grid-to-plate capacitance at test frequency to minimize plate-to-grid feedback.

Eliminating the grounded grid section and moving the output circuit over to the grounded cathode section forms a triode jig circuit. Then, addition of a screen connection and removal of the neutralization coil produce a pentode jig circuit.

Precautions in jig construction include use of short-lead high-quality bypass capacitors and placement of coils in different planes when used in the same compartment (Fig. 2).

Specifications for the post amplifier include (Fig. 3):

- (1) A 200-megacycle center frequency at the input
- (2) A maximum 3-db bandwidth of 5 megacycles
- (3) Sufficient gain in conjunction with the noise figure meter to

read the noise figure of the unit itself

(4) A maximum noise figure of 6-db

(5) A 50-ohm input and output

The post amplifier can assume several configurations. A straight-through 200-megacycle amplifier or frequency conversion to an i-f frequency can be used. With frequency conversion, a commercial vhf tuner with its input modified to 50 ohms (unbalanced) can be coupled to a 44-megacycle i-f amplifier. Total gain of the post amplifier should be approximately 75-db and should be reducible by 20-db.

MEASUREMENT PROCEDURES

—Block diagrams in Fig. 4 illustrate setups for neutralization, gain, bandwidth and noise-figure measurements.

Neutralization of single triodes and cascode tubes begins with B+ to the tube under test off. A modu-

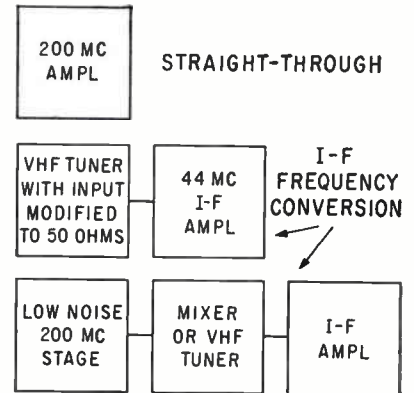

AMPLIFIER configurations connected to test jig output may be straight-through or conversion to i-f frequency may be used—Fig. 3

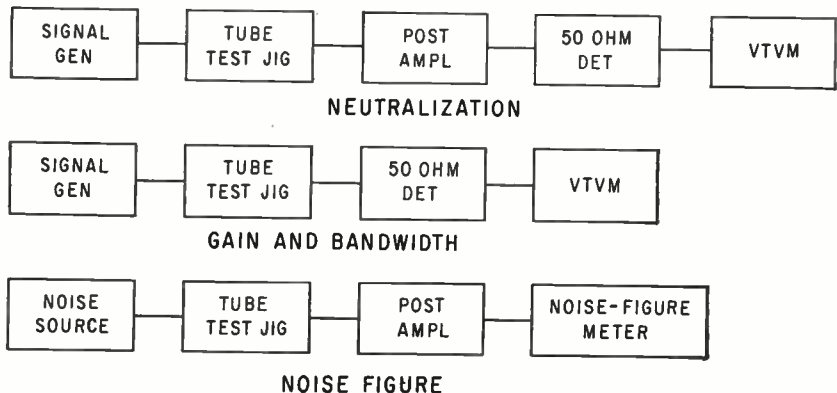

SUCCESSIVE procedures shown are performed before making noise-figure measurement—Fig. 4

lated 200-megacycle signal is then applied and the neutralization coil tuned for a null on the vtvm.

Gain and bandwidth are then checked with the indicated setup.

With rated voltages applied to the tube, maximum vtvm indication adjustments on the input and output pi networks and the plate circuit tuning are made. Signal generator is then tuned to 3-db points on either side of center frequency to determine bandwidth (characteristic of crystal detector should be checked to determine what 3-db reduction represents on the vtvm). The bandwidth measurement checks output circuit loading to assure proper jig operation.

In measuring gain, a reference point is established on the vtvm with the jig in the circuit. The jig is then removed and the signal generator output increased to obtain the same reference point. Gain is the ratio of the two output voltages. Gain measurement serves three purposes: checks tube under test, checks the jig, and helps correct for second-stage noise.

The noise-figure measurement setup is shown in Fig. 4. Following the manufacturer's manual for setting up the noise figure meter, the gain of the post amplifier is adjusted so that the total gain of the jig and post amplifier is sufficient for noise-figure meter functioning. The input pi network of the tube under test is then adjusted for a minimum noise-figure reading. The second-stage noise figure and the noise-matched gain of the jig is read in a similar manner and the corrected noise figure calculated from the well-known Friis formula.

The Hewlett-Packard test set is specified for use in the system because it has the capability of continually monitoring the noise figure with a direct readout in db.

Aerospace Production Aided by Automated System

AUTOMATIC PRODUCTION management system installed by Sperry Phoenix is claimed to be first large-scale computer control in the production of varying quantities of complex electronic equipment. Cen-



the home of **PRACTICAL INGENUITY IN ELECTRONICS**

This modern 250,000 square foot plant is a far cry from the Company's modest beginning in 1944. Today, in this main plant, in Bloomington, Indiana, modern manufacturing methods—with an abundance of technical know-how—combine to produce the world's finest TV Tuners and FM Tuners.

Here, and elsewhere throughout the Tarzian industrial complex, some 2000 employees produce such diversified electronic products as:

TV TUNERS **FM TUNERS** **SEMICONDUCTORS**
BROADCAST EQUIPMENT **AIR TRIMMERS**
MAGNETIC TAPE **FM RADIOS and AM/FM RADIOS**

(In addition to the extensive manufacturing facilities, Sarkes Tarzian, Inc. owns and operates six full-time radio and TV stations in Indiana.)

The engineering excellence, reliability and sensible pricing of ALL Tarzian products are a part of the approach to "Practical Ingenuity in Electronics." Our reputation for customer satisfaction has been built on this philosophy. We intend to keep it that way.

Electronic Products of Tomorrow—Today



SARKES TARZIAN INC

east hillside drive • bloomington, indiana edison 2-7251



**slash production costs with
new automated coil winder
... fewer operators
... more coils per operator**

Leesona No. 116 will wind 400 to 1,000 bobbin coils per hour... with one operator.

All the operator does, as the rotary table brings the winding heads to her, is load bobbin on arbor, clip start wire.

Automatically the No. 116 closes tailstock, tapes start lead, resets counter, starts winding, stops at ± 2 turns, waxes or tapes finish lead, indexes arbor, cuts wire, ejects and sorts.

It winds two or more different coils up to 3" diameter by $2\frac{3}{8}$ " long... simultaneously. Supports and winds from 100 lb. wire container, and stops when spool or container is empty. Six to twelve two-speed heads wind wire AWG 16 to 50 and finer.

No. 116 is designed by Robert Bachi. We build it to the customer's specifications.

For details call your nearest Leesona representative.



LEESONA CORPORATION
Warwick, Rhode Island

B.2.2

Offices: 5700 West Diversey Ave., Chicago, Ill. 1500 Walnut St., Phila. 2, Pa.

Sales Representative: A. R. Campman, Los Angeles, Calif.

Offices and demonstration rooms in Heywood, England; Paris, France; Frankfurt, Germany

tered in a Univac Solid State 90 magnetic tape computer, the \$100,000 system is expected to cut current inventories by more than \$1-million dollars. Also, it may reduce by 30 days systems' negotiating, planning procurements and component purchasing.

**Torch for Industrial Use
Has Extra Electrodes**

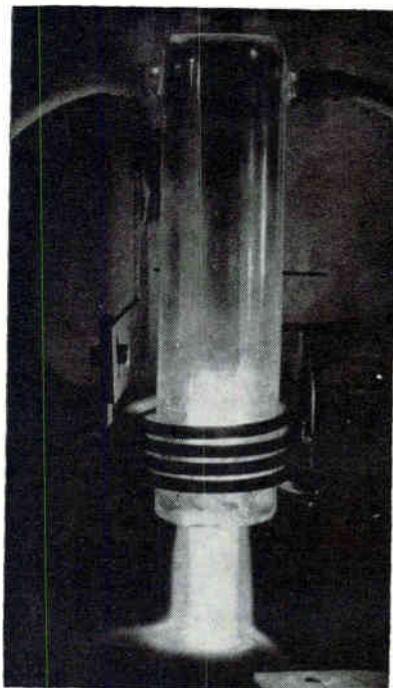

PLASMA TORCH with superimposed electrodes provides 10,000-15,000 degree K temperatures. Anode lies inside silica glass cylinder above high-frequency induction coil

LOW-COST technique to boost ionizing power of high-frequency plasma torches has been found by a French research team. Higher power increases the 10-15,000 K degree temperature zone at center of torch flame. This would facilitate work in: preparation of high-purity metals with high melting points (tantalum, molybdenum, tungsten, etc.); thermal treatment of refractory oxides; drawing monocrystals.

A pair of electrodes on the axis of the high-frequency ionizing coil and located above and below the plasma gives power boost. Direct current or line frequency power is applied to electrodes. Threshold voltage required for additional

ionizing power is 20 volts. Applied potentials up to 50 volts at currents of 450 amps were used. No obstacle is seen for using power of several hundred kilowatts qualifying the torch as an industrial tool.

Development is joint effort of Centre National de la Recherche Scientifique's metallurgical chemistry laboratory and Societe de Traitements Electrolytiques et Electrothermiques, subsidiary of CSF.

Computer Determines Tolerances for Optics

RESEARCH scientists of the Armour Research Foundations have successfully programmed an IBM 7090 computer to design optical systems.

Computer design is expected to help determine manufacturing tolerances of high-performance optical components—a problem previously solved by trial-and-error experimentation.

Computer design reduces the large amount of time and labor expended in the early stages of lens system design. With the basic programming set into the computer, a finished system design is generated using fed-in specifications on required characteristics.

Skin-Tight Packaging

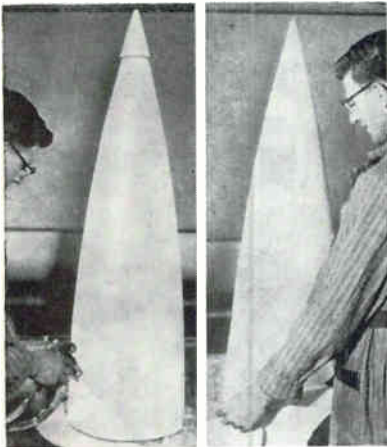

EVALUATION by Raytheon of spray-on, strip-off plastic coating for packaging radome and other Hawk missile components indicated 95-percent saving on repainting and restenciling during production. Material, designated SC-1071T, is manufactured by Spraylat Corp.

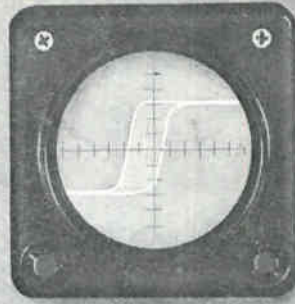

Measure all 5 important pulse-jitter parameters

RANGE



... quickly, easily, accurately

Detect jitter to 0.5 nanosec. — measure absolute prf jitter from 5-100,000 nanosec; 5-100 nanosec width or relative (pulse-to-pulse) jitter; display disturbing frequency, derive video output. This direct-reading instrument is specifically designed for jitter test. Save time, prevent error, improve accuracy in development, production, system check with the reliable, sensibly-priced MODEL PJ-1.

Call your POLARAD Field Engineer for a prompt, free demonstration!

N.E.R.E.M. — Booths #311-312



POLARAD POLARAD
ELECTRONICS CORPORATION

World Leader in Microwave Instrumentation
43-20B 34th Street, Long Island City 1, New York

CIRCLE 212 ON READER SERVICE CARD

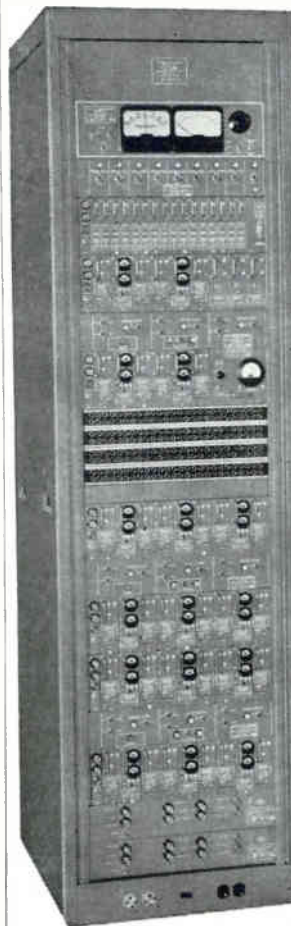

NEW BETTER-THAN-EVER RELIABILITY

for long-distance point-to-point communications



NORTHERN RADIO

NEW 16-CHANNEL TRANSISTORIZED VOICE FREQUENCY DIVERSITY CARRIER TELEGRAPH TERMINAL TYPE 235 MODEL 3 MIL DESIGNATION AN/FGC-61A

... All units militarized: components and design approved by U.S. Military.

... Converters have equalized gain and adjustable time delay in each channel for better diversity performance and interchangeability.

... Switching Panels provide "local" or "remote" selection of 2-channel or 4-channel diversity modes.

... Combiners have adjustable gains in each channel, for complete switching flexibility, and the combining follows an ideally modified square law function for both 2-channel space or frequency and 4-channel space plus frequency diversity.

... Keyers have adjustable "threshold" sensitivity control and simplified input circuit selection.

... Dotter and Delay Indicator provides test keying signal source for keyers and delay equalizers in all channels.

Write for complete literature.

Pace-Setters in Quality Communication Equipment

NORTHERN RADIO COMPANY, inc.
147 WEST 22nd ST., NEW YORK 11, NEW YORK

In Canada: Northern Radio Mfg. Co., Ltd., 1950 Bank St., Billings Bridge, Ottawa, Ontario.



MORE TIMING PROBLEMS

more effectively solved...

...because HANSEN
takes more time
to be sure!



HANSEN SYNCHRON® Timing Motors and Movements are results of thorough and continuous research and development. None is released until it has been solidly tested and proved for its applications. Each is a product of more than 50 years of specializing in this one area.

This adds up to an unequalled backlog of engineering experience that you command at Hansen. Whatever your timing problem, you can count on Hansen engineers to come up with the most effective solution — with the timing motor or movement that has been *pre-proved right* for the job.

Distance no obstacle to 
Hansen service

Hansen service knows no limits — as present customers know from profitable experience. A company airplane stands ready to fly Hansen engineers to study "on-the-job" difficulties — and to determine the surest solution to every timing problem.

SEND TODAY for complete data on all Hansen SYNCHRON Motors and Clock Movements.



HANSEN REPRESENTATIVES:

THE FROMM COMPANY
Chicago, Illinois
H. C. JOHNSON AGENCIES, INC.
Binghamton, N.Y.
Fayetteville, N.Y.
Rochester, N.Y.
Schenectady, N.Y.
Williamsville, N.Y.
WINSLOW ELECTRIC COMPANY
Essex, Connecticut
New York, N.Y.
Philadelphia, Pa.
EXPORT DEPARTMENT
15 Moore Street, New York, N.Y.

Test Equipment Cart Model 30-1

The Model 30-1 Basic Cart was designed for easy handling of counters. It is large enough to handle single large or several small test units. The base provides storage for test leads and auxiliary equipment. To provide maximum utility, various alternative modifications have been developed. Shipped knocked down.



\$131.50

Specifications

- Color Dark Brown
- Handles Nickel Plated
- Hardware Nickel Plated
- Cushion 5/16" Felt
- Construction Heavy Gauge
- Size 23" x 23" x 36 1/2"
- Weight 90 Pounds (basic cart)
- Basic Model (less drawers) \$59.50

NORTHEASTERN

ENGINEERING INCORPORATED

DEPT. 2A, MANCHESTER, NEW HAMPSHIRE

AFFILIATE OF ATLANTIC RESEARCH CORPORATION

Employment Opportunities Open At All Levels

CIRCLE 213 ON READER SERVICE CARD

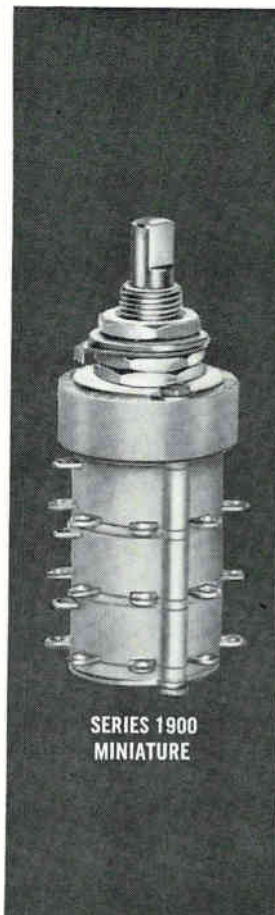

SERIES 1900
MINIATURE

Janco rotary selector switches have been tested to independent requirements which exceed MIL-S-6807A and MIL-S-3786A.

reliable ROTARY SELECTOR SWITCHES

The following are examples of these exceeded requirements: ALTITUDE tests prove capabilities of continuous operation at a pressure and temperature equivalent to 120,000 feet. VIBRATION tests prove capabilities of normal operation while being subjected to frequencies between 10 and 2000 cps with an applied acceleration of 40 G's.

QPL SR04E36C3HP, SR04E30C3HP.

For further information and new 12-page catalog, write Janco Corporation, 3111 Winona Avenue, Burbank, Calif.

JANCO
CORPORATION

CIRCLE 214 ON READER SERVICE CARD

electronics



**Are you a
COMPLETELY INFORMED
electronics engineer?**

Today you may be working in microwaves. But on what project will you be working tomorrow? You *could* have read **electronics** this past year and kept abreast of, say, microwave technology. *There were 96 individual microwave articles between July, 1961 and June, 1962!*

But suppose tomorrow you work in some area of standard electronic components, in semiconductors, in systems? Would you be up-to-date in these technologies? Did you read the more than 3,000 editorial pages that **electronics'** 28-man editorial staff prepared last year?

electronics is edited to keep you current *wherever* you work in the industry, *whatever* your job function(s). If you do not have your own copy of **electronics**, subscribe today via the Reader Service Card in this issue. Only 7½ cents a copy at the 3 year rate.

electronics



**10 MC frequency
counter/standard**

**A New Concept
In Precision Measuring**

The Model 14-20C 10 MC Frequency Counter/Standard combines the features of a precision counter and a high stability frequency standard into an advanced-design unit.

Specifications:

Simultaneous and independent use of both frequency standard and counter.

Stability of ± 1 part in 10^8 per day; ± 5 part in 10^8 per week.

Nine standard decade output frequency steps of 0.1 cps to 10 mc provided by frequency synthesizer. Gate time from 1 millisecond to 100 seconds.

Counts any one of nine decade frequencies from 0.1 cps to 10 mc for period and time interval measurements.

Self checks counting and gate circuits at any of these frequencies in all combinations of available gate times.

Operates within all ratings over a temperature range of -20°C to $+55^\circ\text{C}$, and humidities up to 95%.

Operates from an external 100 kc or 1 megacycle reference frequency.

Other features include:

Frequency range . . . 10 cps — 10.1 mc

Period DC to 100 kc

Input power 115 vac; 50-60 cps (400 cps opt.)

In-line Readout 8 place \$2,200

Vertical Readout \$1975

NORTHEASTERN

ENGINEERING INCORPORATED

DEPT. 1A, MANCHESTER, NEW HAMPSHIRE

AFFILIATE OF ATLANTIC RESEARCH CORP.

Employment Opportunities Open At All Levels

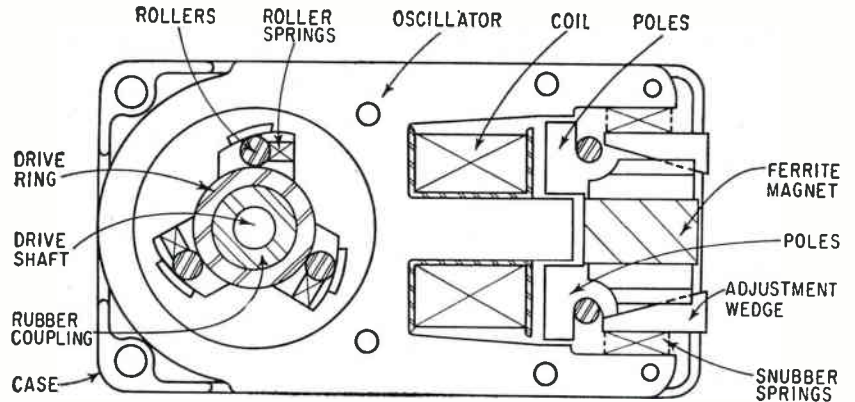
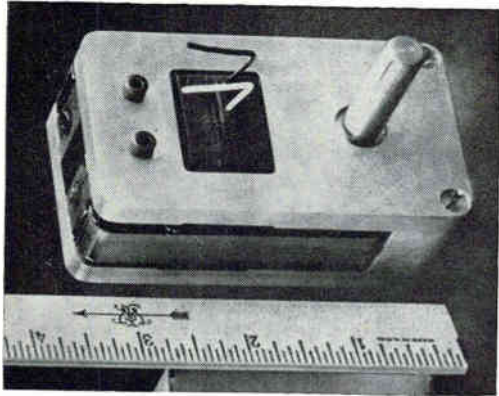

Infinite Resolution Stepping Motor

Uses cam and wedge for 0 to 25 rpm adjustable at 80 inch-pounds torque

ANNOUNCED by Energy Conversion Systems Corp., Grafton, Wisconsin, the Enercon oscillating-type electric motor is adjustable between 0 and 25 rpm and develops up to 80 inch-pounds torque with detent accuracy within 5 minutes of arc. Typical dimensions (Model 45) are $2\frac{1}{2} \times 1\frac{3}{4} \times 1$ inch, weight is 12 oz and the device is equivalent to a conventional electric motor

with gear train, clutch and brake mechanism. Power required is 110 v, 60 cps. Efficiency is approximately 85 percent, it contains four moving parts and has either forward or reverse rotation. Speed and direction of rotation is either by manual or automatic methods, and the unit can be stalled and overloaded without damage to the drive mechanism. The oscillator is formed in the shape of an E-magnet with the coil wound around the center pole. Since the current is alternating, polarity of the electromagnet is reversed 60 times per second. Into the gaps of the electromagnet

are inserted the poles of a ferrite magnet which is permanently polarized to supply four sets of working pole faces. Oscillatory motion between the ferrite magnet and electromagnet is transformed into increments of shaft motion by a cam and wedge having a 17-degree wedging angle. Roller springs bear against the rollers and the face of the wedging chamber. Motion of the oscillator causes the rollers to bite in one direction and slip in the other. Motion is a few thousandths of an inch and the wedge and roller also act as a reverse brake.

CIRCLE 301, READER SERVICE CARD

Medium Power Transistor Has Multiple Uses

NEW from General Instrument Corp., 600 West John St., Hicksville, N. Y., is the 2N2648 pnp germanium alloy junction transistor capable of linear operation at collector currents in excess of one ampere. It is also an efficient high-

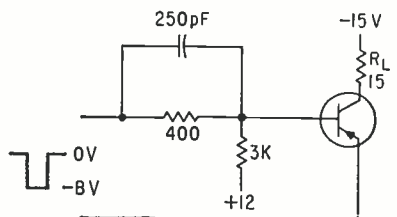

current, high-speed switch with extremely low collector saturation resistance. Useful frequency range is to 10 Mc. Typical rise time switching 1 ampere with gain of 10 is 0.12 μ sec, switching 1 ampere with gain of 50 is 0.8 μ sec, V_{ce0} at I_c of 100 μ a is 35 v minimum, I_{cbo} at V_{ce} of 15 v is 5 μ a maximum, h_{FE} at I_c of 1 ampere and V_{ce} of 0.5 v is 80 minimum, h_{FE} at I_c of 100 ma and V_{ce} of 0.3 v is 100 minimum, and $h_{\beta a}$ at V_{ce} of 5 v and I_c of 1 ma is 10 Mc minimum. As a lamp driver, minimum gain is 80. Alpha cutoff frequency of 10 Mc combined with

saturation resistance of less than 0.5 ohm at one ampere allows use as core driver or magnetic drum and tape head drivers. The sketch shows typical operation with rise time of 0.8 and delay plus storage of 1.4 μ secs. Dissipation at 25 C case temperature is 1.2 w. (302)

Reed Relay Uses Nylon Frame to Reduce Stress

RECENTLY announced by Wheelock Signals, Inc., 273 Branchport Ave., Long Branch, N. J., the series 260

Exceeds Adjustment Life Requirements of Mil-C-14409A by 600%

**new
from
JFD**

Model MCD643 (range: 1-28 pf.)

Shown approx. 3X actual size



actual size



CANADIAN PATENT #604,810
U.S. PATENT #2,922,093

- IT IS HERE... a new kind of capacitor that combines the precise tuning capability of a piston trimmer, the long-lived adjustment of an air variable—and the rugged Max-C construction with its triple range. ■ THE REASON: A new ultra reliable anti-backlash adjustment mechanism with full-thread engagement. ■ THE PROOF?—Virtually no thread wear after 500 cycles of adjustment. Mil-C-14409A specifications call for 75 cycles. ■ Other Super Max-C capacitor advantages are: 1. MULTI-TURN instead of 180 degree rotation of air variables. 2. FACTORY PRESET TORQUE at any value between 1 and 8 inch ounces can be supplied upon special request. 3. HIGHER SHOCK AND VIBRATION RESISTANCE. 4. KNOB CONTROL possible when panel mounted because of the fixed position of the adjustment screw throughout the tuning range. 5. EXTENDED CAPACITANCE RANGE of 300 per cent beyond that of conventional precision piston trimmers due to proven Max-C embedded electrode construction. 6. COMPLETELY SEALED INTERIOR CONSTRUCTION locks out humidity and other atmospheric elements (greatly exceeds salt spray and humidity cycling requirements of Mil-C-14409A). 7. ULTRA-LINEAR TUNING—absolute repeatability. 8. Q FACTOR IS: 500 guaranteed minimum at 1 MC. 9. INSULATION RESISTANCE is 10^6 megohms. 10. DC working voltage is 1000 VDC. 11. LOW temperature coefficient of capacitance. 12. LOW inductance and low loss for higher frequency use. 13. No derating from -55°C to $+125^{\circ}\text{C}$. 14. Rugged shock and vibration resistance. 15. Dielectric strength is 2000 VDC. 16. New JFD plating for excellent RF conductivity and noise-free tuning protects all metal parts from corrosion and improves life of adjustment. Panel mounting and printed circuit types are available: 1-14 pf., 1-28 pf., 1-42 pf., 1-60 pf., 1-90 pf. Write for Bulletin MCD-62

JFD ELECTRONICS
CORPORATION
Components Division

15th Avenue at 62nd Street, Brooklyn 19, N. Y.
Phone 212 DE 1-1000 • TWX212-833-7001 Cable-JEFDEE N.Y.

JFD WESTERN • 909 So. First Ave. • Arcadia, Calif.
Phone: Hillcrest 6-0312

JFD MIDWESTERN • 6330 Hermione St. • Chicago 46, Ill.
Phone: 775-5424

JFD MIDWESTERN-OHIO • 7415 Montgomery Rd.
Cincinnati 36, Ohio • Phone 421-1166

JFD NORTHEASTERN • Ruth Drive, P. O. Box 228
Marlboro, Mass. • Phone: HUNtley 5-7311

JFD CANADA • 51 McCormack Street • Toronto,
Ontario, Canada • Phone ROger 2-7571

JFD ELECTRONICS (ISRAEL) LTD. • Industrial area B,
Building 23 • Azor, Israel • Cable Address:
JFD AZUR, ISRAEL

for maximum
reliability

SPECIFY BIRTCHER PCB-TAINERS®



NEW— LOW COST SPRING CLIPS TO RETAIN PRINTED CIRCUIT BOARDS

PROVIDE EXCELLENT GROUND AND THERMAL PATHS

Birtcher PCB-Tainers simplify design and production, provide important cost savings. PCB-Tainers are tested to retain printed circuit boards under more than 30Gs, vibration up to 2000 cps. Material is beryllium copper for excellent electrical ground and thermal path. Standard lengths for 3/32-in. and 1/16-in. boards.

Available from
authorized distributors



Send for new technical
data sheet with
drawings, test report,
complete details.

THE BIRTCHER CORPORATION

INDUSTRIAL DIVISION

745 S. Monterey Pass Rd. • Monterey Park, Cal.

TUBE/TRANSISTOR/COMPONENT
RETENTION AND COOLING DEVICES

reed relays are cradled and locked within the cavity of a shock-absorbing nylon frame with relay leads pre-cut, pre-bent and pre-positioned. Coil voltages range from 6 to 48 v, nominal rated power from 125 to 400 mw, dissipation from 1 to 2.7 w, operate time between 0.6 and 1.2 ms, release time from 0.06 to 0.2 ms, and contact bounce is 0.2 ms. Contacts are rated at 125 ma, 250

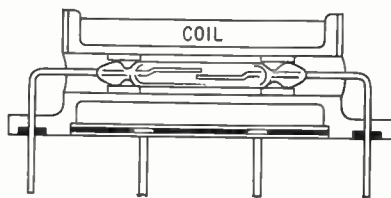

v at 4 w although up to 0.8 ampere may be switched at reduced life. Expected contact life is 3×10^6 at rated load, closed resistance is typically 100 milliohms and open resistance typically 1.5×10^{12} ohms. Open contact capacitance is less than 1 pf and contact-to-coil capacitance is less than 2 pf. Relay height is 0.4 inch to allow card stacking in printed circuit applications. Internal atmosphere is an inert gas and contact material is diffused gold in nickel iron. The design features one molded part serving both as coil bobbin and relay frame as shown in the sketch. The reed is protected from stresses by the unitized shock-absorbing frame and the leads are formed, cut and positioned before anchoring. Mounting strains applied to the terminal leads are transmitted to the frame rather than the glass capsule.

CIRCLE 303, READER SERVICE CARD

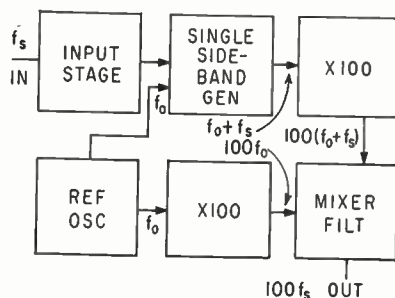

Frequency Multiplier For Audio Region

RECENTLY announced by Oread Electronics Lab., Inc., 925 Iowa Street, Lawrence, Kansas, the model MX-

101 wideband frequency multiplier features precision frequency multiplication by 100 over entire decades of frequency in the audio region. It accepts sine-wave inputs from 100 mv to 100 v rms and produces a pulse 100 times the input frequency. Input bandwidth is 300 to 3,300 cps, but any 3 Kc band between 150 cps and 50 Kc is available. The device can be used to increase accuracy by 100 and/or decrease time required by 100 in measurement of audio frequencies by digital counters. Straightforward frequency multiplication is limited to narrow bandwidths making it impossible to directly multiply over a wide range of low frequencies. The device overcomes this limitation of small bandwidth by transplanting the low input frequency to a high single-sideband frequency where the wide change in input frequency results in a small bandwidth. The sketch shows operation. After conventional multiplication of both the single sideband and reference signals by 100, a mixer and low-pass filter develops the difference between the two multiplied signals. This frequency is exactly 100 times the input frequency. Various 3 Kc input frequency ranges are obtained by changing the reference oscillator frequency while using the same single-sideband filter. (304)

Measuring Temperature Difference of Liquids

MANUFACTURED by Delta-T Co., P.O. Box 473, Santa Clara, California, the model 75 differential temperature transducer can be used to indicate, record and control the true difference in temperature between flowing liquids. Sensitivity is 0.223 mv per degree F temperature differential, accuracy is ± 0.07 F and maximum operating temperature level is 250 F. Fluid pressures in excess of 1,500 psi may be accommodated. Time response to step change in temperature differential is less than 0.5 second. The device requires no calibration, amplification or power supply. A 20 junction thermocouple arrangement connected 10 hot and 10 cold in series senses temperature differential. Output comes from a 3-connector plug isolated from the metal casing.

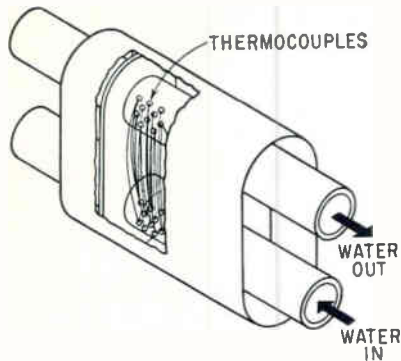

The transducer is a very low impedance source (80 ohms) and generates a relatively large signal (typical 10 mv) linear in terms of temperature difference with excellent common-mode rejection and effective electromagnetic shielding. It is ideal for use in the vicinity of electric-arc heaters where strong electric or magnetic fields, high pressures and stray electric currents are present. (305)

Potentiometer Wire of Precious Metal Alloy

SECON METALS CORP., 7 Intervale St., White Plains, N. Y., has developed a potentiometer wire designated Secon Alloy 20-245. This precious metal alloy has a temperature coefficient of resistance of less than 20 parts per million, and a specific resistance of 245 ohms per circular mil foot. It has a tensile strength of 140,000 ppsi. It can be used with light wiper pressures. Excellent life and noise results can be obtained even in sizes below 0.001 in. diameter. (306)



Test Jack Designed For Limited Space

SEAELECTRO CORP., 139 Hoyt St., Mamaroneck, N. Y., announces a Press-Fit test jack for application in chassis where extension below chassis must be held to a minimum and costs dictate the use of an inexpensive test jack. The SKT-0500 features a stamped beryllium

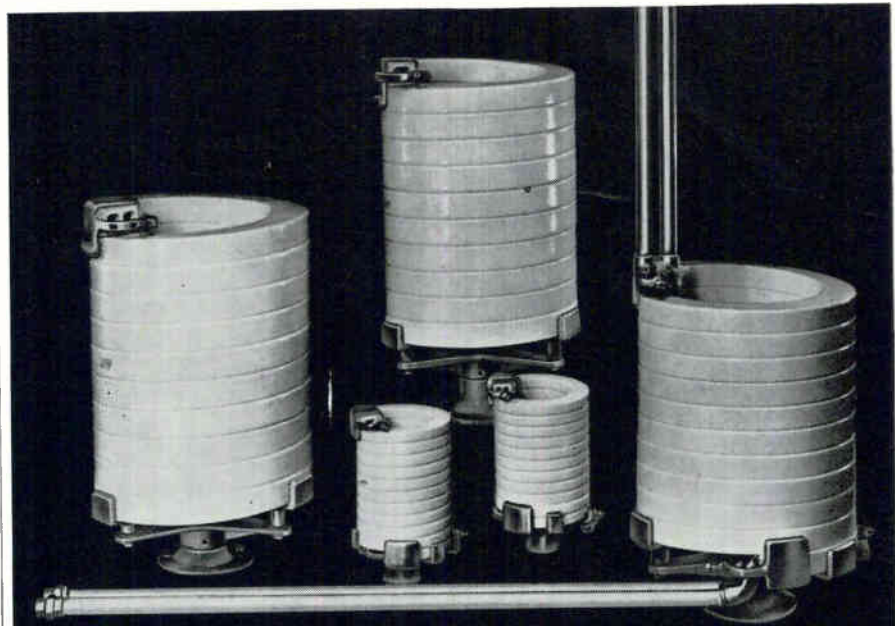

LAPP PORCELAIN WATER COILS

...in all these standard sizes to save you time and money

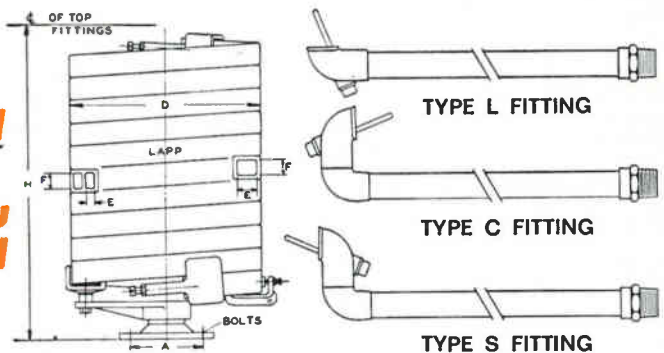

WATER COILS—DIMENSIONS IN INCHES

Cat. No. Basic Unit*	Single or Twin	Equiv. Pipe Size	A	D	E	F	H	Aver. Length in Feet	Number of Turns
22957	T	1/4	2 1/4	5 1/4	3/32	3/32	9 1/2	12	11
10723	T	3/4	4 5/8	12	5/16	3/4	18	29	10 3/4
10190	T	1	4 5/8	13 3/8	3/4	1 1/16	22 1/2	31	10 1/2
27016	S	3/8	2 1/4	5 1/4	1/2	5/16	10 1/4	12	11-30°
10719	S	1 1/4	4 5/8	12	1 1/4	1	22	28	10 1/2
10729	S	1 1/2	5	15	1 5/8	1 1/8	23 3/4	32	9 1/2-22°

*Basic unit includes ceramic coil, base, spider, cemented clamping fittings and leakage current tap. Specify type of fitting, top and bottom ("L" "C" or "S") and length of lead pipe required—36" is standard. Lead pipe is standard—flexible metal hose can be furnished. Special length coils and fittings are available—standard units only are shown here.



Save with our standards. But if you need specials, count on us for them too. Either way, Lapp gives you service and quality you can depend on.

WRITE for Bulletin 301-R.
Lapp Insulator Co., Inc.,
200 Sumner St., LeRoy, N. Y.

*measures
.002 microvolts!*

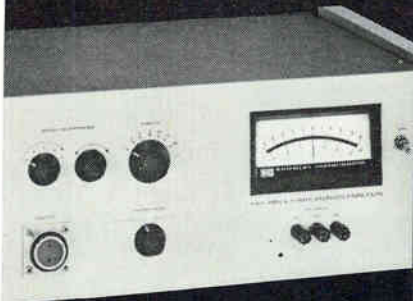

KEITHLEY MILLI-MICROVOLT METER

The Keithley Model 149 is the most sensitive electronic voltmeter available today, having a signal-to-noise ratio that approaches the theoretical limit. Recommended for use with thermocouples or thermopiles, the Model 149 is also ideal in cryogenics investigations and Hall Effect studies.

Zero suppression up to 100 times full scale adds versatility for the user. Line-operated, the Model 149 can accommodate either a floating or ground-referenced input. Output is 5 v or 5 ma on all ranges. Brief specifications:

- **range:** 0.1 microvolt to 100 millivolts in 13 overlapping 1x and 3x steps
- **noise:** less than 6×10^{-10} v rms with shorted input
- **input impedance:** 10K ohms on 0.1 μ v range rising to 10 megohms on 100 μ v scale
- **stability:** within 0.01 μ v per hour
- **speed of response:** to 90% fs in .5 seconds on most ranges
- **accuracy:** 2% fs on all ranges
- **price:** \$895.00

Other MICROVOLT METERS:

Model 150A 1 μ v sensitivity \$750.00
Model 151 100 μ v sensitivity \$420.00

full details in latest catalog . . .



**KEITHLEY
INSTRUMENTS**

12415 Euclid Avenue • Cleveland 6, Ohio

copper contact and virgin Teflon bushing. It will accept an 0.050 in. (± 0.001 in.) diameter probe. Overall length of the test jack is 0.207 in. For applications where color coding is desired, they may be had in any of 10 EIA colors.

CIRCLE 307, READER SERVICE CARD

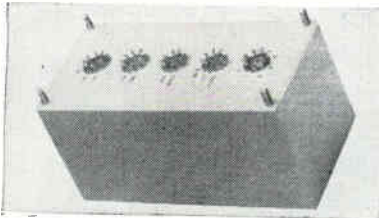

Precision Delay Line Offers Low Distortion

COLUMBIA TECHNICAL CORP., Woodside 77, N. Y. Type CTC-1853 has ten matched units to within ± 0.25 percent. Time delay of the 5,000 ohm unit is 1.0 millisecc ± 0.25 percent. Operating temperature range is -55 C to 125 C. Distortion is less than 2 percent. Other features: phase linearity within ± 0.5 percent; attenuation 1.5 db max; frequency response 14 Kc -3 db down; multi-taps of ± 0.75 percent accuracy. Size is $3\frac{1}{2}$ in. by $3\frac{1}{2}$ in. by $6\frac{3}{8}$ in. (308)



IR Source Diode for Optical Communications

TEXAS INSTRUMENTS INC., P.O. Box 5012, Dallas 22, Texas. A gallium arsenide infrared source diode, the SNX-100, has been announced as an experimental device for engineering evaluation. It may be applied in such applications as a source for equipment in secured optical communication links, transmission of tv signals, light source for tape or card reader on com-

LET US HELP YOU CUT COSTS!

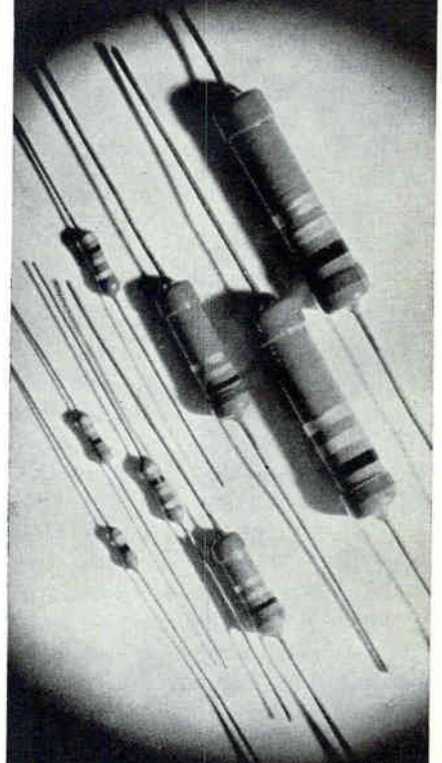

CARBON FILM RESISTOR

Rohm

**TOYO
ELECTRONICS
INDUSTRY
CORPORATION**

P, O, BOX 103 CENTRAL
KYOTO JAPAN

puters and source in IR radar equipment. It is designed to operate as a forward biased diode to emit light of a relatively narrow spectral width in the near infrared. The output can be easily modulated linearly with the forward bias current. The device has been successfully modulated at frequencies from d-c through 900 Mc. (309)



Standoff Capacitors Rated at 500 V D-C

CAMBRIDGE THERMIONIC CORP., 445 Concord Ave., Cambridge 38, Mass., has added four new series of general-purpose, ceramic dielectric, fixed, standoff capacitors to its line. Ideal for by-pass, filter and non-critical coupling circuits, they meet the rugged performance characteristics of MIL-C-11015. All are designed for operation from -55°C to $+85^{\circ}\text{C}$ and are rated at 500 v d-c. The 3251 series is available with capacitance values from 47 to 470 μmf ; the 3252, from 47 to 1500 μmf ; the 3254, from 680 to 1500 μmf ; and the 3255, from 1,000 to 4,700 μmf . All are available with tolerances of either ± 10 percent or ± 20 percent. (310)

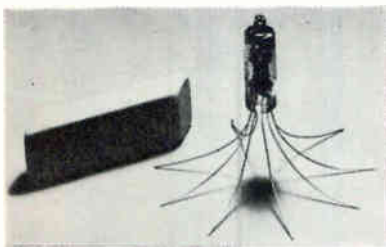

Heater-Cathode Triode Has Low Noise Output

RAYTHEON CO., 55 Chapel St., Newton 58, Mass. The high mu CK8096 subminiature heater-cathode triode is said to be about 20 db lower than conventional triodes in microphonic noise output due to reductions of structural resonances within the audio frequency range. Quiescent noise referred to the grid at 10 cps is -130 dbv per cycle and at

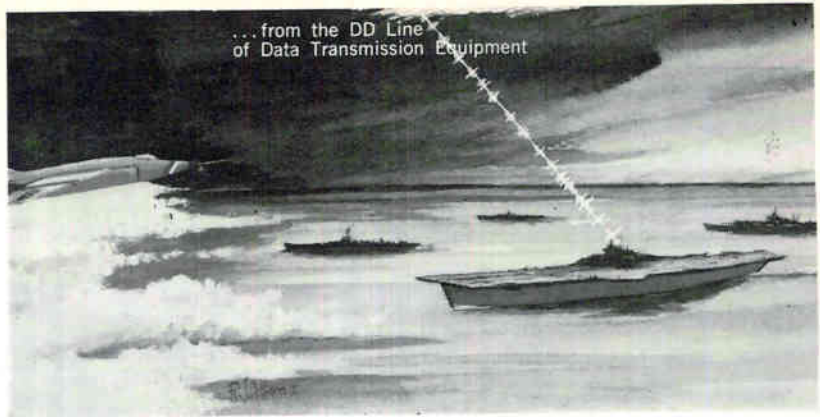

HIGH SPEED DIGITAL DATA TRANSMISSION OVER A SEA PATH?

YES!
WITH SEPATH

Rixon SEPATH equipment provides the solution to a challenging problem: how to transmit high-speed digital data via hf radio. Better, SEPATH does it without obsoleting existing communication terminal equipment. Best, SEPATH equipment is in service and available now!!!

Basically, a high-speed serial binary data stream is fed into the SEPATH transmit terminal where it is converted into parallel low-speed data streams suitable for propagation through multipath conditions. These are then transmitted simultaneously over existing radio teletype channels. At the receiving station, this parallel information is regenerated and reassembled into serial form, and then sent to its destination. Encryption? No problem.

For further information, contact our applications engineers . . .

RIXON ELECTRONICS, INC.

2121 INDUSTRIAL PARKWAY—MONTGOMERY INDUSTRIAL PARK—SILVER SPRING, MARYLAND
TELEPHONE: 622-2121 TWX: 301 622-2292

CIRCLE 216 ON READER SERVICE CARD

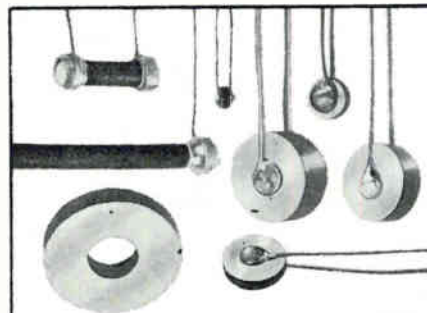

HIGH STABILITY THERMISTORS

Temperatures to 300°C with leads, greater sensitivity with lower resistance at 25°C , time constants as low as .4 sec in .050" dia. discs, and exceptional stability are outstanding features. 200 Standard items available. Innumerable variations of assembly, size, geometry, resistance and temperature coefficient; resistance tolerances to $\pm 1\%$ and ratios to $\pm 0.5\%$, can be produced to specifications. Reliability is assured by a rigid quality control system.

WRITE FOR DETAILED
ENGINEERING DATA

Thermonetics Incorporated

7246 ETON AVE., CANOGA PARK, CALIF.

CIRCLE 217 ON READER SERVICE CARD

**PUTS THE BEST IN
CREATIVE ELECTRONICS
INTO YOUR HANDS**

Send for
FREE
Catalog

28 pages of professional electronic equipment in kit and wired form—for Lab . . . Line . . . Home

EICO, 3300 N. Blvd., L.I.C. 1, N. Y. E-1A
 Send free 32-page catalog & dealer's name.
 Send new 36-page Guidebook to HI-FI for which I enclose 25¢ for postage & handling.

Name _____
 Address _____
 City _____ Zone _____ State _____

3300 N. Blvd., L.I.C. 1, N. Y.
 Export Dept., Roburn Agencies
 431 Greenwich St., N. Y. 13, N. Y.

CIRCLE 137 ON READER SERVICE CARD

137

Pulse magnetrons, used in commercial all-weather radar systems, are part of the extensive line of Litton microwave tubes and display devices. For information write to San Carlos, California. In Europe, Box 110, Zurich 50, Switzerland.

LITTON INDUSTRIES
ELECTRON TUBE DIVISION

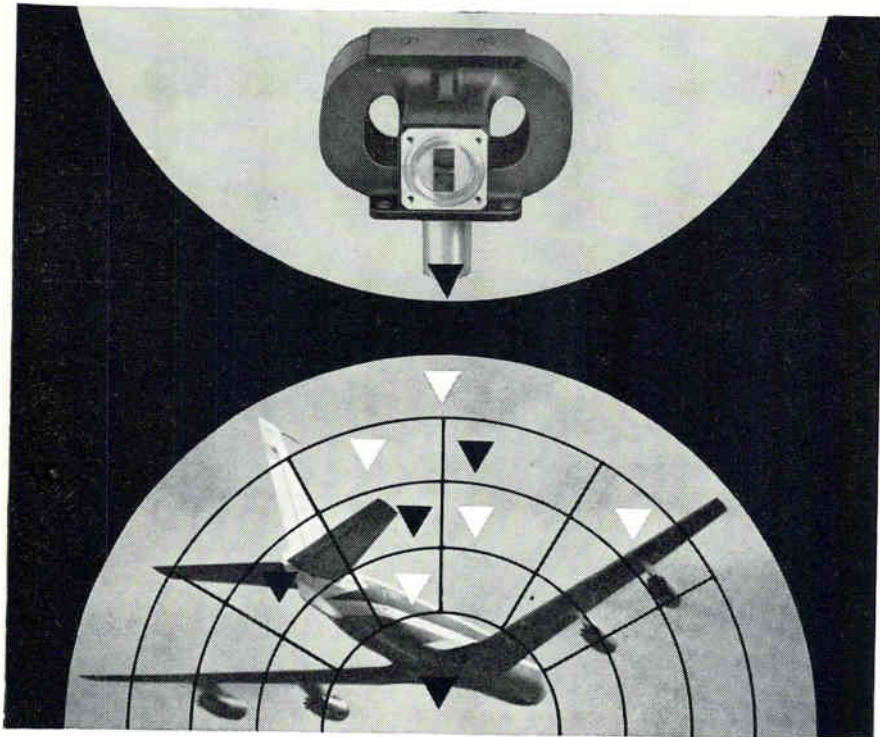

CIRCLE 218 ON READER SERVICE CARD

1,000 cps is -153 dbv per cycle. Built to withstand impact shock of 450 g, acceleration of 1,000 g, and vibration of 10g over extended periods, the tube has been tested to operate at altitudes of 60,000 ft.

CIRCLE 311, READER SERVICE CARD

Core Memory
Meets MIL 16400

AMPEX CORP., 934 Charter St., Redwood City, Calif. The RM-3 military core memory is available in 128, 256, 512, 1024, 2048 or 4096 word sizes, with 4 to 36 bits per word in two-bit increments. It has a memory cycle of 3 μ sec and a buffer cycle of 2 μ sec. It can perform split-cycle operation in 4 μ sec. A temperature stabilizing enclosure chamber permits operation at temperatures from 85 C to below zero deg C. (312)

Casting Compound

WEMS, INC., 4807 W. 118th Place, Hawthorne, Calif. WEMS-105, a two-component epoxy based resin system that cures at room temperature, is used to embed or pot welded electronic modules where light weight is important. Kits available in $\frac{1}{4}$ and $1\frac{1}{2}$ pint sizes. (313)



Slip Ring Capsule
Contains 136 Circuits

SLIP RING CO. OF AMERICA, 3612 W. Jefferson Blvd., Los Angeles 16, Calif. Series 1517 inertial guidance slip ring capsule is designed for missile flight simulator tests. This low noise level assembly performs up to 10,000 hr continuous operation for accurate checks of components alignment and calibration of complete inertial guidance naviga-



HOW TO
INCREASE YOUR
READING CAPACITY

EECO's block, punched-tape reader can digest 80, 96, 120 or 160 bits of information at a step (depending upon the model you select). It's better designed for applications like machine tool control and automatic checkout and tests. For instance, it offers a complete test per block; identification of data function by position in block; elimination of data storage records and address decoding circuits. Straight-forward programming by blocks. Standard units read 80, 96, 120, 160 bit blocks. In modular or standard 19" rack mounting units. Takes 1", 8-level paper or mylar tape punched on 0.1" centers. Reader head designed for either forward or reverse reading. Most models are bi-directional. Write for data sheets.

Automation Division
Electronic Engineering Company
of California
1601 E. Chestnut Avenue • Santa Ana, California
Phone: 547-5501, P.O. Box 58 • Representative in
Western Europe and Israel: Electronic Engineering
S.A., C.P. 142 Fribourg, Switzerland. EE 2-50

tional systems. It contains 136 circuits: 18 five-amp, 8 two-amp and 110 one-amp circuits. Overall dimensions: 6 in. long by 1.25 in. diameter.

CIRCLE 314, READER SERVICE CARD



High Vacuum Relay Has SPDT Contacts

RESITRON LABORATORIES, INC., 3860 Centinela Ave., Los Angeles 66, Calif. Type R-7 high vacuum relay has applications in switching pulse forming networks, antenna change-over system, switching in explosive atmospheres and general switching in high voltage equipment for ground and airborne applications. The high vacuum minimizes contact arcing and maintains the contacts free from oxidation which insures stable and low contact resistance. (315)



A-C Null Detector Tunes From 20 to 200 Kc

BOONTON ELECTRONICS CORP., 738 Speedwell Ave., Morris Plains, N. J., offers model 51-A a-c null detector. Intended primarily as an indicator for use with l-f impedance bridges, there is a provision for discriminating against all frequencies but the one to which it is tuned. Tuning range is 20 to 200 Kc. When used as an impedance bridge indicator, it can be adjusted to show separately when resistive or reactive balancing takes place. External frequency standards can be switched in for checking or accurately setting the frequency of the generator which is to power the bridge. (316)

ELECTRONICS ENGINEERS WITH VISION WILL RECOGNIZE THIS COIL DESIGN ADVANCEMENT AS A NEW INDUSTRY STANDARD FOR COIL FABRICATION AND PACKAGING.

Now Electronics Engineers can expect more from a molded coil. Delevan's new Molded Shielded Fixed Coil reaches out to high inductance values in a miniature size. Electromagnetic shielding, feature of Series 1537-700 parts, is fully effective not only along the body but also at the ends of the coil guaranteeing efficient shielding regardless of your packaging configuration. The length of the molded body permits lead mounting of .400" PC hole spacing.

Series 1537-700 is a high quality product with reliability built into every design feature and manufacturing process. You will find it worthy of the Delevan name.

SPECIFICATIONS:

- Size: 0.157" Diameter; 0.375" Length
- Shielding: Less than 2% coupling
- Inductance: 0.1 uh thru 120,000 uh (74 values)
- Environment: Grade 1, Class B, MIL-C-15305

Delevan 
ELECTRONICS CORPORATION
 A Subsidiary of American Precision Industries, Inc.
 270 QUAKER RD. • EI • EAST AURORA, N. Y.

1537-700 MOLDED "SHIELDED" FIXED COILS



Write for further information on 1537-700 Molded "Shielded" Fixed Coils Today.

CIRCLE 141 ON READER SERVICE CARD



Your electronics BUYERS' GUIDE should be kept in your office at all times—as accessible as your telephone book.



**LAUNCHED
FOR
MORE
ACCURATE
AIRBORNE
TELEMETRY**

New solid state,
completely transistorized
airborne VHF/FM
telemetry transmitter

There's safety in numbers — especially those transposed from the exceptionally reliable TS-2 telemetry transmitter, designed and produced by Advanced Electronics. Proven performance has earned it a prime spot in telemetry systems for a major space vehicle... with many other important applications imminent to meet its advanced technology. This new solid state, completely transistorized unit delivers 2.0 watts minimum into a 50 ohm load... an exciting achievement for such a compact package.

There are other FM and AM telemetry transmitters and amplifiers in the line. Their fine record of space age attainments is indicative of Advanced Electronics' unique capabilities. We invite you to consult with our specialized engineering staff to help expedite your telemetry program.

Write or call for details and literature.

SEE OUR TELEMETRY CATALOG AD:

eem File System Sec.
electronic engineers master 5200

**ADVANCED
ELECTRONICS
CORPORATION**
2 Commercial St., Hicksville, L. I., N. Y. • OV 1-5400
TELEMETRY TRANSMITTERS & AMPLIFIERS •
POWER SUPPLIES • R.F. FILTERS

Literature
of the Week

WIRE WOUND RESISTOR Dale Electronics Inc., Columbus, Neb. Bulletin R-72-T describes the type G series precision wire wound power resistor.

CIRCLE 317, READER SERVICE CARD

MAGNETIC COMPUTER Burroughs Corp., Detroit 32, Mich. An 8-page technical information bulletin contains a well illustrated article on the D210 magnetic computer. (318)

PRECISION VARIABLE ATTENUATOR Weinschel Engineering, Gaithersburg, Md. Single-sheet bulletin describes model 905 variable attenuator that covers continuously the attenuation range to 10 db from d-c to 1,000 Gc. (319)

MEMORY CORES Electronic Memories, Inc., 9430 Bellanca Ave., Los Angeles 45 Calif., has available a one-page guide to ferrite memory core types. (320)

CLUTCHES/BRAKES Vibrac Corp., Alpha Industrial Park, Route 129, Chelmsford, Mass. Brochure presents data on small (servo size 11, 15, 16) magnetic dry particle clutches and brakes for precision instruments and servo systems. (321)

MIXERS Brinkmann Instruments, Inc., 115 Cutter Mill Road, Great Neck, N. Y. Four-page folder covers three-dimensional Turbula mixers designed for unusual mixing and cleaning problems. (322)

SUBMINIATURE CONNECTORS Continental Connector Corp., 34-63 56th St., Woodside 77, N. Y., has available Form SM1062, a 16-page subminiature connector catalog. (323)

RESEARCH/ENGINEERING Ryan Industries, Inc., 888 E. 70th St., Cleveland 2, O., has available a brochure on applied and basic research/project engineering services in cryogenics and related subjects. (324)

STRAIN GAGE ACCELEROMETER Consolidated Electrodynamics Corp., 360 Sierra Madre Villa, Pasadena, Calif. Bulletin 4204 describes a tri-axis strain gage accelerometer. (325)

PELLET TYPE THERMISTORS Gulton Industries, Inc., 212 Durham Ave., Metuchen, N. J. Bulletin T104 covers the D series of pellet type thermistors for three-dimensional circuit packages. (326)

DIGITAL MODULES Engineered Electronics Co., 1441 E. Chestnut Ave., Santa Ana, Calif. A 48-page catalog deals with the G-series transistorized digital circuit board modules. (327)

OVERVOLTAGE/UNDERVOLTAGE SENSORS Perkin Electronics Corp., 345 Kansas St., El Egundo, Calif., Technical data sheet describes three over-

NOW

**VTVM
TO
1500 Mc**

Model 1041C \$310
WIDER FREQUENCY RANGE
20cps to 1500 Mc.

GREATER SENSITIVITY
300 mV full scale AC/DC

HIGHER ZERO STABILITY
Transistor stabilized power

HIGHER ACCURACY
±2% full scale

HIGH IMPEDANCE
1.5 pf AC
100 MΩDC



**MARCONI
INSTRUMENTS**

DIVISION OF ENGLISH ELECTRIC CORPORATION
111 CEDAR LANE • ENGLEWOOD, NEW JERSEY
Main Plant: St. Albans, England

CIRCLE 215 ON READER SERVICE CARD
electronics

Authoritative . . . the most exhaustive handbook on microwave practice . . . contains the fundamental principles of physics . . . indispensable for all active in microwave research.

MICROWAVE ENGINEERING

BY A. F. HARVEY

Royal Radar Establishment, Malvern

Special Offer

February 1963, 1245 pp.
Special price until
February 28, 1963, \$29.50
Thereafter: \$35.00

This unique handbook fulfills the need for a comprehensive record of the principles, techniques, and applications of microwave engineering, and it is timed to include the many outstanding advances made in recent years. The modern and complete coverage of material will, for several years to come, not only prove useful to the microwave engineer practicing in the fields of antennas, components, electron devices, and systems, but also be a general guide to those who are new to the microwave field, as well as serving as a source of reference to research students, and others in the educational field. To maintain a reasonable overall size, the information density has been kept high, and the text is supplemented by extensive bibliographies of world archival literature dating from the close of the last century to the present day.

Contents (sections):

Microwave Circuits and Materials
Microwave Antennas and Devices
Microwave Communication Systems

SYNTHESIS OF FEEDBACK SYSTEMS

By ISAAC M. HOROWITZ

Guidance and Controls Division,
Hughes Aircraft Company

January 1963, about 725 pp., \$16.50

This book will undoubtedly be regarded as a fundamental work in its field. It has been designed to be equally understandable and useful to both graduate students and practicing engineers interested in feedback control, whether in electrical, mechanical, aeronautical, chemical, or other branches of engineering. For graduate courses it will be an excellent textbook. The first six chapters are suitable for use in an introductory course for senior undergraduate students. The mathematical background assumed includes calculus through Laplace transforms.



ACADEMIC PRESS
NEW YORK AND LONDON

111 Fifth Avenue, New York 3
Berkeley Square House, London, W.1

CIRCLE 220 ON READER SERVICE CARD
January 4, 1963

voltage/undervoltage sensors developed for use in conjunction with d-c power supplies. (328)

CIRCUIT MODULES LFE Electronics, 1079 Commonwealth Ave., Boston 15, Mass. Use of germanium and silicon circuit modules for low power, high density efficiencies in digital systems is described in data bulletin series 2300 and 2350. (329)

H-F DISCRIMINATOR Data-Control Systems, Inc., Danbury, Conn., offers a series of specification sheets describing model GFD-4 high frequency discriminator. (330)

WHITE ROOM CLEANERS Branson Instruments, Inc., 37 Brown House Road, Stamford, Conn., has released a 4-page illustrated folder entitled "Ultrasonic Cleaning for White Rooms." (331)

TEST EQUIPMENT PRD Electronics, Inc., 202 Tillary St., Brooklyn 1, N. Y. Bulletin 900 describes a line of electronic instrumentation for microwave systems. (332)

SILICON RUBBER Dow Corning Corp., Midland, Mich. Bulletin 09-036 provides designers with detailed engineering data on a complete line of elastomeric raw materials. (333)

UHF TRANSLATORS Adler Electronics Inc., One Lefevre Lane, New Rochelle, N. Y., has available an eight-page paper titled "UHF Translators for Expanding Television Coverage." (334)

RESIN CORE SOLDER Kester Solder Co., 4201 Wrightwood Ave., Chicago 39, Ill. Kester "44" resin core solder is described in a two-color envelope size pamphlet. (335)

DIODE REFERENCE GUIDES National Transistor, 500 Broadway, Lawrence, Mass., has released two new subminiature glass diode reference guides. (336)

MICROWAVE TUBE BROCHURE Varian Associates, 611 Hansen Way, Palo Alto, Calif., offers a brochure featuring tubes and components for heavy radar, radar astronomy and linear accelerator use. (337)

D-C PREAMPLIFIER Inland Motor Corp., Northampton, Mass. Bulletin describes an npn-transistor plug-in type d-c voltage preamplifier, with reversible polarity, for use in servo systems. (338)

DIODE TESTER Test Devices, Inc., 3014-B So. Halladay St., Santa Ana, Calif., has released a technical bulletin on the model 1050 diode tester. (339)

ENGINEERED PLASTICS Taunton Division, Haveg Industries, Inc., Taunton, Mass., has published an updated brochure on engineered plastics for space, electronics, aviation and industrial applications. (340)

SELENIUM SURGE SUPPRESSORS Fansteel Metallurgical Corp., North Chicago, Ill. Selenium surge suppressors designed to protect silicon devices from transient surges that might otherwise destroy them are described in a bulletin. (341)



ONLY \$74.50 NET
MODEL 250B
(battery powered)

Complete Transistor Lab

NEW TRANSISTOR AND TUNNEL DIODE ANALYZER

Look at this "SECO PLUS"—a complete transistor lab for incoming transistor and diode stock inspection and for servicing transistorized equipment!

- Requires no set-up data
- Identifies NPN and PNP transistors immediately
- Provides dynamic GO-No Go test without removing transistors from circuit
- Provides accurate DC analysis of transistors out of circuit
- Indicates transistor leakage and gain
- Matches transistors of similar types by AC dynamic test or DC analysis
- Tests signal and power transistors, also tunnel and zener diodes
- Indicates tunnel diode negative resistance characteristics
- Indicates diode forward conductance and reverse leakage current
- Includes VOM meter with appropriate ranges

Here's the most rapid, complete and accurate semi-conductor test set in the medium priced field. You'd expect to pay much more for a set that—needs no setup data—includes a "speed test socket"—reads BOTH Icco and Icco leakage currents—subtracts Icco leakage for TRUE gain readings. Available in two models: (1) the AC powered 250A at \$86.50; and (2) the "B" battery powered 250B at \$74.50. Choice of metal or wood case. Both include 24" test leads with slim line test prods.

See the new Model 250 Transistor and Tunnel Diode Analyzer at your electronics supply dealer or send in the coupon below for complete information.



SECO ELECTRONICS, INC.
1243 South Clover Drive, Minneapolis 20, Minnesota
Please rush information on the Model 250 Transistor and Tunnel Diode Analyzer plus full line folder describing complete range of Seco test equipment.

NAME _____
COMPANY _____
ADDRESS _____
CITY _____ STATE _____

CIRCLE 143 ON READER SERVICE CARD 143

WEMA Board Elects Officers



WEMA EXECUTIVE COMMITTEE. Newly elected officers of the Western Electronic Manufacturers Association include, seated, from left, Philip E. Renshaw, Emmet G. Cameron, Burgess Dempster; standing, Virden E. Scranton, Orison Wade, William H. Heflin, and E. E. Ferrey

EMMET G. CAMERON, executive vice president of Varian Associates, was elected president of the Western Electronic Manufacturers Association (WEMA) at a recent meeting of the association's board of directors in Palo Alto. He was among the founders of WEMA 20 years ago. Cameron is president of the Palo Alto Chamber of Commerce.

Elected vice presidents of the western industry group were Burgess Dempster, president, Electronic Engineering Co. of Calif., Santa Ana; William H. Heflin, general manager, Beckman & Whitley Inc., San Carlos; Orison Wade, assistant chief engineer, General Dynamics/Astronautics, San Diego; Philip E. Renshaw, chairman of the board, Tally Register Corp., Seattle, and Virden E. Scranton, assistant general manager, Motorola Semiconductor Products division, Phoenix.

Kenneth T. Larkin, associate director of electronics research, Lockheed Missiles & Space Co., Palo Alto, was elected secretary of the association, and Robert M. Ward, vice president, Beckman Instruments Inc., Fullerton, has been

appointed treasurer.

Other directors of the association include Henry M. Bailey, Cohu Electronics Inc., San Diego; James H. Cannon, Cannon Electric Co., Los Angeles; Kenneth F. Julin, Leach Corp., Los Angeles; James G. Kirwan, Electro Scientific Industries, Portland; John S. McCullough, Litton Industries, Electron Tube division, San Carlos; William J. Miller, Burton Manufacturing Co., Northridge, Calif.; Albert J. Morris, Radiation at Stanford, Palo Alto; John S. Rydz, Nuclear Corp. of America, Phoenix; Walter G. Scott, IBM, San Jose, and Andrew J. Unetic, Bourns Inc., Riverside.

ITT Promotes Two Executives

PROMOTION of two executives of International Telephone and Telegraph Corp. has been announced by Harold S. Geneen, president.

William M. Duke was elevated to general manager—defense operations for ITT and will continue as president of ITT Federal Labora-

tories, Nutley, N. J.

George A. Banino was appointed executive vice president of ITT Federal Laboratories. He also continues as division president of ITT Kellogg Communications Systems.

Aerojet-General Elects Fletcher

ELECTION of James C. Fletcher as vice president-advanced systems of Aerojet-General Corp., Azusa, Calif., has been announced by W. E. Zisch, Aerojet executive vice president.

Fletcher is chairman of the board of Space-General Corp., Aerojet's space systems subsidiary. He is also at present a consultant of the President's Science Advisory Committee and a member of the Command and Control Planning Panel.

In his new position, Zisch pointed out, Fletcher will be responsible for assuring that Aerojet and its subsidiaries are marshaling their entire resources to assure maximum capability to undertake over-all systems or subsystems.

Philco Board Names Wilson Oelkers

THE BOARD of directors of Philco Corporation has elected Wilson H. Oelkers a vice president.

Oelkers is general manager of the company's Lansdale division which manufactures tubes, transistors and solid state devices at plants in Lansdale and Spring City, Pa.



IBM Elects Piore As Board Member

INTERNATIONAL BUSINESS MACHINES CORP., New York City, has announced the election of Emanuel R.

COLLEGE IS BUSINESS' BEST FRIEND

Business employs almost half of the product of colleges—the college graduate. Business management is largely composed of college graduates. Business concerns benefit extensively from the research colleges engage in. Business owes college a great debt.

Higher education is facing during the next decade greatly enlarged student enrollments, the problems of an explosion of knowledge, and the need to meet ever growing demands for ever better educated men and women.

These problems involve vastly increased costs which cannot be met out of present income.

The operating cost of higher education today is over four and a half billion dollars a year and will at least double in this decade.

Business and industry, as major beneficiaries of American higher education, must recognize a responsibility to contribute their fair share.

American business corporations produce much of the nation's wealth. They have enormous power for good. We believe they can exercise it in a meaningful way—as many do now—by providing voluntary support for colleges and universities of their choice.

These conclusions, and the following statement of conviction, were outcomes of a recent conference of business leaders sponsored in New York by the Council for Financial Aid to Education, Inc.

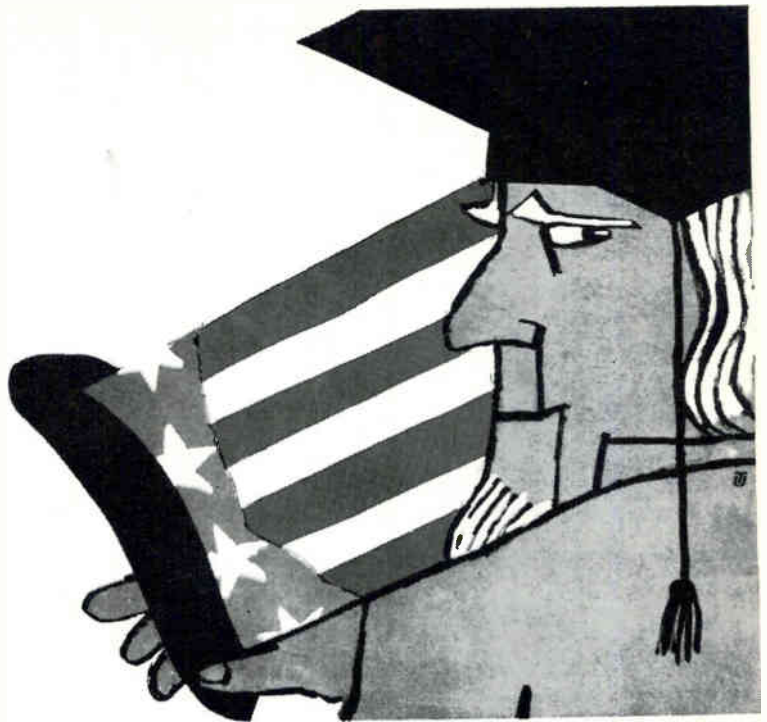

A STATEMENT OF CONVICTION

We believe that, in the light of the present urgency, now is the time for a broader and deeper participation by the business community in the support of higher education. We therefore call upon our colleagues in American business and industry to help spread the base of voluntary support of higher education as a necessary supplement to the extensive support which busi-

ness now provides to education through taxes.

We urge responsible management to think through its opportunity and its obligation to adopt meaningful programs of voluntary corporate support to those colleges and universities whose service and quality they wish to encourage and nurture. We on our part will do no less.

KENNETH H. KLIPSTEIN,
American Cyanamid Co.

JOSEPH A. GRAZIER,
American Radiator & Standard
Sanitary Corporation

M. NIELSEN,
The Babcock & Wilcox Co.

HARMON S. EBERHARD,
Caterpillar Tractor Co.

HAROLD H. HELM,
Chemical Bank New York
Trust Company

F. W. MISCH,
Chrysler Corporation

FRANK O. H. WILLIAMS,
Connecticut General Life
Insurance Company

WESLEY M. DIXON,
Container Corporation of America

THOMAS C. FOGARTY,
Continental Can Company, Inc.

SAMUEL LENHER,
E. I. du Pont de Nemours & Company

MARION B. FOLSOM,
Eastman Kodak Company

LEWIS B. CUYLER,
First National City Bank

RALPH J. CORDINER,
General Electric Company

LEONARD F. GENZ,
General Foods Corporation

GEORGE RUSSELL,
General Motors Corporation

JOHN C. GRISWOLD,
W. R. Grace & Company

JERRY McAFEE,
Gulf Oil Corporation

GEORGE S. DIVELY,
Harris-Intertype Corporation

FRANK R. MILLIKEN,
Kennecott Copper Corporation

JAMES C. DONNELL II,
Marathon Oil Company

REINHARD A. HOHAUS,
Metropolitan Life Insurance Co.

STUART T. SAUNDERS,
Norfolk & Western Railway Co.

STANLEY DE J. OSBORNE,
Olin Mathieson Chemical Corp.

WILLIAM CARPENTER,
Pittsburgh Plate Glass Co.

CHAMP CARRY,
Pullman, Incorporated

JAMES T. GRIFFIN,
Sears, Roebuck and Company

H. GERSHINOWITZ,
Shell Development Company
Shell Oil Company

E. L. STEINIGER,
Sinclair Oil Corporation

JOHN E. SWEARINGEN,
Standard Oil Company (Indiana)

M. J. RATHBONE,
Standard Oil Company (N. J.)

CHARLES E. SPAHR,
Standard Oil Company (Ohio)

J. ERIK JONSSON,
Texas Instruments, Inc.

HARRY B. McCLURE,
Union Carbide Corporation

J. S. JOHNSON,
U. S. Rubber Company

W. HOMER TURNER,
U. S. Steel Foundation, Inc.

R. D. LILLEY,
Western Electric Company, Inc.

ALFRED S. GLOSSBRENNER,
Youngstown Sheet & Tube Co.

*JAMES B. BLACK,
Pacific Gas & Electric Co.

*G. KEITH FUNSTON,
New York Stock Exchange

*NEIL McELROY,
The Procter & Gamble Co.

*DE WITT WALLACE,
The Reader's Digest

*IRVING S. OLDS,
Former Chairman of the Board
U. S. Steel Corp.

*FRANK W. ABRAMS,
Former Chairman of the Board
Standard Oil Co. (N. J.)

*WALTER D. FULLER,
The Curtis Publishing Co.

*DEVEREUX C. JOSEPHS,
Former Chairman of the Board
New York Life Insurance Co.

*ROBERT E. WILSON,
U. S. Atomic Energy Commission

*FRANK H. SPARKS, President
Council for Financial Aid to
Education, Inc.

*Director, Council for Financial Aid to Education



Published as a public service in cooperation with
The Advertising Council and the Council for Financial Aid to Education.

FREDDY

by *RUPE*



What you need, Freddy, in order to screen out those unwanted signals, is a **REEVES-HOFFMAN CRYSTAL FILTER** (or maybe in your case just the container would be good enough). Like Freddy, perhaps you have a need for a good filter system. If so, why not get the facts now about Reeves-Hoffman crystal filters, available in frequency ranges from audio to 30 mc to meet commercial or military specifications. Are we coming through loud and clear? Then write for bulletin QCF.

REEVES-HOFFMAN
CARLISLE, PENNSYLVANIA
DIVISION OF DYNAMICS CORPORATION OF AMERICA

PRODUCERS OF PRECISION
FREQUENCY CONTROL DEVICES...
crystals • crystal-controlled
frequency sources, standards,
filters • component ovens.

CIRCLE 221 ON READER SERVICE CARD

Piore as a member of the board of directors. Piore is IBM vice president, research and engineering.

The former chief scientist of the Office of Naval Research joined IBM in 1956 as director of research. He was elected a vice president in 1960.

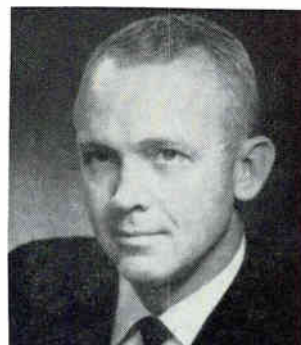

Tamar Hires Barnhart As Chief Engineer

SIMON W. BARNHART has been appointed chief engineer of Tamar Electronics, a division of Tamar Electronics Industries, Inc., Gardena, Calif.

Prior to joining Tamar, Barnhart was department manager of the Armament Control division of Autonetics where he supervised 200 engineering personnel in all phases of engineering on airborne radar, armament control systems, and associated ground support equipment.

Kollmeyer Joins Adler Electronics

JASPER C. KOLLMEYER has joined the Systems Engineering department, Government Products division of Adler Electronics, Inc., New Rochelle, N. Y., as an executive engineer. He was formerly manager of systems design with ITT-Kellogg Co.

Adler produces telecommunications systems and communications equipment.

TRW Microwave Names Price

APPOINTMENT of Oliver R. Price as manager advanced development, TRW Microwave division, Canoga Park, Calif., has been announced. He will be responsible for TRW's

FINE WIRE

Custom Melting, Complete Redrawing, Strand and Vacuum Annealing Services for fine wire processing to customers' specifications.



WRITE for valuable brochure containing fine wire compositions, pertinent properties and applications.

- for
- Semiconductors
 - Resistors
 - Potentiometers
 - Thermocouples
 - Electronic Tubes
 - Other Electronic Applications

in
precious, base, exotic
and special metals
— bare or
insulated



CONSOLIDATED REACTIVE METALS, inc.
115 Hoyt Avenue — Mamaroneck, N. Y. — OWens 8-2300



Hanover Fair

Market Place for World Trade

The Hanover Fair is many things.

It is the world's largest international trade fair devoted to business only.

Its display of products includes materials, equipment, and machinery for a broad range of industrial applications.

It continually serves as a fundamental instrument for direct sales negotiation and marketing analysis at the international level.

Its strict policy of assigning exhibits according to product category and the comprehensive scope of each product area assure the opportunity for profitable business contacts.

The Hanover Fair 1963 will have 5400 exhibitors from 27 countries and a total display area of 6,372,000 sq. ft.

**April 28-May 7
Hanover, Germany**

For information, room reservation forms, and tickets of admission:

**GERMAN AMERICAN
CHAMBER OF COMMERCE**
666 Fifth Avenue
New York 19, N.Y.

CIRCLE 222 ON READER SERVICE CARD
January 4, 1963

increased activity in company and contract supported R&D programs in microwave antennas and components.

Prior to joining the Thompson Ramo Wooldridge Inc. division, Price was chief engineer at Micro-Radionics and for several years was a member of the R&D Laboratories at Hughes Aircraft where he headed the advanced studies section.



McCulloh Takes New Position

WILLIAM L. MCCULLOH has joined Frequency Engineering Laboratories as senior electronic engineer in the firm's Systems division. His new duties will involve engineering development of countermeasures equipment.

McCulloh was formerly senior electrical engineer at Lockheed Electronics Co.



Hare Accepts Post At CTS of Canada

WILLIAM F. J. HARE has been named director of research at CTS of Canada, Ltd., Ontario, Canada. He will head research on solid state devices and investigate the development of new and diversified products for the firm's Canadian electronics market.

Prior to joining CTS, Hare was a member of the technical staff of

Save time with these tested transistor design circuits

Here's a ready source of quick, time-saving answers to your transistor circuit problems . . . practical guidance on essential phases of today's semiconductor developments. Because these three volumes bring you the successful work of practicing engineers, every topic has permanent reference value and contributes to the Library's usefulness in your work.



You'll have at your fingertips hundreds of *proved* transistor circuits — with all the necessary design information and component values required to utilize them in your own designs — and save valuable man-hours of time and effort.

TRANSISTOR CIRCUITS LIBRARY

Edited by
John M. Carroll
Managing
Editor
Electronics

3 vols. 932 pp.,
1735 illus. and
tables, \$24.95—
payable \$8.95 in
10 days, \$8.00
monthly

Praise by
experts . . .

" . . . a valuable
reference to
the circuit de-
signer and en-
gineer."
—*Electronics*

" . . . useful to
those who are
entering the
field of semi-
conductor cir-
cuit design."
—*Control*

" . . . a conven-
ient and com-
prehensive
source of trans-
istor informa-
tion."
—*Radio-Elec-
tronics*

These three big manuals supply hundreds and hundreds of transistor circuits ready to be adapted to your specific needs . . . give valuable material on transistor characteristics, structures, and techniques. Articles, photographs, design charts, nomographs, and ready-to-use circuits cover a vast range of applications . . . from simple one-transistor "push-pull" amplifiers . . . to complex computer switching circuits with high-power transistors. You get data and circuits for home-entertainment and broadcast equipment . . . computer and servomechanism circuits . . . missile, aircraft, and satellite equipment . . . industrial, scientific, and medical devices . . . and many more.

Library includes . . .
Transistor Circuits and Applications
Modern Transistor Circuits
Design Manual for Transistor Circuits

Save \$3.55. Bought separately, these books would cost you \$28.50. But under this special Library offer, they come to you at a \$3.55 saving—and you pay in small, convenient installments if you desire.

SEE THIS LIBRARY 10 DAYS FREE Direct From Publisher

McGraw-Hill Book Co., Dept. L-1-4
327 W. 41st St., N. Y. C. 36

Send me the Transistor Circuit Library. In 10 days I will (check one) remit full price of \$24.95; or only \$8.95 in 10 days and \$8.00 monthly. Otherwise I will return books postpaid.

PRINT

Name

Address

City..... Zone..... State.....

Company

Position

For price and terms outside U. S., write McGraw-Hill Int'l., N. Y. C.

L-1-4

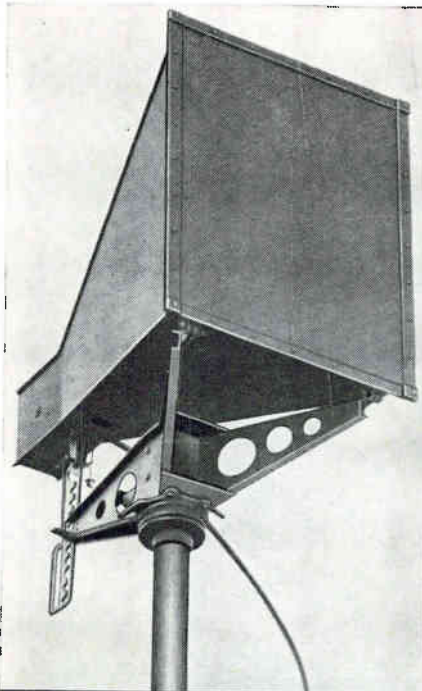

ANTENNA CAPABILITIES

The advanced design and precision construction of Ainslie antenna systems and associated equipment bear testimony to nearly two decades of microwave communication, detection and identification experience. By virtue of complete design-to-delivery capabilities and facilities, Ainslie Corporation offers its customers not only comprehensive standard lines of mesh, spun and horn antennas, but also the flexibility required to develop custom designed prototypes for on-schedule delivery.

We invite your inquiry.



Ainslie

CORPORATION

531 Pond Street
Braintree 85, Massachusetts

semiconductor device development at Bell Laboratories, Murray Hill, N. J.

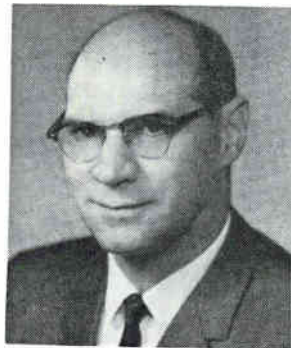

Newbury Accepts Century Position

WILLIAM F. NEWBURY, former manufacturing manager of Sylvania Electric Products, has been named production manager for Century Electronics & Instruments, Inc., Tulsa, Okla., developer and manufacturer of electronic instruments for the aerospace industry.

Newbury was affiliated with Sylvania from 1952 until recently joining Century.

Blumkin Assumes New Post

R. BLUMKIN, formerly chief engineer at General Resistance Inc., has been appointed vice president of engineering at R-Tronics, Inc., Jamaica, N. Y.

R-Tronics manufactures resistors and networks.



Electronic Memories Hires Hathaway

APPOINTMENT of Bernard Hathaway as director of manufacturing

for Electronic Memories, Inc., Los Angeles, Calif., is announced.

Electronic Memories, Inc., is engaged in the development, design and manufacture of ferrite memory cores and core memory systems for both military and commercial applications.

Before joining EMI, Hathaway was director of manufacturing engineering for Ampex Computer Products Co.

PEOPLE IN BRIEF

Executone, Inc., promotes Albert Bower to exec v-p and R. T. Capodanno to v-p in charge of manufacturing and engineering. New titles at United Aircraft's Norden div.: Ernest J. Greenwood, from operations mgr. to div. v-p, operations; Will M. Quinn, Jr., from engineering mgr. to div. v-p, engineering. James F. Manning advances to systems mgr. for information storage systems at IBM's General Products div. Richard C. Lindsay, formerly with the Rand Corp., appointed asst. to the president of Electronic Communications, Inc., for operations analysis and planning. Walter D. Eisenhower, previously with Western Electric, named mgr. of the Semiconductor Development dept. at the Electronic Components div. of Burroughs Corp. John J. Bohrer, director of R&D for International Resistance Co., elected a v-p of the firm. Hugh S. Allen, Jr., leaves Lang Worth Feature Programs to join Kahn Research Labs, Inc., as director of engineering applications. Joy Mfg. Co. ups Patrick W. Zilliagus to mgr. in the electrical products dept. of the Industrial div. Albert N. Leman, from Leece-Neville Co. to Heinze Electric Co. as chief engineer. Hirschel Schwartz, recently with Gudeman Co., appointed chief engineer at PCA Electronics, Inc. Donald C. Wright, formerly with General Electric Co., now a member of the technical staff of Micromega Corp. John J. Burke, senior v-p of Lear Siegler Inc., elected a director of Technical Systems Inc. Daniel C. Sweeney moves up to v-p of U.S. Sonics Corp.

What's your *present* job in electronics? What will you be working on tomorrow? Do you know the latest electronic developments *outside* your particular specialty that may affect your work?

Below is a sampling of topics within the 3,000 plus editorial pages produced per year by electronics' 28-man editorial staff. No matter where you work today, or in which job function(s), **electronics** will keep you fully informed as an electronic engineer. Subscribe today via the Reader Service Card in this issue. Only 7½ cents a copy at the 3 year rate.

electronics

IS EDITED TO KEEP YOU FULLY INFORMED
ON ALL PHASES OF ELECTRONICS

34 Articles	129 Articles	90 Articles	84 Articles	44 Articles	172 Articles
Air Traffic Control	Amplifiers	Antennas	Biophysics	Capacitors	Communications
158 Articles	55 Articles	97 Articles	92 Articles	95 Articles	50 Articles
Computers	Crystals	Data Processing	Detectors	Diodes & Diode Circuits	Filters
84 Articles	49 Articles	104 Articles	77 Articles	83 Articles	73 Articles
Generators	Infrared	Instruments	Lasers & Masers	Magnetics	Memories
179 Articles	96 Articles	64 Articles	53 Articles	75 Articles	48 Articles
Military Electronics	Microwaves	Modulators	Networks	Oscillators	Plasma & Ion Engineering
87 Articles	109 Articles	122 Articles	99 Articles	142 Articles	81 Articles
Pulse Techniques	Radar	Satellites	Semiconductors	Space Electronics	Switches & Switching Circuits
51 Articles	65 Articles	56 Articles	90 Articles		
Thin Films	Transducers	Transistors	Tubes		

electronics

WEEKLY QUALIFICATION FORM FOR POSITIONS AVAILABLE

ATTENTION: ENGINEERS, SCIENTISTS, PHYSICISTS

This Qualification Form is designed to help you advance in the electronics industry. It is unique and compact. Designed with the assistance of professional personnel management, it isolates specific experience in electronics and deals only in essential background information.

The advertisers listed here are seeking professional experience. Fill in the Qualification Form below.

STRICTLY CONFIDENTIAL

Your Qualification form will be handled as "Strictly Confidential" by ELECTRONICS. Our processing system is such that your form will be forwarded within 24 hours to the proper executives in the companies you select. You will be contacted at your home by the interested companies.

WHAT TO DO

1. Review the positions in the advertisements.
2. Select those for which you qualify.
3. Notice the key numbers.
4. Circle the corresponding key number below the Qualification Form.
5. Fill out the form completely. Please print clearly.
6. Mail to: Classified Advertising Div., ELECTRONICS, Box 12, New York 36, N. Y. (No charge, of course).

COMPANY	SEE PAGE	KEY #
ATOMIC PERSONNEL INC. Philadelphia, Penna.	84**	1
BUREAU OF NAVAL WEAPONS Sunnyvale, Calif.	82**	2
DOUGLAS AIRCRAFT CO. Missile & Space Systems Division Santa Monica, California	19*	3
HARVARD UNIVERSITY Cambridge 38, Mass.	153	4
NAVY DEPT. (BUREAU OF SHIPS) Washington 25, D. C.	152	5
PAN AMERICAN WORLD AIRWAYS INC. Guided Missiles Range Div. Patrick Air Force Base, Fla.	151	6
ROME AIR MATERIEL AREA (AFLC) Griffiss Air Force Base, Rome, N. Y.	153	7
SPACE TECHNOLOGY LABORATORIES INC. Sub. of Thompson Ramo Wooldridge Inc. Redondo Beach, Calif.	15	8
U. S. ARMY Harry Diamond Laboratories Washington, D. C.	152	9
P 1179	84**	10

** These advertisements appeared in the Dec. 14th issue.
* This advertisement appeared in the Dec. 28th. issue.

(cut here)

electronics WEEKLY QUALIFICATION FORM FOR POSITIONS AVAILABLE

(Please type or print clearly. Necessary for reproduction.)

(cut here)

Personal Background

Education

NAME

HOME ADDRESS

CITY ZONE STATE

HOME TELEPHONE

PROFESSIONAL DEGREE(S)

MAJOR(S)

UNIVERSITY

DATE(S)

FIELDS OF EXPERIENCE (Please Check)

1463

CATEGORY OF SPECIALIZATION

Please indicate number of months experience on proper lines.

- | | | |
|--|--|---------------------------------------|
| <input type="checkbox"/> Aerospace | <input type="checkbox"/> Fire Control | <input type="checkbox"/> Radar |
| <input type="checkbox"/> Antennas | <input type="checkbox"/> Human Factors | <input type="checkbox"/> Radio-TV |
| <input type="checkbox"/> ASW | <input type="checkbox"/> Infrared | <input type="checkbox"/> Simulators |
| <input type="checkbox"/> Circuits | <input type="checkbox"/> Instrumentation | <input type="checkbox"/> Solid State |
| <input type="checkbox"/> Communications | <input type="checkbox"/> Medicine | <input type="checkbox"/> Telemetry |
| <input type="checkbox"/> Components | <input type="checkbox"/> Microwave | <input type="checkbox"/> Transformers |
| <input type="checkbox"/> Computers | <input type="checkbox"/> Navigation | <input type="checkbox"/> Other |
| <input type="checkbox"/> ECM | <input type="checkbox"/> Operations Research | <input type="checkbox"/> |
| <input type="checkbox"/> Electron Tubes | <input type="checkbox"/> Optics | <input type="checkbox"/> |
| <input type="checkbox"/> Engineering Writing | <input type="checkbox"/> Packaging | <input type="checkbox"/> |

	Technical Experience (Months)	Supervisory Experience (Months)
RESEARCH (pure, fundamental, basic)
RESEARCH (Applied)
SYSTEMS (New Concepts)
DEVELOPMENT (Model)
DESIGN (Product)
MANUFACTURING (Product)
FIELD (Service)
SALES (Proposals & Products)

CIRCLE KEY NUMBERS OF ABOVE COMPANIES' POSITIONS THAT INTEREST YOU

1 2 3 4 5 6 7 8 9 10 11 12 13 14 15 16 17 18 19 20 21 22 23 24 25

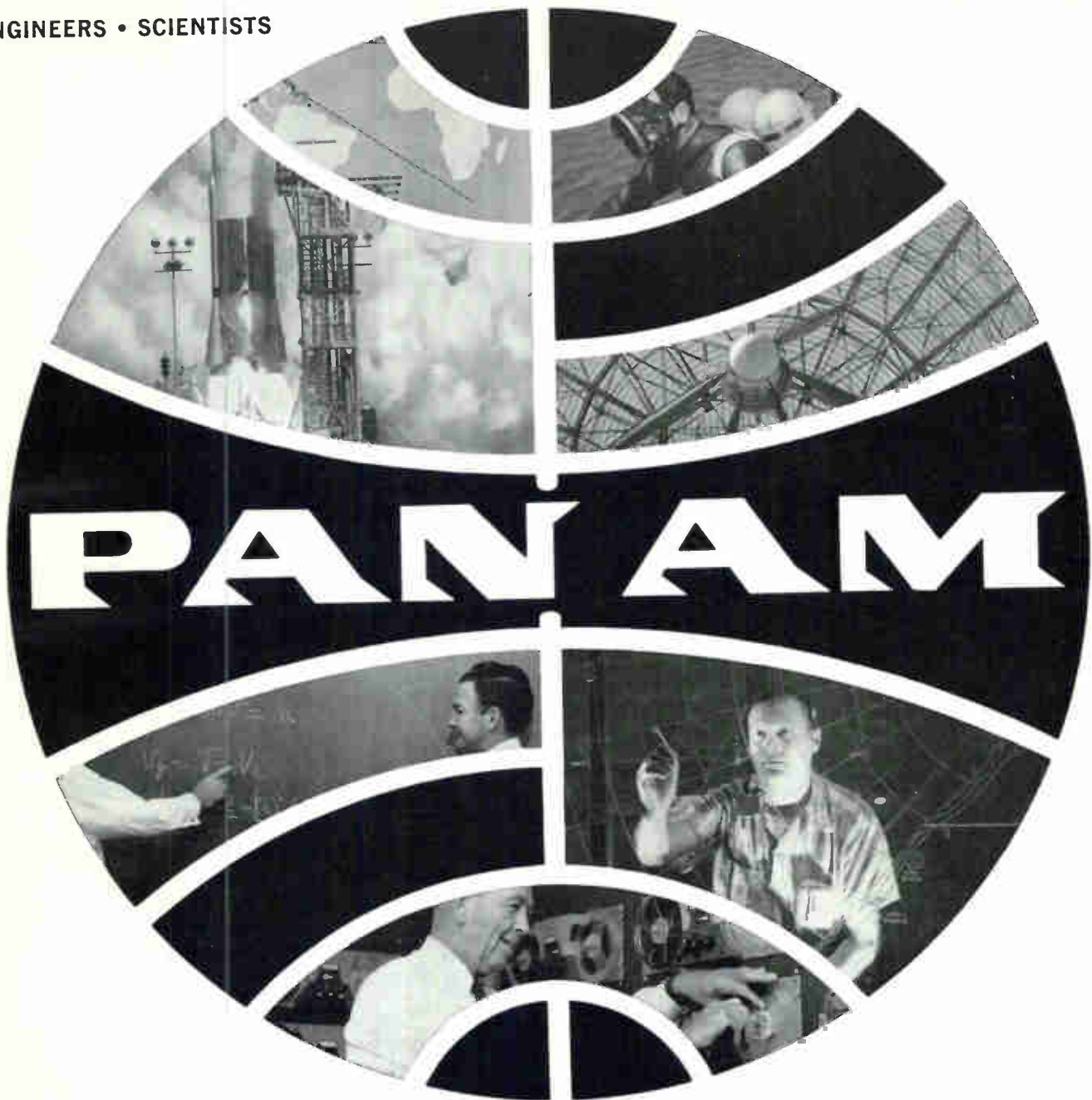

encyclopedic exposure to the whole world of space vehicle & missile technology

is basic to engineering with PAN AM* at the Atlantic Missile Range. □ The reason: engineers and scientists here strive to match the capabilities of each new launch vehicle with range test systems of equal or greater accuracy. Our engineers and scientists have pushed the past and present instrumentation systems to their operational limits—and have gone on to create a whole new range technology. They have developed design criteria and are providing technical direction for global tracking and telemetry systems, combining the latest techniques from all areas of electronics, optics and infrared. □ Today, forward looking groups at PAN AM's Guided Missiles Range Division are not only planning for this year's and next year's tests but are considering range requirements five through fifteen years ahead—requirements to test manned space vehicles still on the drawing boards or "existing in concept" only.

OPPORTUNITIES NOW EXIST to join PAN AM at the Cape in developing range systems hemispheric, global and celestial in scope—and share in the exceptional professional development implicit in these assignments.

Systems Engineers—EE's, Physicists & Mathematicians capable of assuming complete project responsibility for new range systems. Instrumentation Planning Engineers—EE's, Physicists to be responsible for specific global range instrumentation concepts.

Senior Engineers & Scientists—PhD's in Math, Physics, Celestial Mechanics, Astronomy or Electronics.

Experience in one or more of these areas: Pulse radar, CW techniques, telemetry, infrared, data handling, communications, closed circuit TV, frequency analysis, command control, command guidance, underwater sound, timing, shipboard instrumentation.

Why not write us today, describing your interests and qualifications in any of the areas above. Address Dr. Charles Carroll, Dept. 28A-1, Pan American World Airways, Incorporated, P.O. Box 4336, Patrick Air Force Base, Florida.

*Carrying on Range Planning, Engineering and Operation of Atlantic Missile Range for the USAF since 1953. An equal opportunity employer.



GUIDED MISSILES RANGE DIVISION
PATRICK AIR FORCE BASE, FLORIDA

NOW FORMING

*A select group of
Electronics Engineers*

*to manage the
Installation,
Maintenance
& Reliability*

*Programs for Naval
shipboard electronics*

Get in on the ground floor for these
TOP-LEVEL opportunities by contacting
the Director—Industrial Relations
and Manpower, Code 720-A.

The increasing complexity of electronic equipments and systems on board the Navy's surface and sub-surface ships has spot-lighted the importance of installation and maintenance engineering more than ever before. Therefore, the Bureau of Ships is establishing an *ELECTRONICS MAINTENANCE CENTER* in Norfolk, Virginia, to take over the management of—and the responsibility for—shipboard INSTALLATION, RELIABILITY, MAINTENANCE and PRODUCT IMPROVEMENT requirements for

- ECM and RADAR,
- COMMUNICATIONS
- SONAR, and
- SUPPORT Systems

As yet, this is not a large organization, but the implications for the future are interesting. These will be pivotal positions which will give a man with a few years experience—and some management potential—an insight and influence that may be limited only as the individual himself is limited. Since he will be responsible in his own area for relations with design and development people in the Bureau, with industrial contractors, with operating units and support activities, and with counterparts in other Bureaus—he will have ample opportunity to know, and become known.

In all, there are openings for perhaps 30 engineers, and as many technicians, with these numbers to increase steadily as the Center takes over more of its assigned responsibilities. Starting salaries range up to \$12,845 (\$13,615 by January 1st, 1964), and offer the important benefits of Career Civil Service. The Center will be located in Norfolk, Virginia . . . where climate and costs are just right for ocean front living.

bureau of ships

Department of the Navy, Washington 25, D.C.

a message to R&D-oriented

EE's and Physicists

from an old friend in Washington, D.C.

We have several staff openings for Electronics Engineers and Physicists at our research laboratories in northwest Washington, D. C., just off Connecticut Avenue.

Our 1400 or more scientists, engineers and support personnel perform research in advanced electronic and electro-mechanical fuzing and guidance systems . . . and other electronic ordnance devices such as range finders, self-adaptive controls,

and optical and acoustical sensors.

We are—or, rather, we were—DOFL, the Diamond Ordnance Fuze Laboratory, a highly-respected government research organization. Now, however, we have a new name, and new expansion plans that are calling for research into nuclear radiation and reactors, plasma physics, fluid logic systems, fluid amplification, lasers (of course), stochastic processes, organic and metallo-

organic polymers, binary semiconducting compounds, microelectronics, quantum mechanics . . . and literally dozens of others.

You'll like the work, the facilities, the location, the benefits of Career Civil Service . . . and the freedom of research that may take you well beyond our primary missions. (For those interested in advance degree work, our programs are among the best you'll find anywhere.)

Want to learn more? Get in touch with James L. Charney.

HARRY DIAMOND LABORATORIES formerly **DOFL**

DEPARTMENT OF THE ARMY

Connecticut Avenue at Van Ness, N.W. • Washington 25, D. C.

EMPLOYMENT OPPORTUNITIES



The advertisements in this section include all employment opportunities — executive, management, technical, selling, office, skilled, manual, etc.

Look in the forward section of the magazine for additional Employment Opportunities advertising.

— RATES —

DISPLAYED: The advertising rate is \$40.17 per inch for all advertising appearing on other than a contract basis. Contract rates quoted on request.

An advertising inch is measured 7/8" vertically on a column—3 columns—30 inches to a page.

Subject to Agency Commission.

UNDISPLAYED: \$2.70 per line, minimum 3 lines. To figure advance payment count 5 average words as a line.

Box numbers—count as 1 line.

Discount of 10% if full payment is made in advance for 4 consecutive insertions.

Not subject to Agency Commission.

An opportunity in the area of
High Energy Particle Physics

HARVARD UNIVERSITY

has openings for

ELECTRONICS ENGINEERS

to join small groups of scientists and engineers in the development of instrumentation for the world's largest electron accelerator—a 6-BEV alternating gradient synchrotron. Experience or knowledge of fast pulse transistor circuitry, power supplies and interconnections desirable.

Resumes and inquiries concerning this opportunity are invited

PERSONNEL DEPARTMENT

HARVARD UNIVERSITY

1352 Massachusetts Avenue
Harvard Square, Cambridge 38, Mass.

An equal opportunity employer

"IN-SERVICE" ENGINEERS ROME AIR MATERIEL AREA

(A major component of Air Force Logistics Command)

Rome Air Materiel Area has been assigned the mission of providing Ground Communications-Electronic logistic support to the Air Force. A very vital facet for fulfilling this responsibility involves those engineering functions necessary to insure the performance integrity of the C-E equipments and systems once they become operational.

TYPICAL RESPONSIBILITIES OF ROAMAs "IN-SERVICE ENGINEERS" ARE:

- Modification or rehabilitation of operational Ground C&E equipments by correction of design deficiencies.
- Development of engineering specifications for support of procurement.
- Providing engineering design criteria to insure maintainability, serviceability and reliability of operational C&E equipment.
- Performing engineering liaison with AF Contractors.

CURRENT AND FUTURE ASSIGNMENTS
CREATE AN EVER INCREASING DEMAND FOR:

Electronic Engineers (all options)
Electrical Engineers
Mechanical Engineers
General Engineers

TO MONITOR AND PERFORM WORK ON VITAL PROJECTS IN THE FOLLOWING AREAS:

Search and Detection Radar
Missile Guidance and Tracking
Digital and Analog Computers
Beacon and Identification Equipments
ICBM Communications Sub-Systems
Communications Ancillary Equipments
Electronics Systems (Warning, Intelligence, Command, Support)

We have an immediate and urgent need for Graduate engineers, to insure the operational readiness of Ground C-E systems and equipments. Current demands at Rome Air Materiel Area for in-service engineering support are heavy. Increased mission responsibilities will entail even heavier demands in the future.

ROAMAs Directorate of Materiel Management provides an immediate career opportunity for graduate Electronic, Electrical, General and Mechanical Engineers. Ground Communications and operational Electronics Systems and Equipments are subject to continuous change consistent with advances in the state of the art. Keep abreast of the continuous scientific advancements as a contributor to the engineering accomplishments of the Air Force in the highly specialized fields of communications electronics.

For more information about Air Force Civilian career opportunities in "In-Service" Engineering submit your resume to:



Mr. William Pagano
Professional Scientific Recruiter

ROAMA
GRIFFISS AIR FORCE BASE
Rome, New York

SEARCHLIGHT SECTION

(Classified Advertising)

BUSINESS OPPORTUNITIES EQUIPMENT - USED or RESALE

DISPLAYED

The advertising is \$27.25 per inch for all advertising other than on a contract basis. AN ADVERTISING INCH is measured 7/8" vert. on a column, 3 cols.—30 inches—to a page. EQUIPMENT WANTED or FOR SALE ADVERTISEMENTS acceptable only in Displayed Style.

—RATES—

\$2.70 a line, minimum 3 lines. To figure advance payment count 5 average words as a line. BOX NUMBERS count as one line additional. DISCOUNT of 10% if full payment is made in advance for four consecutive insertions.

UNDISPLAYED

Send NEW ADVERTISEMENTS or Inquiries to Classified Adv. Div. of Electronics, P. O. Box 12, N. Y. 36, N. Y.

EXCELLENT USED LABORATORY EQUIPMENT

H-P #626A SHF SIG. GEN. 10-15.5 G.C., LIKE NEW	\$1685
H-P #628A SHF SIG. GEN. 15-21 G.C., LIKE NEW	\$1490
G.R. #805C STD. SIG. GEN. 50 KC-50 MC, EXCELLENT	\$ 695
MEAS. CORP #84R SIG. GEN. 300 MC-1000 MC, EXCELLENT	\$ 695
KAY MEGAMATCH SWEEPER 10 MC-1 G.C., 30 MC SWEEP WIDTH	\$ 415
RUTHERFORD B7 PULSE GENERATOR, ALMOST NEW	\$ 430
DUMONT 401 SCOPE, DC-200 KC, 10 MV/CM, NEW CRT	\$ 190
TEKTRONIX PLUGINS 53/54 "B", 53/54 "K", each	\$ 65

— SELL OR TRADE, MAKE OFFER —

ELECTRO DIGITAL VOLTMETER, DUA 400, .001-999.9 VDC, .01% AUTO RANGING.
ENDEVCO TRIAXIAL ACCELEROMETER #2223 & 2616 3 CHANNEL LAB. AMPLIFIER
FREQ. METERS—PRD 579A, 1.6-2.6 GC; FXR N410A, 1-4 GC
LINK AVIATION 250400 PHASE COMPARATOR & PWR SUPPLY, SERVO ANALYSIS.
ALL WITH MONEY-BACK GUARANTEE. FOB BERKELEY, ADD. CALIF. TAX IN CALIF.

SPECIALTIES RESEARCH, BOX 2116 S. BERKELEY STA., BERKELEY 5, CALIF.

CIRCLE 950 ON READER SERVICE CARD

FOR RESEARCH — DEVELOPMENT & EXPERIMENTAL WORK

Over 10,000 different electronic parts: waveguide, radar components and parts, test sets, pulsers, antennas, pulse xmtrs, magnetrons. IF and pulse amplifiers, dynamometers, 400 cycle xmtrs, 584 ant. pedestals, etc.
PRICES AT A FRACTION OF ORIGINAL COST!
COMMUNICATIONS EQUIP CO.
343 CANAL ST., N. Y. 13, W.O. 6-4045
CHAS. ROSEN (Formerly at 131 Liberty St.)

CIRCLE 951 ON READER SERVICE CARD

RADIO RESEARCH INSTRUMENT CO.

AUTO-TRACK & TELEMETRY ANTENNA PEDESTALS
3 & 10 CM SCR. SRA AUTOTRACK RADARS
AN/TSP-10 SEARCH, AN/TSP-10 HT. FINDERS
AN/FPN-32GCA, AN/APS-10 NAVIG. & WEATHER
AN/APS-13B PRECISION AN/APS-15B PRECISION
AN/APS-31A SEARCH, DOZENS MORE.
5-12 MEGAWATT HIGH POWER PULSERS.

RADIO RESEARCH INSTRUMENT CO.
550 Fifth Ave., New York Judson 6-4691

RADAR SYSTEMS & COMPONENTS/ IMMEDIATE DELIVERY

CIRCLE 952 ON READER SERVICE CARD

LOOKING FOR USED/SURPLUS ELECTRONIC EQUIPMENT/COMPONENTS?

For an up-to-date listing of such equipment see Searchlight Section of Dec. 14th.

OVER 2,000,000 RELAYS IN STOCK!

Send for Catalog 55
Universal RELAY CORP.
42 WHITE ST., N. Y. 13, N. Y. • WAIker 5-6900

CIRCLE 953 ON READER SERVICE CARD

INDEX TO ADVERTISERS



Audited Paid Circulation

Academic Press	143	• Hewlett-Packard Company.....	10, 11	Sarkes Tarzian Inc.....	127
• Acromag, Inc.	120	• Hitachi, Ltd.	101	Seco Electronics Inc.....	143
• Advanced Electronics Corp.....	142	• Hitemp Wires Inc.....	24	• Sierra Electronic Div. of Philco	6
• Ainslie Corporation	148	Hughes Aircraft Co.....	115	Signetics Corp.	5
Airpax Electronics, Inc.....	123	I B M.....	74, 75	Souriau et Cie.....	111
Airtronics International Corp.....	73	• J F D Electronics Corp.....	133	Space Technology Laboratories, Inc...	15
Amplex Corp.	14	Janco Corp.	130	Sperry Microwave Electronics Co., Div. of Sperry Rand Corp.....	25
Arena	110	• Japan Piezo Electric Co., Ltd.....	155	Sprague Electric Co.....	9, 23
Audax	110	Jerrold Electronics Corp.....	4	Tektronix, Inc.	97
Birtcher Corp., The.....	134	Kauke & Company, Inc.....	40	Texas Instruments Inc. Industrial Products Groups.....	31
• Budelman Electronics Corp.....	40	• Keithley Instruments, Inc.....	136	Thermonetics Inc.	137
• C S F.....	112	• Lapp Insulator Co., Inc.....	135	Thompson-Houston	103
• Celco-Constantine Engineering Labs...	118	Leesona Corp.	128	Thompson-Varian	109
Chatillon & Sons, John.....	121	• Litton Industries Inc. Electron Tube Div.....	138	• Toyo Conepaper Co., Ltd.....	115
• Clairex Corp.	102	Machlett Laboratories, Inc.....	27	• Toyo Electronics Industry Corp.....	133
• Clarostat Mfg. Co., Inc.....	42	Marconi Instruments	142	Toyo Musen Co., Ltd.....	22
Consolidated Reactive Metals, Inc....	146	McGraw-Hill Book Co.	147	• United Transformer Corp.....	2nd cover
• Constantine Engineering Labs.....	113	Midland Mfg. Co.....	121	Varian Associates	37
Coors Porcelain Co.....	23	Minnesota Mining & Mfg. Co. Mincom Div.	103	Videon	110
• Daysstrom Incorporated Potentiometer Div.	125	Mitsubishi Electric Mfg. Co.....	19	Welch Scientific Co., The.....	126
Transicoil Div.	39	Motorola Semiconductor Products Inc.	41	• Westinghouse Electric Corp.....	98, 99
DeLevan Electronics Corp.....	141	NRC Equipment Corp.....	38		
Despatch Oven Co.....	22	National Semiconductors Ltd.....	120	CLASSIFIED ADVERTISING	
Di Aero Corp.....	32	• New Hermes Engraving Machine Corp.	115	F. J. Eberle, Business Mgr.	
Drusch	109	• North Atlantic Industries, Inc.....	100	EMPLOYMENT OPPORTUNITIES.151-153	
duPont de Nemours & Co., Inc., E. I.	76	• Northeastern Engineering, Inc....	130, 131	EQUIPMENT	
• Electrodynamic Instrument Corp.....	104	• Northern Radio Co., Inc.....	129	(Used or Surplus New)	
Electro Instruments Inc.....	117	Origin Electric Co., Ltd.....	122	For Sale	153
Electronic Engineering Co. of Calif.	138	Paradynamics Inc.	22	INDEX TO CLASSIFIED ADVERTISERS	
• Electronic Instrument Co., Inc. (EICO)	137	Philco Corporation Sub. of Ford Motor Co.....	119	• Communications Equipment Co.....	153
• Fairchild Semiconductor Corp. 3rd cover, 156		• Polarad Electronics Corp.....	129	Harvard University	153
• Federation Nationale des Industries Electroniques	105, 106, 107	• Potter Instrument Co., Inc.....	21	Navy Dept. of the (Bureau of Ships)...	152
Florida Development Commission.....	35	Precision Instrument Co.....	17, 18	Pan American World Airways Inc.....	151
Flying Tiger Line.....	29	• Radio Corp. of America.....	4th cover	• Radio Research Instruments Co.....	153
General Electric Co. Power Tube Dept.	33	Radio Materials Co.....	95	Rome Air Material Area (AFLC)....	153
• General RF Fittings, Inc.....	121	• Raytheon Company	13	Specialties Research	153
German American Chamber of Com- merce	147	• Reeves-Hoffman Div. of Dynamics Corp. of America	146	• Universal Relay Corp.....	153
Gudebrod Bros. Silk Co., Inc.....	34	Ribet-Desjardins	111	U. S. Army, Harry Diamond Labora- tories	152
Hamilton Standard Div. of United Aircraft Corp.....	36	• Rixon Electronics, Inc.....	137	• See advertisement in the July 25, 1962 issue of Electronics Buyers' Guide for complete line of products or services.	
• Hamlin, Inc.	40	• Rochar Electronique	113		
Hansen Mfg. Co., Inc.....	130	• Rohm Mfg. Co.....	122		

electronics



Audit Bureau
of Circulations



Associated Business
Publications

Audited Paid Circulation

JAMES T. HAUPTLI

Advertising Sales Manager

R. S. QUINT:
Assistant Publisher Buyers'
Guide and Business Manager
FRED STEWART:
Promotion Manager
B. ANELLO:
Market Services Manager

RICHARD J. TOMLINSON:
Production Manager
GEORGE E. POMEROY:
Classified Manager
HUGH J. QUINN:
Circulation Manager

ADVERTISING REPRESENTATIVES

ATLANTA (9):
Michael H. Miller, Robert C. Johnson
1375 Peachtree St. N.E., Trinity 5-0523
(area code 404)

BOSTON (16):
William S. Hodgkinson, Donald R. Furth
McGraw-Hill Building, Copley Square,
Congress 2-1160 (area code 617)

CHICAGO (11):
Harvey W. Wernecke, Robert M. Denmead
645 North Michigan Avenue, Mohawk 4-5800
(area code 312)

CLEVELAND (13):
Paul T. Fegley
55 Public Square, Superior 1-7000
(area code 216)

DALLAS (1):
Frank Le Beau
The Vaughn Bldg., 1712 Commerce St.
Riverside 7-9721 (area code 214)

DENVER (2):
J. W. Patten
Tower Bldg., 1700 Broadway,
Alpine 5-2981 (area code 303)

HOUSTON (25):
Joseph C. Page, Jr.
Prudential Bldg., Halcombe Blvd.,
Riverside 8-1280 (area code 713)

LOS ANGELES (17):
Peter S. Carberry, Ashley P. Hartman,
W. C. Gries
1125 W. 6th St., Huntley 2-5450
(area code 213)

NEW YORK (36):
Donald H. Miller, Henry M. Shaw,
George F. Werner
500 Fifth Avenue, LO-4-3000
(area code 212)

PHILADELPHIA (3):
Warren H. Gardner, William J. Boyle
6 Penn Center Plaza, LOcust 8-4330
(area code 215)

SAN FRANCISCO (11):
R. C. Alcorn
255 California Street, Douglas 2-4600
(area code 415)

LONDON W1:
Edwin S. Murphy Jr.
34 Dover St.

FRANKFURT/Main:
Matthée Herfurth
85 Westendstrasse

GENEVA:
Michael R. Zeynel
2 Place du Port

"Headquarters for Business Information"

McGraw-Hill Technical and Business Publications

American Machinist/Metal-
working Manufacturing
Aviation Week and Space
Technology
Business Week
Chemical Engineering
Chemical Week
Coal Age
Construction Methods and
Equipment
Construction Daily
Control Engineering
Electrical Construction
and Maintenance
Electrical Merchandising Week
Electrical Newsletter
Electrical West

Electrical Wholesaling
Electrical World
Electronics
Engineering Digest
Engineering and Mining Journal
E & MJ Metal and Mineral
Markets
Engineering News-Record
Factory
Fleet Owner
Industrial Distribution
National Petroleum News
Nucleonics
Nucleonics Week
Platt's Oilgram News
Platt's Oilgram Price Service
Power

Product Engineering
Purchasing Week
Science Week
Textile World

Overseas only:
Automobile International
(English, Spanish)
Ingenieria Internacional
Construccion (Spanish)
International Management
(English, Spanish,
Portuguese editions)
Metalworking Production
(Great Britain)

Available by subscription only — to qualified persons actively engaged in the field of the publication. For subscription rates and information describing the editorial coverage of any of the above publications, write to: Subscription Manager, Circulation Department, McGraw-Hill Publishing Company, 330 West 42nd Street, New York 36, N. Y.

Acoustical Components of Superior Quality

JAPAN PIEZO supplies 80% of
Japan's crystal product require-
ments.

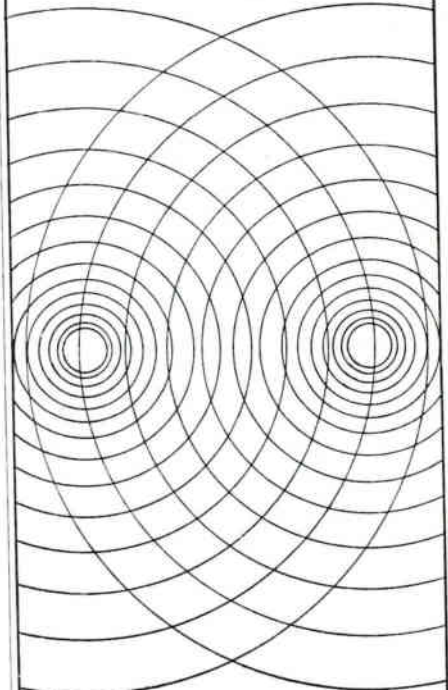

STEREO CARTRIDGE

Crystal — "PIEZO" Y-130
X'TAL STEREO CARTRIDGE

At 20°C, response: 50 to 10,000 c/s
with a separation of 16.5 db. 0.6 V
output at 50 mm/sec. Tracking
force: 6 ± 1 gm. Compliance: 1.5×10^{-6} cm/dyne. Termination: $1M\Omega$
+ 150 pF.

Write for detailed catalog on our
complete line of acoustical products
including pickups, microphones,
record players, phonograph motors
and many associated products.



JAPAN PIEZO ELECTRIC CO., LTD.

Kami-renjaku, Mitaka, Tokyo, Japan

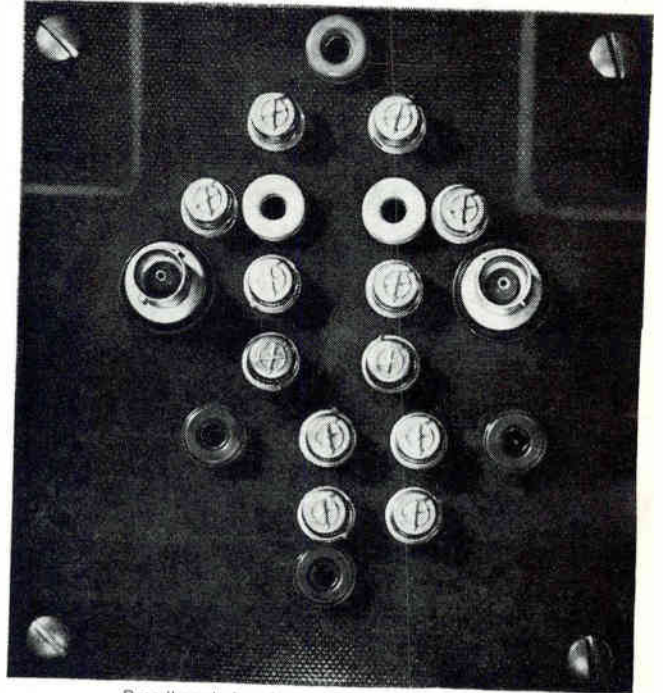
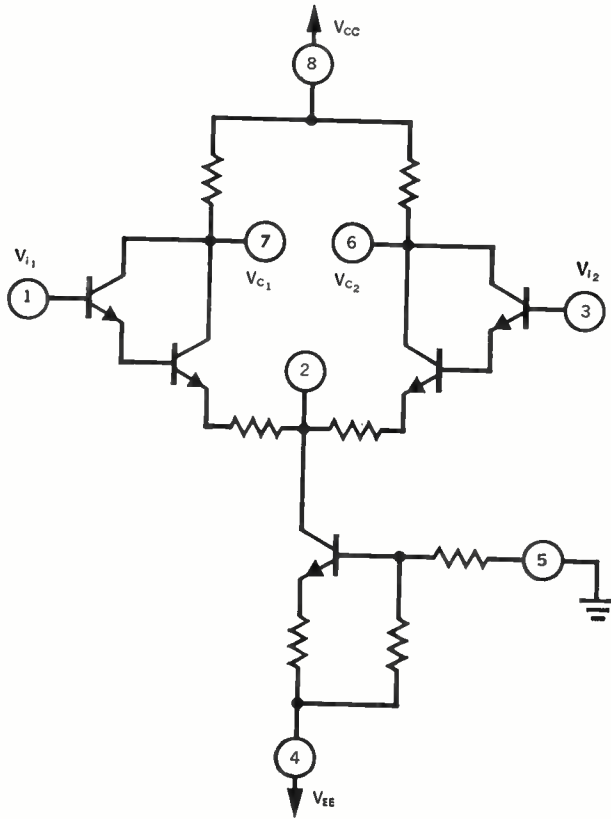

Breadboard of custom microcircuit components.

You design and breadboard it.

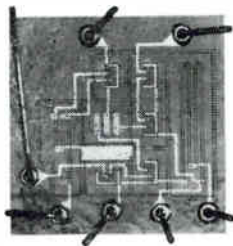

(Actual size → ■)

We integrate it.

What you do: Using data sheet information for Fairchild custom design components, you develop a worst-case circuit design. You can then breadboard the components and experiment until circuit performance meets your requirements exactly. The transistors, resistors, capacitors and diode arrays are Fairchild production microcircuit components physically separated and mounted in standard packages. Thus, your breadboard working model is a functional replica of the finished integrated microcircuit.

What we do: Fairchild uses your proven breadboard design with its specifications to develop masks and test equipment for manufacturing the integrated microcircuit. The circuit elements are diffused into a single chip of silicon using the Planar* process and intraconnected using an evaporated metal over oxide process†. Delivery is within ninety days from acceptance of your custom design. The finished microcircuit product possesses the same reliability demonstrated in over nine million hours of operating life tests on Fairchild Micrologic units. Data sheets sent on request.

FAIRCHILD
SEMICONDUCTOR

FAIRCHILD SEMICONDUCTOR/545 WHISMAN RD., MOUNTAIN VIEW, CALIF./YORKSHIRE 8 8161/TWX: 415-969-9165/A DIVISION OF FAIRCHILD CAMERA AND INSTRUMENT CORPORATION

* Planar: a patented Fairchild process. † M.O.O.: a patented Fairchild process.

CIRCLE 901 ON READER SERVICE CARD

RCA MICROELECTRONIC PACKAGES OFFER FOUR PROVED WAYS TO MINIATURIZE YOUR CIRCUITS

RCA's Broad Line of Packaged Circuits Meets Today's Needs for High Component Density, Proved Reliability, Broad Circuit Applications, and Volume Availability

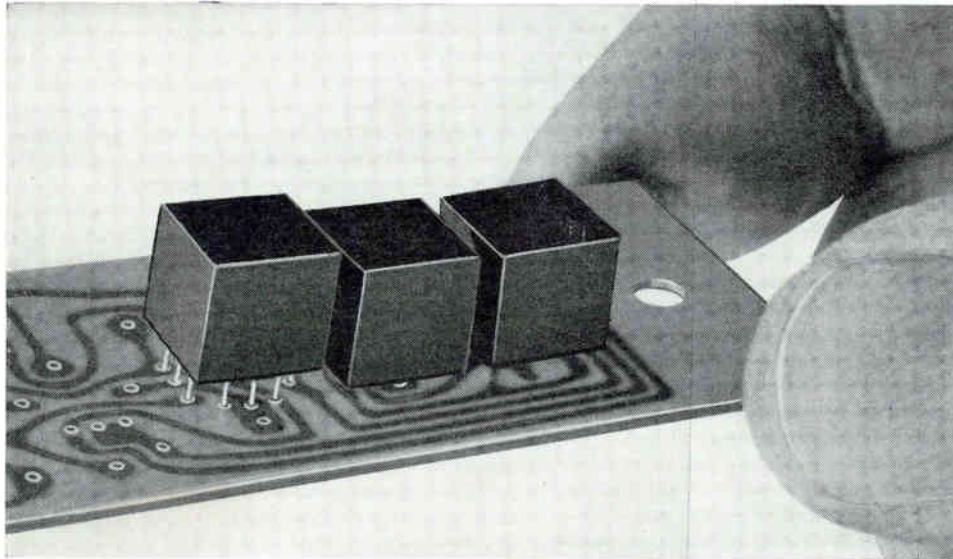

RCA Micromodules Offer Proved Reliability Backed By Over 100 Million Element-Hours of Life-Test Experience

Today's only high-density packaged circuits with this kind of life-test experience. Failure rates for RCA Micromodules are now less than 0.02% per 1000 hours at full ratings. Your *digital, analog, or linear* circuits can be supplied as RCA Micromodules...you can get working samples in a matter of days, quantity deliveries within 2 to 3 weeks. For example, RCA engineers converted one aircraft electronic package from conventional printed board construction to 16 working Micromodules in just 76 hours.



RCA Minimodules Offer Conventional-Component Economy in High-Density Format

Low-cost RCA Minimodules are precision built using reliable, conventional components, closely-packed, interconnected and encapsulated to meet the mechanical and environmental requirements of MIL specifications. RCA Minimodules can be supplied in the quantity you require, in the format you need, with terminal arrangements to meet your assembly requirements. Minimodules are available now for immediate delivery.

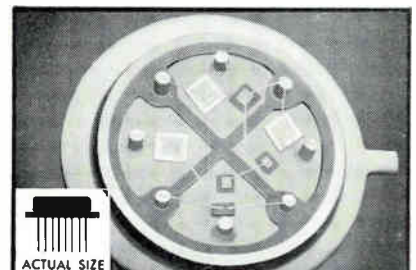

New RCA Digital Micro Circuits Switch in 7 Nanoseconds

First of a series of compact logic circuits—the RCA DMC-100 uses advanced silicon elements for ultra-high speed and new design flexibility. The RCA DMC offers excellent noise immunity, switching speeds to seven nanoseconds, high operating reliability and low power dissipation. The RCA DMC-100—designed for use in gates, adders, flip-flops, shift registers and multivibrators—is now available for immediate delivery.

RCA OFFERS MADE-TO-ORDER CUSTOM PACKAGING SERVICE

If your requirements call for special configurations, RCA packaging specialists—drawing on RCA's broad background in miniature packaging and using RCA's wide range of facilities—will develop special versions of RCA's standard packages, new advanced packaging techniques for your circuit designs, or new solid state circuit packages to solve your packaging problems.

For complete information on RCA's broad circuit packaging capability call your RCA Field Representative. For further technical data, write RCA Semiconductor & Materials Division, Commercial Engineering, Section MN1-1, Somerville, New Jersey.

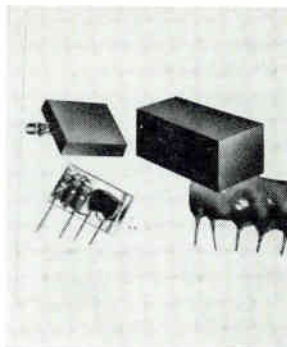

**THE MOST TRUSTED NAME
IN ELECTRONICS**

EAST: 744 Broad St., Newark 2, N. J., HU 5-3900 • 731 James St., Room 402, Syracuse 3, N. Y., GA 4-5591 • NORTHEAST: 64 "A" St., Needham Heights 94, Mass., HI 4-7200 • SOUTHEAST: 1520 Edgewater Dr., Suite No. 1, Orlando, Fla., GA 4-4768 • CENTRAL: Suite 1154 Merchandise Mart Plaza, Chicago 54, Ill., WH 4-2900 • 2132 East 52 St., Indianapolis 5, Ind., CL 1-1405 • 5805 Excelsior Blvd., Minneapolis 15, Minn., WE 9-0676 • 714 New Center Bldg., Detroit 2, Mich., TR 5-5600 • 7905 Carpenter Freeway, Dallas 7, Tex., ME 1-9720 • Continental Terrace Bldg., 2785 North Speer Blvd., Room 301, Denver 11, Colorado, 477-1688 • 605 Marlton Pike, Erlton, N. J., WO 3-8000 • Greater Baltimore Area, 1725 "K" Street, N.W., Washington 6, D.C., FE 7-8500 • WEST: 6801 E. Washington Blvd., Los Angeles 22, Calif., RA 3-8361 • 1838 El Camino Real, Burlingame, Calif., OX 7-1620 • 2250 First Avenue So., Seattle 4, Wash., MA 2-8816 • GOVERNMENT: 224 N. Wilkinson St., Dayton 2, Ohio, BA 6-2366 • 1725 "K" Street, N.W., Washington 6, D. C., FE 7-8500. RCA International Div.: 30 Rockefeller Plaza, N.Y. 20, N.Y. Cable Address: Radiointer, N.Y.