

February 9, 1962

# electronics

A McGraw-Hill Publication 75 Cents

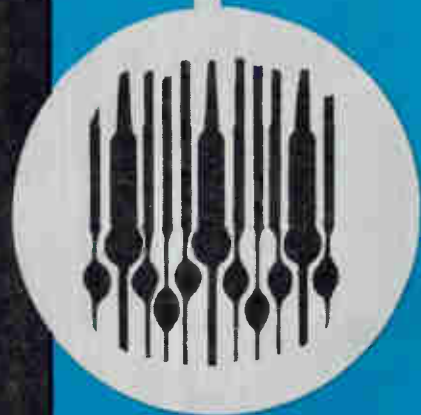

# BIONICS

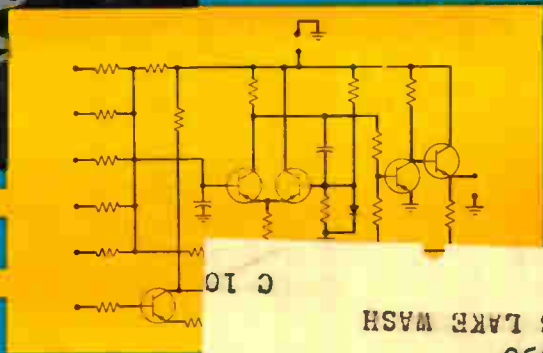
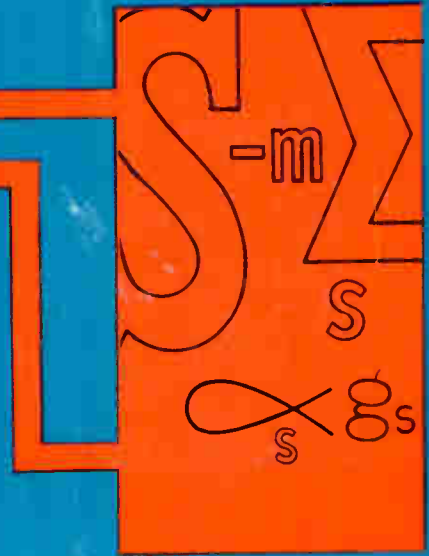
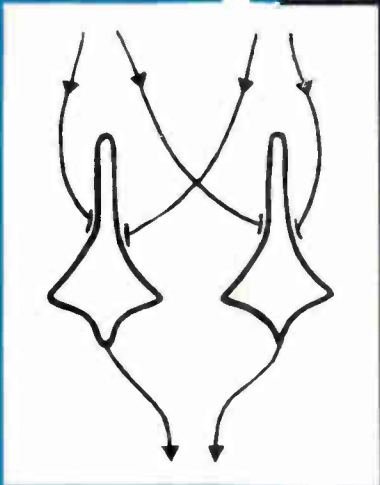

C 10

ROLAND KISSLER  
BOX 956  
ROSES LAKE WASH

# RACK, STACK or CARRY

Each new *hp* instrument is simultaneously a self-stacking bench model, a rack mount instrument, or a readily portable field unit. New *hp* instruments developed since 1960 have been engineered to this master modular plan, based on EIA rack and panel standards. This instrument configuration completely eliminates individual instrument mounting and system assembly problems.

Get the basic story from these pages, then ask your *hp* representative for a demonstration.



Bench model instruments in the new modular form factor are rack mounted merely by removing the feet and attaching two brackets furnished. Shown: Model 716A Klystron Power Supply.



Feet furnished with  modular instruments snap quickly in place without tools, permit "no-slip" stacking. You have a "rack-less rack" that places a maximum of easily arranged instrumentation immediately at hand. Shown: Models 457A AC/DC Converter, 120B Oscilloscope, 5532A Counter.

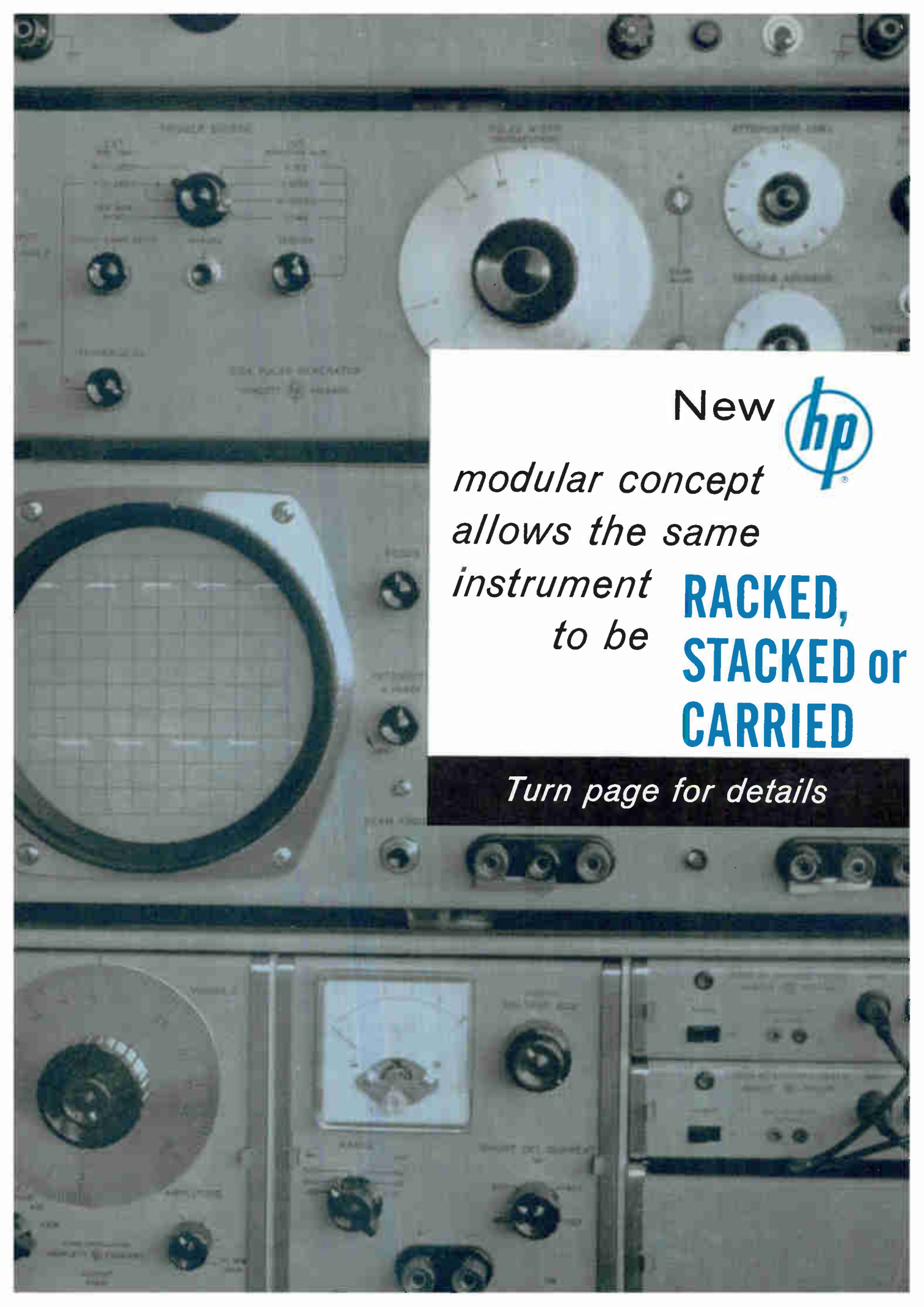

New   
*modular concept  
allows the same  
instrument  
to be* **RACKED,  
STACKED or  
CARRIED**

*Turn page for details*

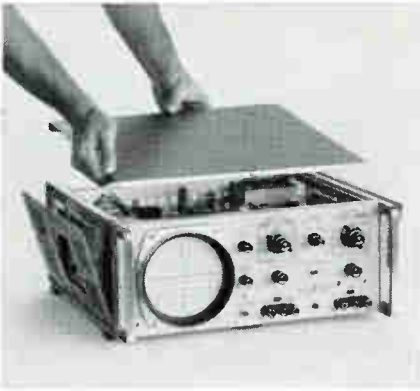

Wasteful duplication of structure, employing internal chassis and frame plus external case, is eliminated in the new  $\Phi$  modular design. All instrument elements are attached to an aluminum frame, and the package "skin"—top, bottom and sides—comes completely free for fast, total accessibility to every part of the instrument. Shown, Model 120B Oscilloscope.



Every new  $\Phi$  modular instrument or sub-module in adapter cabinet is instantly convertible to "brief case" portability by simply latching on an accessory cover panel. The instrument is completely protected and easy to carry.

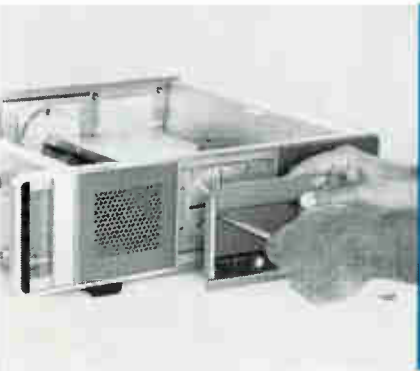

Instrument handles are quickly removable for mounting on low friction slides. Instrument rotates almost 360° on positive detents for complete accessibility without removing it from the rack. Shown (top to bottom and left to right) 723A Power Supply, 204B Oscillator, 456A Current Probe, 495A Microwave Amplifier, 5532A Electronic Counter.



New  $\Phi$  instruments are full rack width,  $\frac{1}{2}$  rack width, or  $\frac{1}{3}$  rack width, depending on their most efficient form factor. Instruments less than full rack width are easily rack mounted or logically grouped for field use by mounting in adapter cabinets available from  $\Phi$ . Cabinet partitions are movable to fit any combination of sub-module instruments. Shown (top to bottom and left to right) Models 723A Power Supply, 204B Oscillator, 456A Current Probe, 495A Microwave Amplifier, 431A Power Meter, 415C SWR Meter.

## HEWLETT-PACKARD COMPANY



1501 Page Mill Road, Palo Alto, California. Area Code 415, DA 6-7000. Sales and service representatives in all principal United States areas; *Europe*, Hewlett-Packard S.A., Rue du Vieux Billard No. 1, Geneva; *Canada*, Hewlett-Packard (Canada) Ltd., 8270 Mayrand Street, Montreal.

7528

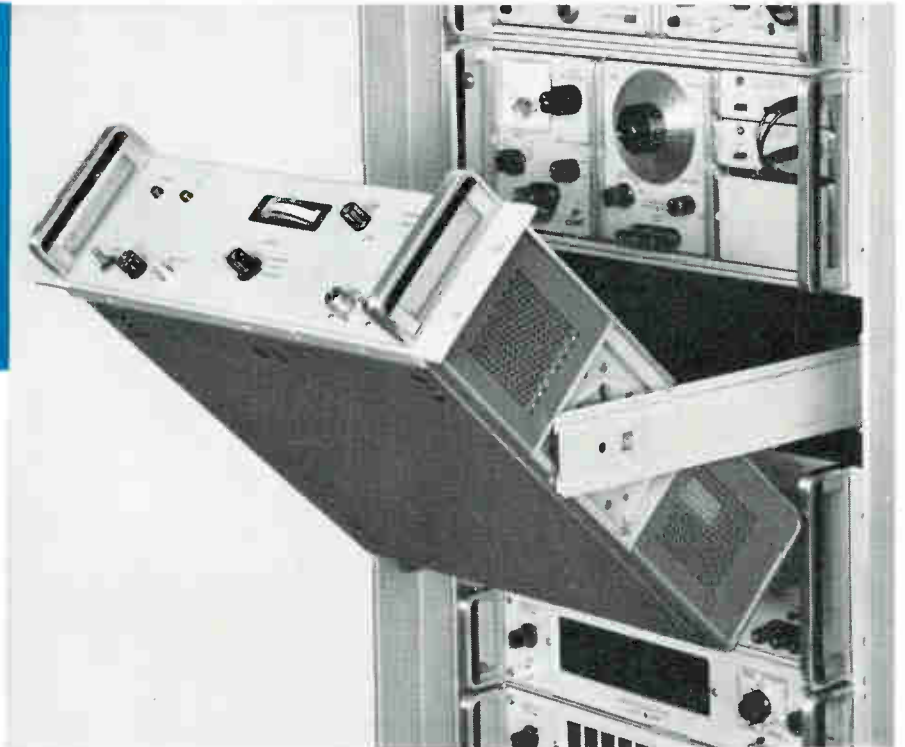

# electronics

A McGraw-Hill Publication 75 Cents



W. W. MacDonald, Editor

J. M. CARROLL, Managing Editor  
 SENIOR EDITORS: Samuel Weber, George W. Sideris. SENIOR ASSOCIATE EDITORS: William E. Bushor, Michael F. Wolff. ASSOCIATE EDITORS: Michael F. Tomaino, Sylvester P. Carter, William P. O'Brien, John F. Mason, Thomas Emma, Sy Vogel, Leslie Solomon, M. M. Perugini, George J. Flynn, Laurence D. Shergalis. ASSISTANT EDITORS: Nilo Lindgren, Stanley Froud, Stephen B. Gray, Roy J. Bruun, George V. Novotny, Leon H. Dulberger. REGIONAL EDITORS: Harold C. Hood (Pacific Coast, Los Angeles), Thomas Maguire (New England, Boston), Cletus M. Wiley (Midwest, Chicago). ART DIRECTOR: Harry Phillips; Howard R. Berry. PRODUCTION EDITOR: John C. Wright, Jr. EDITORIAL ASSISTANTS: Gloria J. Meurer, Bernice Duffy, Lorraine Rossi, Virginia T. Bastian, Lynn Emery, Laura W. Smith, Bette H. Snyder, Rosemary Abbruzzese, Judy Haskins. FOREIGN NEWS BUREAU: Director, John Wilhelm, Alyne Elias. London—John Shinn, Derek Barlow, Nicholas Landon. Bonn—Peter Forbath, James Morrison, Silke McQueen. Paris—Robert Farrell, Arthur Erikson. Milan—Gene DiRaimondo. Mexico City—Bruce Bendow. Rio de Janeiro—Leslie Warren. Moscow—Stewart Ramsey. Tokyo—Richard Hallaron, Charles Cohen, John Yamaguchi.

JAMES GIRDWOOD, Publisher

**SPOTLIGHT ON NERVOUS SYSTEM.** Drawing of human nervous system is surrounded by recent bionics developments. Clockwise: formal representation of neurons, section of rods and cones in retina of eyes, mathematical representation of neuron and electronic neuron. *First article in a four-part series on bionics, p 37* COVER

**MILITARY ELECTRONICS** Engineers Battle Complex Defense Problems. Counter-countermeasures, warhead-decoy discrimination and microminiature telemetry sets are some topics at convention in Los Angeles. *One speaker tells how to increase range of radars by 50 percent* 20

**HOMOGENOUS SEMICONDUCTOR DEVICES** Have Bright Future. Cryosars, bokotrons, ultrasonic wave amplifiers and helicons are some of the devices emerging from research in doped, but junctionless, devices. *These traveling-wave type components have high power at high frequency* 26

**MAGNETODIODE** Looks Like a Promising Computer Switch. Four-terminal, negative-resistance device switches relatively high currents with application of small magnetic field. *Switching rates, now 100 Kc, may be stepped up to megacycle range* 27

**LUNAR SOFT LANDING** Systems. Optical scanning gear, three-dimensional radar and a system that combines inertial, optical and radar techniques are proposed. *Simplest is one that controls rocket thrust by sensing rate of angular change* 28

**MINIATURE COMPUTER** Made of Cores and Wire. Really solid-state computer has only multiaperture cores as active elements. *Developers say it's slow, but reliable and maintenance-free* 30

**BIONICS: Electronics and the Life Sciences.** Part I of a four-part series. Biological systems like a radar-sonar-equipped fishing bat or the infrared homing device of the rattlesnake can help engineers solve perplexing problems. *Applications include self-organizing computer systems and pictorial data processing schemes as well as missile guidance.* N. A. Lindgren 37

**HALL GENERATORS** as Contactless Commutators. A Hall generator can chop d-c in any desired pattern. The d-c voltage is converted to a magnetic field and the pulsed control current is passed through the generator. Both field and current must be present to get the a-c voltage output. *These commutators are fast and experience no contact wear.* T. J. Marcus 43

Contents continued

Published weekly, with Electronics Buyers' Guide and Reference issue, as part of the subscription, by McGraw-Hill Publishing Company, Inc. Founder: James H. McGraw (1860-1948).

Indexed Annually in Buyers' Guide and Reference issue.

Title ® registered U.S. Patent Office; © Copyright 1962 by McGraw-Hill Publishing Co., Inc. All rights reserved, including the right to reproduce the contents of this publication, in whole or in part.

Executive, editorial, circulation and advertising offices McGraw-Hill Building, 330 West 42nd Street, New York 36, N. Y. Telephone Longacre 4-3000. Teletype TWX N.Y. 1-1636. Cable McGrawhill, N. Y. PRINTED IN ALBANY, N. Y.; second class postage paid at Albany, N. Y.

OFFICERS OF THE PUBLICATIONS DIVISION: Nelson L. Bond, President; Shelton Fisher, Wallace F. Traendly, Senior Vice Presidents; John R. Callahan, Vice President and Editorial Director; Joseph H. Allen, Vice President and Director of Advertising Sales; A. R. Venezian, Vice President and Circulation Coordinator; Daniel F. Crowley, Vice President and Controller.

OFFICERS OF THE CORPORATION: Donald C. McGraw, President; Hugh J. Kelly, Harry L. Waddell, Executive Vice Presidents; L. Keith Goodrich, Executive Vice President and Treasurer; John J. Cooke, Vice President and Secretary.

Subscriptions are solicited only from those actively engaged in the field of the publication. Position and company connection must be indicated on orders. Subscription rates: United States and Possessions, \$6.00 one year; \$9.00 two years; \$12.00 three years. Canada, \$10.00 one year. All other countries \$20.00 one year. Single Copies, United States and Possessions and Canada 75¢. Single copies all other countries \$1.50.

THE PUBLISHER, UPON WRITTEN REQUEST FROM ANY SUBSCRIBER TO OUR NEW YORK OFFICE, AGREES TO REFUND THAT PART OF THE SUBSCRIPTION PRICE APPLYING TO COPIES NOT YET MAILED.

Subscribers: Please address all correspondence, change of address notices, subscription orders or complaints to Fulfillment Manager, Electronics, at above address. Change of address notices should provide old as well as new address, including postal zone number if any. If possible, attach address label from recent issue. Allow one month for change to become effective.

Postmaster: Please send Form 3579 to Fulfillment Manager, Electronics, 330 West 42nd Street, New York 36, New York.



Audited Paid Circulation

CONTENTS continued

SEMICONDUCTOR ANALOG of a Cold-Cathode Counter Tube. Decade counter from Poland has ten *p-n* junctions on an *n*-type semiconductor bar with ohmic contacts at each end. *Operating principle resembles that of the unijunction transistor.* A. Ambroziak 46

HIGH-SPEED ENCODING With Resistor-Transistor Logic. Extends design concepts of binary full adder to multistage cascade encoder. *These rtl circuits require few components, reducing cost and improving reliability and speed.* S. C. Chao 48

AUTOMATIC SENSITIVITY CONTROL for Vidicon Tv Cameras. Control voltage first reduces gain of video amplifier until noise output is negligible then starts to reduce target voltage. *Camera adjusts automatically to a 50 to 1 change in scene illumination.* P. C. Kidd 52

DEPARTMENTS

Crosstalk. *Wasted Manpower?* 3

Comment. *Operation Survival, Needles in Space* 4

Electronics Newsletter. *Air Force-Navy TFX Fighter Project Gets off the Ground* 7

Washington Outlook. *Industry Takes Sides on Tariff Reduction: Big Companies Say Yes, Small Firms, No* 12

Meetings Ahead. *Audio Engineering Society Spring Convention* 32

Research and Development. *Coils Operate Stepping Relay at Higher Speed* 60

Components and Materials. *Flash Adjustment of Film Resistance* 70

Production Techniques. *Processing Printed Circuit Boards in Small Shops* 82

New Products Design and Application. *Infrared Photospectrometer, Silicon Rectifier Bridge* 92

Literature of the Week 100

Plants and People. *Itek Begins Major Expansion* 122

Index to Advertisers 138

## Wasted Manpower?

IT WAS RECENTLY STATED by the Army's assistant secretary for research and development that the present method of selecting contractors for military development projects constitutes "a great waste of scientific manpower." When a large number of companies prepare proposals, he said, engineering effort put into the proposals alone is frequently as much as the successful bidder utilizes to conduct the development project itself.

A similar complaint was voiced recently by the Department of Defense's director of electronics. He said he sampled six companies, found that they devote 12 percent of their engineering effort to writing proposals and generally use their best engineers for this.

The problem has been even more widely recognized for some time, and a number of suggestions have been made to reduce the "waste." But most suggestions beg the real problem. Speaking bluntly, it is the government that controls and perpetuates the bidding methods now used. And it is the government's responsibility to find and put into practice a method acceptable to both government and industry.

One suggestion is that the government be more selective in choosing the companies it invites to prepare proposals. But, bureaucracy being what it is, this might channel the bulk of military R&D into a relatively few companies of known competence and, by ignoring lesser-known firms, cut the military off from fruitful ideas.

Another suggestion is that government scientists originate or manage systems development. This isn't new—it is already being done by the military through their own laboratories and non-profit engineering contractors. But government scientists are no less fallible than industry's scientists, and probably chase up as many blind engineering alleys. If they aren't allowed to "waste their time" investigating several approaches, the government will again be restricting the amount of brainpower brought to bear on a project.

Moreover, industry has protested—rightly so, we think—that if government keeps advanced development in-house it will weaken our strongest defense, the energy and inventiveness of private

industry. The philosophy of "let the government invent it" runs counter to the tradition and practice of free enterprise, which has made the United States a great industrial power.

A third suggestion is that the government continue to solicit proposals from all firms with the inclination and ability to tackle a projects, but that the proposal merely outline approaches to a system without working out engineering details. The approaches would then be evaluated by government scientists. Detailed proposals would be invited only from companies submitting approaches considered most feasible.

This compromise has, in fact, been suggested by DOD's director of electronics. We think it is a good alternative to present practice. One basic groundrule would be needed: if a company submits a usable idea it gets first crack at the R&D contract. If the government has an overriding reason for placing the engineering work work elsewhere then the originators of the idea should be compensated fairly.



### Coming in Our February 16 Issue

SOLID STATE commutator using electroluminescent and photoconductive elements is described by R. D. Stewart, of General Electric. Since light from the elements couples with photoconductors in this commutator, some physical interconnections are eliminated. This makes for greater fabrication simplicity than, for example, in a comparable transistor commutator. Another report in this issue outlines British developments, as revealed at their annual physics show. The reporter is our man in London, Derek Barlow. The British, by the way, are going to restrict exhibits at next year's show to devices and equipment deemed novel by a scientific screening committee.

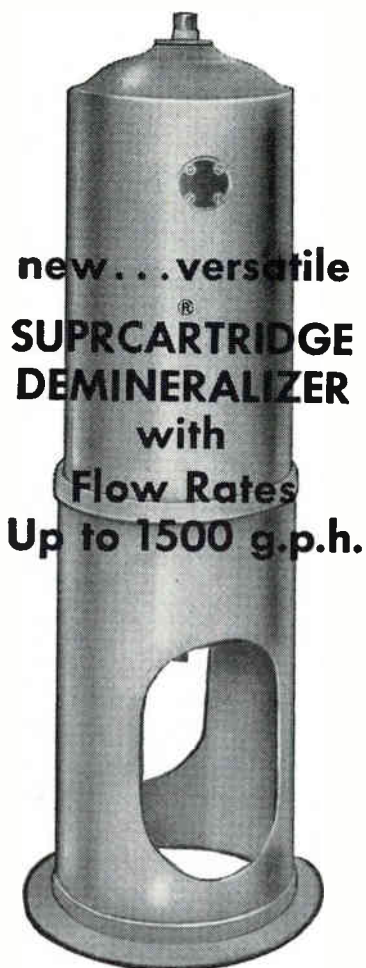

new... versatile  
 SUPRCARTRIDGE  
 DEMINERALIZER  
 with  
 Flow Rates  
 Up to 1500 g.p.h.

- 1 Can be used anywhere in your plant under pressure up to 100 p.s.i.
- 2 Combines high flow rates with convenience of cartridge operation.
- 3 Permits cartridge renewal to suit individual requirements.
- 4 Regenerator available for reactivating cartridges in your own plant.
- 5 High flow rates at lowest equipment cost.
- 6 Cartridge with holder occupies space of only 15" x 15" x 46" high.
- 7 Suprcartridge may be installed at one or at several convenient locations in your plant.

Write for new Suprcartridge  
 Bulletin #177.

**Barnstead**  
 STILL AND STERILIZER CO.

84 Lanesville Terrace, Boston 31, Mass.

## COMMENT

### Operation Survival

I have just finished reading your special report entitled Nuclear Attack and Industrial Survival, appearing in the Jan. 12 issue (p 35). You deserve the highest commendation for preparing and publishing this most graphic and informative manual of information.

Do you plan to make this available as a separately bound publication?

E. F. JOHNSON  
 President

E. F. Johnson Company  
 Waseca, Minnesota

This 16-page report was actually prepared by 19 McGraw-Hill editors, and appeared last month in all 29 domestic McGraw-Hill and F. W. Dodge publications.

Reprints are available at 20¢ each for less than 100; 15¢ each for 100 or more; 10¢ each for 1,000 or more. Address "Operation Survival," P. O. Box 573, Times Square Station, New York 36, N. Y.

### Needles in Space

I must take issue with you on your observations in *Crosstalk* (p 4, Nov. 24, 1961). There can be no moral justification for any country to project "needles" over, or pollute with radio-activity the air in, any other country. If you wish to foul your own backyard, that is your own prerogative, but if you wish, on the woolly premise that these are not normal times, to contaminate the air in any other country, or interfere with the space over any other country, then it should be self-evident that the permission of that country should be obtained first.

As a widely-read periodical, surely your attitude to fundamental principles should be more mature than that displayed by your flip-pant comment.

K. H. ULLYATT  
 Ottawa, Ontario, Canada

The editorial concerning Project West Ford's orbiting dipole belt was not published lightly, but only after weighing the objections

of some radio astronomers and others. The West's access, through possible man-made interference, to the normally-used long-range communications media must be insured. Evidence that such interference can be accomplished is extensive. Survival, it seems to us, qualifies as moral justification.

Further, we have been careful to report objections to the project (see, for example, p 29, Sept. 8, 1961). It is notable that all such protests, by Westerners, that have come to our attention have been private opinions, not official protests. Quite obviously, the Canadian government, and other Western governments, share our view that anything which increases the West's chances of maintaining defense communications is worth whatever inconvenience it may cause.

There is, as yet, no proof that any inconvenience would result. Plans are to disperse the dipoles about a quarter of a mile apart, and the dipoles themselves are about the size of an eyelash. As for polluting space, the difference between a dipole belt and other satellites is merely a matter of degree. In any event, the number of dipoles would be infinitesimal compared with the number of natural particles that exist in space.

### Core Memory

In the Dec. 29 issue (p 28) you ran an article, Iterative Techniques Widen Applications of Analog Systems, which discussed the equipment shown at the Eastern Joint Computer Conference. The third paragraph on p 29 states that the "basic unit of the TM-4 tape memory is a plastic strip with 30-mil ferrite cores mounted along the edge."

This is incorrect. The 30-mil core strip is the basic unit of the LQ Ferrite Core Memory, which is discussed in paragraphs two and three on p 29. The TM-4 is a digital tape handler that employs vacuum buffer chambers and tape tensioning arms for better start and stop characteristics, with gentle tape handling.

ROLLIN BAUGH  
 Ampex Corporation  
 Redwood City, California



# TUNG-SOL HIGH PERFORMANCE

GENERAL PURPOSE  
MINIATURE COMPUTER TRIODE

## 7719

Directly replaces parallel-connected 5965 and 7062 twin-triodes while providing these added advantages for designers of computer circuits:

- Higher transconductance
- Very sharp cut-off
- Much higher plate dissipation
- Linear transfer characteristics
- Very high perveance
- Improved reliability

The Tung-Sol 9-pin miniature 7719 general purpose triode is the latest addition to the Tung-Sol family of top-rated, high-reliability tubes for computer service. Rated at 6 watts plate dissipation, the 7719 incorporates many design and construction features which assure computer users the maximum number of hours of trouble-free peak performance.

### CHECK THESE ADDITIONAL BENEFITS:

- Freedom from cathode interface and reduced electrical leakage . . . Achieved through use of a passive cathode alloy and lower heater power per unit area.
- Minimization of grid emission . . . The 7719 is designed with heavy grid support wire and a double connection to the grid for cooler operation allowing use of 1 megohm grid circuit resistance.
- High stability . . . Use of heavier stock plate material assures more even distribution of heat and lower plate temperature. Cool operation further guaranteed by cool cathode and low bulb temperature (175°C at 6 watt dissipation).
- Very little "island" formation . . . Optimized geometry minimizes island formation thereby providing sharp cut-off, linearity and high perveance.

Typical applications of the 7719 are found in totem pole amplifiers to drive function-generating potentiometers, cathode followers, and multivibrators. Full technical details on the 7719 are available immediately on request.

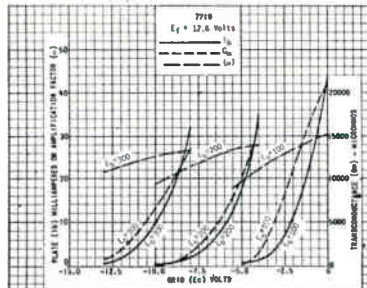

### RATINGS

Heater Voltage (Series)	12.6 ± 0.6	Volts
Heater Voltage (Parallel)	6.3 ± 0.3	Volts
Maximum Plate Voltage	330	Volts
Maximum Plate Dissipation	6.0	Watts
Maximum DC Cathode Current	40	Ma.
Maximum Heater-Cathode Voltage:		
Heater Negative With Respect to Cathode <sup>®</sup>		
Total DC and Peak	200	Volts
Heater Positive With Respect to Cathode:		
DC	100	Volts
Total DC and Peak	200	Volts
Maximum Bulb Temperature	175	°C

 **TUNG-SOL<sup>®</sup>**

Technical assistance is available through: Atlanta, Ga.; Columbus, Ohio; Culver City, Calif.; Dallas, Texas; Denver, Colo.; Detroit, Mich.; Irvington, N. J.; Melrose Park, Ill.; Newark, N. J.; Philadelphia, Pa.; Seattle, Wash. In CANADA: Abbey Electronics, Toronto, Ont.

# FOR Bi-directional power monitors, 2 to 1000 MC, POWER 1 to 1000 watts! MEASUREMENT



- Four power level ranges with each plug-in
- Power range down to 1 watt full scale
- Nine plug-ins for wide frequency coverage
- Linear scale on all power ranges
- No correction factor required for calibration on any range

Power is read directly on a linear scale with accuracy of  $\pm 5\%$  on Sierra 164 Series Bi-Directional Power Monitors, which permit intermittent or continuous measuring of incident and reflected power, plus convenient matching of loads to lines. Direct connecting, they measure forward and reverse power merely by turning a plug-in control. No connections to switch.

Complete frequency coverage is provided with nine plug-in elements, each offering four power ranges selectable by the turn of a knob. Power capacity ranges from 1 watt full scale to 1000 watts full scale, frequency coverage from 2 to 1000 MC. Plug-in versatility is indicated in the adjacent table.

Calibration is adjustable on each range independently, so that no correction factor need be applied. The power monitors are available with Type N, C, LC, HN or UHF male or female connectors. High directivity and low insertion VSWR assure maximum accuracy with minimum disturbance to the transmission line under test. No auxiliary power is required.

Sierra Model 164  
Power Monitor, \$110.00.

PLUG-IN ELEMENTS FOR MODEL 164

Model	Full-Scale Power (Watts)	Frequency Range
180-52	0-1/5/10/50	25-52 MC
180-148	0-1/5/10/50	50-148 MC
180-470	0-1/5/10/50	144-470 MC
180-1000	0-1/5/10/50	460-1000 MC
181-250	0-10/50/100/500	25-250 MC
181-1000	0-10/50/100/500	200-1000 MC
270-30	0-50/100/500/1000	2-30 MC
270-75	0-50/100/500/1000	10-75 MC
270-470	0-50/100/500/1000	70-470 MC

## Plus these Power Measuring Instruments

**Directional Couplers** for VSWR, reflection coefficient, power measurements, 1 to 1200 MC. Seven models available covering power levels to 100C watts. \$120 to \$150.

**50-Ohm Coaxial Loads**, including the new 160-1200 three-way termination, 0-1000 MC, with associated accessories for power capacities of 1200, 2000 and 3000 watts. Model 160 Series Loads also available in 1, 5, 20, 100 and 500 watt sizes.

**Low Pass Filters**, to 400 MC, provide low insertion loss (max. 0.4 db in pass band), sharp cut-off, max. 1.5 VSWR, rejection greater than 60 db from 1.25 to 10 times cut-off frequency. Five models, cut-off 44, 76, 135, 230, 400 MC. Power range, 250 watts in pass band, 25 watts in rejection band. \$100 each.

**Termination Wattmeters:** Sierra Series 185 average-reading termination wattmeters, to terminate rf coax lines and measure rf powers, 2 models 0 to 30/100 and 0 to 150/500 watts, 20 to 1000 MC, accuracy  $\pm 5\%$ , max. VSWR 1.2. Model 185A-100, \$260; Model 185A-500, \$375.

*Data subject to change without notice. Prices f.o.b. factory*



## SIERRA ELECTRONIC CORPORATION

A Division of Philco Corporation

7307A BOHANNON DRIVE • DAVENPORT 6-2060 • AREA CODE 415 • MENLO PARK, CALIF., U.S.A.

Sales representatives in all major areas

Canada: Atlas Instrument Corporation, Ltd., Montreal, Ottawa, Toronto, Vancouver  
Export: Frazer & Hansen, Ltd., San Francisco

# ELECTRONICS NEWSLETTER

## TFX Fighter Program Gets off the Ground

WASHINGTON—Air Force has awarded study contracts to General Dynamics' Fort Worth division, with Grumman as an associate, and to Boeing for detailed designs of an advanced TFX fighter plane. Within 90 days, one of the two companies will be selected to go ahead with full-scale development.

According to a source here, the project will blossom into "the biggest military aircraft order since World War II."

TFX will be built for both Air Force and Navy, reflecting efforts by Defense Secretary McNamara to have both services use the same advanced fighter. But there will be minor design differences so Air Force can use it as a fighter-bomber and Navy as a carrier-based fighter.

No details on electronic gear were available yet, but Navy is to install its own fire control system (ELECTRONICS, p 14, Dec. 29, 1961).

## Photosensing Semiconductor Is Submillimeter Detector

LONDON—Royal Radar Establishment has developed a fast-response semiconductor device for detecting radiation in the 0.2 to 8.6-mm band. It is made photoconductive at these wavelengths by applying a 6,000-gauss magnetic field to reduce impurity interactions in *n*-type indium antimonide. A superconducting niobium solenoid provides the field. The device operates at temperature of 1.5 K.

## Air-Cooled Laser Gives Kilowatt Output Power

GENERAL ELECTRIC reported this week that it has developed an air-cooled ruby laser which fires at a rate of 10 bursts per second, giving a peak output power of 1 Kw for an input of 200 watt-seconds (2 Kw for 1/10 sec). Duration of individual bursts is 200 microseconds.

The laser is intended for use in optical radar. J. P. Chernoch, project engineer at GE's General Engineering Lab, said high-intensity bursts are more suited to long-

range operation than lower-power c-w laser beams.

A ruby 3 in. long and  $\frac{1}{4}$  in. in diameter is being used. Experiments in welding and heat-cutting of metals and ceramics are also being made, using a ruby eight inches long. GE says the main problem remaining is increasing efficiency, so size and weight of equipment can be reduced.

## Matched Mounts Double Varactor Paramp Band

MOUNT-MATCHING technique will double percentage bandwidths of varactor parametric amplifiers of either reflection (negative resistance) or upconverter types, B. B. Bossard and R. Pettai, of RCA, reported at the AIEE meeting last week.

They got 9.5 db gain, a 3-db bandwidth of 830 Mc and noise figure of 1.8 db in an S-band paramp,

## Something for Everybody

LOS ANGELES—There'll be drastic changes in WESCON's technical program format this year, according to David Langmuir, chairman, and Urner Liddel, vice chairman of the technical committee.

Under consideration is confining hardware and circuits papers to morning sessions, devoting afternoons to authoritative discussions of industry developments and progress in terms businessmen can understand.

The usual 40 sessions will likely be reduced to 20. Some 80 papers will be chosen from the 400 expected to be submitted. About 1,240 exhibits booths are anticipated

while other reflection types showed single-channel amplification bandwidths over 2 Gc.

Self-resonant properties of the varactor diode are matched to pass-band characteristics of a holding structure. The mount provides an optimum impedance load for the diode, by a simple impedance transformer. Structural arrangement and control of varactor bias voltage also give broad bandpass idler circuits. A minimum of external circuits are needed.

## French Are Working On Submillimeter Carcinotron

CSF, OF FRANCE, is developing a 0.5-mm Carcinotron, it was revealed at the AIEE meeting in a paper by G. Convert (presented by P. Guenard). The tube is expected to oscillate with 100-amp per sq cm beam.

At 4 mm, output of 10 to 15 watts has been obtained and one Carcinotron has operated several hundred hours at 0.7 mm with more than 2 mw output. An experimental 1-mm, 1-watt c-w tube is expected in a year.

## Japanese Firm Plans Color Tv Using Lawrence Tubes

TOKYO—Sony has filed an application seeking government approval for technical licensing agreements on the single-gun Lawrence color tv tube. The company is buying manufacturing and sales rights from Paramount Pictures Corp. The contract calls for cooperation to perfect the tube for commercial production. Sony also said it plans to come out with the new color set during the second half of 1963.

## Modified Tacan Will Tell Plane-to-Plane Distance

TACAN air navigation sets in Navy planes will be modified to indicate to pilots how far one aircraft is from another, as well as giving distance and direction from Tacan ground stations.

General Dynamics/Electronics will supply modification kits under a \$2.1-million contract. A transistor modulator will be substituted for

the vacuum-tube modulator now in airborne sets.

Air-to-air ranging, GD says, will improve Tacan's tactical utility. Potential applications include use as a beacon for aerial rendezvous, refueling and maintaining transport plane spacing.

## Radar Set to Measure Velocity of Projectiles

RADAR CHRONOGRAPH sets to measure the velocity of field artillery and anti-aircraft shells will be produced by Admiral under a \$425,000 Army contract. Detecting projectile speed by continuous wave doppler shift, it will operate at 10.5 Gc and display speed in ft per second after a preselected delay of up to  $\frac{1}{2}$  second.

## IRE-AIEE Merger Plans Outlined at AIEE Meeting

MECHANICS of effecting the proposed consolidation of IRE and AIEE were tentatively outlined at the AIEE meeting last week. Some of the plans are:

To call the organization the Society of Electrical and Radio Engineers (SERE) or possibly Institute of Electrical and Electronic Engineers (IEEE); to have seven regions in North America and an eighth for the rest of the world; to make each IRE or AIEE section a SERE section.

Professional technical groups would be based on existing groups in each society. Membership grades would correspond to existing grades and dues would be the lowest now prevailing in each society for each grade. Two general meetings would be held yearly.

## Nuclear Power Generator To Produce 10w for 10 years

ROYAL RESEARCH CORP., Hayward, Calif., announced last week that it will produce a radioisotope-fueled (cesium-137 or strontium-90) thermoelectric generator which will produce 10 watts for 10 years.

The company says it costs \$44,000 (\$400 a watt-year), occupies 1.27 cu ft (0.013 cu ft/watt-year) and weighs 400 lb. It will withstand an

ocean depth of 36,000 ft.

Operation is similar to the AEC's Snap systems. The company says design is an outgrowth of R&D for AEC on a 5-watt, 3 to 5-year power source to be used by Lamont Geological Observatory in a deep-ocean seismic station.

## Strain Gages and Computer Weigh Moving Freight Cars

CHICAGO—International Railroads Weighing Corp., Northfield, Ill., says it has a strain gage-computer system that weighs freight cars as they move through yards at 6 mph. Weight is printed out after an analog-to-digital converters averages hundreds of wheel hits on a weigh-bridge. A car is weighed in three-fourths of a second.

American Railway Engineering Association says it tested the system on 15 cars a year ago, but that results were inconclusive and tests by railroads were recommended. AREA said it weighed 15 cars, found all but one came within its test tolerance of 0.2 percent.

The company says it now has the approval of the Association of American Railroads. It estimates the potential market at 4,000 systems.

## Agency Will Battle Air Force's Information Bulge

LAST WEEK, the Air Force Office of Scientific Research set up a new agency, the Directorate of Information Sciences. One reason: information is being produced faster than it can be handled or used efficiently.

The directorate will use the entire Office of Aerospace Research as a "pilot plant" for new techniques. The directorate will also survey all communications methods, including electronic data processing.

Harold Wooster, the new director, estimates as much as 90 percent of basic research done in the past has been lost or unrecorded. One Air Force project to code and index research reports "rediscovered" 3,000 reports worth \$36 million.

The directorate will have two divisions, research and technical information.

## In Brief . . .

FORD will be offering two-way, five-channel, citizens-band radios made by Raytheon as optional equipment in 1962 cars.

PHOTOTYPESETTER using a magnetic-to-punched tape converter is being offered by Mergenthaler Linotype to people who want computer data set in regular type or book form.

CHEM-ELECTRO RESEARCH, Van Nuys, Calif., reports a new line of barium-titanate capacitors as small as 0.06 by 0.075 inch.

ANTICIPATION of commercial f-m broadcasting in Japan this year has set manufacturers planning increased production, cuts in domestic and export prices.

BENDIX is selling hospitals an automatic, conveyor-fed ultrasonic cleaner for surgical instruments and small utensils.

ETHIOPIA has given Page Communications Engineers a \$2.3 million contract to modernize equipment at 23 airports.

NAVY is supplying an AN/FPQ-6 radar (p 26, Dec. 15) to NASA's Wallops Station, for \$4 million.

MILLION-DOLLAR contracts include \$4 million to Norden for search radar and data processing units for Navy's new A2F-1 Intruder aircraft; \$2.2 million to General Dynamics/Electronics for AN/ARM-53 and 54 asw system checkout equipment; \$1.4 million to Barnes for infrared horizon sensors for Agena space vehicles.

OTHER CONTRACTS include \$648,178 to Hoffman Electronics for tacan sets; \$500,000 to Maxson Electronics for asw devices; \$475,000 to Martin-Marietta for digital multimeters; \$465,000 to Potter Instrument for line printers; \$360,000 to Craig Systems for transportable equipment shelters; \$345,000 to General Atronics for radar test and other studies; \$354,000 to Electro-Optical Systems for additional R&D on electric propulsion engines.

# Now! For the first time...



## TEST ELECTROLYTIC CAPACITORS

**Safely...  
Accurately...  
Simply!**

### SPECIFICATIONS

#### Capacitance

Range: 0 to 120,000 $\mu$ F at 120 cps  
Accuracy:  $\pm$ (1% of reading + 10 $\mu$ F)  
Sensitivity:  $\pm$ (0.1% of reading + 10 $\mu$ F)

#### Dissipation Factor

Range: 0 to 120% at 120 cps  
Accuracy:  $\pm$ (2% of reading + 0.1% DF)  
Sensitivity:  $\pm$ (0.2% of reading + 0.05% DF)

#### Maximum Voltage to Unknown

A-C: 0.5v RMS at 120 cps  
D-C: 0-600v (external)

#### Null Detection

Built-in Galvanometer to  
Indicate Bridge Balance

#### Power Input

105-125v, 60 cps, 15w

#### Case

Sturdy Aluminum Cabinet with  
Blue Textured Finish, Grey Panel

#### Dimensions

12" Wide x 12" High x 9" Deep

Note: Also available in 115v and 230v, 50 cps models

■ The Sprague Model 1W1 Capacitance Bridge introduces a new concept in bridge design. Built by capacitor engineers for capacitor users, it incorporates the best features of bridges used for many years in Sprague laboratories and production facilities.

■ The internal generator of the 1W1 Bridge is a line-driven frequency converter, and detection is obtained from an internal tuned transistor amplifier-null detector, whose sensitivity increases as the balance point is approached. It has provision for 2-terminal, 3-terminal, and 4-terminal measurements, which are essential for accurate measurement of capacitors with medium, low, and high capacitance values, respectively.

■ The Model 1W1 Capacitance Bridge will not cause degradation or failure in capacitors during test, as is the case in many conventional bridges and test circuits. The 120 cycle a-c voltage, applied to capacitors under test from a built-in source, never exceeds 0.5 volt! It is usually unnecessary to apply d-c polarizing voltage to electrolytic capacitors because of this safe, low voltage.

For complete technical data on this precision instrument, write for Engineering Bulletin 90,010 to Technical Literature Section, Sprague Electric Company, 35 Marshall Street, North Adams, Massachusetts.

### ELECTRONIC PRODUCTS by SPRAGUE

CAPACITORS

RESISTORS

MAGNETIC COMPONENTS

TRANSISTORS

INTERFERENCE FILTERS

PULSE TRANSFORMERS

PIEZOELECTRIC CERAMICS

PULSE-FORMING NETWORKS

HIGH TEMPERATURE MAGNET WIRE

CERAMIC-BASE PRINTED NETWORKS

PACKAGED COMPONENT ASSEMBLIES

FUNCTIONAL DIGITAL CIRCUITS

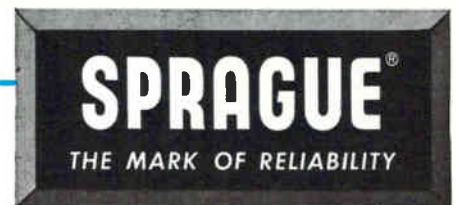

'Sprague' and '®' are registered trademarks of the Sprague Electric Co.

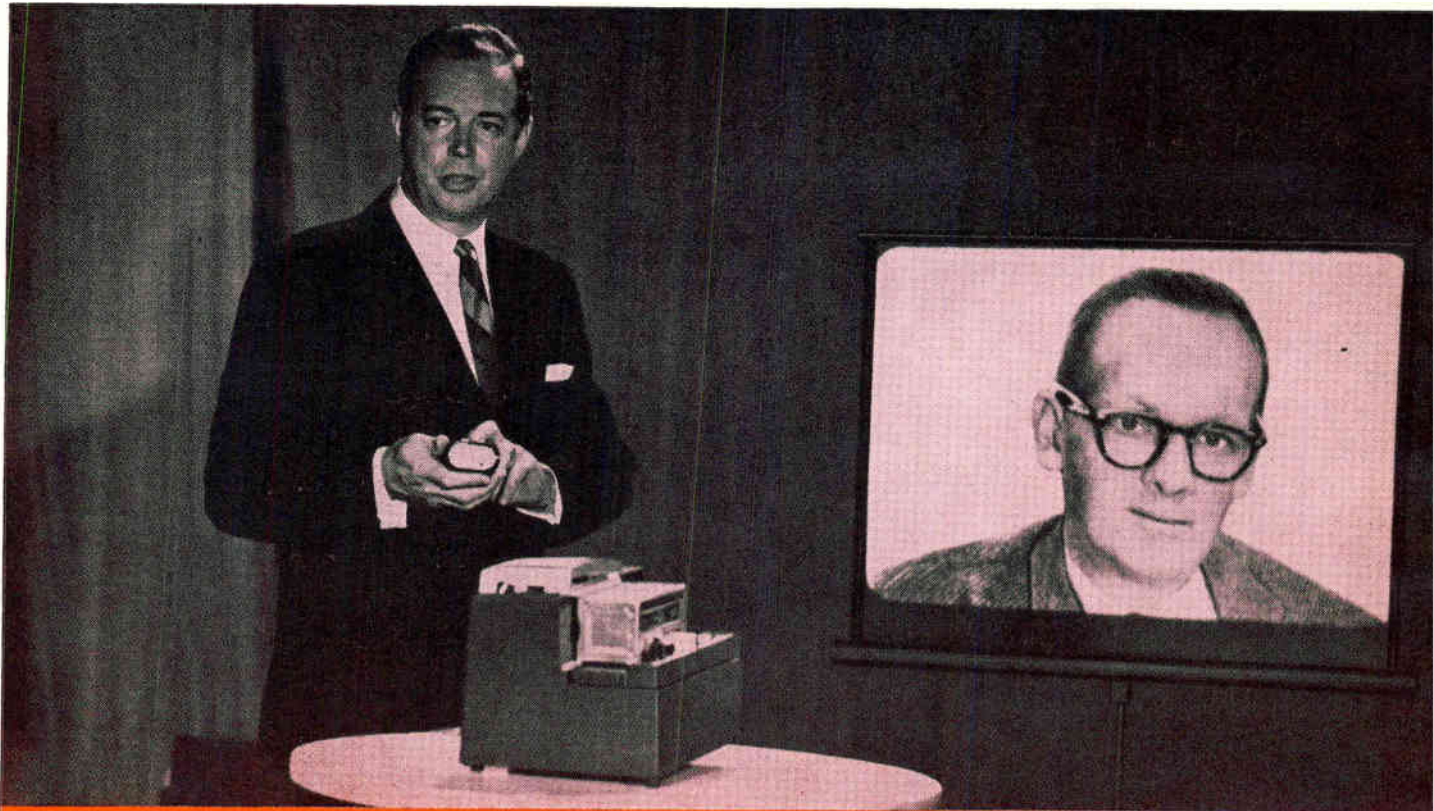

**SLIDE SHOW BY REMOTE CONTROL** Slides are changed and focus is sharpened by tiny wireless remote control unit with new Airequipt Superba Sonic projector. Mallory Mercury Batteries were chosen for control unit because of their higher energy content, lower internal resistance, long service life . . . plus greater convenience to the user because of less frequent battery changes.

## Put extra sales power into new products

Scale down the size of your new product. Make it more easily portable. Add to its service life and dependability. Turn battery power into selling power . . . by designing with Mallory Mercury Batteries.

These are the high-performance batteries chosen for reliability in ultra-critical military and space applications, and for superior service in many kinds of industrial and consumer products. Here's why.

Mallory Mercury Batteries deliver 3 to 4 times more energy per unit volume, last 3 to 5 times longer than conventional batteries. Voltage remains steady during their discharge life, relatively unaffected by temperature from  $-65^{\circ}$  to  $+80^{\circ}\text{C}$ . They withstand temporary overloads of up to 1 amp. Mallory Mercury Batteries can be stored for six years or more without serious loss of capacity. And they're leakproof.

Choose from a broad line of single or multiple voltage cells. Custom power packs developed on request. Write for engineering data or to arrange a consultation.

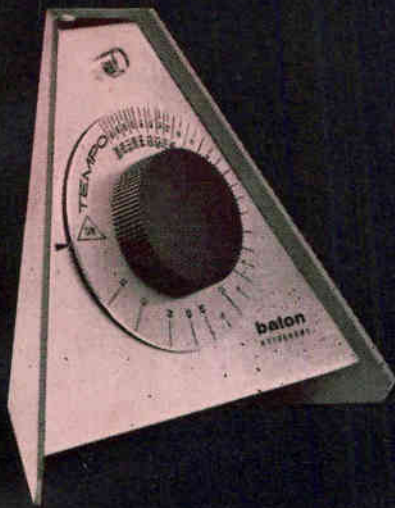

**TRANSISTORIZED METRONOME**, the "Baton" designed and made by Connecticut Technical Corporation, flashes in synchronization with audible beat, is powered by Mallory Mercury Battery that provides 5 years or more average service. Mallory was selected for constant voltage discharge, long-term service.



## with Mallory Mercury Batteries

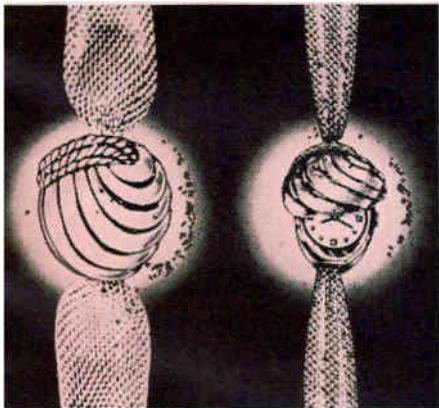

**LUCIEN PICCARD WATCH WITH BUILT-IN LIGHT** New "Lumin-escape\*" is tiny watch with flower-seed-size bulb that lights when cover is raised. Mallory Mercury Battery was choice for small size, long-lived dependability. Battery is scarcely larger than a sequin.

\*Trade Mark Registered by Lucien Piccard

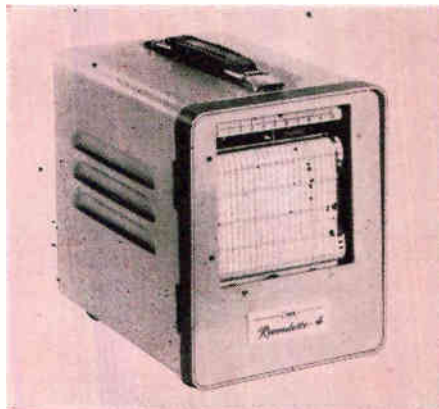

**PORTABLE POTENTIOMETER** New recorder made by Instrument Corporation of America uses Mallory Mercury Battery as constant voltage reference against which input signal is nulled by potentiometer circuit. Mallory was specified for enduring voltage precision of  $\pm 1/2\%$ , freedom from leakage, long life in service and storage.

*Mallory Battery Company  
North Tarrytown, N.Y.  
a division of P. R. Mallory & Co. Inc.*

**P. R. MALLORY & CO. Inc.**  
**MALLORY**

*Mallory Batteries Ltd., Crawley, Sussex, England  
Mallory Battery Company of Canada Limited,  
Clarkson, Ont.*

# WASHINGTON OUTLOOK

**ELECTRONICS PRODUCERS** are split over the President's request for broad authority to negotiate tariff cuts with the European Common Market and other industrial countries of the world—including Japan.

Some big companies are lining up in favor of the idea. Many smaller outfits, particularly those making parts and components, want protection against low-cost imported items that are competing with them for business.

The parts division of the Electronic Manufacturers Association, led by Robert Sprague, of Sprague Electric, has set up an information program to circulate in the industry—not publicly—data on impact of imports on their business. Sprague has testified in Congress on the subject, too.

Kennedy wants authority to negotiate away completely over a five year period the tariffs on items for which Europeans and the U.S. account for 80 percent of world trade. On other products he wants authority to cut tariffs by 50 percent. However, there are provisions he asks that would enable him to keep present protection for the import sensitive industries.

It's around the specifics of this part of the program that most of the battle will rage. At the moment, the best guess is that a bill isn't likely to be approved by the Committee before June. In general, the outlook for passage of legislation acceptable to the administration is good.

## HOW MUCH WILL TARIFF CUTS HURT?

**TOP-RANKING** military procurement officials will gather at a special procurement management improvement conference to be conducted by the Pentagon at Williamsburg, Va., Feb. 14-16. The meeting is closed to industry. Over 200 officials will participate in the session.

The meeting, the first of its kind, will be a brainstorming session on such questions as incentive contracting, procurement authorities and responsibilities, small business awards and subcontracting.

## DEFENSE BUYERS TO HUDDLE

**FINAL HEARINGS** on easing patent regulations of the National Aeronautics and Space Administration have been held by the House Committee on Science and Astronautics' subcommittee on Patents and Scientific Inventions.

Purpose is to change the National Space Act so NASA can take patent rights on contracting developments, but would not be required to do so. Now, NASA can waive patent rights, but the administrator must justify such action. As a result, only six or seven waivers have been issued.

Overshadowing the bid to alter Space Act patent provisions is a move to write one uniform policy for all government agencies on patents developed under government contract by industry. Each agency now has its own patent policy. Despite congressional and administration desires for a uniform patent policy, there seems little chance for one this year.

## HELP ON PATENT GRAB?

**FIRST LOAN** to an electronics company has been made under the new area redevelopment program. Semi-Onics of Lowell, Mass., a new firm that makes transistors, resistors and capacitors, has received \$97,500. The loan runs for 10 years, interest is four percent a year.

Granted by the Commerce Department's Area Redevelopment Administration, which provides aid to communities with persistently high unemployment rates, the loan will supplement local private and public investment. It will purchase equipment and machinery, resulting in employment of 110 persons.

## FEDERAL LOAN TO COMPANY



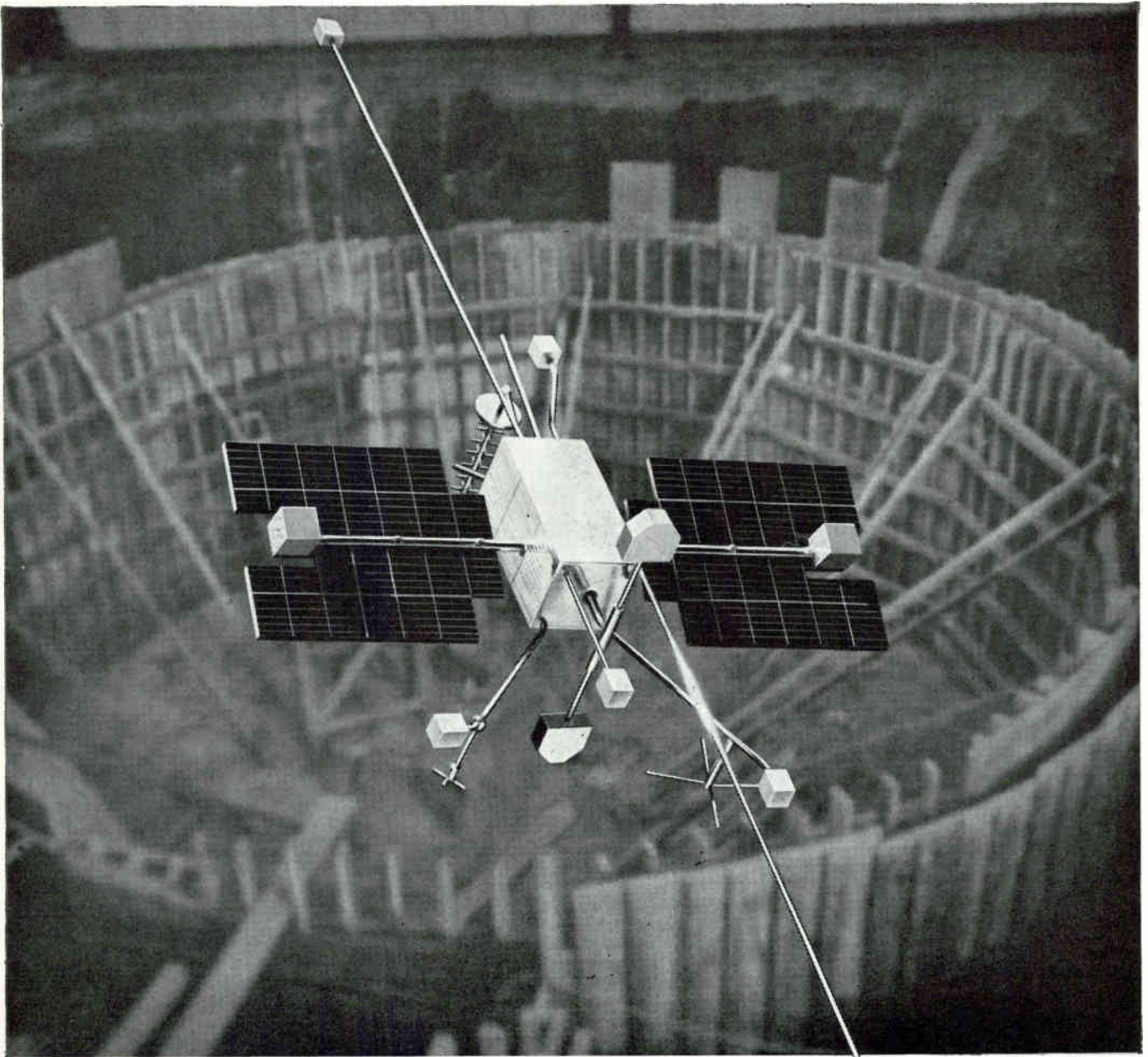

## Today OGO hovers above a crater on earth

Soon a new space chamber 30 feet in diameter will fill this deepening bowl of earth. Here OGO (NASA's Orbiting Geophysical Observatory) will be subjected to conditions of solar heating, vacuum, and vehicle radiation to the cold of outer space. The new space chamber will be the sixth at STL. It will enable engineers and scientists working on OGO, Vela Hotel and other STL projects to test large, complete spacecraft as well as major subsystems. And along with other advanced facilities at STL's Space Technology Center, it will provide unusual scope for engineers and scientists to verify and apply new techniques in design, development and fabri-

cation of spacecraft. STL's expanding space programs have created new opportunities for engineers and scientists in the following fields: Aerodynamics, spacecraft heat transfer; Communication Systems; Electronic Ground Systems; Power Systems; Propellant Utilization; Propulsion Controls; Re-entry Body Evaluation; Systems Analysis; Thermal Radiation; and Trajectory Analysis. All qualified applicants are invited to write Dr. R. C. Potter, Manager of Professional Placement and Development, for opportunities with STL in Southern California or at Cape Canaveral. STL is an equal opportunity employer.



**SPACE TECHNOLOGY LABORATORIES, INC.**

*a subsidiary of Thompson Ramo Wooldridge Inc.*

P.O. Box 95005-J, One Space Park, Redondo Beach, California • P.O. Box 4277, Patrick AFB, Florida

Los Angeles • Vandenberg AFB • Norton AFB, San Bernardino • Dayton • Cape Canaveral • Washington, D.C. • Boston • Huntsville

# FREQ. STDS.

## AND PRECISION FORK UNITS 1 TO 40,000 CYCLES

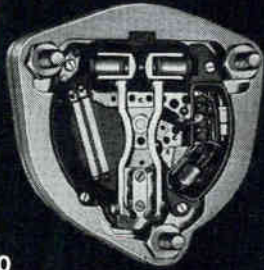

**TYPE 10**  
1 3/8" x 1 3/8" x 3/8"

This frequency standard (360 or 400 cycles) is accurate to  $\pm 50$  parts per million at 10° to 35°C. Aging has been greatly minimized.

External power of 1.4 volts at 6 microamperes powers the unit.

**TYPE 2007-6**



**TYPE 25**



**TYPE 2001-2**



### TYPE 2007-6 FREQUENCY STANDARD

Transistorized, Silicon type  
Size, 1 1/2" dia., x 3 1/2" H., Wt., 7 oz.  
Frequencies: 360 to 1000 cy.

Accuracies:

2007-6  $\pm 0.2\%$  ( $-50^\circ$  to  $+85^\circ\text{C}$ )

R2007-6  $\pm .002\%$  ( $+15^\circ$  to  $+35^\circ\text{C}$ )

W2007-6  $\pm .005\%$  ( $-65^\circ$  to  $+85^\circ\text{C}$ )

Input: 10 to 30V DC at 6 ma.

Output: Multitap, 75 to 100,000 ohms

### TYPE 2001-2 FREQUENCY STANDARD

Size, 3 3/4" x 4 1/2" x 6" H., Wt., 26 oz.

Frequencies: 200 to 3000 cycles

Accuracy:  $\pm .001\%$  at  $+20^\circ$  to  $+30^\circ\text{C}$

Output: 5V at 250,000 ohms

Input: Heater voltage, 6.3 - 12 - 28

B voltage, 100 to 300 V, at 5 to 10 ma.

Accessory Modular units are available to divide, multiply, amplify and power this unit.

### TYPE K-5A FREQUENCY STANDARD

Size, 3 1/2" x 3" x 1 1/4"

Weight, 1 1/2 lbs.

Frequency: 400 cycles

Accuracy: .03%,  $-55^\circ$  to  $+71^\circ\text{C}$

Input: 28V DC  $\pm 10\%$

Output: 400 cy. approx. sq. wave  
at 115V into 4000 ohm load (approx. 4W)

### TYPE 25 PRECISION FORK

Size, 5/8" dia. x 2 1/4"

Weight: 2 ounces

Frequencies: 200 to 1000 cy.

Accuracies:

R-25T and R-25V  $\pm .002\%$  ( $15^\circ$  to  $35^\circ\text{C}$ )

25T and 25V  $\pm .02\%$  ( $-65^\circ$  to  $85^\circ\text{C}$ )

For use with tubes or transistors.

### INQUIRIES INVITED

For over 20 years we have made frequency standards and precision fork units for applications where consistent accuracy and rugged dependability are vital. Shown are just a few typical examples.

Some users integrate our products with instruments of their own manufacture. In other cases we develop complete assemblies to meet special needs.

You are invited to submit any problems within the area of our activity for study by our engineering staff.



## AMERICAN TIME PRODUCTS

DIV. OF BULOVA WATCH COMPANY, INC.

61-20 Woodside Ave., Woodside 77, L. I., N. Y.

WESTERN OFFICE, 234 N. LAKE AVE., PASADENA, CALIF.

WEIGHT, SPACE PROBLEMS?

# REPLACE

ALMOST ALL  
SUBMINIATURE  
GLASS TYPES

WITH TRANSITRON'S  
EXPANDED LINE OF  
SILICON MICRODIODES

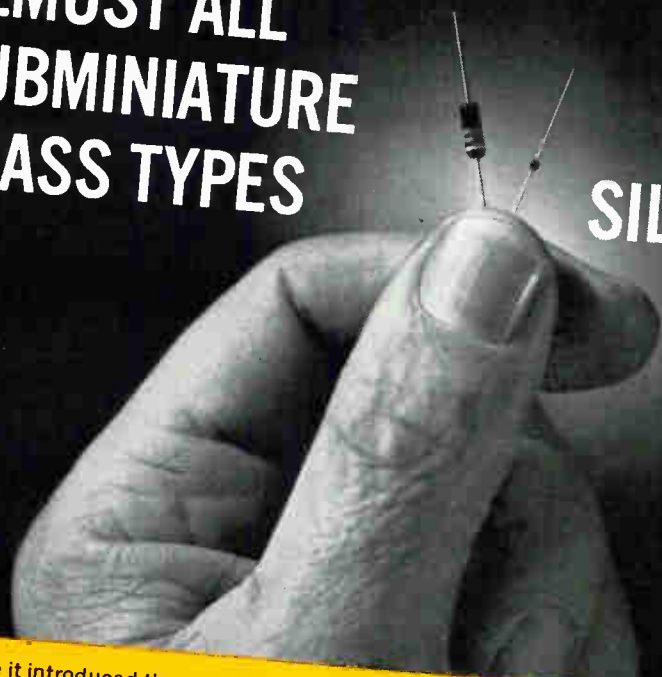

## RECOMMENDED REPLACEMENT CHART

MICRODIODE TYPES		SUBMINIATURE GLASS TYPES
<b>Very Fast Switching Types</b>		
TMD-50	replaces	1N993 (S266G)
TMD-914	replaces	1N914
TMD-916	replaces	1N916
<b>Fast Switching Types</b>		
TMD-24	replaces	1N625, 1N626 1N659
TMD-25	replaces	1N627, 1N658 1N662, 1N663
TMD-27	replaces	1N628, 1N629 1N661, 1N643
<b>High Conductance Types</b>		
TMD-41	replaces	1N456, 1N456A 1N461, 1N461A 1N482 thru 1N482B
TMD-42	replaces	1N457, 1N457A 1N462, 1N462A
TMD-45	replaces	1N483 thru 1N483B 1N458, 1N458A 1N459, 1N459A 1N463, 1N463A 1N464, 1N464A 1N484 thru 1N485B
<b>Micro Voltage Regulator Types</b>		
TMD-01	replaces	1N705, 1N751
TMD-02	replaces	1N708, 1N752
TMD-03	replaces	1N709, 1N753
TMD-04	replaces	1N710, 1N754
TMD-05	replaces	1N711, 1N755
TMD-06	replaces	1N712, 1N756
TMD-07	replaces	1N713, 1N757
TMD-08	replaces	1N714, 1N758
TMD-09	replaces	1N715
TMD-10	replaces	1N716, 1N759

NOTE: The MICRODIODE types listed above are similar to their conventional-size counterparts within the limitations of power dissipation . . . Transitron engineers will be glad to discuss with you comparative specifications as they affect your particular replacement designs.

Since it introduced the first all-glass packaged silicon microdiode with TRUE hermetic sealing, Transitron has continued to expand its line until today it offers, in quantity, the widest variety of high-quality silicon microdiodes in the industry.

While Transitron still remains an exclusive source for micro "zeners", further developments have made possible the introduction of a series of very fast switching, low capacitance microdiodes particularly well-suited for use in extremely high speed transistorized computer circuitry. The family includes Transitron's TMD-50, and TMD-914 and TMD-916 — microequivalents of the popular subminiature glass 1N914 and 1N916.

The rugged all-glass construction and true hermetic sealing of Transitron's microdiodes provide exceptional long-term reliability over a wide range of environmental extremes. Their compatibility with conventional semiconductor circuitry can help you miniaturize your existing design through replacement of standard subminiature glass types with microdiode equivalents. All are available in quantity and are especially recommended for critical computer applications where small size, light weight and excellent stability are required . . .

For further information, write for Transitron's "Microdiode" bulletins.

Watch for still further significant developments in micro-miniaturization from Transitron. Soon to be announced.

VISIT TRANSITRON AT THE SALON INTERNATIONAL DES COMPOSANTS ÉLECTRONIQUES — FEBRUARY 16-20



# Transitron



electronic corporation  
wakefield, melrose, boston, mass.

SALES OFFICES IN PRINCIPAL CITIES THROUGHOUT THE U. S. A. AND EUROPE • CABLE ADDRESS: TRELCO

# Save 7% of Your electronics BUYERS' GUIDE Advertising Costs ACT NOW!

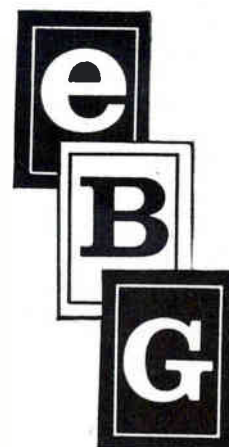

Order your advertising for the 1962 electronics BUYERS' GUIDE now. Study these exceptional discounts. You can earn up to 10% in discounts. You will see four distinct ways to save money. Here is how the "Early Bird" discount structure works:

In addition to volume discounts for Multiple Page, run-of-press, advertising, a discount of 7% on the earned rate will be allowed on ads of ½ page or more, provided insertion order is received by February 15, 1962, and plates are supplied to the publisher by April 25, 1962.

In addition to the volume rates for inserts, a discount of 7% of those rates will be allowed providing insertion order is received by February 15, 1962, and inserts are supplied to the publisher by May 25, 1962. See your local advertising representative, listed on the last page of this issue for complete details.

Multiple Page Discounts	
2 pages .....	discount earn 3%
4 pages .....	earn 4%
6 pages .....	earn 6%
8 pages .....	earn 7%
12 pages .....	earn 8%
16 pages .....	earn 9%

Special rates for furnished inserts	
2 pages .....	per page \$715
4 pages .....	682
6 pages .....	654
8 pages .....	616
12 pages .....	600
16 pages .....	583
20 pages .....	566
24 pages .....	550
28 pages .....	533
32 pages .....	517
over 32 pages .....	489

(Orders and complete plates to be sent to 330 West 42nd Street, New York 36, N.Y. Inserts to be shipped to National Publishing Co., Lanston Building, 24th and Locust Street, Philadelphia 1, Pennsylvania. Marked: Electronics Buyers' Guide.)

## electronics BUYERS' GUIDE & Reference Issue



A McGraw-Hill Publication / 330 West 42nd Street, New York 36, N.Y.

## Resistors?



# STACKPOLE matches every requirement

If you have a burning yearning for improved resistor dependability coupled with on-time deliveries, here's a hot tip:

**In Performance** Stackpole Coldite 70+ fixed composition resistors go well beyond MIL-R-11 requirements—with added dividends in load life, moisture resistance and humidity characteristics. For extra reliability, their carbon resistance elements and outer insulating shells are cold-molded of similar materials. These are formed by a new process into a solid, homogeneous structure that remains free from catastrophic failure or erratic changes in resistance in severe environments.

**In Production** Stackpole Coldite 70+ Resistors re-

main one of the easiest components to solder either by dip or iron. They're the only resistors having leads that are solder dipped—not once, but twice—in addition to the usual tin coating. That's why leads stay smooth and tarnish free even after months in storage.

**In Appearance** it's hard to match their smooth, glossy finish and uniform, easily-read color codes. And this attractive appearance lasts even after scrubbing with solvents.

Stackpole Coldite 70+ Resistors are available in MIL-R-11 Type RC-20 (½-watt), Type RC-32 (1-watt), and Type RC-42 (2-watts) . . . in all standard resistance values, and at ordinary resistor prices.

Electronic Components Division  
**STACKPOLE CARBON COMPANY**  
St. Marys, Penna.



CERAMAG® FERRITE CORES • VARIABLE COMPOSITION RESISTORS • SLIDE & SNAP SWITCHES • CERAMAGNET®  
CERAMIC MAGNETS • FIXED COMPOSITION CAPACITORS • BRUSHES FOR ALL ROTATING ELECTRICAL EQUIPMENT  
ELECTRICAL CONTACTS • GRAPHITE BEARINGS, SEAL RINGS, ANODES • HUNDREDS OF RELATED CARBON & GRAPHITE PRODUCTS.

**Hundreds of miles up** where the only heat a satellite encounters is a fleeting thing... or a mile-and-a-half down where geologists' drills probe toward the earth's molten core... VECO Thermistors telemeter data and trigger thermal recording mechanisms with predictable reliability.

Reliability is the reason engineers in every field specify VECO Thermistors and Varistors where precision thermal or electrical measurement and control are critical. They

know their Thermistor and Varistor reliability programs begin at Victory. Unsurpassed quality control is the reason. Not one VECO product ever leaves the plant until it individually passes tests for reliability far exceeding applicable specifications. VECO quality control processes are accepted under MIL-Q-9858 standards.



**VICTORY**  
ENGINEERING CORPORATION  
122 Springfield Ave., Springfield, N. J.

THERMISTORS • VARISTORS • CHOPPERETTES • COMBUSTION ANALYZERS  
THERMISTOR CATHETERS AND NEEDLES • THERMAL CONDUCTIVITY CELLS  
MATCHED THERMISTORS • THERMISTOR AND VARISTOR KITS  
HYPSONETERS • LOX THERMISTORS • AND MANY OTHER PRODUCTS



**FREE:** Whether you want to dig a mine or design a satellite, you'll find VECO's Thermistor-Varistor Catalog valuable in producing high-reliability circuitry.

For Thermistor-Varistor  
Engineering Assistance  
and Unique Displays  
see **VECO** during the  
**1962 IRE Show.**  
The Henry Hudson Hotel,  
W. 57th St. (opposite the  
N. Y. Coliseum).  
**SUITE 462.**

how to  
take the  
temperature  
of up  
or down

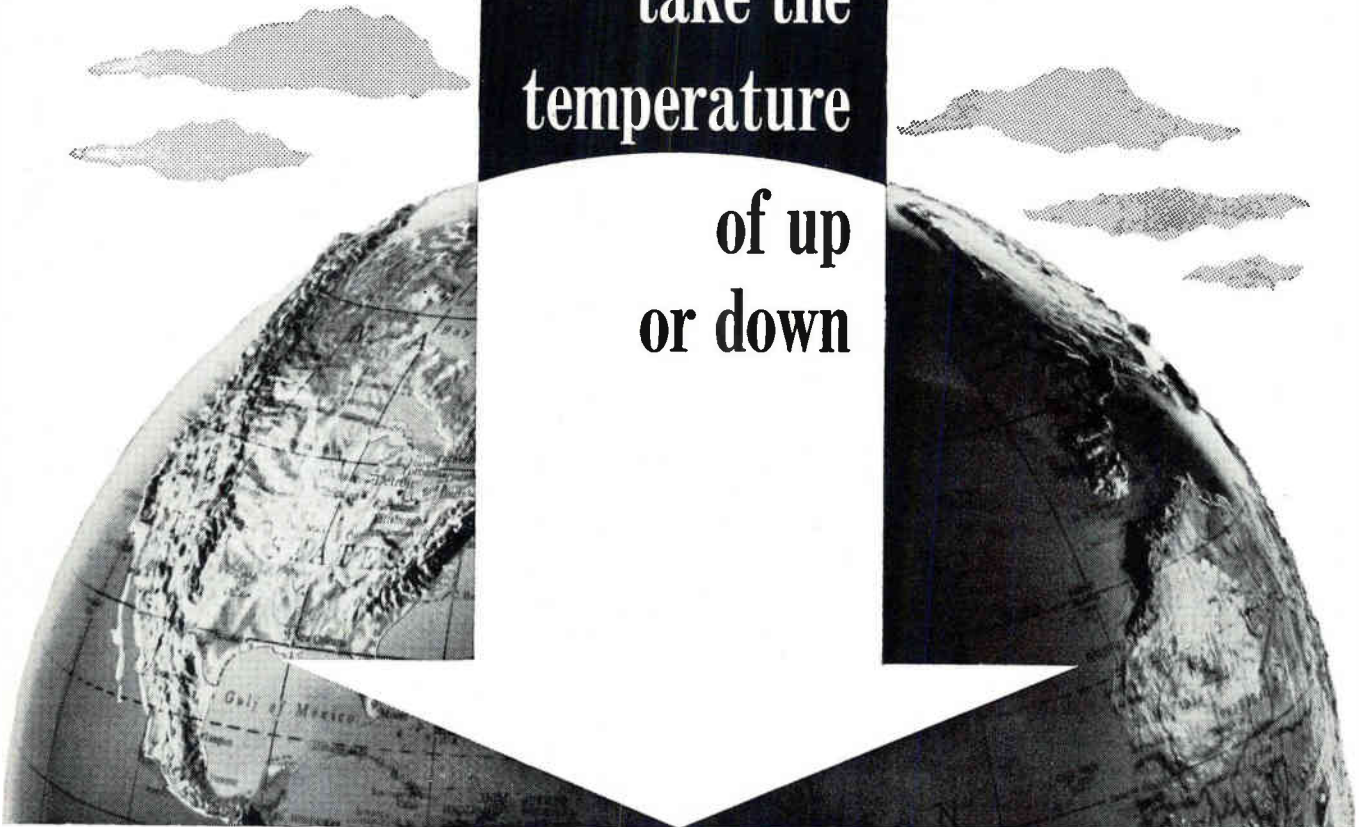

# Sanborn<sup>®</sup> 7-Channel FM tape system for \$6800\* complete

uses interchangeable FM and direct  
record/reproduce electronics  
entirely contained in 7" x 19" panel space

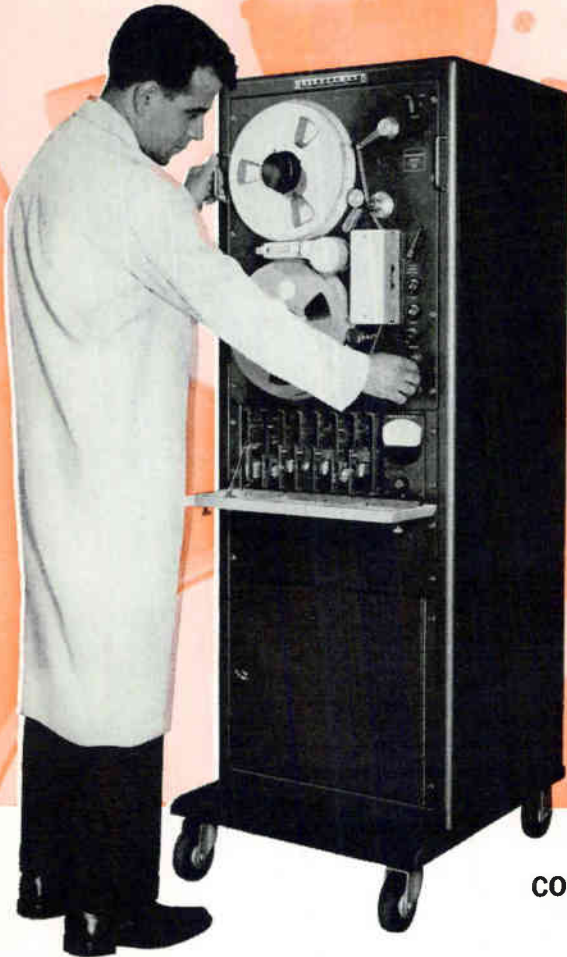

COMPARE PERFORMANCE, PRICE PER CHANNEL

Here is the ideal combination of high performance and economy in a 7-channel, 4-speed system that meets IRIG Telemetry Standards. *Versatility* is another advantage. The Model 2000 system uses interchangeable Sanborn FM or direct record/reproduce electronics — all solid-state, in 7" of panel space — and you can have any combination of direct and FM channels simply by changing circuit cards. Recording capability may be extended beyond the system's minimum input levels through the use of Sanborn "850" and other compatible amplifiers.

The Model 2000 Magnetic Data Recorder has four speeds and uses standard 1/2-inch tape on 10 1/2-inch reels. All controls are on the front, and several convenience features are included: an integral FM Alignment Meter that eliminates the need for electronic counters, an automatic squelch, a tape footage counter, and provision for using one channel for flutter compensation.

Complete details are available from Sanborn Sales-Engineering Representatives in principal cities throughout the U. S., Canada and foreign countries.

\*Price FOB Waltham, Mass., in Continental U. S. A.; subject to change without notice. State and local taxes must be added where applicable.

(Specifications subject to change without notice)

## SPECIFICATIONS

*Input*  $\pm 2.5$  V into 10,000 ohms, single ended, adjustable.

*Output*  $\pm 2.5$  V into 1,000 ohms or more, single ended; level, position adjustable.

### Bandwidths (Max)

Speed	FM	Direct
3 3/4"/sec	0-625 cps	50-6,250 cps
7 1/2"/sec	0-1,250 cps	50-12,500 cps
15"/sec	0-2,500 cps	50-25,000 cps
30"/sec	0-5,000 cps	100-50,000 cps

(100% modulation on FM =  $\pm 40\%$  carrier deviation)

*Linearity* Max dc nonlinearity: 0.5%

*Drift*  $\pm 0.5\%$  of full scale for 10 V power line change, 10°C ambient temperature change, or for 24 hours at constant power line voltage and ambient temperature.

### Signal-to-Noise Ratio (Min)

*Direct*: 40 db at all speeds.

*FM*: 40 db RMS at 30"/sec and 15"/sec; 35 db RMS at 7 1/2"/sec; 33 db RMS at 3 3/4"/sec.



Readout, as well as input monitoring during magnetic recording, may be provided by this compatible 17-inch, 8-channel Viso-Scope or other Sanborn monitoring instruments, or by direct writing systems.



**SANBORN  
COMPANY**

INDUSTRIAL DIVISION  
175 Wyman Street, Waltham 54, Massachusetts

CIRCLE 19 ON READER SERVICE CARD

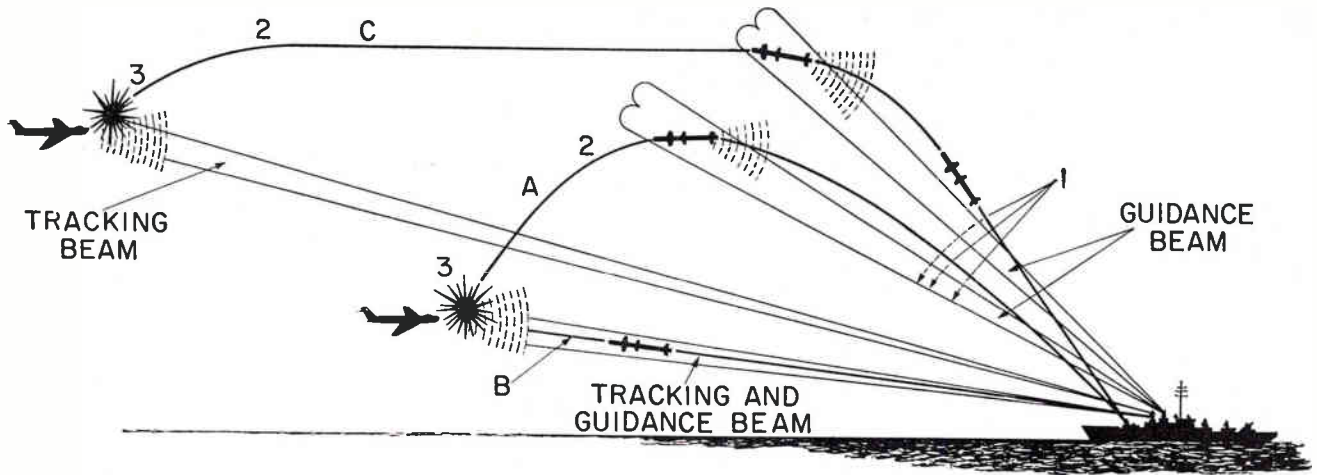

Sketches used by Sperry designers to illustrate war games approach to counter-countermeasures evaluation. Opposite page is an overall naval tactical problem. Above, are possible missile trajectories (A, B, C) using mid-course (1, 2) and terminal guidance (2, 3)

## Military Electronics Engineers Battle

By HAROLD HOOD  
Pacific Coast Editor

LOS ANGELES—The growing diversity and complexity of military electronics was illustrated this week by the variety of systems and techniques reported at the IRE's National Winter Convention on Military Electronics.

S. Adelman and S. M. Shinnors, of Sperry Gyroscope, catalogued no less than 15 counter-countermeasures techniques. Among these were pulse compression, frequency agility (rapid, random variation), f-m pulsing, limiting and video integration, doppler c-w radar to tell chaff from targets, sidelobe suppression, time compression, triangulation, balanced mixing, and more.

The authors set up a war games approach for system evaluation, creating hypothetically the countermeasures arrayed against a naval task force. Considered were noise, swept-f-m, c-w and target repeater active jammers; chaff, rotating or modulating reflectors, ionized gas, trailing wires and decoy passive jammers. The possibility of radar-homing missiles was also investigated.

They also outlined the susceptibility to countermeasures of guid-

ance techniques such as command, beam-rider, and radar, heat, light and electromagnetic homing.

G. A. Cato, of Electro-Optical Systems described how to find enemy ICBMs in midcourse with a proposed warhead-decoy discrimination system. A space platform is launched to go into cotrajectory with the ICBM and its decoys. The warhead is found by rapid electronic sorting and mass-measurement techniques. The latter phase uses submissiles from the platform.

Submissile velocity change due to impact is measured by ground-based radar to determine target mass. Cato said a prime advantage is keeping all complex electronics on the ground. Ultimately, the warhead kill charge could be carried by the platform. Early warning of enemy firings could be provided by ships and planes patrolling enemy borders, or by Midas or Loftter-type satellites.

Details of Autonetics' microminiature Mautel pcm telemetry sets for space-borne data acquisition systems were revealed for the first time by T. R. Denigan. He said size and weight have been reduced 85 to 90 percent.

Most circuits are digital, made up of three types of functional blocks consisting of a single dif-

fused silicon chip. P and n type diffusions are connected by vacuum-deposited conductor patterns that determine if the chip is one of two gates or a flip-flop.

The system includes 32 signal conditioners, 128 primary multiplexers, 512 submultiplexers and a clock source. Barker code words synchronize frames (128 nine-bit words) and messages (16 frames). A programmer generates four timing signals, each positive for two-word periods and at ground for two-word intervals. Bit rates are up to 500 Kc.

The set weighs four lb, takes 0.03 cu ft, requires 12 w of power. Denigan said mean time between failures is five years.

Improvements of six to nine db in radar sensitivity can be had by retrofitting with low-noise diode parametric amplifiers, said H. D. Tenney, of MELabs. He reported tests of a unit his company developed for several L-band radars.

A seven-db decrease in receiver noise, he said, means 50 percent increase in range and a five-fold reduction in minimum detectable target size at a given range.

Devices now available are stable and reliable, Tenney said, thanks to improvements in ferrite devices, klystron pump power sources and



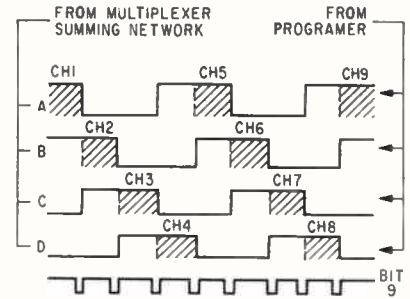
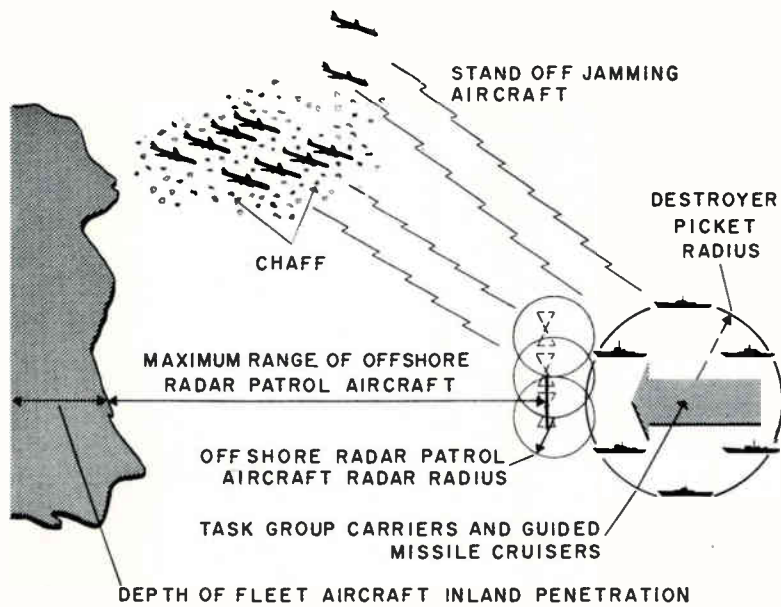

Summing and switching signals for Autonetics' microminiature teletype set



Bottom view of wave antenna switching unit

## Complex Defense Problems

better varactor diodes.

Cape Canaveral is getting a 100-Mc to 12.7-Gc spectrum surveillance system, to ease interference problems, reported A. J. Valluzi, of Pan American, and J. C. Rote, of ITTFL. It will automatically monitor and analyze instrumentation systems before launches, provide radiometric density records for frequency allocations and locate and identify interference.

Major subsystems are an r-f front end, signal analysis unit, data converter and programmer-comparator with associated displays. The front end is an electronically scanned superheterodyne unit using narrow-band, tunable backward-wave preamplifiers and converters. This is reported to eliminate crystal mixer burnout, assure wide dynamic range and reduce spurious response.

Surveillance data from 10 geometrically spaced bands is displayed on five two-gun crts, presenting a panoramic picture of the entire frequency spectrum. A multiple events recorder and computer give histograms of frequency activity for a particular period.

A. D. Bailey and M. R. Weiner, University of Illinois, put together a medium- and high-frequency, wide-aperture, radio direction

finder for a materials cost of \$250. They used 36 wave antennas (Beverage wire) laid out like spokes in a 250-ft wheel. Wideband transformer matches impedances, a 36-position ring counter sequences signals, voltage output to the receiver is shown on an oscilloscope. It detected signals as small as six to 10 mv per meter, covered frequencies of 0.7 to 25 Mc.

L. Farkas, of RCA, described equipment aboard the *USAS American Mariner* for operational use of Transit navigational satellites. Accuracies of one mile have been achieved and accuracies of one-tenth mile are anticipated. The shipboard equipment consists of three major subsystems, the receiver, data sampling and conversion, and computer.

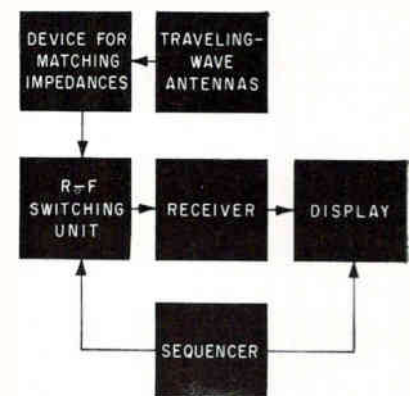

Traveling-wave antenna radio direction finder uses 36 wire spokes 250 feet long

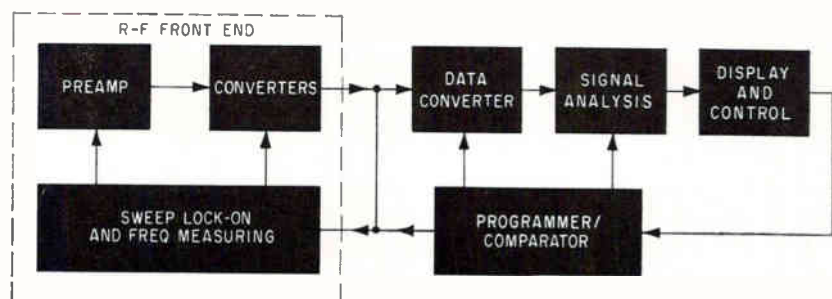

Simplified block diagram of spectrum surveillance system to be installed at Cape Canaveral



# how much should a SUB-MINIATURE switch cost?



E62 SERIES

Now, a military quality sub-miniature switch at commercial price!!

Overtravel, on basic switch,  
.040 minimum

FULL LINE OF ACTUATORS

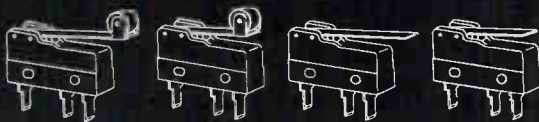

CALL OR WRITE

**CHERRY ELECTRICAL PRODUCTS CORP.**  
P. O. BOX 62 HIGHLAND PARK, ILL.

## NEED 65-80 db ISOLATION BETWEEN TRANSFORMER WINDINGS?

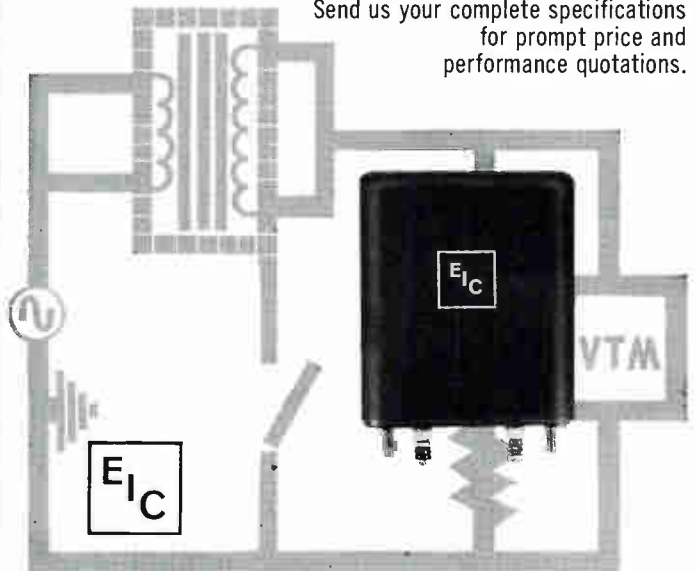

You do if your project involves very low signal levels. This was the case recently when a major transistor manufacturer specified EIC custom transformers with 65 db isolation between windings, from 60 cycles to 10 kc. (We can give you 80 db if required.) Insulation resistance specified (winding to winding and winding to case) was 300,000 megohms. Send us your complete specifications for prompt price and performance quotations.

**ELECTRODYNAMIC INSTRUMENT CORPORATION**

Subsidiary of Reed Roller Bit Company

JA 6-3761 • 1841 Old Spanish Trail • Houston 25, Texas

CIRCLE 200 ON READER SERVICE CARD



## TKK INDUSTRIAL MOTORS

Lowest Drain, Minimum Noise,  
Longest Life — at Low Cost



RM-170 T



FM-250 R

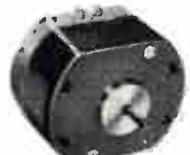

FM-250 N

### APPLICATIONS

- \* Tape-recorders
- \* Record-players
- \* Clacks
- \* Shavers
- \* Music Boxes
- \* Cinemas
- \* Turntables
- \* Automations
- \* Other Appliances

type	voltage (D.C.)
RM-170 T models	1.5 ~ 3.0 V
RM-170 S models	1.5 ~ 6.0 V
RM-170 SC models	3.0 ~ 12 V
FM-250 N models	1.5 ~ 4.5 V
FM-250 R models	1.5 ~ 6.0 V

Large orders executed reliably and on schedule by the world's largest factory specializing in D.C. magnetic low current motors (Output: up to 2½ million units per month!) Your detailed inquiry is invited — your satisfaction guaranteed.

## MABUCHI SHOJI K.K.

37, Kabuto-cho 2-chome, Nihonbashi, Chuo-ku, Tokyo, Japan  
C.P.O. Box 1084, Tokyo Cables: "NIHONKAKOCO TOKYO"

CIRCLE 201 ON READER SERVICE CARD

electronics

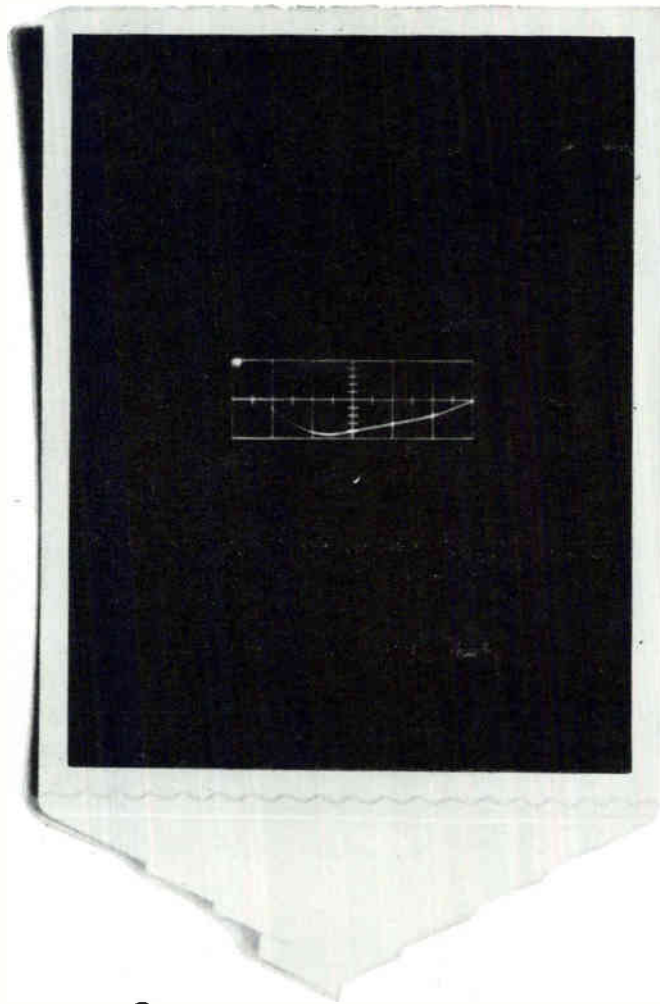

## 2 nanoseconds/cm: impossible to photograph until now

Polaroid has a new film that is so fast, it will reproduce scope traces that are almost invisible to the naked eye. The one above, a scintillation pulse, has never been photographed until now. Pulse duration was ten nanoseconds. Scope sweep speed was 2 nanoseconds/cm. *The new 10,000-speed Polaroid PolaScope Land film produced a finished usable print ten seconds after exposure.*

The maximum writing speed of the 10,000-speed film is about twice that of the Polaroid Land

3000-speed film, which is currently the standard for high speed photography. The new film not only gets "impossible" pictures, it also produces far better shots of slower pulses and steady state waveforms. Because of its high speed, less light is required; camera aperture and scope intensity can be reduced considerably, producing sharper pictures.

And besides oscillography, the PolaScope film opens up new possibilities in applications where light is at a premium, such as pho-

tomicrography and metallography. It is not suited, however, for pictorial work due to its high contrast and relatively coarse grain.

PolaScope film (designated Type 410) is packed twelve rolls to a carton. The price is actually lower than the 3000-speed film.

The film can be obtained through industrial photographic dealers. For the name of the dealer nearest you, write to Technical Sales Department, Polaroid Corporation, Cambridge 39, Massachusetts.

**New Polaroid Land 10,000-speed film for oscillography.**



**FEATURES** | **LOW POWER**  
**SIMPLE CIRCUITRY**  
**SMALL SIZE**

Announcing  
the  
**SOLION**  
a new  
family  
of  
electronic  
devices

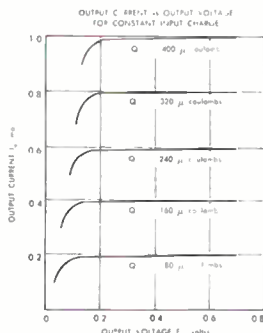

SE series, 0-1 ma output proportional to time integral of 0.1 to 40 μa input. Completely reversible, accepts inputs of either polarity. Applications: integrator, timer, low frequency amplifier.



SD series, sensitive to pressure changes of as low as 1 dyne/cm<sup>2</sup>, frequency response .0005 to 1 cps. Applications: detectors for linear acceleration and pressure variation.

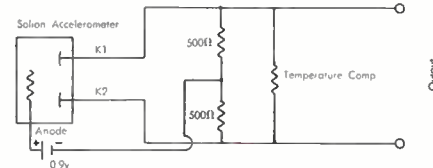
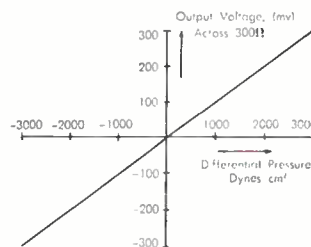

Loop modification of SD type. Threshold sensitivity of .001 rad/sec<sup>2</sup>. 0 to ±300 mv output proportional to angular acceleration. Applications: guidance and positioning.



SV series, .002 to 5 μa input, output 0-60 mv calibrated proportional to time integral of input. Ultra miniature, extremely low power; either visual or electrical readout. Applications: timers, integrators, elapsed time.

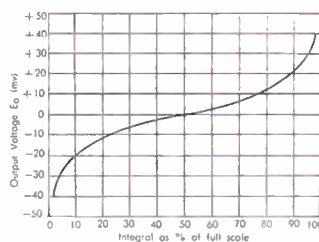

WRITE FOR COMPLETE INFORMATION



**TEXAS RESEARCH AND ELECTRONIC CORPORATION**  
HOME OFFICES: MEADOWS BUILDING, DALLAS, TEXAS EM 8-1393

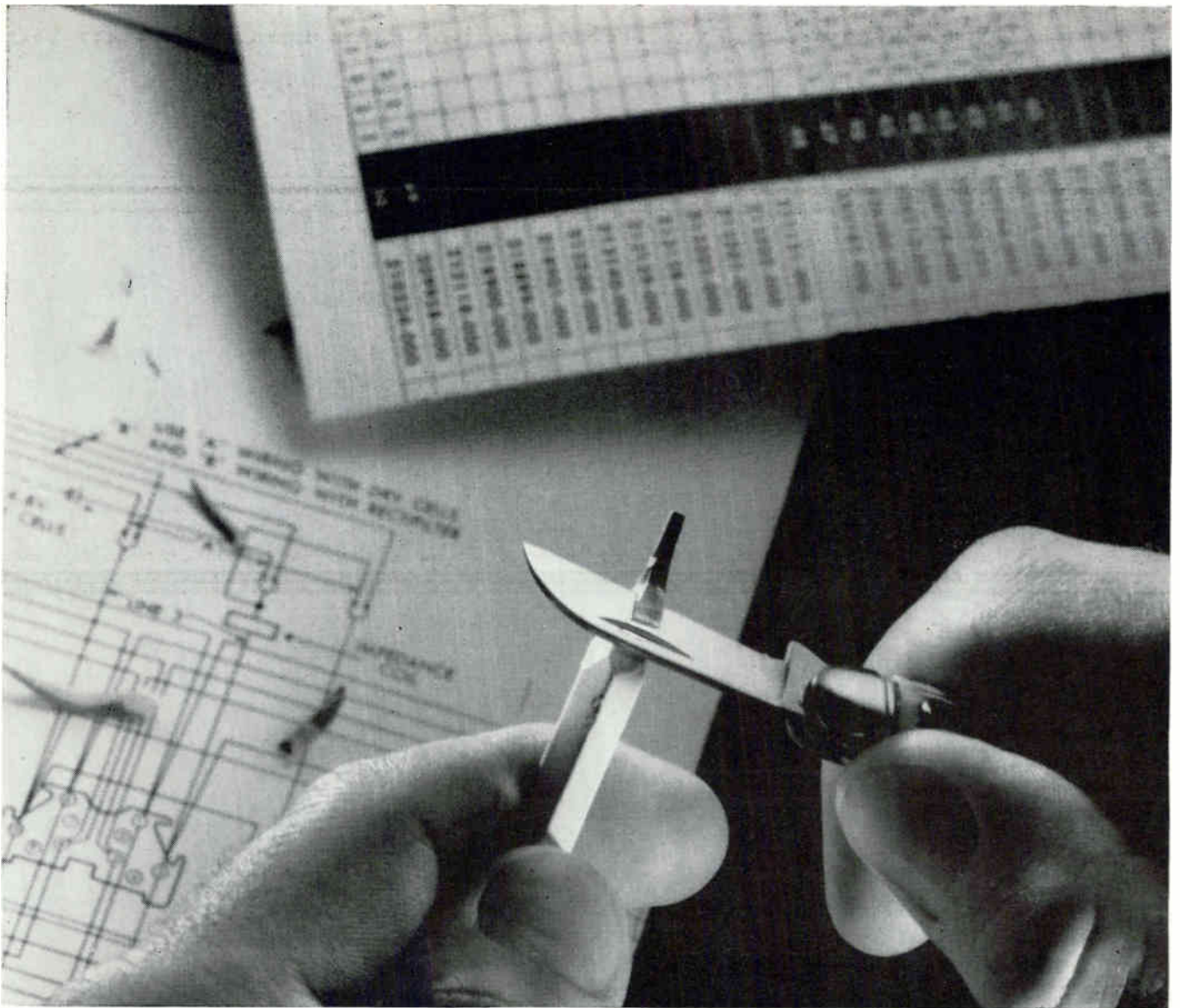

## Sorry, but your resistor specs just went out of date

Now Corning supplies total  $\Delta R$  less than 3% with no derating

Start a design with known limits of resistance deviation as tight as that and you can specify other components with more certainty and more freedom.

Drop an amplifier stage? Use broader tolerance, cheaper tubes or transistors?

	Model	Resistance (ohms)	Corning Design Tolerance
NF (Meets Mil-R-10509D)	60	100 to 100K	3%
	65	100 to 348K	
N (Meets Mil-R-10509D)	60	10 to 133K	3%
	65	10 to 499K	
	70	10 to 1 meg.	
C (Meets Mil-R-22684)	20	51 to 150K	5% (plus purchase tolerance of either 2% or 5%)
	32	51 to 470K	
	42S	10 to 1.3 meg.	

That's what our new *Corning Design Tolerances* are all about. They give you a percent deviation from nominal that includes the purchase tolerance, maximum  $\Delta R$  due to TC, and maximum load-life drift. They're based on extended performance at full power and 70°C. ambient for over 30,000 hours.

We've assigned them to resistors that cover the 10 ohm—1 meg. range: the fusion-sealed NF, the precision N, and the low-cost, high-performance general purpose C.

A new folder, "Design Tolerances for Tin Oxide Resistors," gives you full information. Write for a copy to Corning Glass Works, 539 High St., Bradford, Pa. . . . and sharpen your pencil.

# CORNING

## Electronic Components

# Bright Future Seen for Active Homogenous

By ARTHUR ERIKSON  
McGraw-Hill World News

PARIS—One of the highlights of the 1962 International Solid-State Circuits Conference in Philadelphia next will be an address by Prof. Pierre Aigrain, of the Ecole Normale Supérieure here. He'll talk about active homogenous semiconductor developments, including the Ecole's helicon.

Defined as devices without p-n junctions that amplify or oscillate by an action similar to that of a traveling-wave tube, these devices are expected to have a bright future because they are relatively large in size considering the high frequencies at which they can operate—a characteristic that makes for high peak power outputs.

There are no particular manufacturing problems. The biggest problem seems to be r-f coupling for the inputs and outputs. Possibly, the waveguide may be attached directly to the semiconductor at an angle proportional to the ratio of the electro-acoustic wave velocity in the semiconductor to the phase velocity in the waveguide.

So far, four distinct types of active homogenous semiconductors

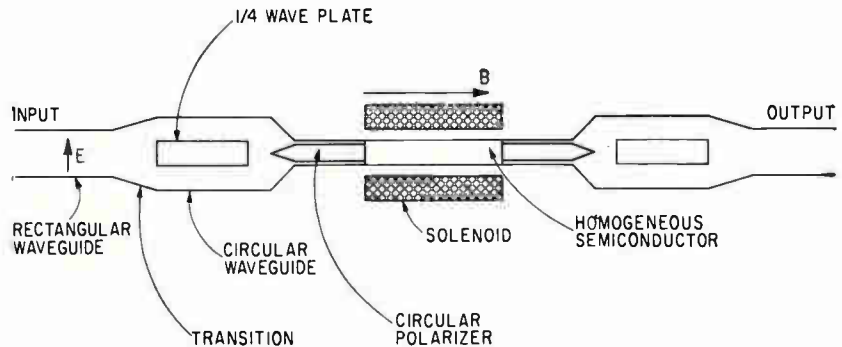

*Helicon's r-f input from rectangular waveguide is converted to circular mode, attacks homogenous semiconductor through constant dielectric*

have been discovered. They fall into two groups: devices that operate from d-c on up, and zero-gain at zero-frequency devices. In the first group, an especially promising type is the cryosar, a negative-resistance device using doped and compensated germanium in which electrons bound to the impurities are ionized by an electric field (ELECTRONICS, p 66, July 10, 1959). By doping with zinc and compensating with antimony, researchers at the Ecole Normale Supérieure have boosted operating temperature to 77 K. Room-temperature cryosars appear possible, perhaps with indium-doped silicon.

Second of the d-c types is the

bokotron, whose operation depends on the fact that the Rutherford electron scattering effect decreases as electron temperature rises. An electric field increases electron temperature and velocity, producing the negative resistance characteristic shown. The device operates at liquid oxygen temperature.

Although a certain minimum critical size apparently exists for the bokotron, it has, like the cryosar, shown a peak power capability of several hundred watts at frequencies as high as 1 Gc.

In the zero-gain at zero-frequency group, interaction of electron motion with a slower wave moving through a solid is the basis of amplification. The acoustic wave of a piezoelectric semiconductor meets the requirements. Ultrasonic waves have been amplified directly in cadmium sulfide crystals at Bells Labs (ELECTRONICS, p 9, Sept. 29, 1961).

Search for a faster-than-acoustic wave for this type of amplification led Aigrain's group to discover the helicon. It utilizes a modified Alfvén wave that exists when a plasma of free particles propagates through a semiconductor. Although attenuation times of helicon waves are thousands of times longer than attenuation times of Alfvén waves in a gaseous plasma, the helicon wave still is faster than an acoustic wave by a factor of at least ten.

Experiments at 10 Gc have confirmed the helicon theory, which Aigrain reported to the 1960 Prague semiconductor conference,

## Conference Marks Resurgence of Tunnel Diodes

PHILADELPHIA—Rebirth of interest in tunnel diodes as a circuit element and advances in semiconductor devices for microwave will be strongly evident at next week's Solid-State Circuits Conference. Nearly 4,000 circuit and device specialists will attend.

Last year's conference was marked by disillusionment with tunnel diodes after the initial burst of enthusiasm in 1959 and 1960. The device is now re-emerging as a promising solution to communications and computer problems. Program chairman R. B. Adler says papers selected will give a balanced view of topics widely publicized in the past with few concrete results.

Microelectronics, of wide interest last year, is relatively lightly represented. Parametric devices for microwave power generation win a complete session this year.

As usual, researchers from a handful of major U. S. companies will dominate technical sessions. But this year, 20 percent of the papers will come from abroad, testifying that Europe is giving the U. S. more competition in R&D, according to J. J. Suran, conference chairman. Perhaps significantly, no Japanese papers were selected.

# Semiconductor Devices

indicating that helicon devices could lead to simple amplifiers with high peak power outputs at centimeter and possibly even millimeter wavelengths.

The helicon theory may also explain the spontaneous oscillation of some semiconductors when a longitudinal magnetic field and intense electric field are applied, as in the oscillistor (ELECTRONICS, p 29,

Sept. 1, 1961. To tap the full potential of the helicon principle, however, new homogeneous semiconductors will have to be found. The helicon wave impedance is low at radio frequencies, implying difficult coupling. A ferromagnetic semiconductor such as iron sulfide, Aigrain thinks, would boost the wave impedance enough to overcome this drawback.

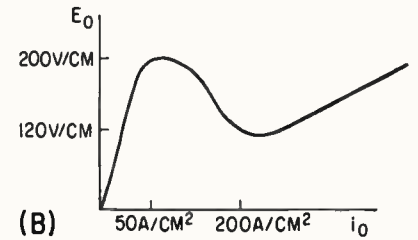
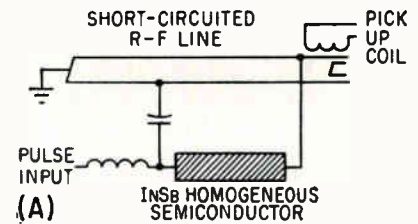

Bokotron circuit (A) and its negative resistance characteristic curve

## Magnetodiode Looks Promising as Switch

NEW YORK—Among new solid-state devices reported at the American Physical Society's recent annual meeting was a four-terminal, negative-resistance semiconductor device called the magnetodiode.

It reportedly operates at higher temperatures than cryotrons and at faster speeds than such four-terminal devices as electroluminescent-photoconductive cells. Potential uses include amplifiers or switches in computers.

I. Melngailis, A. Calawa and R. Rediker, MIT Lincoln Labs, explained operation of an  $n^+p$  indium antimonide magnetodiode, a forward-biased device with  $p$  base-width between 0.5 and 1 mm and resistivity 4 to 160 ohm-cm at 77 K.

At milliampere currents, base resistance becomes the determinant of current value for a given voltage. At these high currents, many minority carriers are injected from the junction into the base region, greatly reducing base resistance from equilibrium. Applying a small magnetic field transverse to current flow reduces injected carriers and increases base resistance. As shown, a 5-gauss field switches 50 ma.

The device could eventually run at megacycle rates. Preliminary tests have shown better than 100 Kc. Moreover, high-mobility materials might permit room temperature operation.

Magnetodiode effect increases

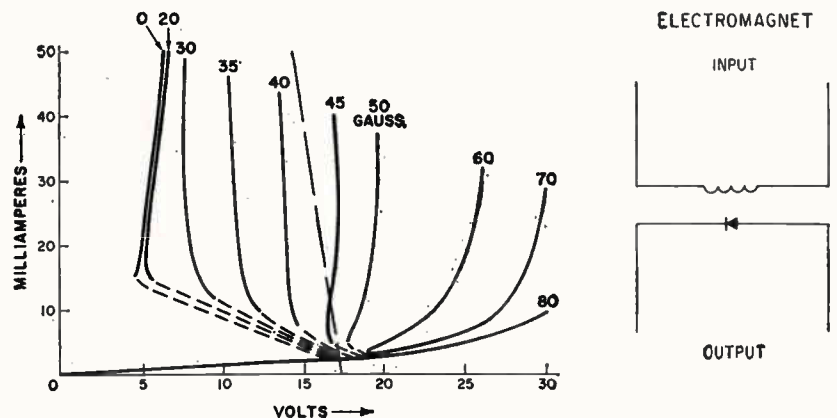

Effect of magnetic field on magnetodiode. It is a four-terminal device with input and output isolated

with basewidth and is not the simple bulk magnetoresistance effect. It is much larger than similar effects in germanium magnetodiodes at room temperature.

J. Pankove and M. Massoulis, of RCA Labs, reported that when a large area  $pn$  junction in gallium arsenide is biased in the forward direction, some carriers recombine radiatively in the junction.

Some of the radiation is due to transition between bands and some to transitions between the conduction band and a deep recombination level about 0.95 electron volt below the conduction band. Conversion efficiency of electric current into infrared was said to be several percent. Current is about 80 milli-

amperes and voltage is 1.49 v.

Excess current was shown by the diode's current-voltage characteristic. This suggests there is a tunneling process, although the diode is not a conventional tunnel diode.

Frequency multiplication in insulating materials was discussed by D. F. Edwards, J. G. Mavroides and Benjamin Lax, of MIT Lincoln Labs. They found quartz, sapphire and zinc sulfide efficient doublers, diamond and glass promising. Doubling effect is enhanced by an electric field. Addition of a d-c field gives the third instead of second harmonic. The work follows that reported last year by P. A. Franken, and others, of the University of Chicago.

# How to Land Softly on

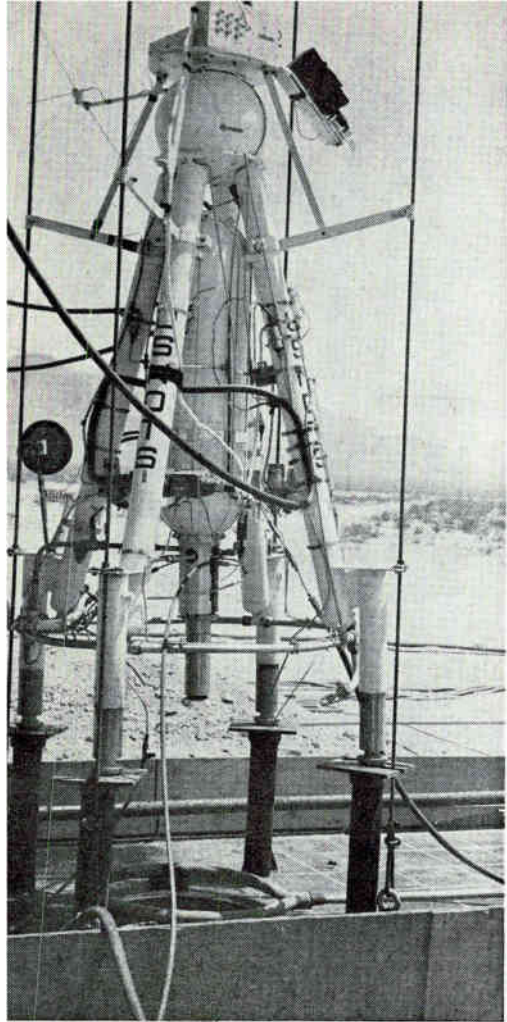

LOS ANGELES—Several papers at the National Winter Convention on Military Electronics this week reflected the military's growing concern with problems of rendezvous and soft landing on the moon. Differing viewpoints on solutions to these problems increased interest in sessions reporting space electronics.

C. E. Hendrix, of Naval Ordnance Test Station, China Lake, for example, stressed design simplicity. He described a soft landing system that combined optical sensing with continuously variable rocket thrust control.

Raytheon's G. J. Bonnelle

stumped for weight and space savings inherent in radar systems for both rendezvous and lunar landings. J. C. Devolites, W. H. Heiss, M. J. Kirby and R. L. Strazzulla, of Sperry, outlined a system called Lasso (Landing-Approach-System Spiral Outgrowth) which integrates inertial, optical and radar approaches.

The NOTS system has been successful in limited flight tests. Essentially an optical angular-rate sensor, it uses an optical scanner which focuses the target on a fixed reticle with alternate transparent and opaque bars.

As the line-of-sight is displaced,

*Navy has been testing optical systems with this contraption*

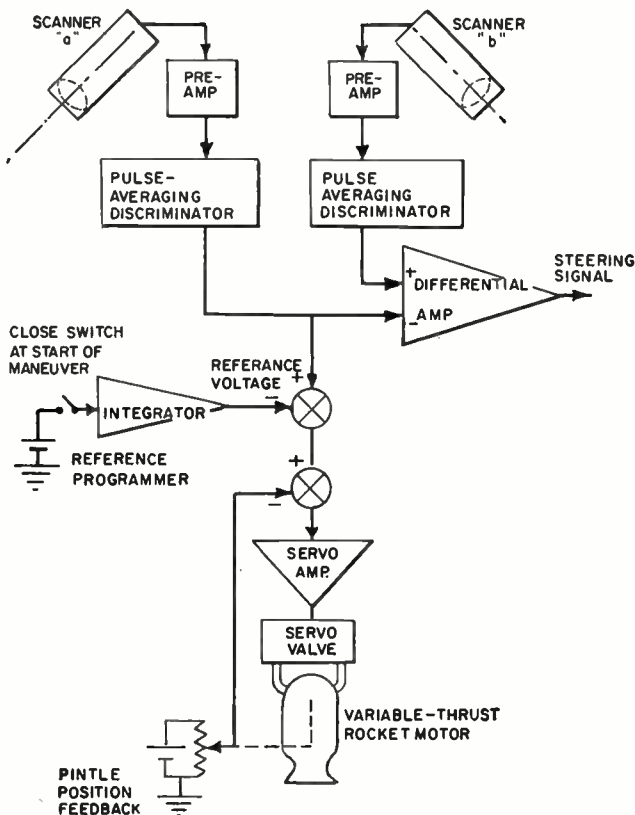

*Prototype Navy system uses two scanners, operational system would have three*

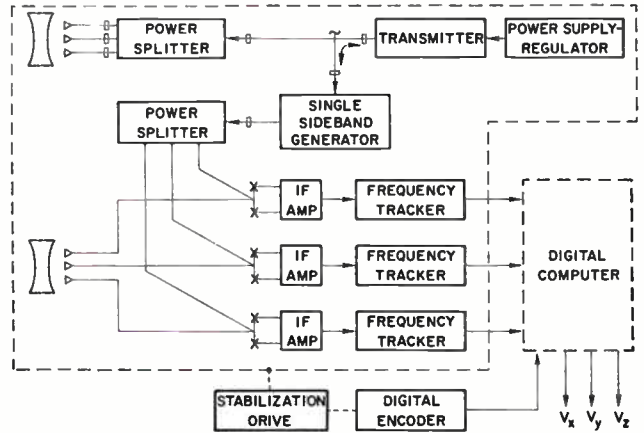

*Raytheon splits radar into three doppler segments for range and velocity measurement*

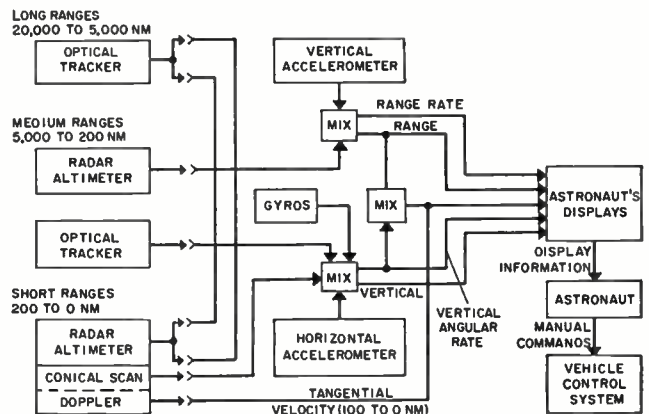

*Optical, radar and inertial returns are integrated in Sperry system*



# the Moon

the target image moves across the reticle. Output of a photocell circuit behind the reticle is at a frequency proportional to the angular rate of the line of sight. Scanner frequency controls rocket thrust.

A two-scanner system is shown. Ultimately, three scanners, spaced at 120 degrees around the spaceship would be used. It would weigh about 10 lb and consume 10 watts.

Raytheon's system, in its simplest form, is a doppler radar using three separate transmitting and receiving antennas. Two of the beams are offset from the local vertical and measure two components of velocity. The other beam, pointing along the local vertical, measures the third component.

Data would be converted to velocity and range information. Transmitter power would be about five watts, permitting satellite rendezvous without a transponder.

## Lasso System Operation

Lasso is designed to measure range, range rate, attitude, radial motion and surface velocity as a space ship comes in to the moon for a landing. It evolved from Sperry's concept, called Spiral, of an inertial-radar reentry altimeter.

The inertial portion gives attitude and motion data. At 20,000 miles out, the optical system begins providing line-of-sight data. At 5,000 miles, the more accurate radar system locks on. Below 250 miles, the radar goes into conical scan. Doppler portion provides surface velocity.

Radar returns are integrated over a large number of pulses, permitting reduction in system size and power while increasing accuracy. The radar operates at 16.6 Gc or 10 Gc.

Approach to earth would be similar. One advantage here, the authors say, is that if radar is blocked by a plasma sheath on reentry, the inertial portion would provide data until radar operation can resume.

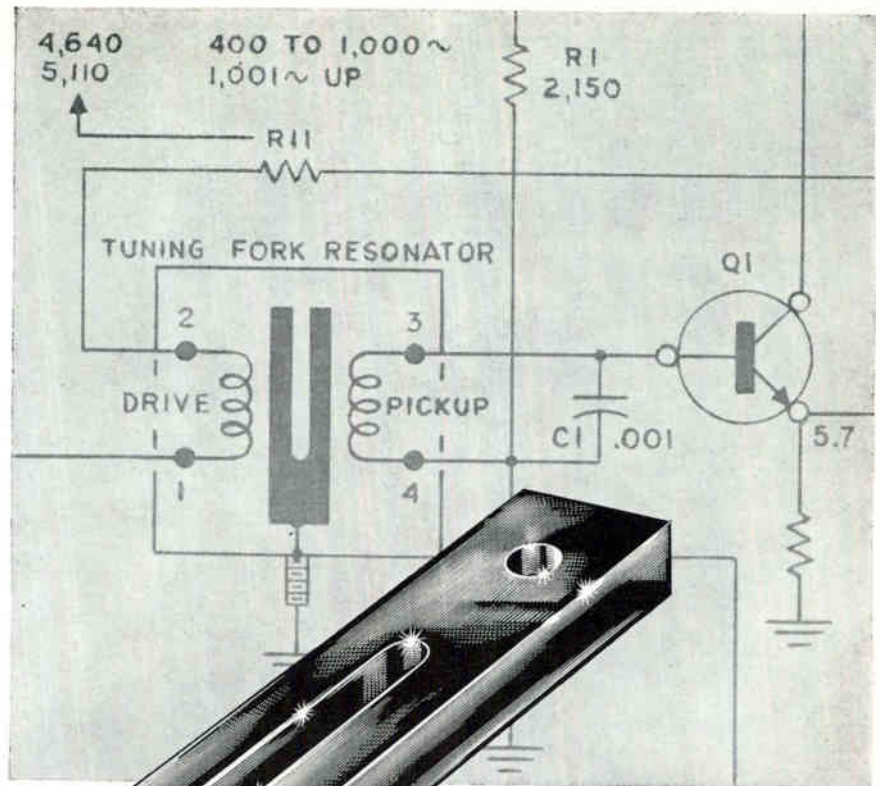

## SYMBOL of PRECISION

Why has the **PHILAMON®** Tuning Fork become the Symbol of Precision for frequency and time standards?

Because of its appearance? Hardly. You'll never see the fork—it is hermetically sealed in an evacuated steel container.

**PERFORMANCE** is the reason. The only reason.

Everything — Philamon's patented design, premium materials, meticulous workmanship and exhaustive testing — is aimed at one goal. Producing a Tuning Fork Resonator which will generate and keep on generating a precise signal.

It is this single-minded emphasis on performance that has given Philamon Laboratories —

### A Reputation for Dependable Frequency Control.

Made to MIL and commercial standards, Philamon's Patented Tuning Fork Resonator is available as a separate component or as the heart of a Philamon Frequency Control Package. These silicon-transistor, modular packages give you a wide choice in preselecting a signal for frequency, accuracy, output voltage and waveshape.

If you have a problem that lends itself to the capabilities of a Tuning Fork Resonator — an instrument also superb as a narrow bandwidth filter — our engineers can, and would like to, help you solve it.

For complete information,



write, phone or wire:

## PHILAMON LABORATORIES INC.

90 HOPPER STREET • WESTBURY, LONG ISLAND, N.Y.

AREA CODE: 516 EDGEWOOD 3-1700/TWX: WBRY 5103/FAX: LPU

# FILMISTOR®

**METAL FILM RESISTORS  
OFFER 5 TEMP. COEFFICIENTS  
TO MEET ALL CIRCUIT  
REQUIREMENTS**

**RUGGED END-CAP  
CONSTRUCTION  
FOR LONG TERM  
STABILITY**

**EXCEPTIONAL  
RESISTANCE TO  
MOISTURE AND  
MECHANICAL DAMAGE**

**SURPASS MIL-R-10509  
PERFORMANCE  
REQUIREMENTS**

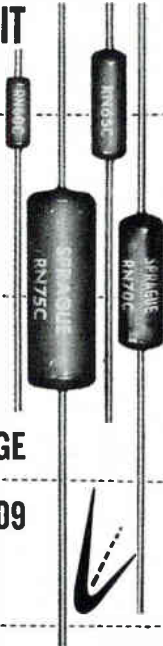

Providing close accuracy, reliability and stability with low controlled temperature coefficients, these molded case metal-film resistors out-perform precision wirewound and carbon film resistors. Prime characteristics include minimum inherent noise level, negligible voltage coefficient of resistance and excellent long-time stability under rated load as well as under severe conditions of humidity.

Close tracking of resistance values of 2 or more resistors over a wide temperature range is another key performance characteristic of molded-case Filmistor Metal Film Resistors. This is especially important where they are used to make highly accurate ratio dividers.

Filmistor Resistors, in 1/8, 1/4, 1/2 and 1 watt ratings, surpass stringent performance requirements of MIL-R-10509D, Characteristics C and E.

Write for Engineering Bulletin No. 7025 to: Technical Literature Section, Sprague Electric Co., 35 Marshall Street, North Adams, Mass.

For application engineering assistance, write: Resistor Div., Sprague Electric Co. Nashua, New Hampshire



'Sprague' and '®' are registered trademarks of the Sprague Electric Co.

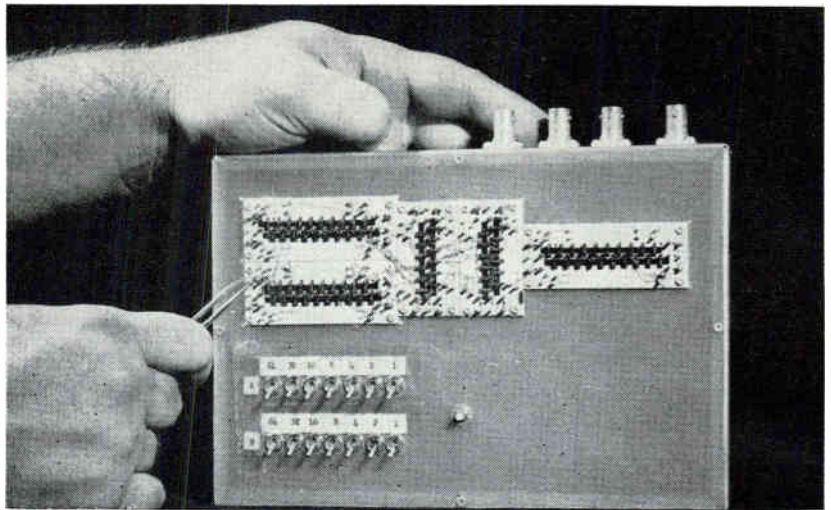

Demonstration model of multiaperture core computer elements

## Cores and Wire Make Miniature Computer

MINIATURE COMPUTER that uses only ferrite cores and copper wire has been announced by Lockheed Missiles & Space Co. The company considers it reliable enough for years of maintenance-free duty in space, or for industrial and communications applications.

Lockheed says it is about 1,000 times as slow as computers using transistors—pulse rate is about 5,000 a second—but claims it is 10 to 100 times as reliable. Multiaperture cores handle basic binary functions. Direction of information flow is controlled by the hole pattern.

The company reports the computer is operating in its lab.

### Chromium Dopes C-W Laser's Ruby Crystal

FURTHER DETAILS on Bell Telephone Lab's c-w ruby laser (ELECTRONICS, p 7, Jan. 26) were given by D. F. Nelson and W. S. Boyle at the American Physical Society meeting.

The active ruby portion of the trumpet-shaped sapphire and ruby crystal is grown from the sapphire, by doping with chromium. The crystal is one inch long and 60 mm in diameter at the flared end.

Exciting light from a specially-designed arc lamp enters the flared end, through a mirror system, is reflected from a mirror at the other end of the ruby and is dispersed through the flared end. Coherent

light produced by oscillations in the ruby exits through a mirror in the center of the flared end. This mirror is less than 100 percent reflective.

Effective pumping intensity is 3 Kw per sq cm. Input power at 930 watts produces a coherent light output of 4 mw. Output might be raised to roughly one watt with further work, perhaps by increasing ruby chromium concentration.

Bell also reported another c-w laser, using a crystal of uranium in calcium fluoride, with an output of 2.56 microns. The system seems to be similar to one previously reported, which uses neodymium in calcium tungstate (ELECTRONICS, p 26, Jan. 12).

E. S. Dayhoff and B. Kessler, of Naval Ordnance Lab, used a camera with a framing rate of 500,000 a second to photograph modes of operation in a ruby laser. They found modes vary in different crystals.

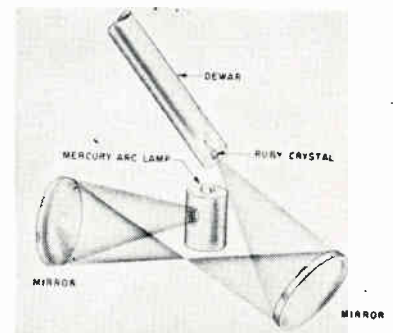

Lens system directs intense pumping light into crystal

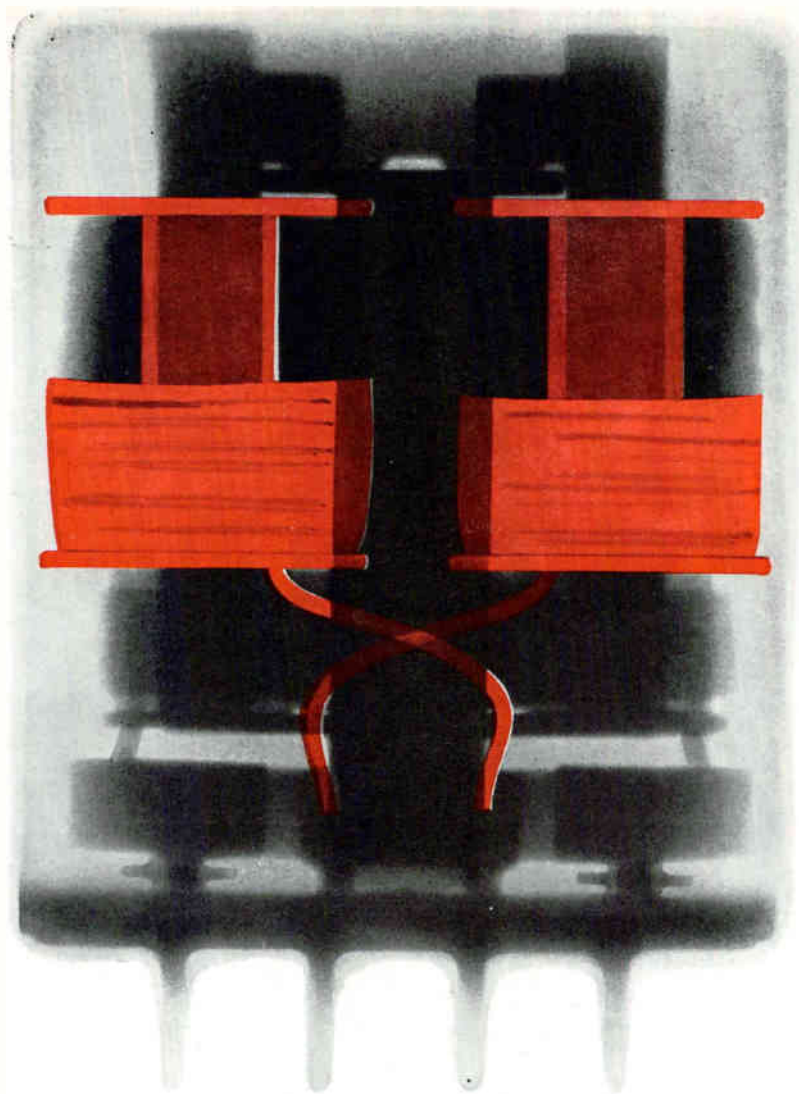

## Injection-molded coil form of **TEFLON<sup>®</sup> FEP** helps subminiature relay meet tough specs

In this versatile subminiature relay, the coil form is molded of Du Pont **TEFLON FEP**-fluorocarbon resin. Because FEP resin is melt-processible, the coil form is rapidly and economically produced by injection molding. These coil forms require insulation resistance of 10,000 megohms minimum at temperatures from 65°C to 150°C. Babcock Relays Division of the Babcock Electronics Corp. found that Du Pont **TEFLON FEP** resin was the only practical material offering the necessary insulating characteristics over this range of temperatures. The new relay meets the rigid MIL specifications for virtually all aircraft and missile applications.

The molding of the coil form of a **TEFLON FEP** resin also made possible miniaturization of the relay—only 1.3" high and slightly over one ounce in weight. And the stability

of **TEFLON** at high temperatures eliminates the major problem of contact contamination by outgassing. The superior electrical properties of **TEFLON** are also utilized in tape and in lead wire in this relay.

This is another example of improved electrical design made possible by the new melt-processible FEP resins, which make **TEFLON** available in the form of easily molded components and in long, continuous lengths of extruded wire insulation. For more information, write: E. I. du Pont de Nemours & Co. (Inc.), Dept. E-29, Room 2526T Nemours Building, Wilmington 98, Delaware.

*In Canada:* Du Pont of Canada Limited, P. O. Box 660, Montreal, Quebec.



**TEFLON<sup>®</sup>**  
FLUOROCARBON RESINS

*TEFLON is Du Pont's registered trademark for its family of fluorocarbon resins, fibers and film, including TFE (tetrafluoroethylene) resins and FEP (fluorinated ethylene propylene) resins.*

BETTER THINGS FOR BETTER LIVING . . . THROUGH CHEMISTRY

**NEW  
TIME-DELAY  
RELAY  
■■■  
ENCLOSED  
SNAP-ACTION  
CONTACTS  
(SPDT OR DPDT,  
5 AMPS)  
■■■  
CONTINUOUS-DUTY  
COIL  
■■■  
MODERATE  
PRICE**



Quite a job, this new Heinemann Type B Relay. Loaded with engineering refinements. Like totally enclosed contacts (for protection against environmental contamination and tampering). And a balanced armature (for improved shock and vibration resistance). And a smaller pole-piece (to reduce chatter noise). • Electrically, the Type B has a lot to offer, too. Most notably, the continuous-duty coil. It permits the relay to work not only as a delay device, but as a load-carrier, too. (In most applications, there is no need for slave or lock-in circuits since the coil can remain energized continuously after actuation.) • Think you might have use for the Type B? It's available in sixteen standard timings, from 1/4 to 120 seconds, and can be furnished for operation on any of a whole slew of AC or DC voltages. Our new Bulletin No. 5004 will give you detailed specifications.

HEINEMANN ELECTRIC COMPANY, 2600 BRUNSWICK PIKE, TRENTON 2, N. J.

SA-2497

## MEETINGS AHEAD

SOLID STATE CIRCUITS, Internat. Conf., PGCT of IRE, AIEE; Sheraton Hotel and U. of Penn., Philadelphia, Pa., Feb. 14-16.

APPLICATION OF SWITCHING THEORY TO SPACE TECHNOLOGY Symp., USAF, Lockheed Missiles and Space; at Lockheed, Sunnyvale, Calif., Feb. 27-Mar. 1.

SCINTILLATION AND SEMICONDUCTOR COUNTER Symp., PGNS of IRE, AIEE, AEC, NBS; Shoreham Hotel, Washington, D. C., Mar. 1-3.

VACUUM COATING Conference, Soc. of Vacuum Coaters; Sheraton-Cleveland Hotel, Cleveland, O., Mar. 6-7.

MISSILES & ROCKET TESTING Symp., Armed Forces Communications & Electronics Association Coca Beach, Fla., Mar. 6-8.

EXTRA-HIGH VOLTAGE COMMUNICATION, CONTROL & RELAYING, AIEE; Baker Hotel, Dallas, Tex., Mar. 14-16.

IRE INTERNATIONAL CONVENTION, Coliseum & Waldorf Astoria Hotel, New York City, Mar. 26-29.

QUALITY CONTROL Clinic, Rochester Soc. for Q.C.; U. of Rochester, Rochester, N. Y., Mar. 27.

ENGINEERING ASPECTS OF MAGNETO-HYDRODYNAMICS, AIEE, IAS, IRE, U. of Rochester; U. of Rochester, Rochester, N. Y., Mar. 28-29.

SOUTHWEST IRE CONFERENCE AND SHOW; Rich Hotel, Houston, Texas, April 11-13.

JOINT COMPUTER CONFERENCE, PGEC of IRE, AIEE, ACM; Fairmont Hotel, San Francisco, Calif., May 1-3.

HUMAN FACTORS in Electronics, PGHFE of IRE; Los Angeles, Calif., May 3-4.

ELECTRONIC COMPUTERS Conference, PGCP of IRE, AIEE, EIA; Marriott Twin Bridges Hotel, Washington, D. C., May 8-10.

NATIONAL AEROSPACE Electronics Conference, PGANE of IRE; Biltmore Hotel, Dayton, Ohio, May 14-16.

MICROWAVE THEORY & TECHNIQUES National Symposium, PGMST of IRE; Boulder, Colo., May 22-24.

SELF-ORGANIZING INFORMATION SYSTEMS Conference, Off. Nav. Rsch., Armour Rsch. Fd.; Museum of Sci., and Ind., Chicago, May 22-24.

### ADVANCE REPORT

AUDIO ENGINEERING SOCIETY Spring Convention: at Los Angeles in the Ambassador Hotel, Mar. 21-23. Titles and abstracts on papers in all phases of audio engineering, particularly the following, should be sent at once to Mr. William H. Thomas, Chairman, AES Spring Convention c/o James B. Lansing Sound, Inc., 3249 Castas Ave., Los Angeles 39, Calif.: FM multiplexing, magnetic tape recording and reproducing, stereophones, audio instruments, loudspeakers, audio transistor applications, sound reinforcement.

**Centralab**  
ERL

*introduces*  
four styles of

**HOT MOLDED CARBON  
POTENTIOMETERS**

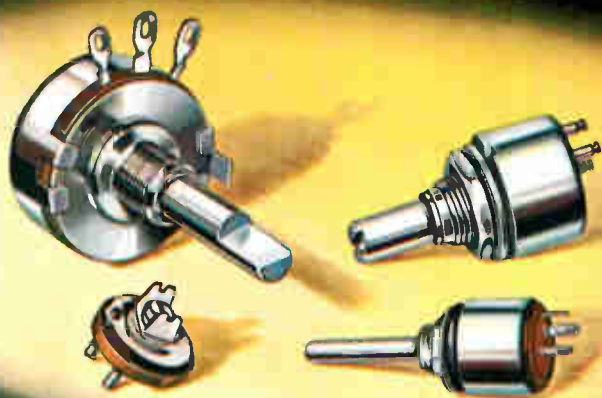

For smooth, noise-free operation and high stability... The widest selection anywhere... Designed to meet **MIL-R-94** environmental and test requirements

Centralab... producer of carbon potentiometers

# CENTRALAB'S MODEL A (RV4 Style)

In addition to the smooth, noise-free operation and high stability for which hot molded potentiometers are well known . . . each model in this series incorporates many features that result in even greater reliability than was previously available. . .

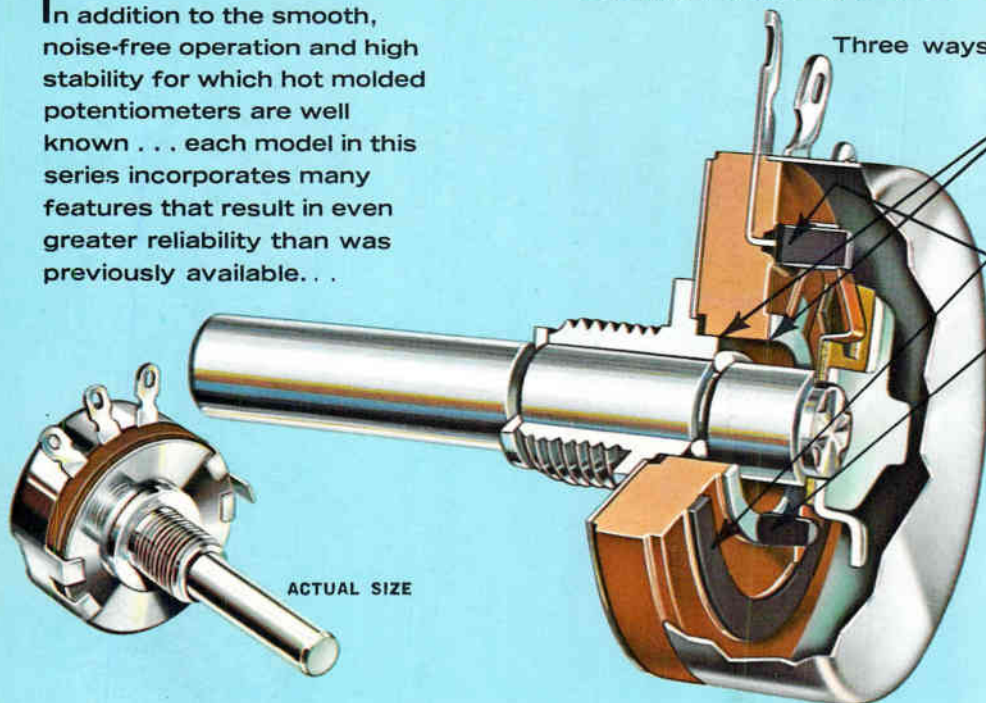

Three ways better than other hot molded units

1. Greatly increased high voltage capability, due to the wide clearance between the bushing and the collector track.
2. Greater freedom from contamination of dirt, carbon particles and sealing compounds, due to the elevated resistance track construction.
3. Exceptionally long noise free operation that actually improves with use, provided by the carbon composition material of which both the collector and pick-off brushes are constructed.

## SPECIFICATIONS:

**RATING:** 2 watts at 70° C.

**SIZE:** 1-3/32" diameter, 37/64" deep from mounting surface.

**CONSTRUCTION:** Completely enclosed. All metallic parts are non-magnetic and corrosion resistant. Available in tandem, triple or dual concentric construction.

**ROTATION:** 312° ±3°.

**TORQUE:** 1.0 to 6.0 ounce inches

**RESISTANCES:** Linear taper, 50 ohms to 5 MEG. Log taper, 100 ohms to 2.5 MEG.

## MODEL N



This intermediate size potentiometer has never before been offered. Rated at 3/4 watt, the Model "N" can replace 2 watt units in many military and commercial applications where size is important.

A flush resistance track is protected against contamination by the raised rim of the insulating base. Although small in size, the model "N" also has carbon composition pick up and collect-or brushes for long, noise-free operation.

The one-piece metal case and bushing is spun over the molded insulating base to provide a near-perfect seal. Triple shaft seals and water-tight panel seals can be supplied.

## SPECIFICATIONS:

**RATING:** 3/4 watt at 70° C.

**SIZE:** 23/32" diameter, 1/2" deep from mounting surface.

**CONSTRUCTION:** Completely enclosed. All metallic parts are non-magnetic and corrosion resistant.

**ROTATION:** 300° ±3°

**TORQUE:** 5.0 ounce inches average.

**RESISTANCES:** Linear taper, 50 ohms to 5 MEG. Log taper, 100 ohms to 2.5 MEG.

## MODEL P (RV6 Style)



Although much smaller than the Model "N", the Model "P" is rated at 1/2 watt and is similar in external construction.

The resistance track is hot molded, flush type. An outstanding feature of the Model "P" is the single carbon brush that serves both collector and pick-off purposes. The one-piece aluminum case is spun over the insulating base to provide a near-perfect seal.

This unit meets all applicable military requirements.

## SPECIFICATIONS:

**RATING:** 1/2 watt at 70° C.

**SIZE:** 1/2" diameter, 15/32" deep from mounting surface.

**CONSTRUCTION:** Completely enclosed.

**ROTATION:** 290° ±3°.

**TORQUE:** 1.5 ounce inches.

**RESISTANCES:** Linear taper, 100 ohms to 5 MEG. Log taper, 500 ohms to 2.5 MEG.

## MODEL T

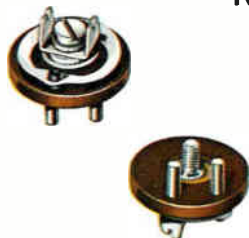

This unique trimmer resistor, or locking-type trimmer potentiometer, is the only hot molded, single turn unit available on today's market. Rated at 1/3 watt, it has been designed primarily for printed-circuit board applications.

The Model "T" has a positive screw actuated lock and is extremely resistant to shock, vibration and acceleration.

These units can be encapsulated in a rigid resin without damage.

## SPECIFICATIONS:

**RATING:** 1/3 watt at 70° C.

**SIZE:** 19/32" diameter, 11/32" deep from mounting surface.

**CONSTRUCTION:** Open (however, rugged construction permits potting of all types).

**ROTATION:** 300° ±3°.

**TORQUE:** Locking type.

**RESISTANCES:** Linear taper, 500 ohms to 5 MEG.

**IMMEDIATE DELIVERY FROM STOCK**

A full range of values of all four types of Centralab hot molded carbon potentiometers are available in quantity, from stock, through Centralab industrial distributors.

**Centralab**  
ERL

THE ELECTRONICS DIVISION OF GLOBE-UNION INC.  
900 E. KEEFE AVENUE • MILWAUKEE 1, WISCONSIN  
In Canada: Centralab Canada Ltd., P.O. Box 400, Ajax, Ontario

CIRCLE 102 ON READER SERVICE CARD

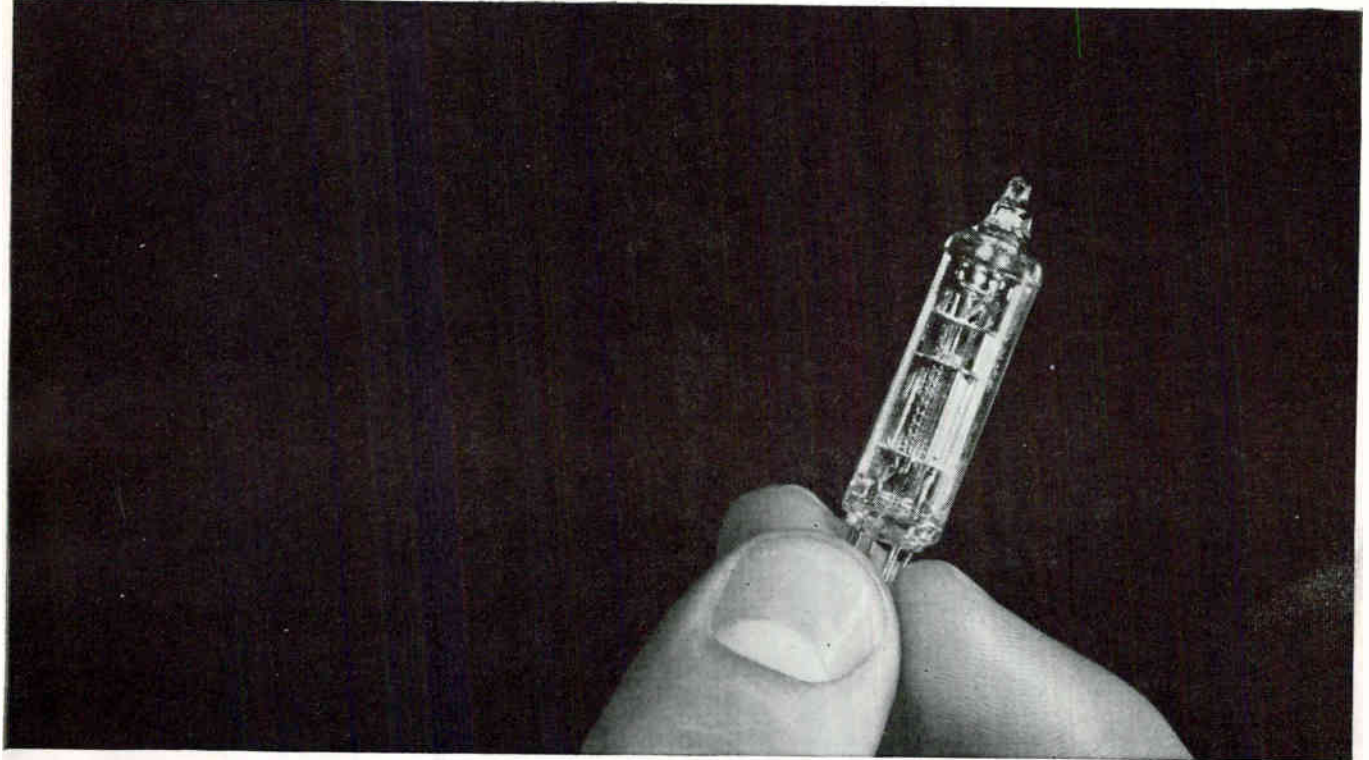

# PRODUCE IT TODAY SELL IT TOMORROW ANYWHERE IN THE U.S.A. WITH



No matter what your product, you'd expect overnight delivery to have a tonic effect on sales, and with AIR EXPRESS it does. You cut costs, too—with savings on warehousing, packing, inventory and insurance. But . . . you don't get all these advantages from just any air shipping service. Only AIR EXPRESS has the 13,000 R E A Express trucks available for speedy pick-up and delivery. Plus priority on all 35 scheduled airlines throughout the U.S.A., including Alaska and Hawaii, Puerto Rico and Canada. Rates? As low as \$5.30 for a 10 lb. shipment, 1,000 miles! **CALL YOUR LOCAL REA EXPRESS OFFICE FOR AIR EXPRESS SERVICE**

**RELIABLE** products from RAYTHEON

**better tube performance looks like this**

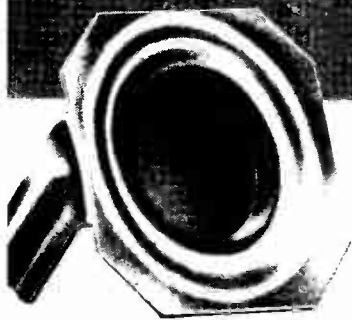
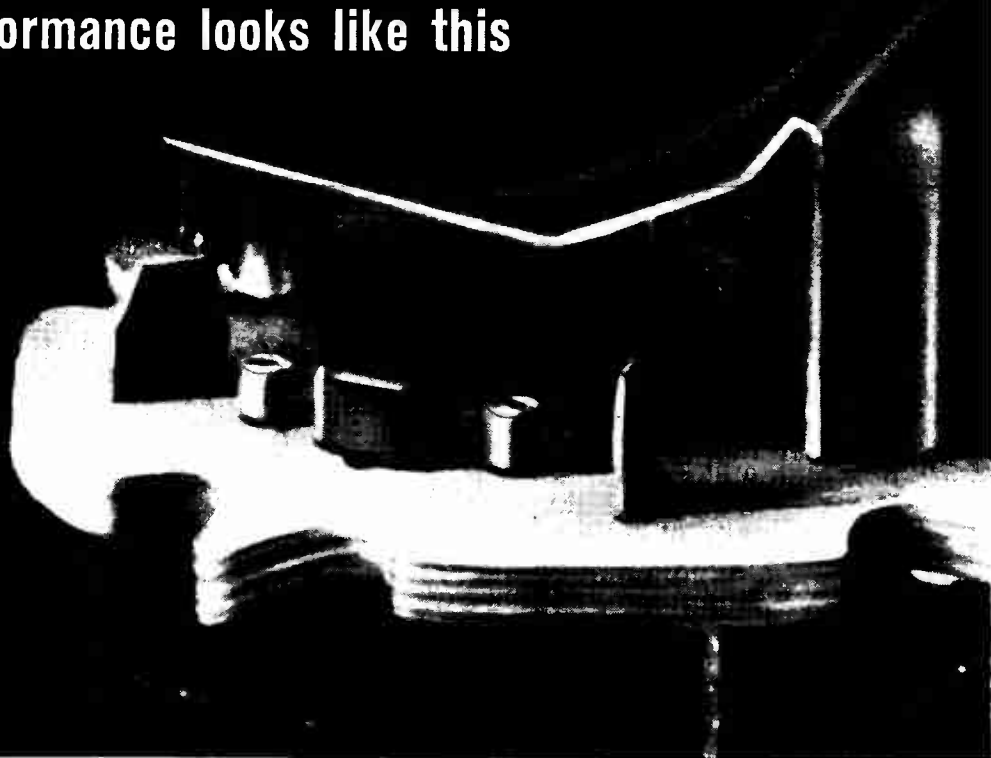

\* Patented

The directional distribution of getter material on the glass envelope is a sure sign of reliable performance of Raytheon tubes. Effective initial tube degassing, directional flash and greater subsequent gas absorption by the exclusive Raytheon pressed-pellet getter\* reduce contamination of tube components for longer, more reliable operation.

The Raytheon pressed-pellet getter is impervious to moisture prior to its use

and is therefore more effective at the time of firing and throughout the life of the tube. Compared to conventional getters, the Raytheon pressed-pellet open cup getter design eliminates spurious metal particles which endanger tube life and performance. *For complete details on Raytheon's line of quality industrial tubes, please write to Raytheon, Industrial Components Division, 55 Chapel Street, Newton 58, Massachusetts.*

*For small order and prototype requirements of reliable Raytheon tubes contact your franchised Raytheon distributor*

**RAYTHEON COMPANY**

**RAYTHEON**

**INDUSTRIAL COMPONENTS DIVISION**



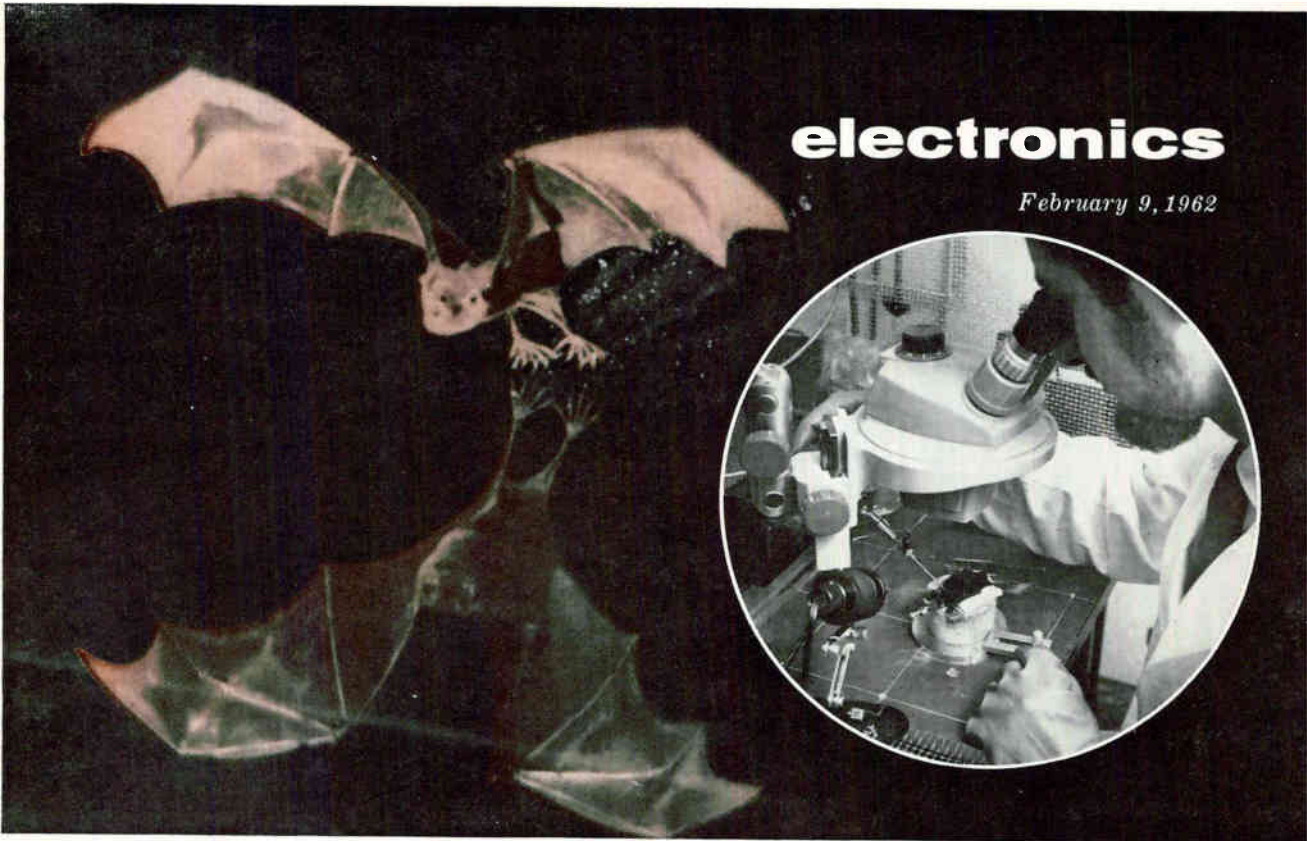

FIG. 1—Tropical bat, the *Noctilio leporinus*, locates fish underwater with a natural radar-sonar system. ONR sponsored studies of this bat by biologist D. R. Griffin of Harvard. At Bell Labs, biophysicist Larry Frishkopf (inset) adjusts microelectrode used to measure responses of bat to sound

# BIONICS

Part I:

## ELECTRONICS AND THE LIFE SCIENCES

*Bionics studies the functions and principles of operation of living systems with a view towards accelerating solutions of complex engineering problems*

By NILO LINDGREN  
Assistant Editor

MOST BEACHGOERS probably look malevolently upon the lowly sand flea and his erratic habits, but it has been discovered only recently that at least one species, the *Talitrus saltator*, can direct himself to the sea on the basis of the moon's position. For his size, this small creature performs "almost unbelievably complex navigational computa-

tions." Today, an engineer designing a miniaturized guidance device that still weighs five pounds might look with a little more professional interest at the "lower orders."

Many serious researchers are now convinced that studies of living systems can be profitable to the electronics engineer and to his industry. Some notable results have already been achieved. For example, fundamental research by Werner Reichardt at the Max-Planck-

Institute für Biologie in Tübingen, Germany<sup>2</sup> on how the beetle *Chlorophanus* reacts to changing optical stimulation (optomotor responses) has led to breadboarding a ground-speed indicator for aircraft that operates like the beetle's eye; it is based functionally on just two of the hundreds of facets that compose its eye.<sup>3</sup> Physiological studies of inhibitory influences in the eye of the limulus (horseshoe crab) by Hartline and his associates at the

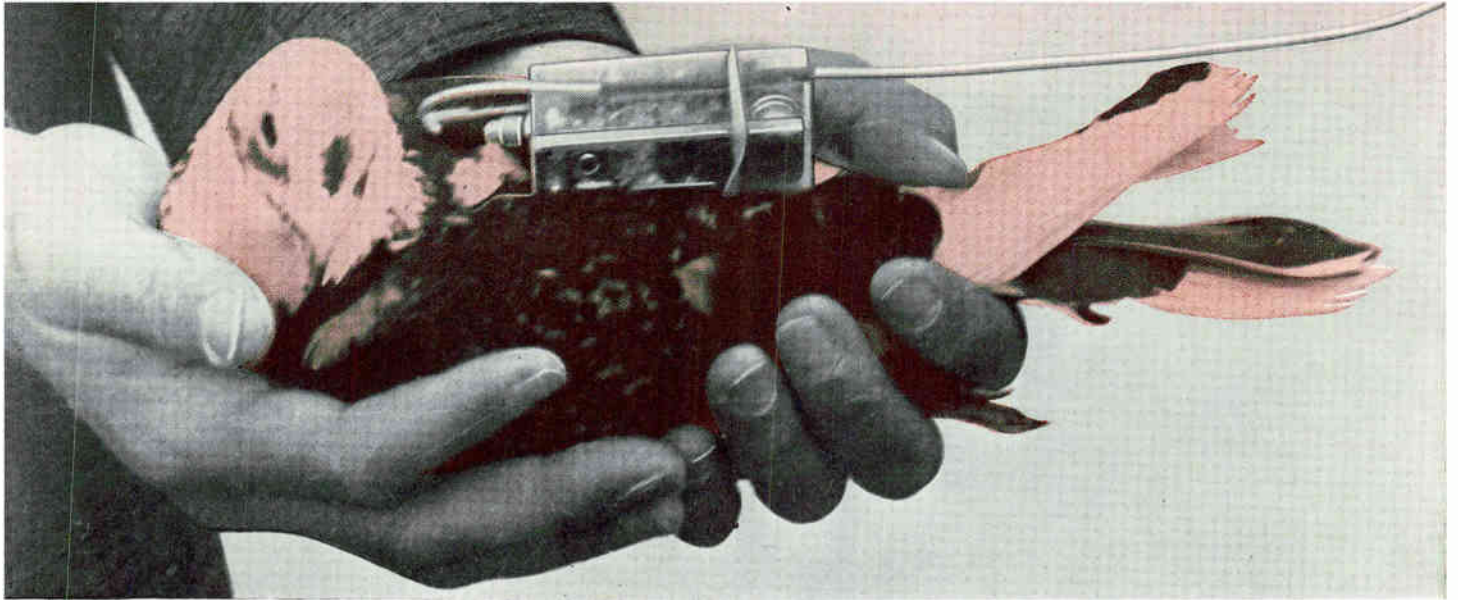

FIG. 2—Bird-tracking system, developed for ONR by American Electronic Labs, Phila., features a powerful miniaturized radio beacon transmitter mounted on bird's back (Navy photo)

Rockefeller Institute have been followed up at the G. E. Advanced Electronics Center, resulting in an electronic eye-model that sharpens contrasts, and which might be applicable in a target or character recognition system.<sup>4</sup>

Biological transducers typically exhibit fantastic sensitivities compared to man-made systems. The noctuid moth, whose ear contains only three nerve fibers, detects the high frequency sonar of bats; he takes evasive action consisting of a wildly gyrating path and then plunging to the ground.<sup>5</sup> The bat himself can detect reflections of his sonar from small objects in high ambient noise. One species of fish can sense a change of electric field in water of 0.003 microvolt/mm.<sup>6</sup> Some fish are also extremely sensitive to odors—one type tested could detect  $1 \times 10^{-11}$  milligram/liter of odorant.<sup>1</sup> The rattlesnake has an infrared sensing organ in the pit between his nostril and eye that responds to a temperature change at its surface of 0.001 deg C.<sup>3</sup> The spider senses victims in his web through sensitive vibration sensors in his legs whose frequency sensitivity can apparently be modified by his engaging in his characteristic bouncing walk.<sup>6</sup>

Had the engineer known these facts a decade ago, he might have shrugged them off and gone back to his business, for biology and engineering were as far apart as they ever were.<sup>7</sup> But with cybernetics and information theory, with advances in electrophysiology, with the rapid developments of our tech-

nology, and with the complexity of today's engineering problems, there has come a change in point of view.

The consciousness that a deliberate pursuit of the understanding of biological functioning and phenomena might accelerate the discovery of design principles to meet today's engineering problems has animated certain sections of the military, notably the Air Force Aeronautical Air Systems Division and the Office of Naval Research, and they are now sponsoring much research requiring the interdisciplinary cooperation of physical and life scientists and engineers.

This new work is called bionics, a name invented by J. Steele of ASD, and officially christened at the first Bionics Symposium held at Wright Field in Sept. 1960. By cross-fertilizing fields traditionally separate in the life and physical sciences, bionics aims at the possible resolution of engineering problems through understanding gained by study and analysis of the functions of living systems. "It is the art of applying knowledge of biological systems and methods to the solution of engineering problems."<sup>8</sup>

The name bionics comes from the Greek word *bion*, which means unit of life; the name does *not* come from a combination of biology and electronics, as some have been led to suppose.<sup>9, 10</sup> In its studies of living systems, ASD emphasizes function—thus, the interest is in how a unit of a living organism *functions* rather than on anatomical location.<sup>9</sup> Also, ASD is careful to point out, bionics is a general field,

involving, on the engineering side, many disciplines.<sup>9, 11</sup>—aeronautical and marine engineering, for example—and not only electronics. An example of how marine engineering has benefited from a bionics type study is the development of a method of reducing the drag of a ship due to turbulence with boundary layer control techniques copied from the porpoise.<sup>8</sup>

Nonetheless, electronics' interests are involved hand and glove with nearly every aspect of bionics. The field includes: fundamental physiological and neurophysiological studies of the human and lower-animal perceptual and cognitive systems, with possible applications in pattern recognition, learning and teaching machines, information storage and retrieval systems; studies of biological transducers and detection systems that may find application in the communications and countermeasures fields; broad studies of how various animals collect, code, process and store information, which are important to the computational field and to the artificial intelligence or self-organizing systems fields; other studies include those of animal servomechanisms and biological clocks. Numerous organizations are now working on physical analogs, simulations, and formal mathematical models of biological functions—the development of artificial neurons and neural-type networks are examples.

Although the bionics name is new, the disciplines on which it draws, in the life and physical sciences, are not. They include biol-

ogy, physiology, neurology, neurophysiology, psychology, psychiatry, epidemiology, electronics, physics, biophysics, chemistry, mathematics, communications, aeronautical and marine engineering, and many others. Most of these sciences were represented at the first Bionics Symposium.

Response to the first symposium, which covered the spectrum of problems being attacked by the physical scientists and mathematicians, was beyond Wright Field's expectations. More than 700 came from different institutes, from universities and from industry. A second symposium, sponsored jointly by General Electric's Advanced Electronics Laboratory and Cornell University, held in late August, early September, last year, shifted its emphasis to the role of biology, to bring contemporary biological investigations directly to the bionicsists. (The papers presented at this meeting are to be published soon by Plenum Press.) Now, Wright Field is planning its second symposium for September, this year. Emphasis of this new meeting will reflect the pace of developments since the 1960 meeting.

This year, the Air Force Bionics and Computer Branch of the Electronic Technology Laboratory at Wright Field will be sponsoring up to fourteen projects in this new interdisciplinary area,<sup>10</sup> some continuations of previous projects, others new. In addition, the Air Force conducts in-house basic research in its Bionics and Neurophysiological Section.

One AF bionics project, the Artron, was awarded to Melpar under two contracts: the first, a theoretical study of generalized machine learning; the second, an electronic realization of neural nets intended to demonstrate a biological function. This project has resulted in the development of a "maze runner" (delivered to ASD last month), which is said to learn as an animal learns, by a kind of Pavlovian conditioning consisting of punishments and rewards. With networks like Artron, the Air Force hopes that it will be able to lick some of its reliability problems.

The Office of Naval Research (ONR), which has conducted a research program in biological orientation for eight years, supports an

## THE ROLE OF BIONICS

*Bionics is open to two different interpretations. On the one hand, it is an imitative science. We aim to learn our lesson from biology and to copy the better gambits of nature. On the other hand, bionics leads us to exhibit life as a special case of a self-organizing system, which is an abstraction born from the theory of cybernetics. Biological self-organizing systems are particularly important because, being such systems ourselves, we have to live with the objects we create, and, naturally, we find the behavior of biologically-fashioned systems intelligible. A biological computer, for example, would be capable of elaborating concepts we could understand. We might argue with it and lead it to modify its attitude. I intend these remarks quite literally. The systems concerned are more than cute or cunning automata.*

*These self-organizing systems arise from an evolutionary process which, though artificial in origin, is as intractable as any process in nature. Because of this, it is not true that we should understand the cogitation of all self-organizing systems. Some are more clever than we and some are completely different. Of these, there are a few able to see order in environments which we should regard as chaotic. These systems are becoming increasingly important for they are the tools and the receivers we need in order to extend our environment either in the sense of knowledge (our universe of discourse and our comprehension of ideas) or in a physical sense (in particular when we aim to control events in outer space or at a subatomic level in physics).*

*In evolution, there is a point at which a species of organism becomes able to modify its environment so strongly that it largely determines conditions of its own development. At*

*this stage, evolution of the species becomes autocatalytic. This happened long ago in the evolution of man. Because of it the environment of man became increasingly man-made and thus increasingly determined by the intellectual objectives which soon replaced mere search for food and association. Most of our work is done manipulating information and in this sense our environment is largely linguistic, but even the physical structures we deal with are organized in a man-made fashion. The benefits of the process are obvious. It is a prerequisite of a civilized development. But like any autocatalysis it can lead to instability.*

*The odd thing is that although we determine the organization of our own environment the order we impose is no replica of our own organization. It is determined by conventions that aim for consistency and repeatability, to yield processes that are readily described, or written in books. Thus our tools tend to be mechanistic, our laws absolute . . . there are discontinuities between ourselves and our world. We speak a different language to our computers.*

*Until recently it was possible to tolerate this discontinuity in communication and control, but nowadays, due to the increasing pace and fruits of technological research we can no longer afford to neglect the fact that ideally, a man-made environment should be an extension of the organization called man. The machines needed are, for the most part, built on a biological plan and this is also the concern of bionics. It is a science which has arisen because we have realized that our world must have a much more biological structure.*

Extracts From A Letter From:

GORDON PASK, System Research Ltd., Richmond, Surrey, England, December 1, 1961

average of thirty projects in biology seeking information useful in electronic design.<sup>8</sup> These include studies in animal migration, notably in birds and turtles, communications studies with porpoises, and sonar in bats (see Fig. 1 and 2). An understanding of how birds, aquatic and terrestrial animals navigate with great accuracy over long distances could lead to new concepts for advanced miniaturized navigation and detection systems.

Many reasons other than mere utility and military urgency are given for the heightened interest in the life sciences. There is the exciting philosophical view that because man's environment is in-

creasingly man-made, this environment must be given a more biological structure (see letter from Pask, above); some, like Heinz von Foerster of the University of Illinois, regard a unification of the sciences, of which there now number more than 1,150, a high necessity;<sup>11</sup> many feel that the scientific tradition has now evolved to the point where it is feasible to tackle seriously the most difficult of all problems, the complete understanding in quantitative terms of the functional organization of the nervous system, the understanding of the phenomena of behavior and of mind—for example, Dr. Warren S. McCulloch of MIT, whom many re-

gard as an important leader of the bionics field, writes of his desire "to reduce epistemology to an experimental science."<sup>20</sup>

Bionics also has its share of critics—some evidently feel that it is attempting to take a short-cut that may prove wasteful in the end, and that the magnitude and difficulty of problems involved in fundamental biological studies have not been appreciated fully.

Whatever the viewpoint and however much controversy might be aroused, is it already clear that the movement towards interdisciplinary cooperation between the life and physical scientists has gained in strength and numbers. In this movement, electronics plays a role of consequence.

It cannot be denied, however, that a prime mover in bionics work is an urgent need. No one is more aware today of the complexity of communications, detection, guidance and control, countermeasures, navigation, surveillance and computation systems than the engineer and the military user of these systems. These involve enormous data processing problems, intimate man-machine relationships that demand self-adaptiveness on the part of the machine. They involve increasingly sensitive detection systems, and the coordination of information from different types of detectors. They involve problems of "organized complexity,"<sup>21</sup> dealing with systems or communities of large numbers of tightly related variables, problems which require new mathematics and logic as well as new design principles. And, above all, they involve problems of reliability that have become all but impossible. For example, modern aircraft require fifty man-hours of ground maintenance for a single hour of flying. The number of electronic parts in a B-58, operational in 1960, was 97,000. The B-17, operational in the 1940's, had only 2,000 electronic parts. Functionally, these new systems more and more resemble living systems.

Historically, a number of important technological and theoretical developments have facilitated the interdisciplinary movement and the advance into bionics. Technologically, the development of solid-state physics, the advances of molecular engineering, or micro-

miniaturization, have brought within reach the possibility of constructing systems containing components which for number and size begin to be comparable to the biological system. Microminiaturization aims at building  $10^{11}$  components in a cubic inch using electron-beam machining and electron microscope techniques.<sup>13</sup> Rough estimates of the number of neurons in the central nervous system run between  $10^{10}$  and  $10^{11}$ . (Neurons are considered to be the basic logic elements, or relays, of nervous tissue.)

In addition, the development of high-speed, high-capacity computers has made it possible to begin studying organizational problems on a level of complexity comparable to biological neural networks. Thus, it has become possible to simulate certain aspects of human information processing. There are now at least a half dozen such simulation programs now in existence studying human problem solving, learning, perceiving and thinking tasks.<sup>14</sup> One researcher speaks of the digital computer as a kind of pseudodissector for studying neurophysiological events.

Theoretically, the viewpoint of the human nervous system as a fantastically complex processor of information was made possible through the now classical "Cybernetics" of Norbert Wiener, published in 1948. Dealing with control and communication in both the animal and the machine, it threw a bridge across many disciplines.

Development of electrophysiological techniques and instrumentation has proceeded apace with developments in electrical knowledge and electronics, and has deepened the understanding of nervous functioning. Galvani's famous work with frog's legs took place in 1791; the electroencephalogram (eeg), the oscillating potential of the brain (usually not more than 200 microvolts in man when recorded through the scalp), was discovered by Richard Caton in 1875—he called them feeble currents; the invention of electronic amplifiers made it possible to study the eeg in detail; it was observed early that these brain potentials appeared to be driven to the frequency of an intermittent light shone in the eyes (photic stimulation), but a quantitative demonstration that the brain

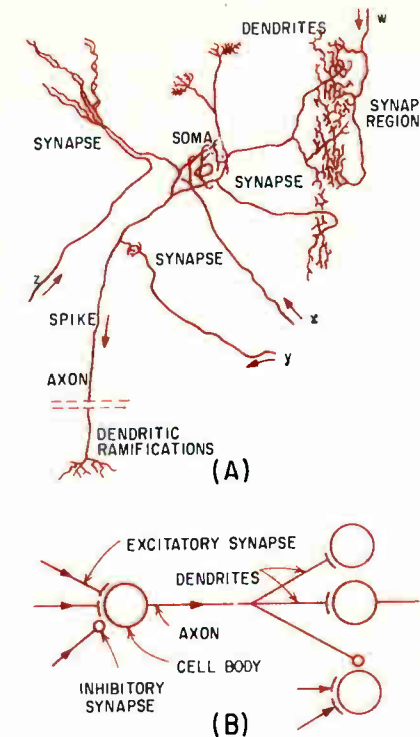
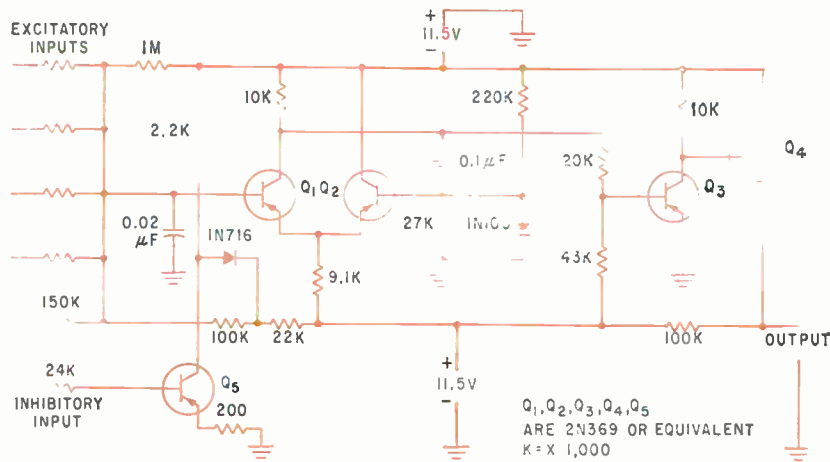

FIG. 3—Schematic of neuron from a crab (A). Simplified formal representation of neuron properties (B)

rhythm followed the flash frequency appeared only in 1946 when Grey Walter and his associates used automatic analysis. Mary Brazier, in her history of the development of concepts relating to brain electrical activity, states: "The concept of electroencephalographic potentials being concomitants of the excitability changes of cortical neurons is basic to today's thinking."<sup>15</sup>

In addition to the eeg, there is a steady potential difference between the outside of the cortex (the relatively thin outer layer of the brain) and the white matter within. These potentials also exhibit slow fluctuations with changes in metabolism; this phenomenon has been studied more effectively with the recent development of chopper circuits.

Despite the many interesting discoveries made with eeg measurements, analytic physiological interpretation of them has been limited, and subject to dispute, because electrodes placed on the outside of the scalp pick up only the electrical activity of the cortical or surface neurons. This has been compared to placing electrodes on the outside of an IBM computer, and deducing the internal operations or the basis



**BASIC PARAMETERS OF NEUROMIME**

(1) RESTING THRESHOLD	-1.5V FOR STEADY TRANSDUCER-LIKE INPUT (RHEOBASE) -3.0V FOR TYPICAL SINGLE SPIKE INPUT	(4) SPIKE OUTPUT	0.8 TO 1.2 mSEC PULSE OF -10V AMPLITUDE
(2) TEMPORAL SUMMATION	TIME CONSTANT: 0.46 TO 1.2 mSEC, DEPENDING ON INPUT CONFIGURATION	(5) REFRACTORINESS	ABSOLUTE $\approx$ 1.0 mSEC
(3) DELAY	0.1 TO 1.0 mSEC, DEPENDING ON FIRING FREQUENCY AND INPUT CONFIGURATION	(6) FIRING FREQUENCY	0-600 CPS
		(7) INHIBITION	GRADED SUBTRACTION FROM EXCITATION
		(8) POWER	81mW

FIG. 4—Electronic artificial neuron designed by Leon Harmon of Bell Labs closely simulates summation, variable threshold, excitation, inhibition, refractoriness and delay of biological neurons. This neuron is being sold (\$45.) by Perceptive Research Products, Yonkers, N. Y.



FIG. 5—Using assemblages of neuromimes, Harmon has demonstrated some functions of nerves in the eye and the ear

of the observed radiations. Even this comparison pales, when it is observed that the brain's operation is far more complex than that of the computer.

What was needed was an analytical study of the intimate events involved in single nerve cells. This was made possible with the introduction of the intracellular electrode (or microelectrode), by Ling and Gerard, in 1949. With the microelectrode, a glass capillary tube with outside dimensions on the order of a few tenths of a micron and filled with a conducting salt solution, measurements were made on single neurons, with the result that radical changes were wrought on the understanding of the nature of physiological substrate of nervous functioning.<sup>16</sup> As with developments in particle physics, the known forms of nerve cell activity have multiplied in number and complexity.

The basis of the modern analytical understanding of nervous system functioning is the neuron doctrine (largely the work of Cajal). In this doctrine, single nerve cells and their processes, together called the neuron, were considered the basic units involved in nervous function. It was the discovery of

all-or-none electrical events (impulses or spikes) in single nerve fibers, lasting about one millisecond and followed by a short refractory period when no further pulse could appear, that led to the view that the nervous system was a kind of digital computer. Coding of information occurs in the system, since the intervals between pulses vary, according to sensory stimulation—essentially a pulse-coded system. These all-or-none spikes were all that was known until 1938, and it was believed that they prevailed across the entire neuron. Now they are viewed as being characteristic only of the axon (see Fig. 3A), which is a greatly elongated extension of the nerve cell (or soma), varying in length from a fraction of an inch to several feet.<sup>17</sup> (Neuron cells vary considerably in size, and most measurements have been made only on the larger cells.) Once triggered, the spike may travel long distances without attenuation. The axons generally terminate among dendritic ramifications. It is now believed that signals impinging on a neuron do not spread to become pulses directly, but are integrated out of both excitatory and inhibitory inputs which converge along

presynaptic paths *w, x, y, z* in Fig. 3A), producing potentials about the cell body (soma). Firing occurs, probably near the axon base, after some arbitrary threshold has been exceeded. It has also been found that some neurons have more than one axon and can deliver two non-identical pulse-coded outputs simultaneously in different directions.

The dendrites, or tree-like structures, have electrical characteristics radically different from the nerve cells and axons. That the dendrites play an important role in eeg potentials has been suggested by many neurophysiologists.<sup>15</sup> It has been speculated that the brain waves are synchronized subthreshold dendritic potentials of many neurons summed, and are possibly a physiologically significant causal agent.<sup>18</sup> One investigator at MIT's Lincoln Laboratory who has simulated neuron-like nets on a computer has noted some similarities between the overall behavior of his nets and those found experimentally (eeg) with cats.<sup>18</sup> He stresses, however, that a great deal more work must be done before it will be known whether these results are meaningful. The range of speculation about these basic physiological events

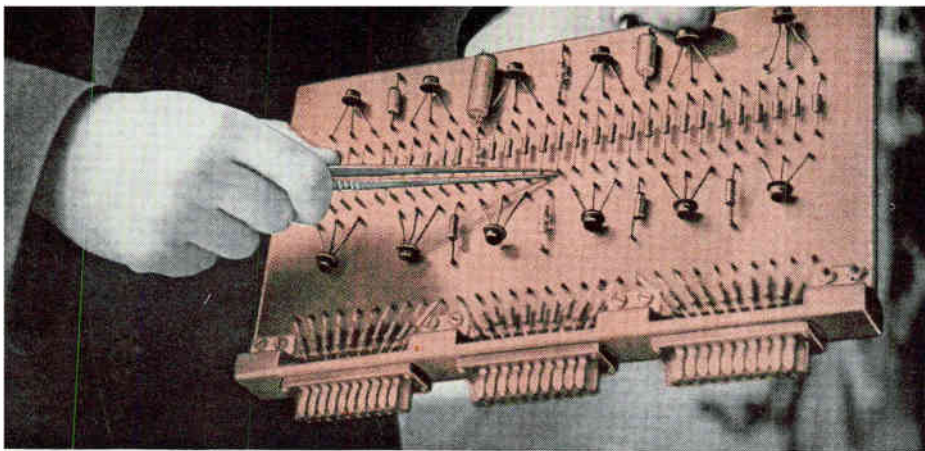

FIG. 6—Russian electronic model of nerve cell built by Vilnius engineers (Fotokhronika Tass)

might be gauged by citing the suggestion made by one author that there might be some relation between the adult alpha-rhythm and the extremely low-frequency naturally occurring electromagnetic oscillation in the cavity between the surface of the earth and the bottom of the ionosphere, both of which are about 8 cps.<sup>19</sup>

Although recent investigation has much modified the picture of neuronal events in biological systems, it has been the fundamental logical operations of neurons and their role in the coding, processing and flow of information that has been of most interest to engineers. The engineer takes the view that the essential role of neural structure is to manipulate information, and he feels that by building simplified neuron models, both experimental and mathematical, greater comprehension of neural events may be gained. Figure 3B shows a simple formal model. Many types of neuron models of varying complexity and verisimilitude — mechanical, chemical and mathematical—have been devised over the years.

Recent electronic neurons (see also Crosstalk, last week), such as that in Fig. 4, featuring both complexity and flexibility, have in some cases yielded surprising and interesting results that could not have been predicted mathematically without great difficulty. The work of Leon Harmon, an engineer, and Willem van Bergeijk, a biologist, at Bell Labs on the eye and the ear are notable in this respect (see Fig. 5). Neuron models or analogs go under various names—artificial neurons, neuromimes,<sup>20</sup> neuristors,<sup>17</sup> Artrons (originally called rerons).

Harmon of Bell Labs stresses that

it is important to distinguish two philosophies involved in neural modeling. "One school," he points out, "seeks to make its neurons simulate biological functions as closely as possible. Input-output relationships are made to be consistent with what is known of the biological parameters. The intent is to study the probable information-processing functions of neurons and in so doing to elucidate further the operations of the biological system."<sup>21</sup> At Bell, experimental simulation work keeps closely in touch with fundamental physiological research (wet work). Intensive studies have been made on the auditory systems of bats (see Fig. 1 inset), frogs and fish.

The second group, "by far the most populous", explore large-scale behavior of many quasi-neuron elements connected randomly. The results of such simulations may be physiologically of little significance; however, such work may result in some interesting engineering hardware. Artron, for instance, although called a neuron, is really a statistical switch.

This discussion of neurons and neural nets should not leave the reader with the sense that these subjects are the central interest of bionics, nor that physiological questions touched on here are near resolution. Both these views would be misleading. However, recent discoveries indicate that a great deal more coding and processing of information goes on in the peripheral systems of animals (at the level of the biological transducers) than had previously been supposed. Comprehension of simpler neural events is prerequisite to the understanding of living systems at any level—the

behavior of the creature in his environment, the operation of his sensors and his servomechanisms, on down to the subcellular level. The picture of the functioning and role of the central nervous system is still dark, and investigators have had necessarily to take the "easiest" problems first, at the periphery.

In addition, at this point in time, there exist fundamental problems even on the level of verbal communications across the disciplines. The development of a common quantitative language for the physical and life sciences is thus also a fundamental concern of the bionicsists.

## REFERENCES

- (1) E. F. Uretz, *et. al.*, Creature Communication, Literature Review, Armour Research Foundation, Ill. Inst. of Tech., July 31, 1961.
- (2) W. Reichardt, Autocorrelation, A Principle for the Evaluation of Sensory Information by the Central Nervous System, p 303 in "Sensory Communication", ed. by W. A. Rosenblith, M.I.T. Press & Wiley & Sons, Inc., 1961.
- (3) H. E. Savely, Air Force Research on Living Prototypes, 1960 Bionics Symp., WADD Tech. Report 60-600, Dec. 1960.
- (4) D. Hildebrand, An Electronic Model of the Limulus Eye, G. E. Advanced Electronics Center Report R61ELC68, Sept. 1961.
- (5) K. D. Roeder and A. E. Treat, The Detection and Evasion of Bats by Moths. *Amer. Scientist.* 49, 1961.
- (6) C. Walcott and W. G. van der Kloot, The Physiology of the Spider Vibration Receptor, *J. Exp. Zool.*, 141, No. 2, July 1959.
- (7) W. A. van Bergeijk and L. D. Harmon, What Good Are Artificial Neurons? 1960 Bionics Symp., WADD Tech. Report 60-600, Dec. 1960.
- (8) L. M. Butsch, Jr. and J. E. Steele, Bionics, An Aid to the Art of Survival. ARDC 7th Annual Sc. and Eng. Symp., Boston, Nov. 1960.
- (9) Conversation with Dr. J. R. Mundie, Chief of Bionics & Neurophysiology Section, WADD.
- (10) Conversation with Col. Butsch, Capt. Knapp, and Mr. C. Gwinn, Bionics and Computer Branch, ETL, WADD.
- (11) J. E. Keto, Bionics—New Frontiers of Technology Through Fusion of the Bio and Physio Disciplines, 1960 Bionics Symp., WADD Tech. Report 60-600, Dec. 1960.
- (12) H. von Foerster, Univ. of Ill., in Preface to 1960 Bionics Symp.
- (13) M. M. Perugini and N. Lindgren, Microminiaturization, General Survey, *ELECTRONICS*, p 103, Nov. 25, 1960.
- (14) H. A. Simon, Modeling Human Mental Processes, RAND Corp. Report P-2221, Feb. 20, 1961. Also *Proc. WJCC*, May 1961.
- (15) M. A. B. Brazier, The Development of Concepts Relating to the Electrical Activity of the Brain, *Jour of Nervous & Mental Disease*, 126, No. 4, April 1958.
- (16) T. H. Bullock, Neuron Doctrine and Electrophysiology, *Science*, 129, April 17, 1959.
- (17) H. D. Crane, Neuristor Studies, Stanford Electronics Labs., Tech. Report No. 1506-2, July 11, 1960.
- (18) B. G. Farley, Some Results of Computer Simulation of Neuron-Like Nets, Lincoln Lab., M.I.T., Symp. on Computer Techniques in Physiology, Atlantic City, April 15, 1961.
- (19) R. M. Stewart, The Structure of Conditioned Logic Nets, Space Electronics Corp., Symp. on Biomedical Eng., San Diego, Calif., April 21, 1961.
- (20) W. S. McCulloch, What Is a Number, That a Man May Know It, and a Man, That He May Know a Number?, *General Semantics Bulletin*, No. 26 and 27, 1960.
- (21) L. D. Harmon, Studies With Artificial Neurons, 1: Properties and Functions of an Artificial Neuron, Bell Telephone Labs. Report.
- (22) W. A. van Bergeijk, Nomenclature of Devices Which Simulate Biological Functions, *Science*, 132, No. 3435, Oct. 28, 1960.

## USING HALL GENERATORS AS

# Contactless Commutators

*Signal voltages to be commutated are used to produce the magnetic field inputs to Hall generators. Other input is switching current.*

*Sampling rate is in excess of 30 kilocycles*

By T. J. MARCUS\*

Westinghouse Electric Corp.,  
Pittsburgh, Pa.

COMMONLY USED mechanical commutators, which are troublesome and require considerable maintenance, can be replaced in circuits that commutate several voltage sources alternately to a common bus. Most common scanning systems use a mechanical switch that can take varied forms. Such a switch has limited speed and contact wear from friction is a serious problem. Hall generators can be used in high speed switching to replace these mechanical switches.

The Hall generator is a semiconductor device having two inputs and one output. The voltage at the output is proportional to the products of the two inputs. One input is the current into the semiconductor device while the other input is the magnetic field through it.

Figure 1 shows two Hall generators connected for commutation of two d-c signals. The d-c input sig-

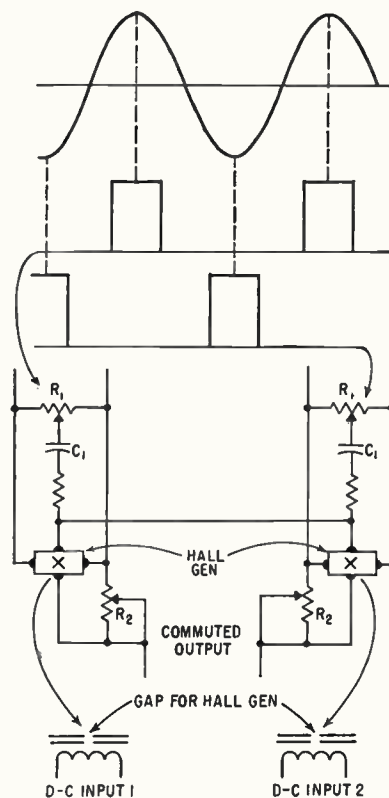

FIG. 1—Hall generator is placed within air gap of split-C core. Air gap minimizes inductive effect of signal changes and reduces hysteresis effects

nals are converted to magnetic field strengths. A coil wound on a C-core and having its d-c resistance match that of the signal source produces the magnetic field. The Hall generator enclosed in a slot in the C-core is then influenced by this magnetic field. The second input is the control current and unless it is present the first input signal does not appear at the output.

Applying control current causes a proportional part of the input signal to appear at the output. Similarly the rate of keying and the relative lengths of the on and off cycle are determined by the control current. Accuracy depends upon the constancy of the peak flat of the control current. An automatic constant current control device holds the current at a fixed level during all on periods.

Hall generators have a small inherent electrical unbalance (it is difficult to place the output leads exactly at the null points). For large signals this unbalance may be disregarded. However, under small signal conditions the unbalance voltage may be a sizable percentage of the signal value. A second source

\* Now with North American Aviation Corp., Columbus, Ohio

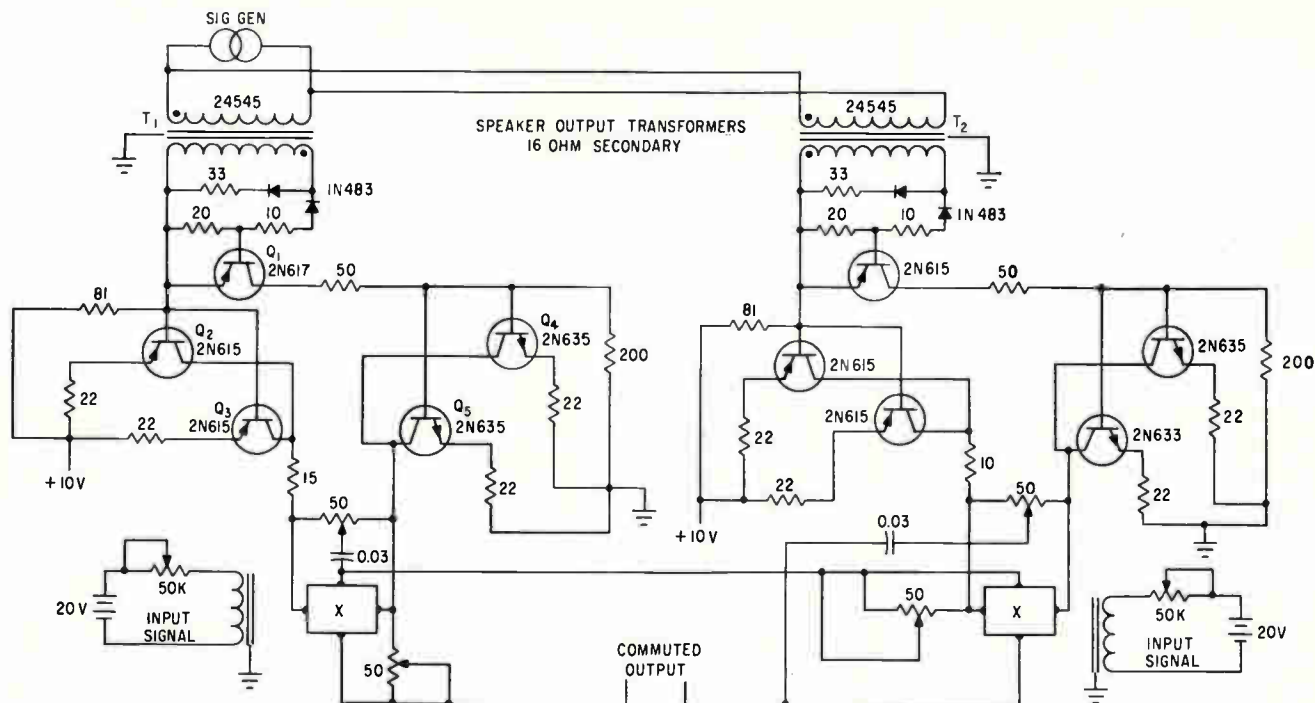

FIG. 2—Frequency response of Hall generator ( $10^{12}$  eps) does not limit keying rate

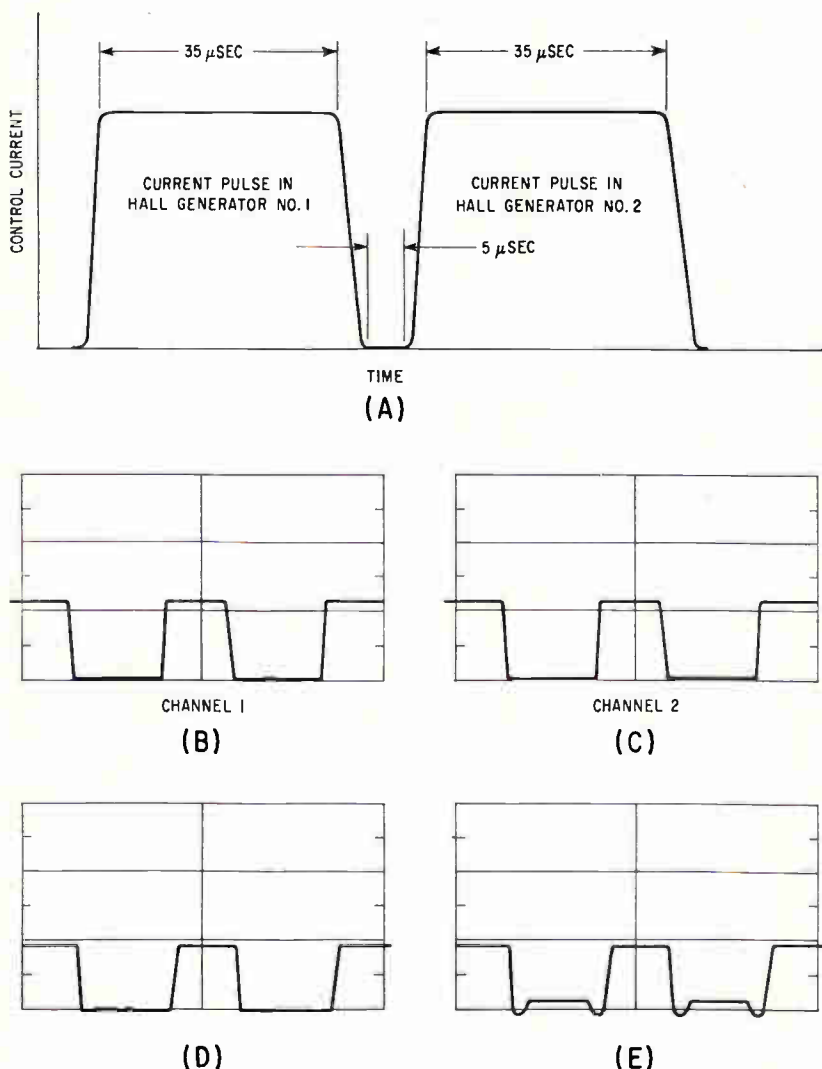

FIG. 3—Time relationship of control currents (A) and typical output wave shapes (B to E)

of inaccuracy is the voltage spike induced from the control current leads to output leads of the Hall generator during the fast rise and fall of the control current.

Figure 1 shows two compensating connections. The potentiometers  $R_2$  apply a small amount of the control current voltage to the output leads. These potentiometers are adjusted to produce zero output voltage from the Hall generators while control current is flowing and the magnetic field is zero. Potentiometers  $R_1$  in combination with capacitors  $C_1$  adjust the amplitudes of spikes delivered out of phase to cancel the spikes caused by induction.

These two compensations, which reduce the disturbance to a minimum, are necessary when using small input magnet fields. Potentiometers  $R_2$  can be adjusted to reduce the Hall generator unbalance output to an immeasurable value. Potentiometers  $R_1$  are adjusted to eliminate 60 percent of the spike peak output. Phase shifts of the two cancelling voltages prevent complete cancellation. However the latter disturbance exists only at the rise and fall times of the square wave control current pulse. The value is then considerably reduced.

Twisting the control current leads in one pair with output leads in another pair reduces the effect of



the radiated magnetic field. This may eliminate the  $R_1$ ,  $C_1$  requirement.

In Fig. 1, the output connections of the two Hall generators are in series. Resistance of the output circuit is 1 to 5 ohms. As a result, the voltage output from one of the Hall generators is not reduced by the series connection even though the load resistance may be comparatively low. The number of such circuits is not limited to two but may be extended to any indefinite number. For more than two, the outputs of all Hall generators are connected in series, ending in one pair of terminals combining the total commutated voltages of each input.

The waveforms in Fig. 1 show how the control current circuits of the two Hall generators are pulsed alternately. During the instant the control current flows, a proportional part of the input d-c signal appears at the output terminals. Thus, commutation takes place and the combined inputs appear at output terminals in sequence. If three or more signals are to be commuted, duplicates of each Hall generator circuit are added with all Hall generator outputs connected in series and the control current pulses staggered to produce sequential pulsing.

Figure 2 shows the circuit used to develop current pulses for sequential control current pulsing and its connection to the Hall generators. The control circuit features adjustment of the off time between pulses and the flatness of peak current. Relatively high control currents are delivered and electrical

isolation between each Hall generator is provided. Isolation is necessary because the outputs of the Hall generators are connected in series.

In Fig. 2 the primaries of  $T_1$  and  $T_2$  are fed out of phase with respect to each other by the signal generator. Secondary of  $T_1$  is half-wave rectified to drive the base  $Q_2$  and  $Q_3$ . These transistors are in a class-B mode. Alternate half cycles from the signal generator then cause current to flow from  $Q_2$  and  $Q_3$  into  $Q_1$  and  $Q_4$ . The currents of  $Q_2$  and  $Q_3$  and the currents of  $Q_1$  and  $Q_4$  then pass through Hall generator as control current.

Paralleling the transistors raises the current in Hall generator, thus raising the sensitivity. Single transistors would work as well provided the switching times are suitable.

The right hand side of the figure shows an identical circuit. Triggering is on the opposite half cycle of the signal generator.

The circuit opens both sides of the Hall generator to prevent a sneak circuit from occurring through the common battery connection. The Hall generator contains a low resistance to all four terminals.

The pulse current waveform shown in Fig. 3A shows the timing of the rise, fall and duration of both Hall generator outputs. The waveform and spacing is adjusted in the pulsing circuit.

Figures 3B and C show the control current waveform of each Hall generator. The off time of one wave corresponds to the on time of the other with 5 microseconds in be-

tween as shown in Fig. 3A.

Figures 3D and E show the signals at the commuted output terminals of Fig. 2. The commuted output voltage with voltage applied to one input and zero voltage applied to other inputs is shown in Fig. 3D. Figure 3E is the same except a low voltage is applied to the input which was previously zero. Each input voltage can be individually adjusted without affecting the other.

Input-output voltage relationship is shown in Fig. 4. The output voltage shows the peak flat value read on an oscilloscope.

When there are more than two inputs to be commuted, the pulsing technique becomes more involved. However, present circuits can be applied for consecutive triggering. Such a circuit would be that found in a frequency counter. These are in common use as event counters and for frequency measurement.

As shown in Fig. 5, a pulse train of the desired repetition rate is fed to the input of the frequency counter. The output would trigger the input 2N615's each in turn. This would cause successive commutation of each input signal to a common output pair of terminals.

The commuting (sampling) rate of Fig. 2 exceeds 30 Kc and the peak noise output with no input signal applied is 105 microvolts rms. The signal ratio of output to input is 0.003. Amplification must be used to recover the signal loss. However, only one amplifier is necessary regardless of the number of inputs.

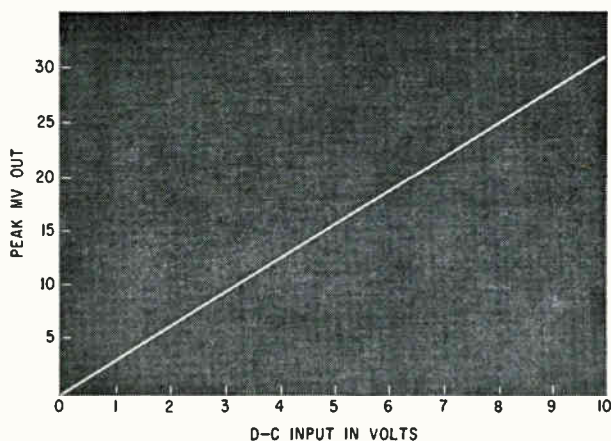

FIG. 4—Linear relationship of output and input of contactless commutator

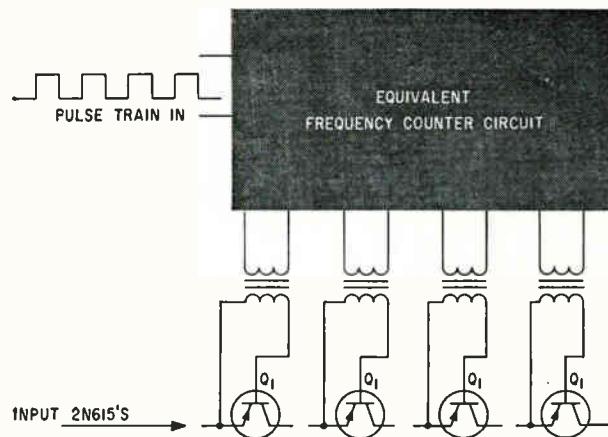
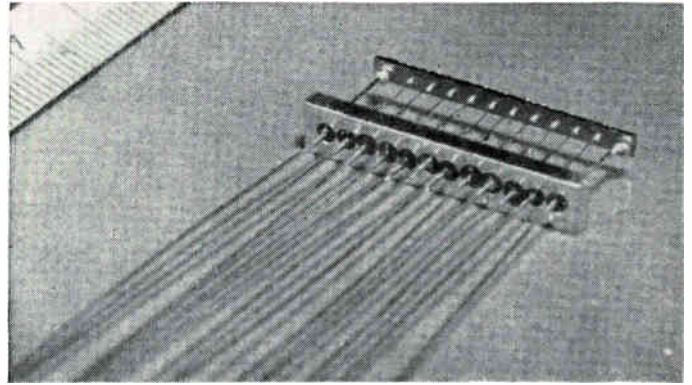

FIG. 5—Signal generator is replaced by more complex pulsing technique

# Semiconductor

## Analog of a

# Cold-Cathode Counter Tube



Device with ten  $p$ - $n$  junctions on an  $n$ -type semiconductor bar and nonrectifying end contacts

By ANDRZEJ AMBROZIAK

Institute of Fundamental Technical Problems,  
Polish Academy of Sciences, Warsaw, Poland

THIS article describes a new multi-junction semiconductor device that may be used as a decade counter or as a staircase waveform generator.

The device (photo) consists of an  $n$ -type semiconductor bar with nonrectifying contacts at either end. On one side of the bar are formed ordinary  $p$ - $n$  junctions, distributed at equal intervals. Such elements can be successfully produced in germanium and silicon by alloying.

If a d-c biasing voltage is applied between the nonrectifying contacts, it produces a linear voltage distribution through the bar. The current-voltage characteristic measured between the negative ohmic contact and each of  $p$ - $n$  junctions is typical of the negative resistance characteristic exhibited by a double-base diode.<sup>1</sup> Such a characteristic admits the operation of a junction in either of two stable states: in the nonconducting or off state, corresponding to a low current; or in the conducting or on state, corresponding to a high current. Thus, every  $p$ - $n$  junction of the device can be operated either as a bistable or as a monostable stage of the device.

The characteristics of the consecutive junctions are shifted with respect to one another in accordance with the positions of the dif-

ferent junctions and the voltage distribution along the bar. The principle underlying the counting action is modification of potential-distribution along the semiconductor bar that is caused by current in each semiconductor junction. In turn, the modified potential-distribution along the semiconductor bar alters the current-voltage characteristics of neighboring junctions. For instance, on being switched on by the  $n$ th pulse from the off state to the on state, yet maintaining a constant value of current, the  $n$ th junction shifts the characteristic of the  $n + 1$  junction so that it can now be similarly switched by the  $n + 1$  pulse.

The circuit of the counter is shown in Fig. 1A. Before counting starts, that is, for time  $t < t_1$ , the voltage distribution in the bar is linear (Fig. 1B and 1C). Each  $p$ - $n$  junction is subject to a voltage that is the difference between the voltage applied from the tap of the voltage divider in the input circuit and the voltage drop in the bar at the point opposite the junction. The bias voltages from the voltage divider should be so chosen that the voltages on all the junctions are negative, that is, all the junctions are in the reverse or off state. The voltage-current characteristics of

the first two junctions are shown in Fig. 1D. The operating point of the first junction previous to counting is denoted by  $A$  and that of the second junction by  $B$ . At  $t_1$ , that is, at the instant the first pulse appears, junction 1 begins to conduct but not the others, since all junctions except 1 require internal feedback from an adjacent junction in the on state before they can be triggered by a pulse. The holes injected into the bar by the conducting junction begin to lower the resistivity in the region between the junction and contact  $B_1$ . This leads to a change in the voltage distribution along the bar, so that at  $t_2$ , the instant when the first pulse vanishes, it is of the shape shown in Fig. 1C. At this instant junction 1 is already able to sustain itself in the conducting state, whereas junction 2 is not yet in the conducting state. The concentration of holes in the region between junction 1 and contact  $B_1$  is finally established at  $t_3$ ; the corresponding voltage distribution is shown in Fig. 1C. The operating point of junction 1 now settles at point  $A'$ , whereas the characteristic of junction 2 is shifted, as shown by the dashed line  $I_2'$  in Fig. 1D. The second pulse, which occurs after time  $t_3$ , will cause the transfer of the operating point of junction 2 to  $B'$ , simultaneously preparing junction 3 for switching by the third pulse, and so on.

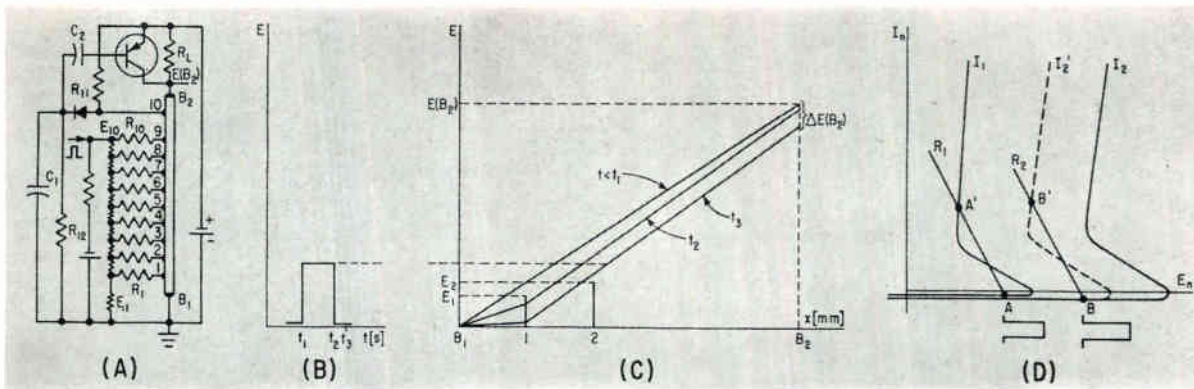

FIG. 1—Circuit of a decade counter (A); time relationships of the input pulse (B); distribution of voltage in semiconductor bar at different times (C);  $E$ - $I$  characteristics of the first two  $p$ - $n$  junctions (D)

*Device may be used as a decade counter or as a staircase waveform generator*

Thus, after nine pulses all the nine bistable stages of the device called the Semdectron are in the on state. Switching each of the junctions from the nonconducting state to the conducting state by the successive pulses, gives corresponding increases in the output current of the device and a decrease in the voltage at the point  $B_2$ . The negative pulses at point  $B_2$  may be used for switching the junctions from the off to the on state in the same manner as the positive pulses at input of the circuit.

The tenth pulse triggers junction 10 (fig. 1A), but this last junction is operated as a monostable one-shot multivibrator. This mode of operation is obtained by suitable choice of the values of the resistances  $R_{11}$  and  $R_{12}$ .<sup>2</sup> Since the stable operating point of junction 10 can lie only in the off region, after being triggered by the tenth pulse, junction 10 remains conducting until the capacitor  $C_1$  discharges through  $R_{12}$ . At the end of the capacitor discharge, junction 10 ceases to conduct and the multivibrator circuit remains in this stable state until the arrival of the next trigger pulse, namely, the 20th pulse.

The pulse obtained from capacitor  $C_1$ , which has a duration determined by the time constant of the monostable circuit, is used for steering the transistor. During the duration of this pulse, the transis-

tor shorts out the load resistance of the device. This produces a positive pulse at point  $B_2$ , sufficient in magnitude to restore all the previous nine junctions to the off state. This pulse may also be used for triggering a succeeding decade.

Thus, after the tenth pulse all

the junctions will be in the off state, which is equivalent to restoring the initial state of the device.

The principle of operation has been corroborated experimentally on prototypes of germanium counters with five  $p$ - $n$  junctions. These were made of  $18 \times 2 \times 0.4$  mm  $n$ -type germanium bars of resistivity about 30 ohm-cm. The nonrectifying contacts as well as the  $p$ - $n$  junctions, 0.6 mm in diameter, are distributed at regular intervals along the bar.<sup>3</sup>

A practical circuit using this counter is shown in Fig. 2, which also shows the oscillogram of the voltage at point  $B_2$ . It depicts clearly the short negative counting pulses as well as the corresponding variations in the value of the voltage  $E(B_2)$  after each pulse. The positive peak of  $E(B_2)$  after each fifth pulse, which restores the initial state of the device, may also be seen on the oscillogram.

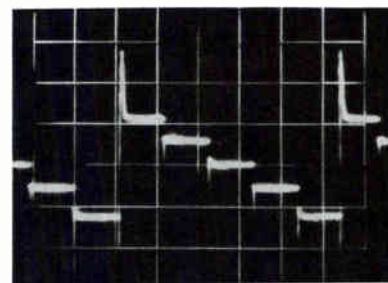
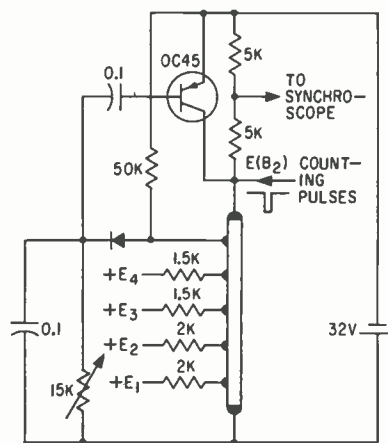

FIG. 2—Practical circuit (top) with five  $p$ - $n$  junctions, and oscillogram (bottom) of voltage  $E(B_2)$ , at 2 volts and 1 msec per division

#### REFERENCES

- (1) I. A. Lesk and V. P. Mathis, The double-base diode: a new semiconductor device, *IRE Convention Record*, Part 6, March 12, 1953.
- (2) J. J. Suran and E. Keonjian, A Semiconductor Diode Multivibrator, *Proc IRE*, 43, 7, p. 814, July 1955.
- (3) A. Ambroziak, A Semiconductor Pulse Counter, *Bulletin de l'Académie Polonaise des Sciences, Série des sciences techniques*, IX, 3, p. 179, 1961.
- (4) J. T. Wallmark, Design Considerations for Integrated Electronic Devices, *Proc IRE*, 48, 3, p. 293, March 1960.

# High Speed Encoding With

*Versatile binary encoder uses few components in achieving operating times as fast as a fraction of a microsecond. Circuit adds several numbers without having to perform a carry. Encoder's applications include its use in a simultaneous multiplier*

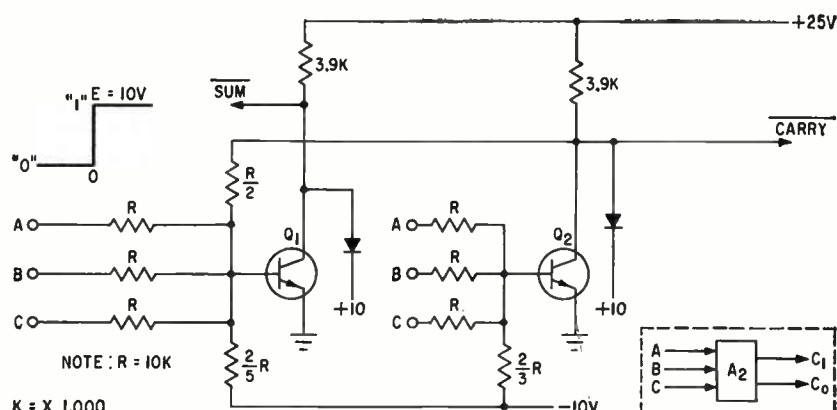

FIG. 1—Inputs to binary full adder go to A, B, and C inputs of  $Q_1$  and  $Q_2$ . Broken-line enclosure shows block diagram of full adder

By S. C. CHAO  
 Instrumentation Div., Ampex,  
 Redwood City, Cal.

RESISTOR - TRANSISTOR - LOGIC (rtl) circuits have several advantages over other digital circuits.<sup>1, 2, 3</sup> Since rtl circuits can require fewer components and logic stages, their use reduces over-all cost of large digital systems and improves reliability and speed. Furthermore, many rtl designs, such as the binary full adder<sup>1</sup> shown in Fig. 1, do not require highly-precise components and voltage sources. This article extends the design principles of the binary full adder to a multi-stage cascade-type binary encoder. First, consider the binary full adder.

Initially, both  $Q_1$  and  $Q_2$  (Fig. 1) are biased off. If biasing is expressed in current units, where  $I = E/R$ , the bias on  $Q_2$  is  $-1.5I$  and the bias on  $Q_1$  is  $-0.5I$ ; note that the net biasing on  $Q_1$  of  $-0.5I$  results from  $+2I$  units being derived from the collector of  $Q_2$  and  $-2.5$  units being derived from the  $2/5 R$  resistor that is coupled to the

base of transistor  $Q_1$ . When any one of the three inputs, A, B, or C, is high,  $Q_1$  conducts;  $Q_2$  does not conduct, since it is biased at  $-1.5I$ . When two inputs are high,  $Q_2$  conducts, withdrawing  $+2I$  from the base of  $Q_1$ ;  $Q_1$  goes off, since its net bias is now  $-0.5I$ . When three inputs are high, both  $Q_1$  and  $Q_2$  conduct. The voltages at the collectors of transistors  $Q_1$  and  $Q_2$  represent

the complement of the input sum. For example, the sum of three ONE'S, which equals a sum and carry, is represented by (approximately) zero volts at both collectors, the bars above the sum and carry indicating the complement, or NOT, condition. Allowable voltage and resistance tolerances are between 25 to 30 percent.

Functioning of the multistage

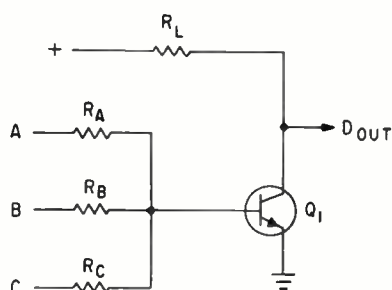

$$D = \overline{A + B + C}$$

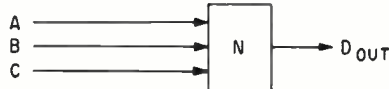

## THE NOR CIRCUIT

The rtl NOR circuit that is shown in the schematic and block diagram is the basic building block of the binary full adder (Fig. 1) that comprises the binary encoder discussed in this article. As indicated by the logic equation above the block diagram, if any one (or more) of inputs A or B or C is applied to transistor  $Q_1$ , there will not be a positive output at D

# Resistor-Transistor-Logic Circuits

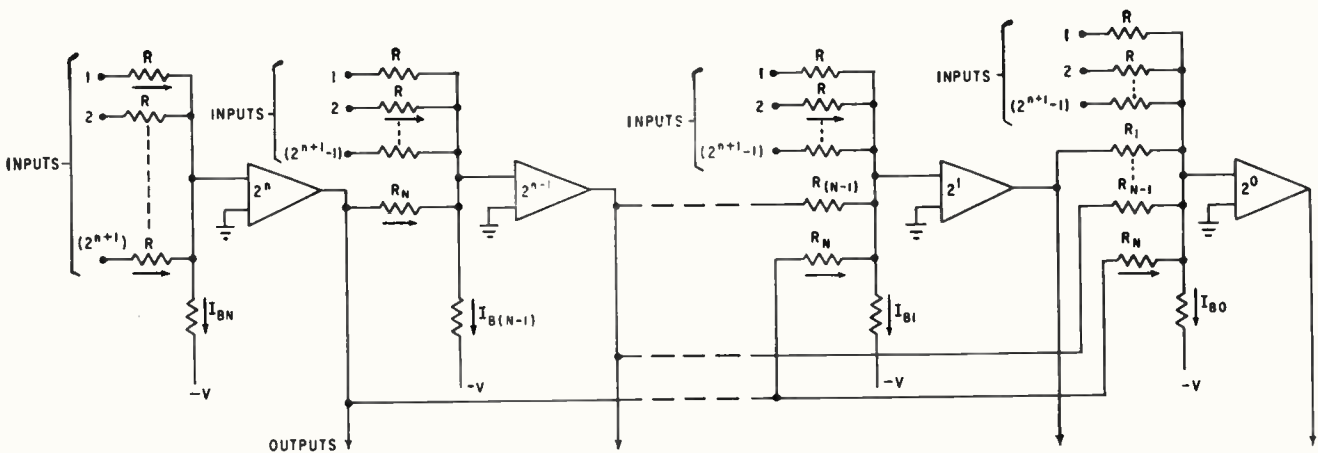

FIG. 2—This is the basic binary encoder configuration. Its output voltages comprise the complement of the sum of its inputs. The  $2^n$  amplifier goes on if  $2^n$  (or more) inputs are 1; it stays off if less than  $2^n$  inputs are 1

binary encoder shown in Fig. 2 is similar to that of the binary full adder. This encoder takes care of the CARRY operation internally, saving many of the logic steps taken by conventional adder. Encoding time is essentially the combined response time of all the stages, and can be made as low as a fraction of a  $\mu$ sec by using high-speed circuits. Here, a group of binary num-

bers, 1, 2 . . .  $(2^{n+1} - 1)$ , each represented by one of two voltage levels, can be added together at the same time. The sum, in inverted (complement) form, is obtained at the outputs of comparing amplifiers  $2^n, 2^{n-1} \dots 2^1$  and  $2^0$ . These comparing amplifiers are current summing amplifiers with characteristics that: (1) The input current summing points are at ground po-

tential, which is assumed to be the 0 level of a binary number; (2) the input impedance is low in comparison with the summing resistors; and (3) the output, inverted in phase with respect to the input, is clamped at either level, depending upon whether the amplifier is cut-off or conducting. These are saturating amplifiers without ambiguity in output levels except possibly the least significant bit,  $2^0$ .

In simple form, say when  $n < 5$ , these amplifiers are just single-transistor multilevel rtl circuits.<sup>1</sup> As the number of stage increases, single rtl circuits do not provide enough gain and sensitivity, especially the higher-order stages. Silicon mesa transistors, which have low leakage current and high gain, may be used in these amplifiers.

There are three types of current at summing point at the input of a comparing amplifier (Fig. 2):

- (1) Signal currents—When any input is 1 ( $E$  volts) unit current  $I = E/R$  flows into the summing point. For an  $m$ -bit encoder  $m = (n + 1)$ , a maximum of  $(2^n - 1)$

TABLE I—Conventional

Multiplication of  $14 \times 13$

1 1 1 0
× 1 1 0 1
-----
1 1 1 0
0 0 0 0
1 1 1 0
1 1 1 0
-----
1 0 1 1 0 1 1 0

TABLE II—Simultaneous

Method of Multiplying  $11 \times 13$

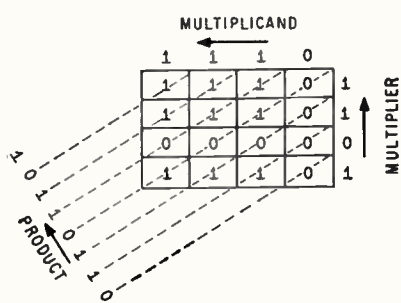

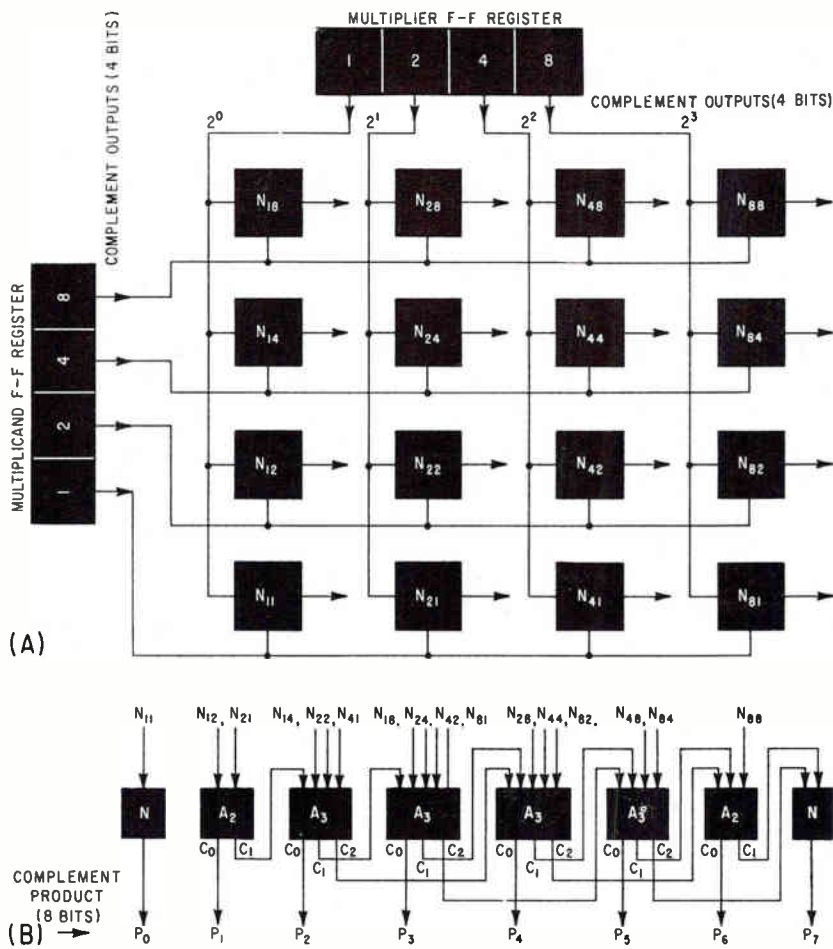

FIG. 3—Simultaneous multiplier comprises the NOR (N) blocks of matrix (A) and N, A<sub>2</sub> (full adder) and A<sub>3</sub> (encoder) circuit blocks (B)

inputs are allowable.

(2) Negative bias currents —  $I_{n0}/I \approx 2^n - \frac{1}{2}$ ,  $I_{n(n-1)}/I \approx 2^n + 2^{n-1} - \frac{1}{2}$ , ...  $I_{n1}/I \approx 2^n + 2^{n-1} + 2^1 - \frac{1}{2}$  and  $I_{n0}/I \approx 2^n + 2^{n-1} + \dots + 2^0 - \frac{1}{2}$ . A general term can be written as  $I_{B1}/I \approx (\sum_{j=1}^n 2^j) - \frac{1}{2}$ . These currents flow in the opposite direction to that of the signal currents.

(3) Positive-bias currents — When the output of the most-significant-bit amplifier ( $2^n$ ) is high, (at  $E$  volts) it applies a positive-bias current of  $2^n$  units to each of the following stages. Similarly, the second most-significant-bit amplifier applies a positive bias current of  $2^{n-1}$  units to each stage to its right; and so on. Hence,  $R_n = R/2^n$ ,  $R_{n-1} = R/2^{(n-1)}$  ...; and soon. Loading of the amplifiers due to positive-bias current tapers off from the most to the least significant bits.

Unit current  $I = E/R$  should be small to limit loading at the higher-

order bits to a reasonable value. Its precise value is a compromise between leakage current and required gain.

At the stand-by condition, when all inputs are 0's, the resultant bias condition at the various input junctions are such that when  $2^n$  inputs are 1, the  $2^n$  amplifier goes on. Since the output of the  $2^n$  amplifier is now approximately 0 volts, it withdraws a positive-bias current of  $2^n$  units from each of the following stages. For example, application of input voltages to inputs No. 1 and 2 turns on only the  $2^1$  amplifier. This method is the same as subtracting half scale from the unknown, and then trying the difference on the next bit. If the  $2^n$  amplifier does not go ON, the binary inputs try to turn on the following bit amplifier.

For example, consider a 4-bit encoder ( $n = 3$ ), whose maximum capacity is  $2^{(n+1)} - 1 = 15$ . The negative bias currents are  $I_{ns}/I = 2^n -$

$\frac{1}{2} = 7\frac{1}{2}$ ,  $I_{n2}/I = 11\frac{1}{2}$ ,  $I_{n1}/I = 13\frac{1}{2}$  and  $I_{n0}/I = 14\frac{1}{2}$ . The positive bias currents, starting from the highest bit, are 0, 8, 12 and 14 units respectively. Hence the resultant bias condition at the 8, 4, 2 and 1 stages are  $-7\frac{1}{2}$ ,  $-3\frac{1}{2}$ ,  $-1\frac{1}{2}$  and  $-\frac{1}{2}$  respectively. When any number, between 0 to 15, of inputs are 1's, the binary-coded sum, in complement form, appears at the outputs of the comparing amplifiers.

This encoder may be used where more than two binary numbers are to be added at the same time to speed-up computation. Complementary circuits<sup>3</sup> and NOR circuits are used to complete the system logic. In general,  $n$  need not be larger than three, since a 4-bit adder can handle 15 inputs. Hence, tolerance margin is not a serious problem.

This encoder can also be used in a high-speed binary multiplier. The conventional method of multiplying two binary numbers generally employs a multiply (partial product) and shift technique. The final result is obtained by adding all the partial products along vertical columns. Table I gives a simple example ( $14 \times 13 = 182$ ) of binary multiplication. This method requires many computer steps like multiply-store-shift-add which involves a large number of clock time.

With a simultaneous multiplier,<sup>4</sup> steady-state signals representing the multiplicand and multiplier are simultaneously applied to the input lines; after the transients in the multiplier stop, the product appears on the output lines. The encoder described here is suitable for use in a simultaneous multiplier, since it reduces the number of active elements, cost and physical size of the multiplier. Furthermore, total multiplication time is many times shorter than that of the conventional method. Table II indicates the scheme by which the simultaneous multiplier shown in Fig. 3 functions; this multiplier uses 3-stage binary encoders ( $A_3$ ) of the type shown in Fig. 2.

The multiplication example listed in Table II is  $14 \times 13 = 182$ . The blocks comprising the  $4 \times 4$  matrix simultaneously perform individual multiplications of multiplicand and multiplier digits; the number within each box of Table II shows

the partial product of each of these multiplications. The diagonal broken lines indicate the summing process that occurs after partial-product multiplication and that produces the product, 182, in binary form.

In Fig. 3, the complements of the numbers held by the 4-bit multiplicand and multiplier go to the  $4 \times 4$  matrix. This matrix consists of NOR gates; one of these NOR gates is shown in Fig. 4A. The 16 partial-product outputs of the matrix (Fig. 3A) go to logic blocks (Fig. 3B), which add the partial products and come up with the complement of the product ( $P_0$  to  $P_7$ ). Block  $A_2$  of Fig. 3B is the 2-stage adder shown in Fig. 1. Block  $A_3$  of Fig. 3B is the 3-stage encoder shown in Fig. 4B (and indicated in Fig. 2).

Although 42 transistors are used (excluding the input multiplicand and multiplier registers), only 34 transistors would be necessary if some of the NOR circuits were eliminated by using two types of transistors. With 2N1499 madt transistors, settling time of the 3-stage encoder was less than  $0.4 \mu\text{sec}$ ; the maximum time to produce an 8-bit product is about  $1.2 \mu\text{sec}$ . With 1-percent-tolerance resistors, critical voltage margins are  $\pm 5$  percent.

Multipliers like this can be extended to handle much larger numbers. If tolerance is a problem, a compromise can be made by using 3- and 7-input encoders and rtl circuits as building blocks to handle

any size of multiplication. Total computing time would still be many times smaller than that of multiply-shift devise, or even a simultaneous multiplier synthesized from standard AND-OR, half and full adder circuits.<sup>5</sup>

Another possible application of binary encoders is as high-speed analog-to-digital converters.<sup>6</sup> In Fig. 2, if the binary inputs at each stage are replaced by a single unknown voltage, with a full scale of  $E$  volts, and a single mixing resistor  $R/(2^{n+1} - 1)$ , this device becomes a fast analog-to-digital converter. Conversion time is limited only by the response time of the comparing amplifiers. The resolution of this converter is  $E/(2^{n+1} - 1)$ . Commercial converters have 6 to 10 bits resolution, or an accuracy ranging from one to one tenth of one percent. Therefore, the design of accurate high-speed comparing amplifiers is the heart of the design problem, since a simple rtl circuit would no longer be applicable.

The comparing amplifier should have short rise and recovery time even under severe overloading conditions. Also, it should have stable gain and low drift, which is required for most operational amplifiers. Chopper-stabilized amplifiers are not suitable for high-speed application due to their limited bandwidth. From a circuit design standpoint, high speed (wide band) and high accuracy are two conflicting factors, and a compromise has to be made. Recent improvement in

low-leakage surface passivated silicon transistor open up the possibility of designing wide band amplifiers with drift figures comparable to that of a chopper type.<sup>7</sup> For sample-hold or pulse-gated type converters, a-c amplifiers may be used and the drift problem is not serious.

Experimental amplifiers using high-speed mesa transistors and direct interstage coupling show a typical response time about 1 to 2 microseconds. A matched-pair differential front end helps to minimize the drift. Negative feedback reduces the input impedance to the desired value and improves the stability of the amplifier. It is not intended here to give any specific circuit design, because it is not at all unique and varies with requirements such as speed, accuracy and cost. Information on cascade or ripple type converters can be found in References 8 and 9.

#### REFERENCES:

- (1) S. C. Chao, A Generalized RTL Circuit and Some Applications, *IRE PGEC*, EC-8, p 8, Mar. 1959.
- (2) S. C. Chao, Supplementary to the above paper, *IRE PGEC*, p 371, Sept. 1960.
- (3) S. C. Chao, Complementary RTL Circuits, *Semiconductor Prod.*, p 47, Mar. 1961.
- (4) C. D. Todd, A High Speed A to D Converter, *Semiconductor Prod.*, p 29, Mar. 1961.
- (5) R. K. Richard, "Arithmetic Operations in Digital Computers," Chap. 5, Van Nostrand.
- (6) C. D. Todd and M. M. Morishita, High Speed D.C. Comparator, *Electronic Equip Eng.*, p 58, Feb. 1961.
- (7) P. J. Benetean, The Design of High-Stability D. C. Amplifiers, *Semiconductor Prod.*, p 27, Feb. 1961.
- (8) D. Savitt, A High Speed  $A$  to  $D$  Converter *IRE PGEC*, p 31, Mar. 1959.
- (9) Converter Samples Analog at 5 Mc, *ELECTRONICS*, p 94, Apr. 7, 1961.

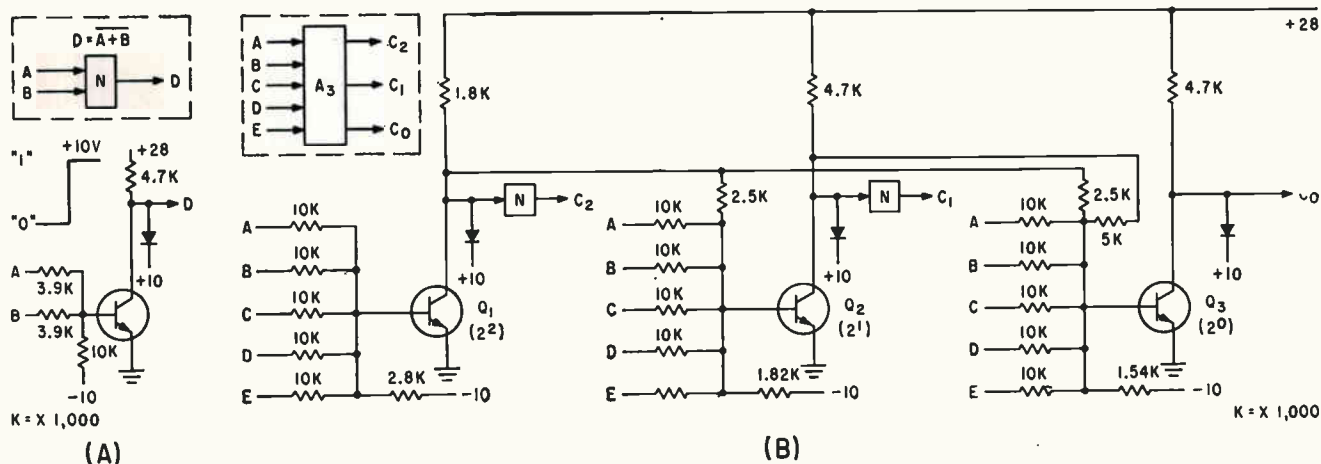
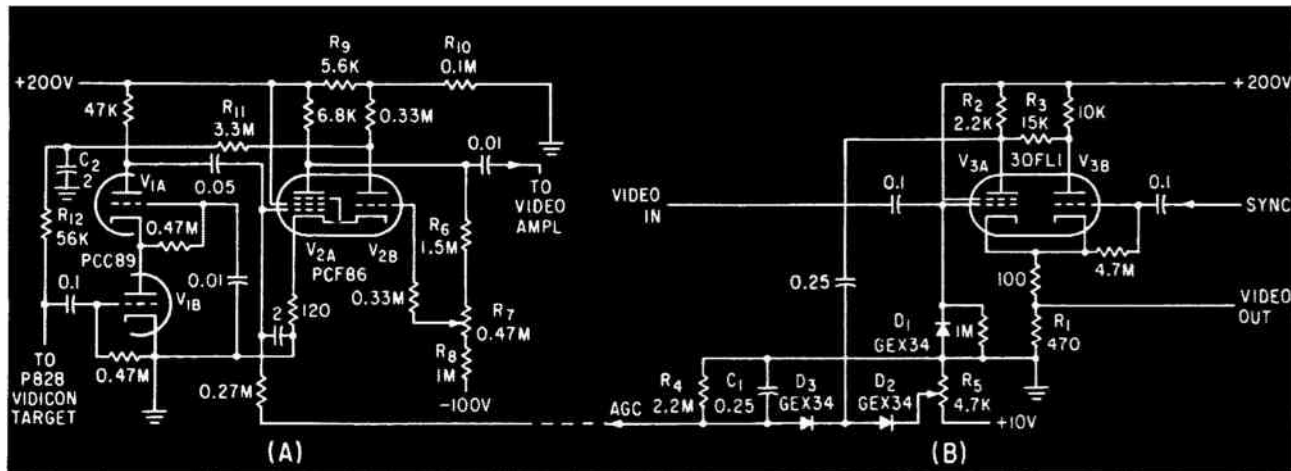

FIG. 4—NOR circuit and block diagram (A); (B) is 3-stage binary encoder used in simultaneous multiplier



First two stages of video amplifier (A); output stage of the video amplifier (B)

## AUTOMATIC SENSITIVITY CONTROL FOR VIDICON TV CAMERA

By P. C. KIDD  
Murphy Radio Limited,  
Welwyn Garden City,  
Hertfordshire, England

INDUSTRIAL television cameras usually require automatic sensitivity control. When all or part of the scene lighting is provided by daylight, intensity will vary with time of day and weather conditions; if the lighting is artificial the scene may be changing or the camera may be panned or tilted. Under these conditions it is necessary to adjust camera sensitivity if the maximum amount of information is to be transmitted.

The circuits used in the Murphy MR 760 television camera enable it to give good pictures with changes of at least 50 to 1 in ambient lighting level. The sensitivity of a vidicon camera tube can be adjusted over a wide range by varying the voltage applied to the target electrode, but more than this is necessary for best results.

When a camera has sufficient sensitivity to work in poor light, it will show some noise in the reproduced picture, and this may be acceptable. However, when more light is available the camera must produce pictures having a good signal-to-noise ratio. The signal-to-noise ratio of a vidicon tube is good and the noise seen on the picture is

almost entirely due to the first amplifier stage. Therefore if the sensitivity of the camera is controlled only by the vidicon target voltage, amplifier noise will always be present.

The control voltage first reduces the gain of the video amplifier until the noise output is negligible, and then starts to reduce the vidicon target voltage.

Output stage of the video amplifier is shown (B). Positive-going, blanked video is fed on the grid of  $V_{2a}$ , the d-c component being restored by  $D_1$ . Large amplitude, negative-going, mixed syncs are fed to the grid of  $V_{3a}$  which is driven beyond cutoff and therefore clips the sync pulses which appear across  $R_1$  and add to the video, providing the composite output waveform.

To provide a larger signal in the correct sense for the age diode, a load,  $R_2$ , is put in the anode of  $V_{3a}$ . In the absence of  $R_2$  the signal across  $R_1$  would consist of an amplified negative-going video waveform, plus negative-going sync pulses due to the cathode coupling to  $V_{3a}$ . In the absence of any video output the sync on  $V_{3a}$  anode would still produce an age voltage. To overcome this, positive sync pulses appearing on the anode of  $V_{3a}$  are coupled by  $R_2$  to  $V_{3a}$  anode, where they cancel out the negative pulses, so that only the negative-going

video signal will be left.

This signal is applied to diodes  $D_2$  and  $D_3$ , which rectify the video peaks and produce negative age voltage across  $C_1$  and  $R_4$ , the resistor  $R_4$  providing an adjustable delay voltage to set the output level.

The circuit of the first two stages of the video amplifier (A), tube  $V_1$ , is a cascode amplifier, the signal from the vidicon target being fed to the grid of  $V_{1a}$ . From the anode of  $V_{1a}$ , the signal goes to the grid of pentode  $V_{2a}$ , and from its anode to the next video amplifier.

The age control voltage is fed to the grid of  $V_{3a}$ . The anode of  $V_{2a}$ , in addition to its video coupling, is also d-c coupled to the grid of  $V_{3a}$  through potentiometer chain,  $R_3$ ,  $R_2$ ,  $R_1$ . When  $R_1$  is adjusted to cut off  $V_{3a}$ , its anode will rise to a potential determined by  $R_2$  and  $R_3$ ; this voltage, which is decoupled by  $R_4$  and  $C_1$ , is fed through  $R_5$  to the vidicon target.

When the signal from the camera exceeds the preset level, the negative age voltage going to the grid of  $V_{3a}$ , reduces its gain as the light input to the vidicon increases. As the bias on  $V_{3a}$  drops, its d-c anode voltage rises;  $R_1$  is adjusted so that when the gain of  $V_{2a}$  is reduced sufficiently to remove most of the amplifier noise from the output signal,  $V_{3a}$  begins to conduct and thus reduce the vidicon target voltage.



# TWO SIGNIFICANT NEW TELEPHONE TYPE RELAYS

a cool, cool  
**COIL**  
AC MODEL  
(18°C. RISE AT  
115V 50/60 CY.)

a low-cost  
**SENSITIVE**  
20 MILLIWATTS  
DC MODEL

BOTH MADE BY  
**P & B**

\*\*\*\*\*  
*Like Janus, that ambivisioned  
Roman god, our Development  
Engineers look in all direc-  
tions to design superior relays  
for both AC and DC power.*  
\*\*\*\*\*

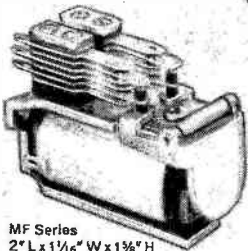

MF Series  
2" L x 1 1/8" W x 1 1/8" H  
(4 Form C)

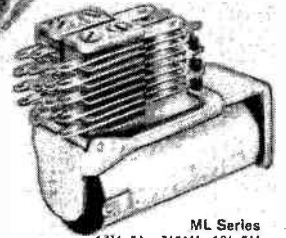

ML Series  
1 3/32" L x 3/4" W x 1 1/16" H  
(6 Form C)

## NEW AC TELEPHONE TYPE RELAY HAS LOW COIL TEMPERATURE RISE

Our MF relay has 30° to 40°C. *less* coil temperature rise than similar AC relays. *Advantages?* Consumes less current, usually requires less expensive circuit components (e.g. smaller transformers), and is generally more sensitive (2.3 VA) than mine-run AC telephone type relays. No need for expensive cooling devices, either.

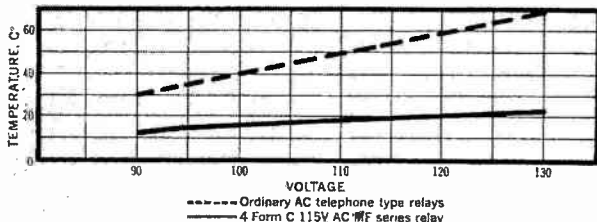

Will switch loads from dry circuit to 5 amperes, 115V AC resistive. Rated for continuous duty.

Write or call today for full information.

## NEW DC TELEPHONE TYPE RELAY CAN OPERATE IN TRANSISTOR CIRCUIT

Sensitive, small and inexpensive. These three qualities endear this relay to design engineers. Requiring only 20 milliwatts per movable at 25°C. ambient, the ML will operate in low-powered transistorized circuits.

Surprisingly, the ML sells for considerably less than similar competitive relays.

### ML SERIES ENGINEERING DATA

**GENERAL:**  
**Life:** Contacts: 100,000 operations min. at rated load.  
**Mechanical:** 10 million operations minimum.  
**Temperature Range:** DC: -45°C. to +85°C. standard. (+105°C. avail. on spec. ord.)  
**Enclosure:** Available hermetically sealed or dust covered.  
**Terminals:** Pierced solder lugs standard. Available with printed circuit or taper tab No. 78 AMP terminals.

**CONTACTS:**  
**Arrangements:** Up to 18 springs, (9 per stack). Bifurcated contact arms are available.  
**Rating:** 3 amps at 115 volts AC resistive at standard power. Other ratings available with additional coil power.  
**COILS:**  
**Power:** DC: 20 milliwatts per movable arm minimum, 3 watts maximum @ +25°C.  
**Resistance:** 33,000 ohms maximum.  
**Duty:** Continuous.

P & B STANDARD RELAYS ARE AVAILABLE AT YOUR LOCAL ELECTRONIC PARTS DISTRIBUTOR



# POTTER & BRUMFIELD

DIVISION OF AMERICAN MACHINE & FOUNDRY COMPANY • PRINCETON, INDIANA  
IN CANADA: POTTER & BRUMFIELD, DIVISION OF AMF CANADA LIMITED, GUELPH, ONTARIO

A compact industrial

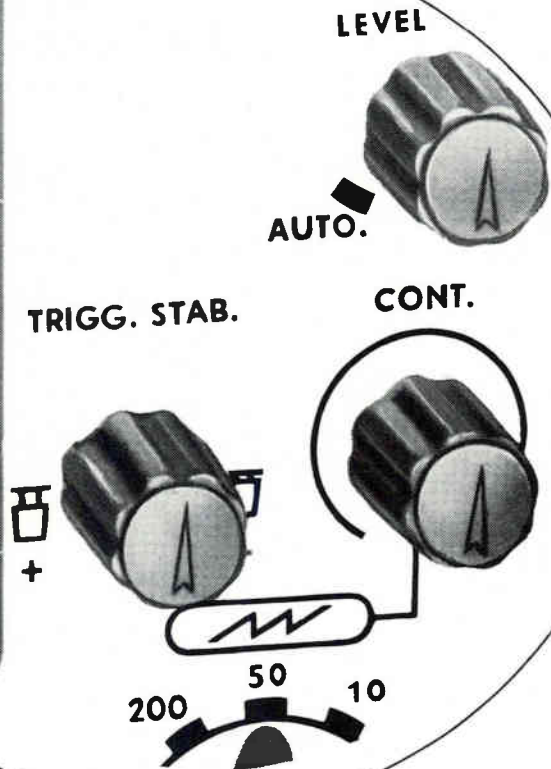

GM 5600

**PHILIPS** *electronic measuring*

Sold and serviced by Philips Organizations all over the world

Further information will gladly be supplied by:

N.V. Philips' Gloeilampenfabrieken, EMA-Department, Eindhoven, the Netherlands

For Canada: Philips Electronics Ind. Ltd., 116 Vanderhoof Ave., Toronto 17, Ont.

# oscilloscope with all facilities

## Important characteristics:

4% calibrated vertical deflection (maximum sensitivity: 50 mV/cm, bandwidth: 0—5 Mc/s)

Optimum trigger stability with manual and automatic level control at repetition frequencies between 10 c/s and 1 Mc/s

Dimensions: 16 x 25 x 34 cm (6.5" x 10" x 13.5")

These three main characteristics make this oscilloscope the standard instrument for service and monitoring applications in industry. It gives just those features you are looking for and which up till now were not available in instruments of this price-class.

## Some other data

### Vertical amplifier

Bandwidth: 0—5 Mc/s (—3 dB), risetime 70  $\mu$ sec  
Sensitivity: 50 mV/cm—20 V/cm in 9 calibrated steps (accuracy  $\pm$  4%)  
Continuous control: 1: 2.5

### Time base

Sweep speeds: 0.5  $\mu$ sec/cm—180 msec/cm in 7 steps and continuously adjustable

### Trigger-possibilities

Internal or from an external source both with pulse repetition frequencies from 10 c/s to 1 Mc/s, as well as from the mains frequency. Stability control and manual or automatic level control.

### Horizontal input

Bandwidth: 5 c/s—2 Mc/s  
Sensitivity: 3—50 V<sub>p-p</sub>/cm (continuously adjustable)

### C.R.T.

7 cm flat-faced with 1.6 kV accelerating voltage

### Probe

Attenuator probe (10:1) available

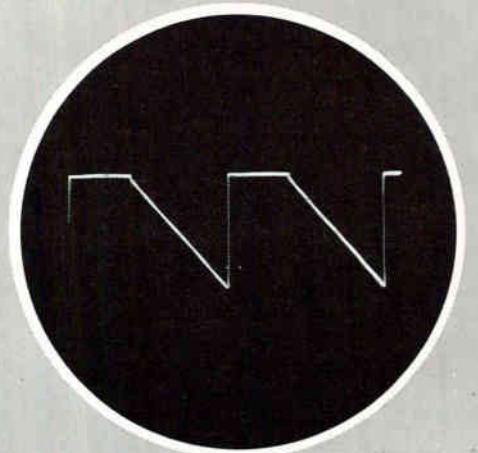

timebase voltage of GM 5600 (triggered position)

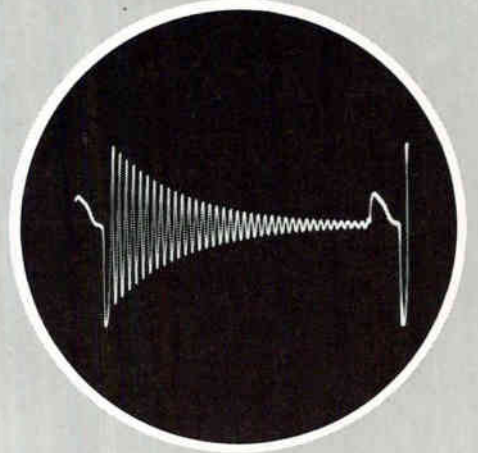

1 Mc/s damped sine-wave on GM 5600

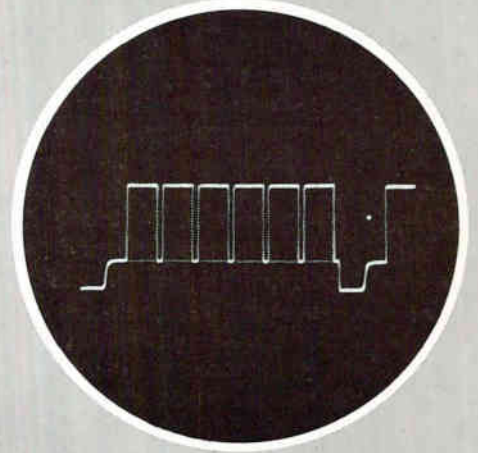

one line of a TV pattern with vertical bars

**instruments: quality tools for industry and research**





PERFECT PERFORMANCE  
IS IN THE BAG WITH  
**SYNKOTE<sup>®</sup>**  
**COAXIAL**  
**CABLE!**

For every specification there's a specific Synkote<sup>®</sup> coaxial cable to deliver flawless performance. Rigidly inspected from wire drawing to shipping room, quality consciousness is built into every foot... be it military or civilian type, small or large size, Polyethylene or Teflon\* insulated, standard or specially constructed. No need to worry about non-performance when you design with Plastoid in mind! Write or call today for full information.

**PLASTOID**  
CORPORATION

42-61 24TH STREET / LONG ISLAND CITY 1, N. Y. / ST 6-6200

\*DUPONT TRADEMARK

# NEW!

TWO DIGITAL INSTRUMENTS WITH  
HIGH-QUALITY FEATURES AND  
LOW-BUDGET PRICE TAGS

1. NLS 484A Digital Voltmeter-Ratiometer With Printer Connection and Built-In Automatic Print Control  
\$1,460, F.O.B. Destination in U. S. A.

2. NLS 784 Digital Ohmmeter With Printer Connection and Built-In Automatic Print Control  
\$1,460, F.O.B. Destination in U. S. A.

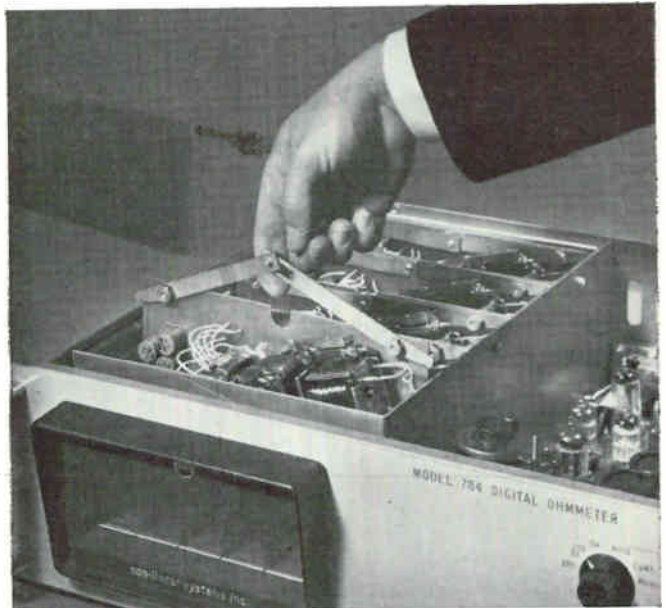

Both the 484A and 784 feature plug-in stepping switches.



The blue tag indicates that the 484A and 784 are NLS "off-the-shelf" instruments. See demonstrators in action today or take delivery on your own instruments within 10 to 30 days.

These new NLS instruments eliminate the need to sacrifice versatility, accuracy, reliability or servicing ease in purchasing a digital voltmeter or ohmmeter in the \$1000-1600 price range. ■ Consider versatility, for example. Some low-priced DVMs don't measure DC voltage ratio, don't have automatic range and polarity changing, and don't provide output and automatic control for printers. The completely automatic 484A *does*. With it, you can measure both DC voltage and DC voltage ratio with  $\pm 0.01\%$  accuracy . . . make measurements faster and easier than with any meter having manual ranging — without the danger of over-loads . . . plug in a printer for data logging . . . plug in accessories to measure AC or low-level DC or for go/no-go testing. With a 784 digital ohmmeter and a printer, you can measure and record resistance automatically and accurately from 0.1 ohm to 10 megs.

■ Or consider the factors that contribute to the basic reliability of the 484A and 784: simple, time-proven design (thousands of earlier models of the same basic design are in use today) . . . quality construction . . . and use of quality components such as heavy-duty plug-in stepping switches and a precision oven for the Zener reference. ■ Then consider servicing. When it's eventually required, servicing can often be handled right on the spot with electronic parts available in most stockrooms. Plug-in stepping switches can be replaced in minutes and 1000-hour-life readout bulbs even faster without use of tools or soldering or opening the instrument. Contact NLS for complete data, a demonstration, or engineering aid for special applications.

**BRIEF SPECS: 484A**—ranges: DC voltage  $\pm 9.999/99.99/999.9$ , DC voltage ratio  $\pm 99.99\%$  . . . accuracy:  $\pm 0.01\%$  of f. s. on each range . . . measuring time: 1 sec. average . . . automatic range and polarity changing . . . input impedance: 10 megs for volts, 1000 megs for ratio . . . AC or low-level DC with accessories . . . automatic control for data logging.

**784**—ranges: 9999./999.9/99.99/9.999/9.999 kilohms . . . accuracy  $\pm 0.05\%$  of reading  $\pm 1$  digit ( $\pm 0.1\%$  of reading above 5 megs) . . . automatic range changing . . . measuring time: 1 sec. average . . . automatic control for data logging.



Originator of the Digital Voltmeter

**non-linear systems, inc.**  
DEL MAR, CALIFORNIA

Yes, they are available...from

**OHMITE**

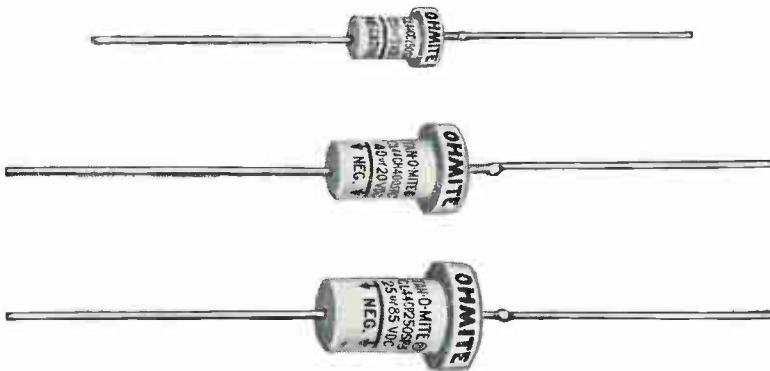

**Tan-O-Mite® Series TS Capacitors Meet All Requirements of CHAR. "C" MIL-C-3965B**

**125°C**

**TANTALUM SLUG CAPACITORS**

Ohmite can supply *all three* sizes of "hat shape" capacitors for use in equipment requiring MIL-C-3965B units. The 29 *basic* stock values as listed at right are the uninsulated type, CL44, with an "S" tolerance of  $-15 + 20\%$ .<sup>\*</sup> They are available also from stock as insulated units, CL45, with plastic sleeves. A "T" tolerance of  $-15 + 50\%$  can be supplied on both types.

Standard tolerance "K,"  $\pm 10\%$ , is offered on commercial units. Special closer tolerances also furnished.

Ohmite manufactures a big, full line of tantalum slug, foil, and wire capacitors for all pertinent MIL specifications as well as commercial applications. Complete details are covered in Bulletins 148, 152, and 159. *Why not write for a set now?*

<sup>\*</sup>"S" tolerance, as furnished by Ohmite, is closer than the MIL "S" tolerance of  $-15 - 30\%$ .

**BASIC STOCK MIL VALUES**

Mfd	DC Rated Volts	Case Size	MIL Designation
30	4	T1	CL44CB300SP3
140	4	T2	CL44CB141SP3
330	4	T3	CL44CB331SP3
25	5	T1	CL44CC250SP3
20	7	T1	CL44CD200SP3
100	7	T2	CL44CD101SP3
250	7	T3	CL44CD251SP3
15	10	T1	CL44CE150SP3
70	10	T2	CL44CE700SP3
170	10	T3	CL44CE171SP3
10	17	T1	CL44CG100SP3
8	20	T1	CL44CH080SP3
40	20	T2	CL44CH400SP3
100	20	T3	CL44CH101SP3
5	33	T1	CL44CJ050SP3
25	33	T2	CL44CJ250SP3
60	33	T3	CL44CJ600SP3
4	40	T1	CL44CK040SP3
20	40	T2	CL44CK200SP3
50	40	T3	CL44CK500SP3
3.5	50	T1	CL44CL3R5SP3
15	50	T2	CL44CL150SP3
40	50	T3	CL44CL400SP3
2.5	70	T1	CL44CN2R5SP3
11	70	T2	CL44CN110SP3
30	70	T3	CL44CN300SP3
1.7	85	T1	CL44CP1R7SP3
9	85	T2	CL44CP090SP3
25	85	T3	CL44CP250SP3



**OHMITE MANUFACTURING COMPANY**  
3610 Howard Street, Skokie, Illinois

Rheostats Power Resistors Precision Resistors  
Variable Transformers Tantalum Capacitors  
Tap Switches Relays R. F. Chokes  
Germanium Diodes Micromodules



# A SUMMIT

in storage tube development

## EXCLUSIVE COAXIAL GUN DESIGN A NEW HIGH POINT IN ITT IATRON\* PROGRAM

Latest additions to the ever-increasing line of ITT Iatron storage tubes are several new models in which both the writing and the flooding guns are symmetrically disposed about the axis of the cathode-ray display tube. This imaginative solution to a difficult packaging problem in radar indicator design eliminates at the same time all possibility of trapezoidal distortion.

Added to the full line of ITT Iatrons with the more conventional off-axis writing gun arrangement, the new coaxial gun models make it possible to specify an ITT

Iatron for virtually any storage tube application—in any diameter from 2½ to 7 inches, to satisfy any requirement with regard to weight, size and desired brilliance under high ambient light conditions.

New and further improved ITT Iatrons, in an even wider range of types, are scheduled for release in the near future. ITT's unlimited access to world-wide research, development and production facilities turns a new design concept into a production model at record pace—in Iatrons as well as other electron tube types.

*Write for information on the complete line of ITT Iatrons. Application assistance is available for your specific requirements.*



ITT IATRON STORAGE TUBES									
TYPE	DIAMETER (in.)	SPECIAL FEATURES	FOCUS†	DEFLECTION‡	TYPE	DIAMETER (in.)	SPECIAL FEATURES	FOCUS†	DEFLECTION‡
7172	2½	Coaxial gun	ES	ES	FW-204	5	Coaxial gun	EM	EM
FW-211	2½	Coaxial gun	ES	ES	D-3001	5	—	ES	ES
7173	4	—	EM	EM	FW-212	5	Coaxial gun	ES	ES
7174	4	—	EM	EM	FW-223	5	Coaxial gun	ES	EM
FW-227	4	2 writing guns	ES	ES	FW-208	7	—	EM	EM
7423	5	—	ES	ES					

†EM = Electromagnetic ES = Electrostatic

**ELECTRON TUBE DEPARTMENT ■ COMPONENTS DIVISION**  
INTERNATIONAL TELEPHONE AND TELEGRAPH CORPORATION, CLIFTON, NEW JERSEY

ITT COMPONENTS DIVISION PRODUCTS: POWER TUBES • IATRON STORAGE TUBES • HYDROGEN THYRATRONS  
TRAVELING WAVE TUBES • SELENIUM RECTIFIERS • SILICON DIODES AND RECTIFIERS • TANTALUM CAPACITORS

CIRCLE 59 ON READER SERVICE CARD

# Coils Operate Stepping Relay at Higher Speed

By F. W. KEAR

Lytle Corp., Albuquerque, N. M.

NEW APPLICATIONS for stepping relays have become possible because of the incorporation of magnetic detents to locate stepping-relay positions. The magnetic detents permit higher speeds, and the direction of stepping can be reversed.

The stepping relay in Fig. 1 consists primarily of two stepping coils, an armature and the contacts. The stepping coils are fixed in position within the relay housing using set screws. Coils are wound in layers in a metallic form that is machined with teeth in its outer shell corresponding to the location of the stepping relay contacts. The teeth, and the corresponding relay contacts, are spaced equally around the circumference.

Both coil forms are constructed identically. When the forms are installed in the relay housing, they are positioned so that the teeth of one form are aligned exactly 180 degrees out of phase with the teeth of the other form. Teeth of identical size and spacing are machined in the relay armature. The relative position of the armature and coil teeth after the relay has been assembled is shown in the figure.

The armature is mounted on a

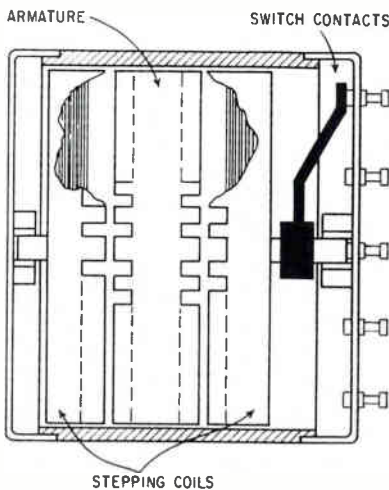

FIG. 1—Teeth of one stepping coil are 180 degrees out of phase with those of the other

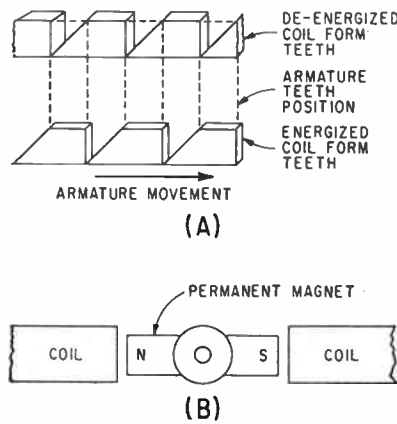

FIG. 2—Pulse applied to deenergized coil (A) moves armature to right, and reset arrangement (B) returns armature to reference position

shaft and locked in position. The shaft is supported at each end by bronze bushings. The relay wiper arm is also mounted on this shaft. If the circuit configuration permits, the armature can serve as the common connection for the wiper arm. When the circuit must be isolated, a slip ring and brush is used.

Operation is shown in Fig. 2A. When power is switched to the deenergized coil at the top, the differential in magnetic flux moves the armature to the right. The relay wiper arm is thus positioned on the next contact. The next pulse energizes the other coil, moving the wiper to the next contact. The relay can be stepped in the opposite direction by reversing the order in which the two coils are pulsed.

The relay can be returned to a reference or starting point with a reset coil and permanent magnet, as shown in Fig. 2B. A number of such reference points can be established in a single relay. If several reference points are used, the relay seeks the nearest reference point when pulsed for reset. Both stepping and reset coils operate from a d-c source of 12 to 30 volts.

In constructing the relay, all torque loads must be minimized. Although the relay will operate with wide variations in torque loads,

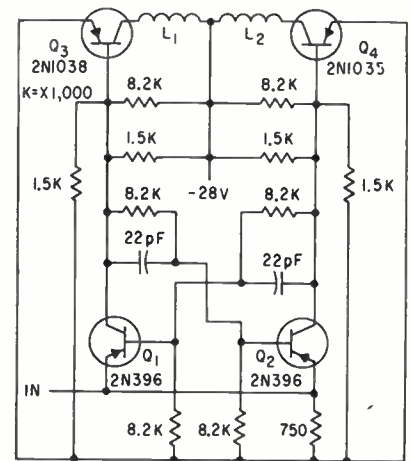

FIG. 3—State of flip-flop  $Q_1$ - $Q_2$  determines which stepping coil is energized

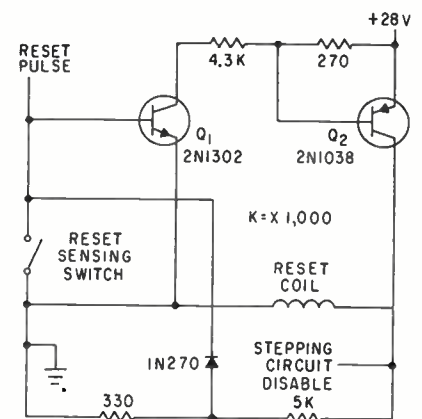
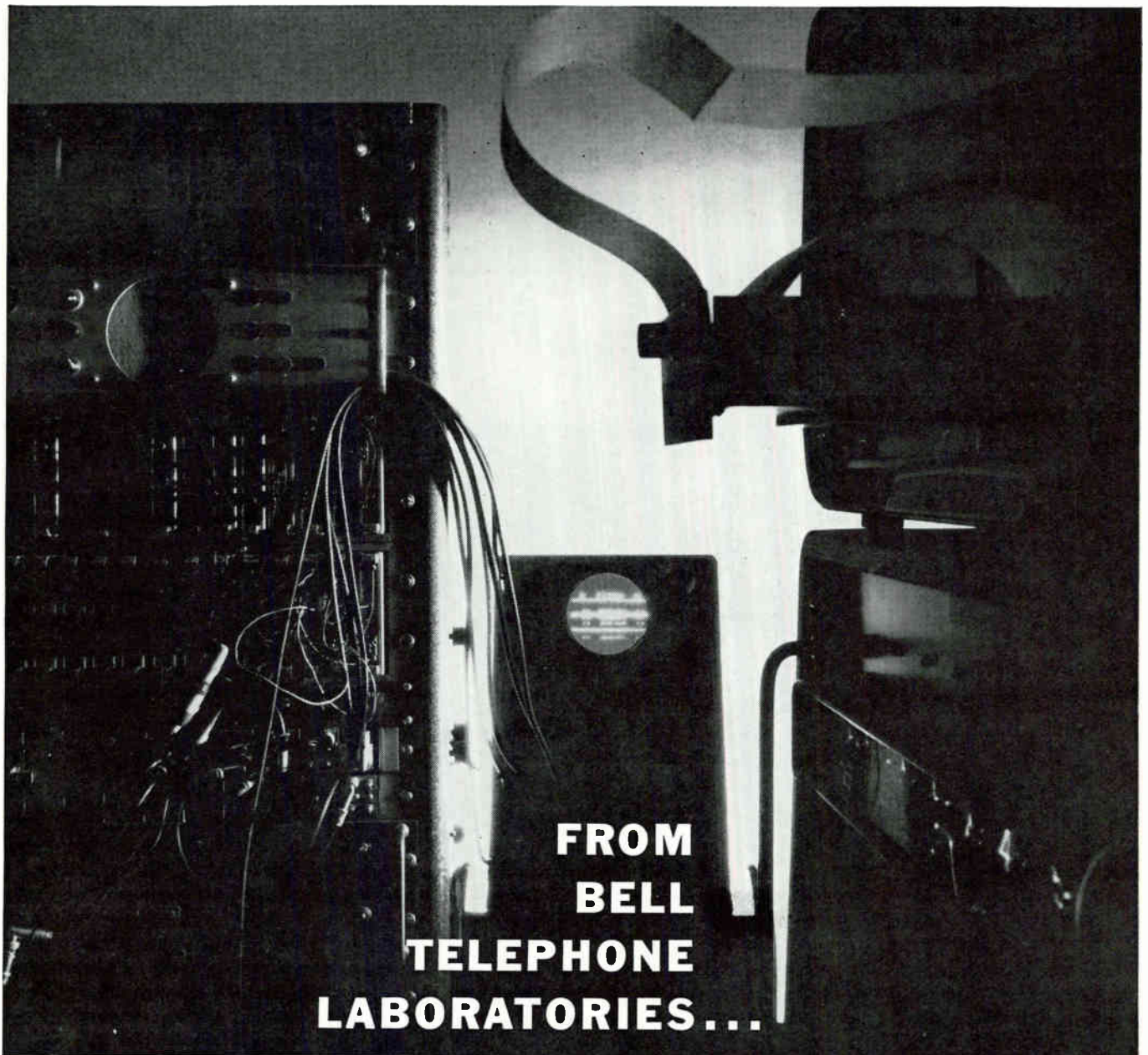

FIG. 4—Circuit provides disabling voltage to stepping circuit during reset

such loads have some effect on speed. To limit torque loads, bearing alignment and armature balance must receive careful attention. An imbalance that opposes reset coil torque greatly increases reset time. Similarly, imbalance that opposes stepping torque reduces stepping speed.

In the typical stepping circuit in Fig. 3, an input signal is fed to the emitter of saturating flip-flop circuit  $Q_1$ - $Q_2$ . The condition of the flip-flop is sensed by driving transistors  $Q_3$  and  $Q_4$ . Since the stepping coils are in the collector circuits of  $Q_3$  and  $Q_4$ , either  $L_1$  or  $L_2$  is ener-





## FROM BELL TELEPHONE LABORATORIES...

The fundamental capabilities of pulse transmission are under study at Bell Laboratories. At a transmission rate of 200 million bits per second, for example, PCM could simultaneously transmit 3000 telephone conversations on a single circuit.

## AN INTRIGUING DEVELOPMENT IN TELEPHONE TRANSMISSION

Bell Laboratories engineers have applied a method of transmitting telephone conversations which uses a series of ON-OFF pulses rather than the continuous electrical signals generally used since the time of Alexander Graham Bell's first famous message.

The method is called Pulse Code Modulation. With PCM the telephone caller's voice is sampled every 1/8000th second. Each sample is then encoded into a series of ON or OFF pulses, and these pulse groups are sent over the regular telephone line. Spaced periodically along the line are repeaters which clean up and amplify the pulses. At the receiving end the pulse groups are decoded and the caller's voice is reconstructed.

Since the pulses are of very short duration, it is possible to interlace many different voice messages and send them all over one line. For example, in a PCM system now operating between Newark and Passaic, N. J., a single pair of wires carries as many as 24 one-way voice signals.

Other systems for carrying more than one voice signal over a single telephone line have been developed and are in widespread use. PCM, however, provides special advantages, for example, in cable circuits connecting telephone offices in a congested metropolitan area.

PCM in its present practical form for cable circuits has been made feasible by Bell Laboratories' invention and development of the transistor, the key element necessary for a small economical system.

Currently, PCM systems carrying much larger bundles of communication channels are under study at Bell Laboratories. The goal as always is the improvement of Bell System communication services.



**BELL TELEPHONE LABORATORIES**

World center of communications research and development

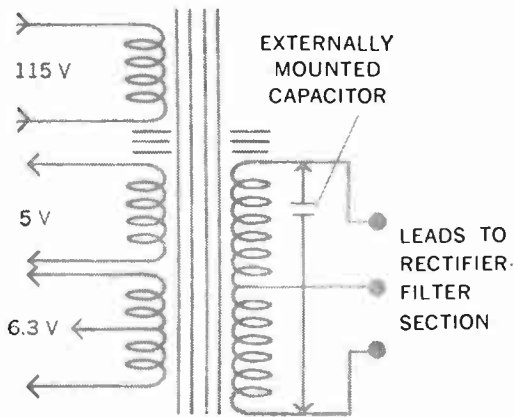

## CV TRANSFORMER HAS TV "SNOW" STOPPED COLD!

SOLA PLATE-FILAMENT TRANSFORMERS NOT ONLY CONTROL "SNOW" FOR COMMUNITY TV SYSTEM, BUT ALSO EXTEND TUBE LIFE 30%. Spencer-Kennedy Laboratories, Boston, Mass., manufactures and sells 12-channel community TV systems to local owner-operators in otherwise "blacked-out" signal areas.

SKL's problem: assure TV set owners freedom from "snow" — a problem experienced in the early days of the system due to line-voltage variations beyond the local utility's area of control.

SKL called on SOLA. Recommendation: replace the regular transformer inside the SKL pole-hung amplifier with a special SOLA constant-voltage plate-filament transformer. Result: now line voltage is controlled and tube voltage is stepped-up simultaneously. The SOLA unit functions both as a transformer and line-voltage compensator. And amplifier tube life has increased 30% to boot, cutting tube- and tube-labor expense for SKL system owner-operators.



If regulation is any part of your problem in electronic and electromechanical design, facts on stock CV units are available from SOLA distributors everywhere. For Custom Engineering to solve special problems, contact any of our District Offices.

SOLA ELECTRIC CO., 1717 Busse Road, Elk Grove Village, Ill., HEMPstead 9-2800  
IN CANADA, Sola-Basic Products Ltd., 377 Evans Ave., Toronto 18, Ontario

**SOLA**



Division of Basic Products Corporation

For all your a-c and d-c power supply requirements or special engineering, contact your nearest SOLA representative:

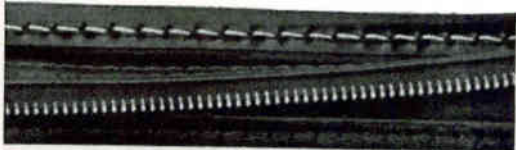

**CALIFORNIA**, San Francisco; Sola Electric Co., Three W. 37 Ave., San Mateo, Flreside 1-6538  
 • Los Angeles; Sola Electric Co., 2907 West Vernon Avenue, AXminster 2-0166

**COLORADO**, Denver; Slaybaugh & Thompson 100 W. 13th Avenue; AComa 2-5826

**FLORIDA**, Winter Park; James Millar Assoc., P. O. Box 1603; Mldway 7-7407

**GEORGIA**, Atlanta; Millar-Hutto, Inc., 1036 Peachtree Street N. E., TRinity 6-0919

**INDIANA**, Indianapolis; R. O. Whitesell & Assoc., 6620 E. Washington St.; FLleetwood 9-5374

• Ft. Wayne; R. O. Whitesell & Assoc., Central Bldg., EAstbrook 3287

**IOWA**, Des Moines; McDowell-Redlingshafer Sales Co., 3615 Olive St.; JEfferson 3-3277

**KENTUCKY**, Louisville; R. O. Whitesell & Assoc., 400 N. 38 Street; SPRing 6-2024

**MASSACHUSETTS**, Newton; Sola Electric Co., 272 Centre Street; Blgelow 4-3354

**MICHIGAN**, Detroit; R. C. Merchant & Co., Inc., 18411 W. McNichols Rd.; KEnwood 5-6000

**MINNESOTA**, Minneapolis; Heimann Co., 1711 Hawthorne Avenue; FEderal 2-5457

**MISSOURI**, Kansas City; McDowell-Redlingshafer Sales Co., 1103 E. Armour; WEstport 1-5622

• St. Louis; McDowell-Redlingshafer Sales Co., 3615 Olive Street; JEfferson 3-3277

**NEW JERSEY**, Little Ferry; Sola Electric Co., 84 Industrial Avenue; HUbbard 9-1060

**NEW YORK**, Buffalo; R. W. Mitscher Co., 487 Ellicott Square Building; TL 4-2517

**NORTH CAROLINA**, Charlotte; Ranson, Wallace & Co., 116½ E. 4th St.; EDison 4-4244

**OHIO**, Cleveland; Sola Electric Co., 14235 Detroit Avenue; LAkeapwood 1-8038

**PENNSYLVANIA**, Philadelphia; Sola Electric Co., (Philadelphia answering service — WAInut 2-5340); or 210 North 6 Street, Camden 2. N. J.; EMerson 5-7744

• Pittsburgh; R. G. Sidnell & Co., 675 Princeton Blvd.; CHurchill 2-1476

**TEXAS**, Dallas; Robert E. Nesbitt Co., 1925 Cedar Springs; RIVERSide 7-4145

• Houston; Robert E. Nesbitt Co., 4810 Hazard, JACKson 8-3811

**WASHINGTON**, Seattle; Northwestern Agencies, Inc., 4130 First Ave. So.; MAine 3-8882

**WASHINGTON, D. C.**; Sola Electric Co., contact 8719 Colesville Rd., Silver Spring, Md.; JUAniper 5-0331



**CIRCLE 63 ON READER SERVICE CARD**  
 February 9, 1962

gized, depending on the condition of the flip-flop.

A reset circuit is shown in Fig. 4. To prevent opposition of stepping and reset torques, the reset circuit

de-energizes the stepping circuit during reset. The reset circuit also includes a latching feature to keep the reset coil energized until the wiper senses the reset contact.

## Auto Ignition Has No Breaker Points

BREAKER POINTS and condenser are eliminated from automobile and truck distributors using a new electronic ignition system. The function that has been performed by cam-operated breaker points for about forty years is accomplished with a magnetic pulse generator that lasts the life of the cars. In addition, the magnetic pickoff arrangement does not require periodic adjustment. (See *ELECTRONICS*, p 12, Dec. 15.)

The electronic ignition system has been developed by Motorola, Inc. It is said to be undergoing tests by several major automobile and truck manufacturers. Original cost is slightly higher than that of conventional ignition systems. However, the manufacturer claims that the first time that breaker points are replaced in a conventional distributor, the added cost of the new system would be offset. The cost of all additional breaker point replacements with associated servicing charges would be saved. The additional operating costs resulting from faulty breaker points would also be eliminated.

Several shortcomings have long been recognized in the conventional ignition system. Changes in engine design as well as in fuels have aggravated some of the problems. A number of substitutes have been proposed but their advantages have sometimes been limited, their costs high or they were quite complex.

The higher operating speeds of the newer engines, where output of the conventional ignition system is characteristically lower, and the higher compression ratios, require that breaker points be in good condition to avoid misfires. Deposits on spark plugs from gasoline additives also require that points be in good operating order. Point chatter at higher operating speeds can also cause misfiring. Stronger springs to prevent contact bounce can cause more rapid wear of the

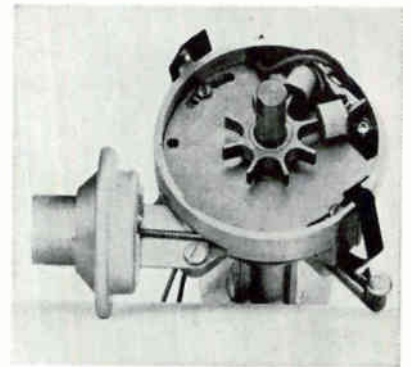

*Distributor cam is replaced by toothed wheel that generates pulses in magnetic pickoff*

cam follower, requiring more frequent adjustment to maintain the correct contact gap.

Because breaker points are completely eliminated from the ignition system shown in the photograph, all problems associated directly with their operation are also eliminated. The electronic ignition system includes a magnetic pulse generator, a transistor amplifier and an ignition coil. Pulses are generated as the toothed wheel rotates past a small magnet.

The magnetic pickoff eliminates the problem of deteriorating contact surfaces, and there is no wear because there is no physical contact. Breaker-point bounce at high speeds cannot occur, and dwell time or pulse duration is constant at all engine speeds. Output at higher engine speeds is actually higher.

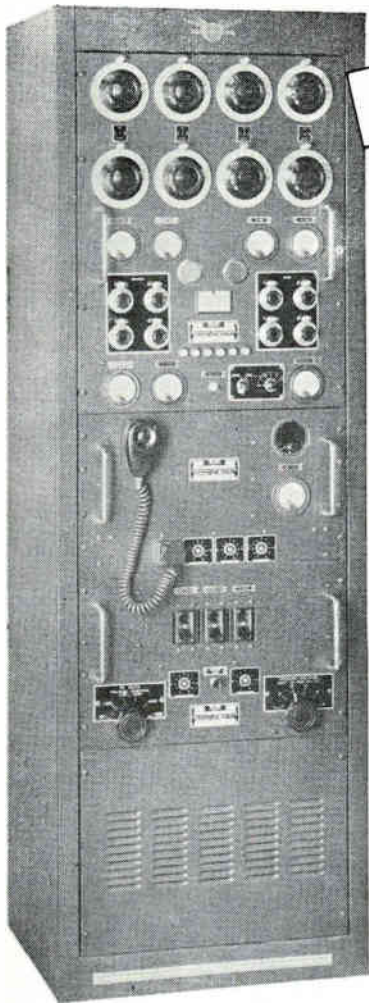

FCC-ACCEPTED  
TYPE AVAILABLE

# The world-famous **AEROCOM 1046** **TRANSMITTER**

## **1000 W CARRIER POWER** **WITH HIGH STABILITY**

The Aerocom 1046 Transmitter is designed to give superior performance for all point-to-point and ground-to-air communications. It is now in use throughout the world in climates ranging from frigid to tropical (operates efficiently at  $-35^{\circ}$  to  $+55^{\circ}$  Centigrade).

As a general purpose High Frequency transmitter, the 1046 supplies 1000 watts of carrier power with high stability (above  $-10^{\circ}$  Centigrade:  $\pm .003\%$  for telegraph and telephone. Temperature controlled oven for FSK). Multi-channel operation is provided on

telegraph A1, telephone A3 and FSK (Radio Teletype). It can be remotely controlled using one pair of telephone lines plus ground return with Aerocom Remote Control Equipment. Front panel switches and microphone are included for local control.

Four crystal-controlled frequencies (plus 2 closely-spaced frequencies) in the 2.0 - 24.0 megacycle range can be used one at a time, with channeling time only two seconds. Operates into either balanced or unbalanced loads. The power supply required is nominal 230 volts, 50 - 60 cycles, single phase.

The housing is a fully enclosed rack cabinet of welded steel, force-ventilated through electrostatic filter on rear door.

Telegraph keying (A1): Up to 100 words per minute. Model 1000 M Modulator (mounts in trans-

mitter cabinet) is used for telephone transmission; a compression circuit permits the use of high average modulation without over-modulation. Model 400 4 Channel exciter is used for FSK.

Output connections consist of 4 insulated terminals (for Marconi antenna) and 4 coaxial fittings Type SO-239, which can be used separately or in parallel in any combination. For 600 ohm balanced load, Model TLM matching network is used, one for each transmitter channel.

As in all Aerocom products, the quality and workmanship of Model 1046 are of the highest. All components are conservatively rated. Replacement parts are always available for all Aerocom equipment.

Complete technical data on Aerocom Model 1046 available on request.

*Also available — Aerocom Model 446 with 350 watts nominal carrier power and Model 100TFA—100 watts*

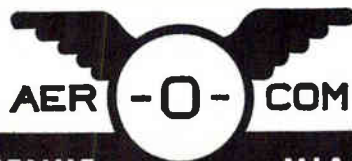

3090 S. W. 37th AVENUE

MIAMI 33, FLORIDA

# new

*precision resolver developments by*

FOR GUIDANCE • STABILIZATION • COMPUTER APPLICATIONS

*Reeves*

## 10-SECOND ACCURACY PANCAKE RESOLVER

Integral bearings permit direct mounting to gimbal structures of stable platforms. Beryllium housings provide highly stable operation in environments with extreme temperature variations.



## 20-SECOND ACCURACY SIZE 23 RESOLVERS

Double-ended design simplifies their incorporation into data transmission systems.



## HIGH IMPEDANCE PANCAKE RESOLVERS

Tuned impedance of 80,000 ohms makes these units ideally suited for use as control receivers. Rotor and stator assemblies may be independently attached to their mounting members. Standard units have an accuracy of 3 minutes of arc. One-minute accuracy can be supplied on special order.



## 0.005% FUNCTIONAL ACCURACY PANCAKE RESOLVER

100% compensated Resolver with integral Class III precision rotor gear. The ideal unit for high accuracy computer chains.

## 0.01% FUNCTIONAL ACCURACY SIZE 23 RESOLVER

100% compensated winding. Extreme accuracy in a standard resolver case size.

For complete information, write for Technical Data File 102.

Qualified engineers seeking rewarding opportunities in these advanced fields are invited to get in touch with us.



**REEVES INSTRUMENT CORPORATION**

*A Subsidiary of Dynamics Corporation of America, Roosevelt Field, Garden City, New York*

February 9, 1962

*Reeves*

CIRCLE 65 ON READER SERVICE CARD 65

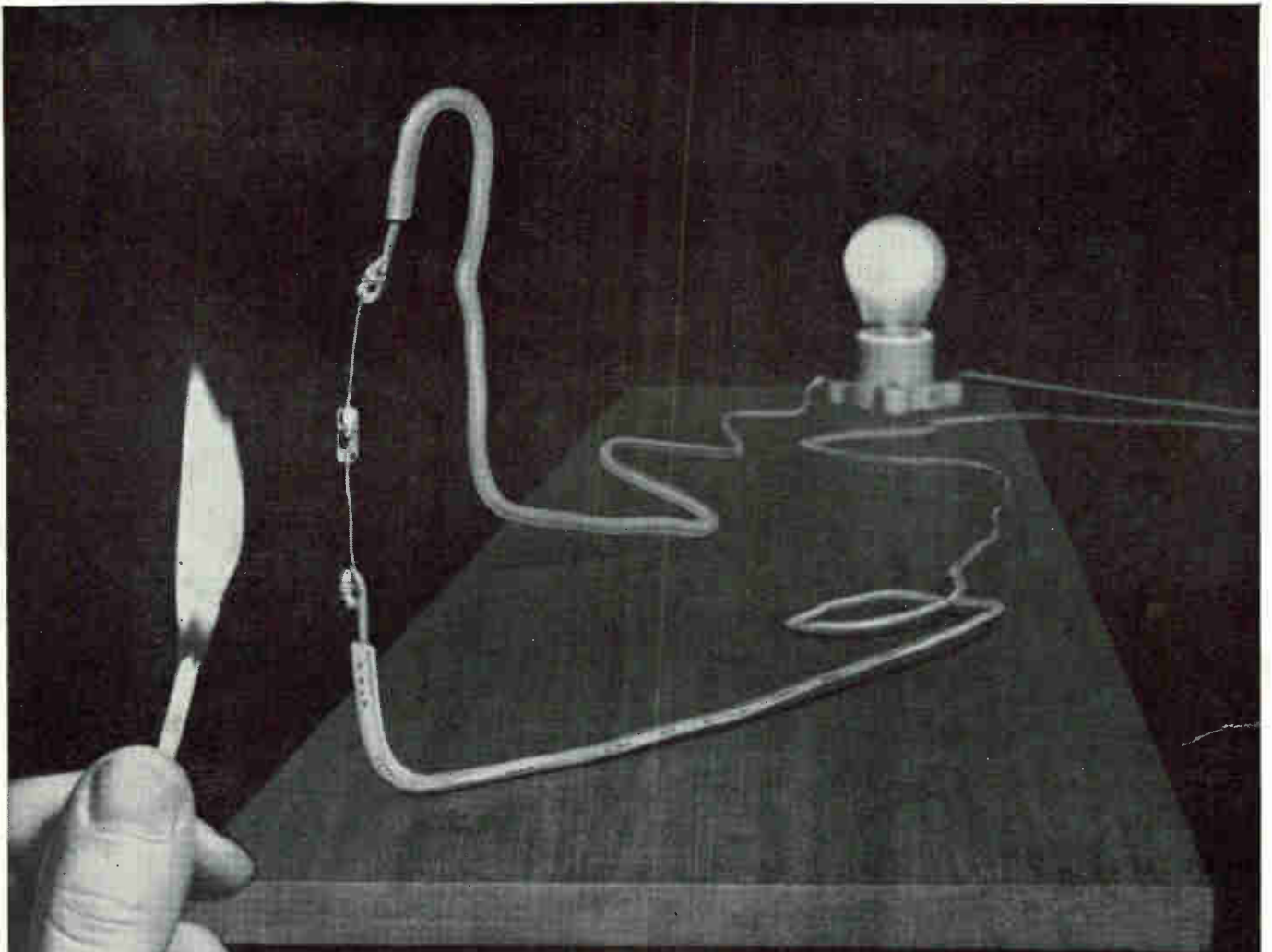

## NEW! LIGHT ACTIVATED PNP SWITCH!

Activate this new subminiature silicon switch with the dimmest light, and you can switch up to 160 watts of power continuously with complete electrical isolation between input and output.

Despite its very small size ( $\frac{1}{3}$  inch long,  $\frac{1}{8}$  inch diameter) the new ZJ235 is rated at 400 ma d. c. in latching applications, with a surge current rating of 5 amps. Voltage ratings are from 50 to 400 volts. A short impulse of light of as little as 80 foot candles will trigger the ZJ235 into conduction.

So let the light dawn. How can you apply this remarkable solid state switch with its high power, simplified circuitry and typical semiconductor reliability?

In card and tape reading? Character recognition? Logic circuitry? Relay replacement? Explosion proof static switches? Subminiature static relays? Alarm circuitry? Tower light monitoring?

Think about it. Our Application Engineering Center will be glad to assist you. Your inquiries on the ZJ235 light activated switch are welcome. Just ask your G-E Semiconductor Sales Representative, or write Section 16B48, Rectifier Components Dept., General Electric Company, Auburn, New York.

GENERAL  ELECTRIC

# Now — A 3/8" Potentiometer With 1/2" Performance

NUMBER 21 — NEW PRODUCT SERIES

Measuring just 3/8" x 3/8" x .20," Bourns wirewound Trimpot® Model 3280 embodies the performance and features of potentiometers occupying twice the volume. The unique central mounting hole makes this improvement possible. It permits the same size resistance element as that used in 1/2"-square potentiometers and the same 1 watt rating, as well as maximum operating temperature of 175°C. In addition, Model 3280 offers 25-turn screwdriver adjustment and positive end-stops with a clutch feature eliminating any possibility of damage due to forced adjustment.

Where miniaturization is the object, you can mount 14 of these tiny units in one square inch of circuit-board space. Mounting is simple and sure. A small projection on the corner of the case fits into a corresponding recess in the next unit for fast, positive stacking; if just one unit is being mounted, a small extra

hole drilled near the mounting hole in the circuit board will facilitate interchangeability and admit the projection to lock the potentiometer in place.

Outstanding reliability is ensured by a sealed, all-plastic case and Bourns' exclusive, indestructible Silverweld® multi-wire termination. Units meet or exceed Mil Specs, including MIL-STD-202A, Method 106 for humidity.

Max. Operating Temperature: +175°C  
 Power Rating: 1 watt @ 70°C; 1/2 watt @ 125°C  
 Resistances: 100Ω to 50K  
 Humidity: MIL-STD-202A, Method 106 (cycling)

Model 3280 is available immediately with printed circuit pins (from either narrow edge or flat side of case) or flexible leads. Write for complete data.



ACTUAL SIZE

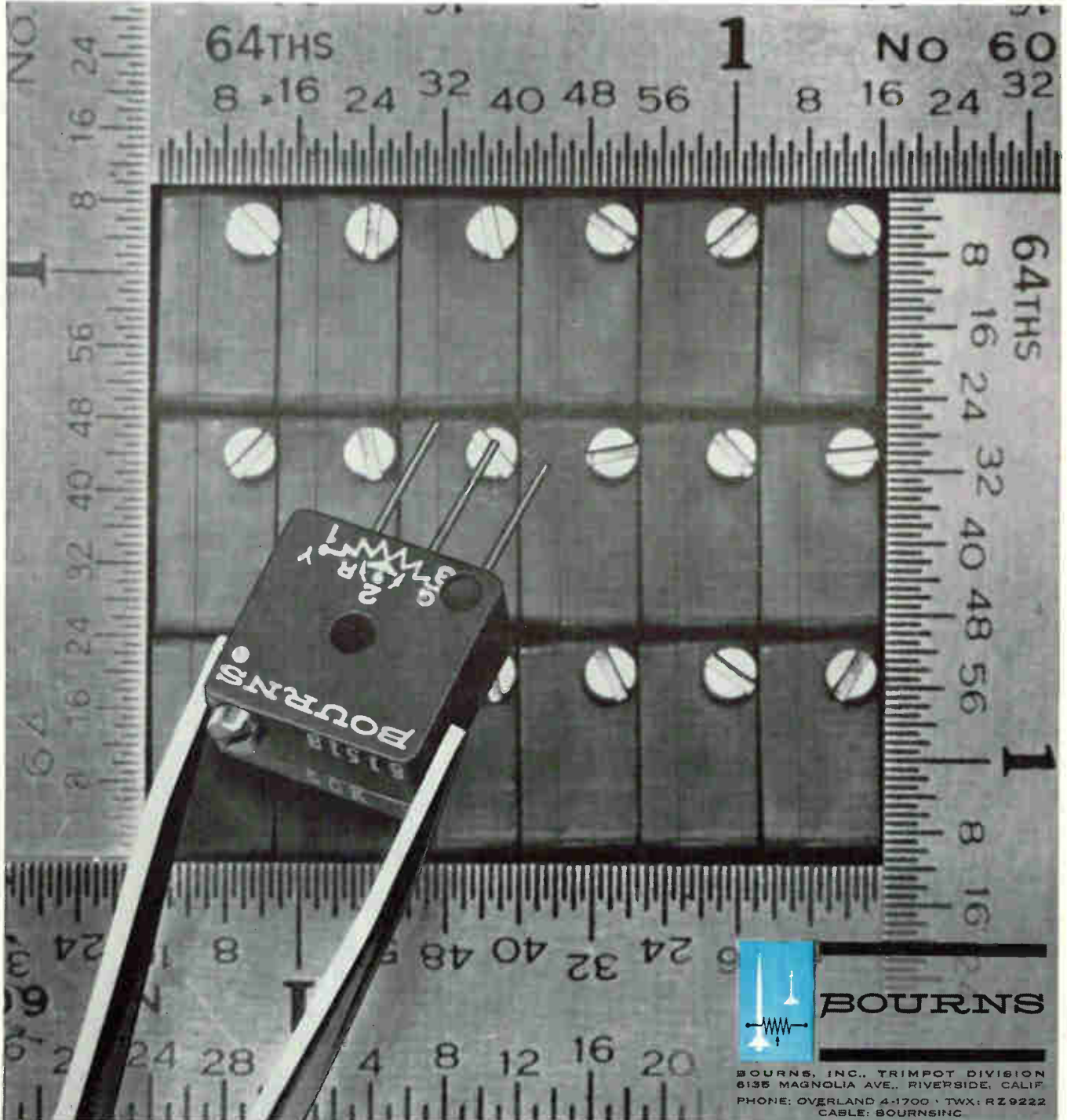

**BOURNS**

BOURNS, INC., TRIMPOT DIVISION  
 6135 MAGNOLIA AVE., RIVERSIDE, CALIF.  
 PHONE: OVERLAND 4-1700 • TWX: RZ 9222  
 CABLE: BOURNSINC

Manufacturer: Trimpot® potentiometers; transducers for position, pressure, acceleration. Plants: Riverside, California; Ames, Iowa; and Toronto, Canada

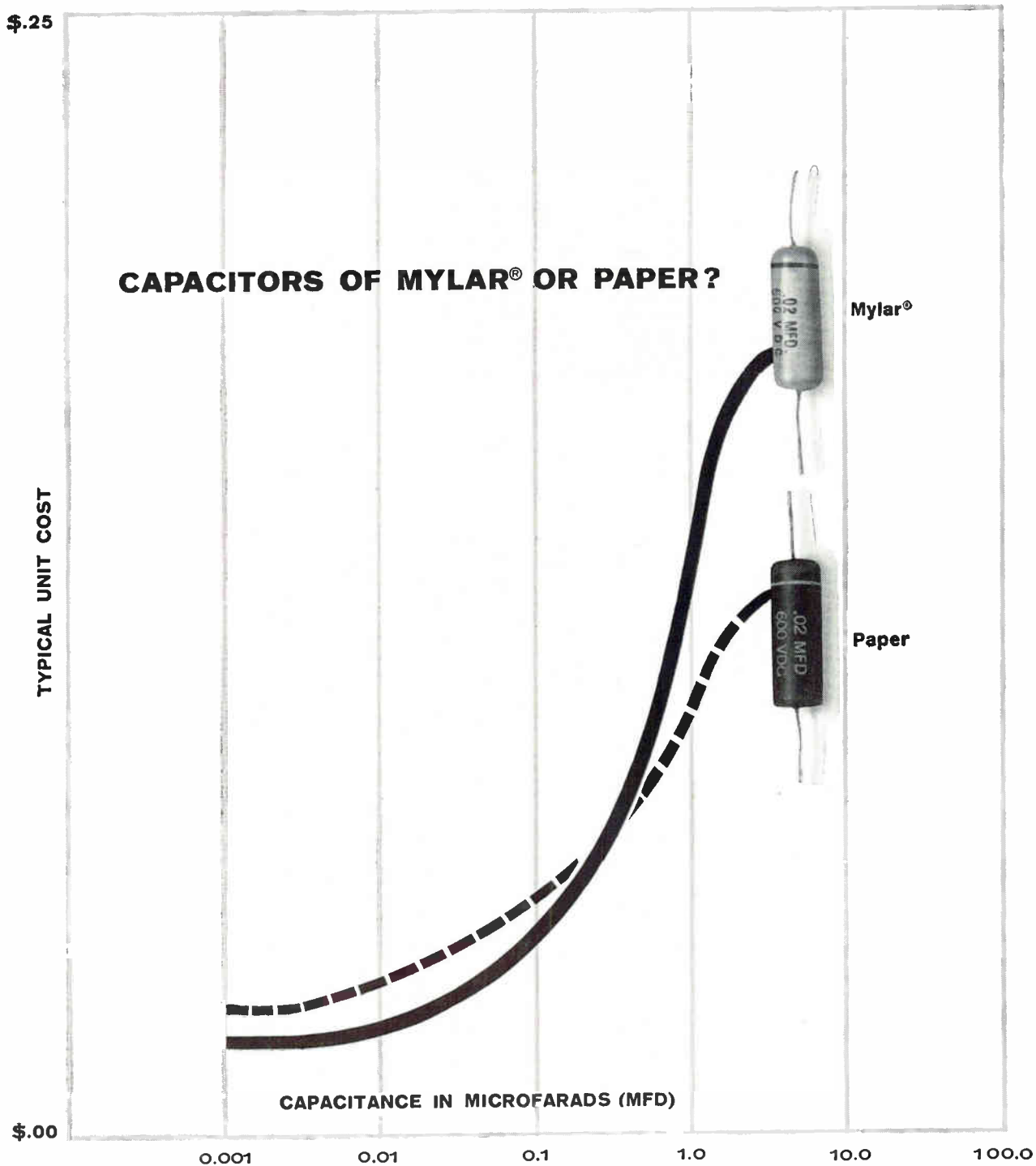

## Close in price . . . but check the performance!

Before you freeze that circuit design, check your capacitors. "Mylar" units or paper? There's a difference in performance—but not in price!

That's right. Few engineers may realize it, but capacitors of "Mylar" are comparable in price to paper units of similar capacitance and performance. The chart above, taken from a study of prices of representative capacitor manufacturers, shows that on an "average" basis there is little difference in price.

What it means is that you get all the extra advantages of "Mylar" insulation—higher dielectric strength, smaller size, greater capacitance stability over a

wide range of temperature and moisture conditions—all at similar cost.

Think about it. Then check "Mylar" capacitors yourself. We have a free booklet describing performance, availability and cost comparison of "Mylar" capacitors. Get one by writing to Du Pont Company, Film Department, Wilmington 98, Delaware.



BETTER THINGS FOR BETTER LIVING  
... THROUGH CHEMISTRY

only **DUPONT** makes

**MYLAR®**  
POLYESTER FILM



# Smaller diameter for complex hook-ups with **Beldfoil\*** shielded cables



Beldfoil\*  
Shielding

Conventional  
Shielding

Where shielding is required you can reduce the size and weight of your cable with Beldfoil shielding. This new development can greatly reduce the diameter of multi-conductor cables.

Multi-cable hook-ups can also be confined to less area. In many applications Beldfoil shielded cables can replace combined and complex hook-ups of twisted pairs and individual conductors laced together.

Beldfoil is a lamination of aluminum foil with Mylar† which provides a high dielectric strength insulation that is small in diameter, light in weight and low in cost. Its superior characteristics give 100% isolation between shields and adjacent pairs.

For audio and radio frequency applications, it eliminates cross-talk and is ideal for stationary or limited flexing.

The cable cross sections shown below (outer jacket not shown) are just a few of the many intricate and diverse ways Beldfoil has been used to solve a specific shielding problem for a customer.

If you have a space or design problem on shielded cables Belden engineering can help you.

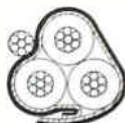
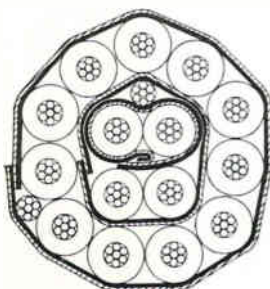
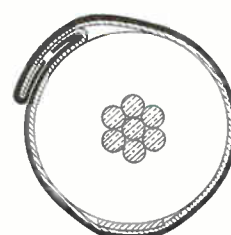
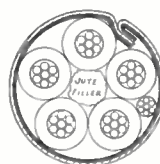
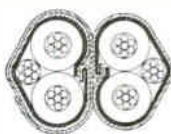
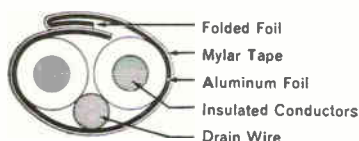

power supply cords • cord set and portable cordage  
• electrical household cords • magnet wire • lead wire  
• welding cable • automotive wire and cable

\*Belden Trademark Reg. U. S. Pat. Off.

† du Pont Trademark

# Flash Adjustment of Film Resistance

By EDWIN H. TOMPKINS  
 Armour Research Foundation,  
 Chicago, Ill.

ELECTRONIC FLASH units with capacitor storage energies from 1,000 to 100,000 watt-seconds are being used to an increasing extent in the study of fast thermal and photochemical reactions. The short intense pulses of light from these units can evaporate, fuse, or cause chemical changes in small particles or thin films which do not occur with longer illuminations of the same integral energies. Even carbon or tungsten can be evaporated significantly by a 10,000 watt-second flash. The work reported here,

uses energies of this order to evaporate resistive material from carbon and nickel-chromium alloy film resistors after the terminal electrodes are applied but before encapsulation.

A simple calculation shows why a flash of light of reasonable intensity can evaporate carbon. Consider a sphere of black material of radius  $r$ , heat capacity  $c$ , and density  $d$  (all assumed independent of temperature) illuminated by a square pulse of light duration  $\Delta t$ , and intensity  $I$ . For particles of diameter larger than the wavelengths of incident light, the energy intercepted by the sphere during  $\Delta t$  is  $\pi r^2 I \Delta t$  and this will heat it

$\Delta T = 3/4 I \Delta t / rcd$  degrees, if there is no loss by radiation or conduction. A value of  $I \Delta t = 1 \text{ cal/cm}^2$  is easily obtained, and for  $r = 10^{-4} \text{ cm}$  (1 micron) and  $cd = 1$  (which it is for graphite at about 600 C) the calculated value of  $\Delta T$  is 7,500 deg C. Even if the particle behaves as a black-body emitter of radius  $r$ , it would go to over 4,000 deg C (if it did not evaporate). When the particle is in a conductive medium there is an optimum radius for maximum temperature,<sup>1</sup> which is typically about 5 microns. For a film of black material on a thermally conductive substrate the problem is complicated by the fact that the light is absorbed through



System for rapidly adjusting film resistors could be used to adjust resistances in microcircuit films and in composite printed circuits

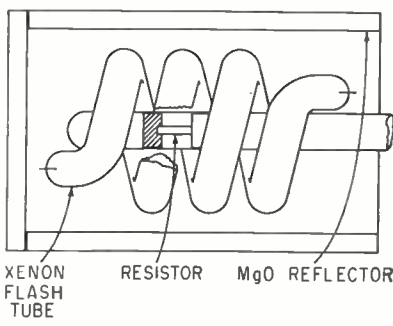

FIG. 1—Geometry of flash tube

TABLE I. FLASH REMOVAL OF CARBON FROM FILMS

Stage of Treatment	Resistance in Ohms			
	Res. 1	Res. 2	Res. 3	Res. 4
Before flash exposure	81.34	97.31	91.72	67.63
After 1 flash	81.25	109.15	96.33	82.63
After 2 flashes	84.59	127	113.7	92.45
After 3 flashes	86.83	136.6	126.1	108.9
After 4 flashes	89.76	148.3	.....	117.7
After standing overnight	.....	149.9	128.8	.....

TABLE II. EFFECT OF FLASH ON THIN ALLOY FILMS

No. of Flashes	Film No. 1		Film No. 2	
	Resistance, Ohms	Increase, Ohms	Resistance Ohms	Increase, Ohms
0	4,718	.....	3,472	.....
1	5,098	380	3,568	96
2	5,807	709	4,267	699
3	7,922	2,115	5,060	793
4	9,790	1,868	5,450	390
5	12,790	3,000	6,490	1,040
6	13,870	1,080	6,994	504

No. of Flashes	Film No. 3		Film No. 4	
	Resistance, Ohms	Increase, Ohms	Resistance Ohms	Increase, Ohms
0	4,183	.....	5,183	.....
1	4,913	730	5,919	766
2	6,243	1,330	7,644	1,695
3	7,070	827	8,610	1,034
4	9,200	2,130	9,753	1,143
5	9,950	750	10,670	917
6	10,520	1,320	12,510	1,840

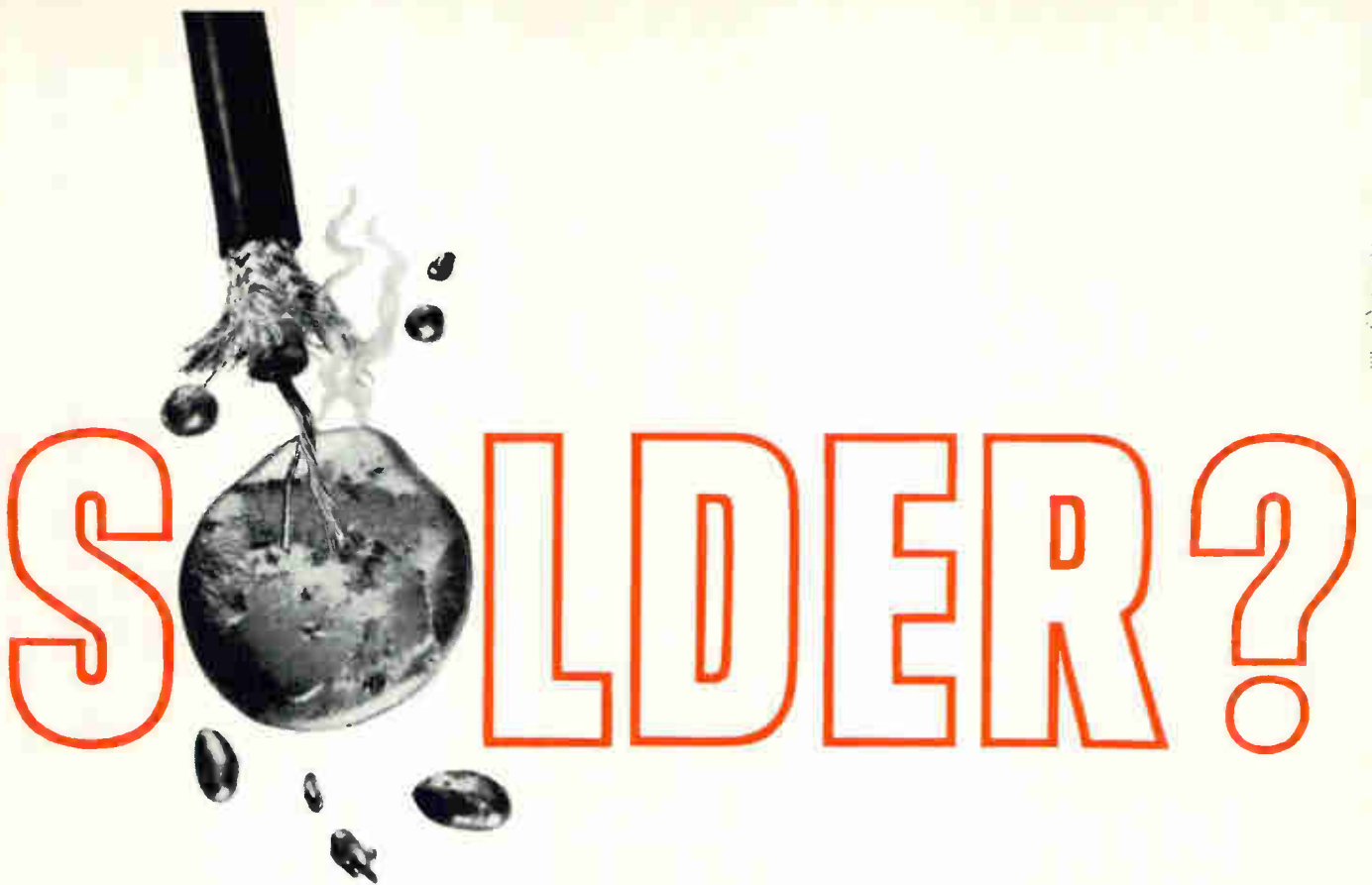

# FORGET IT! AMP has a **crimp** for coaxial connections

AMP rolled out all 20 years of its initiative in solderless termination techniques to meet the double challenge of coaxial wire termination. The goal: get rid of the solder; get rid of the double danger of burned insulation; get rid of the overtime in labor and costs; and measurably increase reliability.

AMP's new COAXICON\* contact line gets rid of the solder. In its place, the COAXICON contact technique gives you the fastest, lowest-installed-cost crimped coaxial wire termination available anywhere in the industry.

One crimp does it—one stroke of an AMP tool attaches a COAXICON contact **simultaneously** to coaxial outer braid and inner conductor.

The COAXICON contact line has remarkable depth, for both single and multiple-connector applications. COAXICON contacts will accommodate the popular sizes of coaxial cables from RG 196/U to RG 62/U having stranded and solid conductors and have a very low VSWR in the KMC ranges when used with cables having a nominal impedance of 50 ohms.

Invite AMP COAXICON contacts to save you time and money on your specific coaxial application.

\*Trademark of AMP INCORPORATED

**AMP**  
INCORPORATED  
HARRISBURG, PA.

AMP products and engineering assistance are available through subsidiary companies in: Australia • Canada England • France • Holland • Italy • Japan • Mexico West Germany

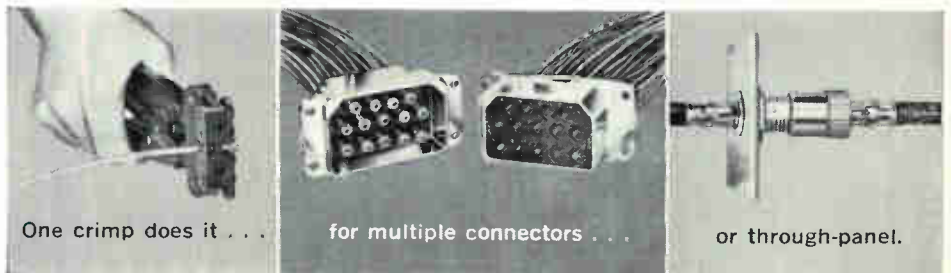

One crimp does it . . .

for multiple connectors . . .

or through-panel.

# got a VHF preamp problem?

LEL's VHF Telemetry Pre-amplifier (Series TP) may provide the ideal solution to your problem. Designed for installation at or near the receiving antenna, the TP series are low noise weatherproofed units for outdoor use. Power Supply for operation from 115V, 50 to 400 cycles is self-contained.

Whatever your problem in the application of receiving equipment, LEL can answer it with off-the-shelf hardware of practical up-to-the-minute engineering design — and performance that's just plain hard to beat.

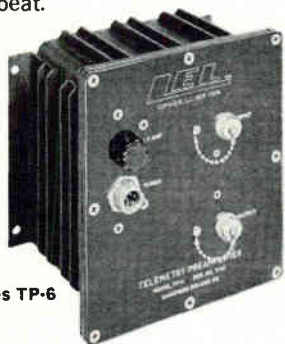

Series TP-6

## SPECIFICATIONS

Frequency	available from 100mc to 1200 mc
Gain	26db
Bandwidth	5 to 10mc
Noise Figure (Typical)	1.5db @ 136mc 3.0db @ 400mc

See us at  
Booths 2106-2108, IRE Show

# LEL INC.

Akron Street, Copiague, L. I., N. Y.  
AMityville 4-2200

TABLE III. EFFECT OF LOWER ENERGY FLASHES ON AN ALLOY FILM

No. of Flashes	Voltages of Last Flash	Resistance Res. 5 Ohms	Resistance Res. 6 Ohms
0	.....	1,190	1,271
1	2,000	1,190	1,272
2	2,500	1,194	1,275
3	3,000	1,167	1,190
4	3,100	1,070	1,104
5	3,200	929	996
6	3,300	812	841
7	3,400	768	771
8	3,500	707	699.1

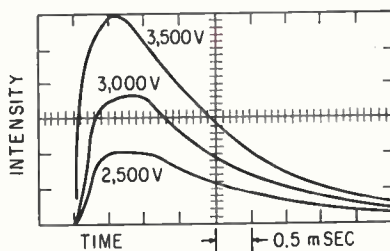

FIG. 2—Flash intensity-time traces for three voltages

some depth in the film and that practical films are rough, but it is apparent that high spots in the film will be heated more than other parts and that light pulses of the order of a millisecond or less are required. Only for such short times are the light intensities high enough to maintain thermal gradients in the film at the required  $10^6$  to  $10^7$  deg C/cm. For shorter times in the microsecond range mechanical effects from rapidly expanding gases may be serious. Even for 2 millisecond pulses, many plastic surfaces sound like rifle shots.

The flash tube in Fig. 1 was fired from 1,300  $\mu$ f capacity at voltages up to 4,000 v. This system is readily adapted to simultaneous illumination of about 100 resistors, and the general method is adaptable to automation. In automatic resistance adjustment, a lamp would flash repeatedly until a bridge circuit or other system indicated that the resistance of the resistor was the same as that of a standard.

In Fig. 2 the curves of the light pulses for three firing voltages were obtained by feeding the signal from a RCA 931A photomultiplier tube into a 531A Tetrax oscilloscope and by starting the horizontal sweep with the voltage

pulse used to fire the flash tube. The photomultiplier tube does not respond to the longer wavelengths emitted by the flash tube, but the initial rising parts of the curves are probably close to the actual intensity curves because the tube emits the ultra violet and short visible wavelengths first.<sup>2</sup> These curves are given because the effects of the flash were strongly dependent on the firing voltage (Table III).

The effects of flash illumination are listed for four black carbon resistors supplied by Electra Manufacturing Company, and shown in Table I. The terminal electrodes of the resistors were protected from the light by aluminum holders. The flash tube was fired at 3,500 v and the resistors were held in air. When the air was replaced with argon there was no significant difference, which indicates that the basic process is an evaporation of the resistor film, not an oxidation.

The effect of flash on thin alloy films is given in Table II. In general, the process appears most useful for carbon and thin metal films.

The close control of resistance which is possible by flashing, for lower initial voltages on the flash tube, are listed in Table III.

Variations of this technique are numerous. With a helical mask and a special flash tube, helices might be cut by flashing instead of by the current mechanical method.

This work was sponsored by the Electra Manufacturing Company, Independence, Kansas.

## REFERENCES

- (1) L. S. Nelson and J. L. Lundberg, *J. Phys. Chem.* 63, 433, 1959.
- (2) H. N. Olsen and W. S. Huxford, *Soc. Motion Picture and Television Engineers*, 55, 285, 1950.

## ANNOUNCING THE ALL NEW VARIAN G-14 GRAPHIC RECORDER

1 MV SPAN... PLUS 10 MV, 100 MV, 1 VOLT SPANS INSTANTLY SELECTABLE • ALL TRANSISTOR CIRCUITRY • PEN SPEED 0.6 SECONDS FULL SCALE • ZENER DIODE REFERENCE • 0.5% ACCURACY AT 10 MV • FULL SCALE ZERO PLUS SUPPRESSION

The all new G-14 is carefully designed to provide the optimum combination of performance, operator convenience, versatility, size and price. Solid state circuitry, high negative amplifier feedback, rugged construction, quality components and null-balance potentiometer operation provide stable, accurate and reliable recording. Complete specifications available from the Instrument Division.

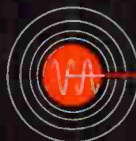

**VARIAN associates**  
PALO ALTO CALIFORNIA

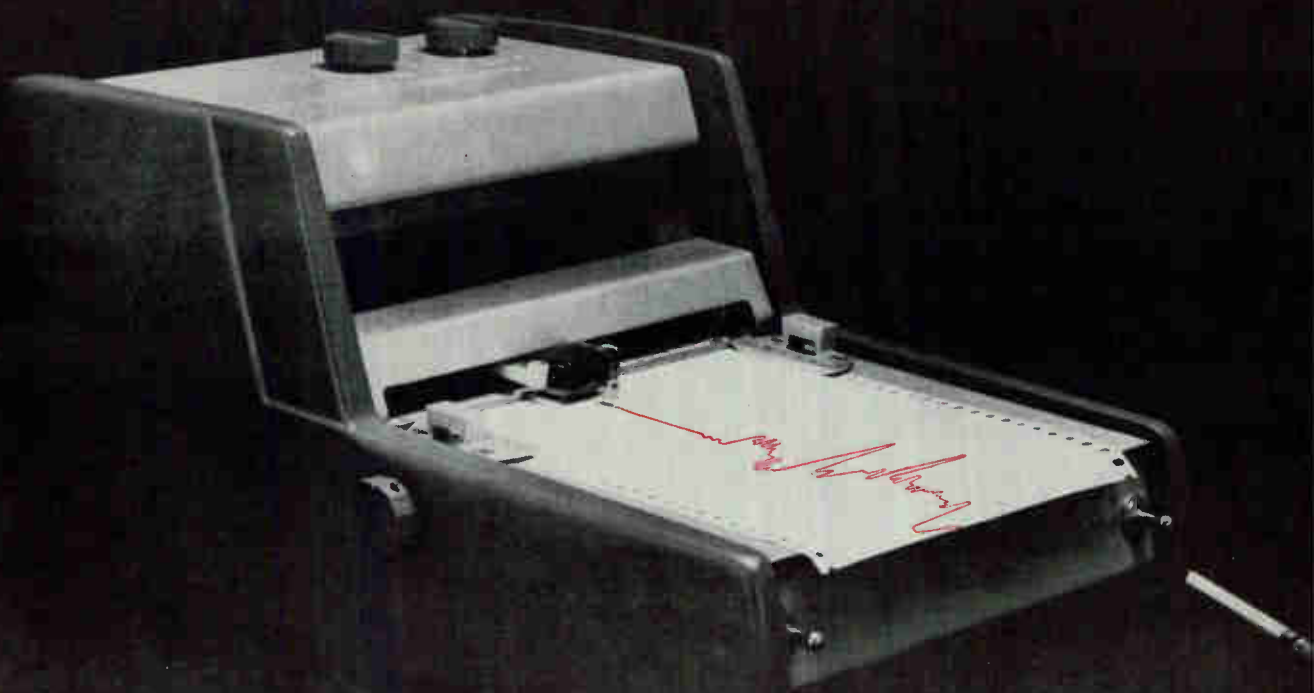

Highly Reliable

# HITACHI "SEMI-CONDUCTORS"

For Industrial Use  
Switching Transistors and Diodes

2SA18  
2SA41  
2SA42  
2SA86  
2SA208  
2SA209  
2SA210  
2SB66  
2SB67  
2SB68  
2SB81  
2SB82  
2SC89  
2SC90  
2SC91

Hitachi semi-conductors provide the basis for the excellent capacity of the Hitachi Electronic Computer HITAC 103.

1N34A  
1N35  
1N38A  
1N56A  
1N60  
1S77  
1S78  
1S79  
1S84

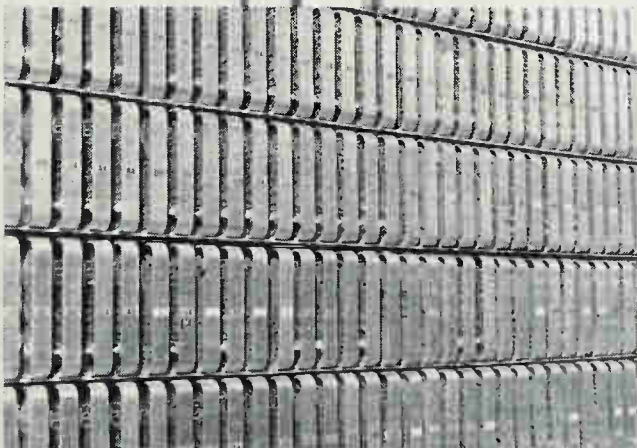

Back of HITAC 103.



**Hitachi, Ltd.**

Tokyo Japan

Cable Address: "HITACHI" TOKYO

# LOW LEVEL SUBCARRIER OSCILLATOR FOR FM TELEMETERING

- DIFFERENTIAL FLOATING INPUT
- HIGH COMMON MODE REJECTION
- EXCELLENT ENVIRONMENTAL STABILITY



ACTUAL SIZE

## SPECIFICATIONS:

<b>Power Input Required:</b>	$\pm 28 \pm 10\%$ , 25 ma max.
<b>Modulation Sensitivity:</b>	$\pm 7.5\%$ frequency deviation with $\pm 10$ MV or 0 to 20 MV
<b>Input Impedance:</b>	10K (nominal).
<b>Linearity:</b>	Better than 0.5% DBW, best straight line.
<b>Output Voltage:</b>	0.5 VRMS minimum into 8K.
<b>Output Impedance:</b>	47 K.
<b>Harmonic Distortion:</b>	0.75% max.
<b>Frequency Response:</b>	$\pm 0.5$ db (mod. index of 2.5)
<b>Amplitude Modulation:</b>	$\pm 0.5$ db max.
<b>Common Mode Rejection:</b>	100 db minimum from DC to 1000 cps for common mode inputs up to 10 volts peak to peak. 140 db minimum at DC.
<b>Drift:</b>	$\pm 1\%$ DBW, for 8 hours static environment
<b>Temperature:</b>	Center frequency and sensitivity stable $\pm 2\%$ DBW, $0^\circ\text{F}$ to $185^\circ\text{F}$ . Operational $-60^\circ\text{F}$ to $212^\circ\text{F}$ .
The center frequency and sensitivity will not vary more than $\pm 1\%$ DBW under the following environmental conditions.	
<b>Acceleration:</b>	150 G, any axis.
<b>Shock:</b>	100 G, 11 ms, any axis.
<b>Vibration:</b>	20 G, 20 to 2000 cps in 5 minute sweeps in any axis.
<b>Altitude:</b>	Unlimited.
<b>Humidity:</b>	MIL-E-5272.

## NEW DORSETT MVO 20

New from Dorsett Electronics is the Model MVO-20, a realistic approach to reliability in the design of solid state, low level subcarrier oscillators.

Silicon semiconductors are used throughout a circuit which provides balanced differential input, excellent common mode rejection and stable data over a wide environmental range.

The MVO-20 is packaged in the die cast Dorsett "20" series No. 2 module compatible with other

"20" series telemetry components. Distortion and intermodulation are held to a minimum through careful package design. Components aren't cramped to rob reliability. The package is small enough to meet most system configuration requirements.

If you can't afford to take chances on reliability, be sure to evaluate the Dorsett Model MVO-20 low level subcarrier oscillator for your next telemetry requirement.



## DORSETT ELECTRONICS, INC.

P. O. BOX 862 • NORMAN, OKLAHOMA • JEFFERSON 4-3750

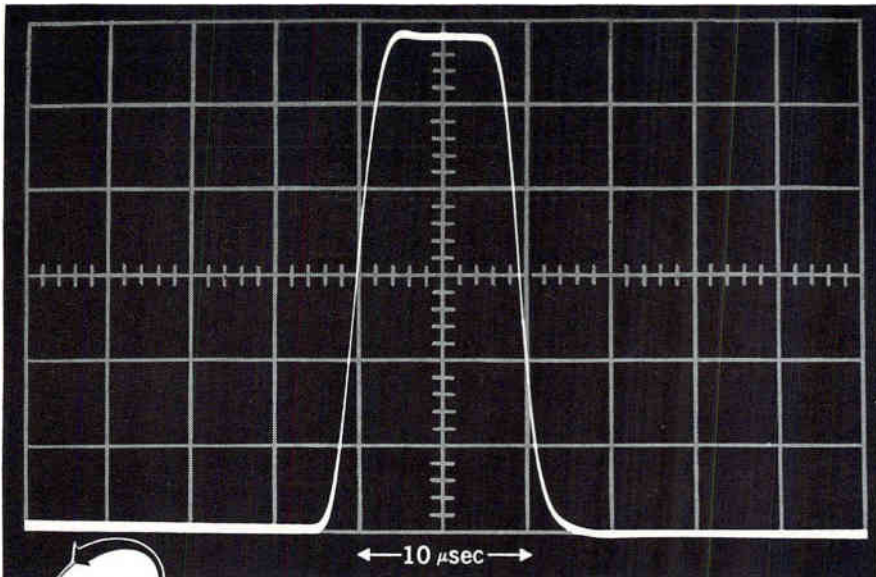

Unretouched Polaroid photograph of a 10- $\mu$ second pulse after processing through DCS' GOV-3 and GFD-4. Subcarrier frequency: 750 kc  $\pm$ 40% deviation. Output filter: 150 kc Gaussian.

## Now! Capture transient events like never before!

### • Virtually no overshoot • Fastest rise time attainable

Want to capture transients that have eluded you up to now? Or, if you are getting them, want them more faithfully? The photo above proves it can be done—providing you use DCS high-frequency FM subcarrier oscillators and discriminators. These new DCS components are based on a high-frequency current switching device, operating with unsaturated transistors in a manner that permits very long recovery periods. Result: faster rise time than ever before possible, with virtually no overshoot!

Components now available for immediate, off-the-shelf delivery:

### DCS High-Frequency VCO (UNIDAP Configuration)

High-frequency VCO plug-in modules for all standard DCS UNIDAP systems. Standard frequencies available: 250, 400, 550, 700 and 850 kc, all  $\pm$ 40 kc. Also 800 kc,  $\pm$ 300 kc. Others available on request. Permits analog intelligence frequencies to 300 kc to be converted to FM subcarriers for both direct tape recording and multiplexing.



Model GOV-3

### DCS High-Frequency Discriminator



Model GFD-4

High-frequency, phase-lock playback discriminator for use with standard DCS UNIDAP and telemetry data systems. Recovers data from all DCS airborne and ground high-frequency VCO's. Also used with standard DCS predetection telemetry recording and standard DCS frequency translation systems. Output intelligence frequencies up to 300 kc.

For more information, complete specifications, etc., write to Dept. E-2-3.



## DATA-CONTROL SYSTEMS, INC.

*Instrumentation for Research*

Los Angeles • Santa Clara • Wash., D. C. • Cape Canaveral  
Home Office: E. Liberty St., Danbury, Conn. • Pioneer 3-9241

**first  
choice of  
all 4**

research

design

production

management

Because the BUYERS' GUIDE satisfies the buying and specifying needs of all four segments of the industry! Gives more information in less space. Easier to use. Only the BUYERS' GUIDE has been screened for usefulness over a 20 year period... comes to you compact, complete and accurate.

gives more to all 4!

**electronics  
BUYERS' GUIDE  
and REFERENCE ISSUE**



# Three steps to rho

## Specify Dope-sil\* . . . for easy, consistent, on-target resistivity

If you use the Czochralski technique for growing single crystal silicon, you should consider this simple, three-step procedure for accurate, reproducible doping:

**Step 1:** Use nomograph to determine total atoms of dopant required.

**Step 2:** Select Dope-sil pellets containing the required total doping atoms. Dope-sil is the Dow Corning trademark for accurately pre-measured doping modules.

**Step 3:** Add the Dope-sil pellets to your pre-packaged Dow Corning hyper-pure silicon crucible charge.

And that's it! No need for long, involved calculations. No need for a delicate laboratory balance, the weighing of powders, grinding . . . other involved procedures.

How about accuracy? Resistivities are on-target . . . within closer tolerances than the accepted industry practice.

For more information on Dope-sil, on pre-packaged Dow Corning crucible charges, and copies of these easy-to-use nomographs, write Hyper-Pure Silicon Division, Dept. 4202.

\*Trademark for Dow Corning's doping modules

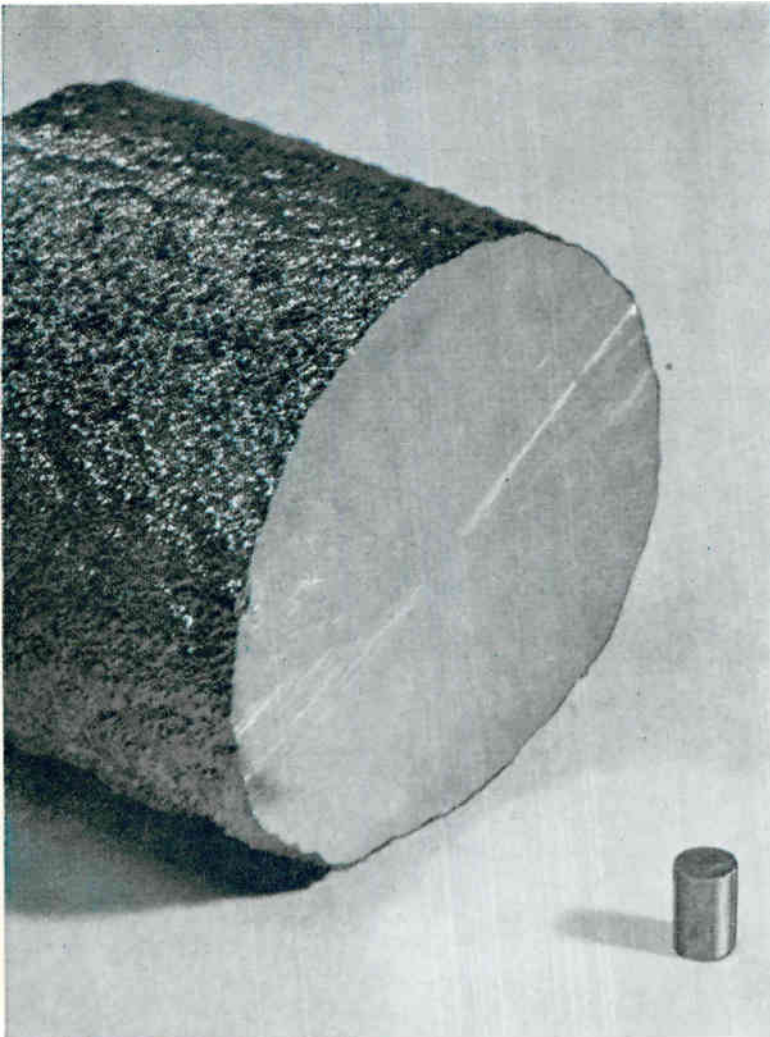

STEP 1

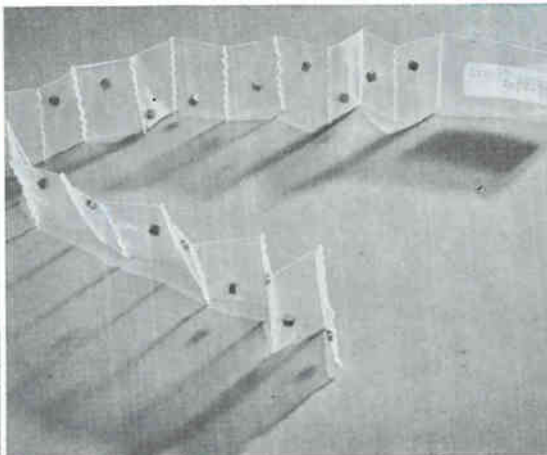

STEP 2

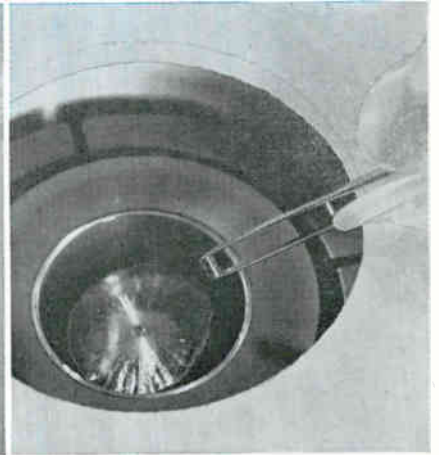

STEP 3

**Dow Corning CORPORATION**

HYPER-PURE SILICON DIVISION • HEMLOCK, MICHIGAN

# THE EMPIRE UPSTATE

America's richest supply  
of skilled labor

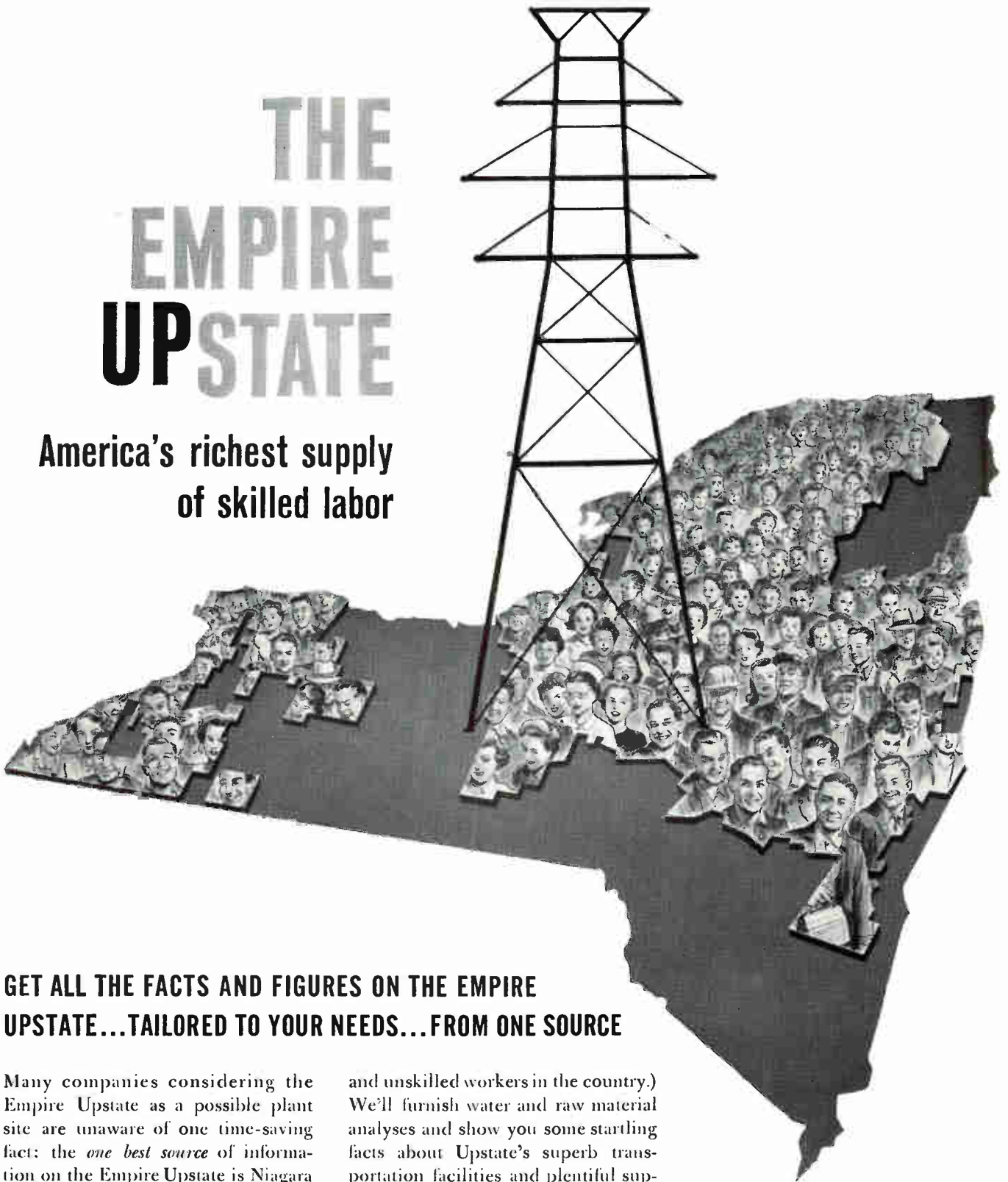

## GET ALL THE FACTS AND FIGURES ON THE EMPIRE UPSTATE...TAILORED TO YOUR NEEDS...FROM ONE SOURCE

Many companies considering the Empire Upstate as a possible plant site are unaware of one time-saving fact: the *one best source* of information on the Empire Upstate is Niagara Mohawk's Area Development Department.

What can we do for you? Well, we'll find you the right plant site. We have a complete inventory of buildings and available sites throughout Upstate's 22,000 square mile area. We'll give you a complete, detailed breakdown of the labor force. (Upstate, N. Y. has the richest supply of skilled

and unskilled workers in the country.) We'll furnish water and raw material analyses and show you some startling facts about Upstate's superb transportation facilities and plentiful supply of low-cost electric power and natural gas.

We'll also get the answer to any other questions that may be peculiar to your business. This service is yours for the asking . . . free of charge . . . and in strictest confidence, of course. As a starter, write us on your company letterhead and we'll put you on the mailing list for the Empire Upstater,

a publication that will keep you up to date about booming Upstate, N. Y. Write Richard F. Torrey, Director of Area Development, Niagara Mohawk Power Corporation, Dept. E-2, 300 Erie Blvd. West, Syracuse 2, N. Y.

**NIAGARA**  **MOHAWK**  
INVESTOR OWNED • TAXPAYING

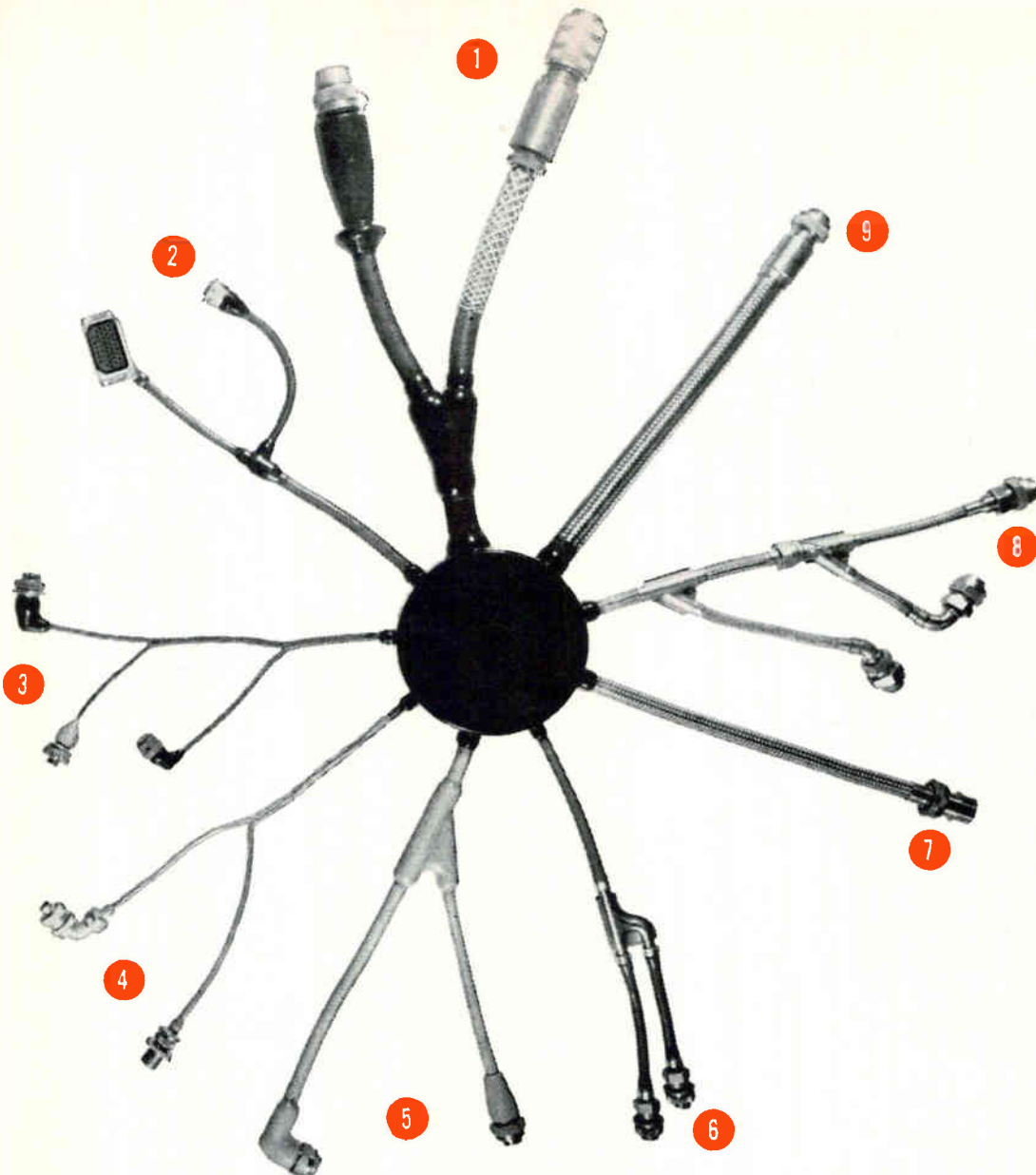

## TYPICAL BENDIX® SPECIAL-PURPOSE CABLES THAT SOLVE CRITICAL ENVIRONMENTAL PROBLEMS

- 1 Heavy Duty—Ground Support Cable
- 2 Benseal® Missile Control Cable
- 3 Fabric Braided—Aircraft and Missile Control Cable
- 4 Metal Braid—Aircraft Nacelle Cable
- 5 High Temperature—Radiation Resistant Cable
- 6 High Temperature—Lightweight—Missile Cable
- 7 "Wet Wing" Aircraft Fuel Cell Cable
- 8 Rewirable—Jet Engine Control Cable
- 9 High Temperature—1500° F.—Thermocouple Cable

Bendix cables—products of over a quarter-century of design and manufacturing experience—are proving their complete reliability in a countless variety of applications involving critical environmental conditions. For complete information, write us at Sidney, New York.

**BENDIX CABLES • BENDIX CONNECTORS**

*Designed together to work best together*

**Scintilla Division**



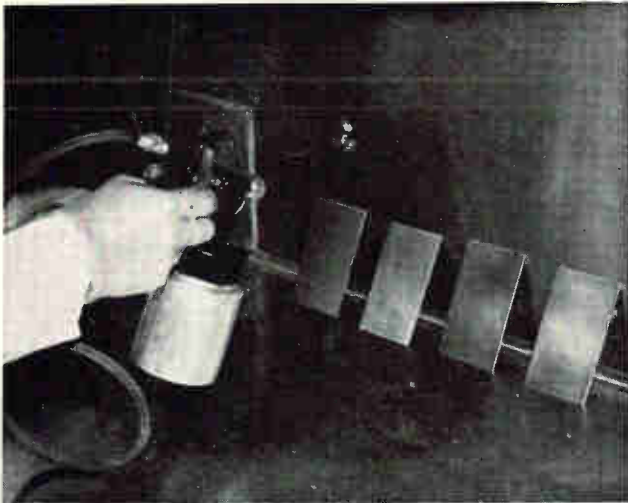

The PC boards have been cut to size and cleaned, and are being sprayed with sensitizing material. Four fine sprayings give satisfactory results

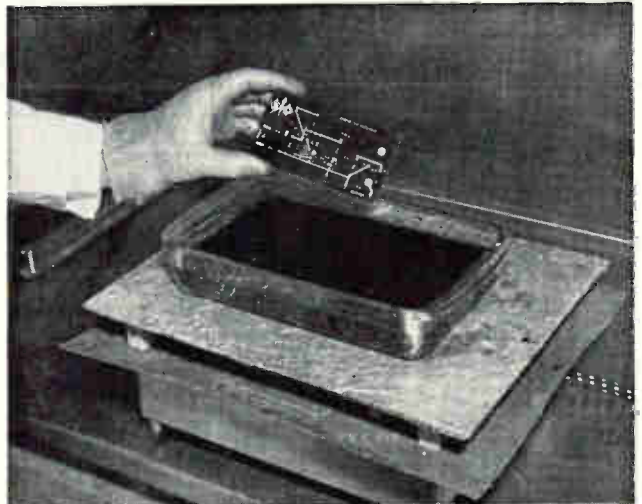

A typical PC board after etching. The etch solution is held at 120 F by a hot plate; a rocking motion is developed by driving the hot plate with a phonograph motor

## Processing PC Boards in Small Shops

By KENNETH F. DAY,  
U.S. Army Signal Missile Support  
Agency, White Sands Missile Range,  
New Mexico

WITH THE WIDE USE of printed circuits boards, it is now necessary for those fabrication shops and design laboratories working with substantial quantities of electronic equipment to be able to duplicate boards and to fabricate original boards. At the present time two options are generally available to the small shop and laboratory: circuit board fabrication by an external source, or "do-it-yourself" kits. Neither method has proven to be wholly satisfactory from the standpoint of economy or responsiveness. The need for a process better suited to small lot production led to a study to determine what improvements could be made in current processes.

With two major objectives in mind—economy of operation and a practical method by which the work could be accomplished—a careful study of printed circuit board processing was conducted to select the materials to be used and the method of using the materials. The process arrived at has been found to be both economical and practical.

Printed circuit board is pur-



Sensitized board is placed in printing frame

chased in bulk quantity, in sheet form. It can be cut to any size desired with sheet metal shears and a Do-All saw. A fiberglass epoxy resin board was selected for general use because of its rigidity, its heat and flame resistance, non-chemical "weeping" and the ease with which it can be cut or machined.

Cleaning the board before use is an important step. If the board is especially dirty, or the copper shows signs of oxidation, the board should be washed in a 15 percent solution of hydrochloric acid. To neutralize the acid, the board is washed in a 10 percent solution of ammonium hydroxide, then air-dried.

If the board is reasonably clean, it need only be surfaced before sensitizing. Cleaning can be done with an abrasive household cleaner or fine steel wool. If a cleaner is used, the board should be thoroughly washed and thoroughly dried. If steel wool is used, the board need only be wiped clean of the dust or residue.

After the board is clean it is ready for sensitizing. Once this process is started, the board must be handled under reasonably safe light conditions until it is etched. Under no circumstances should prolonged exposure to ultra-violet rays be permitted. The cut and cleaned board is placed upright and photosensitized by spraying with an extremely fine mist of Kodak (KPR) Photo Resist. Four passes at each board are made with the spray, with each board rotated 90 degrees after each pass. The board is then placed in a thermostatically controlled circulating oven, and held at 200 F for five minutes. Drying helps to establish the bond between the board and the Resist. The finish produced by the abrasive cleaning previously mentioned also helps to make this bond possible. If the board is not to be used immediately it can be stored, if it is carefully

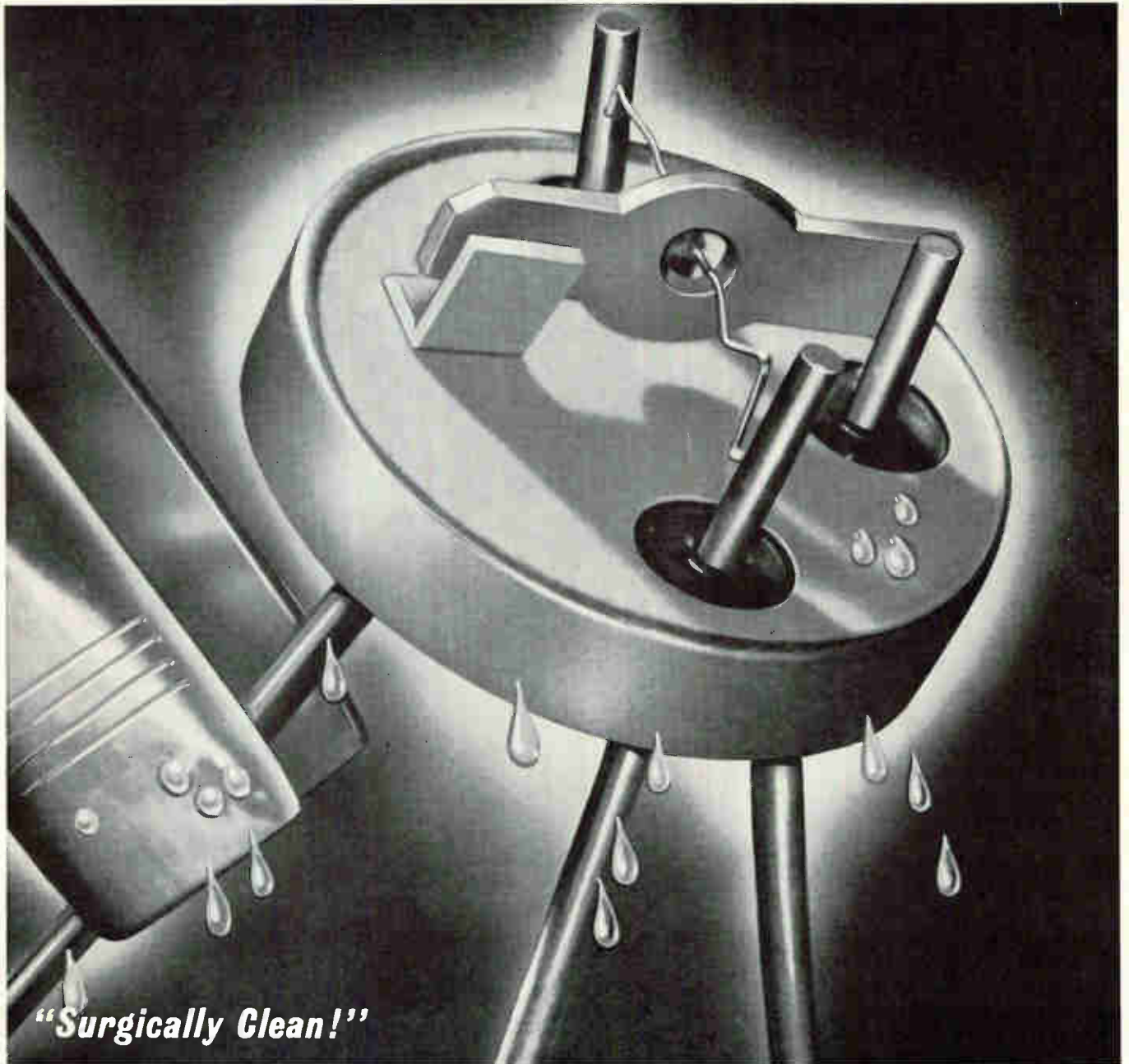

**"Surgically Clean!"**

## ...when you use new Du Pont "Perone" 30 to clean and etch your electronic components

"Perone" 30 is a new 30% hydrogen peroxide developed by Du Pont specifically for cleaning and etching electronic components. The excellent stability of "Perone" 30 permits you to prepare etching solutions that best meet your own requirements. The specifications on "Perone" 30 exceed those required by the A.C.S. and are the most rigid available!

**"PERONE" 30**  
Hydrogen Peroxide

### NEW GRADE OF DU PONT HYDROGEN PEROXIDE EXCEEDS A.C.S. SPECIFICATIONS

	"Perone" 30	A.C.S.
Assay	30.1-30.5%	28% min.
Residue after evaporation	20 ppm max.	50 ppm max.
Free acid as H <sub>2</sub> SO <sub>4</sub>	30 " "	30 " "
Chloride (Cl)	1 " "	10 " "
Nitrate (NO <sub>3</sub> )	5 " "	10 " "
Phosphate (PO <sub>4</sub> )	5 " "	5 " "
Sulfate (SO <sub>4</sub> )	1 " "	5 " "
Ammonium (NH <sub>4</sub> )	5 " "	10 " "
Aluminum	1 " "	" "
Iron (Fe)	0.5 " "	0.5 " "
Heavy Metals as (Pb)	0.5 " "	1 " "

"Perone" 30 is shipped in a new non-returnable 15-gallon polyethylene-in-steel overpack drum that insures its purity during shipment. Samples are available for your own evaluation. For more information on "Perone" 30 contact your Du Pont Representative, or write: Du Pont, Electrochemicals Department, Room #2061, Peroxygen Products Division, Wilmington 98, Delaware.



BETTER THINGS FOR BETTER LIVING... THROUGH CHEMISTRY

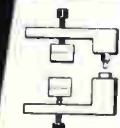
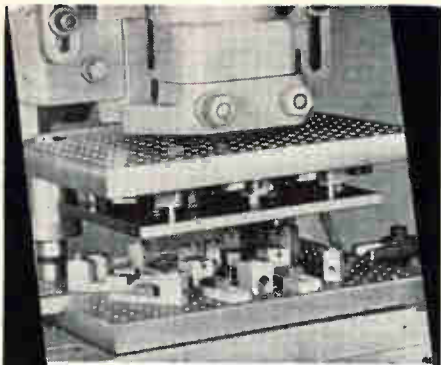

**Punch Multiple Holes  
in One Operation  
with REUSABLE DI-ACRO  
ADJUSTABLE PUNCHES AND DIES**



Di-Acro Adjustable Punches and Dies offer you an inexpensive means of rapid tooling for multiple punching of holes of a variety of shapes and sizes. They will do the job in a fraction of the time it would take using a single station punch press and at a fraction of the cost of standard tooling. All tooling can be arranged in a countless number of patterns so that most multiple hole punching jobs can be accomplished in one operation. Tooling can be reused again and again. Holes can be as close together as  $\frac{3}{4}$ " on centers. A template locates your punches and dies accurately. All Di-Acro punches and dies are concentric, readily interchangeable. Standard rounds, squares, rectangles, ovals, D's and other shapes in a variety of sizes are available from stock.

Di-Acro Adjustable Punch and Die catalog is complete with detailed instructions and prices on all die sets, punches and dies. Consult the yellow pages of your phone book for the name of your nearest Di-Acro Distributor or write us for your free copy.



Pronounced die-ack-ro



**DI-ACRO CORPORATION**  
432 Eighth Ave.  
Lake City, Minn.

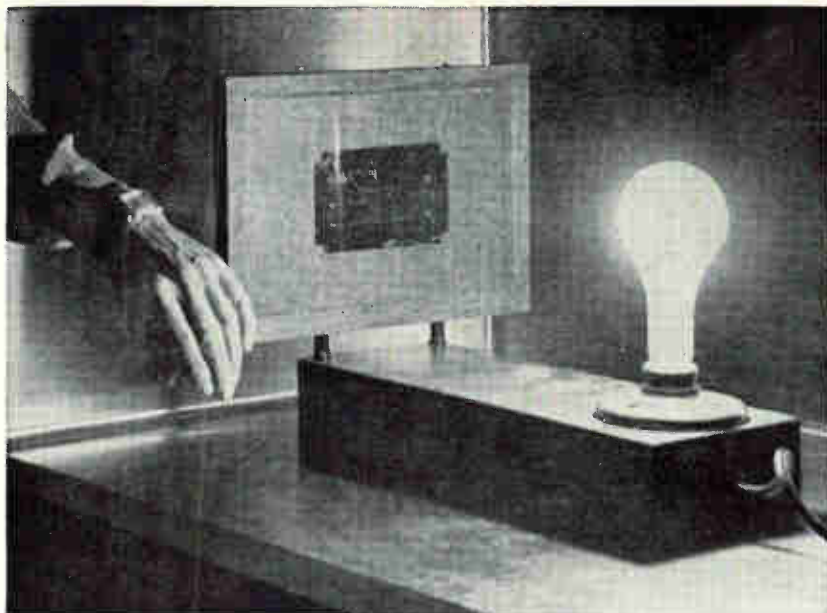

*Exposing the sensitized plate is accomplished with direct sunlight or an ultraviolet sun lamp*

wrapped in a light-proof material such as aluminum foil.

When the board is ready to be exposed, it is placed in a printing frame with a photographic negative of the desired circuit, with the copper side of the board turned to the emulsion side of the negative. To produce sharp and distinct negatives, the circuit is drawn 4 to 5 times the size of the final board. Black India ink or black photographic tape is used to form the wiring. The expanded scale layout is then photographed and, in the same operation, is reduced to the size required.

The sensitized board is exposed by placing it in direct sunlight for 5 minutes or by illuminating it with a high wattage ultraviolet sun lamp for  $7\frac{1}{2}$  minutes. After exposure, the board is removed from the printing frame and placed in a glass tray containing Kodak (KPR) Photo Resist Developer for from 30 seconds to 2 minutes, depending upon the strength of the developer. Gentle agitation during developing helps wash away the dissolved Resist. Next, the board is air-dried, then washed in luke warm water. If the water clings to the board, it has not been thoroughly developed and it must be dried and returned to the developer. After developing, the board should be placed back in the oven for approximately 3 minutes, since lines remaining on the board

can be softened by the developer; heating also assures hardening of the circuit lines.

To etch, the board is placed copper side down in a glass tray containing enough glass marbles to support the board on a horizontal plane, and enough etching solution to exceed the height of the marbles by  $\frac{1}{4}$  inch. The solution is held at 120 F by a thermostatically controlled hot plate; the hot plate also is made to oscillate during the etch. Etched copper, from areas not protected by the Resist, falls freely through the marbles; etching time is approximately 5 minutes.

The etching solution is composed of 454 grams ferric chloride, 650 cc water, and 85 cc hydrochloric acid. The hydrochloric acid acts as a catalyst to stimulate the chemical action. After etching, the board is washed thoroughly in luke warm water to remove destructive sediment or chemicals that may have been left. Prior to assembly, the Photo Resist covering the etched circuit is removed with a cloth and KPR developer. If the board is not to be used in the near future, the Resist can be left on the circuit lines. This protects the copper from corrosion and oxidation.

It is important that the entire process take place in a well ventilated room because of the chemical fumes given off. Also, each person involved should wear rubber gloves and a protective apron or coat.

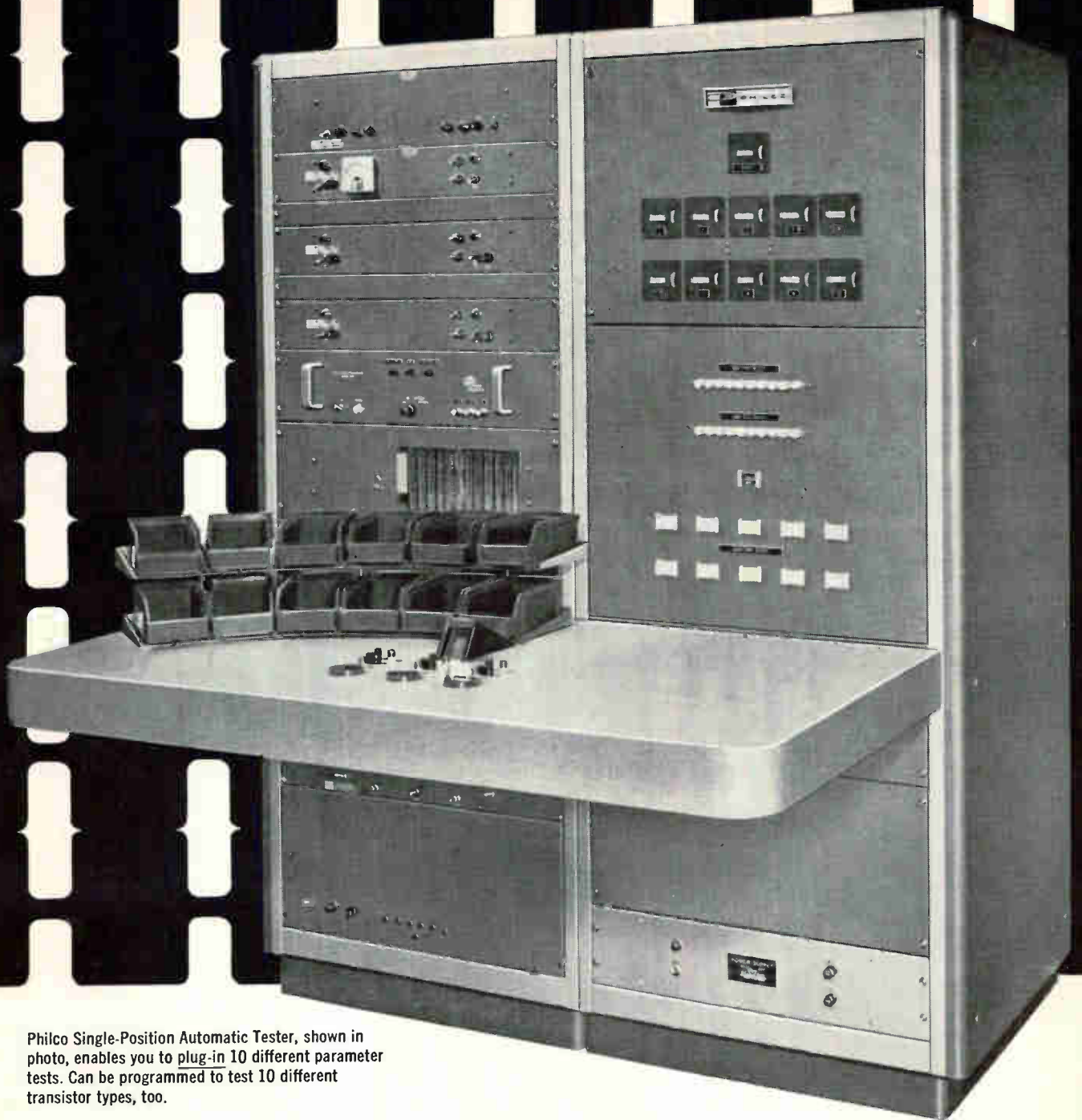

Philco Single-Position Automatic Tester, shown in photo, enables you to plug-in 10 different parameter tests. Can be programmed to test 10 different transistor types, too.

## PHILCO TRANSISTOR TESTERS

Philco Proved-in-Use Equipment Enables You to Inspect Incoming Kc or Kmc Transistors, in Tray or Truckload Quantities. For any Transistor testing requirement—incoming inspection, production testing, or reliability testing, Philco offers proved-in-use equipment exactly suited to your needs. For complete information write Dept. E11962E.

Equipment Development and Manufacturing Operation

# PHILCO

A SUBSIDIARY OF *Ford Motor Company*  
LANSDALE DIVISION • LANSDALE, PENNSYLVANIA

CIRCLE 83 ON READER SERVICE CARD

# new! NARDA ferrite isolators

designed and manufactured  
by NARDA MICROWAVE!

## • broadband coaxial ferrite isolators

Excellent electrical characteristics with extreme versatility!  $\frac{7}{8}$ " coaxial line construction allows higher power operation with  $\frac{7}{8}$ " connectors, up to 20 kw peak, 400 watts average. (Normally supplied with Type N,  $\frac{3}{8}$ " connectors; 10 kw peak, 10 watts average.) Features 15 db isolation and 1 db max. insertion loss. VSWR is 1.25 max. based on 2:1 load mismatch; 1.15 max. into matched load. Model 1233: 2.0-4.0 kmc; model 1233-1: 3.0-5.5 kmc; \$450. each.

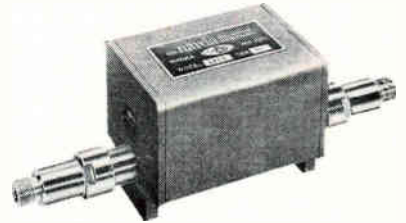

## • low power broadband waveguide ferrite isolators

Provide maximum load isolation and minimum insertion loss over full standard waveguide frequency ranges. Extremely useful for maintaining signal source stability and eliminating long line and frequency pulling effects. Front-to-back ratios are the highest available on the market today: C Band-26:1, \$250; XN Band-25:1, \$225; XB Band-30:1, \$235; X Band-30:1, \$220.



## • high power broadband waveguide ferrite isolators

The only line of high power isolators that covers all of X Band with just two models (8.2-10.0 kmc and 10.0-12.4 kmc), each with front/back ratio of 40:1. Input power rating: 250 kw peak, 300 watts average, achieved through use of special high Curie temperature ferrite materials. VSWR is 1.05 max. with matched load; 1.10 max. with 3:1 mismatch. Only \$175 each. Model with same VSWR, 28:1 front/back ratio, 300 kw peak, and 300 watts average, for 7.05-10.0 kmc, \$195.

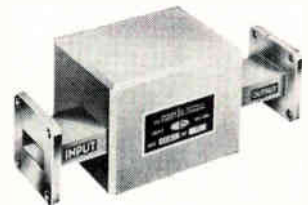

## • other ferrite devices— consult NARDA for:

• Circulators • Phase shifters • Modulators • Attenuators • Special Isolators

For more information, write to Dept. E-1-1



the narda microwave  
corporation

PLAINVIEW, L. I., NEW YORK

AREA CODE 516 GE 3-9000



## General Atomic Offers

# EXTENSIVE PULSED RADIATION TEST FACILITIES

General Atomic's unusual combination of pulsed radiation facilities is now available on a scheduled basis to industry and government organizations for conducting transient radiation effects testing. These facilities include, at a single location, the TRIGA Mark I and Mark-F reactors and the high-energy Electron Linear Accelerator. This broad range of testing capabilities can be put at your disposal for programs ranging from fundamental studies of transient radiation effects to the environmental testing of specific components and systems.

The TRIGA reactors developed by General Atomic are designed to yield reproducible, high intensity pulses of neutrons and gamma rays. The demonstrated safety of these reactors which permits individuals to remain in the immediate vicinity during operation, provides both experimental accessibility and convenience. The TRIGA'S high rate of pulsing makes it possible to generate useful data quickly and easily.

The 45 Mev 700 milliamperere L-band Electron Linear Accelerator provides extremely short pulses of high energy electrons, gamma rays or both. Experimental versatility, a requirement in many research programs, is made possible by selection of energy range, pulse width and pulse repetition rate. Facilities are available for testing under cryogenic as well as high temperature conditions.

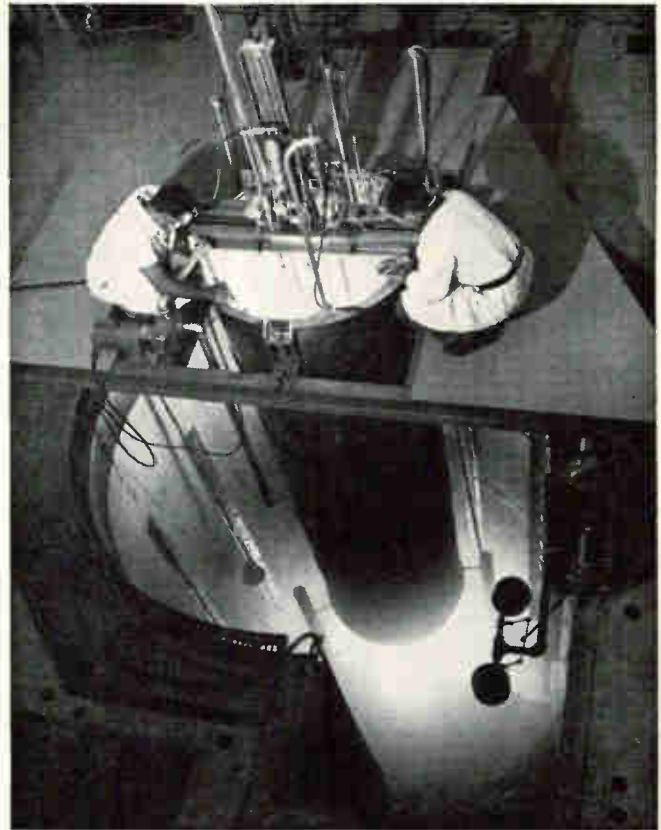

In addition to the skilled personnel who operate the facilities, scientific and engineering staff members with extensive experience in transient radiation effects testing programs are available to assist in planning and executing specific research programs.

For full information on these facilities and arrangements for their use, write to Applications Group-FE, General Atomic, P.O. Box 608, San Diego 12, California.

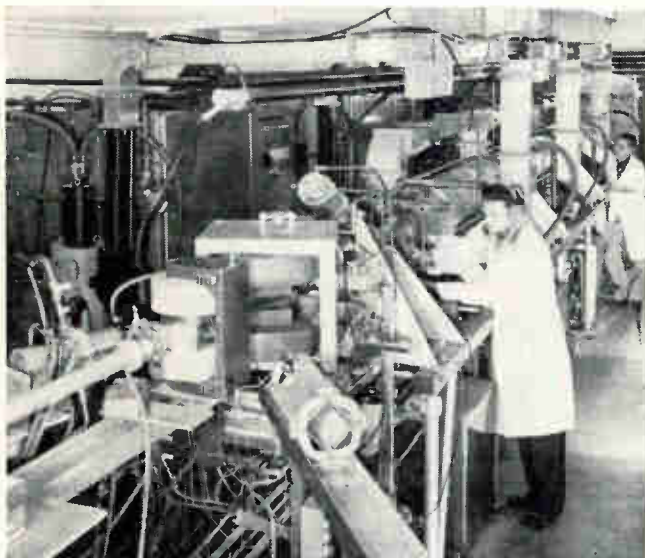

### PERFORMANCE DATA

	TRIGA Mark-F	TRIGA Mark I
Peak power during pulse	1200 megawatts	800 megawatts
Pulse width at half maximum	13 msec	15 msec
Integrated fast neutron flux (in core)	$6 \times 10^{14}$ nvt.	$4 \times 10^{14}$ nvt.
Peak fast neutron flux	$4 \times 10^{16}$ nv.	$2 \times 10^{16}$ nv.
Estimated gamma dose (in core)	$6 \times 10^5$ R	$4 \times 10^5$ R
Estimated peak gamma dose rate (in core)	$4 \times 10^7$ R/sec.	$2 \times 10^7$ R/sec.

### L-Band Electron Linear Accelerator

Maximum energy	45 Mev
Pulse width	0.01 to 15 $\mu$ sec
Pulse repetition rates per second	single, 7.5 to 720
Maximum beam current	700 milliamperes
Gamma ray dose per pulse	$\sim 50$ R
Gamma ray dose rate during pulse	$10^7 - 10^8$ R/sec

**GD** GENERAL DYNAMICS | GENERAL ATOMIC DIVISION



## Mallory Aluminum Electrolytic Capacitors

For your products ranging from home instruments to military electronics, you can find any electrolytic capacitor you need in the Mallory line . . . unbeatable for quality, variety and performance. 85° ratings, MIL types, subminiatures, wax tubulars. Name it and you can get it . . . from stock at factory prices from Mallory Distributors. Write for latest catalog.

Distributor Division  
P. O. Box 1558, Indianapolis 6, Indiana



This Coordinately-Actuated Crossbar Matrix Performs Code Conversion at Punched-Card or Tape Rates with Electro-mechanical Simplicity & Reliability.

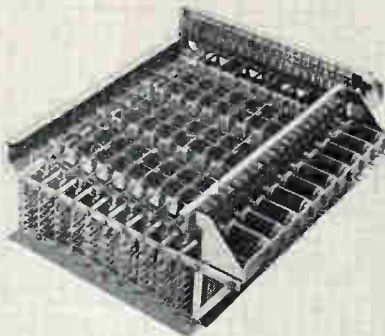

Overdesign is not only expensive, but vulgar, too. Encoding, decoding, format conversion, and short-term storage need not involve microsecond techniques, equipment, or costs. That is why many modern digital-circuit designers employ the unique\* Cunningham Crossbar when matrix logic and moderate speeds dictate its choice.

Investigate the *sophisticated simplicity* of the Crossbar.

\*A conceit supported by U.S. and Foreign Patents.

**Cunningham**  
ESTABLISHED 1838  
SOPHISTICATED SWITCHING SYSTEMS  
BOX 516, ROCHESTER 2, NEW YORK

Plant & Offices:  
Honeoye Falls, N. Y.  
Phone: Honeoye Falls 485  
TWX RO 572-U

CIRCLE 202 ON READER SERVICE CARD



Write for our catalogue

Good parts work best!

Intermediate Frequency Transformer IFT



The high standards of MITSUMI electronic components are insured by a fully-automated assembly system, and double-checked by rigid quality controls. Mitsumi Electric Company is Japan's largest manufacturer of components for radio, television and communications equipment.

POLYVARICON Variable Capacitor



## MITSUMI PARTS

MITSUMI ELECTRIC CO., LTD.  
Koma, Kitatama, Tokyo



CIRCLE 203 ON READER SERVICE CARD  
electronics

# FULL FIVE DIGITS—ALL SOLID STATE



## Eitronic

**880** the most significant achievement in digital voltmeter reliability in 7 years!

**It's quick!** Twenty readings per second—faster than the eye can follow. This high speed operation eliminates reading delays due to cycling caused by decreasing voltages.

**It's accurate!** Production 880's provide a true, absolute DC accuracy of 0.01%. This figure is the total of all errors. The temperature-controlled Zener diode reference is stabilized to better than 0.005% for months.

**It's reliable!** Costlier components, conservatively designed solid state circuits, rigorous "pyramid" testing during manufacture and an accelerated aging program equivalent to 100 hours of actual operation, give the 880 exceptionally high field reliability.

**It's quiet!** All switching in the 880 is accomplished elec-

tronically by movement of electrons and "holes" in a crystal lattice. Since the logic contains no moving parts there are no contacts to clatter or wear and no noise.

**It's cool!** All-transistorized circuitry eliminates the problem of heat dissipation, especially advantageous where continuous operation is required.

**It's completely automatic!** The operator simply reads the numbers in the readout. Even decimal point placement and polarity indication are automatic. Operator error is virtually eliminated.

**It's available now!** 880's are available for immediate delivery. Your nearest EI field office can arrange a demonstration and provide complete information and prices. Call today.

*Another significant breakthrough in digital instrumentation from*

**Electro Instruments, Inc.**

*Engineers: Challenging opportunities now available. Contact Mr. Harvey Fleming.*



8611 BALBOA AVENUE,  
SAN DIEGO 11, CALIF

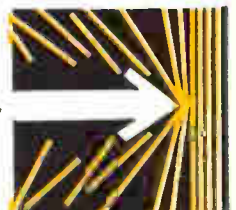

CIRCLE 87 ON READER SERVICE CARD

**Who needs feedback?** The patented chronometric governor of this standard DC Timing Motor is a tyrant. Without any other circuitry, it holds the motor output speed within  $\pm 0.1\%$  while driving charts, cams, contacts, actuators or other devices. It holds the rate even if output shaft load, line voltage, or ambient temperatures change. And that's just the standard model of this little gem. Custom variations can do even better, under special conditions. The A. W. Haydon Co. knows all about timers and timing. If you have a specific timing problem, you ought at least to have our literature. Bulletin MO 802 is yours for the asking. (On 5800 Series chronometrically governed DC Motors)

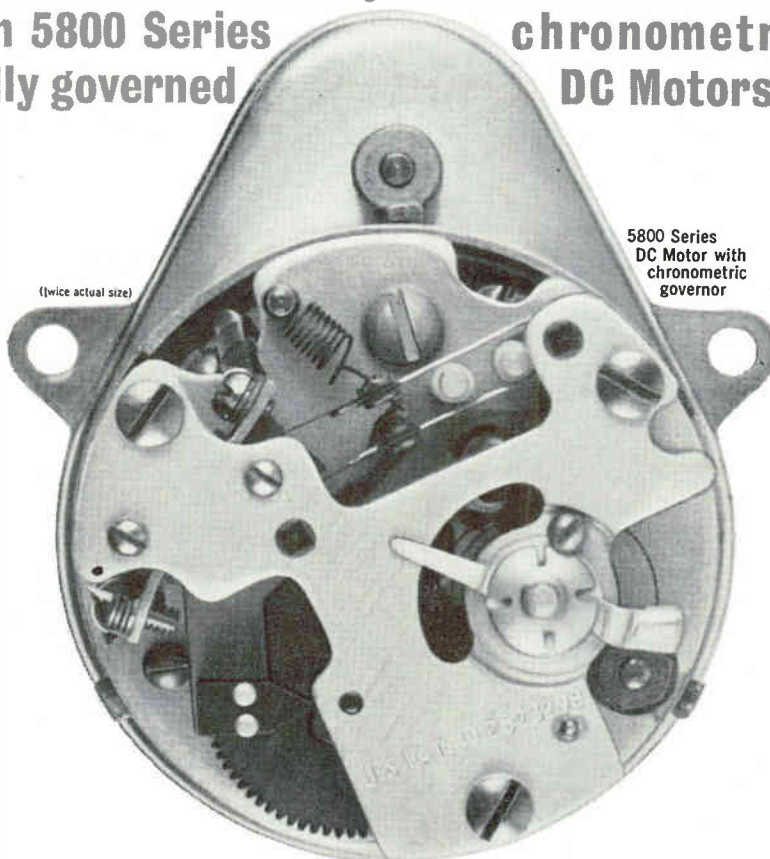

5800 Series DC Motor with chronometric governor

**THE AWH HAYDON COMPANY**  
235 North Elm Street, Waterbury 20, Connecticut

Discrete signals in noise background are easily detected and measured on SB-7bZ display. Automatic high sampling rate (6.7/sec.) speeds measurements.

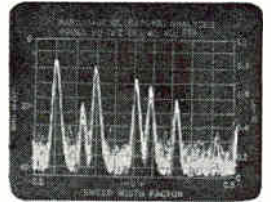

**versatility  
+ economy**

**Panoramic's  
ULTRASONIC  
SPECTRUM  
ANALYZER  
SB-7bZ**

**200 cps to 300 kc**



Up to  $25\mu\text{v}$  sensitivity and exceptional dynamic range with simple, convenient operation are combined in one compact, low-priced instrument. Standard equipment at military installations and in industry, the SB-7bZ is ideally suited for:

- Ultrasonic noise and vibration analysis
- Communication system analysis—wire carrier and VLF radio
- FM Telemetry subcarrier channel analysis
- General Fourier analysis

The SB-7bZ features:

- Variable sweep width: 0 to 200kc
- Amplitude scales: 40db log, 20db linear and 2.5db expanded
- Resolution: variable from 100 cps to 2kc
- Sensitivity:  $250\mu\text{v}$  for full scale deflection, calibrated to measure signals as low as  $25\mu\text{v}$
- Sweep rate: 6.7/sec., synchronized to power line, plus provisions for variable sweep rates when used with accessory equipment
- 5" high-persistence CRT Tube

Write, wire, phone now for detailed specifications bulletin; and ask to be put on our regular mailing list for the PANORAMIC ANALYZER featuring application data.



Sec. 2900

Formerly Panoramc Radio Products, Inc.  
530 So. Fulton Ave., Mt. Vernon, N. Y.  
OWens 9-4600 • TWX: Mt-V-NY-5229  
Cables: Panoramc, Mt. Vernon, N. Y. State

**CIRCLE 204 ON READER SERVICE CARD**  
electronics

# TRY THIS GERMANIUM HIGH FREQUENCY TRANSISTOR

# Quiz!



Descriptive Facts	Select Semiconductor Manufacturer(s) that best qualifies in each category			
	MOTOROLA	Mfr A	Mfr B	Mfr C
<b>1</b> Which manufacturer(s) bakes-out all germanium high frequency devices at the high temperature of 200°C to ensure stability?				
<b>2</b> Which manufacturer(s) selects materials that are capable of withstanding at least 3½ times the temperature at which the devices are rated, with minimum melting points 250° higher than rated T <sub>j</sub> max.?				
<b>3</b> Which manufacturer(s) offers devices with superior power dissipation without resorting to metallic oxide impregnated silicon greases to boost dissipation?				
<b>4</b> Which manufacturer(s) makes its own clear glass mesa headers, permitting positive visual inspection of devices?				
<b>5</b> Which manufacturer(s) ensures product reliability by growing its own epitaxial materials?				
<b>6</b> Which manufacturer(s) has proven its ability to produce high-reliability mesas by its success in the Minuteman program, which has an objective reliability level of only .0007% failures per thousand hours of operation?				
<b>7</b> Which manufacturer(s) was the first to introduce the 2N960 series of six new germanium epitaxial mesa switches that will replace several hundred similar old-type devices in 90% of all applications?				

These are seven of the more important process and leadership areas that indicate a superior capability in high frequency transistor manufacturing. To find out who is the leader in germanium high frequency transistors, add up your check marks in each column. High-scoring manufacturer wins quiz.

You can win every time — every Motorola customer benefits by Motorola's mesa reliability. All Motorola mesas are a result of the same process and quality control procedures that produce Motorola's high-reliability "Minuteman" mesas.

Every Motorola customer benefits by Motorola's broad line, which includes low-cost, non-epitaxial mesas as well as the new, ultra-high-speed, epitaxial switching devices.

And every Motorola customer benefits by Motorola's volume production which keeps prices down and availability up... direct from the factory or from any of Motorola's 27 stocking distributors.

In addition to Motorola's new high-speed epitaxial mesa switches — the 2N960-62 and 2N964-66, which will replace hundreds of old type devices — Motorola also offers more than twenty other popularly priced germanium epitaxial and non-epitaxial mesas.



**MOTOROLA**  
Semiconductor Products Inc.

A SUBSIDIARY OF MOTOROLA, INC.

1789

5005 EAST McDOWELL ROAD • PHOENIX 8, ARIZONA

**MOTOROLA DISTRICT OFFICES:**  
Belmont, Mass. / Burlingame, Calif. / Chicago / Cleveland / Clifton, N. J. / Dallas / Dayton / Detroit / Garden City, L. I. / Glenside, Pa. / Hollywood / Minneapolis / Orlando, Fla. / Phoenix / Silver Spring, Md. / Syracuse / Toronto, Canada.

## TRANSISTOR SELECTION CHART, MOTOROLA EPITAXIAL 2N960 SERIES

TYPE	Minimum BV <sub>CS0</sub> @ I <sub>c</sub> = 100 μAdc		Minimum h <sub>FE</sub> @ V <sub>CE</sub> = 0.3 Vdc, I <sub>c</sub> = 10 to 100 mAdc		Maximum Turn-off Time* @ I <sub>c</sub> = 10 mAdc	
	15 Vdc	12 Vdc	20	40	85 nsec	100 nsec
2N960	✓		✓		✓	
2N961		✓	✓		✓	
2N962		✓	✓			✓
2N964	✓			✓	✓	
2N965		✓		✓	✓	
2N966		✓		✓		✓

\*Turn-off time in transistor-resistor logic circuits, without speed-up capacitors. These units are approximately 10 times faster in RC circuits.

## TRANSISTOR SELECTION CHART, MOTOROLA NON-EPITAXIAL 2N968 SERIES

TYPE	Minimum BV <sub>CS0</sub> @ I <sub>c</sub> = 100 μAdc			Minimum h <sub>FE</sub> @ V <sub>CE</sub> = 0.5 Vdc, I <sub>c</sub> = 25 mAdc		Maximum Turn-off Time* @ I <sub>c</sub> = 10 mAdc		
	15 Vdc	12	7	20	40	150	175	275 nsec
2N968	✓			✓		✓		
2N969		✓		✓		✓		
2N970		✓		✓				✓
2N971			✓	✓				✓
2N972	✓				✓			✓
2N973		✓			✓			✓
2N974		✓			✓			✓
2N975			✓		✓			✓

\*Turn-off time in transistor-resistor logic circuits, without speed-up capacitors. These units are approximately 10 times faster in RC circuits.

For more information on any of Motorola's broad line of germanium mesas, contact your Motorola District Office, or call or write: Motorola Semiconductor Products, Inc., Technical Information Department, 5005 East McDowell Road, Phoenix 8, Arizona.

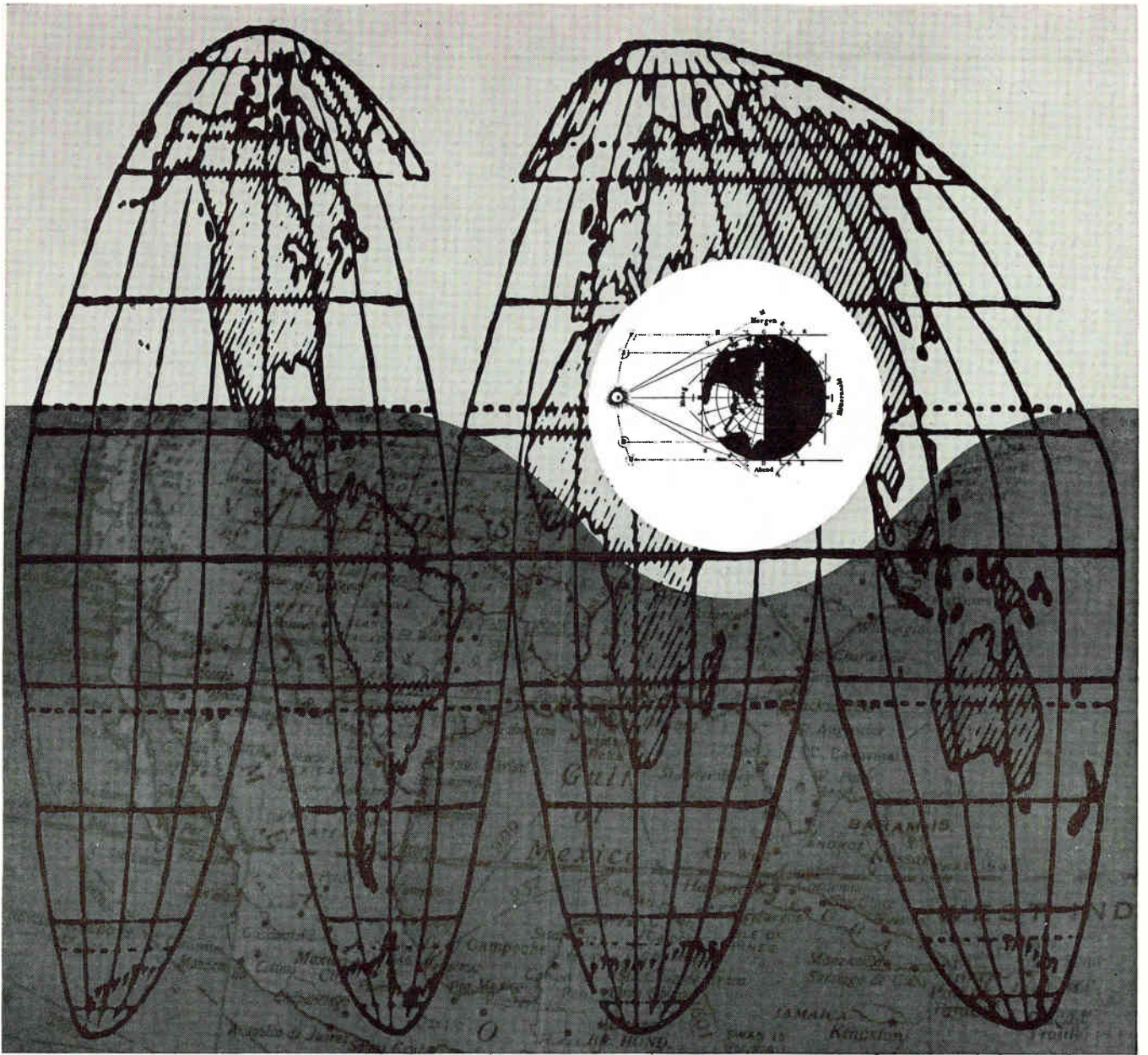

## purposeful imagination....in form

The men of Aerospace exercise high technical competence and constructive imagination in the creation and assessment of form and configuration for advanced ballistic missile and space systems. □ As a partner of the Air Force-science-industry team, Aerospace Corporation is chartered exclusively to serve the United States Government in this mission. The men of Aerospace provide advanced systems analysis and planning; theoretical and experimental research; general systems engineering and corresponding technical direction of programs. □ Through concept, research, development and completed mission the men of Aerospace improve the form of components, equipments, and systems. Trade-offs and interface considerations are objectively appraised on the basis of performance, reliability, and cost. □ Men with the depth and breadth of experience required to solve these interdisciplinary problems are needed by Aerospace Corporation, an equal opportunity employer. Highly skilled engineers and scientists with advanced degrees are invited to contact Mr. George Herndon, Room 110, Aerospace Corporation, P. O. Box 95081, Los Angeles 45, California. □ Organized in the public interest and dedicated to providing objective leadership in the advancement and application of science and technology for the United States Government.

 **AEROSPACE CORPORATION**  
2400 EAST EL SEGUNDO BLVD., EL SEGUNDO, CALIFORNIA

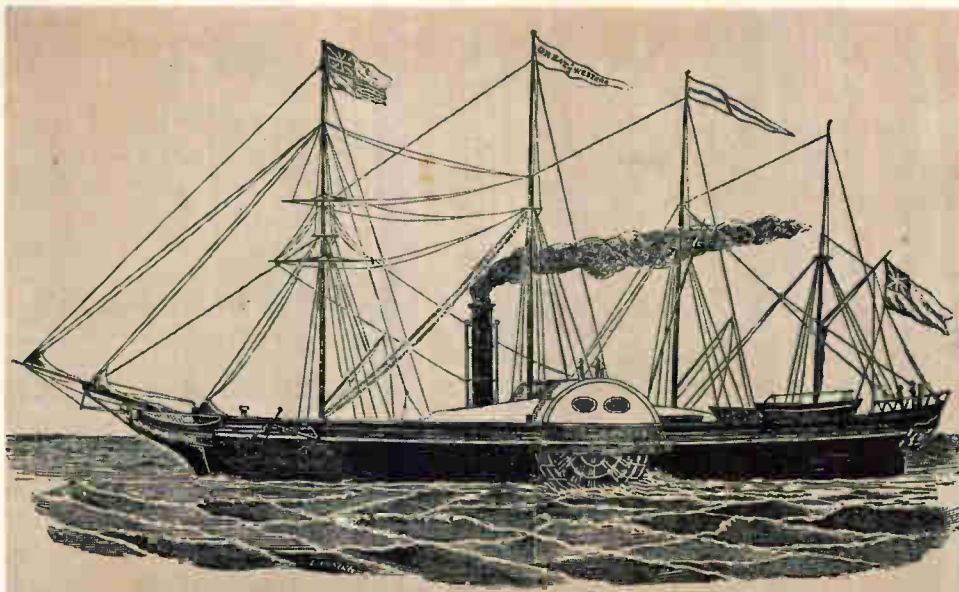

In 1838, the British steamer Great Western initiated passenger service between Bristol, England and New York City. This trip, made regularly without recoaling, was the first continuous scheduled steamship line for passengers across the Atlantic. It became immediately popular due to its reliable schedules. Where sailing vessels frequently were becalmed for days or blown off course by Atlantic gales, the Great Western paddle-wheeler steadily to her destination and arrived with a dependability remarkable for that time.

### **THE GREAT WESTERN**

# RELIABLE



Reliability has been designed into every Daystrom Squaretrim® at the very beginning. The resistance element is wound into grooved insulation on the mandrel so it can't pile up under shock and vibration. The adjustment gear is an anti-backlash nylon part. The anodized aluminum case gives greatest heat dissipation. The Squaretrim has proven its reliability so well that more engineers specify it than all other square trimmers combined. Send for catalog of over 2000 models.

### **THE SQUARETRIM® SUBMINIATURE POTENTIOMETER**

**DAYSTROM, INCORPORATED**  
POTENTIOMETER DIVISION  
ARCHBALD, PENNSYLVANIA • LOS ANGELES, CALIFORNIA

# DESIGN AND APPLICATION

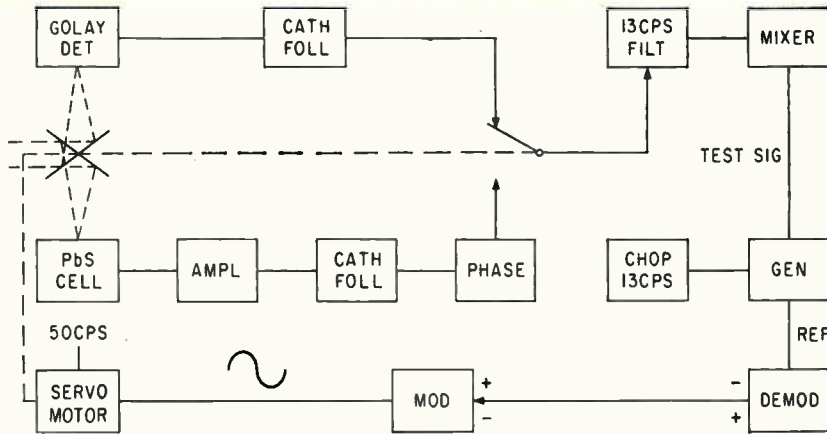

## Infrared Photospectrometer SCANS BETWEEN 1 AND 25 MICRONS

NOW ON THE MARKET from Perkin-Elmer Corporation, Norwalk, Connecticut, is the Model 125 high-performance infrared photospectrometer developed by Bodenseewerk Perkin-Elmer and Co., G.M.B.H., West Germany. This spectrometer is a double-beam, optical-null instrument designed for routine and research use. High resolution at fast scanning speeds with low noise levels starts with two gratings, mounted back-to-back on a rotatable grating in standard Ebert arrangement. These are used

only. Changeover from one grating to the other occurs automatically at 5 microns. The gratings are used with potassium-bromide fore prism monochromator of the Littrow type. Scanning is linear in wavenumber and spectral bands are recorded in linear transmittance units. Scanning time can be adjusted from three minutes per scan to one week per scan continuously. It uses air-cooled Globar sources in combination with either a pneumatic Golay detector or a lead sulfide detector chosen by the operator.

**CIRCLE 301 ON READER SERVICE CARD**

erated by magnetic amplifier voltage control or regulator systems between the transformer and the rectifier bridge. The other sketch shows a single-phase bridge with a polarized cell connected across the d-c output line. This configuration is used where voltage transients may be reflected back to the bridge from the d-c load side of the rectifier. Specifically, in cases where an inductive input filter is used, and the load suddenly switched off, the energy storage in the magnetic circuit of the filter choke can cause the voltage on the filter capacitor to rise to a level that can damage or destroy the rectifier diodes. The cell provides a low-resistance path to discharge this capacitor voltage.

**CIRCLE 302 ON READER SERVICE CARD**

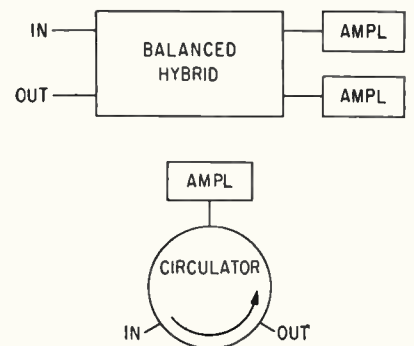

## Microwave Amplifier USES TUNNEL DIODE

RECENTLY announced by International Microwave Corporation, 1 Seneca Place, Greenwich, Connecticut, is a line of tunnel diode microwave amplifier modules. These modules are combined with a circulator or balanced hybrid for practical applications. The noise figure is 5 db or less, being lower in the lower-frequency models. Gain-bandwidth product averages  $2 \times 10^9$ . Gains available in this series of coaxial, fixed-tuned fixed-gain amplifier units are 10 db, 15 db and 20 db. These modules have not experienced spurious oscillation when connected

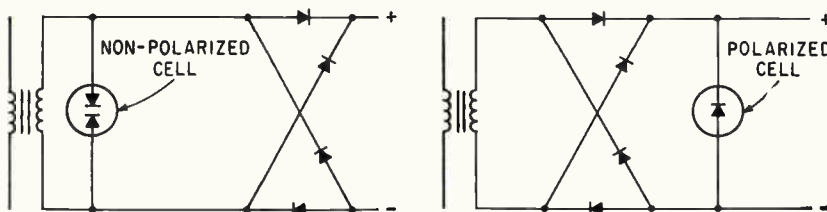

## Silicon Rectifier Bridge BUILT-IN TRANSIENT CLIPPER

INTERNATIONAL RECTIFIER CORP., 233 Kansas St., El Segundo, California offers the KlipSel protected rectifier stack. One sketch shows a single-phase bridge with a non-polarized transient protector connected across the a-c input terminals

to the rectifier bridge. The cell filters out turn-on and turn-off voltage transients which may be generated by the transformer supplying voltage to the rectifier bridge. It also filters out transients from external sources or those gen-



# NEW FROM SORENSEN



Dependable  
Economical



## PRECISION REGULATED TRANSISTORIZED DC SUPPLY

Tubeless circuitry, regulation of  $\pm 0.05\%$  line and load combined and an output voltage range of 4.5 to 9.0 V DC are features of the Sorensen Model Q6-60A. Output current range is 0 to 60 Amps, and ripple is 0.5 mV at nominal output voltage  $\pm 10\%$ .

The Q6-60A is completely self-protected and particularly suitable for critical applications requiring "spike free" output, precise regulation and high currents.

## DC POWER SUPPLY

0 to 40 V DC at 0 to 2 Amps.

The new versatile, fully transistorized QR40-2A DC Power Supply incorporates all the basic features of Sorensen QR Supplies. In addition, it provides regulated current, adjustable current limiting, and programmed output voltage. Provisions for external sensing permit accurate voltage regulation at remote loads. Available for either standard 19-inch rack mounting or in self-contained cabinet, the QR40-2A will easily adapt to your requirements. Write for complete specifications and literature on this dependable, economical power supply.

### SPECIFICATIONS

INPUT VOLTAGE RANGE	105-125 at 50 to 400 cps.
DC OUTPUT VOLTS	0 to 40 V DC
DC OUTPUT CURRENT	0 to 2 Amps. DC
VOLTAGE REGULATION (Line & Load Combined)	$\pm (0.01\% + 1 \text{ mV})$
RIPPLE (RMS) AT 60 CPS.	150 Microvolts
CURRENT REGULATION (Line & Load Combined)	$\pm 0.15\%$
RIPPLE CURRENT	30 Microamps.
RESPONSE TIME	50 Microseconds
CABINET SIZE	17" x 12 1/4" x 5 1/2"
RACK HEIGHT	5 1/4"

A UNIT OF RAYTHEON COMPANY



RICHARDS AVENUE • SOUTH NORWALK • CONNECTICUT

CIRCLE 93 ON READER SERVICE CARD

You get up to  
100,000 insertions  
with . . .

## BARNES TRANSISTOR SOCKETS

Ideal for  
rigorous testing  
applications  
breadboarding  
and as a high  
quality component

- Small size saves space on fixtures and equipment
- Gold-plated, spring temper, beryllium copper gives better contact
- Minimum insertion force and chamfered entrances save time
- Teflon\* body allows fast compression mounting into  $\frac{1}{8}$ " round holes
- Contact wipe and "through" guide holes eliminate cleaning
- Units withstand continuous use at 150°C
- Fit all transistors with 3 or 4 lead wires such as TO-5, TO-8 and TO-18
- Low capacitance and loss factor

These popular BARNES Test Sockets are available from stock at 65¢ to \$1.75, depending on quantity and type. We can supply test sockets for all transistors including power types, or for any component or assembly with lead wires.

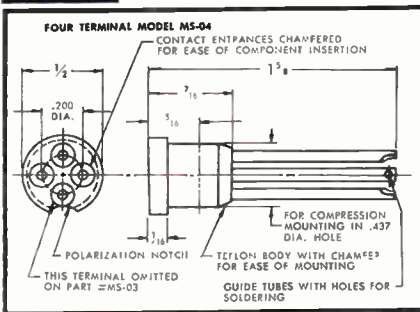

\* DuPont Reg. T.M.

Write, wire or phone for prices and details.

**BARNES DEVELOPMENT  
COMPANY**



LANSDOWNE, PA.  
(215) MADison 2-1525

to waveguide-coaxial transducers, when operated with circulators that contain many serious mismatches outside of the operating frequency band or when operated from d-c power supplies having a variety of source impedances. Output signal saturation occurs at -27 dbm and power supply requirements are 0.12 v at 4 ma.

**CIRCLE 303 ON READER SERVICE CARD**

### Radiation Detectors SILICON SURFACE BARRIER

MOLECHEM, INC., P.O. Box 531, Princeton, New Jersey, announces its silicon surface barrier radiation detectors. These devices are useful for detection and energy measurement of any energetic charged nuclear particles such as alphas, betas, protons, deuterons, mesons and fission fragments. They also re-

	Gridded Gas Ion Chamber	Scintillator & Phototube	Photographic Emulsion	Surface Barrier
Size	20 in <sup>3</sup>	10 in <sup>3</sup>	<1 in <sup>3</sup>	<1 in <sup>2</sup>
Weight	100 oz	20 oz	<1 oz	<1 oz
Optimum Energy	30 KeV	150 KeV	10 KeV	<20 KeV
Resolution				
Stopping Power	40 MeV	>100 MeV	100 MeV	40 MeV
Approx. Cost	\$2,000	\$200	\$2,000	\$100
Data Acquisition Rate	10 <sup>5</sup> /hr	10 <sup>7</sup> /hr	10 <sup>2</sup> /hr	10 <sup>5</sup> /hr

a for 5 Mev alpha particles    b for  $\alpha$  particles

spond to electromagnetic radiation over the visible, ultraviolet and X-ray portion of the spectrum and can be made to respond to neutrons with the use of an appropriate conversion material. The table shows a comparison to other detector devices with the number referring to generic types rather than specific instruments. The detectors can provide surface areas as large as 3.0 cm<sup>2</sup> with sensitivity volumes nearly 1 mm thick and energy resolution significantly below 30 KeV.

**CIRCLE 304 ON READER SERVICE CARD**

### Magnetic Material HIGH ENERGY

GENERAL ELECTRIC CO., 7850 Neff Road, Edmore, Mich., announces Lodex, a new p-m material that permits development of wafer-thin

loudspeakers. Advantages are: high magnetic uniformity and flux distribution from magnet to magnet; excellent dimensional stability; high resistance to stray magnetic fields, vibration and temperature; and ease of manufacturing.

**CIRCLE 305 ON READER SERVICE CARD**

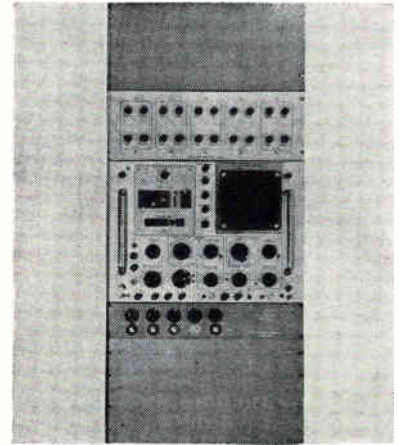

### Five-Gun CRT NO TIME SHARE

SYSTEMS RESEARCH LABORATORIES, INC., 500 Woods Drive, Dayton 32, O. Model 237 five-trace oscilloscope is a valuable tool for use in comparison and analysis of various types of complex waveforms. It is useful when performing multichannel correlation or analysis of telemetry data, missile tracking information and RADINT, ELINT or COMINT intelligence data. A quick-look of prerecorded multitrack magnetic tapes can reduce by several hours the time normally required to reduce such data.

**CIRCLE 306 ON READER SERVICE CARD**

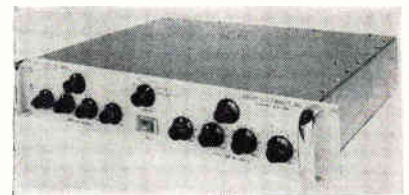

### Voltage Reference DUAL-CHANNEL

BINARY ELECTRONICS, INC., 30-48 Linden Place, Flushing 54, N. Y. Model 6101-R-DCV provides voltage outputs in 1 mv steps over the range of +9.999 to -9.999 v, and outputs from both channels can be randomly commanded by the introduction of binary-coded-decimal contact closures to programming

connectors, at the rear of the unit. Accuracies of the reference voltages and resistive dividers are both  $\pm 0.01$  percent, giving an absolute max error of  $\pm 0.02$  percent for any voltage setting, and a Weston cell has been incorporated to conveniently verify calibration accuracy.

**CIRCLE 307 ON READER SERVICE CARD**

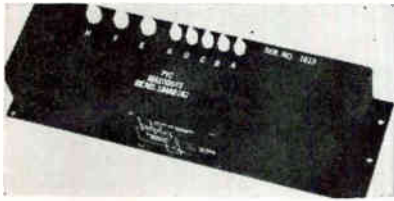

### Filament Regulator FOR AIRBORNE USE

POLYPHASE INSTRUMENT CO., Bridgeport, Pa. Precise, solid state filament regulator is magnetic amplifier controlled. Designed to supply 6.4 v d-c to tube filaments, these regulators operate from a 3-phase, 400-cps, 208 v line. Rated output on a typical regulator is 30 amp. Ripple voltage is less than 20 mv rms. Two percent regulation and low ripple are maintained at any preset voltage level over extreme conditions of temperature, load, line voltage and frequency.

**CIRCLE 308 ON READER SERVICE CARD**



### Decade Counting Units SOLID STATE

COMPUTER MEASUREMENTS CO., 12970 Bradley Ave., San Fernando, Calif. Line of transistorized decade counting units covers range from d-c to 35 Mc. Five basic plug-in units are available. The lightweight, compact units consume only a fraction of the power of their

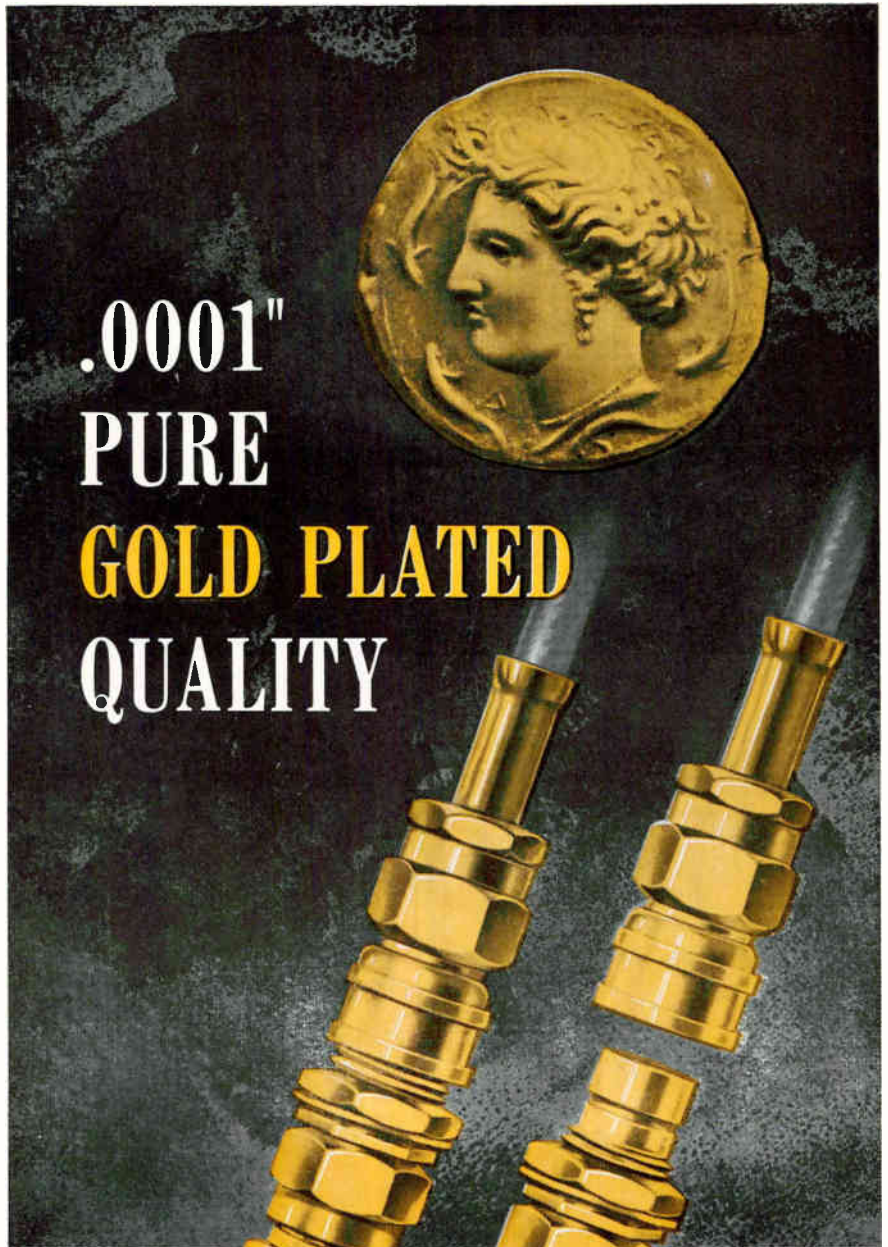

# .0001" PURE GOLD PLATED QUALITY



## sub-miniature r.f. connectors

### POINTS OF SUPERIORITY

- ★ **Clamp-on and Crimp-on designs** that exceed the strength of the cable itself.
- ★ **Screw-On or Snap-On mating.**
- ★ **Exclusive tapered teflon insulator design** eliminates air pockets and flashovers.
- ★ **Compact, lightweight.**
- ★ **High-efficiency impedance matching** in all types.
- ★ **Long line of sub-miniature connectors and accessories.**

Not just gold flash, but a true, .0001" thick pure gold plating is just one of the many genuine points of superiority of ConheX connectors. We use pure gold plating because we know it provides higher conduction, better resistance to corrosion, and over all it's more in keeping with the genuine overall quality of the ConheX design.

Write for complete catalog of the fastest growing line of sub-miniature connectors in the world...



*Sealectro and only Sealectro*

**MAKES "CONHEX" CONNECTORS  
SEALECTRO CORPORATION, MAMARONECK, N.Y.**



## KEARFOTT SYNCHROS AND RESOLVERS FOR GIMBAL APPLICATIONS

Wide range of mounting configurations available—special adaptations to order. High-accuracy components, maximum error of 20 seconds of arc, in quantity production. Greater accuracy as required. Housing materials aluminum or beryllium for weight reduction; stainless steel available in many standard units.

### SPECIFICATIONS

Typical Part Numbers	Function	Excitation	Accuracy
3Z6390-001	Resolver	20v 900 cps	3 min.
CZ06360-002	Transmitter	115v 800 cps	20 sec.
	Resolver		
5Z6360-009	Resolver	115v 800 cps	3 or 5 min.
3Z6210-006	Synchro	As req'd	2 min.
1/3Z6360-006	Resolver	115v 800 cps	20 sec.

For complete data write Kearfott Division, General Precision, Inc., Little Falls, New Jersey.

# KEARFOTT

## KEARFOTT NAVIGATIONAL COUNTERS



Direct visual counter display with large numerals enables lower valued increments of angles to be easily read in terms of minutes and seconds of arc. Precision design, rugged construction, durable materials. With odometer or Geneva drives. Temperature range  $-65^{\circ}\text{C}$  to  $+90^{\circ}\text{C}$ ; meet military requirements for shock, vibration, case size.

### CHARACTERISTICS

Part Number	Maximum Count	Counts Per Rev.	Maximum Speed RPM	Break-Away Torque IN. OZ.
C160432-( )	179° 59'	20'	1200	.75
C160431-( )	179° 59.9'	2'	1200	1.0
C160435-( )	179.9°	2°	1200	.75
C160433-( )	99.9	2.0°	1200	.75
C160434-( )	999.9	2.0°	1200	.75
MK 3 MOD 1	359.	2.0°	1800	.35
C160407004	359.9	2.0°	1800	.35

For complete data write Kearfott Division, General Precision, Inc., Little Falls, New Jersey.



# GENERAL PRECISION

vacuum tube counterparts and can be provided with either vertical numeral display or the Nixie read-out. Prices range from \$100 to \$400.

**CIRCLE 309 ON READER SERVICE CARD**

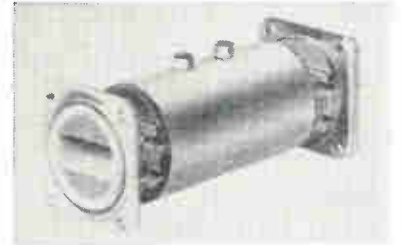

## Low Loss Filter HIGH Q

MICROWAVE DEVELOPMENT LABORATORIES, INC., 15 Strathmore Rd., Natick, Mass. Model 90FP166 has its filter network constructed in a circular waveguide to achieve low loss and high Q. The loss at  $f_0 = 0.7$  db and the rejection at  $f_0 \pm 8$  and  $f_0 \pm 58$  respectively is 3 db and 27 db. The  $f_0$  can be factory tuned to any frequency between 9.2-10.0 Gc. Invar construction enables the unit to operate from  $+15^{\circ}\text{C}$  to  $+85^{\circ}\text{C}$ .

**CIRCLE 310 ON READER SERVICE CARD**

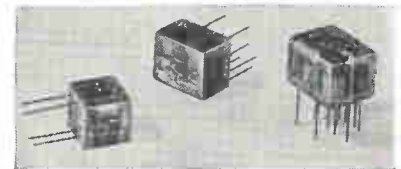

## Logic Modules LOW POWER

ELECTRONIC PACKAGING CO., 1325 Gaylord St., Long Beach 13, Calif. Logic modules require only a 1.5 v power supply and exhibit very high fan-out characteristics up to 1 Mc operation. They are all welded, epoxy encapsulated components suitable for wide applications in logic circuit design. Each module weighs less than 12 grams and occupies less than  $\frac{1}{2}$  cu in. of space. Terminals are 20 mil tinned dumet with 10 mil spacing.

**CIRCLE 311 ON READER SERVICE CARD**

## Microwave Diodes SOLDER SEALED

SYLVANIA ELECTRIC PRODUCTS INC., Woburn, Mass. The D-4175 and D-4175A hermetically sealed micro-

wave mixer diodes are measured for conversion loss at 23,980 Mc and feature a maximum storage temperature of 150 C. They are suited for applications in satellites and aircraft. In quantities of 1-99 units, the D-4175 is priced at \$6.50 each and the D-4175A at \$7.90.

**CIRCLE 312 ON READER SERVICE CARD**



### Welded Modules

#### DIGITAL CIRCUIT

CONTROL LOGIC, INC., 11 Mercer Road, Natick, Mass. Completely welded digital circuit modules operate from d-c to 10 Mc. They are available in high density ejection-molded modules, 1.6 in. by 0.8 in. by 0.5 in. with up to two circuits per module, as well as a card series with up to 4 modules mounted on 2.75 by 5.5 in. glass epoxy cards. There are three series—one, 100 Kc for control and automation; another, 2 Mc for general purpose data handling; a third, 10 Mc for high speed logic and timing.

**CIRCLE 313 ON READER SERVICE CARD**

### Power Source

MID-EASTERN ELECTRONICS, Springfield, N. J., has developed MP40-0.5 portable power source with d-c output of 0 to 40 v at 0 to 500 ma. regulation 0.05 percent. Price is \$176.

**CIRCLE 314 ON READER SERVICE CARD**



### Encapsulation Cups

#### NONMETALLIC

GIBSON-EGAN CO., P.O. Box 5352, Pasadena, Calif., has available encapsulation cups of unfilled and glass filled polycarbonate in a wide range of sizes and configurations. This material features very high



SHOWN ACTUAL SIZE

## KEARFOTT SIZE 5 COMPONENTS For Servo System Miniaturization

- Synchros
- Servo Motors
- Synchronous Motor
- Motor Generators
- Gearheads, Brakes, Clutches

A complete family of Size 5 components for every servo system function is now available from Kearfott. This series affords complete latitude in miniaturization, with performance and reliability normally found in much larger units.

Stainless steel housings, shafts and bearings protect against environment—add to stability under shock and vibration. • Standard 26-v, 400-cps excitation. • Synchro and resolver accuracy  $\pm 10$  min. • Operating temperature range  $-55$  to  $+125$  C. Computer-designed for optimum performance.

For complete data write Kearfott Division, General Precision, Inc., Little Falls, New Jersey.

# KEARFOTT



## WELDED MINIATURE TRANSISTORIZED AMPLIFIER

This encapsulated 5-watt amplifier, approximates one cubic inch in volume. Component elements are mounted in a high-density three-dimensional mass, and leads are interconnected by resistance spot welding. This process assures extremely high reliability.

High stiffness-to-weight ratio of the encapsulated amplifier makes it particularly suitable in missile and high-speed-aircraft applications under extreme shock and vibration.

<b>CHARACTERISTICS</b>	Mounting Base	$-55$ C to $+125$ C
	Weight	1.5 oz. max
	Signal Frequency	400 cps $\pm$ 20 cps
	Gain	Adjustable
	Gain Stability	$\pm 3$ db ( $-55$ C to $+125$ C)
	Typical Loads	Kearfott Size 8, 10, 11 & 15 Motors

For complete data write Kearfott Division, General Precision, Inc., Little Falls, New Jersey.



# GENERAL PRECISION

# FLUKE CHOSE PENTA'S PL-175A BEAM PENTODE FOR ABOVE-AVERAGE VOLTAGE REGULATOR PERFORMANCE

The low internal voltage drop of beam pentodes is one of the reasons they are ideal for voltage regulator applications. Penta PL-175A beam pentodes, for example, were chosen by the John Fluke Manufacturing Co. for use in their Model 334A precision-calibrated reference power supply, which provides from zero to 3111 volts at currents up to 400 milliamperes, with a calibration accuracy of 0.1%.

William L. Wise, Chief Engineer of Fluke's New Product Development Department, chose the PL-175A for the Model 334A because of "...uniformly excellent tube characteristics, tube to tube; superior performance at low plate voltage; high plate current for moderate screen voltage, and good perform-

ance versus price... With many units now in service, we've experienced no tube failures to date."

The PL-175A, interchangeable with most 250- to 400-watt power tetrodes, is not only highly useful in voltage regulator applications, but also provides excellent performance as a linear RF amplifier in single-sideband service. In both applications, the patented, exclusive Penta vane-type suppressor grid, which channels the electron flow, is the reason for the superior performance of the PL-175A.

Write today for further information regarding the PL-175A. A factual data sheet, the name of the Penta representative nearest you, and application assistance are yours for the asking.

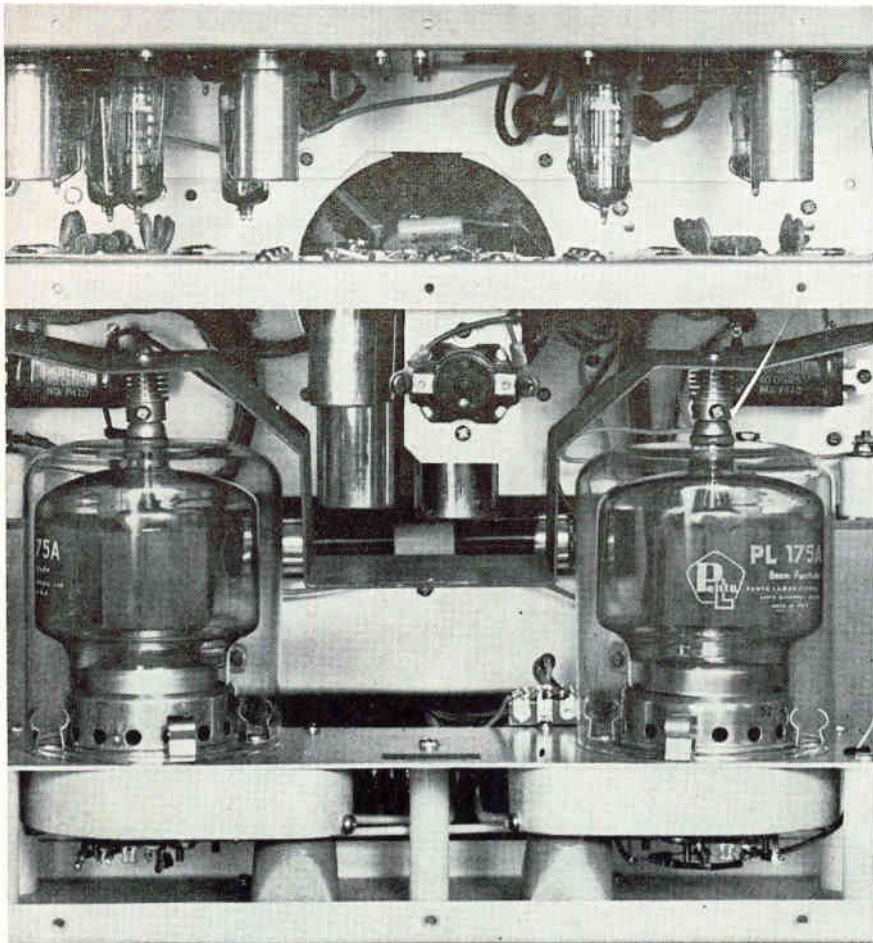

## PENTA LABORATORIES, INC.

212 North Nopal Street, Santa Barbara, Calif.

Export Agents: Frathom Co., New York 17, N. Y.



Trade Mark Reg. U. S. Pat. Off.

VISIT BOOTH 2736 AT I.R.E. SHOW

impact strength. Cups are suitable for continuous service in temperatures as high as 300 F and as low as -60 F. Among the advantages are light weight, freedom from corrosion and elimination of costly tooling and potting molds.

**CIRCLE 315 ON READER SERVICE CARD**

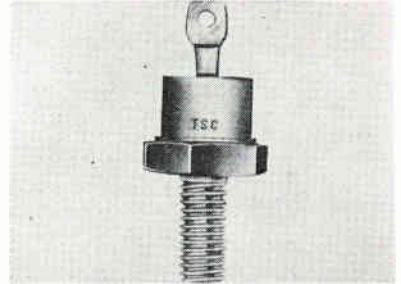

### Silicon Rectifier

WELDED-HAT

TRANS-SIL CORP., 55 Honeck St., Englewood, N.J., announces type MR rectifier for maximum half-wave currents up to 3.0 amp at pivot as high as 800 v. Weight of the double-diffused silicon junction stud-mounted unit is 0.8 oz. Series is capable of handling a maximum reverse current of 20  $\mu$ a and one cycle surge current of 75 amp, at operating temperatures as high as 150 C. Thermal resistance is 3 deg C/w.

**CIRCLE 316 ON READER SERVICE CARD**



### Circulator

AND ISOLATOR

MICROMEGA CORP., 4134 Del Ray Ave., Venice, Calif., offers a uhf circulator that can be mechanically tuned from 750 Mc to 1,000 Mc. A calibrated dial permits tuning within seconds. A built-in load converts the unit into an isolator. Minimum isolation is 20 db; max insertion loss, 0.6 db; bandwidth, 10 percent; max vswr, 1.25; connectors, type N.

**CIRCLE 317 ON READER SERVICE CARD**

## PRODUCT BRIEFS

VACUUM-ATMOSPHERE FURNACE high-temperature. K. H. Huppert Co., 6840 Cottage Grove Ave., Chicago 37, Ill. (318)

MICROWAVE MIXER DIODE for use at S-band. Sylvania Electric Products Inc., Woburn, Mass. (319)

PULSE GENERATOR transistorized. Automatic Timing & Controls, Inc., King of Prussia, Pa. (320)

POWER SUPPLY highly flexible, Kepeco Inc., 131-38 Sanford Ave., Flushing 52, N. Y. (321)

RADAR BEACON compact unit. Motorola Inc., 8201 East McDowell Rd., Scottsdale, Ariz. (322)

SILICON LOGIC MODULES priced with germanium circuits. Scientific Data Systems, Inc., 1542 Fifteenth St., Santa Monica, Calif. (323)

FERRITE ISOLATOR weighs 2.3 oz. Hycon Mfg. Co. 700 N. Royal Oaks Drive, Monrovia, Calif. (324)

MOTOR CONTROL SWITCH rated at 70 h-p, 600 v a-c. American Solenoid Co., Inc., U. S. Highway 22, Union, N. J. (325)

SINGLE-PHASE STATIC INVERTERS 60 to 2,000 cps. Arnold Magnetics Corp., 6050 W. Jefferson Blvd., Los Angeles 16, Calif. (326)

SILICON CARTRIDGE RECTIFIERS with axial leads. Electronic Devices, Inc., 50 Webster Ave., New Rochelle, N. Y. (327)

LONG LIVED COMPUTER for outer space. Lockheed Missiles & Space Co., Sunnyvale, Calif. (328)

MINIATURE CONNECTORS center screwlock. DeJur Amsco Corp., 45-01 Northern Blvd., Long Island City 1, N. Y. (329)

GEAR TRAINS deliver ratios from 3:1 to 125:1. Sterling Instrument, 17 Matinecock Ave., Port Washington, N. Y. (330)

PROGRAMMED PULSE GENERATOR for nsec development work. Rese Engineering Inc., A & Courtland Sts., Philadelphia 20, Pa. (331)

SOUND SPECTROMETER small and light weight. Industrial Acoustics Co., Inc., 341 Jackson Ave., New York 54, N. Y. (332)

now

4

NEW

# SOLID STATE POWER SUPPLIES



## ELECTRONIC WELDING

### High Resolution Dual Range Circuits

— LOW —      — HIGH —  
for fine resolution in thin film lead attachment and whisker wires.      2 POWER SUPPLIES IN 1      for precisely controlled energy levels in joining heavier wires up to 0.040

By employing two entirely separate circuits, these new solid state units give best resolution in both ranges. Attaching fine wire whiskers and joining micro components are among the many applications where this fine degree of resolution assures production weld consistency.

The high range is designed for standard lead materials in high density component packaging. Voltage regulation, to within 0.5% for input variation between 100 and 130 volts is standard on Models 1049 and 1059. Immediate delivery on all models. For more information, write Weldmatic Division/Unitek, 950 Royal Oaks Drive, Monrovia, California.

#### PICK THE MODEL THAT BEST FITS YOUR NEEDS—

- MODEL 1039—**  
Energy Storage Range  
Low: .04 to 3 watt-seconds  
High: .2 to 15 watt-seconds
- MODEL 1049—With Voltage Regulation**  
Energy Storage Range  
Low: .04 to 3 watt-seconds  
High: .2 to 15 watt-seconds
- MODEL 1058—**  
Energy Storage Range  
Low: .04 to 9 watt-seconds  
High: .2 to 45 watt-seconds
- MODEL 1059—With Voltage Regulation**  
Energy Storage Range  
Low: .04 to 9 watt-seconds  
High: .2 to 45 watt-seconds

#### THEN TEAM IT WITH A POWER-MATCHED WELDMATIC HEAD



Patented pure force-firing action, absolute linear electrode movement, and fastest follow-up are among the many outstanding features that make these heads the best choice for any precision bonding assignment.

WELDMATIC DIVISION / UNITEK

# VHF RECEIVERS

**NEW!**

**TYPE  
501**

**AM - FM - CW**



For telemetering and monitoring applications and as an excellent general purpose VHF laboratory receiver, CEI offers the completely new type 501 unit.

Frequency	55-260 mc with fine tuning
Noise figure	6.0 db, maximum
IF (first)	21.4 mc
IF bandwidths	300 kc: FM, AM, CW 10 kc: AM, CW
Sensitivity, FM (300 kc bandwidth position)	4 uv produces at least 23 db s/n with 100 kc deviation and 1 kc modulation
Sensitivity, AM (300 kc bandwidth position)	3 uv produces at least 10 db s/n with 50% modulation at 1 kc. 2 uv produces 21 db s/n (in 10 kc bandwidth position)
Size	19" x 3 1/2" x 15 1/2"
Weight	18 lbs.
Power requirements	115/230V, 50/60/400 cps, 30 W

FOR COMPLETE SPECIFICATIONS WRITE:

Communication  Electronics, Inc.  
4900 HAMPDEN LANE BETHESDA, MARYLAND

CIRCLE 100 ON READER SERVICE CARD

## Literature of

**MICA DATA** Spruce Pine Mica Co., Spruce Pine, N.C., has published a brochure entitled "A Guide for Users of Fabricated and Uncut Mica." (333)

**REFERENCE VOLTAGE STANDARDS** Bellows-Valvair, Jackson Electronic Div., 695 Johnston St., Akron 6, O. Bulletin VS-24 covers Voltaloc ultra-high stability solid state reference voltage standards. (334)

**ANECHOIC ROOMS** Industrial Acoustics Co., Inc., 341 Jackson Ave., New York 54, N.Y. An 18-page booklet describes anechoic rooms and their uses. (335)

**SILICON POWER TRANSISTORS** Westinghouse Electric Corp., Youngwood, Pa., has available a technical data bulletin on 30-ampere silicon power transistors. (336)

**LINEAR POWER CONTROLLERS** Norbatrol Electronics Corp., 356 Collins Ave., Pittsburgh 6, Pa. Bulletin tells how reactor replacement in furnace control is possible with linear power controllers. (337)

**GRID BOARDS** Corning Electronic Components, Bradford, Pa. Two new configurations of Fotoceram grid boards, used for prototype printed circuitry, are described in an illustrated data sheet. (338)

**MICROWAVE CALIBRATION** PRD Electronics, Inc., 202 Tillary St., Brooklyn 1, N.Y., offers a 10-page *PRD Report* entitled "A Microwave Calibration Test Set For A Seven Octave Band." (339)

**TEFLON TERMINALS** Microdot Inc., 220 Pasadena Ave., S. Pasadena, Calif. Bulletin TML-1 lists specifications of a line of Teflon insulated terminals. (340)

**RELAYS** Hi-G, Inc., 20 Bradley Field, Windsor Locks, Conn. A 40-page catalog, No. 861, features balanced rotary armature relays, electronic time delay relays, and special products. (341)

**LAMINATED PLASTICS** Formica Corp., 4595 Spring Grove Ave., Cincinnati 32, O. New product folder describes high pressure reinforced laminated and molded plastics. (342)

**BANDPASS FILTERS** Applied Research Inc., 76 S. Bayles Ave., Port Washington, N.Y., has published a new data sheet for its HFF(A)-G

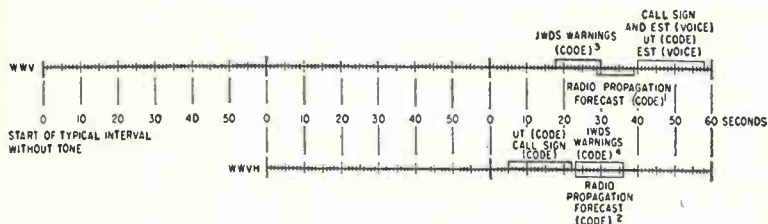

## PRIMARY STANDARDS

Whether you want to pace a city's clocks or time the transit of an artificial satellite, you'll find the standard time intervals and frequencies broadcast by the National Bureau of Standards of vital assistance.

You'll find a complete run-down on this NBS service in your 1961 **electronics Buyers' Guide** and Reference Issue, plus information on how you can obtain NBS calibration of practically any secondary standard, from resistance to the complex elements of the tensor permeability matrix.

Wealth of information like this makes your 1961 EBG a primary reference volume in the electronics field. You'll find new uses for it every day.

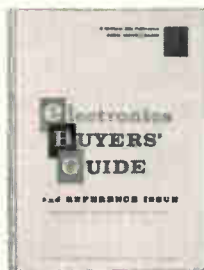

**electronics BUYERS' GUIDE** and Reference Issue



The Basic Buying Guide in Electronics since 1941



# the Week

series of bandpass filters, frequency range 30 to 100 Mc. (343)

**TRANSDUCER CONVERTERS** Sanborn Co., 175 Wyman St., Waltham 54, Mass. Bulletin describes transducer converters that provide an inexpensive plug-in facility for operating carrier excited transducers. (344)

**RESOLVERS** Vernitron Corp., 602 Old Country Road, Garden City, N.Y. Bulletin R-4 8 100-11-1 illustrates and describes the size 11 resolvers for 400, 800, and 10,000 cycle operation, manufactured to military specifications. (345)

**SERVOMOTOR** Helipot Division of Beckman Instruments, Inc., 2500 Harbor Blvd., Fullerton, Calif., has issued a data sheet on a 26-v, 400-cycle size 5 servomotor. (346)

**TRANSFORMER SIMULATOR** Electronic Research Associates, Inc., 67 Factory Place, Cedar Grove, N.J. Technical bulletin describes a multi-output power and control transformer simulator. (347)

**D-C POWER SUPPLY** Perkin Electronics Corp., 345 Kansas St., El Segundo, Calif., offers a brochure on the model TVCR040-05 voltage-and-current-regulated d-c power supply. (348)

**PUSHBUTTON SWITCHES** Micro Switch, Freeport, Ill. Bulletin 22 describes a line of unlighted push-button switches for use in commercial-industrial equipment, aircraft, missile guidance, and data processing systems. (349)

**ALTITUDE-SENSING SYSTEM** Leeson Moos Laboratories, 90-28 Van Wyck Expressway, Jamaica 18, N.Y. Data sheet fully describes the Ionoswitch altitude-sensing system. (350)

**TRANSDUCERS** Electronic Medical Systems, Inc., 1449 University Ave., St. Paul 4, Minn. Information sheet describes transducers designed for high signal-to-noise ratio with minimum artifact. (351)

**MICROWAVE ANTENNAS** Mark Products Co., 5439 W. Fargo Ave., Skokie, Ill., has released a 12 page brochure covering microwave antennas ranging from 400 Mc through 12,700 Mc. (352)

February 9, 1962

**Phil  
Greenstein  
can  
show  
you...**

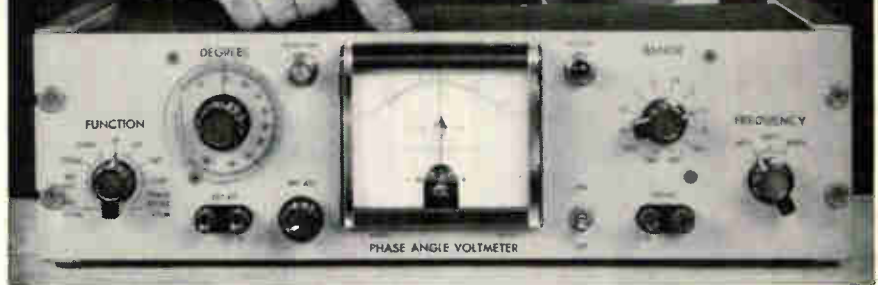

## how North Atlantic's Phase Angle Voltmeters solve tough ac measurement problems ... in the lab or in the field.

Designed for critical tasks in circuit development, production and testing, North Atlantic's Phase Angle Voltmeters provide direct reading of phase angle, nulls, total, quadrature and in-phase voltages—with proven dependability even under field conditions. Your North Atlantic engineering representative can quickly demonstrate how they simplify ac measurement jobs from missile checkout to alignment of analog computers—from phasing servo motors to zeroing precision synchros and transducers.

Shown below are condensed specifications for single-frequency Model VM-202. Other models include high sensitivity, three-frequency and broadband types.

Voltage Range.....	1 mv to 300 v f.s., 12 ranges
Voltage Accuracy.....	±2% f.s.
Phase Accuracy.....	dial: ±1°; meter: ±3% of F.S. degrees
Signal Frequency.....	1 Freq., 30 cps—10 kc
Input Impedance.....	10 megohms
Reference Input.....	100 K, 0.25 v min.
Meter scale.....	3-0-3, 10-0-10 linear
Phase Angle Dial.....	4 scales, 90° (elec.) apart
Nulling Sensitivity.....	.2 microvolts (phase sensitive)
Harmonic Rejection.....	55db (with filters)
Dimensions.....	5¼" h. x 19" w. x 7⅞" d.

The North Atlantic man in your area has full data on standard and special models for laboratory, production and ground support. Call today for his name, or request Bulletin VM-202.



**NORTH ATLANTIC industries, inc.**  
TERMINAL DRIVE, PLAINVIEW, L. I., NEW YORK • OVERbrook 1-8600

# STC

LOW NOISE

TRAVELLING WAVE TUBES

for S-BAND RADAR

### W9/2E

Typical Noise Factor 8.5 dB

With voltages fixed for broad band operation 2.5 to 4.1 Gc/s

Typical Gain 40 dB

### W10/3E

Typical Noise Factor 6.2 dB

With voltages optimised for a spot frequency between 2.7 and 3.3 Gc/s (circuit 495-LVA-003) (illustrated with antimagnetic screening) or between 2.8 and 3.8 Gc/s (circuit 495-LVA-006)

Typical Gain 23 dB

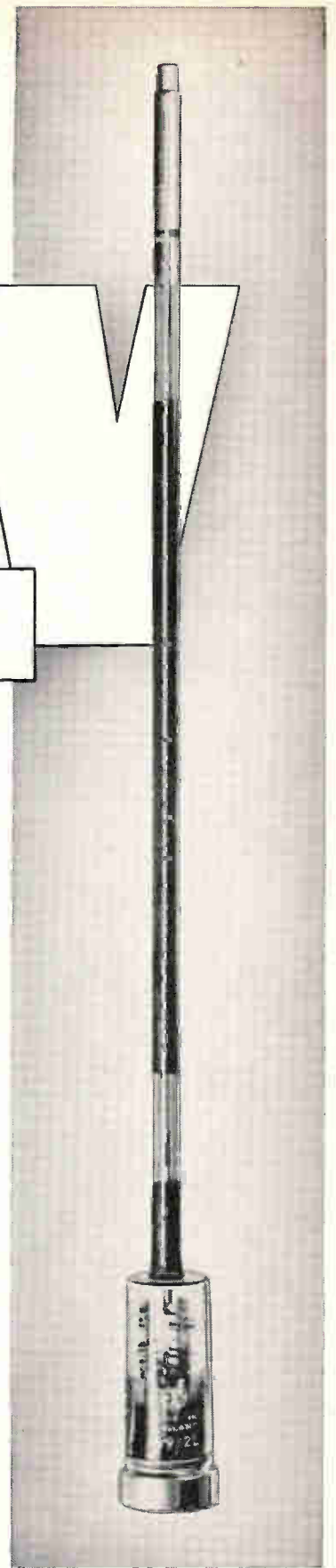
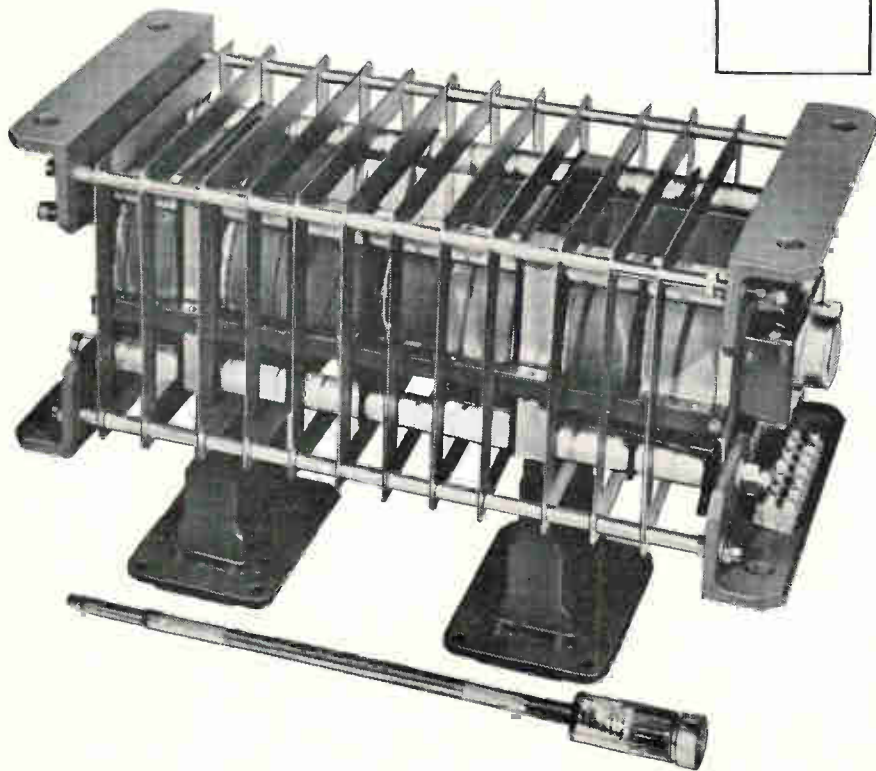

Send for full data and new edition of brochure MS113



61/8MS

**Standard Telephones and Cables Limited**

VALVE DIVISION: BRIXHAM ROAD · PAIGNTON · DEVON · ENGLAND

USA enquiries for price and delivery to ITT Components Division, P.O. Box 412, Clifton, N.J.

ITT

TO INSURE PEACE  
**ANYTIME, ANYWHERE**

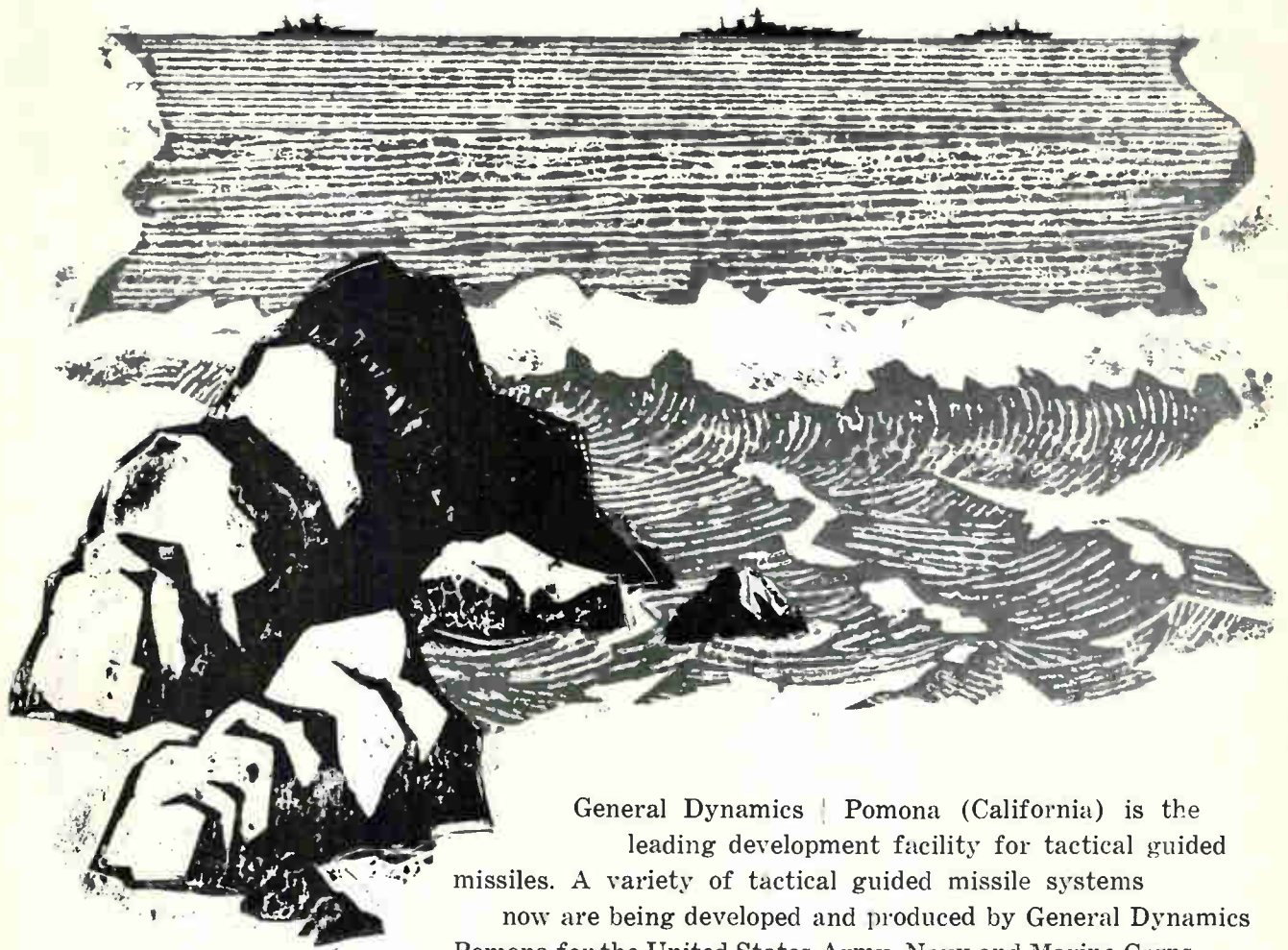

General Dynamics | Pomona (California) is the leading development facility for tactical guided missiles. A variety of tactical guided missile systems now are being developed and produced by General Dynamics Pomona for the United States Army, Navy and Marine Corps.

Still more weapons for defense will be needed in the future.

- As a result, General Dynamics | Pomona offers many exacting opportunities to the creative Scientist and Engineer.

Positions for Scientists and Engineers in the following fields:

*Optical and Infrared Systems Design*  
*Solid State Component and Circuit Design*  
*Radar Systems Analysis and Design*

*Automatic Test Equipment Design*  
*Control Systems Dynamic Analysis*  
*Analog Computer Application and Design*

You are invited to write B. L. Dixon, Engineering Personnel Administrator  
General Dynamics | Pomona, 1677 W. Fifth Avenue, Pomona, California  
"An Equal Opportunity Employer" — U. S. Citizenship or Dept. of Defense Clearance Required

**GENERAL DYNAMICS | POMONA** 



# 6BK5

## V.H.F. TRIODE

Frame-Grid semi-remote cut-off triode for use as an r.f. amplifier in television receivers.

### ANOTHER MULLARD FRAME-GRID TUBE

Increased gain, reduced microphonics, and better controlled characteristics — these are the advantages you get when you specify Mullard frame-grid television tubes.

#### CHARACTERISTICS

$V_a$	135	V
$I_a$	11.5	mA
$V_g$	-1.0	V
gm	15	mA/V
ra	5.4	k $\Omega$
$\mu$	78	
$r_{gt}$ (f=200 Mc/s)	275	$\Omega$
$V_g$ for 100:1 reduction in gm	-4.2	V

#### SUPPLIES AVAILABLE FROM:

IN THE U.S.A.  
International Electronics Corporation  
81 Spring Street, New York 12, N.Y.  
Worth 6-0790

IN CANADA  
Rogers Electronic Tubes & Components  
116 Vanderhoof Avenue, Toronto 17, Ontario.  
Hudson 5-8621



'Mullard' is the trademark of Mullard Limited  
**Mullard**  
ELECTRONIC TUBES

BRITAIN'S FIRST CHOICE FOR FIRST EQUIPMENTS

MULLARD OVERSEAS LTD, MULLARD HOUSE, TORRINGTON PLACE, LONDON, ENGLAND



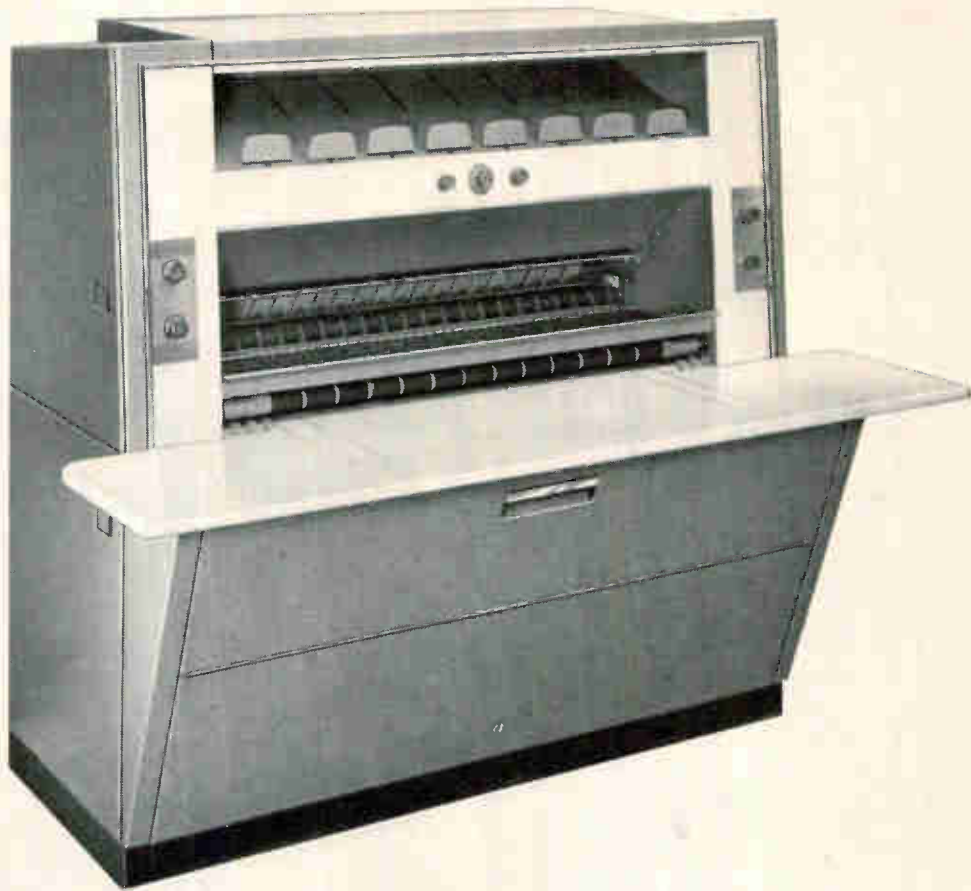

## *Why a machine that develops whiteprints from the back?*

Simple. In the first place, the new Ozalid Printmaster® 900 develops dual-sided materials in one pass! . . . But, also important, single-coated papers are developed through the back of the base stock, as well as from the front, insuring prints with no under-developed images to fade or discolor. And, with the exclusive Ozalid sleeveless developer section, the 900 develops plastic-coated papers without sticking. Print speeds to 75 fpm, hi-intensity 100 or 150 wpi lamp, balanced cooling and simplified speed control give you unmatched reproduction versatility.

**The most machine for the money on the market!** Get all these extras at no extra cost—instant reversing switch, automatic exhaust timer, enclosed roll holders, automatic feed safety device, lamp intensity switch, instant-start variable speed control, remote ammonia supply attachments. Send coupon for full details.

**OZALID**

WE REPEAT

**OZALID**

Division of General Aniline & Film Corporation

In Canada: Hughes-Owens Co., Ltd., Montreal.

OZALID, Dept. 182  
Johnson City, N. Y.  
Send complete details on the new  
Printmaster 900.

NAME \_\_\_\_\_  
FIRM \_\_\_\_\_  
ADDRESS \_\_\_\_\_  
CITY \_\_\_\_\_ ZONE \_\_\_\_\_ STATE \_\_\_\_\_

# WE CAN HELP YOU...IF...

If you're shopping for high performance relays, Leach makes the kind of relays that best resist heat, shock and vibration ...the kind planes, missiles, computers and other electronic equipment use. And we've

been in this relay race for 42 years.

Here are some of the relays Leach makes to meet the exacting requirements in hundreds of applications. Which one do you need?



**SUBMINIATURES.** A complete line of crystal can relays gives you big performance in small packages in every standard relay configuration. Standard, Half-Size, Sensitive and Magnetic Latch in 0.20 inch grid spacing and "lazy S" header design. Each type is capable of switching loads from low level to 2 amp in aerospace and electronic control applications. Bulletin CC-861.

**BALANCED-ARMATURE RELAYS.** Offer high resistance to shock (50 G's) and vibration (15 G's to 2000 cps) in 5 to 15 amp switching. They meet or exceed MIL-R-6106, MIL-R-25018, and MIL-R-5757D. Choice of over 4000 variations of 20 basic types. Bulletin BA-859.

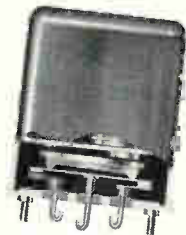

**ROUND CAN RELAYS.** This family group comes in contact configuration of 2, 4, and 6 PDT and in contact ratings ranging from dry circuit to 10 amps. Bulletin RC-300.

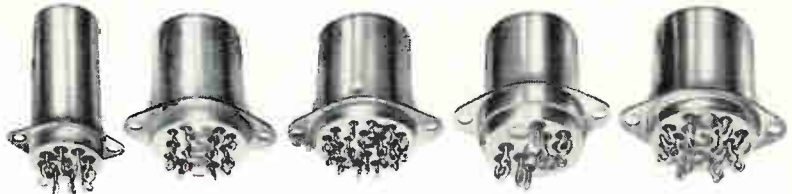

**TIME DELAY RELAYS.** This optional output, off-the-shelf line is made with precision printed circuit construction. Includes time delays on release and time delays on operate--in a timing range of 100 milliseconds to 60 seconds. Available with fixed or adjustable timing to meet your most critical requirements. And they're all 100% inspected during manufacture to insure highest reliability! Bulletin TD-200.

## THERE'S MORE...

Write Leach right now. Get all the facts and specs on all the relays above. Or call in a Leach Sales Engineer for help on any critical application problem.

# LEACH

Seattle 8, Washington  
South Annex Bldg., Room 201  
King County Airport,  
Boeing Field - Parkway 5-6978

Palo Alto, California  
814 San Antonio Road  
Yorkshire 8-4408

New York, New York  
405 Lexington Avenue  
Suite 3204  
YUkon 6-2520

Waltham, Massachusetts  
235 Bear Hill Road  
Twinbrook 9-1930

Los Angeles 17, California  
1101 Wilshire Blvd.  
HUntley 2-0790

Dayton 2, Ohio  
333 W. First St., Room 250  
BALdwin 2-8652

Washington, D. C.  
1700 K Street, N. W.  
Suite 307 - STerling 3-1147

**CORPORATION** 18435 SUSANA ROAD, COMPTON, CALIFORNIA  
EXPORT: LEACH INTERNATIONAL S. A.



## CALL THIS NUMBER ON FEBRUARY 12

And your ad can still be in **BUSINESS WEEK** February 17

**New "Short-Notice Closing" offers last-minute, same-week insertion for two pages of advertising every 1962 issue.**

We think this is the fastest short-notice ad closing of any major national magazine. It gives you an opportunity for truly timely announcements to the most influential audience in America — *management men*.

Here are the details:

**Deadline for Reservations: Monday at 4 p.m.** Our Business Department in New York must have your reservation, *at the latest*, by 4 p.m. on Monday of week-of-issue. For quickest service, wire (TWX N.Y. 1-1636) or phone K. D. Reynolds, Production Manager,

BUSINESS WEEK, LOngacre 4-3000 (Dial New York Area Code 212).

**Deadline for Plates: Tuesday at 1 p.m.** To meet our "Short-Notice Closing," your plates must be in the hands of our Production Manager, in our New York office (330 West 42nd Street, New York 36, N.Y.), by 1 p.m. on Tuesday of week-of-issue, *at the latest*. (Sorry, no extensions possible.)

Your advertisement will be in copies in-the-mail Thursday.

**Size of Units: Black-and-White Page or Spread.** Either two single black-and-white, non-bleed full pages, or one black-and-white two-page spread (gutter bleed only) per issue. Only complete plates can be accommo-

dated. Corrections, additions, or plate refinements are not possible on so fast a schedule.

**Price:** A premium of 10% will be charged over and above regular advertising space rates for the "Short-Notice" closing service. Agency commission applies to premium.

With BUSINESS WEEK's "Short-Notice Closing," you can tie in with current events, announce model changes, take advantage of dramatic timeliness. It's a way to get *fast* decisions — from America's important decision-makers.

**BUSINESS WEEK**  
A McGraw-Hill Magazine



**Behlman-Invar**  
is to electronic power as  
**Haig is to Haig**



And to determine what Behlman-Invar means to you,  
B/I has a complete catalog of AC and DC power supplies  
which is yours for the asking. Ask!



**BEHLMAN-INVAR ELECTRONICS CORP.**

1723 Cloverfield Blvd., Santa Monica, California

CIRCLE 205 ON READER SERVICE CARD

# TYPIT®

FOR  $\Phi$   $\alpha$   $\omega$   $\oplus$   $\angle$   $\ominus$   $\Re$   $\ll$   $\gg$   $\$$   $\neq$   $\Pi$   $\div$   
 $\mathcal{A}$   $\mathcal{L}$   $\mathcal{F}$   $\mathcal{Z}$   $\mathcal{G}$   $\diamond$   $\sigma$   $\mathcal{M}$   $\mathcal{U}$   $|$   $\mathcal{I}$   $\mathcal{N}$   $\Sigma$   
 $\uparrow$   $\mathcal{B}$   $\mathcal{T}$   $\mathcal{S}$   $\frac{1}{8}$   $\mathcal{I}$   $\infty$   $\alpha$   $\neq$   $\int$   $\mathcal{L}$   $[ ]$   $\acute{e}$



- Over 450 special characters available
- **TYPIT** fits any standard typewriter
- Insert symbols as you type
- 4 seconds per symbol

Call your local **TYPIT** dealer for a demonstration and a current catalog. See Science 19 Jan. 1962 for the **TYPIT** dealer near you, or write to us.

**TYPIT** a product of...  
**mechanical enterprises, inc.**  
3127 Colvin Street, Alexandria 3, Virginia

110 CIRCLE 110 ON READER SERVICE CARD

# Lepel

High Frequency  
**INDUCTION  
HEATING  
UNITS**

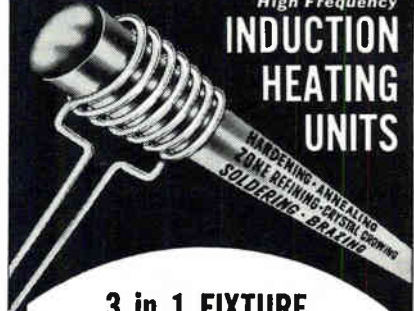

## 3 in 1 FIXTURE

for

- FLOATING ZONE REFINING AND CRYSTAL GROWING
- HORIZONTAL ZONE REFINING
- CRYSTAL PULLING

This Lepel 3 in 1 unit is designed for production work as well as for research and development laboratories doing experimental work on semiconductor materials, thermoelectric materials and ultra pure metals. This combination fixture provides facilities for horizontal zone refining, floating zone refining and crystal growing. All these facilities may not be required in a single program but the rapid progress in materials science emphasizes the need for just such versatile equipment.

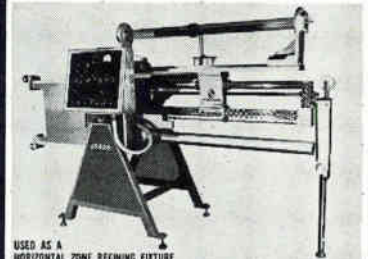

USED AS A HORIZONTAL ZONE REFINING FIXTURE



USED AS A FLOATING ZONE FIXTURE

USED AS A CRYSTAL PULLING FIXTURE

This fixture consists of the three attachments and the basic unit which contains the traverse and programming mechanism. All three attachments and the generator can be operated from the control panel.

The change from floating zone operation to horizontal zone refining to crystal pulling require less than a half hour.

Our engineers will process your work samples and return the completed job with full data and recommendations without cost or obligation.

WRITE FOR LEPEL CATALOG

**Lepel** HIGH FREQUENCY  
LABORATORIES, INC.

55th ST. & 37th AVE., WOODSIDE 77, N. Y.  
CHICAGO OFFICE: 6246 WEST NORTH AVE.

CIRCLE 206 ON READER SERVICE CARD  
electronics



**NOW**  
store transients  
with your standard  
oscilloscope



Missile Test

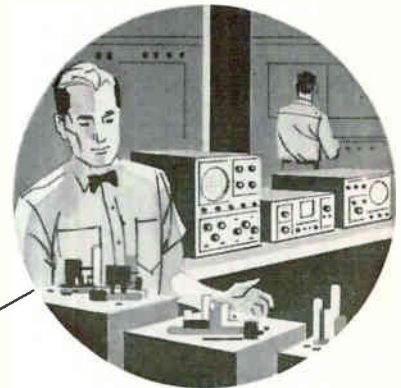

Production Testing



Medical Research



Quality Control



Environmental Test

## Use a HUGHES MEMO-CORDER\* Storage Instrument

Most oscilloscope users find applications where the ability to store traces of fleeting, non-recurring transients would save much time, effort and expense. Until now, oscillographic storage capability required investment in larger, more expensive storage instruments for which only limited use might be found.

The new HUGHES MEMO-CORDER multi-function storage unit changes all this. A precision instrument for laboratory or production use, it is compact and highly portable. You can use it anywhere. The MEMO-CORDER indicator is readily connected and adaptable to most conventional oscilloscopes. Gives you oscillographic storage

when and where you want it. And best of all is its moderate price.

**Added capability!** Matched amplifiers make the Hughes MEMO-CORDER indicator an ideal instrument for X-Y plotting. Excellent as a read-out or display device for systems applications.

Ask Hughes for full information on how you can add storage capability to your present oscilloscopes with the MEMO-CORDER storage unit. Write, wire or telephone today! **HUGHES INSTRUMENTS, VACUUM TUBE PRODUCTS DIVISION**, 2020 Short Street, Oceanside, California.

For export information, write: Hughes International, Culver City, California.

### OPERATING CHARACTERISTICS

Sensitivity: 0.25 v/div.  
Bandpass: DC to 1.25 MC +  
Rise Time: less than 0.27  $\mu$ s  
Writing Speed: 10<sup>6</sup> in/sec.  
Erase Time: less than 150 ms

\*TRADE-MARK, HUGHES AIRCRAFT COMPANY

Creating a new world with Electronics

**HUGHES**

HUGHES AIRCRAFT COMPANY  
VACUUM TUBE PRODUCTS DIVISION

**FEW make MORE  
precision resistors  
than  . . . ( now, there's a  
little-known fact! )**

**FEW make MORE  
PRECISE resistors  
than  . . . ( that will surely  
evoke an argument! )**

**FEW can match the  
 QUANTITY of  
types ( more than 450  
available! )**

**NOBODY can offer  
prompter DELIVERY  
in any quantity—at lower  
prices - or higher quality  
than  !!**

*Write for free catalog.*

<b>WIRE WOUND</b> Precision	<b>METAL FILM</b> Precision	<b>CARBON FILM</b> High Voltage High Frequency High Megohm	<b>RESISTANCE NETWORKS</b> Precision units— canned or encapsulated
--------------------------------	--------------------------------	---	--

\*Conformance to MIL-R-93: MIL-R-9444: MIL-R-14293A:  
MIL-R-10683A: MIL-R-10509C

 **Resistance Products Co.**  
914 S. 13th Street, Harrisburg, Pa.

$$\Delta_{av} = \left( \frac{\sum \sigma^2}{n} \right)^{1/2} - fM/C_0$$

**GLASS**

**KEEPS IN STEP  
WITH ENGINEERING AT  
FRIEDRICH & DIMMOCK**

A glass tube the size of a human hair with a hole down the center! Impossible? Not at Friedrich & Dimmock. Our engineers make available Micro Glass Capillary Tube drawn to precision tolerances in ultra miniature sizes. Another instance in which glass keeps in step with engineering at Friedrich & Dimmock.

Whether you need regular or Micro Glass Capillary Tubing or engineering assistance, you will find our engineering staff friendly, experienced and anxious to serve you.

For additional information or assistance, write or call

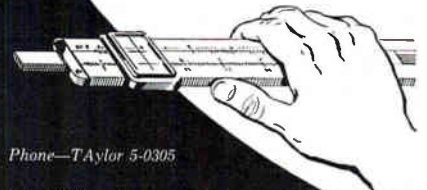

Phone—Taylor 5-0305

Friedrich & Dimmock, Inc.  
Dept. Micro, P. O. Box 230  
Millville, New Jersey



*A Better View of Industry and Science through Glass*

CIRCLE 207 ON READER SERVICE CARD

**You Get Things Done With  
Boardmaster Visual Control**

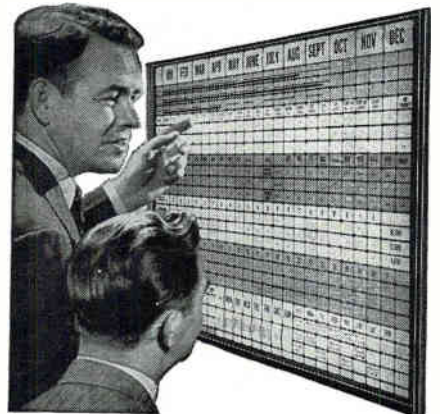

- ☆ Gives Graphic Picture of Your Operations—Spotlighted by Color
- ☆ Facts at a glance—Saves Time, Saves Money, Prevents Errors
- ☆ Simple to operate—Type or write on Cards, Snap in Grooves
- ☆ Ideal for Production, Traffic, Inventory, Scheduling, Sales, Etc.
- ☆ Made of Metal. Compact and Attractive. Over 500,000 in Use

Full price **\$4950** with cards

**FREE** 24-PAGE BOOKLET NO. C-20  
Without Obligation

Write for Your Copy Today

**GRAPHIC SYSTEMS**  
YANCEYVILLE, NORTH CAROLINA

CIRCLE 208 ON READER SERVICE CARD

Around the world it's **KEW**







MODEL F-98



MODEL EW-16



MODEL P-22



MODEL VR-2P



MODEL VO-38



MODEL TK-20A



MODEL FL-202



MODEL PV-200



MODEL TR-A



SWR & RF WATTMETER

**KYORITSU ELECTRICAL INST. WORKS, LTD.**  
 No. 120, Nakane-cho, Meguro-ku, Tokyo, Japan  
 Cable Address: "KYORITSUKEIKI TOKYO"  
 Tel: (717) 0131-5 • 0151-3

CIRCLE 209 ON READER SERVICE CARD



Seen  
the new  
**IDEA  
INDEX  
IN EBG?**

The **INDEX** to the editorial articles in **electronics** magazine, previously published annually in a December issue, now appears **ONLY** in the **EBG**. Another original **EBG** idea that saves time and trouble for users! Keep your **EBG** copy on your desk!

**EXTRA!**

Also in the **EBG** are condensed **ABSTRACTS** of *all* the editorial feature articles which have appeared to date in 1961. Another reason why **EBG** is used more by all four — men in research, design, production and management.



McGraw-Hill Publication,  
330 West 42nd St., New York 36, N. Y.



February 9, 1962

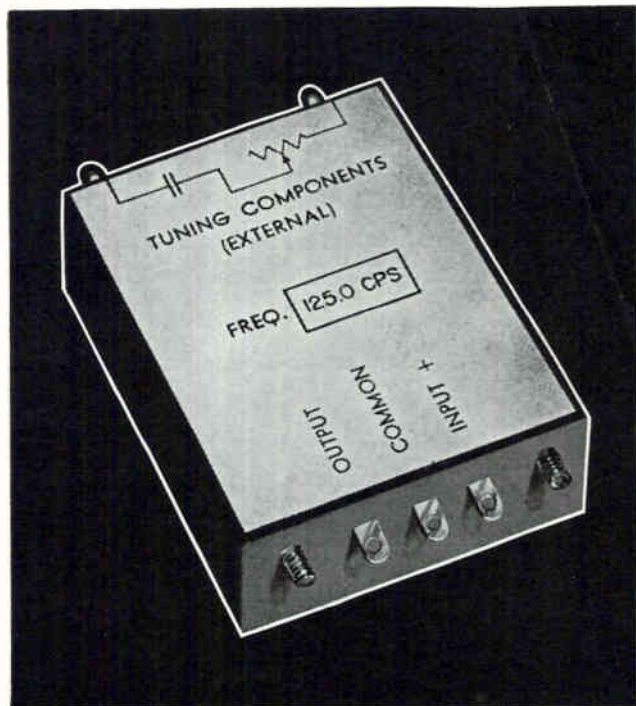

# NEED A FREQUENCY?

**FREQUENCY SOURCES  
RANGE: 10 cps to 10 kcs**

WHY LET SOMEONE ELSE DISCOVER ALLEN TYPE C OSCILLATORS? (and someone does discover these unique transistorized frequency generators for another new application almost every day.)

Allen Type C Oscillators provide **THREE IMPORTANT ADVANTAGES:**

- Surprisingly **LOW COST**
- Uniform pre-tested **QUALITY**
- "Same-week" delivery for your specified frequency

The efficient mass-production of high quality frequency sources, indispensable to the success of Allen electronic organs, now contributes to the great flexibility of Type C Oscillator production.

You are invited to investigate this unusual component. Write Dept. 2302 for illustrated technical data.

COMPONENTS DIVISION  
**Allen** ORGAN COMPANY, INC.

MACUNGIE, PA., PHONE 965-9801

CIRCLE 113 ON READER SERVICE CARD

113

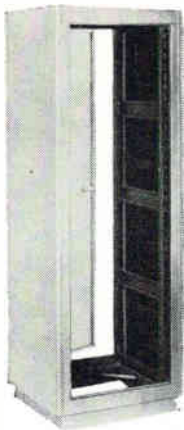

# ECONOMICAL ATTRACTIVE PRACTICAL

SERIES **SIXTY**  
CABINET RACKS

FURNISHED COMPLETELY ASSEMBLED READY FOR USE. NO CHANCE OF ERROR IN ORDERING MULTIPLE COMPONENTS. SAVE TIME AND COST IN COMPLETING ASSEMBLY.

All welded frame with perforated "U" braces at sides. Components may be mounted to adjustable front rails or side braces. Both types have same basic construction. Upright model available in 16 sizes and inclined panel model in 3 sizes. Both models furnished in choice of two-tone gray or two-tone blue.

Series Sixty cabinet racks are the most practical as well as economical for a single piece of equipment or multiple instrumentation system. See them at your local Bud distributor or write us for literature.



**BUD RADIO, INC.**  
CLEVELAND 3, OHIO

CIRCLE 210 ON READER SERVICE CARD

NEW FROM T/I

## HIGH SPEED A-D CONVERTER

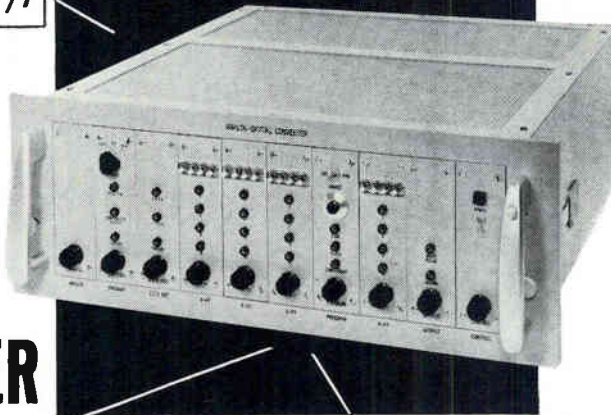

1.5  $\mu$  sec per bit

Automatic Zero Stabilization

Texas Instruments Model 834 Analog-Digital Converter is a versatile, all solid state instrument combining high speed with high accuracy. Basic speed is 25 microseconds per conversion (40,000 12 bit conversions per second); accuracy is  $\pm 0.05\%$  of full scale,  $\pm 1/2$  the least significant bit. The instrument provides full scale ranges of  $\pm 2.5$ ,  $\pm 5.0$ , and  $\pm 10.0$  volts with an input impedance of 200,000 ohms. Modular construction allows modification of output logic levels and digital code to suit various system requirements.

Write for complete information.

APPARATUS DIVISION  
PLANTS IN HOUSTON  
AND DALLAS, TEXAS



**TEXAS INSTRUMENTS**  
INCORPORATED  
3609 BUFFALO SPEEDWAY  
P. O. BOX 66027 HOUSTON 6, TEXAS

114 CIRCLE 114 ON READER SERVICE CARD

### WHITNEY-JENSEN COMPLETE "SHEET METAL SHOP" for Punching-Notching-Forming

48" UNIVERSAL BRAKE

MAKE ALL  
KINDS OF  
CHASSIS  
BRACKETS  
BOXES  
PANELS  
CABINETS  
BRACES  
SHIELDS  
ETC.

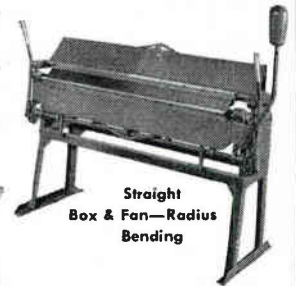

Straight  
Box & Fan—Radius  
Bending

NO. 118

HAND METAL PUNCH

Capacity — 2" hole  
thru 14 ga. mild steel  
— 1/4" hole thru 3/8".  
High and deep throat.  
Powerful cam action.  
Bench or floor models.



NO. 100

HAND METAL NOTCHER

Capacity — 6" x 6" 90°  
notch in 16 ga. mild steel.  
Versatile. Cam action.  
Adjustable gauges.



Write us Now for Complete  
Information and Prices

**WHITNEY METAL TOOL CO.**

722 Forbes St., Rockford, Ill.

CIRCLE 211 ON READER SERVICE CARD

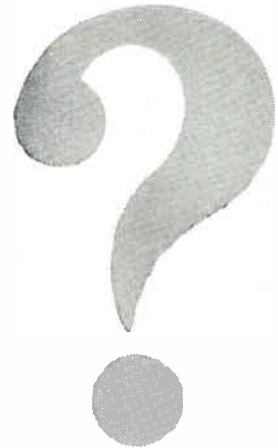

## Are you selling the whole buying team

Tough competition demands that the electronics man be reached and sold wherever you find him: *Research, Design, Production, and Management.* Only advertising in electronics reaches all four... the same men your salesmen call on. Put your advertising where it works *hardest*....

in **electronics**

electronics

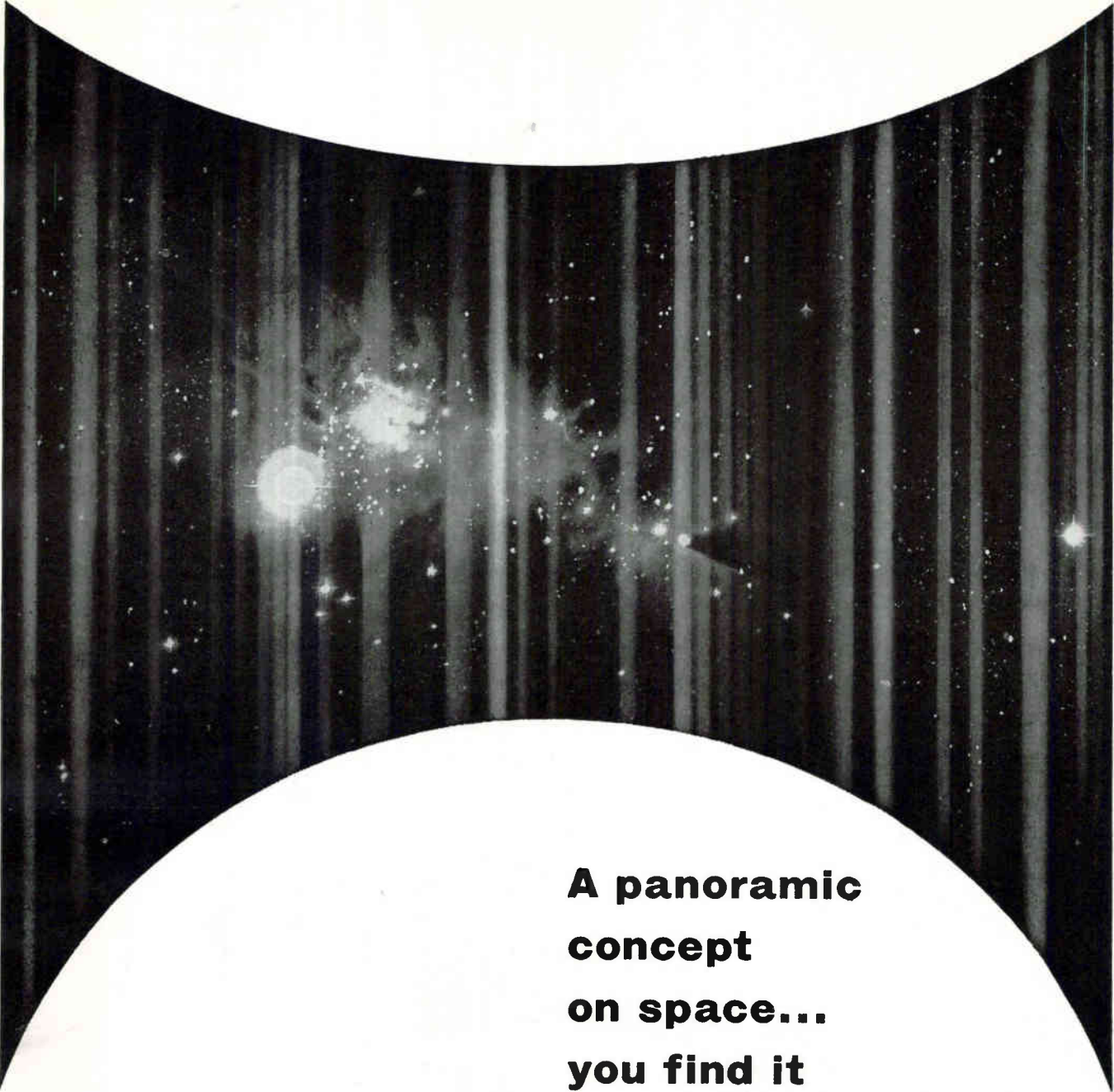

**A panoramic  
concept  
on space...  
you find it  
at Lockheed**

Long experience and proven capability give Lockheed a great advantage: perspective on space. This results in programs that cover the broad spectrum of aerospace dynamics; that present the most far-reaching technological problems; that offer endless creative challenge to Scientists and Engineers; that give them new concepts to explore—new goals to reach.

This far-ahead program in the concepts and vehicles of space creates a climate most favorable to advancement in the state of the art as well as in professional status.

**Scientists and Engineers** with an eye to a secure and

rewarding future will find these openings at Lockheed worthy of serious consideration: Aerodynamics; thermodynamics; dynamics; electronic research; servosystems; electronic systems; physics (theoretical, infrared, plasma, high energy, solid state, optics); electrical and electronic design; structural design (wing, empennage, fuselage); human engineering; reliability; wind tunnel design. Write today to Mr. E. W. Des Lauriers, Manager Professional Placement Staff, Dept. 1502, 2408 N. Hollywood Way, Burbank, California. An equal opportunity employer.

**LOCKHEED** CALIFORNIA COMPANY  
A DIVISION OF LOCKHEED CORPORATION

# HIGH PURITY METALS AND ELECTRONIC MATERIALS

## METALS AND ALLOYS

ALUMINUM	ANTIMONY
ARSENIC	BISMUTH
CADMIUM	GOLD
INDIUM	LEAD
SILVER	TIN
	ZINC

High purity alloys are made from these metals to customer specifications.

## STANDARD FORMS

INGOTS	SHEET
BARs	SHOT
RODS	POWDER
RIBBON	WIRE

## PREFORMS

Preforms are available in a range of sizes and shapes such as discs, dots, washers, squares and spheres. Enquiries are invited on our alloy preforms.

## COMPOUND SEMICONDUCTORS

### INDIUM ANTIMONIDE

Available as crystals, wafers, circles, rings and other shapes made to precise tolerances.

## CHEMICALS

SALTS      SOLUTIONS

# COMINCO PRODUCTS INC.

Electronic Materials Department  
933 West Third Avenue  
Spokane, Washington  
Ph. RI 7-7103      TWX: SP 311



# dip. rac

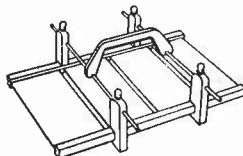
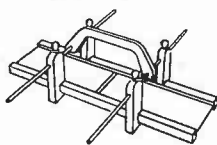
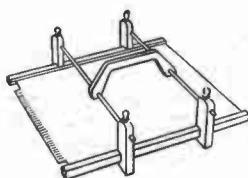

## NEW! THE FIRST AND ONLY UNIVERSAL PRINTED CIRCUIT DIP SOLDERING FIXTURE!

DIP-RAC is widely adjustable to accommodate an infinite variety of printed circuit cards. Eliminates necessity to build custom fixtures for different sizes and types of boards. Eliminates tooling-up time, use of welding clamps, tongs and other make-shift devices.

DIP-RAC assures a far higher quality-level with less labor. Holds printed circuit assemblies firmly during thermal shock cycles . . . minimizes warp. Thoroughly tested through 80,000 immersions — no deterioration of fixture — no contamination of solder pot!

Price \$29.50 F.O.B. Malden, Mass.



Davenport 4-8250

**DEFIANCE PRINTED CIRCUIT CORP.**

144 COMMERCIAL ST.  
MALDEN 48, MASS.

CIRCLE 212 ON READER SERVICE CARD



## UNICABINET

THE ULTIMATE IN CABINETRY  
BY

## DAHLSTROM

CUSTOM BUILT OF STANDARD  
DESIGN - enables you to specify

- SIZE
- FINISH
- TRIM
- CHASSIS
- SLIDES
- R F SHIELDING
- VENTILATION
- INTERNAL STRUCTURES

usually without tool charge!

Send for UNICABINET BROCHURE to-day

## DAHLSTROM MFG. CORP.

JAMESTOWN, NEW YORK

CIRCLE 213 ON READER SERVICE CARD

electronics

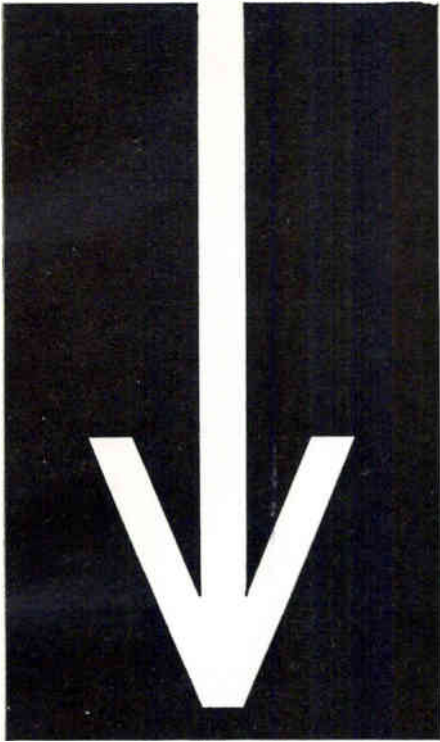

# WHY

## MAJOR C. R. TUBE MFGRS. RECOMMEND SYNTRONIC YOKES

Syntronic yoke procedure originated the industry standard for specification correlation between yoke, c. r. tube and circuitry. For a helpful, time-saving checklist covering all physical and electrical yoke parameters and their determining conditions, request ELECTRONICS reprint #12-59. Thorough correlation enables Syntronic to guarantee accepted specifications.

Call your nearest SYNTRONIC REP today

<b>Boston-New Eng.:</b>	NORwood 7-3164
<b>New York Area:</b>	OXford 5-3727
<b>Phila. Area:</b>	MOhawk 4-4200
<b>Wash.-Balt. Area:</b>	APpleton 7-1023
<b>Indianapolis:</b>	VIctor 6-0359
<b>Los Angeles:</b>	CUmberland 3-1201

## *syntronic* INSTRUMENTS, INC.

100 Industrial Road, Addison, Illinois  
Phone: Kingswood 3-6444

The industry's broadest yoke line . . . already tooled for quantity production. Or, yokes can be custom designed to your precise requirement.



CIRCLE 214 ON READER SERVICE CARD  
February 9, 1962

One of a series EXPLORING THERMISTOR APPLICATIONS

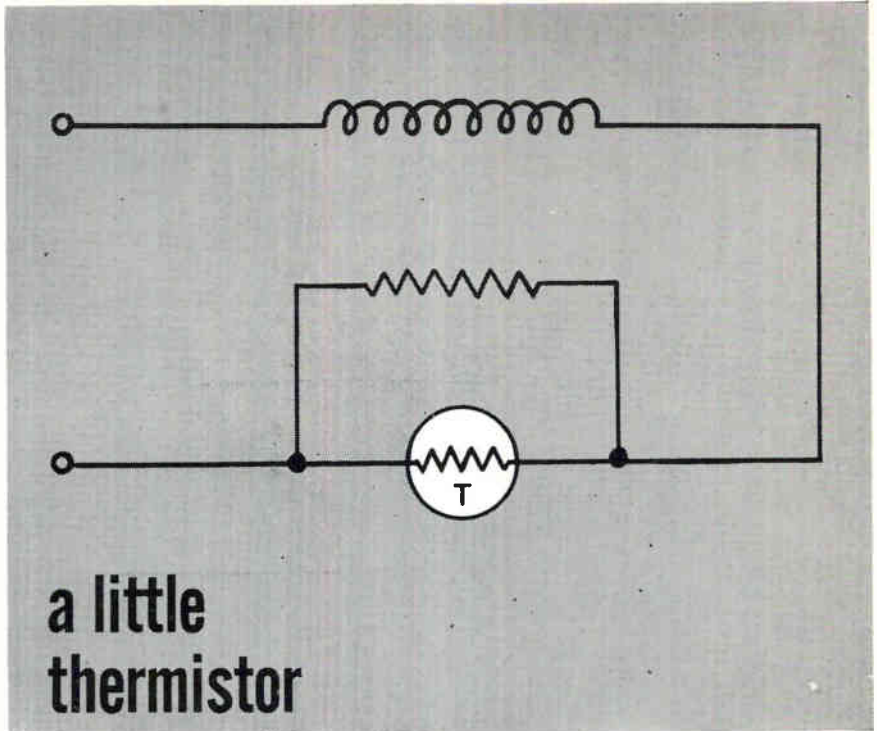

## a little thermistor makes a big difference in a temperature compensation circuit

Most circuit elements have a positive temperature coefficient of resistance. Like copper in a meter coil, for instance.

Such a circuit must be temperature-compensated, and a little thermistor is just the ticket. We merely introduce a thermistor and a resistor into the circuit. The thermistor is shunted by the resistor, and the result is a negative temperature coefficient equal to the positive coefficient of the copper.

Smart engineers have used this idea in magnetic and transistor amplifiers. By thermistorizing amplifiers, they have achieved compensation and a constant gain over broad ambient temperature ranges.

There are many other ways of putting thermistors to work. Temperature control, liquid level measurement, time delay and remote control circuits, or you name it.

**There are just two kinds of thermistors, really:** ordinary, which are good; and FENWAL ELECTRONICS', which are a little bit better. One reason is that FENWAL ELECTRONICS pioneered in this business. Another is that we can suit your application exactly — for the simple reason that FENWAL ELECTRONICS has the most complete line of thermistors available anywhere.



For details, application assistance, and new Thermistor Catalog EMC 4, write:

63 Fountain Street, Framingham, Massachusetts



THE MOST COMPLETE LINE ANYWHERE . . . beads and glass probes . . . discs . . . washers . . . rods . . . probe assemblies . . . El matched pairs

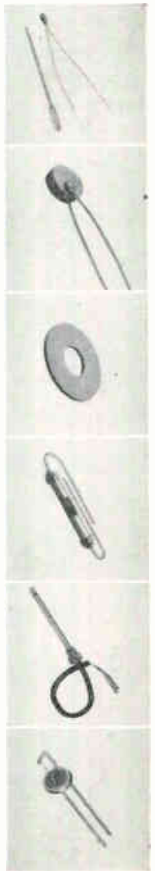



**THIS SEAL GUARANTEES YOU  
REAL LACING ECONOMY...  
increased production  
with fewer rejects!**

Always specify Gudebrod whether you use one spool of lacing tape or thousands because Gudebrod lacing tape is produced under strict quality control. Gudebrod checks and rechecks every lot of tape to insure that it meets the highest standards . . . higher standards than those required to meet MIL-T specifications.

Gudebrod helps increase your production because we carefully test, measure and maintain close tolerances on such characteristics as slip resistance, fray resistance, breaking strength, wax content, fungistatic effectiveness. These and other tests assure you that when Gudebrod lacing tape is used production increases. *Knots don't slip . . . harnesses stay tied . . . assemblies remain firm . . . there are fewer rejects!*

Whatever your lacing needs—Teflon\*, dacron†, glass, nylon, high temperatures, special finishes—Gudebrod makes it or will produce a tape to meet your special requirements. If you want a tape to meet 1500°F . . . Gudebrod Experimental Research Project 173 is the answer. If you want a tape that meets MIL-T-713A . . . Gudelace® (Style 18 Natural) is the answer.

**MAKE THE H-R TEST!** Write for samples of Gudelace or other Gudebrod lacing tapes and have them tested in your harness room. Compare a harness tied with a "Quality Controlled" Gudebrod tape and any other tape. This test will convince you that when you specify Gudebrod you specify *real* economy—increased production with fewer rejects.

Write for our free Technical Products Data Book. It explains Gudelace and other Gudebrod lacing tapes in detail.

\*Dupont's TFE fluorocarbon fiber.

†Dupont's polyester fiber.

## GUDEBROD BROS. SILK CO., INC.

Electronics Division  
225 West 34th Street  
New York 1, New York

Executive Offices  
12 South 12th Street  
Philadelphia 7, Pa.

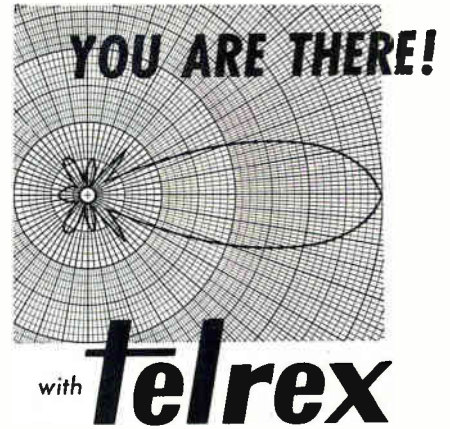

## “BEAMED-POWER” ANTENNAS

NOW MAILING! PL88 — technical data, pricing bulletin describing Advanced-design commercial and citizen-band base-station antennas and accessories. Includes Tower, Rotator, "Baluns," Mast and Transmission line data, plus nice-to-have-around "info." Request your copy, today; no obligation.

WORLD RENOWNED AND RESPECTED  
PERFORMANCE -6 to 1500 MC.



ASBURY PARK 25, NEW JERSEY, U.S.A.

CIRCLE 215 ON READER SERVICE CARD



## Operational guidance for buyers

That's what your 1961 **electronics Buyers' Guide** and Reference Issue gives you . . . this year more than ever before.

Your **EBG** is bigger and better this year than ever . . . and more helpful than ever . . . with more new exclusive features than ever. Keep it close at hand, you'll find it's useful day in and day out.

**electronics  
BUYERS' GUIDE**  
and Reference Issue

The Basic Buying Guide  
in Electronics *since 1941*



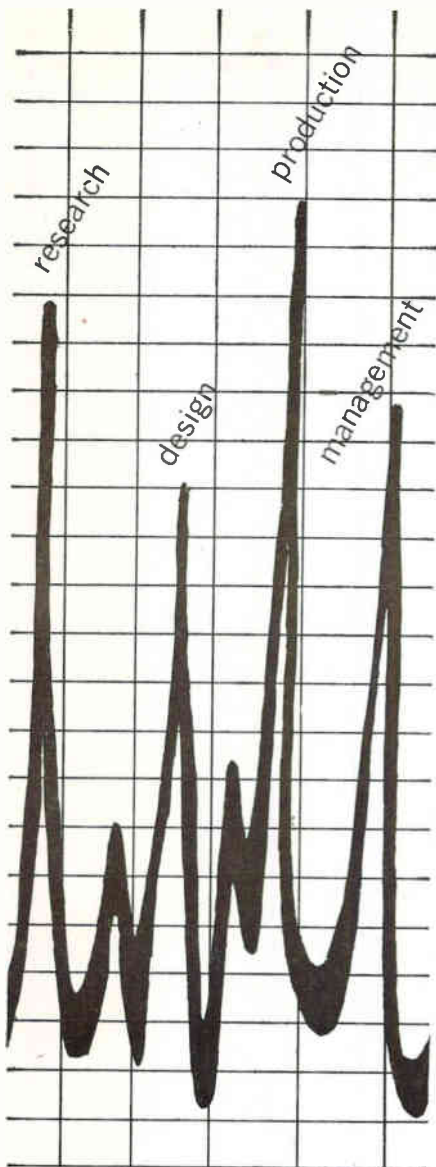

## IT'S READ MORE BY ALL 4!

electronics magazine interprets electronics for electronics men every week. The latest components, economic trends, military applications. Technical data you'll want to file and keep. Get the facts first with a personal subscription (don't be low man on a routing slip). Mail the reader service card (postpaid) to **electronics**, the magazine that helps you to know and to grow! Rates: three years for \$12, one year for \$6; Canadian, one year for \$10; foreign, one year for \$20. Annual **electronics** BUYERS' GUIDE (single issue price \$3.00) included with every subscription.

subscribe today to  
**electronics**

February 9, 1962

# DATAPULSE 200

## DATA GENERATOR

*is a general purpose  
digital test instrument*

*The 200 Data Generator is a source of simulated serial data, serial words, or pulse programs. Output is fully controllable as to clock rate, word or frame length, data content, data format, and output signal characteristics.*

Photo of core memory courtesy of Ampex Corporation

DATA CHANNELS AND CYCLE LENGTH 1 to 100 serial bits single channel or 1 to 50 serial bits two channels.

CLOCK RATES Variable 2cps to 2mc, external clock, or push button clock.

DATA RECYCLE Continuous recycling or single cycle on command.

SYNC OUTPUTS Clock sync, bit no. one sync, or selected bit sync.

DATA OUTPUT Selectable 1/0 coding within the data cycle for each channel.



PROVISION FOR TWO OUTPUT UNITS IS MADE FOR PRESENTATION OF CHANNELS ONE AND TWO DATA.

*P 901 output unit provides simultaneous pos. and neg. pulse outputs with variable fast rise and fall times.*



*P 902 output unit provides a variable DC level pulse output or a modulated carrier output.*

*Write for more detailed information.*

### Additional Datapulse products

#### 104 PULSE GENERATOR

Repetition rate to 10mc  
±40v into 50 ohms output  
Pulse width from 20 nanosec. to 500μ sec.  
Delay from 50 nanosec. to 10 millisecc.

# DATAPULSE

INCORPORATED

509 HINDRY AVE. INGLEWOOD 1, CALIFORNIA  
Data Systems • Pulse Instrumentation  
ORchard 1-7713 Oregon 8-3983

# 100,000,000

## Pulses/Sec

### from TI

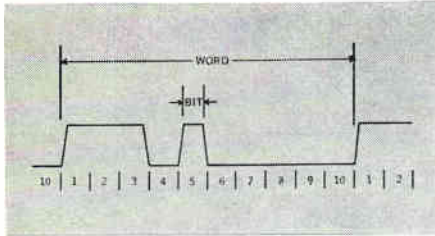

#### PROGRAMMED PULSE GENERATORS

- Bit Rates up to 25 MC
- 10 Bit Programmable Words

#### GENERAL PURPOSE PULSE GENERATORS

- PRF 100 cps to 25 MC
- Variable Pulse Width and Delay
- Variable Rise and Fall Times
- Pulse Mixing
- Plus and Minus Outputs

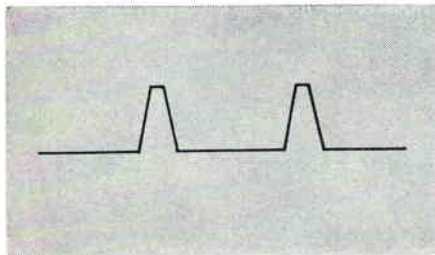
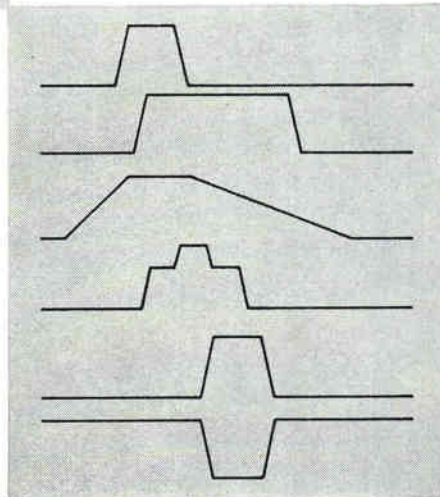

#### CLOCK PULSE GENERATORS

- PRF 100 cps to 100 MC
- Rise and Fall Times—  
Less Than 4 nanoseconds
- Pulse Width—  
Less Than 8 nanoseconds

Texas Instruments complete line of pulse instrumentation features compact design and high reliability through use of all solid state circuitry. Versatile modular construction permits custom combination of desired performance characteristics.

Write for complete information

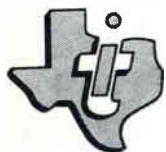

## TEXAS INSTRUMENTS INCORPORATED

APPARATUS DIVISION  
3609 BUFFALO SPEEDWAY  
P. O. BOX 66027 HOUSTON 6, TEXAS

501



## BROADBAND HIGH FREQUENCY MATCHING TRANSFORMERS

(1 KW to 20 KW)



*Unbalance to Balance  
or Vice-Versa and  
Impedance Matching...*

Frequency range: 2 to 30 mc.

Power ratings: 1KW, 5KW  
and 20KW.

These high frequency transformers are ideal for matching unbalanced radio transmitter outputs to balanced amplifiers and balanced antennas. Standard impedance transformations: 50 to 70 ohms unbalanced to 150, 300 or 600 ohms balanced as required. Other impedance ratios available on special order.

Low insertion loss — low SWR — good balance.

Pioneers in the development of baluns and unique RF coupling devices B&W again sets a standard.

Drop us a card requesting Spec Sheet.



**BARKER & WILLIAMSON, Inc.**  
Radio Communication Equipment Since 1932  
BRISTOL, PENNSYLVANIA • STILLWELL 8-5581

CIRCLE 216 ON READER SERVICE CARD  
electronics

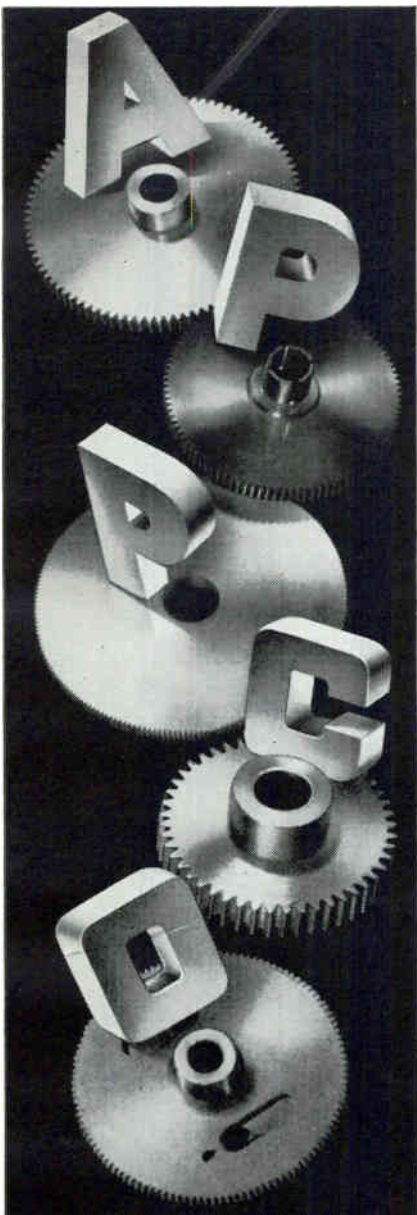

## PRECISION STOCK GEARS

### CERTIFIED RELIABILITY AND PRECISION

Every APPCO Gear is made to A.G.M.A. specifications. Certified to tolerances. Sealed in plastic to assure dirt-free, "factory-fresh" precision. APPCO Gears are available in 32, 48, 64, 72, 96 and 120 diametral pitches of 14½° and 20° pressure angles. Spur gears, pin or clamp type . . . hubless and anti-backlash. For complete details write for new catalog to

**ATLAS PRECISION PRODUCTS CO.**

Castor & Kensington Aves.  
Philadelphia 24, Pa.  
Div. Prudential Industries



# APPCO

CIRCLE 217 ON READER SERVICE CARD  
February 9, 1962

# Itek

## Crystal Filters do Wonderful Things

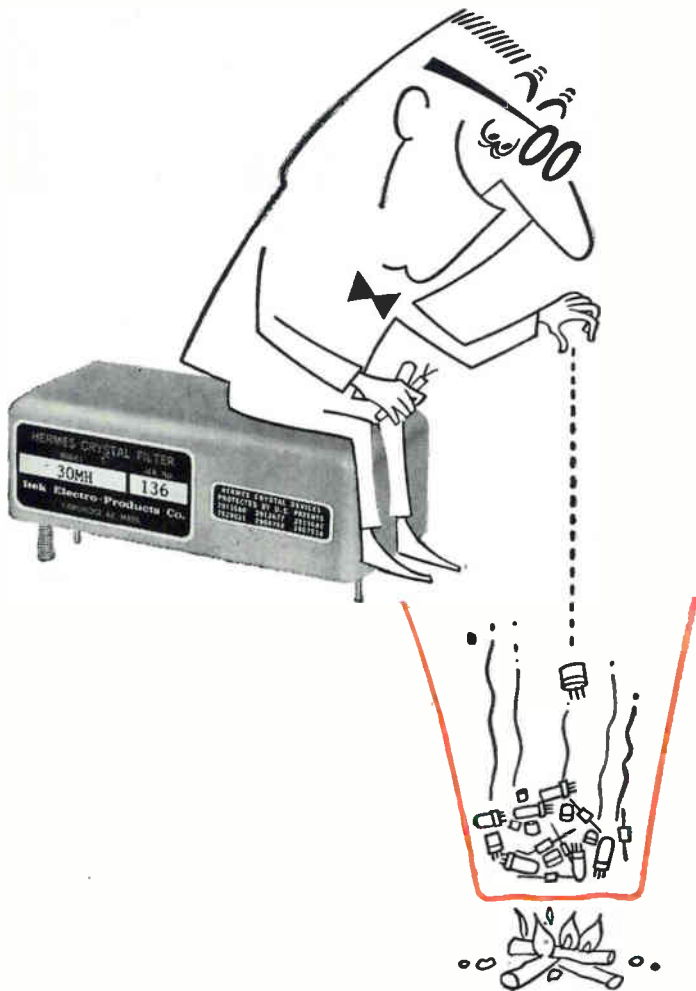

Dropping excessive components is a wonderful thing! At a receiver's antenna or first IF, Itek Crystal Filter 30 MH means no multiple conversions, no desensitization, near straight-up attenuation — enough components saved to fill a trash burner.

Perhaps you don't need a 30 megacycle, highly selective, 125 KC bandpass filter. But could you use the ingenuity that built one? Could Itek technical leadership help you?

Of course, the world's largest and most complete selection of stock crystal filters is available, too. Choose from more than 3,000 Itek-Hermes designs.

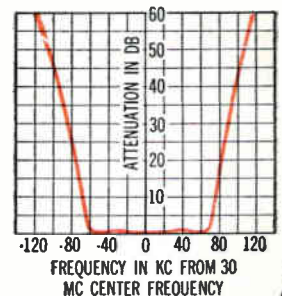

Write for free Brochure "WEEKS KACFAACP" or, What Every Engineer Should Know About Crystal Filters At A Cocktail Party. You'll enjoy it!

## Itek Electro-Products Company

75 CAMBRIDGE PARKWAY, CAMBRIDGE 42, MASS. A DIVISION OF

CIRCLE 121 ON READER SERVICE CARD

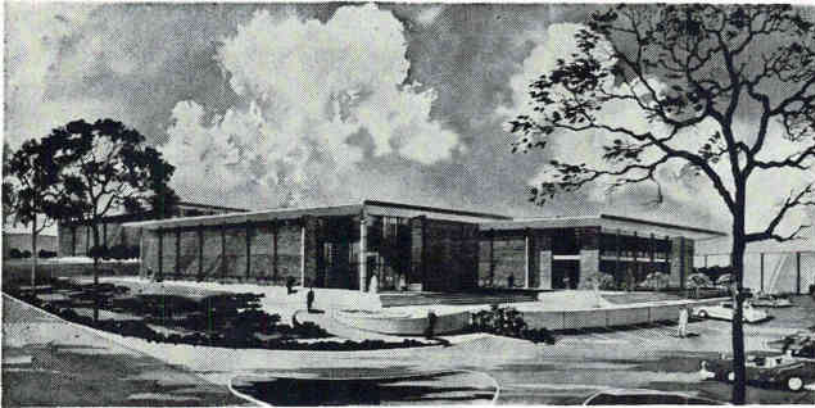

## Itek Begins Major Expansion

GROUND-BREAKING for a major expansion of administration and laboratory facilities for Vidya, Inc., and Palo Alto Itek, divisions of Itek Corp., was recently held at Stanford Industrial Park, Palo Alto, Calif. The West Coast ceremonies represented half of a coast-to-coast ground-breaking for facilities that will physically expand Itek by 20 percent in mid-1962.

The Palo Alto expansion comprises three buildings (shown in architect's sketch): a 12,000-sq-ft administrative unit, a 15,000-sq-ft research unit and a 27,000-sq-ft shop and laboratory unit. The ceremonies began at the same time ground was broken in Burlington, Mass., for a new 58,000-sq-ft building of Itek Electro-Products.

Richard S. Leghorn, Itek president, stated that the two projects represent the next step in a program that already has expanded facilities 38 percent in the past year to support company scientists and engineers with the latest in plant equipment for advanced information technology.

Wallace Davis, president of Vidya, Inc., said one administrative and research building will provide special "think shops" for top management. Vidya specializes in related to aerospace problems in areas as hypersonic and high temperature physics.

... of Itek Palo Alto building will be

a combined engineering laboratory and prototype model shop to be shared with Vidya. Itek Palo Alto concentrates largely on photo-optical technology.

"The 1961 physical expansion at Itek Laboratories was matched by a 12 percent increase in sales and a 40 percent gain in backlog," Leghorn added. "I am fully confident that our current investment in the Burlington and Palo Alto facilities will provide the springboard for similar growth on the part of Itek Electro-Products and Itek Palo Alto and Vidya, Inc."



### Mallory Capacitor Elevates Maxwell

JOHN MAXWELL, formerly director of engineering, has been appointed technical assistant to the president of Mallory Capacitor Co., a division of P. R. Mallory & Co. Inc., Indianapolis, Ind.

His new responsibilities will include: research and development

planning; contact with government agencies; contact with industry associations; contact with major industrial customers; maintaining relationships with foreign affiliates in the Common Market.

### Madigan Electronic Corp. Joins NYRAD Team

MADIGAN ELECTRONIC CORP., Carle Place, L.I., N.Y., has become a member of the New York Research & Development Team, according to an announcement by Cyrus Adler, president of the team. The R&D group is comprised of New York area technical companies who bid jointly on military and commercial research and development projects.

The NYRAD Team was formed in May 1960, and has headquarters at 150 Broadway, New York City. It was recently approved by the Small Business Administration and has submitted its initial joint bid on an engineering project for the U.S. Signal Corps, with the Madigan Corp. as team leader.



### ECI Appoints Hansel V-P of Engineering

APPOINTMENT of Paul G. Hansel as vice president of engineering at Electronic Communications, Inc., St. Petersburg, Fla., is announced.

Hansel's most recent position has been that of chief radio engineer for Servo Corp. of America.

### Cornell-Dubilier Names Palfi

THOMAS PALFI has been appointed engineering manager of the Cornell-Dubilier Electronics Custom-Pak division in Providence, R.I. He will be responsible for design and production engineering of the di-

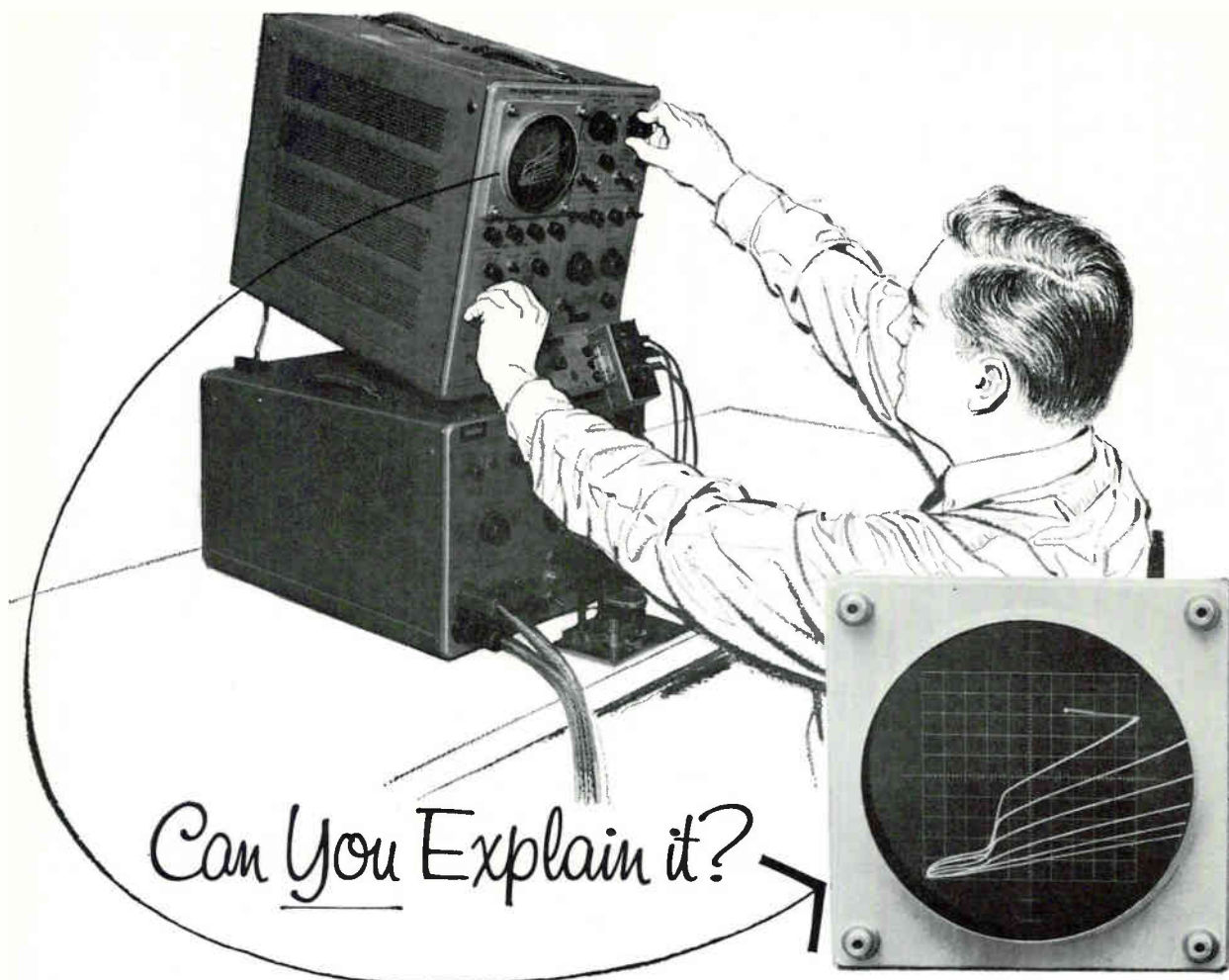

When a transistor performs like this on a curve tracer, we like to know why. Sometimes the answer is obvious. Then again, we may find it not so easily explained. This our semiconductor device people like. They enjoy sinking their teeth into a knotty problem and sticking with it till they shake out the answer—and it usually doesn't take long at Delco.

Why? Easy.

When you toss a problem to a group of talented men . . . provide the necessary research tools . . . in an environment that encourages personal initiative and achievement . . . you can't help getting results. This combination has helped build a position of leadership for Delco in the development and production of semi-conductor devices.

We intend to keep it that way—through expanding facilities and fresh talent.

Our new R&D center—125,000 sq. ft.—houses laboratories equipped with the latest in sophisticated research facilities. Our new semiconductor manufacturing center—226,000 sq. ft.—scheduled for operation this June, will provide an expanded capability in the production of silicon rectifiers. All of which adds up to new opportunities in research, development and production of silicon rectifiers.

solid state electronics



DELCO RADIO DIVISION OF GENERAL MOTORS  
KOKOMO, INDIANA

• **SEMICONDUCTOR DEVICE DEVELOPMENT—**

BS in Physics, Metallurgy or Electrical Engineering; minimum of 2 yrs. experience in high current silicon rectifier development; must be capable of developing these devices and maintaining technical responsibility through pilot production.

• **PHYSICISTS, CHEMISTS AND METALLURGISTS**

For semiconductor device development; experience in encapsulation, alloying and diffusion, chemistry of semiconductor devices, materials (to lead a program on metallurgical research of new semiconductor materials).

• **ELECTRONIC ENGINEERS—**

Experienced in machine controls (relay and/or static) to assist in the development and application of static transistorized controls.

• **TRANSISTOR PROCESS ENGINEERS—**

EEs, MEs, and IEs to develop and create new processes for manufacturing germanium and silicon semiconductor devices and to develop automatic and semi-automatic fabrication equipment. Experience preferred.

If you're looking for an opportunity to fully exercise your personal competence . . . among men of like talent . . . in unmatched facilities . . . then let us hear from you. Send your resume today to the attention of Mr. Carl Longshore, Supervisor Salaried Employment, Dept. 102

*An equal opportunity employer*

to these CEC detectors a leak is a

# LEAK

*They find the smallest leaks as easily as they find the big ones. CEC's 24-120 Helium Leak Detector*

(right) is so sensitive that it locates and measures leaks as small as  $5 \times 10^{-11}$  atm cc/sec—leaks in pressurized or evacuated components . . . leaks in the lab, shop, or field. And on the production line, the 24-120 with its test-port station finds leaks faster than any other instrument of its kind. Now look at Radiflo (left), CEC's radiation-sensing leak detector. Its sensitivity of  $1 \times 10^{-5}$  to  $1 \times 10^{-11}$  atm cc/sec. plus high-output, automatic activation make it the only leak detector economically feasible for 100% leak checking of mass produced components like transistors, diodes and relays—checks 2500 units per hour! Got a leak? Better call your nearest CEC office or write for the complete story in Bulletins CEC 24120-X17 and CEC 24510-X12.



## CEC

Analytical & Control Division

**UNIONIZED ELECTRODYNAMICS**

BERKELEY, CALIFORNIA • A SUBSIDIARY OF BELL & HOWELL

READER SERVICE CARD

vision's standard lines and custom work in package circuits.

Previously, Palfi has been associated with Epsco Corp., the Circuit-Pak department at Raytheon, and the Semiconductor division of General Electric.



### Sylvania Promotes Thomas Longo

APPOINTMENT of Thomas A. Longo as director of research and engineering for the Semiconductor division of Sylvania Electric Products Inc., Woburn, Mass., is announced. Sylvania is a subsidiary of General Telephone & Electronics Corp.

Longo joined the General System in 1958 as head of the semiconductor engineering group of the Automatic Electric Co. and in 1959 transferred to Sylvania as manager of the telephone semiconductor group. Prior to his new assignment, he was manager of the Advanced Device Research Laboratory of the Semiconductor division.



### Vitramon Appoints David Alfred

DAVID S. ALFRED has been named process engineering supervisor at Vitramon, Inc., Bridgeport, Conn.

Alfred had served as chief engineer of Microwave Casting & Engineering Corp. in Waltham, Mass., prior to joining Vitramon, and pre-

123

electronics

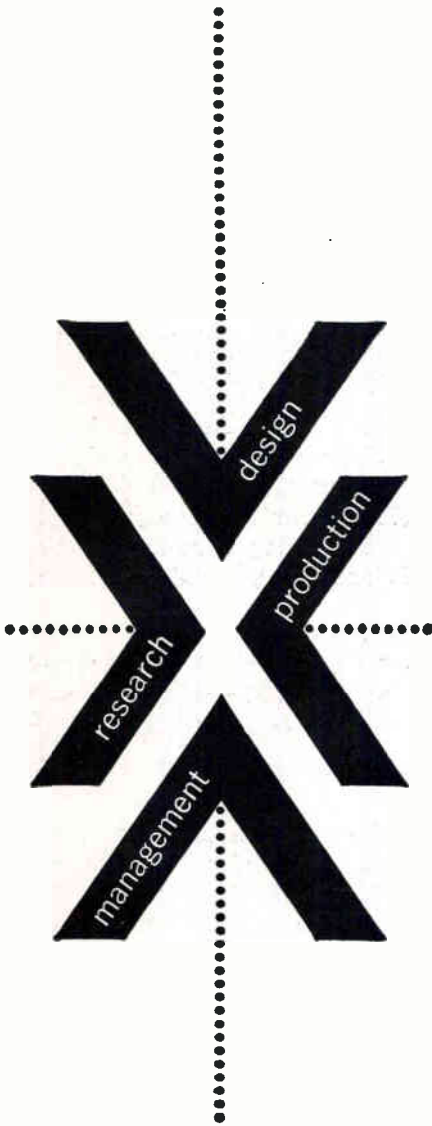

**it's read  
more  
by all 4!**

**electronics** magazine covers engineering and technically interpreted market trends every week. Government, military and economic developments, new applications, and technical data you'll want to file and keep. Subscribe now and read it first (don't be low man on a routing slip). Mail the reader service card (postpaid) to **electronics**, the magazine that helps you to know and to grow! Rates: three years for \$12; one year for \$6; Canadian, one year for \$10; foreign, one year for \$20. Annual **electronics** BUYERS' GUIDE (single issue price \$3.00) included with every subscription.

subscribe today to  
**electronics**

February 9, 1962

# New accuracy, faster response in industrial temperature sensing

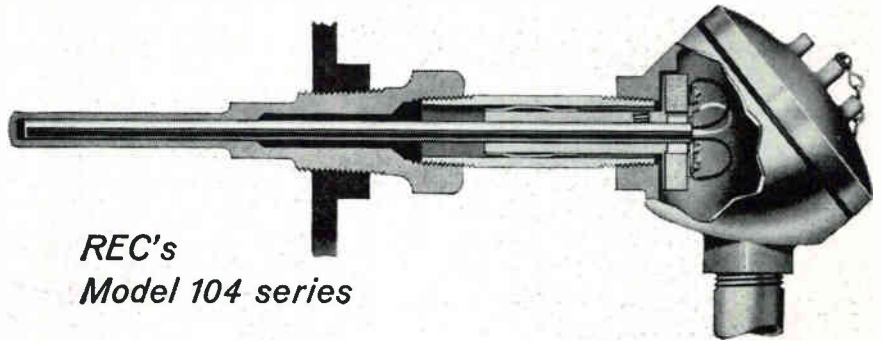

*REC's  
Model 104 series*

Performance that approaches laboratory standards is now available in an industrial temperature sensor—and at far less than laboratory instrument prices. The new Model 104 series of platinum resistance temperature sensors from Rosemount Engineering offers you these features:

- Wide range: from  $-260^{\circ}\text{C}$ . to  $+750^{\circ}\text{C}$ .
- Accuracy: within 0.1% at  $0^{\circ}\text{C}$ .
- Stability: within  $0.1^{\circ}\text{C}$ . after 10 consecutive temperature shocks from  $600^{\circ}\text{C}$ . to  $20^{\circ}\text{C}$ .
- Fast response: time constant of less than 2 seconds.
- Ruggedness: unaffected by 35G or 3,000 psi pressure.
- Versatility: mounts in standard thermowells or directly into pressure vessel with tapered thread fitting.

Structurally the REC Model 104 element is highly pure platinum, mounted strain-free in a ceramic rod, and normally hermetically sealed into a stainless steel well from .082" to .375" in diameter. It is carefully made using production techniques developed during Rosemount's many years of supplying ultra-precise sensors for critical aerospace and laboratory applications.

For further details on how the new REC Model 104 sensors will fit your application, write for Model 104 bulletin or outline your specific problem.

### **A complete precision line**

Rosemount Engineering Company designs and manufactures high quality precision equipment in these lines:

- |  |  |
|--|--|
| <b>Air data sensors</b>                                    | <b>Surface temperature sensors</b>                   |
| <b>Total temperature</b>                                   | <b>Pressure sensors</b>                              |
| <b>Pitot-static tubes (de-iced)</b>                        | <b>Accessory equipment and aeronautical research</b> |
| <b>Immersion temperature sensors (including cryogenic)</b> |  |

For more information please write for the REC catalog. Specific questions on any temperature or pressure problems are welcomed.

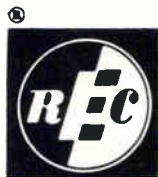

**ROSEMOUNT  
ENGINEERING  
COMPANY**

4900 West 78th Street • Minneapolis 24, Minn.

**SPECIALISTS IN TEMPERATURE & PRESSURE M**

# BALLANTINE True RMS VTVM model 350

Measures  
wide  
range of  
waveforms  
with  
**1/4% ACCURACY**



For highly accurate voltage measurements, the uncertainty introduced by waveform distortion limits the use of average and peak-responding instruments. The Model 350 is a 0.25% accurate, true rms-responding instrument designed to overcome this limitation. It provides the engineer with a rugged, reliable and easy-to-use laboratory or production line instrument. It will measure a periodic waveform in which the ratio of peak voltage to rms is not over 2.

The method of measurement with the Model 350 is similar to balancing a bridge: four knobs are set for minimum indication and the unknown voltage is read directly from a 4 to 5 digit NIXIE® in-line readout. The precision exceeds the stated accuracy by 5 to 10 times. Price: \$720.

#### SPECIFICATIONS

Voltage Range..... 0.1 V to 1199.9 V	Frequency Range..... 50 cps to 20 kc
Accuracy. ¼%, 100 cps to 10 kc, 0.1 V to 300 V; ½% outside these limits	Max Crest Factor ..... 2
	Input Impedance .... 2 MΩ shunted by 15 pF to 45 pF

Write for brochure giving many more details

— Since 1932 —

**B** BALLANTINE LABORATORIES INC.

Boonton, New Jersey

CHECK WITH BALLANTINE FIRST FOR LABORATORY AC VACUUM TUBE VOLTMETERS, REGARDLESS OF YOUR REQUIREMENTS FOR AMPLITUDE, FREQUENCY, OR WAVEFORM. WE HAVE A LARGE LINE, WITH ADDITIONS EACH YEAR. ALSO AC/DC AND DC/AC CONVERTERS, CALIBRATORS, CALIBRATED WIDE BAND AF AMPLIFIER, DIRECT-READING CAPACITANCE METER, OTHER ACCESSORIES. ASK ABOUT OUR LABORATORY VOLTAGE STANDARDS TO 1,000 MC.

CIRCLE 126 ON READER SERVICE CARD

viously was a manufacturing manager of Sylvania Electric Systems, in Waltham.

### Pepping to Serve On NASA Committee

RAYMOND A. PEPPING, manager of advanced engineering spacecraft systems for McDonnell Aircraft, has been named to serve on the Advisory Committee on Missile and Space Vehicle Aerodynamics for the National Aeronautics and Space Administration.

The committee engages in research relating to reentry heating, lift and drag, stability, deceleration, trajectory control and recovery of satellites and other spacecraft.

#### PEOPLE IN BRIEF

William F. Foss, a senior v-p of Motec Industries Inc., elected president, chief executive officer and a director of the firm. F. Judson Snell promoted to division mgr. of the Cedar Engineering div. of Control Data Corp. George Douglas advances to the post of corporate v-p and general mgr. of the Radioplane div. of Northrop Corp. Thomas F. Oehrlein has been elevated to section manager at Martin Marietta Electronics div. Joseph A. Richard, formerly with Electro Circuits, Inc., joins Conductorlab, Inc., as mgr. of manufacturing. Frank F. Yates, ex-Aerospace Corp., appointed director of electronics at Disc Instruments, Inc. Egon E. Loebner, previously with RCA Laboratories, named mgr. of optoelectronics for HP Associates. William D. Myers leaves Raytheon-Spencer Laboratories to become g-m of Resitron Laboratories, Inc. M. P. Dees from Jordan Electronics to Static Devices, Inc., as plant mgr. H. William Welch, Jr., moves up at Motorola Inc. to g-m of the new Solid State Systems div. Edgar Rice, one of the founders of Theta Instrument Corp., assumes the post of president and chief operations executive of the firm. Sylvania Electronic Systems ups Edward W. Doty to asst. g-m of its eastern operation.

electronics



**Checklist of helpful  
BOOKS for the  
ELECTRONICS ENGINEER**

**RELIABILITY PRINCIPLES  
AND PRACTICES**

**Just Out.** Presents fundamental concepts of reliability theory and demonstrates their application to the solution of practical problems. Makes use of effective reliability formulations and mathematical models . . . covers many new developments, particularly with respect to maintainability, availability, and redundancy . . . includes new sampling techniques and deficiency reporting systems. By S. Calabro, Intl. Elec. Corp. 355 pp., illus., \$10.50

**MECHANICAL ENGINEERING  
FOR P. E. EXAMINATIONS**

**Just Out.** Gives helpful guidance to license candidates for the mechanical engineering portion of the P.E. exam through detailed coverage of the type of questions usually asked. From mechanics, machine design, and hydraulics . . . through steam power plants and pumps . . . to refrigeration and air conditioning—every phase of the subject is fully covered. By J. D. Constance, Prof. Engr. 455 pp., illus., \$10.00

**PROGRAMMING AND CODING  
FOR AUTOMATIC DIGITAL  
COMPUTERS**

**Just Out.** Brings you thorough, systematic techniques to help you save time and effort in programming digital computers. Includes vital facts to aid in increasing programming and coding skills, as well as special coverage of computer design. Discusses how the computer installation is organized and operated. By G. Evans II, C. Perry, & R. Keirstead, Stanford Res. Inst. 262 pp., illus., \$9.50

**NAB ENGINEERING  
HANDBOOK**

Use this standard reference from the National Ass'n. of Broadcasters to solve problems in all areas of broadcast engineering more quickly . . . accurately . . . efficiently. This revised and enlarged Fifth Edition covers the entire range of radio-tv engineering . . . contains information and methods constantly needed by engineers, operators, and technicians. Ed. by A. P. Walker, Assisted by G. W. Bartlett. 1728 pp., 1306 illus. & tables, \$27.50

- ELECTRONICS AND NUCLEONICS DICTIONARY.** By N. M. Cooke and J. Markus. 513 pp., 452 illus., \$15.00
- PRINCIPLES AND APPLICATIONS OF ELECTROMAGNETIC FIELDS.** By R. Plonsey & R. Collin. 554 pp., illus., \$12.75
- FOUNDATIONS OF FUTURE ELECTRONICS.** By D. Langmuir and W. Hershberger. 512 pp., \$10.75
- SEMICONDUCTOR DEVICES AND APPLICATIONS.** By R. A. Greiner. 493 pp., illus., \$12.50

**10 DAYS' FREE TRIAL**

McGraw-Hill Book Co., Dept. L-2-9  
327 W. 41st St., New York 36, N. Y.

Send me book(s) checked below for 10 days' examination on approval. In 10 days I will remit for book(s). I keep plus few cents for delivery costs, and return unwanted book(s) postpaid. (We pay delivery costs if you remit with this coupon—same return privilege.)

- Calabro—Reliability Prin. & Prac., \$10.50
- Constance—Mech. Eng. for P.E. Exams., \$10.00
- Evans & Perry—Prog. & Coding for Auto. Digital Computers, \$9.50
- Cooke & Markus—Elec. & Nucleon. Dict., \$15.00
- Plonsey—Prin. & Appli. of Electromag. Fields, \$12.75
- Langmuir & Hershberger—Found. of Fut. Elec., \$10.75
- Greiner—Semiconduc. Dev. & Appli., \$12.50

Name .....

Address .....

City ..... Zone ..... State .....

Company .....

Position .....

For price and terms outside U. S. write  
McGraw-Hill International, N.Y.C. 36 L-2-9

**CIRCLE 218 ON READER SERVICE CARD**  
February 9, 1962

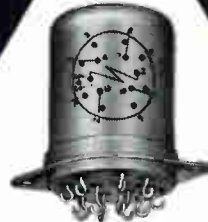

Type FC-4-250  
4P-DT  
(Military designation RY4LB3B3L01)



Type FC-6-250  
6P-DT  
(Military designation RY4LC3B3L01)

**RELAY  
RELIABILITY  
PIONEERS  
OF THE  
SPACE  
AGE**

Redstone . . . Minuteman . . .  
Hawk . . . Bomarc . . . Polaris  
. . . and dozens of other ground and  
airborne equipment programs have benefited from the time proven reliability of Struthers-Dunn FC-4 (4P-DT) and FC-6 (6P-DT) subminiature hermetically sealed can relays. Full quality control extends from incoming materials to finished units. They're made and assembled under spotlessly clean, rigidly controlled environmental conditions. Exacting performance to MIL-R-5757D specifications is doubly assured by constant checking in Dunco's quarter of a million dollar in-plant test laboratories. Greatly expanded facilities assure fast deliveries on both standard and special units.

Write for Data Bulletin FC.  
STRUTHERS-DUNN, Inc., Pitman, New Jersey

**STRUTHERS-DUNN**  
5,348 Relay Types

Sales Engineering offices in: Atlanta • Boston • Buffalo • Charlotte • Chicago • Cincinnati • Dallas • Dayton • Denver • Detroit • High Point • Kansas City • Los Angeles • Montreal • Orlando • Pittsburgh • St. Louis • San Carlos • Seattle • Toronto • Export: Langguth-Olson

**CIRCLE 127 ON READER SERVICE**

# electronics

## WEEKLY QUALIFICATION FORM FOR POSITIONS AVAILABLE

### ATTENTION: ENGINEERS, SCIENTISTS, PHYSICISTS

This Qualification Form is designed to help you advance in the electronics industry. It is unique and compact. Designed with the assistance of professional personnel management, it isolates specific experience in electronics and deals only in essential background information.

The advertisers listed here are seeking professional experience. Fill in the Qualification Form below.

#### STRICTLY CONFIDENTIAL

Your Qualification form will be handled as "Strictly Confidential" by ELECTRONICS. Our processing system is such that your form will be forwarded within 24 hours to the proper executives in the companies you select. You will be contacted at your home by the interested companies.

#### WHAT TO DO

1. Review the positions in the advertisements.
2. Select those for which you qualify.
3. Notice the key numbers.
4. Circle the corresponding key number below the Qualification Form.
5. Fill out the form completely. *Please print clearly.*
6. Mail to: D. Hawksby, Classified Advertising Div., ELECTRONICS, Box 12, New York 36, N. Y. (No charge, of course).

COMPANY	SEE PAGE	KEY #
ATOMIC PERSONNEL INC. Philadelphia, Pennsylvania	132	1
EITEL-McCULLOUGH INC. San Carlos, California	84*	2
ELECTRO-MECHANICAL RESEARCH INC. Sarasota, Florida	132	3
ESQUIRE PERSONNEL SERVICE INC. Chicago, Illinois	130	4
GENERAL DYNAMICS/POMONA Pomona, California	103	5
GRUMMAN AIRCRAFT ENGINEERING CORP. Bethpage, L. I., New York	129	6
INTERNATIONAL BUSINESS MACHINES CORP. New York, New York	131	7
LINK DIVISION General Precision Inc. Binghamton, New York	80*	8
LOCKHEED CALIFORNIA CO. A Div. of Lockheed Aircraft Corp. Burbank, California	115	9
LOCKHEED-GEORGIA CO. A Div. of Lockheed Aircraft Corp. Atlanta, Georgia	14*	10
MICROWAVE SERVICES INTERNATIONAL, INC. Denville, New Jersey	130	11
MOTOROLA, INC. Chicago, Illinois	130	12
NATIONAL CASH REGISTER CO. Dayton, Ohio	132	13
PHILCO WESTERN DEVELOPMENT LABORATORIES Palo Alto, California	133	14
UNION CARBIDE NUCLEAR CO. Oak Ridge, Tennessee	132	15
P-7950	130	16
P-8238	132	17

\* These advertisements appeared in the 2/2/62 issue.

(cut here)

(cut here)

### electronics WEEKLY QUALIFICATION FORM FOR POSITIONS AVAILABLE

#### Personal Background

NAME .....

HOME ADDRESS .....

CITY ..... ZONE ..... STATE .....

HOME TELEPHONE .....

#### Education

PROFESSIONAL DEGREE(S) .....

MAJOR(S) .....

UNIVERSITY .....

DATE(S) .....

#### FIELDS OF EXPERIENCE (Please Check)

2/9/2

- |  |  |                                       |
|--|--|---------------------------------------|
| <input type="checkbox"/> Aerospace           | <input type="checkbox"/> Fire Control        | <input type="checkbox"/> Radar        |
| <input type="checkbox"/> Antennas            | <input type="checkbox"/> Human Factors       | <input type="checkbox"/> Radio-TV     |
| <input type="checkbox"/> ASW                 | <input type="checkbox"/> Infrared            | <input type="checkbox"/> Simulators   |
| <input type="checkbox"/> Circuits            | <input type="checkbox"/> Instrumentation     | <input type="checkbox"/> Solid State  |
| <input type="checkbox"/> Communications      | <input type="checkbox"/> Medicine            | <input type="checkbox"/> Telemetry    |
| <input type="checkbox"/> Components          | <input type="checkbox"/> Microwave           | <input type="checkbox"/> Transformers |
| <input type="checkbox"/> Computers           | <input type="checkbox"/> Navigation          | <input type="checkbox"/> Other .....  |
| <input type="checkbox"/> ECM                 | <input type="checkbox"/> Operations Research | <input type="checkbox"/> .....        |
| <input type="checkbox"/> Electron Tubes      | <input type="checkbox"/> Optics              | <input type="checkbox"/> .....        |
| <input type="checkbox"/> Engineering Writing | <input type="checkbox"/> Packaging           | <input type="checkbox"/> .....        |

#### CATEGORY OF SPECIALIZATION

Please indicate number of months experience on proper lines.

	Technical Experience (Months)	Supervisory Experience (Months)
RESEARCH (pure, fundamental, basic)	.....	.....
RESEARCH (Applied)	.....	.....
SYSTEMS (New Concepts)	.....	.....
DEVELOPMENT (Model)	.....	.....
DESIGN (Product)	.....	.....
MANUFACTURING (Product)	.....	.....
FIELD (Service)	.....	.....
SALES (Proposals & Products)	.....	.....

CIRCLE KEY NUMBERS OF ABOVE COMPANIES' POSITIONS THAT INTEREST YOU

1 2 3 4 5 6 7 8 9 10 11 12 13 14 15 16 17 18 19 20 21 22 23 24 25

# THE SCENE AT GRUMMAN AS VIEWED BY THE *Electronics Engineer*



## *...Small World*

Space environment is being created at Bethpage, L. I. Using large Helmholtz coils, Grumman engineers can cancel the magnetic field at their earthbound test site and duplicate the magnetic environment of any satellite orbit around the earth. Either static or programmed time-varying magnetic fields can be generated in this facility. The Helmholtz coils and other devices reproduce many of the same environmental conditions encountered by an orbiting satellite. Literally putting a volume of orbital space in a room, this space simulator was constructed to test space hardware similar to that of the Orbiting Astronomical Observatory which Grumman is now building for the NASA.

Grumman electronics engineers are today involved in many interesting and intellectually stimulating projects involving our defenses, our retaliatory capabilities and our vital space activities. Electronics engineers with a similar work orientation are urged to investigate the following immediate positions:

**Automatic Flight Control Systems Engineers**—EE or Physics degree with a minimum of 5 years experience in the design and development of autopilots. Work will consist of the analysis, synthesis and integration of autopilot systems culminating in hardware implementation.

**Radar Development Engineers**—BSEE with a minimum of 4 years experience in the analysis, design and development of airborne radar systems. Should be capable of analyzing the radar system with the end view of integrating the equipment into a complex weapons system. Will fully participate in laboratory and flight development programs conducted in the finest facilities available in a professional atmosphere.

**ECM Engineers** — BSEE or BS in Physics with a minimum of 3 years experience in the fields of radar systems, passive and/or active counter-measures systems, and ECCM systems. Work involves the development of ECM systems and the integration of ECM equipment with navigation and digital computer systems. Background in digital computers and programming is desirable but not essential.

**Digital Computer Systems Engineer**—BSEE with a minimum of 4 years experience in the analysis design and development of digital computers. Will participate in the integration of digital computer into a complex weapons system. A significant part of the effort will be devoted to extensive laboratory and flight development programs.

To arrange an immediate interview, send your resume to Mr. W. Brown, Manager Engineering Employment, Dept. GR-76  
(U. S. citizenship required)



## **GRUMMAN**

**AIRCRAFT ENGINEERING CORPORATION**  
Bethpage · Long Island · New York

All qualified applicants considered regardless of race, creed, color or national origin.

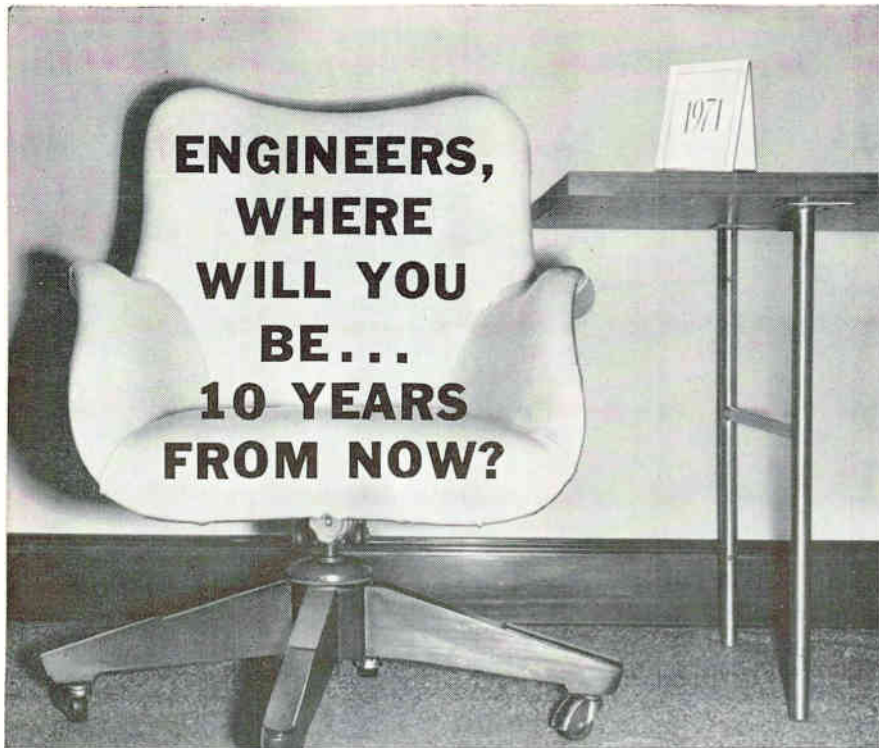

**ENGINEERS,  
WHERE  
WILL YOU  
BE...  
10 YEARS  
FROM NOW?**

Perhaps you've been doing as well as you'd expected—*up to now*. But, if you're apprehensive about the future—if you've wished your assignments were more stimulating—your work more rewarding—you owe it to yourself to investigate the opportunities at Motorola.

Here you will be encouraged to use *all* of your creative talents. You'll work on projects that spark vision, that inspire imagination. Because Motorola is an "engineer's company" you'll be working with respected men who can contribute to your growth—men who are quick to recognize and advance skill. You'll be working for a *secure*, diversified company not wholly dependent on one single market.

There are dozens of fine opportunities covering a wide range of fields of interest—just a few of which are listed below.

Write today. We'll send you a complete description of "Your Life at Motorola"—in Chicago; Phoenix; Riverside, California; Culver City, California; Minneapolis, Minnesota. Naturally your request will be kept in complete confidence.

- Radar transmitters and receivers
- Radar circuit design
- Electronic countermeasure systems
- Military communications equipment design
- Pulse circuit design
- IF strip design
- Device using klystron, traveling wave tube and backward wave oscillator
- Display and storage devices
- Transistor applications
- Crystal engineering
- Sales engineering
- Design of VHF & UHF FM communications in portable or subminiature development
- Microwave field engineers
- Transistor switching circuit design
- Logic circuit design
- T.V. circuit design engineering
- Home radio design
- New product design
- Auto radio design
- Mechanical engineering
- Semi-conductor device development
- Semi-conductor application work

**MR. W. H. HAUSMANN**  
Engineering Personnel Mgr. Dept. D  
4545 Augusta Blvd., Chicago 51, Ill.

All qualified applicants will receive consideration for employment without regard for race, creed, color, or national origin.

 **MOTOROLA inc.**

## EMPLOYMENT OPPORTUNITIES

The advertisements in this section include all employment opportunities — executive, management, technical, selling, office, skilled, manual, etc.

Look in the forward section of the magazine for additional Employment Opportunities advertising.

### — RATES —

**DISPLAYED:** The advertising rate is \$40.17 per inch for all advertising appearing on other than a contract basis. Contract rates quoted on request.

An advertising inch is measured  $\frac{3}{4}$ " vertically on a column—3 columns—30 inches to a page.

Subject to Agency Commission.

**UNDISPLAYED:** \$2.70 per line, minimum 3 lines. To figure advance payment count 5 average words as a line.

Box numbers—count as 1 line.

Discount of 10% if full payment is made in advance for 4 consecutive insertions.

Not subject to Agency Commission.

## MICROWAVE COMMUNICATIONS ENGINEERS

Ankara - Teheran - Karachi  
Bangkok - U. S.

Work involves engineering, supervision of installation, operation and maintenance of microwave communications systems.

College Degree Mandatory

## MICROWAVE COMMUNICATIONS TECHNICIANS

Must be qualified by education and experience to inspect installation, operate and maintain microwave communications systems to insure quality and performance standards.

Technical or trade school training mandatory.

Families May Accompany  
Usual Overseas Benefits

Send detailed resumes to:

P-7950, Electronics  
645 N. Michigan Avenue, Chicago 11, Ill.

### COMMUNICATIONS APPLICATION ENGINEER

Analysis of advanced electronic communication systems including radio, carrier, telephone, microwave.

Must have design and marketing experience with commercial and military users.

EE degree, 5 yrs. exp. min.

Send Resume to:

Microwave Services International Inc.  
Consulting Engineers  
Route 46 Denville, N. J.

### TEN ENGINEERS

Ground & Airborne Communications  
\$8,000 to \$18,000 Year

Positions cover a vast range of equipment systems & techniques. Also advanced development work in Airborne single sideband transceiver & solid state circuit design & micro-miniaturization techniques.

ESQUIRE PERSONNEL

202 South State St. Chicago 4, Ill.

The best way to test new equipment is to put it into actual use. But how can the performance of advanced airborne guidance systems be evaluated without spending millions of dollars in production and flight test of equipment? How can the effect of possible design changes be determined? How much can systems and equipment be improved before over-all performance becomes subject to diminishing returns?

Scientists have been exploring these questions—and many more—at the Simulation Laboratory of the IBM Space Guidance Center in Owego, N. Y. For example, they constructed mathematical and logical models of every factor in a major B-52 air strike. Into an IBM computer went simulation data on enemy missiles, radar, fighter defenses, as well as detailed weather and terrain data and complete aircraft performance parameters. After more than 1200 simulated battles were “fought” inside the

computer, the scientists had the answers to their questions.

The IBM people doing simulation studies such as this have extremely varied backgrounds, mathematics, physics, engineering. But they have in common—the ability to “see” physical problems in mathematical terms and to solve them by machine computation. For people with this ability IBM offers the advantages of advanced technical facilities and widely experienced associates.

If you are interested in one of the areas in which IBM is making important advances—semiconductors, micro-waves, simulation, magnetics, superconductivity, or many others—we’d like to hear from you. IBM is an Equal Opportunity Employer. Write to:  
Manager of Technical Employment  
IBM Corporation, Dept. 55401  
590 Madison Ave., N. Y. 22, N. Y.

**IBM**<sup>®</sup>

## **SIMULATION: 1200 air battles inside a computer**

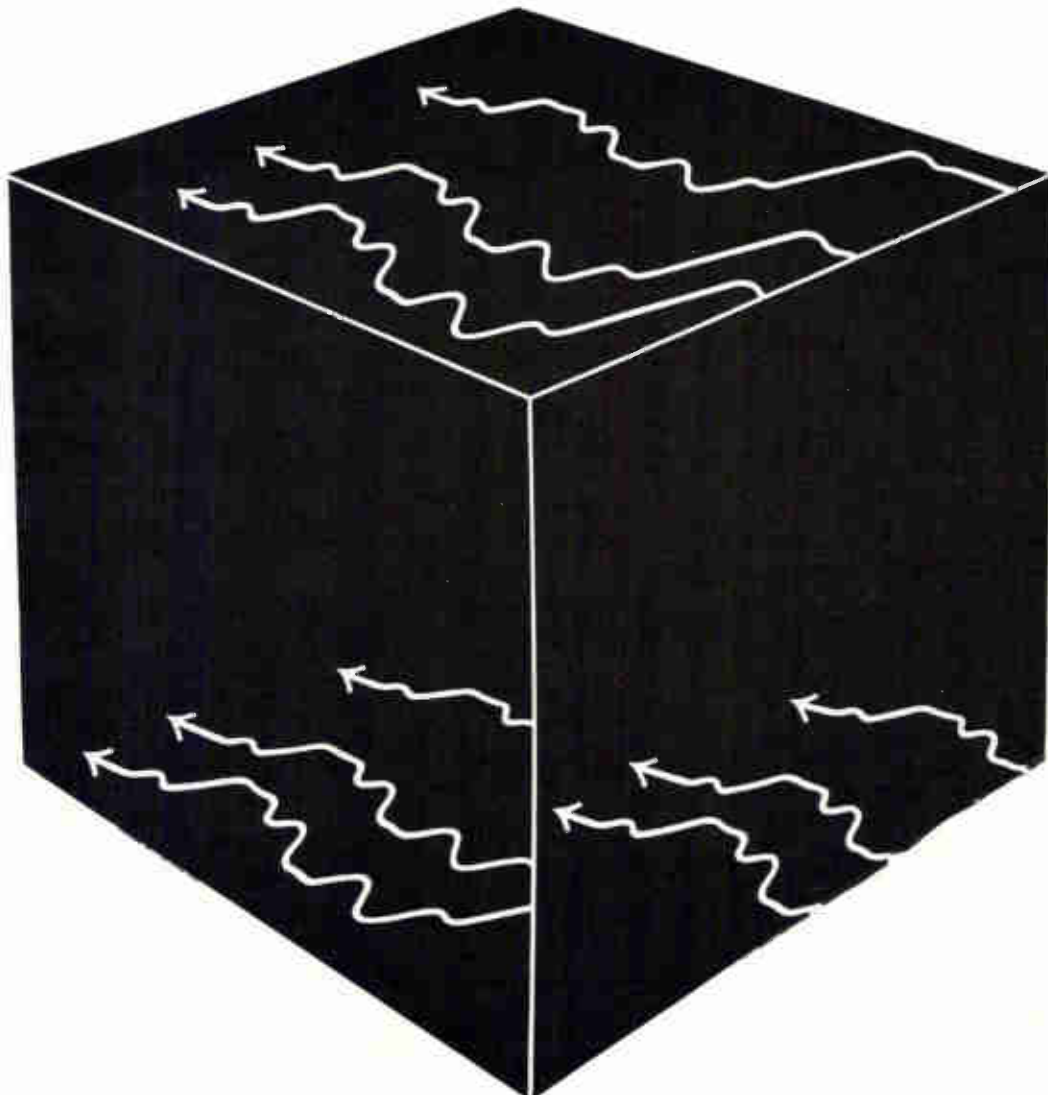

# NCR

## ADVANCED DEVELOPMENT ELECTRONICS

The National Cash Register Company's Research and Development Division located in Dayton, Ohio has opportunity for experienced Senior Engineers and Scientists for the following positions:

NCR's efforts are expanding now to meet the needs of the future for business and government functions. The stable nature of our Company provides an atmosphere for long range planning of personal goals and scientific achievement.

- **DEVELOPMENT PLANNING STAFF** — to conduct studies of electronic equipment requirements for AERO/SPACE projects with background in Microwave Equipment, Digital Computers Electro-Optical Devices, Human Engineering of Controls and Displays, or Navigation and Guidance Systems. Prefer M.S. in E.E. or Physics and 5-7 years experience in Military Development.
- **ENGINEER ANALYST** — to investigate multipath phenomenon relative high frequency communications. BS, EE and some graduate work in mathematics. Prefer experience in information theory and communications.
- **ELECTRONIC ENGINEERS** — BS, EE, 2-5 years in military electronics and familiarity with ground based or airborne equipment development.
- **CIRCUIT ENGINEERS** — BS, EE, 3-5 years in design of electronic equipment using solid state or vacuum tube circuits.
- **LOGIC ENGINEERS**—BS, EE, 2-4 years in design of digital logic circuits.
- **COMPONENT ENGINEERS** — BS, EE, 1-3 years in testing and evaluation of electronic components.
- **COMMUNICATION SYSTEM ENGINEERS**—BS, EE, 5-7 years in the high frequency communication area. Experience in propagation techniques.

To be considered for one of these challenging positions, send resume to:

Mr. T. F. Wade, Technical Placement, The National Cash Register Company, Main and K Streets, Dayton 9, Ohio.

AN EQUAL OPPORTUNITY EMPLOYER



# e·m·r

## Maximum Responsibility FOR **CREATIVE ENGINEERS**

WITH  
**FOLLOW-THROUGH  
CAPABILITIES**

By maintaining a reputation for technical engineering excellence and a position of leadership in research and development, Electro-Mechanical Research, Inc. (e-m-r) has become the largest of all companies specializing in telemetry systems. Today, with the space age bringing new and vital significance to the field of electronics, e-m-r affords mature engineers an environment for maximum responsibility and personal growth.

### **SYSTEMS ENGINEERS — DIGITAL (Telemetry)**

The full weight of the e-m-r engineering approach is brought to bear on these demanding positions. A high level of engineering creativity and skill is required. Most important, there must be a real desire to participate in the entire digital systems effort, including synthesis, development and construction of "custom systems". Compensation proportionate to "follow-through" ability.

Minimum of 3 years experience in detailed design in such areas as digital circuits — using semiconductors and magnetic elements — transistor implemented low level amplifiers, ferrite core memories, logic design of digital computer, analog to digital converters, feed-back amplifiers, servomechanisms, and RF transmitters and receivers — 100 to 1000 megacycle range.

Direct confidential inquiries to  
**ROLAND E. HOOD, JR.**  
Personnel Manager, Systems Division

## electro- mechanical Research, inc.

P. O. Box 3041-C  
Sarasota 2, Florida

An equal opportunity employer

## MARKETING CONSULTANT

We are a leading general management consulting firm, and offer an excellent growth opportunity on our marketing consulting staff for a young man with several years of experience. This should include a year or two of field sales, plus some line or staff level experience in market research, product management, or sales administration. We want experience with a manufacturer of industrial electronic equipment or components. An engineering degree is preferred, or B. Adm., and an M.B.A. or M.A. with a marketing emphasis. Moderate travel, home all weekends, Chicago base. Starting earnings in the \$9,000 to \$12,000 range, depending on qualifications. Please reply fully; confidence will be observed.

P-8238, Electronics  
645 N. Michigan Ave., Chicago 11, Ill.

### **Electronic Instrument Technicians The Oak Ridge National Laboratory Operated by UNION CARBIDE NUCLEAR COMPANY at Oak Ridge, Tennessee Has openings for**

Highly skilled electronic instrument technicians to work with electronic engineers in the development, installation and maintenance of electronic systems. Digital data handling, transistorized pulse height analyzers, analog and digital computer systems are only a few examples.

Minimum high school education, with additional training in electronics and at least three years' experience in installation and maintenance of complex electronic systems. Entrance rate \$3.10 per hour; \$3.16 per hour after six months. Reasonable interview and relocation expenses paid by Company.

**Excellent Working Conditions  
and  
Employee Benefit Plans  
An Equal Opportunity Employer**

Send detailed resume to:

**Central Employment Office  
UNION CARBIDE NUCLEAR COMPANY**  
Post Office Box M Oak Ridge, Tennessee



## E. E.'s

For professional, individualized fee-paid service write for confidential application.

A national employment agency for the Nuclear & Scientific Fields.

**ATOMIC PERSONNEL, INC.**  
Suite 1207L, 1518 Walnut St., Phila. 2, Pa.

ADDRESS BOX NO. REPLIES TO: Box No.  
Classified Adv. Div. of this publication.  
Send to office nearest you.  
NEW YORK 36: P. O. Box 12  
CHICAGO 11: 645 N. Michigan Ave.  
SAN FRANCISCO 11: 255 California St.

### SELLING OPPORTUNITY AVAILABLE

**Prominent Relay Mfrs. want experienced sales representative Metropolitan area. Highest quality low prices—guarantee respectable earnings. RW-8272, Electronics.**

### RESUMES

**Resumes by Richton, the dynamic, dignified approach to best jobs. Expertly prepared, professionally written, custom printed. Complete analysis and evaluation with or without personal visit. Free bonus features. Nationwide service. Free literature. The Richton Company, Dept. F, 1020 Broad, Newark, N. J.**

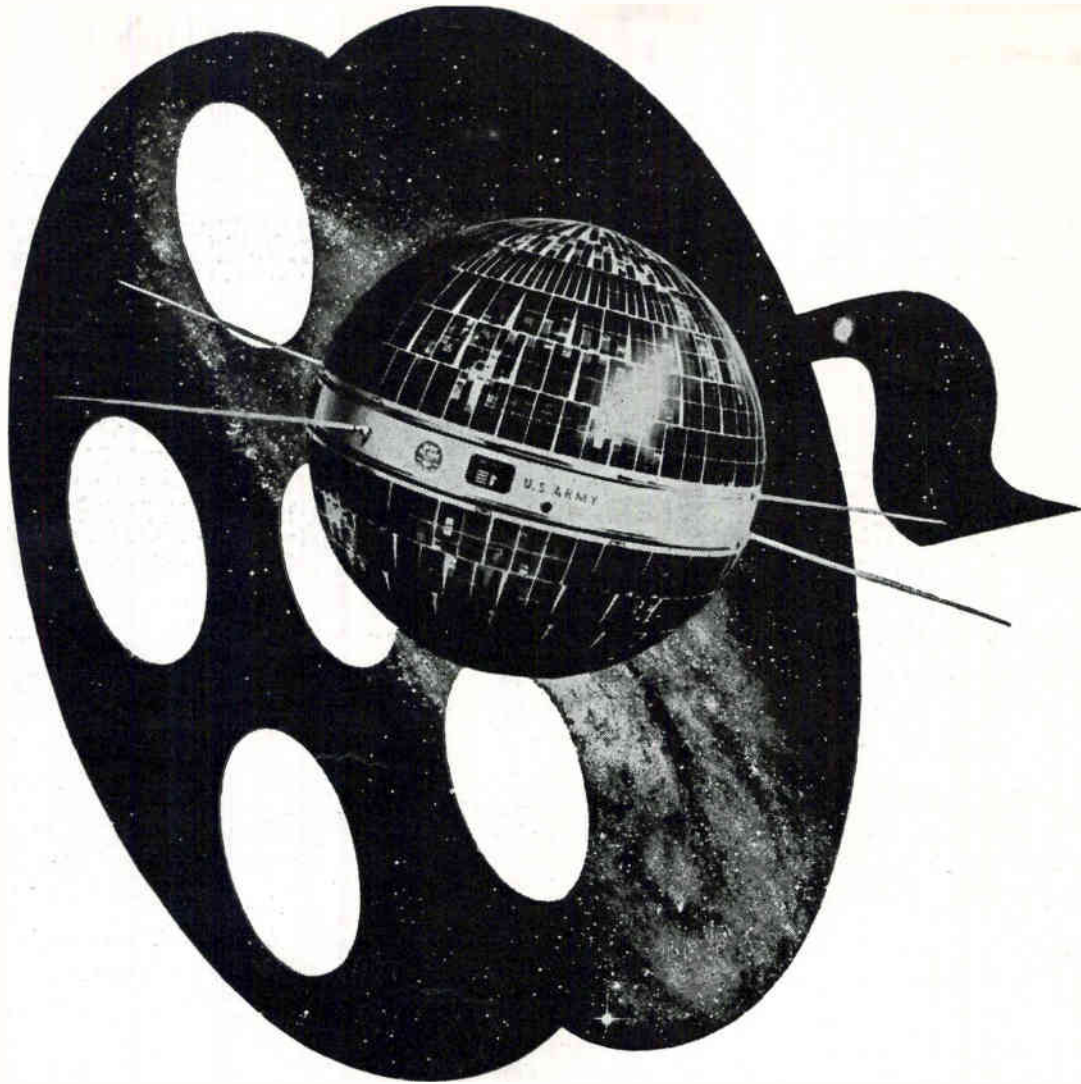

## LP Record—Stellar Style

The message from Courier is just one of the challenges offered to you at PHILCO Western Development Laboratories, whose long record in space communications achievement merely presages the adventure ahead.

From the earliest plans to invade space, PHILCO Western Development Laboratories has played a vital role in satellite vehicle instrumentation, still but *part* of its contribution to space communications. From this newest electronics center on the San Francisco Peninsula comes a continuing flow of advanced missile tracking, range and data processing instrumentation.

Added research projects and growing programs assure *you* a long and rewarding career as a member of the PHILCO Western Development Laboratories. What you think and what you do can be unhampered and uninhibited. Personal recognition and advancement promptly follow performance, with monetary rewards to match. Northern California provides an affluent climate for living, as PHILCO Western Development Laboratories provides a stimulating climate for working. For information on careers in electronic engineering, please write Mr. W. E. Daly, Dept. E-9.

**PHILCO**  
Famous for Quality the World Over



**WESTERN DEVELOPMENT LABORATORIES**

3875 Fabian Way, Palo Alto, California

BUSINESS OPPORTUNITIES

EQUIPMENT - USED or RESALE

**DISPLAYED RATE**

The advertising rate is \$27.25 per inch for advertising appearing on other than a contract basis. Contract rates quoted on request. AN ADVERTISING INCH is measured 7/8 inch vertically on one column, 3 columns—30 inches—to a page. EQUIPMENT WANTED or FOR SALE ADVERTISEMENTS acceptable only in Displayed Style.

The publisher cannot accept advertising in the Searchlight Section, which lists the names of the manufacturers of resistors, capacitors, rheostats, and potentiometers, or other names designed to describe such products.

Send NEW ADS or inquiries to Classified Adv Div. of Electronics P. O. Box 12, N. Y. 36, N. Y.

**UNDISPLAYED RATE**

\$2.70 a line, minimum 3 lines. To figure advance payment count 5 average words as a line.

BOX NUMBERS count as one line additional in undisplayed ads.

DISCOUNT of 10% if full payment is made in advance for four consecutive insertions of undisplayed ads (not including proposals.)

## ANTENNA PEDESTAL SCR 584-MP 61B

Full azimuth and elevation sweeps 360 degrees in azimuth. 210 degrees in elevation. Accurate to 1 mil. or better over system. Complete for full tracking response. Angle acceleration rate: AZ, 9 degrees per second squared EL, 4 degrees per second squared. Angle slewing rate: AZ 20 degrees per sec. EL, 10 degrees per sec. Can mount up to a 20 ft. dish. Angle tracking rate: 10 degrees per sec. Includes pedestal drives, selsyns, potentiometers, drive motors, control amp/dynes. Excellent condition. Quantity in stock for immediate shipment. Ideal for missile & satellite tracking, antenna pattern ranges, radar system, radio astronomy, any project requiring accurate response in elevation and azimuth.

Complete description in McGraw-Hill Radiation Laboratory Series, Volume 1, page 284 and page 209, and Volume 26, page 233.

### SCR 584 RADARS AUTOMATIC TRACKING RADAR

Our 584s in like new condition, ready to go, and in stock for immediate delivery. Ideal for research and development, airway control, GCA, missile tracking, balloon tracking, weather forecasting, anti-aircraft defense tactical air support. Write us. Fully Desc. MIT Rad. Lab. Series, Vol. 1, pps 207-210, 228, 284-286.

### AN/TPS—1D RADAR

500 kw. 1220-1359 mcs. 160 nautical mile search range P.P.I. and A. Scopes, MTI. thratron mod. 5J26 magnetron. Like new. Complete system incl. spare parts and gas generator field supply.

### AN/TPS 10D HEIGHT FINDER

250 KW X-Band. 60 & 120 mile ranges to 60,000 feet. Complete.

### AN/APS—15B 3 CM RADAR

Airborne radar. 40kw output using 725A magnetron. Model 3 pulser. 30 in. parabola stabilized antenna. PPI scope. Complete system. \$1200 each. New.

### 10KW 3 CM. X BAND RADAR

Complete RF head including transmitter, receiver, modulator. Uses 2J42 magnetron. Fully described in MIT Rad. Lab. Series Vol. 1, pps. 616-625 and Vol. II, pps. 171-185 \$375. Complete X Band Radar System also avail. incl. 360-deg. antenna, PPI, syn pwr supply. Similar to \$17,000 weather radar now in use by airlines, \$750 complete.

### 10 CM. WEATHER RADAR SYSTEM

US Navy Raytheon, 275 KW peak output S band. Rotating yoke Plan position Indicator. Magnetron supplied for any S band frequency specified, incl. Weather Band. 4, 20 and 80 mile range. Price \$975. Has picked up clouds at 50 miles. Weight 488 lbs.

### CARCINOTRON

Type CM 706A Freq. 3000 to 4000 mcs. CW. Output 200 Watts minimum. New, with full guarantee.

### MIT MODEL 9 PULSER

#### 1 MEGAWATT—HARD TUBE

Output pulse power 25 KV at 40 amp. Max. duty ratio: 002. Uses 6C21 pulse tube. Pulse duration .25 to 2 microsec. Input 115 volts 60 cycles AC. Includes power supply in separate cabinet and driver. Fully guaranteed as new condition. Full Desc. MIT. Rad. Lab. Series "Pulse Generators."

### 500 KW PULSER

5C22 Hydrogen Thyration Modulator. 22KV at 28 Amps. W/HV & Fil Supplies. 3 pulse length rep rates: 2.25 usec 300 pps. 1.75 usec 550 pps. .4 usec 2500 pps. 115V 60 cy AC Input.

### MIT MODEL 3 PULSER

Output: 144kw (12kv at 12amp.). Duty ratio: 001 max. Pulse duration: .5 1 and 2 micro sec. Input: 115v 400 to 2000 cps and 24 vdc. \$325 ea. Full desc. Vol. 5 MIT Rad. Lab. series pg 140.

### L BAND RF PKG.

20KW peak 990 to 1040MC. Pulse width 7 to 1.2 micro sec. Rep rate 180 to 420 pps. Input 115vac. Incl. Receiver \$1200.

### 225 KW X-BAND RF

4J50 Magnetron KW Generator with dummy load & Dir. Cpir. Variable rep rates. Variable power output 115V 60-cycle AC input. New. \$2200 complete.



**RADIO RESEARCH  
INSTRUMENT CO.**  
550 FIFTH AVE., NEW YORK  
JUDSON 6-4691

CIRCLE 460 ON READER SERVICE CARD

## QUIZ PIC # 1



## WHAT IN THE WORLD (of electronics) IS THIS?

This is our idea of little fun and recreation. Examine the magnified portion of this photograph . . . and see if you can identify this "tool of the industry." If you can't . . . turn to PAGE ELECTRONICS ad on page 136 for the answer.

CLUE: It's not a crystal ball . . . but it is used in predicting weather.

CIRCLE 461 ON READER SERVICE CARD

### FOR LEASE OR SALE

Plant suitable for experimental, electronic and production work. Fully equipped with machine tools. Location Long Island. Approximately 25,000 feet including air conditioned offices. Approximately 6 years old.

80-8239, Electronics

Class Adv. Div., P.O. Box 12, N. Y. 36, N. Y.

CIRCLE 462 ON READER SERVICE CARD

## LIFSCHULTZ FAST FREIGHT

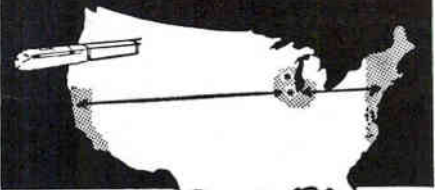

### PIGGYBACK

TO BOTH COASTS

TRUCKLOAD RATES

TO BOTH COASTS

•We welcome your inquiry.

PROMPT  
DAILY  
PICKUP  
and  
DELIVERY

## FASTEST TO BOTH COASTS!

CIRCLE 463 ON READER SERVICE CARD

## SEARCHLIGHT Equipment Locating Service

### NO COST OR OBLIGATION

This service is aimed at helping you, the reader of "SEARCHLIGHT", to locate Surplus new and used electronic equipment and components not currently advertised. (This service is for USER-BUYERS only).

How to use: Check the dealer ads to see if what you want is not currently advertised. If not, send us the specifications of the equipment wanted on the coupon below, or on your own company letter-head to:

### Searchlight Equipment

Locating Service

c/o ELECTRONICS

P. O. Box 12, N. Y. 36, N. Y.

Your requirements will be brought promptly to the attention of the equipment dealers advertising in this section. You will receive replies directly from them.

Searchlight Equipment Locating Service  
c/o ELECTRONICS, P.O. Box 12, N.Y. 36, N.Y.

Please help us locate following equipment components.

.....  
.....  
NAME .....

TITLE .....

COMPANY .....

STREET .....

CITY .....

2/9/62



**GET IT from GOODHEART!**

**INTERESTING NEW ARRIVALS:**

American Time Products #2001-2H Freq. Standard 10 kc  $\pm 0.01\%$  is 2 kc fork module plus 5X multiplier module, new, regularly over \$400. with instructions, dwgs. **\$69.50**

Counters module & switching counts above down to 1000, 500, 250 & 125 cy **\$49.50**

Gen. Radio #760-A Sound Analyzer gives exact amplitude of all components 25 to 7500 cps. Regularly \$520.00 only **\$175.00**

Navy OCK R.F. Bridge is same electrically as Gen. Radio's #620  $\pm 916AL$ , 25-5000 kc, specially good for antenna measurements. Like new with all accessories, only **\$195.00**

Aer-O-Com Artificial Antenna DA-200 cranks up to exact L. C. & R of antennas 2 to 22 mc for trimming transmitters up to 200 W Po. Regularly \$425.00. Like new, only **\$175.00**

Boonton 203B Univertor zero-beats your VHF signal generator (50 ohms Zo) at 75 mci then detune to get accurately-calibrated  $\pm 100$  kc to 25 mc. with Vo same as set at your signal generator. Regularly \$420.00, only **\$129.50**

TS-452A/U sweep-freq. signal generator 5 to 100 mc with built-in scope synched to sweep rate. Wavemeter accurate  $\pm 0.33\%$  puts marker on display. Attenuator 0-101 db in 1 db steps accurate  $\pm 1.5\%$ . Certified OK **\$275.00**

**0.1% SORENSEN Line Voltage Regulator**

$\pm 5000S$  regul. against load changes 0-5 kva & line changes 95-130 v, 1 ph 50/60 cy; out. output 110-120 v, holds to 0.1%, Harm. less than 3%. Recovery 1.5 sec. Regularly \$695.00 less spares. New w/ spares orig. pack, 285 lbs fob Utica **\$349.50**  
 $\pm 10002S$  is same except 1 kva, 190-260 in to 230 v out, 1 ph, fob Los Angeles **\$179.50**  
**SOLA BARGAINS!** All standard harm., 1 ph, 4rd regulation, 2 kva, grd 100% OK, 95-125 v, 60 cy in to 115 v out 0-17.4 A, fob Wash. DC or Sunol, Calif. Shpg wgt 250 lbs. Only **\$79.50**  
With taps for 50/60 cy, & dual primary 95-125 or 190-250 v, fob Harrisburg, Pa. **\$89.50**  
Convert above for 230 v  $\pm 1\%$  output with new Westinghouse Autotransformer, 5 kva, 115/230 v, 50/60 cy, fob Los Angeles. Add only **\$45.00**



**R. E. GOODHEART CO.**  
P. O. Box 1220-E Beverly Hills, Calif.

CIRCLE 464 ON READER SERVICE CARD

**CAPACITORS**

MFD VOLTS	PRICE	MFD VOLTS	PRICE
.001 75KV	80.00	1 9000V	24.50
*.025 50KV	29.50	1 16KV	69.95
*.2 50KV	64.50	3 20KV	125.00
+25 15KV	15.95	4 10KV	67.50
+25 20KV	22.50	5 10KV	70.50
+25 32.5KV	44.50	9 10KV	145.00
+5 25KV	29.50	10 5000V	45.00
+1 7500V	8.00	10 5000V	48.00
+1 25KV	59.50		

— SPECIAL —

32 mfd—600 V **\$3.50**  
Comprising four 8 mfd sections, 5 solder lug terms. Dims.  $4\frac{1}{2} \times 3\frac{1}{2} \times 3\frac{1}{2}$ . Large qua. available.  
\* Case Common.  
† Large qua. available.  
Write for complete listing

**MONMOUTH RADIO LABS.**

BOX 247—OAKHURST, N. J.  
CAPITOL 2-0121 ART HANKINS, Prop.

CIRCLE 465 ON READER SERVICE CARD

**COMPUTER DIODES**

Brand new in original manufacturer's packing at a fraction of large quantity OEM prices:

- 56,000 Hughes HD-2311
- 20,000 Hughes HD-6079
- 49,000 Sylvania IN-115
- 3,000 Sylvania IN-119
- 1,500 Amperex IN-480

To be sold as a complete lot, individual lots or any quantity of any number and priced accordingly. Write or phone your requirements. Quotation by return mail, or phone.

**CAPITOL COMMODITIES COMPANY, Inc.**  
4757 N. Ravenswood Avenue  
Chicago 40, Illinois

ALL PHONES: LOngbeach 1-3355

CIRCLE 466 ON READER SERVICE CARD

**TUBE & COMPONENT FREE CATALOG BARRY ELECTRONICS**

512 BROADWAY NEW YORK 12, N.Y. Walker 5-7000 TWX: NY 1-3731

CIRCLE 467 ON READER SERVICE CARD

**SPECIAL PURPOSE TUBES**

OA2	.80	4-65A	10.00	25Z6WGT	1.50	725A	12.50	5751WA	1.50
OA2WA	2.00	4-125A	20.00	26Z25W	1.50	726A	3.00	5763	1.75
OA3	.85	4-250A	32.50	FG-27A	20.00	726B	5.00	5777	150.00
OB2	.60	4-400A	30.00	28D7W	3.50	726C	8.50	5778	150.00
OB2WA	2.00	4-1000A	90.00	FG-32	6.50	NL-760	20.00	5783	1.75
OB3	.70	4AP10	10.00	35T	10.00	802	5.00	5787	2.00
OC3	.50	4B31	12.50	35TG	1.50	803	3.50	5796	8.00
OD3	.30	4C27	7.50	FP-54	100.00	804	15.00	5800 VY-41	5.00
C1A	6.50	4C35	15.00	FG-57	6.00	805	5.00	5803 VY-55	2.25
1AD4	1.50	4CX250B	35.00	RK-60/1641	1.25	807	1.35	5814A	1.35
1B24A	10.00	4D32	15.00	HY-69	3.00	807W	1.50	5829	.75
1B35A	3.00	4E27	7.50	BL-75	3.00	808	1.00	5830/FG41	100.00
1B63A	10.00	4J32	100.00	TG-77	7.50	809	5.25	5836	50.00
1C 3B22	5.00	4J34	100.00	HF-100	10.00	810	15.00	5837	50.00
C1K	6.00	4J50	75.00	100TH	12.00	811	2.50	5840	1.75
1P21	30.00	4J52	25.00	100T1	12.00	811A	4.00	5845	4.50
1P22	8.00	4PR60A	60.00	FG-105	15.00	812A	4.75	5852	3.00
1P25	8.00	4X150A	15.00	F-123A	5.00	813	12.50	5876	8.50
1P28	15.00	4X150D	15.00	FG-172	25.00	814	3.50	5879	1.75
1Z2	1.50	4X150G	25.00	211	2.50	815	2.50	5881 6L6WGB	2.50
2-01C	12.50	4X250B	25.00	212E	25.00	816	2.25	5886	2.50
2AP1A	6.50	4X250F	30.00	FG-235	40.00	826	3.50	5894	18.85
2B23	20.00	5BP1A	9.50	242C	10.00	828	12.50	5915	1.00
2BP1	8.50	5C22	17.50	244A	2.50	829B	9.50	5917 5U4WG	4.00
2C36	22.50	5CP1A	9.50	245A	2.50	832	2.50	5933/807W	1.75
2C39A	9.75	5CP7A	9.50	249B	10.00	832A	7.50	5948 1754	75.00
2C39B	18.75	5D21	7.50	249C	5.00	833A	37.50	5949 1907	50.00
2C40	7.50	5J26	50.00	250R	10.00	834	7.50	5963	1.10
2C42	3.00	5LP1	7.50	250TH	25.00	836	2.50	5964	.85
2C43	7.50	5R4C4Y	1.10	251A	50.00	837	1.00	5965	.85
2C46	5.00	5R4WGA	5.00	254A	2.00	838	1.00	5992	2.50
2C50	4.00	5R4WCB	6.00	FG-258A	75.00	842	7.50	5993	5.00
2C51	1.50	5R4WGY	2.75	259A	3.50	845	7.50	6002/QK221	250.00
2C52	1.50	5R1A	9.50	262B	3.50	849	75.00	6005 6AQ5W	1.00
2C53	8.00	5Y3WGT	1.25	267B	5.00	850	12.50	6012	3.50
2D21	.50	5Y3WGTB	3.00	271A	12.50	851	35.00	6021A	2.00
2D21W	1.00	6AC7W	.50	274A	3.50	866A	1.90	6027/2J42A	100.00
2E22	2.50	6AC7WA	2.00	283A	3.50	869B	50.00	6032	10.00
2E24	2.25	6AG5WA	1.50	287A	3.00	872A	4.50	6037/QK243	50.00
2E26	2.50	6AG7Y	.90	QK-288	250.00	874	.75	6045	1.15
2J42	70.00	6AK5W	1.00	HF-300	35.00	884	1.25	6072	1.50
2J51	50.00	6AK5 (WE)	.75	300B	5.00	885	.85	6073	1.00
2J55	90.00	6AL5W	.60	304TH	25.00	902-P1	3.50	6074	2.00
2K22	25.00	6AN5	1.75	304TL	35.00	913	9.50	6080	3.00
2K25	8.50	6AN5WA	3.50	307A	.40	920	2.50	6080WA	5.00
2K26	35.00	6AQ5W	1.00	310A	3.50	927	1.50	6080WB	10.00
2K28	30.00	6AR6	.75	311A	3.00	931A	3.50	6082	2.50
2K29	25.00	6A56	.85	313C	1.50	1000T	80.00	6087 5Y3WGTB	3.00
2K30	50.00	6A56W	1.00	323A	6.00	R1130B	10.00	6101 6J6WA	1.00
2K33A	200.00	6A57G	2.75	328A	3.00	1500T	125.00	6115/QK351	40.00
2K34	75.00	6AU6WA	1.25	336A	3.00	1603	4.00	6130 3C45	5.00
2K35	250.00	6B4G	3.35	337A	3.50	1611	2.00	6136 6AU6WA	1.25
2K39	150.00	6B4G	.75	347A	1.00	1614	2.75	6146	3.00
2K41	50.00	6B6E6W	1.50	348A	4.00	1616	1.00	6159	3.50
2K42	125.00	6B6W	2.75	349A	2.50	1619	.25	6161	50.00
2K43	150.00	6B6L	20.00	350A	3.50	1620	4.00	6186 6AG5WA	1.50
2K44	125.00	6B6M	25.00	350B	2.50	1624	1.00	6189 12AU7WA	1.50
2K45	20.00	6B6MA	30.00	352A	8.50	1625	.50	6197	1.75
2K47	125.00	6C4W	2.50	354A	10.00	1846	50.00	6198	75.00
2K48	50.00	6C4WA	1.00	355A	10.00	1855	250.00	6199	37.00
2K50	80.00	6C21	17.50	371B	2.50	2050	1.25	6201 12AT7WA	1.55
2K54	10.00	6D4	1.25	388A	2.00	ZB-3200	100.00	6202 6X4WA	1.80
2K55	15.00	6F4	3.50	393A	5.00	5528/C6L	3.50	6211	.50
2K56	50.00	6C6/A	10.00	394A	3.00	5545	20.00	6216	2.75
2P21	40.00	C6J	15.00	395A	3.00	5550	30.00	6233	100.85
2X2A	1.00	C6J/K	20.00	396A/2C51	1.50	5552/FG235	40.00	6236	125.00
3A5	.75	6A4	1.50	398A/5603	3.00	5553/FG258	75.00	6248	500.00
3AP1	2.00	6J4WA	2.50	401A/5590	1.00	5557/FG17	5.00	6263	9.00
3B24W	3.00	6J6W	.60	403B/5591	2.50	5558/FG32	6.50	6264	9.00
3B24WA	5.00	6J6WA	1.00	404A/5847	7.50	5559/FG57	6.00	6265 6B6W	2.00
3B25	2.50	6K4	2.00	407A	3.75	5560/FG95	20.00	6299	37.75
3B26	2.25	6L6GAY	.75	408A/6028	3.25	5561/FG104	40.00	6316/BL800A	100.50
3B28	3.00	6L6WGA	1.50	409A/6A56	1.00	5636	2.25	6322/BL25	15.00
3B29	5.00	6L6WGB	2.50	410R	75.00	5642	2.00	6336	8.00
3BP1A	5.00	6Q5G	2.50	416B/6280	35.00	5643	3.00	6336A	12.75
3C/4B24	4.00	6S17WGT	1.25	417A/5842	9.50	5647	3.00	6344/QK235	500.50
3C22	25.00	65K7W	.75	418A	9.50	5651	.75	6352	7.00
3C23	4.00	65K7WA	2.00	420A/5755	5.00	5654/6AK5W	1.25	6385	5.50
3C24/24G	5.00	65L7WGT	1.00	421A/5998	7.50	5656	2.50	6390	125.00
3C33	7.50	65N7W	.50	422A	10.00	5663	.75	6394	10.00
3C45	3.50	65N7WGT	1.00	429A	6.50	5665/C16J	35.00	6438	5.00
3CX100A5	15.00	65N7WGTA	2.50	GL-434A	10.00	5670	1.00	6463	1.00

## INTERESTING TO NOTE . . .

NEW YORK, N. Y. Feb. 1962:—

Universal Relay Corp., 42 White St., New York 13, N. Y. announces the publication of their 52 page Spring 1962 catalog. With publication of the catalog, they inform their customers that "normal inventory includes over 1,500,000 relays in approximately 30,000 types. In most cases stock is sufficient to give immediate delivery of production quantities.

This catalog is, therefore, not just a listing of items available 'on order' but, by and large, it is an indication of in-stock items (either as complete units or as ready to assembly components).

The average shipment is made within 48 hours. Where coils and frames require assembly, or relays require special testing or adjustment, shipments are made within one week to ten days.

Universal is completely equipped to assemble, adjust and thoroughly test any type of relay. Assembly and test facilities have been imitated by some relay manufacturers.

A personal interest is taken in every order. This interest is maintained as the order is processed. And, it continues even after the customer receives the merchandise until he make sure that it satisfies his needs.

All merchandise is guaranteed, subject to customers' inspection and approval, and may be returned within 30 days for replacement or credit.

The catalog is full of items to fill everyday relay requirements".

Catalogues may be obtained by writing directly to:

### UNIVERSAL RELAY CORP.

42 White Street, New York 13, N. Y.



# NEW

From  
McGraw-Hill

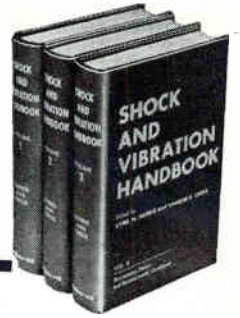

## How to solve major engineering problems in shock/vibration

Here is a 3-volume library of tremendous scope for engineers who must control or minimize shock and vibration. Only in this one authoritative source will you find all the information you need to apply all major aspects of shock and vibration to engineering problems. It more than covers vibration theory fully . . . it also details the most practical specialized phases. Fundamentals, descriptions of apparatus, explanations of methods, practical examples, and useful data are presented in a wealth of detail.

# SHOCK AND VIBRATION Handbook Library

Prepared by a Staff of Specialists  
Edited by Cyril M. Harris and Charles E. Crede  
3 volumes, 2029 pages, 1200 illustrations  
\$47.50, payable \$7.50 in 10 days and \$8.00 monthly

- Basic Theory and Measurements
- Data Analysis, Testing, and Methods of Control
- Engineering Design and Environmental Conditions

72 specialists bring you a comprehensive array of dependable facts . . . in 50 sections. These 3 volumes, the equivalent in compressed information to a large number of technical books, meet the needs of engineers in a wide range of fields . . . mechanical, electronic, air conditioning, aeronautical, civil, chemical, naval, manufacturing, and automotive, to mention a few. Wherever projects for the design of machinery, vehicles, missiles, structures, electrical systems, transportation packages or other devices involve shock or vibration, you can find solutions more readily and effectively here. Contains liberal cross-referencing. Bristled with facts, details, and data.

### 10 DAYS' FREE EXAMINATION

McGraw-Hill Book Co., Dept. FL-2-9  
327 W. 41 St., New York 36, N.Y.

Send me Shock and Vibration Handbook Library for 10 days' examination on approval. In 10 days I will (check one)  remit \$47.50 plus few cents delivery costs; or  \$7.50 in 10 days and \$8.00 a month until \$47.50 is paid. Otherwise I will return books postpaid. (We pay delivery costs if you remit with order; same examination and return privilege.)

Name . . . . .  
Address . . . . .  
City . . . . . Zone . . . . . State . . . . .  
Company . . . . .  
Position . . . . .

For price and terms outside U.S., write McGraw-Hill Int'l., N.Y.C. 36 FL-2-9

### CIRCLE 469 ON READER SERVICE CARD

#### TRANSCO "Y" Type Coaxial Switch SPDT

Miniature Light weight CoAx switch with low VSWR and broad band width. Works to 11 KMC. Separate actuator coils for each circuit. Type "N" connectors, 50 Ohm nominal impedance. Actuator voltage 28 volts DC, 6 Watts each coil.

TRANSCO Number 11100 Our price \$20.00 each. LARGE QUANTITY AVAILABLE.

#### "RED" JOHNSON ELECTRONICS

3311 PARK BLVD., PALO ALTO, CALIF.  
DAvenport 6-6085

### CIRCLE 472 ON READER SERVICE CARD

#### SMALL AD but BIG STOCK

of choice test equipment and surplus electronics

Higher Quality—Lower Costs  
Get our advice on your problem

#### ENGINEERING ASSOCIATES

434 Patterson Road — Dayton 19, Ohio

### CIRCLE 473 ON READER SERVICE CARD

### QUIZ PIC ANSWER #1

#### IT'S A TYPE 725A MAGNETRON . . . Our February SPECIAL at \$45.00 each

We carry a complete line of current and hard-to-get TUBE TYPES . . . including ELECTROMETER • TRAVELING WAVE • PHOTO-MULTIPLIER • POWER • KLYSTRON MAGNETRON • THYRATRON • VOLTAGE REGULATING X-RAY • RECEIVING • ORTHICON • RECTIFYING  
Call or write for prices on any tube type . . . by any manufacturer.

136 Liberty Street  
New York 6, N. Y. • Co 7-4245  
24 Hour Telephone

### PAGE ELECTRONICS

### CIRCLE 471 ON READER SERVICE CARD

# Wilgreen

can deliver Amphenol



Bendix  
Cannon

## CONNECTORS FITTINGS & CLAMPS

We stock more than 5,000,000 MS/AN CONNECTORS . . . of 50,000 variations! In PRODUCTION QUANTITIES . . . we sell BELOW "O.E.M." PRICE and offer IMMEDIATE "OFF-THE-SHELF" DELIVERY!

**FREE** . . . Send for latest brochure and list price chart

WILGREEN INDUSTRIES, Inc.  
102 Warren Street, New York 7, N. Y.  
WOrth 4-2490-1-2 Wire: FXK

### CIRCLE 470 ON READER SERVICE CARD

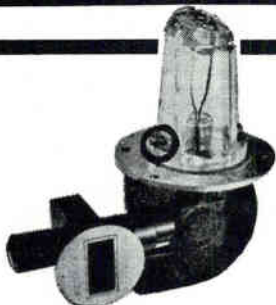

# ELECTRONIC

WAR TERMINATION INVENTORIES  
 ON ON OUR  
 ELECTRONIC  
 NET F.O.B.

WRITE OR WIRE FOR YOUR  
 COMPLETE LINE OF  
 COMPONENTS.

PASADENA, CALIF. DIFFERENTIAL  
 BALL-BEARING  
 GEARS

reverse ratio  
 are 48-tooth,  
 with brass  
 available face.  
 The shaft  
 for then increases  
 in length 3/16"  
 is .377 dia. 1/4" lg.  
 clear the body.  
 each \$15.00

### WITH SPACED-OUT SUN GEARS

reverse ratio spur gears  
 aluminum, 3/32" face, 32  
 teeth, 32 teeth on one side,  
 32 teeth on the other. The  
 sun gears are spaced  
 1/2" apart. 1/4" dia. shaft on  
 1/32" long. OA length 3/4". Re-  
 dia. to clear the body.  
 A6-124 each \$4.50

### 400-CYCLE MOTOR GENERATOR, PU-20

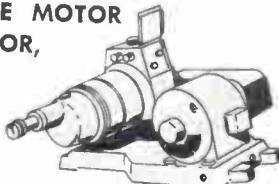

The generator assembly consists of a 1400-watt, 120-volt, 400-cycle inductor-alternator and a 400-watt, 27-volt D.C. generator. The alternator rotor and the D.C. generator armature are mounted on a common shaft, which is dual-belt-driven by a 3-H.P., 1750-R.P.M., 115/230-volt, single-phase 60-cycle electric motor. Weatherproof output box is mounted on top of the stator shell. It contains a rheostat, adjustable resistor, two pin jacks for plugging in an A.C. voltmeter. Size: 28" W., 33" L., 18" H. Weight, approx. 250 lbs. Price \$175.00

### 8-DAY ELAPSED-TIME SURPLUS AIRCRAFT CLOCK



Here's an accurate time-control center that'll help you win your next rallye. It not only tells you the date and time of day right to the second, it's a stop watch that gives you elapsed time in seconds, minutes, and hours! The 24-hour clock simplifies adding and subtracting elapsed time for your navigator. Manufactured by Elgin Watch Co. to exacting military specifications, it will remain accurate in spite of road bumps and vibrations. Uses no electrical connections. Does the job of high-cost equipment. Jeweled/Sweep Second Hand/Luminous Hands and Numerals/25-Hour Dial/Black Face and Plastic Case/3/4" Mounting.  
 Cast the Government \$185.00

Only \$39.95 Postpaid

### SPERRY VERTICAL GYRO



Part #673073, Motor  
 115 volts, 3 phase, 400  
 cycle, 8 watts, 20,000  
 RPM. 3-minute runup, synchro pickoffs, roll  
 360°, pitch 85°. Synchro excitation 26 volts,  
 400 cycle, 150 m.a. Vertical accuracy ±1/2".  
 Weight 3 1/2 lbs. Approx. dim. 5 1/2" L., 4 1/2"  
 W., 4 1/2" H. Price \$35.00

# C&H

SALES CO.

2176-E East Colorado St.  
 Pasadena 8, California  
 MUrray 1-7393

### VARIABLE SPEED BALL DISC INTEGRATORS

(All Shafts Ball Bearing Supported)  
 No. 145 Forward & Reverse 2 1/4" - 0.2 1/4". Input shaft spline gear 12 teeth 9/32" dia. 1/8" long. Output shaft 15/64" dia. x 15/32" long. Control shaft 11/32" x 1/8" long. Cost aluminum construction. Approx. size 3" x 3" x 2 3/4" \$17.50

No. 146 Forward & Reverse 4-0-4. Input shaft 5/16" dia. x 1/8" long. Output shaft 15/64" dia x 9/16" long. Control shaft 11/64" dia. x 11/16" long. Cost aluminum construction. Approx. size 4 1/2" x 4 1/2" x 4" \$18.50 ea.

### SMALL DC MOTORS



- (approx. size over 3/4" x 1 1/4" dia.)
- 5067043 Delco 12 VDC PM 1" x 1" x 2", 10,000 rpm. \$7.50
  - 5067126 Delco PM, 27 VDC, 125 RPM, Governor Controlled 15.00 ea.
  - 5069600 Delco PM 27.5 VDC 250 rpm 12.50
  - #5069625 120 rpm, mfr. Delco, 27 VDC governor controlled \$15.00
  - 5069230 Delco PM 27.5 VDC 145 rpm 15.00
  - 5068750 Delco 27.5 VDC 160 rpm w. brake 6.50
  - 5068571 Delco PM 27.5 VDC 10,000 rpm (1x1x2") 5.00
  - 5069790 Delco PM, 27 VDC, 100 RPM, Governor Controlled 15.00 ea.
  - #5069800 575 rpm, mfr. Delco, 27 VDC, PM reversible governor controlled, equipped with 27 VDC clutch \$17.50
  - 5072735 Delco 27 VDC 200 rpm governor controlled 15.00
  - 5BA10A118 GE 24 VDC 110 rpm 10.00
  - 5BA10AJ37 GE 27 VDC 250 rpm reversible 10.00
  - 5BA10AJ52 27 VDC 145 rpm reversible 12.50
  - 5BA10AJ50, G.E., 12 VDC, 140 rpm 15.00
  - 5BA10FJ401B, G.E. 28 VDC, 215 rpm, 10 oz. in., 7 amp. contains brake 15.00
  - 5BA10FJ421, G.E. 24 VDC, 4 rpm, reversible, 6 oz. in., .65 amp 15.00

### 400 CYCLE PM GENERATOR

115/200 volts A.C. 1- or 3-phase, 200 watts 4,000 r.p.m. Approx. dimensions: 4 3/4" dia., 3" long; 1/2" shaft, AN connector. \$75.00

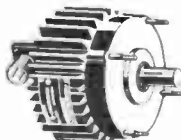

### DIRECTIONAL INDICATOR, TYPE C5C



Mfr. Summers Gyro-scope Company, 115 volt A.C., 400 cycle, 3 phase. Contains direct reading gyro with caging mechanism and power failure indicator. Hermetically sealed case. 5" dial, 0 to 360° PRICE \$22.50

### MINNEAPOLIS-HONEYWELL RATE GYRO (Control Flight)



Part no. JG7005A, 115 volts A.C., 400 cycle single phase potentiometer take off resistance 530 ohms. Speed 21,000 r.p.m. Angular momentum 2 1/2 million CM²/sec. Weight 2 lbs. Dimensions 4-7/32 x 3-29/32 x 3-31/64. Price \$22.50

### SELSYNS- SYNCHROS



- 1CT cont. Trans 90/55V 60 cy. \$27.50
- 1DG Diff. Gen. 90/90V 60 cy. 34.50
- 1F Syn. Mir. 115/90V 60 cy. 34.50
- 1G Gen. 115V 60 cy. 34.50
- 1HDG 37.50
- 1HCT 37.50
- 1SF Syn. Mir. 115/90V 400 cy. 12.50
- 23TR4 torque receiver 34.50
- 23TR6 torque receiver 37.50
- 23CT6 control transformer 37.50
- 23CX6 control transmitter 37.50
- 23TX6 torque transmitter 37.50
- 7DG differential generator 37.50
- 2J1F1 Gen. 115/57.5V 400 cy. 7.50
- 2J1F3 Gen. 115/57.5V 400 cy. 10.00
- 2J1FA1 Gen. 115/57.5V 400 cy. 7.50
- 2J1G1 57.5/57.5V 400 cy. 5.00
- 2J1H1 Diff. Gen. 57.5V 400 cy. 7.50
- 2J5D1 Cont. Trans. 105/55V 60 cy. 17.50
- 2J5F1 Cont. Trans. 105/55V 60 cy. 17.50
- 2J5H1 Gen. 115/105V 60 cy. 17.50
- 2J15M1 Gen. 115/57.5V 400 cy. 17.50
- 5CT Cont. Trans. 90/55V 60 cy. 34.50
- 5DG Diff. Mir. 90/90V 60 cy. 34.50
- 5DC Diff. Gen. 90/90V 60 cy. 34.50
- 5F Syn. Mir. 115/90 VAC 60 cy. 34.50
- 5G Syn. Gen. 115/90VAC 60 cy. 34.50
- 5HCT Cont. Trans. 90/55V 60 cy. 37.50
- 5SDG Diff. Gen. 90/90V 60 cy. 12.50
- 6DG Diff. Gen. 90/90V 60 cy. 25.00
- 6G Syn. Gen. 115/90VAC 60 cy. 34.50
- 7G Syn. Gen. 115/90VAC 60 cy. 42.50
- C56701 Type 11-4 Rep. 115V 60 cy. 20.00
- C69405-2 Type 11-1 Transm. 115V 60 cy. 20.00
- C69406 Syn. Transm. 115V 60 cy. 20.00
- C69406-1 Type 11-2 Rep. 115V 60 cy. 20.00
- C78248 Syn. Transm. 115V 60 cy. 12.50
- C78410 Repeater 115V 60 cy. 20.00
- FPE 49-7 Diehl servo motor, 115 volts, 60 cycle, 10 watts 30.00

### 400 CYCLE, 3 PHASE GENERATOR

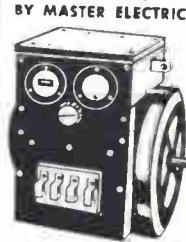

BY MASTER ELECTRIC Type AG, frame 364Y  
 7.5 kw, 3428 rpm, pf  
 .95 Star connected  
 120/208 3 phase, 22  
 amps. Delta connected  
 120 volt single phase  
 6 amps. Self excited.  
 Complete with control  
 box, voltage regulator,  
 AC voltmeter and fre-  
 quency meter. Shaft 1"  
 dia., 2" long; overall  
 dim. of unit: 21" x 18" x  
 20".  
 Price \$395.00 each

### SENSITIVE INTEGRATING GYROS



This is the famous HIG Gyra which is being used in missile guidance systems, radar stabilization and fine control systems. Government cost approximately \$1500.  
 PRICE \$50.00

### 400 CYCLE PM GENERATOR

Mfd. by T K M Electric Corp. Model #A-12  
 120/208 volts, 400 cycle, 1 or 3 phase, 1 kw, pf 0.8, rpm 8,000. Approx. dim. 6" x 5 1/2". Internal spline drive. Price \$100.00

### HONEYWELL VERTICAL GYRO MODEL AG7044A17

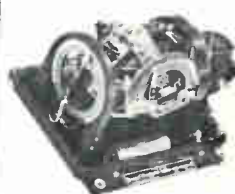

115 volts, 400 cycles, single phase, 35 watts. Pitch and roll potentiometer pickoffs, 890 ohms, 40 volts max. AC or DC. Speed 20,000 rpm, ang. momentum 12,500,000 gm-cm²/sec. Erection system 27 VAC, 400 cycles, time 5 min. to 1/2°; caging mechanism operates on 24 VDC. \$49.50

### DIRECTIONAL GYRO

Mfg. Sperry Part #656519  
 115 VAC 400 N 3 phase

\$35.00 ea.





- Non-Linear Systems, Inc. . . . . 57
- North Atlantic Industries, Inc. . . . . 101

CLASSIFIED ADVERTISING  
F. J. Eberle, Business Mgr.

EMPLOYMENT OPPORTUNITIES 129-133

BUSINESS OPPORTUNITIES . . . . . 134

EQUIPMENT  
(Used or Surplus New)  
For Sale . . . . . 134-137

INDEX TO CLASSIFIED ADVERTISERS

- Ohmite Mfg. Co. . . . . 58  
Ozalid, A Div. of General Aniline & Film Corp. . . . . 105
- Panoramic Electronics, Inc. . . . . 88  
Penta Laboratories, Inc. . . . . 98  
Philamon Laboratories Inc. . . . . 29
- Phileo Corporation . . . . . 83  
Phillips Gloeilampenfabrieken, N. V. 54. 55  
Plastoid Corp. . . . . 56  
Polaroid Corp. . . . . 23  
Potter and Brumfield, Div. American & Foundry Co. . . . . 53

- Radio Corporation of America . . . . . 11th Cover
- Raytheon Company . . . . . 36
- Reeves Instrument Corp., Div. of Dynamics Corp. of America . . . . . 65
- Resistance Products Co. . . . . 112  
Rosemount Engineering Co. . . . . 125

- Sanborn Company . . . . . 19
- Sealectro Corp. . . . . 95  
Security Devices Laboratory . . . . . 140  
Sierra Electronic Corp. . . . . 6  
Sola Electric Co. . . . . 62, 63
- Sorensen & Co. . . . . 93  
Space Technology Laboratories, Inc. . . . . 13  
Sprague Electric Co. . . . . 9, 30  
Stackpole Carbon Co. . . . . 17  
Standard Telephones and Cables Ltd. . . . . 102  
Struthers-Dunn . . . . . 127
- Syntronic Instruments, Inc. . . . . 117

- Telrex Laboratories . . . . . 118  
Texas Instruments Incorporated Apparatus Division . . . . . 114, 120  
Texas Research and Electronic Corp. . . . . 24
- Transifron Electronic Corp. . . . . 15
- Tung-Sol Electric, Inc. . . . . 5
- Varian Associates . . . . . 73  
Victory Engineering Corp. . . . . 18

- Weldmatic Division/Unitek . . . . . 99  
Whitney Metal Tool Co. . . . . 114

- Atomic Personnel Inc. . . . . 132
- Barry Electronics Corp. . . . . 135
- C & H Sales . . . . . 137
- Capitol Commodities Company, Inc. . . . . 135  
Electro-Mechanical Research Inc. . . . . 132
- Engineering Associates . . . . . 136  
Esquire Personnel Service Inc. . . . . 130
- Goodheart Co., R. E. . . . . 135  
Grumman Aircraft Engineering Corp. . . . . 129  
International Business Machines Corp. 131  
Lifschultz Fast Freight . . . . . 134  
Microwave Services International Inc. 130
- Monmouth Radio Labs. . . . . 135  
Motorola Inc. . . . . 130  
National Cash Register Company . . . . . 132
- Page Electronics . . . . . 134, 136  
Philco Western Development Laboratories . . . . . 133
- Radio Research Instrument Co. . . . . 131  
Red Johnson Electronics . . . . . 136  
Union Carbide Nuclear Company . . . . . 132
- Universal Relay Corp. . . . . 136
- Western Engineers . . . . . 135
- Wilgreen Industries Inc. . . . . 136

• See advertisement in the July 20, 1961 issue of Electronics Buyers' Guide for complete line of products or services.

This index and our Reader Service Numbers are published as a service. Every precaution is taken to make them accurate, but ELECTRONICS assumes no responsibilities for errors or omissions.



**SQUARE-LOOP  
TAPE CORES  
TO MEET YOUR  
TOUGHEST  
SPECIFICATIONS**

Speed your specs to Dynacor when you want square-loop tape cores to exact requirements—fast! Here you'll find a dependable combination of personnel, experience and facilities—the know-how to deliver parameters to your very tightest tolerance requirements for switching time, flux, and noise.

Dynacor Square-Loop Tape Cores are manufactured with the high permeability alloys—Grain-Oriented 50-50 Nickel Iron, 4-79 Molybdenum Permalloy, and Grain-Oriented 3% Silicon Iron . . . with fully guaranteed uniformity . . . under rigid standards of control and inspection.

Look to Dynacor for reliable production and swift delivery of your tape core requirements. For your convenience a full line of standard units are stocked for immediate off-the-shelf delivery—Send for bulletins DN 2000, DN 2001, DN 2002.



**DYNACOR**  
**DYNACOR, INC.**  
A SUBSIDIARY OF SPRAGUE ELECTRIC CO.  
35 Marshall St. • North Adams, Mass.

# IN-SENSIBLE?

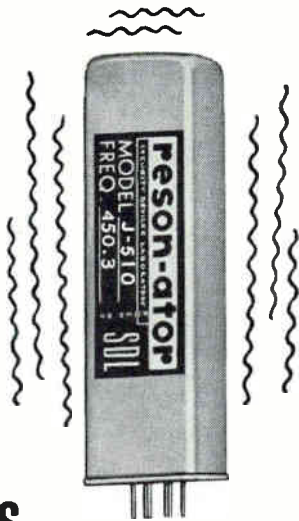

**YES...** our resonant reed relays are virtually insensible to shock, vibration and acceleration. Users swear by them in selective signaling, data transmission, telemetering and remote control systems. SDL frequency selective relays can take it... can *do* it. How about *your* systems problem? We're ready.

#### SPECIFICATIONS: Series J-510

Frequencies: 67 cps to 1600 cps.  
 Bandwidth:  $\pm 2\%$  to  $\pm 2\%$  of design frequency at 10 milliwatt level. Increases to  $\pm 1\%$  to  $\pm 4\%$  at 300 milliwatt level. Adjustable to your specs.  
 Contact Rating: 12 VDC @ 100 milliamps  
 48 VDC @ 10 milliamps  
 150 VDC @ 2 milliamps  
 Contact Dwell Time: 1/20 cycle minimum at 2 VRMS input.  
 Coil Characteristics: You specify, from 3.2 ohms to 5,000 ohms.  
 Temperature Range:  $-40^{\circ}\text{C}$  to  $+85^{\circ}\text{C}$ .  
 Size: .750" x .750" x 3.281". Requires 3.100" above chassis.  
 Connection: Standard seven-pin miniature tube socket.

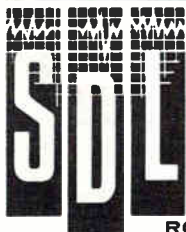

**SECURITY  
 DEVICES  
 LABORATORY**

ELECTRONIC DIVISION OF  
 SARGENT & GREENLEAF, INC.

ROCHESTER 21, N. Y.

electronics



Audit Bureau  
 of Circulations

Associated Business  
 Publications

Audited Paid Circulation

**JAMES T. HAUPTLI**

Advertising Sales Manager

**R. S. QUINT:**  
 Assistant Publisher  
 Business Manager  
**FRED STEWART:**  
 Promotion Manager  
**B. ANELLO:**  
 Marketing Service Manager

**RICHARD J. TOMLINSON:**  
 Production Manager  
**GEORGE E. POMEROY:**  
 Classified Manager  
**HUGH J. QUINN:**  
 Circulation Manager

#### ADVERTISING REPRESENTATIVES

- NEW YORK (36):**  
 Donald H. Miller, Henry M. Shaw, George F. Werner  
 500 Fifth Avenue, OXford 5-5959
- BOSTON (16):**  
 William S. Hodgkinson, Donald R. Furth  
 McGraw-Hill Building, Copley Square, Congress 2-1160
- PITTSBURGH (22):**  
 David M. Watson  
 Four Gateway Center, Express 1-1314
- PHILADELPHIA (3):**  
 Warren H. Gardner, William J. Boyle  
 6 Penn Center Plaza, LOcust 8-4330
- CHICAGO (11):**  
 Harvey W. Wernecke, Robert M. Denmead  
 645 North Michigan Avenue, Mohawk 4-5800
- CLEVELAND (13):**  
 Paul T. Fegley  
 55 Public Square, Superior 1-7000
- SAN FRANCISCO (11):**  
 R. C. Alcorn  
 255 California Street, Douglas 2-4600
- LOS ANGELES (17):**  
 Peter S. Carberry, Ashley P. Hartman  
 1125 W. 6th St., Huntley 2-5450
- DENVER (2):**  
 J. W. Patten  
 Tower Bldg., 1700 Broadway, Alpine 5-2981
- ATLANTA (9):**  
 Michael H. Miller, Robert C. Johnson  
 1375 Peachtree St. N.E., Trinity 5-0523
- HOUSTON (25):**  
 Joseph C. Page, Jr.  
 Prudential Bldg., Holcomb Blvd., Jackson 6-1281
- DALLAS (1):**  
 Frank Le Beau  
 The Vaughn Bldg., 1712 Commerce St. Riverside 7-9721
- LONDON W1:**  
 Dennis McDonald  
 34 Dover St.
- FRANKFURT/Main:**  
 Stanley R. Kimes  
 85 Westendstrasse
- GENEVA:**  
 Michael R. Zeynel  
 2 Place du Port

"Headquarters for Business Information"

#### McGraw-Hill Technical and Business Publications

- |   |                                  |                          |
|---|----------------------------------|--------------------------|
| American Machinist/Metalworking Manufacturing | Electrical Wholesaling           | Product Engineering      |
| Aviation Week and Space Technology            | Electrical World                 | Purchasing Week          |
| Business Week                                 | Electronics                      | Science Week             |
| Chemical Engineering                          | Engineering Digest               | Textile World            |
| Chemical Week                                 | Engineering and Mining Journal   |                          |
| Coal Age                                      | E & MJ Metal and Mineral Markets |                          |
| Construction Methods and Equipment            | Engineering News-Record          | Overseas only:           |
| Construction Daily                            | Factory                          | Automobile International |
| Control Engineering                           | Fleet Owner                      | (English, Spanish)       |
| Electrical Construction and Maintenance       | Industrial Distribution          | Ingenieria Internacional |
| Electrical Merchandising Week                 | National Petroleum News          | Construccion (Spanish)   |
| Electrical Newsletter                         | Nucleonics                       | International Management |
| Electrical West                               | Nucleonics Week                  | (English, Spanish)       |
|   | Platt's Oilgram News             | Portuguese editions)     |
|   | Platt's Oilgram Price Service    | Metalworking Production  |
|   | Power                            | (Great Britain)          |

Available by subscription only — to qualified persons actively engaged in the field of the publication. For subscription rates and information describing the editorial coverage of any of the above publications, write to: Subscription Manager, Circulation Department, McGraw-Hill Publishing Company, 330 West 42nd Street, New York 36, N. Y.

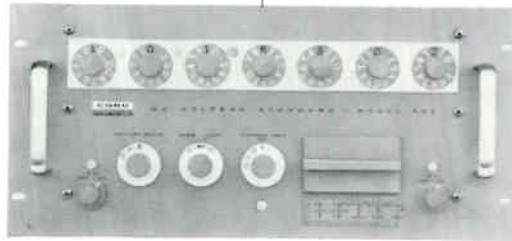

*KIN TEL's remarkable Model 303 DC Voltage Standard*

## NEW! DC STANDARD ACCURATE AND STABLE ENOUGH TO CALIBRATE ANY DIGITAL VOLTMETER!

Now there's a compact source of accurate, precisely adjustable DC from zero to over  $\pm 1100$  volts for just about any laboratory or industrial application—including calibrating and testing digital voltmeters! It's KIN TEL's Model 303 DC Voltage Standard.

*1  $\mu$ v-step adjustments.* Look at its seven decaded controls. These readout-type dials let you control output in microvolt steps from 0 to over  $\pm 11$  volts, in 10-microvolt steps to over  $\pm 110$  volts, and in 100-microvolt steps to over  $\pm 1100$  volts.

*0.01% accuracy, 0.005% stability.* The output is accurate to within 0.01% of the dial setting, and is stable to within 0.0025% for over eight hours and to within 0.005% for over 30 days. Resolution is 0.1 part per million of full scale.

*5, 10, 15, or 25 ma current.* With the 303, you can get up

to 25 milliamperes of current on any voltage range, or you may limit the output by panel control to 5, 10, or 15 milliamperes. If the current you select is exceeded or if the output voltage deviates from the dial setting, an overload relay automatically disconnects the output terminals and causes an indicator lamp to glow.

*Floating guarded circuit.* Because the circuit is fully isolated from both ground and chassis, and is completely shielded and guarded, you may operate it either grounded or floating. Common-mode rejection is 120 db at 60 cps. Separable, sampling terminals provide effective source impedance at the load of 0.001 ohm.

Price: \$2995. F.O.B., San Diego. (50-cps operation at additional cost; programmable, AC/DC, and cabinet versions at factory request.) Write for literature or demonstration.

Visit our booth (No. 3605) at the IRE Show. March 26-29.

Representatives in all major cities. 5725 Kearny Villa Road, San Diego 12, California. Phone 277-6700 (Area Code 714)

**COHU**  
ELECTRONICS, INC  
KIN TEL DIVISION

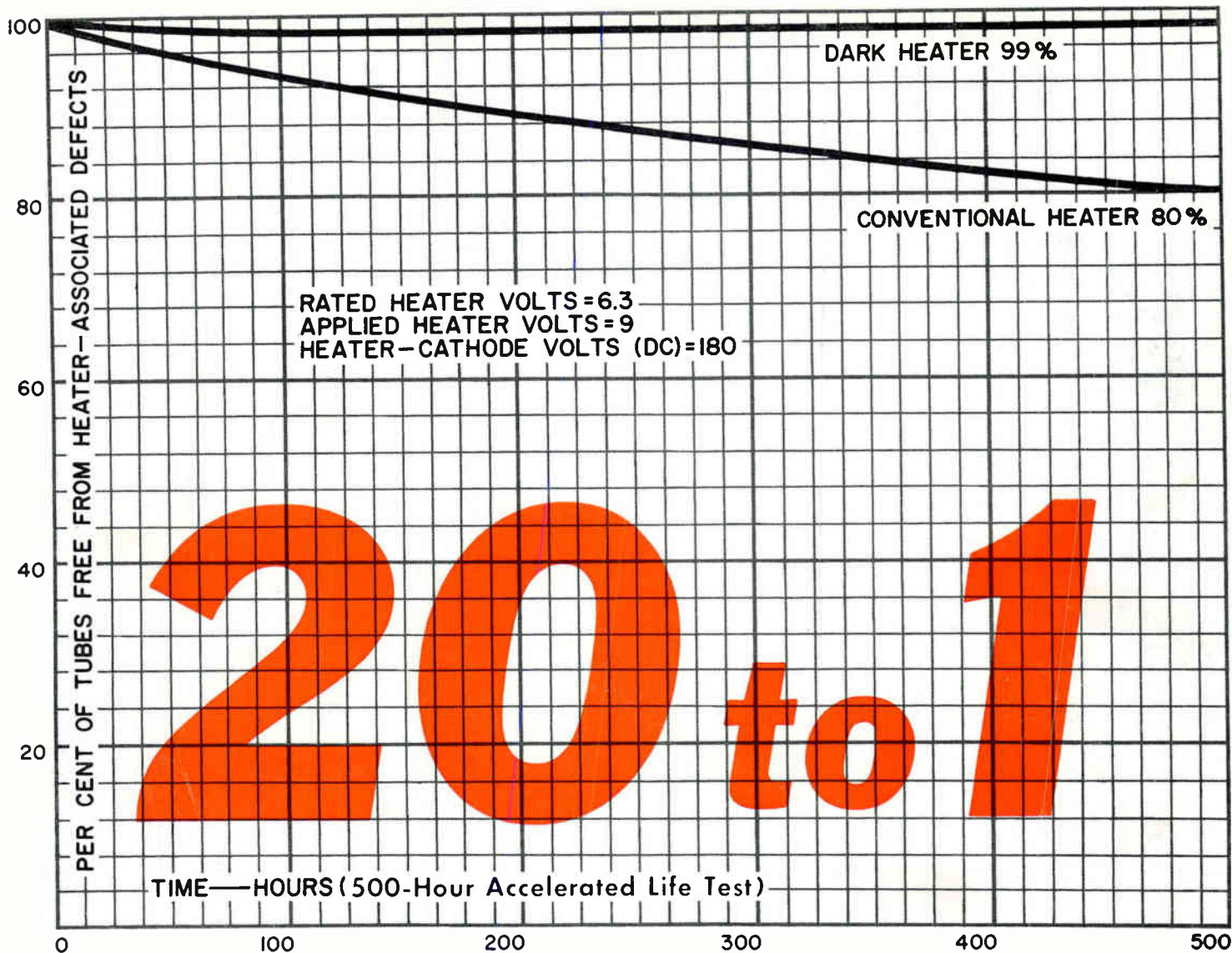

## *reduction in tube failure due to heater-associated defects with revolutionary new RCA "Dark Heater"*



Reduction of tube failures due to heater-associated defects by the amazing factor of 20 to 1 after a 500-hour accelerated heater life cycling test—that's the latest performance triumph chalked up by the revolutionary RCA "Dark Heater".

While tubes with conventional heaters experienced 20 heater-associated defects per 100 tubes, tubes with the "Dark Heater" experienced only one!

Tests were conducted at 143% of rated heater voltage (9 volts for a 6.3-volt type) and at a heater-cathode voltage of 180 volts. Operating cycle was one minute on two minutes off. These 500-hour life tests are the equivalent of operation of a heater for 14,500 hours at normal heater voltage. These tests represented more than a quarter of a million tube hours.

The principle of this remarkable electron tube innovation is quite simple. Since a dark

body emits heat more efficiently than a white body, the "Dark Heater" can operate at about 350°K below the temperature of a conventional heater—yet still produce the required cathode temperature. This means:

- **Longer Heater Life**—as the tests prove, these lower temperatures result in a 50% increase in the ultimate tensile strength of the operating heater wire, and reduce internal stress by 25% during heater "on-off" cycling.

- **Less Chance of Heater Failure.** Reduced operating temperatures and smaller thermal change in cycling minimize tendency toward recrystallization and burnout.

- **Heater-Current Stability on Life.** Conventional heaters often show rising heater current characteristic on life. The "Dark Heater", however, maintains a remarkably stable current characteristic throughout its life.

- **Reduced AC Heater-Cathode Leakage and Hum.** Use of the "Dark Heater" reduces AC leakage and hum particularly "spike" or pulse leakage currents. In addition, lower heater temperature reduces both AC and DC leakage from heater to cathode and heater emission to other tube electrodes.

- **Improved Mechanical Stability.** Cooler operation minimizes changes in heater shape during life, reducing the chance of heater damage or shorts.

- **Greater Safety Margin in H-K Voltage Ratings.** Cooler operation means greater safety margin in present H-K voltage ratings.

Engineering is complete on the inclusion of the Dark Heater in some 200 of the most popular, high-volume OEM RCA receiving tubes—and most are already being delivered. For full information on "Dark Heater" tube types now (or soon to be) available, consult your RCA Field Office.



The Most Trusted Name in Electronics

**RCA ELECTRON TUBE DIVISION—FIELD OFFICES...EAST:**  
744 Broad Street, Newark 2, N. J., HUmboldt 5-3900 •  
**MIDWEST:** Suite 1154, Merchandise Mart Plaza, Chicago  
54, Ill., WHitehall 4-2900 • **WEST:** 6801 E. Washington  
Blvd., Los Angeles 22, Calif., RAymond 3-8361 • 1838  
El Camino Real, Burlingame, Calif., OXFord 7-1620