

electronics

EVAPORATING FILM CIRCUITS

*Turntable does
20 at once, p 70*
(Photo below)

STEREO TEST GENERATOR

*For f-m multiplex
receivers, p 37*

SQUELCH SYSTEM

*Uses double
superhet, p 44*

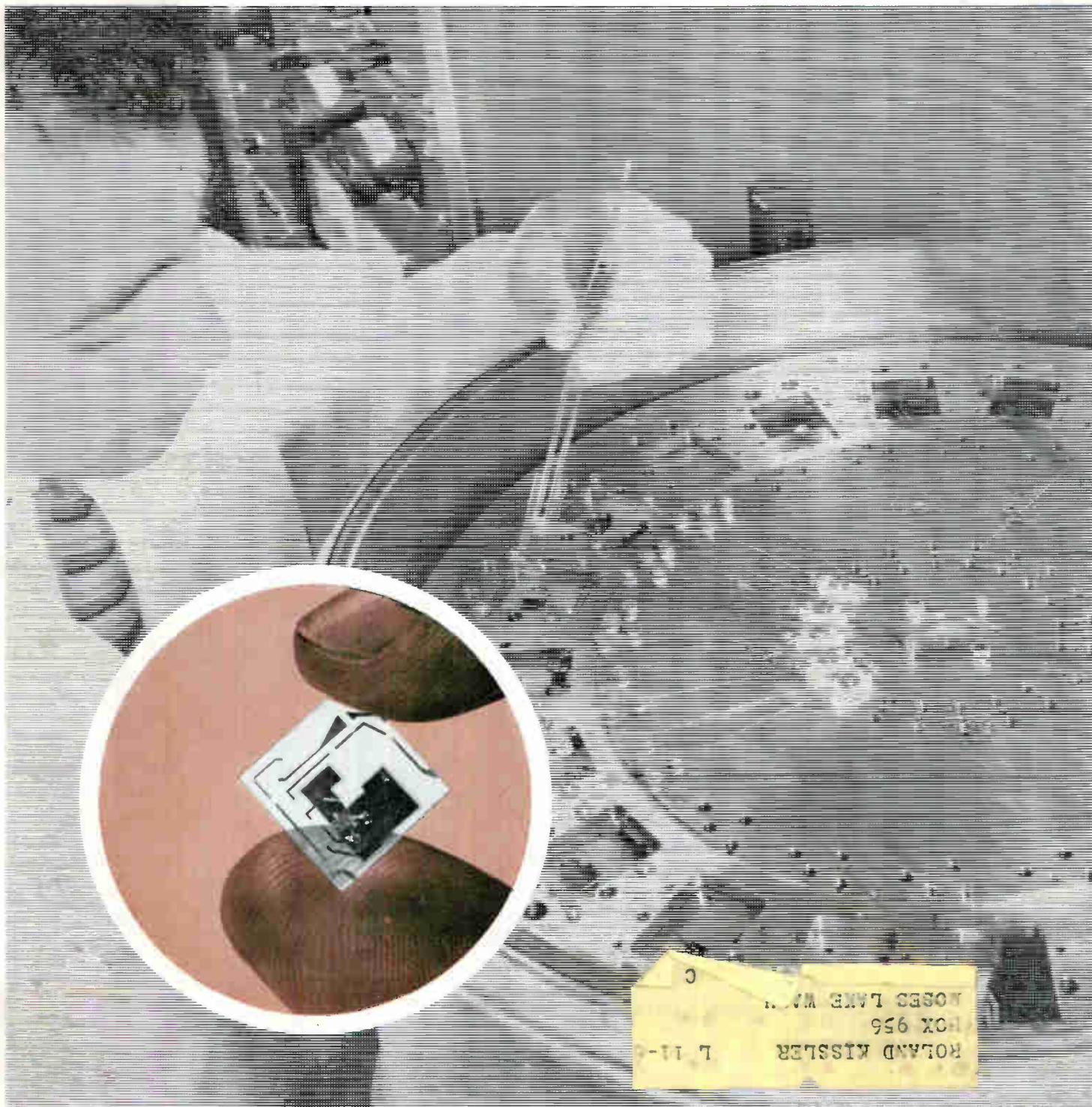

ANOTHER ADVANCED MICROWAVE TUBE DEVELOPMENT
FROM RAYTHEON'S SPENCER LABORATORY

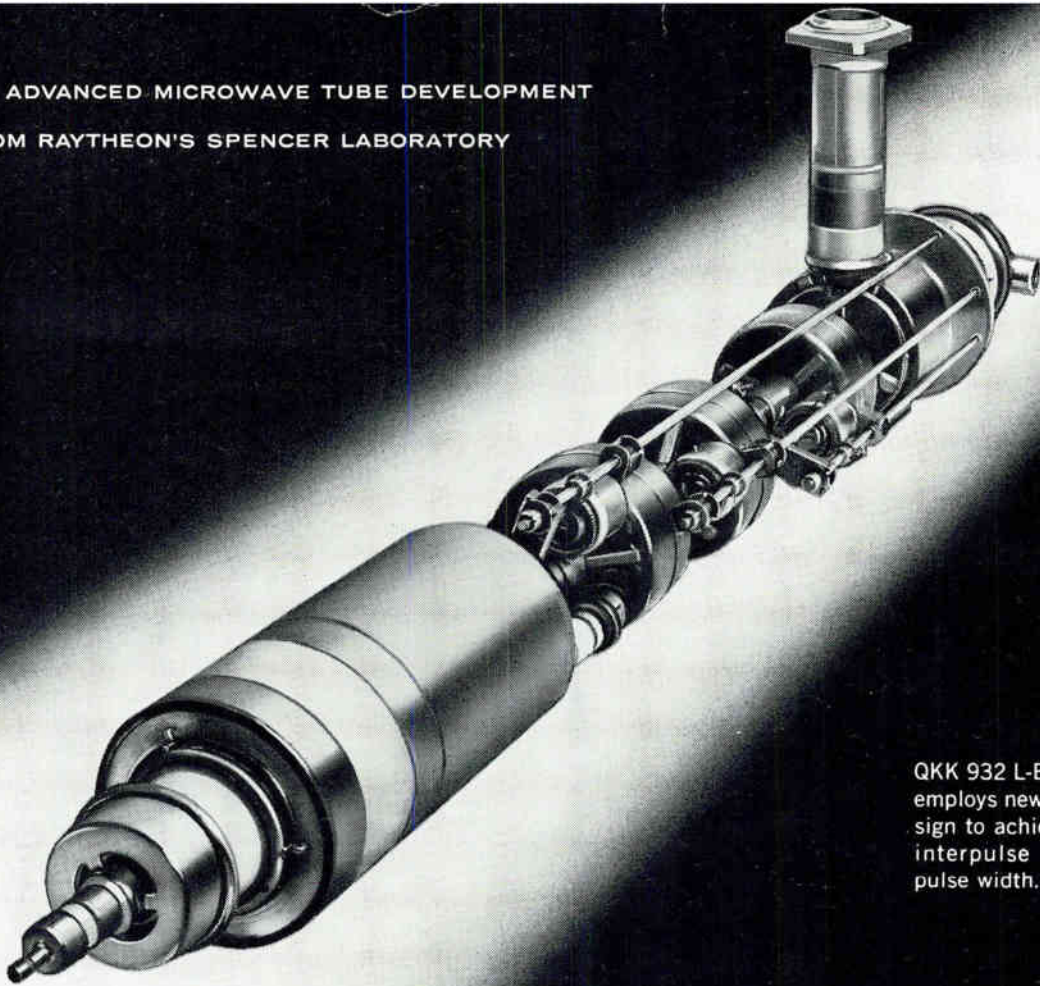

QKK 932 L-BAND KLYSTRON employs new hollow beam design to achieve long life, low interpulse noise, and wide pulse width.

SOMETHING NEW IN KLYSTRONS

Raytheon's QKK 932, first to use magnetron injection gun and modulating anode, offers the advantages of:

- Longer tube life.
- Modulating Anode μ of 3.
- Extremely low interpulse noise.
- Long pulse operation (up to 1000 μ s or longer).

The QKK 932 is a 4-cavity, solenoid focused klystron with a peak power output of 35 kw. The tube is mechanically tunable from 1250-1350 Mc, and has 40 db minimum gain with a minimum efficiency of 35%.

A series of hollow beam injection gun klystrons, from 8 watts CW to 2 Mw peak, are in advanced stages of development. Write today to Raytheon Company, Microwave & Power Tube Division, Waltham 54, Massachusetts.

QKK 932—GENERAL CHARACTERISTICS

Peak Power Output.....	35 kw min.
Frequency (tunable).....	1250-1350 Mc.
Gain	40 db min.
Efficiency	35% min.
Cathode Voltage.....	25 kVdc
Modulating Anode Voltage..	+7.85 kv (peak), -2 kv bias
Input Connection.....	Type N
Output Connection.....	1 $\frac{1}{8}$ " coax.

RAYTHEON COMPANY

MICROWAVE AND POWER TUBE DIVISION
CIRCLE 251 ON READER SERVICE CARD

electronics

A McGraw-Hill Publication 75 Cents



W. W. MacDONALD, Editor

J. M. CARROLL, Managing Editor
 SENIOR EDITORS: Samuel Weber, George W. Sideris. SENIOR ASSOCIATE EDITORS: William E. Bushor, Michael F. Wolff. ASSOCIATE EDITORS: Michael F. Tomaino, Sylvester P. Carter, William P. O'Brien, John F. Mason, Thomas Emma, Sy Vogel, Leslie Solomon, M. M. Perugini, George J. Flynn, Laurence D. Shergalis. ASSISTANT EDITORS: Nilo Lindgren, Stanley Froud, Stephen B. Gray, Roy J. Bruun, George V. Novotny, Leon H. Dulberger. REGIONAL EDITORS: Harold C. Hood (Pacific Coast, Los Angeles), Thomas Maguire (New England, Boston), Cletus M. Wiley (Midwest, Chicago). ART DIRECTOR: Harry Phillips; Howard R. Berry. PRODUCTION EDITOR: John C. Wright, Jr. EDITORIAL ASSISTANTS: Gloria J. Meurer, Bernice Duffy, Lorraine Rossi, Virginia T. Bastian, Lynn Emery, Laura W. Smith, Bette H. Snyder, Rosemary Abbruzzese, Judy Haskins. FOREIGN NEWS BUREAU: Director, John Wilhelm, Alyne Elias. London—John Shinn, Derek Barlow, Nicholas Landon. Bonn—Peter Forbath, James Morrison, Silke McQueen. Paris—Robert Farrell, Arthur Erikson. Milan—Gene DiRaimondo. Mexico City—Bruce Bendow. Rio de Janeiro—Leslie Warren. Moscow—Stewart Ramsey. Tokyo—Richard Hallaron, Charles Cahen, John Yamaguchi.

JAMES GIRDWOOD, Publisher

EVAPORATING THIN-FILM CIRCUITS. Turntable for high-vacuum deposition of microcircuits can do 20 circuits during one pump-down cycle. *So far this approach by Lear has given only passive components but active components may be on the way.* See p 68 COVER

ELECTROCARDIOGRAMS BY PHONE. Physician couples his portable ecg to a telephone and dials a heart specialist for consultation. *Three ecg transmission systems should become available this year* 20

SOLID-STATE ANALYZER. Digital and memory circuits process and display coincident nuclear events. *System could be adapted to chemical processing and other uses* 21

LOW ALTITUDE ALTIMETER Uses Radioisotope Backscatter. Photon reflection from ground tells height within an inch. *Small, low-power system could help spaceships land on uneven terrain* 26

SPACE POWER DATA Will Be Made Available to Private Industry by AEC. Companies able to contribute to R&D can qualify. *But security regulations still prevail* 27

CENTRALIZED PROCUREMENT of Military Electronic Parts. Defense Electronics Supply Center will be buying common-use military components soon. *Variety of parts will be reduced sharply* 28

CARD-TAPE COMPARATOR Sorts Subscription Lists. Memory matches signals from cards and tape. *Tape is prepared by card scanner* 30

F-M STEREO MULTIPLEX Signal Generator. Instrument uses transistors to generate multiplex signal for lining up receivers and adapters. *Schmitt trigger gates out-of-phase amplifiers on and off to produce suppressed-carrier signal.* S. Feldman 37

Contents continued

Published weekly, with Electronics Buyers' Guide and Reference issue, as part of the subscription, by McGraw-Hill Publishing Company, Inc. Founder: James H. McGraw (1860-1948).

Indexed Annually in Buyers' Guide and Reference issue.

Title ® registered U.S. Patent Office; © Copyright 1962 by McGraw-Hill Publishing Co., Inc. All rights reserved, including the right to reproduce the contents of this publication, in whole or in part.

Executive, editorial, circulation and advertising offices McGraw-Hill Building, 330 West 42nd Street, New York 36, N. Y. Telephone Langacre 4-3000. Teletype TWX N.Y. 1-1636. Cable McGrawhill, N. Y. PRINTED IN ALBANY, N. Y.; second class postage paid at Albany, N. Y.

OFFICERS OF THE PUBLICATIONS DIVISION: Nelson L. Bond, President; Shelton Fisher, Wallace F. Traendly, Senior Vice Presidents; John R. Callahan, Vice President and Editorial Director; Joseph H. Allen, Vice President and Director of Advertising Sales; A. R. Venezian, Vice President and Circulation Coordinator; Daniel F. Crowley, Vice President and Controller.

OFFICERS OF THE CORPORATION: Donald C. McGraw, President; Hugh J. Kelly, Harry L. Waddell, Executive Vice Presidents; L. Keith Goodrich, Executive Vice President and Treasurer; John J. Cooke, Vice President and Secretary.

Subscriptions are solicited only from those actively engaged in the field of the publication. Position and company connection must be indicated on orders. Subscription rates: United States and Possessions, \$6.00 one year; \$9.00 two years; \$12.00 three years. Canada, \$10.00 one year. All other countries \$20.00 one year. Single Copies, United States and Possessions and Canada 75¢. Single copies all other countries \$1.50.

THE PUBLISHER, UPON WRITTEN REQUEST FROM ANY SUBSCRIBER TO OUR NEW YORK OFFICE, AGREES TO REFUND THAT PART OF THE SUBSCRIPTION PRICE APPLYING TO COPIES NOT YET MAILED.

Subscribers: Please address all correspondence, change of address notices, subscription orders or complaints to Fulfillment Manager, Electronics, at above address. Change of address notices should provide old as well as new address, including postal zone number if any. If possible, attach address label from recent issue. Allow one month for change to become effective.

Postmaster: Please send Form 3579 to Fulfillment Manager, Electronics, 330 West 42nd Street, New York 36, New York.



Audited Paid Circulation

CONTENTS Continued

MICROWAVE RELAY: Designing With Traveling-Wave Tubes. System uses high-power microwave amplifiers, horn antennas and special frequency-shifting plan. *Designers chose low-deviation f-m as compromise between pulse modulation and high-deviation f-m*

DOUBLE SUPERHET Controls Receiver Squelch. Carrier-operated squelch system uses double-superheterodyne reflex principle to detect presence of carrier. *May reduce receiver removals due to maladjusted squelch.* J. M. Tewksbury 44

MEDICAL ELECTRONICS Part VII: Studying Life Processes. Spectroscopy, radiography and photometry help identify and measure characteristics of living matter. *Electronics aids in conquest of disease and search for secret of life itself.* W. E. Bushor 47

ASTRONAUT RESCUES Require Redesign of Space-Capsule Beacon. Visual display of encoded pulses eliminates ambiguity in identification and gives direction. *Cuts both recovery time and number of planes and ships needed.* J. G. Richter 50

DEPARTMENTS

Crosstalk. *Symbols and Standards* 3

Comment. *Proprietary Piracy, Radar Meteorology* 4

Electronics Newsletter. *Complaint from Government: Too Many Incompetent Electronics Firms* 7

Washington Outlook. *Congress May Air Non-profit Contractor Dispute* 12

Meetings Ahead. *Broadcast and Television Receivers Spring Conference* 32

Research and Development. *Horn Patterns Are Recorded to Tenth Harmonic* 56

Components and Materials. *Connector Design Provides Positive Linear Contacts* 60

Production Techniques. *Evaporator Deposits Microcircuits* 68

New Product Design. *Mechanical Sampling Switch Has No Slip Rings* 75

Literature of the Week 82

People and Plants. *Beck: Analyze . . . Then Choose* 84

Index to Advertisers 96

Symbols and Standards

ONE OF THE MOST frustrating situations currently confronting the designer of semiconductor circuits is the wide range of terminology and symbology used for some of the newer devices.

There is, even now, a way out of this maze of confusion: use the terms and symbols developed by the various technical committees of the IRE and AIEE. They have already been adopted by the American Standards Association as part of a proposed revision of Y32.2, "Graphical Symbols for Electrical and Electronic Diagrams." They have been adopted by the Armed Forces as part of MIL-STD 15.1, dated October 30, 1961. And they have been submitted to the International Electrotechnical Commission by the U. S. delegation.

Shown here are semiconductor symbols about which there has been considerable controversy. There are many more. We will publish a chart showing 364 symbols and 127 letter combinations for all commonly used electronic devices, including semiconductors, in our issue March 23. Meanwhile, let's start standardizing on these.

DIAGNOSIS. One physician, a specialist in children's heart ailments, is turning his practice over to his associates for a year so he can freshen his techniques at one of the nation's leading medical centers. He especially wants to become more familiar with the most recent advances in electronic diagnostic equipment.

He knows about much of the diagnostic equipment **ELECTRONICS** has reported during the past year and is interested in an article on electrocardiogram transmission by phone which we are publishing this week (p 20). However, in his office, he uses only a handful of tried and proven types of equipment—x-ray, fluoroscopes, eeg, and the like.

Physicians, he says, would welcome many of the newer systems if they could be sure of their relia-

bility and if maintenance were no problem. Too often, the most interesting of the new systems are expensive, cranky and one-of-a-kind. What every physician really wants from electronics, he says, is a really reliable, low-cost (\$100 or less) electronic stethoscope. Right now, he puts his faith in good quality acoustic stethoscopes and his practiced ear.

Coming In Our January 26 Issue

BANANA TUBE. Although it sounds a bit Rube Goldbergish, an approach to color television described by P. Schagen, of Mullard, is less expensive than using conventional color picture tubes. His tube has three separate bands of color phosphors across the face. The colors are mixed by a rotating drum and are displayed with the aid of special optical devices.

H. J. Galbraith, of Motorola, tells about a completely self-contained ultrasonic doppler navigation aid. Its purpose is to guide soldiers to their destination, even if they have to push the set through mud. Other developments reported include clutter reduction methods for air route surveillance radar, by W. W. Shrader, of Raytheon; how to use neon bulbs in precision oscillator control circuits, by J. M. Tewksbury, of Bendix; a low-duty-cycle tunnel-diode tester, by L. M. Zappulla, of RCA, and energy detectors for satellites, by J. W. Freeman, of Iowa State University.

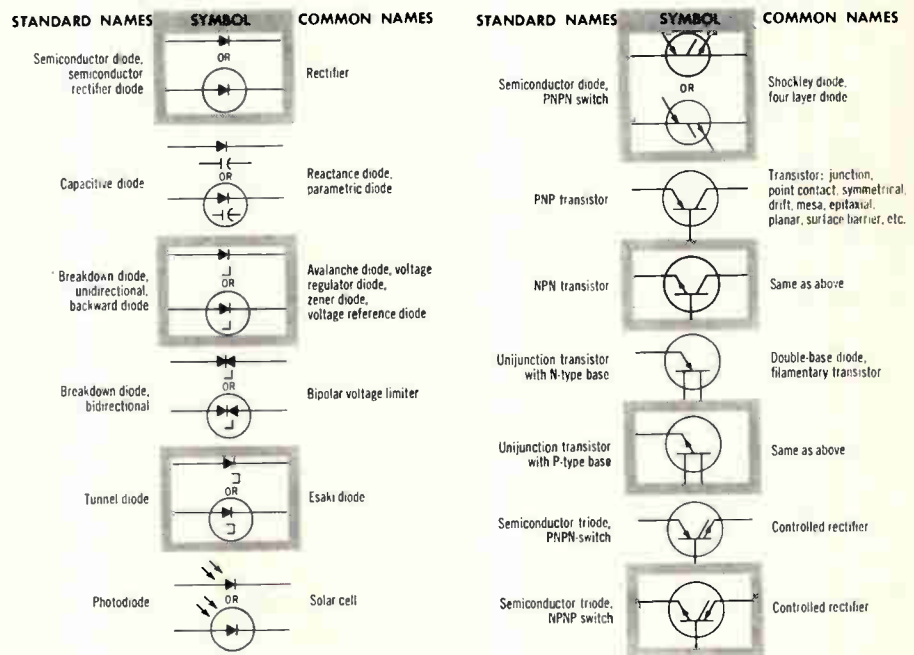

FOR STANDARDS LABORATORIES



MODEL AS-1 PRECISION ATTENUATOR SET

This set contains eight Weinschel precision coaxial attenuators in a solid walnut, velvet-lined case. Included in the set are Weinschel Model 210 attenuators and Weinschel Model 50 attenuators, in attenuation values of 3, 6, 10, and 20 db. The set covers the frequency range of DC to 12.4 kmc. All eight attenuators are made with Weinschel's own stable film resistors, and have stainless steel bodies and stainless steel connectors which give maximum life with minimum wear.

CERTIFICATE OF CALIBRATION

A Certificate of Calibration showing calibration data for each attenuator is supplied with the set. The certificate gives DC resistance and insertion loss at three frequencies for each attenuator.

WEINSCHTEL ENGINEERING 10503 METROPOLITAN AVENUE KENSINGTON, MARYLAND									
Certificate of Calibration					SERIAL NO. 1				
MODEL AS-1 Insertion Loss in 50 Ohm System at 10°C ± 0.2°C, 1 Milliwatt CW Input Power Maximum									
MODEL 210 ATTENUATORS									
Serial Number	Nominal Value	DC Resistance in Ohms			Insertion Loss				
		Female To Male	Male To Ground	DC	Source and Load 50Ω	< 1.0	< 1.0	< 1.0	< 1.0
20059	3 db	34.46	3.00 ± 0.1	X	3.1 ± 0.1	2.2 ± 0.1			
24469	4 db	67.70	5.65 ± 0.1	X	6.0 ± 0.1	6.0 ± 0.1			
28347	10 db	133.40	9.05 ± 0.1	X	10.0 ± 0.1	10.1 ± 0.1			
28408	20 db	228.40	X	18.5 ± 0.1	19.8 ± 0.1	20.6 ± 0.1			
MODEL 50 ATTENUATORS									
Serial Number	Nominal Value	DC Resistance in Ohms			Insertion Loss				
		Female To Male	Male To Ground	DC	Source and Load 50Ω	< 0.1	< 0.1	< 0.1	< 0.1
22189	3 db	17.15	151.10	3.01 ± 0.1	3.05 ± 0.1	3.10 ± 0.1			
22610	4 db	32.69	81.35	6.03 ± 0.1	6.10 ± 0.1	6.10 ± 0.1			
22757	10 db	51.22	61.04	10.01 ± 0.1	10.0 ± 0.1	10.00 ± 0.1			
24310	20 db	82.20	51.26	20.02 ± 0.1	20.10 ± 0.1	20.10 ± 0.1			
Date: AUGUST 15, 1960 Test Engineer: _____ Warranted Job No: 0-4566 Chief Engineer: _____ CALIBRATION STANDARDS AS APPLICABLE ARE TRACEABLE TO NATIONAL BUREAU OF STANDARDS 3113-5/61									

Write today for complete specifications.

WEINSCHTEL ENGINEERING

KENSINGTON, MARYLAND
Phone: LOCKWOOD 4-0121

TWX: KENS 446

COMMENT

Proprietary Piracy

In the Dec. 22 issue (p 4), I particularly noted the *Crosstalk* editorial entitled Proprietary Piracy. I am in a position to have observed closely a recent spinoff in which the parent views are closely and substantially those of your editorial. The child's view, with much justification, is quite different.

I encourage you to continue the exploration of this general field. It needs much clarification and light. For example, I know of spinoffs that were not primarily motivated by a feeling that "working for wages is holding him back." I suspect that management myopia is responsible for more spinoffs than is generally recognized. This is particularly true of the management of one of our major eastern manufacturers, whenever leadership fails, not necessarily in providing for sales growth or profits, but in providing an atmosphere suitable for growth of the individual, a revolution (spinoff) results.

And in another area involving piracy, have you noticed how frequent it is that mountains of government monies are spent to develop an R&D mouse? Whereupon, after a discrete interval, the expenditure of a few dollars of company money suddenly yields significant "proprietary" breakthroughs in the same area of research. Here is another topic for you: What is proprietary information? I notice that many complaints of proprietary piracy are in reality complaints by the pirate that he was hijacked.

KENNETH A. YOUNG
Kenneth A. Young
Associates, Inc.
Groton, Mass.

Radar Meteorology

One of our most critical problems in the Weather Bureau is the extraction of information and transmission to remote locations. The radar operator, with the observing aids we have given him, is an extremely efficient filter, and relatively little information is passed on by him.

It is pretty well agreed among radar meteorologists that data

transmission to remote locations (fifty-plus miles) is best accomplished by conversion of radar information to digital form for transmission over standard telephone lines. The difficulty lies in developing a system capable of producing the information desired at a reasonable price. We have had several contacts with engineering firms who have developed rather exotic data processors, but these companies have very little, and in some cases no appreciation of our meteorological requirements. Usually, equipment designed and built for other purposes is not suited to us, and these companies could save considerable time and effort if they consulted competent meteorologists first.

An inexpensive device is needed for extracting doppler information from standard pulsed weather radars. The Weather Bureau has been operating a c-w doppler for some time for experimental purposes, but purchase of a number of units seems to be not feasible at this time. A simple modification to our existing pulsed radars appears to us to be the most economical and has the best chance for funding in future years.

Radar meteorology is beginning to show signs of some maturity after years of growing. We have begun to develop operational techniques that are objective in nature rather than subjective. We are rapidly moving toward use of quantitative data, chiefly in terms of measuring echo density. However, present methods of radar calibration are very subjective; for instance, determining minimum detectible signal using a signal generator, and we find it very difficult to develop calibration procedures that ensure standardized performance in a network of thirty or more radars. We would like to achieve an overall accuracy of about 2 db, using personnel who are not engineers, meaning our radar operators, who are meteorologists and who understand very little about metrology. Once the data have been properly quantized, the large amount produced lends itself very nicely to automatic processing.

S. G. BIGLER
Weather Bureau
U.S. Department of Commerce
Washington, D. C.

LAMBDA

Convection Cooled Transistorized Regulated Power Supplies

AVAILABLE FROM STOCK

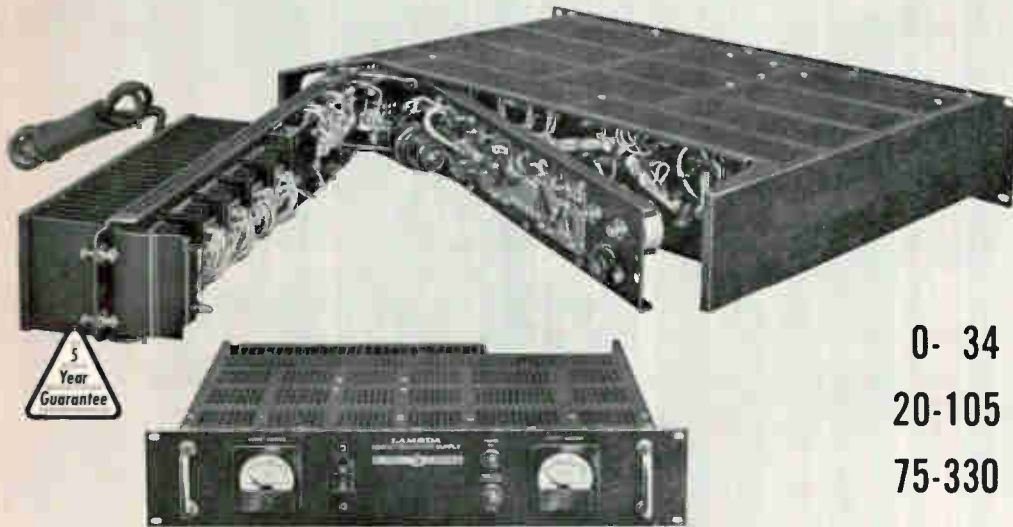

LA SERIES

0- 34 VDC 5, 10, 20 AMP
 20-105 VDC 2, 4, 8 AMP
 75-330 VDC 0.8, 1.5, 3 AMP

SPECIAL FEATURES

- Convection Cooled—No internal blowers or filters—maintenance free
- Ambient 50°C
- No Voltage Spikes or overshoot on "turn on, turn off," or power failure
- Guaranteed 5 years
- Remote programming over Vernier band
- Hermetically-sealed transformer designed to MIL-T-27A
- Easy Service Access
- Short Circuit Proof
- Constant Current Operation—Consult Factory

ALL MODELS 105-140 VAC INPUT

CONDENSED DATA—LA SERIES

DC OUTPUT (Regulated for line and load)

Model	Voltage Range (1)	Vernier Band (2)	Current Range (3)	Price (4)
LA 50-03B	0- 34 VDC	4 V	0- 5 AMP	\$ 395
LA100-03B	0- 34 VDC	4 V	0-10 AMP	510
LA200-03B	0- 34 VDC	4 V	0-20 AMP	795
LA 20-05B	20-105 VDC	10 V	0- 2 AMP	350
LA 40-05B	20-105 VDC	10 V	0- 4 AMP	495
LA 80-05B	20-105 VDC	10 V	0- 8 AMP	780
LA 8-08B	75-330 VDC	30 V	0- 0.8 AMP	395
LA 15-08B	75-330 VDC	30 V	0- 1.5 AMP	560
LA 30-08B	75-330 VDC	30 V	0- 3 AMP	860

Regulation (line) Less than 0.05 per cent or 8 millivolts (whichever is greater). For input variations from 105-140 VAC.

Regulation (load) Less than 0.10 per cent or 15 millivolts (whichever is greater). For load variations from 0 to full load.

Ripple and Noise Less than 1 millivolt rms with either terminal grounded.

Temperature

Coefficient Less than 0.025%/°C.

(1) The DC output voltage for each model is completely covered by four selector switches plus vernier range.

(2) Center of vernier band may be set at any of 16 points throughout voltage range.

(3) Current rating applies over entire voltage range.

(4) Prices are for unmetred models. For metred models add the suffix "M" and add \$30.00 to the price.

AC INPUT

105-140 VAC, 60 ± 0.3 cycle⁽⁵⁾

(5) This frequency band amply covers standard commercial power line tolerances in the United States and Canada. For operation over wider frequency band, consult factory.

Size

LA 50-03B, LA20-05B, LA 8-08B 3½" H x 19" W x 14¾" D
 LA100-03B, LA40-05B, LA15-08B 7" H x 19" W x 14¾" D
 LA200-03B, LA80-05B, LA30-08B 10½" H x 19" W x 16½" D

SEND FOR COMPLETE LAMBDA CATALOG.



LAMBDA ELECTRONICS CORP.

515 BROAD HOLLOW ROAD • HUNTINGTON, L. I., NEW YORK • 516 MYRTLE 4-4200

Western Regional Office: 230 North Lake Avenue, Pasadena, California • Phone: Code 213, MUrray 1-2544

New England Regional Office: 275 Boston Post Road, Marlboro, Massachusetts • Phone: Code 617, HUrtle 5-7122

Middle Atlantic District Office: 515 Broad Hollow Road, Huntington, L. I., New York • Phone: Code 516, MYrtle 4-4200

Versatile programming

plug-in programming for each individual column, code options with plug-in column cards

Fast data transfer

takes just 2 msec;
prints up to 5 lines per second

Flexible BCD input

1-2-2-4 BCD input is standard; dual input available

all yours with this new 562A SOLID STATE DIGITAL RECORDER

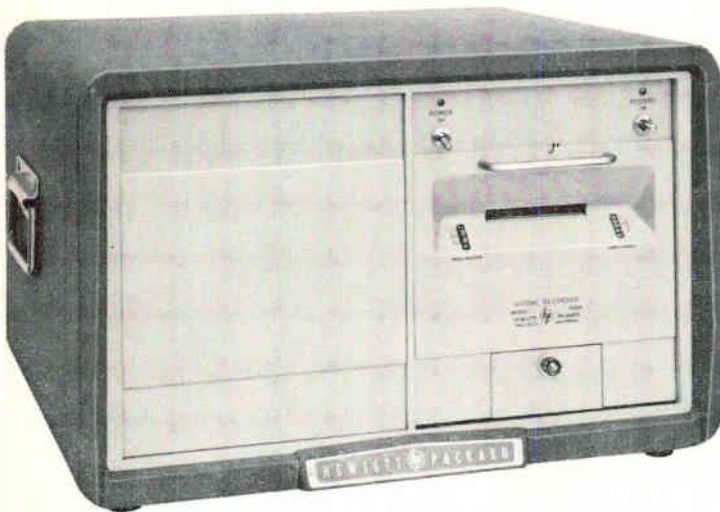

SPECIFICATIONS

- Printing Rate:** 5 lines/sec. maximum
- Column Capacity:** To 11 columns (12 available on special order)
- Print Wheels:** 12-position, 0 through 9, a minus and a blank (Many special character wheels available from stock)
- Driving Source:** Parallel-entry 4-line BCD, 1-2-2-4. Other codes available on plug-in cards. Source reference voltages establish "0" and "1" states, which may be as much as 100 v above or below ground. "1" state 4 to 75 v above "0" reference. Driving power approx. 30 μ a into 270,000 ohms.
- Print Command:** \pm pulse, 20 μ sec or greater in width, 6 to 20 v.
- Hold Signal:** (Available for each data source) -7 v to + 15 v and + 15 v to -7 v.
- Transfer Time:** 2 msec
- Paper Required:** Standard 3" roll or folded
- Line Spacing:** Single or double, adjustable
- Size:** Cabinet, 20 $\frac{3}{4}$ " x 12 $\frac{1}{2}$ " x 18 $\frac{1}{2}$ "; Rack, 19" x 10 $\frac{1}{2}$ " x 16 $\frac{7}{8}$ " deep behind panel.
- Price:** $\text{\$}$ 562A (cabinet) or $\text{\$}$ 562AR (rack mount) $\text{\$}$ 1,600.00 to $\text{\$}$ 2,200.00 depending on options. $\text{\$}$ 580A Digital-Analog Converter, price on request.

New, solid state $\text{\textcircled{h}}$ 562A Digital Recorder prints digital data on 3" paper as fast as 5 lines per second, each line containing up to 12 digits. The instrument incorporates a unique data storage unit for each digit column that allows the data source to transfer data to the recorder in just 2 milliseconds, after which the source is free to collect new data.

Besides the standard parallel-entry 4-line BCD code (1-2-2-4), you can easily use other 4-line codes just by substituting plug-in column cards. Ten-line code operation (without data storage feature) is also available with plug-in cards.

Further, $\text{\textcircled{h}}$ 562A accepts dual input (optional) and prints data simultaneously from two unsynchronized sources. A "patch panel" permits programming these two separate, unsynchronous inputs (even if coded differently) in any manner. Combinations of plug-in column code cards and "patch panel" column programming give complete flexibility in both dual-source data acquisition and data print positioning.

Analog output for high-resolution strip chart and X-Y recording is available as an extra-cost built-in feature of the 562A or through the new $\text{\textcircled{h}}$ 580A Digital-Analog Converter, a separate solid state, high-precision instrument.

Designed for use with solid state and vacuum tube counters, Model 562A is ideal for a wide variety of individual and system applications. Call your $\text{\textcircled{h}}$ representative today.

HEWLETT-PACKARD COMPANY

1501 Page Mill Road
Cable "HEWPACK"

Palo Alto, California, U.S.A.
Davenport 6-7000

Sales representatives in all principal areas

HEWLETT-PACKARD S. A.

Rue du Vieux Billard No. 1
Cable "HEWPACKSA"

Geneva, Switzerland
Tel No. (022) 26. 43. 36



ELECTRONICS NEWSLETTER

Too Many Incompetent Electronics Firms?

WASHINGTON—"Many industrial firms who bid on military contracts have less than a desirable degree of competence," said Finn J. Larsen, Army's assistant secretary for R&D, during his controversial banquet address to the Eighth National Symposium on Reliability and Quality Control last week.

Larsen said this was especially so in electronics. His point was this: a few engineers with a good idea land a contract, form a company, become engrossed in business side of their venture and let incompetent engineers handle the project and other contracts.

He claimed that while nearly one-third of the thousands of other small businesses started each year fail, "almost none" of the more than 4,000 small electronics firms begun in the past five years have gone out of business.

"This seems to be a clear indication that we are almost certainly carrying too many of these as marginal and submarginal business operations, and that our government is not getting its money's worth from many of them," Larsen said.

Larsen also criticized the "great waste of scientific manpower" in military contractor selection. Proposals made by 10 or more bidders frequently require as much engineering effort "as the successful bidder utilizes to conduct the development project." He also called on engineers to stress functionally simple designs and to "avoid the temptation of unnecessarily upgrading or refining a weapons or communications system"

Transistor Modulators Control Electric Cars

ALLIS-CHALMERS reports it has a static controller for battery driven vehicles that gives smoother operation and less power drain than the sequential shorting of accelerating resistors with contactors. A pulse width modulation technique is used to continuously vary average or d-c voltage delivered to the traction motor.

Transistors are employed in a switching mode. The unit can incorporate silicon controlled rectifiers to handle high voltages. Added feature, says the company, is inherent protection from motor, battery or controller damage from overcurrents caused by stalling or overload.

Satellite Share Sales Are Sought by Senator

WASHINGTON—Plan to solve the problem of ownership of a communication satellite system is proposed by Sen. Robert S. Kerr (D-Okla.), chairman of the Senate Space Com-

mittee. He has introduced legislation to set up a \$500 million private corporation with membership open to both domestic and international firms.

Under Kerr's plan, 5,000 shares valued at \$100,000 each would be sold. The minimum holding by any one company would be five shares. Satellites would be supplied by NASA and rates charged for satellite communications would be controlled by FCC.

The plan is patterned closely to one favored by the administration, but is not administration sponsored. President Kennedy will send Congress an official administration plan for ownership of a system within the next few weeks.

Army Opens Integrated Communications Network

ARMY BEGAN using this month its new communications system, Scan (Switched Circuit Automatic Network). It ties together in a single network more than 180 Army, Navy and Marine Corps installations in the U. S. The system will transmit

voice, secure voice, data and facsimile.

Army had been using a variety of manually switched networks and point-to-point private line circuits. The new system, developed by AT&T, lessens the vulnerability of the Army's communications by routing messages through alternative switching centers.

Scan has four switching centers located at Santa Rosa, Calif.; Hillsboro, Mo.; Rockdale, Ga., and Frederick, Md. These locations were selected because they are outside major target areas and make maximum use of trunklines which bypass major population centers.

NASA Checking Up on Down-to-Earth Results

COMMERCIAL BYPRODUCTS of space research and development are being investigated by the University of Denver Research Institute under a \$56,745 grant from NASA. The agency wants to know what products, processes, systems and materials are being produced for civilian use and how the results of research can be spread. Some authorities expect commercial byproducts of the space program will exceed those of military developments during World Wars I and II.

1962 Small Boat Sales Estimated \$16 Million

NEW YORK—At the opening of the National Motor Boat Show last Friday, J. Leonard Lovett, marine products manager of Raytheon, estimated pleasure boatmen would buy \$12 million in electronics gear this year. Sales to small commercial boats would add \$4 million, he said.

Predictions are based on advance orders for boats, which tend toward record 1960 levels. Sales slacked off in 1961. Steady growth of electronics sales is expected in the future. In the next five years, marine radiotelephones are expected to double from today's level of 90,000 licensed units.

New equipment at the show caters to the desires of offshore yachtsmen for navigation aids that are easy to operate and draw less

power. At least two lines of Japanese equipment were displayed along with domestic direction finders, radar, loran, depth sounders, radiotelephones and other equipment.

Spaceship Designed Like Accelerator is Proposed

UNIQUE METHOD of loading space ships with enough energy to accelerate them to the speed of light has been proposed by a New Mexico Highlands University professor. A. A. Kraus, Jr., says that a vehicle sent toward the sun could reach the required speed in a month.

The vehicle would have an ionizer at one end and a voltage gradient along its length. As it passes through hydrogen, the gas is ionized and protons are accelerated toward the rear. If there are enough free protons near the sun, Kraus says, no ionizer would be needed and the vehicle would be reduced to a simple voltage generator.

Kraus proposes a three-stage feasibility program. First, send a probe near the sun to measure proton and hydrogen distribution, temperature, magnetic field and other parameters. Next, try a test vehicle. Third, send a returnable vehicle to a nearby star.

Army Medics Consider Remote Signal Device

Development of a lightweight signaling and tracking system is being considered by the Army Medical Equipment Development Laboratory, Fort Totten, N.Y. The transmitter would weigh six ounces or less and would be operated by an involuntary physiological response if the wearer became unconscious. A portable tracking device would monitor signals within a radius of 300 yards. Such a system could be used to locate casualties.

Semiconductor Technology Pushed by East Germans

EAST GERMANS are stepping up research on ultrapurification of materials, particularly semiconductors.

Like the West (ELECTRONICS, p 41, July 7, 1961), they are working on techniques to measure impurities of less than one part per million and their goal is impurity detection at the parts per billion level. Researchers are turning toward carbides and III-V compounds.

Robert M. Bakish, research director of Alloy Electronics, who attended a recent conference at Dresden, reports his impression that the East Germans have high capability in the pure materials field, independently of any Russian backup. Impurity detection limits were defined as 10^{-10} by activation analysis, 10^{-7} by emission spectroscopy and 10^{-5} or 10^{-6} by mass spectroscopy, in a review paper.

Bakish also reported that a multi-stage electron beam melting furnace has been developed by M. von Ardenne, of Dresden. The beam impinges on work after passing through differentially evacuated stages. Differential pumping allows pressures as high as 10^{-2} mm Hg in working chambers. The gun is refocused at the end of each stage.

Second Echo Balloon Rips and Tears Apart

NASA'S PLANS to further test the feasibility of using large, reflecting balloons as passive communications satellites went awry on Monday when a 135-foot sphere ripped and tore apart as it was being inflated.

The concept was demonstrated by the 100-ft Echo still in orbit after 18 months. That balloon, made of aluminized Mylar, has lost 60 percent of its reflectivity, indicating it has lost its spherical shape.

The new Echo was constructed differently, in an effort to develop balloons that would retain their shape after the inflation gas was lost. It consisted of Mylar laminated on each side with aluminum foil. As a sublimating powder expanded the balloon, the foil was to stretch beyond its elastic limit. This was expected to make the sphere rigid.

The Thor launch vehicle was equipped with a miniature television camera and a recoverable motion picture camera to watch the inflation. The schedule calls for placing a rigidized sphere in a 700-mi-high polar orbit this spring.

In Brief . . .

MISSILE EQUIPMENT contracts announced last week include \$33 million to Autonetics for Minuteman guidance control system production; \$4 million to Lockheed, for Polaris.

MISSILE SERVICES awards include \$2.7 million to Westinghouse Electric for Polaris launch R&D; \$1.9 million to Telecomputing Services for reduction of test data; \$1 million to Avco-Everett for MHD and reentry studies.

MUNTZ TV is making a 19-in. tv set in the \$100 price class. It uses eight tubes, including six Compactrons.

NORWAY and Sweden have ordered long-range air traffic control radars from Selenia SpA, of Italy. The Norwegian installation will be remotely operated by microwave relay.

AIR FORCE says it will locate its new equator-watching space tracking radar in Florida. Contract will be awarded in March.

HALLICRAFTERS is sponsoring a citizens' band radio emergency organization called React, with Chicago headquarters.

MOTOROLA has formed a Solid State Systems division in Phoenix.

LABORATORY FOR ELECTRONICS has acquired 100 percent of Elenik Engineering, a Swedish industrial electronics firm.

IBM ANNOUNCES orders from Britain for 130 type 1401 computers, is shipping three 7070's to Japan.

NATIONAL CASH is installing one of its NCR 315 systems at a Washington, D.C. savings and loan association.

UNITED ARAB REPUBLIC has ordered a 1-Mw, \$1.25 million radio transmitter from Continental Electronics.

AIRCRAFT ARMAMENTS has a \$13 million Army contract to modify and manufacture Nike missile training devices.

FILMISTOR[®]

METAL FILM RESISTORS OFFER 5 DISTINCT TEMPERATURE COEFFICIENTS TO MEET ALL CIRCUIT REQUIREMENTS

**RUGGED END-CAP
CONSTRUCTION
FOR LONG TERM
STABILITY**

• • •

**EXCEPTIONAL
RESISTANCE TO
MOISTURE AND
MECHANICAL DAMAGE**

• • •

**SURPASS MIL-R-10509
PERFORMANCE
REQUIREMENTS**

Providing close accuracy, reliability and stability with low controlled temperature coefficients, these molded case metal-film resistors outperform precision wirewound and carbon film resistors. Prime characteristics include minimum inherent noise level, negligible voltage coefficient of resistance and excellent long-time stability under rated load as well as under severe conditions of humidity.

Close tracking of resistance values of 2 or more resistors over a wide temperature range is another key performance characteristic of molded-case Filmistor "Metal Film" Resistors. This is especially important where they are used to make highly accurate ratio dividers.

Filmistor "Metal Film" Resistors are automatically spiralled to desired resistance values by exclusive Sprague equipment. The metallic resistive film, deposited by high vacuum evaporation, bonds firmly to special ceramic cores. Noble metal terminals insure low contact resistance.

The resistance elements, complete with end caps and leads attached are molded in dense, high temperature thermosetting material to form a tough molded shell for maximum protection against mechanical damage, moisture penetration and repeated temperature cycling.

Filmistor "C" Resistors, in 1/8, 1/4, 1/2 and 1 watt ratings, surpass stringent performance requirements of MIL-R-10509D. Characteristics C and E. Write for Engineering Bulletin No. 7025 to: Technical Literature Section, Sprague Electric Co., 35 Marshall Street, North Adams, Mass.

*For application engineering assistance write:
Resistor Division, Sprague Electric Co.
Nashua, New Hampshire*

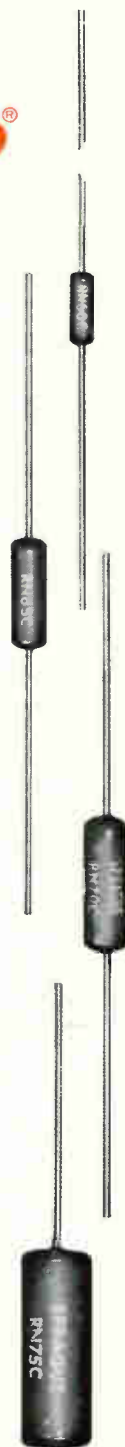

SPRAGUE COMPONENTS

RESISTORS
CAPACITORS
MAGNETIC COMPONENTS
TRANSISTORS

INTERFERENCE FILTERS
PULSE TRANSFORMERS
PIEZOELECTRIC CERAMICS
PULSE-FORMING NETWORKS

HIGH TEMPERATURE MAGNET WIRE
CERAMIC-BASE PRINTED NETWORKS
PACKAGED COMPONENT ASSEMBLIES
FUNCTIONAL DIGITAL CIRCUITS



"Sprague" and "®" are registered trademarks of the Sprague Electric Co.



Single-Place Gyrocopter by Bensen Aircraft Corp.

Get a close-up of pleasant near-the-plant living in SOUTHSIDE VIRGINIA

Whether leisure means a boat and a rod, a gun and a dog, or a trowel and a flower bed to you, you'll find Southside Virginia life pleasant as all outdoors. And it's all within minutes of your desk, whether you locate in the countryside or in one of this area's charming, hospitable, and conservatively governed communities.

It's one reason why Southside Virginia's surplus of home-grown workers would rather stay home. A fifth of its manpower and four fifths

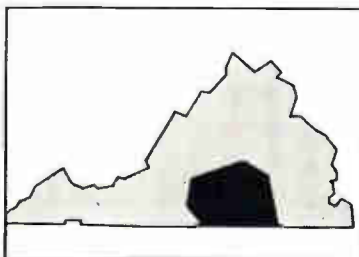

of its woman power are available to staff new industries. Ask VEPCO for data on the proven high productivity of these men and women. Ask, too, about available sites and their cost-saving advantages. Write, wire or phone.



VIRGINIA ELECTRIC and POWER COMPANY
Clark P. Spellman, Manager Area Development
Electric Bldg., Richmond 9, Virginia • Milton 9-1411
Serving the Top-of-the-South with 2,049,000 kilowatts
—due to reach 3,019,000 kilowatts by 1964.

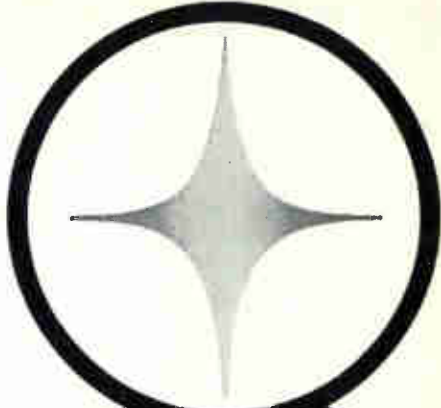
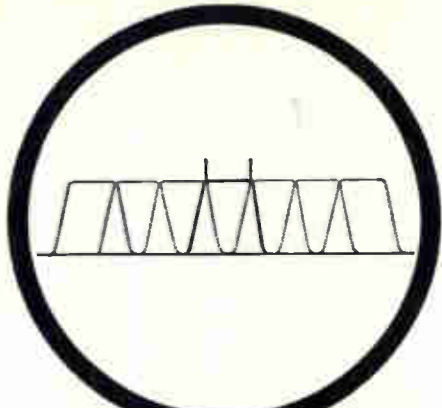
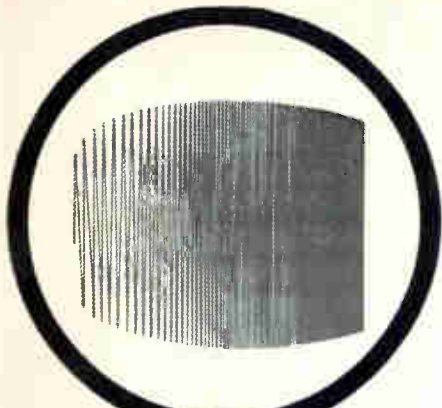

Sweep: Frequency Response of Headsets — e.g., 300 cps to 3,000 cps on a 5 cps sweep



Sweep: TV Receivers — e.g., 170 to 220 mc at a 60 cps "Line" Rate

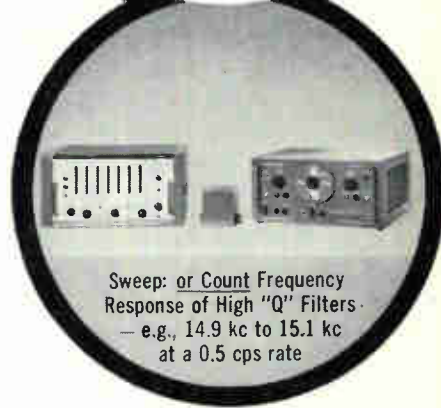

Sweep: or Count Frequency Response of High "Q" Filters — e.g., 14.9 kc to 15.1 kc at a 0.5 cps rate

Complete VERSATILITY... Audio, Video, VHF

KAY *Ligna-Sweep* SKV® All-Electronic SWEEPING OSCILLATOR

935 - B



50 CPS TO 220 MC IN 12 BANDS • WIDE RANGE OF SWEEP WIDTHS
VARIABLE REP RATES • MANUAL AND AUTOMATIC OPERATION

- Single wide-sweep video displays from 10 mc down to 1 kc.
- Linear and logarithmic sweeps of 0.2 cps to 30 cps; or sweep locked to line frequency.
- Audio Sweep of 50 cps to 20,000 cps.
- 8 fixed, narrow-band video frequency sweeps for repetitive operations.
- Fundamental frequency 10 mc to 220 mc (widths to 30 mc plus).
- High-level output of 1 V rms into 70 ohms. AGC'd to ± 0.5 db over widest sweep.
- Manually-operated control for varying oscillator frequency.
- Fixed pulse-type markers or variable marker provision.

Price: \$1295.00 F.O.B., Factory (\$1425.00 F.A.S., New York).

The wide frequency range, extensive choice of sweep widths and repetition rates make the Kay *Ligna-Sweep* SKV a most useful sweeping oscillator.

For high frequency work, the unit provides 9 sweep bands, operating at fundamental frequencies for wide, stable sweeps from 10 to 220 mc. At the low end of the spectrum, an audio frequency sweep from 50 to 20,000 cps is provided. High order stability permits frequency sweeps to as low as 50 cps.

For checking high-Q circuits and low-frequency response characteristics, either log or linear sweeps at variable rep rates down to 0.2 cps are available. This wide choice of sweep rates (continuous to 30 cycles, and fixed line lock) makes it easy to select that highest *rep rate* which gives both an *accurate response* display and easiest, brightest viewing on the scope screen. With the manual frequency control, the trace on the scope screen may be held and examined in detail, (counted precisely, measured on a VTVM) at any frequency point on the scope display.



Check Video Bandpass — e.g., 1 kc to 10 mc at 1 cps rate



Check Radar IF's — e.g., 25 to 35 mc at 30 cps



Check Audio Bandpass — e.g., 50 cps to 20 kc at 1 cps Log Sweep

Write for Complete Catalog Information

KAY ELECTRIC COMPANY

DEPT. E-1

MAPLE AVENUE, PINE BROOK, N. J.

CApitol 6-4000

WASHINGTON OUTLOOK

EXPLOSION IN EDUCATIONAL TV demands during the next decade is indicated by a survey conducted by the National Association of Educational Broadcasters, underwritten by the Department of Health, Education and Welfare. The survey covers tv prospects in all levels of education.

Educators say they need at least 1,472 channels. There are now only 2,200 tv stations assigned for both uhf and vhf and both educational and commercial use. There are now 275 channels assigned to education, 187 uhf and 88 vhf. Of these, 60 are in use: 40 vhf and 20 uhf. The need is seen for 825 additional uhf stations and 97 more vhf stations, to meet the goals of a national education network and the desires of numerous communities for two to 12 channels with simultaneous broadcasts.

IF NAB CALCULATIONS are anywhere near accurate, future demand for uhf channels could equal present demand for vhf. This would hinge on success of FCC's drive to get uhf sets in the hands of viewers, through legislation requiring manufacture of all-channel receivers. When many viewers have uhf sets, a collision between educators and commercial interests scrambling for uhf stations is readily imaginable.

There are signs educational tv is beginning to snowball. FCC Chairman Minow is pushing hard, got a vhf educational station for New York City. Purdue's test of airborne transmission is getting high marks. The District of Columbia just got its first station.

SMOLDERING DISPUTE over government contracting with nonprofit organizations may flare on the space front in Congress this year. The House Committee on Science and Astronautics has made a staff study, may hold hearings this session. Industry complaints have centered on the heavy amount of military contracting with nonprofit groups.

Now, inertial guidance firms are disturbed because NASA chose MIT's Instrumentation Laboratory to develop the navigational system for the Apollo spacecraft. NASA says the laboratory pioneered much of the work in this field and has proved its capability. However, companies argue that there should have been competitive bidding, that industry talent may be eroded from lack of work. Complaints have been taken to Republican congressmen.

HIGHWAY RESEARCH BOARD, an arm of the National Academy of Sciences-National Research Council, will spend \$400,000 in the coming fiscal year to study feasibility of using electronic controls to automate highways. Bureau of Public Roads already is looking into what is feasible on a theoretical basis.

The eventual goal—roadway electronic controls that would pilot cars at fixed speeds and intervals—is probably many years away. More immediate possibilities are devices that would warn of traffic jams ahead, order shifts of traffic into alternative lanes and routes, signal speed changes and otherwise improve traffic flow.

A number of firms have done considerable research and development work in this field, among them RCA, General Motors, Thompson Ramo Wooldridge, Westinghouse and Bendix. RCA has offered equipment for the Highway Research Board's study.

A now-disbanded planning group of outside experts advising the Kennedy administration on transportation policy concluded last year that full highway automation already is technologically within grasp. It recommended an experiment on a 100-mile stretch of superhighway to be built between two major cities within the next two years. Public Roads officials, however, view the planning group's outlook as overly optimistic.

FOR CW ILLUMINATORS
AND NAVIGATION

LOW NOISE OSCILLATORS

1 WATT TO 50 WATTS

Varian Associates' family of low-noise oscillator klystrons assures superior performance in such applications as CW illuminators, fixed-frequency doppler navigation transmitters, and similar uses.

All tubes in this low-noise family are two-cavity klystron oscillators. All are fixed-frequency. All are electrostatically focused. They cover a wide power range (from 1 W to 50 W). Tubes in K_u-band include the air-cooled VA-503B and the liquid-cooled VA-504B. Tubes in X-band include the air-cooled VA-514 and VA-508 and the liquid-cooled VA-511. All are available now.

Characteristics of the VA-511 are typical of the oscillators in this group. The VA-511 produces 50W minimum power at 10 kMc, and operates at 10 kV, 60 milliamperes. FM noise is less than 1 cycle. Weight, less than 24 oz.; size: 6¼ in. x 2¼ in. x 1¾ in.

For additional technical information on this fine family of klystron oscillators, address Tube Division.

SCALE: 2/3 ACTUAL SIZE

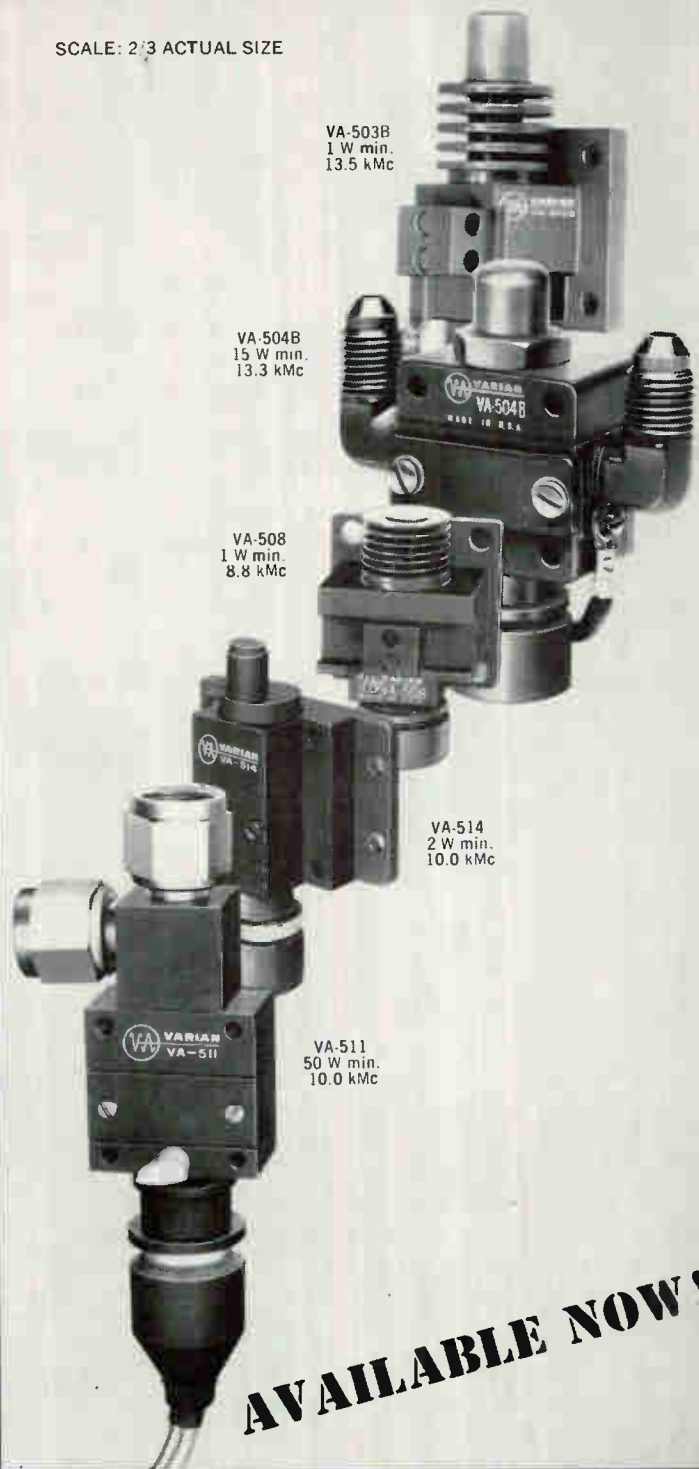

VA-503B
1 W min.
13.5 kMc

VA-504B
15 W min.
13.3 kMc

VA-508
1 W min.
8.8 kMc

VA-514
2 W min.
10.0 kMc

VA-511
50 W min.
10.0 kMc

AVAILABLE NOW!

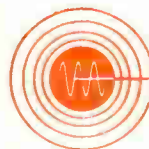

VARIAN associates

PALO ALTO 1, CALIFORNIA

Subsidiaries:

BOMAC LABORATORIES, INC.
VARIAN ASSOCIATES OF CANADA, LTD.
S-F-D LABORATORIES, INC.
SEMICON ASSOCIATES, INC.
SEMICON OF CALIFORNIA, INC.
VARIAN A. G. (SWITZERLAND)

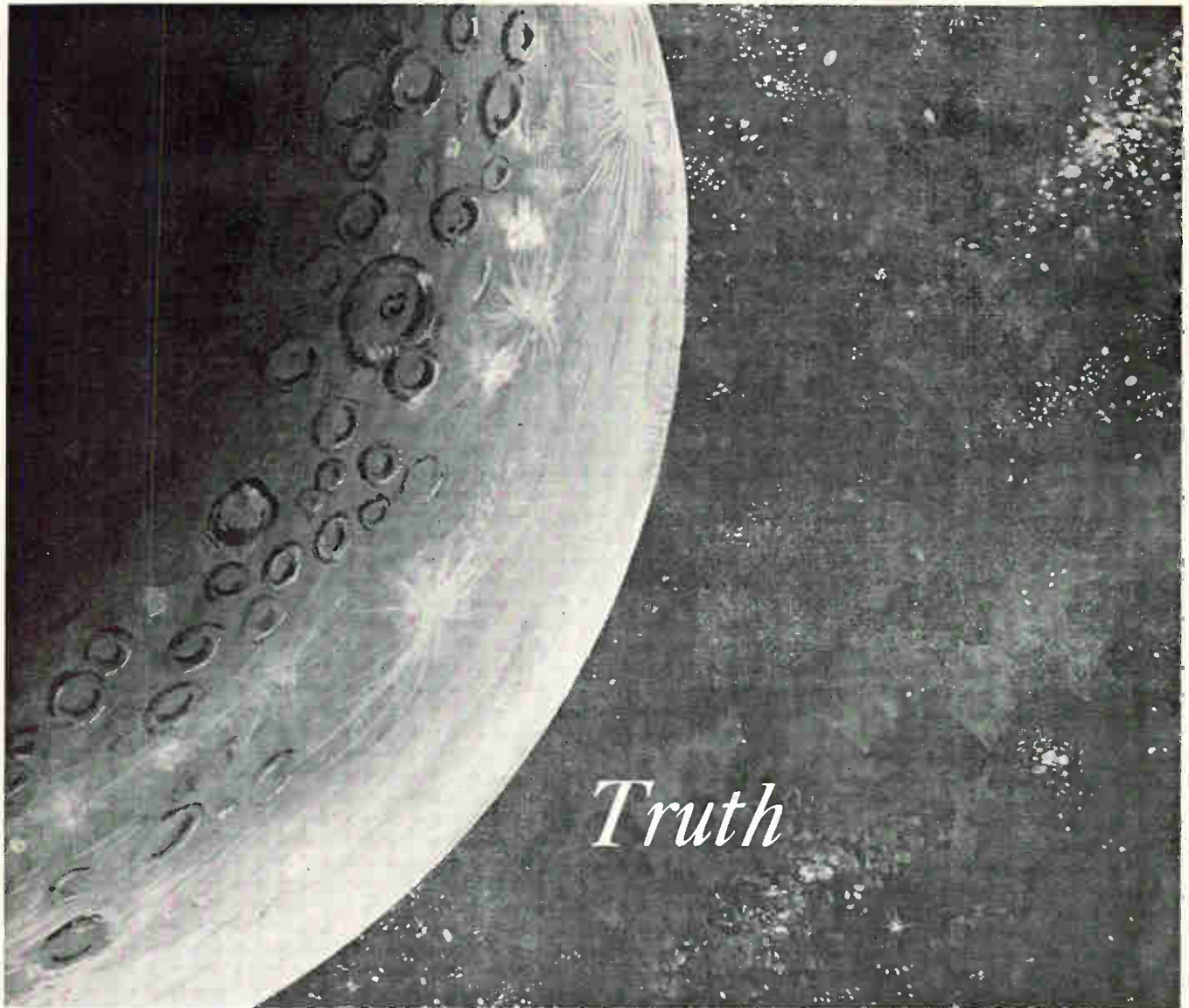

Truth

We are born to inquire after truth... Montaigne

Men of intellectual curiosity whose vision is unhampered by tradition are needed for challenging career positions with Guided Missiles Range Division of Pan American World Airways, Inc.

GMRD, as prime contractor to the U. S. Air Force, is expanding the Planning, Engineering and Operations Departments and continuing to create new staff positions for physicists, engineers and mathematicians with B.S., M.S., and Ph.D. degrees.

Compare your present position with the new opportunity of a career with GMRD.

If you are then interested in knowing specific details, address your resume in confidence to: Professional Employment Manager, Guided Missiles Range Division, PAN AMERICAN WORLD AIRWAYS, INC., Dept. W-45, P. O. Box 4336, MU 113, Patrick Air Force Base, Florida. Inquiries will receive prompt replies and all qualified applicants will be considered for employment without regard to race, creed, color or national origin.



GUIDED MISSILES RANGE DIVISION

PATRICK AIR FORCE BASE, FLORIDA

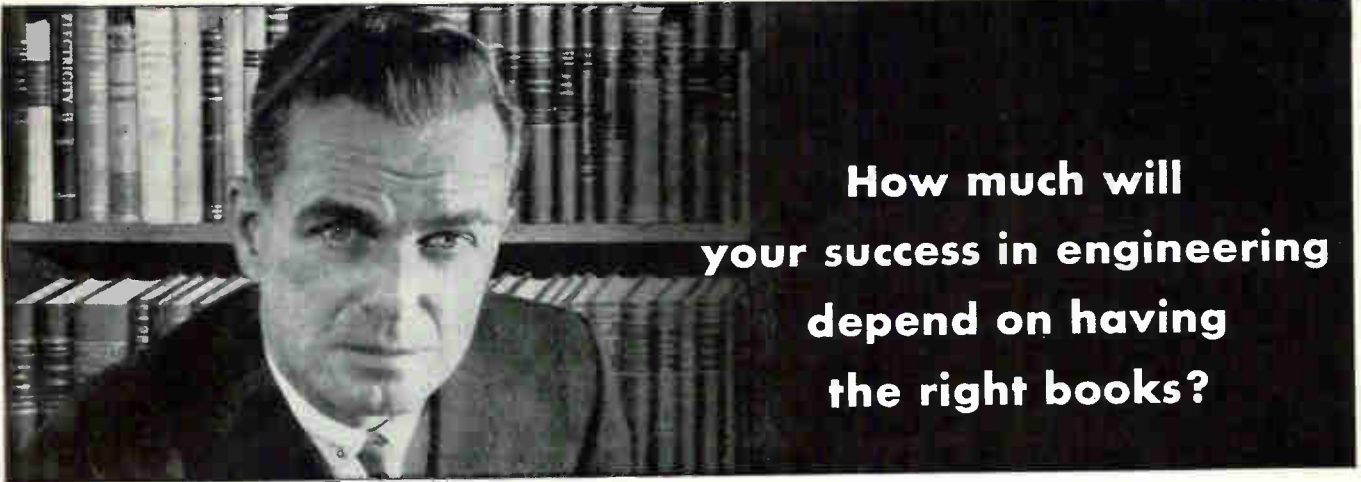

How much will
your success in engineering
depend on having
the right books?

The Electronics and Control Engineers' Book Club helps you keep ahead in your field . . . at a savings

Start your membership with any of these selections:



Transistor Electronics by D. DeWitt and A. L. Ross-off. Full coverage from basic fundamentals to detailed mechanisms.

Publisher's Price, \$9.00
Club Price, \$7.65

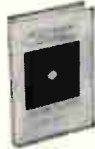

Electronic Digital Computers by C. Smith. What they are, how they function, and their underlying principles.

Publisher's Price, \$12.00
Club Price, \$10.25



Control Engineers' Handbook by J. C. Truxal. A wealth of practical help on automatic feedback control systems.

Publisher's Price, \$22.50
Club Price, \$19.10



Mathematics for Electronics with Applications by H. M. Nodelman and F. W. Smith, Jr. Methods for solving practical problems.

Publisher's Price, \$7.00
Club Price, \$5.95



Epoxy Resins by H. Lee and K. Neville. Fully treats their modern applications and technology.

Publisher's Price, \$9.00
Club Price, \$7.65



How to Become a Professional Engineer by J. D. Constance. Authoritative guidance applicable in all states.

Publisher's Price, \$6.00
Club Price, \$5.10



Management for Engineers by R. C. Heimer. Practical know-how for the engineer-manager, covering every management area.

Publisher's Price, \$7.50
Club Price, \$6.40

Your engineering career owes a great deal to books. Why not take advantage of this convenient, economical way to have the best professional books available when you need them? THE ELECTRONICS AND CONTROL ENGINEERS' BOOK CLUB brings you the essential technical literature in your field. It also helps you overcome today's high cost of building a professional library by saving you an average of 15% from publisher's prices.

How the Club Operates. You regularly receive free of charge *The Electronics and Control Engineers' Book Bulletin*. This gives complete advance notice of the next selection-of-the-month, as well as many alternate selections. If you want the main selection you do nothing; the book will be mailed to you. If you want an alternate selection—or no book at all—you can notify the Club by returning the convenient card enclosed with each *Bulletin*.

Saves You Time and Money. You agree only to the purchase of three books in a year. Certainly out of the large number of books in your field offered in any twelve months there are at least three you would buy anyway. By joining the Club you save both money and the trouble of searching.

Send No Money Now. Just check the book you want as your first selection on the coupon below. With it you will be sent *Electronic Designers' Handbook* for only one dollar. Take advantage of this offer and receive two books for less than the regular price of one. (If coupon is detached, write to The Electronics and Control Engineers' Book Club, Dept. L-1-19, 330 W. 42nd St., New York 36, N. Y.)

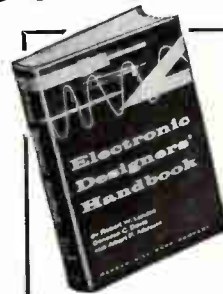

ACCEPT THIS
\$17.50 BOOK
FOR ONLY **\$1.00**

with membership in
The Electronics and
Control Engineers'
Book Club

ELECTRONIC DESIGNERS' HANDBOOK

By R. W. Landee, D. C. Davis,
and A. P. Allrecht

Provides fundamentals and data to help you in the design of all types of electronic equipment. A large number of the circuits used in many different applications are covered, together with theoretical and technical discussions and explanations, design examples to show application of theory, and graphical and tabular data needed in day-to-day design work.

Electronic Designers' Handbook is typical of the selections of THE ELECTRONICS AND CONTROL ENGINEERS' BOOK CLUB. All books are chosen by qualified editors and consultants. Their thoroughgoing understanding of the standards and values of the literature in your field guarantees the authoritative nature of the selections.

(NOTE: If you already own this volume, you may substitute any other book on this page as your DOLLAR book. Check two books below and you will receive the higher priced selection for only \$1.00.)

CLIP AND MAIL THIS COUPON TODAY

The Electronics and Control Engineers' Book Club, Dept. L-1-19
330 West 42nd Street, New York 36, N. Y.

Please enroll me as a member of The Electronics and Control Engineers' Book Club. You will bill me for my first selection indicated at right at the special club price and \$1 for *Electronic Designers' Handbook* (or alternate choice), plus few cents delivery costs. (The Club assumes this charge on prepaid orders.) Forthcoming selections will be described in advance and I may decline any book. I need take only 3 selections or alternates in 12 months of membership. (This offer good in U. S. only.)

PLEASE PRINT

Name

Address

City..... Zone..... State.....

Company

NO RISK GUARANTEE: If not completely satisfied, you may return your first shipment within 10 days and your membership will be canceled.

Send as my first selection: (If more than one book is checked we will send the higher priced selection as your \$1.00 book.)

- Transistor Electronics, \$7.65
- Electronic Digital Computers, \$10.25
- Control Engineers' Handbook, \$19.10
- Mathematics for Electronics with Applications, \$5.95
- Epoxy Resins, \$7.65
- How to Become a Professional Engineer, \$5.10
- Management for Engineers, \$6.40

Save 7% of Your electronics BUYERS' GUIDE Advertising Costs ACT NOW!

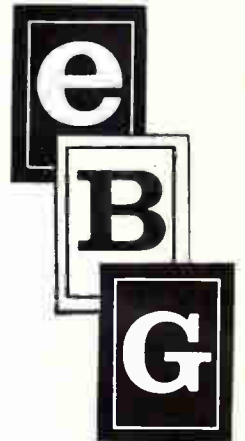
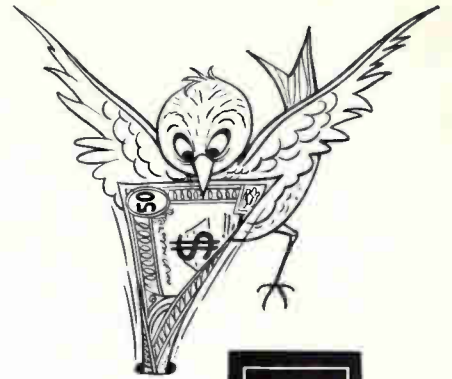

Order your advertising for the 1962 electronics BUYERS' GUIDE now. Study these exceptional discounts. You can earn up to 10% in discounts. You will see four distinct ways to save money. Here is how the "Early Bird" discount structure works:

In addition to volume discounts for Multiple Page, run-of-press, advertising, a discount of 7% on the earned rate will be allowed on ads of 1/2 page or more, provided insertion order is received by February 15, 1962, and plates are supplied to the publisher by April 25, 1962.

In addition to the volume rates for inserts, a discount of 7% of those rates will be allowed providing insertion order is received by February 15, 1962, and inserts are supplied to the publisher by May 25, 1962. See your local advertising representative, listed on the last page of this issue for complete details.

Multiple Page Discounts	
2 pages.....	discount earn 3%
4 pages.....	earn 4%
6 pages.....	earn 6%
8 pages.....	earn 7%
12 pages.....	earn 8%
16 pages.....	earn 9%

Special rates for furnished inserts	
2 pages.....	per page \$715
4 pages.....	682
6 pages.....	654
8 pages.....	616
12 pages.....	600
16 pages.....	583
20 pages.....	566
24 pages.....	550
28 pages.....	533
32 pages.....	517
over 32 pages.....	489

(Orders and complete plates to be sent to 330 West 42nd Street, New York 36, N.Y. Inserts to be shipped to National Publishing Co., Lanston Building, 24th and Locust Street, Philadelphia 1, Pennsylvania. Marked: Electronics Buyers' Guide.)

electronics BUYERS' GUIDE & Reference Issue



A McGraw-Hill Publication / 330 West 42nd Street, New York 36, N.Y.

EFFICIENT AUTOMATIC MULTI-POINT MEASUREMENT

*New Input Scanner programs
up to 100 data points to
one measuring device*

With off-the-shelf Dymec instrumentation it's simple to measure pressure, flow, temperature, velocity, volume—any parameter that can be converted to or related to a voltage, frequency, time interval or period, resistance or current.

Using the DY-2901 Input Scanner as the basic instrument in a system, for example, you can program rapid measurement of up to 25 points—or up to 100 inputs with the DY-2902/3/4 slave scanners. Built-in programming, channel identification and latch-lock input connectors increase versatility and provide money-saving utility. Channels to be measured are selected by front-panel buttons and programmed by an internal pin board which lets you select function and range of the measuring equipment.

With the DY-2901, you can make more effective use of other Dymec instruments such as the DY-2401 Integrating Digital Voltmeter, the DY-2410 Multi-Converter, and the DY-2540 Coupler. Application Note 15 describes complete Dymec Systems capabilities.

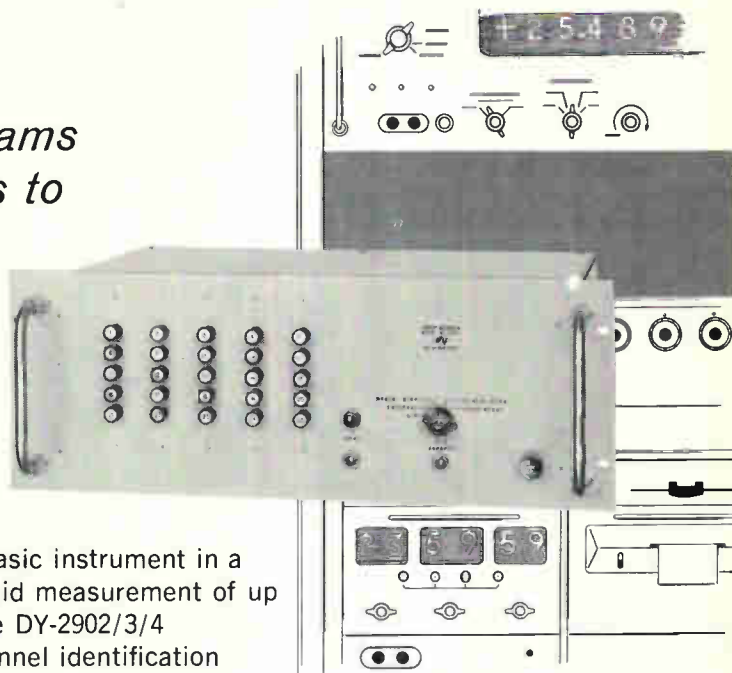

Here are some of the inputs you can measure with these systems:

- dc voltage, from a few mv to 1,000 v
- ac voltage, from a fraction of a volt to 750 v rms, 20 cps to 100 KC or more
- frequency, dc to 10 MC or more
- time interval or period, from less than 1 nanosecond to 100 days
- resistance, fractions of an ohm to 100 megohms or more
- current, from 10^{-9} amps to 10 amps or more

And here are some of the features your Dymec system can provide:

- **Scaling:** Multiplying factors can be pre-set to provide digital readings in desired measuring units (psi, gpm, rpm, etc.)
- **Ranging:** Measuring equipment can be automatically programmed to desired range for each channel
- **Normalizing:** Separate multiplying factor can be supplied for each channel to relate all measurements to a par value
- **Scale Expansion:** Zero offset provides high measurement resolution on each range
- **Sequence:** Individual channels can be omitted from any measurement cycle

Call your Dymec/Hewlett-Packard representative today or call direct for specifications on the DY-2901 Input Scanner (\$1,950), DY-2401 Digital Voltmeter (\$3,750), DY-2410 Multi-Converter (\$1,975), DY-2540 Coupler (typically \$1,200 to \$2,400), or other Dymec instruments for versatile systems application.

D Y M E C
A Division of Hewlett-Packard Company



Space
orbits around
FLORIDA

after
you decide to put a
plant in Florida,

locate where
the action
is!

st. petersburg

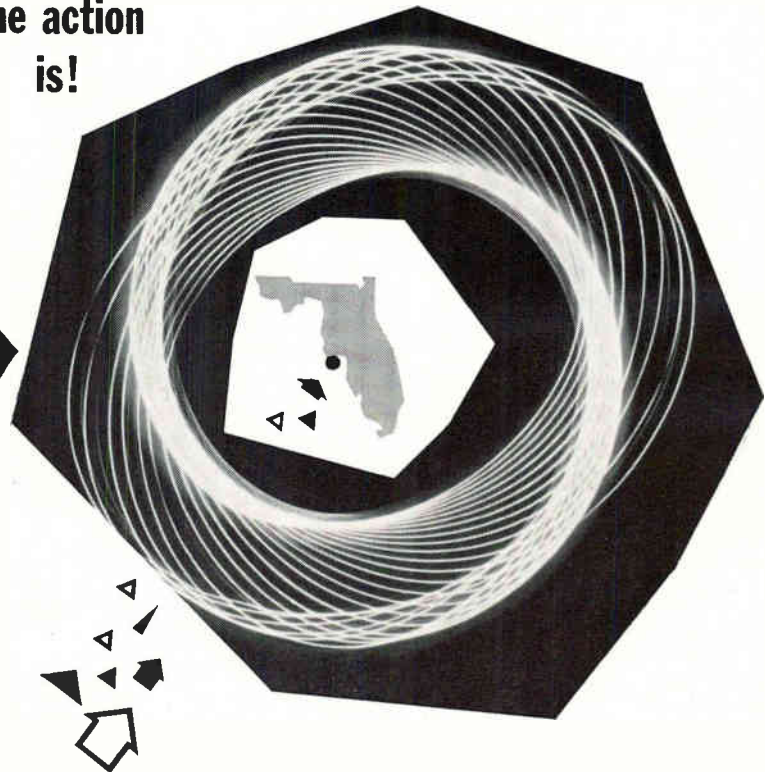

The control of space is in Florida . . . because the people who will control it live here. Why not? It's nicer living here. And St. Petersburg land prices are within reason. Come and get it . . . locate where the action is—St. Petersburg. Write, wire or phone in confidence ► **GREATER ST. PETERSBURG CHAMBER OF COMMERCE, Jack Bryan, Dept. E, St. Petersburg, Florida**

St. Petersburg is the Florida Home of: ALLSTATE INSURANCE • AMP • BABCOCK & WILCOX • CONTINENTAL OPTICAL • ECI • GENERAL CABLE • GE • GENERAL NUCLEAR ENGINEERING • INTERNATIONAL RESISTANCE • MILTON ROY • HONEYWELL • SPERRY

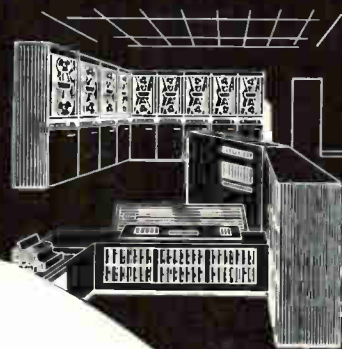

Hathaway

COMMUTATORS

will add up to **1000%** longer life in any application!



TYPE RSB—Compact, for applications where low cost is a factor.



TYPE RSC—Precise phasing control for systems requiring break before-make operation, or controlled time periods between adjacent decks.

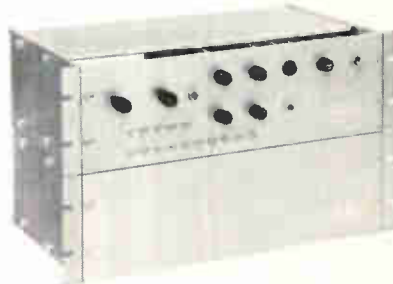

DRIREED ELECTRONIC COMMUTATOR—Solid state, nonmechanical, high speed operation, versatile logic and programming sequencing.

In applications where exceptional life is a design consideration, Hathaway commutators offer important advantages when compared with either conventional mechanical or electronic units.

And design potential is nearly unlimited because of these special features:

Contact rating: 10,000,000 operations at 100 milliamperes, 115 V 60 cps resistive, 10,000,000 operations at 125 milliamperes, 28 vdc resistive. 1,000,000,000 operations dry circuit. **Natural contact frequency:** 2,700 and 2,800 to 3,200 cps. **Vibration:** 20 G's to 2,000 cps, energized or non-energized with no fault operation. **Noise:** Useable in the low microvolt region. **Isolated dual-ended contacts.**
Permanent lubrication prior to assembly. Low cost.

For detailed information, write, wire or phone us at the address below.



**HATHAWAY
DRIREED
RELAY**

Heart of Hathaway Commutators is the Drireed—industry's most nearly perfect switch.

Hathaway

INSTRUMENTS, INC.

A SUBSIDIARY OF THE LIONEL CORPORATION
5802 EAST JEWELL AVENUE, DENVER 22, COLORADO



Skyline 6-8301
TWX DN 656

Phone Lines Transmit Data on Heart Beats

PHYSICIANS will soon be able to transmit electrocardiograms (ecg) by telephone, for long-distance consultation with cardiologists. The heart specialist can listen to the heartbeats while watching the ecg being traced by a recorder.

Although several physicians both here and abroad have used the telephone technique experimentally, no wide-scale application exists. However, three such systems now under test are expected to become operational this year. They could be used by physicians in communities without cardiologists, or by physicians on ships equipped with radiotelephones.

The systems developed by Mnemotron Corp. and Electronic Medical Systems use acoustic coupling to a telephone. The other, by Bell Telephone, uses direct electrical coupling. Laws regulating wire tapping generally require acoustic coupling, but Bell can install its system just as it does ordinary phones.

One advantage of the acoustic systems, though, is that physicians can carry the transmitting unit and forward an ecg directly from a patient's home to medical centers for analysis.

Bell's special data-phone sets transmit what is termed "live" ecg information. Prototype models pick up the cardiac signal by electrodes connected to the phone unit. An amplified electrical representation of the ecg is transmitted and is traced at the receiving end by a Minneapolis-Honeywell Visicorder.

Mnemotron's Sonolink has a six-ounce transmitter that clips onto the telephone mouthpiece. It converts ecg signals to pulse frequency modulated sound, audible as a soft,

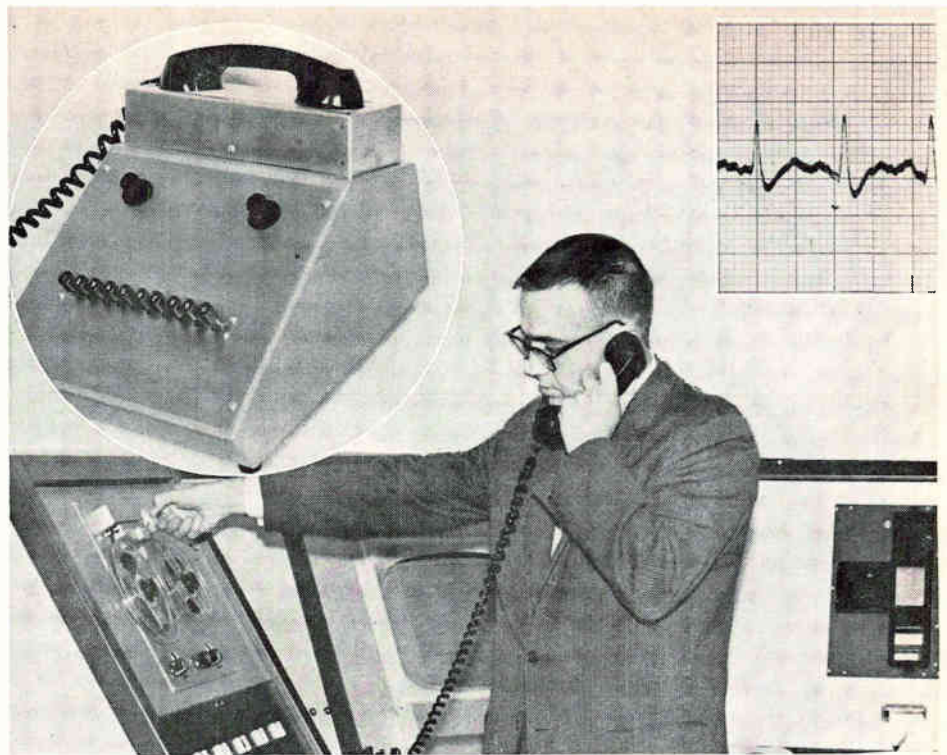

Ecg sent by telephone from Atlantic City, N. J., to Electronic Medical Systems' offices in St. Paul, Minn., is monitored, recorded and analyzed at receiving console. Insets show the transmitter and portion of ecg

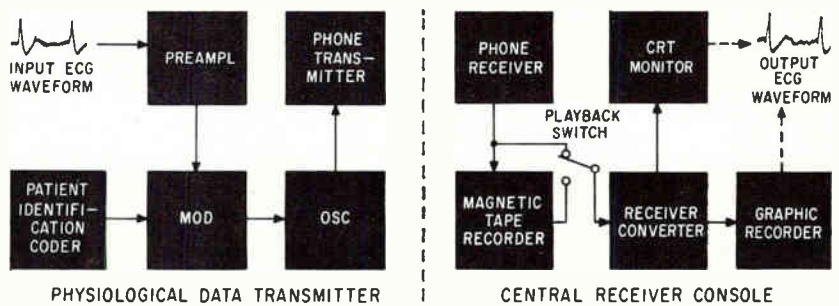

Data flow of EMS's system. The receiver can service many portable ecg transmitters

continuous beep of varying pitch. The receiver clips onto the telephone earpiece. It reconverts the data and feeds it to a conventional ecg, tape recorder or oscilloscope.

Electronic Medical Systems reports it has obtained high-fidelity transmission of 500 miles with a similar system. Data reliability is ascribed primarily to a high signal-to-noise ratio.

The physician uses a portable transmitter to acoustically couple the patient's ecg to the phone. A bandtype chest electrode requires only one lead from the patient to the amplifier. The physician can manually insert codes that identify the physician, patient and time of recording. Records can be played back, so analysis can be made at any time convenient to the special-

ist and the inquiring physician.

All three of these companies report that systems for transmitting other physiological data, such as electroencephalograms, are underway.

Another recent development in this field is a fetal heartbeat monitor built by Dr. Saul Larks, of Marquette University, working with Magnavox researchers at Fort Wayne, Ind.

Signals picked up by small sensors on the mother's abdomen frequency modulate a small four-tube transmitter which is acoustically coupled to a telephone mouthpiece through a 1.5-inch loudspeaker. Center frequency is 1.75 Kc and output is in the one-watt range. An eight-by-five-inch, seven-tube receiver converts the data for record-

ing and display on a cro.

The device can be used from the 11th week of pregnancy to term. Marquette expects it to help specialists detect congenital heart or metabolic diseases which cause miscarriages.

Lockheed has a radiocardiograph designed to clip onto a patient's clothing. The transmitter, which looks like a fountain pen, is connected to electrodes which are taped to the patient's chest. Output can be fed into phone lines, so physicians can monitor the heartbeat while the patient goes about his normal activities.

The rights to this device were recently given by Lockheed to the Heart Research Foundation, of Los Angeles. The Foundation says it will be made available to cardiologists soon.

Computer and Sensors Form Artificial Hand

MECHANICAL manipulator that can feel and remember shapes and perform simple operations on the "knowledge" acquired has been built by an MIT graduate student to study artificial intelligence.

The system can recognize blocks, pile up the blocks or, if it finds a box, load the blocks into the box. The student, H. W. Ernst, programmed MIT's TX-O computer to perform the cognitive processes and equipped the manipulator with 30 devices which give it a sense of touch and position.

EIA Parts Section To Study Coil Spec

COIL SECTION has been organized as part of the inductive components subdivision of the Electronic Industries Association's parts division, the division chairman, W. Myron Owen, of Aerovox Corp., has announced. Section chairman will be Harry W. Waddell, of Jeffers Electronics division of Speer Carbon Co. One of the group's first activities will be to determine EIA action to develop a high reliability version of MIL-C-15305 (r-f and i-f coils).

Solid State Nuclear Analyzer

SOLID-STATE multiparameter recorder analyzer developed by Argonne National Laboratory is reported to combine slow record-fast search of magnetic tape with the precision and repeatability of digital data handling.

Opening of a neutron shutter starts a scaler counting crystal oscillator clock pulses. A neutron's arrival at the target sets the stage for detection of two coincident gamma rays. A coincidence pulse terminates the clock and opens linear gates, starting analog to digital conversions. Binary notation of pulse heights and neutron time of flight across magnetic tape takes about 200 μ sec.

The record station's 256-channel core memory monitors and provides for visual display of information transferred to tape from any of three tracks. The memory also permits a check on retrieval of data from tape, since data accumulated in monitors is identical to that played back at search station.

Organization and analysis of recorded events takes place at the search station, where a 1,024-word memory is provided in conjunction with a flexible set of window-like restrictions imposed on gamma ray parameters. Restriction gate is as-

sociated with each of four memory quadrants. Operating like a digital single channel analyzer, each window adds one count to the memory when the input's numerical value equals or exceeds the lower boundary, but is less than higher boundary.

Single search pass of 2,500-ft tape containing three million events takes $3\frac{1}{2}$ minutes, providing for linear or semilog display of four 256-channel spectra on a crt. Read out by typewriter, punched tape or x-y recorder takes five minutes.

The system could be adapted to chemical, aerodynamic and other processes as well as nuclear analyses, according to Argonne developers. It uses 2,100 transistors and 3,300 diodes.

Vacuum Chamber Tests Full-Scale Spacecraft

SPACE ENVIRONMENT chamber recently placed in operation at Bendix-Systems division, Ann Arbor, is large enough to test full-scale spacecraft. It measures 20 ft in diameter by 27 feet long. Altitudes up to 250 mi can be simulated in the chamber.

Biomedical Telemetering Belt



Miniature telemetering instruments, developed by Boeing for space medicine research, can be worn on belt, allowing subject to move freely. Arnoux Corp. will make the equipment



M I C R O S W I T C H P r e c i s i o n S w i t c h e s

**MICRO SWITCH
"V3" SWITCHES...
VERSATILITY,
RELIABILITY, SMALL
SIZE AND NEW
HIGHER CAPACITIES**

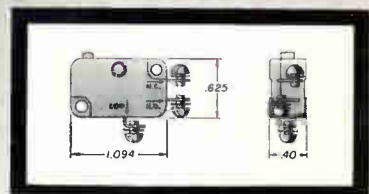

Here is one of the most widely used snap-action switches in industry. Ever since MICRO SWITCH introduced the first "V3" twenty years ago, these miniature controls have been providing the solution to switching applications requiring small size with high electrical capacity.

"V3" precision snap-action basic switches are listed by Underwriters' Laboratories and CSA for 15 amps, 125-250 vac. Continual new improvements and variations have extended their versatility, performance and reliability. A wide range of actuators, operating characteristics, terminal designs and special features such as gold contacts for low energy circuits makes the "V3" useful in a variety of products—in aircraft, industrial equipment, appliances, vending machines and business machines. Standard "V3's" conform to requirements of MIL-S-6743. For more information, look in the Yellow Pages for our Branch Office nearest you, or...

WRITE FOR CATALOG 63 "SMALL BASIC SWITCHES"

A COMPLETE SELECTION TO MEET MOST REQUIREMENTS



Quick connect terminals.
SPDT. 15 amps.



Screw terminals.
SPDT. 15 amps.



Screw terminals.
SP-NC. 15 amps.



Screw terminals.
SP-NO. 15 amps.



Long life. 10 million
operational life. SPDT.



High-temperature.
Withstands up to
600° F. SPDT.

VARIETY OF TERMINALS AND CIRCUITRY

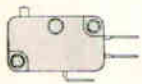

Quick Connect
Terminals

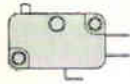

Solder Lug
Terminals

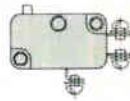

Screw Terminals

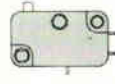

Short Solder
Lug Terminals

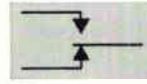

Double-Throw

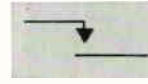

Normally-Open



Normally-Closed

"V3" SWITCH ASSEMBLIES

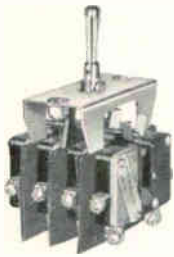

Multi-Circuit Toggle Switches
available with 4 to 12 SPDT
switches. Above: 8-switch unit.
(Catalog 73.)

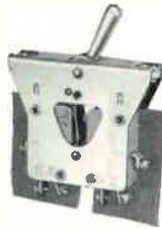

3-Position Toggle Switches
make or break in all three lever
positions. (Catalog 73.)



Rotary Selector Switches available with
from one to eight switching units and
two to eight detent positions. (Data
Sheet 86.)

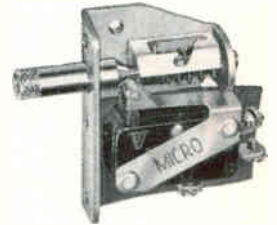

Door Interlock Switches for safeguarding
electrical equipment. Wide variety available.
(Data Sheet 186.)

COMPLETE RANGE OF AUXILIARY ACTUATORS



Leaf Actuator



Roller Leaf Actuator



Low Force Lever
Actuator



Long Leaf Actuator



Low Force Roller
Actuator



One-Way Roller
Leaf Actuator

MICRO SWITCH, FREEPORT, ILLINOIS

A Division of Honeywell

In Canada: Honeywell Controls Limited, Toronto 17, Ontario



Honeywell

MICRO SWITCH Precision Switches

**NEED
65-80 db
ISOLATION
BETWEEN
TRANSFORMER
WINDINGS?**

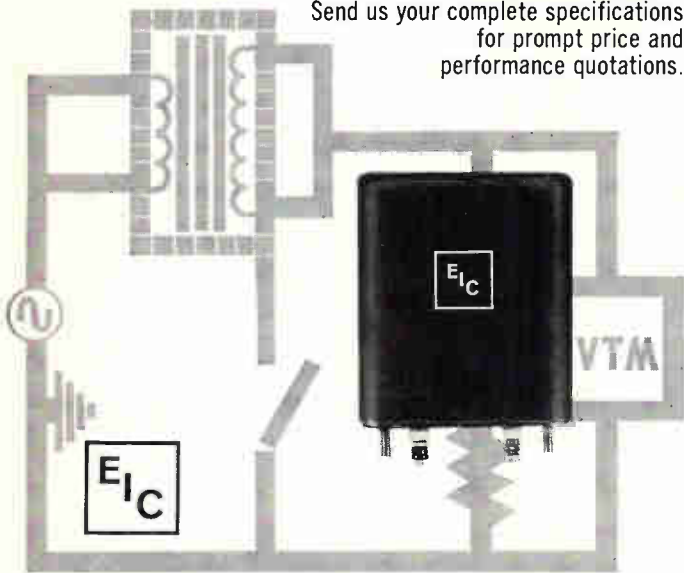

ELECTRODYNAMIC INSTRUMENT CORPORATION

Subsidiary of Reed Roller Bit Company

JA 6-3761 • 1841 Old Spanish Trail • Houston 25, Texas

CIRCLE 200 ON READER SERVICE CARD

You do if your project involves very low signal levels. This was the case recently when a major transistor manufacturer specified EIC custom transformers with 65 db isolation between windings, from 60 cycles to 10 kc. (We can give you 80 db if required.) Insulation resistance specified (winding to winding and winding to case) was 300,000 megohms. Send us your complete specifications for prompt price and performance quotations.

When you need **POWER...**

choose **NICAD**[®]

**NEW
Nickel Cadmium
Rechargeable
Batteries**

SEALED CELLS

Hermetically sealed and rechargeable, Nicad batteries are small in size, require no maintenance, operate in any position. They make practical the battery operation of many types of equipment not previously suited to dry, mercury, or lead acid types.

VENTED CELLS

High surge power cells, in sintered or pocket plate types, are capable of sustained voltage at high discharge rates over a wide temperature range. They have extremely long life... little or no maintenance. For more of the POWER story, write

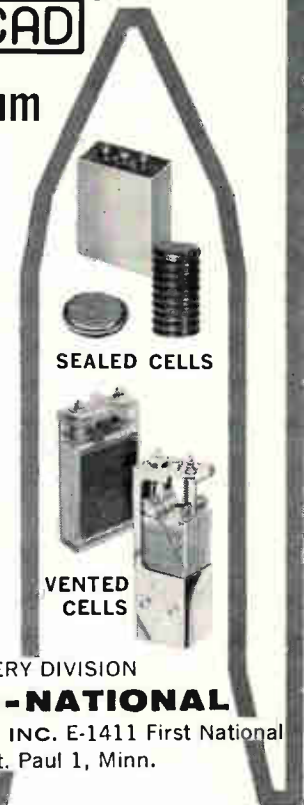

NICAD BATTERY DIVISION
GOULD-NATIONAL
BATTERIES, INC. E-1411 First National
Bank Bldg., St. Paul 1, Minn.

CIRCLE 201 ON READER SERVICE CARD

Learn more about your **BIGGEST CUSTOMER**

In 1961, military and space electronics exceeded, in dollar volume, the total of industrial electronics, consumer electronics, and the replacement components *put together* . . . just *one* fact from the "Summary of Electronics Markets" in your 1961 **electronics Buyers' Guide** and Reference Issue.

What's more, EBG follows up this interesting market fact with a statistical analysis of the military and space market, a military and government procurement guide, a list and descriptions of procuring agencies, and other information that helps you translate facts into profits for your business. You'll find daily use for EBG all year long.

electronics BUYERS' GUIDE and Reference Issue

The Basic Buying Guide in Electronics *since 1941*

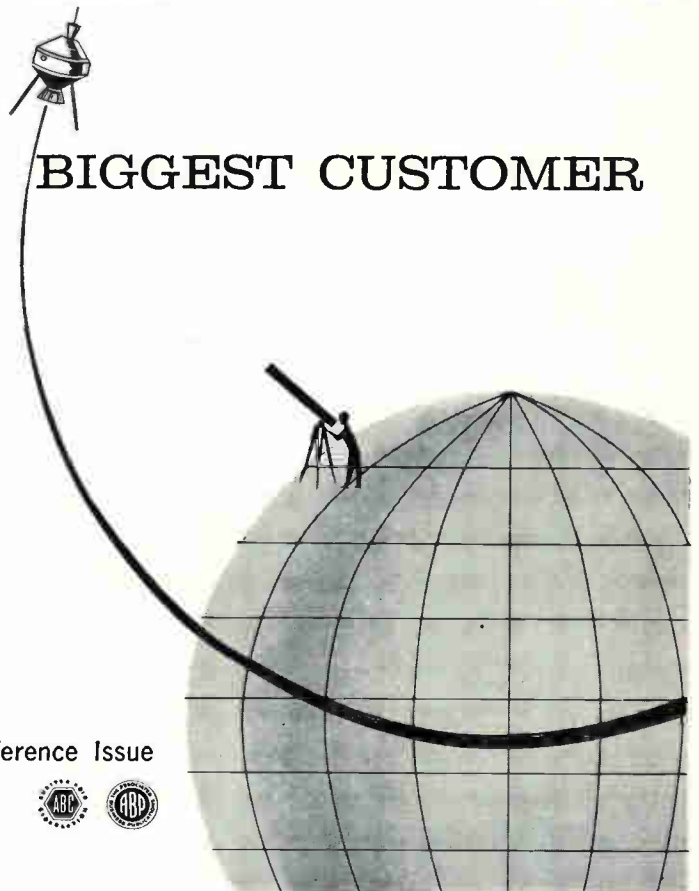

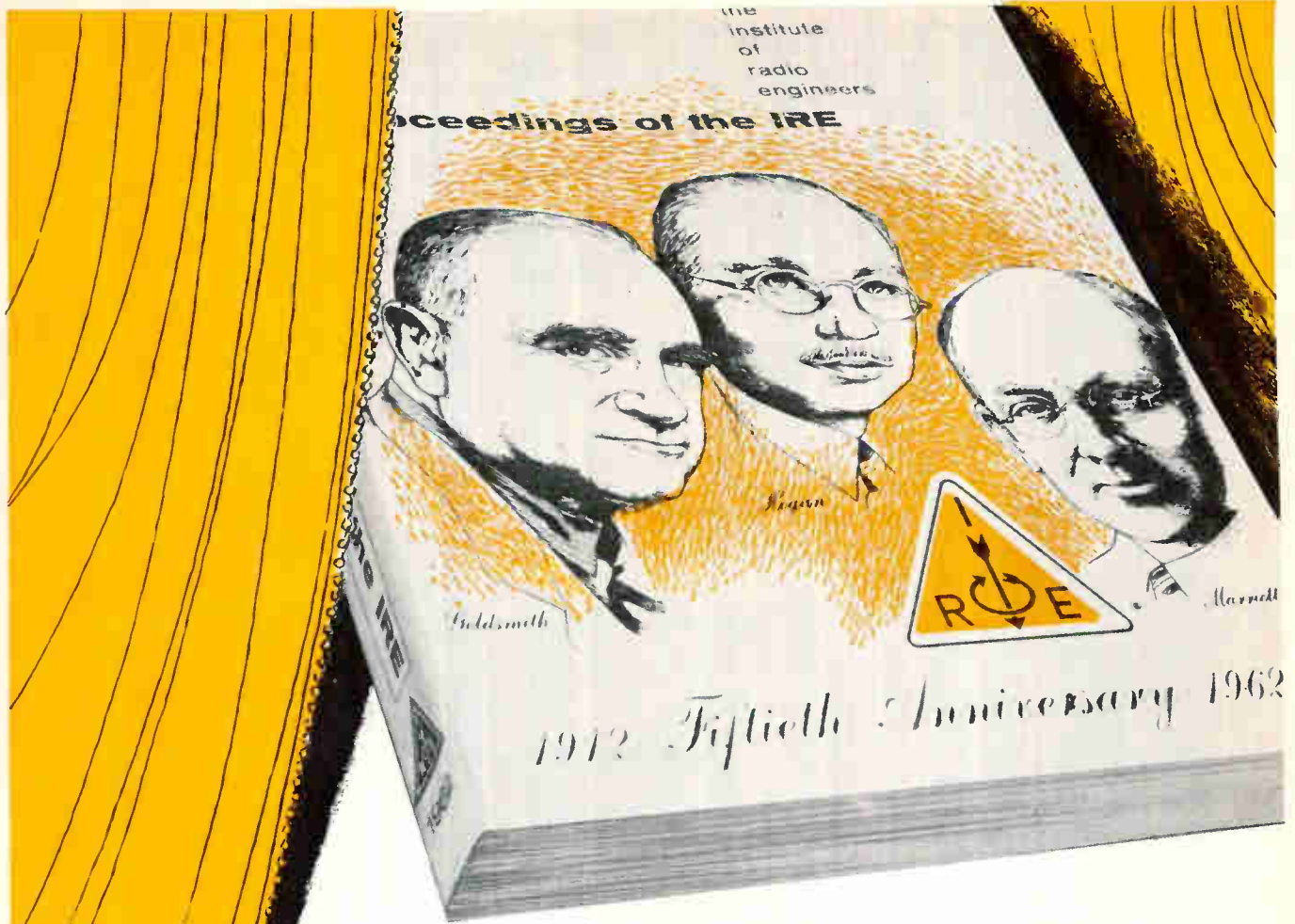

FROM THE WORLD'S GREAT ELECTRONICS EXPERTS,
A REFERENCE WORK YOU WILL TREASURE ALWAYS

GOLDEN ANNIVERSARY

ISSUE OF **Proceedings**

In honor of the IRE's 50th anniversary, the May 1962 issue of *Proceedings of the IRE* will survey the progress of electronics from 1912 to 1962. It will forecast the future of electronics for the next 50 years. And this special issue of *Proceedings* will have more than 600 pages of additional editorial text, discussing developments in

- | | | |
|--------------------|--------------------------|--------------------------------------|
| Nuclear Science | Electronic Computers | Antennas and Propagation |
| Circuit Theory | Automatic Control | Broadcast and Television Receivers |
| Broadcasting | Vehicular Communications | Product Engineering and Production |
| Education | Communications Systems | Reliability and Quality Control |
| Audio | Engineering Management | Radio Frequency Interference |
| Instrumentation | Industrial Electronics | Space Electronics & Telemetry |
| Electron Devices | Bio-Medical Electronics | Microwave Theory and Techniques |
| Components Parts | Ultrasonics Engineering | Human Factors in Electronics |
| Information Theory | Military Electronics | Aerospace & Navigational Electronics |

Electronics experts from all over the world contribute to make this anniversary issue concise yet all-inclusive. 100,000 copies will be printed. Only members of the IRE, in good standing in May 1962, and subscribers will receive a copy. We regret that unlike special issues of the past, no copies can be made available to non-members, or for single copy sales. As a member of the IRE you will find the May anniversary issue of *Proceedings* the master reference work you will treasure always.

*Reserved for
IRE Members
only!*



The Institute of Radio Engineers • 1 East 79th St., New York 21, LE 5-5100

Low-Altitude

By HAROLD C. HOOD
Pacific Coast Editor

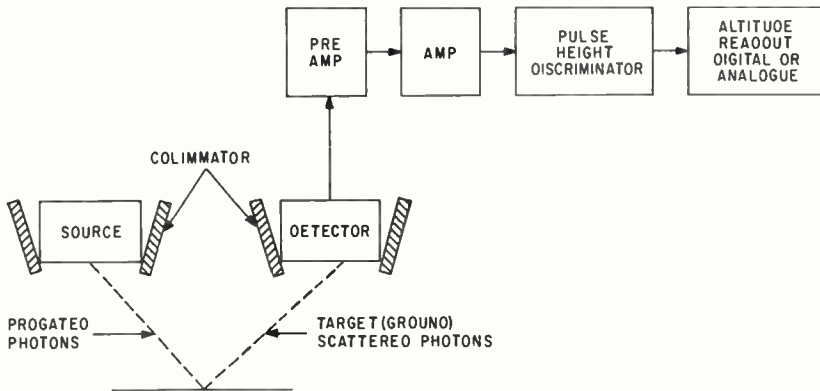

Reflections are sensed by multiplier phototube in scintillator system or by p-n junction in solid-state version

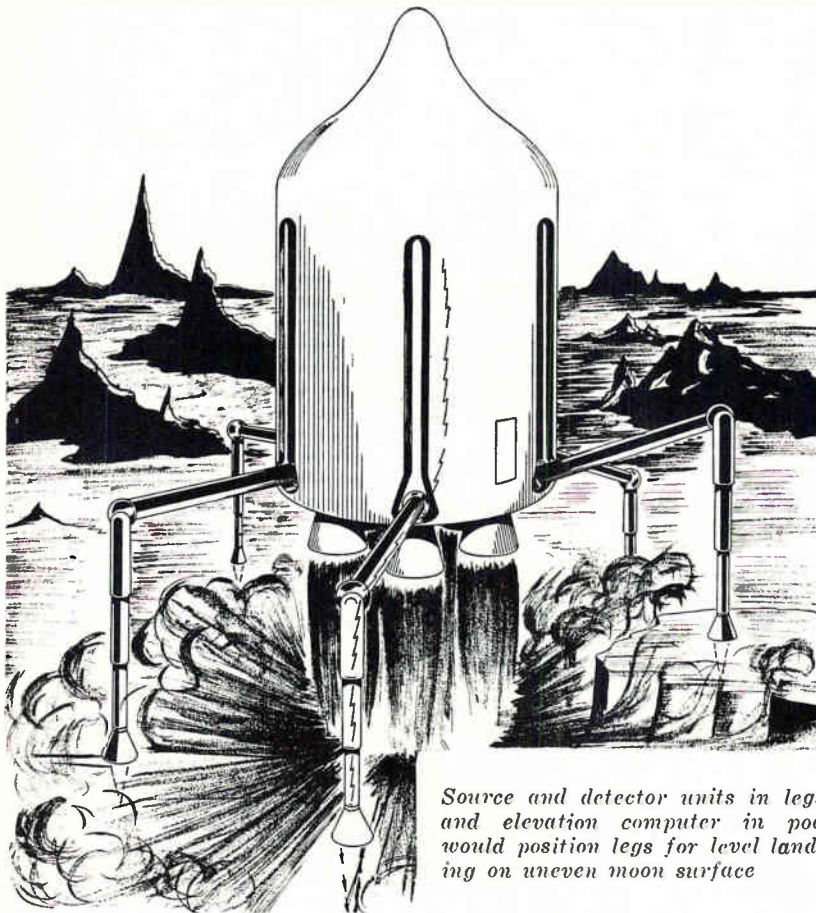

Recent tests in the New Mexico desert measured cosmic ray background for calibration of radioisotope distance measuring devices

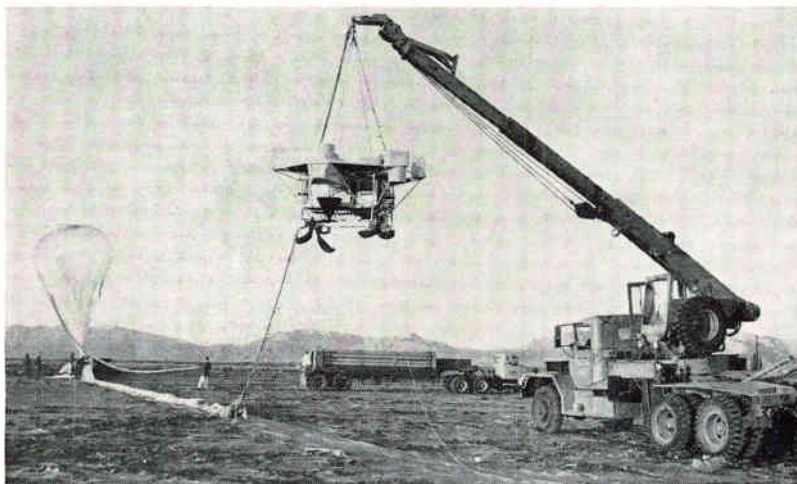

LOS ANGELES—A sensitive low-altitude altimeter based on radioisotope backscatter techniques is reported under development at Giannini Controls Corp. It gives promise of easing landing problems of spacecraft as well as aircraft.

Early tests of the lightweight, all-weather height-above-terrain indicator point to accuracies greater than one inch at the critical eight-to-10-ft "flare out" height for fast-landing jet aircraft. Its developers claim that, unlike conventional pressure and radar altimeters, accuracy of the new device improves as the gap between ground and instrument is closed.

Basically, the system consists of a radioisotope source, such as Cobalt⁶⁰, from which photons are propagated, and a solid-state or scintillator detector which picks up the reflected particles returning to the vehicle. Giannini envisions a 100-millicurie source for most applications, appropriately backshielded from the detector and from vehicle passengers or crew.

Maximum weight of the detector is 10 pounds, dimensions are eight in. high by three in. diameter. With a solid-state detector, it would measure two in. square and three in. long.

No power is required for the gamma radioisotope source and the detector needs less than 2 watts. Giannini points out that this is much less than power that 30 Gc or higher-frequency doppler radar packages need to attain comparable accuracies.

Simple digital electronics are used throughout. Altitude readout is a digital counter calibrated in feet or an analog scale, as desired. Cost of the entire system when in production will be about \$3,000.

The block diagram shows the basic system used for either the scintillator or the solid-state configuration. In the former, a sodium

Altimeter Uses Radioisotope Backscatter

iodide crystal or plastic scintillator at the face of a photomultiplier tube receives the reflected photons. The signal is amplified and fed through a pulse height discriminator.

In the solid-state version, energy levels of reflected particles are sensed by a back-biased silicon PN junction and the signal is fed to the preamplifier.

Since the gamma source is not a coherent one, reflected photons are received in a Poisson distribution which is passed through scalars in the pulse height discriminator. The distribution sequentially becomes Gaussian and then regular, making accurate, consistent read-outs possible.

Lunar landing is another application anticipated by Giannini. When lunar vehicles soft-land on the moon, it will be of utmost importance to determine their proximity to the surface just before impact, and to achieve level landings. These must be made on unfamiliar terrain and on ground whose profile and supporting ability are unknown. In the case of round-trip vehicles, once the craft topples the possibility of a return voyage to earth is highly unlikely.

Developers propose the use of a combination altimeter-densitometer system in each landing leg of the space vehicle. Intelligence received would be fed through two pulse height discriminators and commutated to determine positioning of each leg. Leg positions are adjusted so that one leg does not sink too far into a quicksand-like substance or another land on a higher ledge of ground.

For the densitometer function, a low-energy photon source would be required. The regular 100-millicurie source would be used for sensing distance above ground.

The following formula for the count rate indicates why excellent short distance resolution is possible, since count rate varies inversely

with the square of the distance. The count rate, I , received at a detector of area A_D , at a distance R from the ground (or other scattering medium), and a source strength I_s is given by:

$$I = \frac{I_s A_D n f}{4 \pi R^2} e^{-(\mu_a / \rho_a)(\rho R)}$$

where n is detector efficiency, f is backscatter factor (≈ 10 percent for Co^{60}), μ_a / ρ_a is absorption coefficient ($0.06 \text{ cm}^2/\text{gm}$ for Co^{60}) and ρ is air density ($1.293 \times 10^{-3} \text{ gm/cm}^3$ at sea level).

The company says that maximum practical range of the instrument in its present configuration is 200 feet. Accuracy of the indicator when used for airliner landing approach would not be appreciably effected by slush on the runway, or by a course over water immediately before contacting the runway, the company adds.

There reportedly is no safety hazard to personnel involved because of the radioactive source. Giannini points out, for example, that in a nonrepeating emergency situation, a person could hold the

100-millicurie source in his hand one foot from his body for 40 hours without injury.

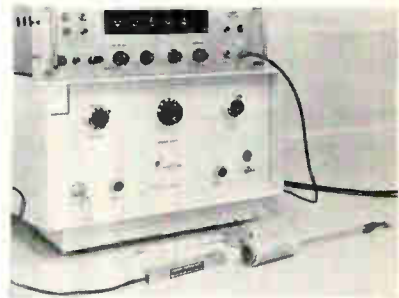

Test for measuring radiation scattering in air. Source is in the cylinder; the solid-state detector and preamplifier drive the scaler

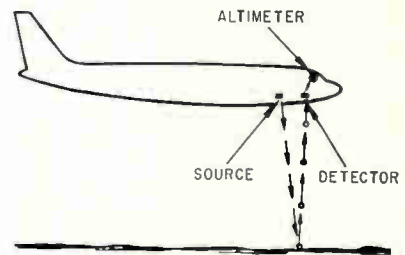

In airplane, altimeter indicates height detected by photon backscatter

Industry to Get AEC Data on Space Power

CLASSIFIED nuclear space power and propulsion system data will be made available to private industry under the Atomic Energy Commission's access permit program for development of peaceful uses of atomic energy. The regulations were amended recently.

Companies meeting security qualifications can obtain restricted data for private business and research uses. Applicants must show that they will contribute to R&D in this field, or are engaged in or preparing a study program for AEC, or are furnishing an access permittee with professional services.

Four new categories of classified information come under the regu-

lation: C-90, nuclear reactors for ramjet propulsion; C-91, reactors for rocket propulsion; C-92, systems for nuclear auxiliary power (Snap), and C-93, advanced concepts for future application.

AEC has been stepping up its research in space power and propulsion (ELECTRONICS, p 107, Nov. 17). Figures for the last two fiscal years are:

	1961	1960
	(\$ millions)	
POWER SYSTEMS		
radioisotope	2.9	3.1
reactor	14.3	8.4
PROPULSION SYSTEMS		
rocket (Rover-space) ..	25.1	15.5
ramjet (Pluto-missile) ..	23.1	16.3

Parts Supply Center Gets Set to Open

DEFENSE ELECTRONICS Supply Center (DESC) will become an operating element of the new Defense Supply Agency on July 1. Location for the center will be Gentile Air Force Station, Ohio. Facilities and resources of nearby Dayton Air Force Depot which already manages much of USAF's electronic supply will also become part of the center.

The Air Force is now installing a new automatic high-speed communications system, known as Comlognet, at the Dayton depot. The system, which will be operational Oct. 1, will interchange traffic with other military teletypewriter and data networks. A transceiver connection to Columbus, Ohio, will link the Air Force facility with Army and Navy communications systems which can thus be tied in with the world-wide USAF transceiver network.

General and special office equipment is on hand or due to be installed to support the center's requirements. Automatic data processing gear includes the Sperry Rand 1105, IBM 650B and Univac 1. Related punch card equipment to

support the computers is in place.

DESC is scheduled to employ 3,476 military and civilian personnel by September, 1964. Dayton Air Force Depot will employ 1,999 in support of DESC operations and a Facility Support Unit will require 321 employees. Less than 10 percent will be military.

USAF will assign 414,000 line items to DESC. By Sept., 1964, when it is in full operation, the center will have reviewed 1,020,000 items for management including anticipated item growth. This total will be reduced to approximately 680,000 net items by simplification, standardization and commonality actions.

DOD estimates that DESC will manage an inventory worth about \$400 million in fiscal year 1963. This will increase to \$500 million in 1964. Annual procurement is expected to reach \$143 million in the first year of operations and \$198 million the second year. Sales to the military services are estimated at \$165 million in 1963 and \$220 million in 1964. Receipt and issue transactions at the wholesale level

are expected to attain a volume of 5 million the first year and 7 million the second year of operation.

The study made by Maj. Gen. C. B. Root, USAF, with a joint staff participation, that resulted in these actions, noted that requirements for new parts increase 20 percent annually, far outstripping the retirement of "old" components. U. S. Reserve Forces and Military Assistance Program countries continue to generate requirements for "old" parts even when U. S. Forces can retire items from their inventories.

The military services are managing and distributing electronic parts in the U. S. as follows:

Army—The Army Signal Supply Agency, Philadelphia, Pa., and depots at Tobyhanna, Pa.; Sacramento, Calif.; Lexington, Ky.; and off-site warehouses at Fort Worth, Texas, and Atlanta, Ga.

Navy—Electronics Supply Office, Great Lakes, Ill., with depots at Oakland, Calif.; Norfolk, Va., and Bayonne, N. J.

USAF—Gentile Air Force Station, Ohio, and Rome, N. Y.

The military services will jointly establish item management coding for the assignment of items to DESC and the retention of other items for their own management.

The first category of parts scheduled for integration is electron tubes. DESC will manage Federal Stock Group 59 items (electrical and electronic components) and Class 6145 items (wire and cable).

Mechanical Hands—and Feet and Eyes

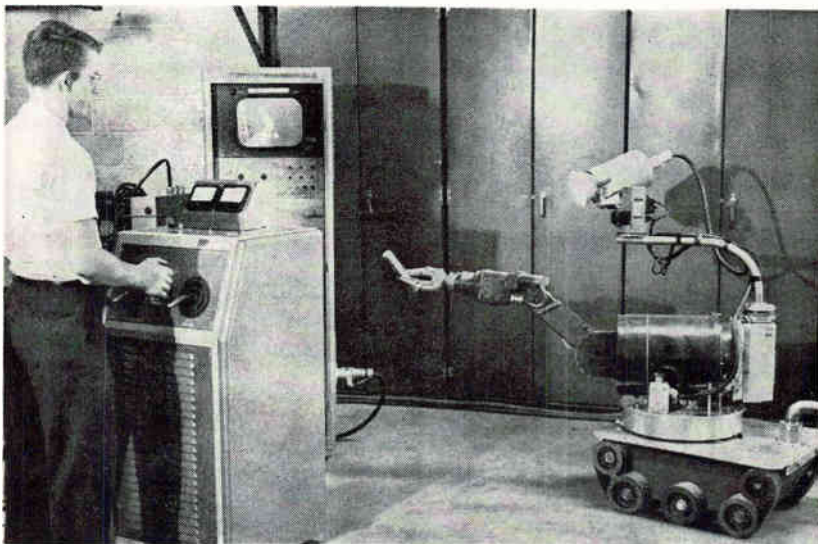

Remotely-controlled mechanical manipulator with tv camera picks up nuclear fuel element at AEC's Hanford Works. System was set up by General Electric, which manages the facility, to handle chores in hazardous areas

France Will Increase Applied R&D Budget

PARIS—The French government is planning further boosts in applied research expenditures, which have already been doubled in the past three years. Although firm plans have not been announced, it is expected that equipment outlays for nonmilitary research will total some \$300 million over the next four years.

For nonmilitary research in

EDP Time Clock



Completion of an installation on a F-104 at Lockheed is reported by supervisor who inserts his badge and punched card in a remote Edge (Electronic Data Gathering Equipment) system reporter. Lockheed is installing 400 of these, plus central computers, to automate production management. RCA designed the system

1962, \$91.5 million has been allocated for operating expenses and \$31.5 million for new equipment. Energy conversion and oceanography will get major shares.

France's space effort is tagged at \$17 million for 1962. About half the money will be used to contribute to a program aimed at getting a French satellite aloft by 1964 or 1965. An American-built launch vehicle would be used. Remaining funds will finance France's share of the European cooperative space project.

Continuing the practice established over the past three years, a single director aided by a 12-man scientific cabinet will direct the research efforts of more than a dozen ministries. The cabinet will be made up of men from government and industry.

To spur private research, the government is planning additional tax inducements. Benefits will include stepped up depreciation write-offs for research equipment and facilities, tax offset for financial participation in government-approved research centers, and exemptions from income taxes on profits for contract research organizations, in some special cases.

GIANT PLOTTING

New, ultra compact 30" x 30"
X-Y Plotter

with the quality, convenience and functions
you expect in a Moseley recorder



The Moseley Model 7 Autograf Recorder combines in one 6" deep instrument all the facilities needed for rapid, accurate 30" x 30" plotting of two variables in ranges from 30 mv to 300 v full scale. Accuracy is better than $\pm 0.1\%$ of full scale, and maximum pen speed is 20"/second for each axis. The instrument may be rack mounted or used in table position.

Its large recording area makes the Model 7 ideal for point plotting of digital data with Moseley digital-to-analog conversion accessories. Modular construction makes it easy to adapt for time base operation, ac input, logarithmic conversion, or curve follower operation with either magnetic or optical followers.

Selector switches provide 13 voltage ranges, 1 millivolt/inch to 10 volts/inch. Dual drive cables assure accurate X and Y alignment, with X and Y servo systems completely independent and isolated from ground.

Model 7 uses either individual sheets of graph paper or 50-yard roll charts. Price, \$6500.

*Call your Moseley representative today
or write direct for detailed information.*

AUTOGRAF recorders

F. L. MOSELEY CO.

409 N. Fair Oaks Avenue, Pasadena, California

7523

SPRAGUE®

MODEL 500

INTERFERENCE LOCATOR

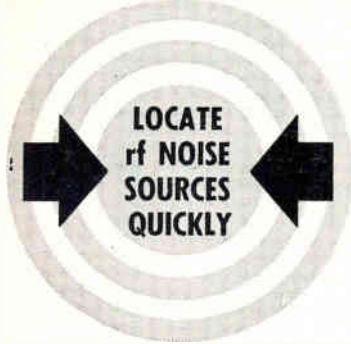

This versatile instrument is a highly sensitive interference locator—with the widest frequency range of any standard available unit! Model 500 tunes across the entire standard and FM broadcast, shortwave, and VHF-TV spectrums from 550 kc. to 220 mc. in 6 bands.

It's a compact, portable, rugged, versatile instrument—engineered and designed for most efficient operation in practical field use. It features a transistorized power supply, meter indications proportional to carrier strength as well as sensitivity of 5 microvolts minimum for 5% meter deflection over entire tuning range.

For full details, send for brochure IL-106.

SPRAGUE ELECTRIC COMPANY
35 Marshall Street, North Adams, Mass.



Compares Cards and Tape

INFORMATION HANDLING system recently developed for F. W. Dodge Corp. simultaneously compares punched cards and magnetic tape to identify subscribers slated to receive construction reports. The machine sorts through subscriber lists at rates over 5,000 addresses a minute—a job formerly done by hand.

Customers' requirements and report material are categorized into over 1,200 definitive units in three major fields of interest. Tape frames identify the subscriber by number and the types of reports he wants. Corresponding holes in a punched card identify the type of report being distributed.

The card is scanned photoelectrically on a drum driven coaxially with the tape reader. When signals from a tape frame and the card match in memory units, the matching signal passes through gates and a pulse amplifier to a counter.

The counter passes the signal on to an indicator lamp at a numbered subscriber box. The counter has two functions: keeping track of which tape frame is being read and switching the signals to the proper

lamps. After the tape file has been compared with a report card, clerks distribute copies of the report to the indicated boxes and reset the system.

The same equipment prepares the tape files. Subscriber preferences are punched on a card similar to the report card, the card is scanned and the signals are recorded. The memory is bypassed, but the frame number appearing on the counter is used to identify the subscriber.

The system was developed and built for F. W. Dodge by Shepard Laboratories, Inc., of Summit, N.J., under direction of the inventor, Allen L. Grammer, of Newark, N.J. F. W. Dodge is a subsidiary of McGraw-Hill Publishing Co.

Monitors in Eight Cities Will Check Auto Exhausts

SAN FRANCISCO—The second of a proposed eight-link chain of air contaminant monitoring stations was opened here late last month by the U. S. Public Health Service.

Sponsored by the San Francisco Bay Area Air Pollution Control District and USPHS, the monitoring station will automatically sample and analyze the downtown San Francisco atmosphere as part of a Public Health survey to determine effects of auto exhausts on human health in urban areas. Gases to be sampled and studied include sulfur dioxide, nitric oxide, nitrogen dioxide, carbon monoxide, hydrocarbons, ozone, and oxidants.

The instrumentation system is comprised of scintillation counters provided with strip chart recorders and analog-to-digital converters which will automatically tape-punch all data for computer analysis. Instruments were provided by Beckman Instruments.

The San Francisco sampling station will eventually be time standard-calibrated with seven similar stations to be set up in other metropolitan areas. These are Los Angeles, Detroit, Washington, D. C., New Orleans, Philadelphia, Chicago, and Cincinnati. The latter has been operating since November.

Bar Chart Recorder



Remote recorder made by Electronic Associates, Inc., provides cost and production control information for up to 40 production or data processing machines. Machines can be monitored continuously



"get
your own
copy"

just compiled: **Selecting The Correct Delay Line**

For the Specifying Engineer, selection of the correct delay line is now simplified. A new manual from Shallcross concisely covers: Characteristics, Specifications, Applications and Special Features of all delay lines in both the Electromagnetic and Sonic Groups. Also included: Testing Procedures, Determination of Size, Reducing Delay Line Costs, and new Standard Definitions and Terminology. This new booklet is the product of Shallcross' long experience in the design, engineering and manufacture of custom-built delay lines for critical applications. If you're a Specifying Engineer, you'll want your own personal copy. It's yours for the asking. Just check the reader service card or write: Shallcross Manufacturing Company, Selma, North Carolina.

INSTRUMENTS • RESISTORS • SWITCHES • ATTENUATORS • DELAY LINES

Shallcross

Time-tested Standard of the Resistor Industry!

EVANOHM[®]

SPECIFICATIONS

Nominal composition
75% Nickel
20% Chromium
2.5% Aluminum
2.5% Copper

Specific resistance 20°C
800 ohms/cm²
134 microhm cm

Coefficient of linear expansion
20° to 100°C
.000014/°C

Specific gravity
8.10 gm/cc

Pounds per cubic inch
.293

Magnetic attraction
None

Average tensile strength
180,000 psi

Thermal conductivity
0.152 W/cm²/°C

Mean thermal EMF vs copper 0°C to 100°C
1 μV/°C

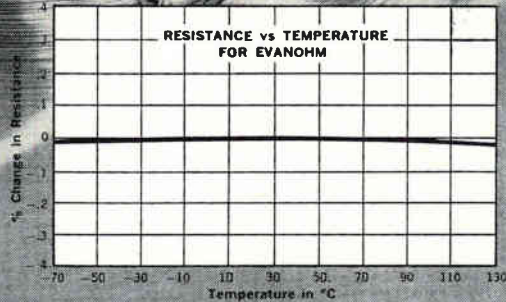

Specify EVANOHM for exceptional stability over wide temperature ranges. This WBD precision resistance alloy provides high specific resistance, low temperature coefficient and low thermal EMF to copper. It is especially recommended for high reliability applications... resistors, precision instruments, missiles and critical equipment. Available in bare wire, enameled or insulated.

FINE WIRE ALLOYS IN A FULL RANGE OF RESISTIVITIES

ALLOY	Nominal Composition	Resistivity (ohms/cm ²)	T.C. of Resistance (ohms/ohm/°C, 20-100°C)	Specific Gravity gms/cc
Evanohm [®]	75 Ni-20 Cr-2.5 Al-2.5 Cu	800	±.000005† (-65° to 125° C.)	8.10
Tophet A [®]	80 Ni-20 Cr	650	.000085	8.412
Tophet [®] C	61 Ni-15 Cr-bal. Fe	675	.00013	8.247
Cupron [®] (Constantan)	55-Cu-45 Ni	294	±.000020	8.90
Balco [®]	70 Ni-30 Fe	120	.0045	8.46
Ballast [®] (Pure Nickel)	99.7 Ni	48	.0060	8.90
30,60,90,180 Alloys	Cu-Ni	30-180	.00130 -.00018	8.90

†.002" and finer



Call or write for EVANOHM brochure to—

WILBUR B. DRIVER COMPANY
NEWARK 4, NEW JERSEY — Telephone: HUmboldt 2-5550

In Canada: Canadian Wilbur B. Driver Co., Ltd., 50 Ronson Drive, Rexdale (Toronto)

PRECISION RESISTANCE, ELECTRONIC AND MECHANICAL ALLOYS FOR ALL REQUIREMENTS

MEETINGS AHEAD

ELECTRICAL ENGINEERING Exposition for Electrical-Electronics Industry, AIEE; N.Y. Coliseum, N.Y.C., Jan. 29-Feb. 2.

REDUNDANCY TECHNIQUES FOR COMPUTING SYSTEMS, Office of Naval Research; Dept. of Interior Aud., Wash., D. C., Feb. 6-7.

MILITARY ELECTRONICS, PGMIL of IRE; Ambassador Hotel, Los Angeles, Feb. 7-9.

SOLID STATE CIRCUITS, Internat. Conf., PGCT of IRE, AIEE; Sheraton Hotel and University of Pennsylvania, Philadelphia, Pa., Feb. 14-16.

APPLICATION OF SWITCHING THEORY TO SPACE TECHNOLOGY Symp., USAF, Lockheed Missiles and Space; at Lockheed, Sunnyvale, Calif., Feb. 27-Mar. 1.

SCINTILLATION AND SEMICONDUCTOR Counter Symp., PGNS of IRE, AIEE, AEC, NBS; Shoreham Hotel, Washington, D. C., Mar. 1-3.

MISSILES & ROCKET TESTING Symp., Armed Forces Communications & Electronics Association; Coca Beach, Fla., Mar. 6-8.

EXTRA-HIGH VOLTAGE COMMUNICATION, CONTROL & RELAYING, AIEE; Baker Hotel, Dallas, Tex., Mar. 14-16.

IRE INTERNATIONAL CONVENTION, Coliseum & Waldorf Astoria Hotel, New York City, Mar. 26-29.

QUALITY CONTROL Clinic, Rochester Soc of Q. C.; U. of Rochester, Rochester, N. Y., Mar. 27.

ENGINEERING ASPECTS OF MAGNETO-HYDRODYNAMICS, AIEE, IAS, IRE, University of Rochester, Rochester, N. Y., Mar. 28-29.

SOUTHWEST IRE CONFERENCE AND SHOW; Rice Hotel, Houston, Texas, April 11-13.

JOINT COMPUTER CONFERENCE, PGEC of IRE, AIEE, ACM; Fairmont Hotel, San Francisco, Calif., May 1-3.

HUMAN FACTORS in Electronics, PGHFE of IRE; Los Angeles, Calif., May 3-4.

ELECTRONIC COMPONENTS Conference, PGCF of IRE, AIEE, EIA; Marriott Twin Bridges Hotel, Washington, D. C., May 8-10.

NATIONAL AEROSPACE Electronics Conference, PGANE of IRE; Biltmore Hotel, Dayton, Ohio, May 14-16.

ADVANCE REPORT

BROADCAST & TELEVISION RECEIVERS Spring Conf., PGBTR of IRE: at O'Hare Inn, Chicago, June 18-19. Papers particularly sought on new products and new concepts of component and circuit design. Deadline for papers is February 15, but authors should submit 50-100 word summaries at their earliest convenience to: Mr. Al Cotsworth, Zenith Radio Corporation, 6001 W. Dickens Ave. Chicago 39, Illinois.

ELECTRONIC ENGINEERS

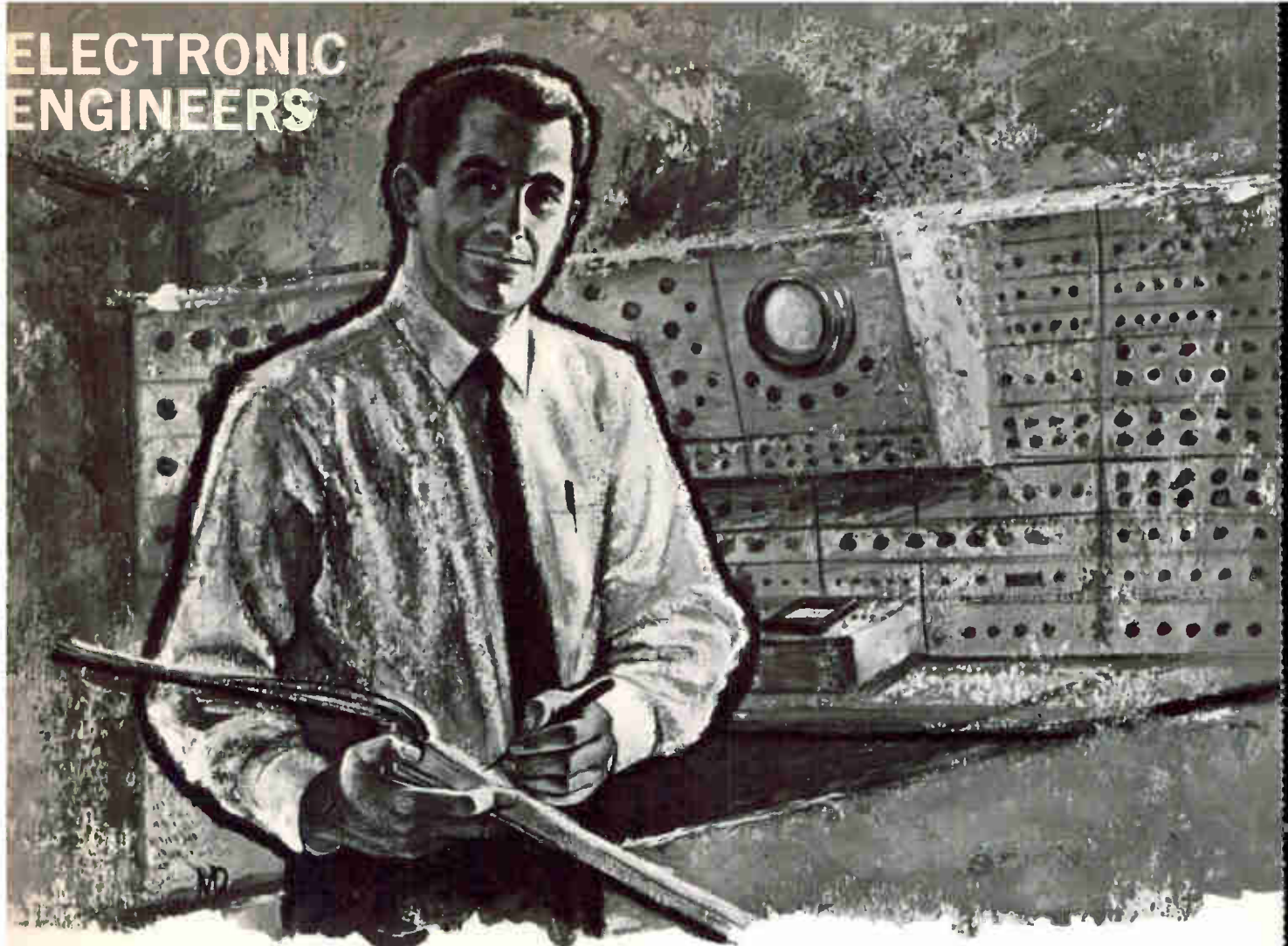

At General Dynamics|Astronautics, the electronic engineer enjoys the freedom and prestige afforded men who are creating and testing the space and missile systems of the future.

General Dynamics|Astronautics needs circuit designers for systems design and integration of:

LAUNCH CONTROL CIRCUITS. These are relay and transistorized open loop, and sequential switching circuits for the automatic control of the count-down process for the Atlas missile.

TEST EQUIPMENT DESIGN. Switching and analogue circuitry for automatic test and checkout equipment. Assignment will be of a project nature from conception to production.

TRACKING SYSTEMS DESIGN. Communications, pulse and phase shift techniques for the design of ultra-precise missile and satellite tracking systems.

TELEMETERING DESIGN. Communications, modulation, and data sampling techniques for telemetering and data acquisition systems.

Inquiries are also invited from scientists possessing doctorate degrees and the desire to do research beyond the state of the art in communication techniques and solid state devices.

You will be associated with General Dynamics|Astronautics, the company that designed, builds and tests this country's first operational ICBM.

These positions provide stability, growth opportunity and the satisfaction of working on a program which is both highly advanced and of vital significance to the future of the free world.

You will find more information on the back of this page and a convenient, confidential Professional Placement Inquiry. A prompt reply to your inquiry will be forthcoming from Mr. R. M. Smith, Manager of Industrial Relations Administration-Engineering, Dept. 130-90, General Dynamics|Astronautics, 5720 Kearny Villa Road, San Diego, California.

GENERAL DYNAMICS



GENERAL DYNAMICS
ASTRONAUTICS

ENGINEERS AND SCIENTISTS

General Dynamics | Astronautics is located in San Diego, California, one of the fastest growing communities in the United States. Situated 10 miles north of the Mexican border and a little over 100 miles south of Los Angeles, San Diego and its environs enjoy a year round mild, sunny climate with smog-free air. The 30 miles of coastline are dotted with private and public beaches, inlets, and bays where fishing and water sports prevail year long. Engineers and scientists find the temperate climate and variety of after hour activities add up to superb living and working conditions all within 15-20 minutes from home.

General Dynamics | Astronautics' plant is one of the largest and newest facilities in the free world for research, development and production of long-range missiles and space vehicles.

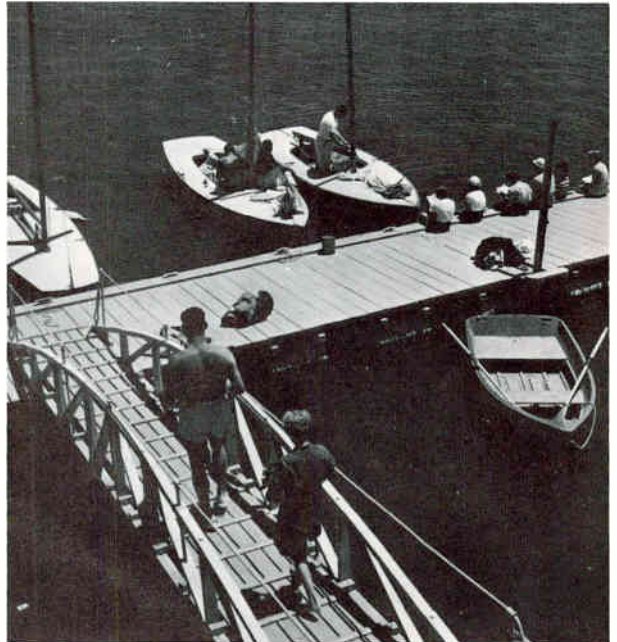

In addition to the positions described on the other side, openings also exist in these and other specialties:

Technical Writing • Field Engineering • R. F. Systems
• Technical Instruction • Human Factors • Landlines •
Launch Control Systems • Closed Loop TV Systems
• Telemetry • Ground Support Equipment • Auto-
pilot • Guidance • Systems Checkout.

Technical openings also exist in other specialties. Write Mr. R. M. Smith, Manager of Industrial Relations Administration-Engineering, Dept. 130-90, General Dynamics | Astronautics, 5720 Kearny Villa Road, San Diego 12, California.

AN EQUAL OPPORTUNITY EMPLOYER

GENERAL DYNAMICS



GIANNI D
ASTRONAUTICS

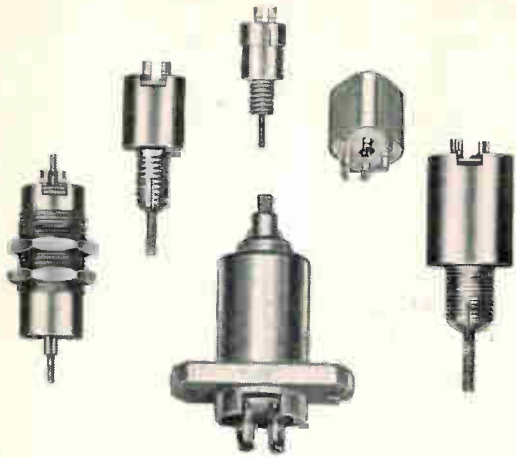

We wind to your specs

CAMBION® has all the facilities and forms — standard, printed circuit and shielded — required to wind coils to your exact specifications . . . with quick deliveries in any quantities you order . . . and *quality-guaranteed* like all CAMBION components. Whatever qualification testing you might require is also available in CAMBION's fully equipped environmental laboratories, for thorough checking of your coils before shipment. Technical service is as prompt as deliveries, too. Have a CAMBION Sales Engineer call to discuss your requirements for custom wound coils, or mail your blueprints to Cambridge Thermionic Corporation, 437 Concord Ave., Cambridge 38, Massachusetts.



CIRCLE 202 ON READER SERVICE CARD

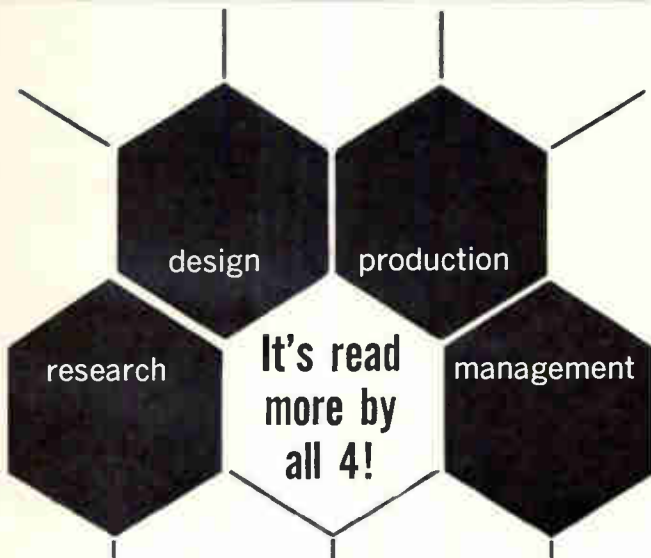

There's more data in **electronics**, the magazine that gives you the latest technical and engineering information every week *plus* business and government trends. Subscribe now. Mail the reader service card (postpaid) to **electronics**, the magazine that helps you to know and to grow! Rates: three years for \$12, one year \$6, Canadian, one year for \$10; foreign, one year for \$20. Annual **electronics** BUYERS' GUIDE (single issue price \$3.00) included with every subscription.

subscribe today to **electronics!**

January 19, 1962

NEW DESIGN DATA ON MAGNETIC AMPLIFIERS



—latest **ARNOLD** folder enables you to design and build a unit to your exact needs.

Armed with the data in this folder, you can create an optimum design for a 12-watt magnetic amplifier . . . get the closest possible control over its design and construction . . . for control of servo motors, regulated power supplies, etc.

You build the amplifier around its basic component — the saturable reactor. Twenty-four **ARNOLD** saturable reactors are described in the folder. There's full information as to what associated components are necessary, and how to use the components in a proper magnetic amplifier circuit.

In buying just the saturable reactor, you get far more latitude than in buying a whole black box. And you won't have to prepare comprehensive specs., or depend on an outside source for the complicated designs.

Write for new **Arnold** Catalog. It's yours for the asking.



ARNOLD MAGNETICS CORP.

6050 W. Jefferson Blvd., Los Angeles 16, Calif.
Vermont 7-5313

CIRCLE 203 ON READER SERVICE CARD

For
greater
stability
under
higher
heats

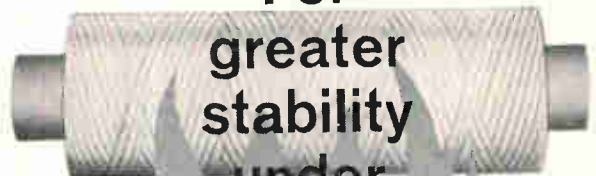

**HEMINWAY
& BARTLETT**

DACRON LACING CORDS AND TAPES

These flat-braided Dacron lacing tapes and cords are specially processed for stability under higher heats. Fungus-proof, non-slip finish ties faster, easier, tighter.

Available wax-coated, wax-free or with G. E. Finish. Write today for free samples.

THE HEMINWAY & BARTLETT MFG. CO.

Electronics Division: 500 Fifth Avenue, New York 36, N.Y.
Distributor — Alpha Wire, New York

CIRCLE 35 ON READER SERVICE CARD

35

THRESHOLD DETECTOR



1.5 MC TUNED AMPLIFIER

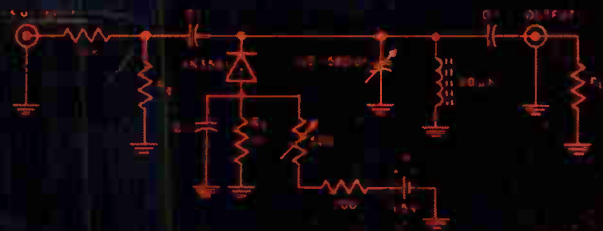

BISTABLE FLIP FLOP

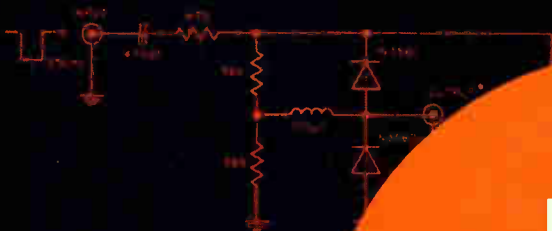

MEMORY CELL

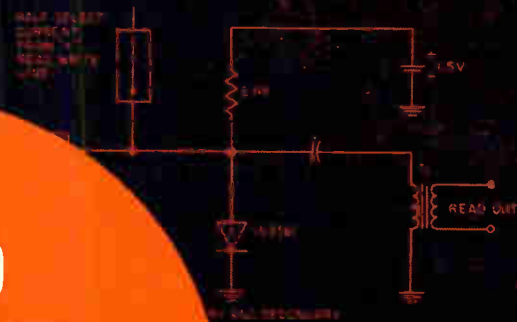

PHILCO TUNNEL DIODES FIND WIDESPREAD APPLICATION

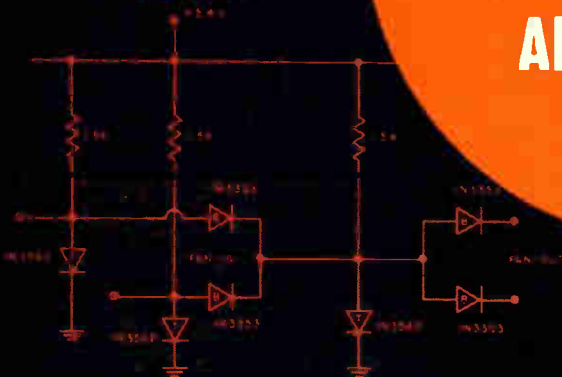
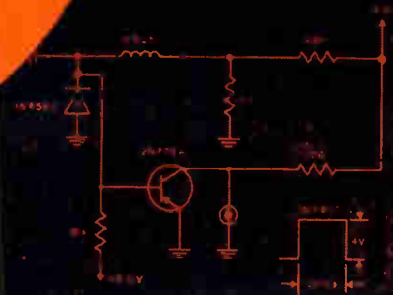
BACKWARD DIODE COUPLED
"OR" GATEONE SHOT MULTIVIBRATOR
WITH
HIGH GAIN INVERTER

In their second year of production, Philco tunnel diodes have come of age. These ultra-high speed, bistable, electrically precise devices have found popular use . . . in control systems . . . in computers . . . and in communications.

Philco, in addition to its production for recently established applications, has developed prototype versions of high current tunnel diodes—up to 10 Amps.—for thin-film memory driving, current surge protection in power supplies, and thermoelectric power conversion. Another new development at Philco is microenergy electronics—cooler operating circuits containing both transistors, tunnel diodes, and backward diodes.

Now that tunnel diode applications are established, and prices are compatible with production requirements, let Philco help you evaluate tunnel diode possibilities in your designs. Write Dept. 11962S.

All Philco Tunnel Diodes are
Immediately available from your Philco
Industrial Semiconductor Distributor.

PHILCO



Famous for Quality the World Over

LANSDALE DIVISION, LANSDALE, PENNSYLVANIA



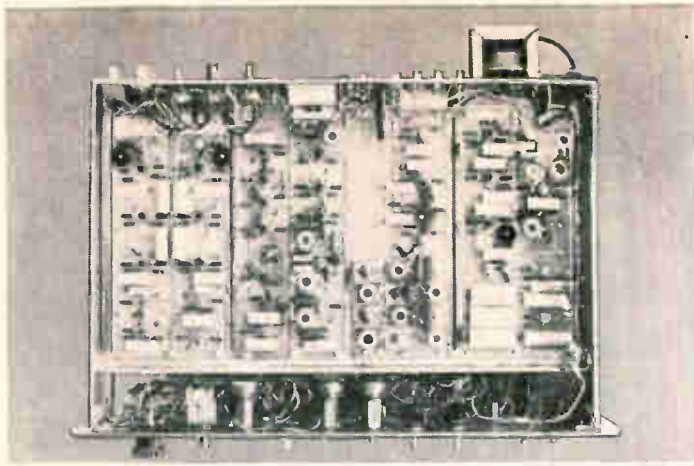

Use of transistors makes a compact unit. Switches are used to select operating conditions

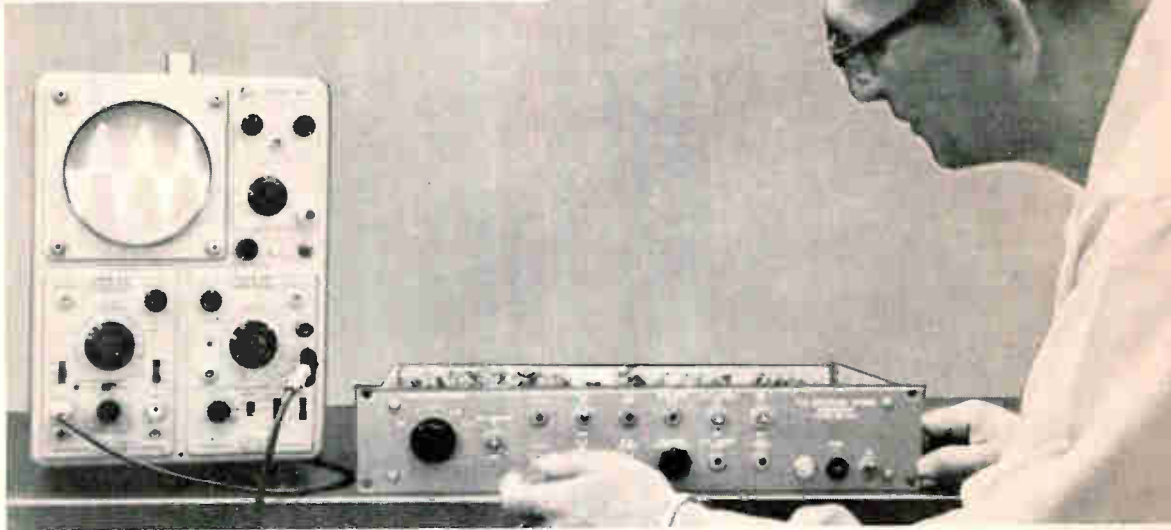

STEREO F-M MULTIPLEX Alignment Signal Generator

Transistor unit generates complete FCC approved stereophonic multiplex signal for receiver and stereo adapter design, testing and alignment

By **STANLEY FELDMAN**, Test Equipment Engineering, Consumer Products, Motorola, Inc., Chicago, Illinois

STEREOPHONIC MULTIPLEX SIGNAL as finally accepted by the FCC can be written $(E_L + E_R) + (E_L - E_R) \sin \omega t + K_1 \sin (\omega t/2) + e_{s.c.}$ where $(E_L + E_R)$ represents the sum of the left and right input audio signals; $(E_L - E_R) \sin \omega t$ is a suppressed-carrier double-sideband signal, or the product of the difference of the left and right signal and a 38 Kc carrier; $K_1 \sin (\omega t/2)$ is a reference 19 Kc subcarrier used in the receiver to synchronize the local oscillator for separation of the left and right information; and $e_{s.c.}$ is a

background f-m signal whose carrier is approximately 67 Kc. According to FCC specifications, it should be possible to transmit this background signal simultaneously with the stereo multiplex signal with the minimum of crosstalk, and is included in this generator primarily for making this check in testing receivers and adapters.

The system used in the multiplex generator is shown in Fig. 1. The right channel input feeds a phase inverter to obtain $+R$ and $-R$ signals for matrixing. The left channel input feeds an emitter follower which supplies $+L$ to the matrix. Both $(L + R)$ and $(L - R)$ can be obtained from matrix

by resistor adding.

The $(L + R)$ signal feeds a feedback amplifier whose gain is determined principally by the ratio of feedback resistor and input R-C network. Adjustment of C in the input makes it possible to precisely set the preemphasis characteristics. The output of the $(L + R)$ amplifier feeds an L-C network which delays the $(L + R)$ signal to compensate for the envelope delay in the suppressed-carrier signal.

The $(L - R)$ signal goes through an identical amplifier and feeds the suppressed-carrier modulator section. The $(L + R)$ signal, the suppressed carrier signal, and the 19 Kc reference carrier are resistively added and passed through a low-pass filter, which is flat to 53 Kc. Frequency components of the suppressed-carrier signal above 53 Kc are undesirable and attenuated by this filter. The output of the filter is resistively added to the SCA background f-m signal and fed into the output amplifier.

The technique used for generating the suppressed-carrier signal is shown in Fig. 2. The 38 Kc signal is fed to Schmitt trigger Q_3 and Q_4 which furnishes 38 Kc square waves of 0 and 180 degrees phase. These square waves gate transistors Q_2 and Q_5 ON and OFF. The collector supply voltages for Q_3 and Q_4 are emitter followers Q_1 and Q_6 , which furnish d-c voltages with superimposed $(L - R)$ audio signal. The $(L - R)$ signal out of Q_2 can be considered + phase and the $(L - R)$ signal out of Q_5 is 180 degrees out of phase with Q_2 . The output of the two gates is summed at the input to Q_4 and results in a suppressed square-wave carrier signal. Using Fourier series to describe the circuit, the output of Q_4 can be written:

$$e_2 = [E_{dc2} + (L - R)] \left[\frac{1}{2} + \frac{2}{\pi} \sin \omega t + \frac{2}{3\pi} \sin 3 \omega t \dots \right]$$

The output of Q_5 would be:

$$e_5 = [E_{dc5} - (L - R)] \left[\frac{1}{2} - \frac{2}{\pi} \sin \omega t - \frac{2}{3\pi} \sin 3 \omega t \dots \right]$$

Addition of the two collector waveforms give:

$$e_3 + e_5 = \frac{E_{dc2} + E_{dc5}}{2} + 4 \frac{(L - R)}{\pi} \sin \omega t + \frac{4}{3\pi} (L - R) \sin 3 \omega t + [E_{dc2} - E_{dc5}] \left[\frac{2}{\pi} \sin \omega t + \frac{2}{3\pi} \sin 3 \omega t \dots \right]$$

Making E_{dc2} equal to E_{dc5} by adjustment of the bias of Q_5 , and passing the above through a capacitor to eliminate the d-c component results in:

$$(e_3 + e_5) = \frac{4}{\pi} (L - R) \sin \omega t + \frac{4}{3\pi} (L - R) \sin 3 \omega t \dots$$

Passing this through a low-pass filter to eliminate the 3rd harmonic and higher-frequency components results in the suppressed carrier signal. $K (L - R) \sin \omega t$.

This technique resulted in a highly-stable and linear-suppressed-carrier generator. The 38 Kc carrier can be suppressed approximately 60 db below maximum signal level over short intervals, and will maintain approximately 46 db rejection over days of operation.

Generation of the SCA signal is accomplished by

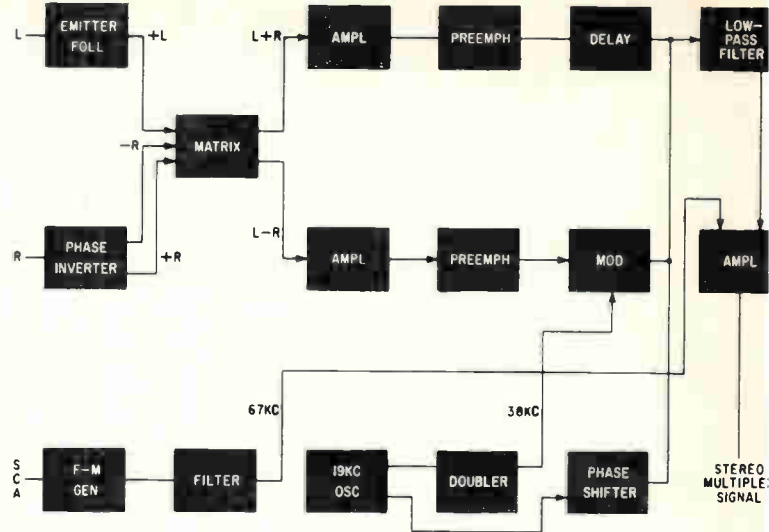

FIG. 1—Low-pass filter in stereo circuit cuts off at 53 Kc; SCA 67-Kc signal is passed through a bandpass filter flat between 59 and 73 Kc

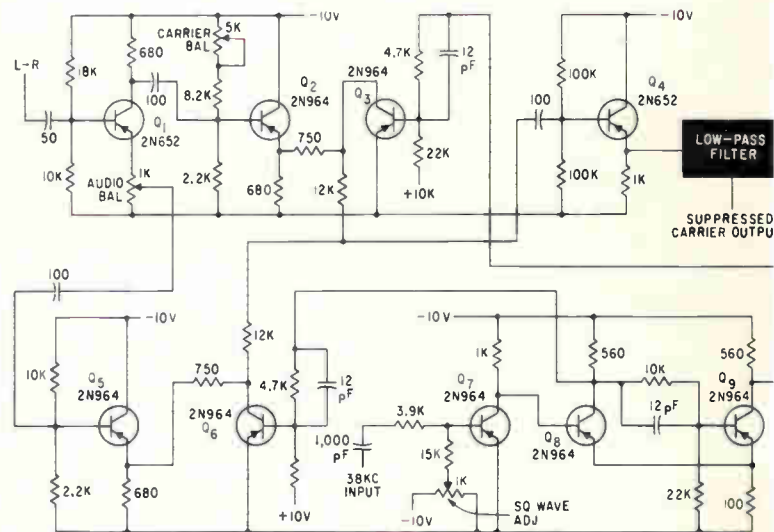

FIG. 2—Suppressed-carrier circuit of stereo signal generator. Output is 38 Kc modulated by L-R signal. Carrier frequency is suppressed

bias modulating a symmetrical stable multivibrator and passing the frequency modulated square wave through a band-pass filter which is flat from 59 to 73 Kc.

Switches are used to select any desired operating conditions. It is possible to generate $L + R$ or $L - R$ separately with or without pre-emphasis, the SCA subcarrier can be inserted or removed and other necessary alignment circuits have variable controls.

The unit is made up of four printed circuit boards which occupy the main area of the chassis. The power supply consists of two simple zener diode regulated supplies +10 v and -10 v, and uses approximately 15 watts of line power.

The author acknowledges Dominick Wisniewski for his assistance.

Complete stereo multiplex signal generator used for testing and alignment of receivers and multiplex adapters

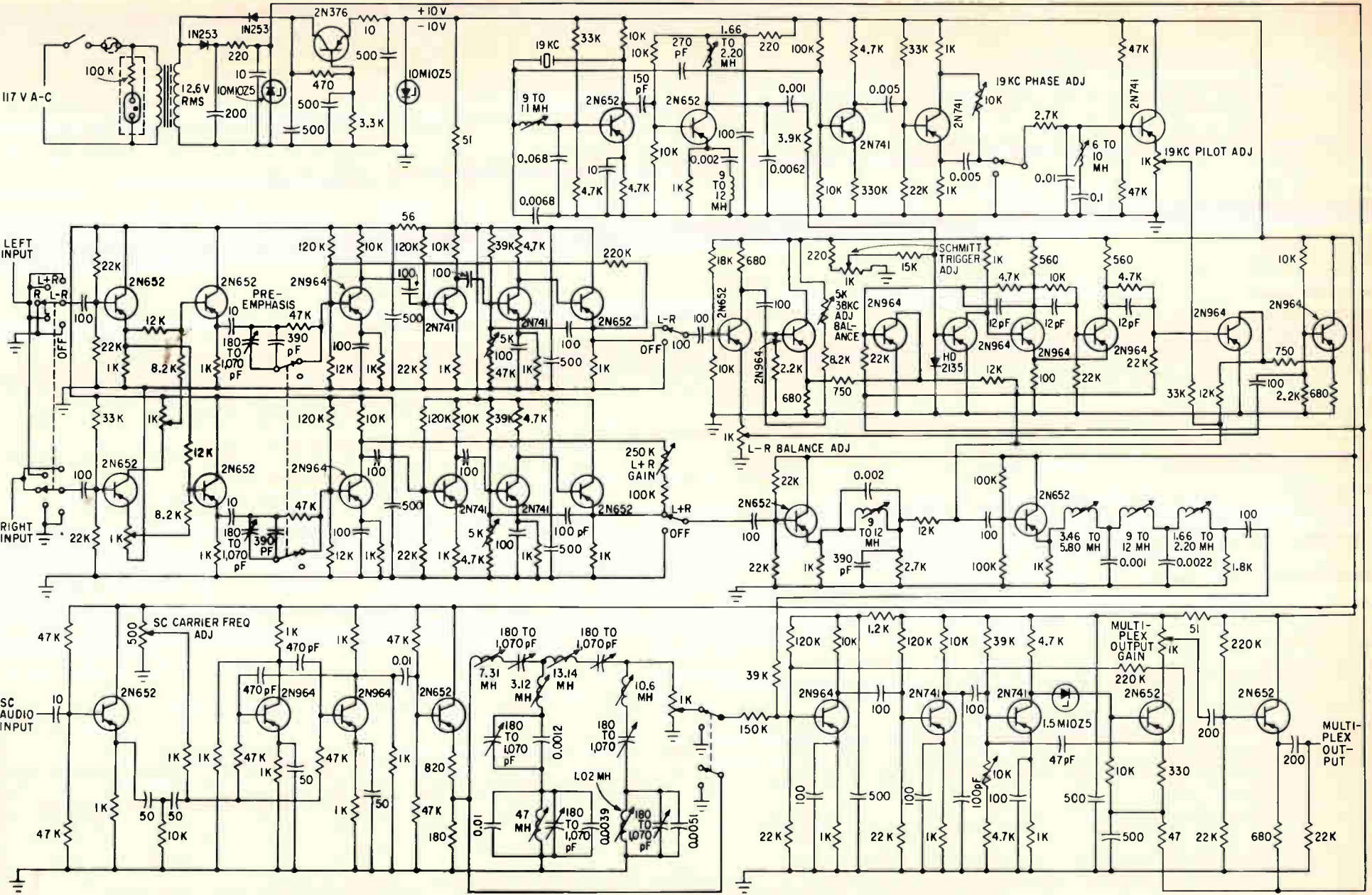

MICROWAVE RELAY

Designing With Traveling-Wave Tubes

High-power microwave amplifiers, horn antennas, frequency-shifting plan provide high capacity, reliable communications system

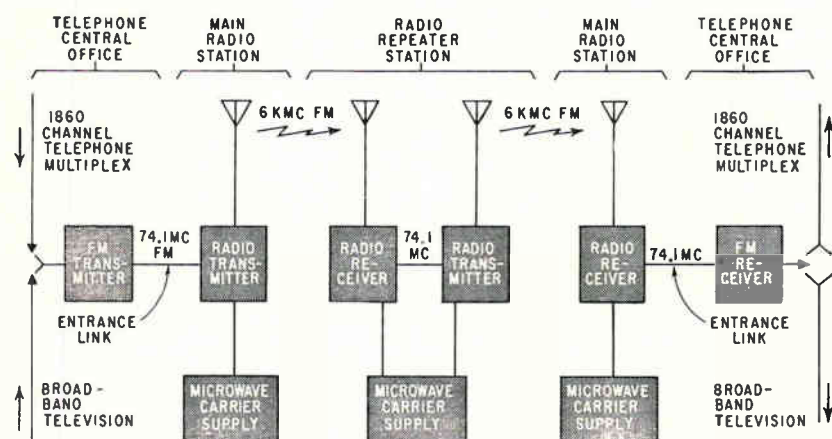

FIG. 1—Terminal stations and a typical repeater station in microwave communications network

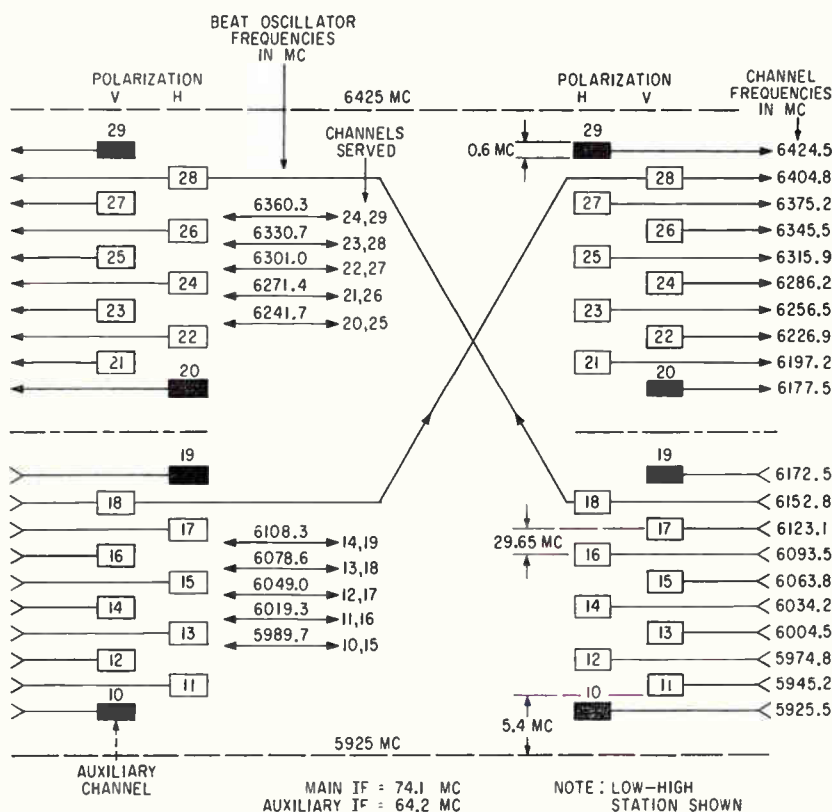

FIG. 2—Frequency plan for the system. Signal received on channel 18 (6,152.8 Mc) is retransmitted on channel 28 (6,404.8 Mc)

NEW LONG-HAUL microwave system combines a number of advances in communications system design developed at Bell Laboratories in recent years. The TH system has been developed to provide eight 10-Mc wide-band and two 0.6-Mc narrow-band channels for telephone and television transmission.

Designed to supplement the present transcontinental TD-2 system which operates in the 4-Gc band, the TH system operates in the 5,925 to 6,425 Mc band. Six of the eight wide-band channels are in use at all times. The other two are kept as standby. Each wideband channel can handle up to 1,860 telephone circuits or one television channel plus 420 voice circuits. The two narrow-band channels are in the guard band between the broadband transmitters and receivers and also at the edge of the band. These two channels provide circuits for transmission of alarm signals from unattended stations, switching signals in case of failure of a regular circuit and for voice circuits between station operators.

Figure 1 shows the entire system. Each circuit consists of a broad-band f-m transmitter using a traveling-wave tube with an output of 5 watts over the operating range. Receiving equipment consists of a low-noise f-m receiver at each of the eight broadband channels that converts the signal to a 74.1-Mc intermediate frequency. At each repeater station, the signal is not demodulated, but converted into a preassigned transmission frequency that differs from the received frequency by 252 Mc.

The system frequency plan minimizes crosstalk, Fig. 2. The 5,925



*Typical relay station
in Bell System's
TH cross-country
microwave network*

signal frequency is not changed except to switch channels. Bell Laboratories' engineers chose a third system for use in the TH links. Here the signal is converted to an i-f frequency at the receiver and passed on to the transmitter modulator. Use of this frequency permits a common interconnection between parts of the system. There is also greater ease in separating and switching channels.

Past experience with other microwave systems has indicated that an i-f of about 70 Mc is a good compromise in the amplifier design between the vacuum-tube input conductance and broadband coupling network design.¹ The frequency chosen, 74.1 Mc, is an odd multiple of channel spacing.

Type of modulation was the subject of wide study.¹ Pulse modulation systems give excellent noise and distortion performance through a series of repeaters, but require large bandwidths. High-index frequency modulation is unsuitable for the same reason because it trades bandwidth for noise performance.

Single-sideband suppressed-carrier transmission, on the other hand, makes efficient use of the spectrum, but requires a high degree of linearity to reduce distortion. Power amplifiers at 6 Gc with the required linearity probably could not be built at the present state of the art.

A compromise was chosen for the TH system. Low-deviation frequency modulation was chosen because it requires a relatively narrow band and will tolerate compression in the amplifiers. Optimum frequency deviation was found to be ± 4 Mc peak based on

to 6,425-Mc band is divided in equal parts. At each repeater station, transmitters operating in both directions use one portion of the band, while receivers operating in both directions use the other portion. Frequency assignments are reversed at the next repeater station. When a signal is received, it is converted to the 74.1 Mc i-f, passed to the transmitter and converted to a microwave frequency that is the received frequency plus or minus 252 Mc. If the signal is received on the lower portion of the 6-Gc band, the transmitted signal will leave the repeater at that frequency plus 252 Mc. A shift to the lower portion of the band is performed if the signal is received in the top half. This 252-Mc shift is common to all signals, and minimizes coupling between antennas pointed in the same direction.

The system has been improved over the TD-2 system only where an improvement was indicated by past experience.¹ Where the TD-2

approach was best, the design was not changed.

Among the first of the design improvements was the development of the horn reflector antenna, Fig. 3. The most important consideration was the possibility of simultaneous use of the antenna for the TD-2 system and the TH system as well as a proposed TJ (11 Gc) system. This antenna uses a circular waveguide feed that permits it to transmit cross-polarized signals in all these bands. Antennas with vertically polarized channels are placed next to antennas carrying horizontally polarized channels. Tests show that an adjacent channel signal is attenuated about 25 db in the entire system.

Three types of repeater systems are available to the communications system designer. In the first, the r-f signal is demodulated and amplified, and this baseband signal modulates the transmitter for retransmission. A second system is the r-f to r-f repeater in which the



FIG. 3—Horn antenna handles signals in the 4, 6 and 11 Gc bands simultaneously

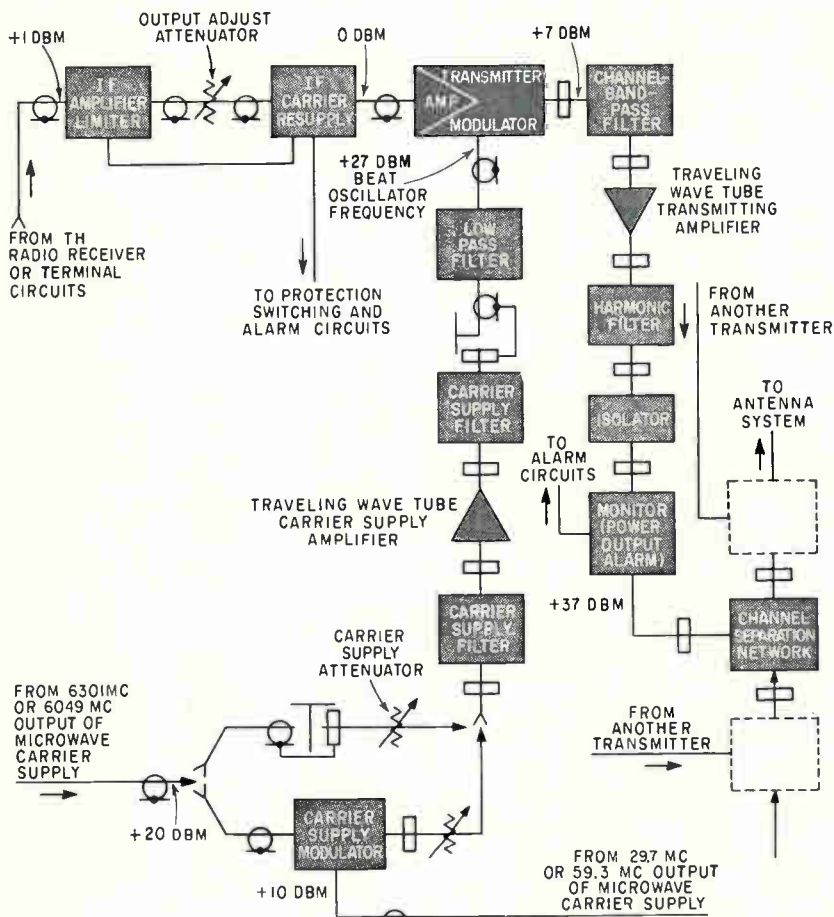

FIG. 4—Two twt amplifiers are used in transmitter. Carrier resupply prevents noise interference caused by carrier loss

the availability of a high-power transmitter tube, the receiver noise figure and system distortion.

To achieve reasonable output, the Western Electric Type 444A traveling-wave tube was adopted for use. This twt has an output of 5 watts in the 6-Gc band. The twt amplifier has a gain of about 32 db. A filter follows the amplifier to attenuate the second harmonic an additional 25 db.

Two twt amplifiers are in each transmitter, Fig. 4. One twt amplifier is in the signal path as an amplifier, and another as a carrier supply amplifier.² As an amplifier, the gain and frequency response is flat over the entire band. To minimize the noise contribution of the twt amplifier to the system, the amplifier gain is held to between 30 and 35 db. Tube gain is reduced by lowering the helix voltage.

Carrier supply amplifier output is about 0.5 watt. Allowable gain is determined by noise. The carrier supply and carrier supply amplifier provide the beat-oscillator frequency for the transmitter modulator. A second twt amplifier at a single frequency seems inefficient, but it saved introducing a second type of microwave amplifier into the system and allowed the use of a common power supply for both.

The power required to focus the tube and for its cooling is held to a minimum to increase reliability of the equipment at unattended locations. The amplifier package allows replacement of the twt with a minimum of down time and adjustment.

Conversion of the 74.1-Mc i-f to microwave frequency is done by a parametric amplifier up-converter used as the transmitter modulator. A Western Electric 427A varactor diode is matched to WR159 waveguide by a diode mount. By displacing the coaxial cable off center in the waveguide, the resistive component of the diode impedance can be matched to the characteristic impedance of the waveguide. This distance is adjustable to compensate for differences in diodes.

Reactance is partially cancelled by a fixed short in the waveguide behind the coaxial extension. Remainder of the reactance can be cancelled by an adjustable short in the coaxial line.

If sufficient negative bias is applied to it, the 427A diode is capable of giving conversion gain. But because the diode's impedance becomes more frequency sensitive as gain is increased, the diode is operated at low conversion gain. Bias is set at about -1 volt for 0-db gain.

Another design feature is the common microwave carrier supply. Fig. 5. In a fully equipped repeater station, 40 beat oscillator signals are required. To reduce the number of components and increase the reliability of the system, a common beat oscillator supply was designed. Oscillator frequency is 14.82593 Mc which makes channel spacing 29.65 Mc. Since beat oscillator frequencies are to be symmetrical about the center of the band (6,175 Mc), the i-f was chosen to be 74.13 Mc. The frequencies generated in the carrier supply are obtained from the crystal oscillator by multiplication chains and shift modulators. Harmonics are the second, fourth, 408th and 425th. Two vhf signals are provided at 29.65 Mc and 59.30 Mc. Two microwave signals at 6,049 Mc and 6,301 Mc are also provided.

With separate beat oscillator supplies, a failure of one supply would put one channel out of commission. With the common supply, a failure would put the system out of commission. However, a second complete supply is provided with automatic switching.

Should a carrier be lost by fading, the gain of the limiter reaches maximum in a few millimicroseconds, and the gain of the main i-f amplifier reaches maximum in a few microseconds. This action causes saturation of the twt amplifiers with resultant noise spread over a wide band.

To avoid noise interference from carrier loss, a carrier resupply unit is designed into the system. It replaces a lost carrier within 0.1 millisecond. This prevents other repeaters from going to full gain and reduces the limiter gain to attenuate incoming noise.

High-frequency transistors having an h_{fe} cutoff of 750 Mc are used in the oscillator and amplifier stages of the carrier resupply. In the equivalent circuit, Fig. 6, these

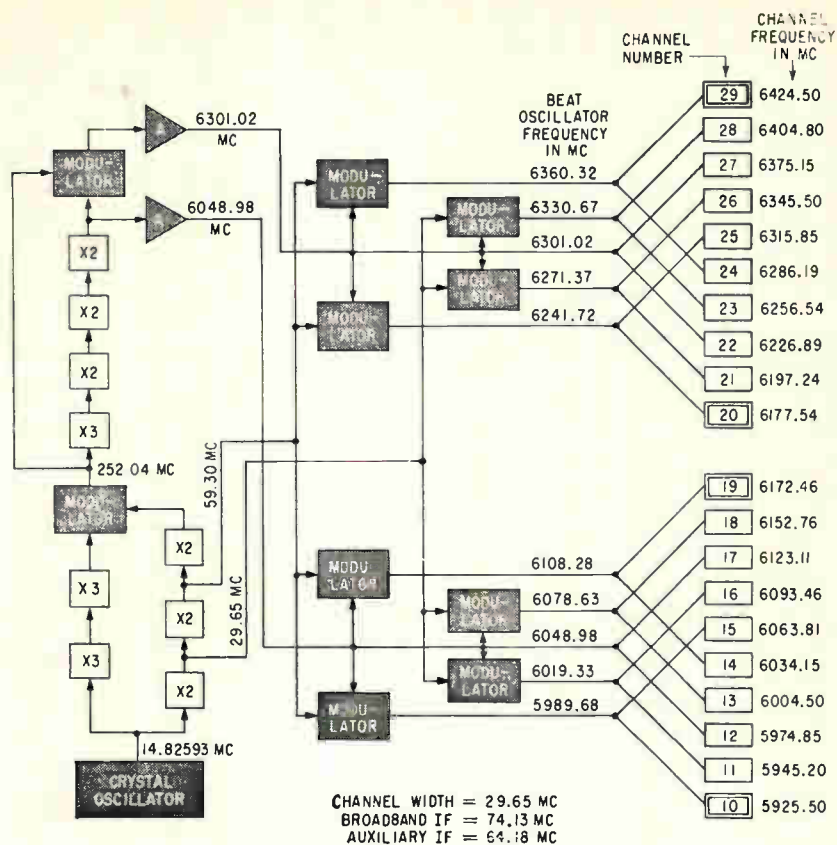

FIG. 5—Beat oscillator frequencies in each station are generated by the single crystal oscillator, lower left

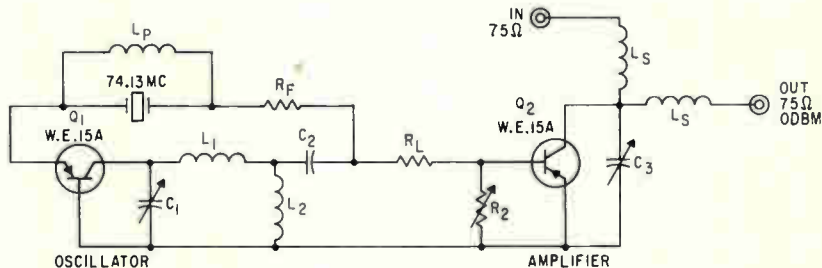

FIG. 6—Carrier resupply i-f oscillator and amplifier replace lost carrier within 0.1 millisecond

transistors, Q_1 and Q_2 are switched from cutoff to their operating point from cutoff to their operating point. Rapid starting of the crystal oscillator is assured by providing resistor R_f in series with the crystal to lower its Q . The crystal operates in the series resonant mode at 74.1 Mc. Inductor L_p tunes out parallel crystal capacitance.

Circuit C_1, L_1, C_2, L_2 acts as a transformer at 74.1 Mc and provides current gain to maintain oscillation and feed load R_L . The crystal is in the feedback loop of grounded-base transistor Q_1 . Transistor Q_2 is a grounded-emitter amplifier with a current gain of about 15 db. A

wide-band, low-pass filter, consisting of L_s, C_3, L_s , bridges the collector of Q_2 across a 75-ohm coaxial line. Carrier power output is adjusted by R_2 .

An automatic switching system in the system protects against signal loss from fading and equipment failure.³ Monitor circuits are also supplied.—L.D.S.

REFERENCES

- (1) J. P. Kinzer and J. F. Laidig, Engineering Aspects of the TH Microwave Radio Relay System, *The Bell System Technical Journal*, November 1961.
- (2) P. T. Sproul and H. D. Griffiths, The TH Broadband Radio Transmitter and Receiver, *The Bell System Technical Journal*, November 1961.
- (3) A. J. Giger and F. K. Low, The Automatic Switching System of TH Radio, *The Bell System Technical Journal*, November 1961.

Receiver Squelch Control Uses Double Superheterodyne

Squelch level in a receiver usually has to be set at a compromise value to cover all operating circumstances. Here squelch level is automatically adjusted to suit incoming signals

By J. M. TEWKSBURY, Bendix Radio Division, Baltimore 4, Md.

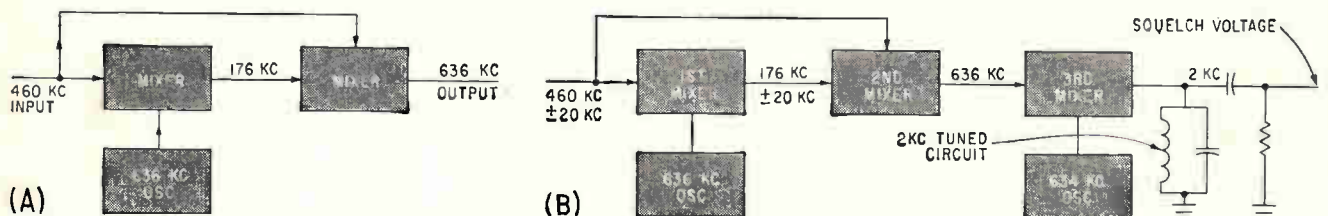

FIG. 1—Double superheterodyne process delivers a 636-Kc output (A); block diagram of actual circuit (B) shows how the 2-Kc squelch-control voltage is developed

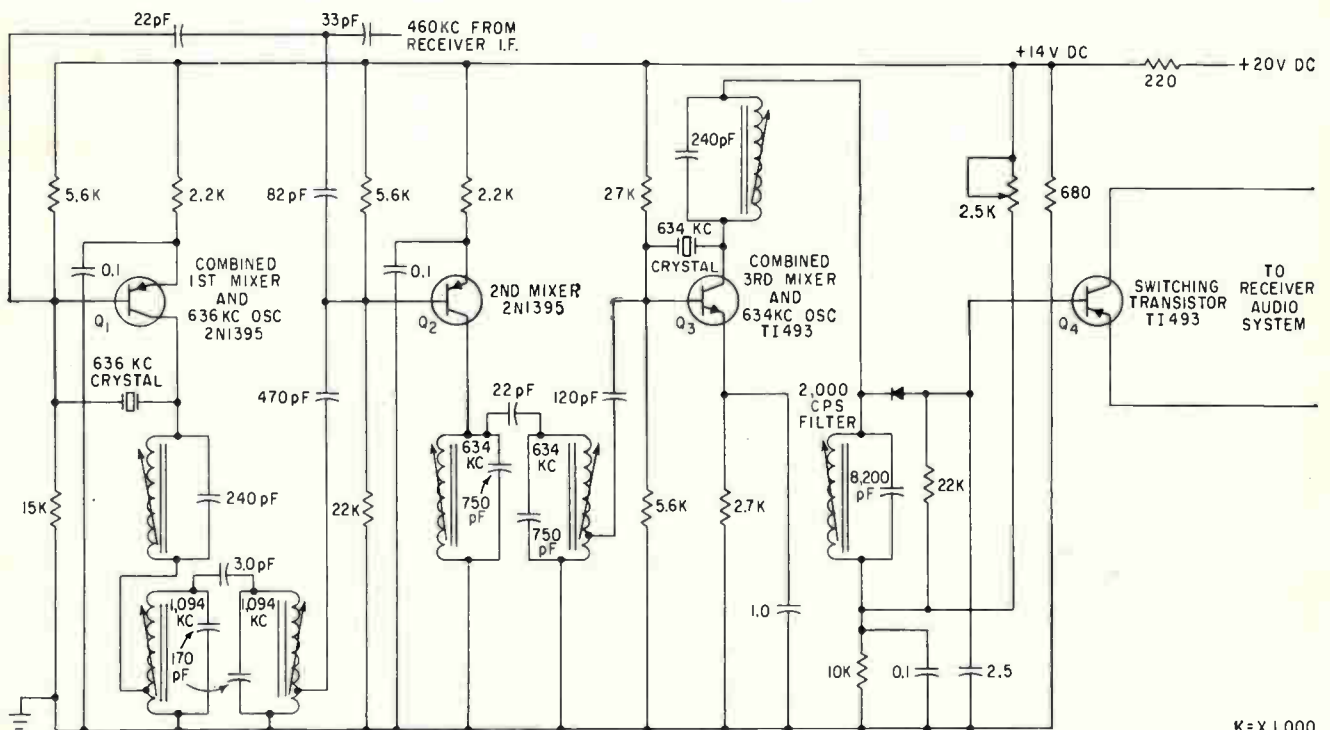
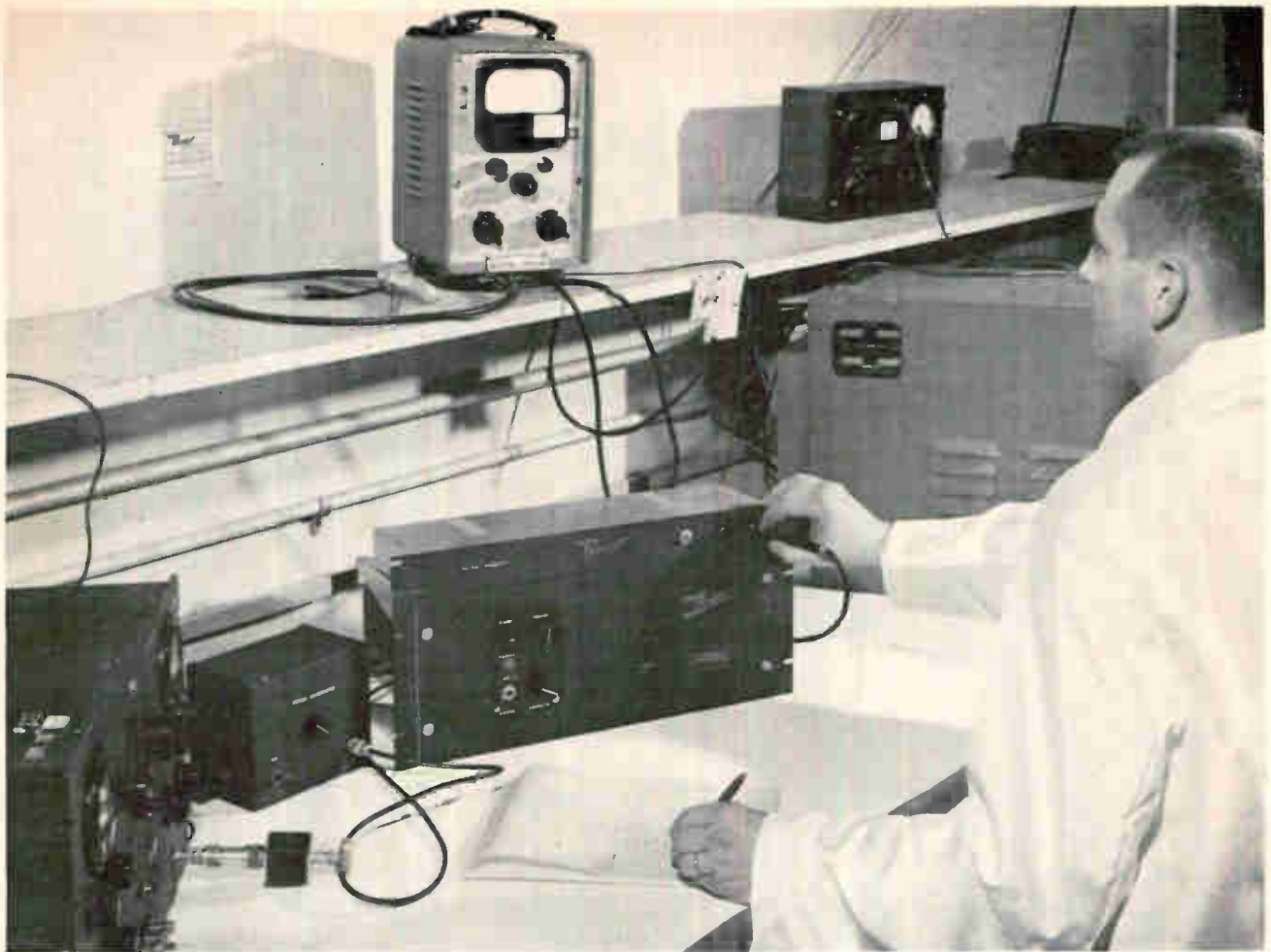

FIG. 2—Mixer stages Q_1 and Q_2 use one transistor for both mixing and generating the local oscillator signal. The final 2-Kc output is rectified for switching the squelch transistor Q_4 .

K=X 1,000



Technician Bob Coburn injects noise spikes from a d-c motor directly into receiver antenna to check squelch unit signal-to-noise ratio. Squelch unit (immediately beneath Coburn's hand atop receiver) mutes receiver until carrier signals are received

THE IDEAL SQUELCH CIRCUIT prevents audio output from a receiver during periods when intelligible signals are not being received and thereby relieves the operator of annoyance from atmospherics or man-made static.

Often a number of receivers are operated simultaneously in control towers and communication centers. Malfunction of squelch systems adds to the room ambient noise level at the operating position and impairs operation.

A reliability survey of aircraft electronic equipment indicated that a large percentage of the unscheduled removals of communications receivers were due to squelch problems. Since a plane flies over areas that have varying noise levels, it is difficult to arrive at an optimum squelch setting. When an airborne receiver unsquelches in a noisy area, it is subject to removal at the next stop with the notation: noisy receiver. On the other hand, if the

squelch is set at a higher level, there is a chance that the pilot will be unable to hear a weak station. In this case, the receiver may be removed with the complaint: low sensitivity.

This squelch system is carrier operated and detects the presence of the carrier by the double superheterodyne reflex principle.

Because of transmitter frequency tolerances and receiver drift, vhf receivers for network use have a passband that is usually much wider than required to pass the signal.

The double superheterodyne reflex circuit operates so that any signal in the passband will be converted to a single crystal-controlled frequency. This signal frequency is subjected to carrier detection that develops the voltage to unsquelch the receiver.

Figure 1A illustrates the operation of the double superheterodyne reflex circuit. Frequencies are suit-

able for use with the receivers to which this squelch system was adapted.

A 460-Kc input is mixed with a 636-Kc crystal-controlled oscillator voltage and the difference frequency of 176 Kc is selected and applied to a second mixer. In the second mixer, the 176-Kc signal is combined with the original 460-Kc input to produce an output of 636 Kc.

To illustrate a property of this circuit, assume an input signal of 440 Kc. The first conversion produces 196 Kc, which, when mixed with the input gives an output of 636 Kc.

Likewise, a 480-Kc input signal is first converted to 156 Kc, and this combination will also produce a 636-Kc output. This circuit is connected to the last i-f stage of a communications receiver in which the i-f passband extend from 440 Kc to 480 Kc; any signal in this passband then would be converted

to 636 Kc. The 176-Kc channel must have a bandwidth of at least 40 Kc.

The output of the double superheterodyne reflex circuit is confined to a specific frequency. Since it is known beforehand that the carrier will be at a specific frequency, it is possible to use a stable oscillator for carrier detection.

The block diagram in Fig. 1B illustrates the complete circuit. The 636-Kc output is heterodyned with the voltage delivered by a 634-Kc crystal-controlled oscillator. The 2,000-cycle beat note is filtered and rectified, developing a d-c voltage that activates the audio stages and unsculches the receiver.

The first experimental version of this squelch system was designed for use with the RG-9C receiver. Equipped with low-noise first stages, this receiver is intended for weak signal areas. Having a noise figure of 4.5 db, the RG-9C shows a signal-to-noise ratio of 6 db at an input of 0.45 microvolt. Consistent squelch openings at carrier levels as low as 0.08 microvolt are possible with the squelch arrangement, and the system is completely impervious to noise.

When extremely high level noise inputs are applied to the receiver, the receiver's avc system tends to maintain a nearly constant level in its last i-f stage. The noise input to the squelch system is thus limited and this prevents the squelch from becoming blocked or saturated, or otherwise inoperative.

The receiver's avc action has a further desirable effect since noise develops an avc voltage that reduces the signal in the last i-f. Consequently, a higher level of signal is then required to open the squelch. Tests with this unit showed that if it were adjusted to open at a given signal-to-noise ratio, this ratio would remain constant in the

presence of high noise levels. This is advantageous in voice communications because it insures that squelch openings will occur at a constant level of intelligibility.

An all-transistor version of the squelch circuit is shown in Fig. 2. This device was similar to the all-tube version except that the first conversion was to the sum frequency of 1,096 Kc. The complete unit was mounted on the front panel of the receiver.

The first mixer-oscillator, Q_1 of Fig 2, receives the signal from the last i-f stage of the receiver at an amplitude of about one-half volt. This signal, when mixed with the self-generated 636-Kc signal produces the first conversion frequency that is selected by the tuned circuit in the collector. Output of the first mixer-oscillator is about one volt.

In the second mixer Q_2 the i-f voltage is combined with the signal from the first mixer-oscillator. The second mixer delivers an output of approximately one volt at 636 Kc.

The mixer-oscillator circuit Q_3 beats the incoming 636 Kc from Q_2 with its own internally generated 634-Kc signal to produce a 2,000 cps beat note. A high-Q tuned circuit improves the signal-to-noise ratio and the filtered 2,000 cps tone is then fed to the squelch switching transistor Q_4 that controls the receiver audio system.

In the experiments, the all-transistor squelch unit gave consistent squelch openings at five tenths microvolt input, while the associated receiver had a 6 db signal-to-noise ratio at an input of 2.5 microvolts.

Noise tests were made in the laboratory using a noise generator as shown in Fig. 3A with the d-c motor connected capacitively to the antenna terminal of the receiver. As measured on the avc bus, this noise source produced the equivalent

of a 40-microvolt continuous carrier. It is representative of the type of noise in most installations.

All of the squelch units can be adjusted to open on 0.5 microvolt or less, but they still remain closed when subjected to the full output of the noise generator.

In converter circuits of this type there must be a minimum of r-f leakage between stages. Any leakage from the 636-Kc oscillator voltage to the third mixer can cause a continuous 2,000-cycle output even when no input signal is applied. The voltage thus developed can be detrimental to the operation, especially if it happens to be out of phase with the normal 2,000-cycle signal. In applications some residual voltage can be tolerated but it reduces the dynamic range of the squelch system.

An alternate saving of components can be made if the d-c output voltage is derived from a phase detector. The sketch shown in Fig. 3B illustrates the operating principle. The carrier voltage at the output of the second mixer is of the same frequency as the first crystal oscillator. When these two signals are applied to a phase detector, a d-c voltage is developed providing the proper phase relationship has been maintained. This voltage can be integrated over a long period to produce an effective bandwidth that is narrower than the bandwidth obtained by a tuned circuit. The phase detector circuit also has an advantage in that it requires only one crystal.

Using the phase detector the frequency stability of the oscillator is not critical since both channels of the phase detector originate from the same source. A self-excited oscillator can be used. However, the first conversion channel must have a wider bandpass to accommodate the frequency drift of the oscillator.

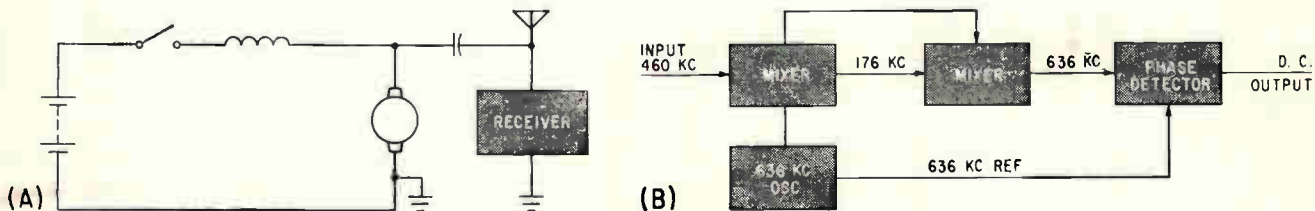

FIG. 3—Direct-current motor generates noise signal for testing receiver (A). Phase detector system (B) saves components in producing the d-c squelch control voltage

MEDICAL ELECTRONICS

PART VII (Last of a Series)

Studying Life Processes

Contributions of spectroscopy, radiography and photometry in identifying and measuring characteristics of living matter

By WILLIAM E. BUSHOR,
Senior Associate Editor

POWERFUL as microscopic techniques are in visualizing life processes (see Part VI), they cannot provide the quantitative identification and evaluation often required. This article will discuss some of the measuring instruments involving electronics which are now at the disposal of medical researchers.

Ultraviolet Spectroscopy—A microspectroscope is a combination of a microscope and a spectroscope on whose screen spectrum lines can be observed. Television augments this conventional measuring instrument through employment of extremely sensitive pickup tubes that operate with minimum amounts of light, and exceed the sensitivity of the eye and photographic film. Using uv light, measurements of the fluorescence from living cells stained with acridine dyes in concentrations considerably less than previously used are possible.¹

Microspectral fluorescence emission from single cells stained with acridine orange have been recorded on a high-sensitivity tv pickup tube at Western Reserve U.² An image orthicon and an intensifier-image orthicon tv camera are used with a high-power monochromator whose exit slit has been removed. The light source is a high-pressure mercury-vapor concentrated arc lamp with colored glass filter. Light passing through the microscope is dispersed by the monochromator and the spectrum focused on the tv pickup tube. Intensity variations with wavelength of the received light are displayed on a line selector and photographed. These images are used to generate curves of the fluorescence emission spectrum. This instrument will permit study of fluorescent carcinogens in living tissue and autofluorescence of living cytoplasm.

Infrared Spectroscopy—Each molecule has a unique ir absorption spectrum that consists of many in-

dividual absorption lines. In organic material containing complicated multicomponents, the complete ir spectrum is nearly equivalent to the sum of the spectra of the individual compounds. Thus by recording and cataloging the spectra for the individual pure compounds in various substances, an unknown specimen can be identified and analyzed rapidly using comparative techniques.³ Ir spectroscopy has been used in medical research to perform analytical research in the structural determination and synthesis of penicillin and cortisone. Studies of naturally occurring biological samples extracted and handled as chemical mixtures such as cholesterol in blood and barbiturates, and research on the role of steroids in metabolism also have been done with ir spectroscopic techniques.

Applications of ir microspectroscopy, wherein an achromatic reflecting microscope is combined with an ir monochromator or spectrometer, include determination of the spectra of tissue, living muscle



Research chemist investigates moisture content of living tissue using Schlumberger's model 106 nuclear magnetic resonance analyzer

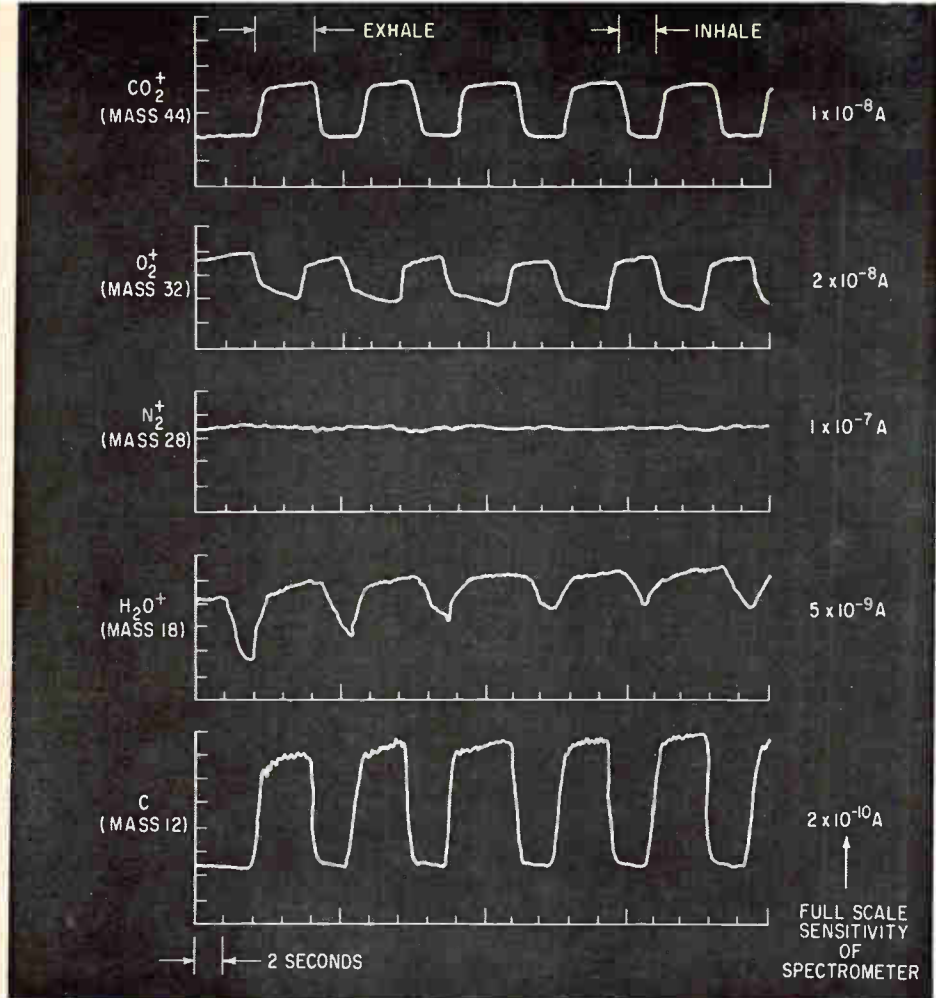

Breath-by-breath analysis of respiratory gases made with Bendix Research's model 17-210 time-of-flight mass spectrometer. Ionizing electron energy used was 60 volts

fibers, bacteria colonies, antibiotics, vitamins, hormones and serums. Also, microanalysis using this equipment has become a powerful weapon in cancer research.

Mass Spectrometers—These instruments for analysis of gases, liquids and solids can handle a wide range of concentrations accurately and with fast response. They analyze a substance by measuring the mass-to-charge ratio of its components. Different ions are deflected by combined electric and magnetic fields, which then focus each type in a beam on a detecting electrode for measurement (see figure).

A time-of-flight mass spectrometer that provides the rapid response characteristics for pulmonary research has been constructed by Bendix' Research Laboratories.⁴ The instrument has a double-grid source that will focus all peaks, regardless of mass, with one setting of instrument operating parameters. Since the time interval during which a mass peak is detected

is much shorter than that during which the original ionization took place, the signal-to-noise ratio and resolving power are substantially increased over those previously obtainable. Also featured is a magnetic multiplier ion detector with unusually high gain and wide band-pass characteristics that uses crossed magnetic and electric fields to control ion trajectories.

R-F Spectroscopy—Nuclear magnetic resonance (nmr) and electron paramagnetic resonance (epr) spectrometers provide researchers with accurate and nondestructive analytical tools for studying living matter.

Researchers predict future applications of nmr and epr will include hydration/dehydration studies, measurement of blood flow without opening the vessel, study of free radical formation and destruction in physiological and neurological processes, and detection of certain pathological conditions for diagnostic purposes.⁵

Basis of the nmr approach is that isotopes of elements can be separately identified according to their differing nuclear gyromagnetic constants. All isotopes having an associated spin, or angular momentum, also possess a magnetic moment that acts like a tiny magnet with a well-defined, unique magnetic strength. The gyromagnetic ratio (spin value/magnetic moment value) for a particular atomic nucleus is a constant. Because this ratio differs from one isotope to the next, the nuclei can be separated and identified by studying their nmr spectra.

One of the most important applications of nmr is in the study of the complex chemical substances obtained from plants. Many of these are ultimately used as drugs. Also, high-resolution nmr spectrometers are being used to study chemical groups involved in binding penicillin and streptomycin to serum albumen.⁶

Varian Associates has recently introduced a high-resolution (1 part in 10⁶) nmr spectrometer that will produce a permanent, repeatable record of the location and character of hydrogen atoms within a molecule. (ELECTRONICS, p 54, Mar. 24, 1961). This instrument has given nmr spectra data on antibiotics, enzymes, vitamins and insecticides.

Schlumberger reports that their wide-line nmr equipment (see photo) is being used to investigate moisture content of tissues (living and dead), diffusion of moisture in tissue, fat content of animal tissues, structure of proteins with absorbed moisture (living and dead), and enzymatic degradation of meats.

The epr spectrometer uses the magnetic properties of electrons to reveal chemical structure and bonding characteristics. Gyromagnetic ratio or spectroscopic splitting factor (total magnetic moment/spin value) for a particular electron is constant for a given atom and environment. This relationship permits detection of free radicals and the study of their complete kinetics. A number of free radical reactions suggested by chemical experiments has been substantiated including enzymatic oxidation reduction and biological photosynthesis.⁷

Epr's have also been used at

the U. of California to indirectly determine why bacteria that have survived freeze drying retain regenerative capacity after prolonged storage in a vacuum, but lose this capacity when stored in air.⁸

Announcement by Melpar of their epr spectrometer that uses a zero-field maser as an amplifier might give a significant increase in sensitivity of measurement—an achievement that could make it possible for the first time to analyze certain reactions in cancer growth. Called the x-band epr spectrometer, the instrument uses a klystron or maser oscillator as a source of microwave energy. Absorption signals created by the microwave beam passing through the specimen are amplified by a maser amplifier before being fed to a narrow-band phase sensitive lock-in crystal detector. From this point conventional spectrometer equipment is used.

Double resonance techniques in which both nmr and epr are employed have also been used to measure reactions of electrons and atomic nuclei simultaneously.⁹

Neutron Research Activities—Electronics is also helping to study the relationship of magnesium content of blood to the viability of blood in storage. From this experimentation, being conducted at General Dynamics' General Atomic division, may come improved methods for storing blood plasma over longer periods of time than presently possible. Also, it may tell if there is a relationship between magnesium content and the blood's condition.

The process, called neutron activation analysis, begins by exposing whole blood in the Trica research reactor for a prescribed time. When the radioactive sample is taken from the reactor, its emitted radiations are analyzed electronically according to their energies and the results recorded graphically. This technique can

also be used to study diseased cells and tissue such as is present in leukemia and cancer.

Neutron spectroscopy may also be of aid to medical or biological research workers.¹⁰ Of interest is the use of threshold radio acti-vants developed to cover the 1.3 to 9,000 ev energy range. The technique is based on the interaction of either steady state or pulsed neutron beams and nuclei having thresholds below which reactions do not occur. All that is required is measurement of radioactivity.

Autoradiography—Another powerful research tool of comparatively recent vintage is autoradiography—a technique by which investigators make laboratory specimens take pictures of themselves. The procedure is simply to inject a radioisotope into a cell or tissue, place the specimen against a photographic emulsion and develop the film to observe the image created by the radioactivity. Applications of autoradiography abound, including studies of metabolism in individual cells, of malignant lesions, of immunity, and of membrane permeability as well as to localize elements in the biological system. Lifetime activities of living cells can be traced showing details on how much of various substances they take up, to what portion of the cell the substance goes and what happens after the cell divides or dies. Scientists at Brookhaven National Laboratory have traced the life cycles of blood cells to determine how long the various types of cells live in the body.

Photometry—Photometers not only can measure the intensity of light sources, but also the amount of illumination reflected from or passing through a biological specimen. Many of microscopy and spectroscopy techniques employ this type measurement. If a photometer is

used with a magnifying system such as an optical microscope, a device capable of giving extremely accurate illumination measurement is evolved called a microphotometer or microdensitometer.

A recording microspectrophotometer for uv absorption measurements of cells has been built by the Karolinska Institute in Sweden.¹¹ A multiplier-phototube amplifier system together with dynode feedback and measuring circuits detect and record small photocurrents at high signal-to-noise ratios. This instrument permits studies of the kinetics of enzyme reactions within a small part of a single, living cell.

A new uv photometer, built by the Starling Corp., was recently developed by the California Corporation for Biochemical Research (Calbiochem). This instrument, essentially a uv densitometer, lets investigators get a quick reading of optical density changes in blood caused by a rise in enzyme content. Such changes often indicate heart damage, hepatitis and other body disorders, and can be detected by this technique before other symptoms can be observed.

An electronic device for automatically measuring rate of enzyme reaction of a sample in optical density changes has been designed by Astra's Medical Engineering division. The instrument can store one hundred samples, add a reagent to and measure rate of optical density change of each, record this measurement and the sample identifying number on a paper tape, and shut itself off when done.

Studies of oxygen uptake of the lungs are being made by the Dartmouth Medical School with a double-beam photometer.¹² Instead of analyzing this uptake in a man or animal as is most often done, a thin layer of hemoglobin-containing solution is exposed to diffusion of gases and the changes in light transmission recorded.

REFERENCES

- (1) L. E. Flory, Television Techniques in Bio-Medical Applications, *Third Int Conf on Med Elect*, July 1960.
- (2) S. S. West and C. N. Loeser, Television Spectroscopy of Biological Fluorescence, *Dig of Tech Papers, 12th Ann Conf on Elect Tech in Med and Bio*, Nov 1959.
- (3) H. L. Hackforth, "Infrared Radiation," McGraw-Hill Book Co., New York, N. Y., 1960.
- (4) G. J. O'Halloran, A Rapid-Response Mass Spectrometer for Respiratory Function Analysis, *paper presented at a Clinic on Inst Req for Psychophysiological Res*, Detroit, Mich, May 1961.
- (5) Personal correspondence with A. R. Arkman, Schlumberger Well Surveying Corp.
- (6) O. Jardetzky and J. J. Fischer, Selective Broadening of NMR Spectral Lines as a Method for the Detection of Specific Molecular Interactions in Biological Systems, *Fourth Int Conf on Med Elect*, July 1961.
- (7) T. Cole, Electron Magnetic Resonance Studies of Free Radicals in Organic Crystals, *paper presented at Symp on Recent Dev in Res Meth and Inst*, Bethesda, Md, Oct 1961.
- (8) R. L. Dimmick, R. J. Heckly and D. P. Hollis, Free-Radical Formation During Storage of Freeze-Dried Serratia
- (9) L. Piette, The Role of Electron Paramagnetic Resonance in Free Radical Chemistry, *paper presented at Symp on Recent Dev in Res Meth and Inst*, Bethesda, Md, Oct 1961.
- (10) C. G. Amoto, Neutron Spectroscopy, *Fourth Int Conf on Med Elect*, July 1961.
- (11) B. Thorell, General Problems of Absorption Measurements in the Cell, *Dig of Tech Papers, 12th Ann Conf on Elect Tech in Med and Bio*, Nov 1959.
- (12) F. Kreuzer and L. Gardeau, A Gas-Hemoglobin Diffusion Photometer, *IRE Trans on Med Elect*, ME-7, July 1960.

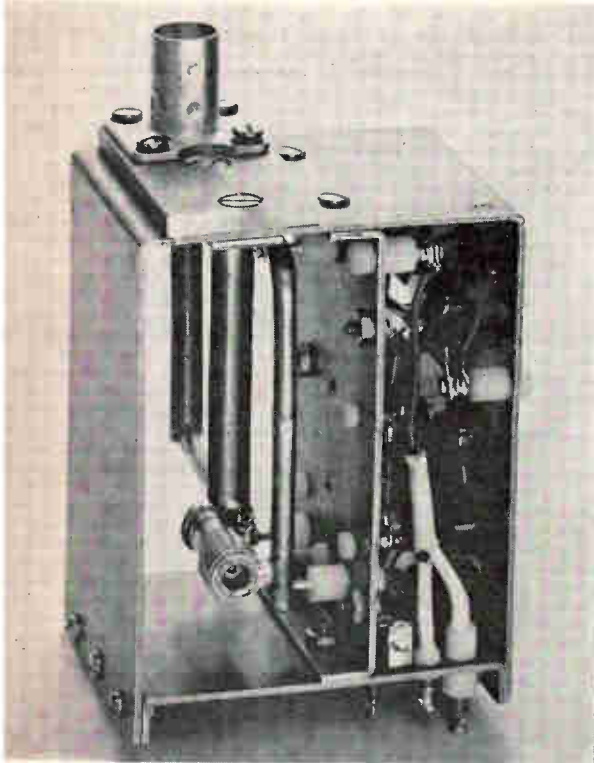

Transmitter was designed to meet missile environmental requirements

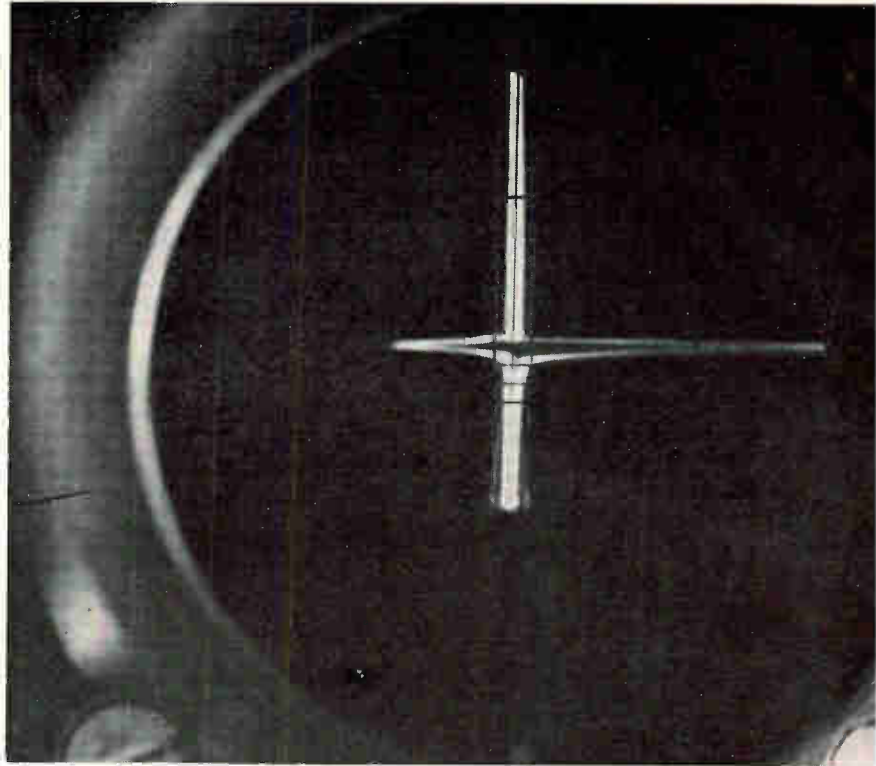

Deflection to the right resulting from stronger signal of starboard antenna is corrected by changing aircraft heading

REDESIGNING Project Mercury Beacons

Rescue beacon provides visual display of encoded pulses that eliminates ambiguity in identification and furnishes directional information. Both recovery time and number of search craft are reduced

By J. G. RICHTER

Manager, Space Communications Dept.
Simonds Precision Products, Inc.,
Tarrytown, N. Y.

RECOVERY beacon system designed for the Mercury space capsule provides positive visual identification and directional information to each search craft. The beacon transmitter successfully used to recover U.S. astronauts provides encoded signals that eliminate confusion even in the presence of other signals at the same frequency.

The Sarah (Search-and-Rescue-and-Homing) equipment has been credited with saving the lives of many aircraft and ship survivors during World War II. Value of the system has continued into the space age, but more demanding requirements have resulted in develop-

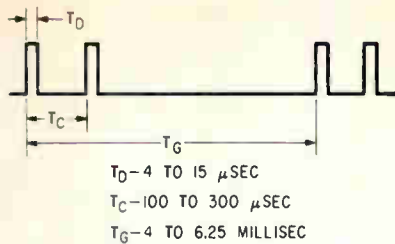

FIG. 1—Duration, pulse spacing and pulse-group spacing are all adjustable to encode beacon transmissions

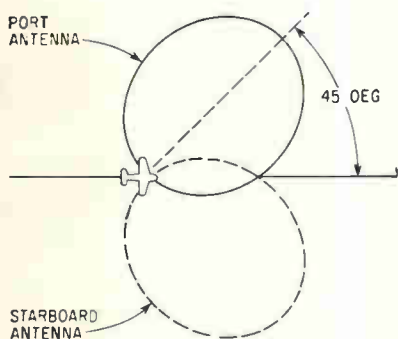

FIG. 2—Lobe switching of two antennas with overlapping patterns provides directional information

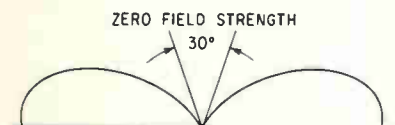

FIG. 3—Absence of display over region of zero field strength enables aircraft to pinpoint beacon

CONDITION	BEACON TRANSMISSIONS	CRT DISPLAY	ALT IN FT
SEARCH			10,000
BEACON PORTSIDE			10,000
EARLY HOMING			5,000
FINAL HOMING			500
POSITION FIX			500
TWO PORT AND ONE STARBOARD			
HOMING ON BOTTOM BEACON			

FIG. 4—Beacon receiver displays for typical search and homing conditions including presence of other beacons

ment of a super Sarah with increased capabilities.

The objective in redesigning the system was to increase its effectiveness; fewer search craft now take less time to pinpoint a beacon-equipped target. The improved performance results from transmitting encoded signals from a more powerful transmitter and providing an unambiguous visual display of received signals that eliminates confusion in identifying aural signals. The receiving system in each search vehicle also provides directional information that enables target location to be established within a matter of feet.

The beacon automatically and continuously transmits groups of pulses at low repetition frequency. In the typical modulation pattern of Fig. 1, pulse duration, pulse

spacing and pulse-group spacing, identified at T_D , T_C and T_G , can be adjusted within the limits shown.

Two directional antennas are mounted in each search craft so that their patterns just overlap in front of the craft as in Fig. 2. Automatic lobe switching of the antennas is accomplished in the superhetrodyne receiver. When beacon pulses are received, a vertical trace appears on the crt screen with horizontal deflections, as shown in the photograph. Signals received by the port antenna cause deflection to the left, while signals received by the starboard antenna cause deflection to the right.

The vertical whip antenna normally used with the beacon is omnidirectional in the horizontal plane. As shown in Fig. 3, field strength immediately above the antenna is

zero throughout an inverted cone having an apex angle of about 30 degrees.

When an aircraft receives the beacon signal, its heading is changed to make the horizontal deflections equal on each side of the vertical trace. As the target is approached, receiver gain is reduced manually because the stronger received signals produce wider deflections. As the aircraft enters the region where beacon transmitter field strength is zero, the trace abruptly disappears from the crt, which indicates that the target is immediately below the aircraft. An accurate fix of beacon location can be established with this display even under the most adverse conditions. Typical search and homing conditions are shown in Fig. 4.

The transmitter provides 100-

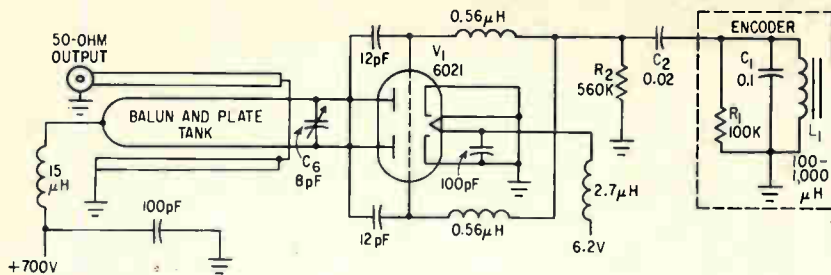

FIG. 5—Dual triode can provide 100-watt pulses because of small duty cycle

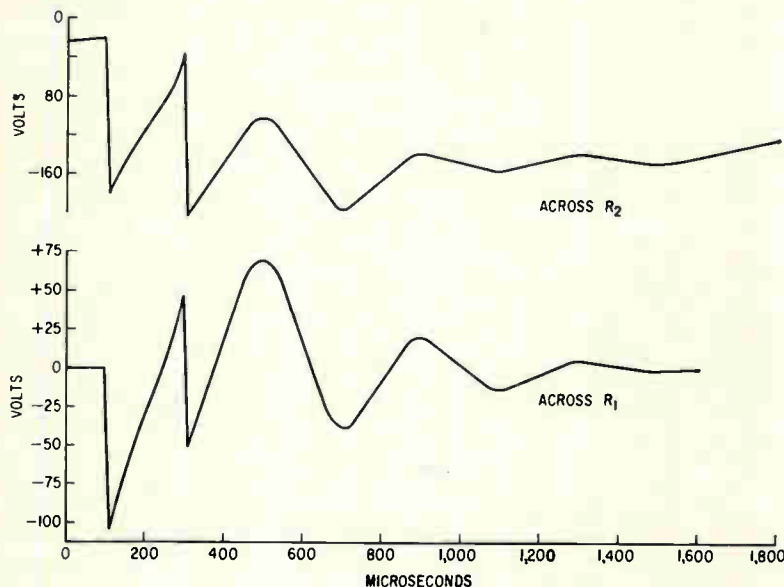

FIG. 6—Low-frequency voltages developed across resistors as a function of time are typical

watt pulse output. In range tests, it demonstrated that 150-mile line-of-sight transmissions to an aircraft at 15,000 feet altitude are obtainable. The transmitter in the photograph was designed to meet the environmental and other conditions of missile flight followed by unattended operation. This service requires small size, light weight, stable operation and high power output with limited power consumption. The transmitter module is 3 by 1½ by 2½ inches and the unit weighs 4 ounces excluding the power supply.

The transmitter circuit in Fig. 5 includes a highly efficient push-pull power oscillator and pulse encoder. Good frequency stability is obtained from 220 to 260 Mc using a transmission-line plate tank and a balun output circuit. Besides providing optimum coupling into a 50-ohm load, the balun limits frequency changes caused by objects

near the antenna. Frequency is set by the plunger-type variable capacitor, C_v .

Subminiature dual-triode V_1 operates at a plate potential of 700 volts, which greatly exceeds maximum plate voltage rating of the tube. However plate power dissipation is within the recommended level because of the low duty cycle. In extended life tests conducted for more than 5,000 hours, no signal deterioration was experienced.

The operating cycle that produces the modulation shown in Fig. 1 begins with V_1 conducting. Voltage across C_1 and C_2 in series becomes increasingly negative, eventually cutting off V_1 after time T_b . The negative voltage across C_1 discharges through choke L_1 at a frequency determined by $\frac{1}{2} / \pi (L_1 C_1)^{\frac{1}{2}}$. The voltage across C_1 changes polarity because of the inductive reactance of L_1 . When the sum of the voltages across C_1 and C_2 again

permit V_1 to conduct, a second pulse is produced at time T_c after the first pulse.

At the end of the second pulse, the tube is held cut off by the negative voltage that has developed across C_2 during the pulses. The slow discharge of C_2 through R_2 requires about 5 milliseconds, after which the tube is permitted to conduct again. A pulse is initiated at time T_c after the first pulse, beginning the cycle again. Typical low-frequency voltages developed across resistors R_1 and R_2 are shown in Fig. 6.

Constant heater and plate voltages determine stability of frequency, pulse and pulse-group spacings, pulse duration and power output. Although stability of frequency, pulse spacing and pulse-group spacing are relatively independent of plate-voltage variations, most circuit parameters are affected by heater-voltage variations.

Mercury batteries are used for beacon power because of their high power capacity. However, voltage of a typical mercury battery when it is first put into service is 6.7 volts, while the end-of-life level is 5.7 volts. Frequency variations resulting from changes in heater voltage, as well as from other causes, are handled by an automatic swept-frequency tuner in the search receiver. Receiver frequency is swept 2 Mc above and below 243 Mc. When a trace appears on the crt, receiver frequency is locked manually.

Plate voltage for the beacon transmitter is provided by a d-c to d-c converter operating from an input of 6.2 volts d-c. This simplifies original and replacement battery requirements since a single 6.2-volt battery provides all power. A converter for the beacon weighs 5 ounces and is 2½ by 2½ by 1½ inches.

The transmitter module is potted in polyurethane foam to increase its shock resistance. In addition to rigid quality control, temperature cycling of selected critical components contributes to overall reliability. The transmitter has successfully withstood shock impact tests of 500 g for 15 milliseconds using a waveshape approximating a half sine wave.

VECO PIONEERS NEW THERMISTOR FRONTIERS

It's mighty important to know if you're working on sub-zero human survival programs for the Armed Forces. That's why scientists tape VECO Thermistors to penguins ... even bury them in penguin eggs ... to record the precision temperature data on living cells that can save lives in Antarctic-type environments.

You may never have to Thermistorize a penguin, but when reliability counts, it's good to know you can count on VECO. Reliability is the reason engineers in every field specify VECO Thermistors and Varistors where precision

thermal or electrical measurement and control are critical. They know their Thermistor and Varistor reliability programs begin at Victory. Unsurpassed quality control is the reason. Not one VECO product ever leaves the plant until it individually passes tests for reliability far exceeding applicable specifications. VECO quality control processes are accepted under MIL-Q-9858 standards.



FREE: If you want to control, measure, or use temperature for any project between the North and South poles, you'll find VECO's Thermistor-Varistor Catalog valuable in producing high-reliability circuitry.



VICTORY
ENGINEERING CORPORATION
122 Springfield Ave., Springfield, N. J.

THERMISTORS • VARISTORS • CHOPPERETTES • COMBUSTION ANALYZERS
THERMISTOR CATHETERS AND NEEDLES • THERMAL CONDUCTIVITY CELLS
MATCHED THERMISTORS • THERMISTOR AND VARISTOR KITS
HYPSONETERS • LOX THERMISTORS • AND MANY OTHER PRODUCTS



how
cool
is a
penguin?



GMW TRON FUSE

Diameter: .270 inch
Length of Body: 1/4 inch



HWA FUSEHOLDER

Diameter: .500 inch
Length with Knob and Terminals: 15/16 inch

ACTUAL SIZES SHOWN

Another BUSS sub-miniature fuse and holder combination

EXTREME RELIABILITY UNDER HIGH SHOCK AND SEVERE ENVIRONMENTAL CONDITIONS.

Rigid construction of fuse and holder assures extraordinary reliability under high shock and vibration conditions. Fully insulated ceramic body isolates fusible element from effect of dust, corrosion, moisture and vapors.

DESIGNED FOR SPACE-TIGHT APPLICATIONS

Panel Mounted. Holder can be mounted on panel by hand. No special tool required to run down holding nut.

Prong type contacts on fuse make it easy to install or replace.

A knob for the holder may be used to make holder water proof from front of panel.

HOLDER CAN BE MOUNTED IN PRINTED CIRCUITS

Terminals of holder can be inserted into holes and soldered on printed circuit board without additional forming.

If desired, GMW fuse may be used without holder and mounted directly into printed circuit boards.

AVAILABLE RATINGS FOR GMW FUSES.

Fuses are made in sizes from 1/10 to 5 amperes for use on circuits of 125 volts or less where fault current does not exceed 50 amperes.

Transparent window in end of fuse body permits visual inspection of fusible element.

Before crystallizing your design using sub-miniature fuses be sure to get full data on the BUSS GMW fuse and HWA holder combination.

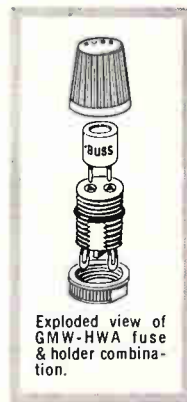

Exploded view of GMW-HWA fuse & holder combination.

IN THE BUSS LINE, you'll find the type and size fuse to fit your every need... plus a companion line of clips, blocks and holders.



BUSSMANN MFG. DIVISION, McGraw-Edison Co., UNIVERSITY AT JEFFERSON, ST. LOUIS 7, MO.



CHESTER

SPECIALISTS IN QUALITY CABLE CONSTRUCTION FOR THE ELECTRONIC INDUSTRY

Single conductors or any number of pairs . . . for coaxial and control applications. As a "specialist in specials" Chester concentrates on meeting the increasing demands of both military and commercial electronics for plastic insulated wire and cable — particularly coaxial cables and multi-conductor constructions. Typical types are shown here. All Chester products may be varied in conducting, insulating, jacketing, shielding or armoring materials to meet your particular needs.

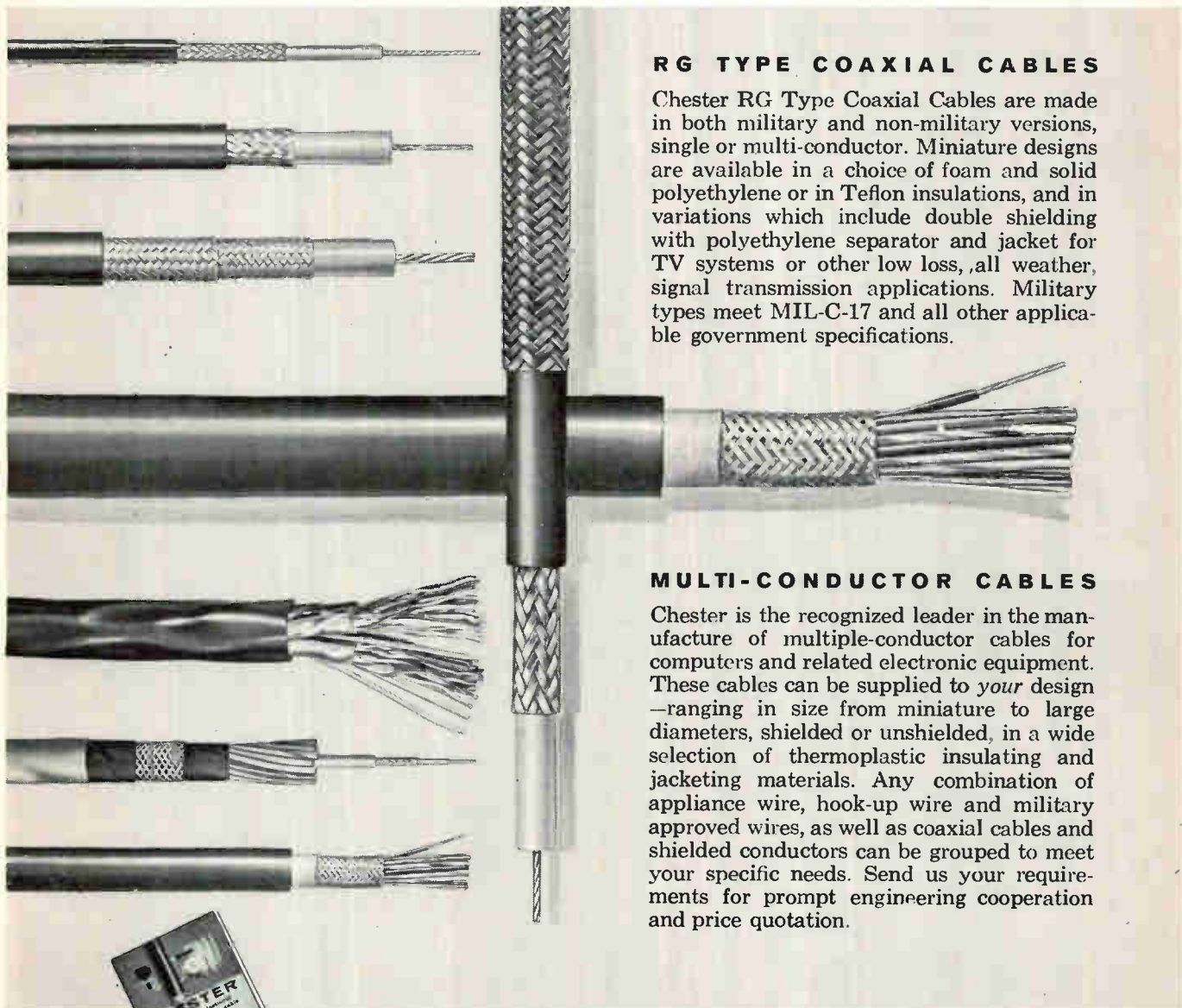

RG TYPE COAXIAL CABLES

Chester RG Type Coaxial Cables are made in both military and non-military versions, single or multi-conductor. Miniature designs are available in a choice of foam and solid polyethylene or in Teflon insulations, and in variations which include double shielding with polyethylene separator and jacket for TV systems or other low loss, all weather, signal transmission applications. Military types meet MIL-C-17 and all other applicable government specifications.

MULTI-CONDUCTOR CABLES

Chester is the recognized leader in the manufacture of multiple-conductor cables for computers and related electronic equipment. These cables can be supplied to *your* design — ranging in size from miniature to large diameters, shielded or unshielded, in a wide selection of thermoplastic insulating and jacketing materials. Any combination of appliance wire, hook-up wire and military approved wires, as well as coaxial cables and shielded conductors can be grouped to meet your specific needs. Send us your requirements for prompt engineering cooperation and price quotation.



NEW, Chester's fact-packed coaxial cable selection guide. Write for your free copy.



CHESTER CABLE CORP., CHESTER, NEW YORK

A SUBSIDIARY OF TENNESSEE CORPORATION

SPECIFY CHESTER WIRE AND CABLE FOR ALL YOUR ELECTRONIC EQUIPMENT NEEDS

Coaxial Cables • Hook-Up Wire • Multi-Conductor Cable • Appliance Wire • Audio Wire • Miniature Wire and Cable • High Voltage Wires
• High Frequency Wires • Antenna Loop Wire • Annunciator Wire • Telephone Wires and Cables • Television Transmission Lines

Horn Patterns Are Recorded to Tenth Harmonic

By O. M. SALATI
D. J. LEWIS

The Moore School of Electrical Engineering, University of Pennsylvania, Philadelphia, Pa.

PATTERN measurements were made for an L-band horn antenna over a 10:1 frequency range. Tests include both horizontal and vertical polarization and were made from well into the Fresnel to the far field.

Available antenna performance data in the near field at other than design frequency and polarization is generally limited to simple aperture shapes and illumination. Although patterns can be estimated or calculated in the design band, it is difficult at other frequencies. The antenna and its transmission line may support higher order modes that affect aperture distribution and thus radiation pattern and impedance. Determining patterns from the calculated pattern of each mode is also difficult but effort would be considerably reduced if the modes present were known.

Cutoff frequencies for all modes that can propagate in the waveguide feed for the L-band horn are listed in table 1. No attempt was made to analyze mode generation and conversion in the horn. Many modes in the table will not be found. Mode selectivity in the transition between generating tube and transmission line reduces the number of

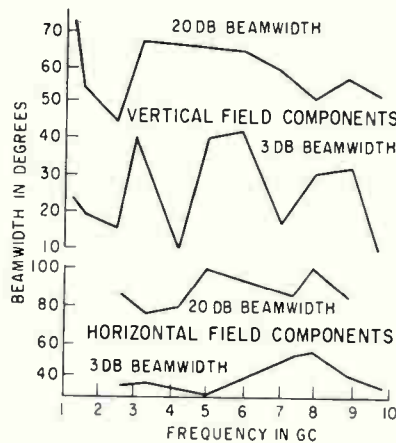

FIG. 2—Beamwidth of horizontal radiation pattern is plotted as a function of frequency

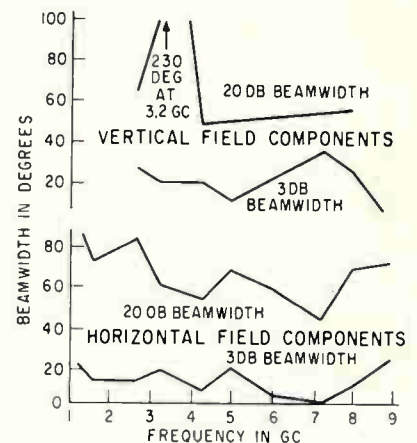

FIG. 3—Beamwidth of vertical radiation pattern is plotted as a function of frequency

TABLE I. TE_{mn} AND TM_{mn} MODE WAVEGUIDE CUTOFF FREQUENCIES

n	0	1	2	3	4	5	6
m							
0	—	1.82	3.63	5.45	7.26	9.08	10.9
1	0.908	2.05	3.71	5.52	7.71	9.12	
2	1.82	2.57	4.06	5.75	7.9	9.25	
3	2.72	3.27	4.56	6.08	8.17	9.16	
4	3.27	4.06	5.13	6.53	8.5	9.76	
5	4.56	4.87	5.81	7.08	8.93	10.13	
6	5.45	5.75	6.53	7.68	9.13		
7	6.35	6.6	7.3	8.35	9.63		
8	7.26	7.47	7.58	9.08			
9	8.17	8.35	8.93	9.81			
10	9.08	9.25	9.76				
11	10						

standardized. No serious ground reflections were found except at the maximum 15-meter range.

Aperture of the L-band exponential horn is 41 by 54 cm and taper length is 93 cm. The vswr measurements in table 2 were made at the horn input waveguide (WR-650) using a coaxial slotted line with a UG-953/U waveguide-to-coaxial adaptor and with a standard L-band waveguide slotted line. Performance was satisfactory in the operating band for both feeds. Measurements at 1 Gc were not made using the waveguide because a stretching section was not available and above 2 Gc because of higher modes in the slotted section. Vswr could be measured to 4 Gc with a coaxial slotted section before higher modes appeared. These results indicate the need for impedance measurements.

Patterns in the vertical and horizontal planes were recorded at 1.2, 1.6, 2.6, 3.2, 4.2, 5, 6, 7.2, 8, 8.9, and 9.9 Gc. Some far field measurements were included at every frequency. The test horn was replaced once in each measurement series with the standard-gain horn used as a field probe. This gave a reference for the entire set of recorded patterns since recorder gain was constant during each series.

To describe results, major lobe is defined as any lobe within 20 db

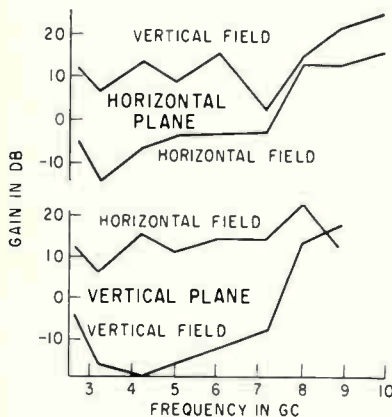

FIG. 1—Gain was measured as a function of frequency at 1 meter distance

measurements, and frequencies were chosen to avoid coincidence with cutoff frequency of any mode.

For the tests, the horn antenna is mounted with its axis 2.78 meters above a roof in an area where reflections are negligible. The horn is mounted on a radar antenna rotator, which is installed on a track-mounted movable tower. The tower permits 15 meters variation in the spacing to a receiving antenna mounted on a stationary wooden tower. Standard-gain exponential horns used to probe and record the radiation field were available in pairs with their gain accurately

Now!

Type RM561 Oscilloscope

with 5-inch CRT
—basically an Indicator
which accepts a wide range
of plug-in units in
both channels.



...in this Tektronix Oscilloscope...
you choose the type and degree of performance you
demand for a particular rack-mount application.



easily interchangeable PLUG-IN UNITS

- ... which drive the crt deflection plates directly.
- ... which house approximately 2/3 of the circuitry.
- ... which contain minimum components and controls.

The Type RM561 bolts directly to a standard nineteen-inch rack, and requires only seven inches of rack height.

TYPE RM561 INDICATOR . . . \$450
5-inch rectangular cathode-ray tube • 3.5 kilovolts accelerating potential • 8 by 10 centimeter viewing area • Z-axis input • 6 calibrated square-wave voltages available—ranging from 1 millivolt to 100 volts • Regulated dc heater voltage thru separate regulator circuitry.

Regulated dc supply operates between 105 to 125 volts or 210 to 250 volts, 50 to 60 cycles . . . provides 85 watts for powering all present and future plug-in units in this series.

Slideout Tracks

To expedite maintenance in the rack, you can order a deluxe tilt-lock Chassis Trak assembly for \$45.00 and install it easily. Or, you can order the Indicator Unit equipped with slideout tracks by specifying the TYPE RM561 MOD171 INDICATOR . . . \$495

AVAILABLE NOW Plug-in units presently available include:

Type 50 Vertical Amplifier Passband—15 cps to 200 kc. Sensitivity—1 mv/cm.	\$115	Type 67 Time-Base Unit Sweep rates—21 calibrated steps from 1 μ sec/cm to 5 sec/cm, accurate within 3%. Magnifier—5X. Triggering—Amplitude-level selection, automatic, or free-run, ac-coupled or dc-coupled, rising or falling slope, internal source, external source, or line frequency. External Input to Sweep Amplifier—1 v/cm sensitivity.	\$150
Type 51 Time-Base Unit Sweep rate—5 ms/cm, calibrated. Magnifier—Variable, uncalibrated, from 1X to 20X. Triggering—Automatic or free-run.	\$135	Type 72 Dual-Trace Unit Identical Channels—5 operating modes: alternate sweeps, chopped, Channel A only (may be inverted), Channel B only, both channels combined at output (B \pm A). Passband—dc to 650 kc.	\$250
Type 59 Basic Amplifier Passband—dc to 400 kc, at maximum sensitivity. Sensitivity—approximately 1 v/cm, attenuation provided by variable potentiometer at the input. Maximum Input Voltage—600 volts.	\$50	Type 75 Wide-Band Unit Passband—dc to 4 mc. Sensitivity—50 mv/cm to 20 v/cm in 9 calibrated steps, with variable control. Risettime—approximately 85 nanoseconds.	\$175
Type 60 1-MC Amplifier Passband—dc to 1 mc. Sensitivity—50 mv/cm to 50 v/cm, calibrated decade-step attenuator (4 steps), with variable control.	\$99.50	Skeleton Plug-In Unit Contains 24-pin connector, latch, front-panel overlay . . . for constructing your own circuits.	\$15
Type 63 Differential Unit Differential input, 50-to-1 rejection ratio at maximum sensitivity. Passband—dc to 300 kc. Sensitivity—1 mv/cm to 20 v/cm in 14 calibrated steps, with variable control.	\$125		

U. S. Sales Price f. o. b. Beaverton, Oregon

AVAILABLE SOON

Plug-in units under development include those for pulse-sampling, four-trace work, high-gain measurements, strain gage and other transducer applications.

For a demonstration, please call your Tektronix Field Engineer.

Tektronix, Inc. P. O. BOX 500 • BEAVERTON, OREGON / Mitchell 4-0161 • TWX • BEAV 311 • Cable: TEKTRONIX

TEKTRONIX FIELD OFFICES: Albuquerque, N. Mex. • Atlanta, Ga. • Baltimore (Towson), Md. • Boston (Lexington), Mass. • Buffalo, N.Y. • Chicago (Park Ridge), Ill. • Cleveland, Ohio • Dallas, Texas • Dayton, Ohio • Denver, Colo. • Detroit (Lathrup Village), Mich. • Endicott (Endwell), N.Y. • Greensboro, N.C. • Houston, Texas • Indianapolis, Ind. • Kansas City, Mo. • Los Angeles, Calif. Area (East Los Angeles, Encino • West Los Angeles) • Minneapolis, Minn. • Montreal, Quebec, Canada • New York City Area (Albertson, L.I., N.Y. • Stamford, Conn. • Union, N.J.) • Orlando, Fla. • Philadelphia, Pa. • Phoenix (Scottsdale), Ariz. • Portland, Oreg. • Poughkeepsie, N.Y. • San Diego, Calif. • San Francisco, Calif. Area (Lafayette, Palo Alto) • Seattle, Wash. • Syracuse, N.Y. • Toronto (Willowdale), Ont., Canada • Washington, D.C. (Annandale, Va.)

ENGINEERING REPRESENTATIVES: Tektronix (Hawaii) Ltd., Honolulu, Hawaii. Tektronix is represented in about five dozen countries by qualified engineering organizations. European and African countries, the countries of Lebanon and Turkey, please contact TEKTRONIX INTERNATIONAL A.G., Terrassenweg 1A, Zug, Switzerland, for the name of your local engineering representative. Other Overseas areas, please write or cable directly to Tektronix, Inc., International Marketing Department, P. O. Box 500, Beaverton, Oregon, U.S.A. Cable: TEKTRONIX.

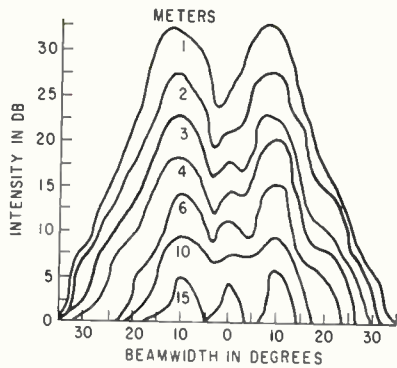

FIG. 4—Vertical field component of horizontal radiation pattern is shown at 8 Gc for various distances

of the strongest part of the pattern and separated by at least 3 db from the rest. Beamwidth is angle between pattern extremes above a specified level and may contain several major lobes. Gain, measured relative to a standard-gain horn, is ratio of an isotropic radiator field to maximum horn field in a given plane for a given polarization. Receiving antenna polarization defines the received field component.

Gain is plotted as a function of frequency for vertical and horizontal field components in Fig. 1. Antenna spacing was 1 meter, always within the near field. Contrary to expectations, gain is nearly constant at all frequencies. Theoretically vertical component gain of the horizontal pattern should equal horizontal component gain of the vertical pattern. The difference indicates lack of symmetry in the horn, track unevenness or incorrect

TABLE II. L-BAND HORN VSWR

Freq in Gc	VSWR waveguide	VSWR coax-waveguide
1	—	1.7
1.2	1.1	1.1
1.3	1.07	1.1
1.5	—	1.12
1.9	1.05	1.1
2	1.1	2.1
2.2		2.6
2.5		1.8
2.8	mode conversion present	6.3
3		3.3
3.1		2.7
3.3		8.9
3.9		3.8
4		4.4

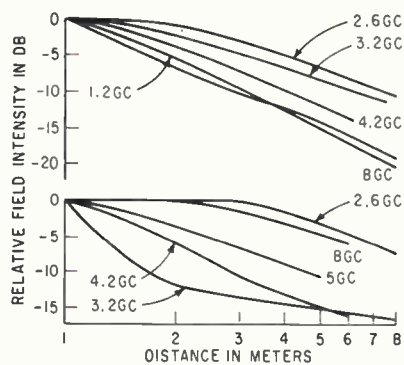

FIG. 5—Vertical (top) and horizontal components of horizontal pattern as a function of distance

horn positioning when polarization planes are shifted.

The 3- and 20-db beamwidths for all field components in both patterns are plotted in Fig. 2 and 3. Although gain curves indicate constant beamwidths, it should not be assumed that no points exist where beamwidth and gain change markedly.

Typical patterns in Fig. 4 show behavior outside the operating band. At higher frequencies, the forward beam is generally broken into smaller beams and considerable cross polarization is evident. Beam breakup almost certainly results from multimode aperture excitation. No explanation is offered for the two- to three-lobe at 8 Gc.

Patterns usually change little beyond 2 or 3 meters separation, suggesting that far field conditions may occur at relatively close range. This idea is supported by the plots of field intensity as a function of frequency in Fig. 5. The data show maximum field strength for each separation with field strength at 1 meter used as a reference. Slope of most curves within about 3 meters approaches 10 db per decade, suggesting that the horn far field is within this range.

Results suggest that gain is relatively constant to the 7th or 8th harmonic and then increases. Design and cross polarization gains become comparable near the 7th harmonic. Beamwidth is nearly constant to about the 7th harmonic, and the number of major lobes changes with distance. The near field-far field criterion that distance is greater than D^2/λ does not apply when other modes are present.

This work was supported by Rome Air Development Center.

LOOK

Constant-voltage transformers and d-c power supplies conveniently available nation-wide.

ALABAMA
Birmingham — James W. Clary Co.
M-G Electronics & Equipment Co.

ARIZONA
Phoenix — Midland Specialty Co.

CALIFORNIA
Glendale — R. V. Weatherford Co.
Los Angeles — Federated Purchaser, Inc.
Oakland — Brill Electronics
Elmar Electronics
Palo Alto — R. V. Weatherford Co.

Pasadena — Electronics Supply Corp.

San Francisco — Pacific Wholesale Co.

COLORADO
Denver — Denver Electronic Supply Co.
Inter-State Radio & Supply Co.
Radio & Electronics Supply Co.
L. B. Walker Radio Co.

CONNECTICUT
Bridgeport — Sprague Electrical Supplies
Hartford — Electrical Supplies, Inc.
Waterbury — Bond Radio Supply

DELAWARE
Wilmington — Radio Elec. Service Co. of Delaware

DISTRICT OF COLUMBIA
Washington — Capitol Radio Wholesalers
Electronic Wholesaler, Inc.

FLORIDA
Melbourne — Electronic Wholesalers, Inc.
Miami — Electronic Wholesalers, Inc.
Orlando — Hammond Electronics
Pensacola — Grice Electronics
Tampa — Thurow Electronics

GEORGIA
Atlanta — Electro Tech Inc.
Specialty Distributing Co., Inc.

ILLINOIS
Chicago — Allied Radio Corp.
Lukko Electronics
Newark Electronics Corp.
E. H. Sargent & Co.
The Welch Scientific Co.

Oak Park — Melvin Electronics

Peoria — Klaus Radio & Electric Co.

INDIANA
Evansville — Ohio Valley Sound

TO SOLA

*the pioneer
in a-c and d-c
regulated power*

thru this nationwide network of distributors

Indianapolis —
Graham Electronics Supply
Radio Distributing Co.
South Bend —
Radio Distributing Co., Inc.
IOWA
Davenport —
TCR Distributors
Des Moines —
Gifford Brown, Inc.
KANSAS
Wichita —
Interstate Electronic Supply Corp.
KENTUCKY
Lexington —
Radio-Electronic Equipment Co., Inc.
Louisville —
P. I. Burks Co., Inc.
LOUISIANA
New Orleans —
Southern Radio Supply Co.
MARYLAND
Baltimore —
Wholesale Radio Parts Co., Inc.
Bethesda —
Empire Electronic Supply Co.
Silver Springs —
Kenyon Electronics Corp., Inc.
MASSACHUSETTS
Boston —
DeMambo Radio Supply Co.
A. W. Mayer Co.
Radio Shack Corp.
Cambridge —
Electrical Supply Corp.
MacAlaster Bricknell Co.
Newton —
Cramer Electronics, Inc.
Springfield —
T. F. Cushing, Inc.
Soundco Electronic Supply Co., Inc.
MICHIGAN
Ann Arbor —
Wedemeyer Electronic Supply Co.
Battle Creek —
Electronic Supply Corp.
Detroit —
Radio Specialties Co., Inc.
Jackson —
Fulton Radio Supply Company
Muskegon —
Western Electronic Supply Co.
MINNESOTA
Minneapolis —
Low Bonn Co.
Northwest Electronics Corporation
Stark Electronics Supply Co.
St. Paul —
Gopher Electronics Co.
MISSOURI
Joplin —
Four State Radio Supply Co.
Kansas City —
Burstin-Applebee Co.
St. Louis —
Walter Ashe Radio Co.
NEBRASKA
Omaha —
Radio Equipment Co.
NEW JERSEY
Mountainside —
Federated Purchaser, Inc.
NEW MEXICO
Albuquerque —
Radio Specialties Co., Inc.
NEW YORK
Albany —
Ft. Orange Radio Dist. Co., Inc.

Binghamton —
Federal Electronics, Inc.
Buffalo —
Radio Equipment Corp.
Summit Distributors, Inc.
Elmira —
Brady Supply Corp.
Long Island City —
H. L. Dalis, Inc.
Lynbrook L. I. —
Peerless Radio Distributors, Inc.
Mineola L. I. —
Arrow Electronics, Inc.
New York —
Harvey Radio Co., Inc.
Milo Electronics Corp.
Terminal Hudson Electronics, Inc.
Poughkeepsie —
Chief Electronics, Inc.
Rochester —
Requa Electrical Supply Co., Inc.
Rochester Radio Supply
Rome —
Rome Electronics, Inc.
Schenectady —
Electric City Radio Supply
NORTH CAROLINA
Asheville —
Freck Radio Supply Co.
Raleigh —
Southeastern Radio Supply Co., Inc.
Winston-Salem —
Dalton-Hege Radio Supply Co.
NORTH DAKOTA
Fargo —
Bristol Distributing Co.
OHIO
Akron —
Akron Electronic Supply, Inc.
The Sun Radio Co.
Cincinnati —
Herrlinger Distributing Co.
United Radio Incorporated
Cleveland —
Pioneer Electronic Supply Co.
Radio & Electronic Parts Corp.
Columbus —
Hughes-Peters, Inc.
Dayton —
The John A. Becker Co.
Srepro, Inc.
Lima —
Lima Radio Parts Company
Toledo —
Warren Radio Company
Youngstown —
Ross Radio Co.
OKLAHOMA
Tulsa —
Engineering Supply Company
Radio Inc.
S. & S. Radio Supply
OREGON
Medford —
Verl G. Walker Co.
Portland —
Central Distributors
Lou Johnson Co., Inc.
Stubbs Electric Co.
United Radio Supply, Inc.
PENNSYLVANIA
Erie —
Erie Industrial Electric Supply
Warren Radio, Inc.
Indiana —
Fischer-Scientific Co.
(Instrument Div.)
Philadelphia —
Herbach & Rademan, Inc.

Pittsburgh —
Cameradio Co.
Fisher Scientific Co.
Radio Parts Co., Inc.
State College —
Alvo Electronics Distributors, Inc.
RHODE ISLAND
Providence —
Wm. Dandreta & Co.
SOUTH CAROLINA
Charleston —
Wholesale Radio Supply Co.
TENNESSEE
Kingsport —
Radio Electric Supply Co.
Knoxville —
Roden Electrical Supply Co.
Memphis —
Bluff City Distributing Co.
Nashville —
Electra Distributing Co.
TEXAS
Dallas —
Engineering Supply Co.
Wholesale Electronic Supply of Dallas
El Paso —
Midland Specialty Co.
Houston —
Busacher Electronic Equip. Co., Inc.
Harrison Equipment Co., Inc.
Sterling Electronics, Inc.
UTAH
Salt Lake City —
Standard Supply Co.
VIRGINIA
Charlottesville —
Virginia Radio Supply Company, Inc.

WASHINGTON
Everett —
Pringle Radio Wholesale Co.
Seattle —
Pacific Electronic Sales Co.
Seattle Radio Supply, Inc.
Western Electronics Co.
Spokane —
Northwest Electronics, Inc.
Tacoma —
C & G Electronics Co.
Wible Radio Supply, Inc.
Walla Walla —
Kar Radio & Electric Co.
WEST VIRGINIA
Beckley —
ChemCity Electronic Distributors
Huntington —
West Virginia Electric Supply Co.
WISCONSIN
Madison —
Satterfield Electronics, Inc.
Milwaukee —
Radio Parts Co., Inc.

S-52-61

SOLA



DIVISION OF BASIC
PRODUCTS CORPORATION
SOLA ELECTRIC CO., 1717 Busse Road,
Elk Grove Village, Ill., HEMPstead 9-2800
IN CANADA, Sola Basic Products Ltd.,
377 Evans Ave., Toronto 18, Ontario.

Connectors Provide Firm Grip

DESIGN OBTAINS POSITIVE LINEAR CONTACTS

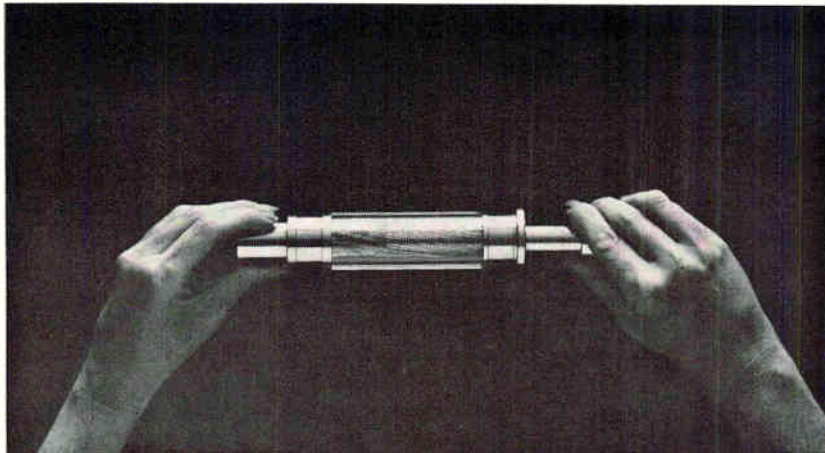

Hyperboloid twist in female receptacle, center of connector, assures reliable contact pressure for pins inserted in socket

TWIST CONNECTORS, developed under a French patent, have their male pins contact a female receptacle that has a basket-weave design, see photo. When the pins are inserted in the socket, the wire contact members are under tension and the arrangement assures a low spring rate with adequate wear allowance. The male plug slides into a smooth surface and grips firmly, there are no sharp discontinuities in slope on the sliding surface, and the insertion and withdrawal forces are even and smooth. Each floating pin receptacle allows enough lateral and angular freedom to compensate for misaligned pins during insertion.

This design concept is known as hyperboloid contact. Used in conjunction with solid pin entry, this socket design is said to result in positive linear electric contact through the elastic wrapping of the pin by each line wire contact.

The wire contact members are made of beryllium copper, silver and gold plated. The solid-entry pin insertion has a burnishing or polishing action which results in improvement of the connector through repeated use.

Because of the flurry of interest shown by engineers in this connector concept at the Wescon show

last fall, a complete line of these Curtac connectors are now being developed for racks and panels, and other applications in the coaxial field.

Connector Applications

Electronic Fittings Corporation, of Bethel, Conn., a subsidiary of the Curtiss-Wright Corporation, is now promoting the twist connectors as a major project. According to company, this connector concept can be applied to any connector application that uses one or more wires. And a big market for these connectors is projected in the r-f field, for airborne and missile applications, ground support equipment, and in printed circuits.

Company claims that their new connectors obtain improvement in voltage loss, are able to handle high currents, and can get excellent wear.

Standard military life tests showed that after 500 insertions and withdrawals, contact resistance of the Curtac connectors averaged four to five times better than required by the specification. The test was extended through 100,000 insertions, with the connector still functioning satisfactorily. The units tested showed an average 13.2 mv loss before testing, well within

the specification. After use, the connectors showed an average 4.9 mv loss.

The twist connectors eliminate chatter and physical damage caused by vibration. In the vibration test, the contacts were monitored for discontinuity by a chatter monitor capable of detecting chatter of 10 microseconds or greater with no evidence of chatter or physical damage. A shock force of 50 G's, with a time duration of 11 milliseconds, also failed to show evidence of physical damage or contact chatter.

Among the Curtac advantages given by Electronic Fittings Corp. are: numerous linear contacts, reliability of the socket due to smooth mating of the contact pins, minimum wear and friction, rugged construction with closed entry, uniformity of production for electro-mechanical end use, manual extraction of multiple pin and socket arrangements, and high electrical performance.

Company is producing a complete line of standard Curtac connectors, with particular emphasis on applications which call for extreme reliability. Miniaturized components include a three-amp rated connector utilizing an 0.025 male pin with 0.10 centers. With no obvious limitations as to size, the company has already made three-quarter inch pins capable of carrying 600 amps or more. Custom made connectors are also being produced for special requirements.

Power Breakthrough Achieved in K_u Band

THREE NEW traveling wave tubes, developed by General Electric under an Air Force contract, are now commercially available.

Two of the tubes provide more power output across their 14,000-to - 18,000 - megacycle frequency



COLD CATHODE TUBES

- count
- readout
- store
- compute
- sort
- control
- time
- switch



GCA10G



GS10H

Baird-Atomic has more different types of cold cathode counting tubes than anyone! All have been field proven... all feature rugged construction, low power requirements and simple circuitry. And B/A tubes are backed by extensive applications engineering service and a network of distributors in the U. S. and Canada.

For more information on Baird-Atomic tubes and services, send today for HANDBOOK OF COUNTING TUBES. Price \$1.00.



BAIRD-ATOMIC, INC.

33 University Road · Cambridge 38, Mass.

Engineers and scientists: Investigate challenging opportunities with Baird-Atomic. Write Industrial Relations Director. All qualified applicants will receive consideration for employment without regard to race, creed, color or national origin.

ADVANCED OPTICS AND ELECTRONICS...SERVING SCIENCE



TWO NEW TUBES

GCA10G — A recently developed tube for the direct coupling of a readout tube to a Dekatron without the need of any additional amplifiers.

GS10H — New, low cost, miniature selector with access to all cathodes. Seated height — 1 1/2".



Dekatron Tubes — Full line of twelve types for totalizing, sorting, programming or controlling. High speed (up to 20,000 cps). Reliable up to 100,000 hours — low current.



Voltage Reference Tube — Useful in high-level stages of DC amplifiers. No jump in characteristic. Constant internal resistance.



Computer Trigger Tube — Inexpensive subminiature tubes especially designed for computer application. Widely used for slow-speed storage applications.



Tetrode Trigger Tube — Designed for Dekatron coupling, readout circuits and bi-directional counting. Reliable in self-quench circuits. Drift-free operation.



tubular capacitors
ultra-high precision
with a
NEW DEGREE
of
RELIABILITY

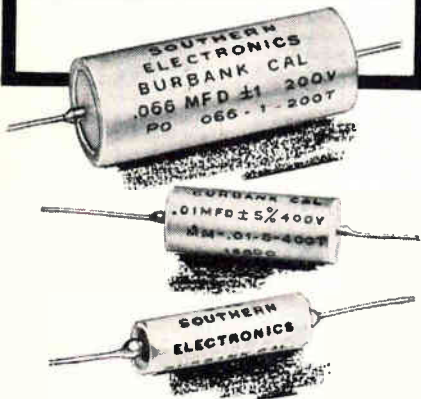

SOUTHERN ELECTRONICS CORP. has long been a leader in the design and manufacture of high-precision tubular capacitors, and has pioneered in supplying them for critical applications in computers, missiles, communications and other high-grade military and commercial equipment. They are made to the same standards as our high-precision polystyrene capacitors so widely accepted for military applications.

SEC tubular capacitors are manufactured under unusually critical quality control standards, resulting in tolerances as low as 0.5% in most values, and hermetic sealing guarantees accuracy over wide environmental changes.

SEC tubulars are available in a wide range of tolerances to meet your needs, from 100 mmfd. to any higher value, in polystyrene, mylar, metallized mylar, teflon and dual-dielectrics.

All SEC tubular capacitors meet or exceed the most rigid MIL-SPECS.

In addition, we manufacture a complete line of tubular capacitors for commercial applications. Let us know your requirements.

Write today for detailed technical data and general catalog.



Pioneers in custom precision capacitor engineering

SOUTHERN ELECTRONICS Corporation

150 WEST CYPRESS AVENUE
 BURBANK, CALIFORNIA

range than any other TWT's now commercially available, according to company report.

The highest powered, Z-5184, has a peak saturated power output of more than 1 kilowatt. The other two, both for continuous-wave operation, are the Z-5183, with a CW output of 10 watts and the Z-5182 with a minimum CW output of 150 milliwatts.

The tubes can be used individually or in tandem sequence, according to engineers at the GE Power Tube Department's Traveling Wave Tube Products Section, Palo Alto, Calif., where the tubes were designed and built.

The broad bandwidth and high gain of the new tubes make them useful in radar, electronic counter-measure equipment, microwave relay systems, and radiometry.

The high-power Z-5184, designed as the final amplifier tube in a pulsed chain, has a small signal gain of 30 db and a minimum saturated gain of 25 db. It is 11-in. long and 5.37-in. in diameter. The tube weighs about 20 pounds, including solenoid.

In mechanical tests, the Z-5184 withstood shock of 50 g for 11 milliseconds and vibration of 15 g up to 3,000 cps. The tube is liquid cooled and operates in ambients of -65 C to 100 C. In typical operation, the tube has a 0.01 duty cycle and pulse length of 10 microseconds.

The medium power Z-5183 is a

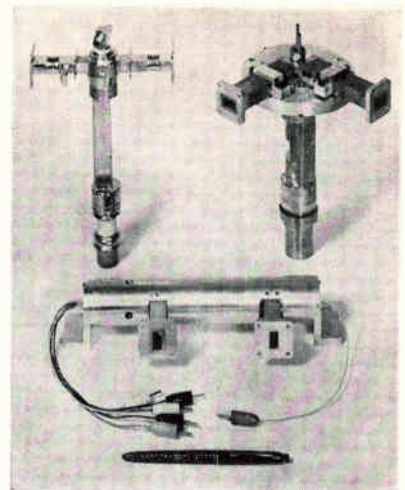

High-powered Z-5184, top left, shown with medium-power Z-5183, top right, and low-power Z-5182, bottom

packaged assembly including the focusing solenoid, tube, and housing with a total weight of about 34 pounds. The tube has a small signal gain of 34 db and a minimum saturation gain of 30 db. The Z-5183 is 9-inches long and 7.4-inches in diameter. Periodic permanent magnet focusing will be available in a very short time.

The low-power Z-5182 has a minimum saturated gain of 30 db and a small signal gain of 35 db. It is periodic permanent magnet focused. The tube is 11.2-in. long, 4-in. high, and 2-in. wide, weighing 3 pounds.

All three tubes are of metal and ceramic construction and may be installed in any position.

Arc Lamp Used For Solar Simulation

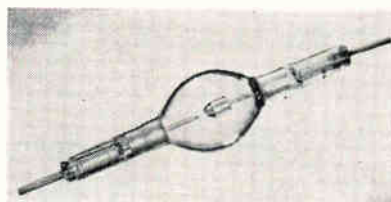

FIVE KILOWATT mercury-xenon arc lamp, developed by Engelhard Hanovia, Inc. Lamp operates at 50 volts and 100 amperes, emits a spectrum similar to sunlight in outer space, particularly in the ultraviolet and infrared ranges. It produces 230,000 lumens.

The lamp's bulb, custom-made from quartz and containing tungsten electrodes, is filled with xenon and mercury. In operation, the lamp

begins as a xenon lamp, with the xenon activated by radio frequency. The xenon is ionized and starts the arc discharge, which in turn vaporizes the mercury and increases the internal pressure.

Special Purpose Crt's

QUANTITIES of special cathode-ray tubes for B-52 bombers have been supplied by Raytheon.

The 10-in tubes have one side window to accommodate superimposed video-mapping information, and another for a camera readout.

Work is being performed under a contract from Warner-Robbins Air Force Base, Macon, Georgia.

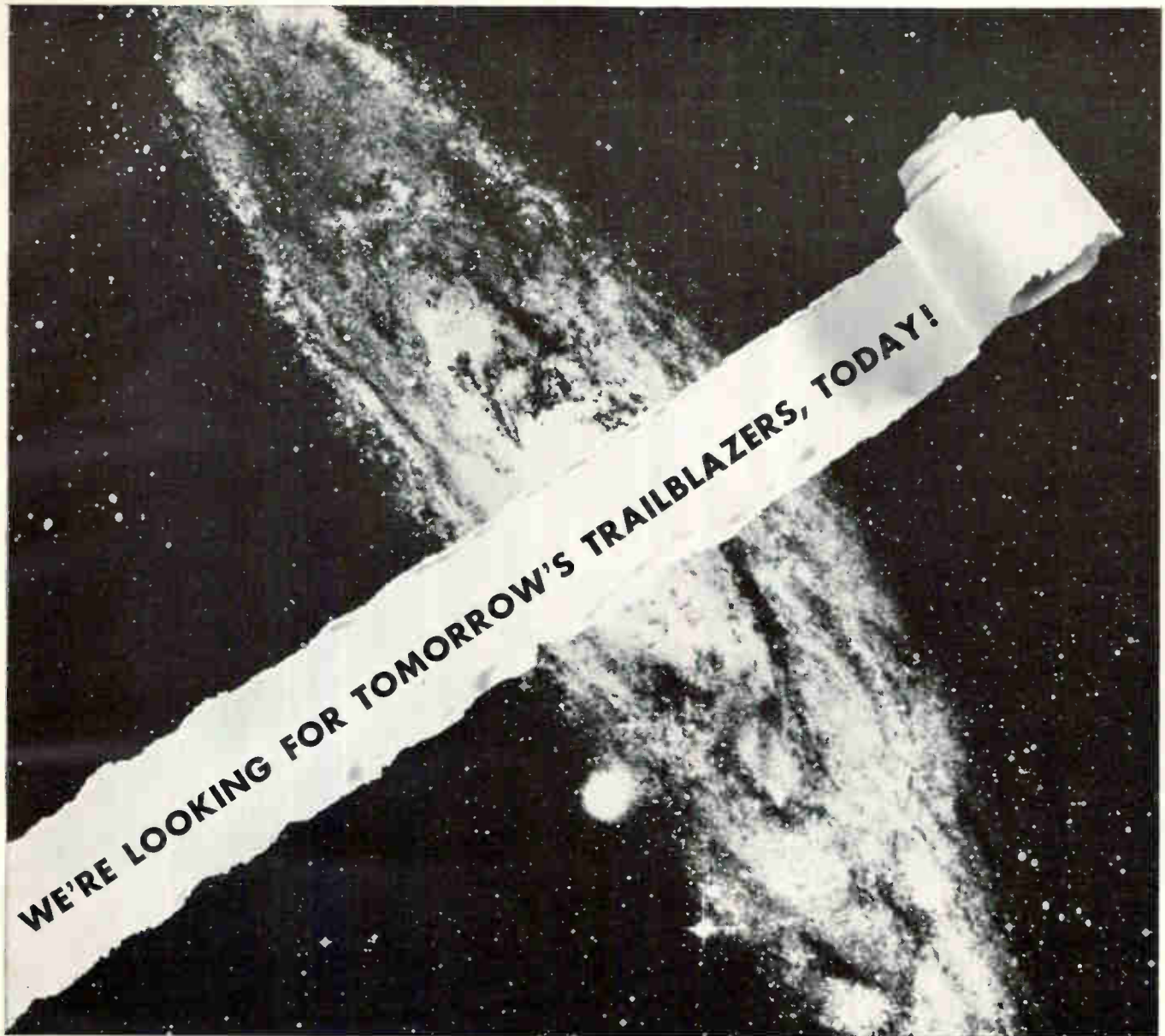

AC, The Electronics Division of General Motors, is now seeking *creative* engineers, physicists and mathematicians to fill important and challenging positions in the Advanced Navigation Field. The positions:

Boston Research & Development Laboratory

(Advanced Inertial Guidance Systems and Components)

Systems Engineers and Mathematicians
 Electronic Circuit Engineers
 Mechanical Design Engineers
 Instrument Engineers
 Electromagnetic Engineers
 Radar Systems Engineers

Los Angeles Research and Development Laboratory

(Advanced Inertial Guidance Systems and Airborne Digital Computers)

Digital Computer Development Engineers

If you are experienced and interested in any one of these positions, please send your resumé to Mr. G. F. Raasch, Director of Scientific and Professional Employment, Dept. 5753, 7929 S. Howell, Milwaukee 1, Wisconsin. We are an Equal Opportunity Employer.

AC SPARK PLUG ⚡ THE ELECTRONICS DIVISION OF GENERAL MOTORS

ACHiever Inertial Guidance for the TITAN II, THOR and MACE . . . Bombing Navigation Systems Integrator for the B-52C&D . . . POLARIS gyros and accelerometers . . . ALRI . . . ACHieverfone mobile telephones

Research and Development Engineers
 Transistor Circuit Design Engineers
 Systems Engineers

Milwaukee

Military Defense Systems, Program and Project Engineers
 Radar Design and Development Engineers
 Radar Systems Engineers
 Radar Test Engineers
 Reliability Program Engineers
 Field Service Engineers
 Electromagnetic Engineers
 Supplier Contact Engineers
 Quality Control Engineers/Analysts
 Technical Writers and Editors
 Scientific Programmers

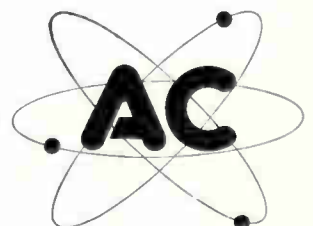

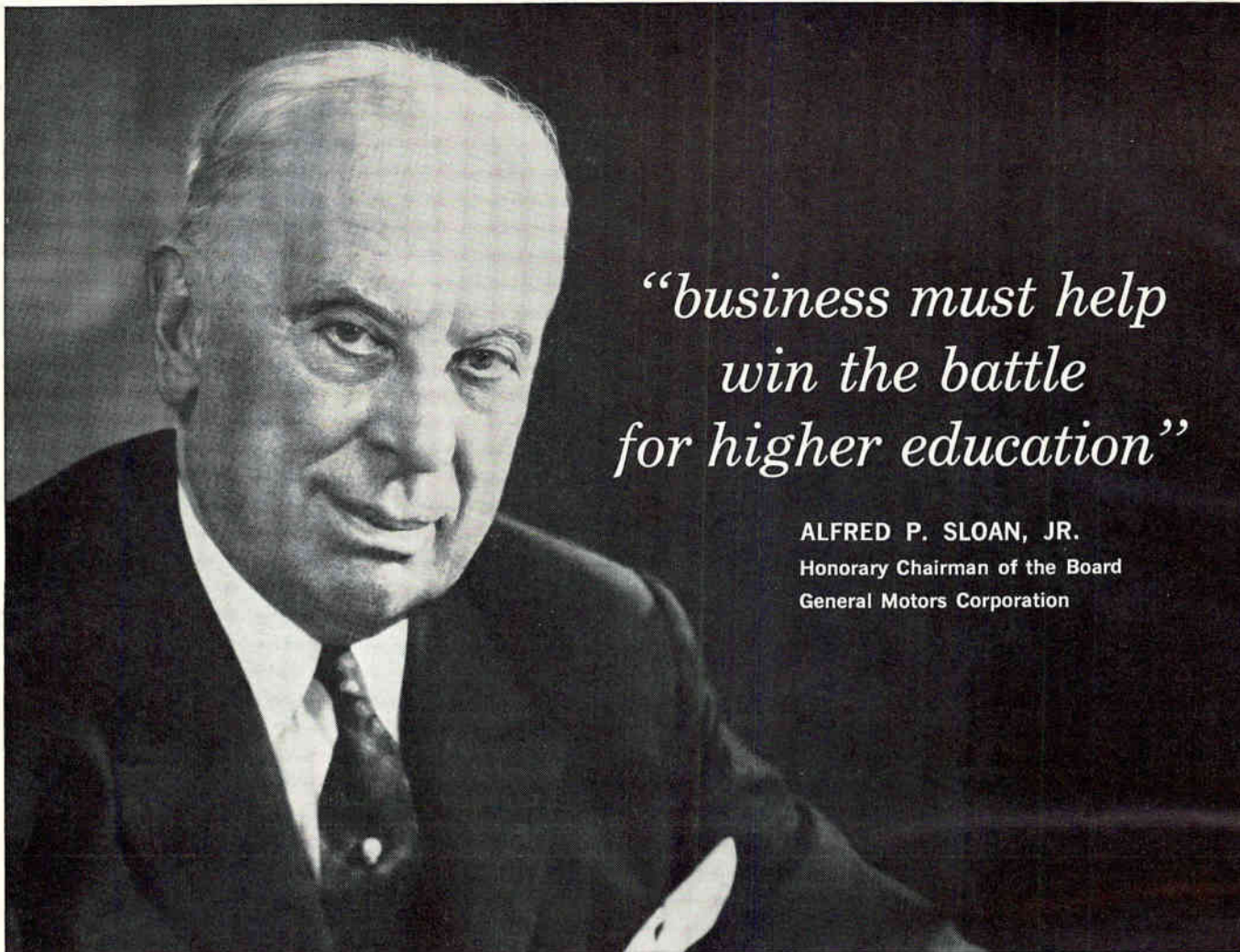

*“business must help
win the battle
for higher education”*

ALFRED P. SLOAN, JR.
Honorary Chairman of the Board
General Motors Corporation

“Regardless of the strengths and attributes our nation possesses, if we fall behind in the field of education, we will fall behind as a world power.

“Our scientific, cultural and economic growth—and our political strength—will depend largely upon the educational facilities we make available to our youth. We owe it to ourselves as a nation; we owe it to our young people who will inherit this nation to provide the financial aid that will make our institutions of higher learning second to none in the world. This is of vital importance to our business community.

“Business must put its support on the line to help win the battle for higher education.”

Today many of our colleges are overcrowded. In ten years, applications will have doubled and we will be faced with an even more serious crisis in our institutions of higher learning. We will need more and better college classrooms, many more well-equipped college laboratories and thousands more of the most dedicated and well-trained professors.

Only increased financial aid will provide our young people with the best college facilities. Only increased financial aid will keep our finest minds from leaving the teaching profession.

For additional information on the crisis faced by higher education write to: Higher Education, Box 36, Times Square Station, New York 36, N. Y.



Published as a public service
in cooperation with The Advertising Council and
the Council for Financial Aid to Education



Get Rocket-Fast Shipment from world's largest STOCK of Stainless Steel Fasteners



No long countdowns here. Allmetal stainless fasteners are stockpiled in advance —ready to go on your order. Fasteners in Commercial, AN, MS specs. You get fast delivery, precision quality, plus mass production economy when buying direct from stock.

Special fasteners also fabricated to your exact requirements on extremely short notice. Full range of raw materials assures prompt service. Simply send blueprint or specifications.

- Pins • Bolts • Nuts • Screws (including slotted and Phillips —magnetic and non-magnetic)
- Washers • Cotters • Rivets
- Rods • Studs • etc.

PHONE OR WRITE for prompt quotation or shipment. Send for catalog.

ALLMETAL®

SCREW PRODUCTS COMPANY, INC.

Manufacturers of Stainless Fasteners Since 1929

821 Stewart Avenue, Garden City, L.I., N. Y.
Phone: Pioneer 1-1200 TWX GCY 603

Midwest Division

6424 W. Belmont Avenue, Chicago 34, Illinois
Phone: AVenue 2-3232 TWX CG 3185

West Coast Division — Office and Warehouse
5822 West Washington Blvd., Culver City, Calif.
Phone: WEbster 3-9595 TWX LA 1472

CIRCLE 204 ON READER SERVICE CARD

January 19, 1962

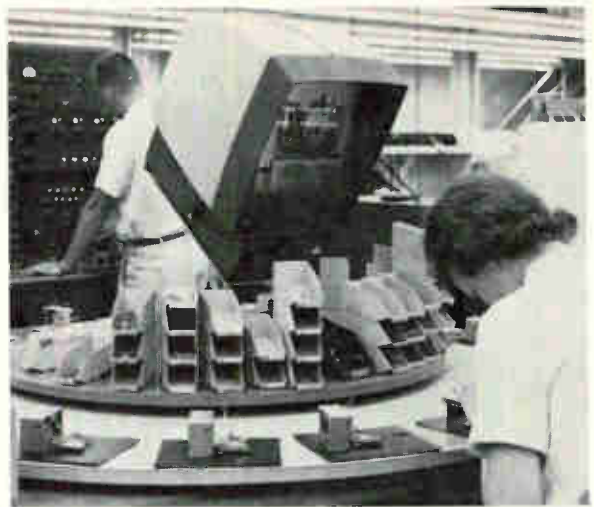
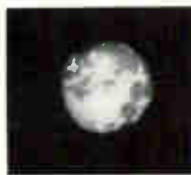

TEXAS BANK IS YOUR PRIME SOURCE OF INFORMATION ON PLANT SITES ANYWHERE IN TEXAS!



Electronics manufacturers are faced with special plant site location problems. Many of them have found the solution in Texas. And because Texas Bank maintains a complete file on every industrial site in the state, it can help you pinpoint the one that's exactly right for your operation. For site recommendations, or information on specific sites, contact Leon Huff, Vice President, Industrial Dept., Texas Bank. No obligation, of course.

Come grow with us



TEXAS BANK

AND TRUST COMPANY OF

DALLAS

Main and Lamar • Dallas, Texas • Rlverside 8-9141 • Member F.D.I.C.

CIRCLE 67 ON READER SERVICE CARD

67



Resistors and capacitors are deposited on 20 substrates at a time in high-vacuum chamber

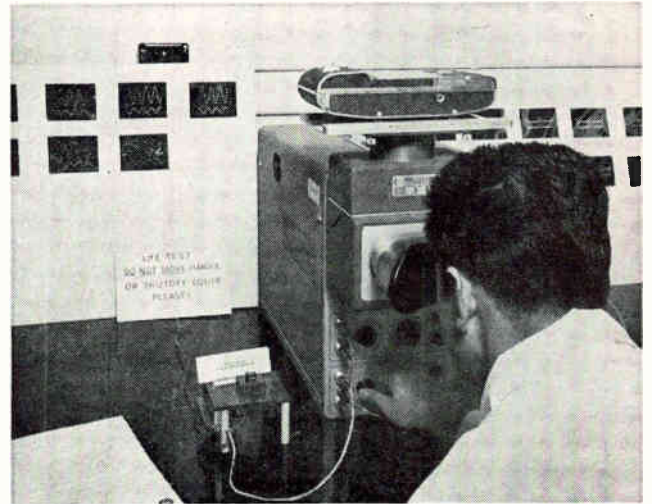

Three-stage deposited circuit servo amplifier undergoes life test, is one of first circuits made on the machine

Evaporator Makes Deposited Microcircuits

A PRODUCTION machine for high-vacuum deposition of integrated microcircuitry, capable of depositing 20 circuits during one pump-down cycle and reportedly able to produce accuracies at least as high as obtainable in the laboratory, has been introduced by the Solid State Physics group of Lear, Inc. Designed on the premise that the prime economic stumbling block of current evaporative processes is the time consumed in evacuating the deposition chamber, heating the substrates and associated jigs to required temperatures, and reverting to atmospheric conditions, the machine can precisely deposit complex resistor, capacitor and conductor patterns on a score of substrates during a single operating cycle.

Operating Principles

A production cycle for the new machine is approximately two hours, with actual fabrication time per circuit less than two minutes. Lear estimates that time savings per batch over previous methods ranges from 20 to 50 hours, and the cost of an average circuit with passive elements only will be reduced to less than a dollar, or considerably below the present cost using con-

ventional printed circuit technique.

Evacuating the chamber to operating atmosphere of 10^{-6} mm to 10^{-7} mm of mercury requires ten minutes. Heating the substrates sufficiently (about 350 C) so that the mobility of the deposited film permits rapid crystallization takes another 25 minutes. An additional 25 minutes is required to cool down to 100 C, during which time inert gases such as helium or argon are bled into the chamber.

Induction heating of the work area is accomplished by a unit mounted in the cover of the chamber; a thermocouple in contact with the substrate mount permits temperature control of ± 2 C.

To date, most of the circuits produced by the machine have been deposited on $\frac{1}{2}$ by $\frac{1}{2}$ -in. soft glass substrates with fired-on solder tabs, but the machine can handle any size up to one inch square. A rotating horizontal steel disc, turned manually by a lever mounted on the operator's console, has twenty stations in which the substrates and masks are mounted flat and parallel to each other.

Materials used in the prototype machine are chrome gold alloy or beryllium copper for conductor pat-

terns, nichrome for resistors, and silicon monoxide for dielectric layers. Two electron bombardment towers, located 12 inches below the turntable, vaporize and direct the flow of the metals used for conductors and resistances.

Resistor Deposition

Six 0.057-inch nichrome wires are fed through holes in a water-cooled copper anode and heated to 1,400 C. Molten metal is bombarded by a hot tungsten emitter and is directed upward toward the masked substrate to produce a resistive pattern. Conductor material is fed into its tower in shot form, evaporated, and similarly deposited onto the substrates.

Dielectric material is vaporized in an oven surrounding a perforated ceramic chimney. One or two ounces of silicon monoxide is packed around the outside of the chimney and sublimates through the perforations and up toward the substrate. The chimney arrangement and its 12-inch distance from the turntable largely eliminates unwanted pinholes.

Solenoid-operated shutters control the flow of vapor to the substrates, and consequently, the thick-

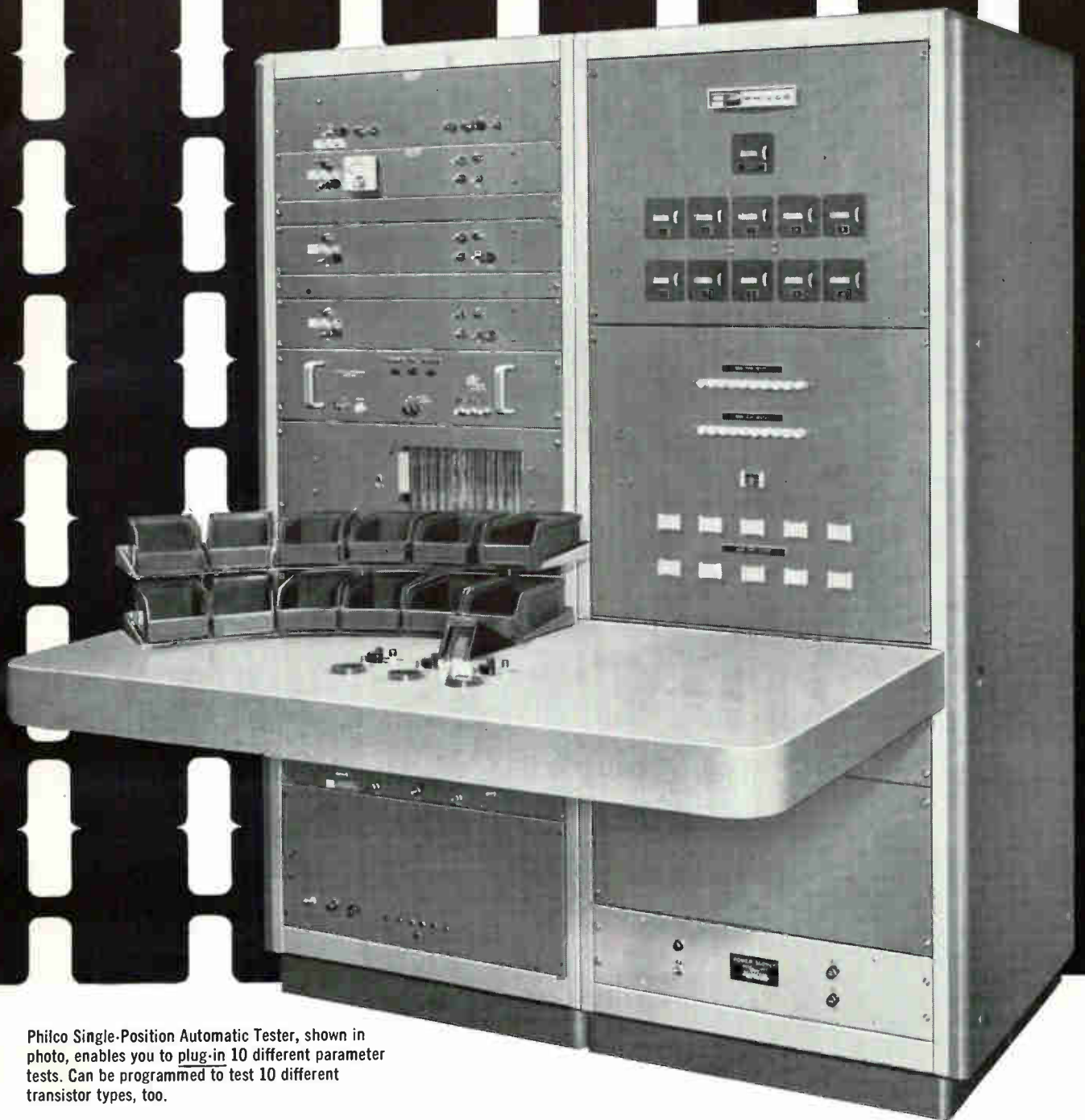

Philco Single-Position Automatic Tester, shown in photo, enables you to plug-in 10 different parameter tests. Can be programmed to test 10 different transistor types, too.

PHILCO TRANSISTOR TESTERS

Philco Proved-in-Use Equipment Enables You to Inspect Incoming Kc or Kmc Transistors, in Tray or Truckload Quantities. For any Transistor testing requirement—incoming inspection, production testing, or reliability testing, Philco offers proved-in-use equipment exactly suited to your needs. For complete information write Dept. E11962E.

Equipment Development and Manufacturing Operation

PHILCO
 *Famous for Quality the World Over*®

CIRCLE 69 ON READER SERVICE CARD

LANSDALE DIVISION • LANSDALE, PENNSYLVANIA

ANOTHER ROYAL spec- mated CORD SET

Customized for
Radio, TV, Hi Fi

Follow the lead of the nation's major manufacturers of communications equipment. Bring power to your products with Royal *Spec-Mated* Cord Sets . . . the pre-engineered components that are mated to your exact needs. They assemble fast, look right, perform right. And Royal *Spec-Mated* Cords add measurable quality advantages to your product, too!

Is time a problem? Then take advantage of Royal's toolroom of stock molds . . . also our broadest-in-the-industry wire line. Get the cords you need when you need them! Send for Catalog No. 5-59. *Royal Electric Corporation, Pawtucket, R.I.*



ROYAL
ELECTRIC 
... an associate of

ness of films deposited. These may be manually operated or automatically controlled. For conductor films, an electric timer controls the time the shutters are open. For resistor films, a digital ohmmeter with an automatic cut-off in the fourth decimal place is used. This ohmmeter reads the resistance of a monitor strip which is deposited adjacent to and simultaneously with the desired pattern. Patterns of 20 to 30 resistors having a combined resistance of up to 200,000 ohms and within a tolerance of 5 percent reportedly are practical. Relatively low-ohm-per-square films are used because of the stability obtainable. A nichrome film of 100 ohms per square when deposited upon a substrate at 350 deg C will be completely crystalline upon removal

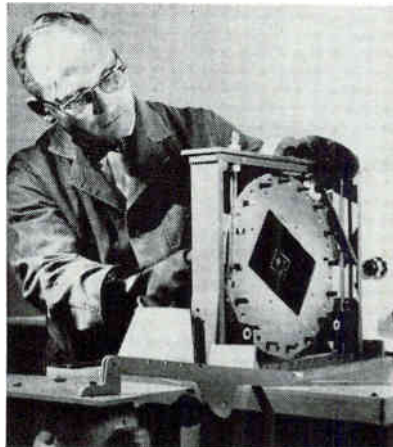

Stainless steel masks are developed from oversize artwork

from the evaporator, and will change less than one percent in total resistance due to subsequent surface oxidation. A film of several thousand ohms per square, on the other hand, can change in resistance from later surface oxidation by 50 percent or more.

Thickness of dielectric deposition is controlled by observing, through a system of lenses and mirrors, the shift in color fringes due to light interference as the material builds up on a monitoring ring of stainless steel. For example, the dielectric shutter may be closed when the operator notices the third green fringe, or the fifth red fringe, and so on. Capacitors to within ± 5 percent are possible.

To date, capacitors have all been three-layer devices. Great care has been taken to prevent foreign parti-

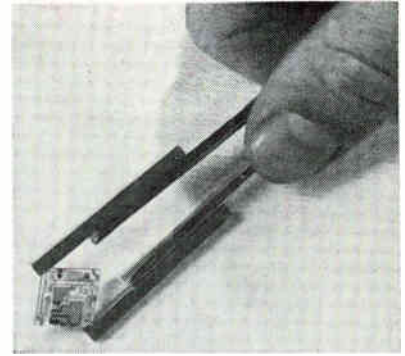

Typical microcircuit produced by the machine

cles and spattering from causing minute pinholes in the dielectric layer—the prime problem in thin-film capacitor fabrication. Typical capacitors have values as high as $0.03 \mu\text{f}$ per square cm, with breakdown of 60 to 100 volts and Qs from 100 to 2,000.

A critical problem in thin film deposition is masking. Masks for the deposition process are etched from type 300 series stainless steel 0.005 to 0.008 inch thick, and frequently have openings less than 0.005 inch in width. Original circuit layout is made 25 times the size of the actual circuit and is reduced photographically in two stages.

Uncased transistors and diodes are presently inserted manually but high priority is being given to the problem of evaporating active elements. One approach is evaporation or electro-deposition of single crystal semiconductor films onto the dielectric substrate.

Another approach is use of the tunnelling phenomena in extremely thin films. Cal Tech has been active in this field and indications are that such films between 10 and 70 angstroms thick will obviate the need for depositing single crystal materials for semiconductor functions.

At present the evaporator produces $20 \frac{1}{2} \times \frac{1}{2}$ inch circuits per cycle. In its next stage of development it will produce $320 \frac{1}{4} \times \frac{1}{4}$ inch circuits at an estimated cost of about one cent each. Eventually, 2,000 circuits 0.1×0.1 inch, with active elements of gallium arsenide, will be produced at one time, with costs estimated at less than one cent each.

The machine will be used to make circuits for the company, to make circuits to specs for other companies, and will also be available on lease.

Use the
POLAROID®
10,000 SPEED
Land Film

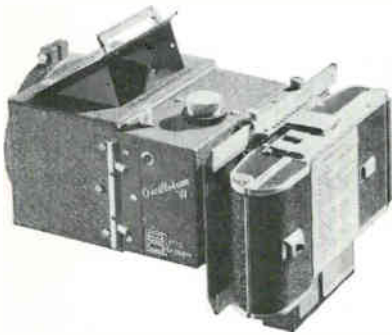

in the new
BEATTIE-COLEMAN
MARK II
OSCILLOTRON

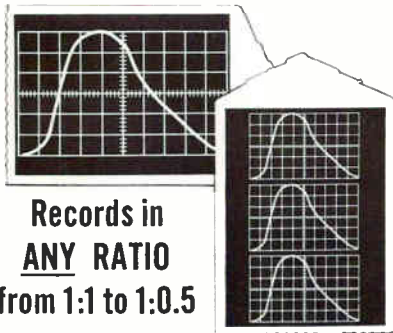

Records in
ANY RATIO
from 1:1 to 1:0.5

Here's the most versatile oscilloscope camera ever made. Especially designed for new 10,000 speed Polaroid Land Type 410 film that records pulses of extremely short duration. Prints in 10 secs. Easily change ratios from 1:1 to 1:0.5 without extra lenses. External focusing. Flat field lens. Electric shutter eliminates cable release. Direct viewing port or hood. Records up to 13 traces on one frame. Dark slide on Polaroid Land Camera back. Records written data on film. Fits any 5" scope. Attractively priced. Send for catalogs on all B-C Oscillotron models now.

"Polaroid"® by Polaroid Corporation



1004 N. OLIVE ST., ANAHEIM, CALIFORNIA
CIRCLE 205 ON READER SERVICE CARD
January 19, 1962

Gertsch announces:

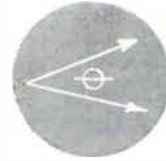

the **CRB** line of
complex ratio bridges



Ideal for voltage and phase comparison.

Measures complex voltage ratios — both in-phase and quadrature — with high accuracy.

These Gertsch CRB instruments are designed for testing 3- or 4-terminal networks, including transformers, synchros, resolvers, gyros, and transducers. The Gertsch line includes:



SOLID STATE BRIDGE—Model CRB-4. Instrument is fully transistorized . . . highly accurate. A self-contained, phase-sensitive null indicator permits rapid measurements. $R_x + R_y$ voltage ratios are read from concentric switch dials. *Battery or line* operation . . . case or rack mounting. Operating frequency range: 380-420 cps. Weight 20 pounds.



COMPLEX RATIO BRIDGE—Models CRB-1B and CRB-2B. In these units, quadrature component reading is indicated either as rectangular coordinate, $\tan \theta$, or θ directly in degrees. Useful for measuring angles as small as $.001^\circ$. Six-place resolution, with high accuracy. Cabinet or rack mounting.

CRB-1B	30-1,000 cps	2.5 f or 200 V max.
CRB-2B	50-3,000 cps	.35 f or 200 V max.



AUTOMATIC COMPLEX RATIO BRIDGE—Model CRB-3. A self-nulling AC bridge with digital readout of both in-phase and quadrature voltage ratios. Excellent for production testing.

Accuracy of bridge is $.002\%$ max. Five-place resolution, with automatic quadrant indication. Unit is self-contained, requiring no external calibration sources, and is equipped for external printer readout.

Complete literature on all units sent on request. Bulletin CRB.

Gertsch
GERTSCH PRODUCTS, INC.

3211 S. La Cienega Blvd., Los Angeles 16, Calif. • Upton 0-2761 • Vermont 9-2201

NEW opportunities in
MISSILE ENGINEERING
for:

**PHYSICISTS
MECHANICAL &
ELECTRICAL
DESIGN ENGINEERS
SYSTEMS
ENGINEERS**

The Hughes Tucson Engineering Laboratory is again expanding its scope of operations. Challenging new opportunities have been created with state-of-the-art advances in missile & space engineering.

The scope of engineering effort at Hughes Tucson includes operational as well as advanced missiles and sub-system designs for space programs.

Specific areas of immediate needs include:

- Circuit Design
- Transistor Techniques
- Electromechanical Design
- Infrared Theory
- Microwave Antenna Design
- Miniaturization
- Hydraulics
- Controls

Engineers and Physicists who like to work on important problems will find this dynamic organization an ideal environment in which to exercise creative talents.

If your goals include — work on vital projects with recognized leaders in the field — to live in the heart of the year-around, healthful Southwestern vacation land — to continue advanced studies (at the University of Arizona) — and to contribute to our Nation's Defense while securing your own future — send your resume to MR. W. A. BARNES.

creating a new world with electronics

HUGHES

HUGHES AIRCRAFT COMPANY
TUCSON ENGINEERING
LABORATORY
Tucson, Arizona

An equal opportunity employer

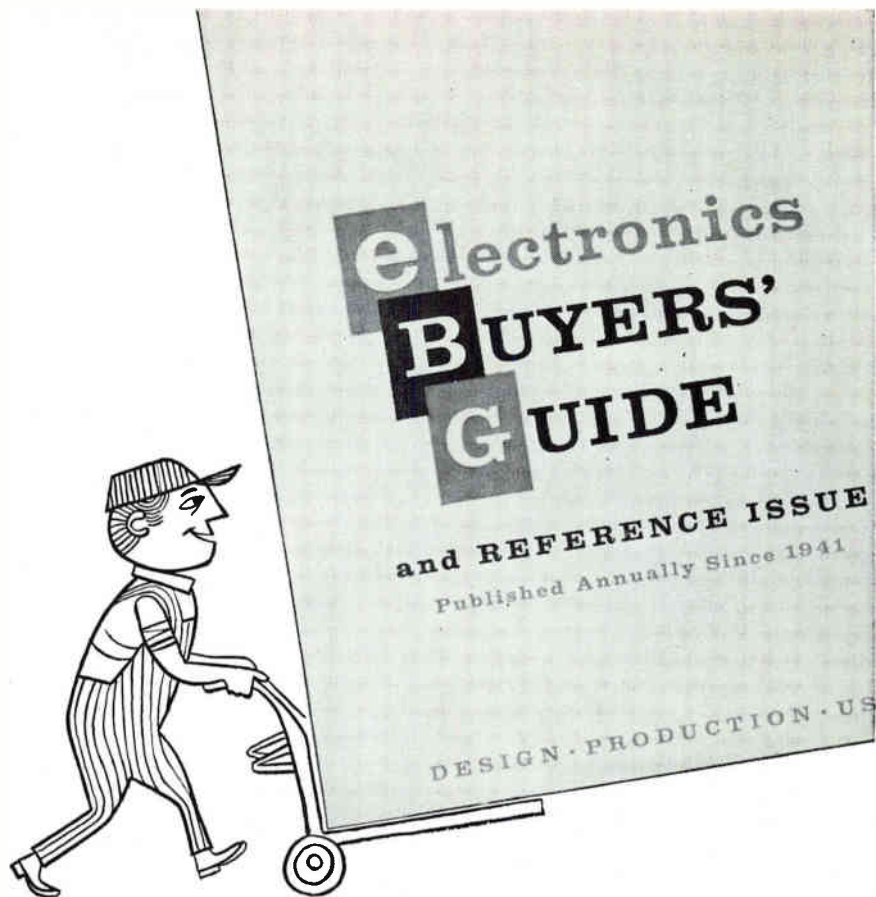

Big book for buyers in electronics

... and for sellers, too. Whether you want to buy or sell in the electronics industry, chances are that information in **electronics Buyers' Guide** and Reference Issue will help you do it better, more easily, more efficiently, or more profitably.

EBG puts key facts at your fingertips, by: Indexing more than 4,700 manufacturers; Listing all up-to-date products, components, materials, services; Giving you company statistics, such as dollar volume of business, number of employees, number of engineers; Giving you the name of the actual man in each company to call for prices, delivery dates, specifications, etc.

Complete information like this puts EBG away ahead in the electronic catalog league. It pays you to know and use the EBG.

electronics BUYERS' GUIDE and Reference Issue



The Basic Buying Guide in Electronics *since 1941*

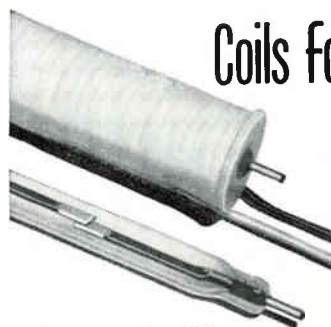

Coils for Contact Capsules

TYPE	DC-V	Ohms	Nom. Watts	Nom. Amp/Turns
S	6	100	.40	250
	12	360		
	24	1400		
M	6	50	.70	250
	12	175		
	24	820		
T	6	100	.35	125
	12	400		
	24	1600		
	32	2800		
	48	4600		

Coto-Coils

Write for Bulletin and Prices

COTO-COIL CO., INC., 65 Pavilion Avenue, Providence 5, R. I.

Coil Windings

WIRE SIZES
#6 to #56
CLASSES A, B, F and H

Since 1917 Coto-Coil has wound all types of coils for every application. Complete design and engineering service is available.

CIRCLE 216 ON READER SERVICE CARD

electronics

IRE SHOW

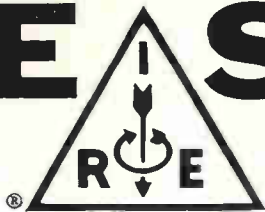

presenting

"THE GOLDEN AGE OF ELECTRONICS"

March 26-29, 1962

The New York Coliseum

... part of the

International Convention of the IRE

The Institute of Radio Engineers

1 East 79th Street • New York 21

Members \$1.00. Non-members \$3.00. Age limit: over 18

CIRCLE 206 ON READER SERVICE CARD

IMPEDANCE COMPARATORS

PRECISE, RELIABLE AND RAPID COMPARISON OF COMPONENTS

- Tests resistors, condensers, Inductors
- Percentage deviation from standard read on large meter
- Rapid response — no buttons to push
- High accuracy and stability
- Self calibrating — requires no recalibration when changing ranges



SPECIFICATIONS

MODEL 60

MODEL 1010

BRIDGE SUPPLY.....	6 Volts	2 Volts
FREQUENCY.....	60 CPS	Either 1 KC or 10 KC
FULL SCALE RANGES.....	± 1%, ± 5%, ± 10, ± 20%	± 5%, ± 10%, ± 20%
IMPEDANCE LIMITS:		
Resistance.....	5 ohms to 5 megohms	5 ohms to 5 megohms
Capacitance.....	500 mmfd. to 500 mfd.	50 mmfd. to 10 mfd.
Inductance.....	15 millihy. to 10,000 hy.	100 microhy. to 100 hy.
PRICE	\$199.00	\$329.00

OTHER MODELS AVAILABLE

MODEL	BRIDGE VOLTS	FULL SCALE RANGES
1000	2.5V-1000 CPS	± 1, 5, 10%
1025	2V-1 KC, 25 KC	± 5, 10, 20%
400	2.5V-400 CPS	± 1, 10, 20%
60-5	.2V-60 CPS	± 1, 2, 10, 20%
60-L	.6V-60 CPS	± 1, 5, 10, 20%

Representatives
in Principal
Cities



INDUSTRIAL TEST EQUIPMENT CO.
55 EAST 11th STREET • NEW YORK 3, N. Y.

CIRCLE 207 ON READER SERVICE CARD

Routine or rush,
specify Delta Jet Freight —

FLIERS BECOME FRYERS



Quick chick trick performed daily by Delta puts poultry on nationwide markets chirping bright. And Delta's fast Air-Truck service now includes markets miles around airport cities. 25 pounds or 5 thousand, always check how little by Delta Air Freight.

EXAMPLES, DOOR-TO-DOOR:

100 lbs. New York to Houston... \$21.10
300 lbs. Miami to Chicago... \$28.95

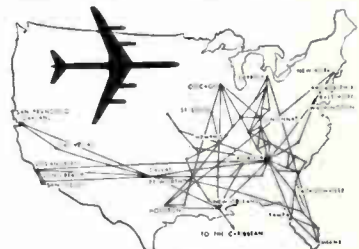

DELTA

the air line with the **BIG JETS**

GENERAL OFFICES: ATLANTA, GEORGIA

DESIGN AND APPLICATION

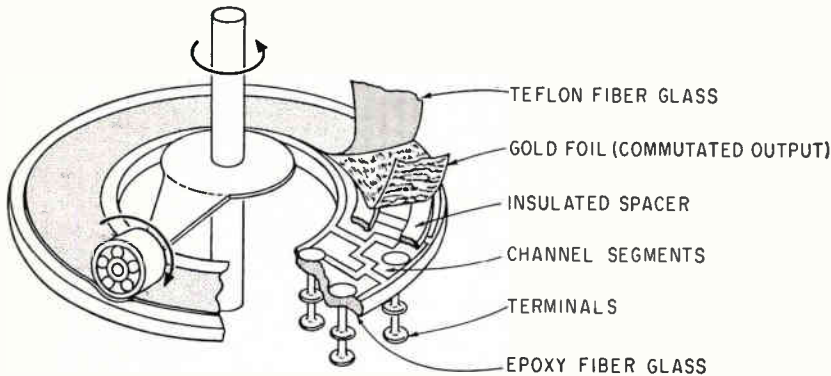

Mechanical Sampling Switch HAS NO SLIP RINGS

A NEW TYPE of sampling switch produced by Datametrics Inc., 87 Beaver Street, Waltham 54, Massachusetts, has a unique electrical contact method that dispenses with sliding friction and slip rings. Called DATACEL, the principle of operation is shown in the sketch. The channel segments are arranged in a circle with the gold foil (commutated output) contact supported away from the channel segments by insulated spacers 0.002-in. thick making an hermetically-sealed enclosure. The upper side of the gold foil (in contact with the miniature ball-bearing depressor), is lami-

nated to a thin layer of Teflon impregnated fiberglass to provide a running surface for the depressor. As the foil is depressed, contact is made from each successive switch segment to the gold foil. The depressor does not carry any current or participate in any electrical activity. Foil displacement is slight and well within elastic limits. Wear tests indicate up to 90×10^6 rotations at speeds of 1,000 rpm. Electrical contact resistance between channel segments and the gold foil is less than 0.01 ohm.

CIRCLE 301 ON READER SERVICE CARD

m-derived networks switched with a 1-pole, 60-position rotary switch. The basic circuit is shown in the sketch. The step-variable delay line is used as the coarse adjustment and the continuously-variable section is used for fine adjustment. To minimize reflection, the source impedance must equal one-half the characteristic impedance of the delay line $R_0/2$, terminals A and B terminated by the characteristic impedance of the line R_0 and the output line connected to a high-impedance load such as the grid of a vacuum tube amplifier or cathode follower. Applications include radar ranging and tracking or precision synchronization of gating circuits.

CIRCLE 302 ON READER SERVICE CARD

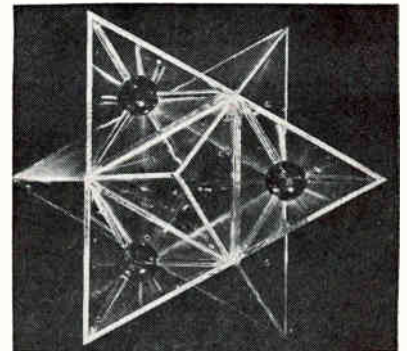

Crystal Model Building Block EASES VISUALIZATION

DEVELOPED at M.I.T., and produced by Therodyne Corp., 239 Massachusetts Avenue, Cambridge, Massachusetts, these crystal model building blocks transfer the frame of reference from close-packed spheres, as in the traditional ball-and-rod crystal models, to the interstices between them which take the octahedral and tetrahedral shapes. Using this system, crystal planes are visual where they must be imagined with conventional ball-and-rod models, they produce coordinated concepts in that chemical formulas of crystal material can be determined very easily, they can

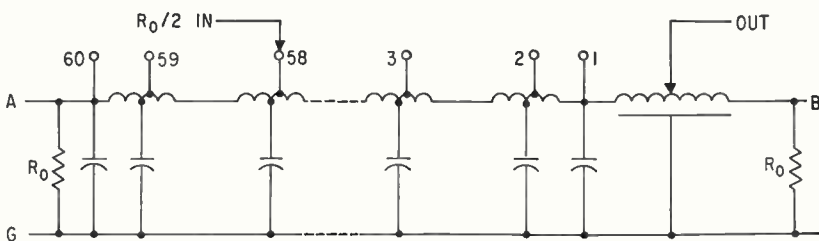

Continuously Variable Delay Line

LESS THAN 8×10^{-11} SECOND RESOLUTION TIME

RECENTLY announced by Ad-Yu Electronics Lab., Inc., 249 Terhune Avenue, Passaic, New Jersey, is a continuously variable delay line with less than 8×10^{-11} second resolution time and a maximum delay

over 30 microseconds. The device consists of two parts; a continuously variable delay line which is essentially a condensed r-f cable and a step-variable delay line consisting of 60 sections of LC



Headquarters for INSULATION TESTING

NEW INSTRUMENTS from Associated Research, Inc. . . . Chicago, Ill.



Insulating Materials Testers

A complete range of instruments for testing solid, sheet and liquid electrical insulations . . . to ASTM, Federal and MIL specifications. Standard designs offer output to 60 kv at 2 kva. Features include provisions for operator safety and line of interchangeable material test fixtures. Special designs built to your requirements.

Measure Insulation Resistance to FIVE MILLION Megohms

The VIBROTEST® megohmmeter is direct reading with an electronic power supply that eliminates cranking and leveling. Multi-range models combine megohm, d-c and a-c voltage measurement in compact instruments with welded steel portable case. Model 250 VIBROTEST® Megohmmeter with 4 1/2" scale, has ranges: 1 to 50, 10 to 500, 100 to 5,000 and 1,000 to 50,000 megohms. Price, \$279.50. Catalog describes many additional models.



Ground Resistance Testers

VIBROGROUND® Ohmmeters measure resistance to ground from electrical and electronic equipment. They are direct reading, self-powered from long life battery. Bulletin available, lists all models as well as instruments for measuring soil resistivity and conductance.



Precision Ohmmeters (1/2 of 1%)

Direct reading resistance measurements are made with an accuracy of up to 1/2 of 1% . . . from 0.05 ohm to 100,000 ohms. Have compensation for battery and lead resistance, self-contained battery. Model 244 has ranges of 0-50/500/5,000/50,000 ohms. Price, \$128.00 . . . Model 246, ranges to 100,000 ohms, \$148.00.



NEW . . . Insulation Testing Manual C-61

WRITE

TODAY



HIGH VOLTAGE BREAKDOWN TO 250 KV

A full range of instrumentation for non-destructive dielectric tests, is offered. Very High Voltage D-C HYPOT® models have output to 250 kv at 25 ma. A-C HYPOT® models are available with output to 150 kv at 25 kva. Features may include: automatic rate of voltage rise control, memory circuit to record voltage at time of breakdown, and many others described in a special catalog.



Mobile HYPOTS® . . . to 120 kv

Mobile high voltage test sets determine insulation breakdown in cables, bushings, transformers, motors and similar equipment. They are readily transportable, have advanced safety features and meet applicable specifications for testing elements of electronic, missile and ground support systems. Widely used by electric utilities and for industrial maintenance. Descriptive bulletin available.



Portable HYPOTS® . . . to 10 kv

Compact instruments for measurement of insulation breakdown voltage and leakage current. Outputs to 10 kv, a-c. Also, with d-c output voltage. New bulletin describes many available models. Model 412 Portable HYPOT® has output adjustable 0 to 1500 v, a-c. Leakage current readout light adjustable from 0.3 to 3.0 ma. Price \$137.50.



Bench HYPOTS® . . . to 45 kv

Semi-portable instruments measure insulation leakage current and breakdown voltage. Available with d-c output voltage to 45 kv at 25 ma, and with a-c output to 35 kv at 2 kva. Bench type welded steel cabinets have carrying handles. There are models with high current output for rapid charging of capacitance loads, to facilitate production testing. Descriptive bulletin available.



Automated Test Equipment

Instruments for automated testing of voltage breakdown, insulation resistance, leakage current, continuity . . . at unlimited test points, with full random access. Illustrated at left, is multi-circuit analyzer for cables, components and circuits . . . with printed tape readout of rejections.



Corona Testing Equipment

New instruments detect and display on oscilloscope, minute traces of corona . . . whether caused by voids within the insulation or other defects. The corona may be studied visually, measured with a calibrator or trigger an alarm. A bulletin on corona testing systems, corona-free HYPOTS®, and corona detectors, is available.

SPECIAL INSTRUMENTATION

Designed to your needs . . . embodying these and related measurements: Continuity, Insulation Resistance, High Voltage Breakdown, Leakage Current, Capacitance and Inductance Bridge. Also, modification of standard instruments will be made as required to meet your applications. When writing, give complete details of your requirement.

D-C Power Supplies . . . to 250 kv

Available as general purpose units or with facilities for specific applications. HYPOT® D-C power supplies are widely used in test and development of capacitors, cables, klystrons and other high voltage devices. Output voltages to 250 kv with full load ratings to 50 ma, are offered. Our engineering department will supply full data on models suitable for your requirements.

10-35.25

INSTRUMENTS for measuring

ASSOCIATED RESEARCH, INC.

3781 W. Belmont Ave. - Chicago 18, Illinois

- Insulation Resistance . . . the VIBROTEST®
- Ground Resistance . . . the VIBROGROUND®
- Earth Resistivity . . . the VIBROGROUND®
- High Voltage Breakdown, AC-DC . . . the HYPOT®
- Special Instrumentation for Laboratory, Production, and Maintenance Needs

1 kc to 500 mc Stable Noise Output is variable in 1 db steps to 20 db

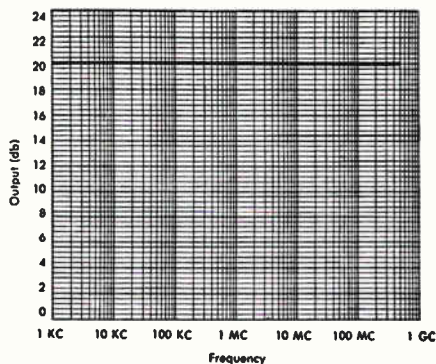

This chart demonstrates the constant noise output, from 1 kc to 500 mc, of Polarad's Precision Noise Generator—Model N-1. Its direct reading, accurately calibrated dial simplifies direct noise figure measurements. □ The noise output is kept at the set level by a feedback circuit so that output noise calibration is independent of terminating resistance. A maximum of 20 db into 50 ohms is available. □ Vernier adjustment is provided enabling 0 to 1 db interpolation for measurements in vacuum tube and transistor amplifiers, receivers and oscillators. Accuracy is ± 0.25 db. □

Write Polarad or call your local Polarad representative (listed in the Yellow Pages) for complete specifications and a demonstration.

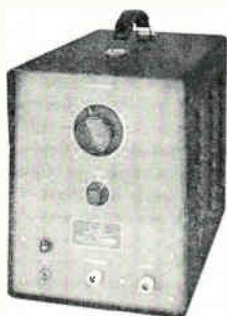

**Model N-1
Precision
Noise
Generator**

POLARAD
ELECTRONICS CORPORATION
43-20 34th Street, Long Island City 1, N.Y.

be used to demonstrate silicate structures and can also be used to demonstrate geometry and orderliness of three-dimensional lattices. The building blocks are available as preassembled models of germanium, silicon and rare earth metals. The photo on p 74 shows configuration of a diamond crystal.

CIRCLE 303 ON READER SERVICE CARD



L-F Time Base MINIATURIZED

FORK STANDARDS, INC., 1915 N. Harlem Ave., Chicago 35, Ill., has developed a miniaturized 1-sec time base. Claiming high frequency accuracy to 0.002 percent, the unit is built around a precision type tuning fork oscillator operating near 1,000 cps. Signal output of the time base oscillator is reduced, using miniaturized circuitry, to any desired frequency from 60 cps down to 1 cps. Frequency accuracy is maintained over a temperature range of 0 to 65 C. Input power is 12 v d-c with output a square wave, 8 v peak-to-peak into 10,000 ohms.

CIRCLE 304 ON READER SERVICE CARD

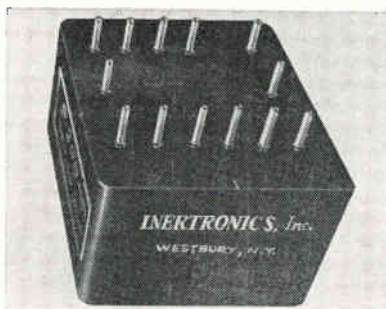

D-C Power Amplifier 2 IN. BY 2 IN. BY 1 IN.

INERTRONICS, INC., P. O. Box 462, Westbury, L. I., N. Y. For use in driving d-c torque motors of 3 w to 100 w capacity from 28 v d-c line, this class B silicon transistor amplifier may be connected for either voltage or current feedback for optimum servo response, and is com-

pletely protected against normal causes of failure. Full output is achieved with 2 v signal into 100,-000 ohm input. Drift is under 10 percent over rated temperature range of -55 C to 125 C.

CIRCLE 305 ON READER SERVICE CARD

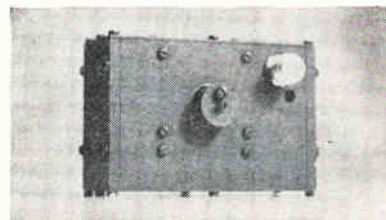

Miniature Amplifier WIDE BAND

SPACE COMMUNICATIONS CORP., 4 Spring Ave., Bergenfield, N. J. Employing advanced multipole techniques, bandwidth obtained for the model 12L13 uhf amplifier is 100 Mc at 10 db gain. Response shape is maximally flat and center frequency at 1,000 Mc. Applicable for pulse and c-w techniques for use as transmitters, signal generators and low-noise receivers. Price is \$250.

CIRCLE 306 ON READER SERVICE CARD

Pulse Generator

ALFRED ELECTRONICS, 3176 Porter Drive, Stanford Industrial Park, Palo Alto, Calif. Pulse generator providing 300 to 450 v for loads up to 250 ma peak is designed for modulating microwave amplifiers.

CIRCLE 307 ON READER SERVICE CARD

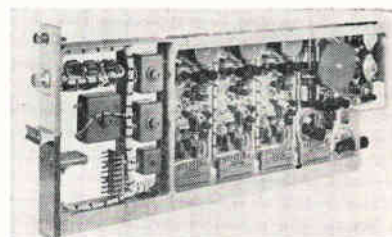

Active Filter LOW PASS

REDCOR DEVELOPMENT CORP., 7760 Deering Ave., Canoga Park, Calif. Model 440A low pass filter is useful in data gathering systems for signal conditioning. The accuracy of the 3 db point, attenuation characteristic, and insertion loss is controlled within ± 0.05 percent of a true Butterworth. Frequency re-

sponse extends to d-c and d-c stability is controlled by high gain chopper stabilization amplifiers. Input impedance is 1,000 megohms and source impedance can vary within 0-5,000 ohms without degradation of accuracy. Prices from \$1,300.

CIRCLE 308 ON READER SERVICE CARD



Microvoltmeter

VERSATILE UNIT

PHYSICAL SCIENCES CORP., 389 N. Fair Oaks Ave., Pasadena, Calif. Model 1101 d-c microvoltmeter is a precision instrument having ± 0.1 percent accuracy in all ranges for measuring outputs of bonded or unbonded strain gages, thermocouples, resistance thermocouples, and low level d-c voltages. Resolution is $1 \mu\text{v}$ on the 1 mv full scale range. Ranges are: $\pm 1,000 \mu\text{v}$; ± 10 , ± 50 , $\pm 100 \text{ mv}$.

CIRCLE 309 ON READER SERVICE CARD

Rotary Pot

DAYSTROM, INC., Archbald, Pa. Weighing only 7 grams max, and with a total overall case length of only $\frac{3}{4}$ in., model 304 is a single-turn unit which emphasizes high linearity.

CIRCLE 310 ON READER SERVICE CARD

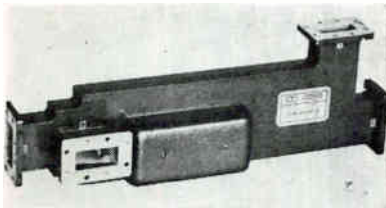

Circulator

FOUR-PORT

RANTEC CORP., Calabasas, Calif., has developed a 4-port waveguide circulator for communication link applications. Model CXB-205 covers



METOHM precision resistors in handy protective "pop-out" package of ten.

NOW!

Ward Leonard precision metal films too!

"METOHMS" OUTDO MIL-R-10509D

Now Ward Leonard offers you the same uncompromising quality, the same superlative reliability in a metal-film precision resistor that you've come to know and expect in Ward Leonard power resistors.

Ward Leonard METOHM molded metal-film precision resistors exceed the requirements of MIL-R-10509D, characteristics B, C, and E. Standard METOHM resistance tolerances are $\pm 1\%$; tolerances to $\pm 0.05\%$ on special order.

METOHMS exceed wire-wound precision resistors in high-frequency performance yet are smaller and lighter weight. And, they far excel other types of precision film resistors in low, and controllable, temperature coefficient of resistivity. Moreover, these low TC's apply over the entire range of resistance values. 2.9

METOHM TYPE	MIL EQUIVALENT	RATED WATTS	OHMIC VALUES		MAX. VOLTAGE RATING
			MIN.	MAX.	
WL 60	RN 60	$\frac{1}{8}$	30	500K	250 V.
WL 65	RN 65	$\frac{1}{4}$	50	1 meg.	300 V.
WL 70	RN 70	$\frac{1}{2}$	50	1.5 meg.	350 V.

You'll find full data on METOHM resistors in Ward Leonard Catalog No. 50. Write for your copy and a list of distributors today. Ward Leonard Electric Co., 30 South Street, Mount Vernon, New York.



RESULT-ENGINEERED CONTROLS
WARD LEONARD
ELECTRIC CO. MOUNT VERNON
 NEW YORK
 RESISTORS • RHEOSTATS • RELAYS • CONTROLS • DIMMERS

NEW

CEC's Portable Moisture Monitor, (26-303) costs only \$435—much less than the model it replaces. The specs are the same: continuous 0-1000 ppm measurement of water in gas streams, laboratory accuracy 5% full scale, 63% response in 30 seconds or less, rugged, portable, operates on battery or a-c power. Want one? Call your nearest CEC office or write for Bulletin CEC 26303-X4.



CEC

Analytical & Control Division

CONSOLIDATED ELECTRODYNAMICS
PASADENA, CALIFORNIA • A SUBSIDIARY OF BELL & HOWELL

the band 5.925 to 6.425 Gc with 20 db minimum isolation, insertion loss less than 0.25 db, vswr 1.15:1 max. Power handling capability is 300 w average and operates over a temperature range of -55°C to $+71^{\circ}\text{C}$. The low swr prevents interchannel modulation distortion.

CIRCLE 311 ON READER SERVICE CARD

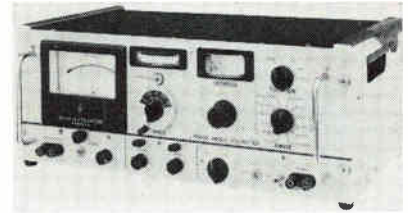

Voltmeter

PHASE ANGLE

NORTH ATLANTIC INDUSTRIES, INC., Terminal Drive, Plainview, N. Y. Model VM-301 broadband phase angle voltmeter combines in one instrument the ability to measure both phase angle and magnitude of complex a-c signals and their vector components with respect to a reference voltage over a frequency range of 10 cps to 100 Kc. It is applicable to amplifier and network design, vibration and telemetry analysis, bio-medical research, phase sensitive null detection in production and laboratory.

CIRCLE 312 ON READER SERVICE CARD

L-F Noise Generator

ELGENCO INC., 1555 Fourteenth St., Santa Monica, Calif. Model 301A noise generator employs a grid-controlled gas thyratron in a transverse magnetic field as the primary noise source.

CIRCLE 313 ON READER SERVICE CARD

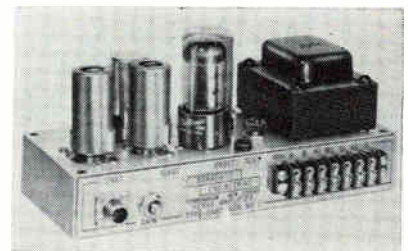

Servo Amplifier

LOW-COST, HIGH-GAIN

SCHAEVITZ ENGINEERING, P. O. Box 505, Camden 1, N. J. The SA-62

may be used for all measurement and control applications in which minute 60-cps signals from a transducer must be amplified to produce up to 5.6 w of controlled undistorted a-c power. It provides reversible power to the control phase of two-phase servomotors with 2,000-6,000 ohms impedance across the control windings. Price is \$125.

CIRCLE 314 ON READER SERVICE CARD



Digital Modules

12 CIRCUITS AVAILABLE

DELCO RADIO DIVISION, General Motors Corp., Kokomo, Ind. Series of silicon digital modules in 12 different circuits operate at a delay-per-stage of less than 25 nsec. It includes digital plug in cards and block modules which operate conservatively at 10 Mc over the complete temperature spectrum of -50°C to $+100^{\circ}\text{C}$.

CIRCLE 315 ON READER SERVICE CARD

Power Supply

KEPCO, INC., 131-38 Sanford Ave., Flushing 52, N. Y. Model ABC 40-0.5M has continuously variable output of 0-40 v d-c at 500 ma; line/load voltage regulation, 0.05 percent.

CIRCLE 316 ON READER SERVICE CARD

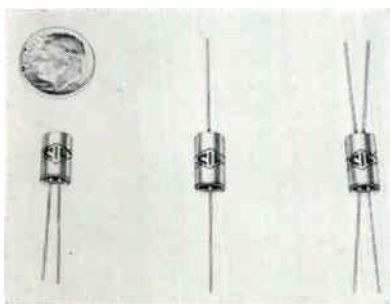

Microinductors

HIGH RELIABILITY

CLIPPARD INSTRUMENT LABORATORY, INC., 7390 Colerain Road, Cincinnati 39, O. Ultra fine wire winding techniques, and a new concept in design and construction, enable

NEWER

CEC's Solids Moisture Analyzer, (26-320) costs only \$1575. It's specific to water...measures total water in solids in five to fifteen minutes. Water is measured by electrolysis – linear response, sensitivity of $0.1\ \mu\text{g}$, accuracy $\pm 5\ \mu\text{g}$ or 2% of full scale reading. Get the complete details. Write for Bulletin CEC 26320-X3 or call your nearest CEC office.



CEC

Analytical & Control Division

CONSOLIDATED ELECTRODYNAMICS

PASADENA, CALIFORNIA • A SUBSIDIARY OF BELL & HOWELL

Behlman-Invar

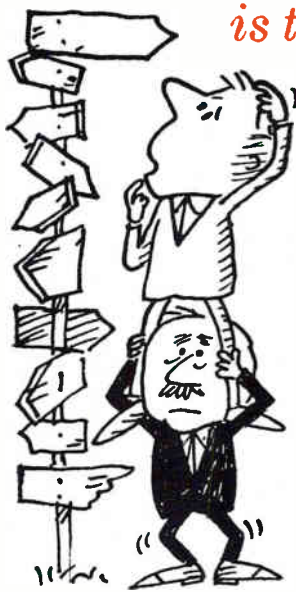

*is to electronic
power
as
Rand
is to
McNally*

*And to determine what Behlman-Invar means to you,
B/I has a complete catalog of AC and DC power supplies
which is yours for the asking. Ask!*



BEHLMAN-INVAR ELECTRONICS CORP.

1723 Cloverfield Blvd., Santa Monica, California

CIRCLE 208 ON READER SERVICE CARD

ANOTHER IMPORTANT BREAKTHRU!

DUROTHERM

Non-freezing Long-Life SOLDERING TIPS

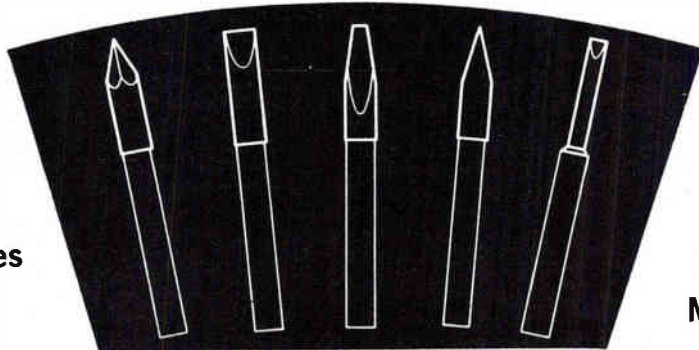

**In
ALL
Shapes
and
Sizes**

**Fit
ALL
Makes**

HI-PERFORMANCE Tips for use in HI-PERFORMANCE, HI-TEMPERATURE Irons. Tips positively cannot stick or freeze in any iron—easily removed after months of service. No need to remove tips daily. Minimum loss of heat delivery. Tip shank immunized from solder, except on working surface at end of tip—prevents creeping of solder into element tip hole and spilling of solder on components.



SEND FOR CATALOG—showing the most complete line of industrial Soldering Irons and Long-Life Clad Tips.

HEXAICON ELECTRIC COMPANY

130 West Clay Ave., Roselle Park, New Jersey

SERVING INDUSTRY FOR OVER A QUARTER OF A CENTURY

80 CIRCLE 80 ON READER SERVICE CARD

these microinductors to withstand more than 10,000 g. Designed for relatively low current circuitry in rockets, missiles and space-age miniature equipment, the ferrite-cored inductors are supplied in three styles: with double leads at one end, with single leads at both ends, and with double leads at both ends.

CIRCLE 317 ON READER SERVICE CARD

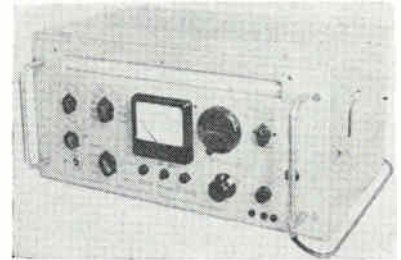

Microvoltmeter

SELECTIVE TYPE

ROHDE & SCHWARZ, 111 Lexington Ave., Passaic, N. J. Type USVH is a highly sensitive receiver with output voltage indicated by a diode voltmeter. Switch selects six input impedances from 50 ohms to 500,000 ohms. Meter is calibrated in volts and db and has an added expanded scale with calibration from 0.7 to 1. Single frequency changing for input frequencies from 10 to 1,000 Kc, double frequency changing for 1 to 30 Mc.

CIRCLE 318 ON READER SERVICE CARD



Power Inverter

AIRBORNE UNIT

AMERICAN ELECTRONICS, INC., 1598 E. Ross Ave., Fullerton, Calif., announces an airborne d-c to a-c, 400 cps, three-phase power inverter for space applications. Model 121-103-501 is capable of delivering a continuous output of 500 or 750 v-a, depending on the cooling process utilized. It maintains its output frequency regulated at ± 0.5 percent. Use of scr's increases overall reliability.

CIRCLE 319 ON READER SERVICE CARD

electronics

**International
Market Place for
World Trade . . .**



**. . . Focal Point
of the European
Common Market**

The Hanover Fair is Europe's most dynamic and effective instrument for first-hand examination and evaluation of new products, ideas, and markets—all international in scope.

The world's leading manufacturers in the electronics industry will present a complete and detailed array of components for a wide variety of industrial and scientific circuit applications.

Statistics on the entire Hanover Fair 1962: More than 5400 exhibitors from 25 countries. Over a million trade visitors from 100 countries. 23 exhibition halls and open-air grounds totaling 6,000,000 sq.ft. display area. All exhibits arranged strictly according to product category for convenient and thorough comparison.

The world buys in
Hanover, Germany
April 29—May 8, 1962

For free brochures, room reservation forms, and tickets, write or phone:



CIRCLE 209 ON READER SERVICE CARD
January 19, 1962

PRODUCT BRIEFS

CONVERTER-REGULATOR for space application. Lockheed Electronics Co., 6201 E. Randolph St., Los Angeles 22, Calif. (320)

UHF PREAMPLIFIERS ultra-low-noise. Community Engineering Corp., State College, Pa. (321)

DIPPING COMPOUNDS high temperature. Isochem Resins Co., 221 Oak St., Providence 9, R.I. (322)

TELEMETERING COMMUTATOR sub-miniature unit. Instrument Development Laboratories, Inc., Attleboro, Mass. (323)

BLOCKING OSCILLATOR TRANSFORMER high powered. PCA Electronics, Inc., 16799 Schoenborn St., Sepulveda, Calif. (324)

MICROWAVE ABSORBERS cones and spears. Electronautics Corp., Maynard, Mass. (325)

WIRE WOUND RESISTORS in 10 and 25 w. Dale Electronics, Inc., Columbus, Neb. (326)

LIQUID P-C COATING cures at low temperatures. Sonap Inc., 184 E. Union St., Allegany, N.Y. (327)

SELENIUM RECTIFIER COLUMNS rated to 1 million volts. International Rectifier Corp., 233 Kansas St., El Segundo, Calif. (328)

P-C CONNECTORS crimp-type contacts. U.S. Components Inc., 1320 Zerega Ave., N.Y. 62, N.Y. (329)

EPOXY MOLDING COMPOUNDS for electronic encapsulation. Mitchell-Rand Mfg. Corp., 51 Murray St., New York 7, N.Y. (330)

SEALED TRIMMER POTENTIOMETER ½ in. diameter. Maurey Instrument Corp., 4555 W. 60th St., Chicago 29, Ill. (331)

STROBOSCOPE-TACHOMETER auto-synchronizing. Power Instruments Inc. 7352 No. Lawndale Ave., Skokie, Ill. (332)

DIGITAL LOGIC CIRCUITS half-adder, buffer, counter adapter. Fairchild Semiconductor, 545 Whisman Rd., Mountain View, Calif. (333)

MONITOR-DETECTOR regulates r-f signal levels. Telonic Industries, Inc., Beech Grove, Ind. (334)

WESTINGHOUSE ULTRASONICS

A reliable production tool . . . cleans almost anything better. Do you

need absolute cleaning of metal, glass, ceramic or plastic parts or assemblies? Westinghouse ultrasonic cleaning can do it. It's fast. Production-line dependable, too: generators are solid-state, transducers are long-life Magnapak and—for insurance—Westinghouse supplies local maintenance and service. Write: Westinghouse Electronic Equipment Department, 2519 Wilkens Ave., Baltimore 3, Md. You can be sure...if it's

Westinghouse

J-3520

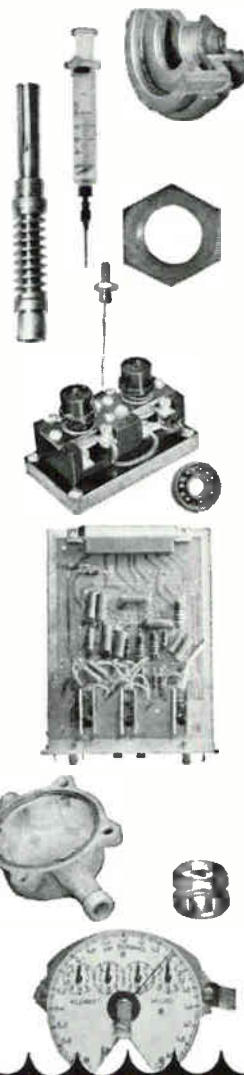

CIRCLE 81 ON READER SERVICE CARD

81

Literature of



DO-IT-YOURSELF HOUSINGS

WITH **BUD IMLOK**

EXTRUSIONS AND CONNECTORS

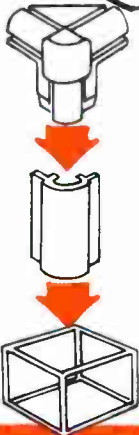

Make housings for production or prototype work quickly and easily with BUD IMLOK extrusions and connectors. All you need are simple hand tools.

More than 50 different types of connectors and extrusions are easily locked together to form the framework of an unlimited variety of types and sizes of housings. Sheet metal is cut and fitted to complete the enclosure.

Solve your special housing requirements and get beautiful enclosures at low cost. See this unique material at your local Bud Distributor or write us for literature.



BUD RADIO, INC.
CLEVELAND 3, OHIO

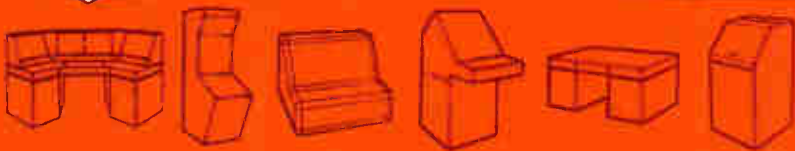

CIRCLE 210 ON READER SERVICE CARD

WHAT'S YOUR TRANSISTOR COOLING PROBLEM?

Whatever it is, you can probably find the solution with a Birtcher Radiator. Available in sizes and designs to most efficiently cool all popularly used (and many special) transistors. Test reports show up to 27% more transistor efficiency!

AVAILABLE FROM AUTHORIZED BIRTCHER DISTRIBUTORS



NEW!
TRANSISTOR
RADIATOR
CATALOG 1-HR

Just off the press — write for it

B

THE BIRTCHER CORPORATION

INDUSTRIAL DIVISION

745 S. MONTEREY PASS ROAD, MONTEREY PARK, CALIFORNIA

GOLD-ANTIMONY CEMENT E. I. du Pont de Nemours & Co. (Inc.), Wilmington 98, Del. Ceramic data sheet No. 2 describes No. 7944 gold-antimony cement designed to replace gold-antimony solder preforms used in the manufacture of diodes and transistors. (335)

DECADES & STANDARDS General Radio Co., West Concord, Mass. Resistance, capacitance and inductance decades and standards are described in a 6-page folder. (336)

MAGNETOSTRICTIVE DEVICES Spectran Electronics Corp., 146 Main St., Maynard, Mass. An 8-page brochure, intended as a facilities resumé, contains much state-of-the-art technical information on magnetostrictive devices. (337)

MATCHED PAIRS & QUADS General Electric Co., Syracuse, N.Y. Specification sheets 70.90 and 70.91 deal with four matched diode assemblies made from ultra high speed and controlled conductance planar epitaxial passivated silicon switching diodes. (338)

SILICON TRANSISTOR OSCILLATOR Solid State Electronics Co., 15321 Rayen St., Sepulveda, Calif. Bulletin covers the model C-110 crystal and heater controlled silicon transistor oscillator. (339)

LOW-NOISE TRANSISTORS Sperry Semiconductor, Norwalk, Conn. A specification sheet describes *pn*p silicon alloy transistors. (340)

TERMINAL BLOCKS DeJur-Amsco Corp., 45-01 Northern Blvd., Long Island City 1, N.Y. Brochure covers an expanded line of solderless terminal blocks with taper pin wiring terminations. (341)

FLEXIBLE PRINTED CIRCUITRY Garlock Electronic Products, Camden, N.J., offers an engineering manual entitled "Flexible Printed Circuitry With Teflon FEP." (342)

HARMONIC FILTER Caswell Electronics Corp., 414 Queens Lane, San Jose 12, Calif. Loose-leaf perforated sheet illustrates and describes a new harmonic filter. (343)

ENVIRONMENTAL EQUIPMENT Temperature Engineering Corp., 1 Tempcor Blvd., Riverton, N.J., has

the Week

prepared a 56-page catalog of temperature processing and environmental equipment. (344)

GROUND SUPPORT UNITS Tenney Engineering, Inc., 1080 Springfield Road, Union, N.J., has issued a 44-page illustrated brochure detailing the products and capabilities of its Ground Support and Systems division. (345)

VULCANIZED FIBRE Taylor Fibre Co., Norristown, Pa. Taylorite 113, a flame resistant vulcanized fibre with high dielectric strength and good mechanical properties is described in bulletin 2.11. (346)

INDICATOR SWITCH Industrial Electronic Engineers, Inc., 5528 Vineland Ave., N. Hollywood, Calif. Two-page catalog provides technical information on a multi-label Cue indicator switch. (347)

LINEAR DISPLACEMENT TRANSDUCER Sanborn Co., 175 Wyman St., Waltham 54, Mass. Bulletin covers a d-c differential transformer with built-in carrier system. (348)

MAGNETIC MODULATORS Transmagnetics, Inc., 40-66 Lawrence St., Flushing 54, N.Y. Performance, theory and applications of magnetic modulators are detailed in 10-page bulletin 200-1. (349)

POWER PACKS Electronic Research Associates, Inc., 67 Factory Place, Cedar Grove, N.J. Catalog sheet covers additions to the Transpac line of solid-state miniaturized high current power packs. (350)

ROLLED CERAMIC CAPACITORS Hi-Q Division, Aerovox Corp., Olean, N.Y. High-capacity, high-reliability rolled ceramic capacitors are the subject of a 2-page technical bulletin. (351)

MODULAR HOUSINGS Stantron, Division of Wyco Metal Products, 6914 Beck Ave., N. Hollywood, Calif. A catalog describes and illustrates a large variety of modular electronic housings. (352)

EPOXY RESIN ADHESIVES Bacon Industries, Inc., 192 Pleasant St., Watertown 72, Mass., offers three data sheets on epoxy resin adhesives compounded for hermetic sealing applications. (353)

BRISTOL HIGH-SPEED RELAYS

■ fast ■ accurate ■ reliable

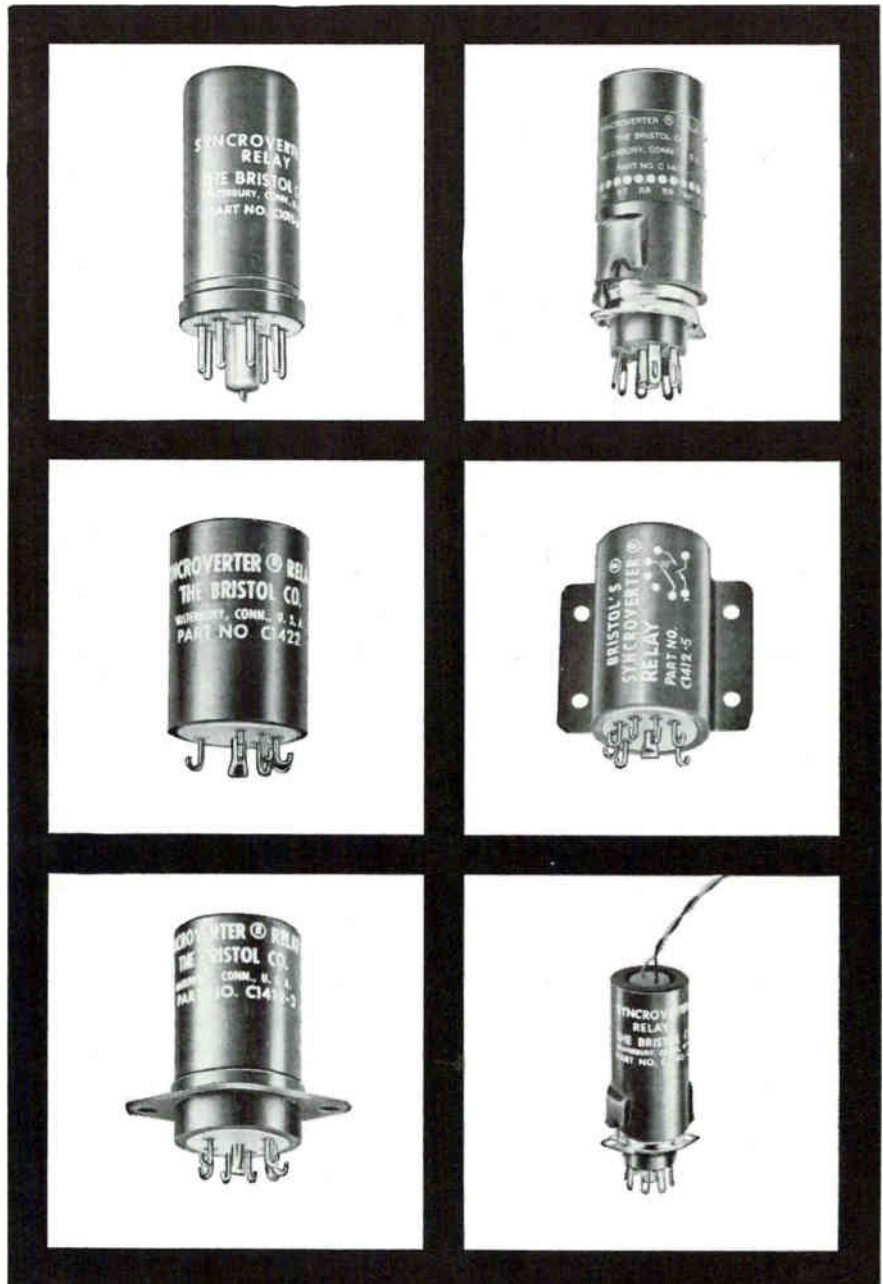

Bristol Syncroverter* high-speed relays are used in the finest and most accurate multiplex systems and analog computers.

Their fast, accurate, uniformly consistent transfer characteristics help cut system errors and build system reliability.

Nearly 100 different models available to meet the stringent demands of diverse applications. Write for detailed specifications.

The Bristol Company, Aircraft Equipment Division, 152 Bristol Road, Waterbury 20, Conn.

A Subsidiary of American Chain & Cable Company, Inc. 1-20



*T.M. Reg. U.S. Pat. Off.

BRISTOL ...engineers for precision, builds for reliability



Beck: Analyze . . . then choose

SOME WEEKS after he became president of Philco Corporation, Charles Beck was leaving his office to address the Philadelphia Chamber of Commerce. Word came that Philco distributors in the Atlanta, Ga., region wanted to hear from their new boss that same evening. Rather than put off either engagement, Charles E. Beck flew to Atlanta practically from the Chamber speaker's rostrum and was back at work in his Philadelphia offices the next day.

Actions like this typify Philco's dynamic young president—recently described by a Ford Motor Co. vice president as the man within Ford who knows most about Philco. Well before the two companies merged, Beck had made a thorough study of Philco and was directly in charge of merger negotiations.

Unworried about learning the intricacies of the electronics industry, Beck says any problem is one of analysis. "Based on analysis, the next step is to choose the right alternative. Do this and the problem is solved."

Long involved in the ins and outs of foreign trade through his Ford affiliations, Beck has some firm feel-

ings on the subject as applied to electronics. He acknowledges the tough challenge imposed by Europe and Japan but insists that the answer is not for America to put up its guard defensively. "We must be more aggressive than ever," he says. "We must fight back. The answer lies in emphasizing efficiency, not in crying for help."

Ask one of Beck's associates what the new executive likes to do by way of relaxation and the answer is usually "Work!". He is a man of few hobbies, lots of drive and countless cigars. He once quipped to a member of his staff that he smokes so many cigars to keep things going for his tobacco-growing friends and neighbors in his home town of Stanford, Ky.

Beck was born on a farm forty years ago, the third of four children. Except for a five-year period he lived and worked on the farm until he left in 1939 to go to Berea College on a scholarship. His excellent high school record included winning the state public speaking championship.

Although he first studied agricultural sciences, he transferred his interests in 1943 to business and

moved to Detroit. He worked for Murray Corp., an auto body manufacturer, and went to the University of Detroit at night.

During the war, Beck served as a B-29 pilot with the 20th Air Force. Most of his duty was in the Pacific. He returned to the Murray Corp., earned BA and BS degrees at Wayne State University and taught night classes in management technology at Wayne for five years.

From Murray, Beck moved to Ford where his talent in management led him eventually to the position at Philco.

Among the many extra tasks that Beck now has is finding a home in the Philadelphia area for his wife Ruth and three children: Bobby, 10; Susan, six; and David, four. The family is living in Dearborn, Mich., for the time being.



D'Onofrio Takes New Sperry Post

APPOINTMENT of Carmine D. D'Onofrio as manager of the Sperry Gyroscope Company's Marine Division, Syosset, L.I., N.Y., is announced.

D'Onofrio returns to Sperry's Long Island industrial complex after a year-and-a-half assignment as assistant manager and then acting manager of the Sperry Utah Co. in Salt Lake City.

Sperry's Marine Division is primarily responsible for development and production of inertial navigation systems, computers and control equipment for the Navy's Polaris submarines.

DuPont Opens Research Laboratory

THE CERAMIC DIVISION of DuPont's Electrochemicals Dept., has moved its research team from the Perth

*Acoustical Components
of Superior Quality*

JAPAN PIEZO supplies 80% of Japan's crystal product requirements.

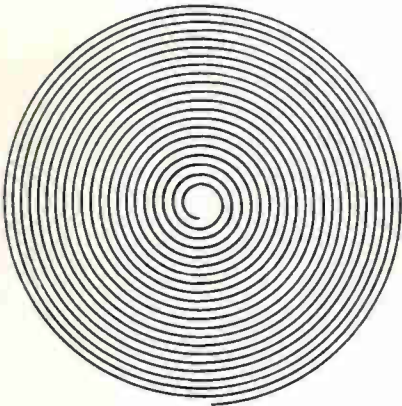

**PHONOGRAPH
MOTOR — DC**
PM — 31-1

9V, 2,500RPM: No-load current, 35 mA; load current, 80 mA. Starting torque, 13 g-cm; load torque, 5 g-m. Size: 2.4 cm x 4.6 cm. Weight: 100 gm.

Write for detailed catalog on our complete line of acoustical products including pickups, cartridges, microphones, record players and many associated products.



**JAPAN PIEZO
ELECTRIC CO., LTD.**

Kami-renjaku, Mitaka, Tokyo, Japan

CIRCLE 211 ON READER SERVICE CARD

January 19, 1962

20 to 200 D.P.

Send your prints
for quotations

- SPURS
- HELICALS
- WORM AND WORM GEARS
- STRAIGHT BEVELS
- LEAD SCREWS
- RATCHETS
- CLUSTER GEARS
- RACKS
- INTERNALS
- ODD SHAPES

Production of fine-pitch gears of extreme accuracy for all kinds of instruments is a specialty of ours.

FOR
INSTRUMENTS

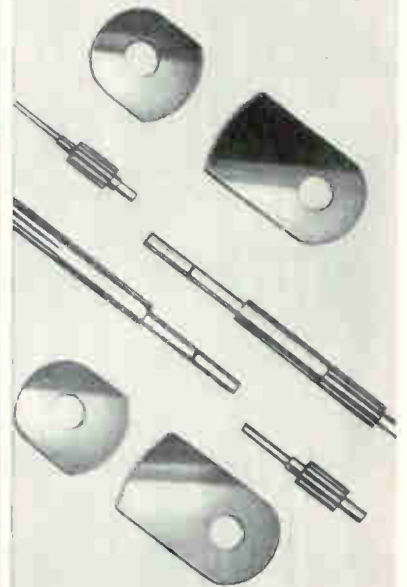

THE *Finest* IN GEARS

Beaver Gear Works Inc.

1021 PARMELE STREET, ROCKFORD, ILLINOIS



CIRCLE 212 ON READER SERVICE CARD

IRE SHOW

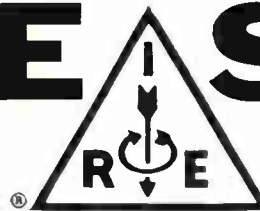

presenting

**"THE GOLDEN
AGE OF
ELECTRONICS"**

March 26-29, 1962

The New York Coliseum

... part of the

International Convention of the IRE

**The Institute of Radio Engineers
1 East 79th Street • New York 21**

Members \$1.00. Non-members \$3.00. Age limit: over 18

CIRCLE 85 ON READER SERVICE CARD

85

NOT NEW

**BUT
STILL
UNIQUE!**



FM SIGNAL GENERATOR



... Model 1066, introduced in '55, was the first instrument to tune 10-470 Mc on fundamentals having low distortion and accurately calibrated FM. Other features such as calibrated electronic fine tuning and 0.0025% carrier stability were revolutionary at that time.

It is still the only instrument with all these features . . . and more. Modernized Model 1066B, new for '62, has fully stabilized power supplies (using semiconductors unknown in '55) and thick, cast RF box. Result . . . even better stability and less spurious modulation. Price \$1575

LOW DISTORTION FM

To 100 kc Dev.; Accuracy 7%

ELECTRONIC FINE TUNING

To \pm 100 kc and directly calibrated

PRECISION RF OUTPUT CONTROL

Continuously adjustable, 0.1 μ V to 0.1V

**NO OTHER GENERATOR GIVES PERFORMANCE
COMPARABLE TO MODEL 1066B.
SPEC. SHEET FREELY AVAILABLE**

MARCONI

INSTRUMENTS

DIVISION OF ENGLISH ELECTRIC CORPORATION
111 CEDAR LANE, ENGLEWOOD, NEW JERSEY
Main Plant: St. Albans, England

Amboy, N.J., plant to Chestnut Run Laboratories, near Wilmington, Del. This research center is primarily concerned with technical assistance to customers and with research related to the development of new products and the application of present products to meet customer requirements.

Products for electronic components to be researched here include silver compositions for conductive coatings; gold, platinum and palladium for transistors, diodes and capacitors; and screenable resistor compositions.



Northeastern Names Production Manager

NORTHEASTERN ENGINEERING, INC., Manchester, N. H., has appointed James P. McGuire as production manager. He was last employed with General Electric as a production administrator on the Polaris fire control system.

Northeastern specializes in production of electronic systems and instrumentation.



Sprague Electric Hires Van Hassel

HERBERT J. VAN HASSEL, JR. has joined the Sprague Electric Co., North Adams, Mass., as product specialist for a-c capacitors. He



yes

Gamewell made a special rotary switch for over 10 million revolutions.

The customer's special application called for a guaranteed useful life of 10 million revolutions . . . tests proved the unit easily exceeded it. Other requirements met by this precision 3 inch unit include make-before-break operation on 80 segments, and critical 5° dwell length. ■ Here's another example of how Gamewell's YES service — **Your Engineered Specials** service — is continually meeting special "pot" and rotary switch needs. We can help with your requirements, too. Write for details.

***Your
Engineered
Specials service**

BLISS
Gamewell®

THE GAMEWELL COMPANY, POTENTIOMETER DIVISION,
1385 CHESTNUT STREET, NEWTON UPPER FALLS 64,
MASS. A SUBSIDIARY OF E. W. BLISS COMPANY.

CIRCLE 213 ON READER SERVICE CARD
electronics

- the ultra
new **YOKE!**



Deflectron*
By **Celco**

**MAJOR ADVANCE IN
THE SCIENCE OF
ELECTRON BEAM DEFLECTION!**

SPOT RECOVERY

Fastest! to 1 μ s

SPOT SIZE

Smallest - by 25%

SPOT SWEEP

Straightest

*** DEFLECTRONS for DISPLAYS**

Where ordinary precision
yokes **FAIL** to meet your
requirements.

Write for NEW "DEFLECTRON"
Data and Standard Yoke
Catalog. 

Celco

*Constantine Engineering
Laboratories Co.*

Main Plant: MAHWAH, N. J. DAVIS 7-1123
PACIFIC DIV.-UPLAND, CALIF. YUKON 2-0215
CENTRAL DIV.-LANESBORO, PA. ULYSSES 3-3500

CIRCLE 214 ON READER SERVICE CARD
January 19, 1962

comes to Sprague from the Gibson Refrigerator division, Hupp Corp.

**Research-Cottrell
Forms New Division**

RESEARCH-COTTRELL, INC., Bound Brook, N.J., has set up an electronics division to market custom designed high-voltage equipment to the electronics industry. The division will offer power supplies, transformers, control systems, and other special electronic equipment, initially in the range of 5,000 to 150,000 v with power outputs to 500 Kw, for specialized uses.

The recently-expanded laboratory and testing facilities will be utilized by the new division.

PEOPLE IN BRIEF

Gen. Graves B. Erskine, USMC (Ret.), has joined the Systems Div. of Beckman Instruments, Inc., as an executive consultant. Sherrod E. Skinner, retired from General Motors Corp., is elected chairman of the board of trustees of Aerospace Corp. Archie P. Kelley is promoted to director of advanced research at AiResearch Mfg. Div. of The Garrett Corp. Amir H. Sepahban, formerly with Philco Corp., named principal staff engineer at Martin Marietta Electronic Systems & Products Div. John R. Thorne, ex-Litton Systems, Inc., now president of the newly formed The Scionics Corp. in Canoga Park, Calif. Leon S. Nergaard advances to director of the microwave research laboratory at RCA's David Sarnoff Research Center. Don Sweet moves up at Electronic Engineering Co. of California to the post of senior group engineer. Kane Engineering Laboratories elevates Max P. Forrer to manager, applied physics group. Seymour Schwartz of Transistor Applications, Inc., elected chairman of the board of its subsidiary, New England Transformer Co. Carad Corp. ups David Simmons to director of engineering. Paul B. Wishart, president of Minneapolis-Honeywell Regulator Co. is elected chairman of the board and chief executive officer. James H. Binger, v-p and director, succeeds him as president.



**ELECTRONIC
COMPONENTS**



Thermoformed plastic trays and containers, firmly holding the articles in position, offer all the protection required in packaging delicate electronic components and parts.



PLASTOFILM offers ideas, unusual and imaginative, to increase your sales, simplify your packaging problems or just add eye appeal and distinction to your products. Write or call us today for illustrated brochures.

"where package ideas are born"



CIRCLE 87 ON READER SERVICE CARD 87

THE SCENE AT GRUMMAN
AS VIEWED BY THE
Electronics Engineer

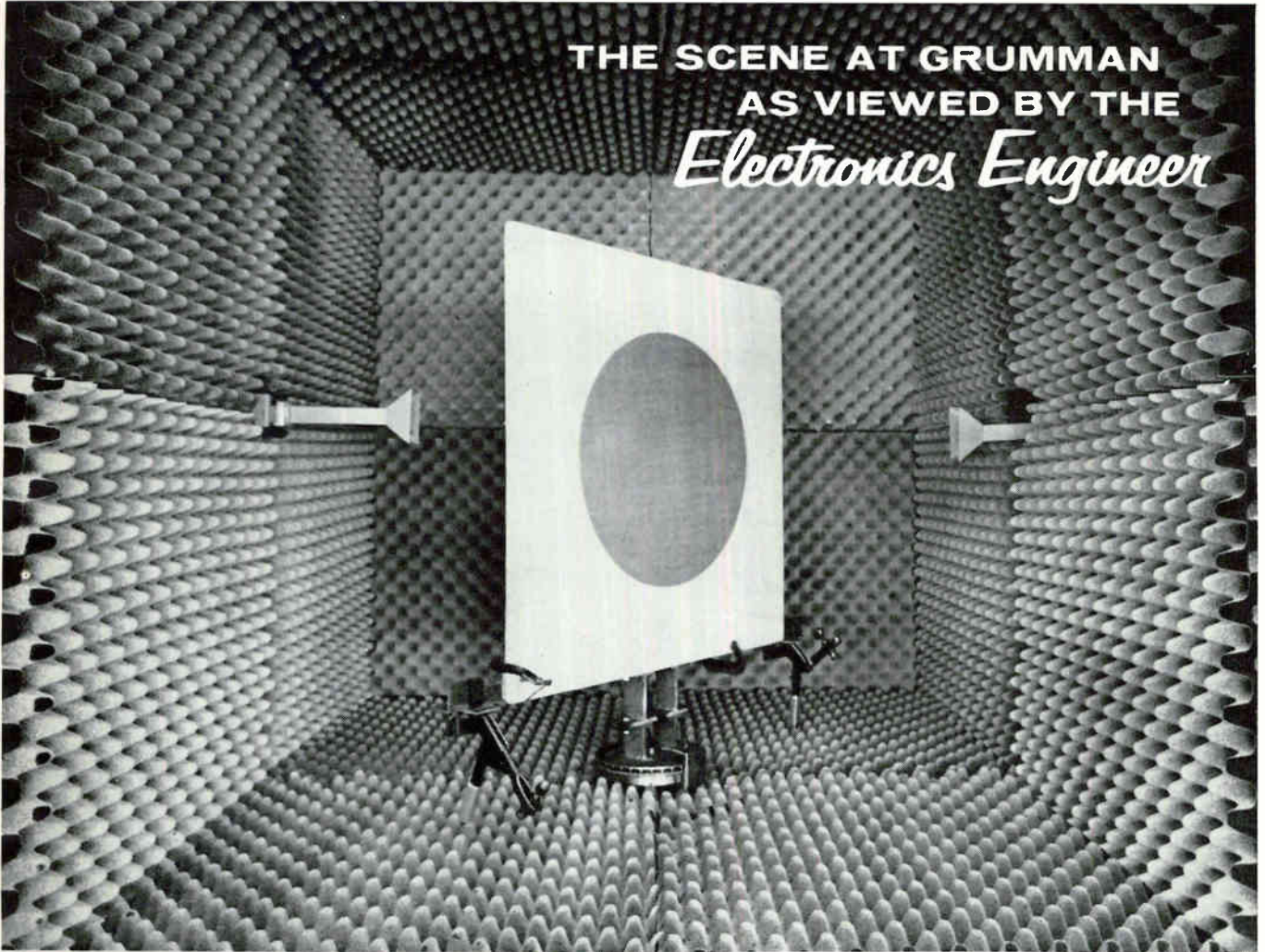

...Dark Room

To obtain the electrical properties of various dielectric materials in the microwave frequency spectrum, Grumman engineers designed this miniature microwave "dark room" (Anechoic Chamber) about a two-horn interferometer. This unique device can accurately determine the "electrical" thickness or effective dielectric constant of flat panel samples of exotic materials which are used in Grumman's continuing advances into "Space" environment. A good example of these advances is the Orbiting Astronomical Observatory (OAO) Grumman is building for the NASA. The OAO is but one of the many programs at Grumman deeply involved with electronics. Electronics engineers who can add to this capability are urged to consider the following positions:

Radome/Antenna Design Engineer—BS in EE or Physics with a minimum of 3 years experience in radome and antenna design. Background in classical electromagnetic theory and advanced math essential. Work consists of analysis and synthesis of radomes, or antennas on current and advanced designs including the use of the IBM computer facilities to develop design techniques.

Digital Computer Systems Engineer—BSEE with a minimum of 4 years experience in the analysis design and development of digital computers. Will participate in the integration of digital computer into a complex weapons system. A significant part of the effort will be devoted to extensive laboratory and flight development programs.

Radar Development Engineers—BSEE with a minimum of 4 years experience in the analysis, design and development of airborne radar systems. Should be capable of analyzing the radar system with the end view of integrating the equipment into a complex weapons system. Will fully participate in laboratory and flight development programs conducted in the finest facilities available in a professional atmosphere.

Data Processing Engineers—Background in digital data processing, logic circuit design, memory devices, R-F modulation techniques and related digital techniques required. Opportunity to participate in advanced design of systems concepts and hardware development. BSEE or BS in Physics with a minimum of 3 years' applicable experience is required.

To arrange an immediate interview, send your resume to Mr. W. Brown, Manager Engineering Employment, Dept. GR-76
(U. S. citizenship required)



GRUMMAN

AIRCRAFT ENGINEERING CORPORATION
Bethpage · Long Island · New York

All qualified applicants considered regardless of race, creed, color or national origin.

EMPLOYMENT OPPORTUNITIES

Philco WDL has immediate and challenging engineering positions open in Discoverer, Midas and Advent programs in these categories:

Data systems engineering

Technical Staff — communications and data systems

Systems test planning

Systems reliability analysis

Design Engineering — surface and vehicle electronics

Human factors and operations analysis

Field tracking station activation

Tracking and control systems design

Logistics and station support

And others

U. S. citizenship or current transferable Department of Defense clearance required.

if your future is for growing...

People at Philco's Western Development Laboratories are proud of their achievements, secure in the steady growth of their company, enthusiastic about their future.

In just four years, Philco WDL has expanded from a staff of 18 to more than 2,000. At the end of this year WDL will open a new 250,000-square-foot facility which will accommodate a continually expanding complement of engineers, scientists and supporting staff members.

Philco WDL, the space organization which designed and built the Courier satellite, conducts an ever-growing development program in tracking, satellite instrumentation, communications, data processing and command—moving hand in hand with the federal government in space exploration and space age defense.

Your growth with a growing company, ideal living on the Northern California Peninsula, professional and monetary advancement commensurate with your own ability—these are some of the advantages and satisfactions of working at Philco Western Development Laboratories.

If yours is one of the fields listed at the left, write today to Mr. W. E. Daly, in confidence, of course, Department E-12.

This new 250,000-square-foot addition to Philco Western Development Labs is further indicative of your future there.

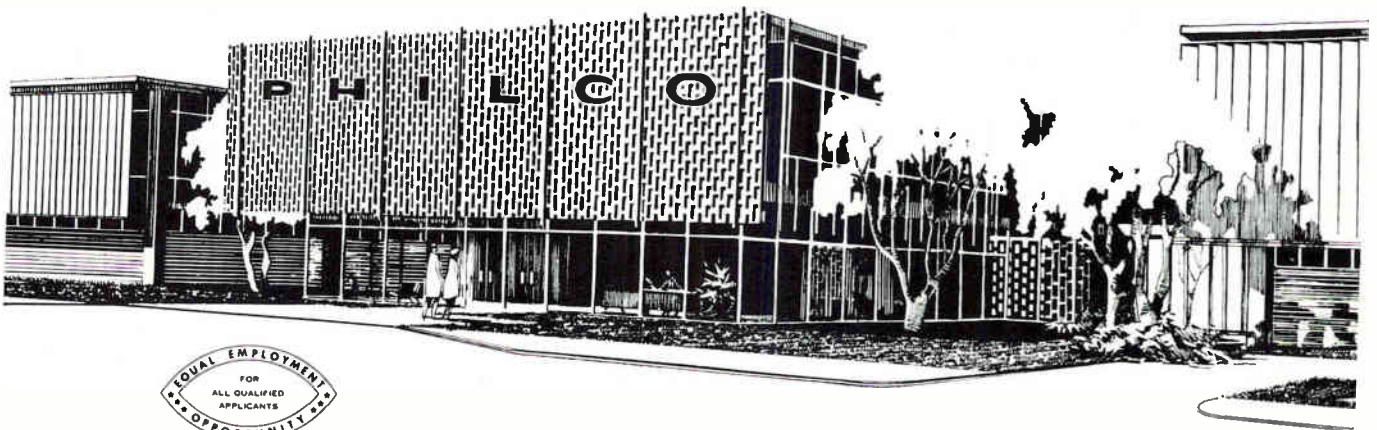

PHILCO
Famous for Quality the World Over

WESTERN DEVELOPMENT LABORATORIES
3875 Fabian Way, Palo Alto, California

CAREERS IN SPACE TECHNOLOGY LEADERSHIP

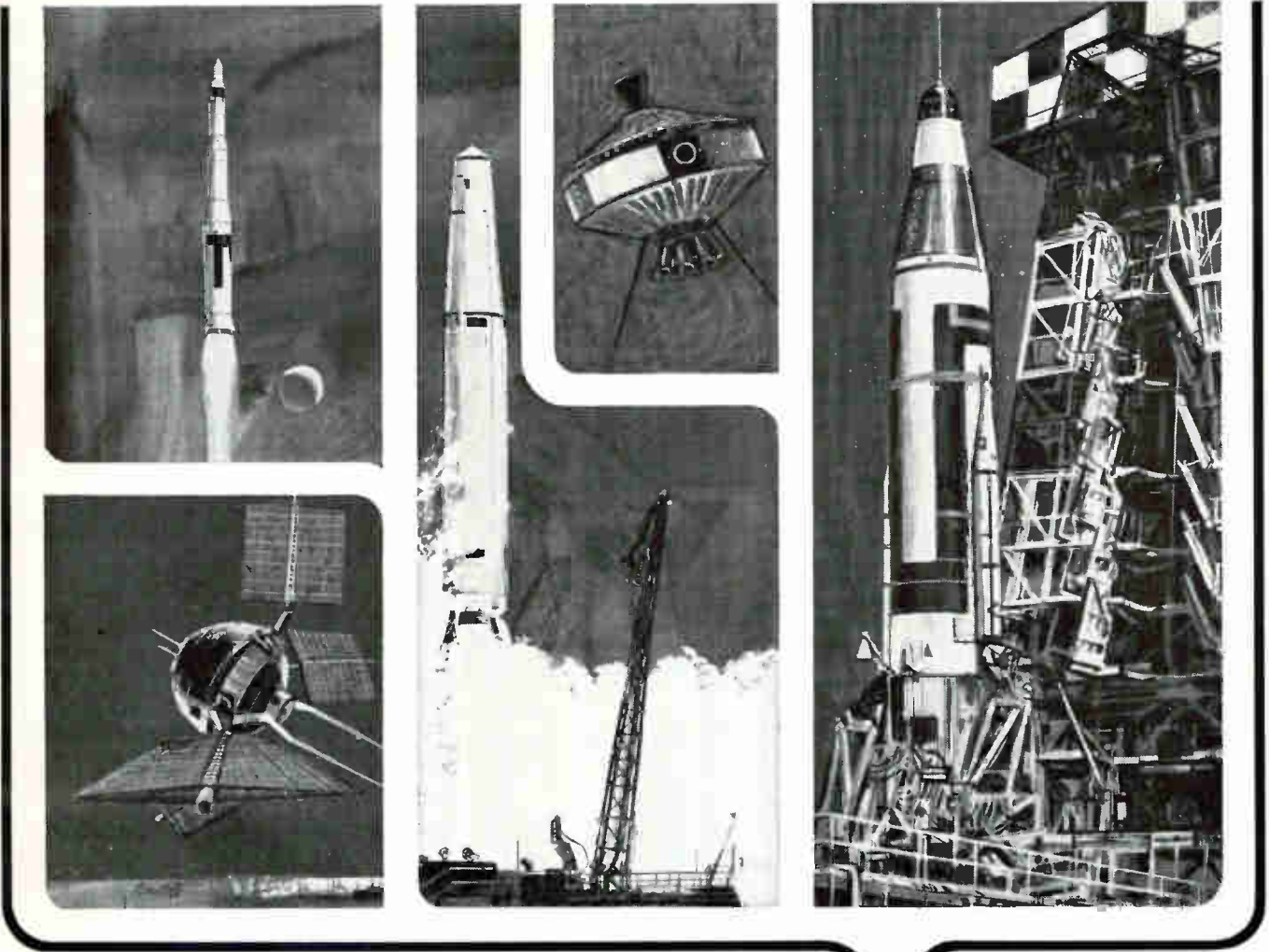

Of particular interest to engineers and scientists is the continuing growth and diversification of Space Technology Laboratories, Inc. What is now STL was founded as the Guided Missile Research Division of the Ramo-Wooldridge Corporation in 1954, when the Ballistic Missile Program was given highest national priority. ■ Assigned contractual responsibility for the program's systems engineering and technical direction, STL has grown in parallel with the need for its capabilities—from a small group of engineers, scientists and administrators to an industrial organization with a professional staff numbering more than 2,000 with 2,500 supporting personnel—from its initial headquarters in a suburban Los Angeles schoolhouse to the ultra-modern STL Space Technology Center nearing completion on a 110-acre site at One Space Park, Redondo Beach, California, close to Los Angeles International Airport. ■ During its years of Space Technology Leadership, STL has contributed importantly to the management of a program that, in a successful race against time, has given this nation the Thor, Atlas, Titan and Minuteman ballistic missile systems. At the same time, STL has been called upon to design, fabricate, instrument and successfully launch Pioneer I, Explorer VI and Pioneer V—all of which were tracked and commanded by STL's world-wide space communication network (SPAN)—and to contribute to the management of the Transit 1B, Transit 2A, Transit 3B, Courier 1B and Tiros programs. ■ Today, STL in addition to its continuing role in the USAF Atlas, Titan and Minuteman programs, is performing research, development, design and construction for three Orbiting Geophysical Observatories (OGO), as well as project coordination and systems planning for Project Relay, both for NASA; and participating in the Army Advent communication satellite project. STL's continuing program of original and applied research covers a broad spectrum of technical disciplines including particle physics, solid state theory, guidance space physics, communication theory, propulsion and power, and electromagnetic systems in the infrared, ultraviolet and microwave regions. ■ The expanding activities of STL create immediate career opportunities in Southern California and at Cape Canaveral for engineers and scientists of talent and vision. All qualified applicants are invited to communicate with Dr. R. C. Potter, Manager of Professional Placement and Development. STL is an equal opportunity employer.

SPACE TECHNOLOGY LABORATORIES, INC.

P.O. BOX 95005-J LOS ANGELES 45, CALIFORNIA
P.O. BOX 4277, PATRICK AFB, FLORIDA

a subsidiary of Thompson Ramo Wooldridge Inc.

Career opportunities exist at STL for qualified engineers and scientists in support of these programs:

ATLAS
TITAN
MINUTEMAN
OGO
ADVENT
RELAY

Los Angeles • Vandenberg AFB • Canoga Park • Norton AFB, San Bernardino • Dayton • Cape Canaveral • Washington, D.C. Boston • Huntsville



ENGINEERS-SCIENTISTS

The
UNIVERSITY
of
MICHIGAN
has openings in
its Research
Laboratories

Space Technology
design & develop space probe satellites & instrumentation

Microwave Tube Engineers research in all areas of physical electronics including microwave tubes, solid state masers, parametric amplifiers, plasma devices & tube techniques

Electronic Circuit Engineers research in radar circuitry, meteorology, transistor circuitry, instrumentation, & electronic systems

Excellent opportunities for experienced Scientists and Engineers. Openings exist for all degree levels. Pleasant midwest location with liberal fringe benefits. Salary commensurate with abilities and background.

Please send resume to:
Research Personnel Office

THE UNIVERSITY OF MICHIGAN

1100 E. Washington
Ann Arbor, Michigan
An equal opportunity employer



A leader in . . .

Design, Development and Manufacturing of

- MICROWAVE ANTENNAS SYSTEMS & COMPONENTS
- ELECTRONIC SYSTEMS
- MAGNETIC INSTRUMENTATION SYSTEMS
- SERVO CONTROL SYSTEMS

Invites . . .

Qualified Engineers and Scientists to explore the challenging opportunities created by increased business volume and facility expansion.

Experienced Engineers and Physicists will find stimulating assignments, career growth opportunities based on performance, and the opportunity to make significant individual contributions toward major state of the art advances in the areas indicated above.

Liberal employee benefits which include insurance, Stock Plan, Profit-Sharing and Educational assistance, combine with the natural advantages of Northern California suburban living to offer an ideal environment in which to work and live.

For further information, please write, sending a copy of your resume to:

Technical Employment



1515 Industrial Way
Belmont, Calif.

"an equal opportunity employer"

PROBLEM: Design and fabrication of satellite instrumentation.

HARVARD UNIVERSITY
has an opening for an
ELECTRONICS ENGINEER

who is interested in research in the field of solar exploration through the development of satellite instrumentation. Experience or knowledge of transistor circuits desirable.

Resumes and inquiries concerning this opportunity are invited.
PERSONNEL DEPARTMENT



1352 Massachusetts Avenue
Harvard Square, Cambridge, Mass.
An equal opportunity employer.

MICROWAVE COMMUNICATIONS ENGINEERS

Ankara - Teheran - Karachi
Bangkok - U. S.

Work involves engineering, supervision of installation, operation and maintenance of microwave communications systems.

College Degree Mandatory

MICROWAVE COMMUNICATIONS TECHNICIANS

Must be qualified by education and experience to inspect installation, operate and maintain microwave communications systems to insure quality and performance standards.

Technical or trade school training mandatory.

Families May Accompany
Usual Overseas Benefits

Send detailed resumes to:

P-7950, Electronics
645 N. Michigan Avenue, Chicago 11, Ill.

electronics

WEEKLY QUALIFICATIONS FORM FOR POSITIONS AVAILABLE

(Continued from page 88)

COMPANY	SEE PAGE	KEY #
MITRE CORPORATION Bedford, Massachusetts	95*	17
PAN AMERICAN WORLD AIRWAYS INC. Guided Missiles Range Div. Patrick AFB, Florida	14	18
PHILCO WESTERN DEVELOPMENT LABS. Palo Alto, California	90	19
REMINGTON RAND Office Machines Div. of Sperry Rand Corp. South Norwalk, Connecticut	126*	20
SANDERS ASSOCIATES INC. Nashua, New Hampshire	125*	21
SPACE TECHNOLOGY LABS., INC. Sub. of Tompson-Ramo-Wooldridge Los Angeles, California	91	22
UNION CARBIDE NUCLEAR CO. Oak Ridge, Tennessee	93	23
UNIVERSITY OF MICHIGAN Ann Arbor, Michigan	92	24
P-7950	92	25

* These advertisements appeared in the 1/12/62 issue.

Electronic Instrument Technicians
The Oak Ridge National Laboratory
 Operated by
UNION CARBIDE NUCLEAR COMPANY
 at
Oak Ridge, Tennessee
Has openings for

Highly skilled electronic instrument technicians to work with electronic engineers in the development, installation and maintenance of electronic systems. Digital data handling, transistorized pulse height analyzers, analog and digital computer systems are only a few examples.

Minimum high school education, with additional training in electronics and at least three years' experience in installation and maintenance of complex electronic systems. Entrance rate \$3.10 per hour; \$3.16 per hour after six months. Reasonable interview and relocation expenses paid by Company.

Excellent Working Conditions
 and

Employee Benefit Plans
An Equal Opportunity Employer
 Send detailed resume to:

Central Employment Office
UNION CARBIDE NUCLEAR COMPANY
 Post Office Box M Oak Ridge, Tennessee



MANUFACTURERS' REPRESENTATIVES

IN THE ELECTRONIC INDUSTRY

SAMUEL K. MACDONALD, INC.

manufacturers representatives over 25 years
 1531 SPRUCE STREET, PHILA. 2, PA.

Territory: Pennsylvania • New Jersey
 Delaware • Maryland
 Virginia • West Virginia
 District of Columbia

Other Offices:
 Pittsburgh
 Baltimore
 Washington, D. C.

SEARCHLIGHT SECTION

(Classified Advertising)

BUSINESS OPPORTUNITIES
EQUIPMENT - USED or RESALE

DISPLAYED RATE

The advertising rate is \$27.25 per inch for all advertising appearing on other than a contract basis. Contract rates quoted on request. AN ADVERTISING INCH is measured 3/8 inch vertically on one column, 3 columns—30 inches—to a page. EQUIPMENT WANTED or FOR SALE ADVERTISEMENTS acceptable only in Displayed Style.

UNDISPLAYED RATE

\$2.70 a line, minimum 3 lines. To figure advance payment count 5 average words as a line.

PROPOSALS, \$2.70 a line an insertion. BOX NUMBERS count as one line additional in undisplayed ads.

DISCOUNT OF 10% if full payment is made in advance for four consecutive insertions of undisplayed ads (not including proposals).

WEAK IN MATH?

Don't let inadequacy in mathematics hold you back. Now you can learn the basic math you must know to succeed as a technical man. Learn through Grantham Schools' unusual home study math course for technicians, engineers, and mechanics. Write for details today.

Write to: Dept. 277-A
GRANTHAM SCHOOLS, INC.
 1505 N. Western Ave. Los Angeles 27, Calif

CIRCLE 460 ON READER SERVICE CARD

NEW INDUSTRY WANTED

Community Has Cash To Help locate industry in western Kentucky lake area. No gimmick! Plenty of water, labor, sites, gas, power, 100% plant financing. For more details call or write, West Hopkins Industries, Box 245, Dawson Springs, Ky.

Senior Systems Scientists, Engineers: Opportunities NOW on World-Wide Digital Communications & Control System — 465-L

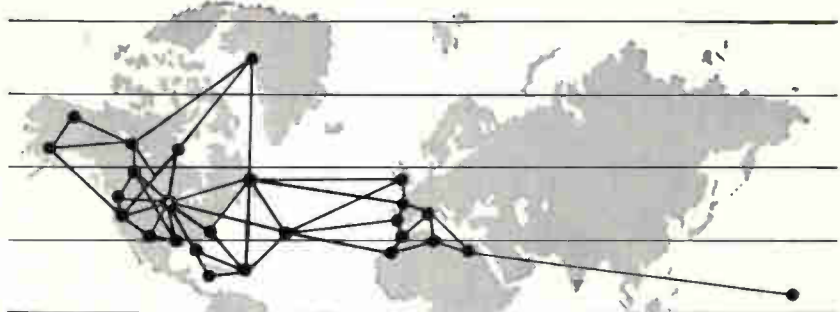

SPLIT-SECOND
COMMAND & CONTROL OF
SAC FORCES AROUND THE GLOBE

These assignments with the Communications Systems Division are under a *prime ITT contract*. The scope of the work is indicated by the scope of the program.

465-L will be SAC's most complex, automatic, secure, data gathering, transmitting, processing and display system, providing detailed, continuously up-dated picture of the GLOBAL STATUS of SAC forces:

- airborne strength, location, fuel radius and target accessibility of each aircraft
- number of missiles on ready
- crew availability for aircraft and missiles
- number of aircraft in maintenance and maintainance time estimates
- force dispositions and target destruction after strike

COMMAND DECISIONS, based on this real-time portrayal of relevant data, will be transmitted instantly to the most remote bases over 465-L's global network.

OPENINGS IN CHICAGO, LOS ANGELES, & FT. WAYNE (IND.) FOR WORK ON 465-L AND OTHER MILITARY AND COMMERCIAL COMMUNICATIONS & CONTROL SYSTEMS

SENIOR COMMUNICATIONS SYSTEMS SCIENTIST, MS-PhD
 Perform fundamental feasibility studies supporting and leading to preliminary systems design.

SENIOR HUMAN FACTORS SCIENTIST, MS-PhD
 Establish, direct, evaluate human factors design; manning requirements.

SENIOR SYSTEMS DESIGN ENGINEERS, BS-MSEE
 Semiconductor circuit design, audio frequency communications, logic, digital data processing, teletype, switching, pulse techniques, machine control.

SENIOR CIRCUIT DESIGN ENGINEERS, BS-MSEE, PhD
 Develop advanced transistorized digital and/or pulse circuits.

SENIOR SYSTEMS ANALYSTS, MS-PhD
 Determine systems requirements, formulate and evaluate functional system specifications.

SENIOR PRODUCT ENGINEERS, BS-MSEE
 Evaluate & redesign computers, switching, data handling equipment, etc. during production stage. Establish test procedures. Must know transistor & logic circuit analysis; Mil Specs.

Also, MANUFACTURING ENGINEERS, TEST ENGINEERS, QUALITY CONTROL ENGINEERS, & SENIOR TECH WRITERS.

Qualified Scientists and Engineers are invited to write in confidence to Mr. D. C. Schaller, Dept. 11A.



COMMUNICATIONS SYSTEMS DIVISION
 500 N. Pulaski Road Chicago 24, Illinois

An Equal Opportunity Employer

if **PANEL SPACE**
or **PORTABILITY**
is your problem...

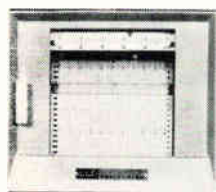

Westronics
Miniature
MULTIPOINT
Recorder Model
M5A is your
perfect solution.

The panel space occupied by the Westronics Miniature MULTIPOINT Recorder is only 8½ x 9¾ inches, or only 25% of the panel space required by most large case recorders.

The Westronics Miniature MULTIPOINT Recorder scans and measures 2 to 12 different input sources at the rate of 5 seconds per point.

Westronics manufactures a complete line of miniature and full size recorders with more optional features than any other manufacturer.



SPECIFICATIONS UPON
REQUEST.

westronics, inc.

TWX FT 8248 U
3605 McCART STREET
FORT WORTH, TEXAS

INDEX TO ADVERTISERS



Audited Paid Circulation

• AC Electronics Div. of General Motors	65	Hexacon Electric Co.	80
• Allmetal Screw Products Co., Inc.	67	• Heyman Manufacturing Co.	95
• Arnold Magnetics Corp.	85	Hughes Aircraft Co.	72
• Associated Research Incorporated	75		
		• Industrial Test Equipment Co.	73
Baird-Atomic, Inc.	61	Institute of Radio Engineers	25, 73, 85
Beattie-Coleman Inc.	71		
Beaver Gear Works, Inc.	85	• Japan Piezo Electric Co., Ltd.	85
Behlman-Invar Electronics Corp.	80		
• Bircher Corporation, The	82	• Kay Electric Co.	11
Bristol Company, The	83		
• Brush Instruments, Div. of Clevite Corp.	3rd Cover	• Lambda Electronics Corp.	5
• Bud Radio Inc.	82		
• Bussman Mfg., Div. of McGraw-Edison Co.	54	• Marconi Instruments	86
		McGraw-Hill Book Co.	15
Cambridge Thermionic Corp.	35	Microswitch, Div. of Honeywell	22, 23
• Celco-Constantine Engineering Laboratories	87	• Moseley Co., F. L.	29
• Chester Cable Corp.	55		
Consolidated Electrodynamics Corp.	78, 79	Pan American World Airways Inc.	14
• Constantine Engineering Laboratories.	87	• Pblco Corporation	36, 69
• Coto-Coil Co., Inc.	72	Plastofilm Inc.	87
		• Polarad Electronics Corporation	76
Delta Air Freight	73		
• Driver Co., Wilbur B.	32	• Radio Corporation of America	4th Cover
Dymec, A Division of Hewlett Packard Co.	17	• Raytheon Company	2nd Cover
		• Royal Electric Corp.	70
Electrodynamic Instrument Corporation	24		
		Shalleross Mfg. Co.	31
Gamewell Co., The	86	• Sola Electric Co.	58, 59
General Dynamics/Astronautics	33, 34	• Southern Electronics Corp.	62
German American Chamber of Commerce	81	Sprague Electric Co.	9, 30
Gerisch Products, Inc.	71	St. Petersburg Chamber of Commerce	18
• Gould-National Batteries, Inc.	21		
Hathaway Instruments, Inc.	19	• See advertisement in the July 20, 1961 issue of Electronics Buyers' Guide for complete line of products or services.	
Hemingway & Bartlett Mfg. Co., The	35		
• Hewlett-Packard Company	6		

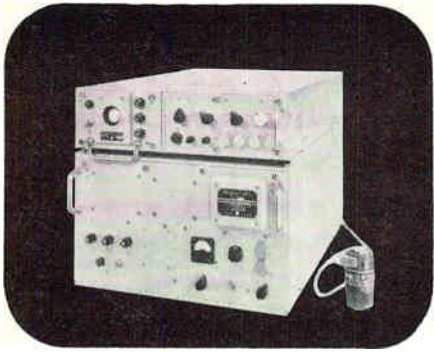

This is the **CODE CONVERTER** which takes Morse Code from the air at all speeds and odd rates and changes dot-dash to lengths of DC which are instantly locked and electrically stored 'til a word is complete on a digital board printer fed they come out code change automated language foreign or ours completely translated — all this from the house that TRAK built.

TRAK MORSE-TO-TELEPRINTER CODE CONVERTER MODEL AN/UGA-3 The AN/UGA-3 is an electronic, completely transistorized digital computer for converting Morse code transmissions into electrical impulses that drive a standard teleprinter.

TRAK TELETYPE MULTIPLEXER MODEL AN/UGC-1A permits the simultaneous transmission and reception of 4 different messages on a single channel.

TRAK TWX-CCIT TRANSLATOR allows two way communication TELEX calls between foreign and domestic stations.

Simply write 59 Danbury Rd. or phone PO 2-5521.



COMMUNICATIONS AND RECONNAISSANCE DEPT.
TRAK ELECTRONICS CO., INC., WILTON, CONN.

electronics



Audit Bureau
of Circulations



Associated Business
Publications

Audited Paid Circulation

JAMES T. HAUPTLI

Advertising Sales Manager

R. S. QUINT:
Assistant Publisher
Business Manager
FRED STEWART:
Promotion Manager
B. ANELLO:
Marketing Service Manager

RICHARD J. TOMLINSON:
Production Manager
GEORGE E. POMEROY:
Classified Manager
HUGH J. QUINN:
Circulation Manager

ADVERTISING REPRESENTATIVES

NEW YORK (36):
Donald H. Miller, Henry M. Shaw, George F. Werner
500 Fifth Avenue, OXford 5-5959

BOSTON (16):
William S. Hodgkinson, Donald R. Furth
McGraw-Hill Building, Copley Square,
Congress 2-1160

PITTSBURGH (22):
David M. Watson
Four Gateway Center, Express 1-1314

PHILADELPHIA (3):
Warren H. Gardner, William J. Boyle
6 Penn Center Plaza, LOcust 8-4330

CHICAGO (11):
Harvey W. Wernecke, Robert M. Denmead
645 North Michigan Avenue, Mohawk 4-5800

CLEVELAND (13):
Paul T. Fegley
55 Public Square, Superior 1-7000

SAN FRANCISCO (11):
R. C. Alcorn
255 California Street, Douglas 2-4600

LOS ANGELES (17):
Peter S. Carberry, Ashley P. Hartman
1125 W. 6th St., Huntley 2-5450

DENVER (2):
J. W. Patten
Tower Bldg., 1700 Broadway, Alpine 5-2981

ATLANTA (9):
Michael H. Miller
1375 Peachtree St. N.E., Trinity 5-0523

HOUSTON (25):
Joseph C. Page, Jr.
Prudential Bldg., Holcomb Blvd.,
Jackson 6-1281

DALLAS (1):
Frank Le Beau
The Vaughn Bldg., 1712 Commerce St.
Riverside 7-9721

LONDON W1:
Dennis McDonald
34 Dover St.

FRANKFURT/Main:
Stanley R. Kimes
85 Westendstrasse

GENEVA:
Michael R. Zeynel
2 Place du Port

"Headquarters for Business Information"

McGraw-Hill Technical and Business Publications

American Machinist/Metal-
working Manufacturing
Aviation Week and Space
Technology
Business Week
Chemical Engineering
Chemical Week
Coal Age
Construction Methods and
Equipment
Construction Daily
Control Engineering
Electrical Construction
and Maintenance
Electrical Merchandising Week
Electrical Newsletter

Electrical West
Electrical Wholesaling
Electrical World
Electronics
Engineering Digest
Engineering and Mining Journal
E & MJ Metal and Mineral
Markets
Engineering News-Record
Factory
Fleet Owner
Industrial Distribution
National Petroleum News
Nucleonics
Nucleonics Week
Platt's Oilgram News

Platt's Oilgram Price Service
Power
Product Engineering
Purchasing Week
Science Week
Textile World

Overseas only:
Automobile International
Ingenieria Internacional
Construccion
International Management
(English, Spanish
Portuguese editions)
Metalworking Production
(Great Britain)

Available by subscription only — to qualified persons actively engaged in the field of the publication. For subscription rates and information describing the editorial coverage of any of the above publications, write to: Subscription Manager, Circulation Department, McGraw-Hill Publishing Company, 330 West 42nd Street, New York 36, N. Y.

this is
the Brush
Mark II . . .

anyone

can
plug
it in

put it
in writing
anywhere



There is no direct writing recorder on the market that approaches the compact Mark II in sheer usefulness. It is a completely integrated engineering tool that can be operated by anyone . . . in the shop or in the field . . . for countless research or design requirements. Every function necessary for uniform, crisp, easily reproduced readouts is "built-in". The Mark II gives you two analog channels plus two event markers; 4 chart speeds; DC to 100 cps response with 40 mm amplitude; 10 mv/mm sensitivity; high input impedance. Ink or electric writing models. Immediate shipment from stock.

brush INSTRUMENTS
DIVISION OF
37TH AND PERKINS **CLEVITE** CORPORATION CLEVELAND 14, OHIO

Nuclear interactions in a bubble chamber, courtesy of Brookhaven National Laboratory



RCA nuvistor

For use in electronic equipment that must perform dependably in strong nuclear radiation fields

Among conventional active electronic circuit components, the RCA nuvistor electron tube is in the class of components *least susceptible to catastrophic failure from nuclear radiation*. In addition nuvistors are commercially available and offer extremely small size, light weight, and exceptionally low power drain.

These facts are of utmost importance to you if you are designing communications or navigational equipment which must provide dependable performance in an environment of strong nuclear radiation. In such an environment, even momentary failure of equipment can disastrously curtail our vital communications or navigation operations.

Recent tests have shown that the RCA-7586 nuvistor triode and the RCA-7587 nuvistor tetrode have given dependable performance after being subjected to a nuclear radiation pulse of extremely high intensity as specified in the Neutron Radiation Damage Test, Military Standard MIL-STD-446A, November 25, 1960.

In these critical equipment design areas, one cannot afford to risk component failure. Specify RCA nuvistor for airborne communications, airborne controls, missile avionic systems, radar networks, telemetering equipment, and ground support equipment.

For additional information, see the RCA Field Representative at our office nearest you.



The Most Trusted Name in Electronics

RCA ELECTRON TUBE DIVISION—FIELD OFFICES
EAST: 744 Broad Street, Newark 2, New Jersey,
HUMboldt 5-3900 • MIDWEST: Suite 1154, Merchandise
mart Plaza, Chicago 54, Illinois, WHitehall 4-2900
WEST: 6801 E. Washington Blvd., Los Angeles 22,
Calif., RAYmond 3-8361 • 1838 El Camino Real, Bur-
lingame, Calif., OXford 7-1620