

electronics

RADAR MAKES WAR MAPS

Dishes identify terrain samples, p 20

(photo below)

THIN-FILM TRIODES

What can they really do? p 29

SERVO AMPLIFIER ON PINHEAD

Latest use of linear microcircuits, p 33

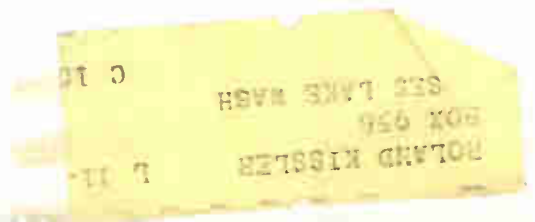
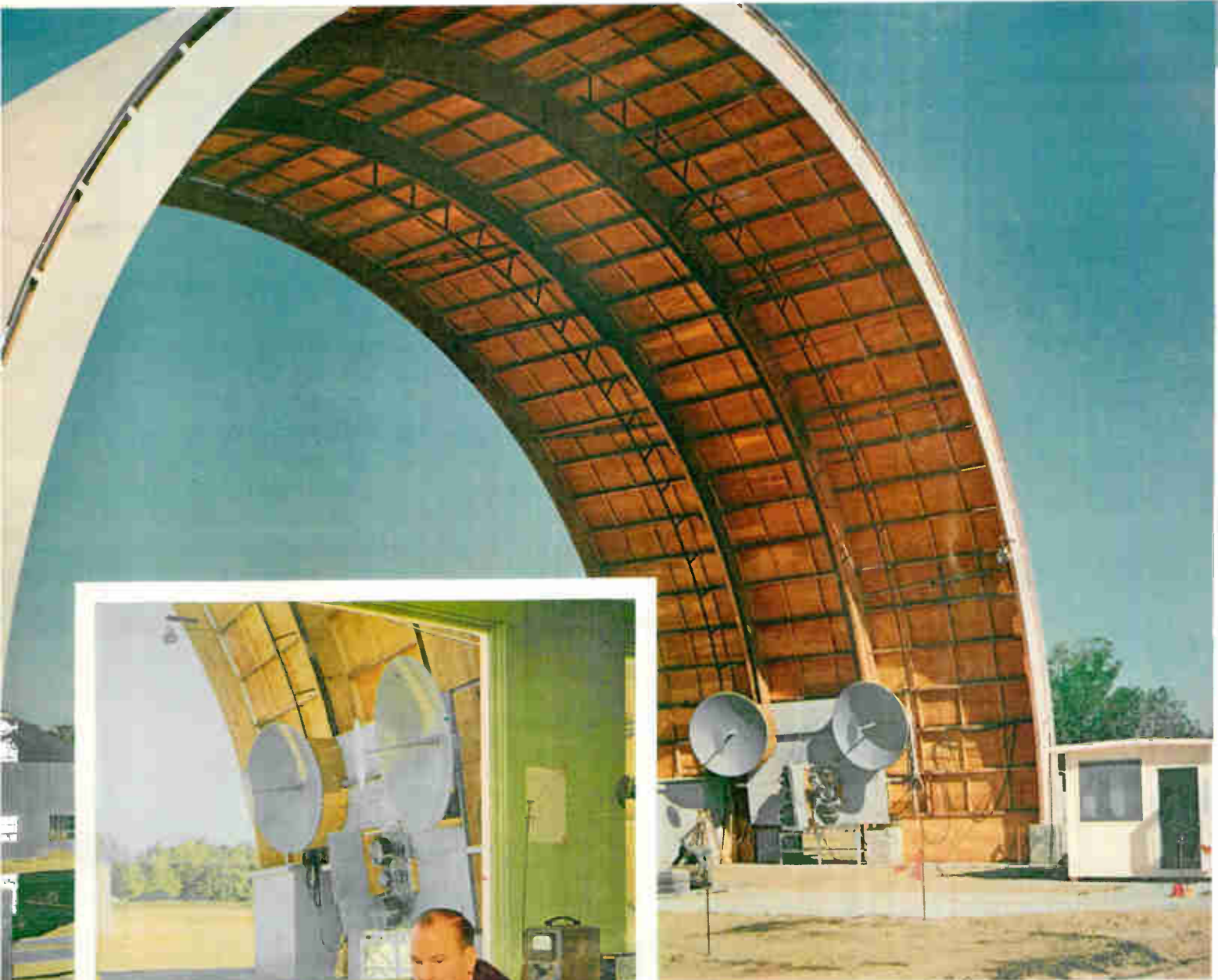

FREQUENCY IN "CHUNKS"



With G-R Unit Oscillators you get low-cost continuous frequency coverage from 20 cycles to 2000 megacycles in eight high-performance packages. These oscillators keep your instrument costs down by giving you greater versatility and freedom in assembling measuring setups. Use one oscillator in setup "A" . . . simultaneously use another in setup "B" . . . something you can't do with one elaborate, expensive generator.

SYSTEMS MANUFACTURERS PLEASE NOTE — G-R Unit Oscillators are compact . . . they find many uses as signal sources in original equipment such as parametric amplifiers, antenna test sets, and biomedical equipment.



1203-B
Unit Power Supply
required for all
Unit Oscillators
... \$50



1210-C
20 cps-0.5 Mc
(5 ranges)

±3%

less than 1%, essentially
complete in 1 hour

3 outputs: Low Z (less than 500Ω) : 0-7v
High Z: 0-45v
Square wave: 0-30v, open circuit

Output of 1210-C
and 1206-B
Unit Amplifier, \$90,
into 600-ohm load

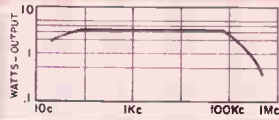

\$180

1211-C
0.5-50 Mc
(2 ranges)

±2% at
no load

0.4%

200 mw

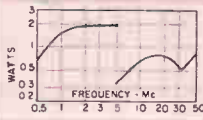

\$305



Type

Frequency

**Calibration
accuracy**

**Warm-up
drift**

**Specified
output
into 50Ω**

Typical output
characteristic
(Using Type 1203-B
Unit Power Supply)

Price

1215-B
50-250 Mc

±1% at no load

0.3%

80 mw

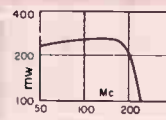

\$210



1208-B
65-500 Mc

±2%

0.5%

100 mw

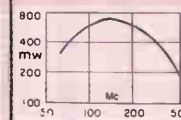

\$230



1209-BL
180-600 Mc

±1%

0.2%

300 mw

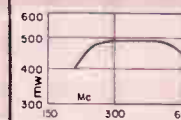

\$260



1209-B
250-960 Mc

±1%

0.2%

200 mw

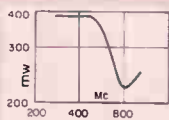

\$260



1361-A
450-1050 Mc

±1%

0.2%

125 mw

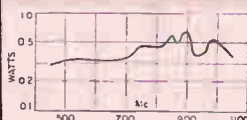

\$285



1218-A
900-2000 Mc

±1%

0.1%

200 mw

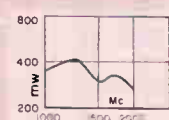

\$465

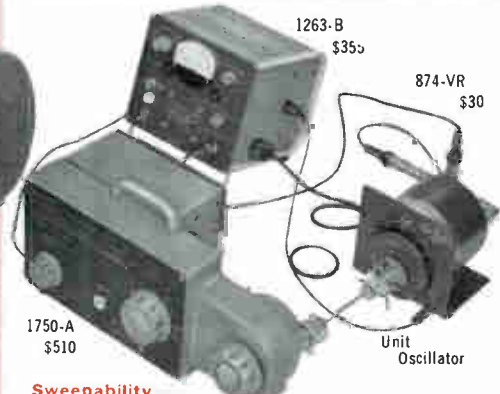

1750-A
\$510

1263-B
\$350

874-VR
\$30

Sweepability . . .

All Unit Oscillators (except 1208-B) can be mechanically swept with the 1750-A Sweep Drive. With it, you can control all the variables: sweep speed, center frequency, and frequency span with three simple knob controls. Also available is the 1263-B Regulated Power Supply, which by feedback techniques maintains Unit Oscillator output constant over frequency (not required for 1210-C).

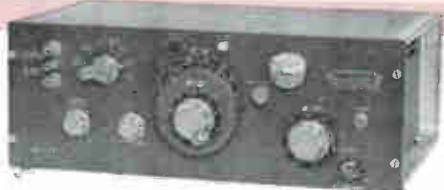

Also Available for 1.7-to 4.1-Gc Applications
new Type 1360-A Microwave Oscillator, \$1100

Internal 1-kc and line-frequency sweep; internal 1-kc square wave modulation, provision for external modulation (pulse, square wave, fm); self-contained power supply.

GENERAL RADIO COMPANY
WEST CONCORD, MASSACHUSETTS

In EUROPE
General Radio
Overseas
Zurich, Switzerland

NEW YORK, N. Y., 964-2722
Ridgefield, N. J., 943-3140

CHICAGO
(Oak Park) 848-9400

PHILADELPHIA, 424-7419
Abington, 887-8486

WASHINGTON, D.C.
(Rockville, Md.) 946-1600

SYRACUSE
454-9323

DALLAS
Fl. 7-4031

SAN FRANCISCO
(Los Altos) 948-8233

LOS ANGELES
HO 9-6201

ORLANDO, FLA.
425-4671

IN CANADA
(Toronto) 247-2171

CIRCLE 900 ON READER SERVICE CARD

electronics

A McGraw-Hill Publication 75 Cents



W. W. MacDONALD, Editor

J. M. CARROLL, Managing Editor
 SENIOR EDITORS: Samuel Weber, George W. Sideris. SENIOR ASSOCIATE EDITORS: Michael F. Wolff, John F. Mason. ASSOCIATE EDITORS: Michael F. Tomaino, Sylvester P. Carter, William P. O'Brien, Sy Vogel, Leslie Solomon, George J. Flynn, Laurence D. Shergalis, George V. Novotny, Leon H. Dulberger. ASSISTANT EDITORS: Nilo Lindgren, Stanley Froud, Stephen B. Gray, Roy J. Bruun. REGIONAL EDITORS: Harold C. Hood (Pacific Coast, Los Angeles), Thomas Maguire (New England, Boston), Cletus M. Wiley (Midwest, Chicago). ART DIRECTOR: Howard R. Berry. ASSISTANT ART DIRECTOR: John C. Wright, Jr. EDITORIAL ASSISTANTS: Gloria J. Meurer, Lorraine Rossi, Virginia T. Bastian, Lynn Emery, Ann Mella, Lorraine Werner, Alice M. O'Brien. FOREIGN NEWS BUREAU: Director, John Wilhelm; Alyne Elias, Betsy Wilson. LONDON—John Shinn, Derek Barlow, Nicholas Landon. BONN—Richard Mikton, Silke McQueen. BRUSSELS — Peter Forbath. PARIS—Robert Farrell, Arthur Erikson. MILAN—Marc A. Messina. MEXICO CITY—Bruce Bendow. RIO DE JANEIRO—Leslie Warren. MOSCOW—Stewart Ramsey. TOKYO—Richard Halloran, Charles Cohen, John Yamaguchi.

W. W. GAREY, Publisher

RADAR TERRAIN ANALYSIS. Radar dishes covering K, X, C and P bands travel along track inside the arch and illuminate soil samples below. Army Corps of Engineers uses Texas Instruments installation to determine reflecting characteristics of soils as a function of incident angle and frequency. *When these data are known radar can plot soil maps for tactical purposes and flood control. See p 20* COVER

AUTO TRAFFIC CONTROLS. More cities are beginning to use computers, both analog and digital, to unsnarl traffic. *This is a coming market for radar, ultrasonic sensors, tv and radio* 14

RADAR SOIL ANALYZERS Will Help Army Map Campaigns. Four-band radar is now gathering soil signatures to aid in system design. *What Army wants is an airborne system, with other sensors as well as radar, that will tell field commanders whether a region's ground conditions are suitable for troop movements* 20

MAN ON MARS—That's Project Rover's Target. AEC and NASA are making progress in a three-stage program to develop and fly a nuclear rocket engine. *But a funds squeeze may slow development. The money decision depends on the success of tests in the next six months* 24

THIN-FILM TRIODES: How Well Will They Perform? There are three distinct classes of thin-film triodes: space-charge-limited, field-effect or hot-electron devices. Each type has unique advantages and disadvantages. *The SCL triode is fastest; field-effect triodes are easiest to make; hot-electron devices may be most tolerant of radiation.* By W. Tantraporn, General Electric 29

MICROCIRCUIT SERVO AMPLIFIER. It's only $\frac{3}{4}$ -inch square but it can drive a size-8 servo motor. This direct-coupled class-A amplifier contains the equivalent of four dozen components on and within a single silicon block. *So-called inside-out transistors are key to its performance.* By M. W. Aarons, United Aircraft 33

ELECTROSTATIC KLYSTRONS: New Design Concept. This S-band klystron produces 15.5 kilowatts peak power with 25-percent efficiency and weighs only five pounds complete. *It uses electrostatic focusing of the electron beam instead of the conventional solenoid or permanent magnet.* By J. R. Hechtel and A. Mizuhara, Litton Electron Tube Corp. 36

EDITORIAL INDEX, July through December, 1962 59

Contents Continued

electronics

December 28, 1962 Volume 35 No. 52

Published weekly, with Electronics Buyers' Guide and Reference Issue as part of the subscription, by McGraw-Hill Publishing Company, Inc. Founder: James H. McGraw (1860-1948).

Title ® registered U.S. Patent Office; © copyright 1962 by McGraw-Hill Publishing Co., Inc. All rights reserved, including the right to reproduce the contents of this publication, in whole or in part.

Executive, editorial, circulation and advertising offices: McGraw-Hill Building, 330 West 42nd Street, New York 36, N. Y. Telephone Longacre 4-3000. Teletype TWX N.Y. 212-640-4646. Cable McGrawhill, N. Y. PRINTED IN ALBANY, N. Y.; second class postage paid at Albany, N. Y.

OFFICERS OF THE PUBLICATIONS DIVISION: Nelson L. Bond, President; Shelton Fisher, Wallace F. Traendly, Senior Vice Presidents; John R. Callahan, Vice President and Editorial Director; Joseph H. Allen, Vice President and Director of Advertising Sales; A. R. Venezian, Vice President and Circulation Coordinator; Daniel F. Crowley, Vice President and Controller.

OFFICERS OF THE CORPORATION: Donald C. McGraw, President; Hugh J. Kelly, Harry L. Waddell, Executive Vice Presidents; L. Keith Goodrich, Executive Vice President and Treasurer; John J. Cooke, Vice President and Secretary.

Subscriptions are solicited only from those actively engaged in the field of the publication. Position and company connection must be indicated on orders. Subscription rates: United States and Possessions, \$6.00 one year, \$9.00 two years, \$12.00 three years. Canada: \$10.00 one year. All other countries \$20.00 one year. Single Copies, United States and Possessions and Canada 75¢. Single copies all other countries \$1.50.

THE PUBLISHER, UPON WRITTEN REQUEST FROM ANY SUBSCRIBER TO OUR NEW YORK OFFICE, AGREES TO REFUND THAT PART OF THE SUBSCRIPTION PRICE APPLYING TO COPIES NOT YET MAILED.

Subscribers: Please address change of address notices, subscription orders or complaints to Fulfillment Manager, Electronics, at above address. Change of address notices should provide old as well as new address, including postal zone number if any. If possible, attach address label from recent issue. Allow one month for change to become effective.

Postmaster: Please send Form 3579 to Fulfillment Manager, Electronics, 330 West 42nd Street, New York 36, New York.



Audited Paid Circulation

RASTER OSCILLOSCOPES for Faster Time Measurements.
This instrument solves the problem of displaying high-resolution time-interval measurements. *It has a television-like display that makes optimum use of the crt face. All circuits use transistors, diodes and tunnel diodes.*

By R. P. Rufer and W. A. Karlotski,
Lawrence Radiation Lab, U. of C. 38

REFERENCE SHEET: Faster Selection of VHF Bypass Capacitors. Chart takes inductance of capacitor leads into account and can avoid errors as great as an order of magnitude. *It is useful at frequencies from 1 Mc to 1,000 Mc and with lead-wire gages from Awg 18 to 24.*

By L. E. Lee, Ball Brothers Research Corp. 44

DEPARTMENTS

Crosstalk. <i>Thin-Film Triodes. Annual Market Report</i>	3
Comment. <i>Diodes and Transients. To Obsolete or Not to Obsolete</i>	4
Electronics Newsletter. <i>Air Force Winning Dynasoar Fund Request</i>	7
Washington Outlook. <i>Bidding for Satellite Stock Starts Jan. 2</i>	12
Meetings Ahead. <i>International Measurements Conference</i>	27
Research & Development. <i>Solid-State Nuclear Gyro Reported Feasible</i>	48
Components and Materials. <i>Will Gallium Alloys Provide New Electronic Light Source?</i>	52
Production Techniques. <i>Microscope and Tv Help Train Technicians</i>	56
Design and Application. <i>Integrated Circuits Form Linear Amplifiers</i>	66
Literature of the Week	69
People and Plants. <i>Computer Maker Occupies New Plant</i>	70
Index to Advertisers	74

CROSSTALK

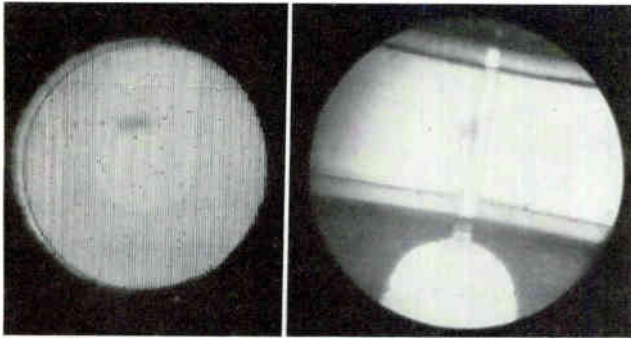

and prospects for each type of triode.

Illustrations in the article show the configurations of these devices schematically, because that makes the explanations easier to follow. The photos here show the hearts of the SCL and field-effect triodes.

On the left is a grid for an SCL triode. Less than an eighth of an inch in diameter, it is formed from lines of gold wrapped in silicon monoxide. On right is a closeup of a field-effect triode's gate electrodes.

THIN-FILM TUBES. There is no doubt that the design of future electronic equipment will lean heavily upon the now-developing art of thin-film circuits. Vastly reduced size is but one of the glowing predictions. Significant advantages are anticipated in certain performance parameters, in the cost of mass-produced circuits and in design flexibility.

Considerable progress has been made in production techniques. Methods of making passive devices like capacitors and resistors have been tamed quite successfully. They can be made by a process akin to the household spray gun. But such active components as transistors and diodes don't get built as easily in the form of thin films.

One class of thin-film active device that does respond to the spray-gun approach is the thin-film triode. They can be built up from layers of electrode and insulating materials, producing a solid-state analog of the familiar vacuum tube. The space charge in a solid, for example, can behave like the space charge in a vacuum.

People working on thin-film triodes don't say that there aren't applications better suited to integrated semiconductor circuits. Nor do they contend that there are no more problems to be solved. But several varieties of thin-film triodes have already been built, they do offer easier solutions to some fabrication problems and they do merit the attention of designers working in the microelectronics field.

Because of these considerations—and because it makes for a darned interesting technical story—our lead feature article this week is all about thin-film triodes and how they perform. The author, W. Tantraporn, of GE, sets forth the basic designs and mechanisms for three distinct types: the space-charge-limited (SCL), field-effect and hot-electron versions. And he candidly discusses the advantages, disadvantages

MARKETING REPORT. New Year's resolutions to do good and work harder are fine for the man in the street, but the businessmen and engineering planners in industry must make plans far more concrete than a few generalizations. This is the time of the year when manufacturers must resolve, in terms of sales and profit prospects, such questions as:

- Are international trends in the electronics field working for or against the manufacturers in the U.S.?

- Is there a profit squeeze in military electronics and if so should we take a longer look at industrial and consumer electronics?

- What about component manufacturing overcapacity?

These are just a few of the questions we asked and got answers to from informed people in the industry during the past few months, while gathering the raw material for our annual market report.

Of course, any manufacturer intimate with a particular facet of electronics has a pretty good idea right now where his specialty stands and where it is heading. The usefulness of our annual market reports—blending as they do informed opinion and statistics on all the facets of the industry—is twofold: it helps one specialist determine what other specialists are up to, and it helps him to determine how to broaden his product range and fit his specialties into growing fields.

For the latest word on where the electronics industry is heading—*ELECTRONICS*, January 4, 1963.

EDITORIAL INDEX. The article-author index beginning on page 59 of this issue is self-explanatory. It represents the end of a series of experiments with respect to frequency and placement.

Next year, we will return to the traditional policy of indexing *ELECTRONICS* just once, in our issue of December 27, 1963. This appears to best meet the needs of a majority of subscribers and, in particular, librarians.

our stock answer is YES

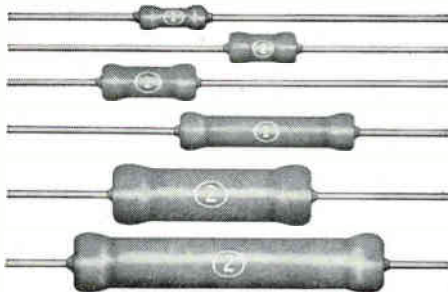

ALL UNITS ACTUAL SIZE

ALL AXIAL LEAD BLUE JACKET RESISTORS

*in 1, 2, 3, 5, 7 and 10-watt
power ratings are carried in
factory stock for immediate
delivery. Place your order now
with your nearest Sprague
District Office or Sales
Representative. Key
Sprague Industrial Distributors
carry most popular ratings
in local stocks.*

SPRAGUE ELECTRIC COMPANY
35 Marshall Street, North Adams, Mass.



COMMENT

Diodes and Transients

This is in regard to the *Comment* letter from reader P. Prouty (p 4, Nov. 9), which concerned my letters (p 4, Sept. 28) and author S. P. Fairchild's response concerning his article, *Avalanche Breakdown of Silicon Rectifiers* (p 68, June 1).

I have a hard time visualizing how capacitance toward ground could carry enough energy from a single transient to kill a diode. If this were possible, then it would be possible to kill it by applying a d-c overvoltage in series with a capacitor of 10 pf (or whatever the ground capacitance of the diode is), and even though I did not make this experiment, I have a hard time imagining that it should ever succeed.

But what reader Prouty writes under (2) perfectly agrees with what I had merely theorized in the last paragraph of my second letter: that continuous exposure of the diode with (not to) smaller inverse current to its Zener voltage, slowly undermines its resistance to overvoltage. For about 60 percent of diodes available. Then, if we use four diodes in series without the screening reader Prouty suggested, we have a chance of $(0.6)^4 = 13$ percent, of getting failure. This percentage agrees with the order of magnitude of experienced failures.

JOSEPH C. FROMMER
Cincinnati, Ohio

Reader Prouty's reply includes a drawing of a series diode string and calculations to show that if a 15,000-volt pulse is impressed across 50 cells, then the voltage across a diode is 5,400 volts, "certainly an impressive value." He continues:

To the best of my knowledge, the exact mechanism by which a voltage transient destroys a semiconductor junction is not well understood. It does appear, however, that the destruction occurs in sub-microsecond times and with only small amounts of energy being consumed in the process. Therefore, calculations

based on the time duration of the transient and the stored charge in the stray capacitances will have to be applied very carefully—particularly if they are to be used to establish criteria for an acceptable situation.

T. P. PROUTY

MHD Research, Inc.
Newport Beach, California

To Obsolete Or Not To Obsolete

Much has been written about engineers' inability to write English well. Naturally we look to *ELECTRONICS* to lead the way. Imagine my astonishment, therefore, to find in your Nov. 23 issue (p 3) your use of "obsolete" as a verb. I am wondering if you are going to fall in the same class as writers of cigarette ads and write "like" an editor should not.

JULIAN LOEBENSTEIN
General Instrument Corporation
Newark, New Jersey

Our dictionary says the use of "obsolete" as a verb is "now rare." In using it as a verb, we have either gone back to the time when it was common to do so, or have moved ahead to the future, when it may again become acceptable by repeated usage. It's only a case of being out of sync.

Feedline Impedances

I am very pleased with your presentation of my article, *Smith-Chart Short Cut Renormalizes Feedline Impedances* (p 53, Nov. 16).

I detect two errors, however, which somehow slipped through. On p 54 under "Broadband Matching," third paragraph, third line, "counterclockwise" should read "clockwise," because the impedance locus is transformed from the antenna (load) *towards the generator*.

The second error, albeit minor, is in Fig. 1, where the arrows should point clockwise in order to be consistent with the text.

DONN V. CAMPBELL
U. S. Army Electronics Research
and Development Laboratory
Fort Monmouth, New Jersey

SANBORN FLEXIBILITY — 7 channels — fm, direct record or any combination/plug-in, all solid-state circuitry/record-reproduce amplifiers on same card/4 speeds — 3¾ to 30 ips; 1⅞ to 15 ips and 7½ to 60 ips optional / 7" high electronics available separately/optional extras include voice channel amplifier, digital input circuit, push-pull input coupler, precision footage indicator, loop adapter and remote control unit. **AT AN UNMATCHED \$7200.**



This new Sanborn/Ampex Model 2007 system conforms to accepted IRIG instrumentation standards, provides 1% system accuracy and bandwidths to 100,000 cps with direct recording, 10,000 cps with FM amplifiers. Max. error due to non-linearity is only $\pm 0.5\%$ on DC, $\pm 1\%$ on AC.

Basic system features include quickly interchanged, readily accessible printed circuit plug-in modules . . . flutter compensation by using one channel to compensate all others . . . alignment of all FM channels with built-in meter and selector switch, eliminating need for electronic counters . . . automatic squelch circuit . . . entire system in only 31" of rack panel space . . . packaging in either mobile console shown or portable cases for tape transport and electronics.

System price of \$7200 includes 7-channel tape transport, transfer chassis, playback preamplifiers, power supply and 7 channels of FM Record/Reproduce electronics, housed in metal mobile cabinet. All prices F.O.B. Waltham, Mass., and subject to change without notice.

Get the complete specifications on this new Tape System — as well as 3 new types of Sanborn Data Amplifiers, 17" Multi-Trace Scope and other related instrumentation — from your local Sanborn Industrial Sales-Engineering Representative. Ask him for your copy of the complete Industrial Catalog.

INDUSTRIAL DIVISION
SANBORN COMPANY
 WALTHAM 54, MASS.
 A subsidiary of Hewlett-Packard Company

CIRCLE 5 ON READER SERVICE CARD



3 PROBLEMS

1. Light-weight, frequency-stable, efficient 10-watt S-Band oscillator for telemetry. Must operate at low voltage, be easily frequency-modulated, small, simple and reliable; must generate minimum stray electromagnetic interference; and must meet typical missile environment specifications.

2. Amplifier of at least 10 watts output over octave bandwidth 4.0 to 8.0 Gc, with minimum of 40 db saturated gain. Must not require separate power for focussing, nor forced air or liquid cooling. Size and weight must be minimum to meet typical missile environment specifications.

3. 15-watt oscillator voltage-tunable over 12% bandwidth in L-Band. Linear frequency/anode voltage characteristic required. Minimize frequency drift with temperature. Must be self-contained; only electrical connections; no mechanical adjustments. Minimum size and weight to meet typical missile environment specifications.

3 SOLUTIONS



1 COMPANY



Three examples of the way Eimac, by creative engineering, meets tomorrow's tube needs today.

X1005 Supported Drift Tube Klystron...
developed under AF33 (616)-8403...
 Weight: 2 $\frac{5}{8}$ pounds
 Frequency Stability: 0.005%
 Efficiency: Above 15%
 Power Output: 10 watts CW
 Frequency: 2.2 to 2.3 Gc.
 Beam Voltage: 1500
 Size: 4 x 4 x 4 $\frac{1}{2}$ inches overall
 Focussing: Entirely internal, no magnets or coils
 Environmental: Meets typical missile specifications.

X1021 Traveling Wave Tube
 Power Output: 10 watts min.
 Frequency Range: 4.0 to 8.0 Gc.
 Saturated Gain: 40 db
 Focussing: PPM
 Cooling: Heat sink
 Size: 13 x 1.83 x 1.89 inches
 Weight: 3.5 pounds
 Environmental: Meets typical missile specifications

X1086 Voltage Tunable Magnetron
 Power Output: 15 watts min.
 Power Output Variation: 1.5 db
 Freq. & Bandwidth: 12% in L-Band
 Frequency/Anode Voltage: Linear
 Temperature Compensation: 0.008% of operating frequency/°C.
 Electrical Connections: Heater, anode, injection voltage only
 Output: Coaxial
 Focussing: Permanent magnet
 Size & Weight: 5 x 3 x 2 in.; 3.2 lbs.
 Environmental: Meets typical missile specifications

More reasons to keep your eye on Eimac—for advanced microwave tubes, high power klystrons, power grid tubes, accessories. Eitel-McCullough, Inc., San Carlos, California. Subsidiaries: Eitel-McCullough, S.A., Geneva, Switzerland; National Electronics, Geneva, Ill. **KEEP YOUR EYE ON**



ELECTRONICS NEWSLETTER

DOD Casting Friendlier Eye on Dyna-Soar

DEFENSE DEPARTMENT will probably grant Air Force's request for \$135 million in fiscal 1964 for X-20 (Dyna-Soar). DOD had cut \$10 million, but Air Force is now substantiating the need and believes DOD will ask Congress for the full amount next month.

The program is on schedule. Air Force sees no technical problems to prevent development of the manned orbital glider. More money would, however, buy better subsystems. One that would be replaced is the guidance system.

Flights are to begin in early 1965 with a manned drop from a B-52. Titan III will boost an unmanned glider into orbit in late 1965 and a manned one in 1966. Titan III's second, third and fourth stages will be test fired in 1964.

Congress has shown more enthusiasm for X-20 than DOD. In 1962, Air Force asked for \$185 million and Congress appropriated it. DOD only wanted \$100 million and that's all it gave Air Force.

For 1963, DOD requested \$135 million, got \$157 million, but so far has only released \$60 million. Air Force hopes it gets at least the other \$75 million in the next six months.

Ship-Base Polaris for Britain Deal is Cooking

WASHINGTON—As President Kennedy and Prime Minister Macmillan met at Nassau last week, Skybolt's fate was virtually sealed. Washington was prepared to offer Britain an alternative strategic nuclear weapon and the candidate was Polaris.

The U. S. appreciates Macmillan's political requirement for big nuclear weapons, say sources here, so Washington agreed to consider a British request for Polaris as an alternative to Skybolt.

As we went to press, odds were that an agreement would be reached to sell Polaris missiles to Britain, probably for deployment on surface vessels. The British are apparently in no shape to invest heavily in a fleet of missile-armed subs.

The British are not interested in Minuteman. They prefer mobile

missiles, not fixed-base missiles that could draw enemy fire to their island.

Operational Transit Is Launched, Receiver Fails

MUCH OF THE USEFULNESS of the first operational Transit satellite, launched last week, was washed out by a failure in the command receiver. The system (p 148, Aug. 11, 1961) is designed to give precise navigational fixes. Day-to-day accuracy depends on corrected orbital data that was to be fed from computers at Point Mugu, Calif.

Navy officials said another Transit will be sent up in about 60 days. A four-satellite network is planned. Polaris submarines with position-keyed guidance systems should be principal early beneficiaries of the program. Position data, for ships or missile guidance systems, is automatically prepared when the shipboard system receives signals from the satellite. The equipment is now in place on some naval vessels.

The equipment may soon be made available to commercial navigators under agreements being worked out by the Defense Department and

NASA. Contractors for the Navy navigation sets (AN/BRN-3) include Westinghouse Electric, Thompson Ramo Wooldridge and Chew Associates. Johns Hopkins' Applied Physics Lab supervises the project.

French Hope to Make Indium-Arsenide Laser

PARIS—Prof. Pierre Aigrain, of the Ecole Normal Superieure, has informed ELECTRONICS that his research group has developed theory for an indium-arsenide laser. They hope to have a device ready in time for the Quantum Electronics Symposium here in February.

Work done so far indicates the laser wavelength is 3 microns, compared to 0.85 micron for a gallium-arsenide laser (p 24, Nov. 16), and conversion efficiency is potentially 100 percent.

Infrared Diode Transmits Voice on 30-Mile Path

BOSTON—MIT Lincoln Laboratory has had moderately good success in transmitting voice over a 30-mile path, using its infrared-generating gallium-arsenide diodes (p 44, Oct. 5) as a source of incoherent radiation. Development of the devices as lasers is also continuing, as is research with other materials, including gallium phosphide.

Emission of high-intensity infrared radiation at 1.6 microns has been observed from forward-biased

Hot Line to Moscow Idea Cools Down

ALL THAT TALK about a Kennedy-Khrushchev hot line is still just talk. Nothing was down on paper last week, said the White House. The President, himself, twice doubted it would be a panacea. He says faster communication is desirable, not crucial.

If a hot line is installed, it would probably be a teletypewriter circuit, to provide printed records. But unless plain language is used, coding and decoding would consume time. One wag said that "if your readers would develop a machine to automatically code and translate presidential prose, we might get somewhere."

There's no problem with plain language messages. Contact has been made by open telephone (by the Soviet Embassy in Washington), radio and broadcasts in the past

gallium-antimonide *p-n* junctions. Optical pumping of the base material produces the same radiation spectrum as *p-n* junction injection.

MIT researchers have noted lack of significant line shifts in absorption measurements and in measurements in magnetic fields up to 90 kilogauss. This indicates, they say, that the radiation is not produced by band-to-band transitions and that it is probably connected with impurities. The radiation spectrum is changed a different impurity.

South Africa Installing 600-Transmitter F-M Net

BONN—Siemens, Telefunken and Rohde & Schwarz have received the lion's share of orders for the first stage of South Africa's f-m station network. First stage includes 80 transmitters.

Bids for the second stage, 100 transmitters, will be published in early 1963. When the network is completed in 1967 it will have cost \$47.5 million and have 600 transmitters at 127 stations.

Each station will have 5 or 6 transmitters to broadcast programs in European and native languages. Switching systems enable 4 to 6 transmitters to use a common antenna.

F-m radio sales in South Africa have been booming, especially in native regions. Most sets sold come from Japan and cost \$50.

Modulation Technique Handles 20 Megabits

YORKTOWN HEIGHTS, N. Y.—Computer information at the rate of 20 million bits a second has been transmitted over a conventional 40-mile microwave tv link by IBM Advanced Systems Development division. Another modulation technique transmitted 8,000 bits a second over a high-quality telephone line.

Emil Hopner, computer communications manager, said a tv-type channel offers possibilities for higher-speed computer communications because it has broad bandwidth and is designed for pulse transmission like the binary signals of computer language. Simple equipment can translate signals between computers and the tv link.

Basically, the system accepts two 10-megabit binary channels and encodes them into a composite signal with amplitude and polarity level dependent on instantaneous relationship between 0's and 1's. The outgoing 20-megabit composite signal modulates the microwave transmitter. At the receiver, a decoder clocks each pulse and delivers the two 10-megabit outputs that are fed to an encoder. The composite signal is recreated and passed through a low-pass filter back to the decoder to serve as the d-c restoration circuit.

First Look at Mariner Data Puzzles Scientists

FIRST LOOK at the data gathered by Mariner II is puzzling NASA scientists. Tentative analysis shows that Venus has a smaller magnetic field than Earth and that its cloud cover is solid rather than broken by surface winds or other weather conditions.

Data on the magnetometer experiment was to be presented this week at the American Association for the Advancement of Science, in Philadelphia, and results on five other experiments at the American Geophysical meeting at Palo Alto, Calif.

If it turns out that Venus has a magnetic field like Earth, this will support theories that Venus was formed much like Earth and still has a hot interior. A weak field could mean that Venus spins very slowly.

No Luck in First Ion Engine Test In Space

FIRST TEST of an ion engine in space was attempted by Air Force from Point Arguello, Calif. last week. Although the booster vehicle successfully placed the experimental equipment in the desired trajectory, Air Force said the ion engine could not operate due to a partial power failure.

This test was the first in a long-range program to investigate feasibility of electric propulsion systems for space applications being carried out by the Air Force Systems Command. The ion engine was a cesium-type made by Electro-Optical in an 80-lb. package.

In Brief . . .

ADMIRAL and Motorola are both predicting black-and-white tv sales will be 6 million sets in 1963. Admiral expects 700,000 color set sales will increase total tv dollar volume by 10 percent.

ANOTHER seismological observatory for Project Vela-Uniform (p 28, Feb. 23, and p 28, May 18) was dedicated last week. Contractors are Texas Instruments and Geotechnical Corp.

RYAN AERONAUTICAL'S new VTOL flight simulator includes a panoramic wrap-around screen to give the pilot peripheral vision. The projector is tied to an analog computer.

AEROSPACE Industries Association sees an aircraft, missiles and space market as high as \$16 billion in 1963. Estimate for 1962 is \$15.5 billion.

BRITAIN won't be getting a second commercial tv network. The government said no. But it is giving BBC another channel and may permit pay-tv.

CON EDISON has asked AEC for permission to build a nuclear power plant in the Queens section of New York City. The 1,000-Mw plant would be the first built inside a city.

NIKE ZEUS passed its last test at Point Mugu, Calif. Army said all three stages of the rocket fired as planned. Testing will continue at White Sands, N. M., and Kwajalein.

THIS COUNTRY'S 200th ICBM went on the firing line last week. Strategic Air Command took over a 12-missile Atlas squadron at Plattsburgh AFB, N. Y. This completes the planned Atlas force.

FAIRCHILD CAMERA & Instrument will produce an advanced photo reconnaissance system for the Air Force. It will provide horizon-to-horizon coverage.

MOLECU-WIRE has been purchased by Superior Tube, which will operate it as a subsidiary.

ANOTHER SOLID-STATE INNOVATION
FROM INTERNATIONAL RECTIFIER

NOW! For the First Time...

fully rated

1 AMP at 50°C

Subminiature
Silicon Rectifiers

200 TO 1000 VOLTS, PRV



actual
size

**HIGHEST PERFORMANCE—
SMALLEST PACKAGE!**

1st of its kind, this new subminiature IR silicon rectifier series offers many circuit optimizing benefits.

1000mA up to 50°C. The first rectifier in its class to be fully rated at an elevated temperature. Delivers a full 667mA at 100°C.

200 to 1000 max. PRV range. Seven standard PRV types to select from (200, 300, 400, 500, 600, 800 and 1000 volt ratings).

0.90 max. FVD... at 25°C and 1000 mA, d-c (0.50 volt max. at 500mA, F.C.A. and 100°C).

50 Amps, max. Peak Surge Current... with 6 Amps, Recurrent Peak Current.

Pure Silver, 0.032" dia. Leads (max.) increase power handling capability and simplify automated assembly.

Economically Priced—places solid-state circuitry benefits within reach of every equipment manufacturer.

1 AMP

MAX. RECTIFIED OUTPUT CURRENT—AMP. D.C.

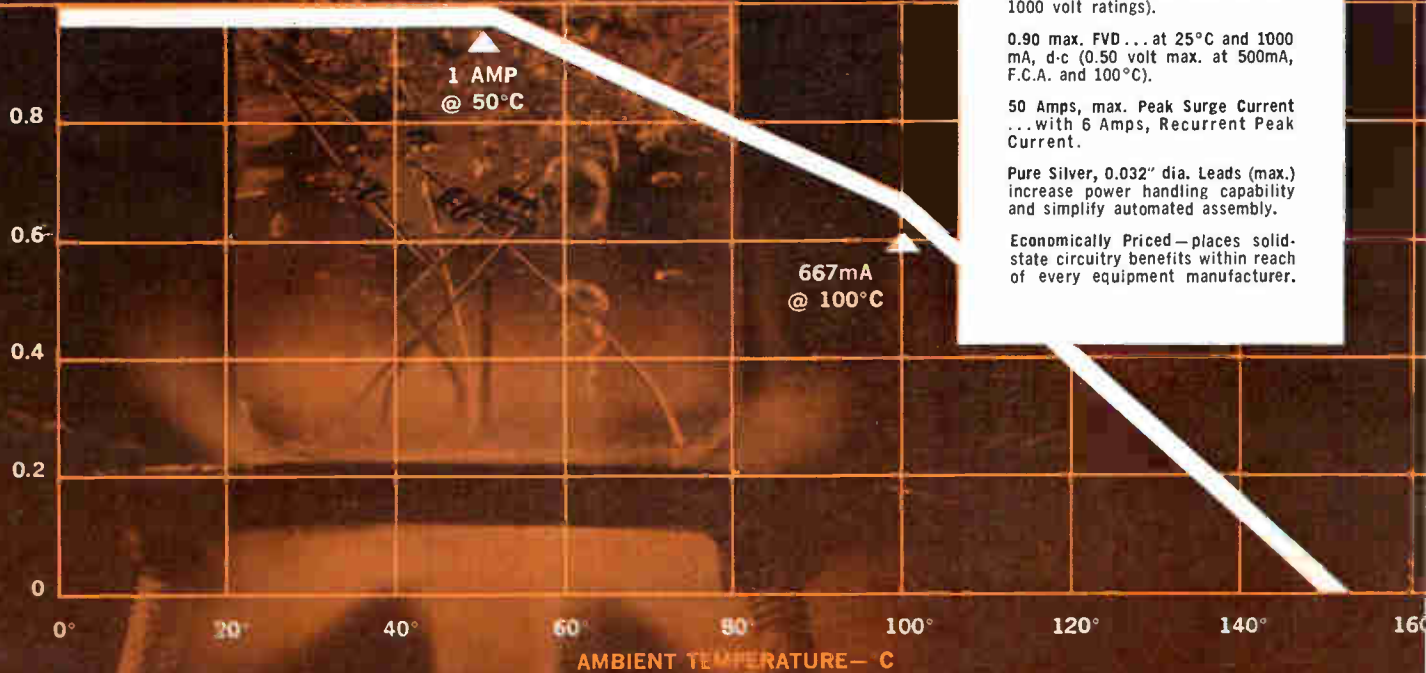

1 AMP
@ 50°C

667mA
@ 100°C

Now, optimize your circuitry by utilizing the *full current rating* of a rectifier at the elevated temperatures normally encountered in ACTUAL OPERATION!

This new line of high-performance, subminiature silicon rectifiers culminates years of extensive R&D investigations in advanced diffusion and encapsulation technology by International Rectifier.

Check out your nearest IR field representative or Authorized Industrial Distributor for technical data and prototype units.

TRYING IS BELIEVING!

**INTERNATIONAL
RECTIFIER**



SYMBOL OF QUALITY IN SEMICONDUCTORS

INTERNATIONAL RECTIFIER CORPORATION: EL SEGUNDO, CALIFORNIA · PHONE OREGON 8-6281 · CABLE RECTUSA · REGIONAL OFFICES IN NEW YORK CITY, CHICKERING 4-0748 · FORT LEE, NEW JERSEY, WINOSOR 7-3311 SYRACUSE, NEW YORK, HEMPSTEAD 7-8495 · CAMBRIDGE, MASSACHUSETTS, UNIVERSITY 4-6520 · ARDMORE, PENNSYLVANIA, MIDWAY 9-1428 · SILVER SPRING, MARYLAND, JUNIPER 9-3305 · CHICAGO, ILLINOIS, JUNIPER 3-3085 HUNTINGTON WOODS, MICHIGAN, LINCOLN 8-1144 · ST. LOUIS, MISSOURI, TEMPLE 8-6333 · LOS ANGELES, CALIFORNIA, OREGON 8-6281 · IN CANADA: TORONTO, ONTARIO, PLYMOUTH 9-7581 · MONTREAL, QUEBEC, VICTORIA 9-3571 INTERNATIONAL RECTIFIER PRODUCTS ARE LOCALLY STOCKED IN QUANTITIES FOR IMMEDIATE DELIVERY AT 85 NATIONWIDE AUTHORIZED INDUSTRIAL DISTRIBUTOR WAREHOUSES

time related measurements

with

9



5211B



5512A



5212A



5532A



5232A



5233L

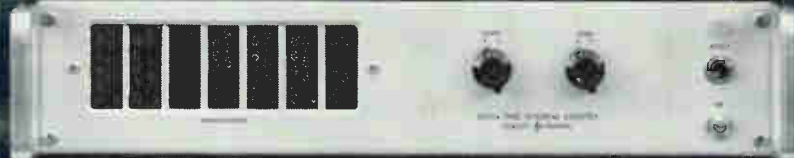

5275A



5245L



5243L

solid state counters!

From precision high speed measurements to economical production testing, one of these counters is right for your job. You can measure frequency, period, multiple period average, ratio, multiple ratio, and time interval.

The advanced line of Hewlett-Packard solid state counters incorporates as standard such features as display storage (continuous display of the most recent measurement until the count actually shifts), higher sampling rates (the time between counts is independent of gate time), -20 to $+65^{\circ}$ C operating range, and BCD output for recorders, systems.

Hewlett-Packard modular construction introduces counters that are bench and rack mount models in a single instrument, front panels are only $3\frac{1}{2}$ " or $5\frac{1}{4}$ " high. Operation is simple, straightforward, making every human-engineered instrument in the line easy to use, even by untrained personnel.

Check the brief description of individual models here. Then check your nearest representative or contact Hewlett-Packard direct for full information and demonstration of the instrument designed specifically for your job:

⊕ 5245L — Makes more measurements with greater accuracy than any other counter available today: Measures frequency, time interval, period, multiple period average, ratio, multiple ratio, scales by decades. Measures to 50 mc directly, 100 mc and 512 mc with plug-in converters. Additional plug-in permits time interval measurements. Time base stability, 3 parts in 10^6 /day. 8-digit resolution in rectangular, close-spaced numeric indicator tubes. Remote programmability of time base and function controls. ⊕ 5245L 50 MC Counter, \$3,250.00. ⊕ 5251A Frequency Converter, to extend counter frequency to 100 mc, \$300.00; ⊕ 5253A Frequency Converter, to extend counter frequency from 100 to 512 mc, \$500.00; ⊕ 5262A Time Interval Unit, 0.1 μ sec resolution, \$300.00.

⊕ 5243L — Identical to ⊕ 5245L, but measures directly to 20 mc, \$2,950.00.

⊕ 5233L — This 2 mc counter measures time interval, frequency, period, multiple period, ratio, and multiples of ratio. Featuring 6-digit resolution in an in-line display of rectangular digital in-line tubes and superior trigger, level controls. Price, \$1,850.00.

⊕ 5232A, 5532A — These 1.2 mc counters measure frequency, period, multiple period average and ratio. Offering 6-digit resolution, they are identical except for readout. The 5232A provides display in improved neon columns, while

the 5532A provides display in long-life numeric indicator tubes. Operating temperature range, as with the other ⊕ solid state counters, is -20 to $+65^{\circ}$ C. ⊕ 5232A, \$1,300.00; ⊕ 5532A, \$1,550.00.

⊕ 5212A, 5512A — Five-digit resolution is provided by these counters, which have a maximum counting rate of 300 kc. They measure frequency, period, multiple period average and ratio. The two instruments differ only in display, the 5212A presenting neon columnar readout, and the 5512A offering digital in-line tube readout. ⊕ 5212A, \$975.00; ⊕ 5512A, \$1,175.00.

⊕ 5211A, B — These counters use line frequency as a time base and measure frequency directly to a maximum counting rate of 300 kc, and they also measure ratio. They furnish 4-digit resolution with neon columnar display. The 5211A offers gate times of 0.1 second, 1 second, and manual. The 5211B offers an additional gate time of 10 seconds. Otherwise, the instruments are identical. ⊕ 5211A, \$750.00; ⊕ 5211B, \$825.00.

⊕ 5275A — This counter measures time interval 10 nsec to 0.1 sec., with 10 nanosecond resolution. The instrument counts 100 mc by a 100-to-1 multiplying circuit. Seven-digit display is in neon columns. Separate 1 mc time base, such as ⊕ 101A required. ⊕ 5275A, \$3,250.00; ⊕ 101A, \$500.00.

Data subject to change without notice. Prices f.o.b. factory.

**HEWLETT
PACKARD
COMPANY**

1501 Page Mill Road, Palo Alto, California, Area Code 415, DA 6-7000
Sales and service representatives in all principal areas; Europe, Hewlett-Packard S.A., 54-54bis Route des Acacias, Geneva; Canada, Hewlett-Packard (Canada) Ltd., 8270 Mayrand Street, Montreal



8130

WASHINGTON OUTLOOK

BIDDING FOR SATELLITE STOCK STARTS JANUARY 2

COMMUNICATIONS COMPANIES can start filing January 2 for authorization to buy stock in the new, privately owned satellite communications company. FCC will determine what communications companies will own stock. There is little chance of any company being denied ownership rights, says an FCC spokesman. Actual stock sales are not expected for several more months.

There is no limit to how much stock a single company can own, but FCC has power to force stock sales between companies to insure wide distribution. Also, half the stock must be held by the general public. Some companies, including AT&T, wanted more definitive rules on initial stock allocations and subsequent offerings, but the FCC has adopted without amendments the rules it had previously proposed.

CAN CIVILIANS SPEND THAT MUCH MONEY?

THOSE RUMORS AND DENIALS about Gen. Lauris Norstad being offered the presidency of the satellite communications corporation point up the caliber of person the 13-man group of incorporators want. Norstad, the allied commander in Europe, quickly denied a job offer was made. Sources close to the embryo company deny that a military man will be picked because that would give the company a semigovernment image, instead of carrying out the private company concept.

Picking a politically acceptable president is not the only problem facing the satellite corporation. Since the corporation will have to lean heavily upon what government programs have taught about communications satellites, the failure of the Relay satellite this month was a sobering development. It emphasized the problems—and costs—of establishing a working system of 30 to 50 satellites.

KENNEDY TO TRY AGAIN FOR EDUCATION ACT

THE WHITE HOUSE will attempt early in the next Congress to win approval of a science and engineering education program. President Kennedy has spoken of the need twice in the last several days and his science adviser, Jerome B. Wiesner, recently made the same point in one of his rare public addresses. Both are seen as laying the political groundwork for the manpower needs report recently issued by a special panel of the President's Science Advisory Committee (p 8, Dec. 21).

The panel recommended an annual outlay rising to \$760 million a year by 1970, for student support and facilities. The panel proposes not only enriching the stream of trained personnel into the electronics and space fields, where talent is becoming concentrated, but improving the sources that feed all the nation's technical and economic needs.

RULE ON LOUD TV ADS HANGS ON TECHNIQUES

FCC ENGINEERS think they may soon come up with objective measurements of factors contributing to objectionable loudness in radio and tv commercials. FCC plans a new rule, aimed at preventing too much contrast between commercials and programs. Volume alone is a minor problem. Rapid-fire delivery, volume expression, and recording techniques seem to cause many of the complaints FCC gets about excessive loudness. When the FCC engineers can measure these factors, the Commission will enact new controls.

COMINCO

electronic materials

high purity metals, alloys, compound semiconductors, fabrications and thermoelectric cooling materials

alloy preforms

When you order Cominco alloy preforms you are assured

- a wide range of sizes and shapes • exceptional uniformity
- consistent accurate control of impurities and alloy constituents
- homogeneity throughout your alloy lot • consistent dimensional accuracy
- precise doping • giving you more reliable contacts, higher yields.

compound semiconductors

Indium Antimonide is available in a variety of grades with electron mobilities up to 800,000 cm²/volt-sec (78°K) and net carrier concentrations from 10¹⁴ to 10¹⁸ cm⁻³ (78°K). We supply single and polycrystalline forms to your specification.

Indium Arsenide is also available for your infra-red and Hall-effect applications.

These compound semiconductors are fabricated to precise tolerances in a wide range of sizes and shapes.

thermoelectric cooling materials

Thermoelectric cooling alloys are available as dimensioned rods and capped elements of rectangular cross section having a figure of merit of 2.8 to 3.0 x 10⁻³ per degree Centigrade. With matched elements, a Δ T of 73°C-75°C, measured in vacuum, can be developed with the hot junction at 300°K.

special packaging

We take exceptional care in packaging your shipment to prevent contamination or in-transit damage to physical properties.

technical service

Our research and development program is continually expanding the range of high purity metals, alloys, compound semiconductors and thermoelectric cooling materials you can order. We invite your enquiries on advanced specifications.

available grades and forms of Cominco high purity metals

product	grade	bars	sheets	wire	powder	shot	rod	ribbon	preforms ³	salts
ALUMINUM	59	✓	✓	✓			✓		✓	
	69									
ANTIMONY	59	✓ ⁴			✓	✓				
	69	✓ ⁴								
ARSENIC	69	✓ ⁵			✓					E ²
BISMUTH	59	✓			✓	✓	✓			
	69	✓ ⁴			✓	✓	✓			
CADMIUM	59	✓	✓	✓	✓	✓	✓		✓	✓
	69	✓ ⁴							✓	
GOLD	S ¹		✓						✓	
	59		✓						✓	
INDIUM	S ¹	✓	✓	✓	✓	✓	✓ ⁶	✓	✓	✓
	59	✓	✓	✓	✓	✓	✓ ⁶	✓	✓	✓
LEAD	59	✓	✓	✓	✓	✓	✓	✓	✓	E ²
	69	✓ ⁴	✓	✓	✓	✓	✓	✓	✓	
SILVER	59	✓	✓		✓	✓ ⁸	✓ ⁸		✓	
	69	✓ ⁸	✓		✓	✓	✓		✓	
TIN	59	✓	✓	✓	✓	✓	✓		✓	
	69	✓ ⁴								
ZINC	59	✓	✓	✓	✓	✓	✓		✓	
	69	✓ ⁴	✓	✓	✓	✓	✓		✓	

1. Standard Grade. 2. Enquiries invited. 3. Preforms are available in a range of sizes and shapes such as discs, washers, squares and spheres. 4. Zone refined semicircular cross section bars. 5. Available either in quartz break-seal ampoules for transfer in a controlled atmosphere to the desired equipment or in standard packaging as dense crystalline pieces of random size. 6. Extruded. 7. Vacuum treated. 8. Vacuum treated for low oxygen content.

COMINCO PRODUCTS, INC.

electronic materials division

933 West Third Avenue, Spokane 4, Washington
Phone Area Code 509 RI 7-7103 • TWX SP311

2602

December 28, 1962

CIRCLE 13 ON READER SERVICE CARD 13

More Computers Going into

Both analog and digital types are now being used in several cities

By **STEPHEN B. GRAY**
Assistant Editor

ELECTRONIC CONTROL of vehicular traffic has quietly grown from a highway curiosity to an everyday working tool over the past five years. Within the past six months alone, seven major installations have been added to the traffic control networks of six large cities, and more on the way.

SPEED AND LANE signals on John C. Lodge Freeway, in Detroit

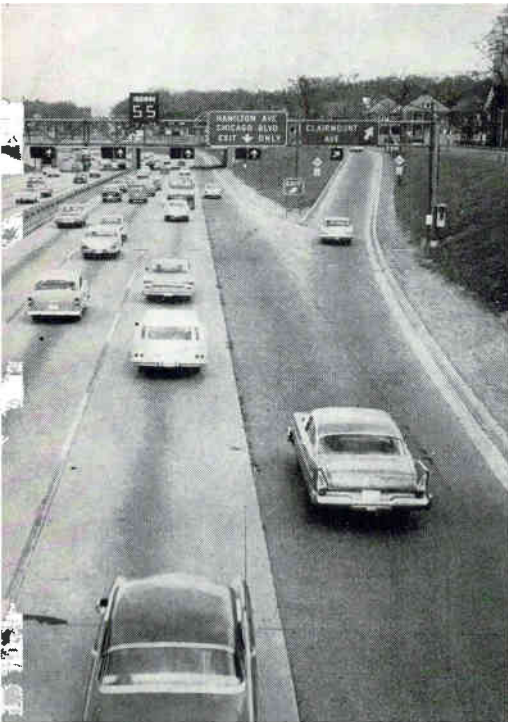

Among the latest developments are:

- Emphasis is being placed on computers. Analog, digital and combination systems are all being actively used and studied.

- New vehicle detection methods to provide computer inputs. Ultrasonics is starting to compete with radar, magnetic detectors and pressure plates.

- Growing use of radio to transmit the collected data to central control locations. Radio is often cheaper than laying cables—one-third as expensive in New York, for example.

TV MONITORS—Last May, a big closed-circuit television system began monitoring a 3.2-mile north-south stretch of the John C. Lodge Freeway near mid-town Detroit. The freeway carries as many as 180,000 vehicles a day.

The tv system, installed by General Electric, has 14 cameras mounted on bridges crossing the freeway. Each camera has a one-inch wide-angle lens for general viewing and a six-inch telephoto lens for fine detail. The camera turrets are rotated from the control center, where they are monitored.

Freeway signs show motorists the most efficient driving speed and which lanes are open to traffic. A red X over a lane closes it to traffic

when the lane is blocked. A green arrow means the lane is open. Entrance ramp signals regulate the amount of traffic entering the road.

The signals, actuated from the control center, are confirmed by a panel that is a miniature replica of the expressway and its speed and lane indicators. The operator, using data from traffic sensors and observing the 14 tv monitors, can change the control signals as traffic conditions change.

ANALOG COMPUTER—Pin-point data on the freeway's traffic is collected by 21 ultrasonic doppler detectors that measure traffic along the route. An analog computer keeps a simultaneous record of traffic speed, volume and occupancy for each lane.

The sensors and computer are made by General Railway Signal Company, which recently installed a similar system to monitor five miles of the Congress Street Expressway in Chicago.

This system has 34 ultrasonic detectors. Analog information is converted to digital data on punch-cards. Cards are processed on a general-purpose digital computer for traffic analysis studies. Operators can anticipate traffic interference far ahead of its occurrence. Minute-by-minute averages of traffic parameters can be computed.

DIGITAL COMPUTER — Last spring, four miles of Sunset Boulevard west from downtown Los Angeles went under control of a Thompson Ramo Wooldridge RW-300 digital computer.

The computer receives information on traffic volume and movement, by phone lines, from magnetic and pressure-type detectors buried in and around the controlled section. The computer uses this data and a stored analysis program continuously to determine the optimum duration of the green lights.

PRESET TIMING — Automatic-Signal division of Laboratory for



TELEVISION MONITORING and traffic-control center for the Detroit freeway with confirmation panel at right

Auto Traffic Controls

WHAT PRICE AUTOMATION?

How much would it cost to automate the traffic controls in an American city?

Any driver who has done battle with the rush-hour traffic in downtown New York City knows that there are few cities that offer more room for improvement in traffic controls.

Starting late next year, New York plans to install new traffic light systems—and computers to control them—in the lower half of Manhattan, from 59th Street to the Battery.

Cost has been estimated at more than \$10 million. With other areas in Manhattan, Bronx, Brooklyn, Queens and Staten Island added, cost would be \$21 million.

New York is considering spending \$14 million over 18 months

Electronics makes a system in which an analog-type computer continuously monitors traffic density and volume with pressure, magnetic or radar detectors.

The system selects the optimum combination of any one of six manually preset cycle lengths and several other timing factors. Data from detectors and instructions to the local intersection controllers are transmitted by a 960-Mc Motorola radio system.

An Automatic Signal installation in Los Angeles uses pressure-sensitive detectors. Interrogated every 1½ seconds, the detectors report traffic counts to a control center in city hall. The system can handle up to 32 detectors at this speed.

A recently completed Seattle installation uses six radar vehicle detectors to control 22 traffic signals in a rural section and an industrial section. Both sections can be handled independently or synchronized, as traffic dictates.

Automatic Signal is also installing a system to control more than 65 intersections throughout Boston's Back Bay.

PRETIMED SYSTEM — Around Christmas, Tampa, Fla., will open a radio traffic control system. The radio portion, punched-tape programmer and coding device are made by Motorola. Traffic detectors, interrogators and special analog computer are made by Eagle Signal Company.

The Tampa system is being installed as a pretimed system, with a punched paper tape controlling a large number of predetermined cycle changes. The punched tape controls a 24-hour period. By using codes, various programs can be intermixed on one tape. Programs will automatically change for the different days of the week, or for such special situations as parades.

Planned expansion would make the system a "universal" type, by adding capability for actuated control. Various time cycles would be automatically activated as the number of vehicles passing a given intersection increased or decreased. The vehicle-count intersection controllers would also be supplied by Eagle Signal.

Lunar Seismometers Will Now Check Ocean Bottom

OCEAN-BOTTOM seismometers and recorders, for use at depths to 15,000 feet, have been designed by the United GeoMeasurements division of United Electro-Dynamics for Scripps Institute of Oceanography. They contain a modification of UGM's lunar seismometers. A digital programmer operates the recorder at desired time intervals and provides real-time correlation of data. Upon completion of the recording, the system rises to the surface for recovery and analysis.

"Nothing is impossible to diligence and skill"
Samuel Johnson

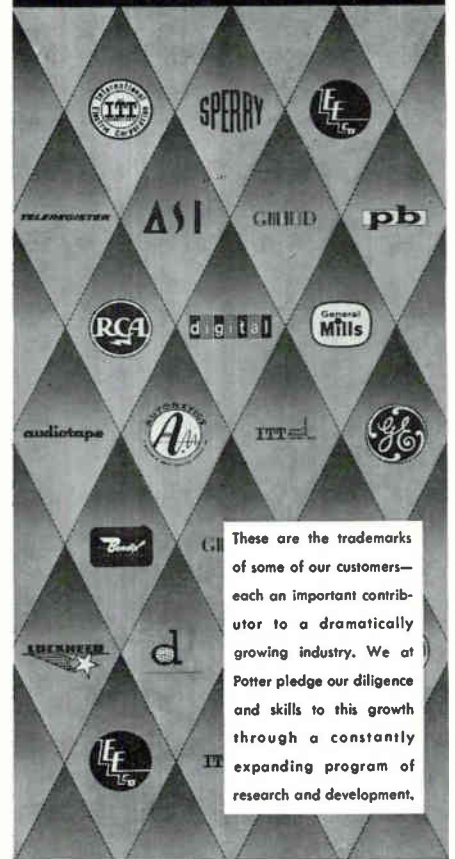

These are the trademarks of some of our customers—each an important contributor to a dramatically growing industry. We at Potter pledge our diligence and skills to this growth through a constantly expanding program of research and development.

POTTER

**Model LP-1200
High Speed
Printer adds
new versatility**

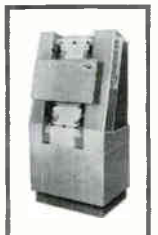

to modern computer systems. This high-performance, extremely reliable printer provides speeds of 1000 lines per minute with a maximum of 160 columns. An optional Format Control feature permits multi-page forms or books to be printed with completely flexible horizontal or vertical format and up to five carbons.

The Potter LP-1200 reflects the engineering-knowledge gained from extensive experience and research in high-speed printing. Solid-state modular electronics enhance reliability and sturdy, simple mechanical design readily adapts to meet customer requirements.

Three models are available: LP-1200—160 (160 columns), LP-1200—132 (132 columns) and LP-1200—80 (80 columns).

Write for specifications.



Manufacturers of:
• Digital Magnetic Tape Systems
• Perforated Tape Readers
• High Speed Printers
• Data Storage Systems

POTTER INSTRUMENT CO., INC.
Sunnyside Boulevard • Plainview, New York

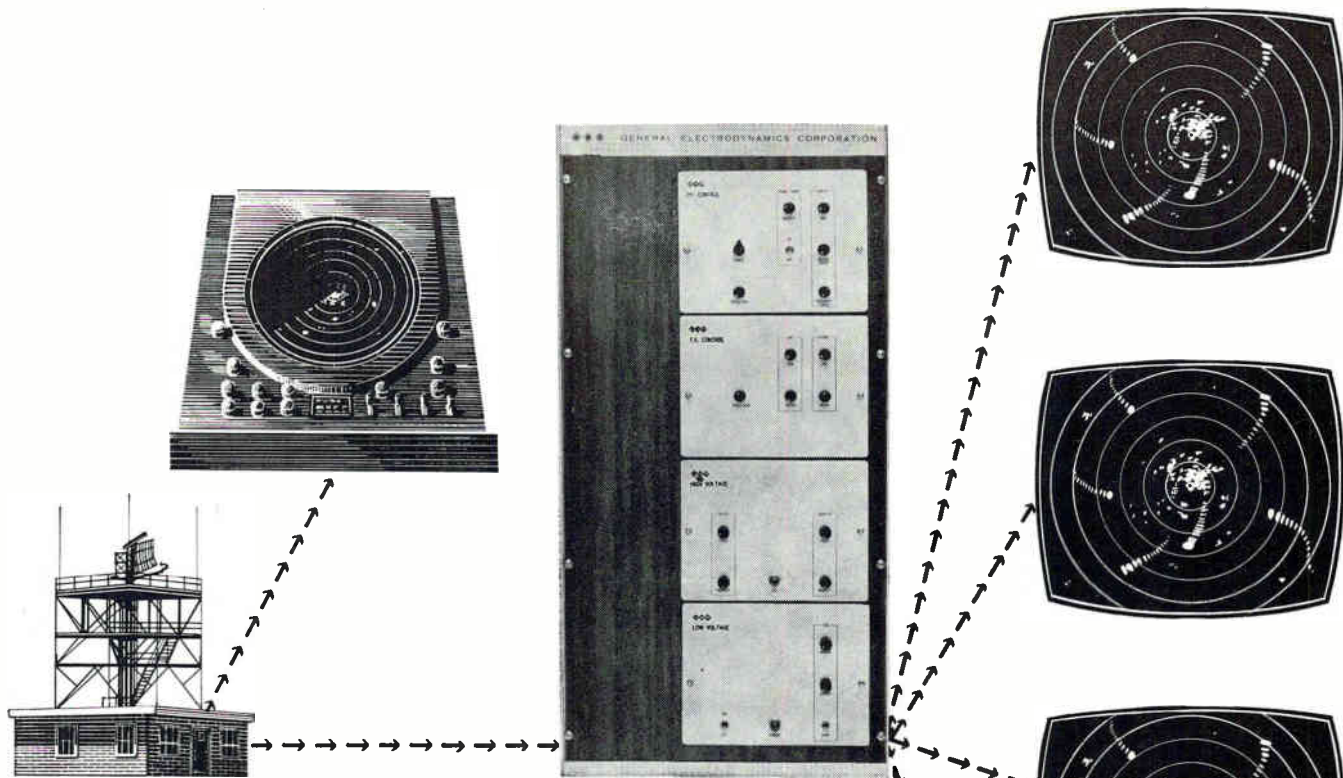

Now Multiple PPI Displays Under High Ambient Light Conditions... With GEC Scan Converter

With GEC's *transistorized* 6021 Scan Converter, it is no longer necessary to look at rapidly decaying PPI displays in dark surroundings. Any number of inexpensive TV monitors can be operated from one PPI source with controlled image storage time affording more reliable evaluation of displayed information.

Readily tailored to your specific requirements through its plug-in functional modules, the 6021 Scan Converter is capable of:

- ◆◆◆ TRANSLATION of video information from one scanning mode to any other.
- ◆◆◆ STORAGE and INTEGRATION of video information.
- ◆◆◆ TIME-COORDINATE TRANSFORMATION for expansion or reduction of bandwidth.

Contact GEC for more information about conversion of radar PPI to TV, TV standards conversion or conversion of slow scan narrow band TV to standard TV or vice versa.

Qualified electronic engineers are needed for work in the field of Scan Conversion. Address inquiries to Professional Placement Manager. An equal opportunity employer.

. . . advanced electronics at work



GENERAL ELECTRODYNAMICS CORPORATION

4430 FOREST LANE • GARLAND, TEXAS • BROADWAY 6-1161



New! Round Lighted Pushbutton Assemblies with four lamps under display screen

MICRO SWITCH Round "Series 2" lighted pushbutton switch assemblies add a new dimension to panel design.

- Modular construction...assemble interchangeable modules without tools.
- Choose from translucent color screens or translucent white screens with color filters over four separate lamps.
- Choice of 20 different switch units.

The new round form modules match the rectangular modules (see other side of page) in size, tactile "feel", screen colors and light output. They are available as indicators only, or as operator-indicators with switch units. Switching action can be momentary or maintained (push on, push off), and with or without magnetic detent coil. Color variations in display screens and guard rings enable panel designers to code control functions. Guard rings come in two heights. Contact a MICRO SWITCH application engineer (see Yellow Pages for Branch Office) or write for Data Sheet 199.



MICRO SWITCH

FREEPORT, ILLINOIS

A DIVISION OF HONEYWELL

IN CANADA: HONEYWELL CONTROLS LIMITED, TORONTO 17, ONTARIO

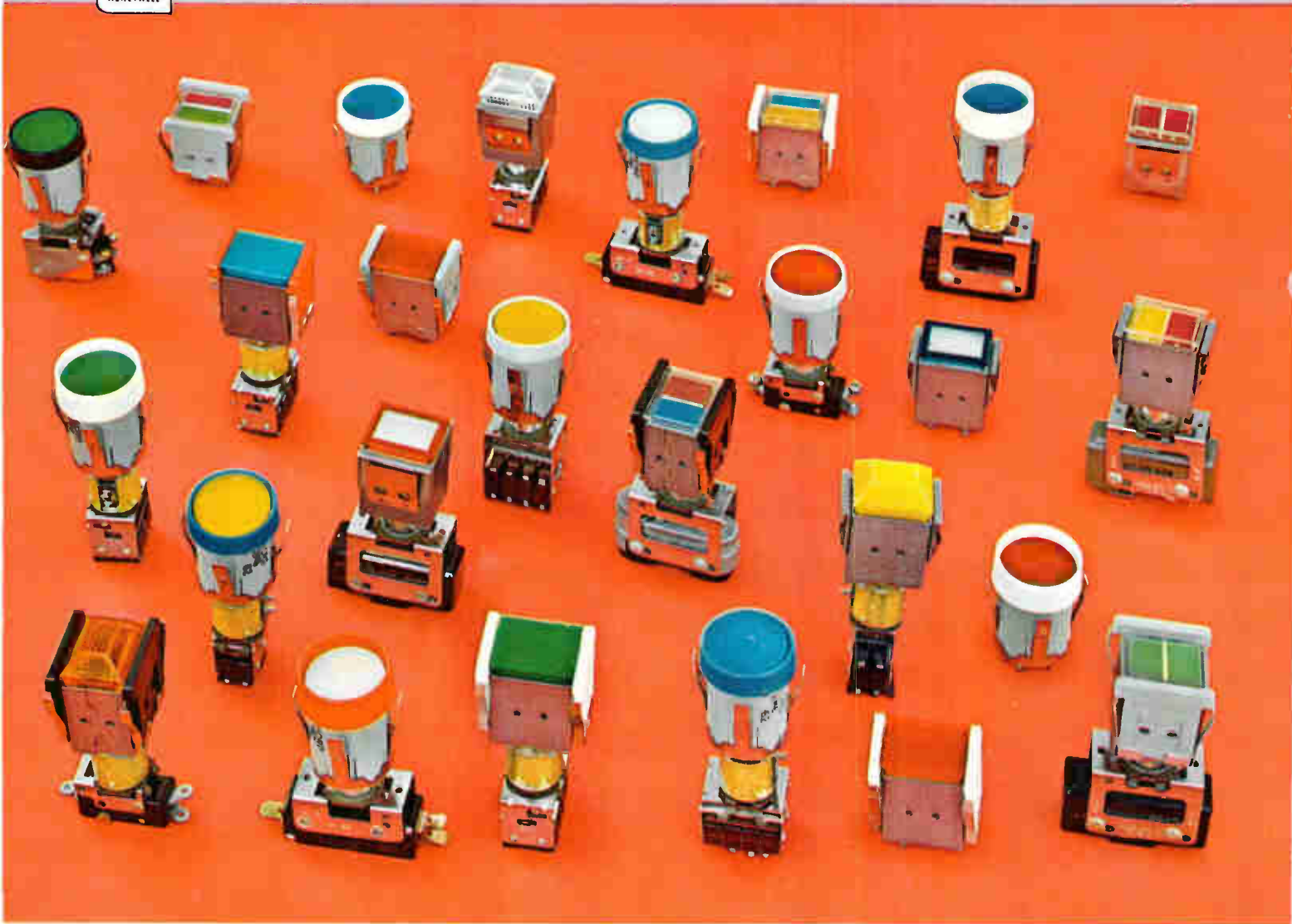

"Series 2" lighted pushbuttons in round or rectangular shape Thousands of combinations of shapes, colors, mounting barriers, switching units

The new round shape display, together with the popular rectangular shape, gives the human factors engineer unlimited panel design possibilities for visual separation of multiple functions—both control and indication.

Under each display screen are four lamps, each lamp with separate termination. Up to four colors can be projected through each screen.

Choose from 20 different switch units—including hermetically sealed and subminiature assemblies. Circuitry and electrical ratings match your requirements! Each switch has the precision and reliability for which MICRO SWITCH is known.

For engineering assistance, call a MICRO SWITCH Branch Office. (See Yellow Pages.) Write for Catalog 67.



MICRO SWITCH

FREEPORT, ILLINOIS

A DIVISION OF HONEYWELL

HONEYWELL INTERNATIONAL Sales and service offices in all principal cities of the world. Manufacturing in United States, United Kingdom, Canada, Netherlands, Germany, France, Japan.

IN CANADA: HONEYWELL CONTROLS LIMITED, TORONTO 17, ONTARIO

Of interest to engineers and scientists

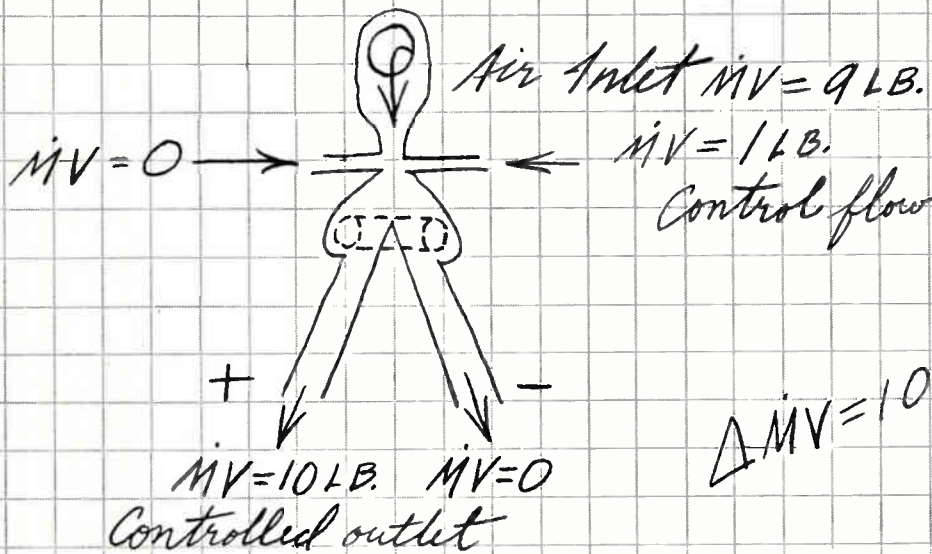

PNEUMATIC CONTROL RESEARCH

...one of the more than 500 R & D programs under way at Douglas

This Douglas sponsored program seeks to provide the aerospace industry with an all pneumatic control system which has no moving parts.

Under investigation are pneumatic amplifiers, flip-flops, proportional flow devices and logic elements—the building blocks for digital computers. Experiments are being conducted in the Douglas Aerophysics Laboratory on advanced techniques in vortex control and the effects of scaling and Reynolds Number.

Important progress has been registered. Success in this field will provide simple, light weight, low cost control systems that will operate under extremes of temperature and radiation.

Of career interest to engineers and scientists
Douglas has entered into a period of greatly expanded activities in programs (like the above)

which relate to tomorrow's technology. Outstanding positions are now open in a wide variety of fields.

We urge you to contact us regarding an important position if your background relates to any of the following: electronics, communications, aerodynamics, astrodynamics, thermodynamics, structures, propulsion or mechanical.

Send us your resume or fill out and mail the coupon. Within 15 days from the receipt of your letter, we will send you specific information on opportunities in your field at Douglas.



MISSILE & SPACE SYSTEMS DIVISION

An equal opportunity employer

Mr. F. V. Edmonds
Missile and Space Systems Division
Douglas Aircraft Company
3000 Ocean Park Boulevard
Santa Monica, California

F-16

Please send me full information on professional opportunities in my field at Douglas.

Name

Engineering or scientific field

Address

City

State

Airborne Soil Analyzers Will Help Army Plan Its Campaigns



ANTENNA CARRIAGE travels in a 60-degree arc inside 50-foot arch to determine best angle for measuring terrain characteristics

Four-band radar now gathers soil signatures to aid system design

By MARVIN REID
McGraw-Hill World News

VICKSBURG, MISS. — During a military campaign, a field commander may turn to an aide and ask: "What's the trafficability of the terrain in the region 10 miles

beyond our right flank?"

What he means is: Is that ground mushy or hard? Can the enemy send tanks in? Will my antitank weapons get bogged down? What's the best road for my mobile missile launchers?

A new kind of radar laboratory, one that will guide the design of an airborne system to answer those questions quickly, went into operation a few weeks ago at the U.S. Army Engineer Waterways Experiment Station here.

The bistatic pulsed radar facility

is part of an overall study of terrain analysis. The station's Army Mobility Research Center (AMRC) is also studying infrared and other sensors.

E. B. Lipscomb, chief of AMRC's Terrain Analyzer Section, visualizes eventually a multisensor system that can be put in an aircraft.

Such a system, Lipscomb says, could perceive, register and integrate data on the makeup of terrain, to give that military field commander the regional trafficability data he needs in a hurry.

Digital and Analog Computers Combined

HYBRID COMPUTER CENTER, for analog-digital simulation and control of industrial processes, has been placed in operation by Minneapolis-Honeywell. Two EAI 231R analog units and a Honeywell 290 digital computer are combined, with special sections for high-speed linkage between the units. The new center will analyze and design process control systems, evaluate operating economics of plants, and simulate complete control programs



DUAL PROGRAM—Lipscomb says the project has two phases:

Primary goal of the first phase is to "fingerprint" terrain properties such as soil type, moisture content, density and other trafficability factors by examining "their electromagnetic characteristics in the ultraviolet-through-radar region of the spectrum."

This phase is being conducted in the lab under controlled conditions with prepared soil samples of known characteristics. Here the effect of varying one particular parameter, such as grain size or moisture content, on the electromagnetic reflectance and emissivity properties of various materials can be determined.

The second phase will be determining the properties of materials under field conditions. Labora-



TRANSMITTING and receiving antennas of the four-band radar system are separated for bistatic studies

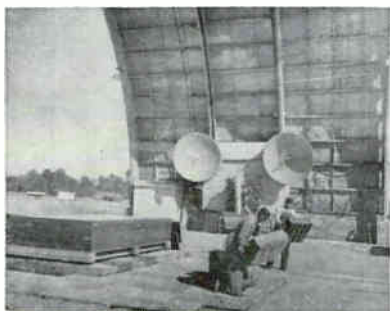

SPECIMENS covered with microwave absorbers provide a zero reference. Here, workmen remove absorbers to bare specimen for reflectivity tests

tory procedures and findings will be extrapolated for field use.

AMRC began infrared sensors studies in October, 1960. Start of the radar tests followed a feasibility study by the Science Services division of Texas Instruments.

In line with phase one, the facility measures and analyzes the effects on radar of soil samples. A catalogue of terrain signatures will be built up for matching with future airborne data.

RADAR SYSTEM — The radar, called Westar (for Waterways Experiment Station Terrain Analyzer Radar), represents two major advances—reducing a complete P-band radar into a laboratory system, and making actual lab measurements with a C-band system.

TI designed and built the system to cover the K, X, C and P bands. The four-band combination was chosen because of Westar's needs.

Lipscomb's group wanted a system that would analyze soil conditions to a depth of at least 18 inches. TI's feasibility study showed that P-band gave deep penetration in wet soils, while the other three bands are useful for analyzing soils of low moisture content. Lipscomb

(Advertisement)

New Film Dielectric Displays Unusual Stability

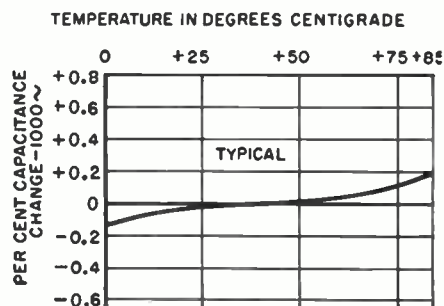

A new duplex plastic film dielectric developed and patented by the Sprague Electric Co. displays practically a zero temperature coefficient of capacitance over operating ranges up to +85 C. The retrace on return to room temperature is within $\pm 0.10\%$.

This new dielectric is currently being used in Sprague Electric's ISOFARAD Capacitors which are finding wide application in critical circuits of color TV receivers. The insulation resistance and dielectric absorption characteristics of these capacitors approach those of polystyrene film capacitors. ISOFARAD capacitors also are said to be superior to silvered mica capacitors in insulation resistance. Their tubular shape makes them more adaptable than silvered mica units for machine insertion on printed wiring boards. For practical purposes, their capacitance stability is equivalent to the more expensive silvered mica units.

Capacitor sections are of extended-foil design and are housed in pre-molded phenolic shells with plastic-resin end seals for protection against moisture and mechanical damage. Standard ISOFARAD Capacitors are rated at 500-volts d-c and are available with capacitance tolerances as close as $\pm 5\%$.

For complete technical data on ISOFARAD Capacitors (Type 145P), write for Engineering Bulletin 2073A to Technical Literature Section, Sprague Electric Company, 35 Marshall Street, North Adams, Massachusetts.

48-248

CIRCLE 200 ON READER SERVICE CARD

new!

NANOSECOND PULSE TRANSFORMERS IN TO-5 TRANSISTOR CASES!

Sprague Type 45Z Subminiature Pulse Transformers are especially designed for use in low-power, ultra-high-speed computer circuitry.

Their TO-5 transistor cases offer several distinct advantages:



1. Another step forward in minification
2. Welded hermetic seal on high-density package
3. Increased uniformity and reliability
4. Compatibility with transistor mounting techniques

In order to suit various installation and packaging techniques, Type 45Z Pulse Transformers are available with standard length wire leads. Weldable or solderable leads can be furnished. Short pin-type leads for use with subminiature sockets are also available.

For complete technical information on Type 45Z Pulse Transformers, write for Engineering Data Sheet 40210 to Technical Literature Service, Sprague Electric Company, 35 Marshall Street, North Adams, Massachusetts.



48-441

CIRCLE 21 ON READER SERVICE CARD

21

reports that early radar results bear out the feasibility report.

While no existing radar was suitable for both laboratory and airborne operations, TI found its existing radars and components in the K., X, C and P bands could be modified from AN/TPS-21 or AN/TPS-33 radar components.

WOODEN ARCH — The 50-foot arch is laminated wood. Microwave absorbants, a high level of signal-range gating and 100-db antenna isolation, help insure that radar recordings are purely from the terrain specimens, says Allen Feder, of TI's Science Services division. Radar echo amplitudes could overlap, just as many object images on a black and white aerial photo could have the identical grey-scale level, Feder adds. Therefore, the best way to get valuable radar signatures appears to be as functions of signal amplitudes γ for the spread of aspect angles θ from normal to grazing incidence.

To provide these γ - θ curves, the antennas are mounted on a carriage that travels from 30 to 90 degrees along the arc of 50-foot radius, centered on the upper surface center of the terrain material specimen.

Arc radius was set at 50 feet to insure that measurement would be made with far-field energy.

Terrain material is contained in a 12 x 6 x 2-foot cart.

The 6 x 12-foot specimen surface dimension encloses all of the radar beam cross section at all aspect angles involved for K., X, and C bands. The 2-foot specimen depth represents maximum C-band penetration in saturated soils.

Normal test procedure is to fill the cart with various types of soils

from different regions. Soil parameters are measured for various natural conditions. Before each test run, the specimen is covered with a microwave absorbant material to give a zero reference. Changes from the zero reference to exposed specimen run show the soil parameters.

Westar can tell terrain material specimen moisture content to 0.1 percent and read specimen temperatures to 0.1 deg C. Specimens can be prepared with grass or snow cover, or can even consist of possible lunar materials. Mines, cables and other objects can be buried in the specimens to determine their radar response. Engineering structure models can be employed for simulation studies.

AIRBORNE SYSTEM — Another objective in designing the laboratory system was to select standard radar equipment that could be modified for later airborne use.

Westar's people expect to know by next July whether a modified version of the Vicksburg radar is feasible for airborne use. If the decision is made to go airborne, it would take another six months to a year to fabricate the system.

AMRC is thinking at this stage of an aircraft equipped with radar, infrared, visible photography, and other electromagnetic sensors.

AMRC is primarily interested in military needs for a system that reliably and rapidly analyzes the top 18 inches of a region's terrain. Other potential applications are highway right-of-way surveying, natural resource surveys and perhaps systems for mapping soils on the moon from a lunar orbiting vehicle.



The increased emphasis on reliability is in part the growth of our Electronic/Aerospace industries but made vital with the manned space flight era. Though the function of an electrical component is primarily electrical or electronic, final reliability lies in the mechanical performance. In wire and cable products, for example, failures due to cut-through, abrasion, and cold-flow have been numerous; these experiences should be a basic factor in design considerations.

Through techniques in applied radiation chemistry, research emphasis at Raychem has been on mechanical integrity. The resistance to abrasion as expressed by MIL-T-5438 and comparative deformation under load characteristics per ASTM D 621 are convincing tests which confirm mechanical toughness not existent in other high temperature insulation systems.

Though spacecraft reliability represents the extreme in mechanical/electrical design needs, this same reliability is a vital part of complex ground-based systems as well.

TELEFEEL? WAIT ABOUT 10 YEARS

NEW YORK—Prototype equipment for the "feelies" of "Brave New World" fame is at least 10 years away.

It will take that long to solve the sensing and display problems associated with feeling at remote distances, indicated T. B. Sheridan, of MIT, at the Human Factors Society meeting.

A true display would reproduce in man the tactile sensation being experienced by remote equipment. Some preliminary experiments with air jets and servo-drive rods have been made, but results are not definitive.

Another technique, translating pressure or displacement into visual readout on an oscilloscope, appears to solve some handling problems and will probably be used in initial equipment



RAYCHEM.
CORPORATION

REDWOOD CITY, CALIFORNIA
CIRCLE 23 ON READER SERVICE CARD

THE FACTS ABOUT WIRE FAILURES

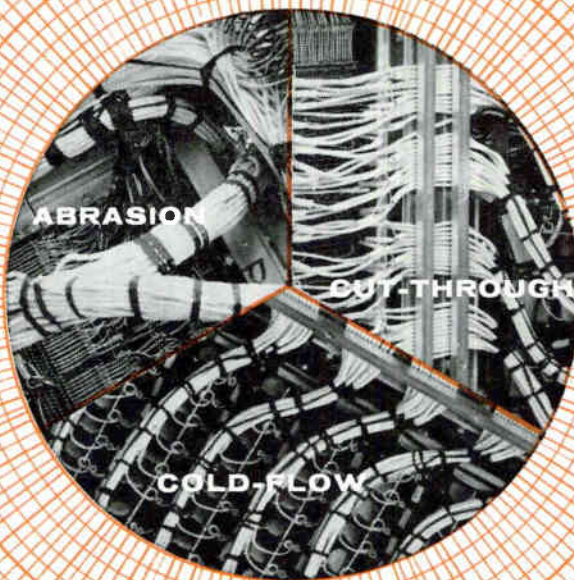

MECHANICAL TOUGHNESS...THE KEY TO RELIABILITY

RAYOLIN N HOOK-UP WIRE

**LEADER IN RADIATION CHEMISTRY
FOR ELECTRONIC WIRE AND CABLE**



**RAYCHEM.
CORPORATION**

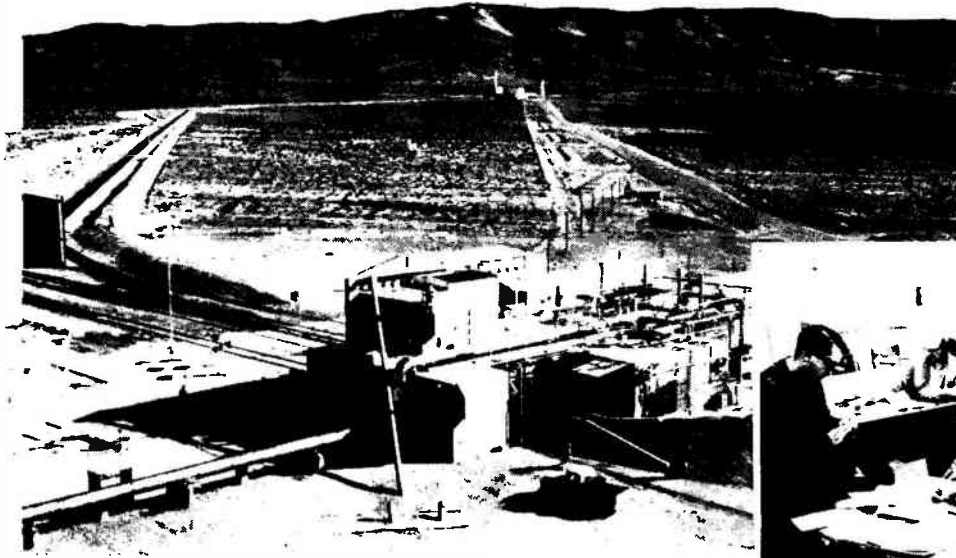

TEST CELL where Nuclear Rocket Development Station has been trying out Kiwi reactors. Assembly building is 1½ miles away

CONTROL POINT for remote operation of Kiwi reactors during tests

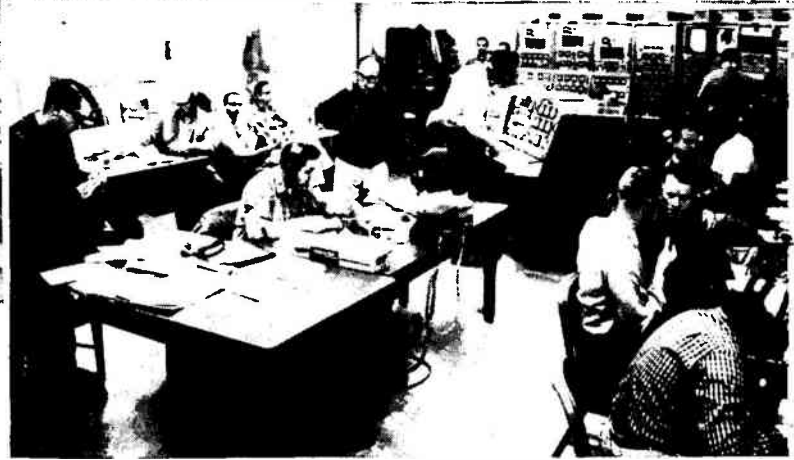

Project Rover's Long-Range Target:

But funds squeeze may slow development of nuclear rockets

By HAROLD C. HOOD
Pacific Coast Editor

MERCURY, NEV. — Five days after the President's visit to the site, newsmen got their first glimpse of the Nuclear Rocket Development Station (NRDS) here. They got some eye-opening figures on Project Rover, the nation's program to develop nuclear propulsion systems

for lunar and planetary flights.

- A nuclear-propelled spacecraft for a manned Martian landing, for example, would weigh one-tenth as much as its chemically propelled counterpart.

- To create a thrust of 50,000 pounds the light-weight flying reactor must produce a million btu per second, or enough energy to boil away a ton of water every two seconds.

- Electronic equipment for one flight vehicle will cost easily \$1 million.

In simplified terms, a nuclear rocket engine consists of a reactor,

a nozzle, and a turbopump. Liquid hydrogen is pumped from the vehicle's tank through the reactor core where it is heated to over 5,000 F in a fraction of a second. Hydrogen gas is then accelerated through the jet nozzle at a specific impulse (thrust per pound of propellant) two or three times that attainable from a chemical combustion engine.

THREE PROJECTS—Rover consists primarily of three projects—Kiwi (a flightless bird), Nerva (Nuclear Engine for Rocket Vehicle Application), and Rift (Reactor-in-Flight Test).

Kiwi provides the basic reactor technology for the entire program. Six Kiwi ground test reactors have been tested, the first in July, 1959, and the most recent last month. (The tests have been successful, by and large. For example, in a test November 30, the cracking of a thermal insulator was the only hitch, according to a NASA spokesman in Washington. Remaining problems are chiefly mechanical and materials design.)

Other tests, including a simulated water entry and a "run-till-destruction" are scheduled over the next two years. Los Alamos Scientific Laboratory runs Kiwi.

ROVER SLOWDOWN IS EXPECTED

The word from Washington last week coincided with the word from Mercury, Nev. Rover will probably get \$200 million in the fiscal 1964, about half of the project's request.

Key factor in the expectation was President Kennedy's statement on his return from Los Alamos:

"The nuclear rocket, even under the most favorable circumstances, would not play a role in any first lunar landing. This will not come into play until 1970 or '71. It would be useful for further trips to the moon or trips to Mars. But we have a good many areas competing for our available space dollars, and we have to try to channel it into those programs which will bring us a result first, on our moon landing, and then to consider Mars."

Rover has to prove itself by next July before a decision will be made on extra money, Kennedy said

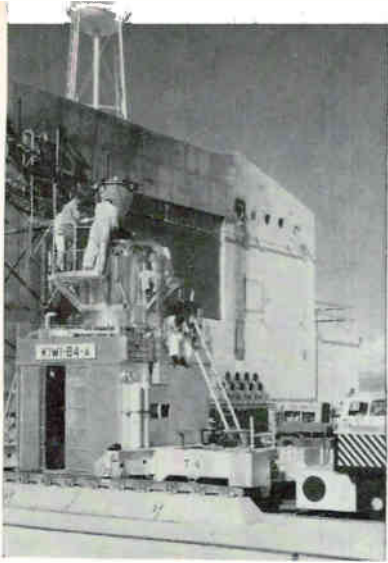

KIWI REACTOR is prepared for testing. This one was tested November 30

Man on Mars

Project Nerva is now in early stages of component development, and will yield a rocket engine suitable for flight in outer space.

The development program for the Nerva engine differs from those for other rocket engines primarily in that all disassembly, maintenance and reassembly must be done remotely and behind heavily shielded walls. (First test-stand firing is scheduled for 1964. As many as 30 or 40 Kiwi-type reactors may be used in tests leading up to a flight model.)

Prime contractor for Nerva is Aerojet-General, with Westinghouse Electric supplying the reactor, AMF responsible for engine assembly and remote disassembly, and Bendix developing control system actuation devices. Edgerton, Germeshausen & Grier is performing instrumentation and control.

FLIGHT TESTS—Lockheed Missiles and Space Co., prime contractor for Rift, is preparing Nerva's flight test vehicle. This will demonstrate nuclear propulsion in flight as a third stage of the C-5 Saturn.

In all, 10 Rift stages will be built. Five will be shipped to NRDS for static tests and four will go directly to Cape Canaveral for

SPECIFY ARNOLD IRON POWDER CORES... COMPLETE RANGE OF SIZES AND SHAPES FOR YOUR DESIGNS



Arnold offers you the widest range of shapes and sizes of iron powder cores on the market.

In addition to toroids, bobbin cores and cup cores—typical groups of which are illustrated above—Arnold also produces plain, sleeve and hollow cores, threaded cores and insert cores, etc., to suit your designs. Many standard sizes are carried in warehouse stock for prompt shipment, from prototype lots to production quantities. Facilities for special cores are available to order.

The net result is extra advantage and

assurance for you. No matter what shapes or sizes of iron powder cores your designs require, you can get them from a single source of supply—with undivided responsibility and a single standard of known high quality.

Arnold's superior facilities for manufacture and test also assure you of dependably uniform cores, not only in magnetic properties but also in high mechanical strength and dimensional accuracy.

● For technical data and other information on Arnold iron powder cores, write for a copy of Bulletin PC-109A.

ADDRESS DEPT. E-12



ARNOLD

SPECIALISTS in MAGNETIC MATERIALS

THE ARNOLD ENGINEERING COMPANY, Main Office: MARENGO, ILL.
BRANCH OFFICES and REPRESENTATIVES in PRINCIPAL CITIES

2841R1A

GREEN PANTOGRAPH ENGRAVERS

● ELIMINATE DELAYS!

● KEEP YOUR OPERATING COSTS WHERE THEY SHOULD BE!



**PORTABLE
40-POUND
BENCH MODEL 106**

*You Make
Your Own
Engraved
Nameplates!*

Here is a speedy, economical 2 or 3-dimensional engraver used by thousands of dollar-conscious companies. It features 5 positive, accurate pantographic ratios; ball bearing spindle with 3 speeds up to 14,000 rpm. Is supplied with one copy carrier that accepts all standard master type sizes. Will actually work up to 10" by any width. Height of pantograph and position of cutter are continuously adjustable.

MODEL D-2 HEAVY-DUTY 2-DIMENSIONAL



Pantograph for milling, drilling and engraving.

Vertical adjustment of scroll table automatic with Pantograph. Features unobstructed on 3 sides to take large work; micrometer adjustment for depth of cut; ball bearing construction throughout; spindle speeds up to 26,000 rpm for engraving or machining; vertical range over 10"; ratios 2 to 1 to infinity — master copy area 26" x 10"

NEW

MODEL D2-201 PNEUMATIC ATTACHMENT

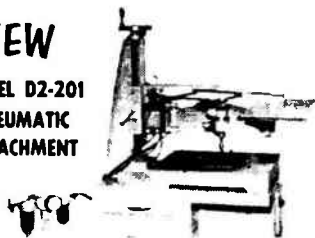

for use with Model D2 Pantograph Engraver to rapidly drill holes in printed circuits by tracing templates. Drills as many as 100 holes per minute. Equipped with foot switch; spindle air cylinder; regulating valve and pressure gauge; filter and oiler. It's ready to use as soon as it's attached to an air compressor.

Write or call for full details and prices.

**GREEN INSTRUMENT
COMPANY, INC.**

Dept. 63, 295 Vassar St.,
Cambridge 39, Mass. Tel. Eliot 4-2989

deep-water lob shots.

First flight, expected in 1967, will carry an inert Nerva engine. The next three trajectories will include nuclear operation of the Rift stage, coast, and nuclear restart. A regular Saturn booster stage will be used, with a dummy second stage. Above the Rift stage will be a special instrument unit.

In late Rift-Nerva phases, NASA will introduce a second family of reactors of enhanced power design, called Phoebus. Phoebus will be another Kiwi-type program of ground testing.

If the budget permits, some design considerations are coming up next year. Whether Phoebus gets under way, and, in fact, whether Nerva-Rift gets a full start, depends on considerations now under way in Bureau of the Budget.

FUNDS TRIMMED—The Space Nuclear Propulsion Office (SNPO) hedges when asked how much it will spend on Kiwi, Nerva and Rift, but one spokesman referred to Rover as "a billion-dollar program." To date \$265 million has been spent. Some \$380 million has been requested for next fiscal year, but informed sources feel this will be trimmed to \$200 million. This will keep the program going at its present level, they say.

SNPO manages the three-pronged program. The office was established in August, 1961, by AEC-NASA agreement, and reports to both agencies.

ELECTRONICS PROBLEMS — In explaining some of the problems faced by his electronics designers, a Lockheed official underlines the fact that Rift must be able to operate satisfactorily in the radiation field set up by Nerva.

"Instrumentation used for conventional liquid hydrogen rockets in the past has been found to be completely unsuitable," he points out.

"Capacitance probes in liquid hydrogen tanks, for example, may be off by a factor of three in the presence of ionization produced by radiation. Another problem area is thermocouples. Since materials having significant density tend to generate heat in the presence of radiation, these may not be accurately indicating the temperature of their



CAVITY REACTOR concept being researched by NASA. Heat from core of fissioning plutonium gas would energize hydrogen propellant

surroundings. One answer is to keep the mass of components to a minimum.

"Ironically, the first time we've had no weight and size limits," he said, "we still have to miniaturize."

Signal noise introduced by radiation is a new problem for Lockheed's circuit designers. Avoiding high impedance loads has helped in some cases and regenerative feedback loops have been employed in others. The use of magnetic amplifiers, high-temperature amplifiers, and filamentless ceramic tubes is being investigated as a means of combatting the high-temperature environments anticipated. Welded module techniques are being used for most of Rift's electronics.

Phased-Array Problem Supplying 2,000 Tubes

BEDFORD, MASS.—Logistics presents one of the toughest problems in phased-array radar systems, said J. S. Cook, of Bell Telephone Labs, at an IRE meeting here. A phased-array system might have 2,000 transmitter power amplifier tubes.

Within 10 years, when phased arrays become competitive with other systems, high-volume production of tubes will be needed and their price will have to decrease by a factor of 100—down to \$50.

Commented one engineer: "Sounds like every phased-array system will have to have a tube factory built along with it."

There is great need for components designed specifically for phased array use, said N. F. Pribble, of Bendix Radio. Attempts to adapt other components result in prohibitive cost. Pribble is design group leader of the phased-array radar for Spadats (p 7, Oct. 19).

MEETINGS AHEAD

MILLIMETER AND SUBMILLIMETER CONFERENCE, IRE; Orlando Section; Cherry Plaza Hotel, Orlando, Florida, Jan. 7-10.

RELIABILITY & QUALITY CONTROL SYMPOSIUM, IRE-PGRQC, AIEE, ASQC, EIA; Sheraton Palace Hotel, San Francisco, Calif., Jan. 21-24.

INSTITUTE OF ELECTRICAL & ELECTRONICS ENGINEERS WINTER GENERAL MEETING & EXPOSITION, IEEE; Statler and New Yorker Hotels, New York City, Jan. 27-Feb. 1.

MILITARY ELECTRONICS WINTER CONVENTION, IRE-PGMIL; Ambassador Hotel, Los Angeles, Calif., Jan. 30-Feb. 1.

QUANTUM ELECTRONICS INTERNATIONAL SYMPOSIUM, IRE, SFER, ONR, Unesco Building and Parc de Exposition, Paris, France, Feb. 11-15.

INFORMATION STORAGE AND RETRIEVAL SYMPOSIUM, American University; International Inn, Washington, D. C., Feb. 11-15.

ELECTRICAL & ELECTRONIC EQUIPMENT EXHIBIT, ERA, ERC; Denver Hilton Hotel, Denver, Colo., Feb. 18-19.

SOLID STATE CIRCUITS INTERNATIONAL CONFERENCE, IRE-PGCT, AIEE, University of Pennsylvania; Sheraton Hotel and U. of P., Philadelphia, Pa., Feb. 20-22.

PACIFIC COMPUTER CONFERENCE, AIEE; California Institute of Technology, Pasadena, Calif., March 15-16.

BIONICS SYMPOSIUM, United States Air Force; Biltmore Hotel, Dayton, Ohio, Mar. 18-21.

IEEE INTERNATIONAL CONVENTION, Institute of Electrical and Electronics Engineers; Coliseum and Waldorf-Astoria Hotel, New York, N. Y., March 25-28.

ENGINEERING ASPECTS OF MAGNETO-HYDRODYNAMICS SYMPOSIUM, IRE-PGNS, AIEE, IAS, University of California; UCLA, Beverly, Calif., April 10-11.

OHIO VALLEY INSTRUMENT-AUTOMATION SYMPOSIUM, ISA, et al; Cincinnati Gardens, Cincinnati, Ohio, April 16-17.

INTERNATIONAL NON-LINEAR MAGNETICS CONFERENCE, IRE-PGEC, PGIE, AIEE; Shoreham Hotel, Washington, D. C., April 17-19.

ADVANCE REPORTS

INTERNATIONAL MEASUREMENTS CONFERENCE, ISA, et al; Stockholm, Sweden, June 1964. No specified deadline has been set for submitting papers, but in view of conference's international character, they should be submitted as soon as possible to: R. D. Douglas, Hydraulic Laboratory, Newport News Shipbuilding and Dry Dock Company, Newport News, Virginia. Subject titles include: general problems of electronics for measuring purposes; border questions on measurement and automation; instruments and methods for measuring electrical and magnetic quantities; radio-engineering measurement instruments and methods; radioactive-radiation measurement.

WHERE WILL ELECTRONICS BE IN 1963?

find out by visiting the

6

th international
exhibition of
electronic
components

FROM FEBRUARY 8-12, 1963

AT PARIS (PORTE DE VERSAILLES)

THE GREATEST WORLD-WIDE
EXPOSITION OF THE ELECTRONICS
INDUSTRY

Components, tubes and semiconductors,
measurement & control instrumentation
electro-acoustical equipment

Send Now For Full Details

FEDERATION NATIONALE
DES INDUSTRIES ELECTRONIQUES

23, rue de Lubeck, Paris—16e—Tel: PASsy 01-16



3

rd
international
symposium
on quantum
electronics

Under the auspices of the French Section
of the I.R.E. and the S.F.E.R.

From FEBRUARY 10-15, 1963

MAISON DE L'UNESCO

Information: 7, rue de Madrid—Paris 8e

From Western Electric—Laureldale

A COMPLETE FAMILY OF WELL-MATCHED, HIGH FREQUENCY TRANSISTORS



USA2N1094



JAN2N1195



USA2N537



2N1645

2 kc–100 Mc Broad Band Linear Amplifier

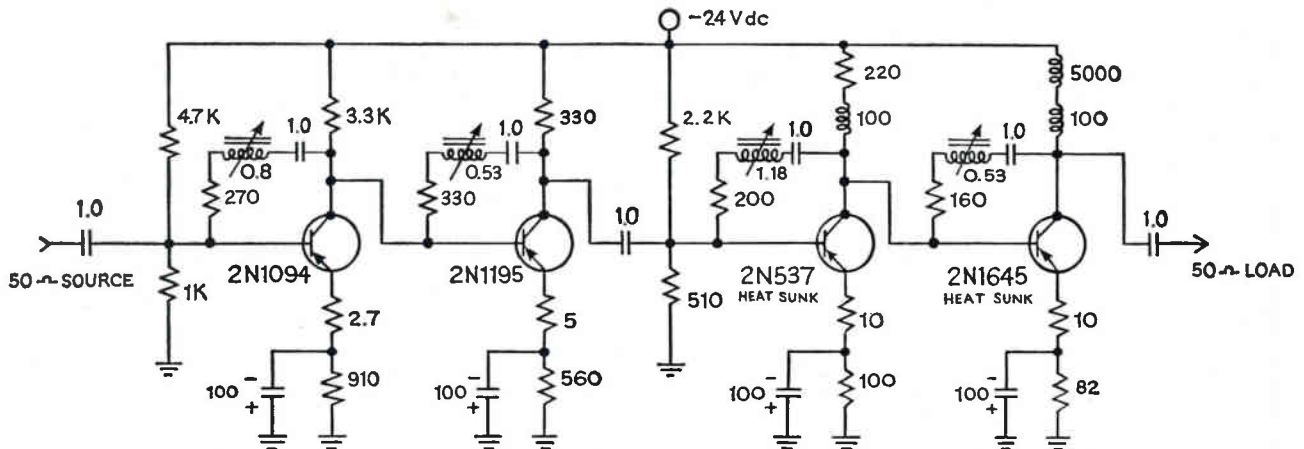

AMPLIFIER CHARACTERISTICS
INSERTION POWER GAIN - 40db
NOISE FIGURE - < 10db FROM 20-100 MC

ALL RESISTANCES IN OHMS
ALL CAPACITANCES IN μ f
ALL INDUCTANCES IN μ h

DEVICE CHARACTERISTICS

	USA 2N1094	JAN 2N1195	USA 2N537	2N1645
f_t (typical) Mc	650	550	600	600
RE h_{ie} (typical) ohms	100	60	45	25
C _{cb} (dir) (typical) pf	1.5	2.3	2.2	10
h_{fe} (typical)	50	45	25	65
BVC _{BO} min vdc	-30	-30	-30	-35

TYPICAL FREQUENCY-GAIN CHARACTERISTICS

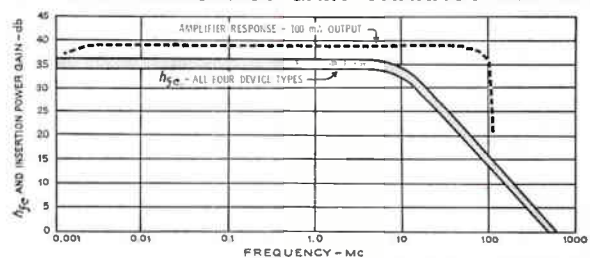

The four germanium transistors described above may be purchased in quantity from Western Electric's Laureldale Plant. For further technical information, price, and delivery, address your request to Contracting Department, Room 102, Western Electric Company, Incorporated, Laureldale, Pa. Telephone—Area Code 215—929-5811.

LAURELDALE PLANT
MAKER OF ELECTRON PRODUCTS



POLYMERIZATION of silicon oil, used as an insulator for grid of hot-electron triode, is observed by author Tantraporn

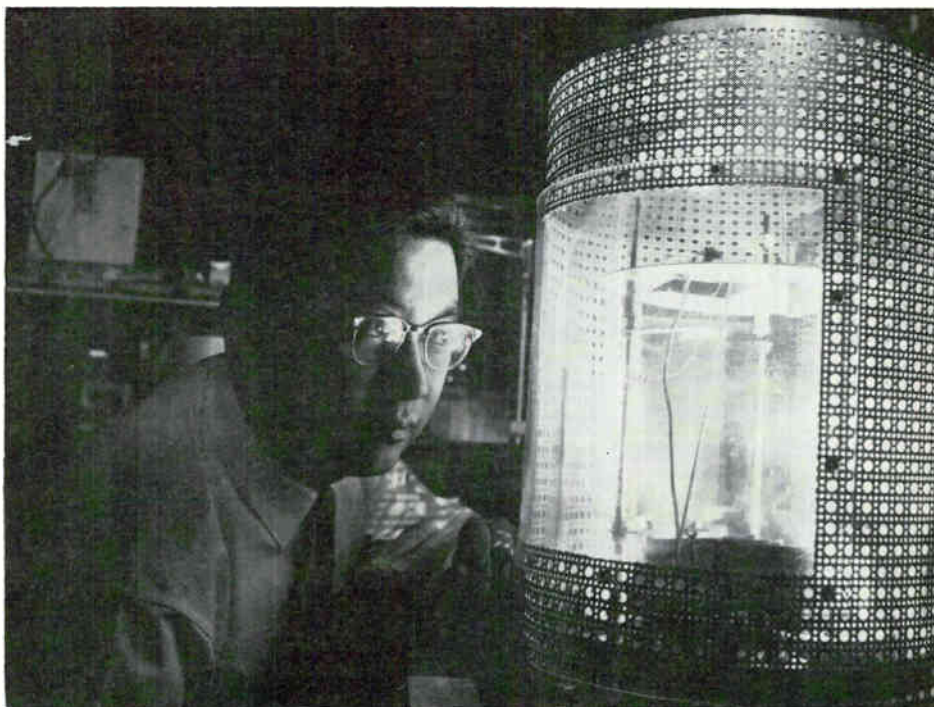

HOW GOOD ARE THIN-FILM TRIODES?

Impact of active thin-film devices can be gaged from current progress. Comparisons are made of performance capabilities and of problems in fabrication and use

By W. TANTRAPORN

Electronics Laboratory, General Electric Company, Syracuse, New York

THIN-FILM TRIODES may ultimately provide a variety of performance characteristics for use in microminiature electronic circuits. For example, the space-charge-limited type should provide the highest operating frequencies and be the least noisy of these devices. Comparable performance can be expected from field-effect triodes in thin-film form, and they should be

the easiest to fabricate and the most versatile. Although the hot-electron triode will be limited to operation at lower frequencies and will probably be the most temperature-dependent, it is expected to be better able to withstand radiation.

Much theoretical and experimental work with new triodes has been reported during the past two years.¹⁻⁸ Many of these triodes con-

tain semiconductor single crystals and are not amenable to present thin-film techniques. If those triodes that can be fabricated in thin-film form are logically classified, their expected performance capabilities can be compared.

Basically, a thin-film triode consists of three electrode terminals that are separated from each other by semi-insulating materials. Insulation requirements are dependent on the operating mechanisms. The mechanism by which the control electrode influences current between the other two electrodes can be used to classify thin-film triodes. On this basis, thin-film triodes can be placed in any of three classes: the space-charge-limited or analog triode and the hot-electron triode and field-effect triodes.

SCL TRIODE—A field must be established in the space-charge-lim-

ited triode between two electrodes in such a way that space-charge neutrality does not hold. This condition is possible in a wide band-gap insulator with the emitter electrode forming a low contact barrier

against the insulator. Such a space charge in the solid is thus similar to the space charge in the vacuum tube except for the different nature of the mobilities.

If a metallic line grid is then in-

serted between the two electrodes to form a blocking contact with the insulator, the grid will function similarly to the grid in a vacuum tube. Since the spacing of the electrodes needed to achieve the space-charge condition is in the micron range, thin-film techniques can be used to fabricate the device. Grid fabrication is difficult, however, since the grid must be in the form of thin lines spaced about 1 micron apart within the insulator film and forming blocking contacts against the insulator.

A single-crystal type space-charge-limited triode² is shown in Fig. 1A. A space-charge-limited triode with single edge grid was demonstrated as early as 1959.¹ A present-day thin-film adaptation of the triode is shown in Fig. 1B with insulating layers replacing the blocking contacts. A blocking contact is difficult to achieve between a thin line and the semi-insulator, which is CdS.

Theoretically, the triode characteristic is expected to be similar to that shown in Fig. 1C. However, the parameters used are optimistic even for the single crystal CdS. The more critical parameters are the mobility of 500 cm² per volt-second and the trap density of less than 10¹⁶/cm³, which cannot be obtained in the polycrystalline state. However, the space-charge condition can be established at small mobility and large trap density by increasing the electric field. Thus it should also be obtainable by decreasing the distance between the electrodes. Space-charge-limited current has been observed in some carefully prepared CdS thin films a few microns thick.

SCL PERFORMANCE—Although the space-charge effect cannot be easily calculated, it is regarded as beneficial in reducing noise within the device compared with other devices operating at the same temperature.⁹ Since it is a majority-carrier device, temperature dependence should be small.¹⁰

Voltage gain in a thin-film SCL triode will probably be about 10. Current gain should be large because of the small grid current. Power gain of about 10⁶ is not unlikely, although actual power level may be small if trap density of the material (CdS) is large. For high

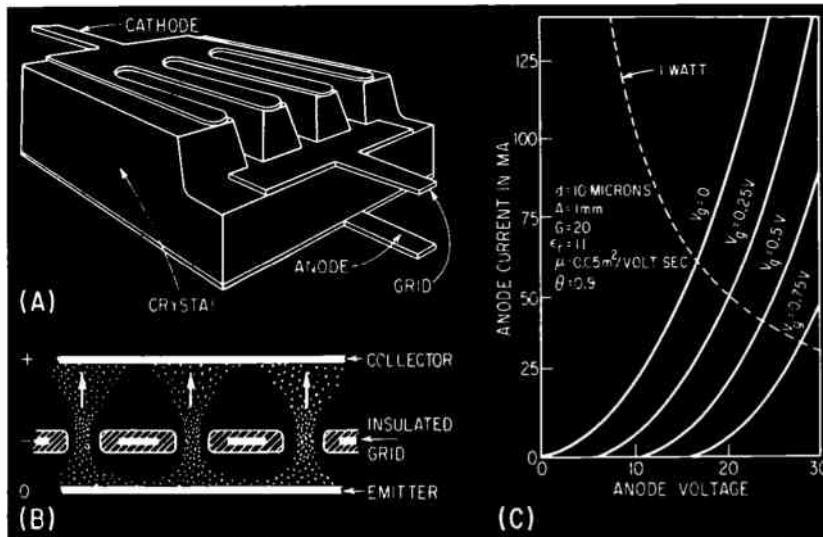

SINGLE-CRYSTAL type space-charge-limited triode (A) has been adapted to thin-film form (B). Triode characteristics (C) have been predicted theoretically—Fig. 1

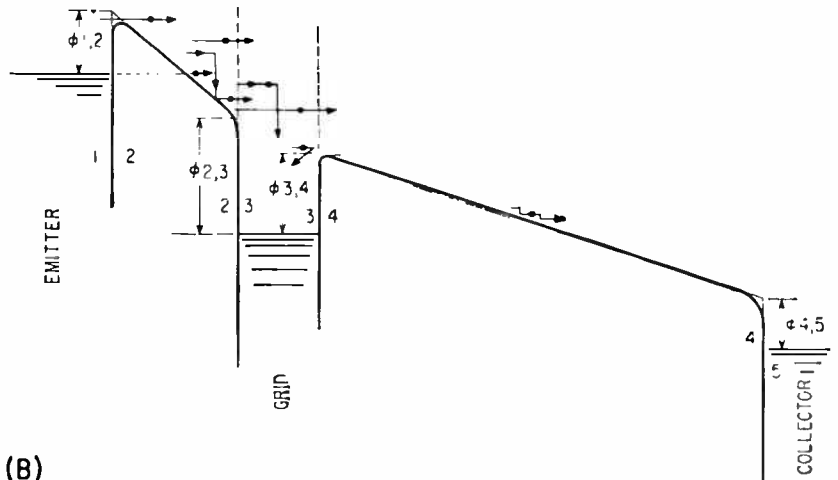
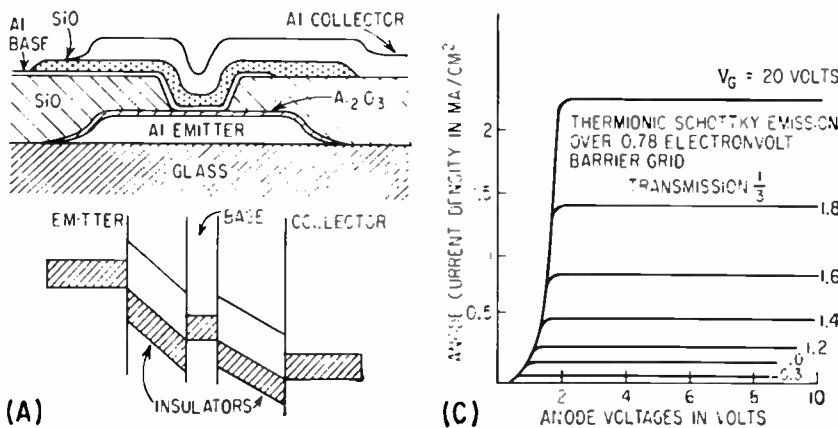

HOT-ELECTRON triode (A) is shown as originally conceived. Energy diagram (B) is for hot-electron triode for which theoretical characteristics (C) are expected—Fig. 2

density of shallow traps, however, the SCL triode is expected to have better frequency characteristics. Triode performance is limited by trapping relaxation time at lower frequencies but becomes better at higher frequencies as the signal modulates only the untrapped charges. Finally, frequency is limited by transition time. Gain-bandwidth product is thus given by the reciprocal of transition time and is about 10^9 cps if anode voltage is 100 volts, spacing is 5 microns and mobility is 3 cm^2 per volt-second.

HOT ELECTRON TRIODE—Considerable interest was first aroused by the hot-electron triode, followed by confusion and finally disappointment. The device as originally proposed³ is shown in Fig. 2A. It was first assumed that electrons left the emitter and entered the grid by a quantum tunneling mechanism.

Another hot-electron triode was reported⁴ that was assumed to work on the same emission mechanism but with the collector portion replaced by a germanium single crystal and an ohmic electrode. It was later pointed out⁵ that current emission was more likely the result of the Schottky thermionic process than of quantum tunneling. Finally it was proved that operation of the triode must depend on another mechanism that is facilitated by the presence of pinholes. This mechanism is now being investigated by the originators of the triode, which is now called the metal interface amplifier. This triode, which is not a hot-electron triode but a field-effect triode, does not fit into the classifications established in this article. It uses a semiconductor single crystal and is not a thin-film device as it is here defined.

An energy diagram of the hot-electron triode is shown in Fig. 2B, which also shows relevant processes. Best operation of this device is achieved under the following conditions: For high emission and to reduce temperature dependence, $\phi_{1,2}$ should be approximately equal to zero. For hot electron transfer through the grid layer, $\phi_{2,3}$ should be about 1 electron volt and should be greater than $\phi_{3,4}$. Thickness of layer 3 should be about 100 angstroms (continuous film). Finally, $\phi_{3,4}$ should be greater than $\phi_{4,5}$.

which should be approximately zero for best collector efficiency.

Experimental evidence was recently reported⁷ of hot-electron transfer across a thin metal film. Unfortunately, a semiconductor (germanium) collector was used in these experiments, although the

same function could be accomplished in principle with a thin insulator layer with a strong bias. The state of the art of the hot-electron triode is thus represented by hot-electron transfer into the semiconductor crystal, and the problem in the future will be to fabri-

STATE OF THE ART IN THIN-FILM TRIODES—TABLE I

Triodes	Field Effect	Space-Charge Limited	Hot Electron
Structures	Semiconductor film of micron thickness. Electrodes on semiconductor surfaces	Semiconductor film of micron thickness between anode and cathode. Fine-line grid embedded in space between	Consecutive layers of emitter metal, emitter insulator, grid metal, collector insulator, collector metal. First two, last two or both may be replaced by semiconductor and ohmic contact
Feasibility	Proven experimentally	Predicted theoretically with preliminary experimental support	Predicted theoretically with experimental proofs for some triode parts
Achievement Dates	1961	1962-63	Late 1963
Anticipated Problems	Optimizing dimensions, developmental improvements	Isolated fine-line grid with spacings about 1 micron	Electron transfer across grid layer difficult in complete structure

EXPECTED THIN-FILM TRIODE PERFORMANCE—TABLE II

Triode	Field Effect	Space-Charge Limited	Hot Electron
Mode of Operation	Voltage controlled, best with positive grid bias. Input resistance 10^6 ohms	Voltage controlled, best with negative grid bias. Input resistance 10^6 ohms	Current controlled, positive grid bias required. Input resistance 1-100 ohms
Frequency Limit	About 10^8 cps (limited by transition time)	10^8 - 10^9 cps (optimized capacitance versus transition time)	10^6 - 10^7 cps (limited by input shunt capacitance)
Main Features	Ease of fabrication, high gain-bandwidth product, versatility (- or + gate)	High gain-bandwidth product, temperature insensitivity, low noise	High tolerance to radiation
Limitations	Reproducibility difficult because of critically small spacings	Grid structure fabrication difficult	Operation limited to low frequencies, temperature dependent, noisy (noise figure about 15 db)

cate a thin-film structure that has and can maintain the barrier heights prescribed.

CHARACTERISTICS — Operation of hot-electron triodes having insulator films of 20 to 1,000 angstroms will necessarily be near the

breakdown condition and will have to be current-controlled. Current gain is less than unity because of absorption of the hot electrons by the grid layer. The power gain that is possible is therefore the result of voltage gain, which is not expected to be large. Power gain of about 100 is considered high if transfer of hot electrons is about 10^{-1} . Theoretical characteristics for likely parameters are shown in Fig. 2C.

Because of the extreme nonlinearity in the current-voltage relationship of the emitter-grid section, input resistance at the operating point will probably be about 100 ohms or an order of magnitude either way and will be shunted by the input capacitance. For an alumina film 20 angstroms thick, capacitance is about 10^{-12} farad per mm^2 . The input section thus limits operation to an upper frequency limit of about 10^6 to 10^7 cps. Although frequency capabilities are lower in the hot-electron triode, this limitation is compensated by its greater resistance to radiation. The thin film becomes essentially a massless absorber of radiation. Tests indicated that thin films are not affected by radiation corresponding to the stronger Van Allen belt.

Temperature dependence of the hot-electron triode will be dominated by emission $e \exp(-\phi_{b,em}/kT)$. Noise figure is expected to be high, represented by a hot-electron equivalent temperature about 40 times room temperature. These disadvantages of the hot-electron triode contrast with the SCL triode.

FIELD-EFFECT TRIODE — The only thin-film triode in the three classes that is presently operational is the field-effect triode. In this device, the control electrode affects the number of free carriers in the space between the other two electrodes. The predominant mechanism operating in this type triode is not presently clear. The effect may be on emission efficiency, the relocation of free charges from an irrelevant to the relevant region or the freeing of trapped charges in the semi-insulator thin film. The mechanism is now being studied in experiments at this laboratory with the aim of controlling or improving it.

The general configuration of the

field-effect triode is shown in Fig. 3A. The charge-redistribution process was assumed for one triode having the suggested configuration shown in Fig. 3B and the predicted performance shown in Fig. 3C. In the Weimer triode, the gate electrode was on the opposite surface from the source and drain electrode.

The results of one phase of the work at this laboratory is shown in Fig. 3D, which indicates the close similarity to the reported results of Weimer and the predicted curve of Ihanola. The results also indicate a trap-emptying mechanism.

Without a definite model, the limits of field-effect triode performance cannot be predicted. However, anticipated performance capabilities based on the reported experimental results should be comparable to those of the SCL triode.

Fabrication is relatively simple. However, producing identical samples may be difficult because of the critically small spacings (microns).

An attractive feature of the field-effect triode is its flexibility. It lends itself to various combinations of electrode positions, dimensions, electrode materials and large ranges of current and voltage, and various electrical configurations.

The state of the art in thin-film triodes is summarized in Table I. Expected performance is provided in Table II.

REFERENCES

- (1) W. Ruppel and R. W. Smith, A CdS Analog Diode and Triode, *RCA Rev.* 30, p 702, Dec. 1959.
- (2) G. T. Wright, A Proposed Space Charge Limited Dielectric Triode, *J Brit IRE.* 20, p 337, May 1960. See also *Solid State Electronics*, 2, p 165, March 1961.
- (3) C. A. Mead, The Tunnel Emission Amplifier, *Proc IRE.* 48, p 359, March 1960. See also *J Appl Phys.* 32, p 646, 1961.
- (4) J. E. Spratt, et al. Hot Electrons in Metal Films: Injection and Collection, *Phys Rev Lett.* 6, p 341, 1961.
- (5) A. M. Lavine and A. A. Iannini, Current Gain in the Metal Interface Amplifier, *Proc IRE.* 50, p 1688, July 1962. See also R. N. Hall, Current Gain in Metal-Insulator Triodes, *Solid State Electronics*, 3, p 320, 1961.
- (6) P. R. Entage and W. Tantraporn, Schottky Emission Through Thin Insulating Films, *Phys Rev Lett.* 8, p 267, 1962.
- (7) D. Kahng, A Hot Electron Transistor, *Proc IRE.* 50, p 1534, June 1962. See also D. V. Genpert, A Metal-Base Transistor, *Proc IRE.* 50, p 1527, June 1962.
- (8) P. K. Weimer, The TFT—A New Thin-Film Transistor, *Proc IRE.* 50, p 1462, June 1962.
- (9) S. Seely, "Radio Electronics," McGraw-Hill Book Company, New York, p 146, 1956. See also ref. 2.
- (10) A. M. Conning, A. A. Kayali and G. T. Wright, Space-Charge-Limited Dielectric Diodes, *J Inst EE.* 5, p 595, 1959.
- (11) W. Tantraporn, Non-Tunneling Hot Electron Triode, 1962 IEEE-APSE Solid State Device Research Conference abstract in Trans PGED.
- (12) H. K. J. Ihanola, Tech Rep 1961-1, Solid State Electronics Laboratory, Stanford Univ, August 17, 1961.

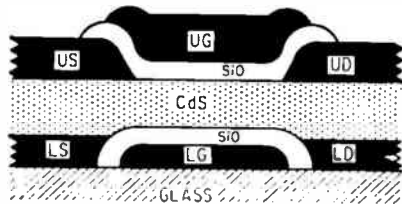

(A)

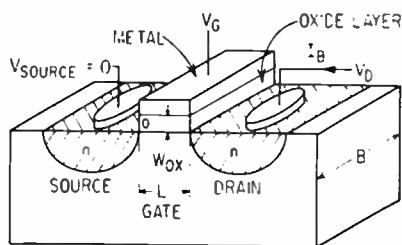

(B)

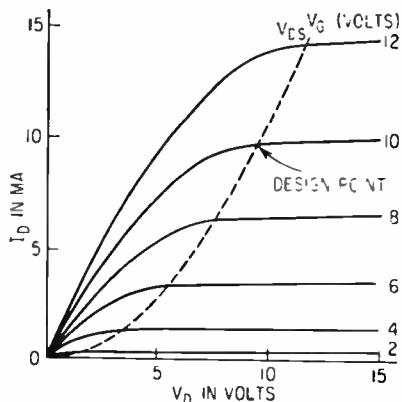

(C)

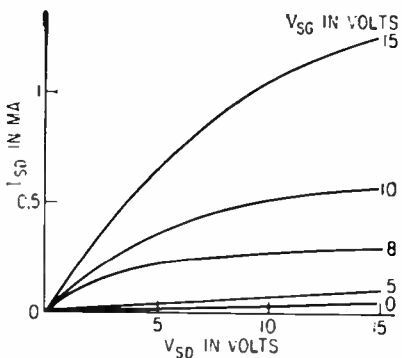

(D)

FIELD-EFFECT triode has general configuration at (A). Charge redistribution process was assumed for suggested triode (B) with predicted performance (C), which is similar to results (D) at this laboratory—Fig. 3

Putting a Servo Amplifier on a Small Silicon Wafer

**MOLECULAR
SERVO amplifier,**
*on fingertip, packs
enough power to
drive a size 8
servo motor*

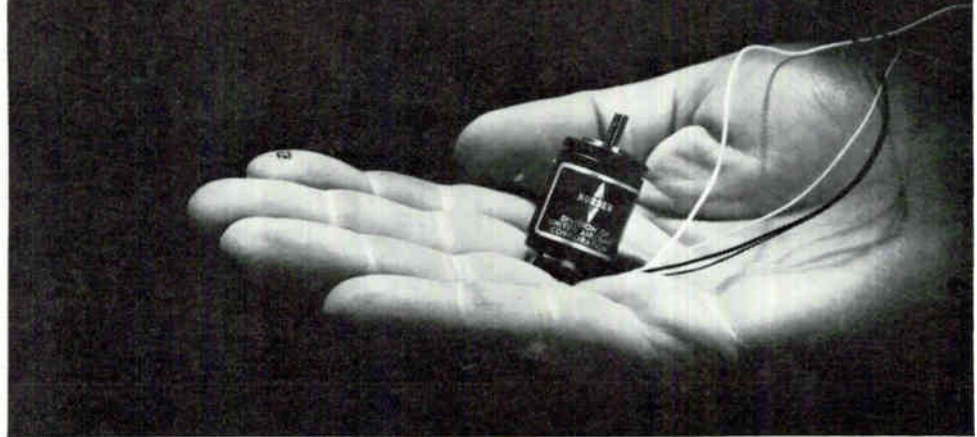

*Inside-out transistors are key to high-power
output of a molecular servo amplifier*

By M. W. AARONS, Norden Division, United Aircraft Corp., Norwalk, Conn.

MOLECULAR SERVO amplifiers with enough power to drive a servomotor are diffused into a thin silicon wafer only $\frac{3}{4}$ -inch diameter. These analog units are the result of several new molecular electronic techniques developed to simplify fabrication and to enable the output stage to deliver a sizable amount of power. An important result is the topological inversion of the transistor structure to achieve extremely low saturation resistance. The geometry of conventional transistor structures was altered by turning the transistor inside-out. It is difficult to use conventional geometry, with all contacts in the same plane and extract the power required.

The amplifier is direct-coupled, class A and contains almost four dozen components. Rated power output is 1.5 watts. All circuit connections are deposited on a passivated surface. The transistors can

sustain 75 volts and deliver up to 200 ma into size 11 and size 8 servo motors.

CIRCUIT—In Fig. 1A, transistors Q_1 through Q_4 form a differential high impedance voltage preamplifier. Transistors Q_5 and Q_6 are emitter follower driver stages, which are zener diode coupled to the push-pull power output stages Q_7 and Q_8 . Re-

NEW APPLICATION OF MOLECULAR ELECTRONICS

To date, most molecular electronic devices have been digital. And they handle relatively low power. This unit is an analog device and can provide enough power to drive standard size servo motors. In fact, the amplifier has driven 3-watt motors

sistors R_{11} and R_{12} provide thermal stabilization for the power stage and guarantee that the zeners are broken down.

Open-loop gain of the differential forward amplifier Q_1 through Q_4 is greater than 2,000. The closed-loop gain, however, is determined by resistor ratios in the differential feedback network: R_1 through R_4 and R_{13} through R_{20} . The overall gain is precisely specified to be 200 by this technique.

Direct-current operating points are stabilized by the common-mode feedback amplifier consisting of Q_9 and Q_{10} with resistors R_{21} through R_{24} . The signal across the output is differentially summed by R_{21} and R_{22} cancelling the a-c components. The d-c component is then amplified and applied to the emitters of the differential input Darlington pair.

The method of isolation, which consists of back-to-back junction surfaces, alters the actual circuit

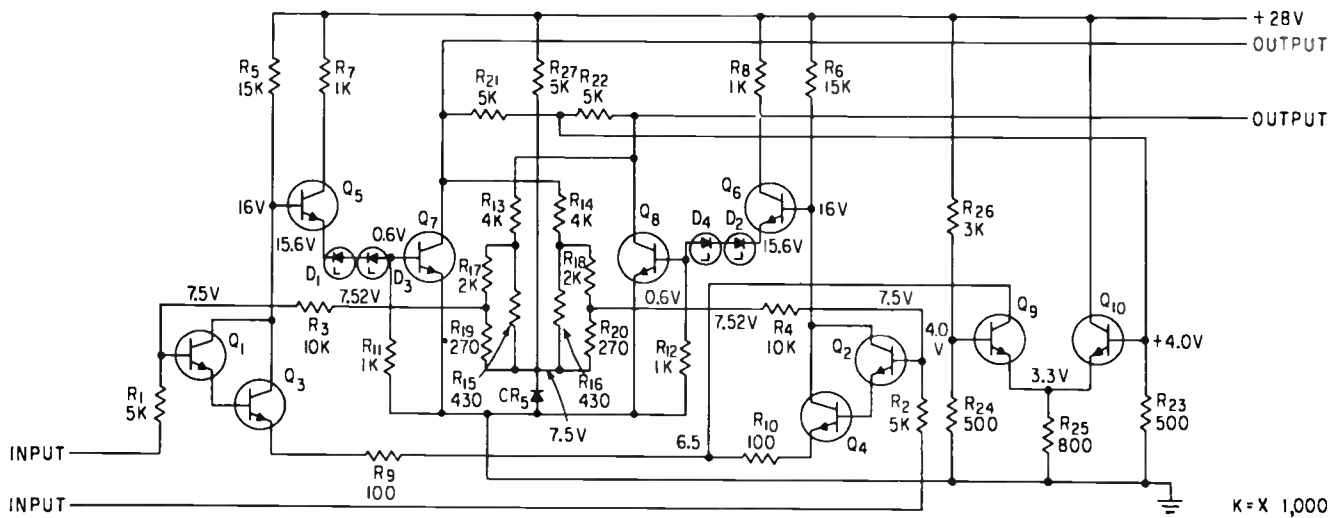

(A)

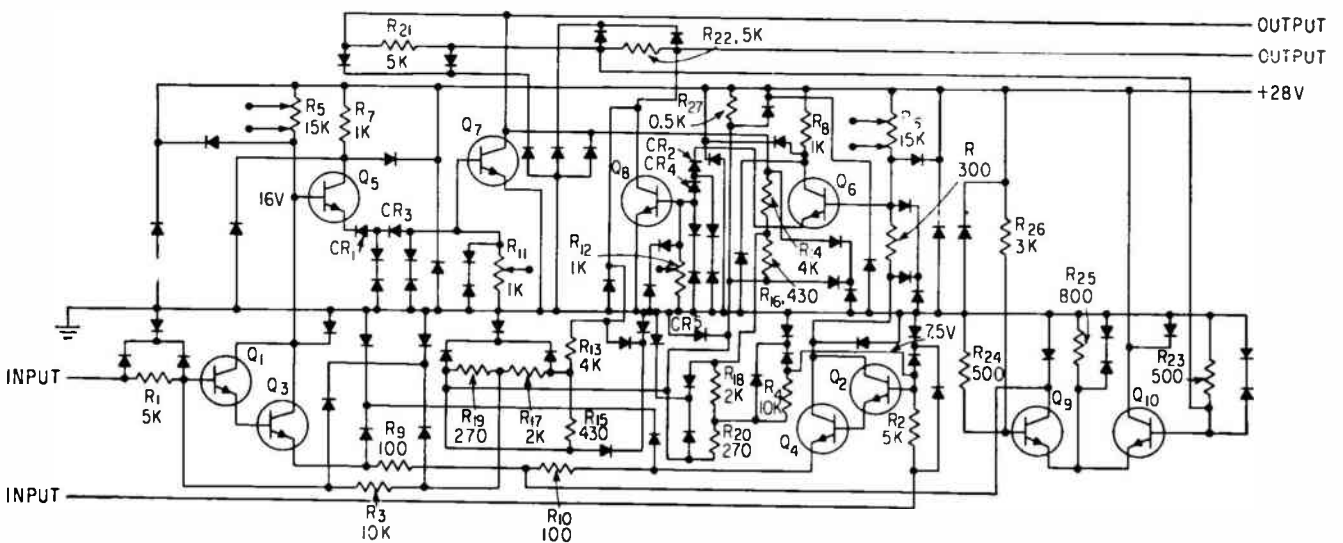

(B)

BEFORE AND AFTER. Schematic (A) is the original circuit of the servo amplifier. When it is fabricated on the silicon wafer, circuit (B) results because of distributed diode planes introduced by the substrate—Fig. 1

operation by inserting distributed diodes in a complicated manner within the circuit, Fig. 1B.

TRANSISTOR DESIGN — Since the circuit must deliver sizable amounts of power, the output stage received a great deal of attention. In conventional power transistors the bulk of the collector body is of low resistivity. Modern n on n' epitaxial planar diffused devices are examples of this geometry. In crystal circuits it is difficult to achieve this result and maintain a collector breakdown of 120 volts. The motor that the circuit drives requires 94 volts peak-to-peak and 120 milliamperes peak current.

To solve the problem of low collector resistivity, 200 to 1 scale models of planar power transistors

were constructed. Emitters and collectors were made of aluminum foil using tape to mask surfaces between collector pads. Solutions of NaOH were mixed in different concentrations to simulate substrate material of 1, 2, 3 and 4 ohm-cm bulk resistivity. The depth of the solution was varied in 0.1-inch increments, simulating 0.5-mil variations in the depth of the collector region. The models were also modified to vary the length of emitter and collector junctions, and the separation of these junctions. A successful topological inversion of the power transistor structure was achieved as a result of data obtained from these models.

INTERCONNECTIONS — A set of rules was developed so that the

complex circuit could be translated into the best arrangement of the elements within the crystal. These rules eliminate interconnection crossovers and require that elements with critical interconnection lengths be close together.

Because the program involved placing an entire electronic system in one crystal of silicon, it was necessary to determine whether process technology was sufficiently advanced to enable initial good yields. Therefore, a layout that dissected the amplifier by symmetry into four distinct circuits, Fig. 2, was chosen. An interconnection scheme was developed that allows a choice of assembly methods depending upon test results of the individual wafers.

The first choice was to intercon-

nect within each independent circuit then dice the wafer to pick and choose the best circuit of each category, Fig. 3. The four 100-mil square chips are then mounted on the same header. Ball-bonded wire connections between chips complete the amplifier.

The second choice was to interconnect within and between four adjacent circuits by deposited aluminum and dice the wafer into complete amplifier chips, Fig. 4. The decision of which way to go is made by electrical tests after ohmic contacts are alloyed to the crystal.

FABRICATION—Circuits are produced from two types of material. The first type consists of a 20 ohm-cm *p*-type crystal upon which is grown a 1-mil 2.5-ohm-cm *n*-type epitaxial layer. The second type is a bulk 2.5-ohm-cm *n* wafer. Processing of the second type is described since the steps are typical of both.

The wafer is lapped and polished to a 4.5-mil thickness. Then a 25,000 angstrom thickness of steam oxide is grown and subsequently etched away. This step removes work damaged crystal layers and yields a smoother surface than mechanical polishing. A 10,000 angstrom thickness oxide is now grown and photoresisted to produce isolation moat contours. Boron from a tribromide source is deposited (C, approximately 10^{21} atoms per cm^3) and simultaneously diffused from top and bottom, thus creating *n* regions that are isolated by back-to-back junction planes. The bases of the transistors, the *p* part of diodes, and all resistor networks are diffused from a boric-acid source. The predeposition is controlled so that a sheet resistivity of 250 ohms per square is maintained. The next step is to diffuse all emitters, make n^+ contact areas in the collector regions, and complete the zeners. A phosphorus pentoxide process is employed for n^+ deposition.

Holes are then etched into the oxide where contact to the crystal is desired. Aluminum is evaporated over the entire wafer and subsequently etched completely off the oxide. The aluminum is spike-alloyed into the crystal. Regrowth of *p* material in the collector regions are prevented by the n^+ diffusion. Interconnection of elements is ac-

complished by a similar procedure of deposition and removal. The aluminum leads are vacuum baked at 500 C to alloy the aluminum into the surface of the oxide layers.

Careful attention to the porosity of the photoresist is maintained throughout to prevent development of pinholes in the oxide. The KPR (Kodak photoresist) is monitored in a crossed Nicol prism arrangement, for small particles and filaments. Impurities reveal themselves by depolarizing light that they scatter. Oxides are routinely checked by exposure to chlorine gas at 950 C. Pinhole counts range between 0 and 10 per wafer.

After dicing, mounting and lead attachment, the circuit is electrically evaluated. The good units are cleaned in deionized water and vacuum baked for 1 hour at 300 C. Hermetic sealing is accomplished by electron-beam welding.

TESTING—To evaluate the servo amplifier functionally, a controlled 400-cps input signal is coupled to the amplifier through a ratio transformer. The input signal is measured both rms and peak to peak. Output of the amplifier is fed into a tuned servo motor, whose primary is open so that the load simulates stalled conditions. The rms output from either Q_1 or Q_2 to ground is then measured. Peak-to-peak output voltage is measured across the motor windings.

Transfer characteristics of the amplifier are determined by adjusting the ratio transformer and reading input and corresponding output voltages. The rms output is only read across half of the output; however, the two halves are 180 deg. out of phase so that they can be added linearly to obtain the total rms output. Quiescent current is approximately 60 ma per power transistor with an additional 10 ma in the B+ circuit. The current swings between 0 and 120 ma, while the rms into the motor winding is 36 volts for a 28-volt supply.

This paper represents the work of a team of scientists and engineers at Norden, who have been supported by United Aircraft Corp. and the Navy Bureau of Weapons. The work was sponsored by the Bureau of Naval Weapons under contract NOw-61-1053-C.

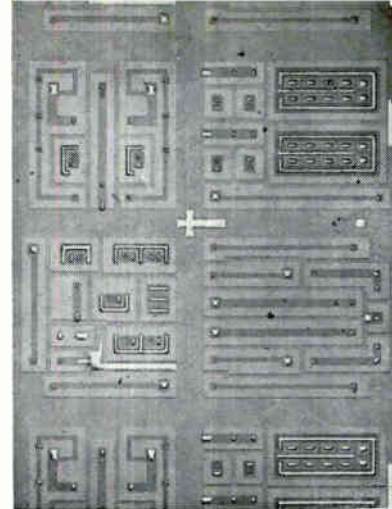

FOUR CIRCUITS comprise the complete amplifier. Here they are shown without interconnections—Fig. 2

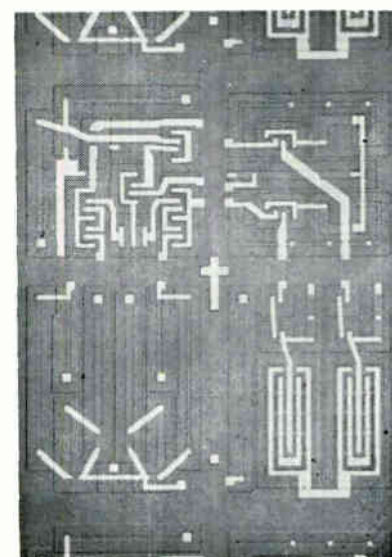

CONNECTIONS within each individual circuit are made first. Then the circuits are tested to determine the next step in fabrication—Fig. 3

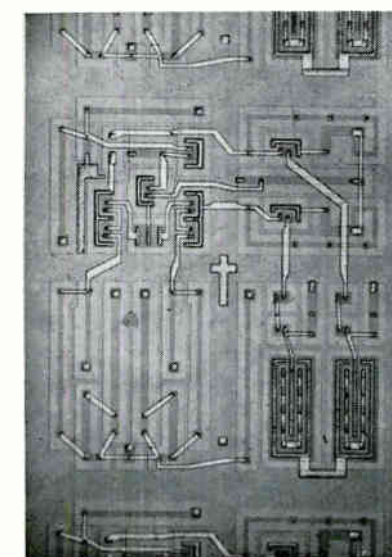

COMPLETED servo amplifier with all interconnections—Fig. 4

New Design Concept Reduces

High-power klystron tube uses electrostatic focusing of electron beam instead of conventional solenoid or permanent magnet. First model of an S-band klystron produces 15.5 Kw peak power with an efficiency of 25 percent. Multimegawatt tubes at L-band are contemplated

By S. R. MECHTEL and A. MIZUHARA

Research Laboratory, Litton Electron Tube Corp., San Carlos, California

THE CONVENTIONAL klystron amplifier is valuable for amplification of r-f signals at uhf and microwave frequencies. It is used widely in radar, communication, navigation and guidance, particle accelerators and television transmission. It is the only device that offers the combination of high gain, high power, good efficiency and long life at these frequencies. Klystrons are relatively insensitive to load changes and retain high efficiency and gain over a wide range of voltages. Other features of klystrons are their simplicity, ruggedness and suitability for mass production.

One of the disadvantages of high-power klystrons is that they require a strong magnetic field in the axial direction for focusing the electron beam. This field is usually generated by an electromagnet, and less frequently by a permanent magnet.

Either way the weight and volume of the magnets is many times that of the tube itself. The permanent magnet also produces a stray magnetic field, which may interfere with other equipment and the solenoid requires a power supply that is inherently heavy and bulky and reduces the overall efficiency. Both the electromagnet and the permanent magnet add to the initial cost.

Elimination of focusing magnets would be highly desirable, especially in mobile, airborne and space systems where space and available power are at a premium, and weight must be kept at an absolute minimum. The application of a conventional klystron is also limited by its focusing magnets in phased-array radar, in which the tubes must be packed densely.

It has been known for a long time that electron beams can also

be focused by electrostatic fields. This is done successfully in cathode-ray tubes and electron microscopes. However, in attempting to use the same principle in a klystron amplifier, the problems encountered are incomparably more difficult. This is due to the high current densities within the beam of a klystron.

FOCUSING—The focusing scheme of the newly developed electrostatic klystron incorporates Einzel lenses. Figure 1 shows an electrostatically focused klystron. The dimensions of the lens system were chosen so that optimum operating performance is achieved with the lens voltage equal to the cathode voltage. This allows the lens electrode to be internally connected to the cathode; therefore, no extra power supply for the lens is required; that is, single voltage operation of the tube is possible. Such an electrostatic klystron retains all the favorable characteristics of a conventional, magnetically focused klystron without the handicap of the magnets.

Figure 2A shows the r-f output of the tube plotted against r-f drive power at a beam voltage of 20 Kv. In Fig. 2B, the saturated r-f output power is given as a function of the beam voltage. Finally, Fig. 2C illustrates the variation of efficiency with the beam voltage. As the curves of Fig. 2 show, the behavior of the tube is the same as that of a conventional klystron.

POWER—The average power of 850 watts, given in the table, was

KLYSTRON weighs only five pounds, which is about 3 percent of the weight of a conventional klystron with magnets

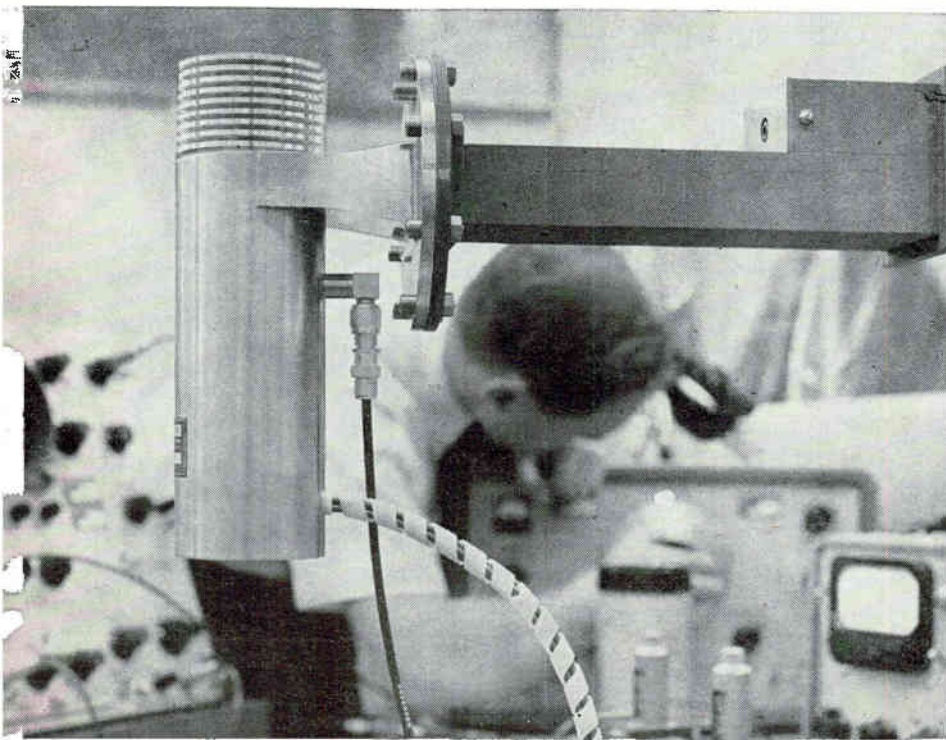

KLYSTRON WEIGHT

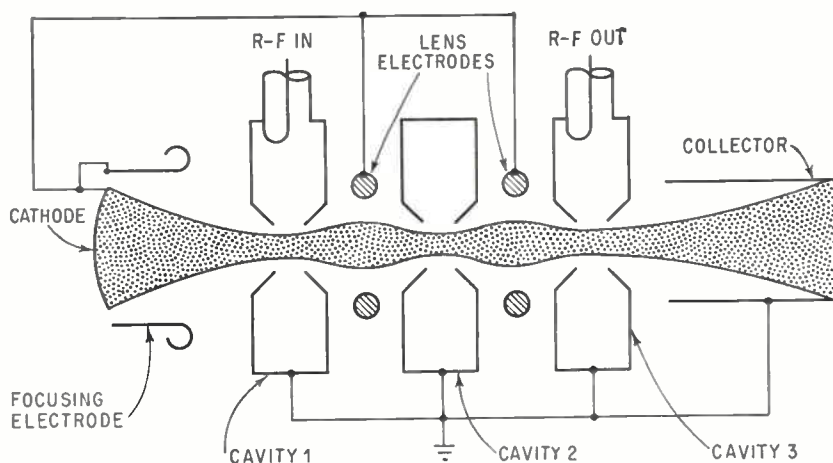

ELECTROSTATICALLY focused klystron, with lens electrodes connected internally to cathode, eliminating extra power supply for lens—Fig. 1

measured when the body of the tube was cooled by a small air blower. With liquid cooling, a much higher average power should be achievable. Furthermore, it is hoped that by improving the electron optics of the tube, its efficiency can be raised to 35 to 40 percent.

The weight of the first experimental klystron was fifteen pounds. The photo shows the latest, fixed-tuned version of the tube, which weighs only five pounds. The weight of the electrostatically focused klystron is only about three percent that of a comparable conventional

klystron with its magnets.

Considerably higher power than the 15 Kw obtained from the experimental model is possible. By scaling the present tube to a beam voltage of 100 Kv, an r-f output power of nearly 1 Mw can be expected at S-band. At lower frequencies, such as L-band, a multimewatt electrostatically focused klystron seems feasible. Higher gain can be achieved by simply increasing the number of cavities.

USES—The new type of klystron amplifier seems especially suitable and important where weight and volume of the tube must be kept at a minimum and stray magnetic fields cannot be tolerated. Applications include radar and communication systems in airborne and mobile applications. The klystron should also prove useful in future satellite and space vehicles, with the advent of nuclear power supplies that are now under development.

One feature of the klystron that can be exploited in certain applications is its ability to be self-supporting on its output waveguide flange. This can be used advantageously where the klystron is mounted directly at the focal point of the antenna; for example, in radar, communications, navigation-guidance, active radio astronomy and telemetry systems.

Perhaps one of the most important applications for the electrostatically focused klystron is in

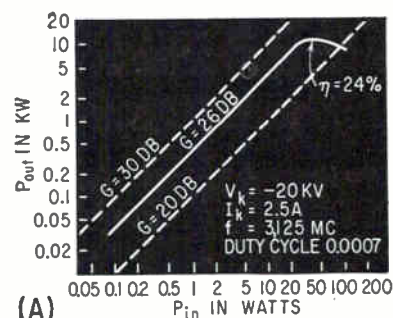

(A)

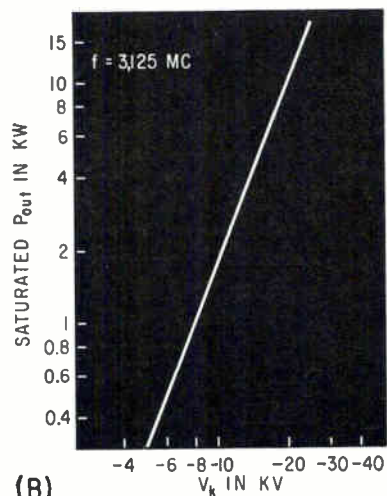

(B)

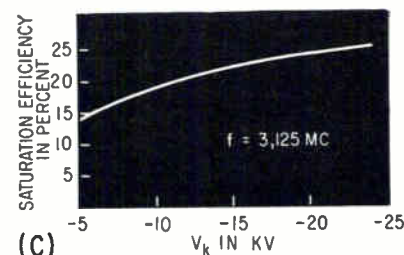

(C)

PERFORMANCE CURVES: power output and beam transmission versus r-f power input (A); saturated power output versus cathode voltage (B); efficiency versus cathode voltage (C)—Fig. 2

RESULTS

This new concept drastically reduces the weight and volume of the high-power klystron, and will be of interest to the military equipment designer.

The first tube made of this type was a 3-cavity klystron for moderately high power levels at S-band. The results achieved are

Frequency	3,125 Mc
Beam Voltage	22.5 Kv
Beam Current	2.8 amp
R-F Output Power	15.5 Kw peak 850 W average
Small Signal Gain (non-synchronous tuning)	
Saturated Gain	23.5 db
Efficiency	25 percent

phased-array radar systems. Because the klystrons are compact and have no magnetic fields, they can be placed side by side with no interaction between tubes. Since the klystron is simple in design and suitable for mass production, the initial cost of such a phased array radar system should prove to be economically practical.

The authors acknowledge the support given by the U. S. Naval Ordnance Test Station, China Lake, California, during the first phase of the work.

Use RASTER

By RICHARD P. RUFER
WILLIAM A. KARLOTSKI,
Lawrence Radiation Lab., Univ. of California,
Livermore, Calif.

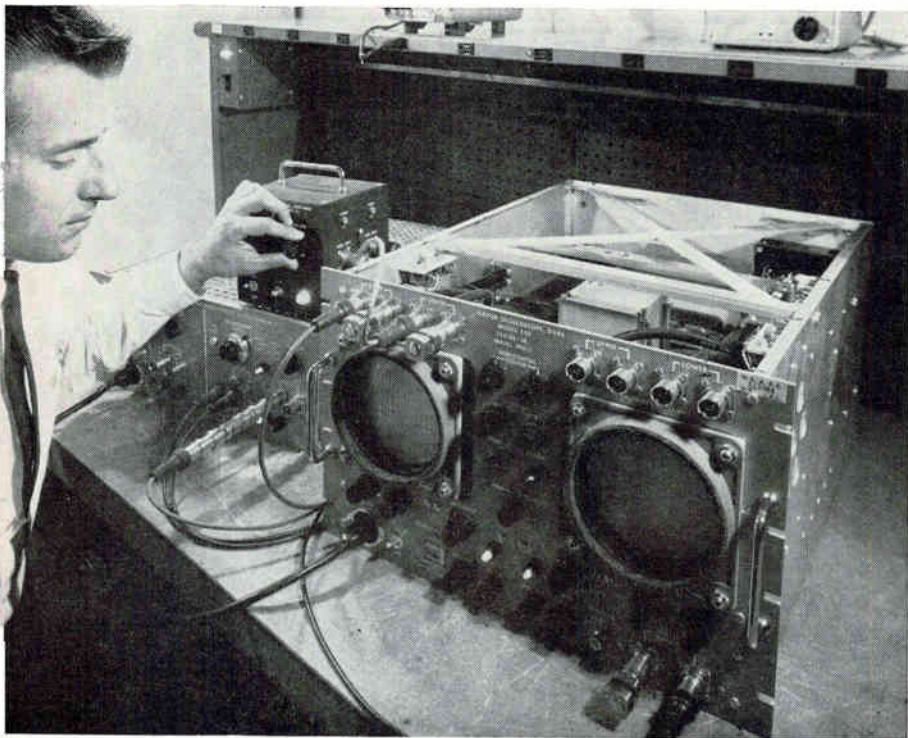

RASTER oscilloscope such as this can be used in any application where the time intervals between various events is required

RASTER OSCILLOSCOPES have been used to measure detonation velocities in high explosives and a basic design has been developed.¹ The design incorporates into a compact package all the circuits and hardware to generate the raster display. It uses transistors. The power consumption is only 100 watts, a considerable advantage over designs using vacuum tubes as active elements.

The design reliability, proved by life tests of over 5,000 hours, shows that silicon transistors can be safely operated at the high voltages needed in cathode-ray-tube deflection systems. The oscilloscope is shown in the photo.

DESIGN—In measuring time intervals, the end points are represented by pulses that could trigger digital time-measuring equipment. However, the amplitude and shape of the pulses may not be accurately known and an analog system such as the raster scope is needed. The design covers time intervals from 0.5 to 100 microseconds, and has a time resolution of 0.05 microsecond.

Complete use of transistors provides reliability, low power consumption, and small size. Good performance is obtained because the subassemblies can be mounted physically near the crt, thus reducing critical lead lengths. Because the design imposed by the crt requires that high voltages be handled by the transistor circuits, silicon mesa transistors are used throughout.

In many of the circuits the transistors operate in the avalanche mode, enabling them to handle reliably high voltages and generate high speed pulses.²

Batteries provide a stable source

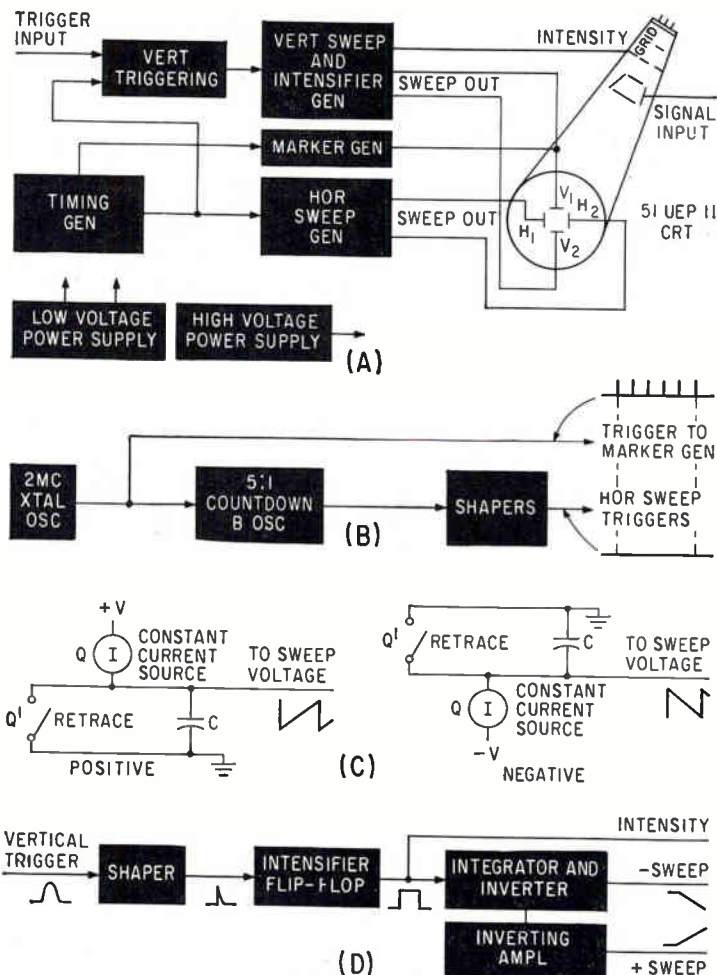

RASTER SYSTEM for new compact oscilloscope (A); and details on timing generator (B), horizontal sweep generator (C), and vertical sweep and intensifier (D)—Fig. 1

OSCILLOSCOPES

for Faster Time Measurements

Test oscilloscopes using tv-type scanning make optimum use of the crt face in displaying high-resolution time-interval measurements. This compact oscilloscope uses transistors, diodes and tunnel diodes for all stages

for the sweep-circuit power supply and are isolated from ground.

DISPLAY—Usually a raster oscilloscope requires a crt with 3 sets of deflection plates, 2 sets presenting the raster display, with the timed pulses applied to the third set. This third set of plates makes the crt versatile since there is isolation between raster scanning and pulse display. The raster system is outlined in Fig. 1A.

The basic horizontal scanning rate for this design is 400 Kc, controlled by a 2-Mc crystal oscillator. The 2-Mc oscillator output triggers a blocking oscillator, which counts down by five to produce the 400-Kc timing pulses for the horizontal sweep (Fig. 1B).

The 2-Mc oscillator output triggers the marker generator which generates time-mark pulses used to time the display accurately. These time-mark pulses are applied to the vertical plate and their rise time, width and fall time are short so that there is minimum interference between the timing pulse and the pulses being timed.

The horizontal sweep generates a push-pull ramp voltage to produce the horizontal scan. The voltage swing is ± 130 v and special silicon mesa transistors are used. To provide the horizontal sweep a capacitor is charged with a constant current (Fig. 1C). Transistor *Q* operates in the common-base mode and provides a constant charging current for sweep capacitor *C*.

Transistor *Q'* discharges *C* to provide the sweep retrace; *Q'* is driven at a 400-Kc rate by a continuous pulse train from the timing unit.

The vertical sweep circuit pro-

vides the scanning voltage to deflect the beam vertically. A push-pull 130-v sweep voltage is required. The crt is biased to cutoff except during the vertical sweep interval. An intensifier pulse turns on the beam when the vertical sweep starts. Vertical sweep is combined with the intensifier gate generator (see Fig. 1D). The shaper provides a latching function that prevents double pulsing of the vertical sweep. The input trigger pulse is shaped and triggers a monostable multivibrator. The on time of the multi determines the time the display is intensified. On time is variable, covering a range of 25 to 100 μ sec. Amplitude of the intensifier pulse is approximately 100 v. The intensifier pulse is integrated to provide the negative ramp voltage for the vertical sweep.

A gain-of-1 inverter provides the positive ramp voltage for the push-pull deflection system.

The intensifier multivibrator uses an avalanche triggering system to

improve the turn-on time of the intensifier pulse.

Trigger input to the vertical sweep circuit is provided by an amplitude discriminator. The circuit also synchronizes the vertical trigger pulse to the horizontal trigger pulse so that the display on the face of the tube will be stationary, making it easier to focus the display.

If a pulse to be timed occurs during the retrace time of the horizontal sweep, it is difficult to measure. To overcome this problem, another indicator is used, whose horizontal sweep is delayed in time. This other indicator called a slave, has all of its functions in parallel with the master except the horizontal sweep.

The timing generator provides a delayed sweep trigger for the slave horizontal sweep. A block diagram of the timing of the horizontal sweeps is shown in Fig. 2.--

CIRCUITS—To facilitate maintenance, most of the electronic func-

WHY A RASTER SCOPE?

Conventional oscilloscopes measure rise times and pulse widths precisely and easily. However, for measuring time intervals between pulses, sweep linearity imposes a basic limitation. If better than 3-percent measurements are required, a raster type scan has an advantage in that it increases time resolution capabilities by the number of total scanning lines in the raster. This article describes a transistor raster oscilloscope for making such high-resolution time-interval measurements

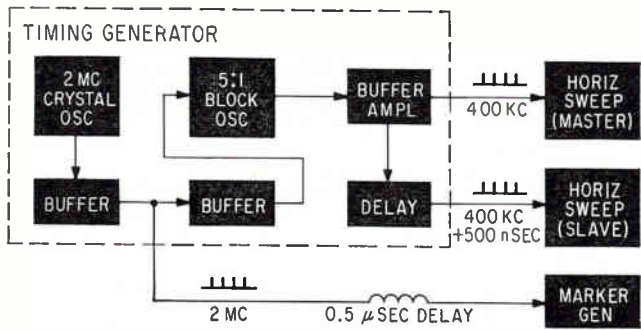

TIMING GENERATOR
provides a delayed sweep trigger for the slave horizontal sweep—Fig. 2

tions are performed with circuits fabricated on printed-circuit assemblies. Major circuit functions may be replaced as a unit.

The timing generator is shown in Fig. 2 and in Fig. 3. Transistor Q_1 is a crystal-controlled blocking oscillator and generates a highly nonsinusoidal voltage across the emitter resistor, R_1 (Fig. 3); C_1 varies the amplitude of the fast-rising part of the emitter voltage and has minimum effect on the repetition rate of the blocking oscillator; C_2 and R_2 differentiate the pulse and the emitter follower, Q_2 , drives the marker timing delay line at point B . Transistor Q_3 is a limiter whose input is differentiated by C_3 and R_3 in parallel with R_1 . The output of Q_3 synchronizes the 5:1 countdown stage, Q_4 , which operates as a blocking oscillator whose recovery time is controlled by C_4 . The synchronizing pulses at the

base are such that the stage will not trigger until the collector voltage has recovered to a certain level.

The 400-Kc pulses across R_5 are reduced in level by the forward voltage drop of FD_{101} diode before being applied to the base of Q_5 . Transistor Q_5 operates in the avalanche mode and its output at D provides the drive pulse for triggering the master horizontal sweep. After being triggered, the collector of Q_5 remains near ground. When the next 2-Mc pulse feeds through T_1 , Q_5 turns off and C_5 charges toward 50 v. This voltage rise is coupled through C_6 and triggers Q_6 . When Q_6 avalanches, it provides an output pulse at point F to trigger the slave horizontal sweep. This output is delayed 500 nsec from the pulse at point D .

HORIZONTAL SWEEP—Circuits to generate the horizontal sweep

are shown in Fig. 4. In the positive sweep, the value of Q_3 collector current is determined by the current supplied by the battery through the + SWEEP AMP control. This constant current charges C_3 to provide a linear sawtooth of voltage to sweep the crt beam. After C_3 is charged toward 150 v, Q_3 will be operating at a point in its avalanche switching region; Q_3 is triggered by the 400-Kc pulse from Q_2 through T_1 and discharges C_3 to provide the sweep retrace.

The important characteristic of Q_3 is its ability to provide a constant current source, which it does over a 150-v collector-voltage range. The important characteristic of Q_4 is that its collector breakdown rating is greater than 150 v.

Negative sweep is similar to the positive sweep except that the capacitor is charged from the minus 150-v bus. This requires the emitter of Q_3 to follow the sweep voltage and requires a special low capacitance pulse transformer. This transformer is constructed by winding miniature coaxial cable around a toroidal ferrite core; the same for T_1 .

The input signal to the horizontal sweep circuit triggers two stages Q_1 and Q_2 , which reshape the timing pulses and retrace the horizontal sweep. Transistor Q_1 is an avalanche-mode blocking oscillator

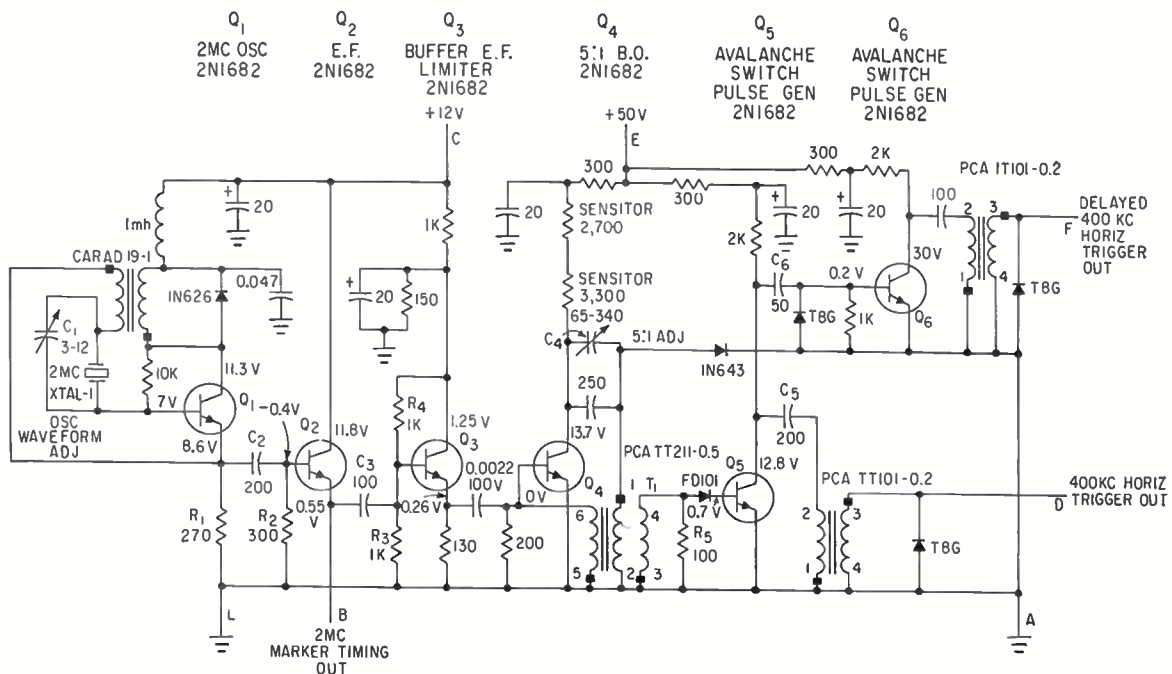

IN TIMING SYSTEM for horizontal sweep, output pulse at point F , which triggers slave, is delayed 500 nsec from pulse at point D —Fig. 3

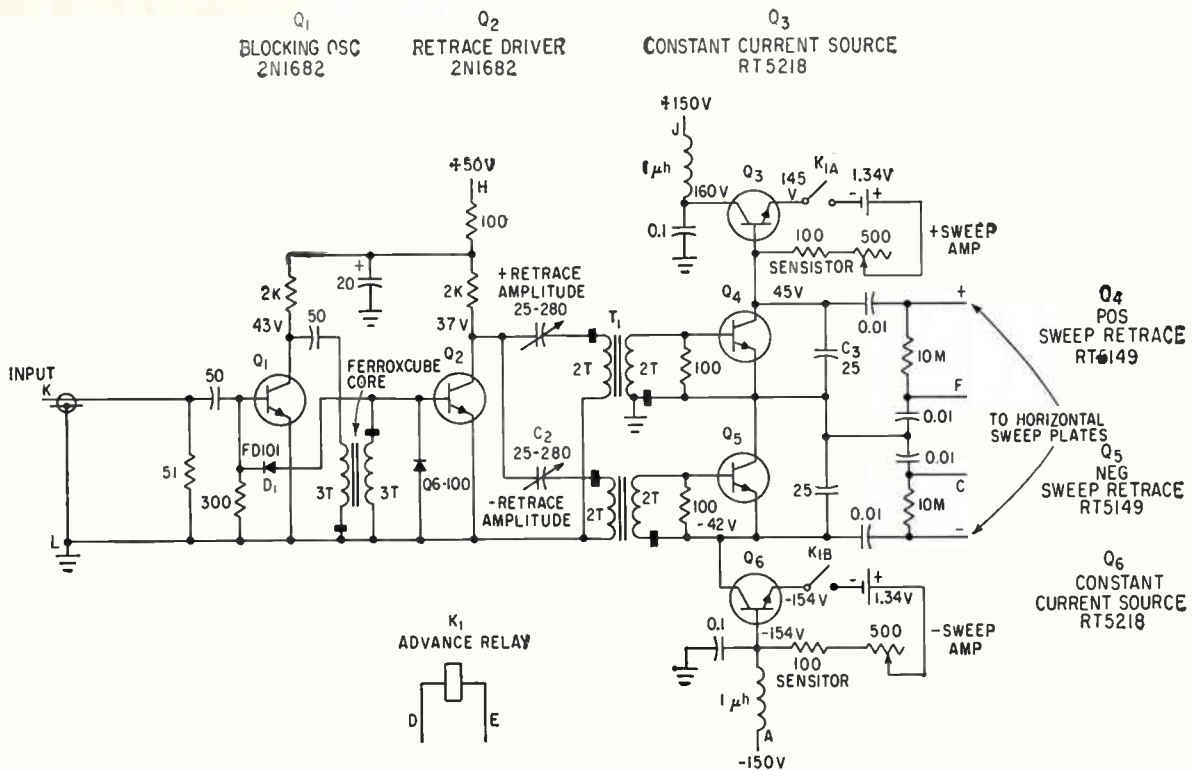

HORIZONTAL SWEEP generator employs similar positive and negative sweeps except for method of charging—Fig. 4

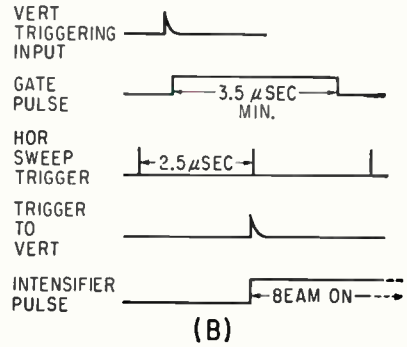
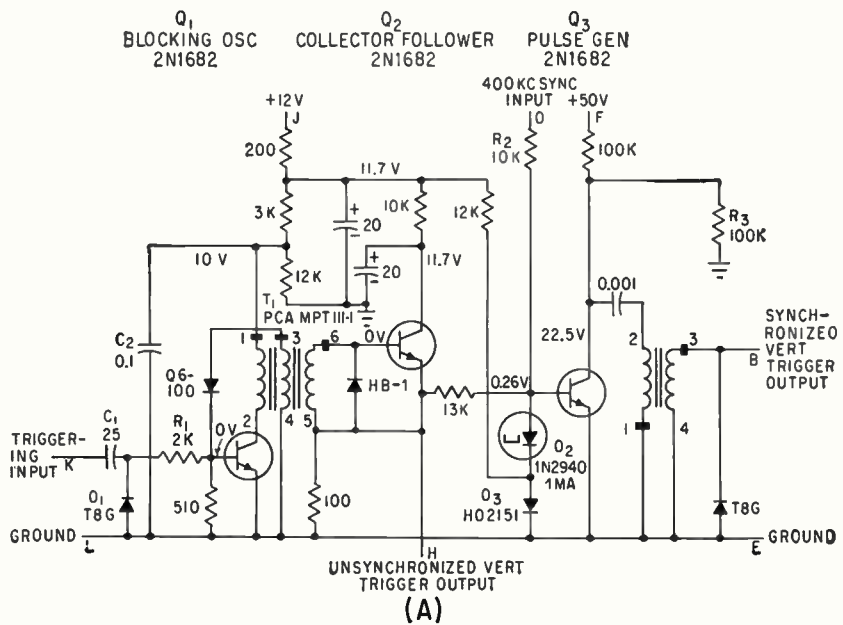

VERTICAL triggering generator (A) and waveform diagram of vertical triggering (B)—Fig. 5

with feedback applied through *D*; *Q*₂ is switched by the output of *Q*₁ and discharges the two 25-280 capacitors through the primaries of the two transformers following. The retrace drive pulses to the negative and positive sweeps are separately variable to compensate for differences in *Q*₄ and *Q*₅ characteristics. Relay *K*, turns off the batteries when the scope is turned off. At a normal 3-ma battery drain, the battery life should be at least 500

hours. Figure 5A shows the vertical triggering circuit. The voltage appearing at the vertical trigger input is discriminated against by a reverse bias. This bias is set by the trigger level control, *R*₁. The input trigger signal must overcome this bias before the vertical triggering circuit will operate. Figure 5B shows a waveform diagram of the vertical triggering. The vertical trigger input (Fig. 5) is differenti-

ated by *C*₁, and the input impedance of the stage *Q*₁. Diode *D*, prevents negative input signals from affecting circuit operation; *R*, attenuates the vertical trigger input applied to *Q*₁.

Transistor *Q*₁ is a blocking oscillator whose output pulse width is greater than 3.5 μsec, determined by *T*₁ and *C*₂. This gate pulse is coupled to point *H* through *Q*₂. When a fire-test switch (not shown) is in the FIRE position this output

triggers the intensifier and vertical sweep circuits. This gate pulse is also coupled into the base of Q_3 .

A 1-ma tunnel diode, D_2 , is used with Q_3 as a coincidence gate; Q_3 generates an output only if a sync pulse is present at point D , and the gate pulse is present at H . The base of Q_3 is biased by the forward drop of D_2 , a germanium diode. This voltage level is below that required to turn on silicon transistor, Q_3 . When a sync pulse from D is present and no gate pulse is present, Q_3 remains off because the current flow through R_8 , due to the sync pulse, is less than the 1-ma peak current of D_2 . However, when the gate pulse is present, more than 1 ma flows through D_2 and it switches, turning Q_3 on. This produces an output pulse at B which is synchronized to the 400-Kc horizontal trigger pulses.

VERTICAL SWEEP—The vertical sweep and intensifier circuits are shown in Fig. 1D and Fig. 6. In the shaper, Q_1 (Fig. 6) triggers the intensifier pulse. It operates in two different modes determined by the position of a fire-test switch.

In the FIRE position of the switch, a current of approxi-

mately $\frac{1}{2}$ ma flows into point C , through R_2 , and through D_7 and D_1 (D_7 is a 1-ma peak current tunnel diode). This current flow establishes a voltage of 0.3 to 0.4 v at the base of Q_1 , when the circuit is reset. This voltage is less than the turn-on voltage of Q_1 . When the signal current supplied by the input trigger through R_1 exceeds $\frac{1}{2}$ ma, the tunnel diode switches to its higher voltage state and transfers most of the current into the base of Q_1 , turning Q_1 on. It remains on until the $\frac{1}{2}$ -ma biasing current supplied to point C is removed.

In the TEST position of the switch, no bias current is supplied to point C . When the trigger signal supplies over 1 ma through R_1 , Q_1 turns on.

Transistor Q_1 is being operated in the avalanche breakdown region of its collector-base junction by the current supplied through R_3 . Its collector voltage is then equal to the breakdown voltage (BV_{CBS}) of the collector-base junction. When the tunnel diode switches current into the base, Q_1 avalanches and discharges C_1 through the primary of T_1 . Reset condition of Q_1 is indicated by a front-panel neon lamp

connected to point D . This lamp is on when Q_1 is off; D_2 equalizes the voltage swing and maintains the collector voltage of Q_1 at the breakdown level when the reset lamp is on.

POWER—The ± 150 -v power supplies are half-wave capacitor input filter types with choke smoothing added to reduce 60-cycle ripple. Zener diodes regulate output. The 50- and 12-v voltages are obtained from a half-wave doubler and regulated by zener diodes.

Modular supplies are used for the 10- and 2-Kv sources. Only line regulation is required since output voltage regulation of the power supplies is adequate. A Sola constant-voltage transformer provides line regulation.

The authors acknowledge the contribution of G. Holladay to the design of the vertical sweep circuit. This work was performed under the auspices of the U. S. Atomic Energy Commission.

REFERENCES

- (1) A. W. Campbell, M. E. Malin, T. J. Boyd, Jr. and J. A. Hull, *Rev Sci Instr*, 27, No. 8, p 567, Aug. 1956.
- (2) R. P. Rufer, *ELECTRONICS*, p 81, April 7, 1961.

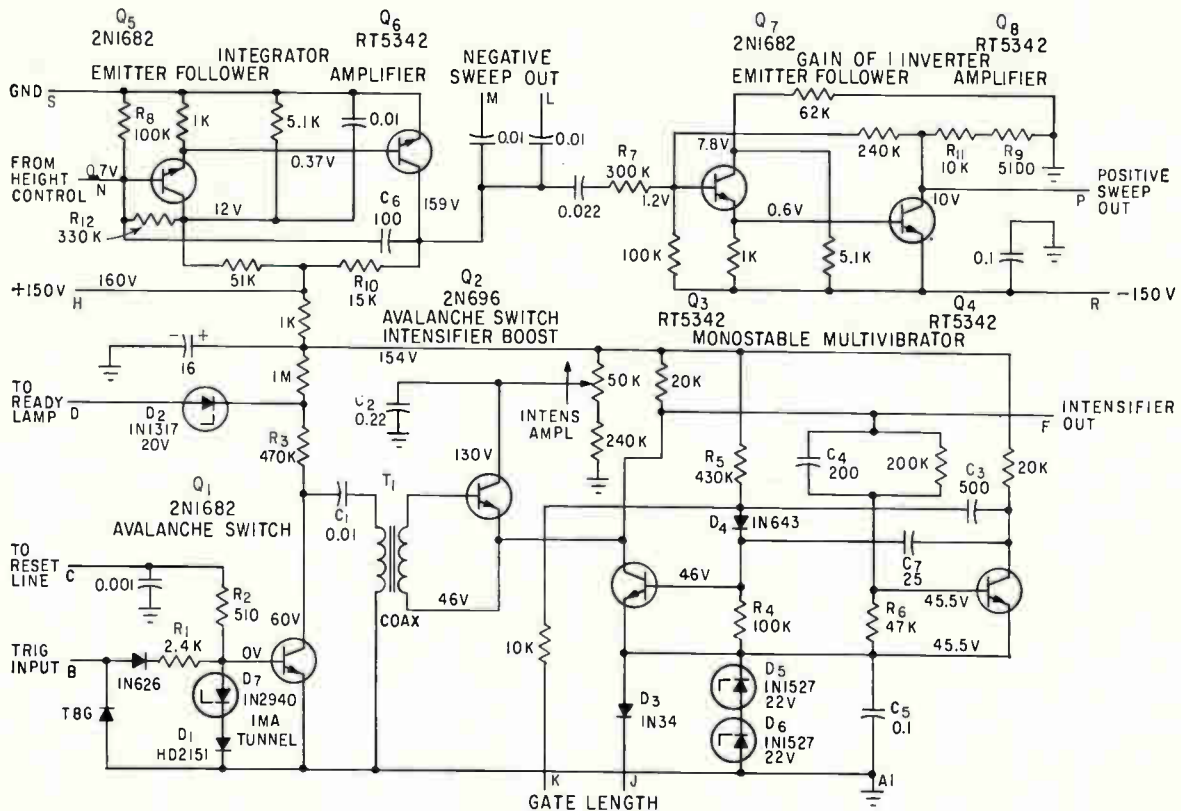

VERTICAL SWEEP and intensifier. In this circuit, Q_1 , which triggers the intensifier pulse, operates in two different modes determined by a fire-test switch (not shown) that feeds into point C —Fig. 6

Which power transistor junction would make your product perform best?

These are cross-sectional photomicrographs of emitter and collector junctions from power transistors produced by four different manufacturers. Which junction would provide better distribution of heat and current? Which junction is stronger, will last longer?

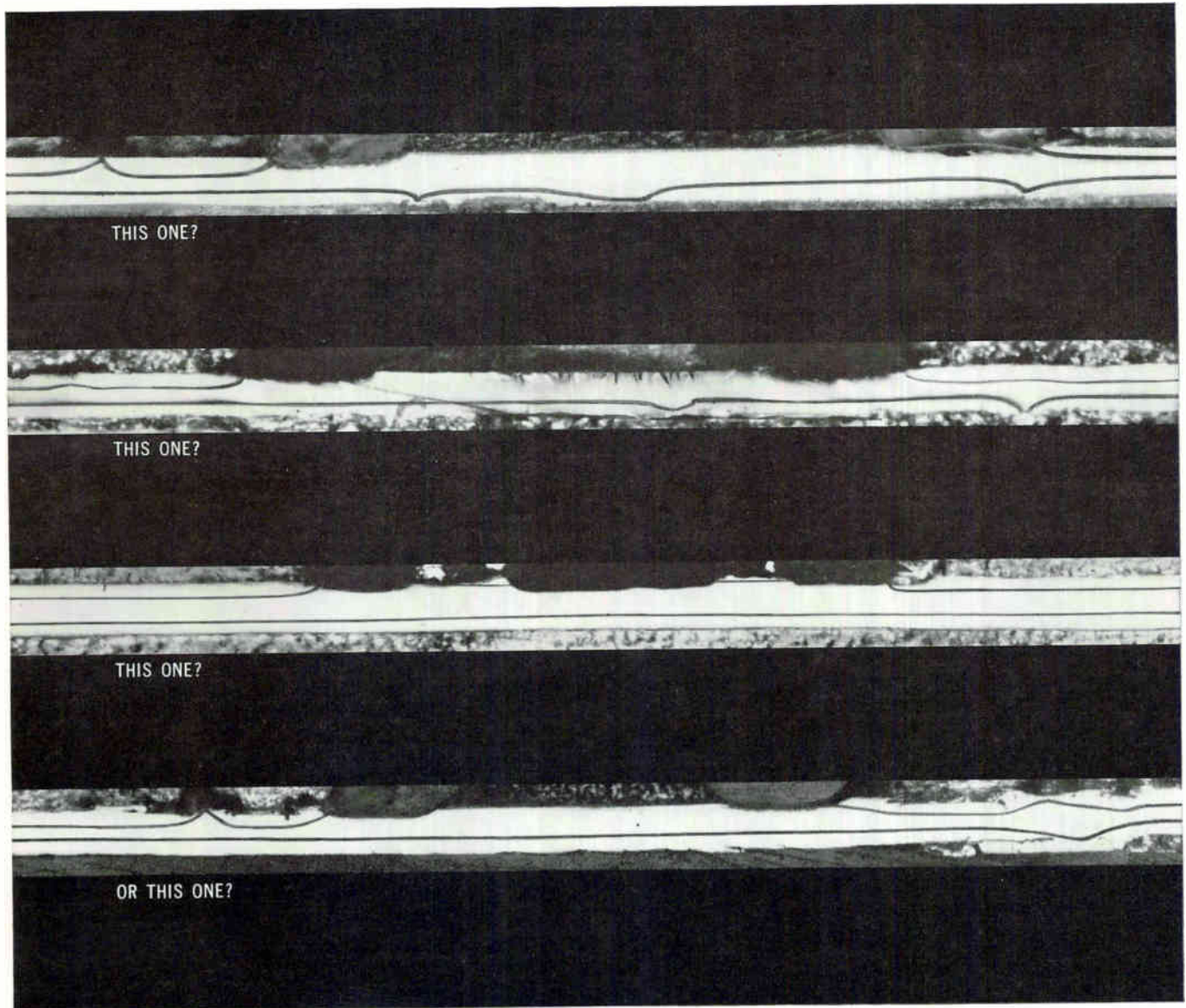

Answer: First, second and fourth samples, top to bottom, are non-planar junctions. Their imperfections allow concentration of current, lead to hot spots and eventual junction failure. Third sample is a planar junction, unique in power transistor fabrication and the result of Delco

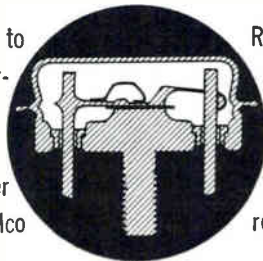

Radio's new Hydrokinetic Alloy Process. Look closely. Isn't it the flattest, smoothest junction you've ever seen? This is another reason why the most reliable power transistors are Delco. We proved it on Minuteman by meeting a 99.997% reliability challenge. May we prove it to you?

Union, New Jersey
324 Chestnut Street
MURdock 7-3770
AREA CODE 201

Detroit, Michigan
57 Harper Avenue
TRinity 3-6560
AREA CODE 313

Santa Monica, California
726 Santa Monica Blvd.
Upton 0-8807
AREA CODE 213

Syracuse, New York
1054 James Street
GRanite 2-2668
AREA CODE 315

Chicago, Illinois
5151 N. Harlem Ave.
775-5411
AREA CODE 312

DELCO
DEPENDABILITY
RADIO
RELIABILITY

General Sales Office: 700 E. Firmin, Kokomo, Indiana, GLadstone 2-8211—Ext. 500 • Area Code 317 • Division of General Motors

Rapid Selection of VHF Bypass Capacitors

By LAWRENCE E. LEE
Ball Brothers Research Corp., Boulder, Colo.

SELECTION of bypass capacitors is usually based on the relation

$$C > \frac{5 \text{ to } 10}{2\pi fR} \quad (1)$$

where R is the load to be bypassed and f is the lowest frequency that will be effectively bypassed.

This relation suggests that the larger the capacitance, C , the better the bypassing action will be. This is true for high values of R or low frequencies. However, for low values of R or very high frequencies, the inductance of the capacitor leads and plates must be considered.

The inductive reactance of the leads at frequencies near 100 Mc becomes so significant that the

bypassing values obtained from Eq. 1 are no longer valid.

CAPACITOR INDUCTANCE—

Figures 1A and 1B illustrate a capacitor and its equivalent circuit. In general, the dielectric and lead losses, r , of r-f capacitors are small and can be neglected when compared to the inductive reactances. Inductance L is the sum of the inductance of the leads, L_s , and capacitor plates l_p . At frequencies near 100 Mc the inductive reactance ωl_p of the capacitor itself is small, and only the reactance ωL_s of the leads is significant.

The inductance of a straight nonmagnetic wire with a length much greater than its diameter can be obtained approximately from²

$$L = 0.005l(2.3 \log_{10} (4l/d - 0.75)) \quad (2)$$

where L = inductance in microhenries, l = length of wire in inches, and d = diameter of wire in inches.

The variation of inductance as a function of length for No. 22 Awg wire is shown in Fig. 1C. This inductance can be appreciable; for example, at 100 Mc a wire one inch long has an impedance of nearly 16 ohms.

BYPASS SELECTION—At resonance, a series RLC circuit has

HIDDEN PARAMETERS

Usually, capacitors are thought of as having only capacitance, inductors only inductance and resistors only resistance. But capacitors also have small amounts of inductance and resistance. Because these parameters are so small they remain hidden. In low-frequency work they are usually disregarded.

At very high frequencies, the hidden parameters suddenly become so important that, if they are neglected, the calculation of bypass capacitance can result in an error of one order of magnitude

nearly zero impedance. By choosing a capacitance that will pro-
(continued on p 46)

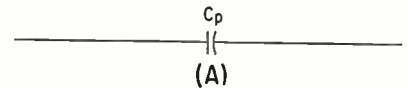

- l_p = INDUCTANCE OF PLATES
- L_s = INDUCTANCE OF LEADS
- r = DIELECTRIC AND LEAD LOSSES
- C_i = IDEAL CAPACITOR
- C_p = ACTUAL CAPACITOR

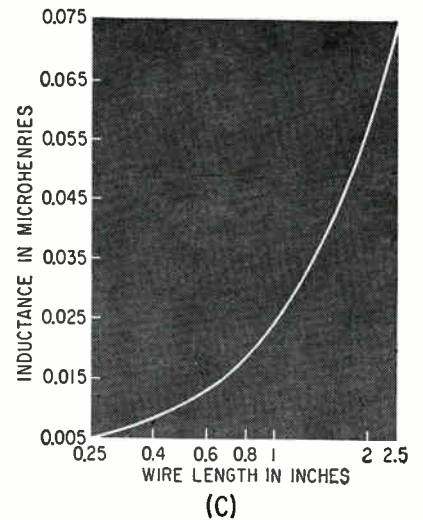
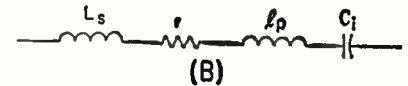

IDEAL CAPACITOR (A) and its equivalent circuit (B). Lead inductance for No. 22 Awg wire as a function of length (C)—Fig. 1

TABLE I—Resonant Frequencies of Capacitors With 1/2-Inch Leads

Frequency Capacitance C	Frequency Calculated From Fig. 2 f (Mc)	Frequency Determined Experimentally f (Mc)
50 pf	145	150
100 pf	100	105
500 pf	45	44
0.001 μ f	32	33
0.005 μ f	14	14.2
0.01 μ f	10	10.1
0.05 μ f	4.5	3.9
0.1 μ f	3.2	3.7

RCA MICROELECTRONIC PACKAGES OFFER FOUR PROVED WAYS TO MINIATURIZE YOUR CIRCUITS

RCA's Broad Line of Packaged Circuits Meets Today's Needs for High Component Density, Proved Reliability, Broad Circuit Applications, and Volume Availability

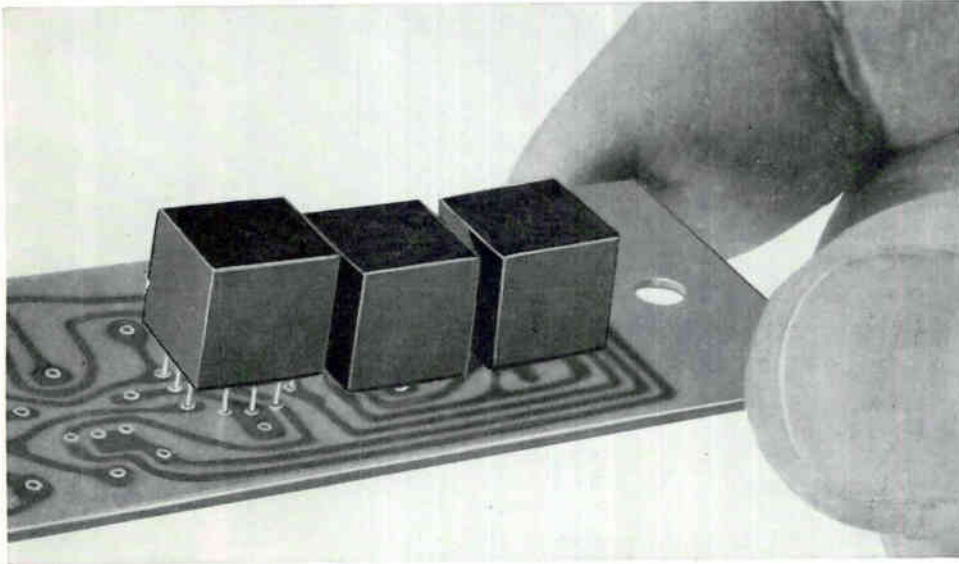

RCA Micromodules Offer Proved Reliability Backed By Over 100 Million Element-Hours of Life-Test Experience

Today's only high-density packaged circuits with this kind of life-test experience. Failure rates for RCA Micromodules are now less than 0.02% per 1000 hours at full ratings. Your *digital, analog, or linear* circuits can be supplied as RCA Micromodules...you can get working samples in a matter of days, quantity deliveries within 2 to 3 weeks. For example, RCA engineers converted one aircraft electronic package from conventional printed board construction to 16 working Micromodules in just 76 hours.



RCA Minimodules Offer Conventional-Component Economy in High-Density Format

Low-cost RCA Minimodules are precision built using reliable, conventional components, closely-packed, interconnected and encapsulated to meet the mechanical and environmental requirements of MIL specifications. RCA Minimodules can be supplied in the quantity you require, in the format you need, with terminal arrangements to meet your assembly requirements. Minimodules are available now for immediate delivery.

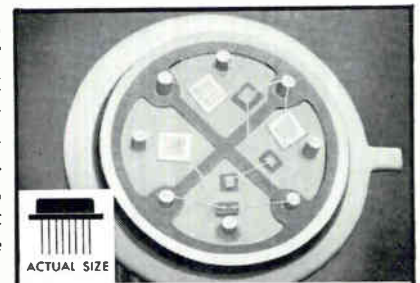

New RCA Digital Micro Circuits Switch in 7 Nanoseconds

First of a series of compact logic circuits—the RCA DMC-100 uses advanced silicon elements for ultra-high speed and new design flexibility. The RCA DMC offers excellent noise immunity, switching speeds to seven nanoseconds, high operating reliability and low power dissipation. The RCA DMC-100—designed for use in gates, adders, flip-flops, shift registers and multivibrators—is now available for immediate delivery.

RCA OFFERS MADE-TO-ORDER CUSTOM PACKAGING SERVICE

If your requirements call for special configurations, RCA packaging specialists—drawing on RCA's broad background in miniature packaging and using RCA's wide range of facilities—will develop special versions of RCA's standard packages, new advanced packaging techniques for your circuit designs, or new solid state circuit packages to solve your packaging problems.

For complete information on RCA's broad circuit packaging capability call your RCA Field Representative. For further technical data, write RCA Semiconductor & Materials Division, Commercial Engineering, Section MN12-4, Somerville, New Jersey.

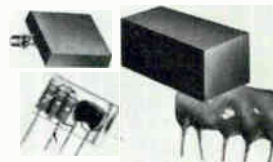

**THE MOST TRUSTED NAME
IN ELECTRONICS**

EAST: 744 Broad St., Newark 2, N. J., HU 5-3900 • 731 James St., Room 402, Syracuse 3, N. Y., GA 4-5591 • NORTHEAST: 64 "A" St., Needham Heights 94, Mass., HI 4-7200 • SOUTHEAST: 1520 Edgewater Dr., Suite No. 1, Orlando, Fla., GA 4-4768 • CENTRAL: Suite 1154 Merchandise Mart Plaza, Chicago 54, Ill., WH 4-2900 • 2132 East 52 St., Indianapolis 5, Ind., CL 1-1405 • 5805 Excelsior Blvd., Minneapolis 15, Minn., WE 9-0676 • 714 New Center Bldg., Detroit 2, Mich., TR 5-5600 • 7905 Carpenter Freeway, Dallas 7, Tex., ME 1-9720 • Continental Terrace Bldg., 2785 North Speer Blvd., Room 301, Denver 11, Colorado, 477-1688 • 605 Marlton Pike, Erlton, N. J., WO 3-8000 • Greater Baltimore Area, 1725 "K" Street, N.W., Washington 6, D.C., FE 7-8500 • WEST: 6801 E. Washington Blvd., Los Angeles 22, Calif., RA 3-8361 • 1838 El Camino Real, Burlingame, Calif., OX 7-1620 • 2250 First Avenue So., Seattle 4, Wash., MA 2-8816 • GOVERNMENT: 224 N. Wilkinson St., Dayton 2, Ohio, BA 6-2366 • 1725 "K" Street, N.W., Washington 6, D. C., FE 7-8500. RCA International Div.: 30 Rockefeller Plaza, N.Y. 20, N.Y. Cable Address: Radiointer, N.Y.

TABLE II—Inductance Of Various Lead Gages

Lead Size (Awg)	Inductance in Microhenries		
	0.5 inch length	1 inch length	1.5 inch length
No. 18	0.0098	0.023	0.0375
No. 20	0.0103	0.0241	0.0392
No. 22	0.0109	0.0253	0.0409
No. 24	0.0115	0.0264	0.0425

TABLE III—Deviation Of Inductance For No. 22 Awg Wire

Lead Length (inches)	Inductance in Microhenries for #22 Awg wire		
	-10 percent	Nominal	+10 percent
0.5	0.0098	0.0109	0.0120
1.0	0.0228	0.0253	0.0278
1.5	0.0368	0.0409	0.0450

duce series resonance with the inductance of its leads, the lead inductance is effectively cancelled. This idea is used to construct the graph of Fig. 2. The reactance as a function of frequency for various capacitors and for 0.5, 1, 1.5 and 2-inch total lead lengths of No. 22 Awg wire is shown. This gage wire was selected because it approximates the wire size used in various capacitors.

Each crossing of an inductive reactance line by a capacitive reactance line indicates the frequency at which the corresponding capacitor is in series resonance with its leads. The optimum bypassing at a particular frequency occurs at these crossing points.

As an example of the lack of effectiveness of capacitance selection using Eq. 1, consider bypassing a 50-ohm load resistance at 100 Mc. A 500-pf capacitor, or even better, a 1,000-pf capacitor would have been chosen. However, from Fig. 2 at 100 Mc, 0.5-inch leads (1-inch total length), have an inductive reactance of nearly 16 ohms. The net reactance bypassing the 50-ohm load would then be: (16 - 1.6)

or 14.4 ohms for the 1,000-pf capacitor and (16 - 3.2) or 12.8 ohms for the 500-pf capacitor. The bypassing is inefficient. Figure 2 indicates that at 100 Mc, 100 pf is the optimum value.

Measurements were made of the resonant frequencies of various types and sizes of capacitors, to verify the theoretical data of Fig. 2. The average experimental values obtained for the various capacitors are indicated in Table I. The results indicate that the graph of Fig. 2 can confidently be used as a guide for selecting r-f bypass capacitors.

LEAD SIZES—Although No. 22 Awg is the most common lead size used in capacitors in the 10 to 1,000-pf range, lead sizes ranging from No. 18 to No. 24 Awg are also used.

Table II shows the inductance for various lengths of lead sizes. Table III shows the 10-percent deviation for No. 22 Awg. Comparing Tables II and III, the inductance for the various wire gages is within the ±10 percent of No. 22 Awg.

The change in resonant frequency of the capacitors due to the change in inductance is³

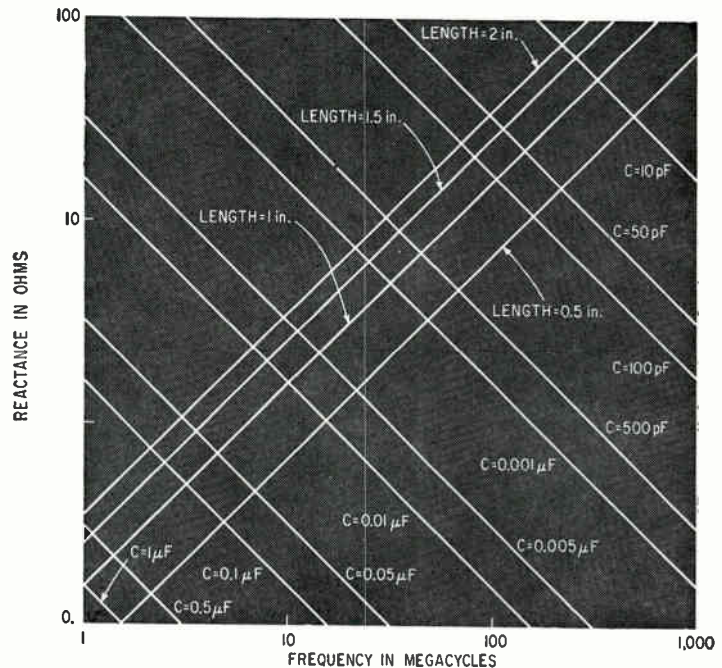

REACTANCES of capacitances and leads as functions of frequency; various lead sizes are shown—Fig. 2

$$f_1 = \frac{1}{2\pi(LC)^{1/2}}$$

$$f_2 = \frac{1}{2\pi(LC)^{1/2}(1 \pm X)^{1/2}}$$

$$f_2 = f_1 \frac{1}{(1 \pm X)^{1/2}}$$

$$f_2 = f_1 \left[1 \mp nX + \frac{n(n+1)X^2}{2!} \mp \frac{n(n+1)(n+2)X^3}{3!} + \dots \right]$$

$$f_2 = f_1(1 \mp 0.5X + 0.375X^2 \mp 0.3125X^3 + \dots)$$

$$f_2 = f_1(1 \mp 0.5X) \text{ for } X \ll 1$$

where f_1 = resonant frequency, L = lead inductance, C = capacitance and X = change in inductance.

Therefore, a 10-percent change in L produces a 5-percent change in the resonant frequency. This represents a 500 Kc change at 10 Mc and a 5 Mc change at 100 Mc. Thus Fig. 1C is valid as an engineering design chart for wire sizes from No. 18 to No. 24 Awg.

REFERENCES

(1) F. E. Terman, "Electronic and Radio Engineering", McGraw-Hill Book Co., 3rd Ed., p 24-26.
 (2) F. Langford-Smith, "Radiotron Designer's Handbook", Wireless Press, Australia, 4th Ed., p 1287.
 (3) C. R. C. "Standard Mathematical Tables", Chemical Rubber Publishing Corp., 11th Ed., p 349.

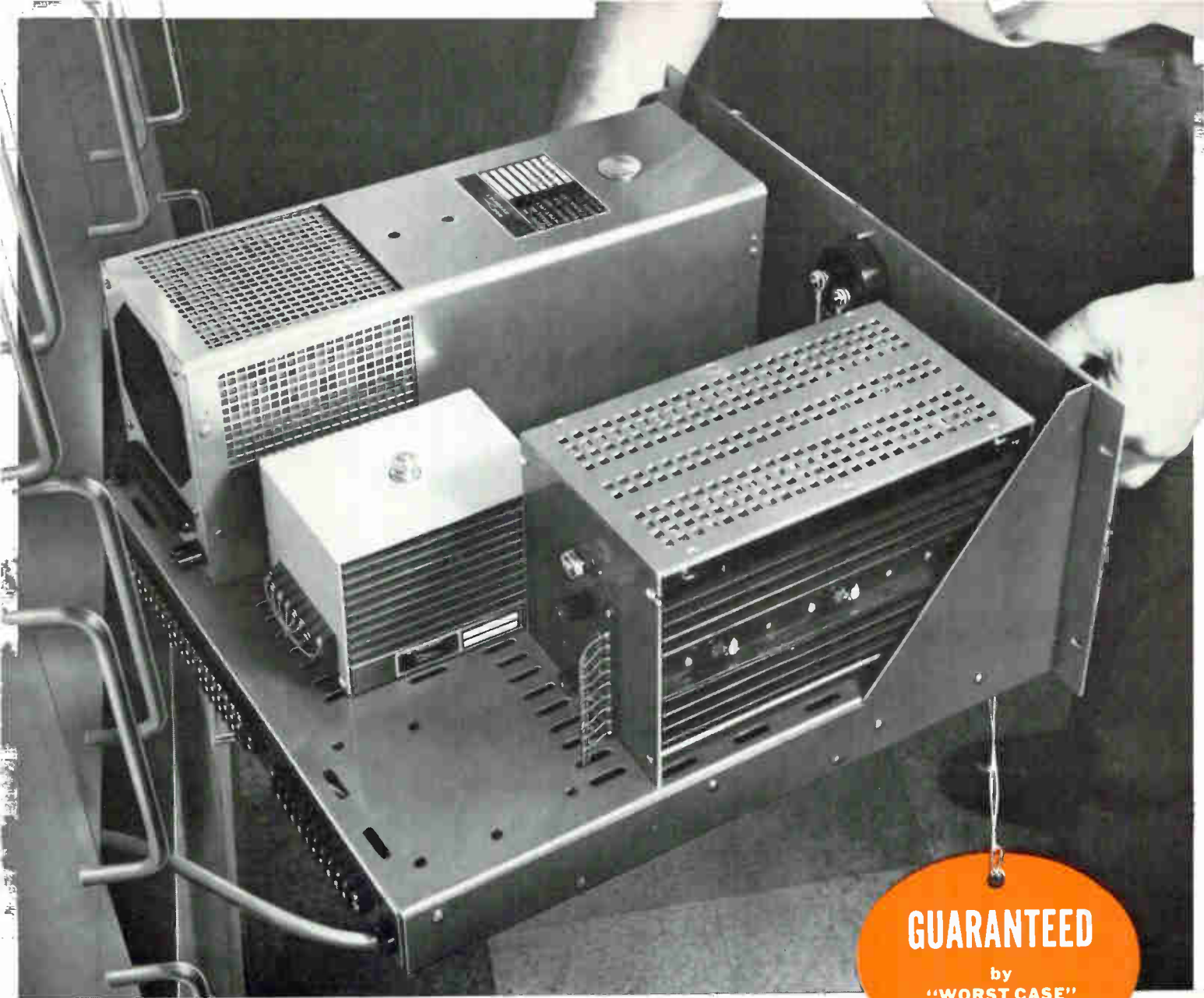

GUARANTEED
by
"WORST CASE"
ANALYSIS

Chances are you'll "plug-in" this power supply only once!

Forget all your old ideas about how long a precision power supply will last . . . how much abuse it can take and still stay accurate.

Once installed, you'll probably never ever touch a Con Avionics transistorized power supply again during the life of the equipment it operates.

Many of these power supplies have survived 20,000 hours under the worst possible conditions without the slightest sign of failure.

The reason? Con Avionics unique design principle "Worst Case" Analysis.

It eliminates 90% of the causes for power supply failure. Increases the accurate life of a power supply substantially. Assures virtually failure-proof performance.

Learn how Con Avionics transistorized power supplies can give you extra protection against costly shutdowns, and substantially reduce your supply cost per operating hour. Write for bulletin on Con Avionics complete line of Transistorized Power Supplies. Or call your local Con Avionics representative.



New LR and XR MODULES for applications to 14 amps. 0.05% or 10 mv Regulation. Ripple: 2 mv. Stability: 0.1% for 8 hours. Operating temp: 45°C as specified, derated to 70°C. Send for bulletins 103 and 104 for details.

CONSOLIDATED AVIONICS CORPORATION

800 SHAMES DRIVE, WESTBURY, L. I., NEW YORK



Solid-State Nuclear Gyro Reported Feasible

Gyro designer's goal nears: space vehicle guidance without moving parts

By MICHAEL F. WOLFF
Senior Associate Editor

DEMONSTRATION by Arma of the feasibility of a solid-state nuclear gyro represents a significant step toward the goal of many guidance system engineers—a gyro without moving parts. The claim is based upon Arma's report that they were able to align protons in an experimental directional gyro and then sense this alignment (ELECTRONICS p 8, Dec. 14).

The nuclear gyro belongs to a class of gyros that would use the angular momentum of atomic nuclei and electrons rather than the conventional rotor momentum as a directional reference (ELECTRONICS, p 20, Feb. 16). Because such gyros would have no moving parts they are expected to be more accurate and reliable than present gyros. They would also require less power

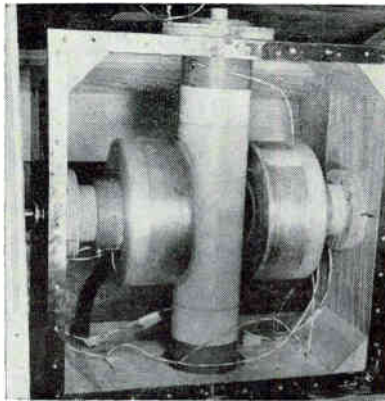

FIRST PUBLISHED closeup of nuclear gyro model shows polarizing and sensing coils. The sample of material is placed inside vertical coil

and produce minimum inertial reaction on a spacecraft.

HOW IT WORKS—There are many possible techniques for orienting and sensing the orientation of nuclear gyro particles. Arma uses nuclear magnetic resonance techniques. Here proton spin vectors

are aligned by simultaneously applying a pulsed d-c magnetic field and a pulsed r-f field. Purpose of the r-f field is to augment the proton alignment process by aligning electrons. These electrons then interact with the protons in such a way as to cause additional protons to be aligned. This phenomenon, cross-relaxation, can increase the number of aligned protons in some materials by a factor of three.

In solid-state materials, the aligned protons decay into randomness in microseconds to hours, depending on the material. However, by continuously aligning the protons with successive pulsing it is believed possible to obtain a directional reference in inertial space.

Duration and shape of the pulses have to be adjusted to the spin relaxation processes within the material. According to Berthold Zarwyn, director of Arma's basic research department, it is preferable to use materials where spin-spin relaxation time and spin-lattice relaxation time differ as little as possible since this ratio determines the gyro signal to noise ratio.

Spin-spin relaxation time characterizes the time it takes for an aligned system of spin vectors to be randomized due to interaction of proton spins. Spin-lattice relaxation time characterizes randomization time due to the fluctuating magnetic field of the lattice acting on a system of aligned spins. Ordinarily spin-lattice relaxation time is much longer than the spin-spin time in solids, whereas in liquids and gases they are almost equal.

SENSING—Within a time that is short relative to the spin-spin relaxation time, another pulsed magnetic field is applied and the deviation from the resonance condition that existed during the previous aligning pulse is measured. For this purpose, ordinary sensing coils are used; the induced voltage is a measure of the magnetization resulting from the spin vector alignment.

Zarwyn said his group had experimented with several solid ma-

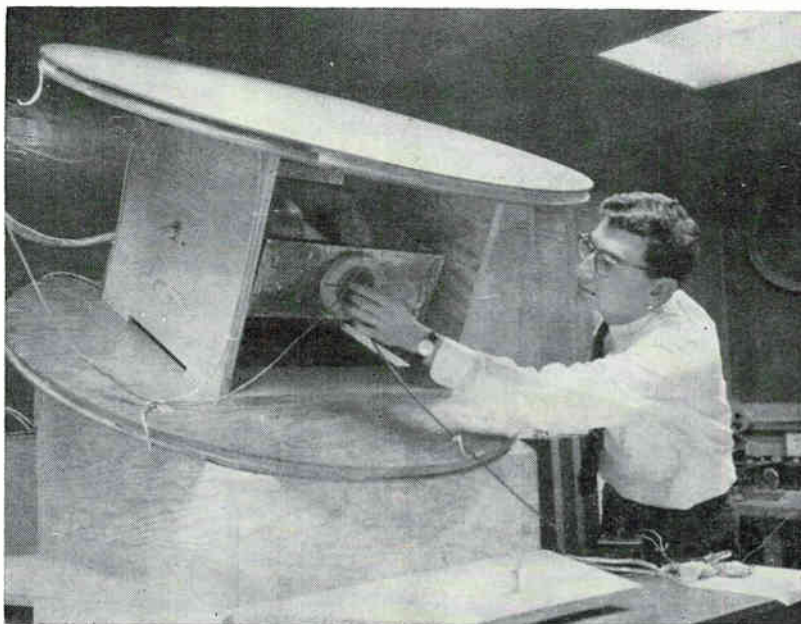

POSITION OF sample material is adjusted in experimental model of nuclear gyroscope by Arma scientist Arthur Eberstein

LOW COST
POWER SUPPLIES
WIDE RANGE
FLEXIBILITY



CHECK KEPSCO



10 MODELS
from 0-2V/1A
to 0-2500V/2ma

STABILITY: Less than 0.05% or 3 mv, whichever is greater, over a period of 8 hours at constant ambient temperature.

RIPPLE: Less than 0.5 millivolt rms.

RECOVERY TIME: 50 microseconds.

AMBIENT OPERATING TEMPERATURE: -20°C to +50°C maximum.

TEMPERATURE COEFFICIENT: Output voltage changes less than 0.05% per °C.

INPUT REQUIREMENTS: 105-125v ac, 50-440 cycles.

PROMPT DELIVERY . . . MOST MODELS FROM STOCK

0.05% REGULATION and STABILITY
TRANSISTORIZED MODELS

MODEL	DC OUTPUT RANGE		INPUT AMPS (MAX.)	OUTPUT IMPEDANCE OHMS MAX.			PRICE
	VOLTS	AMPS		DC to 100 CPS	100 CPS to 1 KC	1 KC-100 KC (+ μhy)*	
ABC 2-1M	0-2	0-1	0.3	0.001	0.01	0.1 +0.5	\$179
ABC 7.5-2M	0-7.5	0-2	0.5	0.002	0.01	0.05+0.5	\$159
ABC 15-1M	0-15	0-1	0.5	0.008	0.01	0.02+0.2	\$159
ABC 30-0.3M	0-30	0-0.3	0.3	0.05	0.02	0.1 +1	\$119
ABC 40-0.5M	0-40	0-0.5	0.5	0.04	0.02	0.04+0.2	\$159

HYBRID MODELS

MODEL	DC OUTPUT RANGE		INPUT AMPS (MAX.)	OUTPUT IMPEDANCE OHMS MAX.			PRICE
	VOLTS	MA		DC to 100 CPS	100 CPS to 1 KC	1 KC-100 KC (+ μhy)*	
ABC 200M	0-200	0-100	0.5	1	0.5	2+1	\$199
ABC 425M	0-425	0-50	0.5	4	1	2+1	\$199
ABC 1000M	0-1000	0-20	0.5	25	2	2+1	\$274
ABC 1500M	0-1500	0-5	0.3	150	2	2+1	\$274
ABC 2500M	0-2500	0-2	0.3	625	2	2+1	\$334

*Effective series inductance.

FOR DETAILED SPECIFICATIONS ON MORE THAN 250 STANDARD MODEL POWER SUPPLIES SEND FOR KEPSCO CATALOG B-621

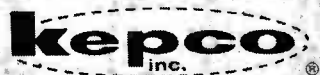

131-38 SANFORD AVENUE • FLUSHING 52, N.Y., U.S.A. • Phone (212) IN 1-7000
 TWX# (212) 539-6623 • Cable Address: KEPSCOPOWER, NEWYORK

See our Catalog in
eem File System Sec. 000
 electronic engineers master

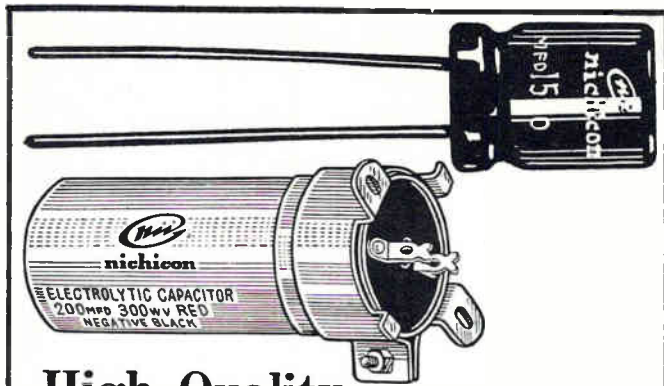

High Quality Nichicon Capacitors

for all electronic equipment

Nichicon research and experience assures remarkable strength and stability in all its capacitors. Nichicon produces a complete line of capacitors designed for every need.

nichicon MAIN PRODUCTS: Oil Paper Capacitor, Electrolytic Capacitor, Tantalum Capacitor, Metallized Paper Capacitor, Ceramic Capacitor, Mica Capacitor and Mylar Capacitor, etc.

Nichicon Capacitor Ltd.

HEAD OFFICE : Uehara Bldg., Oikedori, Karasumahigashi-iru
Nakagyo-ku, Kyoto, Japan
CABLE ADDRESS : CAPACITOR KYOTO

CIRCLE 201 ON READER SERVICE CARD



plug-in type
up to 6 PDT contacts
D. C. operated coil
max. contact rating:
30 W / 40 VA resp.
125 V, 1 amp.
miniature dimensions
2. 1/8" x 25/32" x 1. 3/16"

stock delivery
low prices

H. KUHNKE
ELEKTROTECHNISCHE FABRIK G.M.B.H.
MALENTE/HOLSTEIN, WEST GERMANY
PHONE: 397 TELEX: 026703

CIRCLE 202 ON READER SERVICE CARD

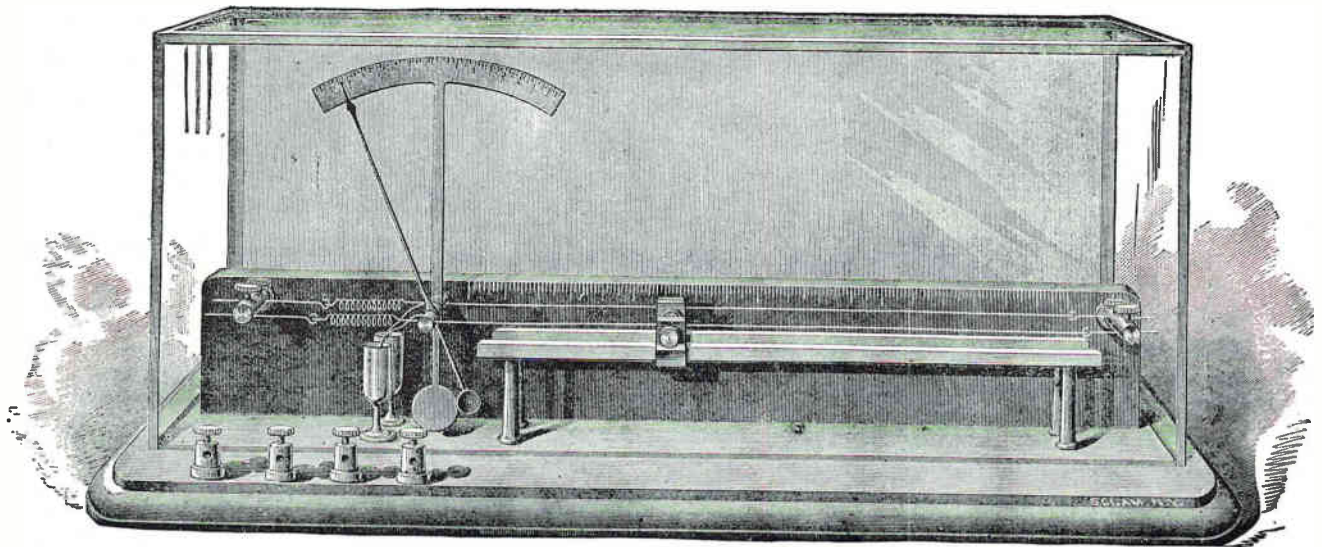

Is it ancient history by the time you see electronics?

Get the facts while they're new. Don't wait for **electronics** on a route slip. Look in this issue for the Reader Service Card. Fill out and mail the "for subscriptions" section. Only 7½ cents a week.

electronics A McGraw-Hill Publication, 330 West 42nd St., N. Y. 36

EXOTIC GUIDANCE SYSTEMS

Two other approaches to guidance, in addition to the nuclear gyro, are being developed by Air Force Systems Command's Research and Technology Division, and were described at the recent American Ordnance Association Meeting in New York by Major Gen. Marvin C. Demler.

- The electrostatic gyro, which exploits the suspension forces between charged surfaces to levitate a spinning spherical rotor in an evacuated case. The rotor is brought up to speeds of the order of 30,000 rpm by induction and allowed to coast down in the vacuum; this is estimated to take between 150 and 500 days.
- Guidance Using Stable Tuning Oscillators, or GUSTO, holds promise for satellites. It uses atomic clocks accurate to a part in 10^{12} . One clock is in the satellite, the other on earth. The two clocks can be compared to each other, or the doppler frequency change that takes place in transmitting a signal from ground to satellite can be measured

materials having relaxation times of the order of milliseconds. Before a practical gyro can be obtained, he said, the size and weight problem caused by the use of big coils to shield the gyro from stray magnetic fields must be solved. Arma is investigating superconducting solenoids for this purpose, as well as ceramics covered with thin superconducting films which can sustain higher magnetic fields than bulk superconductors. "In our opinion this will give the necessary degree of shielding to make an actual gyro operational with the accuracy required for inertial applications and without bulky magnets," Zarwyn said. Other problems include obtaining better resolution and performance, proper switching techniques and materials selection.

The project is sponsored by the Aeronautical Systems division of Air Force Systems Command.

Other firms active in nuclear gyro work include GPL division of General Precision Inc. and Republic Aviation.

Republic is working on a magnetic induction gyro using water doped with paramagnetic salts. Here applied d-c and a-c magnetic fields align the nuclei. Rotation of the sample has the same effect as additional magnetic fields transverse to the original axis of alignment. These fields are measured by sensing the second harmonic content of the modulated a-c signal.

Republic is working on the gyro under contract from Navy's Bureau of Naval Weapons, claims that use of the nuclear principle provides lower drift rate than that of the best existing gyros, very low threshold, and unlimited angular motion.

General Precision is reportedly using optical pumping to align spin vectors.

MAGNETIC INDUCTION GYROSCOPE

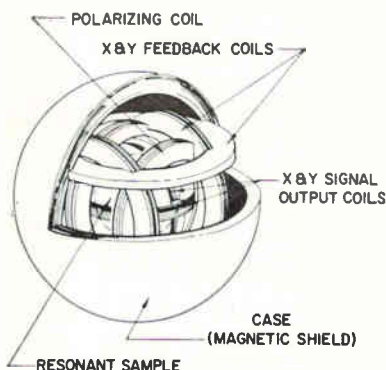

ARTIST'S VIEW of magnetic induction gyroscope under development by Republic Aviation Corp. (left) shows simplicity of construction and absence of moving parts, which is expected to eliminate the complexity and precision required of mechanical gyros (right)

CONVENTIONAL INTEGRATING GYROSCOPE

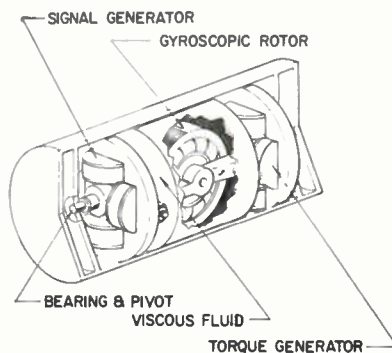

A breakthrough in Radar Modulator Design:

The SI-7K1-U is 40% more efficient with no change in input potential.



custom designed, engineered and produced to customer's exact specifications.

FEATURES — Exclusive fast rise technique in the PFN. Completely revised, regulated filament supply system. Gas filled to provide good dielectric strength over operating temperature range (-55°C to $+100^{\circ}\text{C}$). Accepts short circuits and open circuits without blocking.

SPECIFICATIONS — B + 1500 volts; trigger input — 200 volt peak; variable from 200 pps to 3300 pps; recovery time, 100 Microseconds; output pulse, $3\frac{1}{2}$ Microseconds wide; Amplitude 7.5 KV at 1.2 Amps. with rise time less than 0.3 Microseconds.

For full information about Saratoga Industries complete design, engineering and production facilities, write



SARATOGA INDUSTRIES

A Division of Espy Mfg & Electronics Corp.
Saratoga Springs, N. Y. • Telephone 4100

Will Gallium Alloys Provide New Electronic Light Source?

Scientific community sees interesting potential for electroluminescent chips

DEVELOPMENT of a new electroluminescent light source from a pinhead-size chip of crystalline chemical material was announced recently by General Telephone & Electronics Corporation. Although complete technical details have not been revealed, "this new diode represents a true research breakthrough with significant promise in both military and commercial lighting applications," according to Lee L. Davenport, President of GT&E Laboratories. "One or two years of further work must be accomplished, however, before its full potential can be realized," Davenport said.

The electroluminescent diode is composed of two crystalline semiconductor materials, gallium arsenide and gallium phosphide. Mechanism of injection electroluminescence, involved using these alloys, is scientifically simpler to understand than mechanisms involved using zinc sulfide or cadmium sulfide crystals. More straightforward understanding offers more chance of progress in solving existing problems connected with light efficiencies.

RED LIGHT NOW—Tiny crystal can convert electrical current directly into visible red light with a theoretical efficiency of 100 percent, according to GT&E. As a result, the crystal is expected to lead to a variety of applications where a small-point light source or high-directional beam is required.

Light intensity from gallium arsenide-gallium phosphide diode is typical of that obtained from gallium-arsenide diodes. Gallium arsenide differs from semiconduc-

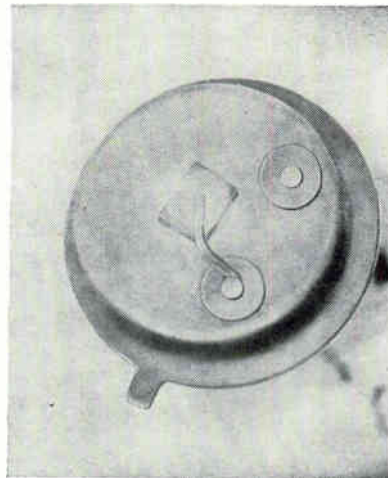

CRYSTAL radiates red light. Current is applied to diode through hair-like wire extending from perimeter of the mounting can

tors like germanium or silicon in fact that light proton is produced in the former. At room temperature, overall efficiency of gallium arsenide-gallium phosphide crystal is now less than one percent. But work on internal absorption and reflection problems should result in higher efficiencies, according to company.

First applications of new light crystals will be in electroluminescent displays. Only a few volts are needed for power drive, and crystals can run off transistor power supplies. Therefore, it will be possible to use electroluminescent chips as tiny electronic lights for indicators in transistorized circuits.

Theoretical quantum efficiency of the gallium alloys is high. However, two practical problems still have to be solved before electronic lights can become practical. Current has to be pushed through these low-voltage diodes, and resistive losses will have to be reduced. Also, more efficient techniques will have to be developed to get the photons out of

the semiconductor junctions.

Formed from a vapor, the flat crystal diode is 1/30th of an inch square, and 1/300-in. thick. When current is applied to the face of the tiny device, its entire surface radiates an intense red light. Surface brightness of this light is substantially greater than similar red illumination from existing electroluminescent lighting. Present developmental efforts are being devoted to further increases in practical efficiency. Present work is directed toward developing efficient techniques for pushing maximum current through the diode and getting the maximum light out.

WHITE LIGHT? — Additional work into a variety of semiconductor materials will be directed towards broadening the range of colors emitted from the diodes with particular emphasis upon the attainment of white light for illumination purposes, according to

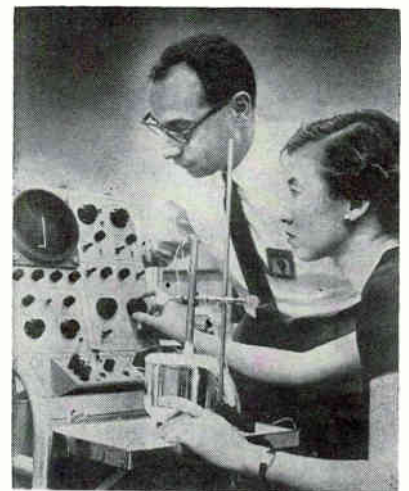

CURRENT flow through gallium arsenide-gallium phosphide light source is viewed on oscilloscope trace by Sumner Mayburg and San-Mei Ku. During laboratory experimentation, crystal is immersed in liquid nitrogen in thermos container directly in front of Miss Ku

ENGINEERS!

CONSIDER THE UNIQUE ADVANTAGES OF THE CLIFTON PRECISION

VARIABLE RELUCTANCE

MULTI-POLE RESOLVER

- Acts as a geared-up resolver without the gears
- Gives extreme accuracy (20 sec. of arc max. deviation)
- Constructed without slip rings and brushes

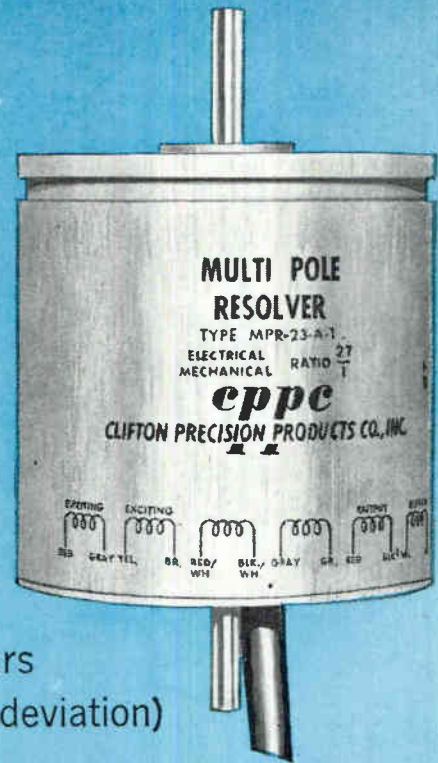

The Clifton Precision Multi-Pole Resolver is a reluctance type unit with all windings placed in the stator. Stepped-up ratios between a mechanical angle and an electrical output are obtained electrically without conventional gearing by varying the winding pattern and the number of teeth in the rotor lamination. Result—savings in cost by eliminating gears.

Another advantage of a reluctance type unit is the absence of sliding contacts with attendant elimination of brush problems such as wear, vibration and noise. In fact, life of the resolver depends on bearing life only.

Both stator and rotor are laminated. Because of the average effect inherent in a laminated construction, the accuracy of these units exceeds by many times the machining accuracy. Repeatability is better than ± 3 seconds of shaft angle and crossover null error spread over one full revolution of less than 20 seconds of arc is obtained.

This unit has been very effectively employed as a "vernier" resolver. When used in conjunction with a regular synchro resolver, extremely accurate system measurements result (see applications below).

Multi-Pole Resolvers are presently operational in the Skybolt missile and Mariner (Venus probe) tracking equipment.

For further information, contact: Sales Dept. 5050 State Rd., Drexel Hill, Pa. Area 215 MADison 2-1000, TWX 215 623-6068—or our Representatives.

APPLICATIONS

VERNIER ANGLE ENCODER. In this system a shaft and angle are converted into a pair of digital numbers (one coarse and one fine) by coupling a standard resolver directly to a multi-pole resolver.

The output of the resolver may be encoded by exciting the primary with a signal of 400 cycles per second and combining the induced secondary amplitude voltages (by means of two-phase shifting networks) into two-phase modulated voltages. The time interval between the respective zero crossings is converted into digital representation by an electronic stop watch (time encoder).

VERNIER ANGLE READING SYSTEM. A visual vernier angle reading system can be built by using the output of the multi-pole resolver to position a standard resolver. The control transformer resolver will go through "n" revolutions for each revolution of the multi-pole resolver (where "n" is the order of the multi-pole resolver). The reading of a dial coupled directly or through gears to the control transformer resolver provides the vernier reading. This technique is most useful in reading the position of a rotary table.

A VERNIER FOLLOW-UP SYSTEM can be utilized much like present two-speed synchro control transformer systems except that the geared-up synchros are replaced by multi-pole resolvers.

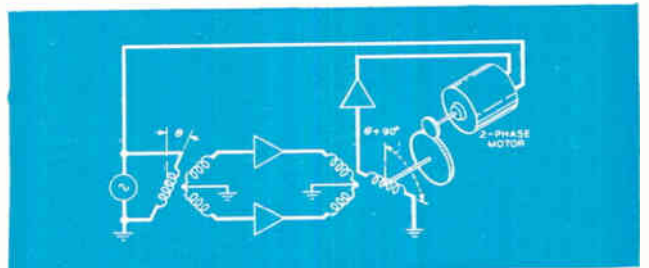

CLIFTON PRECISION PRODUCTS CO., INC.

Clifton Heights, Pa. • Colorado Springs, Colo.

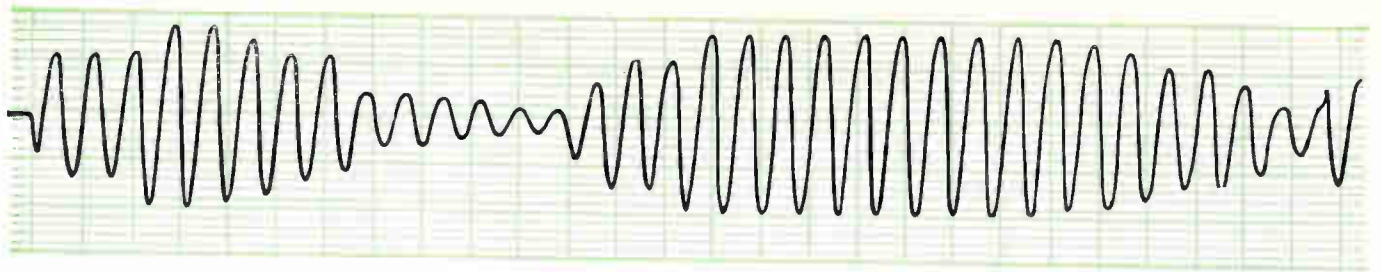

NOW!

RECORD **V**OLTS, **O**HMS, **M**ILLIAMPS
with **ONE** **RECORDER**

ONLY
\$595
COMPLETE

...**NO EXTRAS!**



company officials at GT&E.

Development of the electroluminescent diode source was accomplished by three members of a GT&E team: James F. Black, San-Mei Ku, and Harry F. Lockwood, under the supervision of Sumner Mayburg, scientists in charge of the laboratories solid-state electronics program.

Since most present electroluminescent devices operate in the green, the red light from gallium diodes should augment overall use for electroluminescent devices.

Initial use of the electroluminescent diodes likely will be as indicator lights for electronic equipment. However, according to Davenport, the new device offers greater long-range potential for specialized applications where incandescent lamps are presently used.

Several electronic laboratories are now conducting research on mechanisms of injection electroluminescence, and more reports about their work are anticipated in the coming months.

Plastic Film Disappears In Space Environment

PLASTIC FILM that photolyzes or disappears in the environment of space has been developed by Goodyear.

The film and the wire grid for a passive communications satellite could be mated and packaged in a rocket nose cone, according to Goodyear. After launch, the film, used as a bladder, would be inflated to erect the grid structure. Ultraviolet rays from the sun would then cause the film to disappear, leaving the grid to act as a reflector for radio waves.

Goodyear sees several advantages with this technique. Since the structure does not depend on gas pressure for rigidization, it is not subject to serious degradation due to meteoroid penetration, nor will it undergo large surface changes due to thermal variations.

Similar techniques are being proposed for other applications such as space-borne antennas, Goodyear said.

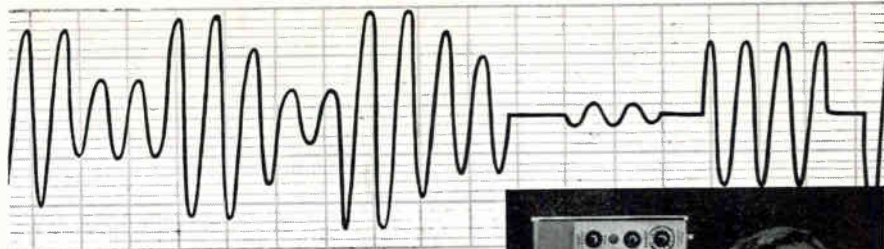

New

Bausch & Lomb

V.O.M.-5 RECORDER

... an all-new, complete 5-inch strip-chart recorder that breaks all precedent in the field ... brings you the finest features of potentiometric recorders for *one low price*. Compare these exclusive advantages, all these "extras" at no extra cost, with any other recorder in its class.

- Five voltage ranges, 10 millivolts to 500 volts D.C.—full scale deflection.
- Six linear ohms scales, 1-to-100,000 ohms full scale, with zener diode D.C. supply.
- Four D.C. current ranges—10 microamperes to 100 milliamperes.
- Five chart speeds, 400-to-1 range.
- Off balance input impedance—over 10 megohms.
- Event marker, with interchangeable pens.
- Function switch with mechanical pen letdown.
- Operates in flat, 30° tilt, or wall-mounted position.
- Compact—only 4¾" x 14½" x 11¾".
- Portable—only 16 lbs.

And more. Lots more! Mail the coupon now for the whole story on this new 5-speed recorder with versatility-plus!

BAUSCH & LOMB



**BAUSCH & LOMB
INCORPORATED**

62336 Bausch Street
Rochester 2, N. Y.

Please demonstrate the V.O.M.-5 Recorder at my convenience.

Send Recorder Catalog D-2032.

Name Title

Company

Address

City Zone State

Microscope and Tv Help Train Assemblers

Numerous personnel simultaneously learn production techniques.

By HARTMUT E. KELLER
Carl Zeiss, Inc.
Los Angeles, Calif.

RAPID training of many personnel in miniature assembly and finishing techniques presented quite a problem in Autonetics' production of inertial guidance system components for Minuteman intercontinental missiles. Because of drastic environmental requirements, the number of personnel in assembly rooms must be restricted to achieve precise control of temperature, humidity and dust. For example, dust count is maintained at about 5 percent of normal for production of velocity meters used in the missile's inertial navigator. This assembly operation was the first to receive the microscope-tv training preparation.

The basic idea is to spread people about in various clean assembly rooms and televise training information to them from a room containing instructor personnel. How-

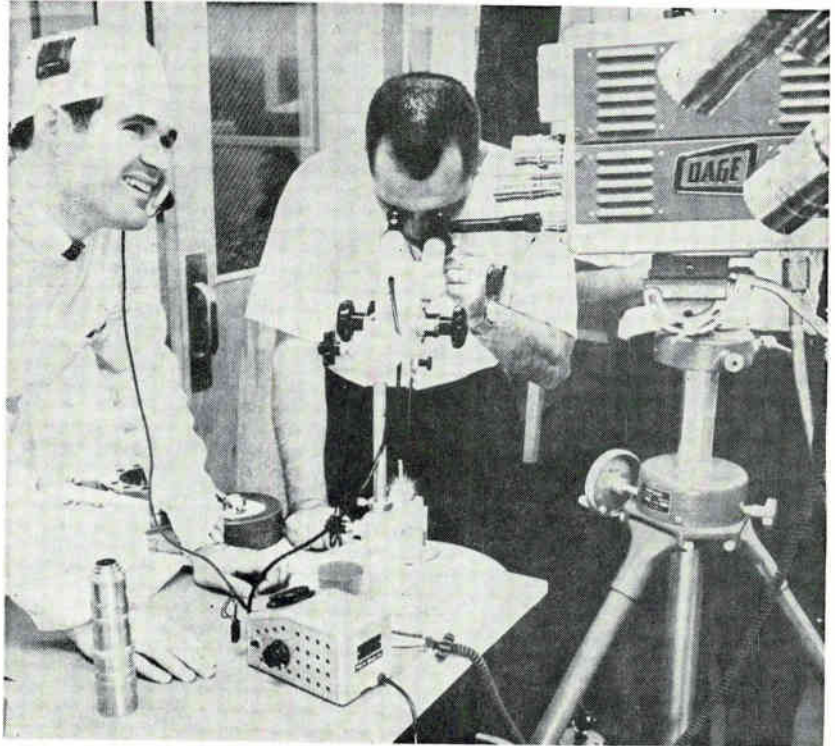

SPECIAL ADAPTER enables tv camera to view miniature components through demonstration eyepiece attachment on binocular viewing tube of Epi-technoscope

ever, microscopes normally used for assembly of miniature components are not equipped to carry a tv camera. A Carl Zeiss Epi-technoscope allows for tv camera attachment and was found to be ideal for televising miniature assembly and finishing procedures.

VIEWING EQUIPMENT — The Epi-technoscope is a stereoscopic instrument giving a three-dimensional image with great depth of field. A built-in magnification changer gives five magnifications, parfocal to each other. Four different focal objectives are available: 125 mm, 200 mm, 300 mm, 500 mm. The working distance with these various objectives is approximately equal to focal length. One of the outstanding features of the Epi-technoscope is the built-in light source that illuminates the object in nearly the same direction as it is observed to permit viewing

of deep-lying objects, narrow crevices, dead holes and orifices. Equipped with a binocular tube, the microscope also has demonstration attachment. Normally used for a second viewer, this attachment takes a special adapter that in turn attaches a close-up tv camera. A moveable pointer needle enables the instructor to direct attention to a specific object or motion within the instruments viewing field.

Either an inclined or straight binocular tube can be used. This assures a convenient and comfortable position of the head of the observer in any direction of observation. The binocular tubes can be used with either 12.5X or 20X eyepieces. Both are focusing eyepieces and can be supplied with reticules for very critical photographic focusing.

PROCEDURE—A continuous image of the instructor's motions, as seen through the Epi-technoscope,

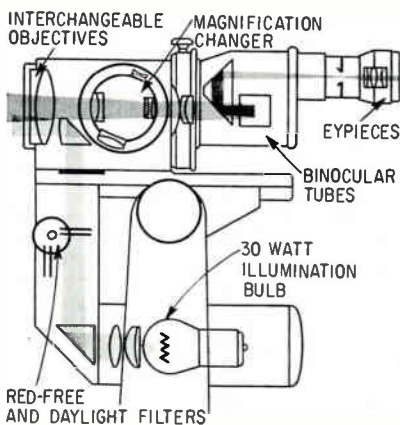

ILLUMINATION is directed within microscope by optical system so that narrow cavities and deep lying objects can be viewed

How Potter & Brumfield precision-cleans missile relays for top reliability!

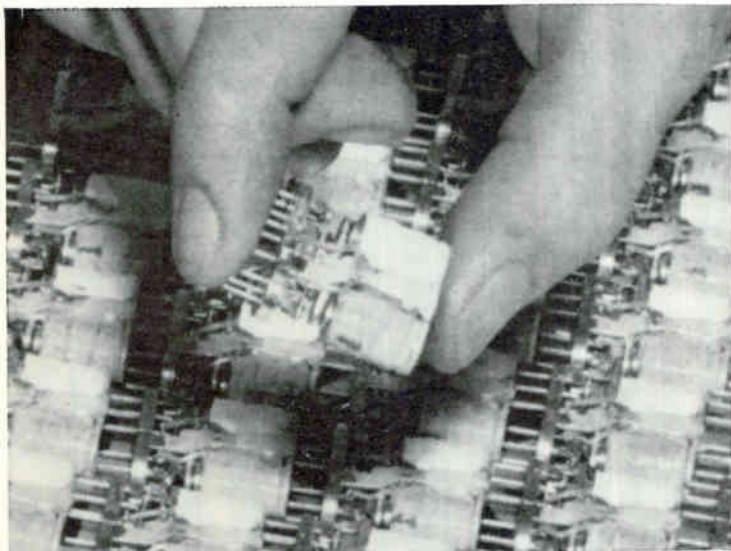

PROBLEM: How to reduce an unacceptably high reject rate on critical "crystal-case" electrical relays (first photo) at Potter & Brumfield, Division of American Machine & Foundry Company... eliminate employee problems of headaches and nausea due to solvent vapors.

SOLUTION: A new cleaning system using "Freon" fluorinated solvents. "Freon" is an excellent selective cleaning agent. It removes solder flux, dust, lint and other contaminants, yet doesn't harm delicate relay parts. Also, "Freon" is virtually non-toxic, thus eliminating complaints about vapors.

In the cleaning process, a basket of relays is first given a 15-second ultrasonic bath in "Freon" TMC, then an ultrasonic bath in "Freon" TF for 15 seconds (second photo), and a 15-second rinse in TF vapor. Because of its low surface tension, "Freon" quickly penetrates the tiny spaces in the relays, allowing precision cleaning of delicate parts.

As a final cleaning step, the relay contacts are washed in a spray of "Freon" TF, while being electrically actuated (third photo). This assures that no particles are entrapped between the contacts. Only the high dielectric strength of "Freon" makes this operation possible.

According to Potter & Brumfield, the adoption of "Freon" solvent cleaning has upgraded product quality, meeting their critically high standards, equivalent to a 17% increase in production capacity while at the same time decreasing labor costs. They point out that "Freon" dries quickly and leaves no residue, and that its non-flammability and low toxicity let them operate without expensive ventilating equipment. They've found "Freon" solvents economical to use because they can be recovered in simple equipment for reuse... over and over again. Most important, "Freon" solvents have eliminated employee complaints on nausea and headaches.

• • • •

We'll be glad to give you help in selecting "Freon" solvents for use in your own cleaning operation. Just write on your letterhead to Du Pont, 2420E12 Nemours Bldg., Wilmington 98, Delaware.

FREON[®]
solvents



BETTER THINGS FOR BETTER LIVING . . . THROUGH CHEMISTRY

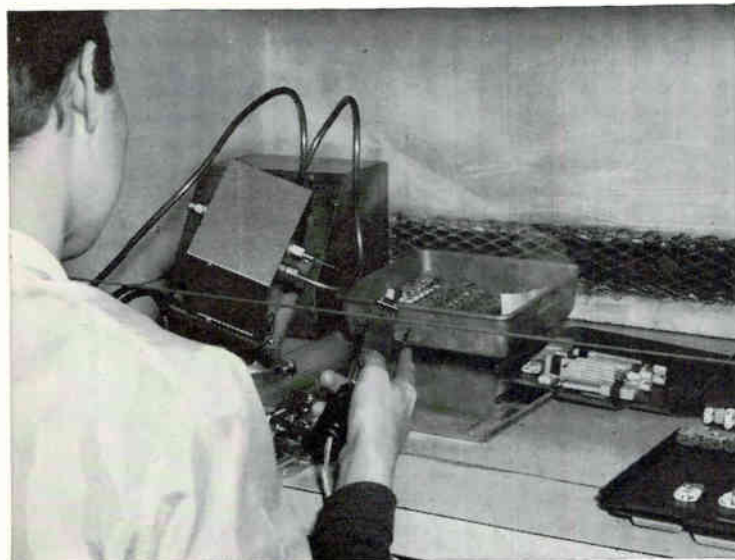

"The Light Touch In Automation and Control"

IBM STARTED USING CLAIREX

PHOTOCONDUCTIVE CELLS

6 Years Ago

as

RELIABLE

System Components

And Still Does!



Reliability in computer components means a great deal to IBM and its customers; down time is extremely expensive. Clairex photoconductive cells, because of their rigidly controlled parameters and ability to perform indefinitely with little or no maintenance, have been among components used for years by IBM. The Clairex cells function as the "eyes" of important IBM light-actuated tape drive controls.

These tape drives are now operating in thousands of computer systems around the world — providing daily proof through performance of Clairex reliability!

You too can enjoy this confidence in supply. Clairex cells have been employed by hundreds of major firms in outer space, photography and dozens of other interesting fields. These cells offer a broad range of characteristics to the design engineer in the largest line of both glass and metal photoconductive cells available to the industry.



CLAIREX CORPORATION

The Oldest Manufacturer of Cadmium Sulfide and Cadmium Selenide Photoconductive Cells

8 West 30th Street, N. Y. 1, N. Y.

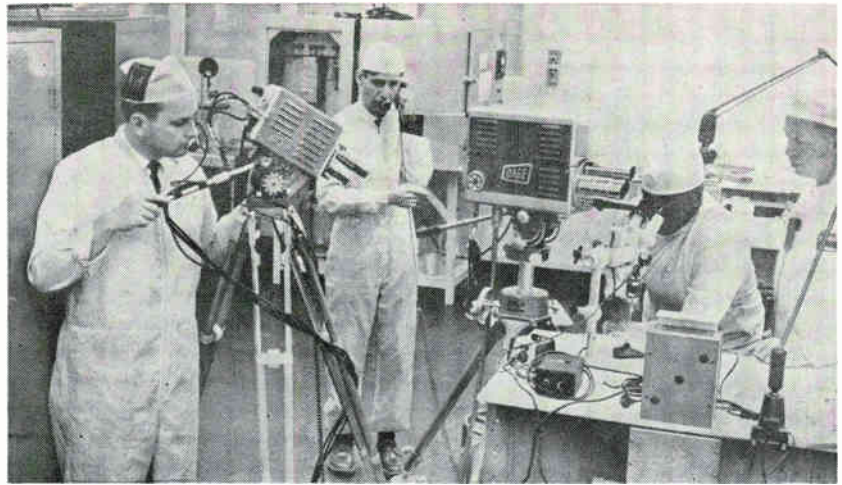

TECHNICIAN INSTRUCTOR teaching assembly techniques and three cameramen are only personnel in main assembly clean-room. Other assembly rooms contain trainees, also in restricted numbers so as not to increase temperature, humidity and dust content

is transmitted by closed circuit tv to 4 television receivers situated in classrooms at the Autonetics plant. The image is magnified 50 to 100 times. The Epi-technoscope as used at Autonetics magnifies 40 times, with the additional enlargement provided by the tv camera and transmitting equipment. The system is able to enlarge the image of an object the size of a pencil head to fill a 21-inch screen. If required, the Epi-technoscope can provide magnifications ranging from 3 to 63 with various eyepieces and objectives.

A second television camera is used in the clean room to transmit long-range views of the instrument and its operator in normal size.

FILM PRODUCTION — Taped training films are produced by Autonetics by means of the same microscope-television combination. Such films came increasingly into demand as the Minuteman missile neared production status and training activity increased accordingly. Television tape has two advantages over motion picture film for this application, Autonetics points out. First, tv tapes can be recorded with normal light, whereas motion picture films would require special lighting and other technical arrangements not permissible in dust-free areas. Second, tapes can be viewed immediately, and segments re-taped on the spot if necessary.

Blue Print Distribution with 2-Mile Tubes

INSTALLATION of a pneumatic carrier system for distributing blueprints to shop areas is being done at Boeing's Transport Division. Expected to pay for itself within a year through time savings, the system cost \$150,000 and uses more than 2 miles of oval-shaped tubing that connects central files to 19 blueprint stations around the plant. Prints placed in 18-inch long cylindrical carriers travel at 35 feet per second; 3,200 prints can be routed in one hour. Digital coding technique routes carrier through system switches to proper station.

Bearings Evaluated

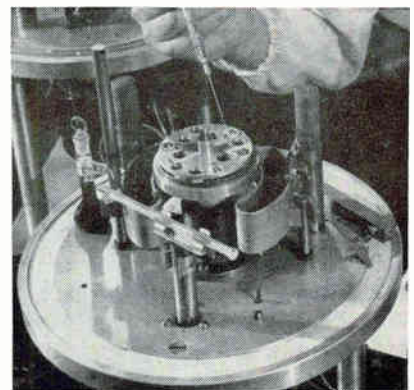

LIFE of memory-drum bearings is determined by Sperry Gyroscope Ball Bearing Simulator. Test time has been cut to 1/200 of previous run-to-failure tests.

McGraw-Hill
Publishing Co.
330 West 42nd Street
New York 36, N.Y.

EDITORIAL INDEX

electronics

July through December, 1962, Vol. 35

January through June index appeared in the electronics Buyers' Guide issue, July 25, 1962.
Reprints of the first-six-months index are available to subscribers without charge on request

A

ACOUSTICS See Audio

AIR NAVIGATION

Air traffic control today and tomorrow Pt 1 p37 Dec 7

Pt 2 Improved navigation aids needed to tighten wasted airspace p46 Dec 14

CRT provides three-dimensional displays p54 Nov 2

ECCANE: Aircraft navigation: is doppler or inertial better? p18 Oct 12

Eliminating the human observer in air and space scouting missions p45 Oct 26

AIRCRAFT

Adaptive control helps X-15 fly 60 miles high p22 Aug 24

New symbols adopted for military planes p30 Jul 6

TFX fighter bomber p18 Dec 14

Testing space craft with induction heaters p38 Aug 24

Transistor systems for precision helicopter flying p20 Oct 5

ALARM SYSTEMS

Ion orbs warn of excessive r-f field strength p58 Jul 20

AMPLIFIERS

(See also Lasers; Magnetic Amplifiers; Microminaturization; Parametric Amplifiers; Transistor Circuits; Tube Circuits)

D-c amplifier uses soliton tetrodes p108 Sep 28

Differential amplifier grows in silicon block p37 Jul 6

Get stability through mismatching p50 Oct 19

High-frequency limiter amplifier solves phase-shift problems p44 Nov 16

How to design transformerless audio-frequency power amplifiers p50 Nov 16

Improved superregenerator has quench converter p52 Sep 21

Key to faster computers: ten-nanosecond amplifier p39 Dec 14

Low-level encoding approach: latest details of Titan II telemetry p36 Nov 23

New approach to serial decoding eliminates static storage p32 Aug 24

New design method optimizes gain-bandwidth p54 Jul 6

New tunnel-diode preamplifier improves phased-array radar p57 Sep 28

Putting a servo amplifier on a small silicon wafer p33 Dec 28

Two easy ways to stabilize power-transistor hi-fi amplifiers p56 Oct 26

Two-way cable repeaters take oceans in stride p24 Aug 31

Ultrahigh impedance amplifier for precise measurements p49 Oct 5

ANALYZERS

(See also Instruments; Test Equipment)

Automatic checkout equipment for today's complex systems p37 Jul 13

ANTENNAS

Antenna bridge measurements p50 Jul 27

Antenna innovation: glass-fiber tube focuses microwave beam p44 Sep 21

Getting maximum bandwidth with dipole antennas p40 Aug 31

Giant Haystack radar facility p49 Nov 9

IRE Symposium: Tropo systems better with seven beams p24 Oct 19

Interferometer is designed for Gemini radar p106 Nov 30

Millimeter waves - what we have, what we need p37 Oct 12

Modem antennas in space communications p39 Sep 7

Northeast Electronics Research and Engineering Meeting Highlights p35 Nov 2

Quadriple dish covers 2-Gc band p28 Jul 27

Ready-reference data simplifies antenna design p50 Dec 21

Smith-chart short cut renormalizes feedline impedances p53 Nov 16

Special antenna for a moon capsule p46 Nov 16

Sputacast plastics achieve reflector precision p134 Nov 30

Steering radar antenna beams with a lossless r-f matrix p50 Jul 13

Up-to-date nomograph aids tropo antenna design p62 Oct 26

ATMOSPHERIC STUDIES

Ionosphere-mapping satellite to try laser-source ranging p20 Sep 7

Long staircase generator p54 Aug 31

Mariner II instrumentation: what will it see on Venus? p42 Dec 14

New communications propagation path may lie above the exosphere p26 Nov 23

Recent refraction data corrects radar errors p52 Dec 7

Scientists prepare to study quiet sun p20 Sep 14

AUDIO

Better speech quantizing for pulse-code modulation p84 Nov 30

Combined coding increases spectrum usage p64 Oct 26

Fiber-optic array recognizes audio patterns p28 Oct 26

How to design transformerless audio-frequency power amplifiers p50 Nov 16

Novel circuit damps transients in voice-operated transmitters p66 Sep 28

Oceanographers grapple with telemetry problems p28 Aug 3

Simple f-m demodulators for audio frequencies p89 Nov 30

Synchronism doesn't matter in pulse-code modulated speech p58 Oct 19

Television audio stereo p28 Jul 6

Two easy ways to stabilize power-transistor hi-fi amplifiers p56 Oct 26

AUTOMATIC TESTERS

Automatic checkout equipment for today's complex systems p37 Jul 13

Checking readiness of missile guidance systems p33 Jul 27

AUTOMOTIVE

Auto buyers are still not sold on transistor ignition systems p30 Oct 26

Computer Applications Symposium: Computer unsnarls traffic in tunnel p18 Nov 16

Industrial engines get breakerless ignition p52 Jul 27

Unique engine tachometer uses only passive components p40 Jul 27

B

BIOPHYSICS See Medical Electronics

BRIDGE CIRCUITS

Antenna bridge measurements p50 Jul 27

Constant-current regulator speeds relay testing p48 Jul 27

Designing special power supplies for voltage-tunable oscillators p48 Nov 2

Microwave conversion efficiency reaches 70% p76 Sep 28

Three ways to measure varactors of the future p49 Sep 7

Using new devices: field-effect transistor oscillators p44 Dec 21

BUSINESS

Aerospace R&D paces West's record-breaking sales p20 Aug 10

Army going into production on micromodules p7 Sep 7

EIA sees \$13.1 billion sales in 1962 p26 Sep 21

Prices of electronic stocks during market shakeout p20 Jul 6

Small companies continue to dominate electronics industry p28 Dec 7

Will new projection system sharply boost color-tv sales? p24 Nov 30

C

CABLES

Compact new instrument finds undersea cable faults p48 Sep 14

Eliminate trial and error in broadband impedance matching p68 Sep 28

Harness boards use full scale photos p102 Oct 19

New cables withstand more heat p60 Aug 31

Smith-chart short cut renormalizes feedline impedances p53 Nov 16

Two-way cable repeaters take oceans in stride p24 Aug 31

CAPACITORS

Failure analysis curb device faults p68 Oct 12

How to design micromodules p37 Sep 14

Increasing corona thresholds in dielectrics p80 Nov 9

Rapid selection of VHF bypass capacitors p44 Dec 28

Reliability of tantalum capacitors increased p78 Sep 14

Switching high microwave power p82 Nov 9

Three ways to measure varactors of the future p49 Sep 7

Tuner elements ride piggyback p54 Aug 3

Unique power supply delivers constant voltage and current p40 Aug 3

CATHODE-RAY TUBES

CRT provides three-dimensional displays p54 Nov 2

CHARACTER READERS

First step in character recognition - image processing with optical panels p35 Dec 21

Handwriting reader recognizes whole words p29 Aug 24

Photo reader aids pattern recognition study p50 Aug 3

Print reader recognizes variety of fonts p58 Dec 21

COAXIAL CABLES See Cables

COLOR TELEVISION

Color Tv based on Land theory uses two single gun tubes p54 Sep 21

Sunflower optics: a new concept in color Tv display p33 Dec 14

Will new projection system sharply boost color Tv sales? p24 Nov 30

COMMUNICATION

Atomic frequency standards for highest accuracy p31 Nov 23

Better speech quantizing for pulse-code modulation p84 Nov 30

Combined coding increases spectrum usage p64 Oct 26

Design of advanced Syncom begins p30 Aug 17

Diode lasers to accelerate optical communications p24 Nov 16

Faster frequency switching with phase-lock oscillators p54 Oct 26

Getting signals through to submarines p52 Sep 14

Grant Haystack radar facility p49 Nov 9

How H-block affected communication links p20 Jul 20

IRE Symposium: Tropo systems better with seven beams p24 Oct 19

Land mobile radio seeks end to frequency squeeze p18 Nov 30

Modem antennas in space communications p39 Sep 7

Modulation technique combats impulse noise p62 Sep 21

New communications propagation path may lie above the exosphere p26 Nov 23

Next step is laser communications: direct demodulation of signals p18 Aug 31

Polarizers modulate laser beam p21 Aug 24

Project Relay communications satellite p46 Oct 5

Single-sideband exciter uses planar silicon transistors p65 Aug 10

Sputacast plastics achieve reflector precision p134 Nov 30

Synchronism doesn't matter in pulse-code modulated speech p58 Oct 19

Telstar aids NASA budget p30 Jul 20

Telstar to offer transoceanic TV p28 Jul 13

Telstar's Tv programs underline U.S. European cooperation p26 Aug 17

Up-to-date nomograph aids tropo antenna design p62 Oct 26

Versatile zener diode array forms high-speed quantizer p52 Aug 17

COMPONENTS

Failure analysis curb device faults p68 Oct 12

How to choose air-tight sealing materials p62 Dec 21

Ordered geometry for component design p86 Sep 28

Reliability: 1962 p53 Nov 30

COMPUTERS

Computer Applications Symposium: Computer unsnarls traffic in tunnel p18 Nov 16

Computer makes maps from stereo photos p28 Aug 31

Cryosar: promising element for tomorrow's computers p39 Aug 17

D-c level shifter checks new computer modules p44 Jul 6

Form logic matrix with diode ribbons p100 Aug 10

Improved electronic differentiator has low noise factor p46 Jul 27

Japan closing computer door p18 Dec 14

Key to faster computers: ten-nanosecond amplifier p39 Dec 14

Latest military computer applications p30 Jul 13

New approach to serial decoding eliminates static storage p32 Aug 24

Nonlinear resistors enhance display-panel contrast p33 Aug 3

Photo reader aids pattern recognition study p50 Aug 3

Versatile analog storage uses ferrite cores p60 Sep 28

CONFERENCES

ACW: Computer makes maps from stereo photos p28 Aug 31

AMA: Eye examinations are automated p52 Aug 3

Amour Symposium: Failure analysis: key to better reliability p28 Oct 12

Computer Applications Symposium: Computer unsnarls traffic in tunnel p18 Nov 16

Conference on Maintainability of Electronic Equipment: Military maintainability specs aim at simplifying repair jobs p28 Sep 14

ECCANE: Aircraft navigation: is doppler or inertial better? p18 Oct 12

EIA Winter Conferences: Panel urges weapons system planners to be more realistic p26 Dec 14

Farnborough Air Show: Missile cutback rocks British aviation electronics p18 Sep 21

IAS: Designers see space guidance systems turning into mosaics of optical cells p26 Jul 6

IRE Symposium: Tropo systems better with seven beams p24 Oct 19

IRE-PGED: Electrostatic focusing gives klystrons greater efficiency p26 Nov 9

JACC: Adaptive automatic control stressed p28 Jul 20

NEC: forum for industry-education cooperation p30 Oct 5

National Electronics Conference technical preview p39 Oct 5

Navy Laboratory Microelectronics Conference: Navy to push microelectronics development programs p24 Oct 12

Northeast Electronics Research and Engineering Meeting Highlights p35 Nov 2

NEREM: New England launches drive for more space work p24 Nov 2

NEREM: What lies ahead for transistors? p62 Nov 16

PGMIL: Latest military computer applications p30 Jul 13

Pacific Energy Conversion Conference: exotic power sources p26 Aug 31

Solid State: New infrared-generating diode transmits television over modulated light ray p24 Jul 27

Symposium: Optical techniques can raise computer speed p30 Nov 9

Symposium: Will diode lasers obsolete earlier lasers? p14 Nov 23

Symposium on Advanced Propulsion Techniques: Lasers can aid plasma propulsion p24 Oct 19

WESCON: Aerospace R&D paces West's record-breaking sales p20 Aug 10

WESCON: Sets new records p28 Sep 7

WESCON: Spotlights frontiers in electronics p30 Aug 10

WESCON 1962: a technical preview p59 Aug 10

CONTROL CIRCUITS

Adaptive control helps X-15 fly 60 miles high	p22	Aug 24
How to select shaft-position encoders	p48	Aug 31
Shaft resetter reduces loading	p62	Sep 7
Testing space craft with induction heaters	p38	Aug 24
Thermoelectric chamber stabilizes p-c board	p64	Aug 17
Transistor circuits control small d-c motors	p48	Aug 24
Transistor systems for precision helicopter flying	p20	Oct 5
Transistors save truck batteries	p30	Oct 12

CONVERTERS

Baliner - frequency-insensitive balanced converter	p46	Nov 2
D-c level shifter checks new computer modules	p44	Jul 6
How to select shaft-position encoders	p48	Aug 31
Improved superregenerator has quench converter	p53	Sep 21
Inexpensive converter gives 5,000 volts d-c	p54	Jul 13
Microwave conversion efficiency reaches 70%	p76	Sep 28
New approach to serial decoding eliminates static storage	p32	Aug 24
New way to multiply Q with transistors	p48	Jul 13
Precise converter takes current analog of digital voltage pulses	p68	Aug 10
Shaft resetter reduces loading	p62	Sep 7
Versatile zener diode array forms high-speed quantizer	p52	Aug 17

CORES*(See also Ferrite Devices; Magnetics; Memories)*

Broaden transformer frequency response	p52	Aug 24
Novel digital signal generator uses magnetic-core peboard	p46	Jul 6
Tristable cores detect errors in binary data	p60	Oct 5
Unconventional approach to pulse-width measurements	p51	Oct 26
Versatile analog storage uses ferrite cores	p60	Sep 28

CRYOGENICS

Cryosar, promising element for tomorrow's computers	p39	Aug 17
Diode makes accurate cryogenic thermometer	p86	Nov 9
Gas process makes superconducting wire	p62	Jul 27

D**DATA PROCESSING**

Air traffic control today and tomorrow Pt 1	p37	Dec 7
Pt 2 Improved navigation aids needed to tighten wasted airspace	p46	Dec 14
Simple f-m demodulator for audio frequencies	p89	Nov 30

DELAY LINES

Glass digital delay lines: new computer component	p60	Nov 9
Novel slotted line uses slow-wave technique	p46	Aug 31
Diplom mode for magnetostrictive delay lines	p43	Aug 31

DETECTORS*(See also Diodes; Infrared; Nucleonics; Photoelectric Devices; Radiation; Transducers)*

Mariner II instrumentation: what will it see on Venus?	p42	Dec 14
Simple f-m demodulator for audio frequencies	p89	Nov 30
Unique two-channel tachometer uses radiolotopes	p44	Dec 7

DIGITAL TECHNIQUES See Pulse Techniques**DIODES***(See also Tunnel Diodes)*

Better ways to protect transistors with zener diodes and fuses	p64	Sep 28
Cooled diode cuts noise in parametric amplifier	p66	Oct 26
Diode lasers to accelerate optical communications	p24	Nov 16
Diode makes accurate cryogenic thermometer	p86	Nov 9
Evaluating integrated-circuit performance	p72	Aug 17
Failure analysts curb device faults	p68	Oct 12
Faster zener diodes make new uses possible	p54	Oct 19
Five new diode circuits for nanosecond microwave switching	p37	Aug 31
Form logic matrix with diode ribbons	p100	Aug 10
Gallium-arsenide diode sends television by infrared beam	p44	Oct 5
Logic blocks offer design flexibility	p58	Jul 27
Microwave conversion efficiency reaches 70%	p76	Sep 28
More on avalanche breakdown	p 4	Nov 9
New approach to locked-pair tunnel-diode logic	p46	Aug 3
New infrared-generating diode transmits television over modulated light ray	p24	Jul 27
New light source from tiny crystal	p52	Dec 28
New vapor-deposition process creates tunnel diodes	p58	Nov 2
Next step in laser communications: direct demodulation of signals	p18	Aug 31
1962 WESCON: a technical preview	p59	Aug 10
PNP-NPN circuits: new look at a familiar connection	p42	Nov 23
Progress and pitfalls in microelectronics	p45	Oct 19
Semiconductor modulators for modern magnetrons	p42	Sep 14
Two transistors equal one constant-current diode	p50	Jul 6
Versatile zener diode array forms high-speed quantizer	p52	Aug 17
Why use silicon rectifiers for high-voltage service?	p46	Dec 7
Will irradiation really improve transistors?	p66	Jul 20

DISPLAYS

Air traffic control today and tomorrow Pt 1	p37	Dec 7
Pt 2 Improved navigation aids needed to tighten wasted airspace	p46	Dec 14
CRT provides three-dimensional displays	p54	Nov 2
Compact new instrument finds undersea cable faults	p48	Sep 14
Eliminating the human observer in air and space scouting missions	p45	Oct 26
First step in character recognition - image processing with optical panels	p35	Dec 21
Improved display panel described	p58	Aug 31
New approach to electroluminescent displays	p68	Sep 14
Nonlinear resistors enhance display-panel contrast	p33	Aug 3
Reliable circuit supplies high peak deflection voltages	p54	Oct 12
Simple curve tracer displays transistor beta	p36	Aug 24
Use raster oscilloscopes for faster time measurements	p38	Dec 28

DIVERSITY RECEPTION

Versatile diversity combiner handles most missile-range signals	p40	Nov 2
---	-----	-------

E**EDUCATION**

Five years? or a better four?	p 3	Dec 14
Preparing tapes for audio-visual aids	p58	Aug 3
Technicians: there aren't enough to meet industry's needs	p28	Oct 5
Who's minding the stockroom?	p 3	Nov 2

ELECTROLUMINESCENCE

First step in character recognition - image processing with optical panels	p35	Dec 21
New approach to electroluminescent displays	p68	Sep 14
New light source from tiny crystal	p52	Dec 28
Nonlinear resistors enhance display-panel contrast	p33	Aug 3

ELECTRONIC COUNTERMEASURES

Using double-ridge waveguide for electronic countermeasures	p50	Oct 5
---	-----	-------

F**FERRITE DEVICES**

Ferrite shapes pose no problem	p56	Dec 14
Garnet simplifies preselector	p29	Dec 14
New trends in low-power ferrite limiters	p40	Dec 21
Tristable cores detect errors in binary data	p60	Oct 5
Versatile analog storage uses ferrite cores	p60	Sep 28

FILTERS

Design problems of modern television transmitters	p53	Jul 20
Easy-to-use nomographs eliminate filter calculations	p92	Nov 30
Easy way to design ceramic resonator filters	p54	Nov 9
Modulation technique combats impulse noise	p62	Sep 21
New magnetic rods simplify circuits	p62	Jul 13
Simplified low-pass filter design	p52	Sep 21

FOREIGN ELECTRONICS

Competition from Japan	p 3	Jul 6
Electronics in Canada	p37	Sep 28
Hong Kong's transistor radio exports soar to 100,000 a month	p24	Sep 28
Japan closing computer door	p18	Dec 14
Japan, revisited	p 3	Oct 19
Japanese aim at computer market	p26	Sep 7

FREQUENCY MODULATION

Can varactors get rid of f-m distortion in reflex klystrons?	p42	Aug 3
New pulse modulation method varies both frequency and width	p50	Oct 12
New trends in low-power ferrite limiters	p40	Dec 21

FUSES

Better ways to protect transistors with zener diodes and fuses	p64	Sep 28
--	-----	--------

G**GENERATORS***(See also Oscillators; Power Supplies; Test Equipment)*

Compact new instrument finds undersea cable faults	p48	Sep 14
Gravity-wave generator is being built	p66	Aug 17
Long staircase generator	p54	Aug 31
Magnetic pickup generates frequency markers	p56	Nov 16
New light-wave generators are tunable	p74	Oct 19
Novel digital signal generator uses magnetic-core peboard	p46	Jul 6
One more transistor makes a linear sawtooth	p50	Dec 7
PNP-NPN circuits: new look at a familiar connection	p42	Nov 23
Simple square-wave generator	p47	Dec 21

GUIDED MISSILES

Automatic checkout equipment for today's complex systems	p37	Jul 13
Checking readiness of missile guidance systems	p33	Jul 27
Farnborough Air Show: Missile cutback rocks British aviation electronics	p18	Sep 21
Low-level encoding approach: latest details of Titan II telemetry	p36	Nov 23
Microwaves measure solid fuel burning rates	p50	Nov 23
Ultraviolet space telescope will scan the stars	p37	Nov 16
Versatile diversity combiner handles most missile-range signals	p40	Nov 2

INDUCTION HEATING

Testing space craft with induction heaters	p38	Aug 24
--	-----	--------

INDUSTRIAL ELECTRONICS

Industrial engines get breakerless ignition	p52	Jul 27
New approaches to electronic self-repair	p48	Dec 28
Providing thermocouple compensation at low cost	p78	Nov 9
Testing space craft with induction heaters	p38	Aug 24

INFRARED

Circuit inspections speeded with infrared	p72	Jul 6
Gallium-arsenide diode sends television by infrared beam	p44	Oct 5
Handy nomogram speeds infrared system design	p64	Oct 19
Laser emits visible and infrared light	p81	Sep 28
Mercury and cadmium improve IR detectors	p84	Aug 10
National Electronics Conference technical preview	p39	Oct 5
Twin tracker follows missiles	p32	Nov 30

INSTRUMENTS*(See also Analyzers; Generators; Recorders; Test Equipment)*

Automatic checkout equipment for today's complex systems	p37	Jul 13
How to measure coulombs in irregular pulses	p72	Aug 10
Mariner II instrumentation: what will it see on Venus?	p42	Dec 14
Microscope - Tv helps train assemblers	p56	Dec 28
Ultraviolet space telescope will scan the stars	p37	Nov 16
Unique engine tachometer uses only passive components	p40	Jul 27

INTEGRATED CIRCUITS See Microminiaturization**INTERFERENCE**

Analysis center begins probe of space tracking RFI	p20	Aug 17
How H-blast affected communication links	p20	Jul 20
Will d-c power cause interference?	p30	Sep 7
Will interference specs get tougher?	p28	Nov 16

INVERTERS*(See also Converters; Power Supplies)*

New circuit design raises inverter frequency limits	p59	Oct 26
Novel design techniques for transistor digital circuits	p42	Aug 24
Overcoming turn-on effects in silicon controlled rectifiers	p50	Aug 17

K**KLYSTRONS**

Can varactors get rid of f-m distortion in reflex klystrons?	p42	Aug 3
IRE-PGED: Electrostatic focusing gives klystrons greater efficiency	p26	Nov 9
New design concept reduces klystron weight	p36	Dec 28
Silver anniversary of klystron	p 3	Aug 31

L**LASERS & MASERS**

Diode lasers to accelerate optical communications	p24	Nov 16
Diode lasers - will they obsolete earlier lasers?	p14	Nov 23
Doppler laser measures speeds down to 0.00004 mph	p26	Jul 20
Field increases laser instantaneous output	p60	Jul 20
Ionosphere-mapping satellite to try laser-bounce ranging	p20	Sep 7
Laser action is observed in glass fibers and rods	p25	Aug 31
Laser emits visible and infrared light	p81	Sep 28
Laser-pumped maser shows way to fill spectrum gap	p58	Jul 13
National Electronics Conference technical preview	p39	Oct 5
New optical masers use dissociative mechanism	p62	Jul 6
Next step in laser communications: direct demodulation of signals	p18	Aug 31
Northeast Electronics Research and Engineering Meeting Highlights	p35	Nov 2
Polarizers modulate laser beam	p21	Aug 24
Single noble gases give 14 more laser frequencies	p28	Nov 16
Symposium on Advanced Propulsion Techniques: Lasers can aid plasma propulsion	p24	Oct 19
Tetracycle-frequency laser would use d-c pumping	p 7	Aug 3
*"Traveling wave" laser amplifies light image	p 8	Aug 10

LOGIC CIRCUITS

Better speech quantizing for pulse-code modulation	p84	Nov 30
Cryosar: promising element for tomorrow's computers	p39	Aug 17
Form logic matrix with diode ribbons	p100	Aug 10
Improved electronic differentiator has low noise factor	p46	Jul 27
Logic blocks offer design flexibility	p58	Jul 27
Low-level encoding approach: latest details of Titan II telemetry	p36	Nov 23
New approach to locked-pair tunnel-diode logic	p46	Aug 3
New entry in microelectronics: high-density silicon matrices	p20	Aug 24
Nonlinear resistors enhance display-panel contrast	p33	Aug 3
Novel design techniques for transistor digital circuits	p42	Aug 24
Progress and pitfalls in microelectronics	p45	Oct 19
Unconventional approach to pulse-width measurements	p51	Oct 26
Unique tunnel-diode circuit performs odd-and-even logic	p61	Oct 19

LOUDSPEAKERS

Loudspeaker experts appraise trends	p70	Dec 7
Loudspeaker rating system proposed	p30	Jul 6

M**MAGNETIC AMPLIFIERS**

New transistor regulator handles 500-watt outputs	p48	Sep 21
Novel bi-level regulator reduces storage capacitance	p74	Aug 10

MAGNETICS*(See also Ferrites; Memories; Superconductivity; Thin Films)*

Cascading ups parametric amplifier gain	p60	Sep 14
Hall probes improve magnet testing	p66	Nov 16
Magnetic pickup generates frequency markers	p56	Nov 16
Measuring acceleration by magnetic suspension	p62	Oct 12
New magnetic rods simplify circuits	p62	Jul 13
Novel digital signal generator uses magnetic-core peboard	p46	Jul 6
Optimum mode for magnetostrictive delay lines	p43	Aug 31
Tristable cores detect errors in binary data	p60	Oct 5
Unconventional approach to pulse-width measurements	p51	Oct 26

MAGNETOSTRICTION

New transformers may bring transistor Tv	p60	Sep 7
Optimum mode for magnetostrictive delay lines	p43	Aug 31

MAGNETRONS

Designing special power supplies for voltage-tunable oscillators	p48	Nov 2
Semiconductor modulators for modern magnetrons	p42	Sep 14

MANPOWER

Aerospace R&D paces West's record-breaking sales	p20	Aug 10
More computing talent on the way from colleges	p26	Sep 28
Technicians: there aren't enough to meet industry's needs	p28	Oct 5
West starts recruiting early	p24	Aug 10
Who's minding the stockroom?	p 3	Nov 2

MARKETING See Business**MATCHING**

Eliminate trial and error in broadband impedance matching	p68	Sep 28
Get stability through mismatching	p50	Oct 19
How copper wire balances parallel power transistors	p47	Nov 23
Smith-chart short cut renormalizes feedline impedances	p53	Nov 16

MEASUREMENTS

Atomic frequency standards for highest accuracy	p31	Nov 23
Hall probes improve magnet testing	p66	Nov 16
Interferometer is designed for Gemini radar	p106	Nov 30
Measuring acceleration by magnetic suspension	p62	Oct 12
Microwaves measure solid fuel burning rates	p50	Nov 23
New ionosphere measurement technique: plasma frequency probe	p81	Nov 30
Twin tracker follows missiles	p32	Nov 30
Ultra-high-impedance amplifier for precise measurements	p49	Oct 5
Unique two-channel tachometer uses radioisotopes	p44	Dec 7
Use raster oscilloscopes for faster time measurements	p38	Dec 28

MEDICAL ELECTRONICS

Eye examinations are automated	p52	Aug 3
Inexpensive monitor reads blood pressure automatically	p40	Nov 23
R-f energy powers latest biomedical devices	p52	Dec 14

MEMORIES

Glass digital delay lines: new computer component	p60	Nov 9
1962 WESCON: a technical preview	p59	Aug 10
Novel digital signal generator uses magnetic-core pegboard	p46	Jul 6
Tristable cores detect errors in binary data	p60	Oct 5

METEOROLOGY

Scientists prepare to study quiet sun	p20	Sep 14
---------------------------------------	-----	--------

MICROMINIATURIZATION

Army going into production of micromodules	p7	Sep 7
Designing circuits on alumina substrates	p68	Oct 5
Designing molecular circuits for use in complex systems	p39	Sep 21
Differential amplifier grown in silicon block	p37	Jul 6
Electron beam cutting for microelectronics	p28	Dec 7
Evaluating integrated-circuit performance	p72	Aug 17
How to design micromodules	p37	Sep 14
How will thin-film triodes perform?	p29	Dec 28
Latest design techniques for linear microcircuits	p47	Oct 12
Micromodules show durability plus radiation resistance	p30	Sep 14
Navy Laboratory Microelectronics Conference: Navy to push microelectronics development programs	p24	Oct 12
New entry in microelectronics: high-density silicon matrices	p20	Aug 24
Progress and pitfalls in microelectronics	p45	Oct 19
Putting a servo amplifier on a small silicon wafer	p33	Dec 28
Split electrode spot-welds microcircuits	p98	Sep 28

MICROPHONES

Microphone calculations for the space age	p66	Nov 9
---	-----	-------

MICROWAVES

Antenna innovation: glass-fiber tube focuses microwave beam	p44	Sep 21
Countermeasures receiver tunes with passive elements	p40	Jul 6
Mariner II instrumentation: what will it see on Venus?	p42	Dec 14
Microwave conversion efficiency reaches 70%	p76	Sep 28
Microwave phototube - new detector for optical receivers	p37	Jul 20
Microwaves measure solid fuel burning rates	p50	Nov 23
Millimeter waves - what we have, what we need	p37	Oct 12
New trends in low-power ferrite limiters	p40	Dec 21
Spun-cast plastics achieve reflector precision	p134	Nov 30
Switching high microwave power	p82	Nov 9
Using double-ridge waveguide for electronic countermeasures	p50	Oct 5

MILITARY ELECTRONICS

Air Force revamping systems procurement operations	p18	Sep 28
Conference on Maintainability of Electronic Equipment: Military maintainability specs aim at simplifying repair jobs	p28	Sep 14
EIA panel urges weapons system planners to be more realistic	p26	Dec 14
Latest military computer applications	p30	Jul 13
Navy prepares for VLF detection of nuclear blasts	p28	Oct 19
Using double-ridge waveguide for electronic countermeasures	p50	Oct 5

MINIATURIZATION

(See also Microminiaturization)		
Ordered geometry for component design	p86	Sep 28
Packaging methods for thin films	p72	Jul 20

MODULATORS

Better speech quantizing for pulse-code modulation	p84	Nov 30
Modulation technique combats impulse noise	p62	Sep 21
New light-wave generators are tunable	p74	Oct 19
New pulse modulation method varies both frequency and width	p50	Oct 12
New tube shifts phase linearly with current	p70	Nov 9
Semiconductor modulators for modern magnetrons	p42	Sep 14
Synchronization doesn't matter in pulse-code modulated speech	p58	Oct 19
Tiny solid-state transmitter may save your life	p90	Nov 30

MOLECULAR ELECTRONICS See Microminiaturization

MOTOR CONTROL

Transistor circuits control small d-c motors	p48	Aug 24
Transistors save truck batteries	p30	Oct 12

MULTIVIBRATORS

Compact new instrument finds undersea cable faults	p48	Sep 14
Eliminating the first stage of a nonstable multi-vibrator	p54	Sep 7
New complementary transistors make series Schmitt circuits practical	p52	Aug 31
Novel design technique for transistor digital circuits	p42	Aug 24
One more transistor makes a linear sawtooth	p50	Dec 7
Simple square-wave generator	p47	Dec 21

NAVIGATION SYSTEMS

Atomic frequency standards for highest accuracy	p31	Nov 23
---	-----	--------

NETWORKS

Smith-chart short cut renormalizes feedline impedances	p53	Nov 16
--	-----	--------

NOMOGRAPHS

Easy-to-use nomographs eliminate filter calculations	p92	Nov 30
Handy nomogram speeds infrared system design	p64	Oct 19
Nomogram calculations for the space age	p66	Nov 9
Nomographs select TV standards	p56	Aug 17
Quick way to find radar range	p56	Sep 7
Up-to-date nomograph aids tropo antenna design	p62	Oct 26

NUCLEONICS

Are satellites needed to detect secret nuclear tests in space?	p28	Nov 2
Atomic frequency standards for highest accuracy	p31	Nov 23
Designers see space guidance systems turning into mosaics of optical cells	p26	Jul 6
Do field-effect transistors resist nuclear radiation?	p56	Jul 13
How H-blast affected communication links	p20	Jul 20
Navy prepares for VLF detection of nuclear blasts	p28	Oct 19

O

OCEANOGRAPHY

Oceanographers decide on frequencies	p18	Oct 19
Oceanographers grapple with telemetry problems	p28	Aug 3
Oceanographers seek exclusive radio channels in marine bands	p26	Sep 7

OPTICS

Antenna innovation: glass-fiber tube focuses microwave beam	p44	Sep 21
Color TV based on Land theory uses two single-gun tubes	p54	Sep 21
Diode lasers to accelerate optical communications	p24	Nov 16
Fiber-optic array recognizes audio patterns	p28	Oct 26
Fiber optics provides high-speed x-ray photos	p74	Nov 9
First step in character recognition - image processing with optical panels	p35	Dec 21
Laser action is observed in glass fibers and rods	p25	Aug 31
Mariner II instrumentation: what will it see on Venus?	p42	Dec 14
Microwave phototube - new detector for optical receivers	p37	Jul 20
Modulation technique combats impulse noise	p62	Sep 21
New infrared-generating diode transmits television over modulated light ray	p24	Jul 27
Polarizers modulate laser beam	p21	Aug 24
Sunflower optics: a new concept in color TV display	p33	Dec 14
Symposium: Optical techniques can raise computer speed	p30	Nov 9
Ultraviolet space telescope will scan the stars	p37	Nov 16

ORGANIZATIONS

Technical operations in the IEEE	p3	Sep 21
----------------------------------	----	--------

OSCILLATORS

(See also Generators; Lasers; Transistor Circuits; Tube Circuits)		
Atomic frequency standards for highest accuracy	p31	Nov 23
Designing special-C transistor L-C oscillators	p42	Jul 27
Designing special power supplies for voltage-tunable oscillators	p48	Nov 2
Eliminating one-count uncertainty in cycle-counting interval timers	p46	Jul 20
Faster frequency switching with phase-lock oscillators	p54	Oct 26
Getting rid of transients in frequency-shift keying	p58	Nov 9
Magnetic pickup generates frequency markers	p56	Nov 16
New light-wave generators are tunable	p74	Oct 19
Testing space craft with induction heaters	p38	Aug 24
Tunnel-diode oscillator delivers R-F and audio	p56	Oct 12
Using new device: field-effect transistor oscillators	p44	Dec 21
Varactor-tuned tunnel-diode oscillator now practical	p50	Sep 21

OSCILLOSCOPES

Simple curve tracer displays transistor beta	p36	Aug 24
Use raster oscilloscopes for faster time measurements	p38	Dec 28

PARAMETRIC AMPLIFIERS

Cascading ups parametric amplifier gain	p60	Sep 14
Cooled diode cuts noise in parametric amplifier	p66	Oct 26
Is this the simplest paramp ever built?	p46	Sep 14
Paramp pump frequency is lower than signal	p66	Sep 21
Paramp that tracked Pioneer IV deep-space probe	p45	Jul 13

PHOTOELECTRIC DEVICES

Designers see space guidance systems turning into mosaics of optical cells	p26	Jul 6
How to select shaft-position encoders	p48	Aug 31
Measuring plating area photoelectrically	p101	Sep 28
Microwave phototube - new detector for optical receivers	p37	Jul 20
New wafers, longer life for solar cells	p120	Nov 30
Next step in laser communications: direct modulation of signals	p18	Aug 31
Photo reader aids pattern recognition study	p50	Aug 3
Phototube used for short flash observation	p72	Sep 14

PHOTOGRAPHY

Aircraft camera records position automatically	p32	Jul 13
Electronically-controlled cameras watch Cuba	p20	Nov 30
Fiber optics provides high-speed x-ray photos	p74	Nov 9
Harness boards use full scale photos	p102	Oct 19
Need an accurate map? Photograph a satellite	p22	Nov 23
Photofabrication makes intricate parts quickly	p74	Sep 7

PLASMA TECHNIQUES

Hollow cathode enhances plasma electron gun	p60	Dec 7
Lasers can aid plasma propulsion	p24	Oct 19
New ionosphere measurement technique: plasma frequency probe	p81	Nov 30
Northeast Electronics Research and Engineering Meeting Highlights	p35	Nov 2

POTENTIOMETERS

Analyzing potentiometer requirements	p68	Sep 21
--------------------------------------	-----	--------

POWER SUPPLIES

Designing special power supplies for voltage-tunable oscillators	p48	Nov 2
Inexpensive converter gives 5,000 volts d-c	p54	Jul 13

Laboratory supply for transistors	p55	Jul 27
Microwave conversion efficiency reaches 70%	p76	Sep 28
More wafers, longer life for solar cells	p120	Nov 30
New circuit design raises inverter frequency limits	p59	Oct 26
Pacific Energy Conversion Conference: exotic power sources	p26	Aug 31
Reliable circuit supplies high peak deflection voltages	p54	Oct 12
R-f energy powers latest biomedical devices	p52	Dec 14
Tiny solid-state transmitter may save your life	p90	Nov 30
Ultraviolet space telescope will scan the stars	p37	Nov 16
Unique power supply delivers constant voltage and current	p40	Aug 3
Why use silicon rectifiers for high-voltage service?	p46	Dec 7

PRINTED WIRING

Circuit boards for R&D without photography	p74	Sep 21
Flash printing of circuit elements	p88	Oct 19
How to design micromodules	p37	Sep 14
Measuring plating area photoelectrically	p101	Sep 28
Stamping process used for circuit boards	p76	Oct 12
Thermoelectric chamber stabilizes p-c board	p64	Aug 17
Wiring patterns bonded to pellet modules	p90	Nov 9

PRODUCTION TECHNIQUES

Checking circuits at minimum cost	p70	Dec 21
Circuit inspections speeded with infrared	p72	Jul 6
Concentric design aids tube production	p74	Oct 26
Electron beam cutting for microelectronics	p28	Dec 7
Epoxy used for short run production	p72	Oct 5
Harness boards use full scale photos	p102	Oct 19
Line of balance shows production problems	p66	Aug 31
L-v percussion welding lowers costs	p60	Dec 14
Making bulbs for double-ended tubes	p82	Aug 17
Making new production ideas work	p70	Jul 13
Microscope - Tv helps train assemblers	p56	Dec 28
Packaging methods for thin films	p72	Jul 20
Photofabrication makes intricate parts quickly	p74	Sep 7
Preparing tapes for audio-visual aids	p58	Aug 3
Process for metalizing ceramic is automated	p116	Aug 10
Reliability of tantalum capacitors increased	p78	Sep 14
Spun-cast plastics achieve reflector precision	p134	Nov 30
Stamping process used for circuit boards	p76	Oct 12
Transistor's leads are its hermetic seals	p56	Aug 24
Ultrasonic cleaning speeds maintenance	p62	Nov 2
X-ray inspection with television display	p74	Jul 6

PULSE TECHNIQUES

Better speech quantizing for pulse-code modulation	p84	Nov 30
Combined coding increases spectrum usage	p64	Oct 26
Compact new instrument finds undersea cable faults	p48	Sep 14
Cryosar: promising element for tomorrow's computers	p39	Aug 17
Faster zener diodes make new uses possible	p54	Oct 19
Glass digital delay lines: new computer component	p60	Nov 9
How to measure coulombs in irregular pulses	p72	Aug 10
How to produce variable width pulses	p48	Dec 21
Key to faster computers: ten-nanosecond amplifier	p39	Dec 14
New approach to serial decoding eliminates static storage	p32	Aug 24
New circuit design raises inverter frequency limits	p59	Oct 26
New pulse modulation method varies both frequency and width	p50	Oct 12
New transistor regulator handles 500-watt outputs	p48	Sep 21
Noncutoff circuits improve trigger switching	p36	Jul 27
Novel digital signal generator uses magnetic-core pegboard	p46	Jul 6
Precise converter takes current analog of digital voltage pulses	p68	Aug 10
Recently derived graphs simplify pulse transformer design	p52	Nov 2
Simple square-wave generator	p47	Dec 21
Synchronization doesn't matter in pulse-code modulated speech	p58	Oct 19
Tape recorder simulates data transmissions	p56	Nov 23
Testing space craft with induction heaters	p38	Aug 24
Unconventional approach to pulse-width measurements	p51	Oct 26
Unique engine tachometer uses only passive components	p40	Jul 27
Versatile discriminator measures pulse length	p48	Aug 3
Versatile zener diode array forms high-speed quantizer	p52	Aug 17

R

RAДАР

Air traffic control today and tomorrow Pt 1	p37	Dec 7
Pt 2 Improved navigation aids needed to lighten wasted airspace	p46	Dec 14
Analysis center begins probe of space tracking RFI	p20	Aug 17
Checking readiness of missile guidance systems	p33	Jul 27
Doubling tracking accuracy with a two-way doppler system	p42	Jul 20
Explanation offered for angels on radar displays	p88	Aug 10
Farnborough Air Show: Missile cutback rocks British aviation electronics	p18	Sep 21
Giant Haystack radar facility	p49	Nov 9
How to select shaft-position encoders	p48	Aug 31
Interferometer is designed for Gemini radar	p106	Nov 30
Ion orbits warn of excessive r-f field strength	p58	Jul 20
Millimeter waves - what we have, what we need	p37	Oct 12
Modern antennas in space communications	p39	Sep 7
Modulation techniques cut radar cost	p56	Aug 31
New tube shifts phase linearly with current	p70	Nov 9
New tunnel-diode preamplifier improves phased-array radar	p57	Sep 28
Northeast Electronics Research and Engineering Meeting Highlights	p35	Nov 2
Pulse doppler gives radar trackers new velocity measuring capability	p20	Jul 27
Quick way to find radar range	p56	Sep 7
Radar cross section measurements: how accurate are they?	p48	Jul 20
Radar trends: superpower and smarter signal processing	p18	Nov 2
Recent refraction data corrects radar errors	p52	Dec 7
Six-in-one radar will track nose cones	p30	Nov 30
Steering radar antenna beams with a lossless r-f matrix	p50	Jul 13
Y-guide: a new type of surface waveguide	p44	Nov 2

RADIATION

Is that radiation belt going away next summer or isn't it?	p22	Dec 14
Mariner II instrumentation: what will it see on Venus?	p42	Dec 14
Ultraviolet space telescope will scan the stars	p37	Nov 16
Unique two-channel tachometer uses radioisotopes	p44	Dec 7
Will irradiation really improve transistors?	p66	Jul 20

RADIO ASTRONOMY

New communications propagation path may lie above the exosphere	p26	Nov 23
---	-----	--------

RAILROADS

Y-guide; a new type of surface waveguide	p44	Nov 2
--	-----	-------

RECEIVERS

Ball-inverter - frequency-insensitive balanced converter	p46	Nov 2
Countermeasures receiver tunes with passive elements	p40	Jul 6
Garnet simplifies preselector	p29	Dec 14
High-frequency limiter amplifier solves phase-shift problems	p44	Nov 16
New trends in low-power ferrite limiters	p40	Dec 21
Synchronism doesn't matter in pulse-code modulated speech	p58	Oct 19
Versatile diversity combiner handles most missile-range signals	p40	Nov 2

RECORDERS

Preparing tapes for audio-visual aids	p58	Aug 3
Tape recorder simulates data transmissions	p56	Nov 23

RECTIFIERS

Microwave conversion efficiency reaches 70%	p76	Sep 28
Mobile dopants turn germanium resistors into two-way rectifiers	p16	Aug 24
New family of rectifiers are reversible	p7	Jul 27
Overcoming turn-on effects in silicon controlled rectifiers	p50	Aug 17
Why use silicon rectifiers for high-voltage service?	p46	Dec 7

REGULATORS

Constant-current regulator speeds relay testing	p48	Jul 27
New transistor regulator handles 500-watt outputs	p48	Sep 21
Novel bi-level regulator reduces storage capacitance	p74	Aug 10

RELAYS

Constant-current regulator speeds relay testing	p48	Jul 27
Taking bounce out of reed relays	p66	Jul 6

RELIABILITY

Armour Symposium: Failure analysis; key to better reliability	p28	Oct 12
Failure analysts curb device faults	p68	Oct 12
Reliability: 1962	p53	Nov 30
Reliability of tantalum capacitors increased	p78	Sep 14

RESEARCH & DEVELOPMENT

Air traffic control today and tomorrow Pt 1	p37	Dec 7
Pt 2 Improved navigation aids needed to lighten wasted airspace	p46	Dec 14
Electronics in Canada	p37	Sep 28
Gravity-wave generator is being built	p66	Aug 17
NASA will spend \$194 million for ground tracking in 1963	p26	Aug 3
New approaches to electronic self-repair	p48	Dec 28
New light-wave generators are tunable	p74	Oct 19
Print reader recognizes variety of fonts	p58	Dec 21
R-F energy powers latest biomedical devices	p52	Dec 14
Telstar aids NASA budget	p30	Jul 20

RESISTORS

Evaluating integrated-circuit performance	p72	Aug 17
How to design micromodules	p37	Sep 14
Mobile dopants turn germanium resistors into two-way rectifiers	p16	Aug 24
Noise levels measured for various resistors	p74	Aug 17
Realistic potentiometer derating	p76	Aug 10

SALES See Business

SATELLITES

Are satellites need to detect secret nuclear tests in space?	p28	Nov 2
Design of advanced Syncom begins	p30	Aug 17
Doubling tracking accuracy with a two-way doppler system	p42	Jul 20
Interferometer is designed for Gemini radar ionosphere-mapping satellite to try laser-bounce ranging	p106	Nov 30
Modern antennas in space communications	p20	Sep 7
Need an accurate map? Photograph a satellite	p39	Sep 7
Project Relay communications satellite	p22	Nov 23
Satellite ownership should be private	p46	Oct 5
Satellite will test thermoelectric panels	p3	Aug 3
Telstar to offer transoceanic TV	p76	Oct 19
Telstar aids NASA budget	p28	Jul 13
Telstar's TV programs underline U. S. European cooperation	p30	Jul 20
European cooperation	p26	Aug 17

SCANNERS

Eliminating the human observer in air and space scouting missions	p45	Oct 26
New approach to electroluminescent displays	p68	Sep 14
Photo reader aids pattern recognition study	p50	Aug 3
Print reader recognizes variety of fonts	p58	Dec 21
Ultraviolet space telescope will scan the stars	p37	Nov 16

SCHMITT CIRCUITS

Eliminating the first stage of a monostable multivibrator	p54	Sep 7
Long staircase generator	p54	Aug 31
New complementary transistors makes series Schmitt circuits practical	p52	Aug 31
Simple f-m demodulator for audio frequencies	p89	Nov 30

SEMICONDUCTORS

(See also Diodes; Transistors)

Designing molecular circuits for use in complex systems	p39	Sep 21
Differential amplifier grown in silicon block	p37	Jul 6
Latest design techniques for linear microcircuits	p47	Oct 12
Mobile dopants turn germanium resistors into two-way rectifiers	p16	Aug 24
New family of rectifiers are reversible	p7	Jul 27
Overcoming turn-on effects in silicon controlled rectifiers	p50	Aug 17
Piezoelectricity and semiconductor effects	p92	Oct 19
Progress and pitfalls in microelectronics	p45	Oct 19
Semiconductor modulators for modern magnetrons	p42	Sep 14
Three ways to measure varactors of the future	p49	Sep 7
Will irradiation really improve transistors?	p66	Jul 20

SERVOMECHANISMS

Testing space craft with induction heaters	p38	Aug 24
--	-----	--------

SMITH CHARTS

Eliminate trial and error in broadband impedance matching	p68	Sep 28
Smith-chart short out renormalizes feedline impedances	p53	Nov 16

SPACE ELECTRONICS

Analysis center begins probe of space tracking RFI	p20	Aug 17
Are satellites need to detect secret nuclear tests in space?	p28	Nov 2
Designers see space guidance systems turning into mosaics of optical cells	p26	Jul 6
Doubling tracking accuracy with a two-way doppler system	p42	Jul 20
ECCANE: Aircraft navigation; is doppler or inertial better?	p18	Oct 12
Eliminating the human observer in air and space scouting missions	p45	Oct 26
Gravity-wave generator is being built	p66	Aug 17
Interferometer is designed for Gemini radar	p106	Nov 30
Lunar orbit rendezvous decision to spur new space contracts	p22	Aug 3
Mariner II instrumentation: what will it see on Venus?	p42	Dec 14
Mariner's long-range telemetry works on phase-shift keying	p26	Oct 26
Modern antennas in space communications	p39	Sep 7
Nasa will spend \$194 million for ground tracking in 1963	p26	Aug 3
Navy prepares for VLF detection of nuclear blasts	p28	Oct 19
New ionosphere measurement technique: plasma frequency probe	p81	Nov 30
New pulse modulation method varies both frequency and width	p50	Oct 12
Paramp that tracked Pioneer IV deep-space probe	p45	Jul 13
Project Relay communications satellite	p46	Oct 5
Scientists prepare to study quiet sun	p20	Sep 14
Space controls center takes shape	p23	Aug 3
Special antenna for a moon capsule	p46	Nov 16
Telemetry concept could speed space program	p60	Oct 12
Testing space craft with induction heaters	p38	Aug 24
Ultraviolet space telescope will scan the stars	p37	Nov 16
Venus in 1962? Mariner to try again	p26	Jul 27
Wanted: radiation-resistant solar cells	p28	Sep 21
X-ray telescope to probe moon and stars	p21	Sep 19

STRIP-LINE COMPONENTS

Five new diode circuits for nanosecond microwave switching	p37	Aug 31
Novel slotted line uses slow-wave technique	p46	Aug 31
Special antenna for a moon capsule	p46	Nov 16
Steering radar antenna beams with a lossless r-f matrix	p50	Jul 13

SUPERCONDUCTIVITY

Gas process makes superconducting wire	p62	Jul 27
--	-----	--------

SWITCHING CIRCUITS

Faster frequency switching with phase-lock oscillators	p54	Oct 26
Five new diode circuits for nanosecond microwave switching	p37	Aug 31
New transistor regulator handles 500-watt outputs	p48	Sep 21
Noncutoff circuits improve trigger switching	p36	Jul 27
Novel circuit damps transients in voltage-operated transmitters	p66	Sep 28
Overcoming turn-on effects in silicon controlled rectifiers	p50	Aug 17
Semiconductor modulators for modern magnetrons	p42	Sep 14
Simple method for plotting tunnel-diode switching waveforms	p49	Dec 14
Switching high microwave power	p82	Nov 9

TELEMETRY

Low-level encoding approach: latest details of Titan II telemetry	p36	Nov 23
Mariner's long-range telemetry works on phase-shift keying	p26	Oct 26
New ionosphere measurement technique: plasma frequency probe	p81	Nov 30
Oceanographers grapple with telemetry problems	p28	Aug 3
Special antenna for a moon capsule	p46	Nov 16
Telemetry concept could speed space program	p60	Oct 12
Ultraviolet space telescope will scan the stars	p37	Nov 16
Versatile diversity combiner handles most missile-range signals	p40	Nov 2

TELEVISION

(See also Color Television)		
Accuracy is improved in vidicon bandwidth tests	p63	Sep 14
Design problems of modern television transmitters	p53	Jul 20
Gallium-arsenide diode sends television by infrared beam	p44	Oct 5
Microscope - TV helps train assemblers	p56	Dec 28
New infrared-generating diode transmits television over modulated light ray	p24	Jul 27
Nomographs select TV standards	p56	Aug 17

Stop transistor failures in magnetic-deflection circuits	p37	Aug 3
Television audio stereo	p28	Jul 6
Tv images of x-ray views	p84	Aug 17
Telstar to offer transoceanic TV	p28	Jul 13
Telstar's TV programs underline U. S. European cooperation	p26	Aug 17
UHF TV gets set for boom	p26	Nov 30
Ultraviolet space telescope will scan the stars	p37	Nov 16

TEST EQUIPMENT

(See also Analyzers; Automatic Testers; Instruments)		
Automatic checkout equipment for today's complex systems	p37	Jul 13
Checking circuits at minimum cost	p70	Dec 21
Checking readiness of missile guidance systems	p33	Jul 27
Compact new instrument finds undersea cable faults	p48	Sep 14
Constant-current regulator speeds relay testing	p48	Jul 27
Hall probes improve magnet testing	p66	Nov 16
Laboratory supply for transistors	p55	Jul 27
Novel slotted line uses slow-wave technique	p46	Aug 31
Reliability: 1962	p53	Nov 30
Simple curve tracer displays transistor beta	p36	Aug 24
Simple test for transistor quality	p80	Sep 28
Tunnel-diode oscillator delivers R-F and audio	p56	Oct 12
Simple test for transistor quality	p80	Sep 28
Will interference specs get tougher?	p28	Nov 16

THERMOELECTRICS

Pacific Energy Conversion Conference: exotic power sources	p26	Aug 31
Satellite will test thermoelectric panels	p76	Oct 19
Thermoelectric chamber stabilizes p-c board	p64	Aug 17

THIN FILMS

Electron beams make insulating films	p74	Oct 5
How will thin-film triodes perform?	p29	Dec 28
Northeast Electronics Research and Engineering Meeting Highlights	p35	Nov 2
Packaging methods for thin films	p72	Jul 20
Progress and pitfalls in microelectronics	p45	Oct 19

TIMERS

Eliminating one-count uncertainty in cycle-counting interval timers	p46	Jul 20
Versatile discriminator measures pulse length	p48	Aug 3

TRANSDUCERS

Diode makes accurate cryogenic thermometer	p86	Nov 9
Glass digital delay lines: new computer component	p60	Nov 9
Inexpensive monitor reads blood pressure automatically	p40	Nov 23
Magnetic pickup generates frequency markers	p56	Nov 16
Microphone calculations for the space age	p66	Nov 9
Piezoelectricity and semiconductor effects	p92	Oct 19
Providing thermocouple compensation at low cost	p72	Nov 9

TRANSFORMERS

Broden transformer frequency response	p52	Aug 24
New transformers may bring transistor TV	p60	Sep 7
Recently derived graphs simplify pulse transformer design	p52	Nov 2

TRANSISTOR CIRCUITS

Better speech quantizing for pulse-code modulation	p84	Nov 30
Constant-current regulator speeds relay testing	p48	Jul 27
D-c level shifter checks new computer modules	p44	Jul 6
Designing class-C transistor L-C oscillators	p42	Jul 27
Designing special power supplies for voltage-tunable oscillators	p48	Nov 2
Differential amplifier grown in silicon block	p37	Jul 6
Eliminating the first stage of a monostable multivibrator	p54	Sep 7
Eliminating one-count uncertainty in cycle-counting interval timers	p46	Jul 20
Get stability through mismatching	p50	Oct 19
Getting rid of transients in frequency-shift keying	p58	Nov 9
High-frequency limiter amplifier solves phase-shift problems	p44	Nov 16
How copper wire balances parallel power transistors	p47	Nov 23
How to design transformerless audio-frequency power amplifiers	p50	Nov 16
How to produce variable width pulses	p48	Dec 21
Improved superregenerator has quench converter	p53	Sep 21
Industrial engines get breakerless ignition	p52	Jul 27
Inexpensive converter gives 5,000 volts d-c	p54	Jul 13
Inexpensive monitor reads blood pressure automatically	p40	Nov 23
Key to faster computers: ten-nanosecond amplifier	p39	Dec 14
Laboratory supply for transistors	p55	Jul 27
Logic blocks offer design flexibility	p58	Jul 27
Low-level encoding approach: latest details of Titan II telemetry	p36	Nov 23
Mariner II instrumentation: what will it see on Venus?	p42	Dec 14
Modulation techniques cut radar costs	p56	Aug 31
New approach to serial decoding eliminates static storage	p32	Aug 24
New circuit design raises inverter frequency limits	p59	Oct 26
New complementary transistors make series Schmitt circuits practical	p52	Aug 31
New transistor regulator handles 500-watt outputs	p48	Sep 21
New way to multiple Q with transistors	p48	Jul 13
Noncutoff circuits improve trigger switching	p36	Jul 27
Novel bi-level regulator reduces storage capacitance	p74	Aug 10
Novel design technique for transistor digital circuits	p42	Aug 24
Novel digital signal generator uses magnetic-core pegboard	p46	Jul 6
One more transistor makes a linear sawtooth	p50	Dec 7
PNP-NPN circuits: new look at a familiar connection	p42	Nov 23
Precise converter takes current analog of digital voltage pulses	p68	Aug 10
Putting a servo amplifier on a small silicon wafer	p33	Dec 28
Reliability: 1962	p53	Nov 30
Reliable circuit supplies high peak deflection voltages	p54	Oct 12
Simple f-m demodulator for audio frequencies	p89	Nov 30
Simple square-wave generator	p47	Dec 21
Single-sideband exciter uses planar silicon transistors	p65	Aug 10

Tiny solid-state transmitter may save your life	p90	Nov 30
Transistor circuits control small d-c motors	p48	Aug 24
Transistor pair provides constant-current drive	p56	Sep 21
Transistor systems for precision helicopter flying	p20	Oct 5
Transistors save truck batteries	p30	Oct 12
Two easy ways to stabilize power-transistor hi-fi amplifiers	p56	Oct 26
Two transistors equal one constant current diode	p50	Jul 6
Ultraviolet space telescope will scan the stars	p37	Nov 16
Unique power supply delivers constant voltage and current	p40	Aug 3
Unique tunnel-diode circuit performs odd-and-even logic	p61	Oct 19
Using new device: field-effect transistor oscillators	p44	Dec 21
Versatile discriminator measures pulse length	p48	Aug 3
TRANSISTORS		
Better ways to protect transistors with zener diodes and fuses	p64	Sep 28
Do field-effect transistors resist nuclear radiation?	p56	Jul 13
Evaluating integrated-circuit performance	p72	Aug 17
Failure analysts curb device faults	p68	Oct 12
Guide to modern junction transistor types	p46	Aug 17
Latest design techniques for linear microcircuits	p47	Oct 12
Logic blocks offer design flexibility	p58	Jul 27
NEREM: What lies ahead for transistors?	p62	Nov 16
New complementary transistors make series Schmitt circuits practical	p52	Aug 31
New entry in microelectronics: high-density silicon matrices	p20	Aug 24
Progress and pitfalls in microelectronics	p45	Oct 19
Simple curve tracer displays transistor beta	p36	Aug 24
Simple test for transistor quality	p80	Sep 28
Stop transistor failures in magnetic-deflection circuits	p37	Aug 3
Transistor's leads are its hermetic seals	p56	Aug 24
Two transistors equal one constant-current diode	p50	Jul 6
Will irradiation really improve transistors?	p66	Jul 20
TRANSMISSION LINES		
Calculate transmission line resonant frequency	p56	Oct 5
Smith-chart short cut renormalizes feedline impedances	p54	Nov 16
Special antenna for a moon capsule	p46	Nov 16
TRANSMITTERS		
Design problems of modern television transmitters	p53	Jul 20
Novel circuit damps transients in voice-operated transmitters	p66	Sep 28

Single-sideband exciter uses planar silicon transistors	p65	Aug 10
Tiny solid-state transmitter may save your life	p90	Nov 30
TUBE CIRCUITS		
Long staircase generator	p54	Aug 31
New design method optimizes gain-bandwidth	p54	Jul 6
Ultrasound-impedance amplifier for precision measurements	p49	Oct 5
Unique two-channel tachometer uses radioisotopes	p44	Dec 7
TUBES		
Concentric design aids tube production	p74	Oct 26
Getters adsorb organic contaminants	p70	Sep 7
Hollow cathode enhances plasma electron gun	p60	Dec 7
Making bulbs for double-ended tubes	p82	Aug 17
Movable electrodes help tube designers	p68	Sep 7
New design concept reduces klystron weight	p36	Dec 28
New tube shifts phase linearly with current	p70	Nov 9
Photofabrication makes intricate parts quickly	p74	Sep 7
Planar triode redesigned for space use	p68	Oct 26
Ultraviolet space telescope will scan the stars	p37	Nov 16
Why Soviets talk up cold-cathode tubes	p54	Nov 23
TUNERS		
Tuner elements ride piggyback	p54	Aug 3
TUNNEL DIODES		
New tunnel-diode preamplifier improves phased-array radar	p57	Sep 28
New vapor-deposition process creates tunnel diodes	p58	Nov 2
Simple method for plotting tunnel-diode switching waveforms	p49	Dec 14
Tunnel-diode oscillator delivers r-f and audio	p56	Oct 12
Unique tunnel-diode circuit performs odd-and-even logic	p61	Oct 19
Varactor-tuned tunnel-diode oscillator now practical	p50	Sep 21

Ultrasonic cleaning speeds maintenance	p62	Nov 2
UNDERWATER ELECTRONICS		
Getting signals through to submarines	p52	Sep 14
National Electronics Conference technical preview	p39	Oct 5
Transistor systems for precision helicopter flying	p20	Oct 5

VARACTORS		
Can varactors get rid of f-m distortion in reflex klystrons?	p42	Aug 3
Three ways to measure varactors of the future	p49	Sep 7
Tiny solid-state transmitter may save your life	p90	Nov 30
Varactor-tuned tunnel-diode oscillator now practical	p50	Sep 21

WAVEGUIDES		
Antenna innovation: glass-fiber tube focuses microwave beam	p44	Sep 21
Countermeasures receiver tunes with passive elements	p40	Jul 6
Eliminate trial and error in broadband impedance matching	p68	Sep 28
Millimeter waves - what we have, what we need	p37	Oct 12
Novel slotted line uses slow-wave technique	p46	Aug 31
Paramp that tracked Pioneer IV deep-space probe	p45	Jul 13
Using double-ridge waveguide for electronic countermeasures	p50	Oct 5
Y-guide: a new type of surface waveguide	p44	Nov 2

WELDING		
Electron beam cutting for microelectronics	p78	Dec 7
L-v percussion welding lowers costs	p60	Dec 14
Split electrode spot-welds microcircuits	p98	Sep 28

WIRE		
Bent wire retains superconductivity	p70	Sep 14
Gas process makes superconducting wire	p67	Jul 27
How copper wire balances parallel power transistors	p47	Nov 23
New cables withstand more heat	p60	Aug 31
Tin-coated wire tests at subzero temperatures	p71	Sep 14

AUTHORS' INDEX

A		
Aarons, M. W., Putting a servo amplifier on a small silicon wafer	p33	Dec 28
Abrams, D., Microphone calculations for the space age	p66	Nov 9
Addeo, E., EIA panel urges weapons system planners to be more realistic	p26	Dec 14
Allen, R. C. & R. S. Hartz, Reliable circuit supplies high peak deflection voltages	p54	Oct 12
Anemiyu, Y. & others, Y-guide: a new type of surface waveguide	p44	Nov 2
Arnold, B. T. & A. L. Stanford Jr., Switching high microwave power	p82	Nov 9
Aron, N., Precise converter takes current analog of digital voltage pulses	p68	Aug 10
Aupperle, E. M. & T. W. Butler Jr., Faster frequency switching with phase-lock oscillators	p54	Oct 26
B		
Baker, K. D. & D. C. Haycock, New ionosphere measurement technique: plasma frequency probe	p81	Nov 30
Balthasar, P., New transistor regulator handles 500-watt outputs	p48	Sep 21
Barlow, D., Missile cutback rocks British aviation electronics	p18	Sep 22
Barta, G. T., Hall probes improve magnet testing	p66	Nov 16
Bauden, D. J., Thermoelectric chamber stabilizes p-c board	p64	Aug 17
Blank, H. G. & others, Nonlinear resistors enhance display-panel contrast	p33	Aug 3
Bockemeier, R. R. & P. W. Wood, Unique two-channel tachometer uses radioisotopes	p44	Dec 7
Boring, K. L. & L. H. Stauffer, Hollow cathode enhances plasma electron gun	p60	Dec 7
Boudreaux, P. J., Providing thermocouple compensation at low cost	p72	Nov 9
Bowers, D. M., Recently derived graphs simplify pulse transformer design	p52	Nov 2
Bowers, J. C. & R. O. Gregory, Simple square-wave generator	p47	Dec 21
Bowker, J. F. & W. F. DeBoice, Differential amplifier grown in silicon block	p37	Jul 6
Brian, D. G. & A. A. Ranger, Harness boards use full scale photos	p102	Oct 19
Briseland, D. L., Packaging methods for thin films	p72	Jul 20
Brown, A. J. & A. Rothbart, Optimum mode for magnetostictive delay lines	p43	Aug 31

Brown, N. H., Improved superregenerator has quench converter	p53	Sep 21
Bruun, R. J., Navy prepares for VLF detection of nuclear blasts	p28	Oct 19
Burgess, R. G. & others, Gallium-arsenide diode sends television by infrared beam	p44	Oct 5
Burlak, O., Better ways to protect transistors with zener diodes and fuses	p64	Sep 28
Butler, T. W., Jr. & E. M. Aupperle, Faster frequency switching with phase-lock oscillators	p54	Oct 26
Byers, W. F., Magnetic pickup generates frequency markers	p56	Nov 16

C		
Campbell, D., Smith-chart short cut renormalizes feedline impedances	p53	Nov 16
Carroll, J. M., Reliability: 1962	p53	Nov 30
Carter, W. L. & P. J. Knoke, Unconventional approach to pulse-width measurements	p51	Oct 26
Casson, W. & R. C. Robinson, Versatile diversity combiner handles most missile-range signals	p40	Nov 2
Catalano, A. J., Line of balance shows production problems	p66	Aug 31
Centner, R. M. & J. R. Wilkinson, New approach to serial decoding eliminates static storage	p32	Aug 24
Chase, S., Jr. & F. Schwarz, Mariner II instrumentation: what will it see on Venus?	p42	Dec 14
Cheney, M. C., New cables withstand more heat	p60	Aug 31
Cherewich, P., Jr., More computing talent on the way from colleges	p26	Sep 28
Cherewich, P., Jr. & L. Solomon, Telstar's Tv programs underlie U. S.-European cooperation	p26	Aug 17
Chiffy, F. P. & J. L. Curley Jr., Three ways to measure varactors of the future	p49	Sep 7
Chin, L. S. F., Measuring plating area photoelectrically	p101	Sep 28
Chin, S. L., New circuit design raises inverter frequency limits	p59	Oct 26
Cohen, C., Japan closing computer doors	p18	Dec 14
Cohen, C. L., New approach to locked-pair tunnel-diode logic	p46	Aug 3
Cook, C. G. & others, New approach to electroluminescent displays	p68	Sep 14
Cullin, H., Taking bounce out of reed relays	p66	Jul 6
Curran, D. J. & J. D. Schoeffler, Easy way to design ceramic resonator filters	p54	Nov 9
Czerwinski, S. D. & F. S. Lim, Tiny solid-state transmitter may save your life	p90	Nov 30
Czerwinski, W. P., Antenna bridge measurements	p50	Jul 27

D		
Dawson, J. W., Spun-cast plastics achieve reflector precision	p134	Nov 30
DeBoice, W. F. & J. F. Bowker, Differential amplifier grown in silicon block	p37	Jul 6
Delaney, W. P., Steering radar antenna beams with a lossless r-f matrix	p50	Jul 13

de Miranda, J. R., Ordered geometry for component design	p86	Sep 28
Diamantides, N. D., Improved electronic differentiator has low noise factor	p46	Jul 27
Diorocco, J. V. & J. W. Peghini, Low-level encoding approach: latest details of Titan II telemetry	p36	Nov 23
DiStefano, R., Jr., How to design micromodules	p37	Sep 14
Distelhorst, I. E. & F. G. Whelen, Mercury and cadmium improve IR detectors	p84	Aug 10
Dobson, H. R. & others, Doubling tracking accuracy with a two-way doppler system	p42	Jul 20
Oulberger, L. H., EIA sees \$13.1 billion sales in 1962	p26	Sep 21
TFX fighter bomber	p18	Dec 14
Duncan, K. W. & R. S. Gordon, Ready-reference data simplifies antenna design	p50	Dec 21

E		
Eberly, W. S., How to choose air-tight sealing materials	p62	Dec 21
Edgerton, H. E. & P. W. Jameson, Phototube used for short flash observation	p72	Sep 14
Embree, M. L. & F. A. Gateka, Semiconductor modulators for modern magnetrons	p42	Sep 14
Emma, T., Prices of electronic stocks during market shakeout	p20	Jul 6
Erikson, A., Oceanographers decide on frequencies	p18	Oct 19
Evander, H. S., Transistor's leads are its hermetic seals	p56	Aug 24
Evans, G. E., Eliminate trial and error in broadband impedance matching	p68	Sep 28
Evans, P. F. & others, New approach to electroluminescent displays	p68	Sep 14
F		
Fleming, Roger, Modulation techniques cut radar cost	p56	Aug 31
Fluke, R. & others, Photofabrication makes intricate parts quickly	p74	Sep 7
Flynn, G. F., UHF TV gets set for boom	p26	Nov 30
Froud, S., Electronics in Canada	p37	Sep 28

G		
Gallagher, O. L. & H. M. Thaxton, Increasing bandwidth of ultrasonic radiators	p60	Jul 6
Gateka, F. A. & M. L. Embree, Semiconductor modulators for modern magnetrons	p42	Sep 14
Geating, C. J., Making new production ideas work	p70	Jul 13
Gellatly, J. S., L-v percussion welding lowers costs	p60	Dec 14
Gilman, W., Epoxy used for short run production	p72	Oct 5
Glover, V., Using new device: field-effect transistor oscillators	p44	Dec 21
Gordon, R. S. & K. W. Duncan, Ready-reference data simplifies antenna design	p50	Dec 21
Grant, C. R. & others, Gallium-arsenide diode sends television by infrared beam	p44	Oct 5

Gregory, R. O. & J. C. Bowers, Simple square-wave generator	p47	Dec 21
Griffin, T. J., Jr., Preparing tapes for audio-visual aids	p58	Aug 3
Gross, T. A. O., Broaden transformer frequency response	p52	Aug 24
New magnetic rods simplify circuits	p62	Jul 13
Grove, R. & others, Handy nomogram speeds Infrared system design	p64	Oct 19
Gudenschwager, P. F. & S. M. Vidulich, Checking readiness of missile guidance systems	p33	Jul 27
Gurley, J. L., Jr. & F. P. Chiffy, Three ways to measure varactors of the future	p49	Sep 7
Gutteridge, R. & L. Pollock, Latest design techniques for linear microcircuits	p47	Oct 12

H

Hall, James H., Reliability of tantalum capacitors increased	p78	Sep 14
Hammerslag, J. G., Form logic matrix with diode ribbons	p100	Aug 10
Hancock, D. J., How copper wire balances parallel power transistors	p47	Nov 23
Haneman, F. G. & G. W. Thomson, Varactor-tuned tunnel-diode oscillator now practical	p50	Sep 21
Hankin, R. B. & M. Ross, Countermeasures receiver tunes with passive elements	p40	Jul 6
Harmon, L. D., Handwriting reader recognizes whole words	p29	Aug 24
Harris, J. H. O., Sunflower optics: a new concept in color TV display	p33	Dec 14
Harris, E. L. & D. J. M. Smith, Novel circuit damps transients in voice-operated transmitters	p66	Sep 28
Hartz, R. S., Stop transistor failures in magnetic-deflection circuits	p37	Aug 3
Hartz, R. S. & R. C. Allen, Reliable circuit supplies high peak deflection voltages	p54	Oct 12
Hashimoto, K., Color TV based on Land theory uses two single-gun tubes	p54	Sep 21
Haycock, O. C. & K. O. Baker, New ionosphere measurement technique: plasma frequency probe	p81	Nov 30
Hekimian, N. C., Getting rid of transients in frequency-shift keying	p58	Nov 9
PNP-NPN circuits: new look at a familiar connection	p42	Nov 23
Henkels, H. W., Designing molecular circuits for use in complex systems	p39	Sep 21
Heymann, A. P., Param that backed Pioneer IV deep-space probe	p45	Jul 13
Hilliard, E. J., Getting signals through to submarines	p52	Sep 14
Hockenberger, R. W., Novel design techniques for transistor digital circuits	p42	Aug 24
Hood, H. C., Mariner's long-range telemetry works on phase-shift keying	p26	Oct 26
Need an accurate map? Photograph a satellite	p22	Nov 23
1962 WESCON: a technical preview	p59	Aug 10
WESCON spotlights frontiers in electronics	p30	Aug 10
Hook, H. O. & H. Weinstein, First step in character recognition - image processing with optical panels	p35	Dec 21
Howell, J. F., How to measure coulombs in irregular pulses	p72	Aug 10
Howells, J. D., Better speech quantizing for pulse-code modulation	p84	Nov 30
Synchronism doesn't matter in pulse-code modulated speech	p58	Oct 19
Hrybyk, B. D., Checking circuits at minimum cost	p70	Dec 21
Hudson, M. J. & others, Gallium-arsenide diode sends television by infrared beam	p44	Oct 5
Huie, J. A. & others, Doubling tracking accuracy with a two-way doppler system	p42	Jul 20
Hutter, R. G. E., Microwave phototube - new detector for optical receivers	p37	Jul 20

I

Ikraht, K. & W. Schneider, Antenna innovation: glass-fiber tube focuses microwave beam	p44	Sep 21
Inose, H. & others, Noncutoff circuits improve trigger switching	p36	Jul 27

J

Jameson, P. W. & H. E. Edgerton, Phototube used for short flash observation	p72	Sep 14
Jarvis, F. T., Wiring patterns bonded to pellet modules	p90	Nov 9
Jeffrey, L. F., Planar triode redesigned for space use	p68	Oct 26
Jepson, S. R., Process for metalizing ceramic is automated	p116	Aug 10
Jones, F. & J. H. Reyner, Compact new instrument finds undersea cable faults	p48	Sep 14

K

Kantor, F. W., New transformers may bring transistor TV	p60	Sep 7
Telemetry concept could speed space program	p60	Oct 12
Karlotzki, W. A. & R. P. Rufer, Use raster oscilloscopes for faster time measurements	p38	Dec 28
Kaufman, A. B., Do field-effect transistors resist nuclear radiation?	p56	Jul 13
Kay, R. H. & others, Doubling tracking accuracy with a two-way doppler system	p42	Jul 20
Kear, F. W., How to select shaft-position encoders	p48	Aug 31
Laboratory supply for transistors	p55	Jul 27
Measuring acceleration by magnetic suspension	p62	Oct 12
Shaft restorer reduces loading	p62	Sep 7
Simple test for transistor quality	p80	Sep 28
Transistor circuits control small d-c motors	p48	Aug 24
Keller, H. E., Microscope - TV helps train assemblers	p56	Dec 28
Kern, G. & others, Handy nomogram speeds Infrared system design	p64	Oct 19
Kerwin, W. J., Simplified low-pass filter design	p52	Sep 7
Keyes, R. J. & others, Gallium-arsenide diode sends television by infrared beam	p44	Oct 5

Kimura, K., Faster zener diodes make new uses possible	p54	Oct 19
Kinney, L. C. & E. H. Tompkins, Flash printing of circuit elements	p88	Oct 19
Knock, P. J. & W. L. Carter, Unconventional approach to pulse-width measurements	p51	Oct 26
Ko, W. H., Tunnel-diode oscillator delivers R-F and audio	p56	Oct 12
Unique tunnel-diode circuit performs odd-and-even logic	p61	Oct 19
Ko, W. H. & W. C. Till, Versatile analog storage uses ferrite cores	p60	Sep 28
Kolarcik, J. J., Versatile zener diode array forms high-speed quantizer	p52	Aug 17
Konkle, K. H. & J. E. Laynor, Key to faster computers: ten-nanosecond amplifier	p39	Dec 14
Kornberg, W. & others, Is that radiation belt going away next summer or isn't it?	p22	Dec 14
Kotzebue, K. L., New trends in low-power ferrite limiters	p40	Dec 21
Kuwachi, N. & others, Y-guide: a new type of surface waveguide	p44	Nov 2

L

Laakmann, P., Designing class-C transistor L-C oscillators	p42	Jul 27
Lambert, L. M. & J. E. McAteer, Cryosar: promising element for tomorrow's computers	p39	Aug 17
Laynor, J. E. & K. H. Konkle, Key to faster computers: ten-nanosecond amplifier	p39	Dec 14
LeCroy, W. O., Jr., Eliminating one-count uncertainty in cycle-counting interval timers	p46	Jul 20
Lee, L. F., Rapid selection of VHF bypass capacitors	p44	Dec 28
Levenstein, H. & others, Handy nomogram speeds infrared systems design	p64	Oct 19
Levine, P. & P. Lubell, Using double-ridge waveguide for electronic countermeasures	p50	Oct 5
Levy, S. & H. Shinitkin, Getting maximum bandwidth with dipole antennas	p40	Aug 31
Lien, D. H., Constant-current regulator speeds relay testing	p48	Jul 27
Liepins, H. & J. W. Martin, Unique power supply delivers constant voltage and current	p40	Aug 3
Lindgren, N., Adaptive automatic control stressed at JACC meeting	p28	Jul 20
Navy to push microelectronics development programs	p24	Oct 12
Pulse doppler gives radar trackers new velocity measuring capability	p20	Jul 27
Radar trends: superpower and smarter signal processing	p18	Nov 2
Linn, F. S. & S. D. Czerwinski, Tiny solid-state transmitter may save your life	p90	Nov 30
Lubell, P. & P. Levine, Using double-ridge waveguide for electronic countermeasures	p50	Oct 5
Lunden, C. D. & L. L. Oh, Novel slotted line uses slow-wave technique	p46	Aug 31
Lundquist, C. R. & C. Strother Jr., Balinverter - frequency-insensitive balanced converter	p46	Nov 2

M

MacGlashan, D. W., New tunnel-diode preamplifier improves phased-array radar	p57	Sep 28
Maguire, T., Giant Haystack radar facility	p49	Nov 9
Maybe there's a new communications propagation path above the exosphere	p26	Nov 23
New infrared-generating diode transmits television over modulated light ray	p24	Jul 27
Northeast Electronics Research and Engineering Meeting Highlights	p35	Nov 2
NEREM: New England launches drive for more space work	p24	Nov 2
Telstar to offer transoceanic TV	p28	Jul 13
Maguire, T. & others, Is that radiation belt going away next summer or isn't it?	p22	Dec 14
Mapham, N., Overcoming turn-on effects in silicon controlled rectifiers	p50	Aug 17
Martin, J. W. & H. Liepins, Unique power supply delivers constant voltage and current	p40	Aug 3
Mason, J. F., Air traffic control today and tomorrow Pt 1	p37	Dec 7
Pt 2 improved navigation aids needed to lighten wasted airspace	p46	Dec 14
Electrically-controlled cameras watch Cuba	p20	Nov 30
NASA will spend \$194 million for ground tracking in 1963	p26	Aug 3
Mathews, B. E. & F. R. Sias Jr., Testing space craft with induction heaters	p38	Aug 24
Mayer, R. J., Is this the simplest paramp ever built?	p46	Sep 14
Maynard, H. M., Photo reader aids pattern recognition study	p50	Aug 3
Mayrovitz, H. M. & A. I. Sinsky, New design method optimizes gain-bandwidth	p54	Jul 6
McAteer, J. E. & L. M. Lambert, Cryosar: promising element for tomorrow's computers	p39	Aug 17
McGuire, H. E., Combined coding increases spectrum usage	p64	Oct 26
McMillin, J. V., Simple curve tracer displays transistor beta	p36	Aug 24
McNeess, Sterling, Movable electrodes help tube designers	p68	Sep 7
Meahl, H. R., Ion orbs warn of excessive r-f field strength	p58	Jul 20
Mechtel, S. R. & A. Mizuhara, New design concept reduces klystron weight	p36	Dec 28
Meserve, E. T., Quick way to find radar range	p56	Sep 7
Mikus, L. E., Tape recorder simulates data transmissions	p56	Nov 23
Mizuhara, A. & S. R. Mechtel, New design concept reduces klystron weight	p36	Dec 28
Moehliman, R. H. & others, Doubling tracking accuracy with a two-way doppler system	p42	Jul 20
Mollinga, T., D-c level shifter checks new computer modules	p44	Jul 6
Morrison, J., Ultrahigh-impedance amplifier for precise measurements	p49	Oct 5

Morrow, R. D., Inexpensive converter gives 5,000 volts d-c	p54	Jul 13
Morwood, R. C., Calculate transmission line resonant frequency	p56	Oct 5

N

Nakahara, T. & others, Y-guide: a new type of surface waveguide	p44	Nov 2
Novotny, G. V., Automatic checkout equipment for today's complex systems	p37	Jul 13

O

O'Connell, J. A. & others, Nonlinear resistors enhance display-panel contrast	p33	Aug 3
Oh, L. L. & C. D. Lunden, Novel slotted line uses slow-wave technique	p46	Aug 31
Ormond, T., New way to multiply Q with transistors	p48	Jul 13
Ottenstein, A. S. & R. L. Paul, Eliminating the first stage of a monostable multivibrator	p54	Sep 7

P

Packham, B. E. & W. C. Sanders, Easy-to-use nomographs eliminate filter calculations	p92	Nov 30
Padalino, M., Tristable cores detect errors in binary data	p60	Oct 5
Parmer, H. W., Two easy ways to stabilize power-transistor hi-fi amplifiers	p56	Oct 26
Paul, R. L. & A. S. Ottenstein, Eliminating the first stage of a monostable multivibrator	p54	Sep 7
Peghini, J. W. & J. V. Dirocco, Low-level encoding approach: latest details of Titan II telemetry	p36	Nov 23
Perry, K., Long staircase generator	p54	Aug 31
Perry, W., Are satellites needed to detect secret nuclear tests in space?	p28	Nov 2
Pirkle, J., Accuracy is improved in vidicon bandwidth tests	p63	Sep 14
Pollock, L. & R. Gutteridge, Latest design techniques for linear microcircuits	p47	Oct 12
Prigozy, S., Designing special power supplies for voltage-tunable oscillators	p48	Nov 2
Pritchard, R. L., Guide to modern junction transistor types	p46	Aug 17

Q

Quist, T. M. & others, Gallium-arsenide diode sends television by infrared beam	p44	Oct 5
---	-----	-------

R

Rakovic, B., One more transistor makes a linear sawtooth	p50	Dec 7
Ramsey, S., Why Soviets talk up cold-cathode tubes	p54	Nov 23
Ranger, A. A. & D. G. Briant, Harness boards use full scale photos	p102	Oct 19
Rasmussen, C. D., Circuit boards for R&D without photography	p74	Sep 21
Ravenhill, P. & H. Smith, Five new diode circuits for nanosecond microwave switching	p37	Aug 31
Reeder, F. H., Atomic frequency standards for highest accuracy	p31	Nov 23
Rediker, R. H. & others, Gallium-arsenide diode sends television by infrared beam	p44	Oct 5
Reed, D. R. & others, New approach to electroluminescent displays	p68	Sep 14
Reinhardt, N. & others, Photofabrication makes intricate parts quickly	p74	Sep 7
Reynold, W. D., Get stability through mismatching	p50	Oct 19
Reyner, J. H. & F. Jones, Compact new instrument finds undersea cable faults	p48	Sep 14
Ribbens, W. B., Cascading up parametric amplifier gain	p60	Sep 14
Richards, R. S., How to design transformerless audio-frequency power amplifiers	p50	Nov 16
Riggs, R. N., Ultraviolet space telescope will scan the stars	p37	Nov 16
Robinson, R. C. & W. Casson, Versatile diversity combiner handles most missile-range signals	p40	Nov 2
Robson, G. & K. R. Whittington, Versatile discriminator measures pulse length	p48	Aug 3
Roos, Willi, Design problems of modern television transmitters	p53	Jul 20
Rose, D., Hong Kong's transistor radio exports soar to 100,000 a month	p24	Sep 28
Rosenfeld, A., Eliminating the human observer in air and space scouting missions	p45	Oct 26
Ross, M. & R. B. Hankin, Countermeasures receiver tunes with passive elements	p40	Jul 6
Rothbart, A. & A. J. Brown, Optimum mode for magnetostrictive delay lines	p43	Aug 31
Roy, R. J. & M. Weiss, Inexpensive monitor reads blood pressure automatically	p40	Nov 23
Rufer, R. P. & W. A. Karlotzki, Use raster oscilloscopes for faster time measurements	p38	Dec 28

S

Samoden, R. A., Increasing corona thresholds in dielectrics	p80	Nov 9
Sanders, W. C. & B. E. Packham, Easy-to-use nomographs eliminate filter calculations	p92	Nov 30
Sasaki, A., Can varactors get rid of f-m distortion in reflex klystrons?	p42	Aug 3
Schaefer, R. A., New pulse modulation method varies both frequency and width	p50	Oct 12
Schink, P., Evaluating integrated-circuit performance	p72	Aug 17
Schneider, W. & K. Ikraht, Antenna innovation: glass-fiber tube focuses microwave beam	p44	Sep 21
Schoeffler, J. D. & D. R. Curran, Easy way to design ceramic resonator filters	p54	Nov 9

Schollhammer, F. L., Electron beam cutting for microelectronics	p78	Dec 7
Schwarz, F. & S. Chase, Jr., Mariner II Instrumentation: what will it see on Venus?	p42	Dec 14
Scott, W. G., Special antenna for a moon capsule	p46	Nov 16
Shannon, H. H., Recent refraction data corrects radar errors	p52	Dec 7
Shelton, G. L., Jr., Print reader recognizes variety of fonts	p58	Dec 21
Sheigalis, L. D., IRE Symposium: Tropo systems better with seven beams	p24	Oct 19
Latest military computer applications	p30	Jul 13
Millimeter waves - what we have, what we need	p37	Oct 12
Oceanographers grapple with telemetry problems	p28	Aug 3
Transistor systems for precision helicopter flying	p20	Oct 5
Shnitkin, H. & S. Levy, Getting maximum bandwidth with dipole antennas	p40	Aug 31
Sias, F. R., Jr. & B. E. Mathews, Testing space craft with induction heaters	p38	Aug 24
Simon, I., How to produce variable width pulses	p48	Dec 21
Sinsky, A. I. & H. M. Mayrovitz, New design method optimizes gain-bandwidth	p54	Jul 6
Skilling, J. K., New complementary transistors make series Schmitt circuits practical	p52	Aug 31
Simple method for plotting tunnel-diode switching waveforms	p49	Dec 14
Sletten, C. J., Modern antennas in space communications	p39	Sep 7
Smith, H. & P. Ravenhill, Five new diode circuits for nanosecond microwave switching	p37	Aug 31
Smith, O. J. M. & E. L. Harris, Novel circuit damps transients in voice-operated transmitters	p66	Sep 28
Sokol, S., Transistor pair provides constant-current drive	p56	Sep 21
Solomon, L., Doppler laser measures speeds down to 0.00004 mph	p26	Jul 20
Radar cross section measurements: how accurate are they?	p48	Jul 20
Solomon, L. & P. Cherevich Jr., Teistar's Tv programs underline U. S.-European cooperation	p26	Aug 17
Stanford, A. L., Jr. & R. T. Arnold, Switching high microwave power	p82	Nov 9
Stauffer, L. H. & K. L. Boring, Hollow cathode enhances plasma electron gun	p60	Dec 7
Strandorf, S. P. W., High-frequency limiter amplifier solves phase-shift problems	p44	Nov 16
Strother, C., Jr. & C. R. Lundquist, Ball-inverter - frequency-insensitive balanced converter	p46	Nov 2

Suran, J. J., Progress and pitfalls in microelectronics	p45	Oct 19
---	-----	--------

T		
Tada, H. & others, Noncutoff circuits improve trigger switching	p36	Jul 27
Tantaporn, W., How will thin-film diodes perform?	p29	Dec 28
Thaxton, H. M. & O. L. Gallagher, Increasing bandwidth of ultrasonic radiators	p60	Jul 6
Theriault, L. J., Why use silicon rectifiers for high-voltage service?	p46	Dec 7
Thomson, G. W. & F. G. Haneman, Varactor-tuned tunnel-diode oscillator now practical	p50	Sep 21
Till, W. C. & W. H. Ko, Versatile analog storage uses ferrite cores	p60	Sep 28
Tint, G., Ultrasonic cleaning speeds maintenance of circuit elements	p62	Nov 2
Tompkins, E. H. & L. C. Kinney, Flash printing of circuit elements	p88	Oct 19
Traeger, H. & others, Photofabrication makes intricate parts quickly	p74	Sep 7
Tranor, F., Unique engine tachometer uses only passive components	p40	Jul 27

V		
Vaughan, T., Up-to-date nomograph aids tropo antenna design	p62	Oct 26
Velez, N. A. & C. L. Vogt Jr., Failure analysts curb device faults	p68	Oct 12
Vidulich, S. M. & P. F. Gudenschwager, Checking readiness of missile guidance systems	p33	Jul 27
Vogel, S., Analysis center begins probe of space tracking RFI	p20	Aug 17
Will interference specs get tougher?	p28	Nov 16
Vogt, C. L., Jr. & N. A. Velez, Failure analysts curb device faults	p68	Oct 12

W		
Ward, F. L., Novel bi-level regulator reduces storage capacitance	p74	Aug 10

Wasserman, M. S. & others, Nonlinear resistors enhance display-panel contrast	p33	Aug 3
Watson, G., Two transistors equal one constant-current diode	p50	Jul 6
Weber, S. & M. F. Wolff, Electrostatic focusing gives klystrons greater efficiency	p26	Nov 9
Weinstein, H. & H. O. Hook, First step in character recognition - image processing with optical panels	p35	Dec 21
Weiss, M. & R. J. Roy, Inexpensive monitor reads blood pressure automatically	p40	Nov 23
Whelen, F. G. & I. E. Distelhorst, Mercury and cadmium improve IR detectors	p84	Aug 10
Whittington, K. R., Simple f-m demodulator for audio frequencies	p89	Nov 30
Whittington, K. R. & G. Robson, Versatile discriminator measures pulse length	p48	Aug 3
Wilcox, D. L., Single-sideband exciter uses planar silicon transistors	p65	Aug 10
Wiley, C. M., Computer Applications Symposium: Computer unsmarls traffic in tunnel	p18	Nov 16
Lasers can aid plasma propulsion	p24	Oct 19
NEC: forum for industry-education cooperation	p30	Oct 5
Technical preview of National Electronics Conference	p39	Oct 5
Wilkinson, J. R. & R. M. Centner, New approach to serial decoding eliminates static storage	p32	Aug 24
Wipson, J. W., Nomographs select Tv standards	p56	Aug 17
Wolff, M. F., Single noble gases give 14 more laser frequencies	p28	Aug 17
Wanted: radiation-resistant solar cells	p28	Sep 21
Will diode lasers obsolete earlier lasers?	p14	Nov 23
Wolff, M. F. & S. Weber, Electrostatic focusing gives klystrons greater efficiency	p26	Nov 9
Wolff, M. F. & others, Is that radiation belt going away next summer or isn't it?	p22	Dec 14
Woo, Way Dong, Novel digital signal generator uses magnetic-core pegboard	p46	Jul 6
Wood, P. W. & R. R. Bockemuhl, Unique two-channel tachometer uses radioisotopes	p44	Dec 7
Woodward, A. & others, Handy nomogram speeds infrared system design	p64	Oct 19
Wormser, H. H., Realistic potentiometer derating	p76	Aug 10

Y		
Yoshida, Y. & others, Noncutoff circuits improve trigger switching	p36	Jul 27

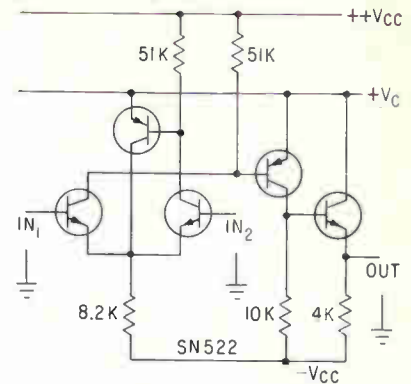
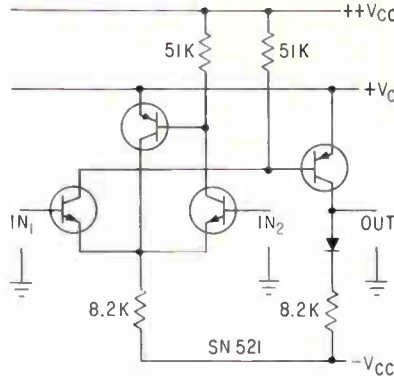

Operational Amplifiers Are Getting Smaller

Integrated circuits have pnp and npn transistors in single silicon block

ANNOUNCED by Texas Instruments Inc., Semiconductor-Components Div., P. O. Box 5012, Dallas 22, Texas, the series 52 linear versions of fully integrated circuits consists of the SN521 basic d-c operational amplifier and the SN522 which is essentially the same amplifier with emitter-follower output. The SN521 open-loop voltage gain is 62 db, common-mode rejection is

58 db, d-c offset referred to input is 2 mv and $\frac{1}{2}$ -power frequency point is 60 Kc. Input impedance is 18,000 ohms differential and 10,000 ohms to ground, output impedance is 8,000 ohms and d-c drift referred to input is 10 μ v per degree C. The SN522 has the same characteristics except output impedance is 150 ohms. The new series are mounted in a flat-form, hermetically-sealed package $\frac{1}{4} \times \frac{1}{8} \times \frac{1}{2}$ inch and weighs less than 0.1 gram. For the first time, two pnp and five npn transistors have been diffused in a single block of silicon. Each transistor can be used as a single diode

if desired. The circuit also contains six tapped resistors with values from 5,000 to 50,000 ohms. The simultaneous-diffusion fabrication technique results in transistor closely matched inputs and since all components are in close thermal contact, excellent input match is maintained throughout operational temperature range. Use is in analog-to-digital converters, feedback amplifiers, integrators, differentiators, servo and other drive amplifiers.

CIRCLE 301, READER SERVICE CARD

Measuring Differential Voltages from 10 Microvolts

NEW from Keithley Instruments, Inc., 12415 Euclid Ave., Cleveland 6, Ohio, the model 660 Guarded Differential Voltmeter is a potentiometric design that operates between 10 μ v and 500 v, and features a 0.02 percent limit of error for readings between 100 mv and 500 v

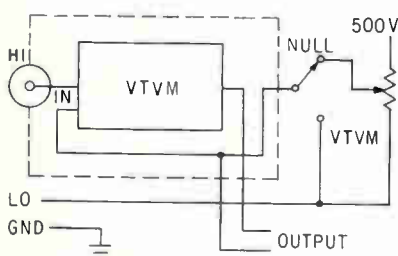

with 0.005 percent repeatability. A zener reference, stable to 0.002 percent per year results in a power supply stability better than 0.005 percent indefinitely. Maximum null sensitivity is 100 μ v full scale with 2 μ v resolution. Other features are in-line digital readout with automatically-lighted decimals, 10 mv recorder output, polarity switch, floating operation up to 500 v off ground, eleven vtm ranges, better than 45 db of 60 cps rejection and fast overload recovery. Overall stability of 0.01 percent per 24 hours is useful for extended measurement duration. The device operates by the potentiometric method with a

stable 500 v supply. A Kelvin-Varley divider (see sketch) performs the potentiometer function and a chopper-stabilized vtm is the null detector. Full guarding of the input and null detector avoids leakage. Voltage required for true null is read from five in-line dials. (302)

Low Noise Amplifier Has High Input Impedance

DEVELOPED by Denro Labs., 2801 15th St., N. W., Washington 9, D. C., the type 600 series Micronoise amplifiers have an input impedance

ELECTRO OPTICS

at **CSF** (FRANCE)

**HIGH POWER, PULSED OR CONTINUOUS,
PORTABLE OPTICAL MASERS**

PHOTO R. BOUILLOT

SOLID STATE OPTICAL MASERS high power pulsed and portable -
(Ruby, Nd^{3+} Glasses)

GASEOUS OPTICAL MASER (Ne - He)

KERR CELLS with adjustable Electrode Spacing

FLASH TUBES

LIGHT MODULATORS piezo optical (100% modulation with 2 volts
in the 100 kc/s range)

by Faraday Effect

DIELECTRIC COATINGS

**CSF COMPAGNIE GENERALE DE TELEGRAPHIE SANS FIL
DEPARTEMENT DE PHYSIQUE APPLIQUEE
BP N° 10 ORSAY (SEINE ET OISE) FRANCE**

**Inquiries welcome through CSF Subsidiary
in the United States : AMERICAN RADIO COMPANY
445, Park Avenue, NEW - YORK 11, NY.**



CSF S.P.A.

December 28, 1962

CIRCLE 67 ON READER SERVICE CARD

67

VITREOSIL[®]

PURE FUSED QUARTZ

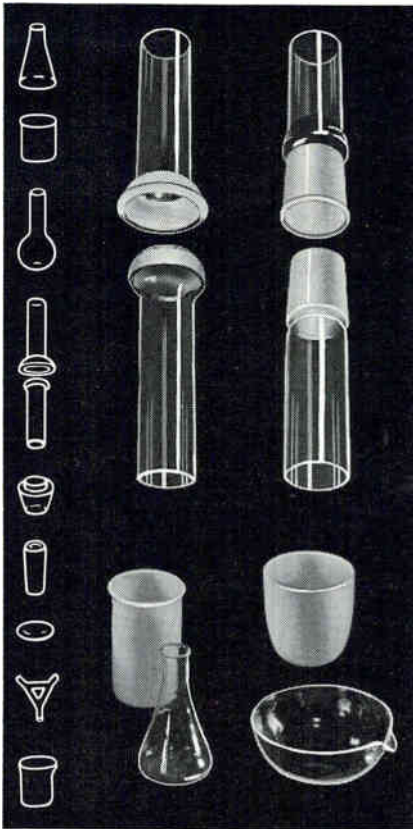

For use in Production of Semi-Conductor Metals

VITREOSIL pure fused quartz can take temperatures in excess of 1000°C and is unaffected by most acids, platinum, or porcelain. Comes in tubes, rods, sheets, and blocks for lenses, laboratory and industrial ware, special fabrication etc. Our know how enables us to hold close tolerances; and metal to quartz seals are a production item.

SPECTROSIL[®], the purest form of quartz known, is recommended where the optimum is required in semi-conductor work. Spectrosil has unique qualities in purity, transparency and homogeneity — fabrication the same as Vitreosil — in clear only.

For more details see Chemical Engineering Catalog, Electronic Engineers Master, or write for our 32 page catalog.

3

THERMAL AMERICAN FUSED QUARTZ CO.
 RT. 202 & CHANGE BRIDGE RD.
 MONTVILLE, NEW JERSEY

resistive component of over 60 meg-ohms shunted by less than 100 pf, integrated noise under 8 μV referred to open or shorted input over a 50 Kc bandwidth, a frequency response between 5 cps and 20 Kc ± 1 db and 1.5 cps to 50 Kc ± 3 db and a voltage gain between 10 and 50. Output impedance is 3,000 ohms at 0.75 v rms and rise time is approximately 10 μsecs . The device is intended for low-level measurements where high input impedance and minimum noise are required. It's small size ($1\frac{1}{2} \times 2\frac{1}{2} \times 4\frac{1}{2}$ inches) and weight (9 oz) permits convenient locating. In the sketch, the field-effect transistor has a typical input resistance of over 100 meg-ohms shunted by less than 100 pf. The integrated noise with input open or shorted is under 8 μV rms

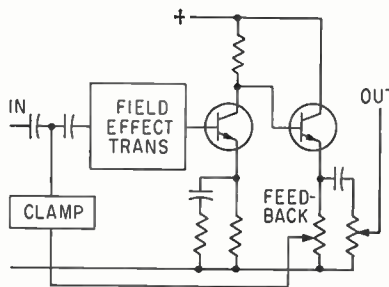

permitting detachable signal energies in the order of 10^{-17} to 10^{-18} watts at the low-frequency end. To avoid junction saturation and long capacitor discharge time from excess input signals, a fast-responding, high-impedance, low-noise clamping circuit is used. Recovery time is 1 to 2 seconds from a 500 v overload at the input. Under normal operating conditions, the clamping circuit presents over 1,000 meg-ohms resistive and 10 pF maximum capacitive loading to the input with noise contribution of 1 μV rms in total bandwidth. The field-effect degenerated stage feeding the low (3,000-ohms) output impedance emitter follower. Devices are available with either BNC or UHF (female) connectors.

CIRCLE 303, READER SERVICE CARD

Microphone Calibrator Generates White Noise

ANNOUNCED by B & K Instruments, Inc., 3044 West 106 St., Cleveland

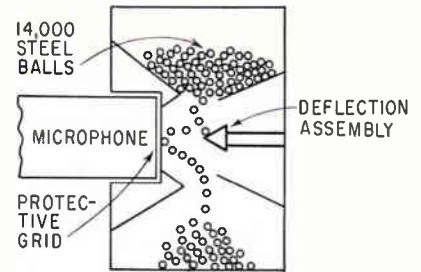

11, Ohio, the noise source model 4240 is a small mechanical-acoustical device producing an approximate white noise spectrum with nearly Gaussian amplitude distribution. It can be mounted on a microphone for quick and reliable field calibration check of sound level meters. Each noise source is individually calibrated to an accuracy of ± 1.5 db and basically consists of two chambers containing approximately 14,000, 1-mm steel balls. During operation, the balls fall from the upper chamber and strike a metal diaphragm while dropping to the lower chamber. This procedure lasts for about 14 seconds and may be repeated by rotating the plastic housing through 180-degrees. The balls striking the metal diaphragm cause an rms sound pressure level of approximately 108 db to be produced at the microphone diaphragm. (304)

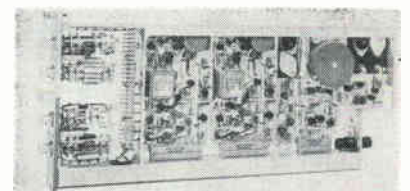

D-C Amplifier Is Dual Channel Unit

REDCOR CORP., 7760 Deering Ave., Canoga Park, Calif. Model 500 is a dual channel d-c amplifier. Two single-ended amplifiers are contained in one case with a common power supply. Embodying completely solid-state design, the plug-in circuit cards used in the amplifier are interchangeable with those in the model 361 differential amplifier. Features include: adjustable gain and bandwidth; bandwidth unaffected by gain change; low noise level; high output current; high input impedance; extreme accuracy, linearity and stability. (305)

Literature of the Week

PHOTOELECTRIC PULSE GENERATORS Dr. Johannes Heidenhain, 8225 Traunreut Uber Traunstein, Western Germany, has published a brochure on photoelectric pulse generators for the measurement of length, angles and revolutions. (306)

CRYOGENIC QUALITY METER Space Sciences, Inc., Natick, Mass. Product data describing a new, high-accuracy cryogenic quality meter have been published. (307)

AIR CORE INDUCTORS Illumitronic Engineering Corp., 680 E. Taylor Ave., Sunnyvale, Calif., has available a 10 page folder on air core inductors featuring highest heat resistance up to 500 F. (308)

SOUND-LEVEL METER B&K Instruments, Inc., 3044 W. 106th St., Cleveland 11, O. An 8-page brochure on the model 2203 precision sound level meter and 1613 octave filter set is announced. (309)

TWO-POLE RELAY Branson Corp., 41 S. Jefferson Road, Whippany, N. J. Technical bulletin covers half-size crystal can relay, model SR, which permits close stacking of p-c boards and dense switching per unit volume. (310)

MICRO DIODES Micro Semiconductor Corp., 11250 Playa Court, Culver City, Calif. Bulletin 119 describes high power (1.5 w) fast recovery (0.5 μ sec) micro diodes. (311)

ANALOG/DIGITAL COMPONENTS Scientific Data Systems, Inc., 1649 Seventeenth St., Santa Monica, Calif. An 8-page bulletin gives full information on a line of fast, low cost silicon analog/digital systems components. (312)

R-F SHIELDED ENCLOSURE Erik A. Lindgren & Associates, Inc., 4515 N. Ravenswood Ave., Chicago 45, Ill. Singlesheet brochure contains description, specifications, performance data and prices of a new portable r-f shielded enclosure. (313)

LAMINATED PLASTICS Insurok Division of The Richardson Co., DeKalb, Ill., has published an engineering booklet about high pressure laminated plastics, properties, characteristics and applications. (314)

SPACE AGE ELECTRONICS DuKane Corp., St. Charles, Ill., has published an illustrated brochure outlining its capabilities in the design and manufacture of space age electronic equipment. (315)

STRAP FRAME GRID TUBES Sylvania Electric Products Inc., 1100 Main St., Buffalo 9, N. Y., offers a booklet titled "Strap Frame Grid Subminiature Tube Manual." (316)

CERAMIC TRANSDUCERS Gulton Industries, Inc., 212 Durham Ave., Metuchen, N. J. An 8-page brochure

covers Glennite ceramic transducers, including high-temperature transducers. (317)

SCIENCE SERVICES Texas Instruments Inc., 1100 Exchange Bank Building, Dallas 35, Texas. An illustrated brochure describes the company's part in government and commercial programs which span the spectrum of earth and space science technologies. (318)

RECORDER/REPRODUCER Magnasync Corp., 5546 Satsuma Ave., N. Hollywood, Calif. Four-page brochure illustrates and describes model TR-1510 multichannel recorder/reproducer for audio monitoring. (319)

PRODUCTS DIRECTORY General Electric Co., Schenectady 5, N. Y. Directory lists all the company's electronic component-products, and for each product, gives all direct sales locations by state and city. (320)

DIGITAL VOLT METER Cohu Electronics, Inc., KinTel Div., 5725 Kearny Villa Road, San Diego 12, Calif. Data sheet describes a digital voltmeter for submarine and other special environment applications. (321)

LIGHTWEIGHT LASER SYSTEM Maser Optics, Inc., 89 Brighton Ave., Boston 34, Mass. Bulletin illustrates and describes series 600 lightweight laser system designed for operation at room temperatures. (322)

METAL FILM RESISTORS Mepco, Inc., 37 Abnett Ave., Morristown, N. J., has issued a revised technical data sheet covering its type FE metal film resistors. (323)

MICROWAVE COMPONENTS Alpha Microwave, Inc., 381 Elliot St., Newton Upper Falls 64, Mass., offers a brochure describing its facilities for designing and manufacturing microwave waveguide components. (324)

WAVEGUIDE COMPONENT SUPPORT Orbitronics, Inc., 3660 E. 40th Ave., Denver 5, Colo. Four-page bulletin discusses microwave waveguide component support which eliminates the problems of alignment and transportation. (325)

SILICON TRANSISTORS Transitron Electronic Corp., Wakefield, Mass., offers a bulletin on the 2N2427 low level diffused mesa type small signal silicon transistors. (326)

TRANSDUCERS U.S. Gauge, a division of Ametek, Inc., Sellersville, Pa. Bulletin F-057 describes a potentiometer pressure transducer designed to withstand 50 g shock and acceleration loads. (327)

ONE-PART EPOXY RESIN SYSTEM Minnesota Mining & Mfg. Co., 2501 Hudson Rd., St. Paul 19, Minn., has published a bulletin on Scotchcast brand resin No. 291, a one-part filled, semi-flexible, 100 percent solids epoxy resin system. (328)

PHOTO-ELECTRIC PULSE GENERATORS

to
LENGTH-MEASURING
ANGLE-MEASURING
SPEED-MEASURING
REVOLUTION-MEASURING

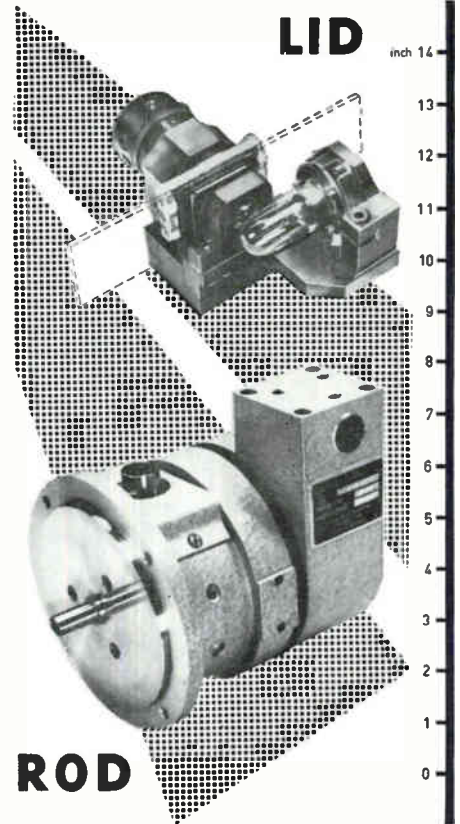

RESOLUTION TILL 0,01 mm
OR .0001 INCH OR
10 000 PULSES PER REVOLUTION
LARGER RESOLUTIONS AND CODED
TRANSDUCERS FOR CIRCULAR AND
LENGTH MOVEMENTS
ON REQUEST

DR. JOHANNES HEIDENHAIN
PRECISION AND OPTICAL
EQUIPMENT · PRECISION SCALES
8225 TRAUNREUT/OBERBAYERN
GERMANY
TELEPHONE 08669-8301

Computer Maker Occupies New Plant

SCIENTIFIC DATA SYSTEMS, Inc., has moved its engineering and administrative staffs into a new 19,000-square-foot, two-story building in Santa Monica, Calif.

Max Palevsky, SDS president, said that there are now 85 people in the new facility and it could comfortably house 150. Plans are to construct a modular addition of approximately the same size next summer.

A glassed-in computer display room off the lobby contains an operating SDS 920 system. On the second floor there is a program preparation room and two classrooms for programming and maintenance classes. Classes in both functions are conducted by SDS every six weeks.

SDS' original quarters in Santa

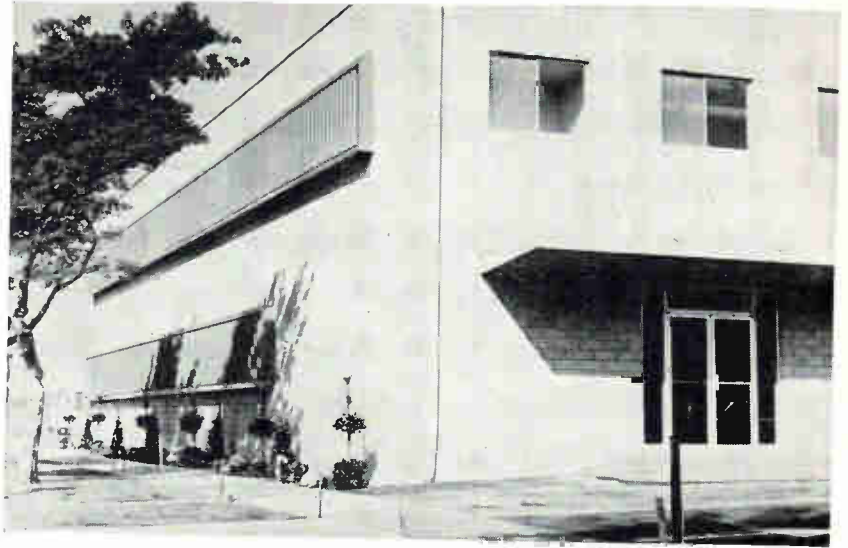

Monica, with 11,000 square feet, will house computer and component production units.

The company is shipping one computer a week now and expects to ship two a week by next fall.

CURTISS-WRIGHT ELECTRONICS...

adding a new dimension to the capability of man

ANTI-SUBMARINE WARFARE TRAINER, designated Device 2F69, combines analog and digital computer techniques to provide a degree of realism never before achieved. Tactical systems fully simulated in this Curtiss-Wright trainer include radar, magnetic anomaly, Julie sonobuoy system, Jezebel, SNIFFER trail detector and certain other weapons used in the destruction of submarines.

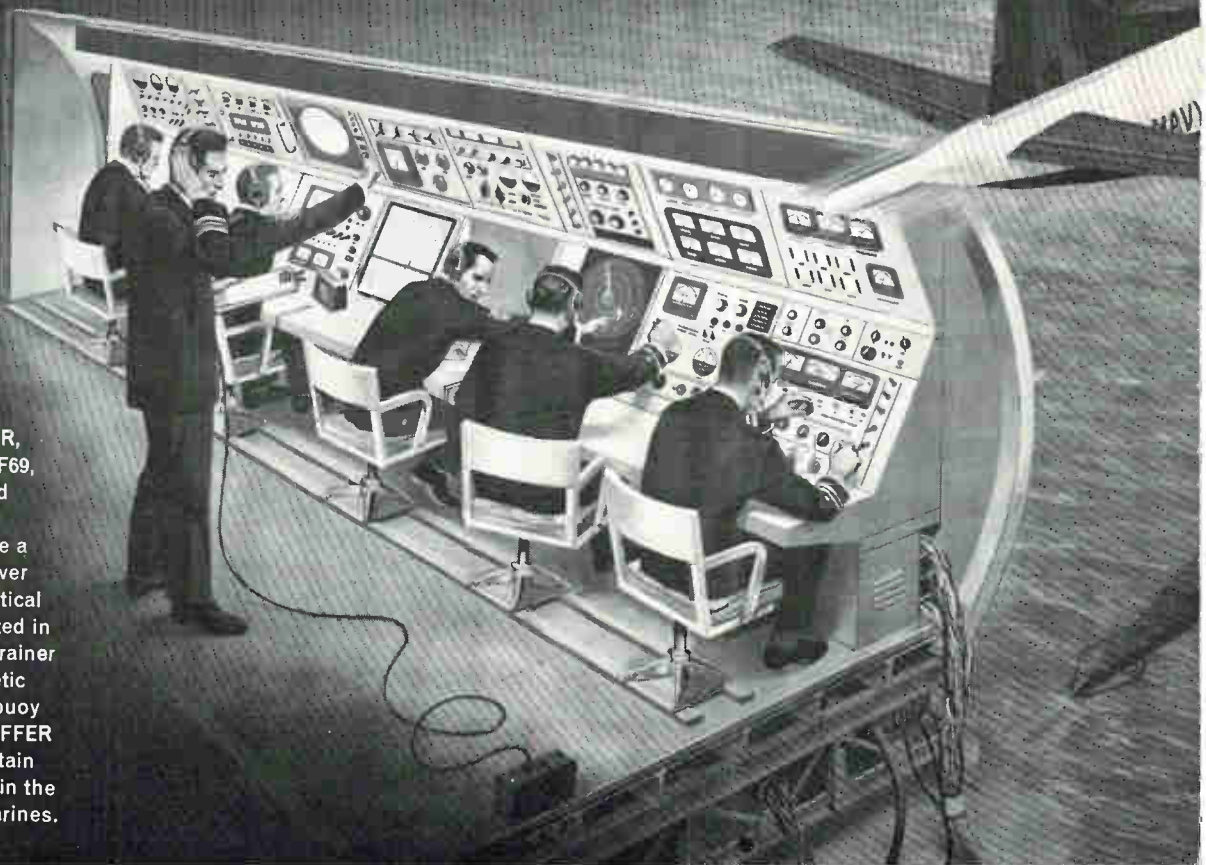

The present backlog is approximately \$2.5 million. SDS manufactures the 910 and 920 computers, digital components including analog-to-digital and digital-to-analog, converters and multiplexers, and digital systems. The company was formed in 1961.

Lear Siegler Forms Defense Systems Group

IN A MOVE to strengthen its position in the military systems contract field, Lear Siegler, Inc., Santa Monica, Calif., has formed a new group called Defense Systems Operations, according to an announcement by John G. Brooks, chairman of the board.

Named to head the new organization is Dan W. Burns, a corporate vice president.

Brooks said Defense Systems Operations is designed to make the most effective use of the capabilities of Lear Siegler's six divisions and one subsidiary engaged in military contract work. These are As-

tronics, Astro Structures and Electronic Instrumentation—all in California; Data and Controls, Long Island City, N. Y.; Instrument, Grand Rapids, Mich.; Power Equipment, Cleveland, O.; and Lear Siegler Service, Inc., based in Grand Rapids, Mich.

Defense Systems will be responsible for multi-division efforts in systems relating primarily to tracking and control; communication and data; range instrumentation and support; instrumented satellite and space probes and tactical weapons.

General Instrument Names Meinken

THE AUTOMATIC MFG. DIVISION of General Instrument Corp., with plants at Newark, N. J., and Beckley, W. Va., has announced appointment of Kenneth C. Meinken, Jr. as vice president. He will share operating responsibilities with Patrick J. Brady, vice president of the division since 1957.

Meinken left the division in 1956. Prior to rejoining General Instrument, he was vice president of General Atronics' Electronic Tube and Instrument division, in Philadelphia, Pa.



DeForest Pioneers Elect President

AT THE ANNUAL MEETING of the DeForest Pioneers, Inc., recently held in New York City, Sidney A. Wood (picture) was elected president of the organization. He succeeds Allen

PROJECT IN POINT: This P3V crew thinks it is closing on an enemy sub!

Simulation reflects the ultimate in the *application* of science and technology. It is the electronic bridge from research to reality. At Curtiss-Wright, electronics simulation systems orient men and machines to missions for many military and industrial programs.

Project in Point: At the Patuxent River Naval Air Station, P3V crews will receive both flight and tactics training on the most complete anti-submarine warfare trainer ever developed. Designed and manufactured by Curtiss-Wright in conjunction with the U.S. Naval Training Device Center, the simulator permits *entire* missions

to be "flown"—search, classification, localization, attack, and destruction of enemy submarines.

Advanced activities like this have created immediate opportunities at Curtiss-Wright Electronics Division for solid state circuit designers, digital computer programmers and others experienced in the application of real-time digital computation to the most challenging problems in simulation. For complete information, please write Mr. Gene Y. Kelly, Manager of Professional Placement, Electronics Division. An equal opportunity employer.



ELECTRONICS DIVISION
CURTISS-WRIGHT CORPORATION

35 MARKET STREET, EAST PATERSON, N. J.

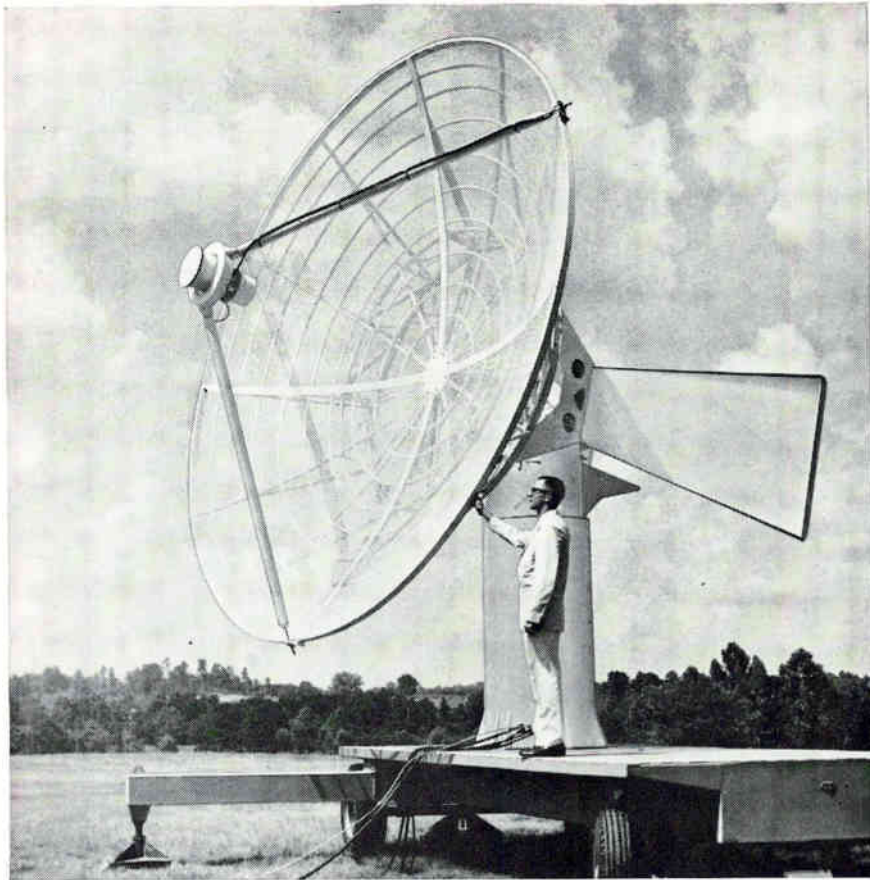

Why S-A Tracking Antenna Pedestal Systems Offer **THE BEST PRICE/PERFORMANCE RATIO**

Versatility, MIL SPEC compatibility, reliability, state of the art manufacturing techniques, quick delivery, and full system capability, you get them all from Scientific-Atlanta.

VERSATILITY. For antennas up to 30 feet diameter, Scientific-Atlanta offers three basic pedestals with output torques from 500 to 10,000 ft.-lbs., velocities to 30°/sec. accelerations to 30°/sec², and accuracies to 0.08° static and $\pm 0.05^\circ$ /rpm. Multiple mode operation; automatic, slave, manual or pre-programmed tracking. A full range of optional extras and accessory equipment is available to meet virtually any operational requirement.

MIL SPEC COMPATIBILITY. Scientific-Atlanta pedestals are designed to operate under MIL SPEC environmental and RFI conditions.

RELIABILITY. Scientific-Atlanta pedestal systems use solid state servos, printed circuit dc motors for long life and quick response, large parallel mounting surfaces for adaptability plus rigidity of antenna mounting, fail-safe brakes, electrical and mechanical limit stops.

MANUFACTURING. Assembly of tracking pedestals from standardized modules allows Scientific-Atlanta to meet a wide variety of customer requirements and pass along the cost benefits of mass production.

QUICK DELIVERY. Most TPS units are available 6 to 8 weeks ARO.

SYSTEM CAPABILITY. Scientific-Atlanta offers its customers a unique and proven capability to provide complete telemetry tracking systems, special antenna systems, and servo-control systems.

FOR MORE INFORMATION, please address Scientific-Atlanta, Inc., P.O. Box 13654, Atlanta 24, Georgia, phone: (404) 938-2930.

SCIENTIFIC-ATLANTA, INC.

B. DuMont, New Jersey industrialist and electronic scientist.

Wood is chairman of the board of Wilbur B. Driver Co., Newark manufacturer of electrical and electronic alloys.

DeForest, inventor of the three-element vacuum tube and often referred to as the Father of Radio and Electronics, died in June, 1961, at the age of 86.

The DeForest Pioneers, Inc. was organized in 1952, and according to their by-laws "for the express purpose of bringing together the men who worked and associated with Dr. DeForest, to perpetuate the memories of those days and to pay tribute to his transcendent genius."



National Company Names Sproul

ROBERT SPROUL has been appointed director of engineering of National Co., Inc., Malden, Mass.

Starting with the company as a section head in 1957, Sproul advanced to the post of chief engineer of the Communications Systems department. In this capacity he coordinated several of the company's major military communications systems developments.

Ling Electronics Advances Klein

LING ELECTRONICS division of Ling-Temco-Vought, Inc., Dallas, Texas, has announced the promotion of E. P. Klein to executive manager of engineering, a new position created with the reorganization of the division's engineering department.

Serving on Klein's staff are

Emory Johnson, chief engineer, high-power electronics; Ken Metzgar, chief engineer, environmental products; Al Carr, chief manufacturing engineer; Scott Cooper, manager of engineering test; and Al Landsman, manager of engineering services.

Klein was formerly Ling's chief systems engineer.

PEOPLE IN BRIEF

F. Robert Naka moves up to technical director for control and sensor systems development at The Mitre Corp. Robert H. Damghajian, formerly with Bendix Corp., joins the Industrial Electronics div. of Aero Service Corp. Theodore H. Crane promoted to director of research and product development at High Vacuum Equipment Corp. R. L. Halpern, previously with Lockheed Aircraft Corp., appointed director of electronic systems at Northrop Ventura. Edward E. Bauman, ex-North Electric Co., named v-p and elected to board of directors of Signalite Inc. H. D. Sprinkle leaves Litton Systems Inc. to become mgr. of Sylvania's Systems Technology Laboratory. Herbert C. Cress, consultant to Huyck Systems Co., is appointed works mgr. Chicago Aerial Industries advances John H. Wolvin to director of research, and Jerome S. Goldhammer to staff assistant for planning. Herbert C. Jenkins, from Sonotone Corp. to Burroughs Corp. as quality assurance and reliability mgr. for the Electronic Components div. John D. Stimson promoted to mgr. of the United AeroSpace div. of United ElectroDynamics, Inc. Operations Evaluation Group ups George A. Westlund to chief of the computer section. David F. Sanders, former president of Lockheed Electronics Co., announces formation of Squires-Sanders, Inc., of which he will be president. Vice president of the new firm will be W. K. Squires, former chief scientist for Lockheed Electronics. Alexander Kreithen elevated to v-p of Documentation Inc.



Good parts work best!

Intermediate Frequency Transformer IFT



The high standards of MITSUMI electronic components are insured by a fully-automated assembly system, and double-checked by rigid quality controls. Mitsumi Electric Company is Japan's largest manufacturer of components for radio, television and communications equipment.

POLYVARICON Variable Capacitor



MITSUMI PARTS

MITSUMI ELECTRIC CO., LTD.
Tokyo, Osaka, New York



CIRCLE 73 ON READER SERVICE CARD

SEARCHLIGHT SECTION

(Classified Advertising)

BUSINESS OPPORTUNITIES

EQUIPMENT - USED or RESALE

DISPLAYED

The advertising is \$27.25 per inch for all advertising other than on a contract basis. AN ADVERTISING INCH is measured 7/8" vert. on a column, 3 cols.—30 inches—to a page. EQUIPMENT WANTED or FOR SALE ADVERTISEMENTS acceptable only in Displayed Style.

Send NEW ADVERTISEMENTS or Inquiries to Classified Adv. Div. of Electronics, P. O. Box 12, N. Y. 36, N. Y.

The publisher cannot accept advertising in the Searchlight Section, which lists the names of the manufacturers of resistors, capacitors, rheostats, and potentiometers or other names designed to describe such products.

RATES

\$2.70 a line, minimum 3 lines. To figure advance payment count 5 average words as a line. BOX NUMBERS count as one line additional.

DISCOUNT of 10% if full payment is made in advance for four consecutive insertions.

UNDISPLAYED

Searchlight Equipment Locating Service

No Charge or Obligation

This service is aimed at helping you, the reader of "SEARCHLIGHT," to locate Surplus new and used Electronic equipment not currently advertised. (This service is for USER-BUYERS only).

How to use: Check the dealer ads to see if what you want is not currently advertised. If not, send us the specifications of—the equipment wanted on the coupon below, or on your own company letterhead to:

Searchlight Section Locating Service

Classified Advertising

c/o ELECTRONICS
P. O. Box 12, N. Y. 36, N. Y.

Your requirements will be brought promptly to the attention of the equipment dealers advertising in this section. You will receive replies directly from them.

Searchlight Equipment Locating Service

Classified Advertising

c/o ELECTRONICS
P. O. Box 12, N. Y. 36, N. Y.

Please help us locate the following equipment components.

.....

NAME

TITLE

COMPANY

STREET

CITY 12/28/62

FOR RESEARCH — DEVELOPMENT & EXPERIMENTAL WORK

Over 10,000 different electronic parts: waveguide, radar components and parts, test sets, pulsers, antennas, pulse xmfrs, magnetrons, IF and pulse amplifiers, dynamotors, 400 cycle xmfrs, 584 ant. pedestals, etc. PRICES AT A FRACTION OF ORIGINAL COST! COMMUNICATIONS EQUIP CO. 343 CANAL ST., N. Y. 13, WO 6-4045 CHAS. ROSEN (Formerly at 131 Liberty St.)

CIRCLE 950 ON READER SERVICE CARD

RADIO RESEARCH INSTRUMENT CO.

AUTO-TRACK & TELEMETRY ANTENNA PEDESTALS 3 & 10 CM. SCR. 584 AUTOTRACK RADARS. AN/TPS-10 SEARCH, AN/TPS-10 MT. FINDERS. AN/FPN-32GCA. AN/APS-10 NAVIG. & WEATHER. AN/APS-15B PRECISION. AN/APQ-35B PRECISION. AN/APS-31A SEARCH. DOZENS MORE. .5-1-2 MEGAWATT HIGH POWER PULSERS.

RADIO RESEARCH INSTRUMENT CO. 550 Fifth Ave., New York Judson 6-4691

RADAR SYSTEMS & COMPONENTS/ IMMEDIATE DELIVERY

CIRCLE 951 ON READER SERVICE CARD

OVER 2,000,000

RELAYS

IN STOCK!

Send for Catalog 55

Universal RELAY CORP.

42 WHITE ST., N.Y. 13, N.Y. • WAJker 9-6900

CIRCLE 952 ON READER SERVICE CARD

INDEX TO ADVERTISERS

Arnold Engineering Co., The.....	25
Bausch & Lomb, Inc.....	54, 55
• C. S. F.....	67
• Clairex Corp.....	58
• Clifton Precision Products Co., Inc.....	53
• Cominco Products, Inc.....	13
• Consolidated Avionics Corp.....	47
• Curtiss-Wright Corp.....	70, 71
Delco Radio.....	43
Douglas Aircraft Co.....	19
Dr. Johannes Heidenhain.....	69
du Pont de Nemours & Co., Inc. E. I.....	57
Eitel-McCullough, Inc.....	6
• Federation Nationale des Industries Electroniques.....	27
• General Electrodynamics Corp.....	16
• General Radio Co.....	2nd cover
• Green Instrument Co., Inc.....	26
• Hewlett-Packard Company.....	10, 11
International Rectifier Corp.....	9
• Kepco, Inc.....	49
• Kuhnke Elektrotechnische, H.....	50
• Microswitch Div. of Honeywell.....	17, 18
Mitsumi Electric Co., Ltd.....	73
• Nichicon Capacitor Ltd.....	50
• Potter Instrument Co., Inc.....	15
• Radio Corp. of America.....	4th cover, 45
Raychem Corp.....	22, 23
• Sanborn Company.....	5
Saratoga Industries.....	51
Scientific-Atlanta, Inc.....	72
Sperry Electronic Tube Div. Sperry Rand Corp.....	3rd cover
Sprague Electric Co.....	4, 21
Thermal American Fused Quartz Co., Inc.....	68
• Western Electric Laureldale Plant.....	28

CLASSIFIED ADVERTISING

F. J. Eberle, Business Mgr.

EQUIPMENT
(Used or Surplus New)
For Sale..... 73

INDEX TO CLASSIFIED ADVERTISERS

• Communications Equipment Co.....	73
• Radio Research Instrument Co.....	73
• Universal Relay Corp.....	73

• See advertisement in the July 25, 1962 issue of Electronics Buyers' Guide for complete line of products or services.

This Index and our Reader Service Numbers are published as a service. Every precaution is taken to make them accurate, but electronics assumes no responsibilities for errors or omissions.

electronics



Audit Bureau
of Circulation

Associated Business
Publications

Audited Paid Circulation

JAMES T. HAUPTLI

Advertising Sales Manager

R. S. QUINT:
Assistant Publisher Buyers'
Guide and Business Manager
FRED STEWART:
Promotion Manager
B. ANELLO:
Market Services Manager

RICHARD J. TOMLINSON:
Production Manager
GEORGE E. POMEROY:
Classified Manager
HUGH J. QUINN:
Circulation Manager

ADVERTISING REPRESENTATIVES

ATLANTA (9): Michael H. Miller, Robert C. Johnson 1375 Peachtree St. N.E., Trinity 5-0523 (area code 404)	LOS ANGELES (17): Peter S. Carberry, Ashley P. Hartman, W. C. Gries 1125 W. 6th St., Huntley 2-5450 (area code 213)
BOSTON (16): William S. Hodgkinson, Donald R. Furth McGraw-Hill Building, Copley Square, Congress 2-1160 (area code 617)	NEW YORK (36): Donald H. Miller, Henry M. Shaw, George F. Werner 500 Fifth Avenue, LO-4-3000 (area code 212)
CHICAGO (11): Harvey W. Wernecke, Robert M. Denmead 645 North Michigan Avenue, Mohawk 4-5800 (area code 312)	PHILADELPHIA (3): Warren H. Gardner, William J. Boyle 6 Penn Center Plaza, LOcust 8-4330 (area code 215)
CLEVELAND (13): Paul T. Fegley 55 Public Square, Superior 1-7000 (area code 216)	SAN FRANCISCO (11): R. C. Alcorn 255 California Street, Douglas 2-4600 (area code 415)
DALLAS (1): Frank Le Beau The Vaughn Bldg., 1712 Commerce St. Riverside 7-9721 (area code 214)	LONDON W1: Edwin S. Murphy Jr. 34 Dover St.
DENVER (2): J. W. Patten Tower Bldg., 1700 Broadway, Alpine 5-2981 (area code 303)	FRANKFURT/Main: Matthée Herfurth 85 Westendstrasse
HOUSTON (25): Joseph C. Page, Jr. Prudential Bldg., Halcombe Blvd., Riverside 8-1280 (area code 713)	GENEVA: Michael R. Zeynel 2 Place du Port

"Headquarters for Business Information"

McGraw-Hill Technical and Business Publications

American Machinist/Metal-
working Manufacturing
Aviation Week and Space
Technology
Business Week
Chemical Engineering
Chemical Week
Coal Age
Construction Methods and
Equipment
Construction Daily
Control Engineering
Electrical Construction
and Maintenance
Electrical Merchandising Week
Electrical Newsletter
Electrical West

Electrical Wholesaling
Electrical World
Electronics
Engineering Digest
Engineering and Mining Journal
E & M Metal and Mineral
Markets
Engineering News-Record
Factory
Fleet Owner
Industrial Distribution
National Petroleum News
Nucleonics
Nucleonics Week
Platt's Oilgram News
Platt's Oilgram Price Service
Power

Product Engineering
Purchasing Week
Science Week
Textile World

Overseas only:
Automobile International
(English, Spanish)
Ingenieria Internacional
Construccion (Spanish)
International Management
(English, Spanish
Portuguese editions)
Metalworking Production
(Great Britain)

Available by subscription only — to qualified persons actively engaged in the field of the publication. For subscription rates and information describing the editorial coverage of any of the above publications, write to: Subscription Manager, Circulation Department, McGraw-Hill Publishing Company, 330 West 42nd Street, New York 36, N. Y.

NOW FROM SPERRY

Megawatts at L band . . .

A megawatt or more at X band . . .

or in between

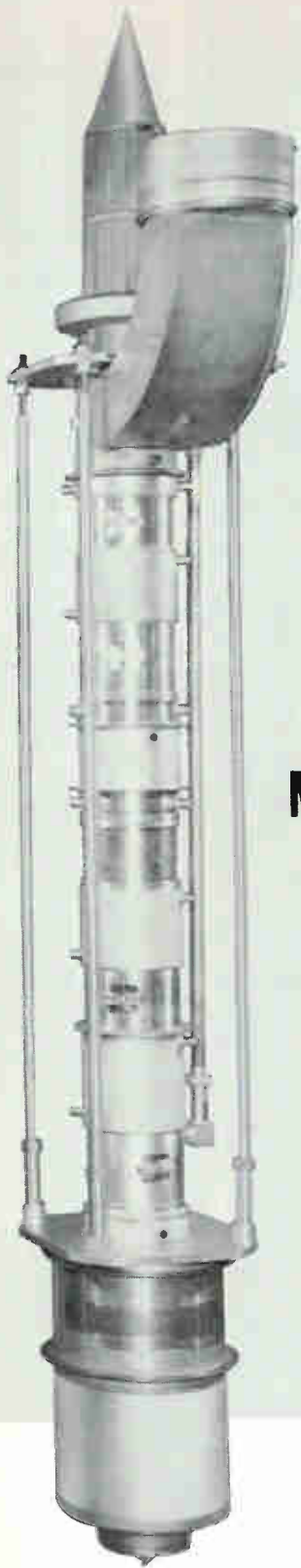

TYPICAL TUBES FROM SPERRY'S MEGAWATT LINE						
Type	Frequency Mc	Bandwidth Mc (1 db)	Peak Po MW	Avg Po kW	Gain db	Joules/Pulse
SAL-305	1215-1365	150	12.5	60	36	375
SAL-320	1300	*	20	60	50	600
SAS-159	2856	*	25	24	50	62.5
SAC-167	5400-5800	100	1.25	8	47	37.5
SAX-151	9000-9500	500	1.0	10	40	30
SAX-191	8830-9200	370	1.25	6	50	37.5

*Fixed-tuned—optimized for linear accelerator service.

For details on Sperry's broadband, high average power, phase linear, high pulse energy megawatt klystrons, write Section 169. Information about a wide selection of classified Sperry microwave tubes is available with proper security clearance and "need to know." Sperry is represented nationally by Cain & Co.



SPERRY RAND CORPORATION
GAINESVILLE, FLA. / GREAT NECK, N. Y.

CIRCLE 901 ON READER SERVICE CARD

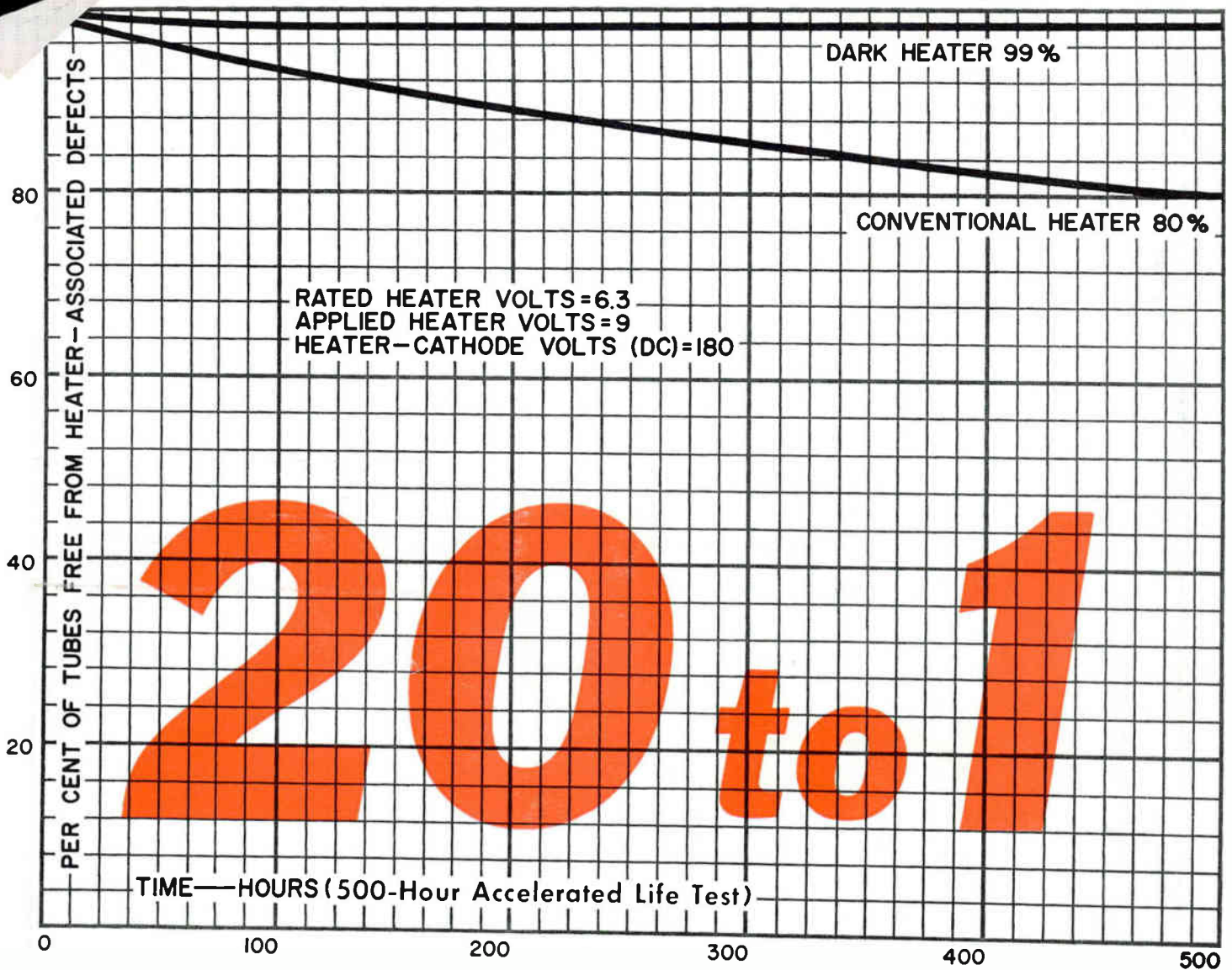

reduction in tube failure due to heater-associated defects with revolutionary new RCA "Dark Heater"



Reduction of tube failures due to heater-associated defects by the amazing factor of 20 to 1 after a 500-hour accelerated heater life cycling test—that's the latest performance triumph chalked up by the revolutionary RCA "Dark Heater". While

tubes with conventional heaters experienced 20 heater-associated defects per 100 tubes, tubes with the "Dark Heater" experienced only one!

Tests were conducted at 143% of rated heater voltage (9 volts for a 6.3-volt type) and at a heater-cathode voltage of 180 volts. Operating cycle was one minute on two minutes off. These 500-hour life tests are the equivalent of operation of a heater for 14,500 hours at normal heater voltage. These tests represented more than a quarter of a million tube hours.

The principle of this remarkable electron tube innovation is quite simple. Since a dark

body emits heat more efficiently than a white body, the "Dark Heater" can operate at about 350°K below the temperature of a conventional heater—yet still produce the required cathode temperature. This means:

- **Longer Heater Life**—as the tests prove, these lower temperatures result in a 50% increase in the ultimate tensile strength of the operating heater wire, and reduce internal stress by 25% during heater "on-off" cycling.

- **Less Chance of Heater Failure.** Reduced operating temperatures and smaller thermal change in cycling minimize tendency toward recrystallization and burnout.

- **Heater-Current Stability on Life.** Conventional heaters often show rising heater current characteristic on life. The "Dark Heater", however, maintains a remarkably stable current characteristic throughout its life.

- **Reduced AC Heater-Cathode Leakage and Hum.** Use of the "Dark Heater" reduces AC leakage and hum particularly "spike" or pulse leakage currents. In addition, lower heater temperature reduces both AC and DC leakage from heater to cathode and heater emission to other tube electrodes.

- **Improved Mechanical Stability.** Cooler operation minimizes changes in heater shape during life, reducing the chance of heater damage or shorts.

- **Greater Safety Margin in H-K Voltage Ratings.** Cooler operation means greater safety margin in present H-K voltage ratings.

Engineering is complete on the inclusion of the Dark Heater in some 200 of the most popular, high-volume OEM RCA receiving tubes—and most are already being delivered. For full information on "Dark Heater" tube types now (or soon to be) available, consult your RCA Field Office.



The Most Trusted Name in Electronics

RCA ELECTRON TUBE DIVISION—FIELD OFFICES... EAST:
744 Broad Street, Newark 2, N. J., Humboldt 5-3900 •
MIDWEST: Suite 1154, Merchandise Mart Plaza, Chicago
54, Ill., Whitehall 4-2900 • WEST: 6801 E. Washington
Blvd., Los Angeles 22, Calif., Raymond 3-8361