

October 26, 1962

electronics

A McGraw-Hill Publication 75 Cents

(Photo right)

ASSEMBLING VENUS PROBE

*Men-in-white install
rocket payload, p 26*

AUTOMATIC SPYING

*No human observer
on missions, p 45*

PHASE-LOCK OSCILLATORS

*Faster frequency
switching, p 54*

TROPO SCATTER

*New antenna design
charts, p 62*

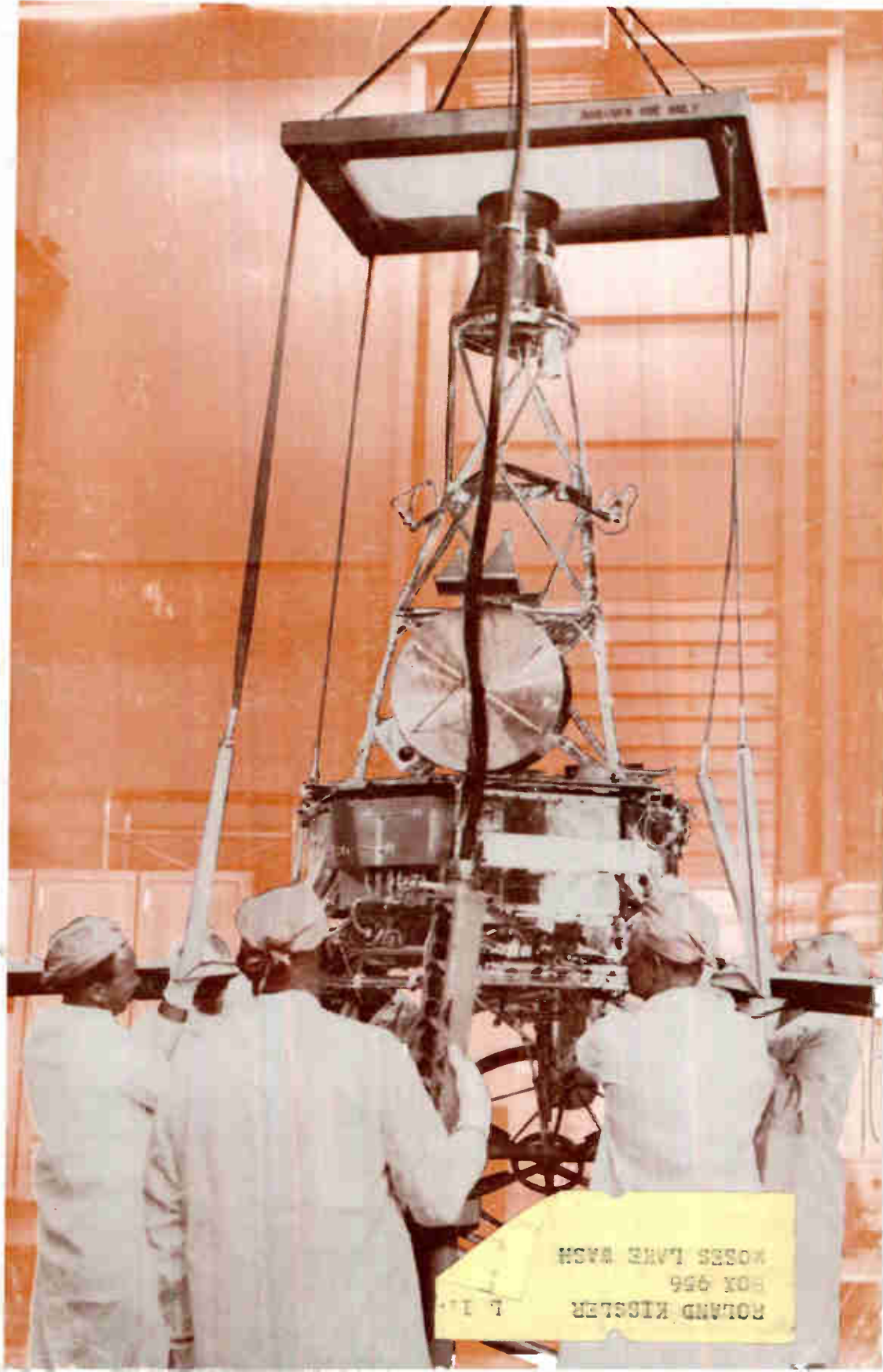

ROLAND RIGLER
BOX 956
MOSES LAKE WASH

1
25-WATT HIGH EFFICIENCY AMPLITRON*
For S-band space telemetry applications, only 14 oz. QKS 997.
*Raytheon Trademark

2
SMALLEST, MOST EFFICIENT M-BWO
Has 3 7/8 inch diameter, delivers 50 watts at 2.2-3.2 kMc. QKA 995.

3
MILLIMETER KLYSTRONS COVER 50-120 kMc
Nine tubes; all tune with single vernier adjustment. QKK 1080.

4
EXTREMELY RUGGED K-BAND KLYSTRON
Has excellent thermal stability, low microphonics. QKK 923.

5
COMPACT ISOLATOR FOR SPACE SYSTEMS
Matches QKS997 Amplitron, 15-20 db min. isol., 1.20 max. VSWR. 1cSL5.

6
IR DETECTORS TO 30 MICRONS
Include variety of types, high sensitivity, fast response. QKN 1004.

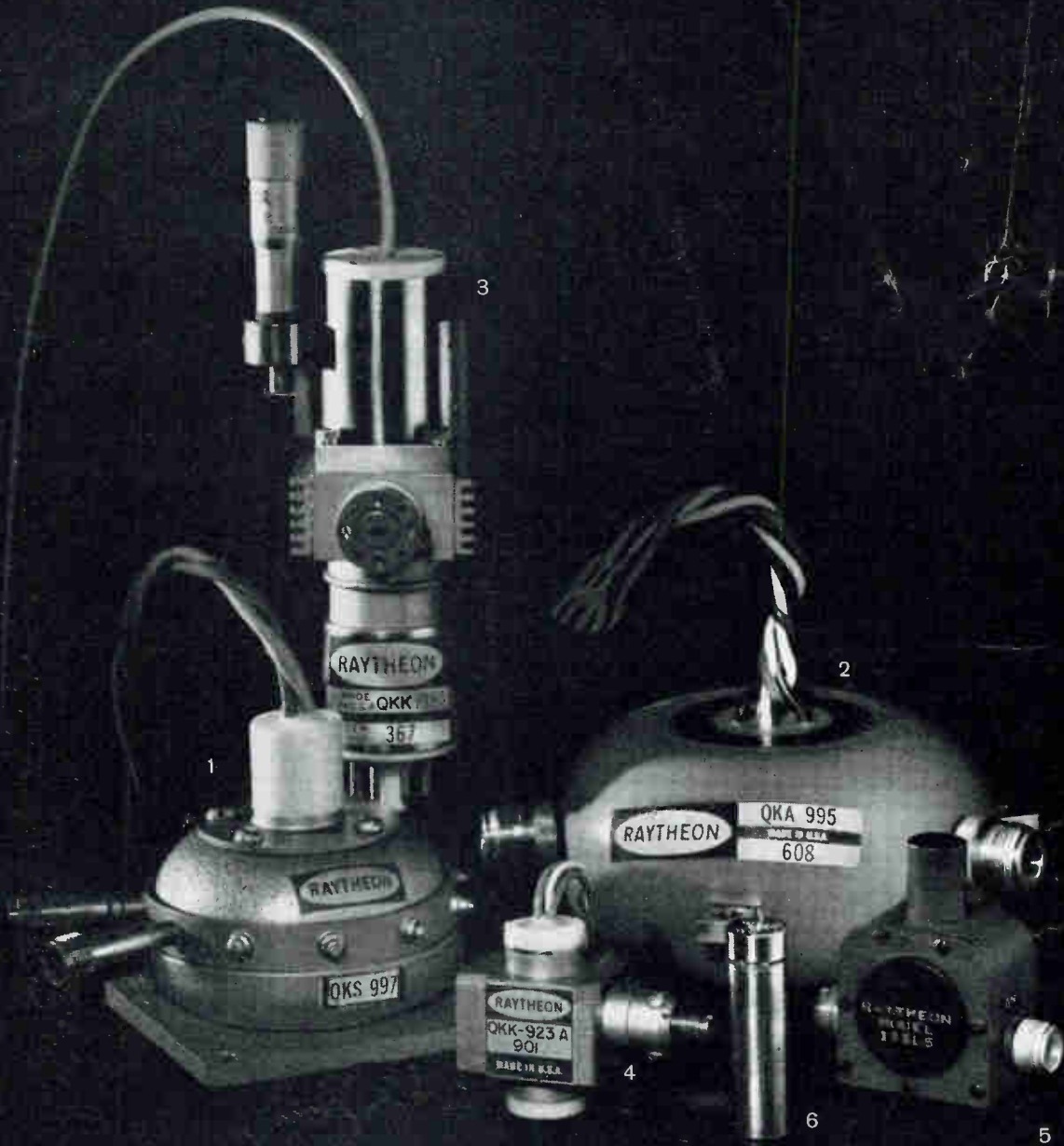

Raytheon accelerates delivery of aerospace microwave tubes

For performance and applications data on these and other aerospace microwave tubes and devices, please write, outlining your particular area of interest, to Raytheon Company, Microwave and Power Tube Div., Waltham 54, Mass.

RAYTHEON

CIRCLE 900 READERS SERVICE CARD

electronics

A McGraw-Hill Publication 75 Cents



W. W. MacDONALD, Editor

J. M. CARROLL, Managing Editor
 SENIOR EDITORS: Samuel Weber, George W. Sideris. SENIOR ASSOCIATE EDITORS: Michael F. Wolff, John F. Mason. ASSOCIATE EDITORS: Michael F. Tomaino, Sylvester P. Carter, William P. O'Brien, Sy Vogel, Leslie Solomon, George J. Flynn, Laurence D. Shergalis. ASSISTANT EDITORS: Nilo Lindgren, Stanley Froud, Stephen B. Gray, Roy J. Bruun, George V. Novotny, Leon H. Dulberger. REGIONAL EDITORS: Harold C. Hood (Pacific Coast, Los Angeles), Thomas Maguire (New England, Boston), Cletus M. Wiley (Midwest, Chicago). ART DIRECTOR: Harry Phillips; Howard R. Berry. PRODUCTION EDITOR: John C. Wright, Jr. EDITORIAL ASSISTANTS: Gloria J. Meurer, Lorraine Rossi, Virginia T. Bastian, Lynn Emery, Rosemary Abbruzzese, Ann Mella, Lorraine Werner. FOREIGN NEWS BUREAU: Director, John Wilhelm, Alyne Elias. LONDON—John Shinn, Derek Barlow, Nicholas Landon. BONN—Peter Forbath, Silke McQueen. PARIS—Robert Farrell, Arthur Erikson. MILAN—Marc A. Messina. MEXICO CITY—Bruce Bendow. RIO DE JANEIRO—Leslie Warren. MOSCOW—Stewart Ramsey. TOKYO—Richard Halloran, Charles Cohen, John Yamaguchi.

W. W. GAREY, Publisher

MARINER II, now nearing Venus, is lowered into test stand at jet Propulsion Labs hangar, Cape Canaveral. Complete mission was simulated here prior to August 26 blastoff making sure that all sensors, instruments and computers were working. *The interplanetary probe will have traveled 180.2 million miles before its Venusian rendezvous. See p 26* COVER

PROGRESS IN PROCESS CONTROLS Reported at ISA Conference. Two digital systems for aiding steelmakers and an all-purpose analog system are described. *One speaker previewed nuclear rocket controls* 22

PHASE-SHIFT KEYING Is Basis for Mariner's Long-Range Telemetry. Pseudonoise Sequences are used to synchronize transmissions. *When the spacecraft goes by Venus, it will be 36 million miles away* 26

FIBER-OPTIC SYSTEM Recognizes Audio Patterns. Technique matches vibration of fiber ends to stored responses. *System can be programmed to pick an audio signal out of noise* 28

ELECTRO-OPTICAL Viewing System. Army tank operators will be able to get a 360-degree view from inside a buttoned-up tank. *It's one of a series of image intensification devices being perfected for combat use* 30

TRANSISTOR IGNITION Systems Sales Climb Slowly. Still optional on 1963 cars, they may be standard equipment on some 1964 models. *But most 1963 cars are featuring alternators* 30

ELIMINATING THE HUMAN OBSERVER in Air and Space Scouting Missions. Human decision-making is too slow in an age of weapons having ever higher delivery speeds. But automatic pattern recognition systems may be able to take over in real time reconnaissance and surveillance operations. *This system uses property abstractive techniques to recognize terrain types and intruding missiles. By A. Rosenfeld, Budd Electronics* 45

PULSE-WIDTH MEASUREMENTS: An Unconventional Approach. Recording microsecond pulse widths can require complex broadband equipment. This system uses magnetic cores as a buffer then records output on conventional magnetic tape. *For a square-loop core in incremental magnetization mode, the number of pulses required to switch the core depends on the pulse width.*
 By W. L. Carter and P. J. Knoke, Syracuse University 51

PHASE-LOCK OSCILLATORS for Faster Frequency Switching. New voltage and current-controlled oscillators permit rapid and convenient frequency changing but require phase-lock circuits when accuracy is critical. *These phase-lock circuits offer both accuracy and fast frequency pull in.* By T. W. Butler, Jr., and E. M. Aupperle, University of Michigan 54

Published weekly, with Electronics Buyers' Guide and Reference Issue as part of the subscription, by McGraw-Hill Publishing Company, Inc. Founder: James H. McGraw (1860-1948).

Title ® registered U.S. Patent Office; © copyright 1962 by McGraw-Hill Publishing Co., Inc. All rights reserved, including the right to reproduce the contents of this publication, in whole or in part.

Executive, editorial, circulation and advertising offices McGraw-Hill Building, 330 West 42nd Street, New York 36, N. Y. Telephone Longacre 4-3000. Teletype TWX N.Y. 212-640-4646. Cable McGrawhill, N. Y. PRINTED IN ALBANY, N. Y.; second class postage paid at Albany, N. Y.

OFFICERS OF THE PUBLICATION DIVISION: Nelson L. Bond, President; Shelton Fisher, Wallace F. Traendly, Senior Vice Presidents; John R. Callahan, Vice President and Editorial Director; Joseph H. Allen, Vice President and Director of Advertising Sales; A. R. Venezian, Vice President and Circulation Coordinator; Daniel F. Crowley, Vice President and Controller.

OFFICERS OF THE CORPORATION: Donald C. McGraw, President; Hugh J. Kelly, Harry L. Waddell, Executive Vice Presidents; L. Keith Goodrich, Executive Vice President and Treasurer; John J. Cooke, Vice President and Secretary.

Subscriptions are solicited only from those actively engaged in the field of the publication. Position and company connection must be indicated on orders. Subscription rates: United States and Possessions, \$6.00 one year, \$9.00 two years, \$12.00 three years. Canada: \$10.00 one year. All other countries \$20.00 one year. Single Copies, United States and Possessions and Canada 75¢. Single copies all other countries \$1.50.

THE PUBLISHER, UPON WRITTEN REQUEST FROM ANY SUBSCRIBER TO OUR NEW YORK OFFICE, AGREES TO REFUND THAT PART OF THE SUBSCRIPTION PRICE APPLYING TO COPIES NOT YET MAILED.

Subscribers: Please address change of address notices, subscription orders or complaints to Fulfillment Manager, Electronics, at above address. Change of address notices should provide old as well as new address, including postal zone number if any. If possible, attach address label from recent issue. Allow one month for change to become effective.

Postmaster: Please send Form 3579 to Fulfillment Manager, Electronics, 330 West 42nd Street, New York 36, New York.



Audited Paid Circulation

CONTENTS continued

HI-FI TRANSISTOR AMPLIFIERS: New Ways to Stabilize Them. Thermal runaway is always a bugaboo when using power transistors and most means of preventing it introduce unwanted distortion. *In one of these circuits stabilizing current biases the input of a complementary symmetry push-pull power amplifier; in the other it biases the input to a preamplifier.*
By H. W. Parmer, U. S. Signal Corps 56

RAISING INVERTER FREQUENCY LIMITS By Novel Circuit Design. Most transistor inverters have operated at relatively low frequencies but this one provides 100 watts at 50 Kc. *The secret is to interpose two monostable gates between oscillator and output amplifier.* By Sze L. Chin, Bendix Semiconductor 59

REFERENCE SHEET: Up-to-Date Nomograph Aids Tropo Antenna Design. Calculating electrical characteristics of troposcatter communications antennas is often very tedious. *This nomograph based on latest figures saves hours of engineering time.*
By T. Vaughan, Antenna Systems 62

DEPARTMENTS

Crosstalk. *As the Crow Flies. Voyager* 3

Comment. *Electronics in Canada* 4

Electronics Newsletter. *NASA Goes Ahead with Ranger Probe Plans* 7

Washington Outlook. *Push Is on for More Coordination of R&D Data* 14

Meetings Ahead. *Optical Masers Symposium* 34

Research and Development. *Combined Coding Increases Spectrum Usage* 64

Components and Materials. *Planer Triode Redesign for Space Use* 68

Production Techniques. *Concentric Design Aids Tube Production* 74

New Products Design and Application. *Converter for Low Levels and Low Frequencies* 80

Literature of the Week 90

People and Plants. *Bell Labs Opens Development Center* 92

Index to Advertisers 99

CROSSTALK

AS THE CROW FLIES. What are the landmarks that an astronaut can use for rendezvous in space? They are certainly not the familiar railway lines and cities used by aeronauts.

Given a road map of the heavens, an astronaut can use such landmarks as stars to plot his course. He can select a well identified star and use his instruments for a fix.

However, for a remotely controlled space vehicle, the process of navigation is less straightforward. Although positional information can be telemetered from the space vehicle to ground for processing and for generating further navigation instructions, the space-derived information must be unambiguous. This is not easy to ensure since a space vehicle does not normally have the facility for selecting and identifying a star. This is because the star tracker cannot yet duplicate the human astronaut's faculty of recognizing particular stars out of the many that are visible.

Here then is a fundamental snag to automatic space vehicle navigation: to identify the star by which bearings are to be taken. But all is not lost. Even though there are many stars that look alike to an electronic eye, there are many groups of stars in unique patterns. Therefore, instead of seeking out a particular star as the basis for navigation, it is possible that a spaceborne camera can look for stars in previously catalogued configurations. It is not necessary to have a computer in the vehicle, nor a library of well known star triangles; instead, the star pattern data can be telemetered to be matched up with ground-based data.

A technique based on this principle is discussed by Dr. Azriel Rosenfeld of Budd Electronics. In his article on p 45 this week, Rosenfeld discusses three related automated recognition methods to speed up navigation processes beyond the limits of human navigators.

VOYAGER. We don't know if Mariner II is still as bright and shiny now as it was when the photos here, on the cover and on p 27 were taken. After all, it has traveled millions of miles and can be considered space-weatherbeaten by now. The information that Mariner II has been sending back confirms that there is weather in space, lots of it—showers of small particles, flowing plasmas and gas, solar winds. And lots of "atmospherics" to make the spacecraft's mul-

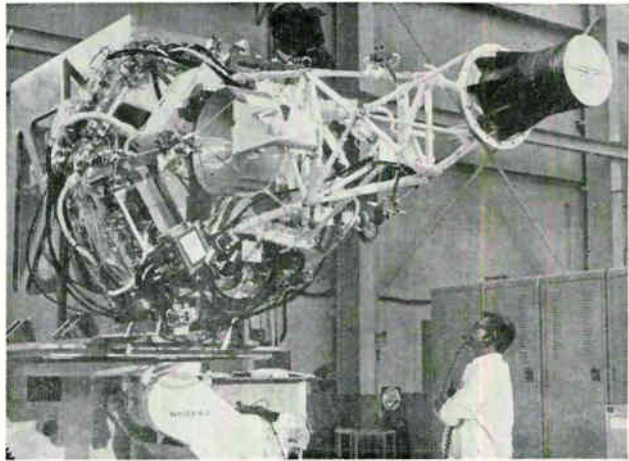

timillion-mile transmissions noisy. The technique that Jet Propulsion Laboratory employed to dig the data out of this noise is outlined in the article on p 26, including, we are told, the first detailed diagram of the data encoding system to be published in a magazine.

CART BEFORE THE HORSE. It was consumer electronics applications—first radios and then television—that spurred the high-volume production of vacuum tubes and helped pave the way for their widespread use in industrial applications. Other components have similarly been boosted into industrial applications by a solid base in consumer products.

Not so with power transistors. Although low-power units like transistor radios and hearing aids have been on the market for years, few consumer devices use transistors to deliver output in the 50 to 100-watt region. But industrial systems have employed transistors to control kilowatts of power for several years. Among the reasons advanced for the delay on the part of consumer electronics manufacturers have been cost and technical difficulties.

Lately, several audio equipment manufacturers have announced transistor hi-fi units powerful enough to drive the big loudspeakers some hi-fi fans want. One company claims transistors improve audio quality. Then, there's the reduction in size, weight, operating temperature and the advantages of coupling directly to the loudspeaker—transistors are a natural for such low-impedance loads as loudspeaker coils.

Assuming that the slow appearance of higher-power transistor sets has been due to circuit difficulties—stabilizing output stages is cited as a prime problem—an article in this issue should help. On p 56, Harry W. Parmer, of the Army R&D Lab, describes ways to stabilize a transistor power stage.

NEW
FROM WEINSCHEL

**BLUE
LINE**

**TP-N
ATTENUATOR**

**3 to 20 db
DC to 2 KMC**



The BLUELINE Model TP-N is a moderately priced coaxial attenuator which combines high quality materials and sturdy construction. It is designed for use in systems and other general utility applications.

Rated for an average power of 1W and a peak of 1 KW, the TP-N features Weinschel film resistors which can withstand appreciable peak pulse powers and reasonable overloads without changes in characteristics.

If you have an application where both price and performance are important, we invite you to write for complete specifications.

For your more exacting requirements, we recommend Weinschel Precision Attenuators.

**BLUE
LINE** By

WEINSCHEL

ENGINEERING

Post Office Box 577

Gaithersburg, Maryland

Tel: Area Code 301-948-3434

TWX: 301-926-3730

Santa Monica, California

631 Wilshire Blvd., TWX: SMON 7185

COMMENT

Electronics in Canada

Thank you very much for the fine write-up on Electronics in Canada (p 37, Sept. 28). We do notice that there are a few errors in it, but, in general, it's a pretty fine write-up on our Canadian effort.

You were very kind to me in mentioning my name so prominently, particularly as "President of Nuclear Enterprises Ltd." when I am General Manager. I must admit you were a little free in quoting me, as I don't quite recognize some of it myself, but you may have picked some of this up from newspapers, who were also pretty free at quoting what I was purported to have said.

Nevertheless, I do appreciate such prominence being given to what was known as "The Organization of Canadian Manufacturers," now changed to "Organization of Canadian-Owned Business," because of C.M.A. objection to the previous name. Our purposes and aims are the same, that is, to represent and promote the environment for the development of wholly Canadian-owned firms. We, of course, have no objection to foreign financing, but we would like to see some of the ownership remaining in Canada.

I think you have done a very fair and a penetrating job of examining the Canadian research and development in the electronics industry.

EDWARD A. SPEERS
Nuclear Enterprises Ltd.
Winnipeg, Canada

Tunnel-Diode Control

In your March 23 edition I read with interest an article, Tunnel-Diode Saturable-Reactor Amplifier as a Control Element (p 43), by R. E. Morgan of GE, Schenectady.

I would like to know whether this unit is now, or will be, commercially available, and whom I might contact for additional information.

DAVID D. WALTERS
Air Reduction Sales Company
Union, New Jersey

Author Morgan replies:

The technique described in the article is widely used. The uses,

that I know of, are integrated into other electronic equipments. These applications include frequency control circuits, telemetering systems, etc. In all cases the tunnel-diode control is a small part of a large system. I do not know of any place the tunnel-diode control is available as an individual unit.

Novel Circuit

In the Sept. 28 issue, the article, Novel Circuit Damps Transients in Voice-Operated Transmitters (p 66), states in the third paragraph that relay K_2 will close after K_1 . From the schematic as printed, I do not think that either will ever close. After reading the article in its entirety, it is very evident that this circuit is, as stated in the title, very "novel."

ROBERT B. WATSON
Federal Aviation Agency
Tucson, Arizona

The ground symbol at the lower right of Fig. 1 should be removed.

Tunnel-Diode Preamplifier

The published version of my article, New Tunnel-Diode Preamplifier Improves Phased-Array Radar (p 57, Sept. 28), contains several errors.

In the last line of the third paragraph (p 58), it should be "an n -type germanium tunnel diode."

Under the equation for the noise figure F (p 58), strike out " $R_a =$ diode series resistance." And strike out the word "rise" at the end of " $R_s =$ diode series resistance rise," so that it reads " $R_s =$ diode series resistance."

Under the gain equation (p 58), rather than $a = (G'_a + G'_s)/G_c$, it should be $a = (G'_a + G'_s)/G_c$. Also, $B =$ total circuit susceptance. Use a capital B , not β .

Under CIRCULATOR, first paragraph (p 59), the last sentence is incomplete. It should read "Two less desirable alternatives are a three-port circulator-coupled tunnel-diode amplifier followed by an isolator, and a three-port circulator-coupled tunnel-diode amplifier followed by a directional filter."

D. W. MACGLASHAN
The Bendix Corporation
Baltimore, Maryland

Only Lambda offers:

Environment-engineered power supplies

mass-produced at Competitive Prices

**NEW
LE SERIES**

DC OUTPUT
(Regulated for line and load.)

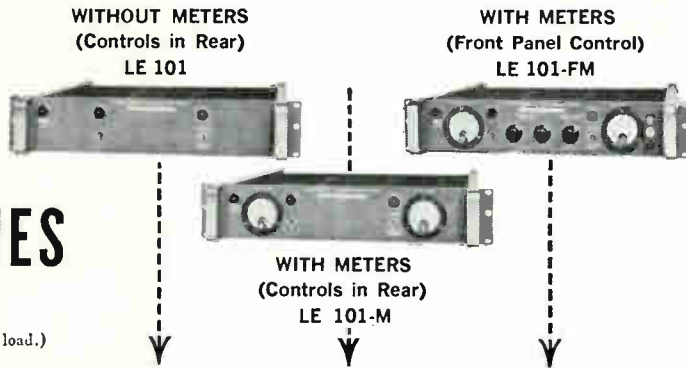

0-36 VDC	5 Amp	LE 101	\$420	LE 101-M	\$460	LE 101-FM	\$470
0-36 VDC	10 Amp	LE 102	525	LE 102-M	565	LE 102-FM	575
0-36 VDC	15 Amp	LE 103	595	LE 103-M	635	LE 103-FM	645
0-36 VDC	25 Amp	LE 104	775	LE 104-M	815	LE 104-FM	825
0-18 VDC	8 Amp	LE 105	425	LE 105-M	465	LE 105-FM	475
0- 9 VDC	10 Amp	LE 109	430	LE 109-M	470	LE 109-FM	480

Plus THESE FEATURES:

- All solid state
- Completely protected
- Adjustable automatic current limiting
- Continuously variable
- Remotely programmable over entire range
- Constant voltage/constant current
- Wide input frequency and voltage range
- Convection cooled—no blowers
- 50°C ambient
- Guaranteed 5 years

CONDENSED TENTATIVE DATA

REGULATED VOLTAGE:

Regulation

(line and load) Less than .05 per cent or 8 millivolts (whichever is greater). For input variations from 105-135 VAC and for load variations from 0 to full load.

Transient Response

(line) Output voltage is constant within regulation specifications for any 15 volt line voltage change within 105-135 VAC.

(load) Output voltage is constant within 25 MV for load change from 0 to full load or full load to 0 within 50 micro-seconds of application.

Remote Programming 50 ohms/volt constant over entire voltage range.

Ripple and Noise Less than 0.5 millivolt rms.

Temperature Coefficient Less than 0.015%/°C.

AC INPUT: 105-135 VAC; 45-66 CPS and 320-480 CPS in two bands selected by switch.

OVERLOAD PROTECTION:

Thermal Thermostat, reset by power switch, thermal overload indicator light front panel.

Electrical:

External Overload

Protection Adjustable, automatic electronic current limiting.

METERS: Ruggedized voltmeter and ammeter to Mil-M-10304B specifications on metered models.

PHYSICAL DATA:

Mounting Standard 19" rack mounting.

Size LE 101, LE 105, LE 109 3½" H x 19" W x 16" D
 LE 102 5¼" H x 19" W x 16" D
 LE 103 7" H x 19" W x 16½" D
 LE 104 10½" H x 19" W x 16½" D

SEND FOR COMPLETE DATA ON LE SERIES



LAMBDA ELECTRONICS CORP.

515 BROAD HOLLOW ROAD • HUNTINGTON, L. I., NEW YORK • 516 MYRTLE 4-4200

Western Regional Office: 230 North Lake Avenue, Pasadena, California • Phone: Code 213, MUrray 1-2544
 New England Regional Office: 275 Boston Post Road, Marlboro, Massachusetts • Phone: Code 617, HUNtley 5-7122
 Middle Atlantic District Office: 515 Broad Hollow Road, Huntington, L. I., New York • Phone: Code 516, MYRtle 4-4200
 Southeastern Region: W. A. Brown & Associates, Inc., Engineering Representatives
 Orlando, Fla. • Fort Lauderdale, Fla. • Huntsville, Ala. • Alexandria, Va. • Winston-Salem, N. C.

**PUSH
BUTTON**

**TEST
SIGNALS!**

**1%
ACCURACY!**

10 CPS

**to
1 MC**



Push-button convenience and repeatability for selecting frequencies from 10 cps to 999 KC makes the new Φ 241A Oscillator ideal for supplying stable test signals for lab or production work. Just push one of five decade multipliers and three frequency push buttons to select any of 4,500 discrete frequencies. You get accuracy of $\pm 1\%$ and repeatability typically better than 0.005%.

Three-digit frequency resolution is provided by the solid-state Φ 241A. Infinite resolution is provided by a vernier control, which extends the upper frequency to 1 MC.

Frequency response is flat within $\pm 2\%$ over the entire range, and a front panel control provides output levels from +10 to -30 dbm, presenting a constant output impedance of 600 ohms. Hum and noise are reduced below 0.05% of the output.

High repeatability, positive push-button operation and compact, rugged solid-state design make the Φ 241A especially suitable for production line or other repetitive testing.

Write today for complete data, or call your nearest Φ representative for a demonstration.

HEWLETT-PACKARD COMPANY

1501 Page Mill Road, Palo Alto, California
Area Code 415, DA 6-7000

Sales and service representatives in all principal areas
Europe, Hewlett-Packard S.A., 54-54bis Route des
Acacias, Geneva; Canada, Hewlett-Packard (Canada)
Ltd., 8270 Mayrand Street, Montreal

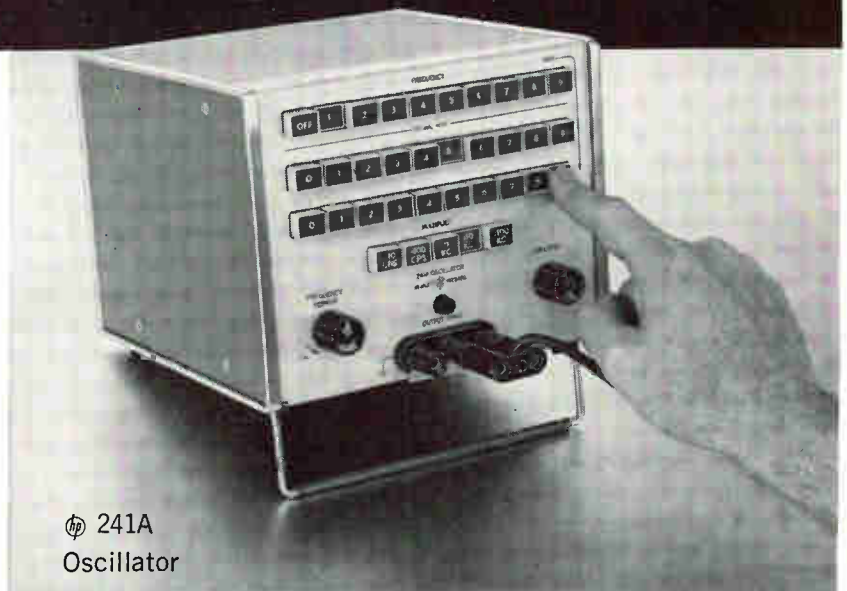

Φ 241A
Oscillator

SPECIFICATIONS

Frequency:	10 cps to 1 MC, 5 ranges, each with 900 frequency increments with vernier overlap
Calibration Accuracy:	$\pm 1\%$
Frequency Response:	$\pm 2\%$ into rated load
Output Impedance:	600 ohms
Distortion:	1% maximum
Hum and Noise:	0.05% maximum of output
Output:	+10 to -30 dbm into 600 ohms (2.5 volts max.)
Dimensions:	6½" high x 7¾" wide x 8" deep. 13 lbs,
Price:	\$425.00

Data subject to change without notice. Prices f.o.b. factory.

7927

ELECTRONICS NEWSLETTER

NASA Goes Ahead With Ranger Probe Plans

WHEN RANGER 5 missed the moon by 450 miles last weekend and moved on to a probable orbit around the sun, it knocked out all hopes for seismological and other experiments on the moon for at least a year. Rangers 3, 4 and 5, all failing in their primary objectives, were to have landed an instrument package on the moon. The next series of Rangers are being designed to televise lunar details to earth.

Rangers 6, 7, 8 and 9 are to be launched in 1963. A NASA spokesman said Monday that Ranger 6 is definitely scheduled for launching in the first quarter of 1963. This series will carry a cluster of six television cameras. The cameras, to be built by RCA, will provide higher resolution than had been hoped for with the cameras on Ranger 3, 4 and 5.

NASA last week announced that it was ordering five more Rangers, numbered 10 through 14, for launch in 1964. What the payloads will be had not yet been determined. However, one goal of this series is to produce information on the moon's origin, constitution and surface. Incorporation of an instrumented capsule is being considered.

Ranger 5 failed to respond to ground commands when its battery ran out Thursday night. Apparently some portion of the solar power supply failed. NASA is confident the solar cells were not knocked out by radiation. The trouble had not yet been diagnosed early this week.

EIA Backs Proposal for Educational Tv at 2 Gc

EIA LAST WEEK backed the FCC proposal to set up educational tv channels in the 1,990 to 2,110-Mc and 2,500 to 2,690-Mc bands (p 8, Sept. 28, and p 7, Aug. 3). In its comment, EIA said the service should be on a developmental basis and that it favors the lower frequency because equipment for that band is readily available.

Adler Electronics, which has been urging FCC approval of the plan, last week asked FCC to establish the service in the 2,000-Mc band. The company said that a 2,000-Mc

system has been tested successfully in the Plainedge, N. Y., school district and that multichannel systems with a range of 20 to 25 miles could be built for one-fifth the cost of standard tv stations. Higher frequencies would require development of costlier equipment, Adler said.

The National School Board Association, National Association of Educational Broadcasters, a number of local and state school boards, universities, and the U.S. Department of Health, Education and Welfare favor using the 2,000-Mc band for educational tv, Adler said.

Neuristor Storage Ring Keeps Pulse in Orbit

SOLID-STATE neuristor has been successfully operated at Stanford Research Institute's Computer Techniques Laboratory. The experimental device is a storage ring around which an electrical discharge pulse can propagate indefinitely without attenuation. It could store one bit of digital information.

Devices now under study are single wafers of three-layer epitaxial silicon material. A chain of 40 emitter junctions form a closed path on one surface. Coupling between emitters is by minority carrier diffusion in the wafer. A circulating pulse discharge takes 26 μ sec to circumnavigate a path length of about 2 cm.

SRI, which has been doing theoretical work on neuristors for several years, said that the experimental neuristors could lead to compact and completely distributed neuristor logic systems. The research has been supported by the Air Force and Navy.

Japanese Expect to Sell 6 Million Radios Here

TOKYO—Japan Machinery Export Association predicts that more than 6 million to 7 million transistor radios will be exported to the U.S. this year, a record high. A spokesman said exports to the U.S. were 3,776,519 units, worth nearly \$37 million, during the first six months of this year, 50 percent more than in the first half of 1961.

Since last year, he said, the Japanese developed markets in Europe in an attempt to stay away from the U.S. market where it seemed extremely difficult to export transistor radios, particularly when major U.S. firms started manufacturing them.

But the U.S. market remained open, he said, because Japanese

Ideographic Composer Ideological Weapon?

LAST WEEK, the newspapers had a little fun with a "Chinese puzzle:" why is the Army paying RCA \$656,000 to build some electro-optical machines to set Chinese type? RCA was mum.

Supposing the Army wanted quickly to disseminate literature in Asia? Should it stand around waiting for somebody to set type from fonts containing 5,000 to 8,500 characters? Or what if the machine's keyboard might make a dandy coder?

The machine will set 100 characters a minute, from a storage of 10,000. Characters are generated from a keyboard composed of 21 basic strokes, 20 geometric symbols and 11 punctuation marks. These codes are transferred by optical, fiber-optic and tv techniques to film used to prepare lithographic plates. The keyboard can be operated manually or automatically with punched tape.

RCA said the machine is an outgrowth of an electromechanical model built by the Graphic Arts Foundation, Cambridge, Mass.

manufacturers shifted from conventional six-transistor radios to high-fidelity radios with six or more transistors. He added that these radios are class A and B types that can be exported without quota. Only class C transistor radios are exported on quota, he said.

Computer Contractor for Space Center Selected

NASA ANNOUNCED last week that it will negotiate with IBM on a contract for the Integrated Mission Control Center (IMCC) at NASA's Manned Spacecraft Center, Houston, Texas (p 23, Aug. 3).

The contract will call for IBM to establish an interim computer facility, determine the computing equipment required for the permanent complex, program the computers for Gemini rendezvous and Apollo earth orbital, lunar orbital and lunar landing flight operations, and install, check out, operate and maintain the computers in IMCC.

The computer complex is planned to be operational in 1964 for Gemini rendezvous flights. Initial tasks under this contract, which include planning and program preparation, will cost about \$1 million. IBM was one of eleven companies which submitted proposals in September.

Monopulse Radar Operating On Atlantic Missile Range

FIRST OF a second generation of C-band monopulse radars is now fully operational on Antigua, station 9.1 on the Atlantic Missile Range. Developed and built by RCA, the AN/TPQ-18 is the transportable version of the AN/FPQ-6 (p 26, Dec. 15, 1961).

An AN/FPQ-6 is installed at Patrick AFB and will be operational Jan. 31. According to Pan American World Airways, range operating contractor, similar radars will be installed on Merritt Island, Grand Bahama Island, Grand Turk, Ascension, Pretoria, South Africa, and the Advanced Range Instrumentation Ship III.

The new radar is capable of skin-tracking a one-square-meter target

at more than 500 nautical miles range and can follow beacon-carrying spacecraft to 32,000 n mi without ambiguity. Angle-tracking error is less than 0.006 degree in azimuth and elevation.

Regenerative Power Source Proposed for Lunar Vehicles

MARTIN MARIETTA is proposing a completely regenerative power system for lunar surface vehicles.

Liquid hydrogen would be converted to gas by heat given off by the vehicle's crew and its electrical and electronic equipment. The gas drives a reciprocator or turbine and goes to a fuel cell. The cell produces additional electricity and radiates excess heat. In the fuel cell, the hydrogen is combined with lithium to produce storable lithium-hydride fuel. Power is stored in a silver-cadmium battery.

A nuclear reactor outside the vehicle would be used to separate the hydride into lithium and hydrogen again.

Next From Japan: 12-Inch Tv Sets

TOKYO—Asahi Special Glass, tv picture tube bulb manufacturer here, has started producing 12-inch, 110-degree tubes. Set makers see a market for a size between the successful 16-inch and 5-inch sets. The new 12-inch tube is expected to be used most in thin, lower-priced portable sets.

Major set makers planned to produce the 12-inch sets by the end of this year, but held off until spring because dealers and distributors still have stocks of about one million 14-inch, 90-degree sets. These sets are six inches deeper than the new 16-inch, 114-degree sets and prices of the 14-inchers have been steadily falling.

Hitachi recently introduced a 16-inch set priced low enough to compete with the 14-inch holdovers, but is discontinuing advertising for several months because of dealer protests. Production, however, continues. The Japanese expect to export the 16-inch sets. They are heavier than American sets.

In Brief . . .

NAVY will try again to put an atomic-powered navigation beacon in the Atlantic (p 8, Sept. 21). Salt water leaked into the beacon on the first try, damaging electronic equipment.

ITT HAS ACQUIRED National Computer Products. Astron Corp. and Renwell Electronics plan to merge. Jerrold Corp. has acquired Analab Instrument Corp. C. K. Williams & Co. has been bought by Chas. Pfizer & Co. Operating assets of Actan Electronics have been acquired by Sealectro Corp. York Research Corp. has purchased Florida Transformer Corp. TelePrompTer announced plans to buy Conley Electronics Corp.

HANDBOOK on exporting and services available from the Department of Commerce is now available for 25¢ from the department, which says many American companies are missing the boat in foreign markets.

GENERAL ELECTRIC reports first sale of the new GE-412 process computer, to Arizona Public Service for use in a power plant. Electronic Associates has sold one of its Hydac computers to McDonnell Aircraft, and Philco one of its 211's to Ford Motor.

AIR FORCE contracts include \$2 million to General Telephone & Electronics for Atlas-Titan security systems, and \$1.1 million to Marquardt for radar equipment.

ARMY CONTRACTS include \$24.8 million to Bendix's Eclipse-Pioneer division for Pershing missile guidance and engineering services, and \$9 million to Sperry Utah for engineering services on the Sergeant guided missile system.

NAVY CONTRACTS include \$2.3 million to General Instrument for classified equipment, \$2 million to Sparton Electronics for sonobuoy devices, and \$1 million-plus to Polarad for R&D on shipboard countermeasures.

our stock answer is

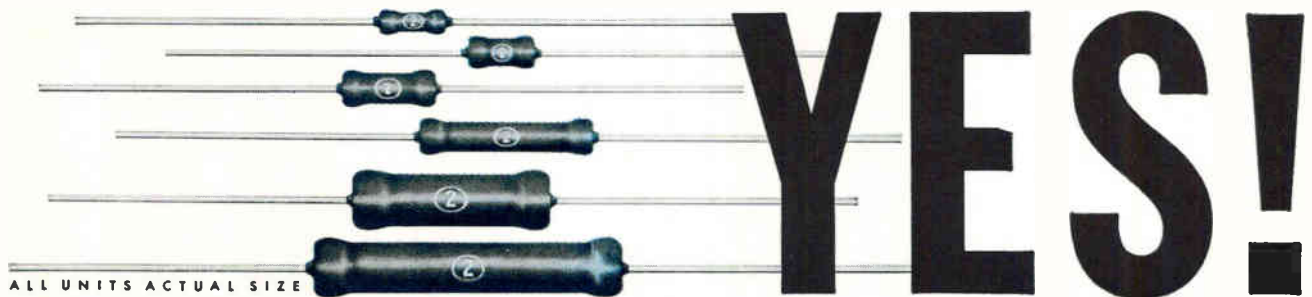

ALL AXIAL LEAD BLUE JACKET RESISTORS

*in 1, 2, 3, 5, 7 and 10-watt power ratings are carried in
factory stock for immediate delivery. Place your order now with your
nearest Sprague District Office or Sales Representative.*

Key Sprague Industrial Distributors carry most popular ratings in local stocks.

S P R A G U E S A L E S O F F I C E S

Ariz.	Phoenix, Sprague Electric Co., 3550 N. Central Ave., 279-5435	Mo.	St. Louis, Sprague Electric Co., 3910 Lindell Blvd., JE 5-7239
Cal.	Los Angeles, Sprague Electric Co., 12870 Panama St., UP 0-7531 or EX 8-2791	N. J.	Camden, Sprague Electric Co., 545 Cooper St., WO 6-1776
	San Francisco, W. J. Purdy of Calif., 312 7th St., UN 3-3300	N. M.	Albuquerque, Bowen & Carlberg Co., 2228A San Mateo Blvd., N.E., AM 5-1579
Colo.	Denver, R. G. Bowen Co., Inc., 721 S. Broadway, RA 2-4641	N. Y.	New York, Sprague Electric Co., 50 E. 41st St., OR 9-1195
D.C.	Washington, Sprague Electric Co., 2321 Wisconsin Ave., N.W., 338-7911		Great Neck, William Rutt, Inc., 123 Middle Neck Rd., HU 2-8160
Fla.	Clearwater, Sprague Electric Co., 1152 Cleveland St., 446-3119	N. C.	Winston-Salem, Sprague Electric Co., 928 Burke St., 722-5151
Ill.	Chicago, Sprague Electric Co., 5942 W. Montrose Ave., MU 5-6400	Ohio	Chagrin Falls, Sprague Electric Co., 24 N. Main St., CH 7-6488
Mass.	North Adams, Sprague Electric Co., Marshall St., 664-4411		Dayton, Sprague Electric Co., 224 Leo St., BA 3-9187
	Newton, Sprague Electric Co., 313 Washington St., WO 9-7640	Tex.	Dallas, Sprague Electric Co., 3603 Lemmon Ave., La 1-9971
Mich.	Detroit, ABM Sales Co., 10116 Puritan Ave., UN 2-1300	Utah	Salt Lake City, R. G. Bowen Co., Inc., 463 E. 3rd St., S., EM 3-4528
Minn.	Minneapolis, H. M. Richardson & Co., Inc., 9 E. 22nd St., FE 6-4078	Wash.	Seattle, Sprague Electric Co., 4601 Aurora Ave., ME 2-7761

*For application engineering assistance write:
Resistor Division, Sprague Electric Co., Nashua, New Hampshire.*

SPRAGUE COMPONENTS

RESISTORS	INTERFERENCE FILTERS	HIGH TEMPERATURE MAGNET WIRE
CAPACITORS	PULSE TRANSFORMERS	CERAMIC-BASE PRINTED NETWORKS
MAGNETIC COMPONENTS	PIEZOELECTRIC CERAMICS	PACKAGED COMPONENT ASSEMBLIES
TRANSISTORS	PULSE-FORMING NETWORKS	FUNCTIONAL DIGITAL CIRCUITS
MICRO CIRCUITS	TOROIDAL INDUCTORS	ELECTRIC WAVE FILTERS



*Sprague' and '®' are registered trademarks of the Sprague Electric Co.



MNEW FROM MNEMOTRON!^{*}

We are silent about the "M" in Mnemotron but not about our new 700 Series Data Recorder. With good reason. For one, it brings the size and cost of data recording systems down to sensible proportions if your data is analog voltage from DC to 5000 cycles per second. And its features would not embarrass even the costliest instrumentation recorder. Here are a few:

COMPACTNESS. A complete 7 channel record/reproduce system uses less than two feet of rack space. A 14 channel system adds less than seven inches more.

ACCURACY. Input-output characteristic is linear within 0.2 per cent with Mnemotron unique Pulse Frequency Modulation (PFM) data conversion technique.

FLEXIBILITY. As many data channels as you need with a choice of channel format. For greatest operating economy, choose up to 7 channels on 1/4 inch magnetic tape, 14 channels on 1/2 inch tape, standard IRIG spacing and track width of 7 channels on 1/2 inch tape.

INTEGRATED RECORD/REPRODUCE MODULES. A single solid-state PFM Data Converter has all the record/reproduce electronics for each channel. Simple rotary switching lets you select data conversion for 3 tape speeds. No additional plug-ins needed.

ISOLATED INPUT CIRCUITS. Input terminals of each channel are isolated from all the others to readily accept data from floating, unbalanced or differential sources.

VERSATILITY. 700 Series plug-in accessories expand instrumentation capability. Typical: Electrocardiogram preamplifiers for recording directly from electrodes. Pulse Record unit for recording trigger pulses, time markers, or stimulus pulses in medical research . . .

PRICE. 7 Channel System from \$6,495

COMPLETE SPECIFICATIONS. Send for your copy today.

^{*} To answer the many inquiries, Mnemotron comes from Mnemosyne, Greek Goddess of Memory.

MNEMOTRON CORPORATION

45 South Main St., Pearl River, New York, 914 PEarl River 5-4015, Cables: Mnemotron, TWX: H99

Subsidiary of Technical Measurement Corporation, North Haven, Conn.



Cubic digital system tests 1100 Clevite diodes per/hr – safeguards reliability

As performance specifications for electronic devices become more stringent and the demand for high reliability units increases, manufacturers must be able to program tests for a quantity of devices simultaneously. The Cubic line of quality digital instruments is designed for easy integration into flexible, multi-purpose testing systems.

At the Clevite Transistor Plant in Waltham, Massachusetts, a Cubic system based on the Model V-70P Digital Voltmeter checks semiconductor devices to assure reliability. This high-speed Cubic system tests more than 1100 computer diodes per hour for reverse leakage current and forward voltage drop. Data obtained from these measurements are recorded and stored on commercial data processing cards. A complete test history of a given diode type with up to five entries on the same card can be made by repetition of these tests after the diodes have been subjected to life tests, operational burn-in and high temperature bake time. The data processing cards representing a manufacturing lot can be screened in a computer system according to a customer's specifications. In this manner, possible diode failures can be culled and the performance or reliability distribution plotted for the entire lot. This Cubic system is one of hundreds especially adapted to a wide variety of industrial applications. For additional information on digital instruments or digital systems, write telling your requirements to Department A-172.



INDUSTRIAL DIVISION
SAN DIEGO 23, CALIFORNIA * ROME, ITALY

OTHER OFFICES: LOS ANGELES, CALIF. — ROME (CUBIC EUROPA S.p.A.) REPRESENTATIVES IN PRINCIPAL U.S. AND CANADIAN CITIES

October 26, 1962

CIRCLE 11 ON READER SERVICE CARD 11

compulsion

... **electronics** generates more of it than any other publication edited for electronic engineers.

Make a magazine compelling reading for your customers and prospects, and an optimum climate for your advertising has been created.

This optimum climate for thoughtful advertising readership is one reason you can be sure your advertising works best when you concentrate it in **electronics**.

electronics  **BASIC IN A MERCURIAL MARKET**

The McGraw-Hill magazine for electronic engineers. Published every Friday. 330 W. 42 St., N. Y. 36. ABC/ABP



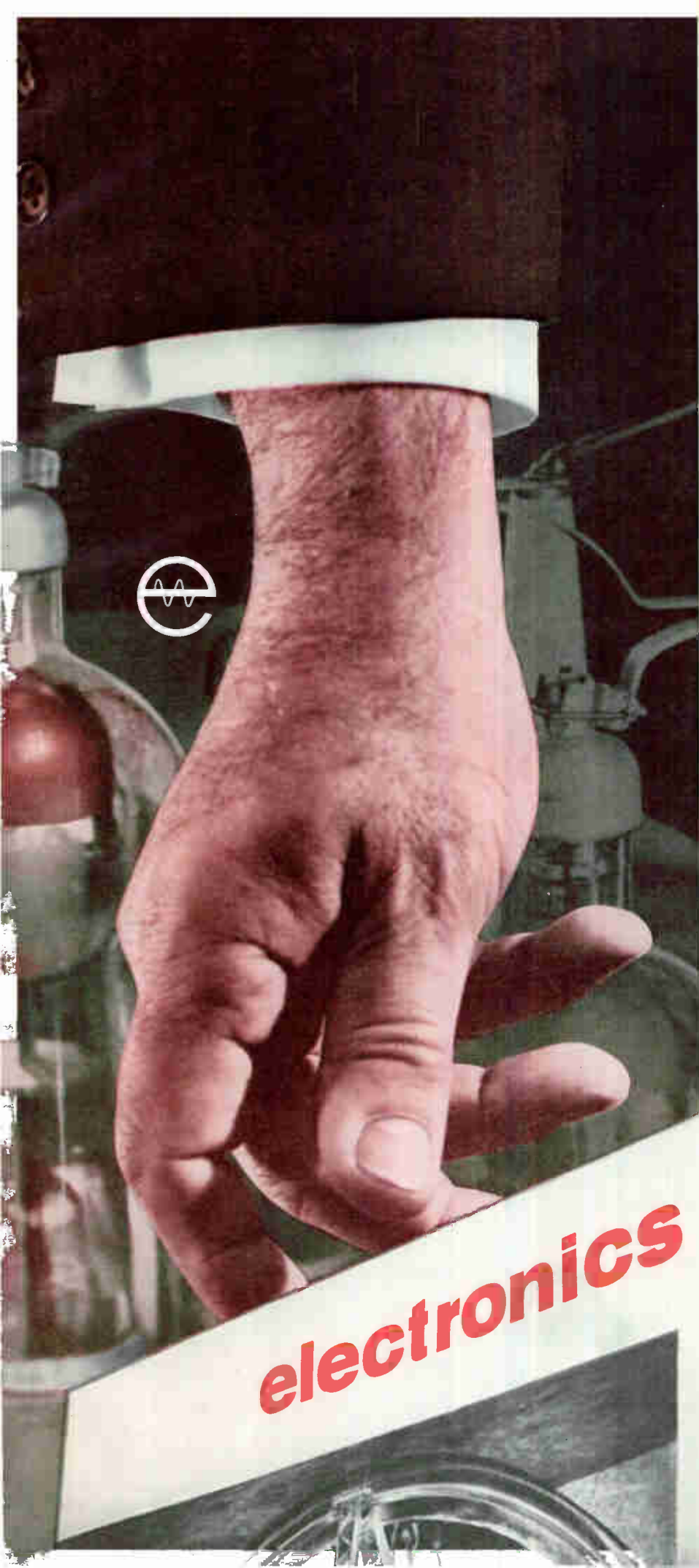

more about compulsion

If a magazine tells you more about your industry's technology than any other, and almost always does so first, any responsible, ambitious engineer is apt to find it compulsive reading. He reaches the sensible conclusion that not to read such a magazine could cost him much in technical knowledge, and much in opportunity to get ahead in his business faster than most.

For 32 years *electronics* has dedicated itself to being *first* with its industry's important news and technological breakthroughs. It has the biggest editorial staff of any electronics publication. It has continuous access to McGraw-Hill's worldwide news services. Its editors average 35% of their time out in the field. It puts an editor on a plane to Europe as quickly as it sends one across the Hudson River. It edits and prints more editorial pages than any other electronics publication.

It has often been said that seldom has any publication so fully deserved to carry its industry's name. *electronics* is the Electronics Industry. And because of this, it is the closest thing there is to compulsive reading in this young and explosive industry.

In a market served by more than 50 publications which are readily available to engineers for free, *electronics* has 57,000 paid subscribers. These subscribers are alert, responsible, and ambitious far above the average. They exert tremendous buying power. They can very conceivably make or break your products' sales future in the \$14-billion electronics market. And they are all yours to reach and sell through the advertising pages of *electronics*.

WASHINGTON OUTLOOK

PUSH IS ON FOR MORE COORDINATION OF R&D DATA

AN INTERLOCKING NET of top officials in each government agency responsible for R&D projects is being set up to deal with the already out-of-hand problem of handling and disseminating scientific and technical information. Congressional leaders have served notice on the administration that they are impatient over the lack of coherent programs to deal with the data dilemma. R&D agencies have been instructed to include specific technical information programs in next year's budget proposals.

The Defense Department, as an example of the government-wide pattern soon to emerge, plans to name a "director of technical information" in the Office of the Director of Defense Research and Engineering, Harold Brown. He will be responsible for bringing together the flow of scientific and technical data produced by military-supported R&D projects. Other but less dramatic coordinating steps have been taken by other federal agencies.

CENTRALIZED INFORMATION SYSTEM SOUGHT

BEHIND THESE ACTIVITIES is the growing inability of scientists and engineers to keep up with the flood of literature pouring out of shops and laboratories. Estimates run as high as \$1 billion a year in waste stemming from the lack of availability of data where and when it is needed. The resultant delay and duplication of effort has given the information-handling problem priority status.

The heart of the Government's deliberations is a still-unpublished report by a panel of the President's Science Advisory Committee. It recommends strong centralization of the government's technical information system, with all lines coming together in the President's Office of Science and Technology. But there's resistance to this idea. Strong centralization and bureaucratization is anathema to many scientific representatives high in the President's councils.

RS-70 DISPUTE NOT OVER YET

THE LONG-SIMMERING DISPUTE over the RS-70 is still unsettled. Air Force recommendations for expansion of the program are now under study by the Joint Chiefs of Staff, but a decision will not be disclosed until the fiscal 1964 budget goes to Congress in January. Congress added almost \$200 million to this year's budget, enough to begin production of three more prototype models. The odds are that Defense Secretary McNamara will reaffirm his opposition to a major stepup in the program.

SUPER SYSTEM TO INTEGRATE APOLLO EQUIPMENT

NASA IS PREPARING to develop a "super-system" to integrate instrumentation systems needed for the Apollo manned lunar landing program. It is dubbed as the most complex system ever to be devised with an unofficial title of "factory-to-space integrated checkout system."

The basic requirement of the new electronic system will be to monitor the lunar landing mission from launch to return landing, reporting instantaneously on the performance of the booster rocket and spacecraft throughout the flight.

General Electric has been contracted to help conceive and design the new system as well as build many of its major components. Cost of the system will run several million dollars, but so far no working estimates have been made.

NASA wants to employ a new concept in the system. It wants to use the same or compatible equipment in static tests that will monitor actual flights.

$$W = \frac{1}{2} CV^2$$

$$R > 2\sqrt{L/C}$$

$$2\sqrt{L/C} > R$$

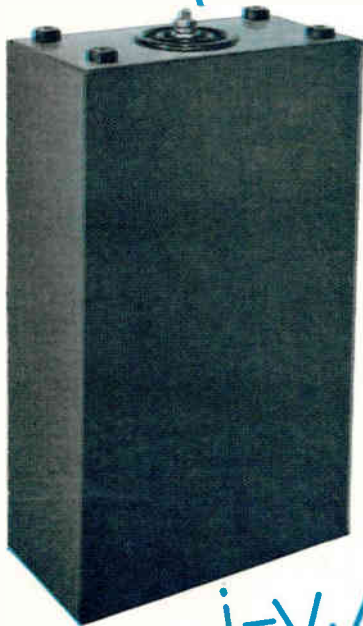

$$2\sqrt{L/C} \gg R$$

$$i = \sqrt{C/L} \varepsilon^{-mt} \sin 2\pi ft$$

L-M Offers Specialty Energy Storage Capacitors For Every Application

Regardless of the application, L-M is prepared to assist you in determining your requirements for capacitors. We have designed specialty energy storage capacitors to meet the requirements of various Government and private agencies, universities and industries.

Line Material Industries, a division of McGraw-Edison Company, is one of the nation's leading manufacturers of capacitors for power-factor correction. L-M capacitor engineers have at their disposal the complete facilities of the Thomas A. Edison Short Circuit Current and High Voltage Surge laboratory at Franksville, Wisconsin, and McGraw-Edison Laboratory for Basic Research at West Orange, New Jersey.

Send For Bulletins

Send for bulletins TSC-100, TSC-101 and TSC-102 today. Mail the coupon or check the Reader Service Card. Line Material Industries, Specialty Capacitors, Milwaukee 1, Wisconsin.

APPLICATIONS

Light & Heavy Duty Energy Storage Capacitors

L-M can supply capacitors for applications like these:

- SHOCK WAVE GENERATORS • INTENSE MAGNETIC FIELDS
- ELECTRO-HYDRAULIC METAL FORMING • PLASMA RESEARCH
- WIND TUNNELS • PARTICLE ACCELERATION • FLASH TUBES
- RADAR PULSE FORMING • FILTERS • CAPACITOR WELDING

575

LINE MATERIAL® Industries



MCGRAW-EDISON COMPANY

Specialty Capacitors



DISTRIBUTION TRANSFORMERS • RECLOSERS, SECTIONALIZERS AND OIL SWITCHES • FUSE CUTOUPS AND FUSE LINKS • LIGHTNING ARRESTERS • CAPACITORS • REGULATORS • OUTDOOR LIGHTING • LINE CONSTRUCTION MATERIALS • PORCELAIN INSULATORS • FIBRE PIPE AND CONDUIT

SEND COUPON TODAY

Line Material Industries, Milwaukee 1, Wisconsin
Please send me your bulletins on Specialty Capacitors.

E-10

Name _____

Title _____

Company Name _____

Address _____

City _____ State _____

Printed Circuit Designers! AVOID Wire Failures at Soldering Temperatures

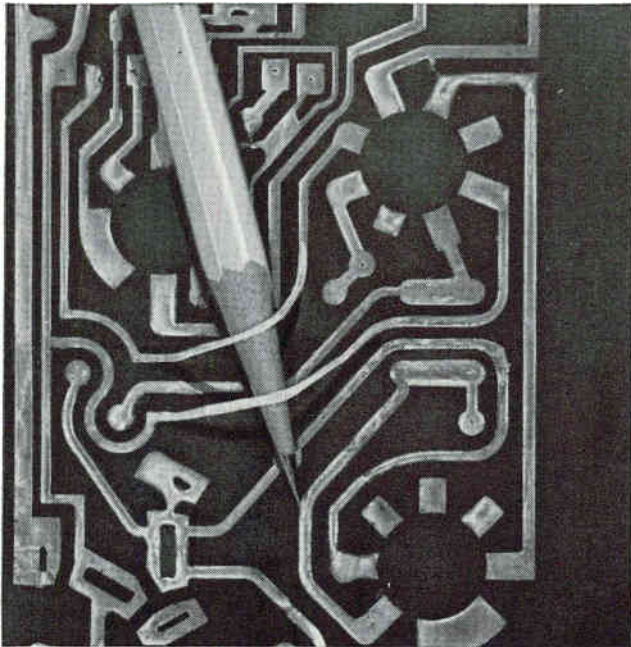

You've never had a printed circuit fail at room temperature. But you may often have experienced loose wire trouble in the soldering pot or during solder roller coating.

Synthane G-10R, a special glass epoxy base laminate, was developed especially to eliminate wire failures during the soldering operation—approximately 500°F.

G10-R meets or beats NEMA and MIL specs for peel strength at room temperature and has a *hot* peel strength of 2 to 4 lbs. per inch of width after immersion for 15 seconds at 500°F* instead of the customary 0.1 to 0.2 lbs. per inch of width.

G-10R is available in sheets 36" x 36" or 36" x 48" and in the usual foil thicknesses. Write for new folder on all Synthane metal-clad laminates.

*Tests made on 1/16 & 1/8" wires.

SYNTHANE

CORPORATION **S** OAKS, PENNA.
GLendale 2-2211 TWX Valley Forge 735U

Synthane-Pacific 518 W. Garfield Ave., Glendale 4, Calif. TWX GLDL 4417U

Synthane Corporation, 36 River Rd., Oaks, Pa.

Gentlemen:

Please send me your latest brochure on Synthane G-10R and other Synthane copper-clad laminates.

Name _____

Address _____

City _____ Zone _____ State _____

 MASER OPTICS, INC.

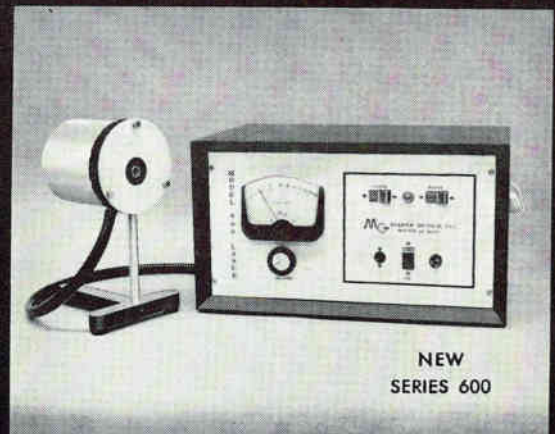

NEW low-cost LASER SYSTEM

\$995 includes:

- Ruby Laser Crystal
- Remote Head Mount

Lease Rates Available On Request

Maser Optic's new Series #600 is the perfect answer to the experimental research needs of universities, schools, and industrial laboratories. This compact, complete laser system operates at room temperature to provide a source of pulsed, coherent, monochromatic light energy. Consisting of an integral power supply and control panel, the #600 has a storage capacity of 400 joules.

Its low price of \$995 includes a modular laser head with two 200 joule Xenon Lamps and a 1/4" x 2" Ruby Laser crystal with multilayer dielectric end coatings. These and other features are detailed in our new facts sheet "Series #600".

Representatives: You are invited to inquire about opportunities in selected areas.

MASER OPTICS, INC.

89 Brighton Ave., Boston 34, Mass.

Send for Data Sheet

CIRCLE 200 ON READER SERVICE CARD
electronics

Kodak reports on:

boron-barium-lanthanum-thorium-strontium glass with neodymium... what we gave them for the cornerstone... the sonic, the ultrasonic, and audible snaps

Laser logic

It was a thrill to hear that this laser rod, unclad though it was, commenced action at a threshold of only 4 joules at room temperature.



Emission: 1.06μ , by transition of Nd^{3+} from $4F_{3/2}$ to $4I_{11/2}$ (not down to ground state, which is $4I_{9/2}$).

Price: \$395 for 2" x $1/4$ " cylinder. More for larger sizes, which are available.

Time to technological obsolescence: inevitably short.

Reputation of supplier: decent.

Name of supplier: Eastman Kodak Company, Apparatus and Optical Division, Rochester 4, N. Y.

Delivery: very fast to the first few early birds who would be uncomfortable to let this one whistle by without a close look; stretching out thereafter.

Premises:

In the rare earths the 4f levels are shielded by the 5s electrons and don't depend on the influence of a crystal field to define their energy in the way that Cr^{3+} levels depend on a crystal field. Therefore they can work in glass. Advantages of glass over crystals are 1) optical homogeneity, 2) potentially larger size, 3) potentially lower cost, 4) the 25 years of practical experience we have had from our commercial pioneering of rare-earth glasses for photographic lenses.

While people ultimately interested in machine tools, communications, and weapons are still feeling out the ground rules of laser engineering, our neodymium-boron-barium-lanthanum-thorium-strontium glass is a good first choice because 1) it emits at a wavelength convenient to phototubes, phosphors, and photography; 2) neodymium requires no refrigerants, since its fluorescence doesn't return the ion to the ground state; and 3) threshold for laser action comes at much lower energy input than neodymium needs in silicate glass. (Whether low threshold implies high over-all efficiency at converting electrical power to coherent radiation needs to be cleared up.)

Instead of silvered ends, customers will prefer dielectric filters tuned to reflect $\sim 100\%$ of the 1.06μ radiation at

one end and 98% at the other end because 1) by interferometric tests in the visible, where the filters are wide open, one can check for homogeneity, end flatness, and end parallelism without removal of the coating; 2) the ends operate solely by interference and don't soak up energy to cook themselves on.

Resist news: thick and fast

An important university recently asked us for a contribution not of money but of a small object suitably symbolic to deposit in the cornerstone of a new building its College of Engineering is putting up. After thinking about it a bit, we sent them three intricately shaped pieces of metal so small that one of them got lost in transit and never found its way into the box that will be opened some day to show our descendants some of the topics that engineers in 1962 regarded as fresh and promising. Is it not true that the engineering mind today is much occupied with working metals and semiconductors in ways to get as much performance as possible from as little bulk as possible?

Doggone right. In addition to making deposits in cornerstones, we have been busy expanding the line of photosensitive resists on which this hot new art so strongly depends. Everybody in it should be delighted to learn of KOR, a new one that's 10 to 15 times as sensitive to arc light and 30 to 100 times as sensitive to tungsten light as Kodak's well-known resist, KPR. This opens up the possibility of exposing KOR by a projected image instead of by contact printing from a master, but the photographic speed is still a little low for an ordinary photographic enlarger. You may wish to fix up some sort of high-intensity projection printer.

KOR is 3 or 4 times as viscous as KPR. As stands to reason, a thick coating requires more exposure than a thin one. Typically, a useful whirled-on KOR coating might require 1100 foot-candle-minutes if applied straight, as compared with 275 when the stuff has been cut 1:1 with KODAK Ortho Resist Thinner before application. When so cut, viscosity about matches that of uncut KPR. By coincidence, the relative prices of the two dopes are such that a quart of the 1:1 diluted KOR costs about as much as a quart of straight KPR.

The flies in the ointment are strictly figurative and not troublesome. For one, since KOR is more heat-sensitive than

KPR, the pre-baking temperature limit is $176^\circ F$ for 10 minutes. For another, since KOR is sensitive out to 550μ instead of just in the u-v, the work area cannot stand tungsten or daylight illumination. Gold fluorescent lamps can be used at 8 feet for not more than 10 minutes.

For more dope on the dope, get in touch with Eastman Kodak Company, Graphic Arts Division, Rochester 4, N. Y. For just the dope, call up a Kodak Graphic Arts Dealer.

Adhesive findings

Mr. Guy V. Martin, 110 Yale Blvd., S. E., Albuquerque, N. M., has reported a piece of valuable information about EASTMAN 910 Adhesive.

He has found it vastly superior to soft solder for transmitting sonic and ultrasonic vibration at temperatures from ambient to $200^\circ F$. When he feeds the energy through a solder bond from a transducer of laminated nickel sheets to an application tip, the solder deteriorates progressively and the transmission drops steadily. An EASTMAN 910 bond acts differently. Without apparent change, it transmits three to four times as long as solder takes to reach disintegration.

When the 910 bond finally snaps, it does so all at once with an audible snap. In the case of aluminum bonded to the nickel, rupture always takes place between the adhesive film and the aluminum. With other metals, plastics, ceramics, or glass bonded to the nickel, the rupture divides itself between one interface or the other and doesn't appear within the film.

Most of Mr. Martin's investigations were done in the 19-20 kc range, with electrical power inputs up to 200 watts. He has been down to a few cycles/sec and up to 60 kc. He believes the adhesive will work well at much higher frequencies. He wonders if somewhere it is being used in building up high-frequency ultrasonic ceramic transducers. We wonder too.

Mr. Martin claims that for some 30 years Kodak has been very obliging in furnishing him helpful information from time to time. We claim that in volunteering his adhesive findings, he has now amply repaid us. We feel we could afford to mention to anyone confronted with supersonic bonding problems that Mr. Martin conducts a business in metallurgical consultation and custom scientific instruments at the aforementioned address. EASTMAN 910 Adhesive is obtainable in a sample kit for \$5 from Eastman Chemical Products, Inc., Kingsport, Tenn. (Subsidiary of Eastman Kodak Company). It develops great strength within a few seconds and requires no curing or drying.

Prices subject to change without notice.

This is another advertisement where Eastman Kodak Company probes at random for mutual interests and occasionally a little revenue from those whose work has something to do with science

Why so many?

We admit it.

Amphenol, more than any other connector manufacturer, accepts responsibility for confronting you with a seemingly endless selection of rack and panel connectors.

There's a good reason.

For some uses, a ten-contact connector the size of an Idaho potato will do just fine. In others, ten connections must be squeezed into a space no bigger than a jelly bean. Still other applications have unique requirements that relate to environment or mating force—even the technical skill of the operator.

WHY WE DO IT

We make a lot of different rack and panel connectors because it takes a lot to satisfy the wide range of applications.

For example: the Amphenol Blue Ribbon® rack and panel connector is widely used in "blind" mating applications. Part of Blue Ribbons' popularity is due to the fact that they mate with a smooth and gradual wedge-like force. Because they mate so smoothly, the "feeling" of correct alignment is unmistakable.

Another advantage of the Blue Ribbon design is the wiping action that occurs as connectors mate. Each time Blue Ribbons are mated, contact surfaces are wiped clean. Combine wiping action with high mated contact pressure, and the result is an extremely low-resistance connection.

THINKING SMALL?

As fine a connector as we know the Blue Ribbon is—it's just not right for the real tiny stuff. Thus, as miniaturized

electronic equipment became popular, Amphenol engineers developed the Micro Ribbon®—a rack and panel connector utilizing the ribbon contact principle, but in as little as one-half the space. Further development produced a circular Blue Ribbon connector which crammed 50 contacts into a diameter just under 3 inches.

Also, there's the question of terminating rack and panel connectors. Often, confined quarters or complex wired harnesses can tax the dexterity of even the most skilled worker

To solve this problem, Amphenol engineers developed rack and panel connectors with Poke-Home® contacts. Poke-Home contacts make it possible to terminate conductors independent of the connector. Contacts are crimped, soldered, or even welded to conductors, then inserted into the connector. Besides simplifying assembly, Poke-Home contacts can be easily removed *after* assembly should circuit changes or repairs later become necessary. Needless to say, Amphenol rack and panel connectors with Poke-Home contacts (Min-Rac 17®, 93 and 94 Series, for example) are popular items with engineers who are forced to think small, spacewise.

BEATING THE ELEMENTS

There's a need for environmentally resistant rack and panel connectors, too. High performance aircraft, missiles and space craft led to the development of Amphenol 126 and 217 Series environmentally sealed rack and panel connectors. (The 217 offers the added feature of Poke-Home contacts.) Other Amphenol rack and panel connectors

can accommodate coaxial connectors; many can be supplied with hermetically sealed contacts. There are rack-to-cable connectors available in every series. There are super-economy types and super-reliable types.

So, when you have a rack and panel connector problem, contact an Amphenol Sales Engineer (or an authorized Amphenol Industrial Distributor). With the broadest line of rack and panels in the industry—if he can't solve it, no one can. If you prefer, write directly to Dick Hall, Vice President, Marketing, Amphenol Connector Division, 1830 South 54th Avenue, Chicago 50, Illinois.

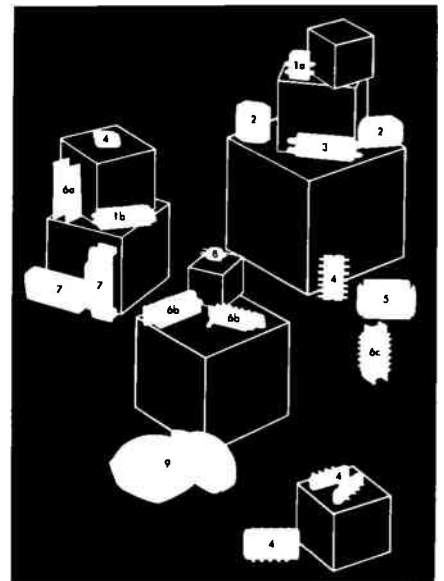

Amphenol connectors shown on the opposite page are: 1—Min-Rac 17 with (a) crimp-type contacts and (b) solder-type contacts 2—94 Series 3—Micro-Ribbon 4—126 Series Rectangular 5—93 Series 6—Blue Ribbon with (a) barrier polarization, (b) pin polarization and (c) keyed shell and barrier polarization 7—126 Series "CNI" 8—126 Series Hexagonal 9—Circular Blue Ribbon



Connector Division / Amphenol-Borg Electronics Corporation



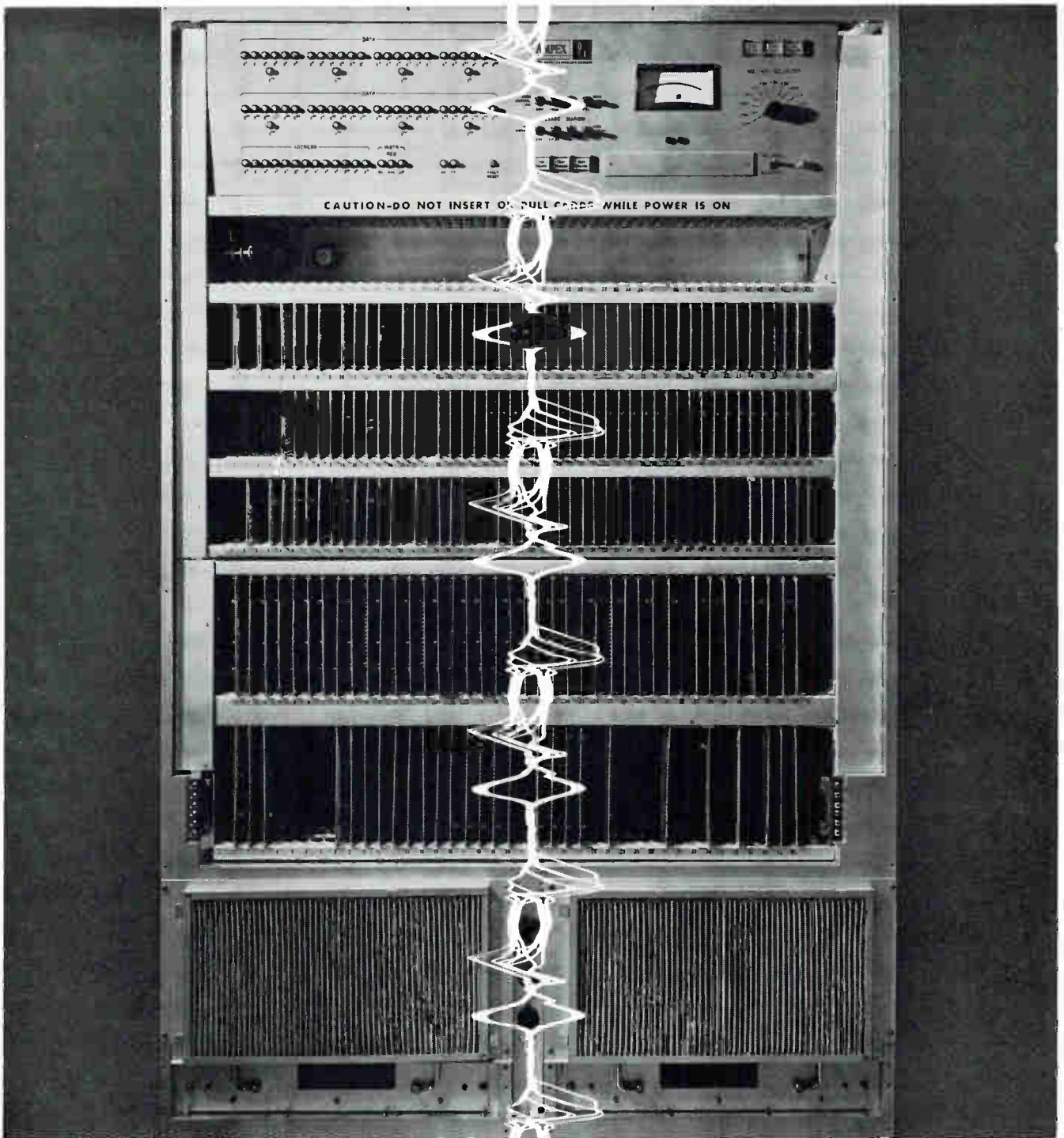

Who knows enough about memories to make this and 39 other models? AMPEX.

Only Ampex brings you such a wide range of core memories—with cycle times from 24 to 1.5 microseconds and capacities from 128 to 32,000 words. These memories have the flexibility needed for random access applications or high speed sequential or buffer operation. Examples? The RB with a capacity of 1024 words and a memory cycle in 8 microseconds. The RVQ with a capacity of 4096 words and memory



cycle in 6 microseconds. The RQL, RQA and LQ each with a 32,768 word capacity and memory cycles in 6, 5 and 1.5 microseconds respectively. These are only five of the 40 models of memories from Ampex. And still more are yet to come. For data write the only company providing tape and recorders for every application: Ampex Corp., 934 Charter St., Redwood City, Calif. Sales, service engineers throughout the world.

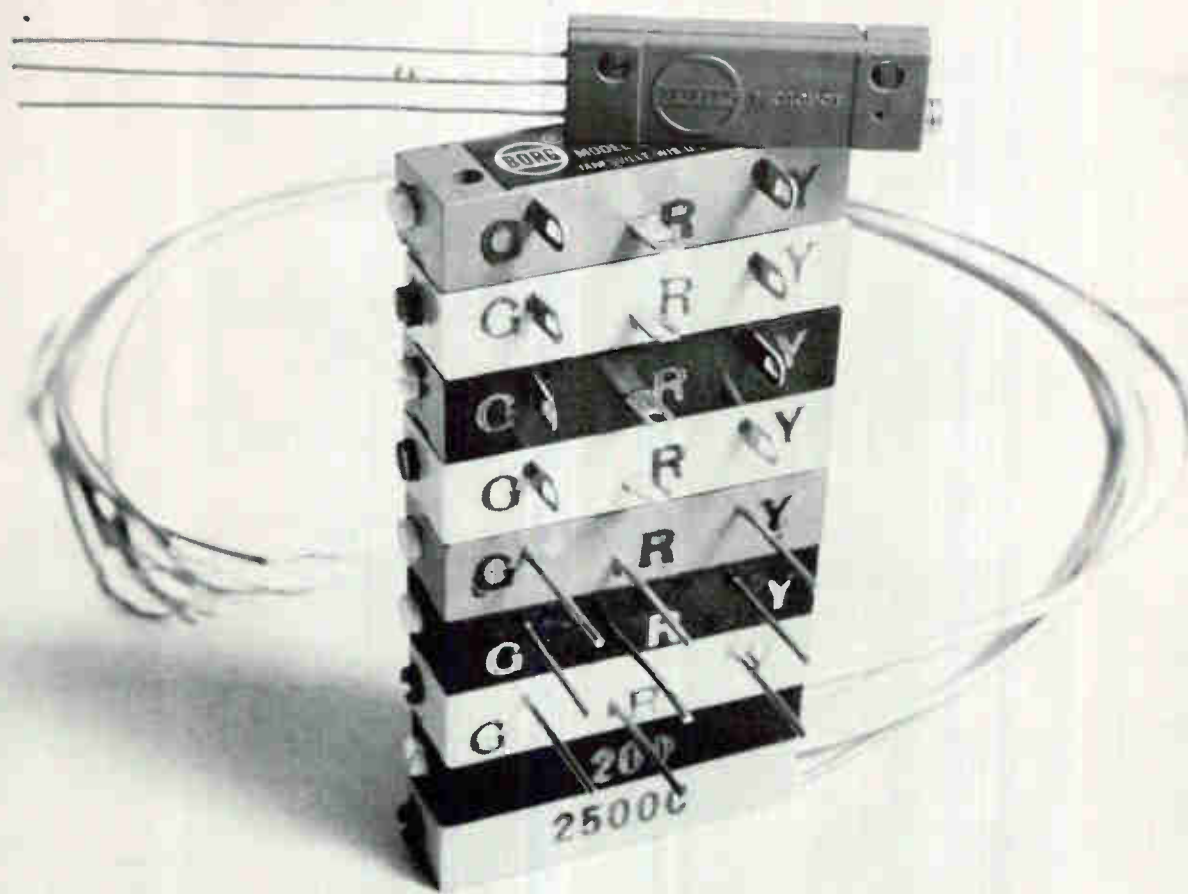

The complete Borg Trimmer line starts at the top

Everything must start someplace. The complete Borg line of Trimming Micropot® potentiometers can be said to start with its latest addition, the subminiature (1" x 3/16" x 5/16") 2700 series. This new Micropot is not only tiny, but a high-temperature, humidity-proof model as well.

However, if a quarter of an inch isn't important to your application, there are six other Borg Trimmer series from which to choose:

- 2800—High temperature, humidity proof, wirewound.
- 990—High temperature, wirewound.
- 992—General purpose, wirewound.
- 993—General purpose, carbon.
- 994—General purpose, humidity proof, wirewound.
- 995—General purpose, humidity proof, carbon.

Here are some of the advantages of-

- ferred by Borg Trimmers: 1. Single-piece, welded terminations. 2. Low-mass contacts. 3. 100% noise test. 4. 100% contact resistance check. 5. 100% ratcheting test. 6. Resistances from ten ohms to one meg.

Selecting the right Borg Trimmer can be a lot easier if you'll call your nearby Borg technical representative or Amphenol-Borg Industrial Distributor. Or, if you prefer, write directly to R. K. Johnson, Sales Manager:



BORG EQUIPMENT DIVISION

Amphenol-Borg Electronics Corporation,
Janesville, Wisconsin.

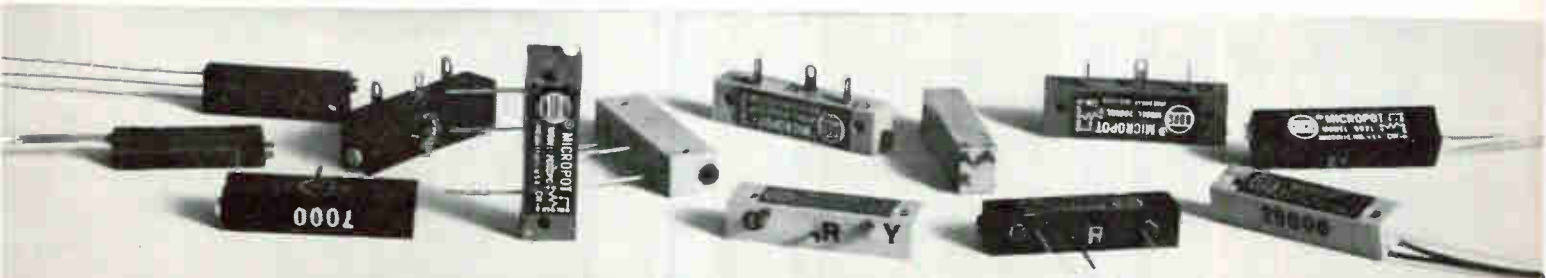

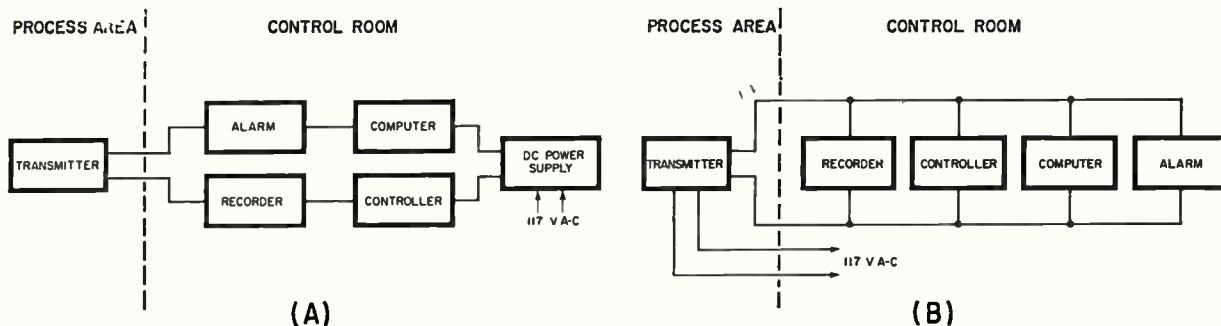

Instrument Meeting Reveals Progress in

Topics range from controls for steel furnaces to rockets

NEW YORK—More than 200 papers, reporting developments in a score of instrumentation fields, were presented last week at the Instrument Society of America conference and exhibit.

Topics ranged from nuclear rocket controls through microwave measurements—including a doppler speedometer for automobiles. A majority of the papers, however, were concerned with bread-and-butter instrumentation—industrial instrumentation, process controls and components for such systems.

PROCESS CONTROLS—Progress in the design of digital-computer control systems for the oxygen steelmaking process was reported by M. W. Wyrod, of IBM, and L. H. Jaquay, of Dravo Corp. This process, introduced in Europe after World War II, is being rapidly adopted by steel firms in the U. S.

While the systems developed by IBM and Dravo for two U. S. steel

mills vary in many respects, both are designed to provide the furnace operators with the information required to optimize the process, raising steel quality and lowering cost. They monitor process variables and calculate the required processing data.

Dravo's system includes a Minneapolis-Honeywell 290 computer and IBM's a 1620. Wyrod said that a new iterative computing technique, nonlinear estimation, is useful for adjusting observed process characteristics to the mathematical model.

Among the analog process controllers described was Motorola's Teletrak, combining series and

parallel systems. As in a regular parallel system, new elements can be added or subtracted as needed, yet it permits a two-wire, instead of four-wire transmission system. Unlike the series-type of system, the failure of one element does not knock out a system, said C. J. Swartwout, of Motorola.

A feature of the system is a specially designed analog computer that permits all amplifier inputs and outputs to be referenced to +1 v. This is better suited to two-wire systems than the zero reference required with general-purpose analog computers, he indicated. Overall advantages of the system are simplicity and flexibility, he said.

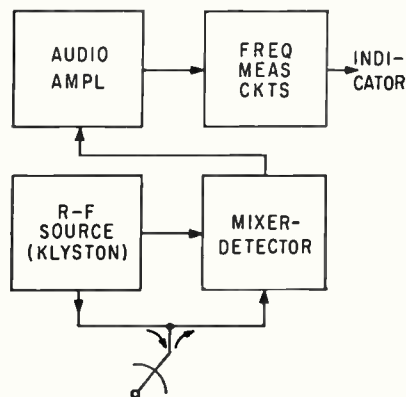

DOPPLER
radar
speedometer
for autos

NUCLEAR SYSTEMS—A preview of nuclear rocket instrumentation was given by P. E. Brown, of RCA. Such rockets are attractive for long-range space flights because of their potentially superior efficiency compared to chemical rockets (ELECTRONICS, p 105, Nov. 17, 1961).

Unlike reactors for electric power, rocket reactors must provide exceptionally high thermal power—to heat the propellant gas—and must run up to full power within about 30 seconds. This necessitates control by a fast-acting computer and also requires transducers able to withstand temperatures of 1,000 C or higher.

Brown outlined an overall control system (see diagram), but reported that many of the transducers needed were still not available. Among the high-temperature sensors that might be usable, he

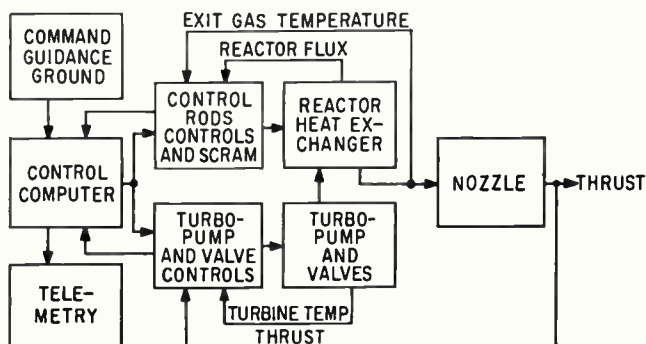

NUCLEAR ROCKET
control system
would use
fast-acting
computer to
match thrust
to propulsion
requirements

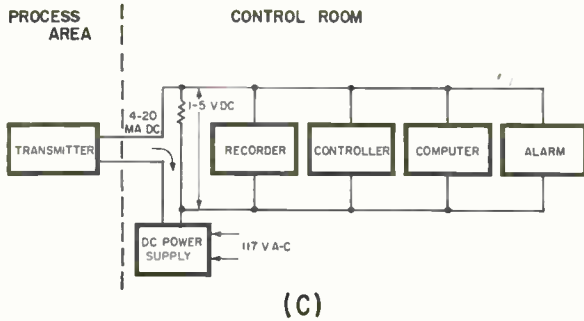

ANALOG CONTROL system developed by Motorola uses features of the series (A) and parallel (B) systems in a combined form (C)

Process Controls

listed graphite ion chambers and silicon carbide-carbon thermocouples.

J. L. Stringer and E. M. Sheen, of Hanford Laboratories, described a radiation detection system that monitors 100 reactor cooling channels to detect fuel failures. It uses only two rotating scintillation detectors, feeding signals to the alarm and indication circuits through slip rings. One is a fast-scanning detector that monitors gross radioactivity and the other scans slowly, permitting more detailed analysis of radioactivity by pulse-height methods.

SPEEDOMETER—An automobile doppler radar speedometer was reported by R. W. Campbell and W. G. Trabold, of General Motors. It was designed to measure vehicle speed during anti-skid brake system tests. Accuracy is better than five

percent at speeds up to 80 mph. Power is provided by the auto's 12-v battery.

The system has a compact klystron-mixer-antenna assembly. The klystron's 10.525-Gc output is coupled directly to the mixer. Most of the r-f energy is directed toward the road surface at an angle of 30 degrees. The return signal is received by the same antenna, detected and mixed with a portion of the klystron energy, to obtain doppler frequency and speed indication.

INERTIAL SYSTEMS—John Horvorka, of MIT, reviewed developments in the use of inertial devices in space systems. He suggested the intermittent use of gyros and accelerometers to conserve power and thus reduce launch weight, but pointed out that the development of instruments reliable in on-off operation is required.

Stock Exchange Automating Ticker

NEW YORK Stock Exchange announced recently that by 1965 it will completely automate its stock ticker and telephone quotation services with a system leased at a cost of \$1.8 million a year. Major components will include two IBM 1410 computers, two IBM 7750 programmed transmission control units, a New York Telephone Co. computer-to-telephone switching system and a 900-characters-a-minute ticker being developed by Teletype Corp.

The IBM system will include 19

optical data readers to gather trading information on the floor of the exchange and a voice assembler to compose telephone quote messages from a prerecorded vocabulary. The telephone quote service will handle up to 400,000 calls daily. The system will also provide voice and printed sales information at trading posts. The equipment will handle a trading volume of 16 million shares a day, several million higher than during the May market drop when the present ticker ran up to more than two hours late.

"Nothing is impossible to diligence and skill"
Samuel Johnson



POTTER

M906 II Tape Transport

couples
high-performance
and reliability . . .

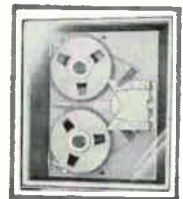

with the lowest price in the industry. The unique design of this versatile transport provides compatibility for a variety of applications in digital data processing and computer systems.

Five tape widths up to 1 1/4" may be accommodated at speeds up to 120 IPS. In addition, data transfer rates of 62,500 BCD digits per second are readily obtained using conventional recording techniques. When used in high-density recording applications, transfer rates of over 450,000 BCD digits per second with drop-outs fewer than 1 bit in 100,000,000 are provided.

Complete specifications for this highly reliable system are available on request.

Manufacturers of:

- Digital Magnetic Tape Systems
- Perforated Tape Readers
- High Speed Printers
- Data Storage Systems



POTTER INSTRUMENT CO., INC.
Sunnyside Boulevard • Plainview, New York

Advertising and Industrial "R & D"...

...An Ominous Contrast In Treatment

This year American industry will spend about \$12 billion for industrial research and development, more than half financed by the federal government. This expenditure, continuing and expanding a tremendous boom in what has been called the industry of discovery, will spawn a veritable flood of new and better products, processes and equipment.

This year American industry will spend about \$12 billion for advertising of all kinds. This is roughly the same amount that industry will spend for research and development.

Without a companion expenditure for advertising, the heavy expenditure for industrial research and development would be, in large part, useless. Advertising provides a crucial link in the process in getting the results of most of the research and development in the form of new products, processes and

equipment to the companies and people who can make effective use of them.

How Advertising & R & D Team Up

This creative relationship between industrial research and development and advertising has recently been stated by Neil H. Borden, Professor of Marketing in the Harvard University Business School, in this way:

"The pace at which new and improved products are introduced now is far beyond anything we knew in pre-war days. A growing, expanding technology is upon us. This is the era of industrial research. The likelihood of survival of a corporation today depends upon its efforts in research and development of new and improved products and processes . . .

"This increasing emphasis on new products tends to increase the importance of advertising and aggressive marketing in an economy such

as ours. Were industry to be curbed in its opportunity fully to exploit the new products which it is bringing to the market, the urge to develop the new would undoubtedly be decreased and the processes that bring about economic growth would be harmed."

Of course, the selling role of advertising is by no means limited to the selling of the new products resulting from research and development. It plays a key part in finding the customers for and completing the sales of many long established products and services. But it remains true that it provides an absolutely essential link in the process required to give a large part of our expenditure for research and development practical usefulness.

An Ominous Contrast

In view of the Siamese-twin economic relationship between industrial research and development and advertising, one might expect to find a comparable attitude of encouragement toward the two lines of endeavor among the policymakers in our National Capital. But here, strangely enough, we encounter a dramatic and ominous contrast.

There is virtually universal approval and encouragement of research and development. Ever increasing governmental appropriations for R & D go sailing through Congress with the greatest of ease. Federal appropriations for research and development have increased fourfold since 1955, topping \$10.5 billion in the fiscal year ending June 30, 1962.

The desirability of tax arrangements which encourage R & D by business firms finds no challenge. There was no opposition to that part of the 1954 revision of the tax code which permitted businessmen to treat R & D expenditures as expenses instead of charging them to their capital account.

Advertising, in contrast, is regarded as a

prime target for the imposition of legislative restrictions and financial burdens. The Washington outposts of the Advertising Federation of America have located in the legislative hopper at this session of Congress no less than 200 proposed bills which, if passed, would place burdens of one kind or another on advertising.

It is contended by some that advertising is in the Washington doghouse because bits of it are conspicuously trivial and also, on occasion, are offensive to high standards of taste and integrity. But the same thing can be said about research and development. It, too, has its sectors — happily limited, as are those of advertising — of triviality and phoniness.

Key Steps in Economic Growth

What, at root, seems to be the explanation of the differences in attitude toward research and development and toward advertising is a failure to see clearly that they are both essential elements in the same crucially important process of economic growth and expansion. Recognition of this basic economic fact in Washington, and the treatment of both R & D and advertising, accordingly, is a key element in the safeguarding of sustained prosperity in the U.S.A.

This message was prepared by my staff associates as part of our company-wide effort to report on major new developments in American business and industry. Permission is freely extended to newspapers, groups or individuals to quote or reprint all or part of the text.

Donald C. McGraw

PRESIDENT

McGRAW-HILL PUBLISHING COMPANY

Mariner's Long-Range Telemetry

By HAROLD C. HOOD
Pacific Coast Editor

Works on Phase-Shift Keying

When the spacecraft goes by Venus, range to earth will be 36 million miles

LOS ANGELES—When Mariner II streaks past Venus at a distance of approximately 20,900 miles in December, engineering and scientific data will be telemetered to earth from a record 36 million miles. With only three watts available to transmit data from 50 engineering and six scientific experiments, an unusual multiplexer or encoder had to be designed.

For the first time, JPL is flying a psk (phase-shift-keyed) system aboard one of its spacecraft. Yielding the minimum error probability for a given signal-to-noise ratio, psk systems use correlation and matched-filter detection techniques and have approximately a 9-db advantage over worst-case frequency-shifted-carrier techniques.

System used is basically a two-channel arrangement, with the data channel making use of psk techniques and the sync channel using a pseudonoise (pn) code generator. Outputs from both are mixed just before transmitter modulation.

PSK TECHNIQUE—Coherent psk consists of biphasic modulation of a carrier by the binary information and transmission of this signal to the receiver, where coherent phase detection is employed to recover the noisy data. Output of the phase detector is passed through a matched filter where the signal is integrated and the noise components averaged over the bit period to maximize the probability of making the correct decision on phase transmitted.

Although the basic concept of psk modulation and detection is simple, the problem of obtaining the required synchronizing signals at the receiver is somewhat complex. Two signals are required for the psk detection process: the coherent refer-

ence for phase detection, and the bit sync for timing of the matched-filter sampling and discharge.

Theoretically, only phasing information is required to establish the proper relationships of the synchronizing signals since all other characteristics, waveform and frequency, are known at the receiver. From a practical standpoint, phase information must be transmitted to the receiver and should be allotted a minimum of the total available transmitter power so as not to degrade the efficiency of the system.

The synchronization process used in the telemetry system has the unique combination of basic properties of phase-coherent, or phase-lock, loops and pseudorandom binary sequences, commonly called pseudonoise sequences.

In addition to bit synchronization, word sync is also required. The telemetry system word rate is the basic sampling rate in the system and the bit rate, therefore, is seven times the word rate since

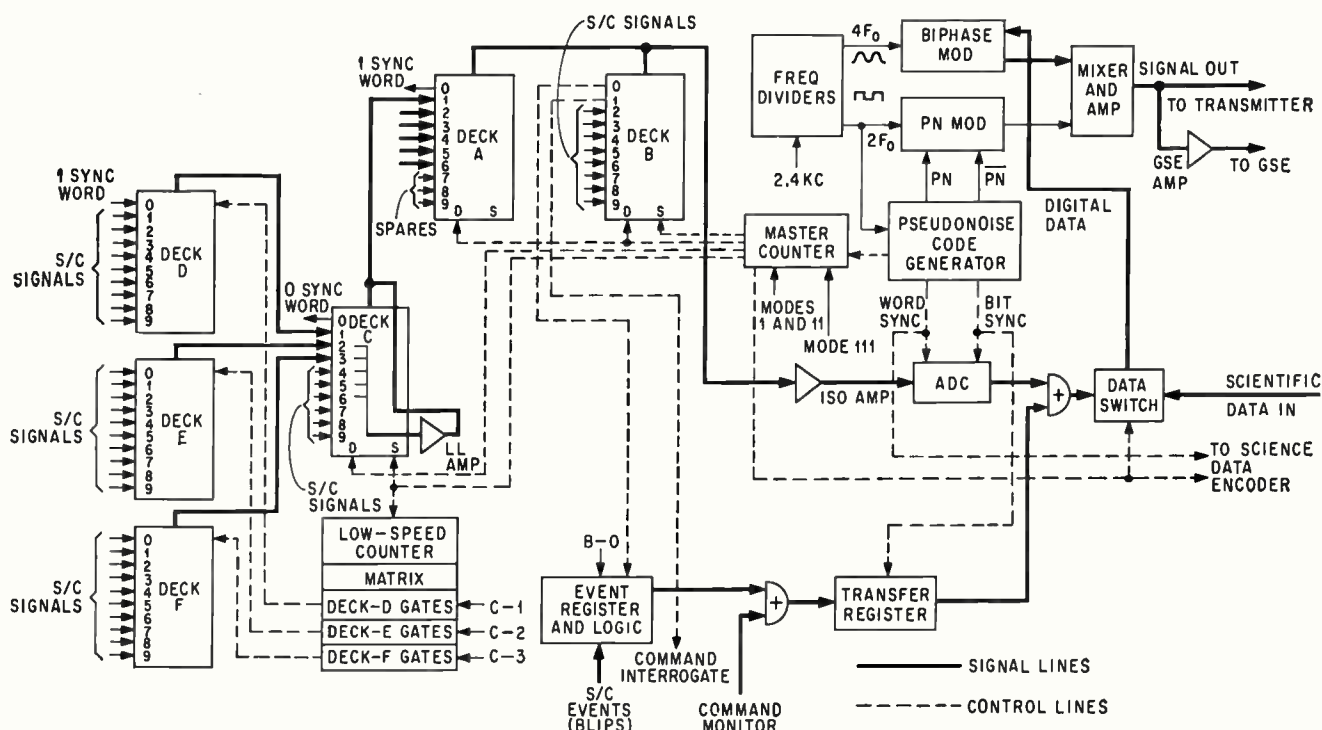

PSEUDONOISE SEQUENCES are used to synchronize telemetry transmissions. This diagram shows the signal flow in the data encoder

each data sample is quantized into a 7-bit binary word and transmitted serially over one subcarrier.

MULTIPLEXER—The telemetry multiplexer is nothing more than a commutator or sampling switch with a primary deck and a number of subdecks. The primary deck is stepped at the data word rate, the second deck at one-tenth the word rate and the third deck at one-hundredth the rate of the primary deck. The choice as to which measurements are placed on each deck is a function of the sampling rate for each measurement.

While both bit and word synchronization are available as a result of the demodulation process, there is nothing inherent in the multiplexing system to identify the source or address of each data sample received on the ground. For this reason, the relatively simple technique of inserting unique frame-identification words is used to identify the individual subdecks and, therefore, the source of the data samples, since they follow in a predetermined order.

An overall description of the Mariner system and techniques was at the 1962 National Telemetry Conference by B. D. Martin and J. C. Springett, of JPL.

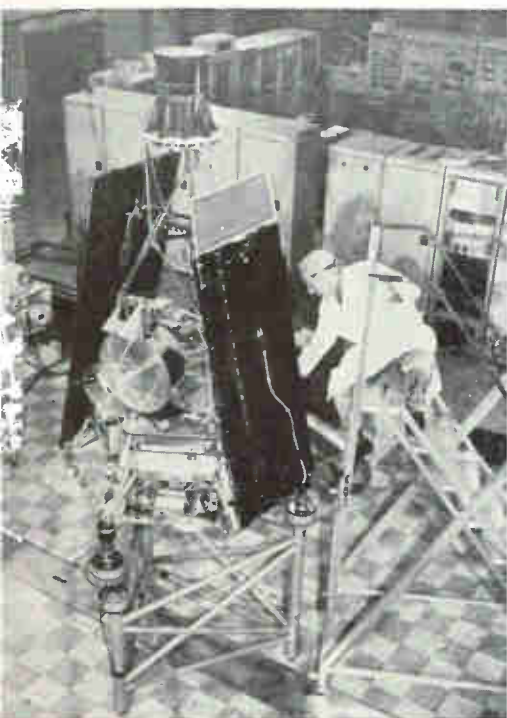

MARINER 2 in launch position with solar panels folded



present a new solid-state 2 MC counter

model A. 1213
maximum counting rate **➤ 2.2 MC**



- Count capacity : 999, 999
- Bright in line readout : 6 digits
- Unit and point indication (displayed)
- High inputs sensitivity : 50 mV to 100 Vrms
- Temperature range : 0 to 50° C (- 10 to + 60° C on test)
- Crystal stability : ± 1 part in 10^6 (longterm)
- Gate time : 0.1—1 and 10 seconds or any other value with external preset time base (optional)
- Time interval measurements : $1\mu s$ to > 10 days
- Pulse duration measurements (polarity + or -)
- Period measurements
- Ratio measurements
- Shock and vibration tested

manufactured by **Rochar**
électronique

Distributed in U.S.A. and Canada by :
WESTON- Newark (N.J.)
for complete information on our line of products and address of our agency in your country please apply to
ROCHAR-ELECTRONIQUE, 51, rue Racine
MONTROUGE (Seine) FRANCE.

SPRAGUE PIEZO- ELECTRIC CERAMIC ELEMENTS



**ELEMENTS
FOR ALL
APPLICATIONS
AS WELL AS
COMPLETE
TRANSDUCER ASSEMBLIES
FOR MOST APPLICATIONS,
SUCH AS UNDERWATER
SOUND AND
VARIOUS ORDNANCE AND
MISSILE DEVICES.**



Sprague-developed mass production and quality-control techniques assure lowest possible cost consistent with utmost quality and reliability. Here too, complete fabrication facilities permit prompt production in a full, wide range of sizes and shapes.

Look to Sprague for today's most advanced ceramic elements—where continuing intensive research promises new material with many properties extended beyond present limits.



**YOUR INQUIRIES
ARE INVITED**

**WRITE FOR
LITERATURE**

SPRAGUE ELECTRIC COMPANY
35 Marshall Street, North Adams, Mass.

SPRAGUE®
THE MARK OF RELIABILITY

DEMONSTRATION of how system recognizes spoken word "five"

Fiber-Optic Array Recognizes Audio Patterns



*Technique matches
vibration of fiber ends
to stored responses*

FIBER OPTIC pattern recognizer that can be self-programmed to distinguish a desired audio signal from other audio signals or noise has been developed at Sperry Gyroscope Co. The new device is named Sceptron for Spectral Comparative Pattern Recognizer.

Sceptrans have recognized spoken words, such as the number five, and units are being built to cover the entire frequency range of speech sounds. Experiments are also being conducted to recognize printed letters and other visual images. Eventual applications foreseen include classifying ships by recognizing active and passive sonar returns, operating office machines by voice and automatically detecting human heart damage.

HOW IT WORKS—Heart of the Sceptron is an array of several hundred to several thousand separate optic fibers cantilevered so they can vibrate independently at their free

end. The fibers are mechanically driven by an electromechanical transducer activated by the audio input. Fiber response is determined by resonant frequency and mechanical Q.

Light beams emerging from the excited fiber tips pass through a light-modulating photographic mask that contains the response pattern of a previously stored signal. Emerging light is detected by a photocell which integrates the total light received during the time interval of the signal to be recognized. In practice, an incoming signal would be classified by selecting the output from one of many Sceptrans in a decision circuit.

The Sceptron operates in real time and accepts amplitude-time information over a frequency range presently 100 cps to 20 Kc. Present density of 300,000 frequency channels per cubic inch is enough to store and recognize 300 complex signatures.

Sperry reported it has military contracts utilizing the Sceptron; one contract calls for delivery of a breadboard system within six months.

**BLOCK
DIAGRAM
of multi-word
Sceptron**

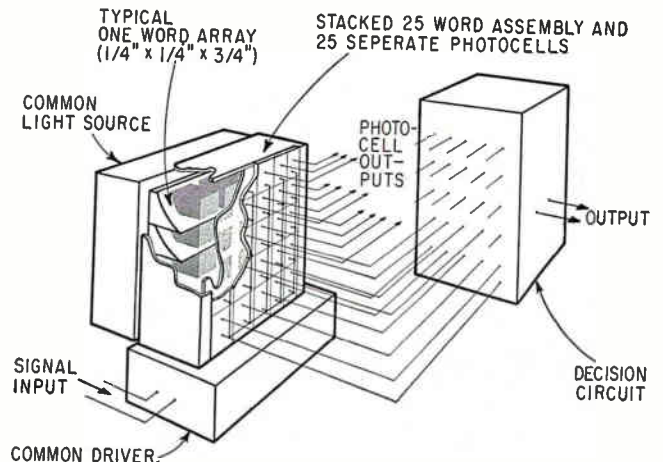



Electric fry pan at 400°F melts solder while G-E silicone compound adheres without melting to the tilted surface.

Even at 400°F G-E Silicone Dielectric Compound won't melt! *(or noticeably bleed, evaporate or dry out)*

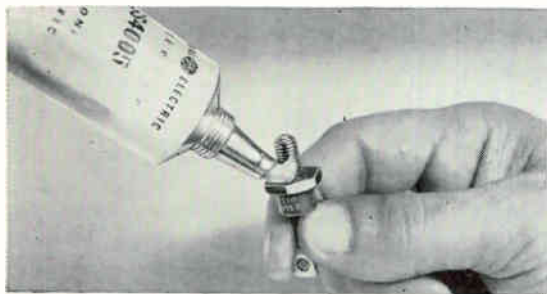

HEAT TRANSFER MEDIA G-E silicone dielectric compounds improve heat transfer from electronic components.



CORROSION INHIBITORS Silicone compounds protect against sticking, moisture, corrosive atmosphere.

General Electric silicone dielectric compounds won't melt at 400°F or solidify at -65°F. These greaselike materials have excellent dielectric properties. They are easily applied, chemically inert, non-corrosive and water repellent.

G-E silicone compounds adhere tenaciously to almost everything, without being subject to oxidation, evaporation or excessive bleed losses. A free sample tube is yours on request, to test as a corrosion inhibitor, release agent, water repellent, insulator, protective coating or heat transfer media. Ask for SS-4067 (general purpose), SS-4005 (meets MIL-1-8660), or SS-4006 (inhibits copper oxidation). Write on your letterhead, describing your proposed application, to Section N1078, Silicone Products Department, General Electric Company, Waterford, New York.

G-E silicone insulating products available from these distributors: San Francisco, Electrical Specialty Co., 158 11th St.; Chicago, Federal Insulation Co., 549 W. Randolph; Detroit, Insulation & Copper Sales, 15605 Woodrow Wilson; Floral Park, N.Y., Punt, Inc., 160 Woodbine Ct.; Philadelphia, Smith of Phila., 1024 Race St.; Chagrin Falls, Ohio, Electrolock, Inc., 28 N. Main.

GENERAL  **ELECTRIC**

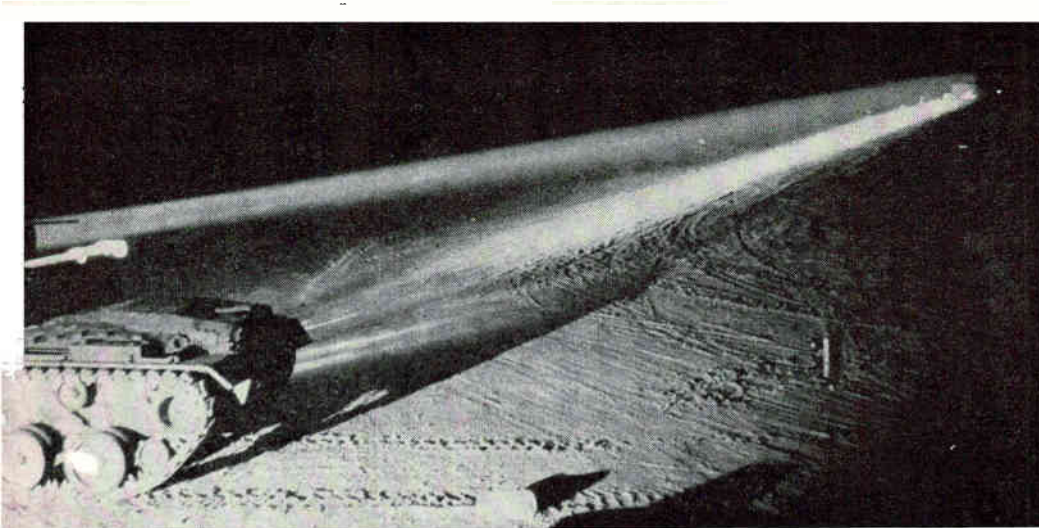

DUAL SEARCHLIGHT, providing visual light or infrared beam, lets tank operators use conventional or infrared viewing aids



IMAGE TUBE sees objects illuminated by near-infrared

New Army Image System Will Give Shielded Vehicles 360-Degree View

Image is collected on hyperbola, intensified and shown on ellipse

DETROIT—The coming generation of military ground vehicles will need viewing systems that permit “blind” navigation and fire control from behind a radiation shield.

Such a system, based on previous Army developments in infrared and image intensification devices, is being developed by the Army Mobility Command (Mocom) here and its Engineer R&D Labs at Fort Belvoir, Va.

An intensifier tube is attached to an image collector on the outside of a tank and the image is projected to the operator inside. The

system gives him an undistorted 360-degree view of his surroundings.

OPERATION—A hyperbolic collector atop the vehicle provides a 360-degree horizontal and 60-degree vertical field of view. The image is transmitted through the intensifier to an elliptical screen around the operator’s head. Distortion is avoided, since the ellipse is a conjugate of the hyperbola and has a reciprocal eccentricity.

Usable projections are obtained from dawn to twilight. The intensifier tube uses a zinc-cadmium-sulfide phosphor (P20). A high-output phosphor under development is expected to provide for starlight viewing.

Mocom calculations of system re-

quirements indicate a photocathode input illumination of 0.2 foot candles, output illumination of 17,700 and minimum resolution of 17 line pairs/mm. Mocom is considering the use of fiber optics to provide flexibility in the placement of operating personnel.

APPLICATIONS—The Air Force and other agencies see possible use of the system in helicopters. It might also be used on spacecraft—NASA presently settles for 180-degree vision. Coupled perhaps to fiber optics, it could substitute for conventional submarine periscopes. And the principle could be adapted to commercial 360-degree tv projectors—in fact, the project originally called for 360-degree tv projection in lieu of the image intensifier.

Auto Buyers Are Still Not Sold on Transistor

But most 1963 cars feature alternators and transistor radios

DETROIT — Automakers predict they will build 6.2 million to 7 mil-

lion of the 300 or so 1963-model cars being shown this week at the forty-fourth National Automobile Show. This is somewhat less than the near-record sales of 1962 models, but is still a source of satisfaction to suppliers of electronic auto-

mobile equipment. Since few electronic innovations are standard equipment, significant gains will only be made in a direct ratio to new car sales.

Transistor ignition systems are still optional in 1963, but may be



NIGHT TV. System uses a sensitive pickup tube



INTENSIFIER tube couples to standard tv orthicon tube to televise night operations. It intensifies images some 80,000 times

Authorities credit the concept to Donald Rees, of Mocom's research facility in Centerline, Mich. Optical calculations were provided by Donald Bowman, of Bowling Green University.

NIGHT VIEWING—Mocom also gave a demonstration recently at the GM Proving Grounds in Milford, Mich., of some of its night viewing projects. The illustrations show some of these systems.

gnition Systems

standard equipment on some 1964 models. Until now, the replacement market has been their only open door. Electric Auto-Lite expects to sell 7,000 of its units in this market in 1962 and about 35,000 in 1963. Also eyeing the aftermarket are

October 26, 1962

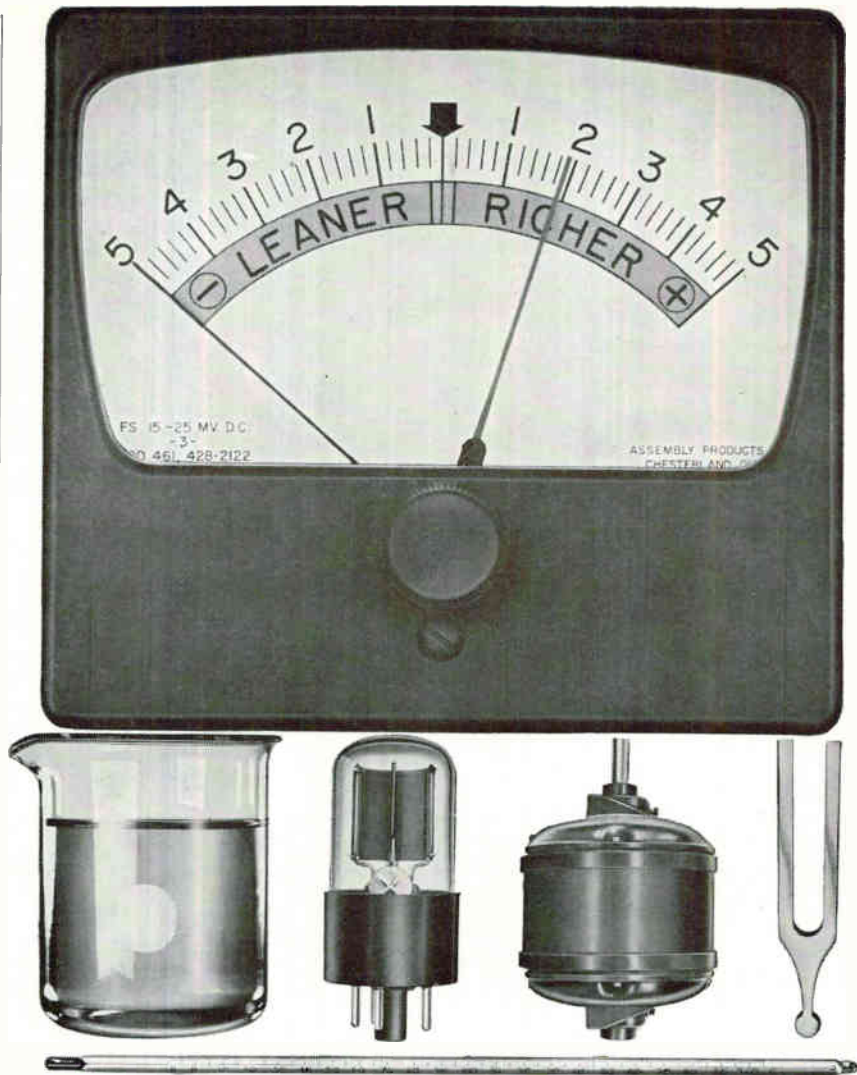

WITH A. P. I. METER-RELAYS YOU CAN MONITOR AND CONTROL JUST ABOUT ANYTHING!

Handy gadget, the A.P.I. meter-relay. You can use it to indicate, monitor, and control practically any electrically transduceable variable. Things like moisture content, pH, motor load, radiation level, temperature, speed, light, sound. And, because it's so highly sensitive (0-5 microamps or millivolts is the minimum range), you can pipe-in thermocouple, strain gauge and other low-level signals directly, without amplification.

It's a highly reliable device, too. You can reasonably expect to get at least 10,000,000 perfect make-break operations. You'll probably get twice that many. We have.

You can spec A.P.I. meter-relays in any range you want, from the minimums mentioned up to 0-50 amps or 0-500 volts, AC or DC. We can calibrate scales in any units you require. Control set-points can be either single (high or low) or double (both high and low). Catalog 4J will give you much useful and interesting information about meter-relays. It will also give you detailed, explicit specs and prices. Yours for the asking, of course.



ASSEMBLY PRODUCTS INC.

CHESTERLAND 4, OHIO

6A 2396

CIRCLE 31 ON READER SERVICE CARD 31

IN THE EXPANDING FIELD OF

PHOTOGRAPHY

THE UNIQUELY CONTROLLED
CHARACTERISTICS OF

CLAIREX[®] PHOTOCONDUCTIVE CELLS

... ARE THE BASES
FOR A GROWING NUMBER OF
PRECISION APPLICATIONS

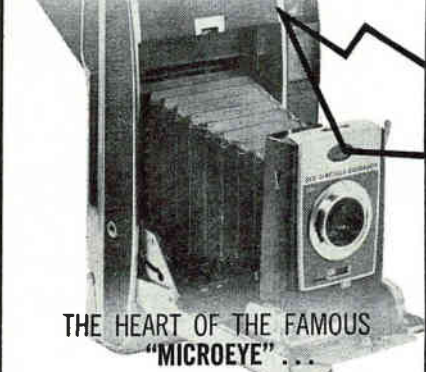

THE HEART OF THE FAMOUS
"MICROEYE" ...

in the Model 900 Polaroid[®] Land Camera is a Clairex cell of special design, with a sensitivity capable of controlling the precise adjustment of the exposure mechanism over a light range from less than 1/10 of one foot-candle to several hundred foot candles.

Clairex Corporation, through:

- CAREFULLY CONTROLLED CHARACTERISTICS
- CUSTOM DESIGN AND
- ULTRA SENSITIVITY

has pioneered the use of photoconductive cells in the photographic industry. A growing number of high quality still and movie cameras, exposure meters, enlargers and projectors are now using Clairex cells.



Approximately 1/2 actual size

The broadest standard line —
5 Series in both glass and metal
packages plus unique abilities to
custom engineer ... because "Photo-
conductors are our only business."

CLAIREX
CORPORATION

8 West 30 Street, New York 1, N. Y.
The Light Touch in Automation and Control



Motorola Automotive Products, with two different mechanisms (one with a magnetic pulse distributor), and Tung-Sol Electric, with a capacitive discharge system.

Ford expects to put extra-cost, optional transistor ignition on some 2,500 to 3,000 of its Super-Duty series trucks. Transistor ignition will also be optional in Ford Galaxies with high-powered 406-cubic-inch engines, but sales volume is expected to be low.

Ford developed its one-transistor system. Only 3 amp is needed to trigger the transistor, compared to about 5 amp in the conventional automobile ignition. Ford relies on contact points to switch the current to the transistor on and off.

Ford claims that single transistor units are inherently more reliable because of their simplicity. Others point out that a single transistor is not yet available with sufficient voltage, current and power rating at reasonable cost to give peak performance and reliability.

Pontiac is offering transistor ignition systems for car engines demanding premium grade fuel—70 percent of its 1962 cars had such engines. Pontiac will use a Delco-Remy system that contains three transistors, a zener diode and five resistors. Unlike part transistor units, such as Ford's it has no moving parts.

The Delco system costs \$75.12, an expensive item for the car owner who can't really tell whether his engine misses with conventional ignition. That is one reason industry observers believe the short-term future for transistor ignition is in trucks.

ALTERNATORS—Every 1963 car built by the major automakers will have an a-c generator, except the Corvair.

Chrysler introduced its first unit on the 1960 Valiant and has built 1,700,000 since. Chrysler's alternator, like the rest, uses six silicon diodes, (three positive, three negative) connected to the stator to change the alternating current flowing from the stator windings to direct current. The alternator regulator is a third the size of that for a d-c generator. Both the current regulator and the circuit breaker are eliminated, leaving only the

single voltage regulator relay.

Delco-Remy's new heavy-duty alternator is self energizing and has a built-in transistor regulator that controls the field current. It features an external adjustment for five voltage settings.

RADIOS—Virtually all radios installed in 1963 cars will be transistor. Studebaker is the only one with transistor radios optional at extra cost over tube-type receivers.

F-m models are available at extra cost for most cars except some compacts, and sales estimates for f-m sets by industry sources range from 5 to 10 percent of all radios installed. Last year, approximately 78 percent of all new cars sold carried a radio.

CRUISE CONTROL—AC Spark Plug's cruise control will be optional equipment on this year's Buicks. The system will hold to within 2.5 miles per hour a pre-selected speed, even on hilly roads. It utilizes the speedometer for setting the desired speed (with a pointer on the speedometer face) and for sensing speed variations.

A transducer sends electrical signals through a transistor amplifier to modulate a vacuum-actuated diaphragm power unit installed on the engine. Throttle position is controlled by the power unit.

Emergency Telephones

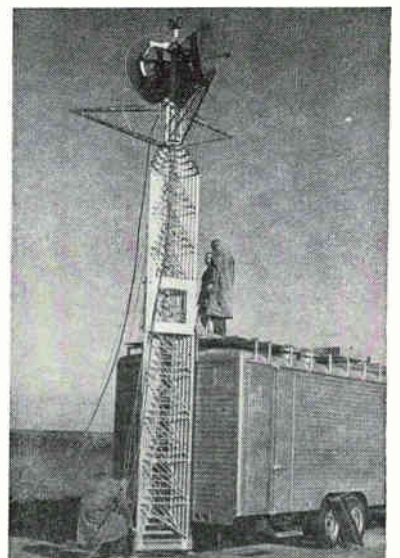

MOBILE microwave link built by Farinon Electric for Southern Bell Telephone provides 24-channel toll facilities for use when lines are downed by weather and other emergencies. Tower raises to 100 feet

ADVANCED
THIN FILM
MICROCIRCUITRY
PROVIDES NEW
DIMENSIONS
FOR LSI
INSTRUMENT
DIVISION
PRODUCTS

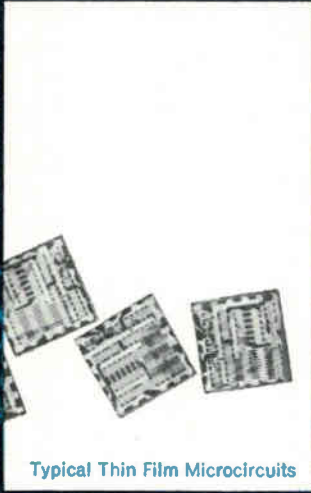

Typical Thin Film Microcircuits

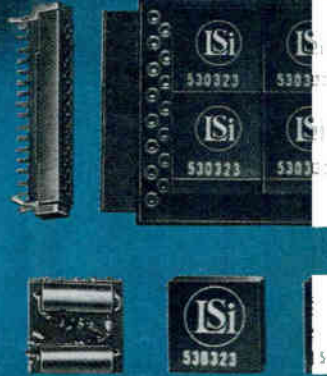

Microcircuit modules perform complex electronic functions formerly requiring assemblies many times their size and weight.

The Task: To provide the aerospace industry highly reliable, miniaturized electronic systems and components utilizing economical, mass produced thin film microcircuitry.

The Solution: A new, semi-automatic high vacuum deposition system developed by LSI for volume production of thin film microcircuitry...now in full scale operation at the Instrument Division. This highly precise production technique, coupled with a unique ability for extreme accuracy in the layout of electronic circuits, offers great flexibility in the design of Instrument Division electronic systems since it combines significant miniaturization with unusual performance and reliability characteristics. Instrument Division customers are being provided products with the many benefits which this unique microcircuitry production process affords, including substantial size and weight reduction, as well as greatly increased performance, reliability and extreme environmental characteristics. This is a portion of the LSI Instrument Division's continuing program to provide the next generation of aerospace guidance and control equipment, as fast or faster than requirements become known.

LEAR SIEGLER, INC.



INSTRUMENT DIVISION

CIRCLE 33 ON READER SERVICE CARD

110 IONIA AVENUE, N.W., GRAND RAPIDS, MICHIGAN

HOW TO LACE FOR



Why Gudebrod's Common Sense Approach to Lacing Problems Pays Dividends for Customers!

Recently a customer involved in the missile program came to us with a problem. He wanted a lacing tape that would be easy to use but must withstand extremely high temperatures . . . well above 1000°F!

We had to admit that we had no such tape. Our high temperature tapes such as GUDE-GLASS® have a maximum temperature range of 800°F. To solve this customer's problem, we developed GUDE-Q®, a revolutionary new lacing tape *that is essentially stable to temperatures in excess of 1500°F.*

GUDE-Q is a flat braid made from continuous length silica fibers that have been especially impregnated with a silicon finish to produce excellent handling and tying qualities. GUDE-Q lacing tape allows harnesses to be easily tied . . . knots don't slip, yet it withstands temperatures in excess of 1500°F.

Creating a new tape to meet high temperature requirements is but one of many ways in which we serve customers' needs. Whatever your lacing tape needs—civilian, military, fungus proofing, high temperature, color coding—Gudebrod's common sense approach to the problem will pay dividends for you because:

1. *Gudebrod lacing tape increases production!*
2. *Gudebrod lacing tape reduces labor costs!*
3. *Gudebrod lacing tape means minimal maintenance after installation!*
4. *Gudebrod is quality—our standards for lacing tape are more exacting than those required for compliance with MIL-T!*

Write today for our Technical Products Data Book which explains in detail the many advantages of Gudebrod lacing tape for both civilian and military use.

Address your inquiry and your lacing tape problems to:



GUDEBROD BROS. SILK CO., INC.

FOUNDED IN 1870

Electronics Division

225 WEST 34th STREET, NEW YORK 1, NEW YORK

MEETINGS AHEAD

MOTION PICTURE AND TELEVISION ENGINEERS Convention and Equipment Exhibit; Drake Hotel, Chicago, Ill., Oct. 21-26.

AEROSPACE & NAVIGATION ELECTRONICS EAST COAST CONF., IRE-PGANE; Baltimore, Md., Oct. 22-24.

COMPUTER APPLICATIONS SYMPOSIUM, Armour Research Foundation; Morrison Hotel, Chicago, Oct. 24-25.

ELECTRON DEVICES MEETING, IRE-PGED; Sheraton Park Hotel, Washington, D. C., Oct. 25-27.

QUALITY CONTROL MIDWEST CONFERENCE, Amer. Soc. for Quality Control; Statler-Hilton Hotel, Denver, Colo., Oct. 26-27.

MEDICINE & BIOLOGY ELECTRONICS TECHNOLOGY CONFERENCE, IRE-PGBME, AIEE, ISA; Edgewater Beach Hotel, Chicago, Ill., Oct. 29-31.

MISSILE & SPACEBORNE COMPUTER ENGINEERING TECHNIQUES CONFERENCE, IRE-PGEC; Disneyland, Anaheim, Calif., Oct. 30-Nov. 1.

TRI-SERVICE ELECTROMAGNETIC COMPATIBILITY CONFERENCE, Office of the Director of Defense Research, Armour Research Foundation; at ARF, Chicago, Ill., Oct. 30-Nov. 1.

PRODUCT ENGINEERING & PRODUCTION NATIONAL CONFERENCE, IRE-PGPEP; Jack Tar Hotel, San Francisco, Calif., Nov. 1-2.

INDUSTRIAL RESEARCH INSTITUTE MEETING; Queen Elizabeth Hotel, Montreal, Canada, Nov. 1-3.

MEDICINE & BIOLOGY ELECTRONIC TECHNIQUES CONFERENCE, IRE, AIEE, ISA; Conrad-Hilton Hotel, Chicago, Ill., Nov. 4-7.

NORTHEAST RESEARCH AND ENGINEERING MEETING, IRE; Somerset Hotel and Commonwealth Armory, Boston, Mass., Nov. 7-8.

LASERS & LASER APPLICATIONS, Ohio State University, at OSU, Columbus, Ohio, Nov. 7-8.

ACOUSTICAL SOCIETY OF AMERICA FALL MEETING; Olympic Hotel, Seattle, Wash., Nov. 7-10.

RADIO FALL MEETING, IRE-PGBTR RQC, ED, EIA; King Edward Hotel, Toronto, Canada, Nov. 12-14.

IEEE INTERNATIONAL CONVENTION, Institute of Electrical and Electronic Engineers; Coliseum and Waldorf-Astoria Hotel, New York, N. Y., March 25-28.

ADVANCE REPORT

OPTICAL MASERS SYMPOSIUM, Polytechnic Institute of Brooklyn, IRE, AIEE, Optical Society of America and U. S. Defense Research Agencies; New York City, April 16-18, 1963. Dec. 15 is the deadline for submitting papers to: Symposium Committee, Polytechnic Institute of Brooklyn, 55 Johnson Street, Brooklyn 1, New York. Specific topics include: quantum electro-dynamics and related topics in physics; materials (solid, liquid and gaseous systems; spectroscopy; optical properties; crystal growth; nonlinear effects; magneto-optic and electro-optic effects); optical maser configurations; systems considerations (communications, radar, astronomy, medicine, instrumentation, industrial processes, phonon modulation).

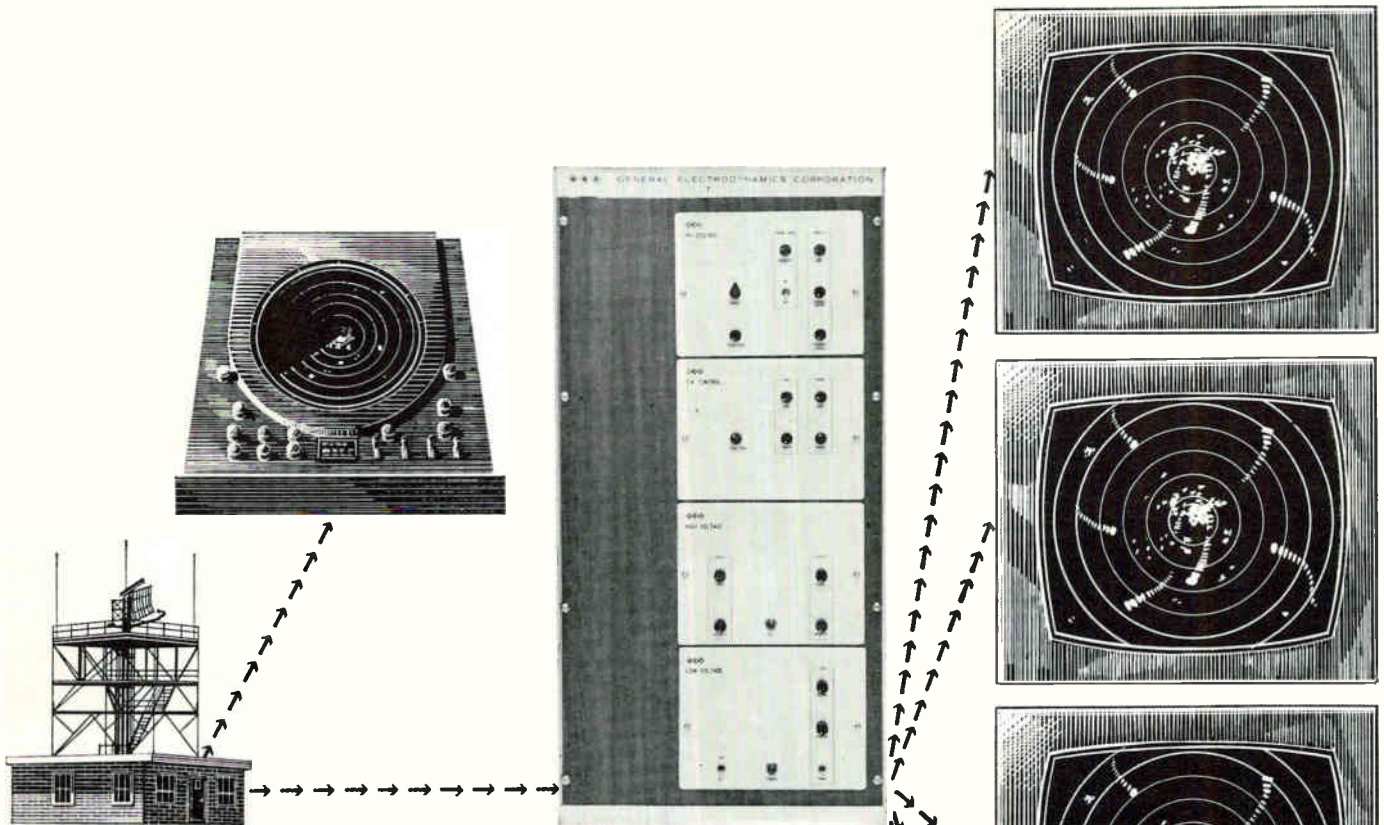

Now Multiple PPI Displays Under High Ambient Light Conditions... With G E C Scan Converter

With GEC's *transistorized* 6021 Scan Converter, it is no longer necessary to look at rapidly decaying PPI displays in dark surroundings. Any number of inexpensive TV monitors can be operated from one PPI source with controlled image storage time affording more reliable evaluation of displayed information.

Readily tailored to your specific requirements through its plug-in functional modules, the 6021 Scan Converter is capable of:

◆◆◆ TRANSLATION of video information from one scanning mode to any other.

◆◆◆ STORAGE and INTEGRATION of video information.

◆◆◆ TIME-COORDINATE TRANSFORMATION for expansion or reduction of bandwidth.

Contact GEC for more information about conversion of radar PPI to TV, TV standards conversion or conversion of slow scan narrow band TV to standard TV or vice versa.

Qualified electronic engineers are needed for work in the field of Scan Conversion. Address inquiries to Professional Placement Manager. An equal opportunity employer.

• • • advanced electronics at work



GENERAL ELECTRODYNAMICS CORPORATION

4430 FOREST LANE • GARLAND, TEXAS • BROADWAY 6-1161

NOW! Over 60 different styles of hard-anodized insulator wafers for all popular power transistors and stud mounted diodes

Greater thermal conductivity than conventional mica wafers.
 Excellent dielectric properties. Insulates semi-conductor from chassis and dissipates heat generated at rated capacities.
 Extremely durable with high abrasion and corrosion resistance.
 Installs between semi-conductor and chassis, heat sink or other surface on which semi-conductor is mounted.

Write for bulletin.
 Inquiries invited for special wafer configurations.

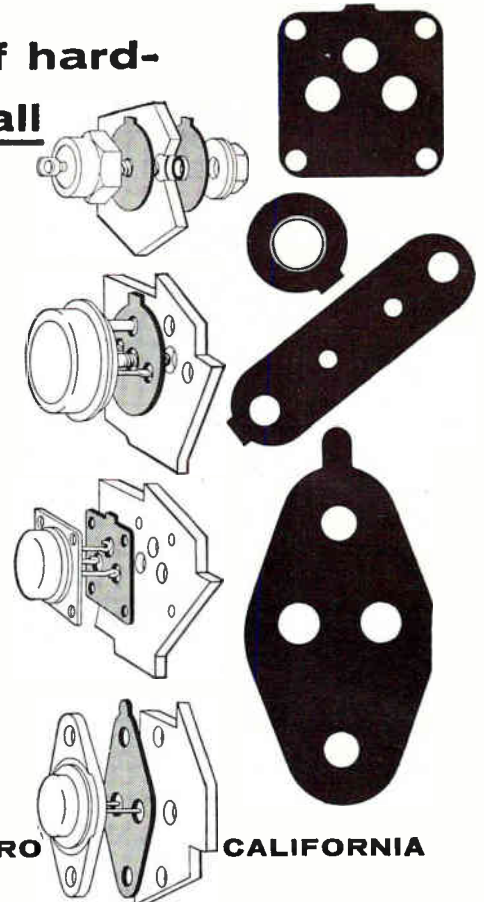

MONADNOCK MILLS • SAN LEANDRO CALIFORNIA
 DIVISION OF
 UNITED-CARR FASTENER CORP., BOSTON, MASS.

OFFICES: ATLANTA, BOSTON, CHICAGO, CLEVELAND, DALLAS, DETROIT, LOS ANGELES, NEW YORK, PHILADELPHIA, SYRACUSE
 CIRCLE 209 ON READER SERVICE CARD

SMALL PARTS STORAGE AND INVENTORY A PROBLEM?



Specifications: Box and lid each are molded in one piece of impact-resistant polystyrene crystal-clear, heavy-walled and reinforced with extra thickness at corners and rims; chemically inert, odorless, tasteless, non-toxic and dimensionally stable. Hand indentations at each end for easy lifting and transport; boxes stack easily for convenience and storage economy. Suitable for parts and findings of any size to capacity. Size 5" x 5" x 1 1/2", four boxes per cubic foot of storage space. Available immediately in any quantity. Shipped 6 per master carton of 8 pounds. Prices: \$1.50 each (6 or 12 pieces) scaled down to \$.85 each (over 720 pieces).

The Find-A-Parts Stock boxes the unique solution. Crystal clear, portable, tightly sealed against moisture and contamination.

Transparent parts boxes may be carried to workbench, yet stack securely when not in use. Indented lid serves as a shallow tray or holds stacked boxes securely.

These boxes are already being used throughout the electronics industry by such outstanding firms as:

- Varian Associates • Sylvania Electric Products Company
- Eitel-McCullough, Incorporated
- Hughes Aircraft Company
- Bourns Laboratories, Incorporated
- Litton Industries
- Lenkurt Electric Company, Incorporated
- Taylor Instrument Company
- Minneapolis-Honeywell Company
- AiResearch Manufacturing Company

FREE SAMPLE TO QUALIFIED REQUESTS Limited to employees of manufacturers listed in 1962-63 Electronics Buyers Guide. Please write on company letterhead.

PACIFIC PLASTIC PRODUCTS
 405 Airport Boulevard
 So. San Francisco, Cal.
 Phone: PO 1-1500



Are you a COMPLETELY INFORMED electronics engineer?

Today you may be working in microwaves. But on what project will you be working tomorrow? You could have read electronics this past year

and kept abreast of, say, microwave technology. *There were 96 individual microwave articles between July, 1961 and June, 1962!*

But suppose tomorrow you work in some area of standard electronic components, in semiconductors, in systems? Would you be up-to-date in these technologies? Did you read the more than 3,000 editorial pages that electronics' 28-man editorial staff prepared last year?

electronics is edited to keep you current *wherever* you work in the industry, *whatever* your job function(s). If you do not have your own copy of electronics, subscribe today via the Reader Service Card in this issue. Only 7 1/2 cents a copy at the 3 year rate.

electronics



VIBRATION NEWS

MB ELECTRONICS • A DIVISION OF TEXTRON ELECTRONICS, INC.
Representatives in principal cities throughout the world

New concept: MB Sine / Noise Discriminator boosts capability of vibration test equipment

More and more vibration test specifications require mixed sine and random signals, as well as independent control and programming of the sine and random spectra. Yet, present test practices for independent control have been impractical, expensive and time consuming.

The new MB Model N234 Sine/Noise Discriminator, when added to your test facility, will provide easier, more accurate mixed sine and random testing. It will also facilitate fundamental sine servo control.

In mixed sine/random testing this unique MB instrument performs four specific functions:

1. Permits control of sine spectrum independent of random noise.
2. Improves accuracy of sine servo control by eliminating resonant distortion from the feedback path.
3. Serves as 10 cps bandwidth spectrum analyzer.
4. Serves as a distortion analyzer.

Regardless of the random spectrum, the N234 provides a fundamental sine signal which can be used for programming constant acceleration; constant displacement; constant velocity; displacement-acceleration crossovers; or special shapes or steps.

Here's another important advantage: Set-up time of mixed sine random tests is reduced to 3 simple steps: (a) set random drive level, (b) set desired sine program and (c) energize sine sweep.

For complete information on how the N234 Sine/Noise Discriminator can improve your test capabilities write to MB Electronics, 781 Whalley Ave., New Haven 8, Connecticut.



A New Galaxy—



New Type IMM 648-1
Shown Actual Size

An entire circuit module compensated for phase, gain and zero drift over entire temperature range.

- 0.1 Cubic Inch Volume
- 0.1 Ounces in Weight
- Infinite Standby and Service Life
- Low Milliwatt Power Consumption
- High Shock and Vibration Resistance
- Electrical zero point and gain, repeatability and stability over entire service life
- Extremely broad bandwidth
- Carrier frequencies as high as 1 megacycle
- Input signal current resolution better than 0.01 μ a
- Absolute reliability



Micro Magnetic Modulator
Type IMM-655-2



Micro Magnetic Modulator
Type IMM-648-1



Micro Magnetic Modulator
Type IMM-664-1

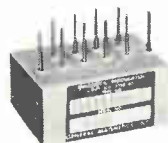

Micro Magnetic Modulator
Type IMM-680-1

1952-1962...weight reduced from 5 ounces to 0.1 ounce! The product of 2 years of intensive development work, new completely microminiaturized magnetic modulators feature an essentially drift-free circuit with superior phase and gain stability over wide environmental ranges. All the ruggedness, dependability, wide dynamic range and stability that are characteristic of the larger magnetic modulators are engineered into this new magnetic circuit. "MICRO MAG MODS" are shock and vibration proof, provide the ultimate in reliability and unlimited life.

of "MAG MOD"®

MICRO MAGNETIC MODULATORS

— provide repeatable data over years of continuous, unattended operation

"MAG MODS" provide four quadrant operation, extreme stability with negligible change of phase, gain and zero position over a wide temperature range. Design is simple, lightweight, rugged with no vacuum tubes, semiconductors or moving parts to limit life. "MAG MODS" offer infinite design possibilities and impedance levels, and are adaptable for algebraic addition, subtraction, multiplying, dividing, raising to a power and vector summing.

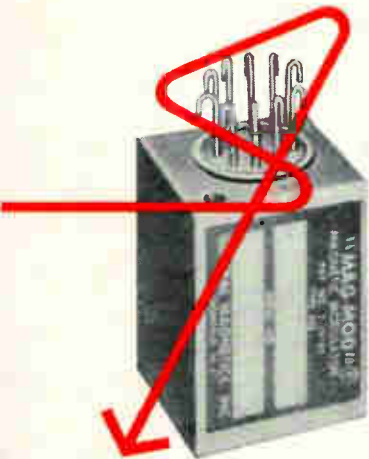

*Absolute Reliability
in Micro Magnetics*

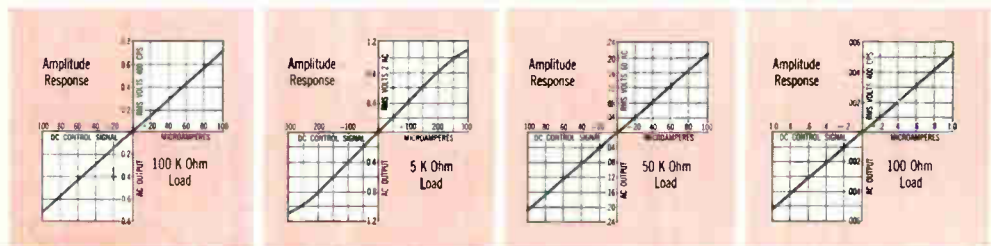

TYPE NUMBER	IMM-655-2	IMM-648-1	IMM-664-1	IMM-680-1
Reference Carrier Voltage and Frequency	3 V @ 400 cps	2 V @ 2 KC	10V @ 60 KC	115 V @ 400 cps
Input Control Signal Range	0 to ±100 μa DC	0 to ±300 μa DC	0 to ±100 μa DC	0 to ±10 μa DC
AM Phase Reversing AC Output Range	0 to 0.8 V RMS @ 400 cps	0 to 1.0 V RMS @ 2 KC	0 to 200 mv RMS @ 60 KC	0 to 30 mv RMS @ 400 cps
RMS mv AC Output/μa DC Signal Input	7 mv/μa	4 mv/μa	2 mv/μa	5 mv/μa
AC Output Null (Noise Level) mv RMS	5 mv RMS Max.	5 mv RMS Max.	10 mv RMS Max.	100 mv RMS Max.
Output Impedance	14 K ohms	1000 ohms	11 K ohms	Approx. 150 ohms
External Load	100 K ohms	5 K ohms	50 K ohms	100 ohms
Zero Drift over Temperature Range	±0.1 μa Max.	0.5 μa Max.	—	0.05 μa Max.
Hysteresis in % of Max. Input DC Signal	0.2% Max.	0.2% Max.	0.5% Max.	0.1% Max.
% Harmonic Dist. in Output Product Wave	15%	10% to 15%	5%	20%
Temperature Range	-55°C to +125°C	-55°C to +125°C	-55°C to +125°C	-55°C to +125°C
Frequency Response	5 K Series, 108 cps	Over 200 cps	Over 5 KC	Over 100 cps
Approximate Weight (in Ounces)	0.2	0.1	0.2	0.2

GENERAL MAGNETICS • INC

135 BLOOMFIELD AVENUE
BLOOMFIELD, NEW JERSEY

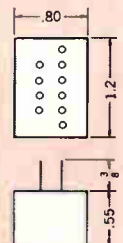
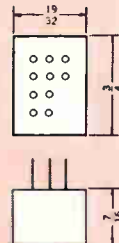
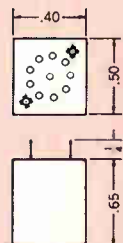
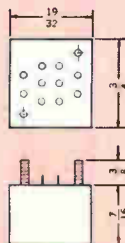

Catalogs are available on Micro Magnetic Modulators, Standard Magnetic Modulators, Miniaturized Multiplying Modulators and Transistor Oscillators. Call or write for your copies, or ask to have a GENERAL MAGNETICS representative contact you for consultation on specific applications.

CIRCLE 39 ON READER SERVICE CARD

NEW FROM EAI!

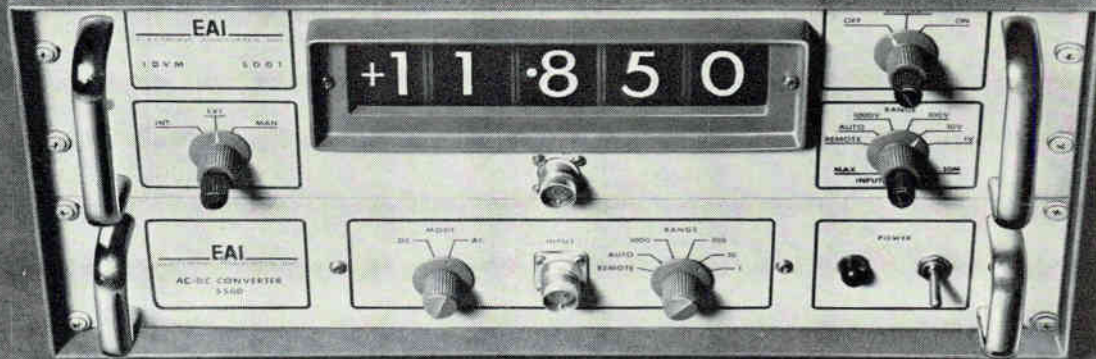

Solid-State, High Speed, Ultra-Stable, Automatic, Programmable AC/DC DVM for \$6,250

Key specifications of the outstanding new EAI Series 5002 AC/DC solid-state digital voltmeter are:

- Range and Resolution: 0.0001 to 1199.9 volts
- Absolute Accuracy, DC: $\pm 0.01\%$ ± 1 digit, AC: $\pm 0.06\%$ + 1 digit to 5 kc, $\pm 0.1\%$ + 1 digit to 10 kc
- Stability: 6 months without recalibration
- Reading time max., DC: 10 ms.**, AC: 160 ms.**
- Input impedance, DC: 10 megohms constant, AC: 1 megohm resistive
- Size: 8 $\frac{3}{4}$ inch by 19 inch RETMA panel

Features include automatic ranging or remote command of range, function, trigger, etc.; complete electrical outputs; overrange protection; in-line, in-plane display; and simple DC calibration for both AC and DC inputs.

**without range or polarity change

Other EAI solid-state instruments with comparable resolution, accuracy, stability, speed and reliability are:



Series 5000 4 digit DC voltmeter



Series 5001 4 digit with overrange, automatic and programmable DC voltmeter



Series 5101 4 digit with overrange, automatic and programmable DC volt-ohmmeter



Series 5003 4 digit with overrange, automatic and programmable AC/DC volt-ohmmeter

Write today for detailed descriptive literature.

EAI

ELECTRONIC ASSOCIATES, INC. Long Branch, New Jersey

we
have
designs
on
space

ELECTRONIC DESIGN ENGINEERS:

Astronautics is a 100 percent space-oriented company. If you share our consuming interest — if you, too, have *designs on space* — then we can offer you participation in a number of highly advanced, technically challenging programs.

And at Astronautics, electronic design specialists are encouraged to *finish what they start*. To make it possible, we provide one of the most advanced electronic development laboratory complexes in the country, plus the latest in production facilities.

The history of Astronautics is bright with significant electronic breakthroughs, achieved through this "start-to-finish" philosophy. To name a few:

AZUSA MARK I AND MARK II TRACKING STATIONS at AMR, used for range safety and vehicle performance evaluation;

AZUSA TRANSPONDERS for Atlas, Titan, Polaris, Minuteman, and other vehicles;

FLIGHT CONTROL AND TELEMETRY SYSTEMS for Atlas weapon systems, Atlas space boosters, Centaur and scientific passenger pods;

TEST AND LAUNCH CONTROL EQUIPMENT for Atlas and Centaur.

Today, designs are under way on a world-wide tracking system to be designed, built, and installed by Astronautics. We're also at work on new techniques in flight control and telemetering systems for a variety of future space programs.

Like to learn more about this great electronic design team and how your talents can grow with it? There are more details on the reverse page, and you'll find a convenient Professional Inquiry Card attached. Mail it today, in complete confidence, of course. If it has been removed, or if you wish to request or furnish more detailed information, write to Mr. R. M. Smith, Chief of Professional Placement and Personnel, Department 130-90, General Dynamics | Astronautics, 5770 Kearny Villa Road, San Diego 12, California.

GENERAL DYNAMICS

**GIIMMID
ASTRONAUTICS**

ELECTRONIC DESIGN ENGINEERS...

JOIN GENERAL DYNAMICS | ASTRONAUTICS... *the company with designs on space!*

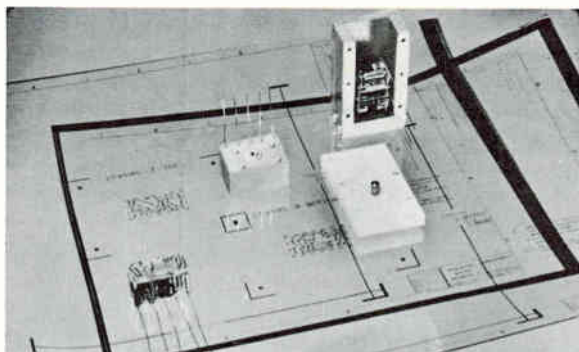

Welded module development



Azusa Mark II Tracking System at Cape Canaveral



Developmental model of 400 MC transponder, utilizing welded module construction

These photos graphically illustrate the interests and achievements of Astronautics in the field of electronics. Permanent positions are now open for outstanding engineers in the areas of specialization described below.



Electron microscope used for epitaxy research

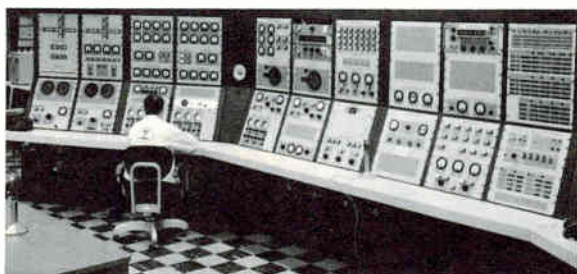

Control console for Azusa Mark II tracking system at Cape Canaveral

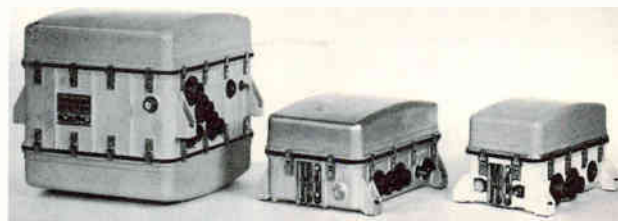

Centaur flight control electronics

Research and Development

These positions are for senior scientists to participate in company-sponsored research in thin films and solid state for applications to microminiaturization, solar energy conversion, and magnetic computer components. Training should be in the area of solid state physics, physical chemistry, electronics, metallurgy or ceramics. Advanced degree preferred.

Launch Control System Design

Assignments involve the study, analysis, and development of complete launch control systems for space vehicles. Problems of electrical, electronic, mechanical and fluid systems are integrated to develop optimum launch system configuration. Knowledge of computer applications, network analyzers, simulators, responders and checkout systems is desirable. An appropriate degree and experience in development of mathematical models of logic systems are required.

Microwave Design

Positions involve investigating use of semiconductor non-linear devices such as tunnel diodes and varactors for microwave application to phase shifting, detection, amplification, diplexing, frequency conversion and other functions necessary to support space and ground based RF tracking and telemetry systems. Will perform design and development work on strip line microwave circuitry, mixers, diplexers, power dividers, filters and harmonic generators. A BSEE or MSEE and appropriate experience are required.

Advanced Electronic Systems

Assignments are on such projects as giant boosters, nuclear-propelled space vehicles, earth-to-moon logistics bus, and space stations. Experience should include advanced design work in such electronic areas as guidance, communications, telemetry, data processing systems, antenna systems, or electronic ground support systems. An advanced degree is required.

Instrumentation Design

Requirement is for engineers able to accept design responsibility for measurement systems to monitor pressure, temperature, position, acceleration, vibration, strain, flow and unique phenomena associated with static and flight test programs. Will perform design and development work on transducers, transducer installation, instrumentation cabling and networks, signal conditioning and data gathering systems. A BS or advanced degree in EE or physics and appropriate experience are required.

Guidance Systems Analysis

Assignments are to originate, improve, and apply advanced techniques to guidance systems development, analysis and flight simulation. A sound background in feedback theory and knowledge of celestial mechanics is desirable. A BS in EE, physics, or mathematics required.

Tracking Equipment Design

Positions are for circuit and system designers with experience in UHF, SHF, and microwave equipment. Solid state background in development of receivers, ultra-stable oscillators, high-frequency, high-powered amplifiers and similar type circuitry desirable. Openings also exist for system designers experienced in CW tracking equipment and related peripheral equipment for development of hardware for ground station and space vehicle applications. A BS or MS in EE, plus appropriate experience, are required for all positions.

OPENINGS ALSO EXIST FOR EE'S IN MANY OTHER AREAS.

Further details will be found on the reverse page. To receive the full story, mail the attached Professional Employment Inquiry Card or communicate with Mr. R. M. Smith, Chief of Professional Placement and Personnel, Department 130-90, General Dynamics | Astronautics, 5770 Kearny Villa Road, San Diego 12, California.



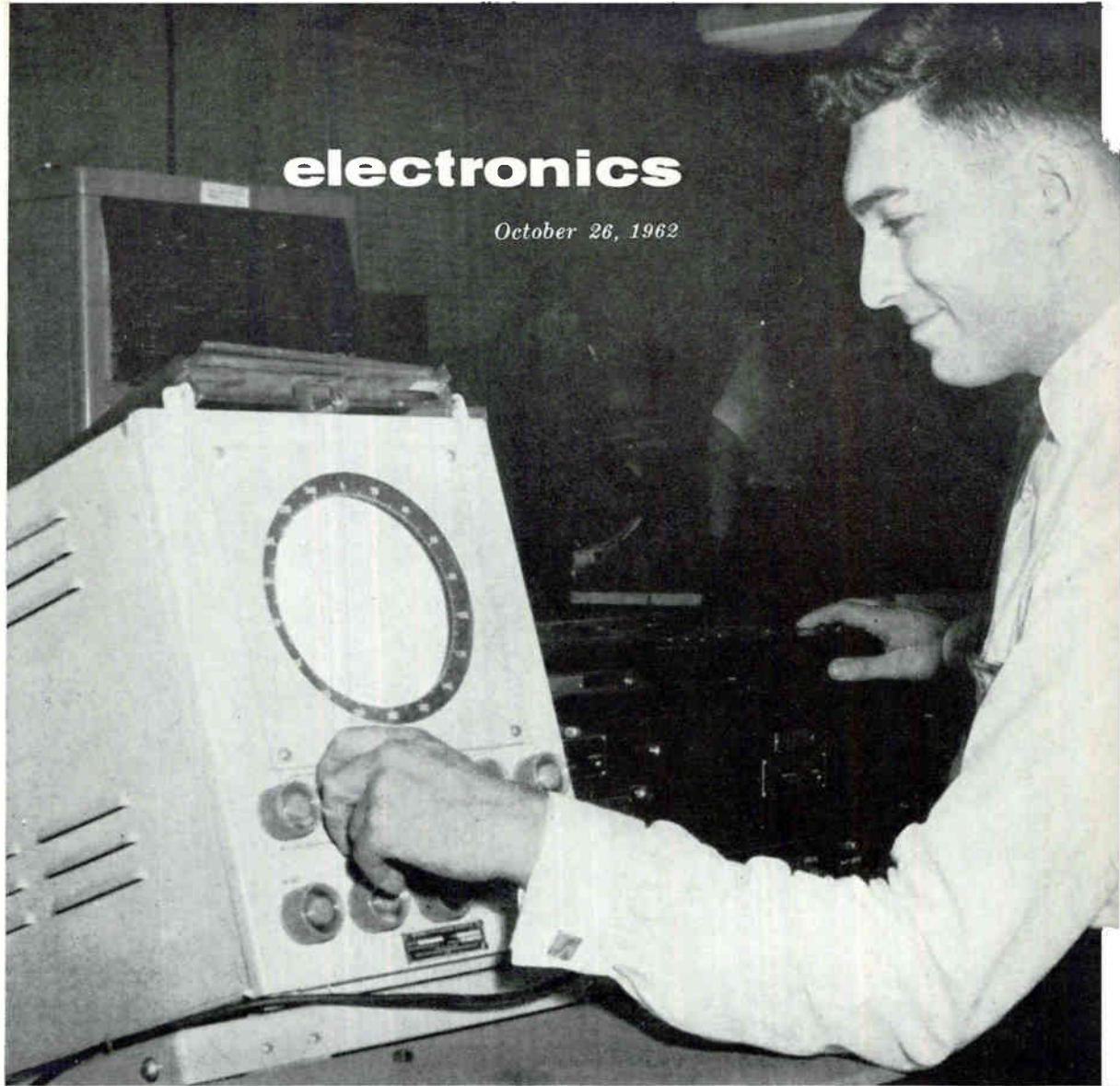

SCANNING DISPLAY on oscilloscope, used in shape recognition system

Eliminating the Human Observer

IN AIR AND SPACE SCOUTING MISSIONS

Systems using property abstractive techniques will be able to recognize terrain types, locate intruding missiles, and identify straight lines on aerial photographs

By AZRIEL ROSENFELD

Budd Electronics, Long Island City, N. Y.

REAL-TIME reconnaissance and surveillance have been made increasingly difficult by the trend toward higher weapon delivery speeds. Shrinkage of the admissible time delay between detection and decision will soon make it necessary to eliminate or at least reduce the human factor in these operations. This will require the development of reliable, fail-safe automatic recognition techniques.

This article discusses three gen-

eral automatic recognition problems, representative of those encountered in surveillance and reconnaissance.

Their solutions lie well within the present state of the data-processing art.

The technique describes a general class of approaches to automatic pattern recognition that may be called property abstractive approaches. In these approaches, recognition is based on the analysis of specific predetermined sets of measurements, made on the observed input. They may be distinguished on the one hand from approaches based on template matching of the total input, and on the other hand from approaches based on statistical sampling and self-organization. In complex input situations the abstractive approaches tend to be more economical of time and equipment.

The recognition problem situations described here have been stated in terms of military surveillance and reconnaissance operations; however, the techniques themselves are applicable to a wide variety of nonmilitary situations.

POINT PATTERN RECOGNITION—Space surveillance systems

may come to rely at least in part on spaceborne sensors. Because of power limitations, these may be passive optical sensors that detect intruding objects against the background of the star field. To predict the path of an intruder, it must

first be located on the celestial sphere. This can be done rapidly and automatically if the star pattern in the intruder's vicinity can be identified. The star-pattern identification problem may be thought of as a problem in auto-

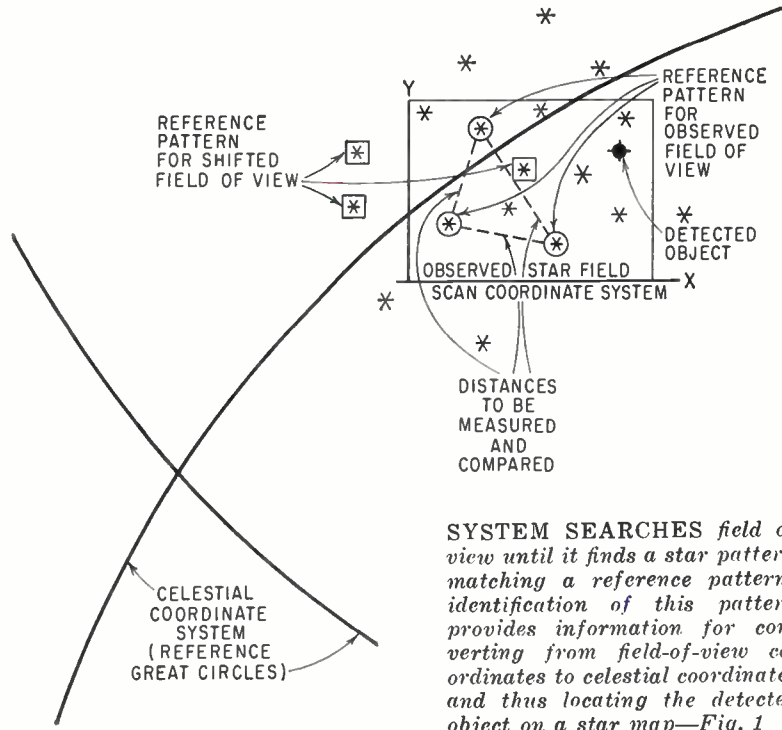

SYSTEM SEARCHES field of view until it finds a star pattern matching a reference pattern; identification of this pattern provides information for converting from field-of-view coordinates to celestial coordinates and thus locating the detected object on a star map—Fig. 1

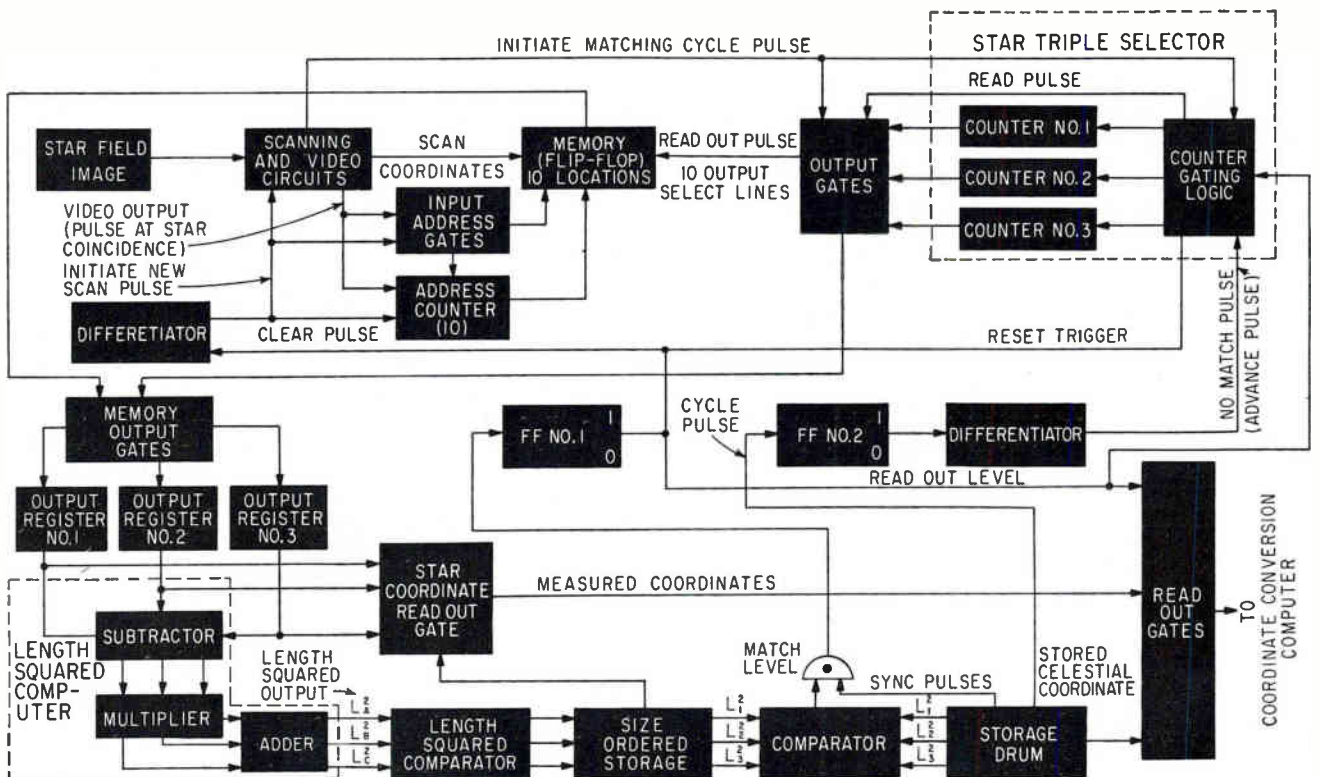

STAR PATTERN recognition system, including memory, computer and input logic circuits is based on point pattern recognition—Fig. 2

matic point pattern recognition.

Natural methods of characterizing point patterns by property abstraction are provided by the basic congruence theorems of elementary plane geometry. For example, two triangles are congruent if and only if the three sides of one are respectively equal to the three sides of the other. This implies that a three-point pattern can be recognized by measuring the distances between the points and comparing the resulting triple of numbers with the triples of interpoint distances for the reference patterns. Unless the triangle is exactly isosceles, recognition of the pattern determines the identity of each of the three points. Similar recognition criteria can be formulated for more complex point patterns.

To locate unambiguously any observed part of the sky, a star-pattern recognition scheme must employ reference patterns unique in the sky, and so distributed that at least one of them lies within every possible field of view. Since any pattern will almost certainly be unique if the measurements used to identify it are sufficiently accurate, the requirement of uniqueness

TEACHING COMPUTERS TO SPY

Machines that recognize and identify patterns, shapes and textures, though opening a wealth of new applications and great possibilities, seem very far off in the future to most of us. However, in this article author Rosenfeld demonstrates that pattern, shape and texture recognition are within the capabilities of today's computers.

He proposes three systems, all based on the property abstractive approach, as distinct from template matching or self-organizing approaches, and shows how they could be used to ease the enormously increasing difficulty of classifying and interpreting reconnaissance and surveillance data

simply serves to restrict the coarseness of the interpoint distance measurements.

The geometry of the star-pattern recognition problem is sketched in Fig. 1. A system for star identification based on point pattern recognition is outlined in Fig. 2.

The star-field image is scanned

and the scan output examined to determine the positions of stars above a preset brightness level or magnitude. This level can be adjusted so that the number of stars in the field that exceed the level is never greater than, say, 10. The coordinates of the scanning spot are fed to a 10-address memory, which may be composed of flip-flops. At the point where the first star is detected a pulse appears on the video output and enables the input gates to position ONE in the memory. Simultaneously, this pulse steps the address counter to address number two where the next detected star is to be stored. At the conclusion of the scanning process a pulse to the star triple selector initiates the matching cycle.

The star triple selector interrogates the memory for the coordinates stored in three of the ten locations. The triples selected include all possible combinations. The first combination chosen is 1-2-3. Should no match result for a given combination, the counters are advanced to the next possible triple.

Should no match occur and the field have been exhausted, the counter generates a reset trig-

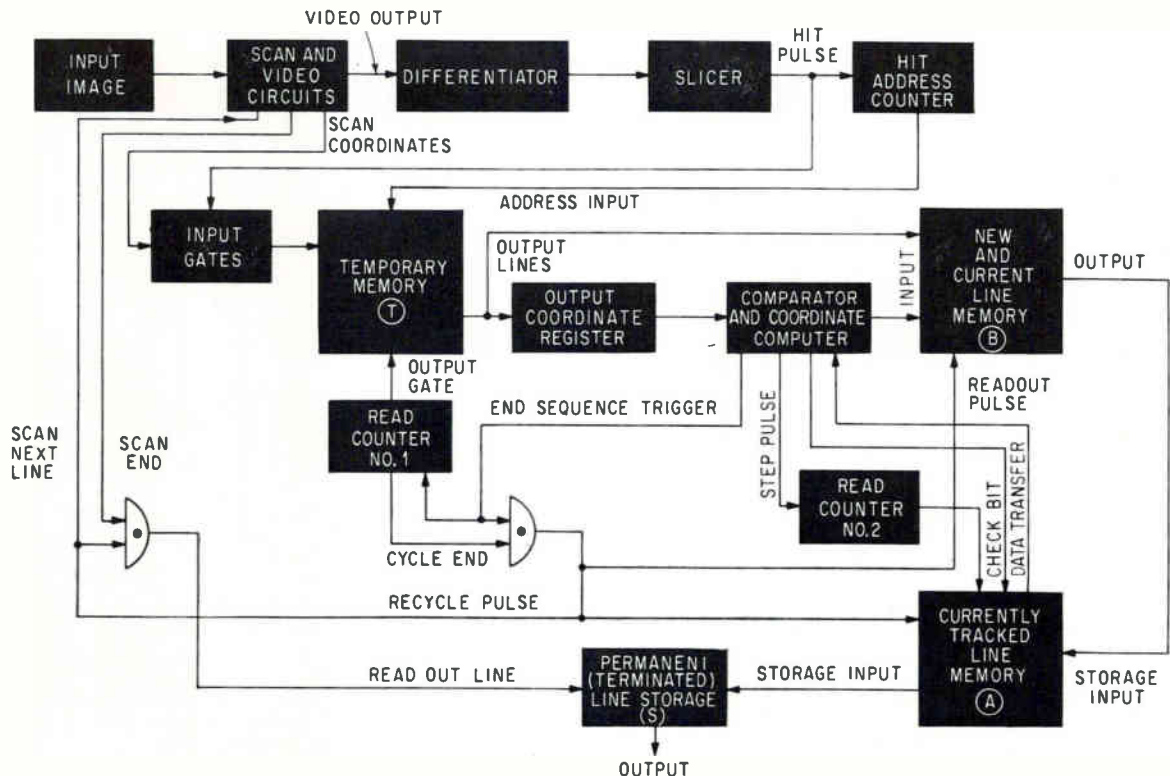

STRAIGHT LINE recognition system is based on constant angle of intersection between tracked line and scanning lines—Fig. 3

LINE HIT TRACKING is illustrated by aerial photograph and outputs of scans along three lines indicated by arrows —Fig. 4

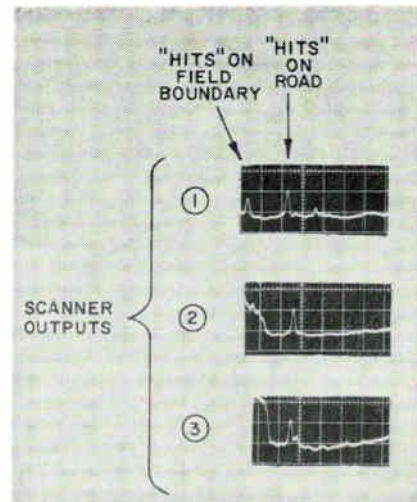
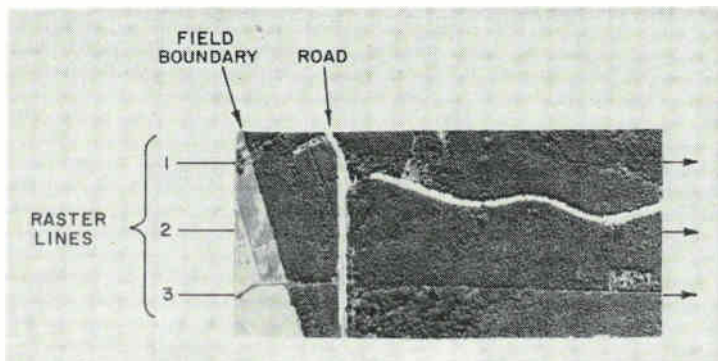

ger which resets the selector, clears the star coordinate memory and triggers the scanning circuits to process another field.

The lengths of the sides of the triangle formed by the selected star triple are next computed. The distance between two points in the image having scan coordinates (x_1, y_1) and (x_2, y_2) is

$$L = \sqrt{(x_1 - x_2)^2 + (y_1 - y_2)^2}$$

Since squared distances determine triangle congruence just as distances do, it is unnecessary to take the square root. The arithmetic thus consists of subtraction of corresponding coordinates, multiplication of these differences by themselves, and addition of the results. This process is done for the three combinations of the selected stars taken two at a time, and the results L_A^2 , L_B^2 , and L_C^2 are formed at the output of the adder.

The quantities L_A^2 , L_B^2 and L_C^2 must be matched against a set of squared triangle side lengths which are stored, say, on a magnetic drum. To facilitate comparison,

each triple should be arranged in order of size, say with largest first. If this is not done, three comparisons are always needed to determine whether the selected star triangle is congruent to a given stored triangle. Preordering by size reduces this required number of comparisons, since if the largest squared distances do not match, no further matching is necessary. The number of comparisons can be reduced further by arranging the stored number triples in order of size of first terms; when these are equal, in order of size of second term; and when these too are equal, in order of size of third terms.

The length squared comparator compares the numbers representing L_A^2 , L_B^2 and L_C^2 and sorts the largest one into the L_1^2 position in the size ordered storage, the next largest into the L_2^2 position, and the smallest into L_3^2 . Simultaneously, the scan coordinates of the stars bounding the longest side of the triangle are gated to the output gate in anticipation of a successful match.

When the set of three squared lengths has been stored in the size ordered storage, the comparator begins matching them with those on the storage drum. Since the drum rotates continually, two additional tracks synchronize the matching operation. One of these is a sync pulse track which generates a pulse for each set of stored data. The second provides a cycle pulse at the start of the stored data, used to denote the start of a cycle and to generate a no-match pulse if no match is found for any of the triples on the drum. This pulse feeds the trigger input of flip-flop No. 2. After the passage of two cycle pulses, the entire drum has been processed, and a no-match pulse is generated by this flip-flop. This in turn advances the counters in the star triple selector.

If a match is found, the stars in the matched triple which belong to its longest side must be the same as the stars whose scan coordinates have been gated to the output gate.

Coordinates are stored on the drum for these two stars in each

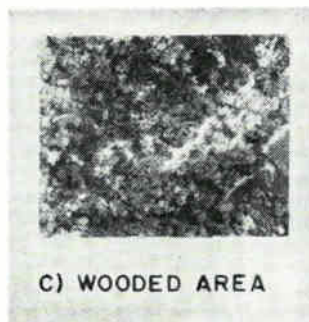
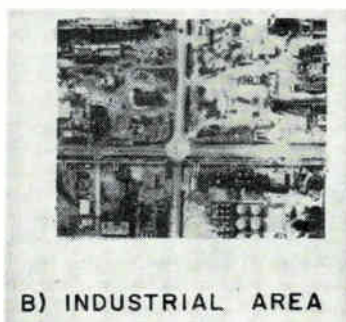
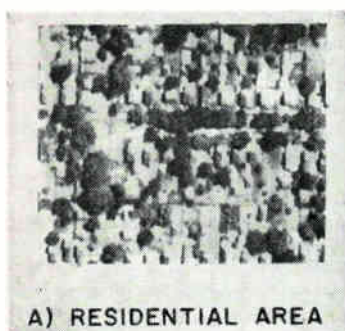

TERRAIN TYPES typical of reconnaissance problems can be automatically identified by statistical analysis as shown

reference triple. The match level energizes an AND gate feeding the corresponding sync pulse from the drum to trigger flip-flop No. 1. This flip-flop gates the read-out gates to permit transfer of the stored and measured coordinates into a coordinate conversion computer.

SHAPE RECOGNITION—Developments in reconnaissance sensors and sensor-carrying vehicles have made enormous quantities of reconnaissance imagery available on virtually a real-time basis. Some means for automatically screening the images early in the interpretation is needed to relieve the human interpreter of routine screening tasks and make it possible for him to devote his attention to those aspects of image analysis which cannot be performed automatically. An example would be the rejection of all frames that contain no cultural features. Since such features almost invariably involve objects bounded by straight lines, a close approximation to cultural feature screening can be achieved if the straight-line boundaries which a picture contains can be automatically recognized.

A property-abstractive method of straight-line recognition is provided by the linearity property that analytically characterizes a straight line: successive intersections of a straight line with the lines of a cartesian raster must be in a linear progression. A straight line can thus be recognized by scanning the image in raster fashion and using conventional linear tracking logic to predict the positions of successive intersections. To avoid computational difficulties, two mutually perpendicular rasters

should be used, and the logic designed to detect only lines making angles of at least 45 deg with the raster.

A system for straight-line recognition based on tracking principles is shown in Fig. 3. The output of the system is a set of numbers that specify the lengths and locations of those straight lines in the image that cross at least three raster lines and make angles with them of 45 deg or more. The input image is scanned and the resulting video signal is then differentiated. A line hit is considered to have been detected when the level of the differentiated signal exceeds a preset threshold. The tracking of such hits from raster line to raster line is illustrated by the series of flying-spot scanner traces in Fig. 4. A hit above the threshold level generates a hit pulse to indicate a sharp change in the video level. The scan coordinates are simultaneously fed to the memory input and the hit pulse gates the coordinate data into the memory. The address counter steps the gating to allow the coordinate data to be stored sequentially in the temporary memory *T*.

Each hit point is next compared with each of the lines, if any, being tracked—that is, which had intersections with the preceding raster line. The coordinate of each new hit point, the coordinate of the last detected point of each current line and the slope of this line are tested to determine whether the new point lies within acceptable limits of error of the predicted path of the line. These limits are determined by the number of times the line has already been detected. Thus, if the line has been detected only once, the allowable error is equal to the space between raster lines, corresponding to a slope uncertainty of ± 1 (i.e., ± 45 deg).

When the line has been detected more than once, the allowable error decreases sharply.

If a new point fits a current line, the data describing this line are updated—that is, the number of raster intersections is increased by one, the coordinates of the new point become the coordinates of the last detected point, and a new average slope is computed. If no

new point fits a current line which has been detected, say, three or more times, the data describing this line become part of the system output. If two new points are close together, both may fit the same current line. The data then must be updated using both new points, so that the line splits in two. Whether or not a new point fits any of the current lines, the point is also taken as the possible initial point of a line; this creates a new current line with the given point as its last detected point, number of detections 1, and slope angle nominally 90 deg (with a ± 45 deg uncertainty). If there are no current lines, as when the first raster line is being scanned, this initial point processing is all that is necessary.

Suppose that n lines have already been scanned and that the system is ready to scan the $n + 1$ st line. At this point, storage *S* contains quadruples of numbers $(n_i, x_i, s_i, k_i) =$ (last raster line on which detected, coordinate of intersection with this line, average slope, number of times detected) describing lines which have terminated; memory *A* contains triples of numbers $(x_j, s_j, k_j) =$ (coordinate of intersection with last or n^{th} line, average slope, number of times detected) that describe the lines still being processed; and memories *B* and *T* are empty. The $n + 1$ st line is now scanned and the coordinate y of each hit point is recorded in memory *T*. Each of these y 's is now processed: For each j , $|x_j + s_j - y|$ is computed and compared with a quantity q_j (the allowable error), which is a decreasing function of k_j . If the absolute value exceeds q_j , nothing further is done. If it does not exceed q_j , the triple of numbers $(y, (y - x_j + k_j s_j) / (k_j + 1), k_j + 1)$ is inserted in memory *B*. This corresponds to the new latest detected point, new average slope, and new number of detections of the line formerly represented by (x_j, s_j, k_j) , which has now been tracked across raster line $n + 1$. At the same time a special check bit is inserted into memory *A* adjacent to the triple (x_j, s_j, k_j) . This bit indicates that the line represented by this triple has continued across the $n + 1$ st raster line



in the above five samples—Fig. 5

and is not yet to be transferred to storage *S*.

This process is performed for the coordinate *y* in combination with every triple in memory *A*. In addition, the triple (*y*, 0, 1) is entered into memory *B*; this represents the possibility that *y* may be the initial point of a new line.

The foregoing processing is applied to every coordinate *y* of a point detected while scanning the *n* + 1st line. When this has been done, all triples in memory *A* which have not received check bits and for which $k_i \geq 3$ are transferred into storage *S*. These triples represent lines which have been detected three or more times and which have terminated at the *n* + 1st line. In addition, an *n* (the number of the last raster line on which these lines were detected) is stored next to each of these triples in storage *S*, making them quadruples as described earlier. Memories *A* and *T* are now erased and memory *B* is shifted into memory *A*. The system is now ready for the processing of the *n* + 2nd line. This discussion applies also when the line being scanned is the first one. Then storage *S* and memory *A* are empty; memory *B* receives only triples of the form (*y*, 0, 1); and nothing is transferred from memory *A* into storage *S*.)

The read counter successively gates the data from memory *T* through the output lines to the output coordinate register which feeds the comparator and coordinate computer. At the end of each comparator sequence, the end sequence pulse steps read counter No. 1 to the next memory address. In addition, when read counter No. 1 has gone through all the addresses, the end sequence trigger is gated with a cycle end signal from the counter and is used to recycle the system. This recycle pulse serves to read the data in memory *B* into memory *A*, to transfer data from memory *A* to the permanent storage *S*, and to initiate the next scan. In the event that the last line has been scanned, a scan end signal from the scanning and video circuits is gated with this recycle pulse to gate the readout line in the storage *S*. During the comparator cycle memory *A* is successively interrogated by a step

pulse from the comparator driving read counter No. 2. This pulse is fed to the comparator by the data transfer line.

TEXTURE RECOGNITION—An analysis of reconnaissance imagery interpretation reveals that shape is not the only basis on which targets are identified. Although shape and size information plays a key role in the recognition of many important target types, it is less important in the identification of basic terrain types, such as urban areas, bodies of water, or wooded areas. For examples of typical terrain types, see Fig. 5. These terrain types may themselves be target areas, or may provide important clues to the identification of targets.

A property-abstractive approach to the identification of terrain types can be based on the analysis of the visual texture of the image.

Texture is here defined as depending on the statistics of the distribution of densities and contrasts in the image.

A region of the image is recognized as showing a given terrain type if a statistically adequate sample of its densities and contrasts has distributional parameters within the range corresponding to the terrain type in question.

A discussion of statistical criteria for the recognition of specific terrain types will not be attempted. Instead, a generalized system of image density and contrast sampling for statistical analysis will be described.

For simplicity, the discussion is based on a one-dimensional or line image. The system can be generalized to one of two dimensions by performing a one-dimensional analysis in every direction through every point of the two-dimensional image. For many practical purposes, however, analyses in a few independent directions will generally yield adequate two-dimensional texture information.

The input to the texture analysis system is a video signal from a scan of the given line image. The system must measure statistical parameters of the distributions of values of the video signal and of its derivative. Since visual perception

is inherently resolution-limited, the signal values and derivatives can be averaged over small time intervals of length corresponding to resolution limits. Although this should be done for an interval of the given length having every possible initial point, this is impractical. Instead, it can be done for consecutive intervals which are significantly smaller than the resolution limit.

A possible implementation of the texture analysis system operates as follows.

The output of the scan circuit is fed to an averaging circuit, basically a capacitor. In a parallel channel the video is differentiated and fed to a similar averaging circuit. These circuits produce an average video and an average differentiated video. The outputs are sampled by a gating circuit controlled by the master oscillator. The sampling is done by transmission gates controlled by the monostable gate generator. The generated gate allows these average levels to feed to a set of *k* level slicers that quantize each input signal to one of *k* levels. Thus for every sample period there is a quantized level for the video and one for the differentiated video.

The memory system consists of a set of counters, one for each output level. The outputs of the slicers are gated into the appropriate counters. The gate is opened by the gating pulse delayed by an amount equal to the delay in the slicing circuits, to avoid timing problems in driving the counters. Thus at each sample period one of *k* counters for the video and one of *k* counters for the differentiated video are advanced. Hence, at the end of a complete scanning cycle the $2k$ counters contain a breakdown of the density and contrast levels encountered in the scanned image.

During the scanning cycle, another counter totals the number of sample periods. At the end of *n* periods, an end scan pulse is generated to indicate that sufficient data are available for statistical analysis.

This work was performed under U.S.A.F.O.S.R. contract AF-49 (638)-1143. The author thanks Sheldon Fink for major contributions to the article.

PROTOTYPE of pulse width encoder demonstrate the feasibility of the device

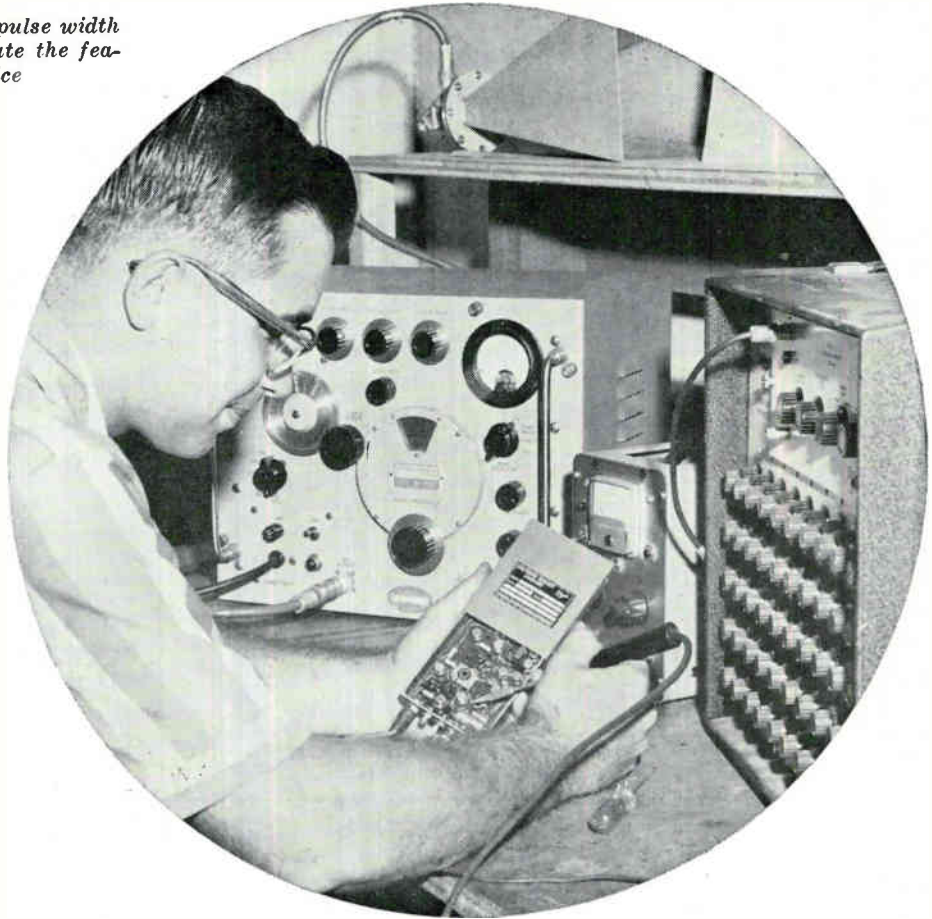

Combining square-loop properties of magnetic material with logic circuits permits processing pulse widths in the microsecond range into a form suitable for storage on conventional 5-Kc magnetic tape

UNCONVENTIONAL APPROACH TO Pulse-Width Measurements

By WILLIAM L. CARTER and PETER J. KNOKE
Electronics Research Lab.,
Syracuse University Research Corp., Syracuse, N. Y.

A NUMBER of digital and analog techniques are in common use for the measurement of microsecond pulse widths. In general analog techniques such as charging a capacitor with the energy stored in the pulse are limited by the need for close component,

HOW MAGNETIC CORES MEASURE PULSE WIDTHS

Recording pulse widths in the microsecond range usually requires complex broadband equipment. In this new technique, the pulses are amplitude limited then dumped into a magnetic core. When the core saturates, a signal is recorded on a conventional 5-Kc magnetic tape and the core resets for the next series of pulses

voltage and environmental tolerances, while digital techniques such as counting at a fixed rate during the on time of the pulse are limited by cost.

This device uses a square-loop core in the incremental magnetization mode. The number of constant-voltage pulses required to switch a core from the 0 state to the 1 state depends on the width of the pulses. The idealized mathematical description of this core-count technique is $(n)(PW) = C$ where PW is the pulse width, n is the number of pulses required to saturate the core and C is a constant. The inherent error in the measurement technique is $1/n$.

Pulse width encoder (PWE) techniques involve an integration, therefore it is necessary that pulse widths remain constant over a given core saturation cycle if individual pulse width information is desired. However, it is easy to obtain pulse-repetition-rate

IDEALIZED hysteresis loop (A) actually has a flyback flux change associated with each incremental flux switch period (B)—Fig. 1

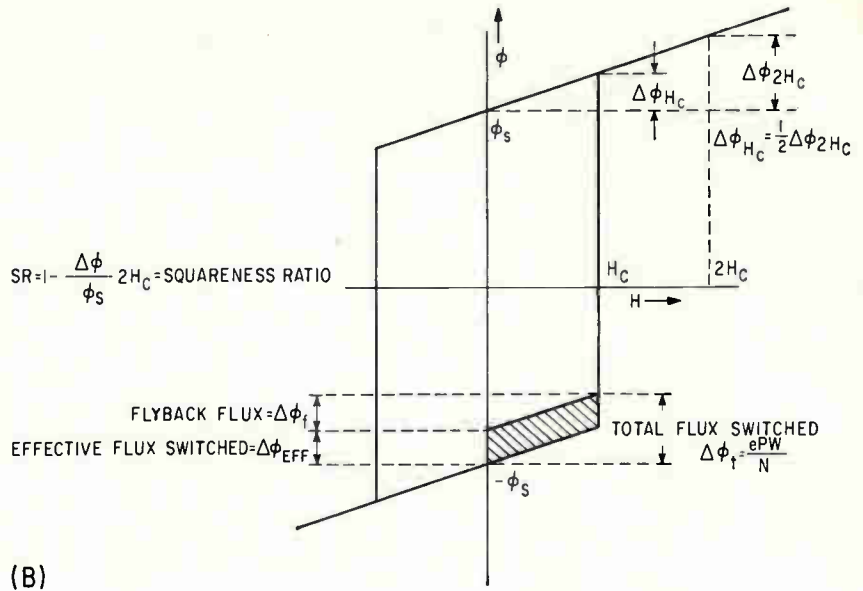
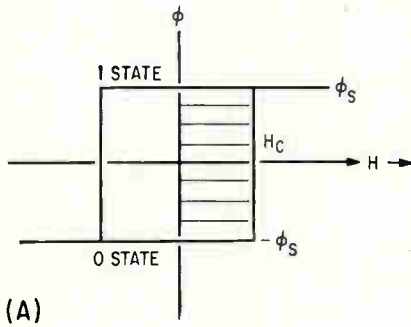

information as well as pulse-width information from the single channel PWE output.

Several articles on magnetic scalars using this principle have appeared.^{1, 2, 3, 4} But this analysis is necessary to understand the use of incremental magnetization. The usual simplified core switching model is used.

IDEALIZED EQUATION—If a square-loop core is initially in the 0 state, a certain energy is required to switch the core to the 1 state. This switching can be done incrementally using a number of constant-energy pulses as shown in Fig. 1A. If pulse voltage is held constant, the number of pulses required for the switching depends only on pulse width. The applicable equation is

$$n = \{N(2\phi_s)\} / [e(PW)] \quad (1)$$

where PW = input pulse width, N = number of turns on core set winding, e = input pulse voltage, ϕ_s = core saturation flux and n = number of input pulses required to switch core.

For N , ϕ_s , and e fixed, the switching equation is

$$(n)(PW) = C \quad (2)$$

where $C = (N)(2\phi_s)/e = \text{constant (dimension of time)}$

This is the equation of a rectangular hyperbola and is an idealized mathematical description of the core-count technique. If enough pulses are presented to the core to complete the excursion from $-\phi_s$ to $+\phi_s$, then n , the number of pulses required to saturate the core or switch from $-\phi_s$ to $+\phi_s$, is inversely proportional to the width of the incoming pulses.

MODIFIED EQUATION—Since the actual hysteresis loop is not rectangular, a flyback is associated with each incremental flux switching as shown in Fig. 1B.

For a single pulse into the core, the original idealized equation may be modified. As $\Delta\phi_t = (e)(PW)/N$ represents the total flux switched by a single pulse, flyback flux ($\Delta\phi_f$) must be subtracted from this value to get effective flux ($\Delta\phi_{eff}$) switched. This flyback

flux may be related to the squareness of the core hysteresis loop by $\Delta\phi_f = \phi_s(1 - SR)/2$ where squareness ratio

$$SR = 1 - (\Delta\phi_{2Hc})/\phi_s$$

Using this result and the fact that $\Delta\phi_{eff} = \Delta\phi_t - \Delta\phi_f$, the flyback modified switching equation is

$$(n)(PW) = \frac{N\phi_s}{e} 2 + \frac{(n-1)(1-SR)}{2} \quad (3)$$

This equation, though based on a simple core-switching model, yields results in agreement with actual data. Using this analysis, the minimum pulse width for device operation may be estimated as that value of PW for which $\Delta\phi_{eff} = 0$.

that is $PW_{min} \cong [(1 - SR)/2][(\phi_s N)/e]$ (4)

PULSE-WIDTH ENCODER—A prototype model was constructed to demonstrate the feasibility of a pulse-width measuring device using the integrating properties of a magnetic core.

The core was a toroidal, tape-wound No. 80530, Magnetics, Inc., Orthonol with $\phi_s = 75$ maxwells and $H_c L = 0.85$ ampere turns.

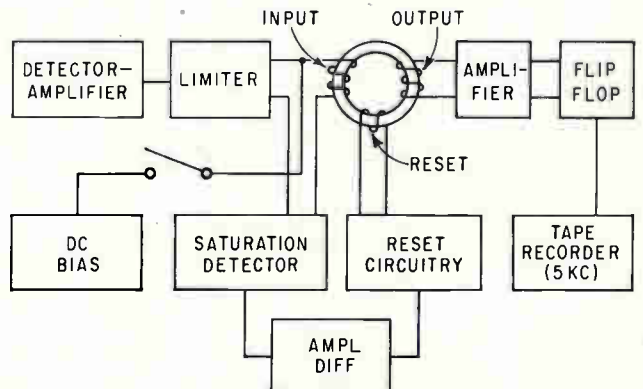

PULSE-width encoder uses a limiter to get constant-voltage input to the core. After core saturates, signal goes to recorder and core resets—Fig. 2

If $N = 170$ turns and $e = 13$ volts, then from Eq. 1

$$C = (n) (PW) = \frac{[N(2\phi_0)]}{e} = 19.6 \times 10^{-6} \text{ sec}$$

The minimum PW measurable using the parameters from Eq. 4 is $\cong 1.5 \mu\text{sec}$.

For values of $PW < 1.5 \mu\text{sec}$, a d-c bias may be placed on the core. This effectively reduces the flyback effect as well as the energy requirements for saturating the core, thereby reducing n for a given PW . Range extension by d-c biasing is essential in obtaining a wide range of PW operation.

A pulsed signal is detected, amplified and limited to obtain a constant voltage input to the core as shown in Fig. 2. A number of effects indicate that the core has saturated. These are input impedance drop, greater flyback and increased input current. Any of these effects may be used to trigger the reset circuit. Sensing increase in input current is the most definite indication of saturation. By placing a current-sensing device such as a resistor or tunnel diode, in series with the input turns, this current increase can be detected. The PWE uses a tunnel diode to sense the increase in input current. This output is then amplified and differentiated and the trailing edge of the pulse triggers the reset circuit as shown in Fig. 3. This insures that the input pulse has ceased before resetting so that the reset pulse will not buck the input pulse. Directly after resetting, a positive spike occurs due to the snap-back voltage $d\phi/dt$ when the reset pulse ceases. This is an indication of saturation. An amplifier placed across the output of the core provides trigger pulses for the flip flop stage. In addition to amplifying the positive pulses that appear at the output because of the transformer action of the core, the amplifier also amplifies the snap-back spike causing an irregular change of state. The number of changes of state between saturation points indicates the number of pulses to saturate the core. From this, PW is found in accordance with Eq. 3. The broadband informa-

tion contained in the pulse width has now been reduced to within the bandwidth capabilities of a 5-Kc magnetic tape recorder. Repetition rates up to 10 Kc can easily be stored on the magnetic tape, since the flip flop changes state at $(\text{prf}/2)$. Thus the prf information contained in the output is actually a bonus.

The pulse width range of the PWE is $0.5 \mu\text{sec}$ to $16 \mu\text{sec}$ at repetition rates up to 5 Kc. However, 20 Kc represents an upper limit of the repetition rate using Orthonol.

ACCURACY—In the ideal case, an exact number of pulses was assumed to saturate the core. This is an idealization, since, in general, the last pulse required to saturate the core will overdrive it rather than exactly saturate it. In exact notation this is $(PW)(n) = C + \epsilon_1$ ($0 \leq \epsilon_1 < PW$) where ϵ_1 is the amount of saturation overshoot.

However, $(PW)(n - 1) = C - \epsilon_2$ ($0 \leq \epsilon_2 \leq PW$) where ϵ_2 is the amount of saturation undershoot. From these equations

$$PW = \frac{C}{n - 1/2} + \frac{\epsilon_1 - \frac{PW}{2}}{n - 1/2} \quad (0 \leq \epsilon_1 < PW) \quad (5)$$

Eq. 5 is exact and PW is exactly determined in terms of C , n and ϵ_1 . In general, only C and n are known and only a range for PW is specified. PW_{max} and PW_{min} can be determined from Eq. 5 where $PW_{\text{max}} = C/(n - 1)$ and $PW_{\text{min}} = C/n$.

The core-count method can deliver only the information that n is some integer. Now, if for a given n , the pulse width PW_{max} is assigned, error can be defined as

$$\text{percent error} = (PW_{\text{max}} - PW_{\text{min}})/(PW_{\text{max}}) 100 = (1/n) (100)$$

For large n , accuracy is good. Accuracy varies inversely with PW ; normally the result is directly proportional.

Temperature tests run on the PWE show the calibration curve changes only slightly with temperature.

REFERENCES

(1) R. I. Van Nice, R. C. Lyman, A Predetermined Scaler Utilizing Transistor and Magnetic Cores, *Proc. National Elec-*

tronics Conference, 11, p 859.

(2) J. R. Horsch, A Reliable Pulse Scaler of Arbitrary Order, *Proc. National Electronics Conference*, 11, p 870.

(3) Raul C. Lucero, Magnetic Scalers,

Special Technical Conference on Non-linear Magnetics (Proc), p 113, 1961.

(4) J. D. Freeman, New Idea in Counting: Incrementally Magnetized Cores, *Electronics*, 35, No. 24, p 40, June 15 1962.

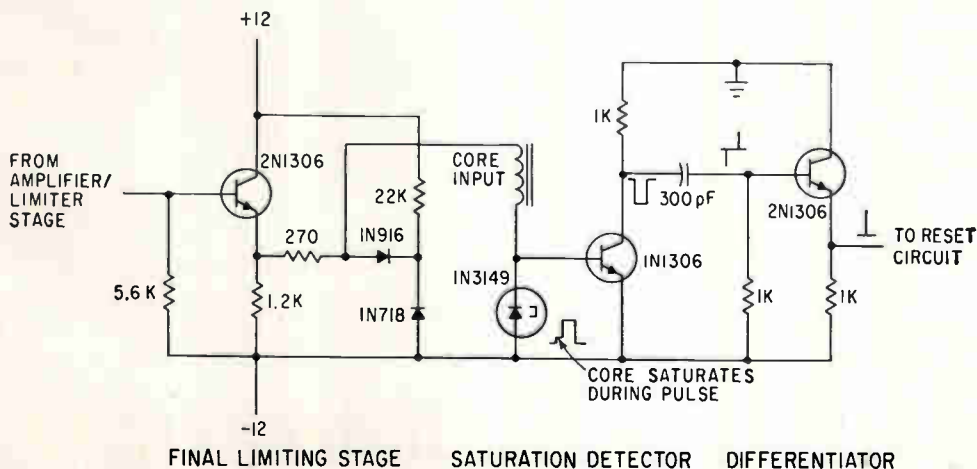

TUNNEL DIODE is used as core-saturation detector in the limiter-detector-differentiator portion of the device—Fig. 3

Faster Frequency Switching With

Modern communications systems require rapid frequency switching and high accuracy. These can be achieved with phase-lock oscillators using new techniques that minimize switching time

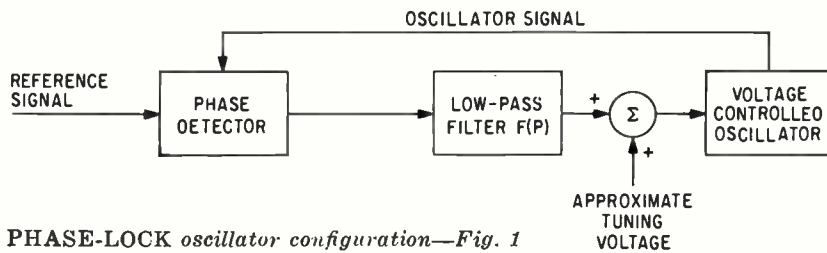

PHASE-LOCK oscillator configuration—Fig. 1

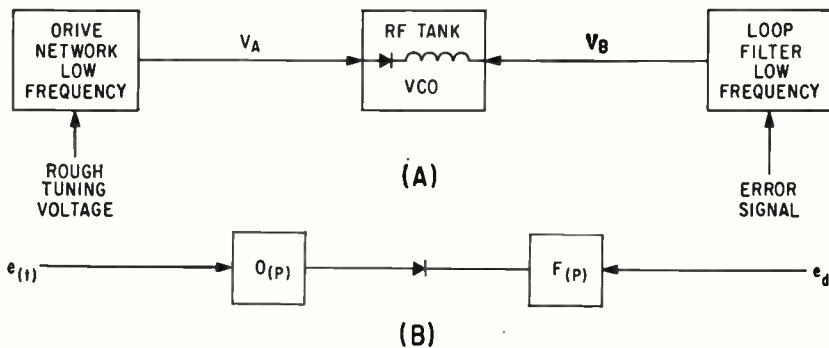

VOLTAGE CONTROLLED oscillator tuning circuit (A) and simplified tuning circuit (B)—Fig. 2

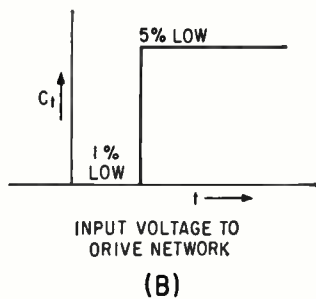
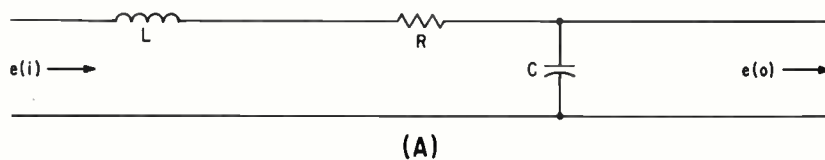

SIMPLIFIED drive network (A), predicted drive (B) and control circuit (C) operation under switching conditions—Fig. 3

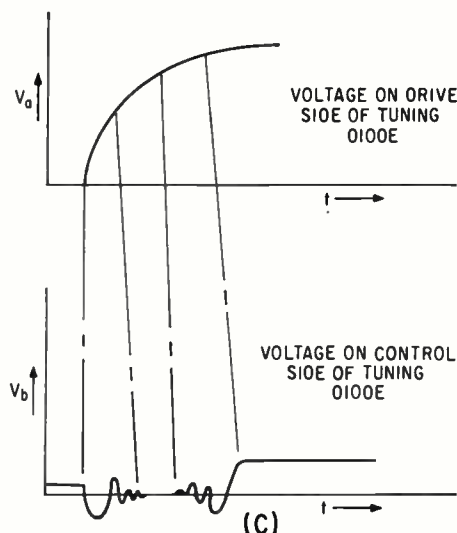

IN THE DESIGN of military communications systems, precise tuning and fast frequency selection are often required. The application of solid-state tuning devices such as the varactor, ferroelectric capacitor and current-controlled inductor offer advantages in flexibility and speed of operation. However, when used in open-loop control circuits, these devices do not have the required accuracy or stability unless combined with phase-lock oscillator (plo) circuits.

Figure 1 shows a typical circuit including a phase detector, low-pass filter (or amplifier) and a voltage-controlled oscillator. The reference signal is a fixed, single-frequency voltage. The output voltage of the controlled oscillator is compared with the reference signal in the phase detector and appears as a low-frequency voltage. If the reference and oscillator signals have no frequency difference, the phase-detector output is a d-c voltage proportional to the difference in phase of the two signals. If these signals do have a frequency difference, the phase-detector output is a time-varying signal with a frequency equal to the difference between them.

The output of the phase detector is modified by the low-pass filter and adds to the approximate d-c tuning voltage; this total voltage tunes the oscillator. As a result of this feedback, the oscillator is capable of locking to the frequency of the reference signal if the error in approximate tuning voltage is not too large.

If the reference is changed to a signal composed of several discrete frequencies, it is possible to lock the oscillator to each of the input components by adjusting the tuning voltage to the correct d-c value for the desired component.

Phase-Lock Oscillators

By T. W. BUTLER, JR., and E. M. AUPPERLE
Cooley Electronics Laboratory, The University of Michigan

A major problem in phase-lock oscillator design is convergence, or the time required to go from one locked frequency to another. This convergence consists of pull-in-time, a function of the feedback loop, and switching-time, the period required for a change in the level of the tuning voltage. Since pull-in time is usually fixed by other system requirements, convergence must be reduced by minimizing switching time.

SWITCHING TIME—Tuning voltage must be applied to the diode through a drive network. The voltage-controlled oscillator (vco) appears as in Fig. 2A. The low-frequency circuit is given in Fig. 2B, where e_d is the phase detector output voltage, F_p is the transfer function of the loop filter, e_{ct} is the tuning voltage, and D_p is the transfer function of the drive network. Assuming F_p meets basic loop requirements and is a known function, the pull-in time for the loop may be closely estimated. For example, a 100-Kc loop will require about 10 μ sec and a 1-Kc loop about 1 msec to pull in if the voltage applied to the diode places the frequency of the vco within the capture limits of the loop. Typical pull-in times will be less than indicated by the example due to greater accuracy in set-on voltages.

Close attention must be given to the design of the drive network D_p , so that the overall convergence time is not appreciably lengthened. Assume that D_p is the transfer function; then, $Dp = 1/(1 + pRC)$.

For a 100-Kc loop, a major part of the convergence time will be associated with the response of the drive circuit, unless the R - C time constant is small. Pick $RC \ll 10 \mu$ sec. This condition usually requires a resistor so small that it

loads the tuned circuit. To get a faster response than possible with this simple network, consider the drive circuit of Fig. 3A. The transfer function for this network is

$$D(p) = \frac{1}{LC} \left(\frac{1}{p^2 + \frac{R}{L}p + \frac{1}{LC}} \right)$$

Let $\omega_0^2 = 1/LC$ and $\xi = (R/2)(\sqrt{C/L})$; thus

$$D(p) = \frac{\omega_0^2}{p^2 + 2\xi\omega_0 p + \omega_0^2}$$

Since it is desirable to minimize the convergence time, a fast rise-time is provided by small ξ . However, a small ξ also implies large overshoot. A compromise choice of $\xi = 0.7$ gives an overshoot of about 5 percent and a rise time of less than $3 \times 2\pi/\omega_0$ sec. To determine the minimum convergence time for a system with a 10- μ sec loop pull-in, set $3 \times 2\pi/\omega_0 < 10 \mu$ sec. As an example, select $3 \times 2\pi/\omega_0 = 3 \mu$ sec which yields $f_0 = 1$ -Mc. Therefore, $1/\omega_0^2 = LC = 10^{-12}/4\pi^2$ and, for $C = 0.0025 \mu$ f, $L = 10 \mu$ h, $R = 1.4 \sqrt{L/C} = 1.4 \sqrt{10 \times 10^{-6}/2.5 \times 10^{-9}} = 90$ ohms.

For faster response, more complex circuits with finite zeros and additional poles can be considered.

CONVERGENCE INDICATION—An indication of the performance

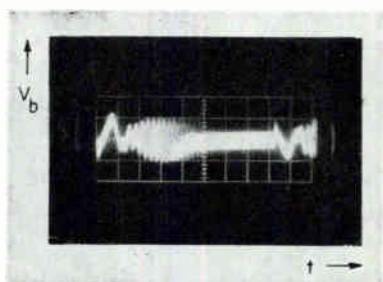

OSCILLOGRAPH presentation of drive and control circuit operation—Fig. 4

SPEED AND ACCURACY TOO

Exotic solid-state devices such as the varactor, ferroelectric capacitor and current-controlled inductor permit changing oscillator frequency quickly and conveniently. But these oscillators are seldom stable or accurate enough in critical applications unless combined with phase-lock circuits.

This technique permits the engineer to design accurate and stable oscillators that can also be rapidly shifted in frequency

of voltage V_b for a prescribed voltage V_a on the drive side of the diode is shown in Fig. 3B and 3C. The input step-voltage (Fig. 3B) is shown as 1-percent below the voltage required for a desired frequency F_1 and 5-percent below that for a second frequency F_2 . This means that for a given frequency, the voltage across the diode must be constant. There must be a d-c correction voltage on the control side of the diode proportional to the error in set-on accuracy of the drive voltage. As voltage V_a rises, V_b drops. As V_a pulls away, a voltage proportional to the beat frequency is obtained. As the vco frequency is driven further from that of the reference, the beat frequency increases and its amplitude decreases until the output of the phase detector approaches zero. As V_a takes the vco closer to the new reference frequency, a high-frequency, low-amplitude beat is observed; this beat goes down in frequency and up in amplitude until the capture range is reached and the system falls into synchronism.

VERIFICATION—Measurement of pto-convergence time was made by applying a repetitive square wave in series with the rough-tuning voltage. The magnitude was great enough to carry it from one locked state to another. The results of this measurement are shown in Fig. 4. The capture time is a function of the starting phase or phase between the vco and reference; when the vco is brought within capture limits, capture time will vary. Maximum convergence time for the plo appears to be about 100 μ sec. Since the plo has a bandwidth of 40-Kc, the pull-in time of the loop is about 25 μ sec.

Two Easy Ways to Stabilize Power-Transistor Hi-fi Amplifiers

Two methods of stabilizing direct-coupled transistor amplifiers. One method uses stabilizing current from a transistor as the input bias current to a complementary-symmetry push-pull pair of a power amplifier. In the other method, stabilizing current from a transistor develops the bias voltage at the base of the input transistor of a preamplifier

By HARRY W. PARMER
U. S. Army Signal Research and
Development Laboratory,
Fort Monmouth, New Jersey

POWER TRANSISTORS have all of the characteristics essential for the design of efficient audio amplifiers that can satisfy the most exacting audio requirements. Such direct-coupled transistor circuits do not require bulky and expensive transformers, even for the output stage. The absence of many heat-producing elements and large transformers permits mounting complete amplifiers in small cabinets with restricted ventilation.

With all of these advantages there has been a decided lag in the acceptance of transistor amplifiers except for units with outputs in the milliwatt range. One of the main engineering problems that has had to be solved in the design of transistor amplifiers capable of providing several watts output has been the tendency for the power stage to go into thermal runaway.

Thermal runaway is caused by changes in the transistor characteristics resulting from the heating generated during normal operation. This increase in temperature results in an increase in base current gain (h_{FE}) and collector cutoff current (I_{CO}) and a reduction in the base-to-emitter resistance (r_{BE}). These changes tend to increase the collector current, resulting in still more heating and the possible destruction of the transistor. The biasing method must compensate

for these changes in characteristics of the power transistors without impairing the audio performance of the equipment.

Resistance or voltage elements in series with the emitter can reduce the tendency for thermal runaway but have the disadvantage of reducing the output power. The use of nonlinear circuit elements is likely to introduce distortion, particularly at high power levels.

BIASING METHODS—This article describes two methods of biasing transistor circuits. A power amplifier circuit, as well as a preamplifier in which these methods of stabilization are used, will be shown.

A direct-coupled amplifier with a push-pull output requires two separate and independent bias-control circuits. One control maintains the steady-state voltage of the output circuit at approximately

one-half of the supply voltage. The second bias control provides sufficient steady-state current through the transistors that operate as class B amplifiers to eliminate crossover distortion. Lack of control of bias current throughout all operating conditions is the principle cause of runaway.

Figure 1 illustrates a technique for controlling biasing current that has entirely different characteristics from the methods normally used. By connecting Q_1 , a *pn*p, to the base of Q_2 , an *n*pn, Q_2 is biased by a current source rather than a voltage source. Resistor R_1 limits the current that transistor Q_1 can draw ($I_{E1\max}$). The maximum current that transistor Q_2 can draw ($I_{C2\max}$) is

$$I_{C2\max} = h_{FE}(Q_2) (I_{C1\max}/h_{FE}(Q_1))$$

This equation does not hold true if the I_C of Q_1 is limited by either its external collector circuit or by its R_C . When its collector current is limited, its base current may approach the value of its emitter current; when this occurs, there is a corresponding change in the h_{FE} of Q_1 . By placing resistor R_2 in series with the emitter of Q_2 , the current drawn by each transistor is reduced in proportion to the value of resistors R_1 and R_2 . As resistor R_2 is varied, the collector resistance of transistor Q_1 will vary to provide a voltage drop comparable to that introduced by this resistor. For example, if the base current gains of the two transistors are the same and the value of *n*pn emitter resistor R_2 equals the value of *pn*p

NOW: A TRANSISTOR HI-FI SET

Power transistors are tempting components to use in hi-fi amplifiers because they do away with expensive coupling transformers and cut down cabinet size.

But power transistors can suffer from thermal runaway. And most biasing arrangements that prevent thermal runaway also introduce unwanted distortion.

The circuits described here prevent thermal runaway without introducing distortion. They are based on a complementary-symmetry approach

emitter resistor R_1 , then the current drawn by each transistor will be one-half of the maximum. Therefore, when the two transistors have similar characteristics and are subjected to the same operating temperature, circuit changes resulting from changes in base-current gain, collector cutoff current and base-to-emitter resistance of the *nnp* transistor will be compensated by similar changes in the *pnp* unit.

In Fig. 1B, *pnp* transistor Q_1 provides bias current for Q_3 - Q_4 , a low-power complementary-symmetry push-pull output stage. Resistor R_2 can reduce the steady-state current drawn by Q_3 and Q_4 . Capacitor C_2 maintains the bases of transistors Q_3 and Q_4 at the same a-c potential at all times. This eliminates any distortion that would result from changes in the collector resistance of Q_1 during operation. The biasing circuit for driver transistor Q_2 is not shown.

POWER AMPLIFIER—Figure 2 shows a complete power amplifier that can deliver up to ten or more watts, depending upon the load impedance and the supply voltage. The function of transistor Q_1 is the same as described for Q_1 of Fig. 1B. Transistors Q_3 and Q_4 drive power transistors Q_5 and Q_6 . Once the design parameters are determined, the value of R_2 can be specified so that a proper steady-state bias current is obtained in transistors Q_3 and Q_4 and in power transistors Q_5 and Q_6 . Due to the constancy of this bias there is no evidence of crossover distortion or heating as a result of improper biasing current.

When the unit functions as an a-c amplifier, the half-cycle current that drives Q_2 is determined largely by R_1 . Since the increase in the R_c of Q_2 that occurs during this period limits the I_c of Q_1 , the base current of Q_1 approaches the value of its emitter current. The R_c of Q_1 will also be at a minimum during this period even though its I_c is limited by the R_c of Q_2 . During the half-cycle that Q_1 is being driven, the base current of Q_1 will be a minimum and its R_c at a maximum. Capacitor C_2 provides a constant bias during this modulation cycle.

To insure that the operation temperature of Q_1 matches the temperatures of Q_5 and Q_6 , a close ther-

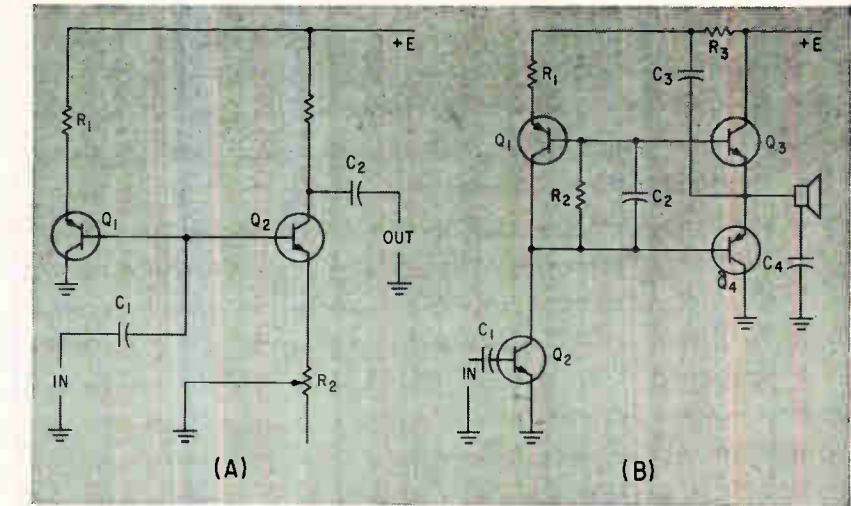

STABILIZATION METHOD uses current source for bias and stabilization (A) Technique is applied to a low-power complementary-symmetry output stage (B)—Fig. 1

mal coupling was obtained by mounting Q_1 on the stud of Q_5 . A molded ceramic coupler constructed out of a material such as beryllium oxide provides such coupling. To achieve fast response this thermal coupler should not be so large as to act as a heat sink between the two units. Ideally, the two transistor units should be constructed within the same case.

Since this method does not introduce negative bias in the power transistor circuit, there will be an increase in the I_{c0} of transistors Q_5 and Q_6 when excessive heating is introduced by overloading or by an external heat source. This increased current will not by itself cause thermal runaway since the

current will quickly return to its normal value when the excessive source of heat is eliminated. Tests indicate that the stability is comparable to that achieved by using a common-base configuration with these transistors.

A voltage-biasing circuit is also shown in Fig. 2. The emitter of Q_7 is connected in series with the output loud speaker to the common connection of Q_5 and Q_6 . The 1,500- μ f capacitor, (C_4 provides an a-c ground and prevents a-c feedback through this circuit. The base of Q_7 is connected to a voltage divider composed of resistors R_3 and R_4 . Resistor R_5 is in series with the collector of Q_7 , and the base of Q_2 to limit the biasing current and to in-

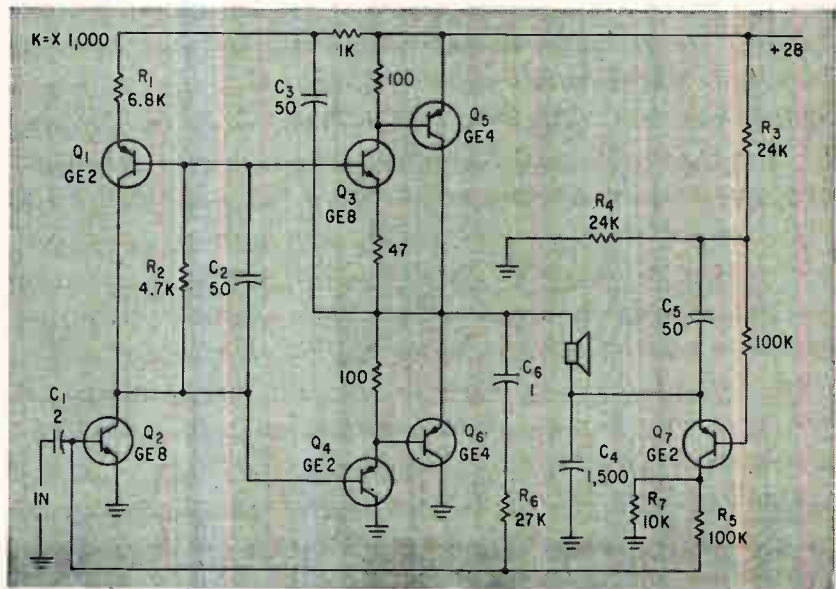

POWER AMPLIFIER can deliver up to 10 watts or more depending upon load impedance and supply voltage—Fig. 2

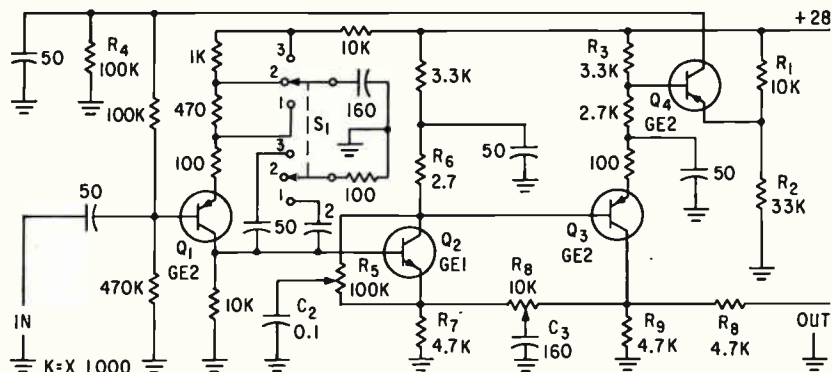

PREAMPLIFIER has switch to select input-impedance, frequency-response or level-compensation networks—Fig. 3

sure that the natural period of this feedback circuit is well below the lowest frequency required in the amplifier. Capacitor C_1 prevents a-c feedback due to variations in power-supply voltage. Desired a-c feedback is provided through capacitor C_2 and Resistor R_6 . Resistor R_7 provides a direct circuit from the collector of Q_1 to ground to insure that the transistor is operated well above its I_{co} value.

PREAMP—The construction of a stabilized preamplifier presents entirely new problems not found in the design of power amplifiers. These result from the requirements for selection of one of several input-impedance, frequency-response and level-compensation networks for each input device. In addition, a variable control of the frequency response is required to compensate for other elements of the system such as recording medium, room acoustics and preference of the listener. Equally important is the requirement for a means of controlling volume level.

Since power efficiency in the preamplifier is not an important design factor, resistive elements in the emitter circuits can help provide d-c stability. Thus, in the preamplifier shown in Fig. 3, complete stabilization is achieved by a voltage-control method. Transistor Q_4 provides a biasing current to the base of Q_1 , this current being a function of the voltage-divider circuit provided by R_1 and R_2 and the voltage drop across R_3 . Resistor (R_4) is connected to ground to insure that transistor Q_4 is operated well above its I_{co} value. Capacitor C_1 prevents feedback due to variation in power-supply voltage. Since

the amplifier is completely direct coupled this control stabilizes all stages. The stabilization accuracy is solely a function of the resistors rather than the individual transistor characteristics. Maximum use of the large emitter resistors is made in introducing negative feedback in the first two stages, rather than employing separate feedback on a multistage basis.

A two-pole three-position switch (S_1) selects input-impedance, frequency-response and level-compensation networks. One pole of the switch varies the input impedance by changing the value of the unby-passed emitter resistance of transistor Q_1 .

The second pole of this switch obtains frequency compensation in the number one position and level compensation in the number three position. The circuits are not intended to be completely correct for any particular input device but are representative of the basic requirements for magnetic pickups in the number one position, tuners in the number two position and piezoelectric pickups in the third position. Detailed design of these circuits should be based on the particular characteristics of the input devices.

An adjustable tone control is provided by R_5 and C_3 . When R_5 is in the center position there is no noticeable effect on the frequency response of the amplifier. Turning R_5 in one direction decreases the high-frequency response by shunting the signal across load resistor R_8 . Turning R_5 in the other direction increases the high-frequency response by bypassing emitter resistor R_7 . This single control provides a gain adjustment close to 40 db of the 10-Kc signal compared

to the gain at 30 cps.

To maintain a direct-coupled circuit and yet provide the volume control at an intermediate stage, R_8 and C_3 are connected between the second and third amplifier stages. At the low-level position C_3 shunts the signal from the collector of transistor Q_3 directly to ground. If C_3 is large there will be no noticeable boost in the base frequencies at low level. If base boost is desired the selection of a smaller capacitor for C_3 or the selection of a smaller capacitor to be inserted in series with R_8 and the collector of Q_3 will provide high-frequency compensation. In the full-volume position the signal in transistor Q_2 is no longer degenerated by emitter resistor R_7 , resulting in maximum gain of the preamplifier.

The output of the preamplifier goes through R_9 to prevent the feedback in the power amplifier (Fig. 2) from being dissipated in C_2 and R_6 , which would impair the performance of the power amplifier, and to permit a smaller coupling capacitor to the power amplifier without introducing objectionable frequency distortion. It is essential that this coupling capacitor be no larger than necessary since the power amplifier cannot reach a stable condition until this capacitor is fully charged. Coupling resistor R_9 also stabilizes the input impedance of the power amplifier without the restriction in voltage swing that would be introduced by an emitter resistor in the first-stage driver circuit.

Many circuits for power supplies are satisfactory for use with these amplifiers. For best performance the power supply should have low impedance and be voltage regulated and well filtered.

Since the amplifier was constructed primarily to demonstrate stabilizing methods, neither selected components nor matched transistors were used. Still, the overall performance was remarkably good showing that stabilizing methods did not introduce distortion. The complete unit had a frequency response flat within one db from 100 to 20,000 cps and distortion less than one and one-half percent from 50 to 10,000 cps. The distortion was less than one percent from 300 to 7,500 cps. Frequency response was flat above 500 cps.

New Circuit Design Raises Inverter Frequency Limits

Most transistor high-power inverters described thus far have operated at relatively low frequencies. Here's how the 50-Kc operation of this 100-watt inverter is achieved

By SZE L. CHIN

Applications Engineering,
Bendix Semiconductor Div.,
Holmdel, N. J.

TRANSFORMER-COUPLED square-wave oscillators using two transistors as alternate switching elements have been widely employed as d-c to d-c power converters and d-c to a-c inverters. In the d-c to d-c converter, the low d-c voltage is changed into a-c, which is stepped up and rectified to provide a high d-c voltage; whereas in the d-c to a-c inverter (Fig. 1A), the a-c output is employed directly without rectification.

DESIGN CONSIDERATIONS —

As operating frequency increases, limiting factors such as power dissipation, core loss, frequency response and storage effect become more severe on the oscillator operation. Therefore, for high power, 30 w or more, the operating frequency is usually no more than 3 Kc. The storage-time effect is the most severe limiting factor at high frequencies. During the storage period, while the transistor on one side of the push-pull amplifier begins to conduct, the transistor on the other side remains on; thus, the two simultaneous collector currents cause magnetic fluxes that buck each other. Thus, high current and voltage spikes are produced. These spikes increase power dissipation and may cause destructive breakdown of the transistors.

The transistors of a high-frequency square-wave oscillator should have low thermal resistance and fast switching times. The

transformer should have low core loss and low leakage inductance. For high power levels, it is advisable to use a low-power saturating oscillator to drive an output class-S—Class-S denotes square-wave drive—push-pull amplifier, since the core of the driver's transformer can be small and the output transformer can be kept below the saturating flux level; this decreases the core loss, improves the output wave shape, and increases efficiency.

If the transistors' storage period is a significant part of the operating cycle, 3 percent or more, a time-delay or pulse-width control technique should be used to prevent the

flow of simultaneous collector currents, since simultaneous flow causes harmful spikes.

If the class-S push-pull amplifier is driven directly by the square-wave oscillator, as in Fig. 1A, the transistor storage effect causes power loss and spikes. Figure 1B shows the waveforms of $i_{c1}(t)$ and $i_{c2}(t)$ and Fig. 1C shows $V_{CE}(t)$. Figure 1B shows the storage time to be about 2.5 μ sec. This means the storage effect causes the transformer to stop functioning during 25 percent of the cycle, thus reducing the output power. Figure 1C shows a V_{CE} spike of 38 volts, even though supply voltage E_s is only

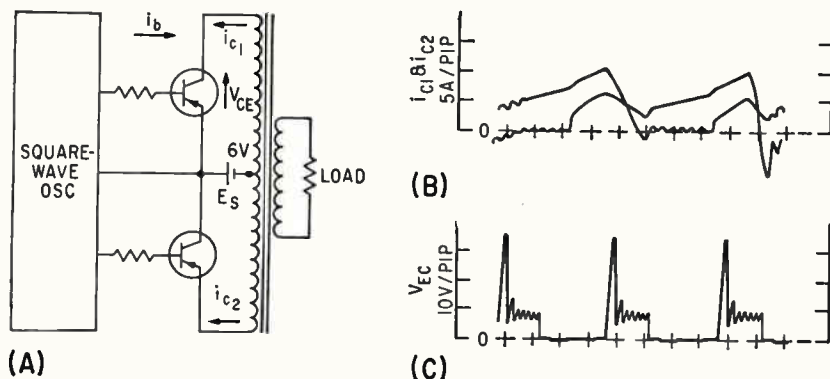

OUTPUT AMPLIFIER of this inverter is driven directly by square-wave oscillator (A). Current waveshapes (B) show effect of storage time (2 μ s per div); (C) shows resulting spike (5 μ s/div) across transistor—Fig. 1

KEY DESIGN FEATURES

(1) A large drive current to output transistors Q_1 and Q_2 (Fig. 3) — $\frac{1}{2}$ the magnitude of the collector current — thus compensating for the low common-emitter frequency, which is only 20 Kc.

(2) Providing a large spike in the reverse base current to the output transistor being switched off (see Fig. 4C) causes a fast sweep-out of the charge stored in the base-emitter junction of this transistor

6 volts. The actual design of the 50-Kc generator, Fig. 2 and 3, compensates for the storage effect by using monostable gates.

GENERATOR DESIGN — The oscillator provides a 50-Kc square wave that is differentiated into spikes. During the beginning of each half cycle, a spike triggers the monostable gate on, which provides a pulse of 6.5 μ sec to drive one

side of the amplifier. Since storage time is 2.5 μ sec and the collector current fall time is about 1 μ sec, the conducting period is 10 μ sec, which is just the half-cycle time of the desired output. At the beginning of the alternate half cycle, the other monostable gate is triggered on to drive the other side of the amplifier. The output is a 50-Kc square wave.

To achieve fast switching, all

transistors are diffused-alloy power (DAP) types. Two medium-power DAP transistors (Q_1 and Q_2) are used in push-pull in the square wave oscillator. The operating frequency is attained by saturating the transformer core. The 0.1- μ f capacitors (C_1 and C_2) in the base path compensate for the leakage inductance and improve switching. The oscillator's output waveform (V_o) is shown in Fig. 4A. Transistor Q_5 of the monostable gate Q_3 - Q_6 is normally on, while Q_4 is normally off. When Q_3 is triggered on, a pulse is generated and transformer coupled through winding 1-2 of T_2 to turn on one side Q_7 of push-pull amplifier Q_7 - Q_8 . Monostable gate Q_4 - Q_6 drives Q_8 the same way. The pulse width is approximately equal to 0.7 $R_3 C_3$ if the influences of the I_{co} , V_{BE} and transformer inductance are neglected. During the on period of Q_3 , the voltage generated at the winding 3-4 of T_2 is coupled to winding 5-6, thus providing an off drive for the Q_7 side of the amplifier. Resistor R_2 , which is in series with winding 3-4 of T_2 , limits the collector current of Q_8 since the reflected impedance across winding 3-4 is low. The reflected impedance is low because the impedance of Q_7 's emitter-base junction at reverse bias is low, as it is for all DAP transistors. Both Q_7 and Q_8 are driven into saturation during conduction to minimize power loss. The gate output waveform V_g (across 5-6 of T_2) is shown in Fig. 4B.

Two 25-amp DAP's, Q_7 and Q_8 , are used in the amplifier. Since the operating frequency is beyond the common-emitter cutoff frequency, which is about 20 Kc, a low collector-to-base current ratio of four is used. Figures 4C and D show the waveforms of I_B and I_C , respectively. Note that the forward I_B is on for about 6.5 μ sec while I_C is on for about 10 μ sec. The high reverse spike of I_B (see Fig. 4C and editorial box) accounts for the fast switching-off time of collector current I_C . This reverse spike is due to the kick-back of gate winding 1-2 of T_2 .

Efficiency of the amplifier is 83 percent; overall efficiency is about 70 percent.

The author thanks Peter Balthasar, for his suggestions.

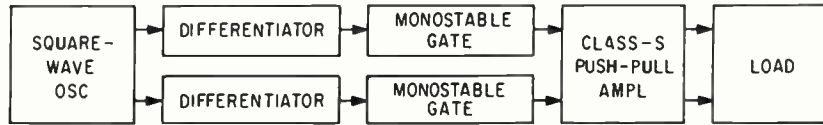

50-KC INVERTER uses monostable gates that are interposed between square-wave oscillator and amplifier—Fig. 2

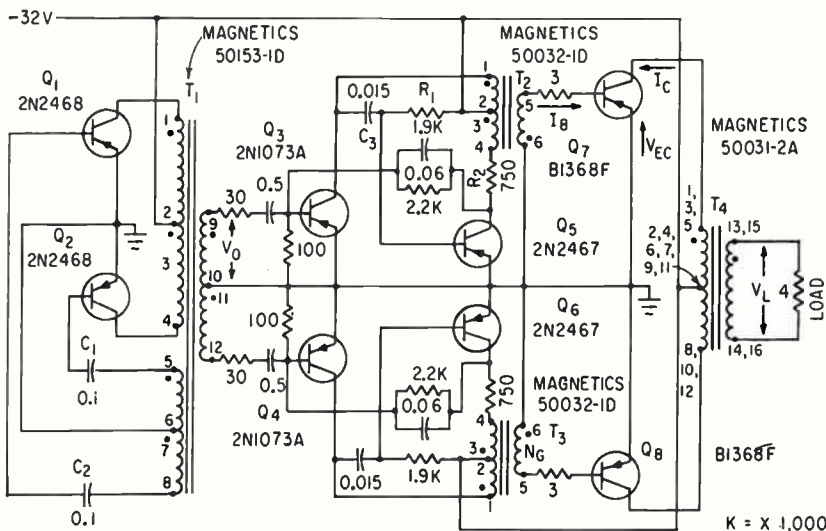

HIGH-POWER INVERTER uses diffused-alloy transistors in all its stages. Transistors Q_7 and Q_8 produce 100 watts, each dissipating only 8.5 watts—Fig. 3

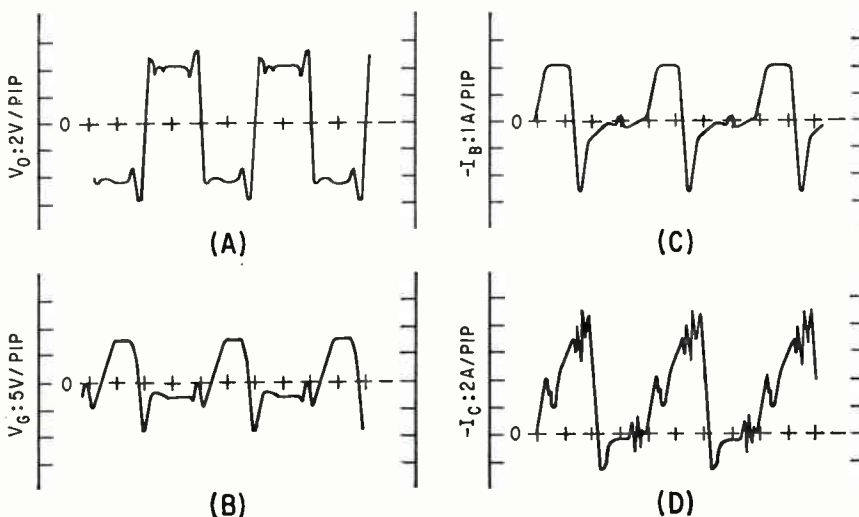

WAVESHAPES all have horizontal time axis of 5 μ sec per pip. Ordinate designations refer to measuring points on schematic of generator—Fig. 4

GUIDANCE CONTROLS CORP. is established to meet the exacting demands of the space and electronic control industries. Benefit by our experience in analysis of control problems, and design and production of components to solve them.

NEW CLUTCHES and BRAKES

GUIDANCE CONTROLS CORP. has developed a complete line of precision clutches and brakes for use in computer, control and servo positioning systems where size/weight ratio and reliability are of the utmost importance.

series 11 clutch



features:

- Zero Backlash
- Zero Endplay
- No Angular Displacement
- No Axial Motion
- Low Current Requirements
- Low Power Consumption
- Meets all Critical Government Specs

...“on target accuracy” with



NEW POTENTIOMETERS and ENCODERS

In addition, GUIDANCE CONTROLS CORP. has developed a line of precision potentiometers and analog-to-digital shaft encoders that meet the strictest military and commercial requirements.

clutch-pot-module

features:

- Low Torque
- Low Noise
- Excellent Stability
- Meets all Critical Government Specs



MODULAR CAPABILITY

All GUIDANCE CONTROLS CORP. units have been designed for the optimum in miniature modularization. Any combination of the 14 components listed are available as indicated in this chart.



MAGNETIC CLUTCH	MAGNETIC CLUTCH	MAGNETIC CLUTCH	MAGNETIC CLUTCH	MAGNETIC CLUTCH
POTENTIOMETER	POTENTIOMETER	POTENTIOMETER	POTENTIOMETER	POTENTIOMETER
ANALOG DIGITAL ENCODER	ANALOG DIGITAL ENCODER	ANALOG DIGITAL ENCODER	ANALOG DIGITAL ENCODER	ANALOG DIGITAL ENCODER
MOTOR	MOTOR	MOTOR	MOTOR	MOTOR
GEAR TRAIN	GEAR TRAIN	GEAR TRAIN	GEAR TRAIN	GEAR TRAIN
SYNCHRO	SYNCHRO	SYNCHRO	SYNCHRO	SYNCHRO
SLIP CLUTCH	SLIP CLUTCH	SLIP CLUTCH	SLIP CLUTCH	SLIP CLUTCH
RESOLVER	RESOLVER	RESOLVER	RESOLVER	RESOLVER
SPRING RETURN	SPRING RETURN	SPRING RETURN	SPRING RETURN	SPRING RETURN
MAGNETIC BRAKE	MAGNETIC BRAKE	MAGNETIC BRAKE	MAGNETIC BRAKE	MAGNETIC BRAKE
LIMIT STOP	LIMIT STOP	LIMIT STOP	LIMIT STOP	LIMIT STOP
ACTUATION DEVICE	ACTUATION DEVICE	ACTUATION DEVICE	ACTUATION DEVICE	ACTUATION DEVICE
CONTROL DEVICE SWITCH	CONTROL DEVICE SWITCH	CONTROL DEVICE SWITCH	CONTROL DEVICE SWITCH	CONTROL DEVICE SWITCH

GUIDANCE CONTROLS CORP.

Commercial Street, Engineers Hill • Plainview, New York

A SUBSIDIARY OF WARNER ELECTRIC BRAKE AND CLUTCH CO.

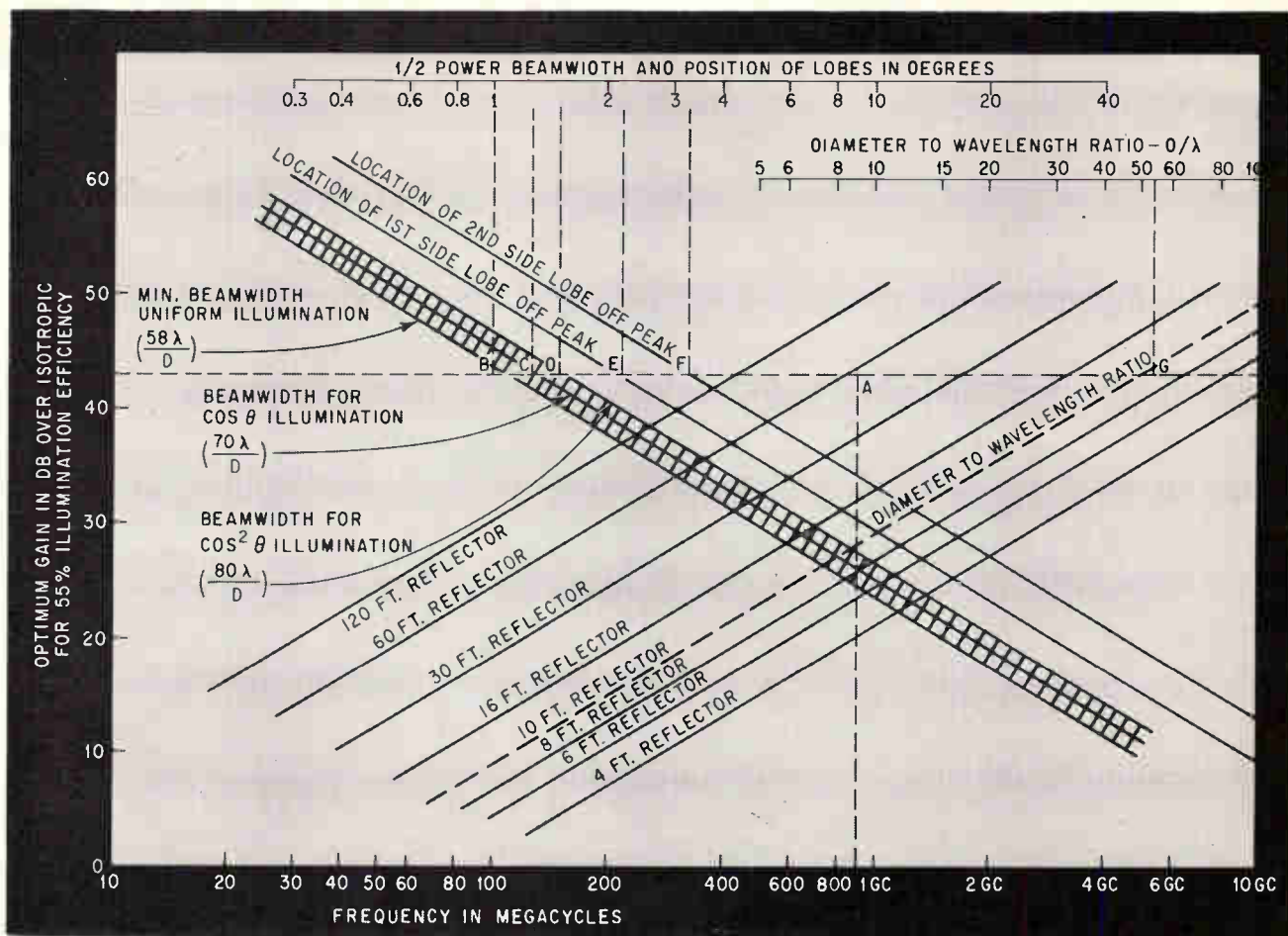

UP-TO-DATE NOMOGRAPH

Aids Tropo Antenna Design

Graphical technique solves for electrical characteristics of reflector-type antennas when only size and frequency are known

By **THOMAS VAUGHAN**
Antenna Systems Inc.,
Hingham, Massachusetts

CALCULATING electrical characteristics of tropospheric communication antennas often entails tedious calculations. The nomograph to be presented is based on up-to-date figures and can be used to save many engineering hours.

The worked example shown is based on a 60-ft antenna operating at 900 Mc.

Optimum Gain—Erect a line at 900 Mc on the frequency scale to where it intercepts the line labeled 60-ft reflector (point A). Draw a horizontal line at this point and note that it intersects the optimum gain scale at 43.2 db.

Beam Width—Points B, C and

D are read from the scale that runs along the top of the graph. Point B shows beamwidth for uniform illumination ($58\lambda/D$) of 1.03 degrees. Point C shows beamwidth for $\cos \theta$ illumination ($70\lambda/D$) is 1.27 degrees. Point D shows beamwidth for $\cos^2 \theta$ illumination ($80\lambda/D$) is 1.5 degrees.

Location of Side Lobes—Point E shows location of the first side lobe is 2.15 degrees and point F shows the second side lobe at 3.24 degrees.

Diameter to Wavelength Ratio (D/λ)—Point G shows that the diameter to wavelength ratio is 54.

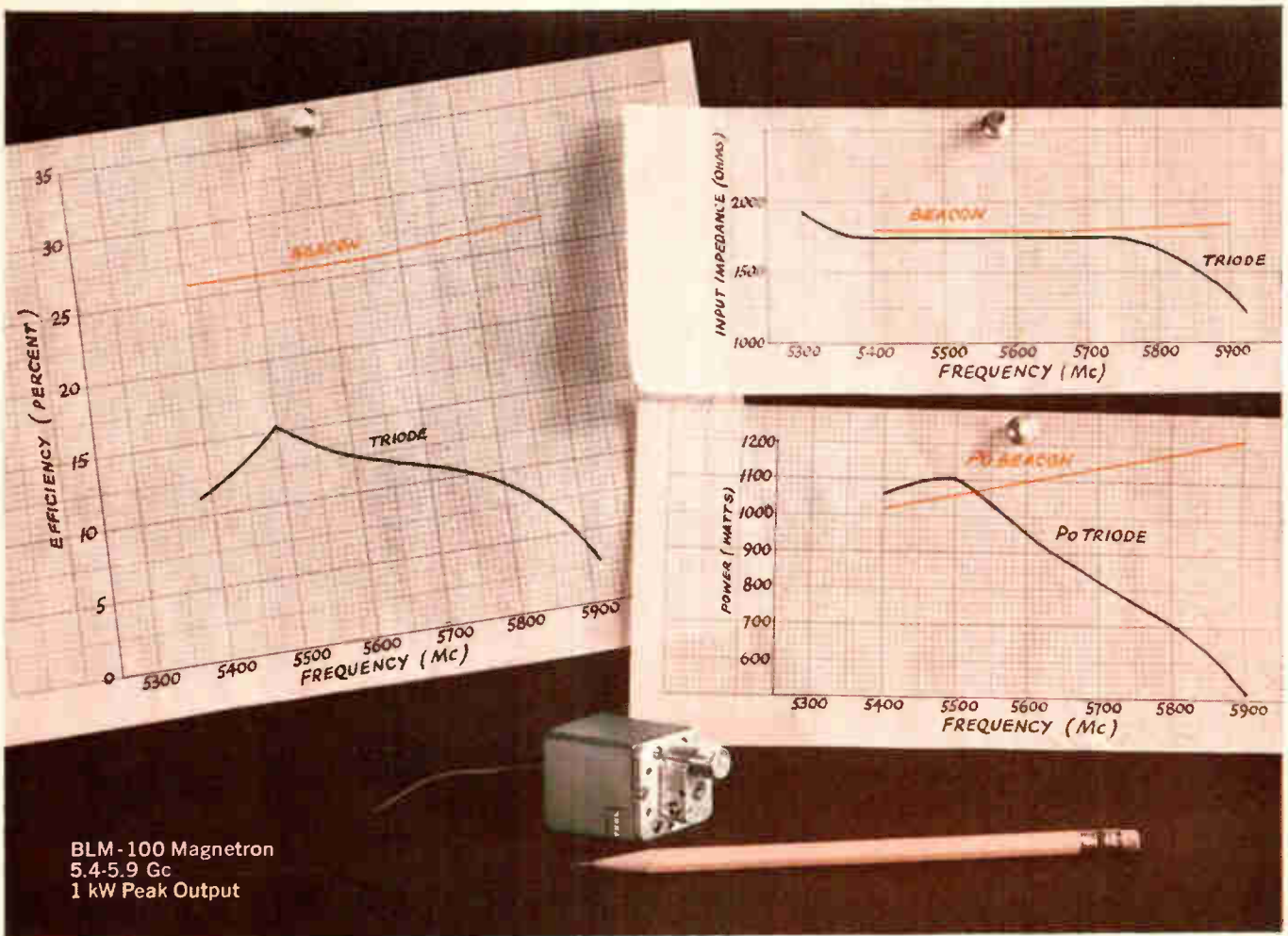

THREE REASONS WHY BOMAC MAGNETRONS MAKE BETTER C-BAND BEACONS

Bomac's C-band magnetrons are ideal for beacon use in the 1-25 kW range for three big reasons: they maintain constant input impedance, full rated power, and high efficiency throughout their entire operating range.

These extremely rugged, miniaturized tubes demonstrate excellent frequency stability under severe environmental conditions, and are specially designed for airborne or missile beacon applications. Typical performance is superior to that of triode oscillator tubes used in similar applications (see curves in illustration). Example: a 100G shock will produce a frequency shift of not over .025 per cent; vibration of 20-2000 cps at 15G's will result in a frequency shift of not over .025 per cent.

Power remains constant within 1 db across the tuning range, and the antenna may be shorted during flight without damage to the magnetron.

Bomac Laboratories is eager to work with your engineering staff to produce microwave tubes suited to your particular electrical or physical requirements. Write for additional information.

Operating Frequency (Gc)	Peak Output (kW)	Pulse Duration (μ sec)	Duty Cycle	Peak Anode Voltage (KV)	Peak Anode Current (A)	Weight (oz.)	Tube No.
5.4-5.9	1.0	1.0	0.0015	2.4-2.7	1.7	8.0	BLM-100
5.4-5.9	1.0	1.00	0.0015	2.4-2.7	1.7	8.5	BLM-125
5.4-5.9	1.4	0.70	0.0007	3.0-3.2	2.0	8.5	BLM-110
5.55-5.75	25.0	0.75	0.001	10.0	8.5	56.0	BLM-109

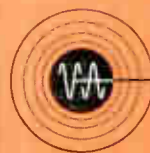

BOMAC laboratories

BEVERLY 1, MASSACHUSETTS

A Varian Subsidiary

Other Subsidiaries of Varian Associates: S-F-D LABORATORIES, INC. • VARIAN ASSOCIATES OF CANADA, LTD. • SEMICON ASSOCIATES, INC. • SEMICON OF CALIFORNIA, INC. • VARIAN A. G. (SWITZERLAND)

Combined Coding Increases Spectrum Usage

Four-megacycle channel accommodates hundreds of subscribers

By HUGH E. MCGUIRE
RACEP Engineering Program Manager
Martin Company, Orlando, Fla.

COMBINING several communications concepts could enable a system to accommodate up to 700 subscribers on a single 4-Mc channel. The system possesses inherent antijamming and interference-rejection characteristics. Simultaneous voice and data transmission can be made, and network and conference call capabilities are provided. Also, no r-f tuning is required in the system, called Racep for Random Access and Correlation for Extended Performance (see *ELECTRONICS*, p 8, March 2).

CHARACTERISTICS — Capabilities of the system and its efficient use of spectrum space are achieved by combining the advantages of a number of communications concepts. For example, a pulse system was chosen, which at low duty cycles provides ample space in the time domain to permit a high degree of coding. In addition, the system uses different frequencies within the band so that coding in time and frequency individually and together permit an even greater amount of coding.

Although resistance to noise jamming varies directly with bandwidth, rejection of mutual and other types of interference is a function of both the type of code used and the type of interference. In a pulse system, mutual and other orthogonal pulse-type interference is completely rejected except for the unlikely occurrence of pulses having the unique time-frequency program of the receiver.

A nonsynchronous system was selected despite the advantages in performance and efficiency of syn-

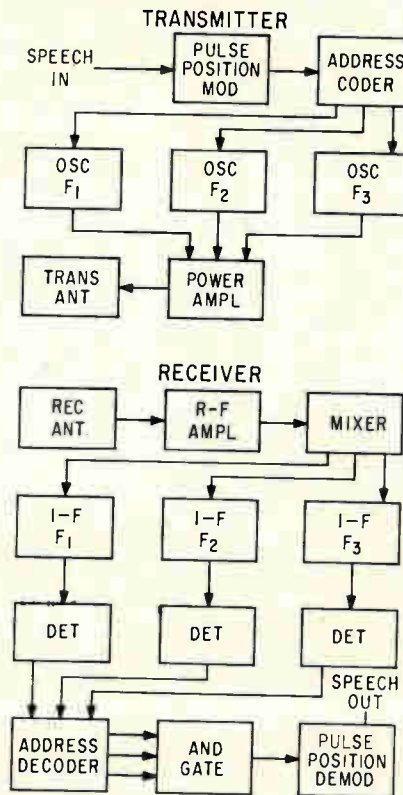

ADDRESS decoder output pulses appear at three-input gate in time coincidence in addressed receiver only

chronism between transmitter and receiver using central timing. The synchronous system would have limited capabilities in two respects. If a central timing unit were disabled by enemy action, the entire system would be made inoperative. Also, range limitations of the central equipment would restrict system operation geographically. On the other hand, feasibility of the nonsynchronous system has been established by extensive tests.

SPECTRUM USE—Efficiency in use of the spectrum can be increased by a random access system in which a single frequency channel is assigned to a large number of subscribers. Also, more effective use of frequencies is achieved by transmitting only during speech.

Further advantage in spectrum use is based on the statistics of

communications. In most vehicular tactical applications, the equipment and its communications capability must always be available for incoming and outgoing calls. However, individual equipment may be used only 10 percent of the time, so that 10 equipments could be accommodated with the same bandwidth. By making this assumption, bandwidth per subscriber compares favorably with spectrum usage.

Capacity of the random access system is a function of the coding or program used and of the discrimination capabilities of the circuits. The address program presently used consists in transmitting three pulses each at a different frequency and at different times. Detection is accomplished by a type of correlation in frequency and time, which provides rejection of mutual and other interference.

OPERATION—In the system shown in the figure, speech is converted to pulses by the pulse-position modulator at an 8-Kc sampling rate. As each pulse appears at the address coder, which is basically a delay line with 16 taps at 2-microsecond intervals, the pulse is positioned at any one of 32 time positions. The addressed receiver accepts only those incoming signals coded in its frequency and time domain and rejects all other signals.

For example, a receiver address code might be 0, 8 and 16. The voice signal in the transmitter is converted to pulses by the pulse-position modulator and supplied to the address coder. At 0 time, the oscillator with center frequency F_1 , of 142 Mc is gated on for 1 microsecond, and the signal is amplified and transmitted.

The received signal is applied through the r-f mixer and to the three i-f amplifier sections. The signal is accepted by the amplifier section designed to pass frequency F_1 and rejected by the other amplifiers. Amplifier output is envelope-



Tinkering Around With a Tough Non-Environmental Connector Application?

Then stop toying with the problem and specify the new Deutsch 500 Series. They're great for low-level flying machines, heavier-than-air equipment, and computational gadgets of all kinds. And they incorporate just about every advanced connector feature you could want... crimp or solder-type contacts that are insertable and removable... rugged glass-filled diallyl phthalate insulators for ease-of-assembly... jackscrews to assist in mating... and guards to protect pin contacts from mechanical damage. Here then is a multiple-contact design ideally suited for those tough non-environmental applications. So get in touch with your local Deutschman today for complete specifications or write for Data File K-10.

DEUTSCH

Electronic Components Division, Municipal Airport, Banning, Cal.

ADVANCED SPECIFICATION ELECTRONIC COMPONENTS

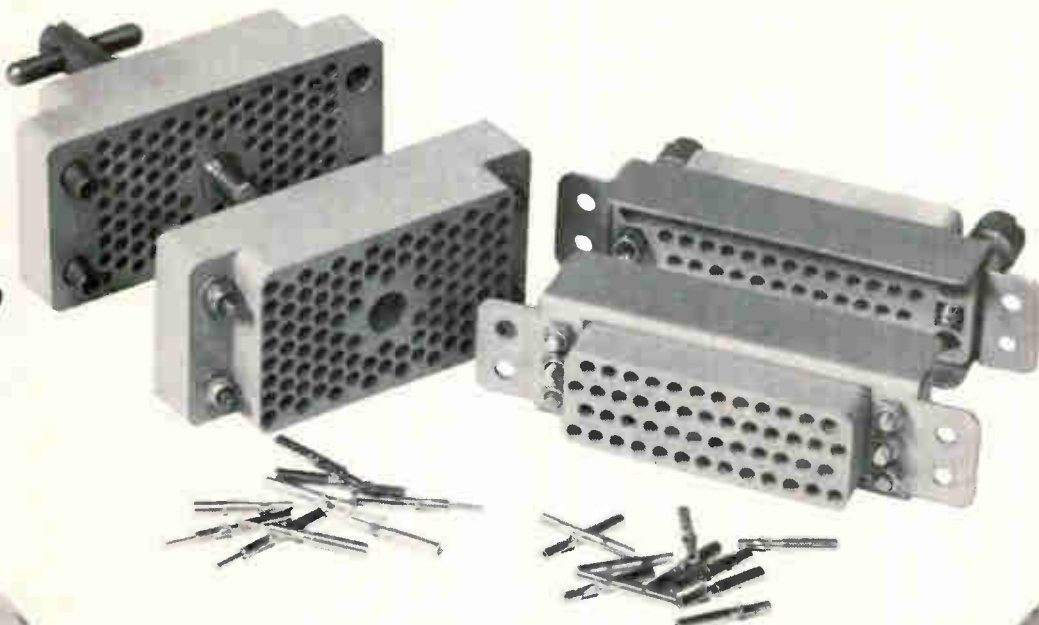



SQUARE-LOOP TAPE CORES TO MEET YOUR TOUGHEST SPECIFICATIONS

Speed your specs to Dynacor when you want square-loop tape cores to exact requirements—fast! Here you'll find a dependable combination of personnel, experience and facilities—the know-how to deliver parameters to your very tightest tolerance requirements for switching time, flux, and noise.

Dynacor Square-Loop Tape Cores are manufactured with the high permeability alloys—Grain-Oriented 50-50 Nickel Iron, 4-79 Molybdenum Permalloy, and Grain-Oriented 3% Silicon Iron . . . with fully guaranteed uniformity . . . under rigid standards of control and inspection.

Look to Dynacor for reliable production and swift delivery of your tape core requirements. For your convenience a full line of standard units are stocked for immediate off-the-shelf delivery—Send for bulletins DN 2000, DN 2001, DN 2002.



SPRAGUE[®]
THE MARK OF RELIABILITY

SPRAGUE ELECTRIC COMPANY
35, MARSHALL ST. • NORTH ADAMS, MASS.

detected and applied to the address decoder, which has a delay line in each of the three signal paths. The signal in the path for frequency F_1 is delayed 32 microseconds and applied to the three-input AND gate.

At the transmitter, the oscillator operating at frequency F_2 of 141 Mc is gated on 8 microseconds after the original speech signal. Oscillator output is amplified and transmitted as before. At the receiver, it is accepted by the amplifier operating at F_2 , and the envelope-detected signal is delayed 24 microseconds so that total delay is again 32 microseconds.

Oscillator F_3 in the transmitter is delayed 16 microseconds, and a delay of 16 microseconds is added in the receiver. Thus the three detected signals that were transmitted at different frequencies and at different times appear in time coincidence at the AND gate. Output from the AND gate is supplied to the pulse-position demodulator, which reconstructs the original voice signal.

The code of each receiver is fixed and no r-f tuning is required. Signals addressed to other receivers having different programs do not appear in time coincidence at the AND gate and are therefore rejected.

The total number of unique codes depends on the sequences in which the three oscillators can be gated on and on the 16 time-delay taps available on the address coder. The only restriction is that only one oscillator can be connected to a single delay-line tap.

OTHER FUNCTIONS—A command-override code wired into each receiver enables a commander to interrupt any communications at his discretion. All transmissions are cut off for the duration of the command signal, after which all equipments automatically resume normal operation. This capability can be incorporated into as many transmitters in a communications network as desired.

The equipment can also be used as a transponder for either voice or data transmissions. In the transponder mode, the signal is transmitted from the originating transmitter to the intermediate re-

ceiver using its code. Output from the intermediate receiver is fed into its transmitter, where it is encoded using the code of the final recipient of the message.

Simultaneous voice and data transmissions are made by providing each receiver with an address code for voice and a different code for data transmissions.

Cooled Diode Cuts Noise In Parametric Amplifier

NOISE FIGURE of a parametric amplifier is comparable to the noise figure of maser amplifiers engineered for systems applications. A commercially available gallium-arsenide varactor diode operating at liquid-helium temperature is used in the L-band amplifier.

The amplifier resulted from a discovery about varactor diode behavior at very low temperatures made at MIT's Lincoln Laboratory. The research is jointly sponsored by the U. S. Army, Navy and Air Force.

The amplifier being tested operates at 1,300 Mc and uses a 13.5-Gc pump. However, comparable operation is believed possible at signal frequencies up to at least 15 Gc. In practice, receiver noise temperature (including circulator) of about 20 degrees K appear possible. Gain and bandwidth of the amplifier are essentially independent of temperature.

Parametric amplifiers have many desirable mechanical and electrical features, including simplicity, ruggedness, broad bandwidth and rapid recovery from saturation by strong transient input signals. Helium-cooled parametric amplifiers with their low noise temperatures could supplant masers in many microwave systems and may also be used where masers are considered impractical.

DIODE NOISE—Since most noise associated with a varactor diode is thermal, cooling the diode reduces noise. However, cooling must not degrade dynamic Q of the diode by increasing diodes losses or the non-linear reactance characteristic. To obtain charge carriers for conduc-

tion in a semiconductor, electrons in the crystal lattice must have enough energy to move either from the valence bands to the acceptor levels or from the donor levels to the conduction bands. Few electrons have this energy as crystal temperature approaches absolute zero.

With fewer charge carriers, resistivity increases. Therefore, noise temperature of a diode in a parametric amplifier should first decrease with decreasing temperature, reach a minimum and then increase.

Gallium-arsenide varactor diodes known to work well at low temperatures were used in experiments at Lincoln Laboratory. The slope of forward-voltage curves in the forward-biased direction did not decrease as expected, and little change in slope occurred between room temperature and 4.2 degrees K. More complete tests verified that r-f losses had not changed and the nonlinear reactance characteristic had not been adversely affected by the lowered temperatures.

Finally, an L-band amplifier was repackaged to accommodate cooling by liquid helium. Performance was essentially the same as at room temperature, but noise temperature was 9.8 degrees K.

This behavior of diodes may result from differences in junctions. Usually a small energy gap exists in a diode between the impurity levels and either a valence band or a conduction band. At room temperature, many electrons have sufficient energy to jump these small gaps, but these transition do not occur at absolute zero. However, the doping level may be increased until the Fermi level falls within the valence bands on one side of the junction and the conduction bands on the other. Charge carriers could then exist on both sides of this junction even at absolute zero.

Parametric amplifiers using gallium-arsenide diodes should function in liquid helium at all the same frequencies at which they can operate at room temperature. Thus amplifiers with effective noise temperatures of 10 degrees K or less appear feasible. Improved diodes should permit operation at higher frequencies.

**Phil
Greenstein
can
show
you...**

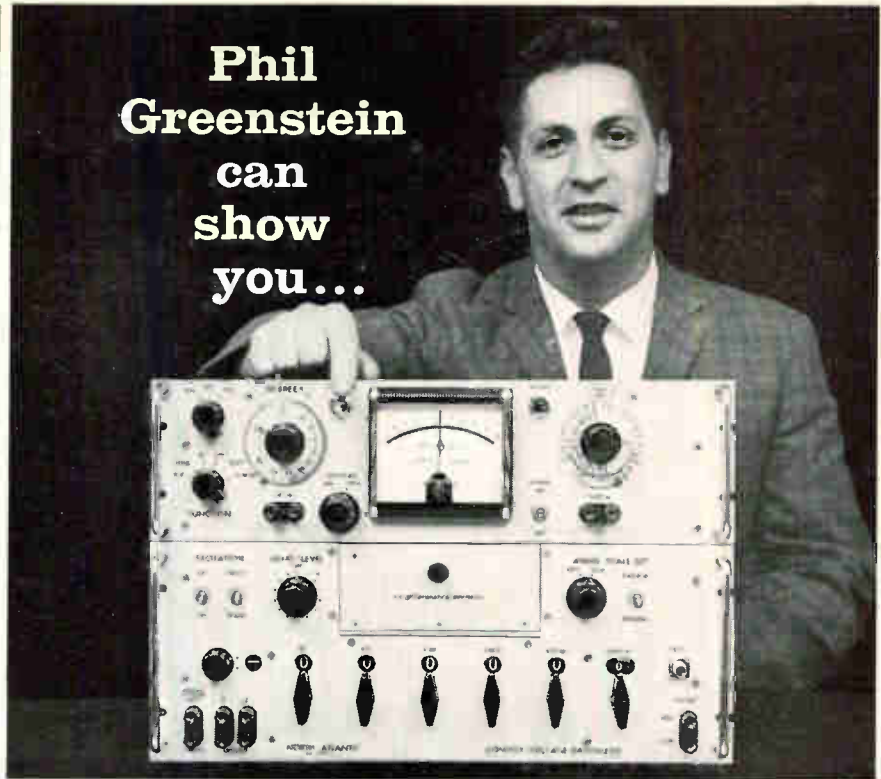

Instrumentation Sales Manager, North Atlantic Industries Inc.

how to measure ac ratios regardless of quadrature

North Atlantic's Complex Voltage Ratiometer is a completely integrated test set for measuring grounded 3 terminal networks. By providing self-calibrated quadrature injection, the Model CVR-551 permits calibrated meter readings of phase angle up to 30° or 300 milliradians full scale, and, in addition, provides direct readings of in-phase and quadrature voltages. As an added feature, the integral Phase Angle Voltmeter* and AC Ratio Box can be used independently. Abridged specifications follow:

In-Phase Ratio Range, R_I000000 to ± 1.111110 with full accuracy
Phase Angle Range, α	± 1.0 to ± 300 milliradians ± 0.1 to $\pm 30^\circ$ (in 6 calibrated ranges)
Frequency	Any specified frequency, 50 cps to 3KC
Input Ratio Error, R_I	$\pm (.001 + \frac{.0001}{R_I} + \delta \tan \alpha)$ % of reading
Phase Angle Error, α	$\pm .0003$ radians or $\pm .017^\circ$ (low ranges) $\pm 3\%$ full scale (high ranges)
Phase Angle Voltmeter* (independently used)	$\pm 2\%$ full scale 1 millivolt to 300 volts (in 12 calibrated ranges)
A.C. Ratio Box (independently used)	1 ppm terminal linearity .35f (300 volts max)

North Atlantic's CVR* line includes 2 and 3 frequency models. All models available with optional 10 ppm Ratio Box control of quadrature injection.

Send for data sheet or contact your local North Atlantic sales representative now for complete information.

®Trademarks



NORTH ATLANTIC industries, inc.
TERMINAL DRIVE, PLAINVIEW, L. I., NEW YORK • OVERbrook 1-8600

Planar Triode Redesigned for Space Use

Quick conversion of existing tube meets space-needs deadline

By **L. F. JEFFREY**

Receiving Tube Department,
General Electric Company
Owensboro, Kentucky

PERFORMANCE of an existing microwave planar triode used for communications systems led to the consideration of modifying this tube, both in rating and in mechanical configuration, to meet stringent satellite requirements.

This development illustrated what can be done to shorten the time required to deliver a specialized component to meet newly defined objectives. The first tubes were delivered within six months after the program began.

While the tube was developed for a specific satellite application, it should find other applications either in its present form or with permissible variations in ratings and cooling structure. Tube can be useful principally in remote, unattended communications systems requiring a microwave power amplifier at frequencies up to 2,900 Mc. Power output available would be dependent upon the total life required. Tube was designed with an objective of a minimum of two watts for an anticipated life of 25,000 hours in broadband operation. Higher powers can be achieved readily at narrow (10 Mc or less) bandwidths with the same life expectancy, or by increasing the rating with a consequent reduction in expected life.

RATING—The modified tube, Z-5457, has an anode rating of 360 volts and 35 milliamperes. The existing type, around which the modified tube was built has an anode rating of 1,000 volts and 90 milliamperes. Changes of the latter included reduction in cathode current



LIGHTHOUSE tubes designed for continuous operation in communications satellite transponders. Large disk serves as heat sink

density close to 70 milliamperes per sq cm and lower dissipation per unit of size.

The new tube employs a high purity nickel cathode in which the high percentage of activators, required in cathodes having densities three to four times greater, is eliminated. This passive cathode is not capable of producing the high peak currents required in certain pulsed applications, but it is adequate where the peak current swing

does not exceed three or four times the average current as in the case of the intended application.

Maintaining the same amount of emission material as used in the original tube, GL-6897, immediately increases the potential cathode life by perhaps three to one.

Cathode structure of the satellite tube has been improved by sintering the active lid to the support structure instead of welding, and by using improved welding techniques in the cathode stem subassembly.

Cathode temperature at the rated heater voltage of 5 volts rms is controlled in manufacture within narrow limits and production is monitored to assure that the final tubes are operating at the optimum cathode temperature as determined by life studies.

CARBON RESIDUE — Extreme care was taken in the cleaning of all tube parts as well as all containers and utensils used in the handling of parts. All halogen-bearing compounds were elimi-

SHORT-ORDER APPROACH

When faced by crowded design-time deadline, designers did not neglect the obvious. They cast about for an available device that fell within ballpark of fulfilling circuit functions, gave reign to creative instinct by seeking methods to re-convert existing device to space-age needs. They bypassed alternate approach of starting from scratch, and spending valuable time trying to discover over again what already existed

SINGER

METRICS
DIVISION

THE SINGER MANUFACTURING COMPANY



RESEARCH AND PRODUCTION of electronic laboratory instruments for precise measurement, calibration and spectrum analysis—subsonic through microwave; and precision electro-mechanical systems and components.

SINGER METRICS DIVISION, THE SINGER MANUFACTURING COMPANY • BRIDGEPORT, CONNECTICUT

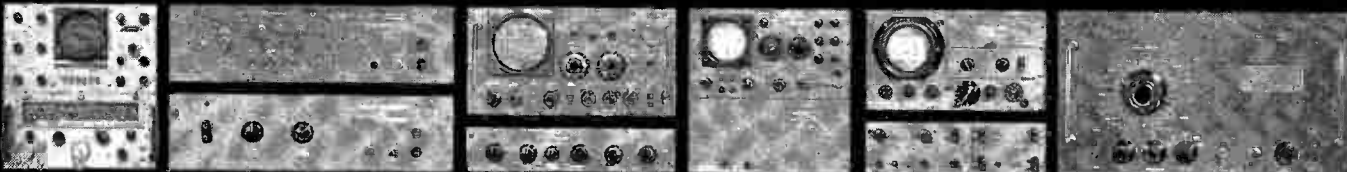

* A Trademark of THE SINGER MANUFACTURING COMPANY



NOW READY:

ANALOG-TO-DIGITAL CONVERTER

NAVCOR MODEL 2201

LOW PRICE: **\$2935**

ACCURACY: **.05%** ABSOLUTE

DELIVERY: **30 DAYS**

Format: Binary, 10 bits plus sign.

Conversion Rate: 10,000 complete conversions per second (9.1 microseconds per bit plus 9.1 microseconds.)

Input Range: ± 10.23 volts; lower or higher ranges available.

Input Impedance: 5,000 ohms; high impedance amplifier optional.

Other models start from \$2,775. Both Binary and Binary-Coded-Decimal formats are available. Options include Sample and Hold, Multiplexing, and Over-Range Indication. For more information, write to NAVIGATION COMPUTER CORPORATION, Valley Forge Industrial Park, Norristown, Pennsylvania.



nated in the operation.

Parts were fired in a controlled hydrogen atmosphere to achieve the lowest possible carbon residue in the cathode and to remove surface oxidation. Only copper plating and copper-gold brazing materials were used internally to reduce voltatality in the active surfaces.

Special tungsten and molybdenum welding fixtures were used in cathode assembly to avoid copper pick-up by the active cathode parts.

Exhaust systems have capabilities of better than 5×10^{-9} millimeter of mercury vacuum and the tubes were baked out on exhaust at 600 deg C to further drive off contaminating elements. This high degree of vacuum and high temperature bakeout results in less initial work for the internal getter and therefore makes gettering action available for a longer period of tube life.

A simple self-compensating bias circuit for the planar triode, Fig. 1, uses a *pn*p transistor in a common emitter circuit acting as an automatic cathode bias regulator. This circuit holds the cathode current constant within plus or minus one percent of the preset value over an extremely wide range of tube characteristics and cathode emission capability.

Tubes of this class are commonly air cooled, but for space applications, the Z-5457 is provided with a heat conducting strap disk



OPERATING trends of tubes observed by author during 1,000-hour stabilizing period. Tests weed out tubes having no chance of survival

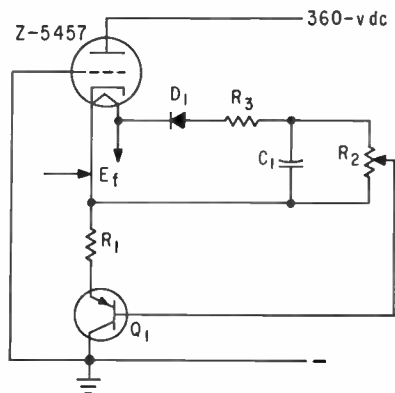

SELF-COMPENSATING circuit automatically adjusts for changes in tube characteristics—Fig. 1

assembly. The heat generated is removed by conduction to a heat sink in the satellite.

Getter Eliminates Pump In Tube Processing

PROBLEM in microwave tube manufacture is to rapidly absorb quantities of carbonaceous gases at normal processing temperatures without need for expensive pumping equipment.

Requirements for getter performance include ability to absorb gases over wide range of practical operating temperatures; without adversely affecting cathode emission; elimination of loose particles commonly encountered with flash getters; and not adding metallic films which can alter interelectrode capacitance.

One leading tube producer reports that use of CerAlloy 400 solved these problems as well as reducing cathode conversion time in a high-powered klystron to two hours from the normally required sixteen to twenty-four hours. Capacity of getter is 110 micron liters of carbon monoxide per mg of getter, low ultimate pressures (at 300 deg. C, equilibrium pressure for hydrogen is less than 1×10^{-4} mm Hg in a closed system); and effective pumping speeds.

Paste can be applied directly to tube parts by a vacuum sintering process, various size pellets with support leads are available for easy mounting; and in strip form, where the getter has been vacuum sintered to nickel, stainless steel, Kovar, and molybdenum substrates, according

measure / analyze, 100 cps - 600 kc signals quickly, easily, with one compact instrument



Model SB-15a (Cabinet Optional)

PANORAMIC SB-15a ULTRASONIC SPECTRUM ANALYZER

Advanced Panoramc's Model SB-15a automatically and repetitively scans spectrum segments from 1 kc to 200 kc wide through the entire range (100 cps to 600 kc) . . . plots frequency and amplitude along the calibrated X and Y axes of a long persistence CRT, or on a 12 x 4 1/2" chart (optional RC-3b). Sweep rates are adjustable from 1 to 60 cps.

Adjustable resolution enables selection and detailed examination of signals as close as 100 cps. Self-checking internal frequency markers every 10 kc. Also internal amplitude reference • Only 8 3/4" panel height. The SB-15a is completely self-contained, uses no external power supply or line regulator.

PANORAMIC PRESENTATION MEANS

- quick signal location, minimum chance of missing weak signals or holes in spectrum
- faster measurements—no tedious point-by-point plots
- reliable spotting for low level discrete signals in noise
- positive identification and dynamic analysis of all types of modulation

ALL THESE APPLICATIONS . . .

- Noise, vibration, harmonic analysis
- Filter & transmission line checks
- Telemetry analysis
- Communication System Monitoring
- Frequency Response Plotting (with Model G-15a Companion Sweep Generator) provides rapid and accurate swept band tests for filters and other networks

Write now for specifications, other applications of Model SB-15a. Get on our regular mailing list for New Product Bulletins.

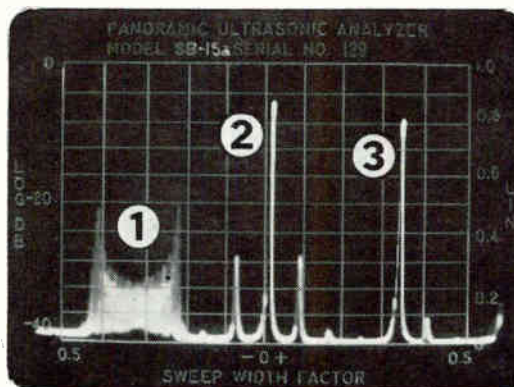

Lab setup shows SB-15a versatility. (1) FM display measures dynamic deviation. (2) & (3) are AM and SSB signals, respectively, with sine wave modulation.

SUMMARY OF SPECIFICATIONS

Frequency Range: 100 cps to 600 kc.
Sweepwidth: Adjustable, calibrated from 1 kc to 200 kc.
Center Frequency: Adjustable, calibrated from 0 to 500 kc.
Markers: 10 kc intervals throughout band. Crystal controlled. Level reference also provided.
Resolution: Automatic optimum resolution plus adjustable I-F bandwidth from 100 cps to 4 kc.
Sweep Rate: Adjustable 1 cps to 60 cps with line synchronization provision.
Amplitude Scales: Linear, 40 db log (extendable to 60 db) and 2.5 db expanded.
Sensitivity: 200 uv to 200 v full scale deflection.
Accuracy: ± 0.5 db from 200 cps to 525 kc.
Input Impedance: 55 k ohms.



See us at NEREM
Booth 609



MANUFACTURED BY



FOREST 6-3201

THE SINGER MANUFACTURING COMPANY

915 PEMBROKE STREET • BRIDGEPORT 8, CONNECTICUT

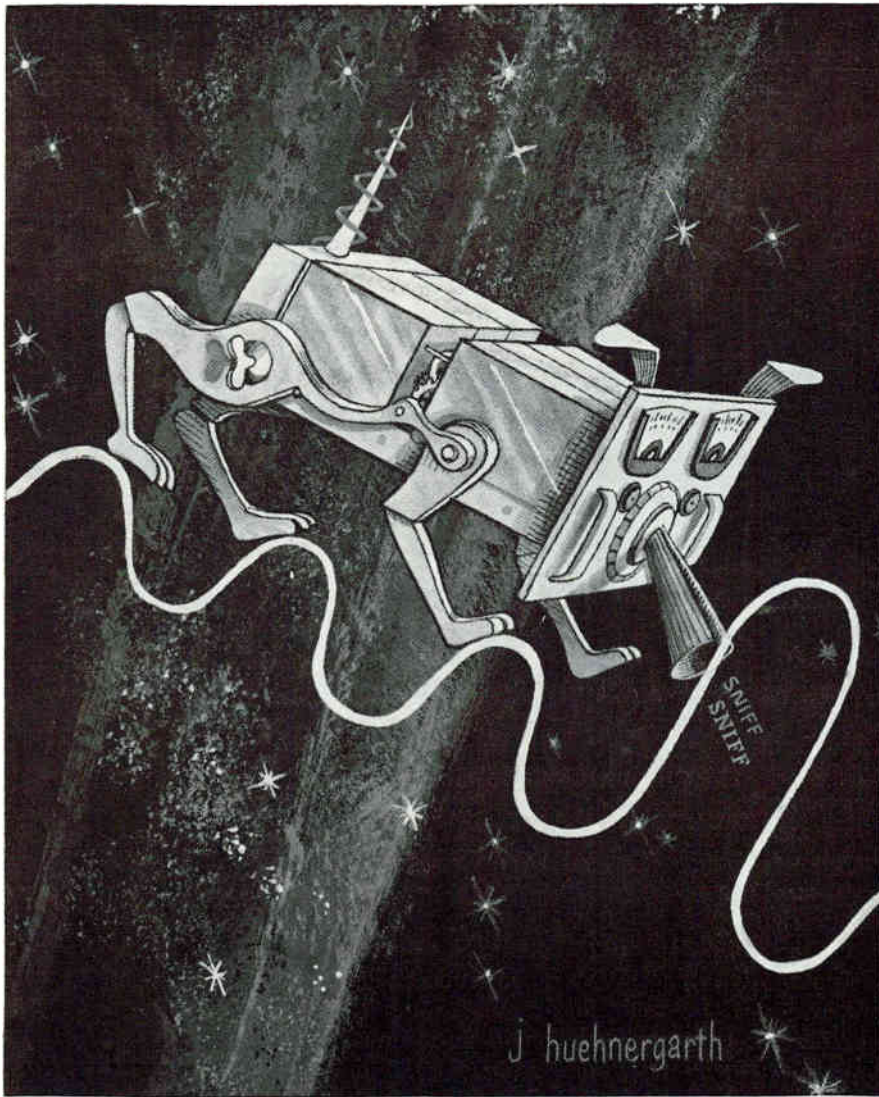

NEMS-CLARKE MODULE

Searches and locks carrier to -145 dbm

When missile and satellite signals are the hardest to find, and hold, this new PCM/PM Module is at its best. It is a phase lock tracking demodulator with anti-sideband lock-out. It searches, tracks and locks onto a carrier signal as low as -145 dbm and will maintain the lock at -150 dbm. AGC of this equipment has been maintained for signal strength lower than locking threshold. Ultra linear phase detector guarantees low distortion reception with a signal modulation as high as 1.4 radians. These new units demodulate either true phase or amplitude modulated signals.

The module is designed to plug into Nems-Clarke 1455-1456A receivers as well as the 1037 deep space probe receiver.



For further information write:
Vitro Electronics, 919 Jesup-Blair Drive,
Silver Spring, Maryland.
A Division of Vitro Corporation of America

VITRO ELECTRONICS

Specifications:

Operation Modes	Automatic, Manual
Automatic Sweep Range	± 5 kc min of VCO center frequency
Manual Sweep Range	± 15 kc of nominal VCO frequency 5,445.00 kc
Tracking Loop Bandwidth	20 & 60 cps (selectable from front panel)
Tracking Loop Sensitivity	Minimum: -150 dbm (Maintain lock), -140 dbm (Automatic search & Lock)

to I. S. Hirshhorn of Ronson Metals.

While mischmetal is actually the predominant rare earth metal used in industry today, there is a growing interest in lanthanum, didymium and other rare earths as additives for improvement of alloys of non-ferrous metals. Rare earths have received renewed consideration as desirable additives for ductile iron, heat resistant stainless steel, and the refractory metals. Other applications being studied include new cathode emitters, and new getters for electron tubes, and intermetallics for transistors and thermoelectric elements.

Rare earths, previously available at much higher prices are now produced in commercial quantities for \$3 to \$35 per pound according to Ronson.

Special Alloys for Low Temperatures

A SERIES of 76 new alloys meets the temperature requirements of semiconductor devices from 47 C to 950 C.

Identified by numbers, the new Alloys Unlimited alloys, according to their research director Leonard Bernstein, fall into 3 groups. Group I has 56 eutectic alloys containing such major elements as Bi, In, Sn, Pb, Cd, Au and Mg. All go immediately from solid to liquid.

Groups II and III containing 20 alloys are multi-component systems which are not eutectic. The major alloy elements in these two groups are in the precious metal family.

Each alloy can be fabricated either as stamped parts to a minimum of 0.002 in. in thickness or as spheres. They can be *p* or *n* doped when bonded to silicon, germanium, III-V compounds, thermoelectric materials, etc. Dopants, according to the manufacturer will be suggested for any application.

Ferroelectrics Developed For Variable Delay Lines

INVESTIGATION has established the feasibility of electrically variable delay lines based on ferroelectrics.

The helical multisection line appears applicable to frequencies up to approximately 500 Mc. Above this range, a strip line would have to be used.

Last week, ITT's S. H. Hoh gave *ELECTRONICS* a brief summary of his group's work in ferroelectric delay media.

Aside from line configurations, the electrical characteristics are highly dependent upon the properties of the ferroelectric materials. Electromagnetic lines per se are lossy in the frequency range from 30 to 1,000 mcps. High Q ferroelectrics are required, therefore, if the total attenuation is to remain reasonable.

At the lower frequency end, the attenuation of the ferroelectric line could be held as low as a standard delay cable such as type KD-261. In addition, its length was reduced by more than 50 percent. The attenuation is quite reasonable for short delay lines as would be required in frequency and phase modulation. Longer delay lines of multiples of microseconds, however, appear less practical due to their high attenuation.

MATERIALS USED—Available commercial ceramics as well as single crystal ferroelectrics were not suitable in the frequency range. A modified barium strontium titanate was developed which had a Q of 100 at 200 mcps. Further improvement appears possible.

The problems of high line capacitance and low impedance can be alleviated with nonuniform field dielectric configurations. Such structures lend themselves particularly well to strip line configurations.

An experimental helical line, based on a nonuniform field distribution was constructed at ITT.

Hoh further reports that a pilot plant has been set up for the production of ultrapure barium titanates for quality components. Furthermore, degradation of barium titanates at elevated temperatures could be greatly reduced.

A paper entitled "Improved Insulation resistance of BaTiO₃ Materials by Fluoride Additions" was presented last week in Boston, before the Electronics Division of the American Ceramics Society.



your check-out
system starts here...

with this Model 442 programmable oscillator

Here's the ideal source of ac stimulus, in a wide-range, low-distortion oscillator. Ideal for automatic testing of components, assemblies, systems — any equipment requiring ac performance evaluation.

The Krohn-Hite Model 442 offers unique coverage at the low end . . . provides remote or automatically controlled ac signals from 0.001 cps to 99.99 kc. Distortion is 0.1% or less throughout the mid range. Output is both sine and square wave simultaneously.

This programmable oscillator has found wide acceptance in component checkout systems, because of its excellent stability (0.05%) and its precise resetability. It is readily adaptable to a wide variety of input program and indicating devices, as well as many output amplitude control combinations.

Other Krohn-Hite programmable oscillators are also available for specialized testing requirements. For example, Model 447 is a stable-amplitude (0.01%), very low-distortion (0.02%) programmable oscillator, covering a frequency range of 1 cps to 100 kc. For automatic oscillator applications requiring superior frequency accuracy, Krohn-Hite's Model 451 offers 0.05% accuracy and covers a range from 1 cps to 20 kc. The Model 453 combines superior frequency accuracy, and amplitude stability, and very low distortion over a range from 1 cps to 20 kc.

So, if you're looking for a reliable, programmable source of ac for automatic or remotely controlled testing — check out these Krohn-Hite wide-range programmable oscillators! Write for full details.



KROHN-HITE CORPORATION
580 Massachusetts Avenue • Cambridge 39, Mass.
Pioneering in Quality Electronic Instruments

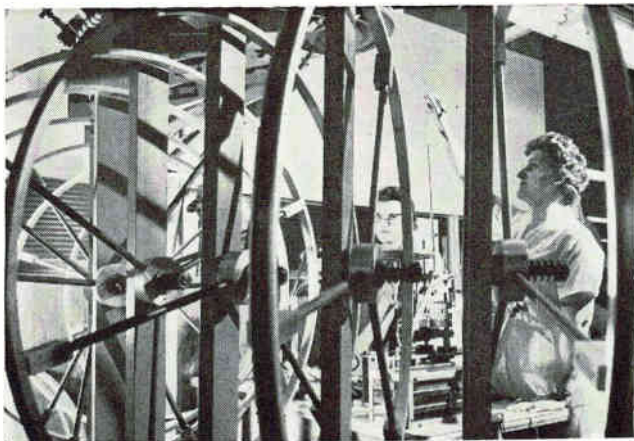

ELECTRODE WIRES from large wheels are fed into tube assembly fixture. Wire does not take permanent bend when stored this way

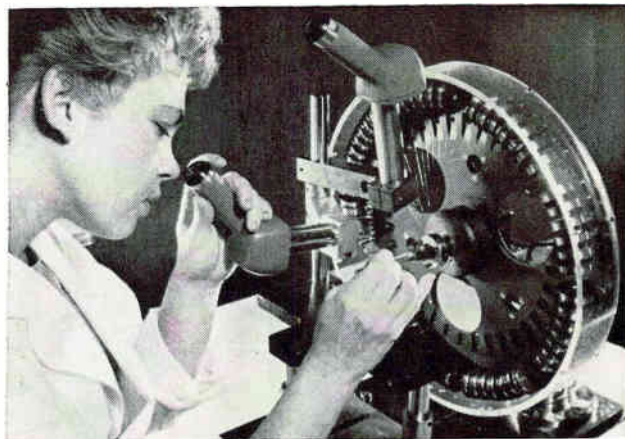

FIXTURE IS loaded with 60 spools of wire for use with grid manufacturing machine; grid will have 60 longitudinal wires wrapped by another wire

Concentric Design Aids Tube Production

Tube design increases product uniformity and speeds production

EASE OF PRODUCTION was one of the advantages sought and obtained by RCA when the Nuovistor tube line was designed. The tube structure is essentially a series of concentric cylinders. Element support is single-ended at the ceramic base, in a cantilever structure, but rigidity is obtained by the flaring flange and the three point support for each element; uniform electrode spacing is obtained by the assembly fixture.

As an example of electrode rigidity, the control grid, which would appear to be subject to vibration, actually has a natural frequency of about 8,000 cps; further, since the grid has a high mechanical Q at its resonant point, other frequencies are severely damped and tube microphonics are low.

PRODUCTION STEPS—The first manufacturing step is the construction of the ceramic bases. A ceramic powder (fosterite), with care-

fully controlled density and composition, is mixed with a binder compound, then pressed into wafers using automatic machines; the formed wafers have through-holes

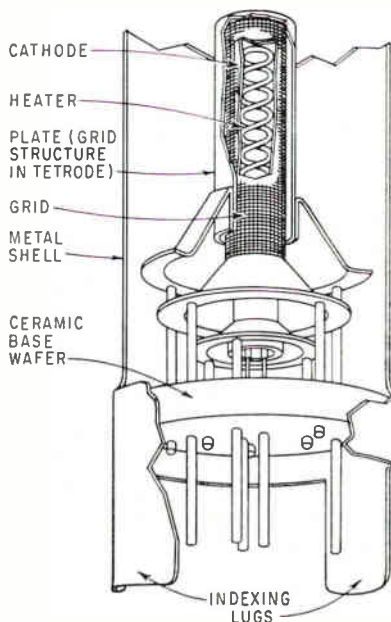

TRIODE IS made of concentric cylinders supported at bottom. In tetrodes the plate structure is replaced by a grid, and another plate cylinder is added from the top, with a ceramic ring for insulation

for element support wires.

The wafers are dipped in a metalizing solution, fired first in air and then in hydrogen, then plated with iron; finally, metal on the flats is ground off, leaving the holes through-plated and the outer rim metallized.

Next step in production is to insert the heater element—with its leads—into the ceramic base. This was one of the toughest production operations and the last to be automated.

A simple jig is then used to assemble the internal tube structure. The jig holds the electrode parts in place until they are brazed together in a hydrogen atmosphere. First the plate cylinder is set in place in the jig, then the plate flange is added on top of it. Next comes the grid cylinder, then its flange; then the cathode-support cylinder and flange. The ceramic base—with heater in place—is added to complete the electrode structure; finally, the element support wires, three for each electrode, are set in place against the bottom of the flanges through the metallized holes in the base. For each tube element, two of the electrode support wires are cut off

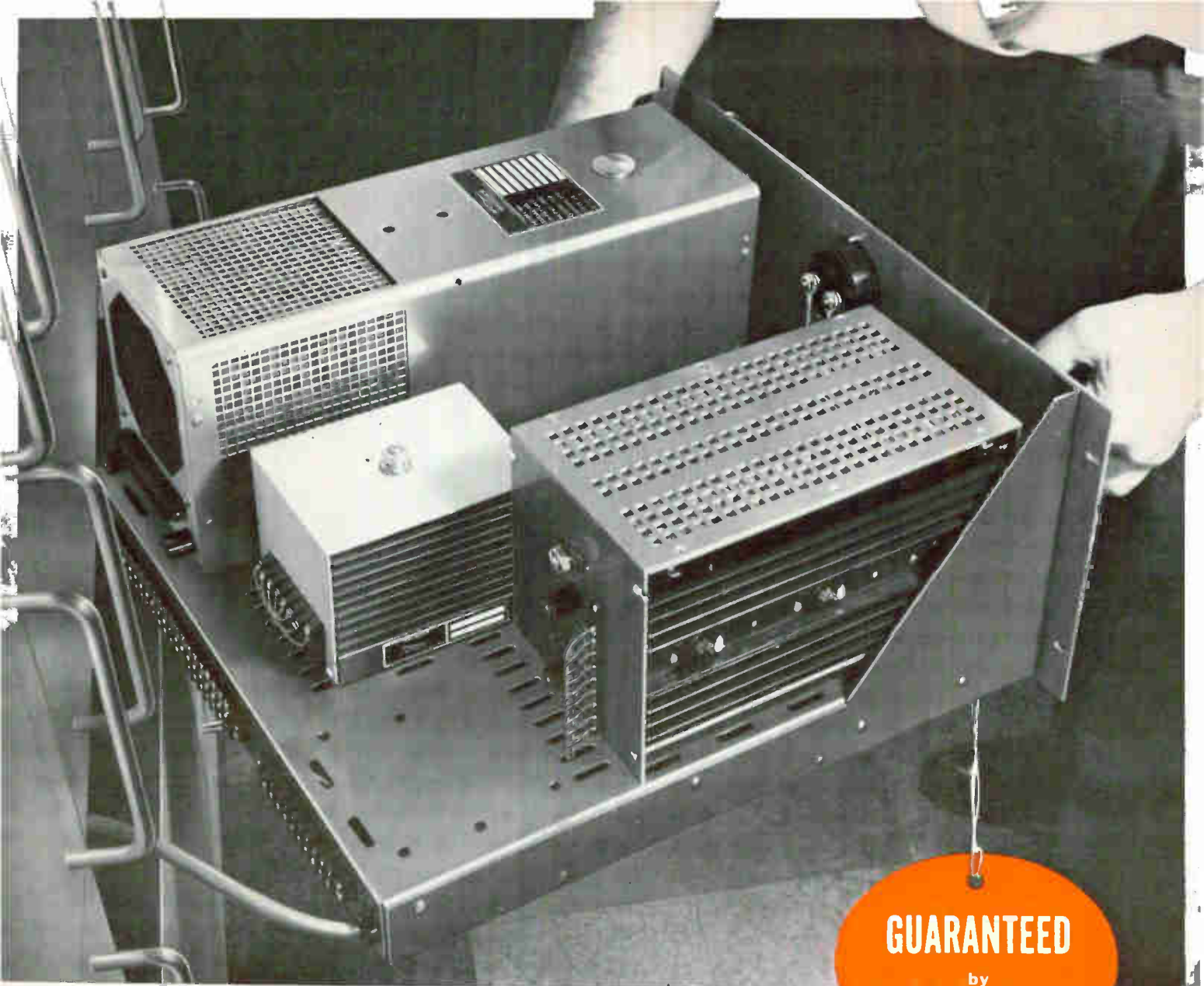

GUARANTEED
by
"WORST CASE"
ANALYSIS

Chances are you'll "plug-in" this power supply only once!

Forget all your old ideas about how long a precision power supply will last . . . how much abuse it can take and still stay accurate.

Once installed, you'll probably never ever touch a Con Avionics transistorized power supply again during the life of the equipment it operates.

Many of these power supplies have survived 20,000 hours under the worst possible conditions without the slightest sign of failure.

The reason? Con Avionics unique design principle "Worst Case" Analysis.

It eliminates 90% of the causes for power supply failure. Increases the accurate life of a power supply substantially. Assures virtually failure-proof performance.

Learn how Con Avionics transistorized power supplies can give you extra protection against costly shutdowns, and substantially reduce your supply cost per operating hour. Write for bulletin on Con Avionics complete line of Transistorized Power Supplies. Or call your local Con Avionics representative.



New LR and XR MODULES for applications to 14 amps, 0.05% or 10 mv Regulation. Ripple: 2 mv. Stability: 0.1% for 8 hours. Operating temp: 45°C as specified, derated to 70°C. Send for bulletins 103 and 104 for details.



CONSOLIDATED AVIONICS CORPORATION

800 SHAMES DRIVE, WESTBURY, L. I., NEW YORK



**CON
AVIONICS**



NONE, REALLY... KEL-F® 81 CAN BE PRECISION

BRAND PLASTIC

MOLDED TO A MICRO-UNIFORMITY WITHIN $\pm .002''$

Your eye can't do justice to the micro-uniformity of intricate precision parts molded of KEL-F 81 Brand Plastic! Exceptional uniformity of this material allows skilled processors to offer new levels of molding precision (within $\pm .002''$) for components in electronic equipment, missiles, many other demanding applications. Machining tolerances are even finer—as close as $\pm .0005''$!

Compression, injection, transfer molding all offer excellent uniformity because of the unmatched processability of KEL-F 81 Plastic. (Chlorine in the unique thermo-plastic structure helps.) It can be extruded, heat treated, or fine machined. ZST testing also assures that material uniformity and molecular weight in finished parts of KEL-F 81 Plastic are consistently high—a 3M requirement for authorized processors!

8 ENVIRONMENT CONQUERING BENEFITS OF KEL-F 81 PLASTIC. 1) *High dielectric stability:* dielectric strength greater than 500 vpm, arc resistance greater than 360 seconds. 2) *High mechanical strength:* excellent tensile, impact and compressive strengths, low cold flow. 3) *Abrasion resistance:* not easily abraded mechanically or by slurries. 4) *Chemical inertness:* resists practically all corrosive media, even LOX! 5) *800 degree range:* -400 to $+400^{\circ}\text{F}$. 6) *Zero moisture absorption:* minimizes surface flashover, blocks water vapor. 7) *Radiation resistance:* retains great strength despite severe exposure. 8) *Infrared transmissions:* permits great thin-section clarity, other optical advantages. For further information and technical assistance, as well as the authorized processor list, see the column at right.

"KEL-F" IS A REG. TM OF 3M CO.

MINNESOTA MINING & MANUFACTURING CO. **3M**

KEL-F 81 Plastic

BRAND

...in typical applications

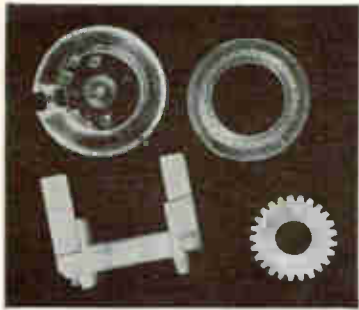

Complexly designed small parts shown above were precision molded by *Pli-O-Seal Manufacturing Inc.*, a subsidiary of *Zero Manufacturing Co.* Included are tiny gears, other small electronic components. KEL-F 81 Plastic may be molded in colors to provide easy coding. Metallic conductors may be incorporated into the design of the molded part.

FOR MORE DATA about KEL-F 81 Plastic for electronics parts, contact the 3M Chemical Division Branch office in Chicago, Cleveland, Los Angeles or Ridgefield, N.J.

AUTHORIZED PROCESSORS OF KEL-F 81 PLASTIC

Adam Spence Corp.,
963 Frelinghuysen, Newark, N.J.

Allied Nucleonics Corp.,
2421 Blanding Ave., Alameda, Calif.

Auburn Plastics, Inc.,
Auburn, N.Y.

Bonny Manufacturing Corp.,
146 Main St., Maynard, Mass.

Carmer Industries, Inc.,
22 N. 26th St., Kenilworth, N.J.

The Fluorocarbon Company,
1754 Clementine, Anaheim, Calif.

Fluorulon Laboratories, Inc.,
Box 305, Caldwell, N.J.

Garlock, Inc.,
Camden 1, N.J.

G-W Plastic Engineers, Inc.,
Bethel, Vt.

Gries Reproducer Corp.,
125 Beechwood Ave., New Rochelle, N.Y.

Modern Industrial Plastics, Div. of Duriron
Company, Inc.,
3337 N. Dixie Dr., Dayton 14, O.

Moxness Products, Inc.,
1914 Indiana Ave., Racine, Wis.

Penn-Plastics Corp.,
100 Fairhill Ave., Glenside, Pa.

Pli-O-Seal Mfg. Co., Sub of Zero Mfg. Co.,
1010 Chestnut St., Burbank, Calif.

Raybestos Manhattan, Inc., Pacific Div.,
1400 Orangethorpe, Fullerton, Calif.

Rockwell Manufacturing Co., Plastics Plant
1350 Fifth Ave., East McKeesport, Pa.

L. W. Reinhold Plastics, Inc.,
8763 Crocker St., Los Angeles 3.

Saunders Engineering Corporation,
3012 Spring St., Redwood City, Calif.

W. S. Shamban Co.,
11617 W. Jefferson Blvd., Culver City, Calif.

Thermotech Industries, Inc.,
3336 Gorham Ave., Minneapolis 26, Minn.

Timely Technical Products, Inc., Industrial
Plastic & Engineering Div., Verona, N.J.

Tube Turns Plastics, Inc., Halochem Products
Div., 3713 Forest Lane, Garland, Texas

For general technical information about KEL-F 81 Plastic, write Chemical Division, Dept. KAX-102, 3M Company, St. Paul 19, Minn.



ASSEMBLY fixtures with tube structures move on conveyor from automatic assembly station



NUVISTORS are being loaded into vacuum baking and sealing chamber

close to the base and the third is kept to make circuit connections.

The copper braze in the hydrogen atmosphere connects cylinders to flanges, flanges to support wires, and wires to the plated holes in the base. After brazing, a coated cathode cup is placed over the cathode-support sleeve.

A ring of brazing alloy is then fitted to the ceramic base and the completed tube structure is placed in its metal envelope. A fixture holding a number of tubes is then placed in a bell jar type chamber; a high vacuum is pulled and radiant heat is applied by passing an electric current through nichrome sleeves, which are in the vacuum chamber; after about 16 minutes the heat and vacuum have outgassed the tubes and cathode breakdown has occurred. The temperature is then increased and the brazing alloy ring melts and seals the tube.

Tube manufacture is now complete, except for a typical ageing process. Getters are not required in these small tubes since the high temperature processing and final outgassing have driven occluded gases and other contaminants out of the tubes.

The simple cylindrical electrodes in the tube presented no production problems, except for the grid structure. The grids are made on a special machine, where 60 strands of nickel plated molybdenum wire are placed longitudinally along a mandrel and wrapped with a strand of copper plated molybdenum: the wrapping wire forms a long helix about the longitudinal wires. The mandrels are then fed into a small oven and a monel braze takes place at each point where the copper-plated and nickel-plated wires cross. The grids are then cut apart for assembly into tubes.

The three brazing operations in tube manufacture are selected such that successive brazes occur at progressively lower temperatures. Difficult heat transfer and timing problems are thereby eliminated.

One of the important characteristics of the tubes is the uniformity of characteristics that is obtained from tube to tube and from batch to batch. Transconductance typically is within ± 10 percent of the median value and interelectrode capacitances are so uniform that fixed value neutralizing circuits are practical in many applications.

New accuracy, faster response in industrial temperature sensing

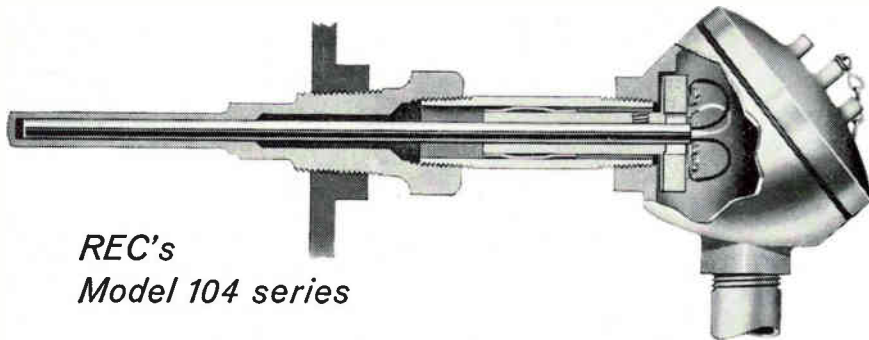

REC's
Model 104 series

Performance that approaches laboratory standards is now available in an industrial temperature sensor—and at far less than laboratory instrument prices. The new Model 104 series of platinum resistance temperature sensors from Rosemount Engineering offers you these features:

- Wide range: from -260°C . to $+750^{\circ}\text{C}$.
- Accuracy: within 0.1% at 0°C .
- Stability: within 0.1°C . after 10 consecutive temperature shocks from 600°C . to 20°C .
- Fast response: time constant of less than 2 seconds.
- Ruggedness: unaffected by 35G or 3,000 psi pressure.
- Versatility: mounts in standard thermowells or directly into pressure vessel with tapered thread fitting.

Structurally the REC Model 104 element is highly pure platinum, mounted strain-free in a ceramic rod, and normally hermetically sealed into a stainless steel well from .082" to .375" in diameter. It is carefully made using production techniques developed during Rosemount's many years of supplying ultra-precise sensors for critical aerospace and laboratory applications.

For further details on how the new REC Model 104 sensors will fit your application, write for Model 104 bulletin or outline your specific problem.

A complete precision line

Rosemount Engineering Company designs and manufactures high quality precision equipment in these lines:

Air data sensors
Total temperature
Pitot-static tubes (de-iced)

Surface temperature sensors
Pressure sensors

Immersion temperature sensors (including cryogenic)

Accessory equipment and aeronautical research

For more information please write for the REC catalog. Specific questions on any temperature or pressure problems are welcomed.

®



**ROSEMOUNT
ENGINEERING
COMPANY**

4900 West 78th Street • Minneapolis 24, Minn.

SPECIALISTS IN TEMPERATURE & PRESSURE MEASUREMENT

Laminated Circuits Made With Dry Process

MULTILAYER high density printed circuits using dry materials only has been developed by New England Laminates Co., Inc., Stamford, Conn.

Material for the compact light-weight system consists of two or more layers of etched circuits on epoxy glass laminate separated by a woven glass cloth impregnated with an epoxy resin. From three to eight circuits can be laminated simply and easily. Insulation resistance is high, and capacitive, resistive and inductive elements can be formed with one multilayer package.

The major shortcoming of the usual wet layup system generally is poor registration. Attempts to press individual laminates together were not always successful because the base laminate and the adhesive were sometimes chemically incompatible. The result was partially cured laminates with poor water absorption characteristics, low solder blister resistance, and reduced electrical properties. By using a dry layup, involving no solvent entrapment, registration of the individual circuits is improved.

The heart of the multilayer system is a thin, fully cured, copper-clad epoxy glass laminate. The laminate has 20-second endurance in molten solder at 500 F and was engineered for high reliability requirements.

The base material can be etched on one or two sides and is available in thicknesses of 0.003 to 1 inch (plus the thickness of the copper cladding).

Uniformity of the laminate allows complex wiring patterns of minimum area. The individual laminate layers are bonded together by an impregnated fiberglass cloth, which is interleaved with the epoxy glass laminates. Lamination occurs when the system is subjected to 600 psi at 340 F for 40 minutes; parameters of the laminating process are not critical, however, and highly precise controls are not necessary. No chemical activation is required. Completed circuits meet MIL-P-13949B requirements.

The laminated circuits can be used for both plated-through and clearance hole type circuits.

A NEW MM WAVE CENTER FOR OKI

Oki's new millimeter wave center was completed this July. This mm-wave center is equipped with complete facilities for up-to-date research, development and manufacturing in the complex field of mm-wave generators and components. All the complex process of production, beginning with precision machining of cavity piece and ending by 24 hour final inspection test, are now op-

erated in a vertical run. Here, in the new center, quantity production is starting for standardized mm-wave tubes; klystron and magnetron 20 KMC thru 100 KMC. Oki Electric has 80 years of experience in the fields of communications and electronics. With more than 10,000 employees in its many other factories throughout Japan, Oki Electric is already rec-

ognized for its complete research, manufacturing, installation and service facilities. The establishment of this new center is another step by Oki Electric as an integrated manufacturer of electronics equipment in modernization. To learn more about the Oki systems of electronics equipment, write to the address below.

OKI
electric industry
co., ltd. TOKYO JAPAN

Butler Roberts
Associates, Inc.
A Subsidiary of
OKI Electronics of America
202 East 44 Street
New York 17, N.Y.
MU-2-2989

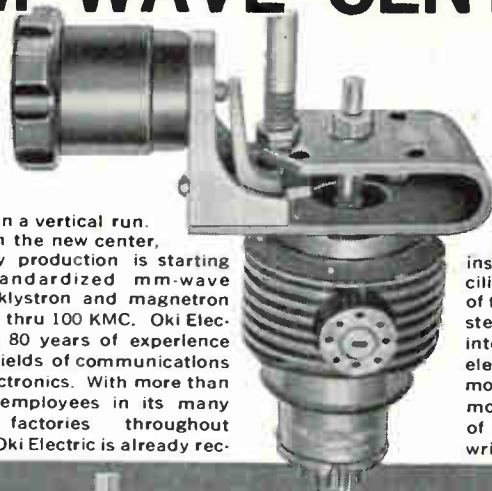

10 Shiba-Kotohirā-cho, Minato-ku, Tokyo, Japan Cable Address: "OKIDENKI" Tokyo

CIRCLE 201 ON READER SERVICE CARD

BEST MINIATURIZED INDICATOR

VU RADICATOR



V-403



SB-305



R-201



R-101

R-101	Tuning indicator and Battery residual capacity indicator
F-102	FM tuning indicator
V-103	Audio level indicator
A-104	AM tuning indicator
SB-105	Stereo balancing indicator
B-106	Battery indicator
R-201	Smaller type tuning and battery indicator
V-203	Smaller type level indicator
B-206	Smaller type battery indicator
R-301	Larger type tuning and battery indicator
V-303	Larger type level indicator
SB-305	Larger type stereo balancing indicator
V-403	VU meter
V-403B	Audio level indicator
SB-405	Null indication stereo balancing indicator

ACCEPTABLE SPECIAL DIAL UPON YOUR REQUEST

DISTRIBUTOR

ATAKA NEW YORK, INC. **ATAKA & CO., LTD.**

633 THIRD AVENUE
16TH FLOOR
NEW YORK 17, N.Y., U.S.A.
PHONE: OXFORD 7-7480

OHEMACHI BLDG.
1-CHOME, OHEMACHI
CHIYODA-KU, TOKYO
PHONE: 201-6411

MAKER
TOYO MUSEN CO., LTD.
75, WAKABAYASHI-CHO, SETAGAYA-KU, TOKYO

CIRCLE 202 ON READER SERVICE CARD

the finest precision
coaxial connectors*

*TNC

General RF Fittings, Inc.
702 BEACON STREET, BOSTON 15, MASSACHUSETTS
Telephone: 617 267-5120

CIRCLE 79 ON READER SERVICE CARD

DESIGN AND APPLICATION

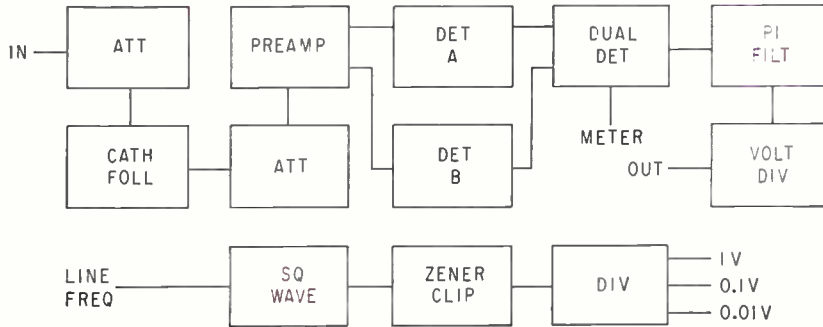

Converter for Low Levels and Low Frequencies

Combination instrument is also a 1% a-c vtm between 5 cps and 100 Kc

MANUFACTURED by Houston Instrument Corp., P. O. Box 22234, Houston 27, Texas, the model HVC-30 a-c/d-c converter voltmeter is a general purpose combination instrument designed to handle signals at low levels and low frequencies to operate digital voltmeters, X-Y recorders, strip-chart recorders, potentiometric voltmeters or separately as a 1% a-c vtm with 10 ranges between 10 mv and 300 v full scale. Accuracy is 1 percent between 5 cps and 100 Kc with usable range to 200 Kc. Input is 10 megohms shunted by 50 pF. The unit also features 25 μ v resolution on lowest range, three full-scale output levels of 1 v, 0.1 v and 0.01

v with no output loading error and fast ripple-free response (0.5 percent) to 5 cps. The 1-percent a-c voltmeter function has 10 db intermediate scale ranges. Meter is 1-percent movement with mirror scale calibrated in volts and db. As shown in sketch, unit has four basic sections; input voltage divider and attenuator, preamplifier with gain of 100, a-c/d-c detector-bridge amplifier and an adjustable output filter. The output signal passes through a pi-section filter to reduce ripple. Shunt filter capacitors are adjustable for acceptable ripple levels at frequencies selected by a front-panel switch. Bridge output is proportional to average value of waveform applied to input. A thermistor compensates for changes in toroid resistance caused by variations in ambient temperature.

CIRCLE 301, READER SERVICE CARD

whose faces are perpendicular to the Z axis. The crystal is placed between two transparent electrodes allowing light to pass in the same direction as the applied electric field. The crystal-electrode configuration is potted with silicone rubber in a phenolic case. As shown in the sketch, a collimated light beam is incident normal to the surface of the polarizer. The beam then passes through the modulator, analyzer and detector (not shown). With no electric field, system passes a minimum of light. When modulating voltage applied, normal uniaxial crystal becomes biaxial splitting incident plane polarized beam into perpendicular components or elliptically polarized light. Intensity of light follows sine squared relation to applied voltage. Frequency responses from d-c to 2 Mc. (302)

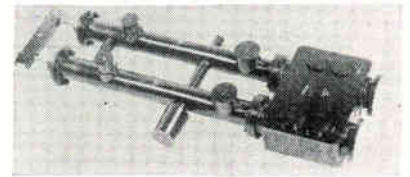

High Power Duplexer Covers Wide Band

TUCOR, INC., 59 Danbury Road, Wilton, Conn. Operating over the 400 to 450 Mc range, the T47V9D duplexer is capable of handling 20 Kw average and 1 Mw of peak power. Vswr, on both transmit and receive, is 1.15, and insertion loss is a maximum of 0.6 db over transmit and receive cycles. Isolation is greater than 50 db. (303)

Light Modulator Uses Pockels Effect

MANUFACTURED by Isomet Corp., 433 Commercial Ave., Palisades

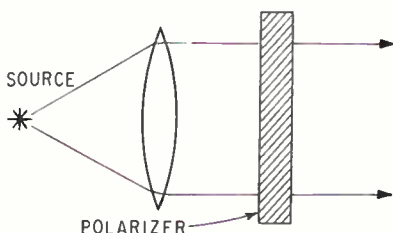

Park, N. J., is an electro-optic light modulator which is a solid-state analogue of the Kerr cell and operating by virtue of the Pockels effect. The solid state light modulator consists of a flat polished plate of ammonium dihydrogen phosphate (ADP), potassium dihydrogen phosphate (KDP) or potassium deuterium phosphate (KD*P)



Clock Oscillator Has Fail-Safe Design

SOLID STATE ELECTRONICS CORP., 15321 Rayen St., Sepulveda, Calif.,

RMC

TEMPERATURE STABLE

DISCAPS TYPE JL

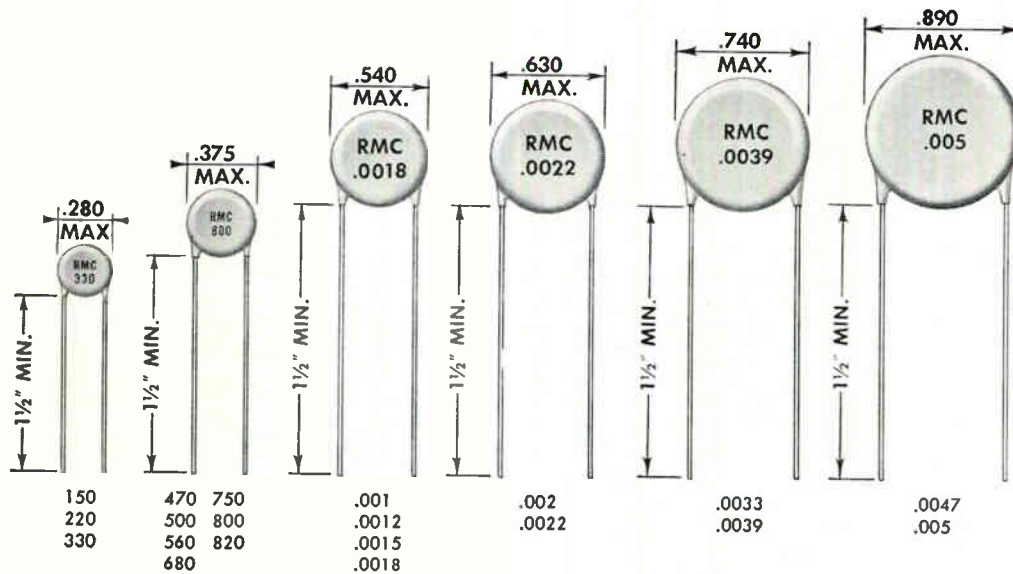

Disc sizes under 1/2" diameter have lead spacing of .250. Discs 1/2" diameter and over have .375 spacing.

SPECIFICATIONS

POWER FACTOR: 1.5% Max. @ 1 KC (initial)
 POWER FACTOR: 2.5% Max. @ 1 KC (after humidity)
 WORKING VOLTAGE: 1000 V.D.C.
 TEST VOLTAGE (FLASH): 2000 V.D.C.
 LEADS: No. 22 tinned copper (.026 dia.)
 INSULATION: Durez phenolic—vacuum waxed
 INITIAL LEAKAGE RESISTANCE: Guaranteed higher than 7500 megohms
 AFTER HUMIDITY LEAKAGE RESISTANCE:
 Guaranteed higher than 1000 megohms
 CAPACITY TOLERANCE: $\pm 10\%$ $\pm 20\%$
 +80 -20% at 25° C



Applications requiring a capacitor that exhibits a minimum of capacity change over an extended temperature range need RMC Type JL DISCAPS. As temperature varies between -55° and $+110^{\circ}$ C, Type JL DISCAPS show a capacity change of only $\pm 7.5\%$ of capacity at 25° C. Standard working voltage is 1000 V.D.C. Type JL DISCAPS are an ideal cost saving replacement for paper or general purpose mica capacitors.

Write on your letterhead for information on Type JL and other RMC DISCAPS.

SARATOGA INDUSTRIES REPORT

A compact, multiple output, high voltage, low current power supply — The SI-2K4-PS.

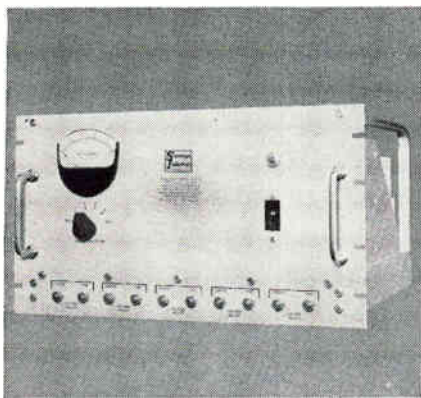

Designed to meet customer's functional specifications.

FEATURES — Solid state circuitry for low current, high voltage applications providing minimum ripple (less than 0.1% peak to peak at full load), noise suppression, and regulation of $\pm 0.1\%$ for line and for load changes of 200 micro amps. This unusual design has five modules, each of which provides an independent regulated output working from a common power source.

SPECIFICATIONS —
 Input—voltage: 116 to 126 VAC, single phase
 frequency: 60 ± 1 CPS
 current: 3 amps RMS Max.
 Each output—
 voltage: —300 to —1800 VDC
 adjustable; resolution ± 1 VDC
 current: 13 MADC Max.
 Construction—rack mounted chassis; standard 19" front panel

For full information about Saratoga Industries complete design, engineering and production facilities write



SARATOGA INDUSTRIES
 A Division of Espey Mfg. & Electronics Corp.
 Saratoga Springs, N. Y. • Telephone 4100

offers the DBCO1171, a 10 Mc module. It consists of a crystal-controlled Butler oscillator with associated buffer amplifier and is primarily intended for use as a master clock for digital systems. A potentiometer is provided and may be adjusted according to the num-

ber of loads to be driven. Fast switching silicon transistors and diodes are used to obtain a clock pulse having fast rise and fall times. Nominal frequency stability is ± 0.01 percent from -40 C to $+100$ C.

CIRCLE 304, READER SERVICE CARD

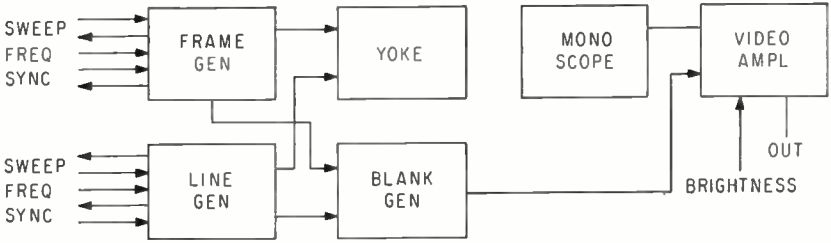

Slow-Scan Video Signal Generator

DEVELOPED by the General Electrodynamics Corp., 4430 Forest Ln, Garland, Texas, the GEC 6014 monoscope video signal generator is a transistorized test set that provides a conventional Indian-head test pattern over a variety of slow-scan frequencies. Any other frequencies can be provided by driving the unit from external signals. Line deflection generator frequency is 5 to 500 cps with output sync of 4 v negative. Input sensitivity is 2 v peak-to-peak. Frame frequency is 0.01 to 1.0 cps with output sync of 4 v negative. Blanking generator output is -10 v.

Video amplifier frequency response is d-c to 100 Kc at 0.5 v with white positive. Resolution is 500 lines. The device resolves 5 gray scales. Frequency and timing can be either internal sweep and internal sync or internal sweep with external sync. There is also a one-shot position where only one frame will be scanned when either a front panel push-button is operated or a negative pulse is applied. A test position allows disconnecting frame generator so that any portion of the signal pattern can be selected for focusing and brightness adjustments. (305)

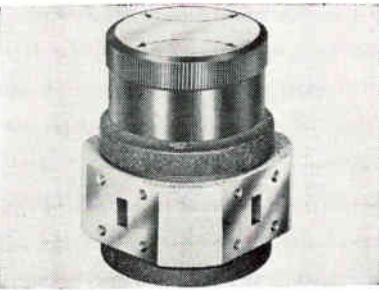

Waveguide Switches Cover 8.2 to 40 Gc

PRD ELECTRONICS, INC., 202 Tillary St., Brooklyn 1, N. Y. The 4000 series of waveguide switches cover 8.2 to 40 Gc in four bands. They are of the 3 and 4 port, 2 position type. They feature low insertion loss of 0.2 db nominal and a vswr of 1.10 max, combined with neg-

ligible crosstalk. Switches also feature small operating torque and strong detent action ensuring complete repeatability of switch settings. Isolation for all units is 60 db. (306)

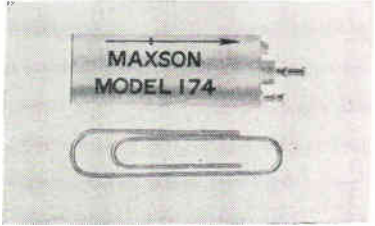

Acceleration Switch Weighs 3/4 Ounce

MAXSON INSTRUMENTS DIVISION, 475 Tenth Ave., New York 18, N. Y. Model 174 is a unidirectional, single

axis, hermetically sealed switch. It actuates equipment without the need of electronic circuitry, in response to a preset value of acceleration. Acceleration range is from 5 to 60 g, with a 09 cross axis sensitivity. Operating temperature range is - 65 F to - 250 F. Contact rating is 100 ma. (307)

Strain Gage Transducers

STATHAM INSTRUMENTS, INC., 12401 W. Olympic Blvd., Los Angeles 64, Calif., announces the Amplibridge strain gage transducers that produce the 5-v d-c output required for telemetry, eliminating need for conventional amplifiers. (308)

Alloy Zener Diodes

MOTOROLA SEMICONDUCTOR PRODUCTS INC., 5005 E. McDowell Road, Phoenix 8, Ariz., has introduced a series of alloy-junction Zener diodes in a voltage range of 3.3 through 7.5 v in the industry standard 1-w flangeless package. (309)

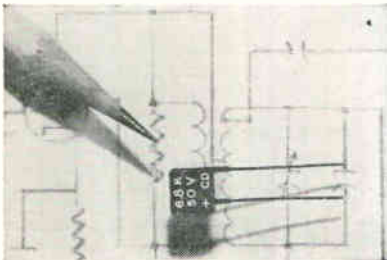

Miniature Capacitor Designed for P-C Use

CORNELL-DUBILIER ELECTRONICS DIV., Federal Pacific Electric Co., 50 Paris St., Newark 1, N. J., has developed a rectangular, solid-tantalum capacitor with ratings up to 50 vdcw. Capacitance values range from 6.8 μ f to 56 μ f at 120 cps. Unit will operate at temperatures from -55 C to +85 C with no voltage derating. It measures 0.325 in. sq, 0.175 in. deep and has 0.175 in. lead spacing. Standard capacitance tolerances \pm 20 percent. (310)

Recorder Conversion Kit

PACIFIC ELECTRO MAGNETICS CO., 942 Commercial St., Palo Alto, Calif., has developed a solid state conversion kit which replaces IRIG

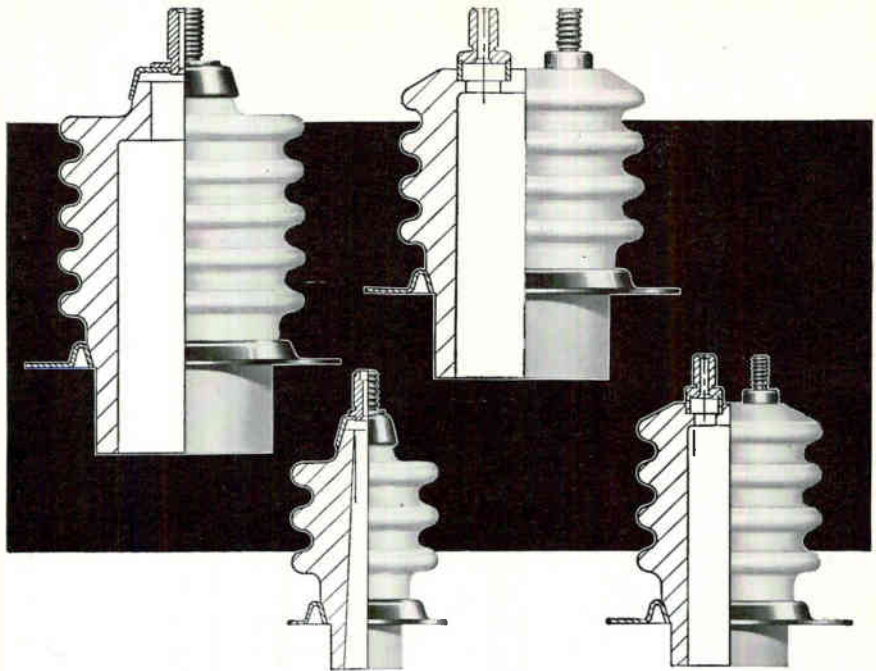

NOW *a new source of technical ceramics*

Here is the first completely integrated manufacturer in the East offering high alumina ceramic components for the most critical military and industrial applications.

Alberox has over 100 standard terminal bushings for use in transformers, capacitors, filters and power supplies. Alberox can often supply special bushings with tooling designed primarily for the standard line. This can pay off for you in time and cost savings.

Unique processing techniques permit standardization of high-fired 93.5% alumina composition for standard line of terminal bushings at no extra cost.

Improved design features help minimize corona and increase dielectric strength . . . assure superior quality and strength compared with the industry standard of 85% alumina content.

With the capabilities to produce the finest ceramics and ceramic-to-metal seals, Alberox can custom-engineer, develop and manufacture bushings for the ultimate in precision applications.

Learn the advantages to be gained by working with Alberox Corporation, the newest, most advanced source of high alumina ceramic components. Phone us at New Bedford: Area Code 617 995-1725.

alberox
corporation

INDUSTRIAL PARK, NEW BEDFORD, MASSACHUSETTS



I would like a copy of your FREE Catalog 362 describing your standard line of terminal bushings.

NAME _____
TITLE _____
COMPANY _____
ADDRESS _____
CITY _____ ZONE _____ STATE _____

Meet You at the NEREM Show—Booth 1612



THIS MACHINE READS OUT MORE THAN ONE ROW AT A TIME

This machine is an EECO punched-tape reader. It reads 80, 96, 120 or 160 bits (depending upon the model selected). Applications: machine tool control; automatic checkout and testing; and many more. Offers: one complete test per block; identification of data function by position in block; elimination of data storage records and decoding circuits; straightforward programming by blocks. In modular or standard 19" rack mounting units. Takes 1", 8-level paper or mylar tape punched on 0.1" centers. Most models are bi-directional. Write for data sheets.

CIRCLE 210 ON READER SERVICE CARD

vacuum tube electronics and heads in rack mount instrumentation tape recorders with double bandwidth electronics and heads.

CIRCLE 311, READER SERVICE CARD

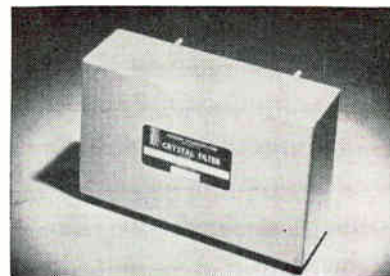

Crystal Filter Used in SSB Receivers

SYSTEMS INC., 2400 Diversified Way, Orlando, Fla., has developed a small size symmetrical bandpass crystal filter operating at center frequency of 100 Kc, with a 3 db bandwidth of 30 cps minimum and a 60 db bandwidth of 180 cps max. Designed for use as a pilot filter in ssb communications receivers, unit measurements are 5 in. in length, 1½ in. in height and 3 in. in width. Model BP-100-.030A provides two outputs whose relative phase varies by 90 deg over passband. (312)

Ribbon Cable

HITEMP WIRES CO., 1200 Shames Drive, Westbury, L. I., N. Y. A flexible, all Teflon Tempbraided ribbon cable is available with a continuous operating temperature rating up to 260 C, and in a wide range of constructions. (313)

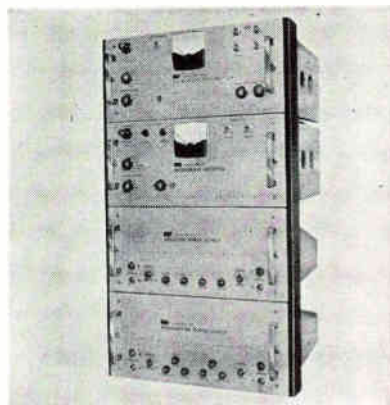

Microwave Equipment Is Highly Stable

JERROLD ELECTRONICS CORP., 15th and Lehigh Ave., Philadelphia 32, Pa., is marketing microwave equip-

Automation Division
Electronic Engineering Company
of California
 1601 E. Chestnut Avenue • Santa Ana, California
 Phone: 547-5501, P.O. Box 58 • Representative in
 Western Europe and Israel: Electronic Engineering
 S.A., C.P. 142 Fribourg, Switzerland. E E 2-49



Coils for Contact Capsules

1 to 5 Reeds
 .095 — .215 dia.
 6 to 48 V.D.C.
 Lead or Pin Term.
 Also Available with Reeds.

Write for Bulletin and Prices

ELECTRICAL CDIL WINDINGS

Wire sizes #6 to #56, Classes A, B, F and H. Complete engineering service available.

Coto-Coils COTO-COIL COMPANY INC.

65 Pavilion Avenue, Providence 5, R. I.

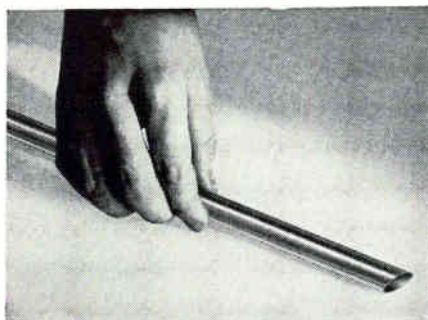

New Meller 12-INCH single crystal ruby laser

For large systems with high laser output power. In .02% and .04% chrome by weight — optically corrected for maximum efficiency, narrowest beam divergence. Guaranteed to laser. Extra slow grown. Annealed for minimum strain. Available in plain and parallel ends, TIR configuration or Brewster's angle.

Also in stock at Meller are ruby rods (all sizes and configurations), sapphire-clad ruby rods, many other single crystals. In addition, Meller provides complete grinding, lapping and coating services. Write or call today. Adolf Meller Company, Box 6001, Providence, R. I. Phone 401-331-3717.



Synthetic Sapphires • Ruby Lasers & Masers
 Alumina Powder

CIRCLE 203 ON READER SERVICE CARD

ment in the 12 Gc band for private industry and commerce. The equipment handles wide band video frequencies up to 8.0 Mc, as well as standard broadcast while maintaining high signal-to-noise ratio. It will also handle in excess of 600 voice channels in message system applications. Frequency stability within 0.005 percent is provided through use of special discriminator circuits and quartz crystal reference oscillators. This is maintained over a temperature range from -20°C to $+55^{\circ}\text{C}$. (314)

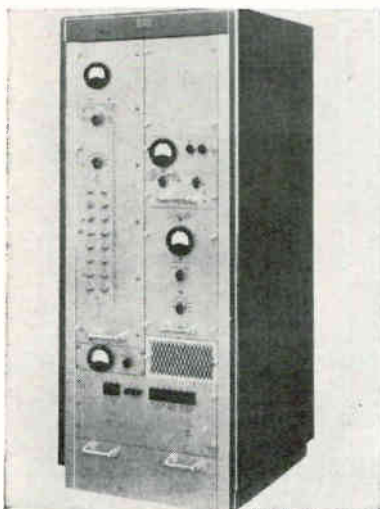

H-F Amplifier Provides 50 Db Gain

ITEK CORP., 10 Maguire Road, Lexington, Mass., offers a 1 Kw, wide band, h-f amplifier which provides a 50 db gain over the entire range of 2-24 Mc without operational tuning. The CT-113 features simultaneous transmission on two or more radiated frequencies; instantaneous frequency changing accomplished by simple drive switching; and automatic antenna selection of operating frequencies. (315)

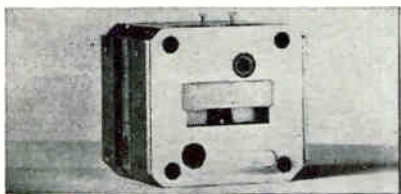

Shorting Switch Operates Over 8.5-9.6 Gc

MICROWAVE DEVELOPMENT LABORATORIES, INC., 15 Strathmore Rd., Natick Industrial Centre, Natick, Mass., has developed a waveguide

take time and...

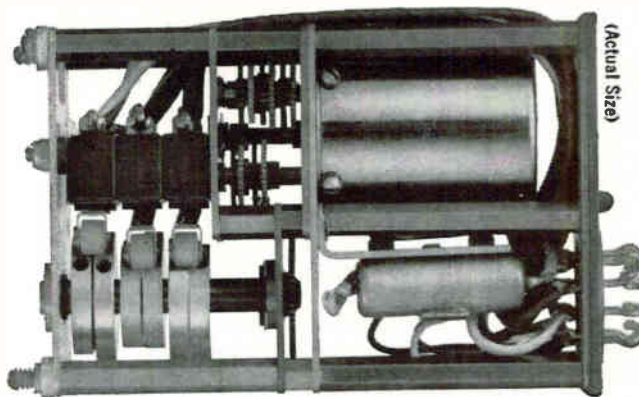

repeat it...

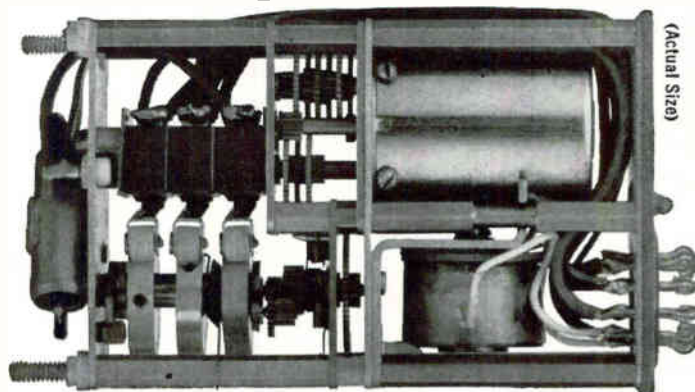

delay it...

The A. W. Haydon Company solves your timing problems with sub-miniature timers designed for the extreme environmental conditions of the aerospace industry. Repeat Cycle Timers continuously program a series of events . . . Time Delay Relays have the added feature of instantaneous reset. All are hermetically sealed in a compact aluminum case. Basic unit is only 1"x2"x3", weighs 7½ oz. All timers are available with dc, or 60 or 400 cps synchronous motors. They meet applicable portions of MIL-E-5272C: **vibration**—5-2000 cps at 10g; **shock**—50g for 11 milliseconds; **temperature**— -55° to $+125^{\circ}\text{C}$. For specifying and ordering information, see your nearby A. W. Haydon representative, or write for Bulletins RC-301 and TD-502.

AWHAYDON
THE COMPANY
235 NORTH ELM ST., WATERBURY 20, CONN.

shorting switch with 60 db isolation. Model 90SW106E is available in EIA waveguide size WR90 and operates over the frequency range 8.5-9.6 Gc. Vswr is 1.15 max.; insertion loss, switch open, 0.20 db max.

CIRCLE 316, READER SERVICE CARD



Recorder-Reproducer Designed for Space Use

LEACH CORP., 18435 Susana Road, Compton, Calif. The MTR-2100 recorder-reproducer is a self-contained, hermetically-sealed unit which records on a quarter inch Mylar-base magnetic tape and pro-

vides up to 120 minutes of recording time at 1.8 ips. It is in use on major satellite programs. (317)

High Speed Counters

PRESIN CO., INC., 226 Cherry St., Bridgeport 5, Conn. Models F108 and F109 high speed electromagnetic counters have 6 digits $\frac{1}{8}$ in. high and require no lubrication during their life which averages over 400 million steps. (318)

H-V Power Supply

UNITED ELECTRONICS CO., 42 Spring St., Newark 4, N. J. Model 30, a 10 Kv to 50 Kv h-v power supply with a current range from 50 to 2,000 ma, is overload protected and conservatively rated for long, trouble-free service. (319)

Cable Brackets

CONTINENTAL CONNECTOR CORP., 34-63 56th St., Woodside 77, N. Y.

Series 1800 cable brackets, designed for use with the series MM22 microminiature rack and panel connectors, provide an extremely light weight cable strain relief for critical circuit packaging. (320)

Tiny Solder-Dip Masks

W. H. BRADY CO., 727 W. Glendale Ave., Milwaukee 9, Wisc. Tiny solder-dip masks furnished on Blue Streak cards are arranged for fast dispensing and application to component mounting holes or connectors on p-c boards to cover areas to avoid solder deposit. (321)

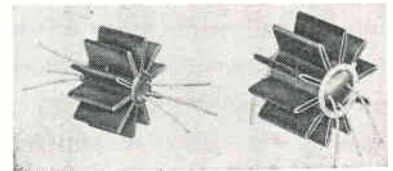

Cooler Accommodates Two Semiconductors

WAKEFIELD ENGINEERING INC., 139 Foundry St., Wakefield, Mass., has

CURTISS-WRIGHT ELECTRONICS...

adding a new dimension to the capability of man

SUBMARINE FBM TRAINING FACILITY, designated 21A37/1, faithfully reproduces cruising depth, position, surface weather, wave conditions, distance and direction to the target. A variety of malfunctions for training can be introduced via pre-punched cards. The magnetic drums of the simulator store 2.5 million bits of data relating to the actual equipment installed in the submarine, the missile control center, and the missile tube area. Instructions can be flashed at the staggering rate of 18-million per minute.



designed a featherweight cooler that accommodates two semiconductors. Thermal contact provides equal temperatures. Slotted Flex-Fin spring-grip design provides max contact for both semiconductors. Two basic sizes fit complete tolerance range of all major JEDEC milliwatt case style. (322)



H-F Galvanometer Spans 0-13,000 Cps

CONSOLIDATED ELECTRODYNAMICS CORP., 360 Sierra Madre Villa, Pasadena, Calif. Type 7-365 extends the useful recording capabilities of

CEC oscillographs to 13,000 cps. It has a rated deflection (a-c peak-to-peak) of 1 in. double amplitude and can be used with all CEC oscillographs having an 11½-in. optical arm. Total sensitivity variation over the entire frequency range (at rated deflection) is not more than ±5 percent from the statistically determined frequency-response curve. (323)

H-V Power Supply

KEPCO INC., 131-38 Sanford Ave., Flushing 52, N.Y. Model ABC-2500M high-voltage, continuously adjustable regulated power supply fills the need for a power source that supplies voltages from 0 to 2,500 v at up to 2 ma in a variable, compact and conveniently operated instrument. (324)

High Power Klystrons

SPERRY ELECTRONIC TUBE DIVISION, Gainesville, Fla., announces high power klystrons that deliver 10 to

50 Kw of c-w energy at microwave frequencies ranging from 4,400 to 10,500 Mc. (325)

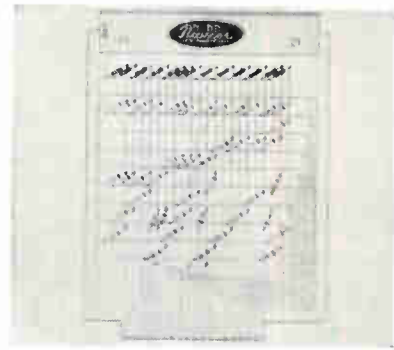

Selection Matrix Priced at \$49

NAVIGATION COMPUTER CORP., Valley Forge Industrial Park, Norristown, Pa. Model 549 selection matrix is used in the construction of successive-approximation analog-to-digital converters. In conjunction with two model 510 Modulo 4 counters, it selects one bit at a time for comparison against the unknown analog input. Price is \$49. (326)

PROJECT IN POINT:

This Polaris launch crew

thinks it is 40 fathoms deep!

Simulation reflects the ultimate in the *application* of science and technology. It is the electronic bridge from research to reality. At Curtiss-Wright, electronic simulation systems orient men and machines to missions for many military and industrial programs.

Project in Point: Today at the Navy's New London submarine school, Polaris launch crews are being trained by the largest, most complex, fully-digital simulator in use for *any* training application. Designed and manufactured by Curtiss-Wright, the simulator not only trains new crews but polishes the skill of Polaris vet-

erans as well. Short of operational experience at sea, no other training method is as practical.

These and additional advanced activities in related fields have created immediate opportunities at Curtiss-Wright Electronics Division for solid state circuit designers, digital computer programmers and others experienced in the application of real-time digital computation to challenging simulation problems.

For information, write Mr. Gene K. Kelly, Manager of Professional Placement, Electronics Division. An equal opportunity employer.



ELECTRONICS DIVISION
CURTISS - WRIGHT CORPORATION

35 MARKET STREET, EAST PATERSON, N. J.

RIBET-DESJARDINS

TECHNICAL ASSISTANCE IS AT YOUR SERVICE

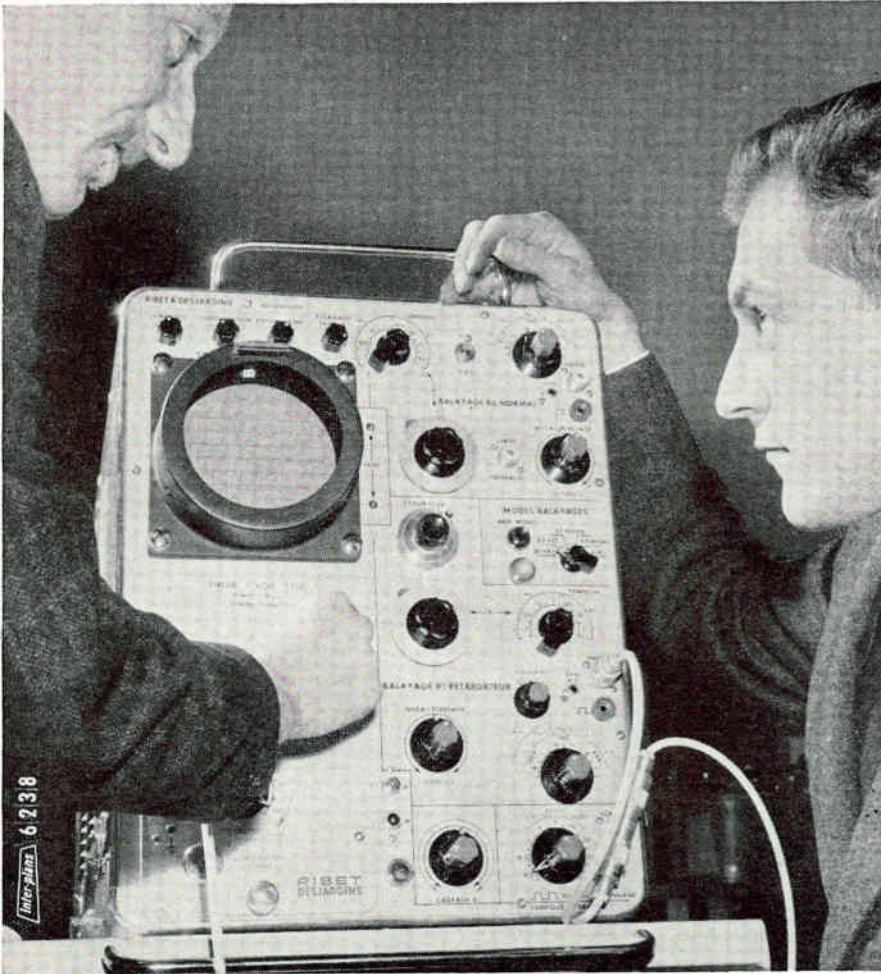

As every user of instruments, you may require the assistance of one of authorized Ribet-Desjardins Engineers.

He is better aware than anyone else of the actual possibilities of your equipment. Let him know your problems and the results you expect. His experience is reliable and his advice will help you find an easier and more adequate operation. If you are planning new applications of your equipment, if you need any other accessory for your oscilloscope, if you wish your engineers to get a thorough knowledge in oscilloscopes, if you are contemplating a maintenance program for your instruments, call first for R. D. Technical assistance.

A fair knowledge of some practical peculiarities of operation is sometimes enough to take full advantage of each instrument specific performances.

Through its authorized representative, the experience of Ribet-Desjardins Technical Department and the everyday experiment of users may be profitable to all. **Do not miss this opportunity of improving the efficiency of your equipment.**

MEASURE & CONTROL DEPARTMENT : 13-17, rue Périer MONTROUGE (Seine)
FRANCE Tél. ALEsia 24-40 + Cable Address : PILACELECT - MONTROUGE
Agencies throughout the world :

NORTH AMERICA (Canada) : ELECTROLINE TELEVISION EQUIPMENT INC.
Room 114,5757 Decelles Avenue - MONTREAL Other areas : addresses sent on request.

PRODUCT BRIEFS

MAGNETIC OPERATIONAL AMPLIFIER for analog computation and control. It operates on 60 cycle a-c. Electronic Control Systems, Inc., P. O. Box 1232, Fairmont, West Va.
CIRCLE 327, READER SERVICE CARD

STRIP CHART EVENT RECORDER with 10, 20, 30 or 42 channels per unit. Portable and flush-mounting case styles are available. Texas Instruments Inc., 3609 Buffalo Speedway, Houston, Texas. (328)

MINIATURE TUBULAR CAPACITOR with weldable leads. It exceeds requirements of military specifications MIL-C-11015B. Gulton Industries, Inc., 212 Durham Ave., Metuchen, N. J. (329)

POWER PACK for h-v applications. It has power output up to 25 w d-c or 35 w a-c. Wabash Magnetics, Inc., Wabash, Ind. (330)

NONDEGENERATE AMPLIFIER for L-band use. Covers the 1,220 to 1,360 Mc frequency range. Sperry Microwave Electronics Co., P.O. Box 1828, Clearwater, Fla. (331)

CABLE-LACER for tying bundles of wire together to form a harness. It can increase production up to 25 percent. Union Special Machine Co., 400 N. Franklin St., Chicago, Ill. (332)

PRECISION CAPACITANCE BRIDGE offers six-figure resolution. Frequency range is approximately 50 cps to 10 Kc. General Radio Co., West Concord, Mass. (333)

MILITARIZED POWER SUPPLY has automatic short circuit protection. Price is \$312 in small quantities. Mid-Eastern Electronics, Springfield, N. J. (334)

HEAT-SHRINKABLE TUBING made of irradiated polyolefin. Flexible for application, it is rigid after shrinking. Sequoia Wire Co., 2201 Bay Road, Redwood City, Calif. (335)

LINEAR INDUCTION POTENTIOMETER gives high output. There are no sliding contacts to wear out and become noisy. Pickering & Co., Inc., Plainview, L. I., N. Y. (336)

L-F LOW-PASS FILTERS feature high accuracy. They were designed for any application in the frequency range from 7.5 to 150 cps. Triad Transformer Corp., 4055 Redwood Ave., Venice, Calif. (337)

COAXIAL ATTENUATORS cover d-c to 2 Gc. Available in attenuation values of 3, 6, 10 and 20 db. Weinschel Engineering, 10503 Metropolitan Ave., Kensington, Md. (338)

P-M ALTERNATOR is only 0.875 in. long. It is used in applications requiring proportional voltage and frequency variation as a function of shaft speed. Kearfott Div., General Precision, Inc., 1150 McBride Ave., Little Falls, N. J. (339)

WAVEMETER is direct reading. It is designed for use in spectrum analyzing devices and other equipment re-

quiring a flush panel mounting design. Frequency Engineering Laboratories, Asbury Park, N. J. (340)

ROTARY SELECTOR SWITCH features 24 positions. It is only 2 in. in diameter. Janco Corp., 3111 Winona Ave., Burbank, Calif. (341)

INSTRUMENT TRANSFORMERS tailored to custom requirements. This includes very high accuracy and low power factor errors. Nothelfer Winding Laboratories, Inc., Box 455, Trenton 3, N. J. (342)

PARABOLIC TELEMETRY ANTENNA SYSTEMS in 4, 6, 8 and 10 ft diameters. They are manually positionable. Technical Appliance Corp., Sherburne, N. Y. (343)

TRIPLE-PLAY MAGNETIC TAPE is ultra-thin. Tensile strength is 40,000 psi. Agfa Inc., Rockleigh, N. J. (344)

SOLID-STATE MICROWAVE SWITCH in miniaturized version. It is suitable for high-shock missile use. Somerset Radiation Laboratory, Inc., 192 Central Ave., Stirling, N. J. (345)

RARE EARTH METALS have high purity. Prices, \$3 to \$35 per lb. Ronson Metals Corp., 45-65 Manufacturers Place, Newark 5, N. J. (346)

OPTICAL PYROMETER measures micro-second temperature changes. It operates automatically. Instrument Development Laboratories, Inc., Attleboro, Mass. (347)

INDUCTION MOTOR is flexible in design and suited for many applications. Stall torque is 0.85 in.-oz. The Lionel Corp., Hoffman Place, Hillside, N. J. (348)

PCM RECORDER/REPRODUCER is a solid state unit. It features high accuracy and long term reliability. Ampex Corp., 934 Charter St., Redwood City, Calif. (349)

SILICONE POWER TRANSISTORS in $\frac{1}{4}$ in. package. They are available in various voltages from 80 v to 200 v. Silicon Transistor Corp., Carle Place, N. Y. (350)

MEGOHMETER measures resistances of polarizable materials. It is line voltage stabilized and fully transistorized. Telostat Corp., 1003 First St. South, Hopkins, Minn. (351)

REED-SWITCH RELAY for computer and data processing applications. Operation is unaffected over wide temperature range. General Electric Co., 903 W. Burlington Ave., Western Springs, Ill. (352)

DRY ELECTROLYTIC CAPACITORS with circuit isolated from the metal case. Units offer high resistance against ingress of moisture. Syncro Corp., Hicksville, O. (353)

MONITOR RECEIVER has 26 preset channels. Frequency range is 225 Mc to 399.9 Mc. Sparton Corp., Jackson, Mich. (354)

Better Measuring from 

ALL SOLID STATE -BUDGET PRICED AT \$1975

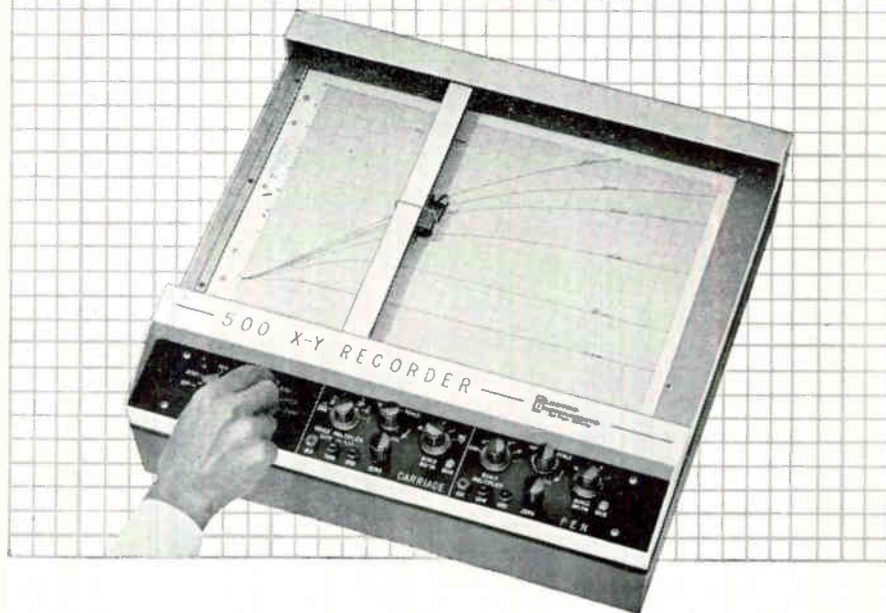

NEW EI Model 500 11" x 17" **X-Y RECORDER** has unparalleled performance and specifications

Place the new Model 500 alongside any competitive 11" x 17" X-Y Recorder. Check them for ease of operation, reproducibility, absence of jitter, speed of response, input sensitivity, time base accuracy, overall mechanical design and any other performance feature you need in a recorder. It's the only way we know to point up the significant design advances provided in the new 500 that will not be found in any competitive instrument. What's more, the 500 is the only totally transistorized 11" x 17" X-Y Recorder available at this low price—just \$1975, f.o.b. San Diego, Calif.

Brief specifications: 25"/sec. slewing speed, both axes; 0.15% full scale accuracy; 1 megohm input impedance, all ranges; 20 input scales from 0.5 mv/in. to 100 v/in.; integral time base; measures 17 $\frac{1}{2}$ " x 19" x 5"; weighs only 32 pounds. May be easily rack mounted without additional fixtures.

You would be wise to get complete information on this newest addition to the only complete line of all solid state X-Y Recorders. Your EI field engineer will be happy to tell you all about it. Call him today, or write direct



Electro Instruments, Inc.
8611 Balboa Avenue, San Diego 12, California

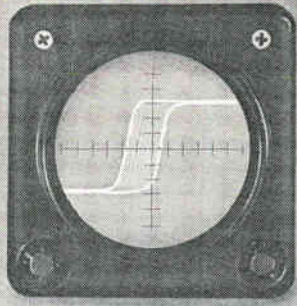

Measure all 5 important pulse-jitter parameters



...quickly, easily, accurately

Detect jitter to 0.5 nanosec. — measure absolute prf jitter from 5-100,000 nanosec; 5-100 nanosec width or relative (pulse-to-pulse) jitter; display disturbing frequency, derive video output. This direct-reading instrument is specifically designed for jitter test. Save time, prevent error, improve accuracy in development, production, system check with the reliable, sensibly-priced **MODEL PJ-1**.

Call your **POLARAD** Field Engineer for a prompt, free demonstration!

N.E.R.E.M. — Booths #311-312



POLARAD **POLARAD**
ELECTRONICS CORPORATION

World Leader in Microwave Instrumentation
43-20B 34th Street, Long Island City 1, New York

CIRCLE 204 ON READER SERVICE CARD

IN DIGITAL DATA COMMUNICATIONS ...

DD LINE = RELIABILITY + FLEXIBILITY + LOW COST

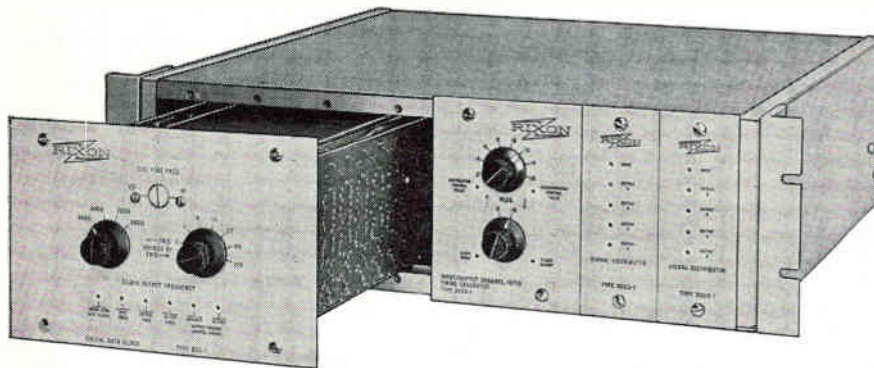

The need for reliable and flexible low-cost data communications equipment has led to the design and development of the Rixon **DD Line**. **DD** is the packaging of basic data communications system components into functional units. Now the system designers can build a system from **DD** modules to meet their exact requirements in either medium—wire line or HF radio circuits. Available now are modulators, demodulators, clocks, phase resolvers, delay equalizers, and serial-to-parallel converters, just to mention a few—at bit rates from 600 to 4800 bps.

Advantage? Reliability and complete flexibility at low cost—a result of over five years experience with data transmission systems.

Availability? Now!!!

RIXON ELECTRONICS, INC.

2121 Industrial Parkway—Montgomery Industrial Park—Silver Spring, Maryland
Telephone: 622-2121

TWX:S Spg 213

CIRCLE 90 ON READER SERVICE CARD

Literature of the Week

COMPUTER SYSTEM General Electric Co., Phoenix, Ariz. Brochure CPB-228P describes a complete GE-225 computer system for a wide range of scientific computations.

CIRCLE 355, READER SERVICE CARD

PISTON TRIMMER CAPACITORS Roanwell Corp., 180 Varick St., New York 14, N.Y. A 16-page catalog describing precision piston trimmer capacitors with characteristics charts is available by writing on company letterhead.

TELEMETRY ANTENNA SYSTEMS Technical Appliance Corp., Sherburne, N. Y. Catalog gives detailed data on a complete line of telemetry antennas and systems. (356)

SINUSOIDAL OSCILLATORS Solid State Electronics Co., 15321 Rayen St., Sepulveda, Calif. Bulletin covers models S-100 and S-200 silicon transistor sinusoidal oscillators. (357)

TANTALUM CAPACITORS General Electric Co., 392 S. Stratford Rd., Winston-Salem, N. C. Bulletin describes porous anode, tantalum electrolytic capacitors. (358)

INTEGRATED CIRCUITS Motorola Semiconductor Products Inc., 5005 E. McDowell Road, Phoenix 8, Ariz., has published a folder on integrated circuit electronics. (359)

WIRE-WOUND POTENTIOMETERS Micro-Letric, Inc., 19 Debevoise St., Roosevelt, L. I., N. Y. Linear and nonlinear function potentiometers for high precision applications are described in a brochure. (360)

DESIGNER HARDWARE Radiation Instrument Development Laboratory, Inc., 4501 W. North Ave., Melrose Park, Ill., offers literature describing versatile hardware for breadboarding, prototype engineering, or special control systems. (361)

SIMPLIFIED TIME DIVERSITY Kahn Research Laboratories, Inc., 81 S. Bergen Place, Freeport, N. Y., has reprints of a paper on Echoplex, a time diversity system for improved transmission of speech over rapidly fading radio channels. Copy obtainable by letterhead request.

D-C STANDARDS LABORATORY Sensitive Research Instruments Corp., New Rochelle, N. Y. Vol. 29 No. 9 of *Electrical Measurements* illustrates and describes a small d-c standards laboratory. (362)

PHOTOMULTIPLIER TUBES EMI/US, 1750 N. Vine St., Los Angeles 28, Calif. Catalog lists over 35 photomultiplier tubes with typical performance curves and condensed applications data. (363)

CRYOGENIC EQUIPMENT Sulfrin Cryogenics, Inc., 1290 Central Ave., Hillside, N. J. Information and detailed illustrations of cryogenic handling

and storage equipment are found in a new 8-page catalog. (364)

METALLIZED MYLAR CAPACITORS Hopkins Engineering Co., 12900 Foot-hill Blvd., San Fernando, Calif. Bulletin C-103 covers a line of ultra-thin 100 v d-c metallized Mylar capacitors. (365)

SWITCHES & RELAYS Cutler-Hammer Inc., 243 N. 12th St., Milwaukee 1, Wisc., offers a 66-page catalog describing a line of military type switches and power relays. (366)

COMPRESSION TERMINALS Electrical Industries, 691 Central Ave., Murray Hill, N. J. Bulletin TCT-62-102 covers glass-to-metal tubular single lead compression terminals. (367)

REGULATED D-C SUPPLIES General Electric Co., Schenectady 5, N. Y. Bulletin GEA-7353 discusses features and advantages of a line of regulated d-c power supplies for computer and other equipment applications. (368)

REED RELAYS Struthers-Dunn, Inc., Lambs Road, Pitman, N. J. Catalog A contains 12 pages of information on Dunco reed relays. (369)

AUTOTRANSFORMERS General Radio Co., West Concord, Mass. Over 200 different models of Variac autotransformers are described in a 28-page illustrated brochure. (370)

SEMICONDUCTOR DIODES Micro State Electronics Corp., 152 Floral Ave., Murray Hill, N.J. A semiconductor diode catalog lists diodes for microwave and computer use. (371)

TUBULAR CAPACITORS Cornell-Dubilier Electronics Division, 50 Paris St., Newark 1, N. J. Wall chart assists designers and engineers to select Demicon capacitors for their particular circuit applications. (372)

CRYSTAL UNIT Dynamics Corp. of America, Cherry and North Sts., Carlisle, Pa. A two-page leaflet gives detailed technical specifications on the 14 to 150 Kc H-element crystal unit. (373)

PULSE GENERATOR Servo Corp. of America, 111 New South Road, Hicksville, L. I., N. Y., offers a 4-page folder describing the Servo-pulse series 2000 precision pulse generator. (374)

SPACE TECHNOLOGY Northrop Space Laboratories, 1111 E. Broadway, Hawthorne, Calif., announces a 16-page brochure illustrating and describing its capabilities in space technology. (375)

INK-RECTILINEAR RECORDER Offner Division of Beckman Instruments, Inc., 2500 Harbor Blvd., Fullerton, Calif., has published a 4-page data sheet on the type S ink-rectilinear Dynograph recorder. (376)

MULTICHANNEL CRYSTAL OSCILLATOR Monitor Products Co., Inc., 815 Fremont Ave., South Pasadena, Calif., offers a data sheet on a multichannel crystal oscillator. (377)

AIRPAX

NEW...IMPROVED

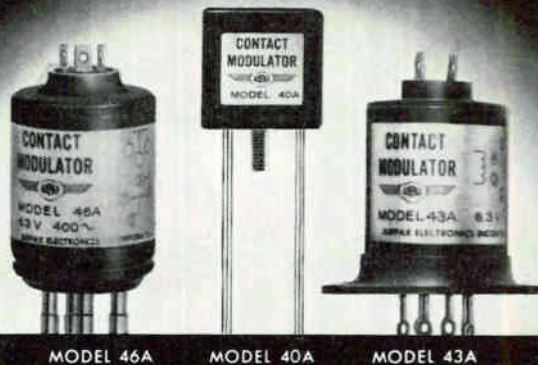

MICRO-MIDGET CHOPPERS

Design changes in the popular 40 Series of Micro-Midget Electromechanical choppers result in perfected contact action which, in turn, assures longer life and greater frequency stability. The change from a basically rigid contact system to a spring compliant type achieves greater contact wipe, less chatter and reduced contact contamination. Unaffected are phase, dwell and drive frequency range. Characteristics of the 40A are as follows:

Drive: 6.3 volts, 400 CPS. Chopper can be operated over 0-1000 CPS drive frequency range.

Contacts: SPDT BBM; will carry signal levels up to 2 MA, 10 V DC max.

Noise: 6 microvolts RMS max. into 1 megohm.
Shock: Withstands 100 G.

Vibration: Withstands 15G from 55 to 2500 CPS.

Dwell Time: 140 to 185 degrees.

Phase Angle: 65 ± 15 degrees.

Life: 2,000 hours.

Weight: 9 grams.

Volume: 0.151 cubic inches.

Detailed specifications on request.



TWX 301-228-3558

PHONE 228-4600

CAMBRIDGE DIVISION • CAMBRIDGE, MARYLAND

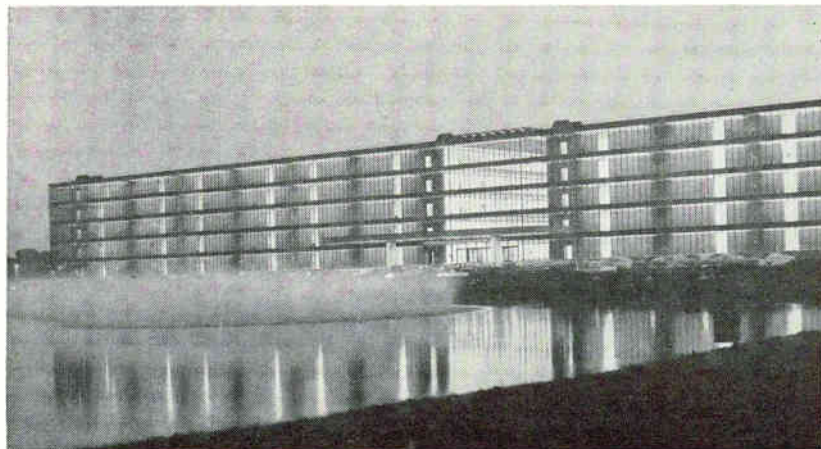

Bell Labs Opens Development Center

BELL TELEPHONE Laboratories' newest center for telecommunications development, a six-story, glass-enclosed building on a 460-acre site at Holmdel, N.J., is now fully occupied and operating.

The Holmdel development center, which is the Labs' fourth major location and the third in New Jersey, was completed this summer after being under construction for nearly three years.

The new laboratory has become the Bell System's main location for the development of telephone switching equipment and systems, customer equipment such as telephones and public booths, and apparatus and systems for the transmission of data over telephone facilities. Some 2,600 engineers, scientists, technicians and supporting personnel work in the center.

The building has a gross area of 715,000 square feet, of which about 360,000 square feet are assignable as work space. Most of the building's service facilities are housed on the first floor. The upper five floors are laid out identically.

All main corridors are on the perimeter with a grid of six cross-aisles in each section (or 12 on each floor) connecting the front and rear main corridors. Laboratories and

offices are located on these cross-aisles.

Distance between front and rear perimeter corridors is 120 feet and each cross-aisle area, including laboratory, aisle and office is 42 feet wide. A 6-foot-by-6-foot modular grid prevails in the laboratory and office space areas. The aisle is normally situated so as to provide 24-foot-deep laboratories on one side and 12-foot-deep offices on the other.

The interior was designed for greater flexibility in the utilization of space and for maximum ease for making rearrangements.

Construction of the Holmdel development center began in August, 1959. The service building was occupied in January, 1960. Initial occupancy of the main building was in October, 1961. The building was completed in June of this year, and fully occupied by the beginning of September.

Future plans call for another two-section building to be added to the existing main building. It would be identical to the main building and would be built onto it, connecting via bridges to the opposite side of the elevator towers. Starting and completion times for this addition are indefinite.



Miller Assumes Additional Post

BURTON F. MILLER has been elected vice president, research and development, of TRW Electronics, Inc., El Segundo, Calif., a position which he will hold in addition to his responsibility as vice president, advanced technical planning, of Thompson Ramo Wooldridge Inc., the parent company.

With his additional responsibilities, Miller will organize and coordinate the technical programs of the companies comprising TRW Electronics, Inc. These companies include Pacific Semiconductors, Inc., Good-All Electric Mfg. Co., Radio Condenser Co., Radio Industries, foreign associates of TRW Electronics, Inc., and the TRW Microwave division.



Temec Appoints Harnois Executive V-P

IN LINE with stepped up activity in manufacturing missile tracking antennas, pedestals, as well as telemetry, radar and microwave communication equipment, Temec, Inc. of Van Nuys, Calif., has appointed Nelson C. Harnois (picture) as executive vice president, according to a statement by William Falstrom, president.

Nelson Harnois was formerly associated with Lockheed's California division where he had been employed since 1940. For the past two

NEW FROM T/I

HIGH SPEED A-D CONVERTER

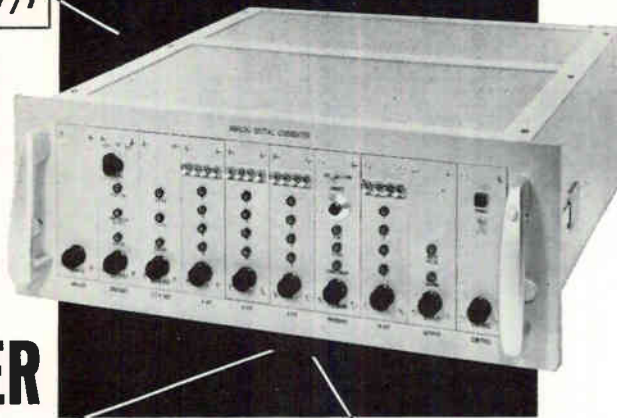

1.5 μ sec per bit

Automatic Zero Stabilization

Texas Instruments Model 834 Analog-Digital Converter is a versatile, all solid state instrument combining high speed with high accuracy. Basic speed is 25 microseconds per conversion (40,000 12 bit conversions per second); accuracy is $\pm 0.05\%$ of full scale, $\pm 1/2$ the least significant bit. The instrument provides full scale ranges of ± 2.5 , ± 5.0 , and ± 10.0 volts with an input impedance of 200,000 ohms. Modular construction allows modification of output logic levels and digital code to suit various system requirements.

Write for complete information.

APPARATUS DIVISION
PLANTS IN HOUSTON
AND DALLAS, TEXAS



TEXAS INSTRUMENTS
INCORPORATED
3609 BUFFALO SPEEDWAY
P. O. BOX 66027 HOUSTON 6, TEXAS 476

CIRCLE 205 ON READER SERVICE CARD

ON PW BOARDS...

INSERT these Components

Up to 10 times FASTER!

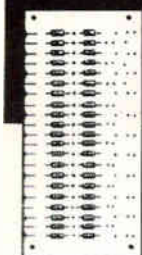

Dynasert Component Inserting Machine slashes costs even if you insert only a few hundred components a week. Equally fast on big or small

boards, long or short runs, small (to .032" diameter) or large components. Model changeover in seconds. Dynasert automatically feeds, trims, bends leads, inserts, and clinches precisely and uniformly. Leads automatically clinched to follow circuit. Send for cost-saving facts and figures, today. Dynasert Dept., United Shoe Machinery Corporation, Boston, Massachusetts.

United

US1-70

DYNASERT

CIRCLE 206 ON READER SERVICE CARD

October 26, 1962

EXPANDING?



Why put YOUR money?
in brick and mortar?

NEW MEXICO

offers tax-exempt financing for land, buildings, tooling exclusively for companies with profitable production and an interest in growing in the space center of the Southwest.



Nuclear-Space
Research Center
of the
Free World

Write today
for Full Details

INDUSTRIAL DIVISION
NEW MEXICO
Department of Development
Box 1300 State Capitol,
Santa Fe, New Mexico

CIRCLE 208 ON READER SERVICE CARD

COMPUTER RESEARCH ENGINEERS & LOGICAL DESIGNERS

Rapid expansion of the Computer Laboratory at Hughes-Fullerton has created several attractive professional opportunities for qualified Computer Research Engineers and Logical Designers. These positions require active participation in bread computer R & D activities in connection with Army/Navy computer systems and new large-scale, general-purpose computers. These multiple processor computers utilize advanced solid-state circuitry, gating and resolution times in the millimicrosecond regions; combine synchronous and asynchronous techniques for maximum speed and reliability.

These professional assignments involve broad areas of logical design, programming and system conception. Fields of interest include:

- Distributed computers
- Advanced arithmetic processing techniques
- Mechanized design
- Asynchronous design techniques
- Utilization of parametrons in computers
- Studies in the utilization of multiple processor computers.

These professional assignments involve such R & D areas as:

- Solid state digital circuitry involving millimicrosecond logic
- Microwave carrier digital circuits
- Sub-microsecond core memory
- Thin film storage techniques
- Functional circuit concepts
- Micro-miniaturization concepts
- Tunnel diodes
- Microwave parametrons
- Circuit organization for maximal-speed computing.

Located in Southern California's Orange County (the nation's fastest growing electronics center), Hughes-Fullerton offers you: a stimulating working environment; private or semi-private offices; long-term stability.

CALL COLLECT TODAY!

For complete information on these challenging assignments, call us collect today! Ask for:

Mr. J. E. TENNEY at:
TRojan 1-4080, ext. 3741.

Or, airmail resume to: HUGHES-FULLERTON R & D, P. O. Box 2097, Fullerton 1, California.

An equal opportunity employer.

HUGHES

HUGHES AIRCRAFT COMPANY

Power Modules - Low Cost Small - Solid State AC-DC Power Supplies

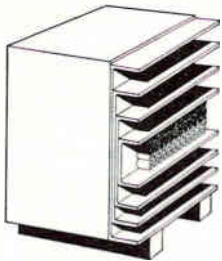

Regulated to $\pm 0.05\%$ vs Broad Line the power supplies offer a wide variety of output voltages. They are compact, low-cost and have very low ripple. They are not harmed by output shorts or overloads applied continuously. And they are field serviceable. Frequency is 60 or 400 cps with less than 1 MV or 5 MV rms ripple. Output adjustment is $\pm 10\%$ screwdriver adjustment. Maximum ambient temperature is 55° C.

CHECK THESE SPECIFICATIONS AND PRICES BEFORE YOU BUY POWER SUPPLIES

OUTPUT VOLTAGE RANGE	OUTPUT CURRENT (AMPS)	SIZE (see dwg.)	$\pm 0.05\%$ ACCURACY			$\pm 0.05\%$ ACCURACY		
			MODEL	TYPE	PRICE	MODEL	TYPE	PRICE
2.2-3.0	0.5	A	115/60-PMR	2.5/.5/05	85.00	115/60-PMR	2.5/.5/5	75.00
2.2-3.0	1.0	C	115/60-PMR	2.5/1/05	125.00	115/60-PMR	2.5/1/5	115.00
2.2-3.0	3.0	D	115/60-PMR	2.5/3/05	170.00	115/60-PMR	2.5/3/5	160.00
2.2-3.0	6.0	E	115/60-PMR	2.5/6/05	220.00	115/60-PMR	2.5/6/5	205.00
5.8-6.3	0.5	A	115/60-PMR	6/.5/05	95.00	115/60-PMR	6/5/5	85.00
5.8-6.3	1.0	C	115/60-PMR	6/1/05	185.00	115/60-PMR	6/1/5	125.00
5.8-6.3	3.0	D	115/60-PMR	6/3/05	190.00	115/60-PMR	6/3/5	180.00
5.8-6.3	6.0	E	115/60-PMR	6/6/05	240.00	115/60-PMR	6/6/5	225.00
8.5-9.3	0.5	A	115/60-PMR	9/.5/05	115.00	115/60-PMR	9/5/5	105.00
8.5-9.3	1.0	C	115/60-PMR	9/1/05	150.00	115/60-PMR	9/1/5	140.00
8.5-9.3	3.0	D	115/60-PMR	9/3/05	195.00	115/60-PMR	9/3/5	185.00
8.5-9.3	6.0	F	115/60-PMR	9/6/05	260.00	115/60-PMR	9/6/5	245.00
11.4-12.5	0.5	B	115/60-PMR	12/.5/05	115.00	115/60-PMR	12/5/5	105.00
11.4-12.5	1.0	D	115/60-PMR	12/1/05	150.00	115/60-PMR	12/1/5	140.00
11.4-12.5	3.0	E	115/60-PMR	12/3/05	205.00	115/60-PMR	12/3/5	190.00
11.4-12.5	6.0	F	115/60-PMR	12/6/05	270.00	115/60-PMR	12/6/5	255.00
16.5-18.5	0.5	B	115/60-PMR	18/.5/05	120.00	115/60-PMR	18/5/5	110.00
16.5-18.5	1.0	E	115/60-PMR	18/1/05	160.00	115/60-PMR	18/1/5	150.00
16.5-18.5	3.0	F	115/60-PMR	18/3/05	210.00	115/60-PMR	18/3/5	195.00
16.5-18.5	6.0	G	115/60-PMR	18/6/05	280.00	115/60-PMR	18/6/5	265.00
22.3-24.4	0.5	C	115/60-PMR	24/.5/05	120.00	115/60-PMR	24/.5/5	110.00
22.3-24.4	1.0	E	115/60-PMR	24/1/05	160.00	115/60-PMR	24/1/5	150.00
22.3-24.4	3.0	F	115/60-PMR	24/3/05	215.00	115/60-PMR	24/3/5	200.00
22.3-24.4	6.0	G	115/60-PMR	24/6/05	280.00	115/60-PMR	24/6/5	265.00
29.2-32.7	0.5	C	115/60-PMR	30/.5/05	125.00	115/60-PMR	30/5/5	115.00
29.2-32.7	1.0	E	115/60-PMR	30/1/05	165.00	115/60-PMR	30/1/5	155.00
29.2-32.7	3.0	F	115/60-PMR	30/3/05	220.00	115/60-PMR	30/3/5	205.00

VOLUME PURCHASES DISCOUNTED

SPECIFICATIONS

- Input Voltage • 100-125 volts
- Frequency • 60 or 400 cps
- Regulation • .05% or .5%
- Ripple • Less than 1 MV or 5 MV rms
- Output Adjust • $\pm 10\%$ screwdriver adj.
- Temperature • Max. ambient 55°C
- Standard Output Voltage • 2.5, 6, 9, 12, 18, 24, 32
- Standard Output Currents • .5, 1, 3, 6 amps



	H	J	K	L	M	N	R	T
A	3 3/16	3 1/16	5	2 7/8	2 9/8	1 5/16	8-32	1 1/4
B	3 1/2	4 1/16	5 9/16	2 1/2	3	1 1/2	10-32	1 1/4
C	3 1/8	4 1/16	5 1/16	2 1/16	3 5/16	1 13/32	10-32	1 1/4
D	4 1/8	4 1/16	6 1/16	3	3 1/16	1 23/32	1/4-20	1 1/4
E	4 1/16	5 1/16	6 1/16	3 3/8	4 1/16	2 1/32	1/4-20	1 1/4
F	5 1/8	6 1/4	7	3 3/8	5 1/4	2 5/8	3/16-18	2
G	6 3/4	6 1/16	7	5 1/4	5 1/16	2 23/32	3/16-18	2

FEATURES

- Regulated $\pm 0.05\%$ vs Line Load
- Wide Variety of Output Voltages
- Compact, Low Cost
- Low Ripple
- Not Harmed by Output Shorts or Overloads Applied Continuously
- Field Serviceable

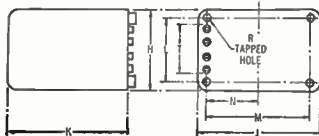

ELECTRODYNAMIC INSTRUMENT CORPORATION

Subsidiary of Reed Roller Bit Company

TWX 713-571-341

RI 8-2760

1841 OLD SPANISH TRAIL

HOUSTON 25, TEXAS

EIC REPRESENTATIVES

CLYDE M. SALISBURY CO., San Francisco, 1453 Seventh Ave.—MO 4-0586 • REPCO SALES, Miami, 401 N.W. 71st Street—PL 7-2911 • ELECTRONIC SALES, INC., Denver 22, 2641 S. Ivy Street—SK 6-4148 • WALLACE AND WALLACE, Los Angeles 15, 1206 Maple Ave.—RI 7-0401.

CIRCLE 94 ON READER SERVICE CARD



Did you swipe this magazine?

Only 7 1/2 cents a week is the easy way! (\$6 one year, \$9 for two years, \$12 three years.) Just fill in the handy "For subscriptions" section of the Reader Service Card in this issue . . . and you'll get instant subscription.

electronics: 330 West 42nd St., N. Y. 36.

years he served as chief engineer in the electronic and armament systems department.

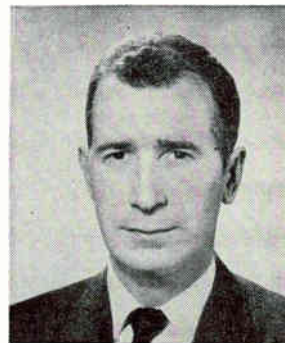

Transistor Electronics Promotes Fernquist

THE BOARD of directors of Transistor Electronics Corp., Minneapolis, Minn., has appointed Cyril L. Fernquist to the new post of vice president of engineering. He has overall responsibility for product design and packaging in both the Tec-Lite and Sub-Contract divisions. He is also the technical advisor for new and custom designed products.

Fernquist joined Transistor Electronics Corp. in 1958 as an electrical-mechanical design engineer.



Teleregister Names H. F. Mitchell

HERBERT F. MITCHELL, JR. has been appointed vice president-advanced systems development of The Teleregister Corp., Stamford, Conn.

For the past year and a half, Mitchell was with Collins Radio Co. where, as a member of the technical staff, he was concerned with the design of a new stored logic communications processor.

Hickok Electrical Elects Chase

ELECTION of Warren H. Chase, vice president of The Ohio Bell Tele-

phone Co., to the board of directors of The Hickok Electrical Instrument Co., Cleveland, O., is announced.

Hickok Electrical manufactures electronic test and control equipment for industry and the government.

Chase is the immediate past president of the AIEE. He has been one of the prime movers behind the pending merger of the 65,000 member AIEE and the 90,000 member IRE of which he is a senior member.



Shure Names Kogen Chief Engineer of R&D

JAMES H. KOGEN, president of the National Electronic Conference, Inc., for 1962, has been appointed chief engineer of the expanded R&D department of Shure Brothers, Inc., Evanston, Ill.

Kogen's former position was that of chief engineer of GPE Controls, Inc. of Chicago.



Burrows Assumes New Post

APPOINTMENT of Carl W. Burrows, Jr., to the newly created post of vice president, Contracts and Service division, Simmonds Precision Products, Inc., Tarrytown, N.Y., is announced.

Prior to joining Simmonds, Bur-

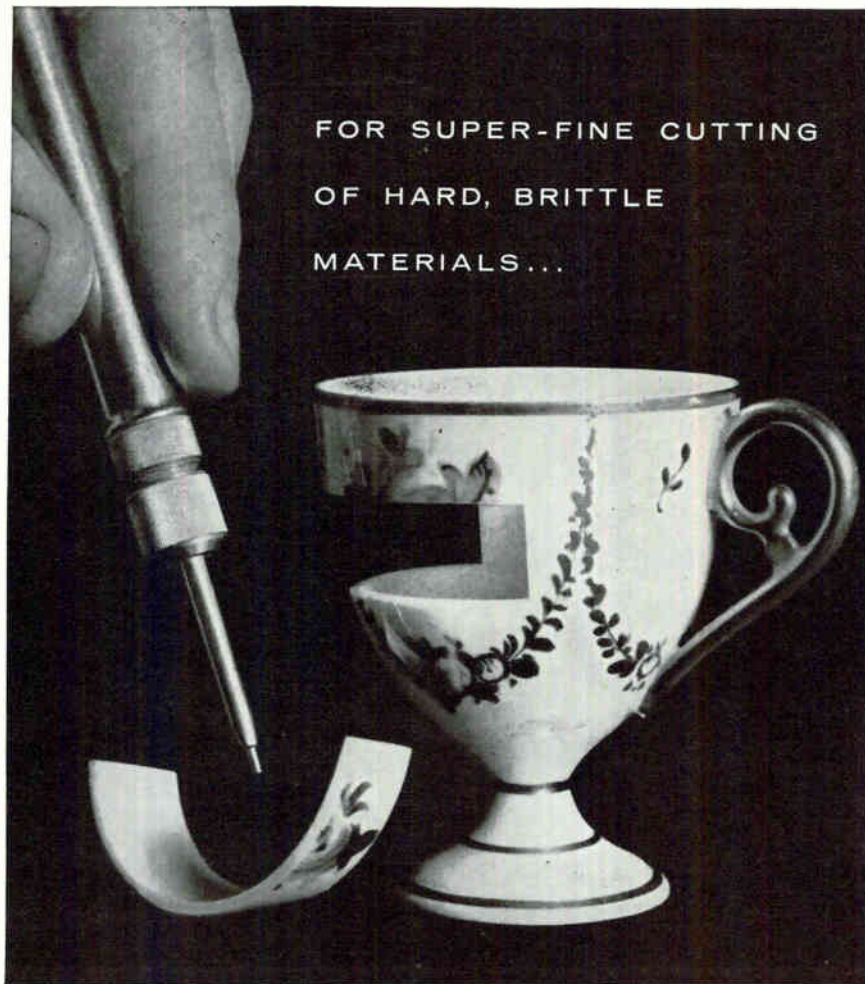

FOR SUPER-FINE CUTTING
OF HARD, BRITTLE
MATERIALS...

THE *S.S. White* Industrial Airbrasive Unit

We don't recommend slicing up the family's fine Limoge China, but this does illustrate the precisely controlled cutting action of the S. S. White Airbrasive Unit. Note how clean the edge is, and how the delicate ceramic decoration is unharmed.

The secret of the Airbrasive is an accurate stream of non-toxic abrasive, gas-propelled through a small, easy-to-use nozzle. The result is a completely *cool* and *shockless* cutting or abrading of even the most fragile hard materials.

Airbrasive has amazing flexibility of operation in the lab or on an automated production line. Use the same tool to frost a large area or to make a cut as fine as .008"!...printed circuits...shaping and drilling of germanium and other crystals...deburring fine needles...cleaning off oxide coatings...wire-stripping potentiometers...engraving glass, minerals, ceramics. Jobs that were previously thought impossible are now being done.

Send us samples of your
"impossible" jobs and let us
test them for you at no cost.

WRITE FOR
BULLETIN 6006.
Complete information.



S. S. WHITE INDUSTRIAL DIVISION

Dept. EU, #10 East 40th St., New York 16, N. Y. • Telephone MU 3-3015 collect.

S.S. White INDUSTRIAL AIRBRASIVE



Bird

JEWEL BEARINGS

CUT YOUR COSTS

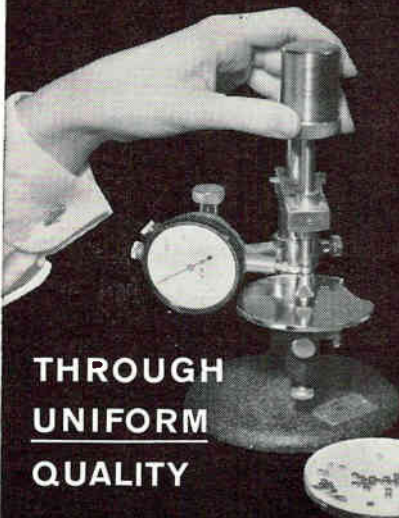

THROUGH UNIFORM QUALITY

Exact quality control standards employed by Bird are your guarantee that every Bird Sapphire or Glass Jewel Bearing, or Complete Jewel Assembly or Cushion Jewel Assembly, is as specified. There's never a chance of inconsistency in dimensions, chemical and physical properties.

As an added benefit, Bird Complete Assemblies cut your manufacturing costs because they reach you ready for immediate installation . . . eliminating all problems with expensive rejects and breakage.

Our engineering staff would be pleased to work with you on your special jewel bearing needs. Write for our free catalog with complete details on properties and uses of jewel bearings.

Richard H. Bird & CO., INC.

1 SPRUCE ST., WALTHAM, MASS.

servicing industry with fine jewels since 1913

Illustration shows concentricity check of jewel assembly, just one of several important quality control steps.

rows was with the Electronics division of General Dynamics Corp., where he served as director of military products.

PEOPLE IN BRIEF

Andrew A. Sterk leaves Philips Electronics to join American Machine & Foundry Co. Alexandria div. as mgr of the instrument and sensor lab. **Thomas H. Herring**, formerly with The Boeing Co., appointed senior project engineer of Genistron, Inc. **John E. Barkley** moves up to asst. g-m of General Mills' Electronics div. **John E. Doody**, previously with Thompson Ramo Wooldridge, now chief engineer and asst. g-m at the Capco div. of Texas Research and Electronic Corp. **Al Anderson**, from Hewlett-Packard to Alfred Electronics as production engineer. **Winfield G. Wagener** advances to mgr., technical services, for the International Operations section of Varian Associates. **W. H. Schaumberg**, ex-Maico Electronics, Inc., named head of engineering and development for the Viron div. of Geophysics Corp. of America. **Joseph A. Volk**, formerly professor of engineering at St. Louis U., joins Beta Corp. as v-p and director of research. **Joseph F. Houdek, Jr.**, previously with The Seeburg Corp., appointed director of manufacturing for all six divisions of the Elgin National Watch Co., Industrial Group. **Martin W. Fletcher**, from Granger Associates to Applied Technology, Inc., as a senior engineer. **William Handley** resigns from Litton Systems, Inc., to accept post of director of quality control for Atohm Electronics. **Arthur W. Vance**, ex-American Systems, Inc., named associate director of advanced systems for the R&D div. of Autonetics. **Nicholas Yaru** promoted to mgr. of the radar div., Hughes Aircraft Co. ground systems group. **James C. Darby** moves up to v-p, Truarc Retaining Rings div., Waldes Kohinoor, Inc. **George C. Crowley**, formerly with Monogram Electric Ltd., appointed staff engineer for Norge div. of Borg-Warner Corp.

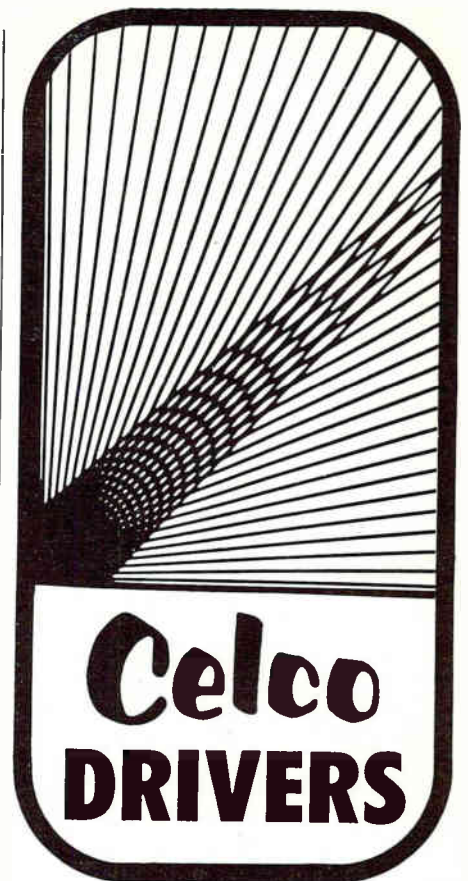

Celco DRIVERS

Beam Position & Write with CELCO DRIVER YOKE PACKAGE

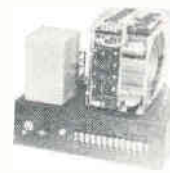

CELCO SOLID STATE DEFLECTION AMPLIFIER AND CELCO DEFLECTION YOKE were used to create the above display.



CELCO YOKE for ultra-high precision — spots smaller by 25% — faster recovery time.



CELCO FOCUSER — up to 4,000-6,000 line resolution at higher frequencies.

All units are available individually or as a package for any of your CRT display problems — write or call:

Celco

CONSTANTINE ENGINEERING
LABORATORIES COMPANY

Mahwah, N. J.	Miami, Fla.	Upland, Cal.
Area Code: 201	Area Code: 305	Area Code: 714
Davis 7-1123	PLaza 1-1132	YUkon 2-0215
Ed Ryder	Walt Faust	Bob Reese

electronics

WEEKLY QUALIFICATION FORM FOR POSITIONS AVAILABLE

ATTENTION: ENGINEERS, SCIENTISTS, PHYSICISTS

This Qualification Form is designed to help you advance in the electronics industry. It is unique and compact. Designed with the assistance of professional personnel management, it isolates specific experience in electronics and deals only in essential background information.

The advertisers listed here are seeking professional experience. Fill in the Qualification Form below.

STRICTLY CONFIDENTIAL

Your Qualification form will be handled as "Strictly Confidential" by ELECTRONICS. Our processing system is such that your form will be forwarded within 24 hours to the proper executives in the companies you select. You will be contacted at your home by the interested companies.

WHAT TO DO

1. Review the positions in the advertisements.
2. Select those for which you qualify.
3. Notice the key numbers.
4. Circle the corresponding key number below the Qualification Form.
5. Fill out the form completely. Please print clearly.
6. Mail to: D. Hawksby, Classified Advertising Div., ELECTRONICS, Box 12, New York 36, N. Y. (No charge, of course).

COMPANY	SEE PAGE	KEY #
ALLEGANY BALLISTICS LAB. Operated by Hercules Powder Co. Cumberland, Maryland	143*	1
ATOMIC PERSONNEL INC. Philadelphia, Pa.	98	2
CURTISS WRIGHT CORPORATION Electronics Div. E. Paterson, N. J.	86, 87	3
DELCO RADIO Div. of General Motors Corp. Kokomo, Indiana	86*	4
DOUGLAS AIRCRAFT CO. Missile and Space Systems Division Santa Monica, Calif.	1D1*	5
GENERAL DYNAMICS/ASTRONAUTICS San Diego, California	41, 42, 43, 44	6
JET PROPULSION LABORATORY California Institute of Technology Pasadena, California	98	7
LOCKHEED MISSILES & SPACE CO. Div. of Lockheed Aircraft Corp. Sunnyvale, California	72, 73*	8
PERKIN ELMER CORP. Commercial Div. Norwalk, Connecticut	142*	9
REPUBLIC AVIATION CORPORATION Farmingdale, L. I., New York	142*	10
SCOPE PROFESSIONAL PLACEMENT CENTER Waltham, Mass.	98	11
P 9758	142*	12

* These advertisements appeared in the October 19th issue.

(cut here)

electronics WEEKLY QUALIFICATION FORM FOR POSITIONS AVAILABLE

(cut here)

(Please type or print clearly. Necessary for reproduction.)

Personal Background

NAME

HOME ADDRESS

CITY ZONE STATE

HOME TELEPHONE

Education

PROFESSIONAL DEGREE(S)

MAJOR(S)

UNIVERSITY

DATE(S)

FIELDS OF EXPERIENCE (Please Check)

10262

- | | | |
|--|--|---------------------------------------|
| <input type="checkbox"/> Aerospace | <input type="checkbox"/> Fire Control | <input type="checkbox"/> Radar |
| <input type="checkbox"/> Antennas | <input type="checkbox"/> Human Factors | <input type="checkbox"/> Radio—TV |
| <input type="checkbox"/> ASW | <input type="checkbox"/> Infrared | <input type="checkbox"/> Simulators |
| <input type="checkbox"/> Circuits | <input type="checkbox"/> Instrumentation | <input type="checkbox"/> Solid State |
| <input type="checkbox"/> Communications | <input type="checkbox"/> Medicine | <input type="checkbox"/> Telemetry |
| <input type="checkbox"/> Components | <input type="checkbox"/> Microwave | <input type="checkbox"/> Transformers |
| <input type="checkbox"/> Computers | <input type="checkbox"/> Navigation | <input type="checkbox"/> Other |
| <input type="checkbox"/> ECM | <input type="checkbox"/> Operations Research | <input type="checkbox"/> |
| <input type="checkbox"/> Electron Tubes | <input type="checkbox"/> Optics | <input type="checkbox"/> |
| <input type="checkbox"/> Engineering Writing | <input type="checkbox"/> Packaging | <input type="checkbox"/> |

CATEGORY OF SPECIALIZATION

Please indicate number of months experience on proper lines.

	Technical Experience (Months)	Supervisory Experience (Months)
RESEARCH (pure, fundamental, basic)
RESEARCH (Applied)
SYSTEMS (New Concepts)
DEVELOPMENT (Model)
DESIGN (Product)
MANUFACTURING (Product)
FIELD (Service)
SALES (Proposals & Products)

CIRCLE KEY NUMBERS OF ABOVE COMPANIES' POSITIONS THAT INTEREST YOU

1 2 3 4 5 6 7 8 9 10 11 12 13 14 15 16 17 18 19 20 21 22 23 24 25

EMPLOYMENT OPPORTUNITIES



The Advertisements in this section include all employment opportunities—executive, management, technical, selling, office, skilled, manual, etc. Look in the forward section of the magazine for Additional Employment Opportunities advertising.

Positions Vacant
Positions Wanted
Part Time Work

Civil Service Opportunities
Selling Opportunities Wanted
Selling Opportunities Offered

Employment Agencies
Employment Services
Labor Bureaus

DISPLAYED

The advertising rate is \$40.17 per inch for all advertising appearing on other than a contract basis. Contract rates quoted on request.

An advertising inch is measured $\frac{1}{8}$ " vertically on a column—3 columns—30 inches to a page.

Subject to Agency Commission.

---RATES---

\$2.70 per line, minimum 3 lines. To figure advance payment count 5 average words as a line.

Box Numbers—counts as 1 line.

Discount of 10% if full payment is made in advance for 4 consecutive insertions.

Not subject to Agency Commission.

UNDISPLAYED

SEARCHLIGHT SECTION

(Classified Advertising)

BUSINESS OPPORTUNITIES

EQUIPMENT - USED or RESALE

DISPLAYED RATE

The advertising rate is \$27.25 per inch for all advertising appearing on other than a contract basis. Contract rates quoted on request. AN ADVERTISING INCH is measured $\frac{1}{8}$ inch vertically on one column, 3 columns—30 inches—to a page. EQUIPMENT WANTED or FOR SALE ADVERTISEMENTS acceptable only in Displayed Style.

UNDISPLAYED RATE

\$2.70 a line, minimum 3 lines. To figure advance payment count 5 average words as a line. PROPOSALS, \$2.70 a line an insertion. BOX NUMBERS count as one line additional in undisplayed ads. DISCOUNT OF 10% if full payment is made in advance for four consecutive insertions of undisplayed ads (not including proposals).

Send NEW ADS to CLASSIFIED ADV. DIV. of ELECTRONICS, P. O. Box 12, N. Y. 36, N. Y.

jpl needs

SYSTEMS ENGINEERS

SPACECRAFT SYSTEMS DESIGN STUDIES

To initiate and develop, for unmanned lunar and interplanetary programs, initial design criteria, mission requirements, advanced capability studies and direction of the systems preliminary design efforts. Direction and management of preliminary design contracts with industry. BS or MS in EE, ME or AE with broad experience and abilities in systems.

Send complete resume to
PERSONNEL DEPT.

JET PROPULSION LABORATORY

CALIFORNIA INSTITUTE OF TECHNOLOGY
4814 OAK GROVE DR. • PASADENA, CALIF.

"An equal opportunity employer"

SCIENTISTS/ENGINEERS

Career opportunities in:

- DESIGN
- RESEARCH
- DEVELOPMENT
- SALES
- MARKETING
- APPLICATION

Specialists in the personalized placement of Electronic Engineers and Scientists, on a national basis, who have a BS or advanced degree. Client companies assume fees and relocation costs.

SALARIES \$6000 TO \$26000

Submit Resume in Confidence to Box E



SCOPE

PROFESSIONAL PLACEMENT CENTER
1277 MAIN ST. WALTHAM, MASS.

E. E.'s
for FEE-PAID Positions
WRITE US FIRST!
Use our confidential application for professional, individualized service... a complete national technical employment agency.
ATOMIC PERSONNEL, INC.
Suite 1207L, 1518 Walnut St., Phila. 2, Pa.

NEED EXPERIENCED ENGINEERS?

Place an "Engineers Wanted" advertisement in this EMPLOYMENT OPPORTUNITIES section. *It's an inexpensive, time saving method of selecting experienced personnel for every engineering job in the electronic industry.* The selective circulation of ELECTRONICS offers you an opportunity to choose the best qualified men available throughout the industry.

For rates & information write

ELECTRONICS

Classified Advertising

Post Office Box 12

New York 36, New York

FOR RESEARCH — DEVELOPMENT & EXPERIMENTAL WORK

Over 10,000 different electronic parts: waveguide, radar components and parts, test sets, pulsers, antennas, pulse Xmt's, magnetrons, 1F and pulse amplifiers, dynamotors, 400 cycle Xmt's, 584 ant. pedestals, etc.
PRICES AT A FRACTION OF ORIGINAL COST!
COMMUNICATIONS EQUIP CO.
343 CANAL ST., N. Y. 13, WO 6-4045
CHAS. ROSEN (Formerly at 131 Liberty St.)
CIRCLE 950 ON READER SERVICE CARD

OVER 2,000,000

RELAYS

IN STOCK!

Send for Catalog SS

Universal RELAY CORP.
42 WHITE ST., N.Y. 13, N.Y. • WALKER 3-6900

CIRCLE 951 ON READER SERVICE CARD
AUTOTRACK TELEMETRY ANTENNA PEDESTALS
X & S SCR-584 & M 33 AUTOTRACK RADAR
AN/TFS-1D SEARCH, AN/TFS-10 HT. FINDERS.
AN/FPN-326CA, AN/APS-10 NAVIG. & WEATHER.
AN/APS-15 B, AN/APS-23 & 31 SEARCH.
S & X BEACONS, VA 800 KLV, CARCINOTRONS.
.25-.5-1-2-3-6 MEGAWATT PULSERS
MICROWAVE LUMINOUS TEST EQUIP.
LARGEST RADAR STOCK IN U.S.A.
RADIO RESEARCH INSTRUMENT CO.
550 Fifth Ave. New York Tel: Judson 6-4691

RADAR SYSTEMS & COMPONENTS / IMMEDIATE DELIVERY
CIRCLE 952 ON READER SERVICE CARD

Antique TELEPHONES

As is complete, decorative purpose \$12.00. Working order, inter-comm. \$15.00. Ext. on dial \$17.50. talking circuit only. Write for complete list. All shipments FOB, Simpson, Pa.
TELEPHONE ENGINEERING CO.
Dept. E-16262, Simpson, Pa.



CIRCLE 953 ON READER SERVICE CARD

Searchlight Equipment Locating Service

No Charge or Obligation

This service is aimed at helping you, the reader of "SEARCHLIGHT", to locate Surplus new and used Electronic equipment not currently advertised. (This service is for USER-BUYERS only.)

How to use: Check the dealer ads to see if what you want is not currently advertised. If not, send us the specifications of the equipment wanted on the coupon below, or on your own company letterhead to:

Searchlight Equipment Locating Service
c/o ELECTRONICS
P. O. Box 12, N. Y. 36, N. Y.

Your requirements will be brought promptly to the attention of the equipment dealers advertising in this section. You will receive replies directly from them.

Searchlight Equipment Locating Service
c/o ELECTRONICS, P.O. Box 12, N.Y. 36, N.Y.
Please help us locate the following equipment components.

NAME
TITLE
COMPANY
STREET
CITY 10/26/62

INDEX TO ADVERTISERS



Audited Paid Circulation

Airpax Electronics, Inc.	91	• Radio Corporation of America...4th cover	
Alberox Corp.	83	• Radio Materials Co.	81
Ampex Corporation.	20	• Raytheon Company.	2nd cover
• Amphenol-Borg Electronics Corp		• Ribet-Desjardins.	88
Connector Division.	18, 19	• Rixon Electronics, Inc.	90
Assembly Products Inc.	31	• Rochar Electronique.	27
• Automatic Metal Products Corp.	99	• Rosemount Engineering Co.	78
		Saratoga Ind.	82
• Bird & Co., Inc., Richard H.	96	Singer-Metrics Div., Singer Mfg.	
Boniac Laboratories.	63	Co., Inc.	69, 71
• Borg Equipment Division, Amphenol-		Sprague Electric Co.	9, 28, 66
Borg Electronics Corp.	21	Synthane Corp.	16
• Brush Instruments, Div. of Clevite		Texas Instruments Incorporated	
Corp.	3rd cover	Apparatus Division.	93
		Toyo Musen Co., Ltd.	79
• Celco-Constantine Engineering Labora-		• United Shoe Machinery Corp.	93
tories.	96		
• Chitrey Corp.	32	• Vitro Electronics.	72
Consolidated Avionics Corp.	75		
Constantine Engineering Laboratories.	96	• Weinschel Engineering.	4
• Colo-Coil Co., Inc.	84	White S. S.	95
Cubic Corp.	11		
• Curtiss-Wright Corp.	86, 87		
Deusch Co., The, Electronics Com-			
ponents Div.	65		
Eastman Kodak Co.	17		
• Electrodynamic Instrument Corp.	94		
Electro Instruments Inc.	89		
Electronic Associates, Inc.	40		
Electronic Engineering Co. of Calif.	84		
General Dynamics Astronautics.	41-44		
General Electric Co.			
Silicone Products Dept.	29		
• General Electrodynamics Corporation.	35		
• General Magnetics, Inc.	38, 39		
• General R F Fittings, Inc.	79		
Gudebrod Bros. Silk Co., Inc.	34		
Guidance Controls Corp., Sub. of			
Warner Electric Brake & Clutch Co.	61		
• Haydon Co., A. W.	85		
• Hewlett-Packard Company.	6		
Hughes Aircraft Co.	98		
Krohn-Hite Corp.	73		
• Lambda Electronics Corp.	5		
Lear Siegler Inc., Instrument Div.	33		
Lowe Material Industries.	15		
• M B Electronics, A Division of Textron			
Electronics, Inc.	37		
Messer Optics, Inc.	16		
Moller Co., Adolf.	84		
Minnesota Mining & Mfg. Co.			
Chemical Div.	76, 77		
Mnemotron Corp.	10		
Monadnock Mills.	36		
• Navigation Computer Corp. (NAVCOR)			
New Mexico Dept. of Development.	70		
• North Atlantic Industries, Inc.	83, 87		
OKI Electric Industry Co., Ltd.	79		
Pacific Plastic Products.	36		
• Panoramic-Singer.	71		
• Polarad Electronics Corporation.	90		
• Potter Instrument Co., Inc.	23		
Preformed Line Products Co.	100		

CLASSIFIED ADVERTISING

F. J. Eberle, Business Mgr.

EMPLOYMENT OPPORTUNITIES .. 98

EQUIPMENT
(Used or Surplus New)
For Sale 98

INDEX TO CLASSIFIED ADVERTISERS

Atomic Personnel Inc.	98
• Communications Equipment Co.	98
Jet Propulsion Laboratory.	98
• Radio Research Instrument Co.	98
Scope Professional Placement Center.	98
• Telephone Engineering Co.	98
• Universal Relay Corp.	98

• See advertisement in the July 25, 1962 issue of Electronics Buyers' Guide for complete line of products or services.

This Index and our Reader Service Numbers are published as a service. Every precaution is taken to make them accurate, but **electronics** assumes no responsibilities for errors or omissions.

HOW
ARE
YOUR

CON
NEC

ION
S?

If they aren't what they should be, then you ought to be specifying Coaxial Connectors by

Automatic

METAL PRODUCTS CORPORATION
323 Berry St., B'klyn 11, N. Y. • EVergreen 8-6057

When you have two wires of same or different diameters to be permanently joined in a perpendicular configuration, wrap on a . . .

Preformed
T-CONNECTOR

T-CONNECTOR

For use on log periodic and circular grid antennas, TAHA towers, and other grid type transmitting and receiving arrays. The finished assembly is strong, safe, neat, permanent. Uniformity of application is assured at every connection.

Cross Tie and L-Connectors also available.

Use the Reader Service Card to request complete information

**PREFORMED
LINE PRODUCTS
COMPANY**

5349 St. Clair Avenue •
Cleveland 3, Ohio •
881-4900 (DDD 216)
600 Hansen Way •
Palo Alto, California •
327-0170 (DDD 415)



Made in accordance with U. S. Patent No. 2,691,865

CIRCLE 211 ON READER SERVICE CARD

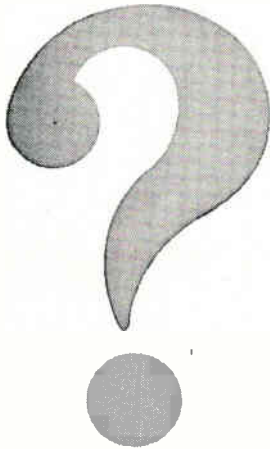

Are you selling the whole buying team

Tough competition demands that the electronics man be reached and sold wherever you find him: *Research, Design, Production, and Management.* Only advertising in electronics reaches all four . . . the same men your salesmen call on. Put your advertising where it works *hardest*

in **electronics**

electronics



Audit Bureau
of Circulations



Associated Business
Publications

Audited Paid Circulation

JAMES T. HAUPTLI

Advertising Sales Manager

R. S. QUINT:
Assistant Publisher Buyers'
Guide and Business Manager
FRED STEWART:
Promotion Manager
B. ANELLO:
Market Services Manager

RICHARD J. TOMLINSON:
Production Manager
GEORGE E. POMEROY:
Classified Manager
HUGH J. QUINN:
Circulation Manager

ADVERTISING REPRESENTATIVES

ATLANTA (9):
Michael H. Miller, Robert C. Johnson
1375 Peachtree St. N.E., Trinity 5-0523
(area code 404)

BOSTON (16):
William S. Hodgkinson, Donald R. Furth
McGraw-Hill Building, Copley Square,
Congress 2-1160 (area code 617)

CHICAGO (11):
Harvey W. Wernecke, Robert M. Denmead
645 North Michigan Avenue, Mohawk 4-5800
(area code 312)

CLEVELAND (13):
Paul T. Fegley
55 Public Square, Superior 1-7000
(area code 216)

DALLAS (1):
Frank Le Beau
The Vaughn Bldg., 1712 Commerce St.
Riverside 7-9721 (area code 214)

DENVER (2):
J. W. Patten
Tower Bldg., 1700 Broadway,
Alpine 5-2981 (area code 303)

HOUSTON (25):
Joseph C. Page, Jr.
Prudential Bldg., Halcombe Blvd.,
Riverside 8-1280 (area code 713)

LOS ANGELES (17):
Peter S. Carberry, Ashley P. Hartman
1125 W. 6th St., Huntley 2-5450
(area code 213)

NEW YORK (36):
Donald H. Miller, Henry M. Shaw,
George F. Werner
500 Fifth Avenue, LO-4-3000
(area code 212)

PHILADELPHIA (3):
Warren H. Gardner, William J. Boyle
6 Penn Center Plaza, LOcust 8-4330
(area code 215)

SAN FRANCISCO (11):
R. C. Alcorn
255 California Street, Douglas 2-4600
(area code 415)

LONDON W1:
Edwin S. Murphy Jr.
34 Dover St.

FRANKFURT/Main:
Matthée Herfurth
85 Westendstrasse

GENEVA:
Michael R. Zeynel
2 Place du Port

"Headquarters for Business Information"

McGraw-Hill Technical and Business Publications

American Machinist/Metal-
working Manufacturing
Aviation Week and Space
Technology
Business Week
Chemical Engineering
Chemical Week
Coal Age
Construction Methods and
Equipment
Construction Daily
Control Engineering
Electrical Construction
and Maintenance
Electrical Merchandising Week
Electrical Newsletter
Electrical West

Electrical Wholesaling
Electrical World
Electronics
Engineering Digest
Engineering and Mining Journal
E & MJ Metal and Mineral
Markets
Engineering News-Record
Factory
Fleet Owner
Industrial Distribution
National Petroleum News
Nucleonics
Nucleonics Week
Platt's Oilgram News
Platt's Oilgram Price Service
Power

Product Engineering
Purchasing Week
Science Week
Textile World

Overseas only:
Automobile International
(English, Spanish)
Ingenieria Internacional
Construccion (Spanish)
International Management
(English, Spanish)
Portuguese editions)
Metalworking Production
(Great Britain)

Available by subscription only — to qualified persons actively engaged in the field of the publication. For subscription rates and information describing the editorial coverage of any of the above publications, write to: Subscription Manager, Circulation Department, McGraw-Hill Publishing Company, 330 West 42nd Street, New York 36, N. Y.

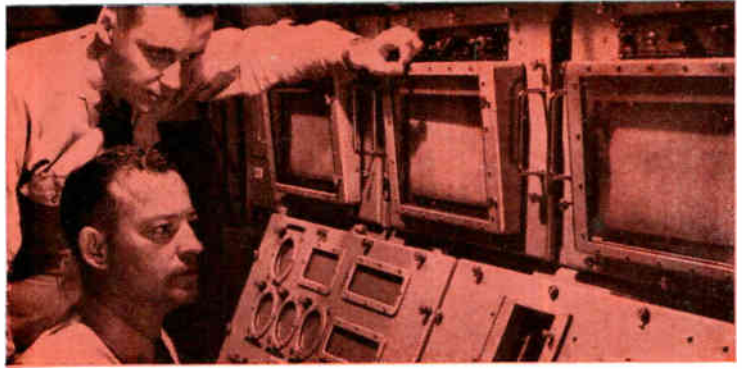

Training Console for POLARIS Navigation Control

in recording
reliability
means
nothing

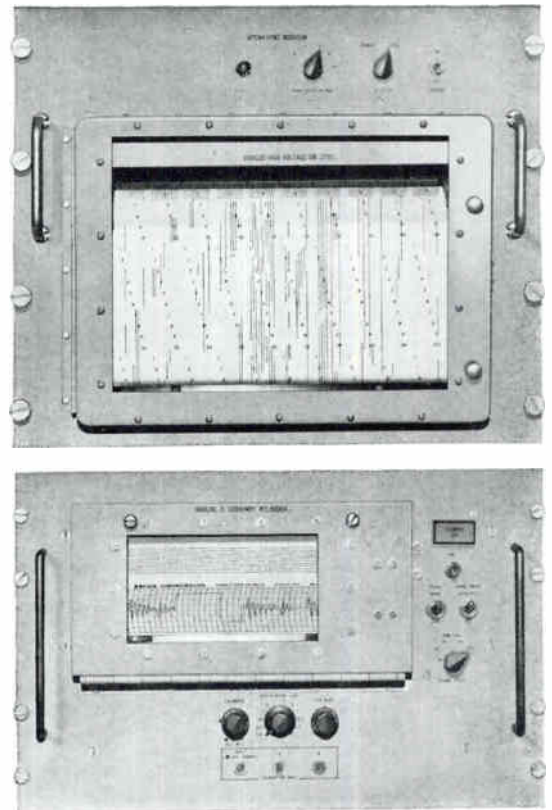

... without the dimension of time. Performing to standards month after month, year after year, is the *true* measure of reliability. It is, in fact, the true measure of Brush Recording Systems that have documented much of the information from vehicles and satellites since the beginning of the space age. That's why Brush is able to design Recording Systems that *originally* meet MIL specs . . . Analog Recorders . . . 120 channel Operations Monitors and the combination AN/SEQ Recorder that simultaneously records both analog data and sequential events. Vital components in every *standard* Brush system conform to these rigid requirements: pen motors, transmissions, circuit boards, hardware and wiring. This capability and experience is unmatched in the industry. Before prototype design becomes a problem—write Brush for complete details.

brush INSTRUMENTS
DIVISION OF CLEVITE 37TH AND PERKINS, CLEVELAND 14, OHIO

CIRCLE 901 READERS SERVICE CARD

Beta vs. Collector Current for RCA's Economy Line of Silicon Power Transistors

DISSIPATION	
2N1700	5 Watts
2N1701	25 Watts
2N1702	75 Watts
2N1703	75 Watts
2N2270	5 Watts
2N2338	150 Watts
2N2339	40 Watts

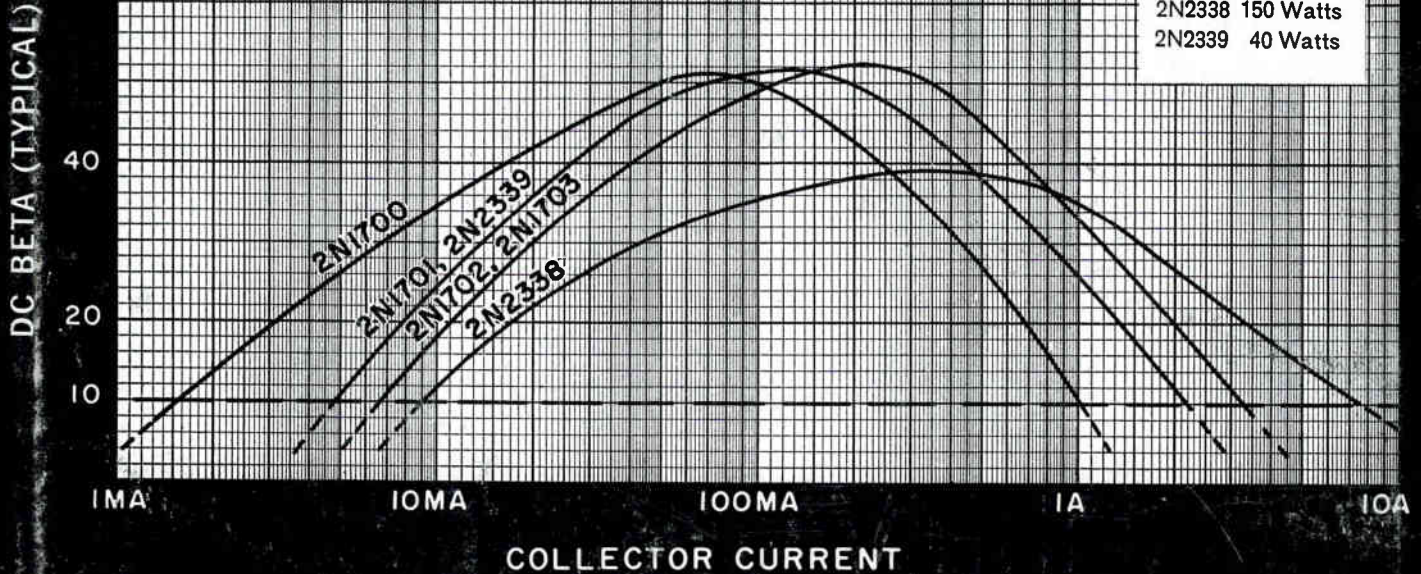

RCA EXPANDS ECONOMY SILICON LINE FOR LOW COST DESIGN FLEXIBILITY UP TO 150 WATTS

Now, RCA adds 3 new types, 2N2338, 2N2339, 2N2270 to its line-up of low-cost silicon transistors at prices starting as low as comparable Germanium Power Types.

Here's RCA's answer to today's value and performance requirements for industrial and military applications... a broad new economy line of silicon transistors. This low-cost, high performance line now includes three new types, 2N2338 and 2N2339, high and medium power types, respectively, and the 2N2270, RCA's new economy version of the "Universal" triple-diffused planar silicon transistor type 2N2102. With these additions, RCA's economy silicon line now offers:

- High dissipation... up to 150 watts
- Top performance at high temperatures... up to 200°C
- Wide-range beta control... up to 10 amps

These low-cost silicon types are immediately available to bring you new economy and greater design freedom for industrial and military circuits demanding the reliability and performance of silicon transistors.

AVAILABLE THROUGH YOUR RCA DISTRIBUTOR



New RCA 2N2270 Triple-Diffused Planar



New 150-watt RCA 2N2338



New 40-watt RCA 2N2339

For new low prices call your RCA representative today. For FREE Technical Bulletin on RCA's Economy Silicon Line, write RCA Semiconductor and Materials Division, Commercial Engineering, Section IN11-4, Somerville, N. J.



FIELD OFFICES...

EAST: Newark, N. J., 744 Broad St., HU 5-3900 • (Camden-Philadelphia Area) Eriton, N. J., 605 Marlon Pike, HA 8-4802 • Syracuse, N. Y., 731 James St., Rm. 402, GR 4-5591 • Baltimore, Md., EN 9-1850 • NORTHEAST: Needham Heights 94, Mass., 64 "A" St., HI 4-7200 • SOUTHEAST: Orlando, Fla., 1520 Edgewater Dr., Suite #1, GA 4-4768 • EAST CENTRAL: Detroit 2, Mich., 714 New Center Bldg., TR 5-5600 • CENTRAL: Chicago, Ill., Suite 1154, Merchandise Mart Plaza, WH 4-2900 • Indianapolis 5, Ind., 2132 East 52nd St., CL 1-1405 • Minneapolis 16, Minn., 5805 Excelsior Blvd., WE 9-0676 • Denver 11, Colorado, Continental Terrace Bldg., Suite 301, 2785 N. Speer Blvd., 477-1688 • WEST: Los Angeles 22, Calif., 6801 E. Washington Blvd., RA 3-8361 • (San Francisco Area) Burlingame, Calif., 1838 El Camino Real, OX 7-1620 • Seattle 4, Wash., 2250 First Ave. S., MA 2-8816 • SOUTHWEST: Dallas 7, Texas, 7905 Carpenter Freeway, ME 1-9720 • GOV'T: Dayton, Ohio, 224 N. Wilkinson St., BA 6-2366 • Washington, D. C., 1725 "K" St., N.W., FE 7-8500 • RCA INTERNATIONAL DIV., 30 Rockefeller Plaza, N. Y. 20, N. Y. Cable Address: RADIOINTER, N. Y.



THE MOST TRUSTED NAME IN ELECTRONICS

CIRCLE 902 READERS SERVICE CARD