

# electronics

A McGraw-Hill Publication 75 Cents

(photo at right)

## AMPLIFIERS BY DOZENS

*Molecular circuits  
on silicon slice, p 39*

## ANTENNA IN A GLASS TUBE

*New way to get  
directivity, p 44*

## VARACTOR TUNES TUNNEL DIODE

*Sweeps microwave  
receivers, p 50*

## TWO-TUBE COLOR TV

*Monochrome  
picture tubes, p 54*

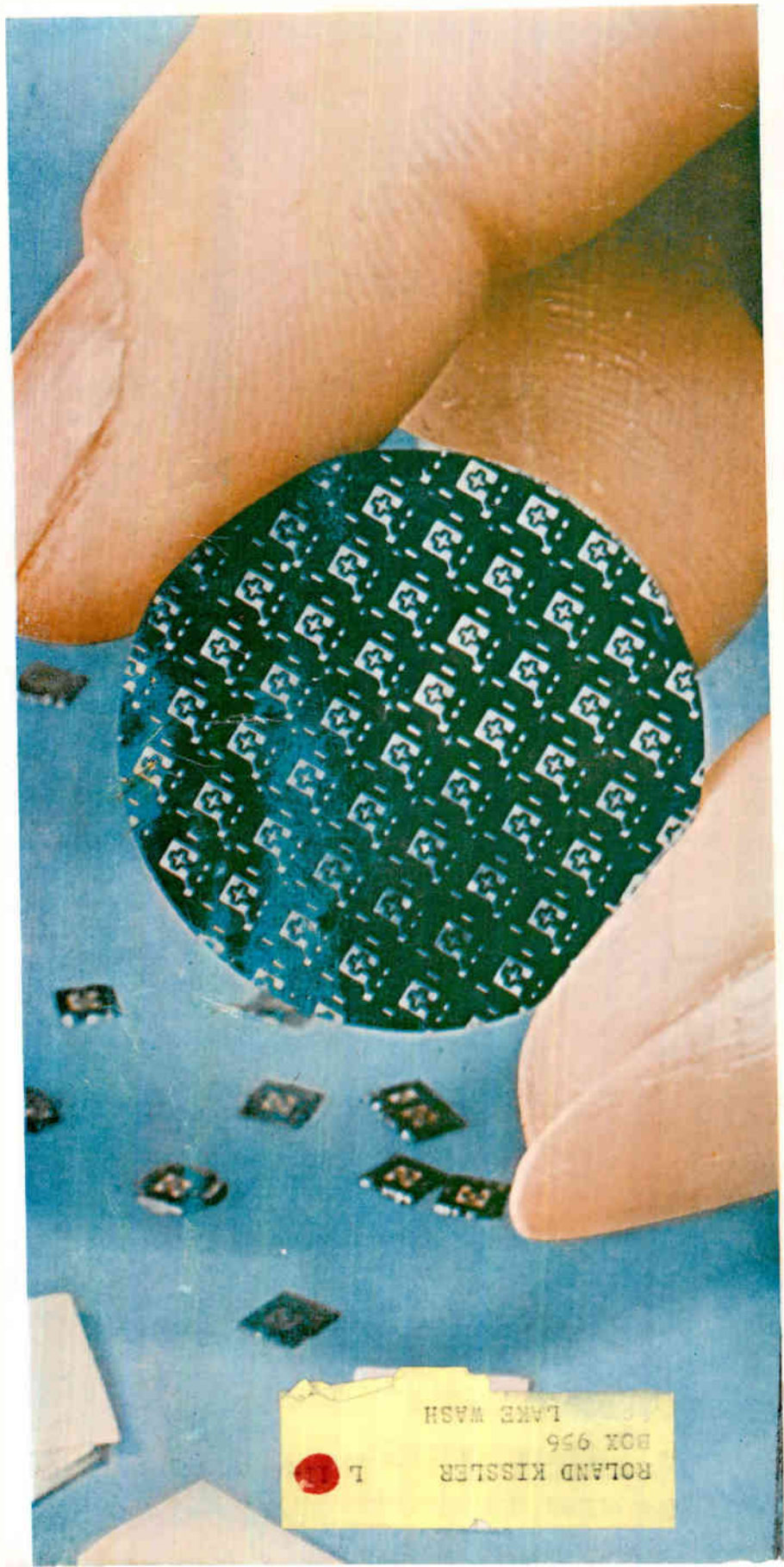

ROLAND KISSLER  
L  
BOX 956  
LAKE WASH

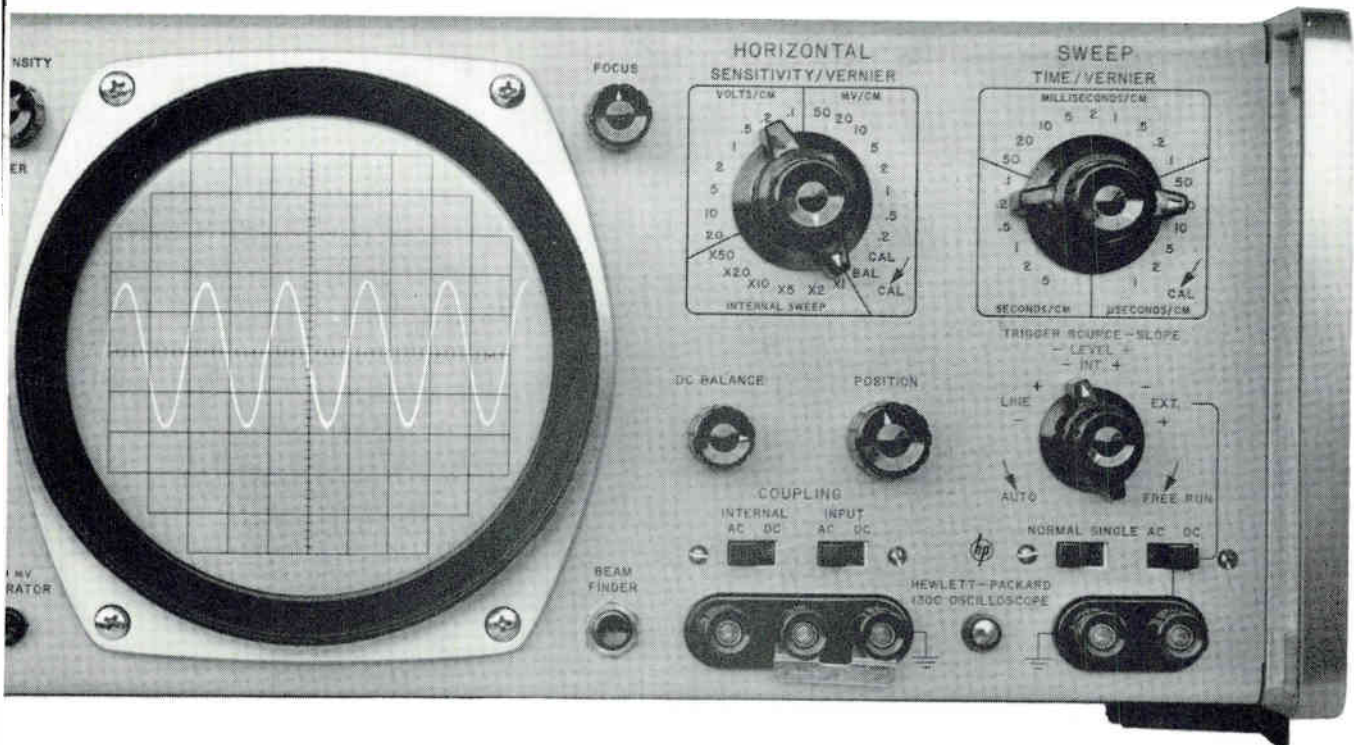

## SPECIFICATIONS

- Internal Sweep:** 21 ranges, 1  $\mu\text{sec/cm}$  to 5 sec/cm, accuracy within  $\pm 3\%$ . Vernier extends slowest sweep to at least 12.5 sec/cm
- Magnification:** X2, X5, X10, X20, X50, accuracy within  $\pm 5\%$  of sweep rates not exceeding a maximum rate of 0.2  $\mu\text{sec/cm}$
- Automatic Triggering:** Base line displayed in the absence of input signal. Internal, 10 cps to 500 KC signal causing 0.5 cm or more vertical deflection; also from line voltage. External, 20 cps to 500 KC,  $< 0.5$  v p-p. Trigger point and slope, zero crossing, positive or negative slope
- Trigger Point Selection:** From +10 volts to -10 volts, positive or negative slope of external signal or internally from any point of the vertical waveform presented on screen. Internal, 0.5 cm or more vertical deflection. External, dc or ac coupled 15 volts p-p or more
- Single Sweep:** Front panel switch

## SWEEP GENERATOR

## VERTICAL & HORIZONTAL AMPLIFIERS

- Bandwidth:** DC Coupled: dc to 500 KC  
AC Coupled (at input): 10 cps to 500 KC  
AC Coupled (in amplifiers for trace stabilization): 25 cps to 500 KC at 0.2 mv/cm sensitivity. Lower cut-off is reduced proportional to sensitivity down to 20 mv/cm where it is 0.25 cps
- Sensitivity:** 0.2 mv/cm to 20 v/cm. 16 ranges in 1, 2, 5, 10 sequence. Attenuator accuracy,  $\pm 3\%$   
Vernier extends minimum sensitivity to 50 v/cm
- Internal Calibrator:** Approximately 350 cps square wave, 5 mv  $\pm 3\%$
- Input Impedance:** 1 megohm shunted by 45 pf, constant on all sensitivity ranges
- Balanced Input:** Available on all sensitivity ranges
- Phase Shift:** Within  $\pm 1^\circ$  relative phase shift to 100 KC

## GENERAL

- External Calibrator:** Approx. 350 cps, 500 mv  $\pm 2\%$ , front panel input
- Cathode Ray Tube:** 10 x 10 cm internal graticule type, P31 phosphor standard, P-2, P-7 and P-11 available, same cost
- Intensity Modulation:** Terminals on rear; +20 volt pulse blanks CRT at normal intensity
- Power:** 115/230 volts  $\pm 10\%$ . 50 to 1,000 cps approx. 90 watts
- Size:** 16 $\frac{3}{4}$ " wide, 7 $\frac{1}{2}$ " high, 16 $\frac{3}{8}$ " deep; brackets furnished for quick conversion to 7" x 19" rack mount. 32 lbs.
- Price:** \$695.00

*Price f.o.b. factory. Data subject to change without notice.*

**HEWLETT  
PACKARD  
COMPANY**

1501 Page Mill Road, Palo Alto, California, Area Code 415, DA 6-7000  
Sales and service representatives in all principal areas; Europe, Hewlett-Packard S.A., 54-54bis Route des Acacias, Geneva; Canada, Hewlett-Packard (Canada) Ltd., 8270 Mayrand Street, Montreal



8003



**200  $\mu\text{v}/\text{cm}$  sensitivity**  
**500 KC bandwidth**  
**Identical X & Y amplifiers**  
**X2 to X50 magnification**  
**No-parallax, no-glare CRT**  
**Automatic triggering, beam finder**  
**One instrument for rack and bench**

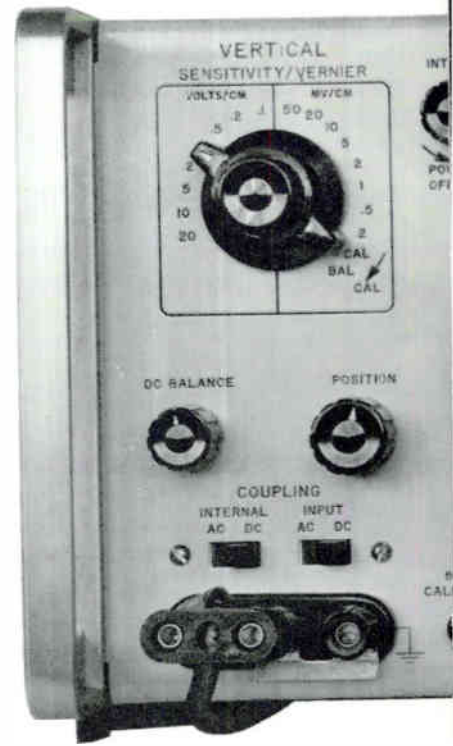

# MEASURE

low-level signals directly  
 with the new hp  
**130C 500 KC Oscilloscope!**

With the new  $\Phi$  130C Oscilloscope you get a full 10 x 10 cm picture of low-level signals without external preamplification. The 130C is ideal for viewing output from low-level transducers, strain gauges, small signals in solid state devices, detected RF, medical, physical phenomena, phase shift, and X-Y plots.

Identical horizontal and vertical amplifiers have 200  $\mu\text{v}/\text{cm}$  sensitivity and 500 KC passbands, with balanced input for rejection of common mode signals. Near identical phase characteristics of the amplifiers (less than  $1^\circ$  up to 100 KC) permit highly accurate phase measurements.

Automatic, versatile sweep circuitry makes the 130C fast and easy for even inexperienced personnel to use. Automatic triggering eliminates complicated trigger adjustments. The push button beam finder brings the trace onto

the screen regardless of control settings. To further aid in locating the trace, a base line automatically appears on the CRT in the absence of an input signal. The automatic feature may be locked out, and a front panel control set to select trigger level and slope for special applications. A single sweep switch allows viewing of transients.

The 130C is equipped with the  $\Phi$  internal graticule CRT that eliminates viewing and photographic parallax error. An etched safety glass faceplate cuts glare making the scope easy to read in high ambient light. Easy access modular construction allows both rack mounting and bench use.

The specifications tell the detailed story. Check them out . . . and then call your Hewlett-Packard representative for a demonstration on your own bench.

# Measure Low-Level Signals Directly

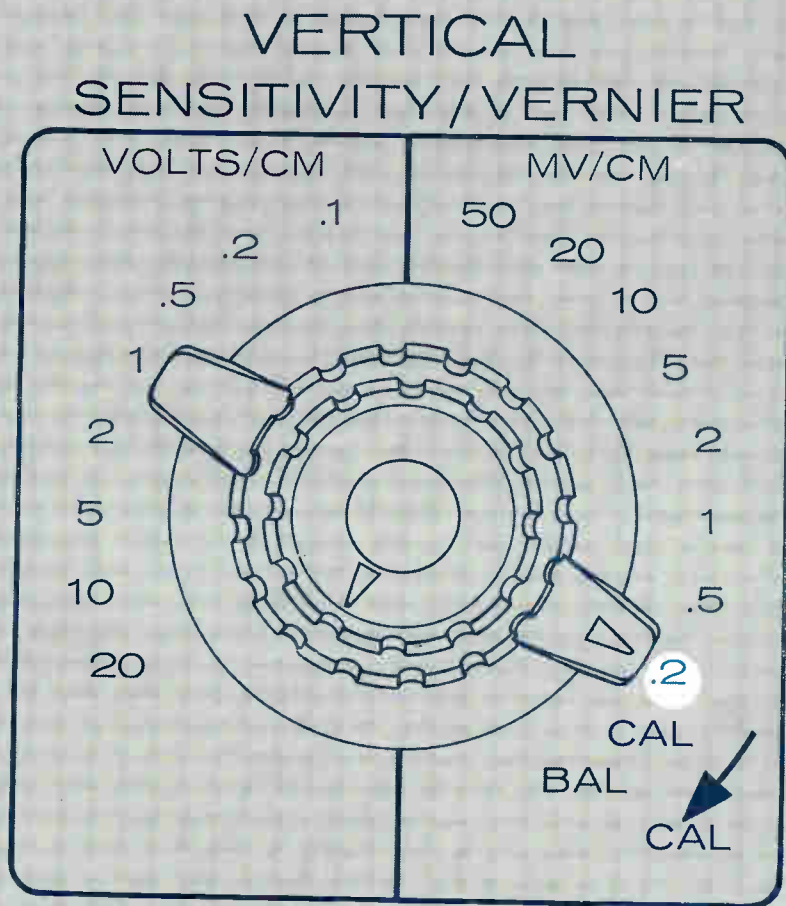

200  $\mu\text{v}/\text{cm}$  sensitivity... 500 KC

New *hp* 130C Oscilloscope



# electronics

A McGraw-Hill Publication 75 Cents



W. W. MacDONALD, Editor

J. M. CARROLL, Managing Editor  
 SENIOR EDITORS: Samuel Weber, George W. Sideris. SENIOR ASSOCIATE EDITOR: Michael F. Wolff. ASSOCIATE EDITORS: Michael F. Tamaino, Sylvester P. Carter, William P. O'Brien, John F. Mason, Sy Vogel, Leslie Solomon, George J. Flynn, Lawrence D. Shergalis. ASSISTANT EDITORS: Nilo Lindgren, Stanley Froud, Stephen B. Gray, Roy J. Bruun, George V. Novotny, Leon H. Dulberger. REGIONAL EDITORS: Harold C. Hood (Pacific Coast, Los Angeles), Thomas Maguire (New England, Boston), Cletus M. Wiley (Midwest, Chicago). ART DIRECTOR: Harry Phillips; Howard R. Berry. PRODUCTION EDITOR: John C. Wright, Jr. EDITORIAL ASSISTANTS: Gloria J. Meurer, Lorraine Rossi, Virginia T. Bastian, Lynn Emery, Rosemary Abbruzzese, Ann Mella, Lorraine Werner. FOREIGN NEWS BUREAU: Director, John Wilhelm, Alyne Elias. LONDON—John Shinn, Derek Barlow, Nicholas Landon. BONN—Peter Farboth, Silke McQueen. PARIS—Robert Farrell, Arthur Erikson. MILAN—Marc A. Messina. MEXICO CITY—Bruce Bendow. RIO DE JANEIRO—Leslie Warren. MOSCOW—Stewart Ramsey. TOKYO—Richard Halloran, Charles Cohen, John Yamaguchi.

JAMES GIRWOOD, Publisher

**SILICON SLICE** will furnish several dozen class-A audio amplifiers each rated at  $\frac{1}{4}$ -watt audio output. Final encapsulated packages will measure  $\frac{1}{2}$  by  $\frac{3}{8}$  by 0.04 inch. Gold wires will lead through glass seal to the amplifiers; the Westinghouse Electric amplifiers will be soldered to their cases to provide a large heat sink. *For tips on systems use of functional blocks, see p 39* COVER

**BRITISH AVIATION** Industry is Shaken by Missile Cutback. Missile development narrows down to three projects. Effect is apparent in equipment at Farnborough airshow. *But the show did feature some new systems including daylight radar* 18

**EIA ESTIMATES \$13.1 Billion** for 1962 Electronics Sales. Reports at the Fall Conference say the government now buys more than half the industry's output. *One of the biggest new markets is command and control equipment* 26

**WANTED: Radiation-Resistant Solar Cells.** Nuclear tests may require redesign of satellite power supplies. *NASA expects a substantial number of its future missions to be affected by radiation from high-altitude nuclear tests* 28

**STRATOSCOPE II Assembly Is Completed.** Electronic payload is forerunner of future satellite experiments. *The new balloon-borne telescope will make its first flight next year* 30

**MOLECULAR CIRCUITS: How to Design Them into New Systems.** A growing number of functional blocks is available to replace various subsystems. These include tuned and untuned amplifiers, oscillators, mixers and large-signal devices. *Design data is conveniently tabulated.* By H. W. Henkels, Westinghouse Electric 39

**NEW ANTENNA DESIGN: Plastic Tube Focuses Microwave Beam.** A helical antenna for 4 to 6 Gc is enclosed in a glass fiber tube. As the helix is withdrawn from the tube, its beamwidth increases. *With a quad helix, half power beamwidth can be smoothly varied from 4 to 40 deg.* By K. Ikrath and W. Schneider, U. S. Army Signal R&D Lab 44

**REGULATING 500 WATTS With a Single Transistor.** This regulator works from a d-c source. Control is achieved by switching the current on and off. *A magnetic amplifier in a feedback loop varies the pulse width to keep output voltage constant.* By P. Balthasar, Bendix 48

**VARACTOR-TUNED TUNNEL-DIODE OSCILLATOR** Now Practical. Receiver local oscillator for 600 to 900-Mc range uses a tunnel diode tuned by a voltage-variable capacitor operated above its self-resonant frequency. *Circuit could be used in sweep-frequency intercept receivers.*

By F. G. Heneman and G. W. Thompson,  
Airborne Instruments Lab 50



Published weekly, with Electronics Buyers' Guide and Reference Issue as part of the subscription, by McGraw-Hill Publishing Company, Inc. Founder: James H. McGraw (1860-1948).

Title ® registered U.S. Patent Office; © copyright 1962 by McGraw-Hill Publishing Co., Inc. All rights reserved, including the right to reproduce the contents of this publication, in whole or in part.

Executive, editorial, circulation and advertising offices McGraw-Hill Building, 330 West 42nd Street, New York 36, N. Y. Telephone Longacre 4-3000. Teletype TWX N.Y. 212-640-4646. Cable McGrawhill, N. Y. PRINTED IN ALBANY, N. Y.; second class postage paid at Albany, N. Y.

OFFICERS OF THE PUBLICATIONS DIVISION: Nelson L. Bond, President; Shelton Fisher, Wallace F. Traendly, Senior Vice Presidents; John R. Callahan, Vice President and Editorial Director; Joseph H. Allen, Vice President and Director of Advertising Sales; A. R. Venezian, Vice President and Circulation Coordinator; Daniel F. Crowley, Vice President and Controller.

OFFICERS OF THE CORPORATION: Donald C. McGraw, President; Hugh J. Kelly, Harry L. Waddell, Executive Vice Presidents; L. Kelth Goodrich, Executive Vice President and Treasurer; John J. Cooke, Vice President and Secretary.

Subscriptions are solicited only from those actively engaged in the field of the publication. Position and company connection must be indicated on orders. Subscription rates: United States and Possessions, \$6.00 one year, \$9.00 two years, \$12.00 three years. Canada, \$10.00 one year. All other countries \$20.00 one year. Single Copies, United States and Possessions and Canada 75¢. Single copies all other countries \$1.50.

THE PUBLISHER, UPON WRITTEN REQUEST FROM ANY SUBSCRIBER TO OUR NEW YORK OFFICE, AGREES TO REFUND THAT PART OF THE SUBSCRIPTION PRICE APPLYING TO COPIES NOT YET MAILED.

Subscribers: Please address change of address notices, subscription orders or complaints to Fulfillment Manager, Electronics, at above address. Change of address notices should provide old as well as new address, including postal zone number if any. If possible, attach address label from recent issue. Allow one month for change to become effective.

Postmaster: Please send Form 3579 to Fulfillment Manager, Electronics, 330 West 42nd Street, New York 36, New York.



Audited Paid Circulation

CONTENTS continued

- IMPROVED SUPERREGENERATOR Has Quench Converter. Superregenerative amplifiers give high gain but often have wide bandwidth and poor signal-to-noise ratio. *This amplifier uses an afc feedback loop in the quench circuit to reduce bandwidth and improve the signal-to-noise ratio.*  
By N. H. Brown, Hughes Aircraft 53
- COLOR-TV SET Uses Two Monochrome Tubes. This Japanese receiver for NTSC color tv operates on the Land two-color principle. It uses two 14-in. monochrome picture tubes and a half-silvered mirror. *One tube has a red plastic cap; the other a green-blue one.*  
By Charles Cohen 54
- CONSTANT-CURRENT DRIVE With Complementary-Symmetry Transistor Pair. Providing constant-current drive to an inductive transducer without allowing d-c to flow in it could require excessive values of supply voltage. *But here it is accomplished by a double emitter follower driving a complementary-symmetry pair.*  
By S. Sokol, Lockheed 56

DEPARTMENTS

- Crosstalk. *Technical Operations in the IEEE* 3
- Comment. *Police Frequency. Trigger Switching* 4
- Electronics Newsletter. *Satellite Will Probe Radiation Belt* 7
- Washington Outlook. *Budget Bureau May Tighten R&D Cost Allowance* 12
- Meetings Ahead 32
- Research and Development. *Modulation Technique Combats Impulse Noise* 62
- Components and Materials. *Analyzing Potentiometer Requirements* 68
- Production Techniques. *Circuit Boards for R&D Without Photography* 74
- New Products Design and Application. *Submarine Low-Frequency Bandpass Filter* 78
- Literature of the Week 87
- People and Plants. *Antenna Systems Building New Plants* 88
- Index to Advertisers 97

# Technical Operations in the IEEE

A MAJOR PROBLEM facing the incoming officers and directors of the new IEEE will be how to merge the technical operations of the IRE and AIEE. There are, altogether, 122 separate technical bodies, many with overlapping responsibilities.

There are 29 professional groups in the IRE. Each one functions as a little institute in its own right. The PGs organize meetings and conferences and publish transactions.

There are 26 technical committees in the IRE. Members are appointed by the president of the institute and the executive committee. The committees range in size from less than a dozen members to nearly 300. The IRE-TCs are concerned almost exclusively with standards work.

There are 67 technical committees in the AIEE. The AIEE-TCs perform the functions of both IRE-PGs and IRE-TCs. They do not publish transactions, although a few groups prepare translations of Russian technical literature. The AIEE-TCs are organized into six technical divisions covering communications, general applications, industrial applications, instruments, power and science.

If the combined IEEE is to be of maximum value to its membership the activities of all these technical bodies must be arranged to minimize duplication of effort and yet permit

each group to draw effectively upon the experience of like-minded groups.

This is a monumental task. Even if we exclude from consideration the IRE Standards Committee (*Crosstalk*, *ELECTRONICS*, p 3, July 27, 1962) and eight AIEE-TCs whose functions are largely administrative, we still have 113 groups.

The first step should probably be to organize the various bodies into technical divisions along the lines of the present AIEE. The executive committees of the various technical divisions could then in due time realign the existing IRE-PGs and AIEE-TCs in accord with these divisions.

They might also take over sponsorship of some IRE-TCs.

There are probably as many ways to set up the new organization as there are members of the IEEE. One arrangement that seems logical would have eight technical divisions: Basic Sciences, Communications Systems, Components and Materials, Computers and Automatic Control, Industrial Applications, Instrumentation, Management and Professional Activities, and Power Generation and Transmission.

The following list shows how existing IRE-PGs, IRE-TCs and AIEE-TCs might fit into such a setup.

## BASIC SCIENCES

Antennas & Propagation (IRE-PG)  
Antennas & Waveguides (IRE-TC)  
Basic Sciences (AIEE-TC)  
Bio-Medical Electronics (IRE-PG)  
Circuit Theory (IRE-PG)  
Circuits (IRE-TC)  
Communications Theory (AIEE-TC)  
Electrical Techniques in Medicine & Biology (AIEE-TC)  
Geoscience Electronics (IRE-PG)  
Information Theory (IRE-PG)  
Information Theory & Modulation Systems (IRE-TC)  
Medical Electronics (IRE-TC)  
Microwave Theory & Techniques (IRE-PG)  
Nuclear Science (IRE-PG)  
Nuclear Techniques (IRE-TC)  
Nucleonics (AIEE-TC)  
Wave Propagation (IRE-TC)

## COMMUNICATIONS SYSTEMS

Aerospace & Navigational Electronics (IRE-PG)  
Audio (IRE-PG)  
Audio & Electroacoustics (IRE-TC)  
Broadcasting (IRE-PG)  
Broadcasting (AIEE-TC)  
Broadcast & Television Receivers (IRE-PG)  
Communication Switching Systems (AIEE-TC)  
Communications Systems (IRE-PG)  
Facsimile (IRE-TC)  
Mobile Communications Systems (IRE-TC)  
Navigation Aids (IRE-TC)  
Power System Communications (AIEE-TC)  
Radio Communication Systems (AIEE-TC)  
Radio Frequency Interference (IRE-TC)  
Radio Frequency Interference (IRE-PG)  
Radio Receivers (IRE-TC)  
Radio Transmitters (IRE-TC)  
Space Electronics & Telemetry (IRE-PG)  
Recording & Reproducing (IRE-TC)  
Space Communications (AIEE-TC)  
Telegraph Systems (AIEE-TC)  
Telemetering (AIEE-TC)  
Television Systems (IRE-TC)

Video Techniques (IRE-TC)  
Vehicular Communications (IRE-PG)  
Wire Communication Systems (AIEE-TC)

## COMPONENTS & MATERIALS

Component Parts (IRE-PG)  
Electrical Insulation (AIEE-TC)  
Electron Devices (IRE-PG)  
Electronic Circuits & Systems (AIEE-TC)  
Electronic Transformers (AIEE-TC)  
Electron Tubes (IRE-TC)  
Electron Tubes (AIEE-TC)  
Electronics (AIEE-TC)  
Industrial Power Rectifiers (AIEE-TC)  
Insulated Conductors (AIEE-TC)  
Magnetic Amplifiers (AIEE-TC)  
Piezoelectric & Ferroelectric Crystals (IRE-TC)  
Relays (AIEE-TC)  
Semiconductor Rectifiers (AIEE-TC)  
Solid State Devices (AIEE-TC)  
Solid State Devices (IRE-TC)  
Transformers (AIEE-TC)

## COMPUTERS & AUTOMATIC CONTROL

Automatic Control (IRE-PG)  
Computing Devices (AIEE-TC)  
Data Communication (AIEE-TC)  
Electronic Computers (IRE-TC)  
Electronic Computers (IRE-PG)  
Feedback Control Systems (IRE-TC)  
Feedback Control Systems (AIEE-TC)  
Industrial Control (AIEE-TC)

## INDUSTRIAL APPLICATIONS

Aero-Space Transportation (AIEE-TC)  
Cement Industry (AIEE-TC)  
Chemical Industry (AIEE-TC)  
Domestic & Commercial Applications (AIEE-TC)  
Electric Heating (AIEE-TC)  
Electric Welding (AIEE-TC)  
General Industry Applications (AIEE-TC)  
Industrial Electronics (IRE-TC)

Industrial Electronics (IRE-PG)  
Land Transportation (AIEE-TC)  
Machine Tools Industry (AIEE-TC)  
Marine Transportation (AIEE-TC)  
Metal Industry (AIEE-TC)  
Mining Industry (AIEE-TC)  
Petroleum Industry (AIEE-TC)  
Production & Application of Light (AIEE-TC)  
Rubber & Plastic Industries (AIEE-TC)  
Textile Industry (AIEE-TC)  
Ultrasonics Engineering (IRE-PG)

## INSTRUMENTATION

Aero-Space Instrumentation (AIEE-TC)  
Electronic & High-Frequency Instruments (AIEE-TC)  
Fundamental Electrical Standards (AIEE-TC)  
Indicating & Integrating Instruments (AIEE-TC)  
Instrumentation (IRE-PG)  
Instruments & Instrumentation (IRE-TC)  
Nuclear Instrumentation (AIEE-TC)  
Recording & Controlling Instrumentation (AIEE-TC)  
Special Instruments & Auxiliary Apparatus (AIEE-TC)

## MANAGEMENT & PROFESSIONAL ACTIVITIES

Education (IRE-PG)  
Engineering Management (IRE-PG)  
Engineering Writing & Speech (IRE-PG)  
Human Factors in Engineering (IRE-PG)  
Military Electronics (IRE-PG)  
Product Engineering & Production (IRE-PG)  
Reliability (IRE-TC)  
Reliability & Quality Control (IRE-PG)  
Symbols (IRE-TC)

## POWER GENERATION & TRANSMISSION

Industrial & Commercial Power Systems (AIEE-TC)  
Protective Devices (AIEE-TC)  
Power Generation (AIEE-TC)  
Rotating Machinery (AIEE-TC)  
Substations (AIEE-TC)  
Switchgear (AIEE-TC)  
System Engineering (AIEE-TC)  
Transmission & Distribution (AIEE-TC)



# When You Need ELECTRIC WAVE FILTERS Depend on Sprague for ✓ SERVICE ✓ DELIVERY ✓ RELIABILITY



Sprague Electric Wave Filters for use in telemetry, telephony, and various types of communications systems and laboratory equipment which require selection and/or rejection of specific frequencies are now being designed by *Modern Network Synthesis*, which assures exact matching of wave filter characteristics to application requirements for Low Pass, High Pass, Band Pass, and Band Rejection filters.



Drawing on Sprague's long experience in component manufacture, wave filter engineers are able to employ capacitor, inductor and resistor production facilities for particular sizes, shapes, and materials best suited for specific filter applications. Unlike most filter manufacturers, Sprague is not dependent upon other component suppliers, therefore faster deliveries can be provided.



To further Sprague capabilities, wave filter design and field engineering offices as well as pilot production facilities are maintained in North Adams, Mass.; Vandalia, Ohio; and Los Angeles, Calif. Specialized mass production facilities are located at Visalia, Calif. and North Adams.

For additional information on Sprague Electric Wave Filters, write for Engineering Bulletin 46000 to Technical Literature Section, Sprague Electric Company, 35 Marshall Street, North Adams, Massachusetts.



## COMMENT

### Police Frequency

This is in reference to the article, Loudspeaker Rating System Proposed, in the issue of July 6 (p 30), which said in part:

"The number of symbols indicates performance number. For example, five gold stars would indicate an excellent speaker with one watt of acoustical power capacity and a frequency range of 20 to 20,000 cops."

When I was a small boy, I thought that our old spindly-legged Emerson had miniature people inside the cabinet who spoke or played music through the 8-inch electrodynamic loudspeaker. It bothered me very much as a child, because I could never see them.

I would like to meet the engineer who can cram 20,000 cops into any speaker. This would really be Big Brother watching. We would have one consolation, however: since there are only five gold stars, only five would be on duty at one time.

If there is a unit or term "cops" used in relation to loudspeakers, I will join hands with Mr. Oswald and Mr. Winter [*Comment* letters on abbreviations, p 4, July 6] and ask for definition of terms as well as abbreviations.

STUART G. MOORE  
Los Angeles, California

While a cop may be described as "a unit of force in the cgs (cop-gangster-syndicate) system," its appearance here is a slip of the typewriter.

### Admiration

For some time now I have been meaning to write and express admiration of your editorial coverage. Your recent Wescon special issue (August 10) has prompted me to do this.

Your feature articles and special departments such as *New Products Design and Application*, *Electronics Newsletter* and *Components and Materials*, to mention only a few, have shown a consistently high editorial standard for which your entire staff is to be congratulated.

How well is your magazine read?

I can speak from experience in answering this question. Recently we were fortunate in having one of our products represented in your *New Products Design and Application* section with an enlarged treatment. The interest and response shown was nothing short of amazing.

Once more, let me offer my sincere congratulations for editorial content that is second to none. Long may your banner wave.

HAROLD TAUB  
Manson Laboratories, Inc.  
Stamford, Connecticut

### Trigger Switching

Thank you very much for publishing our paper. We have found that, due to unavoidable delay, our corrected proofs were not in time. We would most appreciate it therefore if you would make the following corrections in our article, *Non-cutoff Circuits Improve Trigger Switching* (p 36, July 27):

(1) The sentence on line 6, first column, page 37, should read "... they will conduct current from  $I_2$  only. When the input signal  $v_i$  exceeds a threshold,  $S_1$  is on,  $S_2$  is off, or when input signal  $v_i$  exceeds another threshold level in the opposite direction,  $S_1$  is off,  $S_2$  is on."

(2) The subtitle on the 8th line from the bottom of the first column, page 37, should read SCHMITT TRIGGER.

(3) The abbreviation  $V_{c_{1u}}$  occurring 3 times in the second column, page 37, and twice in the first column, page 39, should read  $V_{c_{1u}}$ .

(4)  $R_1$  in the equation in the first column, page 39, should be  $R_2$ .

(5) The expression for  $R_2$  in the second column, page 39, should be

$$R_2 < \frac{E_c - E_{b1}}{E_{b1} [1/R_1 + (I_{c2\ on} - I_{c2\ off})/E_{b2}]}$$

YUICHI YOSHIDA  
Department of Electronic  
Engineering  
University of Tokyo  
Tokyo, Japan

Although galley proofs are sent to authors of technical feature articles, once in a great while there is some unavoidable delay that prevents our receiving an author's corrections in time to change the text accordingly.



# FOR PRODUCTION ECONOMY

## CONSIDER TUNG-SOL PRESS-FIT SILICON RECTIFIER ASSEMBLIES

For applications requiring 3 amps to 75 amps, Tung-Sol production techniques can deliver attractively economical, production-ready rectifier assemblies employing press-fit diodes. Availability of rectifiers in both polarities makes it possible to mount more than one diode on a single heat sink, resulting in assemblies that are the lightest weight available for any given power capacity. They lend themselves to compact designs, as the shortest dimension can be mounted in any of three planes. Minimal operating temperatures in the 1-15 amp range, plus surge ratings to 400 amps and PRV ratings to 600V assure maximum circuit protection.

Tung-Sol press-fit diodes have proved highly reliable in a wide variety of applications. They are hermetically sealed, with welded cases and ceramic-to-metal seals. All have protective finishes to withstand moisture and the corrosive conditions present in normal industrial environments.

For more information about Tung-Sol rectifier assemblies, or press-fit diodes for use with your own heat sinks, contact the Tung-Sol regional office nearest you, or write for Bulletin CT-17. Tung-Sol Electric Inc., Newark 4, New Jersey. TWX: NK193.

### TYPICAL CONFIGURATIONS

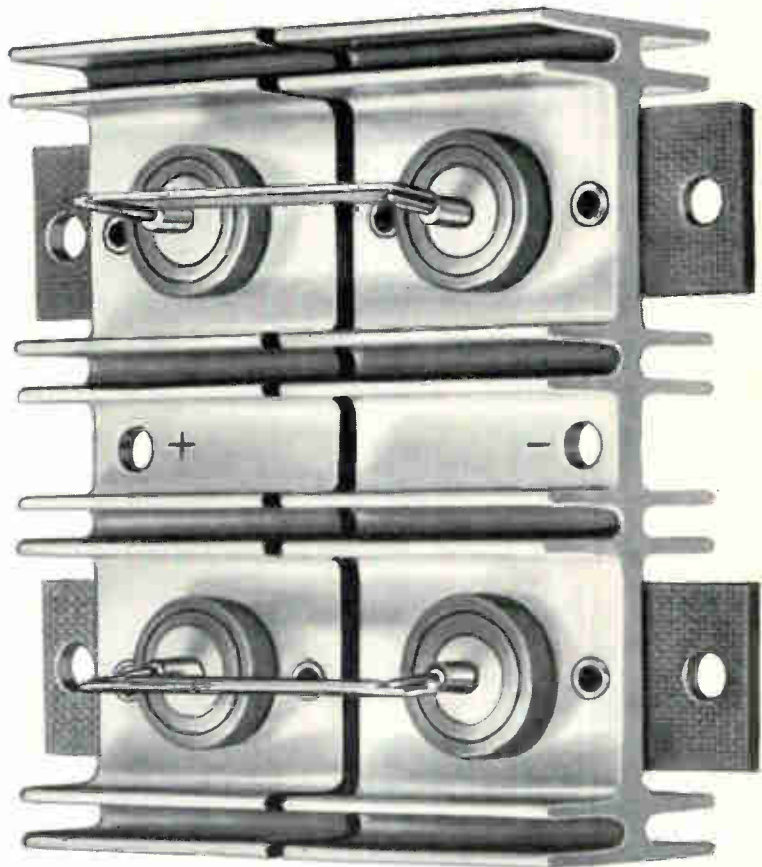
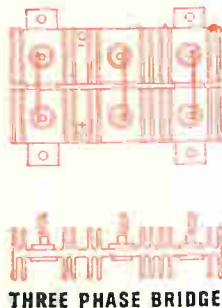
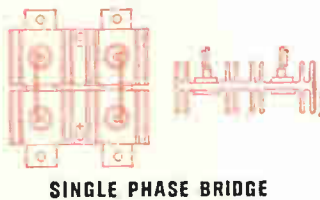
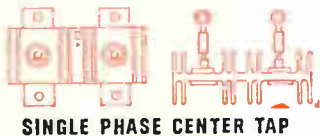

Sales Offices: Atlanta, Ga.; Columbus, Ohio; Culver City, Calif.; Dallas, Tex.; Denver, Colo.; Detroit, Mich.; Melrose Park, Ill.; Newark, N. J.; Seattle, Wash. CANADA: Montreal, Que.; Abbey Electronics, Toronto, Ont.; Prairie Pacific Distributors, Ltd., Edmonton, Alta.

 **TUNG-SOL**<sup>®</sup>



Bi-directional Power Monitors, 2-1000 MC, 1-1000 W  
Termination Wattmeter, 20-1000 MC, 0-500 W



### SIERRA MODEL 164

#### Bi-Directional Power Monitors

For intermittent or continuous measurement of incident and reflected power

Accuracy:  $\pm 5\%$  of full scale

Insertion VSWR: Less than 1.08, 5 watt - 1 kw ranges;  
less than 1.15, 1 watt range

Price: \$110.00 (Type N connectors)

#### PLUG-IN ELEMENTS FOR 164 POWER MONITORS

Full scale ranges 10, 50, 100, 500 watts		
Model	Frequency Range	Price
181-250	25-250 MC	\$75.00
181-1000	200-1000 MC	\$75.00

Full scale ranges 1, 5, 10, 50 watts		
Model	Frequency Range	Price
180-52	25-52 MC	\$110.00
180-148	50-148 MC	\$110.00
180-470	144-470 MC	\$110.00
180-1000	460-1000 MC	\$110.00

Full scale ranges 50, 100, 500, 1000 watts		
Model	Frequency Range	Price
270-30	2-30 MC	\$170.00
270-75	10-75 MC	\$115.00
270A-470	70-470 MC	\$115.00

### SIERRA MODEL 194A-A

#### Peak Power Monitor

Direct-reading rf Peak Power Monitor, reads both incident and reflected power

Frequency range: 200-1215 MC

Peak power ranges: 0-1/3/30 kw full scale

Accuracy:  $\pm 10\%$  of full scale

Insertion VSWR: 1.15 max.

Price: \$780.00

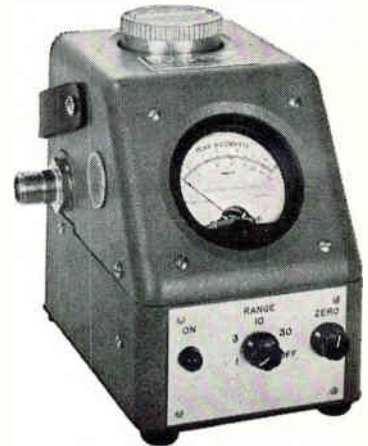

### SIERRA MODEL 185A

#### Average Reading Wattmeter

Especially useful for terminating rf coaxial transmission systems, measuring power

Frequency range: 20 to 1000 MC

Accuracy:  $\pm 5\%$

VSWR: 1.20 to 1 (max.)

Power range: 100FN, 0-30 w, 1-100 w;

500FN, 0-150 w, 0-500 w

Price: 185A-100FN, \$260.00; 185A-500FN, \$375.00



**PHILCO**  
A SUBSIDIARY OF *Ford Motor Company*



**SIERRA ELECTRONIC DIV.**

3885 BOHANNON DRIVE, MENLO PARK, CALIF.  
Phone, Area Code 415, 326-2060



# ELECTRONICS NEWSLETTER

## Satellite Will Probe Radiation Belt

GODDARD SPACE Flight Center is quickly readying a scientific satellite to investigate the artificial radiation belt created by the high-altitude nuclear explosion July 9. The satellite will be essentially a version of Explorer XII, which explored the Van Allen belt.

A NASA spokesman said that no decision has been made whether to use conventional solar cells or special types now under investigation (see p 28). However, the protective quartz glass covering will be increased from 3 mils to 60 mils to provide greater radiation protection. Solar cell contractor is Spectro Laboratory division of Textron Electronics.

Redundant instrumentation is expected to guarantee a 60-day life for the electron flux experiments. Equipment is to be provided by Goddard, Bell Telephone Laboratories and the Universities of New Hampshire and California. Project cost is estimated at \$9 million.

## Orbital Scatter Facility To Go on Air Next June

BOSTON—Project Haystack, the high-power communications antenna facility designed for the Air Force by MIT Lincoln Laboratory, is expected to be ready for tests and calibration by next March and to go on the air in June. First assignment of the X-band system is to exploit the full potential of orbital scatter communications in Project West Ford, the use of an orbiting belt of tuned dipoles as a reflecting medium.

The 120-foot precision antenna has been undergoing in-plant erection since May at the Columbus, Ohio, facilities of North American Aviation and is being vibration tested. It will be disassembled and erected under a 150-foot rigid radome atop Haystack Hill, at Tyngsboro, Mass.

Nearly two years of engineering preceded fabrication. Designers used digital computer analysis to determine the behavior of large, redundant mechanical structures, a technique expected to have wide use in civil engineering.

ture experiments would be made, including microwave forward scatter. The project is sponsored by the Office of Naval Research.

## FCC Hopes to Nudge A-M Stations into F-M

NEW YORK—The reasoning behind FCC's proposed revision of broadcast rules for f-m stations was discussed last week at the EIA meeting by H. L. Kassens, chief of FCC's Aural Existing Facilities Branch.

One of the results expected by the commission is the encouragement of marginal a-m stations to convert to f-m. The frequency assignment plan would assure them of service areas protected against interference, he said.

Kassens said the commission intends to limit station power in the most populous areas of the country, setting up three station classes: Class A, with a maximum power of 3 Kw and range of protection of 15 miles; Class B, 50 Kw and 40 miles, and Class C, 100 Kw and 65 miles. The revisions would provide frequencies needed for f-m expansion, he said.

## Permanent Magnet Rings Make Frictionless Bearing

WORKING MODEL of a magnetostatic bearing—one in which the rotating shaft floats in a magnetic field al-

## Balloon-Borne Cylinder Extends Broadcast Range

MINNEAPOLIS—General Mills researchers this month successfully relayed a video signal between a LaCrosse, Wis., television station and an Air Force base at Wadena, Minn., 260 miles away, in experiments aimed at improving long-range communications between two points.

They employed a passive relay called a "scatterloon"—a laminated aluminum and polyethylene cylinder 23 feet in diameter and 315 feet long. It was suspended vertically from a 15,400-cubic-foot balloon sent to an altitude of 14,000 feet over New Brighton, just northeast of Minneapolis.

In the 40-minute test, WKBT-TV (LaCrosse channel 18) radiated a 251-Kw effective signal to the relay. The relay reflected it to an S-band receiver atop a 100-foot base tower at Wadena. Herbert Raabe, of General Mills, indicated that fu-

## Infrared Tests Light Up Florida Beaches

CAPE CANAVERAL—There was something of a fuss, to put it mildly, the other night when two of Cape Canaveral's 800,000-candle-power searchlights focused directly on the beach at Cocoa Beach, Fla., 10 miles from the cape. Beaches up to 15 or 20 miles away will get the same treatment.

Despite opinions of beach strollers to the contrary, the spotlights serve a useful purpose—improving accuracy of missile tracking infrared data. Spotlight tests are part of an infrared atmospheric transmission program University of Michigan is doing for the Air Force under technical direction of Pan-American World Airways' Guided Missile Range division.

Atmospheric transmission conditions vary. By using the spotlights and a receiving van at Cocoa Beach, engineers can get accurate atmospheric calibrations in about three minutes, before each missile launch. An improvement in data accuracy of 15 or 20 percent is expected



most without friction—has been built at Armour Research Foundation. ARF says that while it is still in the lab stage of development, it may prove more practical than other nonsolid bearings (see p 72, Sept. 30, 1960), since it requires no external power source nor controls.

Two concentric, ring-shaped, lightweight ceramic magnets (In-dox V) are placed so they repel each other, enabling the shaft attached to the inner ring to float. The rings are kept in perpendicular alignment by having the shaft ends abut against endstones and fixing the outer ring in the assembly frame. In space applications, ARF says, operation in vacuum would further reduce friction by eliminating air drag.

## Ship and Its Electronics System Planned Together

NAVY HAS AWARDED Hazeltine a \$2.7-million second phase contract under the Coordinated Ship Electronics Design program to study the merger of naval architecture and electronic systems engineering in the initial design of a guided missile escort ship. Hazeltine expects the coordinated approach to lead to optimum performance of shipboard electronic systems in relation to each other and to operating environments.

Hazeltine is responsible for systems integration and coordination of program activities and, with Sperry Rand will investigate electronic equipment and system problems. Newport News Shipbuilding and Dry Dock Co. is concerned with structural design and installation problems, DECO Electronics is surveying antenna engineering and installation, and Nortronics is designing central test and monitoring equipment.

## Nuclear-Powered Beacon Enroute to Ocean Floor

UNDERWATER sound generator, powered by nuclear energy, was on its way last week to a site 2,500 fathoms deep in the Atlantic some 700 miles east of Jacksonville, Fla.

The Navy expects that ships

using the underwater beacon will be able to use it as a fix for navigation. The beacon is to be used by oceanographic research vessels and is designed to operate without maintenance for two years.

Beacon components were supplied by the Navy's Underwater Sound Laboratory. Martin Marietta supplied the Snap-7E nuclear thermoelectric power system (p 7, April 27) and housing.

## Merchant Ship Autopilot Is Ready for Sea Trials

UNITED AIRCRAFT'S Norden division reports that the merchant ship course computer and steering system being developed for the Maritime Administration is ready for sea trials.

Designed mainly for open-sea navigation, the system computes the bearing between one point and another up to 1,000 miles away after target latitude and longitude is preset into the computer. The steering system, centering on autopilot electronics, receives the command heading and maintains the ship on its course.

Norden said that a new feature of the system is that in addition to dead reckoning, it also presents a constant estimate of position, time and distance to go. It can make corrections for hull and draft and gyro error, and computes set and drift. The size of the system is 18 by 10 by 15 inches.

## NASA Considers Two Stations in Australia

MELBOURNE—Two tentative sites for tracking stations have been selected by a five-man NASA team on a survey visit to Australia. The Ministry for Supply says NASA wants a major tracking station at Carnavon in Western Australia just south of the proposed U. S. naval radio station (p 7, May 25), and a small telemetry and command station near Darwin. The Carnavon station would serve manned space flight and satellite programs and the Darwin station would serve unmanned satellite programs, the ministry says.

## In Brief . . .

ITALY and the U. S. plan a cooperative attempt to launch a satellite from a towable platform on equatorial waters. NASA will supply the rockets, Italy the platform and other gear.

HOME THEATERS, a new company, plans to offer pay-tv in the southwest this year using International Telemeter's closed-circuit system.

TELSTAR II is tentatively scheduled for launch Oct. 10. Telstar I made a live color-tv transmission last Wednesday of a medical panel discussion picked up in England by a Marconi color camera.

ENGLISH steel rolling mill will be controlled by a Thompson-Ramo-Wooldridge TRW-330 computer.

TRION INSTRUMENTS, laser research and manufacturing firm, has been acquired by Lear Siegler. Hitchener Mfg. has bought Delta Microwave. Melpar now has a majority interest in Microwave Physics Corp.

OTHER recent acquisitions include Telephonics Corp. by Instrument Systems Corp., General Magnetics and Electronics Inc. by Estey Electronics Inc., and Chicago Electronic Engineering Co., by Jamieson Industries, Inc.

BURNDY CORP., Furukawa Electric and Sumitomo Electric have formed a joint venture, Burndy-Japan Ltd., to make connectors and related products in Japan.

BULGARIA declares it is establishing a state factory in Botevgrad that will have a production capacity of 7 million semiconductor diodes and transistors in 1964. The announcement indicated that France will supply technical equipment and training.

RECENT military contract awards include \$4.9 million to Bell Aero-systems, radio command for Army's SD-1 drone; \$4 million to LFE Electronics, AN/APN-105 and -131 doppler radar navigation sets and integration of radar altimeters into the 131.

(advertisement)

## New Nanosecond\* Pulse Transformers for Ultra-miniature, Ultra-high Speed Applications



Digital circuit designers will find the new Sprague Type 43Z Nanosecond Pulse Transformers of considerable interest. These tiny transformers have been carefully designed for the all-important parameter of minimum rise time at high repetition rates up to 10 mc.

The new Type 43Z series is comprised of a broad line of 72 pulse transformers in 10 popular turns ratios. They are Sprague's latest addition to the most complete listing of pulse transformers offered by any manufacturer for use in digital computers and other low-level electronic circuitry.

Type 43Z Pulse Transformers are designed so that the product of leakage inductance and distributed capacitance is at a minimum. They are particularly well suited for transformer coupling in transistor circuits since transformers and transistors are very compatible low impedance devices. Nanosecond transformers are equally suitable for transmission line mode of operation, in twisted-pair transmission line coupling, and in regenerative circuits.

The epoxy-encapsulated "pancake" package is excellent for both etched wire board or conventional chassis mounting. To simplify etched-board design, these ultra-miniature pulse transformers are available with leads terminating at the side or the bottom of each unit.

For complete technical information on Type 43Z Nanosecond Pulse Transformers, write for Engineering Data Sheet 40235 to Technical Literature Section, Sprague Electric Co., 35 Marshall St., North Adams, Mass. \*millimicrosecond

CIRCLE 210 ON READER SERVICE CARD

## NEW... for "Bread-Boarding" Your Circuit Designs...



Contains 12 specially-selected Sprague Type 32Z miniature pulse transformers in clear, hinged-lid plastic case, complete with simple instructions.

## SPRAGUE 100Z41 EXPERIMENTAL PULSE TRANSFORMER ASSORTMENT

- Helps you choose the right pulse transformer for your specific application.
- Puts at your disposal 58 turns-ratio/primary-inductance combinations, providing the parameters required in most electron tube or transistorized circuits.
- Primary inductances from 160 microhenries to 43 millihenries.
- Turns ratios from 1:5 step-up to 6:1 step-down.
- Potted, pre-molded case construction facilitates bread-board wiring, permits frequent re-use.

Once you determine needed transformer characteristics, it's easy to get production quantities to your exact requirements from Sprague's broad line of hermetically sealed or encapsulated pulse transformers.

For fast delivery or additional information on the 100Z41 Pulse Transformer Assortment, see your Sprague Products Co. Industrial Distributor, or write Sprague Electric Company, 35 Marshall Street, North Adams, Massachusetts.

45-432 R1



\*Sprague' and '® are registered trademarks of the Sprague Electric Co.

CIRCLE 9 ON READER SERVICE CARD



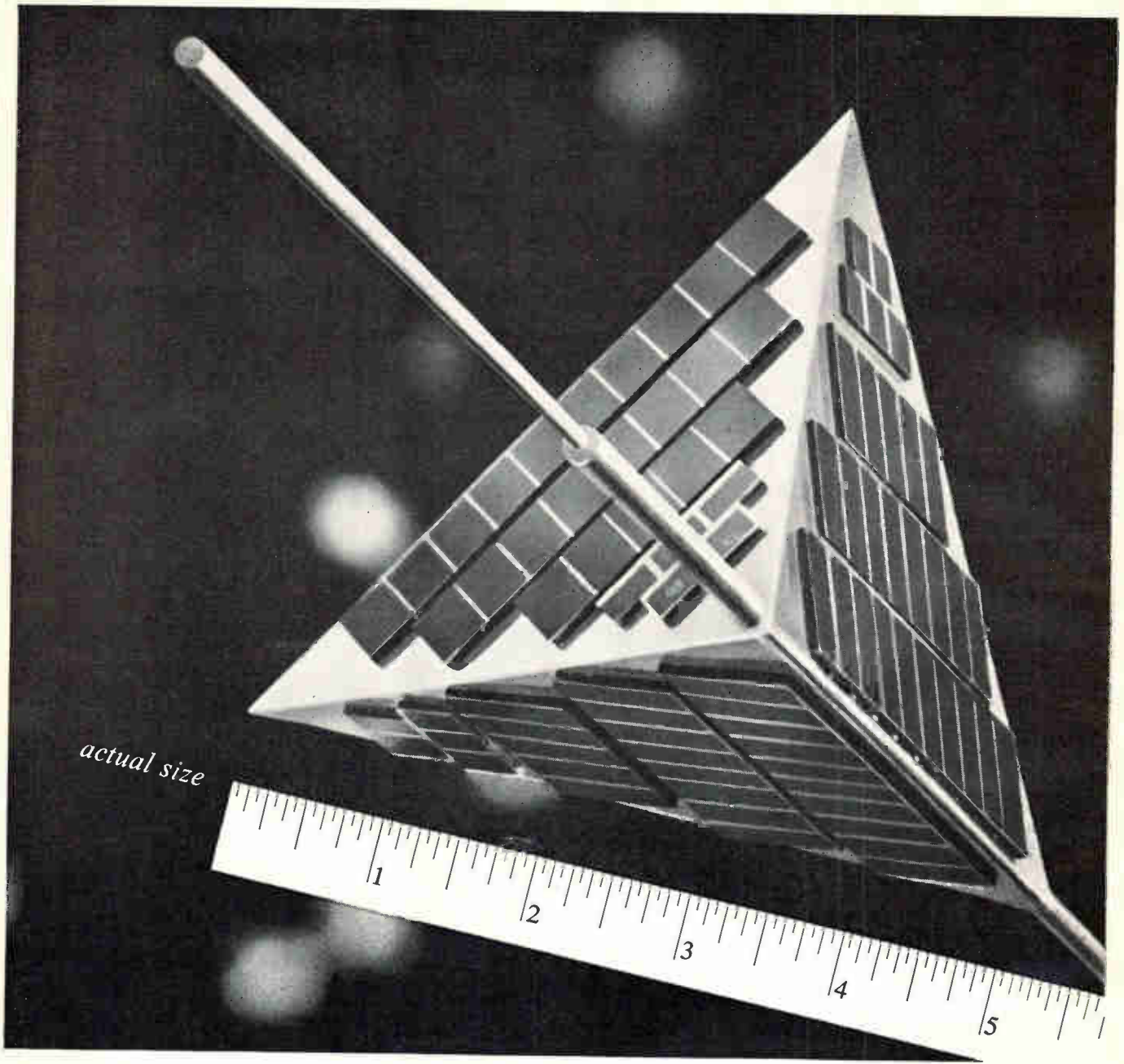

The world's smallest satellite has been developed by Space Technology Laboratories. Its shape will be different from all other satellites before it. STL engineers and scientists have used a tetrahedral configuration to bring about some remarkable characteristics in a space vehicle. There will be no need for batteries nor regulators in flight. The satellite will have no hot side, no cold side. It will require no attitude control devices. No matter how it tumbles in space it will always turn one side toward the sun to absorb energy, and three sides away from the sun to cool instrumentation and telemetry equipment inside. It can perform isolated experiments in conjunction with other projects. Or it can be put into orbit by a small rocket to make studies of its own, up to five or more separate experiments on each mission it makes.

STL is active on hardware projects such as this and as prime contractor for NASA's OGO and an entirely new series of classified spacecraft for Air Force - ARPA. We continue Systems Management for the Air Force's Atlas, Titan and Minuteman programs. These activities create immediate opportunities in: Space Physics, Radar Systems, Applied Mathematics, Space Communications, Antennas and Microwaves, Analog Computers, Computer Design, Digital Computers, Guidance and Navigation, Electromechanical Devices, Engineering Mechanics, Propulsion Systems, Materials Research. For So. California or Cape Canaveral opportunities, please write Dr. R. C. Potter, Dept. G, One Space Park, Redondo Beach, California, or P. O. Box 4277, Patrick AFB, Florida. STL is an equal opportunity employer.



**SPACE TECHNOLOGY LABORATORIES, INC.**  
*a subsidiary of Thompson Ramo Wooldridge Inc.*

496

Los Angeles • Vandenberg AFB • Norton AFB, San Bernardino • Cape Canaveral • Washington, D.C. • Boston • Huntsville • Dayton



**75% smaller**  
than the smallest  
(by volume)

**new size Y Ohmite  
tantalum slug capacitor**

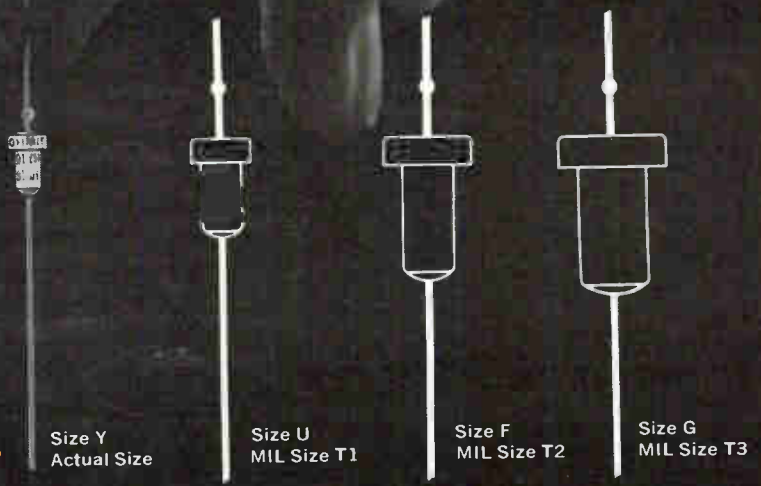

Size Y  
Actual Size

Size U  
MIL Size T1

Size F  
MIL Size T2

Size G  
MIL Size T3

ACTUAL  
SIZES

■ Size Y is the tiniest hat-shaped capacitor ever developed. Its case measures only  $\frac{19}{64}$ " long with a flange diameter of  $\frac{13}{64}$ " and body diameter of  $\frac{1}{8}$ ". Yet this miniature unit offers characteristics equal to any of the larger sizes. Size Y meets all requirements of MIL-C-3965B.

Eleven stock values from 0.91 to 15 mfd (125 volts DC max.) are available for fast delivery. Tolerances of  $\pm 10\%$  (K) and  $\pm 20\%$  (M) are offered in all values. Operating temperature range is  $-55^{\circ}$  to  $+85^{\circ}$ C.

WRITE FOR BULLETIN 159

**NOW**  
**5**

CHOICES IN  
OHMITE  
TANTALUM SLUG  
CAPACITORS



RHEOSTATS • POWER RESISTORS • PRECISION RESISTORS • VARIABLE TRANSFORMERS  
TANTALUM CAPACITORS • TAP SWITCHES • RELAYS • R. F. CHOKES • GERMANIUM DIODES



**OHMITE**  
MANUFACTURING COMPANY  
3610 Howard Street, Skokie, Illinois

# WASHINGTON OUTLOOK

## BUDGET BUREAU MAY TIGHTEN R&D CONTRACT COST REFUNDS

THE BUDGET BUREAU is readying a plan for uniform federal rules on cost allowances for cost-plus-fixed-fee research and development contracts. The plan's aim is reconciling differences between Department of Defense and NASA cost allowance policies and those of AEC.

Differences in present provisions for allowances on independent R&D, bidding costs and home office expenses reflect differing contracting circumstances among the agencies. The bulk of AEC contracts, for instance, are operating-type contracts with AEC supplying all plant and equipment. DOD and NASA have few contracts of that type, so there is a basis difference in cost allowance philosophy between AEC and DOD and NASA.

DOD and NASA believe the government should bear a "normal and reasonable share" of the costs of doing business. AEC reimburses contractors only for costs directly applying to AEC contract work. Defense industry representatives are concerned that the Budget Bureau will extend the more restrictive AEC philosophy to Pentagon and NASA cost-plus-fixed-fee contracts.

## SENATE'S TRADE BILL IS LIKE THE PRESIDENT'S

PRESIDENT KENNEDY is getting just about everything he wants in new trade legislation. The strong bill now near enactment will give him broad authority to negotiate tariff levels that he says will help keep U.S. products competitive in world markets. Political maneuvering by Senator Robert S. Kerr (D.-Okla.) saved the measure from last-ditch efforts by protectionists in the Senate Finance Committee. What came out for Senate consideration is a bill even closer to the President's original request than the measure passed by the House.

The bill gives the President authority to negotiate tariffs to zero on all items on which the U.S. and western Europe control 80 percent of world trade, to cut tariffs by 50 percent on all other items, and to increase tariffs in retaliation if a trade bloc places restrictions on U.S. goods. Domestic industries injured by excessive imports still may petition for tariff protection under a so-called escape clause, but injury now must be proved to an entire industry. Relief for individual firms and workers hurt by imports will come through trade adjustment assistance and federal funds for such purposes as relocation, retooling and retraining.

## FCC AND EIA ALL-CHANNEL TV PROPOSALS HARMONIZE

IN GETTING SET for the shift to all-channel tv receivers, FCC and the Electronic Industries Association continue to see eye-to-eye. FCC agrees with EIA that a crash program to convert to all-channel 1964 models would be wasteful, and proposes an effective date geared to 1965 models. Only sets made before April 30, 1964, without equipment for all 82 tv channels could be shipped interstate after that date.

As for technical standards FCC—like EIA—suggests a noise figure for 70 uhf channels of not over 18 db, and peak picture sensitivity for the uhf channels of not over 8 db more than the average for the vhf on each set. These standards, FCC feels, represent the average characteristics of sets on the market.

1963 SAAB . . . built so well that it has a 24,000-mile/24-month written warranty\*

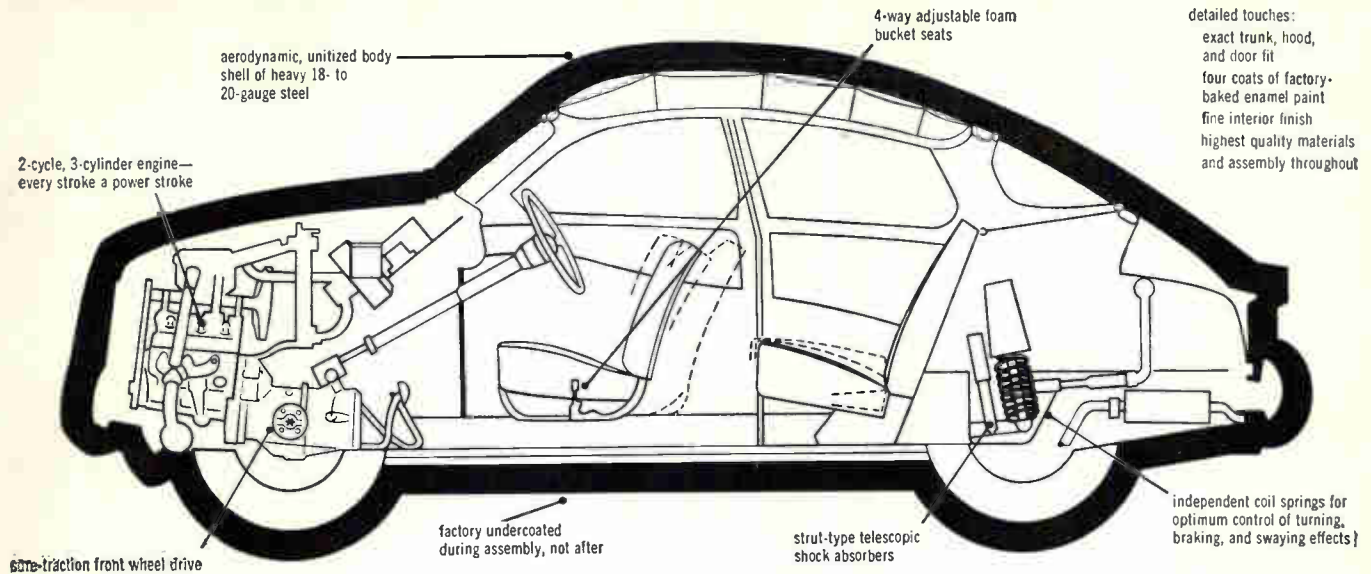

## Take a critical look at SAAB engineering . . .

Aircraft reliability and performance standards are blended with an entirely new approach to over-all automotive design in the Swedish SAAB 96. This car was built to be better, not different . . . built by one of Europe's leading aircraft manufacturers . . .

built for those who enjoy mechanical excellence, technical uniqueness, and extraordinary craftsmanship.

A critical look at all the facts and specifications will prove that SAAB is unquestionably one of the world's best engineered cars.

\*Engine, transmission (3- or 4-speed gear box available), and differential have a written warranty for 2 years or 24,000 miles.

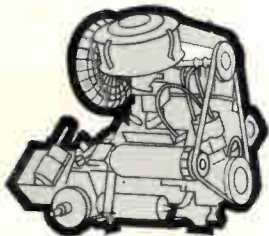

**SAAB ENGINE**, an economical, quiet three-cylinder, two-stroke valveless unit, employs Schnürle principle of charging through the crankcase. Simple, efficient design produces all the power of 6 cylinders with only 7 basic moving parts, eliminates 103 points of friction, wear, potential trouble. Engine proved in world-wide competition driving victories, and by the many SAABs which have delivered low maintenance performance past the 100,000-mile mark.

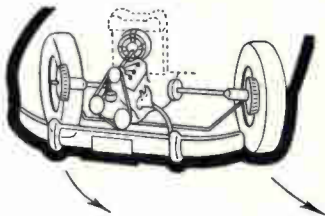

**SAAB FRONT WHEEL DRIVE** transmits engine torque directly to front wheels. The result is extraordinary directional stability and handling ease under all road conditions, plus outstanding traction around corners, over icy, wet, or muddy patches, and snow. Front wheel drive and carefully calculated understeering provide best possible high speed roadability and safety. Other advantages: more comfort (because there is no driveshaft hump) and more trunk and interior space.



**SAAB BODY SHELL** is designed and wind tunnel tested for best possible aerodynamic efficiency. Full belly pan further reduces wind resistance and subdues road noise. Result: increased economy, better performance, excellent stability—even in cross-winds of gale force. Moreover, the SAAB body shell is virtually uncrushable, combining 18- to 20-gauge steel (thicker than most American cars) and rigid unitized construction for optimum safety.



Arrange a test drive at your nearest SAAB dealer. Or write for more information—and the SAAB North American Road Atlas, a 64-page comprehensive travel guide valued at \$1.00, but yours for only 25¢ to cover postage and handling. SAAB Motors, Inc., Dept. 309, 405 Park Avenue, New York, New York.

**\$1895** P.O.E. (little enough for one of the world's best engineered cars)



SAAB MOTORS, INC. — NEW YORK • NEW HAVEN • JACKSONVILLE • ST. LOUIS



PERFORMANCE RELIABILITY WITHOUT COMPROMISE



# FOR ON-COURSE GUIDANCE

## MINIATURE INERTIAL REFERENCE GYROS

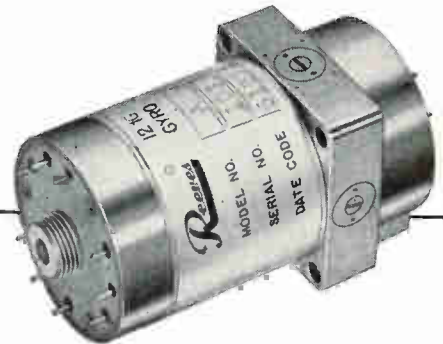

### 12IG

The ultimate in miniaturization  
Trimmed drift rate: 0.1 degrees/hour  
Size: 2.5 inches by 1.25 inches  
Weight: 5.5 ounces  
Angular momentum: 31,600 cgs units  
The ideal unit for miniature stable platforms



### ZERO-ONE

The finest inertial gyro available  
Trimmed drift rate: 0.01 degrees/hour  
Size: 2.8 inches by 2.0 inches  
Weight: 0.7 pounds  
Angular momentum: 280,000 cgs units

These Reeves fully floated miniature integrating Gyros are the most painstakingly engineered and most precisely tested instruments available today for inertial reference and stable platform applications.

Reeves' achievements in the high-precision gyro field consistently emphasize reliability without compromise...and by this we mean that Reeves Gyros are rugged, dependable components produced in quantity to meet rigidly defined performance criteria. Beryllium floats and housings. For complete information, write for Data File 109.

Qualified engineers seeking rewarding opportunities in these advanced fields are invited to get in touch with us.

**REEVES INSTRUMENT CORPORATION**  
A Subsidiary of Dynamics Corporation of America  
Roosevelt Field Garden City, New York

# SOUND SOLUTION

□ Greater power. Higher gain. Lower noise. Lower leakage current. Fewer stages of amplification. Silicon reliability. Physical ruggedness. Extremely small packaging . . . Beltone Hearing Aid Company's transistor specifications for their new miniature Companion Hearing Aid were the highest and most complex ever demanded by their industry. Transitron research, working closely with Beltone engineers, perfected the first glass-packaged nano-transistor that met or exceeded every rigid specification. And Transitron produced it in volume at economical prices.

□ The major packaging breakthrough achieved on the Beltone program now permits Transitron to encapsulate any variety of its comprehensive line of quality small signal silicon transistors in a rugged, uniform glass nano-package. The smallest units of their type yet available, Transitron's "nano-transistors" feature excellent environmental protection, greater durability of leads in mounting, and an enduring resistance to the high vibration and shock levels of modern missile and space technology.

*Beltone*  
needed a  
remarkable  
silicon  
transistor...

Transitron  
research  
created it.

□ Transitron's engineering staff invites your inquiry regarding further details of its nano-transistor packaging capabilities.

□ Today, wherever there's electronics — in medicine, industry, defense, business, space exploration — there's Transitron, continuing to lead the way toward greater miniaturization and increased product reliability and versatility.

**Transitron**   
electronic corporation  
wakefield, melrose, boston, mass.

SALES OFFICES IN PRINCIPAL CITIES THROUGHOUT  
THE U.S.A. AND EUROPE. CABLE ADDRESS: TRELCO



*Crystallizing Ideas  
Into Products*

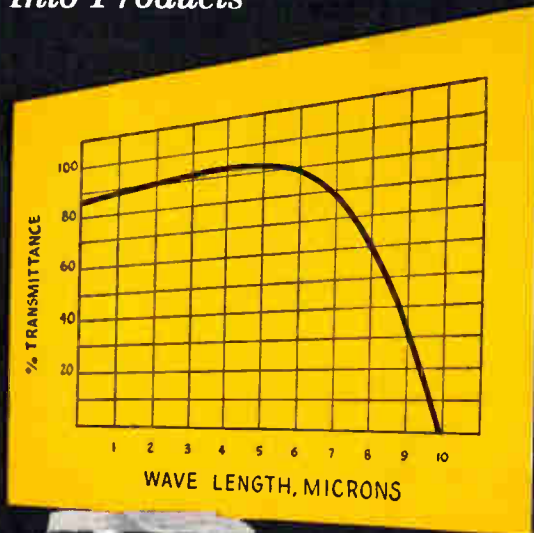

**MAGNORITE\***  
fused MgO crystals  
up to  $\frac{3}{4}$ "...  
*for infrared transmission*

Single, high purity crystals of Norton MAGNORITE fused magnesia are now available in developmental quantities, in sizes up to  $\frac{3}{4}$ ". Larger sizes, produced experimentally, are available in limited quantities.

The chart shows the infrared transmission characteristics of a 0.05" thick MAGNORITE crystal. Because of their refractoriness, the ability of the new Norton crystals to transmit such radiation at elevated temperatures is outstanding.

In addition, Norton techniques permit the introduction of impurities in controlled percentages, to alter electronic properties.

At present, there is a major interest in the use of doped MAGNORITE fused magnesia crystals for laser and maser applications. For further data write to NORTON COMPANY, Refractories Division, 688 New Bond Street, Worcester 6, Massachusetts.

\*Trade Mark Reg. U. S. Pat. Off. and Foreign Countries.

**NORTON**  
REFRATORIES

*Making better products... to make your products better*

16 CIRCLE 16 ON READER SERVICE CARD

**Lacing Problems Solved**

with these  
Specially Processed  
Tapes

**HEMINWAY  
& BARTLETT**

**NYLON or DACRON**  
Cords and Flat Braided Lacing Tapes

- Great stability under high heats
- Tie faster... easier... tighter
- Knots won't slip
- Fungus-proof
- Wax-coated, wax-free or G.E. Finish
- Meets Govt. Spec. MIL-T-713B

*For ultra-high temperature work...*

**TEFLON-COATED  
FIBERGLAS TAPES**

withstand temperatures up to 600°—in  $\frac{1}{4}$ " and  $\frac{1}{8}$ " widths

*Write for full information and free samples!*

**THE HEMINWAY & BARTLETT MFG. CO.**

Electronics Division: 500 Fifth Avenue, New York 36, N.Y.

CIRCLE 211 ON READER SERVICE CARD



5000 LB MODEL 91A SYSTEM

**look to Unholtz-Dickie systems  
for reliable vibration testing**

The accuracy, dependability and economy of each Unholtz-Dickie vibration test system is gained by the unified design of shaker, amplifier and controls. Each system is simple to operate and requires a minimum of control or adjustment. They are easily expanded to meet increased requirements. When you are considering vibration equipment, why not investigate Unholtz-Dickie. Call them collect ATwater 8-3358.

**UNHOLTZ-DICKIE CORPORATION**  
2994 Whitney Ave., Hamden, Conn. ATwater 8-3358

CIRCLE 212 ON READER SERVICE CARD  
electronics





# MISSILE CUTBACK Rocks British

*One result: few new developments are revealed at air show*

By DEREK BARLOW  
McGraw-Hill World News

FARNBOROUGH, ENGLAND — With the British aviation industry rocked by a recent sudden government decision to cut back some missile projects, avionics exhibits at the annual Farnborough air show this month lacked the sparkle and basic new developments that characterized previous exhibits (ELECTRONICS, p. 30, Sept. 29, 1961).

Shifts in government policy are not new in British aviation, but the one made last August is the first to threaten so directly the avionics industry itself. It was the cancellation on the grounds of economy of the Blue Water tactical ballistic missile. As a result, English Electric Aviation, the contractor, is closing its 1,300-man guided missile plant at Luton, Bedfordshire. In all some 2,000 people, 700 of them in associated plants, are affected.

Britain's missile activities now narrow down to the development of

Blue Steel (a guided standoff bomb designed to fill the gap before the U. S.-developed Skybolt is available to the Royal Air Force), additional developments on the Thunderbird and Bloodhound ground-to-air missiles now in service, and two newly announced projects, the CF299 naval surface-to-air missile and the Swingfire, an antitank weapon.

De Havilland's Blue Streak missile—switched from its former military ICBM role—still awaits development to fit it as the first-stage launch vehicle in the European Launcher Development Organization (ELDO) program. Second stage will be developed by France with Germany responsible for satellite development.

The commercial aviation picture is brighter. The development of three new British contenders in the commercial jet liner field, the BAC 11, VC10, the Trident plus the new DH125 executive jet offer good potential markets for civil avionic equipment, especially for automatic landing systems. The Trident will have automatic flareout facilities, the first commercial airliner to do so.

Against such a background, it was not surprising that avionics ex-

hibits revealed at the show showed no set theme, as these highlights illustrate:

**LANDING AIDS** — Developments in radio landing aids for VTOL aircraft are under study at the Royal Aircraft Establishment.

Radio guidance systems, when coupled to the aircraft autopilot, would provide accurate guidance information for a number of alternate approach directions and landing profiles—including non-straight-line profiles—for up to 10 aircraft simultaneously. Since landing sites will be restricted, the system measures continuously azimuth elevation and slant range of the aircraft using ground-based equipment around the landing site.

In the system under study, microwave interferometers measuring the phase-shifts between spaced pairs of antennas determine the direction cosines of the line of sight to r-f beacons carried in the aircraft.

A ground-based computer derives from the direction-cosine measurements of each interferometer the space coordinates of the approaching aircraft. These are compared in the computer with those from

## Tv Updates Flight Control Information

*AIR TRAFFIC CONTROL center in London, responsible for half the British Isles, will use a Marconi closed-circuit tv system to provide aircraft flight data to radar controllers (left). In old system, assistant seated next to controller posted data on his sector. In new system, posting is done remotely (right) and controller can call up data from any sector covered by the center*

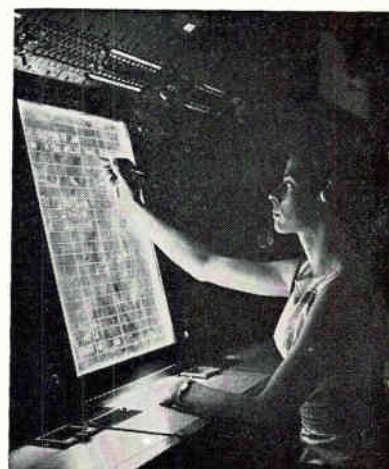
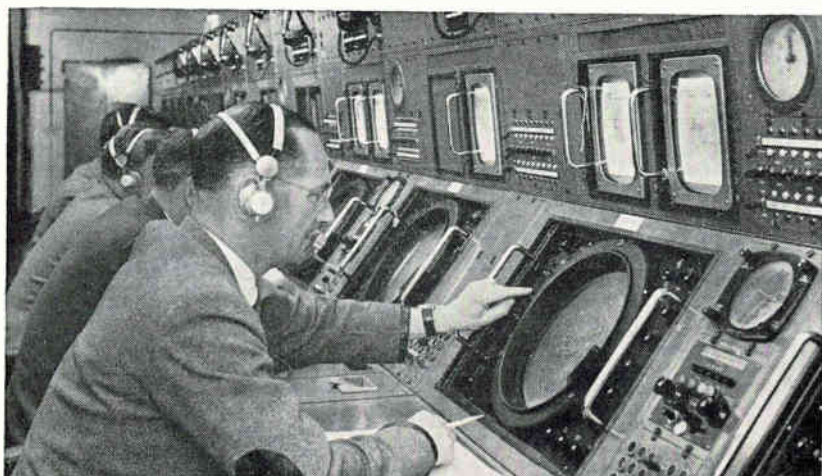

# Aviation Electronics

one of 10 approach paths selected by the ground controller. Resulting difference signals are selectively transmitted to the originating aircraft over a multiplexing data link.

In the aircraft, airborne computers process the error signals according to the different aircraft characteristics and feed into the aircraft autopilot correction signals to bring the aircraft onto the correct approach and landing path automatically.

**DAYLIGHT RADAR**—Installed at Gatwick Airport, London, a daylight radar viewing system developed by Marconi's Wireless Telegraph Company, of Chelmsford, incorporates a new direct-view storage tube. The tube produces a brilliant radar picture from a high-efficiency, short-persistence phosphor and introduces persistence from a separate storage element in the tube.

The viewing surface consists of a normal phosphor on the inside of the glass faceplate. The storage element is an extremely fine metal mesh behind the phosphor surface with a dielectric layer deposited on the side farthest from the phosphor.

Two electron guns are mounted in the tube's neck. One, the flood gun, directs a low-velocity stream of electrons through collimating electrodes. They arrive at the mesh as a parallel beam normal to the mesh and covering its entire surface area uniformly. Secondary emission of electrons from the storage mesh is smaller than the beam current. This tends to drive the mesh negative, preventing the flood-beam electrons from going through the mesh to the phosphor.

The other gun, the writing gun, produces a high-velocity beam, focused to a fine spot at the storage mesh. This beam passes through a deflection system and can be modulated as in a normal crt. When this beam strikes the mesh, secondary emission is high and a positive charge is left on the mesh and allows flood-beam elec-

trons to pass through and strike the phosphor.

Applying a positive pulse to the mesh erases the image traced out by the writing gun, and hence the picture on the faceplate. Controlled pulses can cause the picture to decay slowly. Effective persistence is variable up to a maximum of 10 to 15 minutes.

**FLIGHT PRINTER**—General Precision Systems, of Aylesbury, has developed a flight strip printer in which the strip remains stationary and the printing head revolves through 360 degrees around the paper. It has resulted in an automatic flight plan processing system for air traffic control.

Flight progress strips are printed in desired format in three type sizes and on two colors of paper. Strips are automatically guillotined from the printer, inserted into strip holders and delivered at the top of the appropriate bay on the flight progress board. Here they slide down into reading position.

After the aircraft has passed outside the ATC controller's area, the used strip holders are automatically unloaded, the used paper strips return to store and the unloaded holders go back to the printer for reloading.

**COMPUTERS**—Gaining acceptance are takeoff computers developed by both GPS and Smiths Aviation Division, of London. In both systems, transducers mounted on aircraft undercarriage produce speed information that is electronically integrated to provide distance-run information.

In the Smith system, speed only is displayed on a moving coil meter. The GPS display automatically traces both speed and distance on a cartesian plotter. The curve builds up against a preprinted curve of the aircraft's standard performance, showing any discrepancy before the final decision speed is reached.

"Nothing is impossible to diligence and skill"  
Samuel Johnson



## POTTER

### M906 II Tape Transport



couples  
high-performance  
and reliability . . .

with the lowest price in the industry. The unique design of this versatile transport provides compatibility for a variety of applications in digital data processing and computer systems.

Five tape widths up to 1 1/4" may be accommodated at speeds up to 120 IPS. In addition, data transfer rates of 62,500 BCD digits per second are readily obtained using conventional recording techniques. When used in high-density recording applications, transfer rates of over 450,000 BCD digits per second with drop-outs fewer than 1 bit in 100,000,000 are provided.

Complete specifications for this highly reliable system are available on request.



- Manufacturers of:
- Digital Magnetic Tape Systems
  - Perforated Tape Readers
  - High Speed Printers
  - Data Storage Systems

POTTER INSTRUMENT CO., INC.  
Sunnyside Boulevard • Plainview, New York



75<sup>TH</sup>  
Anniversary  
Year



## THE FINEST TEFLON\* TRANSISTOR SOCKETS ON THE MARKET!



69012-0523  
Compression Mounted  
Transistor Sockets



69012-0524  
Compression Mounted  
Transistor Sockets



69012-0533  
Compression Mounted  
Transistor Sockets



69012-0534  
Compression Mounted  
Transistor Sockets



69018-0523  
Compression Mounted,  
In-Line Transistor & Sub-  
Miniature Tube Sockets



69018-0524  
Compression Mounted,  
In-Line Transistor & Sub-  
Miniature Tube Sockets



69013-0523  
Compression Mounted,  
In-Line Transistor & Sub-  
Miniature Tube Sockets



69013-0524  
Compression Mounted,  
In-Line Transistor & Sub-  
Miniature Tube Sockets



69013-0525  
Compression Mounted,  
In-Line Transistor & Sub-  
Miniature Tube Sockets



69013-0526  
Compression Mounted,  
In-Line Transistor & Sub-  
Miniature Tube Sockets



69013-0527  
Compression Mounted,  
In-Line Transistor & Sub-  
Miniature Tube Sockets



69012-0623  
Compression Mounted  
Transistor Sockets

### LOW LOSS AT HIGH FREQUENCIES . . . SUPERIOR PIN RETENTION

With Teflon TFE insulation, Garlock Transistor Sockets exhibit the lowest dielectric loss ever achieved at high frequencies. In addition, silver-plated, gold-flashed Beryllium copper tubular-type contacts give greatly improved pin retention and life characteristics, offer top protection against vibration. *Garlock Transistor Sockets of Teflon are available from local stock. For full information, contact the Garlock Electronic Products distributor or representative nearest you. Or, write Garlock Electronic Products, Garlock Inc., Camden 1, New Jersey.*

\*DuPont Trademark

*New Garlock  
Exclusive*

The only socket for JEDEC TO-8 type cases (new RF power amplifier transistors). Teflon insulation reduces RF losses to an absolute minimum. Use of a socket prevents transistor injury by overheating when soldered into circuit.

# GARLOCK

ELECTRONIC PRODUCTS

# magnetostrictive memory with a conscience

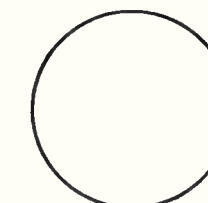
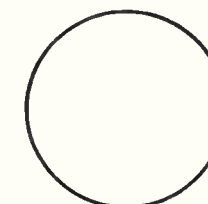
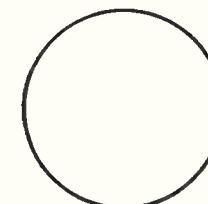
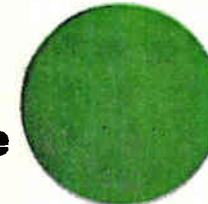
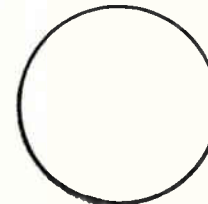
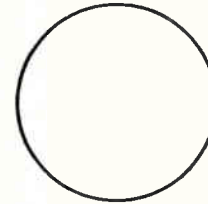
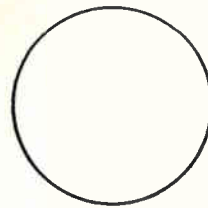

It works—every time, on time, to your specifications! Tempo has eliminated the unconscionable behavior associated with magnetostrictive delay lines as memory units in low-bit capacity computers. Their cost per bit is 1/5 that of drum or disc memories, 1/100 that of core units. And now they work. You can count on precision and reliability, designed-in with typical Tempo skill and guaranteed by double-check quality control in a manufacturing operation where every second man has test responsibilities.

**TEMPO INSTRUMENT INCORPORATED**

Plainview, L. I., New York

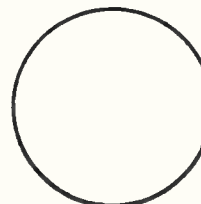
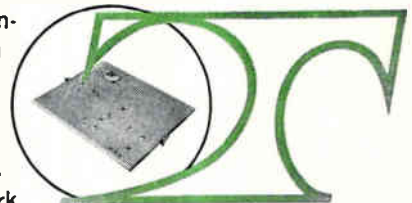



# FILTER DESIGNERS!

## INDIANA GENERAL TEMPERATURE COMPENSATED CUP CORE ASSEMBLIES OFFER YOU ALL THESE ADVANTAGES:

- 1** Seven sizes (International Series) from stock 599" to 1.425" O.D.
- 2** Frequencies — 1 kc to 1.5 mc.
- 3** "Q" values to 800.
- 4** Standard Gapped Inductance Values 40 to 1,000 MH/1000 turns.
- 5** Unmatched temperature stability.
- 6** Available in complete assemblies with trimmer for minimum of 12% adjustment.
- 7** Complete test specifications and performance curves available.

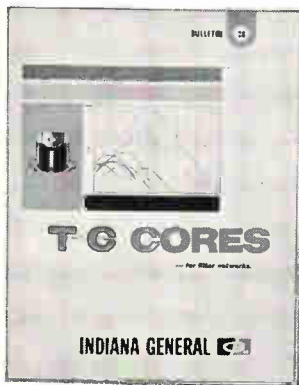
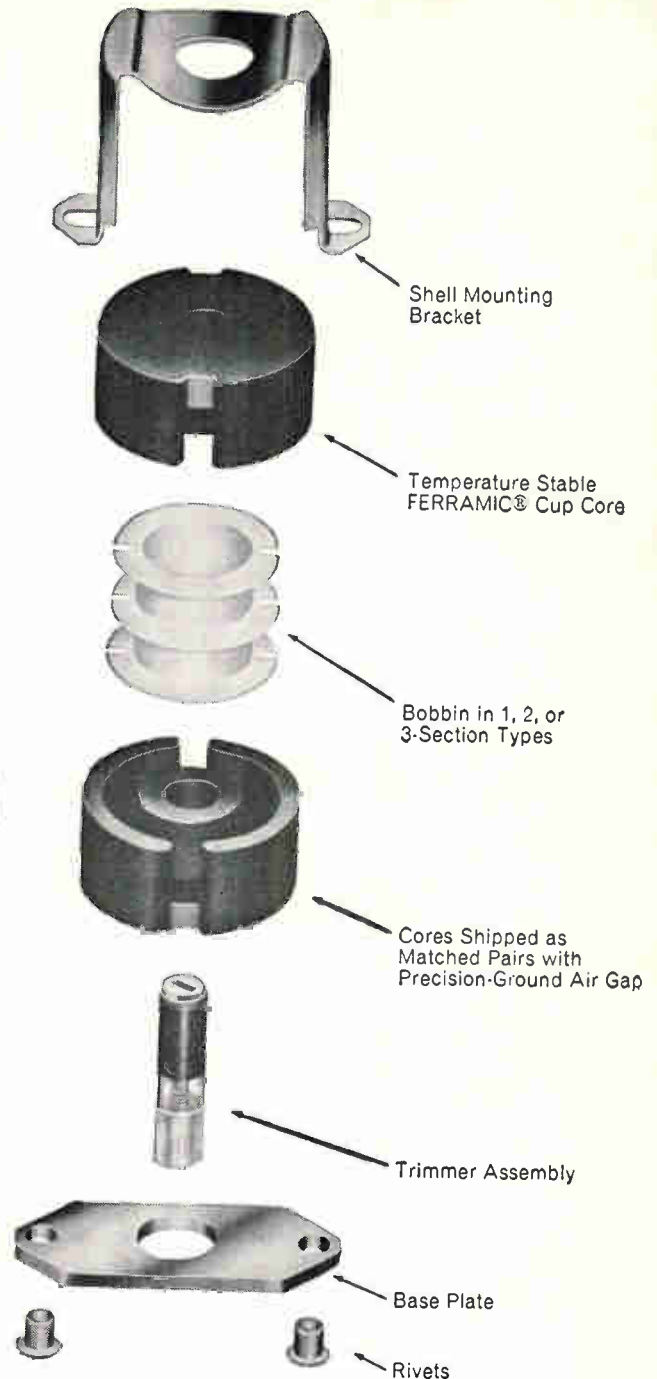

Specify Indiana General TC cup core assemblies next time you order. Wire or call for price and delivery information to Indiana General Corporation, Electronics Division, Keasbey, New Jersey, for complete performance curves and specifications. Request Bulletin 28.

# INDIANA GENERAL





Single Junction } 1500 Volt  
3.3 Amp

TI 1N3775 Rectifier . . . With  $V_F$  1.5 v maximum  
Now you can get a first in high power/high voltage  
rectifier application with Texas Instruments 1N3775.  
This new rectifier gives you 1500 v reverse voltage  
and 3.3 amps average rectifier forward current  
(at 50°C) plus 2000 v minimum breakdown voltage  
and 5  $\mu$ a reverse current — **ALL WITH A SINGLE  
DIFFUSED JUNCTION.**

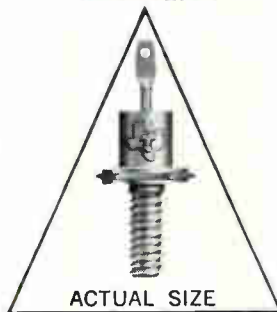

**Additional Benefits of TI 1N3775**

- Pure silver lead minimizes wafer stress during temperature cycling.
- Flexible junction coating is not affected by temperature variations and gives full time wafer protection.
- Silver disc gives improved thermal characteristic during surge conditions.
- Superior welding procedure, quality control, and 100% testing.

**Get Higher Performance and Reliability With These Superior Operating Characteristics**

absolute maximum ratings at 25°C stud temperature (unless otherwise noted)			
$V_{RM}(wkg)$	Reverse Voltage Over Operating Temperature Range		1500 v
$I_O$	Average Rectified Forward Current at 50°C		3.3 amp
electrical characteristics at 25°C stud temperature (unless otherwise noted)			
$BV_R$	Minimum Breakdown Voltage	$I_R = 100 \mu a$	2000 v
$V_F$	Maximum Forward Voltage Drop	$I_F = 2.0$ amp	1.5 v
$I_R$	Reverse Current	$V_R = 1500$ v at 25°C	5 $\mu a$



Send for your  
personal copy  
of this informative  
TI 1N3775 Folder —  
today.  
TI Semiconductor -  
Components division

SEMICONDUCTOR-COMPONENTS  
DIVISION



**TEXAS INSTRUMENTS**  
**INCORPORATED**  
13500 N. CENTRAL EXPRESSWAY  
P. O. BOX 5012 • DALLAS 22, TEXAS

CIRCLE 23 ON READER SERVICE CARD

19399



THIS

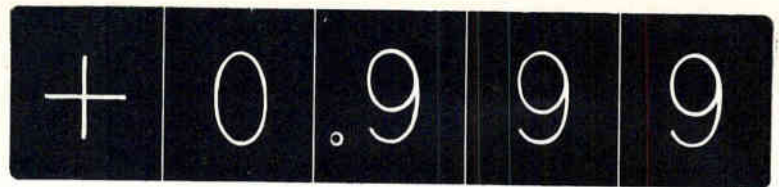

OR THIS

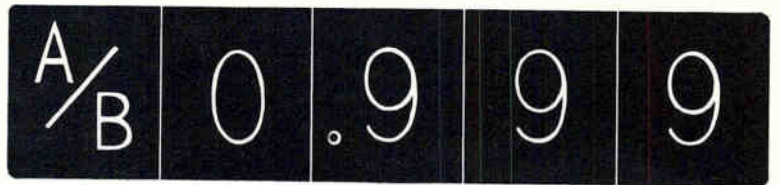

OR THIS

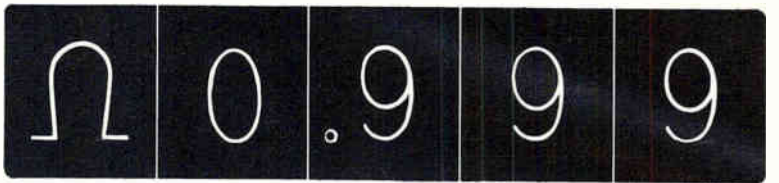

ALL THREE IN ONE INSTRUMENT... THE NEW

# CUBIC VROMETER



**Only multimeter with** the reliability and simplicity of reed relays. Cubic announces the first reed relay instrument to give you the functions of a digital voltmeter, ratiometer and ohmmeter all in one package. The ultra-reliable reed relays in the new Cubic VROMeter have been life-tested for more than 1 billion operations without maintenance, equivalent to 10 years normal use. Price of the VROMeter is the lowest of any multimeter on the market today. For complete information on this remarkable new Cubic product, write to Department A-165, Cubic Corporation, San Diego 11, California; or Cubic Europa, S.p.A., Via Archimede 181, Rome, Italy.



INDUSTRIAL DIVISION  
SAN DIEGO 11, CALIFORNIA • ROME, ITALY

OTHER OFFICES AND REPRESENTATIVES IN PRINCIPAL U.S. AND CANADIAN CITIES



# 8 hrs....

**Some engineers now design high-frequency switching circuits by:**

1. Estimating transistor electrical characteristics at the design operating points rather than at points specified on the manufacturer's data sheet.
2. Allowing for variation in specification limits of devices due to changes in current and voltage.
3. Allowing for parameter variations resulting from changes in temperature.
4. Throwing in a safety factor based upon educated estimates.
5. Breadboarding circuits with limit transistors and checking operation at temperature extremes. Then, when necessary, due to unsatisfactory performance of breadboarded circuits by:
  - Trimming safety margins
  - Refining circuit design
  - Writing specs for special devices
  - Selecting specials at Incoming Inspection

Making these estimates and calculations and doing expensive breadboard testing and analysis wastes valuable time and frequently results in marginal or over-designed circuits...



# or 15 min

**But not YOU if you use Motorola's new 2N964A Designer's Data Sheet**

1. It contains limit curves that fully define "on" conditions from 2 to 100 mAdc ( $I_{FE}$ ,  $V_{CE(SAT)}$ ,  $V_{BE(SAT)}$ ); "off" conditions (leakage, latchup); and "transient" conditions (total charge, rise and fall time constants).
2. Sufficient curves are given on important design parameters to permit easy construction of any other curve desired.
3. Curves define necessary min-max limits.
4. Curves are given for various junction temperatures.
5. Safety factors are included in the curves.
6. Breadboard is used merely to check circuit analysis.
7. The 8-page Motorola "Designer's Data Sheet" contains typical calculations showing step-by-step how you use this complete design information for switching circuits.

In fifteen minutes you'll learn more about this transistor from the Designer's Data Sheet than you could in days of testing. Tightly specified in characteristics, but designed for a broad range of application, the Motorola 2N964A transistor is the ideal high frequency switch for most of your requirements.

For a copy of the Motorola 2N964A Designer's Data Sheet, or for more information, write or call your local Motorola Semiconductor Engineering Representative.



## MOTOROLA

**Semiconductor Products Inc.**

A SUBSIDIARY OF MOTOROLA, INC.

5005 EAST McDOWELL ROAD • PHOENIX 8, ARIZONA

1985



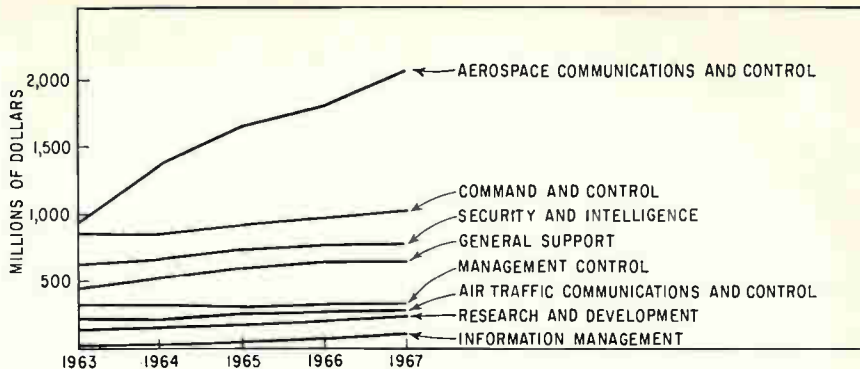
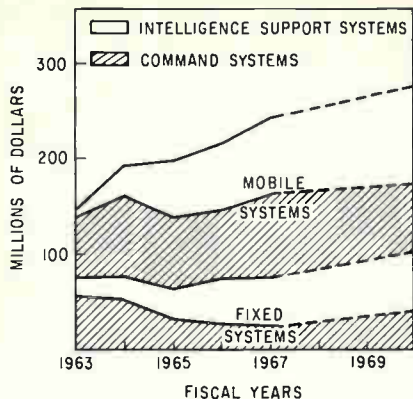

TWO ESTIMATES of markets for information systems. Graph at left, reported by Abraham Katz, of RCA, is the projected market for only command and control processing hardware procurement and RDT&E, not including communication and buffer equipment. At right is International Electric Corp.'s estimate of anticipated growth of various classes of information systems over the next five years, adding up to a total market rising from about \$3.8 billion in 1963 to about \$5.3 billion in 1967

## EIA Sees \$13.1 Billion Sales in 1962

*Association now pegs 1961 sales at \$12 billion, higher than predicted*

By LEON H. DULBERGER  
Assistant Editor

NEW YORK—Electronic Industries Association expects electronic factory sales to reach a record peak of \$13.1 billion for 1962. Profits may not rise at a comparable rate, however, due to increasing foreign and domestic competition.

At its Fall Conference last week, EIA also reported that 1961 was a record high year for electronic sales. In a statement by EIA president Charles F. Horne, final estimated market figure for 1961 was higher than that predicted by the association last November. The earlier figure for 1961 was \$10.15 billion. The new estimate is nearly \$12 billion for 1961.

Horne noted that the government has become the largest customer of the electronics industry. During calendar 1961 the military purchased \$6.7 billion in equipment and services. Government procurement including NASA and FAA was \$7.6 billion. Military procurement alone is expected to reach \$7.6 billion for calendar 1962.

**SALES STATISTICS**—Figures supplied at the conference by EIA's Market Services department give a calendar 1961 sales breakdown

as: combined government military and space, \$6.9 billion; industrial, \$2.2 billion; consumer, \$2.1 billion, and replacement components, \$0.8 billion. Estimated 1962 sales are: government military and space, \$7.7 billion; industrial, \$2.4 billion; consumer, \$2.2 billion, and replacement components, \$0.8 billion.

Strong possibilities for future growth in the industrial market were noted in computing, data processing and industrial control equipment. Sales for these products were \$1.03 billion in 1961, 28 percent over 1960, according to EIA.

Test and measuring equipment, communication, navigation aids, broadcast and commercial sound equipment sales all saw increases of roughly 10 percent in 1961 over the previous year.

**COMMAND AND CONTROL**—Harold Rapaport, of International Electric Corp., led a panel on the rapidly emerging command and control market.

He defined these systems as those designed for selective use of information in performance of planning

implementation and evaluation functions related to decision making and the control of effectors. He gave as an example military and weapons systems.

Rapaport said a large market is emerging due to expanding technological advances and geopolitical changes. Market estimates (illustrated in the graph at right, above) were based on EIA files, government reports and private company contacts, plus adjustments by knowledgeable persons.

Major information system components can anticipate growth from 1963 to 1967 of: data transmission, \$1.3 to \$2.25 billion; software, \$440 million to \$550 million; data processing, \$200 million to \$250 million, and data origination and display, \$50 million to \$100 million.

**F-M STEREO**—A prediction was made by Harold L. Kassens, of FCC, that f-m stereo will ultimately replace monophonic f-m. Total f-m stereo broadcasting stations may reach 300 by next January 1, up from the present 150 f-m stereo stations now on the air.

### GOVERNMENT MARKET ESTIMATES BY EIA

*EIA estimates of electronic procurement by the Department of Defense, National Aeronautics and Space Administration, and Federal Aviation Agency, are, in billions of dollars:*

*Fiscal year 1961: DOD, \$6.2; NASA, \$0.2; FAA, \$0.1  
Fiscal year 1962: DOD, \$7.2; NASA, \$0.4; FAA, \$0.2  
Fiscal year 1963: DOD, \$7.9; NASA, \$0.7; FAA, \$0.2*





**so smooth  
so positive**  
you can almost feel it...

*another common-sense reason for  
choosing a 260<sup>®</sup> VOM*

Reading after reading, the pointer sweeps directly to its destination. No hesitation. No faltering. No indecision. No need to tap the window just to make sure. The 260 lets you concentrate on the test... not on the "tools."

Some people say this is due to the fine Simpson meter. Others to component choice. Still others to circuit design. Actually it's all of these factors blended together by Simpson specialists in the design and manufacture of volt-ohm-milliammeters—expert engineers and production technicians whose judgment is backed by experience with over a million 260's.

So whenever you need a VOM, the logical choice is a Simpson 260. Call your Electronic Distributor. He stocks them in quantity. **\$4895**

complete

**Simpson**

**SIMPSON ELECTRIC COMPANY 5203 West Kinzie Street, Chicago 44, Ill.**  
Phone: (312) ESTebrook 9-1121

In Canada: Bach-Simpson Ltd., London, Ontario  
Representatives in Principal Cities... See Telephone Yellow Pages

# WANTED: Radiation-Resistant Solar Cells

*Nuclear tests may require redesign of satellite power supplies*

By MICHAEL F. WOLFF  
Senior Associate Editor

AS ASSESSMENT of the increased radiation in space from the U.S. July 9 nuclear test continued last week, there were indications that solar-cell power supplies on some future satellites may be redesigned for greater radiation tolerance.

A joint report by the Atomic Energy Commission, Defense Dept., and National Aeronautics and Space Administration said future NASA missions are being reviewed and "it is anticipated that a substantial number of the missions will be affected". NASA spokesmen, at press time, were interpreting the possible changes in the program to mean the type of solar cells to be used. To date, NASA said, no satellite launch schedules have been changed. Conceivably, future findings, as well as more nuclear testing, might cause schedule delays.

**WHAT'S HAPPENED**—Apparently, the increase in radiation is

## ATTN: RADIO ASTRONOMERS

*While more electrons were trapped as a result of the July 9 test than had been expected, the government report said the observed increase of radio noise was about as expected. Observations made between 18 and 120 Mc show the noise is now:*

- Nowhere more than twice the cosmic noise prior to the test.
- Decreasing at about 10 percent per week.
- Confined to low magnetic latitudes.

*Although the noise will be detectable at these low latitudes for a long time if special techniques are employed, the report claims the noise does not constitute a significant problem to radio astronomy*



SOLAR CELLS and transparent sapphires are being attached to a developmental model of Telstar communications satellite by Bell Labs engineer

largely due to beta particles (resulting from the decay of fission products) being rejected into the earth's magnetic field. Result is a new electron belt superimposed on the inner portion of the natural Van Allen belts.

The report said this radiation caused a rapid deterioration of the solar-cell power supplies on the U.S.—British Ariel satellite in 3 to 4 days and on Navy's Transit IVB and Traac satellites in 24 to 36 days. Power supplies for these satellites had been designed without extra shielding, to keep size and weight down, and had been expected to withstand only natural radiation. It was known that a 25 to 30-percent reduction in output would probably terminate useful transmission, according to the report.

**SOLAR CELLS**—Fact that solar cells, like other semiconductors, are subject to radiation damage is well

known, and has sparked several approaches to increasing the radiation resistance of ordinary cells.

One approach is to use the so-called *n-on-p* cell, made by diffusing phosphorus into the surface of a *p*-type silicon crystal rather than by diffusing boron into *n*-type silicon as in ordinary *p-on-n* cells.

Telstar uses these *n-on-p* cells, shielded by 30 mils of synthetic sapphire, and was reportedly unaffected by the nuclear test. The report cites Telstar's performance as "very satisfactory" and concludes that solar-cell power supplies can have a satisfactory life in such a radiation environment. Conceivably, this approach might be used on some future satellites.

Other techniques have also been under study. One of these involves increasing the base resistivity.

The Telstar cells have base resistivities of 1 ohm-cm. For 1-Mev electrons (greater than most Van



Allen belt electrons) this will improve lifetime or tolerable dosage by a factor of 10 over *p-on-n* cells. Recent experiments have indicated, however, that by increasing resistivity to 10 ohm-cm it may be possible to achieve an improvement factor of 30 to 40.

A second approach is the graded-base solar cell. Here a gradient in the base impurity concentration is introduced by diffusion. This causes an electric field to accelerate the photon-produced carriers toward the junction, resulting in a cell preliminary data indicates may be 30 to 50 times more resistant.

**GALLIUM ARSENIDE**—Another approach is to use gallium arsenide instead of silicon. Preliminary experiments here indicate possible improvement by a factor of 500.

Large-area cells with thin films of gallium arsenide are also under study, as are cadmium-sulfide large-area cells. It is hoped that such cells may have good radiation properties if 5-percent efficiencies can be achieved.

These approaches are all under study by NASA. W. R. Cherry, head of NASA's direct energy conversion project, emphasized, however, that these programs had been planned for over a year and have not been influenced by the recent Pacific tests. He added that while other power sources were also being investigated, efforts were not being accelerated because of the recent radiation disturbance.

## High-Resolution Tv

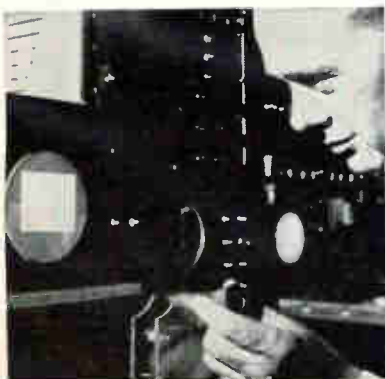

**IMAGE** of eight pages of text seen on crt screen can be read when blown up, Itek reports. Company will make tubes, scanning up to 5,000 lines an inch, for its information handling systems

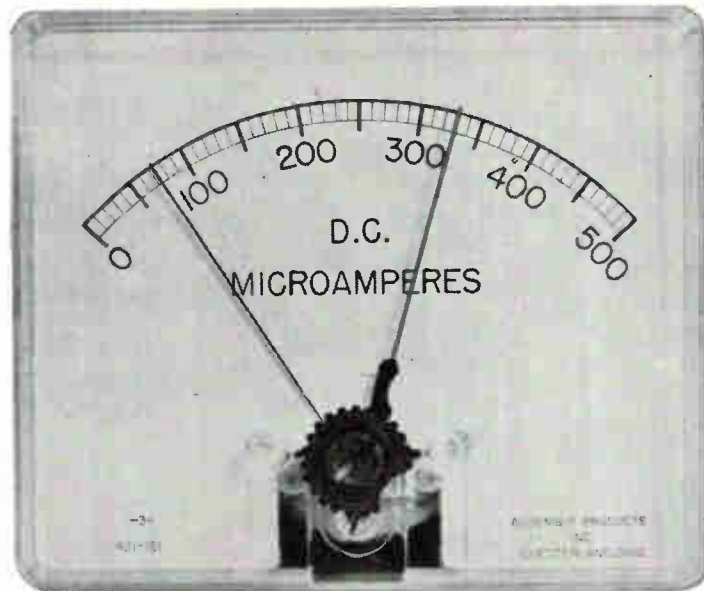

## BARGAIN

Indication and Control... about \$40.00

An API meter-relay like this one costs about forty dollars. Quantity prices are substantially less.

Even at the single-unit price, though, the meter-relay is a great bargain.

Can you think of any other way to get both indication and control for so little? In such a compact, easy-to-install package? With such excellent reliability? (API meter-relays are capable of at least ten to twenty million operations without a contact failure.)

The things you can do with a meter-relay are limited only

by your imagination. Right now, API meter-relays are being used to monitor and control everything from bearing temperature to radiation level.

Our new Bulletin 5-A describes our entire line of meter-relays, both locking-coil and continuous-reading types. It provides detailed technical information and includes schematics of the various types of control circuits you can design with API components. The Bulletin is yours for the asking.



**ASSEMBLY PRODUCTS, INC.**  
CHESTERLAND 4, OHIO

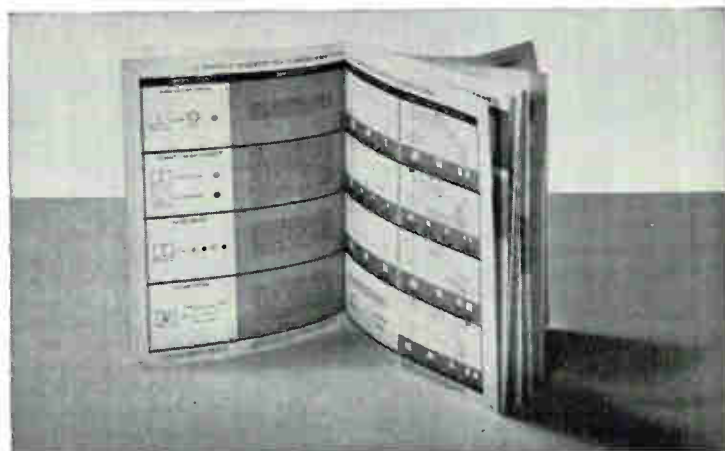

SA 2657



# FILMISTOR®

METAL FILM RESISTORS  
OFFER 5 TEMP. COEFFICIENTS  
TO MEET ALL CIRCUIT  
REQUIREMENTS

RUGGED END-CAP  
CONSTRUCTION  
FOR LONG TERM  
STABILITY

EXCEPTIONAL  
RESISTANCE TO  
MOISTURE AND  
MECHANICAL DAMAGE

SURPASS MIL-R-10509  
PERFORMANCE  
REQUIREMENTS



Providing close accuracy, reliability and stability with low controlled temperature coefficients, these molded case metal-film resistors outperform precision wirewound and carbon film resistors. Prime characteristics include minimum inherent noise level, negligible voltage coefficient of resistance and excellent long-time stability under rated load as well as under severe conditions of humidity.

Close tracking of resistance values of 2 or more resistors over a wide temperature range is another key performance characteristic of molded-case Filmistor Metal Film Resistors. This is especially important where they are used to make highly accurate ratio dividers.

Filmistor Resistors, in  $\frac{1}{8}$ ,  $\frac{1}{4}$ ,  $\frac{1}{2}$  and 1 watt ratings, surpass stringent performance requirements of MIL-R-10509D, Characteristics C and E.

Write for Engineering Bulletin No. 7025 to: Technical Literature Section, Sprague Electric Co., 35 Marshall Street, North Adams, Mass.

For application engineering assistance, write: Resistor Div., Sprague Electric Co. Nashua, New Hampshire



Sprague® and ® are registered trademarks of the Sprague Electric Co.

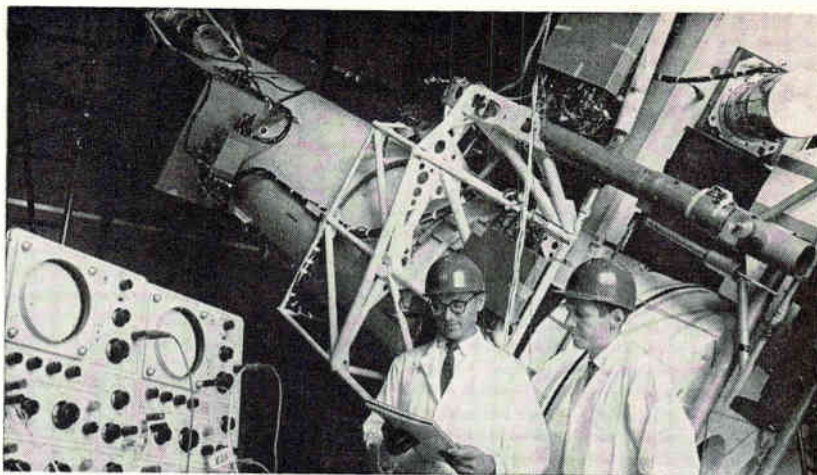

STRATOSCOPE II, being checked out after assembly, will supply preliminary data to pinpoint portions of the spectrum that will be investigated later by space probes and satellites

## Stratoscope II Assembly Completed

*Electronic payload is  
forerunner of future  
satellite experiments*

NORWALK, CONN. — Balloon-borne astronomical telescope Stratoscope II, assembled by Perkin-Elmer under joint sponsorship of the National Aeronautics and Space Administration, National Science Foundation, and Office of Naval Research, will make its first flights early in 1963.

Carried by an unmanned helium balloon to 80,000 feet, the 6,300-lb payload consists of a 36-in. reflector telescope together with camera, infrared spectrometer, and auxiliary equipment. Stratoscope II will analyze the composition of planetary atmospheres and of nebulae.

The electronic package includes a remotely controlled guidance system capable of pointing the telescope and maintaining its orientation, for hour-long exposures, within 0.02 second of arc; a 40-channel command system and a 64-channel telemetry system; a 10-Kw-hr nickel-cadmium battery power supply; and two television cameras. All equipment is controlled and monitored from a special equipment van.

After the telescope has been oriented using one tv camera and monitor, the automatic guidance system maintains precise orienta-

tion through the other tv camera, sighting on two stars as dim as ninth magnitude. The guidance system must compensate smoothly for the rotation of the earth as well as for any movements of the balloon.

Martin Schwarzschild of Princeton University, director of the project, said that Stratoscope II and its remote control systems are forerunners of experiments aboard satellites and deep-space probes, which up to now do not have the capacity to carry high-resolution telescopic and spectroscopic equipment. He named the Orbiting Astronomical Observatory satellites and planetary fly-by probes as examples of projects that will benefit by the techniques developed in Stratoscope II, as well as by the results of Stratoscope investigations.

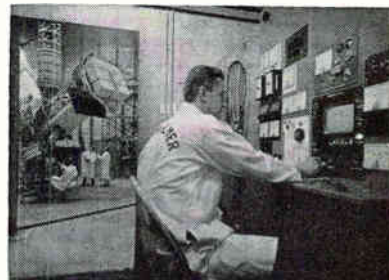

MOBILE CONTROL van contains equipment to operate and monitor telescope from up to 150 miles away. Tv screen, right, is used to roughly aim the telescope; meters and indicators monitor 64 telemetered measurements



**20 CPS TO 200 KC  
ULTRA STABLE "AUDIO"  
SWEEPING OSCILLATOR**

**KAY**  
*Sona-Sweep* MODEL M  
**141-C**

**New Alignment Technique**

The Sona-Sweep Model M adapts the accepted techniques of r-f swept frequency alignment to audio and ultrasonic (e.g., tape recorder) bandpass measurements and adjustments. In addition, the highly stable response curve developed by the Model M and the parallel display provided by its manual control, give easier, more accurate checks of high Q filters and sharp slope devices.

**Detecting At Audio**

A major disadvantage of previous sweeping oscillator techniques for use at audio frequencies has been the difficulty of obtaining a clean envelope response. Usually, no single audio frequency detector covers the octaves of the full audio range. Often, too, the large bypassing necessary slows down detector response so as to make it inaccurate for changing (swept) conditions. To eliminate this difficulty, a synchronous detector has been provided, giving adequate bypassing down to about 200 cps.

**Single Trace With Markers**

A clean, detected envelope of audio frequency bandpass characteristics clearly defines amplitude vs frequency. The increase in trace intensity provided by the detected signal (rather than by a diffused a-f pattern) makes it much easier to view the response characteristics and to monitor any adjustments of the circuit under test. The sharp pulse type markers provided by the Model M precisely and clearly define critical points along the trace.

**Model M — A Complete System**

The Model M provides a complete measurement system, including—logarithmic, linear

and manual sweeps, or a calibrated c-w signal; sharp, "crystal," pulse type frequency markers and precision step attenuator.

**Variable Center Frequencies**

The Model M is a double heterodyne sweep generator employing three crystal controlled oscillators. Either linear or log sweeps are available with center frequencies continuously variable between 20 cps and 200 kc. The swept output is blanked during retrace time, providing a zero-voltage base line. To eliminate phasing adjustments, a sawtooth voltage, synchronized with the swept output, is available to drive the X-axis of the scope.

**Varied Sweep Rates**

For checking high-Q circuits and low frequency response characteristics, variable rep rates down to 0.2 cps are available. This wide choice of rep rates, continuous to 25 cycles, plus a 30 cycle lock, permits selection of the optimum rep rate which gives an accurate response display of the circuit being tested, plus ease of viewing on the scope screen.

**Varied Sweep Widths**

Sweep widths are continuously variable from 20 cps to 200 kc. In each of three steps—2 kc, 20 kc, 200 kc—new modulating circuits are switched in to provide maximum stability in each range.

**Logarithmic Sweeps**

A nominally logarithmic sweep, most useful for studying audio and video low pass circuits, provides an expanded view of the low frequency end, while showing overall frequency characteristics.

**Manual Sweep**

A manually controlled swept output provides a means of varying cw signal in synch with the oscilloscope display. The manual control covers the same frequency range to which the Model M is set for electronic sweeping. It can be used to examine response characteristics in detail, or in response to cw and near cw conditions. When the Sona-Sweep is used with an electronic counter and accurate voltmeter, it can perform all the checks where cw is preferred. In addition, it can utilize the counter and its scope synchronization feature to frequency calibrate the oscilloscope display.

**High Level Output**

The Model M delivers a high level output of 5 volts rms into 600 ohms over the entire frequency range. The built-in, precision step attenuator provides up to 59 db of attenuation in discrete steps. An additional 6 db of variable attenuation is provided. Output is flat within  $\pm 0.5$  db.

**SPECIFICATIONS**

**Center Frequency Range:** 20 cps to 200 kc. Continuously variable.

**Sweep Width** — Three ranges: 20 cycles to 2 kc., 200 cycles to 20 kc., 200 cycles to 200 kc.

**Sweep Output And Repetition Rates:** Sawtooth for horizontal deflection of scope trace. Low impedance output, approx. 3 V pp.

a. Fixed at 30 cps in Line-Lock mode.  
b. Variable 0.2 to 25 cps for logarithmic sweep.

c. Three continuously variable linear ranges: 0.2 cps to 1 cps, 1 cps to 5 cps, 5 cps to 25 cps.

**Output Level:** 5 volts rms into 600 ohms.

**Flatness:**  $\pm 0.5$  db over widest sweep.

**Markers:** (Optional): Ten crystal pulse type markers, positioned at customer specified frequencies; e.g., 200 cycles, 500 cycles, 1 kc, 2 kc, 5 kc, 20 kc, 50 kc, 100 kc and 200 kc.

Markers designated for use at wide sweep (200 kc) are not applicable to other sweep widths. Specify whether for wide (200 kc) or narrow (less than 20 kc).

**Calibrated CW Output:** 20 cps to 200 kc.

**Built-In Attenuator:** Switchable steps, 3 db, 6 db, 10 db, 20 db, 20 db, plus 6 db variable.

**Power Supply:** Input approximately 220 watts. 117 volts ( $\pm 10\%$ ), 60 cps B+ electronically regulated.

**Dimensions:** 19 $\frac{3}{8}$ " x 10 $\frac{7}{8}$ " x 16 $\frac{1}{2}$ ".

**Price:**

\$1295.00 f.o.b. factory \$1425.00 f.a.s. N.Y.

\$17.00 ea. for markers \$19.00 ea. for markers

**Weight:** 57 lbs.

**KAY ELECTRIC COMPANY**

Dept. E9 • MAPLE AVE., PINE BROOK, MORRIS COUNTY, N. J. • CApitol 6-4000

- Sweep audio frequencies high-Q filters, tape recorders.
- Ultra-stable narrow frequency sweeps 20 cps to 200 kc.
- 200 cps to 200 kc in single frequency sweep.
- Both linear and logarithmic sweeps plus manual sweep control.
- Built-in audio detector.
- Fixed and variable pulse type markers.



MICROPIX® multi-purpose cathode ray tubes, used in high-resolution applications, are part of the extensive line of Litton display devices and microwave tubes. San Carlos, California. In Europe, Box 110, Zurich 50, Switzerland.

**LITTON INDUSTRIES**  
ELECTRON TUBE DIVISION

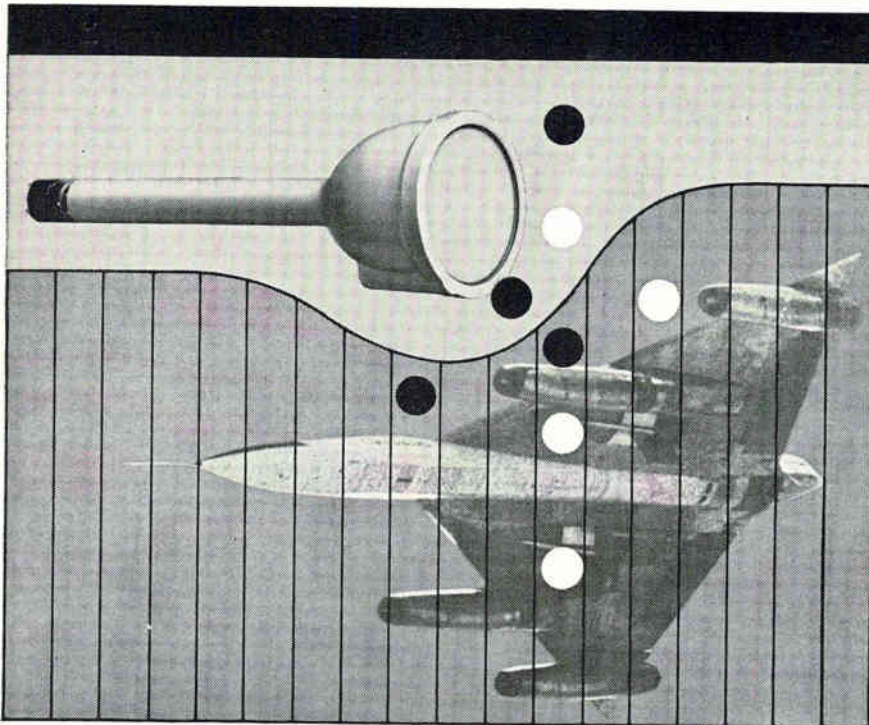

CIRCLE 200 ON READER SERVICE CARD

## MEETINGS AHEAD

BROADCAST ANNUAL SYMPOSIUM, IRE-PGB; Willard Hotel, Washington, D. C., Sept. 20-29.

VALUE ENGINEERING & ANALYSIS CONFERENCE, EIA; Statler-Hilton Hotel, St. Louis, Mo., Oct. 1-2.

COMMUNICATIONS NATIONAL SYMPOSIUM, IRE-PGCS; Hotel Utica and Municipal Auditorium, Utica, N. Y., Oct. 1-3.

SPACE ELECTRONICS & TELEMETRY NATIONAL SYMPOSIUM, IRE; Fountainsbleau Hotel, Miami Beach, Fla., Oct. 2-4.

ELECTRICAL ENGINEERS FALL GENERAL MEETING, AIEE; Pick-Congress Hotel, Chicago, Oct. 7-12.

NATIONAL ELECTRONICS CONFERENCE, IRE, AIEE, et al; Exposition Hall, Chicago, Ill., Oct. 8-10.

AUDIO ENGINEERING SOCIETY ANNUAL FALL CONVENTION; New York, N. Y., Oct. 8-12.

MAGNETOHYDRODYNAMICS CONFERENCE, Michigan State University; at the University, East Lansing, Mich., Oct. 10-11.

AEROSPACE ELECTRICAL ELECTRONIC EQUIPMENT & SYSTEMS DISPLAY, Aerospace Electrical Society; Pan Pacific Auditorium, Los Angeles, Oct. 10-12.

PHOTOGRAPHIC ELECTRONIC SYMPOSIUM, Soc. of Photo. Scientists Engineers; Washington, D. C., Oct. 12-13.

ELECTRICAL INSULATION CONFERENCE, Nat. Acad. of Sci.; and the Nat. Research Council; Hershey Hotel, Hershey, Pa., Oct. 14-17.

URSI-IRE FALL MEETING, URSI, IRE-PGAP, et al; Ottawa, Canada, Oct. 15-17.

SPACE PHENOMENA & MEASUREMENTS SYMPOSIUM, IRE; Statler-Hilton Hotel, Detroit, Mich., Oct. 15-18.

INSTRUMENT-AUTOMATION CONFERENCE AND EXHIBIT, Instrument Society of America; Coliseum, New York City, Oct. 15-19.

MOTION PICTURE & TELEVISION ENGINEERS CONVENTION AND EQUIPMENT EXHIBIT; Drake Hotel, Chicago, Oct. 21-26.

AEROSPACE & NAVIGATIONAL ELECTRONICS EAST COAST CONF., IRE-PGANE; Baltimore, Md., Oct. 22-24.

RESEARCH AND ENGINEERING NORTH-EAST MEETING, IRE; Somerset Hotel and Commonwealth Armory, Boston, Mass., Nov. 5-7.

IEEE INTERNATIONAL CONVENTION, Institute of Electrical and Electronic Engineers; Coliseum and Waldorf-Astoria Hotel, New York, N. Y., March 25-28.

Do you solder ... THIN FILMS  
... DOT MODULES  
... MICROELECTRONICS ?



MODEL H10  
12 Watts  
115 Volts AC-DC

# HEXAACON HORNET

- is your iron!

- SMALLEST IRON - ONLY 5 7/8"
- SMALLEST TIP DIAMETER - 1/32"
- SHORTEST DISTANCE FROM WORK - 1 15/16"
- LOWEST WATTAGE - 12 WATTS
- HOT TIP GETS IN AND OUT FAST
- NO DAMAGE TO INSULATION
- FASTEST WORKING TEMPERATURE
- LIGHTWEIGHT

DUROTHERM Non-Freezing Long-Life Tips  
1/32", 1/16", 1/8"

Gets into tight places. Plastic handle, cooled thru ventilated design and concave stainless steel which reflects heat away from hand.

**HEXAACON ELECTRIC COMPANY**  
130 West Clay Avenue, Roselle Park, New Jersey



SERVING INDUSTRY AND CRAFTSMEN FOR OVER THIRTY YEARS





SANGAMO  
SANGAMO  
SANGAMO  
SANGAMO  
SANGAMO  
SANGAMO  
SANGAMO  
SANGAMO  
SANGAMO  
SANGAMO  
SANGAMO  
SANGAMO  
SANGAMO  
SANGAMO  
SANGAMO

# SANGAMO

## ELECTROLYTIC COMPUTER GRADE CAPACITORS

- MAXIMUM CAPACITY IN SMALLEST CASE SIZE
- HIGH RELIABILITY ■ HIGH ACCEPTANCE

Sangamo Type DCM Capacitors are *computer grade*—have more capacitance per case size—operate under high ambient temperatures, are rated for high ac ripple currents, and add stability and long life to low voltage power supplies. That's why they are used by such computer makers as:

BENDIX	NATIONAL	REMINGTON RAND
BURROUGHS	PHILCO	ROYAL McBEE
GENERAL MILLS	RCA	SOROBAN
IBM	RAYTHEON	STROMBERG-CARLSON

Sangamo was the first manufacturer to produce and establish standards for high reliability, computer grade electrolytic capacitors, and can engineer and produce units to meet your most exacting specifications. Complete information is yours for the asking.

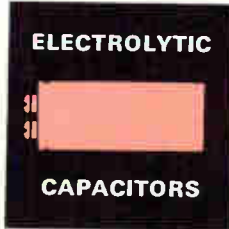

**SANGAMO ELECTRIC COMPANY**  
SPRINGFIELD, ILLINOIS

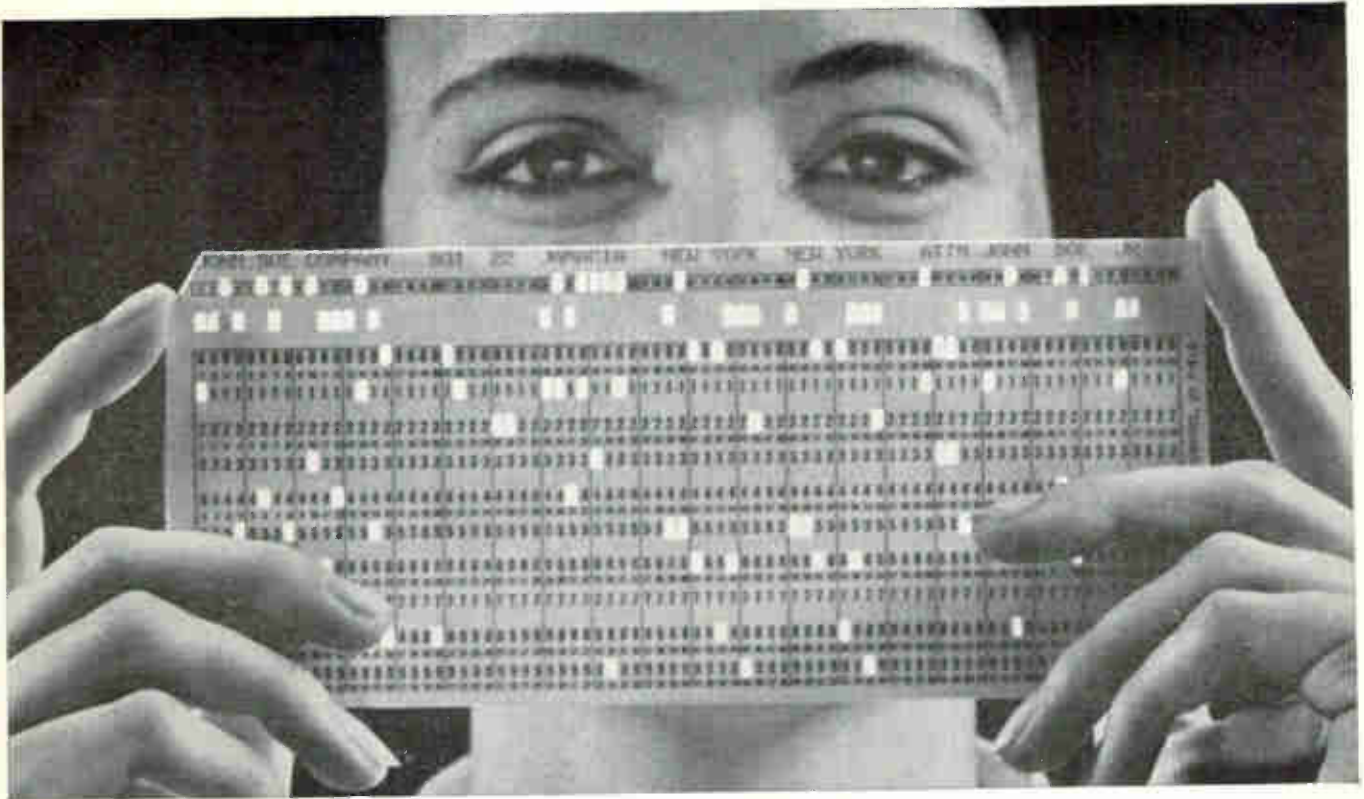

# PROCESS IT TODAY USE IT TOMORROW ANYWHERE IN THE U.S.A WITH



35<sup>th</sup> Anniversary  
1927-1962  
*first and finest Air Shipping service*

Delivery speed is vital with punched cards . . . and data processing centers are never farther away than overnight when you ship by AIR EXPRESS. It's the only shipping service with air priority on all 38 scheduled U.S. Airlines . . . everywhere in the U.S.A., Puerto Rico and Canada. A dependable service at a low cost—5 lbs. go 1,000 miles for \$3.53. 13,000 R E A Express trucks provide speedy door-to-door service, on or beyond airline routes. For shipping or receiving, whatever your business, be sure to specify AIR EXPRESS. It's as close as your telephone.  
**CALL YOUR LOCAL R E A EXPRESS OFFICE FOR AIR EXPRESS SERVICE**



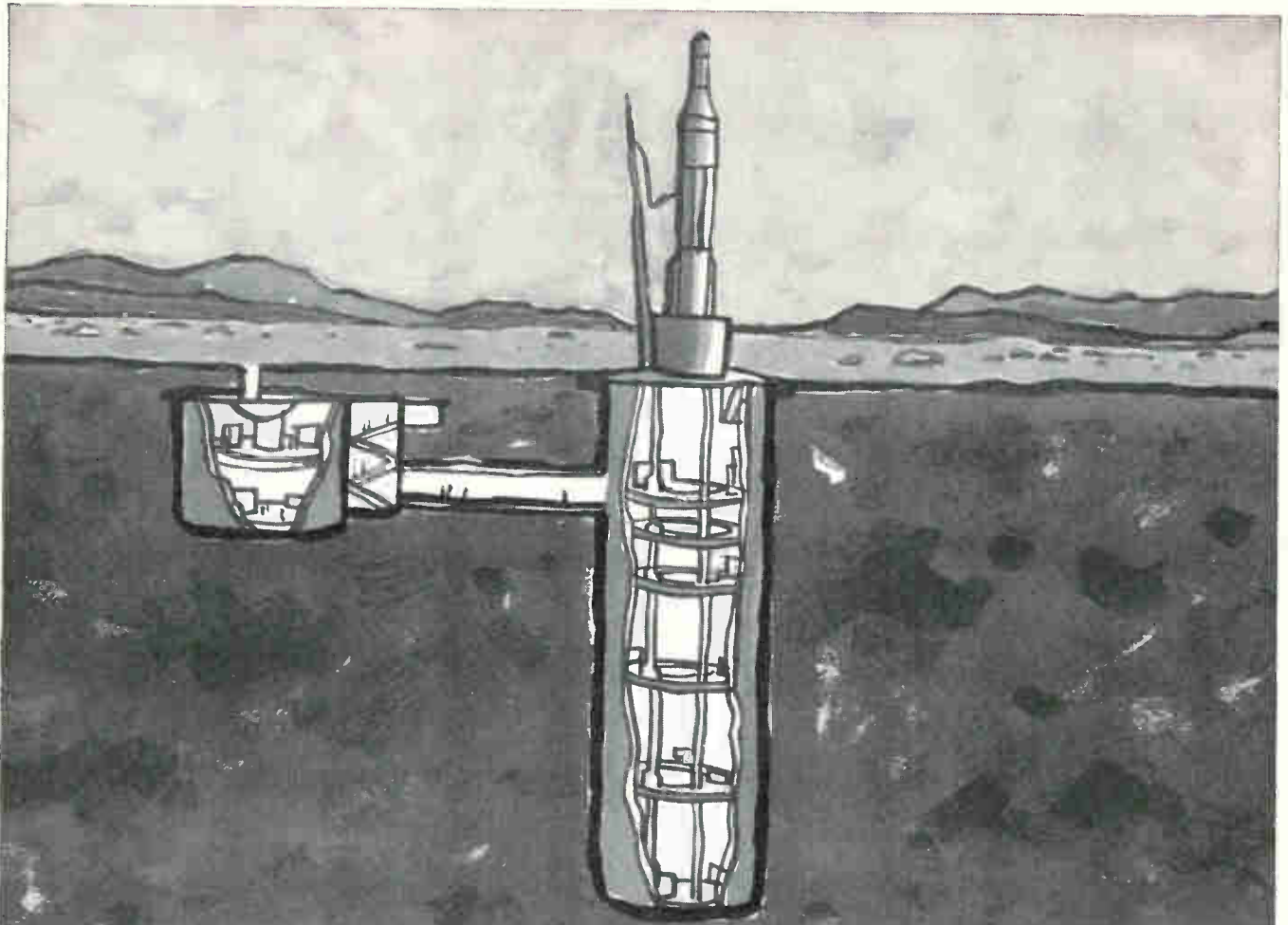

## DO YOU, JOHN DOE, SPECIFY GSE CABLES and ASSEMBLIES?



...and work on applications where oil, ozone, and weather resistance *really* count? You've plenty of company, John Doe. Other problems include the absolute necessity of good flexibility and stand-up to impact, bending, and twisting over an ambient temperature range from  $-65^{\circ}\text{F}$  to  $+160^{\circ}\text{F}$ —not to mention rough installations, reeling and unreeling over dry, rocky ground.

John, that reliability bit has more punch than we might think. Hitemp ground support cable and cable assemblies—CONFORMING TO MIL C-13777C—are precision-engineered for tough customers, like yours and mine. Applications? Power and transmission lines; ground support equipment cables for guided or ballistic missile launching pad; and test equipment cables for unmanned aircraft.

And how about this one, John? Hitemp has the whole

setup required to make complete, ready-to-use assemblies—all complying with "13777C". Modular units that save real money in original and installation costs, as well as long-term economy. This also includes the entire custom design routine—whatever you need.

Hitemp is a rare one, John. We can write to them about our problem, send for their "Condensed Catalog", and possibly even their engineering assistance. What can we lose?

### **HITEMP WIRES CO.**

a Division of Simplex Wire & Cable Co.

1200 SHAMES DRIVE, WESTBURY, NEW YORK  
1532 S. CALIFORNIA AVE., MONROVIA, CALIF.



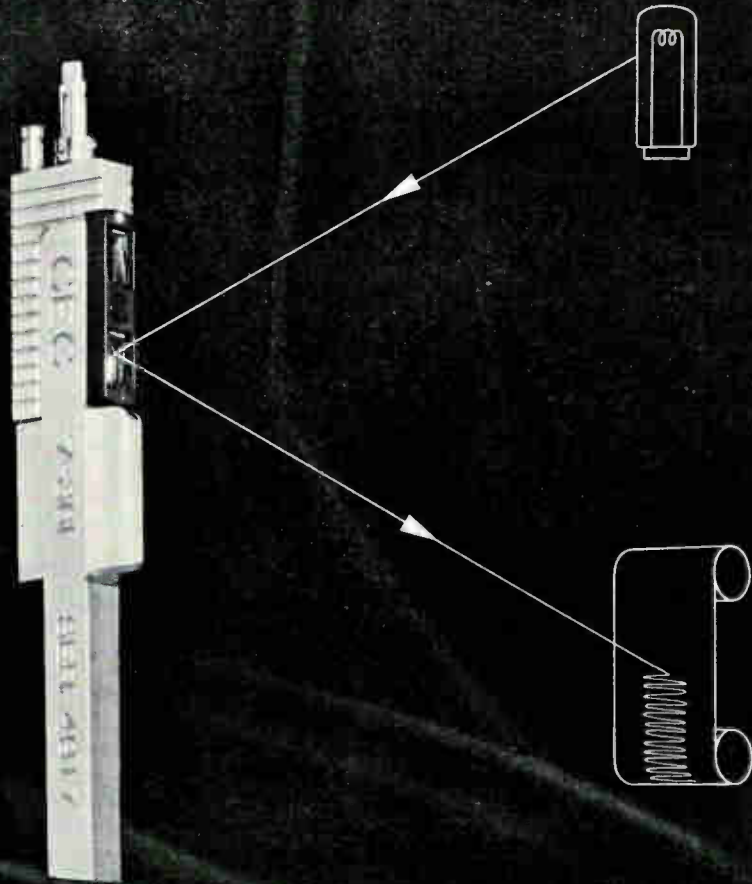

## Greatest range of capabilities

**CEC Galvanometers** in 33 different types make CEC oscillographs the most versatile recording instruments available today. Each of these precision galvanometers is specially designed and constructed to give you dependable performance . . . greater range of frequencies . . . greater range of sensitivities . . . unique application possibilities. To understand the full measure of these capabilities, send for the valuable packet of technical information listed in the coupon at the right.

**CEC**

**CONSOLIDATED ELECTRODYNAMICS**

DEPT. D1  
360 NO. SIERRA MADRE VILLA  
PASADENA, CALIFORNIA

GENTLEMEN: Please send me the following materials: Galvanometer Selection Chart; How To Get The Most Out of CEC Galvanometers; The Theory of Recording Galvanometers.

NAME \_\_\_\_\_

TITLE \_\_\_\_\_

COMPANY \_\_\_\_\_

ADDRESS \_\_\_\_\_

CITY \_\_\_\_\_ ZONE \_\_\_\_\_ STATE \_\_\_\_\_

**CIRCLE 37 ON READER SERVICE CARD**



When you select a motor for d.c., Globe motors are the most potent performers for every requirement from 1/1000 to 1/10 hp. Miniature PM motors are inherently more efficient than wound field d.c. motors (5% to 10% is common), a virtue you can have in the form of less heat, or more torque per volume. PM motors have fewer parts, hence are more reliable and less costly. If this sounds like grinding an axe, remember that we too make wound field motors in the same size range. Wound field motors are best for universal operation, better for instant reversing or other more sensitive forms of control.

As with all Globe motors, our PM and wound field motors are available with planetary or spur gearheads, brakes, governors, filters and special modifications. Because we specialize in precision miniature motors, we can help you right now. **Call us: many motors stocked for 24-hour delivery.** Ask for Bulletin DC-1 from Globe Industries, Inc., 1784 Stanley Avenue, Dayton 4, Ohio, Area Code 513 222-3741. **GLOBE INDUSTRIES, INC.**



PRECISION MINIATURE MOTORS, GEARMOTORS, TIMERS, ACTUATORS, CLUTCHES, BLOWERS, MOTORIZED DEVICES

# PERMANENT MAGNET MOTORS BEST FOR D.C.?



TYPE GRP 2 1/4" dia. .10 hp @ 4,000-10,000 rpm.



TYPE SD 3/4" dia. .003 hp @ 8,000-17,000 rpm.



TYPE VSS 7/16" flat .002 hp @ 8,000-17,000 rpm.



TYPE SS 7/8" dia. .004 hp @ 8,000-17,000 rpm.



TYPE VS 7/16" flat .0025 hp @ 8,000-17,000 rpm.

MOTORS SHOWN ACTUAL SIZE



TYPE VT 3/8" dia. .0025 hp @ 8,000-17,000 rpm.



TYPE LL 1 1/4" dia. .015 hp @ 6,000-15,000 rpm.



TYPE BD 1 1/2" dia. .022 hp @ 5,000-12,000 rpm.



TYPE MM 1 1/4" dia. .01 hp @ 8,000-18,000 rpm.



TYPE BL 1 1/2" dia. .033 hp @ 4,000-10,000 rpm.

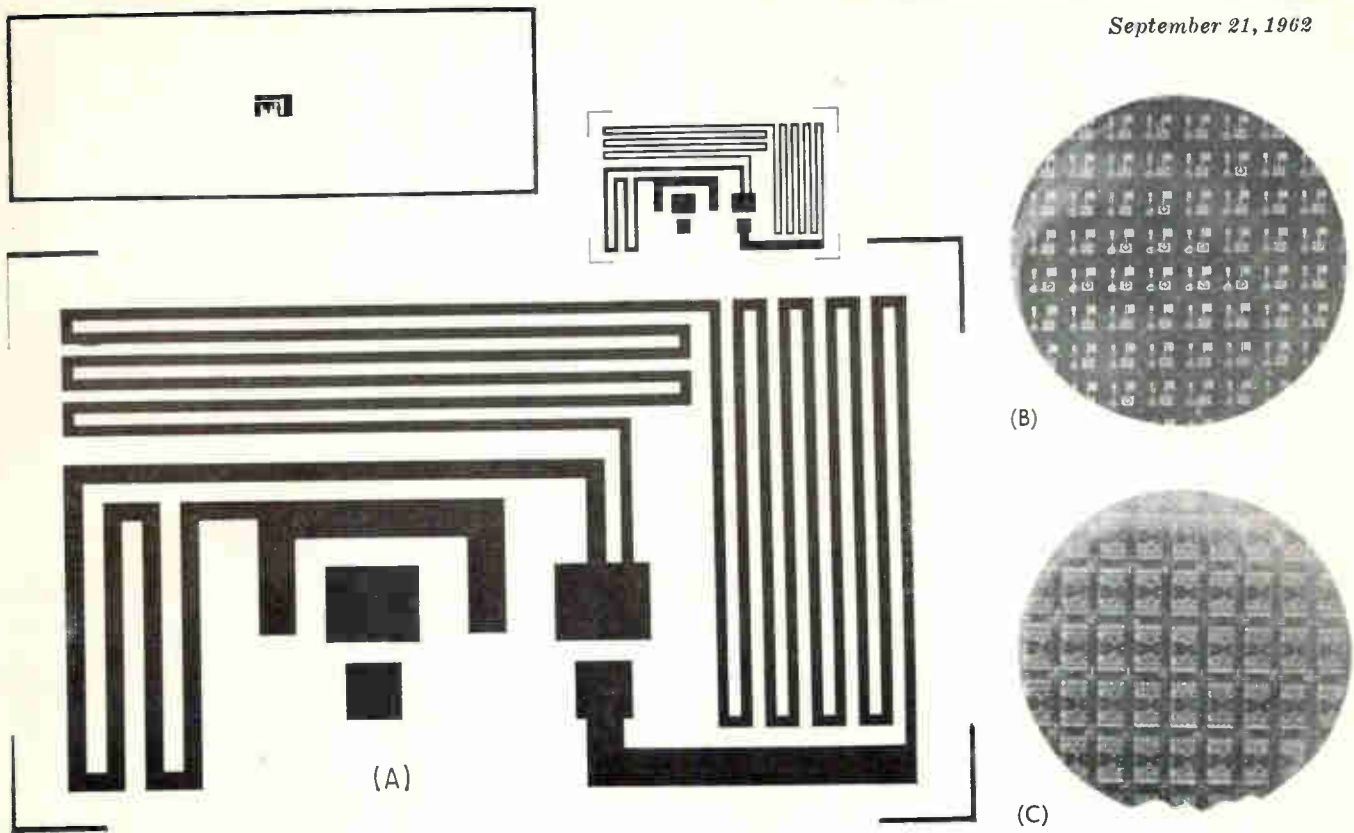

LARGE MASTER MASKS are reduced in two steps to final size (upper left) appropriate for functional electronic blocks (A). On a large silicon slice, many blocks can be made simultaneously: shown here are three-stage amplifiers (B) and five-input double stroke gates (C)—Fig. 1

# Designing Molecular Circuits For Use in Complex Systems

*To use functional electronic blocks in a meaningful systems program, it is necessary to standardize basic system functions. Described here are new blocks under development whose functions are common to many electronic systems*

By H. W. HENKELS,\*  
Molecular Electronics Dept.,  
Semiconductor Div.,  
Westinghouse Electric Corp.,  
Youngwood, Pennsylvania

DESIGNING functional electronic blocks attention is directed towards obtaining a complete electrical function from a complete block of semiconductor material. Such designing does not involve a piecewise translation of a circuit diagram into the block, because the

\* Deceased

relatively low resistivity of semiconductors prevents it and also because semiconductors exhibit special properties that might otherwise not be taken advantage of.

The feasibility of constructing functional electronic blocks has already been demonstrated. However, to develop such blocks in a meaningful systems program it is necessary to examine general system requirements. The approach to system design is to replace various parts or subsystems by functional blocks.

Selecting basic blocks that will adequately perform all or most required system functions presents difficult problems.

In one extreme, every block for every system would be custom made. Even when possible, this approach is prohibitively expensive except for some special systems. At the other extreme, a limited number of standard blocks would be produced. In some areas of the electronics business, in computers for example, a limited number of basic blocks



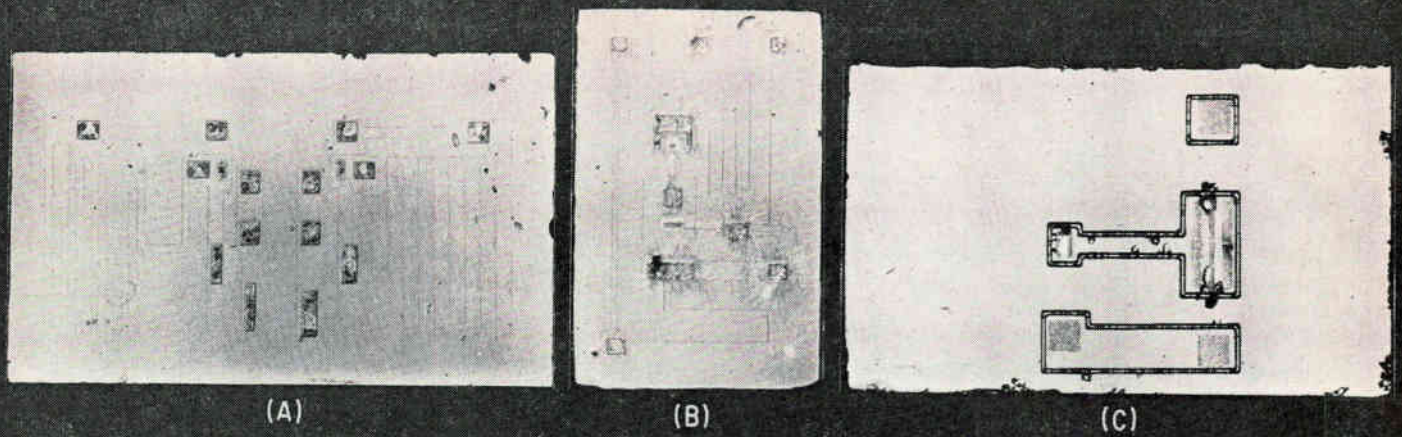

THESE BLOCK AMPLIFIERS include a universal common emitter amplifier (A), a double Darlington amplifier (B) and a uniplaner bipolar amplifier (Unibi) (C)—Fig. 2

can be specified. However, this is generally not possible when considering the entire field of electronics. Probably the most practical approach will involve the production of a considerable number of basic designs that are sufficiently flexible to permit reasonable parameter variation around design centers. An attempt has been made, therefore, to arrive at a limited number of subsystem functions common to a large fraction of military electronics systems.

**MECHANICAL SPECS**—In addition to electrical specifications, mechanical specifications such as size, weight and heat dissipation are needed. In complex systems consisting of a number of subsystems or functional electronic blocks, specifications describing block configuration and interconnection are required. While some aspects of block size, weight and configuration can be treated independently of the overall system by minimizing the former two and choosing the most simple form of the third, compatible with the semiconductor structure, a general knowledge of overall systems requirements is desirable.

Jedec Committee JS-15 recommended that packages should be flat, have external dimensions in multiples of one-eighth inch and lead centers on multiples of 25 mils.

**DESIGN METHODS**—One method of considering functional electronic block design is to use equivalent circuits. Alternately, the flow of field, displacement and diffusion currents in the semiconductor structure can be visualized, or the output

and input characteristics of sections of the structure can be integrated to develop a complete description. Many methods are useful and can produce semiquantitative results. Exact solutions involve complex equations in three dimensions that cannot be handled in reasonable periods of time. First approximations to exact solutions can be obtained using complicated analog systems such as compartmented electrolytic tanks or matrices of resistor-capacitor networks but the approximations are not good enough to justify the time required. In practice, the semiquantitative expressions are used with flexible trial fabrication techniques to obtain experimental solutions.

Different methods of expressing the configuration required are ap-

propriate with different types of functions. For example, in the design of linear amplifiers, equivalent circuits using lumped parameters are useful. On the other hand, with switch structures it is more appropriate to employ a technique of integration of input and output characteristics graphically expressed. With other complex structures, use simplified structural diagrams of the electronic energy levels and trace out field, displacement and diffusion currents.

Despite differences of approach there are no essential differences in the final structures designed. The only differences are in the degrees of sophistication in approach. Design of functional blocks is not accomplished by interconnecting discrete active and passive elements as in conventional circuits. There is, rather, a continuous spectrum of barely distinguishable active and passive regions, and the basic interest is to get a systems function in as direct a manner as possible.

**SYNTHESIS METHODS**—In using an equivalent circuit, the complexity of the circuit must be compatible with the state of the fabrication art. At the present time, feasibility of construction has been demonstrated for a variety of two and three-stage amplifier equivalents. The size of charge storage regions must be compatible with the rest of the block. Capacitances of approximately  $0.01 \mu\text{f}$  can be readily handled. Polarization must be provided in  $p-n$  junction capacitances. Excessively large values of isolation resistance between regions of the block cannot be realized. In-

#### ABOUT THIS ARTICLE AND THIS AUTHOR

As microminiaturization developments have moved along in the past few years, the problem of how to incorporate logically entire new sub-circuits into large electronic systems has come more and more to the forefront of attention. This paper, which describes some of the advanced functional electronic blocks under development, also discusses ideas on how to resolve the systems problem.

Author Henkels, Engineering Manager of the Westinghouse Molecular Electronics Department, was well-known in microminiaturization circles for his work in this field. Mr. Henkels died late this spring. This is his last paper.



AUDIO AMPLIFIER block operates between  $\frac{1}{2}$  and 2 w—Fig. 3

ductors must be avoided, at least at low frequency. Inductor function can, however, be provided by R-C networks. Direct resistive coupling is desirable. It is estimated that about 200 milliwatts can be dissipated safely in load resistors without excessively heating the block.

With these ground rules, equivalent circuits can be constructed and electrical performance tested. Planar multiple diffusion methods employing oxide and photoresist masking have been adapted to the fabrication of functional electronic blocks. These methods are ideal for production of blocks with closely controlled properties and have been used in such a manner that no difficult registration steps are required even in complicated designs.

The structure to be fabricated is laid out on a one-and-a-half by two-foot master plate or series of plates. The master is then reduced in two steps to a final size appropriate for functional blocks, roughly one-eighth by one-quarter inch. The masks are shown in Fig. 1A. The large master is reduced to the final pattern (upper left). The starting material for a functional block is a piece of silicon  $1/8 \times 1/4 \times 0.004$  inch. In many designs the silicon is high resistivity *n*-type, and this will be assumed in the description of the processing of a transistor structure. A diffused region of *p*-type material is produced on the surfaces by conventional techniques. The wafer is then exposed to an oxidizing atmosphere in a high temperature furnace. The oxidation cycle produces a 4,000-Å thick layer of silicon dioxide upon the surfaces.

TABLE 1—SYSTEM REQUIREMENTS FOR FUNCTIONAL BLOCKS

Family (A) Amplification—Untuned	
<i>Internal Match</i>	<i>Output Match (All Relatively Low Impedance 10-1,000 Ohms—Low Frequency)</i>
Audio	Power Parameter
Video—1 Mc	$\frac{1}{2}$ -1 w
Video—10 Mc	1-5 w
R-F—100 Mc	5-20 w
Operational	10-50 w
	$\frac{1}{2}$ w phase inverter
<i>Sensor Match (All Low Power)</i>	Push-pull output 1-5 w
Impedance parameter	Push-pull output > 5 w
< 500 ohms	
500-10,000 ohms	(Freq to 30 Mc)
5,000-50,000 ohms	(Freq to 300 Mc)
50,000-1 megohm	$\frac{1}{2}$ -1 w
50,000-1 meg (low noise)	1-5 w
50,000-5 megohms	> 5 w
Family (A) Amplification—Tuned	
<i>Tunable Amplifiers (All Low Power)</i>	<i>Tuned (All Low Power)</i>
155 Kc	Frequency Parameter
1.2 Mc	100-1,000 cycles
4.3 Mc	205 Kc
12.5 Mc > 200 Mc	155 Kc
	1.2 Mc
<i>Modulators</i>	4.3 Mc
A-M, F-M, P-M (Adaption of amplifiers and oscillators in the same frequency range)	12.5 Mc
	30 Mc
<i>Attenuators</i>	60 Mc
Requirements not well defined (Distributed R-C networks)	120 Mc
	160 Mc
	> 200 Mc
Family (B) Waveform Generators	
<i>Oscillators</i>	<i>Square Wave</i>
< 0.3 Kc	< 10 Kc
0.3-3 Kc	10-100 Kc
3 Kc-30 Kc	100-1,000 Kc
30 Kc-300 Kc	1-10 Mc
300-3,000 Kc	
3-30 Mc	<i>Saw-Tooth Wave</i>
30-200 Mc	< 10 Kc
> 200 Mc	10-100 Kc
	100-1,000 Kc
	<i>Staircase Generator</i>

Next, a thin layer of a photosensitive chemical is spun on the surfaces. The silicon wafer is then located under a microscope slide. There follows the usual series of operations employed in producing high-frequency transistor structures. However, for functional blocks, the photoresist masks are also used in defining resistive areas and in applying metallic contacts so that a series of slides is usually necessary to produce the three-dimensional printed pattern desired. Thus, there may be many masking, oxidation and diffusion steps. However, in all the processing, the silicon wafer is handled as a single piece. There are no delicate hand engraving operations. The complete patterns are produced on the original masters.

After the final diffusion operation and evaporation of contacts, units are tested. In some designs, various parts of the functional electronic block are interconnected by evaporated aluminum regions over the silicon-dioxide covering surfaces; in such cases another test is made after interconnection. Input and output and power supply leads are attached to the blocks by thermo-

compression bonding. Units are encapsulated in hermetic flat ceramic or Kovar cases.

For production refinement, all designs have been modified, and made much smaller, for use with complete slices of silicon. The masks are replicated to provide patterns for complete slices. On a silicon slice about  $\frac{1}{2}$  inch in diameter, from 20 to 30 to 100 functional electronic blocks can be made at once. Figures 1B and 1C show three-stage amplifiers and five-input double-stroke gates, respectively. The processing is carried out on complete slices up to and including interconnection evaporation steps, which provide aluminum contacts.

**BLOCK FEASIBILITY**—To demonstrate technical feasibility of using functional blocks in information processing, many basic blocks have been studied. An important part of the systems program resides in the mutual compatibility of functional blocks to perform general subsystem requirements.

During the last year further analysis of general system requirements has shown the need for a number of additional basic types to



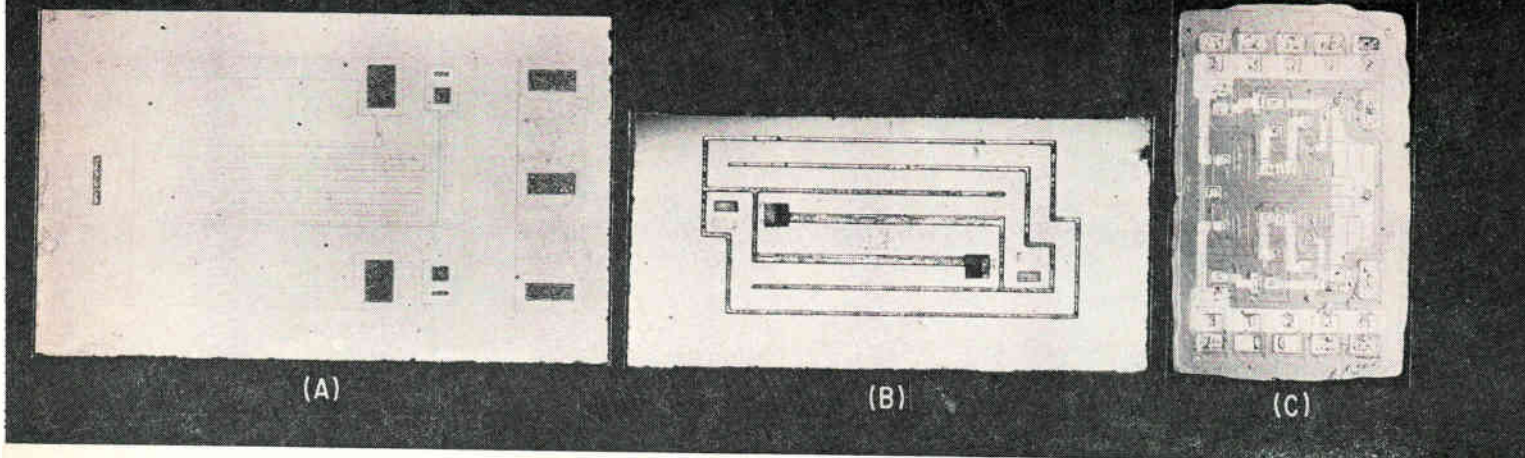

OSCILLATOR-MIXER for 30-Mc range (A), a one-Mc multivibrator (B) and a double stroke logic block (C)—Fig. 4

fill out a catalog of compatible blocks. Table I gives a summary of functions for which functional electronic blocks have been considered.

**UNTUNED AMPLIFIERS**—Internal Match: Common emitter amplifiers and two-stage Darlington amplifiers provide units for low level amplification in the frequency range from d-c to 2 Mc. Impedance levels are intermediate. Power dissipation is in the range of 100-200 milliwatts. Figures 2A and 2B present photographs of a universal common emitter amplifier and a Darlington amplifier, respectively. Structures are double planer diffused using oxide and photoresist masking techniques. Data on a typical Darlington amplifier are in Table II.

**Sensor Match:** Common emitter universal amplifiers and Darlington amplifiers match sensors of low or intermediate impedance. With sensors of high impedance, such as crystal phonograph pickups and infrared photoconductive cells, higher impedance blocks are required.

In the range to about one megohm, the Unibi (uniplanar bipolar amplifier) can be employed. Figure 2C shows a Unibi block. Data on typical amplifiers are found in Table III. The unipolar input structure of this block should operate at low noise levels. The block is designed to provide high input impedance at low noise with high gain.

At higher impedance levels, up to 5 megohms, three-stage Darlington structures can be used. They are designed to match a crystal pickup. The overall gain of typical units falls in the range of 45 db.

**Output Match:** Except in trans-

mitter applications, most output stages operate at audio frequencies. For example, audio amplifiers in communications, servoamplifiers in control systems, ultrasonic and relay drives operate in the frequency range < 100 Kc. There are other important exceptions, for example, writing heads on computers which must operate to 10 Mc. However, most effort has concentrated in the low-frequency range.

An audio amplifier, shown in Fig. 3, has been designed to operate in the range of one-half to 2 watts. Input and output impedances are respectively 100 and 200 ohms, and a power gain of 35 db is achieved at 200-mw output. For the range 5-20 watts, a split phase high level amplifier has been designed; typical data is given in Table IV.

In many applications of molecular electronics, phase inversion is necessary to avoid bulky transformers. A unit operating in the power range of one-half watt would be ideal as drive for high level two-phase amplifiers.

**TUNED AMPLIFIERS**—Table I shows complete coverage of requirements for tuned amplifiers in the range below 200 Mc. The range most adequately covered by meth-

ods compatible with the functional block approach lies between 455 Kc and 4.5 Mc, where tuning is effected by piezoelectric resonators operating in the radial mode. The frequency range between 4.5 and 30 Mc can be covered by thickness mode piezoelectric resonators and by overtone radial and thickness mode resonators. In the 100 to 200-Mc range, the Q's of conductive loops on silicon are high enough to permit considering their use.

**Oscillators:** Family (B) of Table I indicates that modifications of existing amplifiers can readily provide oscillators in the frequency range of 455 Kc to 30 Mc. This has been illustrated by the construction of the crystal controlled oscillator, which works at 30 Mc.

An oscillator-mixer functional block for the 30-Mc range is shown in Fig. 4A. A 30-Mc oscillator signal is mixed with an incoming signal to give a 3-Mc output.

Square-wave generators can be readily constructed from multivibrators operating in the appropriate frequency range. Several designs of a one-Mc multivibrator have been developed. One is shown in Fig. 4B. However, it is probably simpler to construct multivibrators from basic gating circuits.

TABLE II—AUDIO AMPLIFIERS

Unit	Operating Voltage (v)	Operating Current (ma)	Freq (Kc)	Voltage Gain	Current Gain	Power Gain (db)
VJF5	10	6	1-50	170	60	12
VLC4	12	15		130	90	37
VLH1	15	9		70	720	15
VID5	10	12		55	620	16
VLE2	5	5		45	470	41
VMC1	10	9		200	70	47
VMC2	9	5		560	100	37

Mixers: Again, as in oscillators, mixers can readily be constructed by adaptation of basic amplifier blocks. For illustration, this has been done in producing a mixer designed for the 30-Mc range.

Demodulators: A detector has been designed with a built-in distributed filter for operation in the frequency range 100 Kc to 10 Mc. Discriminators can be produced by employing the notch filter.

Wave Shaping: Little direct attention has been given to the problem of wave shaping, since specific requirements have not been defined. However, a complete catalog of basic filters and structures exists to meet such requirements.

Short Time Storage: While requirements have not been well defined, a series of flip flops can meet such requirements. Some attention should be given to the construction of a typical storage system.

Logic Switches: Effort has concentrated upon the development of a universal logic block, the double five-input stroke. A diode transistor configuration has been used as shown in Fig. 4C. Five input channels have been provided for each stroke gate to give maximum flexibility in computer design with a minimum of parts. The fanout of each stroke element is five. Maximum propagation delay is 200 nanoseconds. The saturated diode transistor stroke can be improved to the point where operation beyond one megacycle is possible. As yet, saturated logic gates are being considered for operation above 10 Mc, but little work has been done.

Signal Sampling: The multiple *pnpn* switch provides a block for signal sampling which must have external provisions for commutation. A number of designs have been made. Some development work has been carried out on multiple switches with commutation provided by transverse base fields. There are other designs being con-

TABLE IV—CURRENT GAIN CHARACTERISTICS OF TWO PHASE AMPL

Unit	$I_c \rightarrow$	500 ma		1 amp		2 amp		$V_{CE0}$ at 25 ma	
		$\phi_1$	$\phi_2$	$\phi_1$	$\phi_2$	$\phi_1$	$\phi_2$	$\phi_1$	$\phi_2$
1B	$h_{fe}$	7,500	2,400	5,600	4,000	4,000	2,750	84	160
	$h_{FE}$	3,333	1,666	4,400	2,700	5,000	3,000		
2B	$h_{fe}$	4,000	4,400	3,800	4,000	2,250	2,500	100	180
	$h_{FE}$	1,833	2,000	2,500	2,750	2,858	3,000		
5B	$h_{fe}$	4,000	3,200	4,200	3,300	2,750	2,375	124	148
	$h_{FE}$	1,666	1,715	2,500	2,350	3,440	2,500		
8B	$h_{fe}$	3,200	4,000	2,600	3,600	2,000	2,750	140	116
	$h_{FE}$	1,652	1,400	2,300	2,600	2,250	2,812		

sidered that will provide the commutation without base fields.

STANDARDIZATION — Feasibility of construction of segments of electronic systems has been demonstrated by successful assembly of a number of these.

A variety of audio amplifier systems has been constructed. An experimental phonograph system requires high impedance matches to crystal pickups. Two different blocks have been employed for the high impedance match. The first of these is a Unibi amplifier consisting of a unipolar transistor structure coupled to a bipolar. The second is a three-stage common collector Darlington with feedback. Both have input impedances in the megohm range needed. The low level amplifiers are coupled to the power stages, consisting of two-phase high level amplifiers, by transformers or, more recently, by phase inverter blocks. Such systems are capable of operating to 30 or 40 watts.

The compatibility of a longer series of blocks is illustrated in radio applications. The Air Force ARC-63 communications receiver was built from functional electronic blocks. In addition, a number of radios operating in the citizen's band have been constructed from a series of blocks. Recently a FEB-PAK consisting of a number of compatible blocks which can be assembled to produce a radio operating in the citizen's band, has been made available.

In molecular electronics a great flexibility exists in the design of functional electronic blocks but this flexibility applies primarily to the block manufacturer. Design freedom could be extended to systems engineers provided a complete custom design basis for functional

electronic blocks were reasonable. It is anticipated that this flexibility will in time be developed.

A standardization of functional blocks requires a logical subdivision of basic subsystem functions. This has been done to a large degree. Large numbers of basic subsystems are generally recognized in the industry.

Although it is technically feasible to produce blocks performing complex functions equivalent to several stages of transistor circuits, standardization at such complexity is not achievable without first standardizing more basic functions than have already been selected.

Of primary importance in standardizing is the question of mechanical compatibility. The Electronic Industries Association and the National Electrical Manufacturers Association have set up Jedec Subcommittee JS-15 concerned with integrated electronics. EIA has also set up two other committees. The Microminiaturization Advisory Committee is charged with determining user preferences in standardization. The EIA Parts Committee, P-9, is concerned with new approaches to micromodules and printed circuits. The three committees have acted in joint accord to assure general agreement.

While many obstructions lie in the road, the tremendous effect of standardization on electronic design could certainly make all efforts worthwhile. This is particularly true in military activities. New equipment designs could be much more rapidly translated into operating hardware. Replacement parts storage and servicing could be revolutionized.

Suitable manufacturing techniques for producing functional electronic blocks in large volume are in the process of development.

TABLE III—UNIBI CHARACTERISTICS

$B+$	— 10 v
$I_{total}$	— 1-3 ma (depending on bias)
$Z_n$	— > 2 meg
$Z_{out}$	— 100 ohms
$A_i$	— 2,300
$A_v$	— 10
$A_p$	— 43 db
Distortion < 1 percent at 1 $V_{rms}$ out	
Device is self-stabilizing up to 100 C	



# ANTENNA INNOVATION Glass-Fiber

*Some interesting results using a glass fiber reinforced plastic tube around a helix indicate the possibilities of a variable beam pattern antenna in the 4 to 6-Gc range*

By K. IKRATH

W. SCHNEIDER

U. S. Army Signal Research and  
Development Laboratory,  
Fort Monmouth, New Jersey

**MICROWAVE ANTENNA, Fig. 1,** consists of a glass-fiber plastic tube with a mean diameter of 70 mm, wall thickness of 1.5 mm, and length of 1 meter. The outside surface of the tube is sanded, but otherwise untreated. At one end inside the tube is the helical coupler. It consists of a metal or metalized plastic plate mounted to the glass fiber tube or inserted into the tube. The plate carries in its center the coaxial cable connector of which the inner conductor is continued inside the glass fiber tube in the form of a 9-turn helix wound with a 15 deg pitch around a 16 mm diameter Lucite rod. With the tube removed, the helical coupler is identical to a helix antenna designed to operate in the axial mode at 4 to 5.5 Gc. By providing adjustment of pitch and diameter of the spring wire helix,

Fig. 2A, a tunable helix coupler is obtained. Moving the helix inside the tube changes the radiation pattern, Fig. 2B.

**PERFORMANCE**—Radiation patterns were plotted for three configurations:

- The coupler without the glass fiber tube.
- The coupler with the glass fiber tube.
- The antenna mounted perpendicular to a 12-inch square metal ground plane.

A measurement of voltage standing wave ratios (vswr) on 50-ohm cable for different frequencies and different experimental setups indicates that the tube has practically no influence on input impedance of the helix. Similarly the ground plane does not affect impedance.

Figures 3A, B, C and D show radiation patterns of the helix alone and the helix plus glass fiber tube at 6 Gc without the metal ground plane. Recordings 3A and 3C show the magnitude of the field strength

vector in the vertical plane. Recordings 3B and 3D show the magnitude of the field-strength vector components in the horizontal plane. The shape and width of patterns 3A and 3B are typical of conventional helix antennas. The patterns of the glass fiber tube antenna, Fig. 3C and 3D show that the tube produces a narrowing of the half power beam width of about one-third, both vertically and horizontally. These plots confirm the axial symmetry of the radiation patterns and the essential circular polarization of the radiated wave.

Figures 3E, F, G and H are analogous to the Figures 3A, B, C and D, except that a 12-inch metal ground plane was placed behind the antenna. A comparison of the corresponding patterns measured with and without metal ground plate shows that the influence of the metal ground plate on the radiation characteristics are negligible.

Performance characteristics of the antenna can be summarized as follows: Directivity computed from

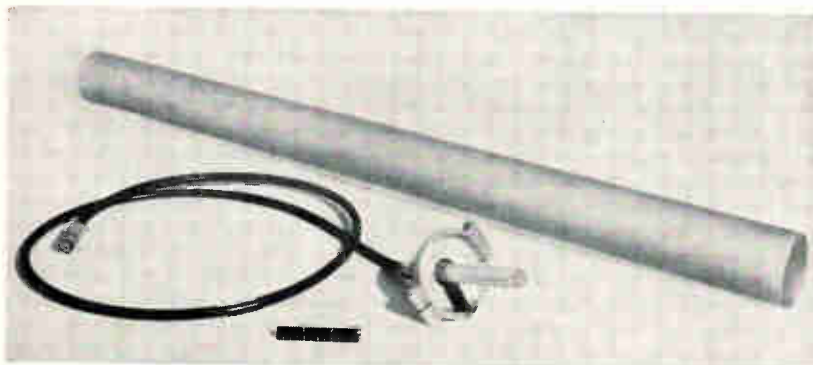

**HELIX AND COUPLER** is the driven element of this antenna and fits into the plastic tube—Fig. 1

## WHY USE GLASS FIBRE?

Many dielectric materials—polystyrene, Lucite, paraffin, flint glass—are used for optical and microwave lenses. Glass-fiber reinforced plastic is used for rigid mechanical structures of almost any shape. It seems logical to exploit its dielectric and mechanical qualities for antenna structures. Glass fiber tubes are extremely strong, stiff and very light. The tubes can be mounted over and onto existing metal microwave radiators and reflectors, serving both as a protective cover and as a microwave beam focusing element

# Tube Focuses Microwave Beam



EXPERIMENTAL ANTENNA using a glass fiber tube is light and rugged

the half-power beamwidth angles indicated on the radiation patterns is between 19 and 24 db. This is about a 10-db improvement in directivity over conventional helix antennas, which is also equivalent to an improvement in gain by 10 db because the glass fiber tube focusing element does not affect the original helix impedance. These figures for the directivity and gain computed from the radiation patterns of glass fiber tube antenna correlate with the gain measurements involving the substitution of standard metal horns, taking differences in polarization and matching of glass fiber tube antenna and horns into account (3 db because of polarization and 1 to 2 db because of matching). Polarization along the main axis of the radiated beam is practically circular. Directivity of the tube antenna, which is physically about 1 wavelength

wide, is equivalent to that of a uniformly illuminated aperture (an ideal dish) four to five wavelengths wide.

These performance characteristics are representative for the straight simple types of these novel glass fiber tube antennas. They may be further improved by tapering of the coupler, flaring of the glass fiber tube radiator and by using more than one tube in a concentric arrangement as for beam focusing, and by glass fiber tube arrays.

**THEORY**—An explanation of the radiation characteristic may be attempted on the basis of Hygens principle by assuming fictitious secondary elementary radiators to be distributed over the surface of the tube. These secondary elementary radiators are thought to be excited by a primary wave

that corresponds to a waveguide mode of the tube. Besides the fact that, in a strict mathematical sense, waveguide modes are not radiating modes, the field configuration of these modes and the related spatial distribution of the secondary elementary radiators must be known. This is usually the case where conventional metal waveguide sections with a resonant  $\lambda/2$  dipole coupler are used as feed systems for dielectric radiator elements.<sup>1, 2</sup>

The field configuration of the excited metal waveguide mode and that of the dielectric element can be assumed to be similar. This approach has been applied to polyrod antennas and other microwave antennas using solid dielectric slabs, wedges and tubes protruding from the mouths of metal waveguide sections and horns with a conventional  $\lambda/2$  dipole coupler. Even



though the theoretical investigation of propagation modes in dielectric waveguides was initiated in 1910 by Hondros and Debye, a theoretically satisfactory solution was achieved only as late as 1949 by M. M. Astrahan.<sup>3, 4</sup>

A real understanding of the mechanism of radiation which must involve other than these dielectric waveguide modes has apparently not yet been achieved. This is especially true in this case where the feed system is not a conventional resonant dipole excited metal waveguide section, but a helix or an equivalent slow wave coupler and where the radiator is not a solid dielectric rod slab or wedge, but an extremely thin-walled glass fiber tube. An infinitely long dielectric tube with dimensions such as our glass fiber tube could only support the hybrid  $HE_{11}$  mode which is also called the dipole mode because of the similarity of the field configuration with that produced by a radial dipole in a circular metal waveguide section. In fact this linear polarized  $HE_{11}$  mode can be excited in this way in polystyrene tubes by using a radial dipole in a metal circular waveguide section as feed system.<sup>4</sup> In accordance with this dielectric

waveguide mode-radiation concept, assume here that a circular polarized version of the above  $HE_{11}$  mode is the source of excitation of the fictitious elementary radiators within the glass fiber tube.

A simple and somewhat crude explanation of the focusing effectiveness of the glass fiber tube may be evolved from experience with leakage from braid-shielded cables and radio frequency interference, suppression, and control. The glass fiber tube can be considered as a dielectric shield acting as an imperfect semitransparent mirror and is polarized by electric charges on the helix inner conductor. The total field in the air space can be represented as coming from the charges on the helix and their imperfect images with respect to the tube surface and from a double layer of charges represented by the tube surfaces. The tube in effect becomes a jump surface of the electrical potential with equivalent associated magnetic curl rings. Thus focusing action can be interpreted by an increase of the effective aperture.<sup>1</sup>

**PRACTICAL USE**—An appreciation of the features of the glass

fiber tube antenna can be obtained by their comparison with those of other conventional narrow beam antennas. These are microwave parabolas several wavelengths in diameter or metal louvers or solid dielectric lenses also with diameters of several wavelengths. Other conventional and experimental microwave antennas use solid dielectric rods, slabs and wedges which protrude from metal waveguides and horns. Their mechanical design does not permit an easy mechanical control of the gain and directivity of the antenna within a wide frequency band.

One of the disadvantages of reflector and lens antennas is their heavy weight and large surface. These antennas need heavy and sturdy support structures to withstand large static and dynamic wind loads. These antennas are impractical for military field use, not only because of the difficulties of handling and transporting large structures, but also because the presence of large metallic structures can be detected by enemy optical, radar and infrared surveillance.

Dielectric microwave antennas employing solid dielectric slabs, wedges, and rods as radiating elements have similar mechanical and electrical disadvantages. Since the dielectric radiating elements must be more than a half-wavelength thick and several wavelengths long, their weight may also be considerable. Expensive low loss dielectric materials, usually polystyrene, must be used since the electromagnetic energy must pass through the dielectric material. As the loss angle of these materials increases with power density, power handling capability becomes more limited. Coupling of electromagnetic energy to the dielectric radiating element is always problematic and limits the full exploitation of the inherently wide frequency bandwidths of the dielectric radiating element. The inherent mismatch between these types of fast-wave feeder systems and the slow-wave dielectric radiator elements is likely to enhance the excitation of spurious modes of radiation. Because practically all of these feed systems are designed for linearly polarized waves, the radiated field is linear polarized.

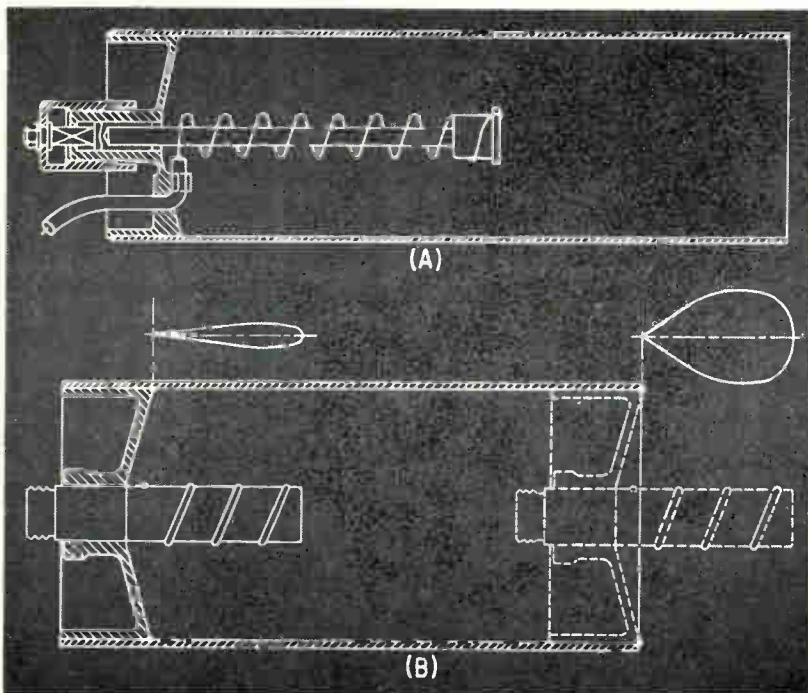

**MOUNTING** of the helix within the tube (A) and a modification showing how the antenna beam pattern may be varied by sliding the helix along the axis of the tube (B)—Fig. 2



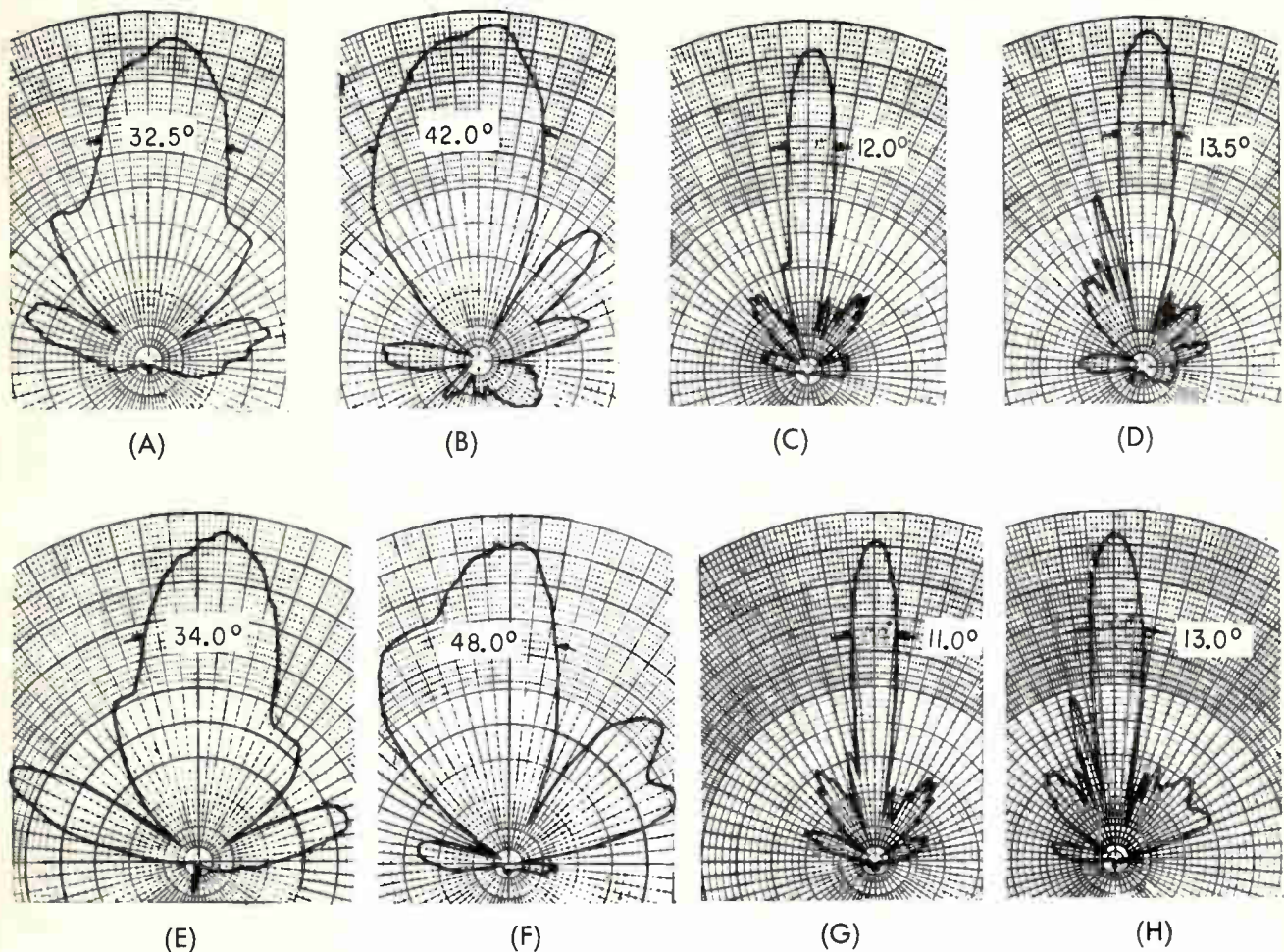

RADIATION PATTERNS of half-power beamwidth at 6 Gc. Vertical pattern (A) and horizontal pattern (B) are of the helix alone. Vertical pattern (C) and horizontal pattern (D) with the glass fiber tube added show focusing. With ground plane, vertical pattern (E) and horizontal pattern (F) of the helix alone show no noticeable effect. Vertical pattern (C) and horizontal pattern (H) with glass fiber tube added to ground assembly show no change compared to (C) and (D). Although 6 Gc is above the operating range of the helix, these patterns show the effect of the glass fiber tube and the resulting usable patterns—Fig. 3

All the disadvantages of mechanical or electrical nature are overcome by the glass fiber tube antenna. This antenna is a novel dielectric tube antenna. That is, the radiating element is the glass fiber tube, whereas the wire helix is the wideband coupler between the coaxial feeder cable and the glass fiber tube radiator.

Efficient coupling of power over a wide frequency range is due to continuous maintenance of a slow-wave phase velocity in the transition from the coaxial feeder cable by the helix coupler to the tube radiator and the large interaction space of the electromagnetic fields between the helix and the tube. Because a large part of the energy flows through the airspace inside and outside the tube, power han-

dling capacity is not limited by the radiator element. A glass fiber tube antenna does not need a large wind catching reflector and its performance is not degraded if the antenna protrudes from a large metal wall of shelter or vehicle.

From the military point of view, the narrow silhouette of the antenna and the dielectric and air material of its structure make its detection very difficult by conventional radar and infrared surveillance techniques. Further, the antenna weighs only a few pounds, is convenient to carry, and can be used in limited space.

A four-element glass fiber tube array is expected to produce a microwave antenna whose half power beamwidth can be varied smoothly from about 4 to 40 deg.

This paper reflects the teamwork of many people in the Laboratory. Special credit is due Mr. Arpin and his colleagues for the manufacture of the glass fiber tube, and to Mr. Le Meune for the manufacture of the couplers. The authors appreciate the support of the Advanced Development Branch, especially of Russel Wagner who conducted the measurements of the performance characteristics.

#### REFERENCES

1. J. D. Kraus, *Antennas*, McGraw-Hill, New York 1950.
2. Meinke, Gundlach, *Taschenbuch der Hochfrequenztechnik*, Springer, Berlin 1956.
3. M. M. Astrahan, Dissertation for Degree of Doctor of Philosophy, North Western University, Illinois 1949.
4. D. G. Kiely, *Dielectric Aerials*, Methuen & Co., Ltd., London 1952.



# New Transistor Regulator Handles

*Increased efficiency is*

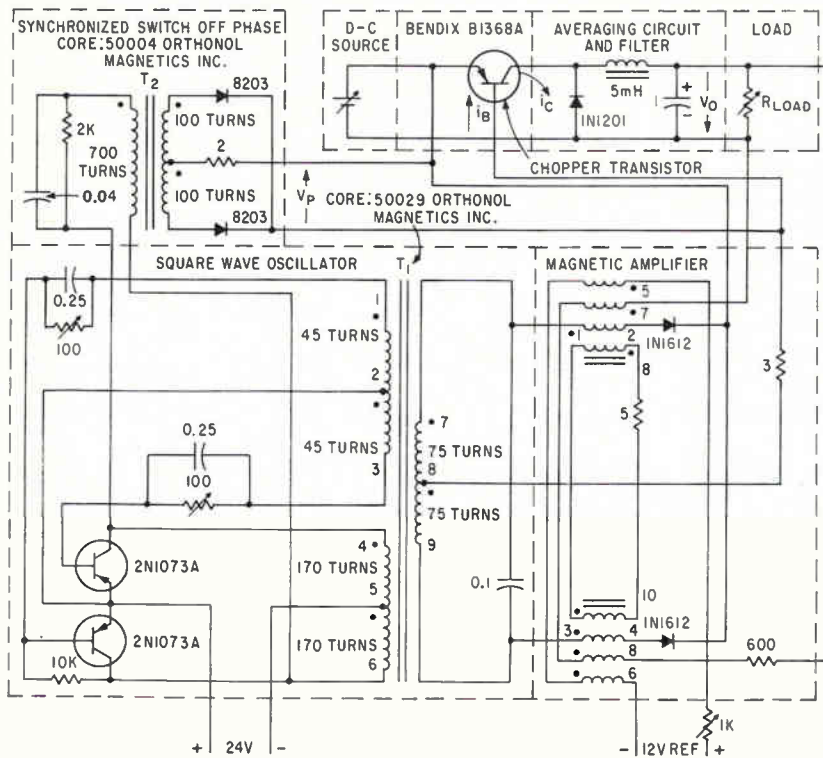

CHOPPER TRANSISTOR plays an important part in this variable pulse width regulator—Fig. 1

TRANSISTOR series regulators working with high input voltage changes have poor efficiencies. Enough voltage must be allowed across the series regulating transistor to account for all combinations of input voltage and load current changes. To provide good heat dissipation, most series regulators must be physically large.

Efficiencies of more than 80 percent are easily achieved with switching regulators; in general, however, regulation is poorer than for series regulators. For good efficiency and regulation, a switching preregulator followed by a series regulator must be used.

**REGULATOR OPERATION**—Fig. ure 1 shows a variable pulse width regulator that handles an output of 500 w. A chopper transistor supplies pulse width modulated power pulses to an averaging circuit and filter. The filter output voltage is compared to the reference voltage by the magnetic amplifier. When this output voltage is greater or smaller than the desired voltage, the magnetic amplifier changes the pulse width to decrease the deviation. The square-wave oscillator supplies a square wave that is pulse width modulated by the magnetic amplifier to drive the chopper transistor. A synchronized switch-off pulse is supplied to the chopper transistor to switch the transistor rapidly through the high power dissipation region.

The 2N1073A power transistors in the square-wave oscillator (see Fig. 1) achieve fast switching at 1 Kc. The 100-ohm variable resistors are adjusted for fast collector current fall time as well as minimum current spikes at the end of the collector current ON time. The 100,000-ohm resistor starts oscillations. The 0.1- $\mu$ f capacitor keeps voltage spikes small across the transistors by providing a low impedance path during switching.

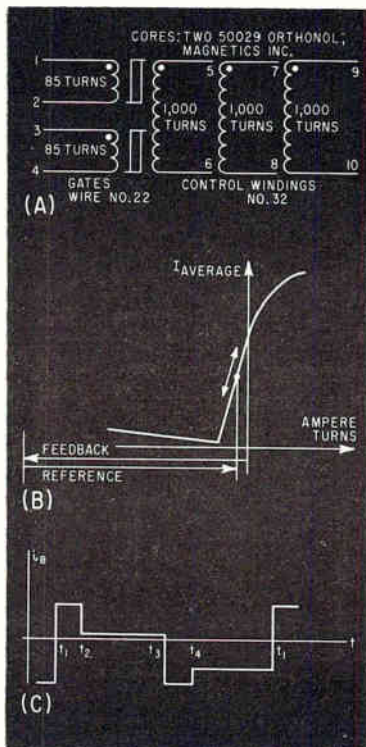

MAGNETIC AMPLIFIER windings (A); average output as function of feedback and reference ampere turns (B); and ideal base current for B1368A (C)—Fig. 2

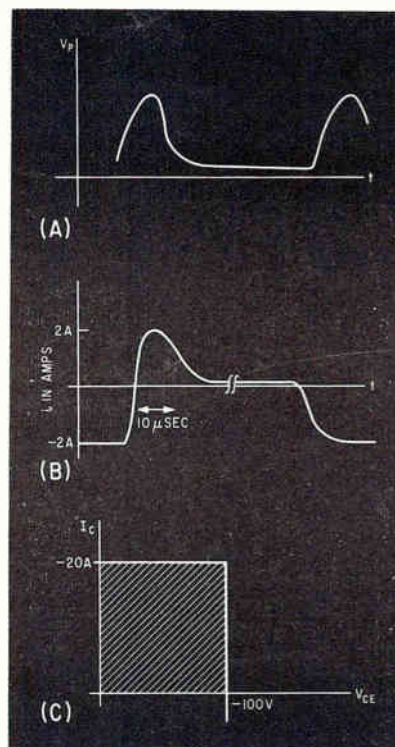

RECTIFIED OUTPUT voltage (A); base current supplied to chopper transistor (B); and area within which transistor can be switched (C)—Fig. 3

# 500-Watt Outputs

By PETER BALTHASAR Project Engineer,  
Bendix Semiconductor Div., Holmdel, N. J.

*achieved with variable pulse width regulator using a single chopper transistor*

Figure 2A shows the windings of the magnetic amplifier. One of the control windings is connected to a 5-ohm resistor to damp regulator oscillations. Figure 2B shows the magnetic amplifier average output current as a function of feedback and reference ampere turns. Reference ampere turns are kept constant. When the feedback ampere turns are increasing, due to a higher output voltage across the load, the average magnetic amplifier output current is decreasing. This means that the magnetic amplifier fires at a later point of the half cycle than before. Lower output across the load than the rated one results in smaller feedback ampere turns and, consequently, the magnetic amplifier fires sooner than before, widening the pulse width of the current supplied by the chopper transistor to the averaging circuit and filter.

Figure 2C shows the ideal base current required by the B1368A. At  $t_1$ , the chopper transistor is driven off. A high base current is supplied to the transistor to sweep the stored carriers out of the base region. After  $t_2$ , a reverse voltage holds the transistor OFF and only a small base current flows. To obtain fast collector current rise time, a negative base current overdrives the transistor until after  $t_3$ , when the base current drops to a value to hold the transistor in saturation.

The magnetic amplifier cannot switch off the base current. Therefore, the base current is switched off whenever the square wave oscillator output changes polarity. The voltage of the square wave oscillator primary is connected to transformer  $T_2$  (Fig. 1) through a capacitor in parallel with a resistor. The rectified output voltage  $V_p$  is shown in Fig. 3A.

The base current supplied to the chopper transistor is shown in Fig. 3B. The circuit provides no overdrive to decrease the collector cur-

rent rise time.

In selecting the chopper transistor, these parameters must be considered: (1) Saturation voltage:  $V_{EC(S)} \leq 0.65$  v at  $I_C = -25$  amp and  $I_B = -2.5$  amp. Saturation voltage must be kept small to minimize power dissipation during the time the transistor is switched on. (2) Emitter base voltage:  $V_{EB} \geq 1.5$  v at  $I_B = 50$  ma. When the transistor is reverse biased, base current should be small to keep power dissipation minimum. (3) Collector cutoff current:  $I_{CO} \leq$

## WHAT KIND OF REGULATOR?

*Switching regulators have many different applications. Those that operate from a-c sources employ thyratrons, magnetic amplifiers, silicon-controlled rectifiers or transistors. The switching element chops off part of the half cycle. For switching regulators that operate from d-c sources, transistors hold an advantage—they can switch currents on and off, while the other devices can only switch currents on. Using only a single chopper transistor, the design proposed by author Balthasar handles 500 watts with more than 80 percent efficiency*

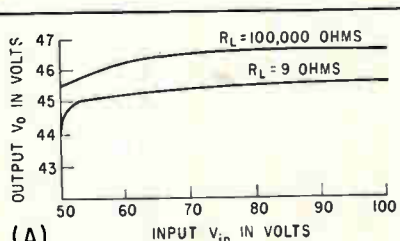

(A)

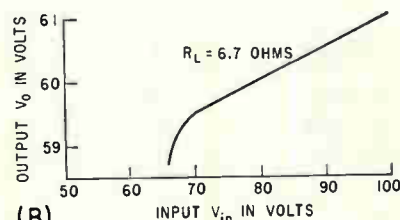

(B)

OUTPUT for load of 9 ohms and 100,000 ohms (A), and for 6.7 ohms (B)—Fig. 4

50 ma at  $V_{BC} = 100$  v and  $T_j = 100$  deg C. Average junction temperature must not exceed 85 deg C during operation. Therefore, the leakage current through the chopper transistor is smaller than 50 ma keeping the power dissipation during the OFF time small. (4) Thermal Characteristic:  $\theta_{J-C} \leq 0.8$  deg C/w. The maximum average power dissipation is 50 w. To keep the junction temperature smaller than 85 deg C, thermal resistance should be as small as possible. A heat sink with  $\theta_{(sink-ambient)} = 2$  deg C/w was used.

The transistor can be switched within the area shown in Fig. 3C. Exceeding the collector current or collector voltage may result in emitter-collector shorts. Absolute magnitude of peak base current  $|I_B|$ , must be smaller than 2 amp. Collector current fall time must be smaller than 30  $\mu$ sec. The maximum peak power dissipated with an inductive load occurs when collector current is switched off. Peak power may be as high as 2,000 w. Longer switching transients may heat the junction so that the transistor fails. The B1368A can be switched from  $I_C = -20$  amp to  $V_{CE} = -100$  v in less than 3  $\mu$ sec using a voltage source with a 1-ohm base resistor, resulting in a base current of  $\pm 2$  amp peak.

**AVERAGING CIRCUIT**—The rectifier must be a fast switch. When the chopper transistor switches on, the rectifier acts like a capacitor and current flows into the cathode ( $i_c$  in Fig. 1). During collector current rise time, the transistor switches through the high power dissipation area too. Most of the chopper transistor's dissipation is due to the switch-on transient.

Figure 4A shows output voltage  $V_o$  as a function of input  $V_{in}$  for a load of 9 ohms and 100,000 ohms. Figure 4B shows  $V_o$  as a function of input voltage  $V_{in}$  for  $R_L = 6.7$  ohms. Efficiency was 82 percent.



# Varactor-Tuned

*Electronically tuned uhf oscillator makes possible rapid, remote receiver tuning. Voltage-variable capacitor operated above its self-resonant frequency is used as the tuning element*

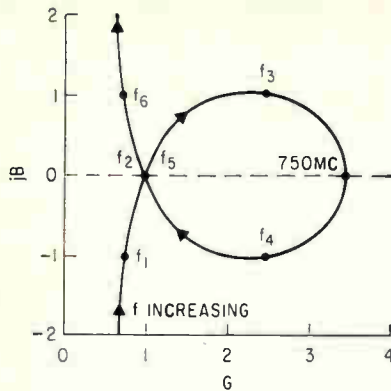

NORMALIZED ADMITTANCE across a low  $Q$  resonator—Fig. 1

By F. G. HANEMAN  
G. W. THOMSON

Airborne Instruments Laboratory,  
Division of Cutler-Hammer, Inc.,  
Deer Park, N. Y.

ADVANCES in the development of tunnel diodes have made the generation of milliwatt levels of microwave power practical. A tunnel diode can be used as a local oscillator in a superheterodyne receiver in place of complex electron tube devices or varactor multipliers.

Synthesis and construction of a voltage-tuned tunnel diode oscillator that uses a voltage-variable capacitor that operated above its self-resonant frequency as the tuning element is described. The oscillator delivers 0.65 to 0.45 mw into 50 ohms over a frequency range of 600 to 900 Mc.

**DIODE SELECTION**—Conditions for maintaining stable sustained oscillations at a given frequency can be stated in terms of the total admittance across the diode negative conductance as:

- (1) The net susceptance ( $B$ ) must be zero.
- (2) The rate of change of susceptance with respect to frequency ( $\partial B/\partial f$ ) must be positive.
- (3) The net conductance must be less than the diode negative conductance at the bias point.
- (4) The total d-c resistance in series with the diode must be less than the diode negative resistance.

For this application it was necessary to deliver power into a 50-ohm load and maintain a half-milliwatt

power level over as broad a tuning range as possible. A tunnel diode (Microstate MS 242) with a peak current of 21.7 ma, a series resistance of 1 ohm, a series inductance of 0.3 nanohenries, a negative resistance (measured at the inflection point) of 8 ohms, and a capacitance of 16.3 pf (measured at the valley voltage) was selected to fulfill the above conditions. The variation of the capacitance is about 20 percent for the voltage swings encountered. The self-resonant frequency was 1.9 Gc, and the resistive cutoff frequency was 3.26 Gc.

A frequency range of 500 Mc to 1,000 Mc for the oscillator was chosen because it is within the capability of commercially available tuning elements and tunnel diodes. Calculations of total admittance required at the diode terminals for oscillation in this range were performed using the simplifying assumption that, for maximum output power, the real part of the admittance across the negative conductance of the diode should be a constant  $\frac{1}{2}$  mho ( $1/2 R_D$ ) for all frequencies in the tuning range. The real part of this admittance shows only a slight variation with frequency. The imaginary part shows that a variation in tuning inductance at the diode terminals of about 5.1 is required to tune the oscillator from 500 to 1,000 Mc.

**VARACTOR SELECTION**—This tuning inductance was achieved by inserting a variable inductance at the diode terminals, in the form of a voltage-variable capacitor whose self-resonant frequency was below the operating frequency of the oscillator. The Pacific Semicon-

ductor PC 117 Hi-Q Varicap chosen had a capacitance change of more than 8 to 1 for a voltage change of 100 volts, below 400 Mc. A tuning range of 600 Mc to 900 Mc was found possible for the combined diode and Varicap.

**POWER DELIVERY**—With selection of the tunnel diode and tuning element, the next requirement is to deliver the oscillator power into a 50-ohm load. A quarter-wave transmission-type transformer will yield the required impedance transformation. However, this also yields a susceptance whose partial derivative with respect to  $f$  is negative. Thus, the fulfillment of one condition for stable sustained oscillation is now in jeopardy, and tuning hysteresis effects can occur.

Figure 1 is a plot of the normalized admittance across a low- $Q$  resonator that is connected to a load through a quarter wavelength of transmission line. In this illustration the resonator is formed by the tunnel diode capacitance and the tuning inductance required for oscillation at 750 Mc. The transmission line connecting the load to the resonator is a quarter wavelength at 750 Mc. The loop in the admittance shows the effect of the transmission line, the existence and size of which is inversely proportional to the  $Q$  of the resonator, and proportional to the load vswr. If more than one quarter wavelength of line is used, the total length affects the size and number of loops in this characteristic.

**TUNING**—Increasing the  $Q$  of the resonator improves the characteristic by a sort of stretching process

# Tunnel-Diode Oscillator Now Practical



TUNNEL DIODE is inserted in oscillator mount

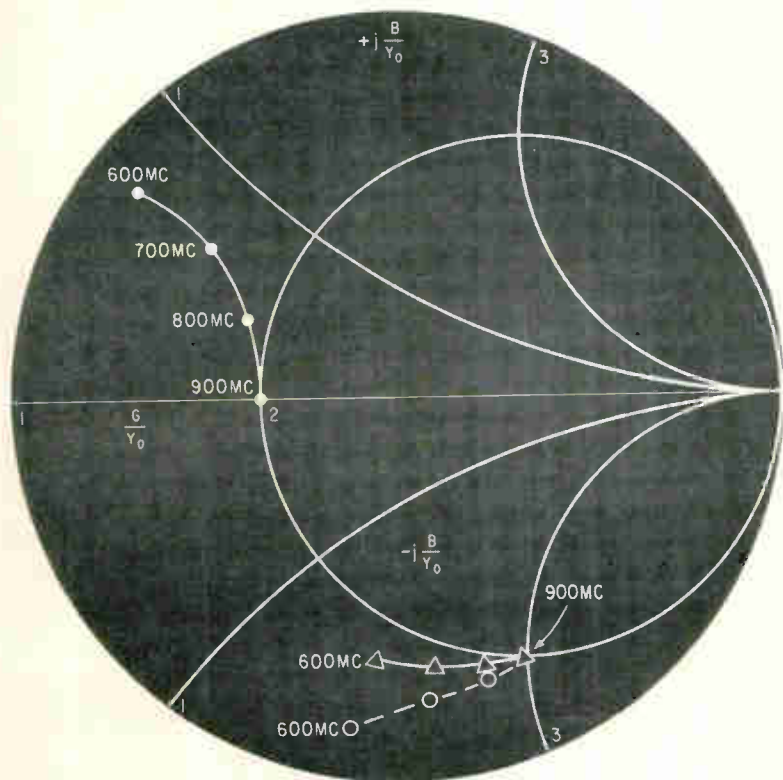

- 50-OHM LOAD TRANSFORMED THROUGH A 25-OHM TRANSMISSION LINE, (A QUARTER WAVELENGTH AT 900MC)
- △ ADMITTANCE DESIRED AT TUNNEL DIODE TERMINALS
- TRANSFORMED 50-OHM LOAD WITH TUNING INDUCTANCE ADDED

SMITH CHART plot, inside unit-conductance circle, shows admittance relationships in the tunnel diode oscillator—Fig. 2

## DESIGN FITS MANY SYSTEMS

Sweeping reconnaissance receivers and communications receivers are among the types that need rapid, remote, wide-range tuning. The varactor-tuned tunnel-diode oscillator described in this article was designed with these requirements in mind. Use of commercially available tunnel diodes and varactors in the prototype design makes commercial production feasible.

until the loop disappears. Tuning the resonator corresponds to shifting the entire curve up or down, parallel to the vertical axis. In Fig. 1, there are three crossings of the  $B = 0$  axis indicating that there are 3 separate frequencies for which  $B = 0$ . The frequencies  $f_2$  or  $f_3$  represent the two possible oscillation frequencies since at the third crossing  $\partial B/\partial f < 0$ . It is important to note that this third crossing occurs at a frequency to which the resonator is tuned and at the point where the transmission line is a quarter wavelength long.

The frequency of oscillation in this case may be either  $f_2$  or  $f_3$ . Assuming that the oscillation frequency is  $f_2$ , tuning the resonator to increase frequency, which corresponds to shifting the entire curve down, will increase the oscil-

lation frequency from  $f_2$  to  $f_3$ . An attempt to tune higher will cause a jump to  $f_3$  since stable oscillation cannot be maintained beyond  $f_3$ , where  $\partial B/\partial f < 0$ . This jump in frequency is tuning hysteresis.

Tuning hysteresis must be considered in the design of a voltage-tuned tunnel-diode oscillator because the resonator is not usually high Q. The resonator is formed by the diode capacitance and an external inductance that are both shunted by the low load resistance required at the diode terminals. The effect can be avoided by assuring that  $\partial B/\partial f$  is positive for all frequencies in the tuning range.

Since the quarter-wavelength line, which connects the load to the resonator, gives rise to the negative  $\partial B/\partial f$ , shortening the length of this line so that the frequency

at which it is a quarter wavelength is outside the frequency range of interest will generally ensure that the total  $\partial B/\partial f$  is positive in this frequency range.

It was found that centering the quarter-wave transformer at 900 Mc was sufficient to ensure that the net  $\partial B/\partial f$  across the tunnel diode negative conductance remained positive for all frequencies in the desired tuning range. The characteristic admittance of this line was chosen to be 40 millimhos to obtain the proper impedance transformation from load to tunnel diode.

The real part of the admittance desired across the diode terminals varies from about 70 millimhos at 600 Mc to 85 millimhos at 900 Mc. With the load admittance equal to 20 millimhos, a quarter-wavelength line whose characteristic admit-



tance is 40 millimhos will approximate the desired transformation.

There is, of course, a susceptive component of admittance presented to the tunnel diode terminals by this impedance transformer at frequencies other than 900 Mc. This susceptance must be considered when tuning the oscillator.

**SMITH CHART**—Figure 2 is a partial Smith Chart plot of the admittance relationships that exist at the tunnel diode terminals when the load is connected to the diode through the quarter-wave transformer. The portion of the Smith Chart shown here is within the unit conductance circle, and the normalizing admittance is the characteristic admittance of the line (40 millimhos).

The transformed load admittance has a real part which varies from 80 millimhos at 900 Mc to about 50 millimhos at 600 Mc. The susceptance varies from zero at 900 Mc to about +30 millimhos at 600 Mc. This is equivalent to a capacitance, being presented to the diode terminals, that varies from zero at 900 Mc to 8 pf at 600 Mc.

To obtain the desired admittance at the diode terminals, it is necessary to add an inductance to the transformed load admittance to yield a susceptance which varies from about 100 millimhos at 600 Mc to about 120 millimhos at 900 Mc. This susceptance variation represents an inductance variation of from 2.66 nh at 600 Mc to 1.48 nh at 900 Mc, which is a change of about 1.8 to 1 in tuning inductance.

Thus, with this tuning inductance added to the transformed

load admittance, a total admittance will be obtained at the diode terminals that closely approximates that desired (Fig. 2). The variation in the real part of the synthesized admittance is somewhat greater than desired; the susceptance variation corresponds exactly to that desired.

The real part of the admittance desired across the diode terminals is based on the assumption that a constant conductance provides maximum power at all frequencies, which is not always true. However, the power output is not a critical function of the load, and the deviation from the desired values of the real part of the admittance is acceptable (Fig. 2).

**FINAL COMPONENTS**—The construction of the final oscillator is shown in Fig. 3.

The tunnel diode is mounted at the end of a short section of transmission line ( $Y_0 = 80$  millimhos). The bias circuit for the diode is composed of a 5-ohm disc resistor ( $R_1$ ) and 1,000-pf bypass capacitor ( $C_1$ ) mounted in parallel directly against the diode to minimize stray inductance effects. The Varicap tuning element is mounted at right angles to the axis of the coaxial line contacting the center conductor about  $\frac{1}{8}$  inch away from the tunnel diode. Voltage is applied to the Varicap tuning element through a 500-pf bypass capacitor.

A d-c return from both bias supplies is obtained by using about 1 inch of high-impedance transmission line that is short-circuited at one end. This line is the bias choke  $L_2$ , and does not affect the tuning

characteristic of the Varicap. The quarter-wave transformer is formed by a 2-inch section of dielectrically loaded coaxial line that attaches to a standard UG58A/U Type N 50-ohm connector.

The tuning range obtained can be lowered by increasing the amount of fixed inductance in series with the Varicap. Using a high breakdown voltage varactor with low series inductance should permit the tuning range to be extended above 1,000 Mc.

Further measurements were made on the oscillator to determine its frequency stability as a function of tunnel diode bias and to determine the harmonic content in the output. The oscillator frequency was found to vary less than 1 percent for a change in tunnel diode bias of  $\pm 10$  percent around the normal operating bias point. This operating bias point was chosen to be the center of the negative resistance region midway between the peak and valley voltages (220 mv). The second harmonic component of the oscillator output was measured as a function of tunnel diode bias. The bias that gave a minimum second harmonic component was 220 mv. At this bias point the amplitude of the second harmonic was about 26 db below the fundamental voltage.

Portions of this work were performed under RADC Contract AF30(602)-2384. In addition, the analysis of the tunnel diode oscillator operation was performed as part of an investigation made in partial fulfillment of the requirements for the M.S. degree at the Polytechnic Institute of Brooklyn.

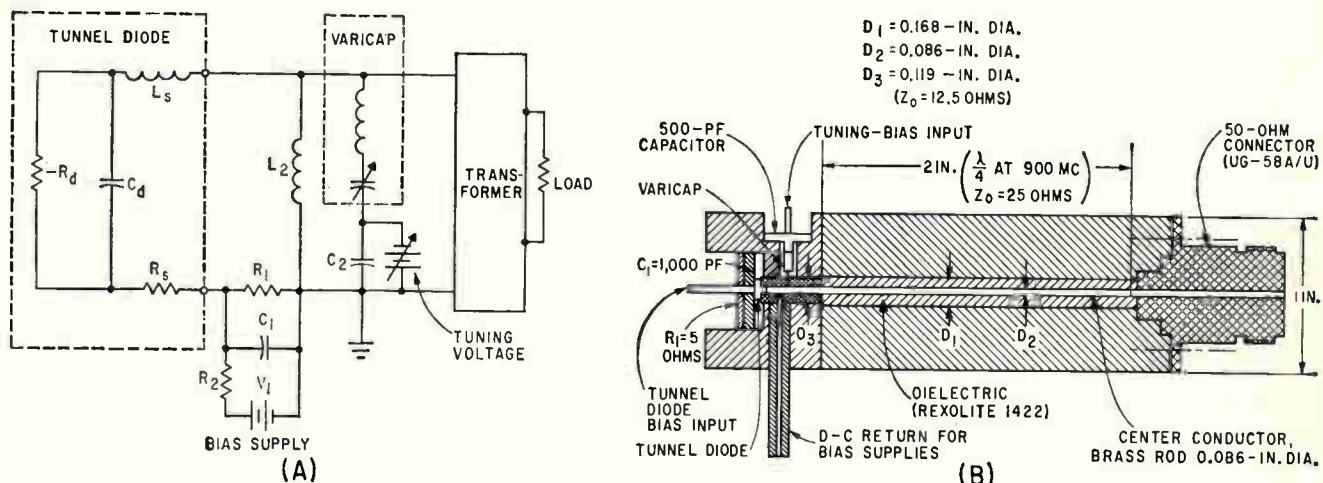

**QUARTER-WAVE TRANSMISSION LINES** are used for component connections shown in equivalent circuit (A) of oscillator (B)—Fig. 3





# Color Tv Based on Land Theory

*Red and green-coated cathode-ray tubes are used to reproduce almost entire color spectrum in this experimental two-color set*

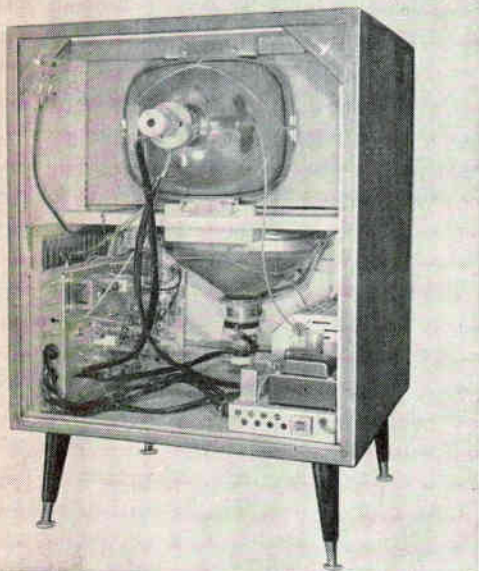

REAR VIEW of cabinet showing cathode-ray tube arrangement

OPTICAL TUNNEL effect is seen in front view of set

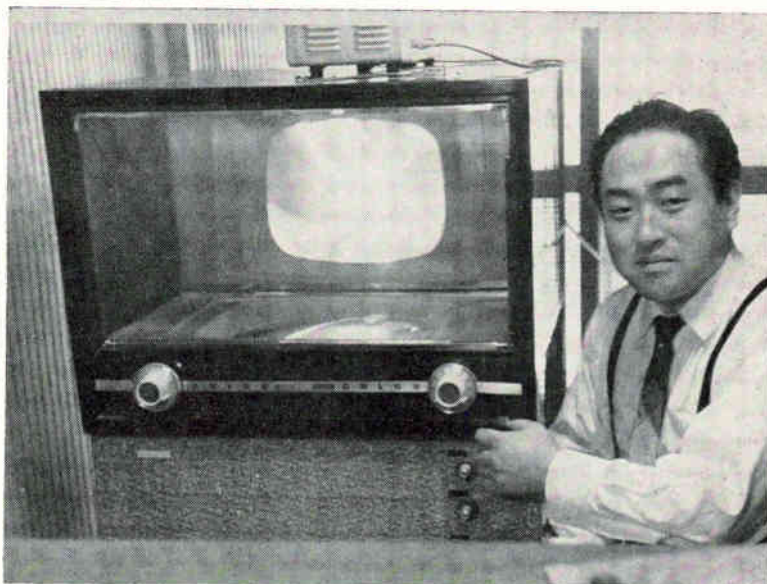

COLOR TV broadcasting using the N.T.S.C. system was started in Japan in 1960 and provides about three hours of color transmission a day. A number of color tv sets, all using the three-gun crt in 14-, 17- and 21-inch sizes, have been produced.

With the introduction of the Land theory of color perception, a number of companies started experimental work to adapt this theory to practical two-color tv, compatible with N.T.S.C. transmissions. The set to be discussed is one that was developed in Japan by K. Hashimoto.

After many experiments with the

Land approach, it was found that the combination of red and white, originally used by Land, had some difficulty in reproducing blues and greens, thus handicapping the transmission of skies and oceans.

**COLOR SELECTION**—The chart shown in Fig. 1A shows what colors can be expected from combinations of two colors of different wavelengths. Area A will reproduce the widest range of colors with the exception of purple. When this area is broken down to a chromaticity chart, such Fig. 1B, the long wavelength (red) is situated between 0.6 and 0.7 microns and the

shorter wavelength lies between 0.46 and 0.55 microns.

To reproduce white a straight line connecting two colors must pass through point *W* (white). If the line passes above point *W*, the white gets yellowish and if below point *W*, the white gets tinged with blue. Human faces will appear magenta.

Since it is easy to identify the color of typical human skin, this color can be used as a reference. As many colors as possible should be reproduced and the color of skies, oceans and grass, not having the red element, should be natural.

The eye is less sensitive in detecting variations in color than it is in resolving differences in brightness. This characteristic resulted in setting up the I and Q axis and permits a significant bandwidth reduction of the chromatic signals. Approximately 1.5 Mc is used for the I signal corresponding to color differences in the range between orange and blue-green. The range between green and purple is covered by the Q signal. As the eye is less sensitive along this axis, the bandwidth is restricted to 0.5 Mc. The composite signal (*Y*) conveys

## TWO-COLOR TV

Most color tv receivers use a three-gun, three-color crt. Some are using various forms of a one-gun crt. There are some variations such as the banana tube (one gun, three colors) and three separate projection tubes (one gun each, three color total). But all are based on three-color theory.

This receiver is based on the two-color theory of Edwin Land (of

Polaroid) and uses two monochrome crt's, one having a green screen and the other using a transparent red-orange plastic overlay to produce the red image. The images are then registered on a half mirror.

It has been manufactured and sold in Japan but because of its physical awkwardness and the problems of viewing the picture down an optical tunnel, it may not find universal favor with consumers

# Uses Two Single-Gun Tubes

By K. HASHIMOTO

Television and Electronics College,  
Tokyo, Japan

the fine detail and occupies the conventional 4 Mc bandwidth.

**EXPERIMENTAL SYSTEM**—An experimental two-color system was tried using orange and cyan but skin colors were tinged with orange and green did not reproduce. Red was chosen as the long wavelength and a green-blue was chosen as the short wavelength.

The circuit of the chromatic portion of the two-color set is shown in Fig. 2. Color phase detection is along the red-green axis. The receiver is a conventional tv type using intercarrier sound.

Two 14-inch crt's are used, mounted with their viewing ends at 90 degrees to each other and a 45-degree semi-mirror is used to form the composite image.

The cathodes of the crt's are connected in parallel and receive the Y signal from the video amplifier. The composite signal is also passed through bandpass amplifiers  $V_1$  and  $V_2$  and supplied to R - Y demodulator  $V_3$  and G - Y demodulator  $V_6$ . The R - Y amplifier  $V_4$  supplies the red crt with its signal while the G - Y amplifier  $V_7$  supplies its crt. Plate load resistors of these two amplifiers have different values to compensate for the difference color levels of the N.T.S.C. signal. Blanking  $V_5$  amplifies the horizontal fly-back pulse and cuts off both color amplifiers during the horizontal fly-back time. It also acts as a d-c restorer.

Color killer  $V_{10}$  cuts off the second bandpass amplifier when a monochrome picture is received. Pentode  $V_8$  is the burst amplifier and is keyed by the flyback pulse.

There are two drawbacks to this experimental two-color tv set; first is the relatively large cabinet size due to the configuration of the two cathode ray tubes used, and, secondly, the angle of vision is narrower than conventional tv viewing because the picture, by necessity, is produced within the cabinet giving it a tunnel-like effect.

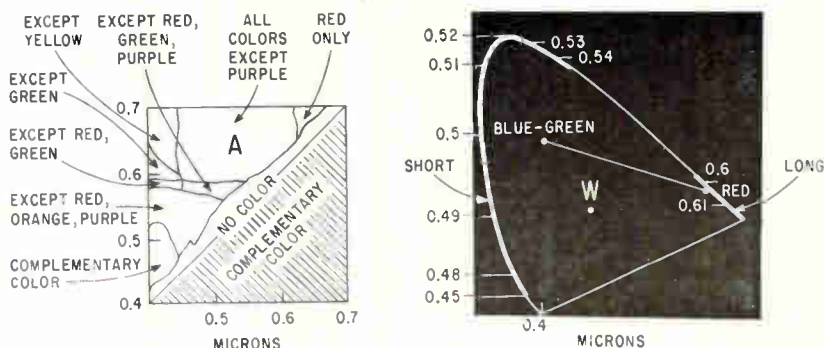
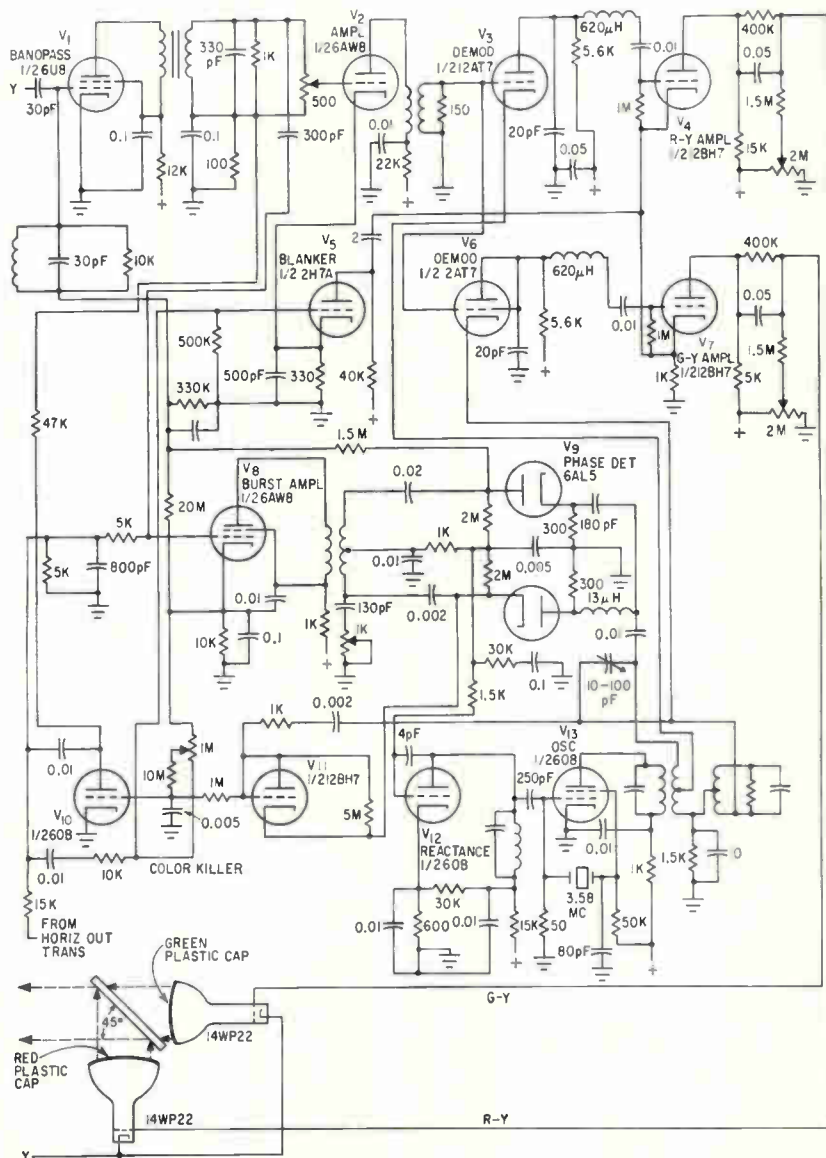

CHART SHOWS what colors can be expected from various combinations of two different colors, left, while chromaticity chart, right, of area A shows location of white—Fig. 1



CHROMATIC portion of two-color receiver accepts composite video from conventional tv set. This system detects along the red-green axis. Conventional picture tubes use colored plastic caps and picture is viewed on half-silvered mirror within cabinet—Fig. 2



# TRANSISTOR PAIR PROVIDES Constant-Current Drive

By STANLEY SOKOL

Senior Engineer, Lockheed Electronics Co.  
Industrial Technology Division  
Metuchen, New Jersey

IN A RECENT application it became necessary to provide a transistor constant-current drive to a transducer with a 60-millihenry inductance without allowing d-c current in the transducer. Since the frequency range is to be from 30 to 30,000 cps, the impedance varies between 11.3 ohms and 11.3 kilohms. Five hundred microamperes peak-to-peak is the maximum current to be supplied. This means that the maximum peak-to-peak voltage across the transducer is  $12,000 \text{ ohms} \times 0.5 \text{ ma} = 6 \text{ v}$

**SOLUTIONS**—A straightforward solution to the problem would be to drive the transducer from a common base (as in Fig. A) or common emitter stage. The trouble with this solution is that a large collector resistor  $R_c$  must be used. Since d-c current cannot be allowed to flow through the transducer, a d-c bias current of 400 to 500 microamperes would have to be supplied from the collector resistor. The output impedance from such a stage would be  $R_c$  in parallel with the output impedance of the transistor. Resistor  $R_c$  would have to

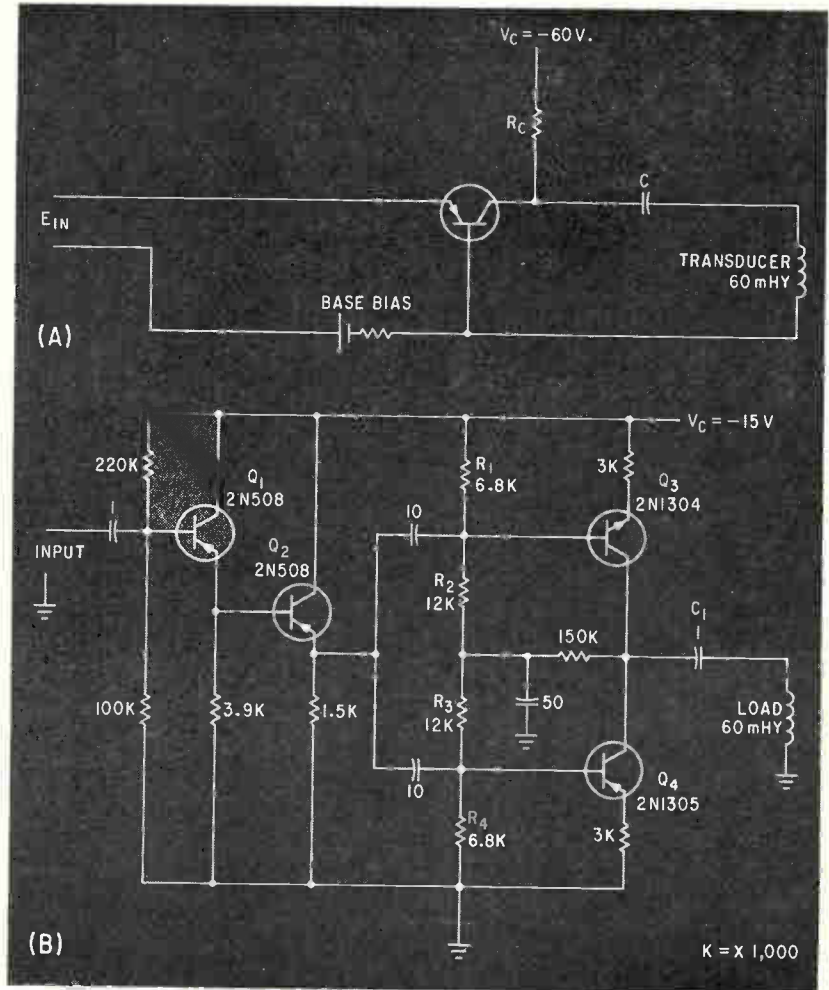

SINGLE-TRANSISTOR constant-current circuit (A) requires higher supply voltage than (B), which uses  $Q_3$ - $Q_4$  complementary-symmetry pair

## NEW APPROACH TO CONSTANT-CURRENT DRIVE

*How do you drive a 60-millihenry transducer at constant current without allowing d-c to flow in the transducer?*

*First thought might be to use a common-base or common-emitter transistor stage. But as the author points out, this approach winds up requiring a value of supply voltage that is impractical for transistor circuits.*

*The answer is to use a double emitter follower driving a complementary-symmetry pair.*

be about 10 times larger than the highest transducer impedance to approximate a constant current source. Thus collector voltage  $V_c$  would be between 48 and 60 volts, that is,  $120,000 \text{ ohms} \times 400$  or  $500 \mu\text{a}$  equals 48 or 60 volts. This is an impractical value of supply voltage for transistor circuits.

Since the supply voltage that was available was 15 volts, another approach was used. The circuit is shown in Fig. 1B.

The constant-current source is achieved here by biasing both  $Q_3$  and  $Q_4$  on all the time so that each transistor ( $Q_3$  and  $Q_4$ ) acts as the

collector resistance for the other. Bias current through the symmetrical pair can be set to  $500 \mu\text{a}$  with relatively little voltage across the transistors. The small signal output impedance of  $Q_3$  or  $Q_4$  remains high so that the parallel combination of the two is 500,000 ohms.

The double-emitter follower formed by  $Q_1$  and  $Q_2$  provides a very low source impedance for driving  $Q_3$  and  $Q_4$ . This low source impedance is necessary for maximum output resistance. Resistors  $R_1$  to  $R_4$  provide bias for  $Q_3$  and  $Q_4$ . Circuit output is flat within 1 db from 30 cps to 30,000 cps.

# NEW TEKTRONIX DUAL-BEAM OSCILLOSCOPE with Sweep Delay and Plug-in Versatility

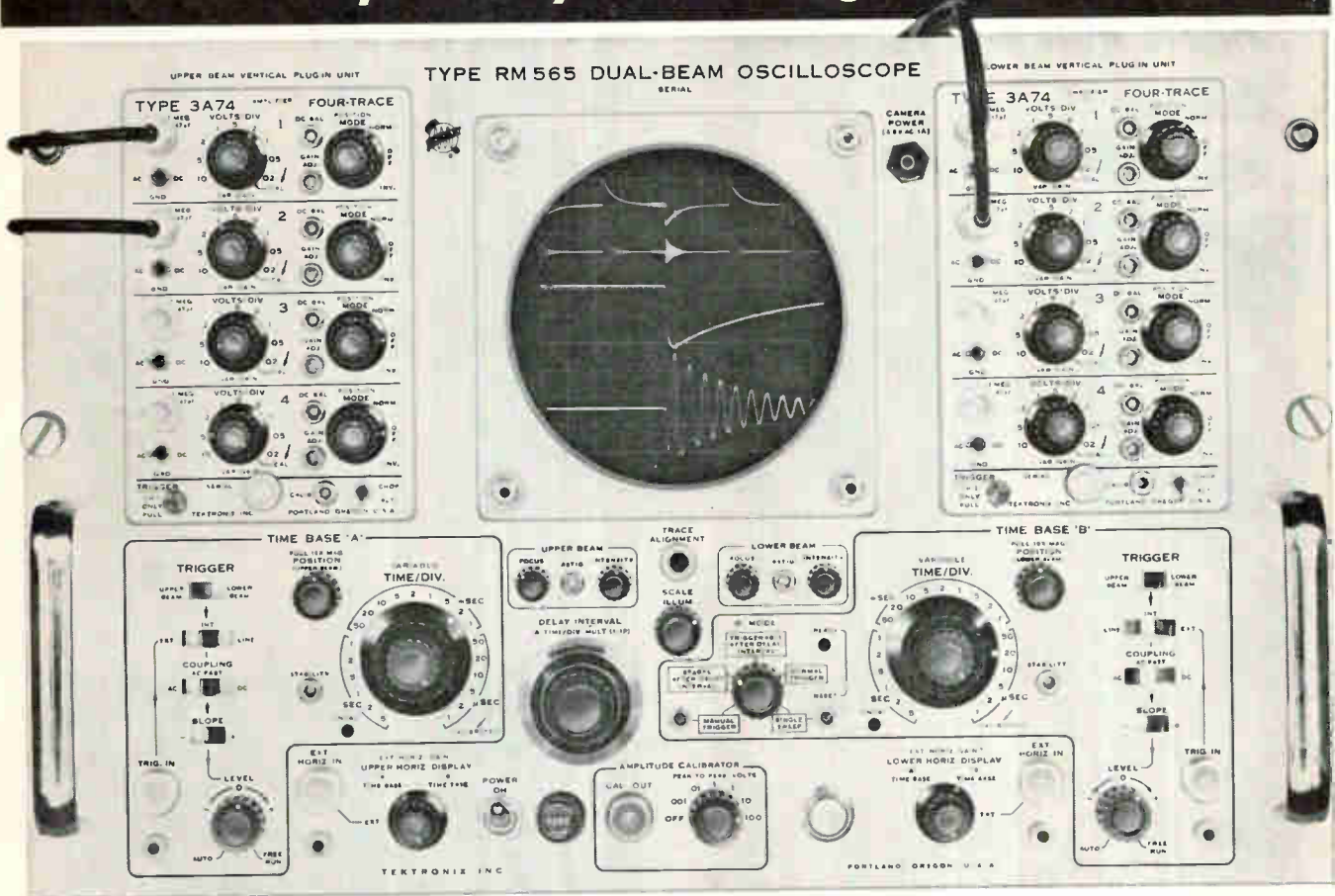

The waveform display represents four time-related functions—two trace-intensified by use of delayed sweep and two expanded presentations of these intensified portions.

Four additional traces are available from this oscilloscope/plug-in combination.

Sweep-delay characteristics include delay interval range of 1  $\mu$ sec to 50 sec, calibrated and continuously adjustable—with 0.5% incremental accuracy and wide-range, jitter-free magnification.

## PLUG-IN UNITS

AMPLIFIER UNITS TYPE	PASSBAND (3-db down)	SENSITIVITY	PRICE
2A60	dc—1 Mc.	50 mv/cm—50 v/cm 4 decade steps with variable control	\$105
2A63—Differential (50:1 rejection ratio)	dc—300 kc.	1 mv/cm—20 v/cm 1-2-5 sequence with variable control	\$150
3A1—Dual Trace (Identical Channels)	dc—10 Mc. (each channel) 6-cm linear scan.	10 mv/cm—10 v/cm 1-2-5 sequence with variable control.	\$410
3A72—Dual Trace (Identical Channels)	dc—650 kc. (each channel)	10 mv/cm—20 v/cm 1-2-5 sequence with variable control.	\$250
3A74—Four Trace (Identical Channels)	dc—2 Mc. (each channel)	20 mv/cm—10 v/cm 1-2-5 sequence with variable control.	\$550
3A75—Wide Band	dc—4 Mc.	50 mv/cm—20 v/cm 1-2-5 sequence with variable control.	\$175

- 2 Completely Independent Beams
- 2 Identical Independent Sweep Systems
- 2 Vertical Amplifier Compartments
- Delayed-Sweep Operation
- Single-Sweep Operation
- Rear-Panel Output Connectors
- Rack-Mount or Cabinet Model

Rack-Mount Model, illustrated.

(Mounts on tilt-lock, slide-out tracks to standard 19" rack.)

Dimensions—12 $\frac{1}{4}$ " high by 19" wide by 22" deep.

Weight—67 pounds.

Type RM565 Oscilloscope (without plug-ins) . . . . . \$1500

Cabinet Model

Dimensions—13 $\frac{1}{2}$ " high by 17" wide by 23 $\frac{3}{8}$ " deep.

Weight—62 pounds.

Type 565 Oscilloscope (without plug-ins) . . . . . \$1400

U.S. Sales Prices l.o.b. Beaverton, Oregon

**For more information on either model of this versatile new dual-beam oscilloscope, please call your Tektronix Field Engineer.**

**Tektronix, Inc.** P. O. BOX 500 · BEAVERTON, OREGON / Mitchell 4-0161 · TWX—503-291-6805 · Cable: TEKTRONIX

TEKTRONIX FIELD OFFICES are located in principal cities throughout the United States. Please consult your Telephone Directory.

TEKTRONIX CANADA LTD: Montreal, Quebec · Toronto (Willowdale) Ontario.

TEKTRONIX OVERSEAS DISTRIBUTORS: Renton Hawaii Ltd., Honolulu, Hawaii. Tektronix is represented in twenty-seven overseas countries by qualified engineering organizations. European countries and the country of Lebanon, please contact TEKTRONIX INTERNATIONAL A.G., Terrassenweg 1A, Zug, Switzerland, for the name of your local overseas distributor. Other Overseas areas, please write or cable directly to Tektronix, Inc., International Marketing Department, P. O. Box 500, Beaverton, Oregon, U.S.A. Cable: TEKTRONIX.



HIGH PERFORMANCE  
STORY FROM UNGAR

## 950° Temperatures from Light-weight, 40 Watt Imperial® Soldering Iron

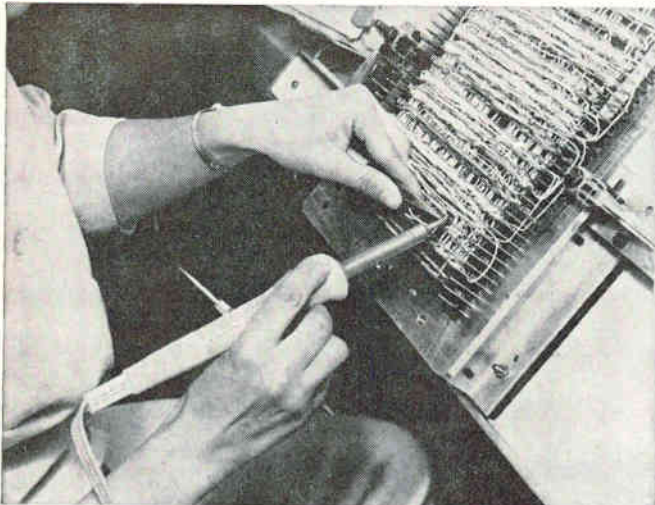

Operator using the Imperial with 40-watt cartridge and #6319 iron clad, gold plated chisel tip.

The Ungar IMPERIAL soldering Iron provides an ideal combination of performance benefits for production soldering requirements—low wattages, high tip temperatures and excellent heat recovery for continuous operation.

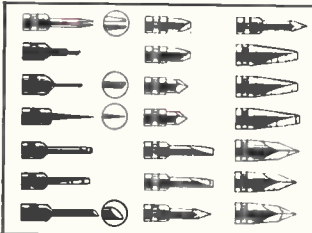

Microminiature diodes or heavy-duty lugs—there's an Imperial tip designed for the job.

Production engineers report IMPERIAL high tip temperatures assure rapid and continuous multi-terminal soldering without danger of radiation damage to sensitive components and circuit boards.

Cost-conscious production line supervisors

have discovered unmatched operating economies with the new IMPERIAL low wattage, high-heat cartridges.

The Ungar IMPERIAL line offers many other significant benefits to production line users. Lightweight and fatigue-free, cool pastel-colored handles and completely interchangeable parts make the IMPERIAL the most versatile iron in use today. Stringent quality control in manufacture assures unmatched reliability. Write for illustrated brochure.

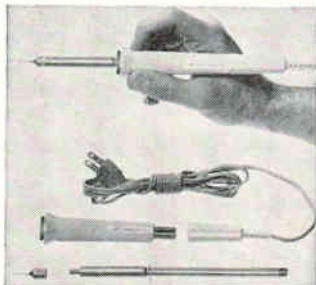

Parts are interchangeable in a matter of seconds at the bench...and without tools.

### UNGAR ELECTRIC TOOLS

Electronic Division of Eldon Industries, Inc.

1475 E. El Segundo Blvd., Hawthorne, California

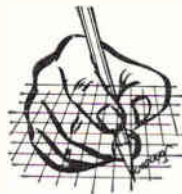

## Time after time engineers specify Johnson connectors!

Whatever the choice . . . sub-miniature nylon connectors for printed circuit use—or Johnson's patented "Six-Way" Binding Post . . . time and time again design and development engineers specify Johnson connectors!

A complete line of nylon and standard connectors, are readily available to meet most military and commercial applications—nylon types include: sub-miniatures for printed circuit applications; insulated solderless tip and banana plugs; tip and banana jacks; tip jack and sleeve assemblies; metal-clad and "rapid-mount" tip jacks; dual banana plugs and a unique, "6-way" binding post. Available in 13 colors for coded applications, nylon connectors are designed to operate throughout an extremely wide temperature range and under conditions of high relative humidity—voltage breakdowns available up to 11,000 volts on some types! For detailed information on the complete Johnson connector line and other Johnson electronic components—write today for our newest components catalog!



**E. F. JOHNSON COMPANY**

2820 TENTH AVENUE S.W. • WASECA, MINN.

# NYLON AND STANDARD CONNECTORS

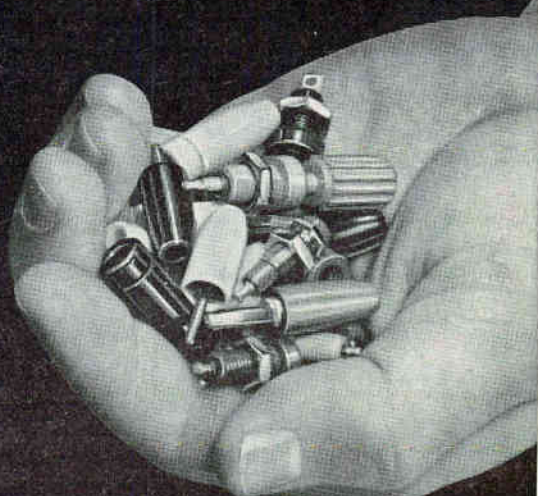

DETAILED COMPONENTS CATALOG AVAILABLE  
—Write today on company letterhead!

• CAPACITORS • TUBE SOCKETS • CONNECTORS • PILOT LIGHTS  
• INSULATORS • KNOBS AND DIALS • INDUCTORS • HARDWARE



Electric fry pan at 400°F melts solder while G-E silicone compound adheres without melting to the tilted surface.

## Even at 400°F G-E Silicone Dielectric Compound won't melt!

*(or noticeably bleed, evaporate or dry out)*



**HEAT TRANSFER MEDIA** G-E silicone dielectric compounds improve heat transfer from electronic components.



**CORROSION INHIBITORS** Silicone compounds protect against sticking, moisture, corrosive atmosphere.

General Electric silicone dielectric compounds won't melt at 400°F or solidify at -65°F. These greaselike materials have excellent dielectric properties. They are easily applied, chemically inert, non-corrosive and water repellent.

G-E silicone compounds adhere tenaciously to almost everything, without being subject to oxidation, evaporation or excessive bleed losses. A free sample tube is yours on request, to test as a corrosion inhibitor, release agent, water repellent, insulator, protective coating or heat transfer media. Ask for SS-4067 (general purpose), SS-1005 (meets MIL-1-8660), or SS-4006 (inhibits copper oxidation). Write on your letterhead, describing your proposed application, to Section N978, Silicone Products Department, General Electric Company, Waterford, New York.

**G-E silicone insulating products available from these distributors:** San Francisco, Electrical Specialty Co., 158 11th St.; Chicago, Federal Insulation Co., 549 W. Randolph; Detroit, Insulation & Copper Sales, 15605 Woodrow Wilson; Floral Park, N.Y., Punt, Inc., 160 Woodbine Ct.; Philadelphia, Smith of Phila., 1024 Race St.; Chagrin Falls, Ohio, Electrolock, Inc., 28 N. Main.

**GENERAL**  **ELECTRIC**



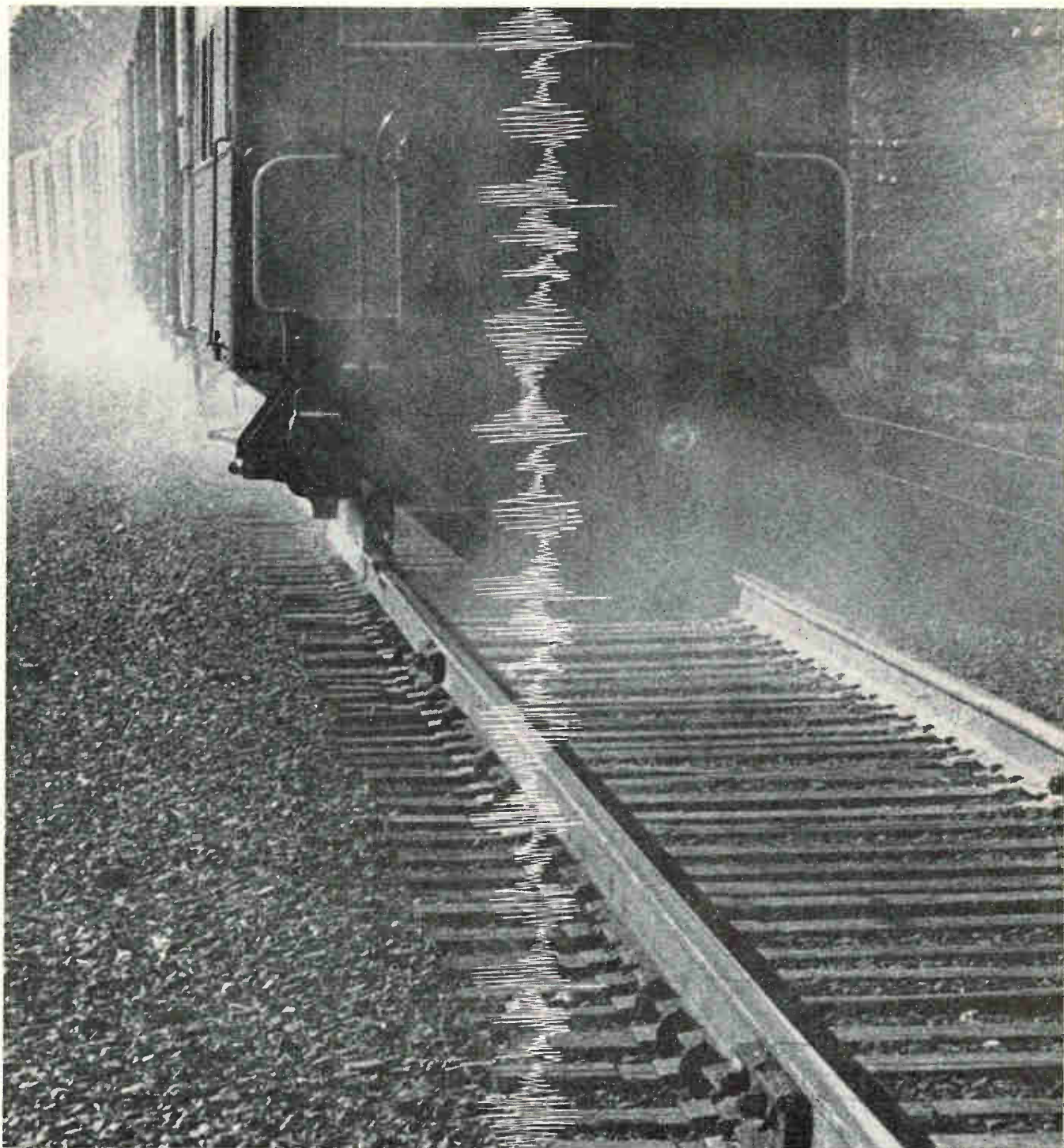

What can ride the rails and still record with laboratory precision? **AMPEX CP-100.**

What a life the CP-100 recorder leads. It even gets shock-mounted in a train to measure the flatness of the roadbed. And never a change in its true instrumentation quality performance. In fact, you'll find the CP-100 right at home in a down-range test van, nuclear submarine—or a clinical laboratory. (It can be rack-mounted.) It provides Direct, FM-Carrier and PDM recording. Is easily accessible: the entire

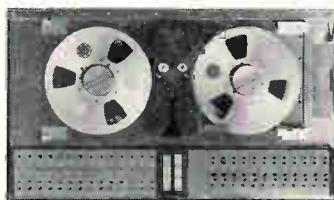

transport assembly lifts up. And it operates on almost any standard source of power, including batteries. The CP-100 is perfect any time, anywhere you need a reliable precise portable. For more data write the only company providing recorders and tape for every application: Ampex Corporation, 934 Charter Street, in Redwood City, California. Sales and service engineers throughout the world.

*Mindpower and Manpower...  
shaping the future in*

## **INTEGRATED CIRCUIT APPLICATIONS**

**SCIENTISTS AND ENGINEERS:** Today Motorola is pacing a scientific revolution in electronics with a disciplined approach to integrated circuit applications. Under the personal leadership of Dr. Daniel E. Noble, the men of the Military Electronics Division are synthesizing the process technology and device design capabilities of Motorola's Semiconductor Products and Solid State Systems Division with military and space requirements. This coordinated effort, unique in the electronics industry, is yielding a new breed of reliable integrated circuit devices resulting from Motorola's broad range of jointly funded contracts with each of the three services, JPL/NASA and other government agencies. To implement programs such as these, marrying the frontier processing techniques of diffusion, epitaxial growth, electronic ceramics and thin films to practical electronic hardware applications, we can offer immediate opportunities to both systems and equipment design engineers experienced in the following areas:

Specification of design constraints imposed by integrated circuits, trade-off analyses for integrated electronic implementation, and electronic systems specification and optimization. Micro-miniature transistor circuit design, special solid state and semiconductor device utilization, computer-aided circuit design, and subminiature packaging techniques, including thermal considerations or basic training in the solid state sciences.

We are particularly interested in programs from which your experience was obtained and the extent of your technical responsibility.

Please address detailed information to our Manager of Engineering at the location of your choice for immediate and confidential attention.

*An equal opportunity employer*



**MOTOROLA**

### **Military Electronics Division**

SCOTTSDALE, Arizona, 8201 E. McDowell Road

CHICAGO 51, Illinois, 1450 N. Cicero Ave. / RIVERSIDE, California, 8330 Indiana Ave.





# Modulation Technique Combats Impulse Noise

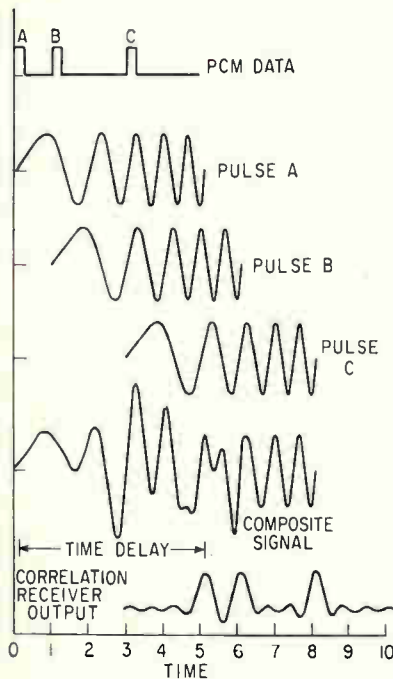

FREQUENCY sweeps started each time pulse is to be transmitted are superimposed to form composite signal—Fig. 1

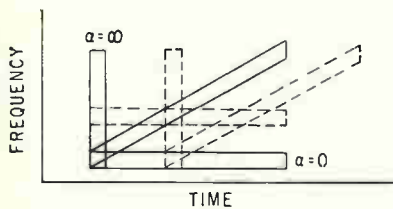

RELATIONSHIP between frequency and time indicates potential effectiveness against noise—Fig. 2

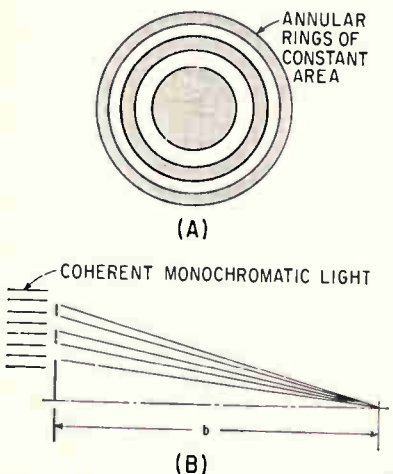

DENSITIES of rings in Fresnel zone plate vary sinusoidally and coherent monochromatic light through plate shown in edge view (B) comes to focus—Fig. 3

*Performance is improved without increasing average power or bandwidth*

SWEPT-FREQUENCY modulation can reduce impulse noise effects on communications systems. The technique can be used singly or with other methods for combating noise, and it can be applied to a variety of communications systems. The concept of swept-frequency modulation (SFM) was reported by J. C. Dute, Institute of Science and Technology, University of Michigan, where it is being investigated under Air Force contract.

SFM does not require additional average power or increased bandwidth, although there is a fixed time delay. The effect of the technique is to spread the energy of impulse noise over a longer time. In the laboratory SFM system, an optical matched filter that can integrate over long periods of time is used to recover the original signal.

OPERATION—The principle of SFM can be most readily understood when it is applied to pulse-code modulation systems, although it can be used with other communications techniques. Errors occur in PCM systems when instantaneous noise amplitude is comparable to pulse detection level or when sufficient noise exists in the negative sense to destroy a signal pulse.

In the simplest form of SFM, a linear frequency sweep is started each time a pulse is to be transmitted. This constant-amplitude, f-m signal is long compared to the noise impulse so that only a small part of the r-f signal is disturbed by the noise. The remainder of the signal can then be reconstructed at the receiver using coherent detection.

Duration of each frequency sweep can be longer than the period between data pulses, and the trans-

mitted signal at a given instant can consist of many such waveforms superimposed, as in Fig. 1.

Expected performance is indicated in Fig. 2, where  $\alpha$  is the time rate of change in frequency for an individual pulse. When  $\alpha$  is small, signal bandwidth is relatively narrow. Data rate can be increased by adding channels, as with frequency-division multiplex. Large values of  $\alpha$  correspond to time-division multiplex. Thus the two methods of multiplexing represent the limiting cases of SFM.

When  $\alpha$  is large, c-w noise does not seriously affect the system because signal and noise occupy little bandwidth in common, and effectiveness against wideband noise is relatively limited. If  $\alpha$  is small, defense is good against wideband noise but poor against c-w noise. Thus  $\alpha$  should be chosen in accordance with the type noise present.

OPTICAL FILTER—To recover the original pulse data, the equivalent of a band-limited, phase-correcting filter is used. Understanding operation of the coherent optical processor requires a knowledge of the diffractive effects of Fresnel zone plates and diffraction gratings when illuminated by coherent monochromatic light.

The rings of the Fresnel zone plate in Fig. 3A are shown clear and opaque, although densities actually vary sinusoidally. The relations developed hold only in the sinusoidal case, which includes square-wave first-harmonic response.

Light from the left of the zone plate in the edge view in Fig. 3B focuses at a distance  $b$  determined by wavelength and ring spacing. Thus the plate acts as a lens.

Transmission characteristics of a film strip density modulated by a linearly swept f-m signal closely resemble those of a radial line segment through a Fresnel zone plate,



# INTERLOCK SAFETY SWITCHES

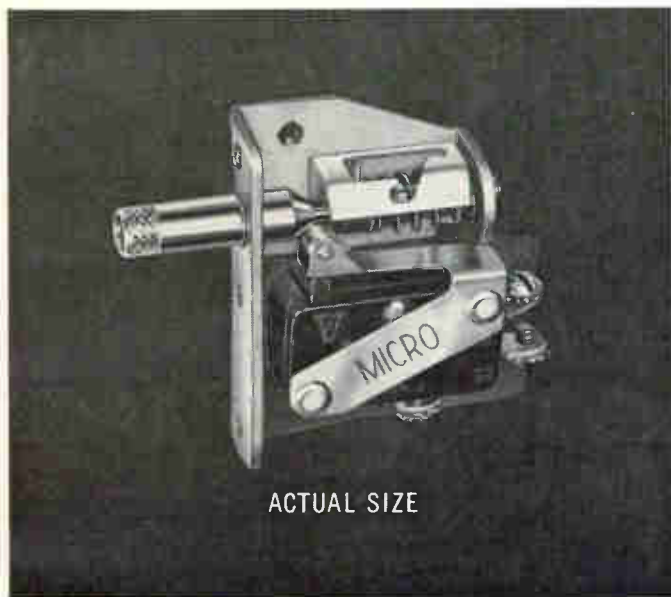

ACTUAL SIZE

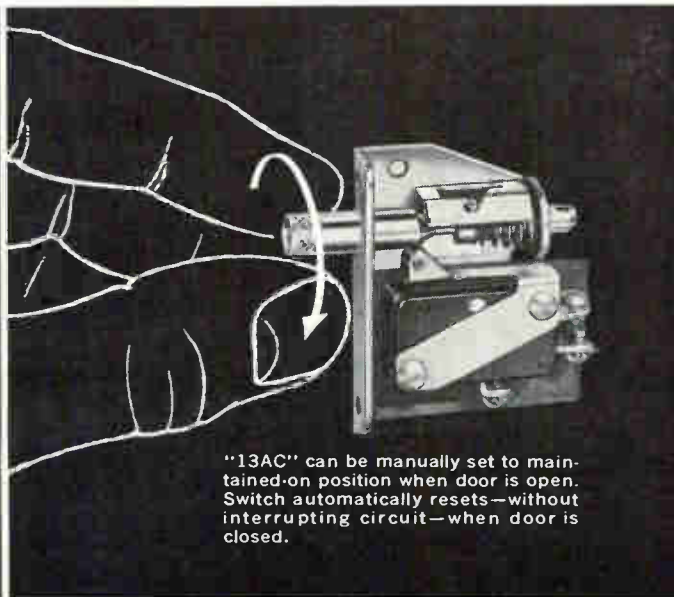

"13AC" can be manually set to maintained-on position when door is open. Switch automatically resets—without interrupting circuit—when door is closed.

## Reliable Protection on Doors or Drawers of Electronic Equipment Consoles and Cabinets

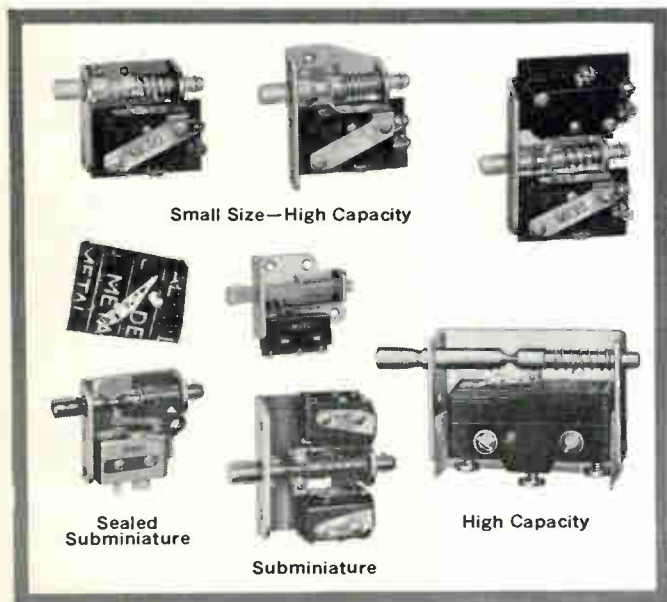

Small Size—High Capacity

Sealed Subminiature

Subminiature

High Capacity

MICRO SWITCH interlock switches automatically break the power circuit when doors or drawers are opened. The plunger can be manually depressed and locked-in, however, to energize the circuit for testing or checking, thus eliminating the use of dangerous jumpers or tie-downs. When the door is closed, normal operation is resumed.

Give your personnel and equipment the protection that has proved itself through the years on thousands of applications. MICRO SWITCH interlocks include sealed environment-proof and high temperature designs, subminiature and multi-circuit assemblies—your choice of more than 150 different interlock switches.

Send for Data Sheet 186 which gives more complete information or see the Yellow Pages for the nearest MICRO SWITCH Branch Office.



**MICRO SWITCH**

FREEPORT, ILLINOIS

A DIVISION OF HONEYWELL

IN CANADA: HONEYWELL CONTROLS LIMITED, TORONTO 17, ONTARIO

HONEYWELL INTERNATIONAL SALES AND SERVICE OFFICES IN ALL PRINCIPAL CITIES OF THE WORLD. MANUFACTURING IN UNITED STATES, UNITED KINGDOM, CANADA, NETHERLANDS, GERMANY, FRANCE, JAPAN.



# INSTRUMENT SERVOS

for measurement, remote display, data conversion, control, computation

North Atlantic's Series 7000 and 8000 Instrument Servos are designed to meet exacting requirements in airborne, ground support and industrial applications. Types available to accommodate most input signals, and providing a wide range of visual, shaft position and signal outputs.

**SBI-8050**  
SYNCHRO INPUT  
SELF BALANCING  
INDICATOR



**SBI-8000**  
SERVO RATIOMETER  
HERMETICALLY  
SEALED

**SBI-8020**  
COUNTER OUTPUT  
SELF BALANCING  
INDICATOR



**SBI-7000**  
DC SERVO  
RATIOMETER

MODEL	OUTPUT	ACCURACY (% full scale)
SBI-7000	single pointer dial	$\pm 0.2\%$ to $\pm 0.5\%$
	linear dial, single pointer	$\pm 0.2\%$ to $\pm 0.5\%$ f.s. numerator
SBI-7070	dual pointer, coarse and 10:1 vernier	$\pm 0.1\%$
SBI-8000	single or dual pointer, counter-pointer	$\pm 0.1\%$ to $\pm 0.5\%$
SBI-7080	counter or counter-pointer	$\pm 0.1\%$ to $\pm 0.5\%$
SBI-7090	digital encoder	$\pm 0.1\%$
SBI-8010	1/8" dia. shaft	$\pm 0.1\%$ to $\pm 0.5\%$ with 15 oz. in. load
SBI-8020	0.999 decimal counter	$\pm 0.05\%$ to $\pm 0.1\%$
SBI-8050	pointer and subdial vernier	$\pm 0.05\%$ to $\pm 0.1\%$

Specifications are for typical production models.

For complete data request SFC-1



**NORTH ATLANTIC**  
industries, inc.  
TERMINAL DRIVE, PLAINVIEW, L.I., NEW YORK  
Telephone: OVerbrook 1-8600

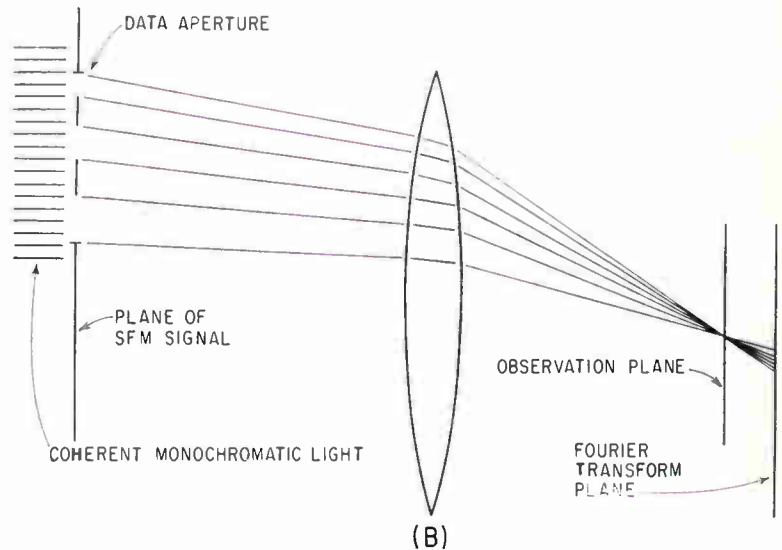
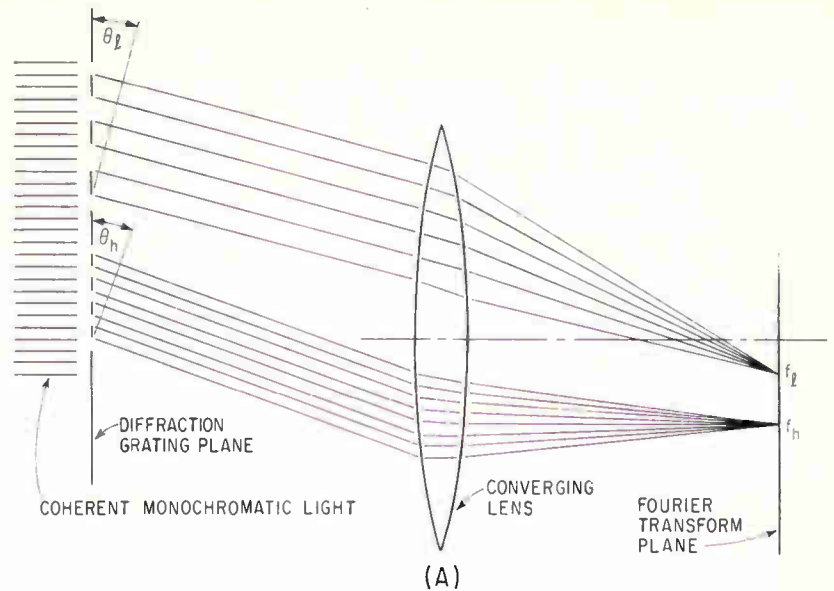

DIFFRACTION grating (A) deflects light at angle determined by slit spacing and width. In composite configuration (B), energy focuses at observation plane—Fig. 4

and the film can be used as a lens.

The diffraction grating in Fig. 4A has many equally spaced, equal-width parallel slits. Coherent monochromatic light illuminating the grating is deflected through angle  $\theta_h$ . Introducing a lens as shown focuses the light at  $f_h$ . Such a grating can be formed by modulating film density with a c-w signal. If slit spacing and width were increased to correspond to a lower frequency, light would be deflected through angle  $\theta_i$ , pass through the lens and focus at  $f_i$ .

Energy of the spectral components from the diffraction grating focuses in the Fourier transform plane, which includes  $f_h$  and  $f_i$ . Regardless of the spacial position of an input signal frequency compo-

nent, its energy always focuses in the Fourier transform plane. Thus a filter can be made by placing a photocell to the right of the transform plane and providing an aperture of a size commensurate with desired bandwidth.

The linearly swept, f-m representation of the original signal can be placed at the data aperture as in Fig. 4B. The Fourier transform of the signal, as modified by the data aperture, is distributed across the Fourier transform plane, but it also focuses sharply at the observation plane. This focusing occurs because the Fresnel zone acts as a lens converging the light, and the light passing through a second lens accentuates the convergence.

When the SFM signal fills the

All-solid-state IF strip of the new  
NEC 7GD-600 Tr system.

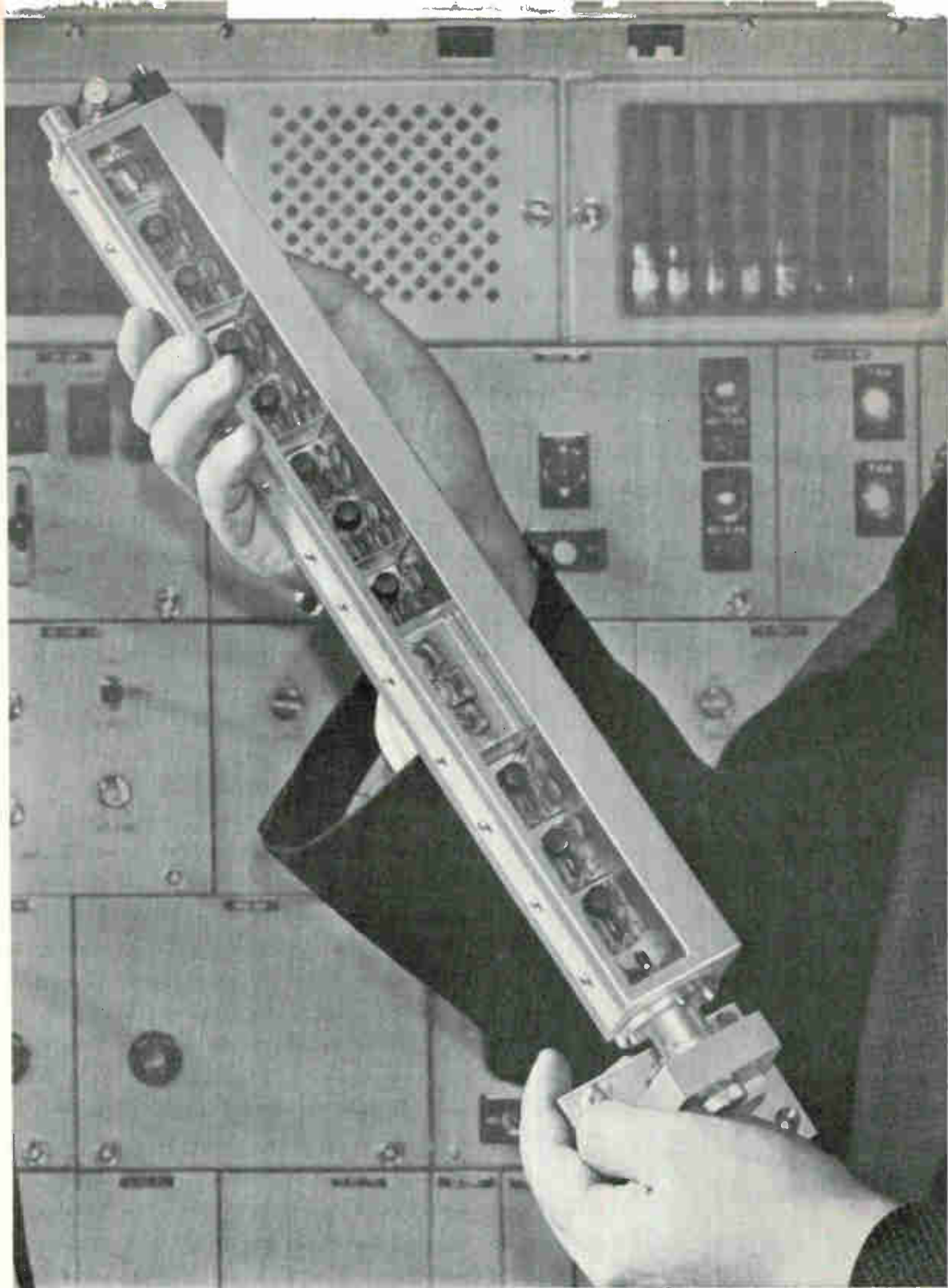

**Microwave:**

## State of the art at NEC

Ultimately, the state of any electronic art can only be judged by the performance of the hardware it produces. Japan today has the highest density of high-performance microwave communication networks in the world. And, over 90% of the publicly-owned systems were built by NEC. To date, NEC has supplied 3875 microwave bays for a total of 2,000,000 channel miles. The latest NEC systems being produced, such as the 7GD-600Tr shown, are completely transistorized except for the microwave tubes. Any way you look at it—frequency coverage, channel capacity, or technical design—NEC covers the microwave spectrum with advanced capability. For microwave multiplex communication systems from 800 to 14,000 megacycles, capacities up to 2400 voice channels, and the most advanced designs in line-of-sight and O/H systems employing vacuum-tube or ultra-compact solid-state approaches, check the state of the art at NEC. This advanced NEC microwave equipment is distributed and sold in the United States by ITT.

Affiliate of  
**ITT**

 Electronics / Communications

***Nippon Electric Co., Ltd.***

P.O. Box 1, Takanawa, Tokyo, Japan

**CIRCLE 65 ON READER SERVICE CARD**



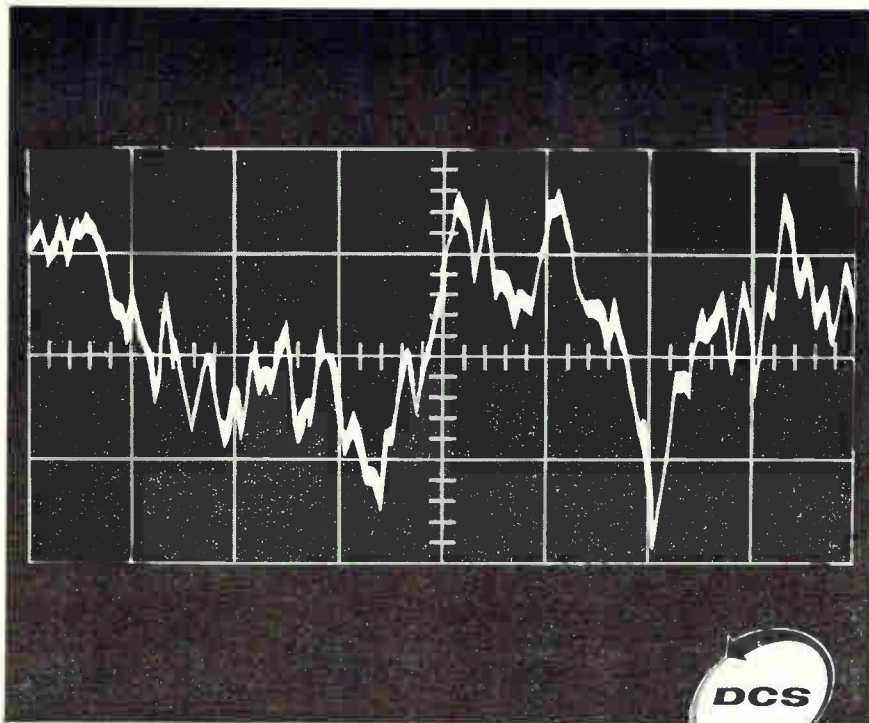

## How do you tell the bits from the noise?

If your PCM ground station is going to work right, you've got to get those PCM bits out of the noise. But, just consider what you face when you try to design hardware to do the job:

First you've got to make a clock—to define the intervals for the bit detector. You figure that maybe a phase lock loop is the answer. A special, unconventional phase lock loop with a long coast time—yet, one with a short acquisition time.

Then, since your bit rate may be low, you build in some DC restoration. You consider the noise from the recorder and anticipate that it may be subtractive in nature, rather than the normal, gaussian type of white noise. So, the equipment must be designed with this in mind. You try non-linear filtering—and happily, your signal/noise ratio seems to improve.

Suppose now you find your recorded square waves are really not so square. On the other hand, these soggy pulses may be all you have. Here, you're in luck, since your phase lock loop accepts some pretty miserable stuff.

Next, you try an integrate-and-dump technique to detect the bits and reject noise components. And you get as much as 2:1 improvement. Then you wonder what codes will be used. To be safe, you build in converters to handle *all* the most popular codes, including Manchester (split-phase).

Sound complicated? It is. Yet, DCS has done it! We've built the equipment (we call it the GPS-4 Synchronizer)—have supplied it to satisfied customers—and are ready to demonstrate it to you.



Contact your nearest DCS branch or call or write us in Danbury. Address: Dept. E-2-6

**DATA-CONTROL SYSTEMS, INC.**  
*Instrumentation for Research*

Los Angeles • Santa Clara • Wash., D. C. • Cape Canaveral  
Home Office: E. Liberty St., Danbury, Conn. • Pioneer 3-9241



aperture, energy distribution across the observation plane is of the form  $(\sin x_2/x)$ . Only for this condition is the matched-filter output of a linearly swept f-m signal the same as a dispersed-only system.

In practice, a d-c information term is avoided because a d-c bias term is added to the film to hold no-signal density midway in its exposure range to record sinusoidal waveforms.

Noise not having the Fresnel zone plate focusing effects of the SFM signals tends to spread uniformly over the detection plane, and a detector sees only the  $(\sin x_2/x)$  distribution of signal power. Noise is the power sum of white Gaussian noise and impulse noise spread so it resembles white Gaussian noise.

### Paramp Pump Frequency Is Lower Than Signal

FREQUENCIES of the pump sources for new type parametric amplifiers are lower than the signal to be amplified. The devices are expected to provide the low-noise characteristics of conventional parametric amplifiers at frequencies of 20 Gc and higher. The increasing cost, size and complexity of the pump sources that would normally be required at higher frequencies is avoided.

The concept for the new parametric amplifiers was investigated and experimentally verified at Laboratory for Electronics, Inc. Operation is based on the use of additional idlers, contrasted with the single idler tank used in conventional nondegenerate parametric amplifiers. The result is that amplification is achieved with the signal being the highest frequency, including internal and pump frequencies.

A parametric amplifier was constructed to verify the theory, which operated at 10 Gc and used a 7.2-Gc pump frequency. Another model is being constructed for a signal frequency of 13.3 Gc and a pump frequency of 9.6 Gc. Basic hardware for both prototypes is conventional coaxial waveguide, pump source, bandpass filters and two or more cavities. Amplification of a 13.3-Gc signal using a 5.6-Gc pump frequency is also planned.

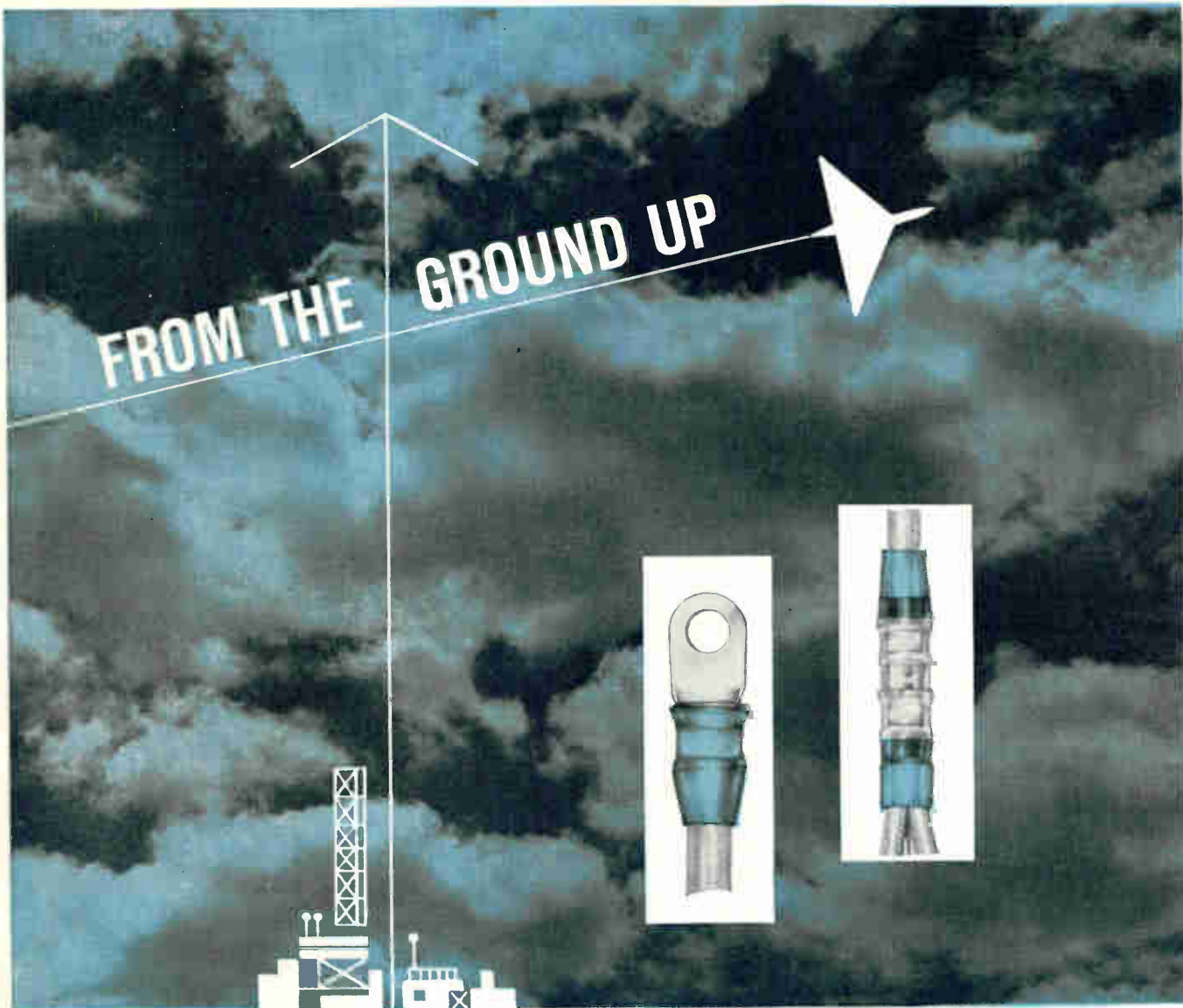

## USE AMP TERMINYL\* *terminals and splices*

From the ground control and communications complexes, to the fastest and highest flying aircraft, today's engineers are faced with the big problem of big wire terminating and splicing. AMP's line of TERMINYL\* big wire (8 to 4/0 AWG) terminals and splices have been engineered to provide the highest degree of reliability for both military and commercial applications, on the ground and in the air. AMP's solderless termination technique makes possible identical and extremely reliable connections . . . possible only thru AMP's matched tool-to-terminal philosophy of crimping. A color coded nylon sleeve provides pre-insulation and long service at temperatures up to 250°F., plus resistance to ester-based oils. The TERMINYL\* line more than meets MIL-SPEC T-7928.

- Cast insulation, with tapered entry ramp, for ease of wire insertion and snug fit over A/N type wire diameters
- Helical tongue design to secure maximum structural utility at minimum weight penalty
- Step-lok attachment of sleeve to terminal barrel, to assure proper positioning of insulation during and after its assembly to the wire
- Splice designs are available in single to single, single to multiple and multiple to multiple wire accommodations.

Write for further information today.

# AMP

INCORPORATED  
Harrisburg, Pennsylvania

AMP products and engineering assistance are available through subsidiary companies in: Australia • Canada • England • France • Holland • Italy • Japan • Mexico • West Germany

\*Trademark of AMP INCORPORATED



# Analyzing Potentiometer Requirements

*Trouble can be avoided by specifying failure limits or allowable degradations*

MAJOR performance specifications now available for precision potentiometers were discussed by Helipot's chief engineer L. T. Peart. Talk was given at a recent meeting of the Precision Potentiometers Manufacturers' Association.

Gist of talk: Both manufacturers and users should understand state-of-the-art limitation of all types. If these limitations are insurmountable, systems must be developed to complement present devices.

Many customers are out looking for contactless transducers such as photoconductive pots, differential transformers, electrical resolvers and nonwirewound precision pots of conductive plastic, cermet, thin metal films, and carbon films. All of these have their proper usage niche, but also their limitations, according to speaker. Some manufacturers who conclude that the general-purpose precision wirewound pot is here for some time to come, are attempting to design around their limitation areas.

**NEW PROGRAMS**—What are the manufacturers doing? Several

things, according to Peart. Added emphasis on R & D, and improvements in quality and service include new programs with wire manufacturers, precious metal alloyers, with continued participation in technological materials advances made by many vendors.

Capabilities are expanded to include pot packages, and design of special purpose units such as infinite resolution wirewounds, a-c pots and motor pots. Research and development is being carried on in contactless transducers and non-wirewound pots.

A reliability survey among the Potentiometer Association's members has highlighted some of the major state-of-the-art limitations, with future effort to be expended on solutions. Projects are now underway to develop and publish standard industry practices for inspection and testing of precision pots.

**USE OF SPECS**—With the myriad of military specs available which can be associated with the potentiometer, it is easy to see why requirements are often misspecified, according to Peart. Of the list given in Table, the first two, MIL-R-12934B and MIL-STD-202B, most closely represent requirements of

the component user. A common misuse is to specify the potentiometer to meet the environmental testing specifications without specifying the failure limits or allowable degradations. If unique or extremely severe requirements are forseen by the equipment designer, these requirements should be spelled out in terms of component function, not the final equipment function.

It is important to understand the relationship of the military environmental specifications to actual operating environments. At best, they can be a guide to the many possible combinations of environment actually encountered.

Suggestions were given for reducing or eliminating customer-created limitations. For example, a potential user may specify "linearity of  $\pm 0.15$  percent". There are at least a half dozen linearity definitions. Which one is required— independent, terminal based, absolute, zero based?

Circuit designers may specify "electrical rotation 350 degrees." What is the tolerance? Is overtravel permitted? Is this a theoretical angle for absolute linearity? Are resistances or voltages important?

User may specify a control outline drawing, but fail to indicate type of bearings required or other criteria enabling manufacturer to provide proper mounting. Requirements may be overspecified or misspecified. A recent survey by the Precision Potentiometer Manufacturers' Association listed opens caused by excessive current through the tap wire, attributed to customer handling, as one of the most serious failures.

**WIREWOUND POTS**—Initial wire linearities of 0.005 percent are commonly met, however this is just the beginning of a long list of factors required to achieve the ever-needed linearity improvement; contact design, coil lubricants, proper bearings, are only a few. Peart pointed out a list of some 16 other factors

## SPECIFICATIONS CITED FOR POTENTIOMETERS

Spec. No.	Properly Designated for
MIL-R-12934B	Precision Potentiometers
MIL-STD-202B	Test Methods and Test Conditions for Environmental Requirements
MIL-R-19518	Outdated. Originally specified for Navy material. Unified services MIL-R-12934B is logical replacement
MIL-R-19A and JAN-R-19 (7)	Semiprecision Pots only
MIL-E-5400D	Aircraft Electronic Equipment
MIL-E-5272C	Environmental Testing of Aeronautical Equipment
MIL-T-5422E	Environmental Testing, Aircraft Electronic Equipment
NAS 710	Outdated. MIL-R-12934B is logical replacement

Compiled by L. T. Peart, from paper "State of the Art Limitations of Precision Wirewound Potentiometers", presented at Precision Potentiometer Manufacturers' Association, Technical Seminar, Aug. 20, 1962

# NOW ASSEMBLED BY CAPS\*

**CANNON AUTHORIZED  
PLUG SPECIALIST**

## MIL-C-26482

(latest revision)

# CANNON KPT MINIATURES



Now Cannon Authorized Plug Specialists offer you better service than ever! Cannon's MIL-C-26482 KPT Miniatures are now assembled to your specific requirements by CAPS at eleven strategic locations throughout the United States. Your orders are processed *immediately* by factory trained personnel—under rigid quality control in strict compliance with Cannon requirements. Wherever you are, you can contact a CAPS quickly...with assurance of the fastest delivery service available from the connector industry. Cannon KPT miniature bayonet-lock plugs are designed and manufactured to meet

all requirements of MIL-C-26482 and are used extensively in aircraft, missile, industrial, and commercial applications. The KPT line, completely interchangeable with *all* MIL-C-26482 bayonet-lock plugs, is provided by CAPS in nine shell sizes and types—24 layout configurations—pin arrangements of from 2 to 61 individually sealed contacts. KPT Miniatures are available from CAPS at factory prices, with cash discounts plus F.O.B. destination in most cases. Contact your nearest CAPS, or write for Cannon's Distributor Directory containing complete purchasing information, to:

\*  
Mountain View, Calif. □ Inglewood, Calif. □ North Hollywood, Calif. □ Denver, Colo. □ Dallas, Tex. □  
Chicago, Ill. □ South Bend, Ind. □ Atlanta, Ga. □ Philadelphia, Pa. □ Great Neck, L.I. N. Y. □ Mineola, L.I. N. Y.

**CANNON ELECTRIC COMPANY**, 3208 Humboldt Street, Los Angeles 31, Calif.





# MIDGET TAP SWITCH

has  
giant  
range

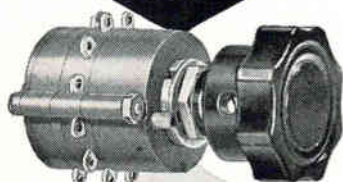

\$3.00 List

## TYPE 3A

MOLDED FROM DIALLYL PHTHALATE

Only 1" in diameter . . . weighs 30 grams . . . as many as 8 decks and up to 12 positions per deck. These are among the features of Tech Labs' new all-molded miniature Type 3A tap switch.

Designed for a wide range of military and commercial applications, this single-hole mounted switch has adjustable stops if fewer than 12 positions, single pole, or 6 positions, double pole, are required.

"Shorting" and "non-shorting" types are available and the switch can be furnished solenoid-operated and hermetically sealed.

## SPECIFICATIONS

**Size:** 1" diameter, 1¼" with terminals. First deck, 1-1/16" long. Each additional deck, ½" long.

**Weight:** First deck, 30 grams. 10 grams for each additional deck.

**Rating:** 1200 volts rms, 2000 VDC, 5 amps (carrying) 115V.

**Insulating resistance:** 100 megohms minimum at 500 volts DC.

**Life:** 1.5 - 2 million revolutions.

**Contact resistance:**

(standard) 6-10 milliohms.

(silver) 3-5 milliohms.

**Temperature range:** -65°C to 100°C.

**Mounting:** Single-hole.

Meets MIL-S-3786A



Write for details  
and prices.

PALISADES PARK, NEW JERSEY

required to achieve linearity improvement, including helixing or curving of resistance elements and various other production techniques.

Fifteen major performance specifications were summarized, among these included: operation at ambients from -65 C to 175 C with wattage deratings to zero at high extremes; linearities commonly met to 0.025 percent (0.01 percent with selection, and 0.007 percent in special multiturn units); initial noise essentially zero. (With one milliamp slider current, pots meet common requirements such as 100 ohms, 25 ohms, and 10 ohms, dependent on resistance).

Noise, after various life and environmental tests averages less than 500 ohms. Some additional random, unpredictable noise of undetermined origins is present to a lesser degree. Equivalent noise resistance consist of much high-frequency

noise, as the measuring methods specified include all energy from d-c to 50 Kc.

Actual resolution, practically never as good as theoretical resolution, can be improved by contact and coil design and processing variables. Must be specified by user if required, and can only be verified by rather expensive testing.

Two million revolutions is common expectancy figure. Sealed units or liquid-filled units are available for adverse air, gas or vacuum conditions. Unsealed units operate at 70,000 feet at 350 v. Operation range is d-c to 400 cps, special a-c pts to 20 Kc. Precision wirewound pots can take vibration to 20 G's at 2,000 cps, with 40 G's possible; and shock to 100 G's at 7 milliseconds. Relatively inexpensive components, these potentiometers are gangable; available in standardized mountings and shafts; easily installed, rugged and versatile.

## Electron Emission From Pn Junctions

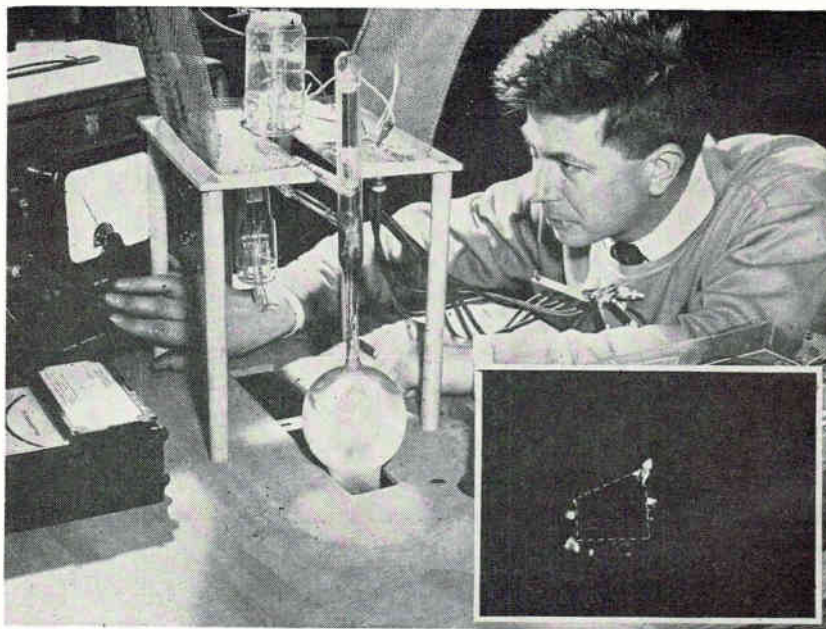

EMISSION pattern imaged on screen (inset photo)

CERTAIN DISADVANTAGES are inherent in thermionic cathodes. The construction of cathodes using reverse biased semiconductor *pn* junctions offers possible advantages. Heater power supplies would be replaced by the potentially much lower power supply for a reverse biased p-n junction and attain very high current densities.

Energetic electrons are produced by the high electric fields in a reverse biased semiconductor *pn* junction, some electrons gaining sufficient energy to be emitted into vacuum. Electron-emitting silicon and silicon carbide junctions have been investigated in the Hirst Research Centre of The General Electric Company Limited, Wembley,

# NEW RADIO TELEMETRY EQUIPMENT FROM GEL

Receivers, Transmitters, Antennas, Accessories and Complete Systems  
Designed to IRIG specifications . . .  
Available in all allocated telemetry frequencies including microwave

GEL telemetry receivers, transmitters, antennas and other radio link equipment are available for off-the-shelf delivery. GEL equipment represents the latest design featuring low-noise, high-sensitivity, high-stability, ruggedness and reliability.

In designing the receivers provisions were made for FM phase-lock detection, AM synchronous detection and predetection recording. The GEL receivers have maximum flexibility and versatility through the use of readily-replaceable plug-in tuning heads, IF strips, and band-pass filters. Transmitters are designed for maximum stability, fidelity, ruggedness and reliability.

Equipment is available qualified to latest environmental and electronic-interference specifications for satellite, missile, aircraft, shipboard and ground-based operation.

GEL's antenna experience and capability extends through all presently-allocated telemetry bands and through 50,000 mc. Complete in-house antenna capability includes the design and manufacture of radomes, reflectors, feeds, plumbing, pedestals, servo and control units, displays and complete systems.

GEL also designs and manufactures Communications, Electronic Countermeasures, Microwave, Educational and Broadcast equipment.

## GENERAL ELECTRONIC LABORATORIES, INC.

8440 Second Avenue, Silver Spring, Maryland, Phone: Area Code 301, JUUniper 8-4535, TWX: SSPG154



1700-MC Special-Purpose Ground Checkout Receiver Type 49A1. One of a series from 900 MC to 2400 MC.



2200-MC Telemetry Transmitter — Environmentally Qualified, Type 19A2.



1-11 KMC Antenna with polarization drive, azimuth and elevation control, Type 113.



30-260 MC General Purpose Receiver, Type 13B1.



1500-MC R-F Telemetry Link, Type 45A1.



215-260 MC Airborne Telemetry Receiver, Type 11F1.

See Us At Booth No. 5  
NATIONAL SYMPOSIUM ON  
SPACE ELECTRONICS AND TELEMETRY  
October 1-5 Miami, Florida

Write or contact GEL Silver Spring or:

General Electronic Laboratories, Inc., 195 Massachusetts Avenue, Cambridge 39, Mass., Area Code 617, UNiversity 4-8500, TWX: CAMB218  
• Fred Harris Associates, Suite 411, 11 W. Monument Avenue, Dayton 2, Ohio, Area Code 513, Baldwin 3-3242 • Kemco, Inc., P.O. Box 998, Irving (Dallas) Texas, Area Code 214, Blackburn 3-6703 • Kemco, Inc., 6427 East Kellog, Wichita, Kansas, Area Code 316, MUrroy 4-8224  
• Collins and Hyde Co., Benet Building, 535 Middlefield Road, Palo Alto, California, Area Code 415, Davenport 6-0647, 0649, TWX: PAL AL 113U  
• Collins and Hyde Co., 5380 Whittier Blvd., Los Angeles 22, California, Area Code 213, OVerlook 5-6540, TWX: MTB 3079U • Gentry Associates, Inc., 1851 Oak Lane, Orlando, Florida, GArden 4-0730 • Gentry Associates, Inc., 4152 49th Ave. South, St. Petersburg, Florida, ORange 1-8306 • Gentry Associates, Inc., 219 Cain Street NE, Decatur, Alabama, Area Code 205 (Huntsville) 534-9771.





U.S. Air Force photo.

## B-58's transmitter —“a kilowatt in a capsule”—uses Bristol choppers

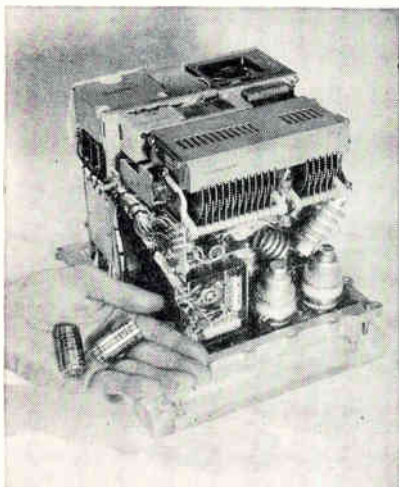

Bristol Syncroverter Chopper (in hand) and 1000-watt power amplifier unit, cover removed.

The HC-101 Communication System, HACON, designed and built for the U.S. Air Force by Hughes Aircraft Company, Culver City, California, is the world's smallest airborne 1000-watt HF Receiver-Transmitter. This small, lightweight, high-performance transceiver was made possible through the use of high-quality components, such as the Bristol Syncroverter\* Chopper.

The **Syncroverter Chopper** is used as the d-c to a-c converter in the servo tuning system of the HACON Automatic Power Amplifier and was chosen because of its compact size, light weight, low noise, and ability to perform properly under the extreme environment produced by immersion in boiling fluorochemical.

In this application, the chopper has measured up to all expectations and has passed all acceptance and qualifications tests required of it.

The **Bristol Syncroverter Chopper** is used in a tremendous variety of airborne and missile-borne equipment—including literally dozens of missile guidance systems. On these exacting applications, the Syncroverter Chopper meets the high reliability standards required.

Send for complete details. More than 200 variations are available.

**The Bristol Company, Aircraft Equipment Division, 152 Bristol Road, Waterbury 20, Conn.**

A Subsidiary of American Chain & Cable Company, Inc.



1.6

\*T. M. Reg. U. S. Pat. Off.

England. Silicon junctions were developed consisting of thin *n*-type layers on *p*-type material.

The thinness of the *n*-type layer allowed electrons to escape from the entire junction area. Silicon carbide grown junctions exhibited emission from the periphery only. This is illustrated in the inset photograph where the electron emission pattern of a silicon carbide junction has been imaged on to a fluorescent screen.

The dotted line is the outline of the silicon carbide platelet containing the junction. Currents of up to 30 microamperes have so far been obtained. While this is small, it is usable for many purposes and further technical advances should lead to devices giving greater currents.

## Gold Electrodeposit Bath for Components

A NEW acid gold-plating solution, which provides high purity gold electrodeposits (24-K) with pore-free characteristics, has been successfully tested in several different applications in the field.

The formulation, known as Englehard's E-55 Gold Cyanide, provides smooth deposits that are lustrous, highly ductile, and have a Knoop hardness of 95—100. Deposits up to several mils thickness can be produced in both still and barrel plating.

The bath is well adapted to the processing of printed circuits, contacts, connectors, diodes, transistors, switches, relays, and glass and ceramic seals. Englehard claims it has excellent stability over long periods of operation and control is relatively simple. When using the new solution, frequent pH adjustments are no longer necessary.

Cathode efficiency of the process has proved high, company says. Using the optimum operating conditions—current density of 5 amperes per square foot, temperature of 150 F., and moderate to vigorous agitation—the cathode efficiency is approximately 95 percent. At a current density of 5 amperes per square foot, a gold deposit thickness of 0.0001 inch can be obtained in seven minutes.

The new solution is suitable for the plating of various base metals.

**BRISTOL** FINE PRECISION INSTRUMENTS FOR OVER SEVENTY YEARS

# More efficient...standardized ground control cable developed with insulation of **TEFLON<sup>®</sup> 100 FEP**

The outstanding electrical, thermal and mechanical properties of Du Pont TEFLON 100 FEP resin have been used to prototype a proposed standardized configuration for ground control cable at missile launching sites. The new cable offers optimum versatility to permit standardization . . . comparable installed cost with significant advantages in weight and reduced size . . . improved reliability at ambient temperatures from -55° to 60°C., unaffected by aging, environmental conditions or chemical attack . . . and electrical properties far exceeding the requirements of MIL-C-13777.

Tests indicate that the use of primary insulation and internal jacketing of Du Pont TEFLON FEP resin permits a 20% reduction in diameter and allows a single cable to do jobs previously requiring four cables.

Sketch of the newly designed cable construction, below, shows the compact configuration made possible by the use of FEP as insulation.

If you are concerned with the design of ground support systems, consider the various advantages offered by FEP: greatly reduced electrical cross talk, reduced size and complexity of cable constructions, improved flexibility and greater reliability under difficult operating conditions.

For more information about the latest developments in wire and cable insulation utilizing Du Pont TEFLON 100 FEP resins, write to: E. I. du Pont de Nemours & Co. (Inc.), Department E-921, Room 2526 Nemours Building, Wilmington 98, Delaware. *In Canada:* Du Pont of Canada Limited, P. O. Box 660, Montreal, Quebec.

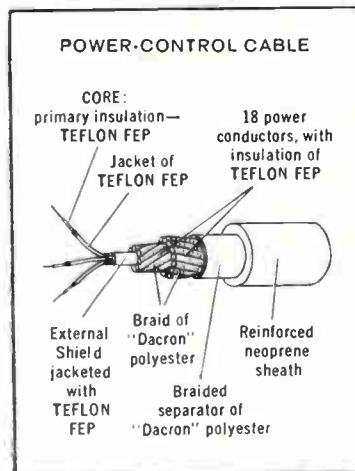

## TEFLON<sup>®</sup>

FLUOROCARBON RESINS

TEFLON is Du Pont's registered trademark for its family of fluorocarbon resins, including TFE (tetrafluoroethylene) resins and FEP (fluorinated ethylene propylene) resins.



BETTER THINGS FOR BETTER LIVING...THROUGH CHEMISTRY<sup>®</sup>





TYPICAL p-c board, ready for etching, left, and etched board with connector plug and copper eyelets added. Using p-c boards in prototype circuits has advantages where stray capacitance and crosstalk effects may influence final circuit

## Circuit Boards for R&D without Photography

*Acid resist tape forms printed-circuit patterns for prototype work*

By C. DOUGLAS RASMUSSEN  
Syracuse University Research Corp.  
Syracuse, N. Y.

THE PRINTED CIRCUIT is now the most commonly used packaging technique for electronic circuits but is usually an awkward procedure in the development of prototype circuits where much cutting and re-wiring is generally necessary. To conform with industrial techniques, especially where the prototype circuit is likely to be duplicated several times, it is advantageous for research and development to drop their usual methods of point-to-point wiring and adopt printed circuits. Also, when the breadboard conforms with the same general layout and package that will be used in the final product, proximity effects such as crosstalk and stray parameters can be accounted for in initial tests.

In our laboratory, all video circuits and portions of i-f circuits are printed on pc cards throughout development. When development is begun, circuits are laid out directly on pc boards with acid resistive

tape. After making all necessary changes and preliminary tests, the new circuit is submitted to the drafting department where photographic techniques are used to make the printed circuit for final packaging. Rolls of thin acid resistive tape and small tape circles for direct circuit layouts are available from several companies. (For example, Chart-Pac Inc., Leeds, Mass., and Techniques Inc., Englewood, N. J.) A convenient size is a  $\frac{1}{8}$  inch linewidth and  $\frac{1}{4}$  inch circles where components are connected to conductor lines. Many other sizes are available.

**INITIAL PREPARATIONS**—The pc board must first be cut to size and cleaned of all foreign material and oxidation. An ordinary drawing board with a parallel straight edge is handy for laying out the circuit. If convenient, a template for all special components should be made to insure that they will plug directly into place on the completed board. A rough pencil layout, showing where connectors, transistors, and other critical and special components will be mounted, is also helpful. The tape is then placed directly on the copper side of the pc board wherever conductor lines are needed. Lines may be curved gradually or bent where required, providing the tape is suffi-

ciently narrow. Line junctions and changes in direction may also be made by overlapping the tape at 90 degree angles. Where components are to be connected to a conductor, small tape circles are superimposed over the tape lines. Copper eyelets will be mounted in small holes within these circles after the board has been etched.

After the circuit has been laid out and checked, precautions must be taken to insure that the tape lines and circles lay perfectly flat on the board. If this is not done, the acid used in etching will undercut the circuit and may cause discontinuities in the desired conductor.

Special care is required where conductor lines are bent and where they overlap. These portions can be pressed firmly into place with a blunt instrument, such as a screw driver, and the entire board surface should be rolled flat with a small, smooth roller.

**ETCHING**—Etching can be accomplished with several different chemicals such as ferric chloride, ammonium persulfate and chromic acids. When tape resist is used, the etching process becomes much more critical than when the normal photographic resist is used.

An inexpensive, easy to use, etching solution consists of 50 percent

# NOW! from **SAGE**



A new **LOW**  
in miniature size  
A new **HIGH**  
in reliable performance

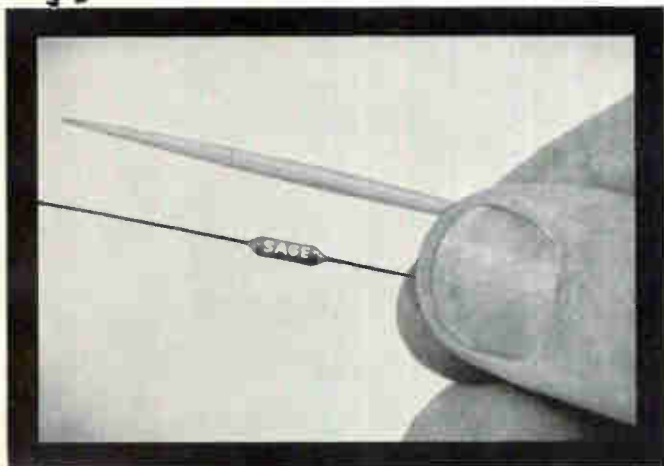

## 1050S 1/2 WATT RESISTOR

Body diameter matches that of an ordinary toothpick, yet this newest addition to SAGE's Type S line is every bit a precision power resistor.

**PRECISION:** Standard tolerance 1%, ranging down to .05%; temperature coefficient  $\pm 20$  ppm/ $^{\circ}\text{C}$ ; 1000 hour load life stability typically is well below .5%.

**POWER:** Rated a conservative 1/2 watt at 25 $^{\circ}\text{C}$ , style 1050S actually can be operated at a full watt, with but slight additional allowance for resistance shift. Construction is non-insulated wire, single layer space wound on a ceramic core. Electrical current path is fully welded and coating is SAGE's exclusive IMPERVOHM silicone resin, long proven for temperature extremes -65 $^{\circ}\text{C}$  to +350 $^{\circ}\text{C}$ .

**OTHER FEATURES:** Standard range .05 $\Omega$  to 4500 $\Omega$ ; non-inductive values to 700 $\Omega$ ; weldable leads on special order; though smaller than MIL body styles, 1050S exceeds essential performance requirements of both MIL-R-26C and MIL-R-93C.



Write Today for test data  
and additional performance details.

# SAGE

**SAGE ELECTRONICS CORP.**  
Country Club Road • East Rochester, N. Y.

CIRCLE 202 ON READER SERVICE CARD

September 21, 1962

## This is the PERFECT "Dust-free" Laboratory



## AMSCO Flexible Film Laboratory Dry Box

This low-cost, transparent "self-contained laboratory" is designed for laboratory or production procedures demanding a controlled, isolated atmosphere . . . whether it be dust-free, moisture-free, toxic compound confining, inert gas atmosphere . . . an almost endless list.

Amsco's disposable Flexible Film Dry Box is ideal for delicate transistor and diode assembly, experimental metallurgy, missile sub-assembly work, instrument assembly . . . even Alpha radiation studies. The clear plastic canopy enables technicians to work comfortably and swiftly with no eye strain.

When not in use the "envelope" may be collapsed into a compact package for convenient storage. Upon completion of certain studies, the canopy may be disposed of and replaced quickly and economically. The chamber size is 48" long x 26" wide x 28" high and is provided with four "working" ports, a large interchange lock for introducing parts and several tubular ducts for service lines. Complete air filtration system is optional.

Won't this low-cost, disposable Dry Box fit into your laboratory or production plans? An Amsco man will be happy to discuss the matter in detail . . . or write for bulletin IC-607.



SCIENTIFIC AND INDUSTRIAL DEPARTMENT

World's largest designer and  
manufacturer of Sterilizers,  
Surgical Tables, Lights and  
related technical equipment for  
hospitals, industry, research



**AMERICAN  
STERILIZER**

ERIE • PENNSYLVANIA

CIRCLE 75 ON READER SERVICE CARD

75



# Turn me on



## 0 to 6kv Output

**3 New SF Precision Power Sources.** Accurate to 0.25% of any output voltage dialed, the Model 120 provides 20 ma over the range of 500 to 2210 vdc, the Model 123, 20 ma from 0 to 6000 vdc, and the Model 133, 20 ma from 0 to 6000 vdc.

Only 3½" high, the Model 120 features in-line controls, regulated filament power, polarity reversal, modular construction, and removable feet for rack or bench use. Stability is 0.005%/hour; regulation, 0.01% for ±10% line or 20 ma load change; and ripple less than 5 mv rms. Price is \$450.

The Model 123, mounted on a 5½" panel, is the most compact 6 kv supply available. Featured are "Handi-Vider" controls, voltage and current metering, and reversible polarity. Electrically, the Model 123 offers 0.005% regulation for either 100% load change or ±10% line change. Stability is 0.005%/hour and ripple less than 5 mv rms. Price is \$895.

Except for the regulation specification of 0.01% for either 100% load change or ±10% line change, the Model 133 is electrically similar to the Model 123. Mechanically, the Model 133 is mounted on a 7" panel which carries a polarity switch and voltmeter. Price is \$695.

For complete information on these modestly priced high quality sources, write for our new catalog. Other SF precision sources with up to 20 kv output are also described.



**SMITH-FLORENCE  
INC.**

Overlake Industrial Park  
P.O. Box 717 • Redmond, Washington  
Phone: TUCKER 5-4389

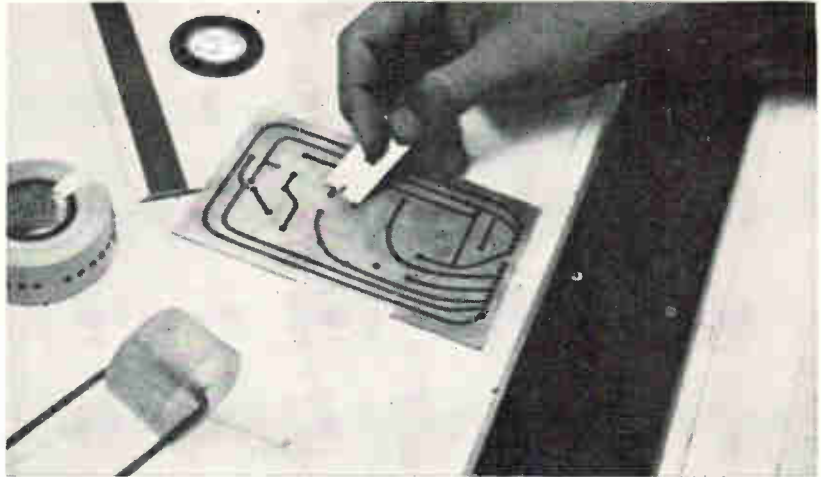

ACID RESIST tape is applied directly to copper side of p-c board. Small circles are added at connection points

water and 50 percent ferric chloride acid. The etching tank or container must be glass, rubber, plastic or other nonmetallic material unaffected by the acid and considerably larger than the size of the board to be etched. A small amount of forced air should be induced into the solution at the bottom of the etching tank to produce agitation.

Suspension of the board, copper side down, on the surface of the etching solution will allow the bubbles formed by agitation to carry away the copper unprotected by the tape. The etching time required should be less than 15 minutes and if this time is exceeded the solution should be changed. The etching solution is detrimental to the eyes and clothing and contact with the skin can be harmful. Proper ventila-

tion and protective clothing will insure protection to the user during this process.

**FINAL PREPARATION**—Upon removal of the pc board from the acid, it should be washed clean with water, making sure no traces of acid remain. The tape resist circles have a small hole in their centers and these can be used to mark drill holes for components. Scrubbing the board with cleanser after the tape is removed will give better solder connections.

The insertion of copper eyelets in the drilled component holes will not only guarantee better electrical connections but will also keep the copper from pulling away from the board when components must be changed.

## Electron Beam Welding in Inert Gasses

**NEW METHOD** of electron beam welding that uses inert gas at atmospheric pressures instead of a vacuum has been developed by General Electric's Materials Joining Engineering Lab at Cincinnati.

It is believed the techniques can be adapted for use with conventional tungsten inert gas welding fixturing, which would reduce beam welding costs several fold.

In the new technique, the weld metal is completely surrounded by a continuing flow of inert gas. The method involves generating electron beams through a series of successively smaller apertures, in a series of differentially pumped

chambers. Since the workpiece is not in a vacuum, the technique is suitable for large weldments.

Alloyd Electronics Corp., Cambridge, Mass., has also announced completion of the feasibility phase of a research contract with the U.S. Air Force for electron beam welding in a non-vacuum atmosphere. In this case, electron beam welding was accomplished in helium. Argon, nitrogen and other low atomic number gasses can also be used. A variety of samples have been prepared at relatively low-voltage (30Kv); for materials with higher depth-to-width ratios, voltages from 100 to 150 Kv are feasible.

Proved through 9,000,000 cycles



# SUSPENSION TYPE METERS

- NO PIVOTS ▪ NO JEWELS
  - NO HAIR SPRINGS
- thus NO FRICTION

## FACTS MAKE FEATURES

**1** No pivots . . . no jewels . . . no hair springs . . . thus NO FRICTION.

**2** Greater SENSITIVITY and REPEATABILITY

**3** RUGGED and ACCURATE. Highly resistant to extreme shock. Accurate to 2% of full scale deflection (coming from line production at 1% maximum tolerance. Greater accuracy available on special order!) Famous Triplet patented Bar Ring Construction.

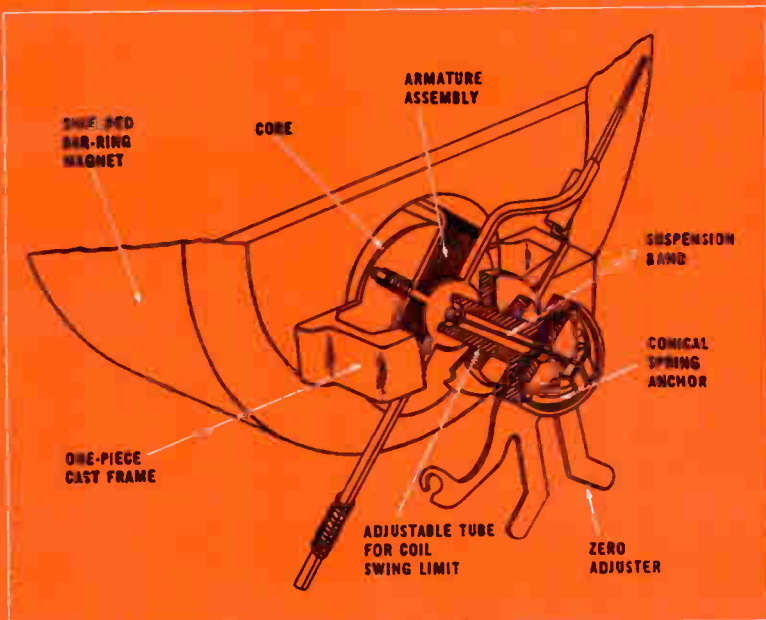

1 1/2 TIMES ACTUAL SIZE

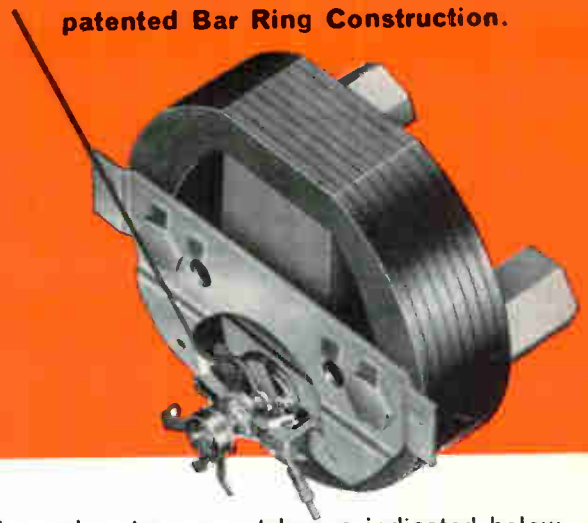

This improved new suspension type movement comes in standard panel meter case styles as indicated below. Meters can be used with almost negligible current drain. Especially applicable to transistor and similar circuits. Their high overload capacity prevents harm from surges many times normal full scale current. These instruments feature a short, very thin, narrow band kept tightly suspended on special spring terminals, which support the coil with its moving counter parts. The Triplet spring is conical in shape, the suspension wire being looped over and fastened to the top cone section. This allows freedom of action for the twisting suspension and added protection against severe shocks. As in all Triplet products, attention to detail makes for longer instrument life.

**THE TRIPLET ELECTRICAL INSTRUMENT COMPANY, BLUFFTON, OHIO**

8 CASE STYLES—11 MODELS—SIZES 2 1/2" THROUGH 8"



MANUFACTURERS OF PANEL AND PORTABLE INSTRUMENTS; ELECTRICAL AND ELECTRONIC TEST EQUIPMENT



# DESIGN AND APPLICATION

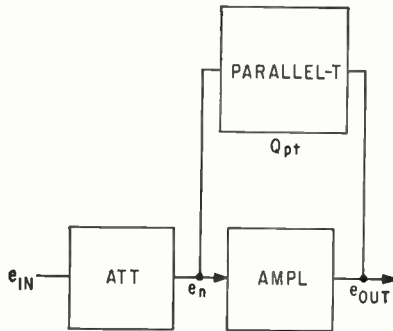
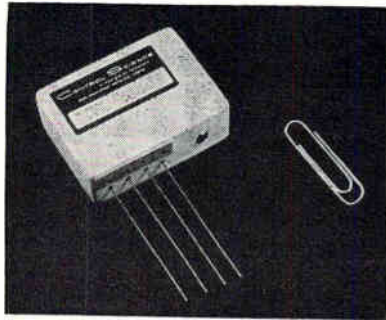

## Subminiature Low-Frequency Bandpass Filter

*Parallel-T filter feedback element is 43 db down at 0.1 and 10f.*

INTRODUCED by Control Science Corp., 5150 Duke St., Alexandria, Virginia, the TF series of bandpass filters feature bandwidths as narrow as 0.67 percent of center frequency (400 cps to 70 Kc) with Q's as high as 150 and 43 db rejection at 0.1 and 10  $f_c$ . Size is 1.25 cubic inch and weight is 23 grams. As shown in the sketch, a parallel-T network having a Q below 0.5 is used as a feedback element in conjunction with a high-gain amplifier A. The  $Q_n$  of the closed-loop feedback amplifier then becomes  $Q_n \cong (A + 1) Q_{pt}$ . The parallel-T network passes,

hence the amplifier cancels, all of the passband frequencies except  $f_c$ , the filter center frequency. This results in a large signal gain between  $e_{in}$  and  $e_{out}$  at this frequency. A series attenuator reduces  $e_{out}$  to approximately  $e_{in}$ . Temperature stability is better than 120 ppm per degree C maximum with 60 ppm per degree C typical throughout range of -30 to +80 C. Input impedance is greater than 1 megohm and supply voltages are 6, 12 or 20 v d-c with a maximum current of 0.5 ma. Primary application is telemetry but can be used in other electronic or infrared systems. Lower frequencies are available at slightly increased package volume.

CIRCLE 301, READER SERVICE CARD

erating in conjunction with an appropriate receiver, demodulates true phase or amplitude modulated signals as low as -145 dbm and will maintain lock at -150 dbm. Antisideband locking assures accurate carrier tracking. Equipment age has been maintained for signal strength lower than locking threshold. An ultra-linear phase detector guarantees low distortion reception with signal modulation as high as one radian. A pulse reshaping circuit is also included. Modules can track frequency shifts due to Doppler or overall receiver-transmitter frequency drifts. The unit accepts a 5 Mc output from the receiver and heterodyne with a vco at the mixer (see sketch). When the phase lock loop locks on the signal, mixer output is same frequency as reference local oscillator (455 Kc  $\pm$  50 cps) and have a definite phase shift from the reference oscillator. Under locking conditions, 455 Kc phase coherent signal is amplified and drives a linear phase detector, an a-m synchronous detector and the main phase lock loop through a narrow band amplifier. (302)

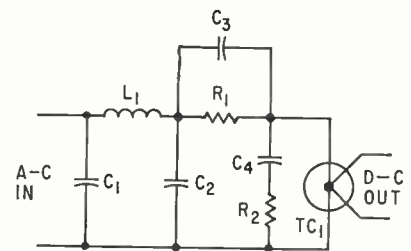

## Thermal Voltage Converters Use Vacuum Thermocouples

ANNOUNCED by John Fluke Mfg. Co., Inc., P.O.B. 7428, Seattle 33, Washington, is a series of 9 frequency-compensated coaxial thermal voltage converters rated between 0.5 and 50 v, developed for measurement of a-c voltages by the a-c/d-c transfer principle. They can be used without calibration curves between 5 cps and 50 Mc. Each of the model A55 converters draws approximately 5 ma from the

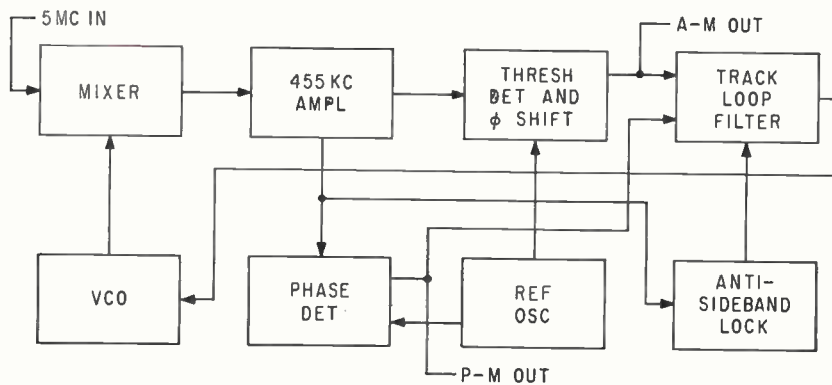

## Phase-Lock Demodulator Operates to -150 DBM

MANUFACTURED by Vitro Electronics, 919 Jessup-Blair Drive, Sil-

ver Spring, Maryland, the solid state PTD-100 pcm/pm module op-

*Of interest to engineers and scientists*

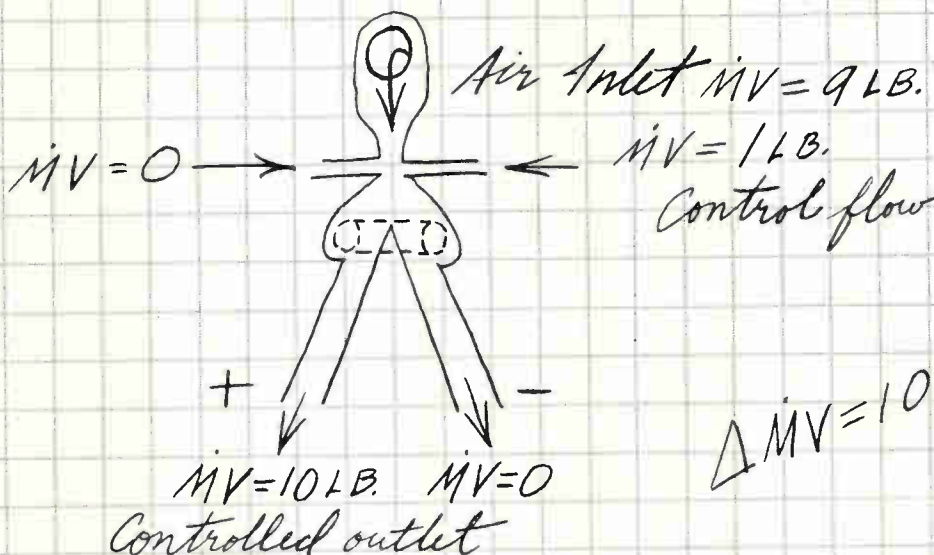

## PNEUMATIC CONTROL RESEARCH

*...one of the more than 500 R&D programs under way at Douglas*

This Douglas sponsored program seeks to provide the aerospace industry with an all pneumatic control system which has no moving parts.

Under investigation are pneumatic amplifiers, flip-flops, proportional flow devices and logic elements—the building blocks for digital computers. Experiments are being conducted in the Douglas Aerophysics Laboratory on advanced techniques in vortex control and the effects of scaling and Reynolds Number.

Important progress has been registered. Success in this field will provide simple, light weight, low cost control systems that will operate under extremes of temperature and radiation.

Of career interest to engineers and scientists Douglas has entered into a period of greatly expanded activities in programs (like the above)

which relate to tomorrow's technology. Outstanding positions are now open in a wide variety of fields.

We urge you to contact us regarding an important position if your background relates to any of the following: electronics, communications, aerodynamics, astrodynamics, thermodynamics, structures, propulsion or mechanical.

Send us your resume or fill out and mail the coupon. Within 15 days from the receipt of your letter, we will send you specific information on opportunities in *your* field at Douglas.



**MISSILE & SPACE SYSTEMS DIVISION**

An equal opportunity employer

Mr. F. V. Edmonds  
Missile and Space Systems Division  
Douglas Aircraft Company  
3000 Ocean Park Boulevard  
Santa Monica, California

F-9

Please send me full information on professional opportunities in my field at Douglas.

Name \_\_\_\_\_

Engineering or  
scientific field \_\_\_\_\_

Address \_\_\_\_\_

City \_\_\_\_\_

State \_\_\_\_\_



# VITREOSIL®

**PURE FUSED  
QUARTZ  
TAKES  
MORE  
SHOCK,  
HEAT  
AND  
ACID**

THAN GLASS  
OR PORCELAIN —  
RESISTS  
TEMPERATURES TO  
1050°C —

HANDLES  
MOST HOT ACIDS  
WITHOUT ETCHING —

WITHSTANDS  
CONSTANT THERMAL  
SHOCK —

EXCELLENT  
ELECTRICAL AND  
OPTICAL  
PROPERTIES —

LABORATORY AND  
INDUSTRIAL WARE —

SPECIAL  
FABRICATION —

**SPECTROSIL®  
FOR PURITY**

ASK FOR  
32 PAGE FREE  
CATALOG —

**THERMAL  
AMERICAN  
FUSED QUARTZ CO.**

RT. 202 AND  
CHANGE BRIDGE RD.  
MONTVILLE, N. J.



source being measured at rated voltage and the resulting d-c output is approximately 7 mv. These converters were developed because of the need to make basic a-c voltage measurements at voltage levels higher than typically feasible with measuring devices terminated in 50 or 600 ohms and at frequencies used in electronic instruments using high-performance feedback amplifiers. Each converter has a voltage operating range from 50 to 100-percent of its rated value. A typical converter equivalent circuit is shown on page 78. The input connector is represented by  $C_1$ ,  $L$ , and  $C_2$ . The multiplier resistor is  $R_1$  while  $C_3$  represents its dominate reactive component. Typical frequency compensating elements are shown as  $C_4$  and  $R_2$  while  $TC_1$  is the thermocouple. Frequency response of the higher voltage converters is by selection of  $C_3$ ,  $C_4$  and  $R_2$  and by using multiplier resistors of special construction. Applications include calibration of low and high frequency a-c voltmeters and measuring amplifier frequency response and signal generator output. Units deviate from NBS standards by less than 0.01 percent to 1 Mc and less than 0.1 percent to 50 Mc.

CIRCLE 303, READER SERVICE CARD

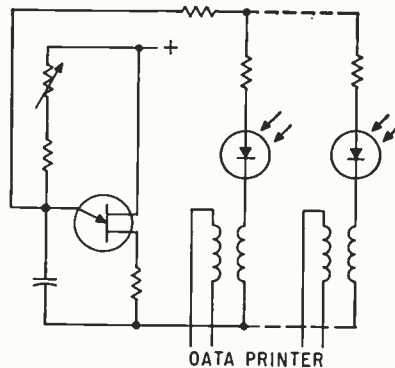

## PNPN Switch Eliminates False Triggering

RECENTLY developed by International Rectifier Corp., 233 Kansas St., El Segundo, California, is a subminiature *pnpn* light-activated switch for use in control, logic and switching circuits. This device enables complete isolation of the input gate signal from the output current thus stray electrical impulses cannot trigger the device until an intentional light beam activates it. Intensities of 100 to 500 ft candles

between 4,000 and 7,000 A, or near it (approximately 12,000 A) are required as a trigger. The sketch shows a typical application in a readout or data processing circuit. Here, light pulses corresponding to holes in punched data cards energize the switches. High current pulses, typically 20 to 50 ma or higher are coupled through pulse transformers to the data printer. The unijunction oscillator resets the system. When the unijunction trigger emitter voltage drops to minimum value during each discharge cycle, bias voltage on the switches becomes too low to supply minimum holding current and the devices will turn off. The variable resistor in the unijunction circuit is controlled by the tape transport synchronizing mechanism. (304)

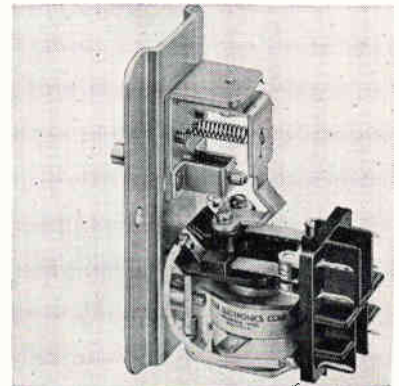

## Manual Reset Relay Weights Four Oz

SNYDER ELECTRONICS CORP., 212 E. North St., Waukesha, Wisc., offers the 218 series manual reset latching relay. The mechanism to reset the relay is mounted on the same base as the relay, therefore it can be factory adjusted for ultimate performance and long life. By simply drilling three holes in the mounting panel, the unit is ready for installation without any further designing of mounting bracket, or reset mechanism. Contact rating: 5 amp at 115 v a-c 60 cycle resistive on  $\frac{1}{8}$  in. diameter contacts, 10 amp on  $\frac{1}{4}$  diameter contacts. (305)

## Surface Analyzer

BRUSH INSTRUMENTS, Division of Clevite Corp., 37th and Perkins, Cleveland 14, O., offers a compact,

mobile surface analyzer system console that contains all instrumentation and accessories necessary to analyze the finish of all types of surfaces including metal, plastic, glass and organic coating. (306)

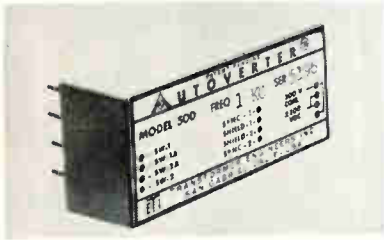

### Solid State Chopper Occupies Small Space

TRANSFORMER ENGINEERS, 1039 E. Valley Blvd., San Gabriel, Calif. Series 10 and 50 Autoverters are solid state inertialess modulators capable of operation from either an a-c or d-c excitation source. Specifications include a noise level of less than  $2 \mu\text{V}$ , a signal input of up to 300 v d-c or peak a-c and a-c or d-c modulation frequencies of from 50 cps to 1 Kc. Unit occupies less than 1.2 cu. in. and is designed for direct p-c mounting. (307)

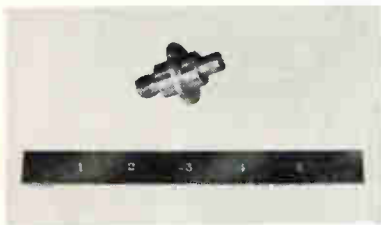

### Rotary Joint Spans D-C to 12.4 Gc

DIAMOND ANTENNA AND MICROWAVE CORP., 35 River St., Winchester, Mass. High speed rotary joint operates over a bandwidth from d-c to 12.4 Gc with a max vswr of 1.5:1. Model 2101 weighs only 3 oz and has an overall length of  $1\frac{3}{4}$  in. It operates at 600 rpm continuous duty with guaranteed life of 10,000,000 revolutions. Connectors are BNC and TNC; torque is 2 oz in. max. (308)

### Limiting Fuses Protect Rectifiers

ENGLISH ELECTRIC CORP., 750 Third Ave., New York 17, N. Y. Line of miniaturized, high interrupting ca-

# EXCLUSIVE!

No one can produce  $1\frac{1}{2}$  inch meters better . . . or faster than Honeywell! You see, Honeywell alone has the special capabilities to turn out such small meters in quantity, with uniform quality and with contemporary medalist styling. Fact is, we make more  $1\frac{1}{2}$  inch meters than any other manufacturer. ■ For catalog, write Honeywell Precision Meter Division, Manchester, New Hampshire.

Medalist meters are available in all practical ranges and in  $2\frac{1}{2}$  inch (MM2) and  $3\frac{1}{2}$  inch (MM3) models.



ACTUAL SIZE

"where electronics meets the eye"

## Honeywell



Precision Meters



# NEW DESIGN

ADDITIONAL WARRANTY  
(Components : 2 years)

# OSCILLOSCOPE

## 245A

GENERAL PURPOSE PORTABLE



- Band width : DC 15-MHz
- Sensitivity : 50 mV/div., DC 5 mV/div., AC
- Direct reading calibration on both axis
- Exceptional brilliance
- Selection of triggering level
- Built-in calibrator
- Dimensions : 21" long, 8" wide, 11 3/4" high.

A SPECIAL OPTICAL SYSTEM INCREASES THE APPARENT DIAMETER OF THE C.R.T. SCREEN UP to 5"

# RIBET-DESJARDINS

TECHNICAL ASSISTANCE IS, AS USUAL, PROVIDED.

MEASURE & CONTROL DEPARTMENT : 13-17, RUE PERIER-MONTROUGE (SEINE)  
FRANCE TEL: ALESIA 2440 + CABLE ADDRESS : PILACELECT - MONTROUGE  
Agencies throughout the world :  
NORTH AMERICA (Canada) : ELECTROLINE TELEVISION EQUIPMENT INC.  
Room 114, 5757 Decelles Avenue - MONTREAL  
Other areas : addresses sent on request

## Heyco Nylon BUSHINGS

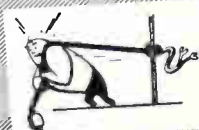

**STRAIN RELIEFS**  
The insulating bushing that anchors a cord set to an electrically operated machine or appliance.



### JUNCTION-TERMINAL BUSHINGS

Eliminate "pig-tails" - Miniature size. Snap-in assembly, color or number coded. Can be used as plug-in receptacle. Simple quick disconnect.

### ACCORDIAN TYPE

Fit curved surfaces

Nylon bushing - brass tab

## HEYCO NYLON Snap Bushings

10 Sizes for holes from 5/16" to 1 1/8" dia. - various inside diameters. Snap locks into panels up to 3/8" thick.



**FREE SAMPLES!** BUSHINGS OF YOUR CHOICE

**HEYMAN MANUFACTURING COMPANY**  
KENILWORTH 2, NEW JERSEY

CIRCLE 203 ON READER SERVICE CARD



### Operational guidance for buyers

That's what your 1962 electronics Buyers' Guide and Reference Issue gives you . . . this year more than ever before.

Your EBG is bigger and better this year than ever . . . and more helpful than ever . . . with more new exclusive features than ever. Keep it close at hand, you'll find it's useful day in and day out.

**electronics BUYERS' GUIDE**  
and Reference Issue

The Basic Buying Guide  
in Electronics since 1941

There's nothing so simple or satisfactory as recording with



Tone shading derived from Alfax Paper captures more information in this recording of the ocean bottom than ever before possible.

"Electricity is the Ink"

Progressive innovators are obtaining vital information never before possible and often unsuspected in such fields as . . .

■ **LONG RANGE RADAR DETECTION**

As opposed to scope cameras, operator sees returns instantly, evaluates more rapidly, gets permanent record with increased sensitivity.

■ **RADAR SAMPLING**

Tone shades keyed to signal intensity provide vivid "picture" of radar return even when bulk of data is gated out.

■ **SONAR ACTIVE AND PASSIVE**

Unparalleled identification and location of returns even in poor signal to noise ratio through integrating capability of Alfax paper.

■ **OCEANOGRAPHY**

High resolution capability, dynamic tone shade response with Alden recording techniques adding synchronizing ease provide "optimization" of underwater sound systems.

■ **FREQUENCY ANALYSIS, SAMPLING AND REAL TIME**

Intensity modulation and frequency vs. real time provide continuous vital information with permanence and past history to achieve previously unattainable evaluation.

■ **SEISMIC STUDIES**

Dynamic response at high writing speeds yields discrete geological data at resolution never before possible.

■ **HIGH SPEED FACSIMILE**

Why? Because of **ALFAX EXCLUSIVES**

- broad, dynamic response of 22 distinct tone shades
- remarkable expansion at low level signal, where slight variation may provide critical information
- information in the sepia area of the color spectrum where the eye best interprets shade differentials in diminishing or poor light
- writing speed capabilities from inches per hour up to 1400 inches/second
- captures 1 microsecond pulse or less
- dynamic range as great as 30 db
- integration capability for signal capture in signal to noise ratio conditions worse than 1 to 4
- resolution capabilities of 1 millisecond = 1 inch of sweep
- accuracy capabilities of few thousandths of an inch
- sensitivity to match most advanced sensing devices

By merely passing a low current through Alfax everything from the faintest trace signal of microsecond duration to slow but saturated signal can be seen instantly, simultaneously.

Alfax Paper, roll-in presentation recorder labs and component recorders for your own experimentation are all readily available.

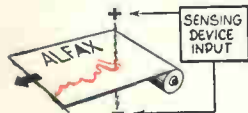

**ALFAX**

PAPER AND ENGINEERING COMPANY, INC.

Alden Research Center, Westboro, Mass. Dept. A-1

capacity current-limiting fuses are designed for the protection of silicon rectifiers and scr's. Available in piv ratings up to 1,000 v and current ratings of 25 through 700 amp, the limiters will not deteriorate under normal load, and will limit transient voltage during fault interruption.

CIRCLE 309, READER SERVICE CARD

**Encapsulations**

UNITED COMPONENTS, INC., 105 Lincoln Ave., Orange, N. J., offers encapsulated circuitry with the exact parameters needed for the most specialized applications regardless of the configuration, electrical, physical or environmental requirements. (310)

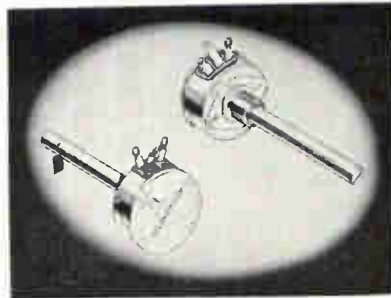

**Wire Wound Pot Rated 5 W at 40 C**

CENTRALAB, 900 E. Keefe Ave., Milwaukee 1, Wis. Style RA20 potentiometer is available in resistances from 3 ohms through 10,000 ohms, linear taper. Standard tolerance is  $\pm 10$  percent. Unit is completely enclosed in a 1 1/2 in. diameter cadmium plated steel case. It is rated at 5 w at 40 C ambient and derates to "0" w at 105 C. (311)

**Miniature Amplifier**

WESTON INSTRUMENTS DIV., Daystrom, Inc., 614 Frelinghuysen Ave., Newark 14, N.J. Model 2020 solid-state differential operational amplifier has wide application in process control, analog computers, and medical electronics. (312)

**Transistor Offers Noise Figure of 0.8 Db**

TEXAS INSTRUMENTS INC., P.O. Box 5012, Dallas 22, Texas. The TI 2N2586 silicon planar transistor

**Instant Graphic Recording**

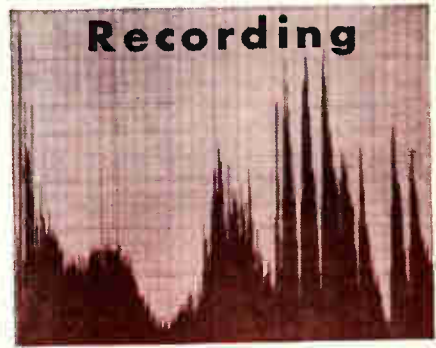

For the first time . . . ultra high speed and precision accuracy in binary graphic display! 660 inches/second recorded at 40 lines/inch. Sweep information is amplitude measured to 15 microseconds or .010" against a grid generated at recorder.

Simple, reliable Alden "flying spot" helix recording techniques combined with ALFAX electro-sensitive paper produce visible, informative "pictures" of sonar, radar, infrared and other instrumentation outputs. Pulse length, relative strength and timing of electronic signals are continuously integrated on a single real-time recording. Data from sampling arrays, time-base signals, or scan or sweep sources are synchronized with the Alden "flying spot" helix and presented as scale model "visual images" of observed phenomena, with new and essential meaning instantly revealed.

Why? Because of **EXCLUSIVE ALDEN RECORDING TECHNIQUES**

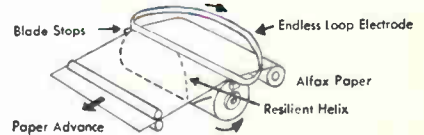

Resilient helix provides low inertia, constant electrode pressure over a wide range of recording speeds. Endless loop electrode deposits ions on the Alfax Paper when a signal appears on the helix. The electrode "blade" moves continuously to provide a freshening of its surface, for thousands of feet of continuous recording. Precision blade stops maintain precise, straight-line electrode relationship to the resilient helix, while protecting paper sensitivity by acting as paper chamber seal-off.

Alden "flying spot" recorders are available . . .

- for any recording speed from 8 rpm to 36,000 rpm
- with any helix configuration — linear 360° sweep — nonlinear — reciprocating — multi-helix
- in any record size — 2", 5", 8", 11", 19" . . . to five foot widths
- plus plug-in modular construction — interchangeability with a high degree of flexibility and adaptability

**It's simple to get started.**



Alden "flying spot" Component Recorders, detachable drives, plug-in electronics, accessories are available to incorporate the Alden instant graphic recording techniques into your instrumentation.

Alden instant graphic recording laboratories — complete with all plug-in units and accessories for fast set up — to cover a variety of recording modes — are available.

**ALDEN**

ELECTRONIC & IMPULSE

RECORDING EQUIPMENT CO., INC.

Westboro, Mass.



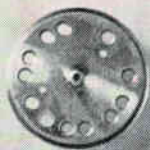

### Only one way to clean it. Ultrasonically.

Complete cleanliness is a must in the production of precision gyroscope parts. A grain of dust, a microscopic fiber, even a fingerprint could spoil its performance.

Manufacturers of these tiny components and assemblies have found only ultrasonic cleaning can do the job properly . . . and high-powered Westinghouse ultrasonic equipment does the job best.

Solid state ultrasonic generators are trouble-free. All-metal Magnapak transducers cannot be overdriven, and deliver more cleaning power per watt than any others.

Westinghouse offers standard equipments in tank sizes from 1½ to 600 gallons, and powers up to 25,000 watts, or cleaning installations engineered to your production problem.

For more information or a demonstration, contact Westinghouse Industrial Electronics Division, 2519 Wilkens Avenue, Baltimore 3, Md. You can be sure . . . if it's Westinghouse.

Westinghouse  Ultrasonics

CIRCLE 205 ON READER SERVICE CARD

has noise figure guaranteed 2 db max at 10 Kc with a generator resistance of 1 megohm. Complete noise characterization is given by guaranteeing 2 db noise figure at emitter currents of 1  $\mu$ a and 10  $\mu$ a at  $R_g$  values of 1 megohm and 10,000 ohms respectively at 10 Kc. A typical noise figure of 0.8 db is achieved with both sets of conditions.

CIRCLE 313, READER SERVICE CARD



### Pulse Amplifier Offers High Output

COMMUNITY ENGINEERING CORP., 234 E. College Ave., State College Pa. Response of the solid state model 4029 is 20 cps to 50 Mc with an output level of 10 v peak to peak, into 75 ohm load. Rise time is 6 nsec with less than 2 percent ringing. Input and output impedance is 75 ohms with a vswr better than 1.5 to 1. Connectors are BNC. Instrument case and enclosed power supply make it a versatile general purpose unit for laboratory and other use. (314)

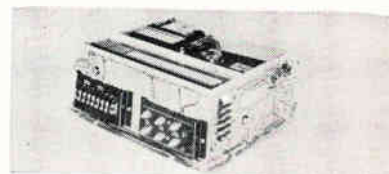

### Dual Output Source Replaces Bulky Units

MID-EASTERN ELECTRONICS, INC., Springfield, N.J., offers an all transistorized dual output power supply. Two d-c outputs, 12 v at 25 amp and 12 v at 1 amp are provided, having ¼ percent combined line and load regulation and less than 0.1 percent ripple. Electronic circuit breakers and 10  $\mu$ sec overvoltage protective circuitry are included for each output. Both supplies are mounted in a single 7 in. high standard 19 in. panel with chassis extending 15 in. behind the front panel. (315)

Write for our catalogue



### Good parts work best!

Intermediate Frequency Transformer IFT



POLYVARICON Variable Capacitor



The high standards of MITSUMI electronic components are insured by a fully-automated assembly system, and double-checked by rigid quality controls. Mitsumi Electric Company is Japan's largest manufacturer of components for radio, television and communications equipment.

## MITSUMI PARTS

MITSUMI ELECTRIC CO., LTD.  
Komae, Kitatama, Tokyo



## PRODUCT BRIEFS

**STATIC INVERTER** with solid state design. It will produce 115 v, 400 cps with frequency accuracy to  $\pm 0.005$  percent. Data & Controls Division of Lear Siegler, Inc., Long Island City, N.Y. (316)

**SOLID STATE VOLTAGE MONITOR** for rugged applications. It is hermetically sealed in a case less than 2 by 2 by 3 in. Cornell and St. George, Inc., 100 Everett St., Westwood, Mass. (317)

**CRYSTAL BANDPASS FILTERS** priced at \$34.95 in small quantities. They feature high attenuation, narrow bandwidth, low loss. Ortho Filter Corp., 7 Paterson St., Paterson 1, N.J. (318)

**RFI SHIELDING STRIPS** are custom-engineered. They combine superior conductivity with extra resiliency for special applications. Technical Wire Products, Inc., 129 Dermody St., Cranford, N.J. (319)

**MINIATURE WIREWOUND CONTROLS** with a 5-w rating in a diameter of  $\frac{3}{4}$  in. Resistance range is 1 to 25,000 ohms without linear taper. P. R. Mallory & Co. Inc., Indianapolis, Ind. (320)

**ANGULAR MOTION TRANSDUCER** produces high d-c output for small deflections. It has negligible reactive force. Brush Instruments, division of Clevite Corp., 37th and Perkins, Cleveland 14, O. (321)

**MICROMODULE CAPACITORS** are temperature compensating. They are rated 50 vdcw at 85C, derated 50 percent at + 125 C. Hi-Q Division, Aerovox Corp., Olean, N.Y. (322)

**SOLID STATE COUNTER** offers max counting rate of 50 Mc. It provides a highly stable time base rated in parts in  $10^6$  per week. Hewlett-Packard Co., 1501 Page Mill Road, Palo Alto, Calif. (323)

**MICROMINIATURE LATCHING RELAY** with hermetically sealed coils. It is available in two-coil construction with a pull-in of 250 mw. Potter & Brumfield, Princeton, Ind. (324)

**HIGH POWER WAVEGUIDE SWITCH** covers from 1.70 to 2.60 Gc. It can handle peak power of 2.6 Mw and average of 30 Kw. Ramcor Inc., 190 Duffy Ave., Hicksville, N.Y. (325)

**STRAIN-GAGE PRESSURE TRANSDUCER** with frequency modulated output. It is available in pressure ranges from 0-5 to 0-20,000 psi gage or absolute. Fairchild Controls Corp., 6111 E. Washington Blvd., Los Angeles, Calif. (326)

**RELAY CLIP** for fast installation. It is valuable where there is a restriction in space. Calfax, Inc., 115 Main St., El Segundo, Calif. (327)

**HIGH POWER LOADS** for systems operating from 2.6 to 12.4 Gc. Max vswr is 1.10. PRD Electronics, Inc., 202 Tillary St., Brooklyn 1, N.Y. (328)

**DIGITAL RELAY TIMER** is solid state in construction. The various functions

# TI has what you need in pulse programming!

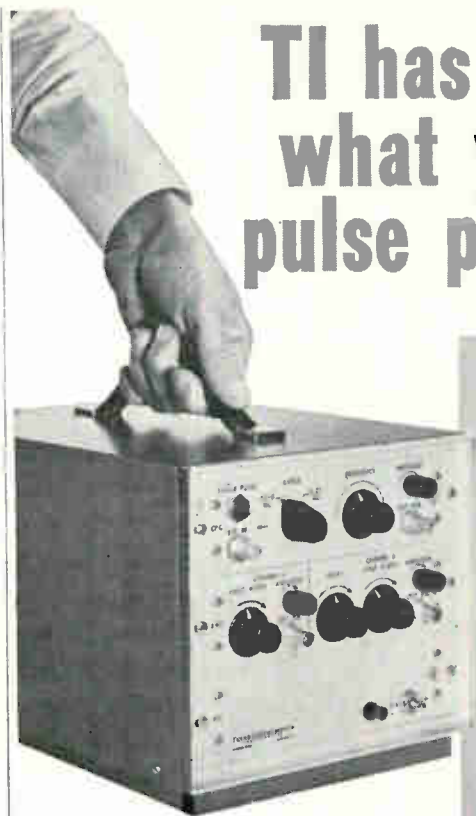

## VERSATILITY

Custom combination of modules for any desired performance characteristics.

## HIGH REP RATE

Repetition rates of 100 cycles to 100 megacycles.

## PORTABILITY

Compact, lightweight, easy to carry.

Texas Instruments Series 6000 Pulse Generators are the smallest instruments available with the advantages of modular construction plus a wide range of operating features which include:

- Variable Width and Delay
- Variable Rise and Fall Times
- Plus and Minus Outputs
- Pulse Mixing
- Programmed and Random Word Generation

TI Pulse Generators combine dependable performance with a high degree of versatility and convenience. Circuitry is all solid state with compact controls. Modular construction provides extreme flexibility in combining features to suit specific applications. Write for complete information.

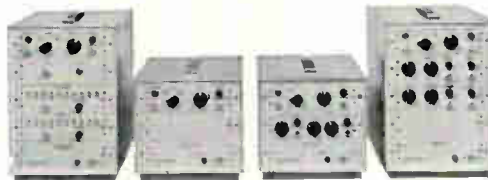

**TEXAS INSTRUMENTS**  
INCORPORATED  
3609 BUFFALO SPEEDWAY  
P. O. BOX 66027 HOUSTON 6, TEXAS





## New "260" Tracemaster gives high performance recording at lower operating costs.

The new "260" AO Tracemaster gives you the best performance-to-cost ratio, plus the best performance-to-cubic inch ratio of any multi-channel recorder you can buy.

**Superior Performance:** The "260" is a 1% recorder! The Band-Amplitude-Product (bandwidth x amplitude), the only useful figure of merit for any direct writing recorder, is five times greater than any recorder other than the "250" AO Tracemaster. The exclusive carbon transfer writing method provides a permanent, reproducible, uniform trace that's finer by 4 to 1 over recorders using thermal or ink writing methods. This extremely thin, high-contrast trace plus the high Band-Amplitude-Product result in unexcelled resolving power. Superior linearity and stability in rectilinear presentation permit full use of this greater resolution at all amplitudes and through all chart speeds.

**Lower Operating Costs:** Stylus pressure on mylar base carbon prints directly on conventional, inexpensive chart paper, yielding excellent recording economy. 100% transistorization and sturdy assembly mean

rugged, trouble-free, 'round-the-clock performance. Individual circuit boards for each recording channel eliminates costly general system breakdowns.

**Flexible Packaging:** What size do you want it? You can order the "260" mounted in the regular floor rack cabinet with wheels for easy maneuverability; or it can be packaged to fit a standard rack width space as small as 27 inches high for space-saving installations.

Get the full story on the AO "260" and the complete line of AO Tracemaster recorders.

### SPECIFICATIONS:

Frequency Response: DC to 100 cps.  $\pm$  1% at 40 mm. peak to peak. Down 3 db. at 125 cps.

Band Amplitude Product: 5000 (i.e. 40 mm x 125 cps.)

Sensitivity Range: 100 mv/cm to 20 v/cm

Chart Speeds: 1 to 250 mm/sec.

Chart Capacity: 1000 ft. roll

American  Optical  
COMPANY

INSTRUMENT DIVISION, BUFFALO 15, NEW YORK

are selected by means of a front panel knob. Computer Logic Corp., 11800 West Olympic Blvd., Los Angeles 64, Calif.

CIRCLE 329, READER SERVICE CARD

**FOILWOUND CAPACITOR** is 75 percent smaller than MIL-C-25C units. Range is 0.001 to 0.047 in 100 v d-c. Good-All Electric Mfg. Co., Ogallala, Neb. (330)

**TAPERED MATCHED TRANSITIONS** permit broadband transformations between waveguides. Prices range from \$40 to \$65 for single and double tapered units. Franklin Technical Corp., Kulpsville, Pa. (331)

**MATCHED MAGIC TEE** in WR187 waveguide. Frequency range is 5.4 to 5.9 Gc. Microwave Development Laboratories, Inc., 15 Strathmore Road, Natick, Mass. (332)

**RUGGED HOLDERS** for subminiature Microfuses. They are rear and front panel mounting. Littelfuse Inc., 1865 Miner St., Des Plaines, Ill. (333)

**PRESSURE TRANSDUCER** weighs only 3 grams. It provides an output of 300 mv full scale. Amelco, Inc., 341 Moffett Blvd., Mtn. View, Calif. (334)

**TAPE TRANSPORT** eliminates programming restrictions up to a tape speed of 120 ips. Data transfer rates up to 242,000 bits/sec are possible. Potter Instrument Co., Inc., Plainview, N.Y. (335)

**MINIATURE TUNING FORK** weighs less than 1 oz. It will operate in launch-level vibration ambients. Gyrex Corp., 3003 Pennsylvania Ave., Santa Monica, Calif. (336)

**CONTINUOUSLY VARIABLE DELAY LINE** with one knob control. Mechanical rotation is 340 deg. Ad-Yu Electronics Lab., Inc., 249 Terhune Ave., Passaic, N.J. (337)

**ROTARY MULTIPOT** offers high reliability, low cost. The potentiometer is rated at 3 w. Daystrom, Inc., Archbald, Pa. (338)

**MULTICHANNEL PULSER** and power supply. Combined package is intended as a test fixture for multiple testing of a number of types of pulse components. Burmac Electronics Co., Inc., 24 Central Drive, Farmingdale, N.Y. (339)

**TEFLON DIELECTRIC CAPACITORS** require no voltage derating from -55 to +200 C. They feature high insulation resistance. Gudeman Co., 340 W. Huron, Chicago, Ill. (340)

**SCR TESTERS** are compact, lightweight. Models are priced from \$69.95. Solitron Devices, Inc., 500 Livingston St., Norwood, N.J. (341)

**CIRCULATORS** for the 8.5-9.6 Gc range. Average power is 75 w. Caswell Electronics Corp., 414 Queens Lane, San Jose, Calif. (342)

**LOAD CELL** with a combined error of less than 0.07 percent. It is available in eight standard ranges between 25 and 1,000 lb. Allegany Instrument Co., 1091 Wills Mountain, Cumberland, Md. (343)

## Literature of the Week

**PRESSURE TRANSDUCER** Consolidated Electrodynamics Corp., 360 Sierra Madre Villa, Pasadena, Calif. Capabilities of the type 4-311 pressure transducer are described in a two-page bulletin. (344)

**MAGNETIC MODULATORS** General Magnetics, Inc., 135 Bloomfield Ave., Bloomfield, N.J. A six-page folder contains illustrations, electrical and mechanical features of a line of Mag Mod standard magnetic modulators. (345)

**SOLDERLESS TERMINALS** J.S.T. of America, Inc., 31 W. 27th St., New York 1, N. Y., offers a brochure on a wide line of terminals and connectors that were tested and proved under extreme conditions. (346)

**CRYSTAL PRODUCTS** Systems Inc., 2400 Diversified Way, Orlando, Fla. Catalog describes a variety of crystal filters, discriminators, oscillators, measurement equipment and frequency control. (347)

**A-D CONVERTER** Daystrom, Inc., Transcoil Div., Worcester, Pa., Bulletin 70-1 covers an analog to digital converter that is actually a shaft angle digitizer. (348)

**RECORDER** Offner Division of Beckman Instruments, Inc., Fullerton, Calif. Data sheet No. 940 describes the type RS. 2-channel portable Dynograph. (349)

**RFI SHIELDING GASKETS** Technical Wire Products, Inc., 129 Dermody St., Cranford, N. J., has available a data sheet on formed knitted wire rfi shielding gaskets. (350)

**TWO-PEN RECORDER** Barber-Colman Co., Rockford, Ill. Bulletin F-11413 describes the series 8000 two-pen strip chart recorder. (351)

**REFLEX KLYSTRON OSCILLATOR** Sperry Electronic Tube Division, Gainesville, Fla. Brochure contains performance data on the SRK-291 reflex klystron oscillator. (352)

**F-M DISCRIMINATOR** Data-Control Systems, Inc., East Liberty St., Danbury, Conn., offers a brochure describing briefly the functions and characteristics of the GFD-3 sub-carrier discriminator and auxiliary equipment. (353)

**COAXIAL CABLES** Prodelin Inc., Hightstown, N. J. Catalog describes semi-flexible aluminum-sheathed coaxial cables and connectors. (354)

**PRESSURE INDICATOR** Taber Instrument Corp., 107 Goundry St., North Tonawanda, N. Y. Specifications and description of the Teledyne pressure indicator model 234-1 are contained in bulletin P-62234-1. (355)

**D-C POWER SUPPLIES** Electronic Measurements Co., Inc., Eatontown, N. J. Specification sheet covers the series PV design group of Regatran semiconductor d-c supplies. (356)

# WORLD LEADER IN THIRD GENERATION ALL-ELECTRONIC DIGITAL VOLTMETERS

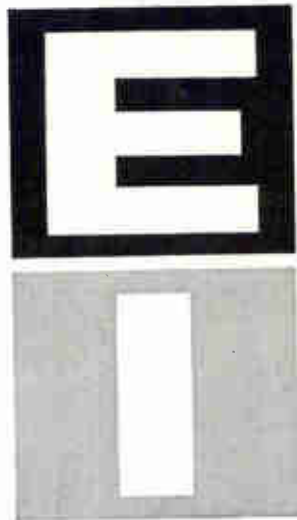

As engineers know, first designs of any transistorized equipment can be tricky . . . uncertain. In the case of digital voltmeters, EI met these problems back in 1957 when we pioneered solid state D. V. M's. By 1959, our second-generation instruments had increased reliability, fewer parts, and better "specs." Today's THIRD-GENERATION, ALL-ELECTRONIC series have even fewer parts, simplified circuitry, improved packaging, and a lower price. Display is quicker than the human eye. Precision and accuracy are unmatched. Available models measure any or all electrical parameters and contain all provisions for systems use. In the past 8 years, over 10,000 EI digital voltmeters have been shipped! There is no short cut to this kind of experience. We invite you to set your standards to EI.



**Electro Instruments, Inc.**  
8611 BALBOA AVENUE, SAN DIEGO 12, CALIFORNIA

For complete information, call the EI office nearest you, or write direct





## Antenna Systems Building New Plants

THREE YEARS after its founding, Antenna Systems Inc. of Hingham, Mass., will open in December a new headquarters and manufacturing plant (shown in sketch) on a 10-acre site at Grenier Field in Manchester, New Hampshire.

Also as part of its expansion program, ASI's Electronic Systems division is building a new 13,000 sq ft facility in Maitland, Fla., for development and production of automatic tracking telemetry antennas and other missile and space systems.

Charles W. Creaser Jr., president, announced that ASI will retain its manufacturing facilities in Hingham, Mass., thus giving the

company a total of 123,000 sq ft of engineering and manufacturing areas in three states after the expansion program is completed.

Founded in December of 1959 with 14 employees, ASI now employs nearly 250 in the design and production of antennas and associated microwave equipment.

At the end of its second full fiscal year on June 30, 1962, the company had recorded record sales of \$3,310,550, compared to \$1,302,134 in the previous fiscal year. Net profit for the second full year of business was \$174,846, representing \$1.52 per share of stock.

ASI reported a June 30 backlog of \$2,500,000.



### Ritucci Advances at Paradyamics

PARADYNAMICS, INC., Huntington Station, N. Y., announces the appointment of Hugo Ritucci as vice president in charge of research. He has held the position of chief electronics engineer for the firm

since its founding in 1961.

Before joining Paradyamics, Ritucci was section head for microwave instrumentation at Microwave Dynamics Corp.

### GE Sets Up Advanced Technology Group

GENERAL ELECTRIC CO. has established an Advanced Technology Services and named George L. Haller to head up the new corporate-level component with the title vice president — advanced technology services. His headquarters will be in Schenectady, N. Y.

In making the announcement GE president Gerald L. Phillippe said the new services component was de-

signed to give the company's operating departments up-to-the-minute counsel and orientation on promising applications of advanced technology.

Prior to his new assignment Haller had been vice president in charge of the company's Defense Electronics division, with headquarters in Syracuse, N. Y.

### Astrosonics Names Research Manager

PHILIP H. WILLIAMS has been named research manager of Astrosonics, Inc., Syosset, N. Y. He will direct research activities in both commercial and military areas, concentrating on the development of new devices utilizing high-intensity acoustic energy.

Williams was formerly associated with Arma Corp. and Fairchild Controls Corp.



### Dynamu Appoints James Flora

DYNAMU, INC., Hicksville, N. Y., designer and manufacturer of audio and video tape heads, has named James Flora chief engineer.

Since 1957, Flora had been associated with IBM, San Jose, Calif., in its Advanced Technology Magnetics Laboratories as senior associate engineer responsible for head design.

### Applied Technology Hires Pekarek

KENNETH L. PEKAREK has joined the staff of Applied Technology, Inc., Palo Alto, Calif., as a senior engineer assigned to advanced receiving system design.

Pekarek comes to ATI from



# Microvolt drift without choppers

**NEW SA112 DC AMPLIFIER**  
DESIGNED FOR USE WITH LOW-LEVEL, LOW-IMPEDANCE SOURCES. IDEAL FOR BATTERY OPERATION.

The SA 112 Amplifier employs solion tetrodes to achieve drift rates of less than 10 microvolts per day (referred to input). Unlike chopper stabilized amplifiers, the very low power requirement makes it ideal for portable operation using economical battery power supplies. The output level and frequency response are suitable for driving 1 ma recording galvanometers.

Featuring high gain, low noise and low drift, the SA 112 is well suited for use with thermocouples, strain-gauges, pyrheliometers and other low-level sources. It provides the most inexpensive system available for measurement or recording of submillivolt D.C. signals.



ACTUAL SIZE

### BRIEF SPECIFICATIONS

<b>VOLTAGE GAIN:</b>	2500. Available in other gains from 500 to 10,000.
<b>RISE TIME:</b>	0.5 seconds.
<b>DRIFT:</b>	Less than 10 $\mu$ v per day.
<b>NOISE:</b>	3 $\mu$ v rms equivalent input.
<b>OUTPUT CAPABILITY:</b>	$\pm$ 1 ma into 2 K load. $\pm$ 5 v open circuit. Not damaged by short circuit.
<b>TEMP. COEFFICIENT OF INPUT ZERO:</b>	Typically 1 $\mu$ v/ $^{\circ}$ C @ 25 $^{\circ}$ C.
<b>POWER REQUIREMENTS:</b>	60 mw total. $\pm$ 7 to 10 v at 3 ma. Two bias batteries of 1.5 or 1.34 v at 0.5 ma.
<b>MECHANICAL:</b>	Standard octal plug-in module.

Price: \$295.00. Delivery: 30 days.

THE SA 112 IS ANOTHER APPLICATION OF SOLION TETRODES. Other applications of TRE solion tetrodes include integrators, timers and adaptive networks.



WRITE FOR ADDITIONAL INFORMATION

**TEXAS RESEARCH AND ELECTRONIC CORPORATION**  
6612 DENTON DRIVE DALLAS 35, TEXAS

MFG.: SOLIONS, CAPCO CAPACITORS, HALLMARK INSTRUMENTS, EASTMAN & CENTRAL D METAL PRODUCTS



# Power Modules - Low Cost Small - Solid State AC-DC Power Supplies

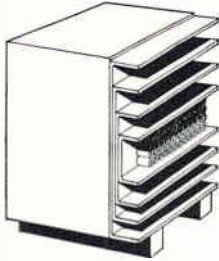

Regulated to  $\pm 0.05\%$  vs Broad Line the power supplies offer a wide variety of output voltages. They are compact, low-cost and have very low ripple. They are not harmed by output shorts or overloads applied continuously. And they are field serviceable. Frequency is 60 or 400 cps with less than 1 MV or 5 MV rms ripple. Output adjustment is  $\pm 10\%$  screwdriver adjustment. Maximum ambient temperature is 55° C.

**CHECK THESE SPECIFICATIONS AND PRICES BEFORE YOU BUY POWER SUPPLIES**

OUTPUT VOLTAGE RANGE	OUTPUT CURRENT (AMPS)	SIZE (see dwg.)	$\pm 0.05\%$ ACCURACY			$\pm 0.05\%$ ACCURACY		
			MODEL	TYPE	PRICE	MODEL	TYPE	PRICE
2.2- 3.0	0.5	A	115/60-PMR	2.5/5/05	85.00	115/60-PMR	2.5/5/5	75.00
2.2- 3.0	1.0	C	115/60-PMR	2.5/1/05	125.00	115/60-PMR	2.5/1/5	115.00
2.2- 3.0	3.0	D	115/60-PMR	2.5/3/05	170.00	115/60-PMR	2.5/3/5	160.00
2.2- 3.0	6.0	E	115/60-PMR	2.5/6/05	220.00	115/60-PMR	2.5/6/5	205.00
5.8- 6.3	0.5	A	115/60-PMR	6/5/05	95.00	115/60-PMR	6/5/5	85.00
5.8- 6.3	1.0	C	115/60-PMR	6/1/05	185.00	115/60-PMR	6/1/5	125.00
5.8- 6.3	3.0	D	115/60-PMR	6/3/05	190.00	115/60-PMR	6/3/5	180.00
5.8- 6.3	6.0	E	115/60-PMR	6/6/05	240.00	115/60-PMR	6/6/5	225.00
8.5- 9.3	0.5	A	115/60-PMR	9/5/05	115.00	115/60-PMR	9/5/5	105.00
8.5- 9.3	1.0	C	115/60-PMR	9/1/05	150.00	115/60-PMR	9/1/5	140.00
8.5- 9.3	3.0	D	115/60-PMR	9/3/05	195.00	115/60-PMR	9/3/5	185.00
8.5- 9.3	6.0	F	115/60-PMR	9/6/05	260.00	115/60-PMR	9/6/5	245.00
11.4-12.5	0.5	B	115/60-PMR	12/5/05	115.00	115/60-PMR	12/5/5	105.00
11.4-12.5	1.0	D	115/60-PMR	12/1/05	150.00	115/60-PMR	12/1/5	140.00
11.4-12.5	3.0	E	115/60-PMR	12/3/05	205.00	115/60-PMR	12/3/5	190.00
11.4-12.5	6.0	F	115/60-PMR	12/6/05	270.00	115/60-PMR	12/6/5	255.00
16.5-18.5	0.5	B	115/60-PMR	18/5/05	120.00	115/60-PMR	18/5/5	110.00
16.5-18.5	1.0	E	115/60-PMR	18/1/05	160.00	115/60-PMR	18/1/5	150.00
16.5-18.5	3.0	F	115/60-PMR	18/3/05	210.00	115/60-PMR	18/3/5	195.00
16.5-18.5	6.0	G	115/60-PMR	18/6/05	280.00	115/60-PMR	18/6/5	265.00
22.3-24.4	0.5	C	115/60-PMR	24/5/05	120.00	115/60-PMR	24/5/5	110.00
22.3-24.4	1.0	E	115/60-PMR	24/1/05	160.00	115/60-PMR	24/1/5	150.00
22.3-24.4	3.0	F	115/60-PMR	24/3/05	215.00	115/60-PMR	24/3/5	200.00
22.3-24.4	6.0	G	115/60-PMR	24/6/05	280.00	115/60-PMR	24/6/5	265.00
29.2-32.7	0.5	C	115/60-PMR	30/5/05	125.00	115/60-PMR	30/5/5	115.00
29.2-32.7	1.0	E	115/60-PMR	30/1/05	165.00	115/60-PMR	30/1/5	155.00
29.2-32.7	3.0	F	115/60-PMR	30/3/05	220.00	115/60-PMR	30/3/5	205.00

VOLUME PURCHASES DISCOUNTED

## SPECIFICATIONS

- Input Voltage • 100-125 volts
- Frequency • 60 or 400 cps
- Regulation • .05% or .5%
- Ripple • Less than 1 MV or 5 MV rms
- Output Adjust •  $\pm 10\%$  screwdriver adj.
- Temperature • Max. ambient 55°C
- Standard Output Voltage • 2.5, 6, 9, 12, 18, 24, 32
- Standard Output Currents • .5, 1, 3, 6 amps

## FEATURES

- Regulated  $\pm 0.05\%$  vs Line Load
- Wide Variety of Output Voltages
- Compact, Low Cost
- Low Ripple
- Not Harmed by Output Shorts or Overloads Applied Continuously
- Field Serviceable



	H	J	K	L	M	N	R	T
A	3 3/16	3 1/8	5	2 1/4	2 3/8	1 3/4	8-32	1 1/2
B	3 1/2	4 1/8	5 3/8	2 1/2	3	1 1/2	10-32	1 1/2
C	3 1/2	4 1/8	5 1/8	2 1/8	3 1/8	1 1/2	10-32	1 1/2
D	4 1/8	4 1/8	6 1/8	3	3 1/8	1 1/2	1/4-20	1 1/2
E	4 1/8	5 3/8	6 1/8	3 3/8	4 1/8	2 1/2	1/4-20	1 1/2
F	5 1/8	6 3/8	7	3 3/4	5 1/4	2 3/4	3/16-18	2
G	6 3/8	6 3/8	7	5 1/4	5 1/8	2 3/4	3/16-18	2

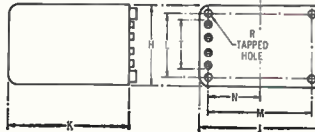

## ELECTRODYNAMIC INSTRUMENT CORPORATION

Subsidiary of Reed Roller Bit Company

TWX 713-571-341

RI 8-2760

1841 OLD SPANISH TRAIL

HOUSTON 25, TEXAS

EIC REPRESENTATIVES

CLYDE M. SALISBURY CO., San Francisco, 1453 Seventh Ave.—MO 4-0586 • REPCO SALES, Miami, 401 N.W. 71st Street—PL 7-2911 • ELECTRONIC SALES, INC., Denver 22, 2641 S. Ivy Street—SK 6-4148 • WALLACE AND WALLACE, Los Angeles 15, 1206 Maple Ave.—RI 7-0401.

CIRCLE 90 ON READER SERVICE CARD

HELP YOUR POST OFFICE  
TO SERVE YOU BETTER  
by  
Mailing Early In The Day!  
Nationwide Improved Mail Service  
Program

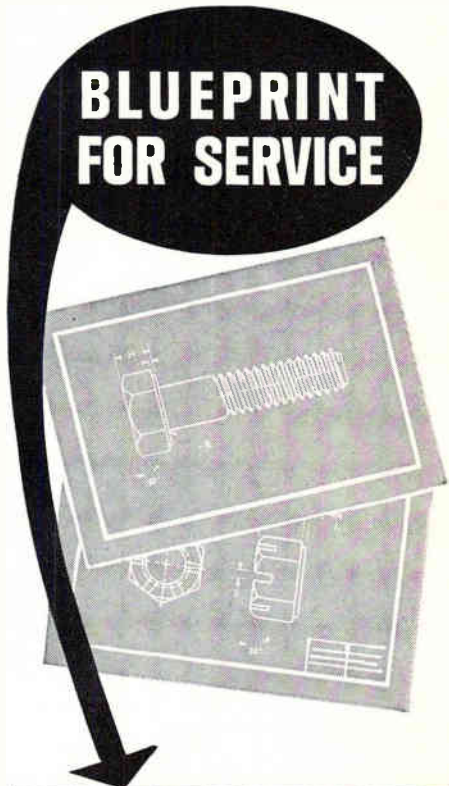

**BLUEPRINT  
FOR SERVICE**

**SERVICE! Important? Of course.** Yet as important as it is, it's often hardest to find... the result of years of experience that go into evolving a "blueprint for service."

ALLMETAL's blueprint for service is a result of well over thirty years of fast, dependable service to industry. When the specs call for stainless steel fasteners, get them days sooner from the world's largest stock... ALLMETAL's, of course. Get them, often weeks sooner, because ALLMETAL's vast stocks of raw materials, and batteries of highly specialized machines are put to use to fulfill your requirements.

Unmatched facilities, warehouses and offices from coast to coast... all are part of ALLMETAL's blueprint for service. All are designed to meet your most stringent requirements.

PHONE OR WRITE  
for prompt quotation  
Send for Catalog

MANUFACTURERS  
OF STAINLESS  
STEEL FASTENERS  
SINCE 1929



## SCREW PRODUCTS COMPANY, INC.

821 Stewart Avenue, Garden City, L.I., N.Y.  
Phone: 516 Pioneer 1-1200 TWX 516-248-7299

Midwest Division  
6424 W. Belmont Avenue, Chicago 34, Illinois  
Phone: 312 AVenue 2-3232 TWX 312-265-1351

West Coast Division—Office and Warehouse  
5822 West Washington Blvd., Culver City, Calif.  
Phone: 213 WEBster 3-9595 TWX 213-937-2719

Bay Area Sales Office  
488 Lytton Ave., Palo Alto, Calif.  
Phone: 327-0310 TWX 415-492-9498

CIRCLE 206 ON READER SERVICE CARD

electronics

Sperry Rand Corp. where he was a research section head working in solid-state telemetry transmitter development.

Applied Technology, Inc., designs and manufactures advanced electronic reconnaissance, active countermeasures and microwave telemetry equipment.



### Hoffman Electronics Appoints Teeter

G. HOWARD TEETER, formerly manager of the base electronics equipment design department for Martin Marietta Corp., has joined Hoffman Electronics Corp., Los Angeles, Calif., in the newly created position of group vice president.

Teeter's responsibilities will be direction and coordination of the Military Products division and Hoffman Science Center.



### Sylvania Appoints Paul Raupach

APPOINTMENT of Paul R. Raupach as manager of project coordination and planning at the Santa Cruz, Calif., systems manufacturing facility of Sylvania Electric Products Inc., is announced.

With Sylvania since 1943, Raupach, prior to his present appointment, managed various planning and procurement phases of a devel-

#### computer power

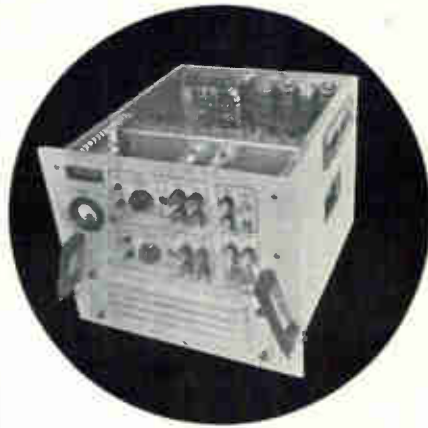

# COMPUTER POWER SUPPLIES FOR 465-L

465-L Strategic Air Command Control computer system power supplies are designed and built by ITT.

These units can regulate from poor quality input and maintain MTBF of 8000 hours to 90% confidence.

*ITT power for high reliability.*

*For further information write Power Equipment and Space Systems Department for Data File E-1858-1.*



**Industrial Products Division**  
International Telephone and Telegraph Corporation  
15191 Bledsoe Street • San Fernando, Calif. • EMpire 7-6161

CIRCLE 207 ON READER SERVICE CARD

#### static inverters



# HIGH EFFICIENCY SOLID STATE INVERTERS

Transistorized 750 VA static inverter power supply from ITT is designed for maximum reliability and efficiency. Harmonic interchange techniques generate stepped waveforms into the filters. Regulation and phase control are maintained by phase shift techniques.

This 400 cps solid state power supply achieves up to 85% efficiency at full load and nominal line, and maintains low total harmonic distortion at the output.

Other Features:

- Input Voltage /swing: 22-34 VDC
- Output Voltage: 115 V phase to neutral 3 Ø 4 wire —WYE  
Adjustable and regulated  $\pm 1\%$
- Distortion: Less than 2%
- Response time: Less than 50 ms.
- Short circuit protection: Automatic current limiting (recoverable)

*For further information write Power Equipment and Space Systems Department for Data File E-1869-1*

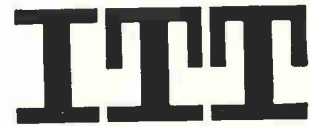

**Industrial Products Division**  
International Telephone and Telegraph Corporation  
15191 Bledsoe Street • San Fernando, Calif. • EMpire 7-6161

CIRCLE 91 ON READER SERVICE CARD



# WRIGHT SPERRY

**GYRO ELEMENTS**  
**PROVEN RELIABILITY**

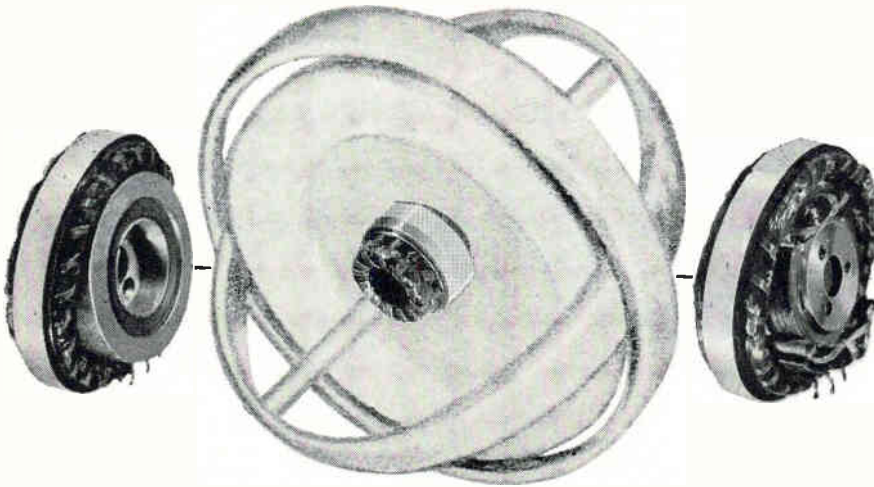

**WRIGHT MACHINERY COMPANY**  
DIVISION OF SPERRY RAND CORPORATION  
DURHAM, NORTH CAROLINA  
TELEPHONE 682-8161

- Pancake Synchros, Resolvers
- Torquers, Spin Motors
- Microsyns, Pick-Offs

CIRCLE 208 ON READER SERVICE CARD

## SERVO NEWS

**VERNITRON .05% ACCURACY**  
**PRECISION RESOLVERS DELIVERED**  
**ON REGULAR PRODUCTION BASIS**



50 through 10,000 cycle  
ALL SIZES—8 through 23  
ALL STANDARD TYPES—Computing, Data Transmission, Phase Shifters and Sweep  
ALL ENGINEERED & MANUFACTURED TO: MIL-R-14346  
ALL AVAILABLE WITH

- Thru-Bore Design
- High Reliability Exclusive Brush Block
- Stainless Steel housings, shaft, bearings
- High voltage capabilities between stator and compensator windings (on feedback units)

A major breakthrough, made possible by VERNITRON specialization in precision synchro and resolver design

WRITE, WIRE, PHONE NOW for complete price, delivery and specification data; ask for NEW Vernitron Condensed catalog . . .

**VERNITRON CORPORATION**

THE QUALITY NAME IN PRECISION SERVO COMPONENTS

618 Old County Rd., Garden City, N. Y.—Pioneer 1-4130 • TWX: C-CY-NY-1147—West Coast Plant: 1742 S. Crenshaw Blvd., Torrance, Calif.—FAirfax 8-2504 • TWX: TNC-4301

opment and production program for the division's central operation at Buffalo, N. Y.

### Datex Corporation Promotes Fritz

WILL FRITZ, formerly head of the encoder and pressure group at Datex Corp., Monrovia, Calif., has been promoted to encoder engineering manager.

He will be responsible for engineering on all Datex shaft position encoders and especially for tailoring encoder products to meet new applications.

### PEOPLE IN BRIEF

Donald F. Munro and Raymond A. Wolf, formerly with Varian Associates and Larry Wright Associates, respectively, have been named engineering mgr. and systems mgr., respectively, at Ultek Corp. G. D. Speake promoted to chief of research of the Marconi Co. Harry A. Marshall, Jr., moves up to military production supervisor at Potter Instrument Co., Inc. George R. Jones, ex-Deutch Fastener Co., now application engineer for Kaynar Mfg. Co., Inc. Robert W. Miller advances at Raytheon Co. to the new corporate post of director of management sciences. Farinon Electric ups three staff members to v-p's: Edward Nolan, Herbert Sutton, and Weston Fisher. Donald Tornburn, formerly with Link Division, General Precision Inc., named manufacturing engineer at Datamec Corp. Joseph Behr, with Radio Engineering Laboratories, Inc., since 1943, elected executive v-p. National Co., Inc., elevates Samuel J. Davy to v-p of engineering. Promotions at Electronic Communications, Inc.: William M. Waters, to mgr. of the electronics section at the Research div.; and Robert G. Walker, to mgr., systems engineering, for the St. Petersburg div. Henry Russell of United Transformer Corp. has been elected president of the Electronic Industry Show Corp. R. G. Canfield, previously with the Micronics div. of Elgin National Watch Co., joins Babcock Relays as project engineer.

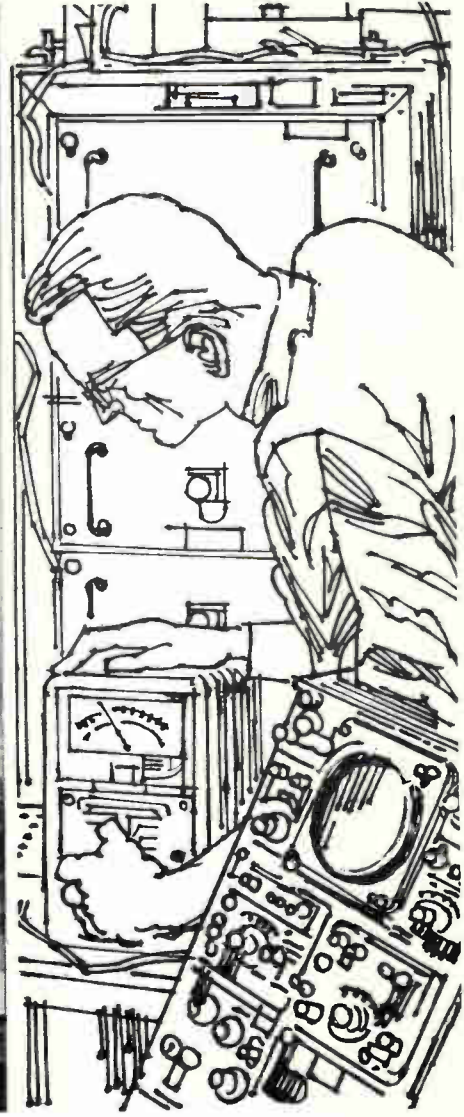
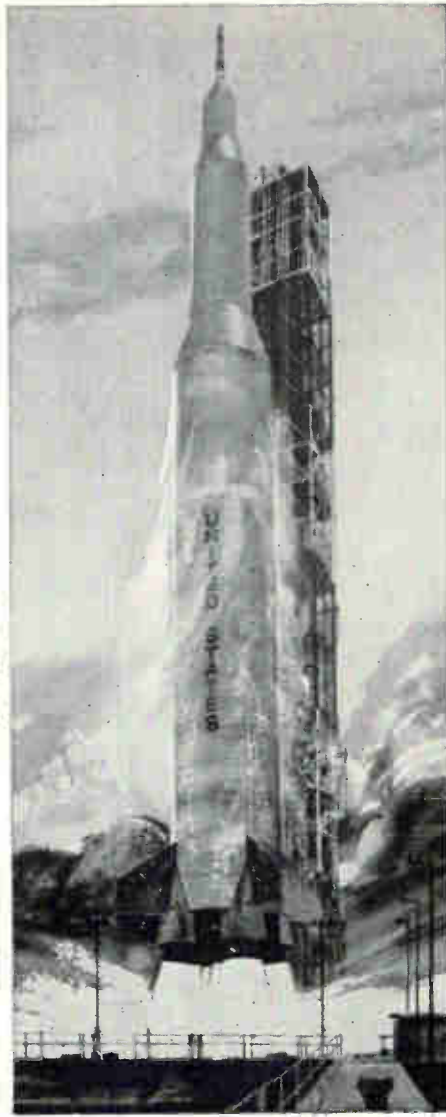
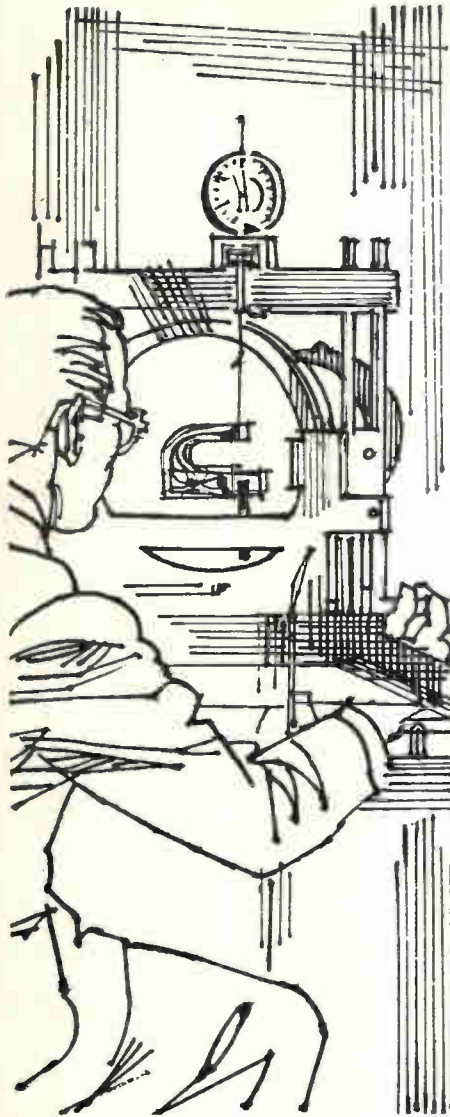

## Saturn openings at Boeing for **STRUCTURAL AND ELECTRONIC/ELECTRICAL ENGINEERS**

Boeing has been awarded primary developmental, building and test responsibility for the Saturn S-IC advanced first stage booster. The Aero-Space Division's newly-formed Saturn Booster Branch has a number of immediate, long-range openings offering professional challenge, rapid advancement and ground-floor opportunities to graduate structural and electronic/electrical engineers.

**STRUCTURAL** engineering openings require knowledge of the air loads, high heating rates, extreme differential temperatures, material oxidation and creep associated with advanced vehicles designed for flight regimes ranging from orbital to normal landing speeds.

**ELECTRONIC/ELECTRICAL** engineering assignments are available in many areas, including the design of electronic equipment, the development of improved design techniques, electronic parts, electronic

packaging techniques and the design and development of improved electronic systems.

Salaries are commensurate with all levels of education and experience. Minimum requirements are a B.S. degree in any applicable scientific discipline. Boeing pays liberal travel and moving allowances to newly-hired engineers. Permanent assignment will be in New Orleans, with initial temporary assignment at Huntsville, Ala. Positions with Saturn and with other expanding missile and space programs at Boeing—including the solid-fuel Minuteman ICBM and Dyna-Soar boost-glide vehicle—are also available at Seattle, Cape Canaveral and Vandenberg AFB, Calif.



*Send your resume, today, to Mr. R. R. Gregg, The Boeing Company, P. O. Box 26088-ECM, New Orleans 26, Louisiana. Boeing is an equal opportunity employer.*

# **BOEING**

Divisions: Military Aircraft Systems • Transport • Vertol • **AERO-SPACE** • Industrial Products—Boeing Scientific Research Laboratories



# electronics

## WEEKLY QUALIFICATION FORM FOR POSITIONS AVAILABLE

### ATTENTION: ENGINEERS, SCIENTISTS, PHYSICISTS

This Qualification Form is designed to help you advance in the electronics industry. It is unique and compact. Designed with the assistance of professional personnel management, it isolates specific experience in electronics and deals only in essential background information.

The advertisers listed here are seeking professional experience. Fill in the Qualification Form below.

#### STRICTLY CONFIDENTIAL

Your Qualification form will be handled as "Strictly Confidential" by ELECTRONICS. Our processing system is such that your form will be forwarded within 24 hours to the proper executives in the companies you select. You will be contacted at your home by the interested companies.

#### WHAT TO DO

1. Review the positions in the advertisements.
2. Select those for which you qualify.
3. Notice the key numbers.
4. Circle the corresponding key number below the Qualification Form.
5. Fill out the form completely. *Please print clearly.*
6. Mail to: D. Hawksby, Classified Advertising Div., ELECTRONICS, Box 12, New York 36, N. Y. (No charge, of course).

COMPANY	SEE PAGE	KEY #
AIR FORCE MISSILE TEST CENTER Patrick Air Force Base, Florida	96	1
ATOMIC PERSONNEL INC. Philadelphia, Penna.	117*	2
DOUGLAS AIRCRAFT CO. Missile & Space Systems Division Santa Monica, California	79	3
ESQUIRE PERSONNEL Chicago, Illinois	116*	4
JET PROPULSION LABORATORY Pasadena, California	95	5
LOCKHEED CALIFORNIA COMPANY A Div. of Lockheed Aircraft Corp. Burbank, California	66*	6
MICROWAVE SERVICES INTERNATIONAL INC. Denville, New Jersey	95	7
MOLONEY ELECTRIC CO. St. Louis, Mo.	95	8
NORTHROP CORP. Norair Div. Hawthorne, California	93, 95*	9
NORTHROP CORP. Space Laboratories Hawthorne, California	93, 97*	10
REPUBLIC AVIATION CORPORATION Farmingdale, Long Island, New York	95	11

(Continued on opposite page)

(cut here)

### electronics WEEKLY QUALIFICATION FORM FOR POSITIONS AVAILABLE

(cut here)

(Please type or print clearly. Necessary for reproduction.)

#### Personal Background

NAME .....

HOME ADDRESS .....

CITY ..... ZONE ..... STATE .....

HOME TELEPHONE .....

#### Education

PROFESSIONAL DEGREE(S) .....

MAJOR(S) .....

UNIVERSITY .....

DATE(S) .....

#### FIELDS OF EXPERIENCE (Please Check)

92162

- |  |  |                                       |
|--|--|---------------------------------------|
| <input type="checkbox"/> Aerospace           | <input type="checkbox"/> Fire Control        | <input type="checkbox"/> Radar        |
| <input type="checkbox"/> Antennas            | <input type="checkbox"/> Human Factors       | <input type="checkbox"/> Radio-TV     |
| <input type="checkbox"/> ASW                 | <input type="checkbox"/> Infrared            | <input type="checkbox"/> Simulators   |
| <input type="checkbox"/> Circuits            | <input type="checkbox"/> Instrumentation     | <input type="checkbox"/> Solid State  |
| <input type="checkbox"/> Communications      | <input type="checkbox"/> Medicine            | <input type="checkbox"/> Telemetry    |
| <input type="checkbox"/> Components          | <input type="checkbox"/> Microwave           | <input type="checkbox"/> Transformers |
| <input type="checkbox"/> Computers           | <input type="checkbox"/> Navigation          | <input type="checkbox"/> Other .....  |
| <input type="checkbox"/> ECM                 | <input type="checkbox"/> Operations Research | <input type="checkbox"/> .....        |
| <input type="checkbox"/> Electron Tubes      | <input type="checkbox"/> Optics              | <input type="checkbox"/> .....        |
| <input type="checkbox"/> Engineering Writing | <input type="checkbox"/> Packaging           | <input type="checkbox"/> .....        |

#### CATEGORY OF SPECIALIZATION

Please indicate number of months experience on proper lines.

	Technical Experience (Months)	Supervisory Experience (Months)
RESEARCH (pure, fundamental, basic)	.....	----
RESEARCH (Applied)	.....	----
SYSTEMS (New Concepts)	.....	----
DEVELOPMENT (Model)	.....	----
DESIGN (Product)	.....	----
MANUFACTURING (Product)	.....	----
FIELD (Service)	.....	----
SALES (Proposals & Products)	.....	.....

CIRCLE KEY NUMBERS OF ABOVE COMPANIES' POSITIONS THAT INTEREST YOU

1 2 3 4 5 6 7 8 9 10 11 12 13 14 15 16 17 18 19 20 21 22 23 24 25

# EMPLOYMENT OPPORTUNITIES



The Advertisements in this section include all employment opportunities—executive, management, technical, selling, office, skilled, manual, etc. Look in the forward section of the magazine for Additional Employment Opportunities advertising.

Positions Vacant  
Positions Wanted  
Part Time Work

Civil Service Opportunities  
Selling Opportunities Wanted  
Selling Opportunities Offered

Employment Agencies  
Employment Services  
Labor Bureaus

## DISPLAYED

The advertising rate is \$40.17 per inch for all advertising appearing on other than a contract basis. Contract rates quoted on request.

An advertising inch is measured 7/8" vertically on a column—3 columns—30 inches to a page.

Subject to Agency Commission.

## RATES

\$2.70 per line, minimum 3 lines. To figure advance payment count 5 average words as a line.

Box Numbers—counts as 1 line.

Discount of 10% if full payment is made in advance for 4 consecutive insertions.

Not subject to Agency Commission.

## UNDISPLAYED

Send NEW ADS to CLASSIFIED ADV. DIV. of ELECTRONICS, P. O. Box 12, N. Y. 36, N. Y.

## EXCELLENT OPPORTUNITY IN SALES

Rapidly growing respected Chicago area manufacturer of audio components has unusual opportunity in O.E.M. sales. Unrestricted territory, about 40% travel. Definite avenue to greater marketing responsibilities, based on performance. We require O.E.M. sales in precision electronic or electrical components; some R&D or market research background would aid in your progress. E.E. or Physics degree essential. Graduate work desirable. Attractive salary and bonus arrangement. Please reply fully; confidence is respected.

P-9645, Electronics  
645 N. Michigan Ave., Chicago 11, Ill.

## DESIGN PROJECT ENGINEER

Expanding Research Laboratory and Manufacturing Facility. Must be capable of handling many varied projects of Research & Development using Tubes & Transistors in the areas of Nuclear, digital and general Test Equipment. Masters or Ph.D. in EE preferred. Send complete resume to:  
**TROXLER ELECTRONIC LABORATORIES, INC.**  
Box 5536, Raleigh, N. C.

# electronics

## WEEKLY QUALIFICATIONS FORM FOR POSITIONS AVAILABLE

(Continued from opposite page)

REPUBLIC AVIATION CORPORATION Missile Systems Div. Mineola, Long Island, New York	116*	12
SCHLUMBERGER WELL SURVEYING CORP. Ridgefield, Connecticut	117*	13
SPACE TECHNOLOGY LABORATORIES INC. Sub. of Thompson Ramo Wooldridge Inc. Redondo Beach, California	10	14
TROXLER ELECTRONIC LABORATORIES INC. Raleigh, N. Car.	95	15
VITRO LABORATORIES Div. of Vitro Corp. of America Silver Spring, Md.	116*	16
P 9645	95	17

\*These advertisements appeared in the 9/14/62 issue.

# jpl needs

## ELECTRONIC PACKAGING ENGINEERS

To develop and apply electronic and electromechanical packaging techniques to assemblies for spacecraft. Background in electronic or electro-mechanical fabrication techniques and knowledge of electromechanical devices. Familiar with preliminary vibration and heat transfer analysis and testing plus general interest in physical sciences. BSME or EE plus 2 years experience minimum.

Send complete resume to  
PERSONNEL DEPT.

## JET PROPULSION LABORATORY

Operated by California Institute of Technology for the National Aeronautics & Space Administration  
4814 OAK GROVE DR. • PASADENA, CALIF.

"An equal opportunity employer"

### COMMUNICATIONS APPLICATION ENGINEER

Analysis of advanced electronic communication systems including radio, carrier, telephone, microwave.

Must have design and marketing experience with commercial and military users.

EE degree, 5 yrs. exp. min.

Send Resume to:

Microwave Services International Inc.  
Consulting Engineers  
Route 46 Denville, N. J.

### ELECTRONICS ENGINEERS

With experience in components or system design for high power radar or communications.

Send Complete Resume  
Including Salary Requirement

D. F. Winter, Vice President  
MOLONEY ELECTRIC COMPANY  
5390 Bircher Blvd. St. Louis 20, Mo.

## ELECTRONIC ENGINEERS

# assignments in engineering ingenuity

If you prefer problems to policy, challenges to conformity, there's growth ahead for you at Republic. Assignments are varied — many on advanced manned aircraft, some on next-generation vehicles. All are an open door to participation in Republic's growing role in aerospace. And to further accelerate personal growth, graduate study with generous company support is available right next door. Brooklyn Polytechnic's Graduate School adjoins Republic's facilities.

### IMMEDIATE OPENINGS IN THESE AREAS:

**FIRE CONTROL** — 3 yrs. exp. Development, design and/or testing of radar and fire control systems.

**ELECTRONIC SYSTEMS** — 3 yrs. exp. Development, design and/or testing of air data computer, gyro reference table, integrated instrument systems.

**DOPPLER SYSTEMS** — 3 yrs. exp. Development, design and/or testing of Doppler navigation systems. Analog or digital exp.

**COMMUNICATION SYSTEMS** — 3 yrs. exp. Development, design of modern airborne communications systems. Troubleshooting exp. desired.

**NAVIGATION SYSTEMS** — 3 yrs. exp. Development and design of Doppler, inertial guidance and radio systems for airborne applications.

**AEROSPACE GROUND SUPPORT** — 3 yrs. exp. Design and development of electronic test equipment for airborne vehicles.

**ELECTRONIC WEAPONS SYSTEMS** — 10 yrs. combined exp. in radar, navigation, automatic flight controls, aircraft power systems, aircraft instruments.

**SYSTEMS INTEGRATION** — 3 yrs. exp. Aircraft or missile electrical or electronic systems analysis, performance and/or subsystem integration.

**ELECTRONIC FIELD ENGINEERS** — 3 yrs. exp. installation, test and automatic checkout of electrical or electronic systems. Assignments to East or West Coast and overseas.

**ANTENNAE AND RADOME** — 3 yrs. exp. Development, design and/or testing of radar antennae and radomes.

**ELECTRONIC INSTRUMENTATION** — 3 yrs. exp. in design and test using oscillograph, strain gauge, temperature, pressure, potentiometer and synchro techniques.

**ELECTRONIC TEST** — 3 yrs. exp. Analysis and test of advanced electronic systems: radar, communications, navigation and identification.

**CIRCUIT DESIGN** — 3 yrs. exp. Aircraft systems interconnections, power generation, distribution, communication, navigation, fire control, autopilot. Must know HIAD requirements and MIL specs.

**INSTRUMENTATION** — Exp. airborne oscillographic, photorecording, tape-recording, telemetering systems, ground reception, data handling and conversion systems.

Write, including salary requirements, to  
Mr. James Hunter  
Professional Employment, Dept. 11J-3

# REPUBLIC AVIATION CORPORATION

FARMINGDALE, LONG ISLAND, NEW YORK  
An Equal Opportunity Employer



# ELECTRONIC ENGINEERS

As an operational component of the AIR FORCE SYSTEMS COMMAND (AFSC), the Air Force Missile Test Center develops, maintains and operates the Atlantic Missile Range (Cape Canaveral) and provides support for national missile and space programs assigned thereto. Consistent with this mission, the Center is also responsible to conduct, evaluate and otherwise participate in USAF test and training operations assigned to the Atlantic Missile Range.

Following are some of the positions available at the AFMTC:

- ELECTRONIC ENGINEER  
(Instrumentation Programming)
- ELECTRONIC ENGINEER  
(Instrumentation Planning)
- ELECTRONIC ENGINEER  
(Range Instrumentation—Ships)
- ELECTRONIC ENGINEER  
(Data Processing)

The vacancies listed above are in the major fields of Electronic Engineering. Specific examples of specialties within each major field are given below.

**Instrumentation:** Engineering management of range instrumentation systems including planning, contract supervision, cost estimating and engineering evaluations on one or more of the following specialties: Telemetry, CW and Pulse Radar, Data Processing, Timing, Data Transmission, Computers, Command Control Radio and Spectrum Surveillance Systems.

**Data Processing:** Engineering management direction of the development of technical support instrumentation plans outlining the manner in which missile test requirements will be met in areas of Data Processing, Data Reduction, Data Translations and Data Transmission and include Planning, Contract Supervision, Cost Estimating and Engineering Evaluations on existing equipment and new systems designs.

Interested applicants should submit applications (Civil Service Commission Form 57) or resumes (list lowest acceptable salary) to the following address:

## CIVILIAN PERSONNEL OFFICER

Air Force Missile Test Center

Patrick AF Base, Florida

Attn: MTPC-2

*An Equal Opportunity Employer*



## PROFESSIONAL SERVICES

GIBBS & HILL, Inc.  
*Consulting Engineers*

Systems Engineering  
Operations Research • Development  
Field Studies • Design • Procurement  
Power • Transportation • Communications  
Water Supply • Waste Treatment

393 Seventh Avenue New York 1, N. Y.

## SEARCHLIGHT SECTION

(Classified Advertising)

BUSINESS OPPORTUNITIES

EQUIPMENT - USED or RESALE

### DISPLAYED RATE

The advertising rate is \$27.25 per inch for all advertising appearing on other than a contract basis. Contract rates quoted on request. AN ADVERTISING INCH is measured 7/8 inch vertically on one column, 3 columns—30 inches—to a page. EQUIPMENT WANTED or FOR SALE ADVERTISEMENTS acceptable only in Displayed Style.

### UNDISPLAYED RATE

\$2.70 a line, minimum 3 lines. To figure advance payment count 5 average words as a line. PROPOSALS, \$2.70 a line an insertion. BOX NUMBERS count as one line additional in undisplayed ads. DISCOUNT OF 10% if full payment is made in advance for four consecutive insertions of undisplayed ads (not including proposals).

## FOR RESEARCH — DEVELOPMENT & EXPERIMENTAL WORK

Over 10,000 different electronic parts: waveguide, radar components and parts, test sets, pulsers, antennas, pulse xmfrs, magnetrons, IF and pulse amplifiers, dynamotors, 400 cycle xmfrs, 584 ant. pedestals, etc.

PRICES AT A FRACTION OF ORIGINAL COST!

COMMUNICATIONS EQUIP CO.

343 CANAL ST., N. Y. 13, W.O. 6-4045

CHAS. ROSEN (Formerly at 131 Liberty St.)

CIRCLE 950 ON READER SERVICE CARD

OVER 2,000,000

## RELAYS

IN STOCK!

Send for Catalog 55

Universal RELAY CORP.

42 WHITE ST., N.Y. 13, N.Y. • Walker 5-6900

CIRCLE 951 ON READER SERVICE CARD

Ideal office for electronics firm in Newton, Mass. Near fabulous Route 128. Has everything. 1500 sq. ft. Pvt. parking.

Write FROST

Box 66, Boston 66 or call LA 7-1800.

CIRCLE 952 ON READER SERVICE CARD

## LOOKING FOR USED/SURPLUS ELECTRONIC EQUIPMENT/COMPONENTS?

For an up-to-date listing of such equipment see Searchlight Section of September 14th.

# INDEX TO ADVERTISERS



## Audited Paid Circulation

• AMP Incorporated	67
Air Express	35
• Alden Electronic & Impulse Recording Co. Inc.	83
• Allfax Paper & Engineering Co. Inc.	83
• All Metal Screw Products Co. Inc.	90
American Machine & Foundry Co.	17
Potter & Brumfield Div.	17
• American Optical Co.	86
• American Sterilizer	75
Ampex Corporation	60
Assembly Products, Inc.	29
Boeing Co., The	93
Bristol Company, The	72
• Cannon Electric Co.	69
Consolidated Electrodynamics Corp.	37
Cubic Corp.	24
Data-Control Systems, Inc.	66
Douglas Aircraft Co.	79
duPont de Nemours & Co., Inc. E. I.	73
• Electrodynamic Instrument Corporation	90
Electro Instruments Inc.	87
• Garlock Electronics Products Inc.	20
General Electric Co.	
Silicone Products Dept.	59
General Electronic Laboratories, Inc.	71
Globe Industries, Inc.	38
Heminway & Bartlett Mfg. Co., The	16
• Hewlett-Packard Company	
<b>Inside front cover</b>	
Hexacon Electric Co.	32
• Heyman Manufacturing Co.	82
Hitemp Wires Inc.	36
Honeywell Precision Meter Div.	81
Hughes Aircraft Co.	98
• Indiana General Corp.	22
International Telephone and Telegraph Corp., Industrial Products Div.	91
Johnson Company, E. F.	58
• Kay Electric Co.	31
Kintel, A Division of Cohu Electronics Inc.	3rd cover
• Litton Industries Inc.	
Electron Tube Div.	32
• Microswitch, Division of Honeywell	63
Mitsumi Electric Co., Ltd.	84
Motorola Semiconductor Products Inc.	25
Motorola Military Electronics Div.	61
• Nippon Electric Co., Ltd.	65
• North Atlantic Industries, Inc.	64
Norton Company	16
• Ohmite Mfg. Co.	11
• Potter Instrument Co., Inc.	19
Potter and Brumfield, Div. American Machine & Foundry Co.	17
• Radio Corporation of America	4th cover
• Reeves Instrument Corp., Sub. of Dynamics Corp. of America	14
Ribet-Desjardins	82

SAAB Motors, Inc.	13
• Sage Electronics Corp.	75
Sangamo Electric Co.	33, 94
• Sierra Electronics Corp.	6
Simpson Electric Company	27
Smith Florence, Inc.	78
Space Technology Laboratories, Inc.	10
Sprague Electric Co.	4, 9, 30
• Tech Laboratories, Inc.	70
Tektronix, Inc.	57
• Tempo Instrument, Inc.	21
Texas Instruments Incorporated	85
Texas Instruments Incorporated Semiconductor-Components Division	23
Texas Research and Electronic Corp.	89
Thermal American Fused Quartz Co., Inc.	80
• Transatron Electronic Corp.	15
Triplett Electrical Instrument Co.	77
• Tung-Sol Electric Inc.	5
Unger Electric Tools	58
• Unholtz Dickie Corp.	16
• Vernitron Corporation	92
West Penn Power	97
• Westinghouse Electric Corp.	84
Wright Machinery Co.	
Div. of Sperry Rand Corp.	92

## PROFESSIONAL SERVICES 96

CLASSIFIED ADVERTISING  
F. J. Eberle, Business Mgr.

## EMPLOYMENT OPPORTUNITIES 95, 96

## BUSINESS OPPORTUNITIES 96

## EQUIPMENT (Used or Surplus New) For Sale 96

## INDEX TO CLASSIFIED ADVERTISERS

Air Force Missile Test Center	96
• Communications Equipment Co.	96
Frost	96
Jet Propulsion Laboratory	95
Microwave Services International Inc.	95
Moloney Electric Co.	95
Troxler Electronic Laboratories Inc.	95
Republic Aviation Corporation	95
• Universal Relay Corp.	96

• See advertisement in the July 25, 1962 issue of Electronics Buyers' Guide for complete line of products or services.

This Index and our Reader Service Numbers are published as a service. Every precaution is taken to make them accurate, but electronics assumes no responsibilities for errors or omissions.

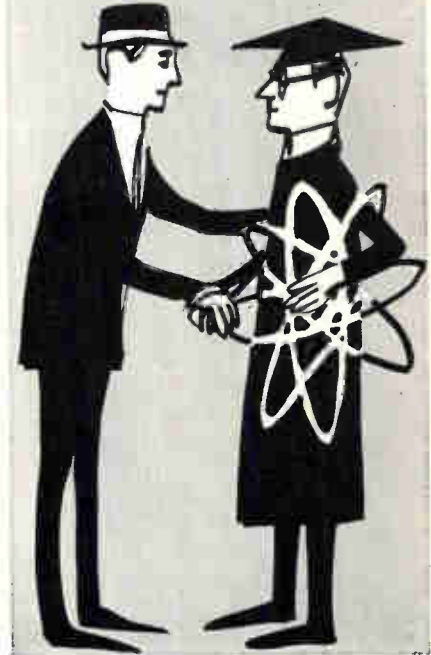

## Pre-production Training of a Work Force at No Cost to You

This is a time-tested and proved-in-use plan in WESTern PENNSylvania by which employees will be trained in whatever skills are needed for YOUR particular operation at no cost to you. For details on labor and training . . . and for complete information on 100% financing of plant space at low, low interest rates . . . and WESTern PENNSylvania's favorable tax climate, wire or call collect or mail coupon below today.

## WEST PENN POWER an operating unit of ALLEGHENY POWER SYSTEM



Now available: Shell buildings at \$2.95 to \$3.25 a sq. ft. can be completed to your specs in 60-90 days. Or select from 200 other industrial properties.

WEST PENN POWER Phone: Temple 7-3000  
Area Development Department (Area Code 412)  
Greensburg, Pennsylvania

EL-2-5-9

Please send me data on:  Pre-production Training  
 Taxes  100% Industrial Plant Financing  
 Industrial Properties

Name \_\_\_\_\_  
Title \_\_\_\_\_  
Company \_\_\_\_\_  
Address \_\_\_\_\_  
City \_\_\_\_\_ Zone \_\_\_\_\_  
State \_\_\_\_\_ Phone \_\_\_\_\_



# COMPUTER RESEARCH ENGINEERS & LOGICAL DESIGNERS

Rapid expansion of the Computer Laboratory at Hughes-Fullerton has created several attractive professional opportunities for qualified Computer Research Engineers and Logical Designers. These positions require active participation in bread computer R & D activities in connection with Army/Navy computer systems and new large-scale, general-purpose computers. These multiple processor computers utilize advanced solid-state circuitry, gating and resolution times in the millimicrosecond regions; combine synchronous and asynchronous techniques for maximum speed and reliability.

These professional assignments involve broad areas of logical design, programming and system conception. Fields of interest include:

■ Distributed computers ■ Advanced arithmetic processing techniques ■ Mechanized design ■ Asynchronous design techniques ■ Utilization of parametrons in computers ■ Studies in the utilization of multiple processor computers.

These professional assignments involve such R & D areas as:

■ Solid state digital circuitry involving millimicrosecond logic  
■ Microwave carrier digital circuits  
■ Sub-microsecond core memory  
■ Thin film storage techniques  
■ Functional circuit concepts  
■ Micro-miniaturization concepts  
■ Tunnel diodes ■ Microwave parametrons ■ Circuit organization for maximal-speed computing.

Located in Southern California's Orange County (the nation's fastest growing electronics center), Hughes-Fullerton offers you: a stimulating working environment; private or semi-private offices; long-term stability.

### CALL COLLECT TODAY!

For complete information on these challenging assignments, call us collect today! Ask for:

**Mr. J. E. TENNEY at:**  
TRojan 1-4080, ext. 3741.

Or, airmail resume to: HUGHES-FULLERTON R & D, P. O. Box 2097, Fullerton 1, California.

An equal opportunity employer.

## HUGHES

HUGHES AIRCRAFT COMPANY

# electronics



Audit Bureau  
of Circulations

Associated Business  
Publications

Audited Paid Circulation

**JAMES T. HAUPTLI**

Advertising Sales Manager

**R. S. QUINT:**  
Assistant Publisher Buyers'  
Guide and Business Manager  
**FRED STEWART:**  
Promotion Manager  
**B. ANELLO:**  
Market Services Manager

**RICHARD J. TOMLINSON:**  
Production Manager  
**GEORGE E. POMEROY:**  
Classified Manager  
**HUGH J. QUINN:**  
Circulation Manager

### ADVERTISING REPRESENTATIVES

#### ATLANTA (9):

Michael H. Miller, Robert C. Johnson  
1375 Peachtree St. N.E., Trinity 5-0523  
(area code 404)

#### BOSTON (16):

William S. Hodgkinson, Donald R. Furth  
McGraw-Hill Building, Copley Square,  
Congress 2-1160 (area code 617)

#### CHICAGO (11):

Harvey W. Wernecke, Robert M. Denmead  
645 North Michigan Avenue, Mohawk 4-5800  
(area code 312)

#### CLEVELAND (13):

Paul T. Fegley  
55 Public Square, Superior 1-7000  
(area code 216)

#### DALLAS (1):

Frank Le Beou  
The Vaughn Bldg., 1712 Commerce St.  
Riverside 7-9721 (area code 214)

#### DENVER (2):

J. W. Patten  
Tower Bldg., 1700 Broadway,  
Alpine 5-2981 (area code 303)

#### HOUSTON (25):

Joseph C. Page, Jr.  
Prudential Bldg., Halcombe Blvd.,  
Riverside 8-1280 (area code 713)

#### LOS ANGELES (17):

Peter S. Carberry, Ashley P. Hartman  
1125 W. 6th St., Huntley 2-5450  
(area code 213)

#### NEW YORK (36):

Donald H. Miller, Henry M. Shaw,  
George F. Werner  
500 Fifth Avenue, LO-4-3000  
(area code 212)

#### PHILADELPHIA (3):

Warren H. Gardner, William J. Boyle  
6 Penn Center Plaza, LOcust 8-4330  
(area code 215)

#### SAN FRANCISCO (11):

R. C. Alcorn  
255 California Street, Douglas 2-4600  
(area code 415)

#### LONDON W1:

Edwin S. Murphy Jr.  
34 Dover St.

#### FRANKFURT/Main:

Matthée Herfurth  
85 Westendstrasse

#### GENEVA:

Michael R. Zeynel  
2 Place du Port

### "Headquarters for Business Information"

### McGraw-Hill Technical and Business Publications

American Machinist/Metal-  
working Manufacturing  
Aviation Week and Space  
Technology  
Business Week  
Chemical Engineering  
Chemical Week  
Coal Age  
Construction Methods and  
Equipment  
Construction Daily  
Control Engineering  
Electrical Construction  
and Maintenance  
Electrical Merchandising Week  
Electrical Newsletter  
Electrical West

Electrical Wholesaling  
Electrical World  
Electronics  
Engineering Digest  
Engineering and Mining Journal  
E & MJ Metal and Mineral  
Markets  
Engineering News-Record  
Factory  
Fleet Owner  
Industrial Distribution  
National Petroleum News  
Nucleonics  
Nucleonics Week  
Platt's Oilgram News  
Platt's Oilgram Price Service  
Power

Product Engineering  
Purchasing Week  
Science Week  
Textile World

Overseas only:  
Automobile International  
(English, Spanish)  
Ingenieria Internacional  
Construccion (Spanish)  
International Management  
(English, Spanish)  
Portuguese editions)  
Metalworking Production  
(Great Britain)

Available by subscription only — to qualified persons actively engaged in the field of the publication. For subscription rates and information describing the editorial coverage of any of the above publications, write to: Subscription Manager, Circulation Department, McGraw-Hill Publishing Company, 330 West 42nd Street, New York 36, N. Y.

which of these

13

KIN TEL instruments  
does your standards  
lab need?

Used in leading standards labs  
throughout the country, they may  
supply the exact degree of accuracy,  
stability, range, and versatility  
your particular laboratory  
applications demand.

CERTIFIED

## STANDARDS

- 1. DC Voltage Standard (Model 303).** So accurate, so stable, you can use it to calibrate any digital voltmeter. Lets you control output from 0 to over  $\pm 1100$  volts in steps as small as 1 microvolt. Accurate to within 0.01% of the dial setting; stable to within 0.005%. Floating guarded circuit. Price: \$2995.
- 2. AC Voltage Standard (Model 601A).** Output is 1 to 501 volts RMS AC, adjustable in 0.1 volt steps and between steps by a multi-turn potentiometer. Voltage accuracy is 0.1%, short term stability is 0.01%. Ideal for calibrating AC measuring instruments, designing servo or gyro equipment, evaluating magnetic properties. Price: \$4500.
- 3. DC Voltage Standard and Null Voltmeter (Model 302).** Used by hundreds for rapid, accurate production calibration of precision measuring instruments and DC power supplies; for the design of DC amplifiers and complex circuitry; for computer reference; for precision reference in calibration and measurement laboratories. Measures and supplies DC from 1 to 502 volts with 0.01% accuracy, 0.002% stability. Price: \$1280.
- 4. DC Voltage Standard and Null Voltmeter (Model 301).** Has an accuracy of 0.02% and stability of 0.01%. Measures and supplies DC from 1 to 501 volts. Price: \$995.

Write for detailed literature or a demonstration of any of these exceptional instruments. Representatives in all major cities. All prices FOB, San Diego, Calif. 50 cps operation at additional cost.

## VOLTMETERS

- 5. DC Digital Voltmeter (Model 501B).** Four-digit, fifth-digit over-ranging. Measures positive or negative DC between 100 microvolts and 1000 volts, with 0.01% (of reading)  $\pm 1$  digit accuracy. Automatic or programmable range; auto polarity. Combines the useful accuracy of a 5-digit voltmeter with the stability, reliability, and price advantage of a 4-digit voltmeter. Price: \$2995.
- 6. AC/DC Digital Voltmeter (Model 502B).** Gives you AC accuracy within 0.1% of reading; over-ranging on both AC and DC; automatic ranging and remote (programmable) control. Measures DC between  $\pm 100$  microvolts and  $\pm 1000$  volts, AC from 30 cps to 10 kc between 1 millivolt and 1000 volts. Four-digit readout. Price: \$4245.
- 7. AC/DC Digital Voltmeter (Model 502BZ).** Similar to the Model 502B (see above). Circuit is automatically and continually calibrated against a Zener diode reference source instead of against an unsaturated mercury-cadmium standard cell. Price: \$4410.
- 8. DC Digital Voltmeter and Ratiometer (Model 507D).** Measures voltages between  $\pm 100$  microvolts and  $\pm 1000$  volts, ratios between  $\pm 0.0001:1$  and  $\pm 999.9:1$  with 0.01% (of reading)  $\pm 1$  digit accuracy. Price: \$3835.
- 9. Militarized Digital Voltmeter (Model 412).** Rugged, programmable, differential. Auto range, polarity. Measures AC and  $\pm$ DC potentials between 0.001 and 999.9 volts. Accuracy is 0.01% (of reading)  $\pm 1$  digit for DC, 0.1% of full scale for AC. Designed to MIL-E-4158A. Price: \$10,000.

## LABORATORY INSTRUMENTS

- 10. Meter Calibrators.** Provide voltages and currents calibrated in absolute units, regardless of line or load variations. Long term stability is  $\pm 0.01\%$ . Ideal for fast, accurate production meter or telemetering calibrations. Use as accurate reference, as wide range null voltmeters, as secondary voltage and current standards. Price: \$1150 to \$2995.
- 11. Electronic Galvanometer and Amplifier (Model 204A).** A combination DC null detector, linear deflection indicator, microvoltammeter, and inverting DC amplifier. *Functionally equivalent to sensitive suspension galvanometers, yet rugged enough for the test van.* Seven decades ranges provide accurate measurement of voltages from 1 microvolt to 10 volts or currents from 100 micro-microamperes to 1 milliamperes at a constant input resistance of 10,000 ohms. Price: \$425.
- 12. DC Microvolt Ammeter and Amplifier (Model 203A).** Provides high sensitivity, drift-free stability, high input impedance. Fifteen voltage ranges cover from 100 microvolts to 1000 volts, full scale; 19 current ranges cover from 1 millimicroampere to 1 ampere, full scale. 3% accuracy. Price: \$750.
- 13. DC Microvoltmeter and Amplifier (Model 202B).** Provides high sensitivity, drift-free stability, high input impedance. Fourteen voltage ranges cover from 300 microvolts to 1000 volts, full scale. Measures as little as 10 microvolts. Price: \$500.



5725 Kearny Villa Road  
San Diego 12, California  
Phone 277-6700  
(Area Code 714)



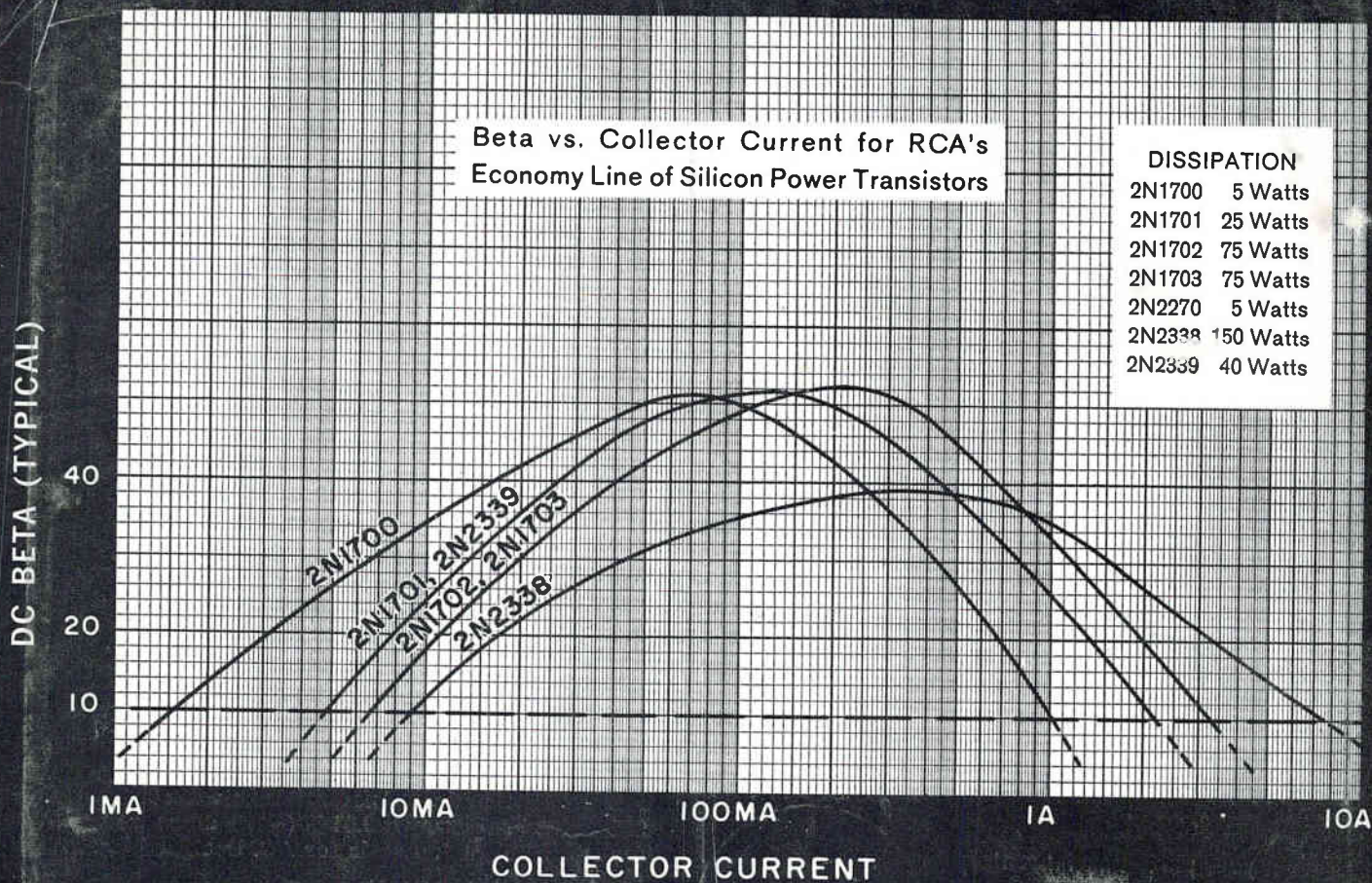

# RCA EXPANDS ECONOMY SILICON LINE FOR LOW COST DESIGN FLEXIBILITY UP TO 150 WATTS

Now, RCA adds 3 new types, 2N2338, 2N2339, 2N2270 to its line-up of low-cost silicon transistors at prices starting as low as comparable Germanium Power Types.

Here's RCA's answer to today's value and performance requirements for industrial and military applications... a broad new economy line of silicon transistors. This low-cost, high performance line now includes three new types, 2N2338 and 2N2339, high and medium power types, respectively, and the 2N2270, RCA's new economy version of the "Universal" triple-diffused planar silicon transistor type 2N2102. With these additions, RCA's economy silicon line now offers:

- High dissipation... up to 150 watts
- Top performance at high temperatures... up to 200°C
- Wide-range beta control... up to 10 amps

These low-cost silicon types are immediately available to bring you new economy and greater design freedom for industrial and military circuits demanding the reliability and performance of silicon transistors.

AVAILABLE THROUGH YOUR RCA DISTRIBUTOR



**THE MOST TRUSTED NAME IN ELECTRONICS**

CIRCLE 902 READERS SERVICE CARD



**New RCA 2N2270**  
Triple-Diffused Planar



**New 150-watt**  
RCA 2N2338



**New 40-watt**  
RCA 2N2339

For new low prices call your RCA representative today. For FREE Technical Bulletin on RCA's Economy Silicon Line, write RCA Semiconductor and Materials Division, Commercial Engineering, Section IN9-3, Somerville, N. J.



**FIELD OFFICES...**

EAST: Newark, N. J., 744 Broad St., HU 5-3900 • (Camden-Philadelphia Area) Eriton, N. J., 605 Marlton Pike, HA 8-4802 • Syracuse, N. Y., 731 James St., Rm. 402, GR 4-5591 • Baltimore, Md., EN 9-1850 • NORTHEAST: Needham Heights 94, Mass., 64 "A" St., HI 4-7200 • SOUTHEAST: Orlando, Fla., 1520 Edgewater Dr., Suite #1, GA 4-4768 • EAST CENTRAL: Detroit 2, Mich., 714 New Center Bldg., TR 5-5600 • CENTRAL: Chicago, Ill., Suite 1154, Merchandise Mart Plaza, WH 4-2900 • Indianapolis 5, Ind., 2132 East 52nd St., CL 1-1405 • Minneapolis 16, Minn., 5805 Excelsior Blvd., WE 9-0676 • Denver 11, Colorado, Continental Terrace Bldg., Suite 301, 2785 N. Speer Blvd., 477-1688 • WEST: Los Angeles 22, Calif., 6801 E. Washington Blvd., RA 3-8361 • (San Francisco Area) Burlingame, Calif., 1838 El Camino Real, OX 7-1620 • Seattle 4, Wash., 2250 First Ave. S., MA 2-8816 • SOUTHWEST: Dallas 7, Texas, 7905 Carpenter Freeway, ME 1-9720 • GOV'T: Dayton, Ohio, 224 N. Wilkinson St., BA 6-2366 • Washington, D. C., 1725 "K" St., N.W., FE 7-8500 • RCA INTERNATIONAL DIV., 30 Rockefeller Plaza, N. Y. 20, N. Y. Cable Address: RADIOINTER, N. Y.