

electronics

TRANSISTOR FAILURE

*Cause and cure in
deflection circuits, p 37*

CONTROLLING REFLEX KLYSTRONS

*Varactor diodes
cut distortion, p 42*

LOCKED-PAIR LOGIC

*Simplifies computer
design, p 46*

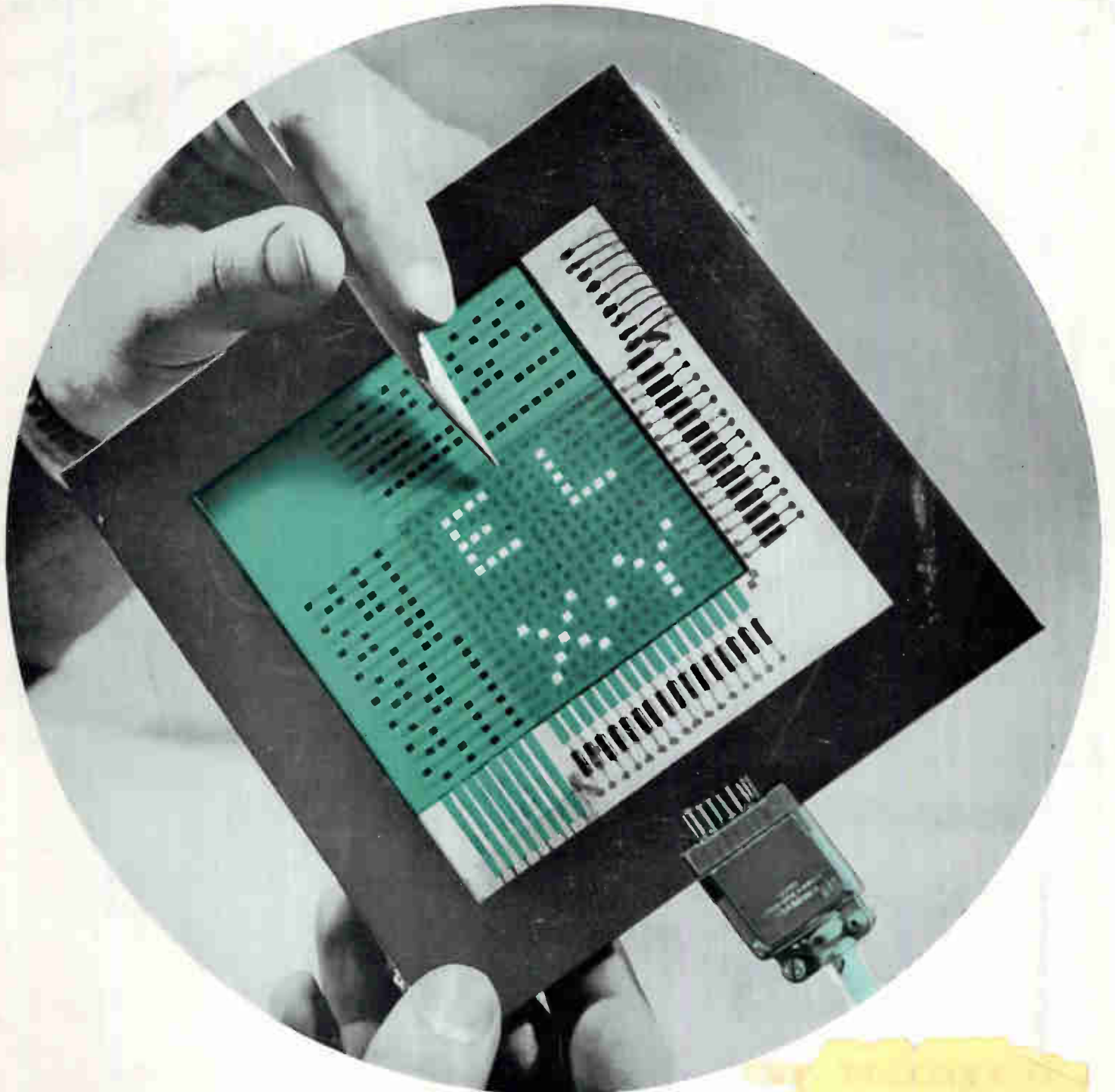

New electroluminescent display panel. What gives it high contrast? See p 33

HOLAND KISSLER
BOX 956
HOODS LANE WASH
L 1

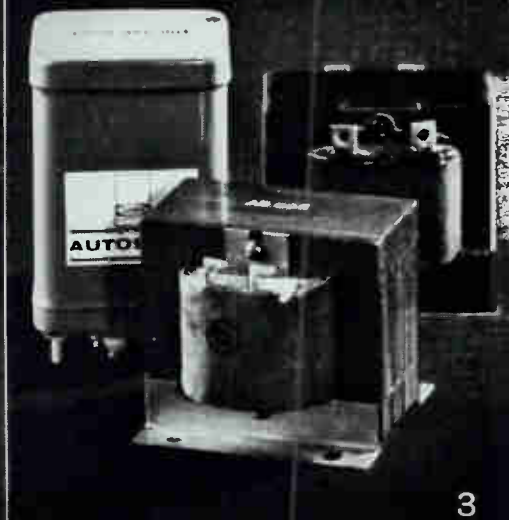

Now, Raytheon gives quote by phone with Autospec

TRANSFORMER USERS:

1. You use unique AUTOSPEC slide rule selector as an aid in specifying your transformer parameters. Slide rule calculations include volt-amps, regulation factors, temperature rise and size information. Technical manual helps, too.

2. You phone Raytheon collect—Waltham, Mass., Area Code 617, TW 9-8400, Ext. 3400. Discuss your needs or questions. Raytheon quotes price plus exact particulars on size, style and electrical characteristics over the phone.

3. You receive your order of transformers that exactly meet your electrical requirements within 3 weeks.

Over 6,500 design engineers now have AUTOSPEC slide rule and catalog/manual. Write for yours. Then call us collect for a quote. Raytheon Company, Magnetics Operation, Waltham 54, Mass.



electronics

A McGraw-Hill Publication 75 Cents



W. W. MacDONALD, Editor

J. M. CARROLL, Managing Editor
 SENIOR EDITORS: Samuel Weber, George W. Sideris. SENIOR ASSOCIATE EDITOR: Michael F. Wolff. ASSOCIATE EDITORS: Michael F. Tomaino, Sylvester P. Carter, William P. O'Brien, John F. Mason, Thomas Emma, Sy Vogel, Leslie Solomon, George J. Flynn, Laurence D. Shergalis. ASSISTANT EDITORS: Nilo Lindgren, Stanley Froud, Stephen B. Gray, Roy J. Bruun, George V. Novatny, Leon H. Dulberger. REGIONAL EDITORS: Harold C. Hood (Pacific Coast, Los Angeles), Thomas Maguire (New England, Boston), Cletus M. Wiley (Midwest, Chicago). ART DIRECTOR: Harry Phillips; Howard R. Berry. PRODUCTION EDITOR: John C. Wright, Jr. EDITORIAL ASSISTANTS: Gloria J. Meurer, Bernice Duffy, Lorraine Rossi, Virginia T. Bastian, Lynn Emery, Bette H. Snyder, Rosemary Abbruzzese, Judy Haskins, Ann Mella, Lorraine Werner. FOREIGN NEWS BUREAU: Director, John Wilhelm, Alyne Elias. LONDON — John Shinn, Derek Barlow, Nicholas Landon. Bonn—Peter Forbath, Silke McQueen. Paris—Robert Farrell, Arthur Erikson. Milan—Marc A. Messina. Mexico City—Bruce Bendorf. Rio de Janeiro—Leslie Warren. Moscow — Stewart Ramsey. Tokyo — Richard Halloran, Charles Cahen, John Yamaguchi.

JAMES GIRDWOOD, Publisher

ELECTROLUMINESCENT PANEL developed at General Telephone and Electronics Labs. The $4\frac{1}{2} \times 4\frac{1}{2}$ -inch display is integrated with two binary decoders, has a spot brightness of 7 foot-lamberts and a resolution of 8 lines per inch. *Contrast is extra-high. See p 33* **COVER**

LUNAR ORBIT RENDEZVOUS Decision to Spur Contracts. Electronic subsystem awards will follow "Bug" contract in Fall. *This is a major modification in plans for a flight to the moon* **22**

RADIO TELESCOPE Outdated by Satellite. Navy's Sugar Grove project is cancelled. *Main reasons are high costs, design difficulties and because satellites are better intelligence gatherers* **22**

SPACE CONTROL CENTER Takes Shape. NASA plans to let construction contracts this fall. *Equipment will cost \$20 million* **23**

NASA WILL SPEND \$194 Million for Ground Tracking in 1963. Networks are being readied for deep space satellites and probes. *Here are the details on equipment to be bought to do the job* **26**

OCEANOGRAPHERS Grapple with Telemetry Problems. Russian interference and a frequency squeeze add to technical problems. *Gathering data requires a variety of radio and acoustic communications equipment* **28**

CONCURRENT PROCESSING Speeds Computer. Executive program raises operating speed and provides subroutines. *Several programs can share new computer's time* **30**

DISPLAY PANEL CONTRAST Enhanced by Nonlinear Resistors. Large-area electroluminescent display panels have been limited up to now in resolution and contrast. *Use of nonlinear resistors eliminates cross-image effects, simplifies interconnection problems.* By H. G. Blank, J. A. O'Connell and M. S. Wasserman, General Telephone & Electronics Laboratories **33**

STOP TRANSISTOR FAILURE in Magnetic Deflection Circuits. Studies show failure rate in power transistors to be proportional to absorbed retrace decay time. *Circuit requirements and device characteristics for high reliability are described.* By R. S. Hartz, Bendix Corp. **37**

UNIQUE POWER SUPPLY Delivers Constant Voltage and Current. All solid-state regulated power supply circuit is automatically programmed to operate in either constant-current or constant-voltage mode. *Either mode can be controlled over wide range of preset values.* By J. W. Martin and H. Liepins, Sola Electric Co. **40**

Published weekly, with Electronics Buyers' Guide and Reference issue, as part of the subscription, by McGraw-Hill Publishing Company, Inc. Founder: James H. McGraw (1860-1948).

Indexed Annually in Buyers' Guide and Reference issue.

Title ® registered U.S. Patent Office; © copyright 1962 by McGraw-Hill Publishing Co., Inc. All rights reserved, including the right to reproduce the contents of this publication, in whole or in part.

Executive, editorial, circulation and advertising offices McGraw-Hill Building, 330 West 42nd Street, New York 36, N. Y. Telephone Longacre 4-3000. Teletype TWX N.Y. 1-1636. Cable McGrawhill, N. Y. PRINTED IN ALBANY, N. Y.; second class postage paid at Albany, N. Y.

OFFICERS OF THE PUBLICATIONS DIVISION: Nelson L. Bond, President; Shelton Fisher, Wallace F. Traendly, Senior Vice Presidents; John R. Callahan, Vice President and Editorial Director; Joseph H. Allen, Vice President and Director of Advertising Sales; A. R. Venezian, Vice President and Circulation Coordinator; Daniel F. Crowley, Vice President and Controller.

OFFICERS OF THE CORPORATION: Donald C. McGraw, President; Hugh J. Kelly, Harry L. Waddell, Executive Vice Presidents; L. Keith Goodrich, Executive Vice President and Treasurer; John J. Cooke, Vice President and Secretary.

Subscriptions are solicited only from those actively engaged in the field of the publication. Position and company connection must be indicated on orders. Subscription rates: United States and Possessions, \$6.00 one year; \$9.00 two years; \$12.00 three years. Canada, \$10.00 one year. All other countries \$20.00 one year. Single Copies, United States and Possessions and Canada 75¢. Single copies all other countries \$1.50.

THE PUBLISHER, UPON WRITTEN REQUEST FROM ANY SUBSCRIBER TO OUR NEW YORK OFFICE, AGREES TO REFUND THAT PART OF THE SUBSCRIPTION PRICE APPLYING TO COPIES NOT YET MAILED.

Subscribers: Please address all correspondence, change of address notices, subscription orders or complaints to Fulfillment Manager, Electronics, at above address. Change of address notices should provide old as well as new address, including postal zone number if any. If possible, attach address label from recent issue. Allow one month for change to become effective.

Postmaster: Please send Form 3579 to Fulfillment Manager, Electronics, 330 West 42nd Street, New York 36, New York.



Audited Paid Circulation

CONTENTS continued

- DISTORTION IN KLYSTRONS:** Can Varactors Be Used to Eliminate It? Differential distortion of f-m in reflex klystrons is troublesome in microwave communications systems. *Experiments indicate use of varactor diode as modulator improves linearity and expands frequency range.*
By A. Sasaki, Kobe Kogyo Corp. 42
- NEW LOCKED-PAIR LOGIC** Operates at High Speed. Although the locked or Goto pair is fast and yields high gain, logical inversion is made difficult by single-ended output. *New practical tunnel diode circuit uses transformer coupling to overcome problem.*
By C. Cohen, McGraw-Hill World News 46
- PULSE-LENGTH DISCRIMINATORS:** A New Approach. Circuit delivers output pulse when input exceeds preset length. *Applications include sorting objects by length, timing and pulse-length measurement.*
By K. R. Whittington and G. Robson, Tube Investments Research Labs. 48

DEPARTMENTS

- Crosstalk. *Satellite Ownership Should Be Private* 3
- Comment. *Ear and Brain versus Electronics. Standard sizes and Exponents* 4
- Electronics Newsletter. *NASA Relaxes Patent Regulations* 7
- Washington Outlook. *Private Satellite Opponents Losing* 12
- Meetings Ahead. *Fourth Joint Automatic Control Conference* 31
- Research and Development. *Photo Reader Aids Pattern Recognition Study* 50
- Components and Materials. *Piston Capacitor Tuner Elements Ride Piggyback* 54
- Production Techniques. *Preparing Tapes for Audio-Visual Aids* 58
- New Products Design and Application. *Oscillator Delivers Clean Sine Waves* 62
- People and Plants. *Controls Company Moves Home Office* 66
- Index to Advertisers 72

Satellite Ownership Should Be Private

PRELIMINARY communications experiments using AT&T's successful Telstar satellite have served to focus attention on the Communications Satellite Act of 1962, now before the Senate. This bill, if passed, would set up a private corporation that would own and supervise all satellite communications systems launched from this country. As presented to the Senate, it differs only in minor ways from the bill which passed the House May 3.

THE CORPORATION, planned to be a profit-making entity, would be run by a board of fifteen directors—three appointed by the President, six elected by stockholding communications common carriers and six elected by all other stockholders. Provision is made to prevent any one person or common carrier from gaining control of this voting stock. Bonds and non-voting stock would also be offered to common carriers, for inclusion in their rate base as a capital investment.

The corporation would own all communications satellites, rent communications channels to common carriers and government, hold conferences with the State Department when dealing with a foreign country if required and use its own initiative to stimulate competition among equipment suppliers and common carriers. Common carriers would retain ownership of ground stations and other facilities.

The bill provides for overseeing of the corporation by the President, Congress, and the Federal Communications Commission.

OPPOSITION to the bill centers around the fact that some feel a government run-privately owned monopoly would be created. Others feel that taxpayers, who helped finance development of launching facilities and other systems associated with the satellite communications program, would not have sufficient voice in running the corporation.

Some opponents think difficulty would be experienced selling a stock that would not return a profit for some time, and then only a regulated profit. Some common carriers initially indicated an unwillingness to purchase bonds and non-voting stock; they would much rather invest in capital equipment.

Inconsistencies have also been pointed out in

the concept of corporation-owned satellites and common-carrier-owned ground stations.

AN ALTERNATE PROPOSAL of complete government control is meeting heavy criticism. Although taxpayer-financed projects would remain under full government control, and dealings with foreign countries

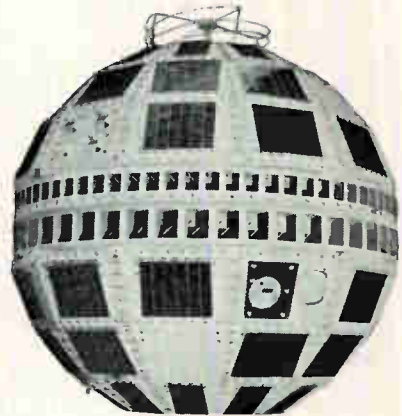

could be closely coordinated with foreign policy, private enterprise would be largely left in the cold, with little chance of making a profit based on its own initiative.

The very fact that private enterprise successfully developed an active communications satellite before the federal government is serving to point out that government control of a communications satellite system could lead to a slowing-up of development.

PRIVATE OWNERSHIP of a communications satellite system has not, even yet, been thoroughly explored.

Private enterprise in purer form than the pending bill could continue in its role of developer and operator.

The government could control launchings.

The FCC could act as a watchdog over use of frequencies.

An existing agency or a new one could pass on usage and rates.

Individual corporations would thus be free to continue betterment of consumer service by active competition.

In any event, it is certainly possible that private enterprise and the federal government could, if the government wished, sit down and draft a more mutually suitable plan for the running of a satellite communications system by private enterprise than the bill awaiting action in the Senate.

Perhaps current discussions there will produce amendments that trend in this direction.

**BLUE
LINE**
NEW
COAXIAL
TERMINATIONS
ARE
RUGGED
STABLE
AND
MODERATELY
PRICED



These BLUELINE Terminations are specifically designed for use in applications where price and performance are important but a high degree of precision is not required.

Despite their lower price, BLUELINE Terminations combine high quality materials and sturdy construction. They feature Weinschel's own film resistors which give excellent resistance to shock and vibration while assuring stability under temperature and humidity cycling.

Pictured above are the BLUELINE Model CT-N Terminations which cover the frequency range from DC to 10 KMC. They are rated for an average power of 1 Watt and a peak of 1 KW. We invite you to write for complete specifications and prices.

For your more exacting applications we recommend Weinschel Precision Terminations.

**BLUE
LINE** By

WEINSCHTEL

ENGINEERING
Kensington, Maryland
Tel: 949-0141 (area code 301)
TWX: KENS 446
Santa Monica, California
631 Wilshire Blvd., TWX: SMON 7185

COMMENT

Ear and Brain versus Electronics

I noticed in the section of your June 8 *Crosstalk* called The Wheat From The Chaff (p 3), you say the ear is way behind modern electronic techniques in picking out signals from a noisy background. To support this you cite a system devised by Robert D. Moore of Princeton Applied Research [described in a technical article on p 40 of the June 8 issue] which will dig out a useful signal (in this case a 4-Kc signal) below the noise.

You might be interested in learning that we have recently conducted experiments in which the human ear-brain combination can be used to extract one relevant binaural voice message from amidst six simultaneous and similar monaural messages (three in each ear). In other words, we have demonstrated that with special utilization of the auditory sense, the human ear-brain combination can extract, with a high degree of intelligibility, one of seven simultaneous voice messages. You will grant that the complexity of a voice message exceeds that of a 4-Kc signal. Can modern electronic techniques dig out this kind of a useful signal? Or, is this still a function that only the human hearing mechanism can accomplish so far?

Incidentally, we would appreciate learning if any of your readers knows of ways or can devise a way for extracting a binaural voice message under the above conditions so that it can be amplified to give a better signal-to-voice ratio.

MAURICE RAPPAPORT
Systems Analysis Program
Management Sciences Division
Stanford Research Institute
Menlo Park, California

It is reassuring to learn that the human being is not yet obsolete.

Standard Sizes and Exponents

The first two letters in *Comment* of 15 June (p 4) have much in common and I will comment on both. A. Hemel accepts that 0•004 is a standard size and blames it on the use of decimal fractions. I maintain that 0•004 is not a stand-

ard size, decimal fraction or not, the standard size being 0•0039 (also note the difference between a decimal point and a period). But then, why use all those insignificant zeros, as in 390,000, just to avoid 0•39? This question leads to the second letter.

R. O. Whitaker proposes the use of exponents to the base ten to avoid a multiplicity of prefixes to units and suggests enclosing the exponent in a circle. This is fine for handwritten notation but is rough on the typist and the printer. The circle has no inherent advantages that I can see, and a more convenient notation could be chosen without detracting from the advantages of an exponential system of notation. The capital letter E could be placed immediately ahead of the exponent, leading to designations such as 39E-10 for 0•0039 μ and 3E9 for a typical microwave frequency. The mantissa should be normalized so that only significant digits are retained. A 120K 10% resistor would always be 12E4 (as it is with its color bands) and never 120E or 1•2E5, and a 1-Meg resistor would be 10E5. For engineering purposes it should not be necessary to include the units at all. Mks units, corresponding to the associated symbol or text, would be understood. What could be easier than writing: Capacitance = 39E-10; or saying: "The capacitance is thirty-nine E minus ten," meaning farads, of course.

An incidental advantage would be to do away with decimal points, thereby removing any confusion with the periods that terminate sentences, and also removing the necessity to place a zero ahead of the point in a decimal fraction.

The use of E within a number to mean exponent should not lead to confusion with other uses of the letter E. Its use in this way is already an established procedure to designate exponents in the floating-point Zebra Simple Code (the Zebra computer, manufactured by Standard Telephones and Cables).

WM. L. CLINK

Ralston, Alberta
Canada

The British decimal point (a period centered vertically) isn't in our fonts. So we've used our smallest "bullet."

NOW!

**RECTANGULAR
CERAMIC CRT**

**ILLUMINATED
INTERNAL
GRATICULE**

**NEW DUAL-TRACE AND
NEW DELAYED SWEEP
PLUG-INS**

with the Tektronix Type 561A Oscilloscope

The Type 561A employs a unique 5-inch rectangular "ceramic envelope" cathode-ray tube with the following features:

1. Illuminated "no parallax" internal graticule on a high-quality parallel-ground plate-glass face.
2. Controllable graticule lighting, permitting trace photography with the same convenience as provided by external graticules.

Other features of this compact new oscilloscope include: Improved regulated power supplies • Regulated dc heater supply • Z-axis input • 3.5-KV accelerating potential • Amplitude calibrator with 18 steps from 0.2 mv to 100 v • Operation from 105 v to 125 v or 210 v to 250 v, 50 to 400 cps.

A wide range of performance characteristics is provided by available plug-in units—from the simple single-channel 2A60 to the dual-channel 0.4 nsec-risetime 3S76. For example, the two latest additions to this ever-growing family of plug-ins, the 3A1 and 3B3, provide high-sensitivity wide-band dual-trace operation combined with calibrated sweep delay.

Type 3A1 Dual-Trace Amplifier Unit

Passband—dc to 10 Mc at 3-db down.

Displays—single trace, dual trace, or algebraic addition.
6-cm linear scan.

Sensitivity—10 mv/cm to 10 v/cm in 10 calibrated steps, 1-2-5 sequence.
Variable sensitivity between steps.

No Signal delay.

Type 3B3 Time-Base Unit

Normal and Delayed Sweeps—0.5 μ sec/cm to 1 sec/cm in 20 calibrated steps, 1-2-5 sequence. Variable adjustment between steps. 5X Magnifier extends calibrated range to 0.1 μ sec/cm.

Precision Delay Interval—0.5 microseconds to 10 seconds.

Triggering—Flexible Tektronix triggering, plus single-sweep operation for normal sweep. Triggered operation to above 10 Mc.

Type 3B1 Same as 3B3 except has uncalibrated delay and does not have single sweep feature.

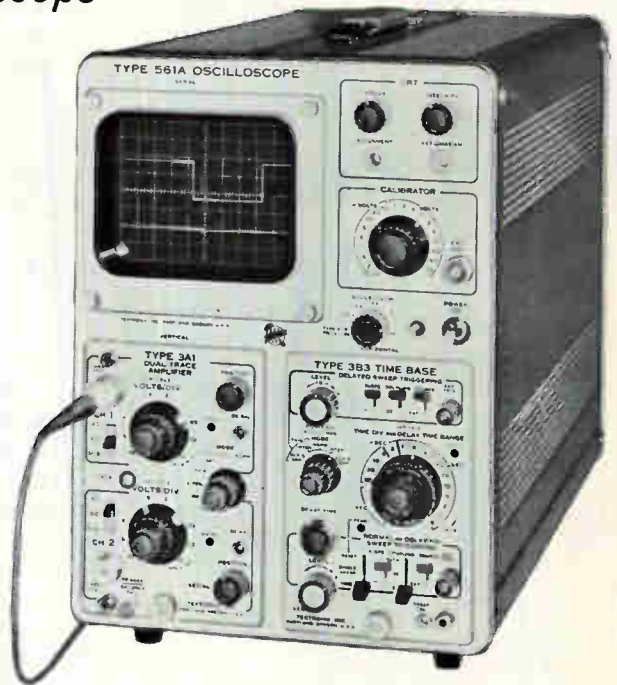

TYPE 561A OSCILLOSCOPE (without plug-ins)	\$470
TYPE 3A1 DUAL-TRACE AMPLIFIER UNIT	\$410
TYPE 3B1 TIME-BASE UNIT	\$475
TYPE 3B3 TIME-BASE UNIT	\$525

U.S. Sales Prices, f.o.b. Beaverton, Oregon

For more information on a Type 561A Oscilloscope and plug-in combinations, please call your Tektronix Field Engineer.

OTHER 2-SERIES AND 3-SERIES PLUG-INS AVAILABLE

AMPLIFIER UNITS TYPE	PASSBAND (3-db down)	SENSITIVITY	PRICE	TIME-BASE UNITS TYPE	SWEEP FEATURES	TRIGGERING	PRICE
2A60	dc—1 Mc.	50 mv/cm—50 v/cm 4 decade steps with variable control.	\$105	2B67	1 μ sec/cm to 5 sec/cm, 1-2-5 sequence, variable between rates. 5X Magnifier. Single Sweep.	Internal, External, Line; Amplitude-Level Selection; AC or DC- Coupling; Automatic or Free-Run; \pm Slope.	\$175
2A63—Differential (50:1 rejection ratio)	dc—300 kc.	1 mv/cm—20 v/cm 1-2-5 sequence with variable control.	\$130				
3A72—Dual Trace (Identical Channels)	dc—650 kc. (each channel).	10 mv/cm—20 v/cm, 1-2-5 sequence, with variable control.	\$250				
3A74—Four Trace	dc—2 Mc (each channel).	20 mv/cm—10 v/cm, 1-2-5 sequence, with variable control.	\$550				
3A75—Wide Band	dc—4 Mc.	50 mv/cm—20 v/cm, 1-2-5 sequence, with variable control.	\$175				
3S76—Dual Trace Sampling (for use with 3T77)	equivalent dc-to-875 Mc. (0.4-nsec risetime)	2 mv/cm—200 mv/cm, 1-2-5 sequence, with variable control.	\$1100	3T77 Sampling Sweep (for use with 3S76)	Equivalent to 0.2 nsec/cm to 10 μ sec/cm, 1-2-5 sequence, variable between rates. 10X Magnifier.	Internal or External, \pm Slope.	\$650

Tektronix, Inc. P. O. BOX 500 · BEAVERTON, OREGON / Mitchell 4-0161 · TWX—BEAV 311 · Cable: TEKTRONIX

TEKTRONIX FIELD OFFICES are located in principal cities throughout the United States. Please consult your Telephone Directory.

TEKTRONIX CANADA LTD: Montreal, Quebec • Toronto (Willowdale) Ontario.

ENGINEERING REPRESENTATIVES: Kentron Hawaii Ltd., Honolulu, Hawaii. Tektronix is represented in twenty-five overseas countries by qualified engineering organizations. European and African countries, the countries of Lebanon and Turkey, please contact TEKTRONIX INTERNATIONAL A.G., Terrassenweg 1A, Zug, Switzerland, for the name of your local engineering representative. Other Overseas areas, please write or cable directly to Tektronix, Inc., International Marketing Department, P. O. Box 500, Beaverton, Oregon, U.S.A. Cable: TEKTRONIX.

SEE THIS TEKTRONIX OSCILLOSCOPE AT WESCON — BOOTHS 751-752-753-754.

PUSH
BUTTON

TEST
SIGNALS!

1%
ACCURACY!

10 CPS

to
1 MC



Push-button convenience and repeatability for selecting frequencies from 10 cps to 999 KC makes the new Φ 241A Oscillator ideal for supplying stable test signals for lab or production work. Just push one of five decade multipliers and three frequency push buttons to select any of 4,500 discrete frequencies. You get accuracy of $\pm 1\%$ and repeatability typically better than 0.005%.

Three-digit frequency resolution is provided by the solid-state Φ 241A. Infinite resolution is provided by a vernier control, which extends the upper frequency to 1 MC.

Frequency response is flat within $\pm 2\%$ over the entire range, and a front panel control provides output levels from +10 to -30 dbm, presenting a constant output impedance of 600 ohms. Hum and noise are reduced below 0.05% of the output.

High repeatability, positive push-button operation and compact, rugged solid-state design make the Φ 241A especially suitable for production line or other repetitive testing.

Write today for complete data, or call your nearest Φ representative for a demonstration.

HEWLETT-PACKARD COMPANY

1501 Page Mill Road, Palo Alto, California
Area Code 415, DA 6-7000

Sales and service representatives in all principal areas
Europe, Hewlett-Packard S.A., 54-54bis Route des
Acacias, Geneva; Canada, Hewlett-Packard (Canada)
Ltd., 8270 Mayrand Street, Montreal

Φ 241A
Oscillator



SPECIFICATIONS

Frequency:	10 cps to 1 MC, 5 ranges, each with 900 frequency increments with vernier overlap
Calibration Accuracy:	$\pm 1\%$
Frequency Response:	$\pm 2\%$ into rated load
Output Impedance:	600 ohms
Distortion:	1% maximum
Hum and Noise:	0.05% maximum of output
Output:	+10 to -30 dbm into 600 ohms (2.5 volts max.)
Dimensions:	6½" high x 7¾" wide x 8" deep. 13 lbs.
Price:	\$425.00
Data subject to change without notice. Prices f.o.b. factory.	

7927

ELECTRONICS NEWSLETTER

NASA Will Relax Its Patent Regulations

WASHINGTON—National Aeronautics and Space Administration is working on rules to loosen its policy on granting patent waivers. Not many waivers are granted under the present policy of issuing them at the administrator's option. The plan is to grant blanket patent waivers when a contract is let, assuring—even before an invention is made—that a company will receive rights to resulting patents.

Blanket waivers will be granted mainly on items that are made commercially, but don't meet NASA specifications. Inventions resulting from producing the items to specifications will belong to the contractor. Such waivers won't be issued for government-financed R&D in new fields of technology.

NASA is also due to make a change in licensing agreements in about a month, to speed up the time taken to get new technology into industrial use. The time, now five years, may be cut to two or three years. If companies don't work the technology in this time, their licenses will be yanked.

The White House plans soon to privately circulate to industry a set of patent rules aimed at getting one standard government policy. Final action, if any, will likely be many months away.

Educational Tv May Get Its Own Broadcast Band

SPECTRUM SPACE outside of the regular uhf-tv bands may be allocated to educational tv broadcasts. Late last week, the FCC asked for comment, by Sept. 17, on a proposal to allow schools to broadcast between 1,990 Mc to 2,100 Mc, or between 2,500 Mc to 2,690 Mc.

The plan would allow schools to operate district networks without using existing uhf channels. Equipment to convert signals for reception on conventional tv sets is available. Adler Electronics, which held feasibility demonstrations earlier this year, said broadcasting would cost less than using cables or leased lines to link schools to a central studio.

An Adler spokesman said the

1,990-2,100-Mc band would probably be more suitable since it is primarily used as for tv auxiliary services linking studios and transmitters. The 2,500-2,690-Mc band is used by fixed point-to-point services and might be more subject to interference from school tv.

Telstar Lives Up to Bell Labs' Expectations

TELSTAR communications satellite is in excellent condition and is functioning as planned, Bell Telephone Laboratories reported last week. The satellite has been used successfully as a repeater for both color and black and white television, one-way and two-way telephone calls, and for transmission of photofacsimile and high speed data.

The satellite's orbit is extremely close to that planned. Tracking and receiving systems have been functioning well. The signal-to-noise ratio at the Andover horn antenna was 43 db during television transmission; this was obtained with an f-m feedback system. Transmission characteristics are exactly as measured on the ground before launch,

indicating launch and space environment had no effect on transmission system (p 28, July 13).

Data telemetered at a rate of 115 items a minute and providing system performance measurements, indicate no solar cell damage during launch, no loss of pressure nor temperature problem inside the satellite. Radiation experiments (p 26, Feb. 16) in the satellite are functioning as planned.

Teracycle-Frequency Laser Would Use D-C Pumping

PALO ALTO, CALIF.—Varian Associates has begun a research program designed to provide a d-c pumped infrared laser with a tuning range of an octave or more in frequency.

The characteristic to be made use of is the anomalously high magnetic moment of some of the electrons and holes in narrow-band-gap semiconductors and semimetals, such as ternary mercury-cadmium-telluride compounds and graphite. The ratio of laser frequency to applied magnetic field (gyromagnetic ratio) is many times higher than for free electrons and may be positive or negative in sign, indicating a high (submillimeter or infrared) frequency for reasonable applied magnetic fields, and the possibility of tuning over wide ranges by varying the magnetic field. The change in sign of magnetic moment may be used to pump the laser by passing direct current through the material.

Measurements on indium antimonide show a characteristically

Communist Chinese Engineers Organize Society

HONG KONG—Report from the official New China News Agency said that a Chinese Electronics Society has been formed in Communist China. Datelined in Peiping, April 21, the report arrived here in July.

The report gave only a general description of the organization meeting and technical sessions. It claimed that a total of more than 10,000 scientific and technical workers in radio electronics attended nine sessions and heard 140 papers.

Stated objectives of the society are to facilitate academic programs and disseminate research achievements. The news agency claimed that China's research has made "rapid progress," particularly since the "big leap forward" in 1958 (p 32, Dec. 23, 1960)

high gyromagnetic ratio of -50 , and a remarkable enhancement of the interaction with the electromagnetic field by an electric dipole interaction. This was explained as being due to the displacement of the carrier in the lattice field of the crystal, by the electric field, which caused extra interaction with the applied magnetic field.

R. D. Bell, company scientist, estimates that solid state lasers using these effects will become available in the wavelength range between 40 and 1,000 microns, where, he said, there are presently no good sources. The tuning field will probably be supplied by a superconducting solenoid magnetic under development.

Cloud Photos Made into Mercator Weather Maps

SATELLITE cloud photos are reproduced on a Mercator projection by a technique developed at IBM. Superimposing several photographs makes possible large-area weather maps. The technique can also be used to make maps from other types of photos.

Films are scanned in discrete portions by a crt beam. Analog output of a photomultiplier tube is converted to a digital signal denoting color tone of the film portion and is recorded on magnetic tape. In a digital computer, the image data is mathematically projected into position on a sphere, then changed to a Mercator image. The output tape is used to make a film of the map by a process that essentially reverses the input process.

Open Plant in Ireland To Compete with Japan

GENERAL ELECTRIC'S Radio Receiver department is establishing a wholly owned subsidiary, E. I. Co. Ltd, at Shannon, Ireland, to manufacture two components used in some G.E. radios. Completion of the facility is expected next January, with production scheduled to start in March.

R. C. Wilson, general manager of the department, said that "our objective is to protect our business and employment in the United

States and help us to remain competitive with the increasing Japanese radio competition that has developed in recent years in the United States." He said the new operation would have no detrimental effect upon Utica, N. Y., employment.

Midwest's Stinted R&D Costs Defense Contracts

CHICAGO—Meeting of several hundred businessmen, labor and educational leaders is being arranged for late September to discuss the midwest's defense contracting problem in greater detail with representatives of government agencies.

At a meeting last week, Robert Steadman, economic advisor to Defense Secretary Robert McNamara, said the area's low level of R&D in private industry is costing it a big share of electronics and other defense contracts, and creating doubts about the future. Universities in the Chicago area have been doing their share. The universities did about \$20 million in R&D in 1960.

Steadman's appearance resulted from a trip to Washington last month by Chicago's Mayor Daley and others seeking to learn why the midwest isn't getting more defense work. He explained the statistics (p 12, July 6) by saying that many negotiated contracts go to areas with the skills needed for highly technical projects. Both business and academic R&D would bring more defense work to the midwest, he said.

Minuteman Ground System Contract Is Announced

COMMAND AND CONTROL ground electronics for USAF's Minuteman ICBM weapon system will be developed by Sylvania's Electronic Systems division. The multimillion-dollar contract calls for design and integration of a blast resistant system to monitor operational readiness of the missiles and provide continuous control of unmanned missile sites. If needed, the ground electronics system would also transmit firing orders and target information to the missiles.

In Brief . . .

LUNAR TRANSPONDER weighing 10 pounds and capable of withstanding landing impact of 3,000 times its earth weight, will be developed by General Dynamics for AFCRL. Among uses will be determining distance from moon to earth.

GOODYEAR AIRCRAFT has two airborne radar development contracts, one worth \$4 million from Army, another from Air Force.

FOLLOW-ON production contract of \$24 million has been received by Melpar from Autonetics for circuit boards for Minuteman ICBM.

SUPPLEMENTAL contract of \$13.8 million has been awarded by Air Force to Sperry-Rand for the MARS tracking ships program. Sperry Gyroscope is to develop a new passive underwater detection system under a \$1.4-million Navy award.

LEAR SIEGLER will build cloud-height detecting radar for the Air Force's worldwide automatic weather system under \$1.3-million order. The radars' frequency will be 35 Gc.

AMPHENOL-BORG is building a plant in Munich, to tap the European market, will start production late this year with 500 employes, expects to expand it to 1,600 employes.

TOSHIBA has developed a 31-Mev betatron for use in cancer study and treatment at the National Institute of Radiological Sciences. X-ray range will be 120 to 2,500 roentgens a minute at a distance of 1 meter.

THREE MORE ground stations and command clock systems for the Nimbus weather satellite will be made for NASA by California Computer Products.

REGENCY ELECTRONICS will be paid a lump-sum royalty by the Electronic Industries Association of Japan, for past use of Regency designs in Japanese-made transistor radios. Royalties will also be paid for future use.

NOW
AVAILABLE
WITH WELDABLE
LEADS

**RUGGED END-CAP
CONSTRUCTION FOR
LONG TERM STABILITY**

**EXCEPTIONAL RESISTANCE
TO MOISTURE
AND MECHANICAL
DAMAGE**

**SURPASS MIL-R-10509
PERFORMANCE
REQUIREMENTS**

AVAILABLE IN
REEL PACKING
FOR AUTOMATED
PWB INSERTION

FILMISTOR[®] METAL FILM RESISTORS

**OFFER 5 DISTINCT
TEMPERATURE
COEFFICIENTS TO
MEET ALL CIRCUIT
REQUIREMENTS**

Providing close accuracy, reliability and stability with low controlled temperature coefficients, these molded case metal-film resistors outperform precision wirewound and carbon film resistors. Prime characteristics include minimum inherent noise level, negligible voltage coefficient of resistance and excellent long-time stability under rated load as well as under severe conditions of humidity.

Close tracking of resistance values of 2 or more resistors over a wide temperature range is another key performance characteristic of molded-case Filmistor Metal Film Resistors. This is especially important where they are used to make highly accurate ratio dividers.

Filmistor Metal Film Resistors, in 1/8, 1/4, 1/2 and 1 watt ratings, surpass stringent performance requirements of MIL-R-10509D, Characteristics C and E. Write for Engineering Bulletin No. 7025 to: Technical Literature Section, Sprague Electric Co., 35 Marshall Street, North Adams, Mass.

*For application engineering assistance write:
Resistor Division, Sprague Electric Co., Nashua, New Hampshire.*

SPRAGUE COMPONENTS

RESISTORS
CAPACITORS
MAGNETIC COMPONENTS
TRANSISTORS

INTERFERENCE FILTERS
PULSE TRANSFORMERS
PIEZOELECTRIC CERAMICS
PULSE-FORMING NETWORKS

HIGH TEMPERATURE MAGNET WIRE
CERAMIC-BASE PRINTED NETWORKS
PACKAGED COMPONENT ASSEMBLIES
FUNCTIONAL DIGITAL CIRCUITS



'Sprague' and '®' are registered trademarks of the Sprague Electric Co.

Now from LAMBDA new LE SERIES Transistorized Regulated

DESIGNED
TO PERFORM
TO MILITARY
ENVIRONMENT
SPECIFICATIONS

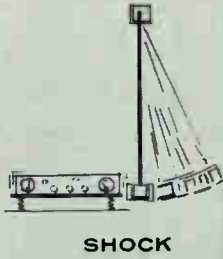

SHOCK



VIBRATION

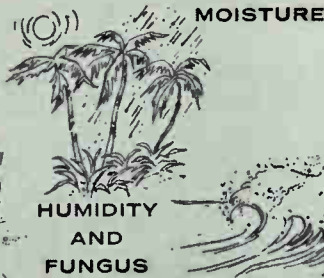

HUMIDITY
AND
FUNGUS

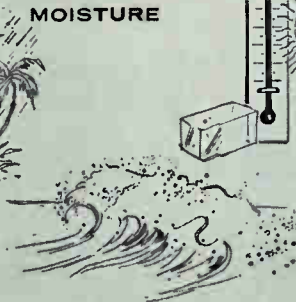

SALT SPRAY

TEMPERATURE



ALTITUDE

E

environment-engineered...

...at mass-production prices

LE 101-FM
LE 105-FM
LE 109-FM

LE 102-FM

LE 103-FM

LE 104-FM

PATENTS
PENDING

for:

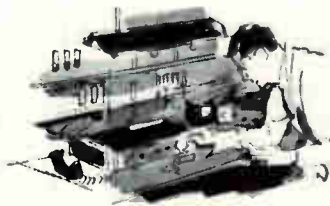

LABORATORY



INDUSTRIAL



MILITARY
APPLICATIONS



LAMBDA ELECTRONICS CORP.

515 BROAD HOLLOW ROAD • HUNTINGTON, L.I., NEW YORK • 516 MYRTLE 4-4200

Western Regional Office: 230 North Lake Avenue, Pasadena, California • Phone: Code 213, MUrray 1-2544
 New England Regional Office: 275 Boston Post Road, Marlboro, Massachusetts • Phone: Code 617, HUrtle 5-7122
 Middle Atlantic District Office: 515 Broad Hollow Road, Huntington, L. I., New York • Phone: Code 516, MYrtle 4-4200
 Southeastern Region: W. A. Brown & Associates, Inc., Engineering Representatives
 Orlando, Fla. • Fort Lauderdale, Fla. • Huntsville, Ala. • Alexandria, Va. • Winston-Salem, N. C.

Power Supplies

CONVECTION COOLED

No blowers or filters; maintenance free.

CONSTANT VOLTAGE CONSTANT CURRENT

by automatic switchover.

**6 MODELS
AVAILABLE**



PATENTS PENDING

COMPLETELY PROTECTED

against—short circuit and electrical overload; input line voltage transients; excessive ambient temperatures. No voltage spikes due to "turn-on, turn-off" or power failure.

WIDE INPUT RANGE

Wide input voltage and frequency range—105-135 VAC, 45-66 CPS and 320-480 CPS in two bands selected by switch.

REMOTELY PROGRAMMABLE AND CONTINUOUSLY VARIABLE

Voltage continuously variable over entire range. Programmable over voltage and current range.

OTHER FEATURES

- Adjustable automatic current limiting.
- 0°C to +50°C ambient.
- Grey ripple finish.
- Ruggedized voltmeters and ammeters per MIL-M-10304B on metered models.



5-YEAR GUARANTEE

**covers all Lambda Power Supplies
including LE Series models**

Every Lambda power supply sold since 1953 has been backed by Lambda's 5-year guarantee, which covers workmanship and materials (except for tubes and fuses).

Visit
LAMBDA
at the Wescon Show
Booths 3421-3422.

LE SERIES

CONDENSED TENTATIVE DATA

DC OUTPUT (VOLTAGE REGULATED FOR LINE AND LOAD)⁽¹⁾

Model	Voltage Range	Current Range	Price ⁽²⁾
LE101	0-36 VDC	0- 5 Amp	\$420
LE102	0-36 VDC	0-10 Amp	525
LE103	0-36 VDC	0-15 Amp	595
LE104	0-36 VDC	0-25 Amp	775
LE105	0-18 VDC	0- 8 Amp	425
LE109	0- 9 VDC	0-10 Amp	430

(1) Current rating applies over entire voltage range.

(2) Prices are for nonmetered models. For models with ruggedized MIL meters add suffix "M" to model number and add \$40 to the nonmetered price. For metered models and front panel control add suffix "FM" and add \$50 to the nonmetered price.

REGULATED VOLTAGE:

Regulation (line) Less than .05 per cent or 8 millivolts (whichever is greater). For input variations from 105-135 VAC.

Regulation (load) Less than .05 per cent or 8 millivolts (whichever is greater). For load variations from 0 to full load.

Transient Response (line) Output voltage is constant within regulation specifications for any 15 volt line voltage change within 105-135 VAC.

(load) Output voltage is constant within 25 MV for load change from 0 to full load or full load to 0 within 50 microseconds of application.

Remote Programming 50 ohms/volt constant over entire voltage range.

Ripple and Noise Less than 0.5 millivolt rms either positive or negative terminal grounded.

Temperature Coefficient Less than 0.015%/°C.

DC OUTPUT (CURRENT REGULATED FOR LINE AND LOAD)⁽³⁾

Current range 10% to 100% rated load for entire voltage range. Full specifications upon request.

AC INPUT 105-135 VAC; 45-66 CPS and 320-480 CPS in two bands selected by switch.

OPERATING AMBIENT TEMPERATURE AND DUTY CYCLE

Continuous duty at full load 0°C to +50°C (122°F) ambient.

OVERLOAD PROTECTION:

Thermal Thermostat, reset by power switch, thermal overload indicator light front panel.

Electrical:

External Overload

Protection Adjustable, automatic electronic current limiting circuit limits the output current to the preset value upon external overloads, including direct short, thereby providing protection for load as well as power supply. Current limiting settable from 10% to 110% of load.

METERS: Ruggedized voltmeter and ammeter to Mil-M-10304B specifications on metered models.

CONTROLS:

DC Output Controls Coarse and fine voltage adjust and current adjust on front panel for models with suffix "FM", all other models same controls are mounted in rear.

PHYSICAL DATA:

Mounting Standard 19" rack mounting.

Size LE101, LE105, LE109 3½" H x 19" W x 16" D
LE102, 5¼" H x 19" W x 16" D
LE103, 7" H x 19" W x 16½" D
LE104, 10½" H x 19" W x 16½" D

WRITE FOR COMPLETE CATALOG

CIRCLE 11 ON READER SERVICE CARD

WASHINGTON OUTLOOK

BACKERS OF PRIVATE OWNERSHIP for a satellite communications system are expected to win over senators demanding government ownership. A bloc of a half-dozen or so senators were arguing at press time that since the government paid for most of the development, the program should not be handed over to industry.

PRIVATE SATELLITE OPPONENTS STALLING

They've been overruled by the administration and the House (which has already passed a bill calling for stock ownership by common carriers and the public), and a majority of the Senate favors private ownership. The lone hope of the holdouts was to delay action on the bill long enough to sidetrack it until next year.

One upshot of the stand for government ownership may be preferential rates for government use, primarily for tv transmissions. There is growing feeling that lower government rates will be approved. World reaction to Telstar tv programs aptly demonstrated the propaganda value of the media, but the U. S. Information Agency could not afford full utilization at commercial rates.

It will be a couple of years, however, before a system is ready for FCC rate approvals.

HERE IS THE SITUATION as the Senate Finance Committee moves into the final days of hearings on the House-approved trade bill (*ELECTRONICS*, p 14, July 13): Senator Paul H. Douglas (D-Ill.) wants to give the President a "strong stick as well as a carrot" to deal with the powerful European Common Market—the stick, special powers to raise tariffs as a lever against European trade restrictions; the carrot, power to lower tariffs.

TRADE BILL HEARINGS NEAR END

Industry and agriculture representatives favoring the bill urged that the special representative for trade negotiations, a post created by the House, be upgraded from ambassadorial to cabinet rank. They also want him to head the new Inter-Agency Trade Council, a top-level forum where industry can state its case against foreign trade restrictions before actual trade negotiations start.

NEGOTIATIONS IN BRUSSELS for British entry into the European Common Market entered a crucial stage last week. The talks were to go past the July 31 deadline and into August. Still moot: EEC's terms for letting Britain into the club and whether the British can meet them. The two big uncertainties are: maneuvering among the six EEC nations over whether and how far to move toward a European political confederation before Britain joins, and the deterioration of Prime Minister MacMillan's position as dramatized by his recent cabinet reshuffle. Last week, however, MacMillan defeated a censure move in Britain's Parliament.

CAN BRITAIN AFFORD EEC'S CLUB DUES?

DEFENSE APPROPRIATION passed by Congress sets a peacetime record of \$48.1 billion, slightly more than the administration requested. The major changes in the R&D budget proposals were additional funds for the Air Force's RS-70 and Dyna-Soar (X-20) projects. Only a token amount of the 50 percent extra for the RS-70 is likely to be spent. (For details on military budget proposals, see *ELECTRONICS*, p 20, June 15; p 26, June 1; p 26, May 15; p 20, May 18, and p 30, April 27).

DEFENSE APPROPRIATION SETS RECORD

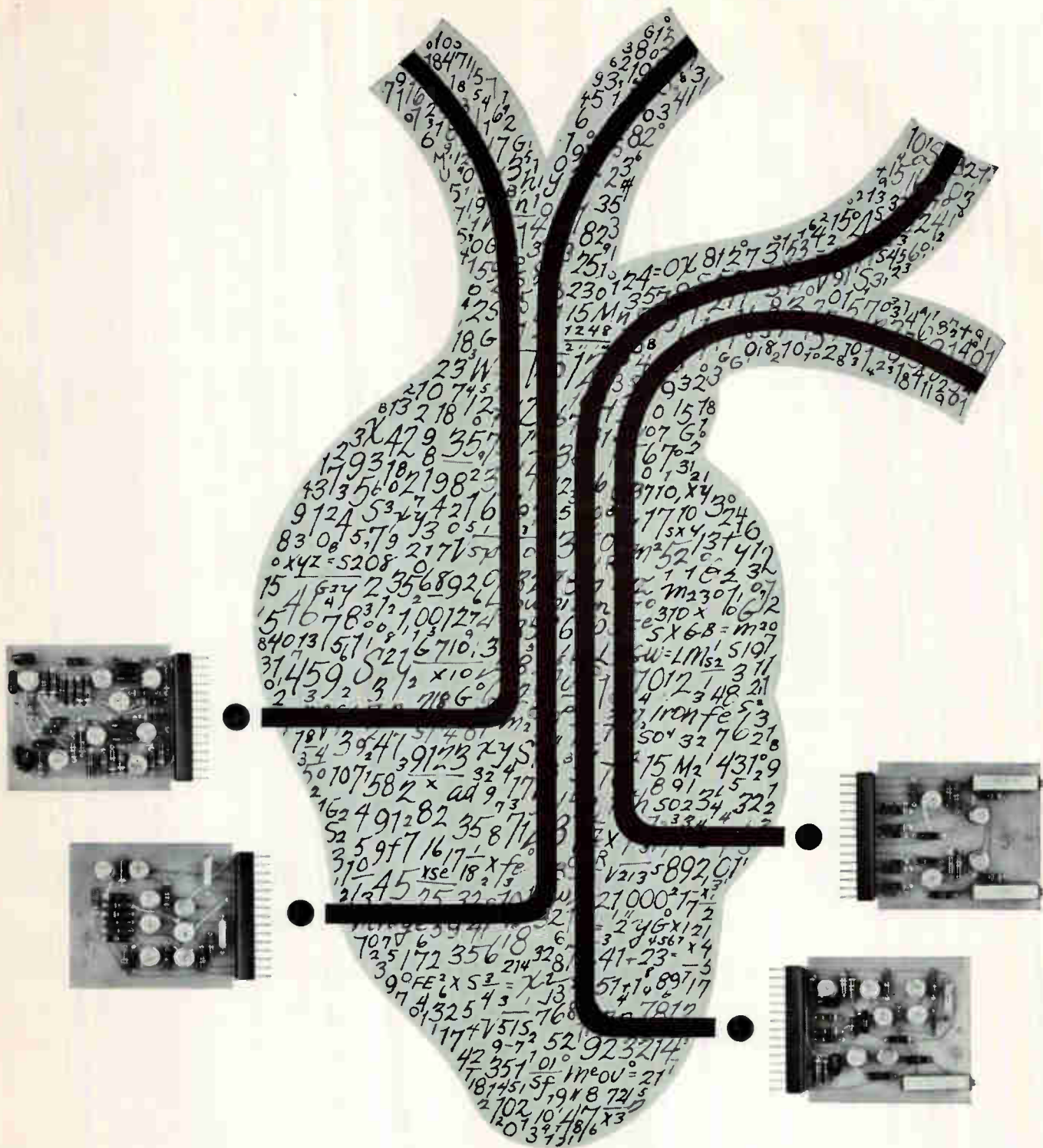

The pulse of the test range...

... the timing system, must operate constantly without fault, to generate and distribute the time code signals essential to test operations. To meet the highest standards of performance and reliability in land and shipborne instrumentation, Vitro has developed its own 500 Series printed circuit plug-in modules. These modules are the building blocks for equipment made to customer specification and include all functions normally encountered in digital systems and computer applications. Standardized mounting and hardware permit rapid and economical breadboarding

and development. □ The Vitro 500 Series modules have been thoroughly proven in complete test range timing systems, time code generators, accumulators, read-out and display units, time signal transmitters and receivers and timing terminal units. □ Let Vitro bid on your test range sub-systems. For complete information write or call Victor Harris, New Projects Office, Vitro Laboratories, 200 Pleasant Valley Way, West Orange, New Jersey (201) RE1-3400.

Vitro

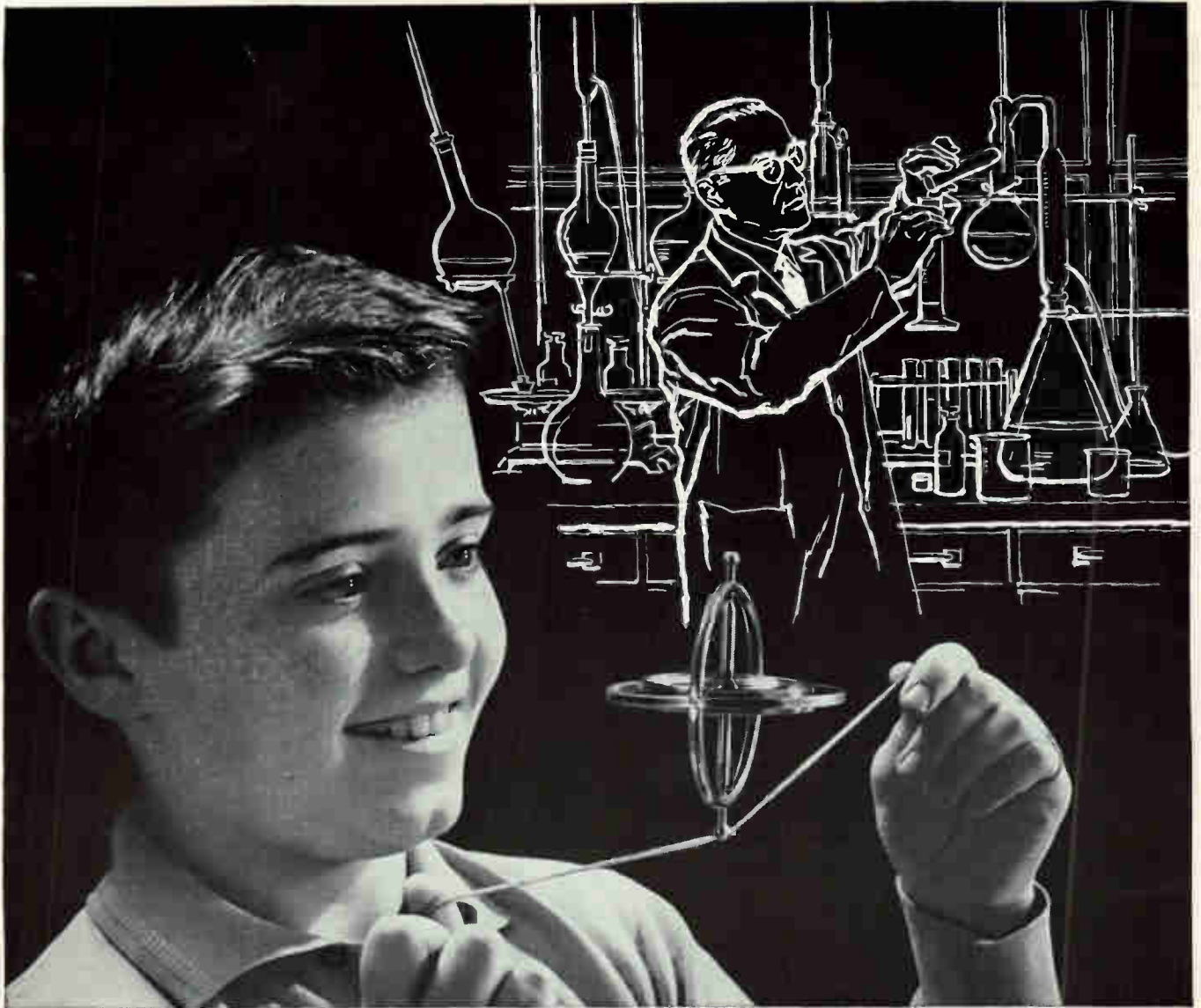

The Future of Your Business

MAY DEPEND UPON HIS EDUCATION

The young mind which today discovers an old principle may someday reveal a new one capable of revolutionizing your business and creating undreamed of growth. But this is possible only if he gets the finest education we can offer.

By the time today's youngsters are ready for college, business and industrial technology will be even more complicated and will require many more trained specialists. To fill this order we must provide our young people with the best possible college educations.

Unfortunately many colleges are already overcrowded. In ten years applications are expected to double. We will need more and better college classrooms and libraries, more efficient college laboratories, and additional top-quality professors. *You can help assure your own future by helping the college of your choice.*

If you want to know what the college crisis means to you, write for a free booklet, "OPEN WIDE THE COLLEGE DOOR," to Higher Education, Box 36, Times Square Station, New York 36, N.Y.



Published as a public service
in cooperation with The Advertising Council and
the Council for Financial Aid to Education



STL ELECTRONICS DIVISION

STL's ELECTRONICS DIVISION is engaged in the engineering development and fabrication of spacecraft, including communication satellite projects, flexible instrument (OGO), and special purpose instrument (698 AM) carrying satellites in systems engineering and technical direction of major ballistic missile systems and a variety of other independent hardware projects. Specific space equipment engineering requirements involve development of improved gyroscopes, automatic digital checkout equipment, advanced satellite and missile antennae, accurate CW radar for space rendezvous (Stelatrac), control systems, and communication systems.

Engineers and scientists are invited to investigate these opportunities:

INERTIAL GUIDANCE PROJECT ENGINEERS

Senior engineers with experience related to guidance system project management, involving:

- Stable Platforms
- Inertial Instruments
- Optical Alignment
- Circuit Analysis
- Systems Test and Evaluation
- Production

INERTIAL GUIDANCE SYSTEMS ANALYSTS

Senior and junior engineers for work in guidance systems analysis, involving:

- Flight Simulation
- Targeting and Trajectory Computation
- Terminal Guidance
- System Synthesis, Optimization and Analysis

POWER SYSTEMS ENGINEERS

Transistor Circuit Design for missile and satellite electrical systems, involving:

- Power Regulation
- Space Power Systems
- Solar and Fuel Cells, Batteries
- Converters/Inverters
- Battery Electro-chemistry

PCM TELEMETRY ENGINEERS

- Digital Design and Fabrication
- Analog to Digital Conversion
- System Design

INSTRUMENTATION ENGINEERS

- Silo/Pad Instrumentation
- Test Stand and Sled Component Instrumentation
- Equipment Testing
- Flight Test Systems

COMMUNICATION SYSTEMS ENGINEERS

Engineers with a broad background and well founded in the concepts of communication systems for military and space communication programs to:

- Propose and Evaluate System approaches
- Devise Mechanizations
- Establish Requirements
- Consider Message Security

COMMUNICATION THEORY SPECIALIST

Background in information theory with a strong understanding of physics, probability, higher mathematics and communication technology to work on:

- Adaptive Communication
- Advanced Coding Techniques
- Analysis of Complex Signaling Problems

ANTENNA AND MICROWAVE ENGINEERS

Analysis, design, and prototype fabrication of advanced satellite and missile systems involving:

- Phased Slot
- Plasma Studies
- High Gain Parabolic Reflectors
- Radar Cross-Section Computation
- Underground Antennas

ELECTRONIC DESIGN INTEGRATION ENGINEERS

- Electro-interference Control
- Electrical Systems Design
- Functional Analysis—Test and Launch Operations
- Integration and Test
- RF Interference
- Systems Test Design
- Interface Specifications

MAN-MACHINE SYSTEMS ENGINEERS

Engineering psychologists and engineers with experience on interdisciplinary projects for research and analysis of space vehicle with man-in-the-loop, involving:

- Human Operator Characteristics
- Design of Advanced Displays
- Human Factors Problems
- Task and Mission Analyses
- Display-Control Compatibility
- Flight Simulator Design

DIGITAL SYSTEMS ENGINEERS

- Data Processing Systems
- Digital Electronic Circuit Design
- Checkout Equipment
- Digital Computer Applications
- Logic Design

GSE ENGINEERS

- Automatic Checkout Equipment
- Digital Systems
- Real Time Data Processing Equipment
- Operations and Maintainability
- Radio Frequency Equipment
- Man-Machine Systems

EQUIPMENT DESIGN ENGINEERS

Responsibility for advance electronic packaging design of spaceborne, missile and AGE equipment, involving:

- Digital, Analog, Communications and RF Equipment
- Wire-Wrap, Welded Modules, and Microminiature Circuits
- Design Review Coordination
- Mechanical Structures Integration

RADIO GUIDANCE & TRACKING ENGINEERS

- Data Analysis
- Guidance Systems
- Data Smoothing and Filtering
- Guidance Equations
- Tracking Systems
- Automatic Control
- Guidance Systems Analysis

PARTS APPLICATION ENGINEERS

- Specifications
- High Reliability Requirement
- Parts Limitations
- Miniaturization Techniques

SPACE MATERIALS & PROCESS ENGINEERS

Adapt and develop materials for space electronic and electro-mechanical equipment involving chemistry, plastics, metallurgy, and vacuum technology:

- Conductive Adhesives, Insulation, Bonding and Welding Methods for Microminiature Electronics
- Space Lubrication, Sublimation, and Sealing Techniques
- Failure Analysis and General Metallography

HEAT TRANSFER ENGINEERS

Thermal design analysis of missile and spacecraft electronics involving:

- Liquid Cooling Systems
- Temperature Control Systems
- Air Conditioning of Ground Installations
- Computer Techniques

ENVIRONMENTAL DATA ENGINEERS

Vibration and Acoustic data analysis of missile and spacecraft involving:

- Flight Instrumentation
- Data Reduction Techniques
- Test Specifications



SPACE TECHNOLOGY LABORATORIES, INC.

One Space Park, Department G, Redondo Beach, California

a subsidiary of Thompson Ramo Wooldridge Inc.

The above opportunities are located at STL's new advanced Space Technology Center in Redondo Beach, near Los Angeles International Airport. At the Center, research and development facilities are augmented by vast facilities for fabrication, integration and test of spacecraft and all associated space-qualified hardware.

Resumes and inquiries for the above openings will receive prompt attention. Please write Dr. Richard C. Potter at STL's address below. STL is an equal opportunity employer.

WESCON DELEGATES: LOS ANGELES INTERVIEWS AUGUST 21-24, CALL F. C. NAGEL, DUNKIRK 7-5130, VISIT STL BOOTH 3607

NEW FROM T/I

HIGH SPEED A-D CONVERTER

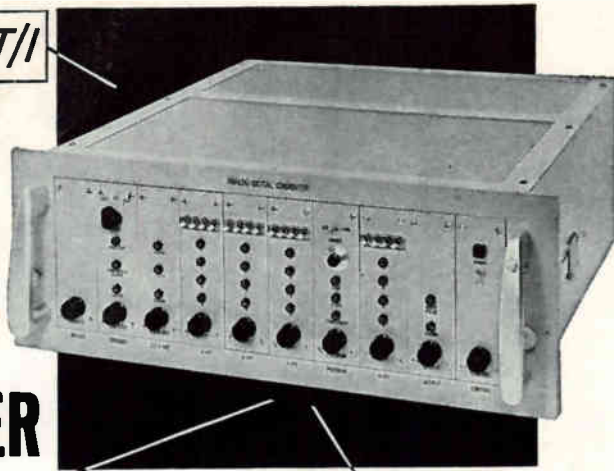

1.5 μ sec per bit

Automatic Zero Stabilization

Texas Instruments Model 834 Analog-Digital Converter is a versatile, all solid state instrument combining high speed with high accuracy. Basic speed is 25 microseconds per conversion (40,000 12 bit conversions per second); accuracy is $\pm 0.05\%$ of full scale, $\pm 1/2$ the least significant bit. The instrument provides full scale ranges of ± 2.5 , ± 5.0 , and ± 10.0 volts with an input impedance of 200,000 ohms. Modular construction allows modification of output logic levels and digital code to suit various system requirements.

Write for complete information.

APPARATUS DIVISION
PLANTS IN HOUSTON
AND DALLAS, TEXAS

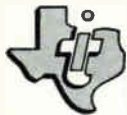

TEXAS INSTRUMENTS
INCORPORATED
3609 BUFFALO SPEEDWAY
P. O. BOX 66027 HOUSTON 6, TEXAS 478

CIRCLE 200 ON READER SERVICE CARD

PLUG-IN STABILITY PACKAGED CRYSTAL OSCILLATORS

For frequency range 60 kc to 15 mc

These compact modules contain glass-sealed crystal units, transistorized circuitry and constant temperature ovens. For precision frequency or time base reference in counters, signal generators and master oscillator systems.

TYPE	STAND-ARD FRE-QUENCIES	SPECIAL FRE-QUENCIES	STABILITY — 24 HRS.		OUT-PUT VOLTS RMS	OVEN HEATER VOLTAGES
			Ambient 25°C	Ambient 0°C-50°C		
CCO-7R	100 kc	60-198 kc	2×10^{-7}	$\pm 4 \times 10^{-7}$	1.5	27 VAC
CCO-7RA	100 kc	60-198 kc	2×10^{-7}	$\pm 4 \times 10^{-7}$	1.5	115 VAC
CCO-7RD	100 kc	60-198 kc	2×10^{-7}	$\pm 4 \times 10^{-7}$	1.5	27 VDC
CCO-7R-2	200 kc	198-300 kc	1×10^{-7}	$\pm 1.5 \times 10^{-7}$	1.0	27 VAC
CCO-7RA-2	200 kc	198-300 kc	1×10^{-7}	$\pm 1.5 \times 10^{-7}$	1.0	115 VAC
CCO-7RD-2	200 kc	198-300 kc	1×10^{-7}	$\pm 1.5 \times 10^{-7}$	1.0	27 VDC
CCO-7M	1 mc	.95-3.0 mc	1×10^{-8}	$\pm 3 \times 10^{-8}$	1.0	27 VAC
CCO-7MA	1 mc	.95-3.0 mc	1×10^{-8}	$\pm 3 \times 10^{-8}$	1.0	115 VAC
CCO-7MD	1 mc	.95-3.0 mc	1×10^{-8}	$\pm 3 \times 10^{-8}$	1.0	27 VDC
CCO-7L	5 mc	3.0-8.0 mc	1×10^{-8}	$\pm 3 \times 10^{-8}$.5	27 VAC
CCO-7LA	5 mc	3.0-8.0 mc	1×10^{-8}	$\pm 3 \times 10^{-8}$.5	115 VAC
CCO-7LD	5 mc	3.0-8.0 mc	1×10^{-8}	$\pm 3 \times 10^{-8}$.5	27 VDC
CCO-7N	10 mc	8.0-15.0 mc	1×10^{-7}	$\pm 3 \times 10^{-7}$	1.5	27 VAC
CCO-7NA	10 mc	8.0-15.0 mc	1×10^{-7}	$\pm 3 \times 10^{-7}$	1.5	115 VAC
CCO-7ND	10 mc	8.0-15.0 mc	1×10^{-7}	$\pm 3 \times 10^{-7}$	1.5	27 VDC

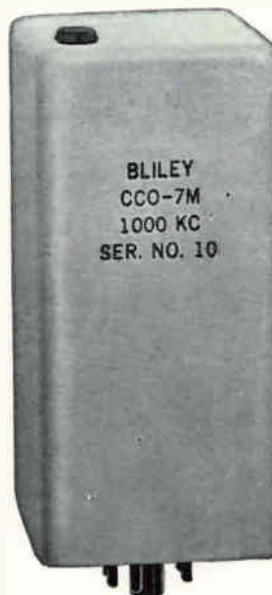

Bliley ...if you buy quality

BLILEY ELECTRIC COMPANY • ERIE, PENNSYLVANIA

Booth 2026 Wescon

electronics fills you in on every phase of the electronics industry each week featuring engineering and technical data every issue. Latest economic trends, technically interpreted, to help you make sound plans. Facts you'll want to file and keep. Subscribe now. Mail the reader service card (postpaid) to **electronics**, the magazine that helps you to know and to grow! Rates: three years for \$12, one year for \$6; Canadian, one year for \$10; foreign, one year for \$20. Annual **electronics** BUYERS' GUIDE included with every subscription.

it's read more by all 4!

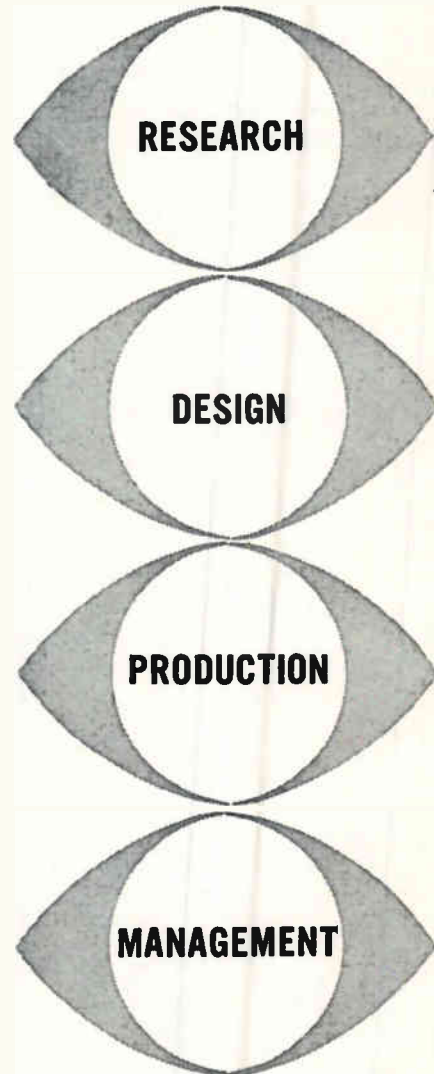

SUBSCRIBE TODAY TO **electronics!**

We
have
designs
on
space

ELECTRONIC DESIGN ENGINEERS:

Astronautics is a 100 percent space-oriented company. If you share our consuming interest — if you, too, have *designs on space* — then we can offer you participation in a number of highly advanced, technically challenging programs.

And at Astronautics, electronic design specialists are encouraged to *finish what they start*. To make it possible, we provide one of the most advanced electronic development laboratory complexes in the country, plus the latest in production facilities.

The history of Astronautics is bright with significant electronic breakthroughs, achieved through this "start-to-finish" philosophy. To name a few:

AZUSA MARK I AND MARK II TRACKING STATIONS at AMR, used for range safety and vehicle performance evaluation;

AZUSA TRANSPONDERS for Atlas, Titan, Polaris, Minuteman, and other vehicles;

FLIGHT CONTROL AND TELEMETRY SYSTEMS for Atlas weapon systems, Atlas space boosters, Centaur and scientific passenger pods;

TEST AND LAUNCH CONTROL EQUIPMENT for Atlas and Centaur.

Today, designs are under way on a worldwide tracking system to be designed, built, and installed by Astronautics. We're also at work on new techniques in flight control and telemetering systems for a variety of future space programs.

Like to learn more about this great electronic design team and how your talents can grow with it? There are more details on the reverse page, and you'll find a convenient Professional Inquiry Card attached. Mail it today, in complete confidence, of course. If it has been removed, or if you wish to request or furnish more detailed information, write to Mr. R. M. Smith, Manager of Industrial Relations Administration-Engineering, Department 130-90, General Dynamics | Astronautics, 5747 Kearny Villa Road, San Diego 12, California.

GENERAL DYNAMICS

GIHID
ASTRONAUTICS

ELECTRONIC DESIGN ENGINEERS...

JOIN GENERAL DYNAMICS | ASTRONAUTICS... *the company with designs on space!*

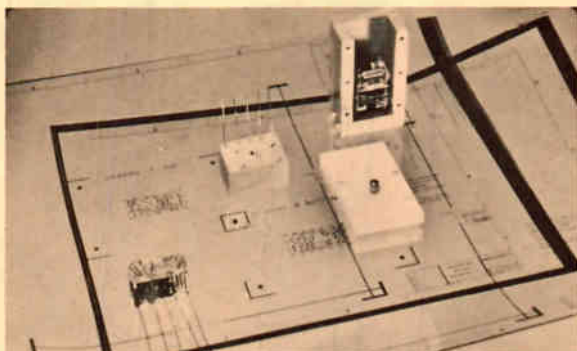

Welded module development



Azusa Mark II Tracking System at Cape Canaveral

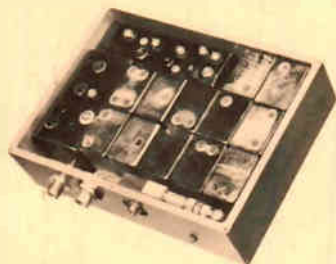

Developmental model of 400 MC transponder, utilizing welded module construction

These photos graphically illustrate the interests and achievements of Astronautics in the field of electronics. Permanent positions are now open for outstanding engineers in the areas of specialization described below.

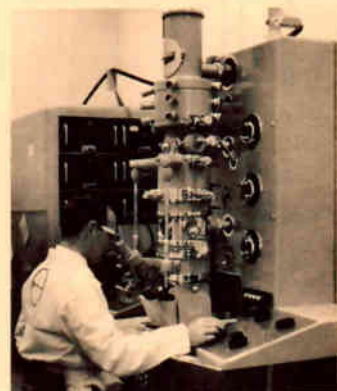

Electron microscope used for epitaxy research

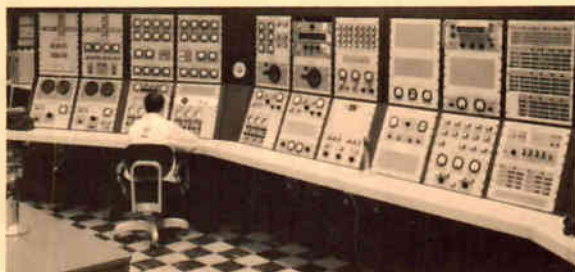

Control console for Azusa Mark II tracking system at Cape Canaveral

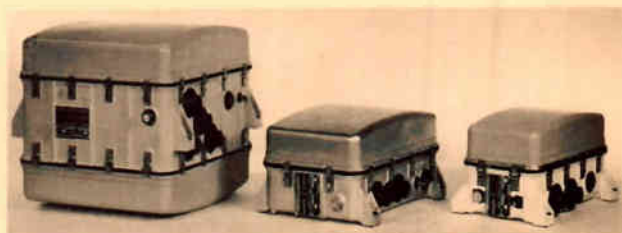

Centaur flight control electronics

Research and Development

These positions are for senior scientists to participate in company-sponsored research in thin films and solid state for applications to microminiaturization, solar energy conversion, and magnetic computer components. Training should be in the area of solid state physics, physical chemistry, electronics, metallurgy or ceramics. Advanced degree preferred.

Launch Control System Design

Assignments involve the study, analysis, and development of complete launch control systems for space vehicles. Problems of electrical, electronic, mechanical and fluid systems are integrated to develop optimum launch system configuration. Knowledge of computer applications, network analyzers, simulators, responders and checkout systems is desirable. An appropriate degree and experience in development of mathematical models of logic systems are required.

Microwave Design

Positions involve investigating use of semiconductor non-linear devices such as tunnel diodes and varactors for microwave application to phase shifting, detection, amplification, diplexing, frequency conversion and other functions necessary to support space and ground based RF tracking and telemetry systems. Will perform design and development work on strip line microwave circuitry, mixers, diplexers, power dividers, filters and harmonic generators. A BSEE or MSEE and appropriate experience are required.

OPENINGS ALSO EXIST FOR EE'S IN THE FOLLOWING AREAS: ADVANCED SYSTEMS DESIGN; FLIGHT PERFORMANCE AND GUIDANCE ANALYSIS; SYSTEMS ANALYSIS; ELECTROMAGNETIC INTERFERENCE CONTROL; RELIABILITY; QUALITY CONTROL; FLIGHT TEST; CLOSED CIRCUIT TV ENGINEERING; ENGINEERING WRITING.

Instrumentation Design

Requirement is for engineers able to accept design responsibility for measurement systems to monitor pressure, temperature, position, acceleration, vibration, strain, flow and unique phenomena associated with static and flight test programs. Will perform design and development work on transducers, transducer installation, instrumentation cabling and networks, signal conditioning and data gathering systems. A BS or advanced degree in EE or physics and appropriate experience are required.

Test Equipment Design

Assignments involve responsibility for the design of electronic test equipment to support missile production and operation. Current activities concern development of equipment to test components, subsystems and complete systems. Experience is needed in low frequency digital and analog techniques, telemetering test and recording, and RF and microwave test and control techniques. A BSEE is required.

Tracking Equipment Design

Positions are for circuit and system designers with experience in UHF, SHF, and microwave equipment. Solid state background in development of receivers, ultra-stable oscillators, high-frequency, high-powered amplifiers and similar type circuitry desirable. Openings also exist for system designers experienced in CW tracking equipment and related peripheral equipment for development of hardware for ground station and space vehicle applications. A BS or MS in EE, plus appropriate experience, are required for all positions.

Further details will be found on the reverse page. To receive the full story, mail the attached Professional Employment Inquiry Card or communicate with Mr. R. M. Smith, Manager of Industrial Relations Administration Engineering, Mail Zone 130-90, General Dynamics | Astronautics, 5747 Kearny Villa Road, San Diego 12, California.

GD

GENERAL DYNAMICS | ASTRONAUTICS

AN EQUAL OPPORTUNITY EMPLOYER

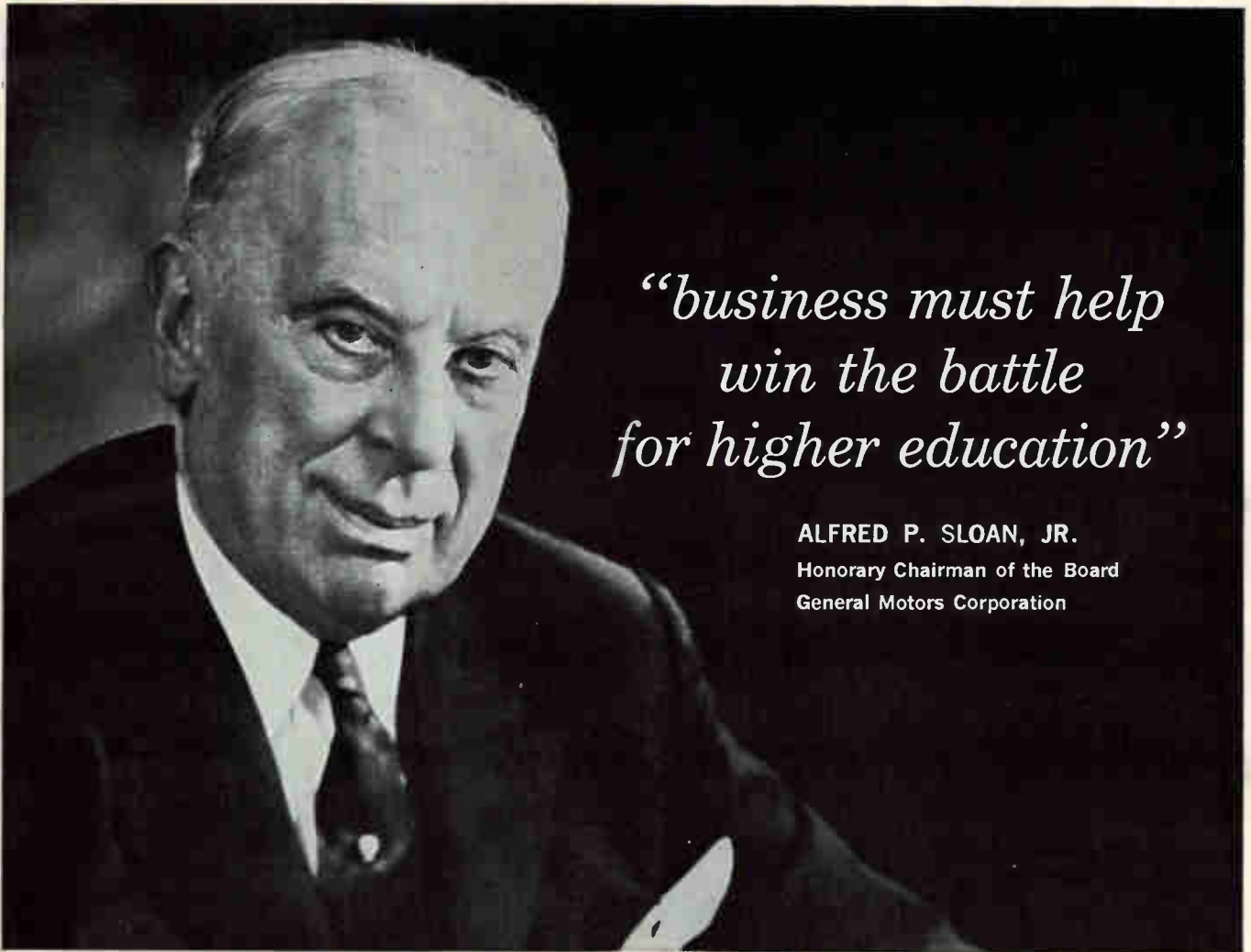

*“business must help
win the battle
for higher education”*

ALFRED P. SLOAN, JR.
Honorary Chairman of the Board
General Motors Corporation

“Regardless of the strengths and attributes our nation possesses, if we fall behind in the field of education, we will fall behind as a world power.

“Our scientific, cultural and economic growth—and our political strength—will depend largely upon the educational facilities we make available to our youth. We owe it to ourselves as a nation; we owe it to our young people who will inherit this nation to provide the financial aid that will make our institutions of higher learning second to none in the world. This is of vital importance to our business community.

“Business must put its support on the line to help win the battle for higher education.”

Today many of our colleges are overcrowded. In ten years, applications will have doubled and we will be faced with an even more serious crisis in our institutions of higher learning. We will need more and better college classrooms, many more well-equipped college laboratories and thousands more of the most dedicated and well-trained professors.

Only increased financial aid will provide our young people with the best college facilities. Only increased financial aid will keep our finest minds from leaving the teaching profession.

For additional information on the crisis faced by higher education write to: Higher Education, Box 36, Times Square Station, New York 36, N. Y.



Published as a public service
in cooperation with The Advertising Council and
the Council for Financial Aid to Education



Lunar Orbit Rendezvous Decision to Spur

Electronic subsystem awards will follow "Bug" contract in Fall

ELEVEN AIRCRAFT manufacturers were asked last week by the National Aeronautics and Space Administration to submit proposals by Sept. 4 for research and development of the Lunar Excursion Module (LEM), or "Bug", that will deliver two men to the surface of the moon and return them to their mother ship, waiting in lunar orbit. (ELECTRONICS, p 12, July 20).

A contract will probably be awarded in October. The invited companies are: Boeing, Douglas, General Dynamics, Grumman, Ling-Temco-Vought, Lockheed, Martin, McDonnell, North American, Northrop, and Republic. Winner of the competition will let subcontracts for electronic subsystems for the two-man craft.

SPACECRAFT—Some of the details of the Lunar Orbiting Rendezvous technique (LOR) were given by D. G. Holmes, Director of the Office of Manned Space Flight, NASA, at the American Rocket Society meeting in Cleveland, late last

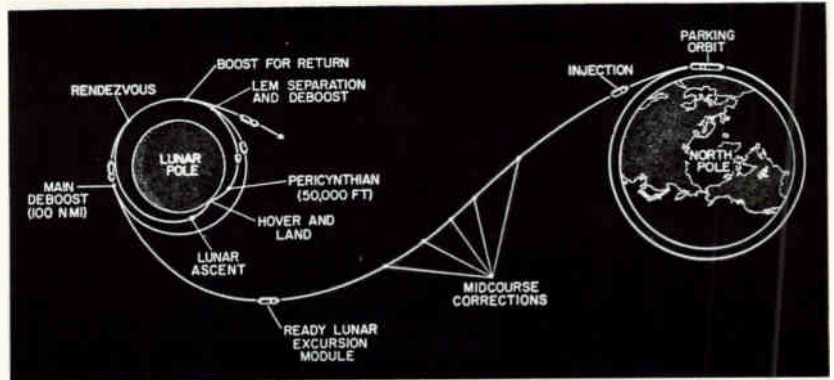

LUNAR ORBIT rendezvous flight sequence described here by Space Technology Laboratories, requires accurate mid-course correction to assure precise, circular lunar orbit

month: The 280-foot, three-stage Advanced Saturn (C-5) will be topped by the spacecraft and ejection tower which reach an additional 75 feet above the booster. The total lift-off weight will be about 3,000 tons.

The spacecraft will consist of three major elements: the command module (weighing five tons), service module (21 tons) and the LEM (12½ tons). North American is prime contractor for the command and service modules.

The command module will carry the three-man crew with guidance, communications and life support

systems. The service module will contain propulsion systems for mid-course maneuvers and for deboost into, and escape from, lunar orbit. Finally, the Bug will carry two of the crew to the moon, along with communications, guidance and propulsion for return to the orbiting command module, and 200 pounds of scientific instrumentation.

Approximately 45 minutes after injection into the flight path, the Apollo crew will make the first mid-course correction maneuver with the service module propulsion system. The magnitude and direction of the maneuver will be determined by computer calculations, backed up by information from the crew and from the ground support systems, which will maintain communication with the spacecraft throughout the mission via the Deep Space Instrumentation Facilities (see p 26 this issue). A number of midcourse maneuvers may be required to place the spacecraft into position for deboost into a precise, circular lunar orbit some 100 nautical miles above the lunar surface.

MOON LANDING—Once in lunar orbit two of the crew will transfer to the Bug, separate it from the command and service modules, and by a combination of manual control and automatic system operation, descend to the surface of the moon. After a stay of a day or more on the moon, the crew will launch the Bug, rendezvous with the mother craft, transfer to the command

Satellites Outdate Radio Telescope

WASHINGTON—After eight years of planning and four years of construction the Navy has been ordered by Defense Secretary McNamara to halt work on the 600-foot steerable radio telescope at Sugar Grove, W. Va. The reason: technological advances in other areas, mounting costs and design problems.

Although the Navy first called it a scientific project, the telescope's main purpose was later identified with military communications and navigation. Unconfirmed reports were that the real purpose was listening to lunar reflections of Soviet communications. Satellites are expected to perform this intelligence task much better.

Cost estimates have risen from

\$60 million in 1958 to \$200 million. The Navy has spent \$41.8 million—mostly for heavy construction—and has obligated \$95.5 million to contractors. Last year, Congress set a ceiling at \$135 million.

Structural weight—30,000 tons—and dish accuracy difficulties were the chief design problems, causing a halt in construction two years ago and redesign.

Efforts are being made to get other agencies to use the facility. NASA might put an 85-foot, satellite tracking and data acquisition antenna there. National Science Foundation is studying the matter, but has its own national observatory only 40 miles away at Green Bank. Another study is being made by the Commerce Department.

New Space Contracts

module, eject the Bug, and take off for earth.

Three guidance techniques will be used on the LOR mission, according to G. Allan Smith, of NASA: space sextant, inertial guidance, and radio command from the earth.

The close coordination necessary between the orbiting command module and the Bug requires rendezvous and docking radar and optical devices in both craft, A. B. Mickelwait, Space Technology Laboratories, told the ARS meeting. Also,

necessary are certain duplications of Deep Space Instrumentation voice, telemetry and tv links, Bug-command module voice links, and guidance and navigation subsystems.

Communication between the Bug and the orbiting mother ship may be accomplished via an earth-based relay station rather than from Bug to command module directly. Reason for this is the short periods of time the command module and the Bug will be in line-of-sight positions.

Space Controls Center Takes Shape

HOUSTON—National Aeronautics & Space Administration's Manned Spacecraft Center, now beginning to take shape here, will let construction contracts early this fall for mission control and data processing facilities, MSC officials report.

The 200,000-square-foot center will house flight control equipment similar to that now used at Cape Canaveral. Cost of equipping the center is expected to exceed \$20 million. Building construction will cost \$9 million.

When the control center is completed in about one year, it will take over control of long-range manned space flights after they are fired from Cape Canaveral. Present plans call for the Canaveral control center to initiate firings and control early stages of flights, then transfer control to the Houston center, MSC reports.

A \$1.2-million structure to house MSC's data processing center will be one of the early buildings constructed on the center's 1,600-acre site about 25 miles south of Houston. A construction contract for it was due to be let this month.

MSC now has its computers and other data processing equipment at a temporary location in Houston. It is expected that additional data processing equipment will be needed by the time the permanent edp building is completed. MSC officials report that time on its present

equipment is already entirely taken up. The center, now paying \$500 an hour on the equipment, is gradually switching over to buying its computers.

In addition to these facilities, present plans call for contracts to be let starting next spring on major research and test facilities that will require considerable electronic instrumentation and control systems.

In the early part of 1963, for instance, contracts are expected to be awarded for a \$20-million environmental chamber, and a \$10-million centrifuge.

A lunar landing simulation facility is also planned to simulate spacecraft response within lunar gravitational environments. At present, although an MSC spokesman says "we haven't the slightest idea what it will look like," plans call for this to be started before the end of fiscal 1963. It is presently tagged at about \$7.5 million.

Meanwhile, construction contracts are expected to be let at two stages this fall for administrative and other buildings. NASA says of the \$90-million budget currently approved for the center, about one-third will go for buildings and laboratories, with the remainder for major research facilities.

MSC now has about 1,500 people in Houston, will have about 3,000 when it starts occupying its permanent facilities in December, 1963.

"Nothing is impossible to diligence and skill"
Samuel Johnson

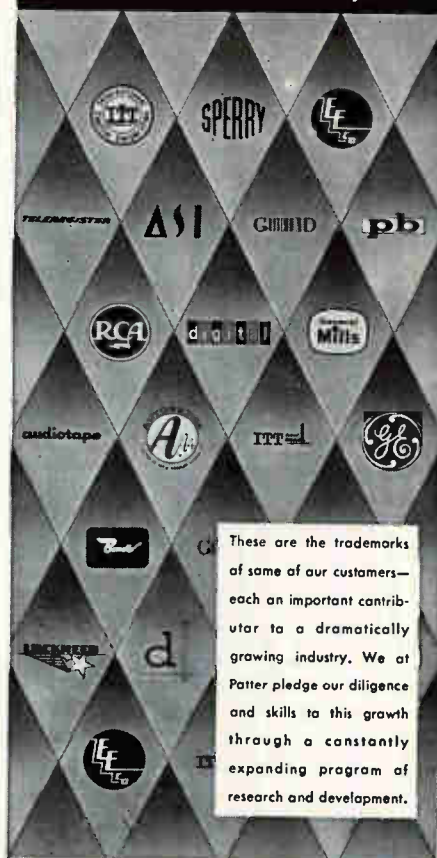

These are the trademarks of some of our customers—each an important contributor to a dramatically growing industry. We at Potter pledge our diligence and skills to this growth through a constantly expanding program of research and development.

POTTER

M906 II

Tape Transport

couples

high-performance

and reliability . . .

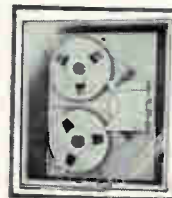

with the lowest price in the industry. The unique design of this versatile transport provides compatibility for a variety of applications in digital data processing and computer systems.

Five tape widths up to 1 1/4" may be accommodated at speeds up to 120 IPS. In addition, data transfer rates of 62,500 BCD digits per second are readily obtained using conventional recording techniques. When used in high-density recording applications, transfer rates of over 450,000 BCD digits per second with drop-outs fewer than 1 bit in 100,000,000 are provided.

Complete specifications for this highly reliable system are available on request.



EUROPE BOUND
VISIT US AT Booth 28
IFIP Interdata Exhibition
in Munich, Germany
August 26 to September 2

POTTER INSTRUMENT CO., INC.
Sunnyside Boulevard • Plainview, New York



circuit designers...is your appointment in space with Hughes?

Today at Hughes you will find one of the country's most active space-electronics organizations. Important new and continuing projects, including SURVEYOR, SYNCOM, Missile Defense and POLARIS guidance systems are growing at unprecedented rates.

This vigor promises the qualified engineer or scientist more and bigger opportunities for both professional and personal growth.

Many immediate openings exist. The engineers selected for these positions will be assigned to the following design tasks: the development of high power airborne radar transmitters, the design of which involves use

of the most advanced components; the design of low noise radar receivers using parametric amplifiers; solid state masers and other advanced microwave components; radar data processing circuit design, including range and speed trackers, crystal filter circuitry and a variety of display circuits; high efficiency power supplies for airborne and space electronic systems; telemetering and command circuits for space vehicles, timing, control and display circuits for the Hughes COLIDAR* (Coherent Light Detection and Ranging).

If you are interested and believe that you can contribute, make your appointment today.

Please airmail your resume to:
Mr. Robert A. Martin
Head of Employment
Hughes Aerospace Divisions
11940 W. Jefferson Blvd.
Culver City 22, California
We promise you a reply within one week.

Creating a new world with ELECTRONICS

HUGHES

HUGHES AIRCRAFT COMPANY
AEROSPACE DIVISIONS

An equal opportunity employer.

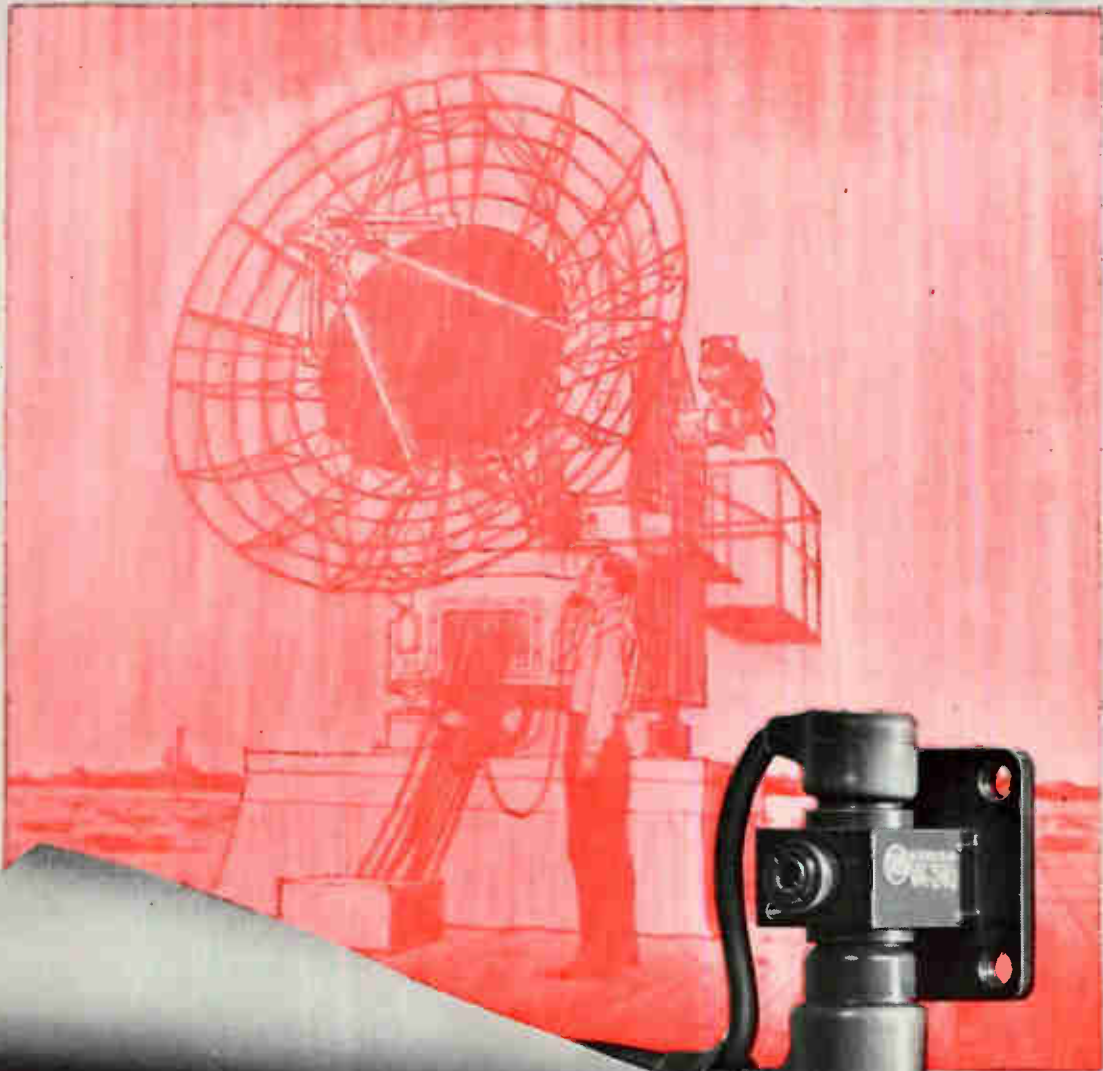

VA-240 12.4-18.0 Gc. 250 mW minimum.

from Varian: STABLE PUMP TUBES FOR PARAMETRIC AMPLIFIERS

Highly stable reflex klystrons by Varian can significantly improve your parametric amplifier system design. Tube types, from 8.2 to 26.5 Gc are available for immediate delivery. From low-cost laboratory models to rugged 70 Gc tubes, all have Varian's inherent high quality of manufacture and performance.

Varian parametric amplifier pump tubes benefit from exhaustive research and testing for metals capable of contributing to precise control of temperature coefficients. For Varian pump tubes, this figure is less than 100 Kc per degree Centigrade. More than a

dozen types of Varian reflex klystrons suitable for parametric pump use are operable in severe environments—200 shock, —55 to +85° C—and demonstrate excellent unattended long life characteristics. Improved optics in tube design provide maximum bandwidth. Power and frequency remain stable over a wide variety of environmental conditions.

Tubes in the VA-240 series (see chart) are rugged, field trimmable, conduction-cooled. Other Varian tubes suitable for parametric amplifier application have similar features. Write Tube Division.

TUBE NO.	OPERATING FREQUENCY (Gc)	MINIMUM OUTPUT (mW)	MECH. TUNING RANGE (Mc)	ELECT. TUNING RANGE (Gc)	BEAM VOLTAGE (volts)
VA-240	12.4-18.0	250	50	40	750
VA-232	15.0-22.0	200	1000	40	750
VA-241	18.0-26.5	200	100	40	800
VA-234	18.0-26.5	100	1000	40	850



VARIAN associates
PALO ALTO 1, CALIFORNIA

Varian Sales Offices: BOMAC LABORATORIES, INC. - S.Y.D. LABORATORIES, INC. - SEMICON ASSOCIATES, INC.
VARIAN ASSOCIATES OF CANADA, LTD. - SEMICON OF CALIFORNIA, INC. - VARIAN A.G. (SWITZERLAND)

NASA Will Spend \$194 Million for

Networks are being readied for deep space vehicles and probes

MORE DETAILS are now available on what the National Aeronautics and Space Administration will buy with the nearly \$194 million, just approved by a Senate-House conference committee, for tracking and data acquisition facilities (ELECTRONICS, p 22, May 4).

The authorization for research, development and operation amounts to \$158,410,000, and for construction of tracking facilities, about \$35,100,000. Included in totals are:

- Systems development for future space mission, \$15,950,000 (Table I).

- Total cost of operating the various networks, \$67,815,000, including \$17,794,000 for the satellite network, \$9,272,000 for the deep space network, \$24,047,000 for the manned space flight network, \$13,234,000 for communications and \$3,468,000 for data processing.

- Equipment and components, \$74,645,000, as itemized in Table II and detailed below.

SATELLITE NET—Over \$20 million will be spent on ground facilities for satellites for replacements

and for new gear to handle the larger volume of data from the big orbiting observatories.

Installation of 136-Mc yagi self-tracking antennas for all stations, which began in 1961, will be completed in fiscal 1963. In addition, mobile stations of medium bandwidth capability, between the yagi type and the large data acquisition facilities of the Alaska type, will be installed to give perigee coverage for the Eccentric Geophysical Observatories (EGO) and emergency support to Orbiting Astronomical Observatories (OAO), Polar Geophysical Observatories (POGO), and the Nimbus satellites.

To support telemetry from scientific and applications satellites, stations will get new receiving, detection and signal conditioning equipment. Ten stations will be equipped with pcm systems, including signal conditioning, synchronizing and decommutation instrumentation, and display gear. Also to be installed are coherent and pcm detectors, and miscellaneous equipment to handle special-purpose requirements of satellites that fail to obtain programmed orbital altitudes and positions.

Procurement and installation of specialized command instrumentation including antennas, transmit-

ters and encoders was begun in fiscal 1962 and will be completed for 10 stations in fiscal 1963. Special real-time, read-out telemetry at selected sites will also be installed to aid command control of satellites such as the EGO and OAO.

New data reduction equipment at Goddard will include digital recording, memory and translation equipment plus analog and digital computing units. For the sophisticated tracking data needed for EGO and Syncom, range and range-rate equipment will be installed at several stations.

MANNED FLIGHT—Almost \$36 million will go toward expansion of nets to support Gemini and Apollo. Although much of the needed equipment can be specified and bought, some must await final decision on techniques to be selected.

Equipment that will be bought for Apollo includes: pcm telemetry ground gear at all stations and real-time telemetry read-out equipment at selected sites; S-band ground-to-capsule communication, telemetry and tracking equipment for selected sites to monitor the R&D S-band equipment to be tested on the orbital Apollo flights; S-band equipment for the Apollo lunar mission to insure compatibility with the existing deep space network.

Present telemetry, tracking and acquisition aid systems and antennas will be modified to make them compatible with the airborne pcm telemetry equipment.

The present Mercury control center will be equipped with additional communication terminal and data transfer equipment to accommodate the increased workload of more complex Apollo missions.

Ranging and positioning terminal equipment will be needed at several existing sites to enable the Apollo orbital mission to reenter and land on land instead of sea. Standard f-m telemetry ground gear is needed at the few sites not so equipped to increase orbital coverage of early Apollo missions.

DEEP SPACE — Heavy flight schedule in deep space for fiscal

Diving Saucer Will Maneuver 2½ Miles Down

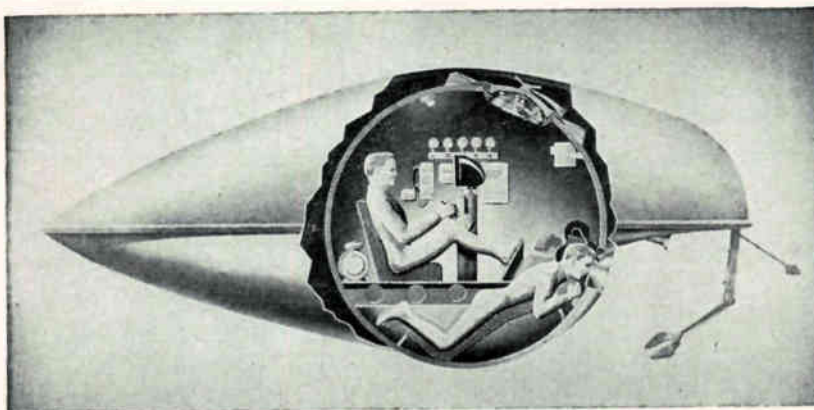

OCEANOGRAPHIC RESEARCH and other tasks are to be performed by three-man craft to be developed by Westinghouse Defense Center. Equipment will include three sonars, gyrocompass, tv, radio communications and a radar transponder to allow the mother ship to locate the craft. The craft, called Deepstar, and a smaller one able to dive to 1,000 feet are expected to be operational by the end of 1963

Ground Tracking in 1963

By JOHN F. MASON
Associate Editor

1963 will require round-the-clock, seven-days-a-week operation, resulting in increased maintenance and heavy replacement of wornout equipment.

To meet the high data reception requirements of the Mariner and Surveyor missions the noise level of the electronic equipment will be reduced by installation of masers. New data recording and handling equipment will be bought for all stations.

Antennas will be converted from prime-focus-feed to a Cassegrain feed system, further increasing the overall system sensitivity. To handle reception of data from three space shots simultaneously (two Surveyors may both be active on the Moon while a Mariner is traveling toward Venus) the deep space frequency band of 2,290-2,300 Mc has been divided into three channels. Multichannel receivers and automatic detection and frequency acquisition electronics will be installed at all stations, enabling them to shift quickly from one mission to another.

Automatic checkout and calibration equipment will be installed at Goldstone to reduce preflight and post-flight preparations and to provide maximum accuracy of tracking data as early in the flight as possible. Also, secondary microwave standards and special receiver and antenna checkout instrumentation will be installed at Goldstone.

Precision time standards, angle encoding equipment and star tracking and pointing equipment will be installed at all sites to upgrade the network tracking accuracy for Mariner and Surveyor.

GROUND COMMUNICATIONS—

The Nimbus and observatory class satellites and Surveyor all require large amounts of data transmitted between ground stations and the control centers. Updated terminal equipment, video monitoring facilities and test equipment, channelization equipment and circuit assurance and checkout equipment must be provided.

More than \$35 million for construction will include \$14.2 for the

TABLE I—SYSTEMS DEVELOPMENT FOR GROUND TRACKING

	1962	1963
Improvement of existing systems and operations:		
Data acquisition.....	\$1,004,000	\$1,503,000
Electronic tracking.....	781,000	794,000
Data processing.....	1,461,000	2,213,000
Spacecraft command.....	805,000	994,000
Antennas.....	2,419,000	2,493,000
Calibration.....	515,000	628,000
System testing.....	852,000	911,000
Subtotal.....	7,817,000	9,536,000
Subsystem development.....		
	1,050,000	1,111,000
New systems development:		
Data acquisition.....	1,165,000	1,194,000
Electronic tracking.....	668,000	975,000
Data processing.....	1,137,000	1,285,000
Spacecraft command.....	357,000	450,000
Optical.....	440,000	837,000
Timing.....	417,000	562,000
Subtotal.....	4,184,000	5,303,000
Total, systems development.....	13,051,000	15,950,000

TABLE II—EQUIPMENT AND COMPONENTS FOR GROUND TRACKING

	1962	1963
Satellite network:		
Maintenance, spares, and replacement.....	\$2,765,000	\$6,778,000
Expansion of network capability:		
Antennas.....		4,674,000
Receiving and recording.....	951,000	3,168,000
Command.....	618,000	2,175,000
Data handling and processing.....	166,000	1,654,000
Tracking.....		1,781,000
Subtotal.....	4,500,000	20,230,000
Manned flight network:		
Maintenance, spares, and replacement.....	3,260,000	3,269,000
Expansion of network capability:		
Augmentation of ground voice communications.....	3,803,000	
Automatic telemetry read-out equipment.....	2,445,000	
AN/FPS-16 radar equipment.....	2,988,000	
Telemetry decommutation equipment at command sites.....	1,494,000	
Data terminal equipment for Bermuda station.....	2,716,000	
Data and computer terminal equipments for the computer center.....	1,630,000	
Computer reprogramming.....	1,090,000	
PCM ground station equipment (receivers, recorders, discriminators, demodulators).....		14,379,000
S-band ground-to-capsule data and voice communications systems.....		5,882,000
Modification of telemetry and acquisition aid systems.....		5,882,000
Control center equipment.....		2,615,000
Ranging and positioning equipment for terminal trajectory instrumentation.....		2,615,000
FM/FM telemetry equipment.....		1,308,000
Subtotal.....	19,426,000	35,950,000
Deep space network:		
Maintenance, spares, and replacement.....	1,945,000	4,095,000
Expansion of network capability:		
Masers.....		1,396,000
Recording and data processing instrumentation.....		785,000
Modifications to DSIF antennas.....		3,050,000
Multichannel receivers and automatic detection and frequency acquisition.....		2,789,000
Automatic checkout and calibration equipment.....		3,316,000
Precision ranging.....		1,569,000
Subtotal.....	1,945,000	17,000,000
Ground communications network.....	546,000	1,465,000
Total, equipment and components.....	26,417,000	74,645,000

advanced antenna system at Goldstone; \$10 million for two new 85-ft antennas at the overseas deep space stations; \$6 million for data acquisition facility in the Far East;

\$3.5 million for an 85-ft antenna at Rosman, N. C.; and \$1.5 million for an advanced data acquisition system at the station at Wallops Island.

Oceanographers Grapple with Telemetry

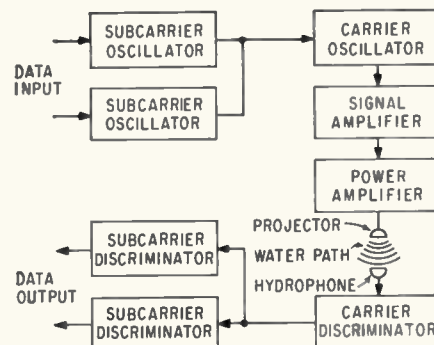
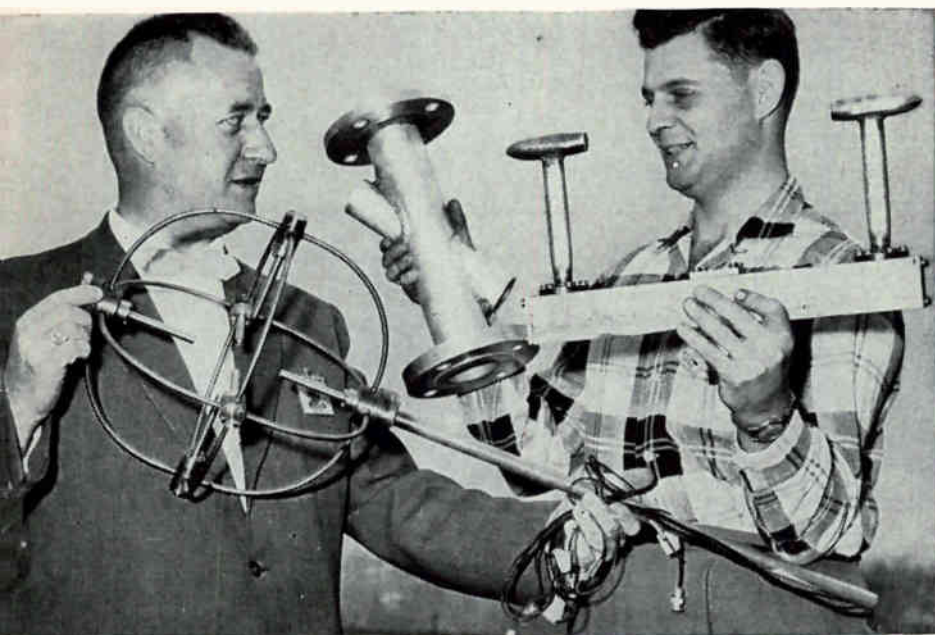

ACOUSTIC TELEMETRY system by Bendix-Pacific transmits voice and 10 channels of data underwater

ACOUSTIC FLOWMETER developed by Westinghouse uses spherical array of acoustic probes to measure water currents in three dimensions. More conventional flowmeters are shown at right

Russian interference and a frequency squeeze add to technical problems

By LAURENCE D. SHERGALIS
Associate Editor

TELEMETRY PROBLEMS faced by oceanographers have been made more urgent by the continuing installation of two large fields of Soviet buoy transmitters—one in the North Atlantic and one in the North Pacific.

U.S. oceanographers have complained about Russian interference on telemetry frequencies but no action can be taken against the Soviet vessels since they do not use call signs.

The already short supply of telemetry frequencies for oceanography is a major problem for researchers in this field. Among the complications are:

- A single frequency range doesn't satisfy oceanographic requirements. Frequencies and telemetering methods may differ according to the type of data to be collected and its use.

- Often, permanent use of a frequency is not needed. An allocation

may be useful only for the few months of a year that a survey lasts.

- All data need not be collected in real time. A buoy transmitter can be interrogated for stored data.

Spot frequencies for such occasional use are not available and other services are not interested in sharing. FCC does not favor unattended transmitters on buoys since they might be hard to reach for repair or adjustment.

Oceanographers have suggested that the FCC reserve frequencies for temporary use by scientists, as one way of relieving the problem.

HIGH FREQUENCIES — Even though the coming move of telemetry into the 2.2-Gc to 2.3-Gc band will make more frequencies available, this won't help oceanographers much. Overwater duct effects, now under intensive study, make line-of-sight transmission useless at certain frequencies and times.

Experiments at Scripps Institute of Oceanography showed that a 100-Mc line-of-sight transmission could not be received with antennas 20 to 30 feet high—800-foot antennas were needed. A 250-Mc signal carried only one-half mile.

Interrogating vhf transmitters from aircraft is probably the most

effective way to get data from a buoy field. Vhf hardware is readily available.

High-frequency, sky-wave transmission is not feasible. Antennas needed are too high, noise and limited bandwidth restrict data rates, and propagation conditions affect reliability of 24-hour reception. The bobbing of buoys makes for wobbling antenna patterns and erratic reception. This effect, first noticed on small-boat transmission at 2 Mc, needs more study.

Robert Walden, of Woods Hole Oceanographic Institute, has reported reliable reception of h-f signals from 20-w to 30-w transmitters at 6.9 Mc over a distance of 750 miles. But selective fading tends to require lower bit rates and 24-hour contact for continuous readings is very unlikely. Diversity reception may be successful, however.

VLF AND CABLES — Although matching transformers will give vlf systems a good impedance match with the ocean, vlf is greatly subject to atmospheric noise. Phase-lock and data-sync techniques must be used. Long, high-power antennas are needed for effective transmission; antennas supported by balloons and kites have not been satisfactory.

Problems

OCEANOGRAPHIC AIMS

Oceanographers use telemetry to gather data on sea parameters like water temperature, current direction and speed, wave height and direction, sea state, light intensity and radioactivity.

Fritz Koczy, of the University of Miami marine laboratory, says these are among the many unknowns of the ocean. Oceanographers want to develop equations that would enable them to predict these processes.

Today, oceanographers are studying such parameters, making predictions and making surveys that use and check the predictions. Tomorrow, they plan to prepare oceanic charts similar to weather maps

Small buoy fields can use submarine cables, armored in shallow water. Unarmored, semiexpensible cables for deep water cost about \$25 a mile. Cables and equipment must be replaceable and instrument packages have to withstand forces over 1 g during heavy seas and high winds.

ACOUSTIC TELEMETRY—Acoustic telemetry is effective for vertical communications in sea water, but not horizontal. There is a multipath problem—three spurious signals are received, one reflected from the surface, one reflected from the bottom and one bounced between surface and bottom. Attenuation is about 1 db a mile.

One system commercially made for this service is an f-m/f-m Bendix-Pacific system (ELECTRONICS, p 53, Jan. 12, 1962).

Acoustic techniques are also used in a transducer developed by Westinghouse Ordnance division. Under test at Woods Hole, it is a flowmeter that can measure water velocity to a fraction of a knot. Speed and direction of ocean currents are indicated in three planes by the time it takes for sound to travel between sets of acoustic probes mounted in a spherical array. It has transistor circuits, no moving parts.



present a new solid-state 20 MC counter

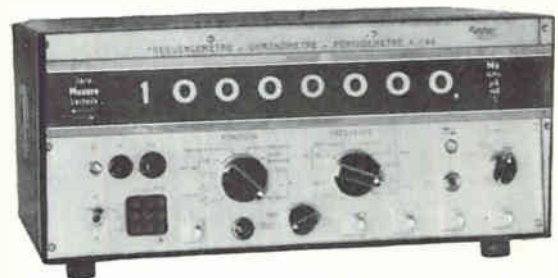

model A. 1149

maximum counting rate

➤ 20 MC

with external aperiodic divider (optional)

➤ 60 MC

- Count capacity : 99, 999, 999.
- Bright in line readout : 8 digits
- Unit and point indication (displayed)
- High inputs sensitivity : 50 mV to 100 Vrms
- Temperature range : 0 to 50° C (-10 to + 60° C on test)
- Crystal stability : a) ± 1 part in 10^{-7} (longterm) b) ± 1 part in 10^{-8}

- Gate time : 0.1—1 and 10 seconds or any other value with external preset time base (optional)
- Time interval measurements 0.1 μ s to > 100 days
- Pulse duration measurements (polarity + or -)
- Period measurements
- Ratio measurements
- Shock and vibration tested

manufactured by **Rochar**
electronique

Distributed in U.S.A. and Canada by :
WESTON - Newark (N.J.)
for complete information on our line of products and address of our agency in your country please apply to
ROCHAR-ELECTRONIQUE, 51, rue Racine
MONTROUGE (Seine) FRANCE.

SPRAGUE PIEZO- ELECTRIC CERAMIC ELEMENTS



**ELEMENTS
FOR ALL
APPLICATIONS
AS WELL AS
COMPLETE**

**TRANSDUCER ASSEMBLIES
FOR MOST APPLICATIONS,
SUCH AS UNDERWATER
SOUND AND
VARIOUS ORDNANCE AND
MISSILE DEVICES.**



Sprague-developed mass production and quality-control techniques assure lowest possible cost consistent with utmost quality and reliability. Here too, complete fabrication facilities permit prompt production in a full, wide range of sizes and shapes.

Look to Sprague for today's most advanced ceramic elements—where continuing intensive research promises new material with many properties extended beyond present limits.



**YOUR INQUIRIES
ARE INVITED**

**WRITE FOR
LITERATURE**

SPRAGUE ELECTRIC COMPANY
35 Marshall Street, North Adams, Mass.

SPRAGUE®
THE MARK OF RELIABILITY

Concurrent Processing Speeds Computer

HEART of the new Univac III large-scale computer is an executive program that controls its concurrent processing. Called Chief (concurrent handling of internal executive functions), this set of routines also automatically controls the scheduling of computer runs, allocation of memory and input-output devices and interruptions.

For example, to read 3,500 punched cards onto magnetic tape, print 5,000 lines from tape and sort 20,000 items on tape would take 21 minutes on previous Univacs because the three jobs must be handled in sequence. The Univac III executive program runs all three concurrently in nine minutes.

SUBROUTINES—Chief consists of five types of subroutines:

- Operational control—schedules applications, loads the program into the computer and performs run-to-run linkage.

- Synchronizer control—controls switching from application to application during concurrent operations, permitting several programs to share available computer time, and monitors all computer input-output channels.

- Contingency control—allows supervisors to modify operations and insert type-ins, and also handles errors due to overflow and use of invalid operation codes.

- Rerun—establishes and executes any necessary reruns.

- Processor error control—recognizes and logs machine malfunctions and interrupts the program when they occur.

Subroutines that had to be programmed in previous Univacs are now handled automatically. As an example, when the machine is fully programmed, and the operator types in the name of the program to be run, the computer types out start and end locations in memory and a table listing allocations of peripheral equipment. If allocations are acceptable to the operator, he types in an acceptance of the designations and indicates go.

PERFORMANCE—Univac III has up to 32,000 words of main memory storage, a 4- μ sec memory cycle

time and an 8- μ sec add time. There are eight general-purpose channels for input-output equipment and five magnetic-tape channels. Using tape synchronizers, up to 32 magnetic-tape units can be accommodated. The Uniservo 3 tape handler transfers 200,000 pulse-phase-modulated digits per second, and holds 4 million characters on a reel of tape, at a recording density of 1,000 pulses per inch.

Infrared Detector Theory Based On Energy Change

PARIS—A new theory for development of tunable infrared detectors, based on cyclotron resonance absorption by free carriers in a semiconductor, was reported by V. Roberts, of Britain's Royal Radar Establishment, at the Agard Avionics Panel meeting.

Radiation absorbed by free carriers (electrons) raises them to a higher energy level in the conduction band. The longer the electron energy relaxation time, the greater the departure from the energy distribution for thermal equilibrium. Roberts said the end result is a change in direct current conductivity.

He concluded that a detector based on this principle could be tuned by varying the high magnetic field needed for infrared detection by semiconductors.

Little Scout Radar



MINIATURE radar developed by Sperry Gyroscope can spot a walking man at over two miles and a truck at 4½ miles. It weighs 40 pounds

MEETINGS AHEAD

ENERGY CONVERSION PACIFIC CONFERENCE, AIEE; Fairmount Hotel, San Francisco, Calif., Aug. 13-16.

PRECISION ELECTRONIC MEASUREMENTS INTERNATIONAL CONFERENCE, IRE-PGI, NBS, AIEE; NBS Boulder Labs., Boulder, Colo., Aug. 14-17.

CRYOGENIC ENGINEERING CONFERENCE, University of California; at UCLA, Los Angeles, Calif., Aug. 14-16.

CIRCUIT PACKAGING SYMPOSIUM, U. of Colorado, et al; at U. of Colorado, Boulder, Colo., Aug. 15-17.

AIRCRAFT & MISSILES JOINT WESTERN REGIONAL CONFERENCE, ASQC; Benjamin Franklin Hotel, Seattle, Wash., Aug. 16-18.

APPLICATIONS & RELIABILITY SYMPOSIUM, Precision Potentiometer Manufacturer's Assoc.; Statler-Hilton Hotel, Los Angeles, Aug. 20.

WESTERN ELECTRONICS SHOW AND CONFERENCE, WEMA, IRE; Los Angeles, Calif., Aug. 21-24.

METALLURGY OF SEMICONDUCTORS CONFERENCE; American Institute of Mining, et al; Ben Franklin Hotel, Philadelphia, Pa., Aug. 27-29.

BALLISTIC MISSILE & SPACE TECHNOLOGY SYMPOSIUM, U. S. Air Force and Aerospace Corp.; Statler-Hilton Hotel, Los Angeles, August 27-29.

MAINTAINABILITY OF ELECTRONIC EQUIPMENT, EIA Engineering Dept. & Dept. of Defense; U. of Colorado, Boulder, Colo., Aug. 28-30.

INFORMATION PROCESSING CONFERENCE, IRE-PGEC, IFIPS, AIFPS; Munich, Germany, Aug. 29-Sept. 1.

INFORMATION THEORY INTERNATIONAL SYMPOSIUM, PGIT and Benelux Section of IRE; Free Univ. of Brussels, Brussels, Belgium, Sept. 3-7.

ADVANCED TECHNOLOGY MANAGEMENT CONFERENCE, IRE-PGEM, AIEE, et al; Opera House on World's Fair Grounds, Seattle, Wash., Sept. 3-7.

DATA PROCESSING EXHIBIT, Assoc. for Computing Machinery; Onondaga County War Memorial, Syracuse, N. Y., Sept. 4-7.

PETROLEUM INDUSTRY CONFERENCE, AIEE and ISA; Carter Hotel, Cleveland, Ohio, Sept. 9-14.

ENGINEERING MANAGEMENT, IRE-PGEM, AIEE et al; Hotel Roosevelt, New Orleans, La., Sept. 13-14.

ADVANCE REPORT

FOURTH JOINT AUTOMATIC CONTROL CONFERENCE, AIC, AIEE, IRE, et al, University of Texas, Austin, Texas, June 19-21, 1963. September 30 is the deadline for submitting 100-word abstracts to: member society headquarters or Otis L. Udike, Department of Chemical Engineering, University of Virginia, Charlottesville, Va., Areas of interest include: control theory, applications, and components.

HOW CHEAP IS "CHEAP"?

"Why should we buy from you when we can get the 'same thing' from other suppliers at a lower price?"

In selecting a supplier of lacing tape (or any component), price and compliance with specifications are not the only criteria. But too often, manufacturers ignore the other factors involved and consequently lose money.

For example, in a \$15,000 piece of equipment there may be only 15 cents worth of Gudebrod lacing tape. It costs \$75 to work this tape. It may be possible to buy the same amount of tape from other suppliers for 2 or 3 cents less . . . it "will meet the specs" according to these suppliers. But one of our customers recently pointed out why he still specifies only Gudebrod lacing tape in such cases.

"We tried buying some cheaper tape that 'met the specs.' Within a few months our production was off by 50% . . . boy, did the production people really scream about that tape. And our labor costs doubled . . . our costing people really flipped!

"Another thing, why should we risk the possible loss of thousands of dollars when the original material cost difference is only a few cents. Once you put cheaper tape on and something goes wrong after the equipment is finished . . . you've had it. No, thank you! We learned our lesson! We buy Gudebrod lacing tape!"

Whether your firm uses one spool of lacing tape or thousands, there are four advantages in specifying Gudebrod for all your lacing requirements:

- 1. Gudebrod lacing tape guarantees increased production!*
- 2. Gudebrod lacing tape guarantees reduced labor costs!*
- 3. Gudebrod lacing tape guarantees minimal maintenance after installation!*
- 4. Gudebrod guarantees quality! On every spool is a lot number and seal which guarantees that all Gudebrod lacing tape is produced under strict quality control. Our standards are more exacting than those required for compliance with Mil-T.*

Our Technical Products Data Book explains in detail the complete line of Gudebrod lacing tapes for both civilian and military use. For your copy write to Mr. F. W. Krupp, Vice President, Electronics Division

GUDEBROD BROS. SILK CO., INC.

Electronics Division
225 West 34th Street
New York 1, New York

Executive Offices
12 South 12th Street
Philadelphia 7, Pa.

Visit us at the Wescon Show—Booth #3506

NOW FULL POWER ALL-DIFFUSED 2N681A & 2N1842B

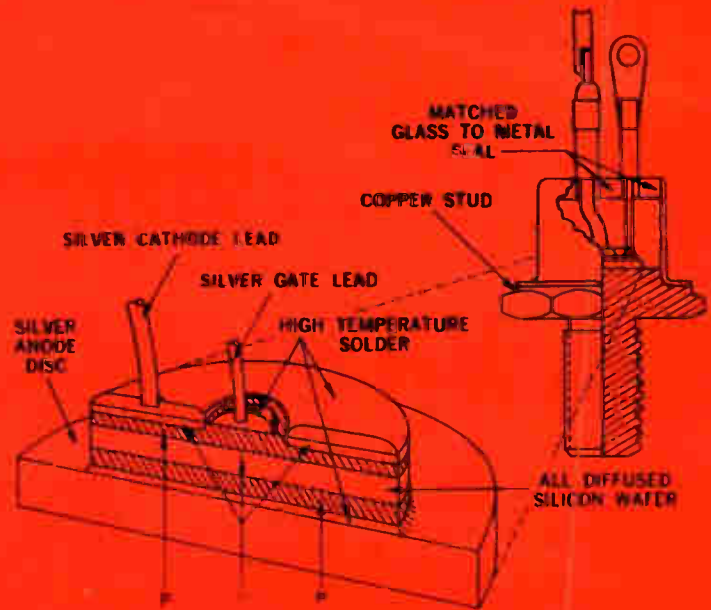

GIVES YOU GREATER VALUE SILICON CONTROLLED RECTIFIERS

■ 18 amp units operate at 18 amp — with peak overload protection; surge rating — 250 amp; 150 amp I²T — “built-in” safety factors.

■ Your mass produced circuits — with TI 2N681A series SCR — have nearly identical electrical characteristics. You get guaranteed min-max gate trigger characteristics... this simplifies your design work.

■ Uniform anode and cathode junctions — a result of the all-diffused process — eliminate alloy junction “hot spots” or spike regions for more reliable operation.

■ Typical low leakage of 0.5 ma or less at 125°C — an inherent result of all-diffused process controls — gives you lower operating junction temperature for increased reliability.

■ TI 2N681A series cool operation and long life result from the high heat-dissipating silver anode disc — a TI 2N681A exclusive.

■ “False Firing” and transient turn-on greatly reduced with TI 2N681A, guaranteed high dV/dt capability — 200 V/μsec at 125°C.

MAKE YOUR OWN COMPARISON

MEET TI AT WESCON

	Surge Current	I ² T	I _{GT} @ 25°C	I _{GT} @ 125°C	@ -55°C	I _{F(off)} @ 125°C	I _R @ 125°C	I _F -65°C @ 180° conduction	dV/dt
NEW 2N681A SERIES	250 a	150A ² sec	40 to 20 ma	20 to 10 ma	60 to 13 ma	1 ma	1 ma	18A	2N681A-687A 200v/μsec @ 125°C 2N688A-689A 100v/μsec @ 125°C
2N681 SERIES	150 a	75A ² sec	NOT GUARANTEED	NOT GUARANTEED	NOT GUARANTEED	6.5 to 4 ma	6.5 to 4 ma	16A	—
NEW 2N1842B SERIES	150 a	75A ² sec	75 to 2 ma	45 to 1 ma	100 to 3 ma	1.0 ma	1.0 ma	16A	—
2N1842 SERIES	125 a	40A ² sec	NOT GUARANTEED	NOT GUARANTEED	NOT GUARANTEED	22.5 to 4.0 ma	22.5 to 4.0 ma	6.5A	—

COMPONENTS DIVISION
CAPACITORS, DIODES,
RECTIFIERS, RESISTORS,
SEMICONDUCTOR NETWORKS,
SILICON CONTROLLED RECTIFIERS



TEXAS INSTRUMENTS
INCORPORATED
13500 N. CENTRAL EXPRESSWAY
P. O. BOX 5012 • DALLAS 22, TEXAS

CIRCLE 32 ON READER SERVICE CARD

Nonlinear Resistors Enhance Display-Panel Contrast

*New design of
electroluminescent displays
for traffic control and
computer readout adds
resolution, eliminates
cross images and
simplifies switching
requirements*

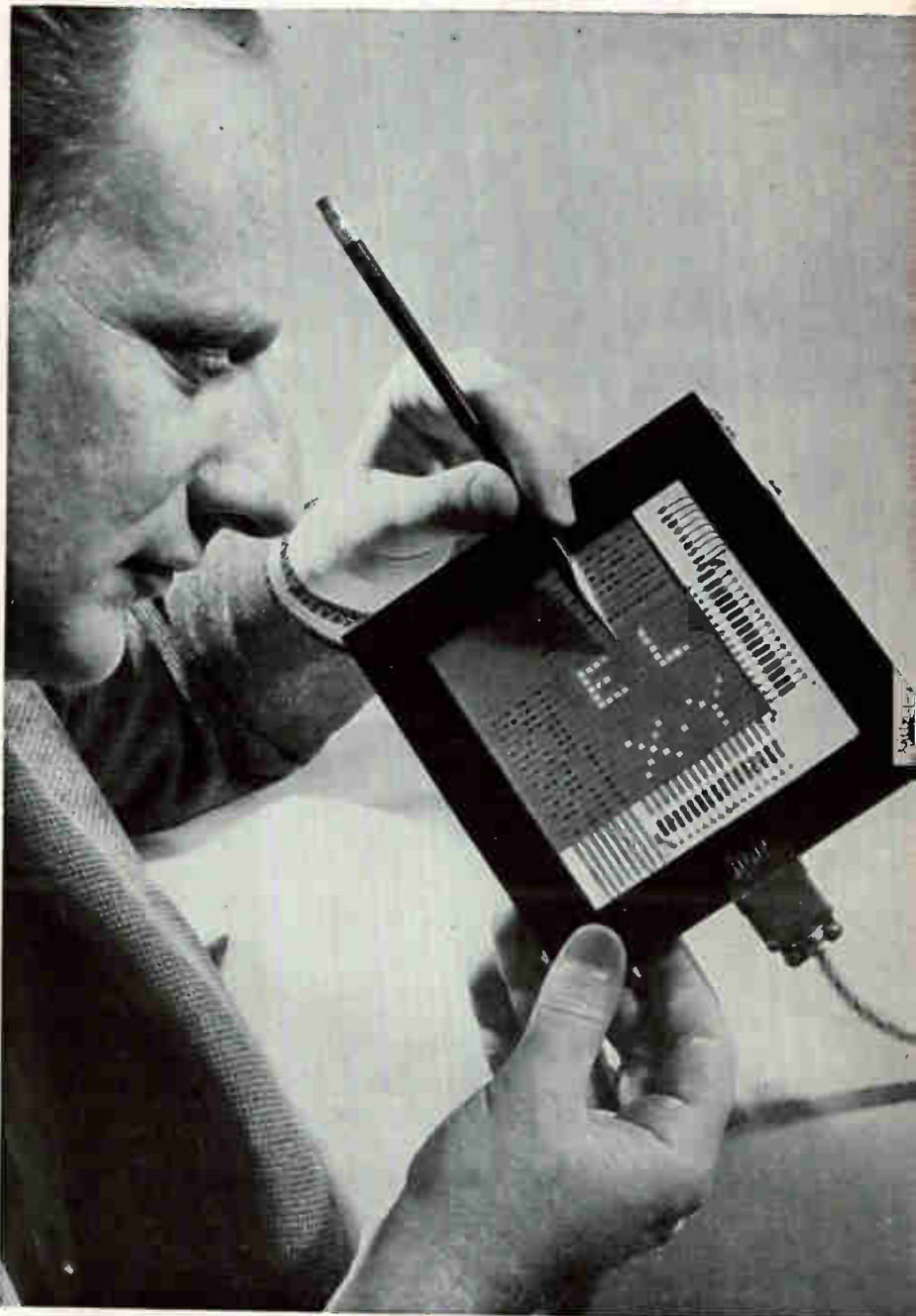

EL DISPLAY panel operating in a random access mode

By H. G. BLANK
J. A. O'CONNELL
M. S. WASSERMAN
General Telephone & Electronics
Laboratories Inc., New York, N. Y.

ELECTROLUMINESCENCE (EL) provides a new approach to constructing large-area displays such as traffic-control boards, situation plot displays and computer read-outs.^{1, 2} The EL lamp, which consists of a phosphor embedded in a dielectric layer placed between two electrodes,

emits light when a voltage is applied to its electrodes. A crossed-grid EL lamp, combined with techniques using a nonlinear resistance (NLR) layer to perform logic and improve contrast, have led to a flat, lightweight electroluminescence display driven directly from binary

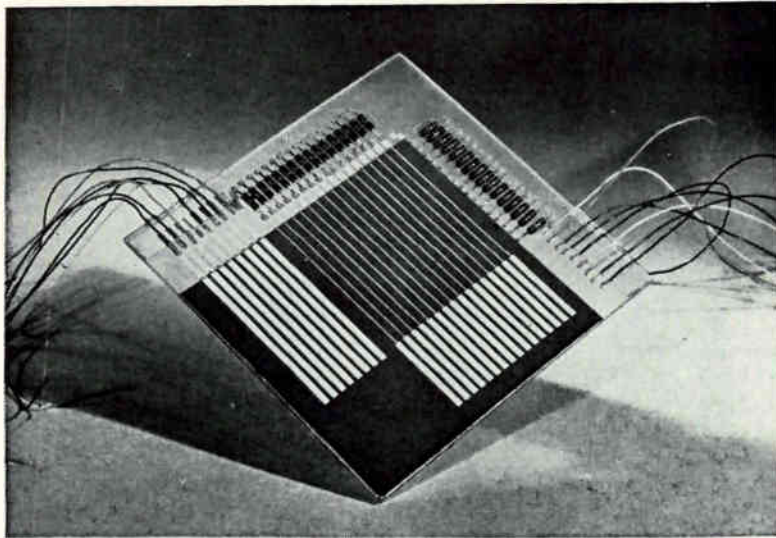

BACK SURFACE of the display panel

inputs. Using the same techniques, panels of larger area and higher resolution can be constructed.

The most common construction for EL displays is the crossed-grid or X-Y panel. The parallel-plate electrodes are divided into strips oriented at right angles to each other. The strips are referred to as the X (horizontal) and Y (vertical) electrodes. An alternating or pulsed voltage applied between an X and a Y strip, causes the phosphor at the intersection to light. By applying voltages to selected pairs of X and Y strips in sequence, letters, numerals and traces can be displayed.

Electroluminescent displays are solid-state devices and do not re-

quire an evacuated envelope as does a c-r tube. Thus, a lightweight flat panel with high density of display elements can be obtained. High resolution, however, requires a large number of input electrodes which, in turn, needs many switching positions. In this device the inputs to be switched are reduced by simultaneously applying binary signals, representing the X and Y coordinates, to two binary-to-decimal decoders. The decoder logic circuits are made of a layer of nonlinear resistor material of the same type used to improve the contrast of the display.³ The similarity of the materials used for the display and the decoder makes it possible to build both components on the same sub-

strate. The electrodes of the crossed-grid panel are extended to form the electrodes of the decoders, thus eliminating the need for separate connections.

The complete display device is a $4\frac{1}{2} \times 4\frac{1}{2}$ -in., 16×16 -element, integrated with two four-binary-bit decoders. The device is operated from a 10-Kc, 250-volt supply and has a spot brightness of 7 foot-lamberts and a resolution of 8 lines/in.

EL DISPLAYS—A cutaway view of a typical crossed-grid EL panel is shown in Fig. 1A. The panel consists of a thin layer of a phosphor, such as zinc sulfide, embedded in a dielectric medium, with the cross-gridded X and Y electrodes on opposite surfaces of the phosphor. For most display devices, the structure is formed on a glass substrate. The lower electrode grid consists of a transparent conductive coating such as tin oxide patterned to form the parallel electrodes. In addition to the bright square produced at the selected X-Y intersection, some light is produced at all other intersections of the selected column and row. The unselected lighted intersections give rise to a cross-grid effect called spurious cross-image effect. The reason for the spurious cross-image is that the all strips are capacitively coupled; thus, approximately half of the applied voltage appears at the unselected intersections of the X-Y strips. The spurious light reduces the contrast considerably, particularly

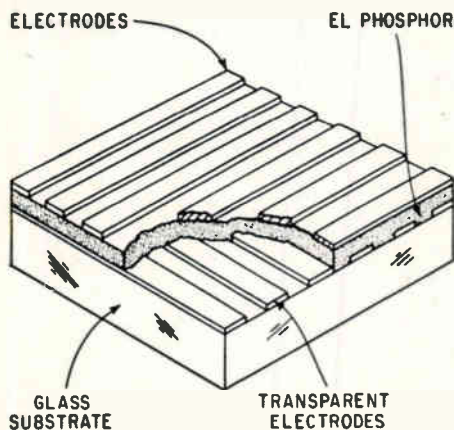

(A)

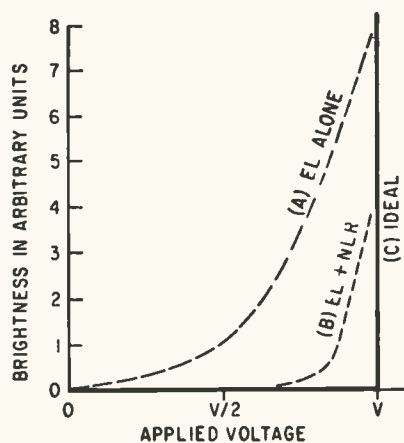

(B)

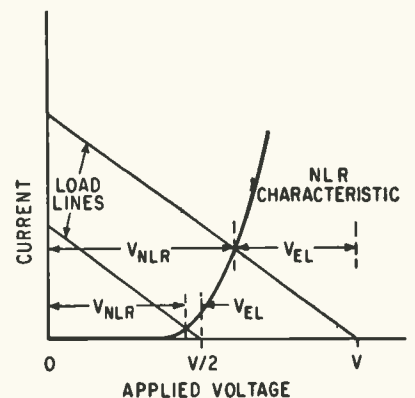

(C)

CROSSED-GRID EL display panel (A). Brightness-voltage characteristics of EL lamps (B). Characteristics of a series NLR-EL circuit (C)—Fig. 1

when a complex image is displayed. Since the brightness-voltage characteristic of the EL material is nonlinear, as shown in curve A of Fig. 1B, the brightness obtained at half voltage is only one eighth of the brightness obtained at full voltage.

A method for eliminating the cross image effect and enhancing contrast is incorporated in the panel. An ideal EL element lights only at full voltage, as shown in curve C of Fig. 1B. The ideal characteristic is approached by placing a nonlinear resistance in series with the EL phosphor (curve B). This is done by interposing an isolating layer having the characteristics of a nonlinear resistor (NLR) between the EL layer and one set of parallel electrodes. The characteristic curve of the NLR layer is plotted in Fig. 1C; the load lines represent the drop across a series EL element. Because of the nonlinear characteristic of the NLR layer, the voltage across the EL element is small when only half-voltage is applied, and increases about ten-fold when full voltage is applied. The brightness discrimination ratio between full voltage and half voltage becomes more than 10,000 to 1, which is more than enough to eliminate the cross-image effect. In addition, because of the greatly reduced capacitance of each element of the crossed grid, the NLR layer increases the impedance of the device. As a result,

the power required from the driving source is reduced and an economy is realized.

ACCESS CIRCUITS—To operate the crossed-grid display panel, an a-c or pulsed voltage source is needed for each of the X and Y strips. The voltages could be provided by a single source mechanically switched to the desired X and Y strips. Use of a binary-to-decimal decoder, driven by gated amplifiers, reduces considerably the space and complexity required for fast switching. Thus, binary signals, representing a selected address, are applied to the decoder which is an integral part of the display panel.

The binary-to-decimal decoders are matrices of AND gates. To illustrate how the decoders drive the display panel, consider first an individual AND gate, then two AND gates (inverted with respect to each other and connected, respec-

tively, to one X and one Y strip of the panel), and finally, the entire decoder matrix.

Figure 2A shows one of the four-bit nonlinear-resistance AND gates. An open switch represents an activated input. The relative output voltage across an impedance Z is shown in Fig. 2B, where the quantity $Z/(R_1 + Z)$ is chosen to be $\frac{1}{2}$. When none to three switches are open, that is, at least one switch closed, the nonlinear resistors maintain the output voltage nearly constant at roughly $V/2$. When all switches are open, the output voltage rises sharply to within $\frac{1}{4}$ of the full supply voltage. Toggle switches are shown in Fig. 2A but circuits incorporating semiconductors can be used.

To provide access to one X and one Y electrode of the crossed grid display, two of these AND gates are arranged in a bridge with the panel as the detector (Fig. 3A). The potentials appearing at the outputs

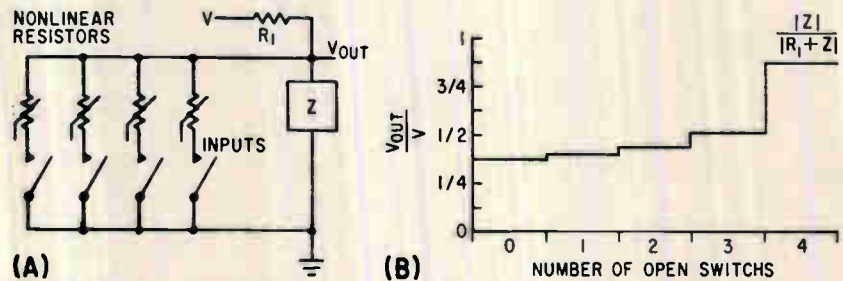

FOUR-BIT nonlinear AND circuit (A); output voltage against number of open switches (B)—Fig. 2

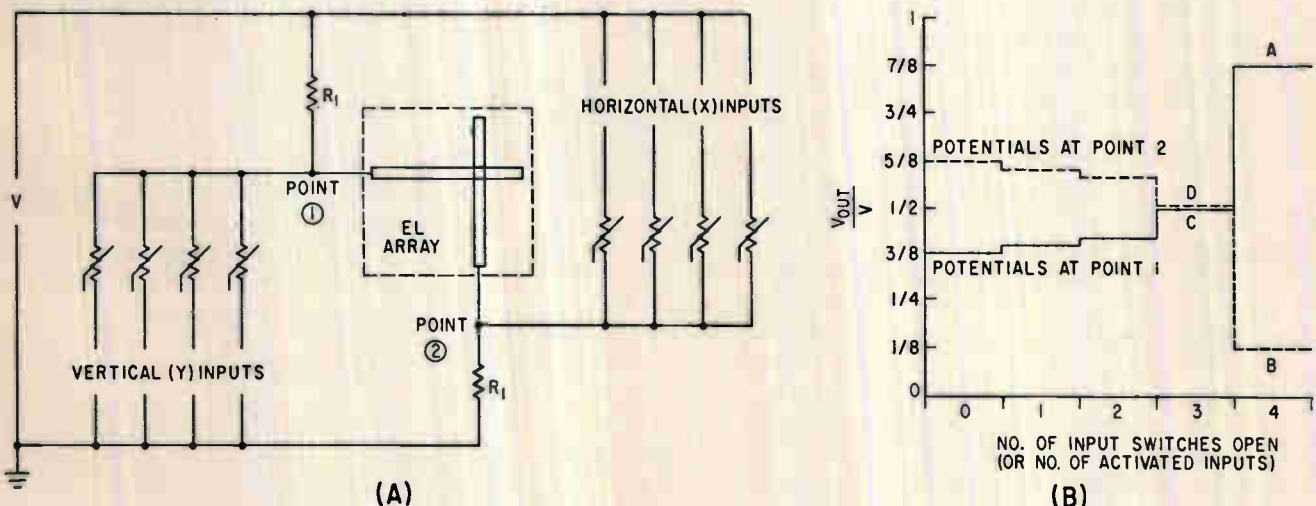

NONLINEAR-resistance decoder and EL display panel (A); output voltage at points 1 and 2 against number of activated (open) inputs (B)—Fig. 3

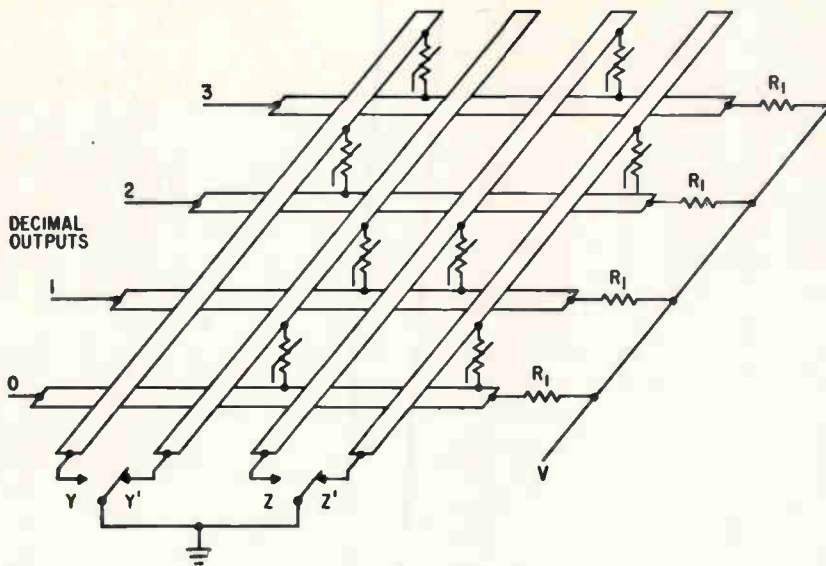

TWO-BIT decoder matrix (output 3 is energized)—Fig. 4

of the AND gates (points 1 and 2) are plotted in Fig. 3B as a function of the state of the input switches. The potential across the intersection of an X and Y element of the display is the difference between the solid and dashed lines of Fig. 3B. For example, the voltage corresponding to a selection, that is, all switches open, is the difference between levels A and B. Each AND gate is within $\frac{1}{4}$ of its side of the supply voltage, V, which results in the appearance of $\frac{3}{4}$ V across the selected intersection. In the worst unselected case one AND gate is within $\frac{1}{4}$ of its end of the supply (all input switches open), while the other is midway between the two sides of the supply (all but one input switch open). This results in $\frac{1}{4}$ V across the unselected elements, as shown in Fig. 3B by the difference between points A and D or B and C. The voltage difference between points 1 and 2 for all other input combinations will be even less. Thus the select output voltage is always at least twice the nonselect voltage and the panel will light only at a selected intersection because the light output at the worst-case unselected intersection will be several thousand times smaller.

Full access to the panel is achieved by connecting one AND gate to each of the 16 X inputs and another to each of the 16 Y inputs. The AND gates of each decoder are constructed in matrix form as shown in Fig. 4. For simplicity,

only a two-binary-bit matrix is illustrated. The binary inputs are applied to the upper electrodes designated Y, Y', Z and Z' (unprimed inputs represent a binary 1, and primed inputs represent a 0). The appearance of an input signal corresponds to removal of the input bus bar from ground potential, that is switch opens. With the switch in the position shown, output 3 is activated. Each of the lower electrodes is connected at the left to a terminal of the crossed grid panel.

It is not necessary to use discrete NLR elements in the decoder matrices. Instead, a continuous NLR layer of polycrystalline material similar to that used for the cross-effect suppression layer is formed between the two sets of decoder electrodes at two side of the panel. Interposed between this NLR layer and one set of electrodes is an insulator layer containing holes so located that the NLR layer is bridged at the proper intersections.

DISPLAY CONSTRUCTION —

The similarity of materials for the EL display and the NLR decoders, and the fact that they can both be formed in continuous layers, makes it possible to form both components, as well as connections between them, on a single substrate. The steps in the construction of the device are:

- (1) A conducting, transparent

layer of the tin oxide is deposited on the surface of the glass substrate and patterned to form the input electrodes of the vertical AND gates, the output electrodes of the horizontal AND gates, the horizontal electrodes of the crossed grid display, and the connections between the latter two.

- (2) A glass enamel insulating layer is applied over the decoder areas so to selectively expose the lower electrodes and permit formation of NLR crossovers.

- (3) An EL phosphor embedded in a glass enamel layer is applied over the display portions of the panel.

- (4) An array of metallic electrodes is vacuum deposited onto the EL layer to define the display elements.

- (5) A nonlinear resistor layer is applied over both the display and the decoder areas.

- (6) A final metallic electrode pattern is vacuum deposited over the NLR layer to form the input electrodes of the horizontal AND circuits, the output electrodes of the vertical AND circuits, the vertical electrodes of the crossed grid, and the connections between the latter two. The device is completed by forming common supply electrode strips, and connecting the 32 linear resistors (R_1), which drive the individual AND gates of the decoding matrices.

The photo of the back surface of the panel illustrates the positions of the decoder circuits on the panel. For larger displays, the decoders would occupy a smaller proportion of the total area.

The power dissipation is 2.5 watts. Since most of the power is consumed in the unactivated AND gates of the decoders, power dissipation will not increase in direct proportion to the display area. The minimum response time for the device, which is limited only by the capacitance of the elements, is about ten microseconds.

REFERENCES

- (1) I. Greenberg, Electroluminescent Display and Logic Devices, *ELECTRONICS*, p. 31, Mar. 24, 1961.
- (2) J. J. Josepha, A Review of Panel-Type Display Devices, *Proc IRE*, 48, p. 1,330, Aug. 1960.
- (3) M. S. Wasserman, Nonlinear Matrices for Logic Operations, *Proc. NEC*, Chicago, Oct. 1961.

HORIZONTAL SWEEP typical system, (A); simple model of the horizontal output circuit, (B)—
Fig. 1

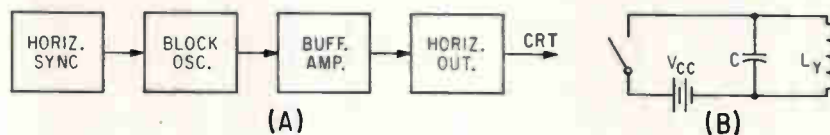

Stop Transistor Failures in Magnetic-Deflection Circuits

Output transistor failures can be traced to energy returned by deflection coil. To eliminate this, consider energy transfer in output circuit design

By RALPH S. HARTZ,

Bendix Semiconductor Division, Bendix Corp., Holmdel, N. J.

HORIZONTAL-DEFLECTION and high-voltage circuit losses account for much of the power consumption in transistor television receivers and other display systems. Larger tubes and wider angles impose rigid demands on deflection circuits and components. A typical deflection circuit is shown in Fig. 1A, and an idealized horizontal output stage in Fig. 1B. The circuit is common in television receivers, but the principles apply to any magnetic deflection circuit.

CIRCUIT OPERATION—When the switch is closed, voltage V_{cc} is impressed across the coil and coil current i_y increases approximately linearly with time

$$i_y = (V_{cc}/L_y)t \quad (1)$$

At a time t_1 , corresponding to the end of the trace period, the switch is opened. Now the circuit consists of an inductance carrying a current I_1 and a capacitor across which there is a voltage V_{cc} . The voltage across the capacitor is in such a direction as to keep the current flowing in the coil until the capacitor is discharged. This corresponds to the period t_1 to t_2 in Fig. 2A. The current and voltage now changes direction and the energy is transferred back to the capacitor at t_2 . The current then goes negative as the capacitor returns its energy to the magnetic field at t_1 . From t_2 to t_3 , di/dt is negative, and at t_3 , di/dt goes through zero and begins to go positive. The magnetic field begins to collapse and at t_3 the capacitor is again charged to V_{cc} , the switch is closed and the stored energy is returned to the battery during the first part of the trace period.¹

In a practical circuit, the energy returned to the battery by the tuned circuit is less than that supplied to it by the battery during the trace period. An equivalent circuit then would have to include the energy-loss elements. The losses in a practical output circuit depend primarily on circuit Q and switching

efficiencies, including the Qs of the yoke and high-voltage transformer, ringing in the secondary of the high-voltage transformer, lead losses, series resistances etc. However, only losses directly associated with the output transistor will be considered.

The ideal switch is replaced by a transistor and a diode as shown in Fig. 2B. At the end of the retrace period, the peak current is less than it was at the beginning of the retrace period. The energy loss is then proportional to the difference in the squares of the two currents

$$\Delta E = (1/2)L(I_1^2 - I_2^2) \quad (2)$$

where I_1 is the initial and I_2 is the final value of yoke current.

The energy loss due to the transistor is explained by the decay of the collector current during the first portion of the retrace period. Figure 2B shows the operating load line of the output transistor. At the beginning of the trace period, the current and the voltage are at point A. The current increases from A to its maximum at point B at the end of the trace period. At this point, the transistor begins to turn off and the decay is along BC DA. The decay path along BC is dependent on the base drive and individual transistor switching characteristics. The energy lost in the transistor during this decay is the time integral of the instantaneous power along BC

$$E = \int_B^C P dt = \int v_{CE} i_c dt \quad (3)$$

While it is desirable to minimize this loss for efficiency, it becomes necessary to minimize it when it is considered that this energy may destroy the transistor.

RANDOM FAILURES—Reports of random transistor failures led to investigation of the dependence of these failures on normally measured switching transistor parameters. These investigations revealed

FREE REPRINT

Single copy of this article available free by simply checking the READER SERVICE CARD

that the only normally measured parameter affecting the failure rate was fall time, and that the failures did not depend on normally measured breakdown voltages. Further investigation showed that the failure rate is proportional to the retrace decay time energy absorbed by the transistor. This agrees with R. P. Miller's finding that power transistor failures depend on their energy characteristics.⁸ The ability of a germanium transistor to absorb energy is inversely proportional to the reverse base current flowing at the time. A large I_b flowing through $r_{b'}$ concentrates the emitter current toward the geometric center of the device, increasing the current density and thereby the likelihood of destruction by localized heating.⁹

REDUCING DECAY TIME—In the circuit of an output transistor whose drive condition and peak collector current are fixed, the energy absorbed will be a function of the rate of rise of collector voltage and collector current fall time. Then for a transistor with a given fall time, an energy reduction may be achieved by reducing the rate of rise of V_{ce} . Compare this energy in a circuit where third-harmonic tuning is employed to one that is tuned to a fundamental frequency. Where third-harmonic tuning is used, some advantage is realized in the reduction of peak voltage during retrace; however, the rate of rise of V_{ce} is increased greatly over the corresponding rise of the fundamental even though the peak of the fundamental may be about twenty percent greater.

Figure 3 compares a fundamental and third-harmonic waveform and the collector current decay on the same time scale. It is assumed that the collector current decays in two microseconds and the length of the retrace period is ten microseconds. The 2N1073B transistor is a diffused-alloy power transistor for which the collector current decay is almost linear, and to a good approximation may be expressed as a linear function of time. The retrace period is ten microseconds and the fall time is two microseconds so the expression for the current is

$$i = I_p (1 - 5 \omega t) / \pi \quad (4)$$

The voltage waveform v , is expressed as the sum of a fundamental and third harmonic, neglecting fifth and higher harmonics

$$v = V_p \sin \omega t + 1/3 V_p \sin 3 \omega t \quad (5)$$

where $V_p = v$ (max) fundamental
The energy expression is

$$E = \int_0^{t = \frac{\pi}{5\omega}} [V_p \sin \omega t + 1/3 V_p \sin 3 \omega t] \left[I - \frac{5I \omega t}{\pi} \right] dt \quad (6)$$

The energy is compared for fundamental and third-harmonic tuning where the fundamental peak voltage is twenty percent higher than the peak of the third harmonic. This increase is generally necessary to maintain the same average voltage over the cycle.

E (3rd harmonic) = $0.128 V'_p I_p T / 2\pi = 0.457$ millijoules (7)
where $V'_p =$ peak 3rd harmonic voltage $I_p =$ peak current in transistor and T is the retrace time.

$$E \text{ (fundamental)} = 0.065 \frac{V_p I_p T}{V'_p I_p T} / 2\pi = 0.078 \times 0.278 \text{ millijoules} \quad (8)$$

where $V_p =$ peak fundamental voltage

$$\text{or} \quad E_{3H} / E_F = 1.64 \quad (9)$$

This shows a 39-percent decrease in energy dissipation in the transistor for fundamental tuning over third-harmonic tuning with identical conditions.

The maximum retrace time tolerable without retrace blanking is in the neighborhood of ten microseconds, but where retrace blanking is used, the maximum becomes about 14 μ sec. In addition to a reduction in the rate of rise of collector voltage, an added advantage is gained since the longer period gives the same average voltage with a reduced peak voltage. Assuming this reduction is peak voltage to be twenty percent, the energy is again reduced. The current decays in $t = \pi / 7\omega$, (which is 1/7 of the 14- μ sec retrace period).

In terms of $(V', I, T) / 2\pi$ since $T_1 / T = 1.4$, the energy dissipated in the transistor for fundamental tuning is now

$$E_F (14 \mu\text{sec}) = 0.049 V'_p I_p T / 2\pi = 0.175 \text{ millijoules} \quad (10)$$

The ratio of

$$E_{3H} / E_F (14 \mu\text{sec}) = 2.62 \quad (11)$$

The output circuit tuned to a third harmonic will pump more than two and a half times as much energy into the transistor at the beginning of each retrace. This ratio is not significant where the absolute mag-

CURRENT AND VOLTAGE waveforms for the model horizontal sweep circuit of Fig. 1 are plotted in (A); load-line plot for the horizontal deflection circuit output transistor, together with model circuit, are shown in (B), illustrating the turn-off current decay along BCDA—Fig. 2

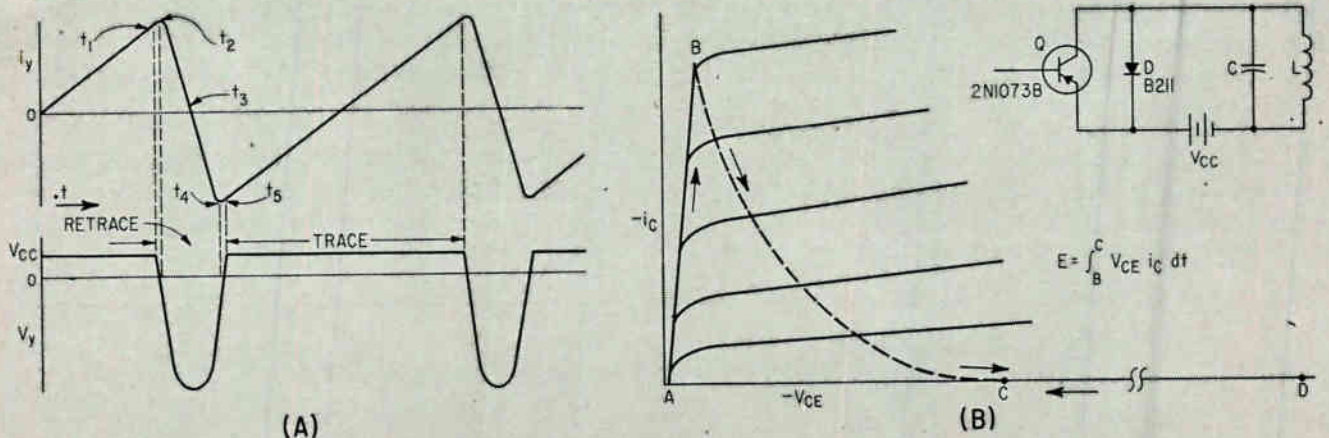

nitudes are small compared to the limitations of the device; however, when the magnitudes approach the device limitations, this ratio is of consequence.

Any of the energies will be reduced with a transistor having a shorter fall time. The dotted line in Fig. 3 shows a transistor collector current decay in a shorter time. It can be seen that the instantaneous voltage is always smaller.

BASE-DRIVE EFFECT—The energy that a transistor can dissipate is inversely proportional to the reverse base current. Furthermore, in a given tuned circuit the amount of energy that a transistor will see is proportional to the fall time. In a given deflection circuit, the peak collector current is determined and therefore the stored base charge is also determined. The fall time will then also be an inverse function of the average reverse base current flowing during the decay time.

The base current must be increased to reduce the total decay time energy; but, the base current must be reduced to increase the energy capability of the transistor. Decay time energy E_D can be plotted as a function of fall time

$$E_D = f(t_f) \quad (12)$$

as shown in Fig. 4A.

Figure 4B shows a plot of fall time as a function of average base current

$$t_f = f(I_b) \quad (13)$$

Decay-time energy is then plotted as a function of base current in Fig. 4C

$$E_D = f(I_b) \quad (14)$$

Superimposing the curve of maximum energy capability against base drive, the region between I_{b1} and I_{b2} is seen as a destructive region, for in it the decay time energy is always greater than the maximum capability of the transistor. The maximum energy rating for a given average base current must never be exceeded.

EFFICIENCY—This is important especially with battery operation. The difference in decay-time losses between the short retrace third harmonic and

FUNDAMENTAL and third-harmonic waveforms plotted to the same time scale as collector current decay to show relative effect—Fig. 3

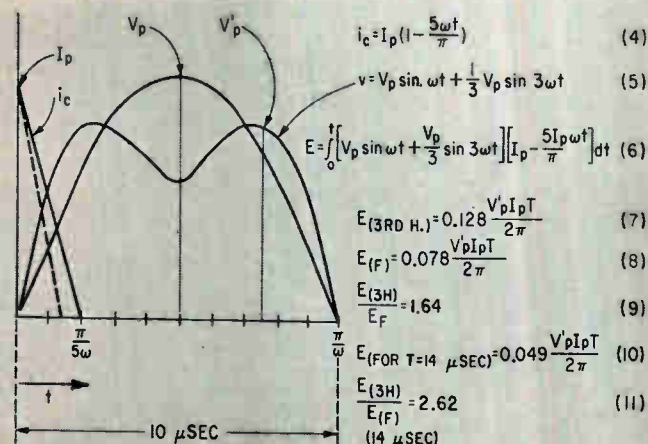

the long retrace fundamental circuit represents considerable power drain. Assuming a peak current of 7 amperes and a peak voltage of 160 volts, Eq. 7 becomes

$$\frac{E \text{ (3rd harmonic)}}{T} = \frac{0.457 \text{ millijoules}}{63.5 \mu sec} = 7.2 \text{ watts} \quad (15)$$

and Eq. 10 becomes

$$\frac{E}{T} = \frac{0.175 \text{ millijoules}}{63.5 \mu sec} = 2.75 \text{ watts} \quad (16)$$

A typical horizontal yoke for a 110-deg picture tube requires about 1.5 millijoules at each end of the trace. The ratio of the energy stored in the yoke to the energy lost in decay time each cycle is then from Eq. 7

$$\frac{E \text{ (stored)}}{E \text{ (lost)}} = \frac{1.5}{0.457} = 3.3 \quad (17)$$

for the third harmonic circuit, and from Eq. 10

$$\frac{E \text{ (stored)}}{E \text{ (lost)}} = \frac{1.5}{0.175} = 8.6 \quad (18)$$

for the fundamental circuit with the 14- μsec retrace.

A transistor to be used in a deflection circuit must have short fall time, the collector-to-emitter voltage capability must exceed the peak retrace circuit voltage, and the energy capabilities must exceed the decay-time maximum energy under the drive conditions during retrace.

The 2N1073B is ideal for this type of switching. Its fast fall time allows it to pass through regions of high instantaneous power in short times, thereby reducing its energy dissipation and, consequently, the likelihood of destruction. The low a-c and d-c input impedance of the 2N1073B presents a nearly ideal condition to the driving source, and also allows high instantaneous off-drive currents that generate the fast fall time associated with the device.⁴

REFERENCES:

- (1) T. Murakami, Ringing in Horizontal-Deflection and High-Voltage Television Circuits, *RCA Review*, March 1960.
- (2) Millman and Taub, "Pulse and Digital Circuits", McGraw-Hill, 1956.
- (3) R. P. Miller, Dependence of Power Transistor Failures on Their Energy Characteristics—*Semiconductor Products*, July 1962.
- (4) F. J. McKendry, "Base-Emitter Reverse Characteristics of Diffused Alloy Power Transistor (DAP)@—Bendix Semiconductor Division, December, 1960.

DECAY TIME ENERGY as function of time, (A); fall time against average base current, (B); decay-time energy against base current, (C)—Fig. 4

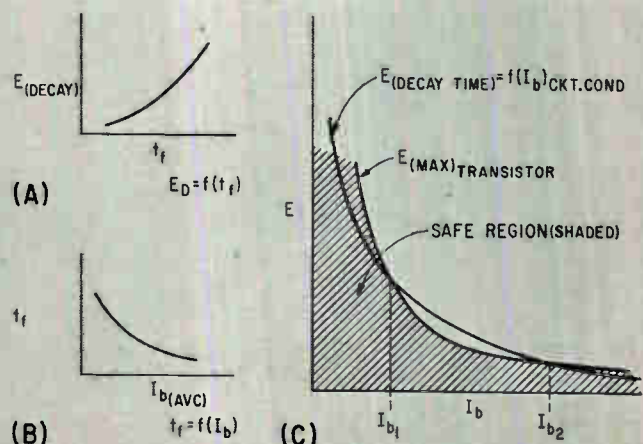

Unique Power Supply Delivers

Solid-state devices control a power supply that must deliver first constant current, then constant voltage in the production of electrolytic capacitors

By JOHN W. MARTIN, Chief Development Engineer

HUGO LIEPINS, Development Engineer, Sola Electric Co., Elk Grove, Ill.

FORMING ELECTROLYTIC CAPACITORS requires a source of regulated d-c power unique in that the power supply must deliver a constant current during the initial forming; then, when the final forming voltage is reached, the supply must deliver a constant voltage. Furthermore, because a wide range of capacitors may be formed by a given supply, current and voltage must be controlled over a wide range of preset values.

The required mode of operation is shown in Fig. 1. The curve indicates that operation starts at a preset level of current, A, which can range from 0.3 to 4.0 amperes. As this current flows through the capacitor being formed, the current must be held constant since the resistance of the capacitor is changing. This means the voltage across the capacitor is increasing; however, it must not increase beyond a preselected value of final forming voltage. Any value of final forming voltage from 200 to 1,000 volts d-c may be selected. Assume a value

such as C has been selected. When the rising voltage (at constant current) reaches B, current regulation ceases and operation continues at constant voltage C. Current regulation is ± 5 percent and voltage regulation ± 1 percent.

Figure 2 shows the connections between the main assemblies. The constant-voltage transformer provides a sine wave of voltage regulated to ± 1 percent for input values of 100-130 volts a-c unaffected by line transients. The a-c output of the constant-voltage transformer is controlled by a saturable reactor.

OVERALL OPERATION — The saturable reactor is the major control element and determines the d-c output voltage and current by varying the a-c input voltage into the step-up transformer. The degree of saturation is determined by the current in the d-c bias winding which, in turn, is a function of the output of a current-difference amplifier or voltage-difference amplifier. The schematics of these am-

plifiers is shown in Fig. 3.

The unit is turned on with the load disconnected through relays. The SET CURRENT potentiometer R_2 in the current-difference amplifier and the SET VOLTAGE potentiometer R_1 in the voltage-difference amplifier are at zero. There is no output from either amplifier, and no input to the driver amplifier. Hence no d-c bias current flows in the saturable reactor. The output is then shorted, and the high impedance of the reactor permits a small current to flow through a 4-ohm current-sensing resistor in series with the output. The voltage drop across this resistor is fed to one side of the current-difference amplifier, which operates from the +17 d-c voltage output of the auxiliary supply. Potentiometer R_2 is adjusted, causing an output signal that is amplified in the driver amplifier and fed to the reactor, lowering its impedance until the desired current flows in the current-sensing resistor. Now the voltage drop across this resistor equals the frac-

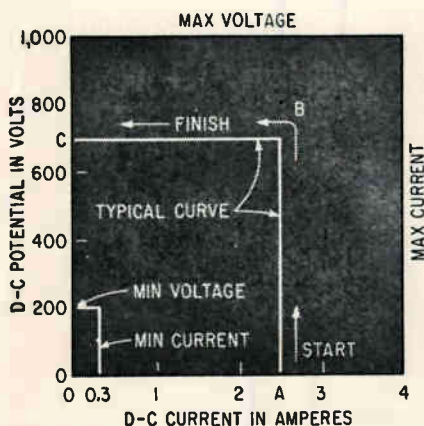

RANGE OF OPERATION of the constant current/constant voltage supply—Fig. 1

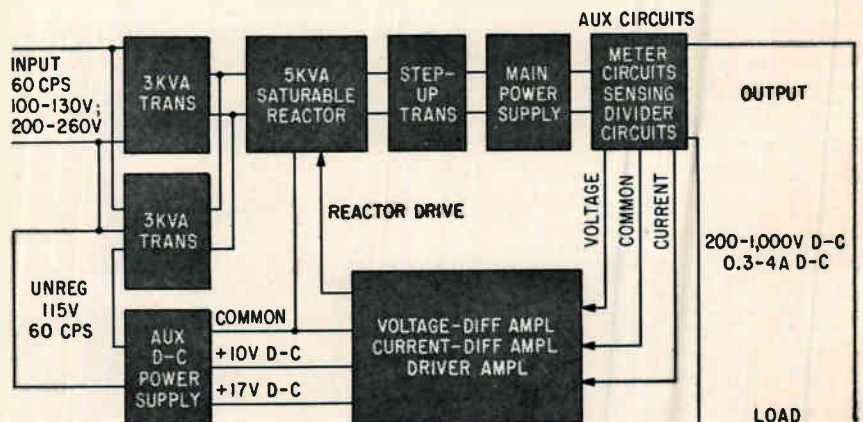

MAJOR ASSEMBLIES of constant current and constant voltage supply. To prevent rapid changes in line voltage from affecting the output, constant voltage transformers are used—Fig. 2

Constant Voltage and Current

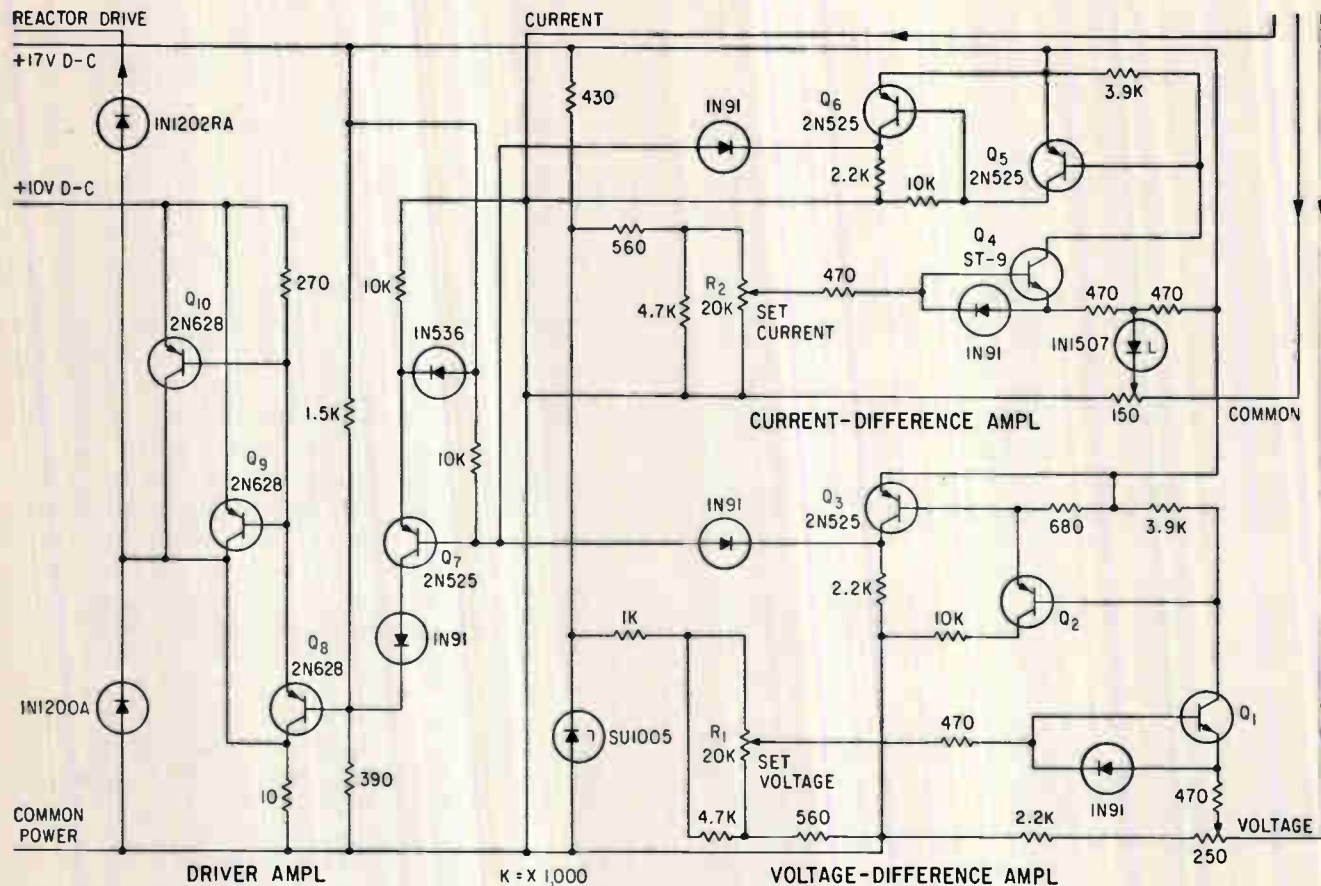

VOLTAGE-DIFFERENCE AMPLIFIER, current-difference amplifier, and driver amplifier—Fig. 3

tion of the reference zener drop selected by R_2 and the output current is clamped at this value. The current-difference amplifier input is then disconnected and the voltage-difference amplifier connected to a 500-ohm tap on a voltage divider in parallel with the output voltage. This portion of the voltage divider can be considered to be a voltage-sensing resistor. Potentiometer R_1 is adjusted and the same action takes place as in the current-difference amplifier. When the voltage drop across the voltage-sensing resistor equals the preselected fraction of the reference zener drop, the output voltage is clamped by the action of the amplifiers and reactor. The load is then connected to the output of the supply, by internal relays, with both difference amplifiers connected to their respective inputs.

The outputs of the difference am-

plifiers control the reactor-driver transistors. Since capacitors are forming from a short circuit, the current-difference amplifier overrides and maintains the output of the supply at a constant preset current. When the voltage developed across the capacitors increases to the preset voltage, the voltage-difference amplifier begins to limit reactor drive. Capacitor-forming current continuously decreases at a constant voltage until the operator turns off the supply. This decreasing of current is a characteristic of the load.

AMPLIFIER ACTION—If a decrease in load current should occur that would cause the output voltage to rise, the increase in output voltage will cause an increased voltage drop across the output voltage divider. This increased voltage will be seen at the emitter of Q_1 which

will cause Q_1 to conduct less, reducing base drive to Q_2 . Transistor Q_2 will in turn, reduce base drive to Q_3 which will reduce base drive to Q_4 . The decreased collector current of Q_4 will result in reduced drive to Q_5 and Q_{10} , thereby decreasing the saturable-reactor control current. This decrease in saturable-reactor control current will cause the reactor to absorb a greater portion of the output voltage of the constant-voltage transformers. Therefore, less input voltage will be supplied to the main power supply and the output voltage will be maintained at a constant value.

When the system is operating in the constant-current mode, output current is sensed as the voltage across the current-sensing resistor. This voltage is applied to Q_4 and the action of the current-difference amplifier is similar to the action of the voltage-difference amplifier.

Can Varactors Get Rid of F-M Distortion in Reflex Klystrons?

Varactor diode used in reflex klystron circuit expands useful frequency range while improving linearity of frequency modulation. Both repeller voltage tuning and varactor tuning can be used simultaneously

By AKIO SASAKI

Research Engineer, Kobe Kogyo Corp., Kobe, Japan

NONLINEAR DISTORTION of frequency modulation (differential modulation distortion)¹, which lowers the quality of communicated

signals, is due to the nonlinear relationships of repeller voltage to frequency in a reflex klystron oscillator (Fig. 1A).

Differential distortion may be compensated for by loading the klystron with an admittance. However, this method of compensation is usually critical, making it too unstable to be used with a reflex klystron. A new solution to the problem of expanding the frequency range, while improving linearity of frequency modulation, incorporates varactor diodes.

The junction capacitance of a varactor diode changes continuously with the bias voltage V_b , according to²

$$C_J = C_0 \left(1 - \frac{V_b}{\phi} \right)^{-1/2}$$

The zero bias capacitance is C_0 ; ϕ is the intrinsic barrier potential (about 0.32 volt at room temperature); and V_b is the bias voltage (negative for reverse voltage).

NEW THEORIES—One method of frequency control is to insert a varactor diode in the output waveguide of a reflex klystron, at a position near the klystron output window. The diode may also be placed in a cavity resonator closely coupled to the klystron (Fig. 1B and 1C).

By changing the bias voltage applied to the varactor diode, the loaded susceptance at the modulation gap is changed (Fig. 1B). In Fig. 1C a change of the resonant frequency of the coupled cavity takes place with a change in bias, resulting in a change in the oscillation frequency. Klystron circuits incorporating varactor diodes are capable of tuning wider frequency

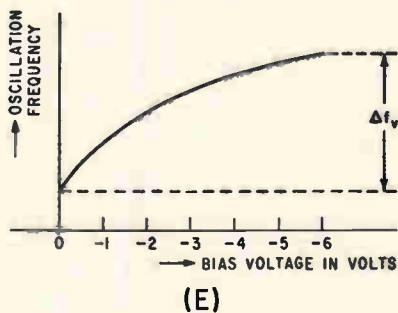
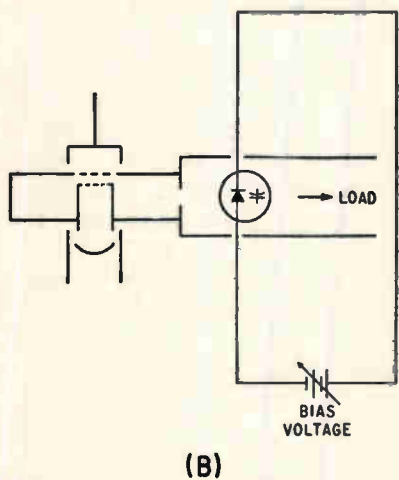
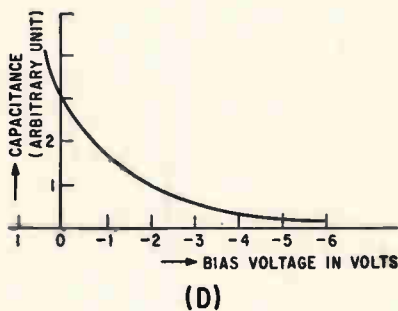
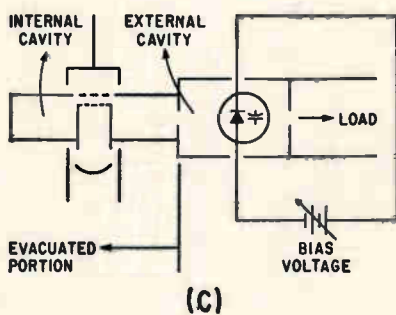
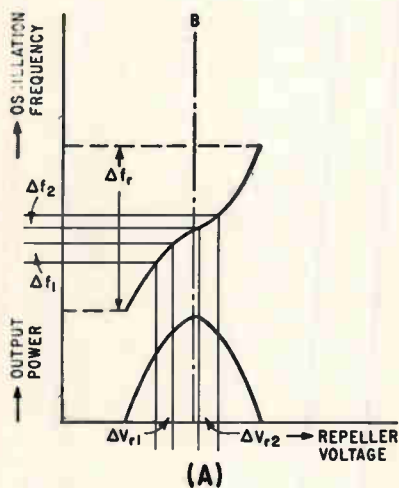

REFLEX KLYSTRON oscillation characteristic shows distortion of frequency modulation (A). Frequency may be controlled by a varactor diode. Diode may be placed in output waveguide of klystron (B), or in a cavity resonator, (C). Since a biased varactor has variable capacitance (D), a new characteristic may be obtained with a varactor diode—Fig. 1

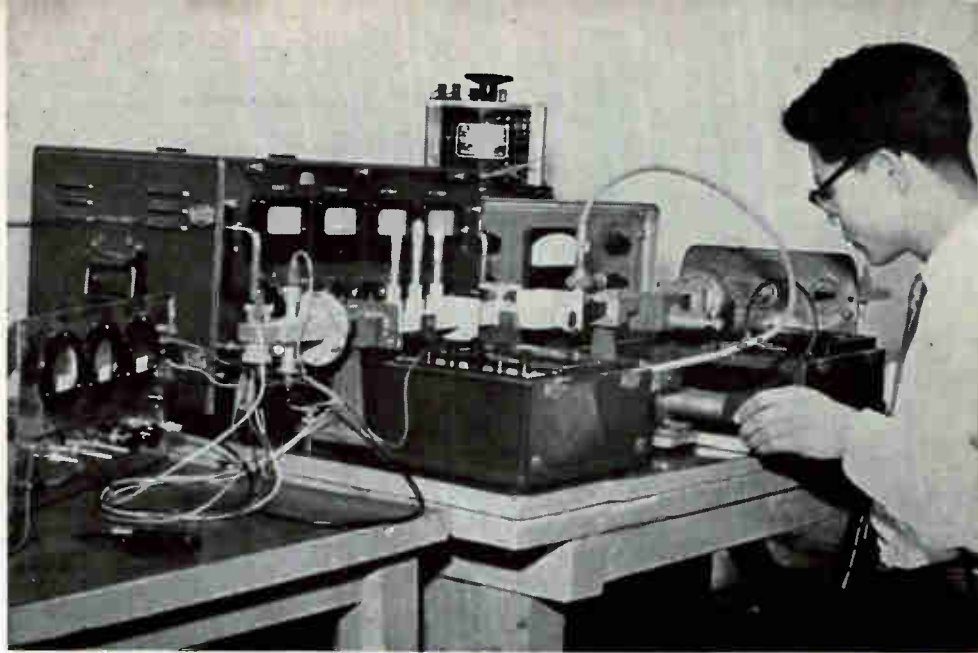
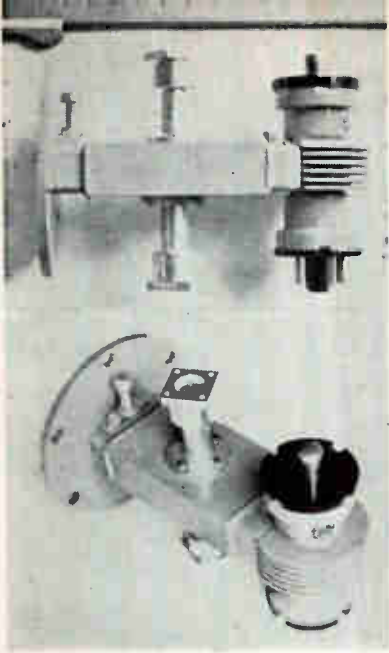

EXPERIMENTAL APPARATUS, used by the author to test his frequency modulation techniques (right), and experimental tube (left). Output of tube is at right, klystron left, and external cavity center. Cylinders protruding from external cavity are varactor diode mounts

ranges than those which repeller voltage is capable of tuning.

Figure 1D shows that the rate of change of capacitance of a varactor diode is greater for smaller bias voltages than for larger biases. By incorporating this diode in the output circuit of a reflex klystron, a frequency versus bias voltage characteristic upwardly convex in shape is obtained (Fig. 1E).

A second method of klystron frequency control utilizes simultaneous variation of the bias voltage of the diode and the repeller voltage of the klystron (Fig. 2A and 2B). This facilitates the superposed controlling of the repeller and bias voltage characteristics indicated in Fig. 1A and 1E.

One case is when the bias tuning range Δf_b is less than that of the repeller tuning range Δf_r . In a reflex klystron, the inflexion point *B* on the frequency characteristic, Fig. 1A, occurs in practical use at the left of the maximum output power point. By superposing the characteristic of Fig. 1E upon that of Fig. 1A, the resultant becomes linear except in the lower frequency region (Fig. 3A). Another case is for Δf_b greater than Δf_r , and occurs when sufficient variation of frequency can be realized by changing the bias voltage. Simultaneous change of the bias voltage and the repeller voltage is equivalent to simultaneous electronic and circuit tuning.

If the electronic conductance, G_e , plus the circuit conductance, G_c , equal zero; and the electronic susceptance, B_e , plus the circuit sus-

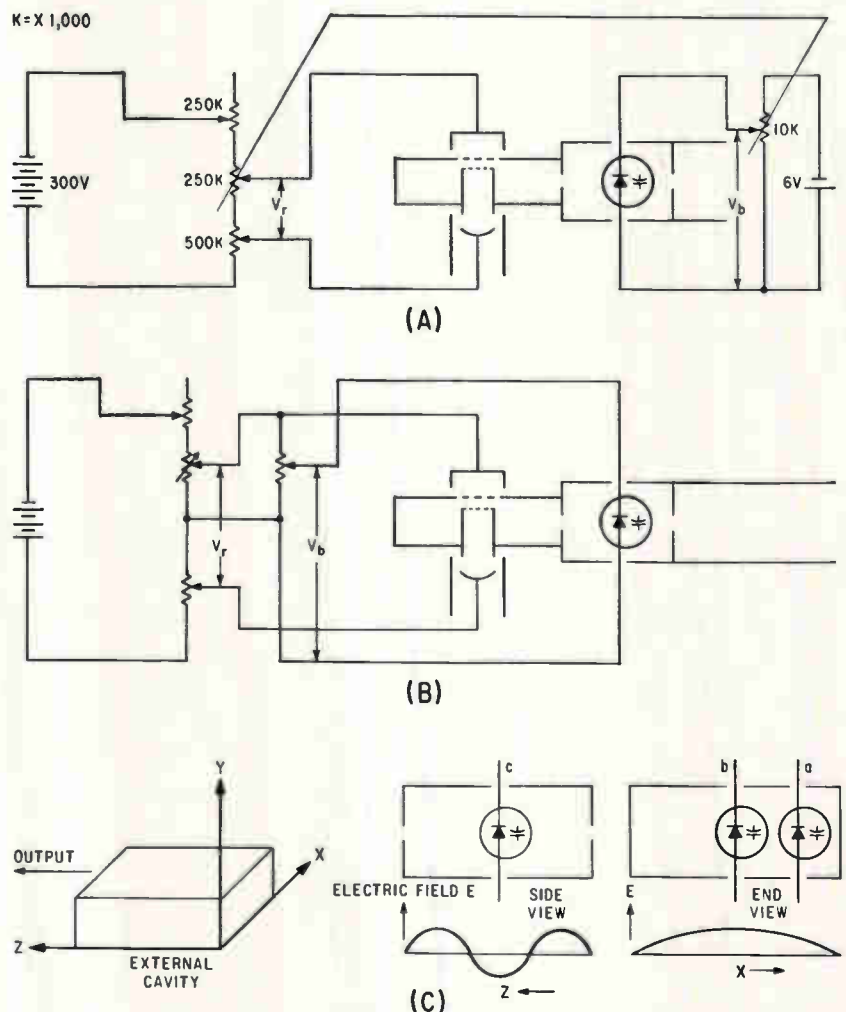

VARYING repeller and bias voltages simultaneously. Separate control sources ganged (A) or a single control source is used (B). Location of varactor in the external cavity with respect to a TE_{013} resonant mode (C). Position (a-c) is the mounting used to obtain Fig. 4, position (b-c) is the mounting used to obtain Fig. 5—Fig. 2

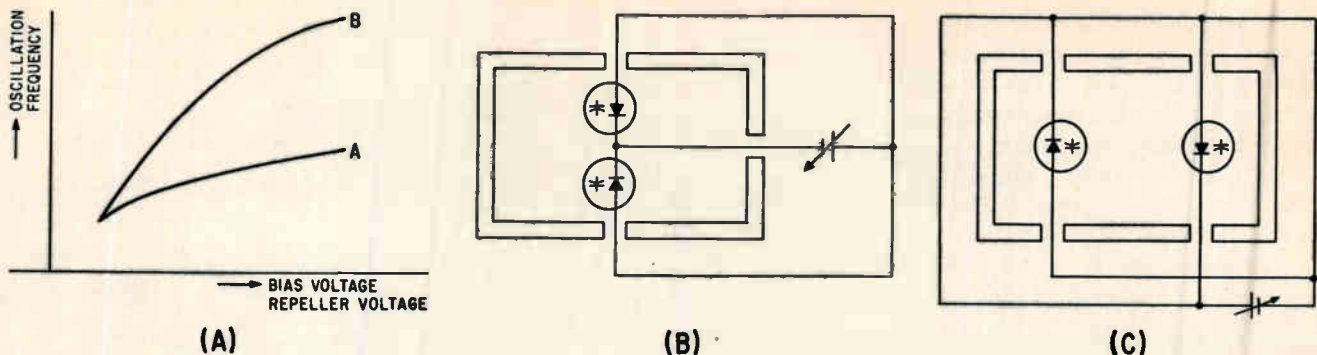

CHARACTERISTICS when bias and repeller voltage are applied simultaneously. Curve A is for $\Delta f_r \gg \Delta f_o$, curve B is for $\Delta f_r \leq \Delta f_o$. (A). Symmetrical positioning of two varactors will result in improved mounting, (B), (C)—Fig. 3

ceptance, B_o , equal zero, the klystron oscillator will oscillate at its maximum output power. At the same time the frequency will be adjustable over the range in which the varactor diode effectively changes the frequency. This suggests the possibility of realizing a klystron oscillator capable of virtually constant power output over a wide range of frequency, with a high modulation sensitivity. The tunable range of frequency will be comparable to that of a backward wave oscillator. This method will not require heavy and bulky magnets to focus the electron beam as is necessary in backward-wave oscillators.

When a varactor diode is subjected to a microwave electric field, a resulting drift of the bias voltage

causes the klystron oscillator to operate in a faulty manner. This effect may be cancelled by placing two diodes in symmetrical positions with respect to the microwave electric field pattern. Diode locations in a TE_{01} mode waveguide or a TE_{012} resonant cavity are illustrated in Fig. 3B and 3C.

EXPERIMENTAL PROCEDURE—An experimental tube was constructed with a conventional 7,000 Mc reflex klystron, 7V204, which has a closely coupled external cavity. An MA450C varactor diode was located in the external cavity (Fig. 2A). A TE_{012} resonant mode was excited in the external resonator, Fig. 2C, to allow space for positioning of the diode in microwave electric fields.

Using the circuit in Fig. 2A, the diode was mounted near the wall of the external resonator in a weak microwave electric field (Fig. 2C). By varying only the repeller voltage, the frequency characteristic, Fig. 4A, followed a third-power curve similar to the usual klystron characteristics. To obtain Fig. 4B, the repeller voltage was kept constant, giving maximum output. The frequency characteristic obtained was an upwardly convex curve, similar to Fig. 1E. The frequency variation obtained for a bias variation of 6 volts was only 2.5 Mc. This may be accounted for by the fact that the diode was mounted close to the resonator wall, where the electric field was weak. The change in shunting capacitance then had little effect on the oscillation frequency of

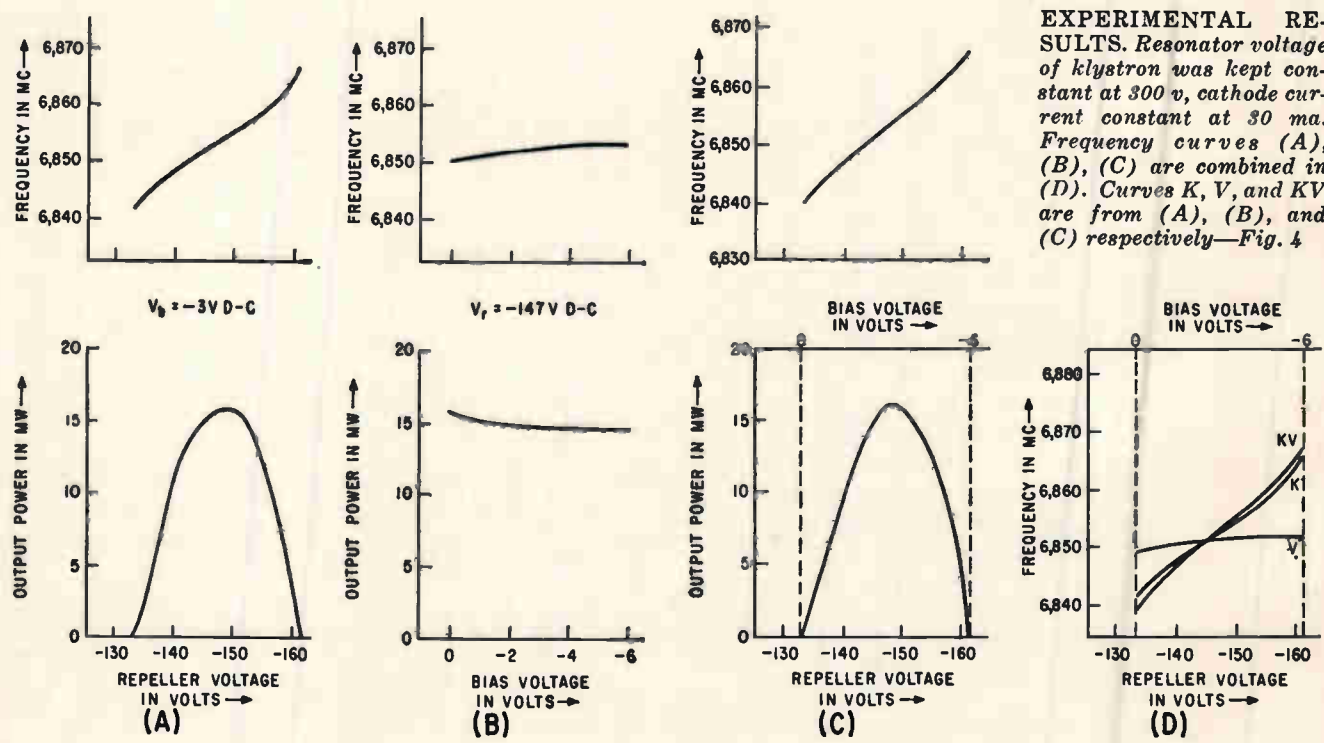

EXPERIMENTAL RESULTS. Resonator voltage of klystron was kept constant at 300 v, cathode current constant at 30 ma. Frequency curves (A), (B), (C) are combined in (D). Curves K, V, and KV are from (A), (B), and (C) respectively—Fig. 4

the klystron resonator cavity.

To improve the frequency characteristic, the bias and the repeller voltage were varied simultaneously under linear proportion, a variation of 28 volts of repeller voltage corresponding to a variation of 6 volts of bias voltage (Fig. 4C).

A second experiment was carried out by mounting an MA450E varactor diode in the external cavity where a strong microwave electric field existed.

A third experiment was carried out with a conventional 6,000 Mc reflex klystron, 7V242, which has closer coupling between the internal cavity and the external circuit than that of the 7V204. An MA450E varactor diode was used. The result indicated an improved linearity in the frequency characteristic (Fig. 5C). The modulation sensitivity at the maximum output power and the variable range of frequency were increased (Fig. 5A, 5B, 5C and table).

PRACTICAL USAGE—Although the results of the experiments are not in full agreement with the proposed characteristics, they suggest the possibility of an approach. One approach might be the use of high Q varactor diodes, so as not to affect the loaded Q of the klystron. Another approach would be to use varactor diodes with a wider range

RESULTS OF REFLEX KLYSTRON USING A VARACTOR DIODE

Location of Varactor Diode	Variation of Frequency by Bias Voltage V_b	by Repeller Voltage V_r		by Voltage V_b, V_r	
		Variation of Frequency	Modulation Sensitivity	Variation of Frequency	Modulation Sensitivity
in Weak Field	2.5 Mc	24.5 Mc	0.65 Mc/v	26.5 Mc	0.78 Mc/v
in Strong Field	9.2 Mc	17.3 Mc	0.59 Mc/v	25.9 Mc	0.95 Mc/v
in Strong Field*	17.2 Mc	23.3 Mc	0.55 Mc/v	39.4 Mc	0.99 Mc/v

(a) With tight coupling between inner cavity and outer cavity

of functional bias voltage, instead of conventional diodes with their limited range of 6 volts. The output power of Fig. 4B is almost flat in that little forward or backward current flows through the diode. This occurs because the diode is mounted in the weak field region. However, the output power of Fig. 5B indicates that there is still some loss of r-f power caused by the appreciable amount of forward or backward current flowing through the diode. Other approaches include the use of a high-perveance klystron capable of delivering maximum output at low loaded Q, and the use of a klystron with a resonant cavity designed to have the

closest possible coupling to the external circuit.

The author is indebted to Professor Y. Koike of Tohoku University, Professor S. Mito of Osaka Municipal University, and to Professor Y. Matsuo of Osaka University for their discussions. He thanks T. Sasaki and K. Komiyama, by whose encouragements the present work has been undertaken; and T. Misugi and H. Iwasawa for their advice; and to M. Inoue and K. Shoriki for their assistance.

REFERENCES

- (1) R. L. Jepsen, T. Moreno, F-M Distortion in Reflex Klystrons, *Proc IRE*, Jan. 1953.
- (2) A. Uhlir Jr., Varactor, Microwave Associates, I.N.C. Brochure.

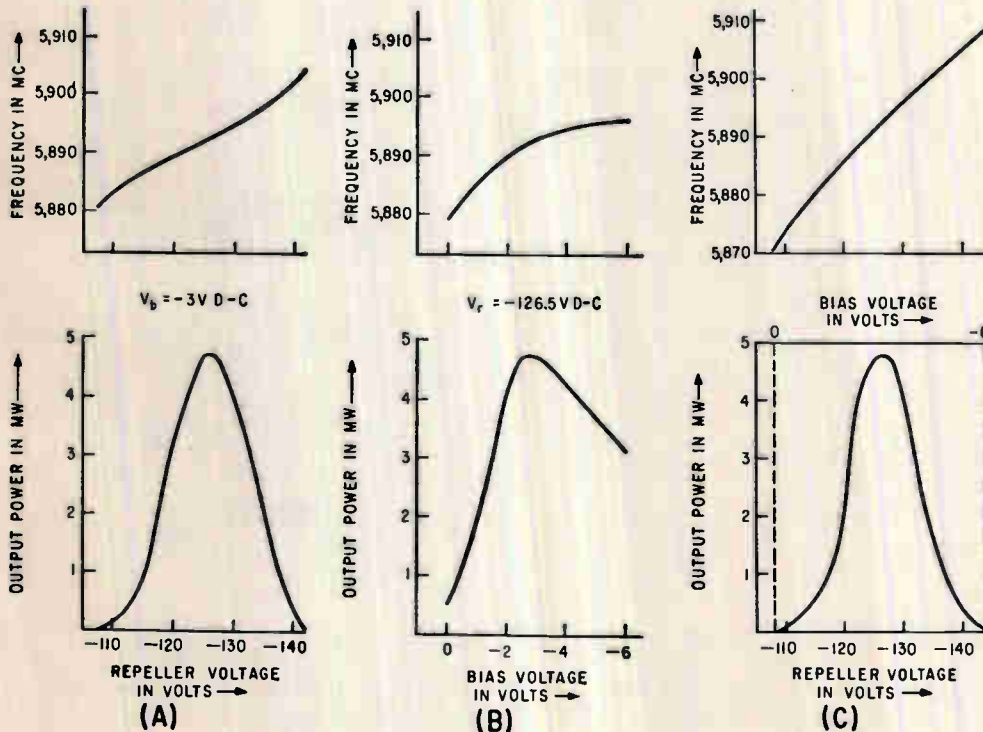

FURTHER OUTPUT AND FREQUENCY characteristics. Resonator voltage was 500 v, cathode current 40.5 ma. Curves and notation of (D) are same as in Fig. 4D—Fig. 5

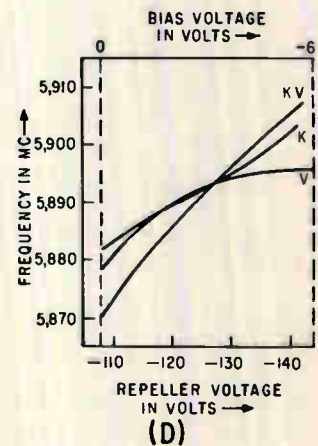

New Approach to Locked-Pair

Ungrounded locked-pair logic can perform all logical functions in a high-speed analog-digital converter and is used to convert analog television signals into pulse-code modulation

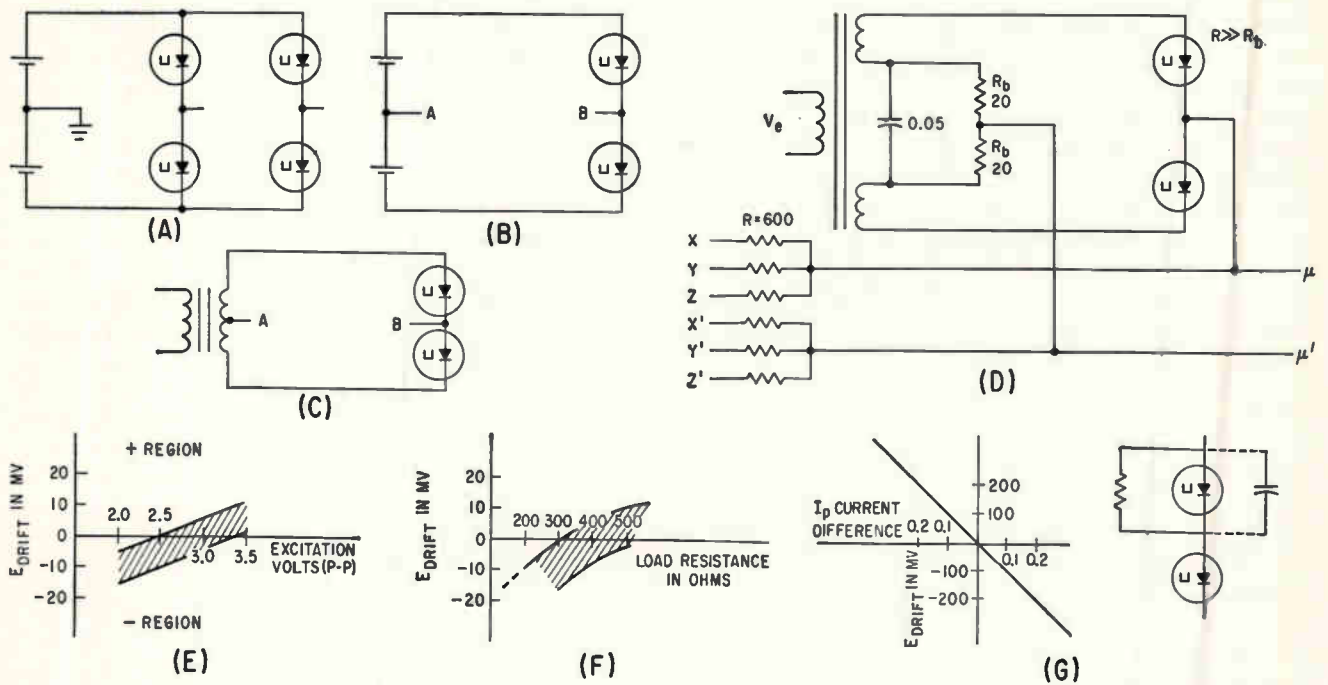

CONVENTIONAL LOCKED pair (A), ungrounded locked pair (B), practical ungrounded locked pair (C) and self-biased diode pair for parametron circuits (D). Trigger characteristics as a function of excitation voltage (E), load resistance (F) and difference in diode peak current (G)—Fig. 1

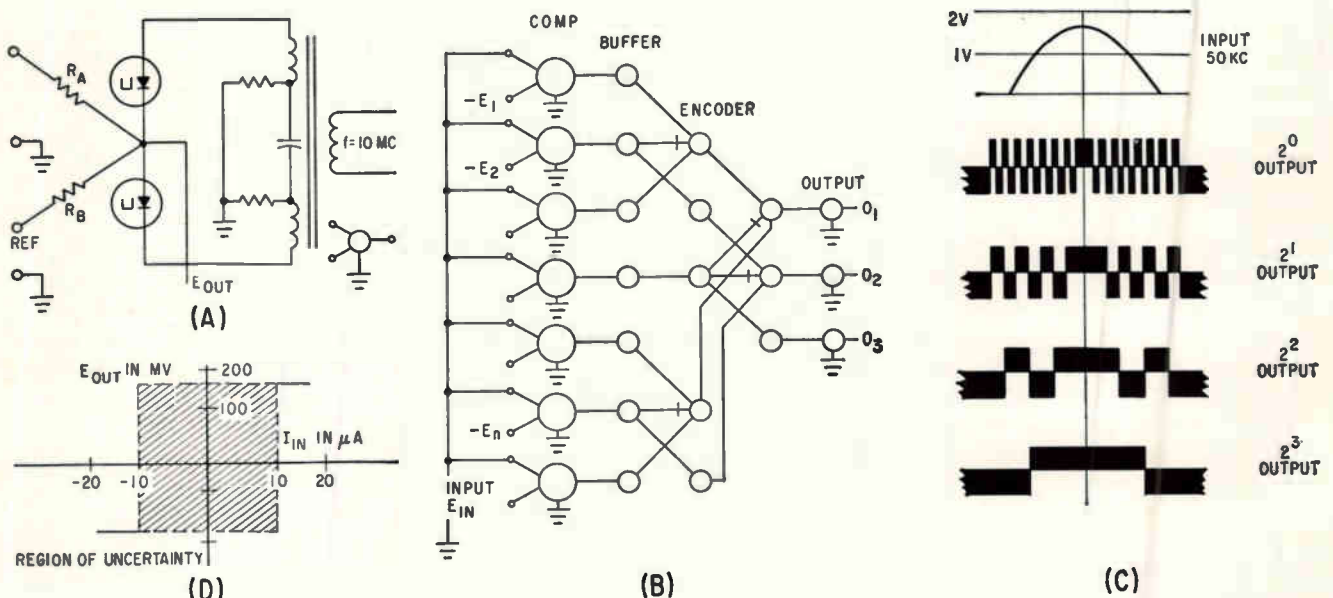

COMPARATOR CIRCUIT with conventional representation (A), eight sampling level circuit (three binary digits) (B), output for sixteen sampling levels (C) and trigger characteristics of a diode pair (D)—Fig. 2

Tunnel-Diode Logic

By CHARLES L. COHEN,

McGraw-Hill World News, Tokyo, Japan

MANY LOGIC CIRCUITS have been developed to take advantage of the high inherent switching speed of the tunnel diode. One of these, the locked-pair (sometimes called Goto pair), has the advantage of high speed and high gain but suffers from the disadvantage that logical inversion is extremely difficult.

Conventional locked pairs as shown in Fig. 1A, are excited by symmetrical positive and negative voltages whose common point is grounded. The single-ended output available from this circuit is what makes logical inversion difficult. Transformer coupling cannot be used between stages for inversion because d-c coupling must be maintained.

Lifting the exciting voltage common point from ground allows both junctions of the diode pair and the common point of exciter voltage to be used as input and output terminals as shown in Fig. 1B. A practical circuit (Fig. 1C), uses transformer coupling of exciting voltage to isolate the common point from ground. Logical inversion can be performed by reversing the polarity of coupling. The transformer also matches the low impedance of the diode pair to the exciting voltage power supply making it easier to drive a large number of circuits.

If the exciting voltage applied to the transformer is sinusoidal, circuit output voltage duty factor becomes small and three-phase excitation is not feasible. To increase the output voltage duty factor, d-c bias is necessary. A self-bias circuit such as shown in Fig. 1D, uses the large backward current of the tunnel diode to get bias voltage, which is superimposed on the sinusoidal voltage.

This diode pair is a majority decision element that permits logical inversion, therefore, logical circuits identical with parametron circuits may be used.

Germanium tunnel diodes with peak currents of 2 ma, 6 pF were used in experimental circuits. Transformers with turns ratio of 20 turns (primary) to 1 turn (secondary) wound on ferrite toroidal

cores were used. It is necessary to keep the secondary winding length short to avoid parasitic oscillations.

Exciting voltage of 6 v peak to peak across the primary induces 300 mv p-p in the secondary. Bias voltage is approximately 140 mv, output voltage is approximately ± 150 mv and duty factor is about $\frac{1}{2}$.

Coupling resistors between stages are 600 ohms. Consequently input current is approximately ± 250 μ a. Diodes are matched for pair unbalance current of less than ± 20 μ a to give circuits a large margin. Under these conditions, sum of fan-ins plus fan-outs may be as large as six. All experiments were performed with a clock frequency of 10 Mc but it appears possible to raise this to approximately 50 Mc.

TRIGGERING — Typical characteristics of the tunnel-diode pair were investigated. During these measurements, precautions were taken to prevent noise from the test instruments from affecting the circuit under test. A parallel resistor was used to balance the diode pair. Trigger characteristics as a function of excitation voltage and as a function of load resistance are shown in Figs. 1E and 1F.

Deviation of the trigger characteristics from zero when load current is increased may be due to the unbalance between the two diodes. Also, the width of the curve representing trigger characteristic may be due to external noise, or stray capacitance or inductance. At present, it is difficult to obtain perfectly matched diodes. Therefore it may be necessary to compensate the diode pair. Figure 1G shows that the parameter having the greatest influence on drift is the difference in I_p (diode peak current). It is advantageous to balance effective I_p by adding a resistor or capacitor as shown in Fig. 1G. The amount of compensation is limited because trigger characteristics may be degraded. Compensated pairs are more susceptible to unbalance by changes such as temperature variations that might affect diode characteristics. Usually, well balanced

pairs require no compensation.

Tunnel-diode pairs, operating at high clock speeds, can be used to perform all logical functions in a high-speed analog to digital converter. The comparator circuit is a diode pair with two input resistors R_A and R_B as shown in Fig. 2A. If the diode pair is perfectly balanced, the output voltage polarity is determined by polarity of the difference between the two input voltages $E_A - E_B$.

Circuits of this type can be arranged as shown in Fig. 2B where one terminal of each circuit is connected to a reference voltage with $-E_1 > -E_2 > \dots > -E_n$. If input signal E_{in} is in the range $E_{m-1} < E_{in} < E_m$, all circuits from $(m-1)$ down will have a negative output while those from (m) up will have a positive output. These outputs can be converted to a binary code by connecting them to buffer and encoding circuits using ungrounded diode pairs. Figure 2B shows connections for an 8 level A-D converter with a clock frequency of 10 Mc for the three-phase exciting voltage. Figure 2C shows the output of a 16 level A-D converter with a 50-Kc sine-wave input.

SAMPLING—It is possible to further increase the number of quantizing levels with the ultimate number dependent on minimum trigger current I_{min} and maximum diode current I_{max} . Figure 2D shows that the minimum trigger current achieved with the experimental circuit is about ± 10 μ a. Calculated minimum trigger current is much lower but external noise, stray capacitance and stray inductance increase its value. Coupling between stages not directly connected would also decrease sensitivity but if coupling resistors are made large and self-bias resistors made small, this effect may be neglected.

This article is based on work performed by Shintaro Oshima, Hajime Enomoto and Kitsutaro Amano, all of the research laboratories of the Kokusai Denshin Denwa Co., Tokyo, Japan.

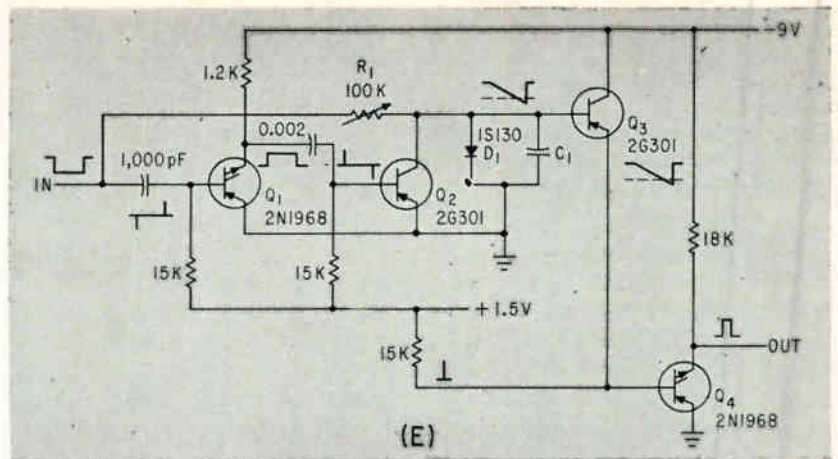
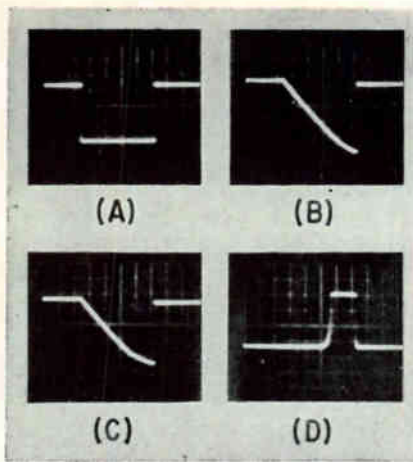

INPUT PULSE at (A) produces waveform at C_1 (B), Q_2 emitter (C) and output pulse (D). One transistor bistable is shown in (E)

Versatile Discriminator Measures Pulse Length

Circuit using two npn transistors generates an output pulse when triggered by an input pulse of more than a predetermined length

By K. R. WHITTINGTON and G. ROBSON

Tube Investments Research Laboratories, Hinxton Hall, Essex, England

DETERMINING the length of an object as it falls past a photocell, direct measurement of pulse lengths either digitally using a multichannel system or in analog form are some of the functions that can be performed by this circuit.

The circuit used in this device uses npn switching transistors. These transistors have their base circuits returned to the positive supply through bias resistors and can remain in either of two stable states—fully conducting or cutoff. If conducting, they can be turned off by application of a positive voltage to the base. If cutoff, they can be turned on by a negative voltage.

For the transistors to operate in this mode, it is necessary for the collector current to be sufficient for the transistors to remain on once they are switched to the on state. In Q_1 in this circuit, a high collector load is used so that this condition is not satisfied and the transistor

will switch off again if the base switching voltage is removed.

CIRCUIT OPERATION — Negative-going input pulses of constant amplitude are integrated by R_1 and C_1 and applied to the base of Q_1 through emitter-follower Q_2 . When C_1 has charged to a sufficient negative voltage, Q_1 will switch on. Capacitor C_1 is discharged at the end of the incoming pulse by inverting the incoming pulse with Q_1 and differentiating to obtain positive and negative-going spikes on the leading and trailing edges respectively. The negative-going spike is used to make Q_2 conduct. This transistor, which is normally biased off, is connected across C_1 and discharges the capacitor at the end of the incoming pulse.

Diode D_1 prevents any tendency for C_1 to charge in the opposite direction. When C_1 discharges, Q_1 automatically switches off.

If the incoming pulses are too short to charge C_1 to the necessary voltage, Q_1 will not switch on. Threshold length is controlled by the setting of R_1 .

It was required that the trailing edge of the output pulse should coincide with the trailing edge of the input pulse. If output pulses of constant length are required, a monostable stage may be added to the output. Alternatively, the output waveform may be differentiated and the leading-edge only used as an output.

The values for R_1 and C_1 allow the discriminator threshold to be set between about $100\mu\text{s}$ and 1 ms. As the switching time of the transistor is of the order of $0.5\mu\text{s}$, this range can be extended down to a few microseconds or up to several hundred milliseconds. Some care in the choice of R_1 and C_1 is required if a linear calibration is required for R_1 .

PRECISION FORK OSCILLATORS and FREQUENCY STANDARDS

Whatever your need... whatever your problem... in frequency ranges from 1 to 40,000 cycles, American Time Products has the package and/or the experience to assist you. For over 20 years American Time has been engineering and manufacturing reliable, accurate and rugged frequency standards, fork oscillators, choppers, tuning, filters, etc. Some are off-the-shelf items. Others are custom developed units and systems. For additional information on the sampling of units shown, on American Time's line, or regarding your own special needs, write Department 2612, Bulova Industrial/Defense Group, 61-10 Woodside Avenue, Woodside, New York.

INDUSTRIAL/DEFENSE GROUP

BULOVA

AMERICAN TIME PRODUCTS

	TYPE	FREQUENCY	ACCURACY	INPUT	OUTPUT	SIZE	WEIGHT
	2001-2*	(typical) 200 to 4000 cy. (specify)	(typical) ±.001% at 20° to 30° C.	B+ 100 to 300V Heater voltage, 6.3-12-28	5V. at 250,000 ohms	3¾" x 4½" x 6" high	26 oz.
	2003	(typical) 200 to 4000 cy. (specify)	(typical) ±.02% at -65° to +85°C ±.002% at +15° to +35°C ±.005% at -65° to +85°C	Heater voltage and B Voltage**	Approx. 5 v. Into 200,000 ohms	1½" dia. x 4½" H.	8 oz.
	2005A***	(typical) 50 to 1000 cy. (specify)	(typical) ±.001% from 15° to 35°C	115V. (50 to 400 cy.)	10 Watts at 115V.	8" x 8" x 7¼" H.	12 lbs.
	2007-6	(typical) 360 to 2000 cy. (specify)	(typical) ±.02% at -50° to +85°C ±.002% at +15° to +35°C ±.005% at -65° to +85°C	10 to 30V. DC at 6 ma.	Multitap, 75 to 100,000 ohms.	1½" dia. x 3½" high	7 oz.
	**** 2111C***	(typical) 50 to 1000 cy. (specify)	(typical) ±.001% at 15° to 35°C	115V., 50 to 75 cy.	115V., 75W.	with cover 10" x 17" x 9" H.	25 lbs.
	2121A***	(typical) 60 cy., 10 watt	(typical) ±.001% from 15° to 35°C	115V. (50 to 400 cy.)	115V.	8¾" x 19" panel	25 lbs.



ACCESSORY UNITS FOR TYPES 2001-2 AND 2003

- L — For low frequencies multi-vibrator type, 40-200 cy.
- D — For low frequencies counter type, 40-200 cy.
- H — For high frequencies, to 30 KC.
- M — Power Amplifier, 2W output
- P — Power Supply
- C — External circuit for 2003

*200-2F for sine wave distortion of less than .5%.

***220V. available on request.

**When used with our "C" unit or similar circuit.

****Panel model — 10" x 19" x 8¾" H.

Photo Reader Aids Pattern Recognition Study

By HAMILTON M. MAYNARD Head, Processing Instrumentation Section
Computer Research Dept., Cornell Aeronautical Lab., Inc., Buffalo, N. Y.

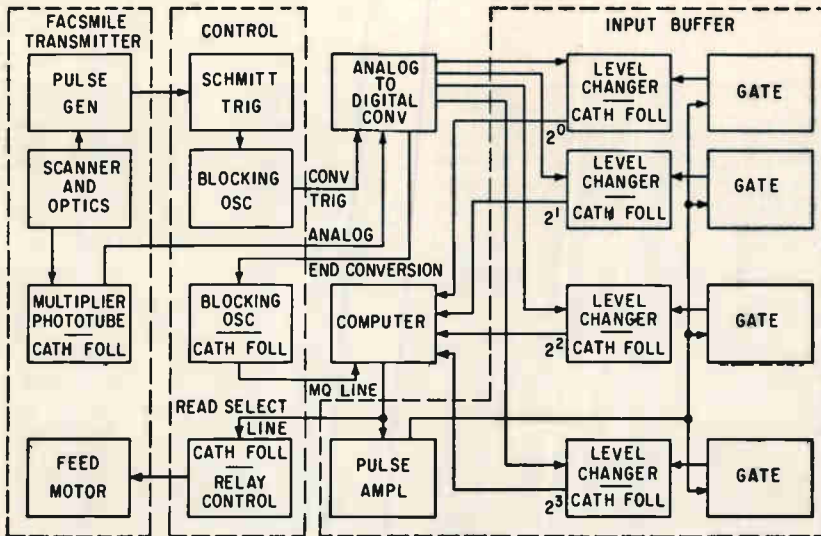

PHOTO INPUT system is synchronized by pulse generator in facsimile transmitter and completely controlled by digital computer

Digitizer permits computer handling of photographic and graphical inputs

PHOTO-INPUT device has been developed that enables photographic or graphical inputs to be supplied directly to general-purpose digital computers. The equipment was needed to test image-processing routines for research in pattern recognition. Working with the device is also providing experience in applying logical designs and in general optical-electrical transducer problems to establish specifications for future special-purpose photo-input devices.

The system shown in the figure uses a standard facsimile transmitter that accepts flat copy 8½ inches wide. It scans at 6 lines per second, corresponding to a feed rate of 3.6 inches per minute. A pulse generator, incorporated into the transmitter to synchronize the system, consists of an inductive pickup and a 180-tooth gear driven by the scanner at five times line-scanning

rate. The resultant clock frequency is thus 5.4 Kc with 900 pulses per line locked to the scanning motion.

DATA CONVERSION—The clock signal, after shaping, is used as a trigger to control conversion time of the analog-to-digital converter. A continuous analog signal from the multiplier phototube in the facsimile transmitter is fed through a cathode follower to the analog-to-digital converter. The instantaneous amplitude of the analog signal at the time of each trigger pulse is converted to a 4-bit binary number and appears on one of the four converter output lines in 22 microseconds. The converter also furnishes an end-of-conversion pulse 0.5 microsecond after conversion, which is shaped and used to control computer read time through the line labelled MQ in the figure.

The input buffer section accepts information from the four converter output lines and modifies the levels corresponding to zero and one to make them compatible with the computer. A gate for each level changer is controlled by the read-

select line of the computer. An open gate permits information transfer, but a closed gate clamps the cathode follower to the zero level. The read-select line also controls copy feed by a relay controlled through a cathode follower in the control section.

The computer completely controls the photo input system. A computer program has been developed that uses the copy content to control registration. A 4-inch black bar ¼ inch wide is placed 0.4 inch above the first line to be read. When the facsimile transmitter is energized starting the scanner, the copy is inserted by hand until it is engaged by the pinch roller using the roller handwheel.

READ-IN PROGRAM—The computer program is read into the computer as usual, and when a step in the program selects the 'real-time input, the read-select line is energized. As a result, the gates in the input buffer are opened and the copy feed motor is started. Another program step initiates a search routine in which the digital information presented on the one-zero bus is examined until the black bar is intercepted. The copy is then advanced 0.4 inch, and a second search routine is used to locate the pedestals (black level interval at the end of each scan line).

When the pedestal has been found, a count is started of the number of MQ pulses received as scanning advances from left to right. When the desired level (100 counts per inch) has been reached, the computer transfers the digital number on the one-zero bus into core storage. Each succeeding sample is transferred until a total MQ count of 900 has been reached. Counting is then continued until the desired level is again reached on the next scanning line (without digital number transfer). Reaching the desired level again initiates

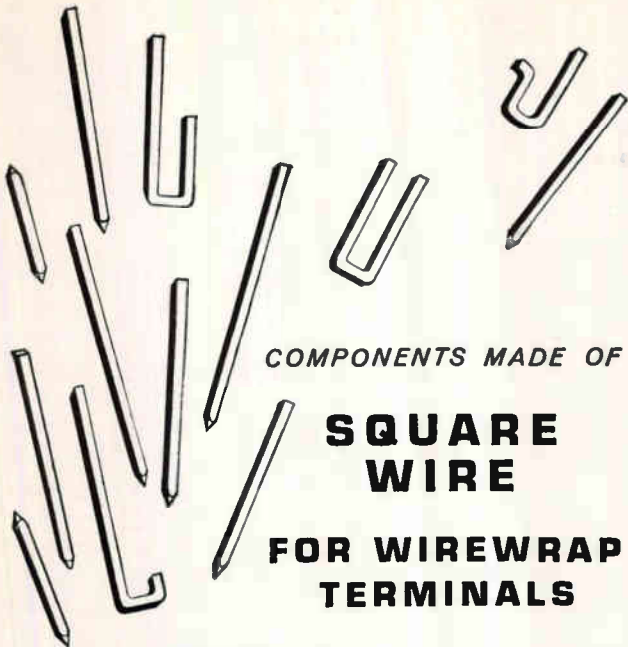

COMPONENTS MADE OF

SQUARE WIRE

FOR WIREWRAP TERMINALS

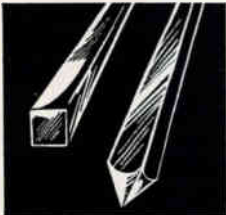

Precision-made on high speed production machines for faster, tighter, more economical connections. Straight wires, square cut-off; straight wires, pointed on one or both ends; or formed wires to specifications. Minimum corner radii. From .015 square to .093 square. Send a blueprint or sample for estimate.

ART WIRE AND STAMPING CO.
18 Boyden Pl., Newark 2, New Jersey

CIRCLE 201 ON READER SERVICE CARD



miniature
rotary
selector
switches
series
3-1900

RELIABLE VERSATILE RUGGED

MIL specs are exceeded by all Janco switches. Outstanding features include an electrical rating of make and break up to 5 amps 115 V AC and 28 V DC and carry 10 amps continuous. They are equally capable of switching signal loads with low uniform contact resistance. Two to twenty-four contact positions are available with an indexing of 15°, 22½°, 30°, 36°, 45°, 60°, and 90°. In addition, Janco offers the versatility of 1 to 32 poles in single or multi-pole construction . . . Write today for new, complete 12-page switch catalog.

JANCO CORPORATION

3111 Winona Avenue • Burbank, California

CIRCLE 202 ON READER SERVICE CARD

August 3, 1962

In 5 YEARS - 7 TIMES MORE
FOREIGN EXHIBITORS

THE GREATEST WORLD-
WIDE EXPOSITION IN THE
ELECTRONICS INDUSTRY

6th international exhibition of electronic components

FROM FEBRUARY 8-12, 1963

IN PARIS

PORTE DE VERSAILLES

Components, tubes and
semiconductors,
measurement & control
instrumentation
electro-acoustical
equipment

Send Now For Full Details

FEDERATION NATIONALE
DES INDUSTRIES
ELECTRONIQUES

23, rue de Lubeck, Paris—16e
Tel: PASSy 01-16



3rd international symposium on quantum electronics

Under the auspices of the French Section
of the I.R.E. and the S.F.E.R.
From February 10-15, 1963
MAISON DE L'UNESCO
Information: 7, rue de Madrid—Paris 8e

CIRCLE 51 ON READER SERVICE CARD 51



specify
**coaxial
cable and**

**wire with
solid tubular
shielding**

UNIFORM seamless tubing drawn over single or multiple strands of insulated wire eliminates radiation and provides coaxial cable with uniform impedance, low attenuation, excellent frequency response and temperature stability. Whether your primary consideration is RF shielding, low noise, low capacitance or high temperatures, UNIFORM's Metal-Shielded coaxial wire and cable is formed of conductors, insulation and shielding metal to meet your special requirements.

UNIFORM specializes in miniature cable with O. D.'s as small as 0.010" but also draws tubing in most metals to O. D.'s up to 0.375" with wall thicknesses from 0.050" down to the ultra-thin 0.0015". This precision tubing may serve as conductors, shields or protective coverings against physical or chemical damage.

Electrically equivalent to the RG/U series, Metal-Shielded coaxial cable and wire can be bent into intricate shapes without dielectric breakdown and with shield and conductor(s) always coaxial. UNIFORM offers it in random straight lengths or coils up to 30 ft. or formed at the mill into desired shapes. Ends are cut and stripped, and all work is completed to close tolerances under exacting quality control.

Write for Bulletin 61 for full details.



UNIFORM TUBES, INC.
COLLEGEVILLE 2, PA.
HUxley 9-7293 TWX-CGV1 1044

transfer of the digital number into core storage, and the cycle is repeated until a predetermined number of MQ pulses has been reached, ending the read-in program.

Thus the recorded area of the copy is controlled vertically by the black bar and the total MQ count and horizontally by the MQ count along the scan line. In the actual program, a packing routine conserves core storage by consolidating nine 4-bit samples into one standard 36-bit computer word, which also enhances flexibility.

APPLICATIONS—The photo reader has contributed to research in automatic character recognition¹ and photo interpretation.² Its availability has led to feasibility studies of many applications not originally evident, such as curve reading. Large volumes of data that appear only as two dimensional plots produced by strip chart recorders, recording oscillographs and oscillo-

scope photographs can be digitized and read into a digital computer. Particle counting and sizing has also been investigated. Copy material produced photographically or by direct deposit on sample cards representing the distribution of material can be read at 16 levels of intensity with spatial integrity. Separating, sizing and counting routines can then be performed.

The photo input device was developed as part of a contract on applications of perceptron concepts to photo interpretation, which is jointly sponsored by Geography Branch, Office of Naval Research and Photographic Management Division, Bureau of Naval Weapons.

REFERENCES

- (1) W. S. Holmes, H. R. Leland and J. L. Muerle, Recognition of Mixed-Font Imperfect Characters, Optical Character Recognition Symposium, Washington, January 16, 1962.
- (2) H. R. Leland, Pre-Processing of Geographic Patterns for Automatic Recognition System, American Association of Geographers' Annual Meeting, Miami, April 23, 1962.

Eye Examinations Are Automated

CHICAGO—Automation of eye examinations and a nerve-locating instrument for heart surgery were among the medical electronics developments reported at the annual meeting of the American Medical Association.

Automating eye examinations will permit some tests to be made in 10 seconds that otherwise require up to a half hour of an ophthalmologist's time, according to Dr. Jerome Gans, Cleveland. The apparatus demonstrated and currently undergoing evaluation uses a thyatron stepping switch to light serially 24-volt miniature light bulbs positioned 5 degrees apart on 12 principal axes of a peripheral bowl, Gans explained to **ELECTRONICS**. Pulse intervals are adjustable depending on response time of the patient.

The patient fixes his attention on a central target and pushes a button as soon as he perceives one of the lights at the outer periphery of his field of view. The machine records the position of the light farthest from the patient that he can identify on each axis. The resulting points can be joined to pro-

vide a pattern of the outer limits of the visual field. Peripheral visual field tests are useful in diagnosis and treatment of glaucoma, brain tumors and neurological diseases.

NERVE PATH FINDER—Electronic apparatus for the location of nerve conducting systems during open-heart surgery was demonstrated by Derward Leplay, Marquette University. A three-pole probe connected to a 50-Kc oscillator and an impedance bridge locates areas of the heart in which impedance is different. Movement of the probe over an area of nerve conduction where impedance is lower unbalances the bridge. Blood clots may also be located because of their different impedance. Unbalancing the bridge causes an audible signal to be emitted from a loudspeaker. By monitoring the speaker and a meter, nerve conduction areas can be located within one millimeter, according to Leplay.

The third probe in the device, which is manufactured by Medtronics, Minneapolis, is used to help solve the dual problems of depth and surface interference. Current

driven deeper into tissues by the third probe locates conduction systems as deep as 3 millimeters.

OTHER DEVELOPMENTS—The Volemetron measures the volume of circulating blood in patients before, during and after surgery. It reduces the time required for such determinations from 1 hour to 15 minutes, according to Drs. Rominger, O'Sullivan and Flandreau, Philadelphia. The equipment is useful for examining elderly patients and for handling cases of stomach hemorrhages, severe burns and during cardiovascular surgery.

The combination of two scintillation detectors and a 120-transistor digital computer calculates blood volume by measuring radioactivity after administration of radioactive albumin. Detectors simultaneously measure and subtract background activity from specific activity of the blood samples. The equipment is manufactured by Atomium Corp., Waltham, Mass.

A sonic tranquilizer for irritable infants, produced by United Medical Products Company, Hopkins, Minn., uses a single-transistor circuit driven by a penlight cell to generate a 300- to 350-cycle tone. The unit is most successful with infants under seven months, reported Drs. J. Olson and E. Nelson, Minneapolis.

Fifty-Millisecond Delay To Process Radar Signals



HIGH-STABILITY delay line combines low insertion losses with 100-Kc bandwidth. Sonic wire delay more than 800 feet long is demonstrated by designers, shown left to right, C. E. Wellman and W. H. Jones at GE Heavy Military Electronics Department

From Electrically Derived Data...

WHC 1 4 3 5 3
SAN 5 2 .6 4
GEC 1 5 5 2 7
NAE 1 3 9 .0 8

List

5 4 7 2 1
3 0 0 .8 1
2 3 .8 6
8 7 1 .8 8 T

Accumulate

x 5 4 4 2 6
x 1 8 .7 3
x .0 0
x 1. 0 1 9. 3 9 8 .9 8 T

Even Calculate

automatically

7 8 .9 0 N
2. 1 8 4 .9 3
1 3 1 6
1



Only **VICTOR** Digit-Matic Offers all Three

**For Complete Adaptability
In Systems Design**

Solenoid-operated parallel or serial entry models adapt to all systems where data must be collected, indicated, processed or correlated in alpha-numeric form. By including automatic calculation, only Victor provides immediate print-out of specialized information without further processing.

1.6 x 10⁸
**DIGIT IMPRESSIONS
WITHOUT FATIGUE
OR FAILURE!**

Equal to ten years normal use. That's the durability factor Victor builds in. It comes from precision design, plated and hardened parts, plus special "printing press" action that ends hammering vibration.

**Flexibility Limited
Only by Imagination**

Special features available include superimposed manual keyboard, split keyboard, time printing and item counting, simultaneous print and tape punch, 2 color printing, custom type faces.

**Now! Rack Mounting Panel
Available—**

Exclusive option permits installation of Digit-Matic accumulators and listers in standard relay racks.

Let Victor analyze your application.
No obligation. Write today.



VICTOR BUSINESS MACHINES CO.
CHICAGO 18, ILLINOIS
DIVISION/VICTOR COMPTOMETER CORPORATION

Tuner Elements Ride Piggyback

Attach components to new piston capacitor, cure stray l-c

PISTON-TYPE trimmer capacitors are precision components used in systems where the circuit demands accurate tuning. Desired capacity for the circuit can be selected to offset variations of other circuit components. This family of small capacitors may be varied by mechanical adjustment through a certain capacitance range.

These capacitors are specified in sophisticated navigational equipment, fixed-frequency receiver-transmitters, missile remote-control navigation, and microwave equipment. Piston or cylindrical types have been made by such firms as J.F.D. Electronics, Corning Glass Works, and Erie Resistor.

ELECTRODE BAND — Roanwell Corporation has now designed several basic types of piston capacitors based on a new construction approach. Components can be soldered directly to an electrode-band assembly of the trimmer unit itself, see diagram. The new series will be shown and evaluated by engineers attending WESCON this month.

In addition to the solid-metal construction, the new piston-capacitor design features a new drive mechanism and precision parts. According to company's Mark Harwood, who designed and developed the new units, the series offer maximum capacity per size, and a bonding process of solid metal to glass or quartz leads to improved performance.

Some 250 to 300 types of capacitors will be offered by Roanwell. All types will be electrically and mechanically interchangeable with presently-available units, and the devices meet all applicable specifications for this type of component.

Capacitance range of the new capacitors are from 4.5 pf to 100 pf. Company claims 30 percent reduc-

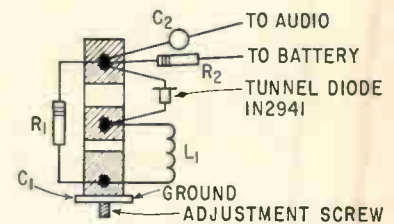
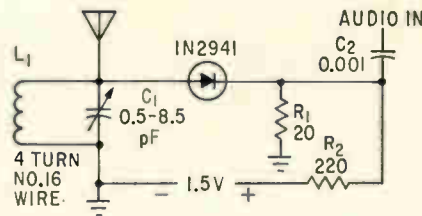

TUNNEL DIODE transmitter (A), used for remote control, is frequency-modulated with audio or other pulses, has frequency range from 50 to 250 Mc. Actual physical layout (B) shows how components are mounted to body of trimmer capacitor

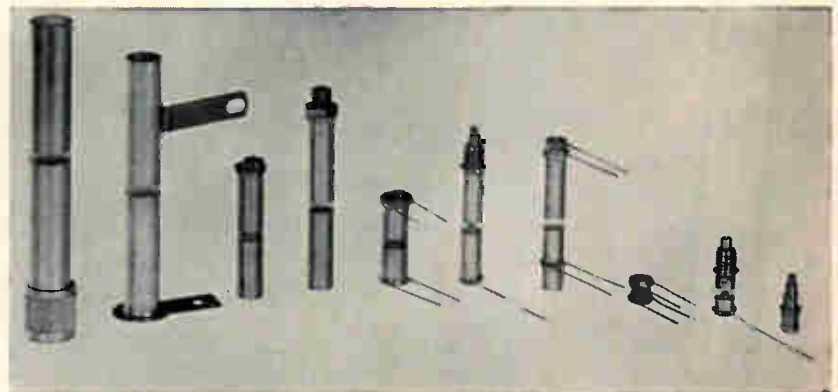

IMPROVED LINEARITY and accuracy, especially in uhf and microwave regions, are claimed for these representative types of trimmer capacitors, developed by Roanwell

tion in size. Tests show minimum capacitance variation of 0.5 pf from specified value from one unit to another in the same lot.

Performance is improved in the vhf, uhf and microwave range, according to Harwood, primarily because user can solder to electrodes at any point on the capacitor. New drives provide uniform torque throughout the capacitance range. The Q , or quality factor, range is from 500 to 2,000, depending on dielectric used. Several types of glasses are being used depending upon the requirements and application of the units: high capacity, high Q glass; high capacity medium Q glass; as well as glass offering nominal values for both capacity and Q .

The new capacitors are classified in basic groupings: a miniature series with nominal capacity and nominal Q (Q is 500 minimum at

one megacycle); a subminiature series with high capacity, nominal Q , closed bottom; and a low capacity piston trimmer with extremely high Q —2,000 min at one Mc.

VOLTAGE BREAKDOWN—Since most piston capacitors are used in some kind of tuned circuit, potential difference existing between components of opposite polarity is an important consideration in circuit design. Proper spacing between components must be maintained to assure that no voltage breakdown will occur which may damage the capacitor, cause a malfunction of the apparatus, or cause damage to other components. Naturally, the higher is the requirement for the working voltage, the larger spacing between components of opposite polarity is required, or artificial means have to be employed to meet

75,000,000 MILE WARRANTY



This relay is going on a 75,000,000 mile trip. It's the BR-7 — one of many Babcock relays selected for the maiden flight of America's first active military communications satellite.

As part of the spaceborne payload, each of these subminiature relays has a vital responsibility. Some will be on 24-hour call for switching communications channels. Others will help reposition the satellite if it creeps off station. Still others will take part in carrying out attitude change commands for orienting solar paddles.

All of them will have to perform, without failure... for 15 months.

Reliability of this order requires more than just sound engineering and careful fabrication. Absolute assurance is needed that performance will match expectations. In short, a "75,000,000 mile warranty".

Babcock's "warranty" is the Failure Rate Report — a documented prediction of performance based on statistical test and evaluation techniques. The "probability of success" for the space-bound BR-7's is more than 99.9% with a confidence factor of 95%, based on 10,000 miss-free contact operations at rated load — another way of saying these relays will do their job for 15 months or 75,000,000 miles.

We'll be happy to send you our general product catalog listing all Babcock reliability-rated relays available from stock, plus information on Babcock's Reliability Program, the first and most extensive company-sponsored program of its type in the relay industry.

BR-5



MICRO/MICROMINIATURE
DRY CIRCUIT TO
1 AMP SERIES
Contact Style/Rating:
SPDT/1 amp res. @ 32VDC,
.050Ω max.
Size: 0.2 x 0.4 x 0.6

BR-7



SUBMINIATURE DRY
CIRCUIT TO
POWER SWITCHING SERIES
Contact Style/Rating:
SPDT, DPDT/2, 5 & 10 amp
res. @ 28VDC or 110VAC,
400 cps Size:
.515 x 1.075 x 1.300

BR-8

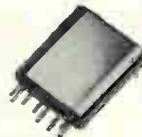

MICROMINIATURE CRYSTAL
CAN SERIES
Contact Style/Rating:
SPDT, DPDT/2 amp res. @
32VDC or 115VAC, 400 cps;
1 amp ind. @ 32VDC
Size: .360 x .790 x .870

BR-9



SUBMINIATURE MAGNETIC
LATCHING SERIES
Contact Style/Rating:
DPDT/5 & 10 amp res. @
28VDC or 110VAC, 400 cps
Size: .515 x 1.075 x 1.300

BR-12

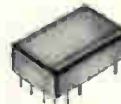

MICROMINIATURE
ULTRASENSITIVE SERIES
Contact Style/Rating:
SPDT, DPDT/2 & 3 amp res.
@ 32VDC or 115VAC, 400
cps; 1 amp ind. @ 32VDC
Size: .400 x .795 x .890,
std.; .800 x 1.250 x .415,
printed circuit.

BR-14



SUBMINIATURE FOUR POLE,
DOUBLE THROW SERIES
Contact Style/Rating:
4 PDT (4 form C)/5, 7.5 &
10 amp res. or 2, 2.5 & 3.5
amp ind. @ 28VDC or
115VAC, 400 cps
Size: 1.000 x 1.075 x 1.300



BABCOCK RELAYS

A Division of Babcock Electronics Corporation
3501 Harbor Boulevard, Costa Mesa, California
CIRCLE 55 ON READER SERVICE CARD



NOW READY:

ANALOG-TO-DIGITAL CONVERTER

NAVCOR MODEL 2201

LOW PRICE: **\$2935**

ACCURACY: **.05%** ABSOLUTE

DELIVERY: **30 DAYS**

Format: Binary, 10 bits plus sign.

Conversion Rate: 10,000 complete conversions per second (9.1 microseconds per bit plus 9.1 microseconds.)

Input Range: ± 10.23 volts; lower or higher ranges available.

Input Impedance: 5,000 ohms; high impedance amplifier optional.

Other models start from \$2,775. Both Binary and Binary-Coded-Decimal formats are available. Options include Sample and Hold, Multiplexing, and Over-Range Indication. For more information, write to NAVIGATION COMPUTER CORPORATION, Valley Forge Industrial Park, Norristown, Pennsylvania.



the proper voltage specifications.

Since most circuits have to operate through a certain temperature range, before a steady state is reached, the amount of capacitance drift due to temperature increase or decrease, also becomes an important factor in selection of a proper piston capacitor. Inasmuch as the proper selection of materials may improve capacitor drift, the actual mechanical design offers more of a challenge to the piston capacitor designer, according to Harwood. Proper mechanical construction may offset effects due to thermal expansion of one component by the same phenomena of another component. Since there is no fixed rule to determine the actual capacitance drift by calculation, the only way to determine the amount of drift is to measure it with special equipment.

Temperature coefficient range of the new piston capacitors is ± 50 ppm per deg C to 200 to 400 ppm per deg C, operating temperature range is -55 to 125 C.

SOLID METAL — Any plating, from tin to gold, is available for the electrode band assembly. The user can solder to electrodes at any point on the capacitor.

Strength of the units depend upon the strength of the metal, not the glass, for support. Outer diameters of the units do not vary more than ± 0.005 in. in same lot. There is no upper limit to diameter or

length. Standard diameters are 0.210 in., 0.250 in. and 0.312 in., and capacitors are available mechanically open or hermetically sealed.

Standard capacitors have a voltage rating of 1,000 volts d-c working voltage and a breakdown voltage of 1,250 v dc at 50 percent relative humidity. Others are available on request.

Drive bushings are made of brass or Invar and four types are available: split bushing, which is claimed to improve existing drives; a nonrotating piston drive which is new; a new nonprotruding lead screw type; and a unitorque bushing.

The new mechanical drive offers an adjustable torque as well as a uniform torque throughout the entire range of the piston capacitor, and in addition, eliminates the problem of flake-off which is often noticeable, especially on piston capacitors having solid-plated drive mechanism.

Capacitors may be panel mounted, designed for printed circuits, floating drive and split stator, and the units are also made without leads. Outer diameters will not vary more than 0.005 in. in the same lot.

Dumet wire leads offer advantages if the printed-circuit type of capacitor should be spot welded.

Extensive work is being continued at Roanwell to further improve the design and to offer a piston capacitor with a nonrotating slug.

Resistor Accuracy for Instrumentation

TIN-OXIDE film resistors were specified for more than a quarter of the general purpose resistor sites and more than half of the precision and power sites in an accurate oscilloscope developed by Analab. The oscilloscope provides accuracy of one per cent in quantitative time and amplitude measurements, thus all components had to be judged critically for reliability and stability.

Special manufacturing techniques make tin-oxide resistors resistant to damage or change. Corning produces them by fusing a metal oxide resistive film to the surface of a Pyrex glass rod, spiral-

ing the film to the desired ohmic value, attaching leads and encapsulating the body. Once the film is fused to the substrate and spiraled, it is extremely stable, inherently impervious to moisture and unaffected by heat of soldering, repeated overloads and normal production handling.

Morton G. Scheraga, Analab president, said N-style and S-style precision tin-oxide resistors were chosen for the new 'scopes because of their low voltage coefficient.

Where power dissipation was high, Corning LPI-style tin-oxide resistors were selected for 'scopes because of low reactance and mini-



ACCURACY OF one percent in quantitative time and amplitude measurements are provided by oscilloscopes here being checked by Analab President M. G. Scheraga. Tin oxide resistors were selected for precision, power and general purpose sites

mum drop-off in resistance with increasing frequency.

In the general purpose sites, C-style tin-oxide resistors were chosen because of performance and and price.

VOLTAGE COEFFICIENT — of tin-oxide resistors averages less than 0.001 per cent per volt, and temperature coefficient is less than ± 0.01 percent per degree Centigrade. Above 300 ohms, the resistors are non-inductive. Noise level averages less than -20 decibels (0.1 microvolt per volt) when measured according to the proposed National Bureau of Standards noise measurement system.

Application of the resistors in the new scopes was conventional, even though circuits represented new design ideas. The instruments utilize a new null balance technique for data readout. Analog data is translated to dials showing direct measurements of time and amplitude, instead of being scaled or interpolated from cathode ray tubes.

Analab's newest oscilloscope, Type 1120R/700, utilized about four percent more tin-oxide resistors than were used in their Type 1100/700 'scope.

So far, according to Scheraga, not a single failure of a tin-oxide resistor has been reported to Analab from the field.

INFORMING THE ENGINEERING MIND

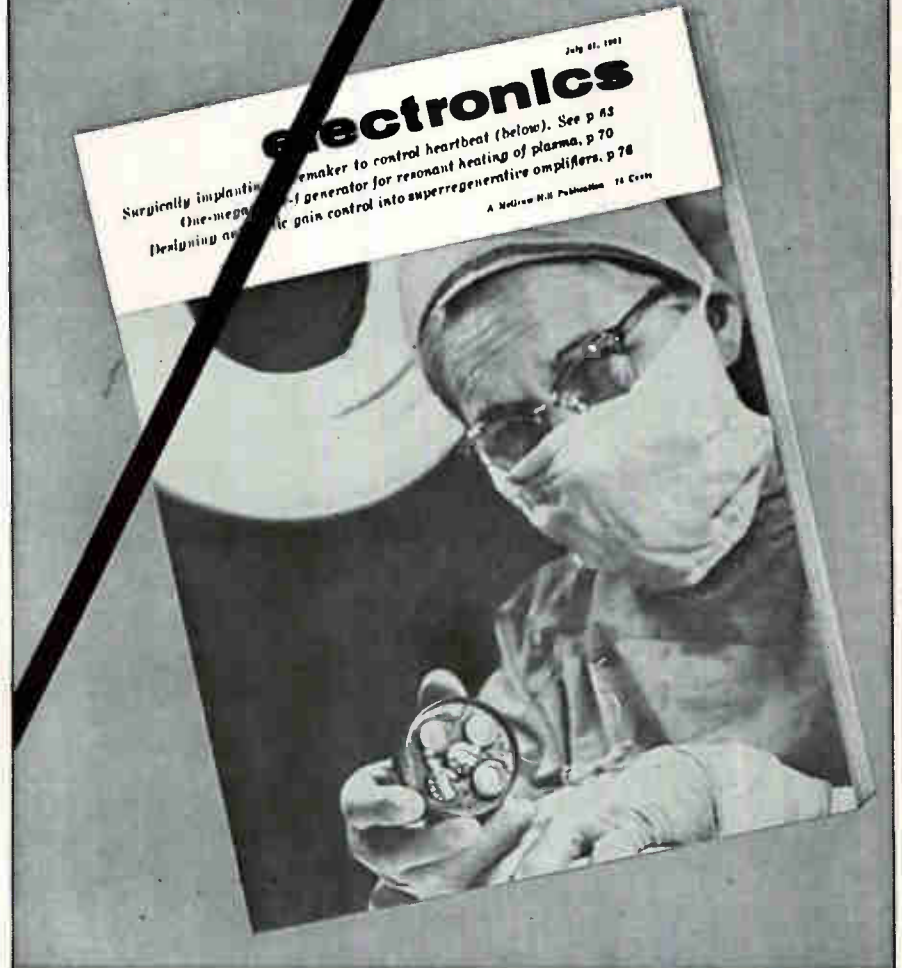

electronics is written and edited specifically to inform... and, more difficult, to keep informed... the engineering minds that ultimately pace and guide the vast electronics industry. To this end, the electronics editorial staff scours the nation and the world to report all important developments in the areas of research, design, production and management.

The result: *must reading* for anyone in these areas of the industry. Don't miss an issue; subscribe today, via the Reader Service Card in this issue, to

electronics

Preparing Tapes for Audio-Visual Aids

Scripts and recorded tapes become production tools, replacing drawings

By **THOMAS J. GRIFFIN, JR.**
Martin Co, Orlando Div.,
Orlando, Fla.

SUCCESS of audio-visual methods in electronic production can be attributed mainly to the reduction in the time required by the operator in finding out precisely what to do next. There are many ways to wire a unit from a wiring diagram; there is only one way to wire it from a set of instructions recorded on tape. Savings in wiring time of 30 to 40 percent over written instructions have been obtained by most users, even though the operator does not speed up actual work motions. Along with speedier assembly goes a reduction of 40 to 50 percent in defects per unit.

Higher quality and speedier assembly go together since the operator has fewer mental and visual

steps to take before proceeding to the next operation. Eye fatigue is reduced, attention is centered closely on the work, and the assembly sequence prescribed by the tape—

and therefore easily optimized—is followed.

Although taped wiring instructions were tried years ago, they were not successful at first primarily because the available machines used up tape too fast. Suitable modern machines have a tape speed of 1½ inches per second, cartridge or reel type feed, ear-phone output, good speech fidelity, and foot pedal control of start, stop and rewind. The machine is not used to force-pace the operator.

Taped instructions work best for small run production of complicated circuits, where one operator usually completes the assembly because it is not economical to set up a sequential wiring line. When large scale production does not warrant a sequential wiring line, audible techniques are desirable, and the more complicated the circuit the better the results.

SCRIPT WRITING—Tapes should be recorded from a written script of the type illustrated. Each step in the assembly and wiring operation should be written into the script, and the steps should be de-

TYPICAL FORM FOR WRITING A SCRIPT

Audio Instruction Script

Sheet..... of.....

Reel No.

UNITRUN WRITER:

ANNOUNCER:

CHECKED BY:

1. Unit XXXX, run number XX. Wiring and assembly instructions.

2. Position unit so that the wiring side is up. The tube socket number five is in the upper right hand corner.

3. Connect bare tinned strap wires between the following locations: in the upper left corner, at tube socket one: between tube socket one, terminal two and the standoff terminal mounted to the right of the tube socket. Between tube socket one, terminal four and terminal six. Between tube socket one, terminal seven and tube socket two, terminal seven.

NUMERICAL
COUNTER
READINGS

Tester for Minuteman Transistors



MANUFACTURE of power transistors with a reliability of 99.997 percent is claimed by Delco Radio, under R&D contract with Autonetics, Minuteman guidance contractor. Test set shown checks out eight parameters of a transistor in eight seconds and records results on punched cards. Transistors are checked in 20-unit racks

eBG
BRINGS
BUYERS
DIRECTLY
TO YOU

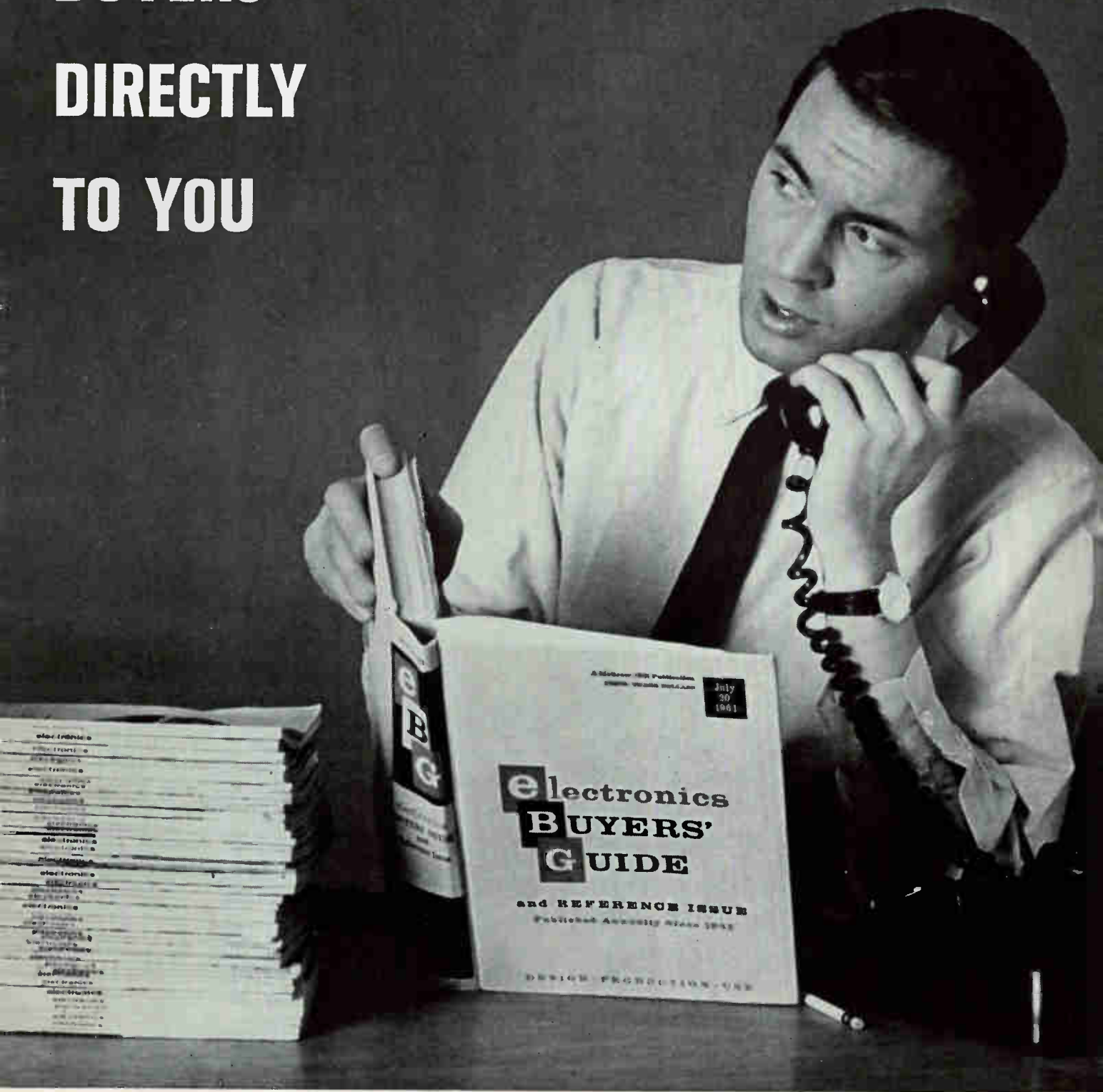

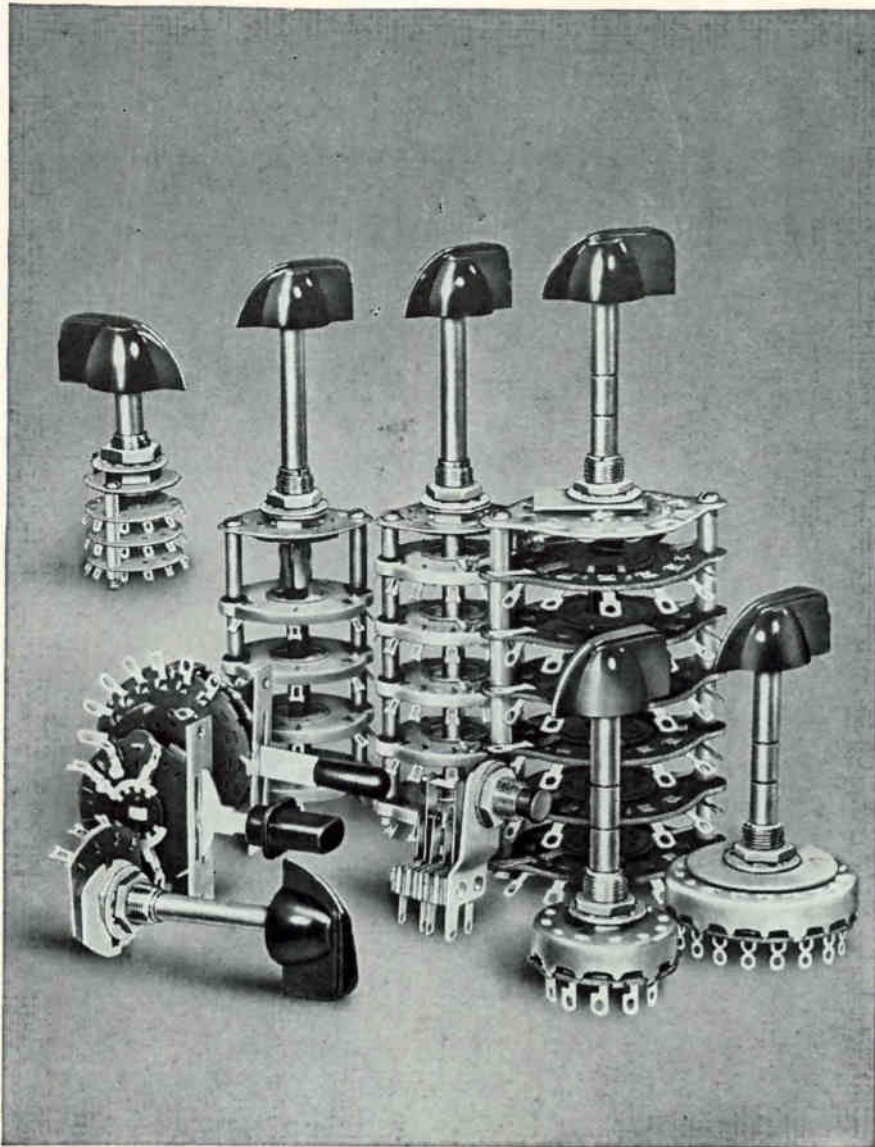

Switches...as you want 'em ...when you need 'em

Need a rotary switch? Or a lever action? Your Mallory distributor can give you off-the-shelf delivery on some 16 different Mallory switch types, in dozens of variations. All the way from the subminiature 12M Mallory-Grigsby to the rugged Mallory 1200-1300 series. There are shorting and non-shorting types . . . phenolic, ceramic, and even glass-epoxy wafers. All made to the strictest quality standards. Call your Mallory distributor—if you don't have his number, write us.

Distributor Division, P. R. Mallory & Co. Inc.
P. O. Box 1558, Indianapolis 6, Indiana



terminated by using the components, tools, wire strippers, soldering irons, etc., that the operator will use in production. The script writer should be familiar with standard shop practices for wiring and assembly, and it is desirable for him to have a knowledge of time and motion economy. An engineer with a background in manufacturing, production, quality control or methods should write the script for the first units in a tape wiring program. Since the script (and eventually the tape) will be used instead of the usual blueprints, it should be checked and signed as regular drawings are.

The first entry in the script identifies the unit being wired and will be something like "Unit XXXX, run number XX. Wiring and assembly instructions." The next instruction should tell the operator how to position the unit, such as "Position the unit so the wiring side is up, with tube socket five in the upper right hand corner."

From this point on the script follows the usual wiring sequence, which in most of the industry is first, point to point or strap wires, then harness wires, then components. Wiring should begin at the upper left, if possible, and move toward the right. After a number of wires have been put in place, soldering instructions are given, as, "Go back and solder the following connections: at socket one, solder ter-

Shoe Cleaner for White Rooms

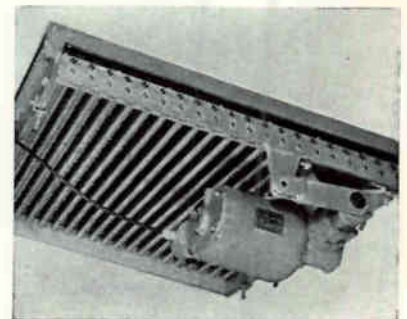

MOTORIZED door mats in several styles are being used at entrances to white rooms and in other plant areas. When a person steps on the mat, a motor drives brushes that clean shoe soles of dust, grime, grit, snow. The mats are being manufactured by Progressive Engineering Co., Holland, Michigan

minals 2, 4 and 7."

Inspection instructions can easily be added into the sequence. These will be something like "Go back and check for solder; at socket one, check terminals 2, 4 and 7; at socket two, check terminals 3 and 6." Inspection instructions can conveniently be inserted after 15 to 20 soldered connections have been made.

The next assembly step is often a wiring harness. Thus, "Insert wiring harness XXXX (identification) into the following path: mount the connector to the chassis in its bracket on the left wall. The first leg of the harness goes up between sockets 2 and 3." Wires in the harness are connected and soldered as before.

Resistors are usually identified as R1, R2, etc., capacitors as C1, C2, etc., and similarly for other components. Instructions for assembly include connection points, how to dress the leads, how polarized devices such as electrolytic capacitors are to go in. The last entry in the script is a statement of completion: "This completes the assembly and wiring of this unit."

RECORDING—When the script has been checked by using it to wire a unit, it is ready for recording. A male announcer with a relatively deep voice should read the script at slightly slower than normal conversational speed; the recording studio or office should be quiet and the tape should have little or no background noise. There should be uniform pauses between sentences and paragraphs but there should be no gaps of silence since the user would have to wait idly for these sections; the operator controls with foot pedal the amount of wait between instructions. All words on the final tape must be clear and distinct.

Placement of critical wires and components can be illustrated with photographs, either 8 × 10 glossies, color shots, or 35 mm slides.

BIBLIOGRAPHY

- Production Aids, E/E Production, p 17, 1961.
- Audio-Visual Manufacturing, Electronic Industries, p 86, Sept., 1960.
- Tape Cuts Wire Test Time, Errors, Electronics, Dec. 16, 1960.
- Tape Recordings Speed Assembly, Electronics, July 24, 1959.
- Tape Recorder Speeds Panel Wiring, Electronics, May 22, 1959.
- A-V Systems Step up Production, Electronics, p 78, Oct. 20, 1961.

have you tried **BIRD**?

READ RF WATTS DIRECTLY

Today everyone who measures RF power in coaxial systems wants the answer in watts. The BIRD Model 43 THRULINE reads watts!

Connect the Model 43 between transmitter and antenna or load. The meter reads RF power directly. Measure forward or reflected power instantly.

No calibration charts. No adjustments. No calculations. No auxiliary power.

Plug-in elements are used to cover 2 to 1000 mc, and powers to 1000 watts.

BIRD Quick-Change (QC) Connectors eliminate adapters. Any standard series of coaxial line fittings may be accommodated.

Write, TWX or call us for complete specifications on the Model 43 and other BIRD products.

Price:

Instrument only . . . \$95.00 each

Plug-in elements . . . \$30.00 each

FOB, Factory



BIRD

ELECTRONIC CORPORATION

30303 Aurora Rd., Cleveland 39 (Solon), Ohio

Churchill 8-1200

TWX CGN FS 679

Western Representative:

VAN GROOS COMPANY, Woodland Hills, Calif.

WESCON SHOW BOOTH 815-816



BIRD Model 43
Thruline Wattmeter

DESIGN AND APPLICATION

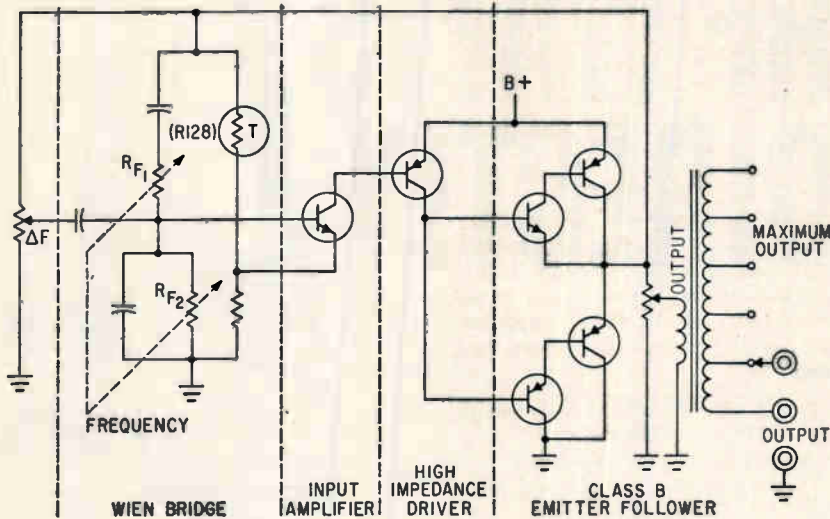

the light passing through the plate and operates remote recorder equipment. Air blasts clean the plate every 15 minutes. Extremely heavy dust loads reduce cycle time. Differences of 1,000 : 1 can be recorded. (302)

Semiconductor Gate Can Block 400 Volts D-C

MANUFACTURED by General Electric Rectifier Components Dept., West Genesee St., Auburn, N. Y., the ZJ224 gate turn-off switch can be turned either on or off at its gate control terminal. Typical switching

Oscillator Delivers Clean Sine Waves

Transistorized oscillator distortion is less than 0.5 percent to any load

ANNOUNCED by General Radio Co., West Concord, Mass., the model 1311-A audio oscillator provides 11 fixed frequency outputs between 50 cps and 10 Kc with an accuracy of ± 1 percent and distortion of less than 0.5 percent under any load condition including short circuit. Any other frequency can be added between 50 cps and 10 Kc by the addition of a pair of precision resistors. Open circuit voltage is adjustable between 0 and 100 v and will deliver

1 w into a matched load. The device will work into any resistive load between 80 milliohms and 8,000 ohms. The oscillator is a Wien bridge with frequency selection made by pairs of matched precision resistors. A metal bead thermistor automatically adjusts to maintain oscillation. Six transistors are used in a single direct-coupled feedback loop. Amplifier input impedance is 10 megohms while output impedance is 0.005 ohm. Output transformer is doubly shielded for isolation, and tapped for five switch-selected output voltages.

CIRCLE 301, READER SERVICE CARD

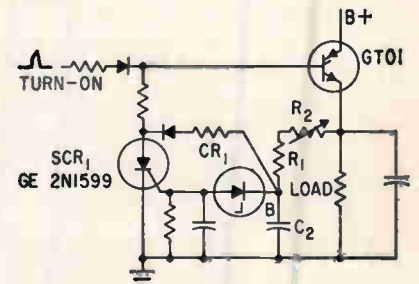

time is one microsecond. Housed in a JEDEC TO-5 package, the unit can block up to 400 v with currents up to 2 amperes. It can be used in low-power inverters, power flip-flops, high-speed solenoid and relay drivers, sawtooth generators, oscillators and ring counters. It also may be used to drive conventional scr's or transistors in high-frequency, high-power inverter applications. Typical application in a high-power pulse generator is shown in the sketch. The GTO₁ is turned on and the load energized by applying a signal to GTO₁ gate input terminal. Full load voltage is then applied to the integrating circuit ($R_1 + R_2$) C_2 . As soon as the voltage across C_2 exceeds break-over potential of zener diode CR₁,

Dust Monitor Records Atmosphere Contamination

RECENTLY introduced by Gelman Instrument Co., 106 North Main St., Chelsea, Michigan, the duct dust detector can be used to monitor many particles such as flyash, cement dust, petroleum catalysts, clays and flour dust at regular 15-minute intervals and record them at remote locations. Dust or flyash particles

collect on glass plates placed in the stack. The servorecorder measures

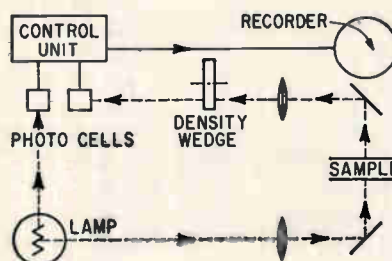

IN DIGITAL DATA COMMUNICATIONS...

DD LINE = RELIABILITY + FLEXIBILITY + LOW COST



The need for reliable and flexible low-cost data communications equipment has led to the design and development of the Rixon DD Line. DD is the packaging of basic data communications system components into functional units. Now the system designers can build a system from DD modules to meet their exact requirements in either medium—wire line or HF radio circuits. Available now are modulators, demodulators, clocks, phase resolvers, delay equalizers, and serial-to-parallel converters, just to mention a few—at bit rates from 600 to 4800 bps.

Advantage? Reliability and complete flexibility at low cost—a result of over five years experience with data transmission systems.

Availability? Now!!!

RIXON ELECTRONICS, INC.

2121 Industrial Parkway—Montgomery Industrial Park—Silver Spring, Maryland
Telephone: 622-2121

TWX: S Spg 213

CIRCLE 203 ON READER SERVICE CARD

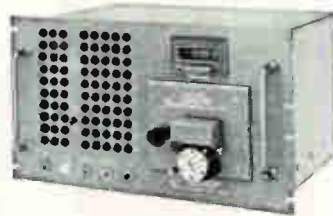

HOW TO INCREASE YOUR READING CAPACITY

EECO's block, punched-tape reader can digest 80, 96, 120 or 160 bits of information at a step (depending upon the model you select). It's better designed for applications like machine tool control and automatic checkout and tests. For instance, it offers a complete test per block; identification of data function by position in block; elimination of data storage records and address decoding circuits. Straight-forward programming by blocks. Standard units read 80, 96, 120, 160 bit blocks. In modular or standard 19" rack mounting units. Takes 1", 8-level paper or mylar tape punched on 0.1" centers. Reader head designed for either forward or reverse reading. Most models are bi-directional. Write for data sheets.

Automation Division
Electronic Engineering Company
of California

1601 E. Chestnut Avenue • Santa Ana, California
Phone: 547-5501, P.O. Box 58 • Representative in
Western Europe and Israel: Electronic Engineering
S.A., C.P. 142 Fribourg, Switzerland. EE 2-50

CIRCLE 204 ON READER SERVICE CARD

Boeing Saturn Openings for TELEMETRY ENGINEERS

The Boeing Company's newly-formed Saturn Booster Branch has immediate openings for Telemetry Engineers. These positions offer professional challenge, rapid-advancement, and, in many instances, ground-floor opportunities to graduate Electronic/Electrical Engineers. At least three years experience in the design and operation of telemeter systems is required, in addition to a B.S. degree.

Responsibilities will include circuit design and documentation required to adapt these systems to the Saturn program. These assignments require experience in the multiplexing and radio-link techniques used in airborne and ground equipment for pulse code, pulse amplitude, and frequency modulated telemeter systems. Assignments will be in Huntsville, Ala., or New Orleans, La.

Send your resume, today, to Mr. R. R. Gregg, The Boeing Company, P. O. Box 26088 - ECK, New Orleans, Louisiana. Boeing is an equal opportunity employer.

BOEING

ACCURATE, RUGGED...

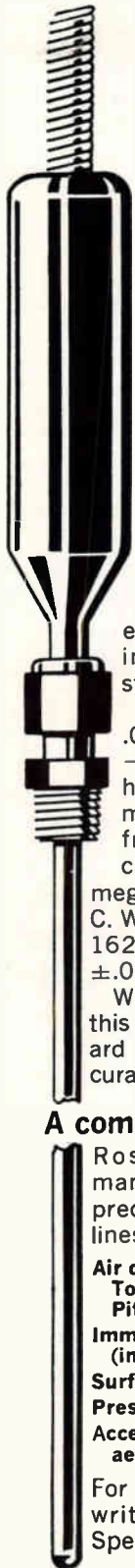

REC's new temperature standard

The new REC Model 162C platinum resistance temperature standard is so stable and accurate it can be calibrated and certified by the National Bureau of Standards.

Yet it is rugged enough to operate under 2,000 psi pressure and withstands sudden, extreme changes in temperature. The Model 162C's fully annealed, high purity platinum wire resistor is mounted essentially strain free within a hermetically sealed stainless steel well.

Stability is better than .005° C. over a range from -200° to +500° C. Self-heating is only .001° C. at 2 ma. Insulation resistance from element to outside case is more than 1,000 megohms at 100 vdc at 500° C. We will calibrate any Model 162C to an accuracy of $\pm .015^\circ$ C.

Write for further details of this new temperature standard that combines great accuracy and ruggedness.

A complete precision line

Rosemount designs and manufactures high quality precision equipment in these lines:

- Air data sensors
 - Total temperature
 - Pitot-static tubes (de-iced)
- Immersion temperature sensors (including cryogenic)
- Surface temperature sensors
- Pressure sensors
- Accessory equipment and aeronautical research

For more information please write for the REC catalog. Specific questions welcomed.



**ROSEMOUNT
ENGINEERING
COMPANY**

4900 West 78th St. • Minneapolis 24, Minn.

SCR_1 will trigger and turn off GTO_1 . Diode CR_2 resets C_2 in readiness for the next cycle. With resistive loads as shown, operation to 400 v and 2 amperes peak current is possible.

CIRCLE 303, READER SERVICE CARD

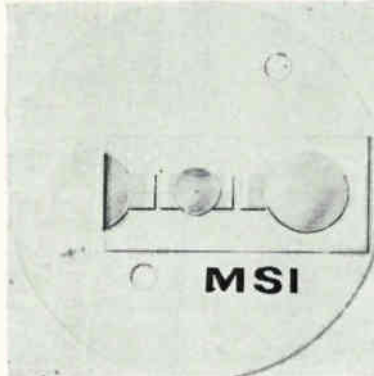

Mica Disk Bolometers Fit Standard Mounts

MSI ELECTRONICS INC., 116-06 Myrtle Ave., Richmond Hill 18, N. Y. The 103 series are available in 4.5 and 8.75 ma bias current values for use in standard bolometer mounts. Square law response error is less than 1 percent for power levels of 0.1 mw with the type 103-4.5, and 0.2 mw with the 103-8.75. When used with standard bridges, power levels of up to 10 mw can be measured with the 8.75 ma element and up to 3 mw with a 4.75 ma element. Vswr is less than 1.5 over 50 Mc to 10 Gc. (304)

Pulse Height Analyzer

PICKER X-RAY CORP., White Plains, N. Y., has developed a dual-channel transistorized pulse height analyzer for accepting pulses of either the same or two different energy ranges from separate scintillation detectors. (305)



K-Band T-W Tube Has Octave Width

MICROWAVE ELECTRONICS CORP., 4061 Transport St., Palo Alto, Calif., has introduced a ppm fo-

cused, magnetically shielded, octave-width K-band twt, covering 10-20 Gc. It meets all temperature and shock requirements of MIL-E-5400, Class II. It weighs 4 lb, measures 14 in. long. Model M2114E is designed for use with ecm receivers, for crystal protection, for reducing l-o radiation, and for automatic gain control. Power output is 5 mw; gain 25 db minimum. Voltage requirement is 1,500 v max at 1 ma. (306)

H-V Power Supplies

PULSE ENGINEERING, INC., 560 Robert Ave., Santa Clara, Calif. Series 204 miniaturized high-voltage power supplies for photomultiplier tubes, which offer laboratory-level performance in airborne size and weight ranges, have been announced. (307)



Waveguide Shutter Protects Radar Crystal

MICROWAVE ASSOCIATES, INC., Burlington, Mass. The MA-761 is a compact, highly reliable waveguide shutter for use in Ka-band (34.5 to 35.2 Gc) applications. It is designed to be easily incorporated in the receiver input waveguide to insure crystal protection from possible damage during equipment shut down. In the open position the insertion loss is 0.2 db max and vswr (open position) is less than 1.10. Isolation in the closed position is 30 db min. Switching time is 0.1 sec. (308)

Tube Shields

INTERNATIONAL ELECTRONIC RESEARCH CORP., 135 West Magnolia Blvd., Burbank, Calif. Fourteen new types of heat-dissipating tube shields will accommodate T9 diameter Compactron tubes in lengths from 1 in. to 3 in., and T12 diameter tubes in lengths from 1½ in. to 4 in. (309)

NEW MANUAL



Instruments for ...

MATERIAL TESTING

New Series 4501 Material Testing HYPOTS® with output to 150 kv, determine dielectric strength in accord with ASTM specifications . . . of solids, sheets, tapes, films, tubing, filling compounds, varnishes, oils and liquids. Fifteen interchangeable test fixtures are available.

CORONA TESTING

New instruments detect and display on oscilloscope, minute traces of corona . . . whether caused by voids within the insulation or other defects. May be measured or studied visually. Illustrated on left, corona tester with integral pickup and detector.

AUTOMATED TESTING

Special instruments for automated testing of voltage breakdown, insulation resistance, leakage current, continuity and other parameters. Unlimited test points or circuit capacity with full random access. Printed tape, punchcard, etc. readout.

Manual S-74 . . . data on methods and equipment for Materials Testing, Corona Testing and Automated Testing.

10-35.26

ASSOCIATED RESEARCH, INC.

"Electrical Testing Instruments Since 1936"

3781 W. Belmont Avenue • Chicago 18, Illinois

CIRCLE 205 ON READER SERVICE CARD

New! MINIATURE AXIAL FANS



with
up to 4 times
greater cooling efficiency!

Characteristic	PAMOTOR Model 1000	Conventional Fan
Type of Motor	induction (capacitor-type squirrel cage)	shaded-pole
Housing	die cast warp-free Zymec	plastic
Output @ 60 cps (0 back pressure) (.25" back pressure) (.3" back pressure)	125 cfm 75 cfm 50 cfm	100 cfm 20 cfm 0
Output @ 50 cps (0 back pressure) (.25" back pressure)	100 cfm 62.5 cfm	75 cfm 5 cfm
Operating Temp. Range	-55°C to +85°C	-18°C to +44°C

The PAMOTOR Model 1000 Miniature Fan is completely interchangeable with conventional units now in use (4 1/8" center-to-center mounting holes). But the similarity ends there.

check this comparison chart!

The Model 1000 Fan meets MIL-T-5422E, Class 2 Environmental specifications. Inside-outside rotating motor design gives flywheel effect, resulting in constant, quiet fan speed. Large surface sleeve bearings mean minimum maintenance, maximum reliability.

For complete specifications and name of nearest stocking distributor, write to:

PAMOTOR, Inc.

312 Seventh Street • San Francisco 3, Calif.

CIRCLE 206 ON READER SERVICE CARD



How to grow a beard...

Sit back and wait for your copy on that routing list. Okay if you like beards. Otherwise, look in this issue for the Reader Service Card. Fill in the "for subscriptions" section. Mail. Only 7 1/2 cents a week.

electronics A McGraw-Hill Publication, 330 West 42nd St., N. Y. 36

Coils for Contact Capsules



1 to 5 Reeds
.095 — .215 dia.
6 to 48 V.D.C.
Lead or Pin Term.
Also Available with Reeds.

Write for Bulletin and Prices

ELECTRICAL COIL WINDINGS

Wire sizes #6 to #56, Classes A, B, F and H. Complete engineering service available.

Coto-Coils COTO-COIL COMPANY INC.

65 Pavilion Avenue, Providence 5, R. I.

CIRCLE 65 ON READER SERVICE CARD 65

Controls Company Moves Home Office



CONTROLS COMPANY OF AMERICA moved its corporate headquarters on August 1 from Schiller Park to Melrose Park, a western suburb of Chicago. The new facilities will enable the company to consolidate its corporate R&D group and its Andrick Tool Mfg. Co. division with the executive office.

The corporation's world-wide business, which employs 4,350 people in 24 plants in the United States,

Canada, South America and Europe, will be directed from the headquarters. Also from this location the company will conduct long-range research and development programs and coordinate engineering and product development projects carried on by its various divisions and subsidiaries throughout the world.

The Andrick Tool Mfg. Co. division, formerly located in a separate building in Schiller Park, produces

automation machinery, special tools, and dies. Control Company's Appliance and Automotive division headquarters will remain in Schiller Park.

Controls Company manufactures controls and control systems for the electronics, aviation, missile, industrial automation, and other industries.

Department of Defense Names Burkhart

E. C. BURKHART, president of Genisco, Inc., West Los Angeles, Calif., has been named to the newly created Defense Industry Advisory Council by the Department of Defense. He will join with some 20 leading industrialists from throughout the country in expediting an interchange of information between defense contractors and the Pentagon so that both may be kept abreast of the rapid pace of technological breakthroughs and the

Checkout Chamber for NASA's Moon Mappers

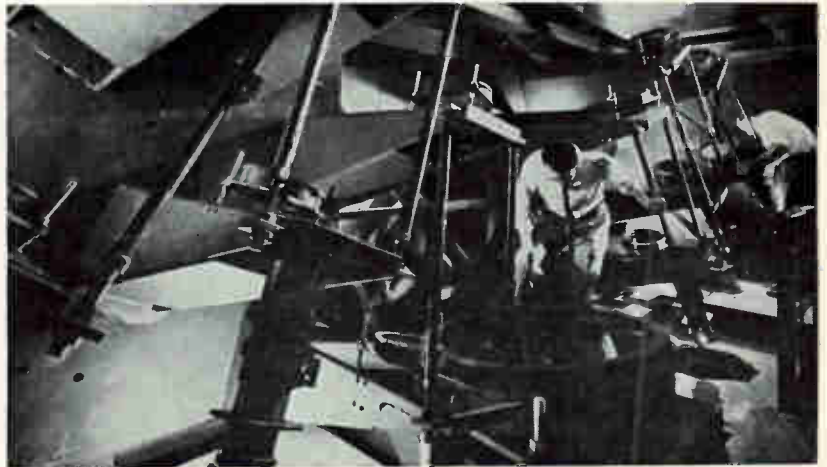

SPACE ENVIRONMENTS LAB costing \$2 million was opened recently by Fairchild Camera and Instrument Corp. at Syosset, N. Y. Key structures include a 3,000-cubic-foot space chamber (left) that can simulate altitudes as high as 330 miles and temperatures of -100 F to 300 F . A photo-optical test structure (right) containing eight infinity-focused collimators can be rolled under the chamber to beam illuminated patterns into sensors under test. A 15-ton shaker can be put into the chamber to simulate launch vibrations. The facility will be used to test aerospace surveillance, mapping and other systems, using photographic, television and infrared equipment. A photo-optical laboratory and other test rooms back up the chamber

NO SLOT LOCK

No
Brushes



No
Commutator

Minimum Mechanical Feedback
Minimum Friction Load
Maximum Life Expectancy
Infinite Resolution

TQ SERIES-DC TORQUE MOTOR

Ranges: 3 oz. in. to 75 lb. ft. torque
 $\pm 8^\circ$ to $\pm 60^\circ$ angular motion
2 to 200 watts power input

Write, wire or phone: DEPT. BL-41

AEROFLEX LABORATORIES INCORPORATED

48-25 36TH STREET • LONG ISLAND CITY 1, N. Y.

CIRCLE 207 ON READER SERVICE CARD



How to grow a beard...

Sit back and wait for your copy on that routing list. Okay if you like beards. Otherwise, look in this issue for the Reader Service Card. Fill in the "for subscriptions" section. Mail. Only 7½ cents a week.

electronics

A McGraw-Hill Publication, 330 West 42nd St., N. Y. 36

August 3, 1962

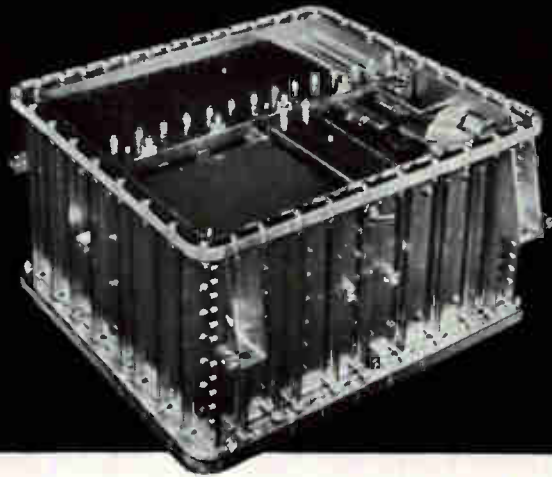

This is the Univac ADD Computer (Aerospace Digital Development). High density packaging makes possible its small, 0.77 cubic foot size.

SYSTEMS ENGINEERS:

The Univac Military Department has requirements for engineers and scientists with experience in the field of command-control systems, weapon systems and aerospace systems. Advanced systems concepts are based on a proven capability of a central computer, such as the Univac 1206 Military Real Time Computer for mobile land or water control and Univac ADD Computer for airborne or space control.

ANALYSTS

Capable of analyzing systems data flow, operational and environmental requirements.

DATA PROCESSING SPECIALISTS

Qualified in analog and digital processes and the analog to digital interface equipment and techniques.

COMMUNICATIONS SPECIALISTS

Qualified in modern communications theory and the interface with other system elements.

PRESENTATION SPECIALISTS

Qualified in all aspects of data presentation and display equipment and techniques, both automatic and manual.

OPERATIONAL SYSTEMS PROGRAMMERS

Senior programmer capable of design and development of machine programs that reflect operational concepts and extract maximum performance from the equipment.

OTHER

There are other requirements for engineers with a capability in such disciplines as stable platforms, inertial guidance and solar power supplies.

To Investigate These Opportunities, Contact The Office of Your Choice:

WILLIAM LOWE
UNIVAC
P.O. Box 6068
San Diego 6, California

R. K. PATTERSON
UNIVAC
Univac Park
St. Paul 16, Minnesota

UNIVAC®

DIVISION OF SPERRY RAND CORPORATION
MILITARY DEPARTMENT • UNIVAC PARK • ST. PAUL, MINN.

Acoustical Components of Superior Quality

JAPAN PIEZO supplies 80% of Japan's crystal product requirements.

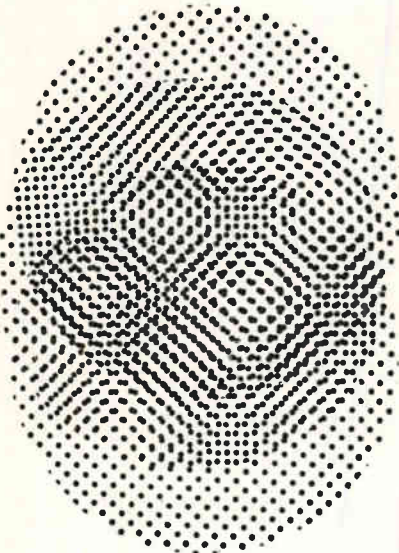

MICROPHONE

Crystal — X-29

At 20°C, 1 KC/s, Sensitivity is -58 ± 5 db. Impedance: 100 K Ω . Capacitance: 1,500 pF.

Write for detailed catalog on our complete line of acoustical products including pickups, cartridges, record players, phonograph motors and many associated products.



JAPAN PIEZO ELECTRIC CO., LTD.

Kami-renjaku, Mitaka, Tokyo, Japan

compression of development and production cycles.

Burkhart is a founder of Genisco, Inc., 15-year-old maker of test and flight equipment for the aerospace industry.



Namon Assumes Executive Post

RICHARD NAMON has been appointed vice president and general manager of Physical Instruments, Inc., Coral Gables, Fla. He replaces Alan Pacela who returns to the faculty of the University of Miami.

Namon was formerly research project head in gyro development at Lear Siegler Instrument division.

Applied Technology Appoints Sahlberg

ALBERT P. SAHLBERG, JR., has joined Applied Technology, Inc., Palo Alto, Calif., as a senior engineer. He was previously associated with Dalmo Victor Co.

Applied Technology, Inc., designs and manufactures advanced electronic reconnaissance, active countermeasure systems and microwave telemetry equipment.



Maxon Electronics Corp. Elects Hays a V-P

ELECTION of Brig. Gen. Charles S. Hays (U. S. Army Ret.) as a vice

president of the Maxson Electronics Corp., New York, N. Y., is announced. He has also been named president of the Maxson Electronics division, which operates as one of the autonomous divisions of the corporation.

In addition to his military service, Hays has been associated with the General Electric X-Ray Corp.

PEOPLE IN BRIEF

Duain A. Bowles and James K. Churchill, formerly with Thiokol Chemical Corp. and Ordtech Corp., respectively, appointed design engineers for the Pelmec div., Quantic Industries, Inc. David H. McConnell of RCA named mgr., engineering, for the Industrial and Automation Products dept. David C. Baker moves up at Scintilla div. of Bendix Corp. to asst. chief engineer for electronic products. Edward F. Miller advances to director of quality assurance at The Technical Materiel Corp. W. M. (Jack) Silhavy appointed technical asst. to the president of Varian Associates. Succeeding him as mgr., field engineering. Palo Alto Tube div., is Clifton Rockwood, formerly mgr., applications engineering. Raytheon Co. ups O. P. Susmeyan to director of interdivisional services. Roger R. Noble, previously with G. A. Philbrick Researches, elected president of Nexus Research Laboratory, Inc. Peter D. Lubell, ex-Narda Corp., joins Airtron as a project engineer for microwave diode devices. George A. Peck leaves Dresser Electronics to become director of mfg. operations for communications at ITT Federal Laboratories. George W. DeLorie, from Sanders Associates, Inc., to Microwave Electronics Corp. as mgr. of quality assurance. E. Eugene Ecklund, formerly with ITT Federal Laboratories, named president of Thomas Electronics, Inc. Clifford J. Helms, ex-Ampex Computer Products Co., now chief engineer, western operations, of Data Products Corp. Frank Woolam, previously with GE, has joined the Scientific Data Systems technical staff.

electronics

WEEKLY QUALIFICATION FORM FOR POSITIONS AVAILABLE

ATTENTION: ENGINEERS, SCIENTISTS, PHYSICISTS

This Qualification Form is designed to help you advance in the electronics industry. It is unique and compact. Designed with the assistance of professional personnel management, it isolates specific experience in electronics and deals only in essential background information.

The advertisers listed here are seeking professional experience. Fill in the Qualification Form below.

STRICTLY CONFIDENTIAL

Your Qualification form will be handled as "Strictly Confidential" by ELECTRONICS. Our processing system is such that your form will be forwarded within 24 hours to the proper executives in the companies you select. You will be contacted at your home by the interested companies.

WHAT TO DO

1. Review the positions in the advertisements.
2. Select those for which you qualify.
3. Notice the key numbers.
4. Circle the corresponding key number below the Qualification Form.
5. Fill out the form completely. Please print clearly.
6. Mail to: D. Hawksby, Classified Advertising Div., ELECTRONICS, Box 12, New York 36, N. Y. (No charge, of course).

COMPANY	SEE PAGE	KEY #
ATOMIC PERSONNEL INC. Philadelphia, Pennsylvania	84*	1
AVCO RESEARCH AND ADVANCED DEVELOPMENT a division of Avco Corporation Wilmington, Massachusetts	86*	2
BRISTOL COMPANY Waterbury, Connecticut	70	3
DOUGLAS AIRCRAFT CO. Missile and Space Systems Div. Santa Monica, California	10*	4
ESQUIRE PERSONNEL SERVICE INC. Chicago, Illinois	84*	5
GENERAL DYNAMICS ASTRONAUTICS San Diego, California	17-20	6
JET PROPULSION LABORATORY Pasadena, California	71	7
MICROWAVE SERVICES INTERNATIONAL, INC. Denville, New Jersey	84*	8
MOTOROLA INC. Chicago, Illinois	71	9
NATIONAL AERONAUTICS AND SPACE ADMINISTRATION Washington, D.C.	84*	10
NATIONAL CASH REGISTER CO. Dayton, Ohio	70	11
NORTHROP CORP. Norair Div. Hawthorne, California	73*	12
NORTHROP CORP. Space Laboratories Hawthorne, California	75*	13
REMINGTON RAND UNIVAC Div. of Sperry Rand Corp. St. Paul, Minnesota	67	14

CONTINUED ON PAGE 70

(cut here)

electronics WEEKLY QUALIFICATION FORM FOR POSITIONS AVAILABLE

(cut here)

(Please type or print clearly. Necessary for reproduction.)

Personal Background

NAME

HOME ADDRESS

CITY ZONE STATE

HOME TELEPHONE

Education

PROFESSIONAL DEGREE(S)

MAJOR(S)

UNIVERSITY

DATE(S)

FIELDS OF EXPERIENCE (Please Check)

8362

- | | | |
|--|--|---------------------------------------|
| <input type="checkbox"/> Aerospace | <input type="checkbox"/> Fire Control | <input type="checkbox"/> Radar |
| <input type="checkbox"/> Antennas | <input type="checkbox"/> Human Factors | <input type="checkbox"/> Radio—TV |
| <input type="checkbox"/> ASW | <input type="checkbox"/> Infrared | <input type="checkbox"/> Simulators |
| <input type="checkbox"/> Circuits | <input type="checkbox"/> Instrumentation | <input type="checkbox"/> Solid State |
| <input type="checkbox"/> Communications | <input type="checkbox"/> Medicine | <input type="checkbox"/> Telemetry |
| <input type="checkbox"/> Components | <input type="checkbox"/> Microwave | <input type="checkbox"/> Transformers |
| <input type="checkbox"/> Computers | <input type="checkbox"/> Navigation | <input type="checkbox"/> Other |
| <input type="checkbox"/> ECM | <input type="checkbox"/> Operations Research | <input type="checkbox"/> |
| <input type="checkbox"/> Electron Tubes | <input type="checkbox"/> Optics | <input type="checkbox"/> |
| <input type="checkbox"/> Engineering Writing | <input type="checkbox"/> Packaging | <input type="checkbox"/> |

CATEGORY OF SPECIALIZATION

Please indicate number of months experience on proper lines.

	Technical Experience (Months)	Supervisory Experience (Months)
RESEARCH (pure, fundamental, basic)
RESEARCH (Applied)
SYSTEMS (New Concepts)
DEVELOPMENT (Model)
DESIGN (Product)
MANUFACTURING (Product)
FIELD (Service)
SALES (Proposals & Products)

CIRCLE KEY NUMBERS OF ABOVE COMPANIES' POSITIONS THAT INTEREST YOU

1 2 3 4 5 6 7 8 9 10 11 12 13 14 15 16 17 18 19 20 21 22 23 24 25

NCR

MILITARY SYSTEMS ANALYSIS ADVANCED PLANNING

ENGINEER ANALYST:

An exciting and continuing program of signal data reduction requires the talents of experienced electronic engineers and mathematicians familiar with military communication and radar systems.

The work requires persons capable of directing their own efforts as well as the efforts of others, and who have the ability to analyze complex data obtained from different types of systems so that meaningful conclusions and suggestions may result. These key positions require an appropriate degree and 7-10 years' experience. Intermediate level positions in similar work are also available.

NOTE: Backgrounds for the above areas of employment should include one or more of the following: measurement techniques, radar, infrared, telemetry, pulse techniques, information theory, mathematical statistics, weapons systems analysis, solid state circuitry, servomechanisms, microwave and antennas.

ADVANCED PLANNING ENGINEER:

Our Advanced Planning Group has need for creative individuals familiar with the advanced technology required for future military systems. Applicants considered for these positions must have technical capability equivalent to Ph.D. level in at least one pertinent area of study and be able to communicate intelligently with other specialists in various disciplines centering around military electronic systems. Applicants must have demonstrated the capability to direct the efforts of others on at least a project level.

To Arrange Interview, Write To:
T. F. Wade, Technical Placement
The National Cash Register Co.
Dayton 9, Ohio

NCR

An Equal Opportunity Employer

EMPLOYMENT OPPORTUNITIES

The advertisements in this section include all employment opportunities — executive, management, technical, selling, office, skilled, manual, etc.

Look in the forward section of the magazine for additional Employment Opportunities advertising.

— RATES —

DISPLAYED: The advertising rate is \$40.17 per inch for all advertising appearing on other than a contract basis. Contract rates quoted on request.

An advertising inch is measured 3/4" vertically on a column—3 columns—30 inches to a page.

Subject to Agency Commission.

UNDISPLAYED: \$2.70 per line, minimum 3 lines. To figure advance payment count 5 average words as a line.

Box numbers—count as 1 line.

Discount of 10% if full payment is made in advance for 4 consecutive insertions.

Not subject to Agency Commission.

Electronic Instrument Technicians The Oak Ridge National Laboratory Operated by UNION CARBIDE NUCLEAR COMPANY at Oak Ridge, Tennessee Has openings for

Highly skilled electronic instrument technicians to work with electronic engineers in the development, installation and maintenance of electronic systems. Digital data handling, transistorized pulse height analyzers, analog and digital computer systems are only a few examples.

Minimum high school education, with additional training in electronics and at least three years' experience in installation and maintenance of complex electronic systems. Entrance rate \$3.10 per hour: \$3.16 per hour after six months. Reasonable interview and relocation expenses paid by Company.

Excellent Working Conditions
and
Employee Benefit Plans
An Equal Opportunity Employer

Send detailed resume to:

Central Employment Office
UNION CARBIDE NUCLEAR COMPANY
Post Office Box M Oak Ridge, Tennessee

SEARCHLIGHT SECTION

(Classified Advertising)

BUSINESS OPPORTUNITIES

EQUIPMENT - USED or RESALE

DISPLAYED RATE

The advertising rate is \$27.75 per inch for all advertising appearing on other than a contract basis. Contract rates quoted on request. An ADVERTISING INCH is measured 3/4 inch vertically on one column, 3 columns—30 inches—to a page. EQUIPMENT WANTED or FOR SALE ADVERTISEMENTS acceptable only in Displayed Style.

UNDISPLAYED RATE

\$2.70 a line, minimum 3 lines. To figure advance payment count 5 average words as a line. BOX NUMBERS count as one line additional in undisplayed ads.

FOR RESEARCH — DEVELOPMENT & EXPERIMENTAL WORK

Over 10,000 different electronic parts: wave-guide, radar components and parts, test sets, pulsed, antennas, pulse xmfrs, magnetrons, IF and pulse amplifiers, dynamotors, 400 cycle xmfrs, 584 ant. pedestals, etc.

PRICES AT A FRACTION OF ORIGINAL COST!
COMMUNICATIONS EQUIPMENT CO.
343 CANAL ST., N. Y. 13, WD 6-4045
CHAS. RDSSEN (Formerly at 131 Liberty St.)

CIRCLE 951 ON READER SERVICE CARD

WEAK IN MATH?

Don't let inadequacy in mathematics hold you back. Now you can learn the basic math you must know to succeed as a technical man. Learn through Grantham Schools' unusual home study math course for technicians, engineers, and mechanics. Write for details today.

Write to: Dept. 2E.
GRANTHAM SCHDDLS, INC.
1505 N. Western Ave. Los Angeles 27, Calif.

CIRCLE 952 ON READER SERVICE CARD

Your Inquiries to Advertisers Will Have Special Value . . .

—for you—the advertiser—and the publisher, if you mention this publication. Advertisers value highly this evidence of the publication you read. Satisfied advertisers enable the publishers to secure more advertisers and—more advertisers mean more information on more products or better service—more value—to YOU.

electronics

WEEKLY QUALIFICATIONS FORM FOR POSITIONS AVAILABLE

(Continued from page 69)

REPUBLIC AVIATION CORPORATION Missile Systems Division Mineola, L.I., New York	86*	15
SPACE TECHNOLOGY LABORATORIES, INC.	15	16
Sub. of Thompson Ramo Wooldridge Inc. Redondo Beach, California		
SYLVANIA ELECTRONIC SYSTEMS • WEST	85*	17
Mountain View, California		
UNION CARBIDE NUCLEAR CO. Oak Ridge, Tennessee	70	18

*These advertisements appeared in the 7/27/62 issue.

Engineering or Science Graduates to be trained as INSTRUMENT SALES ENGINEERS with

The Bristol Company

Leading manufacturer of automation equipment and control systems requires men, preferably 25 to 35 years old, to sell high quality, nationally accepted products to wide variety of industrial markets. Openings in various areas of the country. Successful applicants take comprehensive three-months course at headquarters. Salary and expenses All replies confidential; every inquiry answered. Write: Charles F. Johnson, Mgr. of Sales Training

The Bristol Company

Waterbury 20, Conn.

An equal opportunity employer

Jpl needs

COMMUNICATIONS ENGINEERS

SPACECRAFT COMMUNICATIONS
GROUND SYSTEMS

To hold operational cognizance over spacecraft ground communications equipment. Strong background in digital techniques necessary, including logical and system design. Knowledge of digital circuit design and input/output equipment desirable. Applicant should be familiar with RF demodulation and digital decommutation systems and have some industrial experience. BSEE minimum.

Send complete resume to
PERSONNEL DEPT.

JET PROPULSION LABORATORY

CALIFORNIA INSTITUTE OF TECHNOLOGY
4814 OAK GROVE DR. • PASADENA, CALIF.

"An equal opportunity employer"

"Put Yourself in the

Other Fellow's Place"

TO EMPLOYERS

TO EMPLOYEES

Letters written offering Employment or applying for same are written with the hope of satisfying a current need. An answer, regardless of whether it is favorable or not, is usually expected.

MR. EMPLOYER, won't you remove the mystery about the status of an employee's application by acknowledging all applicants and not just the promising candidates.

MR. EMPLOYEE you, too, can help by acknowledging applications and job offers. This would encourage more companies to answer position wanted ads in this section.

We make this suggestion in a spirit of helpful cooperation between employers and employees.

This section will be the more useful to all as a result of this consideration.

Classified Advertising Division

McGraw-Hill Publishing Co., Inc.

330 West 42nd St., New York 36, N. Y.

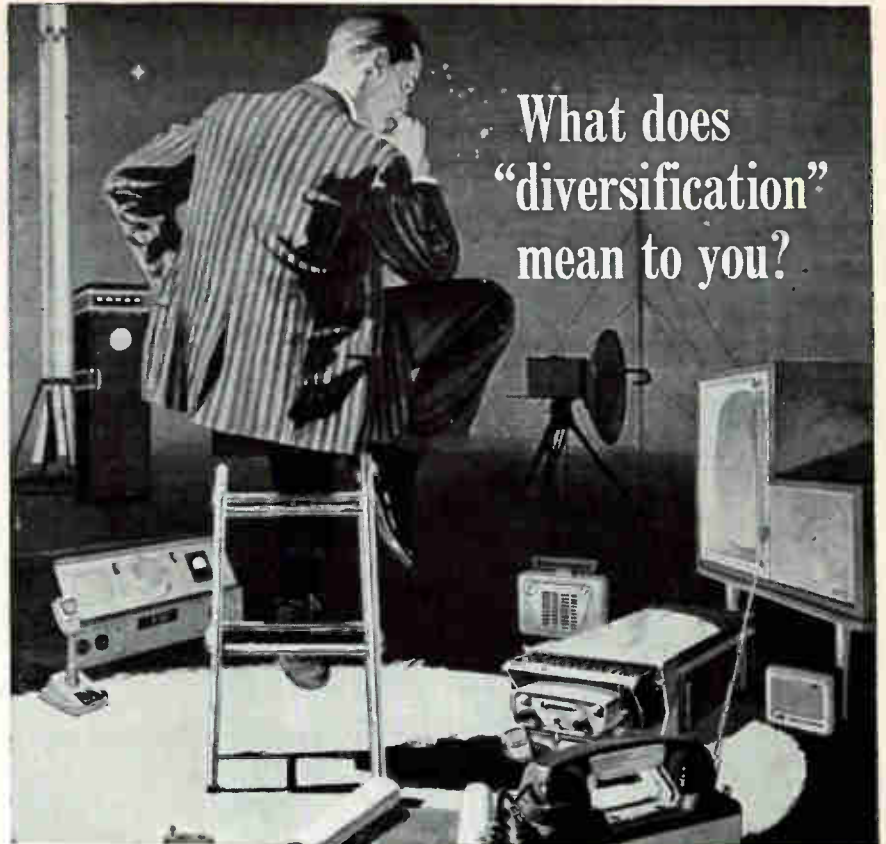

What does
"diversification"
mean to you?

Radar • Radio communications • Microwave • Transistors
• VHF/UHF • Missile guidance • Data processing • Every
advanced phase of electronic engineering!

Which offers you the greatest challenge? The greatest potential?
The greatest reward?

Here at Motorola, exceptional diversification offers you the widest possible choice of the entire state of the art. The horizons are unlimited—and so are the rewards. Engineers are discovering a new sense of achievement and personal fulfillment in selecting the specialized field that parallels their own interests.

You can take your own measure at Motorola. Here you can find the diversification you want. Challenging new assignments. True professional status. Association with highly creative engineering and scientific minds. Unlimited advancement. Write us about yourself today.

- Radar transmitters and receivers
- Radar circuit design
- Electronic countermeasure systems
- Military communications equipment design
- Pulse circuit design
- IF strip design
- Device using klystron, traveling wave tube and backward wave oscillator
- Display and storage devices

2-WAY RADIO COMMUNICATIONS

- VHF & UHF receiver
- Transmitter design and development
- Power supply
- Systems engineering
- Antenna design
- Selective signaling

- Transistor applications
- Crystal engineering
- Sales engineering

- Design of VHF & UHF FM communications in portable or subminiature development
- Microwave field engineers
- Transistor switching circuit design
- Logic circuit design
- T.V. circuit design engineering
- Home radio design
- New product design
- Auto radio design
- Mechanical engineering
- Semi-conductor device development
- Semi-conductor application work

Excellent opportunities also available in Phoenix, Ariz.; Riverside & Culver City, Calif.; & Minneapolis, Minn.

MR. W. H. HAUSMANN

Engineering Personnel Mgr. Dept. D
4545 Augusta Blvd., Chicago 51, Ill.

**AN EQUAL
OPPORTUNITY
EMPLOYER**



MOTOROLA inc.

INDEX TO ADVERTISERS

Aeroflex Laboratories Inc.	67
• American Time Products, Div. of Bulova Watch Co., Inc.	49
• Art Wire & Stamping Co.	51
• Associated Research Inc.	65
Babcock Relays, Inc.	55
• Bird Electronic Corp.	61
• Billey Electric Co.	16
Boeing Co., The.	63
• Brush Instruments, Div. of Clevite Corp.	3rd cover
• Coto-Coil Co., Inc.	65
Electronic Engineering Co. of Calif. ...	63
• Federation National des Industries Electroniques	51
General Dynamics/Aeronautics	17-20
Gudebrod Bros. Silk Co., Inc.	31
• Hewlett-Packard Company	6
Hughes Aircraft Co., Aerospace Div. ...	24
Janco Corp.	51
• Japan Piezo Electric Co., Ltd.	68
• Lambda Electronics Corp.	10, 11
Mallory and Co., Inc., P. R.	60
• Navigation Computer Corp. (Navcor). ...	56
Pamotor Inc.	65
• Potter Instrument Co., Inc.	23
• Radio Corporation of America. ...	4th cover
Raytheon Company	2nd cover
• Rixon Electronics, Inc.	63
• Rochar Electronique	29
• Rosemount Engineering Co.	64
Space Technology Laboratories, Inc. ...	15
Sprague Electric Co.	9, 30
Tektronix, Inc.	5
Texas Instruments Incorporated Apparatus Division	16
Texas Instruments Incorporated Components Division	32
Uniform Tubes, Inc.	52
Univac, Div. of Sperry Rand Corp. ...	67
Varian Associates	25
Victor Business Machines Co.	53
Vitro Laboratories	13
• Weinschel Engineering	4

CLASSIFIED ADVERTISING

F. J. Eberle, Business Mgr.

EMPLOYMENT OPPORTUNITIES...70-71

EQUIPMENT
(Used or Surplus New)
For Sale 70

INDEX TO CLASSIFIED ADVERTISERS

Bristol Company	70
• Communications Equipment Co.	70
Grantham Schools Inc.	70
Jet Propulsion Laboratory	71
Motorola Inc.	71
National Cash Register Co.	70
Union Carbide Nuclear Co.	70

• See Advertisement in the July 25, 1962 issue of Electronics Buyers' Guide for complete line of products or services.

This Index and our Reader Service Numbers are published as a service. Every precaution is taken to make them accurate, but ELECTRONICS assumes no responsibilities for errors or omissions.

electronics



Audit Bureau
of Circulations

Associated Business
Publications

Audited Paid Circulation

JAMES T. HAUPTLI

Advertising Sales Manager

R. S. QUINT:
Assistant Publisher Buyers'
Guide and Business Manager
FRED STEWART:
Promotion Manager
B. ANELLO:
Market Services Manager

RICHARD J. TOMLINSON:
Production Manager
GEORGE E. POMEROY:
Classified Manager
HUGH J. QUINN:
Circulation Manager

ADVERTISING REPRESENTATIVES

NEW YORK (36):
Donald H. Miller, Henry M. Shaw,
George F. Werner
500 Fifth Avenue, LO-4-3000
(area code 212)

BOSTON (16):
William S. Hodgkinson, Donald R. Furth
McGraw-Hill Building, Copley Square,
Congress 2-1160 (area code 617)

PHILADELPHIA (3):
Warren H. Gardner, William J. Boyle
6 Penn Center Plaza, LOcust 8-4330
(area code 215)

CHICAGO (11):
Harvey W. Wernecke, Robert M. Denmead
645 North Michigan Avenue, Mohawk 4-5800
(area code 312)

CLEVELAND (13):
Paul T. Fegley
55 Public Square, Superior 1-7000
(area code 216)

SAN FRANCISCO (11):
R. C. Alcorn
255 California Street, Douglas 2-4600
(area code 415)

LOS ANGELES (17):
Peter S. Carberry, Ashley P. Hartman
1125 W. 6th St., Huntley 2-5450
(area code 213)

DENVER (2):
J. W. Patten
Tower Bldg., 1700 Broadway,
Alpine 5-2981 (area code 303)

ATLANTA (9):
Michael H. Miller, Robert C. Johnson
1375 Peachtree St. N.E., Trinity 5-0523
(area code 404)

HOUSTON (25):
Joseph C. Page, Jr.
Prudential Bldg., Holcomb Blvd.,
Riverside 8-1280 (area code 713)

DALLAS (1):
Frank Le Beau
The Vaughn Bldg., 1712 Commerce St.
Riverside 7-9721 (area code 214)

LONDON W1:
Edwin S. Murphy Jr.
34 Dover St.

FRANKFURT/Main:
Matthée Herfurth
85 Westendstrasse

GENEVA:
Michael R. Zeynal
2 Place du Port

"Headquarters for Business Information"

McGraw-Hill Technical and Business Publications

American Machinist/Metal-
working Manufacturing
Aviation Week and Space
Technology
Business Week
Chemical Engineering
Chemical Week
Coal Age
Construction Methods and
Equipment
Construction Daily
Control Engineering
Electrical Construction
and Maintenance
Electrical Merchandising Week
Electrical Newsletter
Electrical West

Electrical Wholesaling
Electrical World
Electronics
Engineering Digest
Engineering and Mining Journal
E & MJ Metal and Mineral
Markets
Engineering News-Record
Factory
Fleet Owner
Industrial Distribution
National Petroleum News
Nucleonics
Nucleonics Week
Platt's Oilgram News
Platt's Oilgram Price Service
Power

Product Engineering
Purchasing Week
Science Week
Textile World

Overseas only:
Automobile International
(English, Spanish)
Ingenieria Internacional
Construccion (Spanish)
International Management
(English, Spanish)
Portuguese editions)
Metalworking Production
(Great Britain)

Available by subscription only — to qualified persons actively engaged in the field of the publication. For subscription rates and information describing the editorial coverage of any of the above publications, write to: Subscription Manager, Circulation Department, McGraw-Hill Publishing Company, 330 West 42nd Street, New York 36, N. Y.

Brush INSTRUMENTS

The new Brush Recorder Mark 200 made these incredibly crisp tracings. No other recorder in existence can match them. Note the line width. It never varies... regardless of writing velocity, regardless of chart speed. The writing mechanism is electrically signaled by the position-seeking "Metristite" transducer... no parts to wear, infinite resolution, verifiable dynamic 1% accuracy. Traces are permanent, high-contrast, reproducible... on low cost chart paper. The Mark 200 has but three standard controls... attenuator, pen position, chart speed. Such fidelity, simplicity and economy are possible with no other direct writing recorder. Available in both vertical and horizontal models with interchangeable plug-in preamplifiers or signal conditioning push-button controls. Write for details... they'll speak for themselves.

precision and clarity never before achieved...

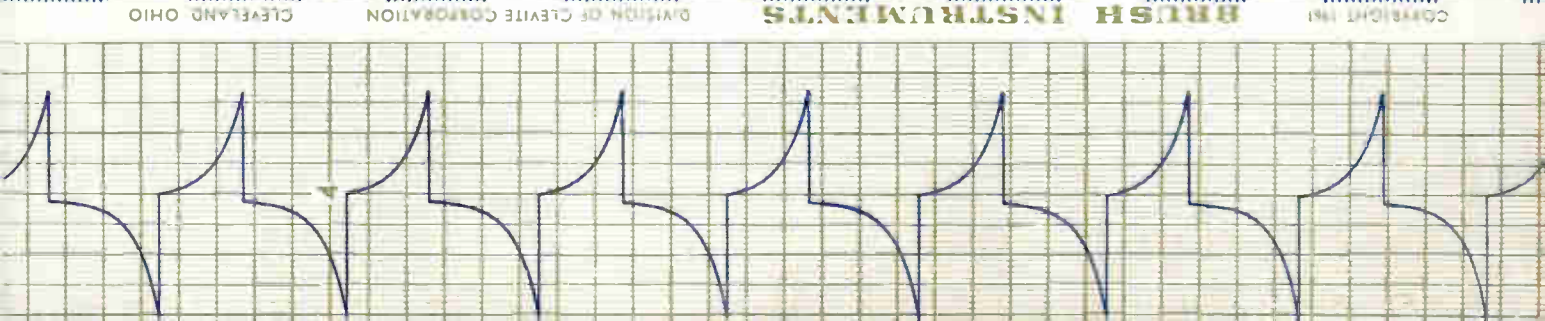
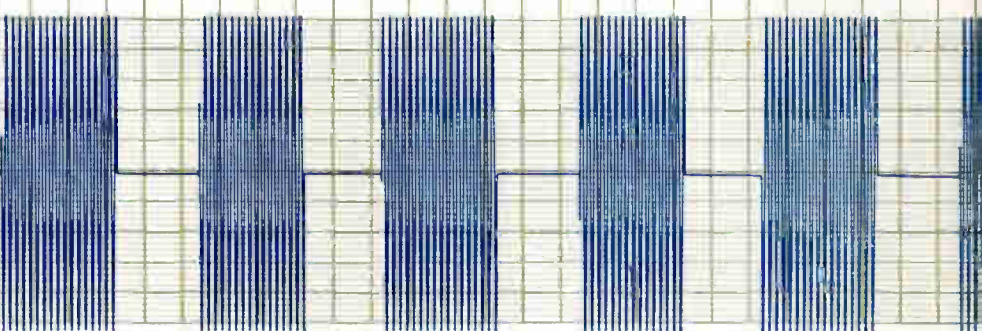
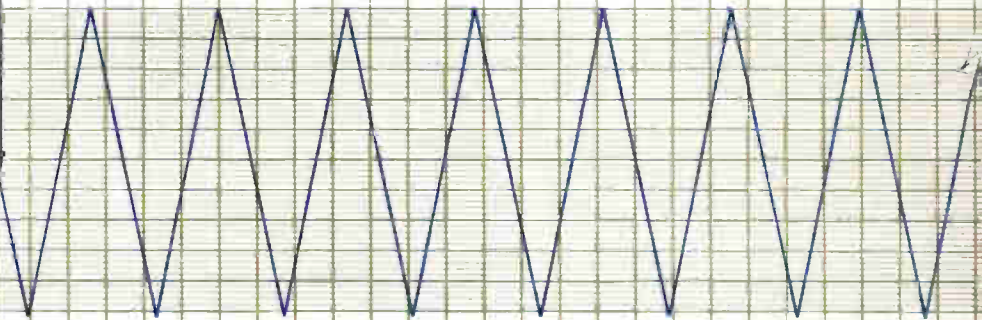
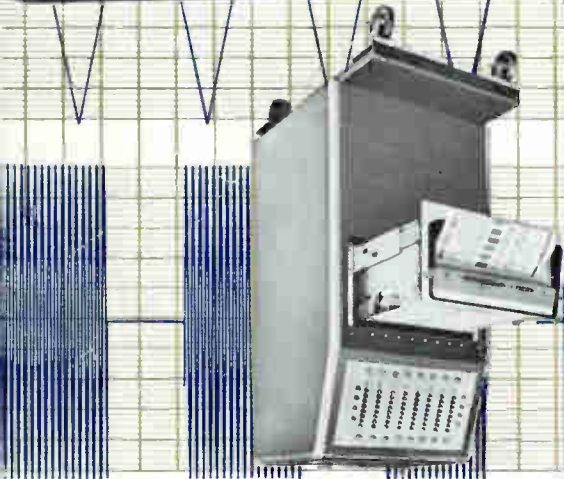
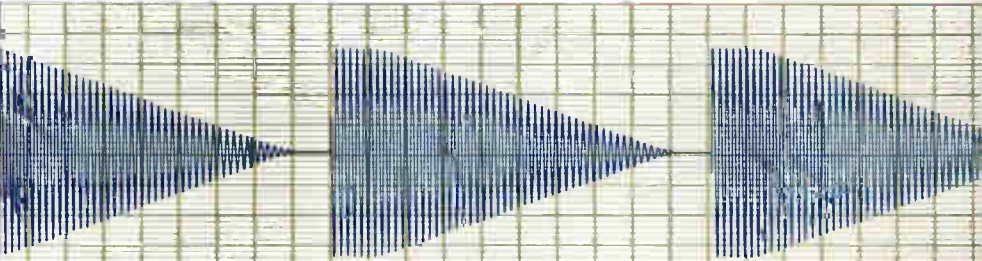

COPYRIGHT 1961

BRUSH INSTRUMENTS

DIVISION OF CLEVELITE CORPORATION

CLEVELAND, OHIO



Unretouched TV Monitor photograph of Echo II collapsing

150
miles
HIGH

RCA-8134 VIDICON IN MINIATURE CAMERA SENDS BACK "LIVE" ACTION TV PICTURES FROM OUTER SPACE



TV pictures of the collapse of Echo II turned a launching failure into a TV triumph—thanks to an RCA-8134 Vidicon in a compact Hallamre Electronics TV camera. From its position in the Thor booster rocket, the camera telecast "live" the balloon's collapse. The pictures are

considered to be the finest ever obtained in "real-time" from space—and enabled scientists to learn immediately what went wrong. As a result they are redesigning the satellite.

The TV camera, just 8" long and 2½" in diameter, was designed around the RCA-8134—an electrostatically-focused, magnetically-deflected Vidicon uniquely adapted to transistorized camera design. With focus coil unnecessary, the Hallamre camera was extremely lightweight and compact—ideal features for space vehicle equipment!



For earth-bound applications, the RCA-8134 is well-suited for industrial or closed-circuit TV. It requires less deflection power, low heater power, and low impedance deflection circuitry. The tube eliminates geometric distortion, provides better corner focus, and offers maximum sensitivity and speed of response.

When your requirements include compact, lightweight, transistorized TV camera design, consider the RCA-8134. For a technical bulletin, write: Section H-19-Q-1, Commercial Engineering, RCA Electron Tube Division, Harrison, N. J.

INDUSTRIAL TUBE PRODUCTS FIELD OFFICES . . . OEM SALES:
Newark 2, N. J., 744 Broad St., HU 5-3900 • Chicago 54, Ill., Suite 1154, Merchandise Mart Plaza, WH 4-2900 • Los Angeles 22, Calif., 6801 E. Washington Blvd., RA 3-8361 • Burlingame, Calif., 1838 El Camino Real, OX 7-1620 • **GOVERNMENT LIAISON:** Harrison, N. J., 415 South Fifth St., HU 5-3900 • Dayton 2, Ohio, 224 N. Wilkinson St., BA 6-2366 • Washington 7, D. C., 1725 "K" St., N.W., FE 7-8500 • **INTERNATIONAL SALES:** RCA International Div., Clark, N. J., FU 1-1000

RCA-8134, electrostatically-focused,
magnetically-deflected Vidicon



The Most Trusted Name in Electronics