

electronics

MILLIMETER WAVE TUBES

Survey of design approaches, p 37

SEQUENTIAL CHROMINANCE

Reduces transmission distortion, p 50

DETECTING RAIL FAULTS

Transistor amplifiers save weight, p 53

Preparing ballistics range for radar study of plasma wakes

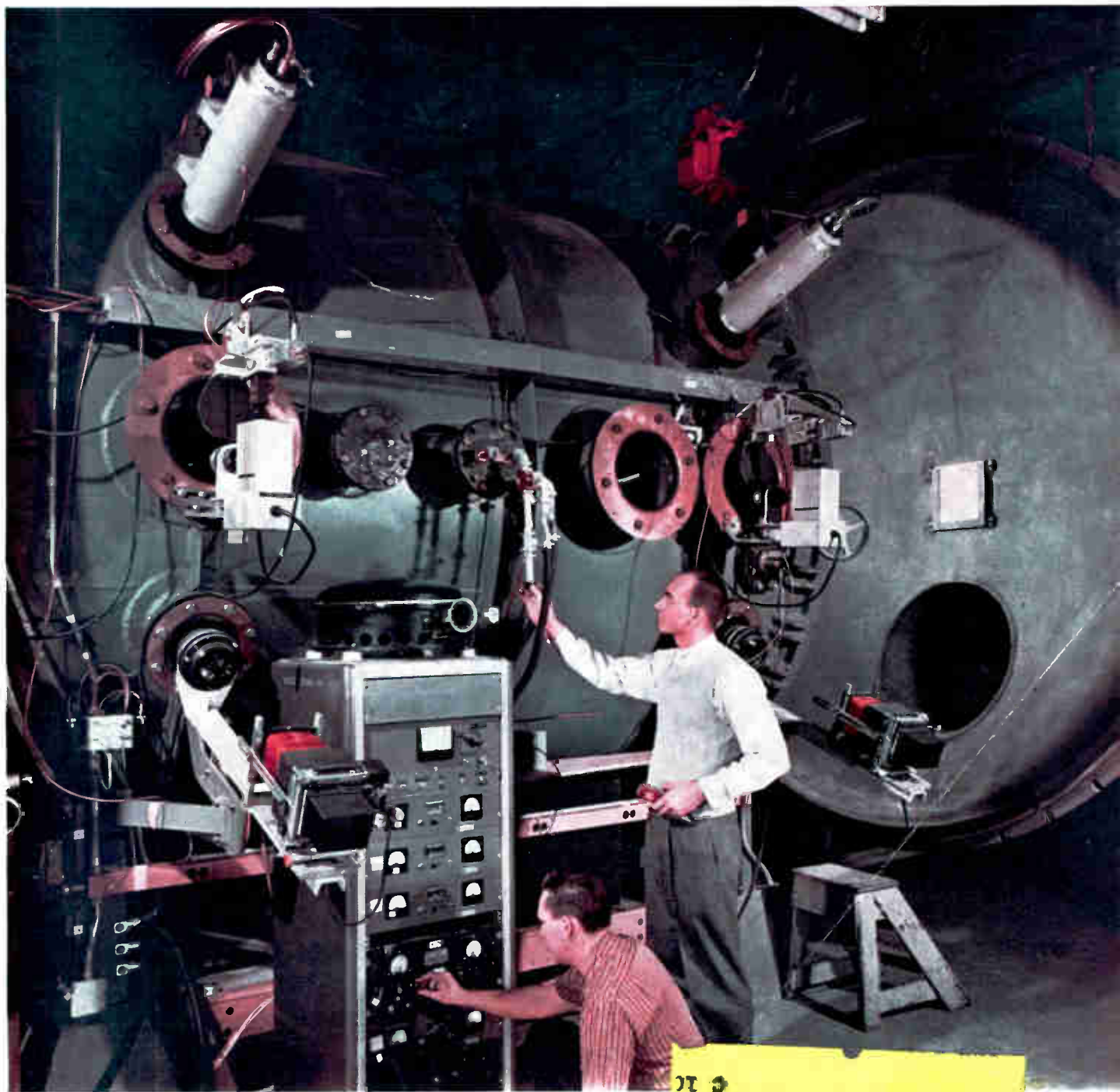

© 1962

ROLAND KISSLER
L 11-
BOX 956
KOSSES LAKE WASH



SPECIAL FILTERS

TO YOUR REQUIREMENTS

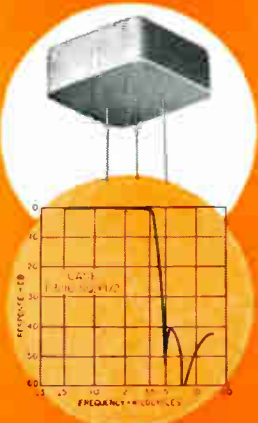

Miniaturized 3.5 KC low pass filter. 10K ohms to .0K ohms. Within 1 db up to 3500 cycles. Greater than 40 db beyond 4800 cycles.

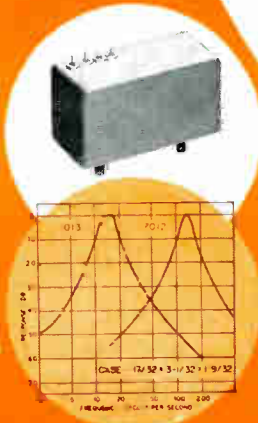

Fifteen cycle and 135 cycle filters for Tacan. 600 ohms to high impedance. Extreme stability -55°C. to $+100^{\circ}\text{C.}$

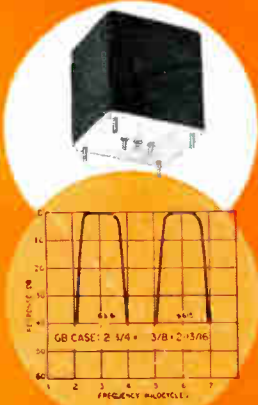

Three KC and 6 KC flat top band pass filters. 400 ohms to 20K ohms. MIL-T-27A; each filter 1.7 lbs.

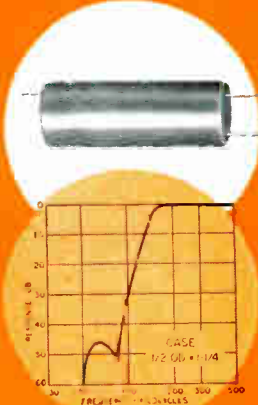

High frequency Mini-filters, .33 oz. MIL-T-27A Grade 3. 150 KC High Pass 3 db to 150 KC, down 45 db below 35 KC. 7500 ohms.

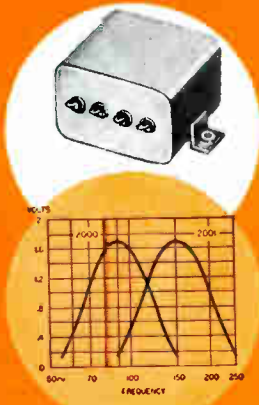

Curves of our miniaturized 90 and 150 cycle filters for glide path systems. $1\frac{1}{4}'' \times 1\frac{3}{8}''$.

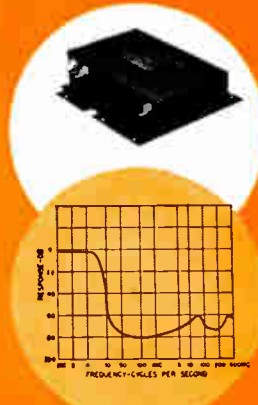

Power line filter from sources of 50 to 400 cycles . . . attenuation from 14 KC to 400 MC . . . 29 cubic inches.

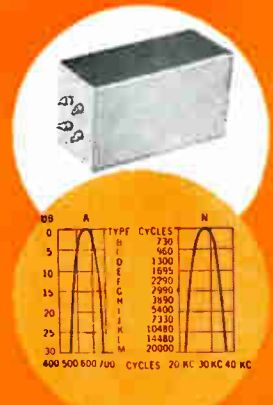

Multi-channel telemetering band pass filters for 400 cycle to 40 KC. Miniaturized units for many applications.

Plus
over 1,000
STOCK ITEMS
with UTC
High Reliability
from your local
distributor



→ write for catalog

UNITED TRANSFORMER CORP.

150 VARICK STREET, NEW YORK 13, N. Y.

PACIFIC MFG. DIVISION: 3630 EASTHAM DRIVE, CULVER CITY, CALIF.
EXPORT DIVISION: 13 EAST 40th STREET, NEW YORK 16, N. Y. CABLES: "ARLAB"

electronics

A McGraw-Hill Publication 75 Cents



W. W. MacDONALD, Editor

J. M. CARROLL, Managing Editor
 SENIOR EDITORS: Samuel Weber, George W. Sideris. SENIOR ASSOCIATE EDITORS: William E. Bushor, Michael F. Wolff. ASSOCIATE EDITORS: Michael F. Tomaino, Sylvester P. Carter, William P. O'Brien, John F. Mason, Thomas Emma, Sy Vogel, Leslie Solomon, George J. Flynn, Laurence D. Shergalis. ASSISTANT EDITORS: Nilo Lindgren, Stanley Fraud, Stephen B. Gray, Roy J. Bruun, George V. Novotny, Leon H. Dulberger. REGIONAL EDITORS: Harold C. Hood (Pacific Coast, Los Angeles), Thomas Maguire (New England, Boston), Cletus M. Wiley (Midwest, Chicago). ART DIRECTOR: Harry Phillips; Howard R. Berry. PRODUCTION EDITOR: John C. Wright, Jr. EDITORIAL ASSISTANTS: Gloria J. Meurer, Bernice Duffy, Lorraine Rossi, Virginia T. Bastian, Lynn Emery, Bette H. Snyder, Rosemary Abbruzzese, Judy Haskins, Ann Mella. FOREIGN NEWS BUREAU: Director, John Wilhelm, Alyne Elias. LONDON—John Shinn, Derek Barlow, Nicholas Landon. Bonn—Peter Forbath, James Morrison, Silke McQueen. Paris—Robert Farrell, Arthur Erikson. Milan—Gene DiRaimondo. Mexico City—Bruce Bendow. Rio de Janeiro—Leslie Warren. Moscow—Stewart Ramsey. Tokyo—Richard Halloran, Charles Cohen, John Yamaguchi.

JAMES GIRDWOOD, Publisher

INSTRUMENTATION at Avco-Everett Research Lab will measure phase shift and attenuation of microwave signals passing through plasma wake of projectile. See p 60 **COVER**

SPORADIC-E. Improved rocket techniques are expected to provide accurate daytime measurement. *Reliable prediction of sporadic-E would permit regular use for long-distance communications* 18

ROAD RADIO to Have 900-Mile Antenna. Only motorists along toll roads would hear broadcasts. *Cost estimate is \$1 million* 19

ARMY SEEKS \$3,817 MILLION. Appropriations request for research, development, test and engineering, missiles and equipment goes to Senate. *Here's a rundown of contract opportunities in the 1963 fiscal year* 26

ALL-CHANNEL BILL Stirs UHF Tv Field. While the marketing picture is still hazy, manufacturers say expansion of uhf tv would push technical development. *Full impact won't be felt for three to five years* 28

AIR-TO-GROUND TELEPHONE Trials Are Expanded. Passengers in aircraft over the northeastern states can talk to anybody on the ground. *Licenses to provide the service nationally are sought* 28

MILLIMETER-WAVELENGTH TUBES: Survey of New Approaches. Discusses backward-wave oscillators, carcinotrons, reflex klystrons, traveling-wave tubes, magnetron amplifiers and linear magnetrons. *Recent developments deal with design of cathodes, cooling, miniature construction and field geometry.* By W. W. Teich, Raytheon Co. 37

DRIFT CONTROL Provides Accurate Expansion Scales for SWR Meter. Each sector of normal decibel range of standing-wave indicator is expandable and automatically normalized upon expansion. *This makes instrument valuable for making attenuation measurements.* By D. L. Howard, Hewlett-Packard Co. 45

TRANSISTOR PAIRS Improve Emitter Follower Performance. Compounded emitter followers have higher input impedances and gains and lower output impedance than conventional emitter followers. *But an emitter-squared follower using a complementary transistor pair is even better.* By T. K. Hemingway, English Electric Aviation, and J. Willis, Southern Instruments 48

Contents continued

Published weekly, with Electronics Buyers' Guide and Reference issue, as part of the subscription, by McGraw-Hill Publishing Company, Inc. Founder: James H. McGraw (1860-1948).

Indexed Annually in Buyers' Guide and Reference issue.

Title ® registered U.S. Patent Office; © Copyright 1962 by McGraw-Hill Publishing Co., Inc. All rights reserved, including the right to reproduce the contents of this publication, in whole or in part.

Executive, editorial, circulation and advertising offices McGraw-Hill Building, 330 West 42nd Street, New York 36, N. Y. Telephone Longacre 4-3000. Teletype TWX N.Y. 1-1636. Cable McGrawhill, N. Y. PRINTED IN ALBANY, N. Y.; second class postage paid at Albany, N. Y.

OFFICERS OF THE PUBLICATIONS DIVISION: Nelson L. Bond, President; Shelton Fisher, Wallace F. Traendly, Senior Vice Presidents; John R. Callahan, Vice President and Editorial Director; Joseph H. Allen, Vice President and Director of Advertising Sales; A. R. Venezian, Vice President and Circulation Coordinator; Daniel F. Crowley, Vice President and Controller.

OFFICERS OF THE CORPORATION: Donald C. McGraw, President; Hugh J. Kelly, Harry L. Waddell, Executive Vice Presidents; L. Keith Goodrich, Executive Vice President and Treasurer; John J. Cooke, Vice President and Secretary.

Subscriptions are solicited only from those actively engaged in the field of the publication. Position and company connection must be indicated on orders. Subscription rates: United States and Possessions, \$6.00 one year; \$9.00 two years; \$12.00 three years. Canada, \$10.00 one year. All other countries \$20.00 one year. Single Copies, United States and Possessions and Canada 75¢. Single copies all other countries \$1.50.

THE PUBLISHER, UPON WRITTEN REQUEST FROM ANY SUBSCRIBER TO OUR NEW YORK OFFICE, AGREES TO REFUND THAT PART OF THE SUBSCRIPTION PRICE APPLYING TO COPIES NOT YET MAILED.

Subscribers: Please address all correspondence, change of address notices, subscription orders or complaints to Fulfillment Manager, Electronics, at above address. Change of address notices should provide old as well as new address, including postal zone number if any. If possible, attach address label from recent issue. Allow one month for change to become effective.

Postmaster: Please send Form 3579 to Fulfillment Manager, Electronics, 330 West 42nd Street, New York 36, New York.



Audited Paid Circulation

CONTENTS continued

KILLING MULTICOLORED GHOSTS on French Television. Proposed color tv system is simplified with f-m subcarrier modulation that reduces transmission distortion by using sequential chrominance. *This is a feature of the Secam system, now contending with a version of our NTSC system to become the standard for French color tv.*
By Pierre Cassagne and Maurice Sauvanet, Campagne Francaise de Television 50

DETECTING RAIL FAULTS With Transistor Pulse Amplifiers. Circuits using an additional transistor for temperature compensation amplifying 8-msec, 10-microvolt pulses from magnetic pickup and drive chart recorder. *Use of light-weight amplifiers permits use of road-rail trucks instead of railroad cars for fault monitoring.*
By H. W. Keevil, Association of American Railroads 53

DEPARTMENTS

Crosstalk. <i>Our Strength in Space</i>	3
Comment. <i>More on Electromagnetic Biology. Components Report</i>	4
Electronics Newsletter. <i>More to Come</i>	7
Washington Outlook. <i>FCC Freezes Radio Station Licenses, Plugs F-M</i>	12
Meetings Ahead. <i>Artificial Intelligence, AIEE Winter General Meeting</i>	32
Research and Development. <i>Unijunction Transistor Pulse-Circuit Design</i>	58
Components and Materials. <i>Report on Components Conference, Progress in Passive Thin-Film Units</i>	62
Production Techniques. <i>Rigid Controls Improve Transistor Reliability</i>	66
New Products Design and Application. <i>Low-Cost Data Transmission System</i>	70
Literature of the Week	82
People and Plants. <i>Scientist-Businessman Looks to Record Year</i>	84
Index to Advertisers	94

Our Strength in Space

DEFENSE DEPARTMENT decision to give serious attention to development of an active military force in space is an important step in the right direction. Unfortunately, it doesn't go far enough.

The plan was announced by Deputy Secretary of Defense, Roswell L. Gilpatric, at the Air Force Systems Command/Industry Management Conference in Monterey, Calif. Gilpatric repeated, and to some extent clarified, the DOD's position at the dedication of the Perkins-Elmer Electro-Optical Research and Engineering Center in Wilton, Conn., a week later.

"To date," Gilpatric said, "we have concentrated on communications, meteorology and surveillance satellites in space." Now, he added, in anticipation of the Soviets' ability to use space offensively we must develop offensive weapons to be used protectively against such threats.

Gilpatric gave as an example of "an offensive weapon" a vehicle we could send up to rendezvous with a hostile orbiting craft, identify it, and on command destroy it. Although he did not mention the project by name, the description fits *Satellite Inspector*, formerly known as *Saint*. Gilpatric made it clear he was not talking about bombing from space. "That," he said, "could still be done more effectively from ground based installations."

Praise for the decision is for finally extending our defense to space, long called "the battlefield of a future war." Disappointment lies in the defensive, rather than offensive, character of the extension.

ELECTRONICS deplors the amount of energy going into defensive rather than offensive weapons systems (*Crosstalk*, p 4, Nov. 17, 1961). To date, our space striking force has not gone beyond weaponry the Soviet Union has chosen to demonstrate to the world. We built missiles after we saw theirs. We upgraded the importance of satellites after Sputnik I. Our real energy and creativity, when we weren't matching Soviet hardware, went into systems for defense. For detection, our billion-dollar Ballistic Missile Early Warning System, and our Samos and Midas reconnaissance and detection satellites. To ward off attack, our Nike Zeus. And to sit tight until the whole thing went away, shelters. These

measures may be helpful, but they could never win a war. Our missile striking force may be impressive and match the Russians' rockets, but it will not out-do them.

Our excuse for the lack of offensive weapons in space has been that ground-based ICBMs are more economical and effective than weapons in space-based platforms, or reentering satellites with nuclear warheads, or missiles that take the long way around and come through the back yard (as Khrushchev has said). The fact, however, that we are "anticipating the Soviet's ability to create offensive weapons in space" indicates we believe such weapons are feasible, that their probability is sufficiently certain to warrant development of means to defend ourselves against them, and that despite the fact they'd be "doing it the hard way" their psychological effects at least would be devastating.

American policy is based in many respects on the premise that strength is vital to deter war. It is time to implement this policy in space by channeling our energies to strike in ingenious ways if attacked, rather than just to stave off the enemy's attack. Such an attitude, more than the actual weapons it would spawn, would be a further deterrent to war.

Coming In Our June 1 Issue

LIGHT PIPES. Fiber optics have recently gained prominence as a method to improve precision, brightness and recording at the viewing end of cathode ray tubes. But there are many other ingenious applications for these bundles of light pipes. Next week, Assistant Editor Novotny will chart some of the ways that electronics engineers can use fiber optics.

Another of next week's technical features, by K. Ishii and C. C. Hoffins, of Marquette University, tells how to get more value for the tunnel diode dollar. High-frequency tunnel diodes cost more than lower-frequency diodes. The article reports techniques for raising operating frequencies.

R. B. Hirsch, of RHG Electronics Lab, describes a variable bandwidth filter, continuously adjusted by a d-c control voltage. Another article, on a Q-multiplier or oscillator insensitive to temperature drift of transistor parameters, comes from J. R. Woodbury, of Stanford Research Institute.

ONLY H-K DIGITAL LOGIC

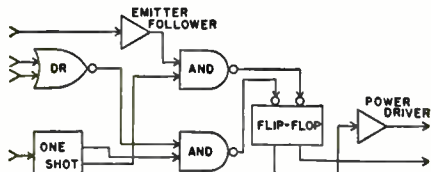

OFFERS THIS



COMBINATION (and over 40,000 others)

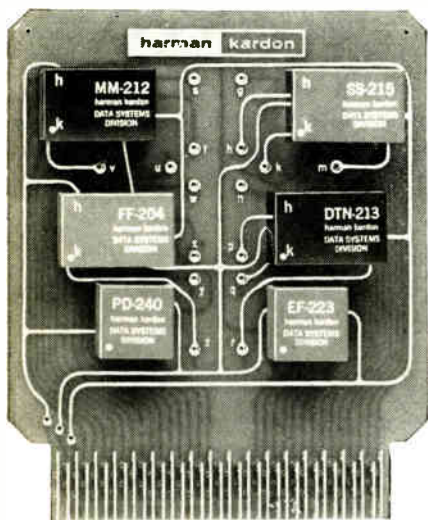

completely assembled
**FROM STOCK
COMPONENTS**
(at competitive prices)

**3 COMPLETE AND COMPATIBLE
LOGIC MODULE SERIES**
250KC • 125°C. • 5/10 MC

Write for complete details—
and free guide to Boolean Algebra!

Data Systems Division

harman kardon

Incorporated ■ Plainview, Long Island

COMMENT

More On Electromagnetic Biology

If someone has implied that A. J. Reynolds has a leaky head gasket, then move over, Brother Reynolds—you have lots of company.

From some crude experiments involving obscure animal and human sensory phenomena, we have also come up with some electromagnetic bionics speculations. Some of these involved paraboloid dishes, rotatable fine-mesh metallic screens, copper shields, and spark oscillators fired through powdered crystals and metallic dusts scattered over vibrated sheets of sandpaper (as hyper-frequency "bar-range jammers").

Our conclusions were that the only way we could explain some of the weird results was to assume that nerves in some way functioned as miniature waveguides, neurons as tiny electrolytic-cell oscillators, and axions as cavity resonators. Their dimensions roughly tally with the rotating screen "cut-off" effects. We suspected some kind of a "carrier" and modulation effect. Nothing conclusive, but this might explain a lot of obscure sensory phenomena.

TED POWELL
Glen Oaks, Queens, New York

Letters from A. J. Reynolds appeared on page 4 of the March 23 and May 4 issues. Letters of rebuttal appeared on page 1 of the April 6 and May 4 issues.

Components Report

Congratulations on the special report on components (p 51, May 11). You have again fulfilled the purpose for which I have subscribed to ELECTRONICS, which is up-to-date information in the industry.

RICHARD P. SMITH
ACF Electronics
Riverdale, Maryland

Those Lab Photos

My grandfather gets a lot of laughs from the tv westerns. The hero always wears a fancy clean shirt and a new hat, looking like he

had just stepped out of a clothing store, and also looking like he had never done a day's work in his life. As my grandfather recollects it from when he was a boy, a cowpoke looked more like a tv badman, meaning not too clean (and as homely as a mud fence) and wearing clothes that had seen much better days.

I like the lab photo on page 79 of the May 11 issue. Those men are in shirtsleeves and really look like they know what they're doing with that X-band setup.

Or look at page 49 of the April 27 issue. Looking at that narrow-band tv lashup, I feel that the author has put plenty of sweat into those circuits.

Now take a look at the lab shots in some other issues. Here is some guy in a new jacket, looking at the apparatus as though he'd never seen it before. The gadget itself is in a closed case. The table is clean, the background seems to be a newly-painted wall, and there isn't anything else in sight except a meter or a scope.

TONY CHURCH
Enid, Oklahoma

Capacitance Meter

In the March 23 *Research and Development* article on page 64, Capacitance Meter Has Linear Scale, by W. Mosinski, what transistor and diode types does the author recommend for this meter.

L. SCHREIBER
AB Deber-Kontroll
Lidingo, Sweden

Author Mosinski recommends:

All *mpn* transistors (Q_1 , Q_2 , Q_3) are 2N396 or similar, all *npn* transistors (Q_4 , Q_5 , Q_6) are 2N233. Diodes D_1 and D_3 are 1N34A, diode D_2 is 1N461. All resistors are half-watt, ten-percent. Other components vary with the range:

Range	C_1, C_2	R_1	Meter
0-1 μ f	0.05 μ f	3.3K	0-1ma
0-0.1 μ f	0.005 μ f	"	"
0-0.01 μ f	0.0005 μ f	"	"
0-0.001 μ f	50pf	"	"
0-100pf	50pf	33K	0-100 μ a

Capacitor C_1 is between the Q_1 collector and the Q_2 base, C_2 is between the Q_1 base and diode D_3 . Ranges above 1 μ f would require further circuit modifications.

Why engineers
are specifying **VK** Capacitors
for CK Capacitor requirements...

VITRAMON, INC. SUPPLIES
PROOF
OF PERFORMANCE
with every shipment



The "proof of performance" for all CK Capacitors ("VK" Capacitors purchased against MIL-C-11015/18 or /19) is enclosed with your order! Automatically and voluntarily, "Vitramon" supplies copies of Acceptance Testing Data — with every shipment.

And test results are impressive! Where absolute conformance to military specifications is essential, CK Capacitors adhere closely to requirements. In critical areas where specifications may be surpassed, CK Capacitors offer reliability "above and beyond." Here's how they measure up:

DISSIPATION FACTOR

MIL. REQUIREMENT	ACTUAL PERFORMANCE
2.5% <i>for all values</i>	1.5% <i>for values thru 680 mmf.</i>
	2.5% <i>for values 820 thru 10,000 mmf.</i>

TEMPERATURE COEFFICIENT

MIL. REQUIREMENT	ACTUAL PERFORMANCE
+30% -56% <i>for all values</i>	±10% <i>for values thru 680 mmf.</i>
	±15% <i>for values 820 thru 10,000 mmf.</i>

CK Capacitors are checked 100% for dissipation factor and capacitance, and to insure that the parts stay within tolerance, only 2/3 of the available capacitance band is used. Parts are checked for Insulation Resistance after being subjected to a seal test consisting of exposure in live steam for 2½ hours under 15 p.s.i. Parts are also gauged 100% for physical dimensions.

MIL PARTS
NOW IN STOCK!

VK Micro-miniature
CERAMIC CAPACITORS
Conforms with MIL-C-11015/18/19



VK 30
case size:
0.3" square
lead spacing:
0.2"



VK 20
case size:
0.2" square
lead spacing:
0.2"

- 10–10,000 mmf
- -55° C to 150° C
- 200 VDC rating

Vitramon[®]
INCORPORATED
P. O. Box 544
Bridgeport 1, Connecticut

PSI ZENER DIODES

Meet your
MIL-design
requirements
on every count

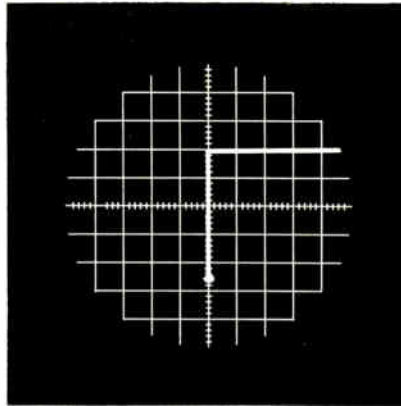

*MIL-S-19500/117 (NAVY)

EIA Type Number	Zener Voltage @ Test Current (Volts)	Test Current (I_z mA)	Dynamic Resistance (ohms)	Maximum Voltage Change 0.1 to 5 mA (volts)
1N962B	11	11.5	9.5	0.50
1N963B	12	10.5	11.5	0.55
1N964B	13	9.5	13.0	0.60
1N965B	15	8.5	16.0	0.70
1N966B	16	7.8	17.0	0.75
1N967B	18	7.0	21	0.85
1N968B	20	6.2	25	0.95
1N969B	22	5.6	29	1.05
1N970B	24	5.2	33	1.15
1N971B	27	4.6	41	1.30
1N972B	30	4.2	49	1.45
1N973B	33	3.8	58	1.60
1N974B	36	3.4	70	1.75
1N975B	39	3.2	80	1.90
1N976B	43	3.0	93	2.10

Forward Current @ 25°C @ 1.5 Vdc 200 mA min

EXCEPTIONAL VOLTAGE REGULATION — Exclusive manufacturing and processing techniques enable PSI to supply you with a complete line of subminiature military zeners offering the best voltage regulation characteristics available today. As indicated in the trace, these diodes demonstrate a virtually non-existent voltage deviation over a wide range of current levels. To assure you of top performance and stability under all conditions, *PSI zeners are 100% scope checked—soft knees, hysteresis and double breaks are completely eliminated.* This outstanding voltage regulation capability is one of the main reasons why PSI is the industry's prime supplier of zeners qualified to MIL-S-19500/117 (NAVY)*

MIL-S-19500/127 (NAVY)

1N746A	1N749A	1N752A	1N755A	1N758A
1N747A	1N750A	1N753A	1N756A	1N759A
1N748A	1N751A	1N754A	1N757A	

1N750 is also qualified to MIL-E-1/1238 (Sig C)

MIL-E-1/1238 (SIG-C)

1N709	1N716	1N718	1N720	1N722
-------	-------	-------	-------	-------

UNEQUALLED DEVICE STABILITY — The unique, high thermal efficiency of the PSI zener packaging provides the heat transfer necessary for extremely low junction temperature and 500-mW dissipation—you are assured of getting the industry's most time-stable zeners. These devices have consistently demonstrated voltage stability figures in excess of .003% / thousand hours.

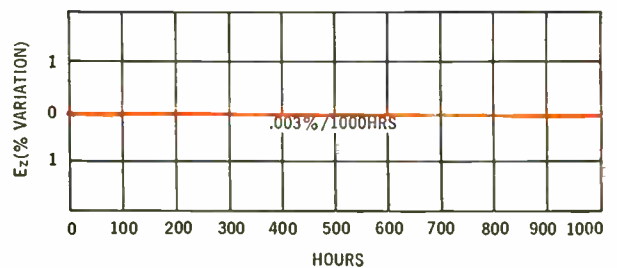

PREDICTABLE TEMPERATURE COEFFICIENTS

—Due to the outstanding time/voltage stability and voltage regulation characteristics of PSI zeners, you can select the *exact* PSI devices required to provide a zero temperature coefficient, or accurately predict TC's at specific current and voltage levels.

TYPICAL TEMPERATURE COEFFICIENT VERSUS ZENER CURRENT. E_z MEASURED AT 5mA

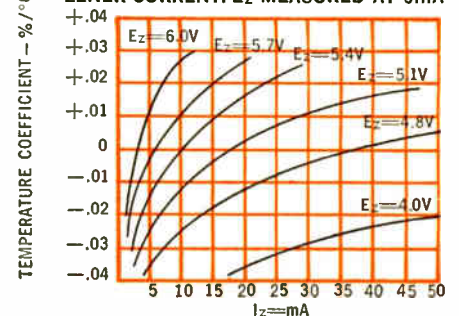

For your military or industrial zener diode requirements, you'll be ahead on every count when you specify PSI. These units are immediately available in production quantities through PSI sales offices and authorized distributors in major electronic centers from coast-to-coast.



TRW Electronics



Pacific Semiconductors, Inc.

SUBSIDIARIES OF THOMPSON RAMO WOOLDRIDGE INC.

12955 CHADRON AVENUE, HAWTHORNE, CALIF.

ELECTRONICS NEWSLETTER

Navy Tests Around-the-World Radar

NAVAL RESEARCH LAB is using over-the-horizon radar techniques to test the possibility of observing effects from Pacific nuclear bursts on a round-the-world basis.

In a recent NRL experiment, receiving and transmitting antennas were placed back-to-back for around-the-world transmission. One very successful evening operation was reported.

Frequencies used were in the 15-Mc to 18-Mc range. Around-the-world pulses were stretched up to 350 nautical miles at times. The spectral bandwidth of principal energy seemed to be about two cps. Azimuthal angle of arrival was noted to vary ± 10 degrees from the reciprocal transmitted bearing.

Signal levels at receiver terminals ran from 20 to 100 mv. This gives total transmission loss from the transmitter output terminals to receiver input of about 170 db.

Navy has at least two projects underway to detect and track missile launchings and trails at long range. One is Project Madre (Magnetic Drum Receiving Equipment) using over-the-horizon radar. The other is Project Teepee, a radio monitoring method to detect missile trails and nuclear explosions using ionospheric backscatter from high-frequency radar transmitters.

Steered Dipole Antenna Improves Overseas Radio

TRANSOCEANIC communications at frequencies of 12 to 18 Mc and higher are reportedly improved by an electronically steered antenna jointly developed by the Army Signal Corps R&D Lab and Avco's Ordnance and Electronics division.

Iscan (inertialless steerable communications antenna) consists of 24 vertical dipoles arranged non-uniformly along a line 14 miles long. Antenna signals are combined through delay lines. The processing center has 14 signal outputs, each corresponding to a different reception angle fixed in space regardless of frequency. Several receivers can be connected to each output, allowing reception of many hundreds of emissions simultane-

ously, according to Avco.

In one transatlantic pulse test, interference was cleared by picking up echoes arriving at different angles and times and channeling them to separate receivers using electronic switches.

Laser Output Amplified By Operation in Tandem

NET GAINS up to 28 db in output of a pulsed ruby laser have been obtained, Raytheon announced this week, by operating two lasers in tandem. The company says the technique overcomes feedback and may make feasible chains of two or more lasers with the advantage of more readily modulated low-power stages. Higher gains are anticipated.

One laser is operated as an oscillator, pumped at approximately 250 joules. The other laser, triggered after the oscillator, operates as an amplifier. It is pumped at about 2,000 joules. Outputs of the two lasers are monitored by phototubes and compared on a dual-beam oscilloscope.

If one spike follows another

IRE Voting Yes

ALTHOUGH the count won't be official until July 10, there are already more than enough proxies received at IRE headquarters to insure the merger of IRE with AIEE, according to George Bailey, IRE Executive Secretary.

Returns are nine to one in favor of the merger, says Bailey, and the total is running far in excess of any previous vote taken by the organization, indicating a high interest in the question

within a few microseconds, the second spike is amplified much less than the first. The cause, temporary exhaustion of available energy states, is being studied, said Peter P. Debye, head of Raytheon's Infrared and Optical Research Lab. Developers are Said Koozekanani, Mikael Ciftan and Andre Krutchkoff.

Radiotelescope Project Gets Underway Again

WASHINGTON—New contractors are taking over construction of the National Science Foundation's 140-foot steerable radiotelescope at Greenbank, Va. The project has more than doubled in cost and has slipped over two years in schedule, due mainly to fabrication problems.

Cost estimate now is \$13.5 million with completion in 1964. The new contracts for fabrication of the shaft and yoke and their on-site erection, totaling \$1,574,060, were awarded Westinghouse Electric, Sun Shipbuilding and Pacific Crane and Rigging.

Balloon Bounce Tests Will Use Dish Array

BOSTON—Four 30-foot parabolic antennas forming a square array at Ohio State University will be used in one of the Air Force communications experiments planned when the 135-foot rigidized Echo II is launched. The array will operate as single antenna to achieve higher sensitivity. The communications group at Electronic Systems Division, Bedford, Mass., also plans Echo II experiments using a new 60-foot dish at Rome Air Development Center, and a transportable communications terminal at Model City, N. Y.

Australia Agrees to U. S. Navy's Big Radio Station

MELBOURNE—Prime Minister Robert Menzies has announced that the United States will build a radio station costing about \$140 million on the North West Cape in Australia, 700 miles north of Perth.

(Previous reports have indicated

that the station, like the vlf station in Cutler, Me., would be used to communicate with Polaris submarines. The dispatch from Melbourne states that the radio station is intended as a communications center for American and allied ships in the Indian Ocean and the western Pacific.)

The U. S. will finance the entire project. About half the cost is for the station and half for housing and other construction. Construction is scheduled to begin early next year and to be completed in late 1965.

Air Potential Monitors Detect Lightning Danger

PATRICK AFB, FLA., will soon get a system to warn of impending lightning dangers, so missile crews can take advance measures to protect against electrical component damage or fueling hazards. A missile on a launching pad acts like a big lightning rod.

Two sensing devices are used. An inverted bowl on a high mast detects the sudden change in air potential—from negative to positive and back to negative—during lightning discharges. A needle-pointed rod detects slowly varying changes in air potential, as measured by current flow into the atmosphere from the point.

Warning lights on nine sensitivity threshold channels and a recorder indicate potential trends. Lightning can be detected at ranges to 100 Km. Air Force Cambridge Research Lab and A. D. Little developed the system.

Nuclear Reactor Rocket Space Vehicle Ordered

WASHINGTON—Lockheed Missile and Space Co. has won an estimated \$180-million contract from NASA to design, develop, fabricate and test Rift (Reactor In Flight Test) by 1966-67. The Rift flight vehicle will test Nerva (Nuclear Engine for Rocket Vehicle Application) under development by Aerojet-General with Westinghouse Corp. as prime contractor. Lockheed will build nine test vehicles. First stage of the advanced Saturn will boost

the nuclear engine into space for powered flight. Nerva will provide thrust by using reactor heat to turn liquid hydrogen into the hot gas ejected from the rocket nozzle.

Regional R&D Libraries Sponsored by Government

TWELVE regional technical report centers are being established by the National Science Foundation and the Department of Commerce's Office of Technical Services. The centers will give scientists and engineers access to complete collections of the government's unclassified scientific and technical reports, bibliographies and other reference material.

Department of Defense, NASA and AEC have agreed to provide copies of their reports for each center. The centers will be at Georgia Institute of Technology, Atlanta; Massachusetts Institute of Technology, Cambridge; John Crerar Library, Chicago; Southern Methodist University, Dallas; University of Colorado, Boulder; Linda Hall Library, Kansas City, Mo.; University of California, at both Berkeley and Los Angeles; Columbia University, New York; Carnegie Library of Pittsburgh; University of Washington, Seattle, and the Library of Congress, Washington, D. C.

British Electronics Gains Fifteen Percent in 1961

LONDON—Sales by the United Kingdom's electronic equipment industry in 1961 amounted to \$376 million, a gain of about 15 percent over 1960. Non-government sales gained 20 percent, from \$161 million in 1960 to \$195 million in 1961.

Exports amount to more than \$87 million of the total 1961 civil sales. Radar and navigational equipment led the way in overseas sales at more than \$25 million, followed by radio communication equipment at \$24 million.

Computers sales were more than \$30 million. Although there was a more than \$7 million gain in computer sales, computer exports fell during the year to \$3.6 million, a drop of almost \$3 million.

In Brief . . .

REPORTS circulating in Melbourne say the USSR has requested a satellite tracking station on Australian territory. The Australian government declined comment.

MAXSON ELECTRONICS has been approved as a prime producer for Navy's Bullpup air-to-surface missile.

GENERAL PRECISION'S Link division will produce C-135 flight simulators using digital computation, under a \$1-million letter contract from Air Force.

SCHEDULE for NBS's radio station WWVH will be changed effective July 1. Instead of four three-minute silent periods each hour, there will be one, at 15 to 19 minutes past each hour.

RCA HAS a \$35.5-million contract from Boeing for the electronic monitoring and launch command network for the first Minuteman ICBM wing, to be located in Montana.

RAYTHEON got a \$19.8-million follow-on contract from Army for Hawk missile guidance production.

BENDIX received a \$5-million letter contract from Army for air-transportable ground terminals to be used with NASA's Syncom satellite communications system.

AIR FORCE awarded GE \$10 million in contracts for radar, air weapons control and aircraft electronic equipment.

OTHER MAJOR military contracts include \$3.6 million to Midwestern Instruments for aircraft malfunction monitor components; \$2.5 million to Electronic Communications for uhf ground terminals; \$1.3 million to Motorola for development of ground-air radios; \$660,912 to Decitron Electronics for shipboard antennas; \$507,738 to Siltronics for d-c generators for field radios.

VARO has a \$14-million NATO contract for static inverters. These will be made in Garland, Texas. Varo and Atlas Werke AG have formed a joint venture to produce static power systems in Germany for the European market.

New from Sprague!

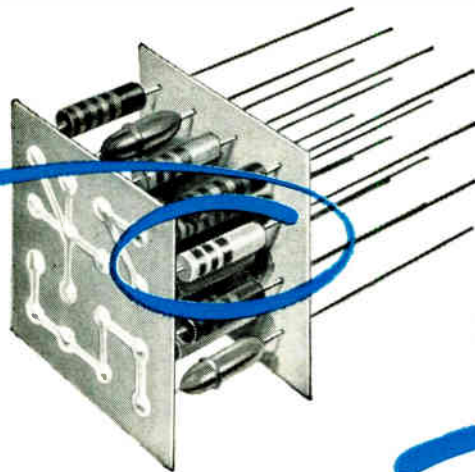

Module and
components
2x actual size

SUBMINIATURE CERAMIC CAPACITORS ESPECIALLY DEVELOPED FOR "CORDWOOD" PACKAGING

Sprague's ALL-NEW Type 252C Tubular Ceramic Capacitors give you a combination of features found in no other single capacitor!

TINY! Only $\frac{1}{4}$ " long, and less than $\frac{1}{8}$ " in diameter

Size is compatible with diodes and resistors for "cordwood" packaging

Can be furnished on lead tape for automatic insertion

Extremely stable - very little capacitance change with temperature

High insulation resistance, high dielectric strength

Stand up under extreme humid atmospheric conditions

Available now in standard ratings from 5 pF to 360 pF, 100 vdc

Operating temperature range, -55 C to +85 C

Standard capacitance tolerances; $\pm 20\%$, $\pm 10\%$, $\pm 5\%$

For complete technical data on Type 252C Ceramic Capacitors, write for Engineering Bulletin 6151 to Technical Literature Section, Sprague Electric Company, 35 Marshall Street, North Adams, Massachusetts.

SPRAGUE COMPONENTS

CAPACITORS
TRANSISTORS
MAGNETIC COMPONENTS
RESISTORS
MICROCIRCUITS

INTERFERENCE FILTERS
PULSE TRANSFORMERS
PIEZOELECTRIC CERAMICS
PULSE-FORMING NETWORKS
TOROIDAL INDUCTORS

HIGH TEMPERATURE MAGNET WIRE
CERAMIC-BASE PRINTED NETWORKS
PACKAGED COMPONENT ASSEMBLIES
FUNCTIONAL DIGITAL CIRCUITS
ELECTRIC WAVE FILTERS



'Sprague' and '®' are registered trademarks of the Sprague Electric Co.

another **Si**  series from **MOTOROLA**

in the standard TO-5 package
types 2N2217, 2N2218 and 2N2219

or in the standard TO-18 package
types 2N2220, 2N2221 and 2N2222 . . .

silicon epitaxial Star* planar transistors

Since the introduction of Motorola's silicon epitaxial Star planar transistor series, many users have commented on its performance. One company is using this new transistor "... because of its outstanding gain at only 2.5 microamperes."

At the other end of the current spectrum, another manufacturer reports the highest gain at high current levels of any type he has previously tried. Both firms made note of the Star planar's unusually high frequency response.

To still another firm the overall broad-range performance of the Star has meant being able to reduce the number of different devices required in their equipment from 7 types to 1 type.

Now for your new circuit designs you can plug in "performance" previously unavailable in any device at any price. And these new Motorola units are priced competitively with older type devices . . . with prices as low as \$3.90 each in quantity.

Determine for yourself what a difference a Motorola Star planar can make in your circuit designs. Check the specifications, and if you have a bona fide application for any of these remarkable new transistors, contact your nearest Motorola District Office. A sales engineer will advise you how you may obtain free samples.

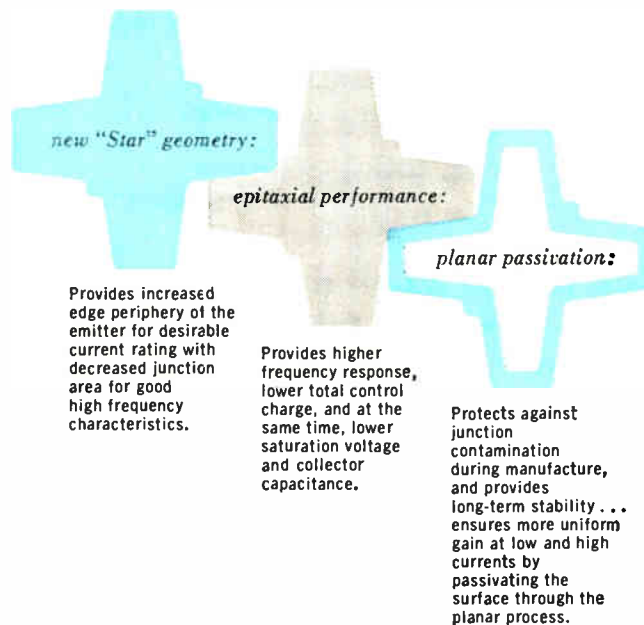

*Star is a trademark of Motorola Inc.



For additional information on Motorola Star planar transistors contact your nearest Motorola District Office

- BOSTONIVanhoe 4-5070
- CHICAGOAVenue 2-4300
- CLEVELAND 831-1440
- DALLAS LAkeside 6-8931
- DAYTON AXminster 3-4164
- DETROIT BRoadway 3-7171
- GARDEN CITY CH 8-8444
- LOS ANGELES ... HOLlywood 2-0821
- MINNEAPOLIS Liberty 5-2198
- NEW YORK GRegory 2-5300
..... Wisconsin 7-7837
- ORLANDO Midway 7-2507
- PHILADELPHIA TUrner 7-7020
..... WAverly 7-6144
- PHOENIX 273-6364
- SAN DIEGO 297-4961
- SAN FRANCISCO ... DIamond 2-3228
- SYRACUSE GRanite 4-3321
- WASHINGTON JUniper 5-4485
- CANADA (Toronto) . PLymouth 9-2222
- OUTSIDE U.S.A. Motorola International Semiconductor Sales, Phoenix, Cable MOTSEM

- 2N2217
- 2N2218
- 2N2219
- 2N2220
- 2N2221
- 2N2222

HERE ARE THE NEW MOTOROLA SILICON EPITAXIAL STAR PLANAR TYPES

COMPARE THESE PERFORMANCE ADVANTAGES OVER OLD TYPE UNITS!

400% HIGHER GAIN BANDWIDTH PRODUCT
The "Star" geometry's smaller emitter area and Motorola's advanced diffusion techniques combine to improve high frequency performance.

ONE-FIFTH THE OUTPUT CAPACITANCE
The reduced area of the "Star," plus the high resistivity epitaxial layer combine to substantially lower collector capacitance.

ONE-SEVENTH THE SATURATION VOLTAGE
With the low substrate resistance of the epitaxial process, collector saturation voltage is greatly reduced.

EXTENDED BETA RANGE — 10 μA to .5 AMPS
Passivated to stabilize characteristics and eliminate surface recombination effects, the Motorola "Star Planar" provides more uniform gain at low and high current.



TO-5 Package (P _o = 0.8 watts)	2N2217	2N2218	2N2219
TO-18 Package (P _o = 0.5 watts)	2N2220	2N2221	2N2222
h _{FE} @ I _C = 150 mA	20-60	40-120	100-300
V _{CE(sat)} volts (max) I _E = 500 mA I _B = 50 mA	—	1.6	1.6
C _{ob} I _E = 0, V _{CE} = 10 V	8 picofarads (maximum) — All Types		
f _T I _C = 20 mA, V _{CE} = 20 V	250 mc (minimum) — All Types		
Switching Time (total) non-saturated	12 nsec (typical) — All Types		
Switching Time saturated	I _{on} I _{off}	26 nsec (typical) — All Types 66 nsec (typical) — All Types	

All values at 25°C ambient



MOTOROLA
Semiconductor Products Inc.

A SUBSIDIARY OF MOTOROLA, INC.

1968

5005 EAST McDOWELL ROAD • PHOENIX 8, ARIZONA

WASHINGTON OUTLOOK

STATION LICENSE FREEZE AIDS F-M

FEDERAL COMMUNICATIONS COMMISSION has slapped a freeze on new grants and transfers of radio station licenses. The aim is to give FCC a breathing spell to design new a-m regulations, upgrade the quality of radio service and improve the industry's financial health.

The Commission hopes to channel some of the demand for a-m stations to f-m. A limited freeze on f-m station grants and transfers has been in effect for several months. FCC intends to complete its new rules for f-m and begin granting new f-m licenses before the a-m study is finished, for the agency pointedly suggested that prospective a-m operators should consider f-m.

For f-m, FCC technicians are designing a schedule of available stations for each locality. This is the practice with tv stations, but previously, radio stations applicants have been free to ask for frequencies wherever they can be fitted in. This procedure, with both a-m and f-m, was leading to serious erosion of engineering standards, FCC officials feel.

AIR FORCE SPARES UP AGAIN?

DEFENSE SECRETARY McNAMARA has urged the Senate to restore \$25 million that the House knocked out of the Air Force appropriation for the communication improvement program. Air Force requested \$142.8 million for equipment changes, replacement and modification, and \$145 million for supplies and materials.

In his own budget review, McNamara said, he reduced the program by \$25 million. He said the additional cut voted by the House "would adversely affect the Air Force's ability to carry out the program." Operational inventories of complex new electronic equipment will be "increasing substantially" in 1963, he said, and "a commensurate increase in spare parts will be required."

TAX BREAK FOR MODERN EQUIPMENT

NEW TAX ADVANTAGES to industry will become effective "by July at the latest," says Treasury Secretary Dillion. "Bulletin F," the Internal Revenue Service guide-book, will be revised to liberalize depreciation allowances. Shorter useful lives will be listed for production equipment, in effect reducing a company's tax bill. Treasury officials estimate total tax reduction will be \$1 billion to \$1.5 billion a year.

This is expected to make purchase of modern equipment more attractive. If a company takes a tax benefit but doesn't actually increase its equipment replacement rate, revenue agents will use a new table of "reserve ratios." If the company's depreciation reserves are too high in proportion to depreciable assets, depreciation allowances may be reduced.

The bulletin will also give most industries a vastly simplified listing of useful lives for manufacturing equipment. There will be as few classes as possible—even a single class for many industries.

SUPPLY AGENCY GETS SET





DEFENSE SUPPLY AGENCY'S Defense Electronics Supply Center, headquartered at Gentile Air Force Station, Dayton, Ohio, will begin operations July 1 by taking over supply management of about 400,000 items now under control of Dayton Air Force Depot and Rome Air Materiel Area. DESC is the new military agency in charge of procurement of common-use electronic items for all military agencies (ELECTRONICS, p 28, Jan. 19).







PRECISION FORK OSCILLATORS and FREQUENCY STANDARDS

Whatever your need . . . whatever your problem . . . in frequency ranges from 1 to 40,000 cycles, American Time Products has the package and/or the experience to assist you. For over 20 years American Time has been engineering and manufacturing reliable, accurate and rugged frequency standards, fork oscillators, etc. Some are off-the-shelf items. Others are custom developed units and systems such as: 1) tuning fork filters, 2) inverters, 3) precision power supplies, 4) timers, 5) fork optical choppers. For additional information on the sampling of units shown, on American Time's line, or regarding your own special needs, write Department 2613.

BULOVA American Time Products DIVISION

61-20 Woodside Avenue, Woodside 77, N. Y.

Precision Fork Oscillators					
TYPES	5	25	2001-2	50N	30
FREQUENCY	200 to 1,000 cps	200 to 1,400 cps	200 to 4,000 cps	50 to 360 cps	240 to 20,000 cps
ACCURACY	±.002% to ±.5%	±.002% to ±.5%	±.001%	±.05% to ±.01%	±.002% to ±.5%
TEMPERATURE RANGES	-65° to +125°C	-65° to +125°C	+20° to +30°C	-55° to +85°C +15° to +35°C	-65° to +125°C
OUTPUT	Dependent on external circuitry used	Dependent on external circuitry used	Approx 5 at 250,000 ohms	Dependent on external circuitry used	Dependent on external circuitry used
INPUT	28 volts or less	28 volts or less	Heater Volt. 6.3, 12, 28	28 volts or less	28 volts or less
B VOLTAGE			100 to 300V at 5 to 10 ma		
SIZE	5/16 x 3/4 x 3"	23/32 x 3"	3-3/4 x 4-1/2 x 6"	1 x 4-1/4"	1-19/22 x 1-19/22 x 1-1/3"
WEIGHT	1-1/2 oz.	2 oz.	26 oz.	4 oz.	3-1/3 oz.

Precision Frequency Standards						
TYPE	10	27	15	32	52	15P Portable
FREQUENCY	360 or 400 cps	360 to 1,300 cps	360 cps 400 cps	240 to 2,000 cps	30 to 360 cps	360 or 400 cps
ACCURACY	±.005%	±.002% to ±.5%	±10 ppm ±250 ppm	±.002% to ±.5%	±.05% ±.01%	±50 ppm
TEMPERATURE RANGE	+10° to +35°C	-65° to +125°C	-40° to +71°C -40° to +71°C	-65° to +125°C	-55° to +35°C +15° to +35°C	0° to 40°C
INPUT	1.4v at 6 microamps	28 volts or less	1.4v at 6 microamps	28 volts or less	28 volts or less	Self-contained Battery
OUTPUT	0.1 volt	8 volts RMS	1 volt	5 volts	5 volts	1 volt
LOAD	50,000 ohms or more	70,000 ohms or more	50,000 ohms or more	50,000 ohms or more	70,000 ohms or more	50,000 ohms or more
SIZE	1-3/8 x 1-3/8 x 3/8"	23/32 x 3"	1 x 2 x 2-1/4"	1-19/32 x 1-19/32 x 1-1/5"	1 x 4-1/8"	1 x 2 x 3-1/2"
WEIGHT	3/4 oz.	2 oz.	4 oz.	3-1/2 oz.	4 oz.	4 oz.



The EITronic Series

SIX NEW DIGITAL INSTRUMENTS
for measuring voltage, ratios, and
resistance with **all-electronic**
speed and reliability

...including the world's first full-5-digit solid state digital voltmeter / ratiometer

They're all-electronic! No moving parts. No contacts to clatter or wear. All the inherent advantages of solid state circuitry: speed, ruggedness, reliability and coolness.

They're fast! 20 readings per second, average. High speed eliminates reading delays due to cycling caused by decreasing voltages.

They're reliable! Carefully selected components, rigorous testing programs and accelerated aging—equivalent to 100 hours of actual operation—combine to give EITRONIC instruments an unequalled mean-time-to-failure figure.

They're accurate! Production EITRONIC instruments provide a

true, absolute DC accuracy of 0.01%; AC 0.1%.

They're automatic! Virtually eliminates operator error. Even decimal point placement and polarity indication are automatic.

They're human engineered! Unique readout tilts to 3 positions, is easy to read whether instrument is used on a bench, at eye level or high in a rack. Modular construction permits exhaustive testing during assembly, facilitates trouble shooting and field servicing.

They're available now! Your EI field engineer has a new 8-page folder which gives complete specifications on the EITRONIC Series. Ask him for a copy today.

Another significant breakthrough in digital instrumentation from

 **Electro Instruments, Inc.**
8611 BALBOA AVENUE, SAN DIEGO 11, CALIFORNIA



Engineers: Challenging opportunities now available. Contact Mr. Harvey Fleming.

ANOTHER EXAMPLE OF RIXON'S SERVICE TO ITS CUSTOMERS

THE DOUBLE D LINE

A SIMPLIFIED MECHANICAL DESIGN OF TERMINAL EQUIPMENT FOR INCREASING RELIABILITY AND DECREASING COST

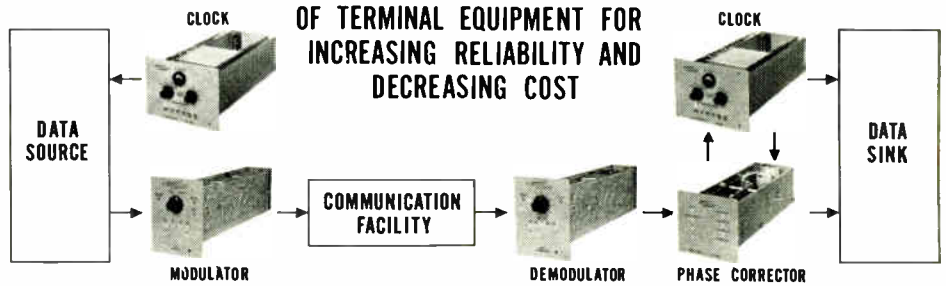

The Problem:

Many data communications systems today are either experimental forerunners of possible major systems of the future or part of an overall experimental program which may or may not be repeated. Because of the uncertainty about the future requirement for the hardware, it is not practical to develop special equipment for each application. This leaves us with the problem of constantly redesigning equipment to fit ever-changing requirements, or having to purchase superfluous equipment to meet the requirements. If a device is needed for development of various timing signals, to be compatible with existing equipment, then the logical answer would be to procure only a timing device—not a complete deck of equipment just to get a timing generator. There should be a solution to any requirement of this type—a solution which would provide complete functional units, each one performing one of the common functions in a data communications system. Incidentally, Rixon has the solution!

The Solution:

Rixon's solution is a new hardware approach based on simple, low-cost functional units with common mechanical features, which has eliminated the heretofore sacred mechanical design features. This naturally has resulted in a drastic reduction of manufacturing complexity, and an equally important improvement in reliability. Mechanical features, whose sole purpose was to provide quick access for mechanical service have now, through redesign, been eliminated—a cost-saving factor. Improved reliability is then achieved by eliminating potential mechanical failure points and by devoting more careful consideration to circuit and component design margins. Therefore, Rixon can furnish you with basic functional units which offer greater flexibility, increased reliability, and at lower cost.

RIXON ELECTRONICS, INC.

2121 INDUSTRIAL PARKWAY - MONTGOMERY INDUSTRIAL PARK - SILVER SPRING, MARYLAND

CIRCLE 201 ON READER SERVICE CARD

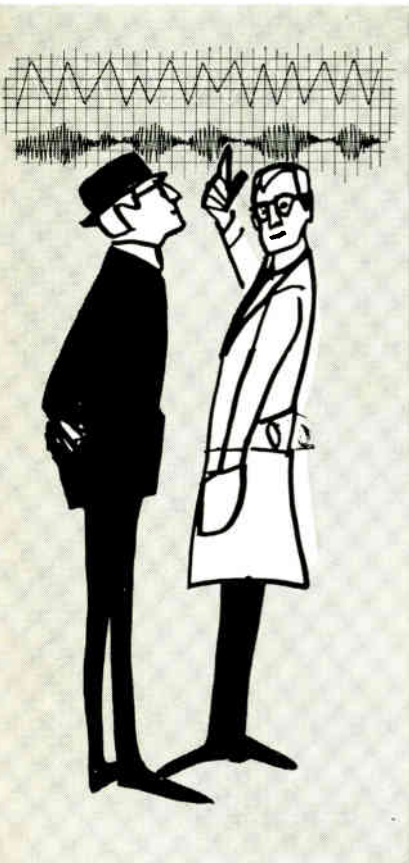

Electronics manufacturers find triple-A work force in WESTern PENNSylvania

Electronics firms locate and expand here because of the triple-A work force: Available . . . Adaptable . . . and with a good Attitude. One firm traveled 20,000 miles, then selected WESTern PENNSylvania; another interviewed 500 job applicants from one help-wanted ad. Pre-production training of a work force at no cost to you . . . plus a favorable tax climate . . . plus 100% industrial plant financing gives WESTern PENNSylvania a top combination of plant location values. Learn more—wire or phone collect or mail the coupon today.

WEST PENN POWER an operating unit of ALLEGHENY POWER SYSTEM



Now Available:
Shell buildings at \$2.95 to \$3.25 a sq. ft.—can be completed to your specs in 60-90 days. Or select from 200 other industrial properties.

WEST PENN POWER, Area Development Department
Greensburg, Pa., Phone: TEmple 7-3000 (Area Code 412)
EL 2-16-5

Please send me data on Labor Availability Pre-production Training Taxes 100% Industrial Plant Financing Industrial Properties

Name _____
Title _____
Company _____
Address _____
City _____ Zone _____
State _____ Phone _____

16 CIRCLE 16 ON READER SERVICE CARD

Test equipment budget too low



double its
value the
Heathkit
way



Heathkit test instruments are professionally designed to meet top performance standards, yet you save up to 50% of the cost of comparable equipment by easy in-plant assembly. Heathkits are the most popular do-it-yourself kits in the world . . . investigate their ability to stretch your instrument budget. Send for your FREE 1962 Heathkit Catalog today!



HEATH COMPANY
Benton Harbor 67, Michigan

Please send FREE 1962 Heathkit Catalog

Name _____
Address _____
City _____ State _____



CIRCLE 200 ON READER SERVICE CARD

electronics

Don't just drop any "can" over an electronic component and expect complete protection from stray magnetic fields. *Completely* protect tubes and transformers with carefully engineered, high-permeability shielding, fabricated to the exact requirements of your components. You get this complete protection with Magnetic Metals shielding. For highest permeability and full effectiveness, Magnetic

Metals shielding is made of carefully annealed molybdenum permalloy or magnetic equivalent, and fabricated to provide the level of magnetic or electrostatic shielding you require.

For a discussion of your shielding needs, write or call today. MAGNETIC METALS COMPANY, Hayes Avenue at 21st Street, Camden 1, New Jersey.

COMPLETE SHIELDING PROTECTION!

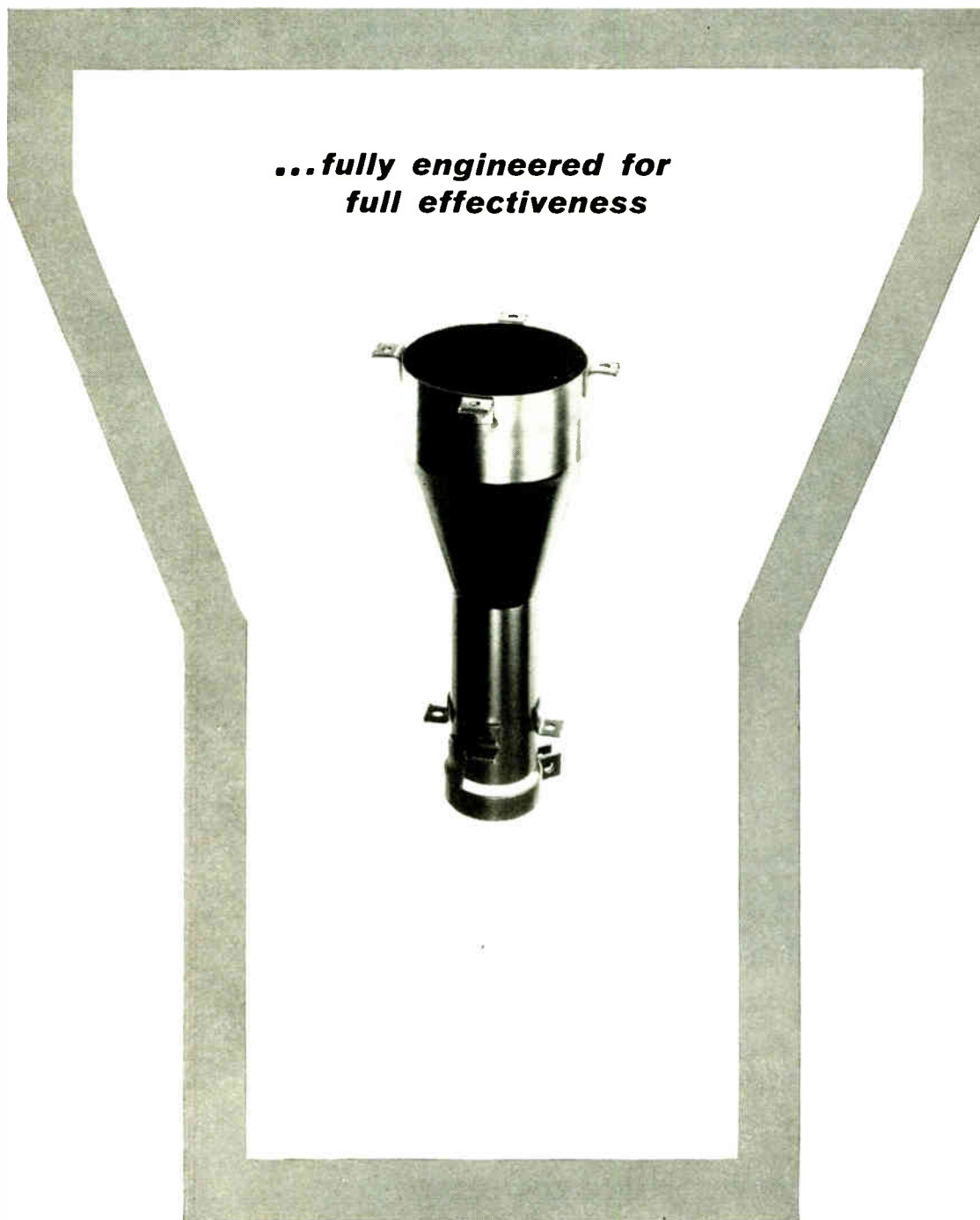

transformer laminations • motor laminations • tape-wound cores • powdered molybdenum permalloy cores • electromagnetic shields

**MAGNETIC
METALS**

Rockets Probe Sporadic-E

By MICHAEL F. WOLFF
Senior Associate Editor

ABILITY to utilize sporadic-E on a day-to-day basis to enhance radio and tv transmission may be a step nearer if an upcoming rocket probe is successful. An Aerobee sounding rocket scheduled for launch this week by NASA will carry a Langmuir probe experiment to directly measure daytime sporadic-E around 100 Km.

The probe was designed by Geophysics Corporation of America to measure electron density with better resolution than radio propaga-

tion techniques will provide.

Scientists hope for reliable information about how these scattered patches of dense E-layer ionization form. Presumably such data could lead to predicting the occurrence of sporadic-E. This would permit propagation of frequencies higher than the maximum normally usable.

Sporadic-E ionization seems quite consistent over the U. S. in May, June and July, and is quite pronounced during the daytime. On transatlantic routes it can raise h-f teletypewriter transmission to Europe by 4 or 5 Mc between the hours of 4 and 8 a.m. Because of this, sporadic-E is predicted generally by an indicated relationship between ionization and solar activity; however, this is not considered reliable on the daily basis that would allow optimum frequency utilization.

Radio propagation and direct sampling are used to study electron density and other determinants of propagation conditions in the ionospheric region too low for satellites (under 200 Km).

Propagation techniques include ground-based ionosondes and one-way propagation of radio signals from rockets to the ground. In the latter technique, two frequencies are transmitted. One is so high the wave passes through the electrons undisturbed, while the lower har-

monic is disturbed. Phase comparison gives electron density.

Electron density can also be measured with incoherent backscatter techniques, although this is not routine. High-power radar like that at Arecibo, P. R. (ELECTRONICS, p 20, Jan. 27, 1961), can determine density to heights above the F₂ layer's main peak.

At present, propagation techniques are superior to direct sampling in giving an absolute value of electron density at a given altitude. However, propagation can miss thin ionization layers like sporadic-E because it makes fewer measurements in an altitude increment. Direct sampling can measure as fast as telemetry will permit—even every few meters. Ideally, direct sampling obtains the shape of altitude distribution of electrons and propagation calibrates measurements at a given altitude.

Direct sampling measures electron and ion density and temperature as they exist around a point. Principal instrument is the retarding potential analyzer in which the current on an electrode is measured as a function of retarding potential, allowing various electron and ion properties to be deduced. Examples are spherical and plane-grid ion traps, measuring ion density and mass spectrum composition, and Langmuir probes, measuring

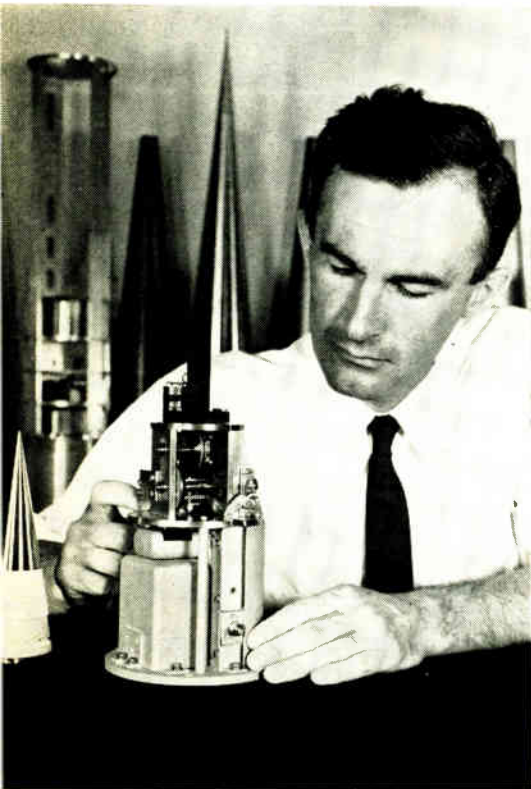

Six-pound electron density probe is examined by L. G. Smith, GCA scientist in charge of experiment. Dark tip connects to electrode in rocket nose

Langmuir probe contains electrometer with 100-percent feedback and Thyrite resistor to produce a compressed scale on the telemetry record. Grid current of 10^{-11} amps is drawn by 6946 tube

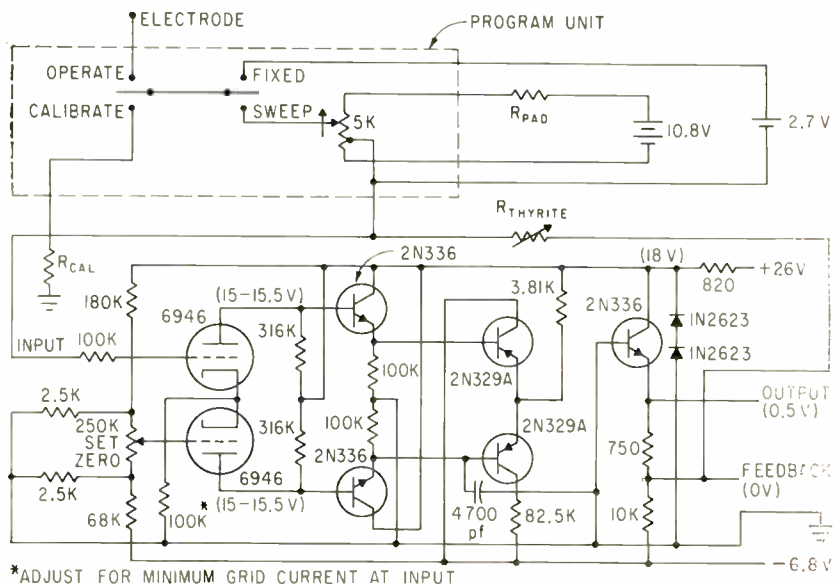

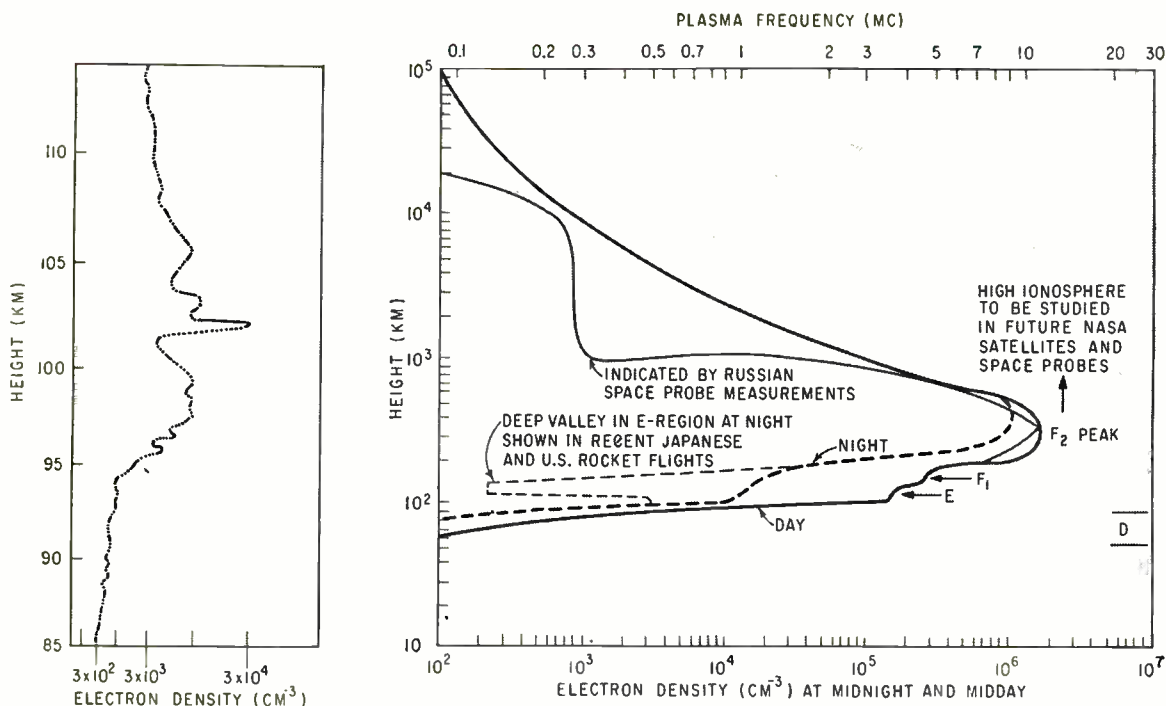

Electron density profile on ascent last Aug. 17; dots are extrapolations (left). Recent data shows changes (light lines, right) in ionospheric profile. Until a year ago, reliable measurements were made only at heights of 90 to 400 Km by day and 200 to 400 Km at night

electron density and energy distribution.

The GCA probe (see photo and schematic) is a Langmuir probe modified by changing the program of the voltage applied to the probing electrode from consecutive sweeps to alternate sweep and fixed voltages. Absolute values of electron density and fine structure in the E-region can be measured.

On its first trial, the technique detected a narrow layer of high electron density 700 meters thick at 102 Km (see chart). This was reportedly the first nighttime rocket measurement of sporadic-E. Interestingly, electron density drops off by a factor of eight in the half Km below the peak of the layer.

It has recently been shown theoretically that, in the presence of the earth's magnetic field, wind shears in the ionosphere can cause steep gradients of electron density, such as this. The theory will be tested later this year by measuring electron density simultaneously with the wind profile determined from sodium vapor trails.

Another shot, the night of Oct. 27, 1961, at a later hour, uncovered several 2-Km thick layers in the E-region. Thin layers of electrons show up better at night when overall ionization is weaker.

Purpose of the upcoming shot is to see if daytime sporadic-E has

the same structure as the nighttime or whether steep gradients of electrons are present instead of layers.

Another major direct sampling method utilizes the r-f impedance probe. In one version, dielectric constant of surrounding plasma, a measure of electron density, is found by measuring capacity of an electrode system at a fixed frequency above the plasma frequency. The other type uses swept r-f voltage to find plasma frequency. This type was flown on the recent Japanese-NASA launch (ELECTRONICS, p 62, March 23) and has measured sporadic-E in the past.

Several electron density measur-

ing techniques will be refined as a result of another shot scheduled for the end of May by NASA's Goddard Space Flight Center. The Aerobee will carry a propagation experiment, fixed-frequency and swept-frequency r-f probes, two Langmuir probes, and an electroacoustic probe. The latter measures the amplitude of electron pressure waves excited in the ionosphere by an r-f signal on l-f antennas.

This flight will not look specifically for sporadic-E, but is to test equipment that could be used for other missions also important to communications, such as spread-F and D-region studies.

Road Radio to Have 900-Mile Antenna

INDIANAPOLIS — Communications Development Co. plans to run a 900-mile-long antenna down three midwestern toll roads. The road-level antenna would provide motorists with news, music, weather, traffic announcements and commercials. Radiation would be limited to a 150-foot radius.

A subsidiary, Indiana Roadar, signed a contract late last month for the Northern Indiana toll road and negotiations for Ohio and Pennsylvania toll roads are under way. The company is seeking a fre-

quency at the low end of the broadcast band. Technical details are being engineered by John Battison and Associates, of Washington, and will depend on completion of contracts with other states.

A tri-state network would require a headquarters transmitter, two boosters in each state and a staff of 60. Installation cost is estimated at \$1 million. Robert Campbell, president of the parent company, says the network would be unique since other tollway nets in development plan to use microwave relay.



VIBRATION NEWS

MB ELECTRONICS • A DIVISION OF TEXTRON ELECTRONICS, INC.
Representatives in principal cities throughout the world

MB's T-388 Automatic Equalizer cuts equalization time to 5 seconds...

Production random vibration is now practical with MB's completely automatic spectrum equalizer. Set up time is eliminated and equalization realized within 5 seconds. Savings in test time and labor for missile and aircraft manufacturing can easily reach many thousands of dollars per missile tested.

Operation of the T-388 automatic equalizer is extremely simple and can be readily handled by non-technical personnel. A flat or shaped spectrum is easily programmed on the spectrum control panel by setting the slide wires. A template of the spectrum can be used for the

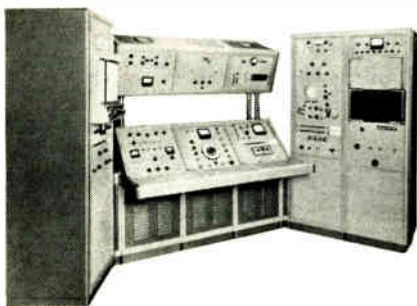

setting as shown above. The equipment does the rest.

The T-388 also provides higher test accuracy and versatility. Equalization to $\pm 1\frac{1}{2}$ db is obtained and equipment automatically compensates shifts in resonant frequencies and changes in amplitudes. Normal frequency range is 15 to 2000 cps in 25 cps bandwidths; any 2000 cps bandwidth can be obtained between 15 and 10,000 cps by simple front panel selection.

Other unique features of the T-388 Automatic Equalizer include:

- Spectrum analyzer has 3 types of readout: 1) precision, direct

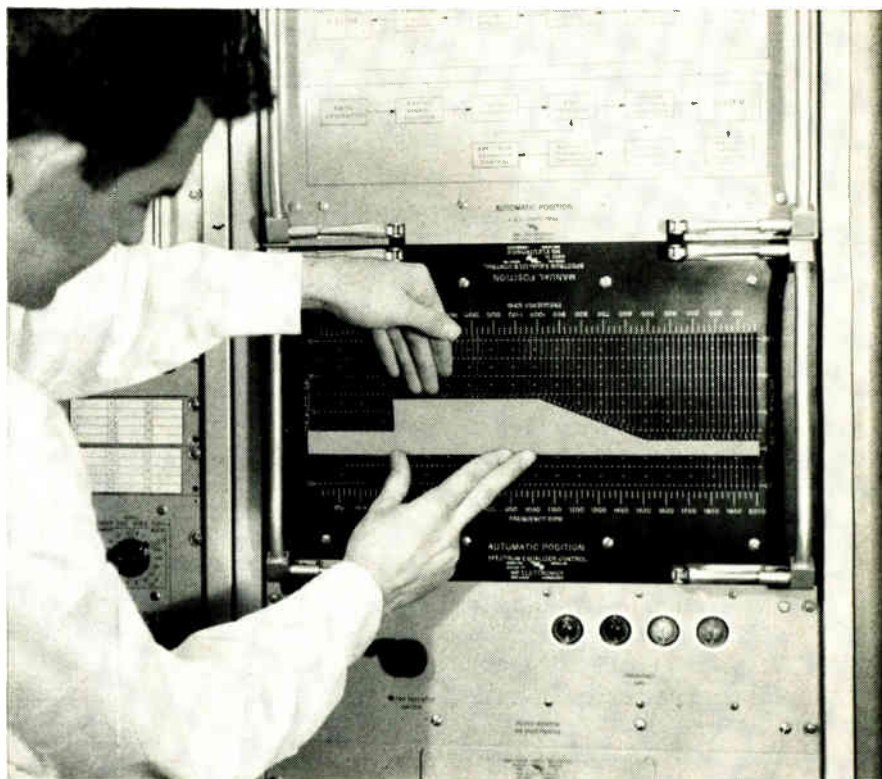

Templates of your test spectrum can be used for rapid set-up of the T-388 Automatic Equalizer.

reading in g^2/cps ; 2) visual display on scope for continuous monitoring; 3) permanent record of test using X-Y plotter.

- Highly accurate equalization through the use of 80 distinct channels of narrow bandwidth (25 cps) covering a 2000 cps band.

A test laboratory equipped with the T-388 unit will not only save many hours of valuable test time, but will also be prepared for present and future test requirements.

For detailed information on the T-388 Automatic Equalizer write to MB Electronics, 781 Whalley Ave., New Haven 15, Conn.

Over 50 Multi-Filter Equalization Systems purchased by leading test laboratories

The important contribution which the MB Multi-Filter Equalization System makes to the field of vibration testing has been recognized by leading environmental testing laboratories. To date over 50 units have been purchased...a remarkable record for equipment of this type.

MB engineers will gladly consult with you on how to apply the unique advantages and savings of the Multi-Filter Equalization System to your test programs.

1/10⁸/SEC-1/10⁶/WEEK

STABILITY

1-12.4 GC

Introducing a compact electronic instrument to control microwave oscillator frequency

**doppler systems
spectrum analyzers
radio astronomy
parametric amplifier pumps
microwave frequency standards
microwave spectroscopy**

You name the application. The Dymec DY-2650A Oscillator Synchronizer will make it easier! Absolute control of frequency is yours when the DY-2650A phase locks your klystron oscillator to a crystal reference, to achieve short-term stability of 1 part in 10⁸ per second, 1 part in 10⁶ per week. Temperature stability is 1 part in 10⁶, 0-50 °C. The DY-2650A requires only a small sample of klystron power—less than -10 dbm.

The DY-2650A will synchronize most reflex klystrons, 1 to 12.4 GC, with complete elimination of klystron drift and minimization of all incidental fm caused by klystron noise, power supply ripple and mechanical shock. You can use it for oscillator stabilization, frequency modulation and control, frequency stability monitoring and fm monitoring.

Frequency modulation and control: Use the DY-2650A to apply fm to a klystron oscillator with deviations up to 500 KC at rates to 50 KC.

Manual frequency control: Over 2 MC range of klystron frequency.

Frequency monitoring: Use an electronic counter or frequency meter to monitor the microwave signal for frequency stability.

FM monitoring: Demodulate fm on the test signal, providing an output for monitoring with a VTVM, oscilloscope or other monitoring devices.

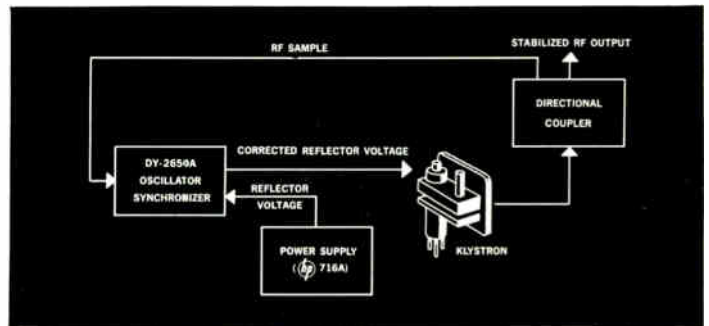
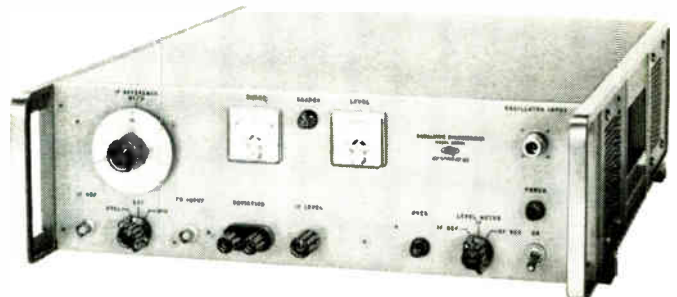

The DY-2650A is essentially a crystal-controlled superheterodyne receiver terminating in a phase comparator. An oscillator sample is mixed with harmonics of the rf reference to produce an intermediate frequency of 30 MC, which is compared in phase with the 30 MC reference. For stabilizing a klystron, the resultant phase error voltage is added in series with the klystron reflector power supply voltage.

SPECIFICATIONS

Frequency range: 1 to 12.4 GC

Stability: 1/10⁸ per second, 1/10⁶ per week (over ± 5°C), 1/10⁶ over range 0 to 50°C.

Output circuitry: Suitable for connection to klystron reflector; floating and insulated up to 2000 v dc. A phase lag network provides optimum characteristics for matching klystron sensitivities from 0.05 to 4 MC/volt nominal.

Input power: Less than -10 dbm.

Price: \$1,450.00, f.o.b. factory.

Data subject to change without notice.

Describe your requirement today to your Dymec/Hewlett-Packard representative, write Dymec for further information or call Dymec direct. Extension 223 or 224.

DYMEC
A Division of Hewlett-Packard Company



Dept. J-6, 395 Page Mill Road, Palo Alto, Calif. Phone DA 6-1755 (Area Code 415) TWX-117-U

7877



DEPENDABLE

TI Semiconductors & Components

from your
AUTHORIZED



**TEXAS INSTRUMENTS
DISTRIBUTORS**

CIRCLE 205 ON READER SERVICE CARD

**RECORDING
STORAGE TUBE SYSTEMS**



Originated and Built By
IMAGE INSTRUMENTS, INC.

■ ELECTROSTATIC PICTURE STORAGE AND RECALL SYSTEMS ■ LOW-LIGHT-LEVEL CAMERA AND DUAL STORAGE TUBE SYSTEMS ■ DOUBLE-ENDED STORAGE TUBE SYSTEMS ■ DATA SUMMATION UNITS ■ COMPUTER OUTPUT STORAGE FOR TELEVISION DISPLAY.

Standard storage tube systems are readily available. A custom-engineered system can be built to meet your special needs.



For further information,
write:

INSTRUMENTS, Inc.
2300 WASHINGTON STREET
NEWTON LOWER FALLS 62,
MASS.
WOODWARD 9-8440

CIRCLE 206 ON READER SERVICE CARD

BRAND NEW!! The world's smallest FM-Tuner Front End
THE NEW MICRO-TUNER MODEL FMT 100 with AGC, low radiation and low noise.

hopt

FMT-4 AM/FM Tuner with common FM and AM Tuning capacitor. Variations with AGC, AFC and the connecting impedances. Also available with 3-gang capacitor.

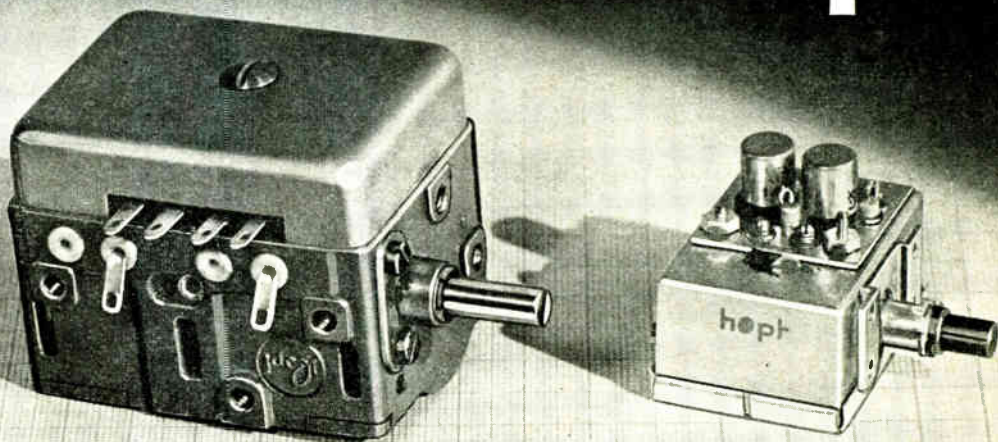

ELECTRICAL DATA

Operating voltage: 8 V
Total current-requirements: 4 mA
Input frequency range: 87.3...108 mc/s
If: 10.7 mc/s
Amplification: 25 dB
Noise figure: 8 KT o
Input impedance: 60 Ohms balanced or unbalanced
Output impedance: 60 or 600 Ohms depending on type
AGC: depending on the r.f. and oscillator transistor used.

AFC: exists, depending on the circuit.
3-db bandwidth: about 350 KC/s

ALSO IN PRODUCTION

FM-Tuner with 3-gang capacitor
AM/FM-Tuner with 2-gang capacitor
AM/FM-Tuner with 3-gang capacitor

In the AM/FM-Tuner the FM and one gang of the AM tuning capacitor are combined in one component. As in the FMT-Tuner, the above tuners are also constructed with some variations in so far as AGC, AFC and the matching impedances.

R + E Hopt KG · Fabrik für Radio- und Fernsehtechnik · Rottweil a. N. (Germany)

We are looking for a representative in the United States with an established reputation in the radio and electronic industry. Please direct inquiries to above address.

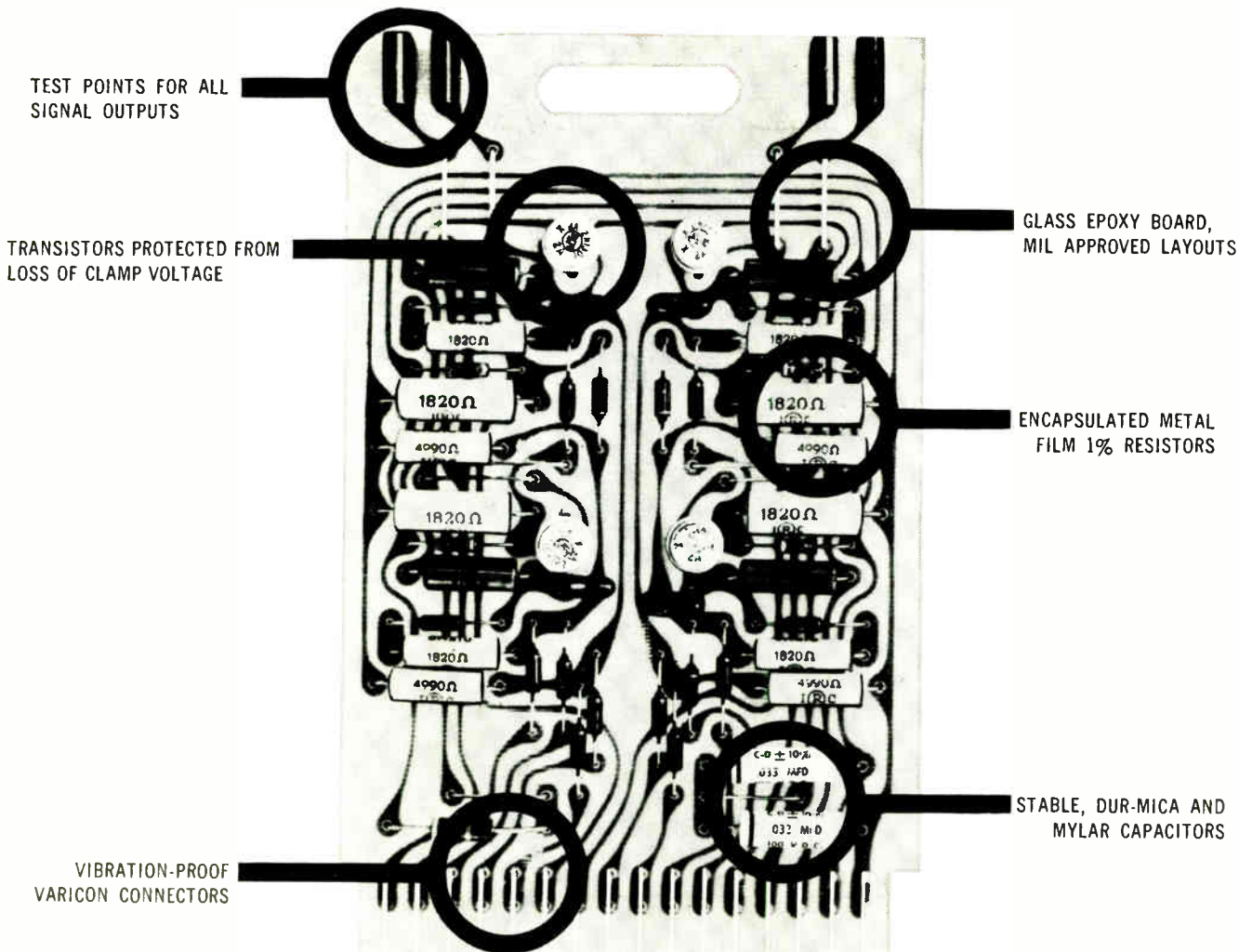

A BASIS FOR DECISION ■

When it comes to choosing a source of supply for packaged logic circuits, on what do you base your decision? It can't be made on specs alone—and if it's based strictly on price it can turn out to be a sad experience. A wise approach is to consider the characteristics of both the supplier and the product. ■ Is the company really in the business of producing logic circuits, or are they just offering something they designed to meet the requirements of a specific systems application? Does the company offer a complete line of standard circuits operating at various speeds, yet completely compatible with one another? Is the company's standard product line fully adaptable — both mechanically and electrically — to MIL spec requirements? ■ Is the product reliable, or has the company shaved the price by using components and materials that satisfy minimum requirements? Have things like input loading and fan-out been considered? Do the circuits include transistor protection from loss of supply voltages? These are all important points to consider — and there are others too, including competitive price. ■ Rese is a major supplier of packaged logic circuits—over 100 standard circuit designs with speeds from 200KC to 5MC—and its principal concern is to provide the designer with the most complete, integrated and flexible set of logical building blocks that can be devised. You can get all the facts you need on which to base a sound decision by contacting Rese Engineering, Inc., A & Courtland Streets, Phila. 20, Pa.

rese

LOGIC CIRCUITS

A & COURTLAND STREETS, PHILA. 20, PA. GL 5-9000

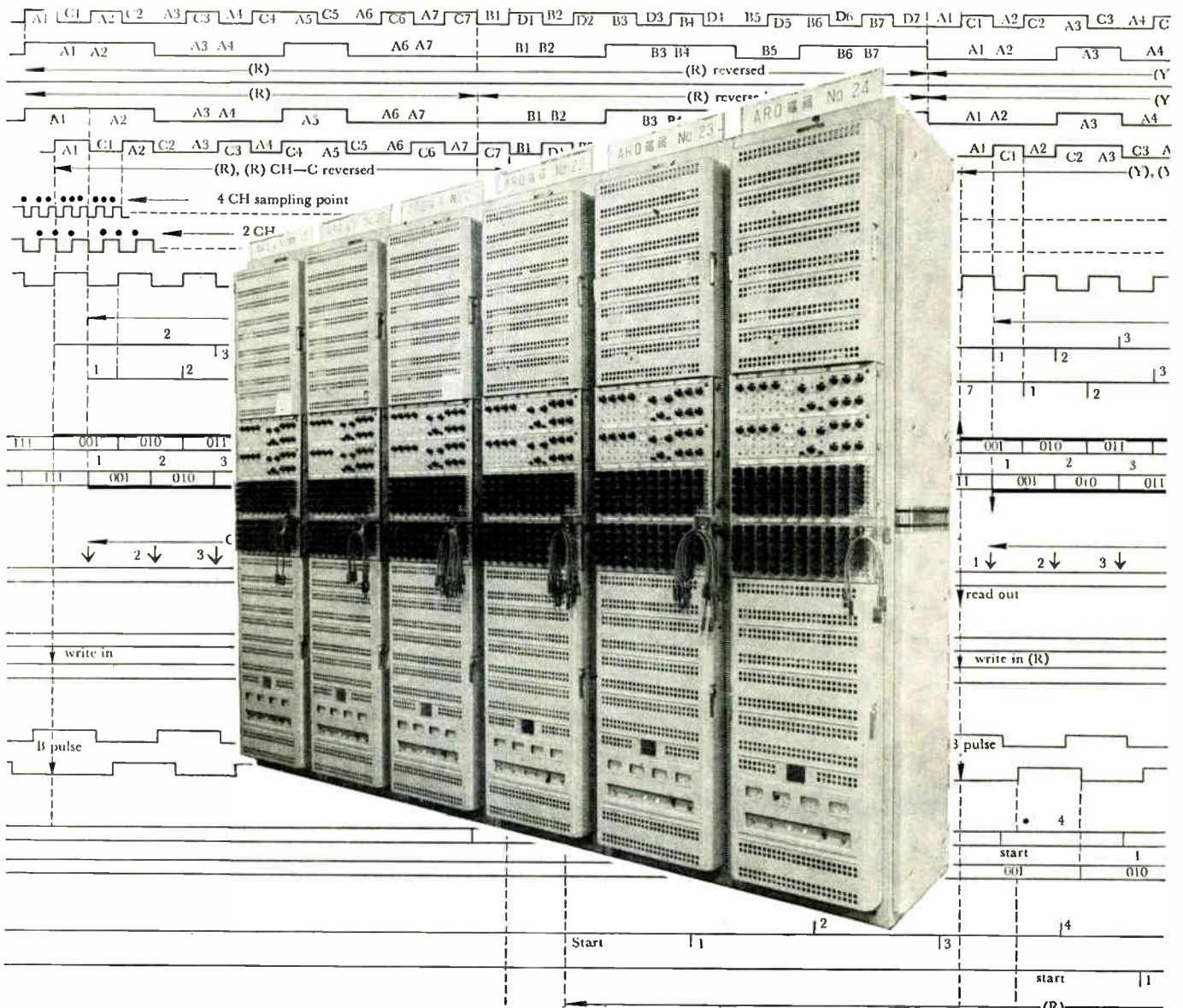

New Parametric ARQ equipment requires much less power, no maintenance

Mitsubishi Electric's TZ-3 ARQ equipment for multiplex telegraphy with automatic error correction employs a new electronic element called the parametron. This device enables the equipment to operate effectively on only one-fourth the power ordinarily required. Unlike regular equipment which depends on mechanical parts, vacuum tubes and semi-conductors, parametric ARQ equipment requires no routine maintenance and takes up only half as much space making possible considerable savings in installation and operating costs. For complete details on the technical specifications of parametric equipment and its extensive capabilities, write:





MITSUBISHI ELECTRIC MANUFACTURING COMPANY
 Head Office: Tokyo Building, Marunouchi, Tokyo
 Cable Address: MELCO TOKYO

LOW POWER SILICON DIGITAL MODULES

ENVIRONMENTALLY PROVED . . . AVAILABLE NOW!

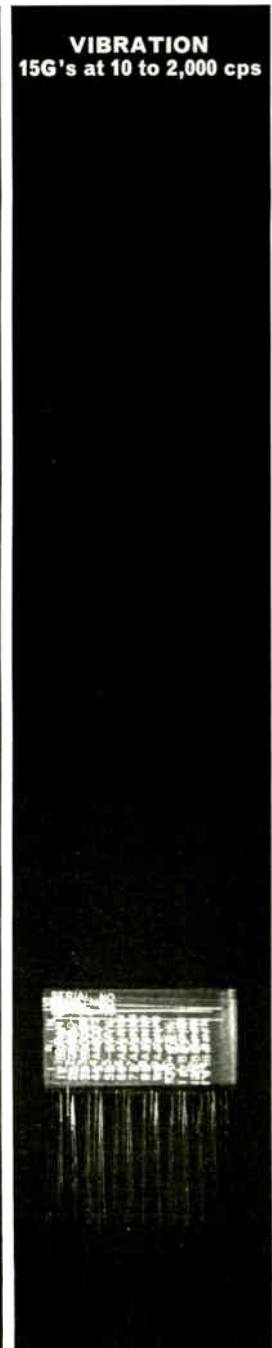
Delco Radio's new silicon digital modules operate on less than 4 mw. of power per logic stage. They are rugged enough to withstand extreme environmental conditions and are small and lightweight. Encapsulated in light foamy epoxy, each module weighs less than 12 grams and occupies less than one-half cubic inch. The basic set of modules includes a bistable multivibrator, a diode NOR gate, a power driver, a monostable multivibrator and an astable multivibrator. From these basic units larger computer subassemblies can be assembled, such as shift registers, adders, binary counters, decimal counters and timing devices. A range of applications—from small scale switching circuits to large computers can be satisfied with these modules. Environmentally proved to:

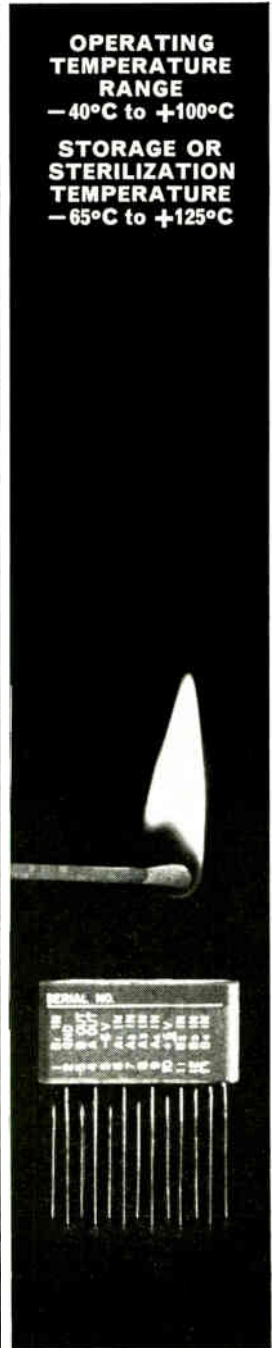
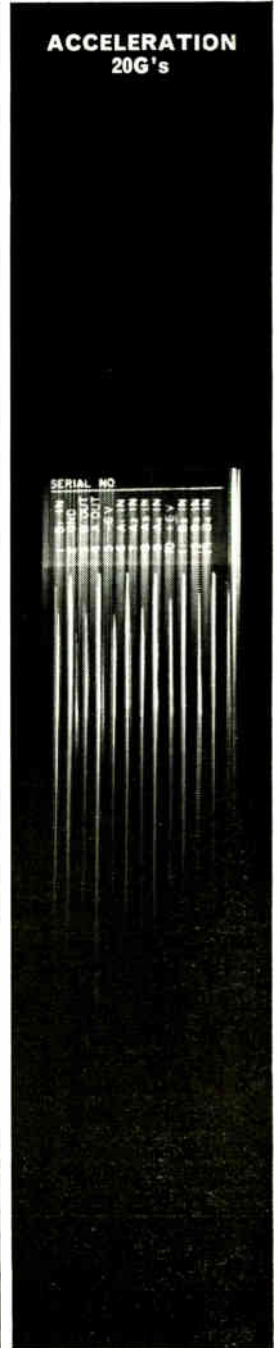
<p>SHOCK 1,000G's in all planes</p> 	<p>VIBRATION 15G's at 10 to 2,000 cps</p> 	<p>HUMIDITY 95% at max. temp.</p> 	<p>OPERATING TEMPERATURE RANGE -40°C to +100°C</p> <p>STORAGE OR STERILIZATION TEMPERATURE -65°C to +125°C</p> 	<p>ACCELERATION 20G's</p> 
--	---	---	--	---

Data sheets are available. Just write or call our Military Sales Department.

Physicists and electronics engineers: Join Delco Radio's search for new and better products through Solid State Physics.

PIONEERING ELECTRONIC PRODUCTS THROUGH SOLID STATE PHYSICS

Division of General Motors • Kokomo, Indiana

**DELCO
RADIO**

ARMY'S 1963 SHOPPING LIST:

\$3,817 Million for Missiles, Gear, RDT&E



Army also wants smaller radar, like this experimental 10-lb set

By JOHN F. MASON
Associate Editor

WITHIN THE NEXT few days, the Senate is expected to vote on the House-approved \$1,317 million appropriations request for Army's research, development, test and evaluation program (RDT&E) and \$2,500 million for procurement of equipment and missiles.

RDT&E Program

About 68 percent of the RDT&E money (\$895 million) will be spent on contracts with industry and other nongovernment agencies, Army says. About seven percent (\$92 million) will go to other government agencies and about 25 percent (\$329 million) is for work in Army R&D labs.

Four systems will get a total of \$447.78 million, or about 34 percent of the total RDT&E funding. Nike-Zeus, antimissile missile, will get \$267.5 million and Advent, synchronous communications satellite, \$95 million. This leaves a total of \$170.78 million for Pershing surface-to-surface missile to replace Redstone, and the Mauler, mobile missile to defend front-line troops against low-flying bombers.

Nike-Zeus will be tested this year

at Kwajalein against ICBMs fired by USAF from Vandenberg AFB, Calif. RDT&E on Pershing is almost complete. Funding will drop to a third of last year's amount.

Mauler development and funding will be stepped up. Provision has been made for an IFF system, probably the Mark XII. Being considered is a mobile command and control system, electronically tied in to any existing battlefield air control system to assist in identifying friendly and enemy planes.

The first Advent test satellite will be orbited this year to test major components. Operational plans call for three Advents in synchronous orbits at all times, probably requiring at least four launchings a year. Design goal for the satellite is one-year mean time to failure, although they are being built with up to three years wear-out capability.

The Advent program is being re-oriented due to the failure of the Centaur vehicle intended as the second-stage booster. Another problem is the decision to make ground stations compatible with NASA's synchronous communications satellite, Syncom.

Basic research will be increased this year to \$35 million. Chemical and biological warfare will get a 50 percent boost to \$107.8 million.

Army is studying new aircraft

concepts such as tiltable wings and ducted fans. Objective is to develop improved vertical and short-take-off-and-land aircraft for surveillance and transport.

A new family of smaller and lighter radios is being developed. They range from miniature radios attached to a soldier's helmet to long-range ssb sets. The Fieldata general computers for command control, fire support, combat intelligence and logistics and administration are now operational and Army is developing procedures.

For combat surveillance, Army wants smaller hand-held surveillance radar, is doing more work on infrared photography and is developing a small metals detector.

Spending for nuclear war equipment continues to decline while conventional warfare items receive increased funding.

Special Forces projects include night vision research, limited-warfare countermeasures equipment, components and accessories, infrared, ultraviolet and visible lights, detection and ranging, viewing and illumination, and the air defense Redeye missile.

Also, tactical communications including manpack low-power ssb h-f radio, quickly erectable lightweight tactical antennas, combination radio for long-range reconnaissance patrols and special

Field surveillance radar powered by GE fuel cell operated by hydrogen from chemical generator and oxygen from air

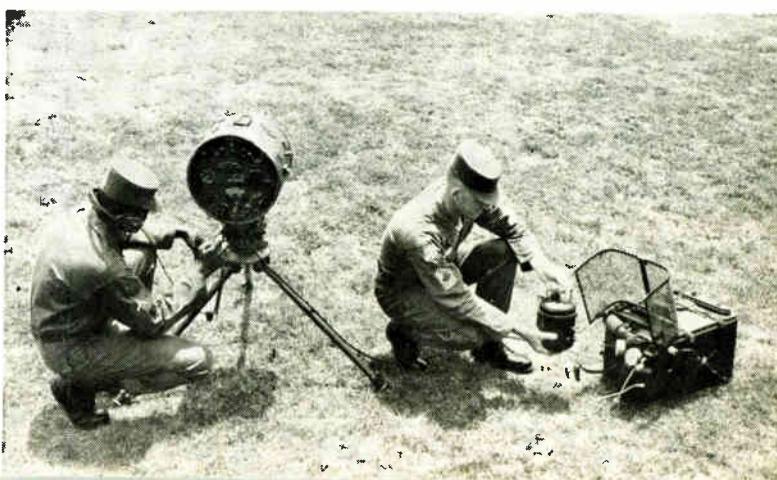



Improved Nike Hercules base in Maryland. Western Electric is prime contractor. GE built high-powered acquisition radar in large radome



Inside the radome, Army missilemen check Hipar antenna

forces, radio equipment for civilian guard units, ground-based combat surveillance equipment and system, navigation and air traffic regulation for remote areas, and an aircraft terrain and obstacle avoidance system.

Procurement (PEMA)

The House passed \$2½ billion for procurement of missiles, aircraft, weapons, ammunition, vehicles, repair parts and support equipment. The majority of funds are for increasing and modernizing Army's fire power capability. Army will continue to buy surface-to-air missiles in support of air defense missions (Nike Hercules) and in support of troops (Hawk and Redeye).

Through 1962, a total of \$2,045.9 million for RDT&E and procurement has been spent on Nike Hercules. For 1963, \$137.8 million is requested. After this, through 1965 an additional \$80.7 million is estimated. By then, Nike Hercules will have cost \$2,261.4 million. The system will continue to be upgraded with high-powered acquisition and target-tracking radars.

Army asked \$10.3 million for Redeye. Although there are still problems in the system, Army plans to award a production contract in October.

Surface-to-surface missiles to be bought are Pershing, Sergeant, the improved Honest John and Little John rockets, and anti-tank missiles.

Funds are provided for Caribou transport aircraft, Iroquois and Chinook transport and utility heli-

copters, and for a new battlefield surveillance helicopter.

Army asks \$166 million for electronics and communications. Major spending is for combat surveillance and target acquisition gear and rugged, light communications equipment to achieve control and direction under the high degree of mobility and dispersion dictated by modern weapons. To meet these needs, Army will buy low-endurance combat surveillance drones and will modernize and replace combat radio, telephone, teletype-writers, and control equipment.

Included in a category called "Other Support" is \$130 million for Unicom, Starcom, Comsec and other fixed, strategic communications systems.

Unicom (Universal Integrated Communications System) now in the last stages of RDT&E, will take care of voice, printed teletypewriter messages, facsimile and will have data storage and forward capability. It will handle classified com-

munications and provide subscriber-to-subscriber networks.

Starcom (Strategic Army Communications System) is a worldwide system that has been developed over the past 20 years. Basically a high-frequency radio system, it consists of some two million radio circuit miles. Unicom will be used with Starcom.

Comsec (Communications Security) will be used in Starcom, for tactical Army field communications and for other special intelligence and intratheatre communications projects.

Army will install a prototype model of the automatic message processing system (Amps) to determine if by automation and computer techniques it is possible to speed up message handling.

Infrared equipment will be a big item in 1963. Army wants to retrofit all main battle tanks with infrared fire control systems. Auxiliary infrared gear includes searchlights, periscopes and binoculars.

WHERE ARMY WILL BUY EQUIPMENT AND MISSILES IN 1963

Procurement method	Number		Value	
	of Items	Percent	(\$ Million)	Percent
Competitive procurement	230	50	1,129	15
Formal advertising	(173)	(39)	(397)	(16)
Competitive negotiation	(52)	(11)	(732)	(29)
Negotiated to maintain production base	50	11	319	12
From government-owned plants	112	25	625	25
Sole-source procurements	16	10	439	17
From other government departments	18	4	16	1
Total number of items in program	456	100	2,528	100

All-Channel Bill Stirs UHF Tv Market and

By THOMAS EMMA, Associate Editor



If the bill passes, uhf converters like this Blonder-Tongue unit may sell more briskly

IF THE FCC's all-channel tv receiver bill passes the Senate this year as expected—it has already passed the House of Representatives—it will probably spur technical improvements in uhf broadcasting and receiving equipment.

Manufacturers of transmitters, antennas and receivers also see a possibility for market expansion in time, although EIA thinks that additional cost will hurt set sales (ELECTRONICS, p 12, March 2). It would take about three to five years after passage for the full impact to be felt—after procedures have been worked out and if the bill passes an expected court test (ELECTRONICS, p 12, May 11).

Receiver manufacturers seem divided in their opinions on whether the legislation will be beneficial. Company spokesmen on both sides minimize technical consideration and base their views on set costs.

RCA, GE and Zenith favored the bill. Other companies are either very reserved or decline to comment. Motorola, while not opposing the plan, feels it may be an injustice to consumers to make them pay for channels they will not use. Admiral asks that close attention be paid to the length of the transition period. Motorola, RCA and some other companies are now making all-channel sets, but these are only

a small fraction of their total output.

The increase in cost to make tv sets able to receive 70 uhf channels as well as the 12 vhf channels has been estimated at about \$30. Besides this, there will be the expense of new or converted antennas.

There will probably be a brisk market for uhf converters during the transition period. Blonder-Tongue feels a \$30 differential is

too high for all-channel sets, that the circuitry to receive uhf can be put into vhf sets for about \$20.

A Capehart spokesman says his company will follow the situation closely and produce according to market demand. Like other tv manufacturers, Capehart thinks uhf tuners will need more attention. The continuous uhf tuners now used may be a drawback on the mass consumer market, but so far no manufacturers are promising step tuners.

Transmitter sales will probably be modest initially because of the many unused uhf transmitters in stations that tried uhf in the late 1950's and suspended operations or changed to vhf. There are now more than 250 such stations.

However, the eventual market is indicated by the number of available uhf assignments, 1,554. Less than 10 percent of these are used or even allocated. Also, much of the \$32 million recently appropriated in the federal matching fund program for educational tv will go to uhf stations.

Most companies are sure that

450-Kv Power Supply

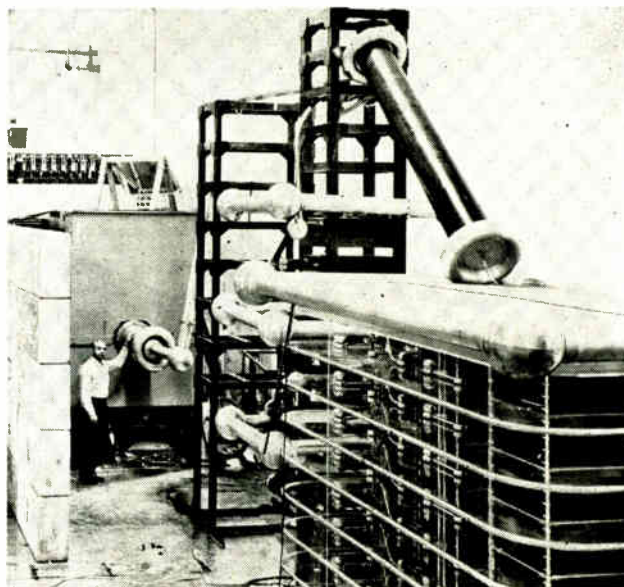

Developed by Radiation at Stanford under Army Signal Corps sponsorship, this 450-kv power supply will be used in testing high-voltage switch tubes and other components. Stored energy totals 18,000 joules. Cascade rectifier units are in nine modular decks

Techniques

wider use of uhf tv will pressure technical improvements in transmitter equipment.

Klystron manufacturers, for example, anticipate increased sales and improved tubes. Continuous-wave klystrons are likely to receive more attention. To compete with tetrodes at 1 Kw to 10 Kw, says a Litton Industries spokesman, klystrons operating at lower voltages with more efficiency are needed.

Varian Associates plans to concentrate on 15-Kw to 75-Kw klystrons, also feels that tetrodes now have the edge at lower power. The firm is now making a 75-Kw klystron for uhf, originally developed for tropscatter, and is planning a line of 15-Kw to 25-Kw continuous-wave klystrons.

Eitel-McCullough says it is ready to quote on klystrons up to 250 Kw if demand warrants. It has 10-Kw klystrons in European uhf tv gear, the company reports, and introduced a line of 12.5-Kw to 50-Kw c-w klystrons last winter.

RCA reports it recently redesigned its uhf transmitters to use silicon high-voltage rectifiers for economical operation at high power and is now working on using improved tubes in r-f circuits. An RCA 50-Kw transmitter is being used in experimental uhf broadcasts in New York City. A company spokesman says power higher than 50 Kw can be expected soon. So far, RCA is not using klystrons.

Discussing uhf tv's technical performance, Ben Adler, Adler Electronics president, says uhf probably will never exactly match vhf. However, he points out uhf equipment has performed excellently in military equipment.

Based on uhf tv translator experience, Adler feels that a proper use of uhf tv lies in many small local stations serving individual communities along the lines of radio broadcasting. He thinks wider use will result in transmitter improvements, but that more work is needed on receivers and home antennas.



ML-8087 Precision Scan Conversion Tube Fast Erase High Resolution

- 1 High resolution: a minimum of 180 range rings/diameter at 50% amplitude modulation; equivalent to 900 TV lines.
- 2 Fast erase: less than 2 seconds erase cycle to reduce stored information to noise level.
- 3 Wide storage range: to meet FAA 1213b specification and beyond.
- 4 High signal/noise ratio, typically 80:1 (peak signal to rms noise).
- 5 Rapid set-up time: only a few minutes installation time is required to adjust tube for optimum operation. No need for critical dynamic focussing of electron beams.
- 6 No variation of output signal with size of written area.
- 7 Only simple video circuits are needed for readout.

Send For Data

MACHLETT

The Machlett Laboratories, Inc.
A division of Raytheon Company
Springdale, Connecticut

TWO OUTSTANDING HIGH-TEMPERATURE MAGNET WIRES

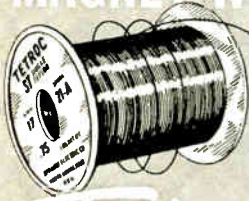

Tetroc

FOR CONTINUOUS OPERATION AT
HOTTEST SPOT TEMPERATURES
UP TO 200°C

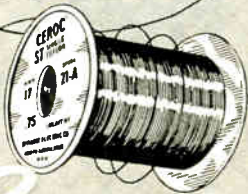

Ceroc

FOR CONTINUOUS OPERATION AT
HOTTEST SPOT TEMPERATURES
UP TO 250°C

For continuous operation at hottest spot temperatures up to 200°C (392°F) and up to 250°C (482°F) for short periods of time—depend upon TETROC—an all Teflon-insulated wire available in both single and heavy coatings.

CEROC is Sprague's recommendation for continuous operation at hottest spot temperatures up to 250°C (482°F) and up to 300°C (572°F) for short periods of time. Ceroc has a flexible ceramic base insulation with either single silicone or single or heavy Teflon overlays. The ceramic base stops "cut-through" sometimes found in windings of all-fluorocarbon wire. Both Tetroc and Ceroc magnet wires provide extremely high space factors.

Write for Engineering Bulletins 405 (Tetroc Wires) and 400A (Ceroc Wires).

SPRAGUE ELECTRIC COMPANY
35 Marshall Street, North Adams, Mass.

SPRAGUE®
THE MARK OF RELIABILITY



Typical private aircraft installation. The second phone is the aircraft intercom. At right is airborne telephone package manufactured by Delco as the CAT-2 Skyphone

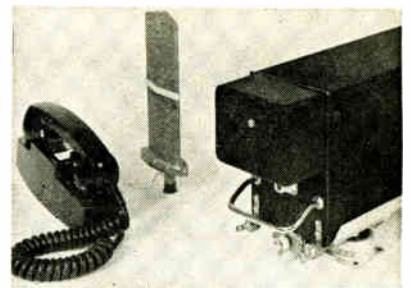

Air-to-Ground Telephone Trials Expand

By **LESLIE SOLOMON**
Associate Editor

PASSENGERS FLYING in aircraft over states north of Virginia and east of the Mississippi will be able to place and receive telephone calls between planes and any ground telephone this summer. And, if FCC approves an AT&T request for regular service, the system would become nationwide in about three years.

This month, FCC granted the Bell System's request for five additional developmental stations, to be located at Elmira, N. Y.; Beckley, W. Va.; Vincennes, Ind.; Dayton and Boston. These stations were approved for the purpose of collecting operating data.

Five stations have been in experimental operation, at Chicago, Detroit, Pittsburgh, New York and Washington (ELECTRONICS, p 22, Dec. 8, 1961). Experiments began with tests at Chicago and Detroit five years ago.

FCC will receive comment until June 11 on AT&T's request to provide regular service. A nationwide system would require 62 more ground stations. Another 20 stations would be needed to provide the service in Canada. Ground stations may cost about \$25,000 and airborne equipment, \$3,500 a plane. Under regular service, airborne units would be customer-owned, licensed and maintained.

Ground and airborne uhf stations have 15-watt transmitters. In regular service, they will use f-m duplex and operate in the 450-Mc band, with a 5-Mc separation air and ground transmission. Ground

stations will be about 200 miles apart and co-channel stations, about 500 miles apart.

Six two-way f-m channels will be used with 50 Kc between them. A common f-m signaling channel will be used for all stations. Sequential tone codes will be used to call the aircraft, each of which will have its own code.

During idle conditions, the aircraft unit automatically reverts to the common signaling channel and the ground station transmits a dial tone. The dial tone is transmitted at a reduced level, approximately 15 to 20 db below normal power output. To complete a call, the airborne station selects the clearest dial tone.

On a ground-originated call, the ground operator will dial the coding number of the desired aircraft. The airborne unit will automatically indicate which channel is being used, the bell will ring and the phone will be ready for use.

To make an air-to-ground call, the customer presses a push-to-talk button, sending a signal to the nearest base station. The signal alerts the aviation switchboard operator. The customer gives her the number and she places the call through conventional telephone methods.

AT&T points out that the system also provides the aircraft pilot with a reserve air-to-ground communications system.

Rates depend on the distance called. A three-minute call between a plane over New York City and Yonkers, N. Y., costs \$1.50. A call to San Francisco costs \$4.



Some things worth looking for in 10-amp "industrial" relays

If you buy heavy-duty, AC or DC plug-in relays, or design equipment which uses them, here's some information that could help you. It deals with small but significant differences among these relays, that are also the very things that ultimately decide whether the relay will work on the 900,000th operation . . . whether there's a strong chance of dangerous overheating when loads approach maximum ratings . . . whether there's real safety when high currents are being switched—in short, how much certainty of operation ("reliability") you're getting for your money.

We've designed a plug-in relay of this type, electrically and mechanically interchangeable with half a dozen others of its kind now on the market, that we believe has a positive advantage to offer you in every one of the characteristics just mentioned. Here are some of the particulars, to back up all this printed confidence:

— to keep the opportunity for trouble as small as possible, parts are rugged, simple and few in number. All contact circuit parts are directly connected to rigid base pins, without wire or solder joints. The solid base aligning plug won't break off either, unless you take a wrench to it. The parts inside the plastic dust cover are carefully designed to use the available space to best advantage—contacts, armature assembly and coil are each of optimum size for long, dependable operation under heavy-duty service.

— 10 amperes will be safely carried, without heat dissipation problems or blue sparks jumping around, by the solid base with specially-molded insulating barriers, solid pins and other

current-carrying members. (Ever try running 10 amps through an ordinary hollow-pin tube base? Some relays do—for a while.)

— contacts close positively with good pressure (in relay parlance, "clean switching") because of ample electromagnetic forces from a big, efficient coil and armature assembly. You don't have to add extra safety margins in operate power just to be extra sure the relay will work. Contacts open with similar dispatch when the release point is reached.

— circuits are opened and closed when they're supposed to be, on the millionth operation as on the first, because mechanically strong parts don't bend and get out of adjustment or fatigue and break after repeated flexing. Moving contacts are mounted on long, U-shaped flat spring strips, instead of on short, delicate pieces sandwiched between layers of phenolic and further demoralized by rivets.

— shocks through wandering fingers or screwdrivers touching the case aren't possible, because the frame is completely independent of and enclosed by the case. (10 amps, even at 28 volts, is a sensation you can do without.)

While this has been a description of the DPDT Sigma Series 46 relay, we think it also offers a good guide to what to look for in any heavy-duty, 10-amp "industrial" relay. The final test, of course, is how the relay works in *your* equipment. You can get a "46" to try right away—either from a local Sigma distributor's shelf or from stock at the plant. Comparing components can be interesting—and often profitable.

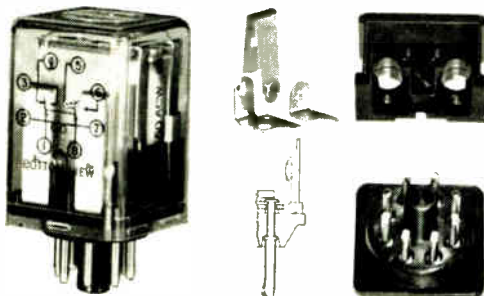

SERIES 46 AC OR DC DPDT RELAYS

CONTACT RATING

— AC: 1200 v-a/pole, with 240V. and 10 amp. maximums; DC: 5 amp. @ 28 VDC

LIFE

— 500,000 operations for 10 amp. loads
Up to 10 million operations for 1 amp. loads

STANDARD SENSITIVITIES

— AC: 4 v-a, DC: 1 watt

PRICE RANGE

— \$3.00 to \$6.80 each, depending on coil resistance, adjustment, contact material and quantity.



SIGMA

SIGMA INSTRUMENTS, INC.

62 PEARL ST., SO. BRAINTREE 85, MASS.

HOW CHEAP IS "CHEAP"?

"Why should we buy from you when we can get the 'same thing' from other suppliers at a lower price?"

In selecting a supplier of lacing tape (or any component), price and compliance with specifications are not the only criteria. But too often, manufacturers ignore the other factors involved and consequently lose money.

For example, in a \$15,000 piece of equipment there may be only 15 cents worth of Gudebrod lacing tape. It costs \$75 to work this tape. It may be possible to buy the same amount of tape from other suppliers for 2 or 3 cents less . . . it "will meet the specs" according to these suppliers. But one of our customers recently pointed out why he still specifies only Gudebrod lacing tape in such cases.

"We tried buying some cheaper tape that 'met the specs.' Within a few months our production was off by 50% . . . boy, did the production people really scream about that tape. And our labor costs doubled . . . our costing people really flipped!

"Another thing, why should we risk the possible loss of thousands of dollars when the original material cost difference is only a few cents. Once you put cheaper tape on and something goes wrong after the equipment is finished . . . you've had it. No, thank you! We learned our lesson! We buy Gudebrod lacing tape!"

Whether your firm uses one spool of lacing tape or thousands, there are four advantages in specifying Gudebrod for all your lacing requirements:

1. *Gudebrod lacing tape guarantees increased production!*
2. *Gudebrod lacing tape guarantees reduced labor costs!*
3. *Gudebrod lacing tape guarantees minimal maintenance after installation!*
4. *Gudebrod guarantees quality!* On every spool is a lot number and seal which guarantees that all Gudebrod lacing tape is produced under strict quality control. Our standards are more exacting than those required for compliance with Mil-T.

Our Technical Products Data Book explains in detail the complete line of Gudebrod lacing tapes for both civilian and military use. For your copy write to Mr. F. W. Krupp, Vice President, Electronics Division

GUDEBROD BROS. SILK CO., INC.

Electronics Division
225 West 34th Street
New York 1, New York

Executive Offices
12 South 12th Street
Philadelphia 7, Pa.

MEETINGS AHEAD

NUCLEAR CONGRESS & EXHIBIT, Engineers Joint Council; Statler Hilton Hotel, New York City, June 4-7.

RADAR ANNUAL SYMPOSIUM, University of Michigan; Ann Arbor, June 6-8.

MOLECULAR BEAMS CONFERENCE, Brookhaven National Laboratory; Upton, N.Y., June 11-13.

ARMED FORCES COMMUNICATIONS & ELECTRONICS ASSOCIATION CONVENTION & SHOW; Sheraton Park and Shoreham Hotels, Washington, D.C., June 12-14.

AEROSPACE TRANSPORTATION CONFERENCE, AIEE; Denver-Hilton Hotel, Denver, Colo., June 17-22.

BROADCAST & TELEVISION RECEIVERS CONFERENCE, IRE; O'Hare Inn, Chicago, Ill., June 18-19.

MILITARY ELECTRONICS, SIXTH NATIONAL CONVENTION, IRE-PGMIL; Shoreham Hotel, Washington, D.C., June 25-27.

ELECTROMAGNETIC THEORY & ANTENNAS SYMPOSIUM, Tech. Univ. of Denmark, et al; Copenhagen, June 25-30.

COMPUTER & DATA PROCESSING SYMPOSIUM, Denver Research Instit.; Estes Park, Colo., June 27-28.

AUTOMATIC CONTROL JOINT CONFERENCE, IRE-PGAC, AIEE, ISA, ASME, AICHE; NY Univ., New York City, June 27-29.

RADIO PROPAGATION COURSE, National Bureau of Standards and University of Colorado; NBS Boulder Laboratories, Boulder, Colo., July 16-Aug. 3.

LUNAR MISSIONS MEETING, ARS; Pick-Carter and Statler-Hilton Hotels, Cleveland, Ohio, July 17-19.

DATA ACQUISITION & PROCESSING IN MEDICINE & BIOLOGY CONFERENCE, U. of Rochester; Strong Mem. Hosp., Rochester, N.Y., July 18-19.

INTERNATIONAL SOUND FAIR, Institute of High Fidelity Manufacturers, Magnetic Recording Industry Assoc., et al; Cobo Hall, Detroit, July 25-29.

INDUSTRIAL RESEARCH CONFERENCE, Columbia University; Arden House, Harriman, N.Y., Aug. 5.

WESTERN ELECTRONICS SHOW AND CONFERENCE, WEMA, IRE; Los Angeles, Calif., Aug. 21-24.

ADVANCE REPORT

ARTIFICIAL INTELLIGENCE SESSIONS OF 1963 WINTER GENERAL MEETING, AIEE; New York City, Jan. 27-Feb. 1, 1963. July 1 is the deadline for submitting 100-word abstract and 500-word informal summary (or entire paper if available) to: B. W. Pollard, Papers Chairman, Artificial Intelligence Sessions, Burroughs Corporation, 6071 Second Avenue, Detroit 32, Mich. Any aspect of artificial intelligence may be discussed. Typical topics include: what is artificial intelligence; role of network models (can artificial intelligence be implemented by neural nets or neuron analogs); utilization of analytic processes; trends in machine augmentation of man's intelligence.

ANNOUNCING

New EIC Representatives

CLYDE M. SALISBURY CO.
 Montrose 4-0586, 1453 Seventh Avenue
 San Francisco 22, California.

WALLACE AND WALLACE
 Richmond 7-0401 (TWX-LA 593), 1206 Maple Avenue
 Los Angeles 15, California.

ELECTRONIC SALES, INC.
 Skyline 6-4148, 2641 S. Ivy Street
 Denver 22, Colorado.

EDWARD F. AYMOND CO.
 DALLAS—3915 Lemmon—LA 6-5233, TWX DL-206-U
 HOUSTON—5010 Carew—MO 6-1804
 NEW ORLEANS—6305 Leslie—834-0196

REPCO SALES
 Plaza 7-2911, 401 N. W. 71st Street
 Miami, Florida.

These distributors can handle your needs for standard off-the-shelf or custom solid state

power supplies, transformers, modulators, demodulators, and recording oscillographs. They

can also give you quotations on top-quality EIC printed circuits.

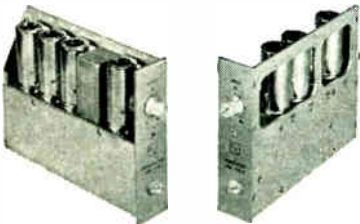

Modulators and demodulators

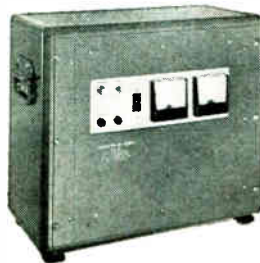

Solid state power supplies

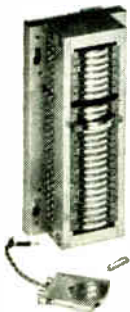

Magnetic recording heads

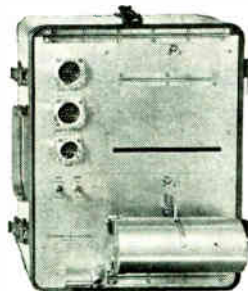

Recording oscillographs



Recording interval timers

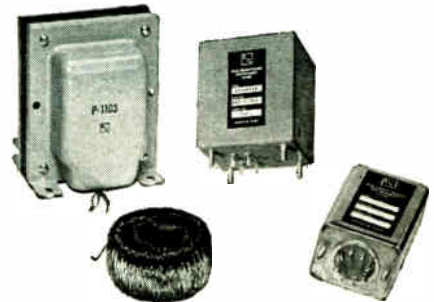

Transformers and chokes

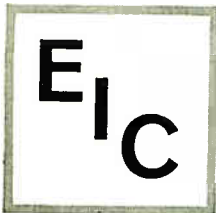

ELECTRODYNAMIC INSTRUMENT CORPORATION

Subsidiary of Reed Roller Bit Company

TWX HO-1147 / JA 6-3761 • 1841 Old Spanish Trail • Houston 25, Texas

Space
orbits around
FLORIDA

after
you decide to put a
plant in Florida,

locate where
the action
is!

st. petersburg



The control of space is in Florida . . . because the people who will control it live here. Why not? It's nicer living here. And St. Petersburg land prices are within reason. Come and get it . . . locate where the action is—St. Petersburg. Write, wire or phone in confidence ► **GREATER ST. PETERSBURG CHAMBER OF COMMERCE, Jack Bryan, Dept. E, St. Petersburg, Florida**

St. Petersburg is the Florida Home of: ALLSTATE INSURANCE • AMP • BABCOCK & WILCOX • CONTINENTAL OPTICAL • ECI • GENERAL CABLE • GE • GENERAL NUCLEAR ENGINEERING • INTERNATIONAL RESISTANCE • MILTON ROY • HONEYWELL • SPERRY

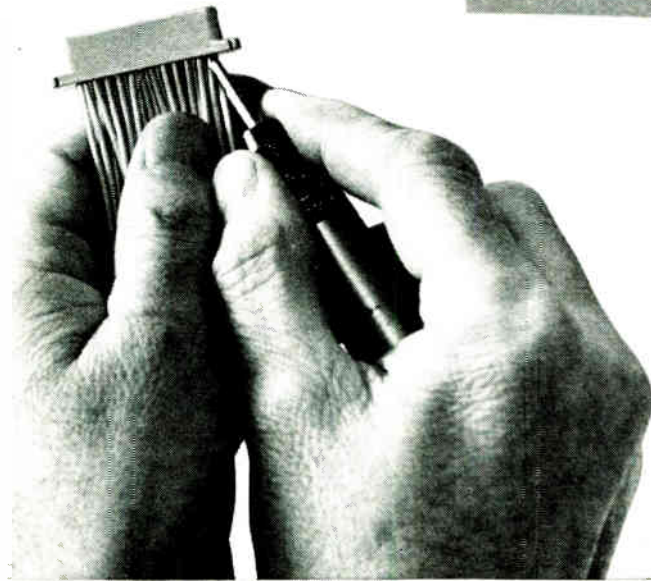
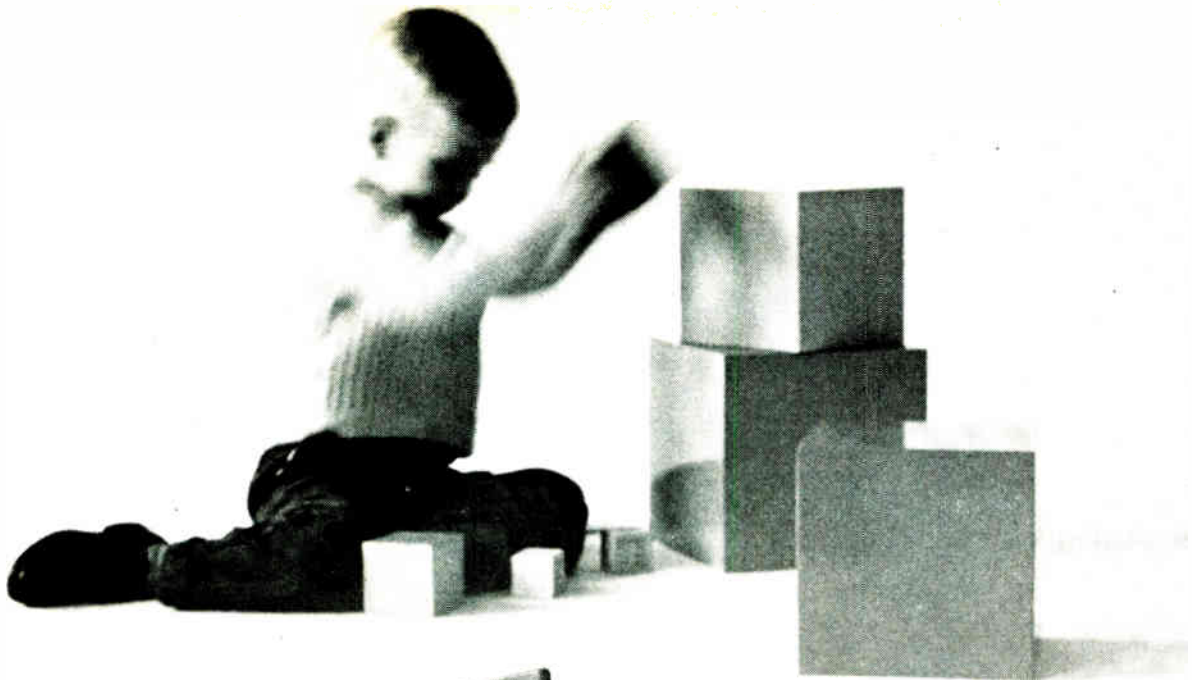

Child's play

Amphenol's new Tiny Tim* micro-miniature rack and panel connector is easy to put together, almost child's play in fact. That's because its Poke-Home® Wire Form contacts are crimped to leads first, then inserted into the connector. No close-quarter soldering. No under-the-magnifying-glass assembly. No fuss, less expense.

But important as easy assembly may be, it's just one feature of the new Tiny Tim. Reliability and economy are two others.

Reliable connections result from the design of Amphenol Wire Form contacts. Four gold-plated, beryllium-copper spring fingers on each male contact exert a firm,

equalizing force at four points on the socket wall. Result: positive contact retention, excellent "wiping" action.

Economy is also a result of contact design. Wire Form contacts are mass produced on high speed, automatic machines. You benefit because lower manufacturing costs mean lower purchase prices.

Other Tiny Tim features are: 1. Wire Form contacts can be easily realigned, even after severe bending. 2. Contact resistance is .0025 to .0030 ohm constant to 1,000 insertion and withdrawal cycles. 3. Maximum continuous current rating is 3 amp; maximum voltage rating is 600 volts @ 60 cps. 4. One-piece molded connector

bodies have excellent electrical characteristics. 5. Available with 5, 9, 17, 25 and 33 contacts.

One last thought. In addition to being ideal for all the usual micro-miniature rack and panel applications, Tiny Tims can also be potted integrally into modules. Interconnections can thus be provided *without* altering the shape or dimensions of the basic module.

For more information on Tiny Tim micro-miniature rack and panel connectors, see your Amphenol Sales Engineer or write: Dick Hall, Vice President, Marketing, Amphenol Connector Division, 1830 S. 54th Ave., Chicago 50, Ill.

*T.M. Amphenol-Borg Electronics Corporation



Connector Division / Amphenol-Borg Electronics Corporation

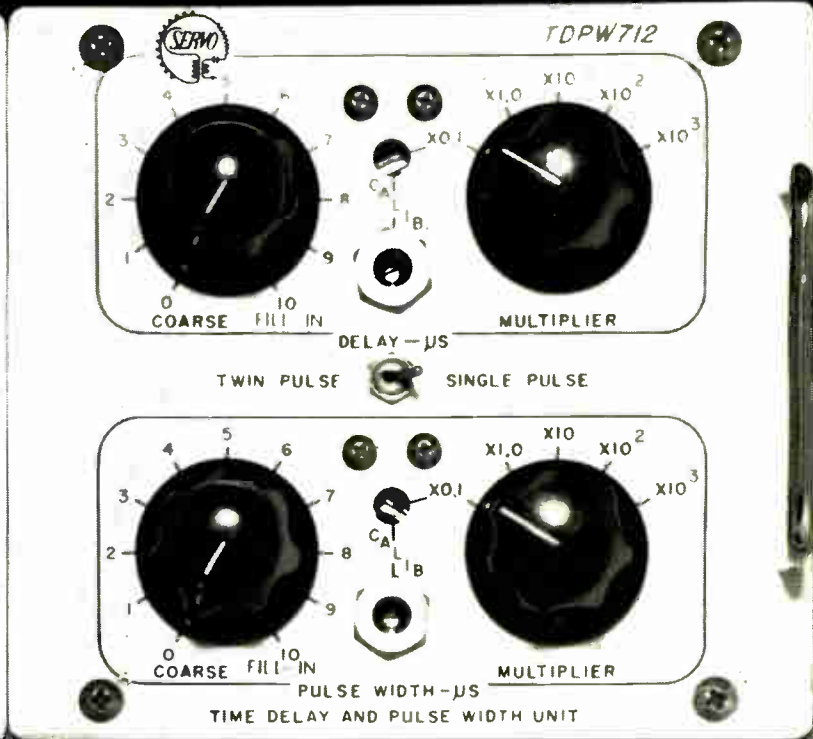
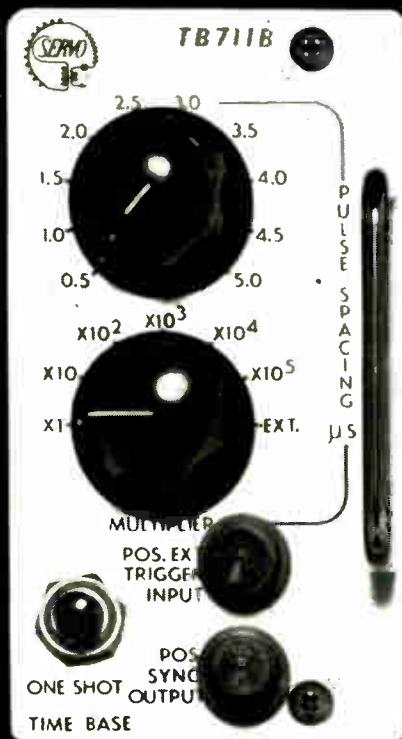

THE NEW MODULAR LOOK IN PULSE GENERATORS ...AND THE NEW DUAL-PULSE CAPABILITY:

The SERVOPULSE™ Model 3450D is a versatile general-purpose pulse generator with *dual-pulse* generation as a standard feature. A completely modularized unit, it allows new features or arrangements to be added by simple modification. The Model 3450D offers rep rates from 2 cps to 2 mc, and provides wide-range performance from long-duration pulses (10 milliseconds) at very low rep rates to 50 nanosecond signals in the mc range. Variable rise time from less than 15 nanoseconds results in extremely clean, controllable pulse forms. This is a highly reliable, ruggedized, compact (20" W x 11½" H x 16" D) instrument. Components and circuitry used are military specification quality. A few more facts: positive and negative polarity; 0.05 to 10,000 μsec delays; 0.05 to 10,000 μsec pulse widths; amplitude ± 50 volts into 50 ohms. The model 3450D is equally useful for laboratory work or production-line testing. Sales and service facilities are available to you from coast to coast...ask for a demonstration. Immediate delivery.

SERVOPULSE™ PRODUCTS
SERVO CORPORATION OF AMERICA
 111 New South Road • Hicksville, L. I., N. Y. • WELLS 8-9700

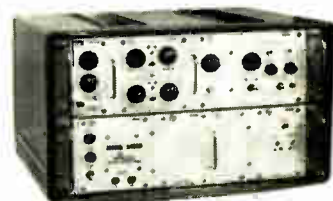

Model 3450D Twin Pulse Generator

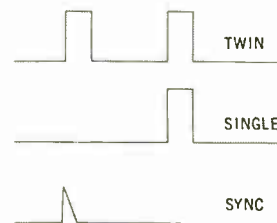

Main Pulse Outputs

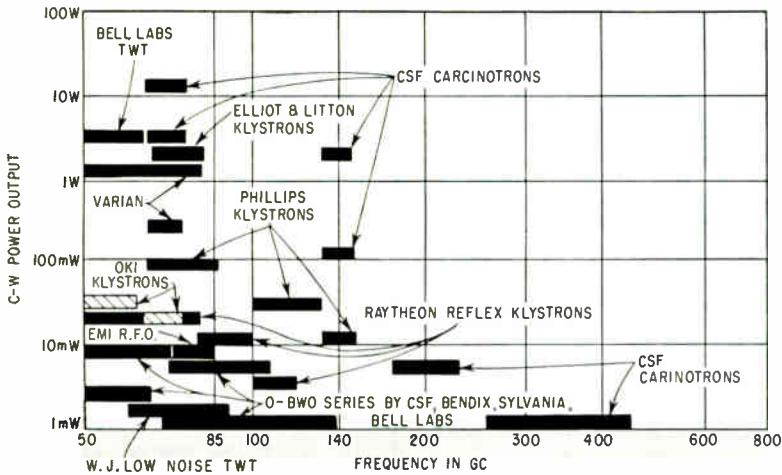

FIG. 1—Power levels for tubes either pulsed or operated c-w above 50 Gc

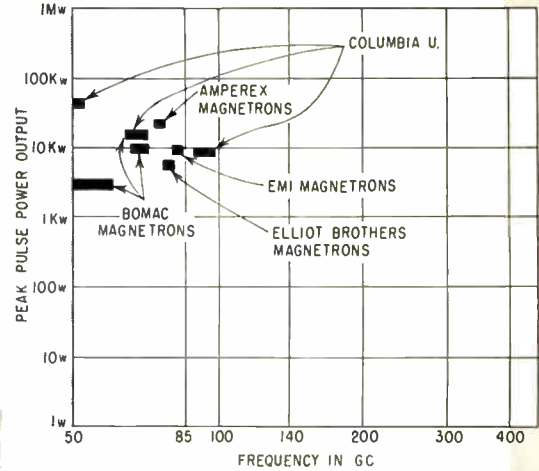

FIG. 2—Millimeter wavelength pulsed tubes

NEW APPROACHES TO Millimeter Wavelength Devices

Many design approaches to tubes for generating and amplifying millimeter and submillimeter wavelengths are under investigation.

Some of the more promising versions are discussed in this survey, including one structure that has generated a few milliwatts at 420 Gc

By W. W. TEICH

Raytheon Company,
Burlington, Massachusetts

PRACTICAL APPLICATIONS of radiation above K-band and on up to laser frequencies are being investigated by many workers throughout the country. Frequencies higher than those now generally available are of interest for several reasons: wide bandwidth, increasing directivity with increasing frequency, molecular and atmospheric absorption in transmission, and miniaturization possibilities.

The bandwidth multiplication inherent to frequency increase is one of the major advantages of higher

frequencies. It is axiomatic that the next decade of the frequency spectrum contains nine times the bandwidth from zero frequency to the beginning of the decade: the bandwidth from 10^5 to 10^6 cps, for example, is 9×10^5 cps, which is 9 times the bandwidth from zero to 10^5 cps.

Since the same number of cycles at a high frequency can be obtained with a smaller percentage of the available bandwidth, bandwidth can often be traded off for efficiency, smaller size or reduced complexity.

Wide bandwidth also means shorter starting time for oscillators and, consequently, the feasibility of precision radars with good time

resolution using short pulses. The starting time of an oscillator, or its buildup Q, is a constant number of r-f cycles (though higher losses at millimeter wavelengths may increase this number somewhat); therefore, minimum pulse duration is nearly a direct function of wavelength.

The greater directivity at higher frequencies results primarily from the practical results of reduced size. Antenna beamwidth is a function of the size of a radiator or reflector in wavelength. Consequently, for a given beamwidth, the antenna shrinks proportionally to wavelength. A 10-meter dish at L-band (1 Gc), for example, has only the

AMPLIFIERS OSCILLATORS	MICROWAVE POWER TUBES		
	TYPE OF ELECTRON STREAM		
	LINEAR BEAM (O-TYPE)	CROSSED-FIELD (M-TYPE)	
TYPE OF CIRCUIT WAVE		INJECTED BEAM	CONTINUOUS CATHODE
BACKWARD WAVE	O-BWA O-BWO (O-CARCINOTRON)	BITERMITRON M-BWO (M-CARCINOTRON)	AMPLITRON STABILOTRON
FORWARD WAVE	TWT (TPO)	CFA (TPOM)	AMPLITRON CFA
STANDING WAVE	KLYSTRON MONOTRON		CIRCLOTRON MAGNETRON

FIG. 3—Millimeter and sub-millimeter wavelength tube types for c-w signal generation and amplification

directivity of a 20-cm dish at V_E -band (50 Gc)

Such a reduction in antenna size allows realization of extremely narrow beamwidths with carefully fabricated antennas of reasonable dimensions.

The property of high directivity is attractive in the design of secure communications systems, where highly directive beams not only reduce the power required for transmission but confine the intelligence to a small volume and make interception or jamming difficult. Absorption of higher frequency radiation by water vapor and chemical constituents of the atmosphere also enhances the privacy of communications. Using a suitable frequency, atmospheric attenuation can limit the distance beyond the desired station that a detectable signal is transmitted. Some systems have been suggested in which either the transmitter frequency or its power level would be adjusted as a function of atmospheric conditions so as to maintain a desired signal-to-noise ratio with minimum overshoot.

Atmospheric absorption can also be used to prevent ground interception of communications between vehicles in space. A frequency near one of the oxygen absorption lines, for example, will be almost completely attenuated in the atmosphere, but at 40,000 feet or more would permit efficient communications.

While the increase in attenuation due to water vapor has in general discouraged moving systems to higher frequencies, there are other

effects that force the move. A space vehicle in reentry generates a plasma sheath that surrounds the vehicle. This sheath is an effective absorber of radiation below plasma resonance. Telemetric links with the vehicle at the usual frequencies, and even as high as X-band, will not penetrate this sheath. There is danger of loss of contact during the most critical few minutes of a vehicle flight. Systems designed at 35 Gc or higher would be above the plasma resonance under most conditions and, consequently, capable of uninterrupted communications.

Other systems can be envisioned in which spectrographic information is generated and utilized. Many molecular transitions occur in the decade above 30 Gc, and instruments for detecting specific constituents are possible.

The emissivity or reflection coefficients of materials also have interesting relations in the millimeter and submillimeter decades. Thermal mapping by detectors sensitive to infrared can give clear indications of objects at elevated temperatures. Device research is continuing towards detectors at longer wavelengths (beyond 30 microns) that would be able to identify radiations from objects with temperatures as low as the human body. At longer wavelengths—across the gap into the upper end of the millimeter spectrum—a similar type of mapping can be achieved with radiometer techniques. Icebergs, for example, can be detected in the ocean because they reflect the cold sky differently than water.

Similarly, the varying reflectivi-

ties of the constituents of the non-homogeneous atmosphere make possible the detection of turbulence in what appears to the eye to be clear air. Improved air navigation systems and more precise meteorological predictions may eventually result from systems utilizing this phenomenon.

Miniaturization is a possibility for millimeter and submillimeter equipment because the size of many of the frequency sensitive portions of the system are directly proportional to wavelength. This is true of antennas for constant beamwidth and also for other parts of the waveguide circuits. However, practical equipment would not scale down with wavelength because many of the auxiliary circuits are not frequency dependent at all; and, unfortunately, there are several factors that prevent complete size reduction with wavelength. In waveguide components, it is impossible to reduce the size of connecting flanges and wall thickness without limit. As a result, many specific millimeter wave components will not be much smaller than similar elements at K-band.

For power generation devices, the possible reduction is additionally limited by the decreasing efficiency or the need for high magnetic fields.

Development of systems employing millimeter and submillimeter radiation is still handicapped by r-f components that are either unavailable or inadequate. Research workers gathering information about physical constants and properties of materials in this region have found it necessary to develop for themselves most of the waveguide components. A few power sources have been available and frequency multiplying has been used to extend their useful range.

In the next few years the need for the characteristics that millimeter wave systems can provide can be expected to accelerate the development and refinement of families of components at several specific bands.

In power generation and amplification, two basic approaches are being followed to develop the devices for practical systems. The first approach would extend the capability of devices like those already in use at X-band, while the second approach would seek new

or relatively unused physical phenomena upon which to base device designs.

Figures 1 and 2 show the power levels available from tubes either pulsed or operated c-w above 50 Gc. For some there are results on one or more laboratory samples, while others listed are available with short delivery times. The O-type backward wave oscillators, available for use up to 140 Gc, can produce a few milliwatts of power for local oscillator or signal generator application. Tubes in this range are manufactured by CSF, Bendix, Sylvania and Bell Laboratories. Above 140 Gc, CSF has tested Carcinotrons at this power level; recently they have generated a few milliwatts at 420 Gc (0.72 mm).

Reflex klystrons are also available up to 140 Gc, with power output in the tens of milliwatts, and in narrow bands with outputs of a few hundred milliwatts. Raytheon, Varian, Elliott Brothers, Litton, E.M.I., Phillips, Amperex and OKI (OKI Electric Industry Co., Ltd., Tokyo) are manufacturers of these devices.

A low-noise traveling-wave tube is under development at Watkins Johnson for the 60 to 90 Gc band. Bell Telephone Laboratories are manufacturing a twt with 500 mw of power output in the 50 to 60 Gc range.

CSF Carcinotrons have been built for relatively high power outputs in bands around 70 and 140 Gc. Over twelve watts has been measured at the lower frequency and three watts at 140 Gc. Varian has reported over one watt of power output from a bwo in the 50 to 80 Gc range.

Magnetrons are available as pulsed sources below 100 Gc. Most of these are based on work supported at Columbia University over a period of many years; typically, they operate at duty cycles less than 0.001. Specific devices are available from Bomac, E.M.I., Elliott Brothers and Amperex.

Although conventional devices, especially magnetrons and klystrons, have been the objects of development projects at extremely high frequencies for a number of years, the continuing progress in

many related fields makes successful devices in this area even more probable today.

The primary types of devices that have been used for generating or amplifying power in the microwave region can be classified as to their operating principles as shown in Fig. 3. These devices in general employ an interaction between an electromagnetic wave propagating on a circuit and a wave propagating on an electron beam.

In the first column of the chart, three classes of devices are enumerated depending on whether the circuit wave with which interaction is encouraged is a backward traveling component (one in which the phase velocity is in the opposite direction to the flow of energy, or group velocity), a forward traveling component (in which phase velocity and group velocity are similarly directed), or a standing wave such as is produced with the resonant cavity of the klystron.

In the top row of the chart, three basic types of electron interaction geometries are specified. The first refers to those devices employing a

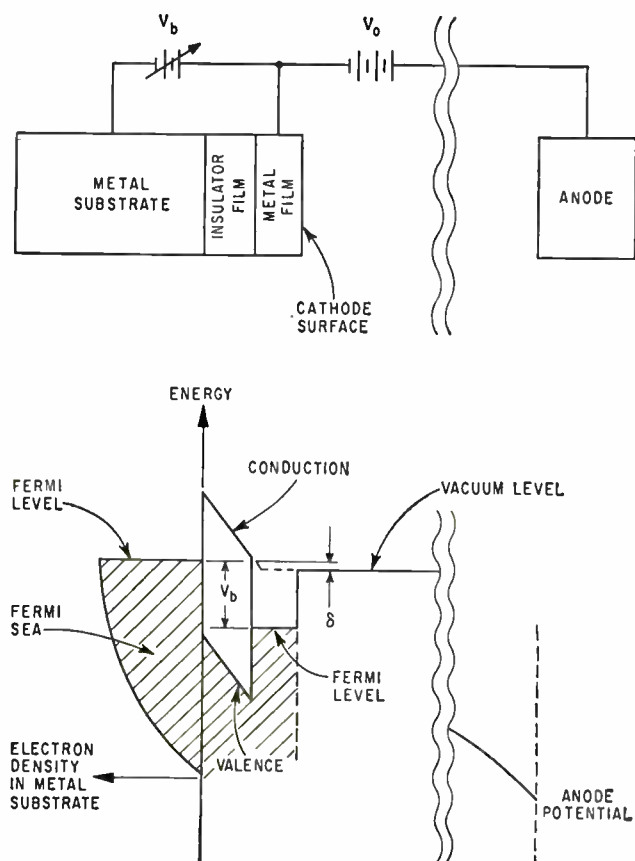

FIG. 4—Proposed tunnel cathode and energy band at zero degrees absolute. Emission is by field effect and emission density should be high

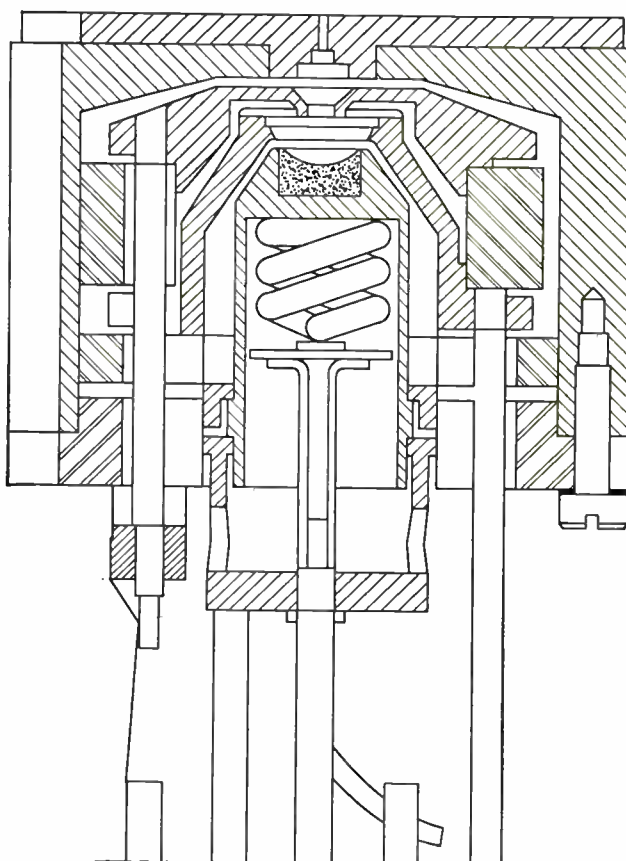

FIG. 5—Gun used in CSF O-Carcinotrons has convergent ratio of about 100, and can produce more than 2 watts at 70 Gc and 10 mw at 140 Gc

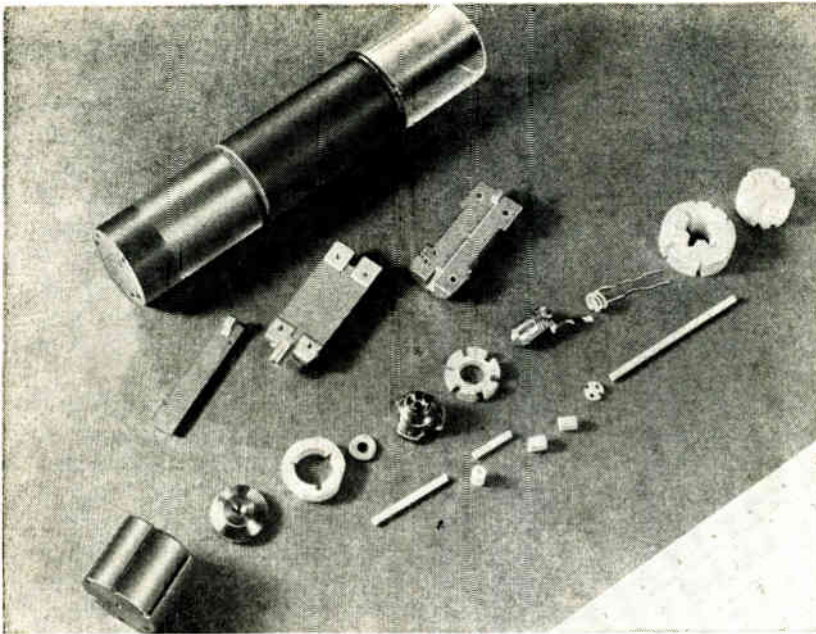

FIG. 6—CSF type COE20 uses gun shown in Fig. 5

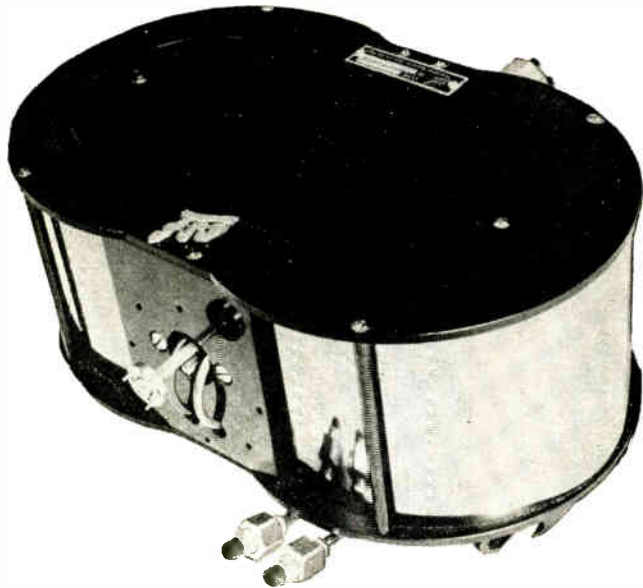

FIG. 7—CSF type COE20 produces useful power at 140 Gc

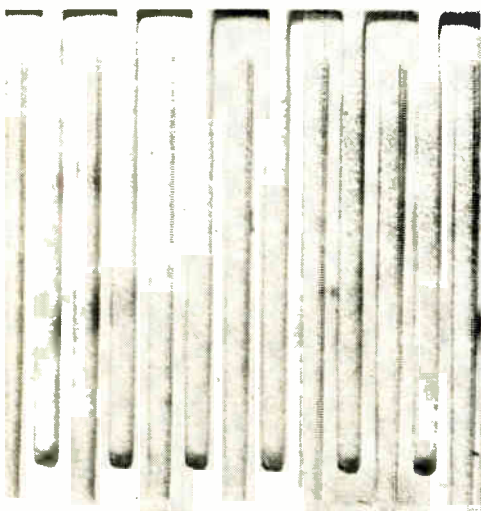

FIG. 8 — Photoetching and photodeposition techniques form an interdigital line on ceramic base (CSF)

linear beam, a beam that progresses down the length of a tube, usually confined by a magnetic field, and falls on an electrode for collection after interaction with the r-f structure.

The other two types are classed together as crossed-field devices in which a magnetic field at right angles, or crossed, to the d-c electric field is essential to the interaction process. Crossed-field devices are subdivided into those that employ an injected beam in which the cathode region is shielded from the r-f voltages and those that employ a cathode extending through the interaction region, with r-f fields present in the critical region near the cathode surface.

Figure 3 also shows the name of the device that employs the particular combination circuit wave and electron-beam interaction specified. The name of the device normally employed as an amplifier (though not necessarily a linear amplifier) is shown in the upper part of the box; the name for the oscillator or power generator version is shown in the lower part.

The classification represented by the chart is helpful in a discussion of the millimeter wave devices since, to a large extent, the factors that are limitations at higher frequencies are common to particular classes of devices.

Beam devices, regardless of the type of circuit interaction, have been most effectively exploited to date in the millimeter wave region. Perhaps the principal feature in a beam device is the separation of functions. The fact that the beam generation, the r-f interaction and beam collection occur successively in the tube permits a separate design and optimization of these functions. The processes are not completely independent but are sufficiently so to permit parallel phases during a development program and to permit progress in one of the processes to be translated quickly into improved overall performance.

The basic limitations of beam type tubes are a result of scaling factors. A successful tube design can be translated to a higher frequency by reducing each dimension by a factor equal to the ratio of the frequencies. The diameter of the beam is reduced by the square of this factor and, assuming constant

current density, this means that power output is proportional to the square of wavelength. However, complete scaling is not usually possible since there are some dimensions, such as the spacing between beam and circuit, that are chosen as small as practical at the lower frequency and cannot be reduced as much as the ratio would indicate without impossible alignment problems. Consequently, a larger dimension would generally be used, which results in a reduction of the coupling impedance and, therefore, in reduced gain, efficiency and power output. A design on this basis deteriorates more rapidly than the square of wavelength.

The more usual object of a development program is to design a tube with power output equal to that of a lower frequency design. Frequency scaling will not be adequate and other steps that effectively raise the power level of the original design must be included.

One approach is to raise the power in the beam by an increase in power density. Either higher current densities are needed from the cathode or the convergent ratio of the gun must be increased.

High-density cathodes have been the subject of many research or development projects in the past years. The impregnated tungsten matrix cathode represents a significant advance in this area and the smooth surface is particularly adaptable to the small dimensions required for millimeter-wave tubes.

Field emission, especially the emission from sharp points, has also received considerable attention, though no effective millimeter-wave application has been made as yet. Engineers at the Compagnie

générale de télégraphie Sans Fil (CSF) envision a device in which a multiplicity of points are arranged within a space in such a way that each point constitutes a monotron oscillator and the outputs are coupled by the structure. Thus, though each point contributes only a small current (at high current density), the number of points that could be used would indicate that useful amounts of power could be generated.

A new approach to high emission has been considered by workers at Stanford and by Wade and others at Raytheon. The cathode considered would have a thin metal surface separated from a metallic base by a thin insulator layer. A schematic of the layers and plot of energy levels is shown in Fig 4. Electrons with sufficient energy in the base metal (a temperature of absolute zero is assumed for the energies in the diagram) tunnel through the insulator layer and progress through the thin metal film. Those with sufficient energy are emitted from the surface into the vacuum space. As arranged, a sorting takes place that should produce a beam with low velocity variations and with a low effective noise temperature.

In addition, since the emission is a field-effect phenomenon, it is expected that emission densities can exceed those available from thermionic cathodes. Again, the smooth surface and thin films suggest application of this type of tunnel cathode to millimeter-wave devices.

High convergent-ratio guns, with conventional cathodes, have been successfully employed by CSF in the design of their O-Carcinotrons

(backward wave oscillators) which have become sources of power as high as 415 Gc (0.72 mm). The gun shown in Fig 5 employs a convergent ratio of about 100 and produces a beam with a current density between 150 and 200 amp per cm which is focused through a 0.008 in. diameter hole. With such a beam the COE 40 produces more than two watts of power in a seven-percent band centered at 70 Gc (4.3 mm). The beam is also employed in the COE 20, which produces ten milliwatts or more of power over a seven percent band centered at 140 Gc (2.14 mm). The tube and its component parts are shown in Fig. 6 and 7.

High convergent ratio guns are difficult to design because of the high space charge forces that must be taken into account and because most designs yield beams with a larger spread in electron velocities than would be desired. However, it is reasonable to expect that beams with densities as high as 500 amp per cm² will be available in the next few years, and that ultimate densities may be between 1,000 and 2,000 amp per cm².

Another step to avoid the limitations of direct frequency scaling is to allow for higher voltage beams. Practical considerations that must be considered include voltage breakdown both within and external to the tube, the hazards of x-rays and the expense of power supplies; all these place an effective limit on the voltage that can be selected.

Coleman and his associates at the University of Illinois have pursued this field of extremely high energy beams both theoretically and experimentally for several years. The Rebatron, which has been a part

FIG. 9—Evolutionary steps in developing a wrapped or curled structure

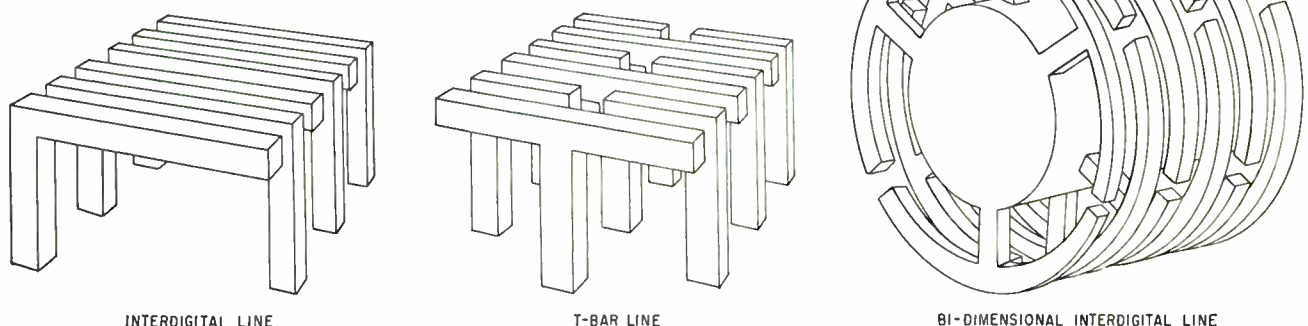

of many of the experiments, is an apparatus for generating a 0.8 Mev beam and tightly bunching this beam at a fundamental frequency in S-band. One approach to the generation of power at millimeter wavelengths has been the extraction of harmonic energy from this beam with an interaction circuit. More than 0.5 watt at 1,000 Gc (0.3 mm) is predicted from the device.

Two coworkers have measured about 100 milliwatts between 30 and 40 Gc by collecting this type of beam on a surface within a cavity.¹ The radiation is coincident with the annihilation of the beam.

Steps can also be taken to obtain higher power output in the r-f structure. The problem is twofold: first, the circuits that result from frequency scaling have dimensions and tolerances that are difficult or impossible to attain by conventional fabrication techniques; second, the circuits must somehow be multiplied in total dimensions to obtain an appropriate interaction area for the power level desired. Millimeter-wave interaction circuits, because of these considerations, will eventually be different from their lower frequency counterparts both in fabrication technique and in electrical concept.

Photoetching and photodeposition may fulfill the requirements for millimeter-wave circuit fabrication. Figure 8 shows the detail of an interdigital line deposited on a ceramic base. The photographic process permits production of uniformly accurate masters as well as reproduction of identical line models. The ceramic base provides rigidity for the line, a means of accurate alignment with the beam and an effective path for cooling the structure.

Etching may also be controlled by a photographic process and thus create a number of wafers of the required geometry to stack, braze and form a laminated-line structure.

Raytheon has long used laminated microwave tube structures, having introduced the process for magnetrons during World War II. They have also employed the technique in the fabrication of O-type backward wave oscillators. Recent additions to this line cover 12 to 18 and 18 to 26 Gc and, as at lower frequencies, use punched wafers to form a laminated interdigital line.

At shorter wavelengths the tolerances on the thickness of the laminations become severe and the openings in the wafers tend to become filled by capillary action if solder is used in assembly. With surfaces that are clean and sufficiently flat, it has been shown that the stack can be put together by pressure welding—applying pressure at elevated temperatures until grain growth occurs across the boundaries and a solid stack is formed.

New circuits, as well as new methods of circuit fabrication, are also under study. Most studies are aimed at finding suitable circuits

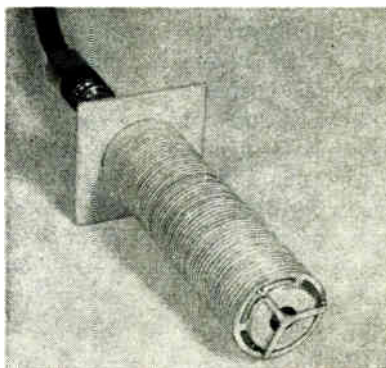

FIG. 10—Laminated multidimensional line is used in S-band O-Carcinotron

that will allow increased dissipation area. Most microwave tubes are essentially one dimensional: most obvious is a backward wave oscillator using an interdigital line. The line is many wavelengths long in the axial direction corresponding to the beam velocity and flow of energy on the circuit. In its transverse direction it is usually limited to less than one-half wavelength so that the interaction fields will be constant in this direction. Extending the structure in the transverse direction would increase beam area and power output, and would usually give lower beam impedance and starting current.

However, if the structure width is increased, means must be found to control the new families of modes that are possible with a field periodicity in the transverse direction. Similar problems in the magnetron were solved by the introduction of strapping or the use of the rising-sun geometry for the anode. These methods control the mode selection by displacing the frequency of the undesired mode. Another technique

is to place lossy material at critical locations in the structure to damp the undesired modes; the technique is common in high power traveling-wave tubes.

The structure need not be planar but can be wrapped upon itself to form reentrant structures in the transverse direction. Figure 9 shows an evolution of this type of reentrancy. The structure can be supported from an inner diameter as shown, in which case a hollow beam would be employed, or it can be supported from an outer diameter with either a solid or hollow beam. Figure 10 shows a laminated multidimensional line for an S-band O-Carcinotron built with this general approach at CSF. They have obtained 20 watts of power at 11 percent efficiency. A beam perveance of 27×10^{-6} was obtained, which permitted operation with 100 to 500 volts.

The toroidal klystron is another example of paralleling interaction processes. These schemes lead to predictions of extremely high power outputs at centimeter wavelengths—nearly an order of magnitude greater than their one-dimensional counterparts. But they can also be combined with new fabrication techniques to produce more modest output powers at frequencies pushed into the millimeter range.

Another linear beam device receiving attention can be described either as a resonant circuit backward-wave oscillator or as an extended interaction klystron. It lies between the extremes of these two devices in their conventional form.

Approached from the bwo con-

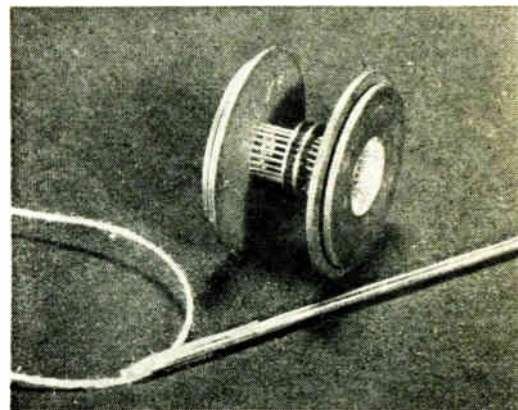

FIG. 11—Anode for X-band c-w Amplitron is cooled by high velocity streams of water

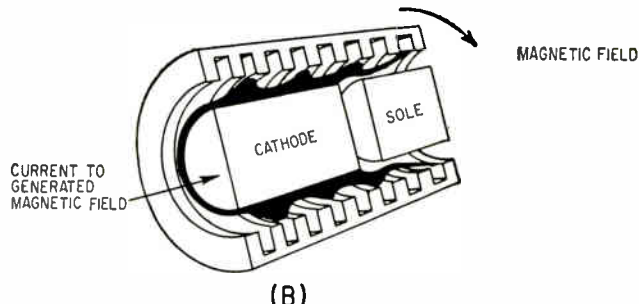
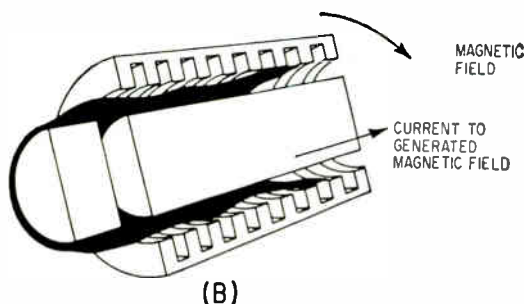
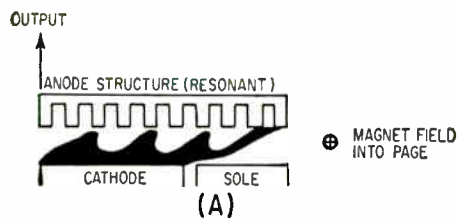
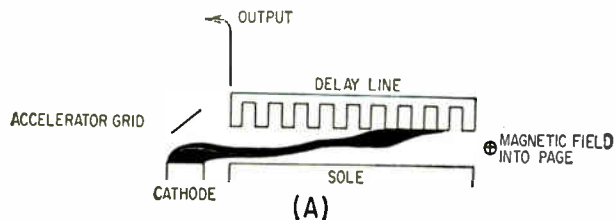

FIG. 12—Linear M-type backward wave oscillator (A) and cylindrical version using the same approach (B), where magnetic field is generated by a current in the sole

FIG. 13—Linear magnetron (A) has seldom been constructed because efficiency is lower than the same size circular version (B)

cept, the circuit is made of higher impedance by a reduction in band-pass; this higher coupling to the beam permits an increase in efficiency, or a reduction of interaction length, or both.

Approached from the klystron concept, the single gap of the tube is replaced by slow-wave structure that may be coupled to a resonant cavity. One formulation of such a device, termed the laddertron by OKI, will produce five watts c-w at 50 Gc.

The principal feature of crossed-field devices is higher efficiency. The interaction process involves direct conversion of potential energy to r-f energy without bringing the electrons to the velocity corresponding to the full applied anode voltage. High efficiency can be an important characteristic at millimeter wavelengths, especially where the size of the total equipment is critical.

Despite higher efficiency, power dissipation becomes important in crossed-field tube design since this dissipation in general occurs through the r-f circuit structure instead of primarily through a collector. Crossed-field tubes must use r-f structures that provide effective electron collection and heat dissipation in addition to good characteristics for the interacting r-f wave. The requirement is not completely absent for beam type tubes, either, since many factors contribute to a greater collection of the beam on

the r-f circuit of these tubes at shorter wavelengths.

At Raytheon, experiments are being continued in the use of high velocity water through small holes to achieve high dissipation densities close to the origin of the heat. An X-band c-w Amplitron with vanes made of tubing has been tested with as much as five Kw per cm² removed by the water from the area exposed to the electron interaction. An eight-millimeter Amplitron under development uses anode tubing 0.008 inch outer diameter and 0.004 inch inner diameter. This anode, shown in Fig. 11, has about 0.1 cm exposed area; with a pressure of 300 psi, water flow is five cc per sec, which would provide for 500 watts dissipation from the anode. Heat transfer to the water is the critical process and the high velocity apparently creates a scrubbing action that sweeps away steam bubbles as they form. This localized boiling is the usual limit on power-handling capability and has limited tubes of conventional design to about 100 watts per cm².

Using tubing for fabricating water-cooled vanes cannot be extrapolated without limit to shorter wavelengths, but the basic heat transfer to high velocity water can be utilized. Fortunately, as structures get smaller the distance the heat must be transferred along the structure before encountering a cooled plane is also reduced. The total temperature rise along this

path is important in tube design and, as the path shortens, it is no longer necessary to consider placing the cooling at the face of the vane.

The magnetic field in a crossed-field device is essential to its operation, and the field required is in general a linear function of frequency. Although the gaps are usually smaller, a practical limit in magnetic circuits is reached with the saturation of the materials commonly employed as pole pieces.

The generation of magnetic fields higher than 10,000 to 20,000 gauss has until recently been a formidable stumbling block to extending crossed-field tubes far into the millimeter range. Actually the generation of high magnetic fields over the longer beam path of a beam type tube has also been a practical limitation. Recent advances in the use of superconductivity, however, gives rise to hopes for fields in excess of 50,000 gauss over useful volumes. Workers at Bell Laboratories have already employed niobium-tin wire in generating a magnetic field of 110,000 gauss. Studies of spin resonances and other physical properties of matter continue to spur these magnetic field studies; they will also have by-products in millimeter-wave devices.

The cathode limitations in crossed-field devices are different for injected beams than for continuous cathodes. With the injected beam, the problems are like those

of the linear beam tubes except that the magnetic field complicates the design of convergent guns and, consequently, much lower convergent ratios have been achieved to date.

In continuous-cathode devices, the cathode is subjected to bombardment by electrons returning as a result of the sorting process. Useful emission in these devices is apparently largely due to secondaries, and much higher emission densities are permitted. The back bombardment also heats the cathode surface and, under extreme conditions, it becomes possible to increase the operating level of the tube by force cooling the cathode.

Inverted versions of the magnetron have been developed in which the anode and cathode positions have been interchanged, thereby giving a larger emission and dissipation area for the cathode. The anode area is less than conventional and anode dissipation may be the limitation on the design.

Magnetron interaction area can be increased by employing a larger number of vanes limited only by the ability to provide adequate separation between the modes associated with such a structure. The use of the technique known as the coaxial magnetron as an alternate version of strapping is particularly useful at higher frequencies. In this technique the cavities associated with the slots of the interaction structure are coupled into a resonant cavity that provides reinforcement of the desired mode and selective damping of the adjacent modes.

As in beam-type devices, the possibility exists of expanding the interaction area by extension in the

transverse direction. CSF has built pulsed TPOM's (crossed-field forward-wave amplifiers — injected beam) employing a double T structure at L-band. It has also been proposed to wrap a linear version of such a device into a cylinder as illustrated in Fig. 12, thus making it cylindrical but not in the usual form. The magnetic field cannot be generated by permanent magnets but can be provided by current flowing through the sole in the axial direction.

The linear magnetron has been extensively analyzed theoretically because it avoids the complexities of polar coordinates and the resulting elliptic functions, but has rarely been constructed. If the electron cloud is collected at the end of the cathode an appreciable loss in efficiency results. A form of depressed collector could be employed, but it is doubtful that this would result in any improvement in efficiency when viewed in the systems sense. Alternatively, the anode structure could be lengthened to permit collecting the entire beam on the anode, and a nonemitting sole instead of a cathode provided for this collection region. This device then becomes physically larger than the cylindrical magnetron and is consequently rejected for the normal microwave frequencies. The greater size is of no great disadvantage at millimeter wavelengths and the device in this form may have some attractive features when circuits and fabrication methods are considered. This form could also be revolved about a center line, as diagrammed in Fig. 13.

The use of crossed-field interac-

tion in a device in which the gain occurs in the direction of the magnetic field and thus at right angles with the gain in the magnetron or Amplitron is also being explored. The concept is termed the Orthotron at the General Electric Research Laboratories, and an X-band model is under study for eventual scaling into the millimeter wave region.

W. C. Brown, of Raytheon's Spencer Laboratory, has described² a device termed the electromagnetic amplifying lens employing quasi-optical coupling. The input wave excites a multiplicity of waveguides around the circumference of the anode. The phase in alternate waveguide is shifted by 180 degrees (Fig. 14) before the guides are opened to form a comb-like structure for interaction with the electron stream. The reverse transition is employed in the output. The interaction is similar to that of the Orthotron except that an inside-out arrangement is planned to provide a large cathode area. Both devices employ slow-wave or standing wave interaction in the transverse direction, while propagation in the axial direction, in which the gain is experienced, is as a fast wave.

The devices discussed have been confined to those that use interaction between r-f waves on an electron stream and waves on a metallic circuit. Many other approaches are also being investigated.

REFERENCE

- (1) Hakki and Krumme, Coherent Generation of Microwave Power by Annihilation Radiation of a Prebunched Beam, *Proc IRE*, 49, No. 8, p. 1334, Aug. 1961.
- (2) W. C. Brown, & G. E. Dombrowski, Analysis of a Crossed-Field Waveguide Amplifier, 1961 Western Electronic Show and Convention, Paper #2/2.

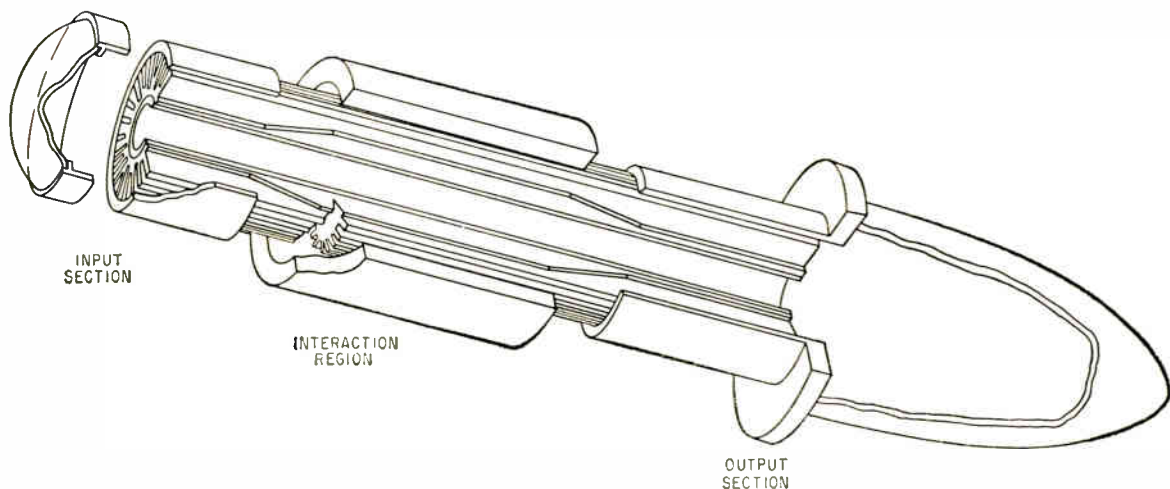

FIG. 14—Quasi-optical coupling would be used in a proposed electromagnetic amplifying lens

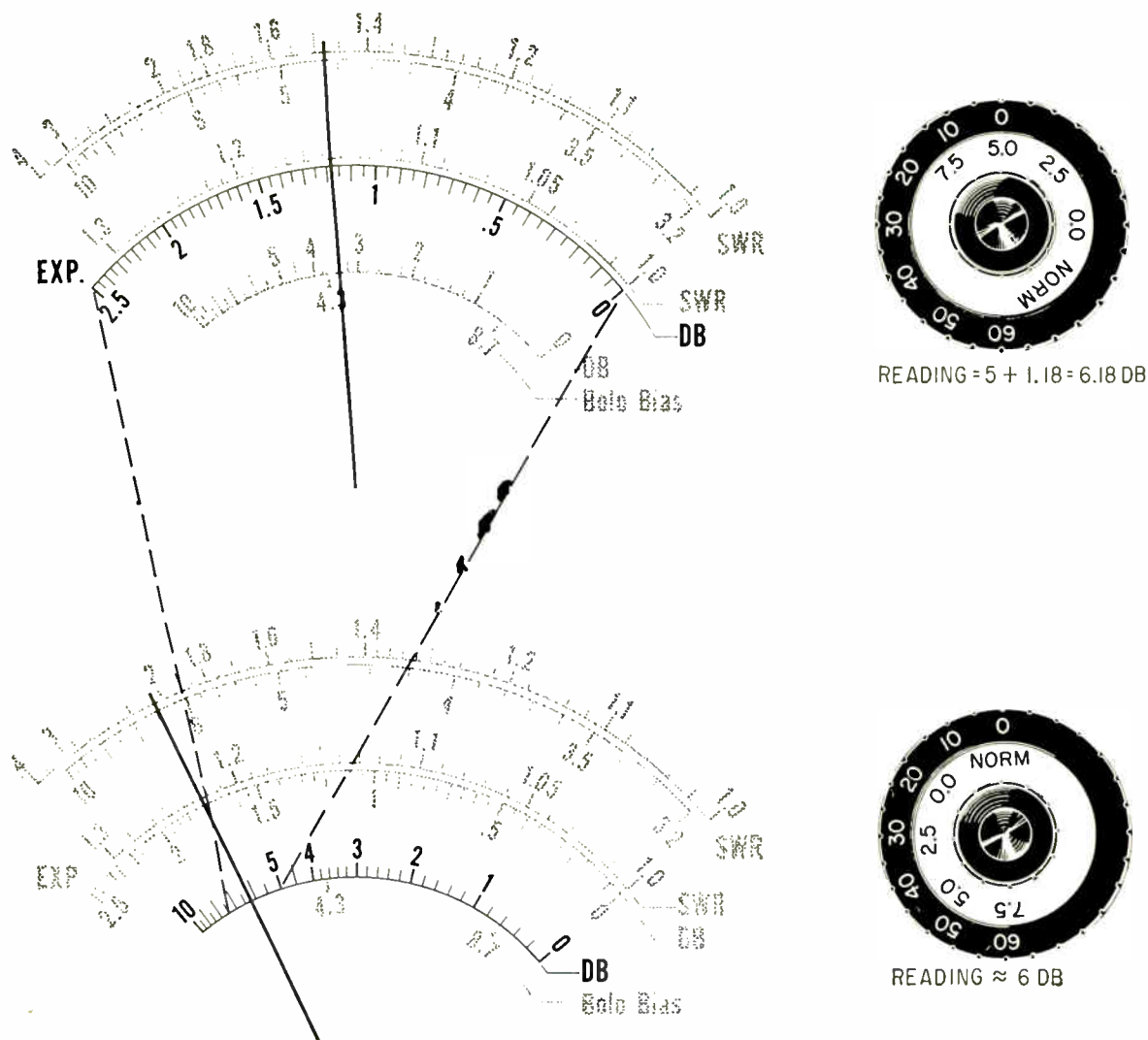

FIG. 1—Reading on regular 0-10 db scale (lower) can be expanded to the 0-2.5 scale (upper) by panel control that also normalizes readings

DRIFT CONTROL ALLOWS Expansion Scales for SWR Meter

Analysis of thermal stability leads to drift compensation using noncritical circuit elements, permitting a stable current to be generated for offsetting the meter pointer for an accurate expanded-scale characteristic

By DARWIN L. HOWARD

Hewlett-Packard Company, Palo Alto, California

ONE OF THE important instruments in microwave measurements is a standing-wave indicator or swr meter. This instrument is a high gain ($\gg 100$ db) audio amplifier, tuned to achieve high selectivity, with an output meter calibrated for standing-wave work. Although these instruments were originally intended for use with slotted-line sections to measure vswr, they have seen increasing service for other measurements, such as microwave attenuation.

For an swr meter to be of value in making attenu-

ation measurements, it must have high resolution over any segment of its attenuation range, and approximately constant resolution throughout the attenuation range so that measurement accuracy will be as independent of magnitude as possible.

Each sector of the normal db range should be expandable and automatically normalized upon expansion so that the instrument can be switched from any normal range to any expanded range without losing the initial reference values.

Such expansion would permit high-resolution measurement of any attenuation value within the dynamic range of the detector. A practical expansion ar-

In addition to the compensation in the power supply, fine compensation depends on selection of R_1 and R_2 in Fig. 3B and 3C, which establish the operating point for transistor Q_3 .

The power supply, Fig. 3D, uses a differential amplifier. The power supply reference in this instrument is a zener diode with a positive temperature coefficient of +2.8 mv per deg C. Thermal compensation is derived from series silicon diodes each with a negative temperature coefficient of -1.9 mv per deg C. Three are in series to provide a negative coefficient for the supply.

This negative coefficient drift compensates for the drift of Q_3 at a specific operating point determined by R_1 and R_2 shown in Fig. 3B and 3C.

Since R_1 and R_2 are already variable in S_{10} and S_{α} , a straightforward solution to determining their proper values is not readily apparent.

However, referring to Fig. 3C, it can be shown that for ideal compensation

$$\frac{R_2}{R_1} = \frac{\left(\frac{K_z + nK_d}{V_z + nV_d} + SK_{\alpha} \right) V_{cc}}{K_{be} + SK_{\alpha} V_{be}} - 1 \quad (5)$$

where $S \approx 1 + \frac{R_1 R_2}{(R_1 + R_2) R_e}$

K_z = temperature coefficient of the reference zener diode (2.8 mv per deg C)

K_d = temperature coefficient of silicon diodes (-1.9 mv per deg C)

n = number of compensating silicon diodes

K_{α} = temperature coefficient of Q_3 gain (measurements of silicon transistors used show this to be 8.68×10^{-3} per deg C. This is equivalent to a β variation from 90 to 75 over 25 deg C).

V_{be} = base to emitter voltage drop in Q_3 (0.7 v)

K_{be} = temperature coefficient of V_{be} for Q_1 (-1.9 mv per deg C)

V_z = zener reference voltage (6.8 v)

V_d = series diode voltage drop (0.7 v)

V_{cc} = power supply voltage (18 v)

Solving Eq. 5, $R_2/R_1 = 0.94$. However, using available resistors, a value of 0.985 actually resulted.

In practice these considerations produced a drift of the order of 2 μ a over a 25 deg C temperature range. This is well within the design limit of the problem, 6 μ a per 25 deg C.

The compensating drift of the power supply stabilizes the offset current to achieve accurate expansion. In addition, the gain must be changed when switching to any expand scale so that the initial reference setting is maintained; that is, the expand scales are normalized. The gain change may be calculated from the meter calibration equation

$$X = \log_{10}^{-1} \left(\frac{-C}{10} \right)$$

where X = fraction of full scale and C = meter reading in db

The gain increase (normalized with respect to the gain in the nonexpanded condition) required to expand any portion of the scale (ΔC) to full scale is

$$\frac{A}{A_N} = \frac{1}{X_2 - X_1} = \frac{1}{\left[\log_{10}^{-1} \left(\frac{-C_2}{10} \right) \right] - \left[\log_{10}^{-1} \left(\frac{-C_1}{10} \right) \right]} \quad (6)$$

This gain is changed with an attenuator design

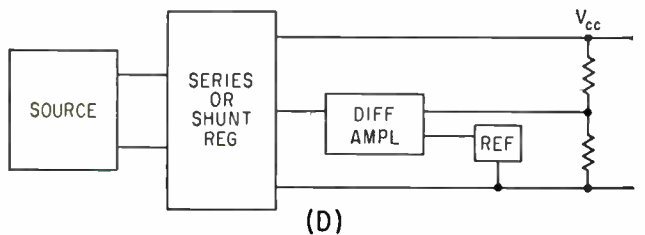
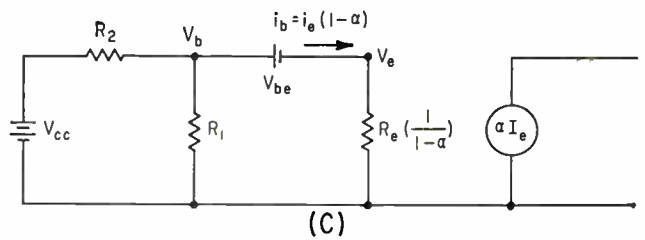
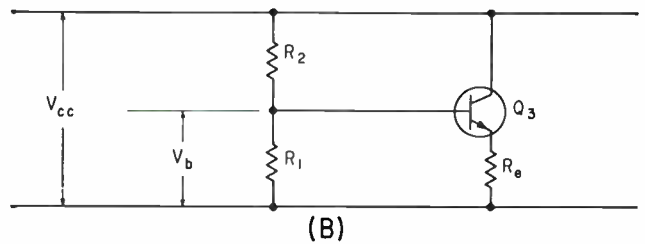
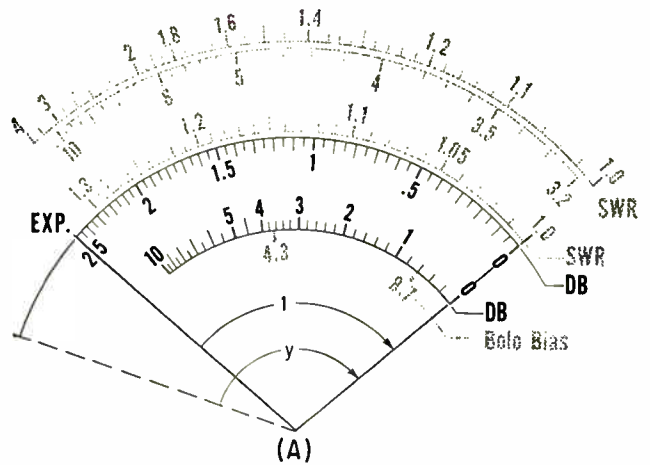

FIG. 3—Meter scale (A) shows definition of terms; transistor amplifier (B) and approximately d-c equivalent circuit (C) with impedances referred to the base; regulated power supply (D)

for each scale to be expanded.

An analysis of often-neglected thermal stability factors has led to a technique for drift compensation that can be accomplished using noncritical circuit elements. An expensive low-coefficient zener reference could have been used in a low-drift power supply, but then elaborate compensation would still have been required at the silicon transistor (Q_3) stage.

The technique, however, permitted a stable current to be generated that could be made to offset the meter pointer in the instrument metering circuit for an accurate expanded scale characteristic.

By gain adjustment each of the four 2.5-db expand ranges (0 to 2.5, 2.5 to 5.0, 5.0 to 7.5, 7.5 to 10) has its end points normalized to full scale, thus permitting accurate attenuation measurements to be made over the dynamic range of the instrument.

Transistor Pairs Improve

Here are several designs of compounded emitter followers. These circuits have higher input impedance and gain, and lower output impedance, than conventional emitter followers

By T. K. HEMINGWAY

English Electric Aviation, Ltd.,
Stevenage, Hertfordshire, England

J. WILLIS

Southern Instruments Ltd.,
Camberley, London, England

OCCASIONALLY an amplifier is needed that has properties such as those of an emitter follower, but having a better performance than can be obtained from a single transistor. This article shows several ways of using a pair of transistors in a stage to achieve better performance.

Simply cascading two emitter followers does not necessarily provide adequate performance; for ex-

ample, output resistance will have a definite minimum value. A better way of using a second transistor is shown in the emitter-squared follower of Fig. 1A.¹ Here, it may be difficult to define the d-c conditions adequately if the circuit is required to work to zero frequency.

Figure 1B shows a redesign of Fig. 1A, using a complementary pair of transistors. The advantage of the circuit of Fig. 1B may best be appreciated by first examining the limitations of the emitter follower. Here all of load current i_o flows into the transistor emitter, and a fraction of i_o , ($i_o/(\beta + 1)$) flows in the base circuit. Since the voltage across the emitter-base junction is substantially constant, circuit input resistance is roughly βR_E and its output resistance (r_{out}) is R_s/β (in parallel with R_E), where R_s is signal source resistance and R_E is emitter load resistance. However, the circuit performance cannot be improved to any desired extent by simply increasing gain—for example, by connecting a series of emitter followers in cascade. The transistor's internal resistance sets a limit to the minimum output resistance attainable by increase of current gain. An alternative approach is to try to keep the current through the transistor relatively constant in spite of changes of output voltage; then the voltage dropped across R_s and the internal resistance of the transistor is constant, so these re-

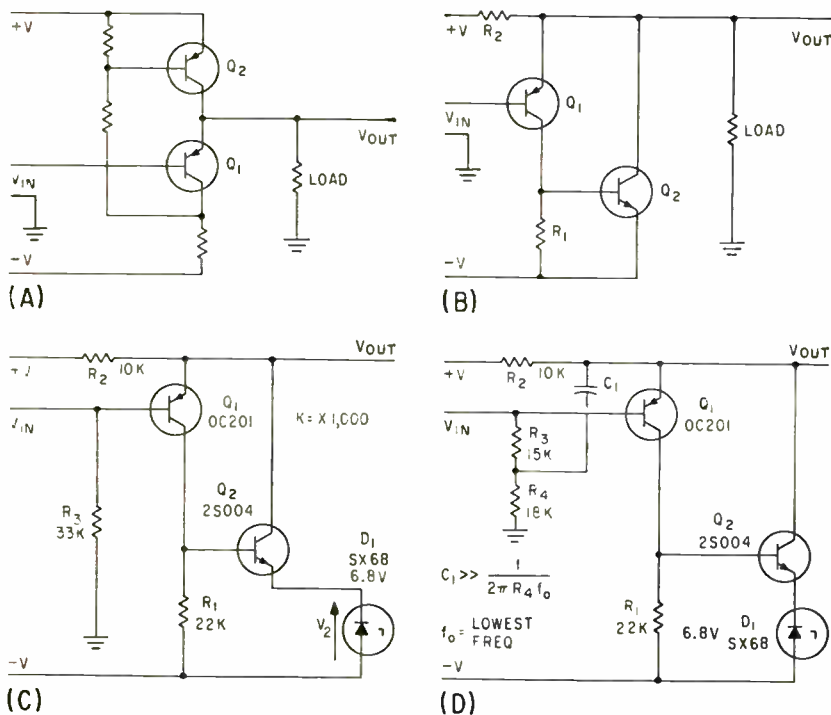

FIG. 1—Emitter squared follower (A), redesigned with a complementary pair (B). Practical circuit of (C) is modified in (D) to reduce shunt effect of R_s

Emitter-Follower Performance

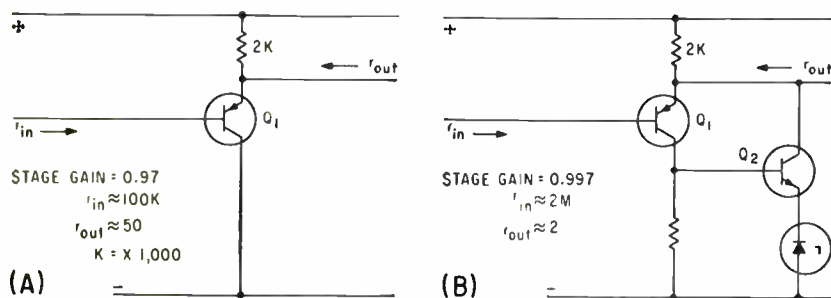

FIG. 2—Comparison between simple (A) and compounded (B) emitter follower circuits. Improved performance (B) merits increased complexity.

distances do not appear in the small-signal equations for r_{out} , as well as for gain and r_{in} . This condition is approximated in Fig. 1B, where the load current is largely supplied by Q_2 . Transistor Q_1 is a normal emitter follower. Its collector current i_c passes through R_1 , thus applying voltage to grounded emitter Q_2 . Any change in i_c causes much larger changes in collector current of Q_2 , and these are fed into the load.

A more practical circuit is shown in Fig. 1C. Here's how d-c operating conditions are established: The base potential of Q_1 is fixed near ground potential; assuming that Q_2 is conducting, then the voltage drop across R_1 equals $V_z + V_{be}$, where V_z is the voltage of zener diode D_1 and V_{be} is the base-emitter voltage of Q_2 . Thus the current through R_1 is $i_c = (V_z + V_{be})/R_1$, and this is equal to the collector current of Q_1 minus base current i_{b2} of Q_2 ; since i_{b2} is relatively small, it can usually be neglected. The current through R_2 is nearly equal to $+V/R_2$ (assuming that the emitter of Q_1 is near ground potential) and equals the sum of Q_1 emitter current and Q_2 collector current. Having already fixed the former, the latter can be set to any desired value by appropriate choice of $+V$ and R_2 .

Figure 1C is a feedback amplifier. Within the feedback loop, Q_2 operates in the grounded-emitter condition and Q_1 in the grounded

base. If similar transistors are used for Q_1 and Q_2 and if source and load are purely resistive, high-frequency performance will be set largely by the beta cut-off frequency of Q_2 . Thus, loop gain should be down to unity before Q_1 begins to contribute much phase shift, so that the loop should always be stable. This is not necessarily true for reactive terminations, since even a simple emitter follower can oscillate when fed from an inductive source and driving a capacitive load. Thus, Fig. 1C could be unsuitable for such applications as isolating a pick-off coil from a shielded cable.

Though the input resistance of Fig. 1C is high, two factors limit the value obtained in practice. The first is the shunting effect of collector resistance r_c of Q_1 ; this places a resistance of somewhat less than r_c across the circuit input. The second and more serious factor is the need for a base-return resistance R_3 since R_3 is directly across the input. Resistor R_3 cannot be made too large, because otherwise base current will make the base voltage of Q_1 too different from ground potential and hence temperature-dependent, thus making the d-c conditions of the circuit less well-defined. At above-zero frequencies, R_3 can be artificially increased by applying positive voltage feedback as shown in Fig. 1D. If circuit gain is G , the apparent value of R_3 becomes $R_3/(1 - G)$, and an improvement of up to $100\times$ may be

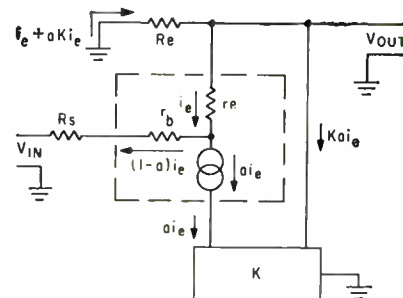

FIG. 3—Here K is somewhat less than β and a is about equal to α .

easily obtained. Capacitor C_1 must have a low reactance at the frequencies concerned, in comparison with the resistance of R_1 ; and R_1 now forms part of the load for the circuit.

It is worth comparing the circuit of Fig. 1C with the original (all *pn*) version of Fig. 1. Although the circuits really only differ in d-c bias conditions, considerable differences in performance stem from this difference. Figure 1A can supply large currents in either direction to the load; Fig. 1C cannot do this, but on the other hand, its operation is almost unaffected by variations in the negative supply voltage $-V$ and not greatly affected by changes in $+V$.

Figure 2 compares the performance of a simple emitter follower with that of the circuit of Fig. 1C. All the improvement in input resistance that is indicated in Fig. 2B is unlikely to be achieved in practice.

An approximate analysis of Fig. 1B, whose equivalent circuit is indicated in Fig. 3, shows that the addition of Q_2 improves circuit properties—compared to the simple emitter follower, Q_1 —by a factor that is somewhat less than the beta of Q_2 ; input resistance is higher, output resistance lower and the gain is nearer unity.

REFERENCE

- (1) *Wireless World*, p 108, March 1958.

F-M Sequential Signals Kill

Experimental color tv system simplified by f-m subcarrier modulation that

By PIERRE CASSAGNE and MAURICE SAUVANET Compagnie Francaise de Television, Paris, France

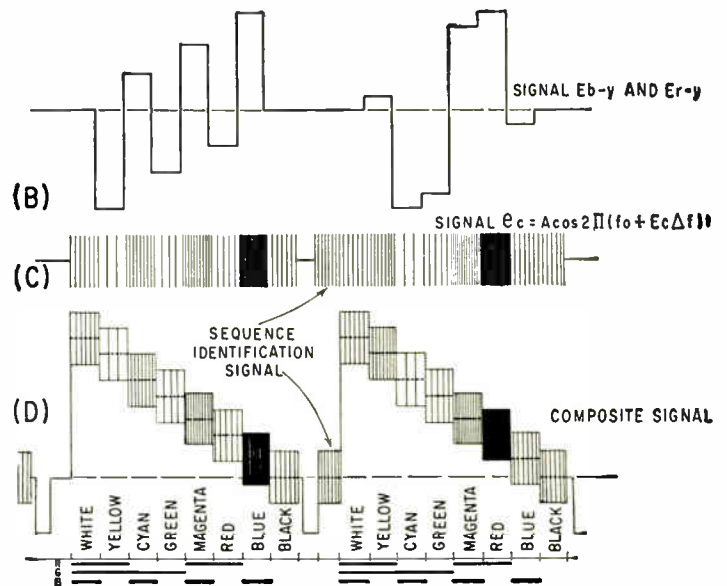
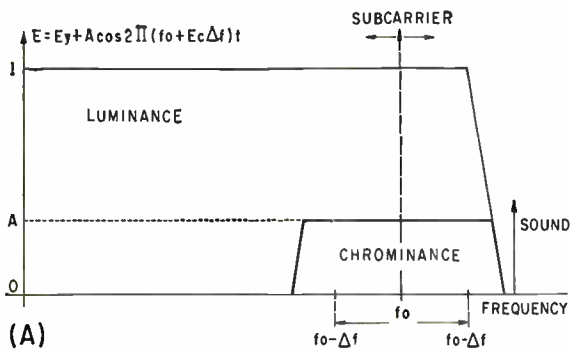

FIG. 1—Frequency spectrum of the composite Secam tv signal (A). Signal amplitude represents luminance of picture spot and the instantaneous frequency of the color subcarrier its coloring. Secam signal (B, C, D) for two lines of a test pattern with bars of white, yellow, cyan, green, magenta, red, blue and black. Signal (B) is the video chrominance signal and (C) is the resulting modulation of the color subcarrier; (D) is composite signal

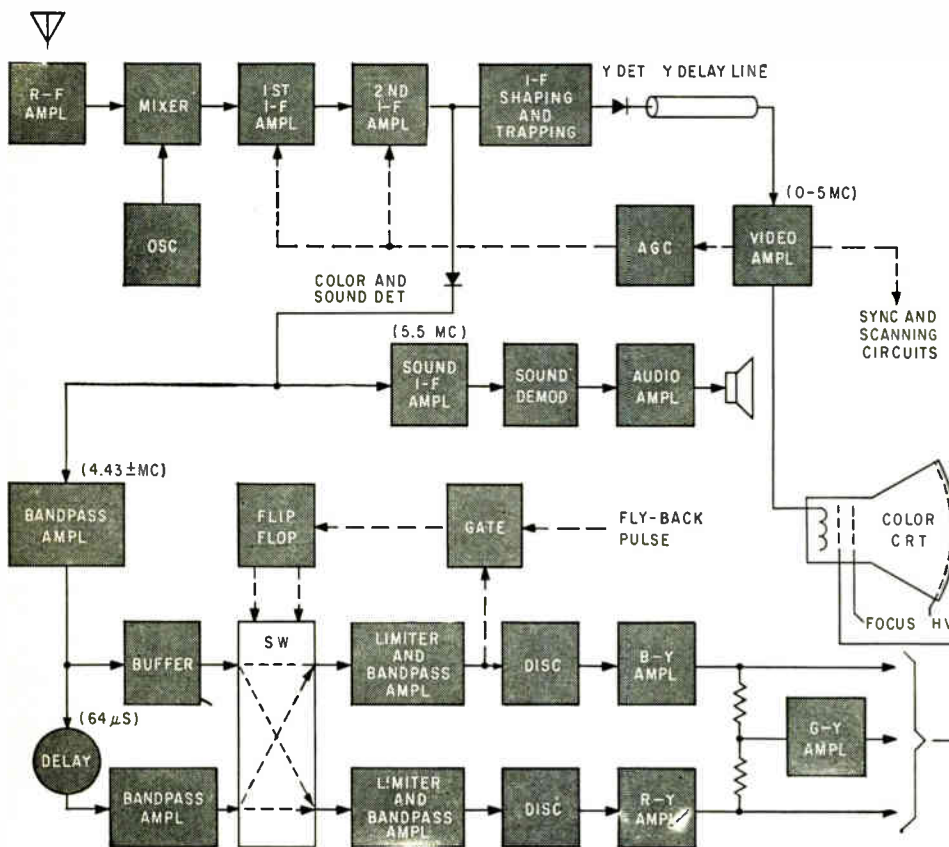

FIG. 2—Complete Secam receiver

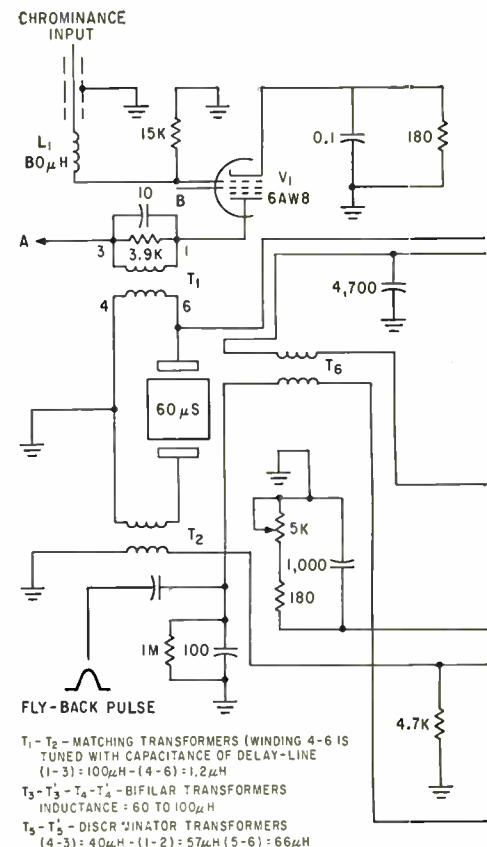

FIG. 3—Chrominance-signal identification

ference signals could be carried out directly at i-f. But the local oscillator would have to be stable within ± 50 Kc.

To eliminate intermodulation between chrominance and luminance signals, a second diode detects the luminance signal. As in NTSC receivers, the black-and-white video circuit needs a short delay line to compensate for the narrow chrominance bandwidth. But it is not necessary to trap the subcarrier; the luminance information is supplied to the crt as the composite video signal without band-limiting. This signal contains the color subcarrier, but since subcarrier amplitude is constant, it affects only the general level of luminosity and has no effect on the gradation of grays in the color picture as received on a monochrome receiver.

In the chrominance circuits for a Secam receiver, Fig. 3, the signal from the color-sound detector is fed to a band-pass amplifier (V_1 , pentode section) with 1 Mc bandwidth on either side of the 4.43-Mc center frequency. Band-pass amplifier output goes to a direct channel through a buffer amplifier (V_1 , triode section) and to an indirect channel through a 64- μ s delay line (length of one line in the European tv standard). An ultrasonic delay line is shown; however a conventional delay line of either lumped- or distributed-constant, or a magnetostrictive line could be used. The ultrasonic line, selected for high repeatability and stability, simplifies factory alignment of associated circuits. Insertion loss of the delay line is compensated by a band-pass amplifier (V_2 , pentode section) but

gain adjustment is not critical—a 6-db difference between the direct and indirect channels is barely visible on the color crt screen because of amplitude limiters in the chrominance channels.

The sequential color-difference signals, direct and delayed, are alternately switched onto two color channels by a 4-diode bridge ($D_1 - D_4$) with d-c isolation by bifilar transformers (T_2, T_3' at inputs, T_1, T_1' at outputs). That way, one channel gets continuously $R - Y$ signals repeated for two successive lines: a direct signal and then the same $R - Y$ signal from the memory when the indirect channel is switched onto the $R - Y$ channel. The other channel, of course, gets $B - Y$ signals repeated for two successive lines. Both the $R - Y$ and $B - Y$ channels are identical: a diode limiter, band-pass amplifier, discriminator and triode video amplifier whose output is fed to the grid of the corresponding color gun.

Outputs of the $R - Y$ (V_3 , triode) and the $B - Y$ (V_4 , triode) final stages are added in a matrix of two resistances to obtain the $G - Y$ signal, which is inverted in a video-amplifier stage (V_5 , triode) and then fed to the grid of the green gun.

The diode limiters (D_5, D_6 for $R - Y$ and D_7, D_8 for $B - Y$) are polarized at a low impedance and hold color saturation at a fixed value. They perform the same function as automatic color control circuits in advanced versions of NTSC receivers.

The discriminators are of the detuned-input type with response approximately linear over a band 900

Kc on either side of the 4.43-Mc center frequency. Center of the discriminator response curve must be held within ± 30 Kc to keep the correct d-c component applied to the grid of the output-stage tube (V_3 or V_4 , triode). But this condition poses no particular problem and the circuit elements need not be especially stable.

Multivibrator V_6 controls the switching diodes that commutate direct and delayed color-difference signals onto the proper channel. The multivibrator is triggered by a pulse that develops across the primary of T_6 during the horizontal flyback pulse if a 4.43-Mc sequence identification signal exists at diode gate D_6 , connected to the output of the $B - Y$ channel band-pass amplifier (V_4 , pentode). Chrominance-signal identification is based on the presence or absence of the color subcarrier during the blanking interval that follows the color-difference signal switched onto the $B - Y$ channel.

This technique of triggering the multivibrator locks the commutation of direct and indirect color-difference signals to the horizontal sweep frequency. At the same time, since the identification signal is extracted after commutation, a pulse across T_6 can develop only if the $B - Y$ signal has been switched onto the proper channel. No commutation error is possible from transmission disturbances, as long as the receiver remains horizontally synchronized. Echos caused by multiple propagation paths, which can affect phase burst in an NTSC receiver, have no effect on Secam colors.

COUNTDOWN STARTED ON EUROPEAN COLOR TV

Europe's hour of decision with respect to color television is fast approaching. This month the cognizant technical commission of the CCIR (Comité Consultatif International de Radioléctricité) will meet in Germany and out of that meeting could come the decisive recommendation.

Two systems are in the running. One is the American NTSC system, modified to meet the European 625-line, 25-frame television standard and the 50-cps line frequency common on the continent. The other is the French-developed Secam (Séquentiel à Mémoire). Both are compatible and both use a wideband luminance signal (called the Y-signal) that corresponds to a normal black-and-white signal. The big difference is the way the two chrominance signals needed to color the picture are handled.

In the NTSC system, a single color subcarrier is modulated simultaneously by the two color-difference signals, using two amplitude modulations in quadrature with suppressed carrier transmission.

In the Secam system, the color signals are transmitted alternatively on a single subcarrier and stored in a one-line memory at the receiver (ELECTRONICS, May 6, 1960, p 57). One stored and one direct signal, then, provide the two color-difference signals. This way of handling the chrominance information cuts the vertical definition for color in half. Even halved, the color definition is higher than the resolving power of the human eye.

Use of a frequency-modulated color subcarrier, a recent improvement of the Secam system, may tip the scales in its favor



Road-rail trucks generally carry 12 amplifiers to obtain data on rail condition

Transistor Pulse Amplifiers Detect Rail Faults

Amplifiers are used in road-rail truck that monitors railroad track for flaw. Equipment uses magnetic pickups that produce a typical pulse of 8 msec and 10 microvolts. Circuits employ an extra transistor for temperature compensation

By H. W. KEEVIL
Detector Car Engineer,
Association of American Railroads,
Chicago, Ill.

TRANSISTOR amplifiers have reduced the cost of constantly monitoring railroad systems to find rails with internal defects.

Until recently a number of rail detector cars, which are large units and expensive to operate, were used for the job. The continuing monitoring expense has been reduced by designing miniaturized test equipment for installation on road-rail trucks. These trucks can operate on the rails while testing and then be set off and run on the highway between test locations.

Part of the miniaturization prob-

lem was to build transistor amplifiers to replace the five and six-tube sets normally used on the rail cars. These amplifiers are for the sole purpose of amplifying single pulses or W waves. These signal waves are produced by inductive pickups when they cut small residual magnetic fields that have been previously set up by defects in the rails.

A typical pulse has a length of 8 msec and a voltage of 10 μ v. The amplifier must have fast response and not block after being overloaded by large input signals. Voltages of several volts are produced by the pickups as they pass over rail joints. These large signals must not block the indication of a defect that may be located just a

few inches following a joint.

The amplifier must have sufficient gain and power output to drive a sensitive relay which in turn operates a pen on a recorder chart.

Circuit A is for an amplifier that meets these requirements. A test car uses various types of pickups, which consist of magnetic cores wound with many turns of fine magnet wire. The d-c resistance varies from 2,500 ohms to 6,000 ohms in the pickups. Due to the wide variation of input impedances, input transistor Q_1 is used in the common-collector mode. This gives a good impedance matching, no reversal of signal and no gain in signal strength.

Transistor Q_2 is connected in a

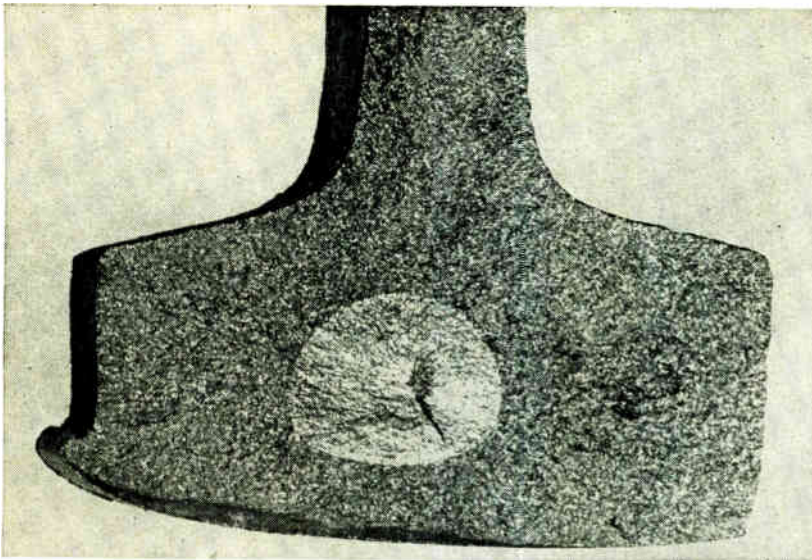

One of the rail defects detected with the pulse amplifiers

common-emitter configuration, giving high gain and signal reversal. Transistor Q_1 is connected common-collector so that the output signal will be negative. A negative signal is required on the input of power transistor Q_2 to obtain the output current needed to drive and load the relay.

Transistor Q_3 has no gain but does have a collector resistor of 4,400 ohms and a 0.5 μf feedback capacitor. This capacitor feeds back a pulse to the input of Q_2 to produce powerful regeneration. This regeneration produces a trigger action and drives Q_2 to cutoff.

The combination of the gain in the second stage plus the regeneration steps up the 10-millivolt input signal to drive the output transistor

Q_4 to more than 15 ma output current. The output relay pulls in at 15 ma.

The amplifier maintains constant sensitivity between -20°F and 120°F . Because of temperature variation, a compensator was incorporated. This consists of transistor Q_5 connected as a temperature-sensing and bias-adjusting device. The compensator is connected into the input of the second stage, the high-gain stage, so that as the temperature changes, the bias is changed automatically to maintain proper overall sensitivity. It is possible to do this at this one point only because the first and third stages are common-collector circuits, which produce no gain.

The compensator, if allowed to

operate full strength, would over-compensate the circuit. A shunt resistor (R_1) of 1,000 to 4,700 ohms adjusts the degree of compensation. This resistor must be adjusted for each amplifier, due to the wide variation in the characteristics of the individual transistors and other components.

Sensitivity is controlled by the R_2 , which adjusts the bias on the input of Q_2 , thus controlling the gain in this stage.

Each road-rail truck uses ten amplifiers of this type. Many of these amplifiers are in daily use and have shown themselves to be reliable and trouble-free.

Circuit diagram B shows an amplifier of a different type. This amplifier is also used on the road-rail trucks. It is a special circuit for the amplification of extremely low frequency signals. Longitudinal defects in the rails produce indications in the order of one cps.

In circuit B, Q_1 is again common-collector for impedance matching. Transistors Q_2 and Q_3 are both common-emitter and high-gain stages to drive the output transistor Q_4 . There is no regeneration in this circuit.

Capacitor C_1 bypasses all the high-frequency signals. Coupling capacitors C_2 to C_4 are 50 μf each to efficiently pass the low frequency signals. Sensitivity is controlled by picking off a portion of the output signal from Q_2 . The output current of the power transistor is adjusted by R_2 . Each road-rail truck uses two amplifiers of this type.

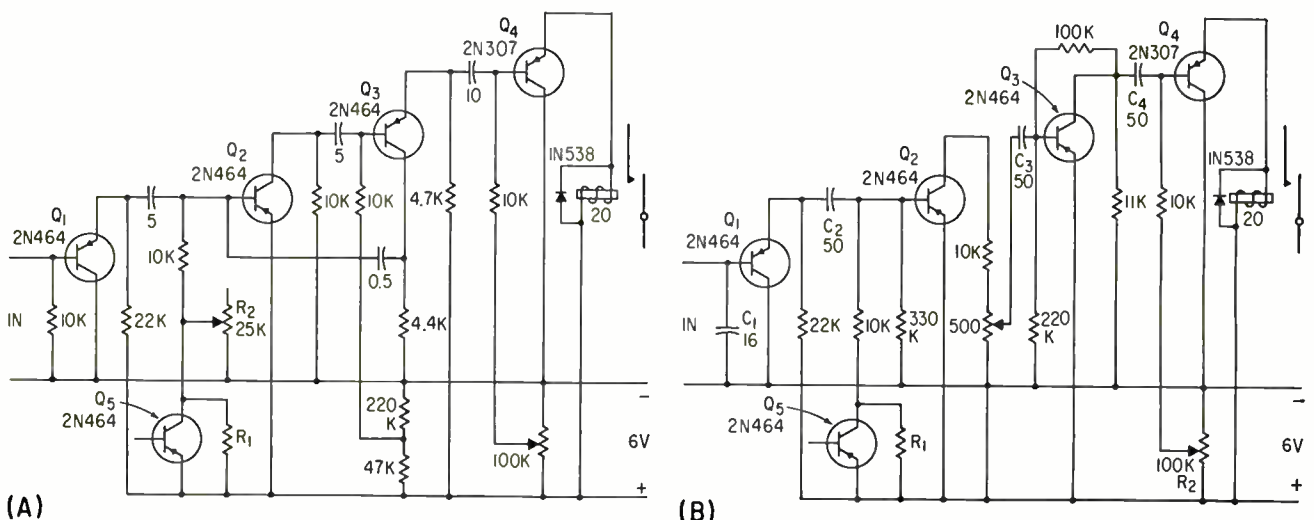

Circuits for the two types of amplifiers used in road-rail truck

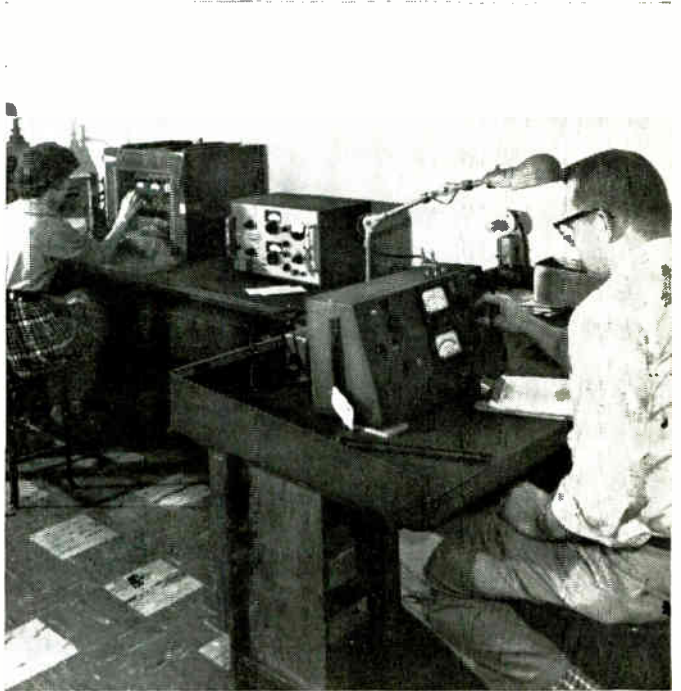
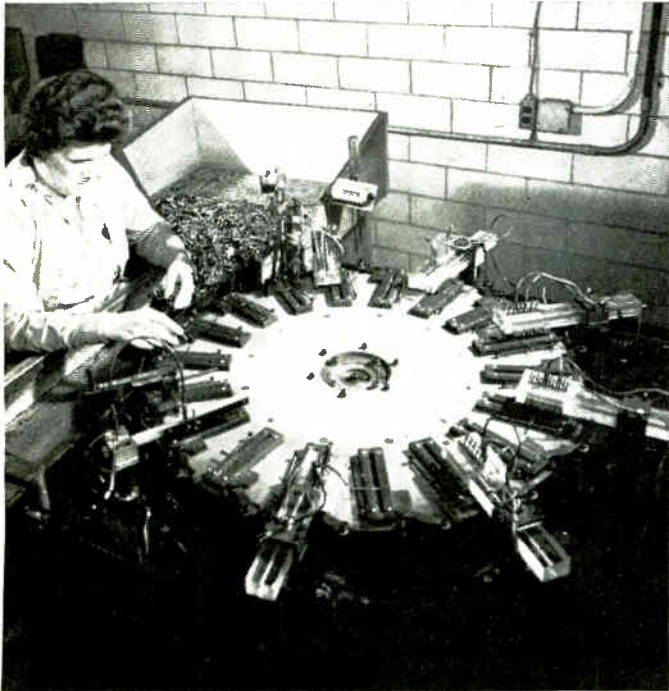

What's so special about Jeffers Electronics?

Extraordinary quality control and inspection facilities for one thing! Jeffers has an elaborate system for checking out inductors, capacitors and packaged assembly components—and everything that goes into them. The Jeffers Laboratory includes devices and procedures for testing performance under extremes of temperature, humidity, vibration, shock and stress far in excess of those encountered in routine service—the kinds of tests that only advanced design and superb engineering can justify.

For example, the laboratory includes the equip-

ment necessary to perform all tests on molded inductors to assure full compliance with the requirements of MIL C 15305. These are resources for insuring reliability that few other electronics manufacturers can match.

Want further information? Write today for literature or technical assistance.



JEFFERS ELECTRONICS DIVISION

Speer Carbon Company, Inc., DuBois, Penna.

COILS • CAPACITORS • PACKAGED ASSEMBLY CIRCUITS

Proof.

The final test report attached to each and every EMI photomultiplier — and to no other leading make — is proof of outstanding performance. Almost as convincing as the difference you notice when you plug in the tube itself. And, performance, of course, is the reason why the most demanding photomultiplier users always specify from the EMI/US catalog describing 37 types—ranging from UV to IR response. Better write for your copy so you can start doing the same. 1750 North Vine Street, Los Angeles 28.

In Europe: EMI Electronics
Middlesex, England.

ELECTRON TUBE DIVISION
EMI/US



SILENT POWER for the hands of time...

SYNCHRON® CLOCK MOVEMENTS

Cut production and assembly costs with Hansen SYNCHRON Clock Movements — simply mount and attach hands. Precision-built, self-starting synchronous movements meet the most rigid requirements of clock manufacture . . . whether you're producing the daintiest bedroom or desk models, wall units for home and office, large display clocks, or programming systems. All moving parts constantly bathed in a sealed, lifetime oil supply. Perfect balance and coordination assure accuracy. (Covers or dust bands available for most models.)

Design assistance by Hansen readily available on your construction or design problems. Special action no problem with Hansen movements for pendulum clocks, oscillating clocks, etc.

Sustained accuracy for all clocks
 . . . up to 26" diameter under glass
 . . . front, rear, or bottom set
 . . . 24, 110, or 220 volts
 . . . 25, 50, or 60 cycles

SEND TODAY for Data Sheet No. 1200,
featuring new D-Type Movements as well
as C-Type.



HANSEN REPRESENTATIVES:
ELECTRIC MOTOR ENGINEERING, INC.
 Los Angeles, Calif., Oakland, Calif.
THE FROMM COMPANY
 Chicago, Illinois
H. C. JOHNSON AGENCIES, INC.
 Binghamton, N.Y.
 Fayetteville, N.Y.
 Rochester, N.Y.
 Schenectady, N.Y.
 Williamsville, N.Y.
WINSLOW ELECTRIC COMPANY
 Essex, Connecticut
 New York, N.Y.
 Philadelphia, Pa.
EXPORT DEPARTMENT
 15 Moore Street, New York, N.Y.

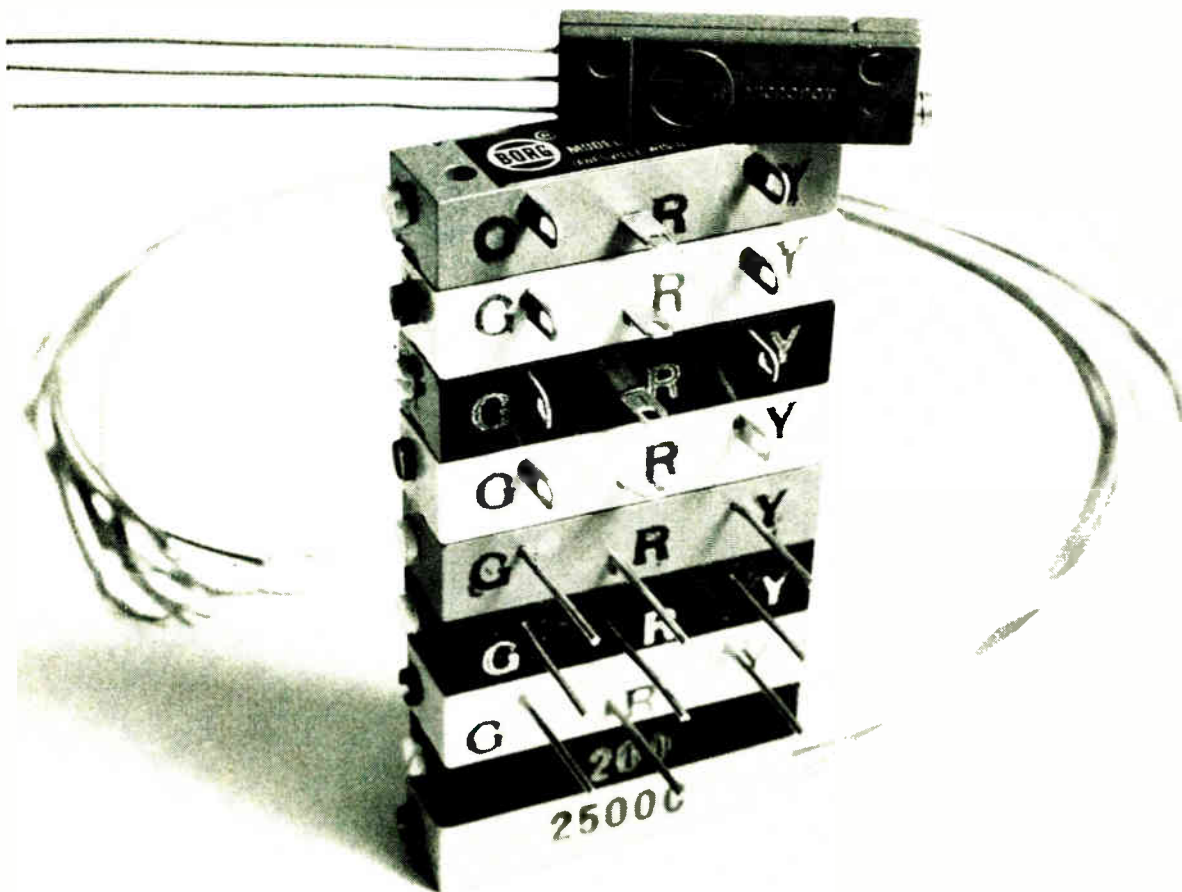

The complete Borg Trimmer line starts at the top

Everything must start someplace. The complete Borg line of Trimming Micropot[®] potentiometers can be said to start with its latest addition, the subminiature (1" x 3/16" x 3/16") 2700 series. This new Micropot is not only tiny, but a high-temperature, humidity-proof model as well.

However, if a quarter of an inch isn't important to your application, there are six other Borg Trimmer series from which to choose:

- 2800—High temperature, humidity proof, wirewound.
- 990—High temperature, wirewound.
- 992—General purpose, wirewound.
- 993—General purpose, carbon.
- 994—General purpose, humidity proof, wirewound.
- 995—General purpose, humidity proof, carbon.

Here are some of the advantages of-

- fered by Borg Trimmers: 1. Single-piece, welded terminations. 2. Low-mass contacts. 3. 100% noise test. 4. 100% contact resistance check. 5. 100% ratcheting test. 6. Resistances from ten ohms to one meg.

Selecting the right Borg Trimmer can be a lot easier if you'll call your nearby Borg technical representative or Amphenol-Borg Industrial Distributor. Or, if you prefer, write directly to R. K. Johnson, Sales Manager:



BORG EQUIPMENT DIVISION

Amphenol-Borg Electronics Corporation,
Janesville, Wisconsin.

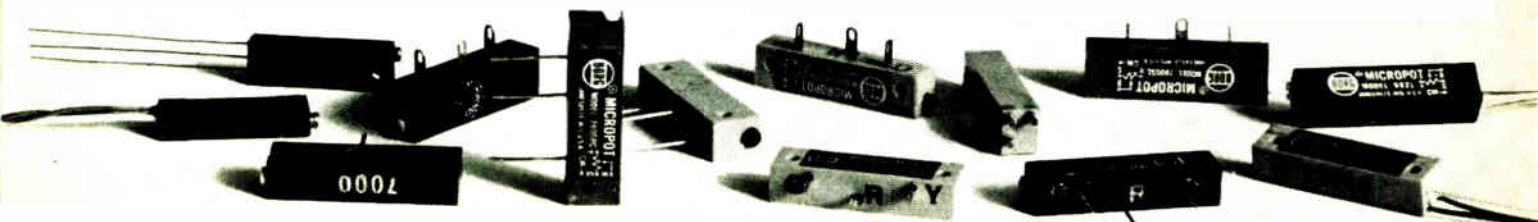

Unijunction Transistor Pulse-Circuit Design

By FRED W. KEAR

Lytle Corp., Albuquerque, N. M.

HIGHLY STABLE negative-resistance characteristic of the unijunction transistor makes this device convenient to use in a great many circuits as an oscillator, pulse generator or timing circuit. The electrical characteristics of this semiconductor device simplifies circuit design because of the reduced number of components required.

The unijunction transistor consists of a bar of *n* type silicon with an ohmic contact at each end. One of these connections is designated RB_1 and the other RB_2 . A third connection made near RB_2 called the emitter is made through a small amount of *p* type material, providing a rectifying function. The equivalent circuit for the unijunction transistor is shown in Fig. 1A. For the circuits to be discussed, interbase resistance R_{bb} is assumed to be 7,000 ohms with the RB_1 to emitter resistance 5,000 ohms and the RB_2 to emitter resistance 2,000 ohms. The emitter to RB_1 resistance is variable, depending on the bias on the emitter.

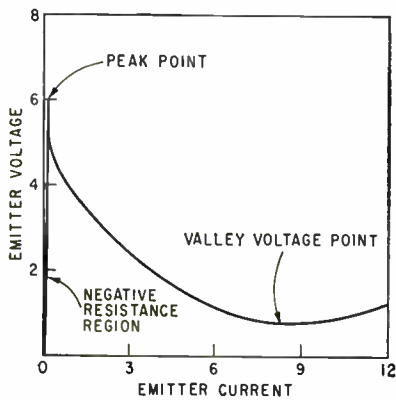
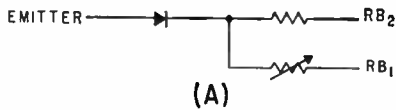

FIG. 1—Equivalent circuit (A) and characteristic curve (B) are shown for unijunction transistor

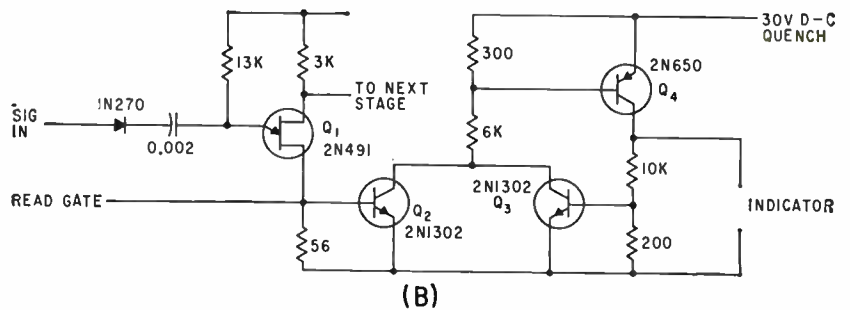
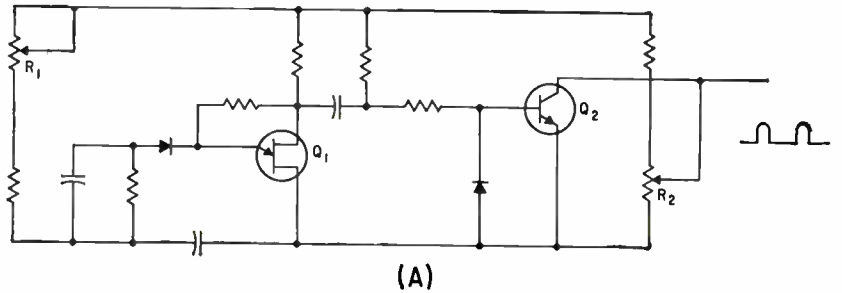

FIG. 2—Pulses of up to 7 volts amplitude are provided at variable repetition rate by generator (A), while counter stage (B) has accompanying readout circuit

Normally, RB_2 is positive with respect to RB_1 . If no bias is applied to the emitter, the device acts as a voltage divider with a portion of voltage V_{bb} appearing at the emitter. If the emitter voltage is less than the interbase voltage, the emitter is reverse biased and very little current flows. If the emitter voltage is greater than the interbase voltage, the emitter is forward biased and current flows. The holes injected in the bar between the emitter and RB_1 result in an increase in the number of electrons in this region and a corresponding decrease in the interbase resistance. The overall result of this behavior is a negative-resistance characteristic. The emitter to RB_1 resistance varies from about 5,000 ohms to 50 ohms with a corresponding change in current I_e from 0 to 50 ma in typical cases. The characteristic curve is shown in Fig. 1B.

A typical application of the unijunction is the pulse generator circuit in Fig. 2A. Transistor Q_1 is connected to provide negative pulses at RB_2 . Pulse repetition rate

is varied by adjusting R_1 . This circuit can deliver pulses of about 15 microseconds duration. Pulse amplitude is adjustable from about 0 to +7 volts. Amplification and polarity reversal of the signal is provided by Q_2 with R_2 used to adjust amplitude of the output pulse.

A unijunction transistor is used as a counter stage with accompanying readout circuit in Fig. 2B. The variation in interbase resistance is sensed by Q_2 when the emitter of Q_1 is forward biased. Transistors Q_3 and Q_4 energize and lock the readout circuit until a quench pulse is applied after the next counting cycle.

The use of a unijunction transistor as a multivibrator with accompanying amplifier is shown in Fig. 3. The time duration for maximum interbase resistance is determined by R_1 , while duration for minimum interbase resistance is determined by R_2 . The periods can be determined experimentally by varying these resistances while maintaining other circuit conditions constant. The use of Q_2 allows it to

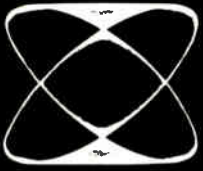

THE SERVOCIRCUIT

Published by SERVO CORPORATION OF AMERICA

SERVOSCOPE® GROUNDTESTS B-52H COMPONENTS

Boeing gives missile bomber components complex fast checkout with SERVOSCOPE

At its big Wichita (Kansas) facility, Boeing's Military Aircraft Systems Division puts electronic assemblies through their paces with the SERVOSCOPE® servo system analyzer. This versatile instrument provides fast direct setting and readout for a multiplicity of tests ordinarily requiring at least six separate instruments and assemblies. In this way, componentry of the complex B-52H is "flown" through its performance envelope without leaving the ground.

Typical Readout

A typical SERVOSCOPE test is the checkout of the electronic assembly for the new ASG-21 "Gatling Gun" lodged in the tail of the B-52H. By analyzing scope patterns—or shift of scope patterns—as signals of various frequencies are fed to the servo system, the investigator observes servo system phase, calculates gain, or measures such transients as overshoot, response time, rise time, or setting time.

Broad Frequency Range

The SERVOSCOPE integrates a sweep generator and a multiple signal generator with a calibrated phase shifter. It generates sine waves, and square wave phasable signals with respect to either electronic linear sweep or sinusoidally modulated reference signals. The analyzer is used to evaluate a.c. carrier and d.c. servo systems, accepting any carrier frequency from 5 to 5,000 cps. In the Boeing tests, a frequency of 400 cycles is generally employed.

Systems-Wide Analyses

In minutes, complete analyses can be made of the most complex servo system—whether electronic, electro-

*Another SERVOMATION® Product

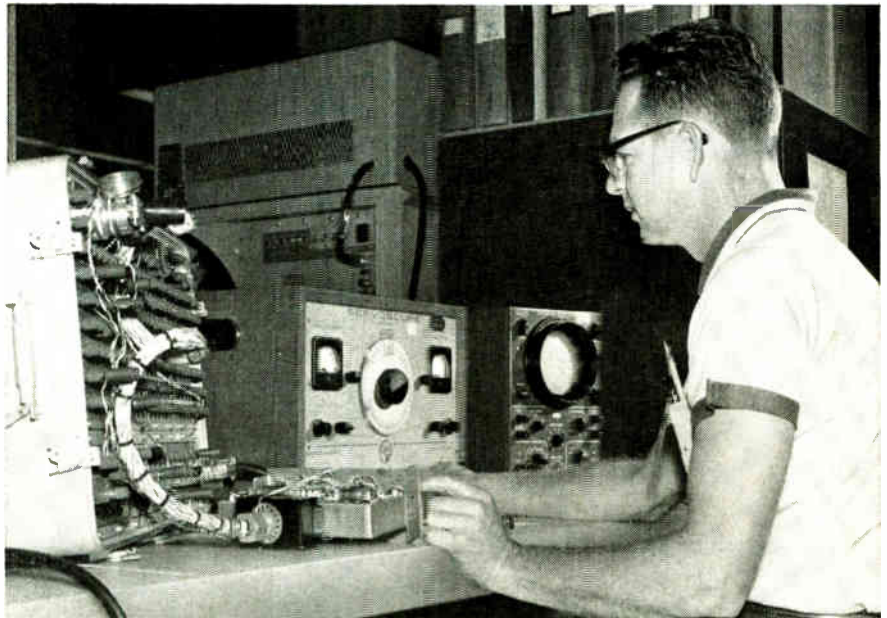

Boeing test engineer checks out instrumentation for the new ASG-21 "Gatling Gun", tail mounted armament on the "H" version of SAC's Stratofortress B-52 bomber and Skybolt missile complex.



mechanical, electrohydraulic or electropneumatic. Since it requires no calibration, the SERVOSCOPE is applicable immediately to different types of tests. SERVOSCOPE is the only servo system analyzer that performs all

of the checks necessary for guidance systems . . . a principal reason why leading missile primes and their subcontractors use it throughout their plants, on the flight lines, and for airborne checkout.



SERVO CORPORATION OF AMERICA • 111 New South Road • Hicksville, L.I., N.Y.

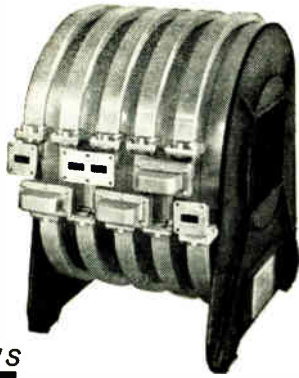

THIS
MICROWAVE DELAY LINE IS

ALL NEW

Tapped X-Band MicroDelay Lines for 8.2 to 12.4 Gc operation provide as many as 8 different delay times from 0.1 to 0.9 microseconds in 0.1 microsecond steps. Units can be employed to provide two or more delay times simultaneously; may be used in cascade with one or more fixed length MicroDelay Lines to provide range from 0.1 to 2.5 microseconds in 0.1 microsecond steps.

IT IS

- Easily Interconnected to experimental equipment.
- Fully Tested — individual data supplied with each assembly.
- Fully Pressurized to prevent moisture entrapment.
- Compact and Light yet rugged.

IT OFFERS

- Low Attenuation below 4.0 db per 0.1 microsecond.
- Low VSWR Values — including fine structures—across full operating band.
- Reliable Performance. There are no moving parts—no electrically controlled switches to fail.

PRICES RANGE FROM \$1150 TO \$2400.
NORMAL DELIVERY SCHEDULE—10 DAYS.

Write for additional information. Your inquiries are also invited on special requirements which cannot be filled by standard microwave units.

MicroDelay

A Division of

FRANKLIN TECHNICAL CORP.
KULPSVILLE, PENNSYLVANIA
Telephone: Ulysses 5-0019

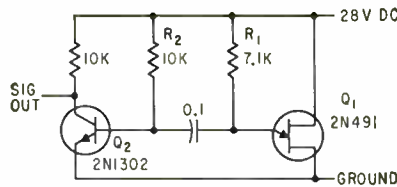
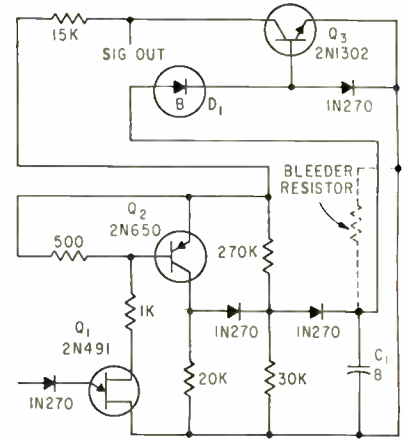

FIG. 3—Multivibrator circuit uses unijunction transistor

FIG. 4—Accelerometer output is converted to voltage analog indicating rate of acceleration or of distance traveled if bleeder resistor is removed



be used for driving a load without affecting the time period.

In Fig. 2 and 3, the unijunction is used with ordinary transistors that would not normally be used because of their parameters. Output is stable and the waveforms nearly perfect. The circuits are not critical with regard to transistor parameters, not likely to stop oscillating because of small variations in component values caused by heating and use fewer components.

The consistency of the output waveform from the unijunction transistor makes it particularly well suited for some digital-to-analog conversion applications, such

as the typical circuit in Fig. 4. This circuit is used to convert the digital output of an accelerometer to a voltage analog indicating rate of acceleration or, when the bleeder resistor is removed from C_1 , distance traveled. Wide variations in the pulse width of the input signal do not affect output pulse width into the capacitor. Thus, for each input pulse, regardless of duration, a constant amount of energy is fed into the capacitor until it is charged to the breakdown voltage of D_1 . This circuit is one example of the many timing circuits that can conveniently use the unijunction transistor.

High-Altitude Ballistics Range

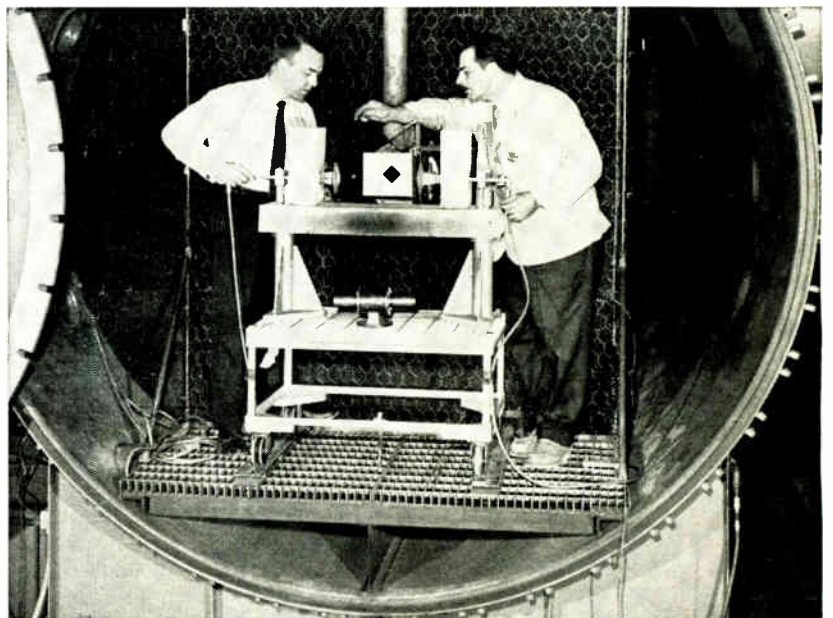

THE FRONT COVER. Final adjustments are made to microwave interferometer before projectile is fired from light-gas gun behind tank, passes where engineer holds suspended ball and impacts inside heavy door at left. Interaction of electromagnetic waves with ionized air in projectile wake may help solve re-entry communications blackout problem.

How to develop
0.01% accuracy
in a
size 23 resolver



First develop a size 23 resolver for naval fire control computers. Next develop one for the B-58's navigational system. Then combine the best features of both, add a couple of new ideas, and produce the Size 23, 0.01% Resolver. That's what Ford Instrument did. With the result that this new resolver has a maximum variation of transformation ratio (with input voltage from 0.3 to 6 volts) that is only 0.02% of 6 volts. Far as we know, this is the most accurate resolver made today. Most durable and trouble-free. Priced right, too. Conforms to Mil-E 5272A. Specify this resolver for application in analog computers, automatic control systems, and data transmission systems for coordinate conversion, precision phase shifting, and similar operations. Bulletin 23TR-61-1 gives full specifications. It's yours for the asking. Write:

2-2

 **FORD INSTRUMENT CO.**
 DIVISION OF SPERRY RAND CORPORATION
 31-10 Thomson Ave., Long Island City 1, N.Y.

CIRCLE 208 ON READER SERVICE CARD
 May 25, 1962

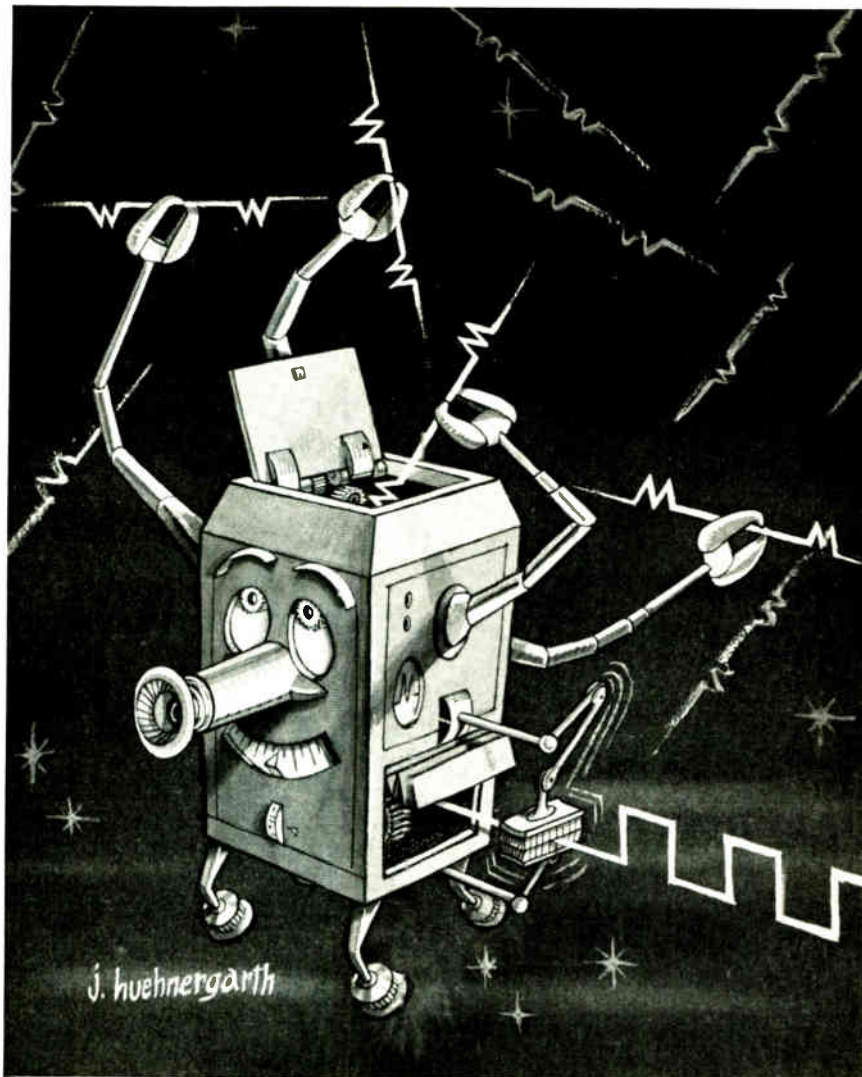

Rejuvenate tired, dirty signals with
NEMS-CLARKE® Universal Combiner!

Recent competitive tests rank this new universal signal-controlled combiner, the DCA 4000, the best of the AGC post-detection combiners. It accepts signals from up to four separate receivers and produces a single output with a signal-to-noise ratio better than the best input signal. It can be used for combining communications signals or any type of signal presently defined under IRIG standards. This equipment was designed and constructed in accordance with the requirements of MIL-E-4158 (USAF) and has a stability of continuous operation for a minimum of eight hours without readjustment.

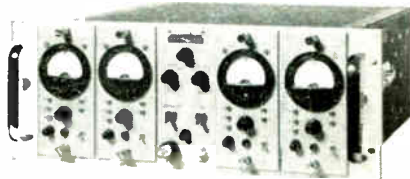

Write for Data Sheet 4000.
 Vitro Electronics, 919 Jesup-Blair Dr.
 Silver Spring, Maryland
 A Division of Vitro Corp. of America

Vitro ELECTRONICS

SPECIFICATIONS

Type Reception FM/FM or FM/Pulse, (PDM, PCM, PAM)
 Diversity Channels 2, 3 or 4
 S/N Ratio Improvement for Equal S/N Ratio Input Signals
 4 channels 5 to 6 db
 3 channels 4 db to 4.7 db
 2 channels 2.0 db to 3.0 db
 Output Impedance 75 ohms
 Stability Eight hours continuous without readjustment

Report Progress For Passive Thin Film Units

By MICHAEL F. WOLFF
Senior Associate Editor

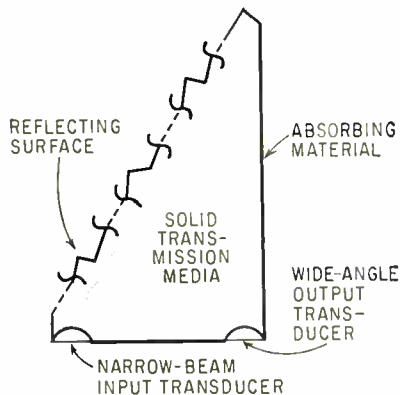

Artist's conception of an operable passively tapped acoustic delay line described by J. E. Taylor of General Dynamics/Electronics

whose stability was reported to exceed that of single metal or alloy films. M. Beckerman said temperature storage at 200 C showed changes in resistance of less than 0.2 percent after 2,000 hours. After 3,500 hours of temperature-humidity cycling at powers from 0 to 11 watts per sq inch, a maximum change of less than 1.2 percent was observed; for 5,000 hours it was less than 3 percent. Temperature coefficient of resistance was -50 ppm per deg C.

The computer was designed for a 500-Kc clock rate; component packing density was 640,000 per cu ft which, it is anticipated, could be raised to 1.5 million.

Microcircuits consisting of thin-film tantalum capacitors and resistors, and diffused silicon active

devices were discussed by T. V. Sikina of Philco Scientific Laboratory. He reported that flip-flops using high-frequency silicon transistors in a multi-header size TO-5 package had operated at 10 Mc under load and 20 Mc unloaded with a fanout of 4. Resistor temperature coefficients were around -100 ppm per deg C; capacitor power factors were typically in the range 0.005 to 0.009.

D. Gerstenberg of Bell Labs reported improving reproducibility in tantalum resistor production by introducing small amounts of nitrogen into the argon sputtering atmosphere. He said stable nitrides are thereby formed that allow consistently obtaining favorable resistor properties (resistivity of 250 micro-ohm-cm, and tempera-

WASHINGTON — Assemblies using passive thin-film components and interconnections can be effectively utilized under military field conditions. Experimental data to support this contention for films deposited both by sputtering and evaporation highlighted the recent Electronic Components Conference.

According to observers, the substantial amount of quantitative information on stability, reliability and other key parameters over thousands of hours contrasted with past years where emphasis was on laboratory feasibility models and fabrication methods.

Thin-film circuit panels for a microminiature space guidance computer were reported by A. E. Lessor of IBM to have exceeded military requirements for shock, vibration and temperature-humidity testing. Circuits consist of diode AND's and OR's, transistor INVERTERS, and emitter follower drivers. The passive networks consist of desistors, insulators and connectors deposited by vacuum-evaporation onto the outer surface of two glass slides which are laminated together to comprise a circuit panel.

The networks use chromium-silicon monoxide cermet resistors

Maser for Satellite Communication

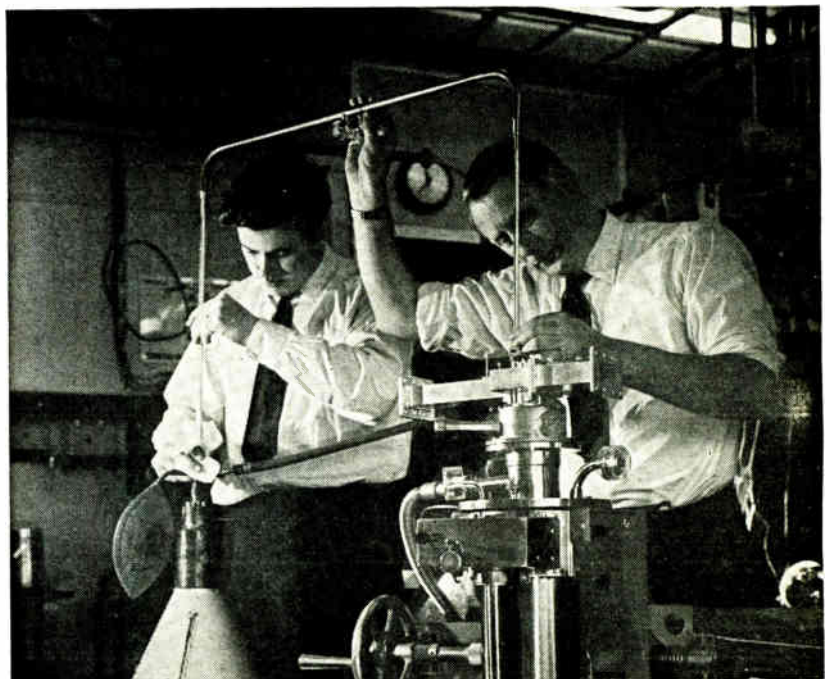

Traveling wave maser amplifier, designed and built by Mullard Research scientists, was recently installed at the G. P. O. Satellite Communication ground station now being erected at Goonhilly Downs, Cornwall. Operating at 4,170 Mc the maser will be used in the first stage of the receiver to amplify signals relayed across the Atlantic via the communications satellite Telstar, expected to be launched this month



Passivation inactivates the junction surface, greatly increasing reliability and stability. Getter and retaining ring are dispensed with.

**NO
GETTER... NO
RETAINING RING**

PASSIVATED 2N332A-338A's

General Electric's new passivated 2N332A thru-2N338A transistors exceed in reliability even the heretofore unsurpassed G-E 2N332 series, an industry standard. General Electric developed its new process for the MINUTEMAN RELIABILITY Program. The surface passivation technique inactivates the junction surface and dispenses with the need for getter and retaining ring.

4700 units now on MINUTEMAN life test at G.E. have operated for 1000 hours without a single failure. These units have already operated for 6,650,000 transistor hours @ 280 mw., and are still on test. This new passivated series may well comprise the most reliable silicon grown-junction triodes available today . . . and they are

in stock now at all General Electric Semiconductor distributors. Every "A" and MIL version of the 2N332A-338A series you purchase from now on will be this new, high-reliability passivated transistor type. And at the same price as before.

Your General Electric Semiconductor Products District Sales Manager can give you complete details. Or write Semiconductor Products Department, Section 16E131, General Electric Company, Electronics Park, Syracuse, New York. In Canada: Canadian General Electric Co., 189 Dufferin Street, Toronto, Ont. Export: International General Electric, 159 Madison Avenue, New York 16, N.Y.

AVAILABLE THROUGH YOUR GENERAL ELECTRIC SEMICONDUCTOR DISTRIBUTOR

GENERAL  **ELECTRIC**

More Relay 25 Amps!

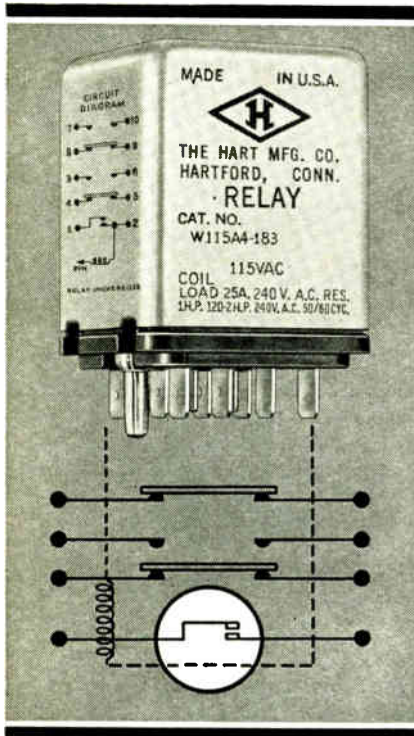

NEW! HOLDING CONTACT With Series "W" Plug-in Relay

You get *more* relay with the new Series WA. It features a new holding coil and contact for momentary contact switching which lets you build "inching" or "jogging" capability into machinery. Like other Series W relays, this new version is:

COMPACT: Measures only 1½" x 1½" x 1¾". Weighs only 10 oz. More compact than most 10 amp relays. You can fit up to fourteen 25-amp circuits into a group of Series W relays occupying a space of only 11½" x 1½" x 1¾".

VERSATILE: a-c or d-c units available with choice of eight different contact circuits.

RELIABLE: Mechanical life in excess of 10,000,000 cycles.

RATED HIGH IN AMPERAGE: Up to 25 amps, 240V, a-c, or 28V, d-c.

EASY TO INSTALL: Spade terminals for socket or quick disconnect installations. Solder or pigtail terminals available.

Write today for Bulletin WU-09 giving specifications and applications of Series W Relays. Additional data on the new WA Relay with holding contact is available on request.

The **HART**

Manufacturing Company

202 Bartholomew Avenue

Hartford 2, Connecticut

Phone: JACKSON 5-3491



ture coefficient of resistance that can be below -50 ppm per deg C depending upon film thickness).

Thermal stability and stability during load life were also improved over those of regular tantalum resistors, he said. The former was close to 0.1 percent during 1,800 hours at 150 C; the latter was mostly less than 0.1 percent for 1,200 hours at ½w load and room temperature.

An apparatus for simultaneously depositing two materials on a substrate to form compound thin films was described by A. Hagenlocher of General Telephone & Electronics Laboratories. The system uses two independent evaporation sources, each heated by an electron beam, to avoid the contamination that occurs by heating in tungsten boats he said.

Function-Oriented Approach

Achieving military system reliability by using microminiature devices in controlled environments was stressed in an invited paper by G. W. A. Dummer of Royal Radar Establishment. In surveying present work on function-oriented approaches, to which he said the majority of United Kingdom microminiaturization researchers are devoting attention, Dummer reported the development at R.R.E. of an epitaxial-planar multiple photocell. In this device separate isolated p-n junctions on a slice of silicon are connected in series to obtain an increase in output voltage at the expense of output current. He also reported that cadmium sulphide film audio amplifiers with voltage gains of 30 had been built at Plessey Research Laboratories.

Several papers were devoted to progress in capacitors. Wolfgang Post of Aluminium-Walzwerke Singen, Germany, reported a 1-cu-cm sandwich of 14 solid aluminum capacitors had been built with a capacitance of 500 µf and working voltage of 3v. H. G. Rudenberg, of Arthur D. Little, reported experimental data for titanium oxide and silicon dioxide capacitors.

New delay lines were described in separate papers by J. E. Taylor of General Dynamics/Electronics and John May, Jr., of Bell Labs.

Taylor described a passively tapped acoustic delay line for time domain synthesis of prescribed waveforms. In such a device (see figure, p 62) a solid transmission media would support transmission of acoustic energy from an input transducer to an output transducer by way of reflection from a sequence of internal reflectors spaced in delay time. Simple delay lines with up to 20 taps (reflecting surfaces) have been fabricated. Taylor said this type of line would be useful for pulse compression systems in radar and low-data-rate, secure, communications.

Space Saving Achieved

Guided-wave ultrasonic delay lines were described by May as being valuable for increasing pulse compression radar range without correspondingly increasing peak power. He said aluminum strip delay lines 70 mils thick and 15 ft long could be coiled into a space 1 ft in diameter; four lines could be interleaved to perform the function of networks previously contained in two 6-ft relay racks.

The conference, which drew approximately 500 persons, was concluded by a report from Donald Levy, of RCA, on reliability data for the micromodule program. He said the operating life-test program for digital modules had indicated a per-element failure rate of 0.0177 percent per thousand hours.

Thin-Film Cryotrons Advance in Britain

CIRCUITS of up to six cryotrons have been constructed in Britain by the National Physical Lab. at Teddington, by vacuum deposition of thin films of tin, lead and silicon monoxide insulator through masks, and tested in a specially constructed liquid helium cryostat.

Measured time constants of 200 millimicroseconds agree with the calculated circuit inductance and restored resistance values.

Objective of the NPL study is a reduction of the variation of cryotron properties from batch to batch.

Vacuum achieved is less than one millionth mm of mercury.

*Acoustical Components
of Superior Quality*

JAPAN PIEZO supplies 80% of Japan's crystal product requirements.

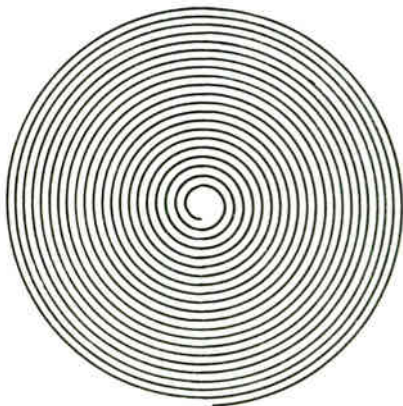

**PHONOGRAPH
MOTOR — DC
PM — 31-1**

9V, 2,500RPM: No-load current, 35 mA; load current, 80 mA. Starting torque, 13 g-cm; load torque, 5 g-m. Size: 2.4 cm X 4.6 cm. Weight: 100 gm.

Write for detailed catalog on our complete line of acoustical products including pickups, cartridges, microphones, record players and many associated products.



**JAPAN PIEZO
ELECTRIC CO., LTD.**

Kami-renjaku, Mitaka, Tokyo, Japan

CIRCLE 209 ON READER SERVICE CARD
May 25, 1962

100,000,000 Pulses/Sec from TI

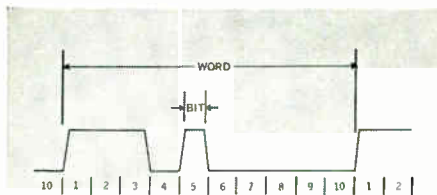

PROGRAMMED PULSE GENERATORS

- Bit Rates up to 25 MC
- 10 Bit Programmable Words

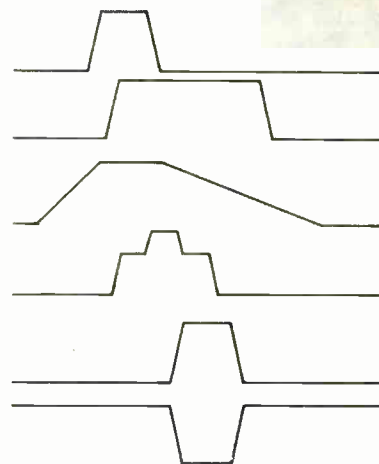

GENERAL PURPOSE PULSE GENERATORS

- PRF 100 cps to 25 MC
- Variable Pulse Width and Delay
- Variable Rise and Fall Times
- Pulse Mixing
- Plus and Minus Outputs



CLOCK PULSE GENERATORS

- PRF 100 cps to 100 MC
- Rise and Fall Times—
Less Than 4 nanoseconds
- Pulse Width—
Less Than 8 nanoseconds

Texas Instruments complete line of pulse instrumentation features compact design and high reliability through use of all solid state circuitry. Versatile modular construction permits custom combination of desired performance characteristics.

Write for complete information

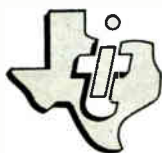

**TEXAS INSTRUMENTS
INCORPORATED**
APPARATUS DIVISION
3609 BUFFALO SPEEDWAY
P. O. BOX 66027 HOUSTON 6, TEXAS

501

CIRCLE 65 ON READER SERVICE CARD 65



Banks of racks are used for d-c dissipation tests of transistors. Small detachable ovens with individual temperature control can be placed over selected racks for testing at elevated temperatures. Special techniques are used to prevent the testing operation from introducing failure from wrong connections, overloads or voltage transients

Rigid Controls Improve Transistor Reliability

TO GET TRANSISTORS with proven reliability, Philco Corporation, Lansdale, Pa., uses two interlocking concepts. First, by means of their automatic transistor manufacturing line and extensive post encapsulation conditioning, they obtain a product with a constant failure rate. The sketch shows the conventional failure curve, with an initial high failure rate that falls off to a stable rate and then increases again as the device wears out. The constant failure rate curve is similar except that it does not have an initial high rate.

When the process is in control, which means that all significant variables in the production process are under control, a constant and uniform failure rate is possible. A stable initial failure rate is not possible if significant production variables are out of control.

Once a constant failure rate and product uniformity have been obtained, it is possible to use sequential life testing to verify the failure rate. The advantage of this technique is that the size of the sample to be tested can be traded off for testing time: the larger the sample

tested, the shorter the required testing time. This trade off cannot be done if the initial failure rate is not constant, since in that case the steep sloping initial failure rate will obscure the stable rate that will be obtained eventually.

The system works as follows: if 100 transistors are tested for 1,000

hours, an accumulation of 100,000 transistor test hours results; if an additional 100 transistors from the next production lot are put on test for 500 hours, the accumulation for this group is 50,000 transistor hours; now, if a constant failure rate has been maintained for both groups of transistors, the total

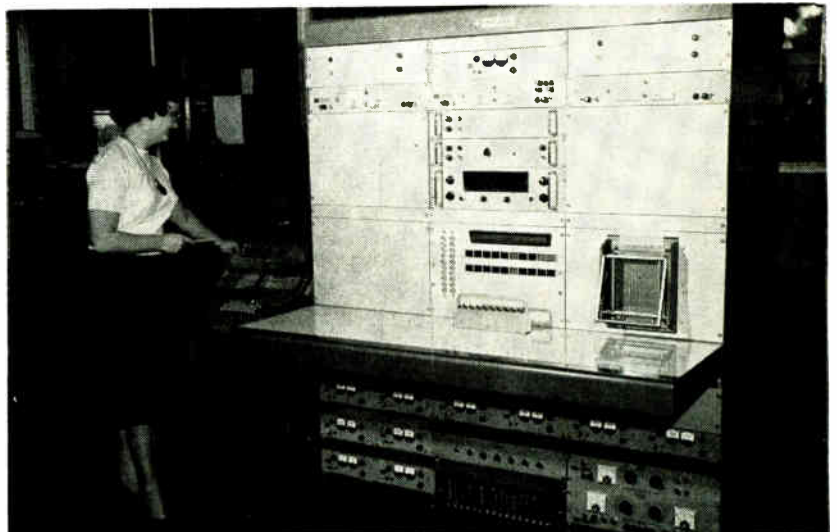

Automatic tester is programmed for each transistor type by a card that has a program interlocked with the transistor magazine. An IBM card, with results of up to eight tests, is generated for each transistor

GET PROVEN
COMPONENT RELIABILITY...
**USE PHILCO
PROVED-IN-USE
EQUIPMENT**

... IN COMPONENT PRODUCTION

... IN COMPONENT TESTING



400°C. HARD-VACUUM OVEN

Industry's finest. Stainless steel muffle. Precise primary and secondary temperature control. Flat profile. Available in 2 sizes: 8" x 8" x 18" and 13" x 14" x 20"

NEW LOW-COST 250°C. VACUUM OVEN

Outstanding quality at a budget price. New Philco vacuum bake-out oven features hard vacuum—down to the 10^{-5} range. Dimensions: 10 3/4" diameter (equivalent to 8" x 8" cross-section), 18" depth.



NEW PHILCO DRYBOXES

Industry's most hermetically reliable dry-boxes. Available in your choice of stainless steel or aluminum.

External coupling of units, unobstructed internal working surface and plug-in compatibility with ovens and other equipment—all these Philco features assure industry's highest standard of atmosphere control.



NEW PHILCO h_{fe} TESTER

A new low-cost way to check transistor current gain. Tester is continuously tuned to process 50kc to over 200mc transistors.



NEW PHILCO SPA®

Inspects Incoming Transistors Automatically

Philco® Single-Position Automatic Tester, shown in photo, enables you to plug-in 10 different parameter tests. Can be programmed to test 10 different transistor types—simultaneously. Protects transistors from outside electrical influences during tests. Contains Philco-designed and built solid state comparator.

For facts on Philco production and testing equipment, and capabilities for custom equipment, telephone (collect) UL 5-4681 (area code 215). Ask for Mr. E. J. Greenholt. Or write Dept. E52562E.

Equipment Development and Manufacturing Operation

PHILCO®

A SUBSIDIARY OF *Ford Motor Company*

LANSDALE DIVISION, LANSDALE, PENNSYLVANIA

CIRCLE 67 ON READER SERVICE CARD

HIGH PURITY METALS AND ELECTRONIC MATERIALS

METALS AND ALLOYS

ALUMINUM	ANTIMONY
ARSENIC	BISMUTH
CADMIUM	GOLD
INDIUM	LEAD
SILVER	TIN
	ZINC

High purity alloys are made from these metals to customer specifications.

STANDARD FORMS

INGOTS	SHEET
BAR	SHOT
RODS	POWDER
RIBBON	WIRE

PREFORMS

Preforms are available in a range of sizes and shapes such as discs, dots, washers, squares and spheres. Enquiries are invited on our alloy preforms.

COMPOUND SEMICONDUCTORS

INDIUM ANTIMONIDE

Available as crystals, wafers, circles, rings and other shapes made to precise tolerances.

CHEMICALS

SALTS SOLUTIONS

COMINCO PRODUCTS INC.

Electronic Materials Department
933 West Third Avenue
Spokane, Washington
Ph. RI 7-7103 TWX: SP 311

transistor test hours are additive, which means that 150,000 test hours can be used as a basis for calculating the reliability of both groups of transistors. The final result is that test results from smaller samples can be combined without loss of statistical confidence.

Verifying Results

But to use the sequential life testing scheme just described it is necessary to obtain a product with a consistent failure rate and then to verify that the failure rate is actually constant from lot to lot. Product uniformity is obtained in this case by an automated transistor production line, using feedback techniques at several points to fabricate each individual transistor of a given lot to the same specifications.

To verify the fact that a constant failure rate had been obtained it was necessary to develop testing equipment that would test all units of a given lot uniformly and that would not of itself or through operator error cause failure of the units being tested. The photographs show the most important items in the testing program.

The storage racks, for d-c dissipation tests only, use special transistor mounting fixtures; once the transistors are inserted in the fixtures they are not removed until all

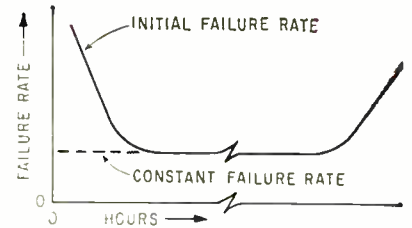

If all significant variables in a production process are under control, the steep sloping initial failure rate is flattened

tests needed to establish reliability have been completed, although the fixtures themselves are transported to other testing equipment at specified intervals.

Heating equipment can be placed over transistors on test, as the photograph shows, for testing at elevated temperatures. The racks into which the transistor fixtures fit are themselves relatively large and heavy, so that thermal shocks are minimized. Actual test hours are logged with clocks and several interlocks are designed into the equipment.

The transistors are removed from dissipation storage tests at 250, 500, and 1,000 hours for more detailed tests on the automatic equipment shown in one of the photographs. The tester is programmed automatically and interlocked with the transistor test fixture such that incorrect tests cannot be performed. As many as eight parameters of

Still Reclaims Expensive Fluids



Blacossolv, a degreasing fluid, reclaimed in a distilling operation by El Segundo Division of Hughes Aircraft Co. About eight hours are required to process each 660 pound drum of the fluid. The fluid costs \$92.40 a barrel and the Division, using about 25 barrels a year, saves an estimated \$2,300 in the operation. Silicone, much more expensive, is also reclaimed, but in much smaller quantities

each transistor can be programmed into the tester, although only six parameters are normally checked. Approximately one second is required for each parameter tested, and an IBM card is generated for each transistor as it is tested.

Accumulated life test data from successive lots are plotted so as to reveal product uniformity and the potential reliability level. This data then permits determination of the qualification level.

The production and testing system produces highly reliable transistors, with a proven failure rate, and at minimum cost, at least to the extent that costs for highly reliable components can be minimized. Costs are minimized as a result of the combination of samples to establish a high confidence level and from the possibility of maintaining a lower inventory of finished goods.

Low Cost Transistor Assembly Technique

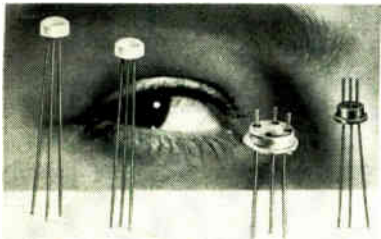

NEW APPROACH to the design and production of hermetically-sealed transistors and diodes by Hermetic Seal Corp., Rosemead, Calif., is claimed to reduce manufacturing costs up to 30 percent.

The design consists of three or more gold plated nail leads, a special base and special compounds for sealing. The design eliminates the usual glass-to-metal seal.

The leads for the transistor are dropped in place; one of the leads has the transistor already mounted and tested. Whiskers are attached to the other leads and a free-flowing compound is dropped on top, thus securing all leads, transistor wafer and mounting base and producing a hermetic seal.

Size T018 bases are presently available. Maximum temperature for continuous operation is 200 C; electrical leakage after assembly is 10¹¹ ohms.

May 25, 1962



Start of a perfect record

This switch on CEC's Type 5-123 Multi-channel Recording Oscillograph performs a significant job. It turns on one of the most versatile instruments of its type available. When a lab needs a multi-channel oscillograph, it will benefit notably from 5-123's features, like (1) twelve discrete speeds from 0.1 to 160 ips, selected by upfront pushbuttons . . . (2) major modules physically and electrically self-con-

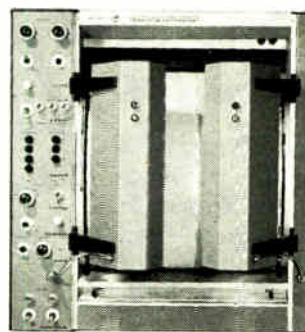

Shown with DATAFLASH

tained for easy replacement or interchange . . . (3) direct-rack mounting . . . (4) optional trace numbering for easier data reduction . . . (5) optional DATAFLASH that provides up to sixty times faster record-access time than any other printout process . . . (6) up to 52-active channels. If you need perfect oscillogram records, you need the 5-123. Call your CEC office or write today for Bulletin CEC 5123-X5.

CEC

Data Recorders Division

CONSOLIDATED ELECTRODYNAMICS

PASADENA, CALIFORNIA • A SUBSIDIARY OF BELL & HOWELL

CIRCLE 69 ON READER SERVICE CARD

DESIGN AND APPLICATION



Low-Cost Data Transmission System

TRANSMITS 200 KC DATA TO 1,000 FT

RECENTLY announced by Packard Bell Computer, 1905 Armacost Ave., Los Angeles 25, California are the DR100 data receiver and DT100 data transmitter capable of transmitting digital data at 200 Kc over distances up to 1,000 ft. In aerospace telemetry, industrial process control on on-line dynamic testing, very often the central digital computer is separated from the data gathering devices by several hundreds of feet. The DT100 module consists of three identical and independent four terminal AND gates also having auxiliary input for expansion. One output has a fixed 100-ohm series terminating resistor and may be con-

nected to approximately 1,000 ft of single twisted-pair plastic insulated intercom cable while the other has no termination network and drives a coaxial cable. The DR100 unit also consists of three identical and independent circuits and is transformer coupled to provide ground and system isolation. Binary true-false or set-reset pulses are provided by the output of each circuit. Auxiliary reset is also available. The transmitter module input for 1 is -7 to -12 v and $35\mu\text{a}$ maximum while for a 0, voltage is -1 to $+0.5$ v at 1.2 ma. Maximum rise time is $0.8 \mu\text{sec}$ and rep rate is 200 Kc.

CIRCLE 301 ON READER SERVICE CARD

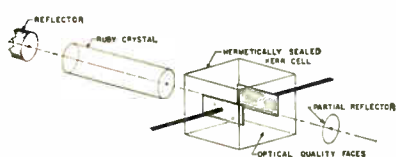

Laser Modulator

USES KERR CELL

ANNOUNCED by Electro-Optical Instruments Corp., 2612 East Foot-hill Blvd., Pasadena, California, is the LPM-60 ruby laser modulation system designed principally for optical harmonic generation, optical ranging and materials research, the device uses a nitrobenzene filled Kerr cell shutter that is incorporated within ruby laser cavities as a Q spoiler for operation in the pulse reflector or other possible modes. The Kerr cells are hermetically sealed and provided with integral expansion bellows. Windows

are guaranteed flat within $\frac{1}{4}$ -in. fringe over the useful aperture from $\frac{1}{4}$ -in. to 0.6 in. Standard cells filled with purified nitrobenzene for use with d-c bias voltages are available as well as short wavelength versions extending as far as 2,400 A in the near uv. Three different cell units are available ranging in aperture from 0.24×0.48 to 0.60×0.90 inch.

CIRCLE 302 ON READER SERVICE CARD

UHF to VHF Converter

MOUNTS NEAR ANTENNA

MANUFACTURED by Microdot Inc., 220 Pasadena Ave., South Pasadena, California, the model 1405 converter is designed to allow existing telemetry receivers in the 215 to 260 Mc range to receive sig-

nals in the 2,200 to 2,300 Mc range. Midfrequency gain is 13 db and falls to 12 db with an input level of -22 dbm and 1 db at an input level of -10 dbm. Frequency response is 3 db over the frequency range and there is 50 db minimum rejection of image frequency and subharmonics. The noise figure is 4.5 db at mid frequency and the local oscillator is crystal controlled at 1,975 Mc with a stability of 0.0005 percent. Input is a low insertion

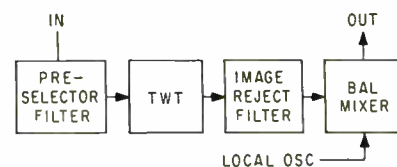

loss (less than $\frac{1}{2}$ db) bandpass filter made up of three mutually-coupled waveguide sections, followed by a twt amplifier. The amplifier is followed by an image reject filter to preclude energy feeding back to the twt. A constant-current power supply is used to prevent continual adjustment of the twt solenoid. The unit is housed in a weatherproof case and can be mounted at the antenna thus minimizing signal loss in lead-in cables.

CIRCLE 303 ON READER SERVICE CARD

Distortion Meter

ALSO A VTVM

BARKER & WILLIAMSON, BRISTOL, PA. Model 410 permits distortion levels to be measured on fundamental frequencies from 20 to 20,000 cps, indicates harmonics up to 100,000 cps. Distortion measurements can be made on signal levels of 0.1 v to 30 v rms. The vtvm provides an accuracy of ± 5 percent over a frequency range from 20 cps to 200 Kc. For noise and db measurements, unit is calibrated in 1 db steps from 0 db to -15 db, the built-in attenu-

Semiconductor News from ELECTRICAL INDUSTRIES

NEW

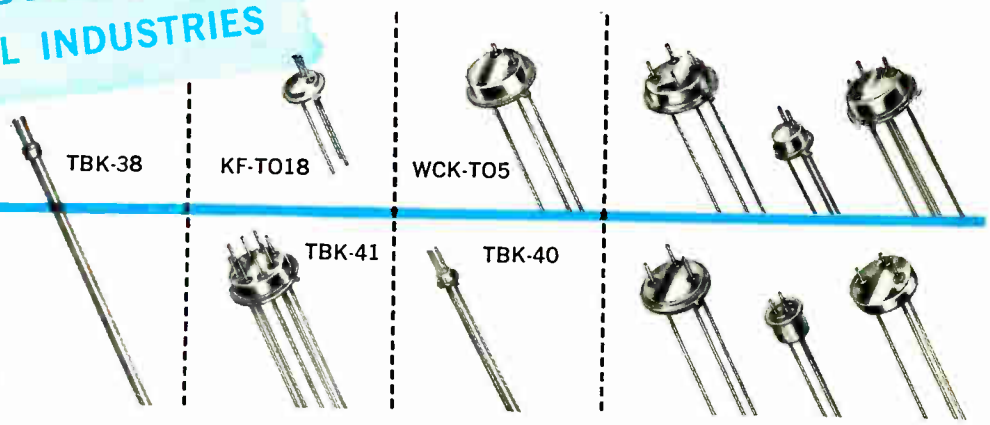

TRANSISTOR BASES

The new Electrical Industries line of hermetically sealed transistor bases includes types for Jedec Series TO5, TO9, TO18, TO33 and TO46 packages, miniatures for hearing aids and other applications, and bases for practically all military and commercial requirements. MIL types equal or exceed military specifications. Available in a broad selection of terminal configurations with finishes of Brite Gold, electro-tin or high purity gold for direct fusion of semiconductor elements to header base. Special plating on order.

TERMINAL CONFIGURATIONS

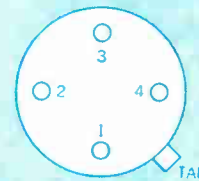

CODING:

- X = No Lead
- G = Ground Lead
- L = Lead Thru Glass
- T = Weld Tab

FIGURE 1

	CODE NUMBER	TERMINALS (SEE FIGURE 1)				LEAD LENGTH IN INCHES (See Figure 2)													
						STANDARD TYPES		MODIFICATIONS AVAILABLE											
						A DIMENSION	B DIMENSION	MOD. A A DIM.	MOD. B A DIM.	MOD. C A DIM.	MOD. D A DIM.	MOD. U A DIM.	MOD. V A DIM.	MOD. W A DIM.	MOD. X A DIM.				
STRAIN-FREE TYPES	K-T05-XGLL	X	G	L	L	.13-.64	1.500-1.532	.020-.025 B DIMENSION = 1.500-1.532	.050-.060	.095-.105	.105-.110								
	K-T05-XLLL	X	L	L	L														
	WCK-T05-XGLL *	X	G	L	L														
	K-T05-TLLL	T	L	L	L														
	K-T018-XGLL	X	G	L	L	.110-.130	.500-.520	.017-.022 B DIMENSION = .500-.520	.025-.030	.045-.055		.110-.130	.017-.022	.025-.030	.045-.055				
	K-T018-XLLL	X	L	L	L														
	KF-T018-XGLL	X	G	L	L	.110-.130	.500-.520	.017-.022	.025-.030	.045-.055									
	K-T033-GLLL	G	L	L	L	.090-.110	1.500-1.532	.020-.025 B DIM. = 1.500-1.532	.050-.060										
	K-T033-LLLL	L	L	L	L														
	TBK-38		3 SPACED 120			5 32	1-5 8												
TBK-40		3 SPACED 120			5 32	1-5 8													
TBK-41		8 SPACED 45			.13-.64	1.500-1.532													
COMPRESSION TYPES	WSF-T05-XGLL	X	G	L	L	.090-.110	1.500-1.532	.020-.025 B DIM. = 1.500-1.532	.050-.060										
	WSF-T05-XLLL	X	L	L	L														
	WSF-T05-GLLL	G	L	L	L														
	WSF-T05-TLLL	T	L	L	L														
	WS-T09-XLLL	X	L	L	L														.095-.105

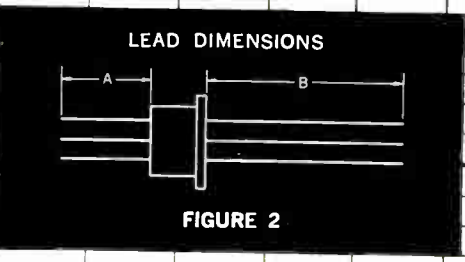

FIGURE 2

* COPPER CLAD

ALSO AVAILABLE - Hermetically sealed clear glass caps for photo-sensitive devices utilizing TO5 and TO18 type bases.



PTC SERIES



ELECTRICAL INDUSTRIES
MURRAY HILL, NEW JERSEY, U. S. A.
A Division of Philips Electronics & Pharmaceutical Industries Corp.

PATENTED IN CANADA, No. 523,390; IN UNITED KINGDOM, No. 734,583; LICENSED IN U.S. UNDER No. 2561520

SPRAGUE PIEZO- ELECTRIC CERAMIC ELEMENTS

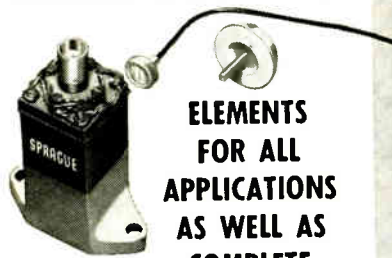

**ELEMENTS
FOR ALL
APPLICATIONS
AS WELL AS
COMPLETE**

**TRANSDUCER ASSEMBLIES
FOR MOST APPLICATIONS,
SUCH AS UNDERWATER
SOUND AND
VARIOUS ORDNANCE AND
MISSILE DEVICES.**

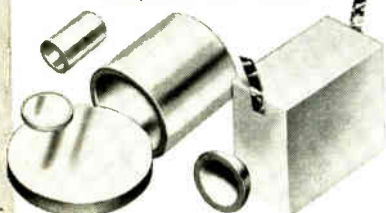

Sprague-developed mass production and quality-control techniques assure lowest possible cost consistent with utmost quality and reliability. Here too, complete fabrication facilities permit prompt production in a full, wide range of sizes and shapes.

Look to Sprague for today's most advanced ceramic elements—where continuing intensive research promises new material with many properties extended beyond present limits.



**YOUR INQUIRIES
ARE INVITED**

**WRITE FOR
LITERATURE**

SPRAGUE ELECTRIC COMPANY
35 Marshall Street, North Adams, Mass.

SPRAGUE®
THE MARK OF RELIABILITY

ator provides additional ranges from -60 db to +50 db in 10 db steps.

CIRCLE 304 ON READER SERVICE CARD

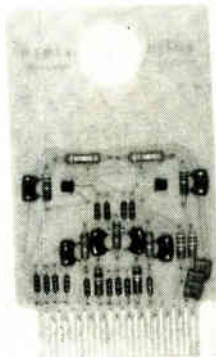

And-Or Gates

10-MC MODULES

SOLID STATE ELECTRONICS CO., 15321 Rayen St., Sepulveda, Calif. Circuit model DCAO1034 consists of seven and-or gates and is suited to applications requiring moderately large numbers of isolated inputs such as encoding or decoding. These diode gates are high speed, high conductance, low saturation resistance and low capacitance units.

CIRCLE 305 ON READER SERVICE CARD

Microwave Receivers

INTERNATIONAL MICROWAVE CORP., 1 Seneca Place, Greenwich, Conn. Solid state microwave receivers, operating in the 2 to 12 Gc range, have a 5.5 db nominal noise figure and information bandwidths to 40 Mc.

CIRCLE 306 ON READER SERVICE CARD

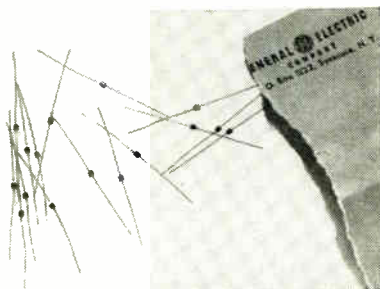

Tunnel-Diodes

GERMANIUM

GENERAL ELECTRIC CO., Syracuse, N. Y., offers 10 germanium tunnel diodes housed in a new, inexpensive axial package designed to optimize the tunnel diode features. Types

1N3712 through 1N3721 are designed for low level switching circuits and small signal applications at high frequencies. Types with peak point current ratings of 1.0, 2.2, 4.7, 10, and 22 ma are available in this series. This parameter is held to a max variation of 2.5 percent on five premium versions, and to 10 percent on the other five versions.

CIRCLE 307 ON READER SERVICE CARD

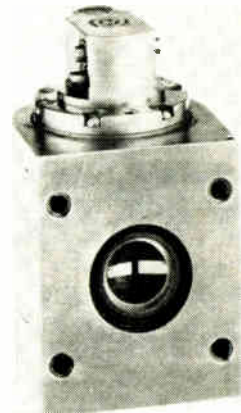

Tunable Magnetron

X-BAND

METCOM, INC., 76 Lafayette St., Salem, Mass., offers a waveguide output 2 Kw X-band tunable magnetron. The MXM-28 is designed to withstand missile type environmental conditions in addition to working under pure vacuum atmosphere.

CIRCLE 308 ON READER SERVICE CARD

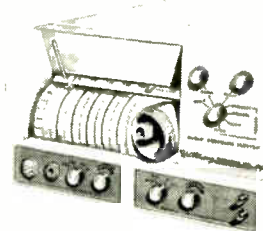

Response Plotter

AUTOMATIC

HATHAWAY INSTRUMENTS, INC., 5800 E. Jewell Ave., Denver 22, Colo., offers the ARP-3 for high-speed, accurate, automatic plotting of frequency response curves. Records can be made in as little time as it takes to make two connections to the system undergoing test, load a new chart, and turn the recording drum. The ARP-3 will plot curves



From Avco...
**new compact
 combat radio
 replaces equipment
 3 times its size**

Assignment from the Army: to develop highly mobile communications equipment for battlefield use, with FM clarity, push-button tuning and accuracy.

Action by Avco: the AN/VRC-12 radio receiver-transmitter—designed, developed and produced by Avco's Electronics and Ordnance Division for the U.S. Army Signal Corps. This communications equipment is now going to Army units and will provide a highly mobile system for use with jeeps, tanks, artillery, command cars and posts.

Outstanding features:

- Light and compact—one-third the size, one-half the weight of the equipment it replaces.
- Virtually immune to noise—920 channels, narrow-band FM, 30-70 megacycles, manual or automatic tuning.
- Completely compatible with manpack or airborne FM radio soon to be made available to troops in the field.

Communications equipment such as this typifies the capabilities of Avco's Electronics and Ordnance Division, suppliers to the armed services and NASA of equipment ranging from large intercontinental radio transmitters to tiny receivers used in Explorer XI.

For complete information on Avco's communications capabilities and how they can serve you, write: Director of Marketing, Electronics and Ordnance Division, Avco Corporation, Cincinnati 41, Ohio.

UNUSUAL CAREER OPPORTUNITIES FOR QUALIFIED SCIENTISTS AND ENGINEERS... REGARDLESS OF RACE, CREED, COLOR OR NATIONAL ORIGIN... WRITE AVCO/ELECTRONICS & ORDNANCE TODAY.

Avco's AN/VRC-12 mobile radio for combat communications

Avco // **ELECTRONICS AND
 ORDNANCE DIVISION**

CIRCLE 73 ON READER SERVICE CARD

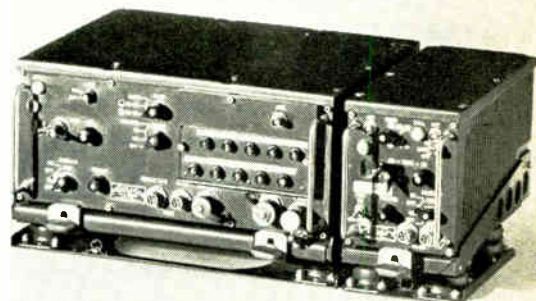

1

New 1N3728 (formerly Rheem RD250), direct replacement
— at about half the price —
for any of more than 250 general purpose
and hv silicon diodes,
is available from Raytheon Distributors coast to coast.

DOES IT AT HALF THE PRICE!

We will be happy to send you the name
of the Raytheon Distributor serving your area.
Please write: Raytheon Company,
Distributor Products Division,
411 Providence Turnpike,
Westwood, Massachusetts

Raytheon Distributors Include:

- | | | | |
|--|---|---|---|
| ALABAMA
Birmingham
MG Electrical Equipment Company
FAirfax 2-0449
Mobile
Forbes Electronic Distributors, Inc.
HE 2-7661 | COLORADO
Denver
Denver Electronic Supply Co.
SKyline 7-3351
Ward Terry Company
AMherst 6-3181 | MICHIGAN
Detroit
Newark-Ferguson Electronics, Inc.
UN 1-6700 | OHIO
Cincinnati
United Radio, Inc.
CHerry 1-6530 |
| CALIFORNIA
Burbank
Valley Electronic Supply Co.
VICTORIA 9-3944
Glendale
R. V. Weatherford Co.
VICTORIA 9-2471
Hollywood
Hollywood Radio & Electronics, Inc.
HO 4-8321
Inglewood
Newark Electronics Company
ORchard 4-8440
OREgon 8-0441
Los Angeles
California Electronics Supply, Inc.
BRadshaw 2-2124
GRanite 7-1208
Federated Purchaser
BRadshaw 2-8771
Kierulff Electronics, Inc.
RICHMOND 8-2444
North Hollywood
Richey Electronics, Inc.
877-2651, 761-6133
Oakland
Brill Electronics
TE 2-6100
Elmar Electronics
TEmplar 4-3311
Palo Alto
Zack Electronics
DA 6-5432
Riverside
Electronic Supply, Riverside, Inc.
OV 3-8110
Sacramento
Sacramento Electronic Supply Co.
GI 1-4821
San Diego
Kierulff Electronics, Inc.
BR 6-3334
Pabtronics Corp.
CY 8-7224
Radio Parts Company
BE 9-9361
Telrad Electronics
AT 1-7754
San Francisco
Fortune Electronics
UN 1-2434
Santa Ana
Airtronic Sales, Inc.
KIMBERLY 5-9441
Santa Monica
Santa Monica Radio Parts Corp.
EXbrook 3-8231 | CONNECTICUT
East Haven
J. V. Electronics
HOBart 9-1310
Stamford
Sun Radio & Electronics, Inc.
DA 5-4336
DISTRICT OF COLUMBIA
Electronic Wholesalers, Inc.
HUDSON 3-5200
Empire Electronic Supply Co.
OLiver 6-3300
FLORIDA
Miami
East Coast Electronics, Inc.
FRanklin 1-4636
Electronic Equipment Co., Inc.
NEwton 5-0421
Orlando
Wholesale Radio Parts Co., Inc.
GARDEN 4-6579
West Palm Beach
Goddard Distributors, Inc.
TEmple 3-5701
ILLINOIS
Chicago
Allied Electronics Corporation
TA 9-9100
Newark Electronics Corp.
STate 2-2944
INDIANA
Indianapolis
Graham Electronics Supply Inc.
MEIrose 4-8486
LOUISIANA
Baton Rouge
Southern Radio Supply Company, Inc.
DI 3-6658
New Orleans
Southern Radio Supply Company, Inc.
TULane 2345
MARYLAND
Baltimore
Wholesale Radio Parts Co., Inc.
MUIberry 5-2134
MASSACHUSETTS
Boston
Cramer Electronics, Inc.
WO 9-7700
DeMambro Radio Supply Co., Inc.
AL 4-9000
Lafayette Radio Corp., of Mass.
HUBbard 2-7850
Radio Shack Corp.
RE 4-1000
Cambridge
Electrical Supply Corp.
UNiversity 4-6300 | MISSISSIPPI
Jackson
Ellington Radio, Inc.
FL 3-2769
MISSOURI
Kansas City
Burststein-Applebee Company
BALtimore 1-4266
Walters Radio Supply, Inc.
VA 1-8058
University City
Olive Industrial Electronics
VOLunteer 3-4051
NEW HAMPSHIRE
Concord
Evans Radio
CAPital 5-3358
NEW JERSEY
Camden
General Radio Supply Co., Inc.
WO 4-8560 (in Phila.: WA 2-7037)
Mountainside
Federated Purchaser Inc.
AD 2-8200
NEW YORK
Binghamton
Stack Industrial Electronics, Inc.
RA 3-6326
Buffalo
Genesee Radio & Parts Co., Inc.
TR 3-9661
Whele Electronics, Inc.
TL 4-3270
Elmira
Stack Industrial Electronics, Inc.
RE 3-6513
Ithaca
Stack Industrial Electronics, Inc.
ITHaca 2-3221
Mineola, Long Island
Arrow Electronics, Inc.
Pioneer 6-8686
New York City
H. L. Dalis, Inc.
EMpire 1-1100
Milo Electronics Corp.
BEEkman 3-2980
Quad Electronics, Inc.
CL 8-9200 (Brooklyn)
Sun Radio & Electronics Co., Inc.
OREgon 5-8600
Terminal-Hudson Electronics, Inc.
CHelsea 3-5200
Utica
Valley Industrial Electronics, Inc.
RA 4-5168
White Plains
Sun Radio & Electronics, Inc.
WHite Plains 9-7715 | CLEVELAND
Main Line Cleveland, Inc.
EXpress 1-4944
Pioneer Electronic Supply Co.
SUSerior 1-9411
Columbus
Buckeye Electronic Distributors, Inc.
CA 8-3265
Dayton
Srepco, Inc.
BALdwin 4-3871
OKLAHOMA
Tulsa
Radio, Inc.
LU 7-9124
S & S Radio Supply
LU 2-7173
OREGON
Portland
Lou Johnson Company, Inc.
CAPital 2-9551
PENNSYLVANIA
Harrisburg
D & H Distributing Co., Inc.
CEDar 6-8001
Philadelphia
Almo Radio Company
WALnut 2-5918
Powell Electronics, Inc.
SA 4-1900
Radio Electric Service Co.
WALnut 5-5840
York
Wholesale Radio Parts Co., Inc.
47-1007
TENNESSEE
Knoxville
Bondurant Brothers Company
3-9144
TEXAS
Fort Worth
SWIECO, Inc.
ED 2-7157 (in Dallas: AN 2-5026)
UTAH
Salt Lake City
W. H. Bintz Co.
EMerson 3-5821
VIRGINIA
Norfolk
Priest Electronics
MA 7-4534
WASHINGTON
Tacoma
C & G Electronics Co.
BR 2-3181
WISCONSIN
Milwaukee
Electronic Enterprises, Inc.
GR 6-4144
Electronic Expeditors, Inc.
ED 2-0616 |

Graybar Electric Company, Inc. — Nationally (see Yellow Pages)



DISTRIBUTOR PRODUCTS DIVISION

WESTWOOD, MASSACHUSETTS

RAYTHEON 1N3728 CUTS DIODE COSTS IN HALF

New high reliability 1N3728 (formerly Rheem RD250) is direct replacement for more than 250 general purpose and high voltage silicon diodes.

Now you can reduce qualification and specification expenses, lower inventory costs, and obtain higher reliability with the Raytheon Rheem 1N3728 *Universal* silicon diode. It is priced at less than one-half the average of manufacturer's published prices for the diodes it replaces, and meets or exceeds all tests and specifications for these units.

The 1N3728 features very high voltage with very low leakage. Reverse leakage is specified at nine points, forward current at ten. Replacement of

standard 100 and 200 volt diodes with the low cost 550-volt 1N3728 greatly increases the safety margin of the reverse characteristic, substantially reducing the major point of diode failure. Dependable performance is assured by more than two years of testing and field use.

For complete data of the 1N3728, please contact the Raytheon Field Office nearest you, or write Semiconductor Division, 900 Chelmsford Street, Lowell, Massachusetts.

MAXIMUM RATINGS @ 25°C		1N3728	UNIT
Peak rectified current	I_F	650	mA
Average rectified current	I_O	200	mA
Surge current (1 sec.)	i_F (surge)	1000	mA
Pulse current (2 μ sec. 1% duty cycle)	i_F (pulse)	2000	mA
Power dissipation (derate 1.4 mw/°C)	P_t	250	mW
Operating temperature	T_A	-65 to +200	°C
Storage temperature	T_{slg}	-65 to +200	°C

SPECIFICATIONS	MIN.	TYP.	MAX.	UNIT
Forward Voltage @ 1 mAdc	.61	.64	.68	V
@ 10 mAdc	.72	.75	.80	V
@ 100 mAdc	.84	.87	.98	V
@ 200 mAdc	.88	.92	1.09	V
@ 400 mAdc	.92	.98	1.20	V
Reverse Current @ 20 Vdc @ 25°C	.0005	.005		μ Adc
@ 100°C	.050	.100		μ Adc
@ 150°C	1.00	2.0		μ Adc
Reverse Current @ 175 Vdc @ 25°C	.010	.025		μ Adc
@ 100°C	.150	.500		μ Adc
@ 150°C	2.0	5.0		μ Adc
Reverse Current @ 400 Vdc @ 25°C	.085	.100		μ Adc
@ 100°C	.500	1.00		μ Adc
@ 150°C	4.0	10.0		μ Adc
Saturation Voltage -65°C to +200°C @ 100 μ A	500	—	—	Vdc
Saturation Voltage @ 25°C @ 100 μ A	550	650	—	Vdc

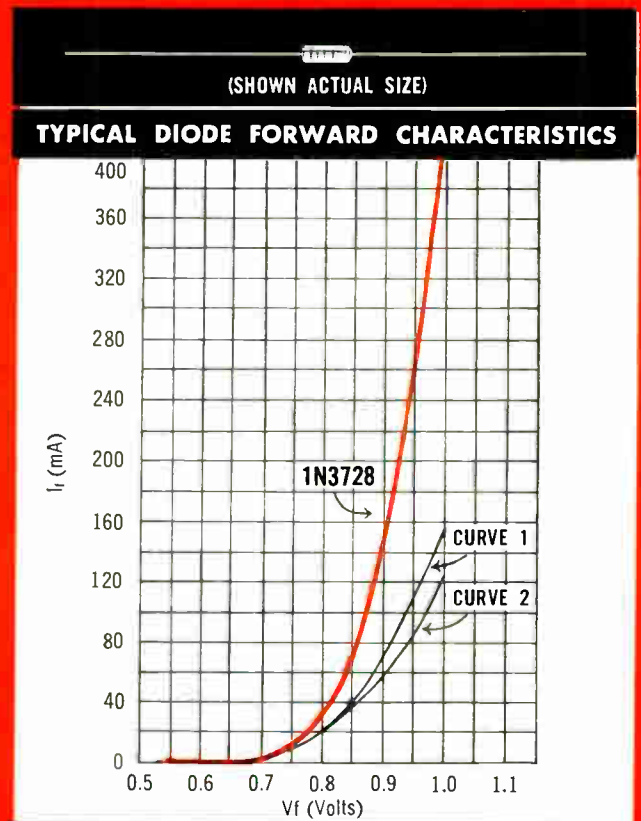

TYPES REPLACED BY 1N3728

Some of the currently-used types replaced by the 1N3728/RD250 are such general purpose, high voltage silicon diodes as:

Type	Curve	Type	Curve	Type	Curve	Type	Curve
1N456	2	1N461	2	1N482	1	1N485	1
1N456A	1	1N461A	1	1N482A	1	1N485A	1
1N457	2	1N462	2	1N482B	1	1N485B	1
1N457A	1	1N462A	1	1N483	1	1N486	1
1N458	2	1N463	2	1N483A	1	1N486A	1
1N458A	1	1N463A	1	1N483B	1	1N487	1
1N459	2	1N464	2	1N484	1	1N487A	1
1N459A	1	1N464A	1	1N484A	1	1N488	1
				1N484B	1	1N488A	1

SEMICONDUCTOR DIVISION

LOWELL, MASSACHUSETTS



CIRCLE 75 ON READER SERVICE CARD

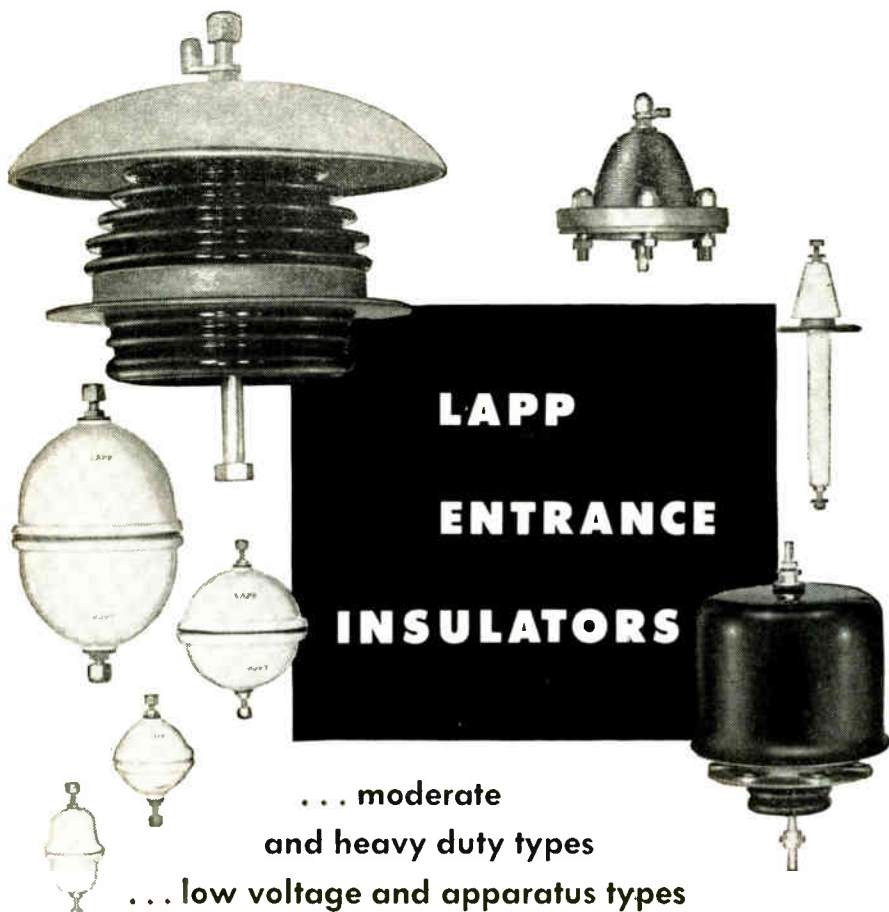

**LAPP
ENTRANCE
INSULATORS**

... moderate
and heavy duty types
... low voltage and apparatus types

A design which uses air as major insulation, with leakage path lengthened by forming porcelain into a bowl, eliminates losses which occur in ordinary types of bushings at radio frequency.

Lapp moderate duty insulators, suitable for a variety of low or medium voltage applications, are the standard type bowls for carrying leads through shields, equipment cases, walls, etc., and practically any indoor use where duty is not too severe.

Outdoor units are designed with corrugated surfaces which provide extra leakage distance for use in contaminated atmosphere. Corrosion-resistant hardware.

A wide variety of types of these insulators is now available as catalog items ... or where requirements necessitate, on special design—for which Lapp engineering and production facilities are excellently qualified. Write for complete descriptive data and specifications. Lapp Insulator Co., Inc., Radio Specialties Division, 192 Sumner Street, Le Roy, N. Y.



Lapp

too complex to be drawn by hand, such as the response of a loudspeaker in a live room. Input to the system to be tested is supplied by a 20-20,000 cps audio oscillator in the ARP-3.

CIRCLE 309 ON READER SERVICE CARD



**Band Pass Filters
HIGH FREQUENCY**

KENYON TRANSFORMER CO., INC., 1057 Summit Ave., Jersey City 7, N. J. Line of h-f filters feature constant time delay characteristics. Filters with center frequencies ranging from 2.0 to 35 Mc are available. Three db bandwidth is 3 percent of f_c ; pass band phase linearity is better than ± 3 percent; 60/6 db shape factor does not exceed 2.5; insertion loss is less than 10 db.

CIRCLE 310 ON READER SERVICE CARD

**Transformers
LOW POWER**

MAGNETIC CIRCUIT ELEMENTS INC., 3722 Park Place, Montrose, Calif. Seventy models of 60 cycle miniaturized transformers have been designed for transistor and other low power applications. Primaries are 115 v rms. Secondaries are from 1.56 to 100 v and are center tapped and bi-filar wound.

CIRCLE 311 ON READER SERVICE CARD

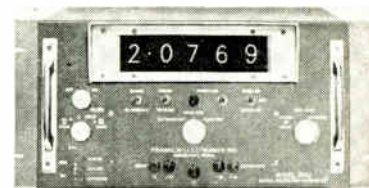

**Digital Voltmeter
AND RATIO METER**

FRANKLIN ELECTRONICS, Bridgeport, Pa., announces a 0.01 percent accuracy transistorized digital voltmeter/ratiometer. Model 1500 has a d-c range of ± 0.00001 to ± 1000.0 v

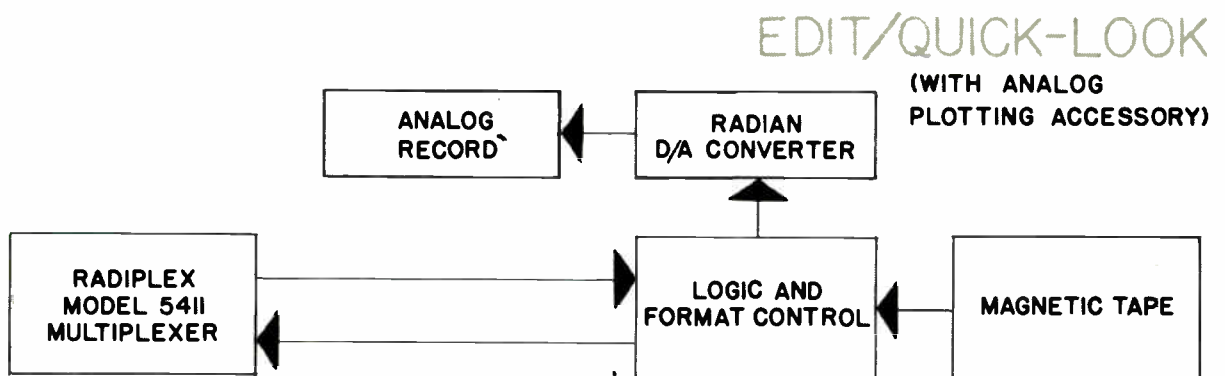
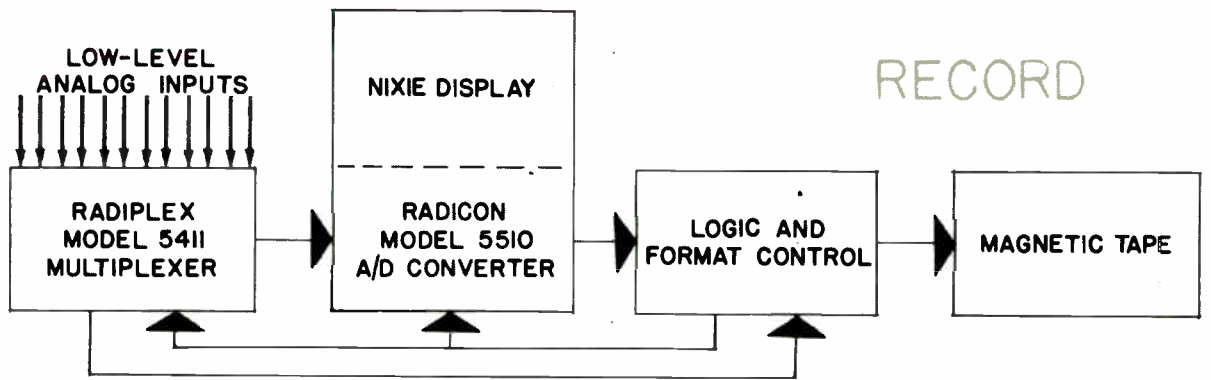

Simplified diagram shows RADATAC in "Record" and "Edit" modes. Sampling rate of 3750 per second provides nominal 80 scans per second for 47 input channels.

HOW TO CUT THE COST OF PREPARING DATA FOR COMPUTER ENTRY

*Radatac bridges the language gap
between transducers and computer*

Whether you own a computer or rent computer time for analysis checkout or process control, RADATAC can save you money. This compact, portable unit converts analog inputs to digital format, stores information, provides display for data editing prior to computer entry.

These features simplify the mechanics of transforming raw data into meaningful results. They let you edit out the less significant data, thus save computer time. They let you bring taped digitized data from plant or lab to the computer, whether the latter be at your home office or at a service center.

RADATAC, originally developed by Radiation, Incorporated for missile program applications, embodies system-proved components. Yet, RADATAC costs far less than an equivalent built-up system.

Investigate the savings you can make on digital data acquisition with RADATAC. Write Radiation, Incorporated, Products Div., Melbourne, Fla.

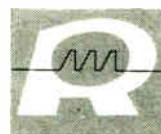

RADIATION
Melbourne

A Division of Radiation Incorporated

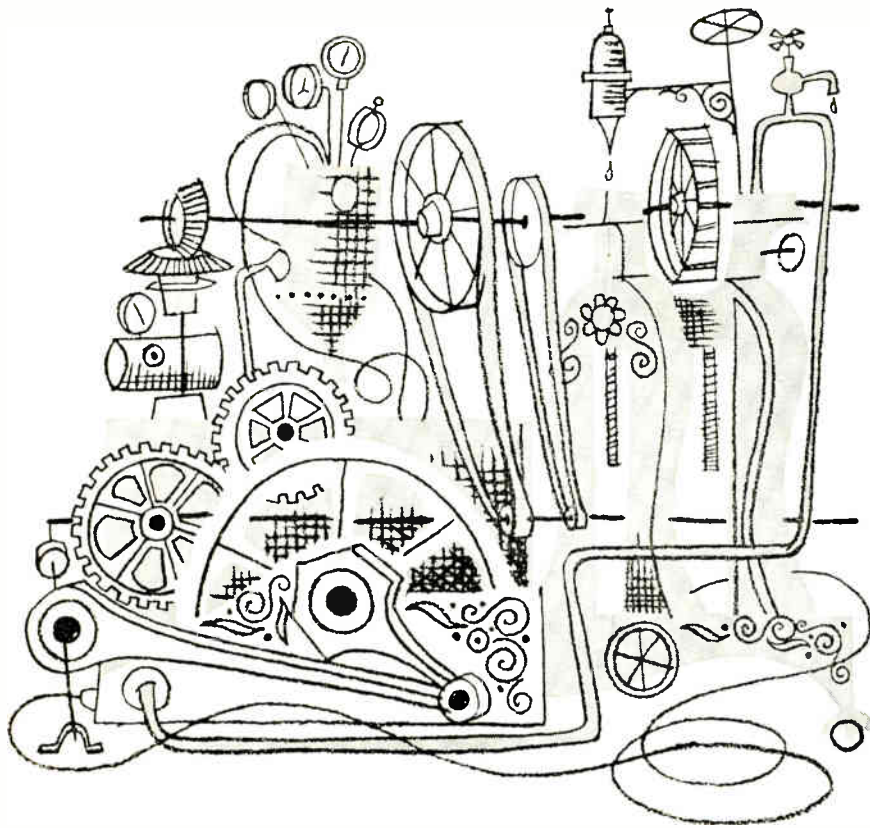

RESOLVED: MOVING PARTS ARE GOOD FOR VACUUM PUMPS

Rebuttal: Not very often. If you're looking for clean vacuums, you're in the market for a VacSorb® Pump

Mechanical roughing pumps are fun to watch. They're fun to keep oiled. But they're not fun to be around when those moving parts wear out. Even with the best high-vacuum pumps going (VacIon® pumps, of course), your vacuum system can clank to a halt if you depend on mechanical forepumps.

Don't despair. There's a happy solution. A VacSorb pump is the ideal companion for a VacIon pump. VacSorb pumps avoid common roughing pump headaches. They have no moving parts. They provide clean, oil-free vacuums. They're highly reliable. Sound good?

Here (as they sometimes say in TV commercials) are the facts: VacSorb forepumps can evacuate a leak-tight system to a pressure of 20 microns Hg or less. How? VacSorb pumping action is achieved by the sorption of gas molecules by a molecular sieve, chilled with liquid nitrogen. Operation? Start your VacSorb pump. Com-

plete your pumpdown. Get ready for the next pumping cycle by warming your VacSorb pump to room temperature and allowing accumulated gas to escape. Start pumping again. Voila!

VacSorb pumps solve all sorts of pumping problems. Contamination? You'll get precious little organic contamination from VacSorb pumps. Vibration? Remember, we said VacSorb pumps have no moving parts; no moving parts, no vibration.

Nitrogen supply for the VacSorb pump is carried in a lock-on, unbreakable foam plastic container.* Clever, eh?

Refrain: If you require clean vacuums, or if mechanical vibration is undesirable, there is a simple three-syllable answer. VacSorb pumps.

We have prepared some data sheets full of pithy, technical words. Write for a copy.

*It also makes an excellent ice-bucket.

VACUUM
PRODUCTS
DIVISION



VARIAN associates

PALO ALTO 1, CALIFORNIA

and a ratiometer range of ± 0.00001 to $\pm 0.50.00$. Range switching as well as polarity switching is completely automatic. Resolution is 1 part in 42,000, and sensitivity is $10 \mu v$.

CIRCLE 312 ON READER SERVICE CARD

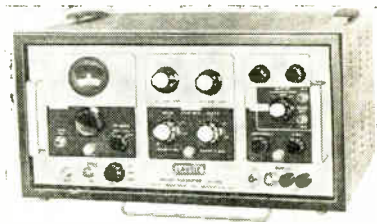

Pulse Generator MODULARIZED

LAVOIE LABORATORIES, Morganville, N. J. Model LA-595 employs three groups of plug-in modules which determine repetition rate, width and delay and output characteristics, respectively. Pulse widths start from 2 nsec; repetition rates range from 0.01 cps to 10 Mc. Modular construction precludes obsolescence and speeds servicing.

CIRCLE 313 ON READER SERVICE CARD

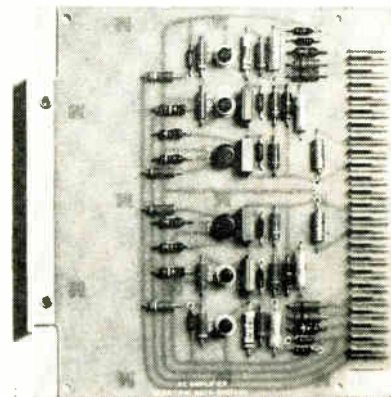

D-C Amplifier

SOLID STATE, SILICON

SCIENTIFIC DATA SYSTEMS, INC., 1542 Fifteenth St., Santa Monica, Calif. Wideband d-c amplifier has operating temperature range of zero C to +100 C. It is mounted on $5\frac{1}{2}$ by 6 in. etched circuit card that can be mounted on $\frac{3}{8}$ in. centers. The HX12 has gains of -1 and -10, gain accuracy of ± 0.02 percent, stability of ± 0.005 percent and linearity of ± 0.001 percent, all at d-c. Bandwidth is 400 Kc with output of ± 10 v at 20 ma. Power requirements are 40 ma at ± 25 v ± 10 percent. Price is \$320.

CIRCLE 314 ON READER SERVICE CARD

PRODUCT BRIEFS

TENSION COMPENSATOR for winding components. Compensating Tension Controls, Inc., Lee Road, Livingston, N. J. (315)

PROGRAMMABLE TIMER 50 millisecond accuracy. Servo Development Corp., 2 Willis Court, Hicksville, L. I., N. Y. (316)

OSCILLOGRAPH for recording transients. Western Electrodynamics, P.O. Box 98, Colorado Springs, Colo. (317)

PHASE ANGLE COUNTER ultra-low frequency. Ad-Yu Electronics Lab., Inc., 249 Terhune Ave., Passaic, N. J. (318)

POWER SUPPLIES high resolution, decade controlled. Kepco Inc., 131-38 Sanford Ave., Flushing 52, N. Y. (319)

1-MC CAPACITANCE TESTER 1/10 sec readout time. Micro Instrument Co., 3851 Sepulveda Blvd., Culver City, Calif. (320)

TANDEM SYNCHROS space-saving package. Daystrom, Inc., Transicoil Div., Worcester, Pa. (321)

PINBOARD resists shock, vibration. Edward J. Stych Engineering, 3032 W. 54th Place, Chicago, Ill. (322)

SILICON RECTIFIERS flangeless. Electronic Devices, Inc., 50 Webster Ave., New Rochelle, N. Y. (323)

HEAT SINKS efficient, inexpensive. Astro Dynamics, Inc., Second Ave., Northwest Industrial Park, Burlington, Mass. (324)

PULSE HEIGHT ANALYZER transistorized. Picker X-Ray Corp., White Plains, N. Y. (325)

PRECISION PRESSURE SWITCH miniaturized. Servonic Instruments, Inc., 1644 Whittier Ave., Costa Mesa, Calif. (326)

MICROWAVE SIGNAL GENERATORS four models cover 900 Mc to 11,000 Mc. Empire Devices, Inc., Amsterdam, N. Y. (327)

LOGIC PANELS programmable. Control Logic, Inc., 11 Mercer Rd., Natick, Mass. (328)

SPECTRUM ANALYZER covers 10 Mc to 43 Gc. Panoramic Electronics.
(continued on page 81)

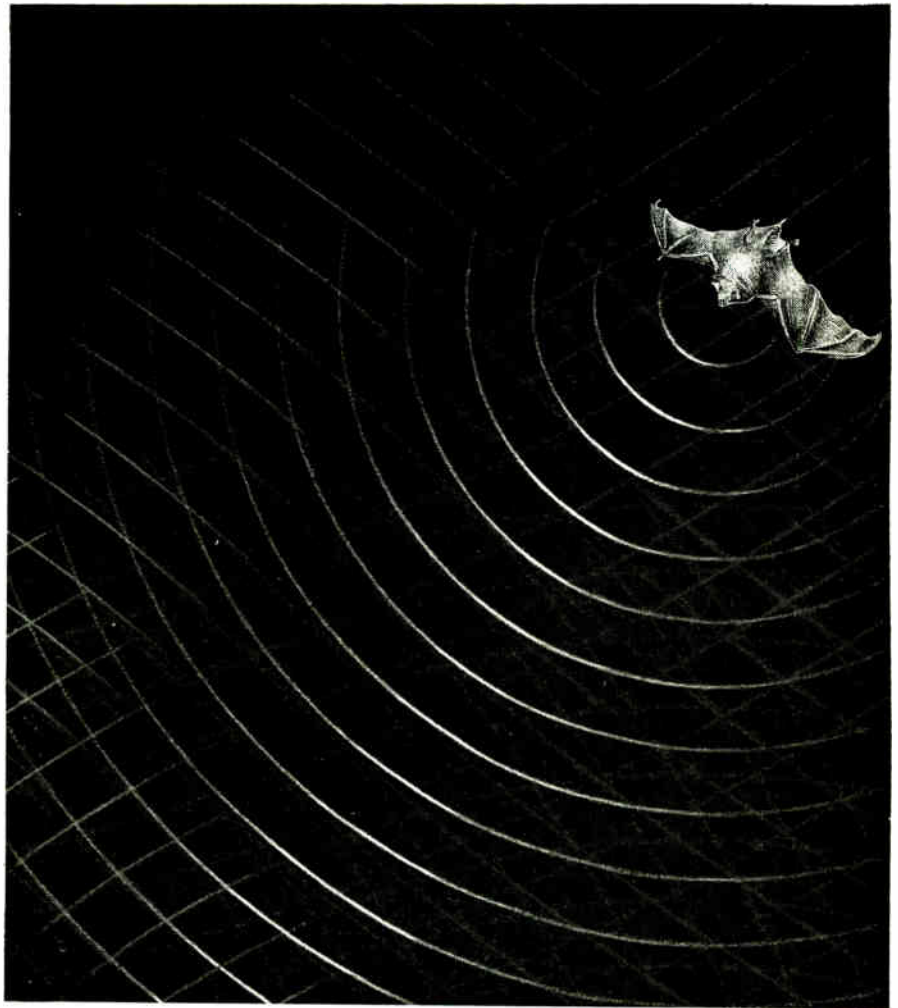

how to capture a bat - underwater - with a PI tape recorder



To satisfy a yen for sea food, a particularly interesting member of the bat family catches fresh fish by reaching beneath the surface. In studying these bats, Harvard Professor Donald R. Griffin captures the bat's "radar" with a microphone in the air and a hydrophone in the water. The pulses of sound are recorded on alternate channels of a PI tape recorder, and played back at reduced speeds so that the original frequencies, 15 to 200 kilocycles, become audible.

In other studies, Professor Griffin has captured bat sounds in stereo. Using a pair of microphones located at different points, he has recorded and measured the arrival time of sound pulses to determine the bat's changing position with respect to the two microphones.

For capturing bat sounds and other dynamic phenomena for conversion to electrical form, PI recorders offer a number of distinct advantages over conventional instrumentation magnetic tape recorders. A brief note from you will capture the details.



**PRECISION
INSTRUMENT**

SAN CARLOS, CALIFORNIA / LY 1-4447

P.I. Invites inquiries from senior engineers seeking a challenging future.

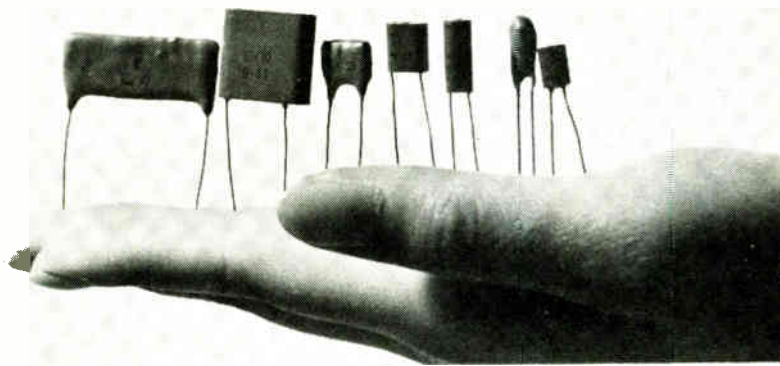

The F/T 'Aloxcon', A New Electrolytic Capacitor: The high quality of tantalum at the low cost of aluminum

Designed for use in printed and transistorized circuits, F/T's newly developed aluminum-oxide electrolytic capacitor 'Aloxcon' functions effectively at temperatures ranging from -60°C to $+80^{\circ}\text{C}$ and frequencies up to 100 kc or more. A semiconductor layer replaces the usual type of electrolytic and so the capacitance of an 'Aloxcon' is less affected by temperature and frequency than other types. 'Aloxcon' capacitors are highly resistant to moisture, and have low leakage current and extremely high life expectancy. They are ideal for transistor circuits requiring low impedance and miniaturization. Detailed specifications and application data available from our representatives.

	Working Voltage (V)	Surge Voltage (V)	Capacitance (mf)					
AR & GR Type (Standard Style)	6	8		1	2	5	10	20
	10	12		0.5	1	2	5	10
	25	30	0.1	0.2	0.5	1	2	
AZ & GZ Type (Compact, moisture resistant style)	6	8				0.1	0.2	0.5
	10	12				0.05	0.1	0.2
	25	30	0.01	0.02	0.05	0.1		

"Where the Future
is Today"



FUJI TSUSHINKI SEIZO KABUSHIKI KAISHA
(Fuji Communication Apparatus Mfg. Co., Ltd.)

Tokyo, Japan

Represented by: The Nissho American Corporation; New York 5, 80 Pine St., WH 3-7840; Chicago 3, 140 S. Dearborn St., CE 6-1950
 The Nissho Pacific Corporation; San Francisco 4, 120 Montgomery St., YU 2-7901; Los Angeles 14, 649 S. Olive St., MA 7-7691

CIRCLE 80 ON READER SERVICE CARD



Did you swipe this magazine?

Only 7½ cents a week is the easy way! (\$6 one year, \$9 for two years, \$12 three years.) Just fill in the handy "For subscriptions" section of the Reader Service Card in this issue . . . and you'll get instant subscription.

electronics: 330 West 42nd St., N. Y. 36.



New solid state, completely transistorized airborne VHF/FM telemetry transmitter

There's safety in numbers — especially those transposed from the exceptionally reliable TS-2 telemetry transmitter, designed and produced by Advanced Electronics. Proven performance has earned it a prime spot in telemetry systems for a major space vehicle . . . with many other important applications imminent to meet its advanced technology. This new solid state, completely transistorized unit delivers 1.5 watts minimum into a 50 ohm load . . . an exciting achievement for such a compact package.

There are other FM and AM telemetry transmitters and amplifiers in the line. Their fine record of space age attainments is indicative of Advanced Electronics' unique capabilities. We invite you to consult with our specialized engineering staff to help expedite your telemetry program.

Write or call for details and literature.

SEE OUR TELEMETRY CATALOG AD:

eem File System Sec.
electronic engineers master 5200

ADVANCED ELECTRONICS CORPORATION
2 Commercial St., Hicksville, L. I., N. Y. • OV 1-6400
TELEMETRY TRANSMITTERS & AMPLIFIERS •
POWER SUPPLIES • R.F. FILTERS

CIRCLE 210 ON READER SERVICE CARD

electronics

Inc., 520 S. Fulton Ave., Mount Vernon, N. Y. (329)

DIGITAL ENCODER 12-channel. Gulton Industries, Inc., 212 Durham Ave., Metuchen, N. J. (330)

MINIATURE TRIODE-PENTODES for tv receivers. Radio Corp. of America, Harrison, N. J. (331)

MONEL WAVEGUIDE SWITCHES 10 models cover 2.6 to 40 Gc. Radar Measurements Corp., 196 Duffy Ave., Hicksville, N. Y. (332)

MILITARY PLUG 3-connector. Switchcraft, Inc., 5555 N. Elston Ave., Chicago 30, Ill. (333)

ELECTRON-BEAM EVAPORATOR controlled-rate. Alloyd Electronics Corp., 35 Cambridge Parkway, Cambridge, Mass. (334)

PHOTOCELL PUNCHED TAPE READER transistorized circuits. Rheem Electronics, 5200 W. 104th St., Los Angeles 45, Calif. (335)

MICROWAVE DIPLEXERS WR430 through WR2300. I-T-E Circuit Breaker Co., 1900 Hamilton St., Philadelphia 30, Pa. (336)

POWER RELAY miniature, 50-amp. Magnecraft Electric Co., 5565 North Lynch, Chicago 30, Ill. (337)

KLYSTRON STABILIZER priced at \$479. Triconix, Inc., Bear Hill, Waltham, Mass. (338)

PICOAMPERE DIODE operable from -65 C to 175 C. Micro Semiconductor Corp., 11250 Playa Court, Culver City, Calif. (339)

D-C POWER SUPPLY versatile unit. NJE Corp., 20 Boright Ave., Kenilworth, N. J. (340)

TUNABLE BANDPASS FILTERS Ku-band. Frequency Engineering Laboratories, P.O. Box 504, Asbury Park, N. J. (341)

DIGITAL PATTERN GENERATOR with flexible fixed memory. Cybernetics, Inc., 132 Calvary St., Waltham, Mass. (342)

BROADBAND BOLOMETERS 10 Mc to 10,000 Mc. General Microwave Corp., 155 Marine St., Farmingdale, N. Y. (343)

COLOR BANDER hand-operated. Markem Machine Co., 205 Congress St., Keene, N. H. (344)

Wanted: Men with unmortgaged minds

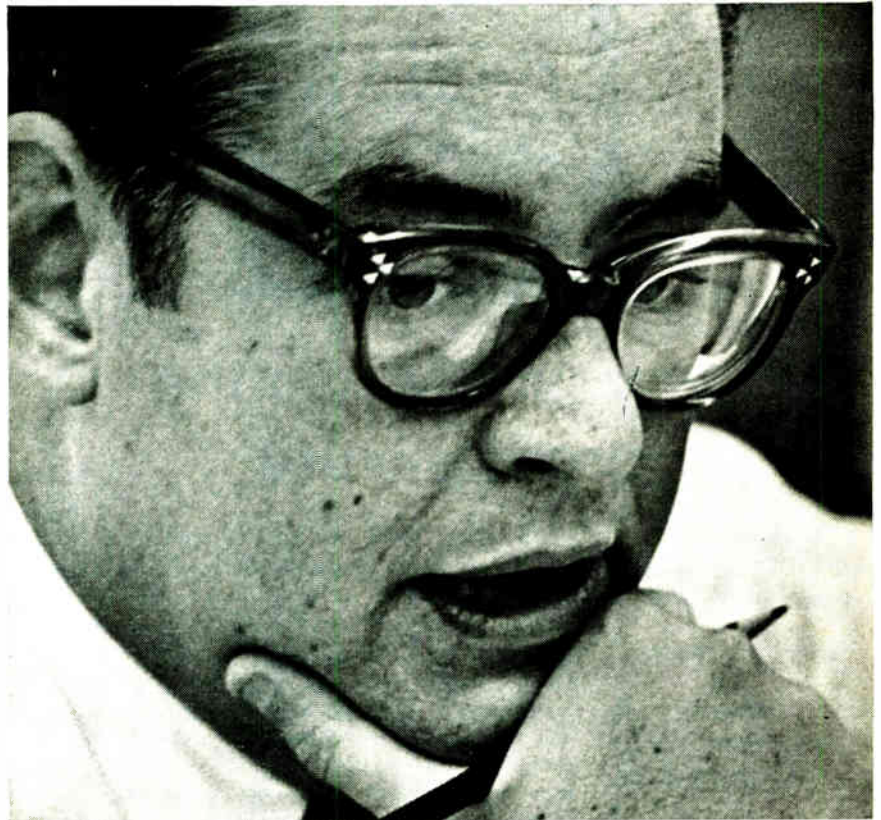

Northrop-Norair needs men who can see with fresh eyes; men who owe no allegiance to accepted ideas. Headstrong men, impatient for tomorrow.

If the shoe fits, come to Norair—where new lines of investigation open all the time, and no new idea is ever out of bounds. Positions are immediately available for:

Engineers in electronic checkout systems who have worked with advanced design and program development.

Engineers whose background is in supersonic aerodynamics, stability and control, inlet design, ducting, and performance analysis.

Engineers familiar with airframe structural analysis.

Scientists specializing in infrared, optics, and electronic research.

Engineers to work in data reduction.

Scientists who know structures research and dynamics.

Scientists who have done supersonic aerodynamic research.

Scientists experienced in working with information and sensing systems, platforms, infrared, sensors, flight controls, airborne computing and data handling systems.

Engineers familiar with programming, operations, and instrumentation for ballistic missile flight test.

Reliability Engineers to assess the reliability and to optimize the configurations and mission profiles of space systems.

Chemical Engineers to work on the development and applications of structural adhesives for aerospace vehicles.

Metallurgical Engineers for research and development on materials and joining.

If you'd like more information about these opportunities and others soon to be available at Norair, write and tell us about yourself.

Write Roy L. Pool, Engineering Center Personnel Office, 1001 E. Broadway, Hawthorne, California.

NORTHROP

AN EQUAL-OPPORTUNITY EMPLOYER

LOCATING IN PENNSYLVANIA...

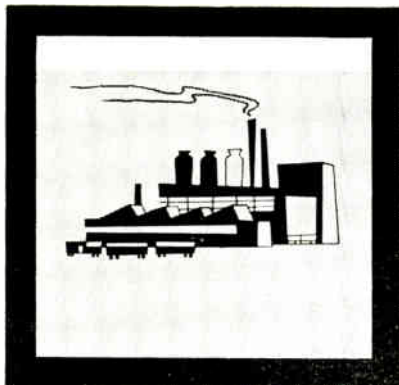

puts your plant in the profit picture

Companies large and small have discovered in Pennsylvania the practical combination of factors on which to build and expand a sound, profitable business . . .

**Markets
Labor
Transportation**

Pennsylvania is strategically situated to serve the major East-Central market and population centers. The ample work force available ranks high in educational levels, productivity and adaptability. An excellent transportation network moves goods and materials quickly and economically.

**Attractive
Tax
Climate**

There is no Property Tax on manufacturer's machinery, equipment or inventory . . . no tax on real property. Manufacturing capital and equipment are exempt from both Capital Stock and Franchise Tax, and from the Sales and Use Tax. There's no Stock Transfer Tax, nor Personal Income Tax.

**100%
Financing**

The "Pennsylvania Plan" offers 100% Financing on lease or lease purchase of plant facilities. At latest count, the Pennsylvania Industrial Development Authority has made 211 project loans, totaling \$26,024,602—to build or expand plants representing an investment of \$77,622,583.

Write for your free copy of "Pennsylvania Plant Location Services"



ADDRESS INQUIRIES TO:



PENNSYLVANIA DEPARTMENT OF COMMERCE
DIRECTOR OF INDUSTRIAL DEVELOPMENT
Room 479 • South Office Building • Harrisburg, Pennsylvania
Phone: CEdar 4-2912

MIDGET TAP SWITCH

has giant range

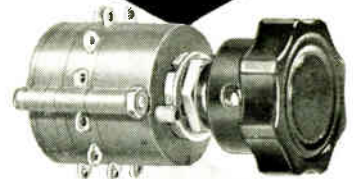

\$3.00 List

TYPE 3A

MOLDED FROM DIALYL PHTHALATE

Only 1" in diameter . . . weighs 30 grams . . . as many as 8 decks and up to 12 positions per deck. These are among the features of Tech Labs' new all-molded miniature Type 3A tap switch.

Designed for a wide range of military and commercial applications, this single-hole mounted switch has adjustable stops if fewer than 12 positions, single pole, or 6 positions, double pole, are required. "Shorting" and "non-shorting" types are available and the switch can be furnished solenoid-operated and hermetically sealed.

SPECIFICATIONS

Size: 1" diameter, 1 1/4" with terminals. First deck, 1-1/16" long. Each additional deck, 1/2" long.

Weight: First deck, 30 grams. 10 grams for each additional deck.

Rating: 1200 volts rms, 2000 VDC, 5 amps (carrying) 115V.

Insulating resistance: 100 megohms minimum at 500 volts DC.

Life: 1.5 — 2 million revolutions.

Contact resistance:

(standard) 6-10 milliohms.

(silver) 3-5 milliohms.

Temperature range: -65°C to 100°C.

Mounting: Single-hole.

Meets MIL-S-3786A

Tech Lab switches are on Qualified Products List.



Write for details and prices.

PALISADES PARK, NEW JERSEY

CIRCLE 211 ON READER SERVICE CARD
electronics

Literature of the Week

BACK DIODES Micro State Electronics Corp., 152 Floral Ave., Murray Hill, N. J. Single-sheet bulletin describes back diodes for computer applications. (345)

COMPUTER DIODES Microwave Associates, Inc., Burlington, Mass., has available the 1962 computer diode short form catalog. (346)

PISTON TRIMMERS JFD Electronics Corp., 6101 Sixteenth Ave., Brooklyn 4, N. Y. Catalog C-62 describes and illustrates a line of piston trimmer capacitors. (347)

POWER SUPPLIES Communication Measurements Laboratory, Inc., 350 Leland Ave., Plainfield, N. J., offers a 14-page catalog on a-c power sources and test equipment. (348)

RESOLVERS Kearfott Div., General Precision, Inc., 1150 McBride Ave., Little Falls, N. J. Condensed catalog presents detailed information on more than 40 resolvers. (349)

DIFFERENTIAL TRANSFORMERS Columbian Research Laboratories, Inc., MacDade Blvd., and Bullens Lane, Woodlyn, Pa. Short form sheet describes a line of lvdts for transducer applications. (350)

SEMICONDUCTORS North American Electronics, Inc., 71 Linden St., West Lynn, Mass., offers a 12-page semiconductor catalog covering its complete line. (351)

DIGITAL COMPUTERS Scientific Data Systems, Inc., 1542 Fifteenth St., Santa Monica, Calif. A 12-page bulletin introduces the 900 series digital computers. (352)

TELEMETERING SYSTEM Datex Corp., 1307 S. Myrtle Ave., Monrovia, Calif. Bulletin describes a solid-state supervisory and data telemetering system. (353)

PRESSURE GAGES Gulton Industries, Inc., 212 Durham Ave., Metuchen, N. J. Miniature piezoresistive pressure gages are described in a 4-page brochure. (354)

TUBE SOCKETS Methode Mfg. Corp., 1700 Hicks Road, Rolling Meadows, Ill. A 52-page tube socket catalog will be forwarded to all requests received on company letterhead.

Northrop Space Laboratories needs impatient men



At its inception, a new enterprise needs impatient men to mold it. Restless men whose minds won't fit the confines of older, more complacent organizations.

Northrop Space Laboratories is just such an enterprise... newly formed, free from preconceived ideas, with a broad range of programs planned in pure as well as applied science, and the enthusiastic support of the Northrop Corporation to carry them out. Men who join this group today will move upward with it, and give it direction through the years of growth ahead. Key openings are available for:

Solid state physicists, to conduct fundamental research on many-body problems as applied to an ultra high pressure program. The goals of this program are to study the electrical and physical behavior of materials under ultra high pressure, to investigate the origin, history and structure of the moon and planets, and to find ways to utilize their natural resources.

Scientists, to perform research in nuclear and radiochemistry, and to conceive and carry out investigations in the fields of activation analysis, dosimetry, gamma ray spectrometry, surface phenomena, and numerous other areas.

Structural engineers, to do stress analysis and optimize the design of advanced space structures.

A plasma physicist, to join our growing program in the measurement of plasma properties, spectroscopy, diagnostics, accelerators, and power conversion devices.

A mathematician-physicist, to concentrate on systems analysis and operations research applied to military and non-military space systems.

Physicists experienced in electro-optical imaging devices and laser theory; engineering mathematicians interested in detection theory, reconnaissance and tracking; electronic engineers who know their way around statistical communications theory and noise phenomena; for new and original work in satellite detection systems.

For more information about these and other opportunities, write to W. E. Propst, Space Personnel Office, 1111 East Broadway, Hawthorne, California. You will receive a prompt reply.

NORTHROP

AN EQUAL OPPORTUNITY EMPLOYER

Scientist-Businessman Looks to Record Year

ANOTHER major step in Giannini Scientific Corporation's development program was taken early this year, with the addition of Hammarlund Mfg. Co. Inc. and of Telemet Corp. which took over the operations of Telechrome Mfg. Co.

Telemet designs and produces video test equipment, telemetry components and systems, and Hammarlund has been a pioneer in the field of electronic communication for more than 50 years.

These new members expand the burgeoning two-year-old family of Giannini Scientific companies to a total of six. Others in the group are, Flight Research, Inc., Richmond, Va.; Micro Balancing Inc., Garden City Park, N. Y.; Plasmadyne Corp., Santa Ana, Calif.; and Wiley Electronic Products Co., Phoenix, Ariz. The corporation also operates Giannini Research Laboratory, Santa Ana, Calif., providing R&D services to all operating companies.

Plotting the course for this growing complex of industrial firms is Gabriel M. Giannini (shown at left, with Adriano Ducati, research scientist). He started Giannini Scientific Corp. in 1959, with Plasmadyne Corp., a research and development organization founded by him three years earlier.

Sales last year (with four companies in the fold) totaled over \$4½ million. With the addition of Hammarlund and Telemet, Giannini forecasts consolidated sales of \$12½ million for 1962.

Although this growth record has been achieved under Giannini's guidance and planning as president of the parent company, he limits his participation in individual company affairs, beyond financial and technical assistance, by maintaining a policy of decentralized authority. Each of the companies in the group is individually managed.

Giannini is a native of Rome, Italy, and was graduated as a doctor of physics from the University of Rome, where he studied physics

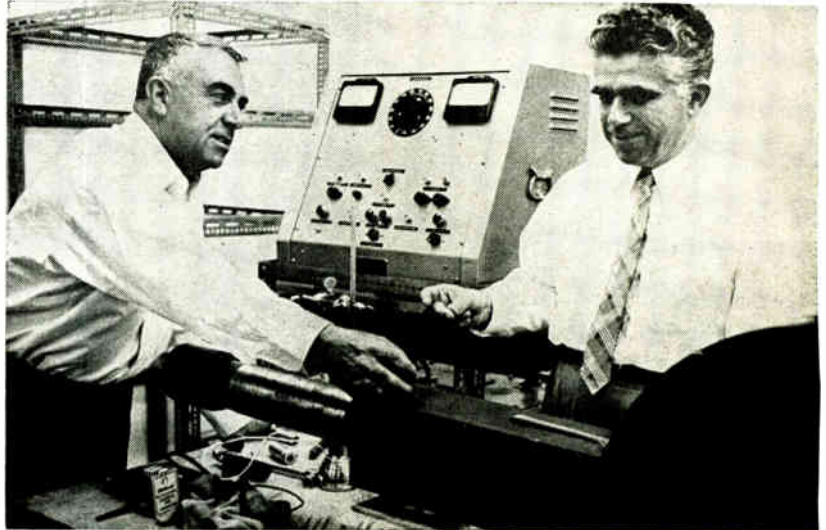

under O. M. Corbine, and Enrico Fermi. He came to the United States in 1931 and went to work as an engineer with RCA and later with Curtis Institute of Music. In 1941 he became associated with Lockheed Aircraft and also lectured at the University of California Los

Angeles. He started Giannini Controls Corp. in 1945 and served as the company's president for 12 years before stepping down to devote full time to business development activity. He has pioneered in electrical propulsion and communications and holds more than 30 patents.

Sprague Electric Names McGail

JACK MCGAIL has been named manager of Sprague Electric Company's Interference Control Field Service Laboratory and manufacturing facilities at Vandalia, O. He succeeds R. E. Swift, who resigned.

McGail had been assistant manager of the company's Dayton, O., ICFS laboratory, prior to its relocation at Vandalia.

Himmel Moves Up In ITT System

ELECTION of Leon Himmel as an assistant vice president of ITT Federal Laboratories, Nutley, N. J., is announced. He will act as deputy to Sven H. Dodington, vice president in charge of aircraft electronics, and assist in directing the engineering, manufacturing, and sales oper-

ations of this group of laboratories.

Himmel has been with the ITT System since 1942.



Howard Manko Joins Alpha Metals

APPOINTMENT of Howard H. Manko as director of solder research and development for Alpha Metals, Inc., Jersey City, N. J., has been announced.

Manko was formerly associated

PROGRESS REPORT on Metallized



and Metallized MICRO-MINIATURES

The ALSiBase family of ceramics, announced early in 1961, has proven so useful that volume production is now an accomplished reality. Flatter, thinner ceramic items are produced with uniformly superior surfaces and with holes, slots, and serrations held to exceptionally tight typical tolerances. These physical characteristics coupled with the excellent dielectric properties of ALSiBase (materials) immediately resulted in such uses as substrates for printed circuits and deposited films.

To help realize the full potential of ALSiBase, rapid advances in metallizing methods have been made. New facilities and techniques now make possible the highly precise patterns required in miniature and micro-miniature ceramic items.

Special equipment, designed and built to meet the exacting requirements of precise metallizing has also proved itself to be adaptable to high quantity production of small metallized ceramics of conventional nature. This has resulted in improved delivery time at current production rates and additional equipment is being installed to meet future demands.

American Lava Corporation offers more than ten years of metallizing experience covering the several metal to ceramic bonding processes in addition to more than 60 years of experience as a custom producer of the widest range of technical ceramics from a single source. American Lava is the place you are most apt to find the answer to any ceramic or metallized-ceramic problem you may encounter.

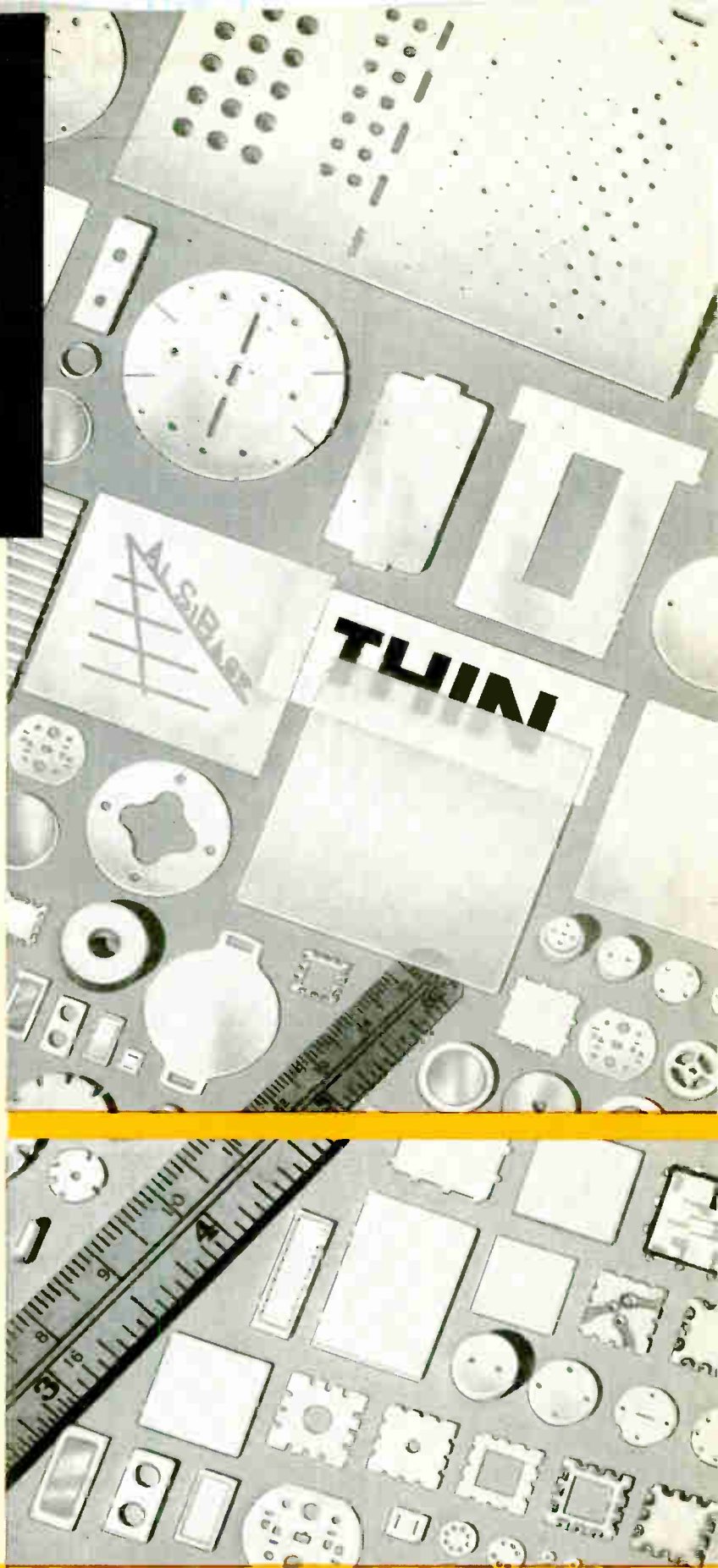

A Subsidiary of
Minnesota Mining and
Manufacturing Company



AMERICAN LAVA CORPORATION

CHATTANOOGA 5, TENN.
61ST YEAR OF CERAMIC LEADERSHIP

For service, contact American Lava representatives in Offices of Minnesota Mining & Manufacturing Co. in these cities (see your local telephone directory): Boston: Needham Heights, Mass. • Chicago: Bedford Park, Ill. • Cleveland, Ohio • Dallas, Texas • Los Angeles, Cal. New York: Ridgefield, N. J. • Philadelphia, Pa. • St. Louis, Mo. • St. Paul, Minn. • So. San Francisco, Cal. • Seattle, Wash.

All other export: Minnesota Mining & Manufacturing Co., International Division, 99 Park Ave., New York, N. Y.

125°C



(ACTUAL SIZE)

-55°C

MEASURED STABILITY

The Paktron Mylar* MR 330 Capacitor has a change less than 2.5%, 25°C — 85°C. Temperature range from —55°C to 125°C derating above 85°C to 50% at 125°C. Other features are low dissipation factor, excellent dielectric strength, good insulation and moisture resistance and low cost. For additional information write.

 **PAKTRON**
PACKAGED ELECTRONICS
DIVISION OF ILLINOIS TOOL WORKS, INC.
1321 LEBLIE AVENUE • ALEXANDRIA, VIRGINIA

AREA CODE 703 King 8-4400

* DUPONT

with the Product Development Laboratory of IBM in Poughkeepsie, N. Y.



Vitro Electronics Appoints Shen

KUCHEN SHEN has been appointed chief engineer of the advanced development section for Vitro Electronics, Silver Spring, Md. He had been chief engineer for Communications Electronics, Inc., of Bethesda, Md.

Hughes Aircraft Hires Carmichael

JAMES CARMICHAEL has joined Hughes Aircraft Company's vacuum tube products division, Ocean-side, Calif., as manager of the division's vacuum equipment product line.

Carmichael was formerly manager of R&D and chief engineer with Vacuum Electronics Corp., Plainview, N. Y.



Nytronics Names David Lupper

DAVID A. LUPPER recently joined the technical staff of Nytronics, Inc., Berkeley Heights, N. J. He was formerly manager of the Materials

Use the
POLAROID®
10,000 SPEED
Land Film

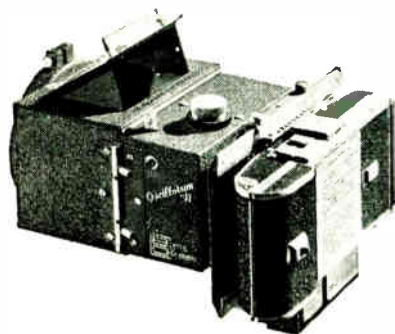

in the new
BEATTIE-COLEMAN
MARK II
OSCILLOTRON

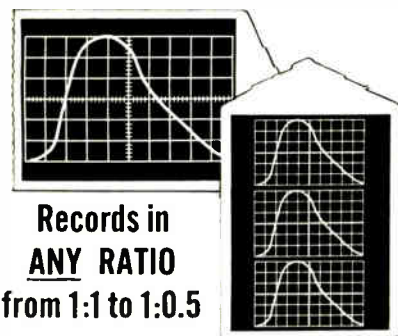

Records in
ANY RATIO
from 1:1 to 1:0.5

Here's the most versatile oscilloscope camera ever made. Especially designed for new 10,000 speed Polaroid Land Type 410 film that records pulses of extremely short duration. Prints in 10 secs. Easily change ratios from 1:1 to 1:0.5 without extra lenses. External focusing. Flat field lens. Electric shutter eliminates cable release. Direct viewing port or hood. Records up to 13 traces on one frame. Dark slide on Polaroid Land Camera back. Records written data on film. Fits any 5" scope. Attractively priced. Send for catalogs on all B-C Oscillotron models now.

"Polaroid"® by Polaroid Corporation



1004 N. OLIVE ST., ANAHEIM, CALIFORNIA
CIRCLE 212 ON READER SERVICE CARD
 May 25, 1962

NOW'S THE TIME TO GET THE FACTS!

DAYTONA BEACH INDUSTRIAL AREAS

**Only 30.6 miles to Project Nova Expansion
 at Cape Canaveral! Strategically situated**

**IN FLORIDA'S
 SPACE AGE
 "GOLDEN
 TRIANGLE"**

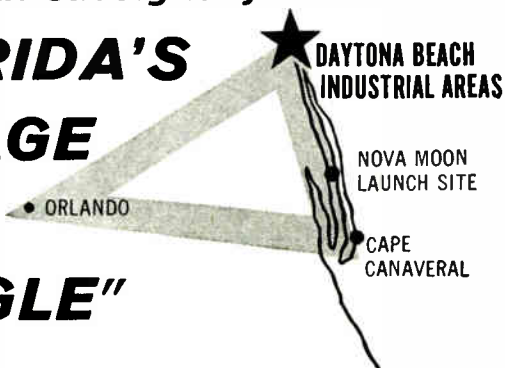

A red-carpet welcome awaits you in the Daytona Beach Industrial Areas! Look at the advantages of locating in this friendly METROPOLITAN AREA:

Ample Manpower—Skilled labor in abundance; favorable wage rates and living conditions.

No Labor Problems—Long record of harmonious management-labor relations. High productivity.

Mild Year-Round Climate—The best of Florida's climate keeps absenteeism at an absolute minimum.

Growing Room—Ample prime industrial sites at low cost; plenty of room for expansion. No crowding. Sensible zoning.

Warm Business Climate—Genuine community interest in industrial development. Full cooperation of local business and government.

Favorable Taxes—No local or state personal or corporate income taxes. No state ad valorem taxes on real or tangible property.

Top Markets—Florida's expanding \$10 billion-plus market... the surging Southeast... nearby Latin America.

Excellent Transportation—Modern highways, airlines, railroads, truck lines, busses, Intracoastal Waterway.

Apple Power, Water, Fuel—Limitless water resources. Electric power capacity to keep ahead of all future requirements. Plenty of natural gas, fuel oil.

THE DAYTONA BEACH AREA COMMITTEE OF 100 pledges its complete cooperation in helping you find a profitable site for plant relocation or branch operation. If financing is a problem, **lease-purchase financing is available.** Direct your inquiry to J. Saxton Lloyd, Chairman, who will hold all such inquiries in his personal file **IN THE VERY STRICTEST CONFIDENCE.**

DAYTONA BEACH INDUSTRIAL AREAS

Ormond Beach • Holly Hill • Daytona Beach • Daytona Beach Shores
 South Daytona • Port Orange



Mr. J. Saxton Lloyd, Chairman
 Committee of 100, Daytona Beach Industrial Areas
 Dept. E-1 Daytona Beach, Florida
 Please send detailed information on the Daytona Beach Industrial Areas.

NAME.....
 TITLE.....
 COMPANY NAME.....
 ADDRESS.....
 CITY..... ZONE..... STATE.....

CIRCLE 87 ON READER SERVICE CARD

THE MOST-USED ELECTROLYTIC RECORDING PAPERS

ARCHIVAL QUALITY ? ? Sharp Definition ?
 Reproducibility ? Dense Black Marking ?
 HIGH SPEED MARKING ? Extensive Gray Scale ?
 High Contrast ?

**No "QUESTION" about it... when you specify
 HOGAN FAXPAPER®**

Whatever the application, HOGAN FAXPAPERS have the characteristics you are looking for in electrolytic recording: high contrast, sharp definition, high-speed marking, dense black marking, extensive gray scale, archival quality, reproducibility by office duplicators. HOGAN FAXPAPER is used for event and data recording, operations monitoring, press service news pictures and weather-map recording, spectrum analysis, ceilomentering, data retrieval readout, plotting and printer plotting, facsimile recording. HOGAN FAXIMILE also makes equipment for such uses.

Write for Facts on Faxpaper to... Dept. E-6

© Faxpaper is a registered trademark of Hogan Faximile Corp.

HOGAN FAXimile Corporation • 635 Greenwich St., New York 14, N. Y.
 A SUBSIDIARY OF TELAUTOGRAPH CORPORATION

CIRCLE 213 ON READER SERVICE CARD

and Ceramics division of Gulton Industries, Inc., Metuchen, N. J.

Beckman Instruments Hires Martin

APPOINTMENT of William L. Martin as manager of engineering for the Berkeley Division of Beckman Instruments, Inc., Richmond, Calif., is announced.

Prior to joining the Beckman organization, Martin was vice president-engineering for Smith-Corona Marchant, Inc., of Oakland, Calif.

PEOPLE IN BRIEF

Thorleif Knutrud, ex-RCA, named engineering specialist at Sylvania's Applied Research Lab. G. C. Dewey Corp. promotes Walter Landauer to v-p and g-m of its subsidiary, Pitometer Log Corp. Norman L. Winter moves up to mgr. of Motorola's Chicago Military Center. Hugh C. Bream, formerly with U. S. Industries, named marketing mgr. of the Astronics Div. of Lear, Inc. Alexander Satin from Hughes Aircraft to General Precision, Inc., as director of long-range planning. Edward R. Arelt advances at Airborne Instruments Laboratory to director of materiel. Charles V. Andersen leaves Ampex Corp. to become v-p in charge of mfg. for KRS Electronics. Emanuel R. Piore, IBM v-p, is named a member of the corporate management committee. John N. Phillips, previously with GE, elected g-m of United Aircraft's Norden div. David J. Whitney, most recently with Andersen Laboratories, named chief ultrasonic delay line engineer at Richard D. Brew & Co., Inc. Audio Devices, Inc., hires Arthur J. Bruno, formerly with Johns-Manville, as mgr. of research and engineering. Robert J. Bibbero, ex-Bulova Watch Co., appointed mgr. of development engineering at Burroughs Control Corp. LFE ups Richard C. Sorensen to president of Tracerlab and of the Keleket X-Ray Corp. Eugene G. Slotta, from Raytheon to Gorham Electronics as manufacturing mgr. Stuart Hyans, eastern sales mgr. of the Electronics div. of Ortronix Inc., also named eastern sales mgr. of the Metro div.

RESOLVER NEWS!

VERNITRON .05% ACCURACY PRECISION RESOLVERS DELIVERED ON REGULAR PRODUCTION BASIS

ALL SIZES—B through 23
 ALL STANDARD TYPES—Computing, Data Transmission, Phase Shifters and Sweep
 ALL ENGINEERED & MANUFACTURED TO:
 MIL-R-14346

ALL AVAILABLE WITH

- Thru-Bore Design
- High Reliability Exclusive Brush Block
- Stainless Steel housings, shaft, bearings
- High voltage capabilities between stator and compensator windings (on feedback units)

A major break-through, made possible by VERNITRON specialization in precision synchro and resolver design and manufacture.

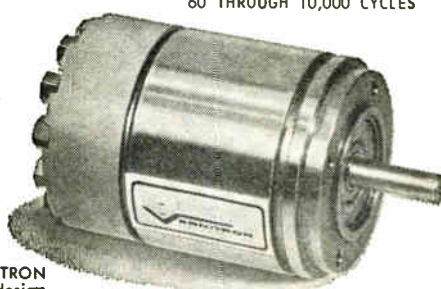

WRITE, WIRE,
 PHONE NOW for
 complete price,
 delivery and speci-
 fication data; ask for
 NEW Vernitron
 Condensed Catalog.

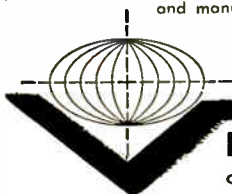

VERNITRON

CORPORATION

THE QUALITY NAME IN PRECISION SERVO COMPONENTS

606 Old Country Rd., Garden City, N. Y.—Pioneer 1-4130 • TWX: G-CY-NY-1147
 WEST COAST PLANT: 1742 So. Crenshaw Blvd., Torrance, Cal.—FAirfax 8-2504 • TWX: TNC-4301

COLLINS CALL

FOR SCIENTISTS & ENGINEERS

EQUIPMENT DEVELOPMENT

- BSEE — Elec. Eng. — 3 yrs. exp. HF or VHF (CR)
- BSEE — Elec. Eng. — 3 yrs. exp. Automatic Test and Checkout (CR)
- BSEE — Elec. Eng. — 6 yrs. exp. Power Servo Design (CR)
- BSEE — Elec. Eng. — 3-5 yrs. exp. UHF (CR)
- BSEE — Elec. Eng. — 3 yrs. exp. Command Control Systems (CR)
- HSEE — Elec. Eng. — 3 yrs. exp. Radar Beacon Work (CR)
- BSEE — Elec. Eng. — 3 yrs. exp. Television Transmission (CR)
- HSEE — GSE Supervisor — 5 yrs. exp. Equipment Development (CR)
- BSEE — GSE Eng. — 3 yrs. exp. Ground Support (CR)

SYSTEMS

- MSEE — System Analyst — 5 yrs. exp. Modulation Technique (CR)
- MSEE or equiv. — System Analyst — 5 yrs. exp. Tracking and Ranging (CR)
- MSEE — System Analyst — 5 yrs. exp. Communications (CR)
- BSEE minimum — GSE Integration Supervisor — 5 yrs. exp. Ground Support (CR)
- MS or equiv. in Physics or Mechanics — System Analyst — 3 yrs. exp. Classical or Celestial (CR)
- BS — Field Supervisor — 5-10 yrs. exp. Airborne Electronics and Communications (CR)
- BS or equiv. in EE — Field Eng. — 3-5 yrs. exp. Com. (CR)
- BSEE minimum — GSE Layout Eng. — 5 yrs. exp. Layout (CR)
- BSME or equiv. — Mech. Eng. Supervisor — 8-10 yrs. exp. Management and Administration (CR)
- BSME or equiv. — Mech. Eng. — 3-5 yrs. exp. Packaging Designs (CR)
- MSME — Mech. Eng. — 3-5 yrs. exp. Thermal Design and Evaluation (CR)
- BSME or equiv. — Mech. Eng. — 3-5 yrs. exp. Environmental Test and Procedures (CR)
- BSIE — Elec. Eng. — 4 yrs. exp. Circuit Design and Com. (D)
- BSEE — Elec. Eng. — 3-5 yrs. exp. Microwave Systems (D)
- BSIE — Elec. Eng. — 3 yrs. exp. Tropospheric Scatter (D)
- BSEE — Elec. Eng. — 2-7 yrs. exp. UHF, Scatter, Microwave Systems Design (D)

GENERAL

- BSEE or higher — Resident Eng. — 3-5 yrs. exp. Communications (CR)
- BSEE or higher — Senior Staff Asst. — 8-10 yrs. exp. TV Theory (CR)
- BSEE — Test. Eng. — 3-5 yrs. exp. Communication Design, Testing (CR)
- BSEE — desirable — Logistics Eng. — 2-3 yrs. exp. Space Program Logistics (CR)
- BSEE desirable — Logistics Supervisor — 3-5 yrs. exp. Space Program Logistics (CR)
- BSEE or higher — Radar Eng. — 1-5 yrs. exp. Antenna Systems (D)
- BSEE — Elec. Eng. — 1-5 yrs. exp. Design Review and Prediction (D)
- BSEE — Project Test Eng. — 1-5 yrs. exp. Quality Assurance (D)
- BSEE — Telephone Eng. — 4-7 yrs. exp. Central Office (D)
- ME or IE — Staff Eng. — 2 yrs. exp. in MTM (D)

DATA

- BSEE or higher — Senior Staff Asst. — 8-10 yrs. exp. Digital (CR)
- MS or PhD — Applied Math — 10 yrs. exp. Business Computing (CR)
- BSEE — Elec. Eng. — 5-8 yrs. exp. Digital Data Design (D)
- Applied Math — Computer Programmer — 10 yrs. exp. with Large Computers (D)
- Applied Math — Business Programmer — ext. exp. Business Data Processing (D)
- Applied Math — Scientific Programmer — ext. exp. Scientific Data Programs (D)
- Math PhD — Logic Program Designer — ext. exp. Planning, Preparing Programs (D)

PLEASE NOTE

On listings marked (CR), send resume to L. R. NUSS,
COLLINS RADIO COMPANY, CEDAR RAPIDS, IOWA

On listings marked (D), send resume to P. NELSON,
COLLINS RADIO COMPANY, DALLAS, TEXAS



electronics

WEEKLY QUALIFICATION FORM FOR POSITIONS AVAILABLE

ATTENTION: ENGINEERS, SCIENTISTS, PHYSICISTS

This Qualification Form is designed to help you advance in the electronics industry. It is unique and compact. Designed with the assistance of professional personnel management, it isolates specific experience in electronics and deals only in essential background information.

The advertisers listed here are seeking professional experience. Fill in the Qualification Form below.

STRICTLY CONFIDENTIAL

Your Qualification form will be handled as "Strictly Confidential" by ELECTRONICS. Our processing system is such that your form will be forwarded within 24 hours to the proper executives in the companies you select. You will be contacted at your home by the interested companies.

WHAT TO DO

1. Review the positions in the advertisements.
2. Select those for which you qualify.
3. Notice the key numbers.
4. Circle the corresponding key number below the Qualification Form.
5. Fill out the form completely. Please print clearly.
6. Mail to: D. Hawksby, Classified Advertising Div., ELECTRONICS, Box 12, New York 36, N. Y. (No charge, of course).

COMPANY	SEE PAGE	KEY #
BRISTOL COMPANY Waterbury, Connecticut	94	1
GENERAL DYNAMICS/ASTRONAUTICS San Diego, California	69, 72*	2
HAMILTON WATCH COMPANY Metals & Electronics Div. Lancaster, Pennsylvania	93	3
INTERNATIONAL BUSINESS MACHINES CORP. Space Guidance Center Owego, New York	91	4
LAWRENCE RADIATION LABORATORY Livermore, California	93	5
LOCKHEED MISSILES & SPACE CO. Div. of Lockheed Aircraft Corp. Sunnyvale, California	88, 89*	6
McGRAW-HILL BOOK CO. Dayton, Ohio	137*	7
MICROWAVE SERVICES INTERNATIONAL, INC. Denville, New Jersey	136*	8
NATIONAL AERONAUTICS AND SPACE ADMINISTRATION Washington, D. C.	91	9
NORTHROP CORP. Norair Division Hawthorne, California	81	10
NORTHROP CORP. Space Laboratories Hawthorne, California	83	11
PHILCO TECHREP DIVISION Sub. of Ford Motor Co. Philadelphia, Pennsylvania	94	12
RAYTHEON CO. Missile & Space Div. Bedford, Massachusetts	92	13
REPUBLIC AVIATION CORPORATION Farmingdale, L.I., New York	92	14

CONTINUED ON PAGE 92

(cut here)

(cut here)

electronics WEEKLY QUALIFICATION FORM FOR POSITIONS AVAILABLE

Personal Background

NAME
 HOME ADDRESS
 CITY ZONE STATE
 HOME TELEPHONE

Education

PROFESSIONAL DEGREE(S)
 MAJOR(S)
 UNIVERSITY
 DATE(S)

FIELDS OF EXPERIENCE (Please Check)

52562

- | | | |
|--|--|---------------------------------------|
| <input type="checkbox"/> Aerospace | <input type="checkbox"/> Fire Control | <input type="checkbox"/> Radar |
| <input type="checkbox"/> Antennas | <input type="checkbox"/> Human Factors | <input type="checkbox"/> Radio—TV |
| <input type="checkbox"/> ASW | <input type="checkbox"/> Infrared | <input type="checkbox"/> Simulators |
| <input type="checkbox"/> Circuits | <input type="checkbox"/> Instrumentation | <input type="checkbox"/> Solid State |
| <input type="checkbox"/> Communications | <input type="checkbox"/> Medicine | <input type="checkbox"/> Telemetry |
| <input type="checkbox"/> Components | <input type="checkbox"/> Microwave | <input type="checkbox"/> Transformers |
| <input type="checkbox"/> Computers | <input type="checkbox"/> Navigation | <input type="checkbox"/> Other |
| <input type="checkbox"/> ECM | <input type="checkbox"/> Operations Research | <input type="checkbox"/> |
| <input type="checkbox"/> Electron Tubes | <input type="checkbox"/> Optics | <input type="checkbox"/> |
| <input type="checkbox"/> Engineering Writing | <input type="checkbox"/> Packaging | <input type="checkbox"/> |

CATEGORY OF SPECIALIZATION

Please indicate number of months
experience on proper lines.

	Technical Experience (Months)	Supervisory Experience (Months)
RESEARCH (pure, fundamental, basic)
RESEARCH (Applied)
SYSTEMS (New Concepts)
DEVELOPMENT (Model)
DESIGN (Product)
MANUFACTURING (Product)
FIELD (Service)
SALES (Proposals & Products)

CIRCLE KEY NUMBERS OF ABOVE COMPANIES' POSITIONS THAT INTEREST YOU

1 2 3 4 5 6 7 8 9 10 11 12 13 14 15 16 17 18 19 20 21 22 23 24 25



NASA HEADQUARTERS

Career Appointments
.....

ASSISTANT DIRECTORS

Office of Manned Space Flight

The Office of Manned Space Flight seeks to appoint three highly qualified professional men to Assistant Directorships of its Integration and Checkout Division. The duties inherent in these positions will have a direct and material bearing on the nation's manned space flight program and require management as well as technical or scientific capability of a high order. Selected applicants will be in a position to build their own technical and supporting staffs.

Assistant Director, Checkout

You will direct the development of manned space vehicle system checkout equipment that will meet overall project requirements. Thus, you will review subsystem checkout design concepts and specifications, insure compatibility of the checkout equipment (being developed by contractors) with system objectives, as well as direct the design and development of an integrated system checkout equipment for Apollo.

The position requires at least a BS in EE and ten years' experience in electronic systems implementation.

Assistant Director, Reliability Assessment

You will assess reliability achieved in the space vehicle system development program, compare the reliability with overall project requirements, and direct a major contractor effort in this area.

Respondents should have at least a BS in EE or Aeronautical Engineering and ten years' broad experience in electronic or aeronautical missile system reliability program implementation.

Assistant Director, Integration

You will be responsible for the implementation of a program to insure the integration of the Apollo space vehicle equipment development program.

Duties require at least a BS in EE or Aeronautical Engineering and ten years' experience in electronic or aeronautical missile systems implementation and direction.

Direct your inquiry in confidence to:
Director of Manned Space Flight, Dept. 200
NASA
Washington 25, D.C.

**NATIONAL AERONAUTICS
& SPACE ADMINISTRATION**

ALL QUALIFIED APPLICANTS WILL RECEIVE CONSIDERATION REGARDLESS OF RACE, COLOR, CREED, OR NATIONAL ORIGIN.

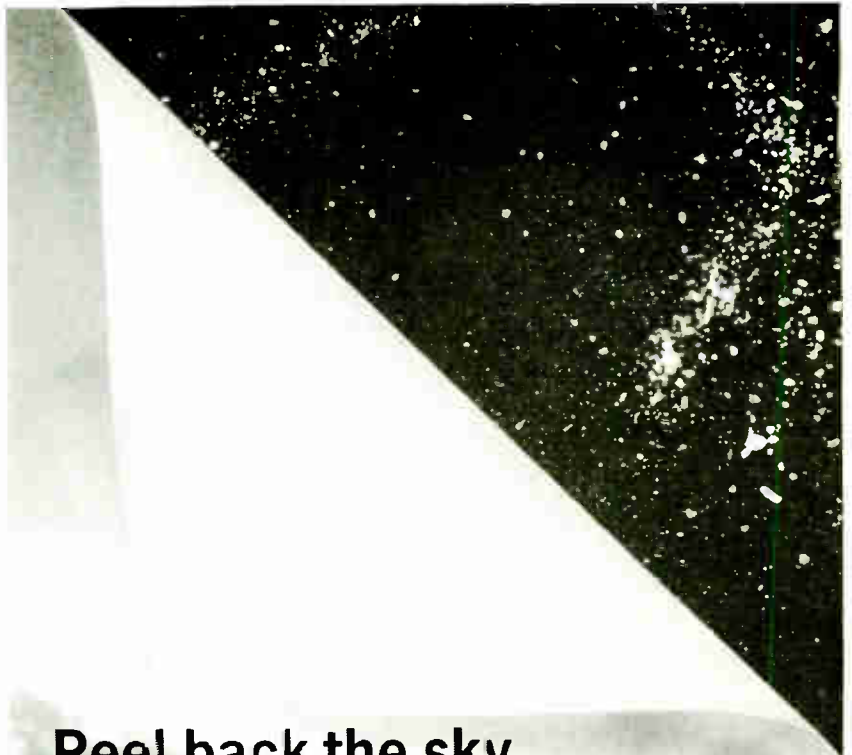

Peel back the sky

IBM Space Guidance Center

IBM engineers and scientists are helping to map the heavens by developing a digital data processor and memory for the NASA Orbiting Astronomical Observatory (OAO).

The memory, largest of its type for space application, will collect observations free of the earth's atmospheric distortion. As the vehicle orbits at 18,000 miles/hr., the data processor will tell the OAO's sensitive telescope where and when to look, check for occulted and malfunctioning star trackers, start and stop each experiment. Over 200,000 bits of information, stored in the satellite's random-access memory, can be telemetered to the ground in 7.5 seconds. In designing the memory and processor, a redundancy technique provided a system far more reliable than conventional designs.

Other projects include: guidance and control systems for manned aircraft, satellites, spacecraft, submarines, and other vehicles. Engineers and scientists are invited to inquire about openings in . . . reliability statistics; logic design; circuit design; programming; quality engineering; control systems engineering; solid-state physics (radiation effects studies); mechanical engineering (heat transfer/stress analysis). IBM is an Equal Opportunity Employer. Please write, outlining your background and interests: Fred Guth, Dept. 554R3, IBM Space Guidance Center, Owego, New York.

IBM

MICROELECTRONICS ENGINEERS

The Bedford R & D Lab of Raytheon's Missile & Space Division (Suburban Boston) offers immediate positions for research and development in the following areas:

1. Thin film
2. Electronic beam design
Vapor deposition, welding and cutting
3. Microelectronic circuit analysis and design
4. Integrated circuit development
5. Semiconductor physics

A small vital group is already at work in these areas, and requires additional high calibre personnel. Openings exist for all degree levels.

Interested candidates should write or call Mr. F. DeChristopher, CRestview 4-7100, ext. 2138, Personnel Department, Raytheon Company, Missile & Space Division, Hartwell Road, Bedford, Massachusetts. An Equal Opportunity Employer

RAYTHEON

MISSILE & SPACE DIVISION

BEDFORD, MASSACHUSETTS

Electronics Engineers

HELP STRUCTURE A

**NEW
DIRECTION**

**IN AEROSPACE
TECHNOLOGY**

Join staff conducting 9 new R&D contracts at Republic's Paul Moore Research & Development Center. Investigations involve instrumentation and antenna design for space craft and re-entry vehicles. Facilities in the Center's Electronics Laboratory include: anechoic chamber providing optimum reflectivity reduction; shielded room with electromagnetically clean environment; standards room with full complement of electronic standards instruments.

ELECTRONIC INSTRUMENTATION. BS, MS. Develop instrumentation for space vehicles. Knowledge of systems integration and telemetry highly desirable.

ANTENNA DESIGN. MS in Physics or EE. Design and development of antennas for re-entry vehicles. Knowledge of window effects and general re-entry radiation blackout problems.

**REPUBLIC
AVIATION CORPORATION**

FARMINGDALE, LONG ISLAND, NEW YORK

An Equal Opportunity Employer

Write to
Mr. George R. Hickman
Technical Employment Manager,
Dept. 11E-4

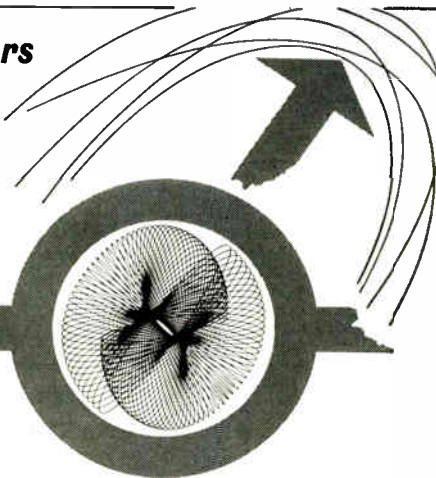

electronics

**WEEKLY QUALIFICATIONS FORM
FOR POSITIONS AVAILABLE**

(Continued from page 90)

SCOPE PROFESSIONAL PLACEMENT CENTER Waltham, Massachusetts	137 ⁰⁰	15
SPERRY GYROSCOPE COMPANY Div. of Sperry Rand Corp. Great Neck, L.I., New York	93	16
TAYLOR INSTRUMENTS COMPANIES Rochester, New York	136 ⁰⁰	17
P-8932	94	18
P-8934	137 ⁰⁰	19

*These advertisements appeared in the 5/18/62 issue.

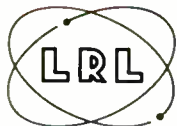

LAWRENCE RADIATION LABORATORY

The Lawrence Radiation Laboratory in the San Francisco Bay Area is operated by the University of California for the United States Atomic Energy Commission.

ELECTRONIC COMPONENT STANDARDS ENGINEER

B.S. or higher degree in E.E. with recent experience in the above or related fields. Will work closely with designers, technical consultants, buyers and suppliers to develop comprehensive standards for procurement and application of high-quality parts, materials, and assemblies.

For additional information, address inquiries to:

Mr. Roi Peers
PERSONNEL DEPARTMENT

LAWRENCE RADIATION LABORATORY

P.O. Box 808 M-34
Livermore, California

U.S. Citizenship Required
*An Equal Opportunity
Employer*

MAGNETICS ENGINEER

Graduate E.E., Physicist, or Metallurgist having 2-5 years experience in measuring & evaluating soft magnetic alloys. Will establish testing procedures for D.C. & A.C. measurements on a select group of alloys, the results of which will govern magnetic alloy manufacturing processes.

A challenging position for candidates willing to accept responsibility & interested in professional growth.

Submit complete resume to:

E. I. ERVIN

Metals & Electronics Div.
HAMILTON WATCH COMPANY
Lancaster, Pennsylvania

POSITION VACANT

Communication Engineer desired by Electric Utility in Southeast. Must be college graduate with several years experience. Position involves supervision, design and application, operation and maintenance of microwave, power line and telephone line carrier, and radio. Good future for the right man. Excellent working conditions. Applications confidential. Write P-8980, Electronics, Classified Adv. Div., PO Box 12, New York 36, N. Y.

Need Engineers?

Contact them through this

EMPLOYMENT OPPORTUNITIES Section

ENGINEERS

WORK IN AN ENGINEERS' ENVIRONMENT

AT SPERRY GYROSCOPE COMPANY



For more than fifty years engineers have acknowledged that Sperry is a good place to work. The reason? Simply stated it's because Sperry possesses a true **engineers' environment**. Here you will find the broad range of programs that insures stability and because of their advanced nature you can forget "off-the-shelf" concepts and start using your creative imagination. At Sperry you will be working with the top men in your specialty and from these men you will gain increased professional competence. Finally Sperry's management is technical management that knows an engineer's problems and recognizes his contributions.

Gain the many advantages of an **engineers' environment** by joining the Technical Staff at Sperry. Openings are currently available for engineers experienced in one or more of these areas:

- GYROS AND INERTIAL COMPONENTS • DIGITAL COMPUTERS • CIRCUITRY • PACKAGING • COMMUNICATIONS • SONAR • RADARS • ASW • STAR TRACKERS • CELESTIAL AND INERTIAL NAVIGATION SYSTEMS • PRECISION GEAR TRAINS • STRESS ANALYSIS • RANGE INSTRUMENTATION • MISSILE INSTRUMENTATION • FIELD ENGINEERING

Inquiries may be sent in complete confidence to:
Mr. J. W. Dwyer, Employment Manager

SPERRY

GYROSCOPE COMPANY

Division of Sperry Rand Corp.

Great Neck, Long Island, N.Y.

An Equal Opportunity Employer

COMPUTER SPECIALISTS

for
Customer Service Program

■ TECHNICAL SCHOOL GRADUATES WITH EXPERIENCE CAN QUALIFY

STATE SIDE LOCATIONS

■ Selected candidates will receive intensive orientation on the Philco 2000 system prior to assignment at customer locations. Candidates must be willing to relocate. Openings are available in major metropolitan areas. Must be technical school graduates or veterans with a minimum of one year installation and maintenance experience on large scale digital equipment.

■ EXCELLENT EMPLOYEE BENEFITS . . . INCLUDING RELOCATION ALLOWANCES

Please Submit Resume To
MR. D. E. DIMMIG
Employment Manager

PHILCO TECHREP DIVISION
A SUBSIDIARY OF Ford Motor Company,

P. O. BOX 4730
Philadelphia 34, Pa.

AN EQUAL OPPORTUNITY EMPLOYER

EMPLOYMENT OPPORTUNITIES



The advertisements in this section include all employment opportunities—executive, management, technical, selling, office, skilled, manual, etc.

Look in the forward section of the magazine for additional Employment Opportunities advertising.

— RATES —

DISPLAYED: The advertising rate is \$40.17 per inch for all advertising appearing on other than a contract basis. Contract rates quoted on request.

An advertising inch is measured 3/4" vertically on a column—3 columns—30 inches to a page.

Subject to Agency Commission.

UNDISPLAYED: \$2.70 per line, minimum 3 lines. To figure advance payment count 5 average words as a line.

Box numbers—count as 1 line.

Discount of 10% if full payment is made in advance for 4 consecutive insertions. Not subject to Agency Commission.

Engineering or Science Graduates to be trained as

INSTRUMENT SALES ENGINEERS
with

The Bristol Company

Leading manufacturer of automation equipment and control systems requires men, preferably 25 to 35 years old, to sell high quality, nationally accepted products to wide variety of industrial markets.

Openings in various areas of the country. Successful applicants take comprehensive three-months course at headquarters. Salary and expenses All replies confidential; every inquiry answered.

Write: Charles F. Johnson, Mgr. of Sales Training

The Bristol Company

Waterbury 20, Conn.

OVERSEAS OPPORTUNITIES EUROPEAN AREA

RADIO ENGINEERS

Minimum 5 years experience in standard and high-frequency broadcasting, emphasis on high power transmitters. Administrative experience desirable.

PROJECT ENGINEER

Electronics experience and BSEE required. Knowledge civil, hydraulics or other engineering helpful.

Travel and housing allowances given.

Submit experience and earnings to

P-8932, Electronics

Class. Adv. Div., P.O. Box 12, N.Y. 36, N.Y.



MANUFACTURERS' REPRESENTATIVES

IN THE ELECTRONIC INDUSTRY

SAMUEL K. MACDONALD, INC.

manufacturers representatives over 25 years
1531 SPRUCE STREET, PHILA. 2, PA.

Territory:

Pennsylvania • New Jersey
Delaware • Maryland
Virginia • West Virginia
District of Columbia

Other Offices:

Pittsburgh
Baltimore
Washington, D.C.

SEARCHLIGHT SECTION

(Classified Advertising)

BUSINESS OPPORTUNITIES

EQUIPMENT - USED or RESALE

DISPLAYED RATE

The advertising rate is \$27.25 per inch for all advertising appearing on other than a contract basis. Contract rates quoted on request. AN ADVERTISING INCH is measured 3/4 inch vertically on one column, 3 columns—30 inches—to a page. EQUIPMENT WANTED or FOR SALE ADVERTISEMENTS acceptable only in Displayed Style.

UNDISPLAYED RATE

\$2.70 a line, minimum 3 lines. To figure advance payment count 5 average words as a line.

PROPOSALS, \$2.70 a line an insertion. BOX NUMBERS count as one line additional in undisplayed ads.

DISCOUNT OF 10% if full payment is made in advance for four consecutive insertions of undisplayed ads (not including proposals).

OUR BUSINESS IS CUTTING



Manufacturers of small electrical or mechanical units, however intricate, with high labor content will find our cost-cutting services interesting.

Our complete overseas facilities in Japan, Hong Kong, etc., provide unlimited services by skilled workers, under trained supervision, for the manufacture of complete units or sub-assemblies to your most rigid specifications. All transactions held in strictest confidence.

Submit sample or blueprint for firm quotation. Get the facts about our cost-cutting services — save dollars and build profits!

OVER 25 YEARS EXPERIENCE IN ELECTRONICS

INTERCONTINENTAL INDUSTRIES, INC.
555 W. Adams Street Chicago 6, Illinois
Established 1938

CIRCLE 460 ON READER SERVICE CARD

FOR RESEARCH— DEVELOPMENT & EXPERIMENTAL WORK

Over 10,000 different electronic parts: waveguide, radar components and parts, test sets, pulsers, antennas, pulse xmirs, magnetrons, IF and pulse amplifiers, dynamotors, 400 cycle xmirs, 584 ant. pedestals, etc.

PRICES AT A FRACTION OF ORIGINAL COST! Visit or Phone—

COMMUNICATIONS EQUIP CO.

343 CANAL ST., N. Y. 13, N. Y.
(Formerly at 131 Liberty St.)
CHAS. ROSEN, WOrth 6-4045

CIRCLE 461 ON READER SERVICE CARD

SCHOOLS

LEARN MATHEMATICS

Today, to get ahead as a technical man, you must understand basic mathematics—logarithms, slide rule, algebraic notation and laws, various equations, progressions and series, etc. Grantham School has just recently developed an unusual home study course which can bring you up to date in these subjects. Don't let inadequacy in math hold you back. Write today.

GRANTHAM SCHOOLS, INC., Dept. 272-A
1505 N. Western Ave. Los Angeles 27, Calif.

CIRCLE 462 ON READER SERVICE CARD

INDEX TO ADVERTISERS



Audited Paid Circulation

• Advanced Electronics Corp.	80	• Servo Corporation of America	36, 59
• Air Products & Chemicals Inc.	95	• Sigma Instruments, Inc.	31
• American Lava Corporation	85	Sperry Carbon Co., Jeffers Electronics	55
• American Time Products		Div.	55
Div. of Bulova Watch Company, Inc.	14	Sprague Electric Co.	9, 30, 72
• Amperelex Electronic Corp.	13		
• Amphenol-Borg Electronics Corp.		• Tech Laboratories, Inc.	82
Connector Division	35	Texas Instruments Incorporated.....	22
Ayco Corp. Electronics & Ordnance		Texas Instruments Incorporated,	
Div.	73	Apparatus Division	65
Beatrice-Coleman Inc.	87	• United Transformer Corp.	2nd Cover
• Borg Equipment Division, Amphenol-		Varian Associates	78
Borg Electronics Corp.	57	• Vernitron Corporation	88
		• Vitramon, Inc.	5
Collins Radio Co.	89	• Vitro Electronics	61
Comcon Products Inc.	68		
Consolidated Electrodynamics Corp.	69	West Penn Power.....	16
Daytona Beach Chamber of Commerce	87		
Deleo Radio	25		
Dynsee, A Division of Hewlett Packard			
Co.	21		
Electrical Industries, Inc.	71		
Electrodynamic Instrument			
Corporation	33		
• Electro Instruments Inc.	15		
EMI Electronics	56		
• Fairchild Semiconductor Corp.	3rd Cover		
Ford Instrument Co., Div. of Sperry			
Rand Corp.	61		
Franklin Technical Corp.	60		
• Fuji Tsushinki Seizo K. K.	80		
General Dynamics Telecommunication	96		
General Electric Co.			
Semiconductor Products Dept.	63		
Greater St. Petersburg Chamber of			
Commerce	34		
• Gudebrod Bros. Silk Co., Inc.	32		
Hansen Mfg. Co., Inc.	56		
Harman Kardon Inc.	4		
• Hart Manufacturing Co.	64		
Heath Co.	16		
Hogan Faximile Corp.	88		
Hopt. R & E.....	22		
Image Instruments Inc.	22		
• Japan Piezo Electric Co., Ltd.	65		
• Lapp Insulator Co., Inc.	76		
• M B Electronics, A Division of Textron			
Electronics, Inc.	20		
• Machlett Laboratories, Inc.	29		
Magnetic Metals Company.....	17		
Mitsubishi Electric Mfg. Co.	24		
Motorola Semiconductor Products			
Inc.	10, 11		
Northrop	81, 83		
Pacific Semiconductors Inc.	6		
Paktron Electronics, Div. of Illinois			
Tool Works, Inc.	86		
Pennsylvania Dept. of Commerce.....	82		
• Phileo Corporation	67		
Precision Instruments Co.	79		
Radiation Inc.	77		
• Radio Corporation of America	4th Cover		
• Raytheon Company	74, 75		
Rose Engineering Inc.	23		
• Rixon Electronics Inc.	16		

MANUFACTURERS' REPRESENTATIVES

MacDonald, Inc., Samuel K. 94

CLASSIFIED ADVERTISING

F. J. Eberle, Business Mgr.

EMPLOYMENT OPPORTUNITIES.....91-94

SPECIAL SERVICES

EDUCATIONAL

EQUIPMENT

(Used or Surplus New)

For Sale

WANTED

Equipment

INDEX TO CLASSIFIED ADVERTISERS

Bristol Company	94
• Communications Equipment Co.	94
Esquire Personnel Service Inc.	94
Grantham Schools Inc.	94
Hamilton Watch Company,	
Metals & Electronics Div.	93
Intercontinental Industries Inc.	94
International Business Machines Corp.,	
Space Guidance Center	91
Lawrence Radiation Laboratory.....	93
National Aeronautics & Space Admin-	
istration	91
Phileo Techrep Division,	
Sub. of Ford Motor Company	94
Raytheon Co., Missile & Space Division	
Republic Aviation Corporation	92
Sperry Gyroscope Company,	
Div. of Sperry Rand Corp.	93

• See advertisement in the July 20, 1961 issue of Electronics Buyers' Guide for complete line of products or services.

This Index and our Reader Service Numbers are published as a service. Every precaution is taken to make them accurate, but ELECTRONICS assumes no responsibilities for errors or omissions.

closed-cycle Cryogenic Cooling

...simplicity
...reliability

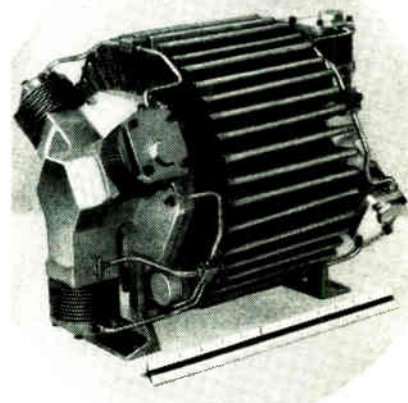

Non-contaminating compressors are one of Air Products many contributions to advance the "state of the art" in cryogenic hardware. These machines offer an order-of-magnitude reduction in compressor size and weight.

At temperatures approaching absolute zero, oil and all constituents of air freeze, causing refrigerator malfunctions. To overcome this problem, Air Products non-contaminating compressors incorporate:

- oil-free running gear
- carbon-filled fluorocarbon piston rings which are self-lubricating
- hermetically sealed compressor-motor package which prevents contaminants from entering the system and refrigerant from escaping

Two- and six-cylinder versions of these compressors are in use with Air Products closed-cycle infrared and maser cooling systems.

ADVANCED PRODUCTS DEPARTMENT
DEFENSE AND SPACE DIVISION



Air Products and Chemicals
INC.

Allentown, Pennsylvania

▶ Air Products manufactures a complete line of cryogenic electronic coolers.

STROMBERG-CARLSON® relays

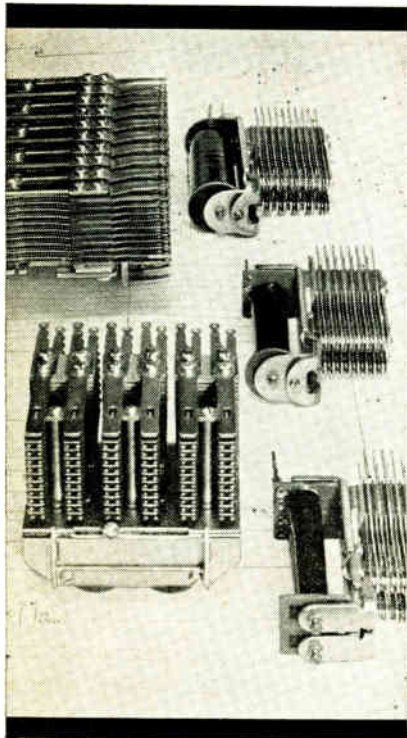

**Telephone-type
quality • reliability
durability**

TYPE A: general-purpose. Up to 20 Form "A" spring combinations.

TYPE B: gang-type. Up to 60 Form "A" spring combinations.

TYPE BB: up to 100 Form "A" springs.

TYPE C: two on one frame. Ideal where space is tight.

TYPE E: characteristics of Type A, plus universal mounting. Interchangeable with other makes.

Types A, B, and E are available in high-voltage models. Our assembly know-how is available to guide you in your specific application. If you desire, we can also provide wired mounting assemblies.

For more information on Stromberg-Carlson Relays, contact our nearest sales office: Atlanta, 750 Ponce de Leon Place N. E.; Chicago, 564 W. Adams Street; Kansas City (Mo.), 2017 Grand Avenue; Rochester, 1040 University Avenue; San Francisco, 1805 Rollins Road.

**GENERAL DYNAMICS
TELECOMMUNICATION**

electronics



Audit Bureau
of Circulations



Associated Business
Publications

Audited Paid Circulation

JAMES T. HAUPTLI

Advertising Sales Manager

R. S. QUINT:
Assistant Publisher Buyers'
Guide and Business Manager
FRED STEWART:
Promotion Manager
B. ANELLO:
Market Services Manager

RICHARD J. TOMLINSON:
Production Manager
GEORGE E. POMEROY:
Classified Manager
HUGH J. QUINN:
Circulation Manager

ADVERTISING REPRESENTATIVES

NEW YORK (36):
Donald H. Miller, Henry M. Shaw,
George F. Werner
500 Fifth Avenue, LO-4-3000
(area code 212)

BOSTON (16):
William S. Hodgkinson, Donald R. Furth
McGraw-Hill Building, Copley Square,
Congress 2-1160 (area code 617)

PHILADELPHIA (3):
Warren H. Gardner, William J. Boyle
6 Penn Center Plaza, LOcust 8-4330
(area code 215)

CHICAGO (11):
Harvey W. Wernecke, Robert M. Denmead
645 North Michigan Avenue, Mohawk 4-5800
(area code 312)

CLEVELAND (13):
Paul T. Fegley
55 Public Square, Superior 1-7000
(area code 216)

SAN FRANCISCO (11):
R. C. Alcorn
255 California Street, Douglas 2-4600
(area code 415)

LOS ANGELES (17):
Peter S. Carberry, Ashley P. Hartman
1125 W. 6th St., Huntley 2-5450
(area code 213)

DENVER (2):
J. W. Patten
Tower Bldg., 1700 Broadway,
Alpine 5-2981 (area code 303)

ATLANTA (9):
Michael H. Miller, Robert C. Johnson
1375 Peachtree St. N.E., Trinity 5-0523
(area code 404)

HOUSTON (25):
Joseph C. Page, Jr.
Prudential Bldg., Holcomb Blvd.,
Jackson 6-1281 (area code 713)

DALLAS (1):
Frank Le Beau
The Vaughn Bldg., 1712 Commerce St.
Riverside 7-9721 (area code 214)

LONDON W1:
Dennis McDonald
34 Dover St.

FRANKFURT/Main:
Matthée Herfurth
85 Westendstrasse

GENEVA:
Michael R. Zeynel
2 Place du Port

"Headquarters for Business Information"

McGraw-Hill Technical and Business Publications

American Machinist/Metal-
working Manufacturing
Aviation Week and Space
Technology
Business Week
Chemical Engineering
Chemical Week
Coal Age
Construction Methods and
Equipment
Construction Daily
Control Engineering
Electrical Construction
and Maintenance
Electrical Merchandising Week
Electrical Newsletter
Electrical West

Electrical Wholesaling
Electrical World
Electronics
Engineering Digest
Engineering and Mining Journal
E & MJ Metal and Mineral
Markets
Engineering News-Record
Factory
Fleet Owner
Industrial Distribution
National Petroleum News
Nucleonics
Nucleonics Week
Platt's Oilgram News
Platt's Oilgram Price Service
Power

Product Engineering
Purchasing Week
Science Week
Textile World

Overseas only:
Automobile International
(English, Spanish)
Ingenieria Internacional
Construccion (Spanish)
International Management
(English, Spanish
Portuguese editions)
Metalworking Production
(Great Britain)

Available by subscription only — to qualified persons actively engaged in the field of the publication. For subscription rates and information describing the editorial coverage of any of the above publications, write to: Subscription Manager, Circulation Department, McGraw-Hill Publishing Company, 330 West 42nd Street, New York 36, N. Y.

Now from Fairchild...

PLANAR FIELD EFFECT TRANSISTOR

high input impedance
low capacitance
low noise figure
low leakage current
TO-51 glass package*

Fairchild's new 2N2458 Field Effect Transistor features the ruggedness and stability of Fairchild Planar construction. Planar total surface passivation with patented metal-over-oxide techniques produces a device which is mechanically large enough for normal, reliable lead bonding techniques but at the same time electrically compact. Results: lower pinch-off voltage (V_p), lower leakage, and lower capacitance than any other field effect transistor. Complete specification sheet available on request.

*The Field Effect Transistor is also available in a standard TO-5 outline, designated the 2N2457.

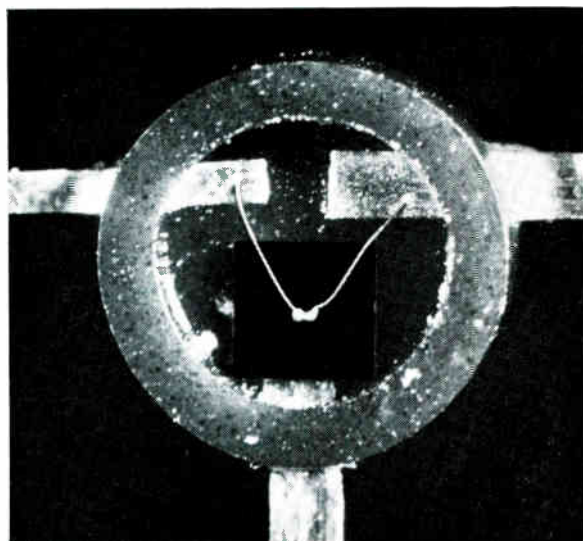

MAGNIFIED 15 TIMES

SYMBOL	CHARACTERISTIC	MIN.	TYP.	MAX.	UNITS	TEST CONDITIONS
BV_{DGO}	Drain to gate breakdown voltage	30	—	—	Volts	$I_D = 1.0 \mu A, I_S = 0$
I_{DGO}	Drain to gate leakage current	—	—	0.1	μA	$V_{DG} = 5.0V, I_S = 0$
$I_{DGO} (150^\circ C)$	Drain to gate leakage current	—	—	0.1	μA	$V_{DG} = 5.0V, I_S = 0$
I_D	Saturation current	200	500	600	μA	$V_{DS} = 5.0V, V_{GS} = 0$
gm	Transconductance (f = 1 kc)	125	200	—	$\mu mhos$	$V_{DS} = 5.0V, V_{GS} = 0$
NF	†Noise figure	—	0.4	—	db	$V_{DS} = 5.0V, V_G = 0$
V_p	Pinch-off voltage	—	3.0	4.0	Volts	$I_D = 0.1 m\mu A$
C_T	Total gate capacitance	—	0.7	1.0	pf	$V_{DGS} = 5.0V$
Z_{in}	Input impedance (f = 1 kc)	—	100	—	M Ω	$V_{DG} = 5.0V, V_G = 0$

†f = 1 kc, power bandwidth of 200 cps, $R_S = 1$ MEG Ω

FAIRCHILD
SEMICONDUCTOR

545 WHISMAN ROAD, MOUNTAIN VIEW, CALIF. • YORKSHIRE 8-816 • TWX: MN VW CAL 853
A DIVISION OF FAIRCHILD CAMERA AND INSTRUMENT CORPORATION

CIRCLE 203 ON READER SERVICE CARD

NEW "UNIVERSAL" TRANSISTOR

RCA
C



UP TO
SILICON TRANSISTORS
NOW ON THE MARKET

HERE NOW IN QUANTITY!

RCA MEETS UNPRECEDENTED DEMAND FOR 2N2102, FIRST "UNIVERSAL"
TRIPLE-DIFFUSED PLANAR SILICON TRANSISTOR.

RCA now announces mass-production availability of the 2N2102, the "universal" triple-diffused planar silicon transistor designed for widest possible application in military and industrial equipment. It can replace up to 40% of all silicon transistors now on the market and will cover a vast majority of your Small-Signal and Medium-Power Applications.

The RCA 2N2102 features high switching speed, high pulsed beta (h_{FE}) at $I_C = 1$ amp, and controlled beta from $I_C = 10\mu\text{a}$ to 1 ampere. It has high breakdown-voltage ratings, high dissipation ratings, low saturation voltages and low output capacitances.

RCA's line of triple-diffused silicon planar transistors now includes the 2N699 and 2N1613.

Call your RCA Representative today or write RCA Semiconductor and Materials Division, Commercial Engineering, Section E-19-NN-4, Somerville, N.J.

RCA-2N2270, New Economy Version of RCA "Universal" Triple-Diffused Planar Silicon Transistor Now Available in Production Quantities.

Now you get many of the performance and versatility features of RCA's 2N2102 in a new economy version, the RCA 2N2270. The 2N2270 offers one of the greatest price/performance values in transistors today. The 2N2270 features operation at high junction temperatures—up to 200°C...very low output capacitance—15 pf max...high minimum gain bandwidth product—60 Mc...useful in applications from dc to 20 Mc...JEDEC TO-5 package.

AVAILABLE THROUGH
YOUR RCA DISTRIBUTOR



THE MOST TRUSTED NAME IN ELECTRONICS

CIRCLE 204 ON READER SERVICE CARD