

electronics

BLOOD-CELL SCANNER

*Counts special cells
automatically, p 53*

(Photo below)

NARROW-BAND TELEVISION

*Uses pseudo-
random scan, p 49*

DEFLECTION AMPLIFIERS

*Simple circuit, 100-Mc
bandwidth, p 64*

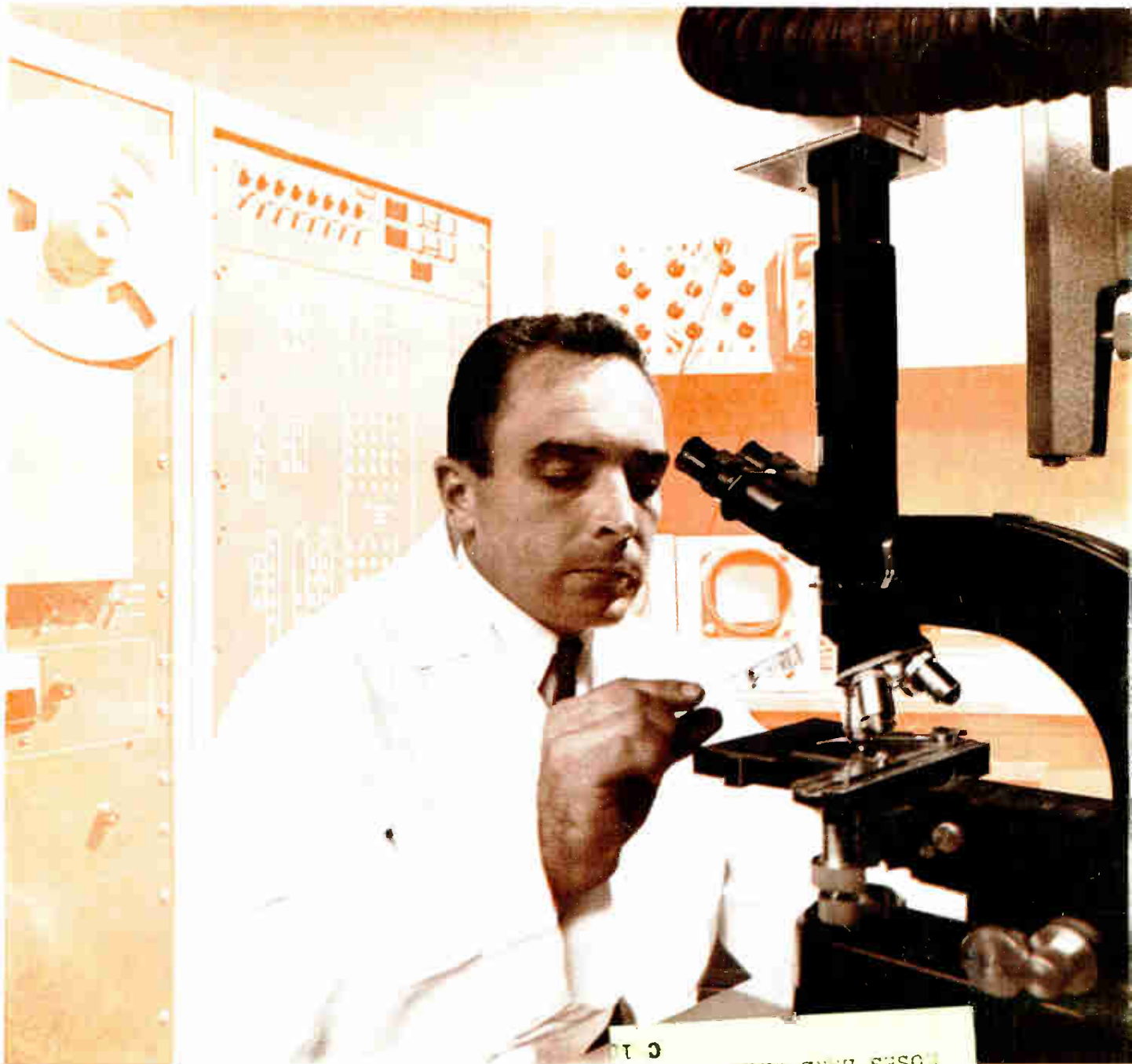

ROLAND KISSLER
BOX 956
ROSES LAKE WASH



NEW

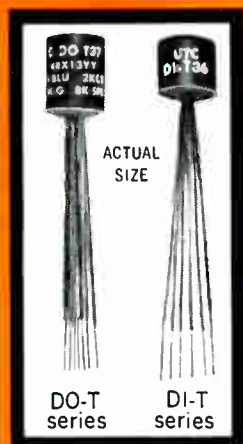

**Revolutionary
DO-T & DI-T**

**Transistor TRANSFORMERS
& REACTORS Hermetically Sealed
to MIL-T-27A**

There is no transformer even twice the size of the DO-T and DI-T series which has as much as 1/10th the power handling ability... which can equal the efficiency... or equal the response range. And none to approach the reliability of the DO-T and DI-T units (proved to, but exceeding MIL-T-27A grade 4).

- High Power Rating up to 10 times greater
- Excellent Response twice as good at low end
- Low Distortion reduced 80%
- High Efficiency up to 30% better . . . compare DCR
- Moisture Proof hermetically sealed to MIL-T-27A
- Rugged Grade 4, completely metal cased
- Anchored Leads will withstand 10 pound pull test
- Printed Circuit Use (solder melting) nylon insulated leads
- Suited to Clip Mounting use Augat #60C9-8A clip



Typical Printed Circuit Positioning

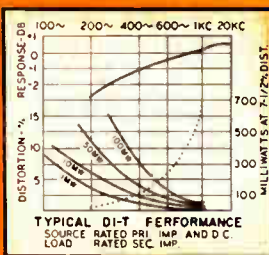
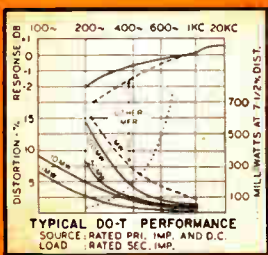

TRANSFORMERS PICTURED DO-T: 5/16 Dia. x 1 1/2", 1/10 Oz.; DI-T: 5/16 Dia. x 3/4", 1/15 Oz.

Write for catalog of over 1,000 STOCK ITEMS with UTC High Reliability IMMEDIATELY AVAILABLE from YOUR Local Distributor



**AND
CUSTOM BUILT
SPECIAL UNITS
TO YOUR
SPECIFICATIONS**

IMMEDIATE DELIVERY FROM STOCK

COMPLETE STOCK LINE LISTING

DO-T No.	Pri. Imp.	D.C. Ma.† in Pri.	Sec. Imp.	Pri. Res. DO-T	Pri. Res. DI-T	Mw. Level	DI-T No.
DO-T37	2000 CT 2500 CT	3	8000 Split 10,000 Split	195	180	100	DI-T37
DO-T38	10,000 CT 12,000 CT	1	2000 Split 2400 Split	560	600	100	DI-T38
DO-T39	20,000 CT 30,000 CT	.5	1000 Split 1500 Split	800		100	
DO-T40	40,000 CT 50,000 CT	.25	400 Split 500 Split	1700		50	
DO-T41	400 CT 500 CT	8	400 Split 500 Split	46	48	500	DI-T41
DO-T42	400 CT 500 CT	8	120 Split 150 Split	46		500	
DO-T43	400 CT 500 CT	8	40 Split 50 Split	46		500	
DO-T44	80 CT 100 CT	12	32 Split 40 Split	9.8		500	
DO-T45	1000 CT 1250 CT	3.5	16,000 split 20,000 split	120		100	
DO-T46	100,000 CT	0	500 CT	7900		25	
DO-T1	20,000 30,000	.5	800 1200	830	815	50	DI-T1
DO-T2	500 600	3	50 60	60	65	100	DI-T2
DO-T3	1000 1200	3	50 60	115	110	100	DI-T3
DO-T4	600	3	3.2	60		100	
DO-T5	1200	2	3.2	105	110	100	DI-T5
DO-T6	10,000	1	3.2	790		100	
DO-T7	200,000 500	0	1000 100,000	8500		25	
			Reactor 2.5 Hys./2 Ma., .9 Hy./4 Ma		630		DI-T8
DO-T8			3.5 Hys./2 Ma., 1 Hy./5 Ma	560			
DO-T9	10,000 12,000	1	500 CT 600 CT	780	870	100	DI-T9
DO-T10	10,000 12,500	1	1200 CT 1500 CT	780	870	100	DI-T10
DO-T11	10,000 12,500	1	2000 CT 2500 CT	780	870	100	DI-T11
DO-T12	150 CT 200 CT	10	12 16	11		500	
DO-T13	300 CT 400 CT	7	12 16	20		500	
DO-T14	600 CT 800 CT	5	12 16	43		500	
DO-T15	800 CT 1070 CT	4	12 16	51		500	
DO-T16	1000 CT 1330 CT	3.5	12 16	71		500	
DO-T17	1500 CT 2000 CT	3	12 16	108		500	
DO-T18	7500 CT 10,000 CT	1	12 16	505		500	
DO-T19	300 CT	7	600	19	20	500	DI-T19
DO-T20	500 CT	5.5	600	31	32	500	DI-T20
DO-T21	900 CT	4	600	53	53	500	DI-T21
DO-T22	1500 CT 600	3	600 1500 CT	86	87	500	DI-T22
DO-T23	20,000 CT 30,000 CT	.5	800 CT 1200 CT	830	815	100	DI-T23
DO-T24	200,000 CT 500 CT	0	1000 CT 100,000 CT	8500		25	
DO-T25	10,000 CT 12,000 CT	1	1500 CT 1800 CT	780	870	100	DI-T25
			Reactor 4.5 Hys./2 Ma., 1.2 Hys./4 Ma		2300		DI-T26
DO-T26			6 Hys./2 Ma., 1.5 Hys./5 Ma	2100			
			Reactor .9 Hy./2 Ma., .5 Hy./6 Ma		105		DI-T27
DO-T27			1.25 Hys./2 Ma., .5 Hy./11 Ma	100			
			Reactor .1 Hy./4 Ma., .08 Hy./10 Ma		25		DI-T28
DO-T28			.3 Hy./4 Ma., .15 Hys./20 Ma	25			
DO-T29	120 CT 150 CT	10	3.2 4	10		500	
DO-T30	320 CT 400 CT	7	3.2 4	20		500	
DO-T31	640 CT 800 CT	5	3.2 4	43		500	
DO-T32	800 CT 1000 CT	4	3.2 4	51		500	
DO-T33	1060 CT 1330 CT	3.5	3.2 4	71		500	
DO-T34	1600 CT 2000 CT	3	3.2 4	109		500	
DO-T35	8000 CT 10,000 CT	1	3.2 4	505		100	
DO-T36	10,000 CT 12,000 CT	1	10,000 CT 12,000 CT	975	970	100	DI-T36
DO-TSH			Drawn Hipermalloy shield and cover 20/30 db				DI-TSH

† DCMA shown is for single ended usage (under 5% distortion—100MW—1KC) . . . for push pull, DCMA can be any balanced value taken by .5W transistors (under 5% distortion—500MW—1KC)
‡ DO-T & DI-T units designed for transistor application only. Pats. Pend.
* Units in tinted area newly added to series

UNITED TRANSFORMER CORP.

150 VARICK STREET, NEW YORK 13, N. Y.

PACIFIC MFG. DIVISION: 3630 EASTHAM DRIVE, CULVER CITY, CALIF.
EXPORT DIVISION: 13 EAST 40th STREET, NEW YORK 16, N. Y. CABLES: "ARLAB"

electronics

A McGraw-Hill Publication 75 Cents



W. W. MacDONALD, Editor

J. M. CARROLL, Managing Editor
 SENIOR EDITORS: Samuel Weber, George W. Sideris. SENIOR ASSOCIATE EDITORS: William E. Bushor, Michael F. Wolff. ASSOCIATE EDITORS: Michael F. Tomoino, Sylvester P. Carter, William P. O'Brien, John F. Mason, Thomas Emmo, Sy Vogel, Leslie Solomon, George J. Flynn, Laurence D. Shergolis. ASSISTANT EDITORS: Nilo Lindgren, Stanley Froud, Stephen B. Gray, Roy J. Bruun, George V. Navatny, Leon H. Dulberger. REGIONAL EDITORS: Harold C. Hood (Pacific Coast, Los Angeles), Thomas McGuire (New England, Boston), Cletus M. Wiley (Midwest, Chicago). ART DIRECTOR: Harry Phillips; Howard R. Berry. PRODUCTION EDITOR: John C. Wright, Jr. EDITORIAL ASSISTANTS: Gloria J. Meurer, Bernice Duffy, Lorraine Rossi, Virginia T. Bastian, Lynn Emery, Bette H. Snyder, Rosemary Abbruzese, Judy Hoskins, Ann Mello. FOREIGN NEWS BUREAU: Director, John Wilhelm, Alyne Elias. LONDON—John Shinn, Derek Barlow, Nicholas Landon. Bonn—Peter Forbath, James Morrison, Silke McQueen. Paris—Robert Farrell, Arthur Erikson. Milan—Gene DiRaimondo. Mexico City—Bruce Bendow. Rio de Janeiro—Leslie Warren. Moscow—Stewart Ramsey. Tokyo—Richard Halloran, Charles Cohen, John Yamaguchi.

JAMES GIRDWOOD, Publisher

LABORATORY TECHNICIAN holds blood-smear slide. Slow-scan tv pickup fits over microscope. In background are tape recorder for storing information, processing computer with quantizing circuits and monitor to display blood-count histogram. *This equipment makes counting rare blood cells a practical research technique. See p 52* COVER

BUSINESS EQUIPMENT SHOW Features Data Retrieval, Controls and Shop Reporting Systems. Equipment is do-something-with-a-fingertip variety. *Among the previews: a personalized information abstracter* 22

BONANZA IN OFFICE EQUIPMENT Seen by BEMA president. Growth rate twice that of other U. S. industries is predicted. *Other observers find the market in Europe just as hot* 22

CESIUM GAS LASER Is Optically Pumped. Exciter is r-f-powered helium lamp. *System puts out coherent light at far-infrared wavelength* 23

AIR FORCE R&D SPENDING Plans Total \$3.75 Billion. Here's a rundown of all the projects that will heavily influence electronics procurement in the next few years. *Biggest chunks are for missiles and command and control systems* 30

MOON FLIGHT SIMULATOR. Capsule is rigged to make crewmen think they've been on seven-day trip to moon. *System includes all the comforts of home plus an analog computer* 32

DIGITAL SEISMOGRAPH Techniques. One system for nuclear detection program can telemeter. *Another solves drift with f-m* 33

NARROW-BAND TV Uses Pseudo-Random Sweep. Coarse scan is 24 cps horizontally, 768 cps vertically. An 18,432-cps triangular wave produces a 24 by 32 dot pattern. Six square waves, clocked to the 18,432-cps source shift dots to produce pseudo-random pattern. *Signal bandwidth is 10 Kc permitting transmission over telephone lines or recording with a home tape recorder.* By S. Deutsch 49

BLOOD-CELL SCANNER Identifies Rare Cells. Slow-scan tv converts microscope image to analog video stored on tape. Video signal is coupled to processor that produces binary video. Computer logic counts and sizes significant image areas to produce image histogram displayed on monitor. *The instrument permits rapid identification of rare abnormal blood cells thought to be present after radiation exposure.* By N. F. Izzo and W. Coles 52

Published weekly, with Electronics Buyers' Guide and Reference issue, as part of the subscription, by McGraw-Hill Publishing Company, Inc. Founder: James H. McGraw (1860-1948).

Indexed Annually in Buyers' Guide and Reference issue.

Title © registered U.S. Patent Office; © Copyright 1962 by McGraw-Hill Publishing Co., Inc. All rights reserved, including the right to reproduce the contents of this publication, in whole or in part.

Executive, editorial, circulation and advertising offices McGraw-Hill Building, 330 West 42nd Street, New York 36, N. Y. Telephone Langacre 4-3000. Teletype TWX N.Y. 1-1636. Cable McGrawhill, N. Y. PRINTED IN ALBANY, N. Y.; second class postage paid at Albany, N. Y.

OFFICERS OF THE PUBLICATIONS DIVISION: Nelson L. Bond, President; Shelton Fisher, Wallace F. Traendly, Senior Vice Presidents; John R. Callahan, Vice President and Editorial Director; Joseph H. Allen, Vice President and Director of Advertising Sales; A. R. Venezian, Vice President and Circulation Coordinator; Daniel F. Crowley, Vice President and Controller.

OFFICERS OF THE CORPORATION: Donald C. McGraw, President; Hugh J. Kelly, Harry L. Waddell, Executive Vice Presidents; L. Keith Goodrich, Executive Vice President and Treasurer; John J. Cooke, Vice President and Secretary.

Subscriptions are solicited only from those actively engaged in the field of the publication. Position and company connection must be indicated on orders. Subscription rates: United States and Possessions, \$6.00 one year; \$9.00 two years; \$12.00 three years. Canada, \$10.00 one year. All other countries \$20.00 one year. Single Copies, United States and Possessions and Canada 75¢. Single copies all other countries \$1.50.

THE PUBLISHER, UPON WRITTEN REQUEST FROM ANY SUBSCRIBER TO OUR NEW YORK OFFICE, AGREES TO REFUND THAT PART OF THE SUBSCRIPTION PRICE APPLYING TO COPIES NOT YET MAILED.

Subscribers: Please address all correspondence, change of address notices, subscription orders or complaints to Fulfillment Manager, Electronics, at above address. Change of address notices should provide old as well as new address, including postal zone number if any. If possible, attach address label from recent issue. Allow one month for change to become effective.

Postmaster: Please send Form 3579 to Fulfillment Manager, Electronics, 330 West 42nd Street, New York 36, New York.



Audited Paid Circulation

CONTENTS continued

CONTROLLED RECTIFIERS for Fast Power Switching. Silicon controlled rectifiers take place of relays in a fast-switching operation. Input pulse transformers provide necessary isolation. Pulse amplifiers are driven by bistable multivibrators. *These switches are useful in either d-c or a-c applications.*
By J. E. Roberts 58

CALIBRATING FREQUENCY STANDARDS with Very-Low-Frequency Transmissions. Phase-tracking system uses receiver, frequency synthesizer, phase comparator, servo-driven phase shifter and transistor power supply. Recording potentiometer displays frequency offset. *Seven vlf stations from 14.7 to 22.3 Kc are remarkably stable; propagation phase shift is negligible.*
By J. D. Echols 60

WIDE-BAND DEFLECTION AMPLIFIERS; How to Design Them. New pentode permits designing deflection amplifiers with 100-Mc bandwidth. Amplifier uses parallel push-pull circuit with lumped-constant components but requires careful compensation. *Use with the 5BHP31 cathode-ray tube; this amplifier can result in vastly improved oscilloscopes.*
By L. L. Kossakowski 64

DEPARTMENTS

Crosstalk. <i>Instant Movies? No Life on Venus</i>	3
Comment. <i>More on Electronic(s)</i>	4
Electronics Newsletter. <i>Administration Plugs Trade Bill</i>	7
Washington Outlook. <i>House Tries Again to Revamp Patent Policy. Military Budgets</i>	12
Meetings Ahead. <i>NEREM. Canadian Symposium on Communications</i>	36
Research and Development. <i>Metals Study. Velocimeter Detects Impurities</i>	76
Components and Materials. <i>Thin-Film Memory Elements for Computers</i>	86
Production Techniques. <i>Teaching Machines as Training Aids</i>	96
New Products Design and Application. <i>Differential D-C Amplifier</i>	104
Literature of the Week	131
Books. <i>Self-Organizing Systems</i>	132
People and Plants. <i>AmpeX Plans Long-Range Expansion</i>	136
Index to Advertisers	146

CROSSTALK

INSTANT MOVIES? Our first technical feature article this week (page 49) discusses a tv system that works on 10-Kc bandwidth. Programs for it can be recorded on magnetic tape with tape speed around 30 inches a second.

This prompts us to ask: when is some enterprising electronics manufacturer going to tie all the ends together and put on the market a home movie system using tape instead of film? It might start a whole new trend in hi-fi pictures.

Advantages of movie-making on tape include the ability to monitor the movie during "filming"—if junior sticks his tongue out, erase the offending portion of the tape and shoot the scene over without wasting footage.

Tape is less expensive than movie film. There is no processing cost and no waiting for the neighborhood drug store to return the film. Copies can be made by rerecording. Commentary and video can be put on the same twin-track tape.

Still exercising our imagination, we can see a low-bandwidth tv system moving telephone-television a notch nearer as an everyday convenience rather than a special purpose data transmission service. Bringing bandwidth down to 10 Kc makes it compatible with high-quality telephone channels like those available with microwave transmission links. Maybe the era of the anonymous telephone call will draw to a close?

The article, by Associate Professor Sid Deutsch, of Polytechnic Institute of Brooklyn, describes a closed-circuit display that gives a resolution comparable with commercial low-cost tv receivers. It uses a psuedo-random scan (Deutsch is explaining this in the photo), but requires two and a half seconds for each scan. That, by the way, is the price of low bandwidth—it takes longer to put the information on the screen.

NO LIFE. A few weeks ago (p 7, April 6) we summarized a Tass report from Moscow on the discovery of oxygen in Venus' upper atmosphere "indicating life may exist on the planet." Our man in Moscow now tells us that the Russian news agency says there ain't no life on Venus. It's too hot—about 300 C on the planet's sur-

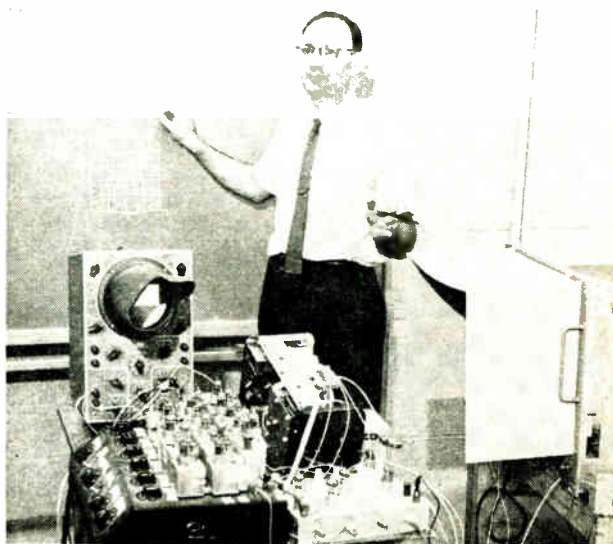

face—and its atmosphere is 75 percent carbon dioxide. The oxygen comes from decomposition of water at high altitudes. We confess that Tass did not say there was life on Venus. What Tass did say was that there is "molecular oxygen without which life or respiration are impossible," and we swallowed the bait.

CASE CLOSED. Historians have always been a bit suspicious of the official reason for Napoleon's demise, cancer. According to AEC Chairman Glenn T. Seaborg, the suspicions might be correct. Scientists recently checked a purported lock of Napoleon's hair using neutron activation analysis. The hair contained 13 times as much arsenic as is normal for human hair.

Coming In Our May 4 Issue

VIRTUES FROM VICES. Temperature variations alter semiconductor device characteristics, a nuisance in most circuits. Next week, L. E. Barton, of RCA Research Labs tells how this change can be converted to an asset in diode and transistor direct-reading thermometers. In another article, M. Beebe and J. Miller, of ITT Federal Labs, show how they dispensed with chopper-stabilized d-c amplifiers during development of a programmed reference voltage source. They used a high-grade zener as the reference source and differential amplifiers to anchor output voltages over a 127-v range. The completed unit fitted into a cookie jar-sized package.

500kc to 100mc
new

rf

JERROLD[®]

Logarithmic Amplifier

Model LA-5100



ACCURATE TO WITHIN
 ± 1 DB OVER 80-DB
DYNAMIC RANGE



This extremely accurate log amplifier enables exact measurements of attenuation in networks, filters, amplifiers, and other devices exhibiting dynamic operating ranges down to 90 db. Write for complete technical data.

- Frequency range 500kc-100mc, with flatness better than $\pm 1/2$ db.
- Four calibrated ranges: Logarithmic 0-40, 0-60, 0-80 db (readable to 90 db) and one linear range 0-20 db (variable gain).
- Continuously variable log-expansion control permits uncompressed presentation of first 5 db of each range.
- Direct-reading meter for point-by-point measurements.
- Oscilloscope output jack for sweep display measurements.
- Designed for rack mounting: 7" x 14 1/2" x 19". \$795.00

JERROLD ELECTRONICS CORPORATION
Industrial Products Division, Dept. ITE-141
Philadelphia 32, Pa.

COMMENT

More on Electronic(s)

I have been a periodics subscriber to *ELECTRONICS* for twenty years and have followed its sometimes erratic course for even longer. The magazine has gradually been invaded by an antics editorial usage; I would hope that it can be stamped out before it becomes a chronics affliction.

Electronic is a splendid adjective, and electronics is just as good a noun. Both ought to remain what they are. I assume that you have an argument up your sleeve for using the second where the first has always sufficed, and I partly understand the distinction you are trying to make. Please forget it. As a modifier, electronics is ugly, unnecessary, close to unpronounceable, and fails its intended function by generating more confusion than it dispels. (Besides, think of the consequences. Must we progress to atomics physicist, ultrasonics aircraft, and perhaps inevitably cata-tonics prose?)

Yours for continued effort toward lucidly presenting electronic ideas to electronic engineers.

G. FRANKLIN MONTGOMERY
Washington, D. C.

It is a pleasure to be told off in such æsthetics prose by electronic reader Montgomery. However, until we are replaced by electronic editors, we shall probably continue to be electronics editors.

Polarized Relays

On page 33 of your 23 March issue, you published a much-needed condensation of graphical symbols. Naturally you omitted much. The most important feature of polarized relays is based on item 66, paragraph 4 of MIL-STD 15-1. I believe your readers would be interested in this as a supplement.

E. U. THOMAS
Grumman Aircraft
Engineering Corp.
Bethpage, Long Island, New York

Item 66 Paragraph 4, MIL STD 15-1:

The proper poling for a polarized relay shall be shown by the use of + and - designations applied to the

winding leads. The interpretation of this shall be that current in the direction indicated shall move or tend to move the armature toward the contact shown nearest the coil on the diagram. If the relay is equipped with numbered terminals, the proper terminal numbers shall also be shown.

WESCON Papers

In the March 2 *Comment* (p 4) we notice a reference made to the 1961 WESCON papers. The 1961 WESCON papers (114 of them) are all available, as stated, from the WESCON Executive Secretaries Office at WEMA (Western Electronic Manufacturers' Association), 1435 South La Cienega Boulevard, Los Angeles 35, California, or they may be obtained from the national distributors which are ourselves, Western Periodicals Company, 5734 Tujunga Avenue, North Hollywood, California. This may answer some questions several of your readers may have.

SOL J. GROSSMAN
Western Periodicals Co.
North Hollywood, California

Frequency Meter

We read with great delight your New Product item on the Lavoie LA-70B frequency meter (p 144, March 9). We want to congratulate you on a very excellent article.

However, there was a typographical error that would have great significance to your readers. The accuracy and the stability of this instrument are both 0.0001 percent, which is five times greater than F.C.C. requirements.

J. G. FRIEDMAN
Lavoie Laboratories
Morganville, New Jersey

Decay, Not Delay

A slight printing error has occurred in my article, Noise-Free Keying Circuit (p 53, Mar. 30).

In the last column, the sentence "By making R_2 variable, both rise and delay times . . ." should read "decay times."

ALEX MARTENS
Bausch and Lomb Inc.
Rochester, New York

Why engineers
are specifying **VK** Capacitors
for CK Capacitor requirements...

VITRAMON, INC. SUPPLIES
PROOF
OF PERFORMANCE
with every shipment

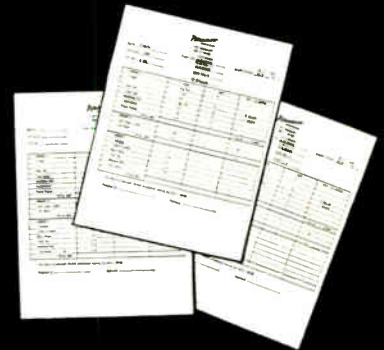

The "proof of performance" for all CK Capacitors ("VK" Capacitors purchased against MIL-C-11015/18 or /19) is enclosed with your order! Automatically and voluntarily, "Vitramon" supplies copies of Acceptance Testing Data — with every shipment.

And test results are impressive! Where absolute conformance to military specifications is essential, CK Capacitors adhere closely to requirements. In critical areas where specifications may be surpassed, CK Capacitors offer reliability "above and beyond." Here's how they measure up:

DISSIPATION FACTOR

MIL. REQUIREMENT	ACTUAL PERFORMANCE
2.5% <i>for all values</i>	1.5% <i>for values thru 680 mmf.</i>
	2.5% <i>for values 820 thru 10,000 mmf.</i>

TEMPERATURE COEFFICIENT

MIL. REQUIREMENT	ACTUAL PERFORMANCE
+30% -56% <i>for all values</i>	±10% <i>for values thru 680 mmf.</i>
	±15% <i>for values 820 thru 10,000 mmf.</i>

CK Capacitors are checked 100% for dissipation factor and capacitance, and to insure that the parts stay within tolerance, only 2/3 of the available capacitance band is used. Parts are checked for Insulation Resistance after being subjected to a seal test consisting of exposure in live steam for 2½ hours under 15 p.s.i. Parts are also gauged 100% for physical dimensions.

MIL PARTS
NOW IN STOCK!

VK Micro-miniature
CERAMIC CAPACITORS
Conforms with MIL-C-11015/18/19



VK 30
case size:
0.3" square
lead spacing:
0.2"



VK 20
case size:
0.2" square
lead spacing:
0.2"

- 10-10,000 mmf
- -55° C to 150° C
- 200 VDC rating

Vitramon[®]
INCORPORATED
P.O. Box 544
Bridgeport 1, Connecticut

SLOTTED LINES for 26 to 110 KMC

FREQUENCY.....full waveguide band
SLOPE.....1.03 max.
PROBE..variable depth adjustment and
built-in slide screw tuner
TRAVEL MEASUREMENT...dial indicator
with 0.01 mm divisions

The TRG Model E740 pictured below is a highly accurate slotted line for microwave measurements in the millimeter region. This is another concrete example of TRG's effort to provide you with the most complete line of millimeter components. Today, TRG is the one and only source for more components covering the entire 26 to 220 kmc region than anyone else. Whatever your problem — a component, or complete systems development — TRG has more of everything it takes, including experience, to place the answers right in the palm of your hands. Please write for Catalog 260A today.



TECHNICAL RESEARCH GROUP, 400 Border St., East Boston 28, Mass.

TRG MODEL E740 SLOTTED LINE provides highly accurate microwave measurements in the millimeter region. Precision linear bearings and a smooth friction wheel drive assure accurate control, and long-life of the probe travel. The 0.003 inch diameter probe features a variable depth adjustment, and a built-in slide screw tuner for optimizing the RF coupling to the waveguide. The unit is neatly packaged in a rugged case to protect against damage and dust.

TRG
PUTS
THE FUTURE
IN THE
PALM
OF YOUR
HAND



FREQUENCY RANGE-KMC	A-band 26-40	E-band 53-50	V-band 50-75	E-band 60-90	W-band 75-110	F-band 90-110	G-band 140-220
MODEL NUMBER	Under Development	E740	V740	E740	W740	Under Development	Under Development

ELECTRONICS NEWSLETTER

Administration Urges Trade Bill Passage

WASHINGTON—The administration has prepared briefs on the effect that passage or nonpassage of the trade expansion bill (see p 12) would have on "import sensitive" industries. The brief on the electronics industry says that passage would help the industry compete in Europe.

If the U. S. can bargain European tariffs down to zero—as the bill allows—U. S. companies would have a competitive edge. The report cites a survey indicating that U. S. wages are higher, but materials and overall production costs are higher in Europe. Also, wages are rising faster there.

If the bill doesn't pass, the report indicates, U. S. companies will face tariff disadvantages. By 1970, for example, U. S. capacitors will have a 14-percent duty in Germany, but French capacitors will have no duty. Today, U. S. transmitters pay 12.8-percent duty in Holland and German transmitters pay 7.2 percent. Unless the U. S. bargains itself into the Common Market by 1970, U. S. transmitters will pay 14-percent duty in Holland and German sets will be duty-free.

The report also cites statistics indicating the U. S. electronics industry is healthy (employment and volume rising), exports more than it imports (\$613 million exports and \$179 million imports in 1961) and that imports amount to only two percent of total U. S. production. Despite Japanese semiconductor imports, U. S. output of semiconductor products has risen from \$40 million in 1955 to \$580 million in 1961.

Educational Tv Getting \$32 Million Federal Aid

WASHINGTON—Educational tv is to get \$32 million in federal aid under a five-year program of grants matching local nonprofit or educational sponsorship. Grants of up to \$1 million to each state are to be provided. Present stations may count 25 percent of their investment toward matching grants for expansion.

National Association of Educa-

tional Broadcasters says there are now 65 educational tv stations with some \$60 million in facilities. About 20 more stations are set to go when federal funds stimulate state appropriations. At least another 100 stations are expected under the five-year program.

The \$32 million program represents a compromise between a \$51 million program previously voted by the Senate and \$25 million approved by the House.

New Army Office Will Handle Technical Buying

WASHINGTON—Maj. Gen. Stuart S. Hoff, chief of R&D for the Army's Chief Signal Officer, will head the Electronics Command of the Army's Material Development and Logistics Command (MDLC).

Under a Pentagon reorganization, MDLC takes over most operations of Signal Corps and other Army technical services. Responsibilities for R&D, procurement and production, inventory management, storage and distribution, mainte-

nance and disposal, and weapon and equipment testing are consolidated in MDLC. In effect, the electronics industry will deal with one Army contracting agency.

The new agency is expected to absorb existing procurement offices, test ranges, labs and similar installations. No date for MDLC to open up shop has been announced, nor have sites been selected.

Nuclear-Powered Beacon To Aid Ship Navigation

NAVY is developing a nuclear-powered sound beacon that would be placed at the bottom of the Atlantic Ocean to provide a fix for ship navigation. It would be used for navigating oceanographic ships.

System components will be supplied by the Navy Underwater Sound Laboratory, New London, Conn. The beacon is designed for a two-year testing program.

The nuclear generator, designated Snap-7E, will be built by the Martin Company. It will produce about 5 w at 4.5 v. AEC has awarded Martin a \$60,000 contract. Heat produced from decay of about 3 lb of strontium 90 will be converted to electricity by 60 sets of thermocouples.

Here's a Television Set Smaller Than a Breadbox

TOKYO—Sony Corp. reports it will begin domestic sales May 20 of a 5-in. tv receiver weighing 8 lb and operating from a-c or 12-v battery

Live Atomic Missiles to Test Electronics?

WASHINGTON—There were persistent reports here early this week that live atomic tests, possibly including the Polaris missile, would start soon unless the USSR and U. S. reach a last-minute agreement on a test ban.

Among the purposes of the some 25 proposed explosions are checkouts of missiles, missile installation protective measures and the effects of nuclear explosions on communications, radar and other electronic equipment (p 9 Dec. 8. and p 9 Nov. 10, 1961).

One of the suspected problems of an antimissile missile, for example, is that the first defensive explosion would blackout nearby electronic equipment.

power. Present production is 10,000 a month, anticipated production is 20,000 monthly by 1963 and 50,000 late next year. Sony says it won't export until the home market is saturated.

The "Micro Tv" uses 24 transistors, including three epitaxial silicon types in deflection circuits, and 20 diodes. A sensitivity of 10 μ v is said to assure reception in weak signal areas. It has pulse agc and automatic noise suppressor circuits, so can be used in a car with an externally mounted antenna.

Data System Will Survey U. S. and World Resources

DEFENSE Atomic Support Agency is developing a computer-supported system that will maintain an inventory of national and worldwide military and economic resources. During wartime, it will assess and report damage to resources and military forces.

The system consists of several installations, including a developmental center at the Pentagon and a data processing installation at an alternate command center. Thompson Ramo Wooldridge's RW division has been awarded a \$450,000 contract to provide requirements, specifications and procedures for data processing, display and communications subsystems.

Cloud Maps Beamed Throughout the World

WEATHER BUREAU last week began eight to 10 weeks of experimental worldwide facsimile transmission of cloud maps based on photographs taken by the Tiros IV satellite.

Information on the service has been sent to the meteorological services in more than 100 nations. The maps will supplement code cloud analyses now sent by international radioteletypewriter, which must be decoded with loss of time and detail.

Superconducting Magnet Traps 25-Kilogauss Field

BOSTON—Fields up to 25 kilogauss have been trapped in superconduc-

ting magnets made of sintered niobium-tin. The magnets are cylinders with outside diameters of 0.5 in. and 0.25-in. holes drilled along the axis.

The cylinders were kept at a temperature of 4.2 K. In each cylinder, the hole was shielded from an external field. At a critical point, the field broke through. The field inside the hole remained constant when the external field was lowered to zero, and continued to be maintained by persistent currents.

Current density in the cylinder walls was calculated to be at least 10⁷ amp per sq cm. The experiments were performed by S. H. Autler at MIT Lincoln Laboratories.

AEC Readies High-Power Space Reactor Program

NEGOTIATIONS are underway between AEC and Pratt & Whitney Aircraft for development of an advanced, compact nuclear reactor for space use. The program, called Snap-50, is to provide in the late 1960's a power source for ion propulsion, communications satellites and other high-power applications.

It was also announced last week that RCA was awarded a \$2 million contract for thermoelectric modules for Snap-10A, a 500-w space vehicle reactor being developed for AEC by Atomics International. Flight tests are scheduled for next year.

RCA said that plans are underway at Atomics International to develop Snap systems providing up to 60 Kw. AEC did not announce power output planned for Snap-50, but said it would be higher than any Snap in development.

High-Pitched Wails Call Deaf to Phone

MELBOURNE—Research lab of the Australian postal service has developed a device to call deaf persons to the telephone. It emits a high-pitched wail at frequencies most favorable to the user's hearing loss. The wail is said to be more audible than the regular telephone ring. The Post Office expects the device will be used commercially with telephone hearing aids.

In Brief . . .

RANGER 4 moon probe, launched Mon. at Cape Canaveral by NASA, failed. NASA believes cause was electronic timer malfunction resulting in failure of telemetry solar panel extension, computer, and sequencer.

ITEK LABORATORIES has a \$500,000 contract to design and build a system that will minify, store and reproduce seismograms for U. S. Coast and Geodetic Survey earthquake research.

MATSHUSHITA ELECTRIC, of Japan, says it will begin production late this year of brushless motors that might obtain speeds of 250,000 rpm. Speed of experimental motors is variable to 30,000 rpm, but limitation is said to be due to type of transistors used to switch current to stator coils.

TROPOSCATTER path loss measuring equipment to be built by Radio Engineering Labs under \$600,000 Air Force contract will be helicopter-transportable so it can rapidly check out transmission routes.

FOREIGN communications systems contracts include \$1.5 million order from Denmark for Collins Radio ssb stations for NATO and the Danish Navy. RCA has a \$2.86 million contract from Liberia.

FAA IS EVALUATING Hazeltine's experimental radar handoff equipment for air traffic control. Marker symbols can be written directly on the radar display, on adjacent sector displays of the same radar, and on other radars.

GUIDANCE TECHNOLOGY has been awarded \$2.25 million in Air Force contracts for vertical gyros and gyro indicators.

EDO CORP. announced a \$1.5 million Navy contract for long-range sonar for submarines.

ADD-ON AIR FORCE contract of \$375,000 for ALT/15 countermeasures equipment raises value of affected Hallicrafters' contract to \$3.3 million. Value of other ALT/15 contracts at company is reported to be "much more" than that.



**TAILORED
TANTAPAK* CAPACITORS**
Epoxy Cast or Metal Encased
to Customer Specifications
Engineering Bulletin 3707



**FEED-THRU
SOLID-ELECTROLYTE
TANTALEX® CAPACITORS**
Type 180D
Engineering Bulletin 3525



**CYLINDRICAL SINTERED-ANODE
TANTALEX® CAPACITORS**
to 175C Operation
Type 140D, 141D
Engineering Bulletin 3800



**HEARING-AID-TYPE
SOLID-ELECTROLYTE
TANTALEX® CAPACITORS**
Type 160D, 161D
Engineering Bulletin 3515A



**HERMETICALLY-SEALED
SOLID-ELECTROLYTE
TANTALEX® CAPACITORS**

POLARIZED Type 150D Engineering Bulletin 3520D	NON-POLARIZED Type 151D Engineering Bulletin 3521
---	--



FOIL-TYPE TANTALEX® CAPACITORS

for 85C Operation Type 110D—plain foil, polarized Type 111D—plain foil, non-polarized Type 112D—etched foil, polarized Type 113D—etched foil, non-polarized Engineering Bulletin 3601A	for 125C Operation Type 120D—plain foil, polarized Type 121D—plain foil, non-polarized Type 122D—etched foil, polarized Type 123D—etched foil, non-polarized Engineering Bulletin 3602A
--	---



**TUBULAR SINTERED-ANODE
TANTALEX® CAPACITORS**

for 85C Operation Type 109D Engineering Bulletin 3700E	for 125C Operation Type 130D Engineering Bulletin 3701A
---	--



**'CUP-STYLE' SINTERED-ANODE
TANTALEX® CAPACITORS**

for 85C Operation Type 131D (industrial) Type 132D (vibration-proof) Engineering Bulletin 3710A	for 125C Operation Type 133D Engineering Bulletin 3711
---	---



**'MICROFARAD-PACKAGE'
TANTAPAK* CAPACITORS**
Type 200D
Engineering Bulletin 3705

SPRAGUE TANTALEX® CAPACITORS

**The Industry's Widest Tantalum Capacitor Line
Eliminates Size-and-Quality Compromises!**

 Sprague makes a Tantalex Capacitor to meet practically every design requirement. When the circuit calls for a tantalum electrolytic, you'll find what you need in the famous Tantalex Line. Pioneer in the development of tantalum capacitors, Sprague has the largest and most complete research and production facilities in the capacitor industry. That's why Sprague, with its unmatched experience, is your dependable source of supply!

*trademark

 Write for Engineering Bulletins on the Tantalex Types in which you are interested (see bulletin numbers above) to Technical Literature Section, Sprague Electric Company, 35 Marshall St., North Adams, Mass.

 Most-frequently-used Tantalex types are available for off-the-shelf delivery at factory prices in pilot quantities to 499 pieces from your local Sprague Industrial Electronic Distributor.

SPRAGUE COMPONENTS

CAPACITORS
RESISTORS
MAGNETIC COMPONENTS
TRANSISTORS

INTERFERENCE FILTERS
PULSE TRANSFORMERS
PIEZOELECTRIC CERAMICS
PULSE-FORMING NETWORKS

HIGH TEMPERATURE MAGNET WIRE
CERAMIC-BASE PRINTED NETWORKS
PACKAGED COMPONENT ASSEMBLIES
FUNCTIONAL DIGITAL CIRCUITS

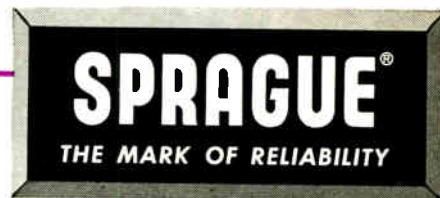

'Sprague' and '@' are registered trademarks of the Sprague Electric Co.

DAYSTROM ROTARY POTENTIOMETERS

**GANG 24 CUPS IN 6 INCHES:
ADJUST IN SECONDS
AFTER GANGING!**



ACTUAL SIZE,
MODEL 319.

The Daystrom 319 Series gangable potentiometer offers a unique advantage never before possible . . . Twenty-four of these can be ganged in a space of six inches, then individually phased after ganging, with no interference to adjacent cups* . . . The result is finite adjustment in a matter of seconds . . . Many hours and dollars can be saved through this feature; you can order the potentiometers already ganged at Daystrom in the number needed, then make final phasing in your circuit . . . The Daystrom 319 Series is ideal for multi-channel applications where space and weight are critical, and offers exceptional stability to shock, vibration, and other severe environmental influences . . . Resistance winding is unique Daystrom "wire-in-the-groove" method . . . Resistance ranges from 100 ohms to 200K are available; power is 2 watts *in still air* at 40°C; operating temperature -55°C to + 150°C; meets or exceeds all applicable MIL specs.

*Patents pending on adjustment method.

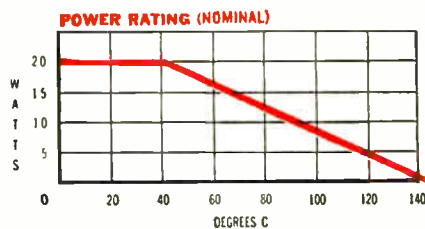

DAYSTROM, INCORPORATED
POTENTIOMETER DIVISION
ARCHBALD, PENNSYLVANIA • LOS ANGELES, CALIFORNIA

DAYSTROM ROTARY POTENTIOMETERS

SUBMINIATURE MULTI-TURN WITH RELIABILITY OF LARGE MODELS:

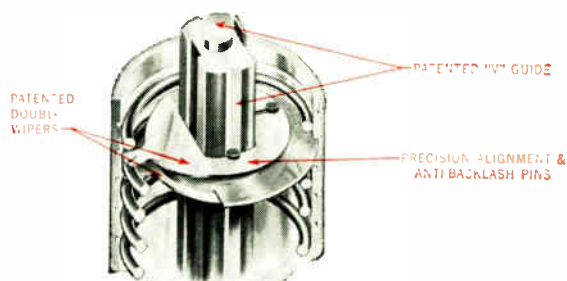

ACTUAL SIZE
MODEL 341

The Daystrom 341 Series offers the unusual benefit of a high-resolution ten-turn potentiometer in a 1"x½" package . . . Much smaller than conventional multi-turns . . . Patented V-Guide within the potentiometer eliminates backlash and resultant error . . . Patented double-wiper arrangement virtually eliminates intermittents due to shock and vibration, and effectively provides finer resolution . . . Patented precision "wire-in-the-groove" method of winding the resistance element still further assures stability to environmental stress . . . Coupled with subminiature size, these features make the 341 Series ideal for avionics systems (ASW, ballistic, and instrumentation) . . . Resistance ranges of 341 Series are from 1K to 600K; power dissipation is 2.5 watts at 40°C *in still air* . . . Meets all applicable MIL specs . . . Can be supplied with patented clutch for servo installation.

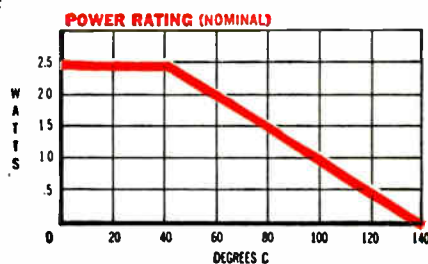

DAYSTROM, INCORPORATED
POTENTIOMETER DIVISION
ARCHBALD, PENNSYLVANIA • LOS ANGELES, CALIFORNIA

WASHINGTON OUTLOOK

PROPOSALS FOR PIECEMEAL changes in the government patent policy are again making their tortuous way through the House of Representatives. Efforts last year to get NASA's practices in line with defense practices passed the House and died in the Senate. There is no reason to believe that this year's try will have better luck.

REVIEW NASA PATENT POLICY

The new attempt to end NASA's statutory patent monopoly (which NASA waives when possible) was reported to the House Science Committee by its patent subcommittee. Changes from last year's try reflect growing opposition to "give-aways" of patents in which government has heavy investment.

But the Senate, where proponents of government ownership of government-finance patents are strong, favors formulation of an overall government policy rather than the House's single-agency approach. The White House's present study of patent policy may provide a focus for action in the next session.

HOUSE OF REPRESENTATIVES has put a new twist into the RS-70 ruckus. In voting a \$47.8-billion defense budget for next year (\$67.5 million under the administrations request) the House earmarked \$52.9 million extra for development of the aircrafts' radar and other electronic components. But it did not provide for the \$320 million expansion in airframe development already authorized by Congress. In effect, Defense Secretary McNamara's cautious approach to the program (p 12, March 30) is being backed.

RS-70 RADAR UPPED

Extra funds were voted to speed up the Dyna-Soar development (for other Air Force R&D requests and changes, see p 30) and to boost production of the Navy's Mark 46 homing torpedo.

THE HOUSE KNOCKED \$25 million off the Air Force's \$636.1-million request for communications and other electronics procurement (p 30, April 20). Apparently concerned about an increase requested for telecommunications spare parts, the committee said that "there is a tendency on the part of those administering these programs to constantly change equipment of this type in order to make any improvement, even though minor in nature. While it is realized (such) equipment is highly essential to the operational requirements of the Air Force . . . tighter control and more stringent review of the changing requirements is in order."

PARE AIR FORCE SPARES

TRADE EXPANSION BILL is being reworked in executive sessions of the House Ways and Means Committee. As indicated by the hearings (p 12, April 13), several soft spots will be remodeled:

TRADE LAW IS BEING REMODELED

Presidential authority to cut tariffs to zero on products sold 80 percent by the U. S. and European Common Market will be spelled out more carefully. Companies will get advance notice of "zero list" products so they can be heard before negotiations start. The committee also leans toward letting industry put an adviser on tariff negotiating teams.

Escape clause protection might well be restored to the bill on the theory that if the President's power to cut tariffs is drastically raised, companies who feel they are damaged by imports should have a chance to get protection. The proposed bill practically eliminates present escape clause protection.

Magnetic Fields

OGO: its first mission. Sometime in 1963, OGO (NASA's Orbiting Geophysical Observatory) will be launched into an elliptical orbit around the earth. It will gather, process and transmit data on the physics of near-earth and cislunar space. Here are some of the studies OGO may undertake in this initial flight: *Energetic particles*, with nine separate experiments on the flux and characteristics of these particles (including cosmic ray and plasma studies). *Radio propagation and astronomy*, through measurements of ambient radio energy not accessible from earth. *Micrometeoroids*, to determine the mass

distribution and direction of interplanetary dust in the vicinity of earth. *Magnetic fields*, their intensity, direction and variation near earth and in space. *Atmospheric measurements*, to study the pressure, temperature and composition of earth and cislunar space. *Ultraviolet scattering*, from hydrogen in space. *Gegenschein photometry*, to study sunlight scattered by interplanetary matter. OGO will be launched into a wide range of orbits and may carry as many as 50 different experiments on each of its missions. This Orbiting Geophysical Observatory will be one of the most versatile earth satellites man has ever built.

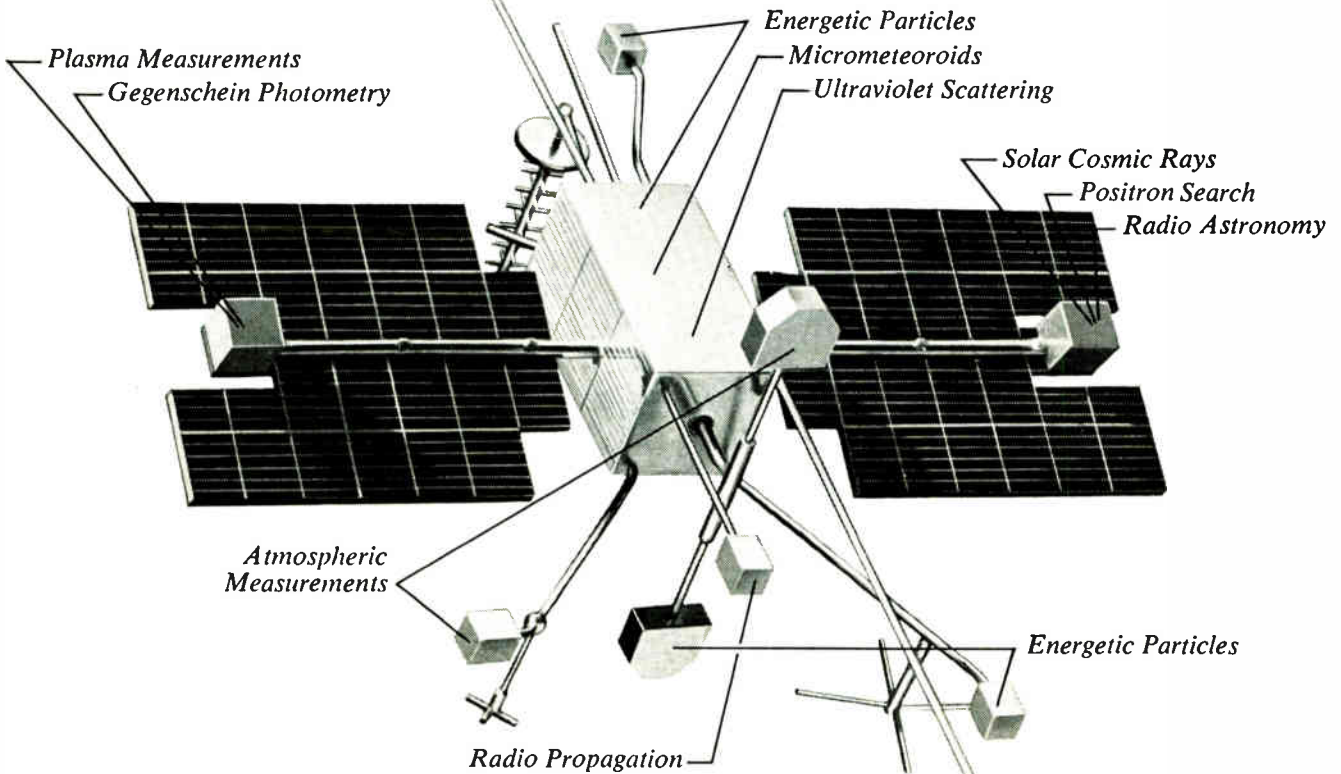

* Captions indicate possible arrangement of instrumentation clusters which OGO may carry.

OGO: its challenge. Today OGO demands advanced techniques in spacecraft design and development to meet its need for flexibility. It is a challenging responsibility to STL engineers, scientists and supporting personnel, who design it, fabricate it, integrate it, and test it. This versatile spacecraft will be manufactured at STL's vast Space Technology Center where expanding space projects (OGO, Vela Hotel and other programs) create immediate openings for engineers and scientists in fields

such as Aerodynamics; Spacecraft Heat Transfer; Analog and Digital Computers; Applied Mathematics; Electronic Ground Systems; Power Systems; Instrumentation Systems; Propellant Utilization; Propulsion Controls; System Analysis; Thermal Radiation; Trajectory Analysis. For Southern California or Cape Canaveral positions, write Dr. R. C. Potter, One Space Park, Department — J, Redondo Beach, California, or P. O. Box 4277, Patrick AFB, Florida. STL is an equal opportunity employer.

VLF Radio Propagation
Magnetic Fields



SPACE TECHNOLOGY LABORATORIES, INC.
a subsidiary of Thompson Ramo Wooldridge Inc.

Los Angeles • Vandenberg AFB • Norton AFB, San Bernardino • Cape Canaveral • Washington, D.C. • Boston • Huntsville • Dayton.



For as little as half the price of a steak dinner you could probably put a five-year guarantee on your product

Be a great shot in the arm for sales, wouldn't it? A five-year warranty tag on your equipment.

A Heinemann circuit breaker or overload relay could make it feasible. (Possibly for less than half the cost of a prime sirloin.)

If this seems far-fetched, you might try talking with a couple of our OEM customers. There are several who offer profitable long-term product guarantees. More than one has hinted to us that such guarantees would be impractical (or even impossible) without the close-tolerance overload protection of a Heinemann breaker or relay.

This 'close-tolerance' thing is important. What does it mean?

A continuous-duty current rating that is calibrated to the precise value you specify. (Even if it's an odd-ball value like 0.010 or 21.7 amps.)

A time-delay response that fits hand-in-glove with equipment operating characteristics. (We offer several time-delay curves for you to choose from. Plus instantaneous response).

The ability to function properly at both high and low ambient-temperature extremes. (Heinemann circuit breakers and relays are magnetically

actuated. Hence, no derating to worry about, no problems of erratic tripping response.)

These are the main points.

There are a number of others. The Heinemann Engineering Guide, Bulletin 201, will give you detailed technical information. A copy is yours for the asking.



**HEINEMANN
ELECTRIC COMPANY**
2600 BRUNSWICK PIKE
TRENTON 2, NEW JERSEY

Heinemann products are now guaranteed for five years as set forth in current sales bulletins.

ANCIENT HISTORY



ΜΥΚΟΝ Εἰς, ΔΥΟ, ΤΡΕἰς
ΤΕΤΤΑΡΕΣ, ΠΕΝΤΕ ἔΤΟΣ

MINCOM HAS
DELIVERED RELIABLE
1-MEGACYCLE PER-
FORMANCE FOR THE
PAST 5 YEARS

Reliable wideband performance at Mincom is an old story — and a good one. Mincom systems were recording and reproducing extremely complex signals at 1 mc as far back as 1955. Today Mincom's 1-mc system, the CM-100, is noted as a pioneer in operational predetection. Another system, the CMP-100, is a smaller mobile unit for recording in the field — also with 1 mc at 120 ips. The CM and CMP (as well as the other two basic Mincom systems) provide the simple, reliable data-gathering capability possible only with longitudinal recording on fixed heads. For all the details on Mincom's dependable wideband instrumentation, write us today.

Mincom Division **3M**
COMPANY
Los Angeles 25, California • Washington 4, D.C.

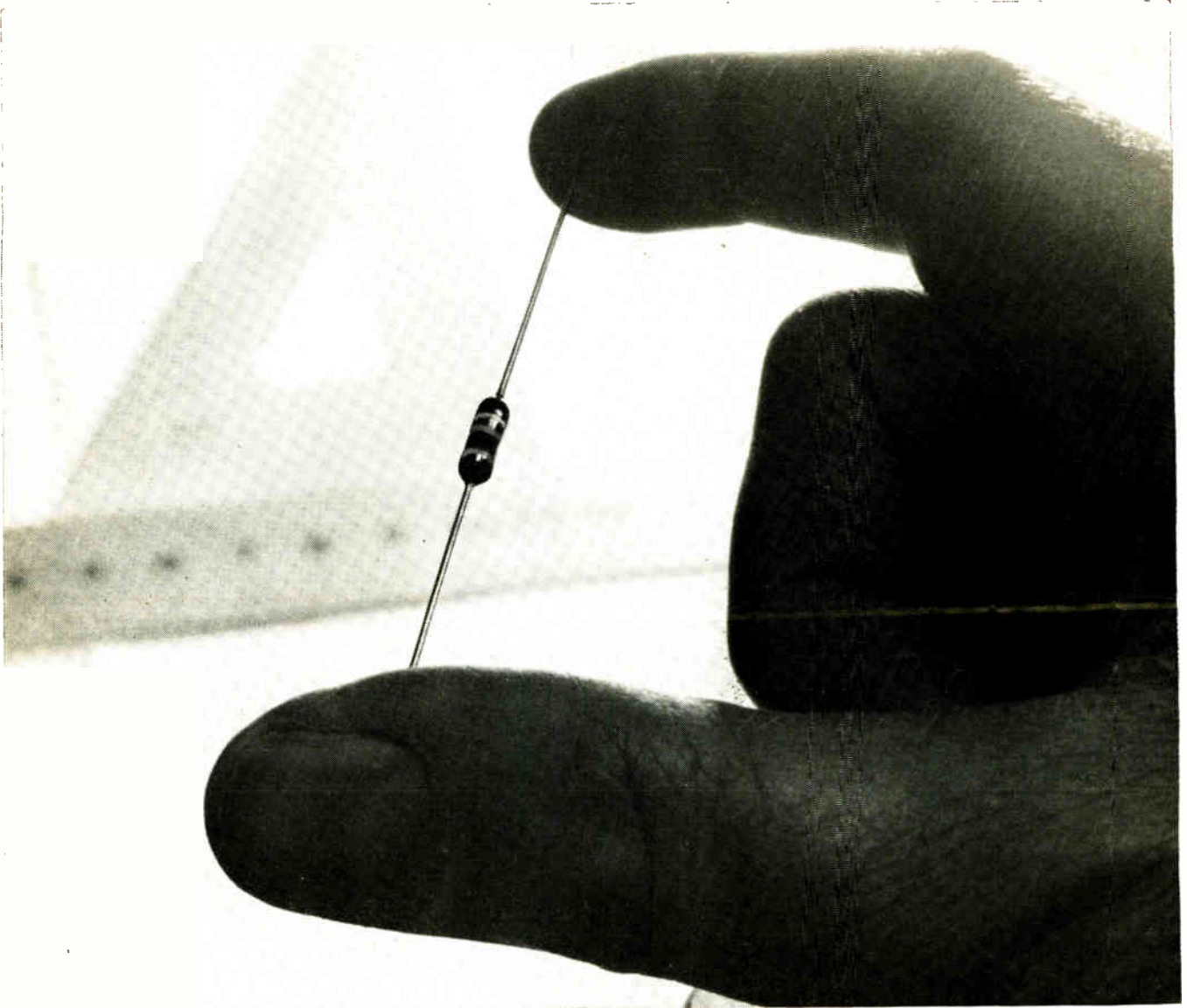

Why more good circuits start with Corning C resistors

First, you get performance within precision parameters from general purpose C-style resistors.

Second, C resistors let you plan a circuit within *known* limits of total resistance change from nominal—as little as 5%. Our new Corning Design Tolerances, based on extended load-life tests, give you that assurance.

Third, you get this predictably high performance at low

cost. C resistors are priced competitively with composition types.

C resistors give you these design advantages uniformly because we control the composition of their materials, and the way those materials bond together, in a continuous process.

C resistors that meet MIL-R-22684 are available from your Corning distributor in four sizes and values.

Get data sheets, test reports, and a brochure, "The Story Behind the Corning C Resistor," by writing Corning Glass Works, 539 High Street, Bradford, Pa.

Type	Wattage	Resistance (ohms)		Nominal Dimensions	Design Tolerance Full power, 70°C.
		min.	max.		
C07, Mil Style RL07	¼	51	150K	.250" x .090"	5% plus purchase tolerance
C20, Mil Style RL20	½	51	150K	.375" x .138"	
C32, Mil Style RL32	1	51	470K	.562" x .190"	
C42S, Mil Style RL42	2	10	1.3 meg	.688" x .318"	

CORNING

Electronic Components

HERE ARE 10 GROUPS OF CENTRALAB SWITCHES THAT MEET

MIL-S-3786A

Finest quality materials and special engineering features result in ultra-reliable performance.

Index parts are heavy cadmium-plated, dichromate dipped steel to meet 100 hour salt spray tests (most MIL specifications call for 50 hour tests). Indexing balls are of stainless steel, not cold rolled steel.

Sections are of steatite Grade L533 (MIL-I-10A) for 125°C operation, of Type PBE phenolic (MIL-P-3115B) for 85°C operation.

Stationary Clips are of coin silver alloy, with double wiping action, 3-plane locking to section, and are lubricated to reduce wear.

For complete data on these and many other Centralab switches, write for Catalog 42-1195 available free on request from



THE ELECTRONICS DIVISION OF GLOBE-UNION INC.
900 East Keefe Avenue, Milwaukee 1, Wisconsin
In Canada: Centralab Canada Ltd., P.O. Box 400, Ajax, Ontario

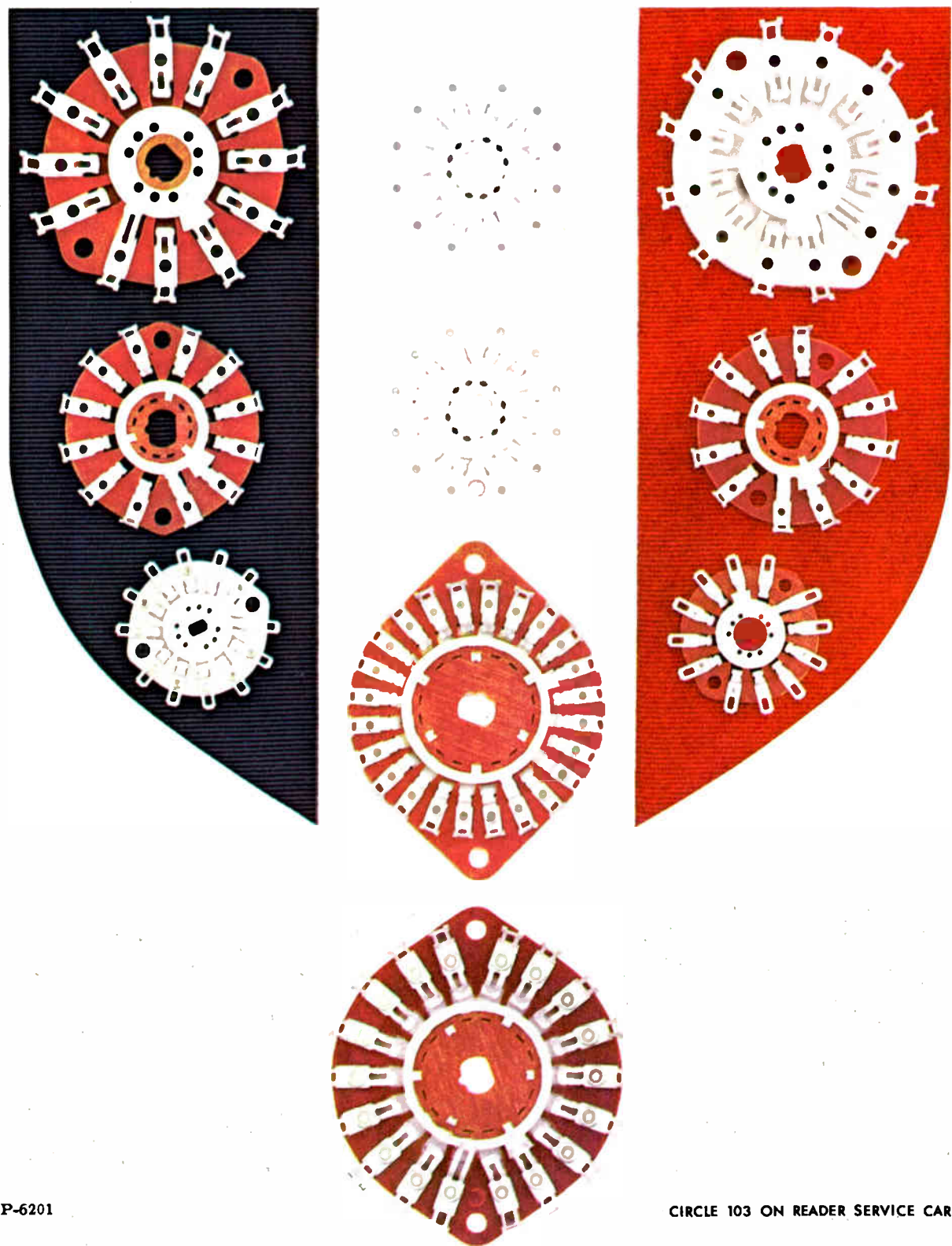

Super Squaremu "79" is a new high-purity alloy of closely controlled composition, an exclusive development of Magnetic Metals. When used in Centricore tape-wound cores, it assures the magnetic amplifier designer the ultimate in core performance and consistent reproducibility of his designs.

Compared with conventional alloys of the same nominal composition, Super Squaremu "79" offers these advantages: ■ High flux density ■ Greater gain ■ Increased

linear range ■ Greater thermal stability ■ Improved uniformity of performance

Centricores made of Super Squaremu "79" deliver the same consistently high performance from core to core and lot to lot, as proved through production quantity runs. They're now available in a new hermetically sealed case, in all standard sizes and shapes. Write or call today for complete specifications. MAGNETIC METALS COMPANY, Hayes Avenue at 21st Street, Camden 1, N. J.

NEW HIGH PERFORMANCE ALLOY



***... makes Centricores®
the most uniform of all
tape-wound cores!***



transformer laminations • motor laminations • tape-wound cores • powdered molybdenum permalloy cores • electromagnetic shields

MMAGNETIC
METALS

What sets the stage for scientific discovery?



H. E. D. Scovil, pioneer developer of the solid state microwave maser, explains a point at a symposium at Bell Telephone Laboratories.

There is no one answer. But surely discovery is more likely when people are stimulated to think in new ways. And nothing more powerfully stimulates scientists and engineers than up-to-the-minute discussion of the latest developments.

Bell Laboratories scientists and engineers make a point of exchanging information on their latest advances not only among themselves but with the great world-wide professional community to which they belong. Last year, for example, Bell

Laboratories specialists delivered over 1200 talks to technical societies and universities. The stimulating exchange of new ideas plays an indispensable role at the world center of communications research and development.



Bell Telephone Laboratories

- **Rack-mounted signal sources for 900-11,000 mc.**
- **High-power coaxial cable that's really flexible**
- **New crimp-type subminiature connectors**

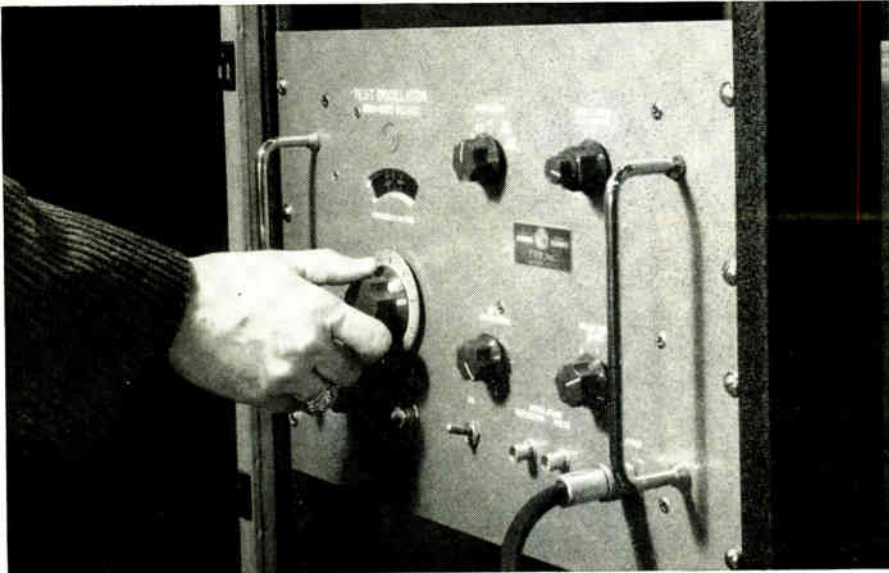

Rack-mounted signal sources for 900-11,000 mc.

Now you can mount FXR's series 772 test oscillators in standard 19-inch racks—for use in laboratories and other permanent test applications. Like the FXR portable models, these new rack-mounted signal sources provide ample RF power in the 900 to 11,000 mc. range.

In all signal sources, power supply and klystron are combined in a single unit. This makes operations safer—exposed klystron wires are eliminated. Klystron replacement is faster and less expensive—as little as 1/4 the cost of klystron replacement in separate power supply and klystron set-ups.

MODEL	FREQUENCY RANGES	PRICE
L772A	0.95 to 2.0 KMC	Portable \$1235. Rack \$1250.
S772A	1.9 to 4.0 KMC	\$1035. \$1050.
C772A	3.95 to 8.2 KMC	\$1340. \$1355.
X772A	7.0 to 11.0 KMC	\$1340. \$1355.
Power Output	10 MW to 100 MW max CW output. Power variable through use of an internal level-set attenuator.	
Modulated Outputs	Internal: CW, pulse or square wave External: Pulse, square wave or FM	
External Modulation Requirements	Pulse: Positive pulse of 30 v. amplitude across 100 K ohms. Pulse width from 0.5 microsecond to square wave. Reflector: sine wave or sawtooth FM, sensitivity from 100 to 200 kc/v.	
Connectors	RF Output: Type N jack. External pulse: Type BNC jack. Reflector modulation: Type BNC jack.	
Power Requirements	115/230 v. AC, 50 or 60 cycles, 150 w.	
Dimensions & Weight	Portable: 11" high X 16" wide X 15" deep; 45 lbs. Rack: 11" high X 19" wide X 15" deep; 45 lbs.	

Single-control tuning lets you set frequencies faster and more accurately ($\pm 1\%$). Frequency remains constant, no matter how you vary the power output, because the klystron reflector voltage automatically

changes with the positioning of a broad-band, non-contacting tuning plunger inside the oscillator cavity.

RF power output ranges from 10 to 100 MW. It's controlled from the front panel, through a level-set attenuator.

The portable models are available from stock; the rack-mounted models are shipped within a month. For more information, circle Reader Card Number 253. ■

High-power coaxial cable that's really flexible



This is a new FXR product—Amphenol type RG-281/U coaxial cable. It was developed for an Air Force electronic counter measures system, where small space required a cable that bends and flexes easily without changing electrical properties. Now, it is available commercially.

Perforated Teflon tape dielectric gives this cable extra flexibility. The tape continuously supports the center conductor...keeps center and outer conductors concentric even when the cable is bent over small radii.

Teflon tape also cuts down moisture condensation at dielectric interfaces because it eliminates voids between cable and connector dielectrics.

Type RG-281/U power cable gives you a VSWR of less than 1.2... a dielectric constant of 1.55... serves as general purpose RF transmission line, easy to install and operates at high temperatures. *For more information, circle Reader Card Number 254.* ■

New crimp-type subminiature connectors

FXR's new Subminax® Series 5116 quick-crimp micro-miniatures make faster, more reliable, less costly cable assemblies. And you don't have to re-design your product to use them, because Series 5116 micro-miniatures are interchangeable with competitive counterparts. In fact, the addition of this new Series to the Subminax line means that you can now specify a Subminax connector that mates with or is interchangeable with any known sub-miniature or micro-miniature coaxial connector on the market today.

The new Subminax Series 5116 has at least three major advantages over other micro-miniatures:

□ *Faster Assembly*—Quick-crimping feature, plus standard crimping tool, makes child's play of cable assembly. For example, Series 5116 plugs and jacks have only three parts, including body assembly. Easier, less critical cable stripping. No braid soldering.



□ *Dependable Delivery*—new FXR micro-miniatures are immediately available from factory stocks or your Amphenol distributor.

□ *Lower Price*—Series 5116 coaxial connectors are priced substantially below current prices for competitive "equivalents."

□ *Technical Facts*: 500 VRMS; impedance: 50, 75 or 95 ohms; gold-plated captivated contacts (solder type); Teflon* insulation; silver-plated body; screw-on or push-on coupling; color coding boots—optional. For use with coaxial cables in the .075 to .115 OD range. *For more information, circle Reader Card Number 255.* ■ *Registered trademark of DuPont

It takes a jeweler to make waveguides at new FXR facility

FXR recently expanded its microwave facilities at Woodside, New York, to meet the growing demand for millimeter waveguides. But expansion is only part of the story. Precision is the other.

The waveguides made here are used in space communications equipment. They have to be extremely

small and extremely accurate. The combination calls for some of the most delicate machining operations you'll see outside a jeweler's shop. Tolerances—as small as 0.0001 inch—are so critical that FXR technicians at Woodside put parts through a final diamond-lapping operation to achieve the necessary accuracy in dimension and surface.

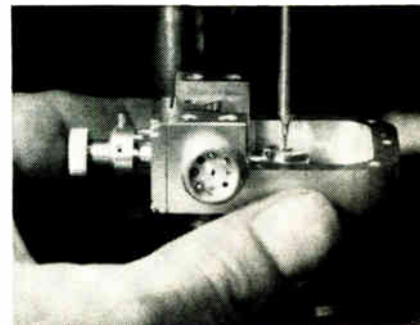

FXR uses Starrett Depth Gauge to check accuracy of slotted waveguide parts within ± 0.0001 inch.

A large engineering staff supports these precision manufacturing facilities. It works with customers in developing special products for microwave applications. ■

The RF Products and Microwave Division Amphenol-Borg Electronics Corporation; 33 East Franklin Street, Danbury, Connecticut.

FXR™

EQUIPMENT SHOW FEATURES

Data Retrieval, Controls, Shop Reporting

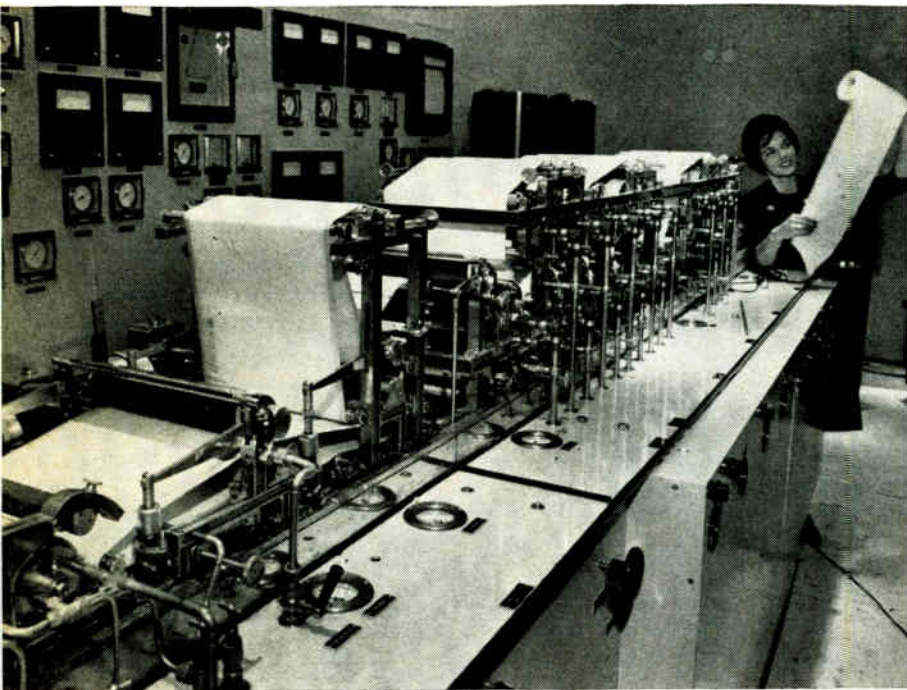

IBM set up a miniature paper mill to demonstrate closed-loop control

By CLETUS M. WILEY

Midwest Editor

CHICAGO — Information retrieval, machine tool and process controls, and centralized shop reporting were the biggest attractions among electronics developments featured by more than 80 exhibitors at the Business Equipment Exposition in Chicago this month.

These and other data handlers—equipment heavily dependent on electronics—made up more than half of the record \$30 million in products at the show, seen by more than 40,000 businessmen.

Among present trends, development of common languages to link various units is widely rated as important today as the early computer breakthroughs were in their day.

Some show-stoppers were:

- Selective Dissemination of Information, previewed by IBM, would supply key men with abstracts of pertinent articles distilled from the flood of information pouring into any organization.

A 1401 computer matches the tape-stored special interest profile of each individual with document profile abstracts of each article on a second tape. Selected lists and abstracts are printed out in about 30 seconds.

- Lektrafile, shown by Remington Rand, directs pencil beams of light across records moving up or down in carriers, to deliver any desired file in about 7.5 seconds.

- The operator of an image control unit developed by Recordak presses a button to key the index number of a document, compacted on a roll of microfilm, into a control keyboard. A control reader abstracts and images the desired document on a screen in four seconds, or prints a facsimile of it in half a minute.

Another Recordak information retrieval system frames strips of

Business Equipment Nears \$5 Billion

CHICAGO — Increasingly electronic, the business equipment market has doubled during each of the past two decades and is now nearing an annual volume of \$5 billion. This industry will outgrow others in the U. S. two-to-one over the next 10 years, Harry Anderson, president of Business Equipment Manufacturers Association, said at the opening of BEMA's annual exposition.

Heavier competition—here and abroad—and accelerated automation, are giving business equipment an important boost, exhibitors agreed. Office equipment sales will jump 10 to 12 percent this year, predicted Joseph Wilson, of Xerox.

"This market grows faster than the general economy," explained Robert Oelman, of National Cash Register. The population boom has created a growing flood of paper work.

Desk-sized data processors are opening up the small office market.

With office population expanding at a rapid rate, electronic dictating equipment is finding today's market 30 percent bigger than ten years ago, according to Lloyd Powell, of Dictaphone.

Data processing offers business equipment manufacturers their greatest sales potential in Europe's Common Market, Charles Campbell of IBM, told a Common Market panel. "Electronic computers are half of our company's total exports," he said. Although Europe is three to four years behind the U. S. in this field today, it can be expected to catch up quickly.

Germany is very automation-minded, reported Angus Wood, of A. B. Dick. The business equipment market growth may reach twice the U. S. rate.

microfilm containing up to 40 catalogue or other information pages in rigid holders. An index system selects the desired microstrip and picks out the desired page within the strip in 4 to 5 seconds.

• Shop reporting equipment shown by Stromberg division of General Time collects data in machine language from combinations of punched identification, job and operation cards. Message transmission units are placed at strategic points in manufacturing plants and department stores.

Factory-to-office data collection hookup makes manufacturing data or messages instantly available to

the factory control center. Transactor system is so rapid, the company reports, that many timekeepers can now handle engineering and stockroom reports too.

• Magnetic ledger cards introduced by National Cash Register store more than 200 digits on the backs of otherwise conventional business forms, combining the advantages of accessible records with the speed, flexibility and storage capacity of magnetic recording.

• DeJur-Amsco introduced an office dictating machine that records on a reusable sheet of pre-grooved magnetic foil and mylar. The recording is automatically fed

into the machine and ejected at the end of a letter.

• For interoffice calls, Tele-Norm has a pushbutton phone that waits if a line is busy and completes the call automatically when the line is free. The caller doesn't lift the receiver until a buzzer signals the call has been put through.

• IBM gave several live demonstrations, including a machine that turned out eight feet of paper a minute. The model showed how a 1710 process control system will run a full-sized mill. Analog data is converted to digital for evaluation in a 1620 computer acting as a closed-loop process control.

Cesium Gas C-W Laser Is Optically Pumped

CONTINUOUS WAVE coherent light, at 7.18 microns in the far infrared has been obtained with an optically pumped gas laser, by Technical Research Group, Syosset, N. Y.

Triple-distilled cesium gas is generated from an oven-controlled reservoir of cesium metal. A temperature of 175 C maintains the required vapor pressure. The gas is excited by light generated from an r-f-powered helium lamp. D-c or pulse power may also be used with the latter allowing peak intensities many times greater than the c-w system.

Exceptionally high coherence is reported for the cesium laser; an estimated laser line width is no more than 0.003 cps at the 7.18

micron operating wavelength.

This narrow line width is achieved without reducing the output power below the 50 μ w normally obtained with the laser. One-mw output is expected with minor changes, such as increasing the output coupling.

Using a flash lamp with peak intensity 1,000 times greater than the c-w lamp now employed, a peak output power of one watt is considered possible. Very high peak pumping powers cannot be applied to a helium-neon laser.

The cesium gas laser was developed by Stephen Jacobs, with Paul Rabinowitz. Gordon Gould also contributed to the project.

Jacobs and his associates are con-

fident that coherent light at 3.2 microns can be generated with the cesium laser with only slight device modifications. In 1961 amplification was reported at 3 microns in experiments by this group, working with cesium. Work was directed toward a 7.18 micron laser as it was considered more readily obtainable.

Angular divergence of the beam is 2 milliradians. This corresponds to the diffraction spread of a plane wave passing through a 3.2-mm aperture.

Using a cesium laser of suitable power, and an external optical system including a one-meter mirror, a beam from just outside of the earth's atmosphere would be one mile in diameter on the moon.

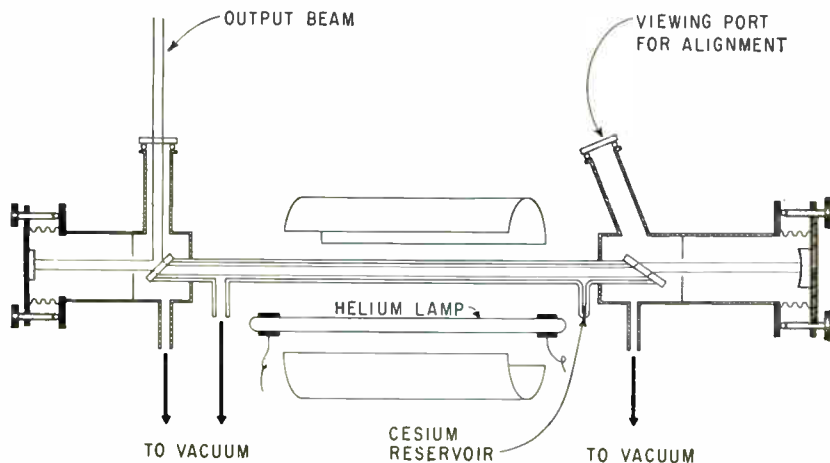

Barium fluoride windows laid against ends of 92-cm tube readily passes ir



Helium lamp source is r-f powered

for a versatile precise instrument... Specify



ELCOR MODEL A 309 A CURRENT INDICATOR AND INTEGRATOR

- Wide Range — 3×10^{-9} to 1×10^{-3} amp in 12 ranges
- Ultra Stable — .01% Per Hour Maximum Drift
- Internal Calibration — For Each Range
- Precise — 0.2% Reproducibility
- Recorder Output
- Field Tested throughout the world

TYPICAL APPLICATIONS:

Monitor and integrate electron and positive ion beam current.
Used with high voltage particle accelerators.
Gas chromatography.
Recording continuous coulombmetric experiments.

The Model A3909A is one of a complete line of current indicators and integrators manufactured by Elcor. For other uniquely designed instruments, isolated power supplies and components... specify Elcor.

for complete information, write, wire or phone:



ELCOR, Incorporated

Subsidiary of Welx Electronics Corporation

1225 West Broad Street, Falls Church, Virginia. Telephone
Code 703 — JE 2-8850 (FAX No.-RF), Falls Church, Va.)

Some areas still open for representation

CIRCLE 201 ON READER SERVICE CARD

SANDERS TRI-PLATE® MODULES quickest way to prove circuit ideas

© Sanders Associates, Inc.

New microwave circuit designs — no matter how advanced or daring — can now be tested quickly, easily, economically. For TRI-PLATE Strip Transmission Line Modules eliminate much of the cost and time-consuming delays in breadboarding circuit designs. ■ The versatile, reusable TRI-PLATE building blocks permit you to go from design to breadboard to prototype and ultimate production with known characteristics. ■ Over 600 TRI-PLATE Modules cover all standard circuitry — hybrid rings, directional couplers, ferrite circulators, phase shifters, power dividers, attenuators, and more. Sanders offers over 150 different Mounts for various semiconductor devices. ■ You, too, can create new directions in microwave, computer and semiconductor circuit design with TRI-PLATE Modules. For complete information, write Sanders Associates, Inc., Microwave Products Department, Nashua, N.H.



CREATING NEW DIRECTIONS IN ELECTRONICS

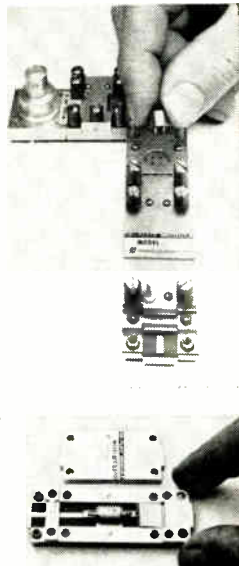

24 CIRCLE 24 ON READER SERVICE CARD

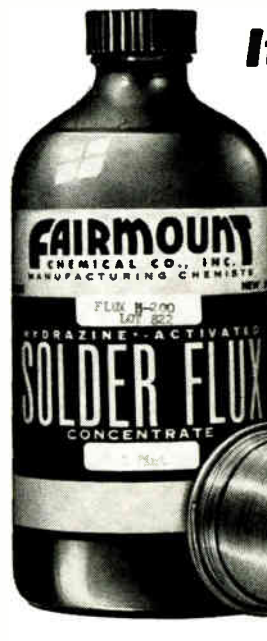

It stands alone

You can't buy HYDRAZINE-ACTIVATED FLUX* or Core Solder under any other brand name. Fairmount is the sole producer.

Hydrazine-Activated Flux and Core Solder offers an exclusive combination of advantages:

- High wetting properties for good "bite."
- Non-corrosive connections.
- Residues removed by heating or water rinse.
- No change on aging.

These performance characteristics were confirmed in a recent evaluation of leading fluxes used in the fields of printed wiring and etched circuitry.

No one flux is best for all purposes. TEST HYDRAZINE FLUX AND CORE SOLDER FOR YOURSELF. The liquid permits pre-fluxing, is useful for soft-soldering a wide range of copper and copper-based alloys. The core solder flows at an ideal rate, leaves a minimum of soldering residues. Write for samples of either, or technical literature.

*U.S. Patent No. 2,612,459 and others

Available only from Fairmount
and its sales agents.

Fairmount
CHEMICAL CO., INC.
136 Liberty St., N. Y. 6, N. Y.

CIRCLE 202 ON READER SERVICE CARD

electronics

NEW... LIGHTWEIGHT
(because it's transistorized)



THE ONLY SPECTRUM ANALYZER YOU TAKE TO WORK!

Now you can make quick, sure measurements by spectrum analysis **out on the job**. Just bring your Polarad Model SA-84T along. It weighs only 100 pounds. Covers the entire frequency range 10 to 40,880 mc in a small self-contained transistorized unit. No other piece of microwave test equipment is handier or more practical for mobile and airborne applications.

And, that's not all. This latest advance in Polarad's complete line of microwave visual analysis equipment offers: sensitivity

to -105 dbm; 12 volt dc or 115 volt ac operation; built-in I-F attenuator, 41 db in 1 db steps; and single knob Unidial® frequency control.

Don't, by the way, consider this instrument for its portability only. It has all the well-known Polarad spectrum analyzer features that will make it your every day lab instrument. And when you need to—take it to work!!! Ask your local Polarad Representative for a demonstration.

MODEL SA-84T SPECIFICATIONS

Frequency Range	10 mc to 40,880 mc
Resolution Bandwidth	20 kc at all frequencies
Sweep Repetition Rate	1 to 30 cps adjustable
Spectrum Calibrator Frequency	±13 mc
I-F Attenuation	Calibrated from 0 to 41 db, variable in 1-db increments; accuracy 0.1 db/db
Operating Temperature	10°C to 55°C (14°F to 131°F)
Dimensions	16 1/4" wide x 17 3/4" high x 18 1/2" deep

POLARAD ELECTRONICS CORPORATION:
 43-20 34th St., Long Island City 1, New York



Please send me information and specifications on:

- Model SA-84T Spectrum Analyzer
- Handbook of Spectrum Analyzer Techniques

My application is _____

Name _____

Title _____ Mail Station _____ Dept. _____

Company _____

Address _____

City _____ Zone _____ State _____

POLARAD

ELECTRONICS CORPORATION

43-20 34TH STREET, LONG ISLAND CITY 1, NEW YORK

FREE LIFETIME
 SERVICE

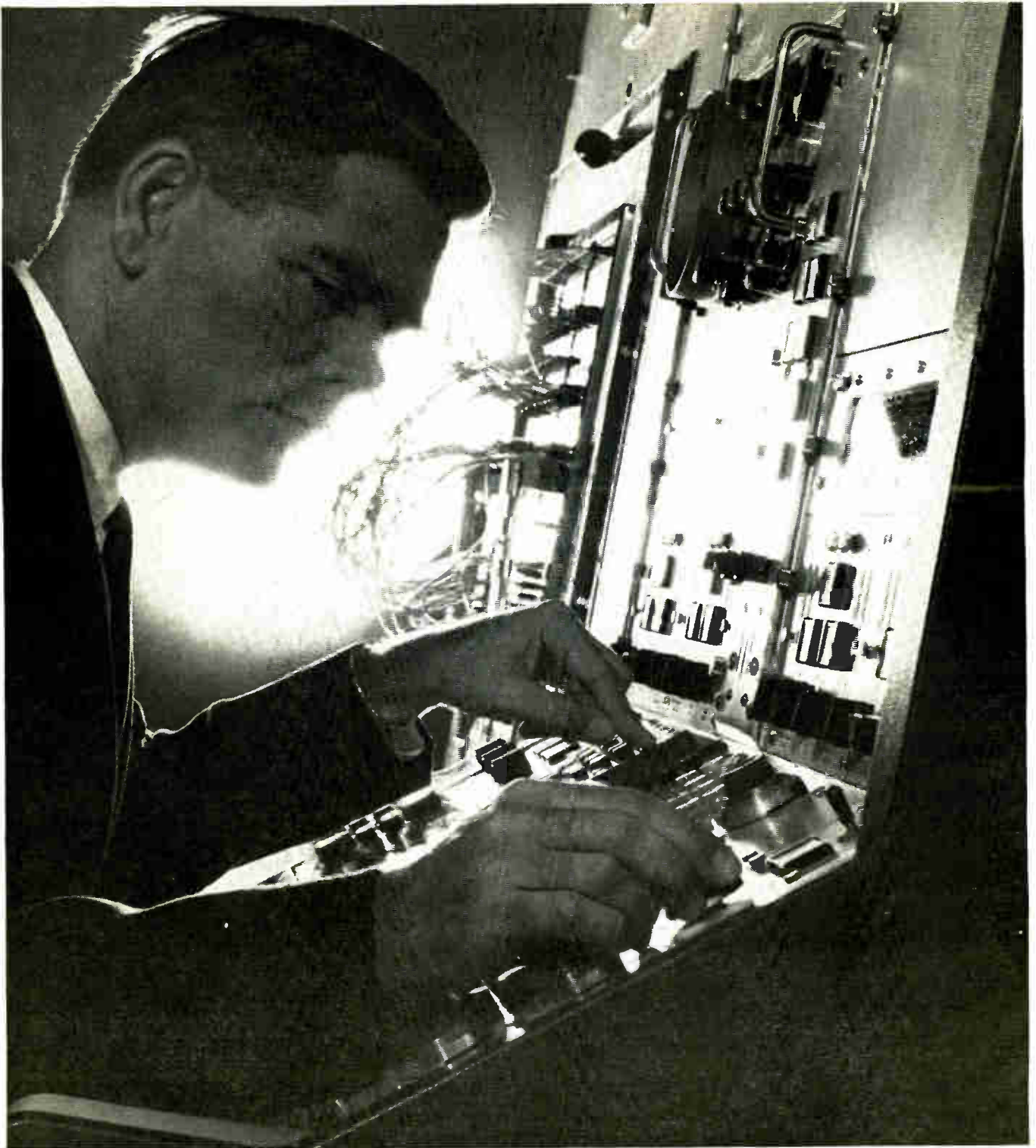

TRULY CENTRALIZED PROBLEM CONTROL is now offered in the new 2100 Series EASE® Analog Computer. Pinboard control for iterative (IDA™) or non-iterative (ELDA™) operation. Domain control. Sector time scale control. As many as 36 different asynchronous computing groups. These are only a few of the advanced features that make this the most flexible and complete simulation tool available. For extensive details, ask for brochure A2100.

Beckman®

INSTRUMENTS, INC.
BERKELEY DIVISION
RICHMOND, CALIFORNIA

C-28



**Mil Spec
Hook-Up Wire
by Belden**

Regularly exceeds the rigid requirements of Military Specifications for electronic or electrical applications. All colors, types, sizes, insulations, and temperature ranges in stock — for immediate shipment. Ask for Catalog 861.

Belden

WIREFORMER FOR INDUSTRY
SINCE 1902 — CHICAGO

magnet wire • power supply cords •
cord sets • portable cordage •
control cables • electronic wire

FREQ. STDS.

AND PRECISION FORK UNITS 1 TO 40,000 CYCLES

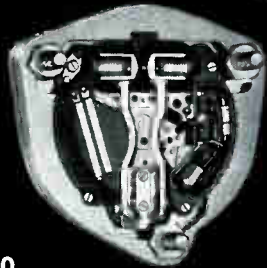

TYPE 10
1 3/8" x 1 3/8" x 3/8"

This frequency standard (360 or 400 cycles) is accurate to ± 50 parts per million at 10° to 35°C. Aging has been greatly minimized.

External power of 1.4 volts at 6 microamperes powers the unit.

TYPE 2007-6



TYPE 25



TYPE 2001-2



TYPE 2007-6 FREQUENCY STANDARD

Transistorized, Silicon type
Size, 1 1/2" dia., x 3 1/2" H., Wt., 7 oz.
Frequencies: 360 to 1000 cy.
Accuracies:

2007-6 $\pm 0.2\%$ (-50° to $+85^\circ\text{C}$)
R2007-6 $\pm .002\%$ ($+15^\circ$ to $+35^\circ\text{C}$)
W2007-6 $\pm .005\%$ (-65° to $+85^\circ\text{C}$)
Input: 10 to 30V DC at 6 ma.
Output: Multitap, 75 to 100,000 ohms

TYPE 2001-2 FREQUENCY STANDARD

Size, 3 3/4" x 4 1/2" x 6" H., Wt., 26 oz.
Frequencies: 200 to 3000 cycles
Accuracy: $\pm .001\%$ at $+20^\circ$ to $+30^\circ\text{C}$
Output: 5V at 250,000 ohms
Input: Heater voltage, 6.3 - 12 - 28
B voltage, 100 to 300 V, at 5 to 10 ma.
Accessory Modular units are available to divide, multiply, amplify and power this unit.

TYPE K-5A FREQUENCY STANDARD

Size, 3 1/2" x 3" x 1 3/4"
Weight, 1 1/2 lbs.
Frequency: 400 cycles
Accuracy: .03%, -55° to $+71^\circ\text{C}$
Input: 28V DC $\pm 10\%$
Output: 400 cy. approx. sq. wave
at 115V into 4000 ohm load (approx. 4W)

TYPE 25 PRECISION FORK

Size, 5/8" dia. x 2 1/8"
Weight: 2 ounces
Frequencies: 200 to 1000 cy.
Accuracies:
R-25T and R-25V $\pm .002\%$ (15° to 35°C)
25T and 25V $\pm .02\%$ (-65° to 85°C)
For use with tubes or transistors.

INQUIRIES INVITED

For over 20 years we have made frequency standards and precision fork units for applications where consistent accuracy and rugged dependability are vital. Shown are just a few typical examples.

Some users integrate our products with instruments of their own manufacture. In other cases we develop complete assemblies to meet special needs.

You are invited to submit any problems within the area of our activity for study by our engineering staff.



AMERICAN TIME PRODUCTS

DIV. OF BULOVA WATCH COMPANY, INC.

61-20 Woodside Ave., Woodside 77, L. I., N. Y.

WESTERN OFFICE, 234 N. LAKE AVE., PASADENA, CALIF.



Reliability at low cost in power supplies...

● Many circuit refinements and improvements are made practical by the availability of (a) small size silicon rectifiers rated up to 800 volts at 500 to 750 milliamperes, and (b) compact high voltage silicon rectifier stacks with peak

inverse ratings to 10,000 volts. A dozen units of the first group and four of the latter are listed below. All are available at realistic cost and will increase reliability over tube supplies.

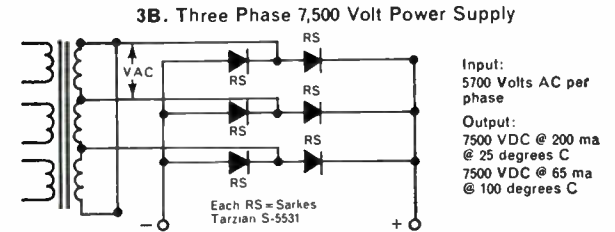
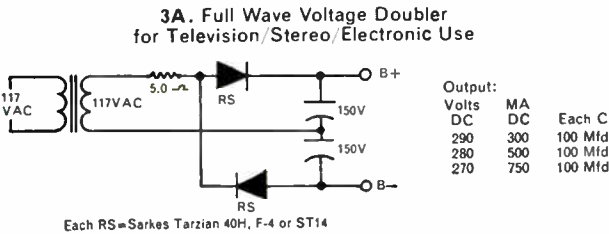
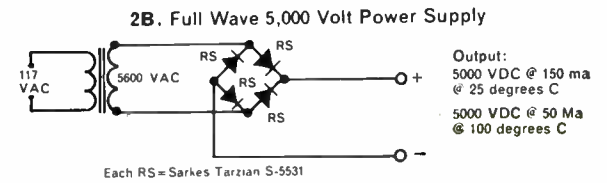
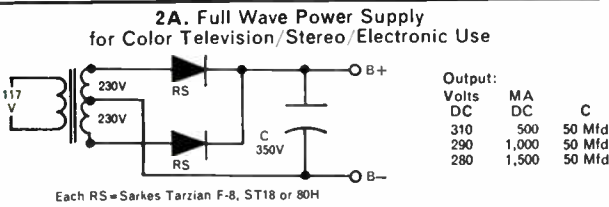
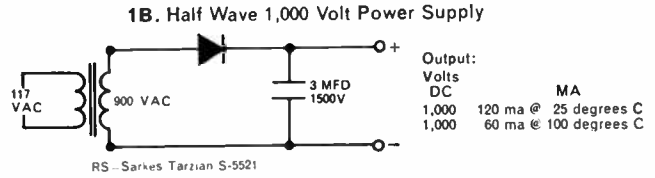
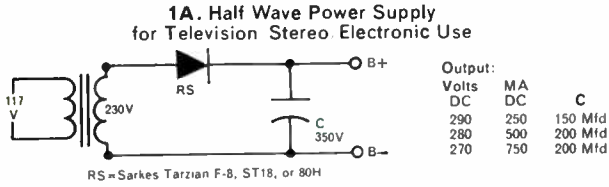

Three general circuits are shown for each of the two groups mentioned above to suggest some of the possibilities. For example: 1-A, a simple half-wave circuit operating off a 230 volt line or with a 1 to 2 step-up transformer, delivers between 270 and 290 volts with a capacitive input; 2-A, with two rectifiers

in a full wave circuit with a center tap transformer, delivers approximately 300 volts across a wide range of current ratings; and so on. Similarly the high voltage rectifiers let you design compact half wave and full wave supplies at moderate cost.

SARKES TARZIAN LOW CURRENT RECTIFIERS

TARZIAN TYPE	MAX. PRV	MAX. RMS VOLTS	MAX. DC MA 55° C	MAX SURGE AMPS	DIMENSIONS
20H 40H 60H 80H	200 400 600 800	140 280 420 560	750 750 750 750	75 75 75 75	
F-2 F-4 F-6 F-8	200 400 600 800	140 280 420 560	750 750 750 750	75 75 75 75	
12 14 16 18	200 400 600 800	140 280 420 560	750 750 750 750	75 75 75 75	
S-5518 S-5521 S-5529 S-5531	1,000 3,000 4,000 10,000	700 2,100 2,800 7,000	200 150 50 25	20 15 5 5	

Whatever your application, let Tarzian engineers consider it for practical recommendation. Catalog available on request.



SARKES TARZIAN, Inc.

World's Leading Manufacturers of TV and FM Tuners • Closed Circuit TV Systems • Broadcast Equipment • Air Trimmers • FM Radios • Magnetic Recording Tape • Semiconductor Devices

SEMICONDUCTOR DIVISION • BLOOMINGTON, INDIANA
In Canada: 700 Weston Rd., Toronto 9 • Export: Ad Auriema, Inc., New York

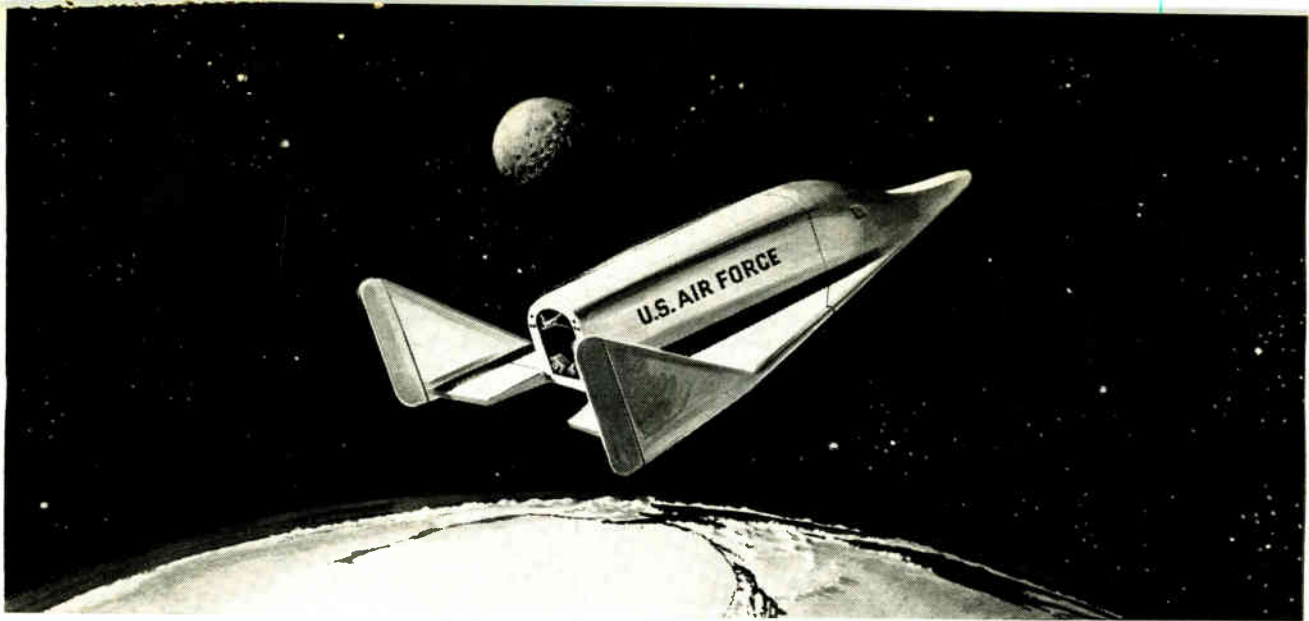

House has voted to increase appropriation for Dyna-Soar by \$42 million, to \$157 million. This is artist's conception, by Boeing, of the manned space glider

Air Force Asks \$3.7 Billion for RDT&E

By JOHN F. MASON

Associate Editor

AIR FORCE has asked for \$3,439 million in new obligating authority for research, development, test and evaluation (RDT&E) for fiscal year 1963. With an additional \$303.9 million authorized in prior years but not spent, the total will be \$3,742.9 million.

Plans for the money were described by Lt. Gen. J. Ferguson, deputy chief of staff, research and technology, USAF, to the Senate Committee on Appropriations.

Appropriations are ear-marked for four major program areas plus a fifth, \$185-million, classified project not described. Largest of the four major categories is the operational development program for readying specific weapon and support systems to meet scheduled dates. Reason this category gets less money this year than last is due to the number of ballistic missiles beyond the test stage plus the cancellation of the Mobile Minute-man program.

Advanced development is up this year, reflecting the healthy, new awareness in the Defense Department that the future will soon become the present and preparations for it must begin ahead of time.

The level of effort in research remains essentially the same. Command operations is up \$100 million

over 1962. This increase will meet Atlantic Missile Range needs for instrumentation ships and range equipment modernization.

Operational Development Program

Strategic Systems—With our basic ballistic missile systems now progressing satisfactorily, this year's effort will go toward improving capabilities for delivering the missile to a target. Some \$182.1 million is asked to develop penetration aids: midcourse and reentry decoys, decreased radar cross section, shielding reentry vehicles.

Besides these finishing touches to present systems, \$10 million will be spent on a follow-on ICBM "to identify feasible solutions of the more critical problems such as mo-

bility, shorter reaction time, larger payloads, better accuracy, increased range, improved reliability, greater targeting flexibility, and improved cost effectiveness."

USAF also asks \$171 million for development, fabrication and test of three partial prototype XB-70 aircraft and a prototype bombing-navigation system. First flight is planned for December.

Skybolt, GAM-87, air-launched ballistic missile requirements are \$146.2 million for 1962 and \$130.6 million for 1963.

Defense Systems—Two items, lumped together under a \$124 million request, are the ASG-18/GAR-9 air-to-air missile and its fire control system for use on a future long-range interceptor, and the Midas satellite.

Midas is being pursued as an R&D program without provision for an operational system at this time. New money will provide for a simpler approach and will increase effort "in selected research areas."

Tactical Systems—There are four items in this category. The RF-110A (the Air Force reconnaissance version of Navy's F-4H is using \$5.7 million of 1962 funds for work on the reconnaissance portion of the system.

Navy's GAM-83 Bull Pup air-to-ground missile is being adapted for tactical use.

DEPARTMENT OF THE AIR FORCE FISCAL YEAR 1963 RDT&E BUDGET ESTIMATE (IN MILLIONS OF DOLLARS)

	FY 1962	Estimate FY 1963
Operational Development	1,810.8*	1,560.2
Advanced Development	730.3	1,096.2
Research Program	319.7	331
Command Operations	159.3	570.5
Classified Project	0	185
Net	3,350.1*	3,712.9
Reimbursements	247.7	210
Total	3,597.8*	3,952.9

* Includes DT&E amounts provided in other Air Force appropriations in FY 1962

The TFX, or F-111A as designated by the Air Force, a long-range multipurpose tactical aircraft for USAF and Navy use, will require \$115.6 million.

Some \$100 million is requested for the Mobile Mid-Range Ballistic Missile, for work on guidance, propulsion, systems engineering and adapting existing technology in the areas of command and control and transporter-launchers.

Command and Control Support Systems—Some of this \$185.8 million is needed for RDT&E for L systems in addition to the \$636.1 million for procurement of hardware for them (ELECTRONICS, p 30, Apr. 20):

\$1.9 million for Continental Aircraft Control and Warning (416-L);

\$5.8 million for NORAD's Combat Operations Center (425-L), for verifying system design and to check out the equipment and man/machine relationships;

\$8.6 million for the Air Force Intelligence Data Handling (438-L), to design and test subsystems covering intelligence functions;

\$6.2 million for system testing of computer programs and operational plans for SAC's Command and Control System (465-L);

\$8.9 million for PACCS (481-L), for overall system analysis and engineering, computer program development work and testing;

\$14 million for fabrication of the major collection subsystems for the 466-L Intelligence Collection system and for engineering tests and evaluation under operational control at overseas sites;

\$15 million for AF Communications System (480-L), to complete development of a communications system to alert SAC, to continue systems analysis, and to begin development of four new items including a secure air/ground communications system for the presidential aircraft.

USAF's portion of the jointly-funded, tri-service, VTOL Utility Transport is \$12 million (\$24 million more will come from Army and Navy). Fabrication of the first test plane will begin in fiscal 1963.

The National Survival Command and Control System requires \$10 million.

Fabrication of five C-141 test

HOUSE CHANGES

House of Representatives last week passed and sent to the Senate the following changes to USAF's request:

Mobile Mid-range Ballistic Missile—Knock the requested \$100 million down to \$80 million. USAF is no longer authorized to undertake the development of the weapon but to initiate a program leading to its development; also, international negotiations should be initiated to assure ultimate utilization of the weapon.

Dyna-Soar—Add \$42 million to the requested \$115 million; also, state in the bill that the total \$157 million is available only for Dyna-Soar.

RS-70—Add \$52.9 million to the requested \$171 million for development of other essential components, principally a radar system.

Contracts for Technical and Management Services—Cut \$5 million from the total \$166,039,000 requested for advisory organizations.

planes will be completed with \$67.6 million.

The Space Detection and Tracking System (Spadats) will take \$21 million, most of which will go for the phased array radar, the remainder for refining techniques to be used in orbit calculations and developing more efficient computer programs.

Operational Support—Most of this \$27.7 million is for electronics and communications: electronic countermeasures, quick reaction capability, and electronic intelligence collection. The ecm programs are the largest in number and cover the field from component development to improvement of aircraft penetration aids. One big item here is to improve the electronic warfare capability of the B-52 fleet.

Advanced Development Program

Advanced Systems—The more than \$200 million increase this year over 1962 represents the government's recognition of the future military role in space. Need to prove specific military requirement for a system before giving it full support has been scrapped.

Without a specific military objective, Dyna-Soar, manned orbital boost-glider, will get \$115 million to complete basic design and assembly of the orbital glider and subsystems and to modify the B-52.

Titan III, a standardized "work horse" which will boost Dyna-Soar into orbit, gets \$174 million.

The Discoverer satellite program, test bed for the Samos reconnaissance and Midas missile detection satellites, needs \$78.5 million.

Agema, used for Midas, Samos,

DEPARTMENT OF THE AIR FORCE FISCAL YEAR 1963 RDT&E BUDGET ESTIMATE (IN MILLIONS OF DOLLARS)

Program Areas	Program Total	Aircraft & Related Equip	Missiles And Rel Equip	Military & Astro-Nautics & Rel Equip	Other Equipment	Military Sciences	Program-Wide Management Support	Total
Operational Development	1,560.2							
Strategic		171	832.1					1,003.1
Defensive		7.6	16.1	100				124
Tactical		115.6	104					219.6
Command Control/Support Systems		79.6	5.9	21	79.3			185.8
Operational Support		14.4	0.2		13.1			27.7
Advanced Development	1,096.2							
Advanced Systems				452.9				452.9
Development Support			42.6	43	26.7	13		125.3
Test Instrumentation			0.1	1.1	23.8			25
Advanced Technology		28	39.7	374	15.9	0.4		488
Development Planning Studies						5		5
Research	331							
Applied		22.2	40	86.6	73.3	32.9		255
Basic				1.5		51.5		56
Research Support				15.5		4.5		20
Command Operations	570.5						570.5	570.5
Classified Project	185					185		185
Total	3,742.9	438.4	1,081	1,095.7	447	110.3	570.5	3,742.9

Totals do not necessarily add, due to rounding

and the upper stage of Titan III will require \$5.4 million.

Satellite Inspector, a spacecraft that will be placed into the same orbit as a target object to inspect it with a number of sensors, will be advanced to the tune of \$40 million. New money will provide for systems engineering, development, test and production of the final stage vehicles, boosters and targets.

The Large Solid Fuel Motor program (\$40 million) will consist of studies and feasibility work.

Development Support—This \$125.3 million will provide specialized technical and scientific efforts by the following corporations: Rand, \$12 million; Anser, \$1 million; Space Technology Laboratory, \$42.6 million; Aerospace Corp.,

NEW APPROACH

This year, for the first time, defense programs proposed for the coming fiscal year have been presented in terms of major military missions. Also, the Defense Department has provided long-range projections of these programs extending through fiscal year 1967

\$33.5 million; Electronic Computer Analysis Center, \$1 million; Lincoln Lab, \$20.2 million; and Mitre Corp., \$15 million.

Test Instrumentation—The Atlantic Missile Range will get 60 percent of the \$25 million for test instrumentation development.

Advanced Technology—Success-

ful research projects are grouped into individual programs in this category. These programs lead to solutions to problems in subsystems or to an operational system development program. There are 24 projects for 1963.

Five projects relate to the Aerospace Plane, at a total cost of \$19 million. Others are Snapshot, nuclear power for spacecraft; stellar inertial guidance, for midcourse and terminal phase missile guidance (phase 1 will identify and evaluate expected problems); and the reconnaissance/strike capability program to detect, locate and identify targets plus providing in-flight guidance data for such systems as the B-70 and the TFX plane.

The latter program integrates data from various sensors such as radar, electro-optical, infrared and electronic intelligence for a central display.

Development Planning Studies—Feasibility studies, exploration of future system concepts, analyses of technology, studies of applications to future systems, and studies identifying the current and potential deficiencies of our technology programs will get \$5 million.

Research Requests

Applied Research—\$255 million is requested for work in 27 areas. Primary effort is placed on improved guidance systems components such as accelerometers, gyros, computers, star trackers and scanners; over-the-horizon radar.

Basic Research—\$56 million will cover basic research in propulsion, materials, electronics, geophysics, biosciences and aeromechanics. One big item is work on lasers.

Research Support—\$20 million will be used for systems synthesis and analysis; rocket probes to investigate physical composition of space, space detection and communications; foreign technology.

Command Operations

Some \$570.5 million will be used for operating ranges, laboratories, airfields and test facilities, management of R&D contracts and in-house engineering services.

Operation of the Atlantic Missile Range is estimated at \$98.4 million; the Eglin Gulf Test Range, \$7.8 million; Arnold Engineering

Capsule Checks Moon Crew



Crewmen at control panel. Course is checked against projected star field



THE MARTIN CO. has built a spacecraft simulator that will enable the crew of a lunar spacecraft to take three to seven-day "trips" on the ground. The company's Space Systems division in Baltimore will study for NASA the effects of confinement on a crew's ability to perform mission tasks.

The capsule is equipped to simulate all phases of a lunar mission, from prelaunch through reentry and landing. It has a complete flight control panel linked to a high-speed analog computer which simulates flight conditions and emergencies.

Packed into the 400-cu-ft capsule are a control room, off-duty lounge and sleeping compartments, galley and lavatory. Crew activities are monitored by microphones, four tv

cameras and 11 control consoles linked to the computer. Problems will be introduced through the consoles.



Capsule stands 17½ ft tall

Development Center, \$28.2 million; and several smaller installations, \$4.6 million.

\$135.7 million is needed for modernization and extension of the Atlantic Missile Range, including \$101 million for range instrumentation vessels and \$34.7 million for new and replacement range instrumentation gear.

Mobile Atlantic Range Ships (Mars) 3 and 4 will get \$65 million from 1963 funds. An additional \$36 million will buy long lead time instrumentation for Mars 5, an advanced penetration aids ship. Funds for Mars 5 will be in the 1964 budget request.

Outline Techniques for Digitizing Seismographs

HOUSTON—Further details on the ocean-bottom seismograph (ELECTRONICS, p 7, March 16) developed by Texas Instruments were reported during SWIRECO by Paul J. Davis, Jr., of TI, during the session on geoscience electronics.

Designed as a detector for the Project Vela-Uniform system (p 30, June 16, 1961), the experimental model is now under test. It is designed to operate at depths to 10,000 ft.

The system uses a 1-cps seismometer and converter for digital recording in real time on magnetic tape. Davis said that 1 millimicron of earth movement gives 0.1 μ v of noise signal. It can be used for telemetering, although the model is not so equipped. It is turned on by a clock or by a signal over a predetermined threshold.

The transducer withstands a pressure of 5,000 psi or more. A diaphragm arrangement in the case permits equalization of inside and outside pressure. Unwanted motion is damped by a viscous oil in the case.

Ted Shutz, of Rice University, described work being done there on a direct-digitizing seismograph that records in analog or digital form. A displacement transducer and frequency modulation are used. F-m, he said, presents little or no drift problem. Sensitivity is 400 cycles for each micron displacement of the boom.



15 Mw Modulator Power 3.0 Mw R-F Power **ML-7560** Ceramic Triode

Coaxial terminal, thoriated-tungsten cathode ML-7560 provides:
15 Mw Pulsed Modulator Power Capability at 1% duty . . .

DC Plate Voltage Max 50 kv

Pulse Cathode Current Max 550 amps

3.0 Mw R-F Pulsed Power capability at 5% duty . . .

Peak Plate Pulse Supply Voltage Max 40kv

Pulse Cathode Current, Max 550 amps

Send for 74 page brochure, "Hard Pulse Modulator Tubes", containing useful information for Radar Design Engineers and others.

MACHLETT

The Machlett Laboratories, Inc.

A Division of Raytheon

Springdale, Connecticut

TWO OUTSTANDING HIGH-TEMPERATURE MAGNET WIRES



Tetroc

FOR CONTINUOUS OPERATION AT
HOTTEST SPOT TEMPERATURES
UP TO 200°C



Ceroc

FOR CONTINUOUS OPERATION AT
HOTTEST SPOT TEMPERATURES
UP TO 250°C

For continuous operation at hottest spot temperatures up to 200°C (392°F) and up to 250°C (482°F) for short periods of time—depend upon TETROC—an all Teflon-insulated wire available in both single and heavy coatings.

CEROC is Sprague's recommendation for continuous operation at hottest spot temperatures up to 250°C (482°F) and up to 300°C (572°F) for short periods of time. Ceroc has a flexible ceramic base insulation with either single silicone or single or heavy Teflon overlays. The ceramic base stops "cut-through" sometimes found in windings of all-fluorocarbon wire. Both Tetroc and Ceroc magnet wires provide extremely high space factors.

Write for Engineering Bulletins 405 (Tetroc Wires) and 400A (Ceroc Wires).

SPRAGUE ELECTRIC COMPANY
35 Marshall Street, North Adams, Mass.

SPRAGUE[®]
THE MARK OF RELIABILITY

Police Use Diversity Radio

BOSTON has awarded General Electric an engineering contract for a novel police radio system. It will use diversity reception to improve communications with patrol cars in outlying areas and harbor patrol boats.

Five remote receivers at fixed points will pick up messages from patrol cars transmitting at 154.89 Mc. In these units, relays with closure time inversely proportional to signal strength will pass audible messages to police headquarters over telephone lines. These are to be transistor receivers that switch to battery power if a-c power fails.

At police headquarters, signal-measuring and "voting" circuits will select the clearest message and announce it to the dispatcher. If other cars are calling at the same time, these will be announced over other loudspeakers. Headquarters will return calls at 39.02 Mc.

There will be two shore pickups for harbor patrol boats. These will have dual diversity antennas at different elevations, to combat over-water fading. Messages will be combined to improve signal-to-noise ratio.

Try Laser for Plasma Density Measurements

TARRYTOWN, N. Y.—Experiments in the use of lasers for plasma diagnostics was reported at the New York section meeting of the American Physical Society.

The technique is similar to microwave interferometer methods (ELECTRONICS, p 33, Aug. 4, 1961), but has the potential advantage of measuring densities greater than 10¹⁸ particles per cu cm, the present limit of microwave interferometers.

The approach described by David Finkelstein, of Yeshiva University, is to measure phase shift and refraction of the laser beam to obtain plasma density and density gradient, respectively.

Finkelstein has irradiated a metallic plasma with a 5-Mw ruby laser designed by Richard Daly at Technical Research Group. Dis-

charge time is 0.1 μsec and the beam is distributed over a few centimeters of the plasma.

Analog Computers Will Monitor Radio Messages

LONDON'S Fire Brigade is getting 96 radiotelephones that will be silent until a valid message is transmitted from a fire station or mobile apparatus. Designed by A. C. Cossor Communications Co., Ltd., a Raytheon subsidiary, the sets incorporate analog computers. While they are receiving, they sort out noise and only announce messages.

X-15 Assigned Role as Space Research Craft

NASA has announced that the X-15 hypersonic aircraft will make at least 35 extra flights in the next two years to carry out aeronautics and space experiments. Among other roles, it will serve as a high-altitude platform for ultraviolet stellar photography, to obtain information on horizon sensors, to measure atmospheric density above 100,000 ft and to obtain infrared and ultraviolet data. The plane is designed to fly above 250,000 ft.

Target-Tracking Tv



Navy has awarded Fairchild Camera and Instrument \$2.3 million contract to produce tv systems like this. They'll be used in Talos missile fire-control system for radar boresighting and visual tracking

TOUCHDOWN ON THE FIRST PASS

A new air traffic surveillance system, Texas Instruments ASR-4, provides accurate position information on this jetliner and other traffic within 60 miles. Result: touchdown on the first pass.



Look to TI for answers to your radar problems in—

- *air surveillance*
- *ground surveillance*
- *submarine detection*
- *missile guidance*
- *fire control*

■ The ASR-4 is industry's answer to a Federal Aviation Agency request: "Develop a surveillance radar system to reduce field-approach congestion and minimize stack-up time at U. S. airports — make it operate reliably in all weather — continuously for 20 years."

■ Many air terminals already have the TI ASR-4. Custom modifications to this versatile radar system can be made to meet your organization's requirements.

APPARATUS DIVISION
PLANTS IN DALLAS
AND HOUSTON TEXAS



TEXAS INSTRUMENTS
INCORPORATED
6000 LEMMON AVENUE
P O BOX 6015 • DALLAS 22, TEXAS





outranks them

If your capacitor rating system is based upon high capacitance, small size, over-all reliability, stability and low cost—then you'll quickly see why Paktron Mylar* Capacitors have such a high ranking. Our model MR-330, MR-700 capacitors meet or exceed the electrical and environmental requirements of MIL-C-19978, MIL-C-91, and MIL-C-11015A. For more specific information write.

PAKTRON
DIVISION OF ILLINOIS TOOL WORKS, INC.

AREA CODE 703 King 8-4400

MEETINGS AHEAD

JOINT COMPUTER CONFERENCE, IRE-PGEC, AIEE, ACM; Fairmont Hotel, San Francisco, Calif., May 1-3.

CLEVELAND ELECTRONICS CONFERENCE, IRE, AIEE, ISA, et al; Engineering and Scientific Center, Cleveland, Ohio, May 1-3.

HUMAN FACTORS IN ELECTRONICS, IRE-PGHFE; Lafayette Hotel, Long Beach, Calif., May 3-4.

POWER INSTRUMENTATION SYMPOSIUM, ISA; Hotel Texas, Fort Worth, Tex., May 6-9.

COMPUTER CONFERENCE, Michigan State University; at the University, East Lansing, Michigan, May 7-8.

ELECTRONIC COMPONENTS CONFERENCE, IRE-PGCP, AIEE, EIA; Marriott Twin Bridges Hotel, Washington, D. C., May 8-10.

NORTHEASTERN DISTRICT MEETING, AIEE; Statler-Hilton Hotel, Boston, Mass., May 9-11.

NATIONAL AEROSPACE ELECTRONICS CONFERENCE, IRE-PGANE; Biltmore Hotel, Dayton, Ohio, May 14-16.

AEROSPACE INSTRUMENTATION SYMPOSIUM, ISA; Marriott Motor Hotel, Washington, D. C., May 21-23.

ELECTRONICS PARTS DISTRIBUTORS SHOW, Electronic Industry Show Corp.; Conrad Hilton Hotel, Chicago, May 21-24.

MICROWAVE THEORY & TECHNIQUES NATIONAL SYMPOSIUM, IRE-PGMITT; Boulder, Colo., May 22-24.

TELEMETERING NATIONAL CONFERENCE, IRE-PGSET, AIEE, IAS, ARS, ISA; Sheraton Park Hotel, Washington, D. C., May 23-25.

IRE SEVENTH REGION CONFERENCE, Seattle Section of IRE; Seattle, Wash., May 24-26.

WESTERN ELECTRONICS SHOW AND CONFERENCE, WEMA, IRE; Los Angeles, Calif., Aug. 21-24.

ADVANCE REPORT

NORTHEAST ELECTRONICS RESEARCH & ENGINEERING MEETING, IRE; *Commonwealth Armory and Somerset Hotel, Boston, Mass., Nov. 5-7. June 11 is the deadline for submitting in triplicate complete papers or 400-500 word abstracts plus 50-word summaries to: Mr. I. Goldstein, NEREM-62 Program Chairman, Raytheon Company, Box 555, Hartwell Road, Bedford, Mass. Suggested but not inclusive topics range through the following fields: radar astronomy, quantum electronics, information technology, plasmas, solid-state devices, engineering management, communication and control, antennas and wave propagation, biophysics and medical electronics, microelectronics, electron devices.*

CANADIAN SYMPOSIUM ON COMMUNICATIONS, IRE; *Queen Elizabeth Hotel, Montreal, Quebec, Nov. 16-17. June 1 is the deadline for submitting in triplicate a 450-word summary and short biographical note to: Mr. Allan B. Osley, Chairman Technical Program, Canadian IRE Symposium on Communications, Box 802, Station B, Montreal, Quebec.*

There's plenty
of brainpower
in

THE
EMPIRE
UP STATE

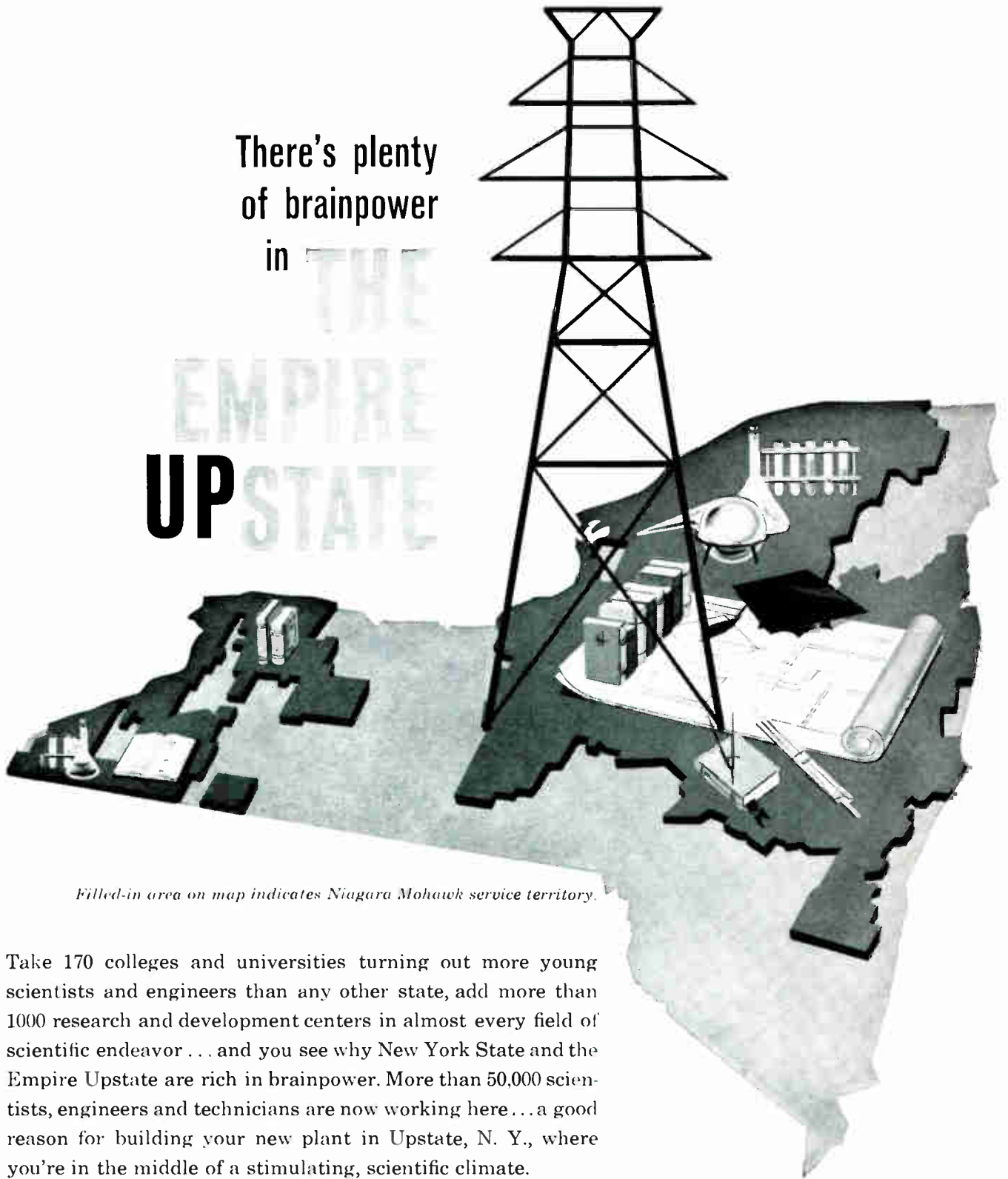

Filled-in area on map indicates Niagara Mohawk service territory.

Take 170 colleges and universities turning out more young scientists and engineers than any other state, add more than 1000 research and development centers in almost every field of scientific endeavor . . . and you see why New York State and the Empire Upstate are rich in brainpower. More than 50,000 scientists, engineers and technicians are now working here . . . a good reason for building your new plant in Upstate, N. Y., where you're in the middle of a stimulating, scientific climate.

You're also on top of the richest market in the world when you locate in Upstate, N. Y. . . . your transportation costs are reduced to the minimum. We have a complete inventory of building and plant sites throughout the Upstate area. Why not let us compile specific facts and figures for you at no cost or obligation. Just write or phone Richard F. Torrey, Director of Area Development, Dep't. E-4, Niagara Mohawk Power Corp., 300 Erie Blvd. West, Syracuse 2, New York . . . Phone GRanite 4-1511.

*Your one best source of information
about the EMPIRE UP STATE*

NIAGARA



MOHAWK

INVESTOR OWNED • TAXPAYING

CIRCLE 37 ON READER SERVICE CARD

CIRCLE 38 ON READER SERVICE CARD →

Why so many?

We admit it.

Amphenol, more than any other connector manufacturer, accepts responsibility for confronting you with a seemingly endless selection of rack and panel connectors.

There's a good reason.

For some uses, a ten-contact connector the size of an Idaho potato will do just fine. In others, ten connections must be squeezed into a space no bigger than a jelly bean. Still other applications have unique requirements that relate to environment or mating force—even the technical skill of the operator.

WHY WE DO IT

We make a lot of different rack and panel connectors because it takes a lot to satisfy the wide range of applications.

For example: the Amphenol Blue Ribbon® rack and panel connector is widely used in "blind" mating applications. Part of Blue Ribbons' popularity is due to the fact that they mate with a smooth and gradual wedge-like force. Because they mate so smoothly, the "feeling" of correct alignment is unmistakable.

Another advantage of the Blue Ribbon design is the wiping action that occurs as connectors mate. Each time Blue Ribbons are mated, contact surfaces are wiped clean. Combine wiping action with high mated contact pressure, and the result is an extremely low-resistance connection.

THINKING SMALL?

As fine a connector as we know the Blue Ribbon is — it's just not right for the real tiny stuff. Thus, as miniaturized

electronic equipment became popular, Amphenol engineers developed the Micro Ribbon®—a rack and panel connector utilizing the ribbon contact principle, but in as little as one-half the space. Further development produced a circular Blue Ribbon connector which crammed 50 contacts into a diameter just under 3 inches.

Also, there's the question of terminating rack and panel connectors. Often, confined quarters or complex wired harnesses can tax the dexterity of even the most skilled worker

To solve this problem, Amphenol engineers developed rack and panel connectors with Poke-Home® contacts. Poke-Home contacts make it possible to terminate conductors independent of the connector. Contacts are crimped, soldered, or even welded to conductors, then inserted into the connector. Besides simplifying assembly, Poke-Home contacts can be easily removed *after* assembly should circuit changes or repairs later become necessary. Needless to say, Amphenol rack and panel connectors with Poke-Home contacts (Min-Rac 17®, 93 and 94 Series, for example) are popular items with engineers who are forced to think small, spacewise.

BEATING THE ELEMENTS

There's a need for environmentally resistant rack and panel connectors, too. High performance aircraft, missiles and space craft led to the development of Amphenol 126 and 217 Series environmentally sealed rack and panel connectors. (The 217 offers the added feature of Poke-Home contacts.) Other Amphenol rack and panel connectors

can accommodate coaxial connectors; many can be supplied with hermetically sealed contacts. There are rack-to-cable connectors available in every series. There are super-economy types and super-reliable types.

So, when you have a rack and panel connector problem, contact an Amphenol Sales Engineer (or an authorized Amphenol Industrial Distributor). With the broadest line of rack and panels in the industry—if he can't solve it, no one can. If you prefer, write directly to Dick Hall, Vice President, Marketing, Amphenol Connector Division, 1830 South 54th Avenue, Chicago 50, Illinois.

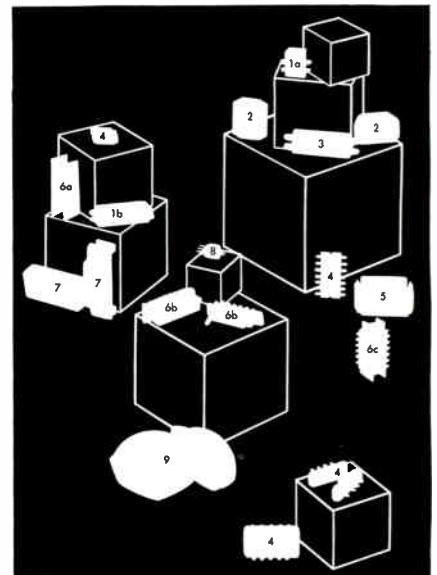

Amphenol connectors shown on the opposite page are: **1**—Min-Rac 17 with (a) crimp-type contacts and (b) solder-type contacts **2**—94 Series **3**—Micro-Ribbon **4**—126 Series Rectangular **5**—93 Series **6**—Blue Ribbon with (a) barrier polarization, (b) pin polarization and (c) keyed shell and barrier polarization **7**—126 Series "CNI" **8**—126 Series Hexagonal **9**—Circular Blue Ribbon



Connector Division / Amphenol-Borg Electronics Corporation

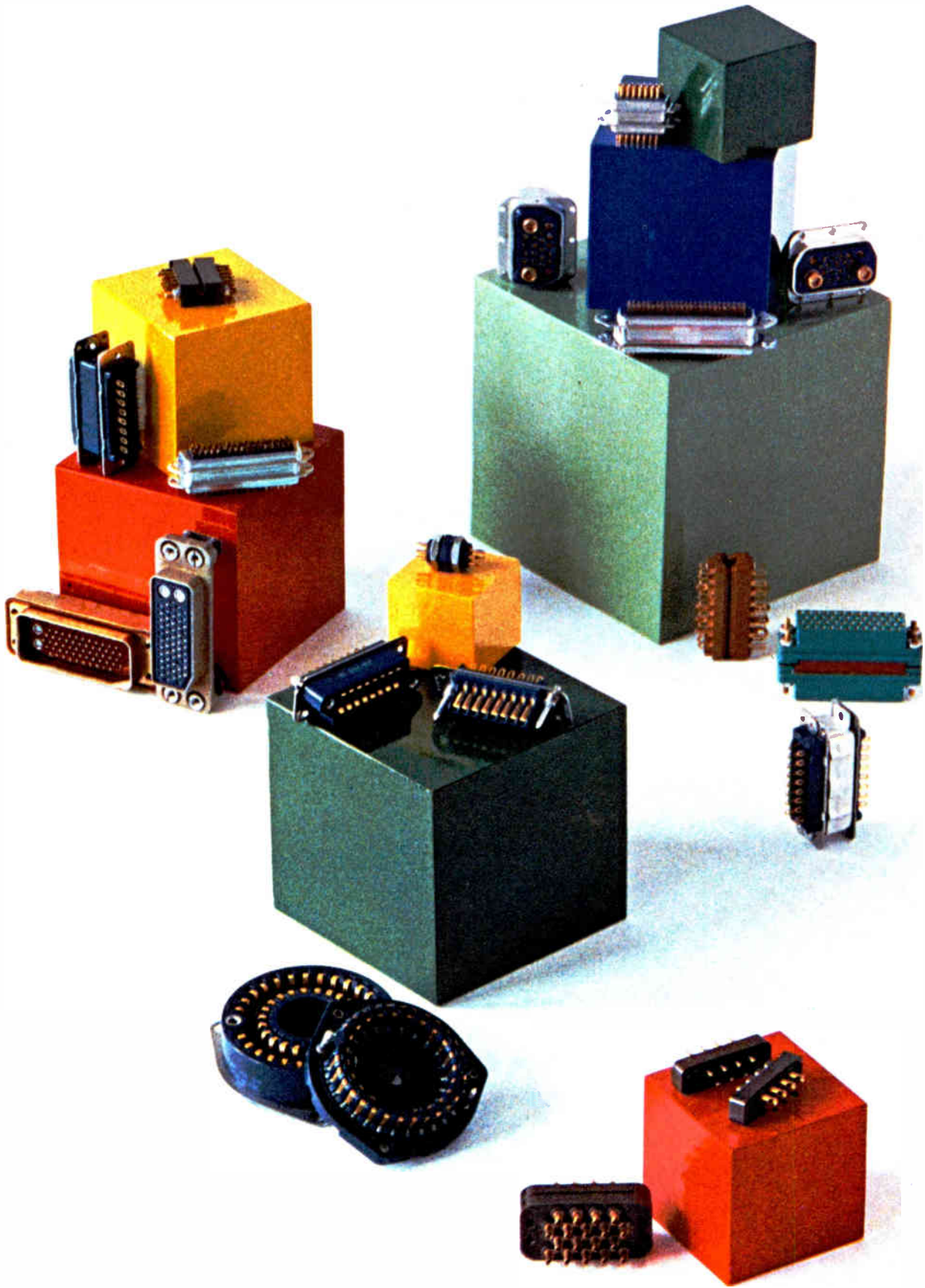

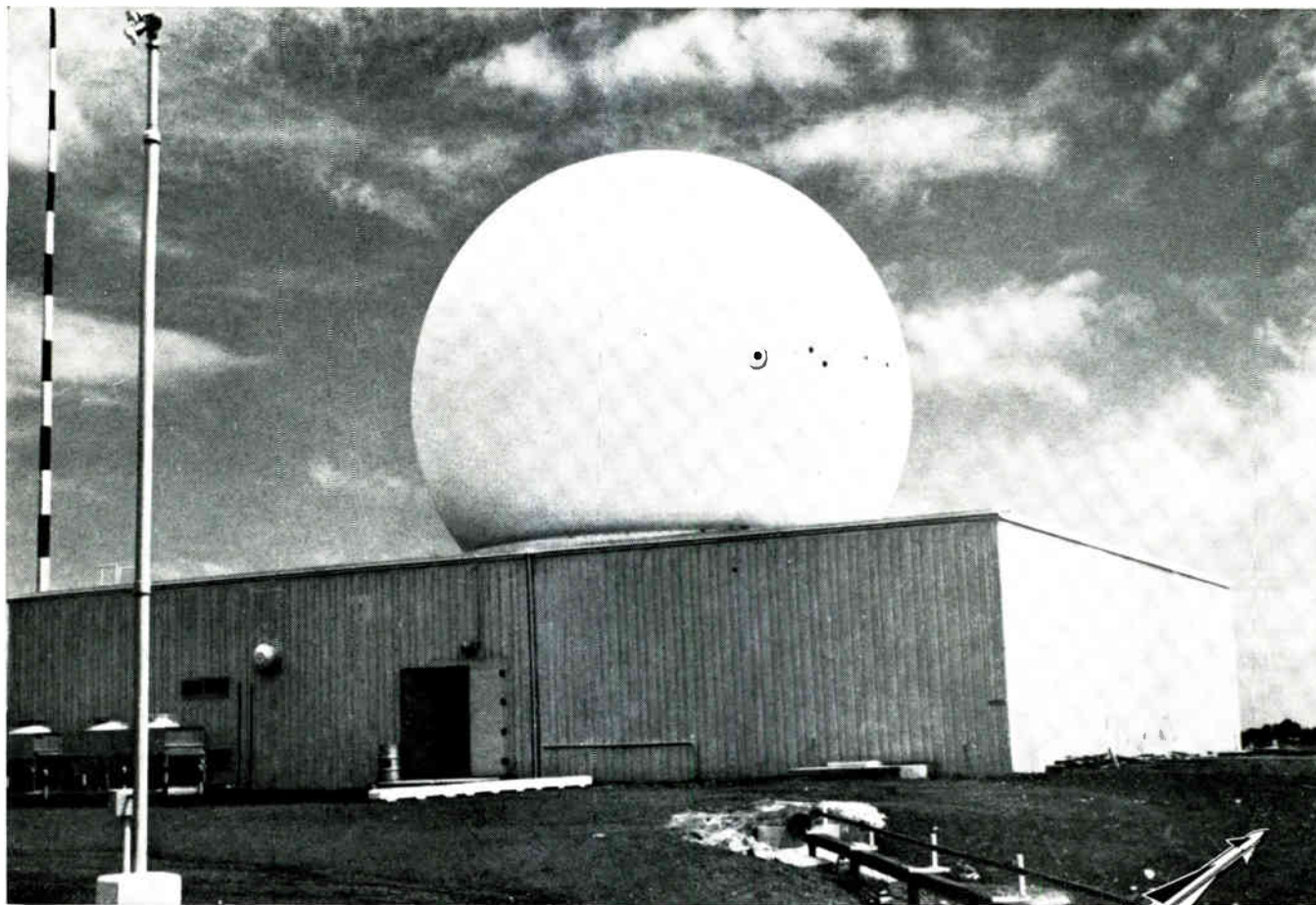

Ground station Nike-Zeus Radar Tracking Unit uses pump motors cooled with FC-43



FC-43 coolant protects vital systems for years, without service!

Maintenance-free service life is an important reason for the increasingly frequent specification of 3M Brand Fluorochemical Inert Fluid FC-43 (and its companion fluid, FC-75). Rarely does it need replenishment, servicing, or maintenance. There is no practical age limit to the life of this inert fluid. It is therefore ideal for closed designs; and in a well-designed system, offers complete freedom from coolant maintenance.

Both FC-43 and FC-75 are inert to chemical, thermal, dielectric change. They undergo no electrical or chemical change in contact with common materials of construction. And are self-healing when subjected to dielectric breakdown. Their resistance to degradation means that coolant qualities are unaffected by limitless use, whether in Arctic cold or Tropic heat! Tests show FC-43 and FC-75 coolants remove 30 to 40 times more heat than less volatile organic liquids when used under boiling conditions.

A Nike-Zeus Radar Tracking Unit's pump motor was submerged in FC-43 by the Lear Romec Division of Lear, Inc. This could be done because the coolant has excellent dielectric and non-reactive qualities. No encapsulation of shaft seals was necessary. And cooling system service is planned for every two years only! For more information about the properties of FC-43 and FC-75, see the Properties Profile to the right; then write for further details.

PROPERTIES PROFILE ON 3M BRAND INERT LIQUIDS FC-43 AND FC-75

ELECTRICAL PROPERTIES

	FC-43	FC-75
Electrical Strength	35KV	35KV
Dielectric Constant (1 to 40 KC @ 75°F)	1.86	1.86
Dissipation Factor (75°F)(1000 cycles)	<0.0005	<0.0005

TYPICAL PHYSICAL PROPERTIES

	FC-43	FC-75
Pour Point	-40°F	-80°F
Boiling Point	340°F	212°F
Density	1.88	1.77
Surface Tension (77°F) (dynes/cm)	16	15
Viscosity Centi-stokes (77°F)	2.74	0.65
Thermal Stability	600°F	700°F
Chemical Stability	Inert	Inert
Radiation Resistance	25% change @ 1 x 10 ⁶ rads	25% change @ 1 x 10 ⁶ rads

For more information on FC-43 and FC-75, write today, stating area of interest to: 3M Chemical Division, Dept. KAX-42, St. Paul 1, Minn.

MINNESOTA MINING & MANUFACTURING CO. **3M**

Now—A High-Performance Potentiometer For As Little As \$3

NUMBER 15—NEW PRODUCT SERIES

Four before you find a better one. The best of potentiometer performance. Model 3367 at only \$3.15 and it guarantees—your own buy a single unit. It meets the highest standards for complete and is built for control applications. A Bourns® control design. Model 3368 is available at slight extra cost.

Model 3367 is a 1000 ohm, 1000 ohm, 1000 ohm potentiometer with resistance from 0 to 1000 ohms and operates in 385°C heat. Model 3367 (wirewound) is available in 0.5 watt. Model 3368 (carbon) 0.25 watt. They meet requirements for stability, accuracy and life. Size for panel and all other applications. Designed for convenience, too. They are the power that let you check your wiring at a glance.

Model 3367 is available immediately from factory and distributor for resistors with resistances of 100Ω to 20K. Model 3368 20K to 1.5M. Your choice of printed circuit pins (standard for interchangeability with most expensive devices) or solder lugs with buffering mount. They are subjected to 100% and statistical sample inspection. All dry solder in the system. Printed circuit board mounting problems. Write for complete information. In stock at distributor.



ACTUAL SIZE

AVAILABLE IMMEDIATELY FROM COAST TO COAST FROM ALMOST 100 STOCKING DISTRIBUTORS

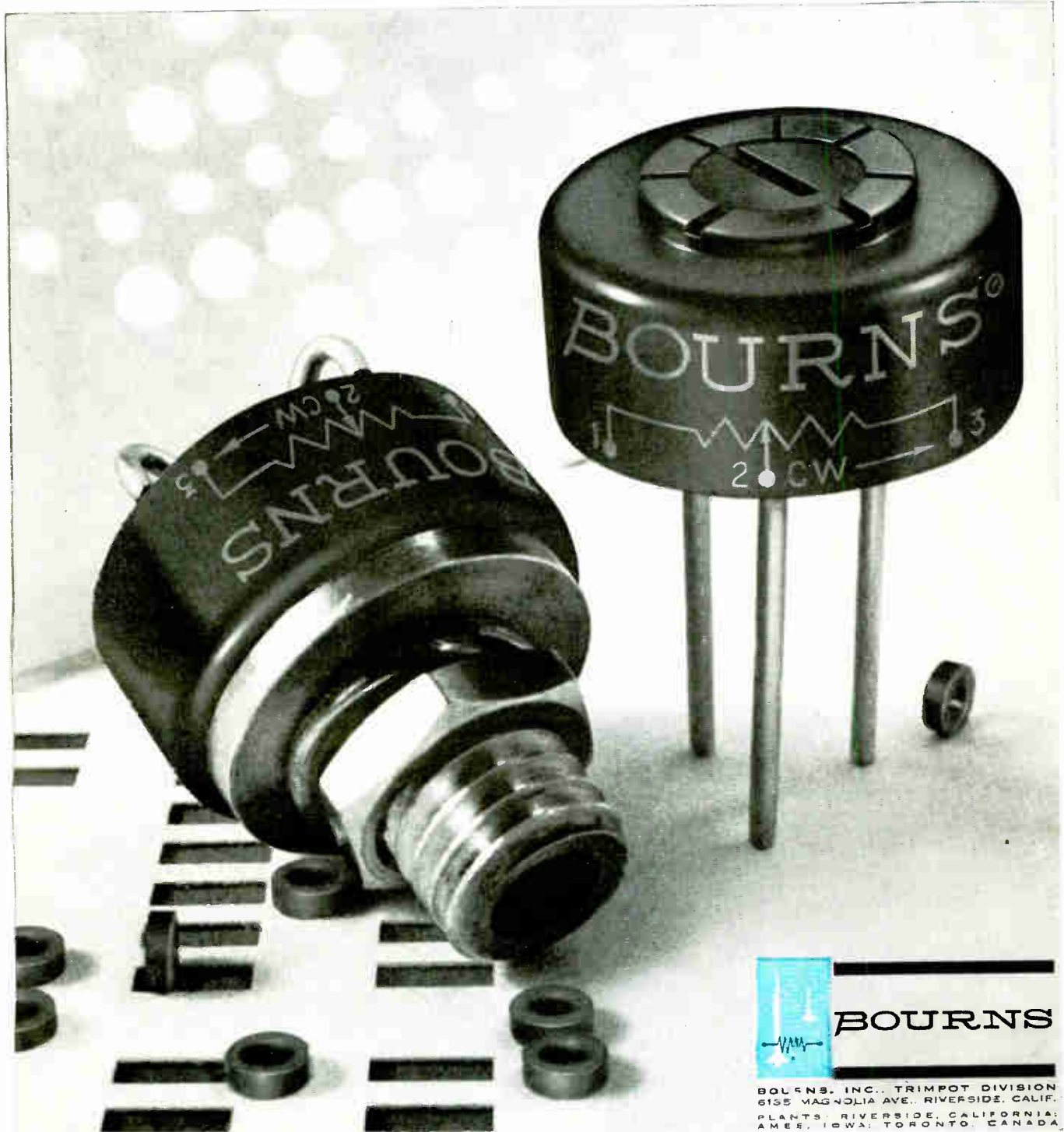

BOURNS

BOURNS, INC., TRIMPOT DIVISION
6155 MAGNOLIA AVE., RIVERSIDE, CALIF.
PLANTS: RIVERSIDE, CALIFORNIA;
AMEE, IOWA; TORONTO, CANADA

Exclusive designers and manufacturers of Trimpot® potentiometers. Pioneers in transducers for position, pressure and acceleration.



TIPS (Technical Information and Product Service)

6 NEW DEVELOPMENTS

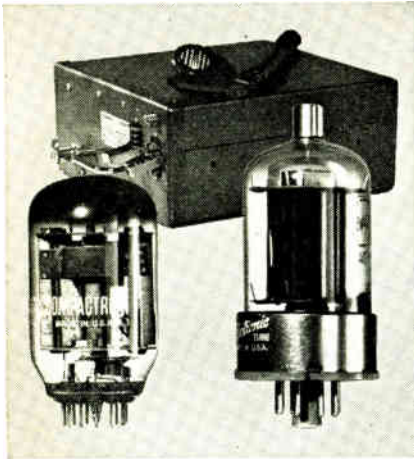

New, high-power 7984 compactron can improve circuit design and extend communication range 10%

Designed specifically for the mobile communication field, G.E.'s newest compactron, when used at 175 megacycles, is rated at 45 watts power output as compared to 35 watts for a type 6146, its standard-tube counterpart. The 7984 delivers its 28% greater power output at less driving power than required for the 6146.

By eliminating the top cap and the composition base, the 7984 compactron saves $\frac{3}{4}$ " in seated height and gets rid of a chronic mobile communication trouble spot—the long loose plate lead. Mechanically rugged, yet lighter in weight than the 6146, the compactron is less susceptible to shock and vibration.

Electronically superior to the 6146, the new 7984 compactron is easier to design into VHF equipment in the 154- to 175-MC range specified for mobile communication equipment. Internal leads have been shortened as much as $\frac{1}{2}$ " by eliminating the phenolic base. Interelectrode output capacitance is reduced by a new beam-shield design. Other improvements include a lower screen circuit power requirement and multiple-pin connections for the compactron elements to make RF-grounding easier.

The 7984 compactron is immediately available in sample quantities. Production quantities will be available in August.

CIRCLE 42 ON READER SERVICE CARD

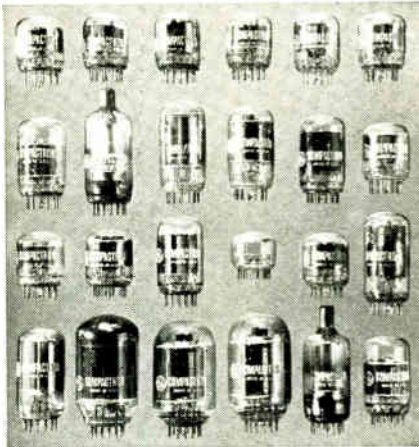

24 compactron types now available

Compactrons . . . G.E.'s all-new 12-pin multi-function devices . . . provide increased reliability and more compact circuitry than tubes or transistors. This is accomplished, partly, by combining several functions into a single, low-profile envelope requiring fewer pins, stems, sockets, welds and handling operations. In a typical AC-DC radio, 3 compactrons do the job of 6 tubes or 8 transistors . . . and do it cheaper and easier. Compactrons use about 35% less power than tubes to perform a given function, yet they deliver more power output. Larger bulb diameter and 12-pin stems decrease bulb temperature about 15%, as compared to similar conventional tube types. The result: increased life expectancy and greater reliability.

Fewer compactrons per function means a saving in sockets, hardware, jumpers and leads. Reduced chassis- and cabinet-size lowers material costs. Labor costs go down because of less hardware to install, less wiring, and fewer solder connections necessary with compactrons. The large-diameter pin circle reduces clustering of components, gives more work room for wiring and increases the arc-over rating to more than 10,000 volts.

Some of today's newest equipment features compactrons . . . TV sets by 3 major manufacturers, portable halogen leak detectors, electronic street lighting controls, multiplex adapters, and single-sideband communication equipment. Perhaps one of the 24 compactron types can help improve your product?

CIRCLE 219 ON READER SERVICE CARD

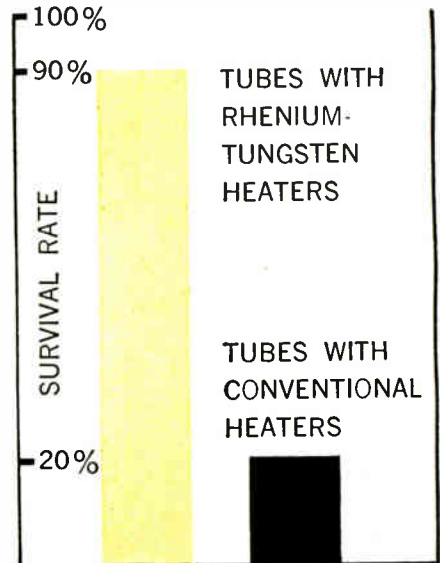

Accelerated 4000-hour, high-voltage destruction test

New rhenium-tungsten heaters increase electron tube reliability up to 4½ times

Rhenium-tungsten heaters, first heater wire material advance in 30 years, were developed to give electron tubes greater ruggedness, better heat tolerance, and improved electrical performance. Greater reliability has been achieved through increased tensile strength of the heater wire and by elimination of heater brittleness and breakage. Reduced heater insulation cracking and heater-cathode shorts, as well as less filament "twisting" during on-off cycling, add to long-term performance.

The new rhenium-tungsten alloy has a higher resistivity to current flow than pure tungsten or conventional tungsten alloys. This allows a large-diameter, rugged filament wire, or a shorter filament length, whichever is more effective in improving specific tube design. Higher resistivity improves electrical performance by reducing the initial surge current—emission is also more stable throughout tube life. Now available on some tube types, this new heater material will be added to other tubes and compactrons where tests indicate opportunities for tangible benefits.

CIRCLE 220 ON READER SERVICE CARD

IN G-E RECEIVING TUBES

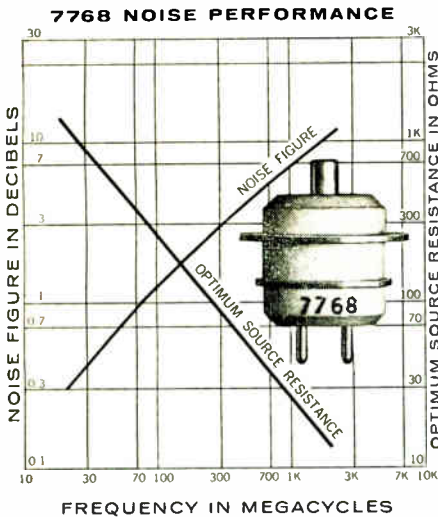

50,000-micromho, low-noise 7768 ceramic tube delivers high gain at wide bandwidths

No other active component can match the electrical performance of the 7768 yet still offer small size and physical ruggedness plus high tolerance to nuclear radiation and high temperature. Value analysis will show you how a gain-bandwidth product of 1600 MC makes the 7768 extremely useful in wide-band circuitry. Its usefulness, however, is not limited to this application alone—7768's have been used at sub-audio frequencies, where flicker noise predominates, and at frequencies up to the C-band.

Constructed of metal and ceramic, the 7768 is inherently resistant to nuclear radiation and requires no special cooling, even in ambients over 200° C. The 7768 has extremely low microphonics and far surpasses Mil Specs for shock and vibration. Centrifuge tests up to 20,000 G's and "soft landing" shocks of 3000 G's have had no adverse effect on the tube. To provide maximum performance, the 7768 planar ceramic triode was designed for high transconductance (50,000 micromhos), minimum capacitance (7.5 pf) and minimum transit time. Maximum ratings include: 330 plate volts, 5.5 watts plate dissipation and 30 ma dc cathode current. Physical size is 1" long by 3/4" diameter.

Free value-analysis data sheets give complete technical details.

CIRCLE 221 ON READER SERVICE CARD

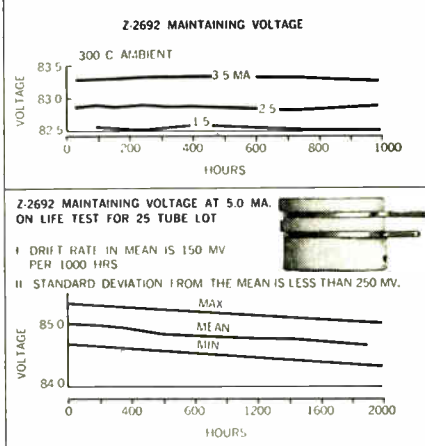

New Z-2692 ceramic voltage-reference tube gives high stability in severe environments

Ideally suited for high-temperature ambients, the Z-2692 has an operating temperature limit of 300° C.—more than twice the temperature limit of the best conventional reference device. Maximum voltage drift during 1000 hours of operation at maximum bulb temperature was only 250 millivolts—an 8-to-1 improvement over some voltage-reference types. Shock tolerance for the Z-2692 is 720 G, compared to about 450 G, maximum, for glass reference tubes.

At room temperatures the Z-2692's stability is equal to, or better than, an equivalent glass or solid-state device. Maintaining voltages range from 82.5 to 105 volts. For higher reference voltages, the Z-2692 is easily adapted to multi-element stacks. (A ten-element stack, 1 1/4" long, provides a stable reference voltage in the 800-1000 volt region.)

Progress Is Our Most Important Product

GENERAL ELECTRIC

Please send more value-analysis information about:

- 7984 Compactron
- 24 Compactron Types
- Rhenium-Tungsten Heaters
- 7768 Ceramic Tube
- Z-2692 Ceramic Voltage-Reference Tube
- TIMM Components

CIRCLE 222 ON READER SERVICE CARD

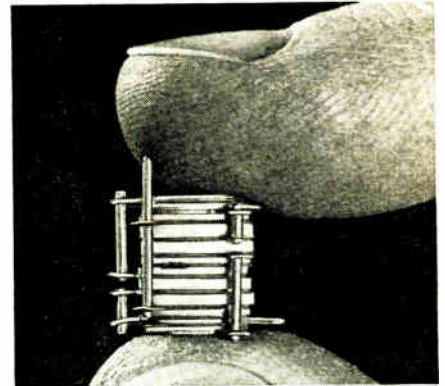

TIMM circuit elements now available

TIMM (Thermionic Integrated Micro Module) circuits represent the only high-temperature (580° C.), radiation-resistant, microminiature concept available today. Ceramic and titanium components tolerate 10,000 times the steady-state radiation of circuits employing solid-state devices. TIMM component densities of as high as 250,000 parts per cubic foot are possible. Individual components are now available for breadboard experimentation, characteristics evaluation, and over-all familiarization with TIMM microminiaturization techniques.

Resistors—1,000 ohms to 100,000 ohms rated at 1/4 watt (at 580° C.)

Capacitors—20 pf to 200 pf units to 300 vdc (at 580° C.)

Diodes
50 volts max. P. I. V.
2 mA DC plate current } (at 580° C.)
2.3v self-bias

Triodes—As a switch (at 580° C.)
off— $E_b=10v, E_k=0v, I_b=100\mu a$ max.
on— $E_b=7.5v, E_k=+2.5v, I_b=2.0$ mA,
 $I_k=200\mu a$

G-E Receiving Tube Dept.
Technical Information and Product Service (TIPS)
Box 1728C, Owensboro, Kentucky

Name.....

Title.....

Company.....

Address.....

City..... Zone .. State.....

CIRCLE 43 ON READER SERVICE CARD

PRECISION WITH SIMPLICITY

FROM DELCO RADIO

That's the big feature in Delco Radio's new 175 VA and 250 VA static inverter power supplies. These *all-transistor* units offer increased reliability through simplified circuits. Both static inverters are designed for either airborne or ground applications and will withstand overload and output short circuit conditions indefinitely, delivering at least 110% of rated output before going into overload protection. Units automatically recover to full output upon removal of overload and short circuit. Units are designed to meet the environmental requirements of MIL-E-5272C. For further information on military electronics write Delco Radio's Military Sales Department.



ELECTRICAL SPECIFICATIONS

175 VA STATIC INVERTER

Input
Voltage: 27.5 VDC \pm 10% per MIL-STD-704

Output
Power: 175 VA single phase 0.5 lag to 1.0 power factor

Voltage: 115 V adjustable from 110 to 120 volts

Regulation: 1-volt change for any variation of load between zero and 110% of full load, and input voltage between 25 VDC and 30 VDC

Frequency: 400 \pm 1 cps.
Frequency changes less than 1.0 cps. for all environment, load and input voltage variation

Distortion: Less than 5% total harmonic

Efficiency: 80% at full load

250 VA STATIC INVERTER

Input
Voltage: 27.5 VDC \pm 10% per MIL-STD-704

Output
Power: 250 VA single phase 0.6 lag to 1.0 power factor

Voltage: 115 V adjustable from 110 to 120 volts

Regulation: 0.7 volt for any variation of load between zero and 110% of full load, and input voltage between 25 VDC and 30 VDC

Frequency: 400 \pm .5 cps.
Frequency changes less than 1.0 cps. for all environment, load and input voltage variation

Distortion: Less than 5% total harmonic

Efficiency: 80% at full load



Division of General Motors • Kokomo, Indiana

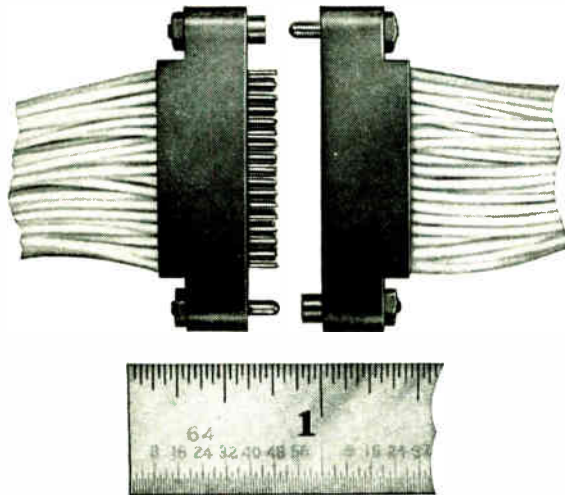

AMP solves small connector problems, too!

Let's put a ruler's edge to this AMPin-cert* Subminiature Pin and Socket Connector. Count the contacts. You'll find a lot packed into less space . . . fifty to be exact in the illustrated configuration. Fifty reliable circuits in minimal space . . . designed to go a long way toward solving those density problems that occur ever more frequently these days. And that's not all . . . with the industry-accepted, AMP automated crimping process, you'll solve your density problem without the worry of fine wire breakage, slow-burns from solder methods, cold solder joints and rigidly soldered contacts that can't be changed. Quick, reliable terminations by the hundreds per hour, crimped in reliability, easy hand assembly and snap-in versatility . . . all these add up to dependable connector performance at the lowest applied cost anywhere.

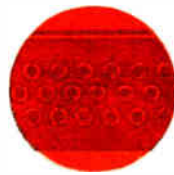

- .060" center to center spacing in cluster arrangement
- .050" center to center possible for alternate application
- 300 volts AC RMS working voltage—or better
- Wire range—26-32 AWG Stranded or Solid
- Insulation support
- Density potential—250 contacts per sq. in.

Get all the facts on this AMPin-cert Subminiature Connector and see how they stack up to your design requirements. Send for them today.

AMP

INCORPORATED
Harrisburg, Pennsylvania

AMP products and engineering assistance are available through subsidiary companies in: Australia • Canada • England • France • Holland • Italy • Japan • Mexico • West Germany

*Trademark of AMP INCORPORATED



Some things worth looking for in 10-amp "industrial" relays

If you buy heavy-duty, AC or DC plug-in relays, or design equipment which uses them, here's some information that could help you. It deals with small but significant differences among these relays, that are also the very things that ultimately decide whether the relay will work on the 900,000th operation . . . whether there's a strong chance of dangerous overheating when loads approach maximum ratings . . . whether there's real safety when high currents are being switched—in short, how much certainty of operation ("reliability") you're getting for your money.

We've designed a plug-in relay of this type, electrically and mechanically interchangeable with half a dozen others of its kind now on the market, that we believe has a positive advantage to offer you in every one of the characteristics just mentioned. Here are some of the particulars, to back up all this printed confidence:

— to keep the opportunity for trouble as small as possible, parts are rugged, simple and few in number. All contact circuit parts are directly connected to rigid base pins, without wire or solder joints. The solid base aligning plug won't break off either, unless you take a wrench to it. The parts inside the plastic dust cover are carefully designed to use the available space to best advantage—contacts, armature assembly and coil are each of optimum size for long, dependable operation under heavy-duty service.

— 10 amperes will be safely carried, without heat dissipation problems or blue sparks jumping around, by the solid base with specially-molded insulating barriers, solid pins and other

current-carrying members. (Ever try running 10 amps through an ordinary hollow-pin tube base? Some relays do—for a while.)

— contacts close positively with good pressure (in relay parlance, "clean switching") because of ample electromagnetic forces from a big, efficient coil and armature assembly. You don't have to add extra safety margins in operate power just to be extra sure the relay will work. Contacts open with similar dispatch when the release point is reached.

— circuits are opened and closed when they're supposed to be, on the millionth operation as on the first, because mechanically strong parts don't bend and get out of adjustment or fatigue and break after repeated flexing. Moving contacts are mounted on long, U-shaped flat spring strips, instead of on short, delicate pieces sandwiched between layers of phenolic and further demoralized by rivets.

— shocks through wandering fingers or screw-drivers touching the case aren't possible, because the frame is completely independent of and enclosed by the case. (10 amps, even at 28 volts, is a sensation you can do without.)

While this has been a description of the DPDT Sigma Series 46 relay, we think it also offers a good guide to what to look for in any heavy-duty, 10-amp "industrial" relay. The final test, of course, is how the relay works in *your* equipment. You can get a "46" to try right away—either from a local Sigma distributor's shelf or from stock at the plant. Comparing components can be interesting—and often profitable.

SERIES 46 AC OR DC DPDT RELAYS

CONTACT RATING

— AC: 1200 v-a/pole, with 240V. and 10 amp. maximums; DC: 5 amp. @ 28 VDC

LIFE

— 500,000 operations for 10 amp. loads
Up to 10 million operations for 1 amp. loads

STANDARD SENSITIVITIES

— AC: 4 v-a, DC: 1 watt

PRICE RANGE

— \$3.00 to \$6.80 each, depending on coil resistance, adjustment, contact material and quantity.

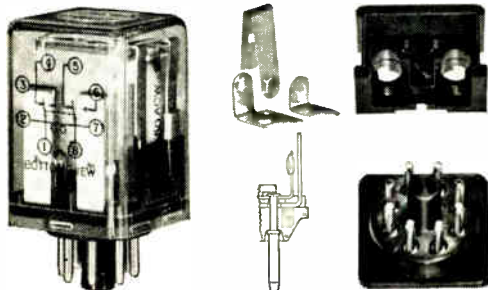

See us in Chicago at Booth 1432
DESIGN ENGINEERING SHOW



SIGMA

SIGMA INSTRUMENTS, INC.

62 PEARL ST., SO. BRAINTREE 85, MASS.

the big choice in fine variable transformers

Select from *four*, big, basic families . . .

VT2	VT4	VT8	VT20
1.5-1.8 amp	3.5-4.75 amp	7.5-10 amp	20-25 amp

● Get *immediate delivery* from your distributor or the factory on 49 stock sizes and types: single transformers, tandems, with and without over-voltage, low voltage, single-phase, three-phase, cased, fixed mounting, portable, 36V, 120V, 240V, and 480V.

● Choose from *many* special features: tandems, multi-taps, motor drives, concentric controls, special windings, shafts of all types, and job-matched enclosures among others.

● Specify from innumerable possibilities in "custom-engineered" combinations with unusual reciprocating motor drives, complex double-track arrangements, rheostats, toggle switches, and precision switches.

● Pick 36V transformers in 5-, 12-, or 22-amp ratings for your transistorized circuits.

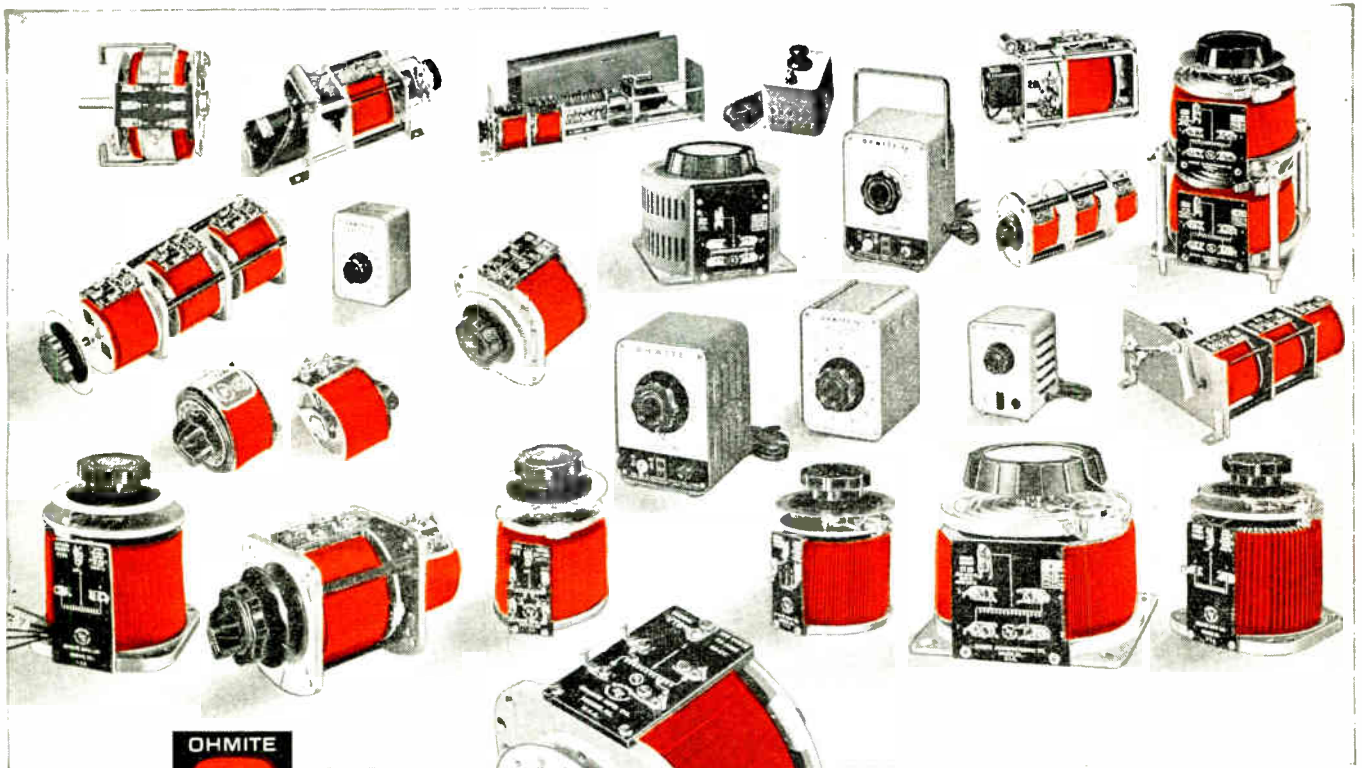

OHMITE

OHMITE MANUFACTURING COMPANY
3610 Howard Street, Skokie, Illinois

Rheostats • Power Resistors • Precision Resistors • Relays • R. F. Chokes • Germanium Diodes • Variable Transformers • Tantalum Capacitors • Tap Switches

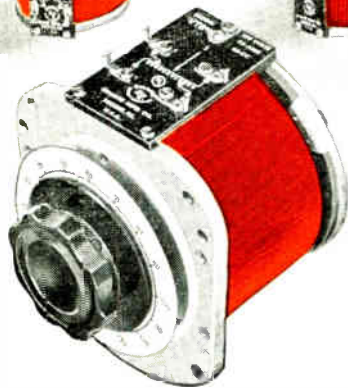

From every aspect, you'll find that Ohmite is a good place to purchase variable transformers. If you need a "special" . . . okay, just tell Ohmite. Need some engineering assistance? All right! What about quantity? Ohmite can handle big orders, medium, and small. The Ohmite VT line of variable transformers is broad and deep. So is the service. Find out by specifying "Ohmite" on your next requirement for variable transformers.

Write for Bulletin 151

NEW PHILCO MADT* COMMUNICATIONS TYPES DELIVER germanium performance at silicon temperatures

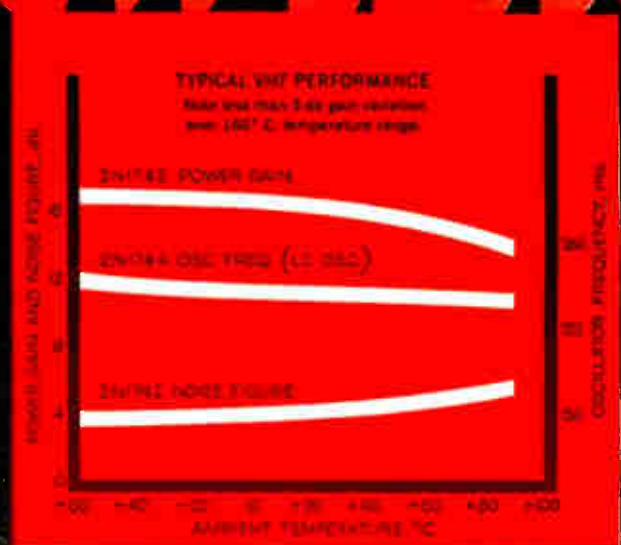
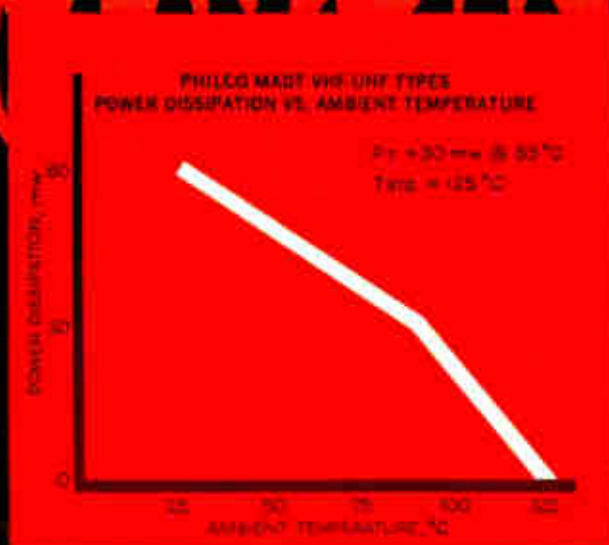

Now Philco, world leader in communications transistors, makes available MADT communications devices with higher temperature and dissipation ratings, for high reliability commercial and military applications. Result: Now you can design optimized circuits with a 2 to 1 derating factor—at all ambient temperatures to 85° C. New Philco MADT power dissipation ratings assure greater design margin. The new ratings are applicable to Philco VHF and UHF communications transistor types 2N1742, 2N1743 and 2N1744. Soon, other Philco MADT communications types also will deliver their superior germanium performances at temperatures previously associated only with silicon.

Now you don't have to compromise performance at high temperatures. Specify Philco MADT for all communications applications—including the updated MADT's for your high temperature jobs.

*Micro Alloy Diffused-base Transistor

For complete data, write Dept. E42762.

Types 2N1742-44 are immediately available from your Philco Industrial Semiconductor Distributor

PHILCO
A SUBSIDIARY OF *Ford Motor Company*
LANSDALE DIVISION, LANSDALE, PA.



Narrow-Band Tv Uses Pseudo-Random Scan

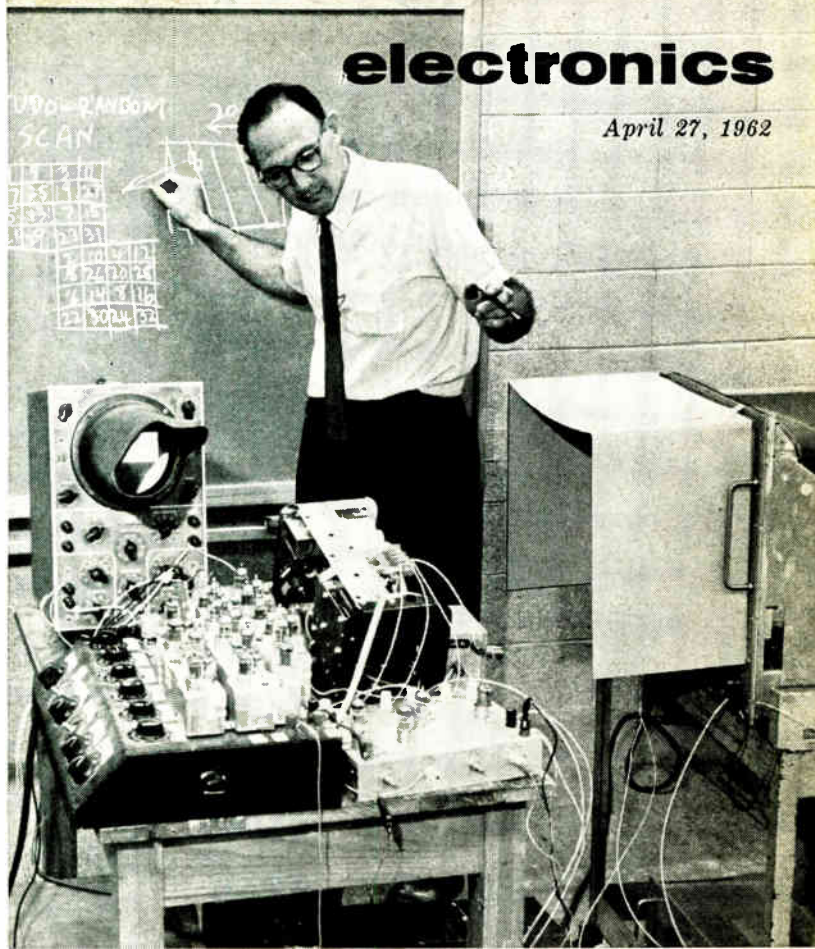

Author at blackboard describing pseudo-random scan

The 10-Kc bandwidth allows closed-circuit transmission over telephone lines. Video tape recording is possible on a standard dual-channel recorder increased to 30 ips

By SID DEUTSCH

Polytechnic Institute of Brooklyn,
New York

A NARROW-BAND television system indicates that pictures of good entertainment value are possible with a bandwidth of only 10 Kc. The entire system is described, although some of the units have not been completed.

The system takes advantage of the low information content of television pictures, the tolerance of human vision for motion deterioration, and the less-than-optimum resolution of conventional pictures.

There is little motion, relative to the screen, in a typical television picture. The cameraman tries to center a rapidly-moving object to prevent its escape to one side of the screen. If the object of interest is a group of people who are talking, only their mouths or arms will be in motion. A swaying type of motion, such as is obtained during a dance performance, is relatively rare.

The eye is extremely sensitive to flicker and finds it annoying. Gradual fades, on the other hand,

are accepted. The 10-Kc system uses a 2.667-second frame period. When an object suddenly moves in the picture, it gradually fades from view in its old location, over a 2.667-second interval, while gradually appearing in its new location. The effect is correspondingly less pronounced if the motion is gradual rather than sudden. The eye will tolerate, with little loss in entertainment value, a blurring effect during rapid motion.

A conventional 4-Mc picture contains about 200,000 visible elements (distinct black or white dots). An inexpensive home receiver, with 2-Mc bandwidth and poor interlacing, yields a "good" picture with about 50,000 elements. The 10-Kc picture contains approximately 45,000 visible elements.

With a bandwidth of 10 Kc it is possible to transmit live or motion pictures by short-wave, record classroom lectures on a conventional tape recorder, use high-quality telephone lines for closed-circuit tele-

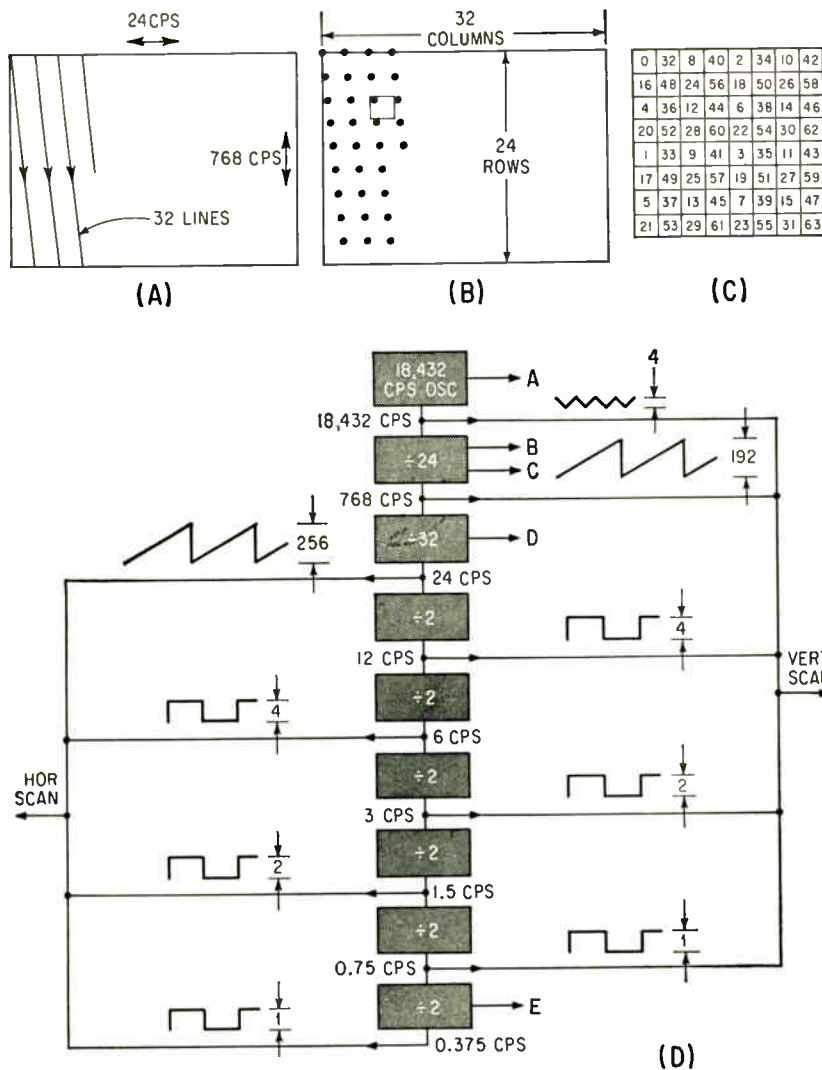

FIG. 1—Evolution of the pseudo-random scan: coarse scan (A); dot scan (B); magnified view (C) of the small square in (B), showing the successive picture-element locations covered by each dot. In the scanning-signal generator (D) the waveshapes are not drawn to scale. The peak-to-peak amplitude of each signal is given in picture-element units. Signals A to E are shown in Fig. 2A

vision, and remove noise in a conventional 4-Mc picture.

The customary scanning motion is one of the worst possible ways in which to cover an area without introducing flicker. The best possible way is to use a random dot scan, that is, to deposit one picture element at a time, but by a beam that hops from place to place in a random manner so that, even if a complete scan requires 2.667 seconds, every region of the picture will be visited several times by the scanning dot during the 2.667-second interval.

A truly random scan is impractical because it cannot be synchronized. The 10-Kc system uses a compromise pseudo-random type of motion. The complete scanning

pattern is developed in three steps, as follows:

First, as in Fig. 1A, a coarse scan is used in which the picture is scanned vertically at 768 cps and horizontally at 24 cps to give 32 lines per field. Vertical scanning is used because less voltage (or current) is required in this direction; hence, in magnetic deflection, less current need be supplied to the low-inductance yoke coil. The 24-cps figure is compatible with motion-picture practice. It is the lowest frequency at which large-area flicker is negligible.

The 768-cps vertical sawtooth is modified by a small 18,432-cps triangle wave to give a stepped waveshape. The resulting raster, as indicated in Fig. 1B, is a dot pattern

with 24 rows of dots per field. The 32 lines of Fig. 1A become 32 columns of dots in Fig. 1B. The scanning beam remains stationary for about 25 microseconds in producing each dot.

Finally, square waves are added to the dot pattern to impart the pseudo-random scanning motion. The entire dot array of Fig. 1B is slightly shifted, every 1/24 second, so that each dot covers a new picture-element location. Figure 1C is a magnified view of the local area covered by the dot in the upper-left corner of the small square in Fig. 1B. At first, the dot is in position 0 of Fig. 1C. One-twenty-fourth of a second later, it appears in position 1; the next 1/24 second later, in position 2, etc. The entire process is repeated after the full local scan of 64 picture elements has been accomplished. The frame period is, accordingly, $64/24 = 2.667$ seconds.

Figure 1C appears to be a random array of 64 numbers. Actually, it is produced with six square waves that are easily generated and synchronized. If the picture is viewed on a long-persistence cathode-ray tube that has 10-percent light output approximately 2.5 seconds after excitation, the pseudo-random local scanning motion should be scarcely noticeable despite the full 2.667 seconds needed to completely cover the picture area.

Since each dot of Fig. 1B involves 8 elements in each direction, the transmission contains 192 elements vertically and 256 elements horizontally, a total of 49,152. About 5 percent of these are lost, in each direction, because of retrace time. The transmission rate is $49,152/2.667 = 18,432$ elements per sec = the dot frequency. The nominal bandwidth is half this figure because two successive black and white elements approximate a 9,216-cps sinewave.

A block diagram of the scanning-signal generator is shown in Fig. 1D. The peak-to-peak amplitude of each signal is given in picture-element units. Starting with the 18,432-cps clock, bistable multivibrators divide down to 0.375 cps. The pseudo-random scan square waves are produced by the block of six bistable multis at the lower end of the diagram.

As in conventional television practice, synchronizing signals are added to the video signal. The 10-Kc system sync signals are simpler than those of conventional broadcasts in that equalizing pulses are unnecessary, but more complicated in that dot and square-wave sync signals must be added. A block diagram of the sync signal generator and subsequent shaping circuits is shown in Fig. 2A. The sync signal waveshape is shown in Fig. 2B.

Vertical and horizontal sync pulses are modulated by a 9,216-cps square wave; this synchronizes a 9,216-cps oscillator in the receiver by a conventional automatic phase control circuit. The 18,432-cps dot triangle is then derived by frequency-doubling the oscillator output.

A second automatic phase control circuit synchronizes a 768-cps oscillator in the receiver to the incoming vertical sync pulses in order to generate the vertical sawtooth.

The 24-cps horizontal sawtooth sync signal is derived, as in conventional practice, by integrating the horizontal sync pulse.

The six bistable multivibrators in the receiver are synchronized with those of the transmitter by reducing, to half its usual width, one out of every 64 horizontal sync pulses. When all of the six bistables of Fig. 1D are in the zero state (first tube off, second tube on), a 1,000- μ sec horizontal sync pulse is substituted for the usual 2,000- μ sec pulse. In the receiver, the 1,000- μ sec pulse generates a reset pulse that places all of the receiver bistables into the zero state.

To minimize bandwidth requirements, the composite video-plus-sync signal (waveform G in Fig. 2C) is sampled by narrow 18,432-cps pulses and then passed through a 10-Kc low-pass filter before it reaches the transmitter output terminals (waveform I in Fig. 2C). In the receiver, the cathode of the picture tube is modulated by an 18,432-cps square wave (waveform J) to yield the original brightness levels (waveform K). Waveform J is derived from the 9,216-cps locally-generated signal, which, in turn, is synchronized to the transmitter vertical sync pulse information carried in the peak amplitude of waveform I.

The video signal is a-c coupled

with an effective time constant of 20/768, or 0.026 second. This results in a small droop (less than 5 percent) between vertical sync pulses. Wherever necessary, d-c components are restored by clamping against the vertical sync pulse tips.

The system has been in operation for several months as a closed-circuit arrangement, but without sync signals; that is, the output of the scanning signal generator of Fig. 1D is fed to both the vidicon camera and to the monitor cathode-ray tube. The latter employs a P19

phosphor having 10-percent light output approximately 0.22 second after excitation. Because of the relatively short persistence of the P19, the dot structure of the pseudo-random scan is excessively annoying when viewed from a normal distance. Somewhat higher scanning frequencies, corresponding to a nominal bandwidth of 40 Kc, yield a good picture even with the P19 phosphor. An attempt is being made to obtain a special phosphor that has the aforementioned characteristic of 10-percent light output 2.5 seconds after excitation.

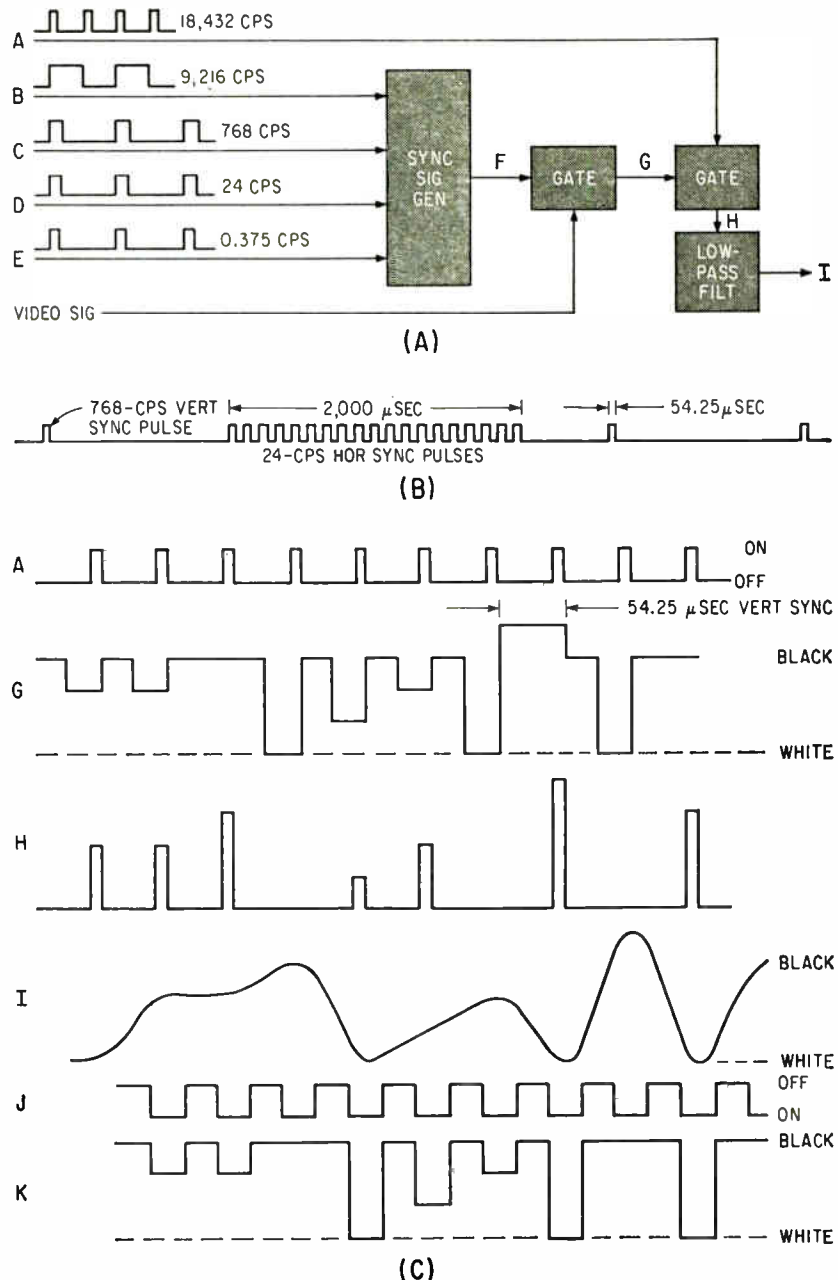

FIG. 2—Synchronizing signal and shaping circuits (A); waveform F (B), in which one of every 64 horizontal sync pulses is half-width; waveforms A through I (C) appear at various points in block diagram (A)

Blood-Cell Scanner Identifies

Experimental system identifies and counts particular cells semiautomatically, using a closed-circuit tv microscope and a special-purpose digital computer. Present application is in studies of blood of people exposed to radiation

By NICHOLAS F. IZZO
WILLIAM COLES
The Perkin-Elmer Corp.,
Norwalk, Connecticut



Television system coupled with a computer can analyze a blood sample in a few moments, a job that formerly took several hours

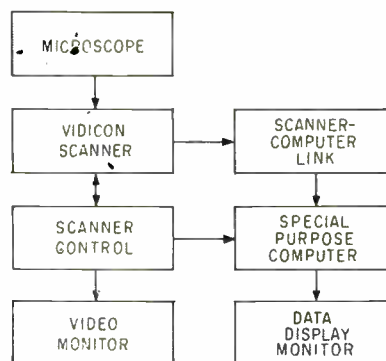

FIG. 1 — System uses television scanning and a computer

MANY electronic equipment aids used by the biologist and medical research worker minimize tedious time-consuming tasks. In hematology, the science dealing with blood, such aids are necessary especially in counting and cataloging the numerous blood cells.

Among unusual blood cells is the binucleate lymphocyte. The Perkin-Elmer Corporation in cooperation with the University of Rochester Atomic Energy Project is studying procedures for automatic blood cell identification using this blood cell as a case in point.

Classical microscopic studies have demonstrated an increased rate of occurrence of the binucleate lymphocyte following a radiation exposure in the maximum permissible range. The rate of occurrence of the binucleate lymphocyte is normally of the order of one per 30,000 white blood cells. White blood cells or leucocytes, are divided into two major classes called lymphocytes and granulocytes.

Tens of thousands of white blood cells in each sample must be examined to make reasonably accurate estimates of the rate of occurrence

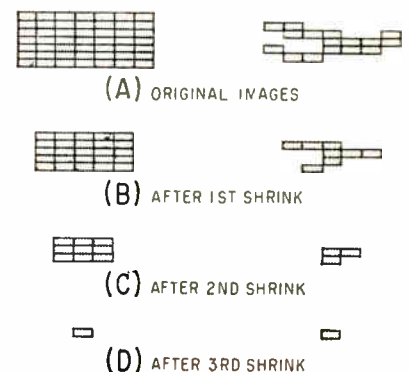

FIG. 2 — Shrink process differentiates between classes of cells

Rare Cells

of the abnormal cell.

Several hours of microscopic examination are required for such an analysis.

This is a slow process and a serious deterrent to the application of the phenomena as a hemotological monitoring aid. It also makes experimental studies time consuming and costly.

Sufficient statistical data is needed to validate the importance of the binucleate lymphocyte and the CELLSCAN™ system is an experimental blood cell scanning and data processing system to demonstrate the feasibility of applying machine techniques to cell identification, thereby increasing the data-acquisition rate.

A block diagram of the system is shown in Fig. 1. A glass-mounted blood smear is placed under the objective of the microscope. The magnified image is focused on the target of a vidicon tube. The video signal is coupled to a video processor that converts analog to binary video. Binary video is coupled to the computer that performs the logic operations. A scanner monitor and a data display monitor display the image field.

The blood-smear sample presented to the scanner is a monocellular layer of blood spread on a glass slide. Biological dyes selectively stain the different cell constituents, that is the nuclei and granules. A narrow-band optical

filter enhances the spectral characteristics of the cell nuclei and granules. The technique used to differentiate between classes of white cells is to count and size the constituents of a given cell.

This technique, the shrink operation, is shown in Fig. 2. The pattern in Fig. 2A represents images of two objects that have been spatially quantized. The shrink operation is applied to them as shown in Figs. 2B through 2D. Peripheral elementary areas are stripped from each quantized image sequentially until a single elementary area remains. By measuring the number of stripping operations required to reduce the initial image to a single elementary area, a measure of the size of the object is achieved.

A feasibility model was built to evaluate the application of this technique to automatic recognition of the binucleate lymphocyte. A Leitz Ortholux microscope is the front end and an oil-immersed, 90-power apochromatic objective lens, with a 1.32 numerical aperture, is used with a 4-power photo-ocular eyepiece to image the blood cell. The image is focused on the target of a GEC 7325 vidicon tube at a 360 times magnification. This tube was chosen because of its low light-level sensitivity (about 0.1 to 0.2 foot candle) and because the physical construction of this tube is such that it can be mounted in a vertical position permitting direct optical

coupling to the microscope eyepiece.

The scanner is a slow-scan television system in which a horizontal scan rate of 60 cps and a vertical scan period of 5 seconds produce a field of 300 horizontal scans for each image. A slow scan rate was chosen so that the output data rate of the scanner would be matched to the data processing rate of the computer. Such a slow rate permits pictorial data recording directly upon magnetic tape at approximately 4,000 bits per second. Thus, a relatively inexpensive audio tape recorder can be employed.

Since white cells are typically 10 to 20 microns in diameter, the field of view is restricted to a square 30 microns on a side, permitting just one blood cell to be imaged by the microscope. Thus, with 300 scanning lines, the elementary sample area or resolution is one-tenth of a micron square. This resolution is required since the separation between nuclei in a binucleate lymphocyte may be of this order. However, computer storage of almost 100,000 bits per field of view is required. To reduce this memory requirement, a video pulse-stretching technique is used. This technique decreases the amount of data to be processed without eliminating useful information. The effect of this horizontal stretch is to increase the horizontal dimension between images in the field of view (white

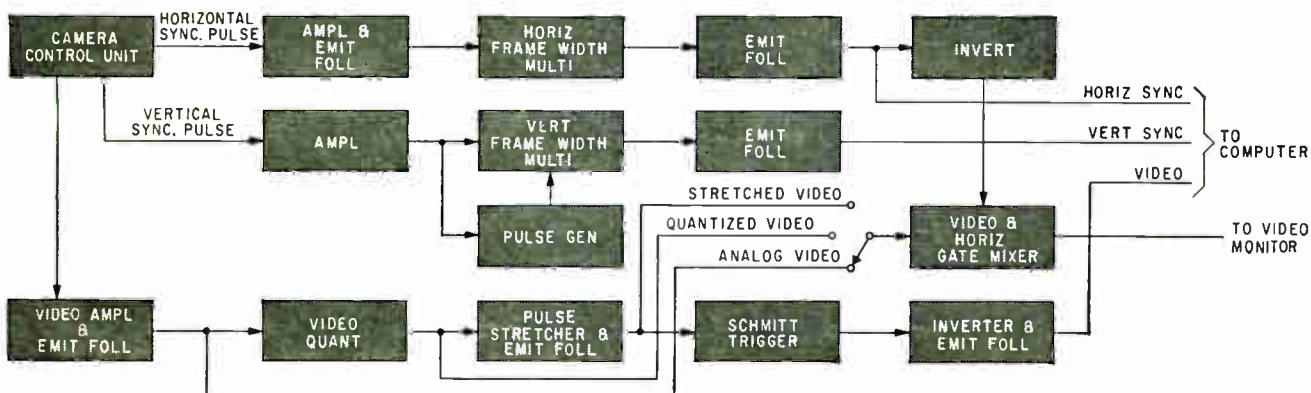

FIG. 3—Scanner computer link feeds computer and video system

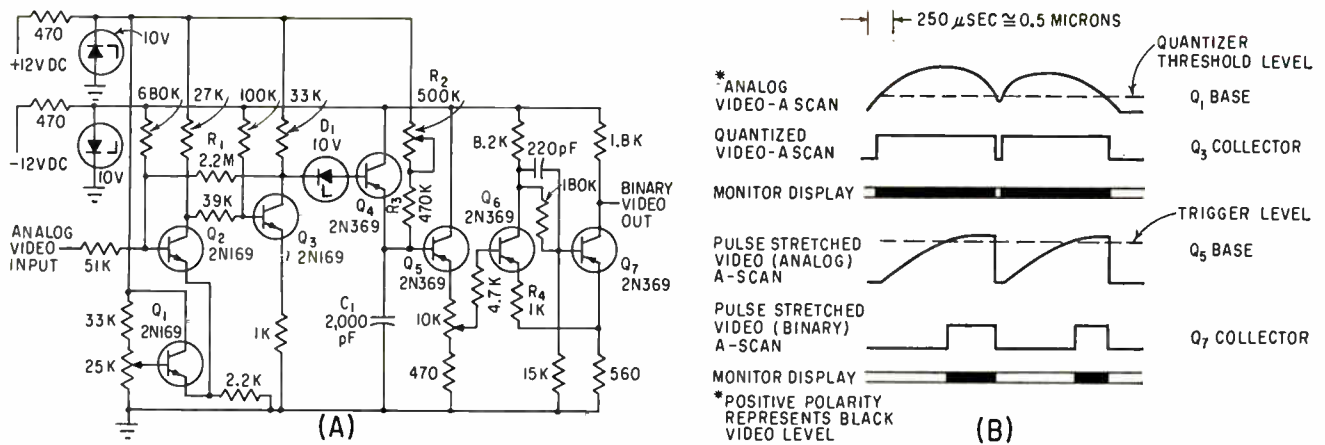

FIG. 4—Processing circuit (A) accepts analog video input and produces a binary video output as shown in (B)

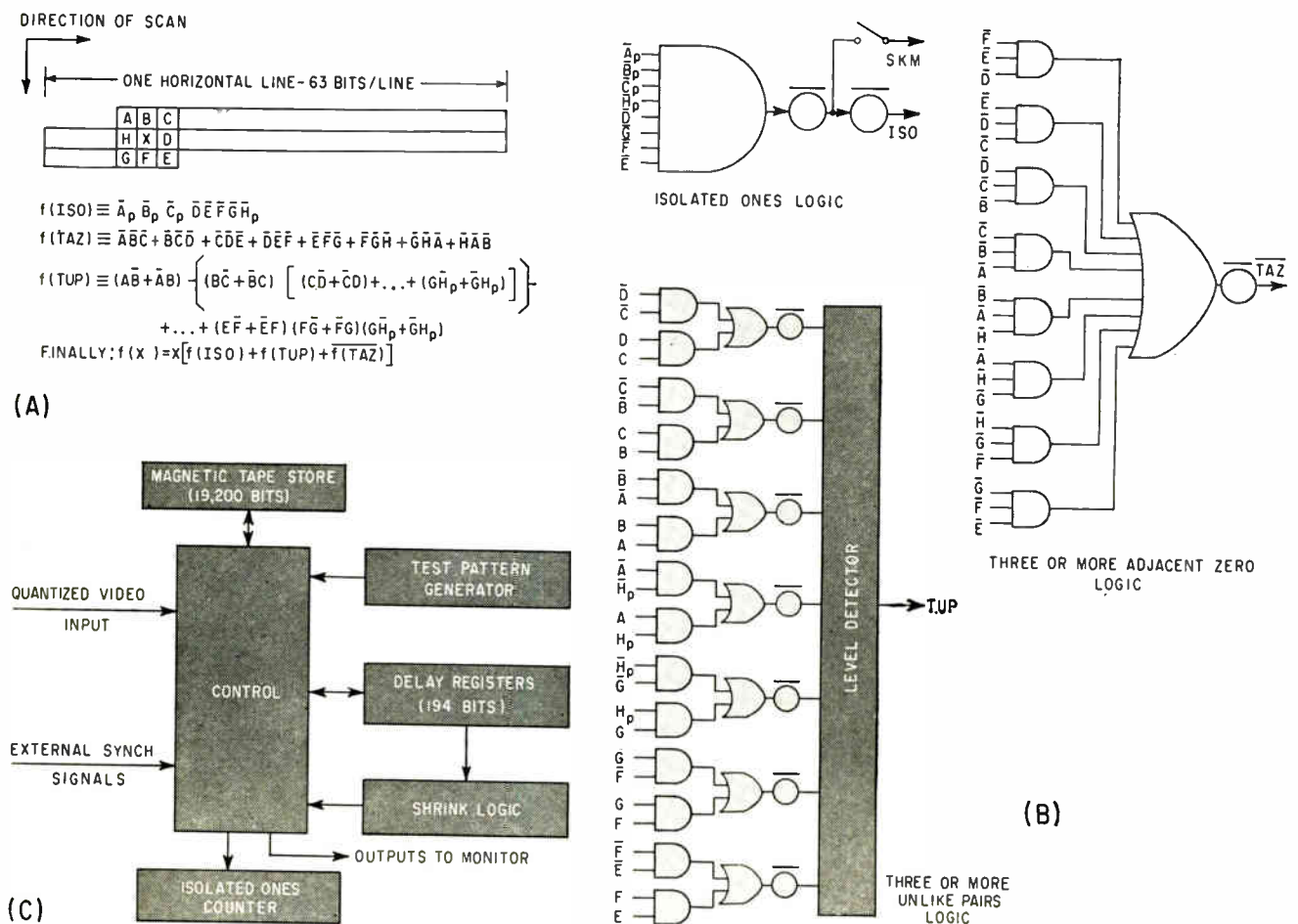

FIG. 5—Shrink algorithm (A) and shrink logic (B). Computer block diagram is shown at (C)

video) by five resolution bits or about 0.5 microns thus shrinking images (black video) by the same amount. The choice of a five-bit white video stretch was governed by the size of granules, cell constituents that identify granulocytes. The five-bit stretch used eliminates images or granules in

the data field smaller than 0.5 micron. However, there is a sufficient number of granules larger than one-half micron that can differentiate a binucleate lymphocyte from a binucleate granulocyte. The pulse-stretching technique reduces one data field to 64 horizontal × 300 vertical bits or a memory re-

quirement of 19,200 bits. Both the quantizing of the analog video and the pulse stretching of the quantized video are accomplished in the scanner-computer link.

A block diagram of the link is shown in Fig. 3. Horizontal and vertical blanking pulses from the scanner are coupled to the link.

Both pulses are reshaped to provide frame-gate pulses and vary the position of the left-hand and top border of the image frame. The computer does not necessarily receive the entire image field from the television microscope, but only that portion that the operator desires the computer to analyze. This selective operation eliminates spurious cells from the field of view.

A schematic of the video processing circuit is shown in Fig. 4A. The analog video output from the camera is coupled to a difference amplifier consisting of transistors Q_1 and Q_2 . The turn-on voltage of Q_1 is determined by Q_2 , which provides a low source impedance, voltage-reference level at the common emitter junction of Q_1 and Q_2 . A fixed threshold voltage is set to quantize each cell image. Positive-polarity video signals larger than the threshold voltage plus V_{be} of Q_2 turns on Q_1 . Resistor R_1 provides positive feedback from the collector of the squaring amplifier, Q_1 , which improves both the fall and rise times of the quantized video from about 200 microseconds to 2 microseconds. The collector supply of the quantizer is zener-diode regulated to minimize the turn-on variations of Q_1 .

The negative-polarity signal at the collector of Q_1 represents the white video level (see Fig. 4B). The signal is coupled through D_1 , a d-c level-shifting 10 v zener diode. Since Q_1 is a *ppn* transistor, the base-to-emitter forward resistance is low for negative pulses and high for positive pulses. Thus, the rise time for positive pulses at the emitter of Q_1 is determined by the R-C time of R_2 , R_3 and C_1 .

An optical resolution of 0.1 micron corresponds to a pulse width of $16,000/300 = 53.3$ microseconds. Thus, the five-bit stretch requires a pulse width of about 267 microseconds. The R-C time of R_2 , R_3 and C_1 is variable from 50 to 500 microseconds to permit different stretch times using actual cell images. A positive-going, exponential voltage results at the base of emitter follower Q_3 (see Fig. 4B), which buffers the R-C network from a Schmitt trigger circuit. The voltage level at which the Schmitt circuit triggers, as well as the R-C

BLOOD CELLS are divided into two major classes; the red cells (erythrocytes) and the white cells (leucocytes). It is the white cell population that is of concern in this article. The two major classes of white cells are lymphocytes and granulocytes. There are about two granulocytes for each lymphocyte. The sub class of lymphocytes whose incidence may be an index of low-level radiation damage consists of lymphocytes having two nuclei. These cells are called binucleate lymphocytes.

GRANULES are much smaller than white cell nuclei. Granulocytes (type of white cells) are characterized by the multitude of granules within the cell membranes (cytoplasm)

time constant, determines the amount of white video stretch. The Schmitt circuit also shapes the video signal. The hysteresis range, that is, the incremental voltage range over which turn-on and turn-off of the trigger circuit is effected, is small (about ± 6 mv) in comparison with the 6-v signal level at this point. The amount of feedback to achieve a minimum hysteresis is controlled by R_4 . The variation of pulse widths is maintained within a fraction of a microsecond. A time sequence of the quantized, stretched and pulse-shaped video is shown in Fig. 4B. Additional circuits provide proper polarity and voltage-level signals to the computer input.

A digital approach to particle counting and sizing is necessary to deal with the irregularly-shaped blood cell constituents. Each constituent consists of a grouping of contiguous binary 1's in the binary image. The computer counts and sizes the image areas that consist of contiguous 1's. The output of the computer is an image histogram for the cell viewed by the scanner. To produce this histogram, the computer operates sequentially on each image bit causing binary 1's on the periphery of any contiguous group of 1's, to be changed to 0's. When a group is reduced to a single binary 1, this is retained and called an isolated one. This is the shrink operation and was originally devised by M.

Golay.² The computer is required to make several sequential examinations (passes) of the image before the image histogram is completed. The number of passes required to reduce the original image to a single isolated binary 1 is proportional to the maximum chord of the original group of 1's. The image histogram is computed by counting the number of isolated 1's in the memory after each pass. This information is then converted into a plot of the total number of groups of 1's in the original image that fall into each of several maximum chord ranges. This plot is the image histogram.

To program the computer to perform the shrink operation, the algorithm shown in Fig. 5A is used. The image bit operated upon is designated X , and its eight neighbors $A, B, C \dots H$. Since the computer sequences from left to right and top to bottom, bits A, B, C , and H have previously been processed. Their processed values are designated A_p, B_p, C_p and H_p .

Three functions are derived from the values of these eight neighbors. The function $f(ISO)$ indicates whether the bit under investigation is an isolated one. The function $f(TAZ)$ indicates whether any three adjacent neighbors are 0. The final function indicates whether the X bit is a link between subgroups of a given grouping of contiguous 1's. This indication is provided by the value of $f(TUP)$ which is 1 when there are three or more unlike neighbor pairs. The $f(TUP)$ function is used to prevent the computer program from producing two isolated 1's when operating upon a dumbbell-shaped original image. The complete shrink algorithm is $f(X_p)$ and is given in the last line. A diagram of the basic logic circuit used to perform the shrink operation is shown in Fig. 5B.

The isolated ones logic shown in Fig. 5B consists of the 0 inputs of all eight neighbors of X . If all the inputs to the ISO AND gate are zero, $f(ISO) = 1$. The three-adjacent-zero logic is shown in Fig. 5B. Eight, three-inputs AND gates which all serve as inputs to a common OR gate are used. The 0 level of three adjacent neighbors are the inputs to each AND gate. Thus, if $\overline{E}, \overline{F}, \overline{G}$, are present at the same

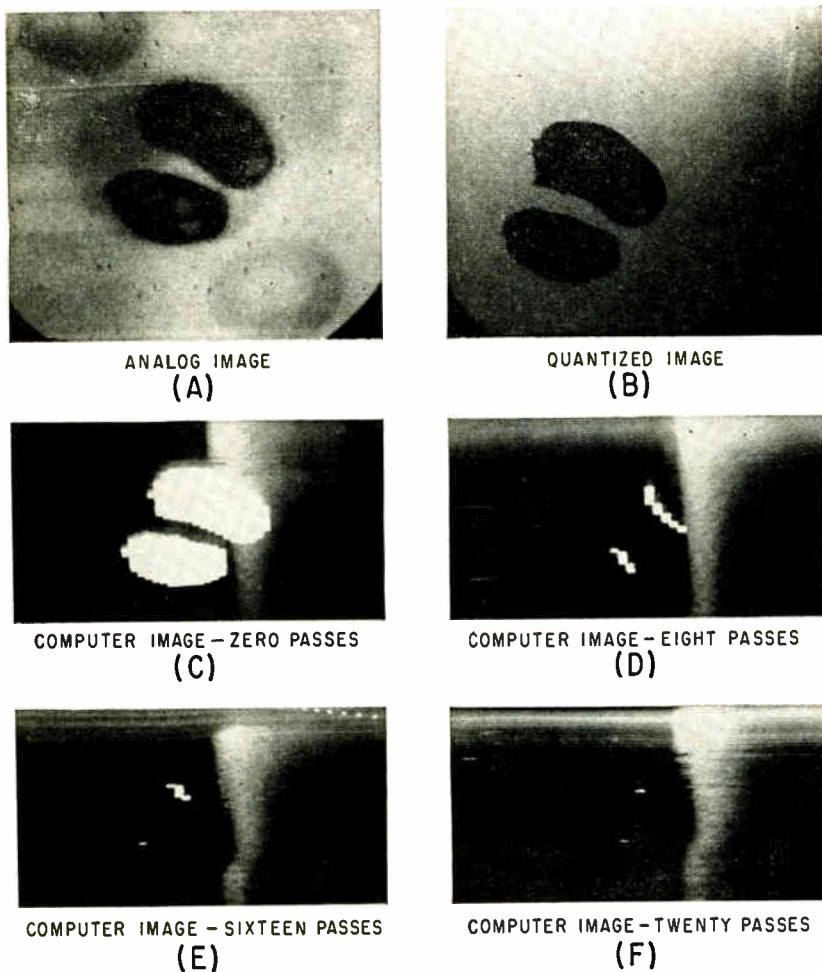

FIG. 6—Typical binucleate lymphocyte shrink process

time, then $f(TAZ) = 1$. The $f(TUP)$ logic is shown in Fig. 5B. Seven exclusive-OR gates, each followed by an inverter, have outputs which are summed in an analog level detector. A sum of three or more individual TUP signals at the detector input provides an $f(TUP) = 1$ signal.

Another logic operation used is called shrink modified. In this mode, the image is complemented, that is, 1 bits are changed to 0 bits and conversely. The shrink operation is then applied to the pattern. This routine is required to shrink images that contain inclusions, for example, an image that has a configuration similar to the letter 0.³

A block diagram of the complete system computer is shown in Fig. 5C. The recorder is a modified audio tape deck with a tape speed of 15 ips. The length of tape loop between the read and write heads is 75 inches, which permits real time recording of the scanner's five-

second vertical frame period. Non-return-to-zero (nrz) recording is used with automatic erase of previous data during writing. One track is used for storing 0's, another for 1's. Internal computer timing signals are obtained from data stored on the tape. This method is economical but presents a problem because of possible track skew during rerecording. A scheme of alternating the 1 and 0 tracks minimizes the effect of skew.

In addition to the magnetic tape loop, additional memory is provided in two shift registers. One shift register stores enough data from the image to give the value of the $A_n, B_n, C_n, \dots, H_n$ neighbors. This requires $2N + 3$ bits = 129 bits, where $N = 63$, the total number of bits in a horizontal scanning line. Another shift register holds $N + 2 = 65$ bits of processed information to provide the A_n, B_n, C_n and H_n data. Three counters are used in the computer. The timing

counter is used with both internally and externally generated timing pulses to divide a horizontal scan line into N intervals. A pass counter counts the total number of times that the initial video image has been processed. The isolated ones counter counts the number of isolated ones in the video image that are found on the tape in one pass.

At the beginning of the data processing run, the computer registers are cleared. Then, under control of synchronization signals from the scanner, the memory is filled with one field of view. The image stored on the magnetic tape is serially transferred to the memory registers and may or may not be operated upon using the shrink algorithm depending upon the setting of controls on the computer console. The computer applies the shrink operation to the image for a preset number of passes, variable geometrically from 4 to 128. After this number of passes has occurred, the computer automatically reverts to a mode of operation wherein the tape continues to be read and the image is rewritten unchanged. At this time, the computer may be ordered to count the number of isolated 1's in the residual image. Thus, the operator is able to complete the image histogram for the field of view that has been stored.

The system is monitored by a video monitor that displays the original or residual image contained in computer memory and by a second monitor capable of displaying either the analog video signal or the quantized signal from the television microscope. An example of the images displayed on the monitors is shown in Fig. 6, which depicts the shrinking of a typical binucleate lymphocyte.

The analog image of this cell is shown in Fig. 6A. It was obtained using a blood sample prepared by the University of Rochester. Here we see not only the two nuclei but also an indication of the surrounding cytoplasm and adjacent red cells. Figure 6B shows the quantized image as displayed by the scanner monitor. Here, the nuclei appear as dark areas on a white background. The lymphocyte cytoplasm and the red cells have disappeared due to thresholding action

of the quantizer in the scanner-computer link.

Figure 6C shows the image of a typical binucleate lymphocyte as stored by the computer and displayed on the computer monitor. The nuclei are now white on a dark background. This is because the computer stores dark areas in the quantized image as clusters of binary 1's which cause intensification of the monitor electron beam. These clusters of binary 1's are smaller than the nuclei in the quantized image. This is due to the pulse stretching action of the scanner-computer link. Once the image is stored by the computer, the computer is caused to count isolated 1's. Here, the count is 0. This number is recorded by the operator as the initial image count, C_0 . The operator then causes the computer to apply the shrink operation.

After each set of four passes, the computer is again required to count isolated 1's. These counts, called C_1 , C_2 , C_3 , etc., are recorded. Figures 6D, 6E, and 6F illustrate the contents of the computer memory after the image of the binucleate lymphocyte has been operated upon by the shrink process for 8, 16 and 20 passes respectively. The two original clusters of binary 1's are not reduced to two isolated 1's until 20 passes have been executed. Then $C_0 = C_1 = C_2 = C_3 = 0$, $C_4 = 1$ and $C_{20} = 2$. A plot of the computer output is shown in Fig. 7A. The operator, by subtraction, produces the image histogram shown in Fig. 7B. Here the values on the ordinate scale have been changed to the number of image constituents and the values on the abscissa indicate maximum chord ranges in microns.

Approximately 100 cells were processed which had been selected statistically by the University of Rochester. Fifty percent of the total cells selected were binucleate lymphocytes. The percentages of other cells were chosen according to their normal incidence but with a slight weighting factor to increase the number of cells selected that it was felt the computer might confuse with the binucleate lymphocyte. The image histogram data of the cells was obtained. A similarity coefficient was calculated for each cell that was processed, and

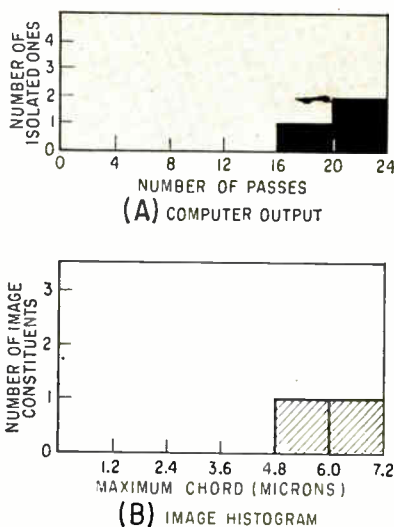

FIG. 7—Typical binucleate lymphocyte histograms

compared with the mean values for granulocytes, normal lymphocytes and binucleate lymphocytes. The similarity coefficients were computed using a method developed by Tanimoto and Ornstein.⁴ The results obtained show that the CELLSCAN system had an 85-90 percent recognition success rate in classifying the group of cells selected. The results obtained indicate that machine identification of the binucleate lymphocyte using the shrink operation is feasible. Several design changes which are contemplated would make the recognition-success rate still higher.

In the feasibility model, about five minutes are required to scan and process one cell where locating the cell, slide movement and focusing are performed manually. An operational system would be required to scan and process a complete slide (about 10,000 to 15,000 leucocytes) within several minutes covering an area of about one centimeter square.

In the demonstration model, about five minutes are required to scan and process one cell where locating the cell, slide movements and focusing are performed manually. An operational CELLSCAN system would be required to scan and process one square centimeter area of sample containing about 10,000 leucocytes within several minutes.

The scanner is required to resolve 0.1 micron elements and operate at its useable scanning rate.

Calculations show that a 1,000 line resolution flying-spot tube imaged on a 100 micron field can scan a sample area in about 30 minutes. The basic limitation of this system is the decay time of the phosphor.

Calculations show that a 750 line resolution vidicon viewing a 75 micron field would require 4 minutes to scan a sample area. These calculations assume scanning rates six times faster than conventional tv rates. White video stretch would be required in both vertical and horizontal directions for the computer to keep pace with the vidicon scanner. A total data input of approximately half a billion bits would be produced. A serial-parallel computer having a multiplicity of 150 shrink logic circuits can be used to operate upon the entire 150 bits of a line simultaneously. Since only 5 percent of the present computer consists of shrink logic, the suggested parallel machine would require only 7.5 times the components of the present computer. A 4 μ sec cycle which is well within the state of the art could be used to attain a total data processing time of about 4 minutes. This machine would require a magnetic core memory with a 3 μ sec read-write cycle and 10 Mc logic. Using present state-of-the-art computer circuitry, an electronic scanner operating at speeds more than 4 times our suggested vidicon scanner would be required.

The authors gratefully acknowledge the support of Dr. M. Ingram of the University of Rochester and the numerous discussions with K. Preston, Jr., and personnel at the Navigation Computer Corporation, Norristown, Penn.

This report is based on work performed under contract with the U. S. Atomic Energy Commission by the Perkin-Elmer Corporation, Norwalk, Connecticut and by the University of Rochester, Atomic Energy Project, Rochester, New York.

REFERENCES

- (1) Ingram, Dr. Marylou. The Occurrence and Significance of Binucleate Lymphocytes in Peripheral Blood After Small Radiation Exposures. *Int Jour Rad Bio. Special Supplement, Immediate and Low Level Effects of Ionizing Radiation*, 1959.
- (2) Perkin-Elmer Engineering Report 5489A (unpublished).
- (3) K. Preston, Jr., The CELLSCAN System—A Leucocyte Pattern Analyzer. *Proc WJCC*, **175**, 1961.
- (4) L. Ornstein, Pattern Recognition, Morphology, and the Generation of Hypotheses, *A.A.A.S. Conv December 30, 1960*.

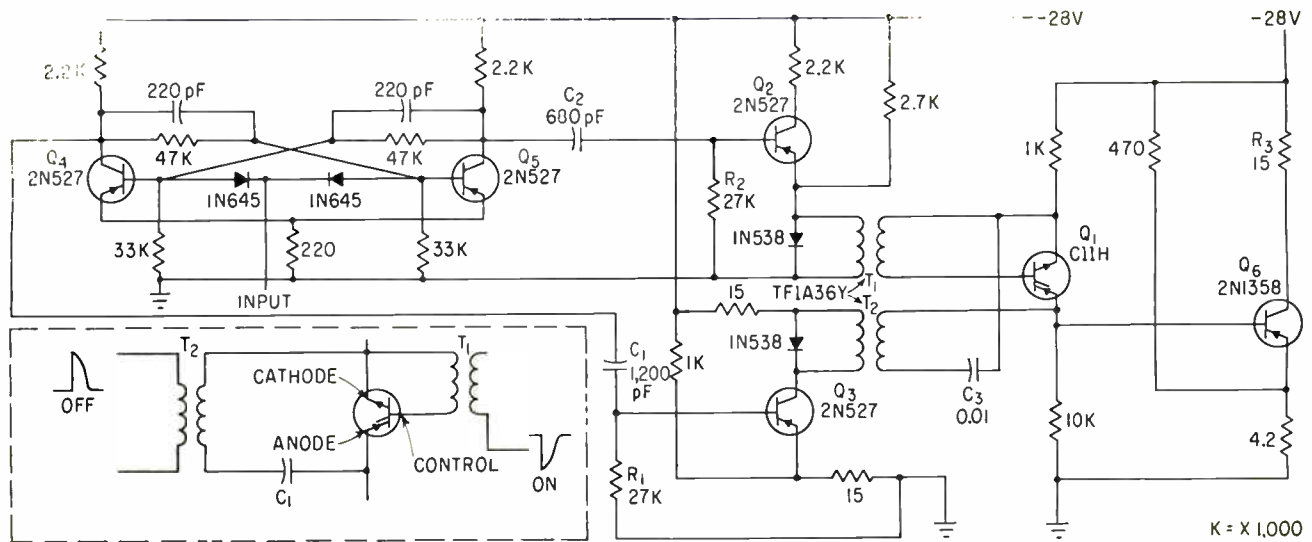

FIG. 1—Inset shows technique for switching an scr on and off. Main schematic shows circuit that switches 22 w d-c

Controlled Rectifiers for

These fast-acting switching circuits use silicon controlled rectifiers to control d-c and a-c power

By J. E. ROBERTS Martin Marietta Corp., Aerospace Div.
Electronic Systems & Products, Baltimore, Md.

SOLID-STATE switching elements do not have the shortcomings of relays and stepping switches. These mechanical switches, which have action times in the order of 1 to 10 milliseconds, are too slow for many applications. Furthermore, when relays operate at these speeds, contact bounce and switching transients make sensing functions impossible.

The switching circuits described in this article use the silicon controlled rectifier (scr) as the basic switching element. These scr's have an action time of microseconds. They are controlled by digital methods, being energized and deenergized by pulses and pulse techniques. Switch inputs are isolated from the output for accurate con-

trol of a-c or d-c power. The scr switch, in the quiescent or active state, draws relatively little power, and is capable of handling large loads.

The scr, an avalanche junction device, blocks current in either direction until a positive voltage is applied to the control gate. With a positive supply of about 2 v at 2 ma applied for 0.5 μ sec, the scr saturates, acting as a normal diode; voltage drop across the scr is < 0.5 v. To restore control, either the cathode must be raised to the anode voltage, or the entire load current must be bypassed for 8 to 10 μ sec. After the scr current is bypassed for the required time, the control junction regains control, and the scr remains cut off. In a-c

applications, the control cathode must be maintained at a positive voltage or the first negative half cycle will turn off the scr.

Pulse transformers that receive 3-v inputs, turn the scr on and off (inset, Fig. 1). These transformers provide a high degree of isolation. Transformer T_1 turns on the scr. Transformer T_2 , which turns off the scr, has a capacitor (C_1) in series with its secondary.

The size of C_1 is critical; while C_1 must be large enough to pass the load current for the turn-off period, it must be small enough so that the R-C time constant does not affect switching speed.

In Fig. 1, a d-c switching circuit, start and stop pulses to scr Q_1 , come from Q_2 and Q_3 , which are the start and stop pulse amplifiers. Multi-vibrator Q_4 - Q_5 drives Q_2 and Q_3 . Negative input pulses to Q_4 - Q_5 of about 3-v peak switch it from state to state. The differentiated outputs of Q_4 - Q_5 drive Q_2 and Q_3 . The differentiating circuits were designed on the basis of amplitude and pulse width, versus loading on the multi-vibrator. To obtain the necessary

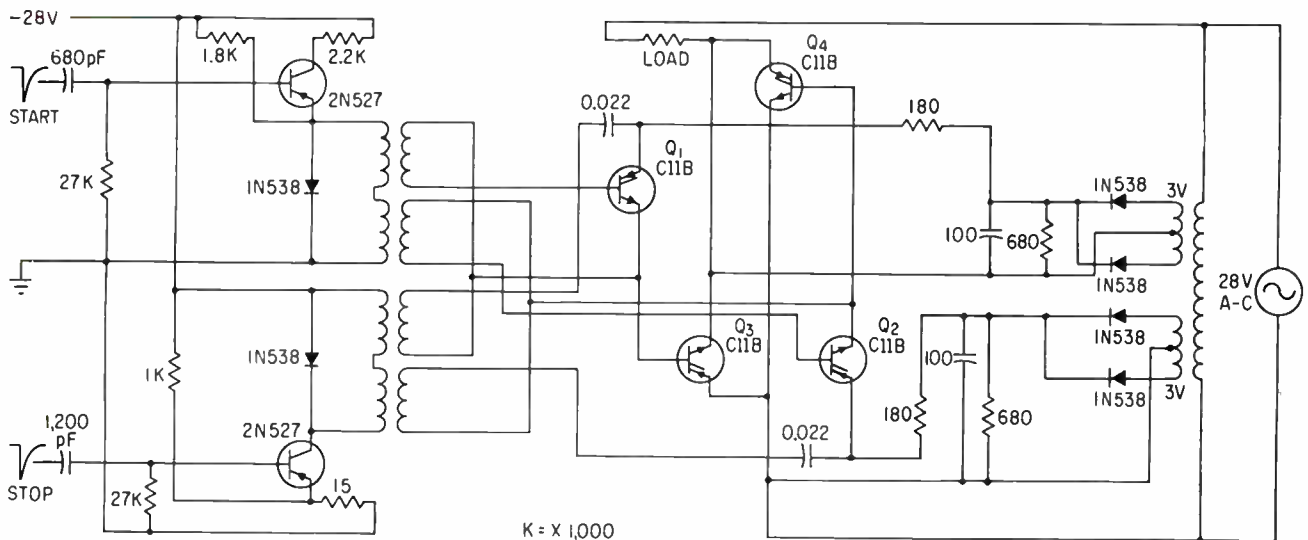

FIG. 2—Switching circuit controls a-c power through load resistor. The scr's that pass load current are Q_3 and Q_4 .

Fast Power Switching

pulse width and amplitude, C_1 and R_1 produce the stop pulse, and C_2 - R_2 produce the start pulse.

Start-pulse amplifier Q_2 generates a pulse of 2- μ sec duration across T_1 , thus turning on scr Q_1 . Stop-pulse amplifier Q_3 generates a pulse of about 8- μ sec duration; this time is sufficiently long to bypass the scr's load current.

The scr is in the base circuit of power transistor Q_4 . Raising and then lowering the base voltage of Q_4 saturates Q_4 and then cuts it off. Since the load on the scr is low, bypass capacitor C_3 is only 0.01 μ f and the keying frequency is greater than 700 cps. Above 700 cps, the multivibrator is unstable due to loading. Transistor Q_4 switches a load of 20 w d-c through the 15-ohm load (R_3).

Figure 2 is an a-c load-switching circuit that is also controlled by start-stop pulses from a multivibrator, as is Fig. 1. To switch 400-cps a-c, a pair of pulsed scr's (Q_1 and Q_2) turn on a pair of load-current-carrying scr's (Q_3 and Q_4) and hold them on for the desired period. The pulsed scr's are between the control

and the load cathodes of the load-current scr's. Each pulsed scr is powered by an individual 3-v source. With a 28-v 400 cps load supply, 350 ma is switched through the load; the a-c crossover drop is only 0.7 v.

The d-c and a-c switching circuits described above provide isolation between input and output. The current drain and response time of each switching circuit is less than 40 ma and 3 μ sec, respectively. The d-c switching circuit can switch d-c power at rates up to 700 cps and the a-c switching circuit can handle a-c power at frequencies up to the cut off frequency of the scr's.

Figure 3 shows waveshapes that illustrate the functioning of the stop-pulse circuit (Q_3) of Fig. 1. Each of the non-rectangular waveshapes of Fig. 3 is drawn so that it is referenced to the stop-pulse input, which is the negative-going rectangular-shaped pulse at the bottom of each drawing.

FIG. 3—Stop pulse across transistor (A); across transformer primary under (B) no-load and (C) load

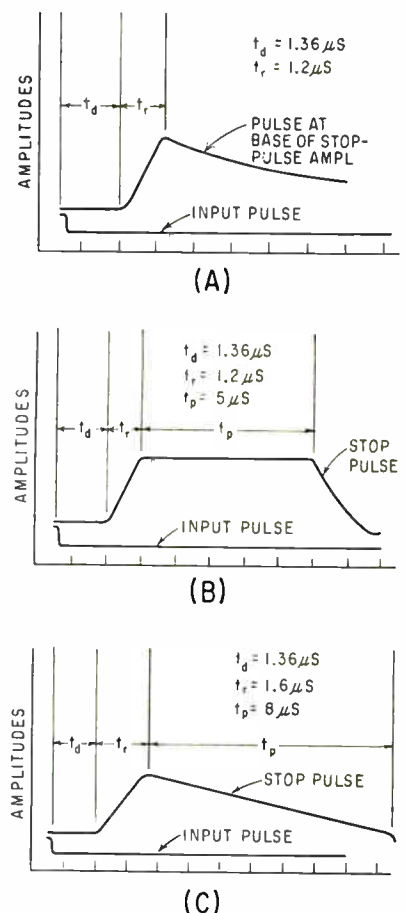

Calibrating

Very-low-frequency transmissions can provide accurate frequency and time measurements. This system has a stability of $\pm 1 \mu\text{sec}$ and can attain accuracies of several parts in 10^{11} with approximately 30 db changes in signal level

By JAMES D. ECHOLS

Research Scientist, Textran Corp.,
Austin, Texas

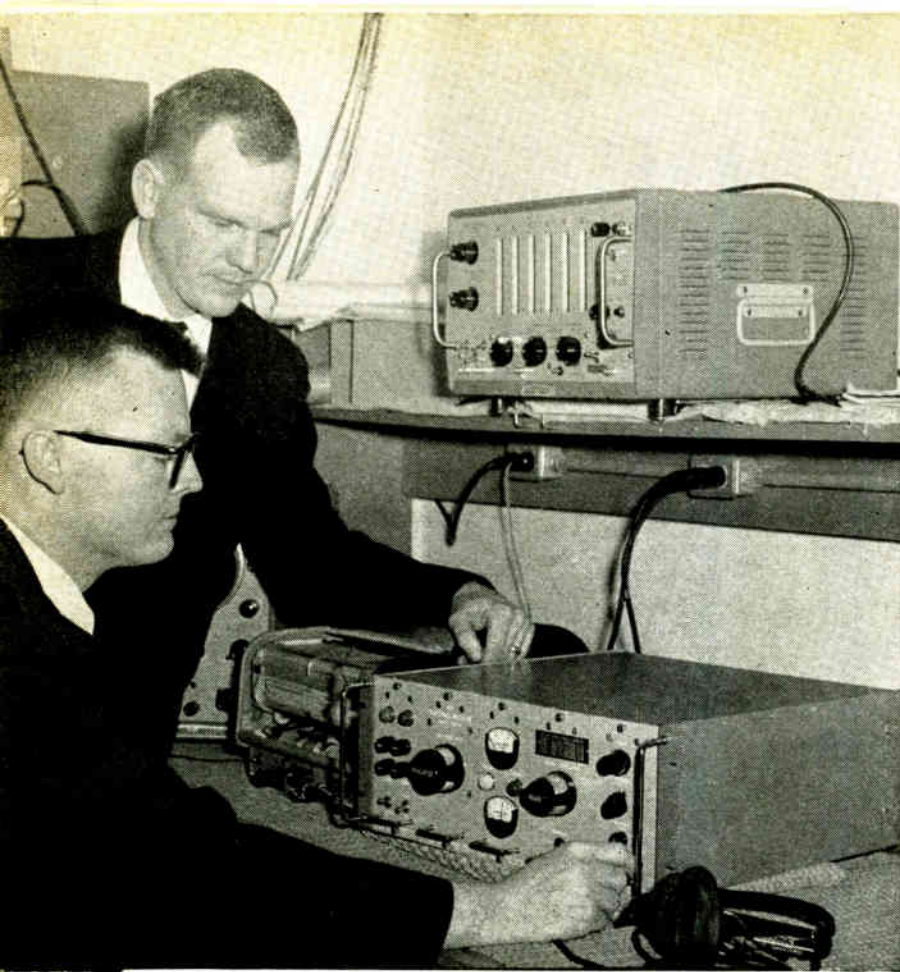

Author (seated) and C. S. Stone, check over receiver system. The strip-chart recorder monitors phase shift and carrier level

SERVICES provided by h-f stations such as WWV are well known. Less well known are the standard-frequency stations in the very low frequency (vlf) band, below 30 Kc. The phase stability and the predictable diurnal variations in the propagation of vlf signals allow frequency comparison to accuracies several orders of magnitude better than that generally attainable with h-f broadcasts.

High-frequency transmissions propagate in the optical ray mode. Distant reception is possible by reflections from the ionosphere and the earth. Unfortunately, the propagation path length varies rapidly and unpredictably with changes in the ionosphere. This variation in phase is negligible for most communication purposes, but it severely limits the accuracy with which a standard frequency can be transferred.

Distant reception in the vlf region occurs in a mode resembling waveguide propagation, with the ionosphere and the surface of the earth forming the upper and lower conducting surfaces of the guide. Propagation in this mode is stable

and, except for geometrical spreading, is little attenuated by distance. For example, vlf experiments over the path between England and the United States indicate residual phase instabilities of only 2 parts in 10^{11} after the cyclic diurnal effects are removed by making observations at 24 hour intervals; transmissions from GBR in Rugby, England, radiating about 30 Kw at 16.0 Kc were received in New Zealand, nearly 12,000 miles away.^{1, 2}

At present there are seven stations regularly transmitting on precisely controlled frequencies, allowing reception of standard frequency signals anywhere in the world.

PRESENT VLF STATIONS

Station	Freq. (Kc)	Place
NAA	14.7	Cutler, Me.
NBA	18.0	Balboa, Canal Zone
NPG	18.6	Jim Creek, Wash.
NPM	19.8	Lualualei, Hawaii
NSS	22.3	Annapolis, Md.
WWVL	20.0	Boulder, Col.
GBR	16.0	Rugby, England

The versatile vlf phase tracking system described here has been designed for operation with any of these frequency-stabilized vlf stations. The complete receiving system is made up of five plug-in, solid state modules: receiver, frequency synthesizer, phase comparator, servo driven phase shifter, and transistor power supply. These modules, as shown in the photograph, fit into a single 7-inch high rack mounting chassis.

Figure 1 shows the operation. The incoming vlf signal is amplified in the receiver module. The phase comparator compares the phases of the amplified vlf signal and a reference signal generated in the frequency synthesizer. The output of the comparator controls a servo motor which drives the phase shifter so as to maintain a phase null. The phase shifted 100 Kc is always coherent with the received carrier. The fractional frequency error or phase rate drift of an external frequency standard, relative to the received vlf carrier-stabilized frequency, may then be determined by observations of the direction of motion and rate of the phase

Frequency Standards

With VLF Transmissions

shifter. Each revolution of the phase shifter represents 10 μ sec equivalent phase change. Therefore, a phase shifter rate of 1 revolution in 100 seconds corresponds to a fractional frequency offset of 1.0×10^{-7} ; 10 μ sec per day represents an offset of 1.16×10^{-10} .

Although a simple receiver might be adequate under ideal conditions, such conditions rarely exist. The received signal will generally be weak, and may be many db below the noise level. The vlf region abounds in atmospheric noise (sferics), particularly in regions of strong thunderstorm activity at the lower latitudes, and in man-made noise. A vlf phase-locked receiver, if required to track reliably under all possible noise conditions over an extended time interval, must incorporate sophisticated circuits.

Figure 2 shows the essential elements of a vlf receiver that has demonstrated highly reliable tracking performance, even under adverse signal/noise conditions. The receiver can use either a simple whip, long wire, or loop antenna; however, a loop antenna is generally recommended for its greater immunity to local electrostatic and precipitation noise and its superior directivity pattern. The vlf carrier signal, after preliminary amplification and filtering at an r-f level, is converted to a 1 Kc intermediate frequency. The basic phase information is retained in this frequency conversion.

The 1 Kc i-f signal, after further amplification and filtering, is phase detected in two synchronous detectors. The output of one detector is the phase error signal to the phase servo; the output of the other, driven in quadrature, produces a coherent agc voltage.

The phase servo motor, gear reduced, is coupled to the 100 Kc phase shifter. The phase shifter is also directly coupled to a front panel mechanical counter that provides a cumulative record of phase

shift. This digital dial display may be interpreted as the difference in time that would be indicated by two clocks, one synchronized to the incoming vlf signal and the other to the local standard. The difference between successive readings on the digital counter divided by the elapsed time gives frequency offset, $\Delta f/f$, directly

$$\frac{\Delta f}{f} = \frac{\text{difference in } \mu\text{sec}}{\text{elapsed time in sec}} \times 10^{-6}$$

A precision potentiometer, gear reduced 10:1 from the phase shifter, allows continuous recording of the

change of time difference with any standard 1 ma or potentiometric chart recorder. Each revolution of the potentiometer represents 100 microseconds drift of the local frequency standard relative to the received vlf signal.

In the experimental development of the tracking receiver, it was demonstrated that some form of agc is essential if satisfactory phase tracking is to be maintained in the presence of wide variations in received signal level. The keying pattern of operational vlf transmitters may range from infrequent

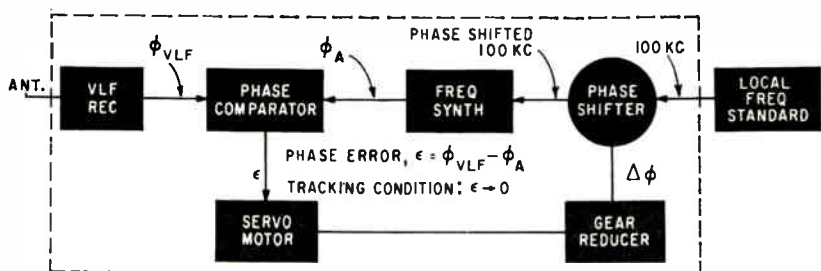

FIG. 1—Basic operation of vlf phase tracking system

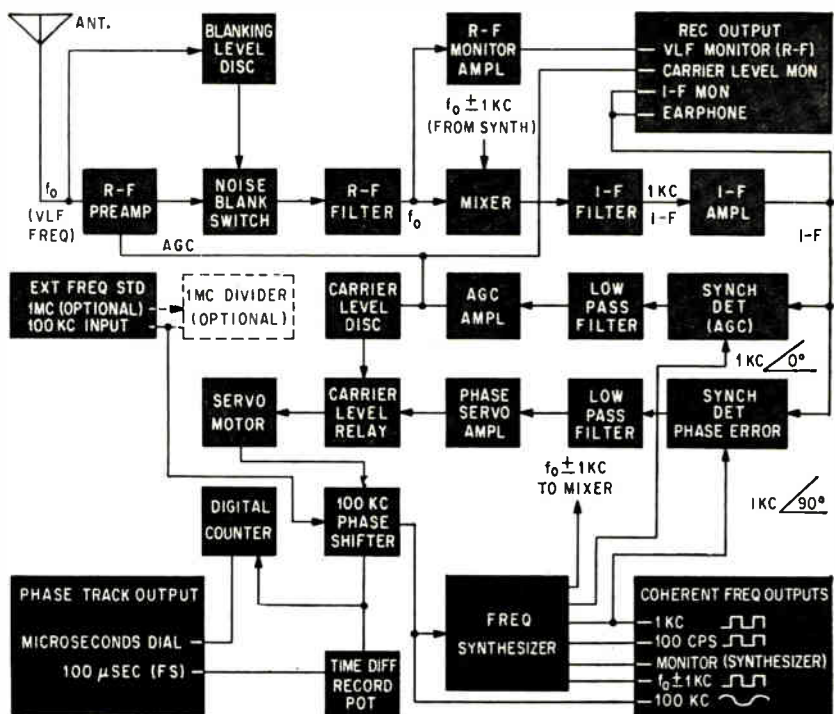

FIG. 2—This vlf receiver has shown highly reliable tracking performance even under bad signal/noise conditions

pulses at low-duty rate to a nearly continuous c-w signal at high keying rates; the resulting average signal level is sometimes observed to change by 5 to 15 db. Diurnal propagation factors and mode interference effects may contribute another 10 to 15 db variation in received signal; thus, a total fluctuation of 15 to 30 db can exist. Without agc, complete loss of phase tracking was occasionally observed whenever the received signal level dropped. This catastrophic condition arises from the fact that without agc to provide a uniform output level in the receiver any decrease in input signal must result in a corresponding decrease in the effective gain in the servo tracking loop.

Good agc allows full utilization of a high receiver sensitivity and permits nearly optimum gain in the tracking servo at all times.

Automatic gain control is achieved by making use of the conductivity characteristics of a fast-recovery computer diode. The diode, a 1N663, acts as a variable, pure resistance, shunting the base of a transistor (Q, in Fig. 3) to ground. The diode is controlled by a coherent voltage derived from the quadrature synchronous detector. This method allows full agc control without the introduction of phase shift in the output signal; the circuit of Fig. 3 exhibits less than ± 0.25 microsecond phase shift over a 40 db input signal range.

The detected agc signal also energizes the carrier level relay in the phase tracking servo. If the vlf signal drops below a minimal value, the carrier level relay is shortly thereafter de-energized. This disconnects the servo system and ensures that the phase shifter will not drift in the absence of a true signal. Servo tracking resumes automatically when the vlf carrier reappears.

The ability of a phase-locked receiver to track weak vlf signals in the presence of strong incoherent noise depends upon frequency selectivity and special noise discrimination techniques. Filter bandwidths become progressively narrower through the system so that linear amplification is always obtained: 500 cps bandwidth in the r-f amplifier, 50 cps in the i-f amplifier, and, nominally, 0.006 cps in the servo tracking loop. A blanking

circuit rejects strong impulse noise at the input to the receiver. Atmospherics, the main source of noise in the vlf region, are particularly susceptible to this noise suppression technique. A 15-db improvement in signal-to-noise ratio can be achieved under exceptionally heavy noise conditions.

In establishing the design objectives of the present receiver, it has been decided that the system should have an inherent capability for operation with all vlf frequency-stabilized stations. There are good reasons for avoiding a limited-design receiver that can operate on only NBA or WWVL. First of all, it is not uncommon for these and other stations to be off the air for routine maintenance and equipment failure reasons. Station NBA, for example, currently stops transmitting for several hours each week. If a frequency calibration must be performed during this interval, it will be necessary that the vlf tracking receiver be switched over to some other station. Also, the new megawatt Navy station NAA, at Cutler, Maine, provides a much stronger signal and greater coverage than either NBA or WWVL. It therefore seems appropriate that a vlf tracking receiver should be able to operate with the 14.7 Kc NAA signal. Finally, mode interference effects may limit reception of a particular vlf station at certain locations. In Austin, Texas, for example, it is generally found that the night-time NBA signal is considerably less stable than the signal received from NPM at much greater range; similar observations have been noted for the reception of WWVL at San Diego.

The present vlf tracking receiver can operate with any existing or proposed vlf frequency-stabilized station. This versatility is achieved by the flexible synthesizer that can generate any desired frequency, in 100 cps increments, throughout the range 13 Kc to 24 Kc. Thus, the only requirement in tracking a vlf station is that the station transmit on the basis of a stabilized-carrier frequency that is an exact integer multiple of 100 cps. Even those stations at intermediate frequencies (NAA at 14.7 Kc, NPG at 18.6 Kc, NPM at 19.8 Kc, and NSS at 22.3 Kc) satisfy this re-

quirement. The receiver, with only minor modifications, can be used in Radux-Omega tracking applications at frequencies down to 10.2 Kc.

The most important application of the vlf receiver is in frequency measurement and calibration of precision oscillators. Use of the equipment is simple. The tracking servo provides continuous frequency deviation information that is readily observable either by noting the difference in digital dial reading or by analysis of chart records obtained from the 100 microsecond potentiometer.

The system stability relative to the received carrier is better than ± 1 microsecond. Therefore, to determine the frequency of a local 100 Kc or 1 Mc source to an accuracy of 1 part in 10^6 (relative to the received vlf carrier) will take 10^6 microseconds or about 16 minutes. A similar observation to the same accuracy utilizing WWV would take about two weeks. By averaging over 24 hour intervals, an accuracy of several parts in 10^{11} is obtainable by vlf methods.

Laboratory personnel have hesitated to adjust frequency standards because of the inaccuracies associated with the determination of frequency errors by WWV monitoring techniques. Several weeks had to elapse before a new frequency rate could be determined with any measure of accuracy. With the vlf tracking receiver, however, it is possible, with confidence, to adjust oscillators to a high degree of accuracy; this adjustment can be performed on a daily basis, if desired, so that aging effects associated with the crystal now assume lesser importance.

The oscillator can be adjusted with ease. An inexpensive 100 Kc crystal (DT-cut) was used as the external frequency standard. Initially, the crystal oscillator was low in frequency with respect to the received NBA carrier by -1.0×10^7 (with a steep phase change of -45 microseconds being recorded during the first 7.5 minutes of the test). The first adjustment of the oscillator was made at $t = 7.5$ minutes. During the next 18.75 minutes, the oscillator showed a phase change of approximately -15 microseconds, corresponding to a fractional frequency error of

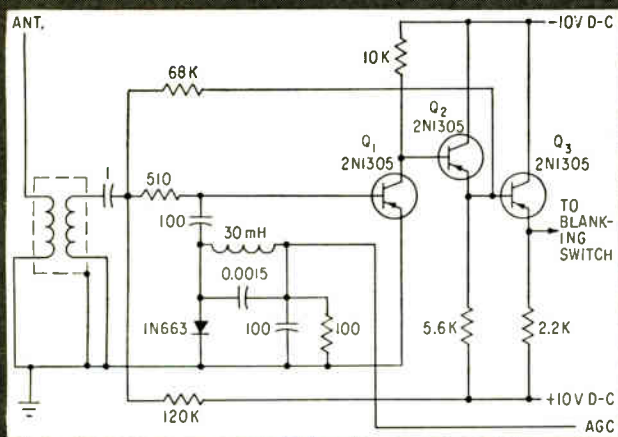

FIG. 3—Radio-frequency preamplifier has ± 0.25 - μ sec phase shift over a 40-db input signal range

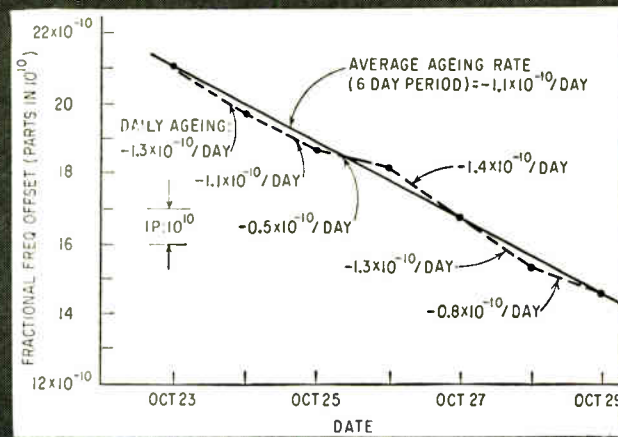

FIG. 4—Measured frequency characteristics of Hermes oscillator relative to received NBA signal

roughly -1.3×10^{-8} . The next adjustment, at $t = 26.25$ minutes, was overcompensated with the result that the phase rate changed slope; the net phase change during the interval $t = 26$ to $t = 52$ minutes was roughly $+8$ microseconds, corresponding to a fractional frequency error of $+0.6 \times 10^{-8}$. Interpolation was then used to make a final, vernier adjustment. A phase drift of roughly $+3$ microseconds was observed during the 3.5 hour interval after the final adjustment; this represents an average frequency error during the same interval of $+2.4$ parts in 10^{10} .

The long term stability and ageing characteristics of crystal oscillators can also be easily determined. Figure 4 shows the measured frequency characteristics of a commercially available 100 Kc oscillator (Hermes) relative to NBA as received at Silver Springs, Maryland. At the beginning of the test the oscillator was high in frequency by 21 parts in 10^{10} ; at the end of the week, the fractional frequency offset had decreased to $+14.7$ parts in 10^{10} . The average ageing rate over 6 days is thus estimated to be -1.1×10^{-10} per day. Aging rates determined by individual measurements on successive days show little deviation from the average value over the full week. The precision of each day's measurement appears to be several parts in 10^{11} .

A reliable vlf tracking receiver can also be used as a reference source for achieving an exceedingly stable clock or timing system. The

phase shifted 100 Kc signal and all other coherent output frequencies remain phase-locked to the received vlf signal. These coherent frequency outputs may be used in controlling a timing system or clock. If such a timing system is initially synchronized with the vlf transmitter or with other timing systems in a net, it will thereafter remain locked to the master station and all slave systems (barring catastrophic failure) even though the elapsed time may extend into days, weeks, or even years.

The problem of initial synchronization of clocks or timing systems at separated locations is analogous to that encountered with an ordinary synchronous (60 cps) electric clock. Some way of accurately setting in zero time of time-of-day into the clock is needed; NBA, for example, transmits timing pulses at precise 1 second intervals. Unfortunately a sharply tuned antenna system is required to transmit with reasonable efficiency in the vlf region. For NBA, the resultant rise time of the modulation envelope is in the neighborhood of 15 milliseconds and the exact start of the transmitted signal is difficult to recognize. Synchronization by observing the start of the NBA pulse will generally be no better than 100 microseconds.

Clocks at widely separated locations can be synchronized to an accuracy of 1 to 10 microseconds by transporting a sufficiently stable and accurate clock between the master and slave stations.⁸ For

microsecond accuracy in synchronization, a transportable clock using an atomic frequency standard source should be employed; however, for synchronization of stations within the United States to an accuracy of perhaps 10μ sec, a stable quartz oscillator frequency standard will be adequate.

The vlf tracking receiver may also be used for investigating vlf propagation phenomena. Phase velocity and attenuation characteristics may be directly monitored by continuous recording of the phase servo and the carrier level output. Propagation phenomena in the vlf region are, at best, only partially understood. For example, little is known about the phase characteristics of the composite signal at the antipodal point away from the vlf station; also, it is believed that nonreciprocal propagation may exist as a result of the interaction of the earth's magnetic field with the vlf electromagnetic energy. Much work remains to be done to explore these phenomena.

Credit for development of the vlf receiver is due to C. S. Stone, Senior Research Scientist and project leader. The author also thanks Mr. Stone for his assistance in preparing this article.

REFERENCES

- (1) J. Pierce, G. Winkler and L. Corke, The GBR Experiment, Nature, 187, p 914, Sept. 10, 1960.
- (2) J. Pierce, Intercontinental Frequency Comparison by VLF Radio Transmission, Proc IRE, 45, p 794, June 1957.
- (3) F. Reder, G. Winkler and C. Bickart, Results of a Long-Range Clock Synchronization Experiment, Proc IRE, 49, p 1028, June 1961.

Designing a D-C to 100-Mc DEFLECTION AMPLIFIER

Most designers use relatively expensive and complicated distributed techniques for wide-band amplifiers. A recently developed pentode permits simpler amplifiers with bandwidths in excess of 100 Mc using conventional design procedures

By L. L. KOSSAKOWSKI, Philips Gloeilampenfabriek N.V., Eindhoven, Netherlands

PRESENT-DAY electron tubes force designers to use distribution techniques in the design of wide-band deflection amplifiers. Apart from being expensive, distributed amplifiers have the disadvantage of requiring much skill and additional equipment for adjustment. The recently developed 7788 pentode combined with the 7377 double tetrode opens the possibility of constructing amplifiers with a bandwidth in excess of 100 Mc.

The deflection amplifier was designed for a 5BHP31 cathode-ray tube, which has a vertical deflection sensitivity of ≤ 7.5 v per cm and a scan height of 4 cm. The effective capacitance of the deflection plates, C_D , is 5.46 pf and is composed of

$$C_D = 2C_{dd'} + C_d \quad (1)$$

where $C_{dd'}$ at 1.43 pf is the capacitance between the deflection plates, and C_d at 2.6 pf is the effective capacitance of each deflection plate

with respect to ground. Adding 2 pf for the capacitance of the wiring and the screen, gives total crt input capacitance of $\cong 7.5$ pf.

The output stage is push-pull, so that each half should supply 15 v, accounting for 3.8 v per cm of the total sensitivity. As shown in Fig. 1, a low-pass L-C filter couples between the output tube and the crt and also between stages. Plate output capacitances with coils L_1 and L_2 form half a section of the L-C filter.

Usually, there is no point in connecting two or more tubes in parallel, because the increase in mutual conductance g_m is outbalanced by the increase in output capacitance. The output capacitance of the tetrode 7377 however is extremely small: about 1.35 pf, which is the order of magnitude of the parasitic wiring capacitance to ground. Even with careful wiring the wiring capacitance is still approximately 1.0 pf. Addition of a second 7377 does not increase the wiring capacitance noticeably, so that the output capacitance C_o is raised from 1.35 +

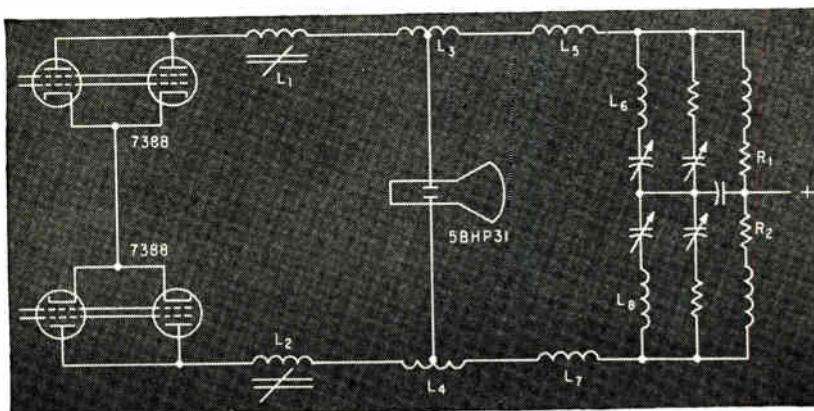

FIG. 1—Cathode-ray tube is coupled to the output stage with a low-pass filter. Double tetrode gives increased g_m .

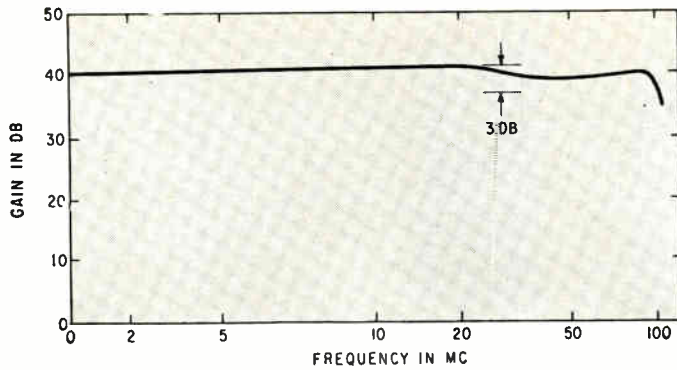

FIG. 3—Overall response curve of amplifier

which have considerable parasitic capacitance.

The two 7377 tubes must be linked so that the two sections of each tube are in push-pull. This is essential to minimize the tube input damping. The two tetrode sections in each envelope have a common cathode, and by connecting the sections in push-pull cathode self-inductance is reduced practically to zero, which eliminates its contribution to the total input damping.

Input capacitance of two sections of the double tetrodes in the output stage is approximately $2 \times 6.5 = 13$ pf. Adding 3 pf for the capacitance of the tube socket and the wiring, gives $mC_k = 13 + 3 = 16$ pf for the m-derived section. Hence, $C_k = 16/1.27 = 12.6$ pf.

To keep the influence of the driver stage on the phase characteristic of the output stage within reasonable margins, it proved necessary to raise the cut-off frequency of the former 1.35 to 1.4 times that of the latter. The cut-off frequency f_{co} of the driver stage should therefore be roughly 185 Mc.

From Eq. 2, the characteristic impedance is therefore

$$Z_c = \frac{1}{(\pi f_{co} C_k)} \approx 135 \text{ ohms} \quad (5)$$

This value can conveniently be obtained by connecting two resistors of 270 ohms in parallel.

Since the output capacitance of the 7788 pentode, including socket and wiring capacitances, is 4.5 pf $< \frac{1}{2} C_k$ ($C_k = 12.6$ pf), the cut-off frequency of the half constant-k section is much higher than the target value of 185 Mc, in fact, approximately 260 Mc according to Eq. 2.

To improve gain at higher frequencies it proved necessary to ap-

ply series compensation of the cathode lead inductance both in the driver and in the preamplifier stage; this is achieved by C_1 and C_2 in Fig. 2.

The cathode resistors conduct d-c and their values should be as low as possible to prevent the amplification factor from being unduly reduced at low frequencies. It was found experimentally that the most suitable value for R_k is 10 ohms, and bypass capacitors C_1 and C_2 being 100 pf.

Cut-off frequency of the preamplifier stage should be slightly higher than that of the driver stage. A value of 200 Mc proved to be convenient. Input capacitance of the driver tubes, including the socket and the wiring capacitance, is 27 pf. From Eq. 5, the characteristic impedance of the coupling filter between the preamplifier and the driver should then be $Z_c = 74$ ohms.

In Fig. 2 no half constant-k section is indicated in the preamplifier stage. This may be explained as follows. Calculation of the theoretical cut-off frequency of this section gives $f_{co} = 480$ Mc. From Eq. 4 it may be calculated that $L_k = 48$ nh so that the required coil should have an inductance of 24 nh. The inductance of the internal lead connection of the tube is roughly 15 nh, which leaves only 9 nh for the external coil; this corresponds roughly to a straight wire of 0.5 mm diameter having a length of 10 mm.

The desired amplification of the complete amplifier is such that the sensitivity should be 100 mv per cm or better. The crt. vertical deflection sensitivity amounts to 7.5 v per cm or better, so that the gain of the amplifier should be at least

75 times. Half the gain is lost in the preamplifier because it also acts as a phase splitter. Since the output stage is of the push-pull type, it contributes twice to the sensitivity, thus cancelling the loss of gain due to the phase splitter. Gain per stage ($G = g_m Z_c$) is—output stage 6.7, driver stage 4.5 and preamplifier stage 3.

The cathode resistor of 10 ohms reduces the effective mutual conductance of the 7788 in the driver stage from 50 ma per v to 33.3 ma per v. A similar reduction is effected in the preamplifier by its functioning as a phase splitter. The effective g_m of the preamplifier is actually only 20 ma per v. The quoted value of $2 \times 20 = 40$ ma per v is to be attributed to the amplifier being of the push-pull type.

Calculated total gain, that is the product of the three stage gains, amounts to 90. Measured gain proved to be 110, corresponding to 40.8 db. The difference between the calculated and measured values is due to the mutual conductance of the 7788 generally being a few percent higher than the rated value of 50 ma per v.

Sensitivity of the amplifier was 65 mv per cm, the sensitivity of the crt being slightly higher than the rated value (approximately 7 v per cm).

Frequency characteristic of the amplifier is shown in Fig. 3. The step function response was investigated with the aid of a fast rise mercury pulser. Rise time of the amplifier (T_a) follows from $T_a^2 = T_i^2 - T_p^2$ where T_i is the 10-percent to 90-percent amplitude rise time measured at the screen of the scope and T_p is the rise time of the pulses from the mercury pulser. The measured rise time of the amplifier was $3.7 \text{ ns} \pm 0.4 \text{ ns}$.

Originally there was some overshoot when a step function was applied. This was eliminated by damping the coils of the half sections of the constant-k filters. Suitable values of the damping resistors was ascertained experimentally.

General practice for wide-band amplifiers, such as screening of output of each stage from its input, one-point grounding, adequate decoupling of the filaments and careful mounting of the components (especially the feed through capacitors) were strictly adhered to.

Three steps to rho

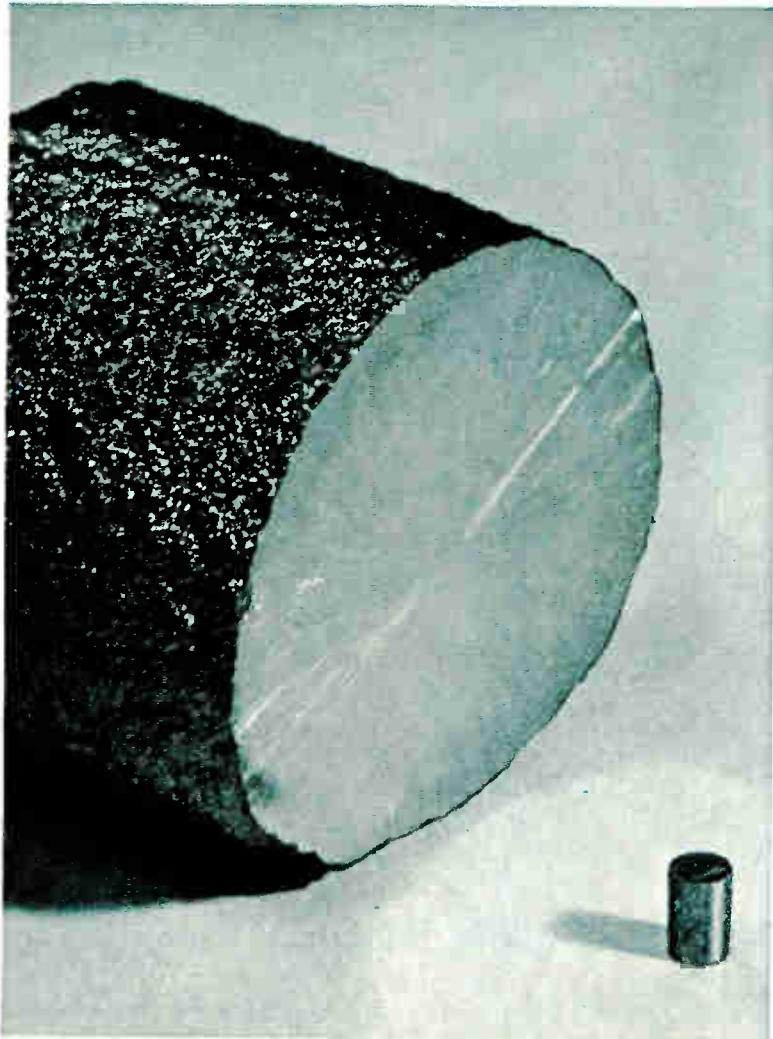

Specify Dope-sil*... for easy, consistent, on-target resistivity

If you use the Czochralski technique for growing single crystal silicon, you should consider this simple, three-step procedure for accurate, reproducible doping:

Step 1: Use nomograph to determine total atoms of dopant required.

Step 2: Select Dope-sil pellets containing the required total doping atoms. Dope-sil is the Dow Corning trademark for accurately pre-measured doping modules.

Step 3: Add the Dope-sil pellets to your pre-packaged Dow Corning hyper-pure silicon crucible charge.

And that's it! No need for long, involved calculations. No need for a delicate laboratory balance, the weighing of powders, grinding . . . other involved procedures.

How about accuracy? Resistivities are on-target . . . within closer tolerances than the accepted industry practice.

For more information on Dope-sil, on pre-packaged Dow Corning crucible charges, and copies of these easy-to-use nomographs, write Hyper-Pure Silicon Division, Dept. 4204.

*Trademark for Dow Corning's doping modules



STEP 1

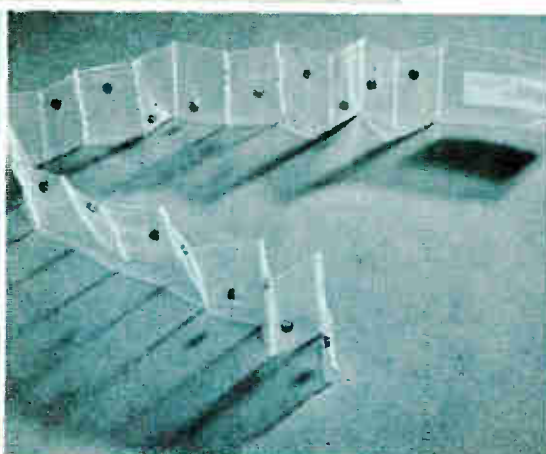

STEP 2



STEP 3

Dow Corning CORPORATION

HYPER-PURE SILICON DIVISION • HEMLOCK, MICHIGAN

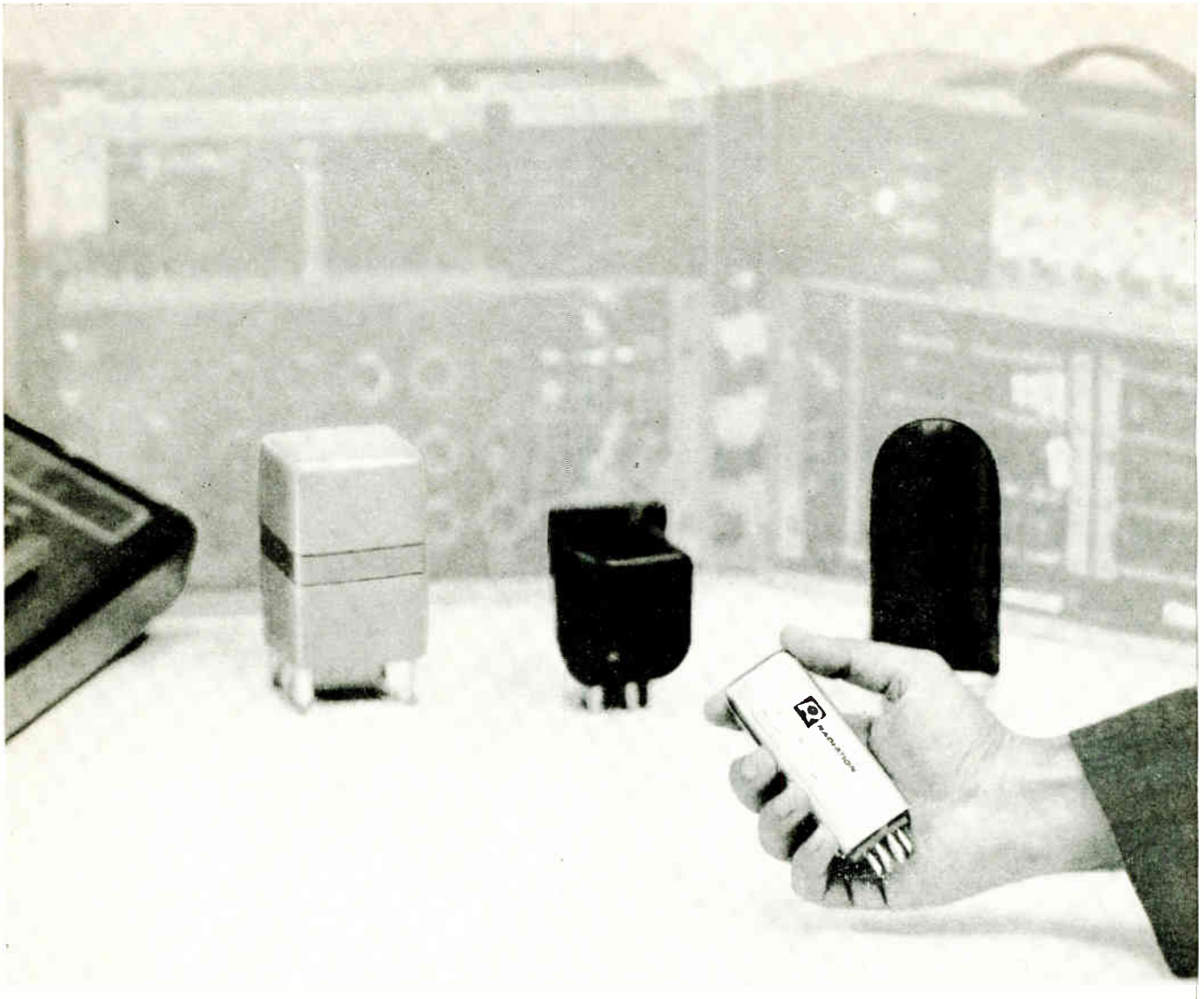

END TELEGRAPH RELAY PROBLEMS...

Simply plug in Radiation's new Solid-State Telegraph Relays. They're designed to replace existing electro-mechanical units in standard teleprinters, telegraph and data circuits. They completely eliminate routine maintenance and tedious contact adjustment... eliminate costly downtime and service calls.

Radiation Solid-State Relays also offer considerable savings in new installations because bias supplies are not required for neutral operation. In addition, there's no need for expensive universal relays since *both neutral and polar* solid-state units are available. These compact relays operate at speeds up to 2,400 bauds with less than 3% bias distortion — at normal telegraph speeds with less than 1% distortion. Built-in circuitry protects against over-voltages, and Radiation's unique output bi-polar feature makes in-

correct polarity connection impossible. The input impedance is essentially resistive, which permits series connection without danger of magnetic interaction.

Write for our new brochure on Models 9210 (neutral) and 9211 (polar) Solid-State Telegraph Relays. If you wish, Radiation engineers will be glad to discuss application of these units in your present or planned system. Radiation Orlando, 5800 McCoy Road, Orlando, Florida.

Radiation Orlando supplies the finest equipment available for commercial communication—distortion and data analyzers, test signal generators, and high-speed strip and page printers. The high efficiency of these units stems from Radiation's broad experience in research and design of advanced aerospace communication systems.

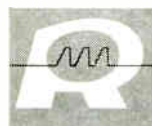

RADIATION
Orlando

A Division of Radiation Incorporated

FROM STC...

FIRST SILICON POWER TRANSISTORS WITH ISOLATED COLLECTOR



85 watts 2N2383

2N389/I 2N424A/I 2N1250/I
2N389A/I 2N1210/I 2N1620/I
2N424/I 2N1211/I 2N1722/I



85 watts 2N2384

2N1208/I 2N1616A/I 2N1618/I
2N1212/I 2N1617/I 2N1618A/I
2N1616/I 2N1617A/I 2N1724/I

Unprecedented transistor series... developed by Silicon Transistor Corporation. For higher reliability—minimum thermal resistance. Silicon power transistors with isolated collector—*Eliminate* these common transistor problems: 1. Cracked Mica Insulators. 2. Scratched Anodized Surfaces. 3. Arcing Around Insulating Hardware.

4. High Case-To-Heat Sink Thermal Resistance. 5. Assembly Mounting Problems.
2N2383 and 2N2384—two new types with $h_{FE}:20$ to $60 @ 1.5$ Amps, $I_{cEX} \leq 1.0$ mA @ 80 volts, saturation resistance $\leq 0.67 \Omega @ 1.5$ Amps.

For specifications and additional information on the entire STC line of silicon power transistors, write:



SILICON TRANSISTOR CORPORATION

CARLE PLACE,
LONG ISLAND,
NEW YORK
Pioneer 2-4100

Fansteel silicon diodes: high-rated for rocket support gear

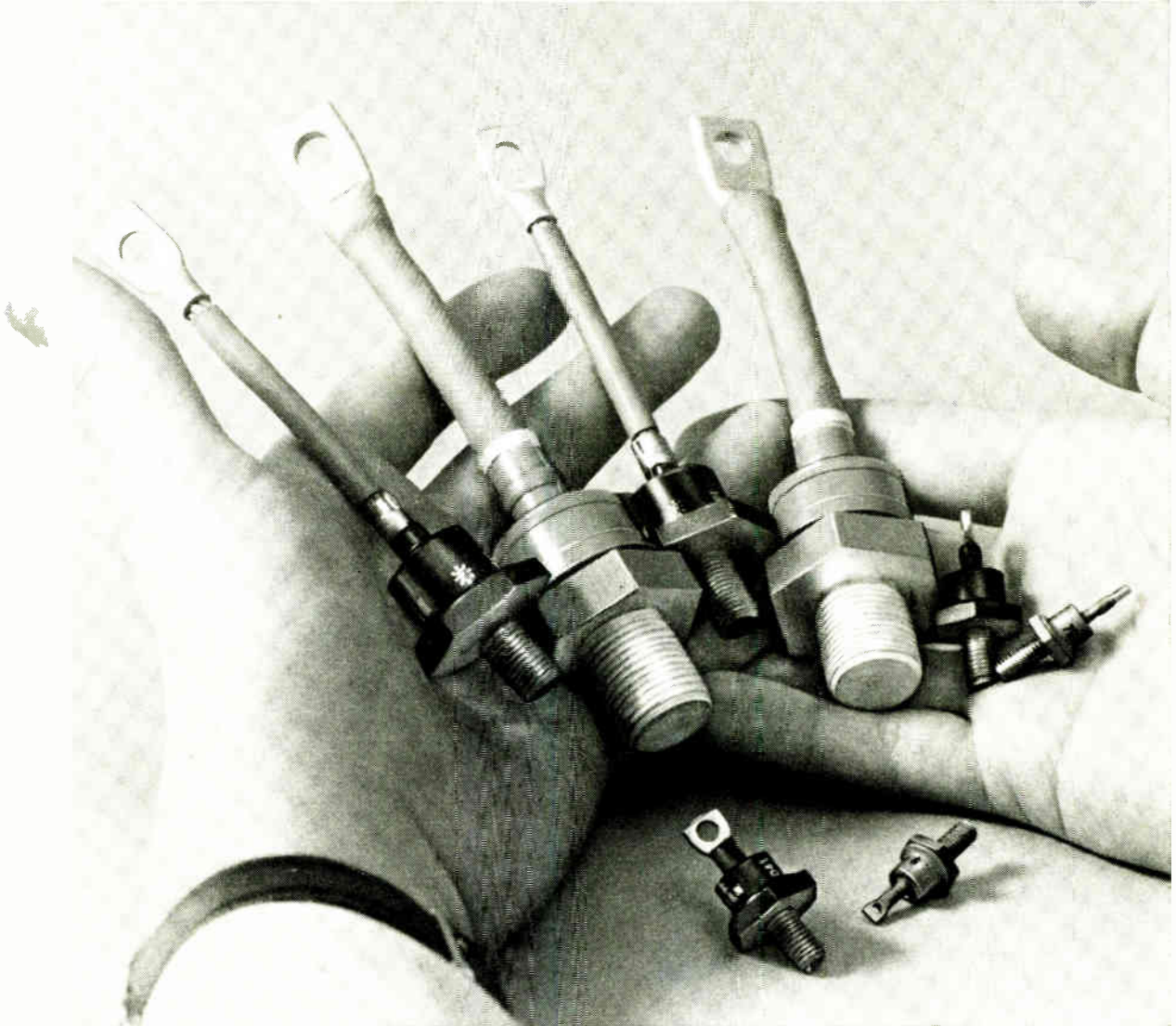

In recent evaluation tests for rocket ground support equipment, Fansteel silicon rectifier diodes were rated near perfect for their extremely high qualifying percentage. On applications demanding long shelf life, high reliability and close performance ratings, Fansteel silicon rectifiers consistently produce top results. What makes the difference? Attention. Attention to design, materials, packaging—to extreme caution in whiteroom procedures, and to a unique testing program that is uncannily accurate. Fansteel silicon stacks and Zener diodes get the same care. Silicon diodes are rated from 6 to 240 amps.; Stacks from 6 amps. up; Zeners available in 1- and 10-watt ratings. For specification data, write the Rectifier-Capacitor Division, Fansteel Metallurgical Corporation, North Chicago, Illinois.



Additional data on Fansteel silicon rectifier diodes is presented in Re-Cap, a bi-monthly publication. To receive, write the Publications Department.

for MINIATURIZED coaxial cables... remember Synkote®

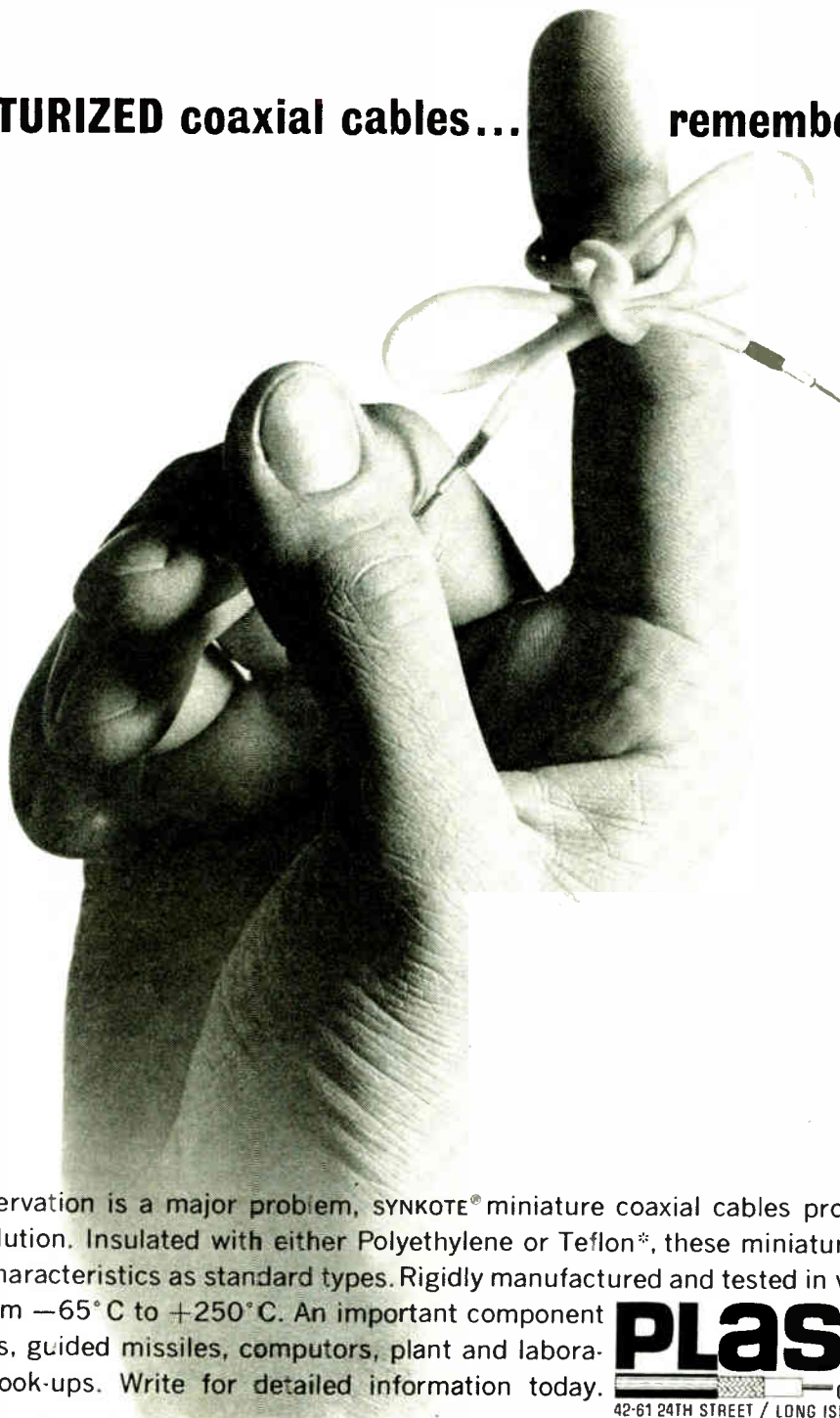

Where space conservation is a major problem, SYNKOTE® miniature coaxial cables provide the engineer with a practical solution. Insulated with either Polyethylene or Teflon*, these miniature cables have the same impedance characteristics as standard types. Rigidly manufactured and tested in various impedance ranges, flexible from -65°C to $+250^{\circ}\text{C}$. An important component for aircraft, rockets, guided missiles, computers, plant and laboratory instrument hook-ups. Write for detailed information today.

PLASTOID

CORPORATION
42-61 24TH STREET / LONG ISLAND CITY 1, N. Y. / ST 6-6200

*DUPONT TRADEMARK



KLYSTRONS
 400-2855 Mc
 100 kw to
 40 Mw Pulse

Here: L-3401
 1254 to 1386 Mc
 Tunable
 5 Mw peak
 (minimum)

Height: 9 ft.



Length: 13 in.

TRAVELING WAVE TUBES
 400-11,000 Mc
 20 mW to 5.5 kw

Here: L-3711
 4000-8000 Mc
 1 W CW (minimum)



CROSSED FIELD AMPLIFIERS
 8500-11,000 Mc
 1 kw CW to 500 kw Pulse

Here: L-3650
 8500-9600 Mc Tunable
 1 kw CW (minimum)

Diameter: 12 in.

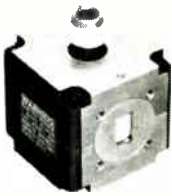

2 in. Cube

MINIATURE MAGNETRONS
 8600-16,500 Mc/30 W to 4.0 kw peak

Here: L-3719
 15,000 ± 100 Mc Fixed
 750 W (minimum)



Diameter: 6 in.

BARRATRON®
 Transmitting Tube
 UHF through X-band
 Broad bandwidths of Near
 White Noise

Here: One of L-3330 Series

1 METER TO 4 MILLIMETERS MILLIWATTS TO MEGAWATTS ELECTRON TUBES BY LITTON



Height: 28 in.

SWITCH TUBES
 150-350 kVdc Collector Voltage
 20-300 A Switching Current

Here: L-3620
 350 kVdc Collector Voltage
 30 A Collector Current



Diameter: 8 in.

M-BWO's
 1000-11,000 Mc
 125-200 W CW

Here: L-3724
 2500-3550 Mc
 Tunable
 180 W CW
 (minimum)

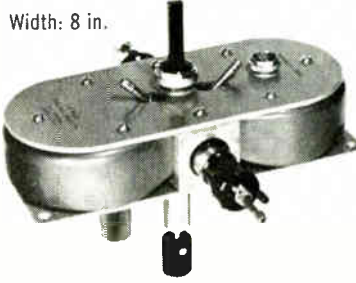

Width: 8 in.

MILLIMETER WAVE TUBES
 18-80 kMc
 .03-50 W

Here: L-3689
 68-80 kMc Tunable
 0.5 W (nominal)

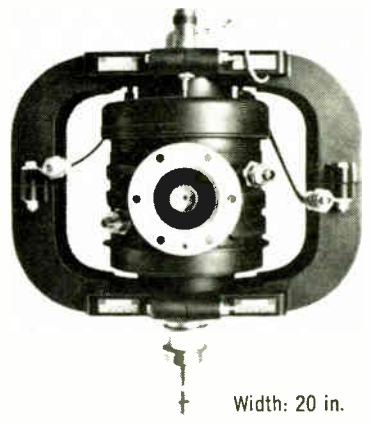

Width: 20 in.

PULSE & CW MAGNETRONS
 406-17,000 Mc
 30 W to 2 Mw peak
 110 to 500 W CW

Here: L-3455
 406-450 Mc Tunable
 2 Mw peak (minimum)

Also latest developments in display devices and accessory equipment. Contact us at San Carlos, California, for complete information.



LITTON INDUSTRIES
Electron Tube Division
 MICROWAVE TUBES AND DISPLAY DEVICES

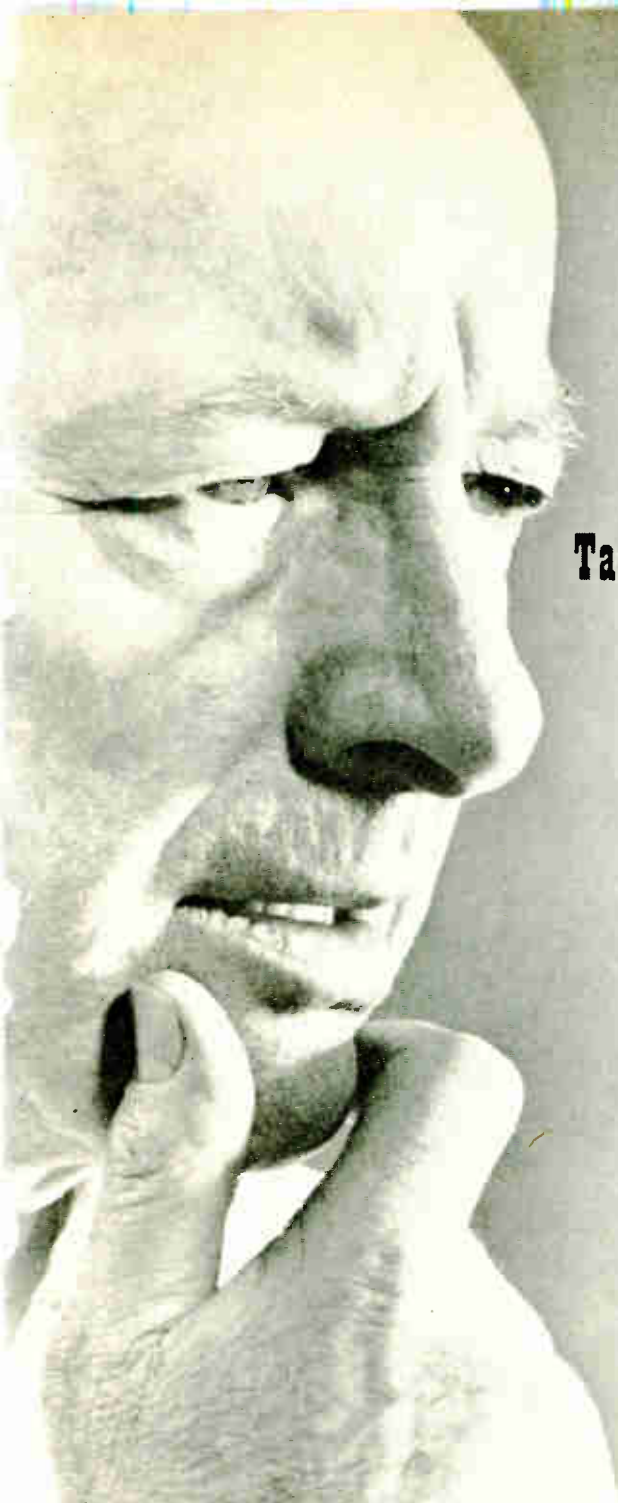

Take an engineer's critical look at

MERCURY-WETTED CONTACT RELAYS

☆☆☆ by **P&B** ☆☆☆

Your product demands a *superior* relay? Can't tolerate contact bounce, welding or pitting? Must have billions of operations? Need fast switching . . . complete stability and reliability? Our JM Series mercury-wetted contact relays meet all these requirements. No other type relay gives you the combination of all these features:

LONG LIFE BILLIONS OF OPERATIONS
NO BOUNCE
HIGH (100 cps) **SPEED**
SUPERIOR RELIABILITY

☆☆☆☆☆☆☆☆



JM Relays are now available at your local electronic parts distributor.



ENGINEERING SPECIFICATIONS
Speed: SPDT Operate: 3 milliseconds (approx.) at 2 watts. Release: 3.2 milliseconds (approx.).
Contact Rating: 5 amperes maximum, 500 volt maximum, 250 volt-amp max. (with required contact protection).
Contact Configuration: Each capsule SPDT, combination of capsules in one enclosure can form DPDT, 3PDT, 4PDT. (All Form D.)
Terminals: Octal type plugs, 8 and 11-pin; Solder lugs; 14 or 20-pin miniature; AN connectors.
Coil Resistance: 2 to 58,000 ohms.

FREE CATALOG
WRITE TODAY



POTTER & BRUMFIELD

DIVISION OF AMERICAN MACHINE & FOUNDRY COMPANY • PRINCETON, INDIANA
IN CANADA: POTTER & BRUMFIELD, DIVISION OF AMF CANADA LIMITED, GUELPH, ONTARIO

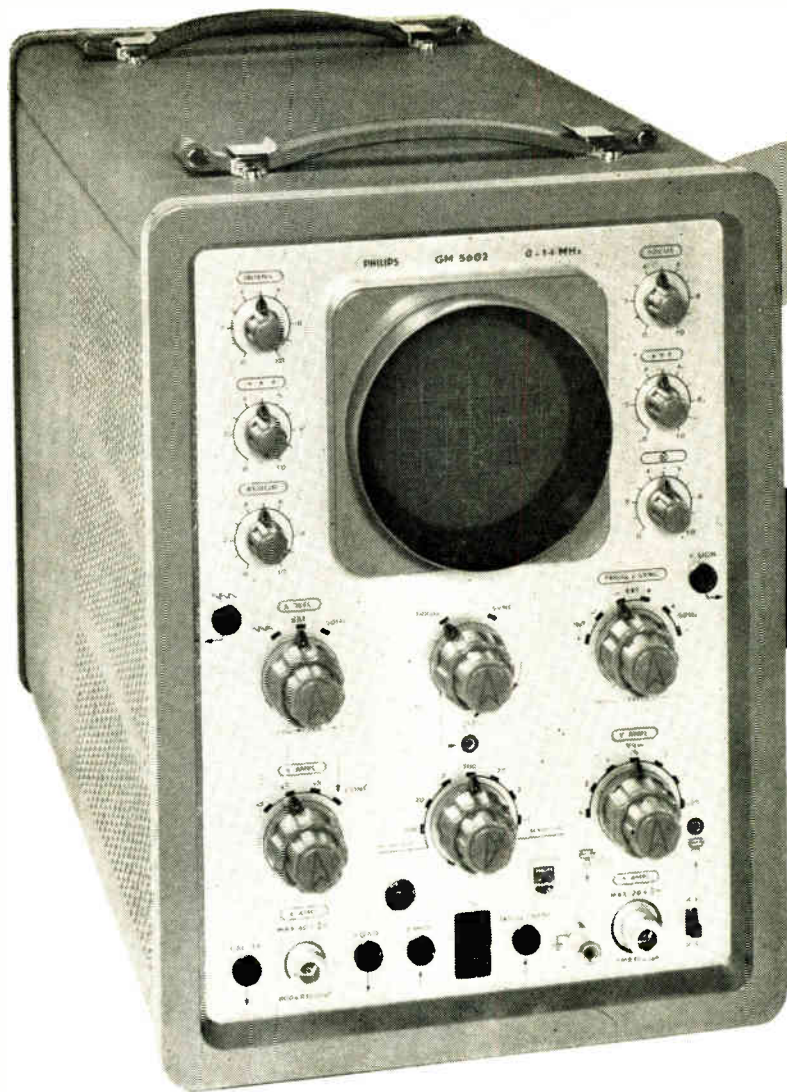

50 mV/cm
D.C. -
14 Mc/s

A general-purpose oscilloscope, easy to operate and suitable for many fields of application. The very stable triggering and the adjustable trigger level ensure a stable picture. A high brilliance also at low repetition rates, a signal delay line in the vertical amplifier and a wide sweep range are other features that make this oscilloscope a valuable laboratory-instrument. A calibration voltage for re-adjustment of the amplifiers is available. The assembly from units with printed-circuits and the removable parts of the casing make maintenance, if necessary, very easy.

PHILIPS *electronic measuring*

Sold and serviced by Philips Organizations all over the world.
 Further information will gladly be supplied by

N.V. Philips' Gloeilampenfabrieken, EMA-Department, Eindhoven, the Netherlands
 For Canada: Philips Electronics Ind. Ltd., 116 Vanderhoof Ave., Toronto 17, Ont.

wide-band oscilloscope, type GM 5602

Vertical amplifier

Frequency range

D.C. - 14 Mc/s (-3 dB) Risetime 25 nsec.

Sensitivity

50 mV/cm - 5 V/cm in 7 calibrated steps, accurate within 3%.
Continuous attenuation to at least 15 V/cm.

Input impedance

1 M Ω in parallel with 22 pF.

Signal delay

A delay line of 0.3 μ sec is included in the vertical amplifier.

Time base

Sweep speeds

0.2 μ sec - 1 sec/cm in 21 calibrated steps, accurate within 3%. Continuous adjustment to 2.5 sec/cm.

Magnification

2 x and 5 x (calibrated) or continuously, uncalibrated, up to max. 5 x.
Accurate within 3%.

Trigger facilities

Internally from the vertical amplifier, internally with mains frequency or externally. The trigger level is adjustable.

Cathode-ray tube

10 cm flat-faced tube with 4 kV accelerating voltage.

Probes

Cathode - follower probe

D.C. - or A.C.-coupling, two screwcaps enable A.C.-coupling with different bandwidth and input capacitance.

Attenuator probe

Attenuation 10 : 1. Input impedance 10 M Ω //10 pF.

Accessories

The oscilloscope is delivered with a complete set of accessories, packed up in a handy case, consisting of:

- Cathode-follower probe
- Attenuator probe
- Adapter to N-connector
- Measuring cables
- Mains cable
- Rubber viewing hood
- Manual

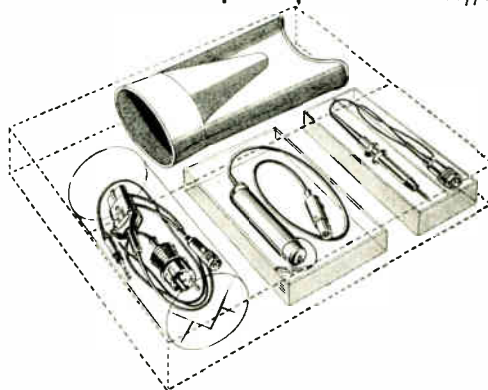

instruments: **quality tools** for industry and research



Metals Study Could Affect Space Program

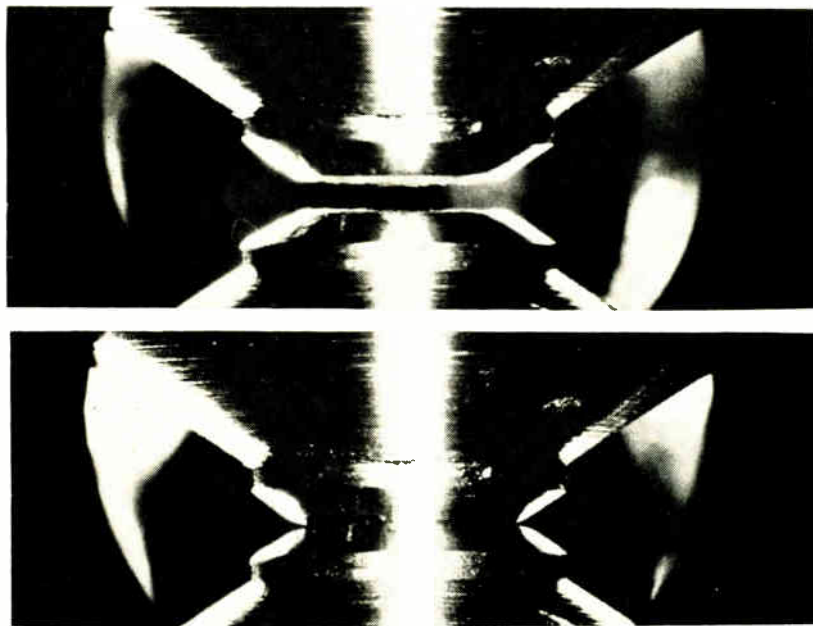

Microphotograph of copper samples in vacuum chamber show 0.03 inch separation above while samples below have fused

ELECTRICAL and physical characteristics may be improved in electrical connections at substantially reduced costs. This conclusion is suggested by the results of an investigation into the effects of the space environment on materials. Conversely, the study indicates that some proposed lunar and interplanetary exploration projects may not be possible with present materials and equipment designs.

The research effort is part of a 12-month study being carried out by National Research Corp. under contract for the National Aeronautics and Space Administration. The study that resulted in the far-reaching implications for space exploration specifically involved adhesion and cohesion of metals in very high vacuum. These effects were investigated using cold welding, in which metals are joined with little or no heat and with no brazing materials.

Cold Welding

Cold welding involves the forcing of two completely clean metal surfaces together in nearly complete

vacuum until they diffuse into each other to form a single homogenous metal. For the experiments, space simulation chambers provided a vacuum of 10^{-10} torr, which is comparable to pressures at altitudes of 500 miles. During the study, nearly perfect welding of a copper specimen was achieved at temperatures as low as 200 C. This specimen of OFHC copper, which is used extensively in electronic components, was broken and rejoined 49 times and as much as 95 percent of its original strength was retained. Welding copper by conventional methods would require melting at 1,083 degrees C and would leave the joint soft and weakened.

The cold welding was achieved in a matter of seconds at pressures of 10^{-10} torr. The absence of gases in the high vacuum prevented the formation of oxides on the surfaces of the metals. Thus the atoms of one metal surface were allowed to join those of the other surface. Even after some contamination of the surfaces, 30 percent cohesion was achieved at room temperature, indicating that perfect cold welding at

room temperature should be possible.

The implications of the results of these experiments could have far-reaching effects on space projects. For example, lunar vehicles might become inoperative if moving metals parts were to grow together in the gas-free environment of the moon. Metal doors on lunar shelters or vehicles might weld shut. Return flights might be impossible if bearing or other metal surfaces that come together should freeze after remaining stationary. Short circuits might develop between closely spaced electrical conductors in vital communications or guidance equipment.

In a more optimistic direction, results of the experiments suggest a greatly improved method for joining metal parts such as interconnecting electronic components. If practical fabricating techniques can be devised, cold welding could be used to connect components or to join other metal parts at substantially lower costs. Unlike soldering or brazing, the two separate metal parts in cold welding would actually blend together. The joint would provide the physical strength and electrical characteristics of bulk metal.

Joining or welding operations usually involve the application of sufficient heat to change the metallurgical structure of the area joined. These procedures can weaken the metal or produce an interface that can be broken under stress, which is particularly undesirable in the environmental conditions encountered by electronic equipment for space applications.

Test Installation

A test facility was designed specifically to perform experiments for this project. The equipment had to enable specimens to be ruptured and rejoined repeatedly under carefully timed, measured and controlled forces. The tests had to be carried out in the high vacuum without

G-E TETRODES AND TRIODES OFFER . . .

HIGHEST AVAILABLE POWER AND DUTY RATINGS TO MEET NEW IFF REQUIREMENTS

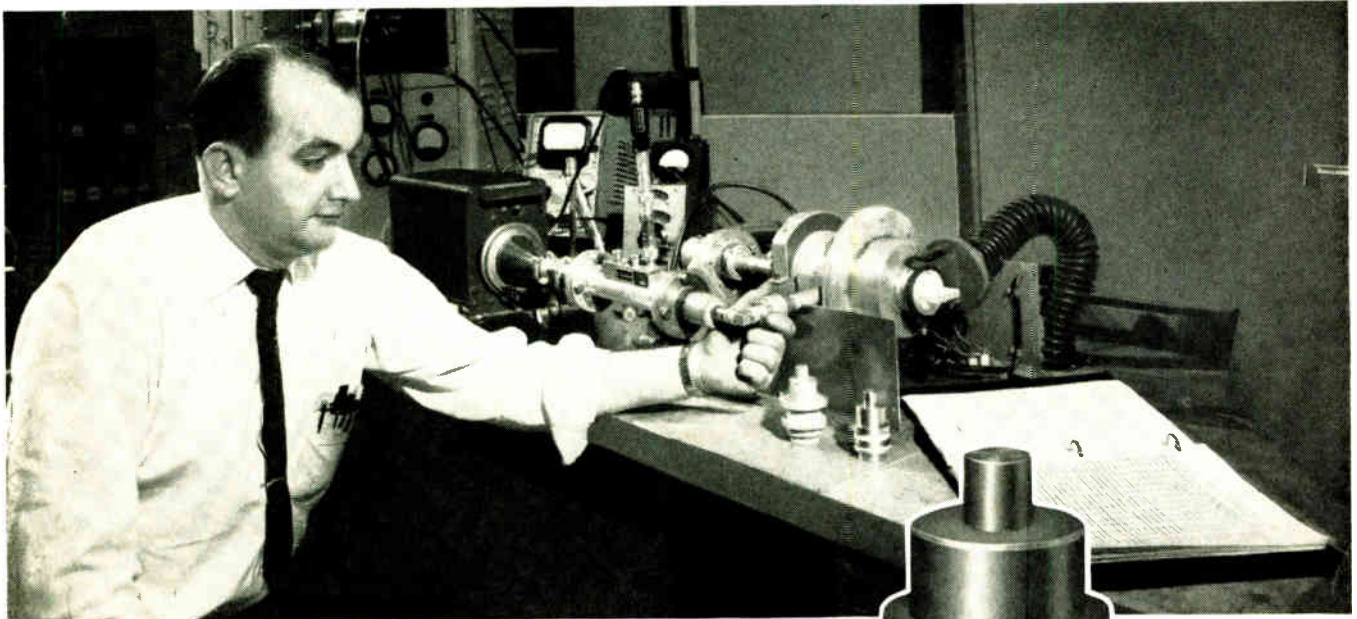

GL-7399 long life is proved in IFF cavity designed by Power Tube Department.

New General Electric metal-ceramic, negative-grid transmitting tubes permit operation at peak power levels up to 10 kw and duty cycles up to .02.

Their outstanding electrical performance and compact mechanical construction simplify military and commercial IFF equipment design, with greater reliability for airborne and ground applications.

For instance, Type ZP-1018 has gain capability up to twice that of any tube type in its class. High power gain in grid-pulsed amplifier service eliminates need for a modulator, offering space- and weight-saving opportunities in circuit design. Heat-sink conduction cooling also reduces component requirements, minimizes package size. Longer life and more reliable performance are achieved by use of a cathode area seven times that of tubes commonly employed in this service.

Type ZP-1025 features internal feedback—an industry first for a tube of its size—which simplifies cavity design for oscillator service in transponders. **TO ORDER**, or obtain more information, call your Power Tube Sales Office. 265-18



ZP-1025 (shown 2 3/8" actual size) reflects design trend in G-E IFF tubes.

TYPICAL OPERATION FOR TUBES NOW IN FAMILY

Tube	IFF Application	Service	Frequency mc	Peak Power KW	Duty
GL-7399	Ground-based Interrogator	Grid-Pulsed Amplifier	1030	10	.01
ZP-1015	Airborne Interrogator	Grid-Pulsed Amplifier	1030	10	.01
ZP-1018	Airborne Transponder	Grid-Pulsed Amplifier	1090	2	.02
ZP-1025	Airborne Transponder	Oscillator	1090	2	.02

POWER TUBE DEPARTMENT

GENERAL  **ELECTRIC**

TELEPHONE TODAY:

SyracuseOL 2-5102	ChicagoSP 7-1600
New YorkWI 7-4065	DaytonBA 3-7151
Clifton, N. J.GR 3-6387	Orlando, Fla.GA 4-6280
Washington, D.C.EX 3-3600	Los AngelesGR 9-7765

How to develop
0.01% accuracy
in a
size 23 resolver



First develop a size 23 resolver for naval fire control computers. Next develop one for the B-58's navigational system. Then combine the best features of both, add a couple of new ideas, and produce the Size 23, 0.01% Resolver. That's what Ford Instrument did. With the result that this new resolver has a maximum variation of transformation ratio (with input voltage from 0.3 to 6 volts) that is only 0.02% of 6 volts. Far as we know, this is the most accurate resolver made today. Most durable and trouble-free. Priced right, too. Conforms to Mil-E 5272A. Specify this resolver for application in analog computers, automatic control systems, and data transmission systems for coordinate conversion, precision phase shifting, and similar operations. Bulletin 23TR-61-1 gives full specifications. It's yours for the asking. Write:

2-2

FORD INSTRUMENT CO.

DIVISION OF SPERRY RAND CORPORATION

31-10 Thomson Ave., Long Island City 1, N.Y.

specimen outgassing, which would create a contaminated atmosphere. Accurate measurements were required of temperature, force, pressure and specimen diameter.

The experiments were carried out

only on a laboratory scale, and practical application of cold welding will require a great deal of additional work in high-vacuum technology and methods must be found for cleaning metal surfaces.

Velocimeter Detects Impurities

QUALITY of a wide variety of commercial products could be controlled by a small acoustic device. It was developed as a research instrument at the U. S. Naval Ordnance Laboratory, White Oak, Md., to determine the velocity of sound in seawater.

Called a velocimeter, the instrument is a five-inch long stainless steel tube with a transmitting crystal transducer at one end and a receiving crystal transducer at the other. A sample of the liquid to be tested is put in the tube and velocity of a sound pulse transmitted through the sample is determined from transit time and the known distance between the two

crystal transducers.

Sound velocity is affected by the impurities present in the liquid so that the velocimeter can be used to detect many types of impurities. For example, it could be used by the petroleum industry to identify and evaluate the purity of products from distillation and cracking processes. Used with suitable electronic systems, the instrument could control the proportions of constituents in mixing antiknock blends or for the bulk production of solutions.

After the velocimeter has been calibrated for a particular liquid, it can also be used as a sensitive temperature gage. If temperature were held constant, accurate pres-

Radiotelescope To Study Atmosphere

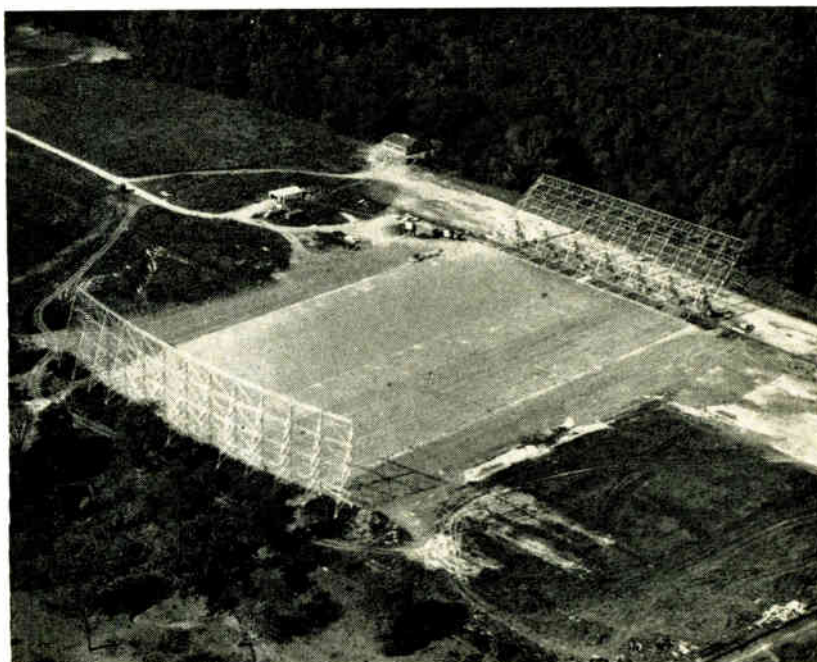

Atmospheric studies will begin this spring at about 1,420 Mc for 4 minutes a day using Ohio State University Research Foundation radiotelescope. Three continuum receivers operating between 1,000 and 1,800 Mc and a 400-Mc radar echo-measuring circuit are multiplexed into 360-ft long parabola at left. Tunable flat screen at right is tilted 50 degrees and separated from parabola by aluminum-plate ground plane covering 3 acres

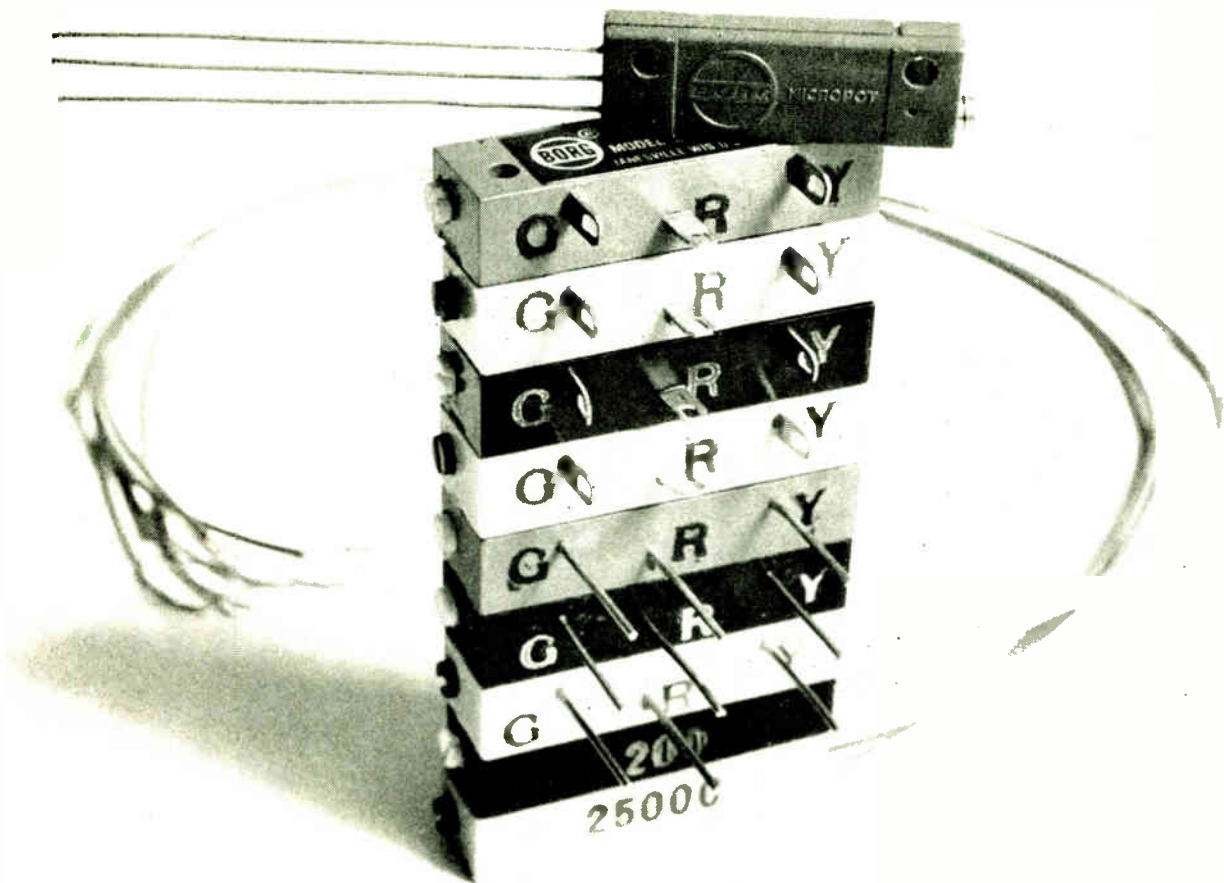

The complete Borg Trimmer line starts at the top

Everything must start someplace. The complete Borg line of Trimming Micropot[®] potentiometers can be said to start with its latest addition, the subminiature (1" x 3/16" x 5/16") 2700 series. This new Micropot is not only tiny, but a high-temperature, humidity-proof model as well.

However, if a quarter of an inch isn't important to your application, there are six other Borg Trimmer series from which to choose:

- 2800—High temperature, humidity proof, wirewound.
- 990—High temperature, wirewound.
- 992—General purpose, wirewound.
- 993—General purpose, carbon.
- 994—General purpose, humidity proof, wirewound.
- 995—General purpose, humidity proof, carbon.

Here are some of the advantages of-

- fered by Borg Trimmers: 1. Single-piece, welded terminations. 2. Low-mass contacts. 3. 100% noise test. 4. 100% contact resistance check. 5. 100% ratcheting test. 6. Resistances from ten ohms to one meg.

Selecting the right Borg Trimmer can be a lot easier if you'll call your nearby Borg technical representative or Amphenol-Borg Industrial Distributor. Or, if you prefer, write directly to R. K. Johnson, Sales Manager:



BORG EQUIPMENT DIVISION

Amphenol-Borg Electronics Corporation,
Janesville, Wisconsin.

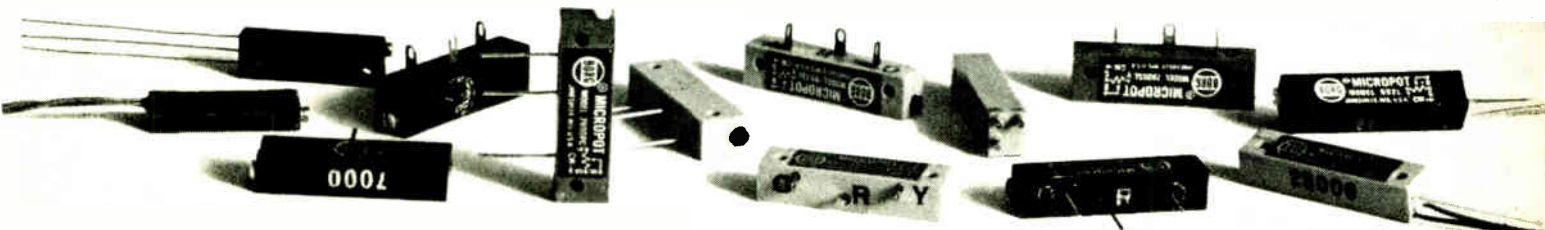

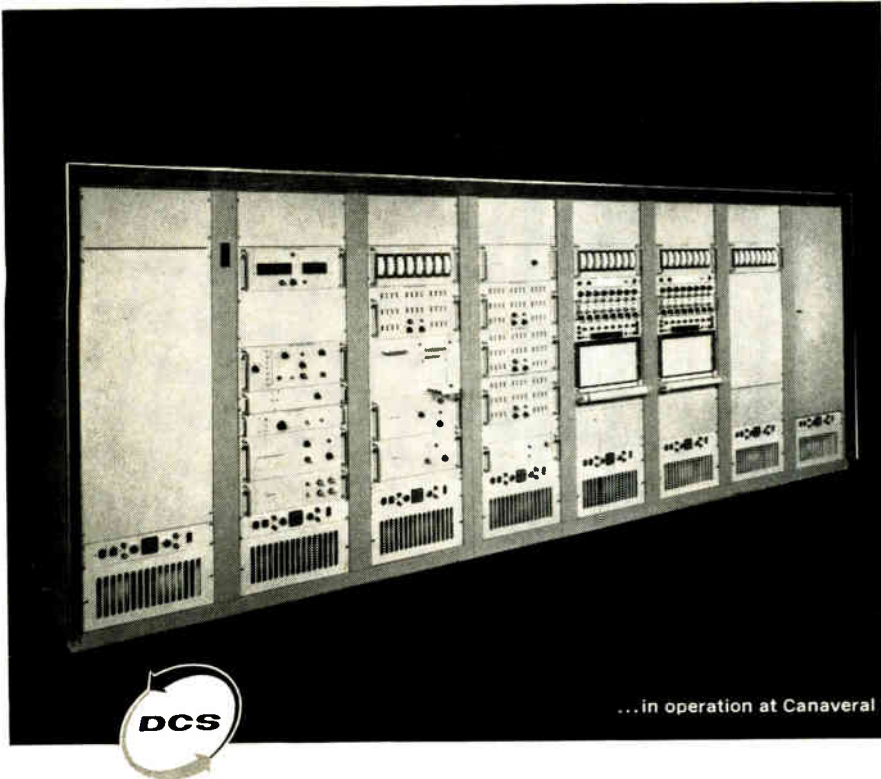

Can you use these unique features of DCS PCM Digital Data Systems?

If you are considering PCM telemetry ground stations or any digital data system, you will be interested to learn what's available from DCS. Designed to the same standards of reliability which have built DCS's reputation in FM analog data systems, DCS digital data systems offer these unique features:

- a signal generator capable of simulating several signal modes and operating conditions
- a pulse synchronizer which optimally recovers data in the presence of severe noise and reconstitutes the pulse train
- automatic synchronization under conditions of gross time base perturbations
- provisions for conventional or majority logic for sync recognition
- a digital-to-analog converter featuring thumb-wheel selection of channel to be presented in analog form

These are only a few of the exclusive features of DCS digital data systems. We'd be pleased to assist you in adapting these proved capabilities and equipments to meet your specific requirements. Call your nearest DCS field office, or write us at Dept. E-1-9.

DATA-CONTROL SYSTEMS, INC.

Instrumentation for Research

Los Angeles • Santa Clara • Wash., D. C. • Cape Canaveral
Home Office: E. Liberty St., Danbury, Conn. • Pioneer 3-9241



sure measurements could be made. Freezing and boiling points of solutions could be found as a function of pressure and temperature.

The Naval Ordnance Laboratory developed the velocimeter to make comprehensive and precise measurements of sound velocity in seawater as a function of temperature, pressure and salinity. The measurements have been interpolated to form a table that takes into account sound velocity at all depths covering 99.8 percent of the oceans of the world. This table is a useful guide for studying undersea acoustics, oceanography and thermodynamics.

Ultrasonic Delay Line Equation Is Evolved

By H. Mack Thaxton
Amersil Quartz Div.
Engelhard Industries, Hillside, N. J.

GENERAL exact solution of the equation for propagation of longitudinal ultrasonic plane waves in dispersive delay lines of varying cross section has been evolved. The solution enables determination of the change in delay of the line with frequency.

Differential equations for ultrasonic plane waves in dispersive delay lines of varying cross section are available in published sources. However, solutions of the equations involved are usually obtained by approximate methods. The equation, usually obtained from Hooke's law and by equating Newtonian forces at opposite faces of the line material, is

$$d^2y/dx^2 + (1/A) (dA/dx) (dy/dx) + (\omega^2/C_o^2)y = 0 \quad (1)$$

where $y = H/A^{\frac{1}{2}}$ in which A is cross section and H is a constant, $C_o = (E/\rho)^{\frac{1}{2}}$ in which E is Young's modulus and ρ is density of the line materials, x is line length and ω is frequency.

Since $dA/dx = (dA/dy) (dy/dx) = -(2A/y) (dy/dx)$, Eq. 1 can be written

$$d^2y/dx^2 - (2/y) (dy/dx)^2 + (\omega^2/C_o^2)y = 0 \quad (2)$$

Solving Eq. 2 using standard methods results in

$$y = (C_1 C_1^{(1/2)} (\omega^2/C_o^2) / (C_1 - \rho \exp^{-(1/2) \omega^2 x C_o^2}) \text{ and } (3)$$

$$y = -(C_1 C_1^{(1/2)} (\omega^2/C_o^2) / (C_1 - \rho \exp^{-(1/2) \omega^2 x C_o^2}) \quad (4)$$

new

FERRITE SWITCHES

> 40db isolation
< 0.2db loss



HYLETRONICS' Model SC1, one of a new series of ON-OFF reflective type microwave ferrite switches, exhibits greater than 50db isolation with 0.1db loss at midband frequency. With no current applied the switch is in the OFF condition to provide fail-safe operation when it is used as a protective device. The coil characteristics may be modified to meet special requirements.

Two units can be packaged to provide a minimum of 80db isolation and 0.4db loss over a 4 percent band.

Because of their outstanding characteristics, the switches are suitable for many systems applications, including standby transmitter switching, duplexing, power dividing, maser and receiver protection.

Switches with similar characteristics may be supplied for use from S to Ku band.

MODEL SC1

Frequency Range	6175-6425 mc
Isolation	40db min.
Insertion Loss	0.2db max.
VSWR	1.20 max.
Switching Time	100 μ sec*
Coil Current	1 amp.
Coil Inductance	12 mh
Length	2 3/8 inches

*Shorter switching times are obtainable in modified designs.

Write for additional information on Model SC1 and other microwave ferrite and semiconductor devices.

HYLETRONICS
CORPORATION
BURLINGTON, MASSACHUSETTS
CIRCLE 205 ON READER SERVICE CARD

Copper-clad laminate should be WORTH the circuit printed on it

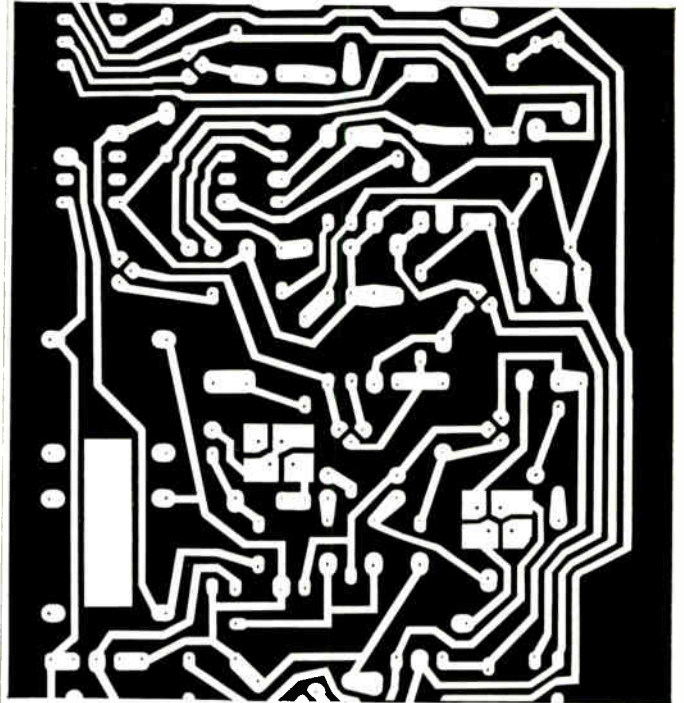

Most printed circuits require a high-quality, reliable copper-clad laminate. Synthane goes to extremes to check foil quality, adhesives and the laminate. We test peel strength at room temperature and at 500°F, using a newly-developed peel tester. Synthane checks blister resistance and heat resistance, and measures the thickness of the entire sheet (not merely the edges) with a new Synthane-designed instrument. Synthane prints and checks test patterns. Be sure the laminate is worth the circuit you print on it. Write for Copper-clad Bulletin.

SYNTHANE

CORPORATION **S** OAKS, PENNA.
GLendale 2-2211 TWX Valley Forge 735U

Synthane-Pacific, 518 W. Garfield Ave., Glendale 4, Calif. TWX GLDL 4417U

Synthane Corporation, 36 River Rd., Oaks, Pa.
Gentlemen:
Please send me new bulletin, "Synthane Metal-clad Laminated Plastics"

Name _____

Address _____

City _____ Zone _____ State _____

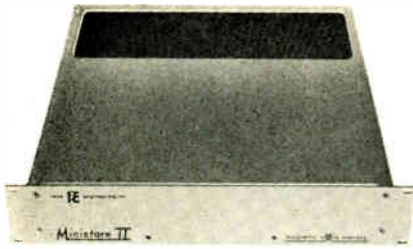

MINISTORE

HOW TO INTEGRATE YOUR MEMORY AND YOUR MONEY

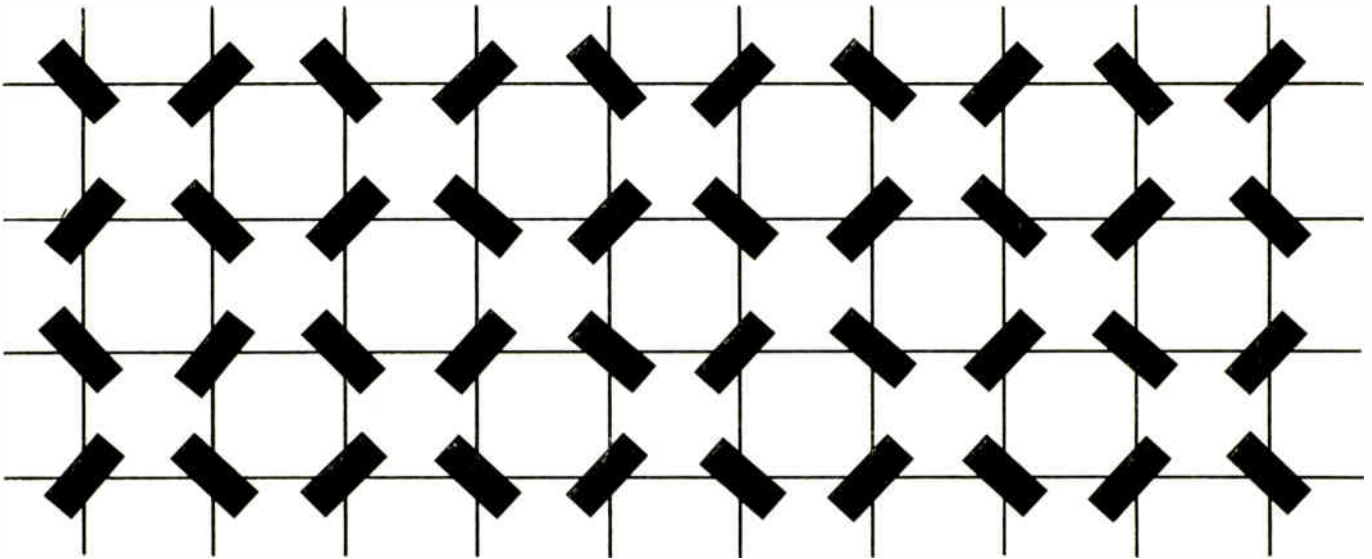

■ Here is a new idea in random access magnetic core storage — the Ministore Memory. Compact, modular and miniaturized, Ministore incorporates a totally different approach to circuit design and uses a superior packaging technique that make possible core storage at 1/2 to 1/3 the price of conventional memories with random access capabilities. ■ Ministore is available in a number of word lengths and bits per word, requires low power because of fewer active circuit elements, operates over a range of voltages normally supplied in digital systems — and can be delivered within two weeks. ■ The outstanding technical achievements of the Ministore design result in a memory with the lowest cost per bit in the industry and assure you a better integration between your memory requirements and your budget limitations. ■ For complete details on Ministore, contact Rese Engineering, or see this exceptional memory in operation at the Spring Joint Computer Conference, Booth 510.

rese

rese  engineering, inc.

A and COURTLAND STREETS, PHILADELPHIA 20, PENNSYLVANIA • GLadstone 5-9000

CIRCLE 82 ON READER SERVICE CARD

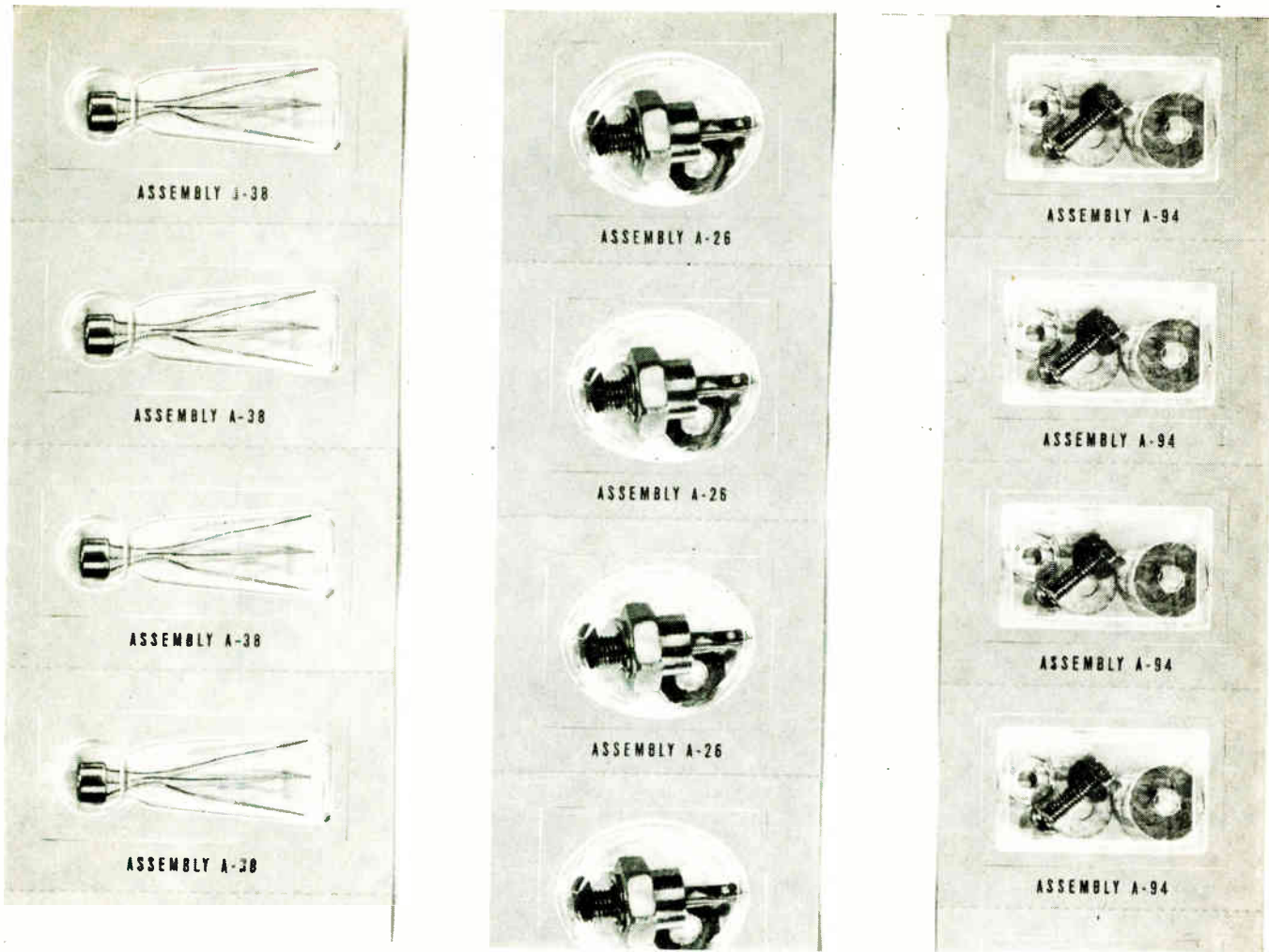

HOW "VISIBLE" PACKAGING CAN IMPROVE YOUR PRODUCTION...YOUR SALES!

"Visible" packaging is a vital new tool being used by leading manufacturers to improve parts handling on the assembly line.

Low cost "blister" packs, made with thermoformed acetate, offer these operational advantages:

- Protection against dust, rust and breakage
- Instantaneous Inventory Checks
- Reduced pilferage and losses
- Speedier assembly
- Improved inspection
- Space on package for printed directions

The Celanese Packaging Materials Center can give you experienced counsel and assistance in evaluating the advantages to you in visible packaging—for both inter-plant use and at the retail level. For more details, return coupon.

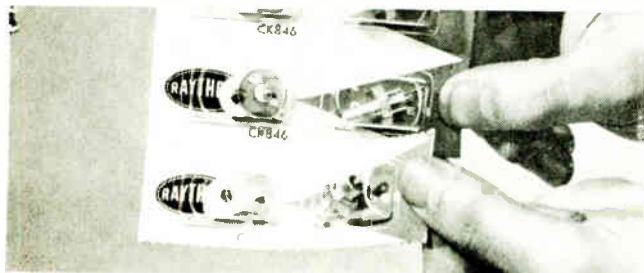

Celanese Plastics Company is a division of Celanese Corporation of America
 Canadian Affiliate: Canadian Chemical Company, Limited, Montreal, Toronto, Vancouver
 Export Sales: Amcel Co., Inc., and Pan Amcel Co., Inc., 522 Fifth Ave., N. Y. 36 N. Y.



Celanese Plastics Company, Dept 168 D
 744 Broad Street, Newark 2, New Jersey

I am interested in receiving more information about "blister" packaging—
 for inter-plant use for retailing of parts

Name _____

Title _____

Company _____

Address _____

Celanese®

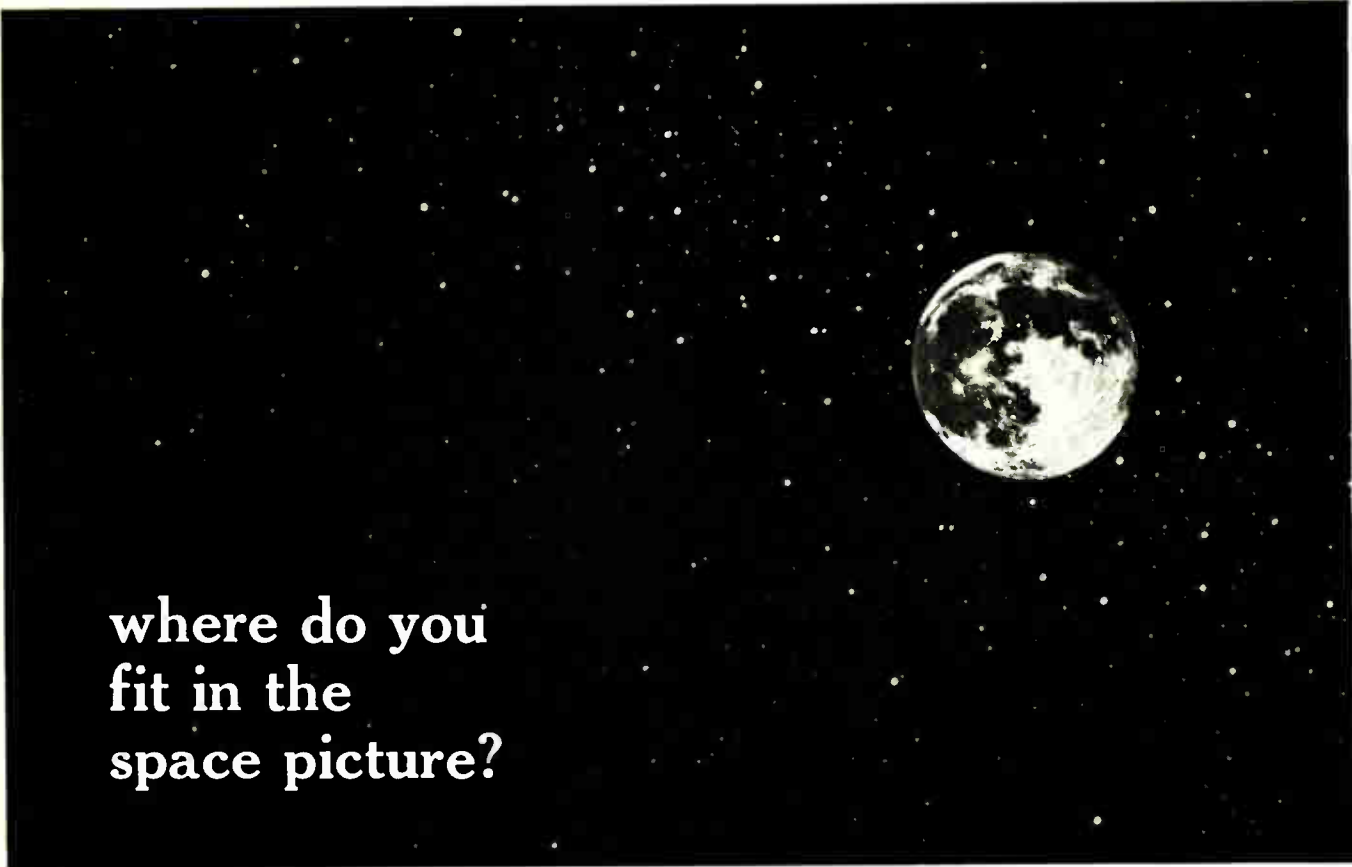

where do you fit in the space picture?

Today, the design and development of space systems, vehicles and weapon systems is achieving an even greater degree of importance than before. Expenditures are increasing. The pace is being stepped up.

Hughes Aerospace Divisions are expanding with each of these progressions. Important projects such as SURVEYOR, SYNCOM, ION ENGINE, ARPAT, BAMBI and advanced POLARIS guidance are now underway. Others will begin soon. This expansion is producing new, challenging assignments that never existed before. The opportunity is for you. You can be a part of, and benefit from, Hughes further expansion into the space picture.

If you hold a degree from an accredited university in Mechanical Engineering, Electronic Engineering or Physics, are a U. S. citizen and have experience or interests related to Aerospace Vehicles or Weapon Systems, you can qualify. A few of the openings include:

controls engineers

Concerns airborne computers and other controls related areas for: missiles and space vehicles, satellites, radar tracking, control circuitry, controls systems, control techniques, transistorized equalization networks and control servomechanisms.

circuit designers

Involves analysis and synthesis of systems for: telemetering and command circuits for space vehicles, high efficiency power supplies for airborne and space electronic systems, space command, space television, guidance and control systems, and many others.

systems analysts

To consider such basic problems as the requirements of manned space flight; automatic target recognition requirements for unmanned satellites or high speed strike reconnaissance systems; IR systems requirements for ballistic missile defense.

infrared specialists

To perform systems analysis and preliminary design in infrared activities involving satellite detection and identification, air-to-air missiles, AICBM, infrared range measurement, air-to-air detection search sets, optical systems, detection cryogenics and others.

Inquire today. Fit yourself into the space picture at Hughes.

Please airmail your resume to:

Mr. Robert A. Martin
Supervisor of Scientific Employment
Hughes Aerospace Divisions
11940 W. Jefferson Blvd.
Culver City 16, California.

We promise you a reply within one week.

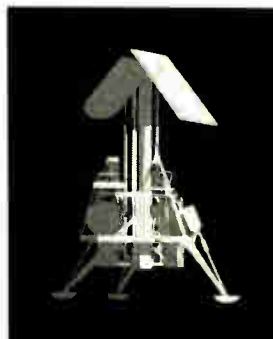

Creating a new world with electronics

HUGHES

HUGHES AIRCRAFT COMPANY
AEROSPACE DIVISIONS
An equal opportunity employer.

30

SECOND synchros & resolvers in BuOrd size 23 configuration

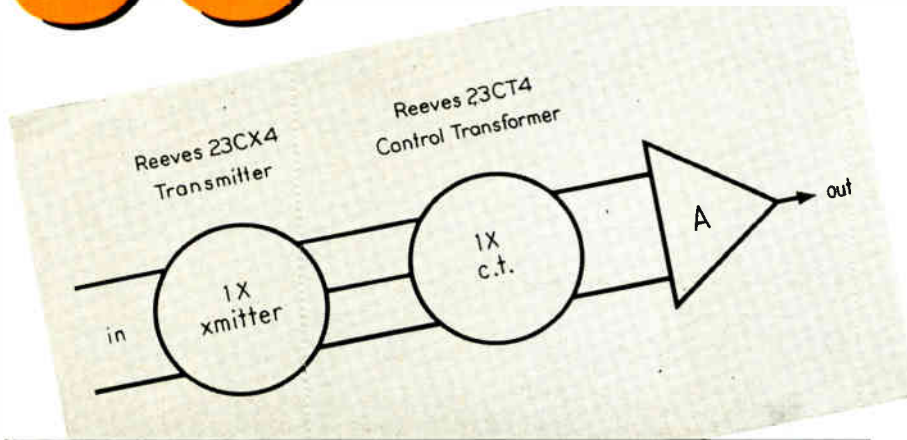

Simplify Data transmission instrumentation —

CONTROL TRANSFORMERS

TRANSMITTERS

3-WIRE SYNCHROS

4-WIRE RESOLVERS

**Eliminate
gear boxes
component duplication
crossover network**



DESIGN FEATURES

- 30 second accuracy on production runs
- 20 second accuracy units available on special order
- Stainless steel housings
- High thermal stability
- Compensated and uncompensated resolver models
- Conform to MIL-S20708A requirements

Reeves high precision size 23 synchros and resolvers represent a major design breakthrough. Their extreme accuracy enables the design engineer to develop data transmission systems with a greatly reduced number of components for an equivalent over-all system accuracy.

Compare the circuit diagram shown above with conventional instrumentation for a basic data transmission system. Two synchros, two gear boxes, and the crossover network have been eliminated. Weight and space have been reduced by a factor greater than 2, and the system accuracy will directly reflect the superior synchro accuracies. Reliability is improved immeasurably and field maintenance reduced to a minimum.

The new Reeves Synchros are the only 30-second accuracy instruments currently available in BuOrd size 23. The series includes both transmitters and control transformers, available for either 60 or 400 cycle input. Write for Data File 103.

REEVES INSTRUMENT CORPORATION
A Subsidiary of Dynamics Corporation of America
Roosevelt Field, Garden City, N.Y.

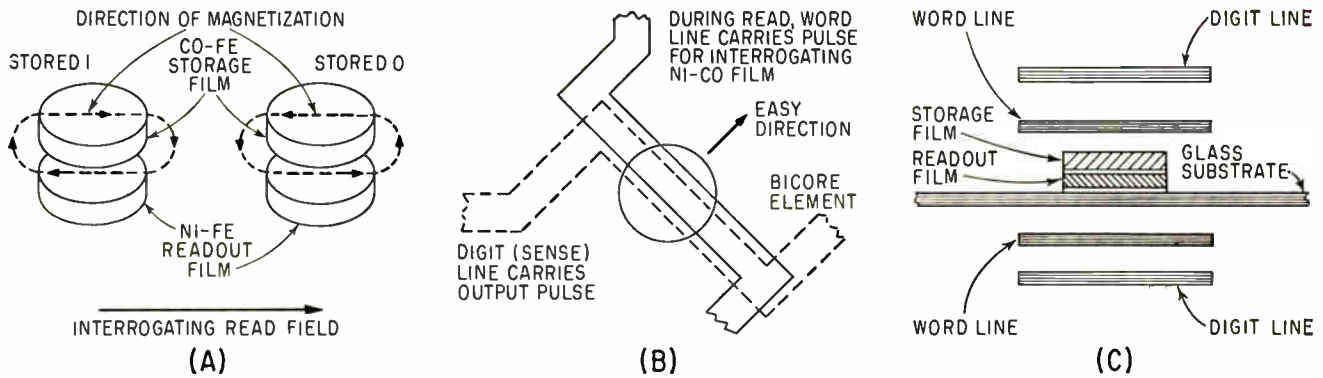

Diagrams show Bicore film element coupling (A), top-view geometry of nondestructive readout word-digit lines (B), and cross section of Bicore film element of substrate with associated conductors (C). Spacing is exaggerated

Thin-Film Memory Elements for Computer

By GERALD BESTLER
 A. A. WICKS,
 Remington Rand Univac, Div. of Sperry
 Rand Corp., St. Paul, Minnesota

CRITICAL PROBLEMS involved in laying down thin-film magnetic elements on substrates, and proper registration of the memory planes have been solved by Univac, and a compact thin-film memory for computer installations is now produced on an assembly line. The thin-film memory is presently used in the Univac ADD (Aerospace Digital

Development) Computer, designed for installations where space and weight are important considerations.

The memory portion of the computer is based on the capability of some metals to retain a magnetic state when a current passes near them. Extremely thin magnetic alloy elements are placed on a thin glass substrate by vacuum deposition. Two thin films are used for each memory element. One film is a high-coercivity cobalt-iron alloy, the other film is a low-coercivity nickel iron element (see diagram above).

The cobalt-iron (Co-Fe) film is the storage element, switched by a strong applied field to the desired state during the 'write' operation. The readout nickel-iron (Ni-Fe) film is switched during the computer 'read' operation. Through magnetic coupling, the remanent state of the latter is determined by the state of the Co-Fe film.

The storage film stores the bit, and the readout film senses the storage film when a current probes the memory disk for information. Each element of the Bicore disks contain essentially a single magnetic domain that can be oriented in two directions. The storage film, with a magnetic domain in one direction, represents a '1'; and an '0' in the opposite direction. Bicore elements retain the basic information imparted to them during a pro-

grammed write function by the associated computer, also indicate their stored contents when sensed.

Thin-film memories switch states in one to ten nanoseconds. Information stored at a memory location, can be changed as required for calculations involving transient and other high-speed phenomena.

The magnetic state of the Bicore element is sensed by conductors assembled in arrays to loop around the deposited Bicore elements. Arrays are cemented to a rigid board. A cross-section of a Bicore element and associated conductors is shown in the diagram above.

A printed wiring board containing Permalloy tape cores, microdiodes and interconnection wiring for the plane, is the associated circuitry used for the selecting storage addresses in the memory. Each plane in the memory now in production, measures approximately six by seven inches and is 112 mils thick. The destructive readout memory planes are folded and stacked.

The printed wiring boards are folded to enclose the wiring arrays and film cores, with each plane later being placed into a group of registered planes called an "eight pack." The eight packs are in turn assembled to form the complete memory stack. By stacking memory planes, Univac has been able to stack 56 memory planes to provide a total memory capacity of 165,988 binary digits (bits) comprised of

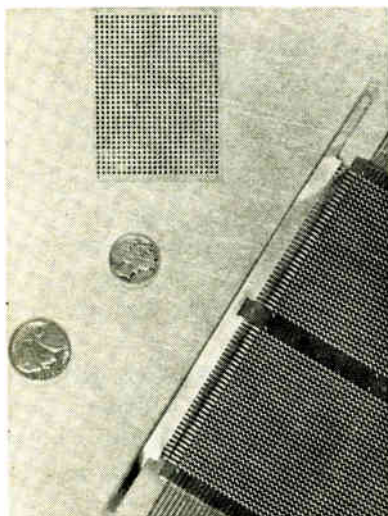

Glass substrate, top, shows deposited thin-film memory disks. Wiring array at lower right contains zig-zag conductors to magnetize disks when substrates are assembled on array

Q.

Who has the facts about aligning a tracking antenna to one second* of arc?

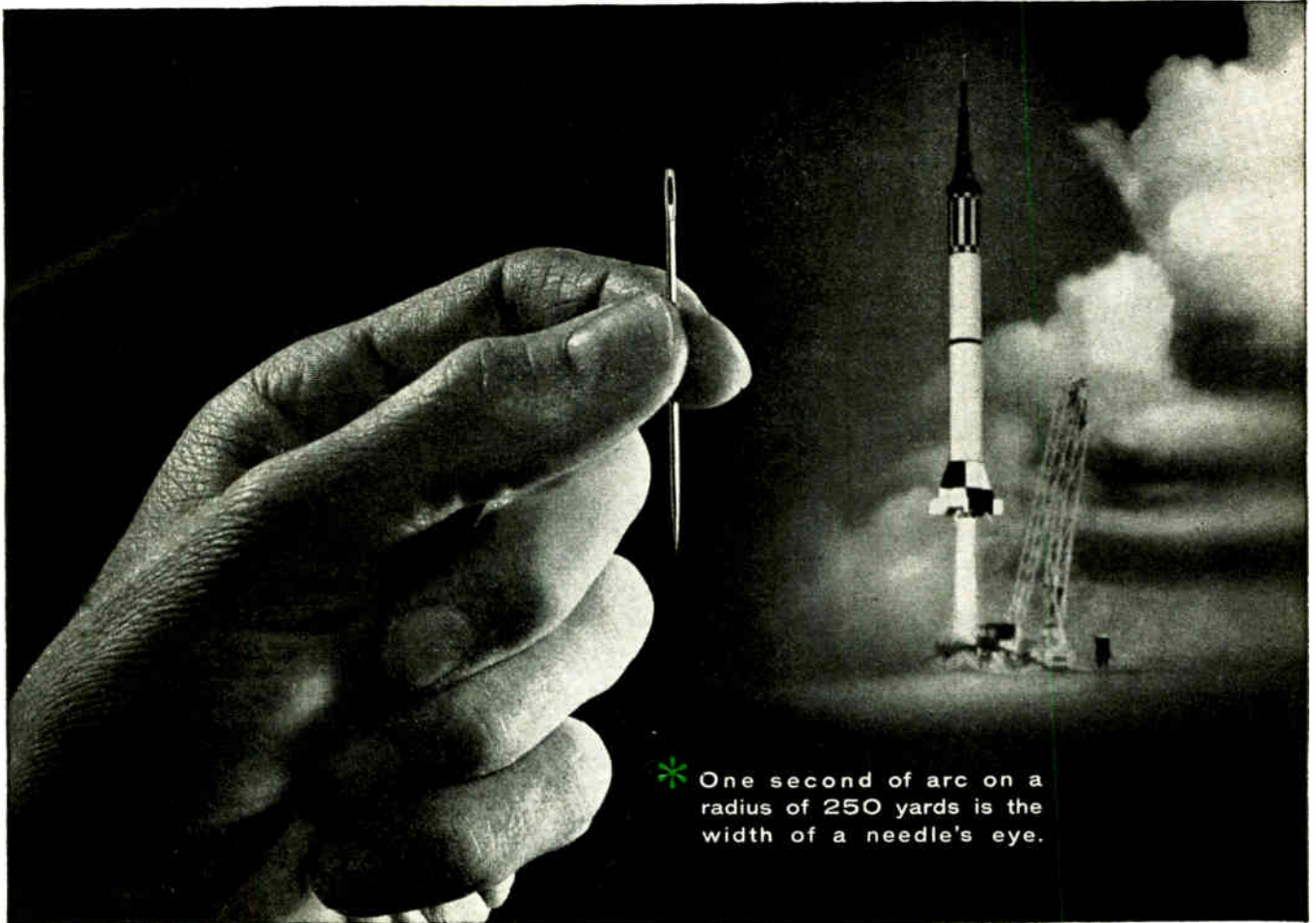

* One second of arc on a radius of 250 yards is the width of a needle's eye.

A.

The Engineers who create Kollmorgen Telescopes

They'll tell you about Kollmorgen's Type 501 Telescope . . . now bore-sighting the radar antenna that sends guidance commands to Atlas missiles. You'll learn that this telescope is the only means of sighting an azimuth and its back azimuth to one second of arc without movement of the instrument's body. Explanation? This telescope has two objective lenses — one at each end of the instrument. Because each objective serves as the reticle for the other, the eye piece is used on one end of the instrument to sight forward . . . on the other end to sight back.

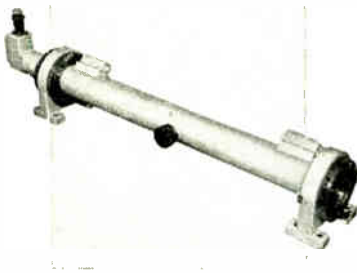

Investigating further, you'll learn that Kollmorgen's solutions of optical problems range in size from small borescopes to massive submarine and hot-cell periscopes . . . in type from Cinerama lenses to missile tracking binoculars . . . in quantity from one of a kind to production runs of thousands.

What is your question? If it is in the area of remote viewing, aligning, testing, measuring or controlling, the answer may already be among the growing number of optical/electronic/mechanical components, instruments and systems engineered and produced by Kollmorgen and its subsidiaries.

Write for literature describing the combined capabilities and facilities of Kollmorgen, Instrument Development Laboratories and Inland Motor Corporation of Virginia.



KOLLMORGEN

KOLLMORGEN CORPORATION • NORTHAMPTON, MASSACHUSETTS

may already have the answer to your next question in optics or electromechanics.

PULSE POINTERS

Double Pulse Generator Recommended For Semi-Automatic Checkout Systems

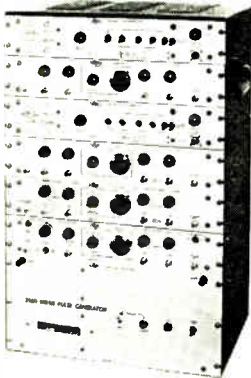

Model 2140A Precision Double Pulse Generator

Fast rise time, calibrated controls, separate or mixed signals—Pulse simulation and control problems are easily resolved over a broad range by the multiple capabilities of SERVOPULSE™ Model 2140A Precision Double Pulse Generator. Reliable output parameters allow immediate use of the equipment without calibration and monitoring instruments. Model 2140A offers wide-range adaptability to special purpose applications through the use of standard pulse and digital circuit modules.

Compact, Medium-Power Pulse Generator Features Modular Adaptability

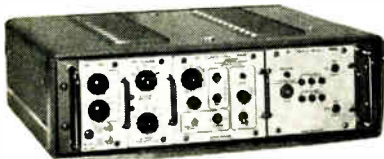

Model 3350A Pulse Generator

Fast rise time pulses are fully controllable in a variety of parameters—Model 3350A Pulse Generator offers broad performance range in a unit designed for console mounting. Uses include pulse circuit design and testing of RADAR, navigational systems, digital computers, and control systems. It may be operated from the internal oscillator, slaved to an external trigger, or used single shot by pushbutton for transient testing. SERVOPULSE™ Model 3350A has 2 mc-2 cps rate and 10 nanosecond rise time.

For complete details, write:

**SERVOPULSE™ PRODUCTS
SERVO CORPORATION OF AMERICA**



111 New South Road
Hicksville, L. I., N. Y.
WE11s 8-9700

6912 words of 24 bits each. Some 6656 of these words may be used by the computer, but are retained in the memory simultaneously with use, providing nondestructive readout.

Programs and mathematical constants used in repetitive computations may be permanently retained in the memory without rewriting them into the memory during use, simplifying computer electronics.

Destructive Readout

To permit scratch pad storage, whereby information may be stored temporarily during a computation, a 256-word destructive readout thin film memory is also provided. Both memories have a cycle time of three microseconds and an access time of 1.5 microseconds.

This memory is contained within one-third cubic foot, including associated circuitry. The actual thin-film portion of the memory has a volume of 200 cubic inches.

The vacuum deposition process, employed in laying down the magnetic deposits of the glass substrate avoids introduction of impurities and lowers the temperature at which the alloy boils.

The condensed alloy deposit is made through an extremely fine-tolerance aperture mask, producing, in the core of the nondestructive readout (NDRO) memory, 768 disks on each substrate at a density of 225 per sq. in., with the disks having a 0.035-in. diameter. The DRO memory is similar in construction, but the deposited material is rectangular in shape. Thickness of the deposition and the rate of evaporation are critical factors.

Problems of maintaining close register-tolerances, and the effects that interacting electrical and magnetic fields produce when memory planes are stacked have been overcome.

These films have a nonmagnetostrictive characteristic: the film does not change dimensions when placed in a magnetic field. The electromagnetic output magnitude does not change when physically distorted.

Memory stacks withstand shock tests of 150 G in three axes, with no damage to the stack and with no change occurring to its stored contents. Stacks were operated under

vibration at 8.5 G with no malfunction. Life tests on the planes have been in progress over 10,000 hours and continue to operate satisfactorily with no indication of anticipated failure. Non-destructive readout planes have been interrogated one billion times during tests with no change occurring to their stored contents.

Additional computers are under development at Univac that will utilize the full access-speed capabilities of thin film memories. Memories are also available as assemblies in stacked arrays for any suitable application. Facilities at the Univac plant in St. Paul are being expanded to increase the production rate in order to meet anticipated demand for film memories.

New Mil Spec For Plastic Control Knobs

THE MILITARY, in recognition of important technical advances in the plastic and molding fields has proposed a new performance spec for plastic control knobs.

According to Jerome Feldman of Knob Corporation of America, it is important that both industrial jobbers and OEM's review their inventory positions in the light of the eminence of the new spec.

The Armed Services Electro-Standards Agency at Fort Monmouth, New Jersey, issued a proposed revision of Mil-K-3926A, and of Military Standard MS91528. The new spec will include, for the first time, a flammability requirement—the plastic material shall be self-extinguishing by ASTM D635-56T.

The following environmental tests will be performed: salt spray, Mil Std. 202B, method 101A; accelerated weathering test, Fed. Std. 406, method 6023; moisture resistance, Mil Std. 202 B, method, 106A; thermal shock, Mil Std. 202B, method 107A.

All knobs are to be marked according to Mil Std. 130, with the MS part number and the supplier's name or code symbol.

The QPL to be established for plastic control knobs is to be covered in Mil-K-3926.

A new series of knobs has been proposed. This will obsolete the small 0.500 series. The O.D. of the new knob is to be 0.575.

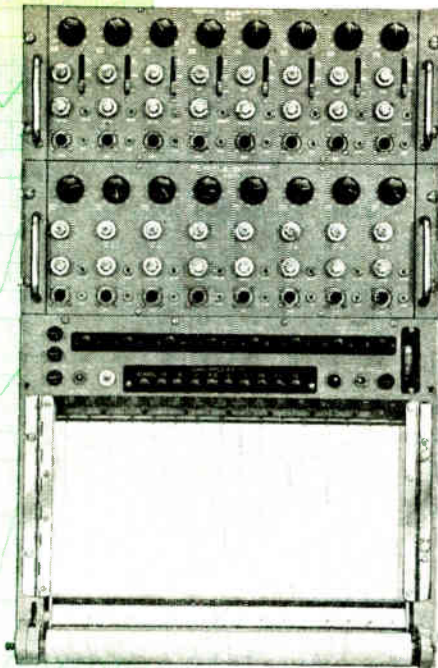

... with Sanborn® High, Medium or Low Gain 8-Channel Amplifiers and Flush-Front Recorder in only 32" of panel space

In the 32" panel space version, Sanborn 16-channel direct writing systems use a flush-front 358-16 Recorder and *any two* "950" series 8-channel amplifiers — available in transistorized high and medium gain types with floating and guarded inputs, low gain with high resistance balanced to ground inputs. Max. sensitivities are 20 uv/mm, 1 mv/mm and 20 mv/mm for high, medium and low gain systems. Frequency response ranges for the three are 100, 125 and 125 cps. Recorder has 9 chart speeds, 8" of visible record, inkless recording in true rectangular coordinates on Sanborn Permapaper® charts.

RECORD 16 VARIABLES

on a single 16" chart

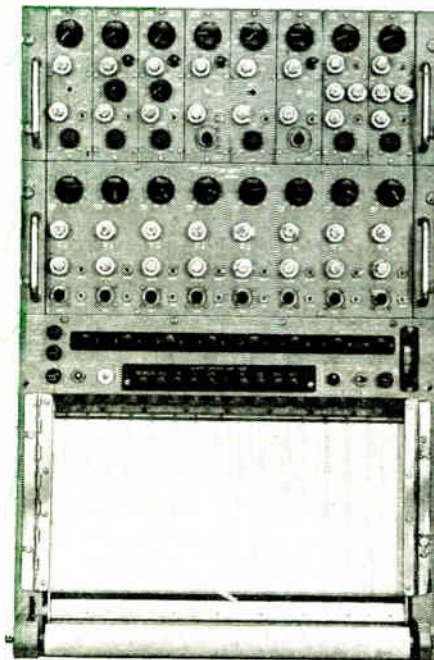

... with 8 channels identical, 8 more with miniature plug-in preamplifiers for greater flexibility

Eight interchangeable, plug-in "850" preamplifiers, each with 7" x 2" panel, plug into chassis with common power supply. Available types are Phase-Sensitive Demodulator, DC Coupling, Carrier and Low Level; MOPA available for Carrier and Low Level excitation. Frequency response is DC to 125 cps, 3 db down at 10 mm peak-to-peak depending on type of preamplifier. Linearity is better than 0.5%. Inputs are single-ended, floating and guarded, or push-pull, depending on type of "850" preamplifier used. Remaining eight channels can comprise any 8-channel "950" amplifier.

With each of these systems, you have a choice of vertical or horizontal chart plane recorders. Flush-front vertical recorder ("350" style) has electrical speed shift, requires only 17½" vertical panel space. Horizontal recorder facilitates viewing and making notations on record, occupies 21½" of panel space, has mechanical speed shift. Both recorders have velocity feedback-damped galvanometers . . . automatic stylus heat control . . . separate timer/marker stylus . . . inkless direct writing on quick loading, rectangular coordinate charts with 20 mm wide channels.

For complete specifications and application engineering assistance, contact your nearest Sanborn Sales-Engineering Representative. Offices throughout the U. S., Canada and foreign countries.



INDUSTRIAL DIVISION

**SANBORN
COMPANY**

175 Wyman St., Waltham 54, Mass.

CIRCLE 89 ON READER SERVICE CARD

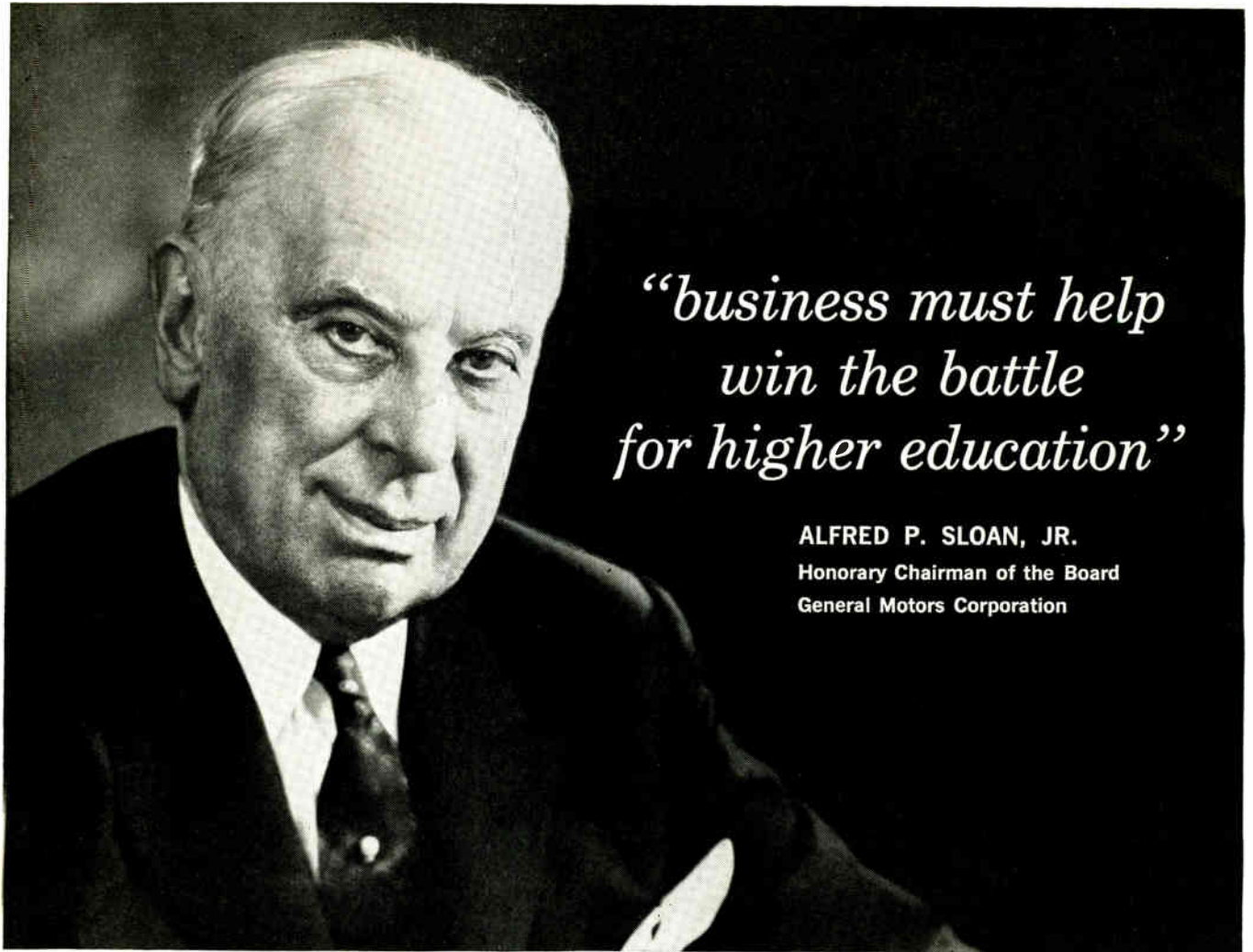

*“business must help
win the battle
for higher education”*

ALFRED P. SLOAN, JR.
Honorary Chairman of the Board
General Motors Corporation

“Regardless of the strengths and attributes our nation possesses, if we fall behind in the field of education, we will fall behind as a world power.

“Our scientific, cultural and economic growth—and our political strength—will depend largely upon the educational facilities we make available to our youth. We owe it to ourselves as a nation; we owe it to our young people who will inherit this nation to provide the financial aid that will make our institutions of higher learning second to none in the world. This is of vital importance to our business community.

“Business must put its support on the line to help win the battle for higher education.”

Today many of our colleges are overcrowded. In ten years, applications will have doubled and we will be faced with an even more serious crisis in our institutions of higher learning. We will need more and better college classrooms, many more well-equipped college laboratories and thousands more of the most dedicated and well-trained professors.

Only increased financial aid will provide our young people with the best college facilities. Only increased financial aid will keep our finest minds from leaving the teaching profession.

For additional information on the crisis faced by higher education write to: Higher Education, Box 36, Times Square Station, New York 36, N. Y.



Published as a public service
in cooperation with The Advertising Council and
the Council for Financial Aid to Education



COST CUTTING CERAMICS FOR TRANSISTOR CIRCUITRY

RMC Magnacaps®

SPECIFICATIONS

3 VOLT MAGNACAP

Capacitance μf. 1 Kc., .05 vrms max. @ 25° C.	Tolerance %	Dissipation Factor (% Max.) 1 Kc., .05 vrms max. @ 25° C.	Insulation Resistance Min. @ 100% Rated DC Voltage R = E/I	Diameter Max. (Inches)	Thickness Max. (Inches)	Lead Spacing ± .035"
.05	+80 -20	3%	60,000 ohms	.265	.156	.250
.10	+80 -20	3%	30,000 ohms	.265	.156	.250
.22	+80 -20	3%	13,600 ohms	.310	.156	.250
.47	+80 -20	3%	6,270 ohms	.425	.156	.250
1.0	+80 -20	3%	3,000 ohms	.615	.156	.375
2.2	+80 -20	3%	1,360 ohms	.880	.156	.375

12 VOLT MAGNACAP

Capacitance μf. 1 Kc., .05 vrms max. @ 25° C.	Tolerance %	Dissipation Factor (% Max.) 1 Kc., .05 vrms max. @ 25° C.	Insulation Resistance Min. @ 100% Rated DC Voltage R = E/I	Diameter Max. (Inches)	Thickness Max. (Inches)	Lead Spacing ± .035"
.05	+80 -20	7%	800,000 ohms	.310	.156	.250
.10	+80 -20	7%	400,000 ohms	.380	.156	.250
.22	+80 -20	7%	180,000 ohms	.575	.156	.375
.47	+80 -20	7%	85,000 ohms	.800	.156	.375
1.0	+80 -20	7%	40,000 ohms	1.045	.156	.375

25 VOLT MAGNACAP

Capacitance μf. 1 Kc., .05 vrms max. @ 25° C.	Tolerance %	Dissipation Factor (% Max.) 1 Kc., .05 vrms max. @ 25° C.	Insulation Resistance Min. @ 100% Rated DC Voltage R = E/I	Diameter Max. (Inches)	Thickness Max. (Inches)	Lead Spacing ± .035"
.02	+80 -20	7%	10 megohms	.380	.156	.250
.05	+80 -20	7%	10 megohms	.520	.156	.375
.10	+80 -20	7%	10 megohms	.695	.156	.375

For applications requiring capacitors with ultra high values and low power factors specify RMC MAGNACAPS. These new units combine the miniature size, reliability and lower costs always associated with ceramic capacitors. Write today on your letterhead for additional information on MAGNACAPS.

DISCAP
CERAMIC
CAPACITORS

RMC

RADIO MATERIALS COMPANY

A DIVISION OF P. R. MALLORY & CO., INC.

GENERAL OFFICE: 4242 W. Bryn Mawr Ave., Chicago 46, Ill.

Two RMC Plants Devoted Exclusively to Ceramic Capacitors

FACTORIES AT CHICAGO, ILL. AND ATTICA, IND.



Cubic announces an a-c converter that works with ANY digital voltmeter!

The new, universal Model AC-85 Converter is now available from Cubic Corporation to provide a means by which precision A-C measurements may be made with all floating input D-C digital voltmeters, pen recorders or *any* similar measuring device. It is a self-contained, self-powered converter that is not dependent upon the device with which it is used.

The AC-85 is fully automatic. It thinks for itself; it senses input voltage and automatically places itself in the correct range. Ordinary automatic ranging converters depend on the voltmeter to tell them when to change ranges and go through a multiple nulling process if a range change is required. This self-ranging converter is faster operating because it only nulls once. The AC-85 has all these features: Nuistor input for maximum stability; input may be floated to 500 volts DC; common mode rejection in excess of 70 db at 60 cps; frequency range 30 cps to 20 kc; accuracy 0.1%; sensitivity 1 millivolt. Price \$1400. For more details, write to Dept. A-130, Cubic Corp., San Diego 11, California; or Cubic Europa S.p.A., Via Archimede 181, Rome, Italy.



INDUSTRIAL DIVISION
SAN DIEGO 11, CALIFORNIA • ROME, ITALY

OTHER OFFICES AND REPRESENTATIVES IN PRINCIPAL U.S. AND CANADIAN CITIES

GUARANTEED

to meet
"WORST CASE"
Conditions



POWER SUPPLY
MODEL SP22-20
20-32 VOLTS
0-20 AMPS
CON AVIONICS

ON 20 A

VOLTAGE ADJUST

New "Switching" Power Supply Gives More Current at Less Cost

Just out. Con Avionics announces a new line of transistorized "switching" power supplies that provide more current, more reliable current, at a lower cost to you.

The secret? This unit continuously turns itself on and off. The result is exceptionally high current for its size and price. High efficiency is built in through low pass dissipation, high reliability, minimum components and small size. Most of the semi-conductors operate in the switch mode, adding to the long life of the supply.

Priced to compete with magnetic amplifier and constant voltage power supplies, the performance characteristics are decidedly superior. Like all Avionics power supplies these new "switching" power supplies are designed and tested by "Worst Case Analysis" for virtually failure-proof performance.

Voltage Range	50 Amp	30 Amp	20 Amp	10 Amp
24 — 32 V DC	SP28-50 \$820.00	SP28-30 \$590.00	SP28-20 \$525.00	SP28-10 \$450.00
18 — 26 V DC	SP22-50 \$820.00	SP22-30 \$590.00	SP22-20 \$525.00	SP22-10 \$450.00
10 — 20 V DC	SP15-50 \$820.00	SP15-30 \$590.00	SP15-20 \$525.00	SP15-10 \$450.00

Prices subject to change without notice.

CONSOLIDATED AVIONICS CORPORATION
800 Shames Drive, Westbury, New York

- Send literature on new "switching" power supplies
 Have representative call with demonstrator

Name.....
Company.....
Street.....
City..... Zone..... State.....

CON AVIONICS

A Member
of The Condec Group

NEW
FROM WESTON

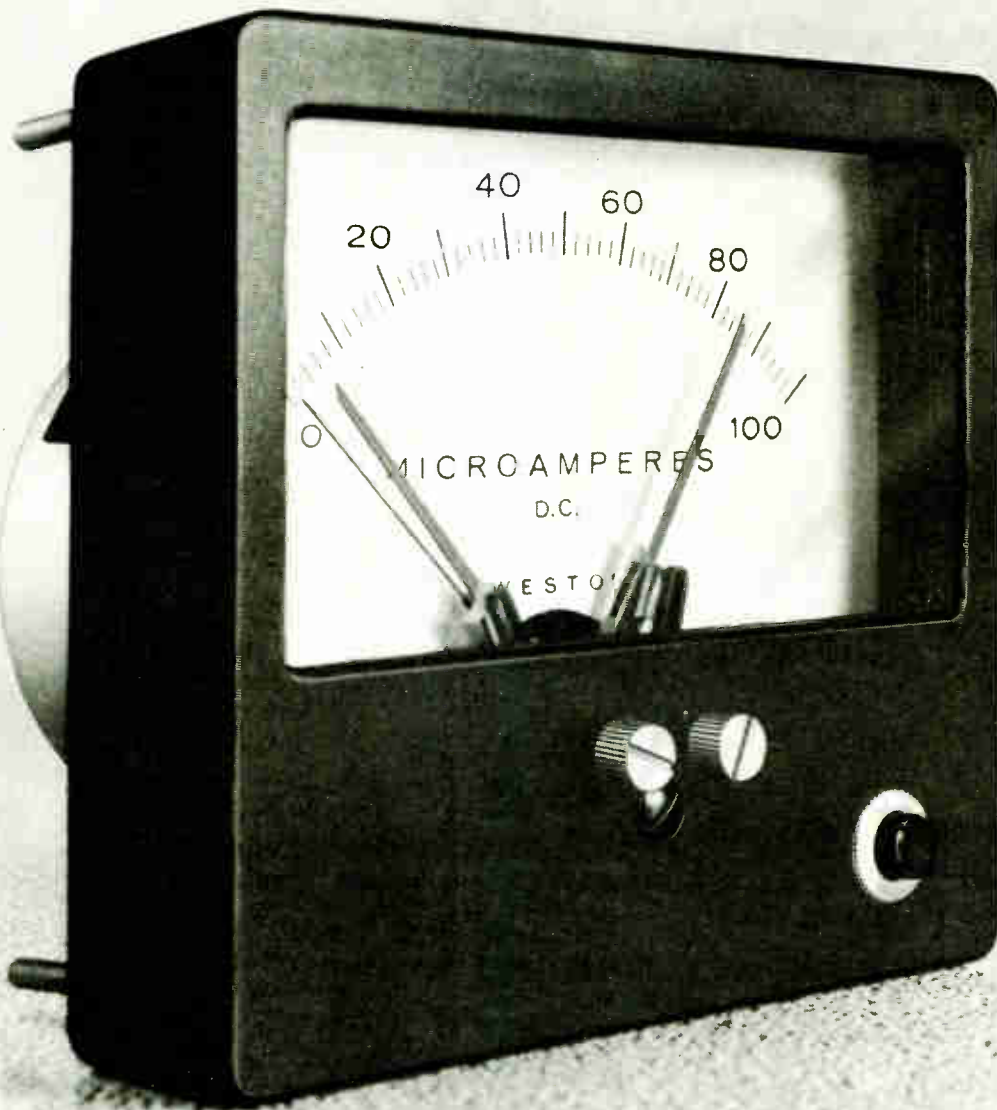

CONTACT

DOUBLE-ACTION PRINCIPLE ASSURES RELIABILITY OF CONTACT CLOSURE

MagTrak™ Relays combine magnetic attraction with a load current contact aiding circuit. This combination increases contact pressure by a factor of 100 times on the most sensitive ranges. Weston's new MagTrak design gives you greatly increased reliability plus easy resetability.

You can always depend on MagTrak—even for low voltage operation and after long periods of inactivity.

- Sensitivities as low as 10 μ a, full scale
- Can operate as a pyromillivoltmeter

- Available with high or low set points, or both
- Standard, self-contained, full-scale ranges: 10 μ a to 5 a and 20 mv to 500 v or higher
- Kilowatt loads can be switched when accessory power package is used
- Scale length: 3.47 inches

Weston supplies the most complete line of relays available. More are now in use than any other kind . . . proof of their dependability. Write for new catalog or applications assistance from our experienced relay engineers. Dept. 200.

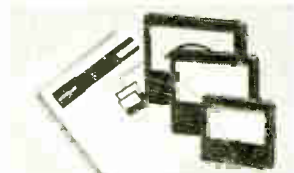

NEW RELAY CATALOG gives details on MagTrak. Another Weston catalog describes the matching line of Series 1900 Panel Instruments, pictured above. Send for both today.

WESTON INSTRUMENTS *Division of Daystrom, Incorporated, Newark 14, New Jersey*

Aerospace Instrumentation • Bimetal Thermometers • Calibration & Test Equipment • Panel & Switchboard Meters • Photosensitive Devices • Precision Metal Film Resistors • Relays & Tachometers • Systems Design & Development

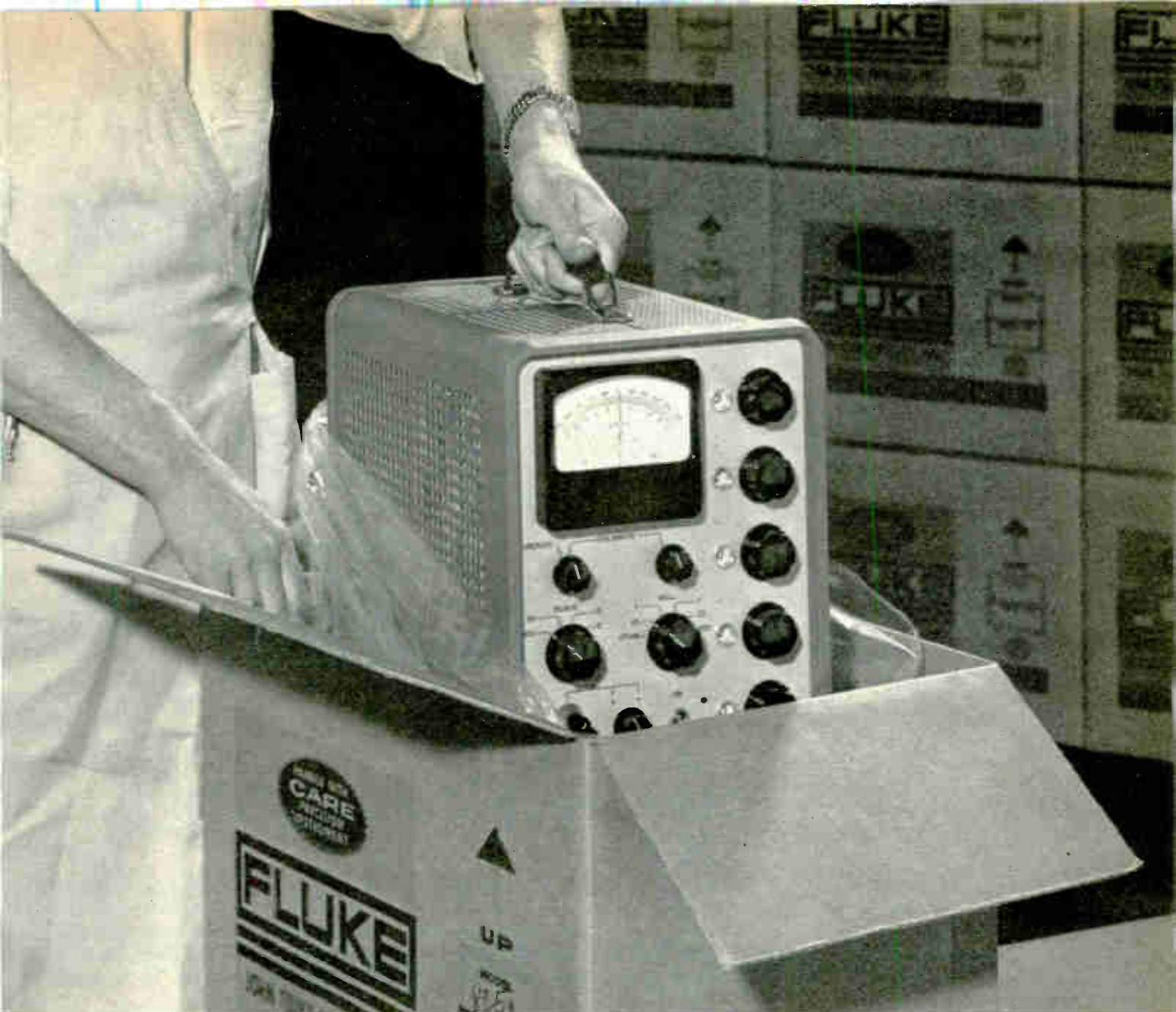

THIS NEW VOLTMETER WAS DESIGNED BY 15,000 CUSTOMERS

You had a hand in the engineering of the **FLUKE MODEL 825A DC DIFFERENTIAL VOLTMETER**. Customer suggestions spanning seven years and 15,000 differential voltmeters have helped create the most versatile and reliable instrument of this type ever offered.

Beginning with an overall accuracy of $\pm 0.025\%$, this advanced model features these significant advantages: recorder output — no zero controls — taut band meter suspension — flow soldered glass epoxy printed circuit boards.

To fully utilize the inherent advantages of high accuracy differential voltage measurements, Fluke Model 825A provides two major features not found in other instruments:

1. Infinite input impedance at null from 0 to plus or minus 500 VDC; this feature is extremely important since all voltages to be measured have significant source resistance. With the Model 825A operated at null, there will be no measurement errors due to circuit loading. The majority of other voltmeters provide a maximum of 10 megohms input impedance. Should the unknown voltage have a source resistance in the order of 5000 ohms, the measurement error due to source loading only will be at least 0.05% and does not include the basic error specification of the voltmeter itself.

2. Polarity reversing switch: A feature that enables you to measure either positive or negative voltages with equal ease. This is not merely a polarity reversal of front panel binding posts—but rather the internal 500 V reference supply is made either positive or negative with the front panel switch. This effectively provides you with two voltmeters for the price of one.

PARTIAL 825A SPECIFICATIONS

OVERALL ACCURACY: $\pm 0.025\%$
 MAXIMUM FULL SCALE NULL METER SENSITIVITY: 1 MV
 MAXIMUM NULL METER RESOLUTION: 5 uv
 STABILITY OF REFERENCE SUPPLY: $\pm 0.005\%$ per hour after warmup or $\pm 0.005\%$ for $\pm 10\%$ line voltage change.
 REFERENCE ELEMENT: Standard cell (zener diode optional)
 INPUT VOLTAGE: 11⁷/234 VAC $\pm 10\%$ from 50 to 400 cps

Write, wire or phone for short form catalog F-162

John Fluke Mfg.
 Company, Inc.
 Seattle 33, Wash.
 Box 7428

FLUKE

INSTRUMENTS

PR. 6-1171 TWX — Halls Lake TLX — 852

← CIRCLE 94 ON READER SERVICE CARD

CIRCLE 95 ON READER SERVICE CARD

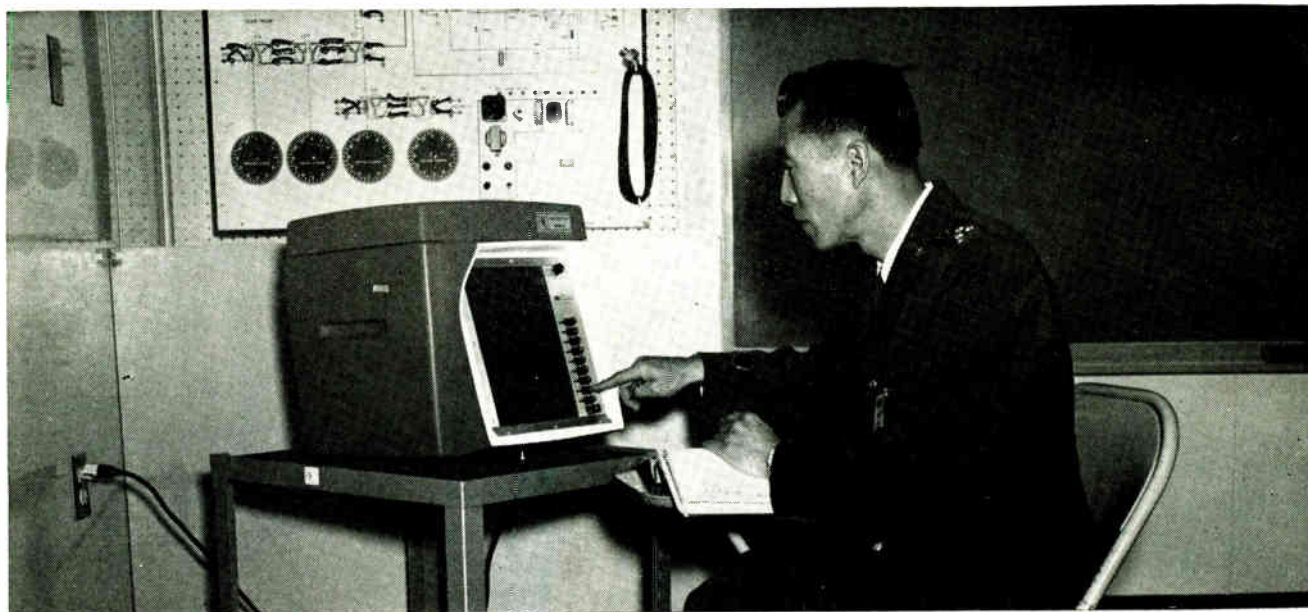

Typical teaching machine has programmed course on roll of film in top, and buttons at right of viewscreen for student to select the answer he thinks is right. Other ways to mechanize the concept include other teaching machines and programmed books

Teaching Machines as Training Aids

By GEORGE SKROBLUS
Kearfott Div., GPI,
Little Falls, N. J.

PROGRAMMED LEARNING using a teaching machine is being used by Kearfott Div., GPI, Little Falls, N. J., to train both their own and customer personnel.

At the present time, commercially available programs in basic electronics are being used but an in-house programming capability has been developed to write programs for inertial guidance systems. After much research, and a trial period of six months, it was decided to go ahead with programmed instruction, since the new teaching technique had adequately demonstrated its effectiveness.

The training problem is a difficult one because of several factors. A large percentage of the company's complex electronic navigational and control systems are built for the armed forces of the U. S. A large amount of the repair and maintenance work is therefore done by military personnel, who often must travel great distances to receive

training. This problem is further complicated by the fact that the armed services of some of our allies also use some of the equipment, which means that a language problem (West Germany and Japan for example) also arises. Programmed instructions are an effective way of solving these problems since programs can be written in any language and can easily be made available at the point of use.

Another group that requires training is the company's own staff of field engineers. These men must know the equipment well enough to train and guide military personnel and to take over when the regular maintenance men run into something they can't handle.

The field engineers naturally spend most of their time in the field and are not available for training as a group. Training, therefore, is normally available by them only as they rotate assignments and visit the home office, and even these visits can be interrupted by a special problem arising in the field. Nevertheless, they must obviously be kept up to date about the latest

equipment being produced. This problem is made even more difficult by continuous advances in the state of the art and by the small lot production typical today of complex electronic equipment.

A third group who require training are the company's shop personnel. Most of the company's products, until recent years, were electromechanical devices such as synchros, servo motors, etc. But training in basic electronics has been found to be vital in today's product line. This group at least has the advantage of being readily available for training.

Teaching Machines

The teaching machine shown in the photograph is made by U. S. Industries Education and Science Div., N. Y., N. Y. and costs approximately \$1,200. The top of the machine contains a roll of film on which the subject being taught is programmed in a series of frames. The first frame is projected onto the viewscreen and gives the student a certain amount of information; at the end of the discussion a



external
individual
CUP PHASING
makes the
BIG
difference

VARI/PHASE POTENTIOMETERS



Only Clarostat Vari/Phase potentiometers offer the **BIG DIFFERENCE** that makes it better than any other variable phasing potentiometer — the exclusive external phasing sliding terminal assembly. Completely eliminates clamping rings and other hard-to-adjust assemblies. To phase: simply loosen set screw, slide terminal in desired direction, tighten set screw, and phasing is completed.

Designed to meet all applicable military, aircraft and industrial applications, the Clarostat Series 54M is manufactured in accordance with applicable sections of MIL-R-19, MIL-R-12934, MIL-R-19518 and NAS-710. Units are available in 2, 2.5, 4.5, 5.5 and 6.1 watts in a wide range of ohmage values, in single or ganged assemblies. Housing is of anodized aluminum.

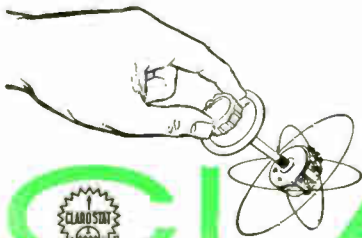

PRECISION POTENTIOMETER DIVISION

CLAROSTAT

CLAROSTAT MFG. CO., INC. DOVER, NEW HAMPSHIRE

Magneline®

ELECTRO-MAGNETIC READOUT INDICATOR

- SILENT
- RELIABLE
- EASY TO READ

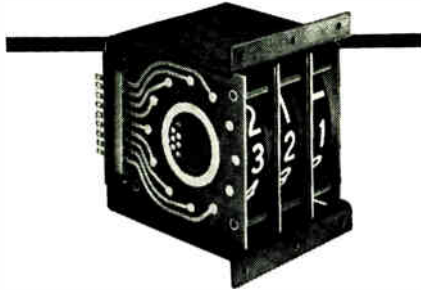

SERIES 10300 "PLUG-IN"

Modules inserted from front of bracket to make firm connection with circuit block. Twelve characters, $\frac{5}{16}$ " by $\frac{13}{32}$ " high. All MAGNELINE® characters screened white on dull black background, do not glare or fade under normal ambient light. Easy to read at 25 feet.



SERIES 10200 "MINIATURE"

Outside dimensions, five digit assembly, $1\frac{1}{8}$ " high x 2" deep x $2\frac{1}{2}$ " wide. Twelve characters, $\frac{13}{64}$ " high, distinct at 9 feet under normal room lighting. Weight per digit less than 1 ounce. Meets specs MIL-E-5272 C and MIL-E-5400 D, Class 2.



SERIES 10100 "STACKING"

$\frac{9}{16}$ " high characters are $\frac{11}{16}$ " on center, easy to read at 30 feet under normal room lighting. Stacking gives maximum character size in ratio to valuable panel area. 10 or 12 positions at 6, 12, 24, 28 or 36 volts.

The MAGNELINE® principle insures reliability and long life. A permanent magnet aligns itself with pole and brings specific character into display position. Character is held in position by magnetic detent until next pulse.

PATWIN
WATERBURY 20, CONNECTICUT
A Division of The Patent Button Company

PHONE:
203-756-3636
TWX: WBY 163



(A)

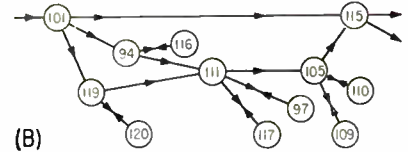

(B)

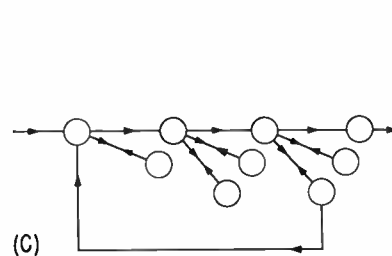

(C)

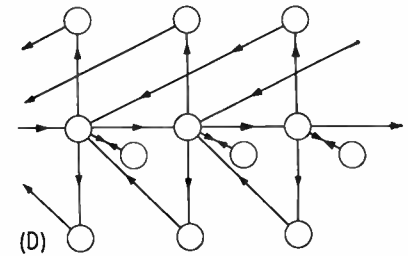

(D)

Student going through a programmed course (A) is presented in frame 101 with three possible answers, of which two are wrong and one is right. Much flexibility in programming is possible, as the frame sequences in (B), (C), and (D) illustrate

question is posed. Two or more answers are also shown and the student makes a choice and presses the appropriate button. The roll of film then indexes to the frame selected and projects it. If the student made a correct choice in answering the question, new information is presented and a new question asked; if he made a wrong choice he will be given more detailed information and then usually referred back to the original material and told to make a new choice as answer.

The subject matter of a given course can be presented in many ways, some of which are shown in the drawing. The shortest path through the course will be taken if the student selects only correct answers. It is primarily in the way wrong answers are handled that programs differ.

The sketch (A) in the drawing indicates the simplest type of procedure; the student has a choice of three answers, two of which send him back to the previous frame and one that goes on to new material and asks a question with two possible answers. Great subtlety is possible in programming, as the other sketches indicate. At (B), for example, a whole sub-program is uncovered if the student shows himself misinformed about the subject. Various washback schemes are possible, as (C) and (D) illustrate.

At the present time there appear to be few limits on the subject matter that can be programmed on teaching machines, except for such obvious subjects as swimming, dancing, etc., although up to now

most work has been done with subjects where the student has little if any background information. Programmed material now available includes courses in mathematics, basic electronics, oscilloscope, slide rule, and many others.

The cost of developing a program for use with a teaching machine will normally run from \$30,000 to \$50,000, but a course already programmed, such as basic electronics, can be obtained for from \$300 to \$400. Another consideration in developing a program is the stability of course content. If content is going to be stable for approximately one year, a programmed course can often be justified on cost alone.

Advantages of programmed teaching appear to be several: the student paces himself, proceeding as fast as necessary to master course content; the instruction itself is excellent, since programs are tested and verified as to effectiveness before programming is considered complete; only minimal guidance by an instructor is required, since all reasonably qualified students will have only a few questions; only a small amount of working or classroom space is needed; student interest is high and motivation is good.

At Kearfott, for example, eight shop men are presently taking the course in basic electronics. Each student spends two hours on each of two days each week at the machine. Total time to finish the course varies from 50 to 200 hours, depending on previous education and other factors.

ANNOUNCING THE ALL NEW VARIAN G-14 GRAPHIC RECORDER

1 MV SPAN...PLUS 10 MV, 100 MV, 1 VOLT SPANS INSTANTLY SELECTABLE • ALL TRANSISTOR CIRCUITRY • PEN SPEED 0.6 SECONDS FULL SCALE • ZENER DIODE REFERENCE • 0.5% ACCURACY AT 10 MV • FULL SCALE ZERO PLUS SUPPRESSION

The all new G-14 is carefully designed to provide the optimum combination of performance, operator convenience, versatility, size and price. Solid state circuitry, high negative amplifier feedback, rugged construction, quality components and null-balance potentiometer operation provide stable, accurate and reliable recording. Complete specifications available from the Instrument Division.



VARIAN associates
PALO ALTO CALIFORNIA





VIBRATION NEWS

MB ELECTRONICS • A DIVISION OF **TEXTRON ELECTRONICS, INC.**
Representatives in principal cities throughout the world

MB's T-388 Automatic Equalizer cuts equalization time to 5 seconds...

Production random vibration is now practical with MB's completely automatic spectrum equalizer. Set up time is eliminated and equalization realized within 5 seconds. Savings in test time and labor for missile and aircraft manufacturing can easily reach many thousands of dollars per missile tested.

Operation of the T-388 automatic equalizer is extremely simple and can be readily handled by non-technical personnel. A flat or shaped spectrum is easily programmed on the spectrum control panel by setting the slide wires. A template of the spectrum can be used for the

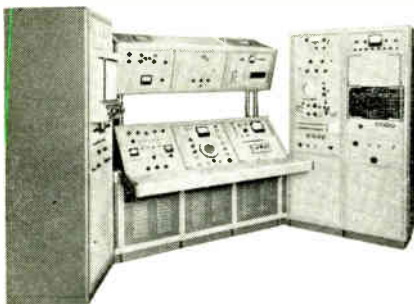

setting as shown above. The equipment does the rest.

The T-388 also provides higher test accuracy and versatility. Equalization to $\pm 1\frac{1}{2}$ db is obtained and equipment automatically compensates shifts in resonant frequencies and changes in amplitudes. Normal frequency range is 15 to 2000 cps in 25 cps bandwidths; any 2000 cps bandwidth can be obtained between 15 and 10,000 cps by simple front panel selection.

Other unique features of the T-388 Automatic Equalizer include:

- Spectrum analyzer has 3 types of readout: 1) precision, direct

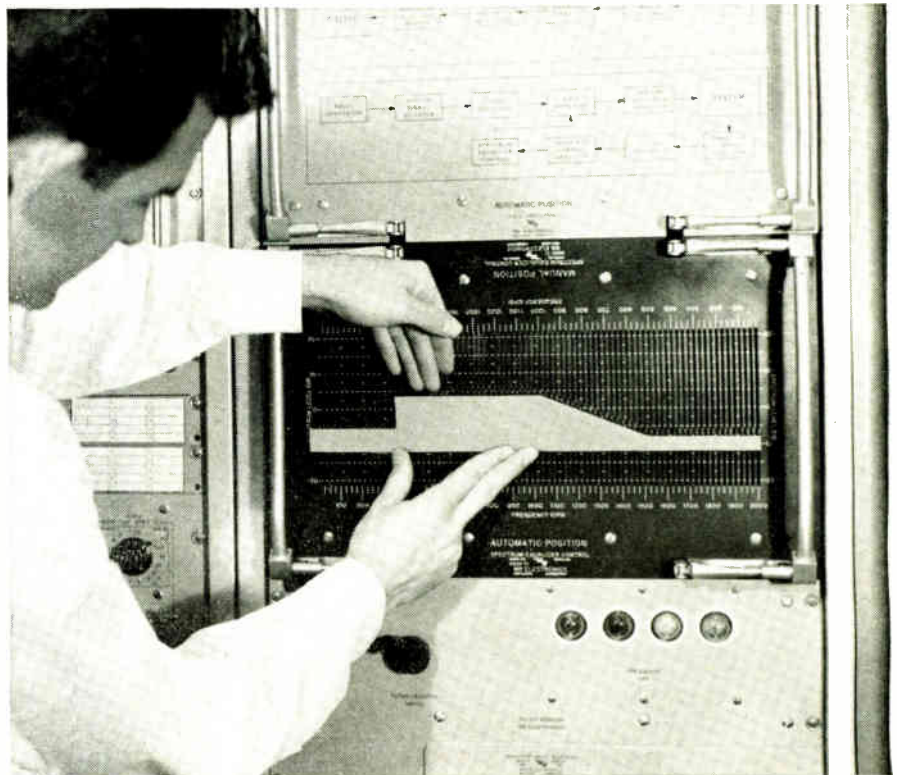

Templates of your test spectrum can be used for rapid set-up of the T-388 Automatic Equalizer.

reading in g^2/cps ; 2) visual display on scope for continuous monitoring; 3) permanent record of test using X-Y plotter.

- Highly accurate equalization through the use of 80 distinct channels of narrow bandwidth (25 cps) covering a 2000 cps band.

A test laboratory equipped with the T-388 unit will not only save many hours of valuable test time, but will also be prepared for present and future test requirements.

For detailed information on the T-388 Automatic Equalizer write to MB Electronics, 781 Whalley Ave., New Haven 15, Conn.

Over 50 Multi-Filter Equalization Systems purchased by leading test laboratories

The important contribution which the MB Multi-Filter Equalization System makes to the field of vibration testing has been recognized by leading environmental testing laboratories. To date over 50 units have been purchased...a remarkable record for equipment of this type.

MB engineers will gladly consult with you on how to apply the unique advantages and savings of the Multi-Filter Equalization System to your test programs.

IN MICROWAVE/CARRIER ENGINEERING

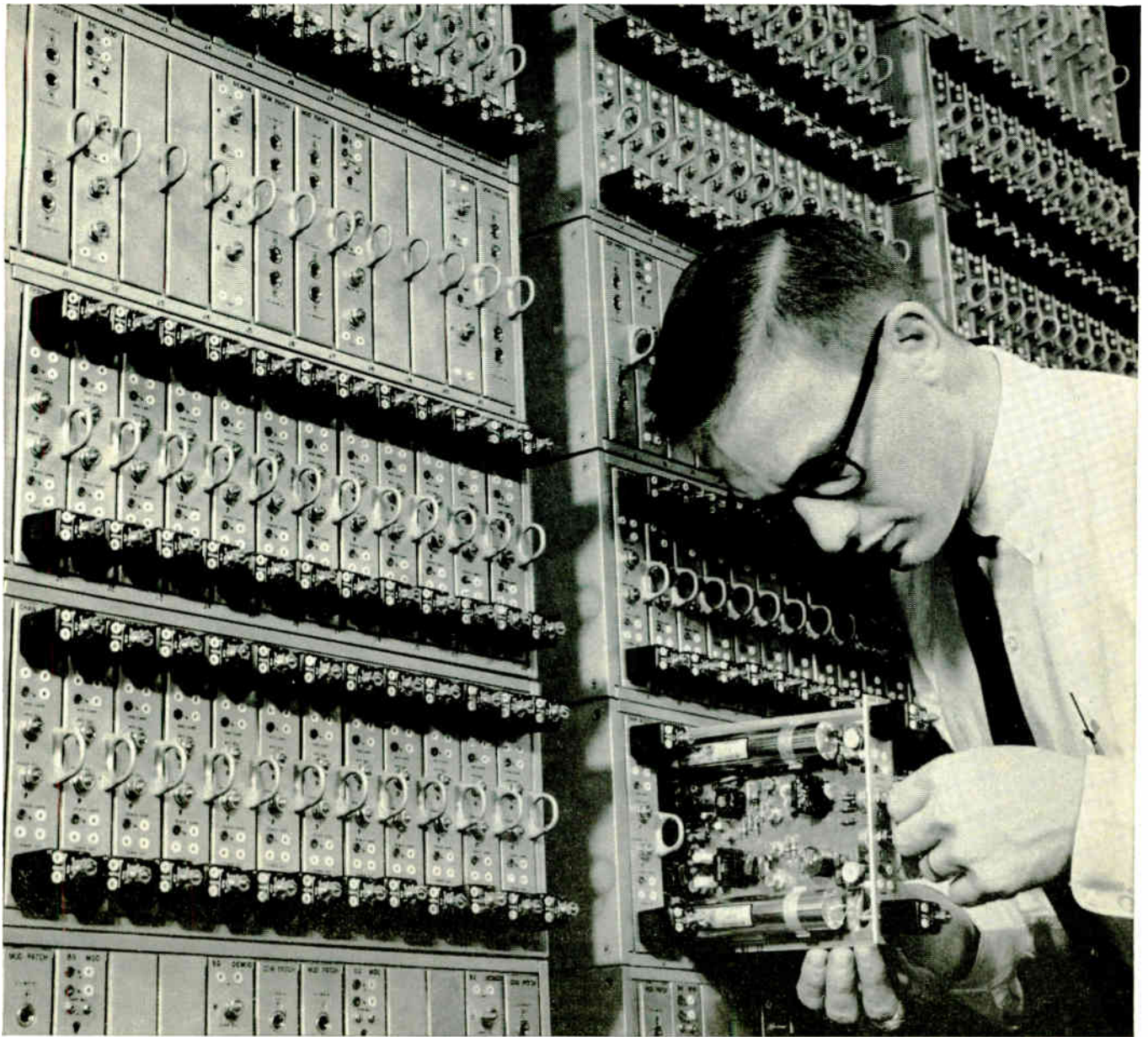

Your Challenge is Greater with COLLINS

Your Assignment: Help design and develop the finest microwave and carrier equipment built.

Your Projects: You have the opportunity to work on both military and commercial projects such as high density multiplex, high speed digital data communication, integrated communications systems, telemetry and remote control, and transportable microwave systems. *And you stay right with your project until product completion!*

Your Company: Collins is one of the nation's leading growth companies with facilities in Dallas, Texas; Cedar Rapids, Iowa; and Newport Beach, California. Collins sales offices and field service installations are located throughout the world.

Collins offers a wide variety of engineering opportunities in ground communication, antenna research, aviation electronics, data systems, amateur, broadcast, components and general systems design.

Now . . . Collins has openings for M.E.'s, E.E.'s, I.E.'s and graduate level physicists in design, research and production. Evaluate your present situation and qualifications. Contact your college placement office or send your inquiry to:

L. R. Nuss
Collins Radio Company
Cedar Rapids,
Iowa

C. P. Nelson
Collins Radio Company
Dallas,
Texas

R. O. Olson
Collins Radio Company
Newport Beach,
California

An equal opportunity employer



STC THERMAL DELAY SWITCHES

For the following operations:—

- Delay in switching on high tension supplies
- V.L.F. Oscillator
- Auto-reset circuit breaker
- Motor-starting



ABRIDGED DATA			
Type	Delay at 20°C		Heater Voltage
	Min.	Max.	
S.102/1G*	44	66	6.3
S.102/1K	44	66	6.3
S.103/1K	36	54	27
S.104/1K	25	35	6.3
S.105/1K	20	30	27
S.106/1K	44	66	19

* Flying Lead Version

Ask for application report MS/117



61/1MS

Standard Telephones and Cables Limited

VALVE DIVISION : BRIXHAM ROAD · PAIGNTON · DEVON · ENGLAND
USA enquiries for price and delivery to ITT Components Division, P.O. Box 412, Clifton, N.J.





MODEL	6db BANDWIDTH
TL-2D5A	2 kc
TL-4D9A	4 kc
TL-6D12A	6 kc
TL-8D16A	8 kc
TL-10D18A	10 kc
TL-16D25A	16 kc
TL-20D32A	20 kc
TL-30D45A	30 kc
TL-40D55A	40 kc
TL-45D60A	45 kc
TL-32E48C	32 kc
TL-50D85C	50 kc

(suffix "A" denotes 455 kc center frequency;
suffix "C" denotes 500 kc center frequency)

Clevite Ceramic Ladder Filters

Now in stock in 12 bandwidths...
80 db rejection in 0.1 cu. in.

Clevite ceramic ladder filters provide more selectivity for their size than any conventional i-f filter. They are fixed tuned and need no alignment—are non-magnetic and non-microphonic. Leading manufacturers now have Clevite ladder filters in their communications equipment. Improve your newest design with these unique filters. Write now for complete specifications—Bulletin 94012, or for selectivity curves available on each stock model. ■ Dimensions: $\frac{5}{16}$ " diameter x $1\frac{1}{2}$ " long. ■ Selectivity: 60 db/6db shape factor from 1.3:1 to 2.6:1. ■ Center Frequency Stability: within 0.2% for 5 years, and within 0.2% from -40° to $+85^{\circ}$ C. ■ Impedance: 1200-1500 ohms. ■ Designed for military environment.

CLEVITE ELECTRONIC COMPONENTS
DIVISION OF **CLEVITE** 232 FORBES ROAD, BEDFORD, OHIO

Field Sales Offices:
New York, N. Y. / Chicago, Ill. / Denver, Colo. / Inglewood, Calif.

DESIGN AND APPLICATION

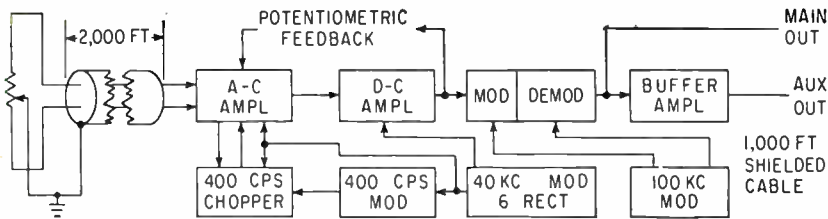

Differential D-C Amplifier

HIGH COMMON-MODE REJECTION

ANNOUNCED by Dynamics Instrumentation Corp., 583 Monterey Pass Rd., Monterey Park, California, is the model 6050 wideband differential d-c amplifier used to amplify strain-gage and thermocouple signals in the presence of very large common-mode signal (up to 300 v peak). At d-c, common-mode rejection is essentially infinite and at 60 cps, rejection is in excess of $10^6:1$ with up to 1,000 ohms input line unbalance. Voltage gains are 0, 10, 30, 100, 300 and 1,000, continuously variable between steps. Gain accuracy is ± 1 percent and stability is ± 0.1 percent. Linearity is better than ± 0.3 percent, d-c to 1 Kc and

± 0.1 percent d-c to 300 cps. Input impedance is greater than 5 megohms, source impedance is less than 1,000 ohms, frequency response is down 3 db at 10 Kc and input-output isolation is 3,000 megohms at 60 cps. Common-mode rejection is greater than 120 db at 60 cps. Noise is less than $10 \mu\text{v}$ between zero and 10 Kc. The system can operate with 2,000 ft of shielded cable between the unbalanced transducer and the input and with 1,000 ft of cable between the output terminals and associated recorders or other measuring equipment. The sketch shows system operation.

CIRCLE 301 ON READER SERVICE CARD

signal to be analyzed is applied to the crystal and the coil driven from a constant-current source with its frequency varied from the fundamental to the frequency of interest. Hall voltage appears only when coil current frequency coincides with fundamental or some harmonic of complex wave. Sum and differences as well as d-c component appear, but only d-c component is of interest.

CIRCLE 302 ON READER SERVICE CARD

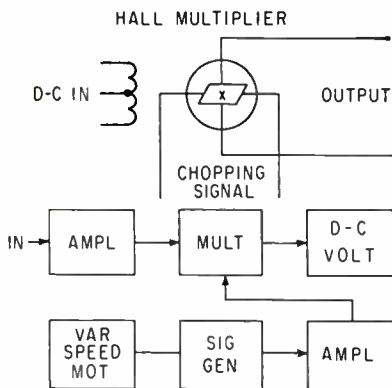

Solid State Multiplier

USES HALL EFFECT

MANUFACTURED by The Omnite Co., P.O. Box 243, Buena Park, California, the physically small (approximately $\frac{3}{8} \times \frac{3}{8}$ dia), light weight (8 grams), $\frac{1}{2}$ -cubic inch vol-

ume SSM 101 multiplier consists of a Hall generator and coil combination whose output is a function of two separate and isolated input currents. Coil input current for maximum linear output is up to 2 ma, d-c resistance is 200 ohms and inductance is 5 mh per section. Crystal input current is up to 100 ma, input and output impedance is 5 ohms nominal, linearity is 2 percent and the frequency is from 0 to 10 Mc. Modulation can range from a few cps to the upper Kc region, and with special coils can operate in the Mc region. Switching transients do not exist and offset voltage is adjustable and may be zero, positive or negative as the application requires. A typical use is in a spectrum analyzer, see sketch, operating between d-c and 300 cps. The

Microwave Oscillators

FOR FIELD USE

RECENTLY announced by International Microwave Corp., 1 Seneca Place, Greenwich, Conn., is a series of portable battery-powered, mechanically-tunable tunnel diode microwave oscillators. These are tunable over a 30-percent band and have r-f outputs of 0.05 mw between 6 and 12 Gc, 0.1 mw between 2.5 and 6 Gc and 0.5 mw between 1 and 2.5 Gc. They are 4 cubic inches including 400 hour mercury batteries. These units consist of a high cutoff frequency tunnel diode terminating a coaxial transmission line and include an impedance transforming network and mechanical variable reactance. Tuning

YES...IT'S THE TINIEST TRIMMER CAPACITOR MADE!

actual size



JFD pin-trim

If you are designing for missile environments or applications requiring more capacity in less space, look in to the Pin-Trim. It provides a practicable solution to the challenge of end-product miniaturization with high operational stability.

The new Pin-Trim delivers: (1) more capacitance per cubic centimeter than any other conventional piston trimmer; (2) 75 per cent less weight and 50 per cent less volume than JFD's own miniature trimmers; (3) greater sensitivity; (4) finer adjustment.

If you are looking for maximum compactness between stacked circuit boards, or less stray capacitance in a given area, check the JFD Pin-Trim specifications for your subminiature trimmer applications.

For further data, call your local JFD Field office or your JFD franchised Industrial Distributor.

- Overall diameter: 1/8 inch. Overall length above panel: 3/8 inch to 1 inch.
- Double the sensitivity of JFD standard trimmers. Special adjust mechanism provides 1C2 turns per inch for extra fine adjustment.
- Increased maximum to minimum capacitance ratio per unit (minimum: 0.5 pf.).
- Operating temperature -55° to +125°C.
- Low temperature coefficient of capacitance.
- Anti-backlash design for precise tuning resolution.
- Low inductance for high frequency use.
- Ultra linear tuning assures accurate alignment—absolute repeatability. Standard slotted end for screwdriver adjustment.
- Rugged shock and vibration resistance.
- 500 V. DC working voltage.
- 10⁶ megohms insulation resistance.
- Q factor of 500 (measured as per JFD #5178).
- 0.5 inch ounce tuning torque.
- Meet or exceed applicable performance requirements of MIL-C-14409A.

JFD Adjustment Tool No. 5284 (illustrated)
available at 85¢.

Model*	Capacitance Range MMF		D.C. Working Volts	Dielectric Strength Measured For 5 Seconds at 50% R.H. at Max. Rated Cap.	Insulation Resistance Measured After One Minute at 500V. D.C. and 50% R.H.	Q Factor Measured Per JFD #5178	Unit Weight Grams	Dimen.**
	Min.	Max.						Max. ±1/32
PT901	0.5	2.0	500	1000	10 ⁶ Megohms	500	0.62	3/8"
PT902	0.5	3.0	500	1000	10 ⁶ Megohms	500	0.64	1/2"
PT903	0.5	5.0	500	1000	10 ⁶ Megohms	500	0.79	3/4"
PT904	0.5	7.0	500	1000	10 ⁶ Megohms	500	0.94	1"

* These units are also available in the same capacitance values for printed circuit boards in models PT911, PT912, PT913 and PT914.
** Length front of panel.

U.S. Patent No: 2,922,093 Canadian Patent No: 604,810

JFD

JFD ELECTRONICS CORPORATION

Components Division • 6101 16th Avenue, Brooklyn, New York • Phone DEwey 1-1000 • TWX-NY25040

JFD WESTERN
P. O. Box 3416
Van Nuys, Calif.
Phone: EMpire 4-4131

JFD MIDWESTERN
P. O. Box 588
Skokie, Illinois
Phone: 675-1140

JFD NORTHEASTERN
Ruth Drive, P. O. Box 228
Marlboro, Mass.
Phone: HUntley 5-7311

JFD CANADA
51 McCormack Street
Toronto, Ontario, Canada
Phone: ROger 9-1129

VARIABLE TRIMMER PISTON CAPACITORS • FIXED METALIZED INDUCTORS • LC TUNERS • DIPLEXERS
FIXED AND VARIABLE. DISTRIBUTED AND LUMPED CONSTANT DELAY LINES • PULSE FORMING NETWORKS

VISIT JFD INDUSTRIAL CONFERENCE BOOTH T-118 AT THE 1962 ELECTRICAL PARTS SHOW

PULSE POINTERS—

Serial Word Generator For Digital Circuitry And Logic Design

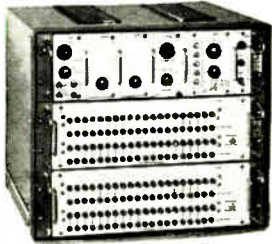

Model 5510 Serial Word Generator

Variable sync bit locations, NRZ and RZ, and complementary outputs —

Models in the SERVOPULSE™ 5500 series offer 1-99 bit word length selection. Fully transistorized for reliability and long life, these instruments are powerful tools for the design and test of shift registers, memory elements, and other logic circuitry. — Units offer flexible basic design features such as 0.5 to 10,000 μ sec (2 mc to 100 cps) clock rate; variable and delayed syncs; arbitrary coding; 0.2 μ sec wide, pos. 4.5 v into 600 ohms clock output; plus complementary NRZ and RZ outputs.

10 mc Pulse Generator Accepts Variety of Standard Modification

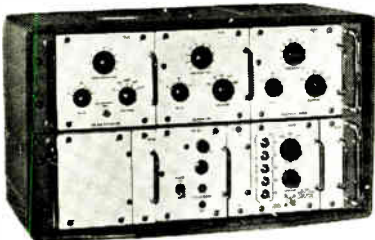

Model 4550A
10mc Pulse Generator

Computer makers like high rep rate and 10 nanosec rise time — Model 4550A Pulse Generator delivers variable parameter test pulses at very high rep rates. It is used to develop and test components, logic circuitry, and high clock rate digital systems. This compact, transistorized instrument can be modified by the simple addition of standard output amplifier modules.

For complete details, write:

SERVOPULSE™ PRODUCTS SERVO CORPORATION OF AMERICA



111 New South Road
Hicksville, L.I., N.Y.
WElls 8-9700

is by twisting the handle, which contains the battery, with respect to the connector flange on which frequency calibration is scribed. Accuracy of tuning is a function of tuning range. Units are loaded with quarter-wave dipoles or horn antennas. This physically small transmitter can be located at remote locations for bore sighting antennas, and system testing and servicing. Provisions can be made for modulating the oscillator.

CIRCLE 303 ON READER SERVICE CARD

Sub-Screen CRT's

VERY LOW HALATION

CONTINENTAL INDUSTRIAL ELECTRONICS CORP., 2724 Leonis Blvd., Los Angeles 58, Calif., has developed a line of ultra high resolution sub-screen cathode ray tubes with very low halation characteristics. They are designed for video recording, fly spot scanning, radar, and the like.

CIRCLE 304 ON READER SERVICE CARD

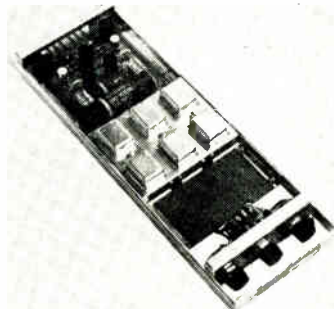

Voice Repeater

IMPROVES TRANSMISSION

MANUFACTURED by Budelman Electronics Corp., 373 Fairfield Ave., Stamford, Conn., is the voice frequency repeater type 251A designed to improve transmission quality of telephone subscriber and trunk circuits. Usable gain is line attenuation less 3 db up to 15 db maximum, maximum undistorted output is +3 dbm, requires 20 ma current, maximum d-c resistance of signal bypass of 44 ohms and a frequency response between 500 and 2,750 cps \pm 2 db. The unit can operate in both directions and is complete with d-c and ringing current

bypass circuits. It can be adjusted using only a linesman's test handset. Two transistor amplifiers are used, one for east-west and another for west-east. Interaction is prevented by a hybrid network. In previous designs, the telephone line was directly connected to the repeater hybrid. In this design, a resistive pad minimizes line impedance variations thus reducing complexity of balance problem. Pad loss is overcome by amplifier gain. The units are 1.5 x 4 x 12 and weigh 2.5 lb.

CIRCLE 305 ON READER SERVICE CARD

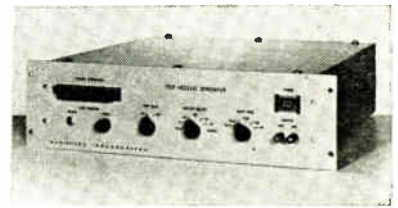

Test Message Generator

ALL-TRANSISTOR

RADIATION INC., Orlando, Fla. Model 7411 transistorized test message generator will replace tape sending devices. It is designed for use on telegraph circuits. Generator provides a test message at a maximum rate of 600 bauds (pps). It produces an accurately timed 80 character message controlled by stop and information pulse length plug-in units. It has been tested in accordance with MIL-T-4807A, and operates in temperatures of 0 to +50 C.

CIRCLE 306 ON READER SERVICE CARD



Tunable R-F Filter

LOW FREQUENCY

TELONIC ENGINEERING CORP., 480 Mermaid St., Laguna Beach, Calif. Model TTF120 is tunable over a range of 80 to 180 Mc It has a

bandwidth of 5 percent \pm 1 percent at the 3 db point extending to 25 percent at 30 db. Frequency is selected by a clearly scaled dial with an accuracy of \pm 1 percent of center frequency. Knob and dial arrangement has a vernier movement with a 5.1 ratio to facilitate precise frequency selection.

CIRCLE 307 ON READER SERVICE CARD

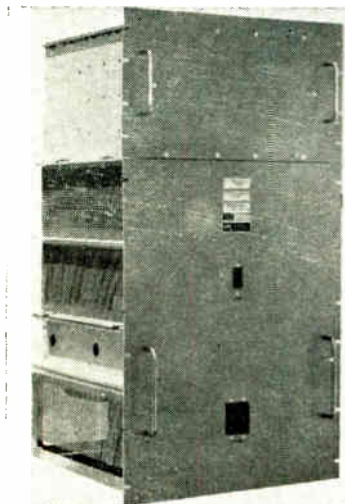

Frequency Converter SOLID STATE

WESTERN DESIGN & ELECTRONICS, 6312 Hollister Ave., Goleta, Calif. The 10037-001 static frequency converter power supply is capable of operating with a variable frequency input of 380 to 1,000 cps and through a system of refined circuit design will produce a closely regulated output of 60 cps with a 2,500 v-a rating which is used to supply power for standard test equipment in the WV-2 airplane. Unit is adaptable to a variety of electronic projects.

CIRCLE 308 ON READER SERVICE CARD

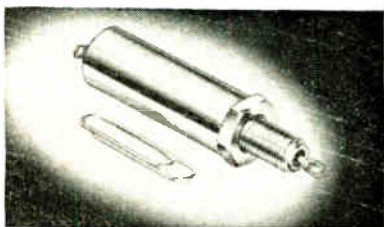

R-F Filter MINIATURE DEVICE

STANDARD ELECTRONICS CO., 1611 W. 63rd St., Chicago, Ill. Series 1100 features hermetic seal, low pass, high attenuation and simplified panel mounting. Units conform to

April 27, 1962

MEASURE RF MILLIWATTS 30 TO 500 MC

Bird's new TERMALINE RF Milliwattmeter provides direct, simple and inexpensive absorption measurement of RF power at milliwatt levels in coaxial systems. No calibration charts. No adjustments. No calculations. No batteries or auxiliary power required.

Specifications: Bird Model 6254

Power Ranges:	Any one of six standard scale ranges of 25, 50, 100, 250, 500 and 1000 milliwatts. Specify scale range desired.
Frequency:	30—500 mc
Impedance:	50 ohm nominal
VSWR:	Less than 1.15
Accuracy:	\pm 5% of full scale
Input Connector:	Female BNC
Weight:	2.2 pounds
Size:	5 $\frac{7}{8}$ " x 4 $\frac{1}{4}$ " x 3 $\frac{3}{8}$ "
Price:	\$85.00, F.O.B. Factory

Contact us for further information on this instrument and other Bird products.

Bird Model 6254
TERMALINE RF Milliwattmeter

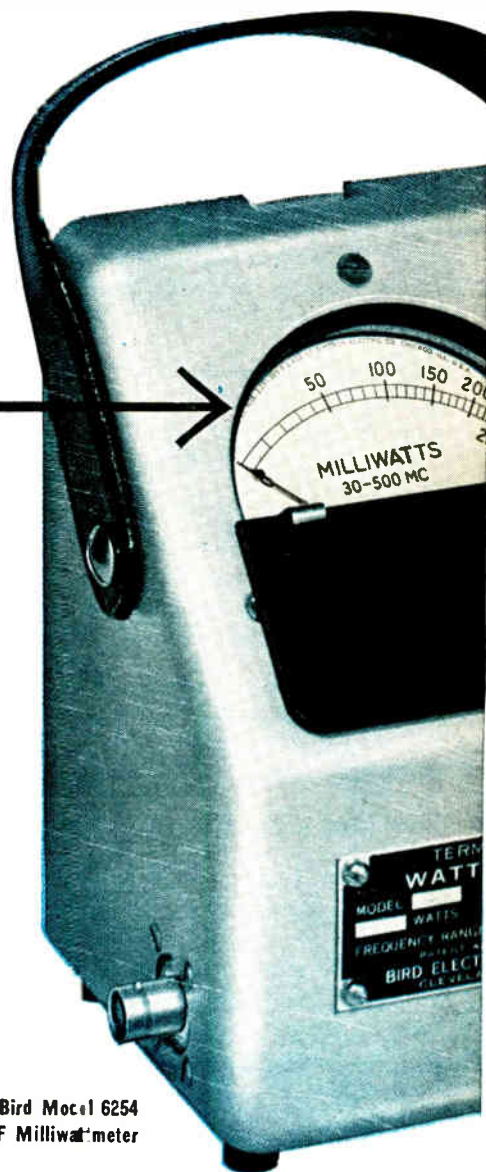

BIRD

ELECTRONIC CORPORATION

30303 Aurora Rd., Cleveland 39 (Solon), Ohio

Churchill 8-1200

TWX CGN FS 679

Western Representative:

VAN GROOS COMPANY, Woodland Hills, Calif.

CIRCLE 107 ON READER SERVICE CARD 107

HOW CHEAP IS "CHEAP"?

"Why should we buy from you when we can get the 'same thing' from other suppliers at a lower price?"

In selecting a supplier of lacing tape (or any component), price and compliance with specifications are not the only criteria. But too often, manufacturers ignore the other factors involved and consequently lose money.

For example, in a \$15,000 piece of equipment there may be only 15 cents worth of Gudebrod lacing tape. It costs \$75 to work this tape. It may be possible to buy the same amount of tape from other suppliers for 2 or 3 cents less . . . it "will meet the specs" according to these suppliers. But one of our customers recently pointed out why he still specifies only Gudebrod lacing tape in such cases.

"We tried buying some cheaper tape that 'met the specs.' Within a few months our production was off by 50% . . . boy, did the production people really scream about that tape. And our labor costs doubled . . . our costing people really flipped!

"Another thing, why should we risk the possible loss of thousands of dollars when the original material cost difference is only a few cents. Once you put cheaper tape on and something goes wrong after the equipment is finished . . . you've had it. No, thank you! We learned our lesson! We buy Gudebrod lacing tape!"

Whether your firm uses one spool of lacing tape or thousands, there are four advantages in specifying Gudebrod for all your lacing requirements:

1. *Gudebrod lacing tape guarantees increased production!*
2. *Gudebrod lacing tape guarantees reduced labor costs!*
3. *Gudebrod lacing tape guarantees minimal maintenance after installation!*
4. *Gudebrod guarantees quality!* On every spool is a lot number and seal which guarantees that all Gudebrod lacing tape is produced under strict quality control. Our standards are more exacting than those required for compliance with Mil-T.

Our Technical Products Data Book explains in detail the complete line of Gudebrod lacing tapes for both civilian and military use. For your copy write to Mr. F. W. Krupp, Vice President, Electronics Division

GUDEBROD BROS. SILK CO., INC.

Electronics Division
225 West 34th Street
New York 1, New York

Executive Offices
12 South 12th Street
Philadelphia 7, Pa.

MIL-S-15773D and are rated at 4 amp 220 v a-c/400 v d-c 60 db attenuation 0.150 to 1,000 Mc. Units also available up to 5 amp ratings and 110 db.

CIRCLE 309 ON READER SERVICE CARD

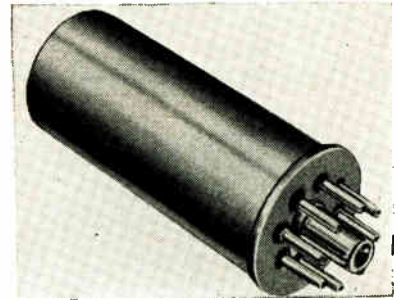

ULF Crystal

800-1,400 CPS

MONITOR PRODUCTS CO., INC., 815 Fremont Ave., S. Pasadena, Calif. The JT ultra low frequency crystal is available in ranges from 800 to 1,400 cps. Temperature to frequency curve of 5 ppm per deg C and stabilities to better than ± 0.001 percent with oven control are available, as are a variety of terminal arrangements. Dimensions are approximately 1.2 in. diameter by 2.8 in. high above chassis.

CIRCLE 310 ON READER SERVICE CARD

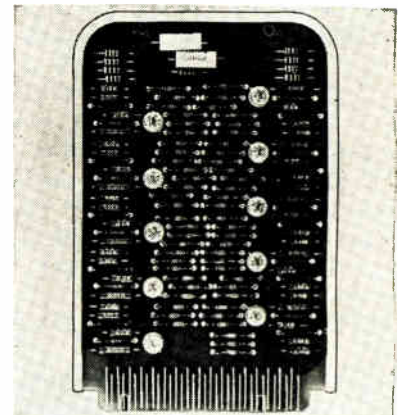

Decoder

OCTAL/DECIMAL

COMPUTER CONTROL CO., INC., 983 Concord St., Framingham, Mass., has added model OD-30 to its compatible series of d-c to 1 and 5 Mc S-PAC digital modules. It contains a prewired binary-to-octal decoder plus additional circuitry to expand the matrix for BCD-to-decimal decoding. Three additional inputs are provided to permit the matrix to be expanded to 16, 32, or 64 outputs

by connecting additional decoders. One of these added input lines may be used for strobing or sampling the matrix.

CIRCLE 311 ON READER SERVICE CARD

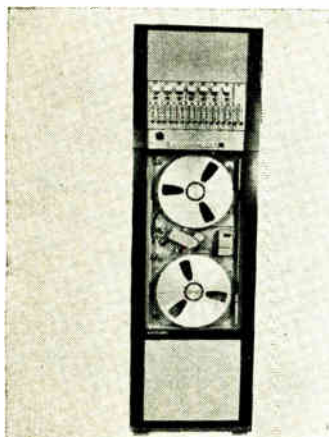

Recorder/Reproducers

TWO MODELS

SANGAMO ELECTRIC CO., Springfield, Ill., offers the 470 series magnetic tape recorder/reproducers. A single module houses 4 speeds of both f-m and direct record/reproduce electronics. The desired mode may be switch-selected from the inside module panel. Lights on the front panel indicate the operational mode. Any required combination of f-m, direct, pcm and digital record/reproduce electronics can be supplied. Two models available: model 471 with normal frequency response (0-10,000 cps in f-m and 100-100,000 cps in direct mode) and model 472 with h-f response (0-20,000 cps in f-m and 100-250,000 cps in direct mode).

CIRCLE 312 ON READER SERVICE CARD

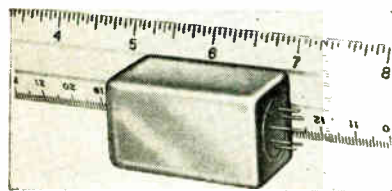

Time Delay Relay

MINIATURE UNIT

EAGLE SIGNAL CO., 202 20th St., Moline, Ill. Timer uses silicon semiconductor devices to obtain time delays with an accuracy of ± 5 percent over a wide range of operating conditions. A small internal relay, with contacts rated at 2 amp, 28 v d-c, provides a spdt load

Itek

Crystal Filters do Wonderful Things



Charming a Doppler signal out of the clutter is a wonderful thing! Itek Crystal Filter 361B stops in the stopband, passes in the passband (with hardly a ripple), and slopes nearly straight up between the two. Similar Itek filters for single side band transmission and reception have been designed up to 40 megacycles.

Perhaps you don't need a Doppler crystal filter. But could you use the ingenuity that built one? Could Itek technical leadership help you?

Of course, the world's largest and most complete selection of stock crystal filters is available, too. Choose from more than 3,000 Itek-Hermes designs.

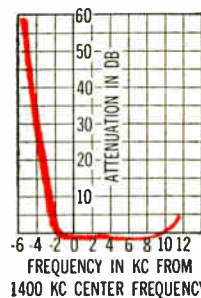

Write for free Brochure "WEESKACFAACP" or, What Every Engineer Should Know About Crystal Filters At A Cocktail Party. You'll enjoy it.

Itek Electro-Products Company

75 CAMBRIDGE PARKWAY, CAMBRIDGE 42, MASS. A DIVISION OF

Itek

BALLANTINE Wide Band, Sensitive VTVM

model
317

Price: \$495
with probe

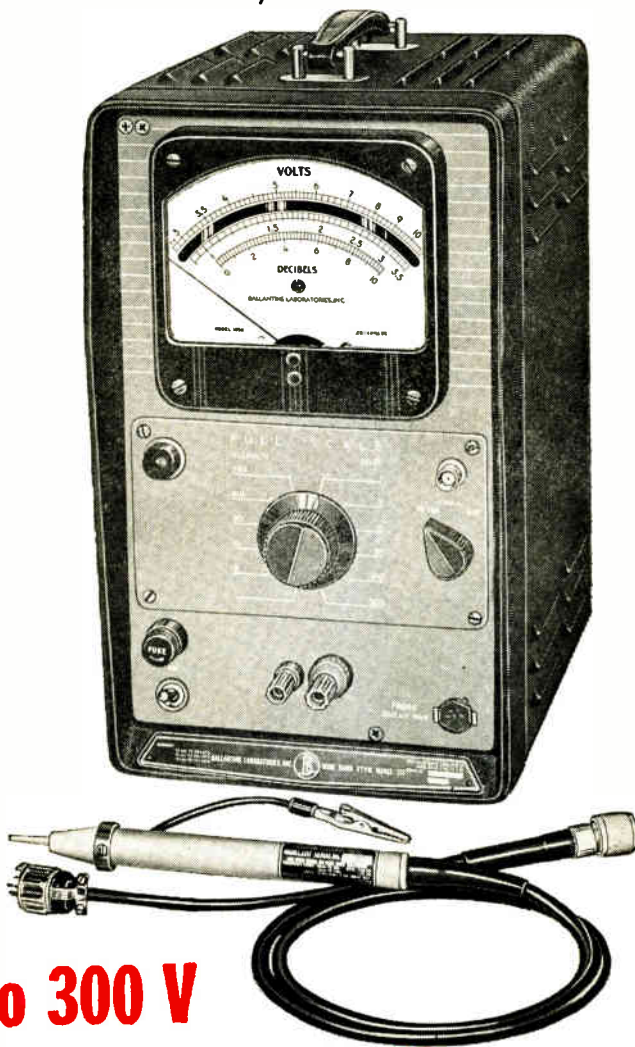

Measures

300 μ V to 300 V

at Frequencies 10 cps to 11 Mc

A stable, multi-loop feedback amplifier with as much as 50 db feedback, and 10,000 hour frame grid instrument tubes operated conservatively, aid in keeping the Model 317 within the specified accuracy limits over a long life. A million to one in voltage range and over a million to one in frequency coverage makes it attractive as a general purpose instrument for measurement of af or rf as well as the complete band. All readings have the same high accuracy over the entire five inch voltage scales. This is typical of all Ballantine voltmeters due to the use of individually calibrated logarithmic scales.

The 317 may be used as a null detector from 5 cps to 30 Mc having a sensitivity of approximately 100 μ V from 10 cps to 20 Mc.

VOLTAGE: 300 μ V to 300 V.

FREQUENCY: 10 cps to 11 Mc (As a null detector, 5 cps to 30 Mc).

ACCURACY: % of reading anywhere on scale at any voltage. 20 cps to 2 Mc — 2%; 10 cps to 6 Mc — 4%; 10 cps to 11 Mc — 6%.

SCALES: Voltage, 1 to 3 and 3 to 10, each with 10% overlap. 0 to 10 db scale.

INPUT IMPEDANCE: With probe, 10 megohms shunted by 7 pF. Less probe, 2 megohms shunted by 11 pF to 24 pF.

AMPLIFIER: Gain of 60 db \pm 1 db from 6 cps to 11 Mc; output 2.5 volts.

POWER SUPPLY: 115/230 V, 50 — 400 cps, 70 watts.

Write for brochure giving many more details

— Since 1932 —

 **BALLANTINE LABORATORIES INC.**
Boonton, New Jersey

CHECK WITH BALLANTINE FIRST FOR LABORATORY AC VACUUM TUBE VOLTMETERS, REGARDLESS OF YOUR REQUIREMENTS FOR AMPLITUDE, FREQUENCY, OR WAVEFORM. WE HAVE A LARGE LINE, WITH ADDITIONS EACH YEAR, ALSO AC/DC AND DC/AC INVERTERS, CALIBRATORS, CALIBRATED WIDE BAND AF AMPLIFIER, DIRECT-READING CAPACITANCE METER, OTHER ACCESSORIES. ASK ABOUT OUR LABORATORY VOLTAGE STANDARDS TO 1,000 MC.

110 CIRCLE 110 ON READER SERVICE CARD

circuit. Device weighs 3½ oz and measures 1 by 1 by 1¼ in. It is temperature compensated to operate over a range of -55 to +100 C at the specified accuracy and meets MIL-E-5272.

CIRCLE 313 ON READER SERVICE CARD

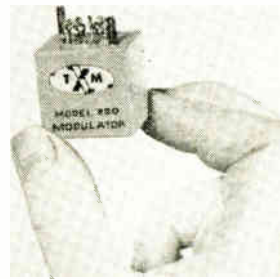

Magnetic Modulator

SUPPRESSED CARRIER

TRANSMAGNETICS INC., 40-66 Lawrence St., Flushing 54, N. Y. Model 220 suppressed carrier magnetic modulator features 1 percent distortion and 1 deg phase shift, 125 cps signal bandwidth with 800 cps carrier, and very long life. Applications lie in amplitude modulation systems requiring low distortion or long life. Modifications involving carrier frequencies to 50 Kc, wide carrier band units including square wave outputs, are available.

CIRCLE 314 ON READER SERVICE CARD

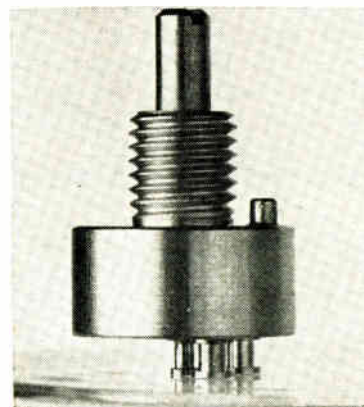

Panel Mount Pot

MINIATURIZED

WATERS MFG., INC., Wayland, Mass. Wire-wound precision pot, the JP/2 is smaller in overall volume than standard ½ in. miniature pots and low in cost. Designed to meet standard and military environmental specifications, it can be interchanged with most ½ in. pots. Available in 10 ohms to 20,000 ohms, it

electronics

will operate over a temperature range from -55 C to $+150\text{ C}$.

CIRCLE 315 ON READER SERVICE CARD

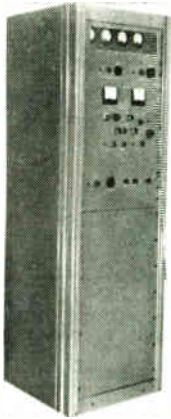

TWT Power Supply VERSATILE UNIT

NARDA MICROWAVE CORP., Plainview, N. Y. Model 15101 twt power supply is designed to deliver all of the required voltages and power for complete twt operation and testing. The beam supply is continuously variable from -2 to -12 Kv by means of both coarse and fine controls on the front panel. The d-c bias supply is also continuously variable from 0 to 250 v negative with respect to the cathode, and it floats at the beam voltage.

CIRCLE 316 ON READER SERVICE CARD

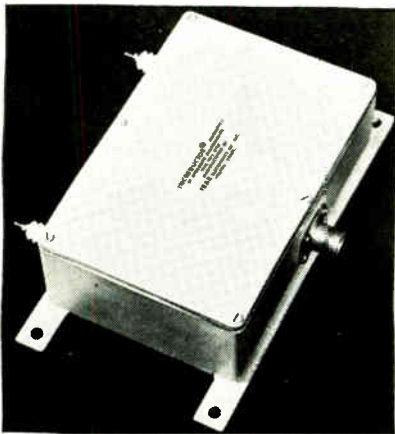

R-F Transformer WIDEBAND

TRAK ELECTRONICS CO., INC., Wilton, Conn. Model HPC-9153 is designed to handle 3.5 Kw of power. It transforms impedances from 72 ohms unbalanced to 600 ohms balanced in the $2\text{-}20\text{ Mc}$ frequency range; and with reduced ratings from $20\text{-}30\text{ Mc}$. It has a vswr of less than

CIRCLE 111 ON READER SERVICE CARD →



P. I. tape recorder secret is an open book

A unique stacked-reel tape magazine is one of many space-saving secrets which enable Precision instrumentation recorders to out-perform conventional magnetic tape instruments many times their size. Other design secrets are push-button selection of function and speed, light beam end-of-tape sensing, front panel calibration and testing, interchangeable tape loop magazines, and all-solid-state plug-in electronics.

All the secrets of these recorders are unveiled in detailed new brochure 67. Write for your copy today.

P. S. — Here's an installation secret — two complete 14-channel analog (or 16-channel digital) recorders mount in only 51" of vertical rack space.



**14 CHANNEL
PRECISION RECORDER**
Loaded magazines can be
interchanged in 5 seconds.



PRECISION INSTRUMENT

SAN CARLOS, CALIFORNIA / LY 1-4441

P. I. Invites inquiries from senior engineers seeking a challenging future.



ENVIRONMENT FOR ACHIEVEMENT

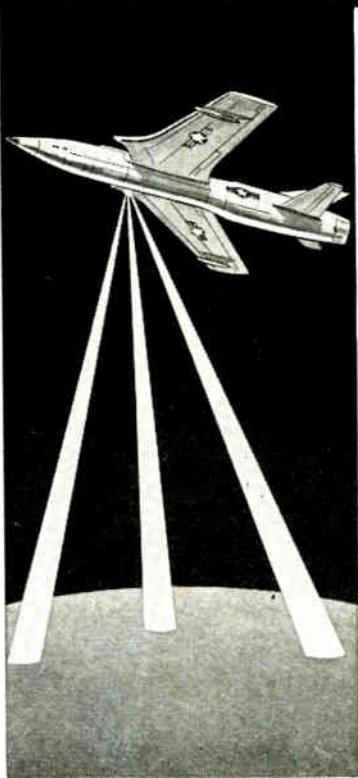

LFE's Airborne Doppler Navigation Systems are automatic, self-contained, and weigh as little as 75 pounds. They are supplied for any aircraft, from U. S. Navy helicopters to Air Force F-105D fighter-bombers. The systems operate anywhere in the world, without reference to ground aids, and independent of weather. They also operate at any speed, any altitude, even during radar silence.

The work environment that fostered this LFE achievement is close to ideal. It includes company-financed research, free inquiry, easy communications, and management that knows its technology. If you feel this environment would further your career, write us now about select new opportunities in:

SYSTEMS, EQUIPMENT & COMPONENTS for

Airborne Navigation Automatic Controls
Radar and Surveillance Ground Support
Electronic Data Processing

Excellent opportunities are also available
at our Monterey, California Laboratory

Write in complete confidence to:



C. E. Fitzgerald
LABORATORY FOR ELECTRONICS
1079 Commonwealth Avenue
Boston 15, Massachusetts

All qualified applicants will be considered for employment without regard to race, color, creed or national origin.

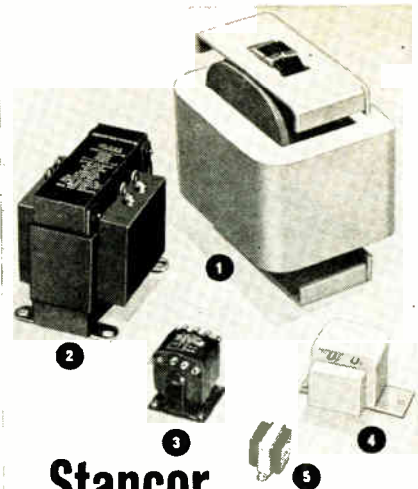

Stancor transformer encapsulations meet mil specs for flammability, humidity, temperature

Stancor Electronics offers the industry's widest range of encapsulation techniques and materials—many developed in our own encapsulation laboratory and available only from Stancor.

Substantial reduction in size and weight without sacrifice of reliability or environmental characteristics can be achieved through the use of Stancor designed and encapsulated transformers.

For help with your transformer design problems, write for the address of our nearest engineering sales office.

- 1 Filter Reactor with epoxy molded coil meets MIL-T-27A, Grade 5, Class R.
- 2 Epoxy molded dual filter reactor, flame retardant material—meets MIL-T-27A, Grade 5, Class R.
- 3 Epoxy dipped filament transformer, 105°C operating temperatures.
- 4 Silicone rubber encapsulated power transformer, 200°C operating temperature.
- 5 MIL-T-27A Filter Reactor with "Scotch Cast" impregnated coil. Entire unit epoxy molded.



RIQAP

Since 1955, Stancor Electronics, Inc., has been operating continuously under RIQAP, the U. S. Army Signal Corps' Reduced Inspection Quality Assurance Plan. When you specify Stancor transformers, delivery time is reduced and incoming inspection is at a minimum. You are assured of the highest quality units for military application.

Factory and product approval has been received from leading military prime contractors.

For Immediate Delivery—Stancor makes available the most extensive line of stock transformers in the industry—through Stancor Industrial Distributors. For a detailed listing of these units, write for Catalog CS-101.

STANCOR

ELECTRONICS, INC.

3502 W. Addison Street • Chicago 18, Illinois
CIRCLE 207 ON READER SERVICE CARD

2:1 and an insertion loss of less than 1 db. Overall case dimensions, including porcelain insulators and mounting bars, are 12 by 15½ by 5 in. Price is \$450 in small quantities.

CIRCLE 317 ON READER SERVICE CARD

Circulator Switch

MICROWAVE TECHNOLOGY INC., 235 High St., Waltham 54, Mass. Model L102S, a low-loss ferrite circulator switch at L-band, is suited for radiometric applications.

CIRCLE 318 ON READER SERVICE CARD

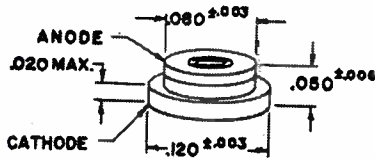

Tunnel Diodes

HIGH FREQUENCY

MICRO STATE ELECTRONICS CORP., 152 Floral Ave., Murray Hill, N. J., has added three h-f types. Germanium types MS 225 and MS 1100 feature minimum cutoff frequencies of 7 and 10 Gc respectively. MS235 has been added to the gallium antimonide line. This unit features a minimum cutoff frequency of 6 Gc and noise constant of 0.85 max. All three are in the low inductance pill box package.

CIRCLE 319 ON READER SERVICE CARD

Voltage Regulator

THE SUPERIOR ELECTRIC CO., Bristol, Conn. Type XR2500 Stabiline automatic voltage regulator, utilizing solid state components, is rated for 2.5 Kva.

CIRCLE 320 ON READER SERVICE CARD



Coax Attenuator

HIGH POWER

WEINSCHEL ENGINEERING, 10503 Metropolitan Ave., Kensington, Md., announces a new high power

ELECTRON BEAM EVAPORATOR SYSTEM

for
PURITY

CONSISTENCY

and
ECONOMY

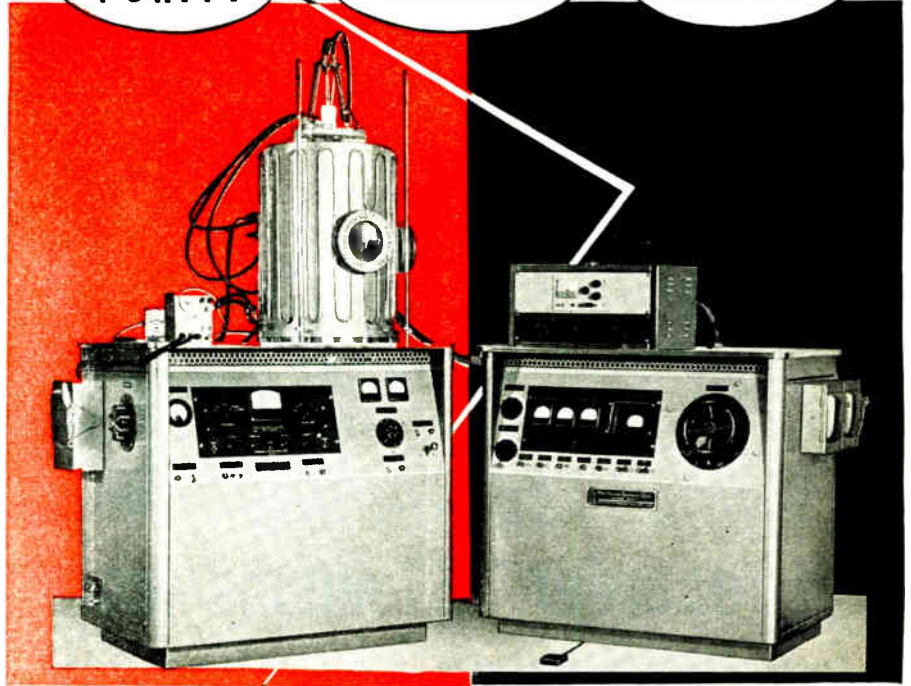

Typical installation at a leading semiconductor manufacturer

High Vacuum Equipment Corporation's newest BEAMATRON® — electron beam evaporator — assures economical production of critical thin film components for the electronic and optical industries.

FEATURES

HVEC's BEAMATRON® has . . .

- STABILIZED ELECTROMAGNETIC FOCUSING
5KW, 30 KV power source is equipped with electrostatic deflection for evaporation of multiple sources during a single cycle. No need to focus through mechanical seals.
- RAPID PUMP DOWN
High capacity 6" diffusion pumping system provides pump down speeds to 10^{-4} torr range within 4 minutes. System maintains high gas handling capacity during the deposition cycle.
- NO BACKSTREAMING OF OIL VAPORS
Water cooled baffle and large liquid nitrogen cold trap prevent backstreaming and clear the system of condensable materials.

Single source responsibility, plus 10 years of know-how in the design and manufacture of electronic and vacuum equipment is your assurance of performance.

You are invited to share the extensive experience of our electron beam specialists. Write or call today for further information.

High Vacuum Equipment Corporation is a subsidiary of Robinson Technical Products, Inc., major producer of vibration damping equipment, capillary and restrictor tubing, electronic sub-assemblies, and custom-designed printed circuits.

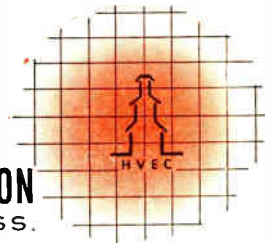

HIGH VACUUM EQUIPMENT CORPORATION
2 CHURCHILL ROAD • HINGHAM, MASS.

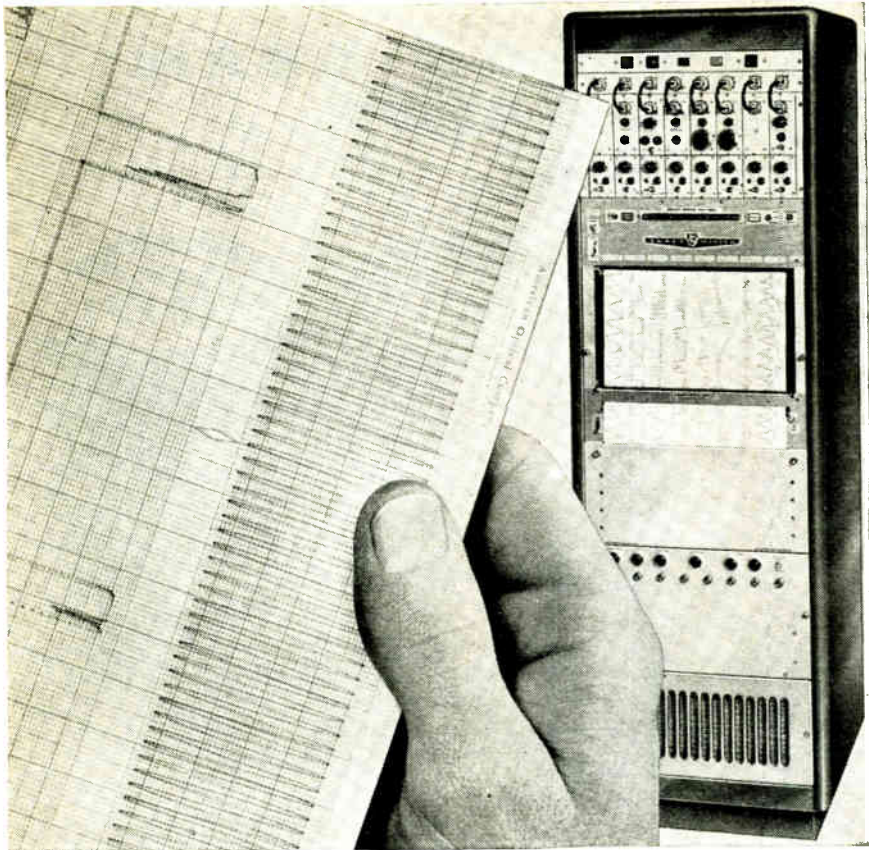

High recorder "Q" means more information on the chart!

BAP and MRP, the most important figures of merit for direct-writing recorders, help establish the "Q" for the Tracemaster systems by expressing performance from the record.

BAP: Band-Amplitude Product—a figure of merit that relates bandwidth to the maximum peak-to-peak amplitude. Tracemaster "250" provides a bandwidth of DC—140 cps (3 db pt.) at 40 mm; i.e. BAP = 140 cps x 140 mm (5,600 mm—cycles/second).

MRP: Maximum Resolving Power—the product of BAP and the definition expressed in line-cycles per second. Tracemaster "250" produces 55 distinctly separable lines, per centimeter (5.5 lines/mm); i.e. MRP = 5,600 mm-cycles/second x 5.5 lines/mm (30,800 line-cycles/second).

An advanced pen motor design plus the completely transistorized circuitry and the exclusive direct-carbon-transfer writ-

ing method all combine to give the AO Tracemaster "250" a "Q" never before available in this class of recorders.

Send for complete information about the remarkable AO Tracemaster 8-channel recorder and American Optical's complete line of outstanding recording systems.

SERIES 250 TRACEMASTER 6-8 channel, Rack Cabinet on casters

FREQUENCY RESPONSE: DC to 110 cps.
± 1% at 40 mm. peak to peak.
Down 3 db at 140 cps.

BAND AMPLITUDE PRODUCT: 5600 (i.e. 40 mm. x 140 cps.)

SENSITIVITY RANGE: 10 Microvolts to 100 v/cm

CHART SPEEDS: 0.2 to 500 mm/sec.

CHART CAPACITY: 1000 ft. roll

American  Optical
COMPANY

INSTRUMENT DIVISION, BUFFALO 15, NEW YORK

closed-cycle IR COOLERS

... temperatures to 80° K
... introduce no microphonics
... need no support equipment

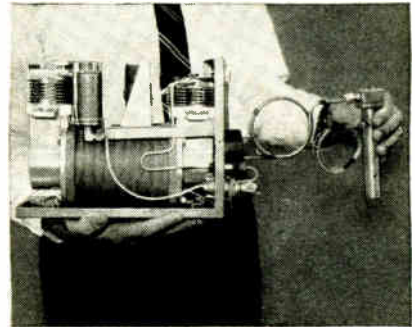

... These original systems utilize highly developed non-lubricated compressors and Joule-Thomson cryostats. Tests on both high- and low-impedance infrared detectors show that Air Products closed-cycle coolers introduce no microphonics into IR systems.

Reliable, compact Air Products cryogenic coolers include the following advanced features:

- Dynamic balancers counteract reciprocating motion of compressor pistons
- Carbon-filled fluorocarbon resin piston rings prevent gas contamination
- Non-orificed heat exchangers generate no measurable microphonics
- Sound-absorbing mounts prevent transmission of compressor-generated microphonics along gas lines

These closed-cycle cryogenic units for IR-detector cooling weigh as little as 16 pounds... measure 5" x 8" x 12" ... provide up to 5 watts of refrigeration at 80° K. Completely self-contained, they require no external liquefiers or high-pressure gas supplies.

For your IR-cooling requirements, consider using a closed-cycle refrigerator. It will enhance your system by reducing need for ground-support equipment.

ADVANCED PRODUCTS DEPARTMENT
DEFENSE AND SPACE DIVISION



Air Products and Chemicals
INC.
Allentown, Pennsylvania

▶ Air Products manufactures a complete line of cryogenic electronic coolers.

CIRCLE 218 ON READER SERVICE CARD
electronics

coaxial attenuator for use in X-band. Model 870, incorporating a new design principle, is capable of handling 20 w e-w input, and will operate at this power level at ambient temperatures up to 125 C.

CIRCLE 321 ON READER SERVICE CARD



TR Tube

FOR HIGH POWER USE

METCOM INC., 76 Lafayette St., Salem, Mass. The MST-32 is a receiver protector TR tube for use in high power systems. It has a power rating of 800 Kw peak with an average power of 2,880 w, and is for use in the frequency range of 3,350-3,650 Mc. The waveguide flange uses a Parker seal gasket.

CIRCLE 322 ON READER SERVICE CARD

Fixed Patchboard

VIRGINIA ELECTRONICS CO., INC., River Road & B. & O. Railroad, Washington 16, D. C., has developed a fixed patchboard that provides a miniaturized patchbay with either single or multiple circuit patchcords. As many as 1,000 contacts can be accommodated on a standard relay rack panel only 5 1/2 in. high.

CIRCLE 323 ON READER SERVICE CARD

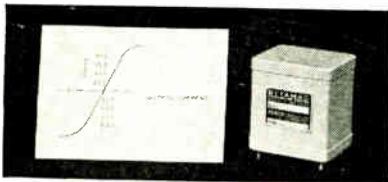

Magnetic Amplifiers

MILITARY TYPE

MILITARY & COMPUTER ELECTRONICS CORP., 900 N.E. 13th St., Ft. Lauderdale, Fla. The Ultramag-Twenty Line of ruggedized instrument magnetic amplifiers measure less than 8 cu in. and weigh about 9 1/2 oz. Units are d-c to d-c and operate in the 1 to 10 μ w control range providing an output of ± 10 v

CIRCLE 115 ON READER SERVICE CARD →

Telemetry all solid-state EDS 610 PCM DECOMMUTATION

UNIVERSAL SYSTEM!— That describes the easy adaptability of the Telemetry modular EDS 610 Decommuration System to perform all types of PCM signal decommuration. The EDS 610 is a rugged system ideal for either fixed or mobile installation. Accepts all types of PCM signals from receiver, tape recorder, or signal simulator, etc., providing outputs for computer, printer, indicator, strip chart and oscillographic recorders, meters, etc.

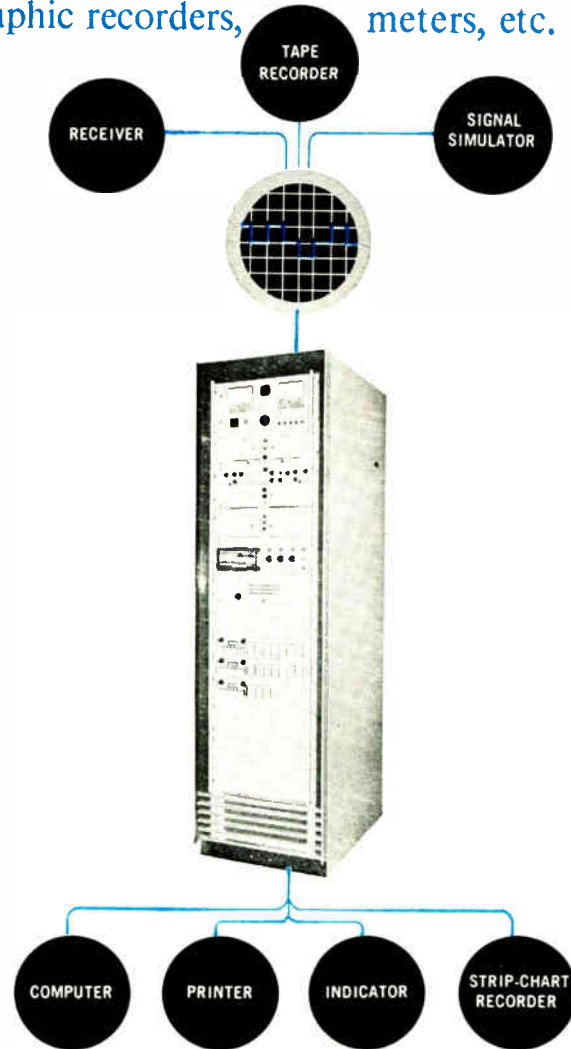

FEATURES ■ Accepts RZ, NRZ Space, NRZ Mark, Bi-phase or Bi-polar input. ■ High Speed System—up to 960,000 bits/sec. ■ Low Speed System—1 bit/sec. and lower. ■ Acquires synchronization at extremely low signal-to-noise ratios. ■ Bit synchronization in less than one frame time. ■ Maintains synchronization over wide bit rate and amplitude variations. ■ Computer-programmable patch boards handle any PCM format, word and frame sync codes. ■ Infinite hold on clock frequency during absence of signal provided by new digital servo loop. ■ Handles subcommutation and supercommutation. ■ Meets or exceeds IRIG PCM standards. ■ All solid-state design. ■ Compact system, modular construction, requires only 31 1/2 inches of panel height. ■ Human-engineered—only three adjustments to operate.

TELEMETRICS INC.

A SUBSIDIARY OF TECHNICAL MEASUREMENT CORP.

12927 S. BUDLONG AVE., GARDENA, CALIF. (TWX CPT: 6144)

44 LEESBURG PIKE, FALLS CHURCH, VIRGINIA (WASHINGTON, D. C.)

SEE US AT THE NATIONAL TELEMETERING CONFERENCE, MAY 23-25

MEASURE WELD REPEATABILITY BEFORE PRODUCTION STARTS

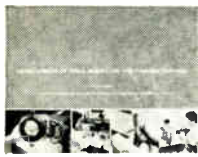

With information yours for the asking, you can set the repeatability of production welds *before* production begins. And repeatability is the essence of weld reliability. The basis for this technique is the WELD SCHEDULE—the heart of controlled production welding.

Full information is obtained in a new technical report now available from Weldmatic. This is another example of Weldmatic leadership—in precision welding technology as well as in the manufacture of resistance welding systems/950 Royal Oaks Drive/Monrovia, California



WELDMATIC DIVISION / UNITEK

across a 1,000 ohm load. They dependably operate in a temperature range of -55°C to $+100^{\circ}\text{C}$.

CIRCLE 324 ON READER SERVICE CARD

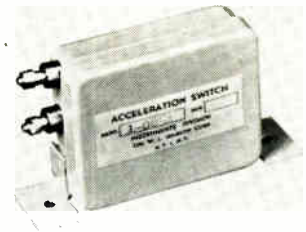

Acceleration Switch

DAMPED-TYPE

MAXSON INSTRUMENTS DIVISION, 475 Tenth Ave., New York 18, N. Y. Model 174 miniature, unidirectional, single-axis switch is designed to close electrical circuits at a preset acceleration value. It has applications as an arming switch in missiles, sensing element in recording type accelerometers and as a parachute release.

CIRCLE 325 ON READER SERVICE CARD

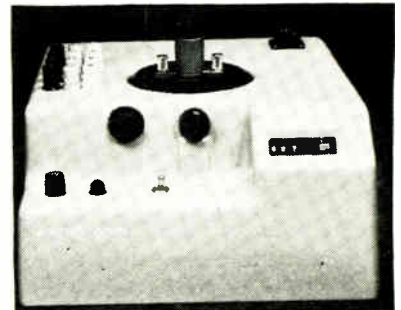

Test Stand

FOR SYNCHROS

ASTRODYNE INC., 121 Clinton Rd., Caldwell, N. J. The STS 2000 is available with a servo drive to automatically position a potentiometer, synchro, or resolver from which a specific ratio can be read and recorded, or it can be supplied as a manually operated stand. Readout counter displays shaft position directly in numerical form.

CIRCLE 326 ON READER SERVICE CARD

Amplifier Modules

HARVEY-WELLS ELECTRONICS, INC., 14 Huron Drive, Natick, Mass. Minus 4 volts to -15 volt level amplifiers are now available for operation at speeds up to 5 Mc for

HOW TO GET MINIMUM NOISE... MAXIMUM GAIN

TYPICAL LOW-LEVEL, LOW-NOISE AMPLIFIER DEMONSTRATING LOW-NOISE CHARACTERISTICS OF TI 2N929 AND 2N930

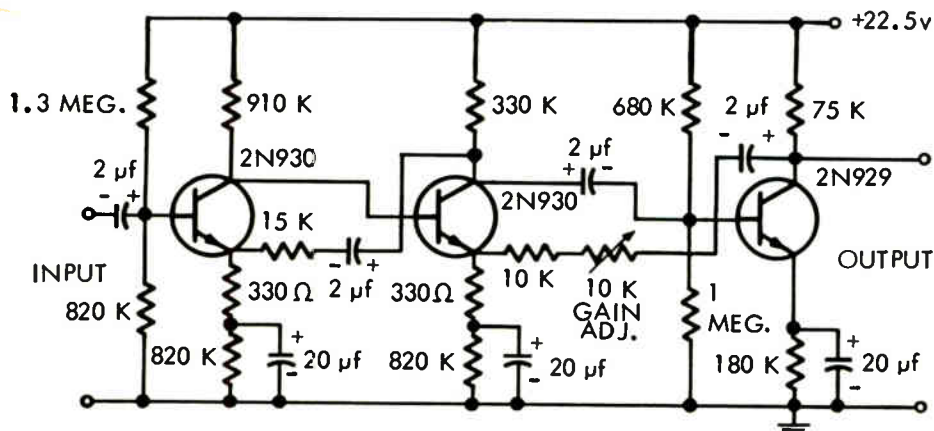

AMPLIFIER GAIN = 1000 = 60 db
 FEEDBACK = 20 db
 NF (SEE GRAPH) = 14 db
 BW ($R_G = 50 \text{ K}\Omega$) = 14 kc
 INPUT IMPEDANCE = 340 $\text{K}\Omega$ @ 1 kc
 OUTPUT IMPEDANCE = 12 $\text{K}\Omega$ @ 1 kc
 FIRST STAGE BIASED AT 10 μA

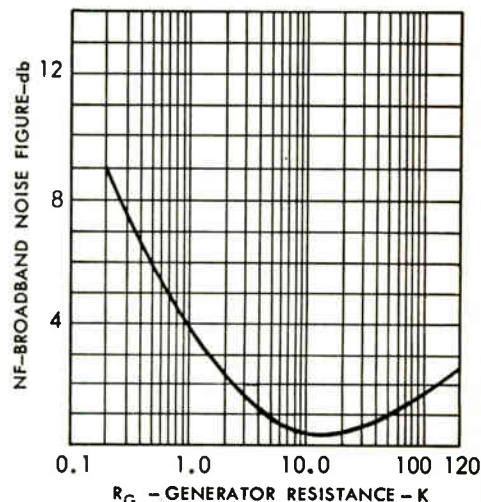

TI 2N929

TI 2N930

low-level / low-noise / high-gain

npn SILICON **PLANAR TRANSISTORS**

	TEST CONDITION	2N929		2N930	
		min	max	min	max
I_{CES}	$V_{CE} = 45 \text{ v}, V_{BE} = 0$		0.01 μA		0.01 μA
I_{CES}	$V_{CE} = 45 \text{ v}, V_{BE} = 0, T_A = 170^\circ\text{C}$		10 μA		10 μA
I_{CEO}	$V_{CE} = 5 \text{ v}, I_B = 0$		0.002 μA		0.002 μA
BV_{CEO}	$I_C = 10 \text{ ma}, I_B = 0$	45 v		45 v	
h_{FE}	$V_{CE} = 5 \text{ v}, I_C = 10 \mu\text{A}$	40	120	100	300
h_{FE}	$V_{CE} = 5 \text{ v}, I_C = 10 \text{ ma}$		350		600
h_{FE}	$V_{CE} = 5 \text{ v}, I_C = 10 \mu\text{A}, T_A = -55^\circ\text{C}$	10		20	
C_{ob}	$V_{CB} = 5 \text{ v}, I_E = 0, f = 1 \text{ mc}$		8 pf		8 pf
$t_{h_{rel}}$	$V_{CE} = 5 \text{ v}, I_C = 500 \mu\text{A}, f = 30 \text{ mc}$	1		1	
N. F.	$V_{CE} = 5 \text{ v}, I_C = 10 \mu\text{A}, R_G = 10 \text{ K}$ Bandwidth 10 cps to 10 kc		4 db		3 db

Now you can design the low-level, high-gain amplifier shown above with typical noise figure as low as 1 db. Advanced low-level planar technology of Texas Instruments 2N929-2N930 series makes possible high-gain at low current levels, plus the extremely low leakage currents necessary for true low-noise performance. ■ For high-impedance transducer applications, the TI 2N929-2N930 permit typical 1 db noise figure at emitter currents below 1 microampere, and generator resistances over 1 megohm. These special characteristics allow direct coupling of low-level, high-impedance sources... advantages previously available only with vacuum tubes and field-effect transistors. ■ For space applications, the TI 2N929-2N930 transistors make possible low power consumption because of high gain at low levels, plus high resistance to radiation effects due to the very thin base region of the devices. ■ These TI transistors will simplify and improve the performance of your low-level circuits. They are available in production quantities from your nearest TI Sales Office or Authorized TI Distributor.

Write for TI's Technical Information Bulletin "Low-Level Operation of the TI 2N929 and 2N930"

TRANSISTOR PRODUCTS DIVISION



TEXAS INSTRUMENTS

INCORPORATED

13500 N. CENTRAL EXPRESSWAY
 P. O. BOX 5012 • DALLAS 22, TEXAS

CIRCLE 117 ON READER SERVICE CARD

ACCELEROMETERS

**Low range
(± 1 g to ± 10 g)...**

For perpendicular-to-base accelerations in the low-g range, CEC's newest accelerometer, the Type 4-205, excels for missile applications—detailed studies between launch and staging—and during static firings as well. ■ It is complementary to the 4-202 and 4-203 across the page. Like them, it has the lowest cross axis response... smallest damping change with temperature... and highest resonant frequency of any comparable instrument available. And it is the smallest temperature-compensated transducer of its type (1.2" x 1.2" x 1.4"; weight under 4.5 oz). Operating temperature range is from -70°F to $+300^{\circ}\text{F}$. ■ For more information, call your nearest CEC sales and service office or write for Bulletin CEC 4205-X1.



CEC

Transducer Division

CONSOLIDATED ELECTRODYNAMICS
PASADENA, CALIFORNIA • A SUBSIDIARY OF BELL & HOWELL

voltage level conversions in high impedance vacuum tube and thyatron grid circuits.

CIRCLE 327 ON READER SERVICE CARD

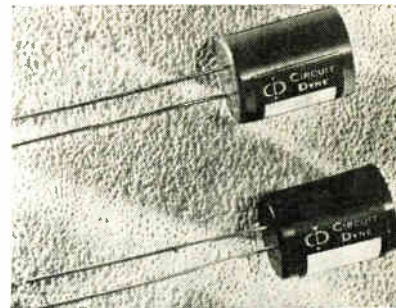

Negative Resistor

LINEAR, STABLE

CIRCUIT DYNE CORP., 480 Mermaid St., Laguna Beach, Calif. Series NR1 Negistors operate over a 4 to 1 voltage range, from 5 to 20 v. Linearity can be guaranteed within ± 2 percent, with power ratings up to 350 mw. Applications include use as a switching element, a bilateral amplifier and a loss corrector in wave filters. It is available with resistance values from 10,000 to 100,000 ohms in increments of 5 percent.

CIRCLE 328 ON READER SERVICE CARD

Molding Material

ROGERS CORP., Rogers, Conn. RX-745 FR is a flame-resistant, Orlon-fiber reinforced phenolic molding compound intended for use in terminal boards, connectors and other applications where shock, fatigue and wear resistance are involved.

CIRCLE 329 ON READER SERVICE CARD

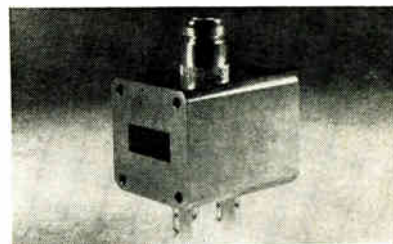

Microwave Switch

SOLID-STATE

SOMERSET RADIATION LABORATORY, INC., 192 Central Ave., Stirling, N. J. Model X451 double-throw switch contains two semiconductor diodes which allow ultra high

switching with low control power requirements. It operates in the frequency range of 8.2 to 12.4 Gc with typical open channel isolation of 21.0 db at 9.3 Gc and closed channel insertion loss of 0.5 db. Switching speed is less than 10 nsec.

CIRCLE 330 ON READER SERVICE CARD

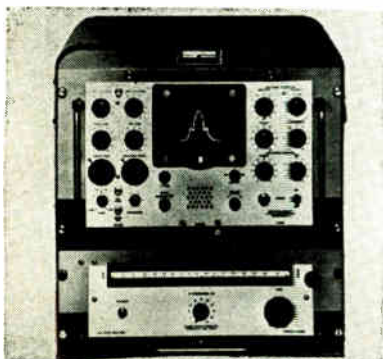

Spectrum Analyzer HIGH SENSITIVITY

LAVOIE LABORATORIES, INC., Morganville, N. J. The LA-21 is capable of evaluating a frequency spectrum containing large numbers of signals with widely different characteristics. It can discriminate between signals differing in amplitude by as much as 80 db and operated by as little as 25 Kc. This allows for the investigation of spurious and harmonic content of signal sources within the frequency range of the analyzer.

CIRCLE 331 ON READER SERVICE CARD

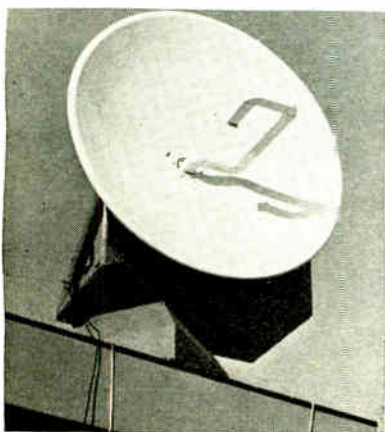

C-Band Antenna FOUR-FT DIAMETER

APPLIED MICROWAVE ELECTRONICS, INC., 6707 Whitestone Rd., Baltimore 7, Md. Spun aluminum parabolic reflector features a special back-up structure to withstand high

April 27, 1962

SPAN THE GAPS

Medium to high ($\pm 5g$ to $\pm 500g$)

Type 4-202 measures accelerations perpendicular to the mounting surface; Type 4-203 measures those parallel to the base. Both transducers are ideal for mobility studies — and missile launch and staging measurements. ■ Also qualified as the smallest temperature compensated instruments of their type (just a cubic inch in size, less than 3 oz in weight) they have the same degree of low cross axis response, stable damping, and high resonant frequency as the 4-205. ■ All three transducers use CEC's simple, ultra-compact unbonded strain gage sensing element that has a non-pendulous mass support virtually unaffected by cross axis vibrations — another reason for saying, "When you think of transducers — think of CEC." More data? Write for Bulletins CEC 4202-X17 and 4203-X7.

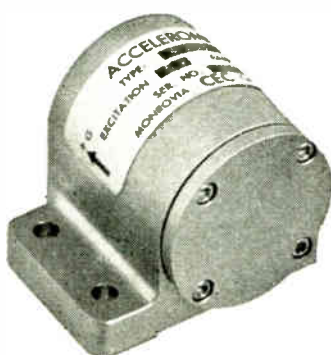

CEC

Transducer Division

CONSOLIDATED ELECTRODYNAMICS
PASADENA, CALIFORNIA • A SUBSIDIARY OF BELL & HOWELL

CIRCLE 119 ON READER SERVICE CARD

119

100,000,000 Pulses/Sec from TI

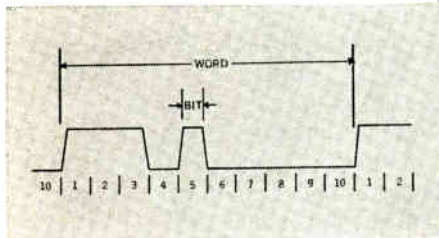
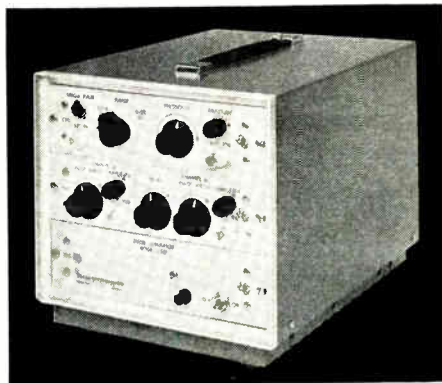

PROGRAMMED PULSE GENERATORS

- Bit Rates up to 25 MC
- 10 Bit Programmable Words

GENERAL PURPOSE PULSE GENERATORS

- PRF 100 cps to 25 MC
- Variable Pulse Width and Delay
- Variable Rise and Fall Times
- Pulse Mixing
- Plus and Minus Outputs

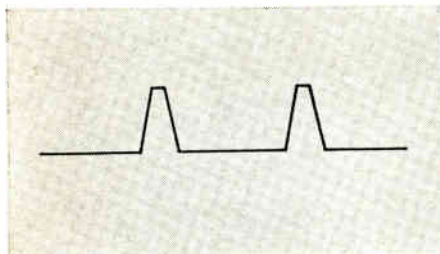
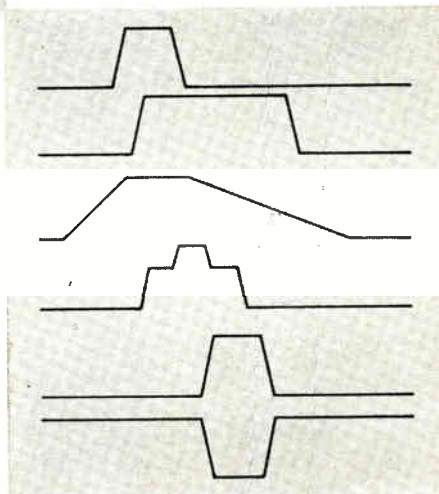

CLOCK PULSE GENERATORS

- PRF 100 cps to 100 MC
- Rise and Fall Times—
Less Than 4 nanoseconds
- Pulse Width—
Less Than 8 nanoseconds

Texas Instruments complete line of pulse instrumentation features compact design and high reliability through use of all solid state circuitry. Versatile modular construction permits custom combination of desired performance characteristics.

Write for complete information



TEXAS INSTRUMENTS
INCORPORATED
APPARATUS DIVISION
3609 BUFFALO SPEEDWAY
P. O. BOX 66027 HOUSTON 6, TEXAS

wind and ice loading. The reflector and feed horn, with a radome for pressurization to 13 psig, operate over the frequency range from 5.4 to 5.9 Gc with a maximum vswr of 1.4 to 1. Nominal gain is 35 db and maximum side lobe level is less than 20 db.

CIRCLE 332 ON READER SERVICE CARD

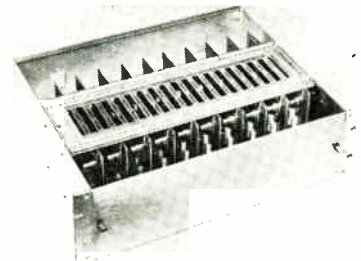

Assembly Pack

FOR ANALOG SYSTEMS

EMBREE ELECTRONICS CORP., 993 Farmington Ave., West Hartford, Conn., has introduced a pack designed to simplify the modular build-up of analog systems, simulators and control loops utilizing operational d-c amplifiers. Model ASAP/5.25 fits a standard 19 in. relay rack and is 5 1/2 in. high by 14 in. deep. Amplifiers and control circuit may be assembled on p-c cards 4.5 in. high. Card spacing is variable on 0.400 in. centers. Company supplies a card mounted stabilized operational d-c amplifier, model 1504 Nuvamp.

CIRCLE 333 ON READER SERVICE CARD

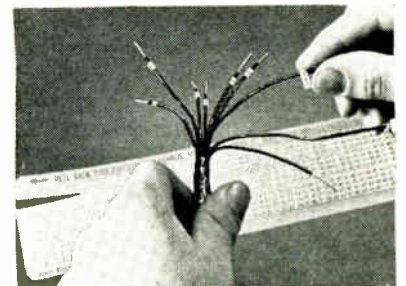

Wire Markers

REINFORCED PLASTIC

W. H. BRADY CO., 727 W. Glendale Ave., Milwaukee 9, Wisc. The B-400 markers provide self-sticking identification for electronic wires, and have positive, permanent adhesion (40 oz per in. of width). The markers will withstand 30 days immersion in No. 10 oil at 65 C (150 F) with no change in legibility or ad-

MORE HIGH POWER TRANSISTORS FROM BENDIX

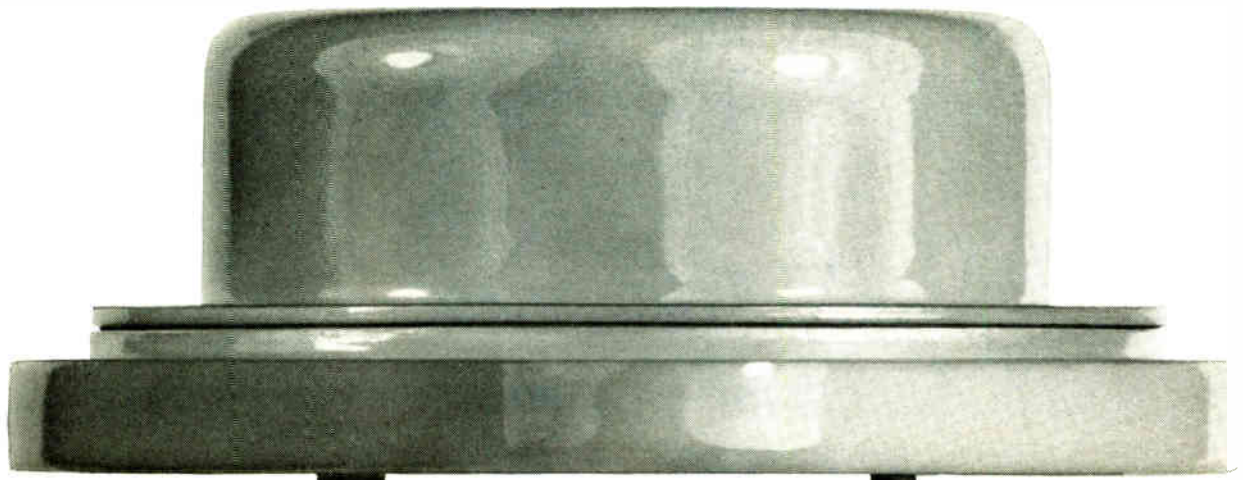

71 NEW TYPES NOW AVAILABLE

The greatly expanded line of Bendix* High Power Transistors offers power switching capabilities up to 25 amps. Characteristics of typical types are listed in the table below. Together with improved design and increased ratings, you get higher gain and flatter beta curves. These high power transistors are categorized in gain and voltage breakdown to provide optimum matching, as well as to eliminate burn-out. They are capable of switching up to 1000 watts. Every Bendix Transistor is 'Dynamically Tested,' an exclusive Bendix quality control process to assure uniformity and maximum reliability. High power transistors also available with lugs. For complete data on the expanded line of Bendix Power Transistors and Power Rectifiers, write us in Holmdel, N. J.



Type Number	MAXIMUM RATINGS			CURRENT GAIN	
	V _{CES} Vdc	I _C Adc	P _C W	h _{FE} @	I _C Adc
2N511-2,A,B	40-60	10-15	80	20-60	10-15
2N513-4,A,B	40-60	20-25	80	20-60	20-25
2N627-2N630	30-75	10	90	10-30	10
2N677,A,B,C	30-80	15	90	20-60	10
2N678,A,B,C	30-80	15	90	50-100	10
2N1031,A,B,C	30-80	15	90	20-60	10
2N1032,A,B,C	30-80	15	90	50-100	10
2N1120*	70	15	45	20-50	10
2N1146-7,A,B,C	30-75	15	87	30	15
2N1549-56,A	30-75	15	90	10-60	10
2N1557-60,A	30-75	15	90	50-100	10

*Also available per MIL-T-19500/68 (SigC)

Bendix Semiconductor Division



Main Office: South St., Holmdel, N.J.—Ph: SH 7-5400 • New England Office: 114 Waltham, Lexington, Mass.—Ph: VO 2-7650 • Detroit Office: 12950 W. 8 Mile Rd., Detroit 37, Mich.—Ph: JO 6-1420 • Midwest Office: 1915 N. Harlem Ave., Chicago, Ill.—Ph: 637-6929 • West Coast Office: 117 E. Providencia Ave., Burbank, Calif.—Ph: VI 9-3961 • Canadian Affiliate: Computing Devices of Canada, Ltd., P.O. Box 508, Ottawa 4, Ont. • Export Office: Bendix International, 205 E. 42nd Street, New York 17, N.Y. Stocking Distributors: Contact nearest sales office for name of local distributor.

Test equipment budget too low



double its value the Heathkit way



Heathkit test instruments are professionally designed to meet top performance standards, yet you save up to 50% of the cost of comparable equipment by easy in-plant assembly. Heathkits are the most popular do-it-yourself kits in the world . . . investigate their ability to stretch your instrument budget. Send for your FREE 1962 Heathkit Catalog today!



HEATH COMPANY
Benton Harbor 67, Michigan

Please send FREE 1962 Heathkit Catalog

Name _____

Address _____

City _____

State _____



CIRCLE 208 ON READER SERVICE CARD

RECORDING STORAGE TUBE SYSTEMS



Originated and Built By
IMAGE INSTRUMENTS, INC.

■ ELECTROSTATIC PICTURE STORAGE AND RECALL SYSTEMS ■ LOW-LIGHT-LEVEL CAMERA AND DUAL STORAGE TUBE SYSTEMS ■ DOUBLE-ENDED STORAGE TUBE SYSTEMS ■ DATA SUMMATION UNITS ■ COMPUTER OUTPUT STORAGE FOR TELEVISION DISPLAY.

Standard storage tube systems are readily available. A custom-engineered system can be built to meet your special needs.

For further information, write:



122 CIRCLE 122 ON READER SERVICE CARD

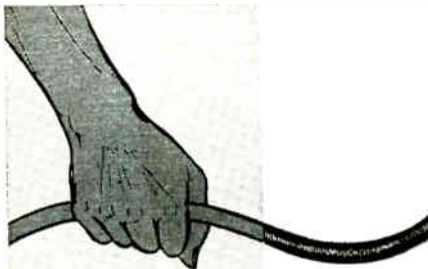

A HIDDEN HELPER

Protects your tubes and components from damage by sagging cable.

—eliminates the old bugaboo of cable entanglement which damages tubes and components in lower chassis each time the one above is withdrawn for service and returned to position.

Our new Cable Retractor's double action maintains constant tension and correct suspension of cable at all times—permits ample cable length for full extension and tilting of chassis without hazard of snagging.

For use with all types of chassis or drawer slides, adjustable to fit varying chassis lengths, simple to install, inexpensive, proven thoroughly reliable in operation.

Mounts on rear support rails on standard 1 3/4" hole increments. Cadmium plated CRS.

Write for Bulletin CR-100A

ORegon 8-7827



CIRCLE 209 ON READER SERVICE CARD

hesion. They resist temperatures to 150 C indefinitely. Only 3 1/2 mils thin, the markers take minimum space in cramped electronic assemblies.

CIRCLE 334 ON READER SERVICE CARD

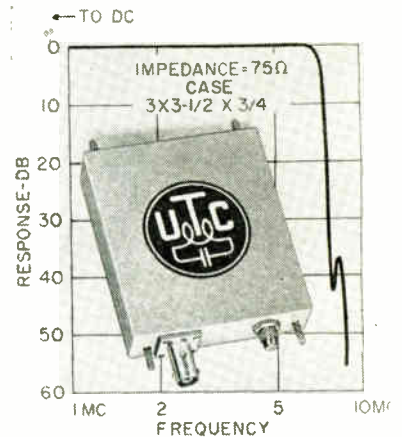

Low-Pass Filter SHARP CUTOFF

UNITED TRANSFORMER CORP., 150 Varick St., New York 13, N. Y., announces a 6 Mc sharp cutoff low pass filter. Response is extremely flat, within 0.2 db from d-c to 6 Mc, and falls off at least 40 db at 8.5 Mc. Impedance is 75 ohms. Filter is manufactured to MIL-F-18327A and shielded to reduce hum pickup. Flat configuration makes it highly compatible for module construction.

CIRCLE 335 ON READER SERVICE CARD

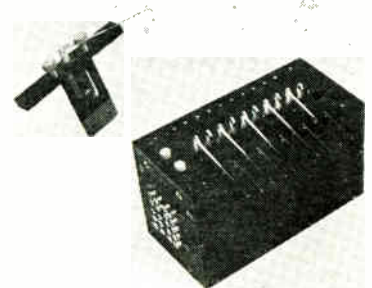

Galvanometer

MULTICHANNEL

ELECTRO MAGNETIC INSTRUMENT CO., INC., 315 Jackson Hill, Houston 6, Texas, has available curvilinear or rectilinear multichannel galvanometers. They permit simultaneous multiple recording, feature interchangeable plug-in pen motors with a peak to peak pen movement of 2 in. and a wide range of undamped frequencies. The alternating pen lengths give complete freedom of

NATIONAL SEMICONDUCTOR

PRESENTS

FOR TELEMETERING and CHOPPING APPLICATIONS

A UNIQUE COMPONENT—THE

INCH*
(INTEGRATED CHOPPER)

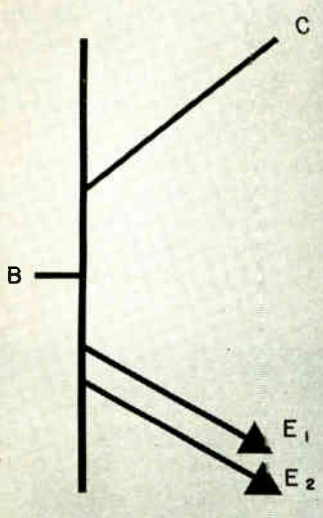

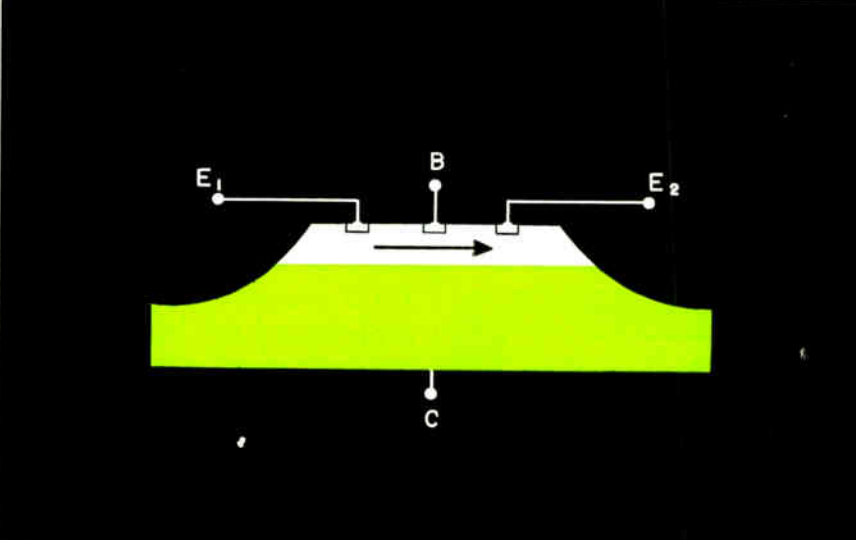

CHARACTERISTICS

V_o Offset V 50 μ V Max. (NS 3001)
(-25° C to 100° C) 200 μ V Max. (NS 3000)

$R_o = \frac{\Delta V_o}{\Delta I_H}$ 10 m Ω Typ.

$\left| \frac{\Delta V_o}{T} \right|$ 0.2 μ V / °C Typ.

R_i 50 Ω Max.

I_{E_1}, E_2 (at 25° C) 0.5 nA Typ.
(at 100° C) 25 nA Typ.

T0-18



APPLICATIONS

The INCH* (integrated chopper) is a stabilized integrated circuit specifically designed for low level electronic commutating, demodulating and high speed chopper applications. This device is ideally suited for these applications because of extremely low offset voltage, leakage currents, saturated dynamic impedance, and transfer resistance. This device features excellent thermal stability with changes in environmental conditions.

FOR COMPLETE TECHNICAL INFORMATION AND DATA SHEETS ON THE NS 3000 AND NS 3001, WRITE PRODUCT MARKETING DEPARTMENT, NATIONAL SEMICONDUCTOR CORPORATION, DANBURY, CONNECTICUT.

*Trademark



NATIONAL SEMICONDUCTOR

CORPORATION

DANBURY, CONN. • TEL. Pioneer 3-7624 • TWX DANB 452-U

Life Savers

for
**ELECTRONIC
EQUIPMENT**

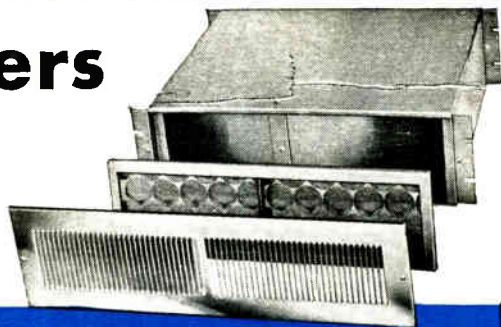

Trans-aire BLOWERS

You will prolong the life of your sensitive electronic equipment and maintain its proper efficiency by dissipating the heat which it generates with a Bud Trans-aire Blower.

Bud Trans-aire Blowers are ideal for use where excessive heat is present in enclosed racks, cabinets or consoles. They are available in three sizes with air displacement capacity from 100 cfm to 750 cfm.

These blowers occupy less area and a smaller panel space than others having similar air displacement capability and are the lowest priced units of equal capacity and performance.

See the Bud Trans-aire Blowers at Authorized Bud Distributors or write for literature.



BUD RADIO, INC.

CLEVELAND 3, OHIO

CIRCLE 210 ON READER SERVICE CARD

MAKING ROOM AT THE TOP

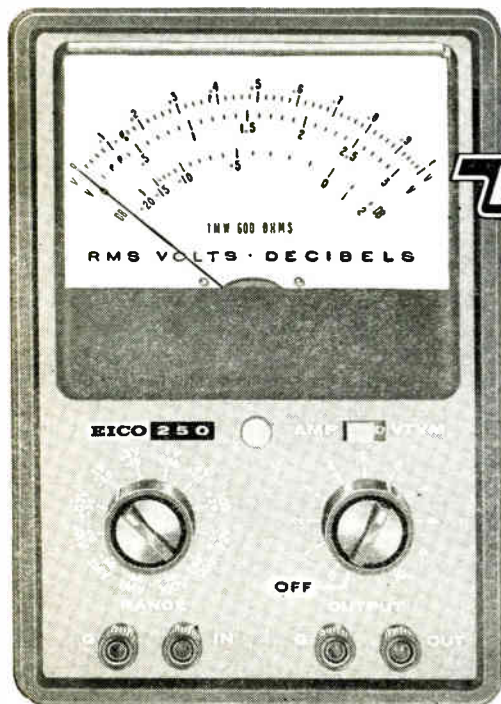

See the 41 additional EICO instruments helpful for your lab and line work. Write for free catalog and name of neighborhood distributor.

EICO Dept. E-4B
3300 N. Blvd., L.I.C. 1, N. Y.
Export Dept.: Roburn Agencies, Inc.
431 Greenwich St., N. Y. 13, N. Y.

EICO creates a new, professional lab quality test instrument series at moderate prices.



**AC VTVM &
AMPLIFIER
#250**

Kit \$49.95, Wired \$79.95

VTVM: 12 ranges from 1mv to 300v rms; response absolutely flat from 10 cps to 600 kc; input impedance 10M Ω shunted by 15 μ f; accuracy \pm 3% of full scale.

Note: Average responding meter calibrated in rms. Linear 0-1, 0-3 scales. Decibel scales based on 0db=1mw in 600 Ω with 10db interval between ranges.

AMPLIFIER: 60db gain on 1mv range; response +0, -3db from 8cps to 800kc; output to 5V rms undistorted, variable down to zero by attenuator control at output; input impedance 10M Ω , output impedance 5K Ω ; hum & noise -40db for signal inputs above 2mv.

DESIGN QUALITY: All frame-grid tubes; 60db frequency-compensated input attenuator ahead of cathode follower with 10db/step attenuator following; two-stage R-C coupled amplifier and full-bridge meter circuit in one overall feedback loop; no response adjustment required in amplifier circuit; single sensitivity adjustment; voltage-regulated power supply. 50/60 cycle operation.

EICO MODEL 255 AC VTVM
Identical to Model 250 described above, but less amplifier facility. 50/60 cycle operation.
Kit \$44.95 Wired \$72.95

Add 5% in the West.

movement to adjacent pens. The MC series are available as standard items in 2, 4, 6, 8 and 10 channel packages.

CIRCLE 336 ON READER SERVICE CARD

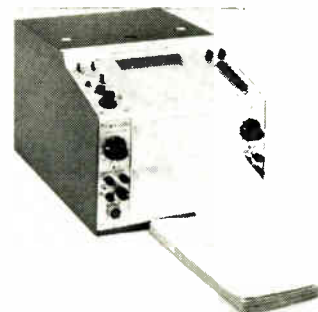

Two-Channel Recorder

MEDIUM FREQUENCY

TEXAS INSTRUMENTS INC., 3609 Buffalo Speedway, Houston, Texas. The Oscillo Riter recorder is suited for use with the majority of transducers of physical phenomenon. Frequency response of the ink writing unit is flat to 200 cps, within \pm 1 db, 10 mm peak to peak. The portable instrument uses the Z-fold chart paper system. The recorder produces a true rectilinear trace with either heat or ink writing methods. It features eight push-button chart speeds.

CIRCLE 337 ON READER SERVICE CARD

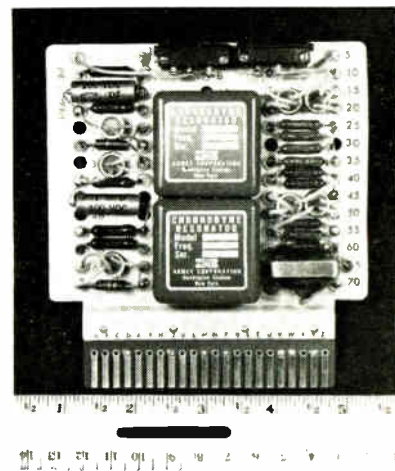

Band Pass Filters

ELECTROMECHANICAL

ARMEC CORP., 195 West Hills Road, Huntington Station, N. Y. Using Chronodyne electromechanical resonators as the tuned frequency elements, these filters require about 3 cu in. per stage and weigh a few oz in militarized versions. The close approach to Butterworth or Chebi-

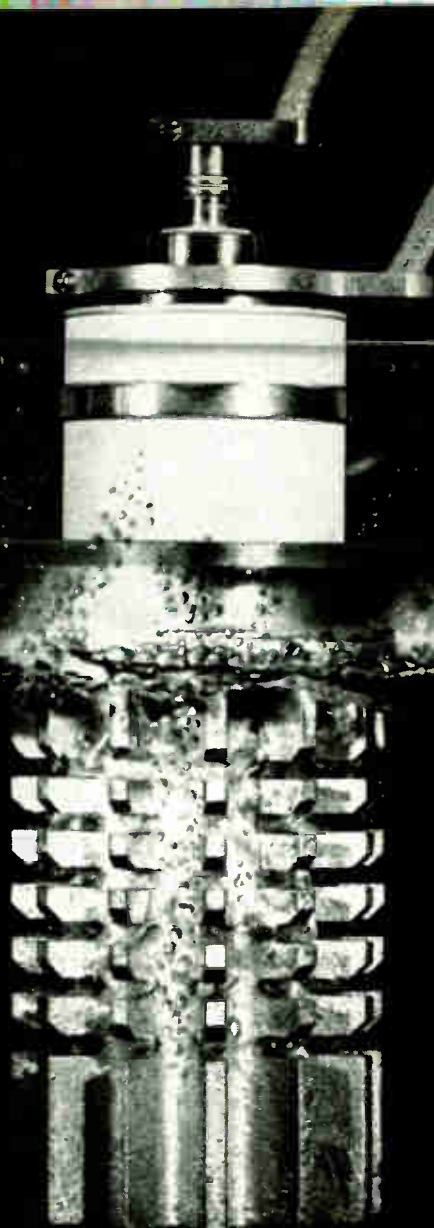

BOILING FOR "COOL" PERFORMANCE

This tube, the new ITT F-7832 Power Triode is in an open glass tank to demonstrate the new evaporative cooling method. Cooling water is shown boiling at the segmented copper cooling fins. Bubbles are rising off the surfaces and steam is escaping. Normally the tube is enclosed in a boiler (photograph at right) which, in conjunction with an external condenser, becomes a complete system.

Conventional water cooling is capable of dissipating 450 watts/sq. in. Forced air cooling dissipates 150. The ITT Evaporative Cooling



System will dissipate in excess of 800 watts/sq. in. It will operate in an overload condition at 1600 watts/sq. in. with no damage. In addition, ITT Evaporative Cooling offers the advantages of noiseless operation, absence of rotating parts such as blowers and pumps, minimum servicing, self cleaning of tube, and minimum liquid coolant. ITT Evaporative Cooled Tubes feature ceramic construction. The new rugged, mesh cathode, another design innovation, provides improved emission per watt, quick heating and excellent temperature stabilization.

ITT

Write for information on the new ITT Evaporative Cooled Power Tubes. Application assistance is available for your specific requirements.

ELECTRON TUBE DEPARTMENT ■ COMPONENTS DIVISION

INTERNATIONAL TELEPHONE AND TELEGRAPH CORPORATION, CLIFTON, NEW JERSEY

ITT COMPONENTS DIVISION PRODUCTS: POWER TRIODES AND DIODES • IATRON STORAGE TUBES • HYDROGEN THYRATRONs • TRAVELING WAVE TUBES • SELENIUM RECTIFIERS • SILICON DIODES AND RECTIFIERS • TANTALUM CAPACITORS

CIRCLE 125 ON READER SERVICE CARD

INSIDE STORY...

of the **SDL** reson-ator

(Frequency Sensitive Relay)

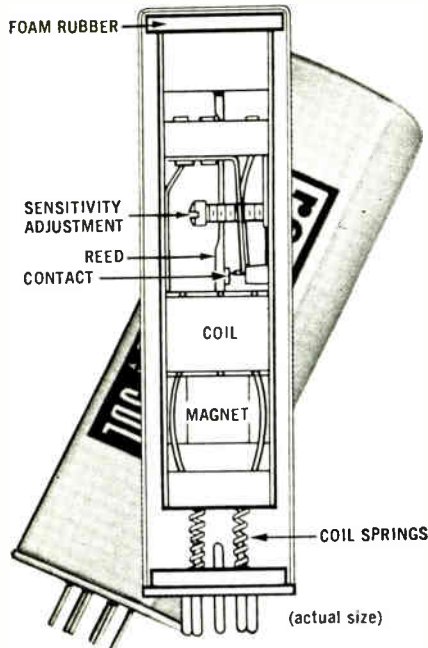

Looking for a frequency-sensitive switch whose major advantages are high selectivity and narrow bandwidth? You've found it!

Note the unique suspension . . . foam rubber at top, coil springs at bottom. This makes our RESON-ATOR virtually insensible to shock, vibration and acceleration. Gold and silver contact points assure minimum arcing and long life.

All critical "inside" components temperature stabilized. This permits RESON-ATOR operation under temperature extremes heretofore impossible. Even the copper can that wraps up the package has a "job." It has a magnetic shunting effect that allows these relays to work in areas where magnetic coupling would impair operation of other, similar units.

New SDL high and low frequency RESON-ATOR relays have hundreds of uses, with new applications being devised every day. Write for complete specifications. We welcome your relay problems.

SDL SECURITY DEVICES LABORATORY
ELECTRONIC DIVISION OF
SARGENT & GREENLEAF, INC.
16 Seneca Ave.
ROCHESTER 21, N. Y.

shev performance criteria is possible due to the frequency stability, low transformer coupling from input to output of each resonator, adjustable Q circuitry, and high amplitude linearity characteristics of the Chronodyne resonator.

CIRCLE 338 ON READER SERVICE CARD

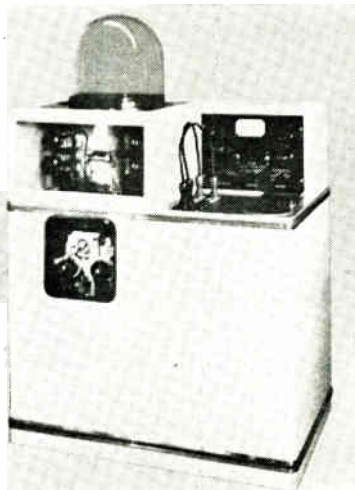

High Vacuum Systems

FAST CYCLING

ILIKON CORP., Natick Industrial Centre, Natick, Mass. Two mobile high vacuum systems now available combine fast cycling capability with low ultimate pressures. Series 202 are useful for thin film deposition, solid-state research, phase diagram studies, alloy development, heat treating, and vacuum melting. They can be brought to a pressure of 10^{-6} mm Hg in less than 30 minutes, and with a cold trap added can be brought to a pressure of 10^{-7} mm Hg.

CIRCLE 339 ON READER SERVICE CARD



Amplifier

SOLID STATE

CASA ELECTRONICS CORP., 2233 Barry Ave., Los Angeles 64, Calif. Model A-110 weighs only 10 oz and features high input and low

**THIS IS A
1 CUBIC FOOT
COMPUTER!**

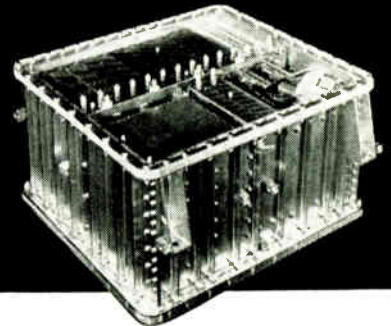

Innovations in high density packaging have compressed the performance of large, room-sized computers to "briefcase" dimensions at Univac. Example—a new Univac computer which measures just one cubic foot! Its thin film memory unit is an 8" cube, storing nearly 160,000 bits of memory. All other circuit components are commercially available items, ingeniously packaged and connected.

Univac continues to meet the challenge of the increasing demands for reliable miniaturization. Qualified personnel interested in both personal and professional advancement are invited to investigate the career opportunities now available on such programs.

Immediate openings include:

RESEARCH ENGINEERS

Attractive positions are now available for Research Engineers. These permanent assignments include circuit development work and the logical design of high speed computer elements.

- TRANSISTOR CIRCUIT DESIGNERS
- ELECTRONIC PACKAGING ENGINEERS
- SERVO-ENGINEERS
- ELECTROMECHANICAL ENGINEERS
- QUALITY CONTROL ENGINEERS
- PRODUCTION ENGINEERS
- RELIABILITY ENGINEERS
- STANDARDS & SPECIFICATIONS ENGINEERS

Send resume of education and experience to:

R. K. PATTERSON, DEPT. T-1

REMINGTON RAND
UNIVAC

DIVISION OF SPERRY RAND CORPORATION

2750 West Seventh St., St. Paul 16, Minn.

There are also immediate openings in all areas of digital computer development at our other laboratories. Inquiries should be addressed to:

F. E. NAGLE, Dept. T-1
REMINGTON RAND UNIVAC
P. O. Box 500
Blue Bell, Pa.

D. CLAVELOUX, Dept. T-1
REMINGTON RAND UNIVAC
Wilson Avenue
South Norwalk, Conn.

(An equal opportunities employer)

50-1 QUADRATURE REJECTION with a PLUG-IN TRANSISTOR AMPLIFIER



INPUT IMPEDANCE 500,000 ohms
 (A wide range of input values may be made available to suit source impedance requirements.)
 LOAD IMPEDANCE 500 ohms
 POWER GAIN 30 Db.
 VOLTAGE GAIN Unity
 PHASE SHIFT Zero
 CARRIER FREQUENCY 380 to 420 c.p.s.
 OUTPUT 450 millivolts minimum saturated signal at 500 ohm output impedance
 INPUT-POWER REQUIREMENTS 28 V.D.C. at 12 ma.; 115 V. 400 c.p.s., 1 ma.



For detailed QUADRATURE REJECTION AMPLIFIER SPECS, MODEL 1805-0500 Write to Dept. TR-30, M. Ten Bosch Inc., Pleasantville, New York

CIRCLE 211 ON READER SERVICE CARD

BANDPASS FILTERS

APPLIED RESEARCH Inc.
 76 SOUTH BAYLES AVE., PORT WASHINGTON, NEW YORK

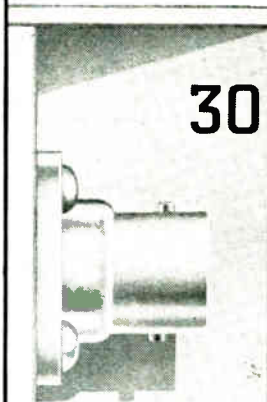

Frequency Range Of
30 TO 2000 mc

- 1% TO 25% BANDWIDTHS
- LOW INSERTION LOSS
- SPECIAL ALIGNMENTS AVAILABLE
- < 4:1 SKIRT RATIOS HAVE BEEN ACHIEVED

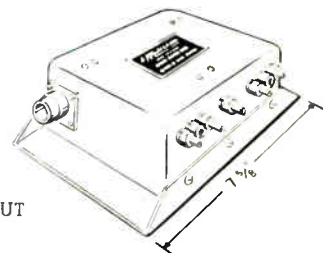

Typical Filter
 MODEL HFF-T(B)-S
 $f_0=1010$ mc BW=280 mc
 < .5db INSERTION LOSS
 50 OHMS INPUT & OUTPUT

Applied Research, Inc.—76 S. Bayles Avenue—Port Washington, N.Y.—Phone 516—PO 7-8707—Integrated RF Components and Sub-Assemblies, VLF thru C Band. Octave Amplifiers to 1100 mc; Band Pass Filters; Low Noise Amplifiers; Frequency Multipliers.

CIRCLE 212 ON READER SERVICE CARD

electronics

Editorial Opportunity

IT DOESN'T HAPPEN OFTEN, but **electronics**, "bible of the industry" and a McGraw-Hill publication, has an opening for an Assistant Editor.

Ideally, the man we are looking for and to whom a post on our New York staff could be a long-term challenge, would have an electrical engineering degree or technical equivalent, practical experience in our field and a demonstrated aptitude for editing, writing, reporting. He probably lives somewhere in the metropolitan area and therefore would have no relocation problem.

Write The Editor, **electronics**, 330 W. 42nd St., New York 36, stating experience, aspirations and past earnings. Mark the envelope "Confidential" and it will be kept that way.



ENGINEERING CASE HISTORY SPECIAL PURPOSE IF SUB-SYSTEMS

PROBLEM:

Customer* had urgent requirement for three specialized amplifier systems, with amplification factor of 10,000 and with an extremely narrow bandwidth. Crystal filter techniques could not be used. Amplifier should have accurately shaped AGC characteristic over a 40 db range and three isolated outputs. First unit required 24 days ARO. Second and Third units required 32 days ARO.

SOLUTION:

RHG designed and built units meeting or exceeding all specifications. The use of temperature compensated, high "Q" interstages plus the use of feedback techniques resulted in extremely stable performance. The application of AGC control voltage to achieve the 40 db of gain reduction did not cause detuning of the critical interstages. First unit delivered at customer's plant 21 days ARO. Second and Third units at customer's plant 30 days ARO.



*Sylvania Electronic Systems, Buffalo, N. Y., under prime contract of Air Force Systems Command, Rome Air Development Center, Griffiss Air Force Base, N. Y.

Send for Catalog 1010B covering standard amplifiers and instruments. Use RHG's custom-engineering service to solve your special problems.



RHG ELECTRONICS LABORATORY, INC.
 94 Milbar Blvd., Farmingdale, N.Y., NY 4-3100



NEW from



The only **IN-CIRCUIT** * **TRANSISTOR TESTER** not requiring identification of transistor leads

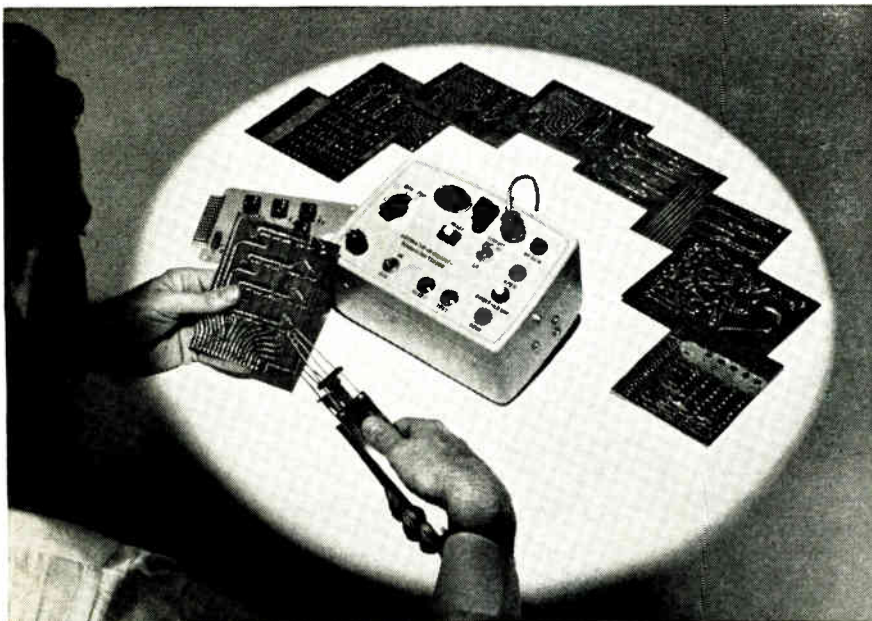

CHECK THESE OUTSTANDING FEATURES

OF THE **AEL** IN-CIRCUIT TRANSISTOR TESTER

- You cannot damage transistor under test . . . this is an automatic lead finding, in-circuit transistor tester. You do not need to know the configuration of the leads.
- Saves countless transistors that would be damaged (through improper lead identification) with other transistor testers.
- No prior knowledge of transistor required . . . you DO NOT need catalogs, specifications, etc. to identify leads. Results in great savings of time.
- Tests transistors both in-circuit and out-of-circuit.
- Each test completed within 2-second time interval.
- Checks for opens—shorts—no gain.
- Tests virtually every type of transistor, including . . . power, switching, small signal, junction, alloy, point contact and military types.
- No meters to read — result immediately indicated by lights.
- No knobs to adjust—no potentiometers—no calibration required.
- Automatically determines silicon versus germanium for self-adjustment of voltages.
- Uses standard 115 volt — 60 cycle input. Power required — approximately 30 watts.

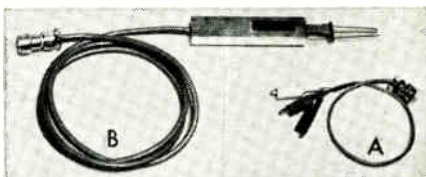

Revolutionary new automatic probe* (B) — permits rapid in-circuit testing with use of only one hand . . . probe contacts are adjusted with slight movement of fingers.
 (A) Clip lead probe supplied as standard equipment.
 (B) Automatic adjustable probe available as optional equipment.
 *Patent applied for

For additional information, write to . . .



American Electronic Laboratories, Inc.
 RICHARDSON ROAD, COLMAR, PENNSYLVANIA
 Just north of Philadelphia

output impedance. Frequency response is from 20 to 20,000 cps, with variable gain from 0.5 to 10, with less than 0.1 percent distortion. Maximum safety is assured, with overload recovery of less than 100 millisecc, for a set input of five times normal. Amplifier will withstand acceleration of 20 g at 10 cps to 5 Kc. due to rugged, solid-state design. Operating temperature, -20 F to 175 F.

CIRCLE 340 ON READER SERVICE CARD



X-Band Circulator

COVERS 9.0-10.0 GC

RAYTHEON CO., Foundry Ave., Waltham 54, Mass. The CMX9 handles up to 2 Kw peak and 20 w average power, and can be supplied for operation at more than 100 Kw peak power. It provides 20 db minimum isolation with a 0.3 max insertion loss. Vswr is 1.30 max. Unit is approximately 2½ in. in diameter and 1½ in. high. Price is \$275 for a single unit or \$160 each for 50 units.

CIRCLE 341 ON READER SERVICE CARD

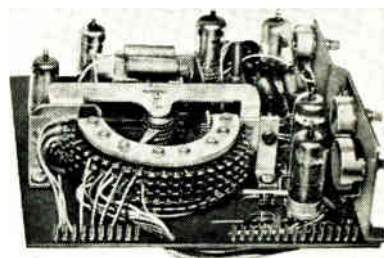

Digital Voltmeters

TWO NEW MODELS

FRANKLIN ELECTRONICS, Bridgeport, Pa. Models 550 and 650 digital voltmeters are now available with an optional range-switching module. High-speed range switching is accomplished by an upscale-downscale system that always seeks the shortest route to a range. Maximum range-switching time is 0.5 sec through all ranges.

CIRCLE 342 ON READER SERVICE CARD

PRODUCT BRIEFS

TERMINAL BOARDS designed for high temperature. Kulka Electric Corp., 633-643 So. Fulton Ave., Mt. Vernon, N. Y. (343)

RADAR C-R TUBE features rear windows. General Atronics Corp., 1200 E. Mermaid Lane, Philadelphia 18, Pa. (344)

TUNABLE INDICATING AMPLIFIER rack-mounted type. Rohde & Schwarz, 111 Lexington Ave., Passaic, N. J. (345)

AUDIO-TONE TRANSMITTER is self-contained unit. Quindar Electronics, Inc., 5 Lawrence St., Bloomfield, N. J. (346)

RETAINING RINGS corrosion resistant devices. Industrial Retaining Ring Co., 47 Cordier St., Irvington 11, N. J. (347)

MILLIOHMETER reads to 10 μ ohms. Keithley Instruments, 12415 Euclid Ave., Cleveland 6, O. (348)

TRANSISTOR TEST SET low current. Fairchild Semiconductor, 545 Whisman Rd., Mtn. View, Calif. (349)

DRILLING MACHINE for p-c boards. Ferranti Electric Inc., Plainview, L. I., N. Y. (350)

AXIAL LEAD COMPONENT HANDLER tests tape mounting resistors. Optimized Devices, Inc., 864 Franklin Ave., Thornwood, N. Y. (351)

SUPERCONDUCTING SOLENOIDS over 50 standard models. Magnion, Inc., 195 Albany St., Cambridge 39, Mass. (352)

HIGH-CURRENT PROBE that permits hanging connections. Sealectro Corp., 610 Fayette Ave., Mamaroneck, N. Y. (353)

CLOCK TRACK WRITER for magnetic drum or disk memory. Harvey-Wells Electronics, Inc., 14 Huron Drive, Natick, Mass. (354)

SHORT TERMINATIONS designed for microwave waveguide. Custom Components, Inc., P.O. Box 248, Caldwell, N. J. (355)

R-F STEP ATTENUATORS accurate from d-c to 3 Gc. Stoddart Aircraft Radio Co., Inc., 6644 Santa

GOT A COIL WINDING PROBLEM?

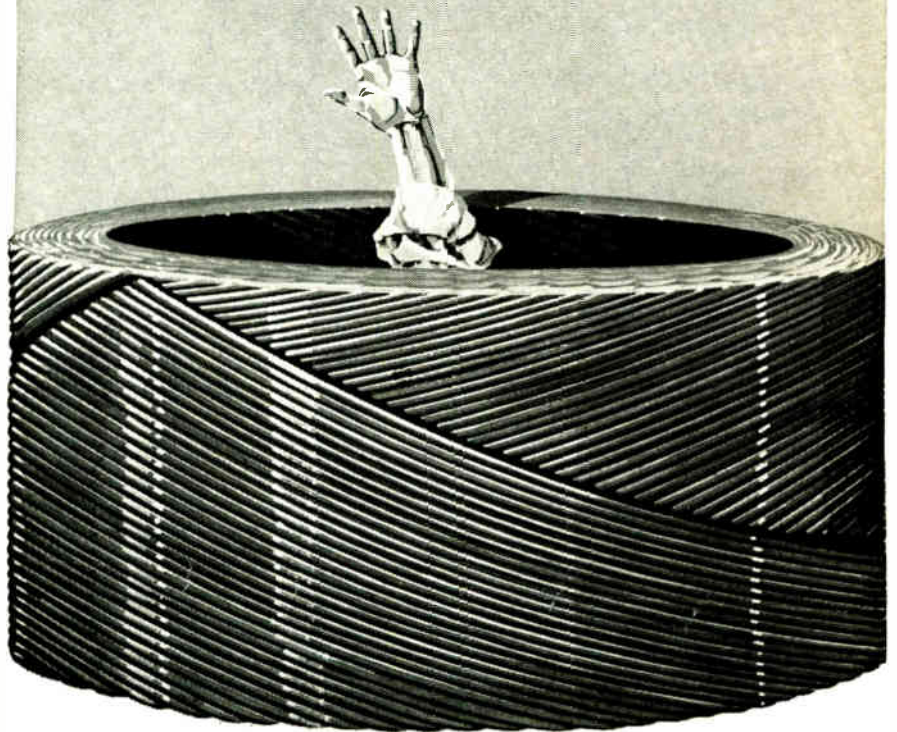

CAMBION® Custom Winding Service can be the answer to your coil winding problems. We're completely equipped to wind your coils precisely, to meet your exact electrical and mechanical specifications. Coils are unconditionally guaranteed in any quantity — as are the more than 10,000 different items in the CAMBION line of electronic components. Your coils can be thoroughly tested in our environmental laboratory whenever necessary, if your problems are unusual. CAMBION is prepared to help you design your coils.

Actually, the CAMBION line of regular and shielded coil forms is so broad and so versatile that you rarely have to resort to special designs. There are models and sizes to meet practically every requirement for both conventional and printed circuits. This means you get faster service, greater dependability and easier procurement over the years. Materials are selected and finishes are applied with the greatest care — and all parts are non-ferrous and electro-plated to withstand severe service conditions.

If you're all wound up in coil winding problems, call on CAMBION. Discover how we can save you both time and money. For estimate, send prints and quantity requirements to Cambridge Thermionic Corporation, 437 Concord Avenue, Cambridge 38, Massachusetts. Phone: TRowbridge 6-2800.

CAMBRIDGE THERMIONIC CORPORATION
CAMBION®
The guaranteed electronic components



PULSE POINTERS

Twin Pulse Feature Now Standard On General Purpose Pulse Generator

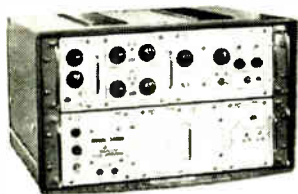

Model 3450D Pulse Generator

Modules expand capability of basic test instrument—Need a variety of special purpose design/test instrumentation? Investigate modular flexibility of Servo Corporation's SERVOPULSE™ Model 3450D. With twin pulse feature now standard, it can readily be modified to perform the function of six special purpose instruments. Rep rate is 2 mc-2 cps; rise time is 15 nanosec-0.5 μ sec, continuously variable.

Modular Concept Applied To Test Instrumentation

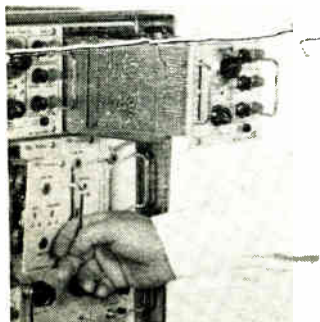

Plug-in module extended for service

Standard sub-assemblies reduce cost of special purpose equipment—

Plug-in modular construction is the basis for low-cost diversification in Servo Corporation's SERVOPULSE™ instruments line. Thirty-three cataloged instruments and 200 standard pulse and digital circuit modules afford unmatched instrument flexibility. Their advanced pulse techniques and circuitry are proved on major missile programs.

For complete details, write:

SERVOPULSE™ PRODUCTS
SERVO CORPORATION OF AMERICA



111 New South Road
Hicksville, L.I., N. Y.
WEIs 8-9700

Monica Boulevard, Hollywood 38,
Calif. (356)

CAPACITORS suitable for space vehicles. Dearborn Electronic Laboratories, Inc., P.O. Box 3431, Orlando, Fla. (357)

TINY CAPACITORS Mylar dielectrics. Cornell-Dubilier Electronics, 50 Paris St., Newark, N. J. (358)

ACTIVATED ROSIN FLUX noncorrosive. Alloys Unlimited Solder, 21-01 43rd Ave., L.I.C. 1, N. Y. (359)

DIODE BEAD MACHINE automatic. Kahle Engineering Co., 3322 Hudson Ave., Union City, N. J. (360)

CONTACT RELAYS mercury-wetted components. Potter & Brumfield, Princeton, Ind. (361)

MINIATURE THERMISTOR BEAD ruggedized. Victory Engineering Corp., 122-48 Springfield Ave., Springfield, N. J. (362)

P-C BOARD HOLDER with welded wire assembly. E. H. Titchener & Co., 8 Titchener Place, Binghamton, N. Y. (363)

TEMPERATURE DETECTORS resistance-type devices. Giannini Controls Corp., 1600 S. Mountain Ave., Duarte, Calif. (364)

PROPORTIONAL CONTROLLER highly accurate. Reeves-Hoffman, Cherry and North, Carlisle, Pa. (365)

ANGULAR MOTION COMPENSATORS single, dual shafts. American Aerospace Controls, Inc., 123 Milbar Blvd., Farmingdale, N. Y. (366)

EVAPORATED COATINGS of precision thickness. Evaporated Coatings, Huntingdon Valley, Pa. (367)

MINIATURE GEARED DIAL features 100:1 vernier ratio. Theta Instrument Corp., 520 Victor St., Saddle Brook, N. J. (368)

PLASTIC-FOAM BLENDER & dispenser. Poly Structures, 41 Montvale Ave., Stoneham, Mass. (369)

R-F TRANSFER VOLTMETER high accuracy instrument. Engelhard Industries, Inc., 113 Astor St., Newark 14, N. J. (370)

IN THE EXPANDING FIELD OF

PHOTOGRAPHY

THE UNIQUELY CONTROLLED
CHARACTERISTICS OF

CLAIREX® PHOTOCONDUCTIVE CELLS

... ARE THE BASES
FOR A GROWING NUMBER OF
PRECISION APPLICATIONS

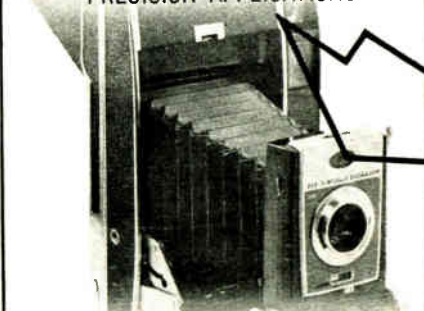

THE HEART OF THE FAMOUS
"MICROEYE" ...

in the Model 900 Polaroid® Land Camera is a Clairex cell of special design, with a sensitivity capable of controlling the precise adjustment of the exposure mechanism over a light range from less than 1/10 of one foot-candle to several hundred foot-candles.

Clairex Corporation, through:

- CAREFULLY CONTROLLED CHARACTERISTICS
- CUSTOM DESIGN AND
- ULTRA SENSITIVITY

has pioneered the use of photoconductive cells in the photographic industry. A growing number of high quality still and movie cameras, exposure meters, enlargers and projectors are now using Clairex cells.



Approximately 1/2 actual size

The broadest standard line —
5 Series in both glass and metal
packages plus unique abilities to
custom engineer . . . because "Photo-
conductors are our only business."

CLAIREX
CORPORATION

8 West 30 Street, New York 1, N. Y.
The Light Touch in Automation and Control



Literature of the Week

HALL EFFECT PACKAGES Helipot Div. of Beckman Instruments, Inc., 2500 Harbor Blvd., Fullerton, Calif., offers a data sheet on Hall effect magnetic packages. (371)

STORAGE TUBES Raytheon Co., 55 Chapel St., Newton 58, Mass. Storage tubes, both dual-gun and single-gun types, are described in a handbook published for design engineers. (372)

PRIMARY RESISTANCE STANDARDS Consolidated Ohmic Devices, Inc., New Hyde Park, N. Y. Primary resistance standards to 0.001 percent are covered in a bulletin. (373)

SEMICONDUCTOR WIRE Secon Metals Corp., 7 Intervale St., White Plains, N. Y., announces availability of a revised edition of its semiconductor wire catalog. (374)

COMPOSITION RESISTORS Campbell Industries, Inc., Dover, N. H., has available a catalog on Fixtohm deposited carbon resistors. (375)

VIBRATION ISOLATORS Korfund Dynamics Corp., 220 Cantiague Road, Westbury, N. Y. A brochure describes low-cost, compact, elastomer vibration isolators. (376)

SEMICONDUCTOR PRODUCTS Motorola Semiconductor Products Inc., 5005 E. McDowell Road, Phoenix 8, Ariz. A catalog covers standard industrial and MIL-type semiconductor products. (377)

DELAY NETWORK Ad-Yu Electronics Lab., Inc., 249 Terhune Ave., Passaic, N. J., offers a bulletin on the type 801 series continuously variable delay network. (378)

TERMINALS AND CONNECTORS Ark-Les Switch Corp., 51 Water St., Watertown 72, Mass. A 68-page catalog gives detailed information on a comprehensive line of terminals and connectors. (379)

CLIMATE CONTROL CABINET Dexon Inc., 3517 Raleigh, Minneapolis 16, Minn., has published a flier offering to send, free of charge, an atmosphere control cabinet set-up design and recommendations. (380)

NOW



MICRO-MIDGET CHOPPERS FROM STOCK!

RATINGS

Drive: 6.3 volts at 60 CPS or 400 CPS

Signal Level: 10 VDC at 2 MA max.

Size: World's Smallest

Contact Action: SPDT BBM

Temperature Range: -65°C to $+100^{\circ}\text{C}$

Life: 2,000 hours minimum

Shock: 100 G

*... plus a
noise level down to
0.6 microvolts!*



CAMBRIDGE DIVISION

CAMBRIDGE, MARYLAND



The Lincoln Laboratory program for ballistic missile range measurements and penetration research includes:

EXPERIMENTAL RESEARCH

Measurements and analysis of ICBM flight phenomena for discrimination and for decoy design purposes, including optical, aerodynamic and RF effects.

SYSTEM ANALYSIS

Studies to apply research findings to advance the technology of ICBM and AICBM systems.

INSTRUMENTATION ENGINEERING

Designing radar, optical and telemetry equipment with which to measure ICBM flight effects under actual range conditions.

RADAR SYSTEMS RESEARCH

Extending the theory and application of radar techniques to problems of discrimination, countermeasures and performance in a dense-target environment.

HYPERSONIC AERODYNAMICS

Study of the flow-fields around re-entering bodies for various body designs and flight conditions. Excellent computer facilities available.

RADAR PHYSICS

Theoretical and experimental studies in radar back-scattering. Interaction of RF radiation with plasmas.

- *A more complete description of the Laboratory's work will be sent to you upon request.*

All qualified applicants will receive consideration for employment without regard to race, creed, color or national origin.

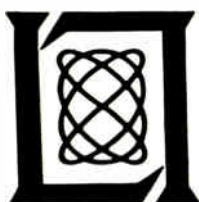

Research and Development
LINCOLN LABORATORY
Massachusetts Institute of Technology
BOX 27
LEXINGTON 73, MASSACHUSETTS

NEW BOOKS

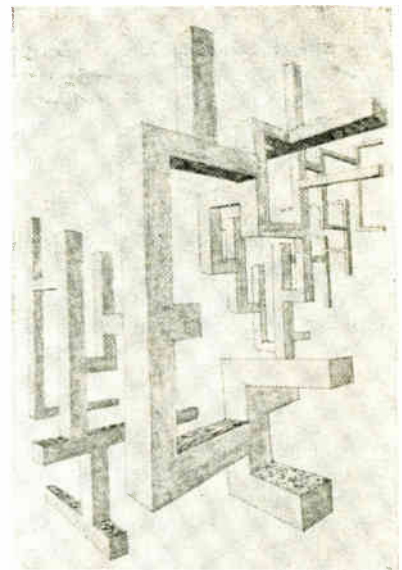

Self-Organizing Systems

Edited by MARSHALL C. YOVITS and SCOTT CAMERON

Pergamon Press, New York, 322 p, \$8.50.

This collection of papers presented at the first Self-Organizing Systems Conference is a fine introduction to the research going on in the growing field dealing with cognitive systems, and will be a necessary background for the next symposium this May by the same sponsors—ONR and Armour Research Foundation. Range of subjects is broad and leaders in this important interdisciplinary field are well-represented. The constructivist illustration (above) appears in Heinz von Foerster's discussion of orderliness in systems, "On Self-Organizing Systems and Their Environments".—N. L.

Synthesis of Optimum Control Systems

By SHELDON S. L. CHANG

McGraw-Hill Book Company, New York, 1961, \$11.75.

A general treatment of the synthesis of maximum performance control systems. Presupposing a knowledge of frequency domain and root-locus techniques of linear servo theory, the author considers the more difficult problem of choosing the parameters of a control system,

MILLIPICOSECOND TUNNEL DIODES



ELECTRONICS
PROGRESS IN SEMICONDUCTORS

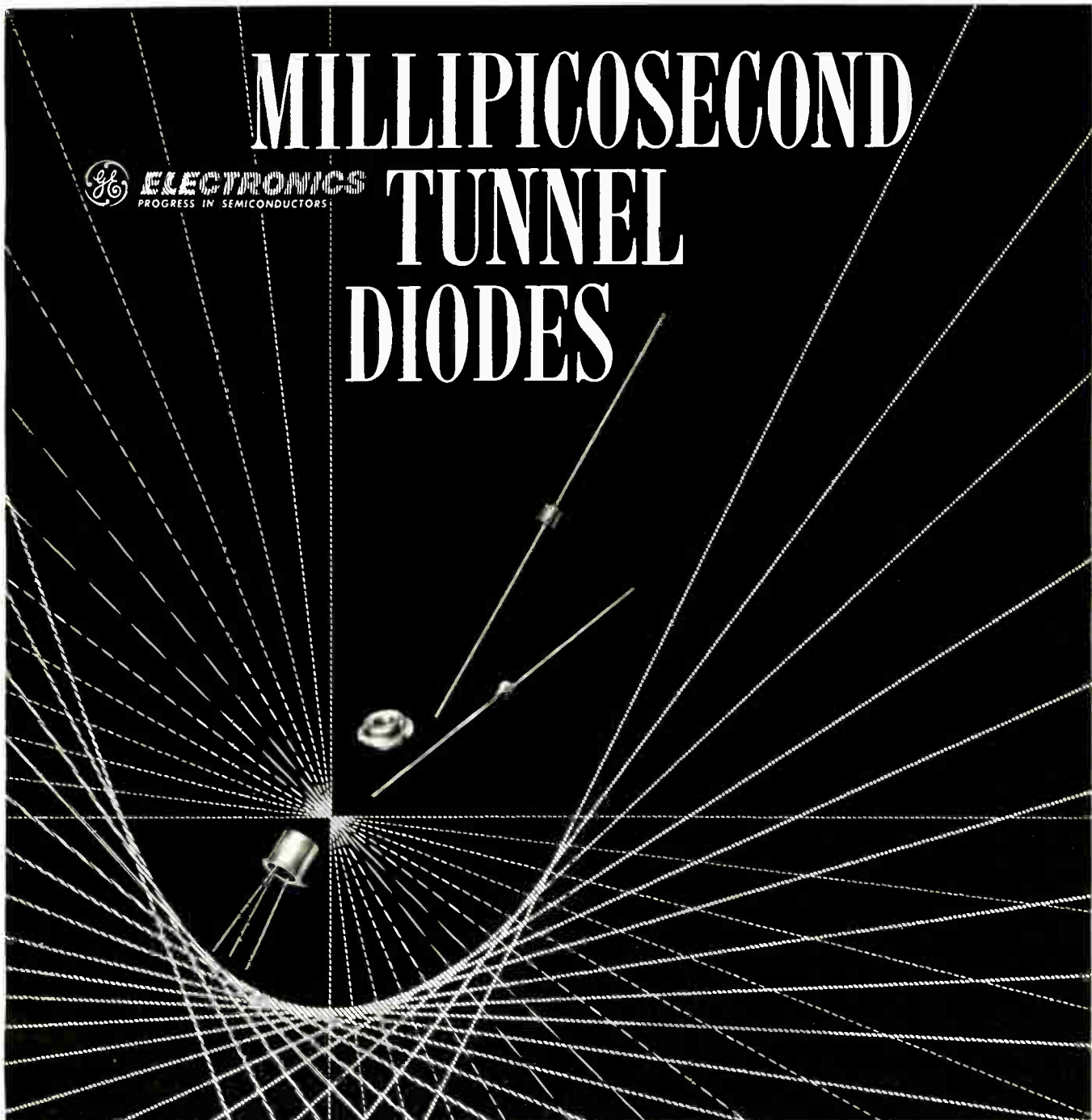

General Electric is currently supplying to customers doing advanced circuit work special tunnel diodes with switching speeds expressed in millipicoseconds (thousandths of a trillionth part of a second....) faster than can be measured by present day instruments. The best of these devices switches in the time it takes light to travel 6/1000 of an inch! We are also supplying the TD-100 series "off the shelf," with nominal switching speeds of 15 to 50 picoseconds. TD-101, 102, 103 and 104 have peak currents of 100, 50, 22 and 10 ma. with maximum capacitances of 6, 5, 4, and 2 pf respectively.

Recently introduced tunnel diode matched pairs (TDP-1 through 5) guarantee peak currents to be DC and AC matched within $\pm 1\%$ over the entire temperature range from 15 to 55° C. making possible high performance logic circuits, memory circuits, and level detectors. Also available: low level switching tunnel diodes in both axial or TO-18 package, with peak forward current ratings from 1 to 22 ma; high speed microminiature switches from 1 to 10 ma; miniature microwave communication tunnel diodes from 1 to 10 ma; and computer back diodes with forward current ratings from 5 to 30 ma. Prices now range as low as \$1.35 in 1000-up quantities.

Ask your G-E Semiconductor Products District Sales Manager about these and other production tunnel diodes *now available* to meet your particular requirements in applications such as switching circuits, oscillators, converters, and data and signal processing. For your free copy of "Applications for Tunnel Diodes" by John Phelps, G-E Manager-Application Engineering, write to Semiconductor Products Department, Section 16D126, General Electric Company, Electronics Park, Syracuse, New York. In Canada: Canadian General Electric, 189 Dufferin Street, Toronto, Ont. Export: International General Electric, 159 Madison Ave., N.Y. 16, N.Y.

GENERAL  **ELECTRIC**

for ANTENNABILITY

LOOK TO



Towers in guyed and self-supporting types for Microwave, FM and TV antenna support, Vertical Radiators, Loran, etc. in all materials.

Antennas for all services from VLF to UHF including Log Periodics, Rhombics, Corner Reflector, Vertical Radiators, etc.

TRYLON offers outstanding Antenna and Tower capability.

Use this knowledgeable, experienced source that offers:

1. Worldwide experience in military, civilian and government applications.
2. Full service and responsibility including: research, development, manufacture and installation.
3. Resourceful, experienced personnel with outstanding records of achievement.
4. Worth-while economies because we do our own manufacturing.

Full line of accessories. Full capability and facilities for testing, research and development.

Write, wire, or phone and let us help you on your requirements.

WIND TURBINE COMPANY

WEST CHESTER, PA. Phone: OWen 6-3110

TRYLON TOWER AND ANTENNA SYSTEMS
RESEARCH • DEVELOPMENT • MANUFACTURE • INSTALLATION

CIRCLE 214 ON READER SERVICE CARD

ON PW BOARDS...

INSERT these Components

Up to 10 times
FASTER!



Dynasert Component Inserting Machine slashes costs even if you insert only a few hundred components a week. Equally fast on big or small

boards, long or short runs, small (to .032" diameter) or large components. Model changeover in seconds. Dynasert automatically feeds, trims, bends leads, inserts, and clinches precisely and uniformly. Leads automatically clinched to follow circuit. Send for cost-saving facts and figures, today. Dynasert Dept., United Shoe Machinery Corporation, Boston, Massachusetts.

United

DYNASERT

CIRCLE 203 ON READER SERVICE CARD

NEW POWER SUPPLY

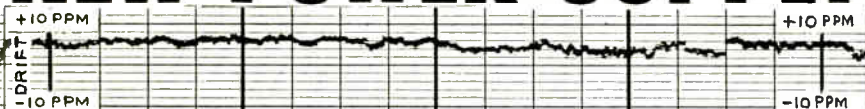

HAS $\pm 0.001\%$ STABILITY

Section of strip chart shows 8-hour stability better than ± 10 ppm ($\pm 0.001\%$) under full load (2 amps) at full voltage (60 volts). POINT FOR POINT, THIS INSTRUMENT OUTPERFORMS ANY PRECISION POWER SUPPLY MADE TODAY.

- 0.0001% line regulation
- 0.0001% load regulation
- ultra-stable, solid state
- accurate digital voltage selector
- completely short circuit protected
- electronic chopper stabilized
- internal/remote voltage sensing and control
- out of regulation indicator
- temperature controlled/stabilized reference
- selectable range automatic current limiting
- true potentiometric null sensing
- less than 50 microvolts (rms) ripple and noise
- less than 10 microhms output impedance

WRITE FOR BULLETIN NO. 101



- no voltage overshoot during turn-on/off
- $\pm 0.01\%$ long term stability
- 25 microseconds recovery time, no ringing
- adaptable to constant current operation



PRINCETON APPLIED RESEARCH CORPORATION

Post Office Box 565 / Princeton, New Jersey

134 CIRCLE 134 ON READER SERVICE CARD

Heyco Nylon BUSHINGS



STRAIN RELIEFS
The insulating bushing that anchors a cord set to an electrically operated machine or appliance.



JUNCTION-TERMINAL BUSHINGS

Eliminate "pig-tails" — Miniature size. Snap-in assembly, color or number coded. Can be used as plug-in receptacle. Simple quick disconnect.

ACCORDIAN TYPE

Fit curved surfaces
Nylon bushing — brass tab

HEYCO NYLON Snap Bushings

10 Sizes for holes from $\frac{3}{8}$ " to $1\frac{1}{2}$ " dia. — various inside diameters. Snap locks into panels up to $\frac{1}{8}$ " thick.



FREE SAMPLES! BUSHINGS OF YOUR CHOICE

HEYMAN MANUFACTURING COMPANY
KENILWORTH 2, NEW JERSEY

CIRCLE 204 ON READER SERVICE CARD
electronics

subjected to either a deterministic or random input, so as to optimize the performance. The design of self-optimizing, adaptive, and non-linear control systems is also considered.

This book is intended as a text for the graduate student, or as a reference book for servo designers or research engineers. An understanding of the Laplace transform and contour integration is essential.

Symbols, Signals and Noise

By J. R. PIERCE

Harper & Brothers, New York, 1961, 305 p, \$6.50.

SUBTITLED "the nature and process of communication", this engaging account of the basic concepts of information theory should be read by all readers of **ELECTRONICS**. The book fills in the gap between cybernetics and information theory.

Although the approach is essentially mathematical in concept, almost no formulas or equations must be struggled through. A good college-level education, not necessarily in engineering or the sciences, is required to understand the sometimes subtle, always well-argued points made by Dr. Pierce.—W.E.B.

Electronic Computers: Fundamentals, Systems, Applications

Edited by PAUL VON HANDEL

Prentice-Hall, Inc., Englewood Cliffs, N. J., 1961, 235 p, \$13.50.

VALUE of this book is that it effectively treats the general principles of operation of both analog and digital computers for persons in industry who have no specialized knowledge in these areas. Previous texts have either attempted too detailed a discussion or spoke non-technically, but also noninformatively.

In addition to the expected material, this volume contains a comprehensive treatment of the digital differential analyzer, and an extensive glossary of computer terms.—W.E.B.



Maximum crystal width with earlier design furnaces

Silicon crystal up to 1 7/8" in diameter and 10" long obtainable with new Model 2804



100%

PRODUCTION INCREASE

with the new NRC CRYSTAL GROWING FURNACE

The new NRC Model 2804 is a "Czochralski method" crystal furnace primarily designed for making single crystal ingots of silicon for semiconductor devices. However, it is easily adaptable for use with germanium and intermetallic compounds with reliability and consistently high quality.

Because the Czochralski method of growing single crystals is a critical process, it needs quality equipment with proven mechanical, thermodynamic and control features. Only from NRC can you buy a quality crystal growing unit with a proven record for high production and more profit. Buy the NRC Model 2804 with complete assurance that you can increase your production rate 100% and own the best equipment of its type available today.

UNIQUE FEATURES OF THE MODEL 2804

- Proven design for performance and reliability
- Inert gas or vacuum operation
- Precise temperature control
- Versatility of use
- Vibrationless mechanical motion-control
- Greater productivity and higher efficiency

Write today for a data sheet on the NRC Model 2804 Crystal Growing Furnace.



A Subsidiary of National Research Corp.

160 Charlemont Street, Dept. 4B
Newton 61, Massachusetts

Ampex Plans Long-Range Expansion

AMPEX CORP., Redwood City, Calif., manufacturer of tape recording equipment, will initiate a long range expansion program this summer with the construction of two new buildings totaling 150,000 square feet and costing \$5 million.

The largest of the two buildings—140,000 square feet—will house corporate headquarters for Ampex International and the Research and Engineering division. The second building will be a cafeteria with meeting rooms.

This construction, scheduled for completion before mid-1963, will culminate stage one of Ampex's planned three-part enlargement and improvement for the Redwood City facilities.

Ampex will vacate 17 of its 22 presently-leased buildings when the stage one construction is completed. After completion, the firm will continue to occupy five of the present buildings, in addition to the two new ones.

Future construction dates have not been set, but include the tentative stage two addition of two

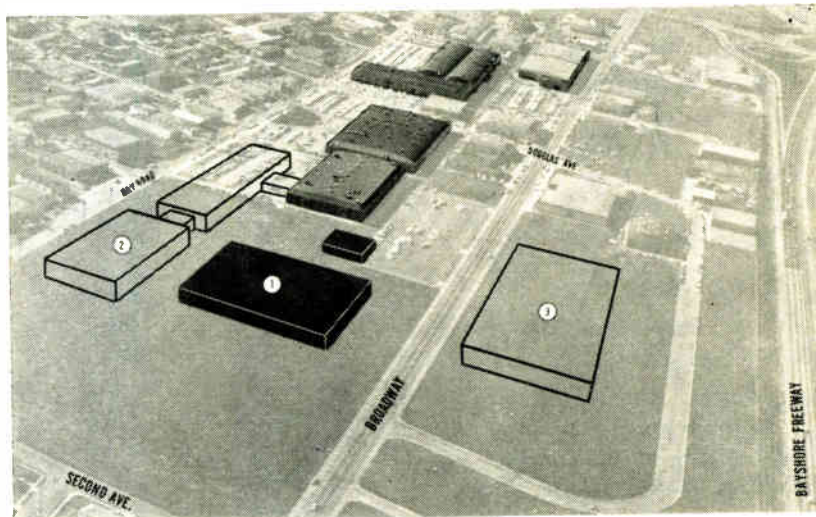

manufacturing buildings totaling 250,000 square feet. A single 170,000 square foot structure will comprise stage three construction.

Completion of the entire plan would give Ampex 7 buildings totaling 750,000 sq ft, providing space for 5,000 employees. Present plans call for retention of two presently occupied buildings.

Second and third stage building

programs will depend on expiration of currently held property leases and upon future growth and need, a company spokesman revealed.

Ampex presently employs 3,000 in Redwood City, 425 in the Audio Division, Sunnyvale, Calif., 1450 in the Computer Products Co., Culver City, Calif., and 250 in the Magnetic Tape Division, Opelika, Alabama.



**RCA Appoints
J. T. Underhill**

JOHN T. UNDERHILL recently joined the Radio Corp. of America, Data Systems division, Van Nuys, Calif., in the capacity of manager of advanced projects. His major areas of responsibility will be missile instrumentation and automatic missile check out.

Underhill was formerly an engi-

neering manager with the Cubic Corp., San Diego, Calif.

Siliconix Moving To Permanent Site

SILICONIX INC., San Francisco, a new firm engaged in design, development, manufacturing and marketing of integrated circuits and specialty semiconductors, will soon move into a permanent plant site in Sunnyvale, Calif. The company was incorporated March 5.

Company officers are Burgess Dempster, president; Richard E. Lee, vice president-general manager; and William B. Hugle, vice president, manufacturing and engineering.

Dempster is also president of Electronic Engineering Co. Lee was

market manager, Transistor Products division, Texas Instruments. Hugle was a vice president of Opto-Electronic Devices.



**Adler Electronics
Promotes Reed**

JOSEPH REED has been named manager of systems planning in the systems engineering department of the

**LOW COST
INSURANCE
AGAINST
TRANSIENT
VOLTAGE**

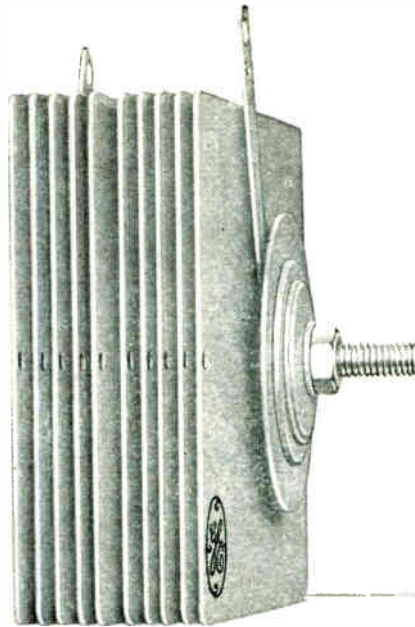
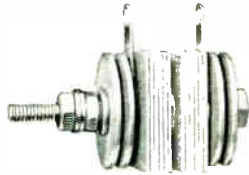

GENERAL ELECTRIC THYRECTOR DIODES

NOW AVAILABLE IN A COMPLETE LINE OF CELL
SIZES CAPABLE OF HANDLING UP TO 300 AMPS
DISCHARGE CURRENT

Increase circuit reliability at lower cost . . . reduce the possibility of expensive equipment breakdown! With G-E Thyrector Diodes, design engineers can now *know* the values to which transients will be limited in their circuit, can select silicon and germanium components rated to operate under known transient values, and can select their components according to *actual design requirements* instead of using over-rated devices.

G-E Thyrector Diodes are specially manufactured selenium rectifiers whose reverse characteristics have been altered to provide a sharp I vs. E trace, making them ideal for voltage surge suppression applications. They offer instantaneous voltage response, relative insensitivity to temperature, non-linear resistance and stability with use. Six cell sizes are available, ranging from $\frac{9}{32}$ and $\frac{15}{32}$ inch diameter disks for mounting in tubes, and 1 x 1 inch, 2 x 2 inch and 5 x 6 inch plates and $\frac{43}{8}$ inch diameter disks for stud mounting.

INSTANTANEOUS VOLTAGE RESPONSE

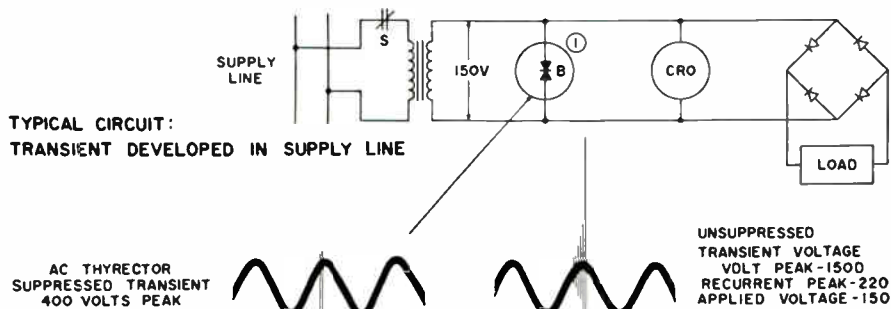

One Thyrector Diode can often save you 10, 20, or even 40 times its cost! Your General Electric Semiconductor Products District Sales Manager can give you complete information. Or write Rectifier Components Department, Section 181065, General Electric Company, Auburn, New York. In Canada: Canadian General Electric, 189 Dufferin Street, Toronto, Ont. Export: International General Electric, 159 Madison Avenue, New York 16, New York.

AVAILABLE THROUGH YOUR G-E SEMICONDUCTOR DISTRIBUTOR

GENERAL  ELECTRIC

REMOTE DATA RETRIEVERS, EVENT AND DATA RECORDERS

OPERATION MONITORS, PRINTER PLOTTERS, TIME QUANTIFIERS

SPECTRUM ANALYSIS, DENSITOMETERS, FACSIMILE RECORDERS



**THE ANSWER TO
YOUR RECORDING PROBLEMS...**

Whatever your recording problem may be—HOGAN FAXimile recorders are available, or can be designed, to fill your requirements. As many as 2000 simultaneously recording styli—up to 100 styli to the inch for high-speed facsimile—chart widths to 30" and feed rates to 50" per second.

HOGAN specializes in electrolytic techniques for event, spectrum analysis, oscillograph and facsimile recording, frequency time analysis, computer printout, automatic high speed plotting and special purpose binary and gray scale recording applications.

"Use Hogan design ability!"

HOGAN FAXimile Corporation • 635 Greenwich St., New York 14, N. Y.
A SUBSIDIARY OF TELAUTOGRAPH CORPORATION

CIRCLE 215 ON READER SERVICE CARD

ANOTHER EXAMPLE OF RIXON'S SERVICE TO ITS CUSTOMERS

**MR. LANTZER SOLVES HIS PROBLEM WITH
A SEMI-CONDUCTOR RELAY**

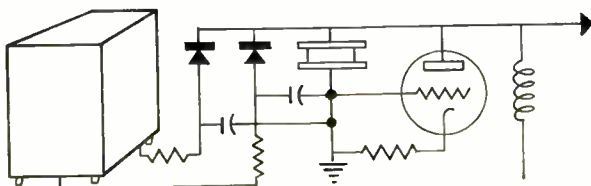

The Problem:

Mr. Floyd Lantzer, Chief Engineer, for Crosley Broadcasting Corporation's complex of high-power shortwave and AM broadcast facilities at Mason, Ohio, was given the problem of modifying one of his transmitters to superimpose a low speed teletype channel by frequency shift keying the oscillator. Two semiconductor voltage controlled diodes were added to the crystal oscillator circuit to produce plus and minus shifts around the normal frequency. Mechanical relay keying of the control voltages required extremely careful adjustment of the relay plus special filtering to overcome key clicks. At best, the solution was never fully satisfactory.

The Solution:

By independently keying the controlling voltages with the two contact circuits of a Rixon polar operated semiconductor relay, Mr. Lantzer achieved complete freedom from key clicks or transients and eliminated sensitive adjustment problems. There are no moving parts in a semiconductor relay so the usual bias, switching delay and contact bounce are nonexistent. Contact closure is inherently "soft" with transistor circuits because of their natural high frequency limitations so "key-clicks" are eliminated at their source.

THIS IS ANOTHER EXAMPLE OF A PROBLEM SOLVED AND A SATISFIED CUSTOMER



ELECTRONICS, INC.
TELEPHONE: 622-2121 TWX: 5-SPG 213

2121 INDUSTRIAL PARKWAY - MONTGOMERY INDUSTRIAL PARK - SILVER SPRING, MARYLAND

Military Products division, Adler Electronics, Inc., New Rochelle, N. Y. He will be responsible for planning and directing the department's proposal activities.

An executive engineer since joining Adler in May 1961, Reed replaces Carmen Auditore who is no longer with the company.



**Muller Assumes
New Airtron Post**

WILLIAM J. MULLER has been named product manager for the Linden, N. J., plants of Airtron, a division of Litton Industries. In his new position, Muller is responsible for the design, development, and engineering of Airtron's flexible and rigid waveguide assemblies, foundry components and precision microwave accessories.

Muller previously spent six years as general manager and chief engineer for Airtron-Canada, Ltd., producing Airtron microwave and aircraft components in Canada.

**Establish Univac
As Separate Division**

ESTABLISHMENT of Univac as an independent division of the Sperry Rand Corp., effective May 1, has been announced by H. F. Vickers, president of Sperry Rand. Univac has been a major segment of the Remington Rand Division of Sperry Rand.

Louis T. Rader, former group vice president and member of the board of ITT Corp., has been named president of the Univac Division. He will report directly to D. L. Bibby, president of the Remington Rand group and a Sperry Rand board member.

Jay W. Schnackel, general man-

ager of Univac, becomes vice president and executive assistant to Bibby.

Univac develops, manufactures and markets a complete line of punched card machines, electronic computers and related control and communications equipment for the commercial and military market.

RCI Appoints Dorman Priest

RESEARCH AND CONTROL INSTRUMENTS, INC., Woburn, Mass., announces the appointment of Dorman E. Priest as technical director. He was vice president for engineering at Calidyne Co. in Winchester, Mass., since 1955.

PEOPLE IN BRIEF

C. A. Hickman leaves Benson-Lehner to join Computer Control Co. as applications engineer. Electrical Utilities Co. promotes A. R. Milliken to chief engineer. Kurt Stern, formerly with Polarad Electronics, now a project engineer with Airtron, div. of Litton Industries. A. M. Smith, previously with General Precision Inc. and Hughes Aircraft, named production engineer for power series rectifiers at International Rectifier Corp. Neil Burgess advances at General Electric to western regional manager of the defense program operation. James C. Callahan moves up to general mgr. of the technical products div. of Packard Bell Electronics Corp. Ivan G. Easton, v-p for engineering, General Radio Co., appointed to panel 14 of the National Academy of Sciences. Halmar Electronics, Inc., ups Richard H. Dawley and Kenneth M. Povenmire to product sales mgr. and chief project engineer, respectively. Harold A. Timken, Jr., ex-Technological Associates, Inc., joins the staff of the Washington Center of C-E-I-R, Inc., as government liaison mgr. Temco Electronics Div. of Ling-Temco-Vought, Inc. has elevated Raymond D. Watson to branch mgr. of manufacturing operations and Charles F. Turrentine to branch mgr. of manufacturing services.

Sub-Miniature Indicator Lights

Conform to applicable Military Specifications.

Mount from FRONT of Panel in 15/32" Clearance Hole

NEON



T-2

Assemblies with Built-in Resistor

(A patented DIALCO feature—U.S. Pat. No. 2,421,321)

Conform to MS25257... Accommodate T-2 Neon Glow Lamps: Type NE-2D (MS25252)

is recommended for general service on 105-125 volts AC or DC. The High Brightness type NE-2J (not MS) may be used on 110-125 volts AC only.

Features: Stovepipe lens molded of high-heat plastic gives 180° light spread; available in choice of signal colors... Two terminals... Rugged construction; phenolic insulation of Mil. Spec. grade... *Anti-rotation* (locking) features prevent rotation of unit while being tightened to panel... For complete data request Brochure L-159C.

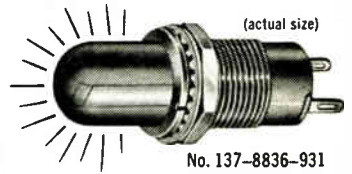

(actual size)

No. 137-8836-931

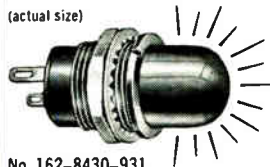

(actual size)

No. 162-8430-931

INCANDESCENT

Assemblies conform to MS25256

Accommodate T-1-3/4 Incandescent bulb with midget flanged base, in voltages ranging from 1.3 to 28 (the 6 V. and 28 V. conform to MS25237).

For complete data request Brochure L-156E.



T-1 3/4

Samples on Request—at Once—No Charge

DIALCO

PILOT LIGHTS

"The Eyes of Your Equipment"



Foremost Manufacturer of Pilot Lights

DIALIGHT
CORPORATION

58 STEWART AVE., BROOKLYN 37, N.Y. • Area Code 212, HYacinth 7-7600
CIRCLE 216 ON READER SERVICE CARD

NOW MONITOR 20 EVENTS ON ONE CHART WITHOUT INK!

The compact *techni-rite* TR 120 lets you monitor up to 20 channels of "ON-OFF" data on a new heat sensitive chart 200 feet in length. This totally new recorder accepts signals from any source — such as missile countdowns — and puts them in writing instantly and accurately.

Check These Unique Features:

- Heat Sensitive Paper No messy ink—no noxious fumes
- Easy Reading The stylus deflects indicating the event
- Stylus Actuation Simple switch closure or voltage direct into stylus electromagnets
- Chart Speeds Four electrically controlled chart speeds

Write for Illustrated Bulletin and Complete Details

techni-rite

An Important New Name in Gaging and Recording

TECHNI-RITE ELECTRONICS, INC. WARWICK, R.I. REgent 7-2000 TWX WRWK 266

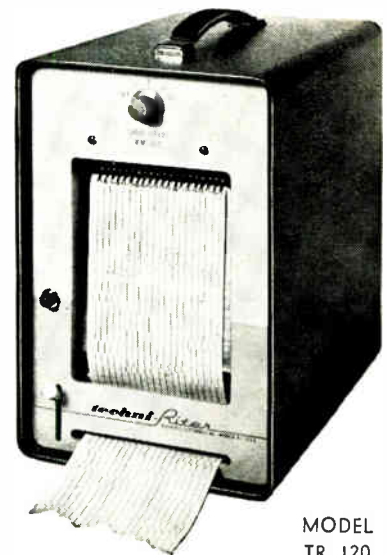

MODEL
TR 120

- Other new *techni-rites*
- TR 6260 sixty channel rack mounting event recorder
 - TR 612 two channel pen motor recorder d.c.—100cps
 - TR 628 eight channel pen motor recorder d.c.—100cps

IBM asks basic questions in computer software

How much work can computers do?



These IBM programmers are describing a machine part in AUTOPROMT, a programming language developed in cooperation with the United Aircraft Corporation.

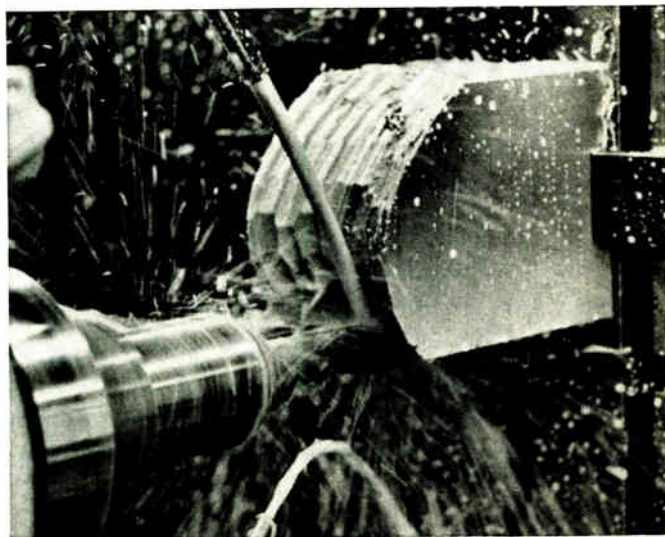

Following orders generated by an IBM computer from an AUTOPROMT program, this numerically controlled milling machine is shaping a section of a hyperbolic paraboloid.

Men use words to symbolize ideas. Computers use a vastly different kind of language. Present computer logic requires instruction in language so rudimentary that each year millions of words of programming are devoted to basically repetitive procedures. Unless ways are found to economize on this instruction, the usefulness of computers may be limited by the shortage of trained personnel to put them to work.

IBM programmers are simplifying communication with computers. Through careful selection and ordering of references to machine structure, they have developed programming systems that transfer a large part of the repetitive work in programming to the computer itself. These systems permit programmers to express their instructions in language resembling English. They also make different machines "look alike" so that programmers can state their problems with as little difficulty as possible. In addition, IBM programmers are experimenting with systems which use the computer's own capacity to construct new programming systems, such as assemblers or compilers.

Programming systems can extend beyond the level of handling machine references automatically to include applications. AUTOPROMT, IBM's system for numerical control of machine tools, is a codification of machine shop language and practice which enables a computer to determine machining instructions from a description of the part's surfaces. The computer

generates the sequence of machine tool paths required to produce the part. IBM has also developed information retrieval systems which reduce the burden of indexing, abstracting or disseminating technical information. One experimental system reduces an article to an abstract by statistically determining the most significant sentences in the article.

Eventually, programming systems may grow beyond boundaries of individual disciplines to include general information on the nature of the physical world. Such systems would be supported by information retrieval systems and inference systems capable of seeing logical consequences of retrieved information. They would allow men who direct computers to focus their attention on creative aspects of future problems. By making systems like these possible, IBM programmers and mathematicians are playing a leading role in applying the computer to ever-widening areas of human knowledge.

If you have been searching for an opportunity to make important contributions in software development, manufacturing research, optics, solid state physics, computer systems development or any of the other fields in which IBM scientists and engineers are finding answers to basic questions, please contact us. Write to Manager of Professional Employment, IBM Corp., Dept. 554Q2, 590 Madison Avenue, New York 22, New York. IBM is an Equal Opportunity Employer.

Engineers & Scientists

RAYTHEON Offers You Challenge and Opportunity Unlimited In Advanced R & D Areas

For R&D personnel who relish the chance to create, innovate, and develop in the varied fields of electronics, Raytheon's Bedford Lab offers unlimited opportunity and challenge. Teaming with an experienced group of pioneers whose capability is demonstrated by the HAWK and SPARROW Missile Systems, breakthroughs in decoy sorting radar techniques, AICBM and tactical missile defenses.

You will work—explore—create in such sophisticated areas as advanced missile systems for aircraft . . . space rendezvous guidance . . . advanced command and control techniques for missile and space applications . . . penetration systems . . . stellar and inertial and re-entry guidance systems.

Other advantages—in addition to Raytheon's comprehensive employee benefit program—include advanced study opportunities at nearby New England educational institutions. That Raytheon maintains a basic interest in your professional stature is evidenced by its recently created "scientific fellow" appointments which foster technical advancement without additional administrative responsibility.

Rewarding positions, in this deeply satisfying environment, are available now as a result of expansion in long-range programs.

Radar Digital Data Processing
Bandwidth Compression for
Digital TV
Pattern Recognition and
Advanced Digital Techniques
Test Equipment Design
Heat Transfer
Aerophysics Engineering
Space Technology
Control Systems
Structures Engineering

Product Design Engineering
(Senior Level Openings)
Aerodynamics
Circuit Design Engineering
Radar Transmitter
Microwave Engineering
Operations Research
(Weapons Systems
Requirements)
Programming
Communications Engineering

Please send your resume or phone collect to Mr. William O'Melia, CRestview 4-7100, Ext. 2138, Raytheon Company, Missile & Space Division, Bedford, Massachusetts (suburban Boston).

RAYTHEON

MISSILE & SPACE DIVISION

BEDFORD, MASSACHUSETTS

An Equal Opportunity Employer

ENGINEERS & PHYSICISTS! DALMO VICTOR CO.

(Division of Textron, Inc.)

A leader in . . .

DESIGN, DEVELOPMENT
and MANUFACTURING of

- MICROWAVE ANTENNAS,
SYSTEMS & COMPONENTS
- ELECTRONIC SYSTEMS
- MAGNETIC INSTRUMENTATION
SYSTEMS

Invites . . .

Qualified Engineers and Scientists to explore the challenging opportunities created by increased business volume and facility expansion.

Particularly attractive positions are currently available in our New Products Development Department: seeking advanced degree Scientists with experience in development of Military Systems.

Other unusual opportunities exist in

- Microwave Systems Design
and Analysis
- Electronic Systems Design
- Servo Design

Liberal employee benefits, which include Insurance, Stock Plan, Profit Sharing and Educational assistance, combine with the natural advantages of Northern California suburban living to offer an ideal environment in which to work and live.

For further information, please write, sending a copy of your resume to:

Technical Employment

DALMO VICTOR

COMPANY
DIVISION OF TEXTRON INC.

1515 Industrial Way
Belmont, California

— an equal opportunity employer —



**MANUFACTURERS'
REPRESENTATIVES**

IN THE ELECTRONIC INDUSTRY

SAMUEL K. MACDONALD, INC.

manufacturers representatives over 25 years
1531 SPRUCE STREET, PHILA. 2, PA.

Territory:
Pennsylvania • New Jersey
Delaware • Maryland
Virginia • West Virginia
District of Columbia

Other Offices:
Pittsburgh
Baltimore
Washington, D.C.

... TO THE EDGE OF SPACE AND BEYOND ...

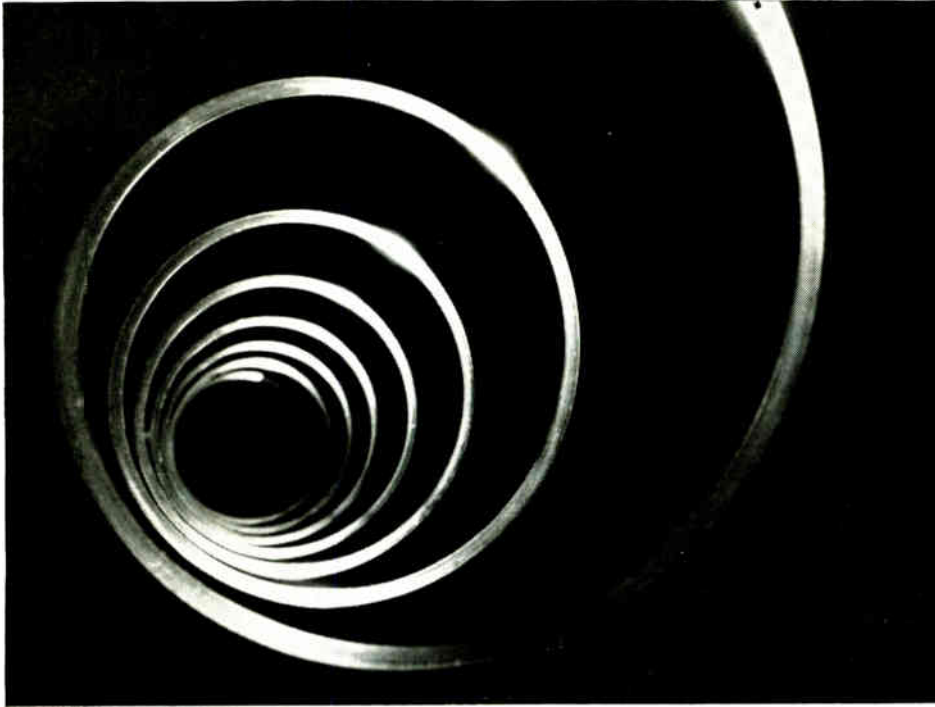

PLANNED PROGRESS

Step by step. Stride by stride. America's space program under NASA is one of carefully planned progress. Every launch, every space probe, every orbiting vehicle contributes specific information to the mass of new knowledge and technology needed to achieve the next goal.

The historic flight of Friendship 7 was a first step. More will follow. Then an 18-orbit mission. Then Gemini, carrying two astronauts, for prolonged investigations in space. And finally Apollo, which in this decade will take men to the moon and back. This is the great leap that will free mankind from his planet.

The civilian space program which NASA implements and directs is a national program with immeasurable by-products for human welfare. It is perhaps the greatest technical effort ever undertaken. Intensive scientific investigations are carried out in every field, and every modern technology. It employs weather and communications satellites, deep space and lunar probes, orbiting observatories. Thousands of problems must be solved, new technologies mastered, space oceans charted, unknown environments studied. All this must be accomplished before true space travel can be achieved by men.

To carry out its directives, NASA needs large numbers of engineers and physical scientists in all disciplines. Career opportunities for qualified men and women holding B.S., M.S., or Ph.D. degrees are virtually unlimited. In this swiftly expanding program, advancement and professional recognition can be rapid.

NASA invites your inquiry to the Personnel Director of any of the following NASA Centers: NASA Manned Spacecraft Center, Houston, Texas • NASA Goddard Space Flight Center, Greenbelt, Maryland • NASA Marshall Space Flight Center, Huntsville, Alabama • NASA Ames Research Center, Mountain View, California • NASA Flight Research Center, Edwards, California • NASA Langley Research Center, Hampton, Virginia • NASA Wallops Station, Wallops Island, Virginia • NASA Lewis Research Center, Cleveland, Ohio • NASA Headquarters, Washington 25, D. C. •

Positions filled in accordance with Aero-space Technology Announcement 252-B. All qualified applicants will receive consideration for employment without regard to race, creed or color, or national origin.

NATIONAL AERONAUTICS AND SPACE ADMINISTRATION



ENGINEERS

WORK IN AN ENGINEERS' ENVIRONMENT

AT
**SPERRY
GYROSCOPE
COMPANY**

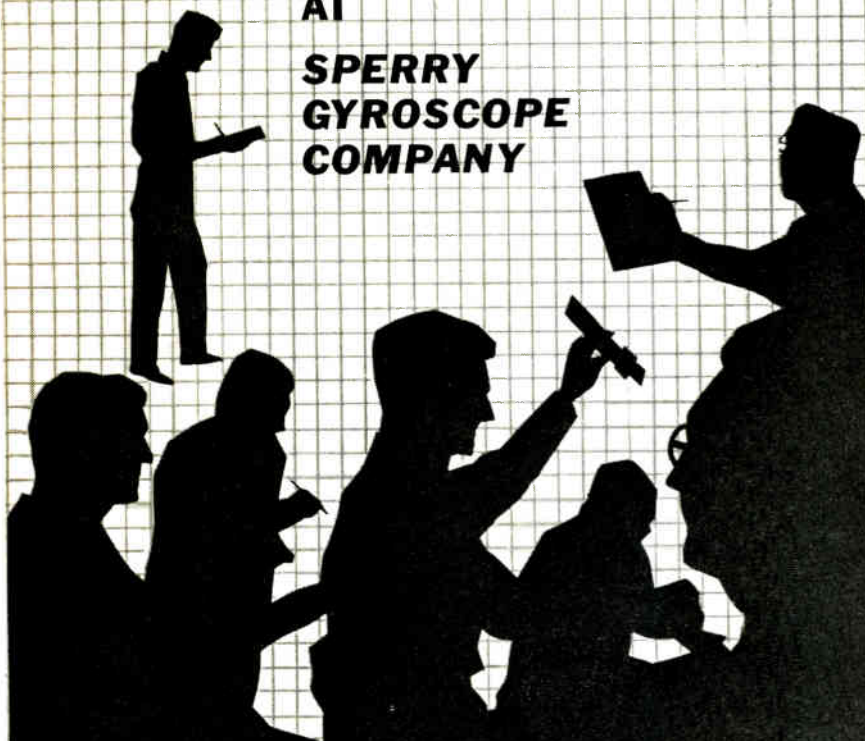

For more than fifty years engineers have acknowledged that Sperry is a good place to work. The reason? Simply stated it's because Sperry possesses a true **engineers' environment**. Here you will find the broad range of programs that insures stability and because of their advanced nature you can forget "off-the-shelf" concepts and start using your creative imagination. At Sperry you will be working with the top men in your specialty and from these men you will gain increased professional competence. Finally Sperry's management is technical management that knows an engineer's problems and recognizes his contributions.

Gain the many advantages of an engineers' environment by joining the Technical Staff at Sperry. Openings are currently available for engineers experienced in one or more of these areas:

- GYROS AND INERTIAL COMPONENTS • DIGITAL COMPUTERS • CIRCUITRY • PACKAGING • COMMUNICATIONS • SONAR • RADARS • ASW • STAR TRACKERS • CELESTIAL AND INERTIAL NAVIGATION SYSTEMS • PRECISION GEAR TRAINS • STRESS ANALYSIS • RANGE INSTRUMENTATION • MISSILE INSTRUMENTATION • FIELD ENGINEERING

Inquiries may be sent in complete confidence to:
Mr. J. W. Dwyer, Employment Manager

SPERRY

GYROSCOPE COMPANY

Division of Sperry Rand Corp.

Great Neck, Long Island, N.Y.

An Equal Opportunity Employer

EMPLOYMENT OPPORTUNITIES



The advertisements in this section include all employment opportunities—executive, management, technical, selling, office, skilled, manual, etc.

Look in the forward section of the magazine for additional Employment Opportunities advertising.

— RATES —

DISPLAYED: The advertising rate is \$40.17 per inch for all advertising appearing on other than a contract basis. Contract rates quoted on request.

An advertising inch is measured 7/8" vertically on a column—3 columns—30 inches to a page.

Subject to Agency Commission.

UNDISPLAYED: \$2.70 per line, minimum 3 lines. To figure advance payment count 5 average words as a line.

Box numbers—count as 1 line.

Discount of 10% if full payment is made in advance for 4 consecutive insertions.

Not subject to Agency Commission.

ADDRESS BOX NO. REPLIES TO: Box No. Classified Adv. Div. of this publication.

Send to office nearest you.

NEW YORK 36: P. O. Box 12

CHICAGO 11: 615 N. Michigan Ave.

SAN FRANCISCO 11: 255 California St.

POSITION VACANT

Sales Manager—Electronic Instrumentation
Manufacturer in Northeast seeks graduate electronic engineer to supervise national sales organization. Demonstrated market performance in ERA markets essential. Must be willing to travel, able to handle applications engineering problems and government negotiations. Stock options available in company with rapid growth record. P-8787, Electronics.

electronics

WEEKLY QUALIFICATIONS FORM FOR POSITIONS AVAILABLE

(Continued from page 140)

SNELLING & SNELLING Boston, Massachusetts	99°	16
SORENSEN Unit of Raytheon Co. South Norwalk, Connecticut	145	17
SPACE TECHNOLOGY LABORATORIES, INC. Sub. of Thompson Ramo Wooldridge Inc. Redondo Beach, California	13	18
SPERRY GYROSCOPE COMPANY Div. of Sperry Rand Corp. Great Neck, L.I., New York	144	19
SVERDRUP & PARCEL AND ASSOCIATES INC. St. Louis, Missouri	99°	20

* These advertisement appeared in the 4/20/62 issue.

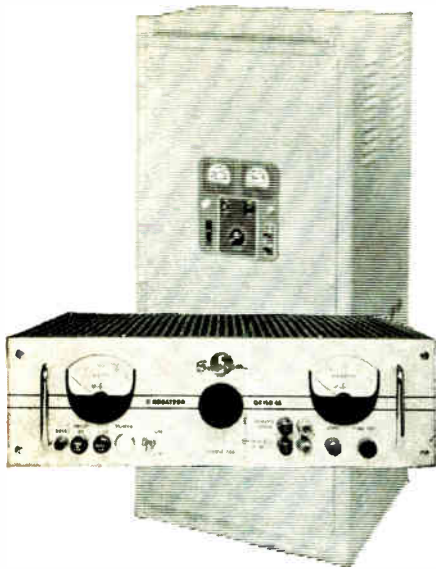

Your Career is a Step Ahead at

Sorensen

Just eight years ago, full range-variable DC Supplies stood four feet high and two feet deep in transformers, vacuum tubes and other gear of "advanced electrical technology."

Today, through sophisticated solid state design and development, Sorensen Power Supplies come in bread box sizes.

Case in Point! Sorensen continues to challenge engineers by working at the forefront of the state-of-the-art.

Present openings in advance development and product design exist for degree holding electronic engineers with 3-5 years' experience and familiarity in:

- AC & DC Switching Circuit Regulators
- Silicon Controlled Rectifiers
- Chopper Stabilized DC Amplifiers

U. S. CITIZENSHIP NOT REQUIRED

Send resume, including salary requirements to:

Miss Evelyn A. Brion,
Manager-Industrial Relations



A Unit of the Raytheon Company
Richards Avenue, South Norwalk, Conn.

An Equal Opportunity Employer

SALES MANAGER

For quality line of
microwave/RF receiving equipment

Outstanding opportunity for creative, experienced man to participate in company growth

Require BS degree, minimum 3 years microwave/RF systems development experience.

Will pay relocation up to 300 miles.

Openings also available in engineering and new products groups for engineers with microwave component and transistor circuit experience.

Write: David L. McPherson, LEL, Inc.
75 Akron St. Copiague, Long Island, N. Y.

Engineering or Science Graduates
to be trained as

INSTRUMENT SALES ENGINEERS
with

The Bristol Company

Leading manufacturer of automation equipment and control systems requires men, preferably 25 to 35 years old, to sell high quality, nationally accepted products to wide variety of industrial markets.

Openings in various areas of the country. Successful applicants take comprehensive three-months course at headquarters. Salary and expenses

All replies confidential; every inquiry answered.
Write: Charles F. Johnson, Mgr. of Sales Training

The Bristol Company

Waterbury 20, Conn.

SEARCHLIGHT SECTION

(Classified Advertising)

BUSINESS OPPORTUNITIES

EQUIPMENT - USED or RESALE

DISPLAYED

—RATES—

UNDISPLAYED

The advertising is \$27.25 per inch for all advertising other than on a contract basis. AN ADVERTISING INCH is measured 7/8" vert. on a column, 3 cols.—30 inches—to a page. EQUIPMENT WANTED or FOR SALE ADVERTISEMENTS acceptable only in Displayed Style.

\$2.70 a line, minimum 3 lines. To figure advance payment count 5 average words as a line.

BOX NUMBERS count as one line additional.

DISCOUNT of 10% if full payment is made in advance for four consecutive insertions.

Send NEW ADVERTISEMENTS or Inquiries to Classified Adv. Div. of Electronics, P. O. Box 12, N. Y. 36, N. Y.

EXCELLENT USED LABORATORY EQUIPMENT

HEWLETT-PACKARD

608D Signal Generator, factory checked, 10 MC.-420 MC., 1/2%	\$860
612A Signal Generator, factory checked, 450 MC.-1230 MC.	785
670SM Motor Sweep Oscillator, Klystron, 2.6-4.0 GC	155
H382A Precision Variable Attenuators, 7 to 10 GC, 0 to 50 db. ea.	195
130A Oscilloscope, DC to 300 KC.	265

TEKTRONIX

545 Oscilloscope, 30 MC., mobile, B, C, G, K plugins, excellent.	1845
Plugin Preamplifiers, B and K.	ea. 70
500 and 500A Scopemobiles, several.	each \$50 to \$65

AIRBORNE INSTRUMENTS

Noise Sources, 70-B-49, '51, and '52 for C, H, and X Bands.	ea. 80
Model 71 Power Supply for Noise Sources above.	95
DUMONT—Model 401 Oscilloscopes, DC to 200 KC, 10 mv/cm.	ea. 195
KAY—Megamatch, Model 181A.	335
PRECISE—20KV-5M-AR1, Regulated High Voltage Supply.	415

W. MURR, 3417 Stewarton Drive, El Sobrante, California

CIRCLE 460 ON READER SERVICE CARD

SEARCHLIGHT Equipment Locating Service

No Cost
Or Obligation

This service is aimed at helping you, the reader of "SEARCHLIGHT", to locate surplus new and used electronic equipment and components not currently advertised. (This service is for "SEARCHLIGHT" only).

How to use: Check the dealer ads to see if what you want is not currently advertised. If not, send us the specifications of the equipment wanted on the coupon below, or on your own company letterhead to:

Searchlight Equipment Locating Service
c/o ELECTRONICS

P. O. Box 12, N. Y. 36, N. Y.

Your requirements will be brought promptly to the attention of the equipment dealers advertising in this section. You will receive replies directly from them.

Searchlight Equipment Locating Service

c/o ELECTRONICS, P.O. Box 12, N.Y. 36, N.Y.

Please help us locate the following equipment components.

NAME

TITLE

COMPANY

STREET

CITY 4/27/62

FOR RESEARCH— DEVELOPMENT & EXPERIMENTAL WORK

Over 10,000 different electronic parts: waveguide, radar components and parts, test sets, pulsers, antennas, pulse xmtrs, magnetrons, IF and pulse amplifiers, dynamotors, 400 cycle xmtrs, 584 ant. pedestals, etc.

PRICES AT A FRACTION OF ORIGINAL COST!

Visit or Phone—

COMMUNICATIONS EQUIP CO.

343 CANAL ST., N. Y. 13, N. Y.
(Formerly at 131 Liberty St.)
CHAS. ROSEN, WO/rh 6-4045

CIRCLE 461 ON READER SERVICE CARD

LEARN MATHEMATICS

Today, to get ahead as a technical man, you must understand basic mathematics—logarithms, slide rule, algebraic notation and laws, various equations, progressions and series, etc. Grantham School has just recently developed an unusual home study course which can bring you up to date in these subjects. Don't let inadequacy in math hold you back. Write today.

GRANTHAM SCHOOLS, INC., Dept. 272-A
1505 N. Western Ave. Los Angeles 27, Calif.

CIRCLE 462 ON READER SERVICE CARD

LOOKING FOR USED/SURPLUS ELECTRONIC EQUIPMENT/COMPONENTS?

For an up-to-date listing of such equipment see Searchlight Section of April 13th.

Acoustical Components of Superior Quality

JAPAN PIEZO supplies 80% of Japan's crystal product requirements.

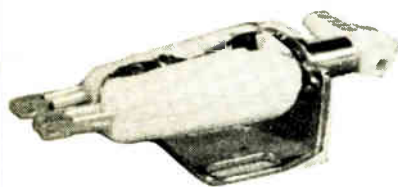
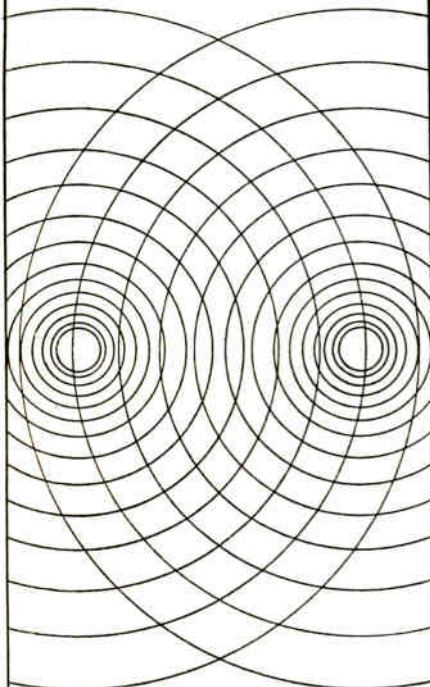

STEREO CARTRIDGE

Crystal — "PIEZO" Y-130

X'TAL STEREO CARTRIDGE

At 20°C, response: 50 to 10,000 c/s with a separation of 16.5 db. 0.6 V output at 50 mm/sec. Tracking force: 6 ± 1 gm. Compliance: 1.5×10^{-6} cm/dyne. Termination: $1M\Omega + 150$ pF.

Write for detailed catalog on our complete line of acoustical products including pickups, microphones, record players, phonograph motors and many associated products.



JAPAN PIEZO ELECTRIC CO., LTD.

Kami-renjaku, Mitaka, Tokyo, Japan

INDEX TO ADVERTISERS



Audited Paid Circulation

- AMP Incorporated 45
- Airpax Electronics, Inc. 131
- Air Products & Chemicals Inc. 114
- American Electronic Laboratories Inc. 128
- American Machine & Foundry Co.
Potter & Brumfield Div. 73
- American Optical Co. 114
- American Time Products
Div. of Bulova Watch Company, Inc. 28
- Amphenol-Borg Electronics Corp.
Connector Division 38, 39
- Applied Research, Inc. 127

- Ballantine Laboratories, Inc. 110
- Beckman Instruments, Inc.
Berkeley Division 26
- Belden Manufacturing Co. 27
- Bell Telephone Laboratories. 19
- Bendix Corporation
Semiconductor Division 121
- Bird Electronic Corporation. 107
- Borg Equipment Division, Amphenol-
Borg Electronics Corp. 79
- Bourns Inc. 41
- Bud Radio Inc. 124

- Cambridge Thermionic Corp. 129
- Celanese Plastics Co. 83
- Centralab, The Electronics
Div. of Globe-Union Inc. 17
- Chafrex Corp. 130
- Clarostat Mfg. Co., Inc. 97
- Clevite Electronic Components
A Div. of Clevite Corp. 103
- Collins Radio Co. 101
- Consolidated Avionics Corp. 93
- Consolidated Electro-dynamics
Corp. 118, 119
- Corning Electronic Components. 16
- Cubic Corp. 92

- Data-Control Systems, Inc. 80
- Daystrom Incorporated
Potentiometer Division 10, 11
- Deleo Radio 41
- Dialight Corporation 139
- Dow Corning Corp. 67

- Eleur, Inc. 24
- Electronic Instrument Co., Inc.
(EICO) 124

- FNR, A Div. of Amphenol-Borg
Electronics Corp. 20, 21
- Fairchild Semiconductor Corp. 3rd Cover
- Fairmont Chemical Co., Inc. 24
- Fansteel Metallurgical Corp. 76
- Fluke Mfg. Co., Inc. John. 95
- Ford Instrument Co., Div. of Sperry
Rand Corp. 78

- General Electric Co.
Power Tube Dept. 77
- Receiving Tube Dept. 42, 43
- Rectifier Components Dept. 137
- Semiconductor Products Dept. 133
- Gudebrod Bros. Silk Co., Inc. 108

- Heath Co. 122
- Heinemann Electric Co. 14
- Heyman Manufacturing Co. 134
- High Vacuum Equipment Corp. 113
- Hogan Faximile Corp. 138
- Hughes Aircraft Co.
Aerospace Divisions 84
- Hylelectronics Corp. 81

- Image Instruments Inc. 122
- International Telephone and Telegraph
Corp., Components Division 125
- Itek Electro-Products Co. 109

- J F D Electronics Corp. 105
- Japan Piezo Electric Co., Ltd. 146
- Jerrold Electronics Corp. 4

- Kollmorgen Corp. 87

- Laboratory for Electronics Inc. 112
- Lapp Insulator Co., Inc. 147
- Lincoln Laboratory 132
- Litton Industries
Electron Tube Div. 72

- M B Electronics, A Division of Textron
Electronics, Inc. 100
- M. Ten Bosch Inc. 127
- Machlett Laboratories, Inc. 33
- Magnetic Metals Company. 18
- Minnesota Mining & Mfg. Co.
Chemical Div. 40
- Mincom Division 15

- NRC Equipment Co. 135
- National Semiconductor Corp. 123
- Niagara Mohawk Power Corp. 37

- Ohmite Mfg. Co. 47

- Paktron, Div. of Illinois Tool Works,
Inc. 36
- Patwin, Div. of Patent Button Co. 98
- Philco Corporation 18
- Philips Gloeilampenfabrieken, N.V. 74, 75
- Plastoid Corp. 71
- Polarad Electronics Corporation. 25
- Potter and Brumfield, Div. American
Machine & Foundry Co. 73
- Precision Instrument Co. 111
- Princeton Applied Research Corp. 134

- RIG Electronics Laboratory, Inc. 127
- Radiation Inc. 68
- Radio Corporation of America 4th Cover
- Radio Materials Co. 91

- See advertisement in the July 20, 1961 issue
of Electronics Buyers' Guide for complete line of
products or services.

- Reeves Instrument Corp., Sub. of Dynamics Corp. of America..... 85
- Remington Rand Univac, Div. of Sperry Rand Corp..... 126
- Rose Engineering, Inc..... 82
- Rixon Electronics, Inc..... 138

- Sauborn Company 89
- Sanders Associates, Inc..... 24
- Sarkes Tarzian Inc..... 29
- Security Devices Laboratory..... 126
- Servo Corporation of America..... 88, 106, 130
- Sigma Instruments, Inc..... 46
- Silicon Transistor Corp..... 69
- Space Technology Laboratories, Inc..... 13
- Sprague Electric Co..... 9, 34
- Stancor Electronics, Inc..... 112
- Standard Telephones and Cables Ltd..... 102
- Synthane Corp..... 81

- Techni-Rite 139
- Technical Research Group..... 6
- Telemetric, Inc..... 115
- Texas Instruments Incorporated Apparatus Division 35, 120
- Transistor Products Division..... 117

- United Shoe Machinery Corp..... 134
- United Transformer Corp..... 2nd Cover

- Varian Associates 99
- Vitramon, Inc..... 5

- Weldmatic Division/Unitek 116
- Western Devices, Inc..... 122
- Weston Instruments A Division of Daysrom Inc..... 94
- Wind Turbine Company..... 134

MANUFACTURERS' REPRESENTATIVES

- MacDonald Inc., Samuel K..... 142

CLASSIFIED ADVERTISING
F. J. Eberle, Business Mgr.

EMPLOYMENT OPPORTUNITIES 141-145

EDUCATIONAL
Books 145

EQUIPMENT
(Used or Surplus New)
For Sale 145

INDEX TO CLASSIFIED ADVERTISERS

- Bristol Company 145
- Communications Equipment Co..... 115
- Dalmo Victor Company, Div. of Textron Inc..... 142
- Gantham Schools Inc..... 145
- International Business Machines Corp. 141
- Lel, Inc..... 145
- Murr, W..... 145
- National Aeronautics and Space Administration 143
- Raytheon Co., Missile & Space Division 142
- Sorenson, A Unit of Raytheon Co..... 145
- Sperry Gyroscope Company, Division of Sperry Rand Corp..... 144

- See advertisement in the July 20, 1961 issue of Electronics Buyers' Guide for complete line of products or services.

This Index and our Reader Service Numbers are published as a service. Every precaution is taken to make them accurate, but ELECTRONICS assumes no responsibilities for errors or omissions.

LAPP COOLING

GIVES LONGER LIFE

TO HIGH-POWER

TUBES



WATER-COOLED

Carrying cooling water which must undergo a change in potential is a job best handled by Lapp Porcelain Water Coils. These coils are completely vitrified, non-absorbent porcelain, white glazed inside and out, providing very low resistance to water flow and eliminating all possibility of contamination in the water. Assuring positive cooling and long tube life, a Lapp Porcelain Water Coil installation represents a permanent investment—a completely trouble-free cooling system.

AIR-COOLED

Use of Lapp standard-design tube supports facilitates circuit design, improves production economy, provides interchangeability and easy replacement. They are compact, efficient and attractive in appearance, with polished nickel-plated brass hardware permanently attached to the body. Equipment manufacturers will realize a triple service from these supports, for they support the tubes and act as an insulator, and channel air over the fins for maximum cooling of tubes.



WRITE for Bulletin 3C1 containing complete description and specification data. Lapp Insulator Co., Inc., 191 Sumner Street, Le Roy, New York.

Lapp

Notice to subscribers . . .

**RECENT INQUIRY
DELAYS DUE TO
CHANGE OVER
TO SPEEDY,
SAME-DAY SERVICE**

Processing of electronics reader inquiry cards has been transferred recently to high-speed computers at a new location.

During the transfer, some delays occurred, and your cards did not reach the advertisers with our usual promptness.

Should you experience a delayed response to recent inquiries, it was occasioned by the change over process, and is in no manner the fault of the advertiser.

We are back on schedule, servicing all cards on a current daily basis.

electronics



A McGraw-Hill Publication,
330 West 42nd St., N. Y. 36



electronics



Audit Bureau
of Circulations



Associated Business
Publications

Audited Paid Circulation

JAMES T. HAUPTLI

Advertising Sales Manager

R. S. QUINT:
Assistant Publisher Buyers'
Guide and Business Manager
FRED STEWART:
Promotion Manager
B. ANELLO:
Market Services Manager

RICHARD J. TOMLINSON:
Production Manager
GEORGE E. POMEROY:
Classified Manager
HUGH J. QUINN:
Circulation Manager

ADVERTISING REPRESENTATIVES

NEW YORK (36):
Donald H. Miller, Henry M. Shaw,
George F. Werner
500 Fifth Avenue, LO-4-3000
(area code 212)
BOSTON (16):
William S. Hodgkinson, Donald R. Furth
McGraw-Hill Building, Copley Square,
Congress 2-1160 (area code 617)
PHILADELPHIA (3):
Warren H. Gardner, William J. Boyle
6 Penn Center Plaza, LOcust 8-4330
(area code 215)
CHICAGO (11):
Harvey W. Wernecke, Robert M. Denmead
645 North Michigan Avenue, Mohawk 4-5800
(area code 312)
CLEVELAND (13):
Paul T. Fegley
55 Public Square, Superior 1-7000
(area code 216)
SAN FRANCISCO (11):
R. C. Alcorn
255 California Street, Douglas 2-4600
(area code 415)
LOS ANGELES (17):
Peter S. Carberry, Ashley P. Hartman
1125 W. 6th St., Huntley 2-5450
(area code 213)

DENVER (2):
J. W. Patten
Tower Bldg., 1700 Broadway,
Alpine 5-2981 (area code 303)
ATLANTA (9):
Michael H. Miller, Robert C. Johnson
1375 Peachtree St. N.E., Trinity 5-0523
(area code 404)
HOUSTON (25):
Joseph C. Page, Jr.
Prudential Bldg., Holcomb Blvd.,
Jackson 6-1281 (area code 713)
DALLAS (1):
Frank Le Beau
The Vaughn Bldg., 1712 Commerce St.
Riverside 7-9721 (area code 214)
LONDON W1:
Dennis McDonald
34 Dover St.
FRANKFURT/Main:
85 Westendstrasse
GENEVA:
Michael R. Zeynel
2 Place du Port

"Headquarters for Business Information"

McGraw-Hill Technical and Business Publications

American Machinist/Metal-
working Manufacturing
Aviation Week and Space
Technology
Business Week
Chemical Engineering
Chemical Week
Coal Age
Construction Methods and
Equipment
Construction Daily
Control Engineering
Electrical Construction
and Maintenance
Electrical Merchandising Week
Electrical Newsletter
Electrical West

Electrical Wholesaling
Electrical World
Electronics
Engineering Digest
Engineering and Mining Journal
E & MJ Metal and Mineral
Markets
Engineering News-Record
Factory
Fleet Owner
Industrial Distribution
National Petroleum News
Nucleonics
Nucleonics Week
Platt's Oilgram News
Platt's Oilgram Price Service
Power

Product Engineering
Purchasing Week
Science Week
Textile World

Overseas only:
Automobile International
(English, Spanish)
Ingenieria Internacional
Construccion (Spanish)
International Management
(English, Spanish,
Portuguese editions)
Metalworking Production
(Great Britain)

Available by subscription only — to qualified persons actively engaged in the field of the publication. For subscription rates and information describing the editorial coverage of any of the above publications, write to: Subscription Manager, Circulation Department, McGraw-Hill Publishing Company, 330 West 42nd Street, New York 36, N. Y.

SILICON PLANAR EPITAXIAL

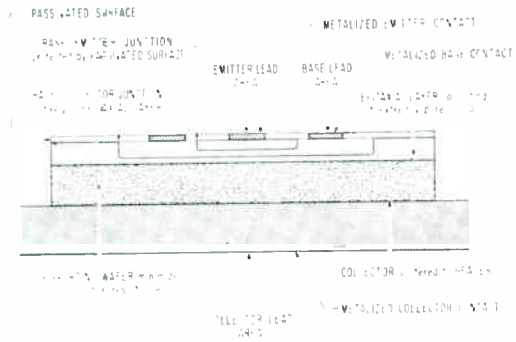

TRANSISTORS

PLANAR CONSTRUCTION features an integral passivated surface of silicon oxide over the junction, protecting it against contamination during manufacture and against change with time. Leakage current is extremely low.

EPITAXIAL CONSTRUCTION consists of a very pure, high-resistivity silicon layer grown on a lower resistance wafer.

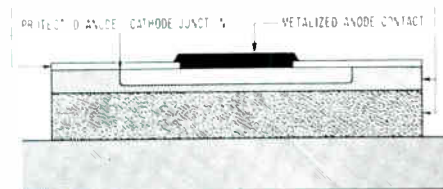

DIODES

PNP TRANSISTORS

2N995 RF and switching device with f_T typical of 150 mc and operation specified to 20 mA with low saturation resistance.

2N996 Same as 2N995 but with f_T typical of 230 mc and operation specified to 60 mA with low saturation resistance.

NPN TRANSISTORS

2N2368 2N2369 High speed saturated switch with f_T typical of 650 mc and operation specified to 100 mA.

2N2297 High current/Low saturation resistance RF or Driver

transistor with f_T typical of 90 mc and operation specified to 1 amp.

2N914 High current saturated switch with f_T typical of 370 mc for logic or driver applications. Specified to 500 mA.

2N918 RF amplifier with available power gain at 200 mc of 15 db minimum. NF @ 200 mc = 6 db typical. Oscillator — up to 1.5 kmc with 300 mW power dissipation.

DIODES

FD-6 series High speed/High conductance diodes with controlled forward conductance up to 300 mA at 1.0V with 2 nsec t_{rr} . For core matrices, avalanche circuitry, logarithmic amplifiers and for pulse applications.

The broadest line in the industry

Fairchild offers the broadest line of Silicon/Planar/Epitaxial transistors and diodes in the industry. Fairchild's Planar uniformity also makes possible and practical many combinations of these devices in matched pairs and quads, or any of a number of special assemblies. Once you've determined your design needs, call your nearest Fairchild Sales Office, or write to the Mountain View address.

Send for complete specification sheets

FAIRCHILD
SEMICONDUCTOR

545 WHISMAN ROAD, MOUNTAIN VIEW, CALIF. - YORKSHIRE 8 8161 - TWX: MN YW CAL 853
A DIVISION OF FAIRCHILD CAMERA AND INSTRUMENT CORPORATION

S.J.C.C. Booths 1 and 2
NAECON Booths 406 and 407

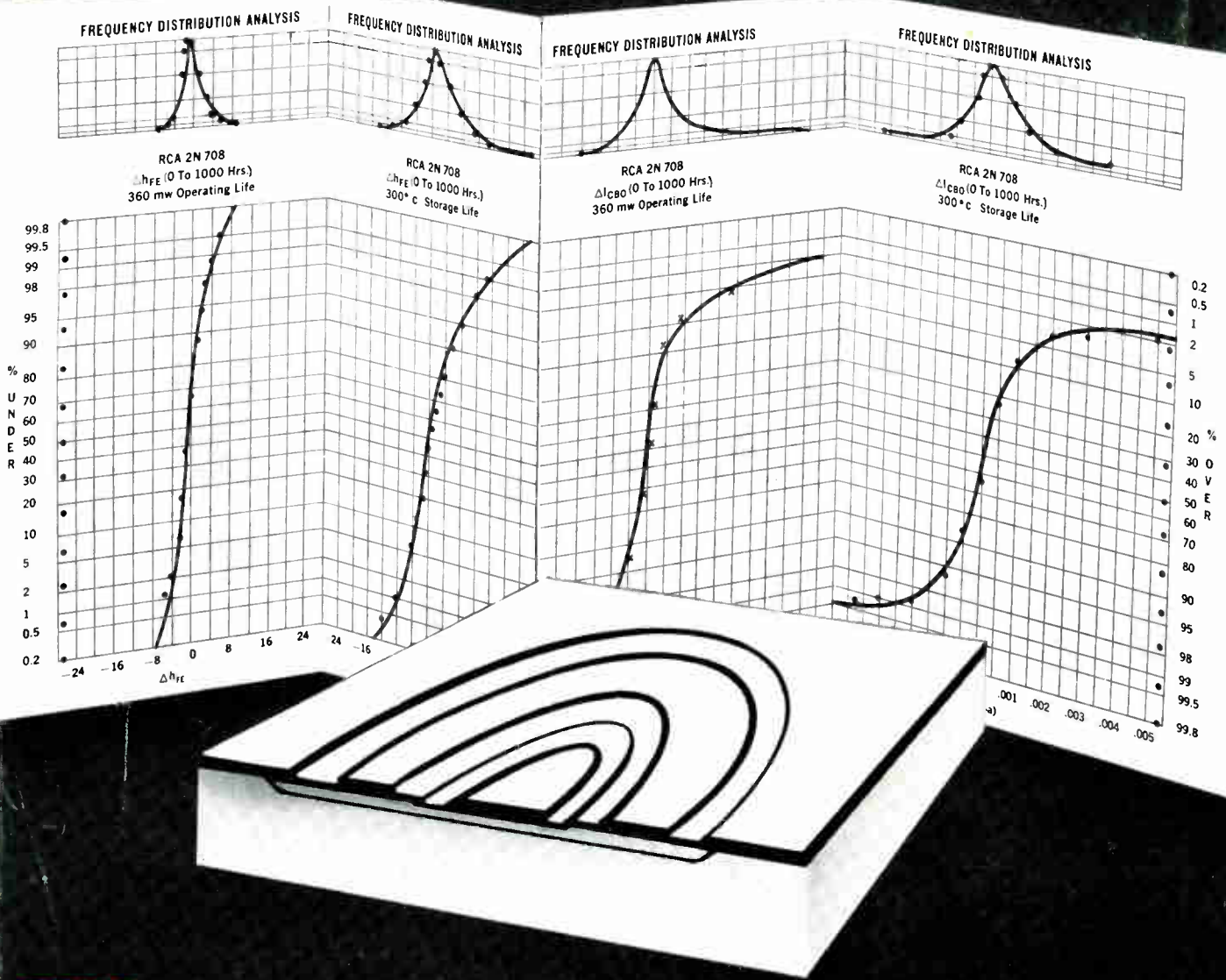

BRING NEW SILICON PLANAR STABILITY TO YOUR COMPUTER DESIGNS WITH THE RCA 2N708 TRANSISTOR FAMILY

All RCA 2N708, 2N706 and 2N706A silicon transistors—now in planar construction to assure a new degree of stability and reliability for your high-speed switching applications

Here's proof of the outstanding stability you get from RCA's 2N708 family. Check these curves which summarize the results of RCA production lot acceptance tests—a dramatic presentation of the actual production lot stability of the RCA 2N708.

In addition, here are some of the other outstanding advantages these high-speed silicon planar computer transistors will bring to your designs:

- Reduced collector cutoff current...by as much as 20 to 1 over mesa types.
- Uniform Beta over wide current range.
- Storage temperatures up to 300°C.

RCA 2N708: Proved high-reliability for very-high-speed saturated switching and high frequency amplifier applications in military and industrial equipment—designed to offer the full advantages of planar construction in low I_{CBO} and in beta stability.

RCA 2N706: Very high speed silicon planar switching transistor designed to meet MIL Specifications. field proved in a wide range of switching applications and backed by a long history of life data.

RCA 2N706A: Improved version of 2N706 for more stringent high speed applications requiring lower collector capacitance and storage time.

Call your RCA Representative today for complete reliability information on RCA 2N708 silicon planar transistors. For additional technical information write RCA Semiconductor and Materials Division, Commercial Engineering, Section D-19-NN-4, Somerville, N. J.

RCA HIGH-SPEED EPITAXIAL TRANSISTORS

RCA 2N1708: First silicon planar-epitaxial computer transistor in the TO-46 package for very high-speed switching applications in data-processing equipment.

RCA 2N2205: Identical electrically to the 2N1708, this very high-speed planar-epitaxial type is in the JEDEC TO-18 package.

RCA 2N2206: In the JEDEC TO-46 miniature package, this high-beta version of the 2N1708 features a minimum beta of 40 and storage time of 35 nsec. max.

Now available from RCA...2N834 and 2N914



The Most Trusted Name in Electronics

CIRCLE 200 ON READER SERVICE CARD