

January 5, 1962

# electronics

A McGraw-Hill Publication 75 Cents

## Our Growing Markets

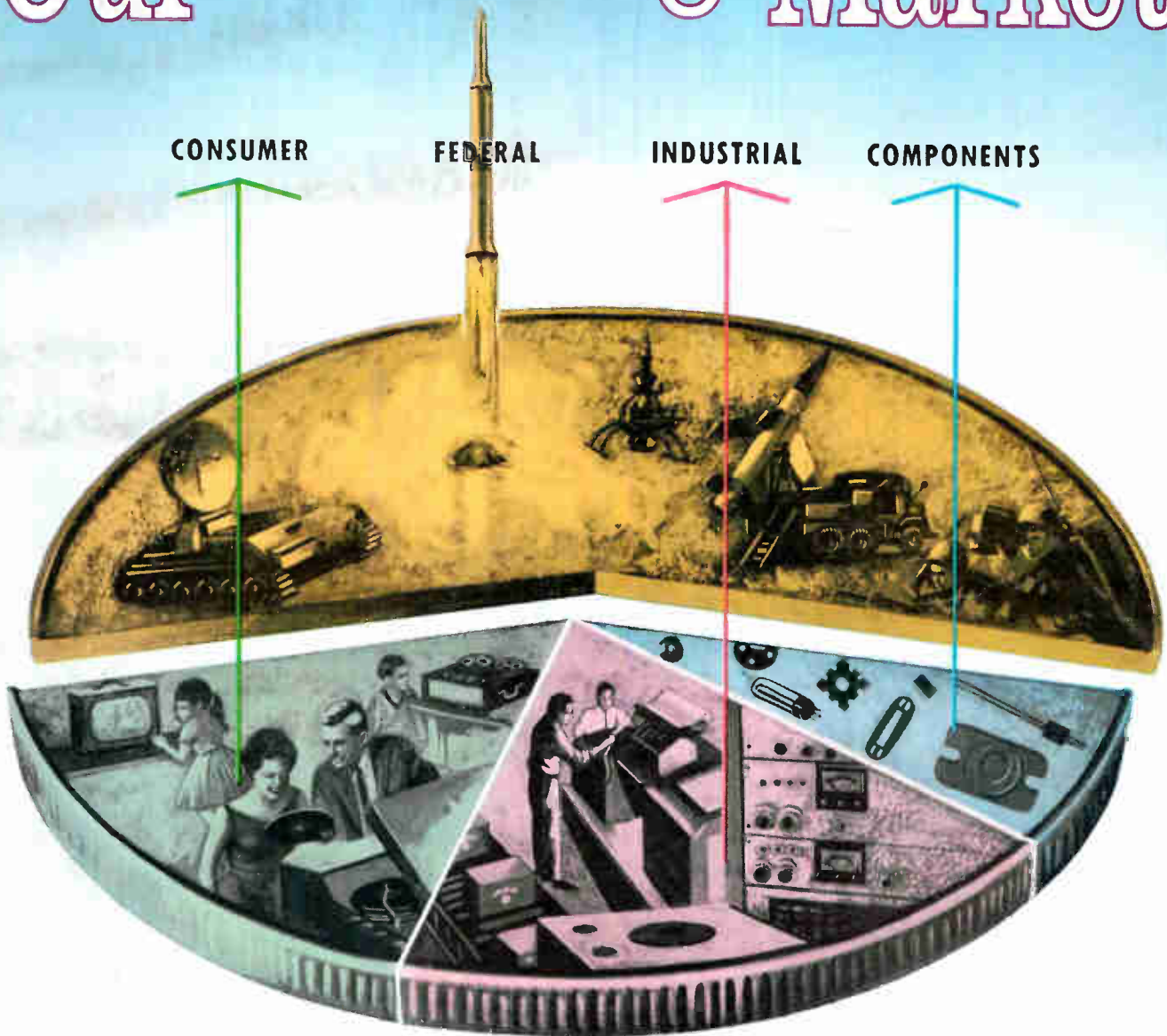

**SPECIAL REPORT** *An Analysis of the Present,  
and a Look Into the Future*

ROLAND KISSLER  
BOX 956  
MOSBY LAKE WASH  
L 11-4



# SPECIAL CUSTOM BUILT POWER

## TRANSFORMERS & REACTORS

New designs for both military and commercial types custom built to YOUR specifications for transistor and tube applications.

Exceptional quality and reliability is provided in all UTC designs. Over 30 years of engineering knowledge and experience backed by complete environmental testing and life testing facilities assure the highest standard in the industry. Full analysis and evaluation of materials are conducted in UTC's Material and Chemical Laboratories. Rigid quality control measures coordinated with exhaustive statistical findings and latest production procedures results in the industry's highest degree of reliability. Range covered in Power Transformers is from milliwatts to 100 KVA.

### SOME TYPICAL APPLICATIONS:

- Current Limiting
- Filament
- Isolation
- Plate
- Transistor Inverter
- Transistor Supply

**SPECIAL  
CUSTOM BUILT  
IRON CORE  
COMPONENTS  
FOR  
EVERY PHASE  
OF THE  
ELECTRONICS  
ART** →



Write for catalog of over 1,000 STOCK ITEMS with UTC High Reliability IMMEDIATELY AVAILABLE from your local distributor.

**POWER TRANSFORMERS • AUDIO TRANSFORMERS  
REACTORS • PULSE TRANSFORMERS • ELECTRIC  
WAVE FILTERS • LUMPED CONSTANT DELAY LINES  
HIGH Q COILS • MAGNETIC AMPLIFIERS  
SATURABLE REACTORS • REFERENCE UNITS**

## UNITED TRANSFORMER CORP.

150 VARICK STREET, NEW YORK 13, N. Y.

PACIFIC MFG. DIVISION: 3630 EASTHAM DRIVE, CULVER CITY, CALIF.

EXPORT DIVISION: 13 EAST 40th STREET, NEW YORK 16, N. Y.

CABLES: "ARLAB"

# electronics

A McGraw-Hill Publication 75 cents



W. W. MacDONALD, Editor

J. M. CARROLL, Managing Editor  
 SENIOR EDITORS: Samuel Weber, George W. Sideris. SENIOR ASSOCIATE EDITORS: William E. Bushor, Michael F. Wolff. ASSOCIATE EDITORS: Michael F. Tomaino, Sylvester P. Carter, William P. O'Brien, John F. Mason, Thomas Emma, Sy Vogel, Leslie Solomon, M. M. Perugini, George J. Flynn, Laurence D. Shergalis. ASSISTANT EDITORS: Nilo Lindgren, Stanley Froud, Stephen B. Gray, Roy J. Bruun, George V. Novotny, Leon H. Dulberger. REGIONAL EDITORS: Harold C. Hood (Pacific Coast, Los Angeles), Thomas Maguire (New England, Boston), Cletus M. Wiley (Midwest, Chicago). ART DIRECTOR: Harry Phillips; Howard R. Berry. PRODUCTION EDITOR: John C. Wright, Jr. EDITORIAL ASSISTANTS: Gloria J. Meurer, Bernice Duffy, Lorraine Rossi, Virginia T. Bastian, Lynn Emery, Laura W. Smith, Bette H. Snyder, Rosemary Abbruzzese, Judy Haskins. FOREIGN NEWS BUREAU: Director, John Wilhelm, Alyne Elias. London—John Shinn, Derek Barlow, Nickolas Landon. Bonn—Peter Forbath, James Morrison, Silke McQueen. Paris—Robert Farrell, Arthur Erikson. Milan—Gene DiRaimondo. Mexico City—Bruce Bendow. Rio de Janeiro—Leslie Warren. Moscow—Stewart Ramsey. Tokyo—Richard Hallaron, Charles Cohen, John Yamaguchi.

JAMES GIRDWOOD, Publisher

**MILITARY AND GOVERNMENT** procurement is today by far the dominant influence on the electronics industry's growth and health. *This year, industrial electronics will also outstrip consumer and component sales.* See p 35 **COVER**

**PREDICTIONS:** Competition Forces Careful Market Selection in 1962. Faced in many cases with lower profits on higher volume, business leaders seek virgin markets. *Serve other industries and use up our surplus production capacity* **20**

**MAN AROUND THE MOON.** Here's a rundown on U. S. and USSR plans for flights to the moon. Chances are that the Russians will make an attempt before we do. *It may even happen this month* **26**

**GLOBAL WEATHER NET.** Air Force is gradually building a system that will semiautomatically gather weather data, process it and swiftly transmit forecasts to stations around the world. *Network will open a new market for special radar* **28**

**ELECTROHYDRODYNAMIC GENERATOR** May Yield Megawatt Power. Changing the kinetic energy of gases to electrical power by a process akin to electrostatics looks promising for space power. *System puts out more electrical power than it uses.* **30**

**OUR GROWING MARKETS.** Annual survey of electronics industry covers industrial, federal, consumer, components and foreign markets. Total for 1962: \$16.8 billion. *Military markets are still the biggest, but the pattern is changing; less money for hardware, more for pure engineering.* T. Emma, S. B. Gray, L. H. Dulberger and B. Anello **35**

**OPTICAL CHARACTER RECOGNITION:** Solving Registration Problems. Vertical registration is a knotty problem in design of optical character recognition systems. The authors discuss several approaches, give theirs in detail. *Sawtooth sweep is compared with earliest character video encountered in vertical sweep. Potential of charging capacitor provides an analog marker.* J. Bauldray and E. Milbradt **77**

Contents continued



Published weekly, with Electronics Buyers' Guide and Reference issue, as part of the subscription, by McGraw-Hill Publishing Company, Inc. Founder: James H. McGraw (1860-1948).

Title ® registered U.S. Patent Office; © Copyright 1962 by McGraw-Hill Publishing Co., Inc. All rights reserved, including the right to reproduce the contents of this publication, in whole or in part.

Executive, editorial, circulation and advertising offices McGraw-Hill Building, 330 West 42nd Street, New York 36, N. Y. Telephone Longacre 4-3000. Teletype TWX N.Y. 1-1636. Cable McGrawhill, N. Y. PRINTED IN ALBANY, N. Y.; second class postage paid.

OFFICERS OF THE PUBLICATIONS DIVISION: Nelson L. Bond, President; Shelton Fisher, Wallace F. Traendly, Senior Vice Presidents; John R. Callahan, Vice President and Editorial Director; Joseph H. Allen, Vice President and Director of Advertising Sales; A. R. Venezian, Vice President and Circulation Coordinator; Daniel F. Crawley, Vice President and Controller.

OFFICERS OF THE CORPORATION: Donald C. McGraw, President; Hugh J. Kelly, Harry L. Waddell, Executive Vice Presidents; L. Keith Goodrich, Executive Vice President and Treasurer; John J. Cooke, Vice President and Secretary.

Subscriptions are solicited only from those actively engaged in the field of the publication. Position and company connection must be indicated on orders. Subscription rates: United States and Possessions, \$6.00 one year; \$9.00 two years; \$12.00 three years. Canada, \$10.00 one year. All other countries \$20.00 one year. Single Copies, United States and Possessions and Canada 75¢; Buyers' Guide \$3.00; Single copies all other countries \$1.50; Buyers' Guide \$10.00.

THE PUBLISHER, UPON WRITTEN REQUEST FROM ANY SUBSCRIBER TO OUR NEW YORK OFFICE, AGREES TO REFUND THAT PART OF THE SUBSCRIPTION PRICE APPLYING TO COPIES NOT YET MAILED.

Subscribers: Please address all correspondence, change of address notices, subscription orders or complaints to Fulfillment Manager, Electronics, at above address. Change of address notices should provide old as well as new address, including postal zone number if any. If possible, attach address label from recent issue. Allow one month for change to become effective.

Postmaster: Please send Form 3579 to Fulfillment Manager, Electronics, 330 West 42nd Street, New York 36, New York.



Audited Paid Circulation

CONTENTS continued

SERVO-TUNED TRANSCEIVER for Airborne VHF Communications. The operator has only to switch in the proper crystal and a servo system using the crystal oscillator output slug-tunes all transceiver tank circuits. *A special bonus in this article is a noise limiter with a 1,000-to-one signal-to-noise ratio. Trick is to use a long time-constant R-C circuit.* K. Makino and T. Yamanaka 82

WHITE NOISE SIGNALS Aid Systems Analysis. Random signals of analytically known and time invariant statistics are needed for simulating, testing and analysing low-band-pass control signals. *The solution is to drive 20 sine-cosine potentiometers through successive gear trains by a single, constant-speed a-c motor.* N. Diamantides 86

SINGLE-TURN RECORDING HEADS. These recording heads for a magnetic drum memory need only a single turn of wire over magnetic material. *You can't get something for nothing. The heads are cheaper and easy to manufacture but they require a large write current.* H. J. Kump 89

HALL GENERATOR Equivalent Circuit Development. Equivalent circuit is synthesized by describing the basic physical phenomena in matrix form and manipulating the matrix. *Permits derivation of current and voltage gain and input impedance. Here's an article for the textbooks of the future.* J. W. Motto, Jr. 90

DEPARTMENTS

Crosstalk. Not Too Far Too Fast	3
Comment. Optical Superheterodyne Receiver	4
Electronics Newsletter. Parts Supply Center	7
Washington Outlook. Spacecraft Rendezvous	12
Meetings Ahead	32
Research and Development. Thermocouple Compensating Circuit Design	98
Components and Materials. Rhenium-Tungsten Alloy Improves Filament Wire	108
Production Techniques. How to Make Reliable Welds	116
New Product Design. Latent Heat of Fusion Controls Crystal Oven Temperature	128
Literature of the Week	154
Books. Introduction to Feedback Systems	156
People and Plants. Philco Realigns Organization	160
Index to Advertisers	170



# Not Too Far Too Fast

AMERICAN MANUFACTURERS, speaking generally, are opposed to reduction of tariffs. It is necessary that they be vocal in their opposition in order to counteract at least equally vocal proponents, and so suggest a compromise. This is our democratic way.

It seems certain that the argument about tariffs in Washington will be a long one. It also seems certain there will be reductions. For a sound argument can be offered that it is in our international political interest to facilitate trade with the common market. And a sound one can also be advanced that some protection of our internal market is still necessary. We think the first argument will take precedence, but not to the exclusion of the second.

While we too hope that American ingenuity can still compete in the export market, it is not easy. Cooperating European nations have considerable ingenuity of their own, and now also have modern production machinery to go with it. They frequently buy raw materials below our costs and, what is more important, their wage rates including fringe benefits are considerably less. Comparative productivity per man-hour can be argued, but not with us. Europeans work hard and well.

It is difficult to imagine how a sufficient number of conventional American products could be sold in Europe in the immediate future to compensate for the loss of internal business if European products of comparable nature came in here without restriction. Specialized items are another story, and can be sold in any market.

The reason for this very real clash between our international needs and our internal needs is the difference between living standards here and in Europe. European standards continue to rise rapidly. Assuming that they must rise still more in the free world's mutual interest, equalization will take time. That's why we urge, on this business of tariff reduction . . .

Let's not take it too far too fast.



## A Fresh Look

LONG-RANGE VIEW of the electronics industry's prospects and problems is difficult to acquire from following week-by-week happenings. Readers tell us that it is hard enough to keep up with technical and business developments in their own specific fields. If the industry were so mature—or so senile—that each man, each company, each product line comfortably filled its niche, it wouldn't matter. But electronics is a new world, not an old one.

Reflecting this need, each year at this time we make a fresh evaluation of the year's many developments and prepare a special market report on what has been happening and what is likely to happen in the electronics business. We don't own a crystal ball. But we do have an informed staff and friends in the industry willing to share their specialized knowledge.

This year's report, "Our Growing Markets" (p 35), shows, for example, that one of the major patterns emerging in the industry is a growing emphasis on specialized components and systems. Characteristic of this are the new military systems. Tied to this trend is a more vigorous search for industrial applications of products and components born in military R&D.

**VERY NARROW**

10kc\*

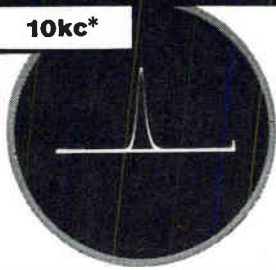

**TO VERY WIDE**

400mc\*\*

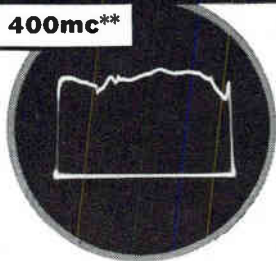

**SWEEP WIDTHS**  
...all in one instrument

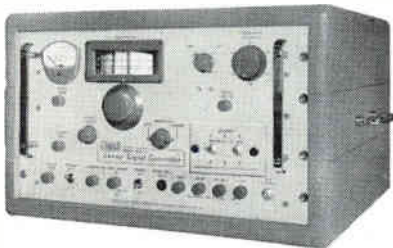

**NEW JERROLD® 900B**  
**SWEEP SIGNAL GENERATOR**

The new Jerrold 900B is the last word in versatility and precision, the ultimate instrument for all your IF, VHF, and UHF sweep requirements. Bench space requirements and test set-up time are drastically cut because so much is already built in:

- Built-in crystal-controlled harmonic markers at 1, 10, and 100mc intervals.
- Built-in variable-gain dc or ac-coupled 'scope preamplifier with 200X maximum gain.
- Built-in precision attenuator from zero to 50db in 10db steps.

Generating sweeps with center frequencies ranging from 500kc to 1200mc, the 900B offers unusual stability with sweep widths as narrow as 10kc and as wide as 400mc. Write for complete technical data.

**\$1,980.00** f.o.b. Philadelphia

\*Typical communication receiver IF (selectivity approx. 6 kc).

\*\*Frequency response of typical wide-band distributed amplifier (4-216 mc).

**JERROLD®** ELECTRONICS CORPORATION  
Industrial Products Division, Dept. ITE-126  
The Jerrold Building, Philadelphia 32, Pa.  
Jerrold Electronics (Canada) Ltd., Toronto  
Export Representative: Rocka International, N.Y. 16, N.Y.

COMMENT

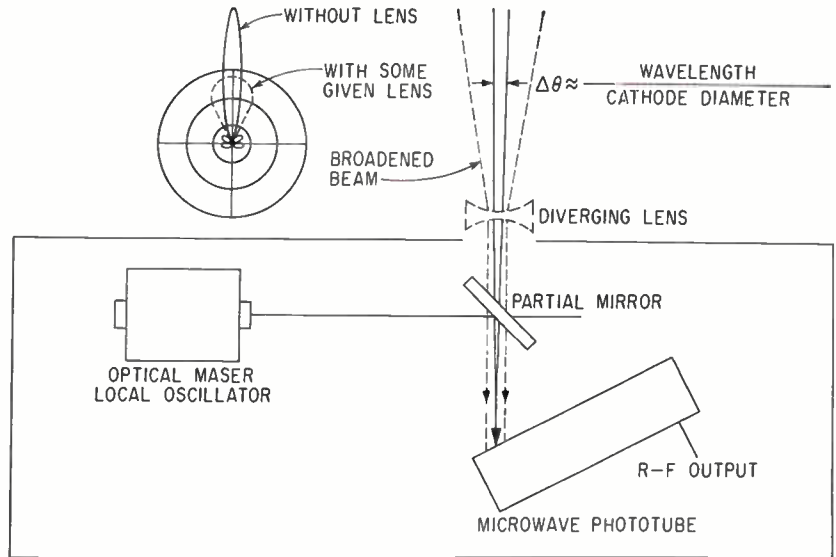

**Optical Superheterodyne Receiver**

I thought your articles on lasers [p 39, Oct. 27; p 40, Nov. 3; p 81, Nov. 10; p 54, Nov. 24] were very well done.

Your Sept. 15 issue (p 20) mentioned photomixing and optical superheterodyne experiments with an optical maser, carried on by B. J. McMurtry and myself at Stanford University. Since then we have continued this work, which is supported by the U. S. Army Signal R&D Lab., Ft. Monmouth, and the Phys. Sci. Div. of OSR.

In the drawing of the optical superheterodyne,  $\Delta\theta$  is the angular width of the cone-shaped beam that carries the received signal to the cathode of the microwave phototube, and is equal to wavelength over cathode diameter, or over the diameter of the local oscillator light-spot on the photocathode, if the spot is smaller than the cathode.

The inset shows polar plots of gain vs angle, with and without an added lens to broaden the beam. Without the diverging lens, the receiving lobe would be very narrow, as the polar plot shows. In other words, as a receiving antenna it would have a very narrow beam, with extremely high antenna gain in the main lobe. If a diverging lens is placed in the beam almost anywhere beyond the partial mirror (the dashed lines show one located at the entrance to the box enclosing all the parts), the lens would

broaden out the receiving pattern as shown. This will also reduce the gain within this broadened lobe.

As a matter of information, the reason the receiving beam is so narrow is that the signal and local oscillator lightwaves must arrive at the photocathode with their wavefronts parallel: the two light-beam wavefronts must have the same relative phase all across the cathode. The reason the nonparallel case won't work is that the two sides of the cathode will produce cancelling rather than adding beats, because of the 180-degree shift in relative phases of signal and local-oscillator waves. The situation is something like a distributed balanced mixer in the non-parallel case, but you're not providing the push-pull i-f input that a balanced mixer requires.

A. E. SIEGMAN

Stanford University  
Palo Alto, California

**East Is East**

In your Electronics Newsletter of Nov. 24 (p 10), in the lower right-hand corner, reference is made to a \$766,587 Air Force frequency counter contract that has been credited to Northwestern Engineering.

We would very much appreciate a correction to indicate that the contract was obtained by Northeastern Engineering.

DAVID S. KROMKA  
Northeastern Engineering, Inc.  
Manchester, New Hampshire

SAVE up to  
**40%**  
 in board space!.....

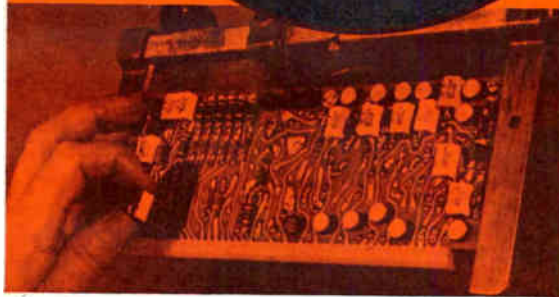
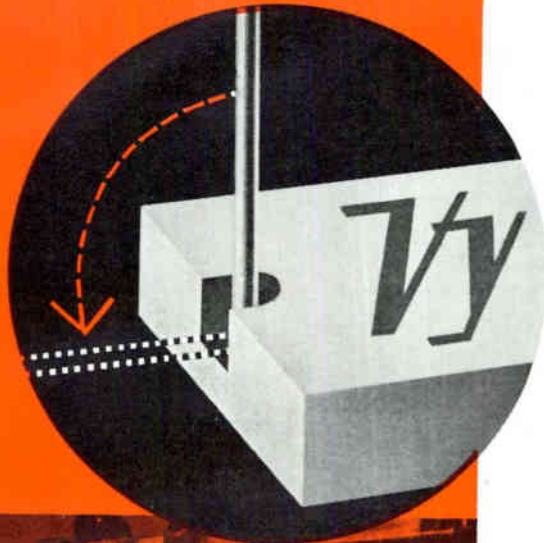

with unique design that offers  
**TRUE**  
**RADIAL LEAD**  
**CONFIGURATION**



**Plus Provision For**  
**Axial Lead Application**

$\frac{1}{4}$ " multiplied by the number of capacitors used on your circuit boards is the amount of space you can save by substituting "VY" Axial-Radial Capacitors for the axial units you may now be using.\* Leads are *inboard* the body in radial configuration, yet may be moved to a *straight* axial position when required. Available in four sizes, 0.5 to 5600 mmf, 300 and 500 v ratings.

\*Assuming minimum allowance of  $\frac{1}{8}$ " for lead bend at each end of body for axial capacitors

**VY** Axial-Radial Capacitors  
 vs. Axial Lead Capacitors

**VY 12 Axial-Radial Capacitor**



Length  $\frac{3}{8}$ "  
 Board Space Required  $\frac{3}{8}$ "

(No allowance necessary for lead bend)

**VY 13 Axial Capacitor**



Length  $\frac{3}{8}$ "  
 Board Space Required  $\frac{5}{8}$ "

**Brand "X" Axial Capacitor**

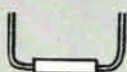

Length  $\frac{11}{32}$ "  
 Board Space Required  $\frac{19}{32}$ "

**CONFORMS TO MIL-C-11272B**

© VITRAMON, INC., 1961

**Vitramon**<sup>®</sup>  
 INCORPORATED  
 P.O. Box 544 Bridgeport 1, Connecticut



Photograph of a Fairchild Teardrop configuration transistor magnified 58 times. Approximate dimensions of actual unit: 50 mils square; 30 mils in depth.

# PLANAR MAKES IT POSSIBLE...

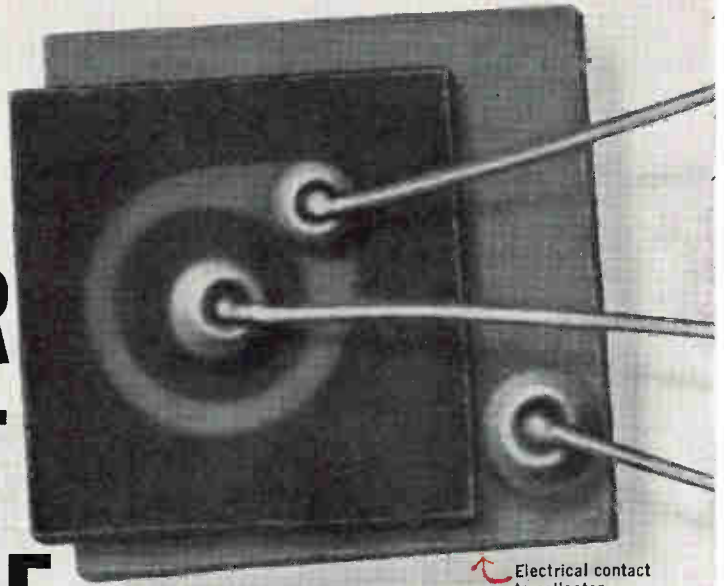

↑ Electrical contact to collector may be made by direct solder to molybdenum tab.

## MOLYTAB\*

ALL FAIRCHILD PLANAR DEVICES ARE AVAILABLE IN MOLYTAB FORM. Never before has there been more dramatic or tangible proof of the natural superiority of Fairchild's Planar process. This process alone provides all the protection these devices need—through all stages of manufacturing and operation. Performance is unchanged by time, use or exposure to foreign matter. MOLYTAB Silicon Planar devices are ideal for many applications where small size and reliability are essential, such as thin film and potted work. For further information on specific devices, contact your local Fairchild Field Sales Office.

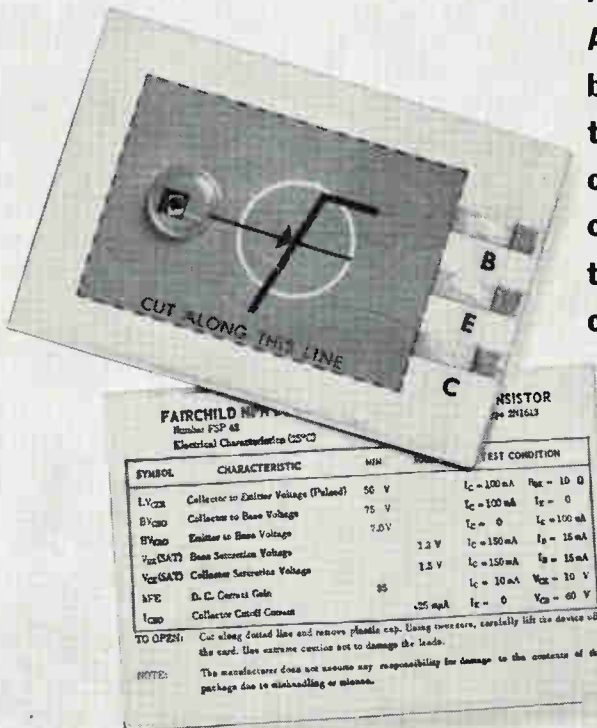

Actual size. Units are delivered as shown for testing in container. Specifications on back of each unit.

\*MOLYTAB is a trademark of Fairchild Semiconductor, referring to any Fairchild Planar transistor or diode mounted on a gold plated, molybdenum substrate. Leadwires are gold for standard welding techniques.

# FAIRCHILD

## SEMICONDUCTOR

545 WHISMAN ROAD, MOUNTAIN VIEW, CALIF. • YORKSHIRE 8-8161 • TWX: MN VW CAL 853  
A DIVISION OF FAIRCHILD CAMERA AND INSTRUMENT CORPORATION

# ELECTRONICS NEWSLETTER

## Parts Supply Center Operational July 1

PENTAGON is setting up a Defense Electronics Supply Center at Gentile AFB, Dayton, Ohio, to handle purchasing, warehousing and other supply management functions for common-use electronic parts. It will become operational July 1. Consolidation of common-use components has been in the works for close to two years.

During its first year of operation, the center plans to reduce from 1.2 million to 680,000 the number of parts used by the services. Standardization, simplification and elimination of duplication will be used to cut down variety. The center will buy \$143 million in parts the first year and about \$198 million the next year. Electron tubes will be the first item handled for all the services.

The center will be one of several major units in the recently established Defense Supply Agency, which began operations January 1. It is in charge of a \$3.2-billion inventory of commercial-type commodities. The bulk of military procurement, end items and specialized major components, will continue in the hands of the usual military agencies.

## Report R-F Modulation By Organic Semiconductor

RADIO-FREQUENCY modulation capability in organic semiconductors (ELECTRONICS, p 68, Jan. 22, 1960; p 31, Apr. 28, 1961) was reported last week by Frank Alexander, head of the semiconductor physics group at American Viscose's research facility at Marcus Hook, Pa. He said polymer samples prepared by Morris Danzig have been used in simple nonlinear devices to audio-modulate r-f energy in the 500-Kc to 5-Mc range.

## Laser Treats Tumor in Retina of Human Eye

PHYSICIANS at Columbia-Presbyterian Medical Center, New York, have been using a laser light source to treat an angioma in the retina of a patient there. The beam, produced by an American Optical Co. instru-

ment called a laser retina coagulator, burns the tissue in microseconds. High speed is reported to decrease danger due to eye movement and heating. Operations performed by conventional high intensity light sources may require as long as a second.

## Physicist Challenges Existence of Photons

PHOTON CONCEPT, which has figured in the development of physics since 1905 when Einstein used it to explain the photoelectric effect, was challenged last week at the American Physical Society meeting in Los Angeles.

James Deer, a research physicist for Iron Fireman Mfg. Company's Electronics division, said the concept can lead to incorrect predictions in certain experimental situations. He claims that atomic absorption and emission problems can be handled without quantizing the electromagnetic field and that a single transition in a source atom

can produce multiple photoelectrons.

Deer offered a new theory, called statistical independence, and proposed experiments to test it. He estimated that experimental work would take two years.

## Overseas Airline Will Use Doppler Navigators

TRANS WORLD AIRLINES plans to inaugurate full-scale use of doppler radar for navigation on its trans-oceanic flights. By agreement with the Transport Workers Union, TWA's 44 navigators will be phased out of their jobs after the automatic equipment goes into operation. United Air Lines uses doppler on flights to Hawaii, but only as an aid to navigators. TWA will place primary reliance on the system.

TWA is equipping 12 jets at a cost of \$1.8 million with a system made by Bendix. Flight crews are now being qualified to use doppler and the air line expects FAA approval soon after Feb. 1. FAA approved the system in principle last September.

## Tv Compression System Uses Digital Technique

LONDON — Television bandwidth compression system under development at the Imperial College of Science and Technology by Prof. E. Cherry is giving compression ratios of 10-to-1. Variable scanning method keeps transmitted frequen-

## Does the Thing Have Any Master Points Yet?

MECHANIZED BRIDGE-PLAYING is being used to test Air Force research programs in voice communication with computer, pattern recognition, machine learning and voice synthesis techniques.

Air Force Cambridge Research Labs chose contract bridge because its problem-solving complications are applicable to military decision-making processes. It is expected that one result of the program will be a computer system that will know enough not to trump its partner's ace.

Actual play of the hand is now under study in an AFCRL program involving machine learning. With bidding and play worked out, final step will be coordination of these programs with spoken-word recognition. Vocal response may also be possible with techniques growing out of speech research



cies adjusted to a desired bandwidth. A detail detector analyzes the picture waveform, deriving digital and control data to define the picture. The digital signals are time-spread to make the most effective use of available bandwidth. Similar systems are under development for facsimile transmission.

## Bank Will Automate All Its Transactions

MELLON BANK, of Pittsburgh, has ordered a battery of machines which will encode, in magnetic ink, all of its financial transactions. Paperwork will then be processed by the bank's computer.

The bank handles almost a million documents daily, including auto loans, bonds and coupons, checks and deposit slips. The encoding system, costing \$250,000, was developed for the bank by National Cash Register.

## Sensors Warn Motorists Slippery Bridge Ahead

WASHINGTON state highway department has installed an ice detector and warning system on the mile-long Nisqually slough bridge north of Olympia. Transducers are embedded in the pavement at one end of the bridge. When the pavement is wet and temperature falls to 33.5 F, warning signs are lit. The device is made by the Kar-Trol Signal Co., Houston.

## Glass Protects Solar Cells From Radiation

ANALYSIS of solar cell performance data telemetered from the Explorer XII satellite shows that glass coatings will protect the cells from radiation belts in space, NASA reports.

Four banks of cells were carried. One bank, unprotected, degraded 50 percent on the first two orbits through the Van Allen belt, another 25 percent during the remainder of the satellite's 112-day life. Cells protected with 20-mil and 60-mil

glass did not degrade and cells with 3-mil coatings degraded about five percent.

Among other experiments was one to measure the electron and proton concentrations in the outer Van Allen belt. Electron concentration is a thousand times less than previously thought. There are more protons, but their energy, below 1-Mev, is no hazard to manned space flight.

## Britain Unfreezes Funds For Two Radiotelescopes

LONDON—Research grants for two radiotelescopes, suspended during the government credit squeeze last July, have been reinstated by the Department of Scientific and Industrial Research.

Cambridge University gets \$1.2 million for a triple paraboloidal telescope, to be completed by 1964. Jodrell Bank, Manchester, was awarded \$661,000 for a fully-steerable system to be built in 18 months.

The Jodrell Bank telescope will have an elliptical bowl measuring 125 by 85 ft and will operate at 21 to 3-cm wavelengths.

## Project Defender Gets Another \$15 Million

AIR FORCE has awarded MIT Lincoln Lab another \$15 million for Project Defender, a missile defense study sponsored by Advance Research Projects Agency.

The lab's work on missile phenomena includes studies of reentry physics, measurements of pellets fired in a hypervelocity test range, radar and optical measurements of Trailblazer reentry test vehicles fired by NASA at Wallops Island, reentry measurements at the Atlantic Missile Range and technical direction of Project Press (Pacific Range Electromagnetic Signature Studies).

Army gave Raytheon another \$1.4 million for Arpat, one of the antimissile studies in Project Defender. Raytheon heads a five-company team. Arpat has so far received \$3.4 million.

## In Brief...

LASER WELDING, machining and cutting systems are contemplated by the Air Force. Aeronautical Systems Division is preparing a list of companies with secret clearance that are capable of developing such a system. No proposals are sought yet.

ADMIRAL'S new 23 and 27-in. tv sets include a Compactron tube circuit to prevent picture distortion.

RUSSIA'S big radiotelescope (p 27, Oct. 27, 1961) will be used to study Jupiter and the sun's corona to a distance of 40 radii.

ANACONDA and Simplex Wire and Cable Companies will produce 1,560 miles—\$7.9 million worth—of armored communications cable to link 150 Minuteman sites in South Dakota.

KOLLSMAN INSTRUMENT will develop optical and electronic instruments and guidance for the Orbiting Astronomical Observatory, under \$1 million NASA contract. Chicago Aerial Industries has a \$1.3 Army contract for reconnaissance drone and aircraft checkout equipment.

GROUND-BASED SYSTEM to track and guide reentering vehicles from distances of 3,000 mi to landing is under study at General Precision. It would use radar, tv, computer and communication subsystems and a world map display.

FMA, INC., reports it is in production on its electro-optical File-Search information storage and retrieval system and has sold one to the Navy. It costs about \$125,000.

IWASAKI Communications Apparatus, of Japan, is negotiating with Solartron, of England, for manufacturing rights to the portable dual-beam oscilloscope made in the U. S. by Packard Bell.

OTHER LICENSING moves: Elliott Brothers, of England, gets rights to Acoustica Associates ultrasonic cleaners; Litton will make and sell Raytheon's microwave cooking components.



**They said  
"PROVE IT!"  
AND  
WE DID!**

The moisture-resistance curves show how Type 160P Difilm® Black Beauty® Capacitors outperform all other commercial tubulars



To test tubular capacitors, we figuratively brought jungle conditions into the laboratory. The curves tell what happened.

Difilm Black Beauty Molded Capacitors withstood almost 4000 hours (95 to 100% R. H. at 40 C) with no change in humidity resistance!

No other tubulars came close to this performance. Difilm Capacitors proved themselves the true answer to moisture problems in entertainment and commercial electronics.



For complete technical data on Difilm Black Beauty Capacitors, write for Engineering Bulletin 2025 to Technical Literature Section, Sprague Electric Company, 35 Marshall Street, North Adams, Massachusetts.

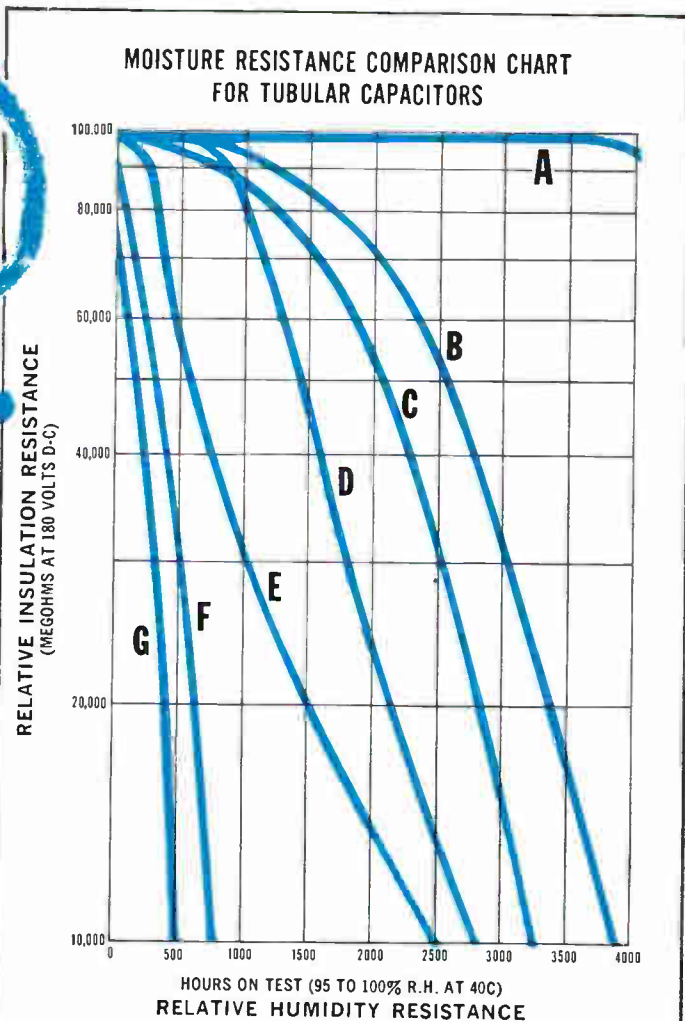

- A. DIFILM® DUAL DIELECTRIC (PAPER and POLY-ESTER FILM), solid impregnant, molded case
- B. PAPER DIELECTRIC, solid impregnant, molded case
- C. DIFILM DUAL DIELECTRIC (PAPER and POLYESTER FILM), solid impregnant, dipped coating
- D. POLYESTER FILM DIELECTRIC, molded case
- E. PAPER DIELECTRIC, wax or oil impregnant, molded case
- F. PAPER DIELECTRIC, solid impregnant, waxed cardboard jacket
- G. PAPER DIELECTRIC, wax or oil impregnant, waxed cardboard jacket

You can get off-the-shelf delivery at factory prices of Replacement Type TM Capacitors (same construction as O. E. M. Type 160P) in pilot quantities up to 249 pieces from your local Sprague Industrial Distributor.

## SPRAGUE COMPONENTS

CAPACITORS  
RESISTORS  
MAGNETIC COMPONENTS  
TRANSISTORS

INTERFERENCE FILTERS  
PULSE TRANSFORMERS  
PIEZOELECTRIC CERAMICS  
PULSE-FORMING NETWORKS

HIGH TEMPERATURE MAGNET WIRE  
CERAMIC-BASE PRINTED NETWORKS  
PACKAGED COMPONENT ASSEMBLIES  
FUNCTIONAL DIGITAL CIRCUITS

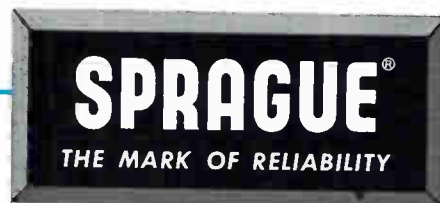

\*Sprague' and '®' are registered trademarks of the Sprague Electric Co.

CIRCLE 10 ON READER SERVICE CARD →  
CIRCLE 9 ON READER SERVICE CARD 9

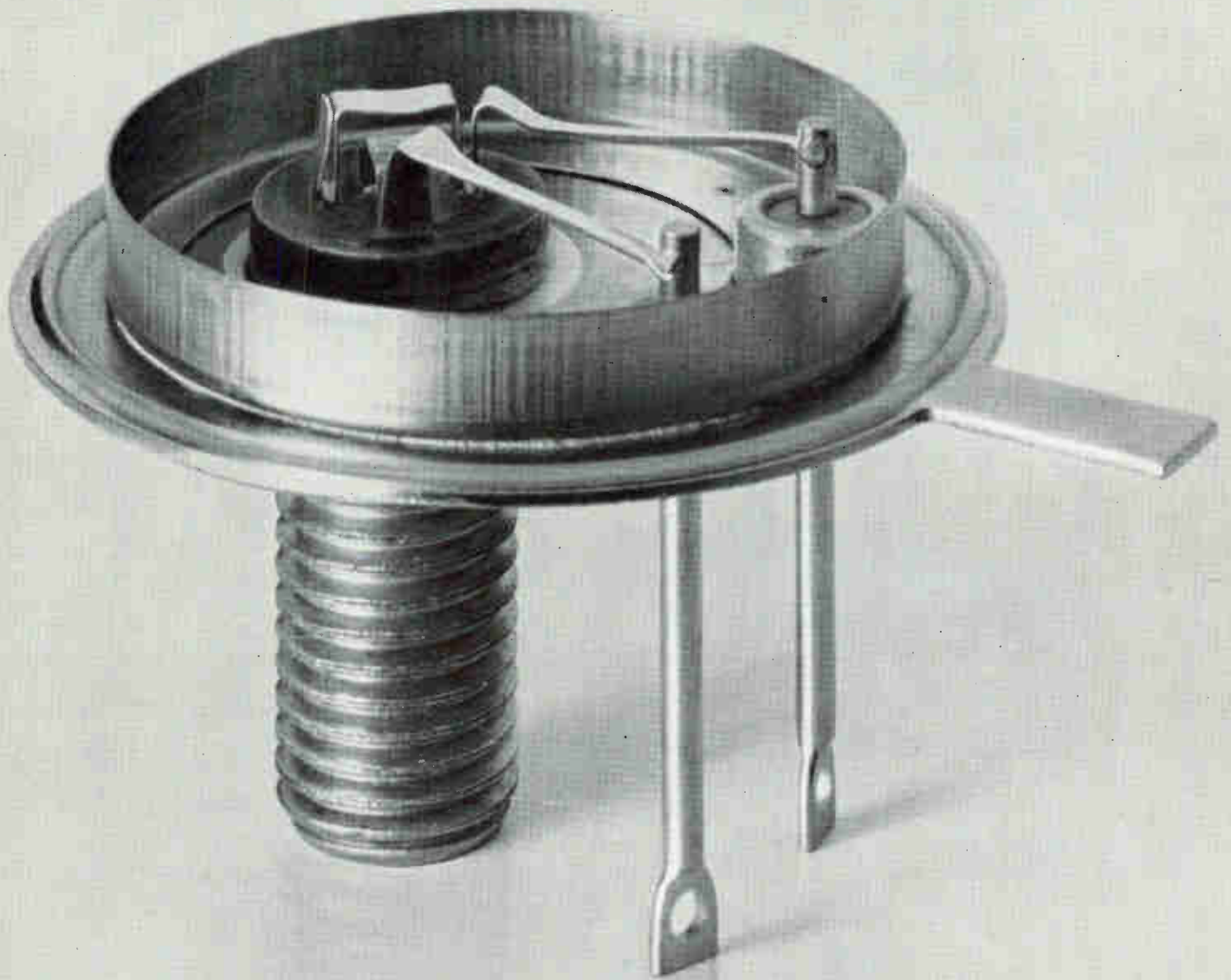

# INSIDE

**Quality Construction in Westinghouse 2N1015 and 2N1016 series of high-power silicon transistors is evidenced by:** Exclusive alloyed bridging techniques which provide positive junction contact to insure reliability under severe vibration and shock. Bridge assembly welded to base and emitter pins for extra support and positive contact. Basic transistor hard-soldered in position to eliminate thermal

fatigue. Protective junction coating that guards against moisture and further stabilizes electrical performance. These precision design features result in very low thermal impedance and high power rating. Upon completion every Westinghouse high-power silicon transistor is 100% Power Tested under full operating conditions to assure True Voltage Ratings.

For immediate "off-the-shelf" delivery, order from these Westinghouse Distributors:



**EASTERN**  
 ACK SEMICONDUCTOR, INC. .... Birmingham 5, Ala /FA 2-0588  
 CAMERADIO ..... Pittsburgh, Pa /EX 1-4000  
 CRAMER ELECTRONICS, INC. .... Boston, Mass /CO 7-4700  
 ELECTRONIC WHOLESALERS, INC. .... Melbourne, Florida /PA 3-1441  
 GENERAL RADIO SUPPLY CO., INC. .... Camden, N.J. /WO 4-8560  
 GENESEE RADIO PARTS CO. .... Buffalo, N.Y. /TR 3-9661  
 KANN-ELLERT ELECTRONICS, INC. .... Baltimore, Md. /TU 9-4242

MILGRAY ELECTRONICS ..... New York, N.Y. /RE 2-4400  
 RADIO AND ELECTRONIC PARTS CORP. .... Cleveland, O. /UT 1-6060  
 SCHWEBER ELECTRONICS ..... Long Island, N.Y. /PI 6-6520  
 Silver Spring, Md. /JU 5-7023

**MIDWESTERN**  
 E.C.I. SEMICONDUCTORS, INC. .... Kansas City, Mo. /WE 1-0829  
 ELECTRONIC COMPONENTS FOR INDUS. CO. .... St. Louis, Mo. /WO 2-9916





# WASHINGTON OUTLOOK

**KEY ROLE IN SPACECRAFT** rendezvous will be given electronics. When the first attempt to join in space a Mercury Mark II capsule and an Agena-B fuel cache is made in mid-1963, radar in the capsule and a transponder in the Agena-B will help bring them together. Infrared devices may bring the craft into proximity for the final approach. A two-foot long cone built on the spacecraft will be seated into the Agena-B rocket and locked into position when the final connection is made. Electrical connections in the cone will be mated with the fuel cache to relay command signals.

**AIR FORCE PLANS** to reequip the Navy's McDonnell F4H aircraft with a fire control system optimized for air-to-ground combat operations. The fiscal 1963 procurement schedule calls for large-scale purchase of the Navy plane. In the Navy version, the F4H's fire control system is optimized for the air-to-air interceptor operations.

Air Force will presumably buy a modified version of the fire control system installed on Republic F-105 fighters. This includes General Electric's toss-bomb computer and North American Aviation's Autonetics search and range radar (Nasarr). Raytheon and Westinghouse are Navy contractors for the F4H fire control system. The Air Force estimates modifications of the F4H at roughly \$500,000 each. But this estimate goes beyond the installation of new electronic equipment.

**AEROSPACE INDUSTRIES ASSOCIATION** estimates sales of aerospace products at roughly \$14.8 billion in 1961, somewhat higher than last year. Unit production of military aircraft fell from 2,700 in 1960 to 2,500 in 1961. But rising expenditures for missiles and space vehicles partially offset the aircraft decline. Missile expenditures amounted to about \$4.6 billion in fiscal 1961 ending last June 30.

AIA figures that sales for the 51 aerospace manufacturers showed a \$500 million increase over 1960 to total \$13.5 billion. Earnings for the firms are estimated at \$240 million for the year, compared to \$184 million in 1960. Sales in 1962 are forecast at about \$15 billion. Commercial aircraft are about 15 percent of the volume.

**FEDERAL AVIATION AGENCY** officials will discuss with manufacturers at a Feb. 27 Washington conference new airborne equipment that will be required for a radar-oriented traffic control system. FAA has begun a five-year program to develop the new system in line with recommendations made two months ago by a presidential task force. The February conference will concentrate on radio-frequency, secondary radar and distance measuring equipment for the new system. Emphasis will be on equipment needs of private and business aircraft.

**AMERICAN TRUCKING ASSOCIATION** is making a concentrated effort to keep the nation's trucking firms informed about the availability and advantages of electronic accounting equipment for their operations. Association is now surveying 1,200 trucking companies with annual revenues exceeding \$1 million to ascertain how much mechanical and electronic data processing equipment they now use, how much is on order, what accounting and statistical chores are now performed by such equipment and what functions users would like to have done by new equipment.

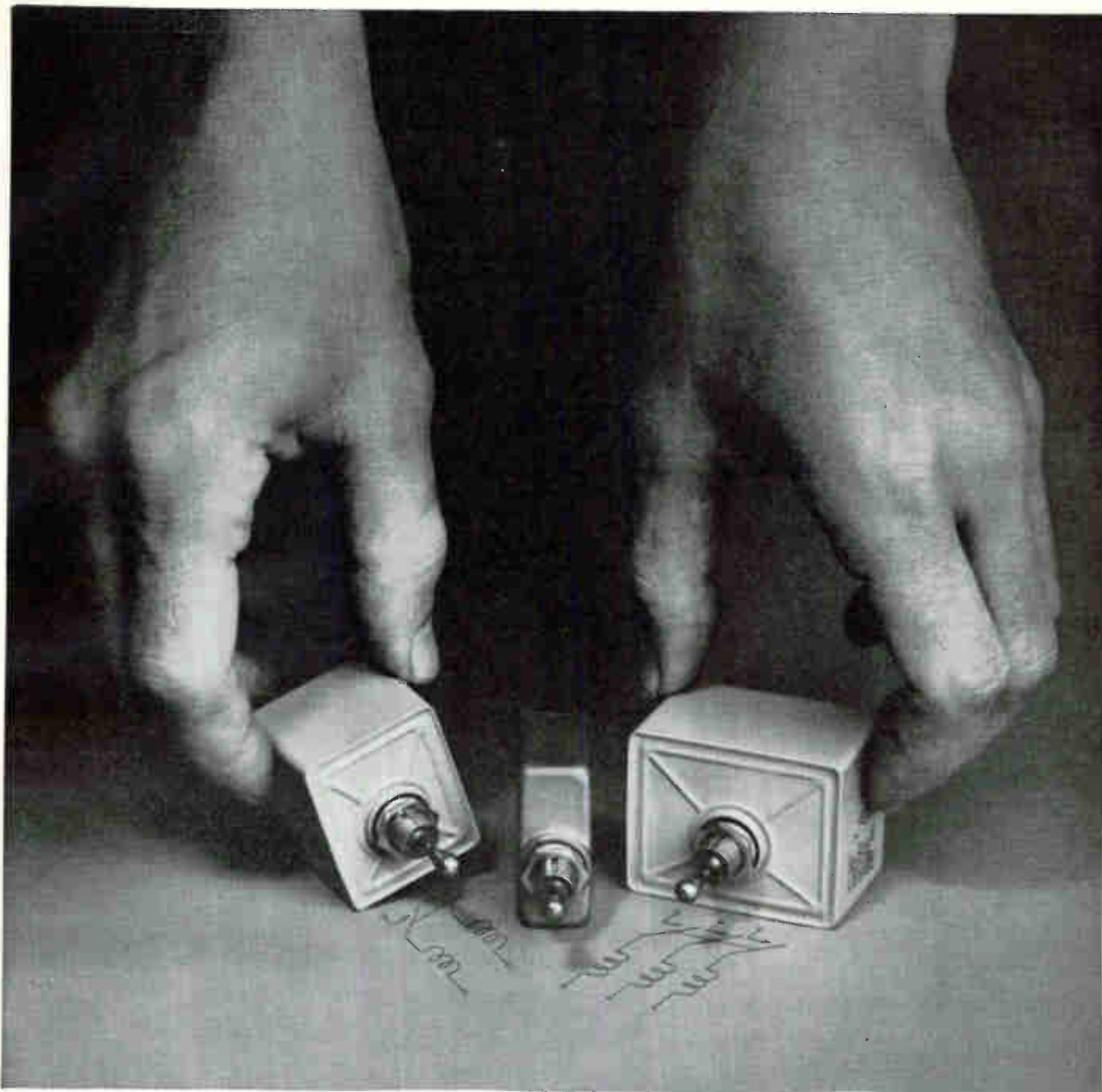

If you are designing for severe-environment service and need polyphase or multiple-circuit protection, these new subminiature two- and three-pole SM breakers can probably help you out.

Built to take rough going, they are designed to meet stringent specs for operation under conditions of shock, vibration, high humidity, sand and dust atmosphere, and salt-sea atmosphere. In addition, they will comply with requirements for explosion-proofing, fungus resistance, and high-altitude operation.

That's not all. The breakers are also temperature-stable (thanks to hydraulic-magnetic actuation). You don't have to derate them for high-ambient service. They will maintain nominal load capacity and calibrated trip points

**Now available  
in multi-pole models:  
Heinemann's  
rugged, Mil-type  
SM circuit breaker**

at any temperature from  $-40^{\circ}$  to  $100^{\circ}\text{C}$ .

And, nicely enough, you don't have to pay a weight or space penalty to get these capabilities. The two-pole SM weighs only  $3\frac{1}{4}$  ounces, and measures just  $1.5 \times 1.25 \times 1.9$  inches (excluding handle). The three-pole model weighs  $4\frac{1}{2}$  ounces, measures  $1.5 \times 1.9 \times 1.9$  inches.

You can have both models in any integral or fractional current rating you need, from 0.050 to 20 amps, with either a "fast" or "slow" inverse time delay, or instantaneous trip. Both can be furnished in voltage ratings of 230V AC (max.), 60 or 400 cycles, or 50V DC (max.).

Our Bulletins 3502 and 3503 will give you complete technical information. A word from you will put them in the mail.

**HEINEMANN ELECTRIC COMPANY**  **2600 BRUNSWICK PIKE, TRENTON 2, N. J.**

SA-2488

# NEW TEFLON MICRO-LOGIC ELEMENT SOCKETS



*Actual size shown*

MADE OF TEFLON\* TFE, these tiny sockets are designed to be used with the new Fairchild micro-logic elements (molex-type semiconductor networks employed in computer and other critical circuits). Designed in collaboration with Fairchild engineers, the Garlock sockets are the only micro-logic element sockets on the market. Through the use of Teflon insulating material and silver-plated, gold-flashed

Beryllium copper contacts, these sockets exhibit unusually low dielectric loss and outstanding pin retention. For immediate availability, *New Garlock Micro-logic Element Sockets are stocked in your locale.* Contact the Garlock Electronic Products distributor or representative nearest you for full information. Or, write GARLOCK ELECTRONIC PRODUCTS, GARLOCK INC., Camden 1, New Jersey. *\*DuPont Trademark*

75TH  
Anniversary  
Year



# GARLOCK

ELECTRONIC PRODUCTS



**CHRISTIE** ANNOUNCES

**100-200-250-400-600 AMP.**

# “TRANSIENT FREE”

## D-C POWER SUPPLIES



**Dynamic  
Regulation  
±0.5 volt**

**Ripple  
1 Millivolt**

**Recovery  
Time  
50 Microsec.**

**Output  
Impedance  
1 Milliohm**

**VOLTAGE RANGE:** 15-36 volt d-c.  
**STATIC REGULATION — LINE & LOAD:**  
±0.05%.

**CURRENT LIMITING:** Adjustable.

**DUAL A-C INPUT:** 220/440 volt,  
3-phase, 60 cps.

**PROTECTION:** Ultra-fast over-voltage  
and over-current protection.

Over 30 Years • D-C Power Supplies • Battery Chargers

**STANDARD FEATURES:** 10-turn voltage  
adjustment pot., voltmeter, ammeter, in-  
put contactor, pilot light.

**OPTIONAL:** Available in 19" rack style.

The above performance specs apply  
to the 100 amp. model. For complete  
specs of all 5 "Transient-Free"  
models, write for Bulletin  
CEC 194.

Some 200 other Power Supply and  
Battery Charger Models in the range  
of 15 to 1500 amp.

Write for catalog.

**CHRISTIE ELECTRIC CORP.**

3400B West 67th Street  
Los Angeles 43, Calif.

**CHRISTIE**

# Save 7% of Your electronics BUYERS' GUIDE Advertising Costs ACT NOW!

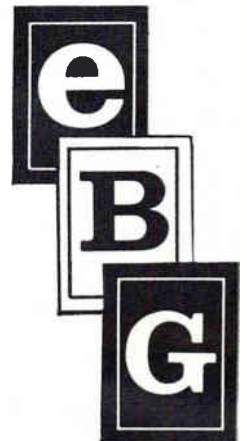

Order your advertising for the 1962 electronics BUYERS' GUIDE now. Study these exceptional discounts. You can earn up to 10% in discounts. You will see four distinct ways to save money. Here is how the "Early Bird" discount structure works:

In addition to volume discounts for Multiple Page, run-of-press, advertising, a discount of 7% on the earned rate will be allowed on ads of ½ page or more, provided insertion order is received by February 15, 1962, and plates are supplied to the publisher by April 25, 1962.

In addition to the volume rates for inserts, a discount of 7% of those rates will be allowed providing insertion order is received by February 15, 1962, and inserts are supplied to the publisher by May 25, 1962. See your local advertising representative, listed on the last page of this issue for complete details.

Multiple Page Discounts	
2 pages .....	discount earn 3%
4 pages .....	earn 4%
6 pages .....	earn 6%
8 pages .....	earn 7%
12 pages .....	earn 8%
16 pages .....	earn 9%

Special rates for furnished inserts	
2 pages .....	per page \$715
4 pages .....	682
6 pages .....	654
8 pages .....	616
12 pages .....	600
16 pages .....	583
20 pages .....	566
24 pages .....	550
28 pages .....	533
32 pages .....	517
over 32 pages .....	489

(Orders and complete plates to be sent to 330 West 42nd Street, New York 36, N.Y. Inserts to be shipped to National Publishing Co., Lanston Building, 24th and Locust Street, Philadelphia 1, Pennsylvania. Marked: Electronics Buyers' Guide.)

## electronics BUYERS' GUIDE & Reference Issue



A McGraw-Hill Publication / 330 West 42nd Street, New York 36, N.Y.



MODEL	60db BANDWIDTH
TL-2D5A	2 kc
TL-4D9A	4 kc
TL-6D12A	6 kc
TL-8D16A	8 kc
TL-10D18A	10 kc
TL-16D25A	16 kc
TL-20D32A	20 kc
TL-30D45A	30 kc
TL-40D55A	40 kc
TL-45D60A	45 kc
TL-32E48C	32 kc
TL-50D85C	50 kc

(suffix "A" denotes 455 kc center frequency;  
suffix "C" denotes 500 kc center frequency)

# Clevite Ceramic Ladder Filters

Now in stock in 12 bandwidths...  
80 db rejection in 0.1 cu. in.

Clevite ceramic ladder filters provide more selectivity for their size than any conventional i-f filter. They are fixed tuned and need no alignment—are non-magnetic and non-microphonic. Leading manufacturers now have Clevite ladder filters in their communications equipment. Improve your newest design with these unique filters. Write now for complete specifications—Bulletin 94012, or for selectivity curves available on each stock model. ■ Dimensions: 5/16" diameter x 1 1/2" long. ■ Selectivity: 60 db/6db shape factor from 1.3:1 to 2.6:1. ■ Center Frequency Stability: within 0.2% for 5 years, and within 0.2% from -40° to +85° C. ■ Impedance: 1200-1500 ohms. ■ Designed for military environment.

**CLEVITE ELECTRONIC COMPONENTS**  
DIVISION OF **CLEVITE** 232 FORBES ROAD, BEDFORD, OHIO

Field Sales Offices:  
Maplewood, N. J. / Chicago, Ill. / Denver, Colo. / Inglewood, Calif.





## **The computer analysis shows we're**

---

*Purchasing would have been more expensive than it looked. It took a computer—sharing honors with IBM's new Capital Investment Program—to lead them to the right answer. This program helps your computer answer many problems such as: Shall you replace or repair existing equipment . . . which line of research is most apt to pay off . . . will expansion pay out . . . shall we buy or make . . . which new ideas are worth backing . . .?*

*Three basic methods lie at the heart of this program: Investor's Method (Rate of Return on Investment), Average Annual Return on Investment, and Payout Period. Use the method that best meets your requirements—the computer prints out the probable results of each proposal, gives you a uniform, accurate guide to sound investment.*

*The Capital Investment Program is written in FORTRAN language; you can run it, for example, on the low-cost IBM 1620 Data Processing System.*



## better off making those parts...

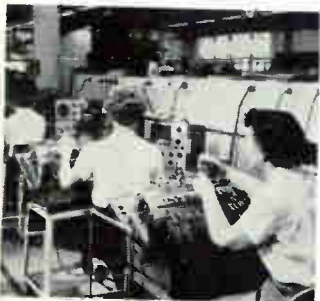

■ *Repair or replace?* Feed all the facts into the computer. CIP helps it pull them together, evaluate them, helps you choose the best alternative.



■ *Which line of research?* This requires knowledge of all the facts. CIP provides a uniform guide to help you make the right decision.



■ *Make or buy?* CIP helps you correlate all the facts such as: materials availability, effect on taxes. Decisions come quicker, easier.

**IBM®**  
DATA PROCESSING

# 1962 PREDICTION:

## Competition Forces Careful Market Selection

*Electronics executives generally agree that the way to bring profits back in line with volume is to sop up over-capacity with new markets*

By THOMAS EMMA, Associate Editor

ELECTRONICS EXECUTIVES talk like deer hunters these days: it's hard to find a buck unless you know your woods. Company leaders are being more selective in the markets they aim at. Producing what the other fellow makes has led in many cases to more industry total volume, but less profit for the individual firm.

Other attitudes expressed generally in recent weeks include continuing reliance on research and development to develop new products and to remain competitive in developing fields. There appears to be a stepup in the trend away from heavy reliance on military and government business and toward industrial electronics.

Here, summarized, are comments on the state of the industry in 1962, as told to ELECTRONICS in recent weeks:

*Turn the profit squeeze to advantage.* With a general slowdown in the growth rate of new military systems, the entire industry is suffering from over-capacity. Developments have concentrated on the military market. To stay healthy and expand, the industry must turn its attention to other markets. The profit squeeze affecting all industries can benefit electronics companies able to devise aids to cheaper, better production. *D. W. Gunther, general manager, semiconductor dept., Westinghouse Electric.*

*The day of the genius is over*—at least for the electronics industry. The need now is for better marketing. Companies with strong marketing organizations are performing satisfactorily, indicating that technical competence alone is not enough. Overwhelming dominance of a company by scientists is the road to mediocrity. Except for space and military activities, the electronics industry competes with other businesses. For example, the company that produces an electronic computer to replace a mechanical computer is in the business machine field, not electronics.

Newer companies will have to compete on that basis to survive. *Henry W. Harding, president, Laboratory for Electronics.*

*New markets more difficult to define.* Electronics grew in the past by creating and developing functionally new products and markets. Today, opportunities lie somewhat more in the direction of making the products of existing industries electronic. These new markets are more difficult to define and serve because of their diversity and fragmentation. The impact of developments on markets depends on how well products and services can be improved by performing functions electronically. Prime factors to watch: international developments and the ability of management to shape the direction of company R&D toward market opportunities. *Wendell R. Smith, vice president for marketing development, Radio Corporation of America.*

*Sales high, profits restricted.* Despite new highs in sales and orders, severe competition is putting the squeeze on profits. Developments to watch include new materials, minia-

turization through molecular techniques, new electric and propulsion power sources. Advances in communications and data processing will be combined with new management techniques. Increased attention will be given technical and management help to underdeveloped nations. *Richard E. Krafve, president, Raytheon.*

*More price competition ahead.* The market is in an adjustment period which will continue with more price competition. Despite short term improvements in hardware demand, the emphasis on R&D will return when international pressures ease. Avoid upsetting price levels by over-engineering products that need not be complicated. Don't rush in to produce large numbers of a product for a small market showing some increase in demand. *Benjamin Katz, vice president, marketing, Monogram Precision Industries.*

*Economies for the small company.* Despite stiff competition and severe price cutting, progress will be made. Products designed within the past year account for 36 percent of this company's orders. The small company must affect time and labor savings by greater use of automatic and semiautomatic test equipment. *Elmer Gertsch, president, Gertsch Products.*

*Cooperation between maker and user.* Semiconductor markets will grow faster than the overall electronics industry. But dollar volume is lagging behind unit volume and must be expanded. The future will see more industrial business, more effect from microminiaturiza-





*D. W. Gunther*



*H. W. Harding*



*W. R. Smith*



*R. E. Krafve*



*Benjamin Katz*



*Elmer Gertsch*



*Sidney Spiegel*



*Donald Boensel*



*George Singer*



*D. A. Potter*



*G. L. Haller*



*J. A. Kennedy*

tion and integrated circuits. Semiconductor techniques can be improved by greater cooperation between maker and user. *Sidney Spiegel, vice president, marketing, Pacific Semiconductors.*

*New power sources gaining importance.* A factor for market growth will be new sources of electrical energy, such as fuel cells. Within the next four or five years there is likely to be a radical transformation in electrical generation and control equipment. Present opportunities are many because of missile and space programs, particularly in ground support gear. *Donald Boensel, vice president, Correlated Data Systems.*

*Short production runs favor small firms.* Due to today's economy, there aren't too many major production runs. This puts the small company at an advantage. Companies organized for mass production runs are having a rough time of it. Since we are suppliers to larger companies, we can get into commercial

markets as these large firms turn their efforts in such directions as commercial microwave. *George Singer, vice president, marketing, Rantec Corporation.*

*Find new ways to finance R&D.* The U.S. cannot afford national cutbacks in research and development spending, but the high cost of R&D programs take them beyond the scope of individual company problems. Automation may be the only way American industry can cut costs to compete abroad. The electronics industry is likely to remain intensely competitive for some time. Industrial markets provide more opportunities than the military market for developments in such fields as facsimile and cortation control. *Donald A. Potter, vice president and general manager, Stewart-Warner.*

*Reinvest profits in R&D.* To continue the rate of achievement that has characterized the industry demands a heavy reinvestment of profits in R&D. The general state

of the electronics industry is one of rapid growth. Rising world population, mounting educational and medical needs are among factors in this expansion. *George L. Haller, vice president and manager, defense electronics division, General Electric.*

*Refill the R&D bucket.* Electronics can look ahead to market booms in consumer and some component areas. But it should pay particular attention to research associated with its own development. Industry should work with universities and research centers so it can be assured of the opportunity to return from time to time to refill the bucket for applied research. *John A. Kennedy, president, James Electronics.*

*Market is good.* The stepup in military aircraft procurement is helping component makers. The present state of the market is good and delivery schedules are more balanced. *Donald Duncan, president, Duncan Electronics.*

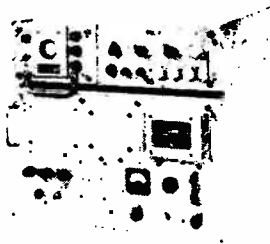

**This is the CODE  
 CONVERTER which takes  
 Morse Code from the air  
 at all speeds and odd rates  
 and changes dot-dash  
 to lengths of DC  
 which are instantly locked  
 and electrically stored  
 'til a word is complete  
 on a digital board  
 printer fed they come out  
 code change automated  
 language foreign or ours  
 completely translated.  
 all this from the house  
 -that TRAK built**

**TRAK MORSE-TO-TELEPRINTER CODE CONVERTER MODEL AN/UGA-3**

The AN/UGA-3 is an electronic, completely transistorized digital computer for converting Morse code transmissions into electrical impulses that drive a standard teleprinter.

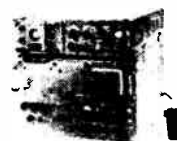

MODEL AN/UGA-3

**TRAK TELETYPE MULTIPLEXER MODEL AN/UGC-1A**

permits the simultaneous transmission and reception of 4 different messages on a single channel.

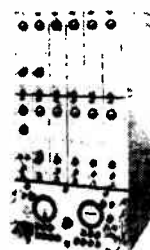

MODEL UGC-1A

**TRAK TWX-CCIT TRANSLATORS**

allows two way communication TELEX calls between foreign and domestic stations.



TWX-CCIT  
 TRANSLATORS

The Communications and Reconnaissance Dept. of Trak Electronics designs and manufactures on a quantity or unit basis, completely within their own plant. This permits package cost quotation at your design 'conception' stage. Our Engineering Section will be glad to offer design and specification assistance if requested.

Simply write 59 Danbury Road or telephone POrter 2-5521.



COMMUNICATIONS & RECONNAISSANCE DEPT., TRAK ELECTRONICS COMPANY, INC., WILTON, CONN.

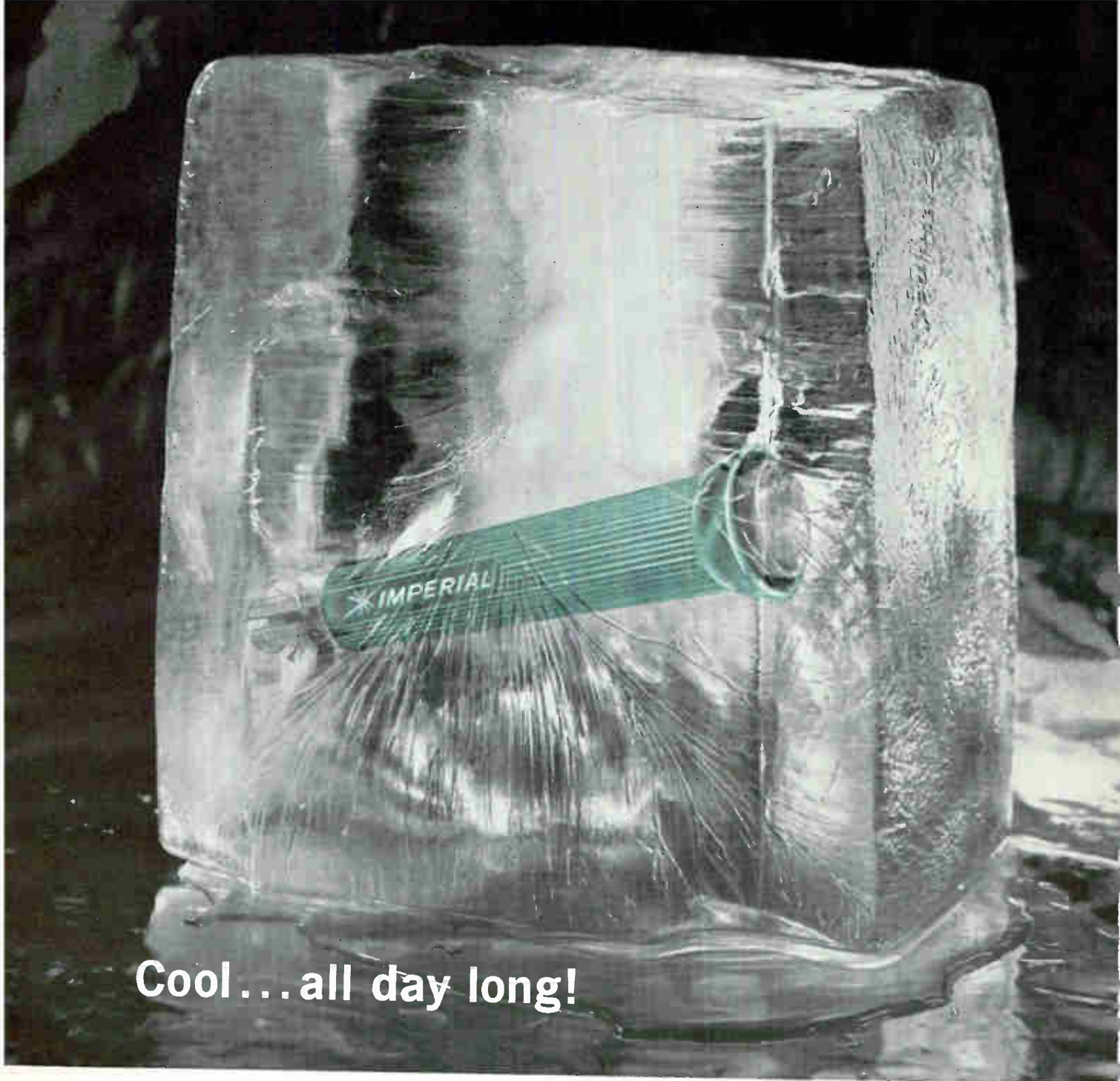

Cool... all day long!

# IMPERIAL

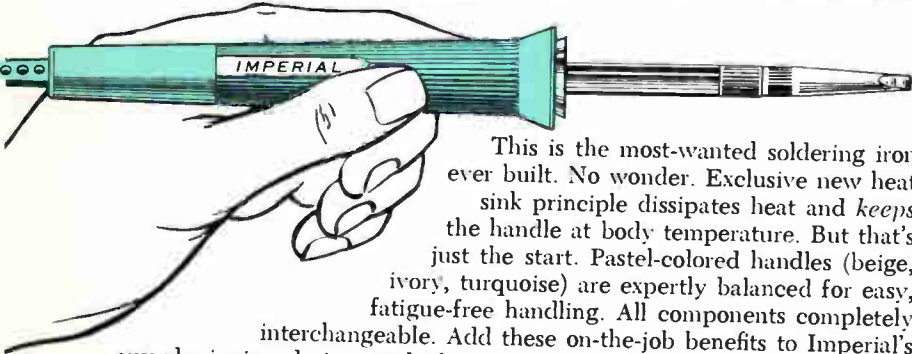

This is the most-wanted soldering iron ever built. No wonder. Exclusive new heat sink principle dissipates heat and keeps the handle at body temperature. But that's just the start. Pastel-colored handles (beige, ivory, turquoise) are expertly balanced for easy, fatigue-free handling. All components completely interchangeable. Add these on-the-job benefits to Imperial's award-winning design, and it's easy to see why this is the most popular soldering iron in the country. Mail this coupon today for all the facts.

UNGAR ELECTRIC TOOLS E-1-62  
 Electronic Division of Eldon Industries, Inc.  
 P. O. Box 1007, Hawthorne, California

*Please send me free full-color IMPERIAL brochure!*

NAME \_\_\_\_\_

TITLE \_\_\_\_\_

COMPANY \_\_\_\_\_

ADDRESS \_\_\_\_\_

CITY \_\_\_\_\_ STATE \_\_\_\_\_

 *accepted standard of the electronics industry*



# PULSE POINTERS

## SOLVE PULSE PROBLEMS FAST



Modular concept extends instrument versatility, guards against obsolescence, cuts costs. Standard modules, designed to accomplish specific instrument and system functions, quickly plug into both front and rear of rack frames. Simplicity is highlighted throughout.

Take the numbers: 3450D, 2140A, 4550A, and 5510. Modify them, expand them, depend on them to provide you with the easiest, most flexible way to solve pulse instrumentation problems fast.

The secret: modular construction and adjustable pulse-forming controls—standard with all *Electro-Pulse* instruments. Interchangeable plug-in printed circuit modules quickly and economically extend instrument performance to meet a host of changing requirements. Integral front panels and controls achieve both electrical and mechanical standardization.

The popular "big four" shown here are only a few of the 33 cataloged instruments in Servo's broad *Electro-Pulse* line, which includes as many as 200 standard pulse and digital circuit modules (both tube and transistor types). Advanced pulse techniques and circuitry, coupled with traditional Servo instrument quality and reliability are another E-P plus.

Write for details...or for a Servo pulse specialist to discuss specific pulse instrumentation problems—and Servo solutions—with you.

Modular flexibility... a Servo specialty... counters obsolescence, cuts pulse costs

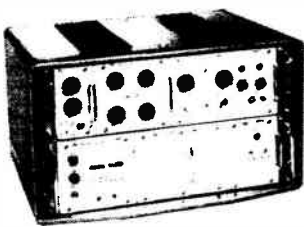

Popular 3450D general-purpose pulse generator quickly converts to six other standard pulse instruments. Versatility for production line or laboratory problems.

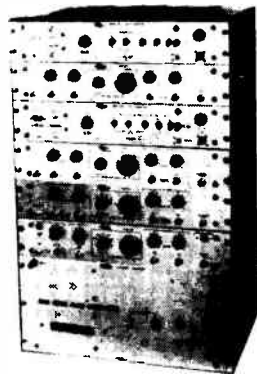

Precision 2140A double pulse generator provides separate or mixed output. Particularly adaptable to programmed operation in conjunction with semi-automatic checkout systems.

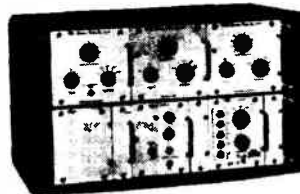

"Workhorse of the engineering lab," transistorized 4550A 10 mc pulse generator features wide range of rep rates, delay times, and pulse widths. Computer makers like its 10 nanosec rise time.

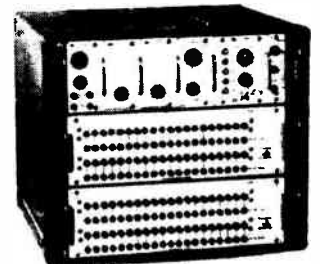

Modular 5510 serial word generator offers broad flexibility for digital circuitry and logic design for a broad range of special digital instrumentation.

*Electro-Pulse Products*



# SERVO CORPORATION OF AMERICA

111 New South Road • Hicksville, L. I., N. Y. • WElls 8-9700

Sales & service offices coast-to-coast • Representatives in major cities

single pulse generators • double pulse generators • word generators • pulse train and pulse code generators • time delay and gate generators • current generators and core testers • modules

Highly Reliable

# HITACHI "SEMI-CONDUCTORS"

For Industrial Use  
Switching Transistors and Diodes

2SA18  
2SA41  
2SA42  
2SA86  
2SA208  
2SA209  
2SA210  
2SB66  
2SB67  
2SB68  
2SB81  
2SB82  
2SC89  
2SC90  
2SC91

Hitachi semi-conductors provide the basis for the excellent capacity of the Hitachi Electronic Computer HITAC 103.

1N34A  
1N35  
1N38A  
1N56A  
1N60  
1S77  
1S78  
1S79  
1S84

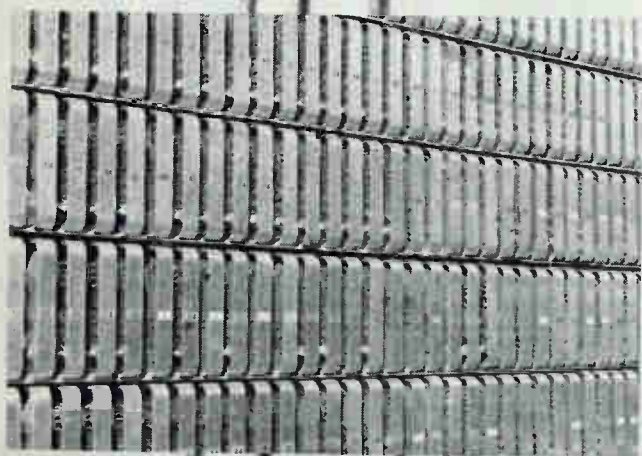

Back of HITAC 103.



**Hitachi Ltd.**

Tokyo Japan

Cable Address: "HITACHY" TOKYO

# Will The Russians Go Around the Moon

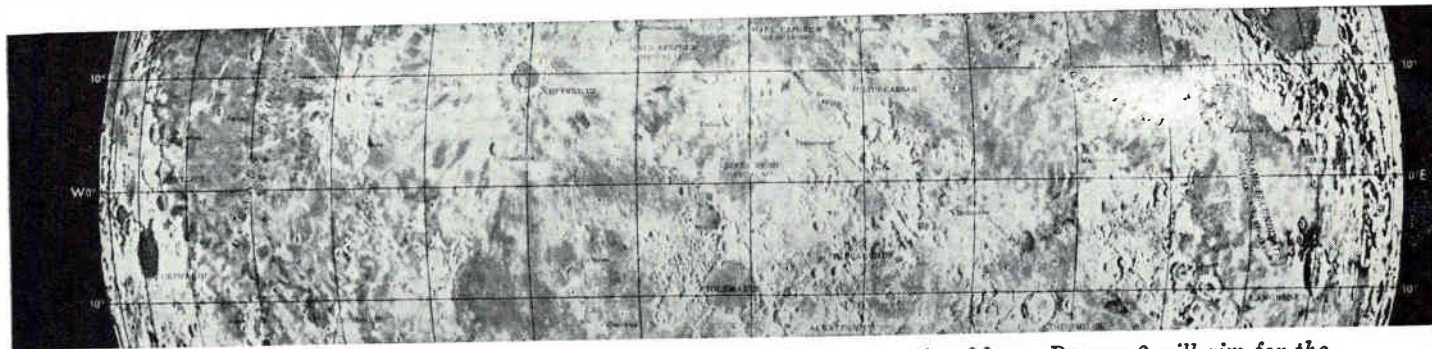

NASA favors the moon's equatorial belt, between 10 deg N to 10 deg S, for operational base. Ranger 3 will aim for the region between Kepler and Copernicus (top left). Soviet Prof Petrovich has said Soviets favor polar region for milder climate (USAF Lunar Reference Mosaic)

*Although the U. S. moon flight program is gathering steam fast, aiming at circumlunar flight after 1965, the USSR may try it in early 1962*

By JOHN F. MASON,  
Associate Editor

RUMORS THAT the Soviets plan to send a man around the moon early in January have been persistent during the past few months.

According to a Reuters report, purpose is to study the moon's surface for a suitable automatic laboratory site. The spacecraft will be launched from Baikonur, about 100 mi east of the Aral Sea. A man will not land on the moon before 1964, Reuters said.

Radio Belgrade said a "lunonaut" on a five-day trip would study the moon's surface with an automatic astronomic observatory and photograph it with a special camera. According to Belgrade, Soviet long-range missiles launched to the Pacific in September tested the mechanism for the circumlunar spacecraft.

On Oct. 1, a Polish writer, Piekarowicz, predicted a Russian flight in 1962 or 1963. Trajectory would be similar to that Lunik III took to photograph the far side of the moon in 1959.

Whether the Soviets will attempt

a lunar mission of any kind in January has not been formally announced by the USSR. If they should send a vehicle to the moon and try to recover it, it will probably not carry a man. Besides the chances of failure in guidance, control, deceleration, heating, and propulsion, there is also radiation.

Although eventually both the Soviets and the U.S. will achieve manned circumlunar flights, the philosophies behind the two missions may well be different. A manned circumlunar flight at this time would have more propaganda value than scientific. NASA regards this specific project as necessary practice for landing a man on the moon.

Circumlunar flight, manned or unmanned, is not the best way to survey the moon's surface. Even at 200 miles—the closest approach a circumlunar flight will probably achieve—camera resolution is not sufficient to survey a proposed landing site. Cracks and rock size, dust and flying debris could not be examined.

Such considerations, however, do not rule out a Soviet attempt to

send a man around the moon. The Soviets are keenly aware of the value of propaganda.

NASA plans to get a usable look at the surface by tv pictures transmitted back from the unmanned Ranger 3 as it approaches the moon for a crash landing early in 1962 (ELECTRONICS, p 24, June 23; p 20, Aug. 4). Six more Rangers will follow. In 1963 there will also be 10 Surveyor missions. They will orbit the Moon, make soft landings, and transmit tv signals, chemical analyses and other data. Besides locating a safe landing spot for men, these unmanned expeditions will provide engineering data for follow-on spacecraft.

For science, they will examine the lunar surface and subsurface for a possible answer to the origin of the solar system.

As a later preparation for manned landing, the Prospector spacecraft will land tons of supplies and equipment at a predetermined depot site, possibly including a jeep type vehicle, a small radiation shelter and rockets to return surface samples to Earth.

Soviet Prof. Petrovich described



# This Month?

Soviet plans for such a mobile station in the *Bulletin of the USSR Academy of Sciences*, according to Soviet news service Tass on Dec. 26, 1959. In Oct., Soviet scientist Mikhaylov announced development of an Earth-controllable, mobile moon-station with tv data link. Soviet writer Varvarov recently proposed a moon-based radio relay station to enhance moon-bounce signals.

To date, NASA has no plans for such a project. Bell Telephone Labs' J. R. Pierce does not feel the moon is suitable for such a relay station. It would be easier to put up a satellite.

The most important results of landing a man on the moon are probably those that can not be foreseen before man gets there. A known possibility is using the moon as a way-station for planetary missions. Piekarowicz predicted the Soviets would have a permanent moon-base for this purpose by 1970. NASA's John H. Discher, assistant director of Apollo spacecraft development, told *ELECTRONICS* such a concept is possible but that the first way-station to other planets might be man-made Earth orbital platforms.

According to Petrovich the Soviets favor the lunar polar regions for an operational base, seeking a milder climate than elsewhere on the moon. This, Petrovich said, was the best place for landing, for launching vehicles back to Earth and for storing fuel.

If Petrovich's views prevail the Russian and American expeditions to the moon may never meet.

NASA, Discher says, likes the region between 10 deg north and 10 deg south of the lunar equator, facing Earth. (See moon photo strip). The local surface appears desirable and heat and cold extremes are not considered insurmountable.

The phase of the moon is not important in timing a circumlunar flight, according to Discher. Even when the Sun is not shining on

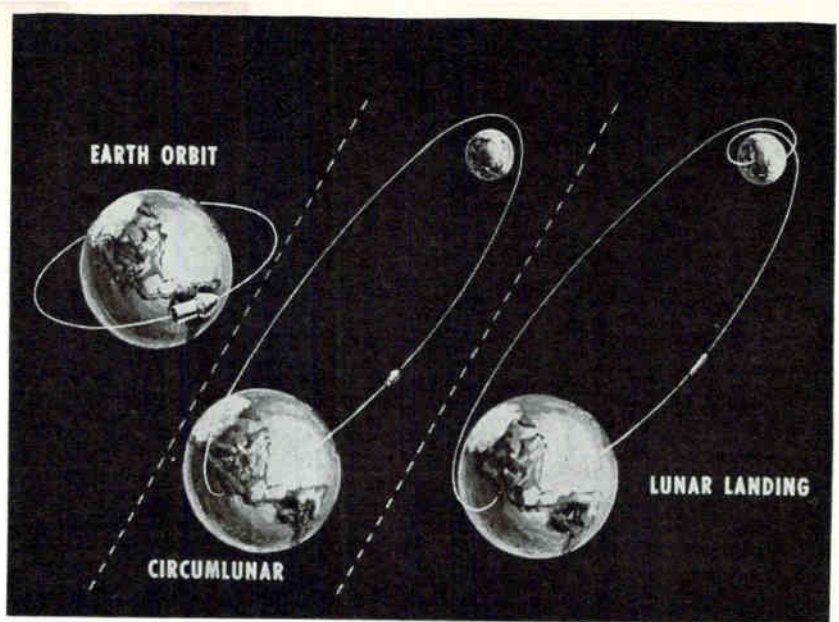

*Circumlunar trajectory will intersect moon's orbit ahead of the moon, then be swung around moon's field of gravity to an Earth-bound direction (NASA)*

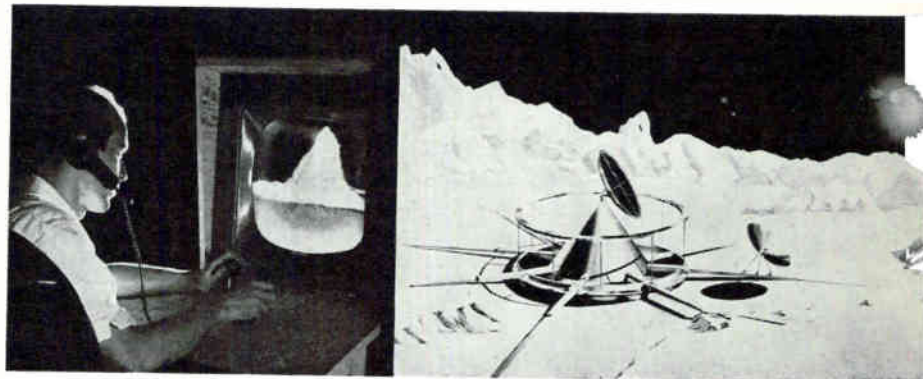

*Moon-based station can televise surroundings to Earth-based receiver (AIL division of Cutler-Hammer)*

the moon, sunlight reflected from the Earth—earthshine—is sufficient for good viewing, as bright as an electrically lighted room.

NASA's first circumlunar manned flight will come after 1965, as step two in the three-step Apollo program. Step one, in 1964, will put three men in Earth orbit. The final Apollo objective in 1969 is landing men on the moon.

Apollo will have three modules: command-center module to house the crew, a propulsion unit, and lunar landing rockets.

In Earth-orbital flights the propulsion unit will return the craft to Earth. It will also be used for orbital maneuvers and rendezvous. North American Aviation will build this and the crew module (*ELECTRONICS*, p 14, Dec. 8).

For circumlunar flights, the propulsion module will return the spacecraft to Earth from any point along the lunar trajectory, provide midcourse and terminal guidance

corrections, place the spacecraft into a satellite orbit around the moon and eject it from that orbit and return it toward Earth. For the lunar-landing mission, the same module will be the takeoff stage from the moon.

For circumlunar flights, Apollo will use a Saturn C-3 or C-4 which will include several F-1 engines in the first stage. NASA believes the C-3 will be capable of a simple figure "8" circumlunar orbit and return. The trip will take six or seven days. Distance from the moon at closest approach will be from 200 to 1,000 miles on the backside of the moon. It will not be at all close to the Earth side of the moon. The more powerful C-4 could put the craft into a 100-mi lunar orbit and later back into a trajectory toward the Earth.

A lunar satellite would have the advantages of proximity, good coverage and continuance. Obtainable data include surface, geo-

logical, magnetic field and mass distribution details.

A circumlunar trajectory is extremely sensitive. If the right initial velocity is not achieved an unguided ballistic trajectory would end up above or below the Earth, rather than on it.

Due to the high possibility of errors in initial velocity and the unappealing consequences, corrections will be made during the Apollo flight. Guidance will be carried on board the craft. An inertial-accelerometer platform will be corrected by optical Earth-moon-star sightings made by the crew. Several corrections will be made on the way to the moon, none in its vicinity if the mid-course corrections were accurate, and several on the return to Earth. (There could be a very crucial moment in the vicinity of the moon. If the velocity is 100 fps too high, the moon's orbital motion and gravitational field could accelerate the vehicle out of the Earth-moon system and into a hyperbolic orbit around the sun.) At about  $\frac{3}{4}$  of the way to the Earth, the pilot will make a guidance correction to align the craft with the narrow corridor through which he must approach the Earth.

Reentry into the Earth's atmosphere poses severe problems of guidance and control, deceleration and heating.

The craft will be entering at 25,000 mph. If it were a simple ballistic capsule it would have to enter a flight-path corridor with an accuracy of only  $3\frac{1}{2}$  miles above or below the trajectory. If the capsule undershoots, the occupants will be destroyed by the high deceleration forces or burn up in the atmosphere. If it overshoots, the vehicle will make another trip into the radiation belts, getting back to Earth several days later, if at all.

NASA is working to improve guidance systems to meet this severe accuracy requirement. The Apollo circumlunar craft, however, will not be ballistic; it will be semi-ballistic with some aerodynamic lifting capabilities. This will increase the permissible entry-corridor to about 40 miles thus alleviating the guidance problem and deceleration.

Once in the atmosphere, guidance instruments will include radar altimeters and bank-angle indicators.

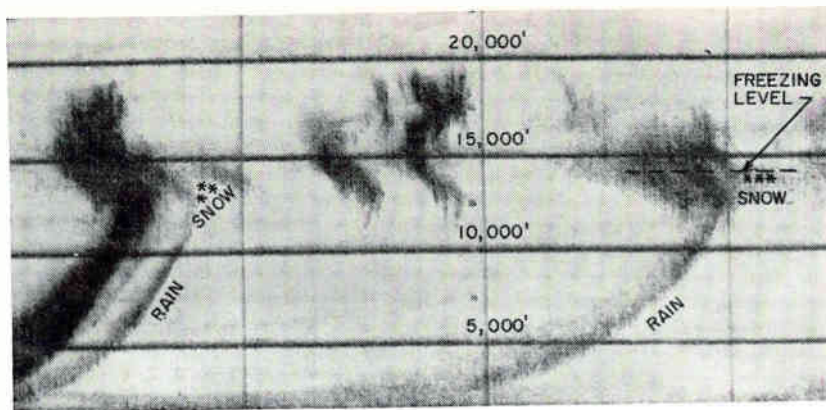

Cloud height radar recording tells forecaster where snow is turning to rain. Slope changes as droplets fall faster

## Global Weather Net Grows

WESTOVER AFB, MASS.—New ground radars and other equipment are being tested at this SAC base and at Hanscom Field, Bedford, as part of the gradual development of the Air Force's global weather system.

The 433L system will eventually be a high-speed network for weather data sensing, processing, forecasting and communications. New techniques will be incorporated without interrupting existing AF weather service.

System test beds at Hanscom and Westover combine radar, tv, computer and teletypewriter to speed data to SAC, TAC and other commands. Col. George A. Guy, of Elec-

tronic Systems Division, Hanscom, is managing the network's modernization. United Aircraft, program integration contractor, has set up a weather system center in Hartford, Conn.

AN/FMQ-5 automatic weather stations are being tested at Westover and Hanscom. These convert sensor data into digital form, compute such parameters as runway visual range, and feed digital outputs to teletypewriters, printers, displays and communication circuits. Information goes to on-base meteorologists and user commands by closed-circuit tv and also is fed to the global system upon periodic demand from a control center.

FMQ-5 is built by Siegler's Olympic division, which also produced the AN/TPQ-11 cloud height radar (ELECTRONICS, p 62, Mar. 31, 1961). This radar, and a Curtiss-Wright storm detection radar, are the first two new devcies in 433L. They are expected to be operational in 1964.

A TPQ-11 has been installed at Hanscom. Working in the K<sub>a</sub> band between 34.5 and 35.6 Gc, it profiles cloud density overhead. It detects cloud bases and tops at altitudes of 500 to 60,000 ft, for crt display and facsimile recording. One of its uses is in forecasting onset and dissipation of fog and precipitation. Information on cloud layers above the fog helps tell when the fog will burn off.

Operational versions of TPQ-11



Radar spots severe local storms approaching from as far as 100 miles



are expected to use 0.5  $\mu$ sec pulses at a rate of 1,000 pulses a second, twice the present rate. A circular-mode magnetron developed by SFD Laboratories under AF contract is in preliminary tests.

The storm detection radar, produced by Curtiss-Wright under Navy contract, is being tested at an AF Cambridge Research Lab site in Maynard, Mass. The main ppi scope uses a new storage and display tube developed by Skiatron and made by National Union Electric. Purple-on-white is used for persistent display. Conventional phosphor gives vertical display of storm intensity and height.

The Air Weather Service's Global Weather Central at Offut AFB, Neb., will have facilities to process and transmit information instantaneously to AF and Army units around the world.

Offut processes weather information in an IBM 7090. Graphs and charts, generated from raw data received by teletypewriters, are disseminated to users throughout the system. Teletypewriter speed may eventually be increased from 100 wpm, at present, to 2,000 wpm.



*Tr sends teletypewritten forecast to user commands. Modified line feed displays 24 characters a line*



*Information from human observers can be fed manually into automatic weather station*

**FIRM FOOTING**

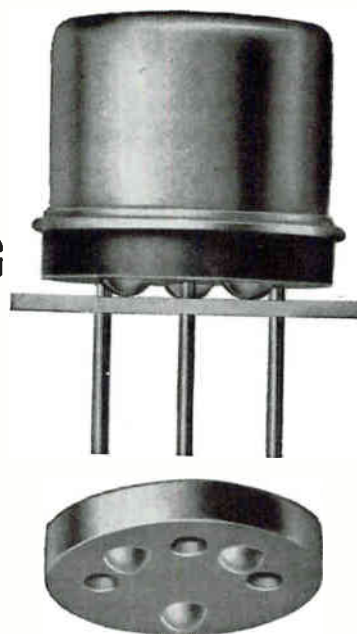

**FOR TRANSISTORS**

Transipads put a little extra security into printed-circuit assemblies. For a cost you count in pennies. A Transipad mounting is rock solid. It eliminates strain on delicate leads, provides vibration-proof separation between them. It isolates the transistor case from contact with printed conductors. And, perhaps most important, it provides a built-in air space to dissipate the heat of soldering (how many transistors have you lost lately through heat shock?). Transipads come in sizes and styles to fit most transistor types; some will convert lead arrangements from in-line to pin-circle, or vice-versa; others will widen lead spacing. Samples and drawings are yours for the asking. A note or a phone call will bring them.



**THE MILTON ROSS COMPANY**

238 Jacksonville Road, Hatboro, Pa. Phone: OSborne 2-0551



## TWO OUTSTANDING HIGH-TEMPERATURE

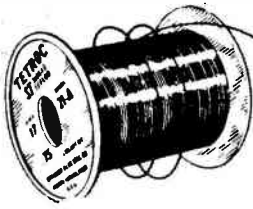

FOR CONTINUOUS OPERATION AT  
HOTTEST SPOT TEMPERATURES  
UP TO

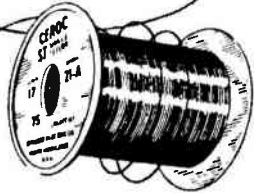

FOR CONTINUOUS OPERATION AT  
HOTTEST SPOT TEMPERATURES  
UP TO

For continuous operation at hottest spot temperatures up to 200°C (392°F) and up to 250°C (482°F) for short periods of time—depend upon TETROC—an all Teflon-insulated wire available in both single and heavy coatings.

CEROC is Sprague's recommendation for continuous operation at hottest spot temperatures up to 250°C (482°F) and up to 300°C (572°F) for short periods of time. Ceroc has a flexible ceramic base insulation with either single silicone or single or heavy Teflon overlays. The ceramic base stops "cut-through" sometimes found in windings of all-fluorocarbon wire. Both Tetroc and Ceroc magnet wires provide extremely high space factors.

Write for Engineering Bulletins 405 (Tetroc Wires) and 400A (Ceroc Wires).

SPRAGUE ELECTRIC COMPANY  
35 Marshall Street, North Adams, Mass.

**SPRAGUE**  
THE MARK OF RELIABILITY

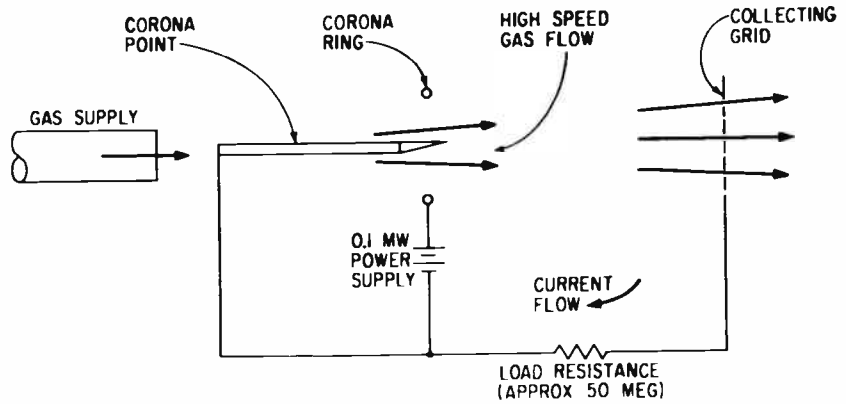

*Kinetic energy of high-speed gas is changed into electricity in GE's electrohydrodynamic generator*

## Gas Energy May Yield Power

ELECTROHYDRODYNAMIC GENERATION of megawatt power may result from investigations underway at General Electric's Missile and Space Vehicle dept. Using the arrangement shown, GE scientists recently reported generating 1.4 milliwatts at 170 v with 0.1 milliwatt being supplied externally.

This is significant, they claim, because it shows that such a system, derived from the electrostatic generator, can produce more electrical power than it consumes. In the GE device the kinetic energy of a moving gas is changed into electricity in a process termed electrohydrodynamics.

Present effort is aimed at developing a practical device for such applications as space vehicle ion engines.

In the experimental generator, which was developed under contract with the Air Force Aeronautical Systems Division, air is forced at near-sonic velocity through a corona discharge and ionized. The resulting electrons are drawn off in the area of the corona field while the ions are pushed down-stream by neutral atoms to a collecting grid where they recombine with the electrons.

Electron flow from the corona through the circuit to the collecting grid constitutes a current of approximately 10 microamperes. GE reports it is now investigating another method of ionization to get higher current.

For gases whose mobility is in the range of 1 cm a second per volt-

cm, calculations show the system could yield 20 Kw a sq meter corona ring area. Efficiency would be low.

Gases or other substances, such as the aerosols, with lower mobility characteristics would give higher efficiencies. Marks Polarized Corp. is reported to have developed an aerosol generator for the Navy that shows promise of high efficiency.

GE reports it is looking at one system, which when used with the new ionization scheme might permit outputs on the order of several megawatts a cubic meter. Also under study are materials for preventing electrical breakdown at 10 Kv.

Because the device is potentially a simple, high-voltage power source, GE researchers see it as applicable to ion engines, which require potentials in the Kv range. It might also be useful for commercial power generation although power densities are not expected to exceed what might be produced by an MHD generator.

## Multichannel Electronic Analgesic Is Offered

WEBCOR will offer to doctors and dentists next year a 10-channel magnetic recorder for analgesic use. The company says it will permit use of music and voice, for more effective results than white noise alone. The physician can superimpose his voice over prerecorded sound.

ANOTHER FINE PRODUCT OF FAIRCHILD RESEARCH

# "FAIRITE" CONDUCTIVE PLASTIC POTENTIOMETERS

Fairchild, the leader in precision potentiometers, takes another giant stride

in technological progress with infinite-resolution, conductive plastic potentiometers having Fairchild reliability "built-in" ■ "Fairite" potentiometers utilize a continuous track of specially prepared, conductive, high impact plastic co-molded with an insulating base of the same heat-resistant material to provide superior performance under temperature and humidity extremes ■ Temperature cycling tests of this advanced Fairchild design shows that resistance values are consistently reproduced ■ Resistance stability is maintained by Fairchild's unexcelled production skills which assure sufficient conductor bulk to virtually eliminate effects of wear ■ Low end-loss positive connections are achieved through co-molding of silver terminations with the conductive track. In addition, track geometry can be varied to obtain optimum functional conformity ■ Reliable operating life of many millions of cycles is assured through the resistance stability of Fairchild's "Fairite" conductive plastic potentiometers. For more information, write Dept. 53E.

**FEATURES: INFINITE RESOLUTION/UNSURPASSED RELIABILITY/RESISTANCE STABILITY/CONSTANT RESISTANCE VALUES/LOW END-LOSS/LONG LIFE/COMPLETE RANGE OF SIZES**

ELECTRICAL		ENVIRONMENTAL	
Resistance Range, ohms	2K — 50K ± 10%	Temperature Range	—65°C to + 150°C
Ind. Linearity	0.5% standard	Humidity	95% to 100% RH at 71°C
Resolution	Virtually infinite (less than .005°)	Vibration	10 G's to 2000 cps
Temperature Coefficient	Negative 3-400 ppm	Life	Over 10 million cycles at 600 rpm
Power Rating	2 watts at 20°C		

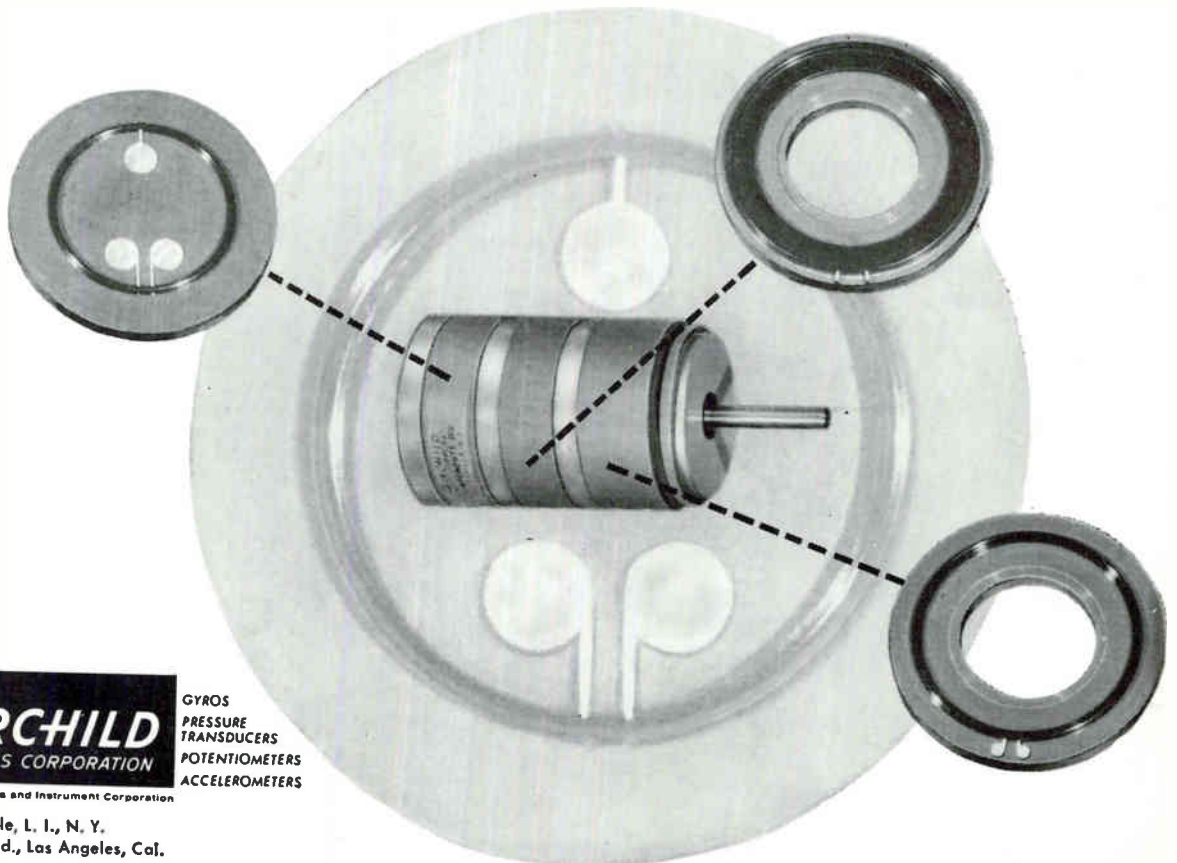

GYROS  
PRESSURE  
TRANSDUCERS  
POTENTIOMETERS  
ACCELEROMETERS

A Subsidiary of Fairchild Camera and Instrument Corporation

225 Park Ave., Hicksville, L. I., N. Y.  
6111 E. Washington Blvd., Los Angeles, Cal.

January 5, 1962

CIRCLE 31 ON READER SERVICE CARD 31

# No Other Electrical Connector Offers So Much SECURITY SIMPLICITY SAVINGS

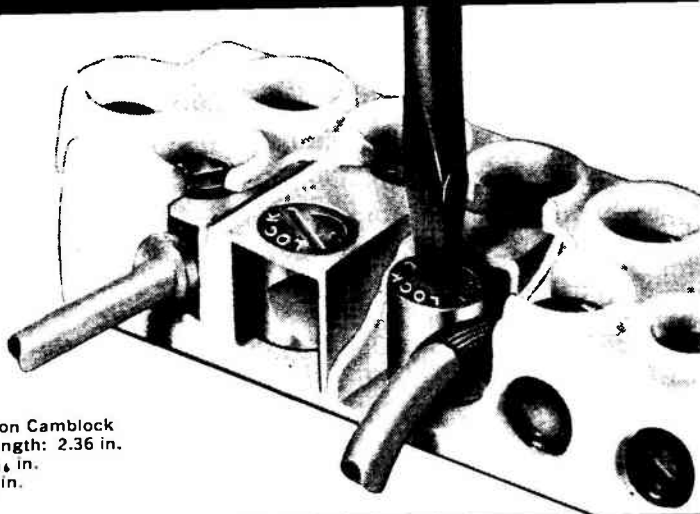

\* Four Station Camblock  
Overall Length: 2.36 in.  
Height:  $\frac{1}{16}$  in.  
Width:  $\frac{1}{8}$  in.

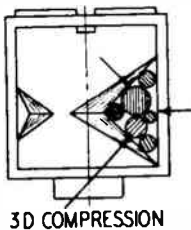

**BETTER POSITIVE LOCKING CONNECTION**, both mechanically and electrically, results from the wedging action of the cam which compresses the wire against the busbar. Camblock construction\* also affords superior insulating characteristics and high vibration values.

**SIMPLE** as . . . (A) stripping the wire, (B) inserting it into terminal block, or binding post connector, and (C) turning the cam.

**ELIMINATION OF SPECIAL TOOLS, LUGS, NUTS, SCREWS, AND SOLDER** makes field service and maintenance easy and quick.

**SUBSTANTIAL SAVINGS IN WIRING LABOR TIME** — on the average of 75% — have been realized by users.

**ONE SIZE CAMBLOCK ACCOMMODATES A WIDE RANGE OF WIRE SIZES . . . #10 to #22AWG** (rated to 30 amps) for the medium series available in 2 to 20 stations.

\*patent pending

Write for technical data sheets and test reports. Camblock Meets or Exceeds MIL-T-16784B. CSA File #19143.

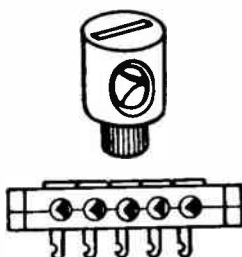

## CAMBLOCK

CORPORATION



A SUBSIDIARY OF WALTHAM PRECISION INSTRUMENT COMPANY, INC.  
221 CRESCENT STREET, WALTHAM 54, MASSACHUSETTS  
Tel: TWINbrook 3-4000 TWX: WALTH 1193-X

## MEETINGS AHEAD

RELIABILITY AND QUALITY CONTROL Symp., PGRQC of IRE, AIEE, ASQC, EIA; Statler Hilton Hotel, Wash., D.C., Jan. 9-11.

OPTICAL CHARACTER RECOGNITION Symposium, Nat. Bur. Stds., Dept. of Interior Aud., Wash., D.C., Jan. 15-17.

ELECTRICAL ENGINEERING Exposition for electrical-electronics industry, AIEE; N.Y. Coliseum, N.Y.C., Jan. 29-Feb. 2.

REDUNDANCY TECHNIQUES FOR COMPUTING SYSTEMS, Office of Naval Research; Dept. of Interior Aud., Wash., D.C. Feb. 6-7.

MILITARY ELECTRONICS, PGMIL of IRE; Ambassador Hotel, Los Angeles, Feb. 7-9.

SOLID STATE CIRCUITS, Internat. Conf., PGCT of IRE, AIEE; Sheraton Hotel and U. of Penn., Philadelphia, Pa., Feb. 14-16.

APPLICATION OF SWITCHING THEORY TO SPACE TECHNOLOGY Symp., USAF, Lockheed Missiles & Space Division; at Lockheed, Sunnyvale, California, Feb. 27-Mar. 1.

SCINTILLATION AND SEMICONDUCTOR Counter Symp., PGNS of IRE, AIEE, AEC, NBS; Shoreham Hotel, Washington, D.C., Mar. 1-3.

MISSILES & ROCKET TESTING Symp., Armed Forces Communications & Electronics Association; Coca Beach, Fla., Mar. 6-8.

EXTRA-HIGH VOLTAGE COMMUNICATION, CONTROL & RELAYING, AIEE; Baker Hotel, Dallas, Tex., Mar. 14-16.

IRE INTERNATIONAL CONVENTION, Coliseum & Waldorf Astoria Hotel, New York City, Mar. 26-29.

QUALITY CONTROL Clinic, Rochester Soc. for Q.C.; U. of Rochester, Rochester, N.Y., Mar. 27.

ENGINEERING ASPECTS OF MAGNETO-HYDRODYNAMICS, AIEE, IAS, IRE, U. of Rochester; U. of Rochester, Rochester, N.Y., Mar. 28-29.

SOUTHWEST IRE CONFERENCE AND SHOW; Rice Hotel, Houston, Texas, April 11-13.

JOINT COMPUTER CONFERENCE, PGEC of IRE, AIEE, ACM; Fairmont Hotel, San Francisco, Calif., May 1-3.

HUMAN FACTORS in Electronics, PGHFE of IRE; Los Angeles, Calif., May 3-4.

ELECTRONIC COMPONENTS CONFERENCE, PGCP of IRE, AIEE, EIA; Marriott Twin Bridges Hotel, Washington, D.C., May 8-10.

NATIONAL AEROSPACE Electronics Conference, PGANE of IRE; Biltmore Hotel, Dayton, Ohio, May 14-16.

MICROWAVE Theory & Techniques National Symposium, PGMTT of IRE; Boulder, Colo., May 22-24.

CIRCLE 33 ON READER SERVICE CARD →





## THIS remarkable plastic may trigger a new (or cost-saving) design idea for you

National Vulcanized Fibre is unique. It's a tough, cellulosic plastic—not mere paper or fiberboard. Vulcanized Fibre possesses an unusual combination of mechanical, electrical and thermal properties. For example . . .

It weighs one-half as much as aluminum, yet is one of the strongest materials known per unit of weight. It's tough, durable and cushions the shock of repeated blows.

Vulcanized Fibre has superior arc-resistance. It comes in standard and special grades, including a fire-resistant grade called "Pyronil." It can be machined, formed or deep-drawn into intricate shapes, and can be combined with other materials . . . aluminum, rubber, "Mylar," copper, laminated plastic, plywood, to name a few.

You can polish it, paint it, lacquer it, emboss it. And regardless of the finish, it resists oils, gasoline, fungi, most solvents. Most surprising is its low cost.

Find out for yourself why National Vulcanized Fibre is "the plastic with a million uses." There's a free sample kit

waiting for you at a nearby NVF sales office. Check Sweet's Product Design File 2b/Na for the one nearest you. Or write directly to Dept. P Wilmington, Delaware.

**116 Choices: One Source** This is the latest count of the different plastics and grades NVF can offer in your search for the *one best material*. Add to this total *the one special grade* that can be developed from scratch to meet your particular need. This full range of materials is backed by complete engineering services . . . from application assistance up to and including the delivery of 100% usable, precision-fabricated parts . . . in any quantity, on time!  
 Call the NVF Sales Office near you. It's a direct line to single-source help on your current materials problem.



**NATIONAL VULCANIZED FIBRE COMPANY**  
 WILMINGTON 99, DELAWARE  
 In Canada: NATIONAL FIBRE COMPANY OF CANADA, LTD., Toronto 3, Ontario

5 grades of polyester



85 Phenolite® laminates



3 thermoplastics . . . nylon, Delrin®, Penton®





There is a curious correlation between leading edge requirements and the state of the electronics art. Both have advanced together, and both move forward in discrete steps. Sixty cycle technology had its own attitudes, components and techniques. These were replaced when millisecond switching became important. Later on, rise times were measured in microseconds, and a corresponding set of components, techniques and attitudes made its appearance. Today, The Nanosecond Edge is the common and critical requirement. And a new generation of techniques has matured. All solid-state design is standard; performance is predicated on new orders of precision, speed and control; and the demands of a new and realistic concept of Reliability affect every design.

A new generation of Test Equipment has also made its appearance. It is typified by the Rese Model 203. This all solid-state, general purpose, pulse generator is *the basic* pulse instrument wherever the Nanosecond Edge has become important. It offers for the first time in the industry guaranteed linear rise and fall times over its entire range—20 nanoseconds to 2  $\mu$ seconds with continuously variable controls over all the parameters of the pulse.

The design of the 203 is based on procedures normally followed in the computer field. All circuits are designed so that the components function at end-of-life values. Tolerancing is done on a worst case basis, and all transistor parameters are derated. The result is a superior instrument which provides that extra edge in Reliability, Controllability, Maintainability and Precision which the problems of design, maintenance and production demand.

For detailed specifications and the full story of the Model 203 contact Rese Engineering, Inc., A and Courtland Streets, Phila. 20, Pa.

THE  
NANOSECOND  
EDGE

pulse generator 203

**rese**

rese  engineering, inc.







# COMPONENTS' MARKETS

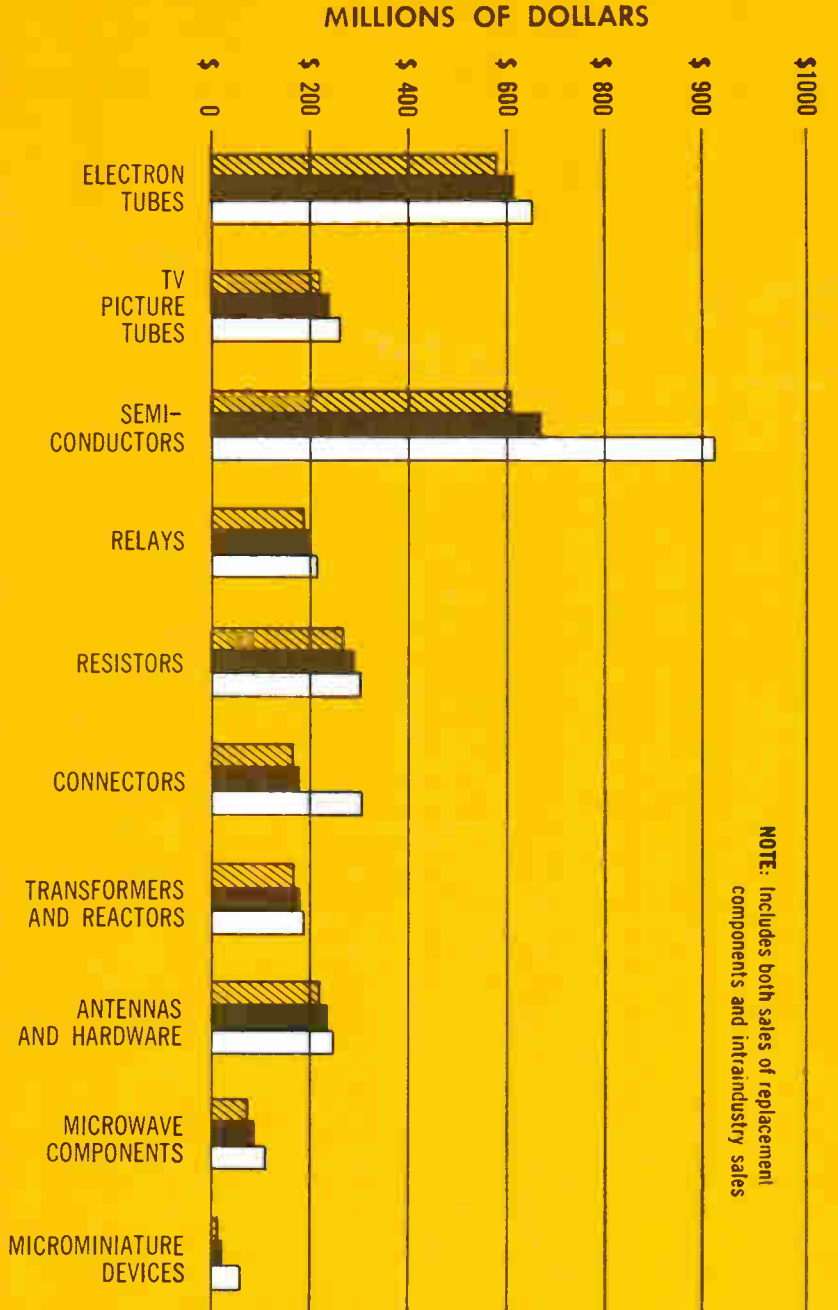

NOTE: Includes both sales of replacement components and intraindustry sales

# SELECTED INDUSTRIAL ELECTRONICS

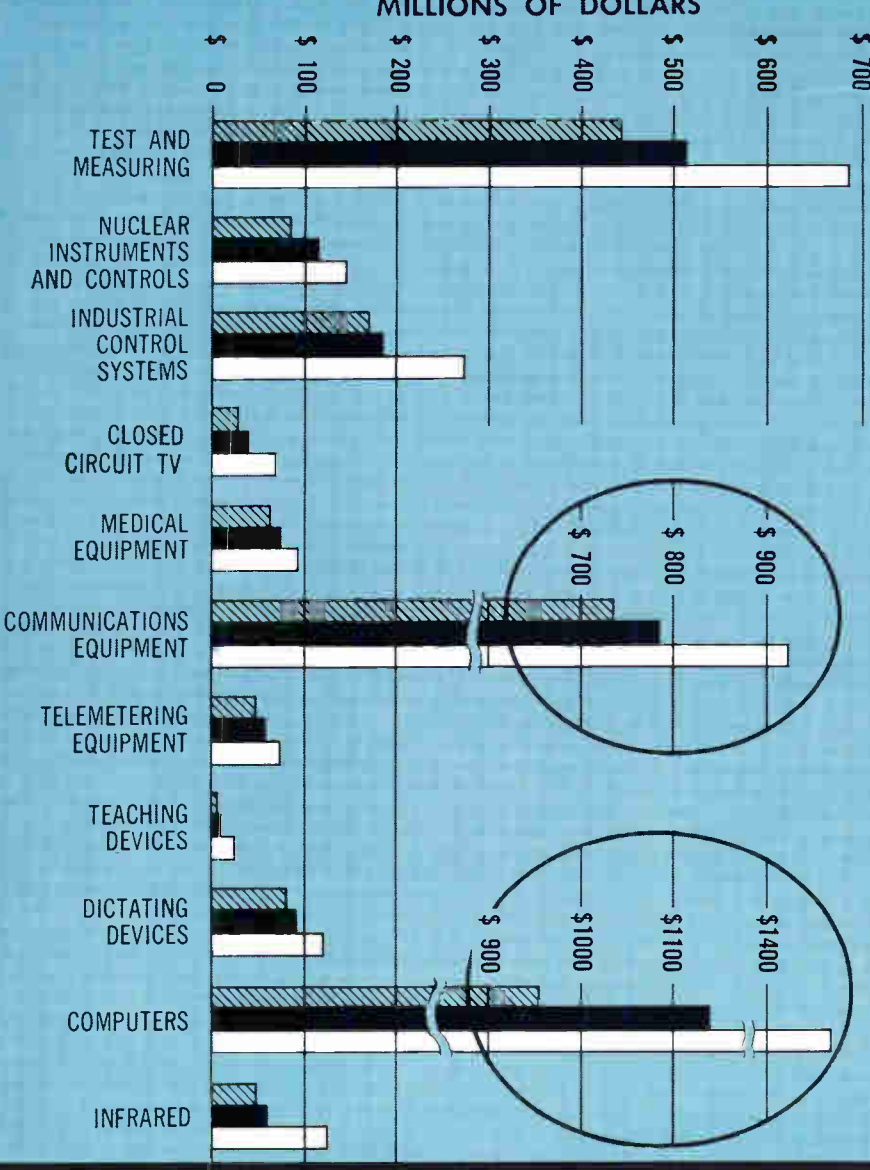

# MAJOR MILITARY ELECTRONIC EXPENDITURES

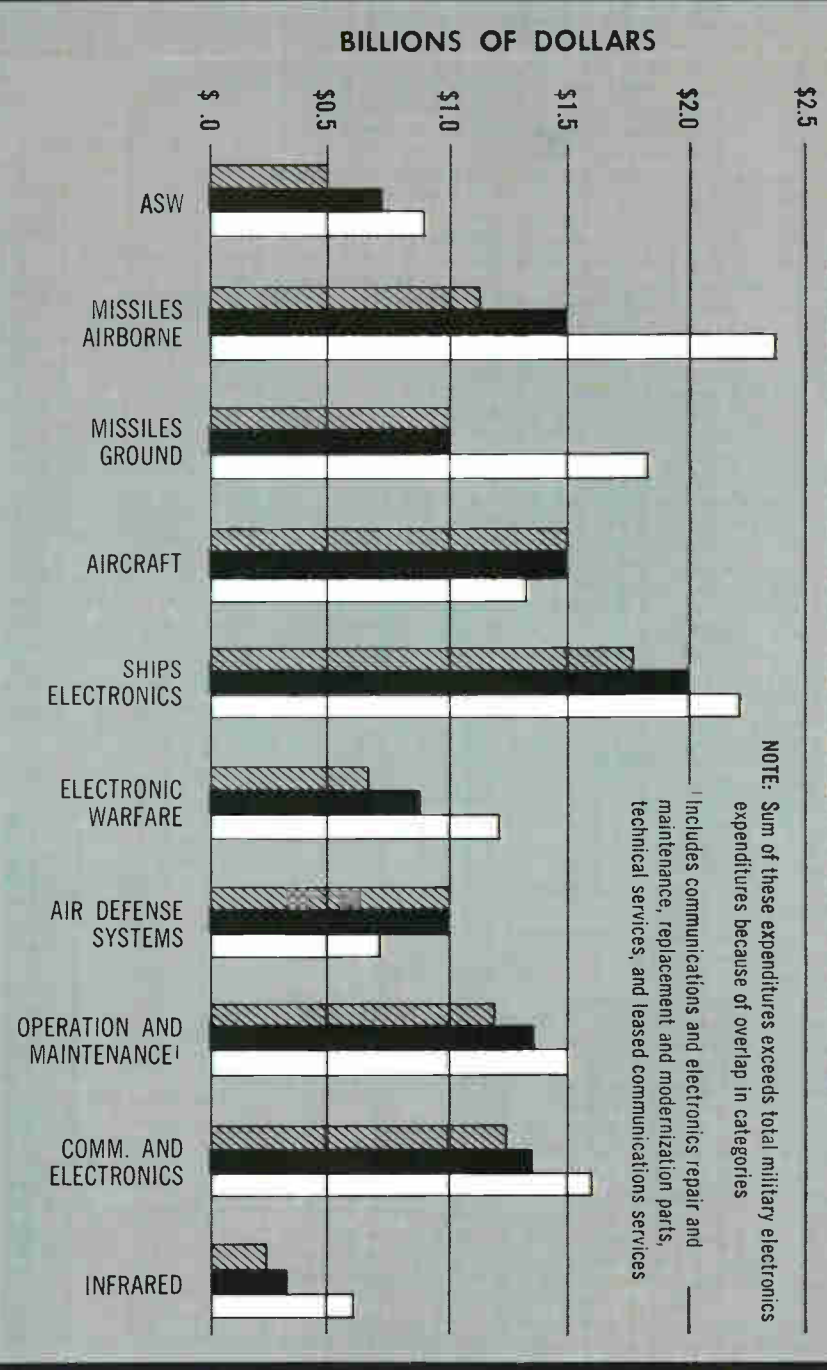

NOTE: Sum of these expenditures exceeds total military electronics expenditures because of overlap in categories  
<sup>1</sup>Includes communications and electronics repair and maintenance, replacement and modernization parts, technical services, and leased communications services

# CONSUMER ELECTRONIC PRODUCTS

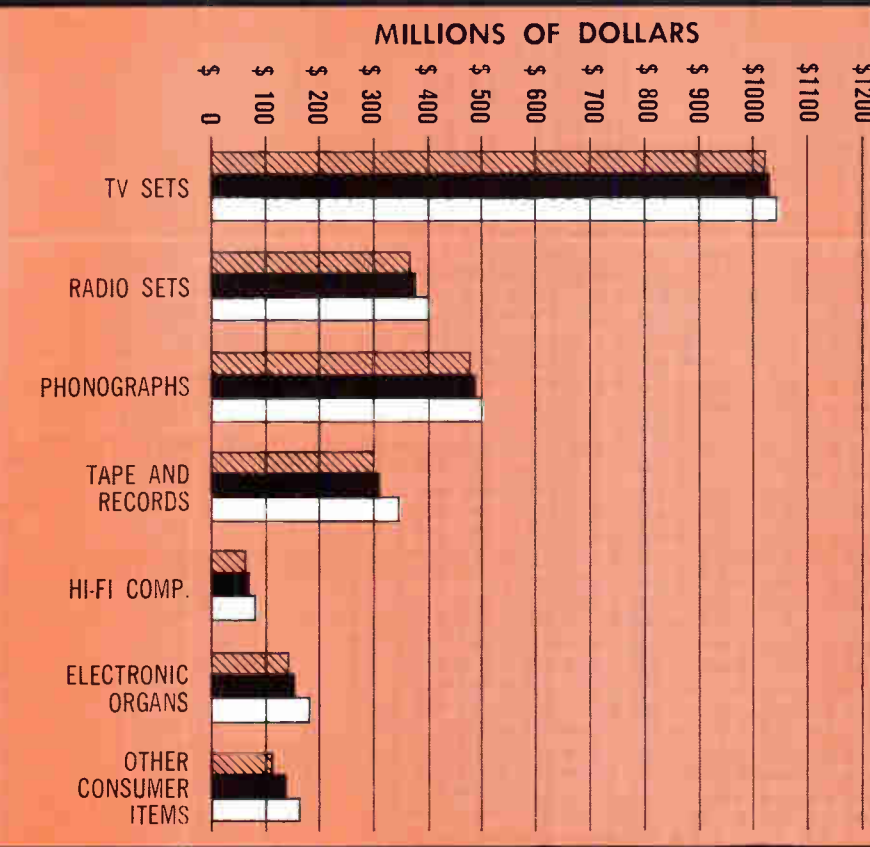

# TOTAL ELECTRONICS INDUSTRY



LEGEND: 1961 (hatched), 1962 (solid black), 1965 (white), 1970 (light blue)

# ELECTRONIC MARKET

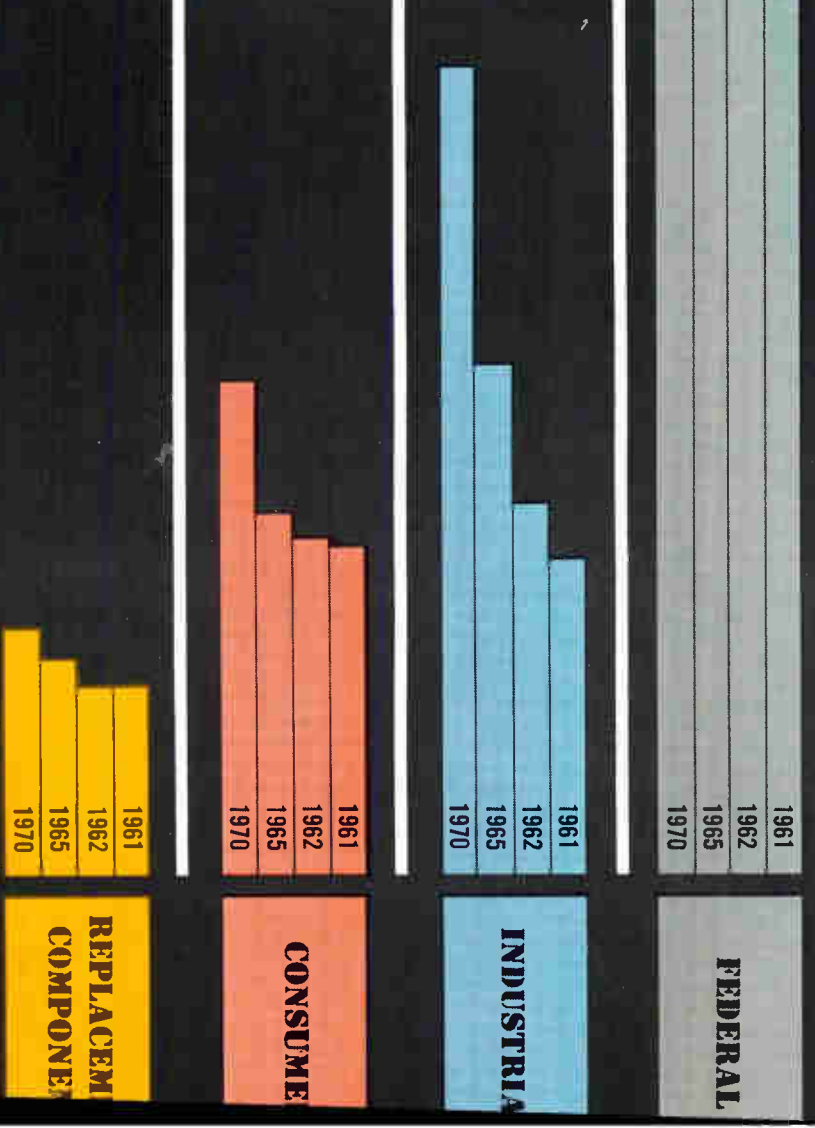



AN ANALYSIS OF  
THE PRESENT,  
AND A LOOK  
INTO THE FUTURE

# OUR GROWING MARKETS . . .

By **THOMAS EMMA**  
Associate Editor

**STEPHEN B. GRAY**  
Assistant Editor

**LEON H. DULBERGER**  
Assistant Editor

**BEN ANELLO**  
Mgr., Market Service Dept.



## INDUSTRIAL MARKETS

Electronics is already important in commerce and industry, and more applications are coming



## FEDERAL MARKETS

Changing patterns stressing research mean more money, but not necessarily more hardware



## CONSUMER MARKETS

Still entertainment-oriented, but with more variety than ever before



## COMPONENTS MARKETS

Some shakeouts, more new technology and increased demand for special items



## MARKETS ABROAD

Elsewhere in the world electronics is reaching major industry proportions, bringing new opportunities and problems



REPRINTS  
AVAILABLE  
1962  
READER SERVICE CARD

© 1962 ELECTRONICS

A McGraw-Hill Publication

# OUR GROWING



**TODAY'S ELECTRONICS DOLLAR—**  
Major share is still from the military, but other parts are growing steadily

## COMPARATIVE SPENDING

PROCUREMENT vs. RESEARCH DEVELOPMENT  
TEST and EVALUATION

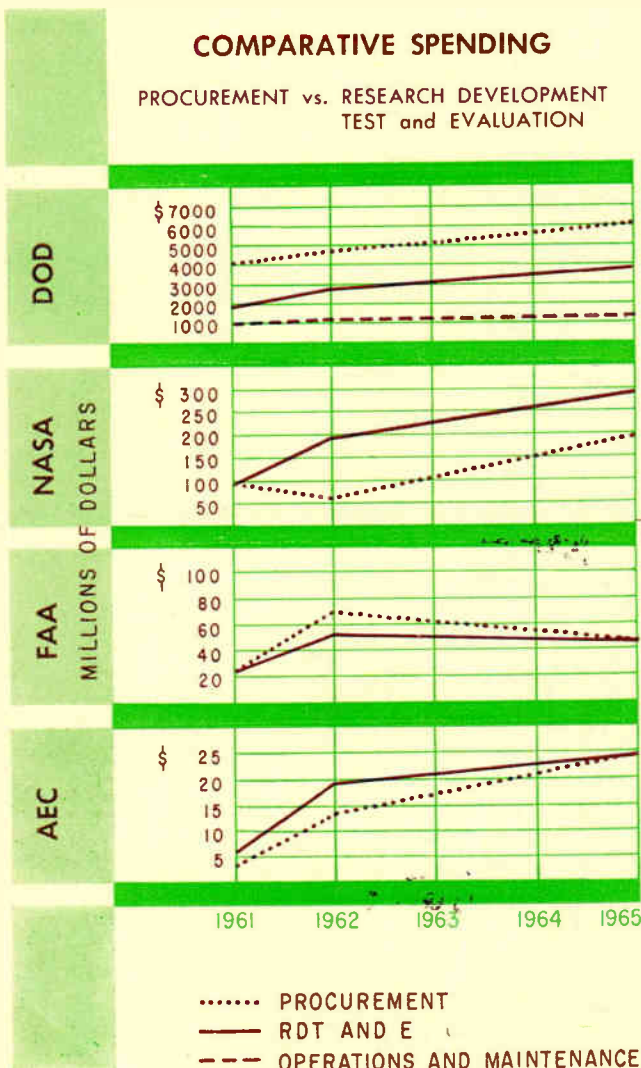

CONTINUED GROWTH against a background of changing patterns will be the main characteristic of the electronics market in the immediate future.

**TOTAL INDUSTRY VOLUME** of \$14.7 billion in 1961 should reach \$16.8 billion this year. By 1965 this figure will probably reach \$20.87 billion, then climb to about \$22.5 billion by 1970.

A major change in the composition of industry figures is already evident. Federal spending will continue to dominate the electronics industry, but increasing percentages of government expenditure will go for research, development, test and evaluation as opposed to direct hardware procurement. In addition, new demands by nonmilitary federal agencies will open additional markets for both goods and services.

**DEFENSE DEPARTMENT** spending last year stood at \$7,300 million, National Aeronautics and Space Administration at \$200 million, Federal Aviation Agency at \$50 million and Atomic Energy Commission at \$10 million.

It is reasonable to expect some leveling off in all four of these categories after 1965, barring a major change in the international situation. Major capital expenditures for major warning systems, electronic warfare complexes and other major installations could be completed or nearing completion. The already visible effects of DOD's shift in policy, giving limited warfare preparedness more attention, will probably be evident throughout the decade as more and more limited combat units are provided with electronic equipment.

**INDUSTRIAL ELECTRONICS**, holding perhaps the greatest promise for long-range future markets, now stands at \$2.63 billion. As more industrial organizations



# MARKETS

turn to electronics, however, this total will climb. This year's level will reach \$3 billion and grow to perhaps \$3.9 billion by 1965. By 1970, industrial electronics could climb to \$6.5 billion.

A major portion of this growth will undoubtedly be in computers, which are already proving themselves industrially in data processing, control, analysis functions and a variety of other areas. Present levels of \$964 million will go to \$1,138 million by the end of this year and should reach \$1,470 million by the end of 1965.

Communications equipment will go from a 1961 level of \$733 million to \$785 million this year. By 1965 a \$918 million level could be reached.

Test and measuring equipment, rising in demand as aids to automation and better production methods, will show rapid strides. Last year's figure of \$449 million will grow to \$513 million by the end of this year and reach \$683 million or more by 1965.

Other categories which will show increases are closed-circuit television, which should reach \$70 million by 1965; medical electronics which should reach \$98 million and nuclear instruments and controls which should go to \$149 million by 1965.

**CONSUMER ELECTRONICS** is likely to show less increase in the next five years, but these are likely to be less spectacular than other segments of our industry. Last year's total was \$2.67 billion. This year's will be about \$2.7 billion. By 1965 the consumer market should be \$2.9 billion and by 1970 it should grow to \$4 billion. In television receivers, radios and phonographs, the shift in emphasis will be towards new developments . . . color in television and stereo in radios and phonographs. Black and white tv receivers, which will go to \$1,030 million by the end of this year, may decline to \$1,000 million by 1965. Filling the gap, however, could be an increase

in color tv receivers, with a possible gain of \$25 million this year over last year's \$75 million, and a climb to perhaps \$140 million by 1965. In a-m radio there will be a dropoff over the next five years, countered by a rise in the market for f-m receivers, particularly those equipped for stereo. Monaural phonographs should remain constant, while stereo record players will surely show at least moderate increases.

**IN THE COMPONENT FIELD**, both in the replacement and in the original equipment categories, a number of items will see leveling or declining markets as the pressure for smaller and more reliable assemblies makes itself felt. The general market picture for replacement components, standing at \$1.5 billion in 1961, will remain about the same in 1962 as in 1961. By 1965 there should be a rise of \$0.2 billion, and the total could go to \$2 billion by the end of the decade.

Receiving tubes, both OEM and replacement will probably see declines in almost all categories as other devices and techniques supplant them, but stepped up requirements in communications and other areas will see a growing demand for special-purpose tubes. This market, which was \$262 million last year will rise to about \$280 million this year and to perhaps \$344 million by 1965.

Semiconductors will continue to grow in importance. Last year's level of \$606 million should climb to \$672 million this year, reach \$939 million by the end of 1965.

Selenium rectifiers, at \$18 million last year, will go to \$20 million this year, but will decline one million by 1965, but other types will show growth.

Filling a variety of demands in military and industrial applications will be microminiature devices of all categories. From last year's \$10 million level, this year's figure will rise to at least \$12 million and soar to perhaps \$60 million by 1965.

# OUR GROWING

THE INCREASING ACCEPTANCE of computers for process control, data reduction, and general office uses will lead an upsurge of industrial electronics markets during the next five years.

The introduction of communication systems to couple the output of data processing installations to multiple end-use points is improving the utility-cost ratio of these equipments. This factor, plus simplified programming of computers is aiding industrial acceptance of electronics.

Demand for test equipment, from single instruments to complete automatic checkout systems is increasing in industry. The use of X-ray equipment, both medical and industrial is growing. Teaching machines for education; and infrared equipment for industrial and railroad use are finding acceptance.

Electronic devices are gaining applications in oceanography, information storage and retrieval, highway control, automobile parking, aircraft safety, and materials testing. The newly invented laser (optical maser) is being groomed for many industrial applications, ranging from communications to medical.

The overview is one of increasingly active markets for well-managed firms selling to industry and business.

**WHO WILL GAIN?** The often predicted general shake out of small electronics firms and unprofitable larger operations is one of the half truths of the business world. Key men within the industry assert that any trend toward a shakeout that may occur in the future will be on a selective basis, and no more dramatic than the day-to-day problems in any highly competitive industry.

Multiple sources exist for most of the products and services supplied to industry and business by the electronics industry. This has imposed new demands on management. To run an electronics firm today requires a firm grasp of the same business practices that are used to succeed in other industries.

It has been suggested that the electronics management man of the coming decade would best be trained only in business; rather than engineering as the men who have for the most part led the field in the last decade, have been. In fact, however, the head man of an electronics firm must be expert in both areas to be fully effective. He requires a strong grasp of the technical problems encountered in developing and producing complex electronic systems, instruments, components, and providing related services.

Additionally an understanding of modern methods of

Control of six spindle turret drill press by prepunched tapes and closed loop feedback system uses ruggedized vacuum tubes. Sperry Rand Corp. equipment uses linear transducer, error detecting null circuit, valve driving amplifier for final hydraulic valve control of machine



# INDUSTRIAL MARKETS

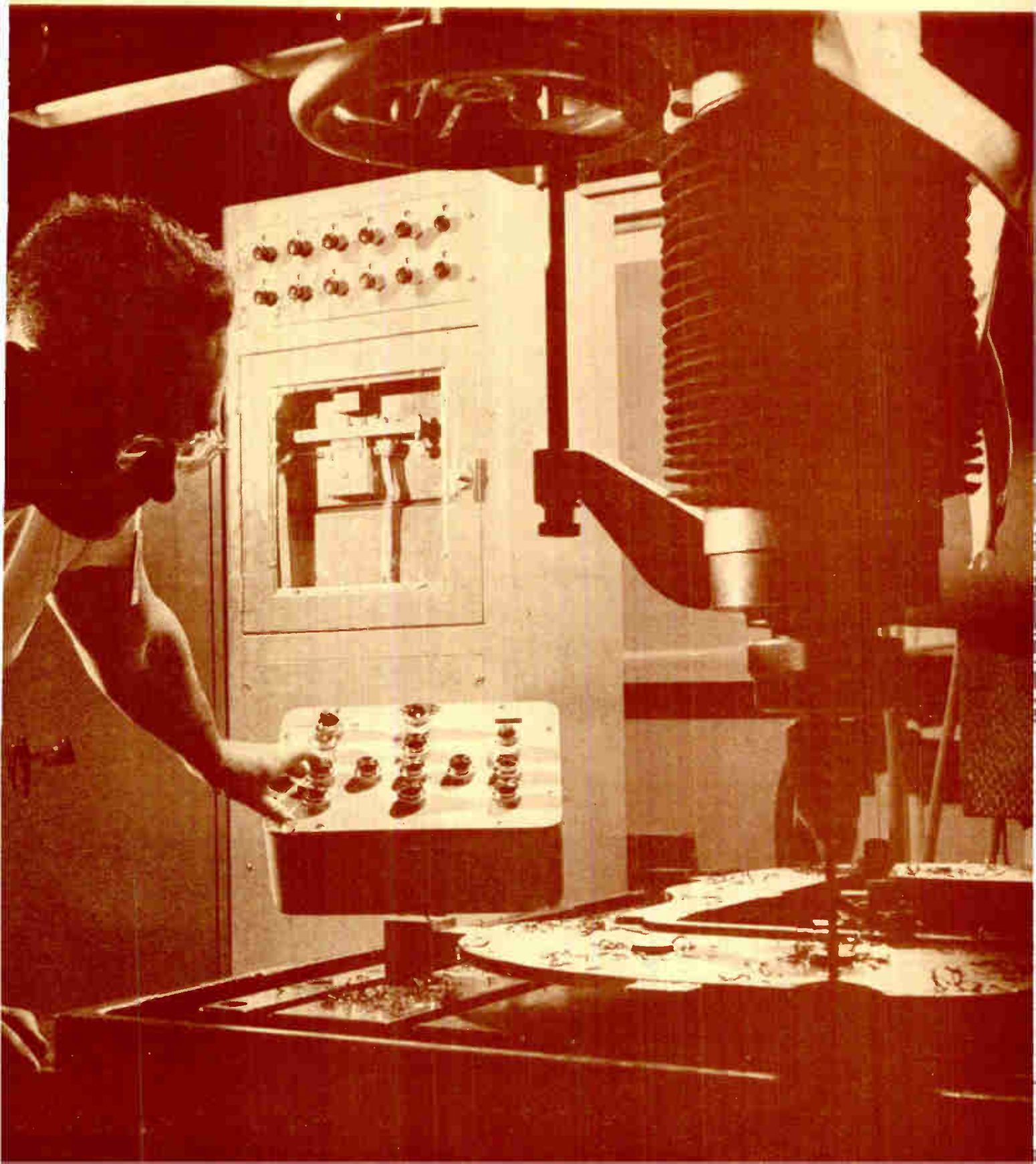



cost control, advertising, product planning, sales techniques and related skills is required.

**COMPUTERS** will advance sharply in sales to industry and office users in the next few years. Acceptance of the computer in many fields has already been achieved. The field of process control, where some computer control has been used with success for several years, should also show a substantial increase in computer applications in the next few years.

Computer control of steel mills, power plants, cement plants, chemical process plants, have all been instituted. New inputs to the computer, such as supplied by X-ray equipment and other transducers, will provide added flexibility of operation.

Automatic control in areas other than process control may find slower acceptance. There are many industry operations that could use computer control, but find it hard to justify the cost of installation. Others cannot quickly overcome the long existing dependence on manual or mechanical means of performing the job.

Also, the absence of skilled electronic technicians in many industries acts against acceptance of complex, computer-controlled installations. Improved reliability designed and built into the computer and its related elec-

tronic gear will help speed customer acceptance.

Thus, in the near future, sales of such items as computer-controlled automatic lathes using magnetic tape may move ahead at a conservative pace. However, in less complex machines such as drill presses run automatically, acceptance may be higher. In the same way, until the cost of installation drops, and clearcut proof of operating economies are given, computer applications such as control of highway traffic, will not increase startlingly. In computer applications, a help is expected from recent gains in the development of automatic programming devices, and related automatic readout systems. One objection to the use of computers in some applications such as data processing has been the lack of trained personnel to program and operate the equipment.

Input-output devices already in use range all the way from character or pattern recognition input equipment; to readout directly on a highspeed electric typewriter. As yet in rudimentary form is the speech programmer that would let the operator speak his request and data into a computer.

Computers are being used in jobs that would have appeared far fetched several years ago. An advertising agency is solving media selection problems with one, sociologists have predicted voting outcomes, a computer is being programmed to assist in diagnosis of diseases,

Entire electrical system of an automobile is checked out against standards in fifteen minutes using electronic analyzer. Performance Measurements Company unit is programed from 35-mm film read with photocells. Inset shows analyzer's format

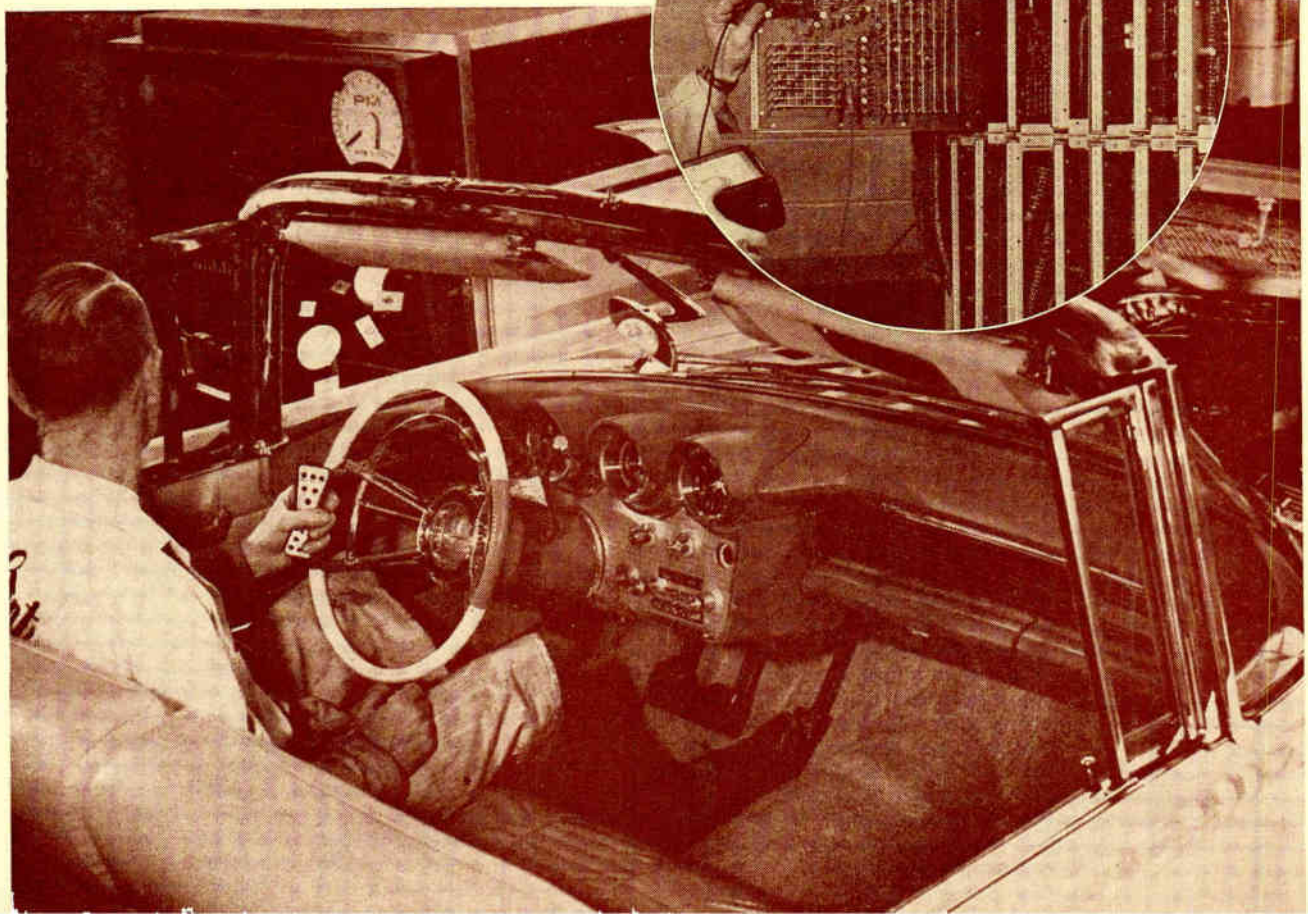



and a computer has been used to simulate the entire human respiratory and circulatory systems.

The use of digital communication systems to transmit information in machine language between distant points over telephone lines is becoming widely used. It promises to increase the utility of a single data-reduction center, to permit its use by outlying offices of a firm that owns one main computer installation.

**INSTRUMENTS**—The market for test instruments is strong, and there is indication that firms in this field are in a position to experience continued growth. However, while industrial applications of test instruments are increasing, many test equipment sales are made primarily because the purchaser is tooling up upon receipt or in expectation of a government contract.

Automatic test equipment, in particular, is finding favor. This is true in automobile manufacturing and maintenance, where tests of ignition systems, engine performance and other functions can be made quickly by use of automated test equipment. Instruments for applications within the electronics industry itself are in growing demand, and should prove an expanding field in the next decade.

**OTHER APPLICATIONS**—The use of infrared devices

such as the railroad hotbox detector for safety inspection, is expected to be a strong sales field.

Innovation of the laser, with its tight beam of high intensity radiation operating at optical frequencies, should in time lead to high data content communication systems for industrial applications.

Development of power modulators for the transmitter, light amplifiers and detector techniques for receivers, and a practical method of excluding atmospheric dust from the transmission path is needed. A land telephone communication system may be expected to evolve in time.

The laser is apt to find applications in the medical field, for its beam can be focused to micron dimensions, allowing it to sterilize small portions of tissue. Possible applications of the laser for use in computers are being researched. Mapping and charting may in time be done with laser-operated radar ranging systems, to an accuracy of fractions of an inch in distances of hundreds of miles.

Ultrasonics is finding a place in automobile counting problems, both in highway and parking field or ramp installations. The design of a counter that will not respond to a human, but will indicate the presence of an automobile even if it is not moving can be accomplished. Ultrasonic industrial cleaning uses are expanding.

Doppler radar also has wide uses in the vehicular traffic field, and is finding application in automobile parking.



Medical probe contains radiation detector and microminiaturized electronics. Hughes Aircraft unit placed in 3-mm catheter can be inserted into human vein to measure radioactive isotopes in the blood stream

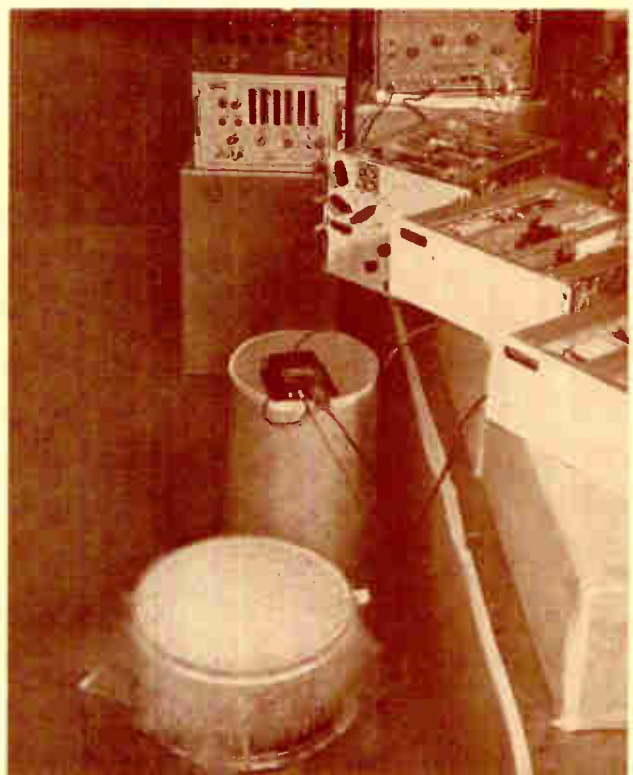

Ultrasonic measurement of liquid nitrogen level is made at cryogenic temperatures. Bogue equipment reads out digitally. Temperature is monitored to correct for speed of sound in medium. Piezoelectric transducer is used

# OUR GROWING

Surface-to-air Hawk missiles now operational with the Army, on trailer-base launcher. Raytheon is the prime for this 20-mile range limited-warfare weapon. Electronics dollar portion of guided and homing type missiles is estimated at 65 percent

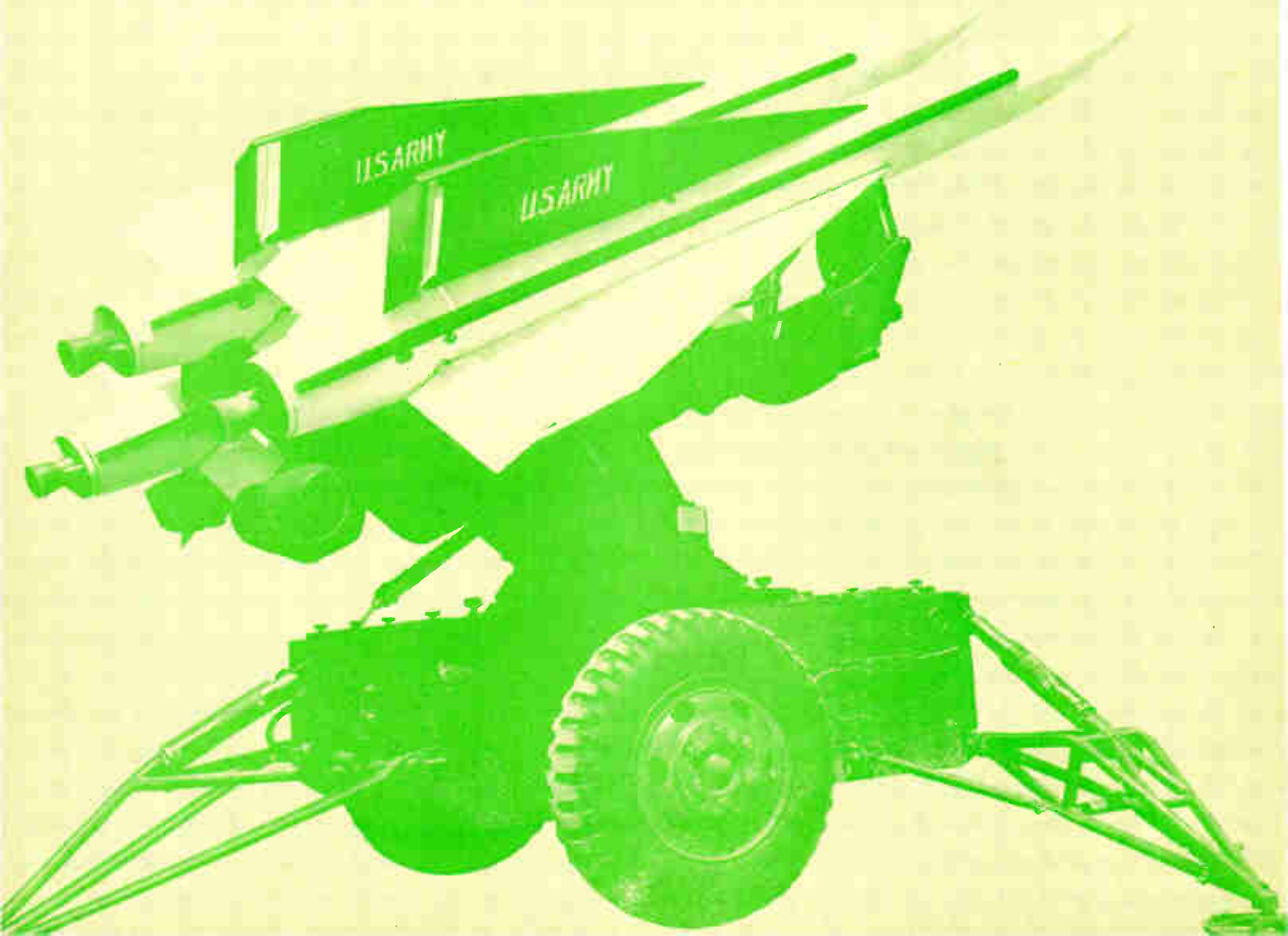



# FEDERAL MARKETS

**MILITARY**—The changing problems of national defense have modified the concept of marketing to the military. It is no longer enough to study procurement lists of past years with only a partial awareness of research and development trends and changing world tensions.

The nation's need at this time for limited warfare weapons has created an increase in the market for electronics hardware already in production.

However, of increasing importance is the fact that military buying of goods as well as services is now being done, to an even greater extent, under the catch-all of Research, Development, Test and Evaluation.

Often a heavily funded project may result in only a few items of final hardware, but it will represent a large expenditure for electronic equipment and services, (engineering and other), during its research and development phases. Rapid obsolescence in weapon-systems and hardware is a hard reality in this decade of changing military positions and rapid technological advances in electronics. Limited production, or no production at all, as in the case to date of Army's Nike-Zeus antimissile missile, does not give a true picture of government electronic expenditures.

The amount spent by the military for the titular category of electronic procurement may decline in future years. However, money spent in the titular category of RDT&E should go up.

The Air Force's project leading to a manned maneuverable space craft, Dyna-Soar is an example of this. In fiscal 1961 a total of \$58 million was spent on all aspects of the project. By now \$185 million has been appropriated for fiscal 1962, on Dyna-Soar's RDT&E budget. The large electronic portion of this project will not then show up on procurement lists directly, and a yearend study of such lists will not reveal its total to the electronic industry.

Research and development holds the key to sales to the military in that they are constantly forcing new techniques into practical application, and discarding the old.

**THE BUDGET**—Congress has approved, at this writing, a \$46.7 billion total defense appropriation for 1962. The exact portion of this figure that is electronic can only be estimated. The reason for this is that many projects of the Department of Defense, and the three military services are not broken down into their electronic portions. The government buys a missile, but has no pressing need to know exactly what amount of its cost is electronic. For some guided missiles, a number accepted for the electronics portion is about 70 percent.

Figures can be extracted with fair accuracy for major hardware procurement, and to a lesser extent for operation and maintenance.

However, in RDT&E such extraction of figures for electronics is not easy. Known and published government figures and statements do, however, give some good clues.

Part of this report includes a table of DOD electronic dollars, broken down for the calendar year 1962, as follows: procurement \$4.971 million, operations and maintenance \$1.220 million, and RDT&E \$3.000 million.

In a statement by Senator Hubert H. Humphrey in the government publication, Coordination of Information on Current Federal Research and Development in the Field of Electronics, Sept. 20, 1961, an estimate of the electronic portion of RDT&E is given:

"A total of \$9 billion is currently expended by the Federal Government for research, development, testing and evaluation. Not less than one-fourth of that sum is spent in the electronics field alone."

Security classifications on RDT&E projects prevents exact evaluation, but estimates in government and industry have ranged from two through five billion dollars, for the military electronics portion.

In the same publication quoted above, under Findings this statement is made:

"An inherent difficulty in managing the overwhelming bulk of information on electronics research and development is that such information tends to be 'buried' within the Defense Department data on weapon systems. This is the case because DOD is logically organized to achieve major security missions, i.e., develop weapon systems, rather than advance the state of the art of a field like electronics."

An example of this is then given:

"The significance of electronics in weaponry may be illustrated by its role in the Polaris program. This program is the Navy's largest research and development operation. Polaris is generally regarded as one of the foremost deterrents to World War Three. Through fiscal year 1960 the Navy had obligated \$2.5 billion for the overall Polaris program. Of this amount, 27 percent was for electronic purposes—\$705 million. Polaris has had 335 contractors and 10,000 subcontractors; of these totals, the electronics phase of the program has involved 112 contractors and 3,000 subcontractors."

To decide on the areas of electronics a firm may pursue in selling the military; its engineering and scientific resources must be considered. Projects are becoming increasingly intricate and technical, and demand a higher

level of ability to produce equipment and techniques acceptable to the military.

In a survey conducted by EIA and DOD it was found that of the estimated 155,000 engineers and scientists doing electronic work in the U.S., about 120,000 are in work supported by the government. Statements by DOD indicate a shortage of serious proportions is expected in the next five years.

It is possible to single out areas of future interest to the military in the field of electronics. This must be done within the restrictions of lack of data due to national security limitations; and the knowledge that an important international political change, or a sudden breakthrough in technology can change such areas from high to low interest.

**ARMY'S** electronic expenditure in the next year in large measure, will be for equipment already designed. The pressing Berlin situation and other similar trouble spots around the world has made buildup for limited war an immediate problem, and does not in all cases allow time for retooling or development of new designs.

However, where tactical requirements demand, and where time allows, Army is pushing developments in electronic instrumented weapons, and support devices. Electronics in applications ranging from infrared detection systems such as sniperscopes, through sophisticated surveillance techniques are receiving attention.

Communications, guidance systems, fire-control equipment and electronic warfare techniques are of interest. Missiles include types similar to the hand-launched, heat-seeking Redeye, the 20-mile Hawk, 75-mile Sergeant and others. One figure accepted in the industry for the portion of a guided missile (not ballistic) that is electronic is 65 to 70 percent. The exact type of guidance, and the mission capability determines the exact proportion, along

with other variables. In an ICBM, some 30 to 35 percent electronics is estimated.

Army's interest in antimissile systems continues, including the still-not-in-production Nike Zeus, and other approaches to the antimissile problem.

One of the Army's needs is development of land-guidance systems. These would allow the positioning of vehicles such as tanks, missile launchers, jeeps and even individual soldiers to an accuracy of yards. It would allow correlation with known terrain features.

**SURVEILLANCE**—Passive systems of detection and identification are desired; these have the advantage of not revealing the user's position. Infrared devices and related techniques are of interest here. Surveillance systems able to operate at the longer infrared wavelengths would detect more of the output radiation of natural objects, and are of interest.

Infrared devices such as helmet-mounted night-driving binoculars, weapon sights, and hand-held binoculars, are being developed or are in production.

Additionally, active infrared surveillance equipment both pulsed and continuous, for long-range use is desired.

Devices that allow soldiers to detect enemy infrared sources are needed. Image-intensifier components and systems, to achieve improved vision capability in limited-light conditions, are being developed. Better phosphors, improved contrast, and lower voltage requirements for light amplifying tubes would be welcomed.

Radars for field surveillance with data-processing equipment built in could aid in tactical evaluation of enemy targets. Audio indicators now used for target indication to the operator, depend on ear sensitivity to an extent.

Power sources and supplies quiet both in the audible and electromagnetic sense are needed. Equipment ranging from miniature to full-sized units are desired to allow





less easily detected operation in tight field conditions. Fuel cells are of interest, as well as atomic fission devices. Means of improving batteries are also being studied.

The laser is an invention of interest to the Army. Lasers generate and amplify coherent light, at high intensity, and narrow bandwidth. The device shows promise for development of systems operating at optical frequencies and capable of increased resolution, accuracy and more compact design than their microwave equivalents.

Laser radars have already been developed by some firms, with ranges to 30 miles. They have a potential accuracy of fractions of an inch at these distances, and can be used for military mapping, target placement for fire control, and in surveillance systems able to trace an outline of the target and reveal if it is a man or a tank. However, production of such radars is some time away and hinges on further R&D.

As far back as July 1960 some scientists indicated belief that a death ray could be developed using the laser.

There have been reports of lasers burning holes in steel. A University of Michigan scientist stated that in the long run, lasers may find their widest application in devices making use of their high energy. He referenced the piercing of steel the thickness of ten razor blades by a laser beam.

Another scientist has said that a laser could be used without further development to blind enemy troops. Others feel that a true death ray is possible using high-power lasers able to pierce armor and devastate troop concentrations.

**COMMUNICATION SYSTEMS** using modulated laser beams are of interest to the Army because of inherent security characteristics obtained from the beam's low divergence. Spreading of less than one foot per mile can be obtained with a tightly focused laser light beam,

making interception by the enemy difficult. A laser communication system for battlefield use might be more secure than telephone lines. A modulated laser beam will allow high information content, due to the wide bandwidth available at the high operating frequency of a laser.

Countermeasures and the directly related technology of counter-countermeasures is of interest to the Army. The need is to disrupt enemy communications and control and prevent them from doing the same to us.

Development of a ground radar able to overcome line of sight limitations for combat surveillance is desired. This would obviate the need for an above-ground system using an aircraft or other elevated platform. Right now, Army surveillance drones using varied sensory devices are in demand, as well as decoy and training drones.

Other Army needs include aircraft communication systems for distances of 50 to 200 miles, collision avoidance systems for aircraft, and airborne tv for combat surveillance.

Other needs include: satellite communication systems, automatic data-processing for field evaluation of tactical data in weapon control. Photographic techniques for surveillance, using electronic subsystems for processing, alignment, light control and other operations are desired.

Electronic means of chemical and biological attack detection, and perhaps control, might be investigated.

Side-looking radar for inspection of enemy territory while flying over friendly lines, with compatible recording equipment is sought.

A passive ranging system that will give distance to a target without revealing position, a color facsimile system for remote map reproduction and electronic equipment for location of water supplies are also in future warfare requirements.

**THE AIR FORCE** is faced with the need to develop mili-



Far left is an all-weather radar used by the Army to spot a single enemy moving a half-mile away, in darkness or fog. The unit, by Sperry Gyroscope, channels signals to the observer's headphones, is an example of the type of equipment Army and Marines require for limited warfare. In photo of left Army helmet-mounted infrared binoculars are used for night driving. Equipment configuration allows free use of hands



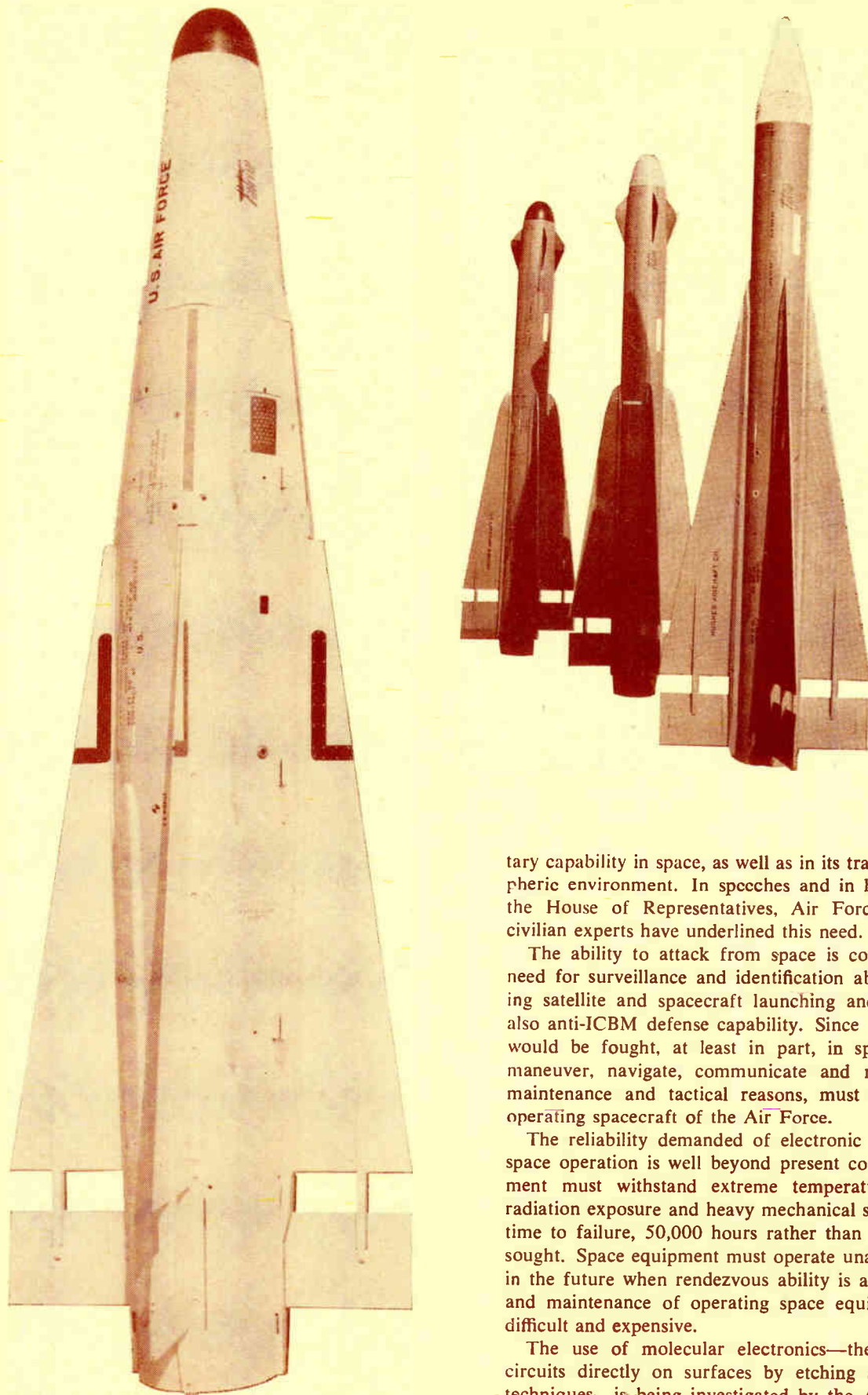

Air Force air-to-air radar guided missile with nuclear capability (left) is the Falcon GAR-11 by Hughes Aircraft. Estimated range, 5 miles. Three smaller Falcon missiles at right are guided by (left to right) radar, infrared, radar

tary capability in space, as well as in its traditional atmospheric environment. In speeches and in hearings before the House of Representatives, Air Force officers and civilian experts have underlined this need.

The ability to attack from space is coupled with the need for surveillance and identification ability in detecting satellite and spacecraft launching and passage, and also anti-ICBM defense capability. Since any future war would be fought, at least in part, in space, ability to maneuver, navigate, communicate and rendezvous for maintenance and tactical reasons, must be realized in operating spacecraft of the Air Force.

The reliability demanded of electronic equipment for space operation is well beyond present concepts. Equipment must withstand extreme temperature variations, radiation exposure and heavy mechanical stress. In mean time to failure, 50,000 hours rather than 1,000 hours is sought. Space equipment must operate unattended. Even in the future when rendezvous ability is achieved, repair and maintenance of operating space equipment will be difficult and expensive.

The use of molecular electronics—the build up of circuits directly on surfaces by etching and depositing techniques—is being investigated by the Air Force as a means of achieving reliability. It can also reduce size and weight.

The Air Force has a unique communications problem brought on by the need to weld together a network of

Prototype test model of airborne digital computer, by Hughes. Unit is now in production for use in Air Force jet all-weather interceptor, can make almost 10,000 basic arithmetical calculations in one second



diverse weapons deployed throughout the world and in space. Identification and command decisions must be made at high speed, on any objects picked up by Air Force's early warning systems. This places a requirement of knitting together BMEWS, Saint (Satellite Inspector), Samos and Midas as well as future systems, along with manned aircraft on round-the-clock deployment, with government and Air Force command centers. A world-circling communications net, using communications satellites or otherwise immune to affects of nuclear blast in the ionosphere is required.

**MANNED WEAPONS**—The build up of ICBM capability by the Air Force does not preclude the use of manned bombers. The same is true of tactical missiles and fighter aircraft. Man can make judgments in a tactical situation beyond the ability of sophisticated machines. The manned bomber, unlike the ICBM can be recalled if a mission is eliminated after dispatch but before reaching the target. Such a craft will be the B-70.

To provide ability for electronic equipment buried in ICBM sites to withstand the effects of possible 100 megaton nuclear warhead detonations nearby, ruggedized manufacturing techniques will have to be employed in Minuteman and similar projects.

Other areas of interest to the Air Force include: power sources able to operate for long periods of time in space, such as nuclear equipment; navigation systems, mapping

equipment, guidance devices and systems; and weather prediction systems using radar and electronic sensors of varied types. Bionics is of interest to Air Force, which is faced with control and computer technology problems that may be solved by bionics-type investigations.

There is a continuing need for electronic warfare (EW) equipment in manned aircraft, including jamming gear to blind radar, destroy communications and deter interception. EW equipment now used in missiles should increase in coming years.

The development of the laser should lead in time to space communication systems operating at optical frequencies. Gamma-ray systems are under study.

The low beam divergence, and large information handling capability of the laser's output, suits it to the coverage of space distances that will confront the Air Force. It has been estimated that in traveling the approximately 250,000 miles to the moon, the circle of light arriving there would be of the order of one mile across. Low power requirements are expected, compared to equivalent microwave systems.

The possible use of the laser's high intensity characteristic may suit it for use in an antimissile system. Requests for study proposals of the uses of the laser's high energy light beams have been sent to industry by the Air Force.

**NAVY'S** requirements for military undersea operations has made antisubmarine warfare (ASW) equipment



of prime interest. The total fiscal 1962 budget for ASW, just under two billion dollars for all phases including ship construction, is an indication of the magnitude of the problem. Navy undersea requirements for electronic equipment exist also in intensified oceanographic research work for military application, and in the well-funded Polaris missile launching and similar submarine programs.

With development of the snorkel submarine, which presents a small breathing apparatus above the surface for short periods of time, detection of the submarine became difficult. Radar was of use during periods of breathing for conventional submarines. Sonar for use against submerged submarines is limited in effectiveness.

Upon development of the nuclear powered submarine, detection of the craft, which can remain submerged for months anywhere in the earth's 140 million square miles of ocean, reached the stature of an almost impossible task.

It is believed that the USSR has nuclear submarines, equipped with long-range missiles. It is not known if they can launch them from beneath the surface nor if all such missiles are ballistic, but their ability to approach our shores undetected is of prime concern.

Long-distance penetration of the sea is achieved to a practical degree at this time only by sound. Thus sonar equipment and techniques are of interest to the Navy,

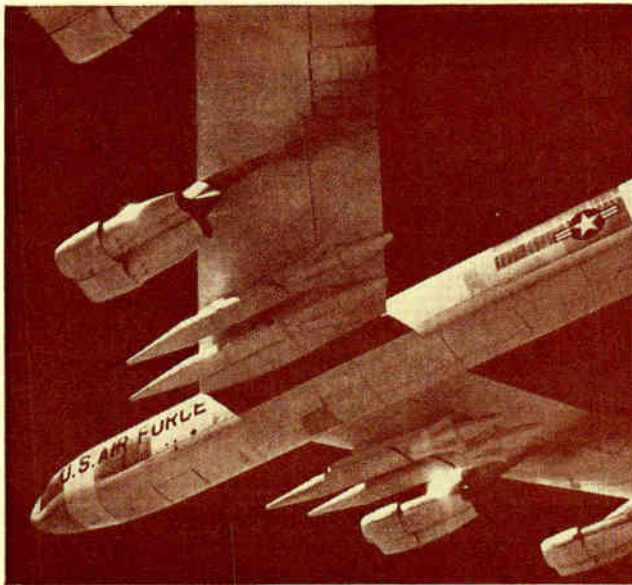

Air Force's air-launched Skybolt missile has over 1,000-mile range. Units are fitted to Boeing B-52H bomber. Douglas is prime for Skybolt

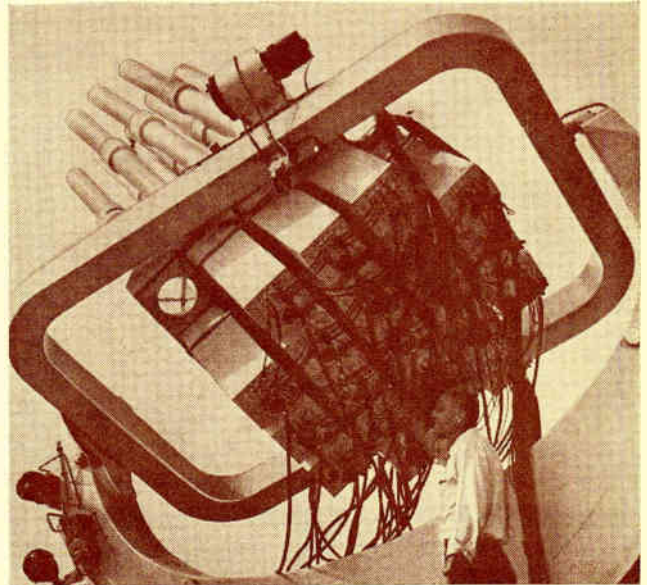

Missile and satellite tracking system for Air Force Systems Command. Facet-eye camera uses 19 refracting telescopes, provides output on image recording tubes

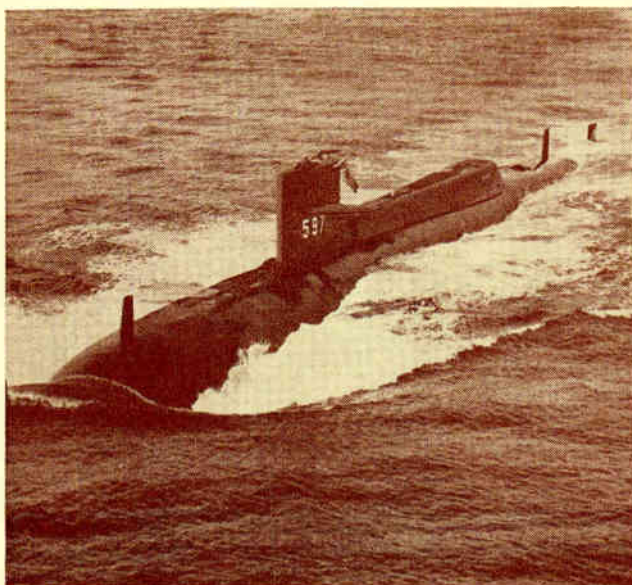

Navy submarine USS Tullibee, designed for antisubmarine warfare is nuclear powered. Vertical fins contain sonar gear. Navy is stepping up oceanographic research, in effort to develop new ASW weapons and techniques



Navy helicopter searches for submarines with sonar dome lowered into sea. Transducer may be lowered below sound bending thermal layers that would allow undersea craft to remain undetected



though Navy is eager to develop new approaches to the problem. Sonars with phased hydrophone arrays, for the passive pickup of moving submarines and high-power, active sonar are both being investigated. The formation of a network of long-range submarine detection stations, as in the recently declassified Artemis project, is an example of the steps Navy is taking in ASW sonar.

The system uses high-power sonar transducers able to project acoustical energy hundreds of miles, coupled with receiving hydrophones in scattered locations to fix the position of an echo-producing object, such as a submarine. Data-processing equipment is required to identify the target from among other possible echo-producing

objects, such as whales, schools of fish, shrimp and decoys. Maximum range with sonar is obtained at low operating frequency. The effects of temperature and also pressure and salinity, cause bending of sound rays. Submarines can hide and operate under these layers of water variation. Means of overcoming this limitation are sought. Placing the transducer below the thermal layer is one approach.

**NONACOUSTICAL METHODS**—The Navy is interested in nonacoustical methods of submarine detection. One technique is the possible use of light undersea. By application of scanning techniques, and the development

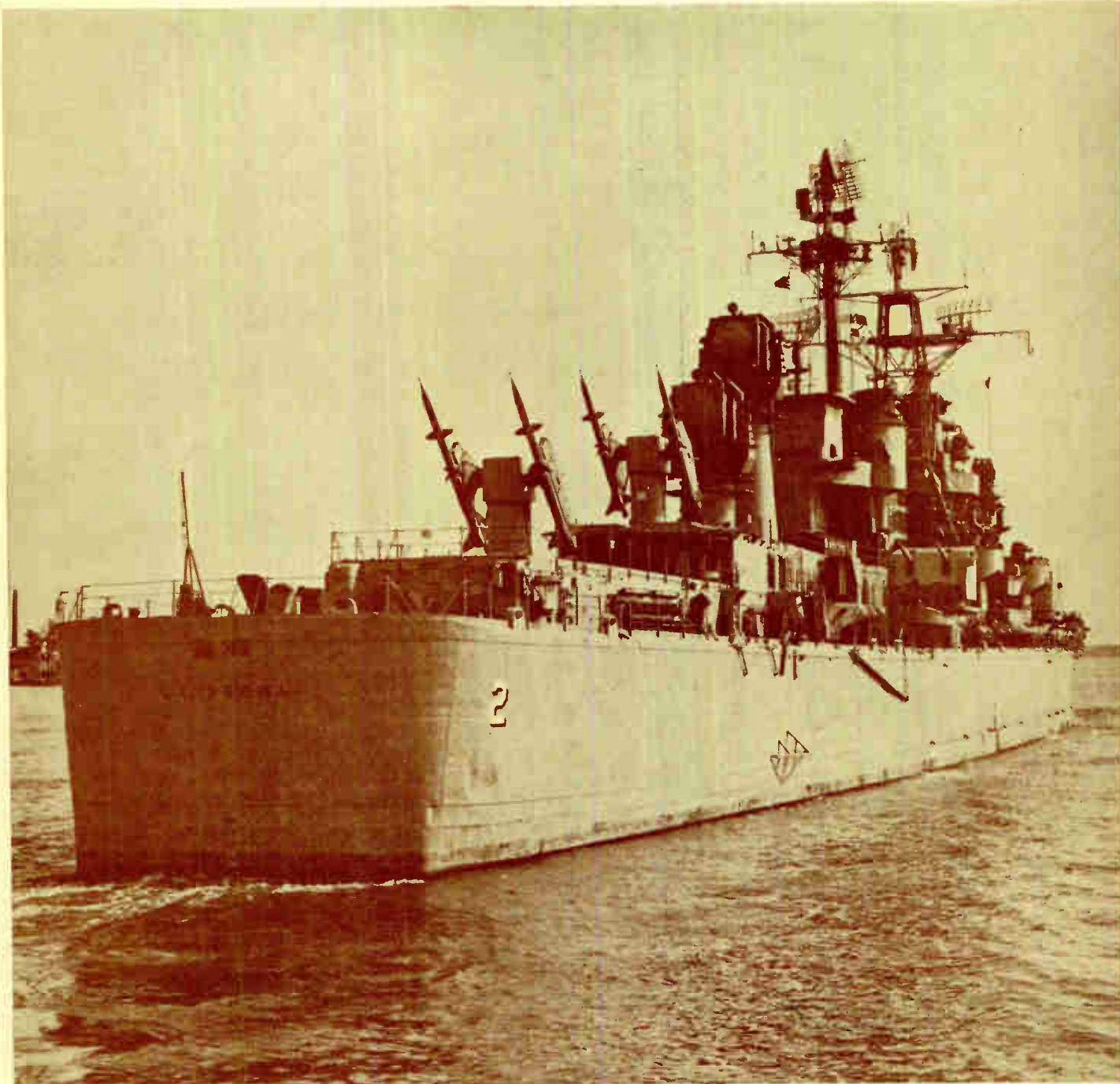

Navy's guided missile cruiser, USS Canberra, equipped with long range, high altitude missile guidance radar, with antennas resembling huge searchlights. Sperry Gyroscope builds the radar, Convair is prime for Terrier surface-to-air missiles

of a high-intensity, coherent light source in the blue-green spectrum, reasonable ranges may be achieved. The development of a laser providing output at the blue-green wavelength is looked for as a useful breakthrough toward this goal. High definition would be achieved with any undersea light system and would make target identification easier.

A method in use is the magnetic-anomaly detector, which measures distortion in the earth's magnetic field due to the presence of a submarine.

The turbulence in water caused by a submarine's engines may allow development of a detection method based on this effect.

A wake of fluorescent material trails behind a submarine, and there are thermal gradients created by the passage of a sub. Infrared detection methods may be of use for the latter. Penetration of the ocean with radio frequencies is generally not practical, but recent observation of certain uhf windows shows some promise here. The rise in the surface of the ocean when a submarine passes may lead to high-definition radar equipment designed to detect this action.

Navy is pushing ahead the design and procurement of advanced sonar equipment, and seeks developments in everything from improved transducers, single-use hydrophones and projectors, sensitive low-noise amplifiers, through a range of equipment including data-processing gear and other specialized systems.

Using sonar, the Navy has developed the helicopter dip method, where a transducer is lowered into the sea from a hovering aircraft, and soundings made during a grid pattern of flight. Magnetic-anomaly detectors for use in aircraft are finding application.

To extend the weapon-delivery range in ASW to that of the detection methods, the Dash weapons system, using a remote controlled helicopter, has been developed. Extensive electronics is employed in control and operation of this drone.

Remotely controlled and homing torpedoes able to seek and destroy a submarine are of interest. The underwater, or surface-to-underwater missile, Subroc, is another example of an attack weapon used by Navy against subs.

Mines are considered effective, and updating World War II designs shows promise of further extending their usefulness. New types are also being developed, using acoustic and electronic sensors.

The navigation equipment used aboard the Polaris-launching nuclear submarines, includes gyroscopes and accelerometers in the inertial-navigation equipment, complex digital computers for course correction computation, and various input navigation aids. These submarines, being funded at an increased rate, demand precision navigation equipment to achieve accurate delivery of their 1,200-mile nuclear tipped missiles. Polaris missiles with 1,500 and 2,500 mile ranges are in the works.

Navy oceanography, part of the recently increased Federal spending in this area, demands advanced electronics ranging from sensors to data reduction systems. Included here are devices to measure wave motion, speed of sound in water, temperature gradients, turbulence, salinity, light transmission, sound propagation and reverberation, and a score of other ocean characteristics.

Sonar for fire-control use, as in the direction of depth-charge placement is being refined and applied in ASW work.

**GENERAL**—Automatic electronic checkout equipment is a must with the high complexity for modern systems. The defense agencies are driving toward more equipment of this nature, so that training skilled technicians becomes less of a problem. Reliability goes up, and the time required for readying equipment for use is cut down.

The use of value engineering, will continue to be pushed by the defense agencies, in an effort to remove frills from designs.

## OUR GROWING NONMILITARY FEDERAL MARKETS

NONMILITARY FEDERAL spending for electronics is climbing fast with no leveling off in the foreseeable future.

One spur is the drive for space exploration which has absorbed into its efforts the combined resources of several nonmilitary branches of the federal government as well as segments of the Department of Defense.

**NASA**—The National Aeronautics and Space Administration, charged with the lead role in space exploration describes its programs as dependent on electronics.

James E. Webb, NASA chief, estimates that half of

each dollar spent for space systems goes for electronics.

Of these dollars, many will go for research, development and testing rather than hardware procurement.

In fiscal 1960, the total NASA appropriation was \$523,575,000. Of this \$333,100,000 was for research and development. Last fiscal year's total appropriation was \$964,000,000, of which \$668,503,000 was earmarked for R&D.

Plans for fiscal 1962 are still somewhat flexible, but show increases over 1961. Funds appropriated for NASA come to more than \$1,784,300,000. Of this, some \$1,-



300,000,000 will go for R&D. In the light of Administrator Webb's estimate, this will mean some \$600 million or more will go for electronics.

Projects which will absorb NASA expenditures fall roughly into four areas: get a team of astronauts on the moon and back safely within this decade; step up development on program Rover, the nuclear rocket; accelerate the program to establish a world-wide satellite communication system and develop a world-wide satellite weather system.

In line with these objectives, NASA's Saturn program will account for heavy expenditures in research and

development. The fiscal 1962 figure of \$224 million represents about 17 percent of NASA's total R&D budget. Saturn's goal is to develop a multipurpose space vehicle using a modular approach for the upper stages to achieve a variety of configurations and functions. Earlier space research programs usually involved a vehicle tailor-made for each experiment. The Saturn concept will allow the same design to be modified to produce a family of vehicles to meet a variety of requirements.

Plans for long duration earth orbit flights, circum-lunar flights and landings as well as returns are grouped by NASA under the Apollo program. The fiscal 1962

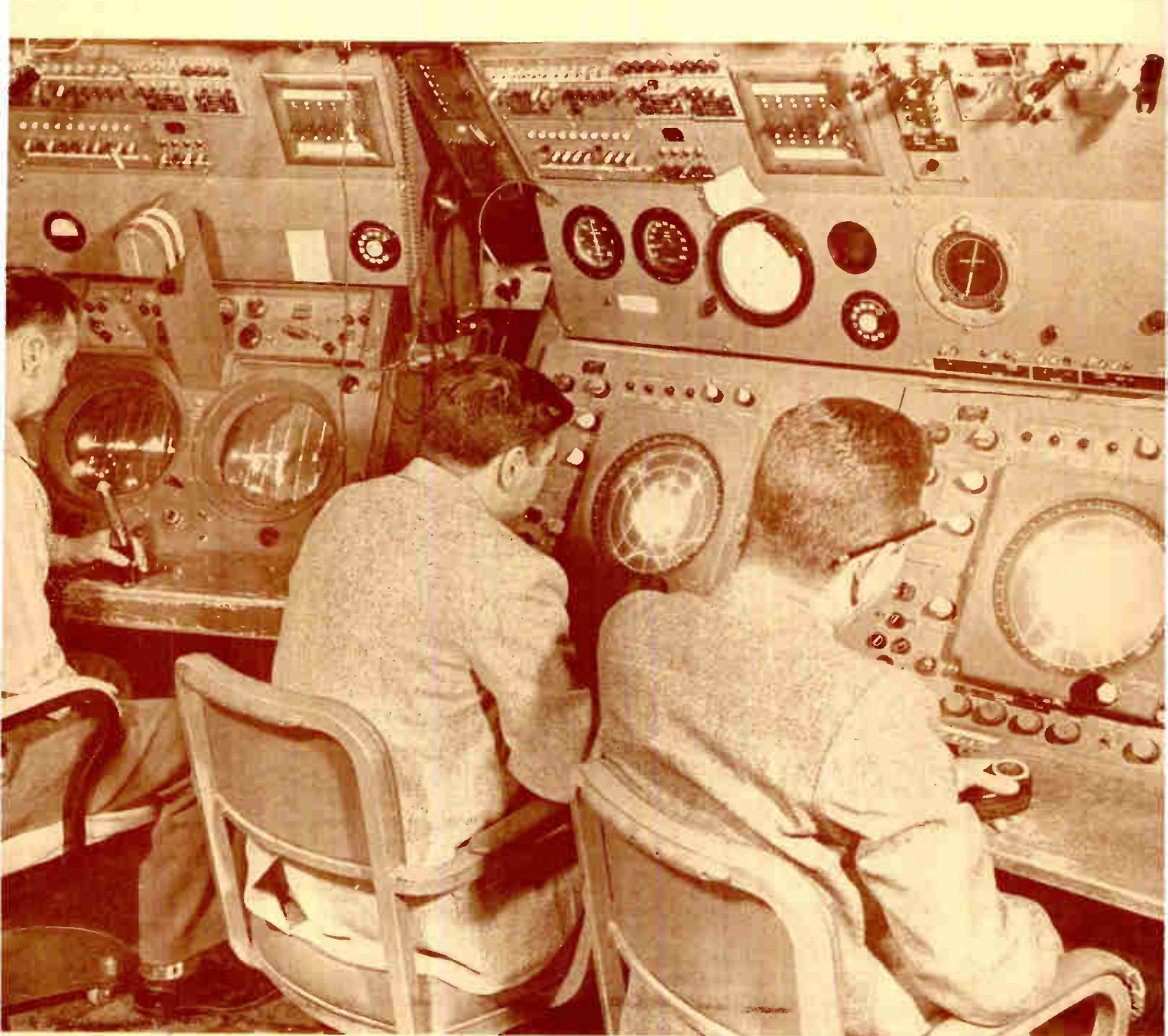

Typical information processing room at a Federal Aviation Agency installation at a large air terminal



R&D budget provides about \$160 million for this purpose and represents some 12 percent of the R&D total.

Lunar and planetary exploration will account for about the same amount of money as the Saturn program. NASA officials expect this exploration program to present challenges in every branch of science. Probing the immediate area of space around the moon will call for specialized rocket control, high-level telemetry systems and a vast array of data-gathering devices. Surface exploration will impose even greater demands. Exploring the space environment and subsequently the surfaces of Mars and Venus will demand higher instrument performances than any present requirements. Wide-band infrared equipment, narrow-band spectrographic gear, data storing systems, long-range command systems and energy sources will all be called for.

Representing about 7.3 percent of NASA's fiscal 1962 R&D budget, communication satellite systems are being examined both in passive and active operation. Studies already conducted through Project Echo show a need for techniques for making rigid reflectors, techniques for ejecting more than one satellite into a predictable orbit and development of ground transmitting and receiving gear including equipment operating at optimum microwave frequencies.

NASA officials say studies indicate that with suitable ground facilities, about 60 Echo-type satellites at 2,000-mile altitudes could provide a world-wide system operable 99 percent of the time.

Development of long-lived components for active communication satellites is one area being probed by NASA. Inherent in this will be research on the behavior of components and systems in the space environment. On the ground, it is expected that an active satellite system will impose new demands on communications and tracking systems.

In addition to the markets for electronic equipment, and research and development that NASA programs are creating, a substantial amount of money will go for rental of electronic equipment, primarily of the data-handling variety. The growing complexity of the mathematical problems in space flight has created the need for some \$5,700,000 worth of data reduction equipment in fiscal 1962 and for some \$11,200,000 in analytical computation work. In addition, the business affairs of the Administration impose the need for some \$2,100,000 worth of further expenditures for electronic computation. Most of these needs are being met through rentals of data-processing equipment.

**FEDERAL AVIATION AGENCY** expenditures over the next half decade may reach a leveling off period. One reason for this is that projects now being worked on anticipate future air traffic demands.

Some evidences of decline in spending are already evident in comparison of research and development budgeting of \$78,400,000 in fiscal 1961 and of \$71,600,000 in fiscal 1962.

Expenditures last year as well as proposed spending in the immediate future may hinge on implementation of FAA's Project Beacon. This plan will utilize as much as possible the tools of automatic data processing, sig-

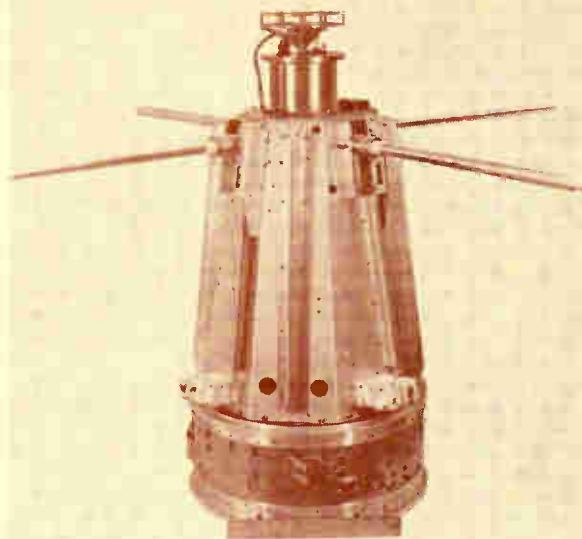

Electron density profile probe developed by National Aeronautics and Space Administration to measure electron density at 4,500 miles up

naling and communications to control the growing amount of air traffic in U.S. skies. In addition to Beacon, plans are being worked on to complete a system of data-processing centers that will act as a nationwide air traffic control network.

### NASA Appropriation Summaries FY-1960-62

	Salaries and Expenses	Research and Development	Construction of Facilities	Total
<b>Fiscal Year 1960</b>	\$ 90,850,000	\$383,100,000	\$ 99,625,000	\$523,575,000
<b>Fiscal Year 1961</b>	\$170,760,000	\$668,503,000	\$124,737,000	\$964,000,000
<b>Fiscal Year 1962 (Requested)</b>	\$226,686,000	\$1,295,539,000	\$262,075,000	\$1,784,300,000

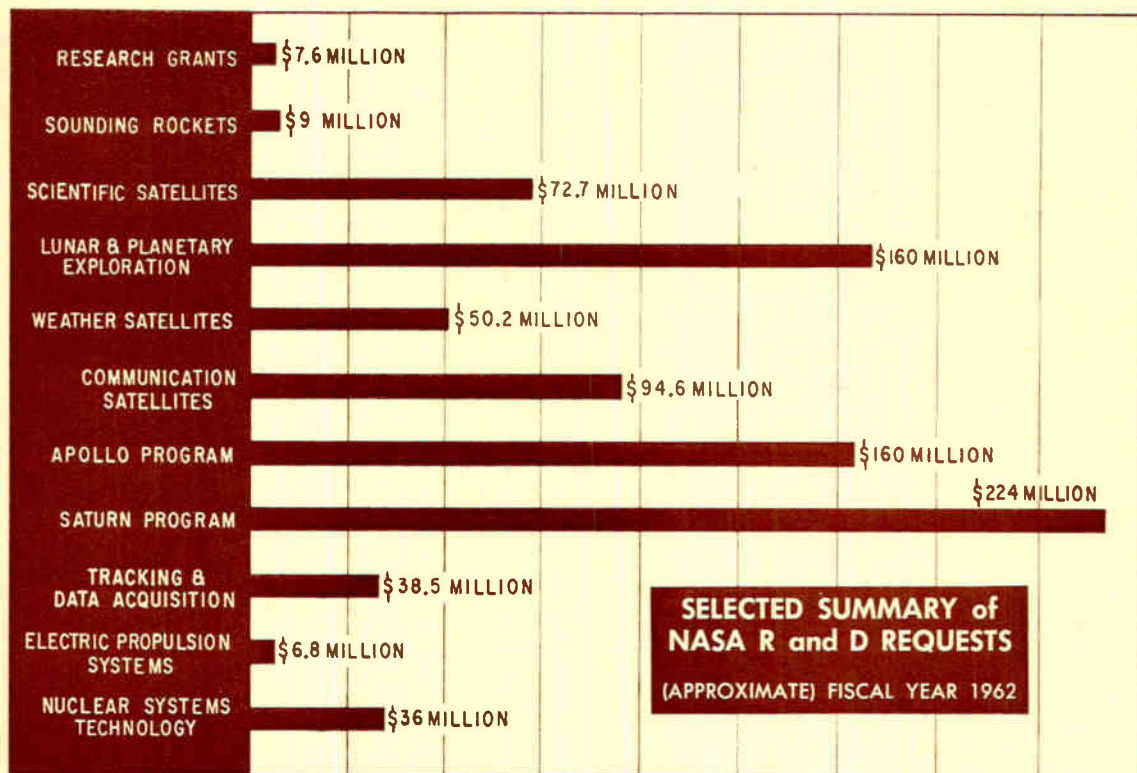

Much of last year's contracting by FAA heads towards these twin goals. For example, thirteen long-range radar installations at about \$2.4 million each are being built. Forty-one bright radar displays at about \$405,000 each are contracted for as well as 14 radar beacon systems at some \$293,000 each.

Thirty locations within the U.S. are being equipped with new teletypewriter facilities for delivery of weather data to the U.S. Weather Bureau, while the Alaskan teletypewriter circuit is being modernized. High-speed circuits are being installed in eight cities at an average cost of \$342,000 and expanded weather data information services are being provided at 10 locations.

A good many FAA installations have been made at locations that are now primarily military rather than commercial in their aircraft operations. In most cases, these air facilities are in a state of changeover and may be used as commercial and civilian airports in the near future. As part of defense planning, however, present FAA-installed equipment is located at these sites to be compatible with possible future military needs.

**AEC**—Following reduced activity during suspension of nuclear testing, the Atomic Energy Commission spending for electronics appears likely to rise over the next five years.

From the present level of \$10 million in calendar 1961, next year should see a rise to more than triple this amount

as more and more control, monitoring and test electronics are needed to match general growth in atomic research and use. Additional thrust will come from AEC participation in Project Rover, aimed at developing a nuclear powered rocket engine, and Project Snap, aimed at developing on-board power units to supply satellites and space vehicles with internally produced electricity.

Weather Bureau spending for electronics will go mostly for data handling and transmission equipment, with other expenditures going for electronic devices and systems to gather meteorological information.

In matters related to meteorology, the Weather Bureau is participating with NASA in some space work. For fiscal 1962, funds have been allocated for spacecraft and launch vehicles. Command and acquisition stations are being built in Alaska and along the East Coast of North America. Total funds for these installations come to slightly over \$12 million. Special-purpose equipment will amount to more than \$3 million. Of this, a good portion will be in electronics. An additional \$2 million will go into data processing and close to \$300,000 will be spent for communications equipment.

**OTHER FEDERAL AGENCIES** such as Federal Communications Commission, Treasury Department, Bureau of Internal Revenue and Federal power projects and law enforcement agencies are also purchasers of electronics equipment.



# OUR GROWING

THE POPULATION explosion and the rise in educational levels are bringing the high levels of purchasing power. Consumer desires are exploited to the point where they are confused with consumer needs, so that what was once considered a luxury item is, or will be, thought of as a necessity. A prime example is the television set, once a status symbol for the privileged few, and now the major source of entertainment.

But where are those increasing consumer dollars going? Television receiver sales, representing 40 percent of the consumer electronics market, have presently leveled off at a little over six million sets a year. Sales of phonographs and radios, each taking about 20 percent of the consumer market, declined somewhat last year as compared with 1960. A big surge may come in color tv, now that many set makers are represented in the market. Promising opportunities exist in the nonentertainment home electronics field, such as in electronic ovens, air purifiers and ionizers, and thermoelectric refrigerators and water coolers.

Making an adjustment to the Schober build-it-yourself spinet organ, which has 88 keys in two manuals, 18 stops, 13 pedals, and weighs less than 100 pounds. Assembly time is estimated at 50 hours

**BLACK-AND-WHITE TELEVISION**—Although 88 percent of U.S. homes have at least one tv set, and this figure may be close to the ultimate saturation percentage, the 1961 tv sales should be over 6.2 million sets, an increase over 1960 (5.9 million), 1959 (5.7 million) and 1958 (5.1 million). At least 6.4 million receivers should be sold every year for at least the next ten years, despite the approach of saturation.

The future market will be largely replacements and extra sets. In 1959 the percentage of replacement sets to total sets in use exceeded substantially, for the first time, the percentage of sets to new tv homes. Last year, replacement sets totaled 3.8 million, or 6.8 percent of the total sets bought, while sets for new tv homes amounted to 1.1 million, or two percent of the 55.6 million sets in use at the beginning of the year.

Optimistic estimates place the yearly tv set sales at 8.5 to 9 million between 1962 and 1970, based on the population increase and a 14 percent replacement rate.

While the 19 and 23-inch picture tubes may dominate

This portable stereo phonograph by Admiral is aimed at the teenage market. When the microphone is plugged into a "sing-along" jack, sound from the microphone comes from the right loudspeaker

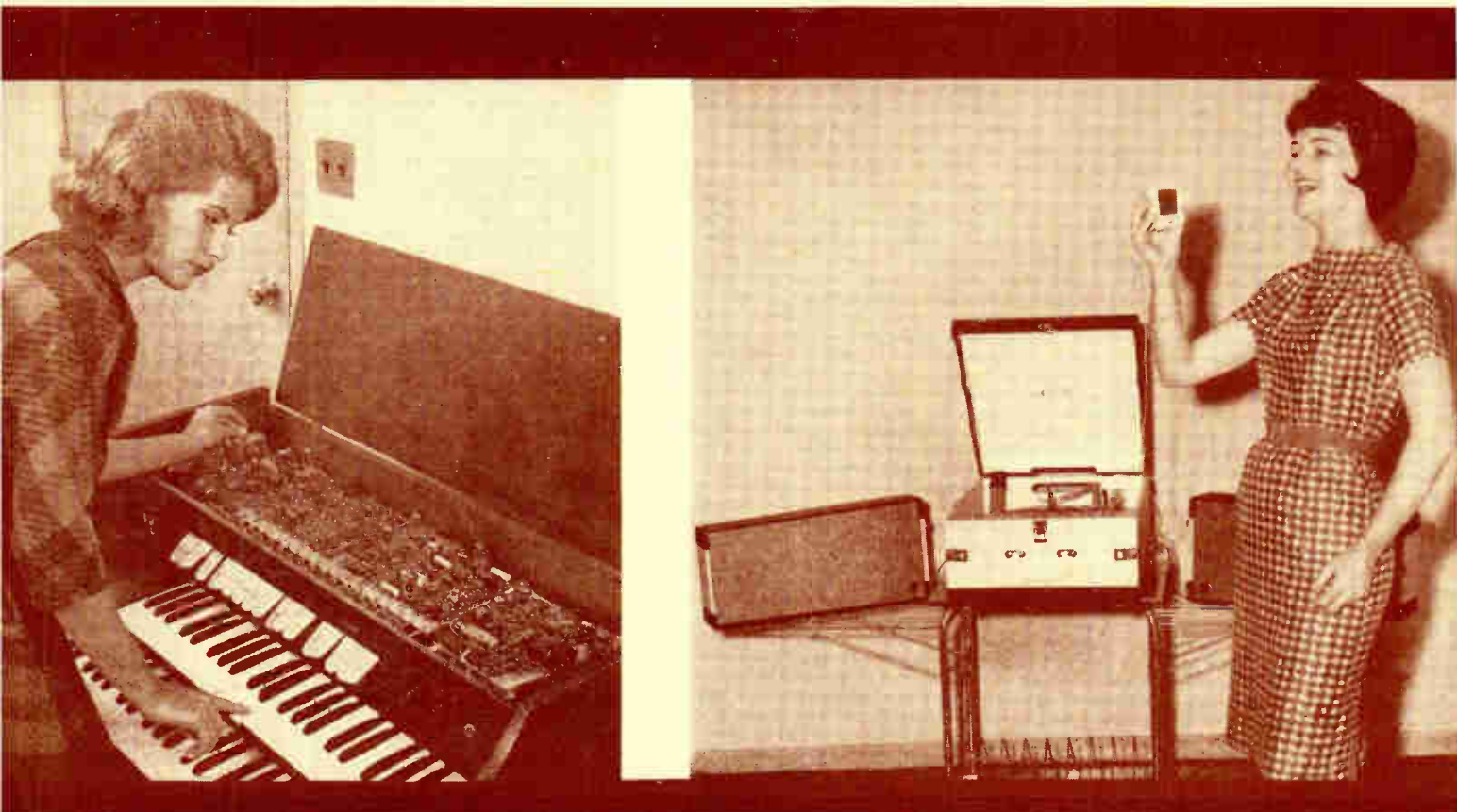

# CONSUMER MARKETS

the black-and-white tv market in 1962, Admiral is stressing the 24 and 27-inch receivers. Sylvania considers the 23-incher to be an attractive size, but says there is a trend toward the larger sizes, particularly the 27-inch.

Although many purchasers stress portability of a tv set when buying one, especially an extra one, the set really doesn't get moved around in the home. Usually it remains in the bedroom, which is coming up fast as the most likely location of the second set.

Many U.S. manufacturers feel that battery-powered portable tv sets are impractical at present. Prices are high, and the picture size small for people who have become accustomed to at least a 19-inch screen.

**COLOR TELEVISION**—A dozen companies are offering color tv sets this winter. RCA, Packard-Bell, Emerson-Dumont, Magnavox, Admiral, Olympic, Sears (Warwick) and Philco have been joined this winter by Zenith, General Electric and Sylvania.

For the hi-fi enthusiast with an interest in short-wave reception, National Radio has styled the NC-105 to appeal to the audiophile as well as the amateur. The front panel provides a high-impedance tuner output



Westinghouse and Motorola both sold color tv receivers from 1955 through 1957, but neither has revealed plans for reentering the field at present.

Color sales have seldom gone over 100,000 sets a year, so that there are about 700,000 sets in use after eight years of sales.

Color sets are selling better than last year, and estimates by top industry people for this year's sales range from 250,000 to 500,000, with one guess of 750,000. The 1961 sales are expected to add up to 150,000.

Increased sales this season are partly due to more color programming. In the half-dozen largest U.S. cities, about 20 to 40 hours of color are broadcast weekly.

Prices of many color tv receivers are in the \$600 to \$700 range. The Sears Roebuck console lists for \$450.

Hopes were once high for Paramount's single-gun Lawrence tube to lower prices, but a Lawrence tube set, when and if it is finally perfected, will cost, according to Paramount, about \$400 on a mass-production basis of half a million sets a year.

Last fall a Japanese company brought out a \$300 color tv set, using two single-gun tubes, and based on the two-color theory developed by Polaroid's Edwin H. Land. The theory was also substantiated mathematically by Huseyin Yilmaz of Sylvania.

**RADIO**—Sales of radio receivers have been rising steadily since 1958. Production, also on the rise since 1958, has for 1961 dropped some five percent below the previous year. Total radio production for 1961 should be 15 million sets, with f-m radios accounting for at least 720,000 units.

A substantial market is in sight for f-m stereo radio, backed by manufacturer support of stereocasting. The half-dozen largest U.S. cities have f-m stereo programming, although sometimes on a limited basis.

**PHONOGRAPHS**—Factory sales of phonographs will show little change in the near future: a rise of less than two percent is anticipated in stereophonic models. The present ratio of stereo to mono, about 15 to 2, will increase to about eight to one in 1965.

**ELECTRONIC ORGANS**—In 1961 retail sales were about \$140 million. The 1962 estimate is \$150 million, indicating a healthy rise in electronic organ sales. Since only a few percent of the market potential has been tapped, several more companies may soon climb aboard the electronic organ bandwagon.

Interesting sidelights are that the electronic organ has not become a status symbol, and that while most people buy a piano for their children, they buy an organ for themselves. One organ maker claims that more new



organs are now bought nationally than new pianos.

Transistor keying is a feature of the Conn organs, which use vacuum tubes for tone generation, as do most organs. Transistor tone generators are used in organs by Allen, Gulbrandsen, Magnavox, and Thomas. The lower-priced market is aimed at by organs in the \$500 range, made by Electro-voice and Estey.

**ELECTRONIC ORGAN KITS**—Although over a dozen companies share the home organ market, the do-it-yourself organ kit business is largely split between two companies, Schober Organ Corp. of New York, and Electronic Organ Arts of Los Angeles.

Schober Organ markets a concert model at \$1,200, a consolette at \$800, and, to compete with the low-priced ready-made organs, a recently introduced spinet at \$550. The spinet uses neon oscillators. This fall Schober plans to bring out a table-top organ for about \$200, with a single manual, divided for accompaniment and melody.

Electronic Organ Arts once offered a dozen kit models, and had a tendency toward selling completed organs. After this company was bought by Dorsett Electronics, the emphasis has been on kits, and the models have been reduced in number with prices beginning at \$1,300.

**AMATEUR RADIO**—The existence of 230,000 amateur radio stations makes the amateur communications market a sizable one. An increasing percentage of radio amateurs build receivers and transmitters from a kit, or buy them ready-made.

The citizens band group is a fast-growing communications field, with well over half a million c-b transmitters in use. The variety of citizen's band equipment is mounting rapidly, and so many c-b stations are already crowding the airwaves that the FCC may soon have to take further steps to stop general rag-chewing.

**ELECTRONIC KITS**—Although the do-it-yourself

builder can save up to 50 percent of the cost of ready-made equipment, many kits are assembled by people who could easily afford the finished equivalent. It is the "pride and satisfaction of personal accomplishment," as one manufacturer puts it, that makes a man spend \$30 for a six-transistor radio kit when he can buy a transistor radio at less than half the weight and price.

The new Daystrom line, made by the Heath company, is sold through dealers. The Daystrom circuits are similar to those in the Heath kits, but there are differences in design, price and packaging. To make the Daystrom kits simpler to assemble, and thereby appeal to a wider audience, tube sockets are riveted to the chassis, critical circuits come partially assembled, more circuit boards are used, resistors and capacitors are laid out in numbered sequence.

Heath uses a tunnel diode in their latest model grid-dip meter.

**ELECTRONIC TOYS**—The electronic portion of most ready-made electronic toys consists of a simple transistor amplifier, such as in a portable voice amplifier. That the price of electronic toys comes high is indicated by the \$10 list price of the portable amplifier, and by the \$30 list price of an infrared phone, which even at cut rates is still about \$20.

Many of the toys that use tubes or transistors are the do-it-yourself kits, variously called electronic workshops (Heath), science kits (GE), or electronics engineering sets (Lionel). The kits are of two types: for building a single item, or making several. For the single item, the price is often high: \$18 list for a GE transistor radio kit. The multiple-project kits cost an average of a dollar per project, and most use solderless connectors, so that a circuit can be set up in a few minutes.

An estimated \$8 million worth of build-it-yourself electronic kit toys will be sold in 1962, and \$20 million in 1971.

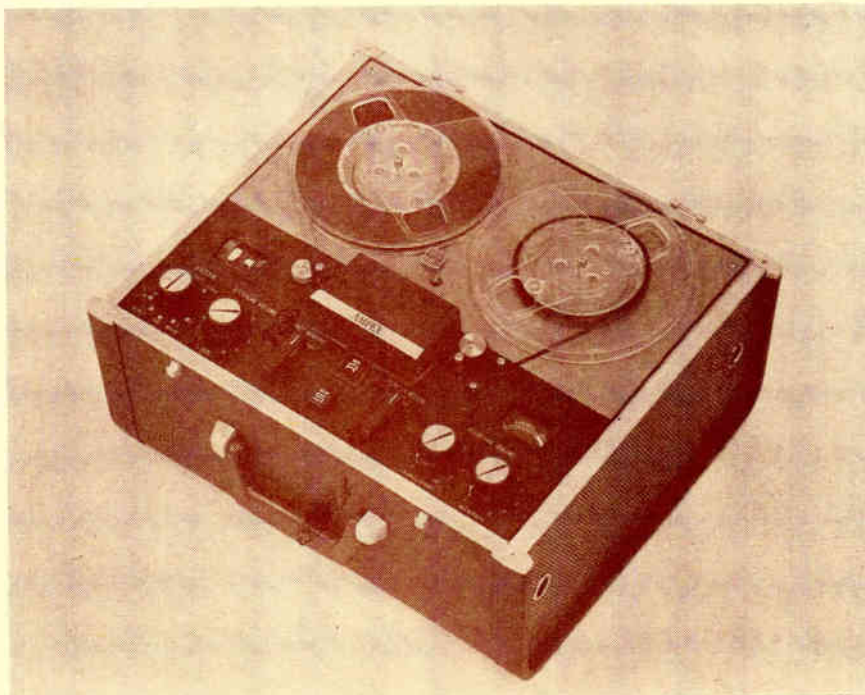

Portable model 1260 four-track stereo and monaural tape recorder and player by Ampex permits separate erasure of each of the four tracks, and uses a three-pole erase head that erases the tape twice

# OUR GROWING COMPONENTS MARKETS

COMPONENT MAKERS are for the most part optimistic about the future, despite the problems of imports, price-cutting and heavy competition. Sales and profits for the first quarter of 1962 should be about the same as for last year.

Sprague Electric's vice-president of sales, Carroll Killen, sees a modest increase in the components market in 1962, and says "we are just now beginning to see results of the release of military orders in the past couple of months. The industrial components market will just hold its own in 1962. Industrial customers, especially computer manufacturers, overestimated their needs in 1961, and so they have over-healthy inventories. The military will start to let some contracts in 1962 for microminiature modular packages with discreet components and component groups. This will gradually build into a big market, since the so-called molecular circuitry is still far away. Also, the modular approach is less costly, and does not force circuit-design standardization."

**ELECTRON TUBES**—Although semiconductors are increasing in use, and heavily in some applications, electron tubes are by no means on the way out. The output of electron tubes of all types is expected to rise two to three percent this year over the 1961 estimate of \$593 million in factory sales. Although receiving tubes may decline two to three percent yearly, this should be offset by a seven-percent rise in the factory sales of power and special-purpose tubes. Traveling-wave tubes are expected

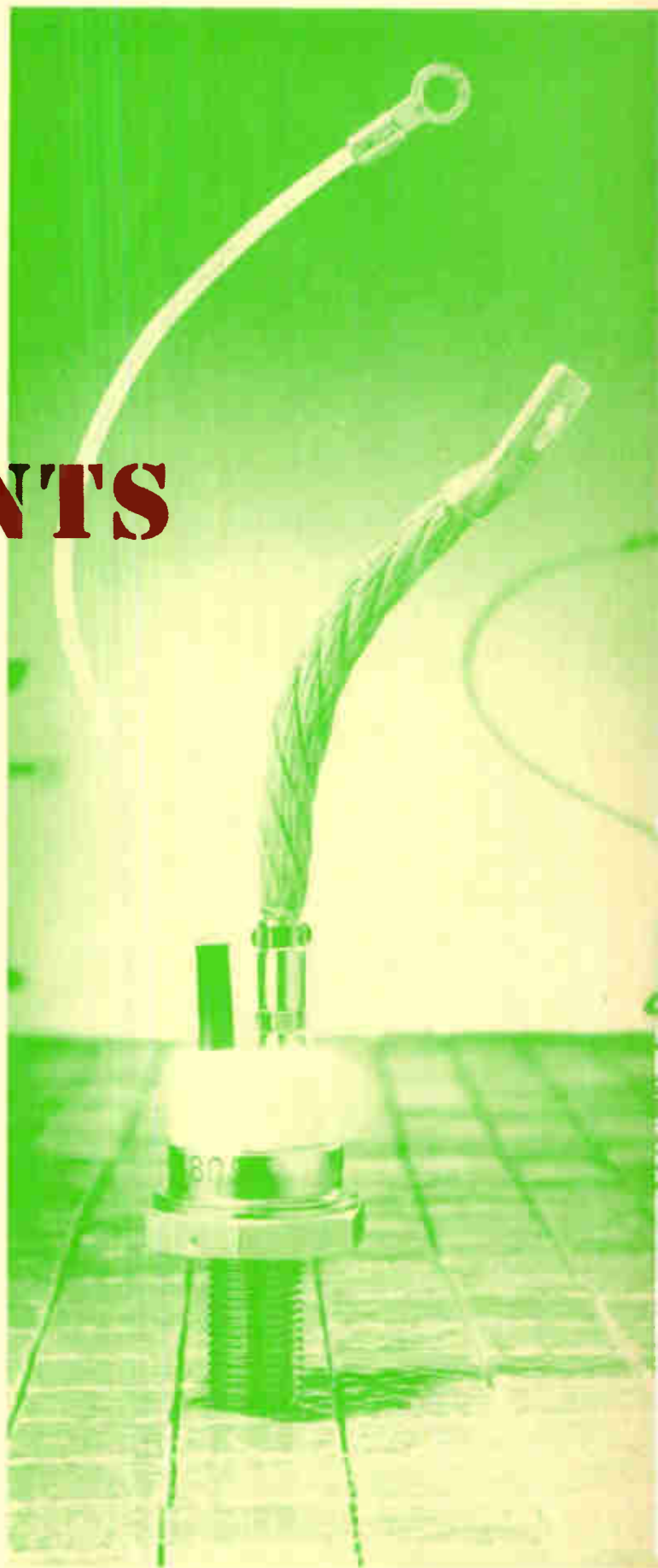

Silicon controlled rectifier by Westinghouse handles up to 300 volts and up to 50 amperes



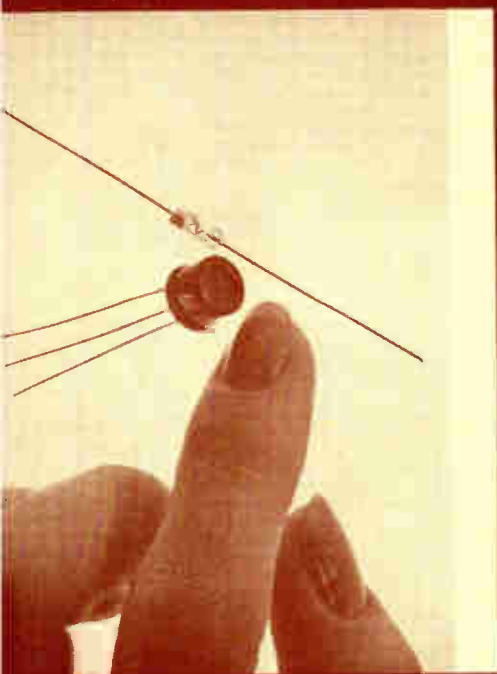

to increase 20 percent; backward-wave oscillators will experience a 40-percent rise.

Two factors are important in the continued existence of electron tubes. One is increased reliability. For example, the failure rate for the average of 16 different Sylvania subminiature tube types was lowered from 5.5 percent per 1,000 hours in 1952 to 0.5 percent per 1,000 hours in 1960. For some tube types, a failure rate of 0.1 percent per 1,000 hours is forecast by Sylvania within the next two or three years.

Tests by Arinc Research Corp. aboard naval vessels show a combined tube removal rate of 15 percent per thousand hours in 1954, which dropped by 1960 to 1.2 percent for miniature tubes and to 0.19 percent for subminiature tubes.

The increased reliability was brought about, not by startling breakthroughs, but by many small innovations, such as changing the bulb design to reduce glass cracking, lint control to eliminate foreign matter, and heater-coil redesign for more uniform coating. Even greater reliability will result in the future if heater burnout is minimized or eliminated. Greater control of saturation emission and interface resistance also should improve the uniformity and long-life stability of electron tubes.

The second factor supporting the tube market is resistance to nuclear radiation. Radiation can radically alter the characteristics of most transistors and similar solid-state devices, and possibly cause circuit failure. Although the effects of radiation on electron tubes range from a reduction of emission current to causing fissures in the tube envelope or breaking the glass-to-metal seals, tubes are resistant to radiation.

According to B. W. Sauter, general manager of Westinghouse's electronic tube division, the downward trend in receiving tubes over the last several years could reverse itself and begin to increase in the next few years. He referred to the way radio sales have held up in the past, and anticipates that the tube replacement market will exist at a substantial level for a long time. Color tv

sets, for example, have an average of twice the receiving-tube complement of present black-and-white tv receivers.

New types of electron tubes show promise for the future. The General Electric multipurpose Compactron tubes will be used by Muntz TV to make a television set with only eight tubes plus the crt, at a retail price of \$100. The Compactron is already in some tv sets of other manufacturers. The nuvistor, RCA's thimble-sized tube, is featured in their current line of tv sets, both color and black-and-white, because of its low noise factor, and is also used in tv cameras, radar sets, and test equipment.

The marketing manager of Raytheon's industrial components division J. Dorfman, says 1962 will be better for tubes than 1961, because pressure to cut prices will diminish. "In 1961, too many customers were using their suppliers as inventory warehouses. The buildup of inventory has begun," he adds.

Dorfman doesn't see a decline for the electron-tube market, and states "There are two plus-factors for entertainment components in 1962. One is that color tv is beginning to crawl, and will soon walk. The second is f-m multiplex stereo. New industry standards make a healthy picture for everyone concerned with hi-fi and f-m generally. Overall, the receiving tube business is in a stable condition, for both the industrial and military market, and adjustments have already been made for the effect of solid-state advances. As for light-emitting tubes, they are part of the display field, which is already launched on expansion and will continue in 1962. Printer tubes, storage tubes and other electronic readout devices should find expanding applications and a bright market in 1962."

Among the expected General Electric developments is an integral tube-cavity combination using a planar triode receiving tube that oscillates at 10 gigacycles, according to W. F. Greenwood, marketing manager of the GE receiving tube department. Two or three major systems applications for GE's thermionic integrated micromodule

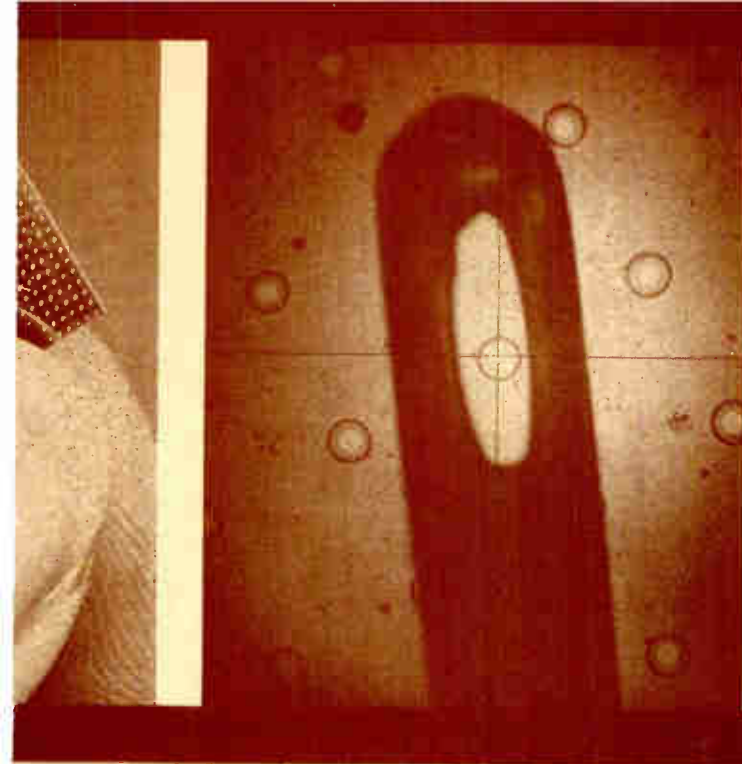

Far left is a GE ZJ235 silicon subminiature pnpn switch that can be triggered with light. Below, in a TO-5 package, is a ZJ227 silicon controlled rectifier that can be triggered by either light or a gate signal, or both. Second photo: subminiature Daystrom potentiometer weighing 7 grams, with overall case length of  $\frac{3}{8}$  inch. A glass film one ten-thousandths of an inch thick seals hundreds of diodes at IBM simultaneously (third photo) for protection, cost reduction and miniaturization. Close-up (fourth photo) shows one of the diodes framed in the eye of a small sewing needle. The wafer is cut into separate diodes ultrasonically

(TIMM) circuits, plus several small black-box applications, should develop in 1962. The company also plans to make TIMM components commercially available for development work by systems designers. Greenwood predicts that growing needs for radiation-tolerant electronic systems should increase the usage of small ceramic receiving tubes. It is expected that radiation tolerance ratings for glass tubes will be established in 1962.

**POWER AND SPECIAL-PURPOSE TUBES** will find the military market showing continued growth. The market growth-rate will be further affected somewhat by NASA and other space budget increases.

During the past few years, equipment and defense systems have become more complex. The field of radar systems is an example. This trend to complexity is expected to continue, and as a result, the cost per installation will tend to increase, the number of projects decrease. Such programs will require tubes with higher output and a higher degree of reliability. The emphasis will be on shorter run, complex, highly reliable tubes designed for specific application.

In 1962 the evolution to space-age requirements for radars for search, surveillance, guidance and communications will bring about the need for higher-power tubes with 10 to 100 times the power output of existing designs. One device to meet these requirements is the multiple-beam klystron (MBK) now being developed by General Electric. Historically, higher outputs have been obtained by using multiple externally linked units, but systems costs in dollars per kilowatt may favor a single, highly reliable unit such as the MBK. Because large blocks of power are required for many systems installations, increased emphasis on efficiency improvement of high-power microwave tubes is anticipated.

Increasing demands for intelligence transmission at high rates, and improved counter-countermeasures techniques, will see further development of wider-bandwidth microwave devices such as voltage-tunable magnetrons,

klystrons and traveling-wave tubes. Multioctave broadband requirements can be met by microwave tubes now in advanced development, provided that requirements become well-defined and funds are allocated.

The market for traveling-wave tubes is expected to grow rapidly. There will be a continued reduction of noise figures for types used in receivers. Improvements in tube designs can be expected to drop the noise figure of existing types an additional 1 to 3 db in the next year.

In the fields of secure communications and deep-space probes, there is not expected to be any rapid change to light beam devices. Stimulated market activity is expected for wide-band, low-noise voltage-tunable magnetrons (VTM) because of greatly improved low-noise characteristics. Further improvements in VTM efficiencies and packaging should increase their use for space applications.

Single-purpose phased-array radar requirements should stimulate the market for microwave tetrodes because of their phase stability. In this area, the needs for broad banding may be solved by integral cavity designs up to low S-band. Ring-bar and other microwave structures now being developed will play an important role in higher-frequency multipurpose phased-array radar systems.

Due to a growing concern with problems of radio-frequency interference, a steady increase in the market for high-power microwave filters is expected.

The military radar tube replacement market will increase. Some observers see the replacement market evolving into a repair business for expensive high-power tubes. Many present tube designs can be repaired instead of replaced, making possible considerable savings to the military.

Economic recovery in many industrial fields should have a favorable effect on the market activity for power and control tubes. This includes ignitrons for electronic steel-mill drives. The European steel-mill market, in its build-up since World War II, has made wide use of



electronic drives. Electronic drives for U. S. applications are expected to increase.

Another growth area is the metal fabricating industry, which includes the automotive industry. Here resistance welding equipment is important.

In public transportation, further developments in the design and use of railway multiunit cars, now being considered, could stimulate market activity for water-cooled and air-cooled ignitrons for motor speed control. In general, the replacement market for industrial tubes should increase modestly.

The rate of growth in the broadcast and communications market will depend largely upon FCC rulings regarding vhf-uhf television. If an upward frequency shift becomes mandatory, a revival of the high-power tube market is expected. Otherwise, the increase rate of new stations is expected to stay at its present nominal level.

Only small gains in the broadcast station replacement tube market are expected.

No significant penetration has yet been made in the consumer market by high-power tubes. One possible exception is the application of magnetrons for electronic cooking. Any acceleration of present activity now being conducted by some range builders could be the stimulus for wide use. Any appreciable market is likely to be several years away.

**TV PICTURE TUBE** markets should increase, according to B. W. Sauter of Westinghouse, for some of the same reasons affecting receiving tubes. Obsolescence of tv sets, new families being formed, two and three-set homes and picture-tube innovations are contributing factors in the future of this market.

Black-and-white picture tubes of the 19 through 21-inch sizes enjoyed high factory sales from 1953 through 1959. In 1961, factory sales of 22 through 25-inch sizes finally pulled ahead of the 16 through 18-inchers. In 1961, EIA changed its tube-size groupings. The 1961 figures show that factory sales of 18 through 20-inch tubes were double the 1960 sales, sales of 21-inch tubes were halved, sales of 22 and 23-inch tubes did 50 percent better, and sales of tubes over 24 inches were about the same.

The only color tv picture tube in general commercial use today is the RCA round three-gun tube. Sales of these tubes are linked directly to the market for color tv sets. Motorola has a rectangular color tube that is said to require a less bulky cabinet, but as yet there is no indication that it will be used in a color receiver. Nor is the Lawrence single-gun tube, owned by Paramount, about to be incorporated in a commercial set.

Although work is being done on flat picture-on-the-wall tubes, they are still not out of the woods. Pictures have been obtained with flat tubes in the laboratories, but as one manufacturer put it, "don't ask us what kind of a picture we've been getting." Sometime this year the Navy may release information on a flat nonvacuum-tube electroluminescent panel developed by Lear for aircraft instrument readout, although it may be some time before a lower-cost panel would be developed for tv use.

**SEMICONDUCTOR** unit sales will rise in 1962, but price-shaving will continue, so that the net result will be

little change in the dollar volume, according to Henry Schunk, marketing manager of the Raytheon semiconductor division. He adds that there will be no market zoom in 1962 for new devices such as tunnel diodes, integrated circuits, avalanche transistors or controlled rectifiers.

Prices have bottomed and are now starting upward, Schunk says. "Inventory buildup has started because customers no longer have barrels of them in stock. Price stabilization is already starting on germanium alloy transistors. In general, entertainment-grade semiconductors will have a stabilized market and price. High-speed types such as mesa, planar and epitaxial, pose question marks. It looks like the supply potential is greater than the actual market."

One trend seen in 1962 is a decrease in special semiconductor type designations.

The price cutting once common in the electron-tube field is now found in the semiconductor business.

Factory sales of semiconductors are expected to rise about eleven percent in 1962, with a 1965 figure of \$939 million, an increase of over 50 percent from the 1961 estimate of \$606 million.

The glamour of the transistor has attracted over 90 U.S. companies to semiconductor production, with a resulting overcapacity. Mergers and dropouts are not uncommon. Among the larger companies, Raytheon, which acquired CBS Electronics' semiconductor business, later bought Rheem Semiconductor.

Westinghouse feels that the rapid price reductions experienced in 1961 should diminish during 1962. However, they believe there is a trend developing toward product simplification and lower costs in high-volume product techniques in the semiconductor industry. It is expected that new emphasis will be placed on markets now using conventional electrical devices, in an effort to supplant these devices with solid-state components. Specific growth components include power-switching devices, represented by silicon transistors and controlled rectifiers; thermoelectric devices for cooling as well as for power generation, and molecular electronics in which functional electronic blocks will be extensively used in commercial products. Some manufacturers believe that germanium devices in general may have a limited future, particularly low-power diodes and transistors. Tunnel diodes have not developed as rapidly as some early predictions had indicated.

Tunnel diodes, although of interest in microwave and special applications, may find less use in computer logic circuits than in small, fast memories, for which they are well-suited by their high speed and low noise.

**TRANSISTORS** this year should see factory sales of about \$371 million, with an annual increase of 15 percent bringing sales up to \$575 million by 1965. Silicon transistors are expected to more than double in sales by 1965, while germanium transistor sales will increase by only 50 percent during that time.

Transistors are being used widely in the armed services. A high increase in military sales, which now account for almost half the total industry sales, seems unlikely in the near future. The Air Force, which went to transistors as soon as possible because of weight and

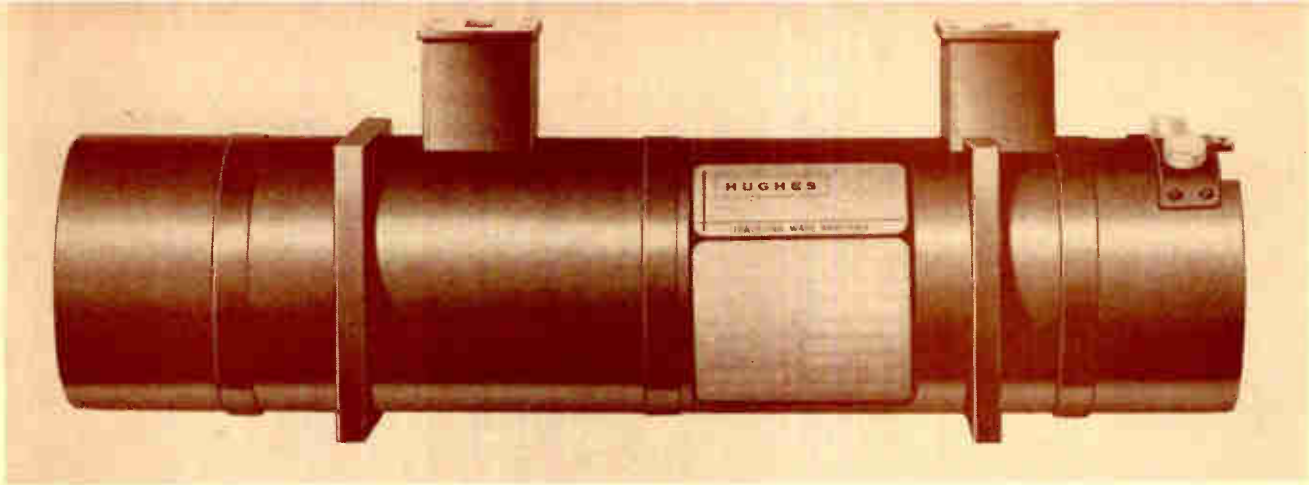

Wire-band PPM (periodic permanent magnet) focused 1-Kw traveling-wave tube by Hughes covers the X-band, with a 40-db gain and a 2-percent duty cycle

size limitations in airborne equipment, is fairly well transistorized. The Navy, which has more room on its ships, uses tubes or transistors as the situation demands, stressing transistors only in such space-limited areas such as submarines, and for reliability. The Army hasn't time to transistorize much of its existing designs in these days of limited-war potential, since it needs the equipment as soon as possible. Much of the limited-warfare equipment is being made to older designs; transistorization is being applied to new types of equipment.

The computer business, which may expand greatly in the second half of this century, uses transistors widely. The IBM 702 used 10,000 tubes and RCA's Bizmac I contained 30,000 tubes. The Philco 2000 contains 56,000 transistors and IBM's Stretch computer uses 200,000 transistors.

**SEMICONDUCTOR RECTIFIER** sales in 1962 are expected by GE to show an increase of 12 percent, which will boost the industry volume \$17 million over the \$140 million estimated by the company for 1961. Continued price pressures and vigorous competition will continue to characterize 1962.

The silicon controlled rectifier should approximate its 1961 performance by doubling sales in the coming year, GE says. "New product introductions will add impetus to the SCR in 1962, particularly in the low-current lead-mounted and high-current areas."

Low-cost product categories in both rectifier and SCR lines will become more attractive to manufacturers of consumer products. Also anticipated, is increased industrial volume in the high-current rectifier area.

Hoffman Electronics has an optimistic outlook for 1962, and feels it can develop applications for control rectifiers in the commercial market. It sees a large potential in commercial applications of 1-amp and 5-amp control rectifiers, is thinking of branching out into higher-power rectifiers. Although some companies feel that the price war is coming to an end, they see more competition in quality for 1962.

**VARIABLE RESISTOR** prices of precision potentiometers have been on the decline since 1958, and Beckman Instruments among others sees no chance of them going up, but feels that there will be a stabilization.

Beckman sees sales growth in the development of new or upgraded products and is branching into different product areas. It sees a market shift in potentiometers. For example, they make a two and a three-inch type, and feel there will be a need for the smaller one-inch type; hence their intention to enter that area. They are also going into specialized components developed to order. Beckman is introducing a Cermet potentiometer, both rotary and rectilinear.

**CONNECTORS** of all types will see larger sales volumes through 1965.

Microdot among other companies expects an increase in sales for this year, and has opened a new facility with a connector department.

Microminiature multipin connector design is beginning to make progress. Miniaturization will be a big trend this year. Microdot attributes the step-up in hermetic seals to tighter requirements.

**TRANSFORMERS** will see more sales and the need for more reliability. "There will be a components shake-out in 1962," says Sylvania's A. H. Plaisted, product sales manager. "Reliability is stirring the pot. Up to now, there has been no feedback on transformer reliability unless it was a catastrophic failure. Sophisticated reliability requirements are now being written into contracts." Another trend in 1962, Plaisted says, will be more sales of transformers that use a conformal coating technique, with epoxy as a sealant, rather than hermetic sealing in a can.

**ELECTROLUMINESCENT PANELS** probably need a major breakthrough before they can challenge cathode-ray tubes in the entertainment market as a basic display device. Although high brightness can be obtained by raising the frequency or voltage, the life of the device is shortened considerably. So for the present electroluminescence will be limited to readout devices, instrument panel lighting, highway road signs and night lights.

**MICROCIRCUITS**, one of the hot fields in components today, is called by Motorola integrated circuits, Texas Instruments refers to them as Solid Circuit microelectronics, Westinghouse names them molecular electronics



or molectronics, and Fairchild Semiconductor uses them for their Micrologic circuits.

Fairchild's Micrologic circuits were introduced as a production item at the IRE Show last March. Six logic elements have been put on the market so far, with a seventh coming out shortly. The introductory price of all the elements is \$120 each in small quantities, but Fairchild anticipates an ultimate price of less than \$10 each in large quantities. Fairchild expects that there will be in operation by the end of 1961 a prototype computer built by one of their customers with Micrologic elements.

Motorola received a \$1.5 million Air Force contract last June for the study of compatible techniques for integrated circuit functions. This speeded up their two-year old program to the point where they expect to have practical circuits available within the first quarter of 1962, although not on a large scale for another two years or so.

Texas Instruments exhibited last fall, jointly with the Air Force, a general-purpose digital computer using 587 microelectronic circuits, with a weight of 16 ounces and a volume of 6.3 cubic inches. These circuits were the basis for the development of the current TI line of six Solid Circuit logic networks. The Solid Circuit SN 502 flip-flop cost \$450 in March of 1960, when it was introduced. An improved flip-flop, the SN 510, cost \$95 in sample quantities last Fall. A volume price of \$5 is predicted within five years. Another series of TI Solid Circuits, for radio and instrumentation, is almost ready for introduction.

Westinghouse, with two Air Force feasibility contracts totaling \$4.3 million, was scheduled to deliver a molectronic communications receiver to the Air Force last month. Westinghouse has a program for invading the consumer market with molectronics. The program includes plans to mass-produce several molectronic circuits by the end of 1961, and to introduce both industrial and con-

sumer molectronic products in large volume and at prices competitive with conventional items. This would mean circuit prices of no more than a couple of dollars apiece.

**CAPACITORS** may see some sweeping changes in the future. Mylar-film dielectric capacitors will continue to replace paper in high-reliability applications, particularly in military equipment, according to the Good-All Electric Company, a division of Thompson Ramo Wooldridge. "This trend is closely tied in with presensitization of military equipment and the result is a need to go to higher densities in component packaging. The projected increase would be about the same as last year."

Tantalum capacitors will increase about the same rate as last year, about 15 percent, Good-All says. "Tantalum is primarily an electrolytic-type capacitor and is used where there is a need for bulk capacitors, in bypass and coupling applications or computer areas. Also, there is much use of tantalum in the Minuteman program."

Capacitor pricing should hold up well, particularly in military applications. Industrial users as well as the military are pressing hard for miniaturization. Emphasis continues to be for more and more quality. Both industrial and military users are pressing for life testing data. There has been no pronounced price-cutting so far.

In an effort to upgrade their quality and to increase longevity, many entertainment-grade users are going after better quality in capacitors. For example, just a few years ago, electronic organs were using dielectric capacitors, and now they are using epoxy potted Mylar capacitors.

There may be a nominal price increase in variable capacitors over the next year or two, due to the new labor rates and also possibly because of the cost of materials, according to Thompson Ramo Wooldridge. "The sales curve for variable capacitors is linked closely to the communications business and primarily to consumer industry."

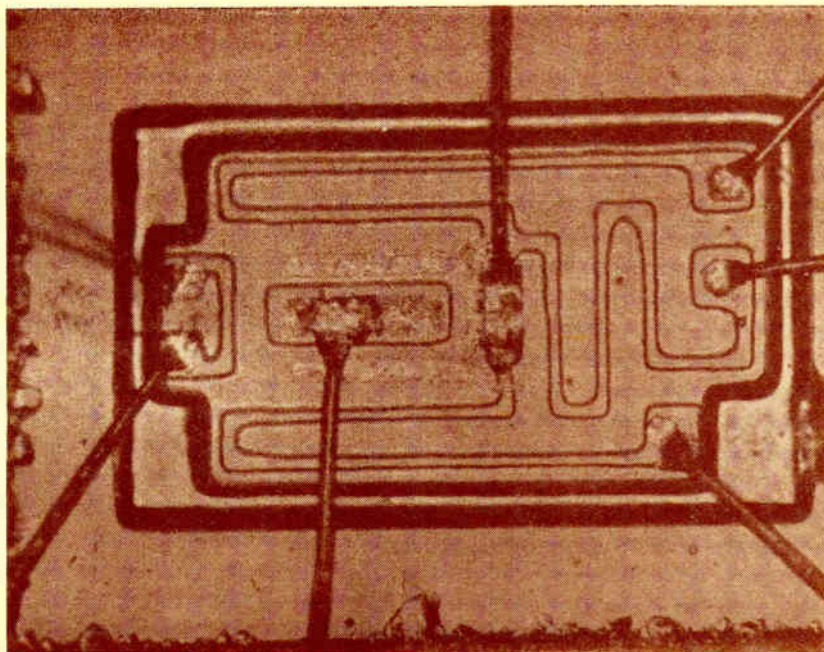

Integrated Motorola circuit prototype of a NOR logic element



British workers assembling ferromagnetic memory cores in the Plessey Co. Ltd. factory, Towcester, England

# GROWING MARKETS ABROAD

**WESTERN EUROPE**—A population of over 300 million, a gross national product between \$400 and \$500 million by 1970 and a high living standard is the environment in which Western European electronics will flourish.

Presently the 18-nation complex resembles the U.S. economy as it was in post World War II years.

**A MAJOR DIFFERENCE** with the U.S. electronics industry as it was 15 years ago, however, lies in the amount of technical information available to European scientists and engineers. Research conducted in America while Europe was digging out of war ruins is for the most part available to the Continent. In addition, there is a general availability of investment capital.

These two factors make electronics in Europe more than a radio/tv business. Coming up fast is specialized component manufacture, industrial electronics, instru-

ments and many other aspects of electronics.

Underlying this growth potential is the increasing importance of the European Economic Community and the European Free Trade Association. The philosophies and accomplishments of these blocs are already cementing Europe together commercially. It appears more and more evident that commercial interests outside these groups may have to join in by establishing facilities that make them an integral part of these economic entities.

Some signs of the health of Europe's electronics industry can be seen in the changing balance of trade. Once almost all of Europe's electronics requirements were filled from imports. Now there are a growing number of items being exported and competing on world markets.

**BRITAIN'S ELECTRONICS INDUSTRY** exceeds \$750



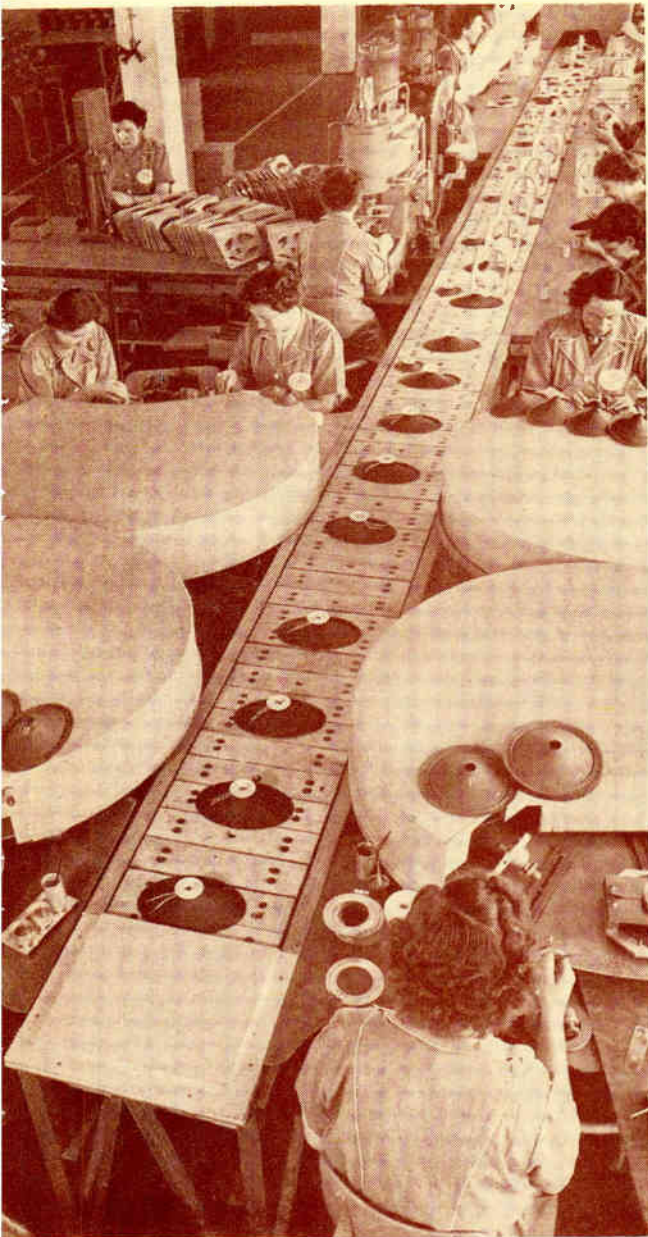

German facility of ITT producing high fidelity loudspeakers

million, over ten times its prewar level. Exports last year were almost \$170 million.

There are about 500 electronics companies in more than 750 plants in England. Also, firms classified in other industries produce a certain amount of electronics goods.

Three British electronics firms have more than 10,000 employees. Forty companies have more than 1,000 employees and produce about 75 percent of the nation's total electronics output. About 300 companies have over 25 employees each. Although many firms are subsidiaries of electrical machinery producers, the number of independent companies is rising.

About half of England's electronic output is in radios, phonographs and tv sets. Last year 2.5 million radios and radiophonographs were produced. After 1957 more tv sets than radios were made. In 1960, however, popularity of transistor radios put the balance in favor of radios once more and raised unit production to record levels. Curtailed installment buying may have damaged

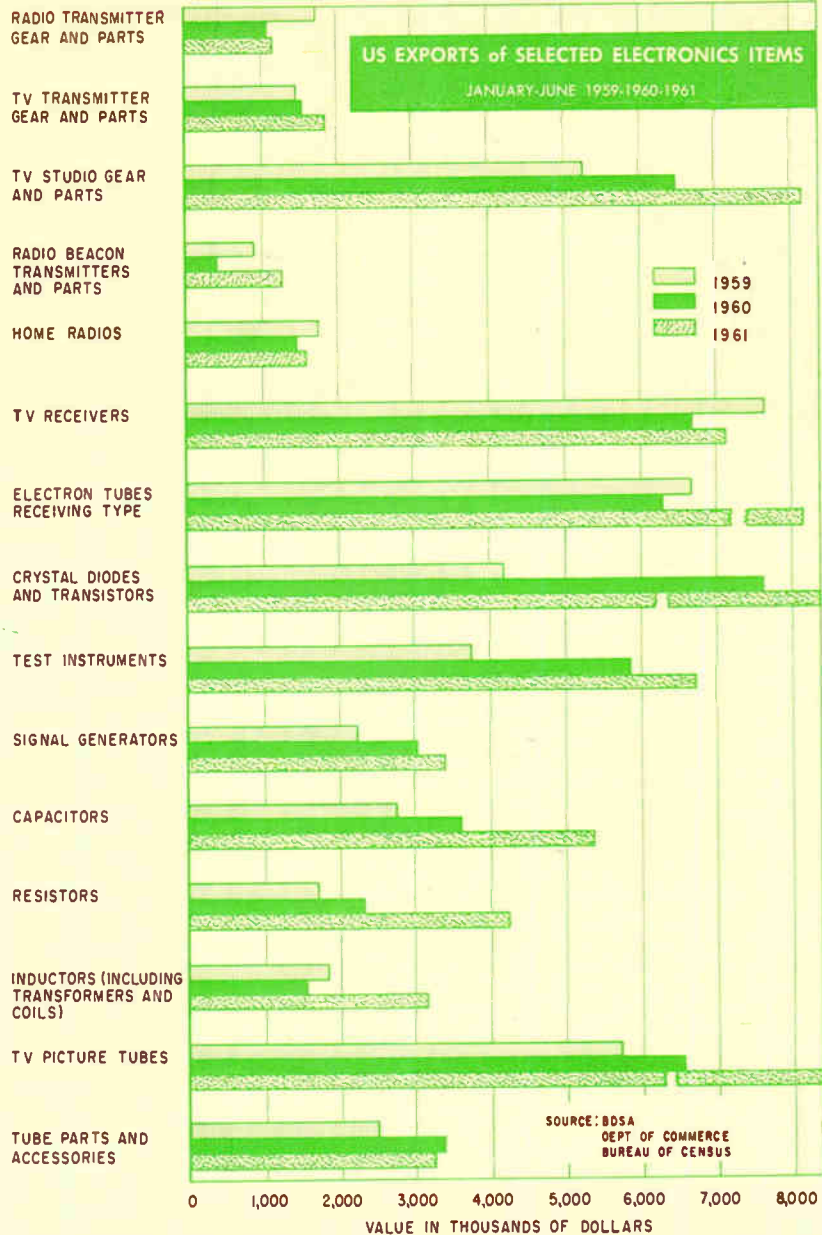

tv sales in recent years.

Electronic capital goods, rising steadily since the war exceeded \$165 million in 1960, with a good share going for computers. There are more than 300 digital computers in use. These along with associated computer equipment are mainly at work in industrial uses. Domestic computer sales top \$17 million. Tube and component production last year exceeded \$90 million.

British electronics exports rose to \$169.5 million in 1960 from some \$90 million in 1954, mainly in such non-consumer goods as navigational aids and communications gear. The former saw some \$50 million in exports last year.

Tube and component exports amounted to \$60 million. Radio receivers, in a slump between 1955 and 1958 are once more showing export gains.

Britain's customers last year were Canada, U.S., Netherlands, Sweden and Australia.

Rising British imports are also noted. In 1954, electronics imports were about \$24 million. Last year they



were \$72 million. Of this, \$21 million was in capital goods.

A feature of British electronics is the amount of effort it puts into research and development. A recent survey shows about 12 percent of net industry output goes back into R&D. Over seven percent of British scientists and engineers working in industry are in electronics. Of these, two-thirds are in research and development.

**BELGIUM'S** growing electronics industry ranks eighth among the nation's business activities. It employs some 30,000 workers who produce about \$200 million worth of equipment, mainly components and subassemblies. Also produced is electronic automation equipment and communications gear.

In components manufacture, the emphasis is on high-quality industrial items rather than mass numbers of commercial pieces. Semiconductors are an important portion of the output and the quantity and quality of transistors has grown steadily. Tube production is high though steady with growth in quality rather than numbers. Emphasis is on the industrial rather than entertainment types. Resistors are produced with the same market in mind and include nonlinear ceramics, photoresistors, varistors and thermistors.

Subassembly work includes a certain amount of miniaturization, but relies primarily on communications equipment, data transmission and telephone gear.

**WEST GERMANY**, bases its electronics industry heavily on radio, tv and communications. Growth is evident, however, in electronic machine tool control, component manufacture and other areas of electronics.

During 1960, West Germany produced 4.8 million radios of all types valued at more than \$190 million. Almost half of the radios were for export. Television sets, including units packaged with radios, phonographs or both, numbered 2.8 million at about \$335 million. About 26 percent of these were exported.

Component manufacture in 1960 is estimated at more than \$150 million. Included in this figure are \$34

million in resistors, \$61 million in capacitors, \$14 million in coils, filters and transformers. About one-quarter of West German component production went to the export market.

German consumer products incorporate a considerable amount of modernity. Some 95 percent of all German tv receivers have 24-in. picture tubes. Thirty percent of the radios are equipped for stereo, 10 percent are cordless and 75 percent can receive on four bands. Half of the new tape recorders are four-track types and over one-third are made for compatible stereo.

There are about a dozen firms producing radar and communications gear. Three of these are U.S. subsidiaries. Production is largely for internal uses in such applications as harbors and air terminals.

**FRANCE**, long involved in radio research, supplied some of the know-how that went into the initial development of microwave radio some 50 years ago. Today, the nation is doing its share to aid the growth of electronics. There are close to forty good sized electronics companies in France and as many of smaller size. A directory of French electronics companies shows a diverse selection of electronics areas ranging from radio receivers to specialized semiconductors.

France has a favorable balance of electronics exports. Imports run to about 3 percent of total French electronics production, while exports run to about 8 percent. This balance is aided by shipments to French zones of influence as well as general world markets.

**ITALY** is seeing some growth in electronics, though perhaps less than some of the more highly urbanized neighboring countries. Most manufacturing is done in central and northern Italy although a considerable amount of foreign capital and Italian funds are being expended in stepping up the pace of electronics manufacture in the south. As is the case with most other continental nations, Italy's electronics industry is concerned primarily with radio and television. Some component manufacture, however, has been started.

**NETHERLANDS** is known in Europe as a supplier of components for a variety of applications. Electron tubes and semiconductors are produced almost exclusively by one company, but in such quantities as to dominate a good bit of Europe's trade. Most of the output goes into equipment by the same firm both within Holland and in other countries. Both exports and imports of tubes and semiconductors have been rising steadily in the Netherlands. Electron tube imports in 1950 were valued at \$1,561, exports at \$12,496. By 1959 imports were \$30,858, while exports came to \$53,955. Recently, Dutch authorities have discontinued publication of import-export figures, but until 1957, Belgium was the main Dutch source of tube imports, with West Germany and Britain following.

A good amount of Holland's communications equipment is made internally. Radiotelephone and telegraph equipment, broadcast gear for radio and tv, studio equipment for television, navigational aids, radar and remote control apparatus are all available from internal suppliers. A certain amount of microwave equipment is imported from West Germany and some mobile radio gear from Denmark. Electronic test equipment and laboratory

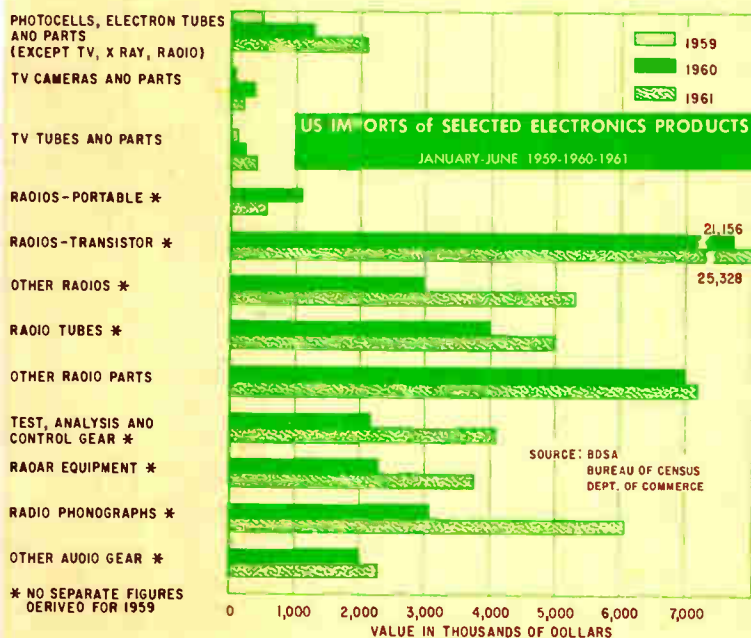





New research center nearing completion outside Tokyo by Tokyo Shibaura cost more than \$5¼ million

gear from the U. S. enjoys a significant sales volume.

**JAPAN** relies heavily on electronics exports for its economic health. Short on such heavy items as coal, iron ore and other major natural resources, manufacturing industries are the mainstay of the economy, and outside markets are essential to maintain these industries.

Japan's electronics industry has grown by leaps and bounds since the early 1950's when television broadcasting began on the islands.

In 1960 Japanese electronics output totaled more than \$1,600 million as compared with \$932 million in 1959 and some \$240 million in 1956.

As is the case with most nations, consumer electronics accounts for the major share of the industry. Fifty-seven percent of Japan's 1960 total was in consumer electronics. Television receivers accounted for \$394 million. This was a rise of 18 percent over the preceding year. Between 1958 and 1959, however, tv sales went up 118 percent.

During 1960, production of radio receivers with three or more transistors came to \$169 million, receiving tubes to \$86 million, tv picture tubes to \$70 million and transistors to \$54 million. Values of commercial, industrial and component output also rose during the 1958-60.

Japan's balance of trade has been dropping since May of 1961 with imports greater than exports. Because of this and other factors, a tighter money policy is prevailing in Japan which will affect capital expansion. This could mean that production levels will not continue climbing at their present rates. Already, the Japanese government has asked manufacturers to voluntarily curtail capital goods spending. Some idea of how this move affects Japan's electronics industry is given by Yamaichi Securities, one of the nation's leading financial houses. Tokyo Shibaura's expansion program calls for more than \$74 million this year, Matsushita plans more than \$17 million, Nippon Electric \$22 million and Hitachi close to \$10 million. It is likely that these and other electronics companies will observe the government request.

Despite this possible production plateau in the short-range future. Japanese electronics is certain to continue its over all expansion.

Present equipment produced extends into virtually every area of electronics from simple transistor radios to computers. Much of this production is and will continue to be in cooperation with foreign companies.

The Finance Ministry of Japan at mid-year 1961

announced that 1,440 technical licensing agreements had been signed with foreign firms. A similar check a year earlier placed the number at 1,090. Of the 1,440 agreements of last year, 350 were in the electrical machinery category which includes electronics.

**LATIN AMERICA** represents a growing volume of the overall world electronics market. Most electronics expenditures in the vast region between the Rio Grande and Tierra del Fuego are for radio and television sets and for communications gear.

Latin America's general average economic activity has doubled in the past 20 years. It is estimated that the total gross national product of Latin America is rising at the rate of five percent annually.

Radio and television are viewed as ideally suited for communicating educational, political and other types of information. It is this factor, perhaps more than any other, which has contributed to the growth of broadcasting in Latin America. Each of the nations has at least one television broadcast station and many have several. Brazil has more than two dozen.

Receivers are made locally for the most part to circumvent the difficulties of foreign currency exchange, tariffs and other obstacles. General set costs run to about \$500 and for the average resident, they are purchased on the installment plan, often under three-year purchase periods. The receivers are of recent or modern design and include many 19-in. and some 23-in. models.

While the tv receiver market is still a long way from saturation, there is a high percentage of radio receivers in Latin America. These too are produced locally for the most part and are usually equipped to receive short wave in addition to a-m.

It is in the field of communication that great promise for Latin American electronics lies. Jungles and other natural obstacles make the region ideal for microwave net works. Growing air traffic is imposing its needs, and a population increasing both in numbers and education will increase the demand for telephone systems.

The competition for markets is evident. In most Latin American nations, the U. S. still maintains a good hold on the market, but West Germany, Netherlands, Japan and United Kingdom companies are developing markets which in some nations exceed those of the U. S. In Uruguay, for example, radio component imports from the Netherlands exceed U. S. shipments. In Colombia, Netherland components run a close second to U. S. with United Kingdom imports trailing closely.

**GUARANTEED**

to meet  
**"WORST CASE"**  
 Conditions



## New "Switching" Power Supply Gives More Current at Less Cost

Just out. Con Avionics announces a new line of transistorized "switching" power supplies that provide more current, more reliable current, at a lower cost to you.

The secret? This unit continuously turns itself on and off. The result is exceptionally high current for its size and price. High efficiency is built in through low pass dissipation, high reliability, minimum components and small size. Most of the semi-conductors operate in the switch mode, adding to the long life of the supply.

Priced to compete with magnetic amplifier and constant voltage power supplies, the performance characteristics are decidedly superior. Like all Avionics power supplies these new "switching" power supplies are designed and tested by "Worst Case Analysis" for virtually failure-proof performance.

Voltage Range	50 Amp	30 Amp	20 Amp	10 Amp
24 — 32 V DC	SP28-50 \$820.00	SP28-30 \$590.00	SP28-20 \$525.00	SP28-10 \$450.00
18 — 26 V DC	SP22-50 \$820.00	SP22-30 \$590.00	SP22-20 \$525.00	SP22-10 \$450.00
10 — 20 V DC	SP15-50 \$820.00	SP15-30 \$590.00	SP15-20 \$525.00	SP15-10 \$450.00

Prices subject to change without notice.

### CONSOLIDATED AVIONICS CORPORATION

800 Shames Drive, Westbury, New York

- Send literature on new "switching" power supplies
- Have representative call with demonstrator

Name .....

Company .....

Street .....

City ..... Zone ..... State .....

**CON  
 AVIONICS**

A Member  
 of The Condec Group



# WORLD'S FIRST 2 kmc TRANSISTOR



PHILCO  
T-2351  
MADT\*

**THE AMPLIFIER WITH 6 db POWER GAIN AT 2 kmc.** From the world's first family of high frequency communications transistors, Philco \*Micro Alloy Diffused-base Transistors, comes the world's highest frequency commercially available communications transistor—Philco type T-2351. This new addition to the Philco MADT family serves as an amplifier, oscillator or mixer. At 1 kmc, it amplifies with 12 db power gain, delivers over 10 mw of output power, and has a maximum noise figure of 10.5 db. Its coaxial package minimizes parasitics and is matched for insertion in 50-ohm coaxial systems.

For EVERY communications requirement, there's a Philco Communications-Designed Transistor . . . with these advantages ■ More db per dollar ■ Industry's lowest noise figures ■ Industry's most usable A.G.C. characteristics ■ Only communications transistors specified to guarantee performance in practical circuits ■ Only Philco guarantees bandwidth specifications ■ All transistor elements are isolated from case in single-ended types ■ Proven MADT reliability.

For complete information, write Dept. E1562

All Philco communications transistors are immediately available from your Philco Industrial Semiconductor Distributor.

# PHILCO®



*Famous for Quality the World Over*

LANSDALE DIVISION, LANSDALE, PENNSYLVANIA



**GUARANTEED**

to meet  
**"WORST CASE"**  
 Conditions

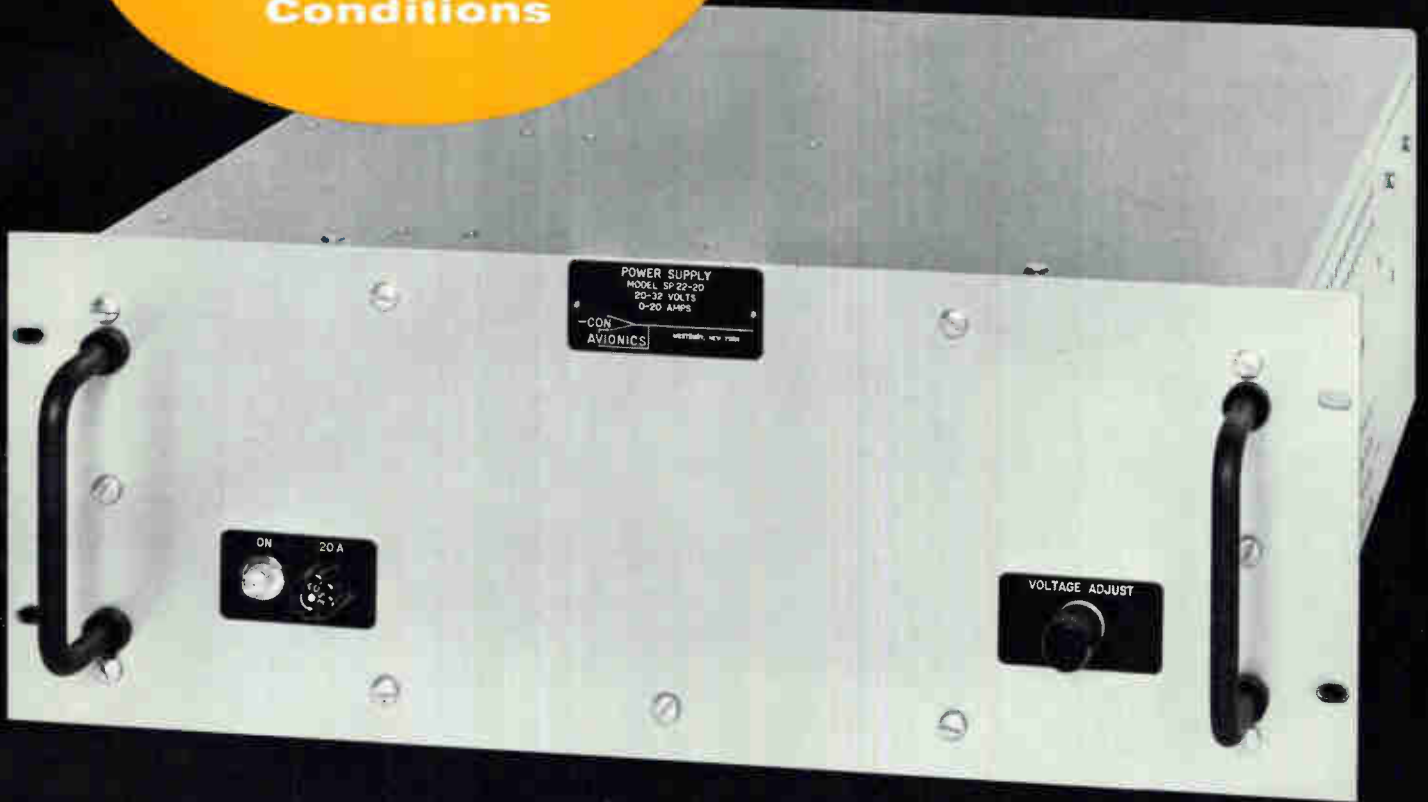

## New "Switching" Power Supply Gives More Current at Less Cost

Just out. Con Avionics announces a new line of transistorized "switching" power supplies that provide more current, more reliable current, at a lower cost to you.

The secret? This unit continuously turns itself on and off. The result is exceptionally high current for its size and price. High efficiency is built in through low pass dissipation, high reliability, minimum components and small size. Most of the semi-conductors operate in the switch mode, adding to the long life of the supply.

Priced to compete with magnetic amplifier and constant voltage power supplies, the performance characteristics are decidedly superior. Like all Avionics power supplies these new "switching" power supplies are designed and tested by "Worst Case Analysis" for virtually failure-proof performance.

Voltage Range	50 Amp	30 Amp	20 Amp	10 Amp
24 — 32 V DC	SP28-50 \$820.00	SP28-30 \$590.00	SP28-20 \$525.00	SP28-10 \$450.00
18 — 26 V DC	SP22-50 \$820.00	SP22-30 \$590.00	SP22-20 \$525.00	SP22-10 \$450.00
10 — 20 V DC	SP15-50 \$820.00	SP15-30 \$590.00	SP15-20 \$525.00	SP15-10 \$450.00

Prices subject to change without notice.

### CONSOLIDATED AVIONICS CORPORATION

800 Shames Drive, Westbury, New York

- Send literature on new "switching" power supplies  
 Have representative call with demonstrator

Name.....  
 Company.....  
 Street.....  
 City..... Zone..... State.....

**CON  
 AVIONICS**

A Member  
 of The Condec Group



# Other Transistorized Power Supplies



**GUARANTEED**

to meet  
**"WORST CASE"**  
Conditions

## AC-DC "MODULAR" POWER SUPPLIES 2 to 305 VDC; 100 ma — 1 amp

Unique heat sink construction of these supplies permits operation in ambient temperatures up to 65°C, when mounted on a typical rack chassis. Power to 30 watts. Adjustable output. 0.1% regulation. Reliable short circuit protection. Small size makes it ideal for electronic assemblies or systems. Guaranteed for two years to meet all specifications.

Input.....105 to 125V AC  
Line Regulation.....0.1% or 10mv  
Load Regulation.....0.1% or 20mv  
Stability.....±0.25% for 8 hours  
Ripple.....0.02% or 5 mv rms  
Response time.....less than 100 microseconds  
Operating Temperature . . . 0C to 65C on a typical rack chassis  
Temp. Coeff.....0.01% per C.

## WIDE RANGE POWER SUPPLIES 0-50 VDC/2, 5, 10 and 15 Amp.



For unusually wide voltage range and high current capacity. Three rack-mounted series available with 0.5%, 0.10% and 0.01% regulation. Completely transistorized. Regulated without "gimmick" pre-regulators. Positive short circuit protection. Guaranteed for two years to meet all specifications. Includes remote sensing and programming, fan cooling with thermostat protection. Over-voltage, current-limiting option.



## LOW COST GENERAL PURPOSE POWER SUPPLIES 0-60VDC/0-1.5 Amp.

A durable, general purpose power supply available with regulated and unregulated outputs. Simple and straightforward circuitry with components used conservatively for long trouble-free life and high reliability. Designed for ease of operation and convenience in bench-mounting. Cases heavily dimpled so two or more units may be stacked on top of each other.

**CON  
AVIONICS**

## WARRANTY

Con Avionics guarantees that its power supplies will meet their published specifications for two years after date of shipment. Guarantee does not cover transistors, diodes, fuses.

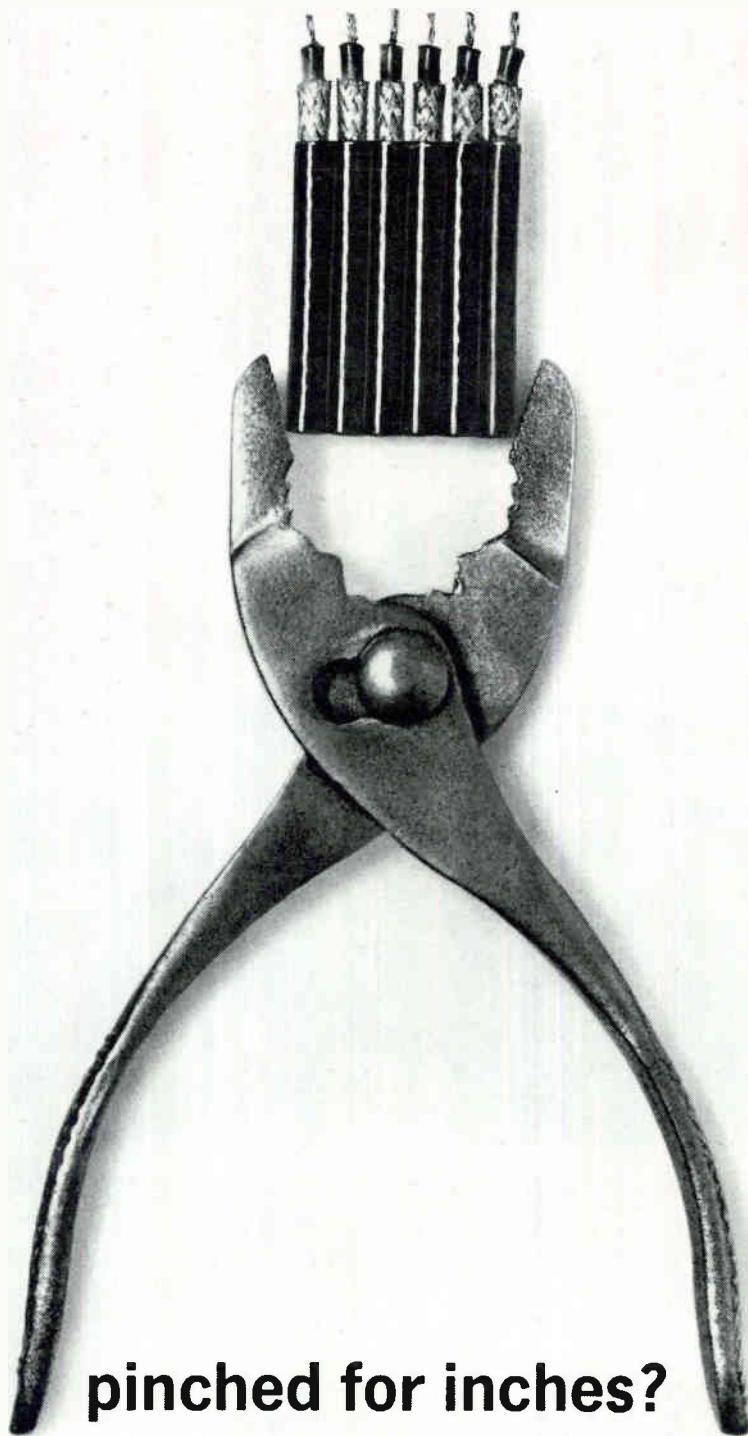

**pinched for inches?**

**Solve small space problems with Synkote® Ribbon Cable**— Single Conductor, Twisted Pair and Coaxial Ribbon Cables. Color coded for quick identification. Strips and separates easily. Rigidly manufactured and tested for highest quality. Available in standard sizes, and in special designs to meet your exact requirements. Ideal for use in electronic equipment where space conservation is essential—computers, missiles. Write for detailed information today.

**PLASTOID**

CORPORATION  
42-61 24TH STREET / LONG ISLAND CITY 1, N. Y. / ST 6-6200



# WORLD'S FIRST 2 kmc TRANSISTOR



PHILCO  
T-2351  
MADT\*<sup>®</sup>

**THE AMPLIFIER WITH 6 db POWER GAIN AT 2 kmc.** From the world's first family of high frequency communications transistors, Philco \*Micro Alloy Diffused-base Transistors, comes the world's highest frequency commercially available communications transistor—Philco type T-2351. This new addition to the Philco MADT family serves as an amplifier, oscillator or mixer. At 1 kmc, it amplifies with 12 db power gain, delivers over 10 mw of output power, and has a maximum noise figure of 10.5 db. Its coaxial package minimizes parasitics and is matched for insertion in 50-ohm coaxial systems.

For **EVERY** communications requirement, there's a Philco Communications-Designed Transistor . . . with these advantages ■ More db per dollar ■ Industry's lowest noise figures ■ Industry's most usable A.G.C. characteristics ■ Only communications transistors specified to guarantee performance in practical circuits ■ Only Philco guarantees bandwidth specifications ■ All transistor elements are isolated from case in single-ended types ■ Proven MADT reliability.

For complete information, write Dept. E1562

All Philco communications transistors are immediately available from your Philco Industrial Semiconductor Distributor.

## PHILCO<sup>®</sup>



*Famous for Quality the World Over*

LANSDALE DIVISION, LANSDALE, PENNSYLVANIA



*Review of problems associated with vertical registration of characters in high-speed optical scanning equipment. Design of a vertical locator for automatic registration is presented*



*Authors Milbradt (left) and Bauldreay check out automatic registration*

# SOLVING REGISTRATION PROBLEMS In Optical Character Recognition

By J. BAULDREAY  
E. MILBRADT,  
Engineering Dept.,  
Farrington Electronics,  
Inc., Alexandria, Va.

A PROBLEM common to all character reading systems is that of irregular registration resulting from human inconsistency and from mechanical imperfections in typewriters, stamping machines and high-speed printing machines. Rarely does a line of printed characters have perfect horizontal and vertical registration, that is, consistent hori-

zontal spacing and a common vertical datum. In general, horizontal registration poses a lesser problem in that character pitch is fairly consistent in most popular type fonts, print wheels are maintained at precise distances apart. Stylus heads are also rigidly spaced. Once the first character in the line is encountered, its foremost point can be used as a reference to time and locate all following characters. There is one exception—the Executive type font with proportional spacing.

In the vertical direction, the whole line may be misplaced from its ideal position; also, individual characters may be offset one from another. This latter effect is fairly common with wheel printers, sometimes with chain printers, and with maladjusted typewriters. To detect the traits of a character and determine their physical relation to one another, some reference is usually established to measure time or distance and fix the specific points at which these traits should appear. The machine might then conclude



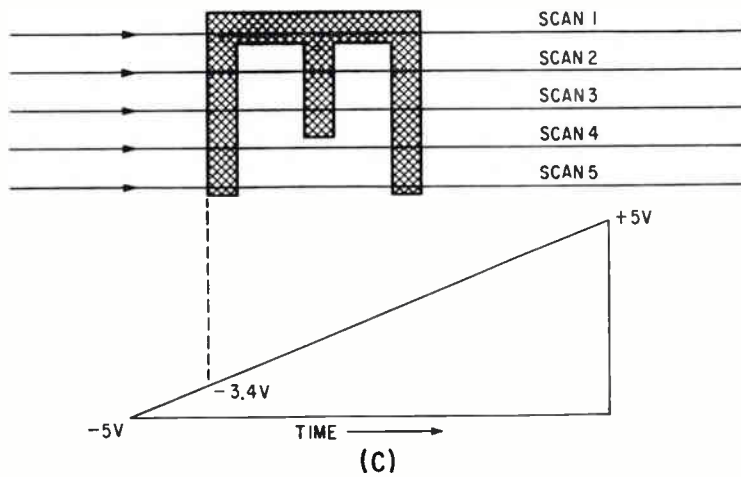
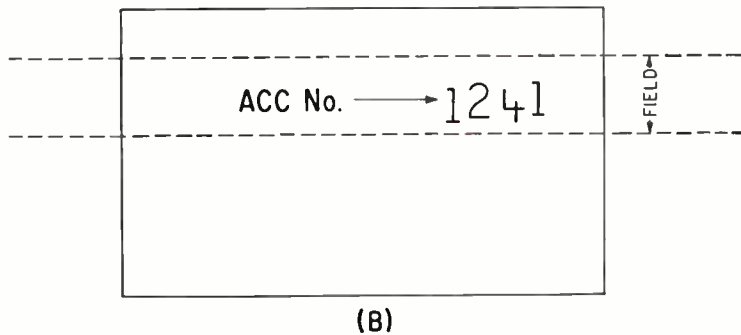
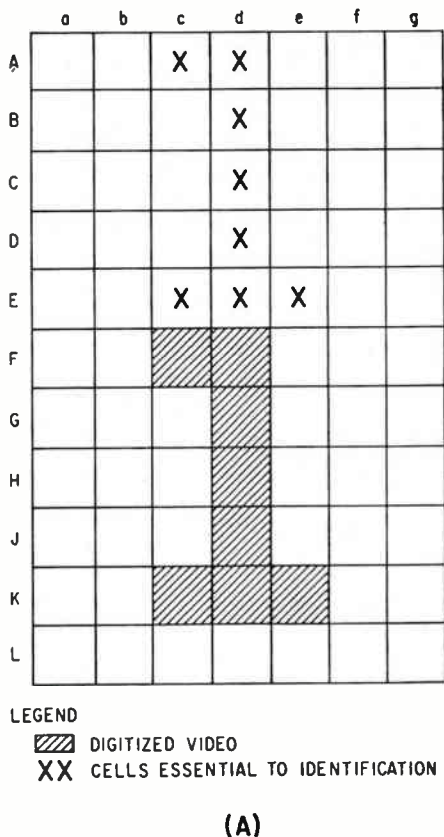

FIG. 1—Matrix identification (A); how scanning field relates to characters on document (B); sweep-locator relation (C); registration and character composition (D)

their combination to represent a particular character and thus establish a recognition. The position of a character cannot be determined accurately if the reference point is poorly defined. It is common to use as a reference either the top or bottom of each character, whichever is more convenient.

Two methods are now used to overcome imperfections in vertical registration: the video pattern is previewed and then shifted to an area where it can be recognized and identified; the character is viewed as it develops during successive scans, and its edge is used as a datum line for recognition decision making. This latter method has, for several years, been used in Farrington Optical Scanners.

The first method is employed by Solartron, Ltd., of Thames Ditton, England.<sup>1</sup> A preliminary reading is made to obtain a registration error, that is, the difference between actual and ideal vertical character position. This error is then fed back to correct the optics of a flying-spot scanning system so that on a second reading the character will appear in the correct position within the scan-

ning field for identification. A somewhat similar approach is employed by Standard E.L.A.G. of Stuttgart, Germany,<sup>2</sup> who first enter their digitized video into a shift register matrix, and then shift the static pattern vertically to a position where it can be compared with other predetermined character configurations. They tackle horizontal registration by a sideways shift, possible since it is a 2-dimensional shifting matrix. Some machines made by the Rabinow Engineering Co. also appear to use the electronic vertical shift. Both approaches are illustrated with Fig. 1A, which shows how the numeral 1 would be held in a matrix-type storage had the relative positions of the numeral and reading field been as shown in Fig. 1B. Assume, for example, that a character which occupies cells Acd, Bd, Cd, Dd, and Ecd (Fig. 1A) would be recognized as a numeral 1. The Solartron attack would be to lower the upper limit of their optical scan by 5 cell heights, bringing the character up and into registration. S.E.L.A.G. would shift the stored character pattern up 5 cell heights to the top of the matrix

where the top and one side would be used as an electronic reference, and the shifted pattern would coincide with the predetermined configuration for the numeral 1. Whether this must be an exact match or a best match varies from machine to machine, but best match methods are the most common.

To appreciate the operation of the vertical locator circuit, it is first necessary to be acquainted with the essentials of recognition used in Farrington optical scanners. The area being scanned is highly illuminated and, by a flying aperture,<sup>3,4</sup> each character is scanned vertically as it moves past the reading station and is broken down into twenty or more vertical samples. The combination of these provides adequate intelligence to permit recognition. Assume that the letter E is broken down into 5 successive scans as shown in Fig. 1C. At the main reading station, the height of the scanning field is about three times that of a character. In general, a greater printing registration error will require a larger scan height in relation to character size. A sawtooth voltage, beginning at -5 volts and

ending at +5 volts, is generated in coincidence with each successive scan such that each black crossing can be marked with a potential proportional to the time that it is encountered after the beginning of the scan: hence, the sawtooth is an analog representation of scan distance from the beginning of the reading field. The vertical locator is concerned only with the first such crossing or earliest video marking the lowest point of the character. This point will vary with any vertical misalignment. As shown in Fig. 1C, the bottom of the letter E is at -3.4 volts or at 15 percent of the field scan height. The vertical locator detects and holds this position in field so that it can be used as a datum point for character interpretation.

This datum point is needed for fixing the relative positions of constituent criteria. Suppose that a fixed scan of adequate height were employed such as to ensure that all characters would be seen, and allowing for a reasonable vertical misalignment from character to character. Fig. 1D shows that confusion would exist in determining whether the letters P, b, the numeral 6, or just extraneous strokes have been seen, since the vertical arrangement of the two strokes could yield a large number of configurations. By using the upper or lower edge of a character as a reference relative stroke position as well as vertical misalignment from character to character is accommodated.

The letter E in Fig. 1C is shown perfect in every detail. However, commercially available reading machines are designed to cope with character and background imperfections such as incomplete characters or specks of dirt which could be mistaken for print. These are practical problems for which equally practical solutions have already been found by builders of reading machines. It would be futile to worry about background interference and character imperfection if one could not decipher perfectly formed characters with a consistent background.

The operation and design of the circuit to locate a line of printed characters and automatically provide a common continuous vertical datum can be analyzed with the aid of the simplified schematic and waveforms of Fig. 2A and 2B. A sawtooth sweep voltage is compared with the earliest video encountered in each vertical sweep and the storage capacitor (Fig. 2A) is charged to a potential which is an analog marker of the distance from the bottom of the scanning field (3.4 volts for the letter E in Fig. 1C). This voltage is available directly for analog purposes and is also used as a reference to trigger a logical output signal. The circuits between the storage capacitor and the logical output are buffers so that current drawn by the output will not reduce the capacitor voltage.

The locator circuit may be used to mark either the top or bottom of a character depending on design

preference. Sweep direction is from bottom to top of the scanning field when marking character bottom; top to bottom when marking character top. Fig. 2B shows the waveforms from scanning the letter E in Fig. 1C. As soon as the video from the bottom of the left hand tall vertical stroke of the E is detected,  $Q_5$  of the long tailed pair  $Q_5, Q_6$  will begin conducting, since the base of  $Q_5$  will be at -3.4 volts of the positive-going sawtooth while the base of  $Q_6$  (point D) is at the reset level of +5 volts. The potential at point A is essentially the same as that of point D. Conduction of  $Q_5$  will result in a positive voltage feedback to the input AND gate (when  $Q_6$  is nonconducting) and thus allow the storage capacitor to discharge through  $Q_1$ . The rate of discharge is determined by the AND gate output potential, the current gain (Beta) of  $Q_1$ , and the divider ( $R_2, R_3$ ) feeding its base. When the discharge is such that the falling voltage at point D equals that of the rising sawtooth, then  $Q_5$  and  $Q_6$  will switch differentially, the input AND gate will close, and discharge of the storage capacitor will cease. This continues in the following scans with the discharge period getting shorter and shorter and the logical signal coming earlier and earlier in the scan until, in the fifth scan, the successive approximations yield the answer of -3.4 volts at point A. With this potential on the storage capacitor, the logical output then switches in coincidence with the earliest video which is, in the ex-

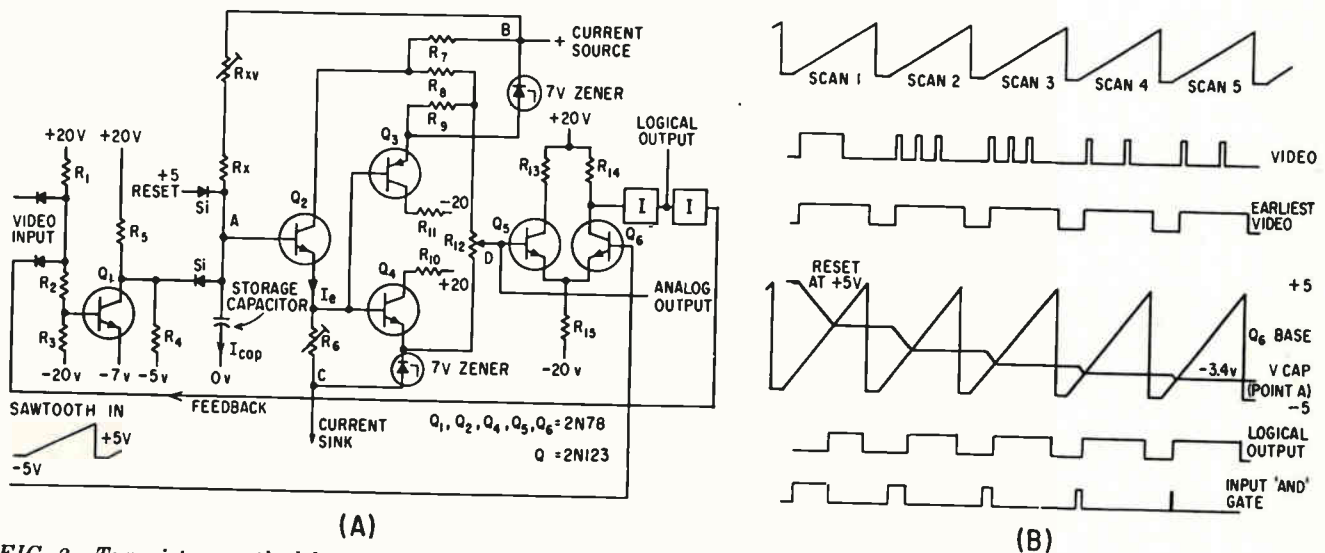

FIG. 2—Transistor vertical locator schematic (A) and locator waveforms (B)



ample of Fig. 1C, the bottom of the letter E. In actual usage, the location is essentially complete after 2 or 3 scans early in character.

The transfer of a change in potential from point A to point D, the switching of  $Q_3$ ,  $Q_4$  and transmission of this fact to stop the discharge of the storage capacitor takes roughly one microsecond. Compensation for this is accomplished by slightly offsetting the level at point D below that of point A and thereby causing  $Q_3$ ,  $Q_4$  to switch just before the capacitor voltage equals that of the sawtooth, thus preventing any overshoot. Transistors  $Q_3$  and  $Q_4$  with voltage limiters  $R_{11}$  and  $R_{10}$ , respectively, are emitter followers between points A and D.

To maintain the reference voltage (-3.4 volts in the example) once established, point B is at all times 7 volts positive with respect to point A. Similarly,  $Q_2 I_e$  will be constant at  $7/R_6$  milliamperes (when  $R_6$  is in kilohms). The two silicon diodes in a cutoff condition can be ignored so that the current into the storage capacitor can be expressed as:  $I_{cap} = I_{rz} - (I_b - I_{co})$ . If this current flow can be adjusted to zero, the storage capacitor will hold its charge indefinitely.

The first term ( $I_{rz}$ ) is as constant as the potential between points A and B, and to keep this potential as stable as possible the 7-volt zener diode is fed from a constant-current source. While these diodes exhibit their lowest incremental impedance at 7 volts, it is still finite and current changes would cause changes in zener voltage. Additionally, 7-volt zeners are close to the zero temperature coefficient of 5.5 volt zeners. The same reasoning applies for the potential A to C.

The second term ( $I_b - I_{co}$ ) is equal to  $I_e/B - I_{co}$ , both of which are temperature dependent. While  $I_e$  is held constant, beta increases roughly  $\frac{1}{2}$  percent for each degree centigrade temperature rise and  $I_{co}$  doubles in 7 deg C. It was decided, therefore, to keep the quantity  $I_e/B - I_{co}$  to a small value initially so that any variation due to a change in temperature would be small. It was for this reason that the 2N78 was chosen with a typical  $I_{co}$  of 0.7 microampere and the high beta at low currents which is characteristic of rate grown junction transistors. The 2N78's used as  $Q_2$

have an  $I_{co}$  of less than 0.3 microampere and beta of greater than 70.

Having these characteristics of  $Q_2$ ,  $R_{10}$  is then adjusted so that 3 microamperes flow through  $R_{10}$  into point A, and  $R_{11}$  is adjusted so that 3 microamperes flow into the base of  $Q_2$ ;  $I_e/B - I_{co}$  should then be (3.3 - 0.3 microampere) at 25 deg C and 3.1 - 0.7 microampere at 35 deg C or a change of -0.6 microampere over this 10 deg C temperature variation. If the storage capacitor is chosen typically to be 0.5  $\mu$ F, then the rate of gain of voltage will range from zero at 25 deg C to

$$\frac{1}{c} \frac{dq}{dt} = \left( \frac{1}{0.5 \times 10^{-6}} \right) \left( \frac{0.6 \times 10^{-6} \text{ volts}}{10^{-3} \text{ ms}} \right)$$

which equals approximately 1 mv per ms or a drift of  $10^{-4}$  of the field height (of 10 volts) per millisecond. Since characters are scanned typically in a few milliseconds, the drift in capacitor potential is negligible.

The locator circuit is not limited to this operation. It is sometimes desirable to have a prelocation signal that gives a logical output at some point earlier in scan, beneath the main locator. In some applications, after an initial fast location, the locator must follow only gross deviation from alignment or a steady drift in outline such as would result from a sloping line of characters. This slowing down of the locator can be effected by loading the junction of  $R_{11}$ ,  $R_2$  to limit the base current of  $Q_1$ .

When it is known that the characters to be read may be erratic in their vertical registration, it may be of advantage to introduce a positive drift at point A so that upon leaving one character, the locator will automatically look for the next to be positioned slightly later in scan.

Some machines use two locator circuits. The first locator previews each character, and the resulting logical output is then fed as a video input to a second locator. This secondhand input is a much better starting condition than the reset level and, therefore, enables a faster and more accurate location by the second or main locator.

Presently, the locator is used as the heart of another circuit which enables a machine to read characters of varying height and obtain a

measure of this height in analog terms so that, subsequently, we are able to measure and position set fractions of a character height.

One application of the locator is in an experimental mail sorter making a two-way sort on letter mail. A more advanced, nearly operational, transistor model for the Post Office Department is being tested. Since the bottom line of the address on an envelope can be almost anywhere within limits, a forward reading station locates the bottom line of the address. The analog output of the forward reading locator is then fed to a position servo mechanism coupled to a mirror in the optical path to the main reading station. By the time the envelope has reached this main station the mirror has been moved so that only the bottom line is presented to the recognition logic. When reading addresses typed with the first letter upper case but following letters lower case, use is also made of a prelocator looking below the main locator. This is of value when dealing with the letters, g, j, p, q, and y, which hang below the main body of a word. Additionally, since the height of the characters varies considerably, the circuit that measures and stores this height is also used on this machine. For example 12-pitch type is about 0.085 in. high and 8-pitch type is about 0.130 in. high.

Figures 3A, 3B and 3C were taken from an oscilloscope tv-type presentation obtained by feeding the sawtooth waveform to the Y deflection plates and blanking the tube cathode with the signal to be viewed or its derivative.

Figures 3A and 3B show an envelope as seen by the forward reading station. The derivative of the locator logical output shows how the locator lowers into the bottom of the bottom line; close examination will show it to be cutting through the e in Research, F in Farrington, 7 in 7019 and the A in Alexandria.

Figure 3C shows the same envelope in the main reading station where only the bottom line of the address is seen. The locator upward drift between words can be seen, with the prelocator duplicating it a little way below.

In another application, a page reader, the vertical locator is used to perform two separate functions.

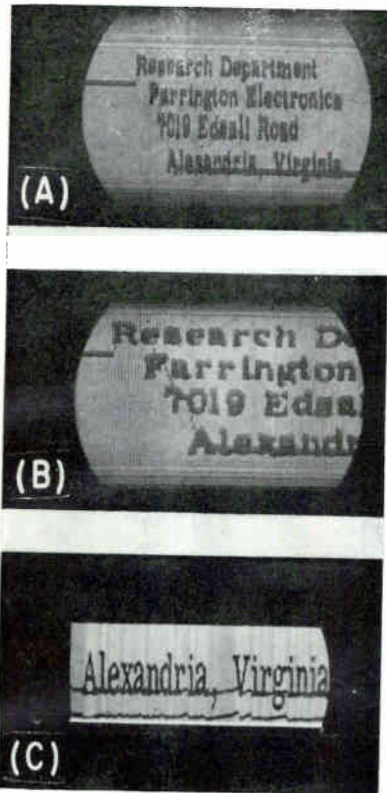

FIG. 3—Oscilloscope presentations

The first function is what might be called the general purpose function of the locator and that is to locate each character to be read vertically within the read zone. Two locators are used as is generally the case. The first locator is allowed to sample recognition pulses from a pre-read station, which is one character space ahead of the main read station. This locator will set to the earliest recognition seen in the scan zone, which is the top of the character when scanning from top to bottom. During the time that it takes the character to pass from the pre-read station to the main read station the position of the first locator, now set to the top of the character, is transferred to a second locator. This second locator continues to mark the position of the top of the character in each scan until it is reset and then set again for the next character. The output of the second locator is used in the recognition program to zone the character vertically. After the second locator is set to the first locator the latter is reset and then allowed to set again on the next character in line.

Figure 4A shows a line of characters where some of the characters are vertically out of registration.

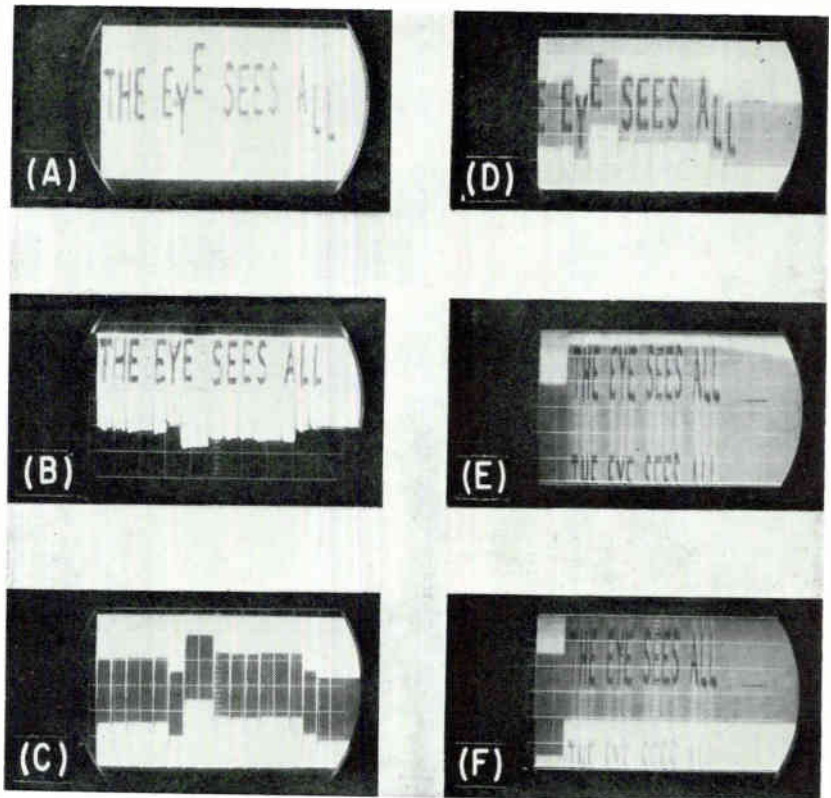

FIG. 4—Operations of vertical locators are traced in these tv presentations

Figure 4B shows the same line with all characters vertically aligned electronically, using the locator. Figure 4C shows how the second locator is used to zone an area within the scan zone in which recognition is allowed to be seen. Figure 4D shows the characters within this zone. All other recognition within the scanning zone, but not in the shaded area, is gated out and is not allowed to confuse the identification of the characters being read. With a page reader, when reading lines of information single-spaced and six to the inch, more than one line is seen in the scanning field. The problem then is to gate out all information other than the line to be read. This is the second function of the locator.

A third locator with a prelocator is used to find and locate on the line to be read. Once the locator has set to the top of the line being read, the prelocator gates out all other recognition except this line. Figure 4E shows how the third locator locates on the top of each character in the top line. Figure 4F shows how the prelocator zones around this line and gates out the second line. The third locator is not reset after each character, but is allowed to drift

down in order to compensate for any vertical misalignment of the line. This can be seen to the right hand side of Fig. 4E.

An apparatus has been described in the literature<sup>5</sup> that has sidestepped the problems associated with vertical registration, but it needs the backing of a matrix method before it can successfully read digits. It is probable that in the future more sophisticated recognition techniques will be developed that will, in themselves, inherently accommodate both character size and registration.

The authors acknowledge the aid of John O'Rosky in preparing this article.

#### REFERENCES

- (1) C. E. G. Bailey and E. O. Norrie, Automatic Reading of Typed or Printed Characters *Proc Elec in Automation Conv.* Cambridge, England, June 27, 1957.
- (2) W. Dietrich, Specialist Discussion Meetings on New Digital Computer Techniques, *Inst of Elec Eng.* London, England, Feb. 16, 1959.
- (3) *Electronic Design*, October 12, 1960, p. 14.
- (4) A. I. Tersoff, Automatic Registration in High Speed Character Sensing Equipment, *Proc EJC*, Dec. 1957.
- (5) Sprik W. Ganzhornk, An Analogous Method for Pattern Recognition by Following the Boundary, UNESCO/NS/1C1P/H094.
- (6) D. Buell, A Character Recognition System Which is Independent of Character, Translation, Size Or Orientation, *Proc EJCC*, 20, p 352, Dec. 1961.



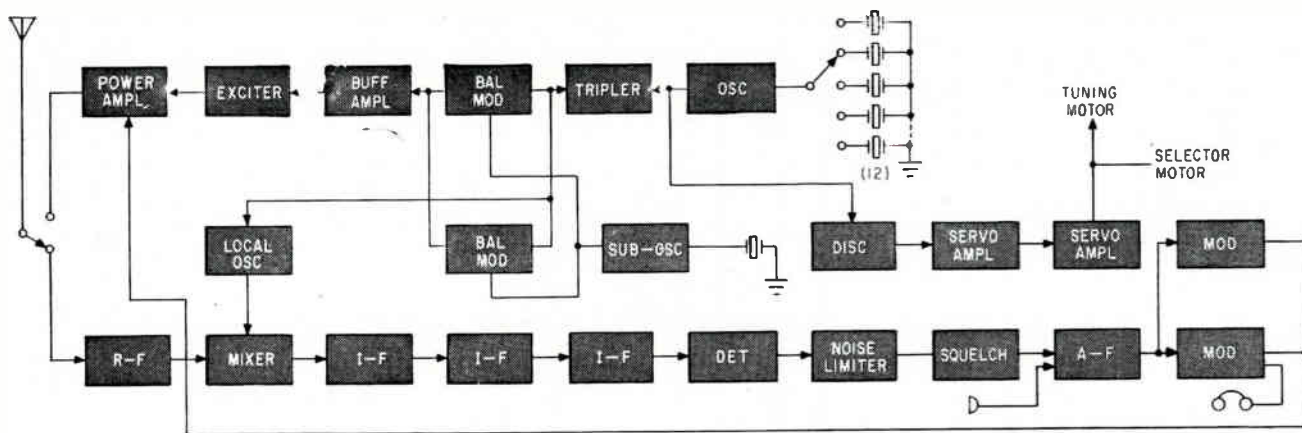

FIG. 1—Model TA-1640 airborne transceiver

# SERVO-TUNED TRANSCEIVER

## for Airborne VHF Communications

By **KENICHI MAKINO**  
**TSUNEO YAMANAKA**

Communication Equipment  
Engineering Dept.,  
Tokyo Shibaura Electric Co.,  
Ltd., Tokyo, Japan

AIR-TO-GROUND vhf communications are indispensable in civil air traffic control to keep airplanes in contact with ground stations. Ground control approach equipment cannot be used without vhf communication to guide a pilot to a safe landing in bad weather.

Installation of vhf ground stations are the obligation of every country in the international air routes. To make contact with these scattered ground stations, airplanes must be equipped with airborne vhf radio equipment, having multi-channel frequencies to communicate with ground stations.

This transceiver has 12 crystal units normally, but the transmitting and receiving frequency is chosen between 118 Mc and 145 Mc by replacing crystal units; this does

not require presetting the tuning system.

The r-f output power of the transceiver is 8 watts and its total power consumption is below 200 watts. Power input is 28v d-c. Voice signals are applied to the r-f carrier as amplitude modulation and the maximum modulation is 95 percent or more.

The receiving sensitivity for 50 mw audio frequency output is below 3 microvolts input. A mechanical filter provides selectivity for the 50-Kc channel separation.

A block diagram of the vhf transceiver is shown in Fig. 1. The receiver is a single superheterodyne with one r-f stage and three i-f stages. The audio output from the detector is coupled to the audio output amplifier (also the modulator), then a noise limiter, avc and squelch circuit and the headphones. Local crystal oscillator output is multiplied by 2x, 3x and 3x multipliers to be injected into the mixer.

In the transmitter, the output of the crystal oscillator is multiplied

by 2x and 3x and mixed with a 3.8333-Mc suboscillator signal in a balanced modulator. The output of the higher sideband of the balanced modulator is then frequency multiplied by a tripler. The r-f power amplifier is amplitude-modulated by a push-pull amplifier, which is the receiver audio amplifier and also as the servo-amplifier.

Up to ten headsets can be connected to the receiver; all can be used at the same time.

Conventional tuning systems of airborne vhf equipment may be classified into five categories:

In the switching system, a separate crystal unit and tank circuit are installed for each frequency, and channel-switching is by selector switch. There are several transmitter and receiver crystals and the switch selects one unit. Only the crystal unit is changed as the tank circuit is wide-band.

In the manual tuning system, the tank circuit is manually tuned with a flexible shaft. Remote control is by motor and servomechanism.

*Transceiver TA-1640H installed  
behind the instrument column  
of a Bell 47G helicopter*

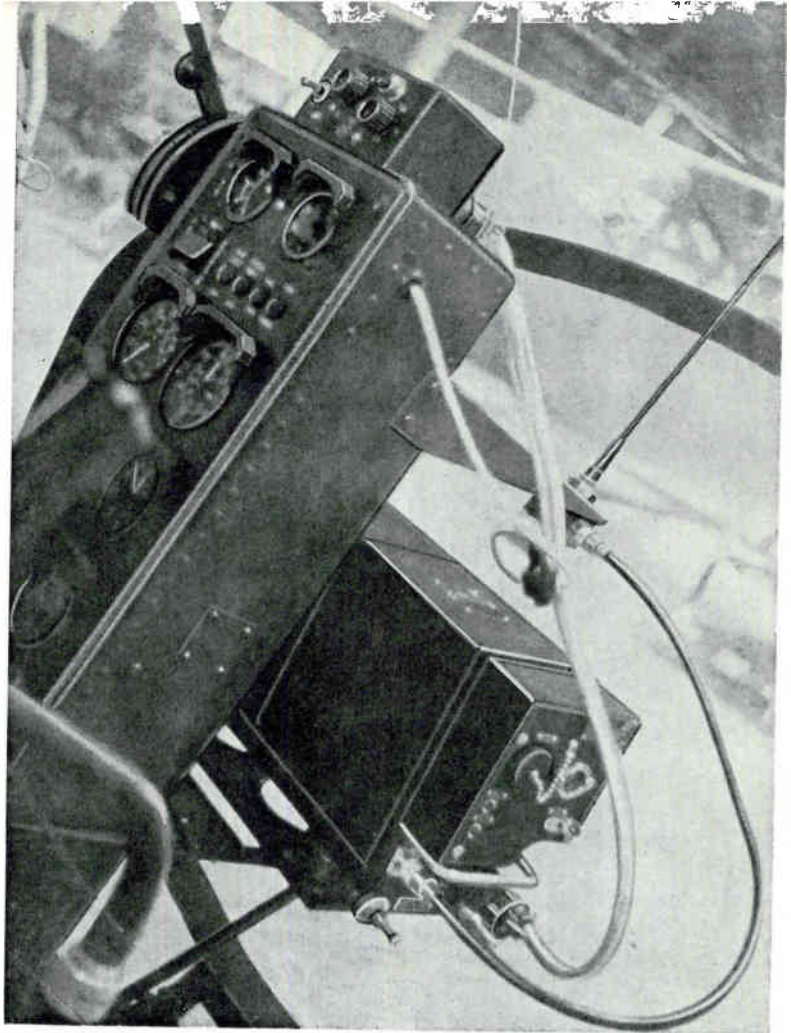

*Transmitter tunes itself  
automatically to any of  
twelve operating frequencies  
by unique servo system.*

*Receiver features  
a noise limiter with a  
1,000-to-1 signal-to-noise  
ratio*

In the mechanical preset system, several cams, driven by ratchet gears and relays, rotate the tank circuits to a preset tuning point. A motor selects the cam to rotate the mechanical tuning circuits to the exact tuning point.

In the decade selecting system, any frequency channel of the band, with intervals of 100 Kc, can be constructed in decade order.

In the electronic automatic tuning system, after the crystal unit starts oscillating, rotation of the mechanical tuning circuit of a later stage will be stopped at the peak of exciting current at the last stage of the transmitter and the receiver local oscillator. The tuning circuits are stopped by a servomechanism, energized by the sensed output of a frequency discriminator circuit.

Each of these systems has advantages and disadvantages with respect to dimensions, weight, number of channels, stability, electrical performance and accessibility. Therefore no distinctive evaluation is possible, but the automatic tuning

system has become common.

The mechanical preset system has been popular because of its compactness, light weight and simplicity of construction. However, the number of frequency channels is limited due to the obtainable accuracy of the mechanical parts. Since the cams and wheels are subjected to impulsive force and wearing, false actions of the tuning mechanism are likely to occur. Moreover, presetting this equipment in the airport maintenance shop is not easy.

The decade selecting system, which combines the crystal oscillator output with the i-f frequency, is one in which a required frequency is built up by combination of crystal oscillators at 1 Mc and at 0.1 Mc. This type of transmitter or receiver can handle 280 channels with about 24 crystal units, even though it is complicated both mechanically and electrically, and the entire equipment becomes heavy and bulky. Therefore, this type is applicable for large airplanes.

The electronic automatic tuning

system, using the grid current of the amplifier stage, has the advantage that it is not necessary to preset the tuning circuit even if the frequency of any channel is changed by replacing the crystal unit. But it has the disadvantage that clutch slipping often causes mis-tuning and strains the mechanical parts, by functioning as a brake.

The difference between the two types of electronic automatic tuning systems is that discrimination, or determination of the tuning point, is not by amplifier grid current, but by a frequency discriminator. When the tuning mechanism passes over the null point of the discriminator, the servo output voltage will change its sense, and reverse the motion toward the true tuning point until the entire circuit is correctly tuned.

One of the features of this transceiver is its system for changing channels with a servo-tuning mechanism. When the automatic tuning system is used, it is necessary only to change the crystal. This means that an airplane flying a



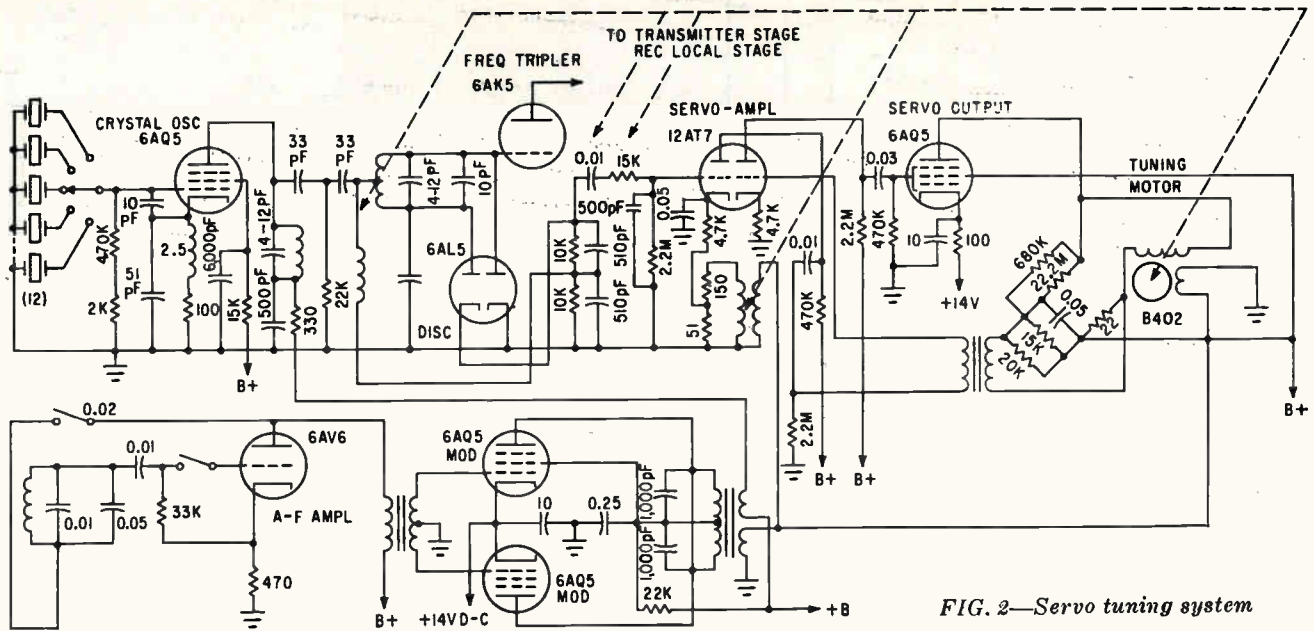

FIG. 2—Servo tuning system

long distance has only to furnish the crystals for the number of frequency channels for the next flight plan. No maintenance nor presetting in the ground shop is needed.

Since the tuning range of the tank circuits of the transmitter and receiver units is wide, a tuning mechanism using carbonyl-slug cores and metal rings is used to vary the inductance. This construction of variable inductance coils is compact, lightweight and reliable during vibration and other ambient conditions. Moreover, variation of inductance is frequency-linear, to make it easy to tune many circuits concurrently. The moving part of the servo is designed for low inertia to avoid any unnecessary hunting motion of the mechanical part.

This slug-tuning system has proved to be more favorable than that of the variable capacitor system, it is easily accessible for maintenance.

The schematic the servo tuning circuit of the transceiver is shown in Fig. 2. The crystal oscillator output is frequency discriminated by a tuning circuit, which is mechanically connected with all other tuning circuits by a servomotor. Since the crystal oscillator is amplitude-modulated by 400-cycle signal during automatic tuning action, the output voltage of the frequency discriminator is a 400 cps signal, whose amplitude is zero at the true tuning points, and whose relative phase angle will change its sense at the tuning point.

Variation of amplitude and phase in regard to the position of the tuning circuit is shown in Fig. 3. The phase of the discriminator output changes from positive to negative at the tuning point, showing whether the circuit is positioned lower or higher than the true tuning point. This makes it possible to sense the direction of rotation of the servomotor regardless of the previous position of the tuning system.

The output of the frequency discriminator is amplified by a servo-amplifier, and the control winding of the servomotor is energized by an amplified 400 cps signal.

In servo theory, this is a first-order system. Therefore, it would be possible to stop at the point of zero error voltage, but for better stability of the servo system, it is advisable to use a negative feedback proportional to the motor speed.

A tachometer is usually used to obtain this negative feedback voltage in similar servo systems. However, in this transceiver, negative feedback voltage is picked off the winding of the servomotor, whose impedance changes by the slip of the two-phase induction motor. When the motor rotates, the impedance changes proportionally with the speed of servomotor, and the increment can be obtained by a bridge circuit in which one arm is the control winding of the servomotor. Omission of the tachometer contributes to the miniaturization of the equipment.

The amplifier of this servo system has high amplification to obtain enough voltage to excite the servomotor at full revolution for the lower voltage output part of the discriminator when it is out of tune. Hence, as seen in Fig. 2, the servomotor is excited by a nearly equal voltage in all ranges except a certain region near the tuning point, and thus the total servo system is one type of ON-OFF or relay servo-system.

Steepness of the characteristic of the discriminator circuit near the tuning point, together with the high amplifier gain, often cause hunting and deteriorate the stability of the system. When the tunable frequency range of the transceiver is wide and consequently the minimum discriminator voltage is small, the amplification of the servo amplifier should be increased; therefore the frequency discrimination circuit should not have too steep a characteristic near the center. An important point in designing this transceiver is to obtain both stability near the tuning point, and higher discriminator voltage at the far end of the tuning range, where the circuits are greatly off-tuned. To cope with the decreased discriminator voltage at the off-tuned range and to get rid of the spurious effect of harmonic or parasitic tuning of the discriminator circuit, a 400-cps bias voltage is superposed on the discriminator output. This bias voltage is induced by magnetic pick-up coils

built in the servo.

The 400-cps a-c power for the servo-system is generated by the transmitter modulator, because this transceiver is intended for installation in small airplanes, which have no 400-cps source. Upon completion of automatic tuning, the 400-cps voltage source is cut off and the relay is released to halt the automatic tuning. The discriminator output becomes zero just when the center frequency of the discriminator circuit coincides with the frequency of crystal oscillator. The turn-off relay is delayed in operation for a period during which the overshooting of the servomechanism corrects itself.

Because of the high gain amplifier and the high gradient of the discriminator near the center frequency, the accuracy of stoppage is high; error is less than 0.1 percent. Temperature compensation is used in the tuning circuit of the discriminator. This tuning system is compact and lightweight and permits an increase in the number of channels by providing the required number of switches to change the crystal.

Special considerations against external noises such as engine noise and acoustic noise are required for airborne equipment. The aircraft antenna is often exposed within the intense field of impulse noises caused by engine ignition.

In modern aircraft the spark plugs are double-shielded, the power source is insulated from ground and shielding covers are almost perfect. However, these measures cannot prevent noise from being generated. The level of noise sometimes reaches hundreds or thousands of times that of the received signal. Even in the presence of such impulse noises, this transceiver is designed to be able to perform satisfactorily.

The cabin of the airplane is filled with equipment and accordingly the receiver is subjected to noise from this equipment. When carried on a small helicopter, this equipment was placed amid an impulse noise field of  $100\mu\text{v}$  per meter, owing to imperfect shielding of sparkplugs, and it was necessary to receive a weak signal on the order of  $2\mu\text{v}$  per meter. The engine noise, being impulsive, contains some carrier-wave component, so that it

can be used to energize the noise-elimination circuit.

A conventional noise-limiting circuit is shown in Fig. 4A and the improved noise-limiting circuit in Fig. 4B. In the improved circuit, the R-C time constant is large and the plate of the detecting diode is negatively charged by the detected input signal. Its voltage is kept steady by capacitor C. Even if the signal includes audio modulation, the voltage at point A will be equal to half the peak value of the carrier signal, and its fluctuation will amount to half the modulation of the signal. When impulse noise is introduced to this detector circuit, the potential at point P will not change, according to the time constant of the circuit, but the voltage at point A increases positively and the limiting diode shuts out the noise by its rectification characteristics. No audible noise can pass this limiter, even if the impulse noise has hundreds of times as large a voltage as the carrier wave.

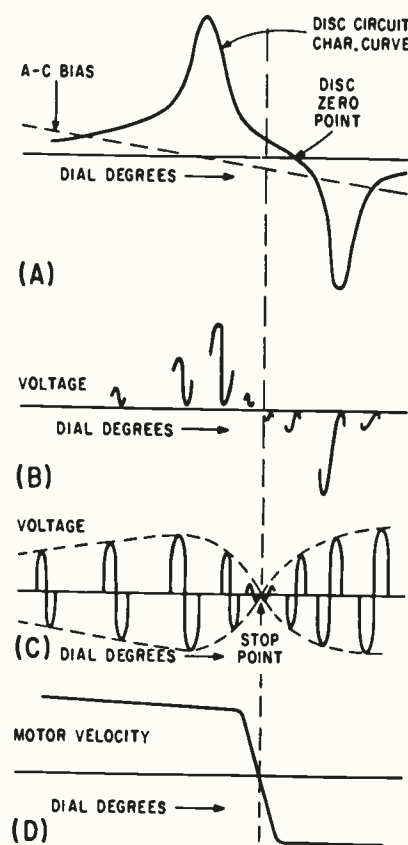

FIG. 3—Operation of the servo tuning system: discriminator circuit static characteristic (A); servo-amplifier input voltage, using a modulated oscillator (B); servo-amplifier output motor control voltage (C); and motor velocity (D)

If the conventional noise limiter (Fig. 4A) is used, strong impulsive noise will leak through the filter circuit that determines the plate potential. Other than the performance of limiter circuit for impulse noise, the characteristics of the avc circuit, which is charged to peak value by strong noises, often cause the decline of sensitivity. The avc circuit should also be designed so as not to be effected in its voltage by the impulse noise. This noise limiter can suppress electrical noise up to approximately 1,000 times that of the signal level with only a slight trace at the audio output.

When noise limitation is insufficient, the clarity of the received signal is deteriorated by cross modulation between signal and noise in the audio-frequency amplifier. With the new noise-elimination circuit, the transceiver gives better sensitivity and articulation than other vhf equipment, even if it is mounted in a poorly shielded airplane.

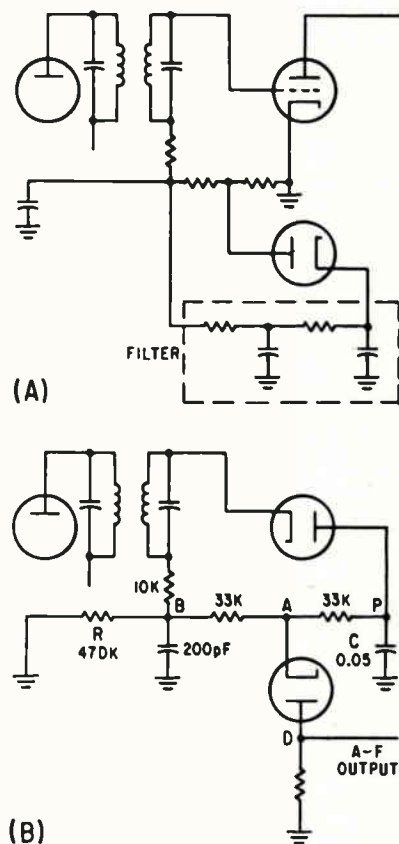
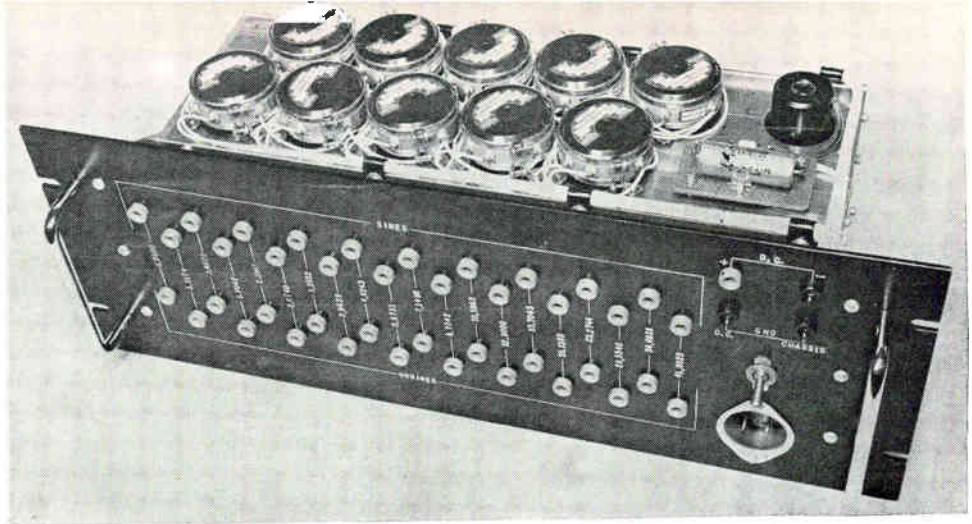

FIG. 4—Conventional noise-limiter circuit (A) and authors' noise limiter circuit (B). In conventional filter, suppression capability is 10. New circuit has capability of 1,000 times with only slight leakage into audio output



*Sine-cosine potentiometers are driven by low speed clock motor to generate low-frequency white-noise signal*



# White Noise Signals

*Pseudo random signal generator is useful for simulating, testing and analyzing low-bandpass control systems. A flat amplitude-spectrum and statistically invariant signal with 420-component frequencies is generated with sine-cosine potentiometers*

By N. D. DIAMANTIDES,  
Goodyear Aircraft Corp.,  
Akron, Ohio

THE ARGUMENT OF PERIODIC TERMS

	$r_0$	$r_1$	$r_2$	$r_3$	$r_4$	•
$r_0$	$2r_0$	$r_0 \pm r_1$	$r_0 \pm r_2$	$r_0 \pm r_3$	$r_0 \pm r_4$	•
$r_1$	$r_1 \pm r_0$	$2r_1$	$r_1 \pm r_2$	$r_1 \pm r_3$	$r_1 \pm r_4$	•
$r_2$	$r_2 \pm r_0$	$r_2 \pm r_1$	$2r_2$	$r_2 \pm r_3$	$r_2 \pm r_4$	•
$r_3$	$r_3 \pm r_0$	$r_3 \pm r_1$	$r_3 \pm r_2$	$2r_3$	$r_3 \pm r_4$	•
$r_4$	$r_4 \pm r_0$	$r_4 \pm r_1$	$r_4 \pm r_2$	$r_4 \pm r_3$	$2r_4$	•
•	•	•	•	•	•	•

RANDOM SIGNALS of analytically known and time invariant statistics are indispensable during control loop and systems design. A random signal value in controls and communications is the so-called white noise. White noise lends itself to a manageable analytical treatment and simplifies the design of filters required to shape it to the degree needed to solve problems.

White noise is composed of an infinite number of sinusoidal signals having the same amplitude but random phases with constant packing density per unit interval on the frequency axis resulting in a signal of a constant power spectral density. On the other hand, a signal within a certain frequency band composed of a finite number of nonharmonic and phase-incoherent sinusoids of the same amplitude has some of the features of white noise, including computational convenience. This signal can be endowed with power spectral density invariance since sinewave generators can be made frequency and amplitude stable. A desirable property of such a device is that the discrete frequencies can be packed close enough that their separation remains beyond the frequency-resolving power of the system subjected to the composite random signal.

An important application for signals of this type is in the field of human psychomotor-response studies. Here not only should the amplitude of the input signal components maintain its value throughout a range of experiments, but knowledge of phase relationships is often needed as well. In addition, the composite signal rules out predictability on the human subject's part, a factor of basic importance in response dynamics. A constant-noise signal generator is also useful in deriving the transfer function of control systems, and in studies of the dynamics of processes and plants; other applications include studies of dynamic systems such as airplanes and missiles, land vehicles and ships. Information can be obtained by applying the constant noise signal directly to the sys-

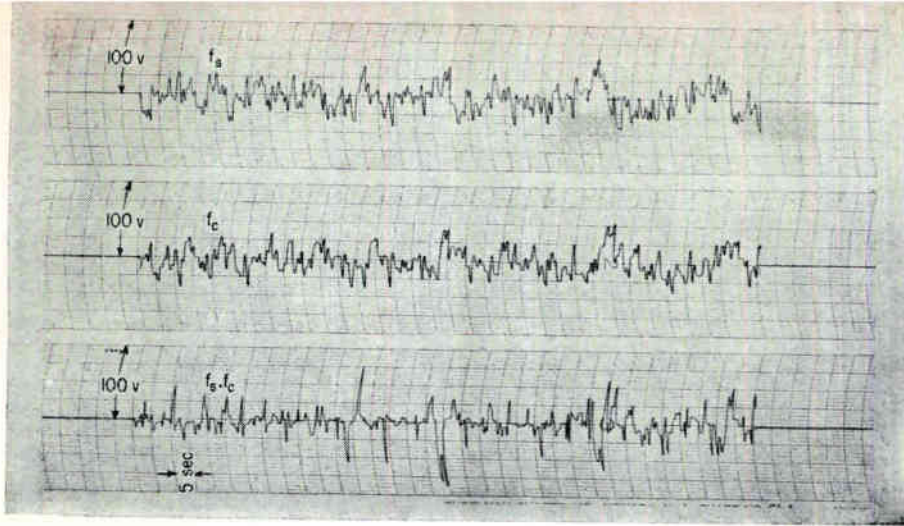

FIG. 1—Samples of white noise signals produced by generator. Random signal would not begin to repeat for  $10^{22}$  years

# Aid Systems Analysis

tem under study, as in constant response studies and in control loops; or the signal can be applied to a simulated system, as in large plants, aircraft and weapons.

The constant noise signal generator shown in the photograph consists of 20 wirewound, sine-cosine potentiometers of one-percent accuracy. The potentiometers are driven from a single, constant-speed, a-c motor at nonharmonic angular frequencies through successive gear trains; the gear trains reduce the speed of rotation from one shaft to the next by the same ratio. The value selected for the fixed gear ratio is

$$r = 23/28 \quad (1)$$

When the potentiometers are biased symmetrically by voltages  $\pm A$ , and the outputs from the sine and cosine wipers are summed separately, the generator produces two signals, one a sine function,  $f_a$ , and other a cosine function,  $f_c$

$$f_a(t) = A \sum_{n=0}^{19} \sin(r^n \omega_0 t + \phi_n) \quad (2)$$

$$f_c(t) = A \sum_{n=0}^{19} \cos(r^n \omega_0 t + \phi_n) \quad (3)$$

Either of two basic frequencies can be selected by a gear shift

$$f_0 = f_{\max} = \frac{\omega_0}{2\pi} = 1 \text{ or } 2 \text{ cps} \quad (4)$$

For  $f_0 = 1$  cps, which will be assumed throughout this article, the lowest frequency component will be

$$f_{\min} = \left(\frac{23}{28}\right)^{19} = 0.0238 \text{ cps} \quad (5)$$

Typical samples of the signals  $f_a(t)$  and  $f_c(t)$  are shown in Fig. 1.

The minimum number of revolutions required by the fastest shaft to allow the other shafts to go through an integral number of revolutions is given by the factor  $28^{19}$ . This is the least multiplier that

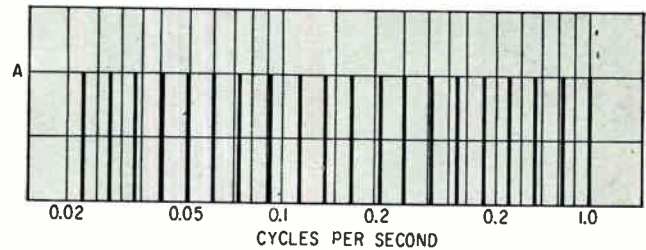

FIG. 2—Spectral density of the signal  $f_c(t)$

changes into integers all terms of the series.

$$1, \left(\frac{23}{28}\right), \dots, \left(\frac{23}{28}\right)^{18}, \left(\frac{23}{28}\right)^{19}$$

When this value is reached, the signal will start repeating. Since each revolution takes one second, the repetition period is

$$T = 28^{19} \text{ sec} \cong 10^{22} \text{ years} \quad (6)$$

The spectral density of either one of the signals  $f_a(t)$  and  $f_c(t)$  is shown in Fig. 2.

The full value of the constant noise generator is realized when advantage is taken of some basic properties of trigonometric functions and computer components are available that are capable of implementing the functions.

One valuable function is obtained when  $f_c(t)$  is squared and subsequently added to two more signals in the following manner

$$F_1(t) = [f_c(t)]^2 + Af_c(t) - 10A^2 \\ = A^2 \left[ \sum_{n=0}^{19} \cos(r^n \omega_0 t + \phi_n) \right]^2 + A^2 \sum_{n=0}^{19} \cos(r^n \omega_0 t + \phi_n) - 10A^2 \quad (7)$$

The series part gives rise to terms of the forms

$$A^2 \cos^2 a = \frac{A^2}{2} + \frac{A^2}{2} \cos 2a \quad (8)$$

and

$$A^2 \cos(a) \cos(b) = \frac{A^2}{2} \cos(a+b) + \frac{A^2}{2} \cos(a-b) \quad (9)$$



The constant terms of components like those in Eq. 8 are neutralized by the term  $10A^2$  in Eq. 7.

The periodic terms arising from the products of Eq. 9 are diagrammed in the table, where each term is represented by the respective value of the multiplier of the basic frequency  $\omega_0$ .

As shown in the table, (p 86) each term appears twice in symmetrical locations about the main diagonal cancelling the factor 1/2 shown in Eq. 9. On the other hand, the terms along the main diagonal appear only once, thus retaining the factor 1/2. Hence

$$F_1(t) = \frac{A^2}{2} \sum_{n=0}^{19} \cos(2r^n \omega_0 t + 2\phi_n) + A^2 \sum_{n=0}^{19} \cos(r^n \omega_0 t + \phi_n) + A^2 \sum_{n=0}^{19} \sum_{m=0}^{19} \cos \left[ (r^n + r^m) \omega_0 t + (\phi_n + \phi_m) \right]_{m \neq n} + A^2 \sum_{n=0}^{19} \sum_{m=0}^{19} \cos \left[ (r^n - r^m) \omega_0 t + (\phi_n - \phi_m) \right]_{m \neq n} \quad (10)$$

The first two sums comprise 20 terms each, while, as shown in the table, the result of each double summation is equal to the sum,  $s$ , of an arithmetic progression having 19 terms (columns), the first of them equal to 19, the last equal to 1, and the ratio also equal to 1; therefore

$$s = \frac{19}{2} (19 + 1) = 190$$

Thus, the number of frequencies contained in  $F_1(t)$  is 420; the highest frequency is

$$f_{\max} = 2r^{19} \omega_0 / 2\pi = 2 \text{ cps} \quad (11)$$

and the lowest (nonzero) corresponding to the smallest difference is

$$D = r^n - r^m = r^n (1 - r^{m-n}) \quad (12)$$

Since  $r < 1$ ,  $D$  is smallest when both

$$n = \text{maximum and } m - n = 0 = \text{minimum} \quad (13)$$

Both these conditions are satisfied when  $n = 18$  and  $m = 19$ ; therefore

$$f_{\min} = (r^{18} - r^{19}) \omega_0 / 2\pi = 0.0052 \text{ cps} \quad (14)$$

The only disadvantage of the signal  $F_1(t)$  is that it contains 20 components,  $(2r^n \omega_0)$ , having amplitudes half as large as the rest of the 420 components.

It can be shown that

$$F_2(t) = [f_s(t)]^2 - 10A^2 = -\frac{A^2}{2} \sum_{n=0}^{19} \cos(2r^n \omega_0 t + 2\phi_n) + \sum_{n=0}^{19} \sum_{m=0}^{19} \cos \left[ (r^n + r^m) \omega_0 t + (\phi_n + \phi_m) \right]_{m \neq n} - \sum_{n=0}^{19} \sum_{m=0}^{19} \cos \left[ (r^n - r^m) \omega_0 t + (\phi_n - \phi_m) \right]_{m \neq n} \quad (15)$$

Consequently, between Eq. 10 and 15

$$F(t) = F_1(t) + F_2(t) + Af_c(t)$$

or

$$F(t) = 2A^2 \cos(r^n \omega_0 t + \phi_n) + 2A^2 \sum_{n=0}^{19} \sum_{m=0}^{19} \cos \left[ (r^n - r^m) \omega_0 t + (\phi_n - \phi_m) \right]_{m \neq n} \quad (16)$$

This signal contains only 210 different frequencies between  $f_{\max} = 1$  cps and  $f_{\min} = 0.0052$  cps, but it possesses an absolutely flat spectrum and sharp cutoff. An additional characteristic of the signal  $F(t)$  is that it contains no harmonic frequencies.

Figure 2 shows a sample of the product

$$[f_c(t)][f_s(t)]$$

and Fig. 3A is the circuit diagram for generating  $F(t)$ .

Figure 3B shows the packing density of the component frequencies of  $F_1(t)$  over intervals 0.1 cps wide. Since the power in each frequency band is proportional to the number of the components within it, the curve represents the power spectral density of  $F_1(t)$ .

The gearing ratios may be selected to obtain any desired mode of frequency separation instead of the geometric progression used here. In certain applications other types of rotary sine-generators may be more suitable than potentiometers.

The author is grateful to J. O. Rhodes of the Advance Systems Predesign Department of Goodyear Aircraft Corp. for supervising the electromechanical design and fabrication of the random-function generator.

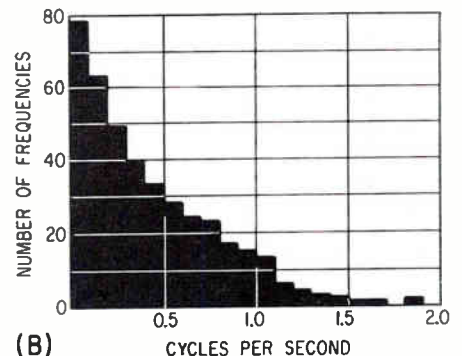
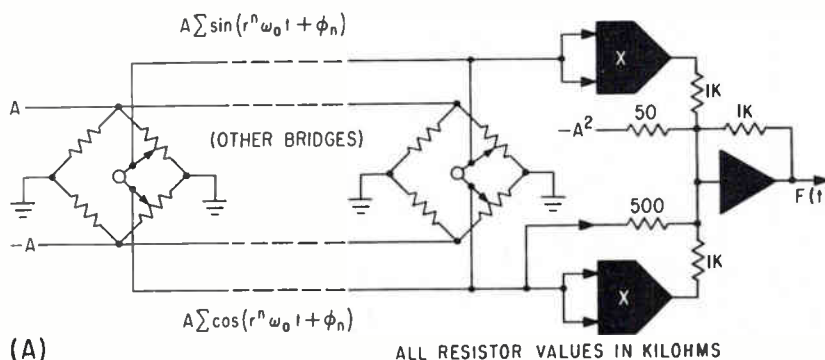

FIG. 3—Motor-driven sine-cosine potentiometers generate nonharmonically related signals from which  $F(t)$  is obtained by computer operation (A). Packing density of component frequencies of  $F_1(t)$

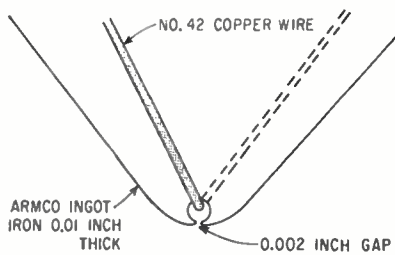
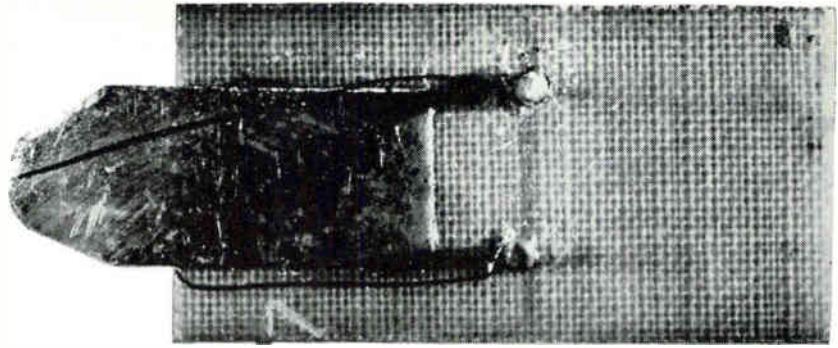

FIG. 1—One turn of wire over magnetic material forms simple recording head



Single-turn head has cost and manufacturing advantages but requires large write current

# Single-Turn Recording Heads

By H. J. Kump,

International Business Machines  
Development Lab., Endicott, N. Y.

A BIT RECORDED with the single turn recording head of Fig. 1 is the same as that recorded by any ring head: two poles similar in shape and amplitude, but opposite in polarity. This is in contrast to the concentric poles recorded by stylus heads, where the outer pole is considerably weaker than the inner pole.

A given volume of magnetic material will produce the highest field in a given air space when the induction  $B$  in the material is that for which the energy product  $BH$  is a maximum. ("Ferromagnetism", R. M. Bozorth, p 348, D. Van Nostrand.) Considering the recorded bit to be the volume of magnetic material, optimum recording can be expected to occur when the self-demagnetization of the bit equals that necessary to produce the maximum energy product in the recording surface. This does not assure that read-back will be optimum. That is to say, a recording surface thickness must exist, for each size bit, for which the fields above the bit will be maximum. To ascertain this thickness for the single-turn head, the head was pulsed with a 50 amp, 2.5  $\mu$ sec pulse above various thicknesses of NiCo plated drum surfaces. The results are plotted in Fig. 2A. Optimum recording is obtained for a coating of NiCo 0.0005 inch thick. (While Fig. 2A shows results for a head-to-drum gap of 0.001 inch, the curve

is approximately correct for gaps from 0.0005 to 0.005 inch.)

When the head-to-drum gap is varied, using the optimum NiCo plating of 0.0005 inch, the curve in Fig. 2B results. The asymptote indicates that the NiCo surface is saturated at a head-to-drum gap of 0.001 inch. The maximum value of the vertical component of magnetic field, over the bit, is 155 oersteds.

When the write current is varied, with head-to-drum gap constant on the same 0.0005 inch thick surface, the curve in Fig. 2C is obtained. Here, the asymptote indicates saturation of the write core. The head-

to-drum gap of 0.003 inch allows operation in a near linear region of the curve of Fig. 2B while avoiding surface saturation. The curves shown are all interrelated to some degree; thus, while a total of 4 db of loss exists at 30 amperes with a gap of 0.003 inch, there is probably no loss when the gap is 0.0005 inch.

Although the single-turn head has cost and manufacturing advantages, it has not been used extensively because of the large (5 to 50 amp) drive current necessary. Related heads are discussed in British patent specification 806,288 (1955), filed by the Clevite Corp.

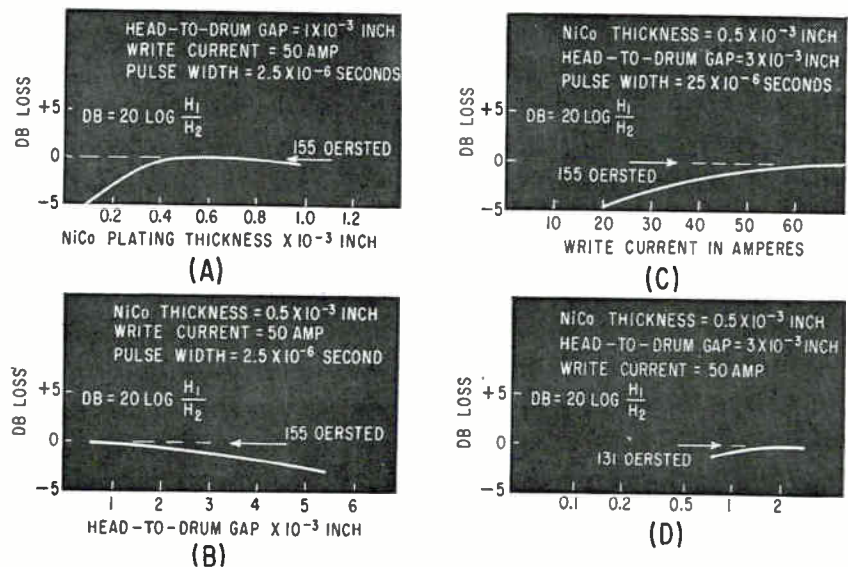
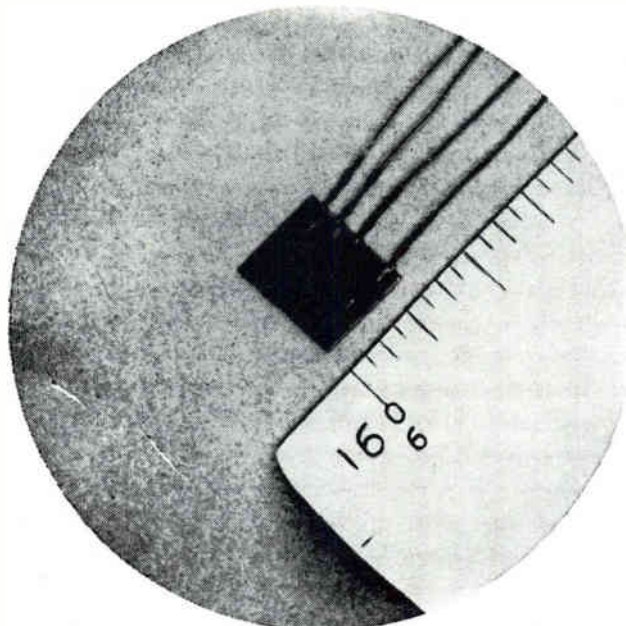

FIG. 2—Optimum plating thickness for single-turn head is approximately 0.0005 inch (A). Optimum thickness saturates for head-to-drum gap of 0.001 inch (B). Asymptote in (C) indicates saturation of writing head rather than surface. Pulse response (D) shows no losses to eddy currents or inductance for 1.5  $\mu$ sec pulses



# Developing the Hall

## Synthesized Hall generator



The Hall generator's inherently small size confers application flexibility and makes the device especially adaptable as a measuring probe

By J. W. MOTTO, JR.

Semiconductor Department, Westinghouse Electric Corp.,  
Youngwood, Pa.

WITH A NEW DEVICE such as the Hall generator, an important step in obtaining extensive application of the device is to supply the circuit designer with an equivalent circuit. This will provide insight into how the device functions and will permit at least semi-quantitative calculations into possible applications.

The equivalent circuit for the Hall generator is synthesized by noting the basic phenomena that take place, describing these phenomena in mathematical matrix form, and finally combining the individual parts by appropriate matrix manipulation into the

equivalent circuit. Using this phenomenological approach, the parameters will all have physical meaning.

The current gain, voltage gain, and input impedance will then be derived in terms of the equivalent circuit parameters to illustrate the use of the equivalent circuit in Hall generator applications.

*Multiplier*—An electric current and magnetic field existing simultaneously in a semiconductor produce a voltage described by

$$V_h = \frac{R_h \times 10^{-8}}{d} (\vec{I}_c \times \vec{B})$$

where  $V_h$  is the resultant Hall voltage,  $I_c$  is the current through the semiconductor,  $B$  is the magnetic field,  $d$  is the thickness of the material in the direction of the magnetic field, and  $R_h$  is the proportionality constant termed the Hall constant. This voltage  $V_h$  is the Hall voltage, discovered by Edmund Hall in 1879, and is directly proportional to the vector product of the control current and the magnetic field.

The property of the Hall generator to multiply its pair of inputs defies representation by conventional circuit components. The closest conventional component would be an ideal transformer having a variable turns ratio directly proportional to magnetic field as shown in Fig. 1A.

The  $Z$  parameter matrix for an ideal transformer is nonexistent, but the  $A$  parameter matrix takes the form

$$[A]_m = \begin{bmatrix} a & 0 \\ 0 & \frac{1}{a} \end{bmatrix} = \begin{bmatrix} KB & 0 \\ 0 & \frac{1}{KB} \end{bmatrix}$$

*Gyrator*—The Hall generator is a linear passive device, and yet it has the additional property of not being bilateral. This has been termed in literature as a gyrator, and has symbol shown in Fig. 1B.

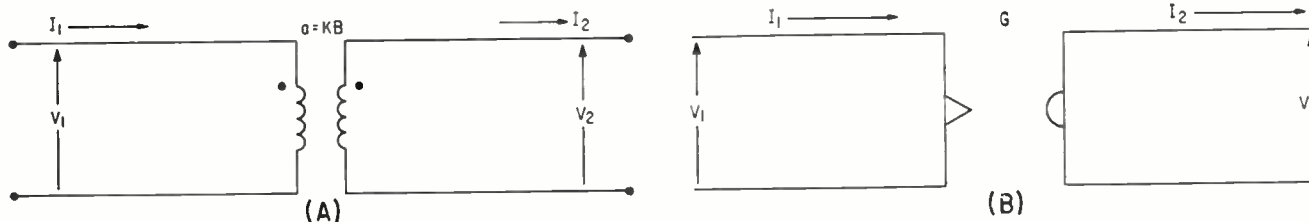

FIG. 1—Transformer with turns ratio proportional to a magnetic field represents the Hall generator's ability to multiply (A); gyrator symbol (B) indicates that although the generator is a linear passive device it is not bilateral

# Generator Equivalent Circuit

*equivalent circuit reduces cut-and-try approach in circuit design*

The  $Z$  parameter matrix for an ideal gyrator is given by

$$[Z]_G = \begin{bmatrix} 0 & -1 \\ 1 & 0 \end{bmatrix}$$

The  $A$  parameter matrix would be given by

$$[A]_G = \begin{bmatrix} 0 & 1 \\ 1 & 0 \end{bmatrix}$$

**Internal Resistance**—The Hall effect is a solid-state analogy of the magnetic deflection of an electron beam in a cathode-ray tube. This Hall effect takes place in a block of conducting material and the resistance of this material must be taken into consideration. There are two internal resistances: the resistance to the flow of control current,  $r_c$ , and the resistance to the flow of output current,  $r_H$ .

Unfortunately, these resistances are also a function of the magnetic field. The increase in resistance with the magnetic field is termed the magnetoresistive effect and is proportional to the square of the carrier mobility<sup>2</sup>; it is therefore large in Hall generators incorporating high-mobility materials. The exact theory for this resistance change is complex; it can, however, be described for the type 803 Hall generators by the empirical equations

$$\begin{aligned} r_c(B) &= R_c(0) + 0.03B^{1.5} \\ r_H(B) &= R_H(0) + 0.03B^{1.5} \end{aligned}$$

Where  $r_c(B)$  is the control terminal internal resistance in ohms,  $r_H(B)$  is the Hall terminal internal re-

sistance in ohms,  $B$  is the magnetic flux density in kilogauss,  $R_c(0)$  is the control terminal internal resistance with  $B = 0$  in ohms, and  $R_H(0)$  is the Hall terminal internal resistance with  $B = 0$ . For most calculations, an exponent of 1.6 could be used for both  $r_c(B)$  and  $r_H(B)$ .

The  $A$  parameter matrices for these simple resistance circuits are given in Fig. 2A.

The four parts of the Hall generator are the control-terminal resistance, multiplier, gyrator and Hall terminal resistance. These are effectively in cascade as shown in Fig. 2B.

The two-port equivalent circuit of several individual two-port circuits in cascade may be found by multiplying the  $A$  matrices of the individual two-port  $A$  matrices<sup>2</sup>.

$$\begin{aligned} [A]_{r_c(B)} &= [A]_{r_c(B)} [A]_m [A]_G [A]_{r_H(B)} \\ [A]_{r_c(B)} &= \begin{bmatrix} 1 & r_c(B) \\ 0 & 1 \end{bmatrix} \begin{bmatrix} KB & 0 \\ 0 & 1/KB \end{bmatrix} \begin{bmatrix} 0 & 1 \\ 1 & 0 \end{bmatrix} \begin{bmatrix} 1 & r_H(B) \\ 0 & 1 \end{bmatrix} \\ [A]_{r_c(B)} &= \begin{bmatrix} A & B \\ C & D \end{bmatrix} = \begin{bmatrix} \frac{r_c(B)}{KB} & \frac{r_c(B)r_H(B)}{KB} + KB \\ 1 & \frac{r_H(B)}{KB} \end{bmatrix} \end{aligned}$$

Transforming the  $A$  equivalent circuit matrix to the  $Z$  equivalent circuit matrix.<sup>3</sup>

$$[Z]_{r_c(B)} = \begin{bmatrix} A & |A| \\ C & -C \end{bmatrix} = \begin{bmatrix} r_c(B) & -KB \\ KB & r_H(B) \end{bmatrix}$$

The two generator equivalent circuit in the  $Z$  parameters is shown in Fig. 3A.

The Hall generator equivalent circuit in terms of the Hall generator parameters can be obtained by

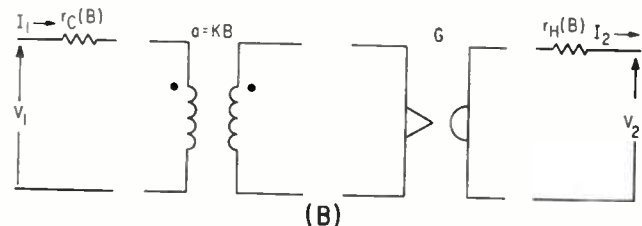
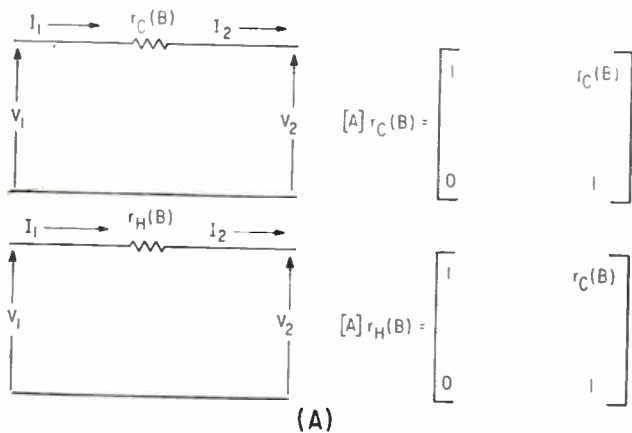

FIG. 2—Equivalent circuits and matrices for Hall generator input and output resistances (A); the four basic parameters: control terminal resistance, multiplier effect, gyrator and terminal resistance are cascaded in (B) to simulate the overall Hall generator effect



direct substitution as shown in Fig. 3B. The terms used in the Hall generator equivalent of Fig. 3B are defined as follows: voltage  $V_c$  is the voltage across control terminal,  $I_c$  is the current through control terminals,  $V_H$  is the voltage across Hall terminals,  $I_H$  is the current through Hall terminals,  $B$  is the instantaneous magnetic field density component that intercepts the Hall generator perpendicular to the plane of its control current.

Resistance  $r_c(B)$  is the control terminal internal resistance and is a function of magnetic field that can be described with reasonable accuracy by  $r_c(B) = R_c(0) + 0.03B^{1.65}$ . Resistance  $r_H(B)$  is the Hall terminal internal resistance. It is also a function of the magnetic field as described by  $r_H(B) = R_H(0) + 0.03B^{1.65}$ .

Coefficient  $K_h$  is the Hall constant:  $R_H/d$ , where  $R_H$  is the Hall coefficient,  $d$  is the thickness of the Hall generator, and  $K_h(I)$  is the inverse Hall constant.

The equivalent circuit shown in Fig. 3B indicates bilateral operation. In normal operation a current passing through the control terminals generates a Hall voltage at the Hall terminals; however, the Hall generator may be used in the inverse mode of operation, that is, a current passing through the Hall terminals generates a Hall voltage across the control terminals.

The equivalent circuit presented will be most applicable to the specific design problems of a given experimental or developmental Hall generator application.

The following are three examples of how it may be used. It has been shown in many texts that using the  $Z$  parameters, the current gain, voltage and input impedance can be expressed as shown in Eqs. 1, 2, and 3

$$A_I = \frac{Z_{21}}{Z_{22} + Z_L} \quad (1)$$

$$A_v = \frac{Z_{21}Z_L}{\Delta + Z_{11}Z_L} \quad (2)$$

$$Z_{in} = \frac{\Delta + Z_{11}Z_L}{Z_{22} + Z_L} \quad (3)$$

where

$$\Delta = Z_{11}Z_{22} - Z_{12}Z_{21}$$

The  $Z$  matrix for the Hall generator equivalent circuit is

$$Z_{eqv\ ckt} = \begin{bmatrix} Z_{11} & Z_{12} \\ Z_{21} & Z_{22} \end{bmatrix} = \begin{bmatrix} r_c(B) & -K_h(I)B \\ K_h(B) & r_H(B) \end{bmatrix} \quad (4)$$

**Current Gain**—For the Hall generator, the forward current gain (Eq. 1) becomes

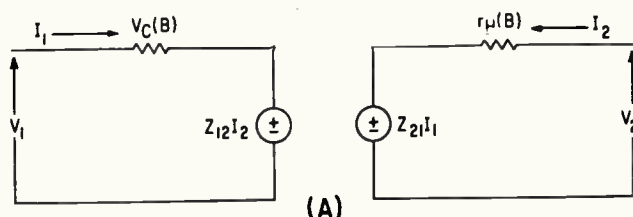

$$A_I = \frac{K_h B}{r_H(B) + R_L} \quad (1a)$$

$$A_I \Big|_{R_L=0} = \frac{K_h B}{r_H(B)} \quad (1b)$$

**Voltage Gain**—For the Hall generator, the forward voltage gain (Eq. 2) becomes

$$A_v = \frac{K_h B R_L}{r_c(B)r_H(B) + K_h^2 B^2 + r_c(B)R_L} \quad (2a)$$

$$A_v \Big|_{R_L=\infty} = \frac{K_h B}{r_c(B)} \quad (2b)$$

**Input Impedance**—For the Hall generator, the input impedance formula is

$$Z_{in} = \frac{r_c(B)r_H(B) + K_h^2 B^2 + r_c(B)R_L}{r_H(B) + R_L} \quad (3a)$$

$$Z_{in} \Big|_{R_L=0} = r_c(B) + \frac{K_h^2 B^2}{r_H(B)} \quad (3b)$$

$$Z_{in} \Big|_{R_L=\infty} = r_c(B) \quad (3c)$$

The input impedance increases when the output is short-circuited owing to the gyrator action of the Hall generator

$$Z_{in} \Big|_{R_L=0} > Z_{in} \Big|_{R_L=\infty}$$

**Inverse Operation**—For inverse operation, the derived formulas are changed to replace  $r_c(B)$  with  $r_H(B)$ ;  $r_H(B)$  with  $r_c(B)$ ; and  $K_h$  with  $K_h(I)$  resulting in

$$A_I(I) = \frac{-K_h(I)B}{r_c(B) + R_L} \quad (1c)$$

$$A_v(I) \Big|_{R_L=\infty} = \frac{-K_h(I)B}{r_H(B)} \quad (2c)$$

$$Z_{in}(I) \Big|_{R_L=0} = r_H(B) + \frac{K_h^2(I)B^2}{r_c(B)} \quad (3d)$$

The equivalent Hall generator circuit is capable of predicting the characteristics of actual Hall generators in action. This facility is useful in developing existing Hall generators applications and will help inquiries into new applications.

Three circuit parameters were derived to demonstrate the use of the equivalent circuit in Hall generator circuit design.

## REFERENCES

- (1) E. H. Hall, On a New Action of the Magnet on Electrical Currents, Johns Hopkins University
- (2) A. H. Wilson, "Theory of Metals," Cambridge University Press, London, 1953
- (3) E. A. Guillemin, "The Mathematics of Circuit Analysis," p. 37, John Wiley and Sons, Inc., New York, 1949
- (4) R. F. Shea, Principles of Transistor Circuits, p. 301, John Wiley and Sons, Inc., New York, 1953
- (5) Olof Lindberg, Hall Effect, *Proc IRE*, 1, 1952
- (6) T. R. Lawson, Jr., The Hall Effect and Its Uses, *Westinghouse Engineer*, May, 1957
- (7) John N. Shive, "The Properties, Physics and Design of Semiconductor Devices," D. Van Nostrand Co., Inc., 1959

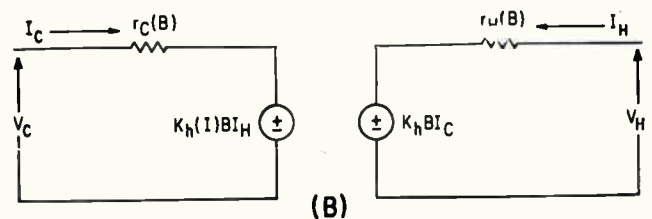
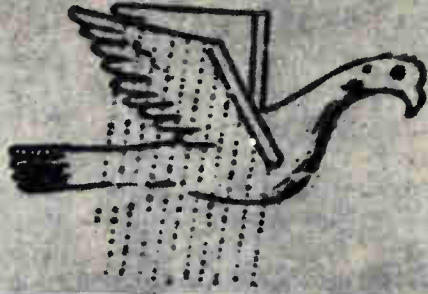

FIG. 3—Two-generator equivalent (A) is a simplification by matrix multiplication while the final equivalent circuit (B) synthesizes all 4 individual components of Fig. 2B



Archytas of Tarentum (428-347 B.C.), Greek philosopher and mathematician, is credited with being almost the first to bring mathematics to human uses. His invention of a wooden pigeon that actually flew is an example of his ingenuity in this respect.

Though we do not know today what means Archytas used to make the wooden bird fly—whether it was a heavier-than-air machine or whether it utilized gases—the concept was definitely original and successful.

## THE WOODEN PIGEON OF ARCHYTAS OF TARENTUM

# ORIGINAL



The space-saving square design for a potentiometer is an original Daystrom contribution. Our patented Squaretrim® started a trend throughout the industry . . . a trend that increases every year. Moreover, Daystrom's original wire-in-the-groove winding process for the resistance element has resulted in exceptional reliability. Add our unusually prompt delivery, and it's obvious why more engineers specify Squaretrims than all other square trimming pots combined. Send for catalog of over 2000 standard models.

## THE SQUARETRIM® SUBMINIATURE POTENTIOMETER

**DAYSTROM, INCORPORATED**  
POTENTIOMETER DIVISION  
ARCHBALD, PENNSYLVANIA • LOS ANGELES, CALIFORNIA



OK, Hugh L. Gordon

Professional Employment Manager,  
Lockheed-Georgia Company  
834 West Peachtree Street  
Atlanta 8, Georgia • Dept. NN-88

# Here's What I Want...

ENGINEERS, CHECK YOUR ANSWERS and MAIL TODAY

- Opportunity for professional advancement: for instance: \_\_\_\_\_
- Opportunity to work on interesting and challenging projects: such as: \_\_\_\_\_
- Long range job security: for instance: \_\_\_\_\_
- Full opportunity to utilize and capitalize on my education: which is: \_\_\_\_\_
- Full opportunity to utilize and capitalize on my experience: which is: \_\_\_\_\_
- Year-round recreational facilities: such as: \_\_\_\_\_
- Income: such as: \_\_\_\_\_
- Professionally advantageous associations: such as: \_\_\_\_\_
- Freedom to work with less red tape: for instance: \_\_\_\_\_
- Desirable fringe benefits: such as: \_\_\_\_\_
- Company stability and prestige: for instance: \_\_\_\_\_
- Pleasant Living conditions: such as: \_\_\_\_\_
- Opportunities for further education: for instance: \_\_\_\_\_
- Recognition of personal contributions: such as: \_\_\_\_\_

**To Join**

Signed: \_\_\_\_\_  
NAME \_\_\_\_\_  
ADDRESS \_\_\_\_\_ PHONE \_\_\_\_\_

THE ENGINEERING CENTER  
**LOCKHEED-GEORGIA COMPANY**  
A DIVISION OF LOCKHEED AIRCRAFT CORPORATION  
AN EQUAL OPPORTUNITY EMPLOYER



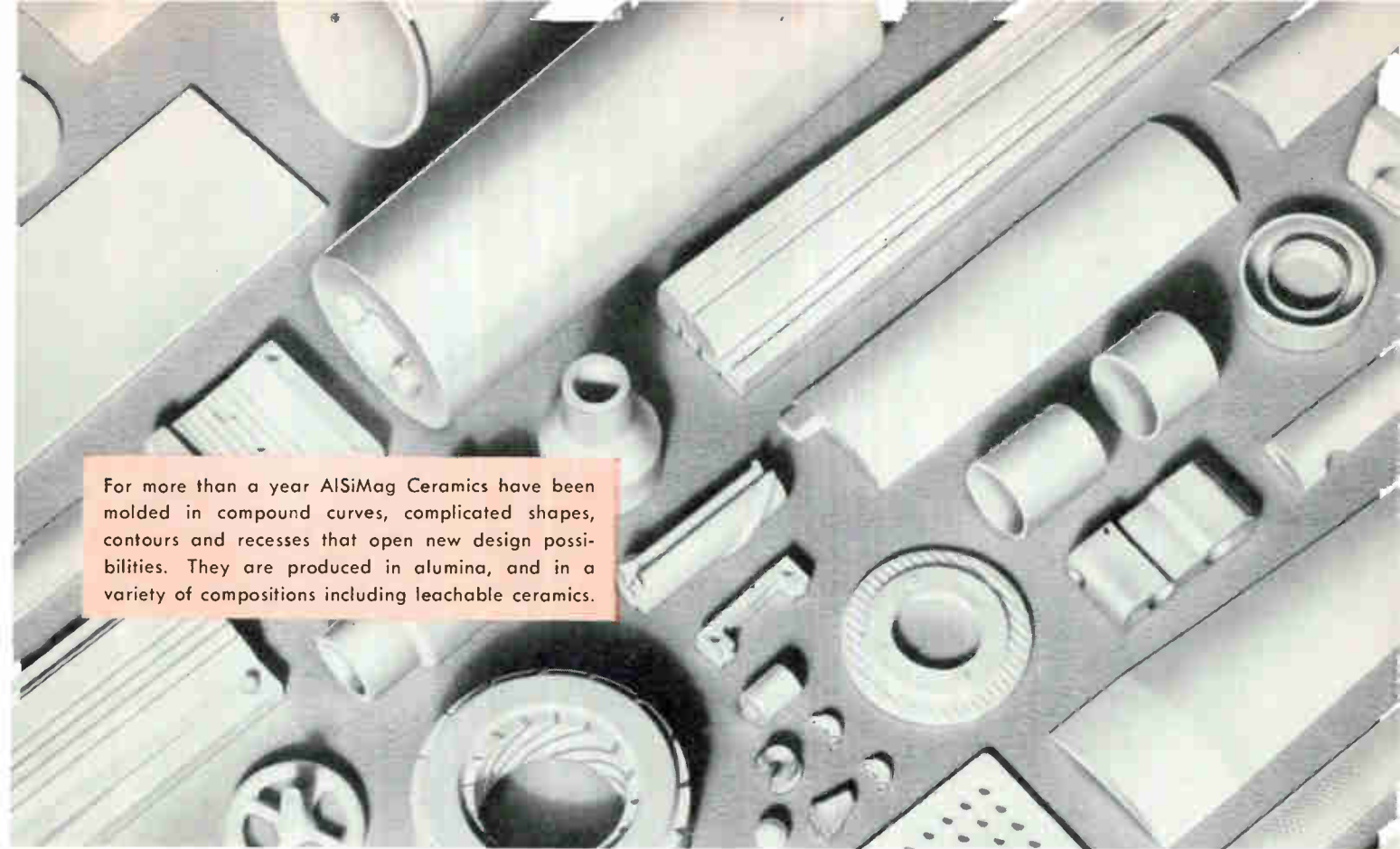

For more than a year ALSiMag Ceramics have been molded in compound curves, complicated shapes, contours and recesses that open new design possibilities. They are produced in alumina, and in a variety of compositions including leachable ceramics.

## NEW SHAPES and NEW TOLERANCES in

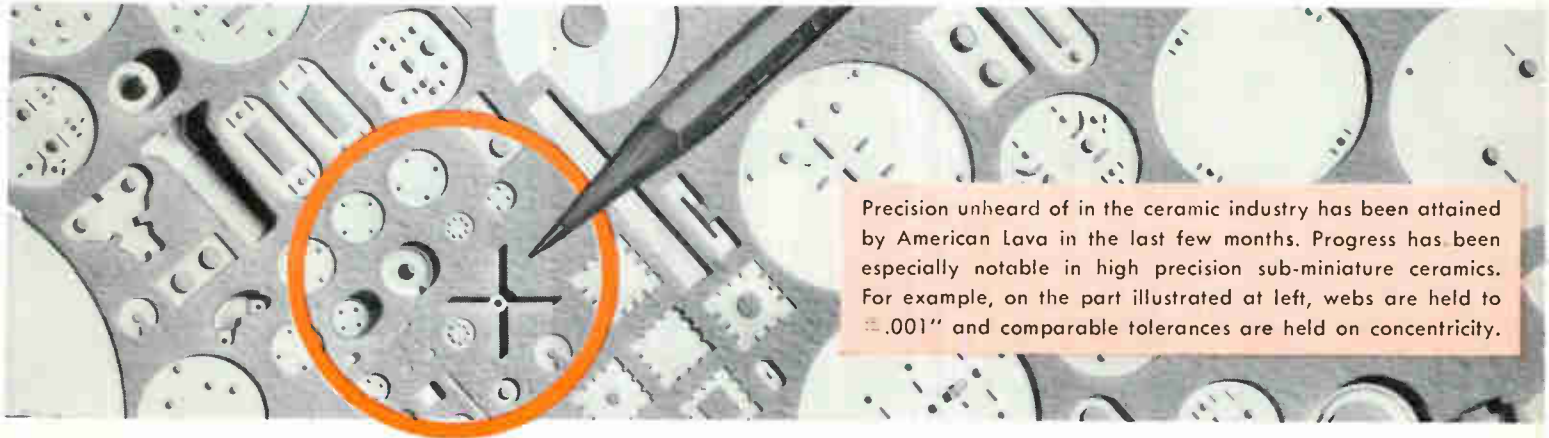

Precision unheard of in the ceramic industry has been attained by American Lava in the last few months. Progress has been especially notable in high precision sub-miniature ceramics. For example, on the part illustrated at left, webs are held to  $\pm .001''$  and comparable tolerances are held on concentricity.

# ALSiMAG<sup>®</sup> custom made technical ceramics

*Engineers with designs formerly considered too complex or impossible as to dimensional tolerances are invited to send sketches or blue prints. Chances are that NOW they can be made in ALSiMAG.*

A Subsidiary of  
Minnesota Mining and  
Manufacturing Company



**AMERICAN LAVA**  
CORPORATION

CHATTANOOGA 5, TENN.  
58TH YEAR OF CERAMIC LEADERSHIP

For service, contact American Lava representatives in Offices of Minnesota Mining & Manufacturing Co. in these cities (see your local telephone directory): Boston: Newton Center, Mass. • Chicago: Bedford Park, Ill. • Cleveland, O. • Dallas, Texas • Los Angeles, Cal. New York: Ridgefield, N. J. • Philadelphia, Pa. • St. Louis, Mo. • St. Paul, Minn. • So. San Francisco, Cal. • Seattle, Wash. All other export: Minnesota Mining & Manufacturing Co., International Division, 99 Park Ave., New York, N. Y.



# For ease of processing

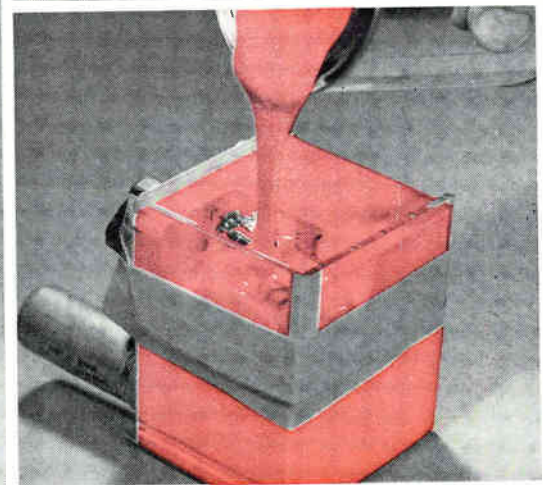
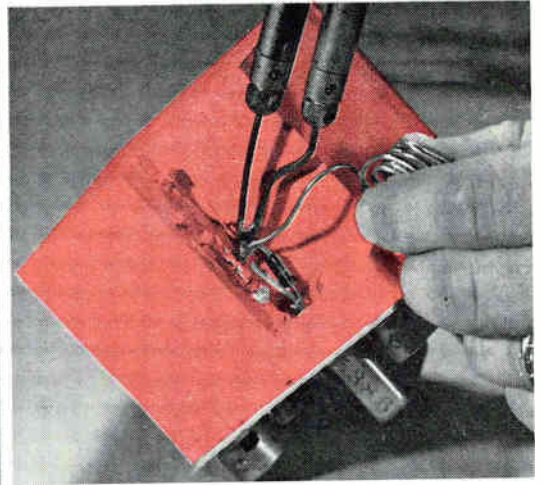
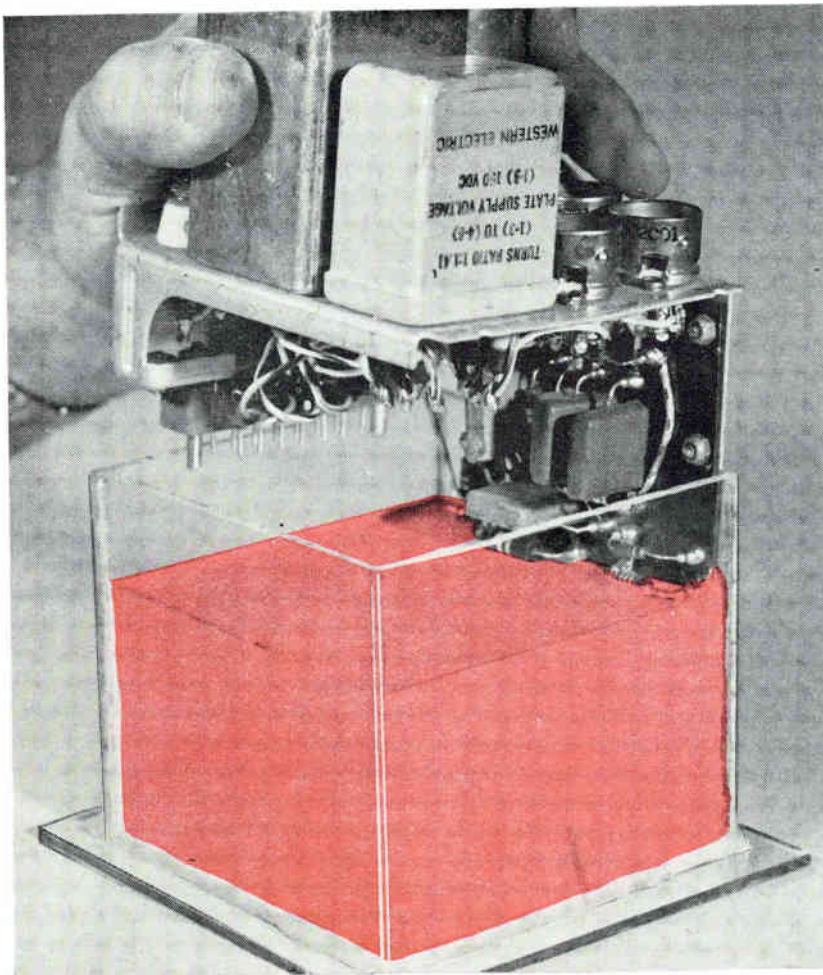

## **Silastic® RTV now gives greater protection with thicker section**

For thick section embedding, specify Silastic RTV 601, a new fluid silicone rubber that vulcanizes at room temperature, cures thoroughly and completely . . . even in deep sections.

Like all potting and embedding materials in the Silastic RTV family, this one has excellent electrical and physical properties — resists moisture, voltage stress, corona, thermal cycling, temperature extremes, aging, weathering, ozone, many corrosive chemicals and their fumes.

Initial processing is easy. Mix RTV 601 with catalyst, vacuum de-air, and pour the low viscosity mixture into the desired area.

No exothermic heat or damaging internal stresses develop. Cure is uniform throughout sections even a foot or more thick. After curing, this Silastic RTV is usable over the wide temperature range of  $-60$  to  $260^{\circ}\text{C}$ .

Embedded circuits can be repaired and components replaced by cutting Silastic RTV away from the defective section with a sharp knife. New Silastic RTV poured into the repaired area restores the original integrity of the encapsulant.

CIRCLE 289 ON READER SERVICE CARD

Dow Corning is your best source of a broad line of silicone fluids, gels, elastomers and rigid forms for potting, filling, embedding and encapsulating.



# Dow Corning

# - specify these silicones

## Solder melts — laminate unaffected

Specified for their excellent resistance to space age environments, silicone-glass laminates are easy to work with, too. Soldering heat doesn't loosen terminals even where complex wiring requires repeated soldering in a small, confined area. Made with Dow Corning silicone resins, glass laminates retain their excellent dielectric properties despite heat, moisture, storage, environmental aging, rapidly changing ambients and vibratory shock. Light in weight, strong at elevated temperatures, they resist ozone, arcing, corona and fungus attack. In addition, they are easy to fabricate and assemble, have good physical properties . . . resist creep under pressure.

CIRCLE 290 ON READER SERVICE CARD

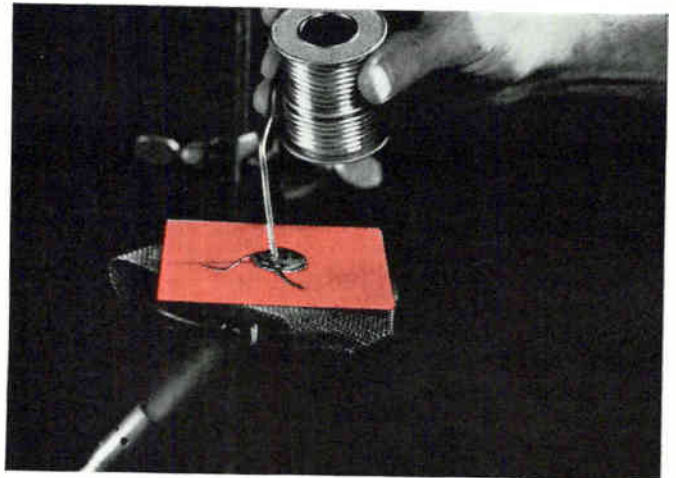

## Silicone compound for heat sink seal

Heat sinks built by Fairfield Controls, Inc., Stamford, Conn., combine pure copper fins with Dow Corning 3 Compound to assure full load operation of silicon control rectifiers within the maximum allowable junction temperature of 125 C. Dow Corning compound with its petroleum jelly-like consistency, provides excellent heat transfer between the 25.5 amps diode shown here and the metallic parts of the heat sink assembly. The operating portion of the rectifier is inside the heat sink, with silicone compound to facilitate heat transfer from the entire diode body to the heat sink proper. At the same time, moisture and contaminants are sealed from the diode lead connections.

CIRCLE 291 ON READER SERVICE CARD

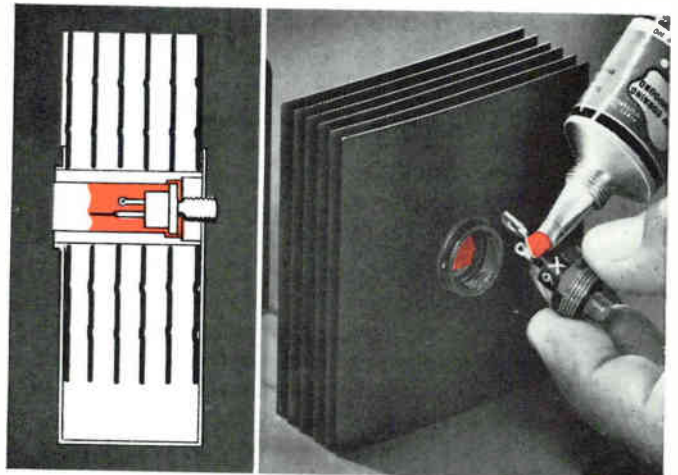

## Key to stability — silicone fluid

Dow Corning silicone fluid is used in a new line of hermetically sealed precision film resistors developed by Key Resistor Corporation of Gardena, California, to "provide the ultimate in long term life and stability." According to Key engineers, "the unique silicone fluid filled construction results in excellent heat dissipation characteristics — minimizes effects of severe overloads." Dow Corning silicone fluids are used as filling and cooling media in numerous electronic and electro-mechanical applications because they maintain initial viscosity over a wide temperature range, are stable at high temperature, are excellent dielectrics . . . offer numerous other advantages.

CIRCLE 292 ON READER SERVICE CARD

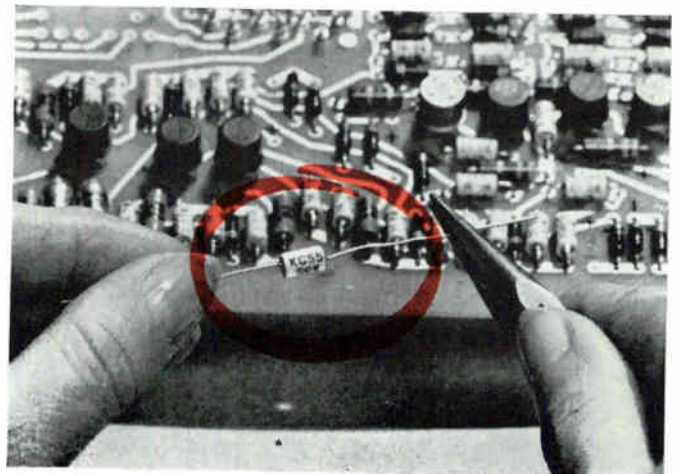

Free 12-page manual, "Silicones for the Electronic Engineer".  
Write Dept. 4201, Dow Corning Corporation, Midland, Michigan.



# Thermocouple Compensating Circuit Design

By J. BRUCE BROWNWOOD,  
Chief Engineer, Transducer Group,  
Servomechanisms, Inc.,  
El Segundo, Calif.

TEMPERATURE-COMPENSATING circuit permits high-accuracy temperature measurements in missile flight testing. The circuit eliminates the need for controlling temperature of one of the two junctions in a thermocouple. It is practical for use in missiles, providing fast response in the rapidly changing environment and consuming limited power.

The extreme heat generated in missile flight requires temperature measurements in all vital areas. Temperature measurements are needed to determine critical aerodynamic surfaces, structural failures caused by extreme heat and engine hot spots. They can also locate over-protected areas where weight can be reduced by eliminating or using less temperature-protective material.

### The Seebeck Effect

An electromotive force is produced in a thermocouple by the temperature differential at the hot junction where temperature is being measured and at the cold junction where the dissimilar metal terminates into the measuring device. To measure voltage accurately at the hot junction, temperature at the cold junction must be either known or controlled.

In laboratories, the cold junction is usually immersed in an ice bath at zero degrees C, where cold junction emf is zero volts and output is proportional only to hot junction temperature. However, this method is not practical for missile flight testing.

In early missile flight tests, thermocouple junctions were immersed in a constant-temperature oven. Although results are accurate, temperature must be maintained above the ambient temperature operating range. Therefore this method is limited to applications where a

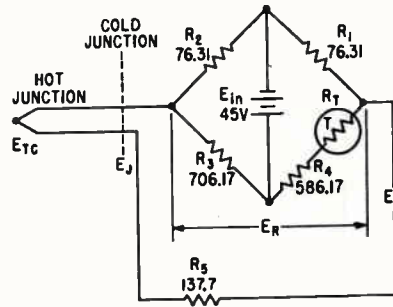

FIG. 1—Bridge output cancels voltage developed at cold junction

FIG. 2—Actual and calculated values (A) are compared for temperature-compensated system and sample calculations (B) are plotted

TABLE I. THERMOCOUPLE OUTPUT AND TEMPERATURE-SENSITIVE RESISTANCE

Temp in deg C	Thermocouple voltage in mv	Temperature sensitive resistance in ohms
-60	-2.2	79.76
-40	-1.5	92.76
-20	-0.77	106.16
0	0	120
20	0.8	134.52
40	1.61	149.8
60	2.43	165.9
80	3.26	182.83
100	4.1	200.64
120	4.92	219.34

finite warmup time and adequate power are available.

The temperature-compensating circuit developed at Servomechanisms, Inc. provides a voltage to compensate cold junction emf. In Fig. 1,  $E_{in}$  is developed at the hot junction (connection of thermocouple wire) and  $E_J$  is developed at the cold junction (connection of thermocouple wires to copper wire). A Wheatstone bridge provides  $E_r$  to cancel  $E_J$ .

The bridge consists of supply voltage  $E_{in}$ , precision resistors with negligible temperature coefficient and temperature-sensitive resistor  $R_1$ . A temperature-sensitive resis-

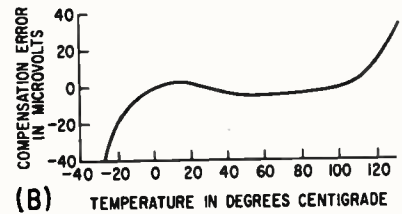
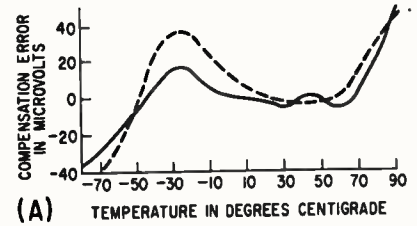

tor of any material may be used and precision windings of chemically pure annealed nickel wire is used in this case because of its relative price.

The general equation for output voltage with an infinite load is  $E_o = E_r - E_J + E_{tc}$ . If  $E_o = E_{tc}$ , voltage  $E_c = -E_J$ . To approximate  $-E_J$  with  $E_r$ , the equation  $E_r = E_{in} R_1 / (R_1 + R_2 + R_3) - E_J R_2 / (R_2 + R_3)$  must be solved for various values of  $R_1$ . For three-point compensation, it can be solved for  $T_a$  with  $R_1 = R_a$  and  $E_r = E_a$ , for  $T_b$  with  $R_1 = R_b$  and  $E_r = E_b$ , and for  $T_c$  with  $R_1 = R_c$  and  $E_r = E_c$ .

The bridge circuit is defined by the resulting equations:  $R_1 + R_2 = (QR_c - R_b) / (1 - Q)$ ,  $E_{in} R_1 = (E_b - E_c) (R_c - R_b) Q / (1 - Q)^2$ ,  $1 / (R_2 + R_3) = 1 / (R_1 + R_2 + R_3) - E_a / E_{in} R_1$ , and  $Q = [(E_c - E_a) / (E_b - E_a)] [(R_a - R_b) / (R_a - R_c)]$ .

### Finding Circuit Values

Typical specifications might include: an alumel-chromel thermocouple, zero degrees C reference junction temperature, zero to 100 degrees C temperature compensation range, 500 ohms maximum output impedance and common mode rejection. Referring to NBS Circular 561, Table 6, of the U. S. Department of Commerce and to Edison Co. Temperature Resistance Table 7 for Chemically Pure Annealed

Look first  
to PSI **NOW**  
**SUPPLYING**  
**ZENER**  
**DIODES**

to **MIL-S-19500/117 (NAVY)**  
plus **MIL-S-19500/127 (NAVY)**

1N746A	1N749A	1N752A	1N755A	1N758A
1N747A	*1N750A	1N753A	1N756A	1N759A
1N748A	1N751A	1N754A	1N757A	

\*1N750 is also qualified to MIL-E-1/1238 (Sig C)

plus **MIL-E-1/1238 (SIG C)**

1N709      1N716      1N718      1N720      1N722

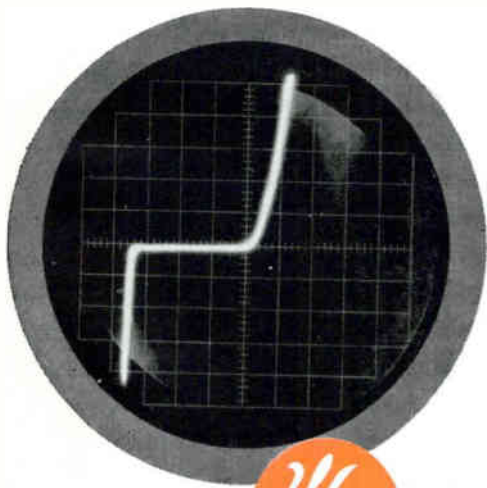

*Pacific Semiconductors, Inc.*

A SUBSIDIARY OF THOMPSON RAMO WOOLDRIDGE INC.,  
12955 CHADRON AVENUE, HAWTHORNE, CALIFORNIA

FIELD OFFICES AND AUTHORIZED DISTRIBUTORS IN ALL MAJOR ELECTRONIC CENTERS. SEE THE YELLOW PAGES OF YOUR TELEPHONE BOOK.

January 5, 1962

**MIL-S-19500/117 (NAVY)**

Type	Zener Voltage (Volts) Nominal	Test Current (mAdc)	Dynamic Resistance (Ohms) <sup>1</sup>	Dynamic Resistance (Ohms) <sup>2</sup>
1N962B	11	11.5	9.5	700
1N963B	12	10.5	11.5	700
1N964B	13	9.5	13.0	700
1N965B	15	8.5	16.0	700
1N966B	16	7.8	17.0	700
1N967B	18	7.0	21	750
1N968B	20	6.2	25	750
1N969B	22	5.6	29	750
1N970B	24	5.2	33	750
1N971B	27	4.6	41	750
1N972B	30	4.2	49	1000
1N973B	33	3.8	58	1000
1N974B	36	3.4	70	1000
1N975B	39	3.2	80	1000
1N976B	43	3.0	93	1500
1N977B	47	2.7	105	1500
1N978B	51	2.5	125	1500
1N979B	56	2.2	150	2000
1N980B	62	2.0	185	2000
1N981B	68	1.8	230	2000
1N982B	75	1.7	270	2000
1N983B	82	1.5	330	3000
1N984B	91	1.4	400	3000

Forward Current: @ 1.5 Vdc      200mA min      @ 25°C

1.  $R_D$  measured at test current with 10% of test current superposed (60 cps rms).

2.  $R_D$  measured 0.25 mAdc with 25μA superposed (60 cps rms).

NOTE: Suffix "B" indicates 5% Zener voltage tolerance; suffix "A", 10%; no suffix, 20%.

PSI offers the broadest coverage of subminiature military type zeners available. Plus zener performance and dependability unequalled in the industry. Every PSI zener is 100% scoped checked — complete elimination of soft knees, double breaks and hysteresis — your assurance of stability and top performance under all conditions. More reasons it will pay you to "Look first to PSI"!

Used as stable references for over two years, PSI zeners have 500 mw power dissipation, the lowest dynamic resistance in the industry and exceptionally low leakage.

Now you can check your old prints and UPDATE TO PSI.

All types now available in production quantities... excellent delivery schedules.

Coming soon! PSI MICRO-ZENERS... 27 types... electrical equivalents of 1N702 thru 1N728... 2 to 39 volts.





## EVERYBODY'S calling for Zippertubing

because they save up to 90% labor costs in cable jacketing and shielding.

ZIPPERTUBING jackets cables in a single operation and is available in a wide range of mil spec materials to meet every need and in sizes to your specifications. Send for our free catalog and take advantage of our confidential consultation and design service.

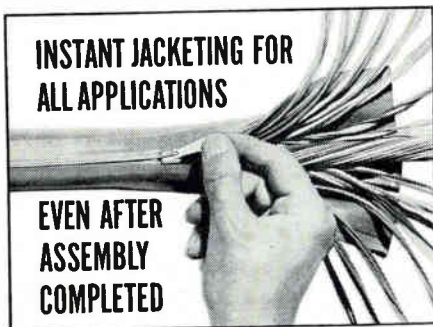

PAT. AND PAT. APP. FOR

THE **Zippertubing**® CO.  
Main Office and Plant:  
13000 S. Broadway, Los Angeles 61, Cal. • FA 1-3901  
Eastern Office and Warehouse:  
470 U. S. Hwy. 46, S. Hackensack, N. J. • HU 7-6261

Nickel Wire, Table 1 can be established.

Three points within the temperature range are  $T_a = 0$  C,  $T_b = 40$  C and  $T_c = 100$  C. Substituting these values into the equation for the bridge circuit, the computed parameters are:  $Q = 0.9411$ ,  $R_1 + R_2 = 662148$  ohms,  $E_{in}$ ,  $R_1 = -3434$  volt ohms and  $R_2 + R_3 = 782.48$  ohms.

To simplify the equation for  $E_r$ , it is assumed  $R_1 = R_2$  so that the equation with the values substituted can be rewritten as  $E_r = -3434 [1/(662.48 - R_1) - 1/782.48]$ . Values of  $R_1$  from Table 1 were substituted into this equation and these values are compared with the thermocouple voltages of Table 1 in Table 2.

Computation accuracy results in an uncertainty of  $5 \mu\text{V}$  in Table 2 but the tracking error is less than  $5 \mu\text{V}$  or less than  $\frac{1}{2}$  degree C from 0 to 100 C. Since deviation outside the range increases rapidly, design parameters must be chosen for each temperature range.

Any desired values can be used for bridge resistors and voltage. Since  $E_{in}$  must usually be an isolated d-c supply,  $E_{in}$  is the controlling factor. In this case, it is assumed that any voltage range is available. The limiting conditions are imposed by output impedance and common mode rejection. If the thermocouple is grounded and the circuit operates into an isolated input like a d-c amplifier, unequal line impedance may cause excessive noise generation because of ground loops.

### Common Mode Rejection

To provide common mode rejection,  $R_3$  is inserted in the lower line. If  $R_3$  is made equal to the resistance of the parallel combination of the bridge circuit, any noise generated because of the grounded thermocouple is attenuated equally on both lines as it appears at the input of the next component. With an isolated d-c supply, both input lines see the same a-c noise bias. A properly designed d-c amplifier will amplify only the difference in potential between the input lines, thus providing common mode rejection. Output impedance then is  $R_o = R_1(R_2 + R_1 + 134.5) (3.53) (10^{-3})$

TABLE II. BRIDGE AND COLD JUNCTION OUTPUTS

Temp in deg C	$E_r$ in mv	$E_j$ in mv	$E_j - E_r$	Equip temp error in deg F
-60	-2.48	-2.2	0.28mv	12
-40	-1.58	-1.5	0.08 $\mu\text{V}$	3.6
-20	-0.70	-0.77	0.03 $\mu\text{V}$	0.9
0	0	0	0	0
20	0.8	0.8	0	0
40	1.61	1.61	0	0
60	2.43	2.43	0	0
80	3.26	3.26	0	0
100	4.1	4.1	0	0
120	4.94	4.92	-0.02 $\mu\text{V}$	0.9

ohms if the lines are balanced and  $R_1 = R_2$ .

Using a 45-volt battery, the values in Fig. 1 can be derived and  $R_o = 340$  ohms.

Although accuracy is limited to  $\frac{1}{2}$  degree C, it is generally determined by the tolerance of other parameters, accuracy of thermocouple wire, temperature-resistance characteristics of the nickel resistor, temperature difference between the cold junction and the temperature-sensitive resistor, and the regulation of  $E_{in}$ . Accuracy better than  $\frac{1}{2}$  degree C over the 100-degree range can be obtained with careful design.

Measurements with a temperature-compensated system are compared with calculated values in Fig. 2A. The system is designed for a temperature range of  $-65$  to  $165$  F with required accuracy of  $\pm 3$  F. The three points dictated by design parameters are  $-35$  C,  $20$  C and  $70$  C. Results of the sample calculations are plotted in Fig. 2B.

The care required in selecting the three points is indicated in Fig. 2. Generally two of the points are chosen near the temperature extremes. For example, while the theoretical compensation for the sample calculation from 0 to 100 C in Fig. 2B is quite close, at  $-60$  C the error is about 12 degrees F. In Fig. 2A, the system using points  $-40$ ,  $20$  and  $70$  degrees C compensates within  $\pm 2$  degrees F from  $-65$  to  $100$  C.

## Microminiature Coaxial Connectors

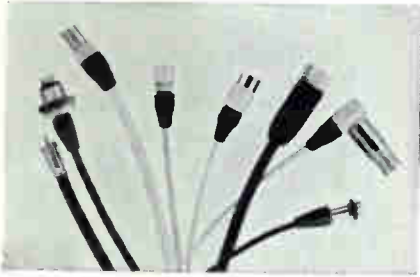

Microdot's microminiature connectors—including the world's smallest 50-ohm coax connectors—are available in over one million combinations. Plugs are available in straight or angle screw types and slide-on versions. Receptacles include printed circuit and bulk-head feed-thru types. Only highest quality materials are used. Conductors are of silver-plated copperweld or cadmium bronze, center contacts are of gold-plated coin silver. Housings are silver-plated brass to assure minimum electrolysis with aluminum panels. "Teflon," "Kel-F," polyethylene, and neoprene are used as dielectrics, jackets, bend relief caps, and pin protectors.

Microdot Inc., 220 Pasadena Avenue, South Pasadena, California

## Crimp-type Connectors



These solderless, coaxial connectors are available in a variety of mounting configurations, including snap-locking versions. Male and female connectors may be mounted interchangeably. Mated length is  $1\frac{3}{16}$ ". Working voltages: 1,000 V. maximum, at sea level; 500 V. maximum, at 60,000 feet. VSWR; less than 1.2 up to 2,000 mc. Life; 5,000 matings, minimum, without electrical deterioration. Tensile strengths of the crimps exceed the breaking strength of the cable. Hard gold plated Beryllium copper and TFE plastic are extensively used to assure optimum reliability.

Microdot, Inc., 220 Pasadena Avenue, South Pasadena, California

## MICROMINIATURE MULTI-PIN CONNECTORS



Visualize 61 contacts in the diameter of a dime... think of slashing connector weight requirements by 33%... estimate the dollar savings in time and inventory of a connector with complete interchangeability of parts. This unique combination of advantages—and more—are built-in features of Microdot's new multi-pins.

In airborne and ground support applications where size, weight and reliability are vital factors, Microdot's unique new multi-pin connector stands alone. Available in three shell sizes and a variety of mounting versions, these rugged connectors are adaptable to a wide range of specific applications (you specify from a wide variety of standard, interchangeable multi-pin component parts to arrive at a connector tailored to your specific application).

Inserts are available in a variety of straight power, straight coaxial, and power-coaxial layouts. Power contacts are interchangeable without changing inserts, allowing hermaphroditic contact arrangements (a mixture of male and female contacts within the same plug or receptacle, allowing hot leads to both plug and receptacle). Closed entry, pure coin silver socket contacts allow heavy currents with low temperature rise. Contact resistance is almost nil. Write today for detailed descriptive literature, Bulletin MP-O.

SIZE DESIGNATION	PLUG O.D.	NO. OF COAXIAL CONTACTS	NO. OF POWER CONTACTS
A	$\frac{3}{4}$ "	up to 7	up to 19
B	$1\frac{5}{16}$ "	up to 12	up to 37
C	$1\frac{1}{2}$ "	up to 19	up to 61

Microdot Multi-Pins are available in disassembled "kit" form or, if you prefer, factory assembled with Microdot cable.

## MICRODOT INC.

220 Pasadena Ave./South Pasadena, Calif.





# PHILIPS microwave

further extended by

## SIVERS LAB products

25 cm  
17 cm  
10 cm  
7.5 cm  
6 cm  
5 cm  
4.5 cm  
3.5 cm  
3 cm  
2 cm  
8 mm  
4 mm  
2 mm

### topics

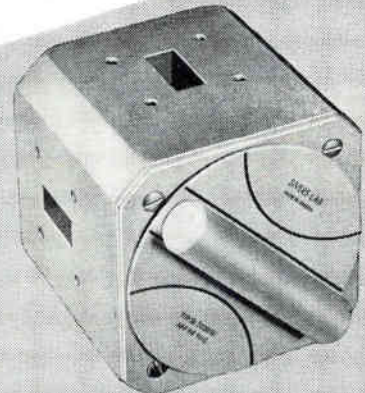

#### Waveguide Switches

These waveguide switches are ideal for switching in both high and low power microwave systems

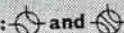
- manual and motor-driven types
- cross-talk attenuation > 80 dB
- VSWR < 1.05
- switching circuits: 

**a much - enlarged microwave programme** Philips have taken over the world-wide sales and service (outside Sweden) of the Sivers Lab microwave equipment, well-known for its advanced design and high quality. The Sivers programme includes a number of frequency bands which were not represented in the Philips microwave range. As a consequence, the integrated Philips-Sivers microwave programme offers an exceptionally wide choice of microwave instruments and components for all wavelengths between 25 cm and 2 mm.

# PHILIPS *electronic measuring*

Sold and serviced by Philips Organizations all over the world

Further information will gladly be supplied by:

N.V. Philips' Gloeilampenfabrieken, EMA-Department, Eindhoven, the Netherlands  
For the U.S.: Philips Electronic Instruments, 750 South Fulton Avenue, Mount Vernon, N.Y.

For Canada: Philips Electronics Ind. Ltd., 116 Vanderhoof Ave., Toronto 17, Ont.

# programme

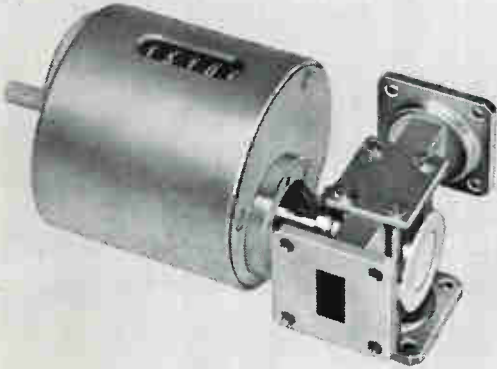

## Direct Reading Frequency Meters

The frequency meters are suitable for experimental hook-ups as well as for panel-mounting in permanent equipment. The cavities can be combined with different coupling elements in order to obtain the required coupling circuits.

- direct readings in Mc/s
- accuracy  $\pm 0.1\%$  (with correction curve  $< 0.05\%$ )
- basic coupling elements:

End-connected waveguide		Passing coaxial	
Passing waveguide		Crystal diode mount coaxial	
End-connected coaxial		Lid	

For coupling 2 and 4 mm components Philips designed the claw flange, which is the only type officially approved by the International Electrotechnical Commission (I.E.C.) for the frequency range from 50 to 120 kMc/s.

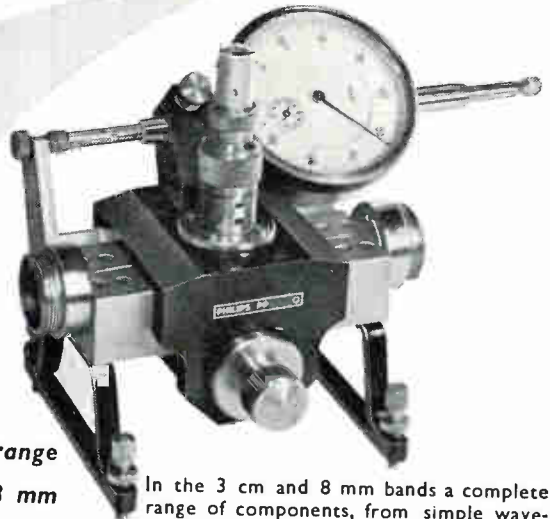
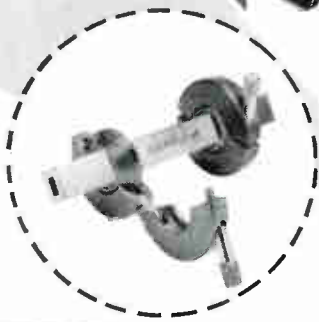

A complete range of 3 cm and 8 mm components

In the 3 cm and 8 mm bands a complete range of components, from simple waveguide stands to high precision standing wave detectors are available. The components can be easily arranged and re-arranged to produce a variety of set-ups.



## 2 - and 4 mm components

For the generation, propagation and measurement of microwaves in the 2 - and 4 mm bands the Philips Research Laboratories developed a klystron and a complete range of components based on many new electrical and mechanical principles. They are important tools in plasma physics, spectroscopy, solid-state research, radio astronomy etc.

**instruments: quality tools for industry and research**





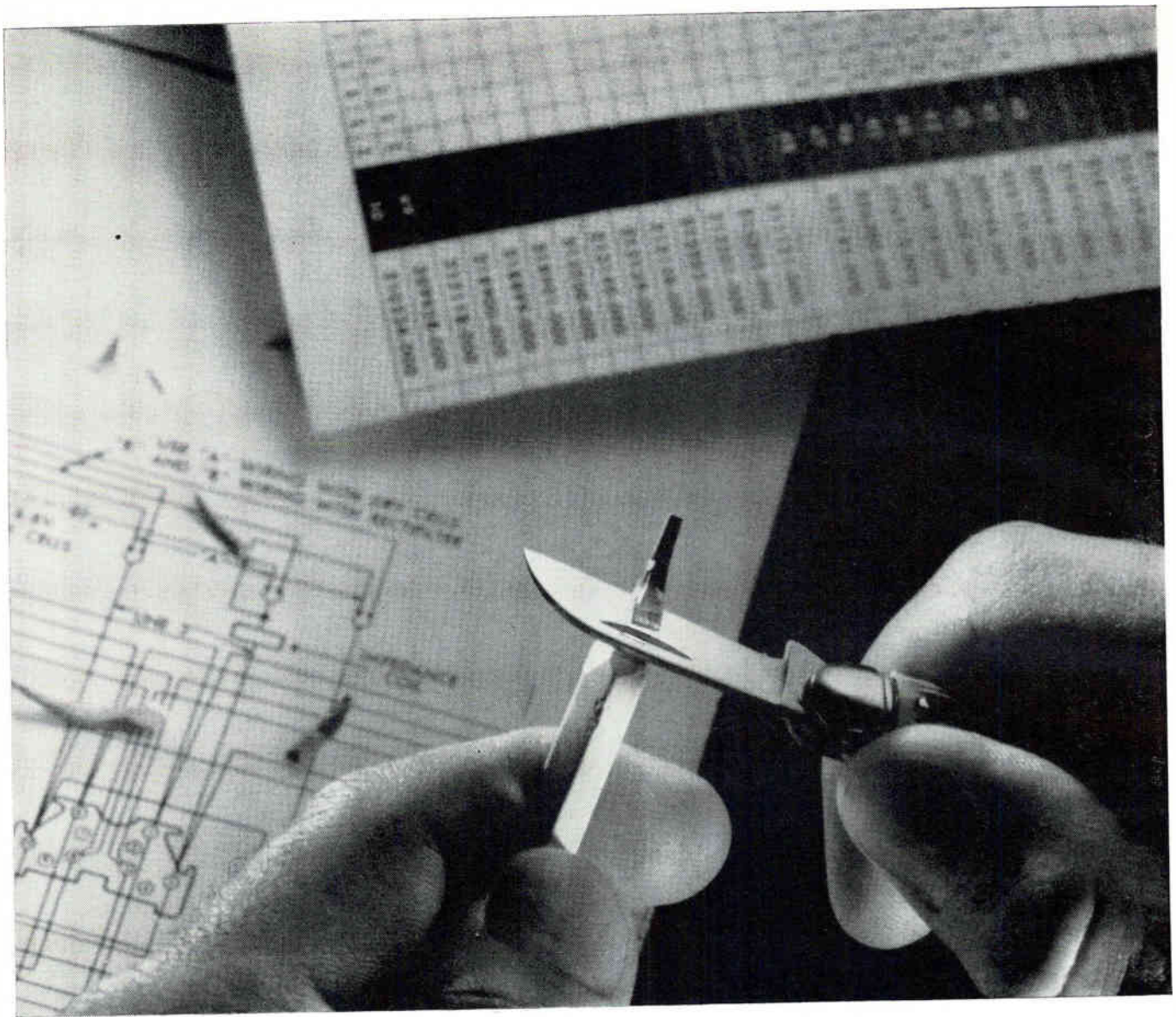

## Sorry, but your resistor specs just went out of date

Now Corning supplies total  $\Delta R$   
less than 3% with no derating

Start a design with known limits of resistance deviation as tight as that and you can specify other components with more certainty and more freedom.

Drop an amplifier stage? Use broader tolerance, cheaper tubes or transistors?

	Model	Resistance (ohms)	Corning Design Tolerance
NF (Meets Mil-R-10509D)	60	100 to 100K	3%
	65	100 to 348K	
N (Meets Mil-R-10509D)	60	10 to 133K	3%
	65	10 to 499K	
	70	10 to 1 meg.	
C (Meets Mil-R-22684)	20	51 to 150K	5% (plus purchase tolerance of either 2% or 5%)
	32	51 to 470K	
	42S	10 to 1.3 meg.	

That's what our new *Corning Design Tolerances* are all about. They give you a percent deviation from nominal that includes the purchase tolerance, maximum  $\Delta R$  due to TC, and maximum load-life drift. They're based on extended performance at full power and 70°C. ambient for over 30,000 hours.

We've assigned them to resistors that cover the 10 ohm—1 meg. range: the fusion-sealed NF, the precision N, and the low-cost, high-performance general purpose C.

A new folder, "Design Tolerances for Tin Oxide Resistors," gives you full information. Write for a copy to Corning Glass Works, 539 High St., Bradford, Pa. . . . and sharpen your pencil.

# CORNING

Electronic Components

# NEW FROM ELECTRONIC MEASUREMENTS

A portable  
POWER SUPPLY  
with all the advantages  
of big semiconductor  
units. Notice the  
continuously  
variable

CURRENT-LIMITER,  
programmability,  
two full-time  
meters . . .  
Size? Just about  
a half inch wider  
than shown here.

PROGRAMMABLE REGATRAN MODEL TR 018-1

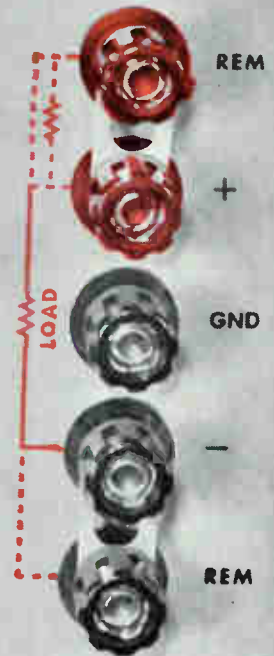

LINE

LINE

DC



1A



1.5A

ELECTRONIC MEASUREMENTS CO. OF RED BANK EATONTOWN, N. J.



## ELECTRONIC

# MEASUREMENTS

COMPANY OF RED BANK  
EATONTOWN · NEW JERSEY



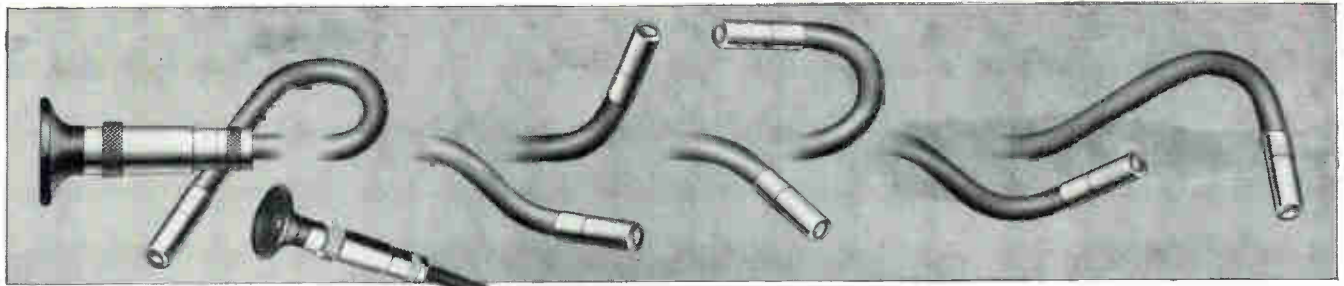

*Focusing eyepiece for convenience of user.*

**For the ultimate  
in precision viewing of  
intricate, hard-to-reach areas . . .**

**A.C.M.I. Fiber Optic  
*Flexible*  
Borescopes**

**F**OR visualization in inaccessible curved areas where a flexible instrument capable of adapting itself to irregular contours is required.

Fiber Optic Borescopes are equipped with focusing eyepiece and fixed or movable objective as required. Illumination can be provided by a flexible fiber optic light carrier with an external light source or an annular fiber optic light carrier attached to the image carrier. Fiber optic light carriers are particularly advantageous for transmission of intense cold light to inaccessible or hazardous areas.

*Please send details and sketch  
of your requirements.*

**AMERICAN CYSTOSCOPE MAKERS, Inc.**

8 Pelham Parkway, Pelham Manor (Pelham), N. Y.

CIRCLE 200 ON READER SERVICE CARD

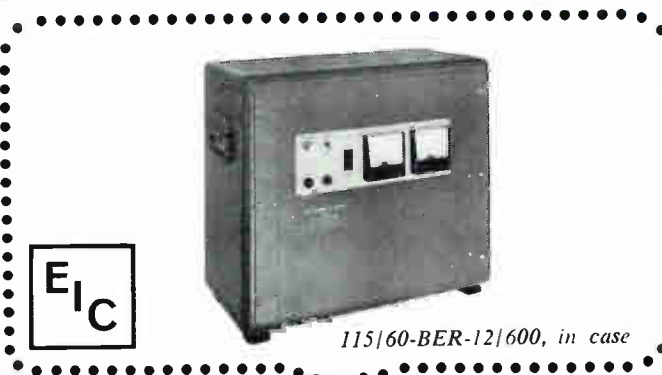

115/60-BER-12/600, in case

**50 amp power supplies  
0.1% regulation**

Model	Output Voltage*	Ripple	Delivery	Price
115/60-BER-12/600	12	1 mv, rms	From stock	\$ 945
230/60-BER-28/1400	28	2 mv, rms	Less than 30 days	\$1750

\*Output voltage adjustable over  $\pm 17\%$  range.

These supplies have magnetic circuit breakers for overload protection, metered outputs, and remote sensing capability. Optional features include modifications for parallel operation and remote programming. Available for 19-inch racks or in case mountings.

Write for complete specifications on these and many other EIC power supplies.

**ELECTRODYNAMIC INSTRUMENT CORPORATION**

*Subsidiary of Reed Roller Bit Company*

JA 6-3761 • 1841 Old Spanish Trail • Houston 25, Texas

CIRCLE 106 ON READER SERVICE CARD

**GENALEX**  
**2way**

**PRECISION  
STEPPING SWITCH**

for circuits which require a switch that steps positively, in either direction, around a bank of 25 contacts. **FEATURING:**

- self-cycle or remote control operation
- 65 steps per second on self-interruption
- bridging or non-bridging wipers
- 20 steps per second from external impulses

*Over 10,000,000 steps in each direction without replacement.*

for complete data on this and other unique GENALEX switches, write:

**IMTRA CORPORATION**

11 UNIVERSITY ROAD, CAMBRIDGE 38, MASS.  
U. S. AGENTS FOR THE GENERAL ELECTRIC COMPANY, LTD. OF ENGLAND

CIRCLE 201 ON READER SERVICE CARD

# BETTER ALLOYS PURER METALS CLEANER WELDS

... with **NRC**  
**Vacuum-Electron  
Beam Systems**

Vacuum electron beam processing melts, welds and evaporates even refractory and reactive metals.

**VACUUM MELTING.** Both development and production size vacuum electron beam furnaces are available for producing ingots of tantalum, tungsten, rhenium, molybdenum, columbium and others.

**VACUUM WELDING.** Complete vacuum electron beam welders are available "off-the-shelf", incorporating the latest developments in both electron beam and vacuum technology. Special custom welders use NRC's "energy conversion in vacuum" experience.

**VACUUM EVAPORATION.** A wide variety of vacuum evaporation-electron beam systems are available for thin film development. NRC is currently supplying systems operating over vacuum ranges from  $10^{-4}$  torr to  $10^{-10}$  torr.

If you are interested in vacuum electron beam processing, either in the development or production stages, check with NRC. Our sales engineers can help you in practical discussions of your needs; complete electron beam laboratory facilities are available on a per diem basis.



Ultra-high vacuum-EB evaporator.



Vacuum-electron beam welder.



A Subsidiary of National Research Corp.  
160 Charlemont Street, Dept. 4-A  
Newton 61, Massachusetts

MANUFACTURING PLANTS AT NEWTON, MASSACHUSETTS AND PALO ALTO, CALIFORNIA

January 5, 1962

CIRCLE 107 ON READER SERVICE CARD 107



# HOW POLARAD'S GENERATORS GUARD



**1953**  
MSG-1 and 2  
950 to 4600 mc



**1962**  
MSG-1R and 2R  
950 to 4600 mc

## 9 years apart...

As you can obviously see, the modern version has had a bit of face-lifting; but that's not all—the main differences lie in improved modulation capabilities; now—the best in the business. For example, internal square wave was 40-4,000 pps, *now* 10-10,000 pps; pulse width was 0.5-10, *now* 0.3-10  $\mu$  sec.; pulse repetition rate was 40-4,000 pps; *now* 10-10,000 pps; pulse delay was 2.5-300, *now* 2-2,000  $\mu$  sec. But oddly enough, we're proud of both the changes and the lack of changes. The changes have certainly made the MSG-1R and 2R a more sophisticated instrument—a better buy than ever. But the lack of really basic change means the 8-year-old version

**exactly  
what  
are the  
differences?**

is far from obsolete — it's still a highly competitive unit — it still possesses unusually high stability and accuracy; its direct-reading frequency and power, UNI-DIAL® control and other convenience features save important time and insure accuracy in either

the lab or the field. Moreover, the fundamental retention of the *essential* design, after eight years, means that these instruments are the most *tried and proven* design that ever came down the pike. Concrete proof of Polarad's policy of "features for the future." Write for a copy of Notes on Microwave Measurements.



# BETTER ALLOYS PURER METALS CLEANER WELDS

... with **NRC**  
**Vacuum-Electron  
Beam Systems**

Vacuum electron beam processing melts, welds and evaporates even refractory and reactive metals.

**VACUUM MELTING.** Both development and production size vacuum electron beam furnaces are available for producing ingots of tantalum, tungsten, rhenium, molybdenum, columbium and others.

**VACUUM WELDING.** Complete vacuum electron beam welders are available "off-the-shelf", incorporating the latest developments in both electron beam and vacuum technology. Special custom welders use NRC's "energy conversion in vacuum" experience.

**VACUUM EVAPORATION.** A wide variety of vacuum evaporation-electron beam systems are available for thin film development. NRC is currently supplying systems operating over vacuum ranges from  $10^{-4}$  torr to  $10^{-10}$  torr.

If you are interested in vacuum electron beam processing, either in the development or production stages, check with NRC. Our sales engineers can help you in practical discussions of your needs; complete electron beam laboratory facilities are available on a per diem basis.

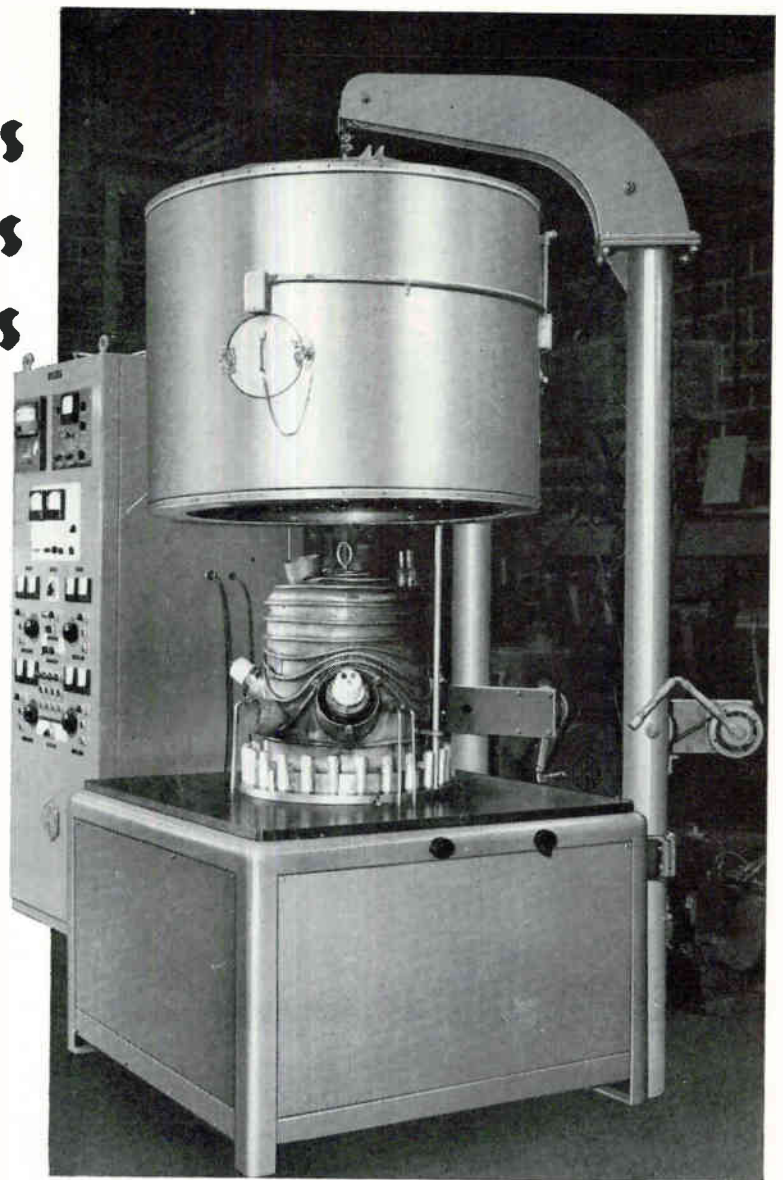

Ultra-high vacuum-EB evaporator.



Vacuum-electron beam welder.



A Subsidiary of National Research Corp.  
160 Charlemont Street, Dept. 4-A  
Newton 61, Massachusetts

MANUFACTURING PLANTS AT NEWTON, MASSACHUSETTS AND PALO ALTO, CALIFORNIA

January 5, 1962

CIRCLE 107 ON READER SERVICE CARD 107

own line of spectrum analyzers which includes 40- and 480-filter analyzers as standard products. Spectra as wide as 50 kc/s can be analyzed. In addition, frequency analysis instrumentation, covering a wide range of spectra and resolutions, is available on special order.

Spectran frequency analyzers also incorporate important electronics features. For example, new solid-state filter-drive circuitry has been developed. This utilizes a transistorized balanced mixer and low-pass filter which increases carrier suppression, reduces extraneous noise, lowers resultant thermal drift, and generally increases dynamic range. The new drive circuits are capable of full 20-watt output and can drive an entire 480-filter bank simultaneously, thus permitting distortionless analysis of complex signals covering the full frequency range.

Spectran instrumentation engineers are presently developing varied means of information readout to allow broader application of their analyzers. Custom instrumentation capabilities are available at Spectran for the adaptation of versatile magnetostriction devices to the problems of frequency selection and analysis.

for additional information on Spectran products and capabilities, address domestic inquiries to the factory address below, export inquiries to Microwave International Corporation, 36 West 44th Street, New York 36, New York.

**SPECTRAN**  
ELECTRONICS CORP.

146 MAIN STREET MAYNARD, MASSACHUSETTS  
CIRCLE 111 ON READER SERVICE CARD (Area code 617) TWinoaks 7-8881



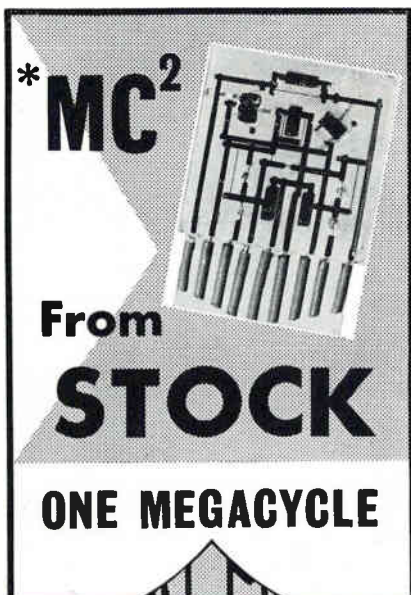

ergy, they will not heat up or burn, thereby permitting higher pulse output and more rapid repetitive rates. The threshold energy levels required are lower because of the reduced losses.

The high-efficiency background coatings are obtained through vacuum deposition of multiple layers of films less than one micron thick with techniques similar to those used by Infrared Industries in the manufacture of Fabry-Perot optical interference filters. The 99.6 per cent reflectance is close to theoretical limits. Best that can be achieved with metallic or mirrored coatings is believed to be around 96 per cent.

The new dielectric coatings also have the advantage of being selec-

company's development departments.

The first orders for the automatic telephone system have come from the Swedish Telecommunications Administration and from the Copenhagen Telephone Company. The Swedish order is for a suburban exchange outside Stockholm with an initial capacity of 4,000 lines, while the Danes have ordered an exchange for the center of Copenhagen, initially for 12,000 lines

### Ceramic Tubes for UHF

A TINY ceramic receiving tube for microwave and space communications, developed by Toshiba, will be utilized in computers and automa-

# HOW POLARAD'S GENERATORS GUARD



**1953**  
MSG-1 and 2  
950 to 4600 mc



**1962**  
MSG-1R and 2R  
950 to 4600 mc

## 9 years apart...

**exactly  
what  
are the  
differences?**

As you can obviously see, the modern version has had a bit of face-lifting; but that's not all—the main differences lie in improved modulation capabilities; now—the best in the business. For example, internal square wave was 40-4,000 pps, *now* 10-10,000 pps; pulse width was 0.5-10, *now* 0.3-10  $\mu$  sec.; pulse repetition rate was 40-4,000 pps; *now* 10-10,000 pps; pulse delay was 2.5-300, *now* 2-2,000  $\mu$  sec. But oddly enough, we're proud of both the changes and the lack of changes. The changes have certainly made the MSG-1R and 2R a more sophisticated instrument—a better buy than ever. But the lack of really basic change means the 8-year-old version

is far from obsolete — it's still a highly competitive unit—it still possesses unusually high stability and accuracy; its direct-reading frequency and power, UNI-DIAL® control and other convenience features save important time and insure accuracy in either the lab or the field. Moreover, the fundamental retention of the *essential* design, after eight years, means that these instruments are the most *tried and proven* design that ever came down the pike. Concrete proof of Polarad's policy of "features for the future." Write for a copy of Notes on Microwave Measurements.



for improved

# MAGNETOSTRICTIVE DEVICES

it's **SPECTRAN**  
ELECTRONICS

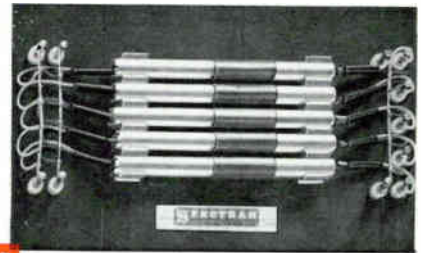

## MAGNETOSTRICTIVE-ROD FILTERS

for frequency reference, analysis, and signal selection

Nearly indestructible Spectran filters are available with center frequencies ranging from 20 kc to 425 kc, and bandwidths from 1 cps to 170 cps. Input and output impedances can range from a fraction of one ohm to several thousand ohms. Skirt slope is 6 db per bandwidth octave for single filters, 12 db per bandwidth octave for dual filters, etc.

Through advances in both design and processing, Spectran filters offer several important advantages. Composition of filter material has been modified and techniques of metallurgical treatment improved to yield a reduced temperature coefficient of 4 parts per million per degree C over the ambient range of  $-20^{\circ}$  to  $50^{\circ}$  C. This is approximately one half the coefficient previously obtainable and, over certain temperature ranges, the coefficient has been reduced to as low as 1 ppm/ $^{\circ}$ C.

Improvements in Spectran coil design have resulted in more efficient magneto-mechanical transduction, and thus in lower insertion loss. In addition to single elements, Spectran filters are available in arrays having substantially zero differential-temperature coefficients. This assures the holding of constant frequency relationship among elements in a filter array.

## MAGNETOSTRICTIVE DELAY LINES

for use in digital computers, radar and communications systems

The magnetostriction line achieves long delays in compact physical space and with low signal loss, and it does so in a structure that is physically rugged and relatively inexpensive. Spectran materials exhibit a low temperature coefficient in Young's modulus, resulting in constant delay times over a wide range of ambient temperatures.

## MULTIPLE-FILTER SPECTRUM ANALYZERS

for instantaneous analysis of sonic and electromagnetic waveforms

The precise spacing of single filter elements to form extended-coverage multiple-filter arrays is a special capability of Spectran. Technicians can provide superior filter arrays because of unprecedented control of temperature and humidity in the Spectran assembly area.

Spectran manufactures filter arrays to customers' specifications and also incorporates them into its own line of spectrum analyzers which includes 40- and 480-filter analyzers as standard products. Spectra as wide as 50 kc/s can be analyzed. In addition, frequency analysis instrumentation, covering a wide range of spectra and resolutions, is available on special order.

Spectran frequency analyzers also incorporate important electronics features. For example, new solid-state filter-drive circuitry has been developed. This utilizes a transistorized balanced mixer and low-pass filter which increases carrier suppression, reduces extraneous noise, lowers resultant thermal drift, and generally increases dynamic range. The new drive circuits are capable of full 20-watt output and can drive an entire 480-filter bank simultaneously, thus permitting distortionless analysis of complex signals covering the full frequency range.

Spectran instrumentation engineers are presently developing varied means of information readout to allow broader application of their analyzers. Custom instrumentation capabilities are available at Spectran for the adaptation of versatile magnetostriction devices to the problems of frequency selection and analysis.

for additional information on Spectran products and capabilities, address domestic inquiries to the factory address below, export inquiries to Microwave International Corporation, 36 West 44th Street, New York 36, New York.

**SPECTRAN**  
ELECTRONICS CORP.

146 MAIN STREET MAYNARD, MASSACHUSETTS  
CIRCLE 111 ON READER SERVICE CARD (Area code 617) TWinoaks 7-8881



# HOW POLARAD'S GENERATORS GUARD



**1953**  
MSG-1 and 2  
950 to 4600 mc



**1962**  
MSG-1R and 2R  
950 to 4600 mc

**9 years apart...**

As you can obviously see, the modern version has had a bit of face-lifting; but that's not all—the main differences lie in improved modulation capabilities; now—the best in the business. For example, internal square wave was 40-4,000 pps, *now* 10-10,000 pps; pulse width was 0.5-10, *now* 0.3-10  $\mu$  sec.; pulse repetition rate was 40-4,000 pps; *now* 10-10,000 pps; pulse delay was 2.5-300, *now* 2-2,000  $\mu$  sec. But oddly enough, we're proud of both the changes and the lack of changes. The changes have certainly made the MSG-1R and 2R a more sophisticated instrument—a better buy than ever. But the lack of really basic change means the 8-year-old version

**exactly  
what  
are the  
differences?**

is far from obsolete — it's still a highly competitive unit — it still possesses unusually high stability and accuracy; its direct-reading frequency and power, UNI-DIAL® control and other convenience features save important time and insure accuracy in either the lab or the field. Moreover, the fundamental retention of the *essential* design, after eight years, means that these instruments are the most *tried and proven* design that ever came down the pike. Concrete proof of Polarad's policy of "features for the future." Write for a copy of Notes on Microwave Measurements.



# MICROWAVE SIGNAL YOUR INVESTMENT

Which Polarad Generator Solves Your Problem? — 500 to 50,000 mc.



Model PMR  
500 to 1,000 mc

Interchangeable FM or pulse modulators. FM modulator provides low distortion wide-range, sine-wave deviation. Pulse modulator provides pulse, square wave and saw-tooth FM. (10-10,000 pps). Calibrated power output: 1 mw



Model MSG 950 to 4,600 mc



Model PMX  
4,450 to 8,000 mc  
6,950 to 11,000 mc

Two interchangeable r-f generator units. Internal pulse and square wave modulation (10-10,000 pps); 0 to -127 dbm power output.

Frequency	Calibrated Power Output	Internal Pulse Modulation				
		Internal Square Wave	Width in $\mu$ sec.	Pulse Repetition Rate in pps	Delay in $\mu$ sec. minimum	FM deviation in mc
MSG-1	950-2,400 mc 1 mw (0 dbm)	40- 4,000 pps	0.5-10	40- 4,000	2.5-300	$\pm 2.5$
MSG-1P*	950-2,400 mc 10 mw (+10 dbm)	10-10,000 pps	0.3-10	10-10,000	2-2,000	$\pm 2.5$
MSG-1R	950-2,400 mc 1 mw (0 dbm)	10-10,000 pps	0.3-10	10-10,000	2-2,000	$\pm 2.5$
MSG-2A	2,000-4,600 mc 1 mw (0 dbm)	40- 4,000 pps	0.5-10	40- 4,000	2.5-300	$\pm 2.5$
MSG-2R	2,000-4,600 mc 1 mw (0 dbm)	10-10,000 pps	0.3-10	10-10,000	2-2,000	$\pm 2.5$
MSG-2P*	2,000-4,600 mc 10 mw (+10 dbm)	10-10,000 pps	0.3-10	10-10,000	2-2,000	$\pm 2.5$

\*Attenuator Accuracy:  $\pm 3$  db between 0 and +10 dbm.  
 $\pm 2$  db below 0 dbm.

All Polarad Signal  
Generators  
(500 to 21,000 mc)  
offer:

Continuously variable attenuators calibrated directly in -dbm.

Internal pulse, FM and square wave modulation, external pulse and multi-pulse modulation.

Delayed and undelayed sync outputs.

UNI-DIAL® tuning with direct-reading frequency dials accurate to  $\pm 1\%$ .

High stability non-contacting klystron cavity chokes for noiseless tuning and accurate calibration.



Model KSS  
GENERATOR SOURCE  
1,050 to 11,000 mc  
In 4 tuning units

Power output: 14 to 400 mw, depending upon frequency; internal square wave 10-10,000 pps; external pulse, square wave or FM modulation; adjustable attenuator.



Model MSG-34  
4,200 to 11,000 mc  
In one instrument

Internal pulse and square wave modulation (10-10,000 pps); 0 to -127 dbm power output; DIGITAL frequency indicator.



Model CSG  
SWEEP GENERATOR  
1,000 to 16,000 mc  
In 5 interchangeable tuning units

Provides high-power microwave signal adjustable from single frequency to 2:1 frequency range; .001 to 100 cps sweep rate; internal modulation: 1,000 cps and 456 kc square wave; external modulation: square wave, FM and pulse.



Model PMK  
10,000 to 21,000 mc  
in 2 tuning units

Two interchangeable generator units. Calibrated power output: +10 dbm (10 mw); internal pulse and square wave modulation (10-10,000 pps); DIGITAL frequency indicator.



EHF SIGNAL GENERATOR  
AND SOURCE  
12,400 to 50,000 mc

Units in this range provide cw signals, 1,000 cps internal square wave, external modulation provisions, accurate frequency calibration. EHF SIGNAL GENERATOR 18,000 to 39,700 mc, 7 plug-in units. Accurate power calibration. EHF SIGNAL SOURCE 18,000 to 50,000 mc, 9 plug-in units. High power output.



Model B  
CODE MODULATOR  
MULTI-PULSE GENERATOR  
950 to 10,750 mc  
in 4 interchangeable tuning units.

Provides 5 independently adjustable pulse channels, each with variable pulse width and delay. Built-in precision oscilloscope.

Because each of these fine test instruments has something special about it, a feature or capability that can suit your test requirements exactly, check through this ad—then get complete specifications from your local Polarad representative.

# POLARAD

ELECTRONICS CORPORATION

43-20 34TH STREET, LONG ISLAND CITY 1, NEW YORK

FREE LIFETIME  
SERVICE



# Acme Electric

## CONSTANT VOLTAGE STABILIZERS

### PROTECT THEMSELVES AGAINST OVERLOAD!

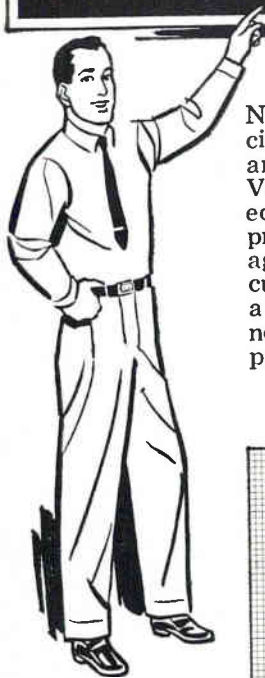

No need to "fuse" the output circuit against overload when an Acme Electric Constant Voltage Stabilizer is part of the equipment. These stabilizers provide automatic protection against overload or short circuit. When load current reaches a critical point in excess of normal operating load, the output voltage is reduced to zero.

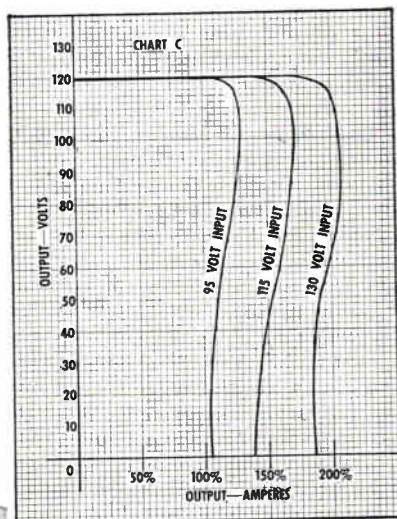
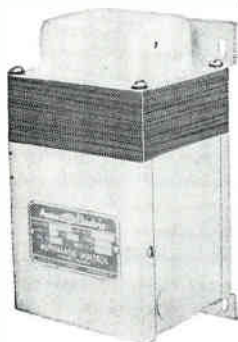

Chart shows performance curves under various voltage inputs and current overload conditions. This current limiting is accomplished automatically.



If you have ever observed the "quickness" of two cycles, 1/30 second, then you'll appreciate the speed with which these stabilizers respond to a fluctuation in line voltage.

Available in sizes from 15 to 2000 VA. Input voltage ranges 95/130, 190/260. Output voltages stabilized at 6.3, 120, 240 volts. Write for catalog 09-B01.

## ACME ELECTRIC CORPORATION

311 Water St.

Cuba, N. Y.

In Canada: Acme Electric Corp. Ltd., 50 Northline Rd., Toronto, Ont.

SAA3519/1967



## DRY PARTICLE INSTRUMENT CLUTCHES & BRAKES



Size 8

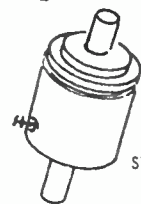

Size 11



Size 15



Cone Clutch

Life: 1000 hours and/or 1,000,000 cycles

Response Times: 2 1/2 to 5 milliseconds

Torque Ranges: 0-100 oz. in.

High Torque to Inertia Ratios

Fixed Field Design

Zero Backlash

Vibrac's Clutches and Brakes, designed to meet the environmental conditions of MIL-E-5272A are available in standard servo sizes.

Ultra smooth operation during continuous slip conditions and independence of torque from rotational speed combine to make Vibrac Clutches and Brakes ideal for servo and tape transport mechanisms.

The miniature Cone Clutch is designed to protect rotary components from excessive torque loads. The conical slipping surfaces have a constant coefficient of static and kinetic friction and operate smoothly during the slip condition: The Cone Clutches can be calibrated through torque ranges from 0-160 oz. in.

Full information available upon request.

## VIBRAC CORPORATION

281 BILLERICA ROAD, CHELMSFORD, MASSACHUSETTS

CIRCLE 202 ON READER SERVICE CARD

## THUMBWHEEL SWITCHES

TABET U.S. Patent 2,841,660

Binary & Digital Meet MIL-S-22710.



- For Critical Reliability Applications.
- Available with internal lighting MIL-L-25467A.



Permanent wafer type, Series TSD-P. Only 1/2" panel space needed per module. Also available in multi-deck series TM.



Removable wafer type, Series TSD-R. For continuous operation applications where interruptions must be held to an absolute minimum.



Permanent wafer type, Series TSB-P. Available in 8, 10, 12 or 16 positions, up to 36 switches per assembly.

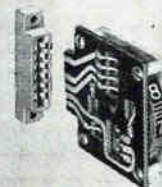

Removable wafer type, Series TSB-R. For applications where maintenance time is valuable and rapid servicing a necessity.

## CHICAGO DYNAMIC INDUSTRIES, Inc.



PRECISION PRODUCTS DIVISION  
1725 Diversey Blvd., Chicago 14, Illinois  
Phone: WEllington 5-4600

CIRCLE 203 ON READER SERVICE CARD  
electronics

# NEW FROM SORENSEN



Compact  
Fully Transistorized

## DC POWER SUPPLY

0 to 40 V DC at 0 to .75 Amp.

The compact new Sorensen Model QR40-.75A is one of the latest additions to Sorensen's line of outstanding products. It features extremely low ripple, precise regulation, programmable output voltage, adjustable current limiting and provisions for remote sensing. Typical applications include powering computer circuits, test and instrumentation equipment, and communications equipment. Negligible on-off overshoot provides protection for transistor circuits. Write for complete specifications and literature.

### SPECIFICATIONS

INPUT VOLTAGE RANGE	105-125 V AC at 50-400 cps.
DC OUTPUT VOLTS	0 to 40 V DC
DC OUTPUT CURRENT	0 to .75 Amp.
VOLTAGE REGULATION (Line & Load Combined)	$\pm (0.01\% + 1 \text{ mV})$
RIPPLE (RMS) AT 60 CPS	150 Microvolts
CURRENT REGULATION (Line & Load Combined)	$\pm 0.15\%$
RIPPLE CURRENT	10 Microamps.
RESPONSE TIME	50 Microseconds
CABINET SIZE	8 1/4" x 9" x 5 1/4"
RACK HEIGHT	5 1/4"

Unit is available for dual rack mounting.



### WIDE RANGE TRANSISTORIZED DC SUPPLY

The QR150-1A is a completely self-protected, transistorized DC Power Supply. Output voltage range: 0 to 150 V DC at 0 to 1 Amp. output current. Combined line and load regulation is  $\pm (0.02\% + 4 \text{ mV})$ . Ripple is 1 MV RMS. *Circuit Design and protective features prevent damage to transistors under overload or short-circuit conditions.*

A UNIT OF RAYTHEON COMPANY



RICHARDS AVENUE • SOUTH NORWALK • CONNECTICUT

CIRCLE 115 ON READER SERVICE CARD



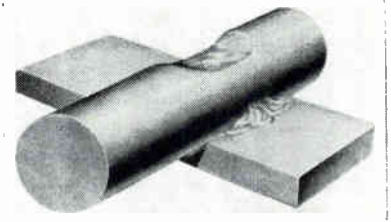
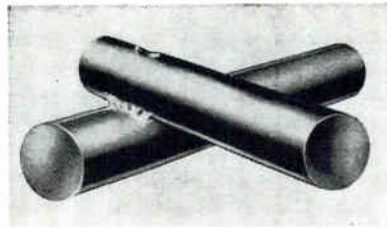
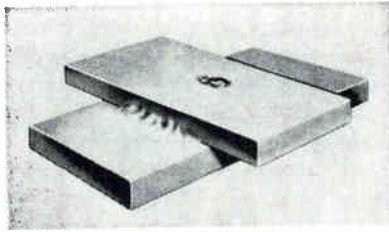

Examples of good welds—A highly reliable weld is obtained when the wires to be welded are clean and positioned correctly, and when electrode force and weld energy are optimized for the materials being welded. A significant amount of metal has melted in each of these welds, indicating that the base or core metals are fused, not just the tinning or coating

## How to Make Reliable Welds

By E. J. MESSNER  
Raytheon Co., Newton, Mass.

TO OBTAIN MAXIMUM reliability from welded connections, all the usual welding procedures must be followed and, in addition, inspection of the materials to be welded must be even more stringent with respect to contamination and nicks in wire and ribbon. Also, the material in the leads of each lot of components is inspected at Raytheon

spectrographically, since the optimum weld-energy cycle depends on the materials being welded. Component manufacturers, because of changes in manufacturing methods, a change in the source of supply, or for other reasons, sometimes change lead materials from one shipment to the next. Changes of lead material are usually of no importance in soldered circuits but they are in welded circuits.

In the welding operation itself it

is not enough merely to have good equipment and an efficient set-up. The electrical path of the welding current is subject to considerable variation in resistance because of the cleanliness and tightness of cable connections and electrodes, and the parallelism and surface condition of the electrodes. These factors can change available weld energy by as much as 25 percent.

One of the biggest variables in making reliable welds is placement

### DEFECTIVE WELDS

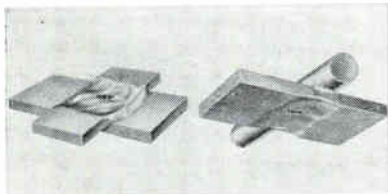

Burned hole in weld reduces weld strength and has poor appearance. Burned holes can result from dirty material, misaligned work pieces, improperly positioned electrodes, improper welding sequence



Blow holes or deep pits cause weakness. Blow holes can develop if the electrode force is removed before the weld is actually made, if the material is dirty or contains a large amount of impurities

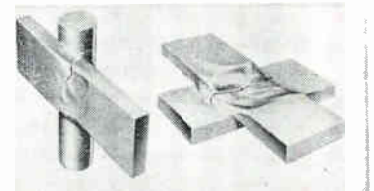

Cracked welds typically result when most of the available electrode force is used to bring badly fitting parts together. Cracks reduce fatigue strength and lower resistance to shock

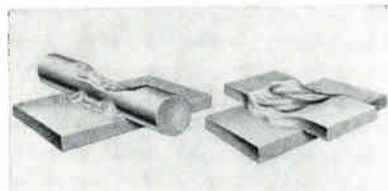

Burned weld has low strength, increased electrical resistance, poor appearance. Welds of this type are caused by improperly aligned electrodes, wrong electrode force, wrong energy for the materials being welded, dirt in the weld area, improper sequence of electrode force and welding current, improperly positioned wires

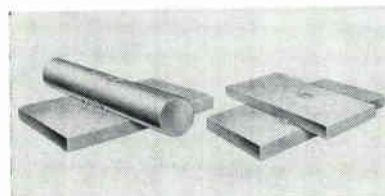

Inadequate weld is weak and has increased electrical resistance. Causes are improper positioning of materials, using materials having low electrical resistance (welding energy too low for the material), improper follow through during the weld cycle, dirty materials, and presenting parallel paths for the welding current (shunting)

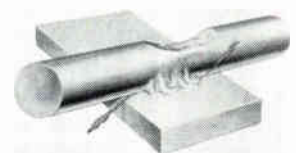

Splashed welds are short circuits waiting for a chance to happen. They are caused by dirty materials, too high a weld current, low electrode force, improper weld sequencing. A splashed particle is particularly likely to break off if its base is small with respect to its length and to the largest portion of its cross section

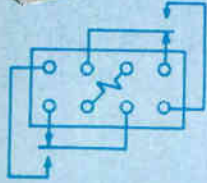

## CRYSTAL CAN MINIATURE REED, RELAY

Only 1.25" x .80" x .40", Dunco MRR2A2B magnetically shielded reed relays replace crystal can types in many applications requiring long life and extreme contact reliability on dry circuit and light load switching. They are highly resistant to shock and vibration. Unit illustrated has 2 Form A and 2 Form B break-before-make contacts. Other contact combinations available.

Non-magnetic terminals provide convenient printed circuit mounting without disturbing operating characteristics. Reed switches separately sealed in glass eliminate contact contamination. Write for Information Bulletin MRR-2.

## GENERAL PURPOSE REED RELAY FOR PRINTED CIRCUITS

Encased in magnetically shielding steel enclosures, Dunco RR2A2BS reed relays have terminals of non-magnetic tinned copper wire. Thus they minimize the effects of external magnetic fields; the changing of relay characteristics by cutting or bending magnetic terminals; and eliminate terminal soldering difficulties. Unit illustrated contains 2 Form A and 2 Form B break-before-make reed contacts. Other combinations available. Inherently stable switching characteristics may be utilized fully without special care in applying the relays. Ask for Dunco Information Bulletin RR-2.

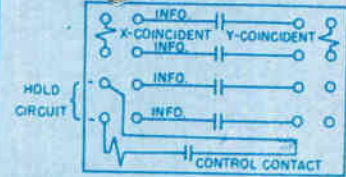
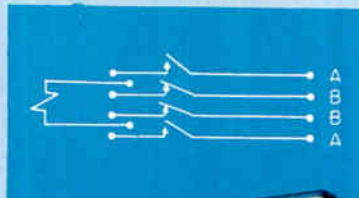

## MINIATURE REED CROSSPOINT RELAY

Designed for coordinate network switching arrays, Dunco Crosspoint Relays feature fast operation; long contact life; excellent contacting reliability; low operating power; and convenient printed circuit card mounting. Five reed switches encased in 3 coils are magnetically shielded in an enclosure only 1.75" x .80" x .40". Simultaneously energizing X and Y coordinate coils closes the contacts. These remain closed until the holding coil is interrupted or a single coordinate coil is reverse pulsed. Ask for Dunco Bulletin MRR-1.

# Here's Reed Relay Progress !

Struthers-Dunn developments like these are helping engineers and designers utilize the full advantages of reed relays . . . *with a minimum of special attention in applying them.* Each basic type is adaptable to numerous modifications and contact combinations. Write for Data Bulletins indicated or send application details for reed relay recommendations. Address: *Struthers-Dunn, Inc., Pitman, N. J.*

# STRUTHERS-DUNN

Pioneers of Space Age Relay Reliability  
Member, National Association of Relay Manufacturers

Sales Engineering Offices in: Atlanta • Boston • Buffalo • Charlotte • Chicago • Cincinnati • Cleveland • Dallas • Dayton • Detroit  
High Point • Kansas City • Los Angeles • Montreal • New York • Orlando • Pittsburgh • St. Louis • San Carlos • Seattle • Toronto •  
(Export Department: 1505 Race St., Philadelphia 2, Pa.)





# STANCOR

ELECTRONICS, INC.  
(Formerly Chicago Standard  
Transformer Corporation)

A shorter name for a broader product line

## Power supplies for thermo- electric devices

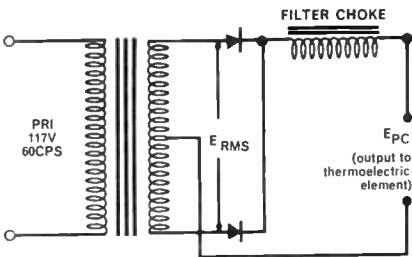

Stancor has designed dozens of these power packs, covering the full range of low voltage, high current applications. We can supply the proper power transformer and choke—or the complete package—to meet critical ripple requirements of thermoelectric devices. Write for Stancor Engineering Bulletin #603 for additional information.

Over 800 Stancor stock transformers, filters toroids, and other components for military and commercial applications, are available for immediate delivery through your local Stancor Industrial Distributor. Ask him for Catalog CS-101.

**STANCOR**  
ELECTRONICS, INC.  
(Formerly Chicago Standard  
Transformer Corporation)  
3502 W ADDISON STREET  
CHICAGO 18, ILLINOIS

### WELDING MISTAKES



A spot of foreign matter on a lead will usually cause a bad weld

The two leads to be welded are not properly centered on the axis of the electrodes

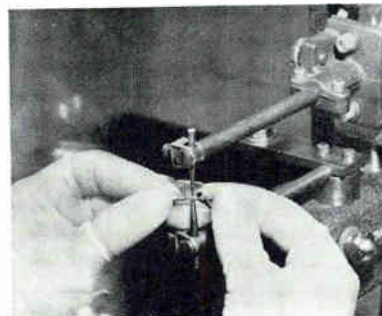
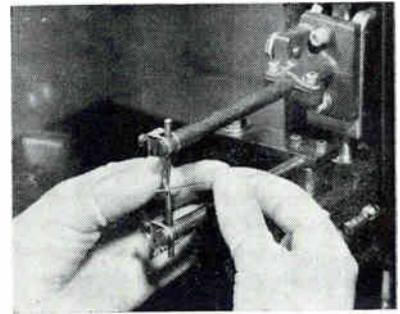

Two transistor leads are touching the bottom electrode. Weld current will be partially shunted through the transistor and may destroy it

Welding on a kink or bend will always produce a weak joint. The two materials being welded should be brought into close contact before the weld cycle is started

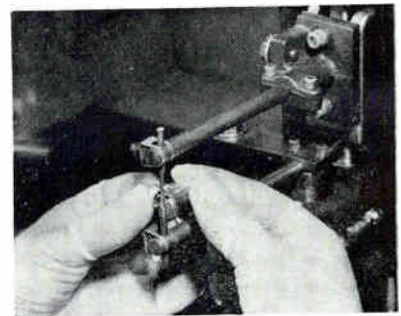

of parts during the welding operation and the electrode pressure the operator applies. Strength tests on welds made with mechanical or air operated electrodes show improved weld consistency. Holding fixtures can be used for part placement in some cases and these fixtures will become more practical when welded modules are designed for automatic production.

Parts placement is of particular importance when connections to semiconductor devices are made. If two or more leads touch one of the

electrodes, the parallel path for the welding current can destroy the device (ELECTRONICS, p 72, Sept. 22, 1961).

Welded joints have already achieved a mean-time-before-failure of over 500,000,000 hours on one computer module made at Raytheon and it is expected that this figure can be improved substantially. The present goal for soldered connections is 20,000,000 hours mtf; a projected future goal for soldered connections is 100,000,000 hours mtf.

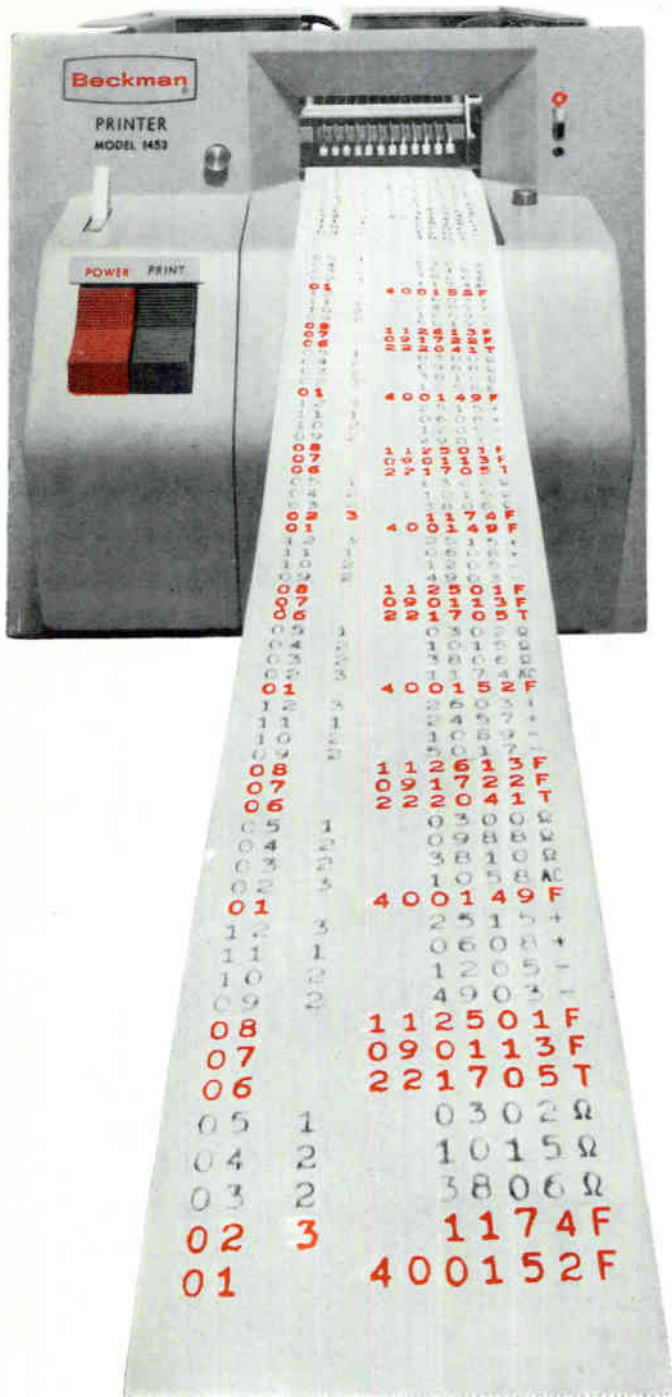

# SOLID-STATE PRINTER WITH NEW CAPABILITIES

With this solid-state 7 to 12 digit printer, you can feed in 4-line BCD data in either a 1-2-2-4, 1-2-4-8, or 1-2-4-2 code configuration *without changing components or interrupting operation.*

Each digit-column of this parallel-entry printer is controlled by a separate solid-state plug-in code module connected independently to the data source. Thus, you can easily pre-arrange digit-columns in any order and into specific groups. Using optional plug-in code modules—which can be interchanged or combined with standard modules—you can apply 10-line *and* 4-line BCD data *simultaneously.*

The Model 1453 can automatically print in black or red to indicate different input sources or off-limit readings. Reliable solid-state circuits and time-proven Burroughs printing mechanism assure you of trouble-free operation.

If you can only spare about 8" x 8" of panel space for a completely self-contained printer, then the compact half-rack Model 1453 is the answer.

Standard 7 digit printer is only \$975. For complete information write for Brochure A1453.

**Beckman®**

INSTRUMENTS INC.  
BERKELEY DIVISION  
RICHMOND, CALIFORNIA



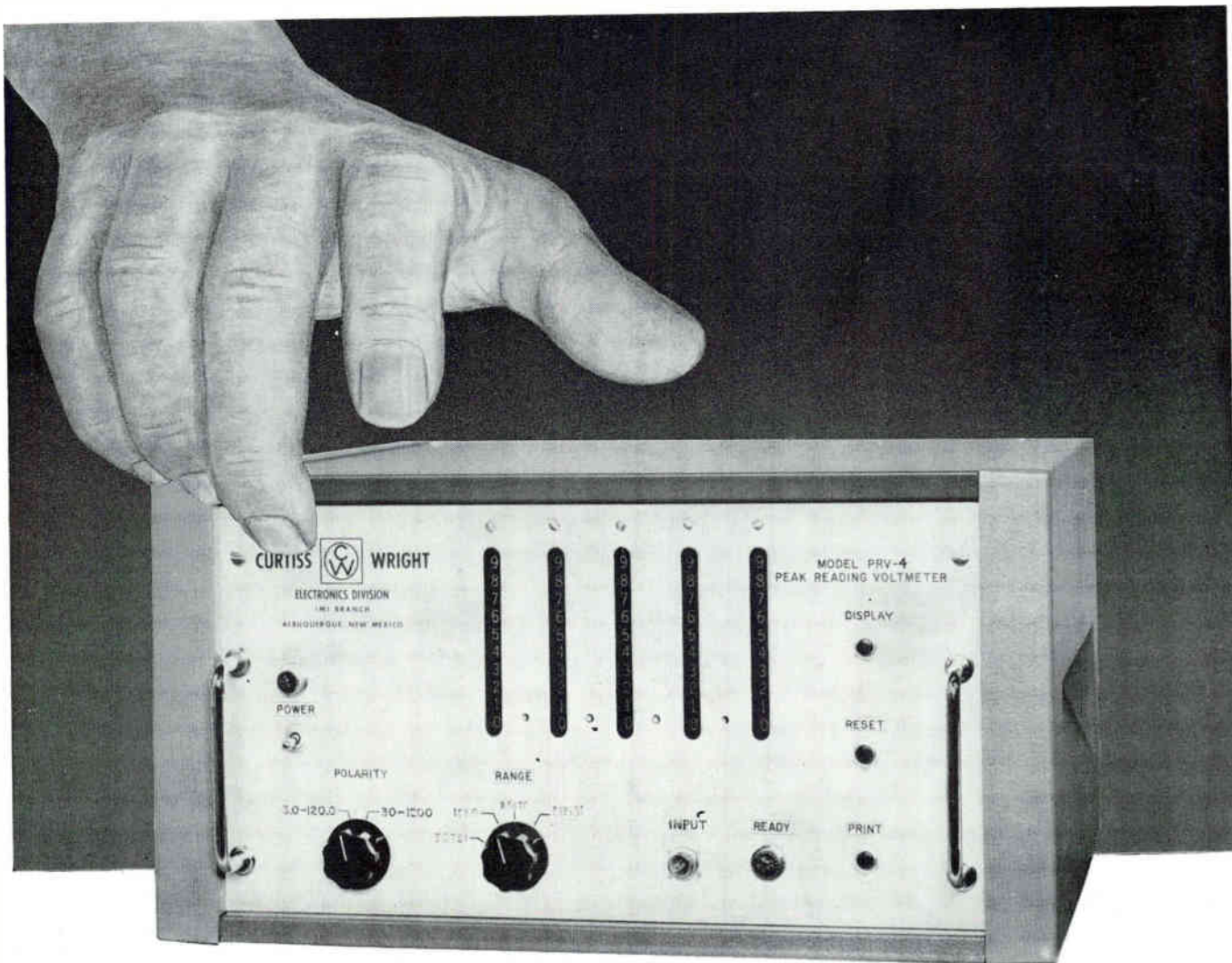

## *Capture...then Read*

### **THE FIRST PEAK OF ANY VOLTAGE**

#### **Single Transient Peak Reading Voltmeter**

**FOR: Blast Studies — Shock Studies**  
**— Transient Voltage Measurements on Aircraft**  
**Power Busses — Measurement of any single transient phenomena which may be characterized by a voltage pulse.**

The Model PRV-4 Single Transient Peak Reading Voltmeter is designed to accept and display the first value of a *positive* or *negative* voltage pulse of arbitrary shape within specified limits. Readout is provided as a four digit decimal value directly in volts with a fifth digit for over-range indication. First peak voltage detected

blocks further input values until reset. A four line 1-2-2-4 coded output line is provided for external printout. The PRV-4 will read out peak amplitude of rectangular pulses of one microsecond or greater pulse width. Readout cycle time, 1 millisecond with accuracy of 0.5% of absolute or 10 counts. Range 30 MV. to 1000 V.

Write to Intermountain Branch for complete specifications on the PRV-4 and other models, or for information on custom units available for unique requirements.

ELECTRONICS DIVISION  INTERMOUNTAIN BRANCH

**CURTISS-WRIGHT CORPORATION**

P.O. BOX 10044 • ALBUQUERQUE, N. M. • PHONE: 345-1661 • TWX: AQ-69

The Oak Approach



Pronto  
-type

## service on prototype switches

*Go ahead and draw!* Just send us your sketch and we'll do the rest. OAK has initiated the fastest delivery cycle in the industry for prototype rotary switches — your switch is completed within *three* days after receipt of your drawings.

That's pretty fast on *your* draw. It's speed made possible by a completely equipped and integrated department devoted to prototype orders *only*. These

special jobs are immediately separated and hand tended through all production stages. Four daily "switch runs" to O'Hare International Airport make sure you get your switch on time.

Layout sheets are available at no cost to help in diagramming your switch. For information on prototype service, products and production scheduling, contact us or your nearest OAK representative.

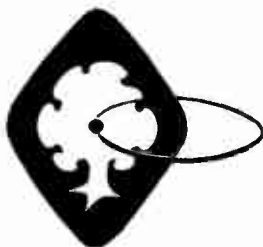

OAK MANUFACTURING CO.

CRYSTAL LAKE, ILLINOIS • Telephone: Area Code 815; 459-5000; TWX: CRYSLK 2350-U;  
Cable: Oakmanco. • Plants in Crystal Lake, Illinois • Elkhorn, Wisconsin

Subsidiaries: OAK ELECTRONICS CORP., Culver City, Calif. • MCCOY ELECTRONICS CO., Mt. Holly Springs, Pa.  
ROTARY AND PUSHBUTTON SWITCHES • TELEVISION TUNERS • VIBRATORS • APPLIANCE  
AND VENDING CONTROLS • ROTARY SOLENOIDS • CHOPPERS • CONTROL ASSEMBLIES



**IN  
AVIATION  
ELECTRONIC  
ENGINEERING**

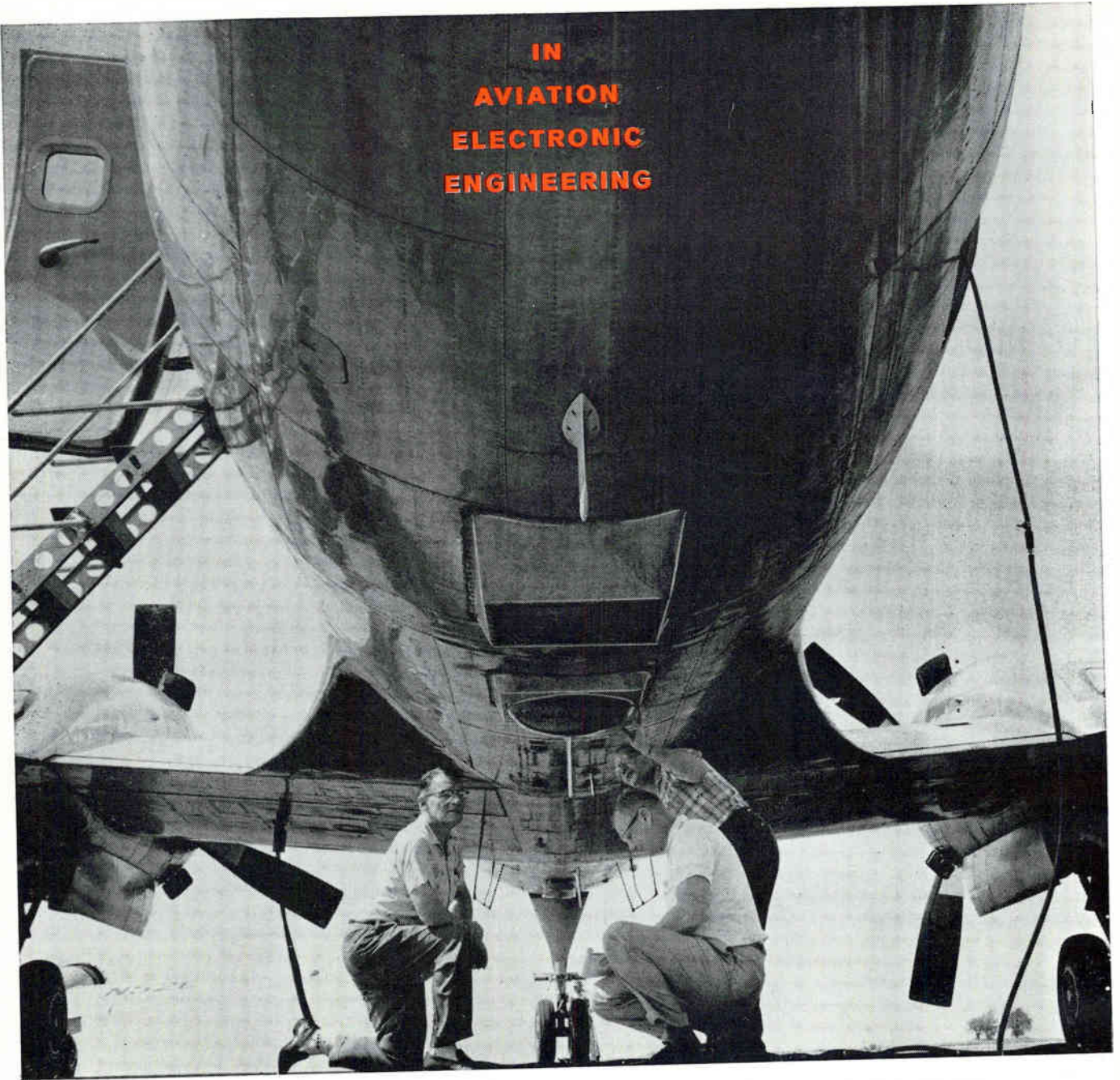

## Your Challenge is Greater with COLLINS

As an engineer at Collins, you help develop the finest avionics equipment built. You have the opportunity of working with top men on advanced instrumentation and equipment such as automatic pilot, solid state communication/navigation systems, antennas, Doppler, distance measuring equipment and weather radar. And you stay right with a project until product completion. ■ Collins, one of the nation's leading growth companies, also offers a wide variety of engineering opportunities in ground communication, antenna research, microwave, data systems, amateur, broadcast, components

and general systems design. Facilities are in Cedar Rapids, Iowa; Dallas, Texas; and Newport Beach, California, with sales offices and field service installations throughout the world. ■ Now Collins has openings for M.E.'s, E.E.'s, I.E.'s and graduate level Physicists in design, research and production. Evaluate your present situation and qualifications. If you are interested in a career with Collins, write:

L. R. Nuss  
Collins Radio Company  
Cedar Rapids,  
Iowa

B. E. Jeffries  
Collins Radio Company  
Dallas,  
Texas

R. O. Olson  
Collins Radio Company  
Newport Beach,  
California

An equal opportunity employer.



**Exclusive ionic "bath"**  
**increases**  
**electrolytic**  
**reliability**

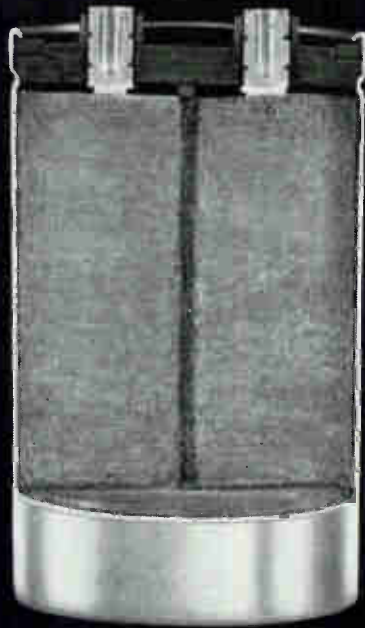

**Inside General Instrument Electrolytic Computer Capacitors** is aluminum foil that has been "taken to the cleaners" to improve its reliability. ■ The etched crevices in aluminum capacitor foil often harbor acidic residues of the etching process. These carriers of corrosive action frequently escape detection in testing, only to show up, embarrassingly, after the capacitor has been in use a while. Chemical baths remove some of them. But only General Instrument — of all manufacturers of electrolytic computer capacitors — passes the foil through a unique ionic cleaning procedure before etching to assure the type of etch that minimizes the potential danger of deep-pocketed crevices. ■ All General Instrument tantalums, micas and paper-films get similar extra care. If you care, specify General Instrument Capacitor Division. Write for engineering bulletin EL-8 and the booklet "Inside General Instrument Capacitor," to Department 200C, General Instrument Corporation, Darlington, S. C.

**GENERAL INSTRUMENT CAPACITORS**



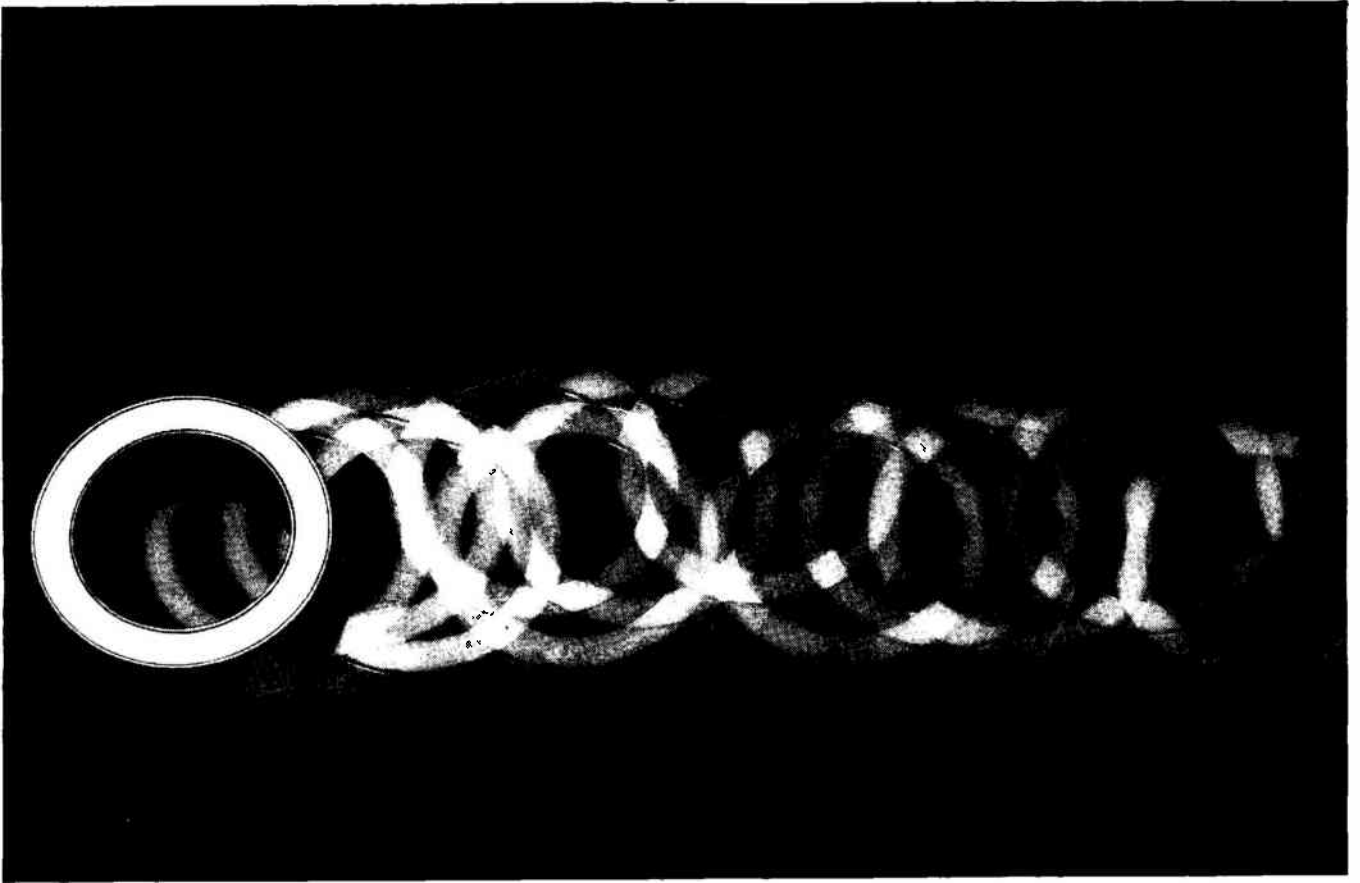

## the strong case for Centricores<sup>®</sup>

**When you're considering magnetic cores it pays to get down to cases. The sturdy aluminum case for Centricores assumes special importance where impact, vibration, heat or mechanical pressure could cause trouble in a control loop you're designing, or where you want to miniaturize an inductive component.**

**The case is ruggedly rigid**, so that you can apply your circuit windings without danger of distorting the core's magnetic properties. And the case is absolutely leakproof. You can vacuum-impregnate Centricores without danger of their damping oil leaking out or foreign matter leaking in. The tightly sealed case also guards against leakage in applications where high ambient temperatures are present, or where Centricores are used in rotating equipment.

**Here's a tip on miniaturization.** The rugged design of the Centricore case permits use of a thinner gage aluminum that shaves fractions of an inch off their size—fractions that can add up to precious inches where you want to scale down component dimensions. *Centricores are the slimmest magnetic cores on the market.*

**Centricores are the most uniform.** They give the exact performance you want, from core to core and lot to lot. Their remarkable consistency in insulation, dimensions, squareness, thermal stability and gain is the product of unique quality controls that begin with the very selection of raw materials and extend through final testing.

**Write for complete data.** Centricores are available from stock from our East and West Coast plants in all standard sizes and magnetic qualities, and in both aluminum and phenolic cases. We will match them within 5 per cent over the entire voltage-current loop, in sets, units or in multiples up to twelve. Write for detailed specifications today.

**MAGNETIC  
METALS**

**MAGNETIC METALS COMPANY**

Hayes Avenue at 21st Street, Camden 1, N.J.

853 Production Place, Newport Beach, California

*transformer laminations • motor laminations • tape-wound cores  
powdered molybdenum permalloy cores • electromagnetic shields*





Model 440  
\$250

## Widest range - highest stability!

**Improved NARDA Solid-State POWER METER  
-portable unit with rechargeable battery-  
measures rf power (0.1 to 10 mw) within 3%!**

Compensated or not—you can't buy a more stable Power Meter for lab use than the new, improved version of Narda's Model 440! Self-balancing, it provides accurate direct reading measurements of either CW or pulsed power. Fully transistorized and powered by a nickel-cadmium battery (rechargeable overnight), it provides complete freedom from deviations due to line voltage fluctuations. Moreover, zero-set controls have been especially re-designed for fine resolution and ease of control on lowest scales.

The 440 may be used for any frequency range for which there are bolometer or thermistor mounts, and provides up to 18 ma bias current. In addition to the five standard scales up to 10 mw, the 440 provides 0.001 to 0.01 mw and 0.003 to 0.03 mw scales (bolometer use only; 4.5 ma preferably) to provide the widest power measuring range available. And in addition, you get all this with an accuracy of  $\pm 3\%$  of full scale reading!

Call your local rep or write us for more complete specifications. Ask, too, for our free catalog of over 600 microwave instruments and components. Address: Dept. E-1-16.

the  
**narda**  
microwave corporation



Plainview, L. I., New York  
Area Code 516 GE 3-9000



# FOR DC-to-15 MC APPLICATIONS

## Tektronix Types 515A, 516

### Oscilloscopes



#### CHARACTERISTICS

##### VERTICAL AMPLIFIER

Frequency Response from dc-to-15 mc (at 3 db down). Risettime of 23 nano-seconds. Sensitivity from 50 mv/cm to 20 v/cm in 9 calibrated steps, continuously variable uncalibrated from 50 mv/cm to 50 v/cm. Constant Input Impedance at all attenuator settings.

##### SWEEP RANGE

Linear Sweeps from 0.2  $\mu$ sec/cm to 2 sec/cm in 22 calibrated rates, continuously variable uncalibrated from 0.2  $\mu$ sec/cm to 6 sec/cm. 5X Magnifier to extend calibrated sweep rate to 40 nsec/cm.

##### TRIGGERING FACILITIES

Automatic or Amplitude-Level Selection (preset or manual) on rising or falling slope of signal, with AC or DC coupling, internal, external, or line—also high-frequency sync to 20 mc.

##### TEKTRONIX CATHODE-RAY TUBE

5-inch crt with 6-cm by 10-cm viewing area and 4-KV accelerating potential.

##### AMPLITUDE CALIBRATOR

11 square-wave voltages from 50 mv to 100 volts, peak-to-peak, available from the front panel.

##### REGULATED POWER SUPPLIES

All critical dc voltages electronically regulated. Power Requirements of 105 to 125 volts or 210 to 250 volts, 50 to 60 cycles—with special models using dc fan motor and operating from 50 to 400 cycles also available.

##### SIZE AND WEIGHT

13½" high by 9¾" wide by 21½" deep—approximately 45 pounds.



These two compact Tektronix Oscilloscopes ideally suit most general-purpose measurement applications in the dc-to-15 mc range. They display bright traces with excellent definition.

You may prefer the Type 515A Oscilloscope if you work exclusively with single-trace applications in the laboratory, in the field, or on the production line. Or, you may prefer the dual-trace facility of the Type 516 Oscilloscope. It offers you four operating modes and independent controls for each amplifier channel—enabling you to position, attenuate, invert input signals as desired.

Regardless of your selection of either of these precision tools, you will find your Tektronix Oscilloscope easy-to-operate and easy-to-keep-operating.

- Type 515A Oscilloscope (50-60 cycles) . . . \$800
- Type 515A MOD 101 (50-400 cycles) . . . . . 835
- Rack-Mount Models also available
- . . . . .
- Type 516 Oscilloscope (50-60 cycles) . . . . \$1000
- Type 516 MOD 101 (50-400 cycles) . . . . . 1035
- Type 516 MOD 108B (significantly improved writing rate at 6-KV on 6 div by 10 div viewing area—each div equals 0.85 cm) . . . . 1075

U. S. Sales Prices f. o. b. Beaverton, Oregon

For a demonstration of these or any of over fifty other Tektronix Oscilloscopes, call your Tektronix Field Engineer.

**Tektronix, Inc.** P. O. BOX 500 • BEAVERTON, OREGON / Mitchell 4-0161 • TWX—BEAV 311 • Cable: TEKTRONIX

**TEKTRONIX FIELD OFFICES:** Albuquerque, N. Mex. • Atlanta, Ga. • Baltimore (Towson) Md. • Boston (Lexington) Mass. • Buffalo, N.Y. • Chicago (Park Ridge) Ill. • Cleveland, Ohio • Dallas, Texas • Dayton, Ohio • Denver, Colo. • Detroit (Lathrup Village) Mich. • Endicott (Endwell) N.Y. • Greensboro, N.C. • Houston, Texas • Indianapolis, Ind. • Kansas City (Mission) Kan. • Los Angeles, Calif. Area (East Los Angeles Encino • West Los Angeles) • Minneapolis, Minn. • Montreal, Quebec, Canada • New York City Area (Alburtson, L.I., N.Y. • Stamford, Conn. • Union, N.J.) • Orlando, Fla. • Philadelphia, Pa. • Phoenix (Scottsdale) Ariz. • Portland, Oreg. • Poughkeepsie, N.Y. • San Diego, Calif. • San Francisco, Calif. Area (Lafayette, Palo Alto) • Seattle, Wash. • Syracuse, N.Y. • Toronto (Willowdale) Ont., Canada • Washington, D.C. (Annandale, Va.)

**ENGINEERING REPRESENTATIVES:** Kentron Hawaii Ltd., Honolulu, Hawaii. Tektronix is represented in twenty-five overseas countries by qualified engineering organizations. European and African countries, the countries of Lebanon and Turkey, please contact TEKTRONIX INTERNATIONAL A.G., Terrassenweg 1A, Zug, Switzerland, for the name of your local engineering representative. Other Overseas areas, please write or cable directly to Tektronix, Inc., International Marketing Department, P. O. Box 500, Beaverton, Oregon, U.S.A. Cable: TEKTRONIX.

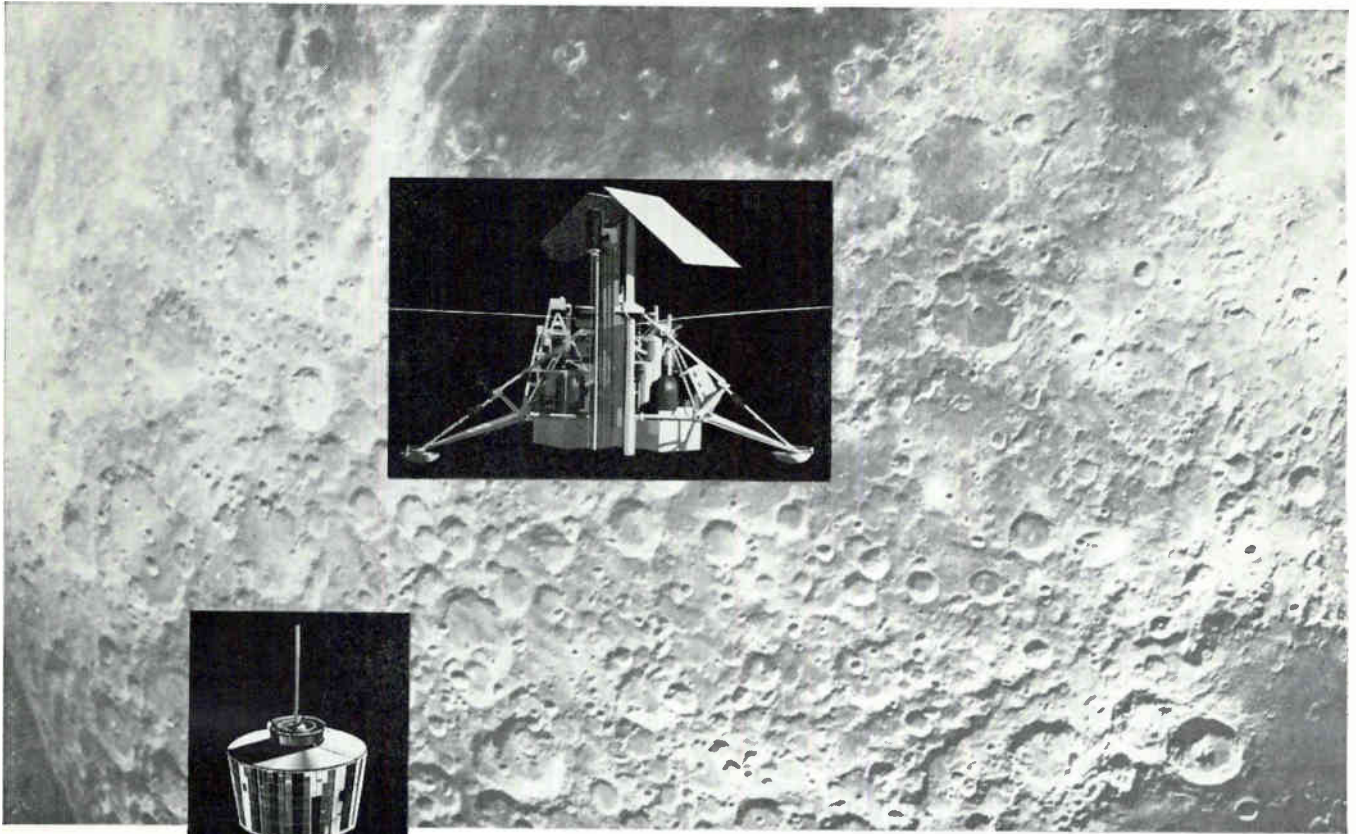

# systems analysts:

Quantify the complex on important projects at Hughes!

SURVEYOR (soft lunar landing spacecraft), SYNCOM (synchronous communications satellites), ARPAT (terminal anti-ballistic missile defense system), BAMBI (anti-ballistic missile defense feasibility study). These are a few of the many important and complex projects under design, development and study at Hughes.

Because of these projects and others important to the nation's defense, preparedness and space effort, Hughes offers more opportunities to Systems Analysts than ever before.

Involved with these positions are the consideration of many basic problems such

as: the proper mix of manned vs. unmanned satellites; the requirements of manned space flight; IR systems requirements for high speed strike reconnaissance systems or unmanned satellites; analysis of weapon systems from conception through development, test and customer use; and many others.

**Inquire today.** If you are a graduate engineer or physicist from an accredited university, a U. S. citizen, and believe that you can contribute to and benefit from the important projects at Hughes, contact us today. Airmail your resume to:

**Mr. Robert A. Martin,  
Supervisor of Scientific Employment  
Hughes Aerospace Divisions  
11940 W. Jefferson Blvd.,  
Culver City 2, California**

We promise you a reply within one week.

An equal opportunity employer.

Creating a new world with ELECTRONICS

**HUGHES**

HUGHES AIRCRAFT COMPANY  
**AEROSPACE DIVISIONS**

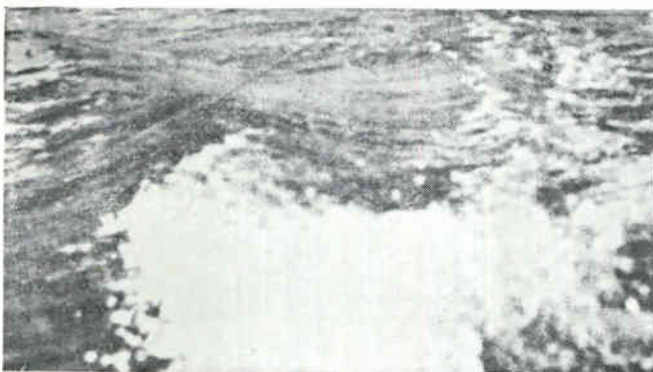



# DESIGN AND APPLICATION

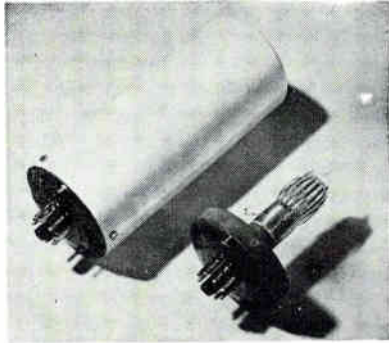

## Crystal Oven Has No Thermostat USES LATENT HEAT OF FUSION

MARCONI INSTRUMENTS, 111 Cedar Lane, Englewood, New Jersey announces a new crystal oven which eliminates temperature fluctuation arising from thermostatic control. Melting point of crystalline naphthalene at normal atmospheric pressure serves as a standard. When the naphthalene is partially melted, and a layer of liquid is in contact with the solid layer, boundary temperature is at melting point temperature and the property of latent heat of

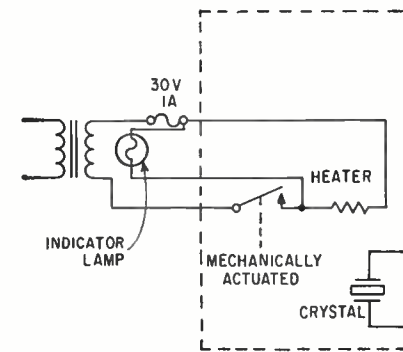

fusion prevents temperature variation. A thin layer of solid is maintained around the crystal chamber by making use of the change in volume accompanying change of state. Volume change operates pressure-sensitive switch controlling power to heater. Type F3006 stabilizes at 79.5 C although further types will stabilize at 48 C. Cyclic temperature variation is claimed at less than  $\pm 0.0014$  C.

**CIRCLE 301 ON READER SERVICE CARD**

## New Fluid Density Meter USES MASS-CONTROLLED OSCILLATOR

CO-ENGINEERING COMPANY, Box 194, Boonton, New Jersey announces the DENSITOR for measuring the density of fluids, mixtures and suspensions. The device uses an elec-

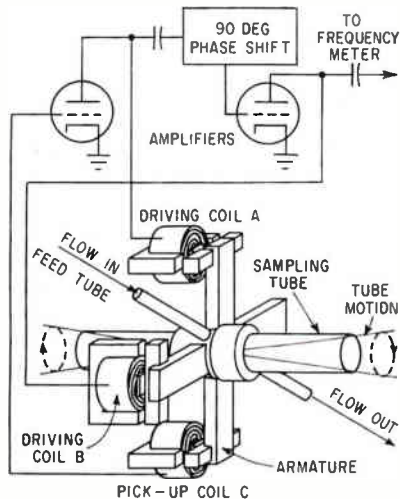
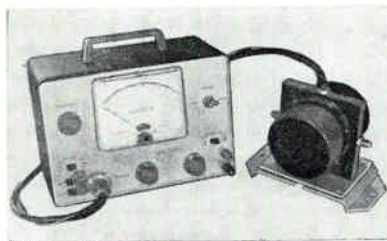

tromechanical vibrating tube as the measuring element. It is supported by a spring suspension and is caused to vibrate at its natural frequency by electromagnets. Two electromagnets driving at right angles cause the vibrating tube to move so that any material within the tube is subjected to unidirectional rotation. A baffle within the tube insures complete exchange of material with flow. The sensing element has three armatures and the sampling tube is suspended by springs within

the frame. Excitation will cause the system to vibrate at its natural frequency. Pickup coils are mounted adjacent to the armatures. If the output of pickup coil C were amplified and fed to driver coil A, oscillations would occur in the vertical plane. If the output signal is shifted 90-degrees and applied to driver coil B, the ends of the sampling tube will trace a circular path. A nutating motion is achieved in which all portions of the tube and contents follow a circular motion. When the sampling tube is filled with fluid, mass will be different, thus altering natural vibrating frequency. Density of fluid is determined by vibration frequency. Maximum full-scale sensitivity is 0.1 specific gravity unit, and will withstand fluid pressures from -15 to +500 psi. Can also be used to measure finely divided soils.

**CIRCLE 302 ON READER SERVICE CARD**

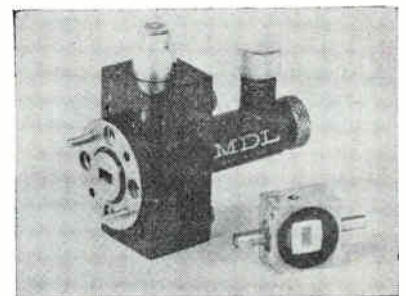

## Crystal Holders RUGGED, LIGHTWEIGHT

MICROWAVE DEVELOPMENT LABORATORIES, INC., 15 Strathmore Rd., Natick, Mass. A WR15 crystal holder, model 15DH16, incorporates compact design and superior performance, making it suitable for microwave system design. Covering the frequency range 68.0-72.0 Gc, unit uses a 1N2792 crystal.

**CIRCLE 303 ON READER SERVICE CARD**

## Precision Eyelets

RAMCO MFG. CO., 540 Westfield Ave., W., Roselle Park, N.J. Eyelet sizes in an o-d range of from 0.046 to

**CIRCLE 129 ON READER SERVICE CARD** →



**BMEWS** ... eyes of the free world

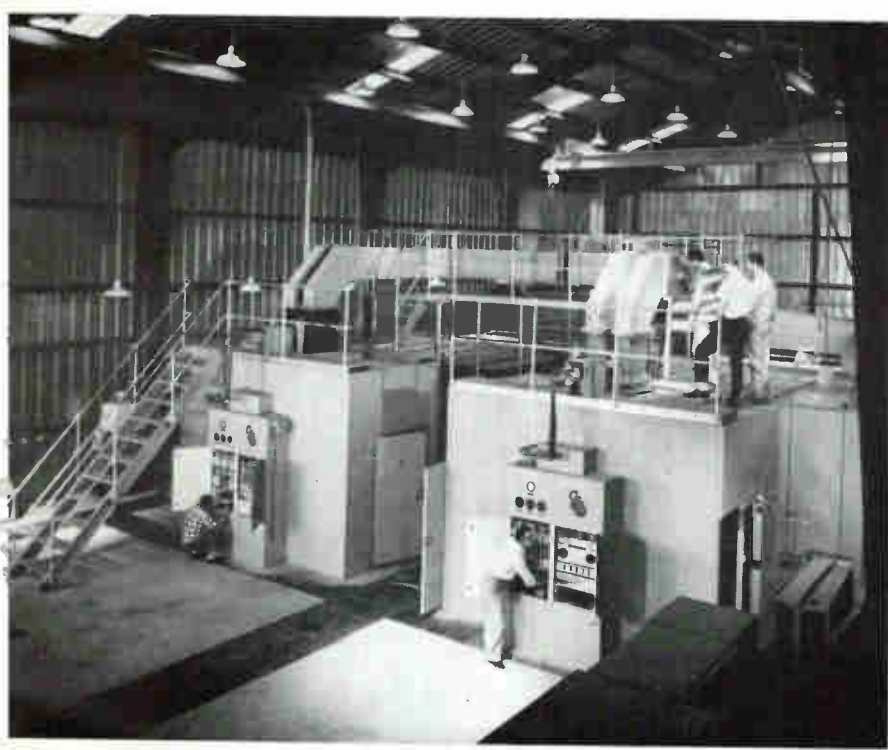

BMEWS ... the Ballistic Missile Early Warning System is the free world's first warning of enemy ICBM attack.

Powerful radars with an accurate range of thousands of miles can detect incoming ICBMs minutes after launching. The transmitters for this defense system are being built by Continental Electronics ... specialists in super power transmitting equipment.

Provided under sub-contract to General Electric and R.C.A., these transmitters from Continental Electronics are another contribution to our country's defense.

# Continental Electronics Co

MANUFACTURING COMPANY

4212 South Buckner Blvd. • Dallas 27, Texas • EVergreen 1-1135 • LTV SUBSIDIARY OF LING-TEMCO-VOUGHT, INC.



DESIGNERS AND BUILDERS OF THE WORLD'S MOST POWERFUL RADIO TRANSMITTERS  
ENGINEERS ... FOR STIMULATING WORK ON THE ELECTRONICS FRONTIERS OF TOMORROW WITH A DYNAMIC, CREATIVE ORGANIZATION, SEND RESUME TO DIR. OF PERSONNEL.



0.100 in. are available in stock sizes for applications in electronic tubes, printed circuitry and other components and devices.

**CIRCLE 304 ON READER SERVICE CARD**

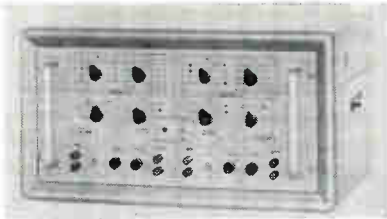

### Filter

#### RESPONSE TO D-C

DYTRONICS CO., 5485 N. High St., Columbus 14, Ohio. Model 722 filter offers two separate variable frequency filters in a single package. The two filter sections may be used in separate circuits as individual filters or may be cascaded to produce more desirable response characteristics. Each section may be operated as either a low-pass or high-pass filter with the cutoff frequencies adjustable from 1 cps to

100,000 cps. As a low-pass, it offers response to d-c; as a high-pass, frequency response extends over 1 Mc.

**CIRCLE 305 ON READER SERVICE CARD**

### Subminiature Switch

U.S. SWITCH CORP., 7 Jefry Lane, Hicksville, N.Y. Model 710 high current switch has a rated life of over 1 million operations; temperature range, -100 to 250 F; contact arrangement, spdt.

**CIRCLE 306 ON READER SERVICE CARD**

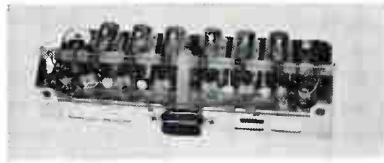

### VHF Amplifier

#### BROADBAND

MOTOROLA INC., 8330 Indiana Ave., Riverside, Calif., has available a low-cost MIL-E-5400 broadband

vhf amplifier. Model LPD01 weighs less than 6 oz and occupies less than 12 cu in. Unit provides 9 db gain over the entire 30 Mc to 300 Mc range. The amplifier is designed as a plug-in module that can be readily cascaded ahead of a tuned receiver, or used as a crystal video receiver by employing a crystal detector.

**CIRCLE 307 ON READER SERVICE CARD**

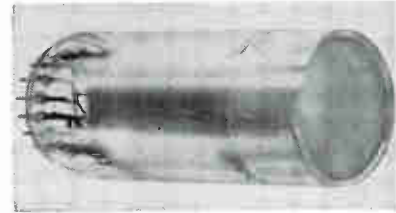

### Photomultiplier Tube

#### LINEAR OUTPUT

EMI/US, 1750 N. Vine St., Los Angeles 28, Calif. The 9637B tube is recommended for general purpose scintillation counting applications where gain stability and good output linearity are required. It has a 44 mm diameter end-window photo-



cathode and six venetian-blind type cesium-antimony dynodes. It has a 15 pin glass base, and is supplied with a matching low-loss Teflon socket.

**CIRCLE 308 ON READER SERVICE CARD**

### Germanium Switch

TEXAS INSTRUMENTS INC., P.O. Box 5012, Dallas 22, Texas, has introduced the TI 2N797 high-speed *npn* germanium mesa switch.

**CIRCLE 309 ON READER SERVICE CARD**



### Summing Amplifiers TRANSISTORIZED

MELCOR ELECTRONICS CORP., 48 Toledo St., Farmingdale, L.I., N.Y. Transistorized summing amplifier

provides quadrature rejection at the null point in a servo loop. Model 1060 features 150:1 quadrature rejection ratio, operates at 400 cps, and has low noise characteristics. It has a summing accuracy of  $\pm 0.05$  percent and 200,000 v input impedance.

**CIRCLE 310 ON READER SERVICE CARD**



### R-F Calorimeter DRY LOAD

MELABS, 3300 Hillview Ave., Palo Alto, Calif., offers a dry load calorimeter for precise and accurate power measurements over the frequency range of 50-75 Gc. Sensitivity is 50  $\mu$ w or better and power

range extends to 100 mw. Power can be determined from supplied calibration curves or obtained to high accuracy by utilizing the built-in d-c calibrator. Price is \$1,550, delivery 60 days.

**CIRCLE 311 ON READER SERVICE CARD**

### Epoxy Casting System

THERMOSET PLASTICS, INC., 4015 Millersville Road, Indianapolis 5, Ind. Resin No. 609 clear colorless epoxy casting system is designed to cure in two hours or at temperatures at low as 175 F.

**CIRCLE 312 ON READER SERVICE CARD**



### R-F Connector CLOSED ENTRY CONTACT

THE DEUTSCH CO., Municipal Airport, Banning, Calif. Subminiature

# NEW MULTI-PURPOSE GLASS-EPOXY LAMINATE

Engineered by Taylor to meet all NEMA standards and military specifications

A new material, Fireban 1011, is the first glass-epoxy laminated plastic to meet all known specifications for high mechanical strength and flame retardance with excellent punchability.

Fireban 1011 has a lengthwise flexural strength of 80,000 psi for 1/16 in. sheet and 76,000 psi for 1/8 in. Crosswise flexural strength is 70,000 and 65,000 psi respectively. It retains over 50% of its strength at 300 F.

Sheets up to 1/16 in. may be cold punched at room temperature without halving. Other important advantages are low moisture absorption, high chemical resistance, excellent electrical properties even after being subjected to severe humidity conditions.

In flame retardance tests proposed by Underwriters' Laboratories Inc., vertical and horizontal extinguishing time is 5 seconds for both 1/16 and

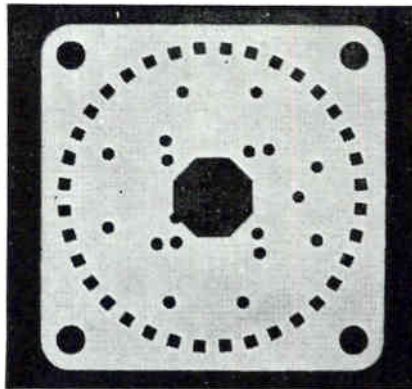

1/8 in. sheets. Fireban 1011 has passed even more stringent tests specified by major users of laminates.

Two types of Fireban 1011 are now available: plain sheets and copper-clad sheets with 1, 2, 3, or 5-oz. copper foil on one or both sides. Sheet thicknesses range from .010 to 2 in. and sheet sizes are approximately 36 x 48 in.

Technical data bulletins give complete information, including

physical, mechanical and electrical properties on both types of Fireban 1011. Write for your copies today. Taylor Fibre Co., Norristown 40, Pa.

**Taylor**  
LAMINATED PLASTICS VULCANIZED FIBRE



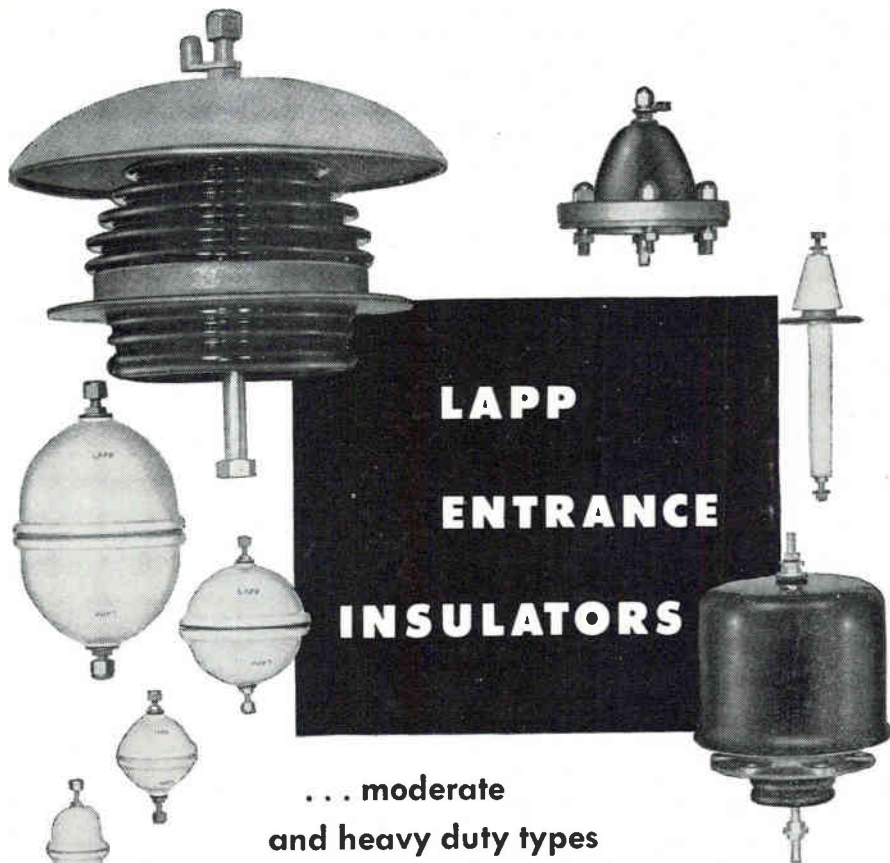

**LAPP  
ENTRANCE  
INSULATORS**

... moderate  
and heavy duty types  
... low voltage and apparatus types

A design which uses air as major insulation, with leakage path lengthened by forming porcelain into a bowl, eliminates losses which occur in ordinary types of bushings at radio frequency.

Lapp moderate duty insulators, suitable for a variety of low or medium voltage applications, are the standard type bowls for carrying leads through shields, equipment cases, walls, etc., and practically any indoor use where duty is not too severe.

Outdoor units are designed with corrugated surfaces which provide extra leakage distance for use in contaminated atmosphere. Corrosion-resistant hardware.

A wide variety of types of these insulators is now available as catalog items . . . or where requirements necessitate, on special design—for which Lapp engineering and production facilities are excellently qualified. Write for complete descriptive data and specifications. Lapp Insulator Co., Inc., Radio Specialties Division, 187 Sumner Street, Le Roy, N. Y.



coaxial connector featuring closed entry contacts is designed for complete environmental performance. It has a retention spring housed within the barrel of the socket inner-conductor. The connector has been tested to a vswr rating below 1.2:1, up to 4 Gc, and is available in 6 alternate key way positions to prevent mismatching in multiple connector applications.

**CIRCLE 313 ON READER SERVICE CARD**

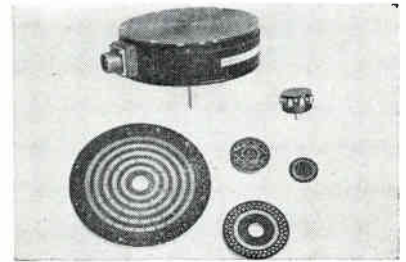

**Rotary Switches  
CONDUCTIVE PLASTIC**

MARKITE CORP., 155 Waverly Place, New York 14, N.Y., offers a line of precision rotary switches for controls and instrumentation. Incorporating completely molded and flush switch plates, the switches achieve elimination of stick-slip phenomena. They offer long wear-life capabilities, with good signal-to-noise ratios when switching light to moderate signals, even under environmental extremes.

**CIRCLE 314 ON READER SERVICE CARD**

**Solid State Sensor**

MICRO SYSTEMS INC., 319 Agostino Rd., San Gabriel, Calif., announces series DO1, a semiconductor displacement transducer for structural test applications.

**CIRCLE 315 ON READER SERVICE CARD**

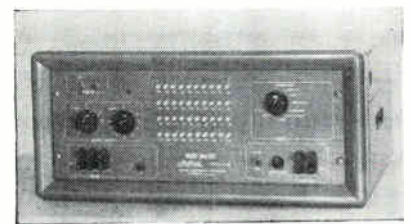

**Word Generator  
AND DISPLAY**

DIGITAL ELECTRONICS CORP., 161 Sullivan Lane, Westbury, L.I., N.Y. Two all-transistorized Word Mas-

ters operate as a word generator and display. They operate from 0 to 500 Kc and 500 Kc to 5 Mc with word lengths up to 40 bits. The versatile model 1040 Word Master has provision for input and output synchronization to other equipment, choice of pulsed or NRZ output with amplitude control and a choice of automatic or manual key input. Output amplitude and sync signals are variable from 1 to 20 v. Prices start at \$1,950.

**CIRCLE 316 ON READER SERVICE CARD**

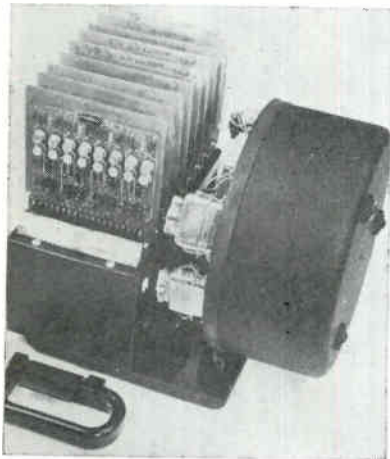

### Magnetic Storage Drum HIGH SPEED

COGNITRONICS CO., Briarcliff Manor, N.Y. Featuring high frequency recording and high pulse densities, the low-cost, small-space model 4-20 provides a high speed drum access storage component for data reduction and processing systems, with pulley and belt drive permitting selected drum speeds to 25,000 rpm. Drum has capacity of up to 50 tracks with individually adjustable heads, employing a record current of approximately 100 ma through either coil.

**CIRCLE 317 ON READER SERVICE CARD**

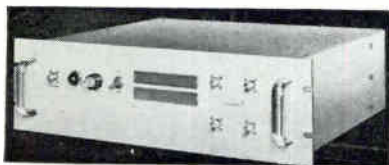

### Multicoupler BROADBAND

APPLIED RESEARCH, INC., 76 South Bayles Ave., Port Washington, N.Y. True broadband coverage from 500 to 1,000 Mc with a better than 10 db noise figure is available with model

## THIS WELDMATIC WELDING HEAD IS USED TO PRODUCE MORE MODULES THAN ALL OTHER MAKES combined

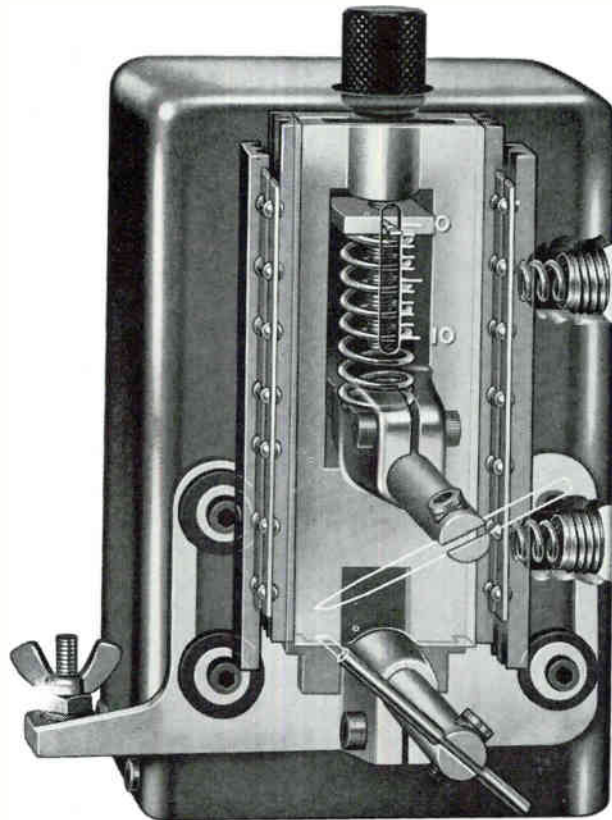

### Here's why—

#### Fastest Follow-Up

Model 1032 combines (1) near-zero inertia of lightweight electrode arm with (2) minimum friction (thanks to self-adjusting spring loaded linear raceways) and (3) low spring-rate driving force, to supply *ultimate* acceleration capability throughout the weld formation period. The vital combination of these 3 factors determines the resultant Weld-Schedule optimum "maximum-strength" area.

#### Absolute Linear Electrode Movement

Long linear ball-bearing raceways allow only perfect, non-wiping action—wiping action being a major contributor to mediocre welds.

#### True Force Firing

Patented, pure force-firing action is designed into the Model 1032. Weld energy is released to the electrodes only—and exactly—when the preset force is reached, regardless of setup configuration.

#### Self-Adjusting Raceways

Dual, linear ball-bearing raceways,

spring loaded for full compliance, compensate for wear, thermal effects, and normal dirt and provide absolute, lowest constant friction over full electrode arm stroke.

#### Minimum Movable Mass

All parts moving during follow-up total less than 4 ozs. Die-cast electrode arm and holder, with electroplated high conductivity interfaces, offer highest welding efficiency yet lowest mass.

#### Full Flexibility and Accessibility

The head features full frontal 3-dimensional access with fully adjustable arm lengths. The head operates at any desired work position, either singly or in double head combinations.

#### Full Line of Tailored Accessories Available

Optimum production weld repeatability results through minimizing operator fatigue. Tailored accessories such as actuators, illuminator, magnifiers, riser assembly, horizontal adaptor, etc., provide these results.

*For detailed specifications write:*

**WELDMATIC DIVISION / UNITEK**

950 ROYAL OAKS DRIVE, MONROVIA, CALIFORNIA



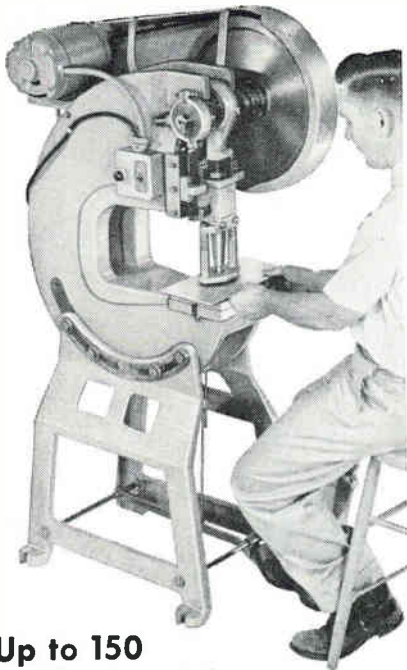

**Up to 150  
Strokes Per Minute...  
NEW DI-ACRO OPEN  
BACK INCLINABLE  
PUNCH PRESS NO. 5**

This new bench type punch press has five tons of power for punching, forming, shearing, marking, riveting, staking or embossing. Single stroke cycling, 150 s.p.m., or continuous operation, 210 s.p.m. Deep 12 inch throat allows working to center of 24" sheet. Spring loaded material stripper—easy to set up—ideal for women operators or inexperienced help. Standard equipment includes motor, brake, flywheel guard, all electrical connections, punch holder, stripper assembly and die holder.

**HAND OPERATED  
PUNCH PRESSES —**

Di-Acro Punch Presses No. 1 and 2 both provide 4 tons of power that will punch holes up to 4" round in 16 ga. mild steel using punches with shear. No. 1 has 6 1/4" throat depth and No. 2 a 12 1/4" throat depth. Both model come with short handle, long handle for heavier materials, punch and die holders turret stripper, back and side gauges.



**PRECISION PUNCHES AND DIES—**

Over 500 sizes of single station Di-Acro punches and dies are available from factory stock, plus adjustable punches and dies for multiple punching in one operation.

For complete information consult the yellow pages of your phone book under Machinery: Machine Tools for the name of your nearest distributor or write us.



pronounced  
"die-ack-ro"

See complete Di-Acro line in  
Sweet's Machine Tool Catalog



**DI-ACRO  
CORPORATION**  
formerly  
O'Neil Irwin Mfg. Co.  
431 8th Avenue  
Lake City, Minn.

HFM-6(A) 50100-4 multicoupler. Unit has four isolated outputs at 50 ohms. Gain, overall, from the 50 ohm input to any output is 10 db minimum. It draws approximately 75 w total from a 115 v line.

**CIRCLE 318 ON READER SERVICE CARD**



**Field Strength Meter  
PORTABLE UNIT**

SMITH ELECTRONICS, INC., 8200 Snowville Road, Cleveland 41, O. Model SM-1 field strength meter is a self-contained, gain stabilized radio receiver of high quality and metered output, reading in both voltage and decibels. It tunes continuously over a vhf range from 52 to 220 Mc and a uhf range from 450 to 900 Mc.

**CIRCLE 319 ON READER SERVICE CARD**

**Waveguide**

BART MFG. CO., Newark, N.J., has produced a lightweight, high accuracy waveguide with electroformed nickel.

**CIRCLE 320 ON READER SERVICE CARD**

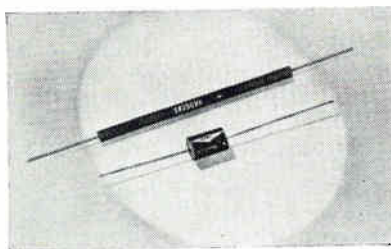

**Selenium Rectifiers  
CARTRIDGE TYPE**

ELECTRONIC DEVICES, INC., 50 Webster Ave., New Rochelle, N.Y. A line of h-v, insulated-case, selenium cartridge rectifiers is suited for compact packaging. Available in ratings from 50 to 25,000 piv, the

**if**

**YOUR PRODUCTS  
NEED**

**PROTECTION**

**YOU NEED**

**HumiSeal<sup>®</sup>  
PROTECTIVE  
COATINGS**

There's a HumiSeal Protective Coating for virtually every electronic use.

Write today for complete data on the HumiSeal line of coatings so you can select coatings best suited for your application.



**COLUMBIA  
TECHNICAL  
CORPORATION**

Woodside 77, N.Y. - YE 2-0800

**CIRCLE 204 ON READER SERVICE CARD**  
electronics

**BIG NEWS** in high-temperature  
precision-molded insulation

# **SUPRAMICA®** **620 "BB" ceramoplastic**

Need a precision-molded insulation material with total dimensional stability under the most adverse thermal cycling, operating to 1200°F. . . . or a material with previously unattainable combination of properties? Check these facts about new SUPRAMICA 620 "BB" ceramoplastic:

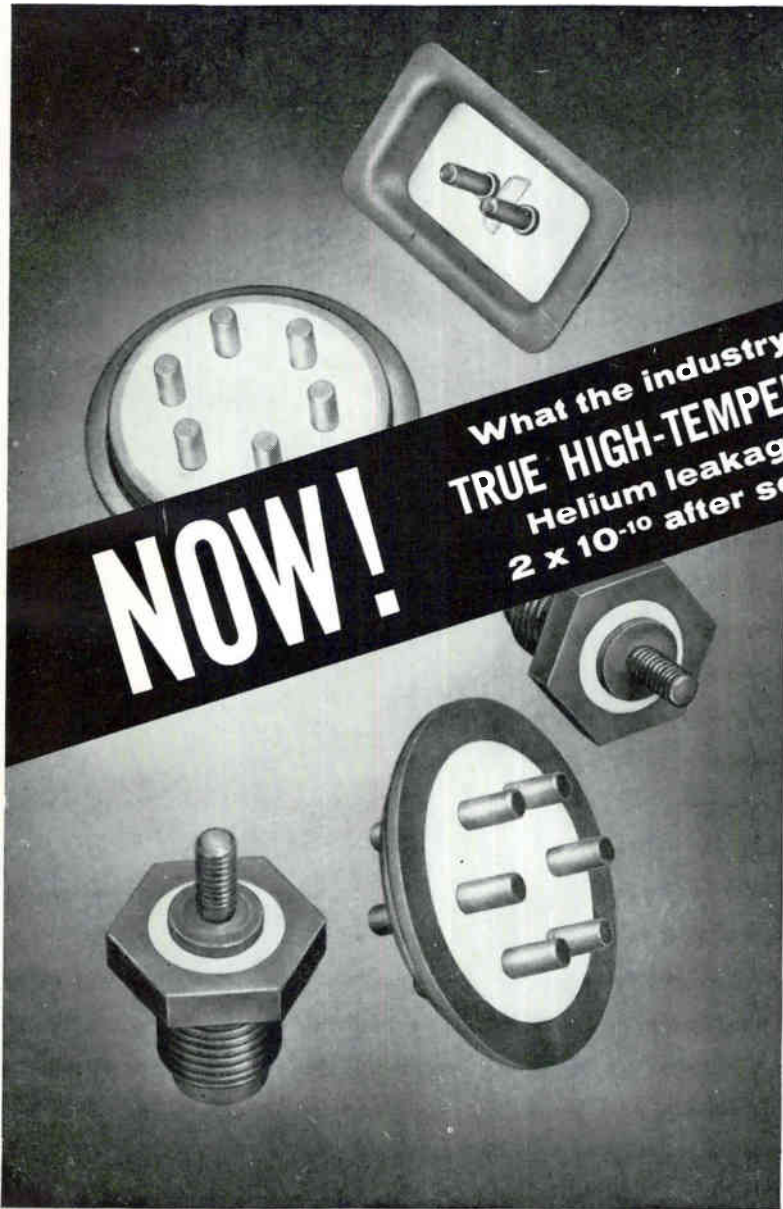

**NOW!**

What the industry has been waiting for . . .  
**TRUE HIGH-TEMPERATURE HERMETIC SEALS**  
Helium leakage rate cc/sec. less than  
 $2 \times 10^{-10}$  after severe environmental tests.

- Maximum temperature endurance of material 1200°F. (unstressed). Heat distortion temperature of material 1100°F. (ASTM D648-264 PSI)
- SUPRAMICA 620 "BB" ceramoplastic can be precision molded to most intricate geometries with gauge-like tolerances.
- SUPRAMICA 620 "BB" ceramoplastic will not carbonize.
- Absolute hermetic seals achieved directly during the molding cycle. Components meet a helium leakage rate of less than  $2 \times 10^{-10}$  cc/sec., after the following environmental tests:
  1. Samples heat shocked a total of 20 cycles from boiling water for 30 minutes directly to ice water for 10 minutes.
  2. Samples heat shocked a total of 5 cycles, from 350°C. for 1 hour directly to room temperature for 10 minutes, to -70°C. for 1 hour, to room temperature for 10 minutes.
  3. Samples heated to 500°C. for 4 hours and directly to room temperature.
- Thermal expansion factor matches many metals and alloys.
- New SUPRAMICA 620 "BB" ceramoplastic features a dielectric strength of 270 volts/mil, 1/8" thickness per ASTM D-149.

WRITE for Information and Engineering Data Sheets on  
**SUPRAMICA 620 "BB"**  
and other MYCALEX® glass-bonded mica  
or SUPRAMICA ceramoplastic insulations.

General Offices and Plant: 120 Clifton Boulevard, Clifton, N. J.  
Executive Offices: 30 Rockefeller Plaza, New York 20, N. Y.

World's largest manufacturer of ceramoplastics, glass-bonded mica and synthetic mica products





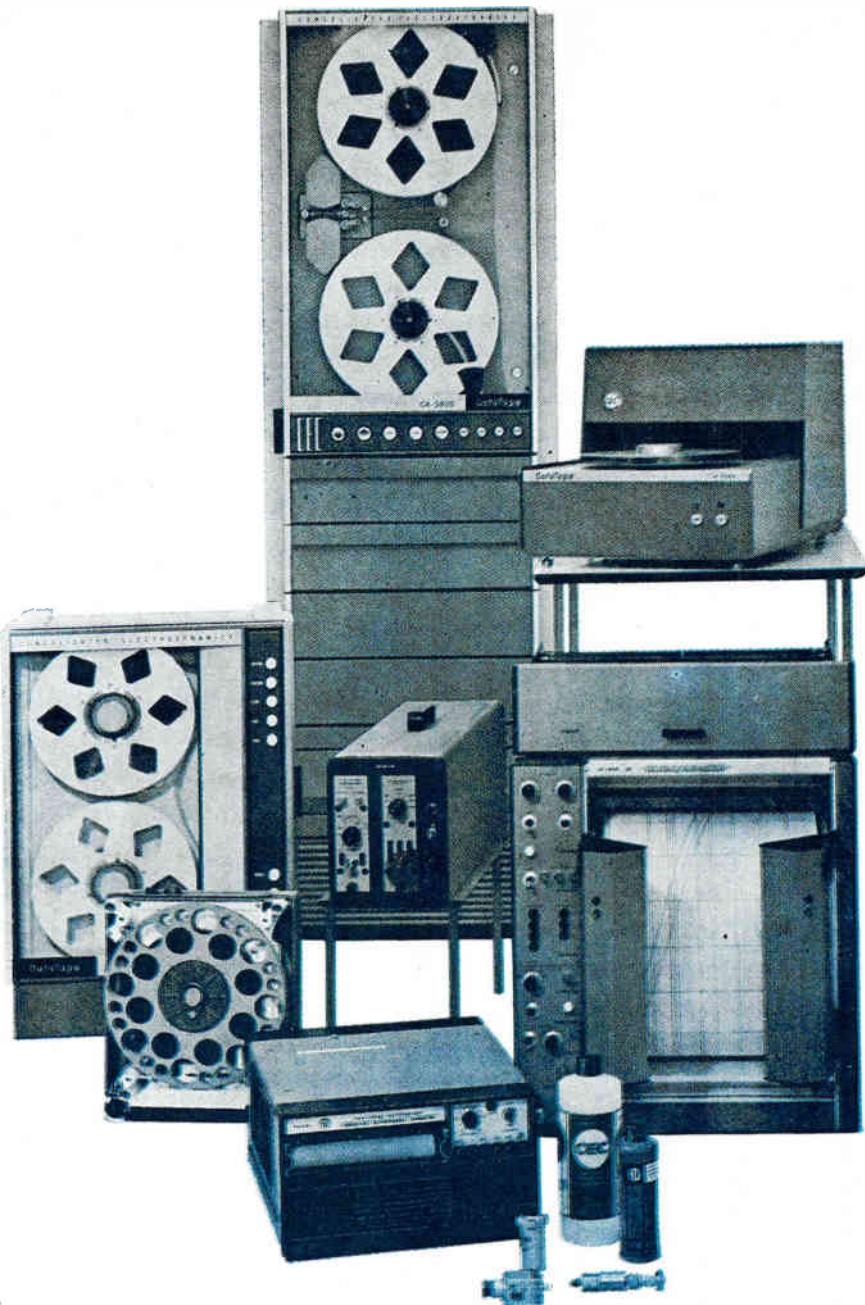

## recognize the family?

You might. They keep the best of company. And they're just part of the *total* data recording capability only CEC can give you. □ There are Magnetic Tape Recorders for ground station systems and portable use . . . Tape Degaussers . . . D-C Amplifiers . . . Multichannel Recording Oscillographs with a complete line of recording papers and processing chemicals . . . Transducers, too. A whole lot. From data input to output, the CEC family is the most extensive and compatible anywhere! □ Special project? CEC can handle it. As they did with the Mercury Space Capsule Recorder shown in the left middleground. For any data recording job, call your nearest CEC office. Or write today for CEC Bulletins 1309-X1 and 1310-X1.

# CEC

Data Recorders Division

**CONSOLIDATED ELECTRODYNAMICS**  
PASADENA, CALIFORNIA • A SUBSIDIARY OF BELL & HOWELL

rectifiers have o-d's from  $\frac{1}{8}$  to  $\frac{1}{2}$  in. and are  $\frac{3}{4}$  to  $9\frac{1}{4}$  in. long. D-C output current ratings at 40 C ambient are 1 ma, 3 ma, 5 ma, 7 ma, and 10 ma. Units have very low forward voltage drop and reverse leakage.

**CIRCLE 321 ON READER SERVICE CARD**

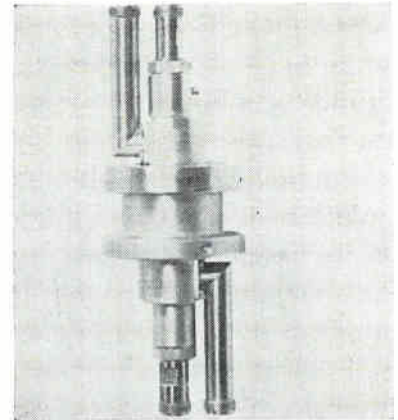

### Coax Rotary Joints DUAL-CHANNEL

GENERAL ELECTRONIC LABORATORIES, INC., 18 Ames St., Cambridge, Mass. Two compact dual-channel coaxial rotary joint assemblies with broad-band frequency characteristics are available. The couplers feature low vswr's and minimal insertion losses with negligible wow. The inner channel of each coupler uses direct contact to allow performance over the frequency range from d-c to 11 Gc. Outer channel is non-contacting and designed to cover approximately an octave band in the S and C frequency ranges.

**CIRCLE 322 ON READER SERVICE CARD**

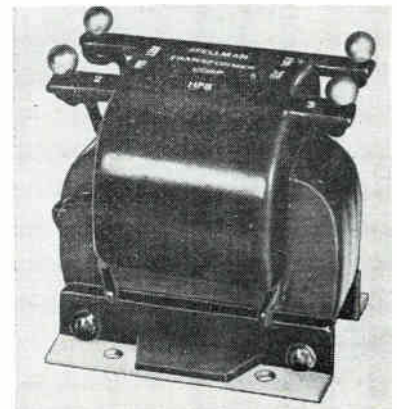

### H-V Transformer 110 V 60 CPS INPUT

SPELLMAN HIGH VOLTAGE CO., INC., 1930 Adey Ave., Bronx 69, N.Y., announces model HP-8 high voltage transformer with output of 8 Kv

rms, 10 ma. Suitable for use in 20 Kv doubler circuit. Unit is 5 in. wide by 5 in. high by 4½ in. deep. Price is \$30 net.

**CIRCLE 323 ON READER SERVICE CARD**



### Variable Attenuators

1.3 TO 4.0 GC

HYCON MFG. CO., 700 Royal Oaks Drive, Monrovia, Calif. Continuously variable attenuator provides a means of attenuation of power from 0 db to greater than 30 db. Unit contains an easily adjusted minimum backlash attenuator blade and is supplied with TNC coaxial connectors at the input and output. Special microwave lossy material was used to obtain 30 db attenuation minimum in the 4-in. long unit at 1.3 Gc.

**CIRCLE 324 ON READER SERVICE CARD**

### Transducer

TRANS-SONICS, INC., P.O. Box 328, Lexington 73, Mass., has available a thermocouple transducer which provides its own cold-junction reference compensation.

**CIRCLE 325 ON READER SERVICE CARD**

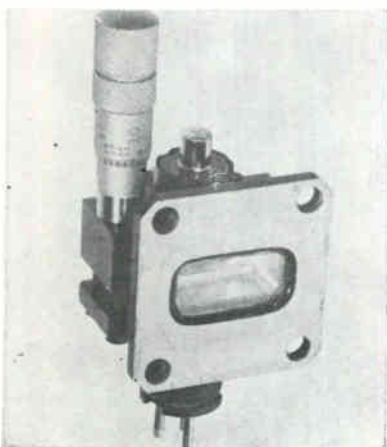

### X-Band Klystron

TUNABLE

METCOM INC., Salem, Mass. Model MXK-26 X-band klystron features a micrometer tuner, an integral cavity, a waveguide output, and a 3-pin Pee-Wee phenolic base. It is

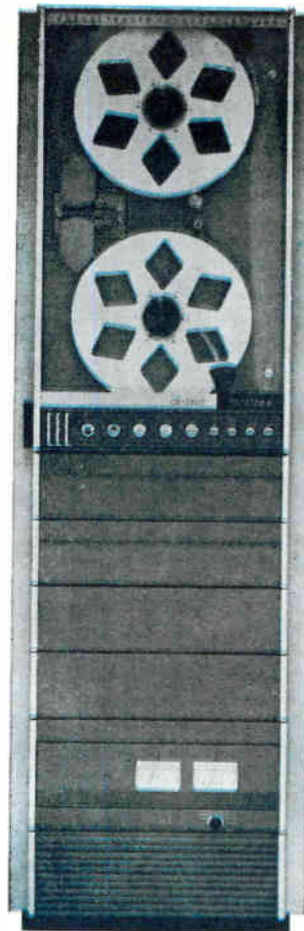

## meet the latest member

For a new product, CEC's GR-2800 Recorder/Reproducer is grown-up indeed. It is more versatile, has a higher stability and costs less than any comparable instrument. Proof is in its features: solid state electronics; direct, FM and PDM modes; plug-in amplifiers interchangeable with PR-3300 electronics; magnetic amplifier tape tension control; six standard speeds 1⅞ to 60 ips; direct record response 100 cps - 100 kc; FM response 0 - 10 kc; and 14-channel recorder/reproducer in a single cabinet. □ Want to know more? Call your CEC office or write for Bulletin CEC 2800-X9.

# CEC

Data Recorders Division

**CONSOLIDATED ELECTRODYNAMICS**  
PASADENA, CALIFORNIA • A SUBSIDIARY OF BELL & HOWELL





## PINPOINT ACCURACY FOR NASA'S SATURN

... by inertial guidance systems tested on

## DUNN TURNTABLES

Precise directional accuracy of missile or space vehicles such as the SATURN depends on the gyros ... which must in turn be precision-engineered.

Right now, Dunn Air Bearing Test Turntables are the only tables available capable of quick, reliable and accurate evaluation of the new generation of ultra-accurate inertial gyros.

Dunn T918 Turntable will be used to test the guidance system of the SATURN. Largest air bearing test turntable ever built, the T918 handles loads in excess of

500 lbs ... tests gyros with drift rates of the order of  $0.001^\circ/\text{hr}$ .

Dunn Air Bearings are an advanced concept design with many varied applications in the aerospace field. We'd like to discuss your aerospace hardware needs ... phone us at Cambridge direct: 491-3300.

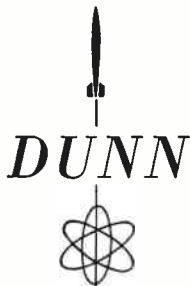

ENGINEERING CORPORATION

38 HENRY STREET

CAMBRIDGE 39, MASSACHUSETTS

• ADVANCED ELECTRONIC SYSTEMS • TEST FACILITIES  
ENGINEERING • RADAR TEST SYSTEMS • INERTIAL PRODUCTS

tunable over a range from 8.1 Gc to 12.1 Gc; has a minimum power output of 100 mw and the resonator voltage is 500 v. Reflector voltage is  $-20$  v min to  $-1,000$  v max. Available from stock for \$225.

CIRCLE 326 ON READER SERVICE CARD



## Delay Lines

MAGNETOSTRICTIVE

COMPUTER DEVICES CORP., 6 W. 18 St., Huntington Station, N.Y. Series of standard magnetostrictive delay lines cover the entire range from 2 to 5,000  $\mu\text{sec}$  in 7 space-saving package sizes. They feature temperature coefficients of delay of better than  $\pm 10$  ppm/deg C; signal to noise ratio of better than 7 to 1; delay trim range of  $\pm 4$   $\mu\text{sec}$  from nominal delay; digital bit rates or frequency response up to 1 Mc for delays up to 2,000  $\mu\text{sec}$ ,  $\frac{3}{4}$  Mc to 4,000  $\mu\text{sec}$ , and  $\frac{1}{2}$  Mc to 5,000  $\mu\text{sec}$ .

CIRCLE 327 ON READER SERVICE CARD

## Miniature Servo

GENERAL PRECISION INC., Librascope Division, Glendale, Calif. Model 100-2 is a miniature servo for use in both analog and digital systems.

CIRCLE 328 ON READER SERVICE CARD

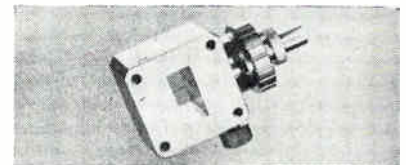

## Slotted Line

FOR X-BAND

SOMERSET RADIATION LABORATORY, INC., 192 Central Ave., Stirling, N.J. Model X103 fixed waveguide slotted line has a stability that permits system as well as laboratory

**REVEAL  
HIDDEN DATA**  
*with the*  
**MINCOM  
SERIES  
CM-100**

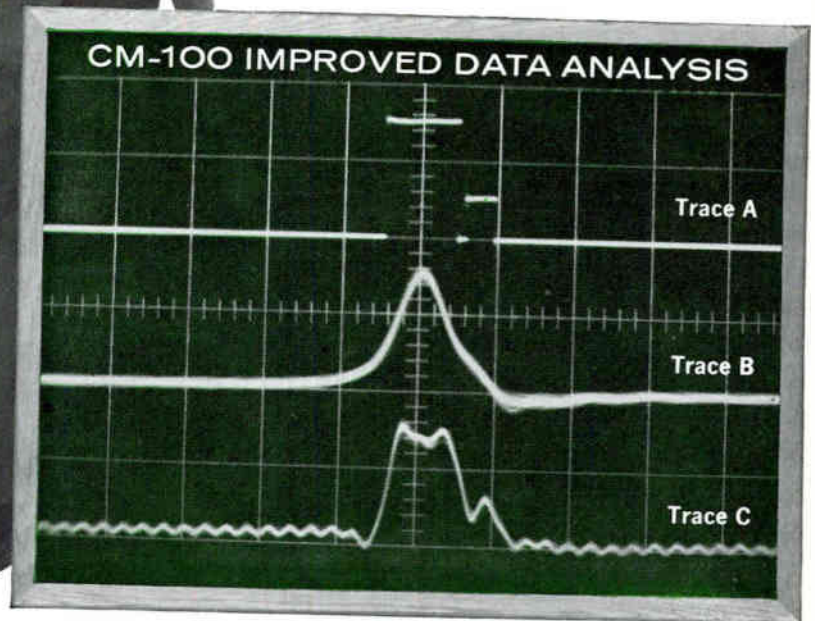
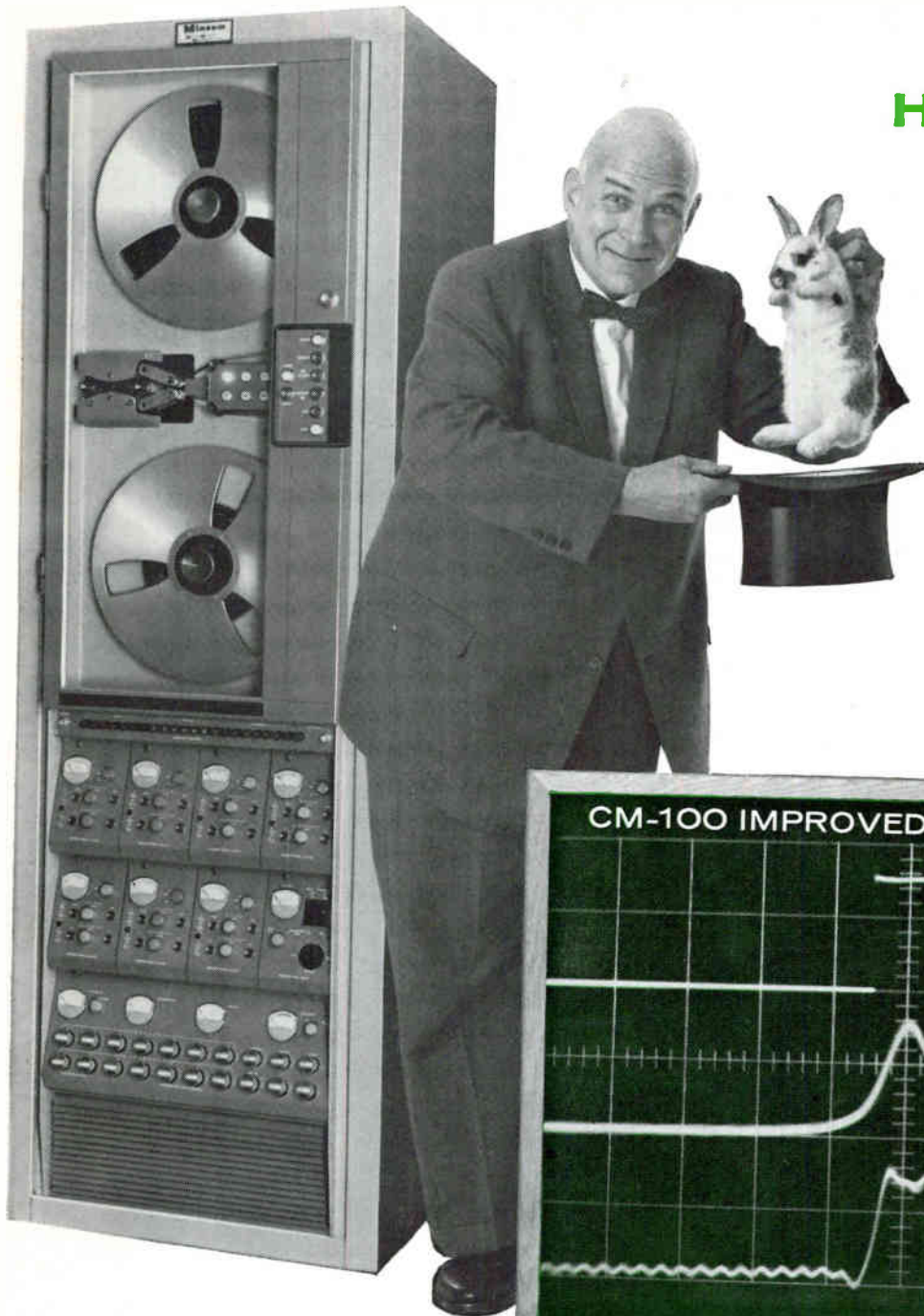

10  $\mu$ s pulse separated from 4  $\mu$ s pulse by 1.2  $\mu$ s space. Trace A: 100-kc system input. Trace B: 100-kc output. Trace C: CM-100 output. Sweep Rate: 10  $\mu$ s/cm. Vertical Deflection: .5v/cm.

Pulses recorded on any standard 100-kc system reveal previously undisclosed data when played back on the Mincom Series CM-100 Video Instrumentation Recorder/Reproducer. At 60 ips, a prerecorded tape from a standard 100-kc recorder will present on the CM-100 an improved frequency response of 200-220 kc  $\pm$  4 db with a practical limit of 250 kc. CM-100's superior playback heads and phase-compensating electronics produce better rise time, correcting for phase shift and overshoot. This recovery of hidden data is only one of the advantages of the CM-100, a 7 or 14-track 1-megacycle system which is now performing predetection recording/reproducing on an operational basis—in FM/FM modulation, PCM and PCM/FM. Write for specifications.

... WHERE RESEARCH IS THE KEY TO TOMORROW

**Mincom Division** **3M** **MINNESOTA MINING & MANUFACTURING CO.**

LOS ANGELES 25, CALIFORNIA • WASHINGTON 4, D. C.





**GUARANTEE  
of Quality**

**This GUDEBROD Lacing  
Tape is Manufactured  
under strict Quality  
Control. Complete test  
data is on file for your  
protection under  
Lot # 18861**

**THIS SEAL GUARANTEES YOU  
REAL LACING ECONOMY...  
increased production  
with fewer rejects!**

Always specify Gudebrod whether you use one spool of lacing tape or thousands because Gudebrod lacing tape is produced under strict quality control. Gudebrod checks and rechecks every lot of tape to insure that it meets the highest standards . . . higher standards than those required to meet MIL-T specifications.

Gudebrod helps increase your production because we carefully test, measure and maintain close tolerances on such characteristics as slip resistance, fray resistance, breaking strength, wax content, fungistatic effectiveness. These and other tests assure you that when Gudebrod lacing tape is used production increases. *Knots don't slip . . . harnesses stay tied . . . assemblies remain firm . . . there are fewer rejects!*

Whatever your lacing needs—Teflon\*, dacron†, glass, nylon, high temperatures, special finishes—Gudebrod makes it or will produce a tape to meet your special requirements. If you want a tape to meet 1500°F . . . Gudebrod Experimental Research Project 173 is the answer. If you want a tape that meets MIL-T-713A . . . Gudelace® (Style 18 Natural) is the answer.

**MAKE THE H-R TEST!** Write for samples of Gudelace or other Gudebrod lacing tapes and have them tested in your harness room. Compare a harness tied with a "Quality Controlled" Gudebrod tape and any other tape. This test will convince you that when you specify Gudebrod you specify *real* economy—increased production with fewer rejects.

Write for our free Technical Products Data Book. It explains Gudelace and other Gudebrod lacing tapes in detail.

\*Dupont's TFE fluorocarbon fiber.

†Dupont's polyester fiber.

**GUDEBROD BROS. SILK CO., INC.**

Electronics Division  
225 West 34th Street  
New York 1, New York

Executive Offices  
12 South 12th Street  
Philadelphia 7, Pa.

applications over the entire X-band (8,200 to 12,400 Mc) range. Residual vswr is 1.01:1 maximum. Insertion length is 1.0 in. Temperature range is -55 to +200 C.

**CIRCLE 329 ON READER SERVICE CARD**



**SWR Meter  
HIGH RESOLUTION**

HEWLETT-PACKARD CO., 1501 Page Mill Road, Palo Alto, Calif. Model 415 C standing wave indicator provides pinpoint resolution for precise r-f attenuation measurements. It is essentially a high gain (greater than 100 db), low noise audio amplifier coupled with an output voltmeter to read swr or db directly. Amplifier is tunable from 980 to 1,020 cps, and the variable 15 to 100 cps bandwidth permits the meter to be used for both high-sensitivity and swept-frequency applications. Price is \$325.

**CIRCLE 330 ON READER SERVICE CARD**



**Ultrasonic Cleaner  
9-GALLON UNIT**

GULTON INDUSTRIES, INC., 212 Durham Ave., Metuchen, N.J. Model MU-1101 mobile ultrasonic cleaner is designed for cleaning medical and

**CIRCLE 143 ON READER SERVICE CARD** →

# AVAILABLE FROM GENERAL INSTRUMENT... FIRST 16 AMP., 500 VOLT TRIPLE DIFFUSED SILICON CONTROLLED RECTIFIER!

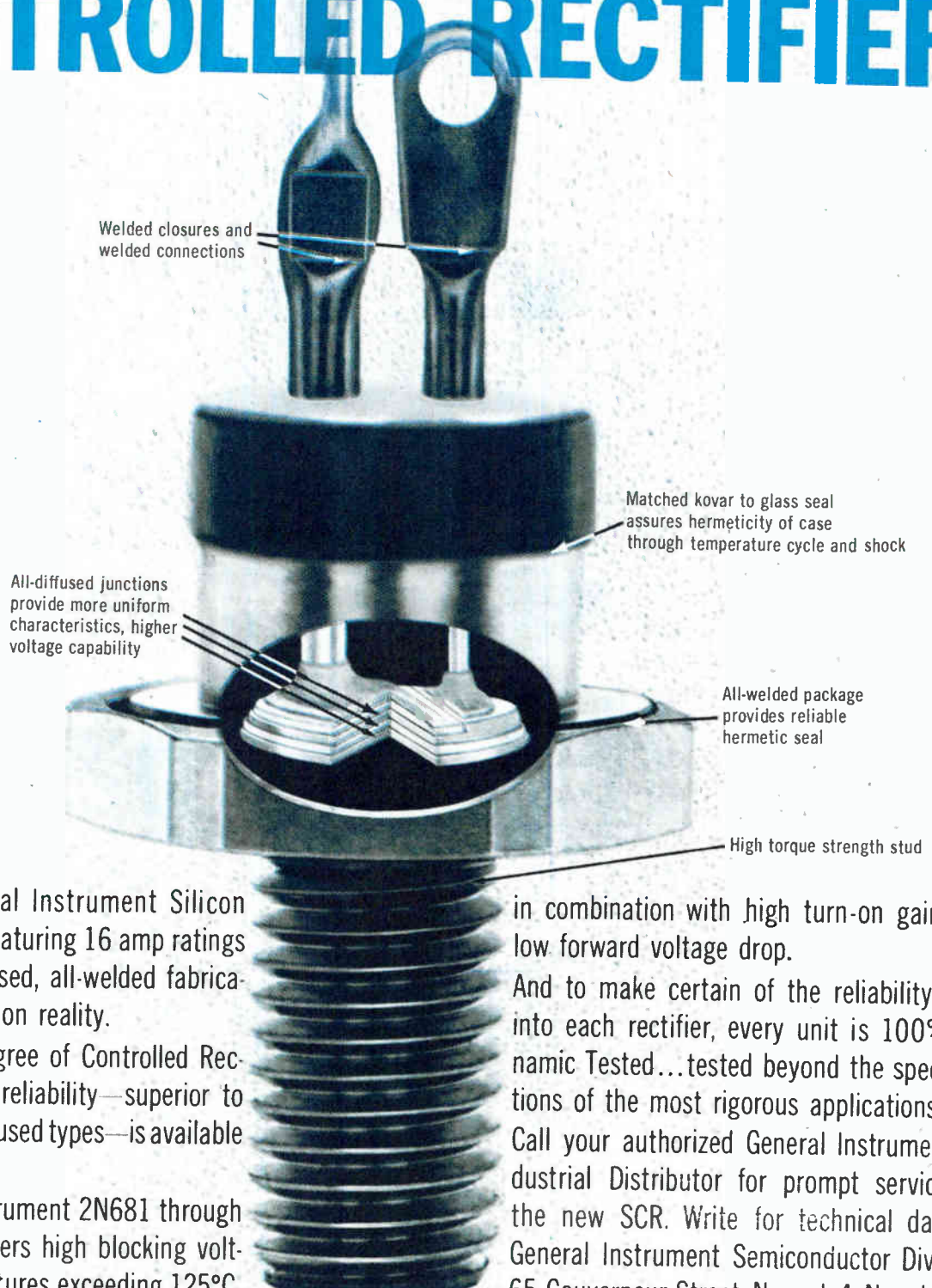

Welded closures and welded connections

Matched kovar to glass seal assures hermeticity of case through temperature cycle and shock

All-diffused junctions provide more uniform characteristics, higher voltage capability

All-welded package provides reliable hermetic seal

High torque strength stud

The exclusive General Instrument Silicon Controlled Rectifier, featuring 16 amp ratings to 500v, and all-diffused, all-welded fabrication, is a full-production reality.

The result: A new degree of Controlled Rectifier uniformity and reliability—superior to conventional alloy-diffused types—is available to you right now.

This new General Instrument 2N681 through 2N689 SCR series offers high blocking voltages even at temperatures exceeding 125°C,

in combination with high turn-on gain and low forward voltage drop.

And to make certain of the reliability built into each rectifier, every unit is 100% Dynamic Tested...tested beyond the specifications of the most rigorous applications.

Call your authorized General Instrument Industrial Distributor for prompt service on the new SCR. Write for technical data to General Instrument Semiconductor Division, 65 Gouverneur Street, Newark 4, New Jersey.

**GENERAL INSTRUMENT SEMICONDUCTOR DIVISION**  
GENERAL INSTRUMENT CORPORATION



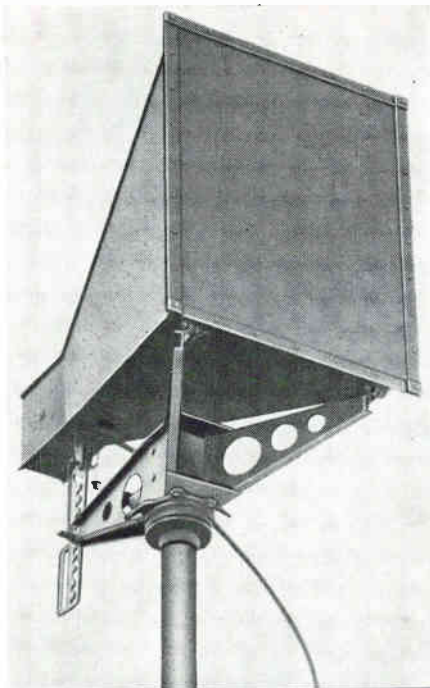

## ANTENNA CAPABILITIES

The advanced design and precision construction of Ainslie antenna systems and associated equipment bear testimony to nearly two decades of microwave communication, detection and identification experience. By virtue of complete design-to-delivery capabilities and facilities, Ainslie Corporation offers its customers not only comprehensive standard lines of mesh, spun and horn antennas, but also the flexibility required to develop custom designed prototypes for on-schedule delivery.

We invite your inquiry.



# Ainslie

CORPORATION

531 Pond Street  
Braintree 85, Massachusetts

surgical tools. It has an automatic timer, is constructed of stainless steel and weighs 340 lb. Cleaning tank measures 19 $\frac{3}{4}$  in. long by 11 $\frac{1}{2}$  in. wide by 10 in. deep.

**CIRCLE 331 ON READER SERVICE CARD**

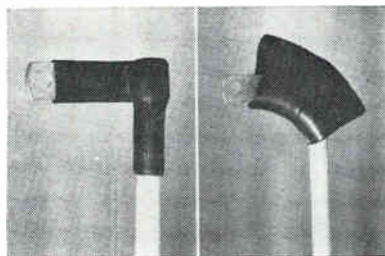

### Flag Boots

#### HEAT SHRINKABLE

RAYCLAD TUBES INC., Redwood City, Calif. Thermofit heat shrinkable flag boots are supplied in an expanded shape to be easily slipped in place over the flag termination. Upon heating in excess of 250 F for a few seconds, the boot shrinks forcibly toward a predetermined shape and size, tightly grasping the cable and flag terminal. The resulting product is a tough, moisture resistant, compact, homogeneous insulation produced at a significant cost reduction.

**CIRCLE 332 ON READER SERVICE CARD**

### Transistor Tester

MOTOROLA SEMICONDUCTOR PRODUCTS INC., 5005 E. McDowell Road, Phoenix, Ariz. Computer-controlled automatic transistor tester can test, select and sort 56,000 transistors per 2-shift day.

**CIRCLE 333 ON READER SERVICE CARD**

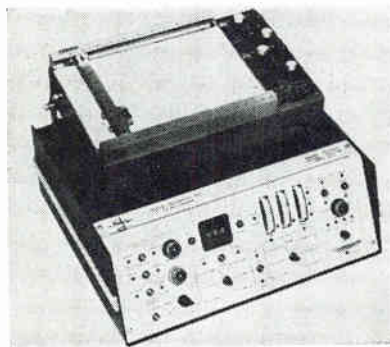

### Dynamic Analyzer ANALOG RECORDING

NUCLEAR INDUSTRIES, INC., 10 Holland Court, Valley Stream, N.Y. Model 121A is a compact, single

## quick source for fine Seamless Tubing in

## NICKEL ALLOYS

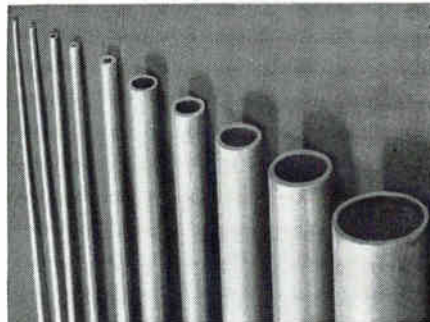

### NICKEL

"A" nickel, 220, etc. Excellent cathode emission, high strength and rigidity at elevated temperatures for electronic and instrument applications.

### MONEL

The all-purpose nickel alloy—non-corrosive, non-contaminating—in chemical processing, food, petroleum, marine, rocket motor applications.

### INCONEL

Resistance to corrosives particularly recommends it for food, dairy and pharmaceutical applications; dental, surgical and industrial instruments; rocket and jet fuel lines, etc.

### 30% CUPRO-NICKEL

Copper-based alloy widely used for fine wire connectors, prongs and electrical contact tips, electrical and medical instruments.

**Sizes:** from .005" O.D. to .375" O.D.  
**Wall Thicknesses:** from .035" to .0005".  
**Tolerances:** to  $\pm 0.00005$ ".

**Delivery:** Normally 3 weeks for tubing, 4 weeks for fabrications.

**Fabricated Parts:** a complete service specializing in burr-free, close-tolerance cutting, bending and flaring.

Write for information on tubing or tubular parts, made from these alloys, as well as many other alloys of aluminum, copper, steel, the precious metals, glass-sealing and refractory alloys.



## UNIFORM TUBES, INC. COLLEGEVILLE 2, PA.

HUxley 9-7276 TWX-CGVL 1044

**CIRCLE 205 ON READER SERVICE CARD**  
electronics

channel, general purpose counting system for recording and analysis of static or dynamic variations in nuclear activity. Fully transistorized, it uses advanced digital to analog conversion techniques. It includes methods of direct analog recording of digital events per unit time or time per unit event. Information is recorded in linear or logarithmic form on an X-Y plotter or strip chart recorder accessory. Price is from \$2,700.

**CIRCLE 334 ON READER SERVICE CARD**

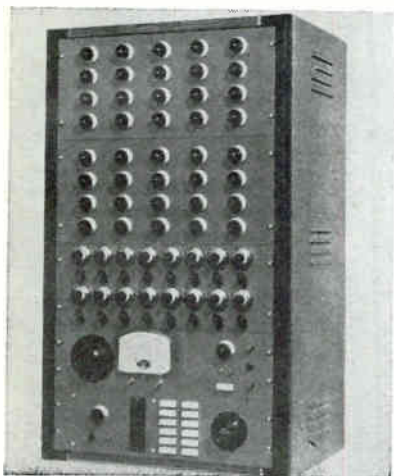

**Transformer Tester**  
GO/NO-GO

MESUR-MATIC ELEC. CORP., Bradford, N. H. Model TT-1-P56 is designed for precision evaluation of 50 and 60 cycle power transformers in the 1 to 1,000 v a-c range. Under actual operating conditions, each winding is tested against every other winding and the frame to preset inspection tolerances. The voltage accuracy of each secondary and tap is individually indicated by go/no-go lights.

**CIRCLE 335 ON READER SERVICE CARD**



**Time Delays**  
ADJUSTABLE

LOGITEK, INC., 54 Rome St., Farmingdale, L.I., N.Y., has available fixed or variable delays to operate

January 5, 1962

**Behlman-Invar**  
**is to electronic power as**  
**pprRemington**

**is-\*to...r**

**Rand**

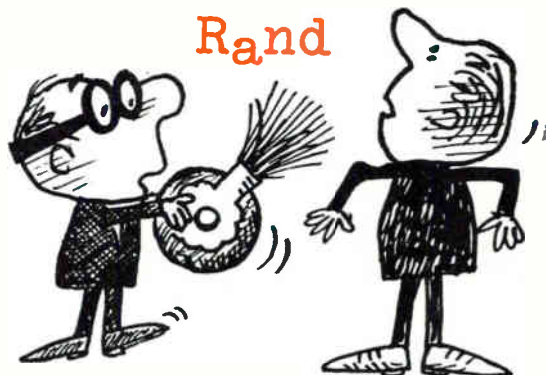

*And to determine what Behlman-Invar means to you, B/I has a complete catalog of AC and DC power supplies which is yours for the asking. Ask!*



**BEHLMAN-INVAR ELECTRONICS CORP.**

1723 Cloverfield Blvd., Santa Monica, California

**CIRCLE 206 ON READER SERVICE CARD**

# IRE SHOW

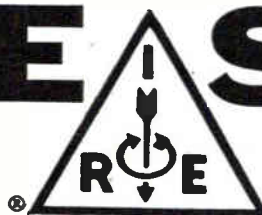

*presenting*

**"THE GOLDEN  
AGE OF  
ELECTRONICS"**

*March 26-29, 1962*

*The New York Coliseum*

*... part of the*

*International Convention of the IRE*

**The Institute of Radio Engineers**  
**1 East 79th Street • New York 21**

**Members \$1.00. Non-members \$3.00. Age limit: over 18**

**CIRCLE 145 ON READER SERVICE CARD**

145





# 10MC FREQUENCY COUNTER/STANDARD

## A NEW CONCEPT IN PRECISION MEASURING

The Model 14-20C 10MC Frequency Counter/Standard combines the features of a precision counter and a high stability frequency standard into an advanced design unit. Specifications are as follows:

- Simultaneous and independent use of both frequency standard and counter.
- Stability of  $1 \times 10^8$  per day and  $5 \times 10^8$  per week calibrated by the primary time-standard "Atomichron."
- Nine standard decade output frequency steps of 0.1cps to 10mc provided by frequency synthesizer. Gate time from 1 millisecond to 100 seconds.
- Counts any one of nine decade frequencies from 0.1cps to 10mc for period and time interval measurements.
- Self checks counting and gate circuits at any of these frequencies in all combinations of available gate times.
- Operates within all ratings over a temperature range of  $-20^{\circ} \text{C}$  to  $+55^{\circ} \text{C}$ , and humidities up to 95%.
- Operates from an external 100KC or 1mc reference frequency.

Other features include:

Frequency range 10cps— 10.1mc  
 Period DC— 100KC  
 In-line readout 8 place

Input power 115/230v,  
 50-60 cps (400 cps opt.)

PRICE \$2,200

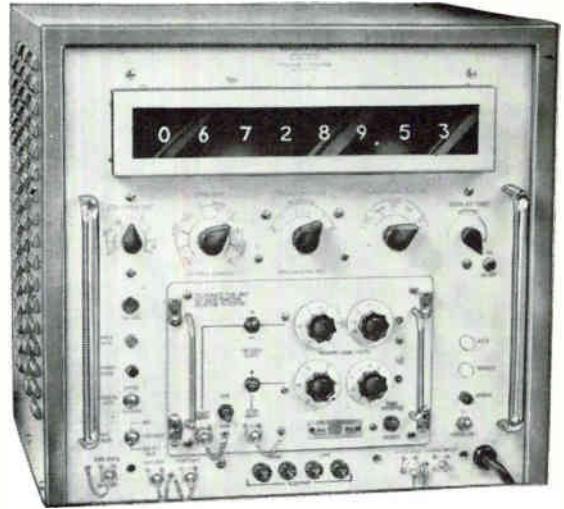

# NORTHEASTERN ENGINEERING INCORPORATED

DEPT. 1C, MANCHESTER, NEW HAMPSHIRE  
 AFFILIATE OF ATLANTIC RESEARCH CORP.

CIRCLE 207 ON READER SERVICE CARD

*For Integrated  
 Communications  
 Systems*

## BUDELMAN

*Microwave  
 and Carrier  
 Offers Greatest Value!\**

- UHF and Multiplex Radio
- Systems Engineering

*Write for free BEC Spec File Today!*

**BUDELMAN ELECTRONICS CORPORATION**

375 Fairfield Avenue

Stamford, Connecticut

\* Because Budelman equipment performs better,  
 costs less to buy and maintain.

CIRCLE 208 ON READER SERVICE CARD

## PINPOINT PRECISION

THROUGHOUT LARGE VOLUME

20" x 20" x 25"

**LOWER GRADIENTS:**

$\pm 1^{\circ} \text{C}$ . over large  
 portion of test volume

**RANGE:**

$-100^{\circ} \text{F}$ . to  $+600^{\circ} \text{F}$ .

**CONTROL ACCURACY:**

$\pm 1/4^{\circ} \text{F}$ .

**HEATING TIME from  $70^{\circ}$ :**

13 minutes to  $350^{\circ} \text{F}$ .

28 minutes to  $500^{\circ} \text{F}$ .

**COOLING TIME from  $70^{\circ}$ :**

6 minutes to  $-65^{\circ} \text{F}$ .

9 minutes to  $-100^{\circ} \text{F}$ .

*Call Delta representative  
 or write direct  
 for specifications*



MODEL 1060B  
 Temperature Chamber  
 Cabinet Optional

**DELTA DESIGN**

INC

3163 ADAMS AVE. SAN DIEGO 16, CALIFORNIA  
 ATWATER 3-3193 • CABLE: DELTA • TWX: SD 6488-U

CIRCLE 147 ON READER SERVICE CARD



# AUGAT

## BATTERY HOLDERS

Accommodate Every Popular Size and Make of Zinc, Mercury and Alkaline Type Batteries

Here is a new, complete line of battery holders, specifically designed to withstand the shock and vibration normally encountered in portable equipment.

These holders are manufactured from steel or beryllium copper and include nylon insulated, silver plated contacts. Insulators are color coded so that battery polarity is clearly indicated.



Write today for Data Sheet No. 3-61. It lists all the important specifications, and a rapid reference chart aids you in choosing the correct holder for a particular battery.

**AUGAT INC.** 30 Perry Avenue  
Attleboro, Mass.

CIRCLE 209 ON READER SERVICE CARD

# SITE SEEKING?



**GREATER ATLANTA'S  
DeKALB COUNTY**  
is the place you are looking for!

- Nine choice industrial districts, ready to go.
- Private financing on buildings. Lease 45¢-65¢ sq. ft. per year. (20,000 sq. ft. or more)
- Dependable labor supply, skilled and unskilled, one of nation's lowest in work stoppages.
- Unexcelled transportation and communications.

**FREE!**

Study on Electronics Manufacturing Opportunity in Georgia, prepared by Georgia Institute of Technology Engineering Experiment Station.

**SEND COUPON TODAY!**



**E. WM. BROOME**

Industrial Manager  
DeKalb County Committee of 100  
P. O. Drawer 759  
Atlanta 22, Georgia  
Telephone 378-3691

Please send book on Electronics Manufacturing Opportunity in Georgia

NAME \_\_\_\_\_  
TITLE \_\_\_\_\_  
COMPANY \_\_\_\_\_  
ADDRESS \_\_\_\_\_  
CITY & STATE \_\_\_\_\_

identify in-flight missiles, aircraft or space probes at distances greatly exceeding the normal reflective path of a ground radar. It includes a transmitter capable of emitting a power output well in excess of 10 w, and a receiver with a sensitivity exceeding -45 dbm. Beacon can operate over the 5,400-5,900 Mc range.

CIRCLE 338 ON READER SERVICE CARD

## Power Supply

RAYTHEON CO., 225 Crescent St., Waltham 54, Mass. Power supply stores and releases precise welding energy of 20 to 225 watt-sec to permit 50 to 120 spot-welds per minute.

CIRCLE 339 ON READER SERVICE CARD



## Data Recorder TRANSISTORIZED

SANBORN CO., 175 Wyman St., Waltham 54, Mass. Model 2000, a 7-channel, 4-speed Sanborn/Ampex magnetic data recording system is priced at \$6,800. Tapes are interchangeable on IRIG standard machines. Recorder uses 1/2 in. tape and has 3 1/2, 7 1/2, 15 and 30 in./sec speeds. Direct recording bandwidth is up to 50,000 cps and f-m bandwidth is up to 5,000 cps.

CIRCLE 340 ON READER SERVICE CARD

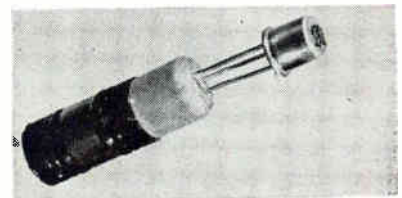

## Epitaxial Switches ULTRA-HIGH-SPEED

TEXAS INSTRUMENTS INC., P.O. Box 5012, Dallas 22, Texas, announces

six new germanium epitaxial transistors for all ultra-high-speed switching applications from 3 ma through 100 ma. Types 2N960 through 2N962 and 2N964 through 2N966 combine high dissipation, low  $I_{CBO}$ , and rugged mesa construction with the epitaxial benefits of low storage time and low  $V_{CE(SAT)}$ . There is no compromise of high breakdown or high beta.

**CIRCLE 341 ON READER SERVICE CARD**

### SPST Diode Switch

CONSOLIDATED MICROWAVE CORP., 850 Shepherd Ave., Brooklyn 8, N. Y. Model X110 high speed diode switch operates in the range of 8.2 to 12.4 Gc with typical isolation of 20 db at 9 Gc and insertion loss of 1.3 db.

**CIRCLE 342 ON READER SERVICE CARD**



### Power Supply

#### AMPLITUDE-REGULATING

GENERAL RADIO CO., West Concord, Mass. New model of the type 1236-B amplitude-regulating power supply provides 1-Kc square wave modulation from an internal generator. Designed for operation with uhf and vhf oscillators, the instrument maintains the oscillator output amplitude constant as the frequency is varied. The square-wave modulation feature permits the use of a tuned audio amplifier following the detector, thus achieving high sensitivity with a simplified setup.

**CIRCLE 343 ON READER SERVICE CARD**



### Transient Indicator

#### DIGITAL READOUT

REGENT CONTROLS, INC., Harvard Ave., Stamford, Conn. Model TD-761M2 automatic maximum voltage

# SENSITIVE, WIDE RANGE: HONEYWELL NULL INDICATORS

*Honeywell Null Indicators have an exclusive core and magnet design that gives you precise null determination with high sensitivity over a wide range of unbalance. Rugged pivot and jewel construction allows them to be used for sensitive null detection where suspension galvanometers cannot. ■ Due to non-linear characteristics, large amounts of unbalance can be observed without overloading, and sensitivity at the null point is greater than with conventional nullmeters or zero center meters. Honeywell Null Indicators are available in both Medalist (16 colors to choose from) and ruggedized models, and come in three levels of sensitivity. ■ To learn more about Honeywell Null Indicators and other meters, write Minneapolis-Honeywell Regulator Company, Precision Meter Division, Grenier Field, Manchester, New Hampshire.*

MM-2 (2½") Model illustrated. Also available in round sealed ruggedized models in 2½" and 3½" sizes.

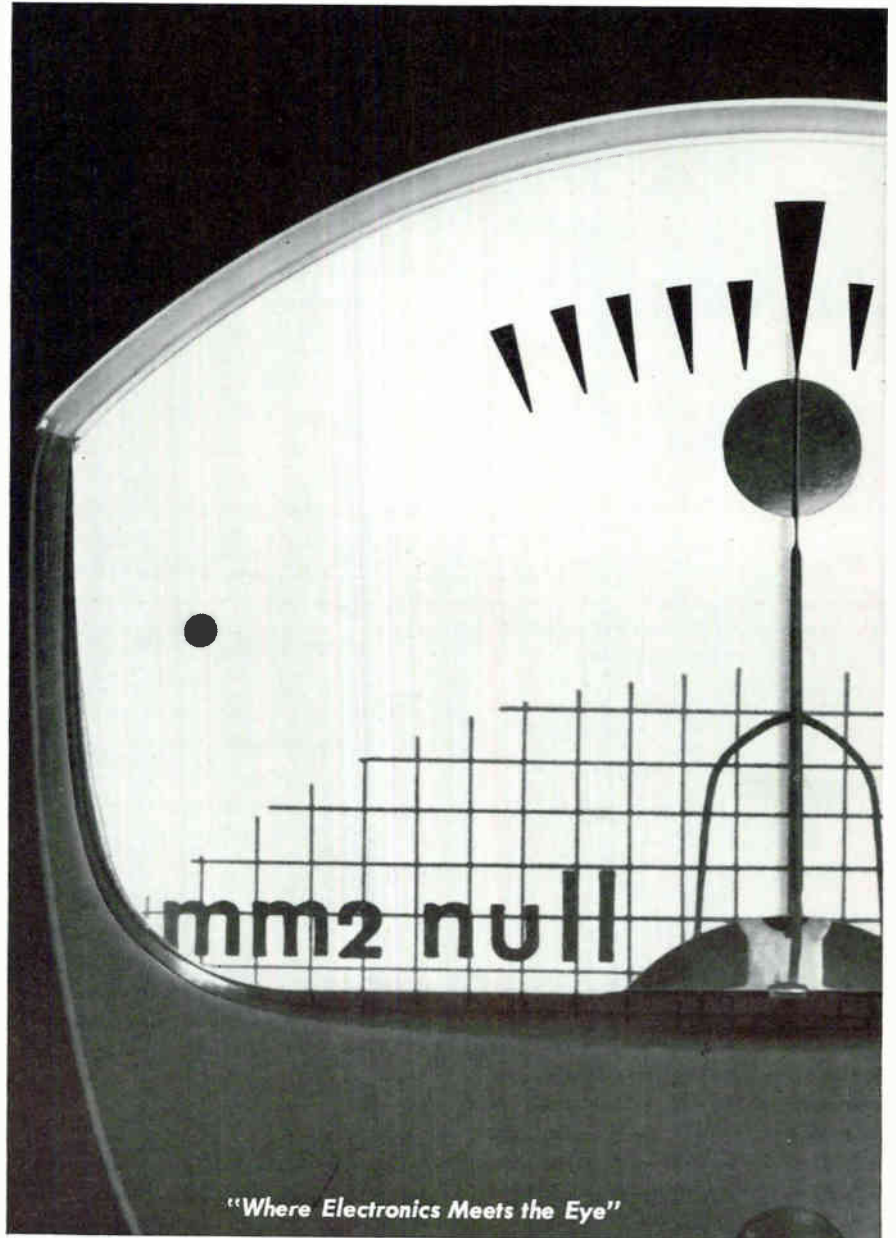

"Where Electronics Meets the Eye"

# Honeywell

**H** Precision Meters

**CIRCLE 149 ON READER SERVICE CARD**

149



**NEW  
HI-RELIABILITY  
WIREWOUND RESISTORS**

provide precision in microminiature sizes



Designed and developed by Hi-Q engineers, the new Aerohm "600" hi-reliability wirewound resistors meet the space-tight requirements of microminiature applications. The "pea-size" 1/8 watt type CE 600 measures only .250" square x .125" thick. The 1/4 watt type CE 601 measures only .250" x .500" x .125" thick. Both types offer outstanding precision (as low as .01%) and performance.

**SPECIFICATIONS**

**WIRING: INDUCTIVE**  
**MAXIMUM VOLTAGE:** 150 VDC  
**MAXIMUM RESISTANCE:** Type 600—1 megohm;  
 Type 601—1.5 megohms  
**TOLERANCES AVAILABLE:** 1% through .01%  
**WATTAGE RATING:**  
 Type 600—.125 watts -55° to +125°C  
 Type 601—.250 watts -55° to +125°C  
 Derated to zero at 150°C  
**TEMPERATURE COEFFICIENT:** Zero ±20 ppm  
 -55°C to +125°C  
 Others available.  
**BOBBIN AND ENCAPSULATION:** Epoxy  
**RESISTANCE WIRE:** Temperature coefficient "E"  
 is standard (15 to 20 ppm). Available in 8 to  
 15 ppm (request quote from factory).  
**APPLICABLE MIL SPECS:** MIL-R-93 and  
 MIL-R-9444.  
**OPERATING TEMPERATURES:** -65°C to +150°C

Write today for complete technical information, including T. C. Performance Data on 500K Ohms and 1 Megohm units.



**AEROVOX CORPORATION**  
 Cinema Plant, Hi-Q Division, 1100 Chestnut St.  
 Burbank, Calif.



indicator is a reliable instrument designed to detect and measure voltage levels. Of particular use in semiconductor electronics, it is fully transistorized, battery operated, and completely portable. Voltage range: 2,000 v maximum. Transient duration: 1 μsec minimum to d-c.

**CIRCLE 344 ON READER SERVICE CARD**

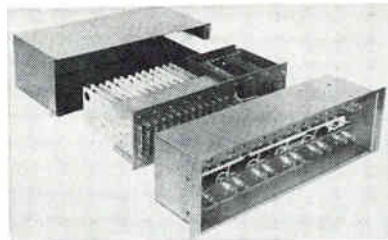

**Annunciators  
TRANSISTORIZED**

ROCHESTER INSTRUMENT SYSTEMS, INC., 273 N. Union St., Rochester 5, N.Y. Completely solid-state, the model AN-100 annunciator circuits are packaged in interchangeable, plug-in modules. Unit is available in four standard sequences, ranging from a simple automatic reset to a momentary alarm and ringback. It operates from either 120 v a-c or 125 v d-c, and is actuated by normally closed or normally open relay contacts or 10 and 0 v d-c at 1 ma.

**CIRCLE 345 ON READER SERVICE CARD**

**Indium Antimonide**

MICRO STATE ELECTRONICS CORP., 152 Floral Ave., Murray Hill, N. J., is producing single crystal indium antimonide suited for use in high mobility devices such as Hall effect isolators, gaussmeters, and ammeters.

**CIRCLE 346 ON READER SERVICE CARD**

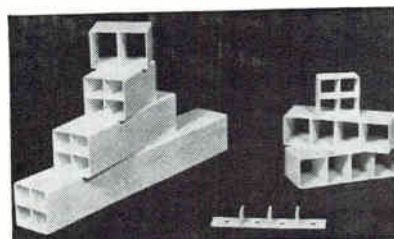

**Multiple Barrier Tubes  
FOR CIRCUIT PACKAGING**

STEVENS TUBING CORP., 86-88 Main St., East Orange, N. J. Formed in multiples of 2, 3, 4 or more at a

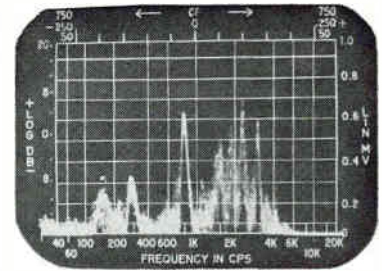

**SEE** answers to noise & vibration analysis problems quickly, accurately with..

**PANORAMIC'S  
sonic spectrum LP-1a  
analyzer**



**Rugged . . . Reliable . . . Economical**

A basic component for waveform study and frequency response curve tracing, the LP-1a is widely used for: • Vibration and noise measurements • Harmonic & IM analysis • Acoustic waveform studies • Medical electronics

**Check these LP-1a features:**

- "Quick-look" log sweep; 40 cps to 20,000 cps in 1 second.
- Adjustable linear frequency analysis for 20 cps to 22,500 cps.
- Automatic optimized resolution with variable IF bandwidth options.
- Residual spurious down more than 60db.
- Optional "M" internal markers at 60 cps, 500 cps and 5 kc (and harmonics).
- Optional "Z" flat face CRT, edge-lit reticule and camera mount bezel.

Write for new Catalog.



Sec. 2900



Formerly Panoramic Radio Products, Inc.  
 530 South Fulton Ave., Mount Vernon, N. Y.  
 OWens 9-4600 • TWX: MT-V-NY-5229  
 Cables: Panoramic, Mt. Vernon, N. Y. State

**CIRCLE 210 ON READER SERVICE CARD**  
 electronics

time, multiple barrier tubes are available in a variety of square or rectangular arrangements in lengths up to 18 in. Materials include glass silicone, epoxy, polyester, and melamine, for high temperature applications in Class H and Class B. Short pieces are useful as potting forms, or as separators in multi-packaged components

**CIRCLE 347 ON READER SERVICE CARD**



**Test Jacks**  
TEFLON INSULATED

SEAELECTRO CORP., 610 Fayette Ave., Mamaroneck, N. Y., announces Press-Fit Teflon-insulated test jacks for use in threaded receptacles. The SKT-43-B1 test jacks are designed to accept a 0.070 in. diameter by 0.250 in. long probe, and have a turret-type terminal. Designed for metal tubes, with threading, the extra-bulk Teflon body presses into the tube, resulting in a very high pull-out strength installation. The Teflon insulation permits a wide operating temperature range, and provides excellent dielectric strength.

**CIRCLE 348 ON READER SERVICE CARD**



**Variable Delay Line**  
NARROW-RANGE

GENERAL RADIO CO., West Concord, Mass. Type 301-S104 variable delay line weighs 1½ oz and has a total range of from zero to 25 nsec ± 10 percent. The line affords a resolution of 0.06 nsec and a pulse rise time of approximately 2.4 nsec at maximum delay. Characteristic impedance is 200 ohms ± 20 percent, and the d-c resistance is 5.5 ohms ± 20 percent.

**CIRCLE 349 ON READER SERVICE CARD**

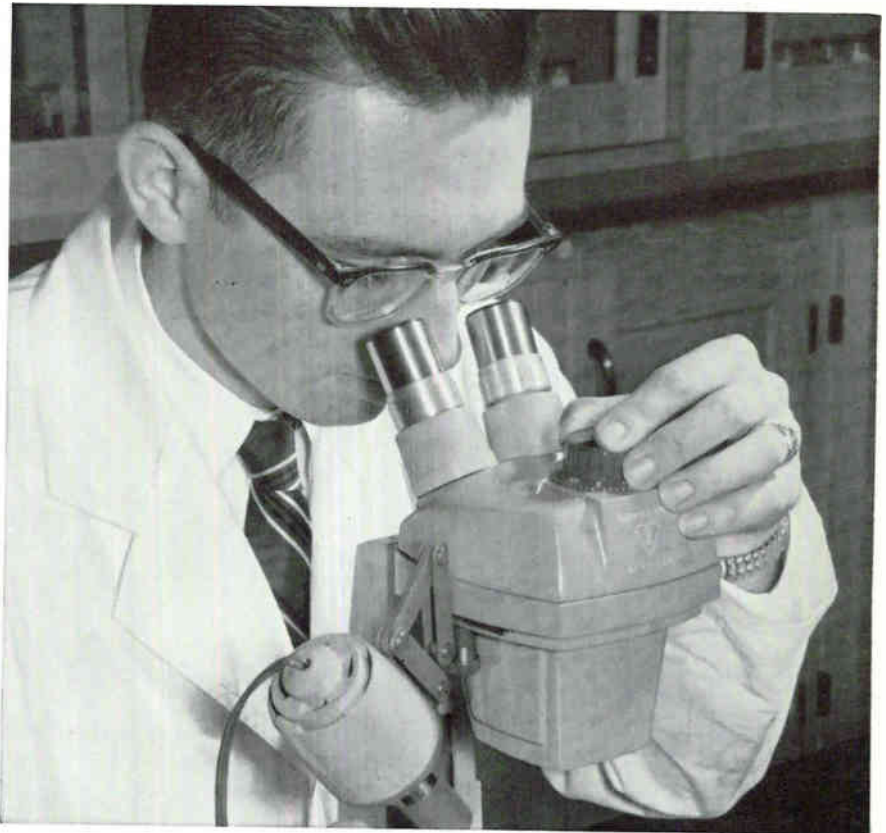

**Why you need both**

**ZOOM and 3-D**  
**for thorough inspection**

Zoom microscopy gives you the exact magnification for each specific inspection need, from big area scanning at lower powers . . . to critical area examination at higher powers . . . to whatever power best shows what you're looking for.

3-dimensional microscopy shows your work piece in depth and in natural position, upright and unreversed from left to right, just as it would be positioned to the unaided eye.

And only Bausch & Lomb StereoZoom® Microscopes give you Zoom and 3-D. See for yourself how this revolutionary new design can save on your inspection jobs by keeping work constantly in focus throughout the continuous magnification range . . . available from 3.5X

to 120X. Just mail the coupon now.



*Made in America, to the world's highest standards.*

**BAUSCH & LOMB INCORPORATED**  
62325 Bausch St., Rochester 2, N. Y.

Please demonstrate StereoZoom Microscopes at my convenience.

Please send Catalog D-15.

NAME .....

COMPANY .....

ADDRESS .....



# AVAILABLE TO YOU...



This New  
**Superior**  
Catalog  
Gun Mount Data . . .

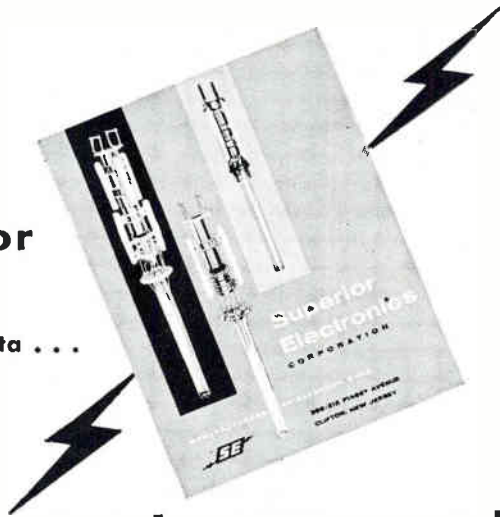

at your request

A 34-page color catalog of electron guns for all types of cathode ray tubes is available. Included is a cross reference chart specifying the correct gun mounts for tubes of domestic and foreign manufacture.

## Superior Electronics Corporation

208-212 PIAGET AVENUE • CLIFTON, NEW JERSEY TELEPHONE AREA CODE 201 772-2500

CIRCLE 211 ON READER SERVICE CARD

WHY IS BOESCH  
THE WORLD'S  
LEADING  
MANUFACTURER  
OF TOROIDAL  
COIL WINDING  
MACHINES and  
ACCESSORIES?

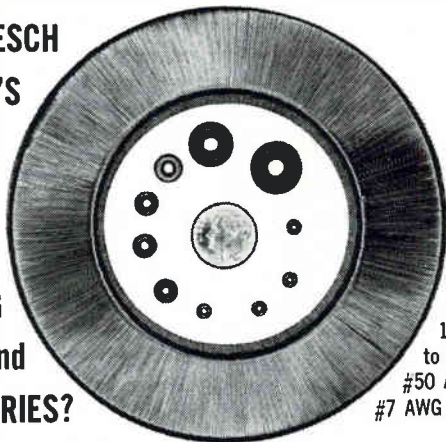

From  
1/32" I. D.  
to 14" O. D.  
#50 AWG to  
#7 AWG wire

**BECAUSE 1.** BOESCH MACHINES ARE RUGGED PRODUCTION WORKHORSES . . . providing continuous high production outputs with a minimum of downtime.

**2.** BOESCH MACHINES ARE EXTREMELY FLEXIBLE . . . each machine is designed to accommodate a wide range of product requirements and operating conditions.

**3.** BOESCH OFFERS THE LATEST AND MOST COMPLETE LINE OF TOROIDAL COIL WINDING EQUIPMENT AVAILABLE.

**4.** BOESCH MAINTAINS A COMPLETE WINDING LABORATORY SERVICE TO HELP CUSTOMERS EXPERIMENT WITH NEW CORES AND DEVELOP EFFICIENT METHODS.



Write For Complete Information

### BOESCH MANUFACTURING DIVISION

Waltham Precision Instrument Company, Inc.  
Danbury, Conn. Tel: Pioneer 3-3886 Teletype: DANB 468

## PRODUCT BRIEFS

**GRAPHIC RECORDER** miniaturized. Assembly Products, Inc., Chesterland, O. (350)

**LITHIUM ION DRIFT DETECTORS** active area: 5 mm by 5 mm. Solid State Radiations, Inc., 2261 S. Carmelina Ave., Los Angeles 64, Calif. (351)

**BALANCED MIXER** for space environments. Hycon Mfg. Co., 700 Royal Oaks Dr., Monrovia, Calif. (352)

**COOLING MODULES** for semiconductors. Deltron Inc., 4th & Cambria Sts., Philadelphia 33, Pa. (353)

**D-C AMPLIFIER** self-compensating. Netherlands Consulate General, Commercial Div., 10 Rockefeller Plaza, New York 20, N. Y. (354)

**R-F FILTERS** and capacitors. RF Interonics, Inc., 15 Neil Court, Ocean-side, L. I., N. Y. (355)

**A-C POTENTIOMETER** military type. Perkin-Elmer Corp., Norwalk, Conn. (356)

**FREQUENCY STANDARD** compact, low weight. American Time Products, Div. of Bulova Watch Co., Inc., 61-20 Woodside Ave., Woodside 77, N. Y. (357)

**DIGITAL PATTERN GENERATOR** versatile instrument. The Magnavox Co., Urbana, Ill. (358)

**VOLT BOX** extends pot range. Central Scientific Co., 1700 W. Irving Park Road, Chicago 13, Ill. (359)

**TRANSMITTING TUBES** for mobile use. Radio Corp. of America, Harrison, N. J. (360)

**MICA CRYSTALS** man-made. Molecular Dielectrics, Inc., 101 Clifton Blvd., Clifton, N. J. (361)

**FREQUENCY SENSOR** automatic reset. Jordan Electronics, 121 So. Palm Ave., Alhambra, Calif. (362)

**VARIABLE RESISTORS** with metal-ceramic element. CTS Corp., Elkhart, Ind. (363)

**BACK DIODES** for nsec switching circuits. Micro State Electronics Corp., 152 Floral Ave., Murray Hill, N. J. (364)

**SILICON MESA TRANSISTORS** medium power. Clark Semiconductor Corp., Walnut Ave., Clark, N. J. (365)

# YES...IT'S THE TINIEST TRIMMER CAPACITOR MADE!



## JFD pin-trim

If you are designing for missile environments or applications requiring more capacity in less space, look in to the Pin-Trim. It provides a practicable solution to the challenge of end-product miniaturization with high operational stability.

**The new Pin-Trim delivers:** (1) more capacitance per cubic centimeter than any other conventional piston trimmer; (2) 75 per cent less weight and 50 per cent less volume than JFD's own miniature trimmers; (3) greater sensitivity; (4) finer adjustment.

If you are looking for maximum compactness between stacked circuit boards, or less stray capacitance in a given area, check the JFD Pin-Trim specifications for your subminiature trimmer applications.

For further data, call your local JFD Field office or your JFD franchised Industrial Distributor.

- Overall diameter: 1/8 inch. Overall length above panel: 3/8 inch to 1 inch.
- Double the sensitivity of JFD standard trimmers. Special adjust mechanism provides 102 turns per inch for extra fine adjustment.
- Increased maximum to minimum capacitance ratio per unit (minimum: 0.5 pf.).
- Operating temperature  $-55^{\circ}$  to  $+125^{\circ}$ C.
- Low temperature coefficient of capacitance.
- Anti-backlash design for precise tuning resolution.
- Low inductance for high frequency use.
- Ultra linear tuning assures accurate alignment—absolute repeatability. Standard slotted end for screwdriver adjustment.
- Rugged shock and vibration resistance.
- 500 V. DC working voltage.
- $10^6$  megohms insulation resistance.
- Q factor of 500 (measured as per JFD #5178).
- 0.5 inch ounce tuning torque.
- Meet or exceed applicable performance requirements of MIL-C-14409A.

JFD Adjustment Tool No. 5284 (illustrated) available at 85¢.

Model*	Capacitance Range MMF Measured Per JFD #5177		D.C. Working Volts	Dielectric Strength Measured For 5 Seconds at 50% R.H. at Max. Rated Cap.	Insulation Resistance Measured After One Minute at 500V. D.C. and 50% R.H.	Q Factor Measured Per JFD #5178	Unit Weight Grams	Dimen.**	
	Min.	Max.						Max.	$\pm 1/32$
PT901	0.5	2.0	500	1000	$10^6$ Megohms	500	0.62	$3/8$ "	
PT902	0.5	3.0	500	1000	$10^6$ Megohms	500	0.64	$1/2$ "	
PT903	0.5	5.0	500	1000	$10^6$ Megohms	500	0.79	$3/4$ "	
PT904	0.5	7.0	500	1000	$10^6$ Megohms	500	0.94	1"	

\*These units are also available in the same capacitance values for printed circuit boards in models TT911, TT912, TT913 and TT914.  
\*\*Length front of panel.

# JFD

## JFD ELECTRONICS CORPORATION

Components Division • 6101 16th Avenue, Brooklyn, New York • Phone DEwey 1-1000 • TWX-NY25040

JFD WESTERN  
P. O. Box 3416  
7311 Van Nuys Blvd.  
Van Nuys, Calif.  
Phone: STate 1-3530

JFD MIDWESTERN  
P. O. Box 588  
Skokie, Illinois  
Phone: 675-1140

JFD NORTHEASTERN  
Ruth Drive, P. O. Box 228  
Marlboro, Mass.  
Phone: HUntley 5-7311

JFD CANADA  
51 McCormack Street  
Toronto, Ontario, Canada  
Phone: ROger 9-1129

VARIABLE TRIMMER PISTON CAPACITORS • FIXED METALIZED INDUCTORS • LC TUNERS • DIPLEXERS  
FIXED AND VARIABLE, DISTRIBUTED AND LUMPED CONSTANT DELAY LINES • PULSE FORMING NETWORKS



# IRE SHOW

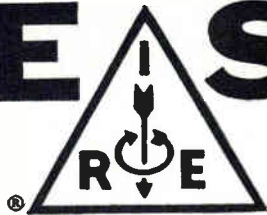

presenting

## "THE GOLDEN AGE OF ELECTRONICS"

March 26-29, 1962

The New York Coliseum

... part of the

International Convention of the IRE

The Institute of Radio Engineers  
1 East 79th Street • New York 21

Members \$1.00. Non-members \$3.00. Age limit: over 18

CIRCLE 212 ON READER SERVICE CARD

## Literature of

**SILICON DEVICES** Electronic Devices, Inc., 50 Webster Ave., New Rochelle, N.Y. Three catalog data sheets cover glass subminiature silicon diodes, silicon Zener diodes, and silicon rectifiers. (366)

**ASSEMBLY MACHINE** Kulicke and Soffa Mfg. Co., Inc., 401 N. Broad St., Philadelphia 8, Pa. Catalog sheet illustrates and describes a precision multi-tool assembly machine designed for microcircuitry research and production. (367)

**INDUSTRIAL ANALYZERS** Weston Instruments Div., Daystrom, Inc., 614 Frelinghuysen Ave., Newark 14, N.J. Bulletin 06-207 discusses the features and specifications of four models of circuit analyzing instruments. (368)

**POWER SUPPLY** Perkin Electronics Corp., 345 Kansas St., El Segundo, Calif., has issued a bulletin on a 125 v, 25 amp silicon rectifier power supply. (369)

**MICROELECTRONICS** Varo Inc. Microelectronics Div., 2201 Walnut St., Garland, Texas, offers literature describing representative pieces of equipment in its microcircuits and microcomponents line. (370)

**SUBMINIATURE PLUGS** Cannon Electric Co., 3208 Humboldt St., Los Angeles 31, Calif. Catalog D-8 lists and describes characteristics of a series of subminiature, rectangular D plugs. (371)

**TRANSFORMER SIMULATOR** Electronic Research Associates, Inc., 67 Factory Place, Cedar Grove, N.J., has available a catalog sheet describing the model TS460 transformer simulator. (372)

**CIRCUIT PROGRAMMING SYSTEMS** Virginia Electronics Co., Inc., River Road & B.&O. Railroad, Washington 16, D.C. Brochure describes a wide variety of sizes in circuit programming systems. (373)

**MOISTURE MONITOR** Consolidated Electrodynamics Corp., 360 Sierra Madre Villa, Pasadena, Calif. Four-page brochure describes type 26-303 moisture monitor. (374)

**ENERGY DISCHARGE CAPACITORS** Sangamo Electric Co., Springfield, Ill. Electrical and mechanical design criteria on energy discharge capaci-



**PUTS THE BEST IN CREATIVE ELECTRONICS INTO YOUR HANDS**



Send for **FREE** Catalog

28 pages of professional electronic equipment in kit and wired form—for Lab...Line...Home

EICO, 3300 N. Blvd., L.I.C. 1, N. Y. E-1A

Send free 32-page catalog & dealer's name.

Send new 36-page Guidebook to MI-FI for which I enclose 25¢ for postage & handling.

Name \_\_\_\_\_

Address \_\_\_\_\_

City \_\_\_\_\_ Zone \_\_\_\_\_ State \_\_\_\_\_

**EICO** 3300 N. Blvd., L.I.C. 1, N. Y.  
Export Dept., Roburn Agencies  
431 Greenwich St., N. Y. 13, N. Y.

**INCREASE**

**PW**

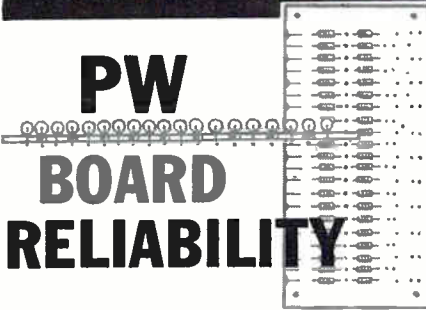

**BOARD RELIABILITY**

**... WITH DYNASERT COMPONENT INSERTING MACHINE**

Depend on Dynasert to insert all types of axial-lead components accurately time after time after time. Automatically feeds, trims, bends leads, inserts, and clinches. Leads automatically clinched to follow circuit, are easier to solder tightly. Inserts both small (to .032" diameter) and large components. Operators are trained quickly, components inserted up to ten times faster. See how Dynasert can increase reliability, cut costs for you. Write today. Dynasert Dept., United Shoe Machinery Corp., Boston, Mass.

**United**

**DYNASERT**

US 1-75

CIRCLE 213 ON READER SERVICE CARD

# the Week

tors are summarized in a state of the art publication. (375)

**TRANSIENT VOLTAGE DETECTOR** Halmar Electronic Products Co. Ltd., 1550 W. Mound St., Columbus 23, O. Brochure illustrates and describes an all-solid state transient voltage detector. (376)

**HALL EFFECT DEVICES** Siemens, N.Y. Inc., 350 5th Ave., New York 1, N.Y., announces a booklet about Hall effect devices for all problems of modern electronics. (377)

**F-M ANTENNAS** Andrew Corp., P.O. Box 807, Chicago 42, Ill., has published catalog B on its Multi-V f-m antenna system. (378)

**REMOTE MONITORING** CompuDyne Corp., 400 S. Warminster Road, Hatboro, Pa. Four-page folder describes Alertra model 901 remote monitoring system. (379)

**SILICON DIODES** National Transistor Mfg., Inc., 500 Broadway, Lawrence, Mass. Catalog B-101 covers a line of silicon double diffused alloy diodes. (380)

**SERVOMOTORS** Helipot Division of Beckman Instruments, Inc., 2500 Fullerton Rd., Fullerton, Calif. Data sheet covers size 15 and 18 servomotors, inertia and velocity damp servomotors, and servomotor-rate generators. (381)

**ELECTRONIC SOLDER** Alloys Unlimited Solder, 2101 43rd Ave., Long Island City 1, N.Y., announces a brochure on its line of electronic and industrial solder. (382)

**BUTTON CELLS** Yardney Electric Corp., 40-50 Leonard St., New York 13, N.Y. Rechargeable Silcad button cells are described in a technical data sheet. (383)

**RADIATION DETECTORS** Molëchem, Inc., a subsidiary of Hamner Electronics, Inc., P.O. Box 531, Princeton, N.J. Technical information on surface barrier silicon radiation detectors is contained in a 4-page bulletin. (384)

**SURVEY METER** Kleber Laboratories, Inc., 2530 N. Ontario St., Burbank, Calif., has available a specification sheet on the model 20 radiation survey meter. (385)

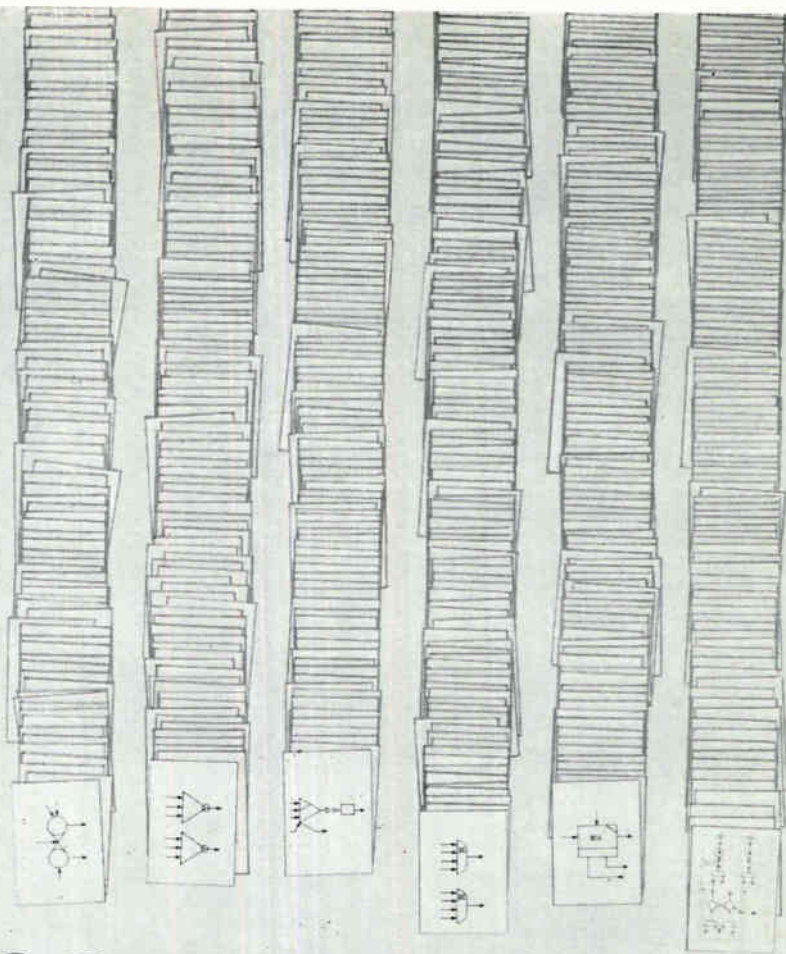

## **EECo... THE FIRST NAME IN CATALOGUED DIGITAL CIRCUIT MODULES**

**can save you both time and money!**

You can design for reliability with EECo digital circuit modules. Start right out with your system or equipment block diagrams and rely on EECo to fill your exact circuit needs. We have the widest catalogued selection of proven digital modules on the market. Eight complete families, totaling more than 200 proven catalogued circuits, assure you of reliability and availability.

*Our Application Engineering staff stands ready to serve you in implementing your digital systems block diagrams. Write today on your company letterhead for complete technical data on any of our families of proven digital circuits.*

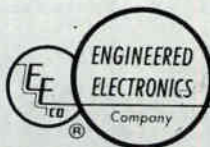

**ENGINEERED ELECTRONICS Company**

1441 EAST CHESTNUT AVENUE • SANTA ANA, CALIFORNIA  
KIMBERLY 7-5651 • CABLE ADDRESS: ENGELEX



# UTICA TOOLS

## NEW UA-200

THE VERSATILE  
MULTI-PURPOSE  
POWER CUTTER  
FOR INDUSTRY  
WITH  
INTERCHANGEABLE  
CUTTING HEADS

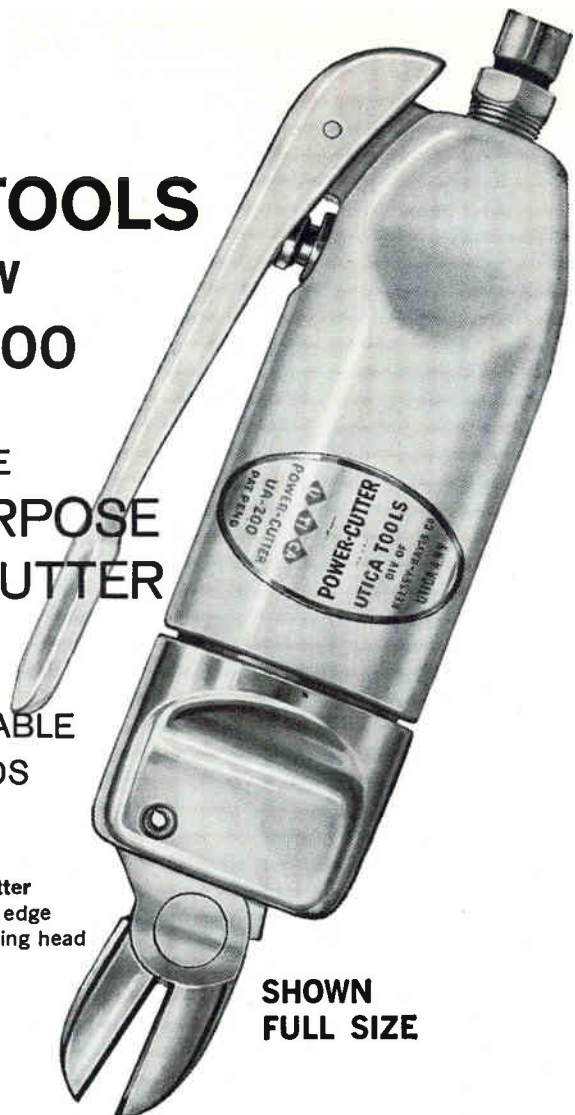

**B-5 Cutter**  
Standard edge  
diagonal cutting head

**SHOWN  
FULL SIZE**

This latest and most versatile addition to the Utica line of production tools is available with four optional, interchangeable cutting heads. Each head is designed for a specific cutting purpose and all have electronically induction hardened jaws. The air cylinder is lightweight, shock-resistant Delrin plastic and the UA-200 is easily operated with a long trigger that fits either hand. And the UA-200 is four times more powerful. Maximum cutting speed with minimum operator fatigue assures higher production in almost any cutting operation. Each UA-200 is equipped with an 8 ft. air hose and your choice of one cutting head. Write for complete information.

### OPTIONAL HEADS FOR VARIED USES



**B-6 Cutter**  
Hairline flush edge  
diagonal cutter head



**B-7 Cutter**  
Cutter-crimper head  
for printed circuits



**B-8 Cutter**  
Diagonal cutting head  
for plastics only

# UTICA

UTICA TOOLS • DIVISION OF KELSEY-HAYES COMPANY, UTICA 4, NEW YORK

## NEW BOOKS

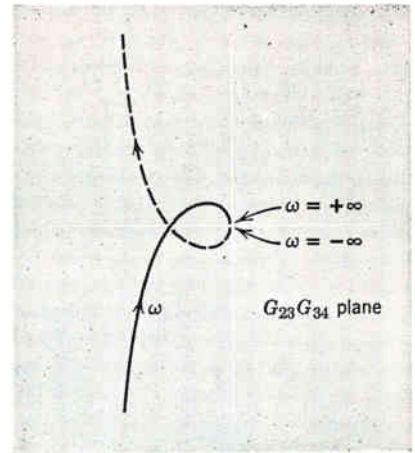

### Introduction to Feedback Systems

By L. DALE HARRIS

*John Wiley and Sons, Inc., Philadelphia, Pa., 1961, 360 p., \$10.50*

A COMPREHENSIVE treatment of feedback, based primarily on the pole-zero, root-locus rather than the sinusoidal approach. Also included is a considerable amount of the pertinent mathematical techniques, including appendices on Laplace transforms and transfer function analysis. Linear oscillating systems are dealt with in a separate chapter.

The book is intended as a text for the engineering student, and provides a solid base in feedback theory that is then applicable to a large variety of problems. Adequate problems are supplied, but there is no bibliography. G.V.N.

### Electronic Amplifier Circuits, Theory and Design

By J. M. PETTIT and M. M. McWHORTER

*McGraw-Hill Book Company, Inc., New York, 1961, 319 p., \$9.75*

STARTING WITH the general theory of amplification, the authors develop analytic techniques for deriving equivalent circuits of amplifiers and interpreting characteristics of the main classes of amplifiers. Tubes and transistors are treated in parallel, and a number of modern techniques for optimizing amplifier performance are discussed. Special consideration is given to stagger-tuning, interstage design

JULY 20, 1961

e

B

G

electronics  
BUYERS' GUIDE  
and  
Reference Issue

PRODUCTS, MATERIALS  
and SERVICES LISTINGS

Registered TRADENAMES

MANUFACTURERS'  
SALES OFFICES

ANNUAL electronics  
INDEX of ARTICLES

VOL. 34 28A

and noise aspects. Examples and problems appear throughout.

The book is written on a senior-student or graduate level, and will serve as a useful handbook to the design engineer. G.V.N.

### Electronic, Radio and Microwave Physics

By D. E. CLARK and H. J. MEAD  
*The Macmillan Co., New York, 1961,*  
521 p, \$25

INTENDED to be a reference work for experienced engineers, teachers and students, this volume places greater stress on fundamentals than applications. Fifteen chapters cover the important principles in the fields of electronics and microwave physics. Parts of this material can be used to supplement primary textbooks for students in these fields. The subject matter is up to date and includes many references. L.D.S.

### Induction Heating

By P. G. SIMPSON  
*McGraw-Hill Book Co., Inc., New York, 295 p, \$11.50*

THIS PRACTICAL and theoretical volume describes design of coils, power systems and generating equipment for typical applications of induction heating. Fundamental electromagnetic and heat-flow theory are reviewed as a basis for practical designs.

### Linear Circuits, Part I: Time—Domain Analysis

By RONALD E. SCOTT  
*Addison-Wesley Publishing Company, Inc., Reading, Massachusetts,*  
510 p, \$6.75.

THIS FIRST part of a two-part book covers the basics of linear circuit theory. Major sections are resistive circuit theory and transients in the time domain.

Prepared as as text for a first course in Electrical Engineering, the book treats circuits as idealized models. For those engineers out of school a few years, the book provides an idea of present course content. Answers to all problems are given, making the text usable as a

# FAST

## ALL SOLID STATE DC AMPLIFIER

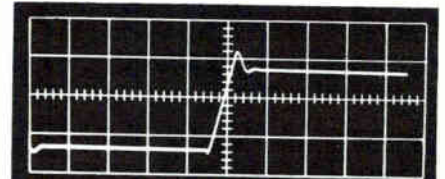

UNITY GAIN WAVEFORM  
REPRODUCTION  
10 KC OUTPUT • 5 VOLTS/CM  
10 MICROSECONDS/CM



\$195

### HALF USUAL COST

If you have applications requiring a miniature DC amplifier with fast frequency response, there's a good chance RIG's new DIFFERENTIAL OPERATIONAL AMPLIFIER MODEL A-2 can cut your amplifier costs 50% or more. Until now, only far higher priced transistorized amplifiers exhibited rise time characteristics comparable to the A-2. Check and compare these specifications:

OPEN LOOP GAIN — 100,000.  
GAIN-BANDWIDTH PRODUCT  
Short Circuit Stable — 200 KC. RISE  
TIME — Less than 10 microseconds at  
unity gain, and at gain of ten; less than  
100 microseconds at gain of one hundred.  
DRIFT REFERRED TO INPUT — Less than two millivolts over  
75°F to 120°F change of ambient; less  
than 100 microvolts over eight-hour  
period at constant temperature.

Request RIG-AMP Technical Bulletin  
for complete details.

ALSO AVAILABLE. Companion, plug-in Power  
Booster for use with Amplifier A-2 in driving  
heavy instrument systems, rotary  
amplifiers, and small DC servos.



**RIDGEFIELD  
INSTRUMENT GROUP**

a Schlumberger division  
Ridgefield, 5 Conn., P.O. Box 337, Idlewood 8-6571



# ELECTRO-PLATED WIRES

For many years this plant has specialized in continuous electroplating of wires... Recently Gold plated Copper wire has found increasing application in the missile field where corrosive atmospheres may be prevalent... Our production equipment permits handling wire in the size range of .001" to .060".... Technological know-how and efficiency assure economy with consistently high quality.

Send us details of your specific requirements



**SIGMUND COHN**  
Mfg. Co., Inc.  
121 South Columbus Ave.  
Mount Vernon, N. Y.



Since 1901

CIRCLE 214 ON READER SERVICE CARD

## any size panels engraved in your own plant

Engrave 1-inch nameplates or 6-foot panels by unskilled labor.

Spindle covers 18 $\frac{1}{4}$ " x 6" in one set-up — more than any other machine of its kind.

Bench type model I-R — \$685.

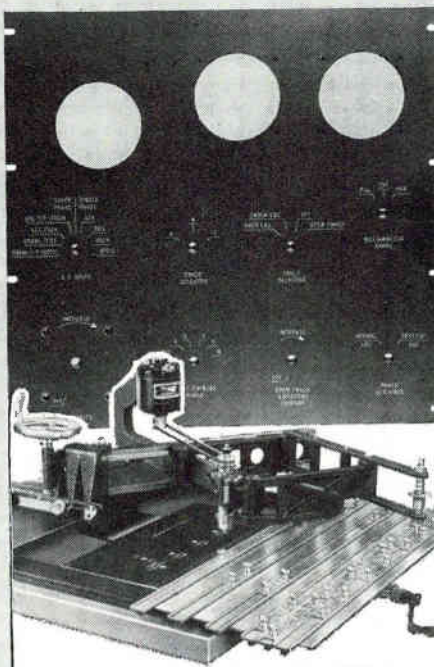

Send for complete catalog ZR-4

**new hermes** ENGRAVING MACHINE CORP.

154 WEST 14th STREET, NEW YORK 11, N. Y. IN CANADA: 359 St. James Street West, Montreal, P. Q.

self-refresher course.

Part II (not reviewed) covers frequency domain analysis. — M.M.P.

## Magnetic Tape Instrumentation

By G. L. DAVIES

McGraw-Hill Book Co., Inc., New York, 1961, 263 p, \$8.50

THIS "attempted exposition of the principles and equipment, their character and limitations" of magnetic tape recording and reproduction of data, as distinguished from voice and music, encompasses almost all phases of instrumentation, and data acquisition and processing systems.

## The Consulting Engineer

By C. M. STANLEY

John Wiley & Sons, Inc., New York, 1961, 258 p, \$5.95.

NONTECHNICAL aspects of the consulting engineer's professional life are covered in this book. Topics include organizing a consulting firm, typical accounting and billing procedures, contracts, ethics, and relations with clients and colleagues. This is a useful guide for a consultant getting started or an engineer contemplating striking out on his own. J.C.

## Basic Radio

By MARVIN TEPPER,

John F. Rider Publisher, Inc., New York, 1961, 776 p, \$13.85 (soft covers), \$14.85 (cloth covers).

THE LATEST in the Rider "pictured text" series, these six volumes represent a surprisingly detailed coverage of basic radio communications, with separate texts on d-c electricity, a-c electricity, electron tube circuits, a-m and f-m receivers, transistors, and a-m and f-m transmitters. Featuring a well-planned drawing on each page, an absolute minimum of mathematics, and a clear writing style at the technical institute level, these books make an interesting introduction to radio or a rapid brush-up on its fundamentals. S.B.G.



If your application requires a high dielectric constant plastic . . . rely on

# STYCAST HiK

Here's a superior rod and sheet stock of loaded cross-linked polystyrene that offers these important advantages: service temperature (continuous) -95° to 215° F; dissipation factor below 0.002. Available in dielectric constants 3 to 15. The standard of the microwave field for wave guides, coax, antenna systems, etc.

For higher temperatures:

## STYCAST HiK 500F

For technical bulletin, charts, write:



**Emerson & Cuming, Inc.**

Canton, Massachusetts    Gardena (L.A.) California

CIRCLE 215 ON READER SERVICE CARD

## HIGH VOLTAGE

### POWER SUPPLIES

INSULATION TESTERS  
PULSE MODULATORS



1,000 to 350,000 Volt Power Supplies  
Regulated or Unregulated

With extensive experience in the use of high voltage techniques KILOVOLT CORP. brings to bear the very latest existing knowledge in the design and development of power supplies for specific applications.

KILOVOLT CORP. is prepared to recommend the standard unit best adapted to your need or custom design and construct an especially suited power source or pulse modulator.

Long used in a wide range of industry KILOVOLT CORP. equipment enjoys an exceptional record of trouble-free performance under the most severe conditions. All units are engineered to provide the maximum protection to the operator and the equipment.

*We'll be happy to help work out your high voltage power and pulse modulator needs. Call on us without obligation.*

**KILOVOLT CORPORATION**    HUBBARD 8-7373  
238 HIGH STREET • HACKENSACK, N. J.

CIRCLE 216 ON READER SERVICE CARD



An Allison Filter in use at Bell Telephone Laboratories

## Allison Variable Filters cover a frequency range of 1 cps to 640 kcps

Here's the answer for a general purpose, tunable, audio-frequency filter . . . an Allison Variable Filter. Allison Filters may be used as high cutoff, low cutoff or band pass filters. Requiring almost no maintenance, these passive network filters have a dynamic range in excess of 120 db. They are excellent for the analysis of transient noises since they have no internal noise and negligible ringing effect. 11 filter models . . . portable and rack mount . . . direct reading . . . prices start at \$345.00 . . . write today for attenuation curves, complete specifications, and prices.

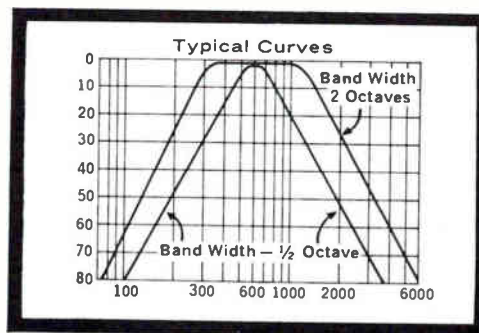

**FREE CATALOG!** Clip coupon, attach to company letterhead, and mail today for a catalog of Allison analyzing instruments.



NAME \_\_\_\_\_

**ALLISON ABS.**

**Allison Laboratories, Inc.**  
11301 OCEAN AVENUE, LA HABRA, CALIFORNIA  
*proved dependable in years of service*

CIRCLE 159 ON READER SERVICE CARD 159





Charles E. Beck



David B. Smith



Donald G. Fink



Henry F. Argento

## Philco Realigns Organization

ORGANIZATION alignments and personnel appointments for Ford Motor Company's new subsidiary, Philco Corp., have been announced by Charles E. Beck, president.

The new corporation is organized by staff and operating functions. Staff functions include finance, legal, engineering and research, government product planning and marketing, industrial relations, public relations, and organization and executive personnel planning. There are nine operating divisions.

Beck said Paul J. Miller, controller; William R. Wilson, treasurer; and Fred G. Reiter, president of Philco Finance Corp., will report to Gene McCormick, vice president-finance. Ernest E. Bareuther, assistant controller, will report to Miller.

The former Philco Research Division has been redesignated the Philco Scientific Laboratory. Donald G. Fink was appointed director reporting to David B. Smith, vice-president-engineering and research.

### Elect John Graham ITT Vice President

ELECTION of John J. Graham as a vice president of International Telephone and Telegraph Corp., New York City, is announced. He will also serve as executive assistant to the president.

Graham comes to ITT after 14 years with RCA, where his most recent assignment was division vice

The former Government and Industrial Group has been reorganized. Henry F. Argento was appointed vice president-government product planning and marketing. Beck said the following executives of the former Government and Industrial Group will continue to report to Argento: Joseph M. Hertzberg, John B. Hunt, Harold E. Rice and A. P. Hill. James E. Leeper, manager of the corporation's Washington office, also will report to Argento.

The following general managers of operating divisions will report to Beck—Henry E. Bowes, Consumer Products Div.; Robert F. Herr, Techrep Div.; Harvey Williams, International Div.; William J. Peltz, Lansdale Div.; Clarence E. Burke, Computer Div.; Frank E. Stehlik, Communications and Weapons Div.; Elmer B. Garland, Communications Systems Div.; Oscar T. Simpson, Western Development Laboratories; and Willard Feldscher, Sierra Electronics Div.

president, operations for electronic data processing.

### Otarion Listener Changes Name

OTARION ELECTRONICS, INC., is the new name of Otarion Listener Corp., Ossining, N.Y. The new name describes more accurately the hear-

ing aid manufacturer's expanding activities in miniaturized electronics, according to Leland E. Rosemond, president.

Otarion recently organized a microminiature controls division, which is concentrating on radio receivers, transformers and actuators, initially for model craft and later for virtually all electronic devices. Research, design, engineering and production of Otarion's hearing aids, audiometers and related equipment was assigned to a new, augmented hearing aid division.

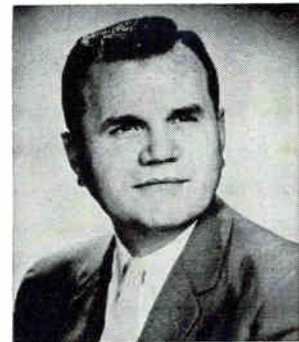

### Budd-Stanley Co. Names Anderson

BUDD-STANLEY CO., INC., Syosset, N. Y., has appointed Tore N. Anderson as vice president for engineering. Company produces precision microwave components and instruments.

Prior to this appointment, Anderson was president of FXR, Inc. and a director of Micromega Corp., an FXR subsidiary.



### Joseph Boyd Joins Radiation Inc.

JOSEPH A. BOYD resigns his post as director of the Institute of Science and Technology at the U. of Michigan, to join Radiation Inc. at Melbourne, Fla., as vice president and



## CIRCUIT DESIGN

If this is your career interest, we have projects involving digital computers of extremely small size. Let us tell you more about this — confidentially. Write to Mr. Harry Laur — Research and Engineering Staff.

Qualified applicants will be considered regardless of race, creed, color or national origin.



LITTON SYSTEMS, INC. Data Systems Division  
Canoga Park, California

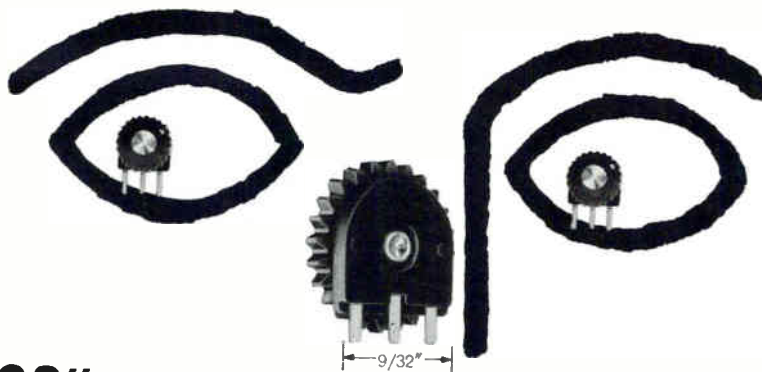

# 9/32" DIA. VARIABLE RESISTORS

Designed for use in miniature transistor hearing aids, miniature radios, telephone equipment, pocket dictating machines, medical equipment and industrial applications where extremely small size and high reliability is essential. Micro miniature M250 Series has knobs in 4 sizes in a choice of colors.

- Ultra quiet element.
- Controlled turning torque can be tailored to customer's knob-size requirements.
- Versatile mounting arrangements.
- Molded phenolic base available in colors to match color of knob—an exclusive feature.
- Noise-free volume adjustment because stud not electrically connected to element—an exclusive feature.
- Limitless variety of tapers and resistances available from 100 ohms through 10 megohms.
- Fast, dependable delivery.

WRITE FOR CATALOG PAGE

**CTS OF ASHEVILLE, INC.**  
Skyland, N. C.

Subsidiary of **CTS CORPORATION**  
Elkhart, Indiana



January 5, 1962

CIRCLE 217 ON READER SERVICE CARD

## Straits Tin Report

**"Sealed" cable** —Tinplate provides a vapor barrier for Western Electric's Stalpeth telephone cable. The conductive copper core has three protective jackets: Aluminum as an electrical shield and lightning protector; continuously soldered .0072-in. corrugated tinplate for corrosion resistance and mechanical protection; and an outer jacket of polyethylene, bonded with asphalt-rubber, for moisture control. The combination of aluminum, tinplate, asphalt-rubber and polyethylene replaces heavy lead sheath.

STALPETH TELEPHONE CABLE

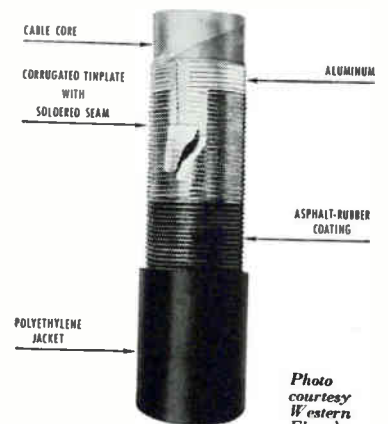

### Tin developments—

- Battery grids are improved by alloying tin, lead and barium.
- Semiconductor contacts are enhanced by an alloy of tin and germanium or silicon.
- Exothermic reaction between tin oxide, powdered aluminum, and calcium fluoride flux successfully welds aluminum conductor cables. Ignition of powder creates a molten tin alloy which flows into joints, sealing cable splices.

### FREE Brochure

16 interesting pages of information about the latest uses of tin in U.S. industry. Write today for your copy.



**The Malayan Tin Bureau**

Dept. S-25A, 2000 K Street, N.W., Washington 6, D.C.

CIRCLE 161 ON READER SERVICE CARD



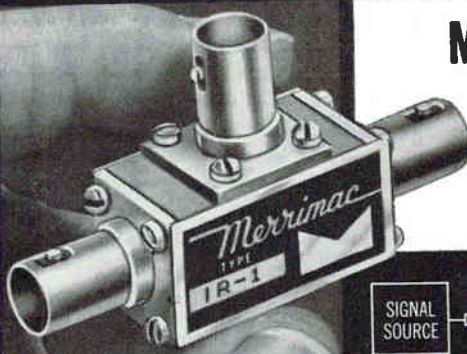

## MATCH IMPEDANCES WITH NEW I-F REFLECTOMETER BY MERRIMAC

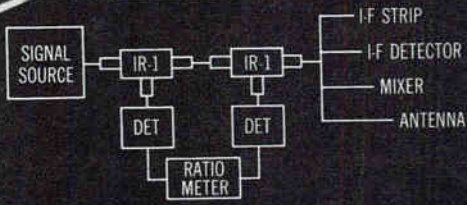

Model IR-1  
range 0.1—25 Mc  
 Model UR-1  
range 10—200 Mc  
 Price **\$85** (either model)

A genuine advance in the state of the art, Merrimac's I-F Reflectometer for matching impedances in microwave circuitry incorporates the vital features of **FLAT COUPLING CHARACTERISTICS** and **HIGH DIRECTIVITY** (20-25 db) making possible accurate VSWR measurements. These broad band directional couplers, the first in a line of new I-F components, extend microwave design techniques to the low frequency portion of the spectrum. They are compact, lightweight and protectively potted...exemplifying Merrimac's advanced methods for developing microwave instruments and components. Write for complete specifications.



### MERRIMAC

RESEARCH AND DEVELOPMENT, INC.  
517 Lyons Avenue, Irvington 11, N. J.

CIRCLE 162 ON READER SERVICE CARD



## "BEST BUY"

for buying or selling in  
the electronics industry

Your 1961 electronics Buyers' Guide and Reference Issue is the one book that "tells all" so far as buying or selling in the electronics industry is concerned.

Use your EBG today, and every day, and see what we mean.

**electronics BUYERS' GUIDE**  
and Reference Issue

The Basic Buying Guide in Electronics *since 1941*

assistant to the president.

Boyd has been consultant for the Institute for Defense Analysis since 1956, consultant for the National Security Agency since 1957, special consultant to the Army Combat Surveillance Agency since 1958, and member, then chairman of the Advisory Group on Electronic Warfare, Office of the Director of Defense Research and Engineering, since 1959.



### Electro-Optical Systems Hires Prince

MORTON B. PRINCE, former corporate vice president of Hoffman Electronics, has joined the staff of Electro-Optical Systems, Inc., Pasadena, Calif., as manager of microelectronics.

In addition to his primary functions in the microelectronics area, Prince will also be active in the company's programs in advanced space power systems using photovoltaic solar cells.



### Sprague Electric Names Moynihan

APPOINTMENT of John D. Moynihan as product specialist for high reliability capacitors at the Sprague Electric Co., North Adams, Mass., is announced.

Moynihan rejoins Sprague after a five-year period as chief engineer



*it's read  
more  
by all 4!*

**electronics** is specially edited to keep you informed about the entire industry. With special issues on Electronic Markets, Modern Microwaves, Search and Probe Systems, and other reports you'll want to file and keep

*subscribe today to* **electronics**

Every Friday, **electronics** gives you the latest engineering developments and technically interpreted market trends. So don't wait till everyone on the routing slip has read it. Subscribe now and read **electronics** first. Mail the reader service card (postpaid) to **electronics**, the magazine that helps you to know and to grow! Rates: three years for \$12, one year for \$6; Canadian, one year for \$10; foreign, one year for \$20. Annual **electronics** BUYERS' GUIDE (single issue price \$3.00) included with every subscription.

January 5, 1962

## Super-Conductors

*Columbium-Tin  
Columbium-Zirconium  
Columbium-Titanium  
Vanadium-X*

These alloys are produced from our electron-beam refined, ultra-high purity materials. Experimental quantities of various compositions in rod, wire, and sheet form are immediately available.

MRC has just moved to a new plant, built to our specifications, on route 303 in Orangeburg, New York. The Advanced Materials Division has an atmosphere-controlled section, equipped with the newest quality control instruments and production tools. This care in production is reflected in the purity of our materials and the true homogeneity of our alloys.

**mrc**

**ADVANCED MATERIALS DIVISION  
MATERIALS RESEARCH CORPORATION  
Orangeburg, New York**

CIRCLE 218 ON READER SERVICE CARD

*SS motor      SS governed      SS planetary*

### FAMILY OF 7/8" D.C. MOTORS

Basic Type SS p.m. motor produces up to 0.3 oz. in. @ 10,000 rpm continuous; 19 standard windings plus specials can meet your speed, torque, and power requirements. Size: 7/8" dia. x 1 3/8"; weight is 2 oz. Voltages 4 through 50 v.d.c. or more. MIL specs. Mechanically governed SS motors can regulate speed within 2%; electronic governors, within a few parts per million. Gear reducers further extend usefulness to 300 oz. in. torque; 21 standard planetary ratios, 28 standard spur gear ratios. If you need a still smaller motor, ask about Type SD (3/4" dia.) or VT (5/8" dia.). Request Bulletin SS from Globe Industries, Inc., 1784 Stanley Avenue, Dayton 4, Ohio.

**GLOBE INDUSTRIES, INC.**

CIRCLE 163 ON READER SERVICE CARD 163





# electronics

## WEEKLY QUALIFICATION FORM FOR POSITIONS AVAILABLE

### ATTENTION: ENGINEERS, SCIENTISTS, PHYSICISTS

This Qualification Form is designed to help you advance in the electronics industry. It is unique and compact. Designed with the assistance of professional personnel management, it isolates specific experience in electronics and deals only in essential background information.

The advertisers listed here are seeking professional experience. Fill in the Qualification Form below.

#### STRICTLY CONFIDENTIAL

Your Qualification form will be handled as "Strictly Confidential" by ELECTRONICS. Our processing system is such that your form will be forwarded within 24 hours to the proper executives in the companies you select. You will be contacted at your home by the interested companies.

#### WHAT TO DO

1. Review the positions in the advertisements.
2. Select those for which you qualify.
3. Notice the key numbers.
4. Circle the corresponding key number below the Qualification Form.
5. Fill out the form completely. *Please print clearly.*
6. Mail to: D. Hawksby, Classified Advertising Div., ELECTRONICS, Box 12, New York 36, N. Y. (No charge, of course).

COMPANY	SEE PAGE	KEY #
AMERICAN INSTRUMENT CO., INC. Silver Spring, Maryland	168	1
COLLINS RADIO COMPANY Dallas, Texas	122	2
DALMO VICTOR CO. Div. of Textron, Inc.	169	3
ERIE ELECTRONICS DIVISION Erie Resistor Corp. Erie, Pa.	168	4
GPL DIVISION General Precision Inc. Pleasantville, New York	75*	5
INSTROM ENGINEERING CORP. Canton, Mass.	73*	6
LITTON SYSTEMS INC. Data Systems Div. Canoga Park, Calif.	161	7
LOCKHEED-GEORGIA CO. Div. of Lockheed Aircraft Corp. Atlanta, Georgia	94	8
MCDONNELL AIRCRAFT St. Louis, Missouri	167	9
MICROWAVE SERVICES INTERNATIONAL INC. Denville, New Jersey	75*	10
NATIONAL CASH REGISTER CO. Dayton, Ohio	168	11
SIKORSKY AIRCRAFT Div. of United Aircraft Corp. Stratford, Conn.	166	12
SPACE TECHNOLOGY LABS., INC. Sub. of Thompson-Ramo-Wooldridge Los Angeles, Calif.	169	13
P-7950	168	14

\* These advertisements appeared in the 12/29/61 issue.

(cut here)

(cut here)

## electronics WEEKLY QUALIFICATION FORM FOR POSITIONS AVAILABLE

**Personal Background**

NAME .....

HOME ADDRESS .....

CITY ..... ZONE ..... STATE .....

HOME TELEPHONE .....

**Education**

PROFESSIONAL DEGREE(S) .....

MAJOR(S) .....

UNIVERSITY .....

DATE(S) .....

### FIELDS OF EXPERIENCE (Please Check)

1562

<input type="checkbox"/> Aerospace	<input type="checkbox"/> Fire Control	<input type="checkbox"/> Radar
<input type="checkbox"/> Antennas	<input type="checkbox"/> Human Factors	<input type="checkbox"/> Radio—TV
<input type="checkbox"/> ASW	<input type="checkbox"/> Infrared	<input type="checkbox"/> Simulators
<input type="checkbox"/> Circuits	<input type="checkbox"/> Instrumentation	<input type="checkbox"/> Solid State
<input type="checkbox"/> Communications	<input type="checkbox"/> Medicine	<input type="checkbox"/> Telemetry
<input type="checkbox"/> Components	<input type="checkbox"/> Microwave	<input type="checkbox"/> Transformers
<input type="checkbox"/> Computers	<input type="checkbox"/> Navigation	<input type="checkbox"/> Other .....
<input type="checkbox"/> ECM	<input type="checkbox"/> Operations Research	<input type="checkbox"/> .....
<input type="checkbox"/> Electron Tubes	<input type="checkbox"/> Optics	<input type="checkbox"/> .....
<input type="checkbox"/> Engineering Writing	<input type="checkbox"/> Packaging	<input type="checkbox"/> .....

### CATEGORY OF SPECIALIZATION

Please indicate number of months experience on proper lines.

	Technical Experience (Months)	Supervisory Experience (Months)
RESEARCH (pure, fundamental, basic)	.....	.....
RESEARCH (Applied)	.....	.....
SYSTEMS (New Concepts)	.....	.....
DEVELOPMENT (Model)	.....	.....
DESIGN (Product)	.....	.....
MANUFACTURING (Product)	.....	.....
FIELD (Service)	.....	.....
SALES (Proposals & Products)	.....	.....

CIRCLE KEY NUMBERS OF ABOVE COMPANIES' POSITIONS THAT INTEREST YOU

1 2 3 4 5 6 7 8 9 10 11 12 13 14 15 16 17 18 19 20 21 22 23 24 25



*pioneer and leading manufacturer  
of rotary wing aircraft*

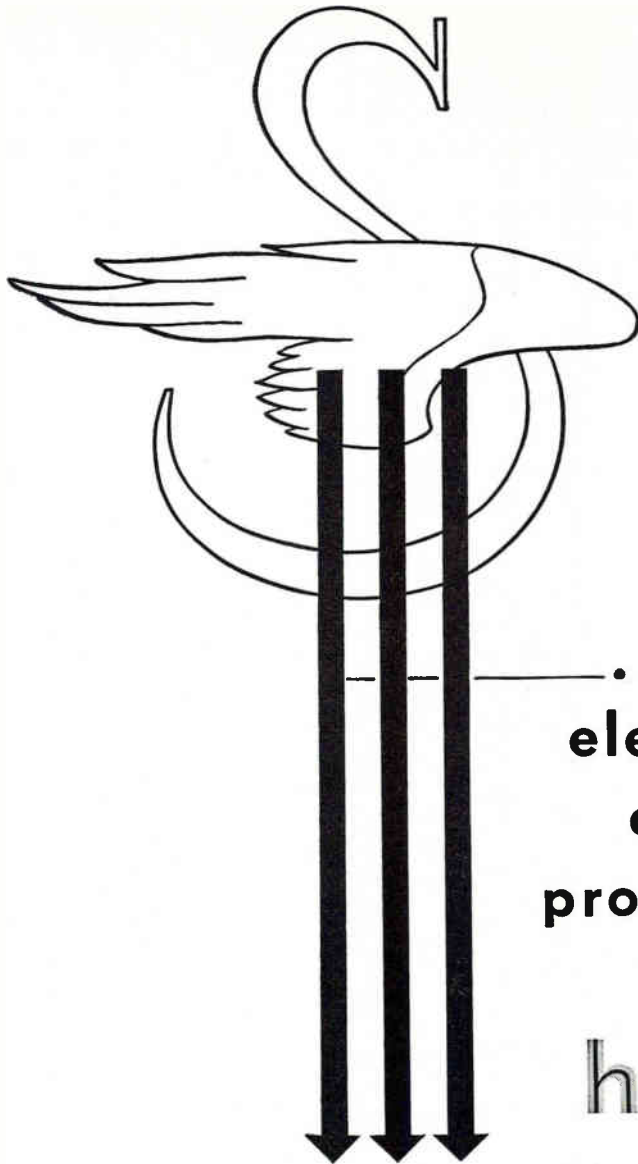

...at **SIKORSKY**  
 electronic engineers  
 can broaden their  
 professional horizons  
 in the field of  
 helitronics

Today, as Sikorsky Aircraft's activities expand in significance and scope, particular emphasis is being directed to a sphere of activity which we term "helitronics". This area embraces a blending of two major technologies: *helicopters* and *electronics*. Specifically, helitronics means the integration of guidance and navigation systems, specialized electronic search and detection equipment to enhance the mission capability of the helicopter; specialized sensors and automatic controls to increase its versatility as an optimum military weapon system and a commercial carrier.

The need for more sophisticated electronic systems offers exceptional opportunities to competent electronic engineers with particular skills in: design • instrumentation • test • development • air-borne systems • production and service support equipment • trainers and simulators.

Unusually interesting openings as Avionics Instructors also exist for men with aircraft electronics experience and a desire to teach.

*If you are interested in these career opportunities, please submit your resume, including minimum salary requirements, to L. J. Shalvoy, Personnel Department.*

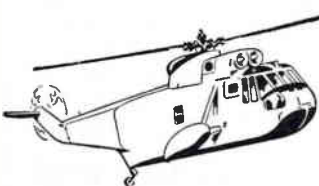

**SIKORSKY AIRCRAFT** STRATFORD,  
 CONNECTICUT  
 DIVISION OF UNITED AIRCRAFT CORPORATION

All qualified applicants will receive consideration for employment without regard to race, creed, color or national origin.

PERSONAL:

Name McDonnell  
 Address St. Louis, Missouri  
 Age 22 yrs.  
 Health Free of Debt - Growing Aerospace Backlog  
 Physical Appearance Complete, modern Aerospace Engineering, Research Laboratories and Production Facilities.  
 Size Over 21,000

MILITARY SERVICE: Contracts with U.S. Navy, U.S. Air Force, U.S. Army and the NASA.

ACHIEVEMENTS:

FH-1 Phantom First Navy jet fighter to land and take off a carrier.  
 F2H Banshee Saw extensive combat in Korea.  
 F-101 Voodoo Holder of 10 world records  
 F3H Demon In service with the Navy  
 Quail GAM-72 Decoy Missile  
 F4H Phantom World's record holder 2 mission fighter  
 Asset Re Entry Research Spacecraft  
 Mercury Spacecraft Carried first American into Space.

FUTURE OBJECTIVE: To design and build, through innovation, those aerospace products which leap across the state of the art to become unique engineering achievements ahead of their time.

# ENGINEERS SCIENTISTS PHYSICISTS

## LET'S SWAP RESUMES

Please complete this form and forward to: Mr. D. F. Waters, Professional Placement, Dept. 62, McDonnell Aircraft, St. Louis 66, Missouri. This is not an application for employment. Your qualifications will be reviewed by our placement staff and you will be advised of positions at McDonnell for which you qualify. You may then make application if you wish.

Name \_\_\_\_\_ Address \_\_\_\_\_  
 City & State \_\_\_\_\_ Phone \_\_\_\_\_ Age \_\_\_\_\_  
 Primary Experience Area \_\_\_\_\_ Number of Years \_\_\_\_\_  
 Secondary Experience \_\_\_\_\_ Number of Years \_\_\_\_\_  
 Additional Comments \_\_\_\_\_

Education: AE \_\_\_\_\_ ME \_\_\_\_\_ Math \_\_\_\_\_ Physics \_\_\_\_\_ Chemistry \_\_\_\_\_ EE \_\_\_\_\_ Astronomy \_\_\_\_\_ Other \_\_\_\_\_  
 Degree: BS \_\_\_\_\_ Date \_\_\_\_\_ MS \_\_\_\_\_ Date \_\_\_\_\_ PHD \_\_\_\_\_ Date \_\_\_\_\_ I would like to receive application form \_\_\_\_\_

I would like to receive literature about professional opportunities at McDonnell

My primary interest is:

- Airborne Communications
- Antenna & Microwave Techniques
- Automatic Test Equipment
- Computer Development
- Digital Technique & Logic Design
- Military Airborne & Solid State Electronics
- Research
- Thin Film Techniques
- Weapons Systems Analysis

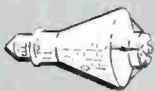

### MCDONNELL

An equal opportunity employer.

Phantom II Fighter and Attack Aircraft • Mercury, Asset and Aeroballistic Spacecraft • Talos and Typhon Missile Airframes and Engines • Quail Decoy Missiles • Rotorcraft • Electronic Systems • Automation



# NCR

## ADVANCED DEVELOPMENT ELECTRONICS

The National Cash Register Company's Research and Development Division located in Dayton, Ohio has opportunity for experienced Senior Engineers and Scientists for the following positions:

NCR's efforts are expanding now to meet the needs of the future for business and government functions. The stable nature of our Company provides an atmosphere for long range planning of personal goals and scientific achievement.

- **DEVELOPMENT PLANNING STAFF** — to conduct studies of electronic equipment requirements for AERO/SPACE projects with background in Microwave Equipment, Digital Computers Electro-Optical Devices, Human Engineering of Controls and Displays, or Navigation and Guidance Systems. Prefer M.S. in E.E. or Physics and 5-7 years experience in Military Development.
- **ENGINEER ANALYST** — to investigate multipath phenomenon relative high frequency communications. BS, EE and some graduate work in mathematics. Prefer experience in information theory and communications.
- **ELECTRONIC ENGINEERS** — BS, EE, 2-5 years in military electronics and familiarity with ground based or airborne equipment development.
- **CIRCUIT ENGINEERS** — BS, EE, 3-5 years in design of electronic equipment using solid state or vacuum tube circuits.
- **LOGIC ENGINEERS**—BS, EE, 2-4 years in design of digital logic circuits.
- **COMPONENT ENGINEERS** — BS, EE, 1-3 years in testing and evaluation of electronic components.
- **COMMUNICATION SYSTEM ENGINEERS**—BS, EE, 5-7 years in the high frequency communication area. Experience in propagation techniques.

To be considered for one of these challenging positions, send resume to:

Mr. T. F. Wade, Technical Placement, The National Cash Register Company, Main and K Streets, Dayton 9, Ohio.

AN EQUAL OPPORTUNITY EMPLOYER

### MICROWAVE COMMUNICATIONS ENGINEERS

Ankara - Teheran - Karachi  
Bangkok - U. S.

Work involves engineering, supervision of installation, operation and maintenance of microwave communications systems.

College Degree Mandatory

### MICROWAVE COMMUNICATIONS TECHNICIANS

Must be qualified by education and experience to inspect installation, operate and maintain microwave communications systems to insure quality and performance standards.

Technical or trade school training mandatory.

Families May Accompany  
Usual Overseas Benefits  
Send detailed resumes to:

P-7950, Electronics  
645 N. Michigan Avenue, Chicago 11, Ill.

### ELECTRONIC ENGINEER

Challenging position for man with BSEE and at least 2 years experience in electronics. Must be capable of electronic design in the field of instrumentation using audio frequencies. Employee benefits and promotional opportunities for qualified applicant. Forward complete resume including salary desired to:

PERSONNEL DIRECTOR  
AMERICAN INSTRUMENT CO., INC.  
8030 Georgia Ave., Silver Spring, Md.  
An equal opportunity employer

### TRANSFORMER ENGINEER

With experience in the design and development of Hi-Frequency and Pulse transformers for commercial and military applications.

Ideal opportunity for ambitious man to develop full potential of present small department. Salary—open. Location—Erie, Pa. Call or send resume to Chief Engineer

Erie Electronics Division  
Erie Resistor Corporation  
645 West 12th Street Erie, Pa.  
GL 6-8592

### Need Engineers?

Contact them through this

EMPLOYMENT OPPORTUNITIES Section

Method for  
measuring  
an engineer...

What's his  
technical  
publication ?



When an engineer pays for a technical publication, it's a safe bet that that is the one he respects most.

He makes it his business to read **electronics**. It keeps him well informed of up - to - the - minute events and developments in the electronics industry and the technology to which he contributes his experience.

Where your recruitment program calls for engineers and other technical people of this calibre, you can reach them in the **EMPLOYMENT OPPORTUNITIES** section of:

**electronics**

A MCGRAW-HILL PUBLICATION  
CLASSIFIED ADVERTISING DIVISION  
POST OFFICE BOX 12 NEW YORK 36, NEW YORK

**SEARCHLIGHT SECTION**

(Classified Advertising)

BUSINESS OPPORTUNITIES  
EQUIPMENT - USED or RESALE

**DISPLAYED RATE**

The advertising rate is \$27.25 per inch for all advertising appearing on other than a contract basis. Contract rates quoted on request. AN ADVERTISING INCH is measured 7/8 inch vertically on one column, 3 columns—30 inches—to a page. EQUIPMENT WANTED or FOR SALE ADVERTISEMENTS acceptable only in Displayed Style.

**UNDISPLAYED RATE**

\$2.70 a line, minimum 3 lines. To figure advance payment count 5 average words as a line. PROPOSALS, \$2.70 a line an insertion. BOX NUMBERS count as one line additional in undisplayed ads. DISCOUNT OF 10% if full payment is made in advance for four consecutive insertions of undisplayed ads (not including proposals).

ADDRESS BOX NO. REPLIES TO: Box No. Classified Adv. Div. of this publication. Send to office nearest you.  
NEW YORK 36: P. O. Box 12  
CHICAGO 11: 645 N. Michigan Ave.  
SAN FRANCISCO 11: 255 California St.

**BUSINESS OPPORTUNITY**

For Sale—Electronic Patent 2,892,965. Best offer and/or terms. BO-7972, Electronics.

**NEW INDUSTRY WANTED**

Community Has Cash To Help locate industry in western Kentucky lake area. No gimmick! Plenty of water, labor, sites, gas, power, 100% plant financing. For more details call or write, West Hopkins Industries, Box 245, Dawson Springs, Ky.

**FOR INFORMATION**

About Classified Advertising,

Contact The McGraw-Hill Office Nearest You.

- ATLANTA, 9—1375 Peachtree St. N.E. TRinity 5-0523  
D. HICKS
- BOSTON, 16—Copley Square COngress 2-1160  
M. SHOVLIN
- CHICAGO, 11—645 No. Michigan Ave. MOhawk 4-5800  
W. J. HIGGINS
- CLEVELAND, 13—1164 Illuminating Bldg. SUperior 1-7000  
I. C. HILL
- DALLAS, 2—1712 Commerce St. VAughn Bldg., RIVERSIDE 7-5117  
J. GRANT
- DENVER, 2—1700 Broadway—Tower Bldg. ALpine 5-2981  
J. PATTEN
- DETROIT, 26—856 Penobscot Bldg. WOodward 2-1793  
WM. H. GINDER, JR.
- HOUSTON, 25—Prudential Bldg., Room W-724 Holcombe Blvd., JACKSON 6-1281  
J. PAGE
- LOS ANGELES, 17—1125 W. 6th St. HUntley 2-5450  
W. C. GRIES
- NEW YORK, 36—500 Fifth Ave. OXFord 5-5959  
H. T. BUCHANAN  
T. W. BENDER - P. BOND
- PHILADELPHIA, 3—Six Penn Center Plaza LOcust 8-4330  
W. B. SULLIVAN - F. W. McCARTHY
- PITTSBURGH, 22—4 Gateway Center EXpress 1-1314  
D. FARRIS
- ST. LOUIS, 8—3615 Olive St., JEFFerson 5-4867
- SAN FRANCISCO, 11—255 California St. DOuglas 2-4600  
J. A. HARTLEY



COMPANY  
DIVISION OF TEXTRON INC.

A leader in . . .

Design, Development and Manufacturing of

- MICROWAVE ANTENNAS SYSTEMS & COMPONENTS
- ELECTRONIC SYSTEMS
- MAGNETIC INSTRUMENTATION SYSTEMS
- SERVO CONTROL SYSTEMS

Invites . . .

Qualified Engineers and Scientists to explore the challenging opportunities created by increased business volume and facility expansion.

Experienced Engineers and Physicists will find stimulating assignments, career growth opportunities based on performance, and the opportunity to make significant individual contributions toward major state of the art advances in the areas indicated above.

Liberal employee benefits which include Insurance, Stock Plan, Profit-Sharing and Educational assistance, combine with the natural advantages of Northern California suburban living to offer an ideal environment in which to work and live.

For further information, please write, sending a copy of your resume to:

Technical Employment



COMPANY  
DIVISION OF TEXTRON INC.

1515 Industrial Way  
Belmont, Calif.

"an equal opportunity employer"



**MANUFACTURERS' REPRESENTATIVES**

IN THE ELECTRONIC INDUSTRY

**SAMUEL K. MACDONALD, INC.**  
manufacturers representatives over 25 years  
1531 SPRUCE STREET, PHILA. 2, PA.

Territory: Pennsylvania • New Jersey  
Delaware • Maryland  
Virginia • West Virginia  
District of Columbia  
Other Offices: Pittsburgh  
Baltimore  
Washington, D.C.

. . . Your advertisement in the MANUFACTURERS REPRESENTATIVES Section of electronics will reach YOUR markets—on a national and world wide scale. You need them . . . electronics reaches them

For full information and rates write:

electronics

Classified Advertising Division  
P. O. Box 12 New York 36, New York



RELIABILITY ENGINEERS and QUALITY ASSURANCE ENGINEERS

Symposium Interviews  
Washington, D. C.

January 9-11, 1962

STL's expanding Reliability and Quality Assurance Program has created positions with responsibility for the developing, implementing and auditing of these programs for advanced weapons systems and space programs. Responsibility extends through all phases, including:

- Proposal Preparation
- Program Planning
- Hardware Development
- Procurement
- Manufacturing & Test
- Field Support

Requirements:

Reliability Engineers—BS in Engineering or Physical Sciences with 5 or more years experience in aerospace or related industries in reliability programs, preferably including hardware design experience.

Quality Assurance Engineers—Positions range from BS in Engineering or Physical Sciences with 2 or more years experience in aerospace or related industries in quality assurance programs—to BS in Engineering with 10 or more years experience, including 5 years in quality assurance planning, and 3 years design engineering experience.

Symposium interviews arranged at headquarters hotel by calling Mr. H. R. Stevens, EXecutive 3-5030, Tues., Jan. 9 thru Thurs. Jan. 11, or send resumes to Mr. H. R. Stevens at STL, an equal opportunity employer.

SPACE TECHNOLOGY LABORATORIES, INC.

P.O. Box 95005E, Los Angeles 45, Calif.

a subsidiary of Thompson Ramo Wooldridge Inc.





- JFD Electronics Corp..... 153
- Japan Piezo Electric Co., Ltd..... 164
- Jerrold Electronics Corp..... 4
- Kilovolt Corp. .... 159
- Lapp Insulator Co., Inc..... 132
- Litton Industries ..... 161
- Lockheed-Georgia Co., Div. of  
Lockheed Aircraft Corp..... 94
- Magnetic Metals Company..... 124
- Malayan Tin Bureau..... 161
- Materials Research Corp..... 163
- Mechanical Enterprises, Inc..... 164
- Merrimac Research & Development,  
Inc. .... 162
- Microdot, Inc. .... 101
- Minneapolis-Honeywell  
Precision Meter Division..... 149
- Minnesota Mining & Mfg. Co.,  
Mincom Division ..... 141
- Mycellex Corp. of America..... 135
- NRC Equipment Co..... 107
- Narda Microwave Corporation..... 125
- National Vulcanized Fibre Co..... 33
- New Hermes Engraving Machine Corp. 158
- Northeastern Engineering, Inc..... 147
- Oak Mfg. Co..... 121
- Pacific Semiconductors, Inc..... 99
- Panoramic Electronics, Inc..... 150
- Phileo Corporation ..... 76
- Philips Gloeilampenfabrieken,  
N.V. .... 102, 103
- Plastoid Corp. .... 75
- Plasto Film Inc..... 170
- Polarad Electronics Corporation...112, 113
- Radio Corporation of America...4th Cover
- Rese Engineering Inc..... 34
- Ridgelfield Instrument Group..... 157
- Ross Co., Milton..... 29

- Servo Corporation of America..... 24
- Sorensen & Co..... 115
- Spectran Electronics Corp..... 111
- Sprague Electric Co.....9, 30
- Stancor Electronics Inc..... 118
- Struthers-Dunn ..... 117
- Superior Electronics Corp..... 152
- Taylor Fibre Co.....130, 131
- Tektronix, Inc. .... 126
- Trak Electronics Co., Inc. .... 22
- Uniform Tubes, Inc..... 144
- Ungar Electric Tools..... 23
- United Shoe Machinery Corp..... 154
- United Transformer Corp.....2nd Cover
- Unitek, Weldmatic Div..... 133
- Utten Drop Forge & Tool  
Division, Kelsey-Hayes Co. .... 156
- Vibrae Corp. .... 114
- Vitramon, Inc. .... 5
- Westinghouse Electric Corp.....10, 11
- Worklon Inc. .... 171
- Yellow Springs Instrument Co., Inc... 146
- Zippertubing Co., The..... 100
- MANUFACTURERS' REPRESENTATIVES  
MacDonald Inc., Samuel K..... 169
- See advertisement in the July 20, 1961 issue  
of Electronics Buyers' Guide for complete line of  
products or services.

# LINT FREE



Work clothes which generate lint can nullify quality control programs and CLEAN ROOM operations costing thousands to implement. Obviously it is important to select work clothes which are truly lint-free. Look for these qualities in clean room clothes.

**FIBER - WORKLON** lint-free apparel is made of continuous filament synthetic yarn, such as DuPont Dacron and Nylon.

**FABRIC - WORKLON** selects and offers the most abrasion-resisting weaves and special constructions most suitable for clean rooms... combining acid-resistant and static-free qualities.

**MANUFACTURING DETAILS - WORKLON'S** well tailored garments provide comfort, appearance and durability... designed for maximum utility and specific clean-room requirements.

**WORKLON** apparel provides all these qualities and more... as a look at our new 20-page catalog will quickly prove. This 1962 **WORKLON** catalog is packed with facts that will help you select the proper apparel for your clean room. For a copy use coupon below. **WRITE TODAY!**

## WORKLON

NEW YORK • LOS ANGELES

Worklon, Inc., Dept. E-12  
253 West 28th St., New York 1, N.Y.

Kindly send free Worklon catalog.

name \_\_\_\_\_  
 company \_\_\_\_\_  
 address \_\_\_\_\_  
 city \_\_\_\_\_ zone \_\_\_\_\_ state \_\_\_\_\_





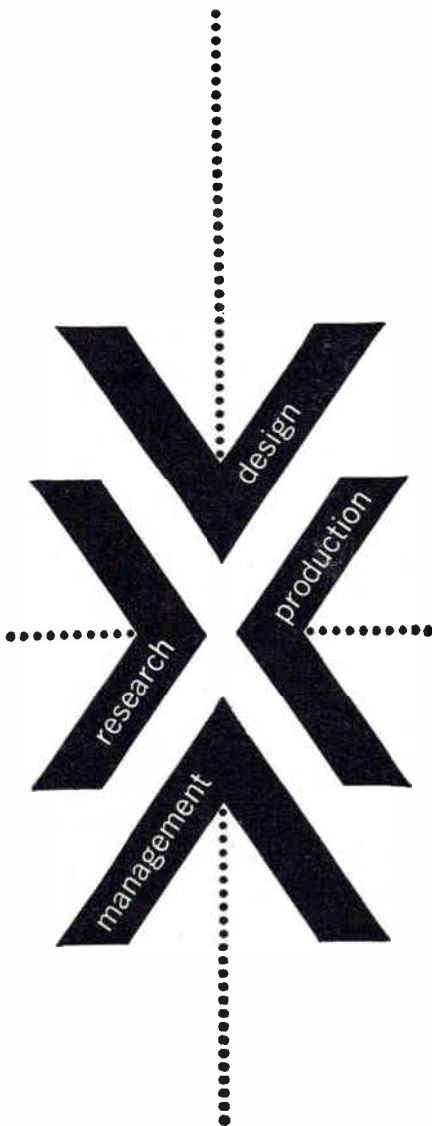

it's read  
more  
by all 4!

**electronics** magazine covers engineering and technically interpreted market trends every week. Government, military and economic developments, new applications, and technical data you'll want to file and keep. Subscribe now and read it first (don't be low man on a routing slip). Mail the reader service card (postpaid) to **electronics**, the magazine that helps you to know and to grow! Rates: three years for \$12; one year for \$6; Canadian, one year for \$10; foreign, one year for \$20. Annual **electronics** BUYERS' GUIDE (single issue price \$3.00) included with every subscription.

subscribe today to

**electronics**

CLASSIFIED ADVERTISING

F. J. Eberle, Business Mgr.

EMPLOYMENT OPPORTUNITIES. 166-169

BUSINESS OPPORTUNITIES..... 169

ADVERTISERS INDEX

American Instrument Co., Inc..... 168  
 Dalmo Victor Co..... 169  
 Erie Electronics Division,  
 Erie Resistor Corporation ..... 168  
 McDonnell Aircraft ..... 167

National Cash Register Company..... 168

Sikorsky Aircraft Division,  
 United Aircraft Corporation..... 166

Space Technology Labs,  
 Sub. of Thompson-Ramo-Wooldridge Inc. 169

• See advertisement in the July 20, 1961 issue of **Electronics Buyers' Guide** for complete line of products or services.

This index and our Reader Service Numbers are published as a service. Every precaution is taken to make them accurate, but **ELECTRONICS** assumes no responsibilities for errors or omissions.

electronics



Audit Bureau  
of Circulations



Associated Business  
Publications

Audited Paid Circulation

JAMES T. HAUPTLI

Advertising Sales Manager

R. S. QUINT:  
Assistant Publisher Buyers' Guide and  
Business Manager  
FRED STEWART:  
Promotion Manager  
B. ANELLO:  
Marketing Service Manager

RICHARD J. TOMLINSON:  
Production Manager  
GEORGE E. POMEROY:  
Classified Manager  
HUGH J. QUINN:  
Circulation Manager

ADVERTISING REPRESENTATIVES

NEW YORK (36):  
Donald H. Miller, Henry M. Shaw, George F. Werner  
500 Fifth Avenue, Oxford 5-5959  
BOSTON (16):  
William S. Hadgkinson, Donald R. Furth  
McGraw-Hill Building, Copley Square,  
Congress 2-1160  
PITTSBURGH (22):  
David M. Watson  
Four Gateway Center, Express 1-1314  
PHILADELPHIA (3):  
Warren H. Gardner, William J. Boyle  
6 Penn Center Plaza, LOcust 8-4330  
CHICAGO (11):  
Harvey W. Wernecke, Robert M. Denmead  
645 North Michigan Avenue, Mohawk 4-5800  
CLEVELAND (13):  
Paul T. Fegley  
55 Public Square, Superior 1-7000  
SAN FRANCISCO (11):  
R. C. Alcorn  
255 California Street, Douglas 2-4600  
LOS ANGELES (17):  
Peter S. Carberry, Ashley P. Hartman  
1125 W. 6th St., Huntley 2-5450

DENVER (2):  
J. W. Patten  
Tower Bldg., 1700 Broadway, Alpine 5-2981  
ATLANTA (9):  
Michael H. Miller  
1375 Peachtree St. N.E., Trinity 5-0523  
HOUSTON (25):  
Joseph C. Page, Jr.  
Prudential Bldg., Halcamb Blvd.,  
Jackson 6-1281  
DALLAS (1):  
Frank Le Beau  
The Vaughn Bldg., 1712 Commerce St.  
Riverside 7-9721  
LONDON W1:  
Dennis McDonald  
34 Dover St.  
FRANKFURT/Main:  
Stanley R. Kimes  
85 Westendstrasse  
GENEVA:  
Michael R. Zeynel  
2 Place du Part

**DAVEN / GENERAL MILLS**  
Blazing new trails in component reliability!

5

*extra features*



*at no extra cost!*

**Daven metal film resistors**

- True glass-to-metal seal plus epoxy encapsulation
- 25 PPM/°C. temperature coefficient over normal operating temperatures at no surcharge
- Weldable leads, which are readily solderable, are standard on all units at no surcharge
- Exceeds MIL-R-10509D, Characteristic C specs
- Off-the-shelf delivery from your Daven distributor

Write for full details on Types DA 2 and DA 4



THE **DAVEN** COMPANY, Livingston, New Jersey

RESISTORS

TODAY, MORE THAN EVER, THE DAVEN <sup>®</sup> STANDS FOR DEPENDABILITY



NOW...  
FROM RCA  
NEW ECONOMIES  
IN 200°C  
SILICON POWER  
TRANSISTORS

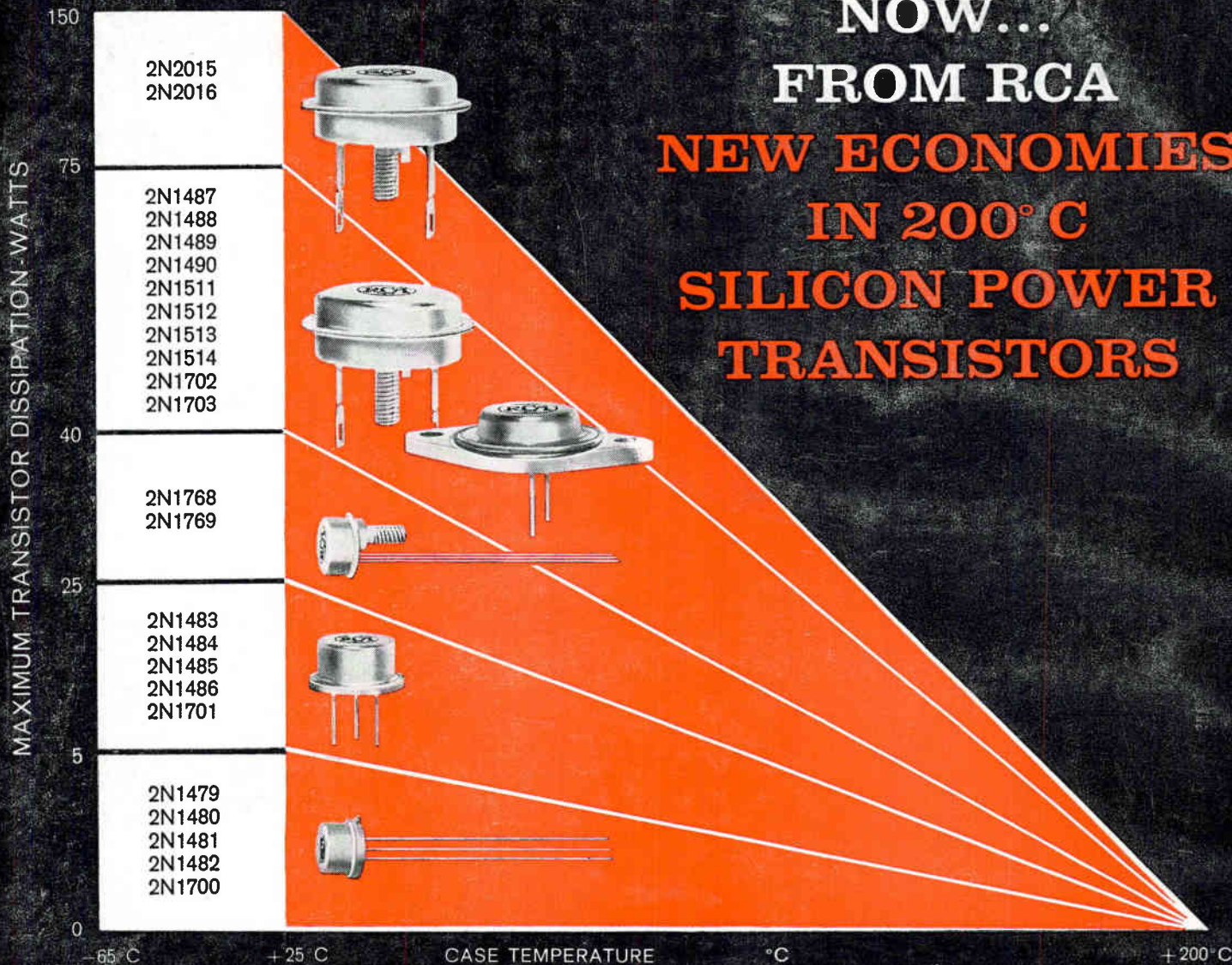

Now Beta-Control! Up To 10 Amperes...Extremely Low Saturation Resistance...  
Power To 150 Watts At Prices Starting As Low As Comparable Germanium Power Types

Check out the outstanding features of these 24 RCA N-P-N diffused-junction silicon power transistors, immediately available at low prices to meet your industrial and military applications requirements:

- Maximum operating temperature—up to 200°C.
- Maximum dissipation capability—up to 150 watts
- Very low thermal resistance—as low as 1.17°C/watt max.
- Very low saturation resistance—as low as 0.25-ohm max.
- High minimum beta
- Narrow Beta Spread

AVAILABLE THROUGH YOUR RCA DISTRIBUTOR

Call your RCA Field Representative today for complete sales and price information. For further technical information, write for RCA Technical Bulletins on these types. For detailed application information on the design of military and industrial equipment using RCA Silicon Power Transistors, send for new 28-page Application Guide on RCA Silicon Power Transistors— (Price: 50 cents per copy). Write to RCA Semiconductor and Materials Division, Commercial Engineering, Section A-19-NN-1, Somerville, N. J.



The Most Trusted Name in Electronics  
RADIO CORPORATION OF AMERICA

RCA FIELD OFFICES . . . EAST: Newark, N. J., 744 Broad St., HU 5-3900 • (Camden, N. J. area), Erlton, N. J., 605 Marlton Pike, HA 8-4802 • Syracuse, N. Y., 731 James St., Room 402, GR 4-5591 • Baltimore, Md., EN 9-1850 • NORTHEAST: Needham Heights 94, Mass., 64 "A" St., HI 4-7200 • SOUTHEAST: Orlando, Fla., 1520 Edgewater Drive, Suite #1, GA 4-4768 • EAST CENTRAL: Detroit 2, Mich., 714 New Center Bldg., TR 5-5600 • CENTRAL: Chicago, Ill., Suite 1154, Merchandise Mart Plaza, WH 4-2900 • Minneapolis, Minn., 5805 Excelsior Blvd., WE 9-0676 • WEST: Los Angeles 54, Calif., Box 54074, RA 3-8361 • (San Francisco area), Burlingame, Calif., 1838 El Camino Real, OX 7-1620 • SOUTHWEST: Dallas 7, Texas, 7905 Carpenter Freeway, FL 7-8167 • GOV'T: Dayton, Ohio, 224 N. Wilkinson St., BA 6-2366 • Washington, D. C., 1725 "K" St., N.W., FE 7-8500