

September 1, 1961

electronics

Applications of plasma in nuclear physics, electronics and space, p 29

How magneto-optical readout permits high-density recording, p 36

Designing crystal-controlled tunnel-diode oscillators, p 40

A McGraw-Hill Publication 75 Cents

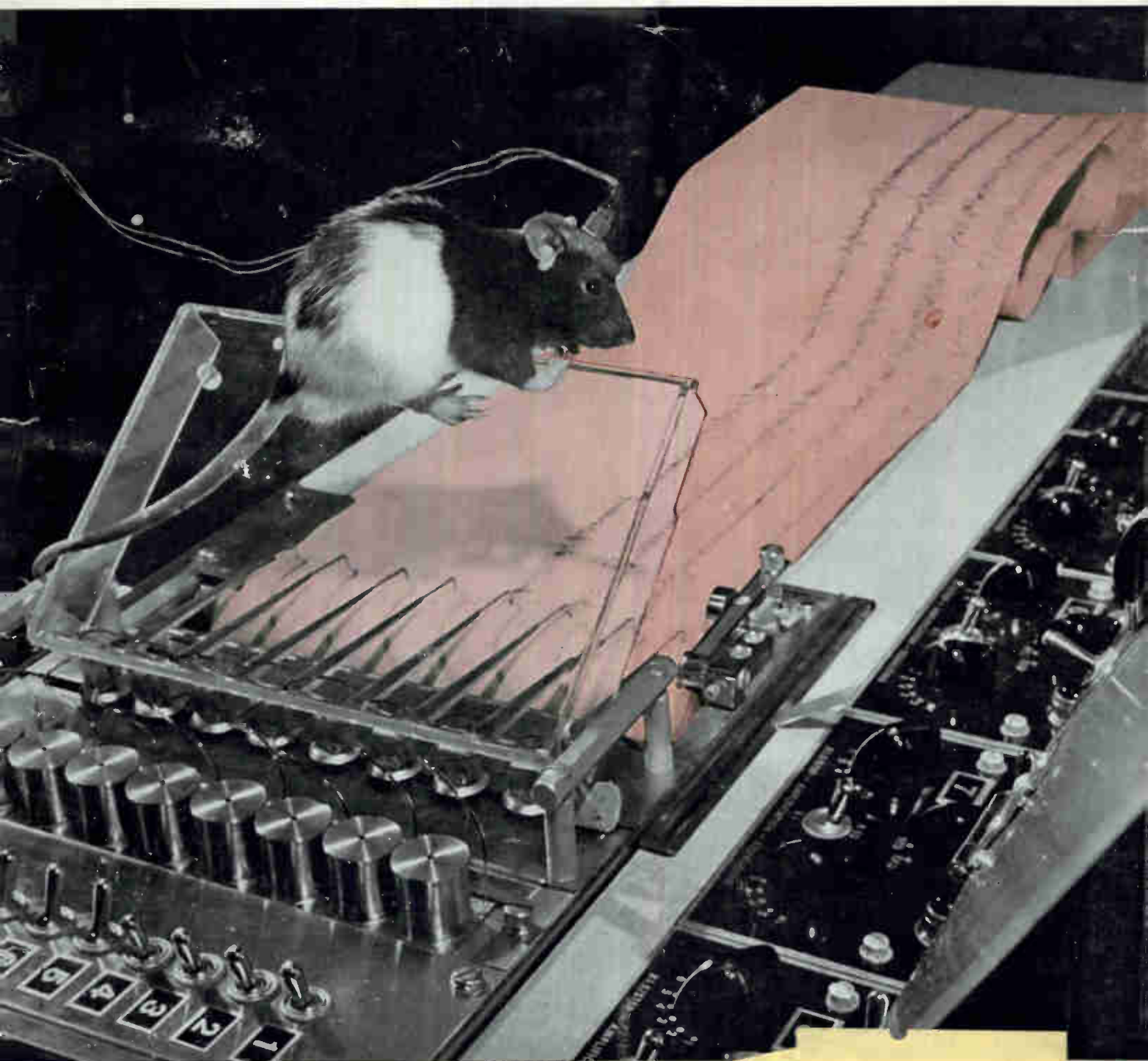

Recording electronically stimulated brain waves

NOVA EAST 21204
906 X01
10400 KILBURN
1 1 1

ANOTHER ADVANCED MICROWAVE TUBE DEVELOPMENT
FROM RAYTHEON'S SPENCER LABORATORY



K-BAND BWO, QKB 891, of a completely new design is extremely rugged and compact.

New K-band O-type BWO's extend Raytheon compatible line to 26.5 kMc

Advanced design provides 40 mW minimum power output in extremely rugged and compact package.

Size and weight of these two new Raytheon backward wave oscillators are barely half that of units now in use.

The QKB 890 and QKB 891 are designed for such applications as swept local oscillators in ECM receivers and test equipment, driver tubes in frequency diversity radars, and pump tubes for broadband parametric amplifiers. Both tubes utilize PM focusing and have grids for low-voltage pulsed operation. For equipment designs requiring close mounting, only two-inch spacing between tubes is necessary.

Write today for detailed technical data or application service to Microwave and Power Tube Division, Raytheon Company, Waltham 54, Massachusetts. In Canada: Waterloo, Ontario.

TYPICAL OPERATING CHARACTERISTICS

	QKB 890	QKB 891
Frequency Range	12.4-18 kMc	18-26.5 kMc
Power Output	40-180 mW	40-180 mW
Delay Line (tuning)	400-1270V	600-2100V
Anode Voltage (fixed)	125V	150V
Cathode Current	17-21 mA	21-32 mA
Filament Voltage	6.3 Volts	6.3 Volts
Waveguide Coupling..	RG91/U	RG53/U

RAYTHEON

RAYTHEON COMPANY

MICROWAVE AND POWER TUBE DIVISION

CIRCLE 251 ON READER SERVICE CARD

electronics

A McGraw-Hill Publication 75 Cents



W. W. MacDONALD, Editor

J. M. CARROLL, Managing Editor
SENIOR ASSOCIATE EDITORS: Samuel Weber, George W. Sideris. **ASSOCIATE EDITORS:** Michael F. Tomaino, Sylvester P. Carter, William P. O'Brien, John F. Mason, William E. Bushar, Thomas Emma, Sy Vogel, Leslie Solomon, M. M. Perugini, George J. Flynn, Michael F. Wolff.
ASSISTANT EDITORS: Nilo Lindgren, Stanley Froud, Stephen B. Gray, Roy J. Bruun, George V. Novotny, Leon H. Dulberger.
REGIONAL EDITORS: Harold C. Hood (Pacific Coast, Los Angeles), Thomas Maguire (New England, Boston), Cletus M. Wiley (Midwest, Chicago).
ART DIRECTOR: Harry Phillips; **Howard R. Berry.** **PRODUCTION EDITOR:** John C. Wright, Jr. **EDITORIAL ASSISTANTS:** Gloria J. Meurer, Bernice Duffy, Lorraine Rossi, Virginia T. Bastian, Lynn Emery, Avis Pomeranz, Florence Hajastron, Laura W. Smith, Bette H. Snyder.

JAMES GIRDWOOD, Publisher

Clues showing possible effects of space travel on the brain are sought in rat studies at Stanford Research Institute. See p 50
COVER

SPACE CONFERENCE. Single sideband folding for navigation satellites, magnetic field guidance are among topics reported **18**

MERCURY PROJECT Gets Realistic Test. Network ready for first orbital flight with mechanical crewman simulator **20**

IEC Adopts New Standards. Report on annual meeting **22**

Pilot Training System Simulates Radar. Optical and computing systems reproduce characteristics of fighter-bomber mission **23**

FCC Ready for UHF TV TESTS. Installations readied in New York **24**

PLASMA ENGINEERING—PART III: Applications of Plasma. Potential applications exist in a variety of electronic devices as well as power and propulsion systems. By M. F. Wolff **29**

MAGNETIC-OPTICAL READOUT of Magnetic Recording. Allows density of 4,000 bits per inch. By T. Lentz and J. Miyata **36**

CRYSTAL-STABILIZED TUNNEL-DIODE OSCILLATORS. Design procedure for 40-megacycle unit is outlined. By J. J. Nagle **40**

Servo-System Positions Telescope in High Altitude Balloon Flight. Rises to 80,000 feet. By W. J. Wichman and M. M. Birnbaum **43**

Feedback Linearizes Voltage-to-Frequency Converter. Operates to 400 cps. By James D. Long **48**

Crosstalk	4	Components and Materials	54
Comment	6	Production Techniques	58
Electronics Newsletter	9	New on the Market	62
Washington Outlook	14	Literature of the Week	69
Meetings Ahead	26	People and Plants	70
Research and Development	50	Index to Advertisers	78

Photo, courtesy General Dynamics Corporation

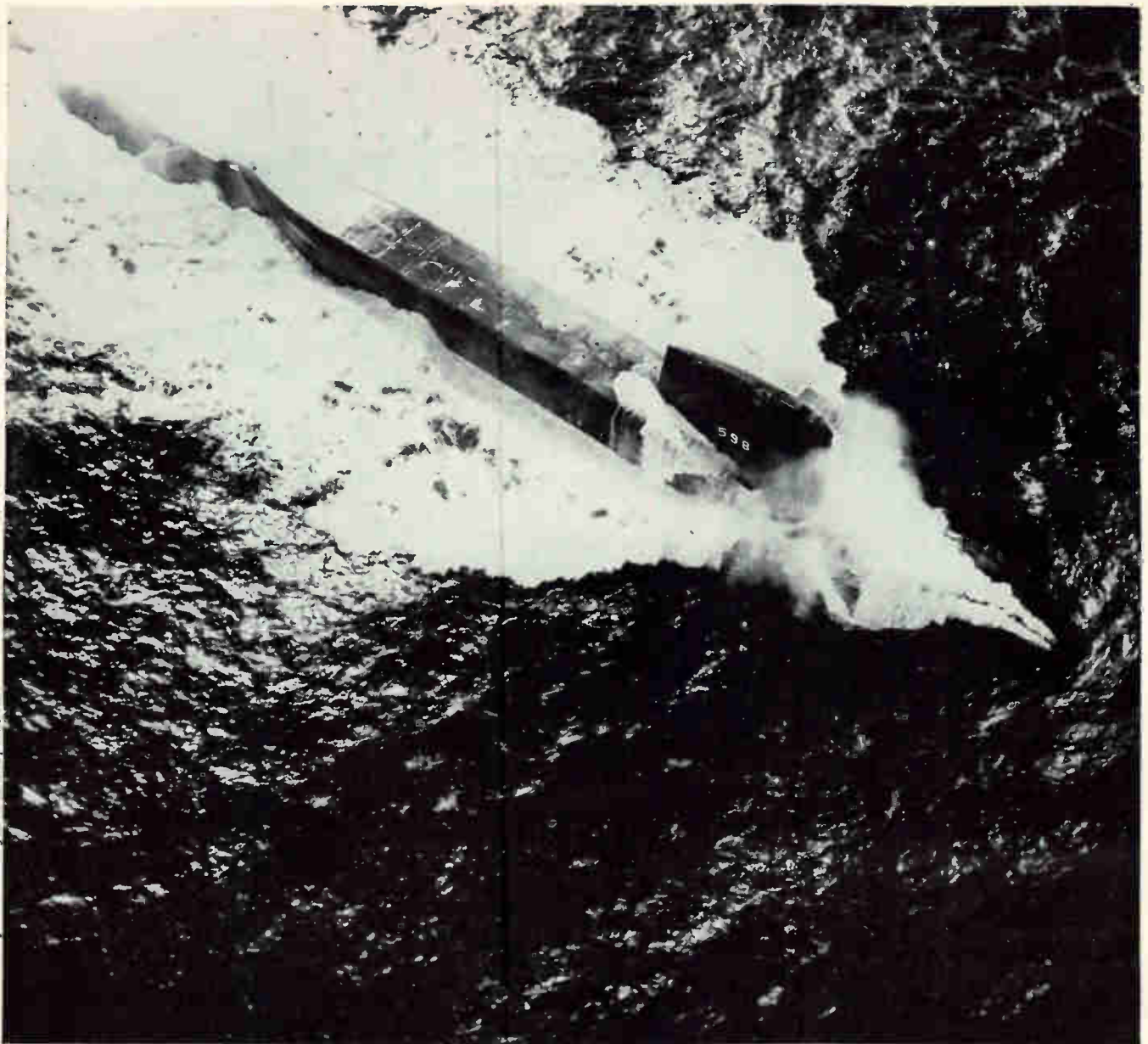

MIGHT on the MAIN

EDO CONGRATULATES THE U.S. NAVY on its mighty deterrent fleet, symbolized by the U.S.S. *George Washington* on operational patrol — fast, far-ranging, Polaris-armed. Edo is proud to share as prime contractor in the Navy's Polaris program by designing and building systems that are being tested and proved daily as the *George Washington* and her FBM sister ships prowl their protective missions . . . "a fleet that will never attack first, but possess sufficient powers of retaliation, concealed beneath the sea, to discourage any aggressor from launching an attack upon our security."*

*President John F. Kennedy's
State of the Union message,
January 30, 1961

Edo CORPORATION
College Point 56, L. I., New York

In Canada:

Edo (CANADA) LIMITED
Cornwall, Ontario

2 CIRCLE 2 ON READER SERVICE CARD

CIRCLE 3 ON READER SERVICE CARD →

1962

1963

1964

1965

1966

All
LAMBDA
Power Supplies
guaranteed
for
5
years

Every Lambda power supply carries a written guarantee that it will perform to specifications for five full years. You can install power supplies now with complete assurance that they will still perform to design standards in 1966. *Lambda's guarantee, which covers workmanship and materials (except for tubes and fuses), has been in effect on all power supplies sold since 1953.* It is your strongest assurance of power supply performance in installations where dependability is an absolute necessity for round-the-clock, heavy-duty service.

SEND FOR NEW LAMBDA CATALOG 61

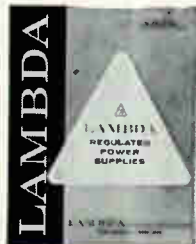

**ALL-TRANSISTORIZED
LA SERIES**

Nine Models Available
Voltages up to 330 VDC—Currents up to 20 Amp
Convection Cooled—Short Circuit Proof



LAMBDA ELECTRONICS CORP.

515 BROAD HOLLOW ROAD • HUNTINGTON, L. I., NEW YORK • 516 MYRTLE 4-4200

Western Regional Office: 230 North Lake Avenue, Pasadena, California • Phone: Code 213, MUrray 1-2544
New England Regional Office: 275 Boston Post Road, Marlboro, Massachusetts • Phone: Code 617, HUntley 5-7122
Middle Atlantic District Office: 515 Broad Hollow Road, Huntington, L. I., New York • Phone: Code 516, MYrtle 4-4200

Published weekly, with Electronics Buyers' Guide and Reference issue, as part of the subscription, by McGraw-Hill Publishing Company, Inc. Founder: James H. McGraw (1860-1948).

Title ® registered U.S. Patent Office; Copyrighted © 1961, McGraw-Hill Publishing Company, Inc. All rights reserved, including the right to reproduce the contents of this publication, in whole or in part.

Executive, editorial, circulation and advertising offices McGraw-Hill Building, 330 West 42nd Street, New York 36, N. Y. Telephone Langacre 4-3000. Teletype TWX N.Y. 1-1636. Cable McGrawhill, N. Y. PRINTED IN ALBANY, N. Y.; second class postage paid.

OFFICERS OF THE PUBLICATIONS DIVISION: Nelson L. Bond, President; Shelton Fisher, Wallace F. Traendly, Senior Vice Presidents; John R. Callahan, Vice President and Editorial Director; Joseph H. Allen, Vice President and Director of Advertising Sales; A. R. Venezian, Vice President and Circulation Coordinator; Daniel F. Crowley, Vice President and Controller.

OFFICERS OF THE CORPORATION: Donald C. McGraw, President; Hugh J. Kelly, Harry L. Waddell, Executive Vice Presidents; L. Keith Goodrich, Executive Vice President and Treasurer; John J. Cooke, Vice President and Secretary.

Subscriptions are solicited only from those actively engaged in the field of the publication. Position and company connection must be indicated on orders. Subscription rates: United States and Possessions, \$6.00 one year; \$9.00 two years; \$12.00 three years. Canada, \$10.00 one year. All other countries \$20.00 one year. Single Copies, United States and Possessions and Canada 75¢; Buyers' Guide \$3.00; Single copies all other countries \$1.50; Buyers' Guide \$10.00.

THE PUBLISHER, UPON WRITTEN REQUEST FROM ANY SUBSCRIBER TO OUR NEW YORK OFFICE, AGREES TO REFUND THAT PART OF THE SUBSCRIPTION PRICE APPLYING TO COPIES NOT YET MAILED.

Subscribers: Please address all correspondence, change of address notices, subscription orders or complaints to Fulfillment Manager, Electronics, at above address. Change of address notices should provide old as well as new address, including postal zone number if any. If possible, attach address label from recent issue. Allow one month for change to become effective.

Postmaster: Please send Form 3579 to Fulfillment Manager, Electronics, 330 West 42nd Street, New York 36, New York.



Audited Paid Circulation

CROSSTALK

REPETITIVELY PULSED PLASMA ACCELERATOR shown in the illustration has operated continuously for three 9-hour runs at GE Missile and Space Vehicle Dept. without being dismantled and is presently undergoing a 100-hour run. This and other plasma devices being studied for space vehicle propulsion are described in the final article of Associate Editor Wolff's three-part series on plasma engineering. The article, which begins on p 29, deals with applications of plasma in controlled thermonuclear fusion, magnetohydrodynamics (MHD) and thermionic power conversion, propulsion and electronics.

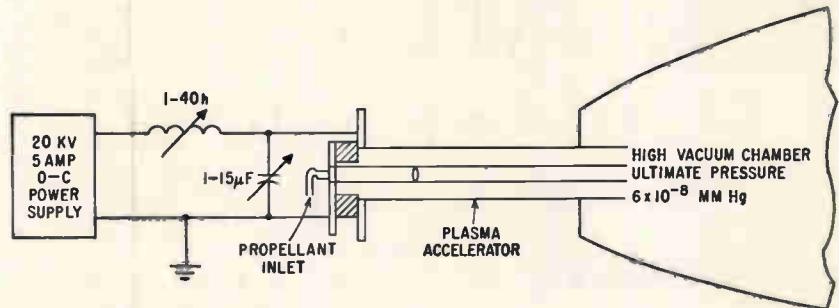

In addition to possibly propelling space vehicles, plasma has other intriguing space applications. Because hypersonic missiles and space vehicles are surrounded by a plasma sheath upon reentering the atmosphere (ELECTRONICS, p 105, May 27, 1960), an applied magnetic field could reduce aerodynamic heat transfer and also be used for attitude control and steering. Use of magnetic fields to improve r-f transmission characteristics is also receiving attention. While it is possible to overcome blackout by transmitting above the plasma resonant frequency, attenuation loss through the sheath and reflection loss at the plasma-air interface can be reduced by applying static magnetic fields of a few hundred gauss through the sheath. Thus, as pointed out by H. Hodara of Hallicrafters in a paper at the 1961 IRE Convention, it might be possible to communicate continuously below the plasma frequency.

Other techniques that might improve communication through the plasma sheath were described by R. Rawhouser of Wright Patterson AFB at NAECON. They are: reducing electron density by cooling the antenna region with water or steam, modifying the shock region by injecting gas, and producing oscillations in the plasma by an electron beam, velocity modulated by the frequency to be transmitted.

To study these effects it is convenient to simulate reentry conditions on the ground. Plasma plays a role here too. For example, MHD researchers are experimentally placing a crossed-field accelerator downstream from the source in a plasma wind tunnel to accelerate the supersonic ionized gas.

Interaction of plasma with magnetic fields also sheds light on many natural phenomena that occur in space. There are MHD theories for the origin of the Van Allen belts, solar flares, the planets, and the earth's magnetic field. Supernovae, such as the Crab nebula, represent a large-scale conversion of internal plasma energy into magnetic field energy.

Ball lightning, a stable spherical form of lightning whose existence is even the subject of controversy, is theorized as being a plasmoid built up by the r-f energy reflected from the ground when air is ionized by lightning. An explanation of this might lead to advances in r-f plasma confinement.

FILMISTOR® 'C'

METAL FILM RESISTORS OFFER 5 DISTINCT TEMPERATURE COEFFICIENTS TO MEET ALL CIRCUIT REQUIREMENTS

**RUGGED END-CAP
CONSTRUCTION
FOR LONG TERM
STABILITY**

• • •

**EXCEPTIONAL
RESISTANCE TO
MOISTURE AND
MECHANICAL DAMAGE**

• • •

**SURPASS MIL-R-10509
PERFORMANCE
REQUIREMENTS**

Providing close accuracy, reliability and stability with low controlled temperature coefficients, these molded case metal-film resistors outperform precision wirewound and carbon film resistors. Prime characteristics include minimum inherent noise level, negligible voltage coefficient of resistance and excellent long-time stability under rated load as well as under severe conditions of humidity.

Close tracking of resistance values of 2 or more resistors over a wide temperature range is another key performance characteristic of molded-case Filmistor "C" Resistors. This is especially important where they are used to make highly accurate ratio dividers.

Filmistor "C" Resistors are automatically spiralled to desired resistance values by exclusive Sprague equipment. The metallic resistive film, deposited by high vacuum evaporation, bonds firmly to special ceramic cores. Noble metal terminals insure low contact resistance.

The resistance elements, complete with end caps and leads attached are molded in dense, high temperature thermosetting material to form a tough molded shell for maximum protection against mechanical damage, moisture penetration and repeated temperature cycling.

Filmistor "C" Resistors, in $\frac{1}{8}$, $\frac{1}{4}$, $\frac{1}{2}$ and 1 watt ratings, surpass stringent performance requirements of MIL-R-10509C, Characteristic C. Write for Engineering Bulletin No. 7025 to: Technical Literature Section, Sprague Electric Co., 35 Marshall Street, North Adams, Mass.

*For application engineering assistance write:
Resistor Division, Sprague Electric Co.
Nashua, New Hampshire*



SPRAGUE COMPONENTS

RESISTORS
CAPACITORS
MAGNETIC COMPONENTS
TRANSISTORS

INTERFERENCE FILTERS
PULSE TRANSFORMERS
PIEZOELECTRIC CERAMICS
PULSE-FORMING NETWORKS

HIGH TEMPERATURE MAGNET WIRE
CERAMIC-BASE PRINTED NETWORKS
PACKAGED COMPONENT ASSEMBLIES
FUNCTIONAL DIGITAL CIRCUITS



'Sprague' and '®' are registered trademarks of the Sprague Electric Co.

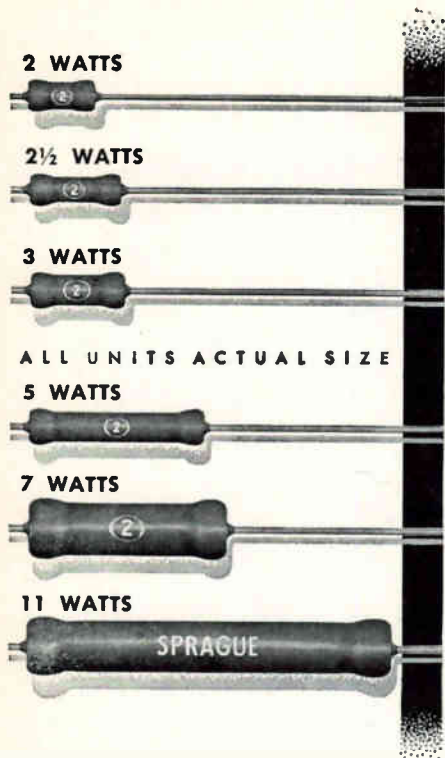

NEXT TIME ... USE TINY
Blue Jacket[®]
WIREWOUND RESISTORS

Sprague builds reliability... efficiency... economy right into minified Blue Jackets with these important features:

- * All-welded end-cap construction with special vitreous-enamel coating for total protection against humidity, mechanical damage, heat, corrosion gives long-term dependability under severe environmental conditions
- * Available in resistance tolerances as close as $\pm 1\%$
- * Low in cost... quick and easy to install

Tiny axial-lead Blue Jackets are specially designed for use with conventional wiring or on printed boards in miniature electronic assemblies. Write for complete technical data in Sprague Engineering Bulletin 7410B.

SPRAGUE ELECTRIC COMPANY
 35 Marshall Street, North Adams, Mass.



COMMENT

Encapsulating Materials

Reference is made to the article "Epoxy Packages for Encapsulating Components" by Samuel Ringel of the Epoxy Products Division of Joseph Waldman and Sons, as contained in the July 7, 1961 issue of *ELECTRONICS* (p 70).

We object to the comparative chart "Characteristics of Materials Used in Preformed Shells" of above mentioned article as featured on page 70, because as far as diallyl phthalate materials are concerned, a distorted picture is conveyed to your readers by assigning low and unrealistic values to said diallyl phthalate materials. The diallyl phthalate materials used for packages for encapsulating components are glass-filled diallyl phthalates of the SDG type . . .

In the following there are listed the established values concerning glass-filled diallyl phthalates, Type SDG of MIL-M-14E:

Characteristics of Glass-filled Diallyl Phthalates Used in Preformed Shells	
Compressive strength, psi.	22,000
Dielectric constant at 1 kv.	4.4
Dielectric strength, volts/mil.	425
Dielectric breakdown, kv.66
Flexural strength face, psi.	10,300
Tensile strength, psi.	5,500
Water absorption, %	0.3
Volume resistivity, megohms.	6.4×10^8
Surface resistivity, megohms.	6.0×10^8

The figures listed in the above chart are the test results obtained by an independent Government Laboratory . . .

FELIX C. KARAS
MESA PLASTICS COMPANY
 LOS ANGELES, CALIFORNIA

. . . We were extremely interested to read an article entitled "Epoxy Packages for Encapsulating Components" by Samuel Ringel in your July 7th issue . . .

Let me suggest after having pursued the literature of four compounders of diallyl phthalate material qualified under MIL-M-14E, Type MDG:

That 25,000 might be a better figure for compressive strength.

That 10,000 might be a better value for flexural strength.

That tensile strength would be

more correct around 5,000.

That a major mistake has been made in listing the values for volume resistivity and surface resistance in megohms. MDG compounds have a value in surface resistance well over 10^7 , not 10^8 as listed in the table. It is standard procedure to test volume resistance and surface resistance after 30 days at room temperature and 100 percent relative humidity. Even so, the volume resistance should be around 10,000 . . .

FOSTER NOSTRAND
FOOD MACHINERY AND
CHEMICAL CORPORATION
 NEW YORK CITY

We contacted author of article who says:

I have reviewed the letters sent to you by Food Machinery and Chemical Corporation and Mesa Plastics . . .

First, an error in transcription was made when I transferred the data from the military spec MIL-M-14E to the table in the article. In the military spec, silicone molding material (MSG) data appears right next to the mineral filled diallyl phthalate (MDG). Inadvertently the values for (MSG) were listed in the table for MDG. I wish to apologize for any confusion this caused. The correct values for MDG are included in the new table I am submitting with this letter (Ed. Note: see p 54).

With reference to . . . phenolic (MFE), diallyl phthalate (MDG) and alkyd (MAG) . . . the values are minimum average values taken . . . from the applicable military spec. No military spec has been written for the epoxy but the values included in the table were taken from government laboratory tests . . .

. . . it should be pointed out that government laboratory tests for MFE, MDG, and MAG are somewhat higher than those listed in the table. This information, however, is known only by the manufacturer of the material . . . The values listed for epoxy . . . are conservative and well below the maximum attainable . . .

SAM RINGEL
EPOXY PRODUCTS, INC.
 IRVINGTON, NEW JERSEY



NORAD ON THE ALERT

Inputs from BMEWS Provide Instantaneous Missile Data Direct to NORAD Headquarters

From our vast outer defense perimeter, over thousands of miles, to the nerve center of the North American Air Defense Command at Colorado Springs, the most advanced concept of data handling and checkout is being utilized in the BMEWS system. The stakes are high, for the purpose is defense of the North American Continent.

At BMEWS installations operated by USAF Air Defense Command, computers read out missile tracking data from giant radars. This information is simultaneously relayed to NORAD's Combat Operations Center.

The Radio Corporation of America is prime systems contractor for BMEWS. At the COC, RCA's Display Information Processor computing equipment automatically evaluates missile sightings, launch sites and target areas. By means of data processing and projection equipment installed by RCA and a team of other electronics manufacturers, the findings are displayed on huge, two-story high

map-screens in coded color symbols, providing the NORAD battle staff with an electronic panorama of the North American and Eurasian land masses.

The handling of BMEWS inputs at NORAD is an example of how RCA data processing capabilities are assuring the high degree of reliability so vital to continental defense.

Out of the defense needs of today a new generation of RCA electronic data processing equipments has been born. For tomorrow's needs RCA offers one of the nation's foremost capabilities in research, design, development and production of data processing equipment for space and missile projects. For information on these and other new RCA scientific developments, write Dept. 434, Defense Electronic Products, Radio Corporation of America, Camden, N. J.



The Most Trusted Name in Electronics
RADIO CORPORATION OF AMERICA

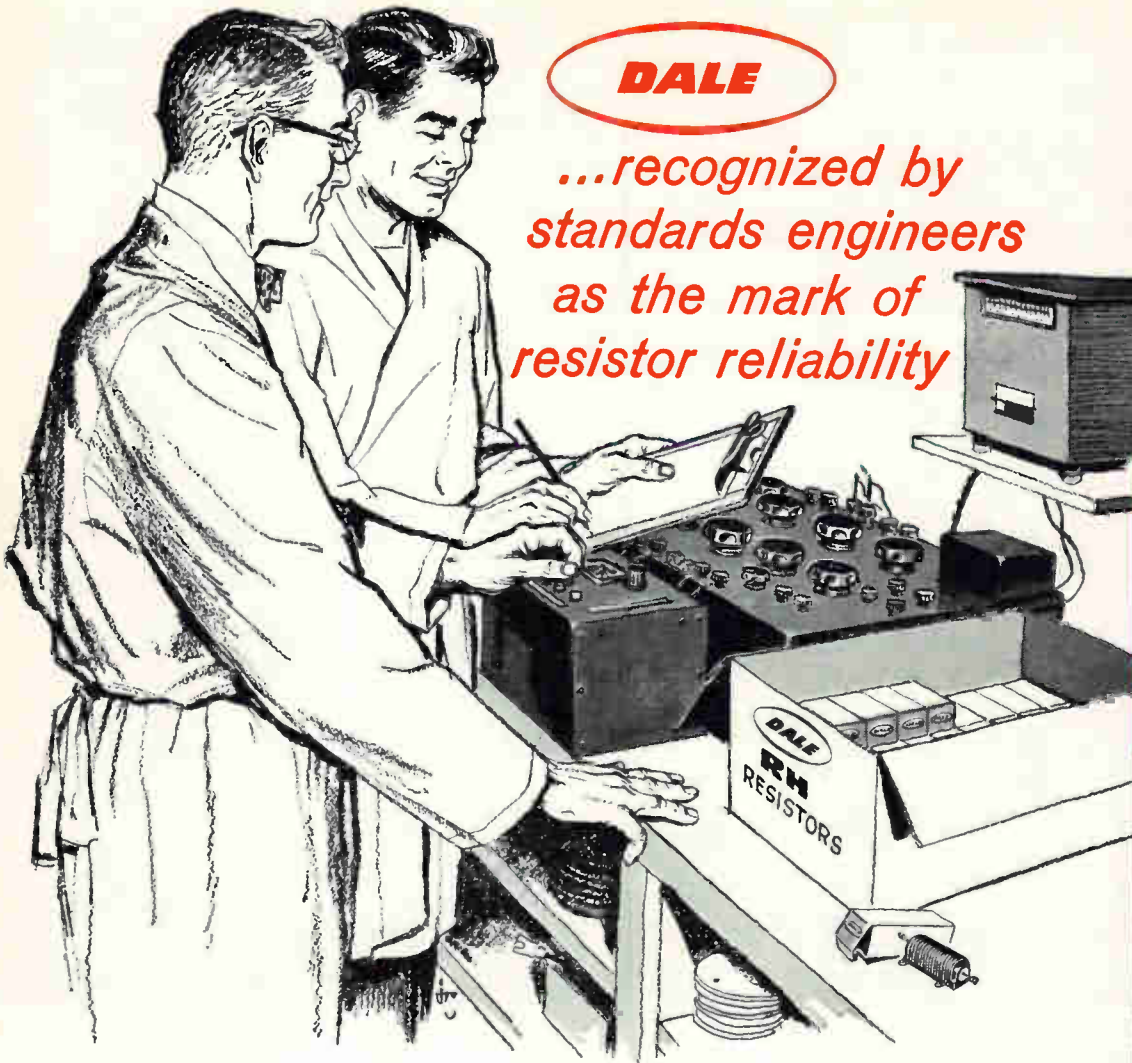

DALE

*...recognized by
standards engineers
as the mark of
resistor reliability*

Each incoming inspection adds weight to the conviction already held by standards engineers: You can depend on Dale resistors for performance as specified.

Dale resistor reliability is the result of Dale's advanced design and stringently controlled methods of manufacture . . . methods which have reached new levels of achievement as part of Dale's super-high reliability development program.

SPECIAL PROBLEMS? Let us help you with your requirements for special resistance products. We make modifications of standard products, resistor networks, matched pairs, etc. Send us your specs.

PROMPT DELIVERY: Whether your need is for a short "test run" or a large production release, Dale offers prompt service, direct from the factory and through a widespread network of distributors.

Write for Bulletin R-21 with handy cross reference file card



DALE ELECTRONICS, INC.

1300 28th Ave. Columbus, Nebraska

A subsidiary of HATHAWAY INSTRUMENTS, INC.

DALE TYPE RH RESISTORS

WIRE WOUND • MINIATURE • HIGH POWER

Designed primarily for application with high power requirements, coupled with precision tolerance. Mount on chassis for maximum heat dissipation. Operate under severe environmental conditions, offering complete protection from salt spray, moisture, vibration and shock.

- RATED AT 5, 10, 25, 50, 100 and 250 watts
- RESISTANCE RANGE from 0.1 ohm to 175K ohms, depending on type
- TOLERANCES: $\pm 0.05\%$; $\pm 0.1\%$; $\pm 0.25\%$; $\pm 0.5\%$; $\pm 1\%$; $\pm 3\%$
- TEMPERATURE COEFFICIENT 20 P.P.M.
- OPERATING TEMPERATURE RANGE from -55°C. to 275°C.
- WELDED CONSTRUCTION from terminal to terminal
- RUGGEDLY HOUSED; sealed in silicone and inserted in radiator finned aluminum housing
- SMALLEST IN SIZE, ranging from $\frac{5}{8}''$ x $\frac{5}{8}''$ to $3''$ x $4\frac{1}{2}''$
- SURPASS applicable paragraphs of MIL-R-18546B (Ships)



ELECTRONICS NEWSLETTER

Berkner Predicts Profit from Space Program

AT WESCON's all-industry banquet, Dr. Lloyd V. Berkner predicted that within the next 50 years actual monetary returns would more than cover the cost of our space programs to that time. Returns would come in the fields of communications and meteorology and to the military.

IRE's president pointed out that communications satellites soon will cut long-distance communications channel costs by a factor of five and would increase channel availability a thousandfold. Space weather projects pioneered by Tiros and Nimbus will eventually make feasible partial control of the world's weather, he feels.

Berkner expressed concern that the cycle of sunspot activity would delay attempts to land a man on the moon. Sun spot activity will reach a maximum in 1970. Radiation from solar thermonuclear blasts would jeopardize the lives of space travelers, he said. Both we and the Russians may have to wait until 1974-76, the low point of the cycle. He foresees at that time major expeditions of multipersonnel spacecraft. Launching and material cost for shielding on manned spacecraft will average \$25,000 a pound, he estimated.

He disputed recent protests by astronomers that scatter communications experiments like Project West Ford (ELECTRONICS, p 11, Aug. 25, 1961) would prove disastrous to radio astronomy operations. He commended various space agencies for their caution to prevent space projects from interfering with communications and astronomy.

A-C Measurement Talks Sought for '62 WESCON

INDUSTRY-WIDE agreement on nomenclature, symbols and identification of error sources for ratiometric measurement was urged at WESCON last week by Malcolm D. Widenor, president of North Atlantic Industries. He said this would be a first step in defining the evolving field of a-c measurement.

Widenor says that a cooperative effort to clarify confusion caused by a lack of definitive symbology is long overdue. He proposes that a technical conference be held next March, to coincide with the 1962 WESCON. Informal meetings to initiate such a conference were held last week, he said.

IR Detector Operates At Room Temperature

ARMOUR RESEARCH Foundation reports development of a cadmium sulfide infrared detector, sensitive to radiation in the 10-micron region, which will operate at room temperature. Since it does not require cryogenic cooling, it is expected to permit lighter, more reliable payloads in early warning satellites.

The detector, the report said, can take advantage of the "window" at 8 to 14 microns to pick up radiation from nose cones or the leading

edges of planes in high speed flight. The CdS crystal responds photoconductively to visible light, but this response is quenched by the absorption of radiation in the 10-micron region.

First Ranger Satellite An Instrumental Success

RANGER SATELLITE launched last week from Cape Canaveral was an instrumental success even though it failed to achieve its planned orbit. Most of the experiments aboard (ELECTRONICS, p 20, Aug. 4, 1961) were operating and the attitude control system was functioning. The sensitive rubidium vapor magnetometer, designed to measure the weak fields in deep space, was overwhelmed by the strength of earth's field. NASA said a few days ago that Ranger would probably not last more than two weeks in its shallow orbit.

Canadians Approve Stereo Broadcasts

MONTREAL—Canada today authorized stereophonic broadcasting in the Dominion. The Department of Transport and the Board of Broadcast Governors have adopted the same standards set by the U. S. Federal Communications Commis-

DOD Wants Communications Geared to War Needs

WASHINGTON—Department of Defense wants telephone and telegraph systems and communications satellites considered a national resource to be federally administered during an emergency. There would be no time in the next conflict for deliberate reorganization, Harold Brown, director of defense research and engineering, told a House commerce subcommittee.

DOD wants communications satellites integrated with long-line domestic telephone and international telegraph systems. The department, Brown said, will encourage private space telecommunications systems by providing technical specifications and circuit requirements, by helping choose ground facilities and by making available launching sites and boosters. The military would use commercial facilities and provide its own only when needed to meet military requirements, he said.

Project West Ford, the orbiting needle belt for scatter communications, will be launched in a few weeks, Brown said. An Advent communications satellite will be launched at an intermediate altitude within a year, as a prelude to later Advents in synchronous orbits at 22,000 miles altitude.

sion, allowing listeners in border areas to tune in stations in either country.

Multiplex authorization is expected to help establish stereo in subsidiary fields, such as broadcasting music to restaurants and other commercial subscribers. The Department of Transport has approved dual programming: music with commercials to regular listeners and the same program, with commercials and announcements deleted, to subscribers.

Figures on the number of Canadian stations planning to broadcast stereo have not been announced. Canadian firms were among the exhibitors showing prototype multiplexers and adapters at the Music Merchants convention in Chicago in July.

Cape Selected as Site for Manned Spaceship Launches

NASA PLANS to buy 80,000 acres north and west of Cape Canaveral and to establish facilities for launching Saturn and Nova-class boosters. These will be used for lunar flights and other missions. The added space, almost five times as large as present facilities, would permit construction of six launching complexes. Land will cost \$60 million. Development and facilities costs were not announced, but could run well over \$1 billion. Present facilities at the Cape Patrick AFB and the Atlantic Missile Range are said to have cost over \$1 billion. NASA is also considering sites for a manned space flight research center.

\$10 Million Computer to Be Produced in Britain

LAST WEEK IN LONDON, Ferranti announced it is going into production on its huge Atlas computer, which costs \$10 million with all peripheral input, output and storage equipment. A pilot model has been operating since 1960. The first complete system is being assembled at Manchester University, which participated in its design.

Atlas is going to the nuclear re-

search center at Harwell. The Atomic Energy Authority says it will be in use early in 1964 and will be made available to universities without charge. Studies of plasma physics, solid state physics and molecular structures of proteins and viruses are planned.

The system can perform about a million simple operations per second or 300,000 complex operations. Its high speed is largely due to incorporation of fast-carry adder circuits, fixed storage of frequently used routines and data, and an automatic supervisory system which enables several programs to run simultaneously.

Cryotron Memory Would Search at High Speed

CRYOTRON ASSOCIATIVE memory under development at Space Technology Laboratories would permit simultaneous, rather than sequential search of records. Memory, proposed by Arthur J. Learn, has logic associated with each cell and is composed of crossed-film cryotrons. Access time for information retrieval is estimated at 0.2 microsecond. System could be used, for example, in language translators. But principal use is expected in learning machines, imitating the brain's association of ideas rather than neuron-level activities.

Does USSR Plan Moon Probe Like Our Surveyor?

LEADING SOVIET scientist speculated—in print—recently that an automated unmanned scout will be sent to explore and analyze the moon's surface before manned spaceships make the voyage. V. V. Dobronravov said the scout would probably carry measuring apparatus, memory units, photo, film and television equipment. The machine can be taught to recognize objects by their form and smell, he said. Dobronravov also indicated that Soviet spaceships use a combination of braking rockets and atmospheric drag under automatic control to slow down their spaceships during reentry.

In Brief . . .

CANADIAN receiving tube manufacturers are raising prices by an average 10 percent in the wake of federal budget proposal of minimum import tax of 10 cents per tube. Picture tube prices have not increased.

BOSTON Federal Reserve Bank reports 85.7 percent of Boston banks and 75.5 percent of New England banks are preprinting checks with magnetic ink for EDP.

PROPOSED Association of Standards Laboratories will meet Sept. 15 during the ISA Conference in Los Angeles.

NASA AND THE Weather Bureau have invited 100 nations to an International Conference on Meteorological Satellites in Washington, Nov. 13-22.

AMERICAN INSTITUTE of Electrical Engineers has received a National Science Foundation grant to translate Russian electronics journals.

IRELAND'S NEW state-owned tv service will use 625 lines. Parallel 405-line transmissions will be used in areas receiving British tv.

INSTRUMENTS to measure man-made microwave interference in space will be developed by Armour Research Foundation under \$429,384 Air Force contract.

U. S. GEOLOGICAL SURVEY has ordered \$500,000 in geophysical equipment from SIE division of Dresser Electronics, for Vela Uniform program.

SUPERVISORY SYSTEM to control refueling at O'Hare Airport, Chicago, will be installed by Electronic Control Products. New refueling system will eliminate trucking gas to planes.

JAPANESE FIRM, Takei Kiki-Kogy claims monthly production of 10,000 pocket lie detectors with wholesale f.o.b. price of \$12.50 and retail price in the U. S. of \$35. The company says it may "herald a new era in family relations as wives give the Deceptograph test to late-returning husbands".

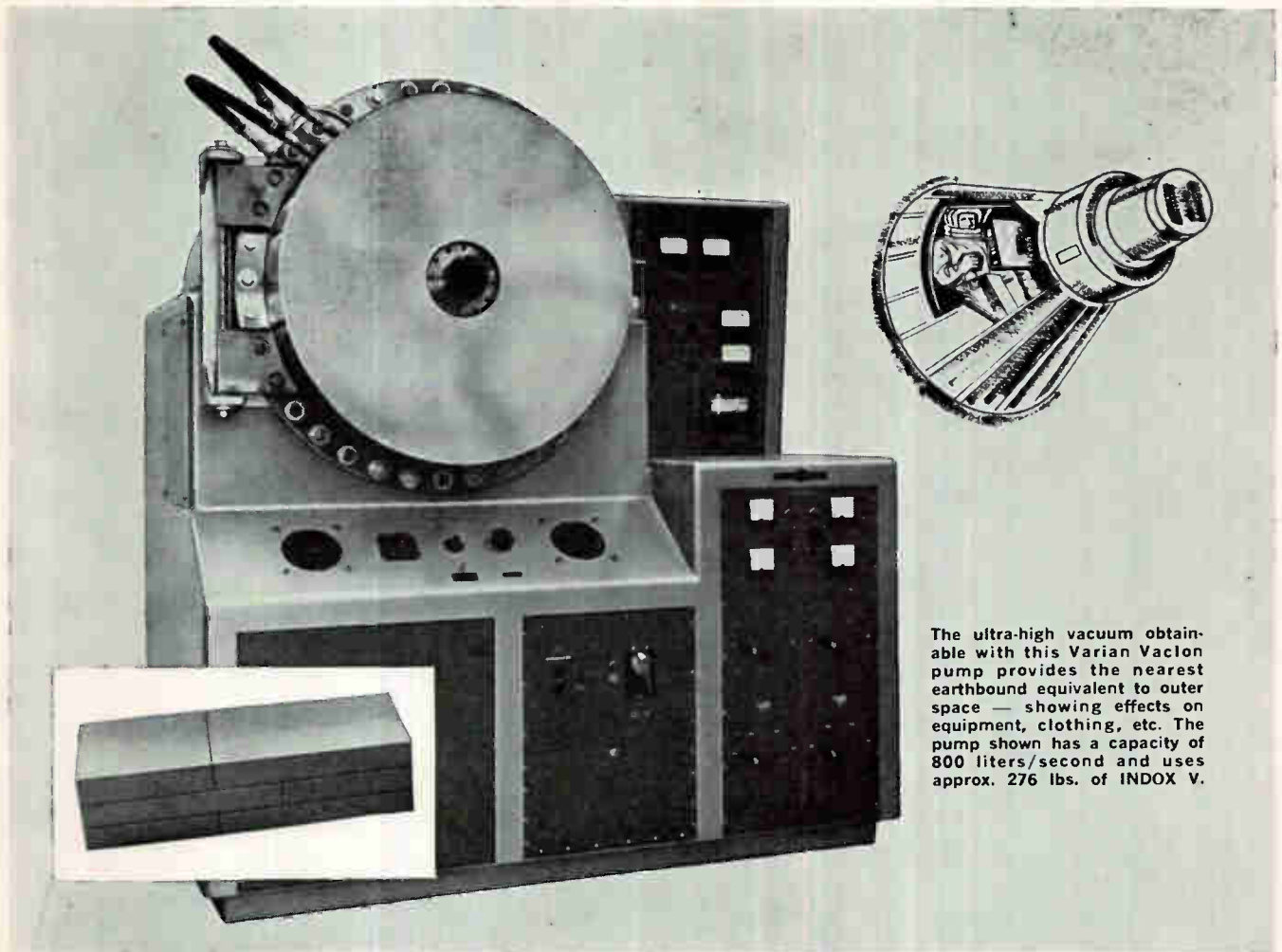

The ultra-high vacuum obtainable with this Varian Vaclon pump provides the nearest earthbound equivalent to outer space — showing effects on equipment, clothing, etc. The pump shown has a capacity of 800 liters/second and uses approx. 276 lbs. of INDOX V.

INDOX[®] V magnets improve space chamber vacuums

Indiana Steel's INDOX V permanent magnets are helping Varian Vaclon pumps obtain verified vacuums past 10^{-9} mm Hg. Result: better space chambers, plus many additional critical vacuum applications.

Advanced design ion pumps, manufactured by Varian Associates, Palo Alto, Calif., are providing ultra-high vacuums with greater efficiency. In fact, these pumps, using powerful INDOX V magnets, are largely replacing diffusion pumps on critical vacuum applications.

After a mechanical roughing pump removes most of the air from a given vessel, the ion pump goes into operation. High voltage is applied, ionizing some of the gas particles and forcing electrons toward the anode. The powerful magnetic field of the INDOX V permanent magnet deflects the traveling electrons into spiral paths, increasing path lengths and, therefore, the number of particle collisions and degree of ionization. Finally, the

ions bombard titanium cathode plates which frees titanium atoms to form stable compounds with the atoms of oxygen and nitrogen which are then deposited on the anode grid. Inert gases are also removed by burial in the cathode and entrapment on the anode.

Varian selected Indiana Steel INDOX V magnets both for their magnetic characteristics and their uniform quality. INDOX V is a highly oriented ceramic magnet material with a peak energy product $3\frac{1}{2}$ times greater than conventional unoriented barium ferrite materials. It is lightweight and extremely resistant to the effects of demagnetization.

Whether it's a question of choice of magnet or a design problem, why don't you take advantage of Indiana's wealth of experience, research leadership and specialized engineering "know-how"? Write today, outlining your needs. For further details on the INDOX family of magnetic materials, ask for Bulletin 18A, Dept. A9.

VALCON IS A TRADEMARK OF VARIAN ASSOCIATES



INDIANA STEEL PRODUCTS

Phone HOward 2-3111 • Direct Distance Dialing Code 219

VALPARAISO, INDIANA

INDIANA PERMANENT MAGNETS



What
will
ISOPLYS®
lead
to
next?

Isoplys (isolated power supplies) were first introduced by Elcor, Inc., now a Welex Subsidiary, back in 1957. Since that time many of our customers have introduced imaginative applications for Isoplys that are new to even its inventors.

The Isoply is more than just new equipment. It represents a totally new concept, for Isoplys are used ungrounded. Unique construction provides extremely low shunt capacitance and low noise. It offers new flexible designs for direct-coupled amplifier circuits that are relatively insensitive to power line fluctuations. They give excellent frequency response.

Bridge, cathode follower, and other type circuits can be improved significantly. Less design and assembly time is needed. Interaction between circuits is substantially reduced which helps not only in design problems but also in simplifying maintenance. Learn how ISOPLYS can help reduce costs and improve performance in circuits you design.



Write for full information: **ELCOR Incorporated**

Subsidiary of Welex Electronics Corporation
Sales / R & D Laboratory / Manufacturing
1225 W. Broad Street / Falls Church, Virginia
JEfferson 2-8850

MEET THE WORLD'S FINEST DISTRIBUTOR TEAM



Francis R. Hine
Airwork Corporation, Miami, Fla.



Lester Avnet
Avnet Electronics Corporation,
Westbury, L.I., N.Y.



John W. Busacker
Contact Electronics, Inc.,
Dallas, Texas



Harold H. Powell
Harold H. Powell Co., Philadelphia, Pa.



Robert Avnet
Avnet Corporation, Los Angeles, Calif.

...serving industry with quality

BENDIX ELECTRICAL CONNECTORS

Each member of this world's finest team heads an organization having experience, ability and facilities unmatched elsewhere in the field of connector distribution. The entire team works toward the same goal—fast, efficient supply of the Bendix® Electrical Connectors best suited to *your* exact needs.

They supply to industry a nearly incredible number of connectors—running into literally tens of thousands of models—through a system pioneered by Scintilla

Division in 1953. This is the *component assembly* technique, which anticipates connector needs and even permits overnight deliveries when required.

Their strategically located stocks are both broad and deep—with factory assembly and quality control standards that are extensions of those we maintain in our own manufacturing operations. Remember when you need high-quality connectors—your Bendix distributor can be an indispensable member of *your* team!

Scintilla Division
SIDNEY, N. Y.



Canadian Affiliate: Aviation Electric, Ltd., 200 Laurentien Blvd., Montreal 9, Quebec.
Export Sales & Service: Bendix International, 205 E. 42nd St., New York 17, N. Y.

**STABILITY
ACCURACY
RUGGEDNESS**



**WEINSCHEL
ATTENUATORS
1 to 80 DB,
DC to 3 KMC**

Accurately constructed of precision parts, and consisting of one or more sections of T-pads, Weinschel Model 50 attenuators are stable, accurate units that will stand up under an amazing amount of abuse. Useful in any application requiring isolation between two components in an RF system, and particularly where they must withstand an occasional overload.

- Stability—made with Weinschel's own stable film resistors, for maximum stability even under peak pulse power and extreme temperature and humidity cycling.
- RETMA color coding—the nameplate is colored with the RETMA color coding for easy identification of values.
- Excellent vibration and shock resistance.
- Equipped with Type N stainless steel connectors for maximum life and minimum wear (Types C and SC also available).
- Critical dimension of inner contact depth is held to ± 0.005 inches for reliable mating of connectors.
- Supplied with a certificate of calibration showing insertion loss test data with guaranteed accuracy explicitly stated.

For complete specifications on Model 50 attenuators write for Weinschel Engineering Bulletin 44. For special attenuators to meet other requirements contact our Application Engineering Department.

**WEINSCHEL
ENGINEERING COMPANY**

PRECISION MICROWAVE MEASUREMENT
COMPONENTS, INSTRUMENTS
AND SYSTEMS.

KENSINGTON, MARYLAND.

Phone L0ckwood 4-0121. TWX: KENS 446.

In CALIFORNIA: 631 Wilshire Blvd.,
Santa Monica. TWX: SMON 7185.

WASHINGTON OUTLOOK

LONG-RANGE instrumentation requirements for oceanography were spelled out to more than 700 representatives of some 400 companies, 32 scientific organizations, government agencies and three foreign countries—Britain, France and the USSR—at the first government-industry oceanographic instrumentation symposium here recently. In addition, 42 companies have already requested reports on the symposium. Stimulating the high interest are estimates that from \$4 to \$5 billion will be spent on ocean research in the next ten years.

Representatives from such companies as Raytheon, ITT, Texas Instruments, Loral Electronics, to name just a few, were given briefings by top government officials on the need for research on the ocean environment and on a major project to survey the oceans.

The prime purpose of the symposium was to acquaint industry with what the government wants to explore the oceans and to stimulate new thinking and techniques in instrument development. Specific development programs will be handled directly between companies and the government agencies handling phases of the program.

DESK-SIZED information retrieval system using all solid-state circuits, developed by Information For Industry, Inc., Washington, D. C., has started limited production. Designed primarily to plug the gap between huge retrieval systems and the small systems, IFI's system can store 500,000 microfilm pages of data on a single 17-inch wide by 400-ft long Kalvar microfilm scroll. Any item on the scroll can be retrieved in an average of 20 seconds. The high-speed retrieval comes from a simultaneous lateral and vertical electronic searching process. Modular in design, the system can be linked with other electronic documentation equipment to automate the system fully. Half-length scrolls can be used to reduce the system's capacity.

Market price for a 500,000-page system will run around \$15,000. Fully automated, high-capacity systems will be priced at \$250,000 to \$300,000. First production models will be completed by late fall with a ten a month production rate expected to be started next April. Marketing of the system will be handled by Information Retrieval Corp., 65 percent owned by IFI. A production contract for \$590,000 has been placed with the Maryland division of Litton Systems, Inc. for the initial production.

NAVY HAS LET a \$2.5-million contract to convert a merchant ship, the Kingsport Victory, to a terminal station for the Army's synchronous satellite communication project Advent.

The ship will be used to communicate with Army shore stations through the Advent satellite. Conversion of the ship will require additional electric power generating equipment, ship-to-shore communications system, helicopter landing platform and aerological facilities.

Project Advent is designed to develop a high-capacity, world-wide real-time radio communications system using three or four 22,300-mile high satellites.

ELECTRONICS companies interested in selling to the Federal Aviation Agency have been instructed to place themselves on a new bidders' list the agency is setting up. To receive invitations to bid on procurement awards, write to FAA, Materiel Program division, Materiel Contracts branch, AF-280, Washington 25, D. C. To compete for research and development contracts, write to FAA, Aviation Research and Development Service, Contracting division, RD-70, Washington 25, D. C.

The FAA has set up an automatic data processing system to handle paper work in distribution of invitations to bid. To keep the list current, the agency intends to drop companies that do not respond to two successive invitations to bid and who do not ask to be retained on the roster.

Yours in this **NEW**

STANDING WAVE INDICATOR

- Pinpoint resolution for precise attenuation measurements
- Scale expansion with no "blind spots," no resetting
- Built-in bolometer protection
- AC or battery operation
- All-solid-state design



Ⓟ 415C Standing Wave Indicator

Model 415C Standing Wave Indicator is a new high-gain, low-noise solid state amplifier and voltmeter calibrated for square-law detectors to read directly in SWR or db. The amplifier is tunable, 980 to 1,020 cps, for matching source modulator or for optimizing several instruments in one system. Variable bandwidth (15 to 100 cps) permits both high sensitivity testing and swept-frequency work.

For highest resolution on precise attenuation measurements, you can expand to full scale each 2.5 db portion of any 10 db range with no "blind spots," and the reference is maintained automatically! This expansion gives you 24 calibrated ranges, 0-60 db, in 2.5 db steps. The 415C also reads directly in SWR; it is ideal for measuring reflection coefficient and extremely useful as a null indicator for audio-frequency bridges.

Two peak-limited bias currents, readable on the front-panel meter and adjustable $\pm 10\%$, prevent accidental bolometer burnout. Other inputs permit operation with crystals and as a null detector.

The 415C has both an ac output for use as a high-gain tuned amplifier and a dc recorder output. High stability with line changes makes the instrument ideal for long-term monitoring. An internal battery pack (optional) makes the 415C completely portable. It is housed in the new Ⓟ modular cabinet, which can mount in half of a rack 7" high, combining conveniently in a single rack width with such companion instruments as Ⓟ 431 Power Meter.

SPECIFICATIONS

Frequency:	1,000 cps $\pm 2\%$ by front-panel control. Special-order frequencies available between 400 and 1,500 cps.
Sensitivity:	0.1 μv rms at 200 ohms and 30 cps bandwidth.
Noise Level:	5 db below full scale at 0.1 μv rms sensitivity, minimum bandwidth.
Bandwidth:	Variable, front-panel control, 15 to 100 cps.
Range:	70 db. Input attenuator for 60 db in 2.5 db steps, accuracy ± 0.1 db/10 db step. Maximum cumulative error, ± 0.2 db.
Expand Accuracy:	± 0.05 db from normal to 0.1 db expand; ± 0.1 db from normal to other expand ranges
Meter Scales:	SWR 1-4; SWR 3-10; expanded SWR $1\frac{1}{3}$ db 0-10; expanded db 0-2.5. Bolo current.
Input:	"Bolo"—200 ohms, bias 8.7 or 4.3 ma; "Crystal"—200 ohms for crystal rectifier; "200 Kilohm"—for crystal rectifier as null detector.
Outputs:	DC (1 ma full scale) for recording. AC (0.25 v rms for full scale deflection) for swept-frequency scope presentation.
Size:	7 $\frac{1}{2}$ " high, 6 $\frac{1}{2}$ " wide, 12 $\frac{1}{2}$ " deep. Weight, 5 lbs.
Accessories Available:	Battery pack.
Price:	\$325.00.

Data subject to change without notice. Prices f.o.b. factory

HEWLETT-PACKARD COMPANY

1085A Page Mill Road Palo Alto, Calif., U.S.A.
Cable "HEWPACK" Davenport 6-7000
Field representatives in all principal areas

HEWLETT-PACKARD S. A.

Rue du Vieux Billard No. 1 Geneva, Switzerland
Cable "HEWPACKSA" Tel. No. (022) 26. 43. 86

LITTON ALL-INERTIAL AUTOMATIC NAVIGATOR INSTALLED IN AN OPERATIONAL FIGHTER



NEW PROOF OF LITTON'S CONTINUING CONTRIBUTIONS TO THE DEVELOPMENT OF INERTIAL NAVIGATION IS FURNISHED BY THE LN-3-2B AUTOMATIC NAVIGATOR THAT IS NOW BEING INSTALLED IN CANADA'S CF-104 FIGHTER.

Three-hundred-and-sixty-degree freedom of aircraft maneuver on every axis is made possible by four-gimbal isolation of the Litton stable platform that keeps the system's accelerometers aligned in inertial space. Voltage signals from the accelerometers are transmitted to a computer where they are integrated to compute vehicle position components.

In addition, an adapter unit provides 27 outputs of pitch, roll and heading angles and ground speed to other equipment in the aircraft such as bombing computer and autopilot.

In flight, tight servo loops hold all sensitive elements of the stable platform at null regardless of acceleration.

Any relative motion between the gyro case, which is fixed to the platform, and the floated gyro rotor, which is fixed in space, is sensed and corrected to keep the platform including accelerometers oriented to vertical and north. Any acceleration along an axis produces an accelerometer torquer current which is proportional to the applied acceleration. This torquer current holds the accelerometer at null, and the same signal is transmitted to the navigation computer.

Another indication of the scope and caliber of Litton inertial engineering is the new combined doppler and inertial navigation system being produced by Litton Systems for the

Lockheed P3V-1 anti-submarine patrol aircraft. The inertial system continuously measures accelerations along the two horizontal axes and computes velocity components and aircraft position in latitude and longitude. Velocity information from the AN/APN-122 doppler radar is used in the inertial navigation system to optimize system performance.

A half dozen other Litton inertial navigation systems have been successfully developed to the operational phase. Still others are now in earlier phases of development.

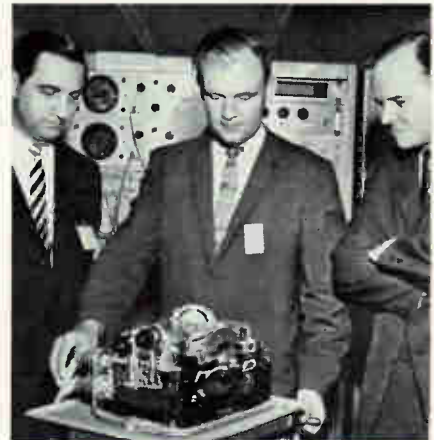

EXAMINING LN-3 STABLE PLATFORM UNDER TEST AT LITTON'S WOODLAND HILLS, CALIF. FACILITY ARE L-R: VIC SYMONDS, LITTON-CANADA; P. LUTN, LITTON-CALIF.; D. BELVEA, DDP.

These programs are being carried forward by engineers specializing in inertial navigation and related techniques. By engineers with their own long-range plans, and the ability to make important contributions to inertial engineering. By engineers who prefer engineering to paper work. By engineers willing and able to see a job through from concept to product.

Are you specially qualified in inertial equipment, computers, data processing systems, tactical data systems, displays, advanced communication techniques? Write today to Donald Krause, Research & Engineering Staff, Litton Systems, Inc., 336 No. Foothill Road, Beverly Hills, California.

Qualified applicants will be considered regardless of race, creed, color or national origin.

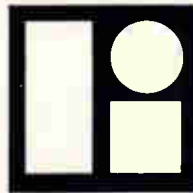
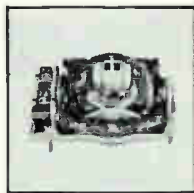

**LITTON
SYSTEMS, INC.**
Beverly Hills, California

DIVISION OF LITTON INDUSTRIES



HIGH MU

LOW MU

MEDIUM MU

(Now: Eimac 10 and 20 kw ceramic triodes for every application!)

There's an Eimac 10 and 20 kw ceramic triode for class AB₁ audio, for class C RF, for class B linear service ... for every application. These rugged tubes provide dependable power through 110 mc—plus large reserves of grid dissipation! For data write: Power Grid Tube Marketing, Eitel-McCullough, Inc., San Carlos, Calif.



Space Conference Speakers Propose

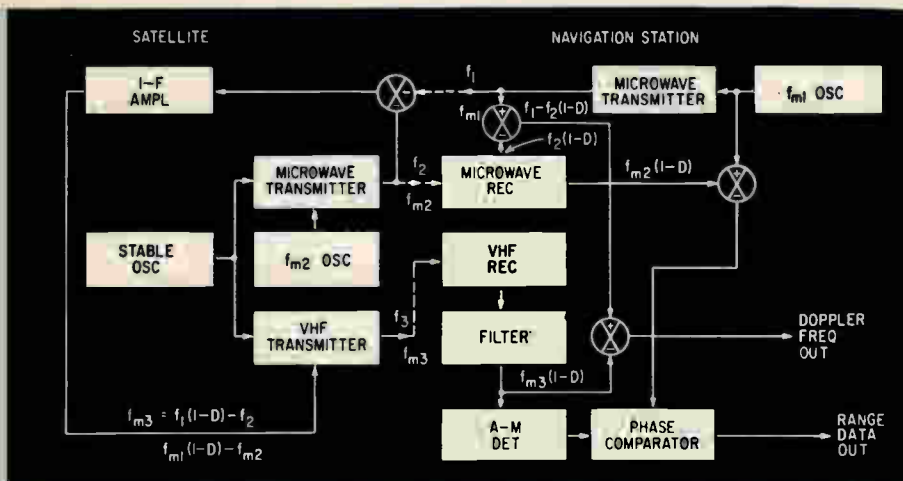

Sideband folding technique proposed for ground navigation with Transit satellite system.

SIDEBAND FOLDING technique for determining the position of a navigation station on earth with signals from a communications satellite was detailed at the recent Guidance, Control and Navigation Conference at Stanford University. The method, which combines techniques developed for the Navy's Transit system (ELECTRONICS, p 148, Aug. 11, 1961) and the Air Force's Azusa project, would reportedly improve the already good characteristics of the Transit system.

Other papers outlined methods of controlling and tracking space vehicles (one of the speakers, however, said space navigation now is in a development stage comparable to the Model T era of automobile evolution). The conference, sponsored by the American Rocket Society and Stanford's aeronautical engineering department, drew 800 scientists and engineers.

The single sideband folding technique was described by J. W. Crooks, Jr., R. C. Weaver and M. M. Cox, of General Dynamics/Astronautics. In the present Transit system, they said, a communications satellite transmits a signal, controlled by a very stable local oscillator, to the navigation station.

The received signal is frequency-compared with a second stable oscillator in the navigation station. Difference in frequency is recorded as a function of time. The fre-

quency difference-versus-time relationship establishes a mathematical model providing latitude and longitude of the station.

More specifically, the required inputs, both functions of time, are (1) satellite position and (2) a series of observed frequency differences between the received satellite signal and the station's frequency reference.

Doppler frequency shift due to rate of change in the line-of-sight distance between satellite and navigation station affects recorded frequency. So does the influence of the ionosphere on the signal transmission. Another factor in frequency comparison and recording is the difference between transmission reference signal frequencies.

The proposed technique would have the satellite transmit two frequencies: one a vhf signal and the other a high order S-band harmonic of that signal. The uhf doppler information is used to "buck out" the major doppler effect at the microwave frequency. The microwave signal, by providing more doppler cycles and much less ionospheric error than a vhf signal, improves accuracy, even when used in the passive mode.

To simplify the navigation station and keep its power requirements low, the satellite receiver sensitivity should be reasonably high. This dictates a narrow receiver bandwidth that includes an

information bandwidth of ranging signals much lower than signal frequency. For example, the one-way doppler frequency shift of a 50-Kc signal to a navigation satellite would be at most about plus-or-minus one cycle per second so the tracking bandwidth can be less than a cycle per second. This requires special detectors with extremely low thresholds—such as correlation detectors—to work down to usable signal powers. These detectors plus post-detector filtering can restore a useful ratio of ranging signal-to-noise. However, in a satellite these techniques supposedly are too complicated to be reliable.

Sideband folding is an alternative technique using the following principle: two signals are injected into a mixer. One is the received signal frequency modulated at f_{m1} and the other the local oscillator signal which is frequency modulated at f_{m2} . Both have an index of about one. If f_{m1} and f_{m2} are very nearly equal, the resulting sidebands are clustered around the intermediate frequency carrier resulting from the difference of the signal and local oscillator carriers. A narrow band amplifier amplitude modulates the sideband signal at the intermediate frequency.

In a proposed system this principle is applied as follows:

The microwave signal transmitted by the satellite is used as the local oscillator signal at the navigation station. It is frequency modulated at f_{m2} (50.3 Kc). A microwave signal transmitted from the navigation station is frequency modulated at f_{m1} (50.0 Kc). The difference between the modulation frequency received at the satellite and that transmitted on the microwave carrier from the satellite appears as amplitude modulation on the subcarrier f_{m3} transmitted over the satellite vhf transmitter.

The frequency and phase information contained in the modulation on the microwave signal $f_{m2}(1-D)$ received from the satellite is combined with the modulation frequency on the microwave signal f_{m1} transmitted to the satellite. (D is the Doppler coefficient equal

New Satellite Navigation Techniques

to the range rate velocity of transmission.) The resultant phase is compared with the phase of the demodulated subcarrier $f_{ms}(1-D)$ received from the satellite on the vhf carrier to supply ranging information.

Other electronic techniques and systems described in presented papers include:

- A method of using the earth's magnetic field in the attitude control of long-life space vehicles. Described by A. G. Buckingham, of Westinghouse's Air Arm Division, it uses "three mutually perpendicular coils for implementing momentum transfer and three mutually perpendicular inertia wheel controls for storing momentum and generating desired angular motions". Momentum transfer to the earth's field is accomplished by measuring the unwanted momentum stored in the inertia wheels with tachometer generators and measuring the components of the earth's field with a magnetometer. Coil currents required to generate the desired momentum transfer torques are then computed.

- Four engineers from GE's Missile and Space Vehicle Department—D. R. McMorrow, C. A. Brown-

lee, S. Dardarien, H. Schwartz—discussed a precision star tracker used in satellites and space probes for attitude control and astronavigation. Key components are a Cassegranian telescope, a nonrotating mechanical scanner, angular pickoff devices, gimbal, photodetector, and servo system. The tracker is reported capable of locating and locking on a star anywhere within a 30-degree cone-of-view and of measuring between this "star line" and reference plane within 10 seconds of arc. The system occupies 0.75 cu ft and weighs 25 lbs.

- Precision radars for tracking space vehicles were discussed by C. R. Woods and E. B. Mullen, of GE's Defense Systems Department. Emphasizing the long baseline techniques required for accurate angle measurement, they described a system operating in near real-time, capable of accuracy of one part per million. Baseline lengths can run to hundreds of miles.

- W. C. Reisner, Jr., of the Franklin Institute Laboratories, investigated the use of a wide band optical mixer tube to detect the difference frequency between two spectral lines from a non-coherent

light source. The tube consists of photosensitive cathode and traveling-wave interaction structure. Interference of two optical signals at the photo-surface modulates the emitted current at the beat frequency. Coupled to a microwave receiver by a helical guide, this attains the signal-to-noise ratio needed to detect frequency differences.

- General conception and design principles of a gyroscope with a rotor supported only by electric fields was described by A. Nord-sieck, of the University of Illinois. The rotor turns freely in a high vacuum. Support is supplied by an a-c passive resonant servo system and read-out is accomplished by photo-electric observation of a pattern on the equator of the rotor. The case is gimballed and made to turn with the rotor angular momentum vector.

Distributors to Get More Factory Sales

FURTHER STRENGTHENING of the distributor's role in industrial electronics (ELECTRONICS p 28, May 12, 1961) was seen at WESCON last week. A prediction in one area—computer building blocks—was made by John A. Hickey, industrial products manager of Raytheon's Distributor Products Division.

He said this would become a "multi-million-dollar market for distributors". The firm recently initiated sales of computer modules through distributors at factory prices. Original equipment manufacturers, however, can still get extra large quantities at the factory at lower prices.

The firm set up its distributor division several years ago to consolidate commercial sales. The division has full profit-loss and inventory control responsibility. At the time, it was pointed out that engineering and production had dwindled to one-third of commercial product costs, while distribution and related expenses accounted for two-thirds.

Space Data Weighs Ton



Tapes by GE cover 32.1 hours of instrumented space flight and 230,000 miles. Vehicles included RBK1, Mark 2, Mark 3, RVX-2, Discoverer NERV

Mercury Space Project to Get Realistic Test

ORBITAL FLIGHT and reentry of a Mercury spacecraft—scheduled for last week—was to give National Aeronautics and Space Administration's space task group a realistic workout of the Mercury Project's huge and complex world-wide system (ELECTRONICS, p 30, Oct. 7, 1960). Realism of the test was to be heightened by the use of a simulated crewman in the flight capsule.

Labeled Mercury-Atlas 4 (MA-4), the test called for one earth orbit. The spacecraft (No. 8) is the same one flown in the aborted one-orbit attempt of April 25. Other objectives of the test included:

- Demonstrating the ability of the modified Atlas launch vehicle to release the craft at the right speed, altitude and flight path angle.

- Proving that on-board systems would operate on a fully automatic basis during a two-hour orbital flight.

- Checking out the braking rocket system and the ability of the craft to withstand 2,000 F reentry temperature for six to seven minutes—eight times longer than required in previous ballistic flights.

The mechanical crewman was designed to fill the cabin with heat

and moisture, simulating a pilot's breathing. In addition to standard Mercury control systems, electronic equipment and sensing devices were installed in an attempt to duplicate a man's judgment and corrective capacity. While the manual attitude control system was closed off, the sensing devices were to drive the automatic attitude control system.

MA-4 was to carry mechanical devices to reproduce the actions of a pilot. A tape recorder, located where the pilot's head would be, was to record flight noises. Other gear included porthole, periscope and instrument panel cameras and environmental monitoring instrumentation. Two 45-minute voice tapes were to broadcast preplanned messages to stations in the network of tracking stations, to check on high frequency and uhf transmissions.

During the flight, information from tracking and ground instrumentation points around the globe was to be funneled into NASA's Goddard Space Flight Center at Beltsville, Md.

The ground system has the capacity to receive more than 1,000 bits of information per second. After almost instantaneous com-

puter analysis, the information is relayed to Cape Canaveral for action. The communications-computing system must operate in near real-time, since each tracking station around the world must be given a position as soon as the spacecraft passes the preceding station. During recovery, impact location predictions must be continually revised and relayed to recovery forces.

The network consists of 18 stations, running roughly on a line from the Cape, across central Africa, Australia, Hawaii and Mexico, then back to Florida. Two ships, in the Atlantic and Indian Oceans, supplant island and mainland stations. All told, there are about 140,000 miles of teletypewriter, telephone and high-speed data circuits.

The network was recently turned over to NASA by an industrial team headed by Western Electric. Other major contractors were Bell Telephone Labs, Bendix, Burns and Roe, and IBM. Lincoln Lab was technical advisor to NASA. Some 20 private and public communications agencies lease to NASA land lines, overseas radio and cable facilities.

As data is received and analyzed, it is displayed at the Mercury Control Center at Cape Canaveral. About 100 types of information register on indicators and a huge range-status map: 10 show biomedical condition, about 30 relate to life support facilities and about 60 give readings on spacecraft equipment.

The system at Canaveral and Goddard handles radar, guidance and telemetry data as well, comparing actual trajectory to a predetermined flight path.

MA-4 was to go into orbit near Bermuda, begin braking off the West Coast of Mexico, reenter over the southeastern states and splash about 200 miles east of Bermuda. The seven Mercury astronauts were at key stations as flight controllers or monitors.

During the first few minutes of flight, the spacecraft could have been rescued if the launch failed. An Abort Sensing and Instrumentation System (ASIS) can fire



Agave antenna installed at Kano, Nigeria, by Cubic Corp. is part of Mercury network. This type of antenna picks up voice and telemetry signals as the capsule appears on the horizon and then tracks the spacecraft

posigrade rockets and release the capsule up to the point the radio inertial guidance system takes over in Atlas.

No further suborbital tests of the Mercury system are planned. The Redstone-boosted ballistic flights, which carried the first two U. S. astronauts into space, accomplished their objectives, NASA said.

Computers May Analyze 95% of All Sentences

A COMPUTER PROGRAM that analyzes word interrelations and order for 95 percent of all sentences is a definite possibility in the next six months, says a U. S. Army review and analysis report on machine translation.

Through a five-step, machine-human translation process, the report estimates the entire output of Soviet technical and scientific literature (estimated from 300 to 600 million words per year) "will be examined at least as far as the abstract stage, and that some 15 to 20 percent of the total will be translated".

Copies of the report are available through the Office of Technical Services, Department of Commerce, Wash., 25, D. C. Order: 171 189. Price: 50¢.

Dense Micrometeorite Band Apparently Envelopes Earth

EVIDENCE THAT a dense band envelopes earth at an altitude somewhere between 47 and 102 miles has been gathered by an Air Force Cambridge Research Laboratory rocket. The rocket used a nose cone formed of plastic petals which open like a flower. Some of the particles collected are smaller than the wave length of light. The band may have been formed by electrostatic trapping. Further tests were to determine altitude more exactly.

The laboratory is also plotting a meteorological profile of the atmosphere between 15 and 45 miles up. More than 200 sounding rockets have been fired, including 24 at hourly intervals in a single day. Data is derived by tracking balloons released by the rockets. The balloons contain an aluminized Mylar corner reflector.

BALLANTINE Wide Band, Sensitive VTVM model 317

Price: \$495 with probe



Measures

300 μ V to 300 V

at Frequencies 10 cps to 11 Mc

A stable, multi-loop feedback amplifier with as much as 50 db feedback, and 10,000 hour frame grid instrument tubes operated conservatively, aid in keeping the Model 317 within the specified accuracy limits over a long life. A million to one in voltage range and over a million to one in frequency coverage makes it attractive as a general purpose instrument for measurement of af or rf as well as the complete band. All readings have the same high accuracy over the entire five inch voltage scales. This is typical of all Ballantine voltmeters due to the use of individually calibrated logarithmic scales.

The 317 may be used as a null detector from 5 cps to 30 Mc having a sensitivity of approximately 100 μ V from 10 cps to 20 Mc.

SPECIFICATIONS:

VOLTAGE: 300 μ V to 300 V.

FREQUENCY: 10 cps to 11 Mc (As a null detector, 5 cps to 30 Mc).

ACCURACY: % of reading anywhere on scale at any voltage. 20 cps to 2 Mc — 2%; 10 cps to 6 Mc — 4%; 10 cps to 11 Mc — 6%.

SCALES: Voltage, 1 to 3 and 3 to 10, each with 10% overlap. 0 to 10 db scale.

INPUT IMPEDANCE: With probe, 10 megohms shunted by 7 pF. Less probe, 2 megohms shunted by 11 pF to 24 pF.

AMPLIFIER: Gain of 60 db \pm 1 db from 6 cps to 11 Mc; output 2.5 volts.

POWER SUPPLY: 115/230 V, 50 — 400 cps, 70 watts.

Write for brochure giving many more details

— Since 1932 —



BALLANTINE LABORATORIES INC.

Boonton, New Jersey

CHECK WITH BALLANTINE FIRST FOR LABORATORY AC VACUUM TUBE VOLTMETERS, REGARDLESS OF YOUR REQUIREMENTS FOR AMPLITUDE, FREQUENCY, OR WAVEFORM. WE HAVE A LARGE LINE, WITH ADDITIONS EACH YEAR. ALSO AC/DC AND DC/AC INVERTERS, CALIBRATORS, CALIBRATED WIDE BAND AF AMPLIFIER, DIRECT-READING CAPACITANCE METER, OTHER ACCESSORIES. ASK ABOUT OUR LABORATORY VOLTAGE STANDARDS TO 1,000 MC.

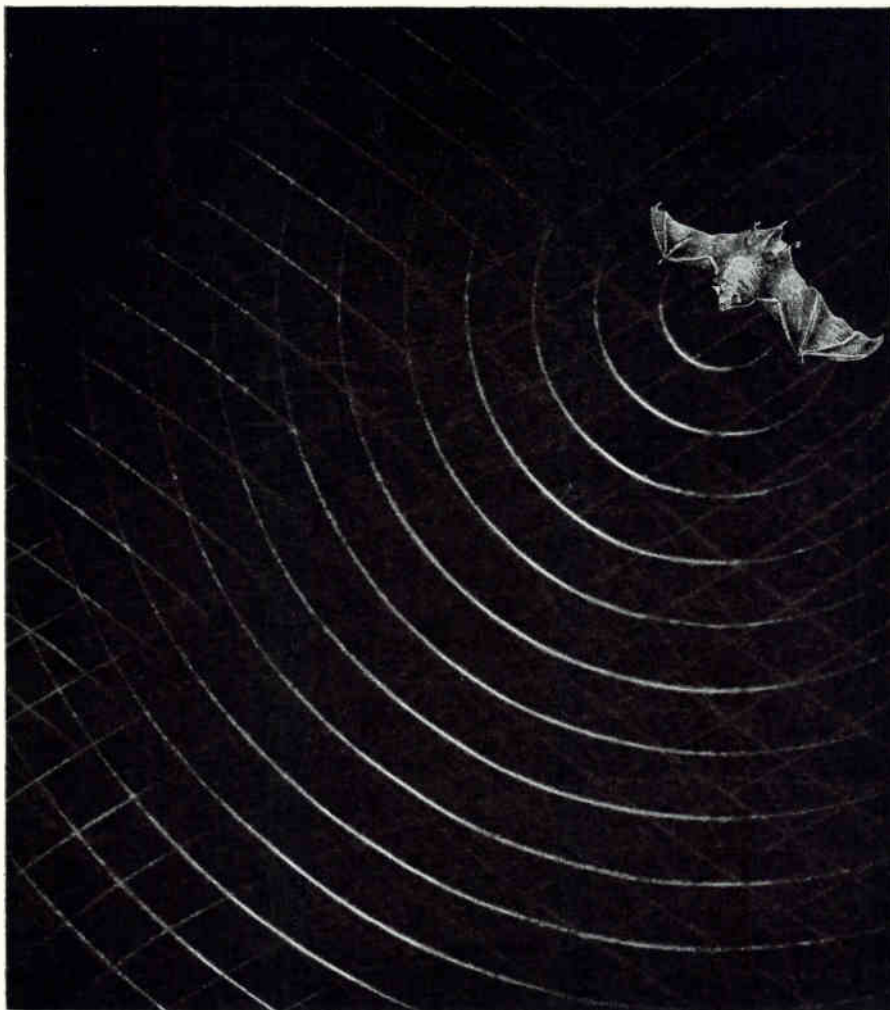

how to capture a bat – underwater – with a PI tape recorder



To satisfy a yen for sea food, a particularly interesting member of the bat family catches fresh fish by reaching beneath the surface. In studying these bats, Harvard Professor Donald R. Griffin captures the bat's "radar" with a microphone in the air and a hydrophone in the water. The pulses of sound are recorded on alternate channels of a PI tape recorder, and played back at reduced speeds so that the original frequencies, 15 to 200 kilocycles, become audible.

In other studies, Professor Griffin has captured bat sounds in stereo. Using a pair of microphones located at different points, he has recorded and measured the arrival time of sound pulses to determine the bat's changing position with respect to the two microphones.

For capturing bat sounds and other dynamic phenomena for conversion to electrical form, PI recorders offer a number of distinct advantages over conventional instrumentation magnetic tape recorders. A brief note from you will capture the details.



PRECISION INSTRUMENT COMPANY
1011 Commercial Street • San Carlos • California
Phone LYtell 1-4441 • TWX: SCAR BEL 30

REPRESENTATIVES IN PRINCIPAL CITIES THROUGHOUT THE WORLD

IEC Adopts 24 Standards During Its 1961 Meeting

ZURICH—International Electrotechnical Commission (IEC) approved publication of 24 draft recommendations for standards at its 1961 annual meeting in Interlaken, Switzerland. Another 74 standards were endorsed for circulation to member countries.

Among actions by the technical committees were:

- Adopted U. S. symbols for semiconductors. These won out over a proposed Swedish system. Swiss proposals for automatic control symbols will be studied by a committee of delegates from IEC, International Standardization Organization, International Federation of Automatic Control and International Federation of Information Processing.

- Named controlled semiconductor rectifiers "pylistors" (from the Greek "pyle", for gate), as suggested by the British. The original proposal, to call them "Thyristors", was rejected although RCA offered to relinquish its trademark.

- Accepted French recommendations for counters with 0.5-percent accuracy, for applications dealing with large quantities of electrical energy.

- Decided on safety specifications for transmitters. Upper limit for low voltage is 50 volts rms and 72 volts peak; lower limit for power is 10 watts.

- Decided on five insulation classes for dry transformers: A (60 C or 140 F), B (80 C or 176 F), E (100 C or 212 F), H (125 C or 260 F), and C (over 125 C or 260 F). Maximum oil temperature rise is 60 C.

- Set up a new technical committee to deal with standardization of winding wires. The committee has a Dutch chairman, L. van Rooij, and a German secretariat.

The meeting was attended by more than 1,000 delegates. The largest delegations were from Great Britain, 124 delegates; Germany, 109; France, 109; Switzerland, 81; Sweden, 55; The Netherlands, 53; U. S. A., 47; Italy, 43; and Japan, 36. Japan, Roumania and the United Kingdom joined Canada, France, Germany, Spain, U. S. and USSR on the Committee of Action.

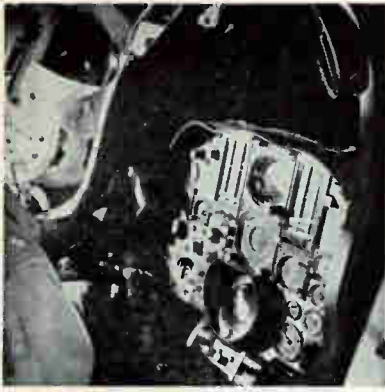

Pilot makes simulated flight in F105-D fighter-bomber

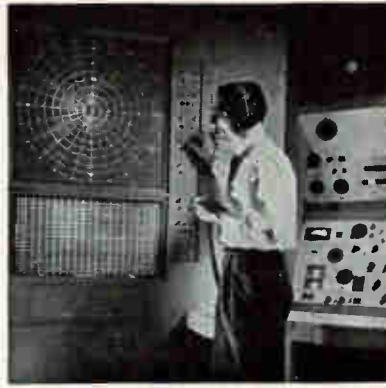

Spiderweb plotting board shows pilot's position in relation to terrain

Pilot Training System Simulates Radar

FLIGHT AND TACTICS simulator developed for the Air Force will train student fighter-bomber pilots in the quadruple role of pilot, navigator, bombardier and gunner. It reproduces the responses of the F105-D, providing the pilot with all flight and weapons system characteristics of an actual mission.

Reportedly the largest simulator made to date (16 tons, nearly 400,000 parts), the \$1,300,000 system goes to the Tactical Air Command, Langley AFB, Virginia. It was designed and built by ACF Electronics, a division of ACF Industries in Maryland.

Requiring three men for operation, the simulator consists of a cockpit and instructor-operator console, a map room and two lines of back-to-back computer and allied equipment.

A major feature of the system is a simulated radar system which is said to provide low-altitude capabilities hitherto unavailable. The NASARR (North American Search and Ranging Radar) portion produces vidicon tube displays for ground and contour mapping and terrain avoidance.

A three-dimensional terrain map and a gray shaded planar map for altitude information are used. Between the maps, a gantry activated by three servomechanisms moves in any direction, depending on movement of the aircraft. A minute light source, representing the area of radar antenna radiation, illuminates the map area over which

the flight path is simulated.

Light originates from a 1-watt super pressure mercury vapor lamp with an arc of only 0.012 inch. It is reflected by a spherical concave reflector through a source relay lens. The lens focuses the light on the end of a four-inch synthetic sapphire pipe.

A folded optical slide projection system shows the instructor and operator where the pilot is in relation to terrain and altitude requirements of particular situations. It consists of eight magazine slide projectors operating independently or simultaneously.

Radio communications and navigation information is supplied by a radio target and facility system.

Saturn Radar Altimeter Range to be 250 Miles

SATURN SPACE VEHICLE will carry high altitude radar altimeters. NASA's space flight center at Huntsville, Ala., has awarded a \$450,000 contract to Ryan Electronics, division of Ryan Aeronautical Co., for design, development and fabrication of the altimeters.

Ryan said the high-altitude altimeters would not be used in the first Saturn booster, since this will have two inert upper stages and will only go about 100 miles. The company recently won radar altimeter and doppler sensor equipment contracts for NASA's Surveyor lunar soft landing vehicle.

*first
choice of
all 4*

research

design

production

management

Because the BUYERS' GUIDE satisfies the buying and specifying needs of all four segments of the industry! Gives more information in less space. Easier to use. Only the BUYERS' GUIDE has been screened for usefulness over a 20 year period... comes to you compact, complete and accurate.

gives more to all 4!

**electronics
BUYERS' GUIDE**
and REFERENCE ISSUE

FCC Ready for UHF Tv Tests

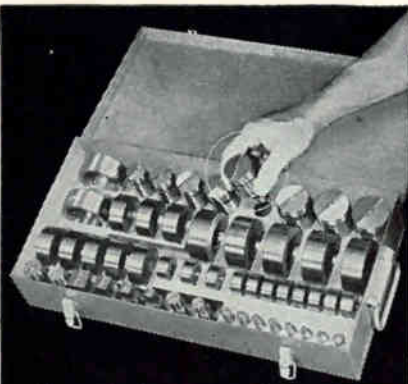

the right punch & die
at your finger tips...
**NEW DI-ACRO
PUNCH PAKS**

Punch Pak No. 1 - \$139.50
Punch Pak No. 2 - \$259.50

- Off the shelf delivery
- Adapters to fit any punch press

Di-Acro Punch-Paks save you money, cut production delays. No time lost looking for the right size or waiting for special orders. Cost is approximately 10 per cent less than individual punch and die sets—with the rugged, steel store-or-carry chest free. All Di-Acro Punches and Dies are precision made of quality tool steel.

PUNCH-PAK NO. 1 contains 30 sizes of round punches and dies from 3/64" to 1/2" in increments of 1/64".

PUNCH-PAK NO. 2 contains round punches and dies from 1/16" to 1/2" in 1/16" increments, round sizes from 1/2" to 2" in 1/8" increments, squares in 1/2", 5/8", 3/4" and 1" sizes, one die holder and two die adapters.

Die Adapter A-2 3/4" diameter—1 1/4" bore, Die Adapter B-2 3/4" diameter—2 1/8" bore.

DIMENSION DATA

All Di-Acro Punches to 1/2" have 1/2" diameter shanks, 2 13/32" length.
All Di-Acro Punches from 1/2" to 2" have 1" diameter shanks, 3 1/8" length.
All Di-Acro Dies to 3/4" are 1 1/4" diameter, 5/8" high.
All Di-Acro Dies from 3/4" to 1 3/8" are 2 1/8" diameter, 7/8" high.
All Di-Acro Dies from 1 1/2" to 2" are 2 3/4" diameter, 15/32" high.

PUNCH AND DIE HOLDERS

which adapt Di-Acro Punches and Dies to any punch press are listed in literature on single station punch and die program. Ask for it... also for literature on new Adjustable Punch and Die program.

For full information consult Yellow Pages of your phone book under Machinery-Machine Tools for the name of your Di-Acro distributor or write us.



Pronounced die-ack-ro
**DI-ACRO
CORPORATION**
Formerly O'Neil Irwin Mfg. Co.
439 Eighth Avenue
Lake City, Minnesota • U.S.A.

INCREASED INTEREST in uhf television by Federal Communications Commission was shown this week by near completion of arrangements for test broadcasts in New York and by a number of proposals now awaiting industry comment.

The New York tests, triggered early last summer, (ELECTRONICS, p 32, June 3, 1960) call for a uhf station atop the Empire State Building to test the feasibility of broadcasts in a large metropolitan area. FCC expects test results will be critical in determining the future of uhf television in large cities.

Adding to the push for more use of uhf tv channels are plans by the Commission to press harder for rulemaking to have all tv receivers made in the future able to handle both uhf and vhf. Other proposed rulemakings call for easing the technical requirements for uhf tv stations and for having uhf station construction permits granted without hearings on a first-come, first-served basis. The heading of the public notice covering these and other uhf proposed rulemakings reads "Comprehensive Actions to Foster Expansion of UHF Television Broadcasting".

Against this background, the New York City test installation is at the stage where all major contracts have been signed. Radio Corporation of America will lease a transmitter and transmission line to the Commission. Final testing of the equipment, delivered this month, is slated for completion before Oct. 1. It will be ready for partial use, however, during September.

The antenna will be supplied by Melpar, Inc. Scheduled installation date for the channel 31 unit is November 10. It will be placed on the main tower and will cost \$9,897. A temporary directional antenna, also by Melpar, will be mounted on an 80th floor window for making comparative tests of circular and horizontal polarization. This unit is slated for completion by Sept. 1.

Receivers for the tests will be provided by RCA Sales Corp. and Jerrold Electronics. RCA will supply 100 monochrome, 15 portable

and 10 color sets. Jerrold will install and maintain 100 table model monochrome and 10 table model color sets and will, in addition, provide seven crews to perform field measurements and install the receivers. The Jerrold contract for \$213,895 covers both sets and crews.

Smith Electronics, Inc., is supplying 12 lightweight field strength meters to measure both uhf and vhf signals.

Operation of the transmitter will be handled by the City of New York under an agreement which includes providing operators and supervisory personnel as well as a portion of the program material. Some operators are already being trained to meet the requirements of the experiment.

The Commission is also making arrangements with New York tv stations and their program sources to provide program material between 9:00 a.m. and 11:00 p.m.

Pigeon Tracks



DEVELOPMENT of improved navigational systems may result from Office of Naval Research studies of pigeon's flight habits using 2 1/2 oz transmitter operating at 140 Mc (photo).

Built by American Electronics Labs, Inc., unit puts 1 milliwatt of r-f power into a modified half-wave dipole antenna. Transistor operated, mercury cells will provide 20 hours of continuous operation.

a **DVM**
tailored to your use

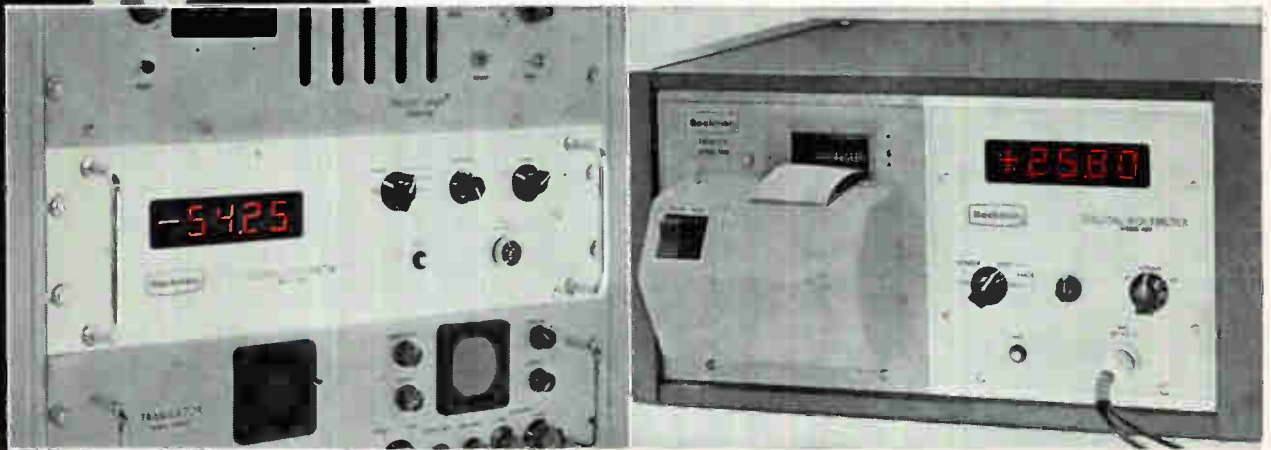
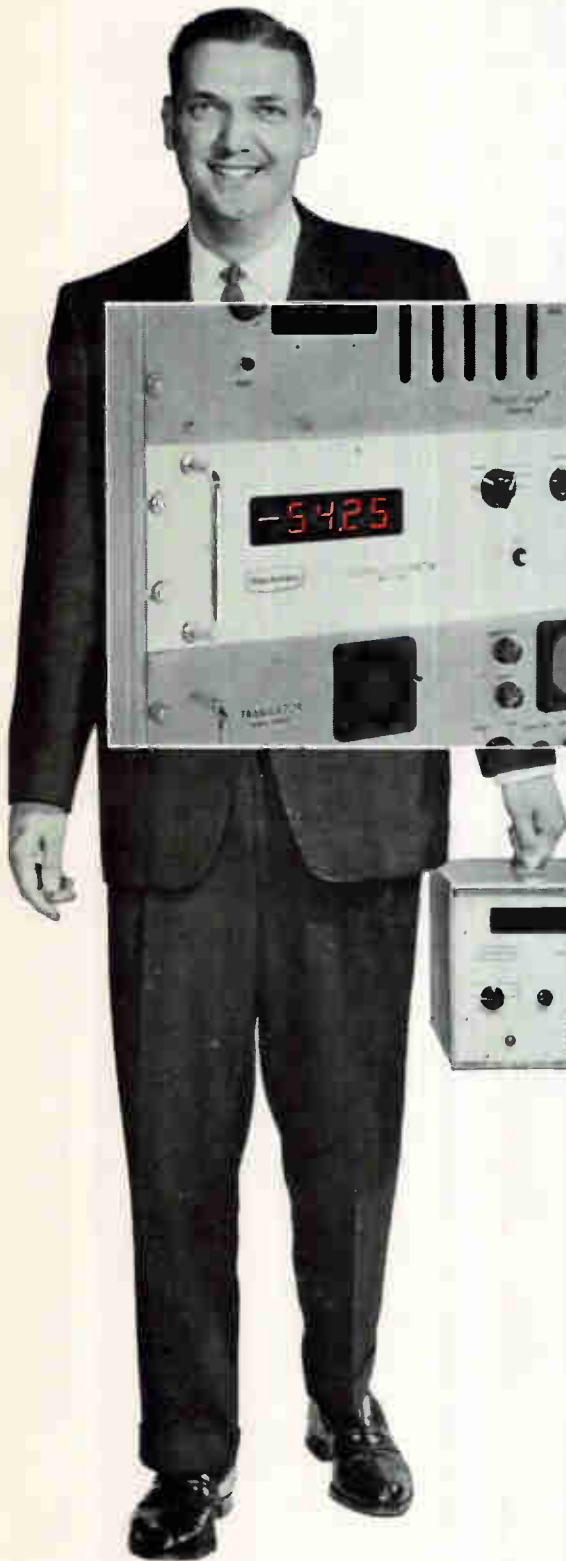

A truly portable package plus two rack mount versions for maximum utility.

This .01% Beckman digital voltmeter/ratiometer — available in three configurations — fits almost anywhere. It comes as either an 8" square portable or half-rack module, or a full rack model just 5¼" high. What's more, it's the most accurate, easy-to-read DVM in its price range. Its exclusive in-line, in-plane readout can be seen across the room and from almost any angle. Operation is quiet and trouble-free because sealed reed relays replace thyratrons to drive the stepping switches. Price is **\$995**. Send for our Brochure A-4011.

- linearity: 0.01% of full scale
- 0.001v to 999.9v dc range
- automatic/hold ranging
- binary-coded output
- automatic decimal point and polarity sign

Beckman[®]

INSTRUMENTS INC.
BERKELEY DIVISION
RICHMOND, CALIFORNIA

MEETINGS AHEAD

Sept. 4-9: Analog Computation, International Conf., International Assoc., for Analog Comp., and Yugoslav Nat. Comm. for ETAN; Belgrade, Yugoslavia.

Sept. 6-8: Computing Machinery, National Conf., ACM; Statler-Hilton Hotel, Los Angeles.

Sept. 6-8: Nuclear Instrumentation Symposium, PGNE of IRE, AIEE, ISA; N. C. State College, Raleigh, N. C.

Sept. 6-8: Space Elec. & Telemetry, PGSET of IRE; Univ. of New Mexico, Albuquerque, N. M.

Sept. 6-13: Electrical Engineering Education, Internat. Conf., ASEE, AIEE, PGE of IRE; Sagamore Conf. Center, Syracuse Univ., Adirondacks, N. Y.

Sept. 8-10: High-Fidelity and Home Entertainment Show, Chicago, Crystal Ballroom, Palmer House, Chicago.

Sept. 11-15: Instrument-Automation Conf. and Exhibit, ISA; Sports Arena, Los Angeles.

Sept. 13-15: Photomultiplier Tube Symp. EMI House, Manchester, W. I. London.

Sept. 14-15: Technical-Scientific Communications, PGEWS of IRE, Bellevue-Stratford Hotel, Philadelphia.

Sept. 14-15: Engineering Management Conf., IRE; Hotel Roosevelt, N. Y. C.

Sept. 20-21: Industrial Electronics Symposium, PGIE of IRE, AIEE; Bradford Hotel, Boston, Mass.

Oct. 1-5: Electromechanical Society; Statler Hotel, Detroit, Mich.

Oct. 9-11: National Electronics Conf. IRE, AIEE, EIA, SMPTE; Int. Amphitheatre, Chicago.

Nov. 14-16: Northeast Research & Engineering Meeting, NEREM; Commonwealth Armory and Somerset Hotel, Boston.

Mar. 26-29, 1962: IRE International Convention, Coliseum & Waldorf Astoria Hotel, New York City.

**this
industrial
thermoelectric
power
converter
grew
out of
military
capabilities**

CAPABILITIES IN RESERVE



THE HOOVER COMPANY ELECTRONICS DIVISION

110 WEST TIMONIUM ROAD TIMONIUM, MARYLAND

Mail address: Post Office Box 181, Baltimore 3, Maryland

with the emphasis on the "r" in: $R_s = \prod_{i=1}^n r_i$

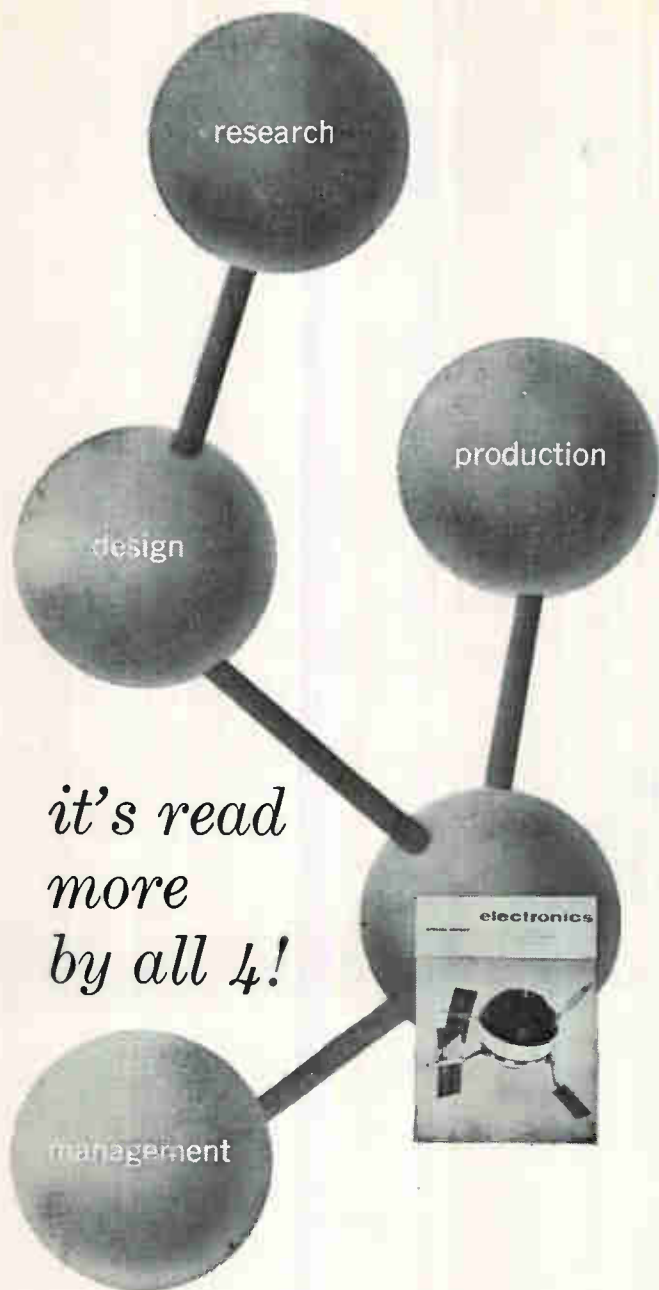

*it's read
more
by all 4!*

electronics is specially edited to keep you informed about the entire industry. With special issues on Electronic Markets, Modern Microwaves, Search and Probe Systems, and other reports you'll want to file and keep

subscribe today to **electronics**

Every Friday, **electronics** gives you the latest engineering developments and technically interpreted market trends. So don't wait till everyone on the routing slip has read it. Subscribe now and read **electronics** first. Mail the reader service card (postpaid) to **electronics**, the magazine that helps you to know and to grow! Rates: three years for \$12, one year for \$6; Canadian, one year for \$10; foreign, one year for \$20. Annual **electronics** BUYERS' GUIDE (single issue price \$3.00) included with every subscription.



This versatile power converter (Model DPC-113), is a symbol as well as a significant improvement in conversion efficiency. It stands for Hoover's "capabilities in reserve," for the broad range of products and creative abilities found in Hoover's industrial spectrum, grown out of Hoover's long-noted work in military applications.



Model DPC-113 is ideally suited for applications whose power source is a thermoelectric generator, fuel cell, low voltage battery... for battery charging equipment in radio and radar beacons, signal buoys at sea, space platforms, microwave link stations, vehicle-mounted equipment, standby power sources in general. With it, applications once regarded as impracticable now become practical.

With its efficiency (greater than 75%), a wide range of input and output parameters is available. Solid state construction eliminates maintenance problems.

Inputs as low as 0.1 volt are practical, and virtually any output, ac or dc, can be supplied. Fully encapsulated, it can even live under sea water indefinitely.

For further information, will you address J. E. Miller

**THE HOOVER
COMPANY**
ELECTRONICS DIVISION

$$R_s = \prod_{i=1}^n r_i$$

1 to 5 mc
COMPUTERS

3 to 20 mc
COMPUTERS

10 to 100 mc
COMPUTERS

For a 1mc or 100mc-clock Computer

THERE'S A PHILCO
150 mw
MADT*



Seven important circuit advantages, inherent in every Philco MADT, are:

1. Tight Parameter Control;
2. Charge-Control Specification;
3. Exceedingly Low V (SAT);
4. Very Low Collector Capacitance;
5. Freedom from Latching;
6. Excellent Temperature Stability;
7. Industry's Best-Documented Reliability.

Four new Philco 150 mw *Micro-Alloy Diffused-base Transistors bring even more versatility to industry's most reliable transistor line. Now, you can benefit from MADT proven product advantages in a broader-than-ever range of applications, including those that require high power dissipation. In addition to an expanding line of 150 mw types, there's the *new ultra-high-speed 100 mw MADT type 2N976—the world's fastest switch.* There's an MADT that gives you optimum cost efficiency for your specific requirements.

For complete information on these high power dissipation MADT's, and application assistance on any transistor circuit, write Dept. E9161.

Philco 150 mw
MADT's are
immediately available
in quantities 1-999
from your Philco
Industrial Semi-
conductor Distributor

PHILCO



Famous for Quality the World Over

LANSDALE DIVISION, LANSDALE, PENNSYLVANIA



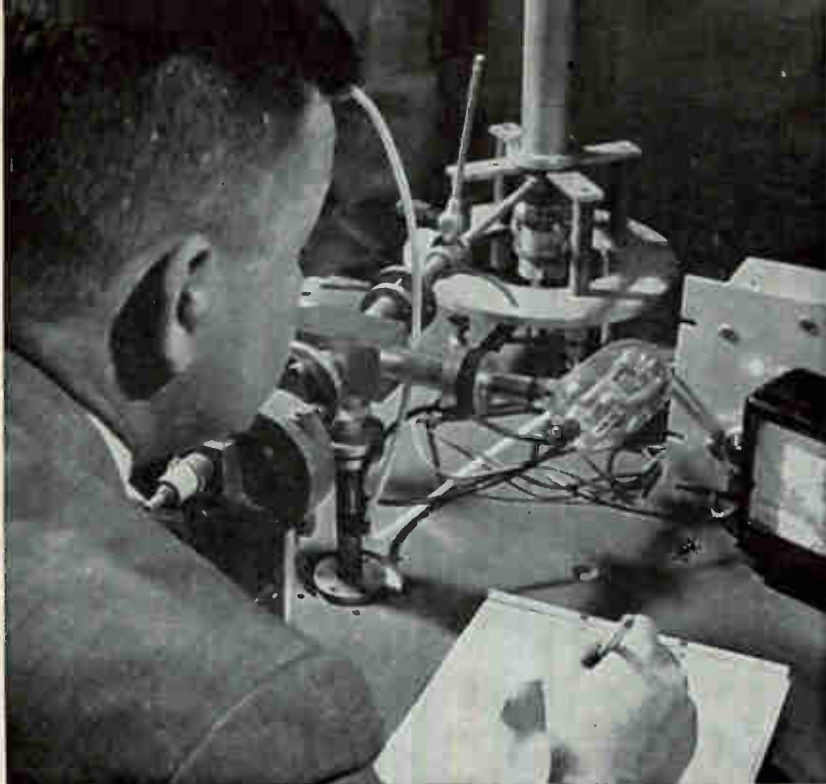

Interaction of an electron beam with plasma has been attained at efficiencies better than five percent by Sperry Electronic Tube division engineers using this experimental circuit. Electron gun at bottom of vertical hydrogen-filled tube fires beam into gas, generating the plasma

Uses include thermonuclear fusion experiments, power conversion and spacecraft propulsion.

Specific electronic applications are microwave traveling-wave amplifiers, backward-wave oscillators, uhf parametric amplifiers.

Also: phase detectors, harmonic amplifiers, mixers and switches

PLASMA ENGINEERING—Part III:

APPLICATIONS OF PLASMA

By **MICHAEL F. WOLFF**,
Associate Editor

WHILE PLASMA RESEARCHERS today are concentrating on understanding plasma physics, much of their work is directed at realizing a variety of practical applications. Although the major effort lies in controlled thermonuclear research, extensive studies are underway in MHD and thermionic power conversion, plasma propulsion, and electronics.

Controlled Thermonuclear Research—Ultimate goal is to develop means of producing useful power from the energy released in nuclear fusion reactions. This involves confining a deuterium or deuterium-tritium plasma at temperatures of the order of 10^8 K for an appreciable fraction of a second. Optimum particle density is of the order of 10^{15} per cu cm.¹

So far, use of magnetic fields

has appeared to be the most promising means of plasma confinement. The methods receiving most attention can be summarized as follows:

(1) Stellarators—externally produced magnetic fields confine plasma in a torus with rotational transform provided either by shaping the torus as a figure eight or by using a regular toroidal tube with an auxiliary helical field.

(2) Injection types of magnetic mirror machines — time-varying magnetic mirrors heat plasma supplied by an external source or trap an injected ion beam.

(3) Self-confinement devices—confining magnetic field is produced by current through the plasma.

(4) Astron—A sheet of relativistic electrons is used to produce and confine the plasma.

(5) Rotating plasma devices—crossed electric and magnetic fields are used to cause the plasma to rotate about the axis of symmetry of

a cylindrical system.

Several stellarators have been used at Princeton University's plasma physics lab. Now nearing completion of systems tests, the model C Stellarator is reported about ready for experimental work.

Discharge tube of the C Stellarator is 20 cm in diameter and shaped in a racetrack configuration with a total length of 1,200 cm. Maximum magnetic field of 55,000 gauss can be held constant for about 1 sec.²

The C Stellarator is intended as a research tool whose large size should give longer experimental time since confinement time increases as the square of the radius. Also, the lower surface-to-volume ratio should decrease impurity levels, thereby cutting plasma cooling losses. Furthermore, diagnostics are expected to be simplified because of the size of the plasma column. Advantages of the stel-

larator geometry are that it should be capable of steady operation and that end losses are eliminated.

A way of reducing end losses in a straight tube is to use magnetic mirrors; various devices using injection into magnetic mirrors are under investigation. These machines, frequently termed pyrotrons, generally use adiabatic compression to heat plasma that is injected into a vacuum.

That it is possible to use magnetic fields to confine plasma stably has been shown with the multiple compression and transfer experiment at Lawrence Radiation Lab (LRL). In this experiment plasma is injected from a washer gun (discussed in part I) at one end and transferred and compressed by a series of magnetic fields. With two stages of compression, plasma has been confined for 1 msec at 35 million deg C with a 20,000 gauss field. Temperature of 100 million deg C is anticipated when installation of the third stage is completed. Field for this stage may be 100,000 gauss.

A different method of creating a hot plasma between magnetic mirrors is being studied in LRL's ALICE (Adiabatic, Low-Energy Injection and Capture Experiment) machine. Here a 20-Kev, 0.5-amp D^+ or H^+ ion beam is neutralized and fed into a 50,000-gauss magnetic mirror confinement region. Pressure is about 2×10^{-9} mm of mercury; ionization of the beam by collision with a low-density background plasma is expected to result in exponentially increasing trapping, and resultant plasma buildup.⁸

Instead of injecting atomic ions, buildup of a low-density plasma by injecting molecular ions into a mirror region is the concept upon which the DCX and OGRA machines are based. In the DCX experiment at Oak Ridge National Lab, a 600-Kev beam of deuterium molecular ions is injected into a d-c magnetic mirror field and broken up by a high-current vacuum arc. The atomic ions thus created are trapped in a circular orbit concentric with the magnetic axis. Plasma densities on the order of 10^{20} ions per cu cm and mean containment times of 10 to 20 msec have been observed. Incoming ion beam is about 5 ma.

A plasma ring of 300-Kev pro-

tons can also be formed without an arc by utilizing the dissociating collisions that occur between the ions and residual gas molecules.⁴ Containment for about 3 seconds has been achieved. Recent work has concentrated on this approach and density of the trapped plasma has been raised to 10^{20} fast protons per cu cm by using a 9-ma injected molecular ion beam.⁵ Future plans call for trying to increase the density by improving the vacuum, or by adding a weak dissociative discharge or arc.

In the DCX-2 now being assembled, the injector will be aimed so as to cause a spiraling of the injected ions with repeated passes through the arc. (See Fig. 1).

OGRA machine at Kurchatov Institute of Atomic Energy in Moscow uses a 200-Kev beam with residual gas for dissociation. Machine is built to produce 10^{18} ions per cu cm and has a chamber 19 meters long and 1.6 meters in diameter.⁶

A third scheme of injection into magnetic mirrors is to inject a high-density plasma burst that distorts the field lines on entry and then disperses within the mirror region. This technique has been used at Los Alamos Scientific Lab (LASL) with a containing device called Picket Fence.⁷

Picket Fence resembles a mirror machine but uses a series of coils in which the adjacent currents are in opposite directions. The plasma is located along the axis and confined by the cusped magnetic field as indicated in the simplified schematic of Fig. 2. Main advantage of this cusped geometry is that it is believed to afford complete hydro-magnetic stability. In the trapping experiments underway at LASL, plasma bursts with average velocities of 10^8 cm per sec are fired from the hydromagnetic plasma gun (discussed in part I) at the magnetic field. If the incoming plasma has an energy $(3/2) \rho v^2$ that exceeds $B^2/8\pi$ then it will pierce the magnetic field (ρ is mass density, v is translational velocity and B is magnetic field strength). In the process of pushing aside the magnetic field, the plasma loses enough energy so that it will remain trapped instead of emerging from the other side. Plasma of about 2 million deg has been trapped at the center of the Picket

Fence for 30 to 50 μ sec.

One problem with the picket fence geometry is that the plasma leaks out of the radial cusps. To overcome this it has been proposed that an external solenoid be used to direct the leaking plasma back through its adjacent cusp into the plasma. With helical coils inside the machine it might be possible to obtain a field that confines the plasma and closes the ends with picket fence geometries in a manner similar to magnetic mirrors.

An attempt to combine cusp confinement with the compression heating of an axial magnetic field is underway in Stevens Institute of Technology's CHALICE (Compressional Heating and Linear Injection Cusp Experiment).⁹ After r-f preionization, 45,000-joule, 50-Kv capacitor banks are simultaneously discharged into two cylindrical one-turn coils with a common axis and opposing currents. Ringing period is 2 μ sec. The rising magnetic field compresses the plasma into two threads along the coil axes. The coil ends are provided with magnetic mirrors and by making the two interior ends of the coils of higher resistivity than the rest of the coil, the mirrors vanish after the compressional heating. This drives the plasma threads into the weak-field central region where they expand into a cusp with the magnetic field lines closing behind them.

Heating process in CHALICE is similar to that which occurs in the high-compression mirror machine configuration known as the theta pinch or Scylla geometry. Rapid compression of a plasma in a magnetic mirror is being studied by several groups including those at LASL, Naval Research Lab, General Electric Research Lab, Aldermaston, (Great Britain) Aachen (Germany) and Fontenay aux Roses (France).

At LASL thermonuclear reactions have been reported for Scylla. Ion temperatures of 2.3 Kev have been achieved for 2 μ sec with a density of 5×10^{16} deuterons per cu cm. In Scylla II, the single-turn coil is energized through four-electrode spark gaps from a bank of ten 0.88 μ f capacitors with voltages as high as 90 Kv.⁹ At NRL a 2-megajoule, 20-Kv capacitor bank is used; GE has a 384,000-joule, 60-

Kv bank to create magnetic fields on the order of 160,000 gauss.

The rapidly increasing axial magnetic field used for magnetic compression produces an azimuthal current in the plasma, thereby bearing an analogy to pinch experiments where a unidirectional current induces an azimuthal magnetic field that constricts the plasma. Distinguishing feature of pinch research is that it involves the study of plasma confinement in magnetic fields from which plasma cannot leak directly but only by gradual diffusion across the field, and where the plasma current is comparable in magnitude to currents in external coils and conductors.¹⁰ Pinch devices are not limited to vacuum magnetic fields, and are suitable to large plasma densities and pressures, and small fusion reactor sizes.

Pinch discharges have been generated in straight cylinders as well as toruses. The conventional pinches, in which the plasma is compressed on its main axis, have been found unstable, and work has turned to inverse or hard-core pinches. Here, the central portion of the conventional pinch is replaced with a solid conductor that carries part of the pinch current. The self-magnetic field produced in the plasma by this current forces the plasma radially outward and the plasma is confined between this field and an external field.

In the Levitron, LRL's toroidal hard-core pinch device, the hard core is a copper ring. Sequence is to quickly remove the ring supports, apply a series of field pulses from the capacitor bank, and replace the supports before the ring has moved appreciably. Combination of the azimuthal magnetic field produced by current through the ring and an axial magnetic field produced by external windings yields a resultant field with high shear that ensures a margin of stability for plasma confinement.¹¹

A fourth method of plasma confinement involves the Astron device, which is expected to be operating in 1962. Here a pulsed 5-Mev, 200-amp electron beam is to be injected into a magnetic mirror field to form a cylindrical layer of rotating electrons (E-layer). These electrons produce a field that is opposite to the mirror field. When

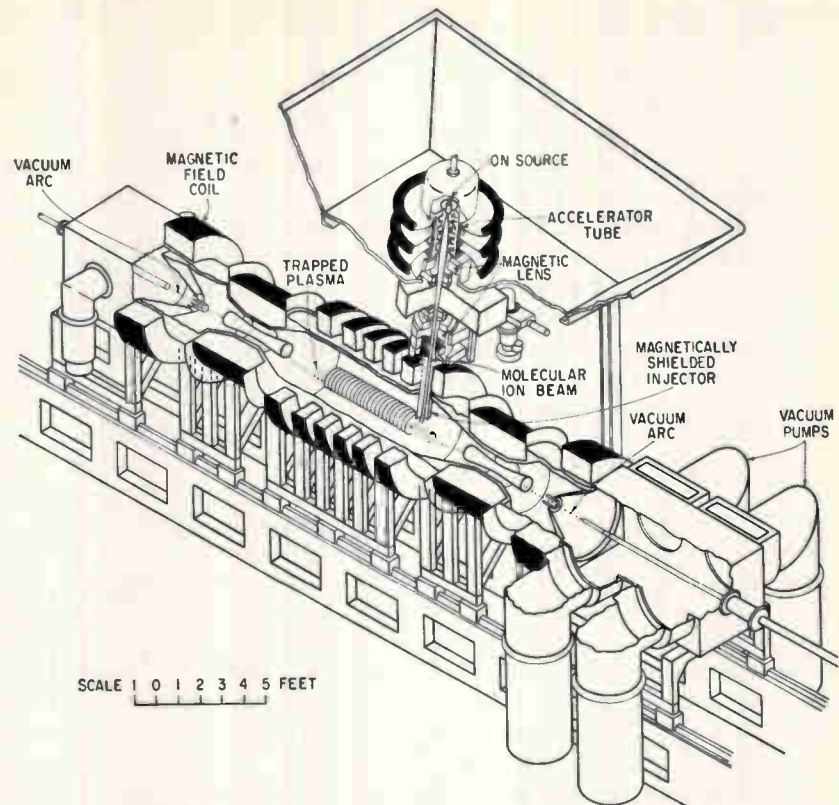

FIG. 1—Presently being assembled at Oak Ridge National Lab, DCX-2 molecular-injection machine is slated for test this autumn

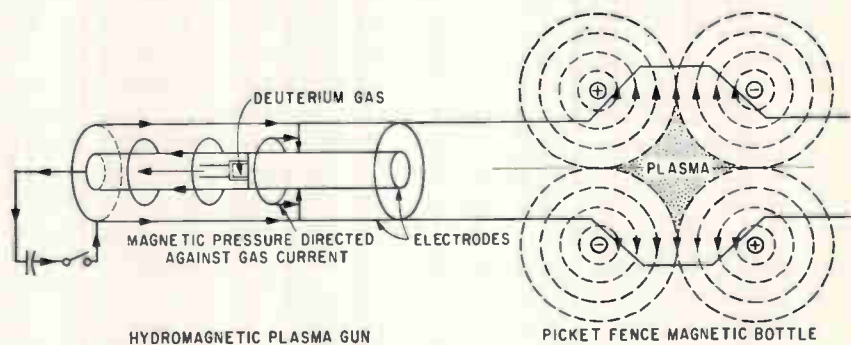

FIG. 2—Picket Fence containment device at Los Alamos Scientific Lab uses hydromagnetic plasma gun to fire burst into cusped magnetic field

the E-layer builds up to a sufficiently large circulating current, the field near the axis should reverse, producing a closed pattern of magnetic lines. This field configuration would be used to confine a hot plasma produced by collisions between the E-layer electrons and a neutral gas admitted slowly into the chamber after the E-layer is built up.

Rotating plasma systems have been under study as a means of confining plasma as well as of heating it.¹² In the homopolar device operating at LRL in Berkeley, a pulse of neutral gas is injected

radially into the center of a long evacuated cylinder. Due to the presence of axial magnetic and radial electric fields, the gas breaks down and starts to rotate before it can expand very far axially. Magnetic field strength is 20,000 gauss; 80 Kv is applied between the central rod and surrounding cylindrical shell.

The homopolar system can store energy and has been shown to act as a capacitor with dielectric constant of 10^6 to 10^8 .¹³

Use of the homopolar device as a generator of high-density rotating plasma has been proposed for a

smaller version of Astron that could operate for short duration.²⁴

In addition to the plasma confinement techniques described above, r-f and inertial-electrostatic methods have been suggested.

Because of skin effect losses, r-f fields have been seen as limited to low frequencies and as supplementary to d-c fields where the r-f would serve to reduce leakage and instabilities.²⁵ With an axial d-c magnetic field containing a plasma column against radial diffusion, it is expected that r-f power of a few kilowatts could be used to seal the ends of the column and contain plasma of density exceeding 10^{24} charges per cu cm at temperatures above 100,000 deg K.

An inertial-electrostatic system in which electrons are projected radially inwards from a spherical surface has been proposed as possibly permitting the production of small regions of thermonuclear plasma.²⁶ The inside of an evacuated sphere serves as a hot cathode electron emitter. At a smaller radius, a spherical grid positive with respect to the cathode accelerates the electrons and a potential hill for electrons builds up in the central region. Positive ions might then be confined in this region.

ITT Labs is working on using a spherical electrode geometry to provide inertial containment of bipolar charges. Ions from deuterium oscillate in a limited volume contained by the field produced by the emitted electrons.

Thermionic Power Conversion—Plasma plays an important role in the thermionic conversion of heat directly into electricity. Space auxiliary power sources are seen as being the most immediate application for thermionic converters. Efficient operation with vacuum diode types, however, requires cathode-anode spacing on the order of a few microns to overcome space charge. For this reason, the negation of space charge by introducing positive ions to form a plasma is receiving considerable attention.

One method of plasma generation is to use the fission fragments from a uranium carbide cathode to produce a plasma in a noble gas such as argon. For a cathode temperature of 2,000 K it has been calculated that power densities of 5 w

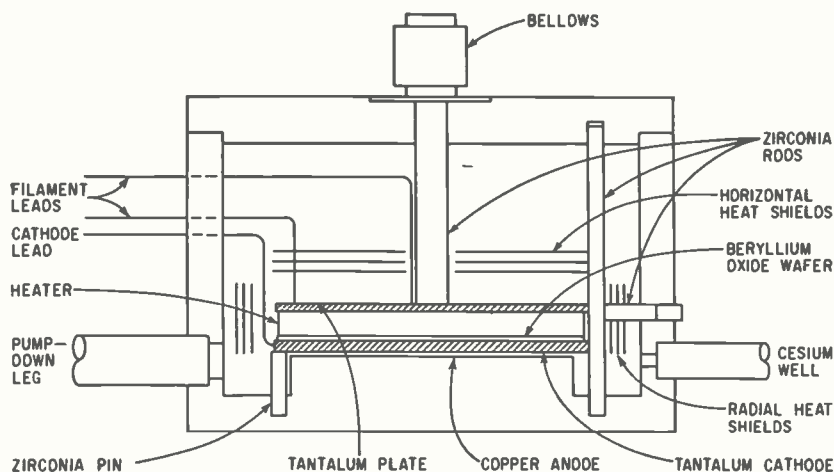

FIG. 3—Flat parallel-plate magnetothermionic generator being built at Republic Aviation Corp. will be used to study possibility of increasing efficiency by adding external magnetic field

per sq inch might be achieved for extended lifetime.²⁷

Second method utilizes plasma synthesis wherein electrons and ions are generated separately and brought together in the interelectrode space to form a plasma.²⁸ This can be done by contact ionization of cesium at a high-work-function emitter where the temperature is around 2,000 C. Because of the materials problems involved at these temperatures, however, some researchers are looking for materials with emission properties permitting operation at lower temperatures (preferably 1,200 C). At these temperatures optimum power output, efficiency and emitter lifetime is anticipated.

Operation around 1,500 C can be achieved by using a cathode where high and low-work-function materials are intermixed. For the range between 1,000 and 1,500 C, however, this technique is not feasible. Researchers at RCA are experimenting with a three-electrode converter in which the ions are emitted by a high-work-function (3.9 v) electrode. A positive bias voltage is applied between this electrode and a 2-v cathode. For cathode temperature of 1,100 C, it is estimated that a practical device might have an efficiency of 10 to 15 percent. Although the converter is basically a d-c device, a-c components have been observed in the range of 100 Kc to a few Mc, increasing as spacing decreases.

Another type of plasma thermionic converter is one in which

the cathode-anode spacing and the vapor pressure conditions are such that there are many electron mean-free-paths between cathode and anode.²⁹ In this condition the plasma is formed by an anomalous low-voltage arc in the interelectrode space. By locating a grid within the cathode sheath, researchers at GE hope to obtain practical triode converters with efficiencies of approximately 20 percent for cathodes at 1,330 deg C.

One problem with large thermionic converters is that the strong currents generated produce transverse magnetic fields which deflect some of the electrons back to the emitter, thus reducing efficiency. To overcome this effect, engineers at Republic Aviation Corp. are experimenting with a magnetothermionic generator (see Fig. 3) in which an externally produced longitudinal field is used to cut down the number of returning electrons. Also, by modulating the field coil current and passing the output through a transformer an a-c device could result.

MHD Power Conversion—Because of the prospect that efficiencies above 55 percent might be achieved, interest is widespread in the possibility of using MHD concepts for central station power plants producing over 100 megawatts.

Most commonly-proposed MHD power system passes combustion gases seeded with potassium or cesium salts through a static magnetic field in a rectangular chan-

nel; electrodes inside the channel supply the current generated by the interaction of the plasma and the magnetic field to an external load. Use of closed cycle systems with nuclear reactors replacing combustion is also under study. Working fluid would be a seeded inert gas such as helium. Overall thermal efficiency of 59 percent has been calculated for one such system assuming a peak helium temperature of 2,500 K.²⁰

In order to obtain sufficient ionization (0.1 to 1 percent) with combustion gases, temperatures above 2,500 K are required. Furthermore, in a practical system these conditions would have to be maintained in corrosive atmospheres and complicated geometries for extended periods. Thus, investigation of high-temperature insulators, electrodes and heat-exchangers is one of the key research areas at present.^{21, 22} Classes of structural refractory materials being studied include the oxides, mixed oxides, carbides, carbon and nitrides.

An alternate approach is to develop techniques whereby the required gas conductivities could be obtained at temperatures below 2,000 K. For example, use of seed materials with ionization potentials below that of cesium, is possible.

Chance of getting increased conductivity at lower temperature by using auxiliary electric power inputs is also under study. This involves increasing electron temperature above gas temperature and, hence, increasing number density, thus permitting exit temperatures more acceptable to heat exchangers than those required for equilibrium conductivity.²³

One problem encountered in MHD generators is that when continuous electrodes are used the Hall effect can cause a significant reduction in gas conductivity and, hence, generated power density. One method of alleviating this problem is to use electrically isolated segmented electrodes.

Because the above systems have d-c outputs and problems with electrode erosion and voltage losses, various induction generators are being considered. Several configurations are possible; one that has been investigated uses a linear channel of rectangular cross-section.²⁴ Multiphase coils on the up-

per and lower sides provide a traveling sinusoidal magnetic field that can interact with the gas flowing supersonically in the same direction. Although a-c power generation is considered feasible, problems such as low power factor indicate the need for high temperatures and velocities.

Propulsion—One application of plasma receiving widespread attention is in electrical propulsion systems.^{25, 26} Electrical propulsion engines are low thrust, high specific impulse devices envisioned as being useful for milli-g, longtime missions such as deep space probes. Systems utilizing plasma for acceleration (as distinguished from ion propulsion) are: (1) electrothermal systems which are essentially ordinary rockets using an arc or resistance heater as the source of thermal energy and (2) magnetic, or MHD, systems in which the plasma receives its momentum and energy from a magnetic field.

Electrothermal systems will develop specific impulses of the order of 1,000 to 2,000 seconds and are reported furthest advanced in development.²⁷ Plasmadyne is working on a 1-Kw model for possible short flight test in 1962; 30-Kw units are under development at GE and Avco. In the arc jet engine a working fluid such as helium or hydrogen is heated by joule heating as it passes through the discharge and then expanded through a nozzle. By using magnetic fields, specific impulses above 2,000 are considered possible. Electrothermal a-c arc jets are under investigation as possibly offering certain advantages in weight, complexity, reliability and cost.²⁸ Experiments with a 3-Mc unit at Wright Air Development division have indicated there is a reduction in electrode erosion over d-c operation at similar power levels (30 Kw) and that the a-c discharge can be maintained in hydrogen.

MHD engines are under study for both continuous and pulsed operation. For continuous operation, several groups are investigating, crossed-field devices. In the simplest crossed-field configuration the plasma flows through a rectangular channel in which two sides are the magnet pole-pieces and the other two are the electrodes. Accelerat-

ing force would be the $j \times B$ Lorentz force. This type of accelerator can also be constructed with concentric electrodes and a coaxial magnetic field to produce a rotating plasma as in the homopolar device.

Researchers into crossed-field acceleration at NASA Langley Research Center are constructing a 1-Mw arc jet to be used with a 1 sq inch channel 12 inches long.

Another type of continuous plasma engine is based on accelerating by electric or magnetic field gradients. Experiments with non-uniform r-f fields are now being conducted at 2.5 Gc by RCA's Astro-Electronics division under a contract with Air Force Office of Scientific Research. In these experiments a mercury plasma is released into an r-f structure having an exponentially decreasing electric field. With a 140-Mc source and a maximum field amplitude of 170 v per cm, a plasma of density below the critical density has been accelerated from 5×10^5 to 25×10^5 cm per sec.²⁹ The same field was used to decelerate a plasma of density above the critical density.

For pulsed plasma propulsion, a variety of plasma guns analogous to series wound and induction motors have been studied. These include T-tubes, button guns, rail guns and electrodeless guns (described in Part I).

Thrusts on the order of 0.2 lb and specific impulse of 5,000 sec are expected with the Repetitively Pulsed Plasma Accelerator (REP-PAC III) being studied at GE's Missile and Space Vehicle Dept. This is a pulsed gas entry coaxial accelerator firing into a vacuum below 10^{-5} mm of mercury. Although the design goal for the present device is 5,000 sec, no difficulties are anticipated for operating in the range 3,000 to 25,000 sec.

Specific impulse range between 5,000 and 12,000 has been reported for Republic Aviation's pulsed plasma pinch engine.³⁰ In this engine a radial pinch is set up by a 3-Kv, 300- μ f capacitor discharge across two nozzle-shaped electrodes. The plasma is driven out the nozzle by the induced magnetic field.

Electronics—If a plasma is confined in a magnetic field, certain oscillations exist such that amplification and oscillation can be ob-

tained by passing an electron beam through the plasma. At frequencies below the plasma frequency, ω , plasma can support forward waves; gain has been observed with the type of amplifier shown in Fig. 4. Since $\omega = 8,980 n^{\frac{1}{2}}$, where n is electron density, the conditions for microwave propagation can be adjusted; possibility of 100-Gc amplification is seen for quiescent plasmas generated by contact ionization of cesium, since this process promises densities of 10^{14} electrons per cu cm (discussed in part I). Russian scientists have reported achieving amplification near 40 Gc with a gas discharge plasma (ELECTRONICS, p 9, April 14, 1961).

Between ω and $(\omega_c^2 + \omega^2)^{\frac{1}{2}}$, where ω_c is electron cyclotron resonance frequency, there are backward waves (group velocity oppositely directed to phase velocity) with which the electron beam can interact as in a bwo. Using a traveling-wave interaction structure in which plasma is formed by the interaction of an electron beam with hydrogen, researchers at Sperry Electronic Tube division have observed narrowband coherent outputs with efficiencies greater than 5 percent. These experiments have been conducted with beam power of 10 to 15 watts and output frequencies of 1 to 2 Gc.

In the amplifier of Fig. 4, the r-f input is coupled onto the electron beam by a metal helix. Use of a metal circuit for this purpose has three disadvantages. First, the electric field set up by the metal circuit varies across the hole in the circuit so there is a limit to the amount of current that can usefully

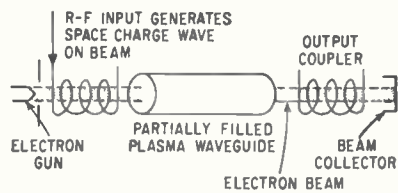

FIG. 4—Typical experimental plasma amplifier couples r-f input onto electron beam by metal helix

interact with the field. Also, there is a limit to the operating temperature and ratio of cathode area to beam cross-section area.

Theoretically, these limitations would be overcome by coupling the input microwave energy directly to the plasma and then radiating directly to space, thus eliminating the metal circuit. Since it is conceivable that plasma can be isolated from a boundary, such a device would not have a low thermal dissipation limit. These theoretical advantages point to the possibility of having higher power devices at a given frequency or conversely. Furthermore, plasma exhibits a high interaction impedance (a few thousand ohms) compared with conventional metallic structures. This could lead to a shorter length device for a given characteristic and also suggests the possibility of better efficiencies.

One idea for eliminating the metal circuit is to have a plasma vary periodically in density or temperature so as to produce a radiating space harmonic. Periodic density variation might be produced by exciting plasma acoustic waves. At higher frequencies power might be directed optically.

Another possibility is to utilize Cerenkov radiator techniques. Here, a bunched relativistic electron beam would be passed close to a dielectric. Image charges inside the dielectric would then move faster than the velocity of light in the dielectric and energy would be radiated. Dielectric Cerenkov cones using a 1-Mev beam bunched at S-band have given radiation at the watt level.²¹

Experiments on traveling-wave plasma parametric amplification are being conducted at Stanford University using a mercury vapor discharge.²² By using pumping power of the order of 50 watts at 700 Mc, and signal frequencies in the range 300 to 450 Mc, an idler frequency has been generated along the length of the plasma, although the resultant signal gain is marginal. With the resonator now under construction it is hoped that two resonant modes at frequencies ω and 2ω will be obtained; the higher mode will be used for pumping. Pump power for the system to oscillate at the subharmonic is expected to be below 1 w.

In experiments on amplification by an electron beam passing through a thermally generated cesium plasma, Stanford researchers have obtained gain figures as high as 12½ db per cm at S band.

Plasma is also being investigated for use in devices such as detectors, phase shifters, harmonic generators, mixers and switches. Idea of a plasma detector is based upon the fact that a microwave pulse can quench the afterglow that follows production of a gas discharge plasma. The decrease in light out-

BIBLIOGRAPHY

- S. Glasstone and R.H. Lovberg, "Controlled Thermonuclear Reactions", D. Van Nostrand Co., Inc., Princeton, N.J., 1960.
 D.J. Rose and M. Clark, Jr., "Plasmas and Controlled Fusion", The M.I.T. Press and John Wiley & Sons, Inc., N.Y., N.Y., 1961.
 U.S. Atomic Energy Commission, Atomic Energy Research in the Life and Physical Sciences, special report, Jan., 1961.

REFERENCES

- (1) M.A. Heald, Experimental Measurements in Controlled Fusion Research, *IRE Trans Nucl Science*, 6, p 33, Sept., 1959.
- (2) N.W. Mather, R.G. Mills and J.G. Murray, Princeton U., The Model C Stellarator Facility, AEC Report MATT-16, Aug., 1959.
- (3) R.F. Post, Fast Neutral Particle Injection into a Mirror Machine, lecture at

International Summer Course in Plasma Physics, Riso, Roskilde, Denmark, 1960 (p 529, Riso Report No. 18).

(4) C.F. Barnett et al, Lifetimes of Fast Ions in the Plasma of DCX, *Phys Rev Lett*, 6, p 589, June 1, 1961.

(5) A.H. Snell, Oak Ridge National Lab, private communication, June 26, 1961.

(6) P.R. Bell et al, Visit of U.S. Controlled Thermonuclear Research Team to USSR, July 1960, AEC report TID-11746, May, 1961.

(7) J.A. Phillips, Los Alamos Scientific Lab paper "Progress in Using Fusion Energy", Nov., 1960.

(8) G. Schmidt et al, Magnetic Compressional Heating and Cusp Confinement of a Plasma, Stevens Inst of Tech report.

(9) K. Boyer et al, Studies of Plasma Heated in a Fast-Rising Axial Magnetic Field (Scylla), *Phys Rev*, 119, p 831, Aug. 1, 1960.

(10) S.A. Colgate and H.P. Furth, Pinch Research, Hearings before Subcommittee on Research and Development of the Joint Committee on Atomic Energy, Eighty-Sixth Congress, Second Session, on Frontiers in Atomic Energy Research,

March, 1960.

(11) C.M. Van Atta, private communication, Jan. 13, 1961.

(12) J.M. Wilcox, A Review of High-Temperature Rotating-Plasma Experiments, AEC report UCRL-8584, Jan., 1959.

(13) O. Andersen et al, Hydromagnetic Capacitor, *J Appl Phys*, 30, p 188, Feb., 1959.

(14) C.C. Chang, Feasibility Study of Transient Version of Astron Thermonuclear Reactor, paper submitted at 2nd Symposium on Engineering Aspects of Magnetohydrodynamics, Phila., Pa., March, 1961.

(15) R.C. Knechtli and D.G. Dow, Plasma Containment by rf and dc Field Combinations, paper presented at American Physical Society southwestern meeting, March, 1960.

(16) W.C. Elmore, J.L. Tuck and K.M. Watson, On the Inertial-Electrostatic Confinement of a Plasma, *The Physics of Fluids*, 2, May-June, 1959.

(17) F.E. Jamerson, Noble Gas Plasma Diode Thermionic Converter, 1960 *IRE International Convention Record*, p 66, Part 9.

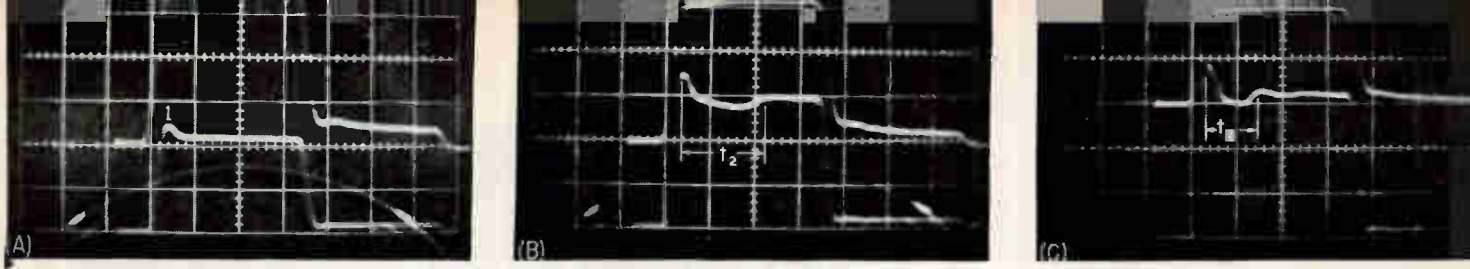

FIG. 5—Observations of plasma self-pinching in indium antimonide at RCA Labs show initial signs of production of electron-hole plasma at point 1 with 3.3 amp (A), conclusion of pinching at end of time t_2 with 6.2 amp (B), and conclusion of pinching at the end of a smaller time t_2 when current is 8.3 amp (C). Upper trace is current and lower is voltage; trace speed is 0.1 μsec per div

put could then be detected with a multiplier phototube.

In the presence of weak or zero magnetic fields, the forward waves in plasma are surface waves. For small plasma diameters, these waves have a high phase shift per unit length which is controllable and could be the basis for a plasma phase shifter.³³ Sperry reports it is working on a practical precision-type plasma phase shifter.

Harmonic generation and microwave mixing have been observed in plasma. Plasma mixers would have no inherent power limitations, might be able to handle a few watts.

Use of plasma waveguides to couple X-band energy from one rectangular waveguide to another has been demonstrated at Space Technology Labs.³⁴ Amount of power coupled from input to output can be varied over more than 30 db by electronically controlling the density of the gas discharge plasma. The coupler operates without a d-c magnetic field, can handle more than 100 watts of pulsed power.

Also, the coupler has been operated as a 5- μsec switch by holding the discharge current at a quiescent value below cutoff, then applying a voltage pulse to the discharge

tube to increase plasma density and turn the switch on.

The plasma of moving electrons and holes that can be formed in semiconductors and semimetals is analogous in some respects to the plasma derived from a gas. Thus, there is the possibility that amplification and oscillation could be obtained by interacting electron beams with the plasma waves in a solid, as described above for gas-discharge plasma devices.³⁵

One advantage solid plasma devices might have over gas devices is that there would be less noise. Material plasmas would be free from non-thermal noise since they are in thermal equilibrium, which is not the case for gas plasmas. Also, because the average energy of plasma in a solid is lower than in a gas, there would be less thermal noise. One semiconductor plasma device under study is RCA's oscillistor.³⁶ Basically the device consists of a 1 sq mm sample of germanium 1 cm long and a load resistance (10 to 100 ohms) connected in series across a 100-v pulsed power supply.

When a magnetic field (10,000 gauss for room temperature operation) is applied approximately

parallel to the applied electric field an oscillating voltage is produced across the load. Frequencies from a few kc to about 10 Mc have been observed, depending upon relative field orientation and semiconductor surface conditions.

Effect of magnetic fields on material plasmas might also be utilized in polarizers since plasmas in a longitudinal magnetic field can produce a measurable rotation in the spectral region from microwave to the far infrared.³⁷

There is also interest in material plasmas as a medium for studying plasma properties and such phenomena as the pinch effect. Electron-hole-concentrations, mass ratios and temperature ratios can be measured and varied; effect of magnetic fields on the plasma has been used to measure dielectric constant.^{37, 38}

Self-pinching of the electron-hole plasma in indium antimonide occurs with electric fields of the order of 200 v per cm. (See Fig. 5.) Pinching has been observed at temperatures of 77 K in *n*- and *p*-type indium antimonide with plasma densities of 10^{14} to 10^{15} per cu cm. The pinching began at a current of about 1,250 amp per sq cm.

(18) K.G. Hernquist, Plasma Synthesis and its Application to Thermionic Power Conversion, *RCA Rev.*, 22, p 7, March, 1961.

(19) E.A. Baum and A.O. Jensen, Thermionic Converter-Design Status and Forecast, paper presented at 15th Annual Power Sources Conf, Atlantic City, N.J., May, 1961.

(20) R.J. Rosa, Magnetohydrodynamic Power Generation Using Nuclear Fuel, 1960 *IRE International Convention Record*, p 72, Part 9.

(21) L. Steg and G.W. Sutton, The Prospects of MHD Power Generation, *Astronautics*, p 22, Aug. 1960.

(22) L.P. Harris, MHD Power Generation—An Application for Magnetohydrodynamics, *Proc 1960 National Electronics Conf.*, p 356.

(23) J.L. Kerrebrock, Conduction in Gases with Elevated Electron Temperature, paper presented at Second Symposium on Engineering Aspects of Magnetohydrodynamics, Phila., Pa., March, 1961.

(24) I.B. Bernstein et al, An Electrodeless MHD Generator, paper presented at Second Symposium on Engineering As-

pects of Magnetohydrodynamics, Phila., Pa., March, 1961.

(25) M.M. Slawsky, Plasma Accelerators, paper presented at 5th National Symposium on Space Electronics and Telemetry, Sept. 1960, Wash., D.C. (also AFOSR TN60-1030).

(26) G.S. Janes, Magnetohydrodynamic Propulsion, Avco-Everett Research Lab research report 90, Aug., 1960.

(27) E. Stuhlinger, Electric Propulsion Development Program, paper presented at American Rocket Society Space-Nuclear Conference, Gatlinburg, Tenn., May, 1961.

(28) R.M. Sponberg, Design Aspects of Electrothermal Propulsion Systems, *Proc NAECON*, Dayton, Ohio, May, 1961.

(29) G.A. Swartz et al, Plasma Acceleration in a Radio-Frequency Field Gradient, *The Physics of Fluids*, 3, Nov.-Dec., 1960.

(30) C.C. Cavalcante, I. Granet and W.J. Guman, Experimental Studies of a Pulsed Plasma Pinch Space Engine, paper presented at SAE National Aeronautic Meeting, N.Y.C., N.Y., April, 1961.

(31) P.D. Coleman and C. Enderby, Megavolt Electronics Cerenkov Coupler

for the Production of Millimeter and Submillimeter Waves, *J Appl Phys.*, 31, p 1,695 Sept., 1960.

(32) G.S. Kino, private communication, Feb. 28, 1961.

(33) A.W. Trivelpiece and R.W. Gould, Space Charge Waves in Cylindrical Plasma Columns, *J Appl Phys.*, 30, p 1,784, Nov., 1959.

(34) W.H. Steier and I. Kaufman, A Plasma Guide Microwave Selective Coupler, paper presented at IRE PGMTT national symposium, Wash., D.C., May, 1961.

(35) H. Kroemer, Microwave Interactions in Bulk Semiconductors, *Proc 1960 International Solid-State Circuits Conf.*, p 86.

(36) R.D. Larrabee and M.C. Steele, The Oscillistor-New Type of Semiconductor Oscillator, *J Appl Phys.*, 31, p 1,519, Sept., 1960.

(37) B. Lax, Magnetoplasma Effects in Solids, *IRE Trans Microwave Theory and Techniques*, p 83, Jan., 1961.

(38) D. Pines, Coherent Excitation of Plasma Oscillations in Solids, *IRE Trans Microwave Theory and Techniques*, p 83, Jan., 1961.

*Polarized light incident
on a surface is
reflected differently if
the surface is magnetized.
Though the difference is small,
it is sufficient to allow
magneto-optic readout
of tapes and disks.
Recording densities to
4,000 bits per inch
have been tested;
higher densities
may be possible*

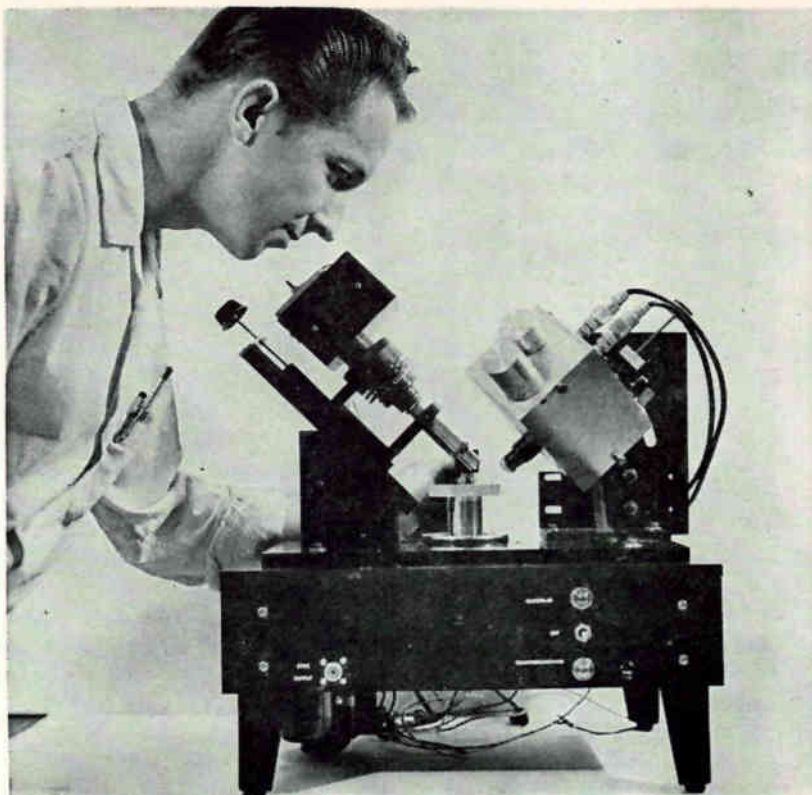

Magneto-optic readout system uses Kerr effect—rotation of plane of polarization when light is reflected from a magnetized surface—to obtain densities of 4,000 bits per inch. Higher densities may be possible with laser as a light source

MAGNETO-OPTICAL READOUT

By T. LENTZ
J. MIYATA,

The National Cash Register Co.,
Electronics Division,
Hawthorne, Calif.

READING BACK the signals from a magnetically recorded track normally is done magnetically, by letting the lines of flux above the track be cut by the read head. Because of the weakness of the flux field, and its curvature, even a minute physical separation between the recorded track and the magnetic readback head causes a sharp drop-off in both signal amplitude and maximum obtainable bit density. If the recorded surface is flexible (tape) the record/playback system is built so that the surface rubs against the head, but when the surface is rigid (drum or disk) mechanical considerations make it difficult to maintain intimacy of contact between the head and mov-

ing surface. The effects of separation between surface and read/write head are shown in Fig. 1.

Several ingenious methods are being used to reduce separation effects—air jet separation, tapered surfaces, accurate machining—but the basic difficulty remains in all flux-sensitive or flux-change-sensitive readback devices, and the ability to record a high density track far exceeds the ability to read it back. To solve this problem, other means of sensing the magnetic pattern have been investigated. One of the most promising uses the Kerr magneto-optic effect.

The Kerr magneto-optic effect is the rotation of the plane of polarization of a light beam when reflected from a magnetized surface. The principal use of the Kerr effect since its discovery in the 19th century has been in the study of magnetic domains, to render such do-

main visible.^{1*} There are three aspects of Kerr magneto-optics: longitudinal, transverse, and polar; the difference arises from the vectorial relationship between the magnetic vector and the plane of incidence. The terms "longitudinal, transverse, and polar" are also used in the magnetic recording industry with much the same meaning, except that in this usage, the pertinent vectorial relationship is that existing between the magnetic vector and the data track. Nearly all magnetic recording in general use today is longitudinal: the recorded magnetic vector lies substantially in the plane of the surface and is parallel to the track. In the longitudinal Kerr effect, the magnetic vector also lies in the plane of the recorded (reflecting) surface and is parallel to the plane of incidence. This effect lends itself to use with thin ferromagnetic

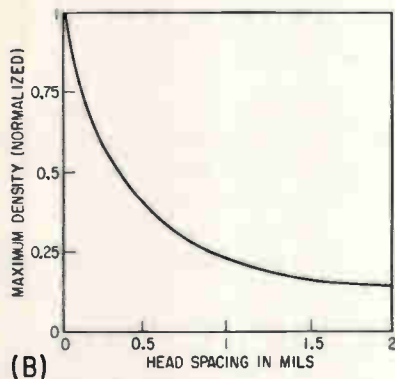
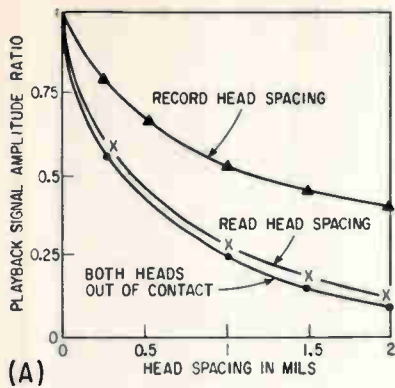

FIG. 1—In the top curve in (A), the read head was in contact. Recording density (B) is maximum for minimum separation

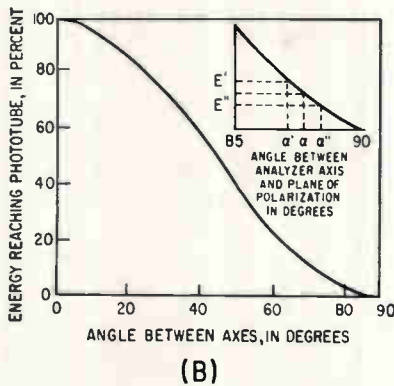
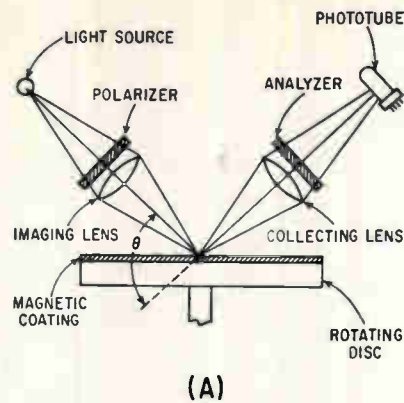

FIG. 2—Research version (A) of magneto-optic reader. Energy transmission to phototube is a function of the angle between the axes (B)

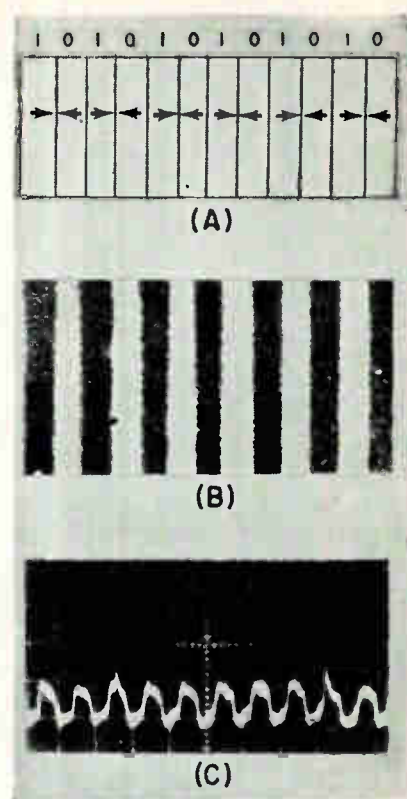

FIG. 3—Magnetic vectors (A), photograph of a magnetic tape using the Kerr effect (B), waveform of recovered signal (C)

OF MAGNETIC RECORDINGS

films, since such films, being essentially two-dimensional, possess a natural tendency to magnetization parallel to their own planes.

A simple device using the longitudinal Kerr effect to read back a magnetic bit pattern is shown in Fig. 2A. The playback head consists of a light source, optical lenses to focus and direct the light beam, a pair of polarizers, and a multiplier phototube.³ The polarizer in the incident beam can be set so that the light striking the film is polarized either parallel or perpendicular to the plane of incidence, and the polarizer (analyzer) in the reflected beam is correspondingly set so that the light is partially blocked. If the reflecting surface is unmagnetized, the plane of polarization of the light beam is not affected by reflection and the amount of light energy that reaches the phototube varies as a function of

the analyzer angle, as shown in Fig. 2B. The plot has the form $\cos^2\theta$, where θ is the angle between the polarization axes of the polarizer and the analyzer. When the reflecting surface is magnetized, the polarization of the reflected beam is rotated slightly, with the direction of rotation depending upon the sense of magnetization. Thus, as illustrated in Fig. 2B, assume the analyzer axis is set at angle α . Surface magnetization in one direction rotates the polarized light so that the light-polarization/analyzer-axis becomes α' , with a resulting energy output E' ; surface magnetization in the other direction rotates the light to α'' , with a resulting energy output E'' . The difference $E' - E''$ is the magneto-optic signal.

For binary coding, one direction of magnetization may be called the ONE state, the other the ZERO state.

A 101010 pattern appears vectorially in Fig. 3A, photographically in Fig. 3B, and electrically in Fig. 3C. The data track was recorded by a conventional record head with conventional drive circuits, and has basically the same magnetic pattern as any tape, disk, or drum track. The recording medium is a film of cobalt approximately 800 Angstroms thick, vacuum deposited on a disc. The signal may also be read back by an ordinary magnetic readback head, but the amplitude is low because of the low remanent flux. Information density in the photograph of Fig. 3B is 40 bits per linear inch. The bit pattern may also be observed visually using the Kerr effect since the thin film is a mirror-smooth surface.

In the basic instrument of Fig. 2A, signals were low and noise was high. The low signal resulted from the fact that angular rotation

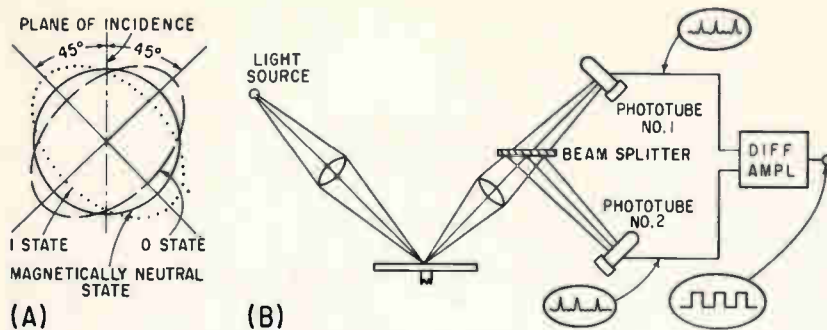

FIG. 4—Polar plot of light energy (A) shows distortion along one axis for one direction of magnetization, distortion along different axis for opposite magnetization. Differential signal recovery (B) removes noise

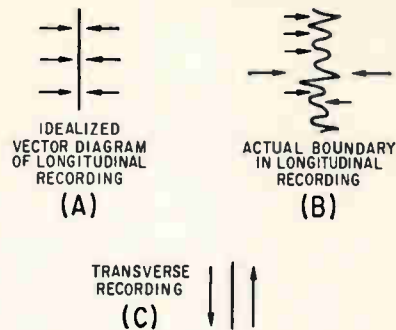

FIG. 5—In longitudinal recordings, boundary walls between closely spaced bits break down

of polarization from one magnetic extreme to the other is 0.1 degree or less (depending on the film used). Two types of noise are present: phototube shot noise, which is white noise proportional to the square root of the light level, and film noise, which results from surface imperfections and dust particles on the film. It can be seen from the \cos^2 shape of the energy transmission curve that the magneto-optic signal maximizes at 45 degrees. But phototube shot noise is also high at this point, since background light increases as the analyzer to polarizer angle (θ) moves from 90 to 0 degrees. The angle at which the signal to-shot-noise ratio maximizes depends on the transmission and extinction qualities of the polarizing system, and the magneto-optic rotation. With HN22 Polaroids, and cobalt film that provides a rotation of approximately 0.1 degree, the optimum setting is about 80 degrees. (When the light is focussed to a small spot, the solid angle subtended by the cone of light results in a small amount of depolarization, which limits the effectiveness of the polarizers. The solid angle subtended in this case was 0.2 steradians.)

Thus the polarizer and analyzer are almost in the crossed position, and the light beam is nearly extinguished before it reaches the phototube. Film surface noise, on the other hand, is an irregular function which cannot be treated mathematically beyond stating that, with any given film, it is proportional to the light level. This noise consists of spikes, corresponding to abrupt changes in light level when the light spot moves

across an area in which the reflectance changes, either because of a discontinuity in the film or the presence of a foreign particle. Such noise causes little difficulty at low bit densities, as in Fig. 3, where the bits cover relatively large areas. At higher densities, however, film noise is frequently so blanketing as to cause numerous dropouts, and although the unit in Fig. 2A proved the theoretical possibility of a MAGOP (MAGNETO-OPTIC) system, its only practical use seems to be as a research tool. In addition to the problem of film surface noise, the configuration is inefficient in that half of the light energy is lost in the initial polarizer.

A peculiar property of the longitudinal Kerr effect allows differential signal amplification and cancellation of film noise. The unique property referred to is that a magnetized surface rotates the perpendicular and parallel components of light in opposite directions. To visualize this phenomenon, consider an unpolarized beam of light that has been reflected from an initially unmagnetized surface; the polar plot of the energy distribution of such a beam is a circle. If a polarizer is placed in the path of this beam and turned through 360 degrees, the amount of light passing through the polarizer is the same at all angular attitudes. When the reflecting surface is magnetized in the ONE direction, the light polarized perpendicular to the plane of incidence is rotated clockwise; the light polarized parallel to the plane of incidence is rotated counterclockwise. The result is a distortion of the polar plot of energy from a circle into an

ellipse. The effect is illustrated in Fig. 4A. Magnetizing the surface in the ZERO direction results in a complementary distortion of the energy pattern.

Thus, in the diagram of Fig. 2, if the polarizer is removed so that unpolarized light is reflected from the film, and the analyzer is set in any position other than parallel or perpendicular to the plane of incidence, a magneto-optic signal can be detected by the phototube. As inspection of Fig. 4A shows, the signal will be greatest when the axis of the analyzer is at 45 degrees to the plane of incidence. It would no longer be possible to observe a bit pattern visually because the signal is superimposed on a large amount of background light. When the surface is in motion, photometric detection is also difficult because the high light level causes film noise to obscure the signal. Selective polarization may also be accomplished in a more useful manner if the analyzer is replaced by an optical beam splitter. This is a device that divides the light beam into two rays, by discriminating between two polarization components that lie at right angles to each other and sending the two rays in different directions (any light beam may be broken up in this manner). The two polarization directions selected in this case are +45 and -45 degrees to the plane of incidence; each ray is monitored by a phototube, as shown in Fig. 4B. In this manner each phototube receives a beam of light identical to what it would receive if only an analyzer were used. Film noise will in general cause an identical and simultaneous rise or fall in the light level striking each

tube. However, the ONE state corresponds to a higher light level on one phototube and a lower light level on the other phototube. Thus the magneto-optic signals are 180 degrees out of phase while film noises are in phase. The voltage outputs of the two phototubes are fed into a differential amplifier where the signals add and the noise bursts cancel.

The beam-splitter system allows efficient use of the optical system, and the resolving power of the magnetic medium itself places the upper limit on storage density. Using a magnetic film with a coercivity of 30 oersteds, and recording a track in the conventional manner, densities of 200 bits per inch were obtained without dropouts or loss in signal amplitude. Above this density the readback signal dropped off sharply. The dropout occurs because longitudinal recording causes opposing poles to butt up against each other (see Fig. 5A); when such a state exists, the domain boundary tends to reduce its energy state by forming a spiked wall as in Fig. 5B. At low bit densities, the only effect of such a ragged wall is to cause a more gradual transition in signal as the light spot moves from one magnetic bit to the next, but at higher densities the walls on either side

of a bit begin to contact each other and the bit deteriorates. Using higher coercivity film (100 oersted), densities of 450 bits per inch were realized. To improve densities by going to higher and higher coercivities causes difficulties, not only in film fabrication, but in the demands that high coercivity media impose on driver circuits, particularly if transistors are to be used.

If the film is magnetized transversely to the track, the magnetic vectors of two adjacent bits lie side by side, as in Fig. 5C. In this case a straight boundary wall is consistent with the lowest-energy-state requirements of domain theory and there is no tendency toward spontaneous bit deterioration.

A transversely recorded track of the desired type can be achieved with a highly anisotropic medium. Most ferromagnetic films exhibit anisotropy to some extent, but some films are anisotropic to such a degree that their remanent state is always along the same axis. Figures 6A and 6B show hysteresis loops for this type of material. The sense of the remanent magnetism may be in either direction along the preferred axis. The only time that the magnetic vector of such a film will lie in any other direction is when it is being coerced by an external field. Upon removal of the

external force, the magnetic vector falls back into whichever sense of the preferred direction is closest to the direction into which the vector had been forced.

Transverse bit patterns are accomplished in MAGOP in the following manner: starting with a thin ferromagnetic film that has high uniaxial anisotropy, the film is positioned so that its preferred direction is perpendicular to the direction of motion under the record head. The head is placed in the customary position for longitudinal recording, except that the gap is slightly turned. That is, instead of the recording field being applied exactly parallel to the track, it is one or two degrees off alignment. When a magnetic ONE is imposed by the record head, the tape is coerced into a magnetic state almost identical to that of conventional longitudinal recording. When the area moves away from the head, however, the magnetic vector flops into the nearest transverse axis. Recording a ZERO has the same effect, except that the final transverse direction is anti-parallel to the ONE direction, because the magnetic vector is pointed in the opposite direction.

The photograph shows the MAGOP unit in its present form, with a beam-splitter and two phototubes. To use the self-turning anisotropic recording scheme, the plane of incidence must be perpendicular to the data track. Figure 6C shows the readback patterns of 1,000 and 2,000 bpi patterns. Microscope studies of bits recorded at 4,000 per linear inch show that good resolution still exists at this level, and the ability to concentrate appreciable light energy into a small spot is presently the limiting factor on density. It is believed that optical masers may raise maximum bit density even higher.

The authors wish to acknowledge the valuable work of R. A. Novison in setting up and making the MAGOP measurements. Our thanks also to M. Orlovic and A. J. Kolk.

REFERENCES

- (1) E. E. Lee, D. R. Callaby and A. C. Lynch, The Use of the Kerr Effect for Studying the Magnetization of a Reflecting Surface, *Proc Phys Soc LXII*, 2, Aug. 1958.
- (2) J. W. Hart, Patterns in Thin Films Make Fast Nondestructive Memories, *ELECTRONICS*, p 126, Feb. 17, 1961.
- (3) J. J. Miyata, Optical Readout of Digital Magnetic Recording, *Communications and Electronics*, p 53, March 1961.

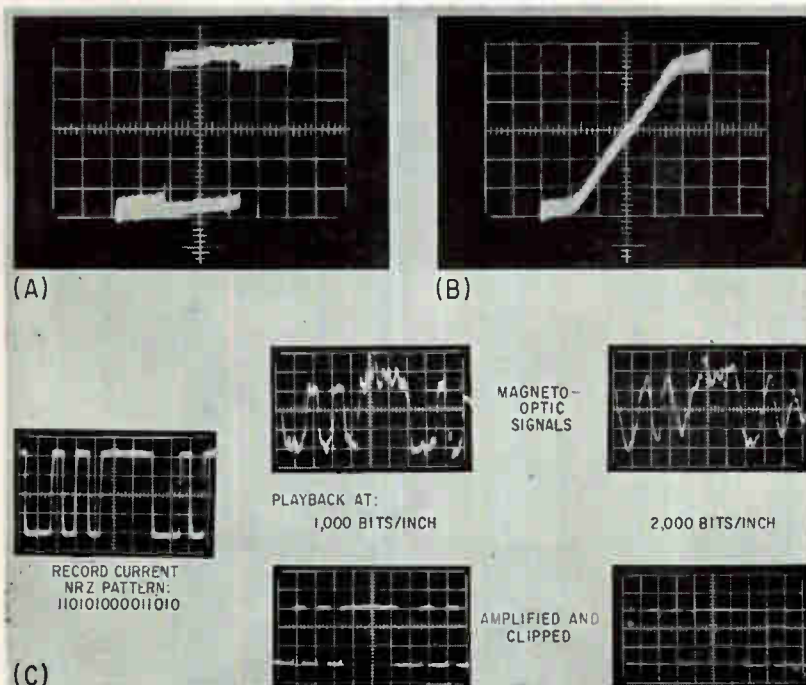

FIG. 6—B-H loops, using Kerr effect, of special film: hard direction (A), easy direction (B). In (C), the record signal is at left, the recovered signals at right

Crystal-Stabilized Tunnel-Diode

Theory and design procedure for crystal-controlled tunnel diode

oscillator that operates at 40 megacycles and has frequency variation

of 7.5 parts per million per degree Centigrade

ONE TUNNEL diode use is as the negative resistance element in an oscillator. Although tunnel diodes are usually considered for use in the microwave region, there is no reason why a tunnel diode can not be used at lower frequencies. Described here is a stable crystal-controlled oscillator that uses a tunnel diode as the negative resistance element. Frequency of operation is 40 Mc.

One of the most desirable features in a crystal-controlled oscillator is that it should oscillate only under control of the crystal. This implies no spurious oscillations and that oscillations stop when the crystal is removed. It has been shown,^{1,2} that to maintain oscillations using a parallel or N-type negative resistance, such as shown by a tunnel diode, the load resistance must equal the negative resistance.

Actually if oscillations are to start, the load resistance must be greater than the negative resistance. If the load resistance is less oscillations are not possible. This places an impedance matching requirement on the circuit, as typical 40-Mc quartz crystals have a series resistance of 10 to 30 ohms while the tunnel diode used has a negative resistance of approximately 120 ohms. Thus, crystal impedance as seen by the tunnel diode must be raised above 120 ohms. The circuit must also provide means of applying the proper biasing voltage to the tunnel diode and provide for damping undesirable oscillations through the power supply.

The most straightforward method of impedance transformation is the two-winding transformer: the impedance transformation can be obtained by adjusting the turns ratio. However, if the crystal is removed or becomes defective the impedance seen by the tunnel diode

becomes high, limited only by the transformer losses. The circuit may continue to oscillate but in a random and uncontrolled manner.

The pi network can also be used as an impedance transforming device. A pi network with series reactance equal in magnitude but opposite in sign to the two shunt reactances has the impedance inverting properties of a quarter-wave line. The relationship between the load impedance, input impedance, and network impedance is³

$$Z_{in} Z_t = Z_o^2$$

as shown in Fig. 1A.

If the load impedance is greater than the characteristic impedance of the line, input impedance to the network will be less than the characteristic impedance of the line. If load impedance is less than the characteristic impedance of the line, the opposite is true. The characteristic impedance of the network is the geometric mean of the load and input impedances.

The series resistance of the crystal is the load impedance of the network and the input impedance of the network is the impedance seen by the tunnel diode. Knowing the crystal resistance and the resistance the tunnel diode must see to sustain oscillations, the characteristic impedance of the network can be found. The impedance inverting property of the network is desirable; if the load impedance becomes high because the crystal is removed or becomes defective, impedance seen by the tunnel diode becomes low and oscillations cease. Bias current for the tunnel diode is applied at the crystal end of the network, since this end has the lowest impedance level. For the same reason, r-f output is also taken from this end. This type of network also acts as a low-pass filter

and helps suppress harmonics caused by nonlinearities of the tunnel diode.

A second form of the pi network is obtained by changing the signs of the reactances as shown in Fig. 1B. This is the high-pass version of the artificial quarter-wave line. Since it is a high-pass filter it suppresses any tendency for the circuit to oscillate at the fundamental frequency of the crystal, and the shunt inductances provide a convenient means of applying bias voltage to the tunnel diode. The circuit described uses the low-pass version of the quarter-wave line.

Referring to Fig. 1C and writing the equations for impedance Z_{in} , setting the imaginary part equal to zero and then solving for ω , the possible frequencies of oscillation are obtained. These are

$$\omega_1 = 0; \omega_2 = \frac{1}{\sqrt{LC}}; \text{ and}$$

$$\omega_3 = \left(\frac{2}{LC} - \frac{1}{C^2 R_o^2} \right)^{1/2}$$

Substituting these values of ω into the real part of the impedance equation, the impedance that faces the tunnel diode for each of the frequencies is found. This substitution gives

$$\omega_1 = 0 \quad Z_{in} = R_o \quad (1)$$

$$\omega_2 = \frac{1}{(LC)^{1/2}} \quad Z_{in} = (L/C)/R_o = \frac{Z_o^2}{R_o} \quad (2)$$

$$\omega_3 = \sqrt{\frac{2}{LC} - \frac{1}{C^2 R_o^2}} \quad Z_{in} = -R_o \quad (3)$$

Equation 1 indicates there is no reactive component at zero frequency. This can be verified by inspection. For the high-pass case this would occur at infinite frequency. Equation 3 says ω_3 depends on R_o so that changes in the load affect frequency. Also there is no impedance transformation with this mode. These facts make this an undesirable mode of operation.

Oscillators

FREE REPRINT

Single copy of this article available free by simply checking the READER SERVICE CARD of the month

By JOHN J. NAGLE,
Missile & Surface Radar Div.,
RCA, Moorestown, N. J.

Equation 2 shows that ω_2 gives the desired impedance-inverting property and that frequency is independent of R_s . This is the desired mode of operation; ω_1 and ω_3 should be suppressed. By making R_s less than the tunnel-diode negative resistance ω_1 can be suppressed. For ω_3 to exist the radical must be positive. If $R_s < \sqrt{L/2C}$ or, $R_s < 0.707 Z_c$ since, $Z_c = \sqrt{L/C}$, the radical will be imaginary and ω_3 will be suppressed. Satisfying these two conditions insures that ω_2 is the only mode of oscillation. Actually, if the second condition is satisfied, the first will be also.

At frequencies removed from the series resonant frequency of the crystal, the crystal is essentially an open circuit. Under this condition the elements of the network become antiresonant at a frequency of $\sqrt{2} f_o$, where f_o is the frequency at which the network represents a quarterwave transmission line.⁸ Fortunately the method used to suppress ω_3 will also prevent the network from becoming antiresonant.

It is now possible to design the circuit shown in Fig. 1D.

The tunnel diode had a negative resistance of approximately 120 ohms. Series resistance of the crystal was 10 ohms. Therefore it is necessary to transform 10 ohms to more than 120 ohms. Characteristic impedance of the network must be greater than

$$Z_c = \sqrt{120 \times 10} = 34.8 \text{ ohms}$$

An impedance of 75 ohms was used. This specifies the inductance and capacitance of the network since $\omega L = 1/\omega C = Z_c$. The effective load resistance of the network R_e is the parallel combination of R_1 , R_2 and the series resistance of the crystal. Since it is desirable that the oscillator not oscillate without the crystal, the parallel combination of R_1 and R_2 is made less than $0.707 Z_c$.

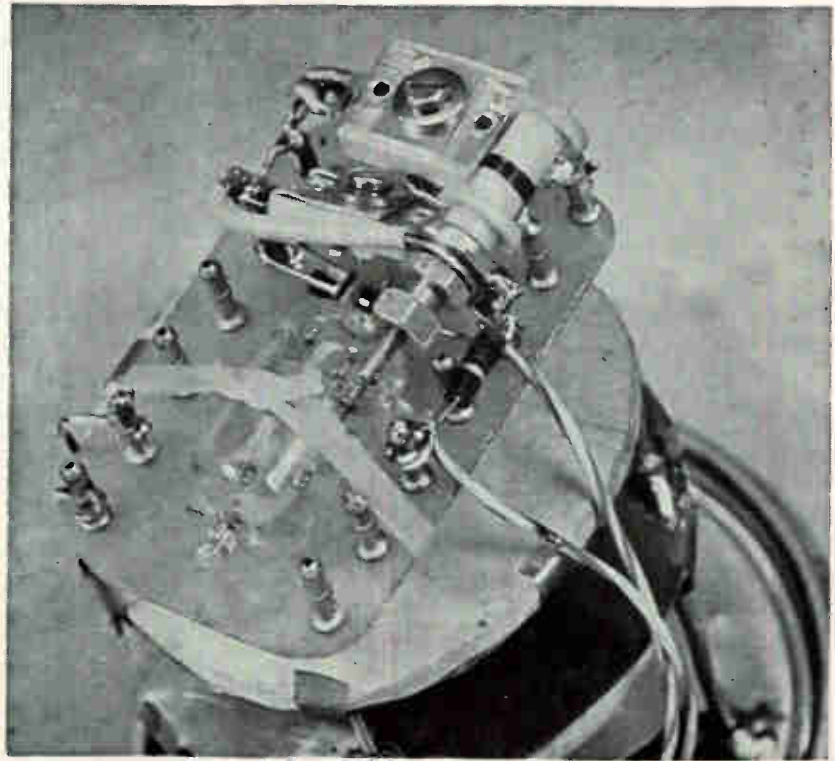

Close-up of oscillator shows component placement

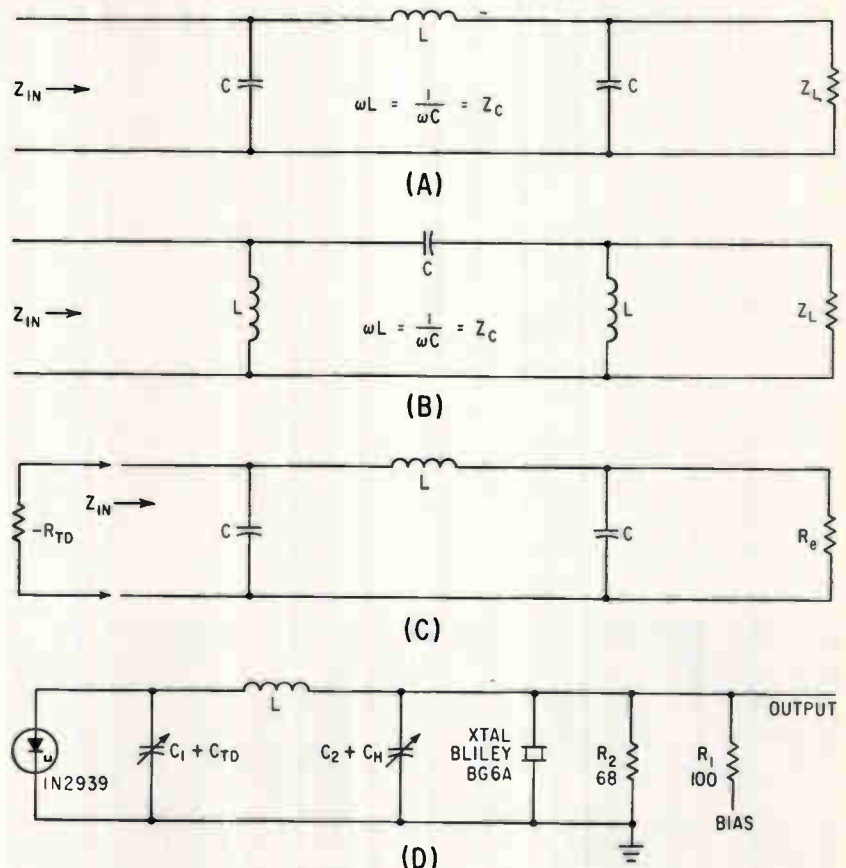

FIG. 1—Low-pass (A) and high-pass (B) versions of lumped constant quarter-wave line. Design equations based on (C) are used to derive final circuit (D)

or $0.707 \times 75 = 53$ ohms.

Output voltage of the bias supply and the bias requirements of the tunnel diode must also be considered in determining R_1 and R_2 . Choosing $R_1 = 100$ ohms and $R_2 = 68$ ohms satisfies the bias requirements; the parallel combination is 40 ohms which is low enough to ensure that the spurious-mode oscillations will be suppressed. This load resistance gives a transformed input impedance of 150 ohms. A load resistance of 150 ohms is high enough that, theoretically, the circuit should oscillate when the crystal is removed. No oscillations were observed, however. This is probably because shunt losses in the network were sufficient to reduce the resistance below 120 ohms. If oscillations had been present, the characteristic impedance of the network could have been reduced slightly, thus lowering the resistance seen by the tunnel diode. With the crystal in the circuit, its series

resistance, 10 ohms, is placed in parallel with the 40-ohm equivalent resistance of the bias supply. Total load resistance is now 8 ohms and the transformed load resistance seen by the tunnel diode is 700 ohms. Oscillation is now possible.

Early models of the oscillator gave random frequency drift of about 1 part in 10^5 over a period of an hour or two. Some of these variations could be correlated to environmental changes in the laboratory such as the opening of a window. Frequency records taken two hours apart show variation of about 30 cycles. Nominal center frequency is 40 Mc.

Packing the oscillator in ice reduced temperature changes to approximately 3 degrees Centigrade for a twelve-hour run. Temperature and frequency were recorded on a two-channel recorder; in nearly every case changes in frequency could be correlated with changes in temperature. Figure

2 shows frequency and temperature for a 25-minute period. Temperature is essentially constant; frequency change is about 1 cycle. During periods of two or three hours, when the temperature remained constant, frequency changes were less than one cycle or 2.5 parts in 10^5 ; this is the limit of the measuring system.

The temperature coefficient of frequency obtained was 7.5 parts per million per degree Centigrade, or nearly that of the crystal alone. Because of this the experiments were not considered sufficiently refined to determine the temperature coefficient of the tunnel diode alone.

The voltage coefficient of frequency was measured 3 parts in 10^7 total frequency change for a ± 6 percent change in voltage. Change in frequency is believed due mostly to a change in tunnel diode capacitance with bias voltage.

An estimate of the maximum available power available from the oscillator can be obtained from

$$P_{\max} = \frac{(I_p - I_v)^2 R_{td}}{8}$$

where I_v is the valley point voltage, I_p is the peak point voltage and R_{td} is the magnitude of the tunnel diode negative resistance. For the 1N2939 this gives

$$P_{\max} = \frac{[(1.0 - 0.1) \times 10^{-3}]^2 \times 120}{8} = 12.1 \text{ microwatts}$$

More recent tunnel diodes should raise this to the several hundred microwatt level. The output spectrum of the oscillator appears free of spurious responses. Figure 3A shows the spectrum on an 800-Kc sweep; Fig. 3B, a 4-Mc sweep.

Oscillators of this type will be useful where r-f power requirements are low, space and weight requirements are stringent and power consumption must be held to a minimum.

The author expresses his appreciation for the work of H. Zimmerman in the design and testing of this oscillator.

REFERENCES

- (1) E. W. Herold, Negative Resistances and Devices for Obtaining It. *Proc. IRE*, 23, 10, p 1201.
- (2) G. Crissom, Negative Impedances and the Twin 21-Type Repeater. *BSTJ*, 10, p 485, 1931.
- (3) W. A. Edson, "Vacuum-Tube Oscillators", John Wiley and Sons, p 221.

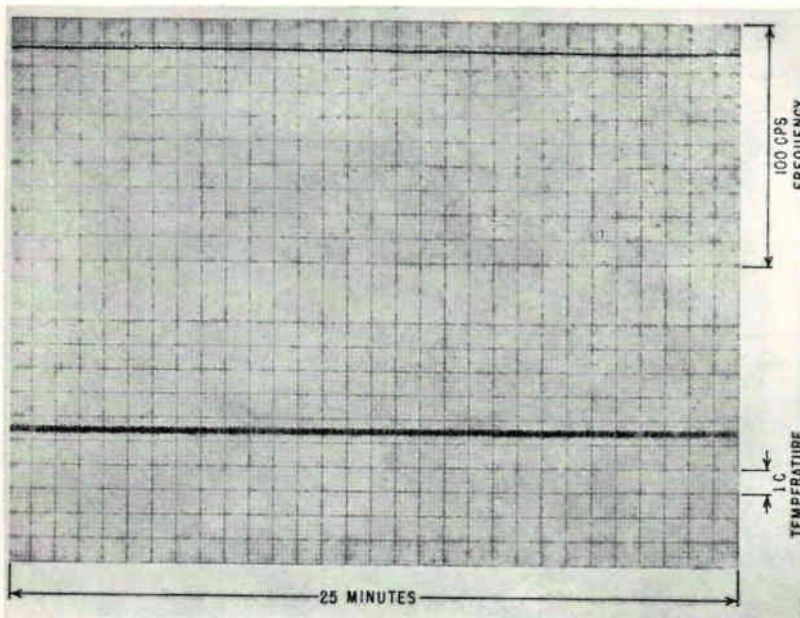

FIG. 2—Frequency check shows variation of about one cycle

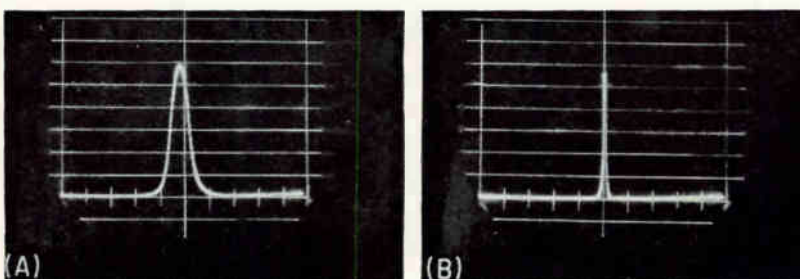
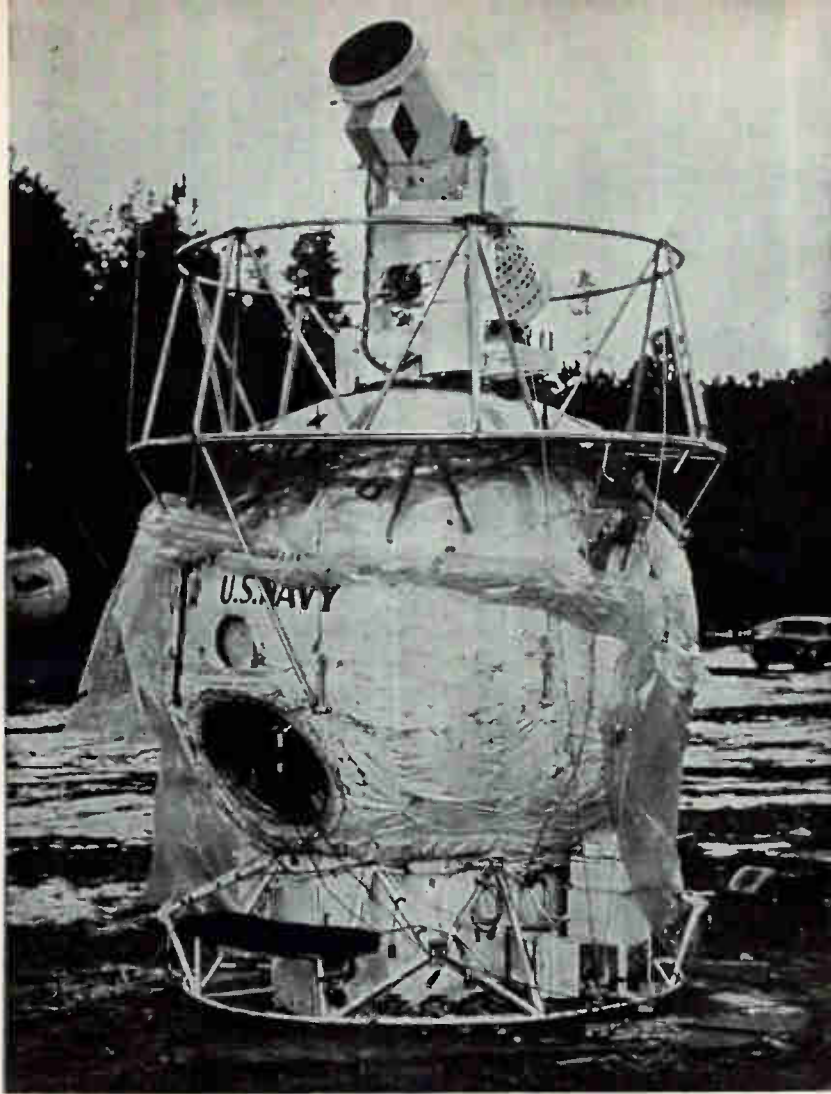

FIG. 3—Spectrum analysis of output using sweeps of 800 Kc (A) and 4 Mc (B) indicates freedom from spurious responses



Telescope atop gondola is servo controlled to cancel sway and vibration when airborne, so that it remains to aligned with target

Pilot and scientists are carried aloft in balloon's gondola to above 80,000 feet for analysis of Venus' atmosphere. Telescope is mounted on gondola roof, and is aligned with chosen star or planet by the servo-controlled star tracker

By W. J. WICHMAN
M. M. BIRNBAUM
Librascope Division,
General Precision, Inc.,
Glendale, California.

Servo System Design for Balloon-Borne Star Trackers

A BALLOON-BORNE research platform, manned or unmanned, is a relatively simple and inexpensive method of placing instruments above the masking effects of earth's atmosphere.

Although some high-altitude observations can be made by rocket or satellite borne equipment, others demand a near-stationary platform for continuous observation.

Continuous observation requires a device that will overcome gondola movements and keep a telescope aligned on its target. This is provided by the servo intelligence of

the automatic star tracker system.

A star-tracker was fabricated for the November, 1959, balloon flight of Stratolab High IV, a 26-hour, two man ascension to obtain a spectrum of the light reflected from Venus.

Analysis of the spectrograph recordings showed water vapor in the atmosphere of Venus, a discovery that has led to speculation on the possibility of some form of life on the planet. The ability to obtain the spectrometer recordings was dependent upon the performance of the star tracker.

The star-tracker system was required to be accurate, rugged, small sized, and had to have: dynamic range in light-tracking ability of 1,000,000:1; average pointing error within 5 seconds of arc to keep a star image continuously focused on a spectrograph entrance slit; capability for tracking stars or planets even though gondola vibrations ranged up to 4 cycles a second; and optical and mechanical parts that can operate after prolonged exposure to temperatures below minus 55 C.

The star-tracker system con-

sisted of a Cassegrainian telescope, a mechanical light-chopper, phase-sensing circuits and a servo system to move the telescope.

Figure 1 is a block diagram of the system, while Fig. 2 shows a schematic of the telescope showing its Schmidt optical system.

The equipment was in an exposed position atop the gondola. During the ascent to 81,000 feet, the temperature dropped to minus 70 C. Pressure was 0.8 inch Hg. Critical portions of the telescope were made of Invar.

Tests showed that the high voltage for the multiplier phototube would arc across several feet at the low pressure. The corona problem was solved by potting all high-voltage components and connectors in RTV 60, a room-temperature vulcanizing silicon-rubber compound.

Figure 3 is a simplified schematic of the signal and servo signal circuits. Gain is controlled by varying the input voltage to the high-voltage supply for the multiplier phototube. This allowed celestial bodies with brightness ranges of from 1 million-to-one, from the full moon to a fairly dim star, to be tracked by changing only one potentiometer setting.

Adjustable gain and damping controls were provided in the transistor servo amplifier circuits for optimum performance settings over a wide range of tracking conditions.

Subminiature vacuum tubes were used in the signal and servo circuits outside the gondola. Voltage amplification, from the multiplier phototube output to the servo-amplifier input, was approximately 25; power amplification was approximately 750,000. Transistor servo amplifiers were used, since inside the gondola they were not exposed to the temperature extremes.

Because system accuracy within 5 seconds of arc displacement between the line of sight to the star and the optical axis of the star tracker was required, a 40-inch effective focal length was selected for the telescope objective.

The choice of a Cassegrainian system, which does not employ cemented surfaces, eliminated problems of separation under extreme temperature conditions.

All sensor and mechanical components had to fit inside a 4-inch diameter cylinder. The need for

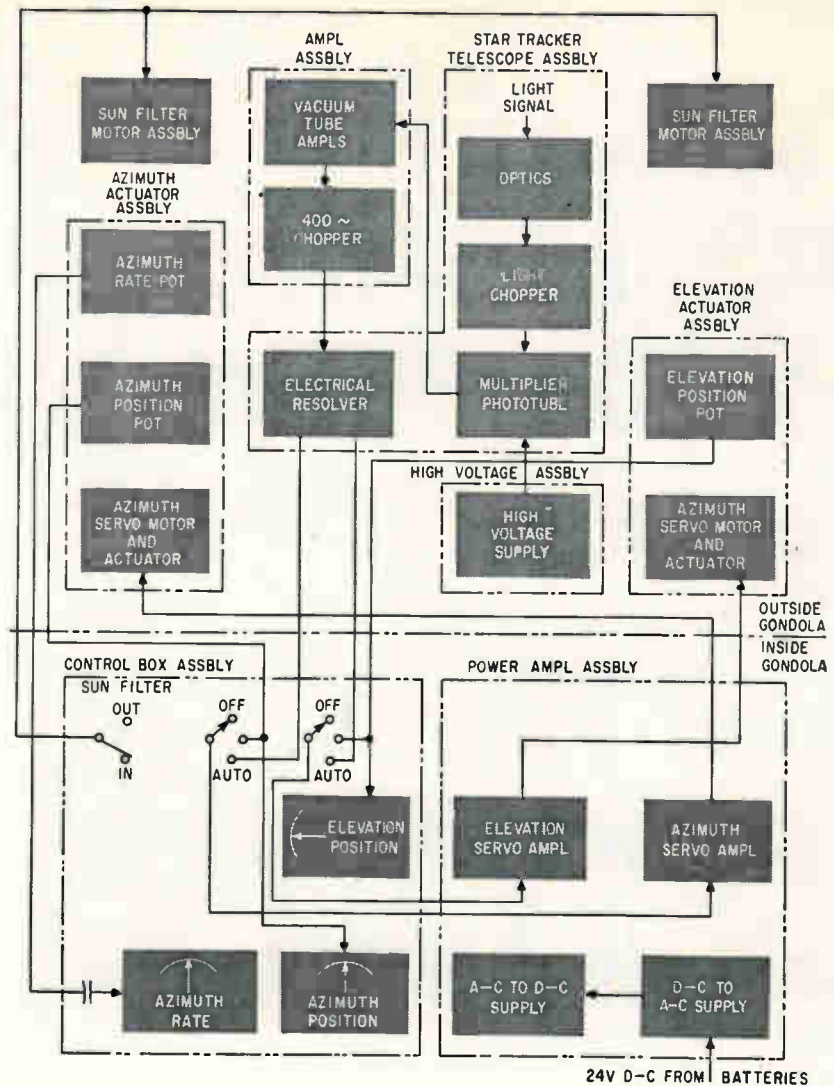

FIG. 1—Overall telescope servo system, showing division of components between those on the gondola's outer surface, and those within the chamber

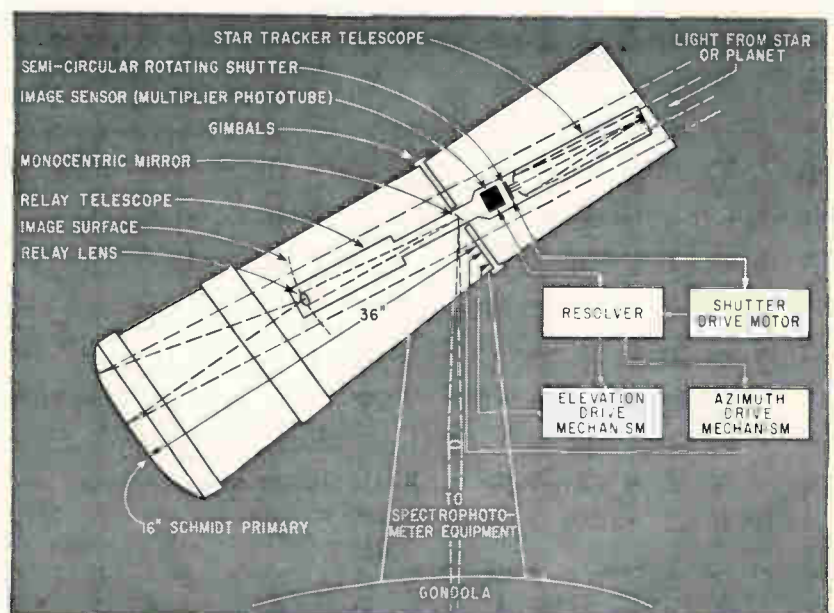

FIG. 2—Optical schematic shows how the telescope delivers light to the spectrum analyzer in the gondola chamber

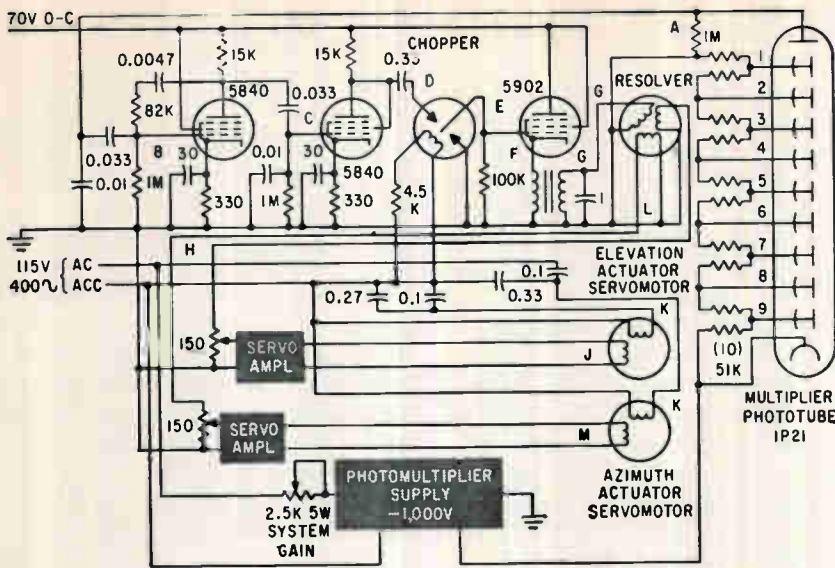

FIG. 3—Gain of the star-tracker is controlled by varying the input voltage to the multiplier phototube, permitting the system to track the brightness range from remote stars to our own moon

optics of minimal diameter was therefore eliminated. The diameter of the primary was made $3\frac{1}{2}$ inches to give a light-gathering ability more than adequate for sensing Mars or Venus with a multiplier phototube.

A field lens was placed near the focal plane to direct all of the light gathered by the primary to the cathode of the multiplier phototube.

A 400-cycle synchronous motor was selected to drive an opaque, semicircular chopping disk and a synchro resolver. Since brush considerations limited the resolver speed to 1,800 rpm, the 400-cycle motor was geared down to 1,800 rpm at the resolver. The chopper and resolver were geared together at a 1:1 ratio to synchronize star chopping and electrical output. This divided the signal into azimuth and elevation components but required gearing. Initially, some of the higher-speed gears showed wear. To overcome the problem, one gear of each mesh was constructed of Nylatron.

The chopping disk and the phase relationship between the 400-cycle chopped error signal and the field of the servomotor provided the signals that moved the star tracker.

A closer view of the chopping disk, Fig. 4, shows a star imaged off-center with the pointing error in elevation only. Fig. 5A shows the error-signal waveshapes and phase relationships at the lettered notations in Fig. 3. The positional relationships of the chopping disk, resolver motor and star tracker azimuth and elevation axis were adjusted so that an elevation pointing error caused the phase relationships shown in Fig. 5A.

The square-wave error-signal output of the multiplier phototube was converted to a triangular wave to prevent 400-cycle noise from modulating the signal. The triangular signal was mechanically chopped at 400 cycles for use with servomotors and servoamplifiers. Chopping of the triangular wave introduced a 180-degree phase shift in the chopper output signal, as shown in line E of Fig. 5A. The chopped error signal was fed to a resolver through a transformer having a low-frequency cutoff response, so that it responded only to the 400-cycle component of the

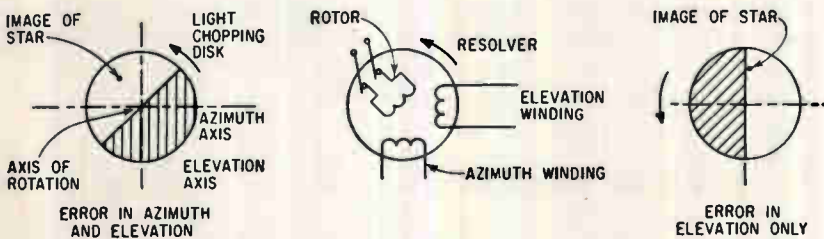

FIG. 4—Chopping disk is driven by gear-teeth on its periphery and is synchronized with the resolver at 1,800 rpm

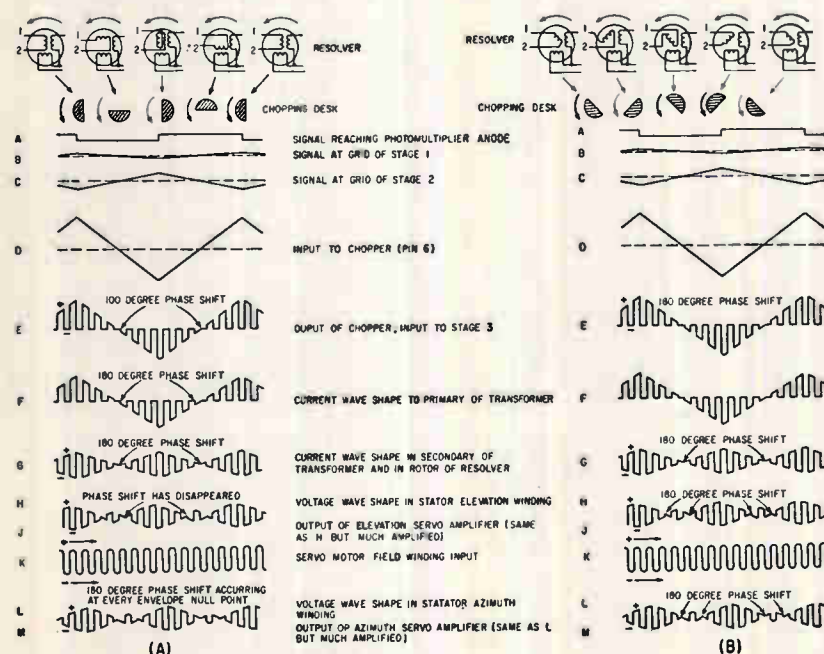

FIG. 5—System waveforms for error in elevation (A) and error in azimuth-plus-elevation (B)

impressed error signal.

The resolver rotor, rotating in synchronism with the chopping disk, induces the 400-cycle chopped error signal in the resolver stator elevation winding, as shown in line H of Fig. 5A. The 180-degree phase shift, from envelope to envelope, that existed in the error signal has disappeared from the stator elevation output winding. This occurs because the relation of the resolver rotor to the stator elevation winding reverses every 180 degrees.

The stator-elevation winding output is amplified and fed to the elevation servomotor. With the error signal 90 degrees out of phase with the field-winding input at every part of the signal in every signal envelope, the elevation servo-motor exerted a unidirectional torque. The rotating servo-motor caused the actuating rods to act on the star-tracker spider frame and align the optical axis with the incoming light rays.

The gearing drove a push rod having 40 threads per inch which was spring-loaded against a 7-inch radial arm attached to the body of the telescope. Two such units at right angles gave azimuth and elevation motions of plus or minus 3 degrees with negligible cross talk between units. The actuator gear-

ing also drove the position-reading potentiometers and limit stops.

The phase relationships for an error in both azimuth and elevation are shown in Fig. 5B. The phase reversals of the error-signal envelopes and those caused by revolutions of the resolver rotor were neither in phase nor 90 degrees apart. Therefore, in both the azimuth and elevation output-error signals from the resolver, the envelope-to-envelope phase shift was 180 degrees. As shown in Fig. 5B, however, this envelope-to-envelope phase reversal occurred when the modulated amplitude of the rotor signal was small and when minimum coupling existed between the rotor and each stator winding. The torque over one complete resolver rotation, in one direction only, is the net of the torque caused by the large error-signal envelope minus the torque caused by the small error-signal envelope.

Two potentiometers are mounted on the main supporting frame, which is bolted to the telescope. The wipers of the center-tapped potentiometers are geared to the azimuth and elevation servo-motors. When the servo-motor-operated azimuth or elevation actuator rods moved the star tracker completely through its azimuth or elevation

angle limits, with relation to the astronomical telescope (plus or minus 3 degrees), the potentiometer wiper traveled from one end of the potentiometer to the other.

The potentiometer outputs are fed to the azimuth and elevation servo amplifiers of the star tracker and to the azimuth and elevation meters of a control panel. A rotary switch on the panel allows the operator to select this centering mode. Then, with the optical axis aligned and locked in coincidence with the astronomical telescope optical axis, the operator visually located and centered the target star in the astronomical telescope's field of view. By turning the rotary switch to automatic, the servo amplifiers were connected to the outputs of the resolver, rather than to the potentiometers and the tracker began tracking the star.

The star tracker telescope angular-difference-meter circuits are shown in Fig. 6. The potentiometers are fed from the 115-volt, 400-cycle bus, through an isolating transformer, and their positional signal is derived from the center-tapped lead and the wiper lead, both of which are carried back to the meter circuit. The meter circuit consists of a d-c microammeter with center zero, two diodes, and a 1-to-1 transformer with a centertapped secondary.

The action of the circuit can be viewed as composed of two voltages, one superimposed on the other. The first voltage, from transformer T_1 , induces a voltage in the meter circuit. For every half cycle, a current flows first through one diode and then through the other. During alternate positive and negative half-cycles, current flows through the d-c microammeter, but in opposite directions, so the meter does not move. The second voltage comes from the voltage difference between the wiper and centertap of the position-indicating potentiometers. For the positive cycle, shown in Fig. 6 (elevation circuit), the voltage from potentiometer centertap to potentiometer wiper causes current to flow into the meter circuit and through the Y diode, which conducts because of the voltages induced from transformer T_1 .

REFERENCES

The Griffith Observer, XXIII, No. 1, Jan. 1959.

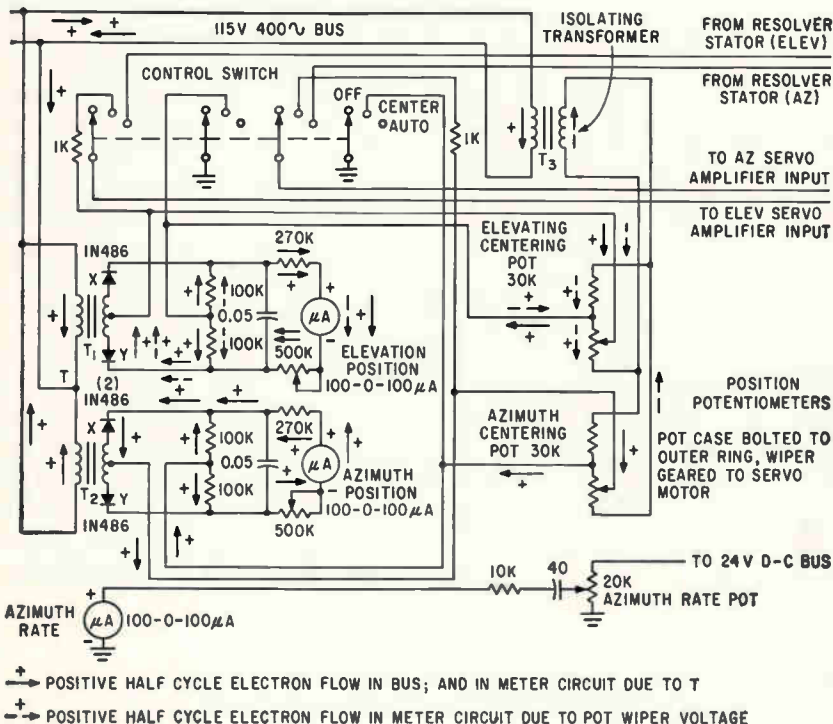

FIG. 6—Star tracker signal is processed to operate elevation and azimuth indicators, which are calibrated in degrees off-axis

**NEW FROM
CINCH...**

BIFURCATED

Printed circuit

board edge connectors

to maintain positive contact!

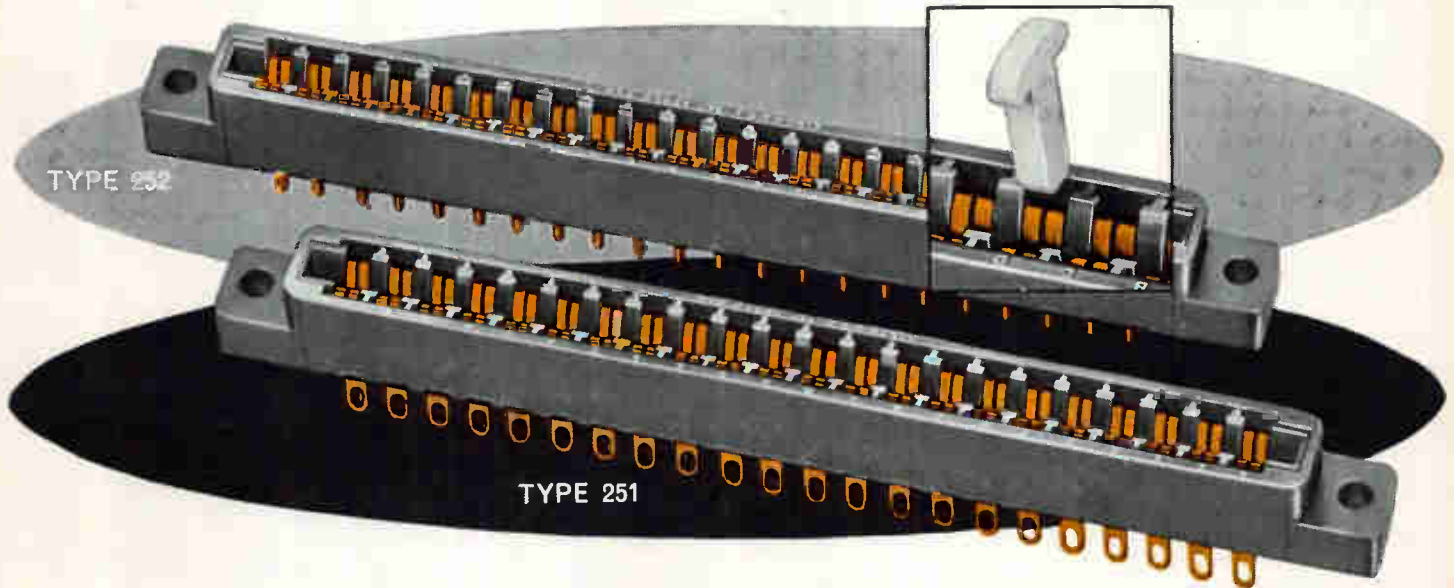

NOW AVAILABLE FOR IMMEDIATE DELIVERY! Bifurcated Contact Connectors with two flexing surfaces instead of one to provide positive contact! . . . accommodate irregularities in Printed Circuit Boards.

TWO TYPES—conventional wiring tail (type 251) or dip solder (for .051 dia. hole) (type 252) . . . with 6 to 25 contact positions (12-50 contacts).

INSULATION—glass filled diallyl phthalate type GDI 30 per MIL-M-19833.

POLARIZING KEYS—can be supplied loose, or inserted in any position designated.

FINISHES—phosphor bronze or beryllium copper00003 Min. Sel-rex. gold plated.

PART NUMBERS—customer part numbers imprinted when required.

MEETS MIL-C-21097 A (ships) specs for printed wiring board connectors.

WRITE FOR FULL INFORMATION TODAY! Complete details and performance specifications on new Bifurcated Cinch Printed Circuit Board Edge Connectors are available for the asking. Write for full information now.



**Cinch
ELECTRONIC
COMPONENTS**

CINCH MANUFACTURING COMPANY

1026 South Homan Avenue • Chicago 24, Illinois
Division of United-Carr Fastener Corporation, Boston, Massachusetts

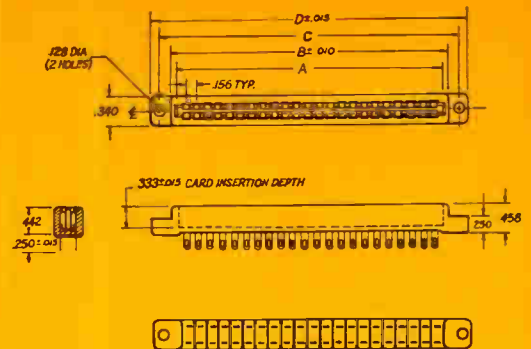

Contact* Positions	DIMENSIONS			
	A	B	C	D
6	1.098	1.239	1.531	1.785
7	1.254	1.395	1.687	1.941
8	1.411	1.552	1.844	2.098
9	1.567	1.708	2.000	2.254
10	1.723	1.864	2.156	2.410
11	1.879	2.020	2.312	2.566
12	2.036	2.177	2.469	2.723
13	2.192	2.333	2.625	2.879
14	2.348	2.489	2.781	3.035
15	2.504	2.645	2.937	3.191
16	2.661	2.802	3.094	3.348
17	2.817	2.958	3.250	3.504
18	2.973	3.114	3.406	3.660
19	3.129	3.270	3.562	3.816
20	3.286	3.427	3.719	3.973
21	3.442	3.583	3.875	4.129
22	3.598	3.739	4.031	4.285
23	3.754	3.895	4.187	4.441
24	3.911	4.052	4.344	4.598
25	4.067	4.208	4.500	4.754

Centrally located plants at: Chicago, Illinois; Shelbyville, Indiana; City of Industry, California and St. Louis, Missouri

*Number of contacts equals contact positions times two.

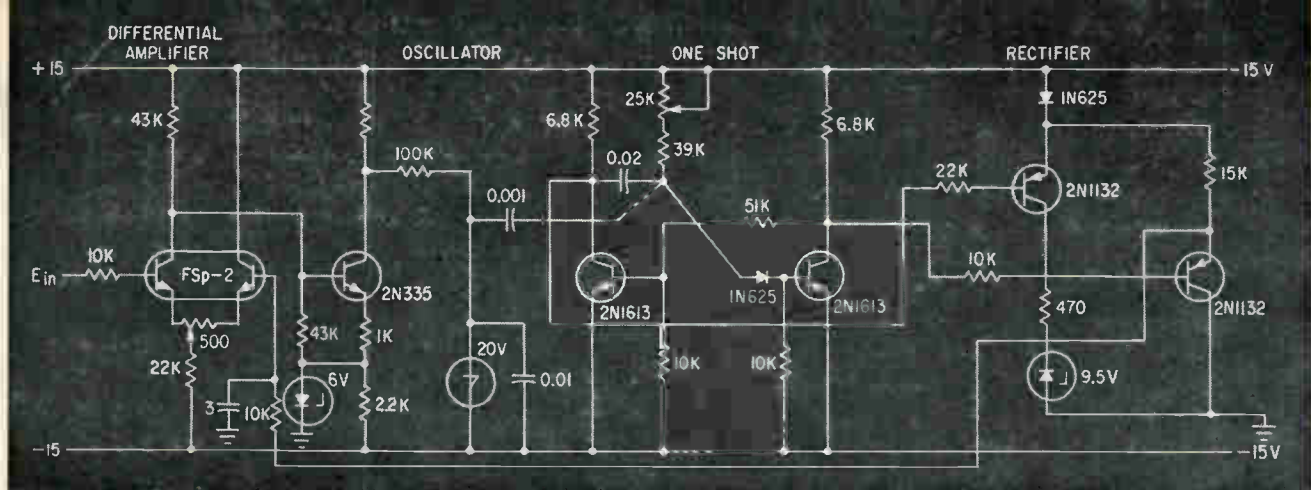

Oscillator is frequency-controlled by input voltage fed through the differential amplifier; frequency dependent voltage-feedback linearizes the relation between input voltage and output frequency

FEEDBACK LINEARIZES

Voltage-To-Frequency Converter

By JAMES D. LONG

Member Technical Staff,
Space-General Corporation,
North Hollywood, California

IN DESIGNING electronic equipment there is often a need for converting voltage to frequency. One simple voltage-to-frequency converter circuit, using feedback to maintain accuracy, is described in this article. The circuit is designed to accept d-c input voltages in the range of 0 to 3 volts and give a maximum output frequency of 400 cps.

The circuit uses a differential amplifier that amplifies the difference between the input and feedback signals and feeds the fre-

quency-determining output to the oscillator, which uses a Shockley four-layer diode. Frequency of oscillation is then proportional to the output voltage of the differential amplifier. The voltage-controlled oscillator triggers a one-shot multivibrator to produce a pulse train of constant width and amplitude and having the same frequency as the oscillator output. This multivibrator output is rectified and filtered to form the feedback signal to the differential amplifier.

If the voltage amplification of the differential amplifier is high, the feedback signal must equal the input signal or the circuit will automatically adjust itself to

satisfy this equality. That is, it will either increase or decrease the frequency of the vco, depending upon whether the input signal is greater or less than the feedback signal.

The Shockley-diode voltage-controlled-oscillator does not itself have a particularly linear voltage-to-frequency characteristic. However, the closed-loop linearity of the system is good owing to the voltage amplification of the FSP-2 and 2N335 transistors. A high degree of gain stability is not required since the effect of the amplifier is to decrease the non-linearity of the voltage-controlled oscillator. Although gain stability of the amplifier is not important, operating point stability is critical because drift in the amplifier will appear as a spurious frequency-determining signal.

To maintain a constant amplitude of the one-shot output pulse, a Zener diode is used to limit the waveform. Also, the saturation voltage of the one-shot output stage must be constant. For the same input voltage, the output frequency can be increased or decreased by decreasing or increasing the period of the one-shot, respectively.

The results obtained from the laboratory breadboard are indicated in the table.

RELATION BETWEEN THEORETICAL AND ACTUAL FREQUENCIES

E_{in} (Volts)	Theoretical Frequency (CPS)	Actual Frequency	Percent Error
0.25	43.9	43.6	-0.7
0.5	76.4	76.4	0
1	141.3	141.3	0
1.5	206.2	206	-0.1
2	271.1	270.9	-0.07
2.5	336	336	0
3	400.9	401	+0.05
3.5	465.8	465.7	-0.02

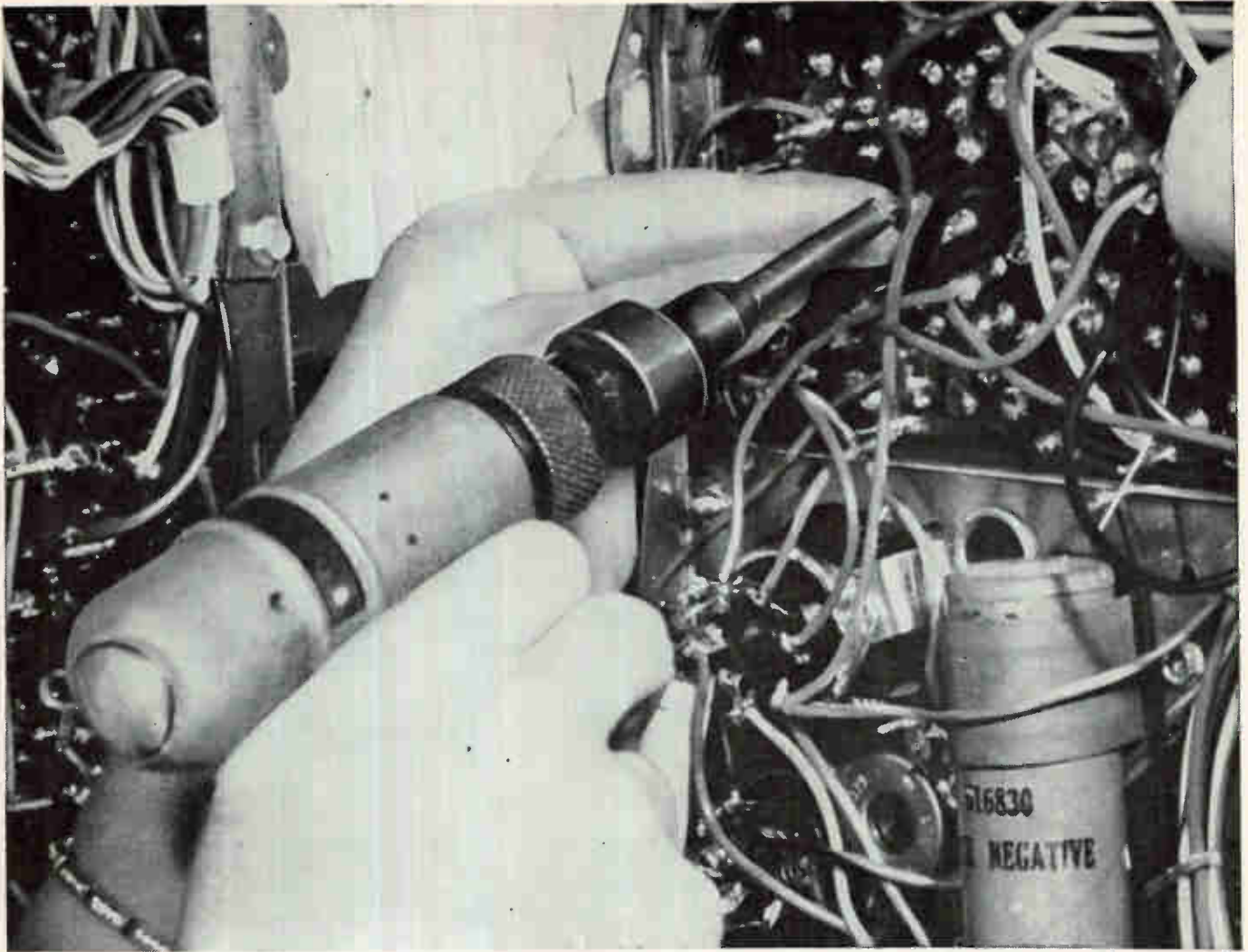

With "Wire-Wrap"[®] tools these hands make 3-second connections

Make expensive hands more profitable. Put your electrical connections on a 3-second production schedule with Gardner-Denver "Wire-Wrap" tools. That's all the time it takes to make a permanent electrical connection using the solderless wrapping method, and absence of heat means greater reliability of your component.

Proof of superiority? Over a billion permanent, solderless wrapped connections with no reported failure. And only Gardner-Denver offers a complete line of equipment for making such connections—including custom-designed, automatic "Wire-Wrap" machines to solve special problems in multiple operations. Write for bulletins.

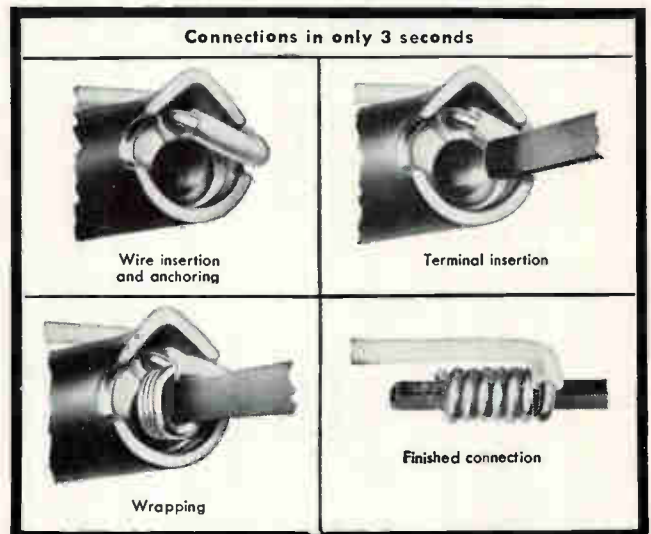

EQUIPMENT TODAY FOR THE CHALLENGE OF TOMORROW **GARDNER - DENVER**

Gardner-Denver Company, Quincy, Illinois—Offices in principal U.S., Canadian and Mexican cities
In Canada: Gardner-Denver Company (Canada) Ltd., 14 Curity Avenue, Toronto 16, Ontario

International: Gardner-Denver International Division 232 Broadway, New York 7, N.Y.
International Offices: Buenos Aires, Argentina; Artarmon, N.S.W. Australia; Brussels, Belgium; Rio de Janeiro, Brazil;
Santiago, Chile; Barranquilla, Colombia; Lima, Peru; Naويا, N. Rhodusin; Salisbury, S. Rhodesia; Johannesburg, Transvaal

Instruments Monitor Evoked Brain Responses

By DR. LUCY BIRZIS, Physiologist,
G. L. PRESSMAN, Research Engineer,
Stanford Research Inst., Menlo Park, Calif.

ELECTRONIC techniques are providing information about the possible dangers to mental health from prolonged exposure to the unusual stresses of space travel. Investigations have already indicated the need to supplement existing experimental equipment with a micro-miniaturized telemetry system, which is now under development.

Questions being raised about space travel include whether it produces cumulative functional changes in the brain, whether the changes are reversible or subject to adaptation, or whether they can be modified by psychoactive drugs or other means. The techniques of space bionics must be applied to explore these questions—first in the laboratory under simulated space conditions—later in the space capsule itself. Rats are good animal subjects for these studies because of their short life span and small size and weight. However, their small head and brain pose technical problems in miniaturization of equipment.

Brain electrodes have been permanently implanted in rats at Stanford Research Institute. The rats are being used to develop more sensitive means for evaluating key functional systems of the brain, particularly those determining mental alertness and emotional reactivity, under conditions of prolonged social isolation, or excessive or restricted sensory inputs.

Electroencephalographs have little value since gross changes in behavior or mental functioning are often not accompanied by visible changes in the pattern. However, response of one part of the brain when another interconnected part is electrically stimulated may provide a measure of sensitivity of the neural network.

At least two electrodes must be implanted in the brain to obtain this information. The electrode pair consists of two insulated nichrome

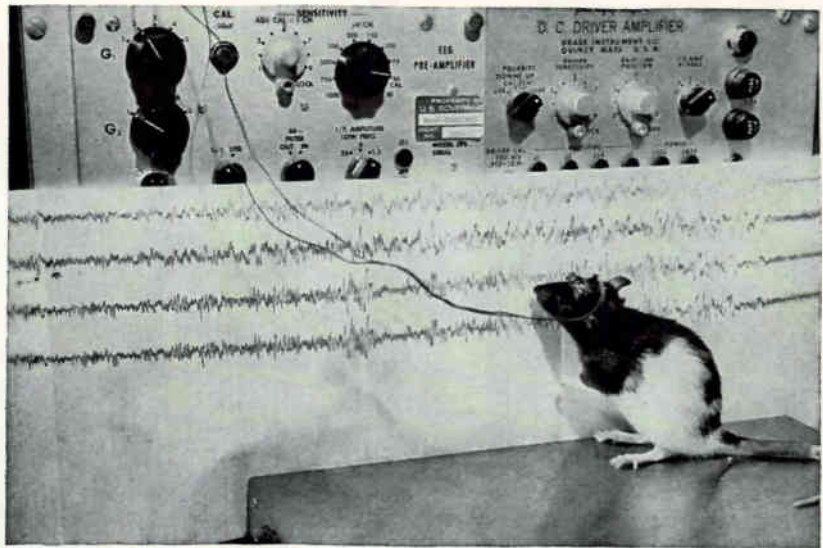

THE FRONT COVER. Evaluating functional systems of the brain requires precise positioning of surgically implanted electrodes in rat brain to provide stimuli and pick up responses

wires twisted together with less than a millimeter of wire bared at the tip. One set of electrodes deep in the brain can deliver electrical stimuli and the other can pick up response potentials from the brain surface. A coiled steel wire soldered to a connector pin is also placed under the skin to ground the rat during the experiment.

To introduce the electrodes into the brain of the anesthetized rat, a stereotaxic device holds the head in a fixed orientation and three millimeter scales in three planes position the electrode pair exactly to correspond with a point on the brain map coordinates. The electrodes, attached to a two-pronged plug, are fixed to the dried surface of the skull with dental cement. The skin is then sutured over the cement plug leaving only the plugs exposed.

Conventional electrophysiological instruments were modified to improve data gathering efficiency. Brain potentials can be recorded on an eight-channel recorder that accepts signals from 10 to several hundred microvolts. Outputs from any two channels can be displayed on a two-beam oscilloscope to observe and photograph transient

waveforms. Usually many traces must be superimposed using triggered sweep and stationary film to make averaged evoked potentials visible above random noise.

A stimulator panel permits each electrode pair to either stimulate or pick up brain potentials and to monitor stimulation current and voltage (brain electrode resistance). The stimulus can be applied to any free electroencephalograph channel or superimposed on a brain wave channel for comparison.

A pulse generator and isolation transformer provide stimulation pulses of 0.1 to 1 millisecond at 0.1 to 10 volts with repetition rates of either 7 to 9 pps or 70 to 100 pps. Trains of 1 to 5 seconds are usually applied. The altering brain system changes brain waves so that a low-amplitude, fast desynchronized pattern is recorded on the surface of the brain. The other system produces a slow, rhythmical, higher amplitude pattern. Factors considered in evaluating these systems are threshold current needed to produce pattern, response duration after stimulation ends and amplitude.

The brain is also stimulated via sense organs to desynchronize the

more than the name is new

Fairchild Stratos Corporation* is a new name-but the new doesn't stop there. There is dynamic new leadership-new energy and enthusiasm-new programs and projects...and the creative technical skills to implement them.

Perhaps most significant are the exciting new career opportunities ahead for creative professionals in such fields as guided missiles, drone systems, space satellite equipment, precision mechanical equipment and sophisticated electronic systems. This is the new look of Fairchild Stratos. This is the plan for sound and vigorous growth for the immediate future and for the long term. Fairchild Stratos is on the go.



* FORMERLY FAIRCHILD ENGINE AND AIRPLANE CORPORATION

- AIRCRAFT - MISSILES DIVISION
HAGERSTOWN, MARYLAND
- AIRCRAFT SERVICE DIVISION
ST. AUGUSTINE, FLORIDA
- ELECTRONIC SYSTEMS DIVISION
WYANDANCH, NEW YORK
- STRATOS DIVISION
BAY SHORE, L.I., NEW YORK AND
MANHATTAN BEACH, CALIFORNIA

10 Megohms

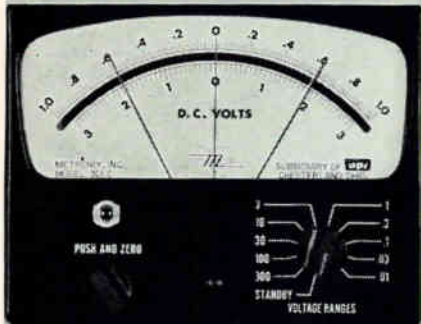

PLUS Control

An electronic voltmeter with a meter-relay

This happy combination makes an extremely versatile and acute instrument.

It has critical measuring ability that goes with high input impedance, in space-saving panel-mounting style.

It also has the reliable, simple control of a locking contact meter-relay, with adjustable set points.

Many difficult functions can be easily controlled: conductivity cells, life testing of components or systems, production testing and sorting, automatic Go-No Go of missile circuits.

Ready When Needed

Metronix DC instruments such as Model 301-C-CMR (illustrated) have input resistances up to 10 megohms. AC input impedances go as high as 5 megohms. Like all Metronix panel-mounting electronic voltmeters (PMEV's), they are always connected—immediately available for continuous monitoring of critical parameters.

Send for data sheets describing Metronix PMEV's in single or multiple ranges, DC or AC, with either meter-relays or conventional indicating meters.

 **METRONIX, INC.**
a subsidiary of Assembly Products, Inc.
Chesterland, Ohio

Telephone: HAmilton 3-4440
Visit Us in Booth 111, NEC

EEG or evoke transients in localized brain surface areas. Repetitive light flashes, sound bursts or sustained tones can be used. Sound is provided by a loudspeaker-audio amplifier that receives regulated pulses from the electrical stimulator.

With the present experimental equipment, only before and after changes in electrophysiological parameters resulting from isolation of the rats can be compared. Information obtained during isolation without handling the rat or removing it from its environment during measurements would be much more valuable. Although lead wires might be left in the plugs during isolation, it would be difficult to keep the rat from chewing or tangling them, and movements would be restricted or artifacts introduced into the record.

A rat-sized telemetry system is needed similar to that used for human brain waves. It would stimulate the brain remotely. The rat would carry transmitter, receiver-stimulator and batteries on its back. Such a system is now under development at Stanford Research Institute.

Hearing Aid Helps Users To Find Sound Sources

EXPERIMENTAL hearing aid enables those deaf in one ear to hear sounds originating on the side of the deaf ear. By providing a binaural effect, the new hearing aid has also achieved partial success in helping users to sense the directions from which sound is coming. Study and experiments are continuing that may provide further assistance to those suffering from this handicap.

The hearing aid was invented by H. J. Salomon, a Haifa journalist, and Leon Shaudinishdi of the Acoustic Laboratory of the Technion, Israel Institute of Technology. In practical tests of the hearing aid, users are said to have found it quite helpful.

Those unable to hear with one ear must constantly make adjustments in position to hear sounds around them, frequently encountering awkward or embarrassing situations because of their handicap. In some cases, such as not hearing

the sound of an approaching vehicle or not perceiving its direction, this handicap can be dangerous. Hearing sounds originating on the side of the deaf ear would be very helpful, while adding the ability to determine directions would almost duplicate normal hearing.

The new hearing aid provides sound from the side of the deaf ear to the side of the healthy ear. In place of the earphone in conventional hearing aids, a small microphone is placed in the deaf ear. Audio signals from the microphone are amplified and the reproduced sound is transmitted to the nerves of the healthy ear by conduction through the bone structure of the skull.

Sounds through the hearing aid and sound waves arriving directly at the healthy ear differ in several respects, some of which seem to be related to the relative positions of the user and the sound source. There is a time or phase difference, a difference in amplitude and the sound passing through the head undergoes some wave distortion. These effects may simulate the natural hearing processes to a degree that can provide the user with enough clues to determine the direction of sound sources.

The small group of volunteer users with this handicap reported experiencing a binaural-like effect. The group, including inventor Salomon who is deaf in one ear, were said to be unanimous in their agreement that the hearing aid was quite helpful. However, additional experiments are necessary before making a final judgment.

Among problems still to be solved is that of three-dimensional hearing. In the presence of many individual sound sources, such as a room crowded with talking people, the source of a particular sound or voice is difficult to sense. However, the inventors believe that a user may learn to make more efficient use of the new information provided by the hearing aid after a period of adjustment.

Continuing study and experiment with the new hearing aid may result in isolating the factors that enable those with normal hearing to determine the directions from which sounds originate and possibly to duplicate the mechanisms in the hearing aid.

*Communication
Effectiveness makes*

*the
"difference between"*

profit and loss!

See

BUDELMAN

... for reliable, economical*
COMMUNICATIONS SYSTEMS
Carrier • Microwave • Paging
For Common Carrier, Industrial, Public Safety,
Transportation and Business Applications
We invite your inquiry for free BEC Spec File
or Systems Engineering assistance.

375 Fairfield Avenue • Stamford, Conn.

*Because Budelman equipment performs better,
costs less to buy and maintain.

CIRCLE 200 ON READER SERVICE CARD

EIC

**gives you
fast delivery on custom
chokes and transformers**

Your needs for custom wound components at competitive costs get fast attention at EIC. Prototypes engineered to your specifications can be supplied within two weeks, and production runs in any quantity can follow immediately.



Write for our Representative Catalog of Custom Transformers, which gives specifications on input, interstage, output and power transformers, transistor power supply transformers, toroidal chokes, and geophysical reactors.

ELECTRODYNAMIC INSTRUMENT CORPORATION

Subsidiary of Reed Roller Bit Company

1841 Old Spanish Trail

Houston 25, Texas

CIRCLE 201 ON READER SERVICE CARD

September 1, 1961

- LOW STARTING TORQUE
- HIGH LOAD CAPACITY
- HOLLOW SHAFT DESIGN

BOWMAR

*Precision
Mechanical
Differentials*

TYPE X-1779

Starting Torque — .1 inch ounce max. at 25°C.; Load Torque—10 inch ounces cont., 40 inch ounces max. momentary; Max. Lost Motion (Backlash) — 15 min. max. with 1 inch ounce reversing load; Speed—700 r.p.m. cont.

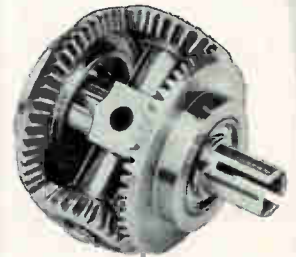

TYPE X-1943

Starting Torque — .1 inch ounce max. at 25°C.; Load Torque—25 inch ounces cont., 75 inch ounces max. momentary; Max. Lost Motion (Backlash)—1.5 min. max. with .5 inch ounce reversing load; Speed—700 r.p.m. cont. (This type equipped with duplexed bearings for maximum accuracy and rigidity).

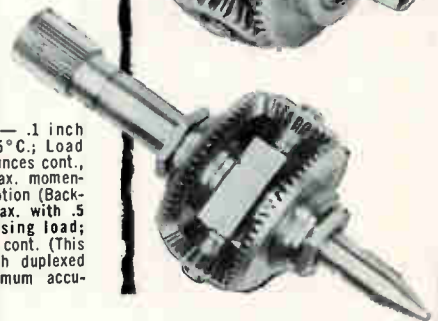

Bowmar Precision Mechanical Differentials are designed for use in systems requiring addition, subtraction or integration of mathematical functions, and for operating various types of servo components. Hollow shaft construction provides nearly unlimited installation flexibility. Plain shafts or pinions can be furnished to satisfy customer specifications; and a variety of end spur gears are available to provide a wide range of end ratios.

SEND FOR "PMD" DATA PACKAGE

BOWMAR

**INSTRUMENT
CORPORATION**

8000 BLUFFTON ROAD
FORT WAYNE, INDIANA

PRECISION MECHANICAL COMPONENTS, PRECISION COUNTERS AND INDICATORS, PRECISION TIMING AND PROGRAMMING DEVICES, PRECISION ELECTRO-MECHANICAL DEVICES, PRECISION SERVO PACKAGES

CIRCLE 53 ON READER SERVICE CARD

53

Thin Film Dielectric for Miniature Capacitors

A CONTROLLED GAS PHASE REACTION technique developed by Nuclear Research Associates., Long Island City, N. Y. may lead to a new class of microminiaturized thin film components. President Melvin P. Ehrlich reports that the process produces essentially pinhole-free, sub-micron thick films on any conventional substrate. The films can be organic or inorganic, and can be formed over relatively large areas, in uniform thicknesses from monomolecular layers to the micron range.

"The thin film field is in its infancy", he states, "and will play an important role in the trend to microminiaturization . . . I believe that the development of complete circuits in thin film form is less than a year away".

Initial company research has been aimed at developing suitable dielectric films for deposited capacitors although work is being done on resistor films, semi-conducting films, and protective coatings. Company claims development of a compatible technique whereby

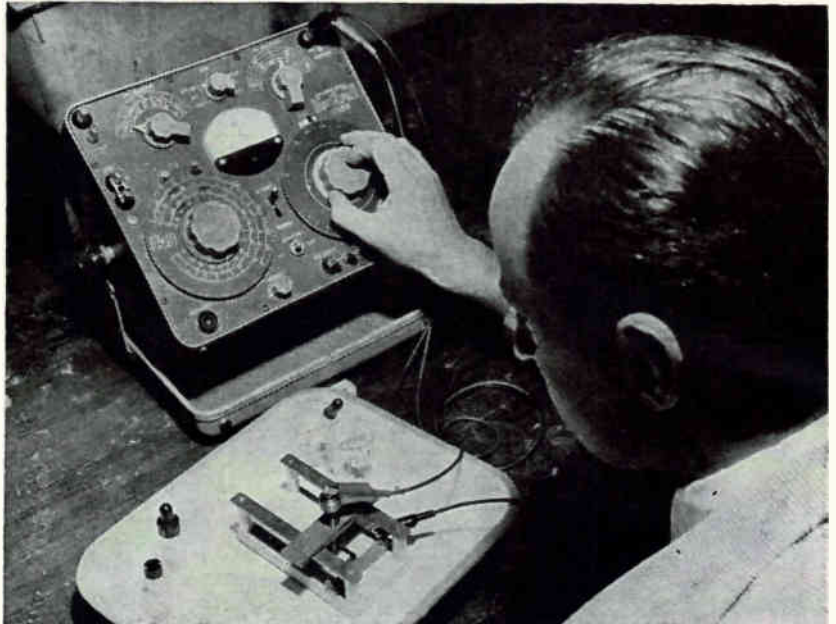

FIG 1—NRA approach to capacitor design is based on determination of figure of merit for dielectric material. Here, engineer tests prototype model

various classes of films can be assembled without disrupting the system within the film-forming chamber.

Conventional thin film techniques

consist of evaporating or sputtering the bulk material in a vacuum chamber to produce the film. Many bulk materials are refractory in nature and are difficult to sputter

SOME MOLDING MATERIALS USED IN SHELLS*

PROPERTY	Phenolic MFE ^b	Alkyd MAG ^b	Diallyl Phthalate			Epoxy	
			MDG ^b	SDG ^c	SDI-5 ^b	Mineral ^d	Mineral Glass ^e
Compressive strength, psi.....	15,000	15,000	18,000	22,000	18,000	22,800	25,000
Flexural strength, psi.....	8,000	7,500	6,800	10,300	8,000	10,900	10M-15,000
Tensile Strength, psi.....	4,200	3,500	4,000	5,500	3,500	5,600	7,000
Dielectric strength							
short-time.....	325	375	325	425	325	400	330
step-by-step Volts/mil.....	275	325	275		300	375	350
Dielectric breakdown kv.....	45	40	40	66	45	59+	62
Volume resistivity, megohms							
158F 100% RH.....	2.0 ^f	2.0 ^f	6.4x10 ⁸	100	2,000	5,000
Surface resistance, megohm							
158F 100% RH.....	5.0 ^f	5.0 ^f	6.0x10 ⁸	100	2,000	5,000
Water absorption, 48 hours 122 F.....	0.10	0.50	0.70	0.30	0.50	0.35	0.20

a—EDITORS NOTE: This chart, supplied by S. Ringel of Epoxy Products, is a revised version of the chart presented in ELECTRONICS, July, 7, p 70, with added material (see "Comment", p 6). Values presented cannot be interpreted as comparative since three criteria are involved: minimum values required for

a particular military specification; government test results; and data sheets supplied by one company.

For use in molding preformed shells, the materials should be evaluated in their specific applications only after careful appraisal of the test conditions.

b—Minimum values per MIL-M-14F except water absorption which is maximum average.

c—Company A Government Test results.

d—Company B Government Test results.

e—Company A data sheet values.

f—Measurements on a 4 inch disk, 1/8 inch thick.

this new

CLECO

number **3** screwdriver

weighs only 12 ounces (just a few ounces more than a manual screwdriver). It delivers the famed Clecomatic accuracy to meet the most exacting production specifications.

Let your nearby Cleco representative customize this fully automatic tool to your precise torque requirements.

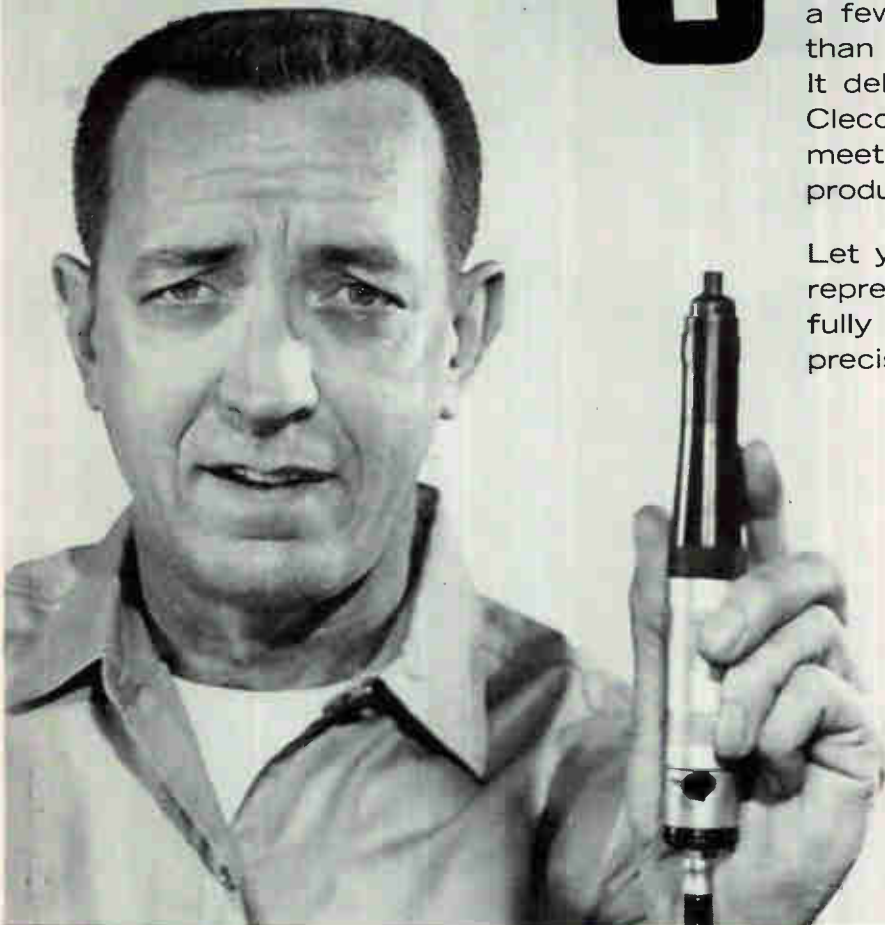

"quality tools engineered for industrial progress"



A DIVISION OF REED ROLLER BIT COMPANY
P. O. Box 2541 • Houston 1, Texas

IN CANADA: Cleco Pneumatic Tool Company of Canada
927 Millwood Road, Toronto 17, Canada



here — at last
is real stability!

0.01% total — from this new transistorized power supply

Add up *all* the factors: line and load regulation of 0.0005%; short-term drift of 0.001%; and, hum and noise of 50uv rms. Result: total stability of 0.01%!

Krohn-Hite's new Model UHR-T361 transistorized power supply is an important new bench supply for development, measurement and research. Its phenomenal stability also makes it ideal for component tests, and powering computer circuits.

Voltage range: 0-36 volts. Current: 0-1 ampere. AC output impedance: 250 microhms. Transient response: 25 usec. Line voltage: 115/230; 50-400 cps.

The extremely tight line and load regulation of the Model UHR-T361, plus its remote sensing feature, permit remote operation with better regulation at 100 feet, 0.001%, than most other supplies at their terminals. The supply also features remote voltage control for automatic programming.

Constant voltage or constant current can be obtained from this supply. The voltage is constant under pulsed or steady-state resistive or reactive loads. The current is constant to within 0.01%.

Krohn-Hite's new UHR-T361 is convection-cooled, and fully protected against short-circuit, overvoltage, overtemperature, and on/off voltage surges.

Get full information on the UHR-T361, and the 3, 5, and 10 amp Krohn-Hite transistorized power supplies.

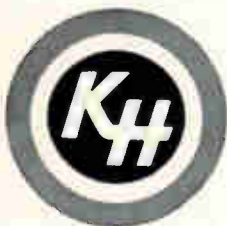

KROHN-HITE CORPORATION

580 Massachusetts Avenue • Cambridge 39, Mass.

Pioneering in Quality Electronic Instruments

or evaporate. In addition, impurities present in the bulk material can affect the parameters of the deposited film.

The NRA technique involves generating a plasma of the bulk material in a vacuum chamber and forming the thin films on the substrate at low temperatures. These films have controllable characteristics and can be deposited to controlled depths and uniformities. Present thickness tolerances is 0.1 micron. Thin films can be prepared from titanium dioxide, lead titanate, and similar materials.

Early experimental capacitors having lead titanate dielectrics have been produced with capacitances of the order of 50 microfarads per square inch. Dissipation factors are low and minimum breakdown voltage for the thinnest films is around 10 volts. Measurements indicate dielectric constants over 100.

The company reports the new filming technique can also produce optical quality multilayer dielectric films on optical components for use in optical systems; an interesting twist as thin film techniques historically stem from the evaporated film processes used for coating precision optics.

Company approach to thin film capacitor design is based on a figure of merit for dielectric materials that combines the most important properties: dielectric constant, power factor, resistance, and voltage breakdown. By considering all of these factors and giving each the proper weight the design engineer can arrive at a figure of merit for the material under test. This approach allows a wide latitude in research and extends the range of materials which may be con-

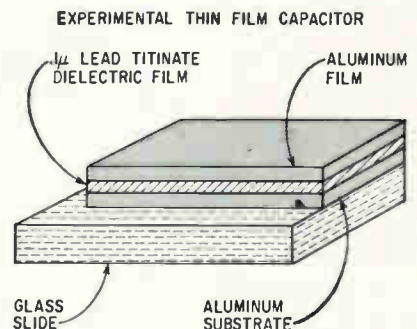

FIG. 2—Experimental thin film capacitor is deposited on glass slide. Thicknesses of layers are not to scale

sidered beyond those presently familiar to the capacitor designer.

The company reports that physical characteristics and intrinsic properties of thin films will often differ considerably from the bulk properties of the same material. As capacitor parameters will show these differences and effects of variation in stoichiometry, an intensive company research program is aimed at determining thin film properties. X-ray diffraction analysis, electron microscope analysis, and absolute thickness determinations are currently under way to characterize thin films in detail.

New Ceramic for Substrates

THE FOLLOWING PROPERTIES of a new translucent magnesium oxide, developed by Minneapolis-Honeywell, point up interesting applications in insulation and heat conduction:

Specific gravity, 3.50 to 3.56 g/cc
Melting point, 2,800 C
Specific heat, > 0.23 cal/gm
Thermal conduct, 0.08 cal/sec/C/cm²/cm
Coef of expan, 13.9×10^{-6} deg C
Compress strength, 100,000 psi or higher
Modulus of rupture, 33,000 psi, improved by acid polishing up to 45,000 psi
Modulus of elasticity, 30.5×10^6
Dielect const, about 9 at 1 Mc (at 100 Kc and 1 Meg)
Loss factor, approx 0.0004 (at 100 Kc and 1 Meg)

Components, mounted on this insulation material would solve shorting-out problems. And the conductivity characteristics would help solve the problem of how to dissipate heat from the active elements.

However, Robert D. Fenity, who is in charge of Honeywell's ceramics laboratory, said they were not yet ready to offer this nontoxic ceramic to industry in production quantities.

The ceramic is made by a normal ceramic process, using a high grade magnesium carbonate. The powder is heated to 1,000 deg C to decompose the carbonate ($MgCO_3$) to the oxide.

NEW FROM T/I

CLOCK PULSE GENERATORS

Very Fast Repetition Rates
(UP TO 100 MEGACYCLES)

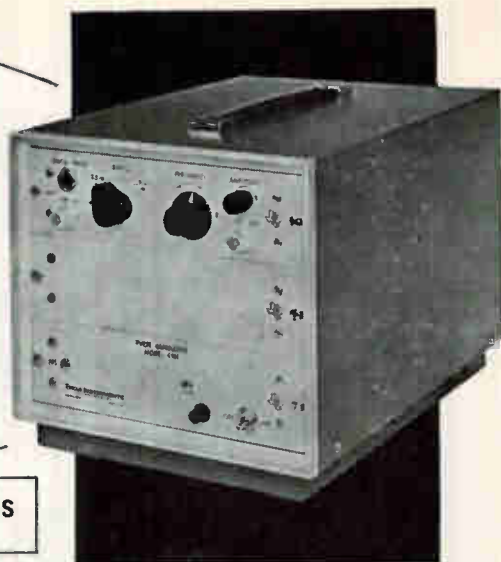

Texas Instruments 6100 Series Clock Pulse Generators include models offering repetition rates from 100 cps to 100 MC. Provision is made for external drive input for single pulse and to permit operation of several generators from master source. All models have pulse width of less than 8 nanosec at one-half pulse height and rise times of 4 nanosec; 0-4 V continuously variable amplitude; 93-ohm output impedance.

Write for complete information.

APPARATUS DIVISION
PLANTS IN HOUSTON
AND DALLAS TEXAS



TEXAS INSTRUMENTS
INCORPORATED
3609 BUFFALO SPEEDWAY
P. O. BOX 66027 HOUSTON 6, TEXAS

461

CIRCLE 202 ON READER SERVICE CARD

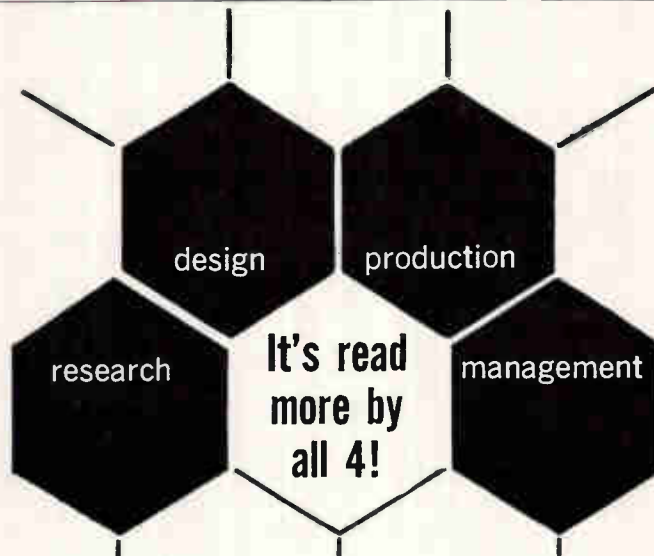

There's more data in **electronics**, the magazine that gives you the latest technical and engineering information every week *plus* business and government trends. Subscribe now. Mail the reader service card (postpaid) to **electronics**, the magazine that helps you to know and to grow! Rates: three years for \$12, one year \$6, Canadian, one year for \$10; foreign, one year for \$20. Annual **electronics BUYERS' GUIDE** (single issue price \$3.00) included with every subscription.

subscribe today to **electronics!**

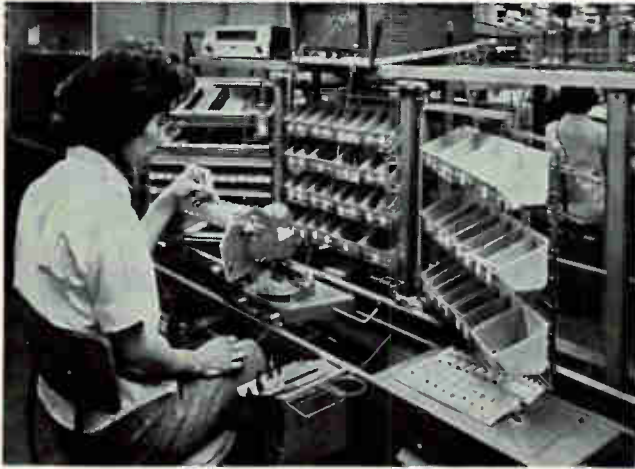

Parts bin numbers are integrated with audio-visual instructions. Operator, listening with earphones to instructions, sets own pace. Work holder moves on rails

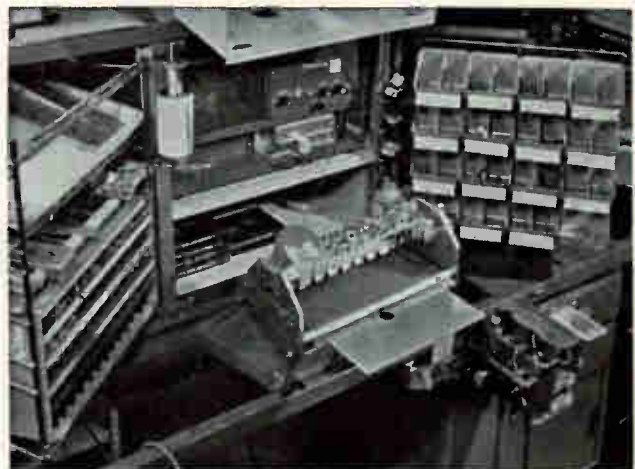

This station has fewer bins and audio-visual unit mounted at eye level. Note consecutive numbering of bins and handy grouping of all tools

Audio-Visual Aids Speed Assembly 40 Percent

WORK STATION which takes full advantage of audio-visual assembly aids and procedures has been devised by General Dynamics Corp., Pomona, Calif. (formerly Convair). The firm reports that the audio-visual stations speeds the production of specific complex electronic assemblies by at least 40 percent over conventional methods, while reducing reject rates.

Design of the work station evolved from a study of lighting, human factors, part and tool holders, storage bins and work simplification procedures. While the station contains several features which facilitate hand assembly, the most important one is the method of gearing part supplies to the audio-visual instructions.

All small components and parts (resistors, capacitors, tubes, nuts, bolts, screws, etc.) are kept in bins at the right of the operator. The parts are numbered in accordance with audio-visual instructions. Bin height and distance are adjustable for each operator.

The bins are numbered in consecutive order of assembly to eliminate confusion. If the slide or tape calls for a part in a particular bin, the operator does not have to know the name of the part or its function. For example, if the slide calls for

part "P-10", it will be found in bin P-10.

At the left of the operator are bins containing wires, labeled W-1, W-2, etc. Again, the operator receives only an instruction to use wire from a specific bin, not a particular type of wire. Since assemblers do not have to identify resistor values, wire color, codes, hardware types, or to read and understand blueprints, the amount of technical skill and training time required is lowered.

The work-holding fixture is mounted on rails so it can be positioned by the operator at the most comfortable working distance. The tool itself is adjustable so the work can be placed in any axis for correct working angle.

Hand tools are kept in racks next to the operator's right arm for easy access, eliminating stooping, straining and reaching. Soldering wire or other materials on spools are kept on one of the two uprights at the center of the work station. On the other upright are holders for the small bottles of anti-fungus varnish, flux and other liquids.

The heart of the station is the audio-visual unit which narrates the step-by-step assembly procedure and shows color slides of each operation. The slides and tape are

controlled by the operator, preventing any arbitrary speedup. Each operator works at his own pace.

The estimate that audio-visual procedures cut production time 40 percent was determined by the following test (the unit assembled during the test was an electronic instrument for the Tartar missile. The Pomona plant also produces Terrier and is developing Redeye and Mauler):

Two experienced assemblers who had never fabricated the complete unit and two new assembly oper-



Swing-out bin frame allows each operator to adjust bins for easiest reaching

ELECTROMAGNETIC COMPATIBILITY ANALYSIS

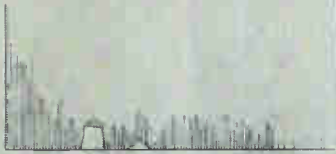

Here is your opportunity for professional growth in a challenging and extremely interesting field, as a member of an outstanding and stimulating scientific team. Armour Research Foundation, specialist in electronic interference evaluation, is now expanding its facilities and staff requirements in the area of Electromagnetic Compatibility Analysis. We are looking for qualified electronic engineers at all levels (B.S. through Ph.D.) for research and applied studies concerned with system analysis and performance prediction. Immediate openings are available at either our *Chicago* or *Washington, D. C.* area facilities for individuals with experience in one or more of the following fields . . .

**RADAR AND
COMMUNICATION
SYSTEM ANALYSIS**

**RADAR MEASUREMENT
TECHNIQUES**

PROPAGATION ANALYSIS

In addition to the cited professional status, staff members receive attractive salaries, up to four weeks vacation, generous insurance and retirement benefits, and tuition paid graduate study. If you are interested in one of these professional opportunities, please reply in confidence to Mr. R. L. Plimpton.

**ARMOUR
RESEARCH
FOUNDATION**

ELECTROMAGNETIC COMPATIBILITY
ANALYSIS CENTER, ANNAPOLIS, MARYLAND

NEW FROM T/I

PROGRAMMED PULSE GENERATOR

Highest Repetition Rates
(UP TO 25 MEGACYCLES)



Texas Instruments 6200 Series provides signals at higher repetition rates than previously available, for applications in high speed logic circuit and memory system development. Ten pulse times are selectable in any combination for each of the two outputs by front panel controls. Other performance specifications similar to the 6500 Series. All TI Pulse Generators use solid state circuitry and modular construction for reliability and versatility.

WRITE FOR COMPLETE INFORMATION.

APPARATUS DIVISION
PLANTS IN HOUSTON
AND DALLAS, TEXAS



TEXAS INSTRUMENTS

INCORPORATED
3609 BUFFALO SPEEDWAY
P. O. BOX 66027 HOUSTON 6, TEXAS

CIRCLE 203 ON READER SERVICE CARD ⁴⁵³

Electroplated
WIRES



Special equipment, built in our own plant, permits us to plate wire continuously... Our electroplates are consistently uniform and well bonded to the base wire... Wires for electrical contacts — in a range of diameters — may be plated with Rhodium, Gold or Platinum... Electrical contacts for handling currents at very low voltages, can be made from our wire, with the greatest reliability.

Write for Brochure

SIGMUND COHN MFG. CO., INC.

121 SO. COLUMBUS AVE., MOUNT VERNON, N. Y.

SIGMUND COHN CORP. OF CALIFORNIA • 151C N. Maple St., Burbank, Cal.





TEMP-R-TAPE®

pressure-sensitive Teflon*

**CLASS H INSULATION
FOR -100°F TO 500°F APPLICATIONS
POSSESSES EXCELLENT ELECTRICAL
AND MECHANICAL PROPERTIES**

Choose the right Temp-R-Tape for your job from a variety of types which combine some form of Teflon*, Fiberglas or Silicone Rubber backing with a silicone polymer adhesive. Temp-R-Tapes are all pressure-sensitive, even those which are thermal curing, and adhere securely to most materials, including Teflon, at extremely high temperatures. Each of these versatile tapes possess a superior combination of electrical, mechanical and physical properties suitable for a variety of applications where high dielectric strength, thermal stability, moisture resistance, durability, low coefficient of friction, non-stick properties, non-corrosiveness, non-aging characteristics or fuel resistance may be required.

TYPICAL USES:

ELECTRICAL — slot lining; interlayer and interphase insulation; harness bundling; splicing; wrapping for microwave components, transformer coils, capacitors and high voltage cables.

MECHANICAL — facings for film guides in electronic instruments, heat sealing bars, chutes, guide rails, and for protection for metals and other materials being chemically cleaned or coated.

AVAILABLE FROM STOCK:

¼" to 2" widths, 18 yd. and 36 yd. rolls and 12" width on liner by lineal yard. Special roll widths slit to order. Temp-R-Tape is sold nationally through distributors.

FREE SAMPLE and folder — write, phone or use inquiry service.

ELECTRICAL AND INDUSTRIAL SPECIALTY TAPES



CONNECTICUT HARD RUBBER CO.

*duPont TM

Main office: New Haven 9, Connecticut

ators were selected. The new assemblers, using the audio-visual station, required 10 hours to produce the first unit. By the fourth unit, their production time had dropped to six hours. The other operators, given normal training, required 10 hours for the first unit and after producing five units still required nine to 10 hours per unit.

At the end of the test, which lasted two weeks, all four assemblers asked to be assigned permanently to the new work stations.

Plastic-Sheathed Bus Bars Simplify Wiring

BUS BARS ASSEMBLED in plastic sheathing are used by Electronic Associates, Inc., Long Branch, N. J., to simplify wiring and wiring modifications in computer systems. In addition to facilitating harness installation, the bars make it easier to add or change operational units without soldering or unsoldering to ground or common supplies.

The sheathing is made in long,

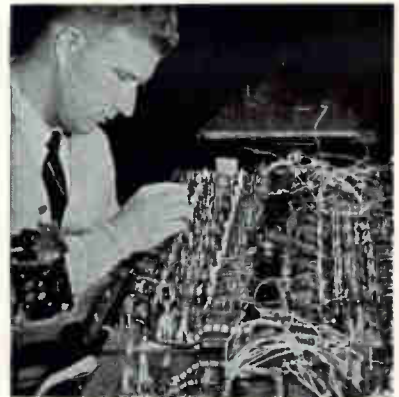

Technician connects complex wiring of computer back panel

extruded lengths and cut to size. In cross-section, they have six vertical slots, nearly closed on top by flares in the vertical ribs. Buses, cut slightly shorter, fit into the slots. The plastic covers the bottom and sides of each bus, and overlaps and extends beyond the bus top. It is almost impossible to short across two buses with tools or wiring.

Buses are prepared with taper-pin holes at intervals of about three-quarters of an inch. Pins on the ends of harness or other wiring are force-fitted into the holes with

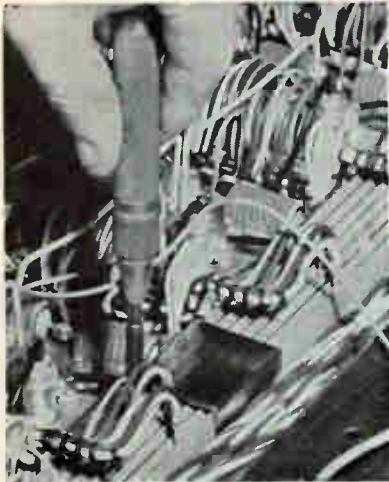

This photo shows use of pin inserter, plastic sheathing and identifying clip

a spring-loaded tool. The wires are color-coded to signify the bus to which each should be connected. Generally, only about half the taper-pin holes are filled during the basic assembly, leaving technicians ample entry for custom requirements.

Metal hold-down clips are placed over the bus assemblies to bolt them to the panel. Wider clips, not bolted, are used to identify the buses. These clips are printed with identifying codes aligned with the corresponding bus. The clips can be relocated as needed to clear taper-pin holes.

Quick-Mix Adhesive



Saran tubes serve as both mixer and applicator for a two-part epoxy adhesive made by Armstrong Cork Co., Lancaster, Pa. The larger tube contains the resin. In the resin is a small tube containing the catalyst. Squeezing breaks the small tube and kneads the catalyst into the resin. The end of the larger tube is snipped off and it is used as the applicator

NEW FROM T/I

VARIABLE WIDTH PULSE GENERATOR

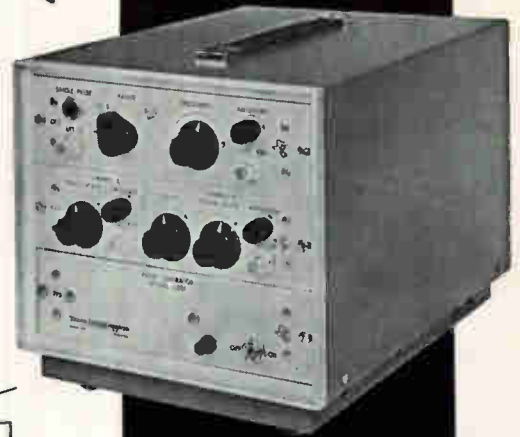

Continuously Variable
Pulse Width and Delay

The 6500 Series includes the features of Texas Instruments 6100 Series plus additional outputs with continuously variable delay from 0-1000 nanosec. All outputs provide controls for continuously variable pulse width from 20-1000 nanosec up to 90% duty cycle. Output amplitude is 0-5 V; rise times of 5 nanosec; repetition rates up to 25 MC.

WRITE FOR COMPLETE INFORMATION.

APPARATUS DIVISION
PLANTS IN HOUSTON
AND DALLAS, TEXAS



TEXAS INSTRUMENTS
INCORPORATED
3609 BUFFALO SPEEDWAY
P. O. BOX 66027 HOUSTON 6, TEXAS

462

CIRCLE 204 ON READER SERVICE CARD

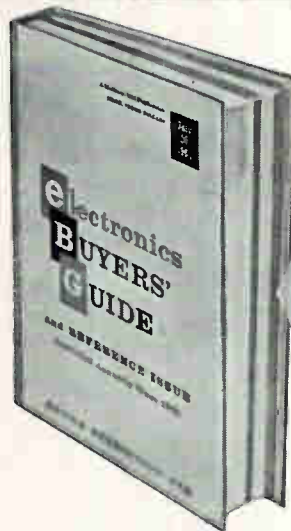

Seen
the new
**IDEA
INDEX
IN EBG?**

The INDEX to the editorial articles in electronics magazine, previously published annually in a December issue, now appears ONLY in the EBG. Another original EBG idea that saves time and trouble for users! Keep your EBG copy on your desk!

EXTRA!

Also in the EBG are condensed ABSTRACTS of all the editorial feature articles which have appeared to date in 1961. Another reason why EBG is used more by all four - men in research, design, production and management.



McGraw-Hill Publication,
330 West 42nd St., New York 36, N. Y.



New On The Market



Infrared Radiation Test Set UNIVERSAL INSTRUMENT

BARNES ENGINEERING CO., 30 Commerce Road, Stamford, Conn. Model 16-110 infrared radiation test set is a complete radiometric measuring system designed to test or evaluate optical systems, detectors or detector electronics, and to determine the effects of changes in configura-

tion. It can also be used as a radiometer or radiation detecting device. Basic test set consists of a motor-chopper assembly, a detector-pre-amplifier assembly and a synchronous rectifier amplifier unit.

CIRCLE 301 ON READER SERVICE CARD

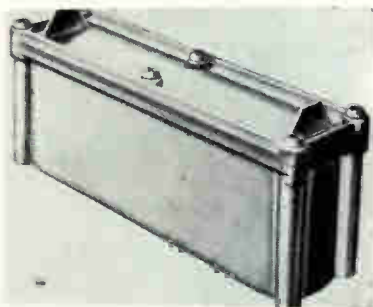

R-F Module LOW LEAKAGE

TRIDEA ELECTRONICS, INC., 1020 Mission St., S. Pasadena, Calif., announces model 217 low leakage r-f module. Basic module consists of a die-cast aluminum box and cover assembly. A circuit board of either tin plated aluminum or copper clad epoxy resin is bolted to the center of the cover plate. All connections are made through connectors in the cover plate. Leakage level with oscillator out of box is 80 db above 1 μ v. With cover and gasket in place, leakage level is reduced to below the receiver threshold level of 1 μ v or - 127 dbm.

CIRCLE 302 ON READER SERVICE CARD

Sonic Doppler System FOR AIRCRAFT

GULTON INDUSTRIES, INC., 212 Durham Ave., Metuchen, N. J. An airborne ultrasonic doppler system measures a flight vehicle's velocity during the last 18 in. of vertical descent. Velocity is recorded on an airborne recorder. System features three ultrasonic transducer units mounted on the nose and main landing gear. The transducers bounce a frequency controlled signal off the runway reflecting surface and receive the return signal. The doppler shift produced in the instrument is a function of closure rate.

CIRCLE 303 ON READER SERVICE CARD

Underwater Electronics TELEMETRY, SONAR

THE BENDIX CORP., Pacific Division, 11600 Sherman Way, N. Hollywood, Calif., has introduced a system that combines telemetry with sonar to provide cableless underwater communication. A range of up to 5 miles with 1 percent accuracy has been achieved, with as many as 10

continuous subcarrier channels. Data information frequency modulates subcarrier oscillators, which in turn frequency modulate a carrier. The carrier operates on any IRIG channel from 10.5 Kc to 52.5 Kc.

CIRCLE 304 ON READER SERVICE CARD

Printing Tube ELECTROSTATIC CHARGE

SYLVANIA ELECTRIC PRODUCTS INC., 730 Third Ave., New York 17, N. Y. An 8½ in. electrostatic charge printing tube reproduces charts, photographs, numbers and words at the rate of 10,000 lines per minute. Type SC-3075 tube uses magnetic

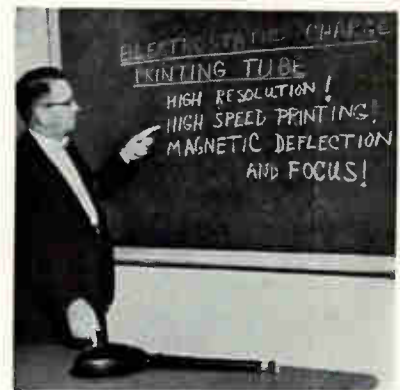

deflection and focus. Writing area of the tube face plate consists of 85,000 wires, 0.001 in. in diameter, spaced 250 wires per in.

CIRCLE 305 ON READER SERVICE CARD

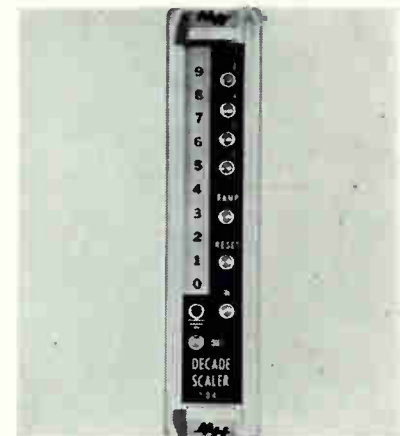

Counter Module COUNT-TO-TEN DEVICE

HARVEY-WELLS ELECTRONICS, INC., 14 Huron Drive, Natick, Mass. This decade scaler utilizes the 8-4-2-1 binary code to count random serial pulses at any rate up to 1 Mc. Any

electronics fills you in on every phase of the electronics industry each week featuring engineering and technical data every issue. Latest economic trends, technically interpreted, to help you make sound plans. Facts you'll want to file and keep. Subscribe now. Mail the reader service card (postpaid) to **electronics**, the magazine that helps you to know and to grow! Rates: three years for \$12, one year for \$6; Canadian, one year for \$10; foreign, one year for \$20. Annual **electronics BUYERS' GUIDE** (single issue price \$3.00) included with every subscription.

it's read
more by
all 4!

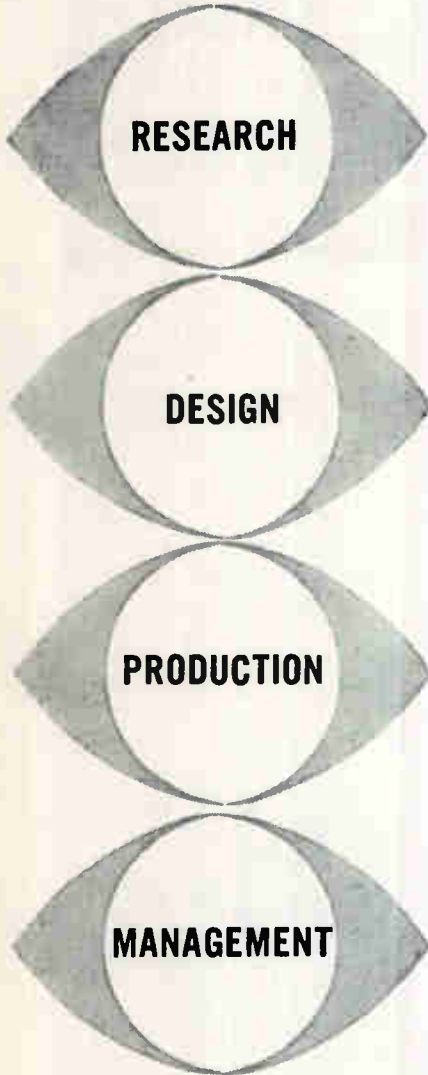

SUBSCRIBE TODAY TO
electronics!

September 1, 1961

NEW FROM TI

HIGH SPEED A-D-A CONVERTER

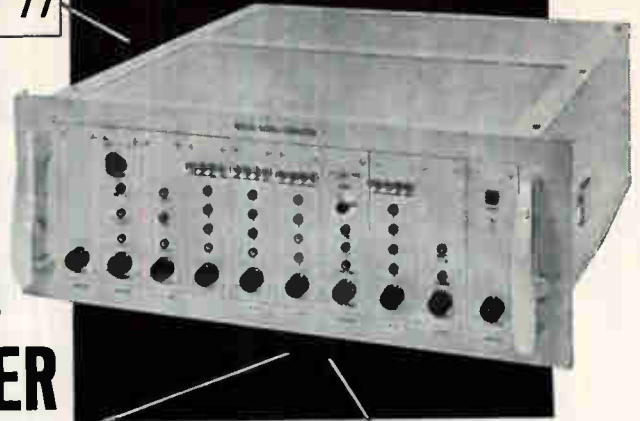

1.5 μ sec per bit

All solid state circuitry

Texas Instruments Model 430 Analog-Digital-Analog Converter, a high speed, all solid state instrument, combines an exceptionally fast conversion time with high accuracy and wide dynamic range. The basic speed (analog-to-digital) is 1.5 microseconds per bit plus 4.5 microseconds per conversion; accuracy is $\pm 0.1\%$ of the input voltage or ± 2 mv, whichever is greater. Dynamic range of the instrument is above 80 db if the full complement of 14 bits (including sign) is specified.

Write for complete information.

APPARATUS DIVISION
PLANTS IN HOUSTON
AND DALLAS TEXAS



TEXAS INSTRUMENTS

INCORPORATED
3609 BUFFALO SPEEDWAY
P. O. BOX 66027 HOUSTON 6, TEXAS

445

CIRCLE 205 ON READER SERVICE CARD

Heyco Nylon BUSHINGS



STRAIN RELIEFS
The insulating bushing that anchors a cord set to an electrically operated machine or appliance.



JUNCTION-TERMINAL BUSHINGS

Eliminate "pig-tails" — Miniature size. Snap-in assembly, color or number coded. Can be used as plug-in receptacle. Simple quick disconnect.

ACCORDIAN TYPE

Fit curved surfaces
Nylon bushing — brass tab

HEYCO Nylon Snap Bushings

10 Sizes for holes from $\frac{1}{8}$ " to $1\frac{1}{2}$ " dia. — various inside diameters. Snap locks into panels up to $\frac{3}{8}$ " thick.



FREE SAMPLES! BUSHINGS OF YOUR CHOICE

HEYMAN
MANUFACTURING COMPANY
KENILWORTH 3, NEW JERSEY

CIRCLE 206 ON READER SERVICE CARD

CHANGEOVER PW Boards

FROM THIS



TO THIS

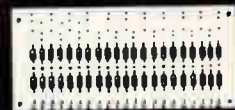

in SECONDS!

Dynasert Component Inserting Machine lets you change from one board type to another in seconds. Little or no retooling, sample runs can be made easily, operator training simplified. And once set up, inserting rates are up to ten times faster! All this plus more accurate and reliable insertions. Send for the cost-saving facts and figures, today. Dynasert Dept., United Shoe Machinery Corp., Boston, Mass.

United

UB 1-69

DYNASERT

CIRCLE 63 ON READER SERVICE CARD

63

number of the units can be cascaded by means of front panel connectors to accommodate counts of any desired length. At the end of any counting, total count in all in-

terconnected scalers is visually displayed on the front panels by neon-lighted decimal digits.

CIRCLE 306 ON READER SERVICE CARD



A-C/D-C Converter-Voltmeter HANDLES LOW LEVEL AND L-F INPUTS

HOUSTON INSTRUMENT CORP., P. O. Box 22234, Houston, Texas. Model HVC-30 a-c/d-c converter-voltmeter provides 25 μ v resolution on lowest scale with only 0.5 percent ripple down to 5 cps. The instrument may

also be used as a 1 percent a-c vtm. Calibration voltages of 0.1 percent are provided on the panel to permit rapid compensation for output loading or long term amplifier drift.

CIRCLE 307 ON READER SERVICE CARD

Frequency Comparator HIGHLY ACCURATE

PIONEER MAGNETICS INC., 850 Pico Blvd., Santa Monica, Calif. The frequency comparator Magacycler is a completely static, self-contained precision detector that produces a d-c voltage or current output whose polarity and magnitude depend on the difference in frequency between two input signals. Difference scale expansion ratios range up to 10/1. Standard outputs available are 0-1 and 0-5 v d-c filtered, 0-50 μ a fil-

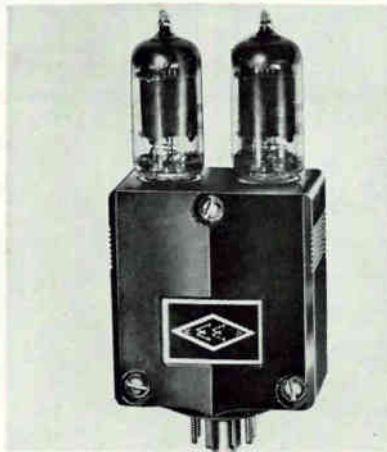

D-C Amplifier OPERATIONAL TYPE

EMBREE ELECTRONICS CORP., 993 Farmington Ave., West Hartford 7, Conn. Model C/100/B is an octal-base plug-in operational d-c amplifier for analog computer and instrument uses. Gain is 30,000 d-c open loop. Bandwidth is over 400 Kc with 0.6 μ sec rise time as unity inverter. Output 3 ma over \pm 100 v d-c; may be short-circuited without damage.

CIRCLE 309 ON READER SERVICE CARD

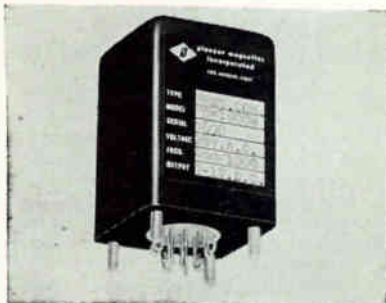

tered and 0-1 ma unfiltered. Seven standard models cover the a-f range to 14,000 cps.

CIRCLE 308 ON READER SERVICE CARD

Switch Actuators LONG LIFE

BAYSIDE TIMERS, 43-69 162nd St., Flushing 58, N. Y., announces two switch actuators that allow on or off from 0 through 350 deg, in contrast to the usual method of using two 180 deg cams, back to back. Model A uses a heavy silver contact rated at 1,500 w incandescent. When used at speeds between 1 and 60 rpm the mechanical life expectancy is over 100,000,000 operations. Model B features a snap switch for applications slower than 1 rpm.

CIRCLE 310 ON READER SERVICE CARD

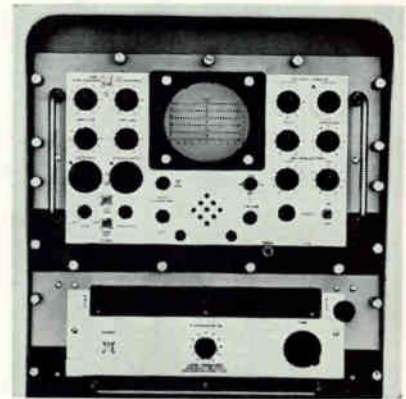

Spectrum Analyzer WIDE RANGE

LAVOIE LABORATORIES, INC., Morganville, N. J. The LA-21 features a wide operating range of 10 to 1,180 Mc in conjunction with very narrow resolution and high sensitivity. It can discriminate between signals separated in amplitude by as much as 80 db, and by as little as 50 Kc in frequency, and by as much as 90 db at 150 Kc separation.

CIRCLE 311 ON READER SERVICE CARD



Electronic Relay SOLID STATE

K-F PRODUCTS, INC., 3100 E. 43rd Ave., Denver 16, Col. Model 120 re-

lay eliminates the need for a separate d-c power supply. It is an all-transistor unit with 25 v, 150 ma d-c output for use with 60-cps a-c, or d-c inputs. The turn-on point is adjustable from 3 to 150 v input by a sensitivity control. An independent hysteresis control is used to determine the relay turn-off point.

CIRCLE 312 ON READER SERVICE CARD

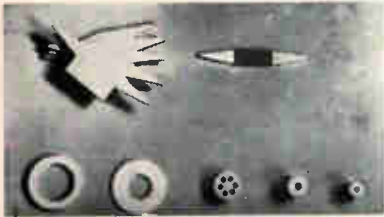

Dielectric Material HIGH TEMPERATURE

CUSTOM COMPONENTS, INC., P. O. Box 248, Caldwell, N. J. CMD-3048 is a high temperature dielectric material, available in rods and sheets. It is usable for continuous operation at temperatures as high as 400 F, with a loss tangent less than 0.001 from 20 Mc through 10 Gc. Typical applications are illustrated. Top: blank pieces and a waveguide ferrite support made out of the white dielectric; bottom: typical coaxial supports.

CIRCLE 313 ON READER SERVICE CARD

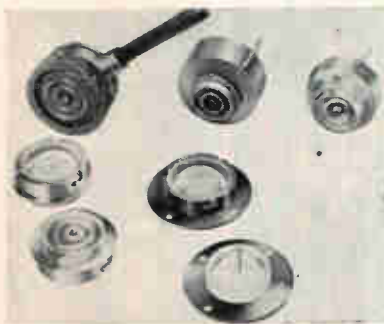

H-V Fittings MINIATURE DEVICES

AMERICAN RESEARCH AND MFG. CORP., 920 Halpine Ave., Rockville, Md., announces h-v, low-loss fittings for use on power supplies, infrared detection units, test equipment, and instrumentation where moderate or low currents are drawn at up to 25,000 v d-c operating potential. Cable assemblies for special applications can be had on short notice.

CIRCLE 314 ON READER SERVICE CARD

Outstanding Missile and Space Openings for Electronic/Electrical Engineers

The Boeing Company, system contractor on the Dyna-Soar manned space glider and weapon system integrator on the solid-fuel Minuteman ICBM, has a number of immediate openings for graduate Electronic/Electrical engineers. These positions, available in areas described below, offer challenge and scope, and exceptional opportunities to advance to higher levels of responsibility and income.

RADIO FREQUENCY INTERFERENCE

Assignments in this area include performing electro-interference tests on military equipment; developing familiarization with RFI specification and compliance requirements; evaluating the physics of generation of electro-magnetic interference and methods of reducing susceptibility to both radiated and conducted interference. Requirements: BSEE degree plus minimum of two years of applicable experience.

ELECTRONICS PACKAGING DESIGN

Duties in this area include evaluation, selection, development and documentation of packaging techniques and systems; evaluation, selection, test and qualification of electronic parts and documenting pertinent engineering information; evaluation, development and application of hardware designs for all types of electronic circuits; design, evaluation and qualification of electronic packaging; selection, design and test of production processes; evaluation, selection, test and qualification of special materials.

Salaries are competitively commensurate with education and experience. Boeing provides travel and moving allowances. In Seattle you'll enjoy the advantages of the uncongested, evergreen Pacific Northwest area, famous for mild year-round climate, unexcelled recreational facilities, modern housing, fine schools and outdoor Western living for the whole family.

Send your resume, today, to: Mr. William B. Evans, The Boeing Company, P. O. Box 3707 - ECF, Seattle 24, Washington. All qualified applicants will receive consideration for employment without regard to race, creed, color or national origin.



NEW Stromberg- Carlson® lightweight telephone handsets



... for a wide range of applications such as dictating systems, mobile radio, carrier and microwave.

These new lightweight Stromberg-Carlson handsets, No. 33 and No. 35, incorporate push-to-talk switches, broadening the range of their applications. Both feature high-gain, high-efficiency transmitter and receiver.

The No. 33 model is furnished with a bar-type switch, located on the underside of the handle.

The No. 35 handset is furnished with a button switch on the side of the handle near the receiver end. Also available with both button and bar switches.

For technical details and ordering information, contact any of these sales offices: Atlanta—750 Ponce de Leon Place, N.E.; Chicago—564 W. Adams Street; Kansas City (Mo.)—2017 Grand Avenue; Rochester—1040 University Ave.; San Francisco—1805 Rollins Rd.

**GENERAL DYNAMICS
/ELECTRONICS**

PRODUCT BRIEFS

PRECISION MILLIVOLT SOURCE direct reading. Monroe Electronic Laboratories, Inc., 7 Vernon St., Middleport, N. Y. (315)

PORTABLE MASERS at X-band. Microwave Technology Inc., 235 High St., Waltham 54, Mass. (316)

INFRARED SOURCE tiny, low-cost. Special Devices, Inc., 16830 West Placerita Canyon Road, Newhall, Calif. (317)

LAB POWER SUPPLY features close dynamic control. Perkin Electronics Corp., 345 Kansas St., El Segundo, Calif. (318)

SILICON TRANSISTOR CHOPPER high voltage. Solid State Electronics Co., 15321 Rayen St., Sepulveda, Calif. (319)

TINY RESISTOR NETWORK thin film. Halex, Inc., 310 E. Imperial Ave., El Segundo, Calif. (320)

DIODE RECOVERY TEST SET automatic readout. Lumatron Electronics, Inc., 116 County Courthouse Road, New Hyde Park, N. Y. (321)

PULSE AMPLITUDE DISCRIMINATOR, SHAPER transistorized. Franklin Systems, Inc., 2734 Hillsboro Road, West Palm Beach, Fla. (322)

POWER SUPPLIES high temperature. Orion Electronic Corp., 108 Columbus Ave., Tuckahoe, N. Y. (323)

SPECTROMETER electron spin resonance. Alpha Scientific Laboratories, Inc., P. O. Box 333, Berkeley 1, Calif. (324)

RFI MEASURING EQUIPMENT covers 1 to 10 Gc. Stoddart Aircraft Radio Co., Inc., 6644 Santa Monica Blvd., Hollywood 38, Calif. (325)

L-V REFERENCE SERIES for voltage clipping, limiting. Semiconductor Specialists, Inc., 5706 W. North Ave., Chicago 39, Ill. (326)

ENVIRONMENTAL CAP for printed-circuit connectors. Modular Electronics, 6211 S. LaBrea Ave., Los Angeles 56, Calif. (327)

MICROMAVE SIGNAL SOURCES compact, lightweight. Wave Particle, 150 So. Second St., Richmond, Calif. (328)

BUILD-YOUR-OWN ELECTRONIC ORGAN

STEP UP TO AN

Artisan

GREATEST
NAME IN
ORGAN KITS

20TH CENTURY
SUCCESSOR
TO THE
PIPE ORGAN



PIPE-LIKE
TONE AND
APPEARANCE

DIRECT FACTORY
TO OWNER
SAVES 50%



PAY-AS-YOU
BUILD

STEP-BY-STEP
INSTRUCTIONS
HOME, CHURCH
AND CONCERT
MODELS

2-3-4 MANUALS
FROM
\$1,750 to \$12,500



WORLD'S LARGEST SELECTION OF ORGAN KITS,
ACCESSORIES AND CUSTOM-BUILT ORGANS

Send for FREE literature

DORSETT ELECTRONICS, INC.

ELECTRONIC ORGAN DIVISION

4949 X YORK BLVD., LOS ANGELES 42, CALIF.

CIRCLE 207 ON READER SERVICE CARD

SNAP ACTION SWITCHES ANNUNCIATORS

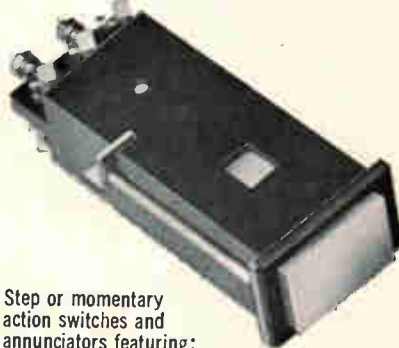

Step or momentary
action switches and
annunciators featuring:

Simple, functional design • Mounting independent of panel thickness • Front of panel lamp replacement • Highest quality construction • Screens in six colors 0.25A - 220 V.D.C. current capacity • 5A - 220 V.A.C. current capacity • Extreme long life

Prices in unit quantities from \$5.00 to \$9.00

Precision rotary switches,
snap action switches and annunciators

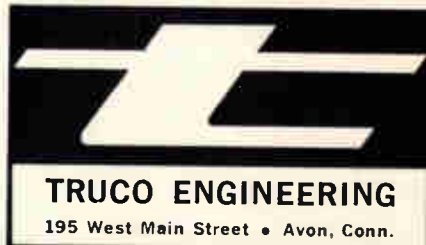

CIRCLE 208 ON READER SERVICE CARD
electronics

Literature of the Week

MEASUREMENT INSTRUMENTS Sensitive Research Instrument Corp., 310 Main St., New Rochelle, N.Y. Volume 28, No. 6 of *Electrical Measurements* describes a radio frequency voltage calibrator and a three phase volt-amp-watt-meter. (329)

BIOLOGICAL COMPUTER Mnemotron Corp., 47 S. Main St., Pearl River, N.Y. Bulletin C-1 gives operational and application information on a portable biological digital on-line computer. (330)

CONTROL PANELS Bodnar Products Corp., 238 Huguenot St., New Rochelle 2, N.Y., has prepared a concise technical bulletin on control panels that exceed MIL-P-7788A requirements. (331)

CONTROL SYNCHROS Vernitron Corp., 125 Old County Road, Carle Place, L.I., N.Y. Bulletin illustrates and describes in detail control synchros size 23, for 400 cycle operation, engineered and manufactured to meet military specifications. (332)

TRIMMING POTENTIOMETER Techno-Components Corp., 18232 Parthenia St., Northridge, Calif., has issued a two-page catalog sheet on a precision 3/8 in. square trimming pot with a resistance value up to 50,000 ohms. (333)

SCREEN ROOMS Erik A. Lindgren & Associates, Inc., 4515 N. Ravenswood Ave., Chicago 40, Ill., announces literature on a 3 oz solid copper r-f shielded room built in demountable sections. (334)

MOLDING COMPOUNDS American-Marietta Co., 3400 13th Ave., S.W., Seattle 4, Wash., has available a bulletin molding with EMC 90 epoxy molding compounds. (335)

COMPONENT OVENS Monitor Products Co., Inc., 815 Fremont Ave., South Pasadena, Calif. Four-page booklet tells how to specify ovens to control the temperature of crystals, oscillators, transistors and other temperature sensitive components. (336)

PRESSURE TRANSDUCER Taber Instrument Corp., 107 Goundry St., N. Tonawanda, N.Y., has published literature presenting updated in-

formation on the model 206 Teledyne bonded strain gage pressure transducer. (337)

DISPLAY SCREENS Micro Switch, Freeport, Ill. Data sheet 193 covers four display screen types for use with series 2 lighted display and pushbutton switch devices. (338)

SLIP RINGS Slip Ring Co. of America, 3612 W. Jefferson Blvd., Los Angeles 16, Calif., has available a catalog that describes and illustrates slip rings, brush assemblies, rotary switches, and commutators. (339)

C-C TV SYSTEMS KinTel Division of Cohu Electronics, Inc., 5725 Kearny Villa Road, San Diego 12, Calif. General applications of closed-circuit television systems are presented in an 8-page, 2-color catalog (6-205). (340)

MAGNETOSTRICTIVE DELAY LINE Deltime, Inc., 608 Fayette Ave., Mamaroneck, N.Y. Applications data, including specific graphic operational characteristics, definitions and a complete description of the type 192 magnetostrictive delay line are now being offered. (341)

DIODE GATE Rese Engineering, Inc., A and Courtland Streets, Philadelphia 20, Pa. Technical bulletin 60-Q describes the type 2011 DG Logix Block diode gate, a 5-Mc plug-in module. (342)

TERMINAL BLOCKS The Thomas & Betts Co., 36 Butler St., Elizabeth, N.J. A line of solderless terminal blocks for communications, data processing and broadcast equipment is described in a four-page brochure. (343)

POT WINDER AND TENSION Geo. Stevens Mfg. Co., Inc., Pulaski Road at Peterson, Chicago 46, Ill. Bulletin illustrates and describes model 435-AML precision potentiometer winder, and model T-435 tension for winding very fine wire on round mandrels. (344)

CERAMIC TUBES General Electric Co., Owensboro, Ky. Bulletin ETD-2713 deals with the company's line of 20 registered and 15 developmental ceramic tube types. Bulletin ETD-2134 covers small ceramic receiving tubes. (345)

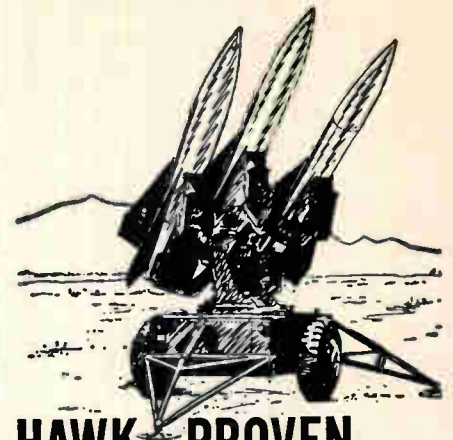

HAWK PROVEN CONNECTORS

LIONEL

Series S-20

Extra Reliability With—

- Shell-Enclosed, Die-Cast Housings
- Diallyl Phthalate Moldings
- Positive Alignment & Polarization
- Minimum Depth in Mated Position
- Beryllium Copper Contacts for Extended Insertion/Withdrawal Life



4 sizes: 13 to 41 high voltage contacts, 2 and 4 coaxial contacts; Meet applicable MIL specs; Materials & specifications modified to meet your special needs.

■ Write Dept. 29-HW for Series S-20 Dimensional Data Sheets



Lionel Electronic Laboratories

(Formerly Anton Electronic Laboratories)

1226 Flushing Ave.
Brooklyn 37, N.Y.



Taishoff: Guide, Don't Push

SCRAPPY VITALITY and an apparently boundless enthusiasm for things that interest him are, perhaps, the outstanding characteristics of Jerome Taishoff, president of Mycalex Corp. of America. These characteristics, developed during a business career which started at the age of sixteen, enable him to manage the affairs of an electronics and materials company, yet make time for an art collection, a philanthropic foundation and a host of other activities.

A recent example of how Taishoff's enthusiasm leads him to espouse causes he believes in centers about the book, "America, Too Young to Die" by Major General De Seversky. Taishoff's feeling that the message of the book was of particularly vital interest to the electronics industry caused him to send autographed copies at his own expense to several dozen company presidents, political figures and publications interested in electronics.

Taishoff's introduction to electronics dates back to about 1929. In that year, he went on a three-week business trip to England. The stay lasted ten years during which time he negotiated on the continent for patent licenses which are still being used by the company he now heads. He became affiliated with a major London brokerage house, and

was at one time the only American transacting business on the London Stock Exchange. During this time he developed his interest in 18th century art and furniture. Some of the results are seen in the office he occupies in New York's Rockefeller Plaza. It is decorated with 18th century masterpieces and furnished in period pieces which include a set of chairs made originally for Clive of India.

The stay in England made a profound impression on him. He still occasionally calls visitors and colleagues, "old boy".

Returning to the U. S. in 1939, he acquired interests in Mycalex and began to make glass bonded mica. By 1941, he had bought the company, which was then a sales subsidiary of Mycalex Co., Ltd. in England. It has been wholly American-owned since then.

Unlike executives whose companies occupy their entire lives, Taishoff finds time for a variety of outside interests. Last year he served on the U. S. Olympics Committee. He is a member of the board of governors of Long Island University and co-chairman of the development council of New York Institute of Technology. He is also a trustee of the Air Force Historical Foundation.

Besides these activities, he is a member of the Metropolitan Opera

Association, the Mayor's Committee for Free Shakespeare in New York, the American Committee on United Europe and the Silvermine Guild of Artists.

His theories on running a business are exemplified by the company he heads. "Hire people who know what they are doing . . . then let them do it. My main function is to set policy and keep the company healthy, not to tell a trained specialist how to do his work. People sometimes need guidance, but they shouldn't be pushed."

He is a strong believer in allowing workers with versatility the leeway of using more than one set of skills and urges his management to give personnel a chance to do more than one kind of job.

His hours of relaxation are spent in a variety of ways ranging from playing with his three grandchildren to gymnastics or a fast game of tennis.



Wainwright Joins Telonic Engineering

TELONIC ENGINEERING CO., Laguna Beach, Calif., announces the appointment of Richard A. Wainwright to the post of chief engineer, filter division.

Prior to joining Telonic, Wainwright was associated with Page Communications as project engineer and later with Rixon Electronics as staff consultant engaged in filter and network design.

Colorado Instruments Names V-P, Engineering

KARL R. WENDT has joined the staff of Colorado Instruments, Inc.,

JANCO MINIATURE

Rotary Selector Switches

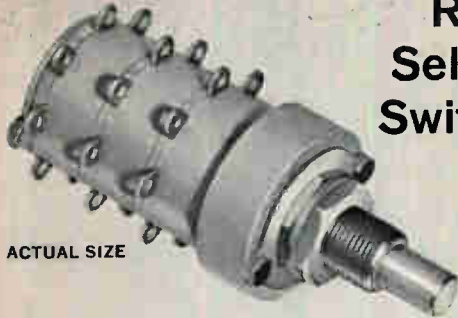

ACTUAL SIZE

SERIES 1900

All Janco switches are designed and built to exceed MIL-S-6807A. Possessing long-life with a high degree of reliability, they exceed the operational and environmental requirements of shock, vibration, altitude, and explosion. Because of their design and construction, all Janco switches are ideally suited for dry circuit and signal level switching applications.

SPECIFICATIONS

Electrical Rating: Make, break, and carry
Up to 5 amps 115V AC and 28V DC resistive,
and 2 amps 28V DC inductive

Contact Positions: 2 to 12 positions

Index: 30°, 36°, 45°, 60°, and 90° indexing

Decks: 1 to 16 decks (single pole)

Write today for complete detailed specifications.

JANCO CORPORATION

3111 Winona Avenue, Burbank, California

CIRCLE 210 ON READER SERVICE CARD

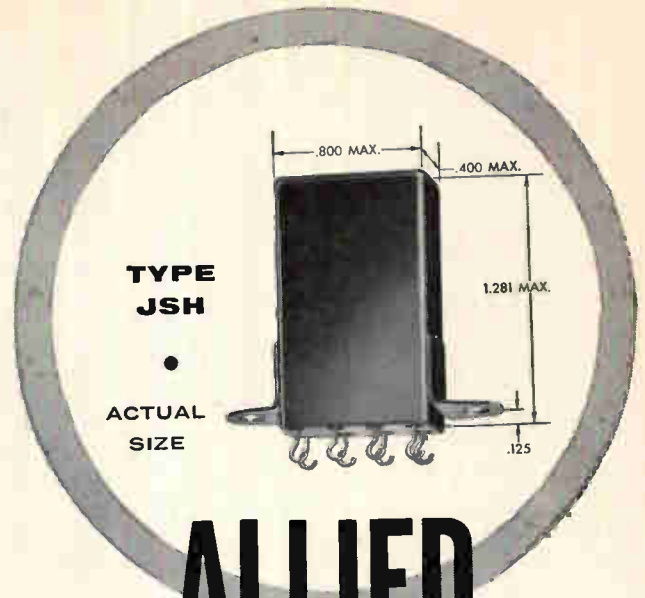

ALLIED CONTROL'S NEW

SENSITIVE 2 AMP RELAY for *15 g to 2000 cps vibration

OPERATING CONDITIONS:

AVERAGE PULL-IN POWER:

SPDT 25 milliwatts at 25°C

DPDT 40 milliwatts at 25°C

CONTACT RATINGS:

Non-inductive — 2 amperes at 29 volts d-c
or 1 ampere at 115 volts a-c

Low level contacts are available on request

VIBRATION:

5-55 cps at 0.12 inch double amplitude

55-2000 cps at a constant 15 g

*20 g available on request

SHOCK:

50 g operational

TERMINALS:

0.2 inch grid spaced

WEIGHT:

1.1 ounce maximum

Write for Bulletin JSH #62



ALLIED CONTROL

ALLIED CONTROL COMPANY, INC.

2 EAST END AVENUE, NEW YORK 21, N. Y.

AL206

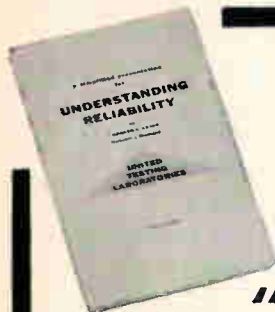

NEW BOOK — A MUST FOR

"UNDERSTANDING RELIABILITY"

164 pages of valuable data by C. E. LEAKE, reliability manager,
UNITED TESTING LABORATORIES

Required reading for those in Design • Testing • Management • Quality Control • Procurement • Production • \$2.95.

Here, for the first time, is a single textbook on "Understanding Reliability"... 164 pages of valuable data simply presented. Contains Basic Concepts, Methods, Product Improvement, Organization, Testing. Many companies have made this book required reading.

Order your copies now from the publisher.

PASADENA LITHOGRAPHERS, INC.

51 E. Walnut, Pasadena, Calif.

Send _____ books, _____ each. Price per book 1-10, \$2.95; 11-25, \$2.75; 26-50, \$2.60; 50 + \$2.50.

NAME _____ POSITION _____

COMPANY _____

ADDRESS _____

CITY _____ STATE _____

Check enclosed Money Order enclosed Send C.O.D.
California orders add 4% sales tax.

CIRCLE 209 ON READER SERVICE CARD

The all-new, all solid-state Philbrick P2 amplifier



NO TUBES, NO CHOPPERS, NOTHING BUT PERFORMANCE. An ingenious arrangement of all solid-state components endows this operational amplifier with the most remarkable and versatile characteristics. *Full differential input:* truly floating with respect to ground. *No common mode error.* *Low input current:* typically 10–11 amps. *Low noise:* typically under 10 microvolts in the dc to 1 kc range. *Sub millivolt long term stability:* less than 100 microvolts drift per day. *Cool running:* typically under 330 milliwatt dissipation. *Wide band pass:* typically under 75 kc as a unity gain follower. *High open loop gain:* typically 30,000. Its output delivers 1 ma at ± 10 volts. The cast aluminum housing fits right in your hand.

Use the P2 for instrumentation, analog computation, and other applications requiring high reliability and accuracy. Take advantage of its differential inputs to perform high impedance operations. **\$210.**
Truly low cost:

SOLID STATE POWER SUPPLY PR 150. For energizing at least 10 P2 amplifiers, the PR 150 has extremely low noise, drift, and internal impedance. Regulation against load, less than 300 microvolts. It provides up to 150 ma at both plus and minus 15 volts. Price: **\$285.**
Please write for further information to:

GEORGE A.
PHILBRICK
RESEARCHES, INC.

127 CLARENDON ST. BOSTON 16, MASS.
COMMONWEALTH 6-5375, TWX: BS 1032, FAX: BSN
REPRESENTATIVES IN PRINCIPAL CITIES
EXPORT OFFICE: 240 W. 17TH ST., N. Y. 11, N. Y.
TEL. CHELSEA 3-5200, CABLE: TRILRUSH

Broomfield, Colo., as vice president in charge of engineering.

His background includes 18 years with RCA; 6 years as manager of the advanced development department of the Colonial Radio Corp. (now Sylvania Electric Products); and 3 years as director for television research of International Telemeter Corp., where he worked on the development of pay tv.



Hoover Company Names Nottingham

R. B. NOTTINGHAM has been named director of engineering at the Hoover Co., Electronics Division, Timonium, Md.

A veteran of more than 20 years in military and commercial engineering and technical management, Nottingham comes to Hoover from the North Electric Co., Galion, O. He was formerly assistant director of research and director of quality control at North.



Gentry Moves Up At U. S. Engineering

APPOINTMENT of Jack T. Gentry as vice president and general manager of U. S. Engineering Co., Van Nuys, Calif., a division of Litton Industries, is announced. He has been general manager of the Litton division since 1958.

U. S. Engineering Co. designs

RTV Silicone Rubber

NOW IN 1-LB. SIZE!



General Electric's liquid silicone rubber that cures at room temperature to form a flexible solid now comes in a new 1-lb. minimum order size.

New 1-lb. jar makes it easy to mix up small batches — less waste for infrequent users, more economy for smaller users.

Ideal for potting, sealing, caulking, encapsulating, and flexible molds, G-E RTV silicone rubber has excellent electrical properties. Usable over temperature range of -65°F to 600°F .

New 1-lb. size is available in 6 viscosities, from easily pourable to thick paste.



For full information, contact the distributor nearest you:

San Francisco

Electrical Specialty Co.
158 Eleventh St.

Chicago

Federal Insulation Co.
549 W. Randolph St.

Detroit

Insulation & Copper Sales
15605 Woodrow Wilson

Jersey City

Smooth-On Mfg. Co.
572 Communipaw Ave.

Floral Park, Long Island, N. Y.

Punt, Incorporated
160 Woodbine Ct.

Philadelphia

Smith of Philadelphia
1024 Race St.

Chagrin Falls, Ohio

Electrolock, Inc.
28 North Main St.

or write: General Electric Company, Silicone Products Dept., Section N958, Waterford, N. Y.

GENERAL ELECTRIC

CIRCLE 211 ON READER SERVICE CARD
electronics

and manufactures multi-layered printed circuits, plated circuits, terminals, and electronic hardware.



Martin-Baltimore
Names A. P. Stern

THE ELECTRONICS DIVISION of The Martin Co., Baltimore, Md., has appointed Arthur P. Stern as director of engineering. He comes to Baltimore from Syracuse, N. Y., where he was manager of the electronic applications laboratory of the General Electric Co.

PEOPLE IN BRIEF

Norman E. Lambert, formerly with Pacific semiconductor, appointed chief applications engineer at Standard Rectifier Corp. Evelyn Anton transfers from General Electric to the technical staff of Auerbach Electronics Corp. Leo A. Nadler promoted to senior project engineer at PRD Electronics. Eugene Fioramonti, previously with Westinghouse Electric, joins Powertron Pacific Corp. as vice president. James A. D'Errico advances to Truarc western division manager at Waldes Kohinoor. Jerome L. Nishball leaves United Aircraft to become a senior consultant with MS&A, Inc. Maxwell B. Bassett, ex-Martin Co., named vice president, systems management and a director of General Precision, Inc. E. C. Stork moves up at Colorado Research Corp. to vice president and general manager. Paul J. Murphy advances at Technical Operations, Inc., to systems engineering dept. head. Van W. Bearinger promoted to general manager of Minneapolis-Honeywell's semiconductor division. Roy L. Merwin leaves Radiation, Inc., to join Systems, Inc. as marketing manager.

September 1, 1961

SEEN THE NEW

IDEA
INDEX
IN
EBG
?

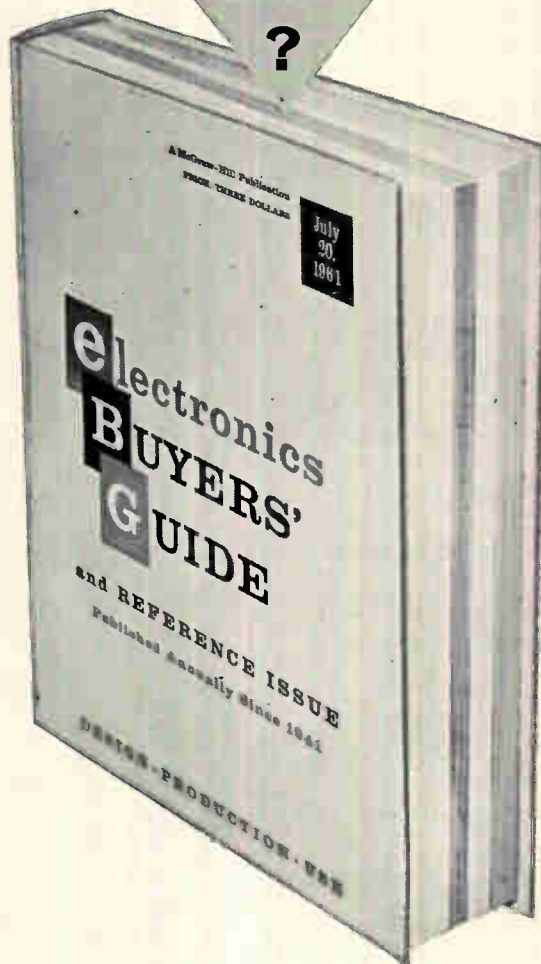

The INDEX to the editorial articles in electronics magazine, previously published annually in a December issue, now appears ONLY in the EBG. Another original EBG idea that saves time and trouble for users! Keep your EBG copy on your desk!

EXTRA!

Also in the EBG are condensed ABSTRACTS of all the editorial feature articles which have appeared to date in 1961. Another reason why EBG is used more by all four — men in research, design, production and management.

electronics

WEEKLY QUALIFICATION FORM FOR POSITIONS AVAILABLE

ATTENTION: ENGINEERS, SCIENTISTS, PHYSICISTS

This Qualification Form is designed to help you advance in the electronics industry. It is unique and compact. Designed with the assistance of professional personnel management, it isolates specific experience in electronics and deals only in essential background information.

The advertisers listed here are seeking professional experience. Fill in the Qualification Form below.

STRICTLY CONFIDENTIAL

Your Qualification form will be handled as "Strictly Confidential" by ELECTRONICS. Our processing system is such that your form will be forwarded within 24 hours to the proper executives in the companies you select. You will be contacted at your home by the interested companies.

WHAT TO DO

1. Review the positions in the advertisements.
2. Select those for which you qualify.
3. Notice the key numbers.
4. Circle the corresponding key number below the Qualification Form.
5. Fill out the form completely. Please print clearly.
6. Mail to: D. Hawksby, Classified Advertising Div., ELECTRONICS, Box 12, New York 36, N. Y. (No charge, of course).

COMPANY	SEE PAGE	KEY #
ARMOUR RESEARCH FOUNDATION Illinois Institute of Technology Chicago, Illinois	59	1
ATOMIC PERSONNEL INC Philadelphia, Pa.	77	2
THE BOEING COMPANY Seattle, Washington	67	3
CENTRAL RESISTOR CORP. Addison, Illinois	95*	4
ERIE ELECTRONICS DIV. Erie Resistor Corp. Erie, Pa.	77	5
ESQUIRE PERSONNEL Chicago, Illinois	95*	6
GENERAL DYNAMICS/ASTRONAUTICS San Diego, California	96*	7
GYRODYNE CO. OF AMERICA, INC. St. James, L. I., New York	76	8
LABORATORY FOR ELECTRONICS Boston, Mass.	30*	9
LITTON SYSTEMS INC. Guidance & Control Systems Div. Beverly, California	16	10
MALLORY ELECTRONICS COMPANY Division of P. R. Mallory & Co., Inc. Indianapolis, Indiana	76	11
MCDONNELL AIRCRAFT St. Louis, Missouri	75	12
TROPICAL RADIO TELEGRAPH CO. Hingham, Mass.	77	13

*These advertisements appeared in the 8/25/61 issue.

(cut here)

(cut here)

electronics WEEKLY QUALIFICATION FORM FOR POSITIONS AVAILABLE

Personal Background

NAME

HOME ADDRESS.....

CITY..... ZONE..... STATE.....

HOME TELEPHONE.....

Education

PROFESSIONAL DEGREE(S).....

MAJOR(S)

UNIVERSITY

DATE(S)

FIELDS OF EXPERIENCE (Please Check)

9161

- | | | |
|--|--|---------------------------------------|
| <input type="checkbox"/> Aerospace | <input type="checkbox"/> Fire Control | <input type="checkbox"/> Radar |
| <input type="checkbox"/> Antennas | <input type="checkbox"/> Human Factors | <input type="checkbox"/> Radio-TV |
| <input type="checkbox"/> ASW | <input type="checkbox"/> Infrared | <input type="checkbox"/> Simulators |
| <input type="checkbox"/> Circuits | <input type="checkbox"/> Instrumentation | <input type="checkbox"/> Solid State |
| <input type="checkbox"/> Communications | <input type="checkbox"/> Medicine | <input type="checkbox"/> Telemetry |
| <input type="checkbox"/> Components | <input type="checkbox"/> Microwave | <input type="checkbox"/> Transformers |
| <input type="checkbox"/> Computers | <input type="checkbox"/> Navigation | <input type="checkbox"/> Other |
| <input type="checkbox"/> ECM | <input type="checkbox"/> Operations Research | <input type="checkbox"/> |
| <input type="checkbox"/> Electron Tubes | <input type="checkbox"/> Optics | <input type="checkbox"/> |
| <input type="checkbox"/> Engineering Writing | <input type="checkbox"/> Packaging | <input type="checkbox"/> |

CATEGORY OF SPECIALIZATION

Please indicate number of months
experience on proper lines.

	Technical Experience (Months)	Supervisory Experience (Months)
RESEARCH (pure, fundamental, basic)
RESEARCH (Applied)
SYSTEMS (New Concepts)
DEVELOPMENT (Model)
DESIGN (Product)
MANUFACTURING (Product)
FIELD (Service)
SALES (Proposals & Products)

CIRCLE KEY NUMBERS OF ABOVE COMPANIES' POSITIONS THAT INTEREST YOU

1 2 3 4 5 6 7 8 9 10 11 12 13 14 15 16 17 18 19 20 21 22 23 24 25

ELECTRONICS

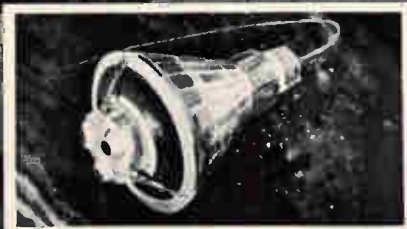

in astronautics



... aeronautics



... and automation

McDonnell achievements in aeronautics, astronautics and automation are often directly related to swift-paced developments in electronics. Wherever McDonnell requirements cannot be met by standard electronics systems, special equipment is designed and developed by McDonnell's own electronic engineers. These consistently demanding objectives have fashioned an electronics division geared to the design of highly specialized systems and components — products which often prove to be broad-scope advancements with many applications. McDonnell Electronics is now being expanded, and desirable openings exist for *electronic engineers* who are qualified to provide leadership in areas of systems and equipment development.

DEPARTMENT and DIVISION MANAGERS

Advanced degree in E.E., M.E. or Physics required
(experience at the supervisory level is desirable
in at least one of the following areas:)

COMMUNICATIONS ● DIGITAL TECHNIQUES ● AUTOMATIC TEST EQUIPMENT ● MILITARY AIRBORNE
& SOLID STATE ELECTRONICS ● ELECTROMAGNETIC FIELD THEORY ● MASER AND LASER THEORIES ●
MICROWAVE TECHNIQUES ● RADIATION AND ABSORPTION PHENOMENA ● ELECTRODYNAMICS

For full details, please submit your resume in complete confidence to:

MR. R. F. KALETTA, PROFESSIONAL PLACEMENT, DEPT. E,

MCDONNELL

P.O. Box 516, St. Louis 66, Missouri

ALL QUALIFIED APPLICANTS WILL RECEIVE CONSIDERATION FOR EMPLOYMENT WITHOUT REGARD TO RACE, CREED, COLOR OR NATIONAL ORIGIN.

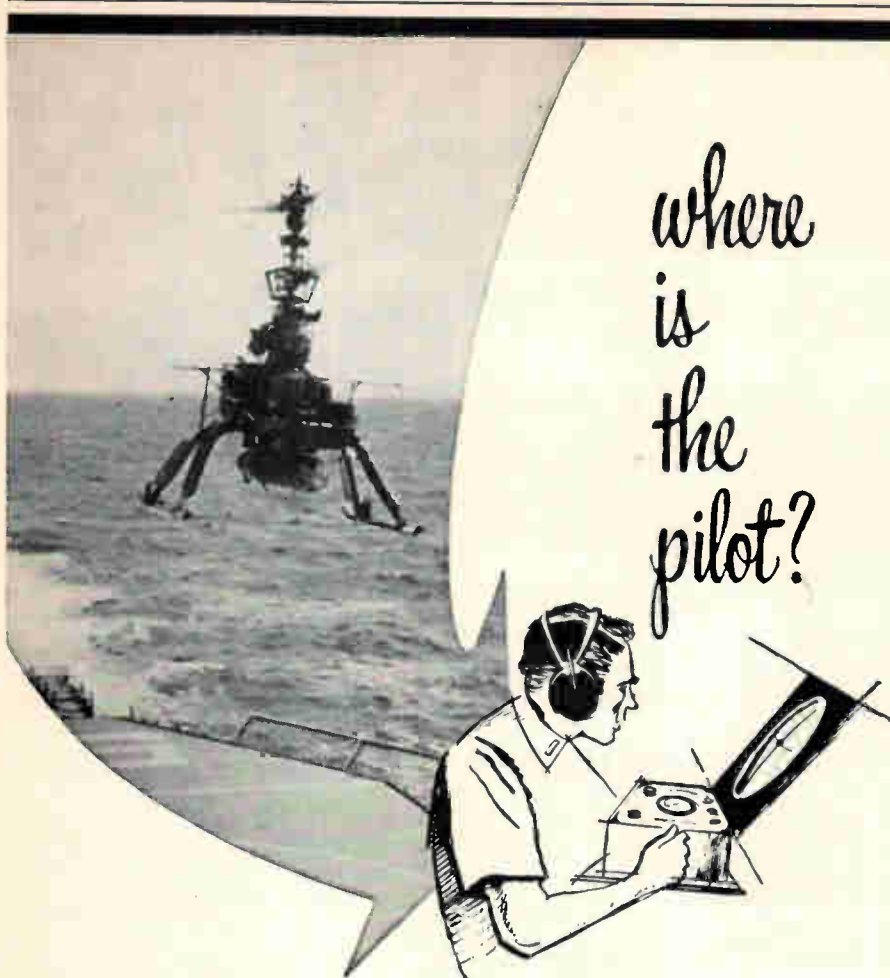

HE HAS BEEN REPLACED BY A FLIGHT CONTROLLER LOCATED AT THE DRONE CONTROL STATION OF THE USS HAZELWOOD (DD531). HE IS FLYING THE GYRODYNE DSN HELICOPTER, ARMED WITH A HOMING TORPEDO, BY REMOTE CONTROL.

The controller has the capability to direct the DSN over the target area, release the weapon, and command it to return and land on the flight deck of the destroyer.

The Gyrodyne DSN helicopter, being unmanned, can fly in foul weather and complete its mission without risk to a pilot's life.

The DSN helicopter is the first remotely controlled helicopter and is considered to be the most versatile remotely controlled flying machine.

The Gyrodyne Company is responsible for development and production of the DSN helicopter including its electronic equipment, and the electronic equipment required aboard the destroyer to control the DSN helicopter.

The work involved in accomplishing such a task is continually creating career opportunities for qualified personnel at various levels in the following fields.

- | | | |
|--------------------|-----------------|----------------------|
| ENGINEERING | CONTRACTS | SYSTEMS—PROCEDURES |
| FLIGHT TEST | FIELD SERVICE | SYSTEMS—AUDIT |
| AERODYNAMICS | PUBLICATIONS | FACILITIES PLANNING |
| STRESS ANALYSIS | TRAINING | DATA PROCESSING |
| DIGITAL DATA LINK | ADMINISTRATION | PERSONNEL RECRUITING |
| ELECTRICAL SYSTEMS | CONTRACTS (LLB) | PRODUCTION PLANNING |
| ELECTRONIC SYSTEMS | FACILITIES | MATERIAL CONTROLS |

Applicants interested in becoming associated with a progressive organization located in one of the most beautiful suburban residential areas on Long Island, are requested to submit confidential resumes to our Personnel Director, Dept. E, Gyrodyne Company of America, Inc., St. James, L. I., N. Y.

Gyrodyne
 COMPANY OF AMERICA, INC.
 AN EQUAL OPPORTUNITY EMPLOYER.

TEST & LIAISON ENGINEER

(Communications)

Reporting to Plant Manager of new Electronics Company, you will be responsible for setting up small department, with primary responsibility for test procedures, design of special test equipment, test estimating, laboratory standards and liaison with manufacturing, engineering and quality control.

Requires BS Electronic Engineering and 5-9 years experience in the above area.

Excellent profit sharing plan and company sponsored graduate program with Purdue University for eligible employees.

Expressions of interest may be addressed to Mr. Dick Williams.

MALLORY ELECTRONICS COMPANY

Division of P. R. Mallory & Co., Inc.
 Indianapolis, Indiana

ADDRESS BOX NO. REPLIES TO: Box No.
 Classified Adv. Div. of this publication.
 Send to office nearest you.
 NEW YORK 36: P. O. Box 12
 CHICAGO 11: 645 N. Michigan Ave.
 SAN FRANCISCO 11: 255 California St.

POSITION VACANT

Medical Electronic Sales Manager or Consultant—Rare opportunity for the right man in New York City. Write about your background and experience to the President of the Interstate Mfg. Corp., 190 Boston Post Road, Orange, Connecticut.

POSITION WANTED

Electronics Engineer—with 11 years experience in design and development of electronic instruments, transistorized telemetry equipment, analog and digital instrumentation systems for military and industrial applications, and with good knowledge of French, German and Italian language—desires an appropriate position with a U. S. company, its affiliate or subsidiary, in Switzerland. Write to PW-7329, Electronics.



MANUFACTURERS' REPRESENTATIVES
 IN THE ELECTRONIC INDUSTRY

SAMUEL K. MACDONALD, INC.
 manufacturers representatives over 25 years
 1531 SPRUCE STREET, PHILA. 2, PA.

Territory: Pennsylvania • New Jersey Delaware • Maryland Virginia • West Virginia District of Columbia	Other Offices: Pittsburgh Baltimore Washington, D.C.
--	---

2 + 2 = 1

Your advertisement in the MANUFACTURERS REPRESENTATIVES Section of electronics will reach YOUR markets—on a national and world wide scale. Yes, it's simple addition. You need them . . . electronics reaches them.
 For full information and rates write:
electronics
 Classified Advertising Division
 P. O. Box 12 New York 36, New York

COMMUNICATIONS ENGINEER

College graduate interested in associating with long established public service company serving Central America. Position open at Engineering Dept., Tropical Radio Telegraph Company, P. O. Drawer 97, Hingham, Massachusetts (Near Boston).

fee paid positions for
E. E.'s

INSTRUMENTATION
CIRCUITRY • TECHNICAL SALES
Write for application • Confidential handling
ATOMIC PERSONNEL, Inc.
Suite 1207-L, 1518 Walnut St., Phila. 2, Pa.
Nat'l Employment Agency with Technical Experience

TRANSFORMER ENGINEER

With experience in the design and development of Hi-Frequency and Pulse transformers for commercial and military applications.

Ideal opportunity for ambitious man to develop full potential of present small department. Salary—open. Location—Erie, Pa. Call or send resume to Chief Engineer

Erie Electronics Division

Erie Resistor Corporation

645 West 12th Street Erie, Pa.
GL 6-8592

SEARCHLIGHT SECTION

(Classified Advertising)

BUSINESS OPPORTUNITIES

EQUIPMENT - USED or RESALE

DISPLAYED

---RATES---

UNDISPLAYED

The advertising is \$24.75 per Inch for all advertising other than on a contract basis. AN ADVERTISING INCH is measured 7/8" vert. on a column 3 cols.—30 inches—to a page. EQUIPMENT WANTED or FOR SALE ADVERTISEMENTS acceptable only in Displayed Style.

\$2.40 a line, minimum 3 lines. To figure advance payment count 5 average words as a line. BOX NUMBERS count as one line additional.

DISCOUNT of 10% if full payment is made in advance for four consecutive insertions.

Send NEW ADVERTISEMENTS or Inquiries to Classified Adv. Div. of Electronics, P. O. Box 12, N. Y. 36, N. Y.

The publisher cannot accept advertising in the Searchlight Section, which lists the names of the manufacturers of resistors, capacitors, rheostats, and potentiometers or other names designed to describe such products.

**SEARCHLIGHT
Equipment
Locating Service**

NO COST OR OBLIGATION

This service is aimed at helping you, the reader of "SEARCHLIGHT", to locate Surplus new and used electronic equipment and components not currently advertised. (This service is for USER BUYERS only).

How to use: Check the dealer ads to see if what you want is not currently advertised. If not, send us the specifications of the equipment wanted on the coupon below, or on your own company letterhead to:

**Searchlight Equipment
Locating Service**

c/o **ELECTRONICS**

P. O. Box 12, N. Y. 36, N. Y.

Your requirements will be brought promptly to the attention of the equipment dealers advertising in this section. You will receive replies directly from them.

Searchlight Equipment Locating Service
c/o **ELECTRONICS**

P. O. Box 12, N. Y. 36, N. Y.

Please help us locate the following equipment components.

.....
.....
.....
.....
NAME

TITLE

COMPANY

STREET

CITY 9/1/61

**Bio-Physical Products
Expansion Opportunity**

Large electronics manufacturing organization is interested in acquiring an electronic bio-physical products manufacturing concern which may find it advantageous to become associated with a company having research facilities on a large scale. Communications on a confidential basis if so required.

BO-7334, Electronics

Class. Adv. Div., P.O. Box 12, N.Y. 36, N.Y.

CIRCLE 460 ON READER SERVICE CARD

AUTO-TRACK & TELEMETRY ANTENNA PEDESTALS 3 & 10 CM. SCR. 584 AUTOTRACK RADARS. AN TPS-10 SEARCH. AN TPS-10 HT. FINDERS. AN FPN-32GCA. AN/APS-10 NAVIG. & WEATHER. AN APS-15B PRECISION. AN/APQ-35B PRECISION. AN APS-31A SEARCH. OZENS MORE. S-12 MEGAWATT HIGH POWER PULSERS. MICROWAVE PLUMBING—TEST EQUIP. LARGEST RADAR STOCK IN U.S.A. RADIO RESEARCH INSTRUMENT CO. 550 Fifth Ave. New York Judson 6-4691

RADAR SYSTEMS & COMPONENTS / IMMEDIATE DELIVERY

CIRCLE 462 ON READER SERVICE CARD

\$10.95 Complete Color Dial Telephones
Factory rebuilt Western Electric in white, beige, ivory, pink, green or blue. If 4 prong plug is required add \$2.00. Fully guaranteed. Write for free list. All shipments FOB.

SURPLUS SAVING CENTER
Waymart Dept. E-911 Penna.

CIRCLE 461 ON READER SERVICE CARD

Your Inquiries to Advertisers Will Have Special Value . . .
—for you—the advertiser—and the publisher, if you mention this publication. Advertisers value highly this evidence of the publication you read. Satisfied advertisers enable the publishers to secure more advertisers and—more advertisers mean more information on more products or better service—more value—to YOU.

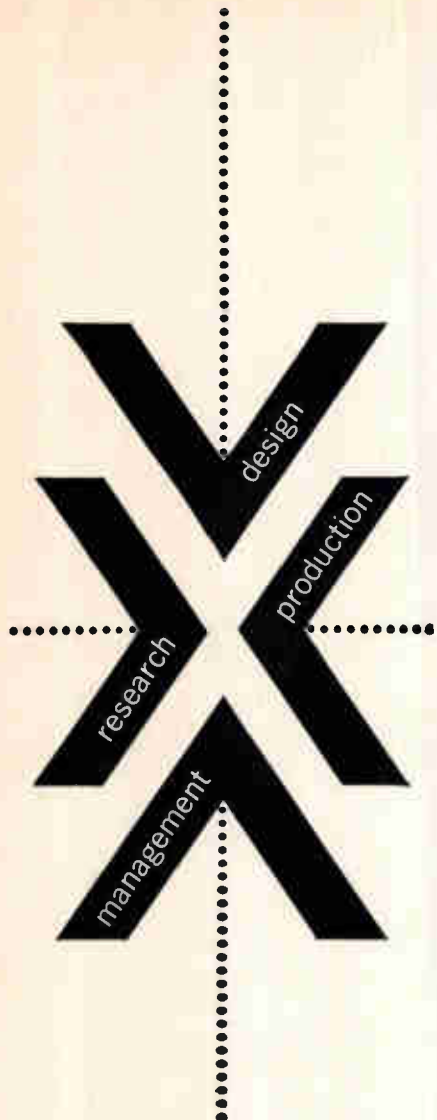

**it's read
more
by all 4!**

electronics magazine covers engineering and technically interpreted market trends every week. Government, military and economic developments, new applications, and technical data you'll want to file and keep. Subscribe now and read it first (don't be low man on a routing slip). Mail the reader service card (postpaid) to electronics, the magazine that helps you to know and to grow! Rates: three years for \$12; one year for \$6; Canadian, one year for \$10; foreign, one year for \$20. Annual electronics BUYERS' GUIDE (single issue price \$3.00) included with every subscription.

subscribe today to

electronics

INDEX TO ADVERTISERS



Audited Paid Circulation

• Allied Control Company, Inc. 71	Janco Corporation 71
Armour Research Foundation 59	
	Krohn-Hite Corp. 56
• Ballantine Laboratories, Inc. 21	
• Beckman Instruments, Inc. Berkley Division 25	• Lambda Electronics Corp. 3
• Bendix Corporation Scintilla Division 13	• Lionel Electronic Laboratories 69
Boeing Co., The 67	• Litton Systems Inc., Div. of Litton Industries 16
• Bowmar Instrument Corp. 53	
• Budelman 53	Metronix, Inc. 52
• Cinch Mfg. Corp. 47	• Philbrick Researches, Inc., George A. 72
Cleco, Division of Reed Roller Bit Co. ... 55	• Philco Corporation 28
• Cohn Corp., Sigmund 59	Precision Instrument Co. 22
Connecticut Hard Rubber Co. 60	
• Dale Electronics, Inc. 8	• Radio Corporation of America 7, 4th cover
Di Arco Corp. 24	• Raytheon Company 2nd cover
• Dorsett Electronics, Inc. 68	
	Sprague Electric Co. 5, 6
• Edo Corporation 2	• Texas Instruments Incorporated Apparatus Division 57, 59, 61, 63
• Eitel-McCullough, Inc. 17	Truco Engineering 68
Elcor, Inc. 12	
Electrodynamic Instrument Corporation 53	United Shoe Machinery Corp. 63
	United Testing Laboratories 71
• Fairchild Stratons Corp. 51	
	Varian Associates 3rd cover
Gardner-Denver Company 49	
General Dynamics Electronics 68	• Welschel Engineering Co. 14
• General Electric Co. Silicone Pmts. Dept. 72	
	• See Advertisement in the July 20, 1961 issue of Electronics Buyers' Guide for complete line of products or services.
• Hewlett-Packard Company 15	
• Heyman Manufacturing Co. 63	
Hoover Co., The 26, 27	
• Indiana Steel Products Div. of Indiana General Corp. 11	Manufacturers Representatives: MacDonald Inc., Samuel K.—76

CLASSIFIED ADVERTISING
F. J. Eberle, Business Mgr.

EMPLOYMENT OPPORTUNITIES...75-77
BUSINESS OPPORTUNITIES..... 77
EQUIPMENT (Used or Surplus New) For Sale 77

INDEX TO CLASSIFIED ADVERTISERS

Atomic Personnel Inc. 77
Eric Electronics Division 77
Gyrodyne Co. of America Inc. 76
Mallory Electronics Company, Div. of F. R. Mallory & Co., Inc. 76
McDonnell Aircraft Co. 75
• Radio Research Instrument Co. 77
• Surplus Saving Center 77
Tropical Radio Telegraph Company 77

• See Advertisement in the July 20, 1961 issue of Electronics Buyers' Guide for complete line of products or services.

This index and our Reader Service Numbers are published as a service. Every precaution is taken to make them accurate, but ELECTRONICS assumes no responsibilities for errors or omissions.

electronics



Audit Bureau
of Circulations

Associated Business
Publications

Audited Paid Circulation

JAMES T. HAUPTLI
Advertising Sales Manager

R. S. QUINT, Assistant Publisher Buyers' Guide and Business Manager; FRED STEWART, Promotion Manager; B. ANELLO, Marketing Service Manager; RICHARD J. TOMLINSON, Production Manager; GEORGE E. POMEROY, Classified Manager; HUGH J. QUINN, Circulation Manager.

ADVERTISING REPRESENTATIVES: NEW YORK (36) Donald H. Miller, Henry M. Shaw, George F. Werner, 500 Fifth Avenue, OXFORD 5-5959; BOSTON (16) William S. Hodgkinson, Donald R. Furth, McGraw-Hill Building, Copley Square, Congress 2-1160; PITTSBURGH (22) David M. Watson, Four Gateway Center, Express 1-1314; PHILADELPHIA (3) Warren H. Gardner, William J. Boyle, 6 Penn Center Plaza, LOcust 8-4330; CHICAGO (11) Harvey W. Wernecke, Martin J. Gallay, 645 North Michigan Avenue, Mohawk 4-5800; CLEVELAND (13) P. T. Fegley, 55 Public Square, Superior 1-7000; SAN FRANCISCO (11) T. H. Carmody, R. C. Alcorn, 255 California Street, Douglas 2-4600; LOS ANGELES (17) Marshall Freeman, Peter S. Carberry, 1125 W. 6th St., Huntley 2-5450; DENVER (2) J. W. Patten, Tower Building, 1700 Broadway, Alpine 5-2981; ATLANTA (9) M. H. Miller, 1375 Peachtree St. N.E., Trinity 5-0523; HOUSTON (25) Joseph C. Page, Jr., Prudential Bldg., Holcombe Blvd., Jackson 6-1281; DALLAS (1) Frank Le Beau, The Vaughn Bldg., 1712 Commerce St., Riverside 7-9721; LONDON W1, Edward E. Schrimmer, 34 Dover St.; FRANKFURT/Main, Stanley R. Kimes, 85 Westendstrasse; GENEVA, Michael R. Zeynel, 2 Place du Port.

FOR CW ILLUMINATORS
AND NAVIGATION

LOW NOISE OSCILLATORS

1 WATT TO 50 WATTS

Varian Associates' family of low-noise oscillator klystrons assures superior performance in such applications as CW illuminators, fixed-frequency doppler navigation transmitters, and similar uses.

All tubes in this low-noise family are two-cavity klystron oscillators. All are fixed-frequency. All are electrostatically focused. They cover a wide power range (from 1 W to 50 W). Tubes in K_U-band include the air-cooled VA-503B and the liquid-cooled VA-504B. Tubes in X-band include the air-cooled VA-514 and VA-508 and the liquid-cooled VA-511. All are available now.

Characteristics of the VA-511 are typical of the oscillators in this group. The VA-511 produces 50W minimum power at 10 kMc, and operates at 10 kV, 60 milliamperes. FM noise is less than 1 cycle. Weight, less than 24 oz.; size: 6¼ in. x 2¼ in. x 1¾ in.

For additional technical information on this fine family of klystron oscillators, address Tube Division.

SCALE: 2/3 ACTUAL SIZE

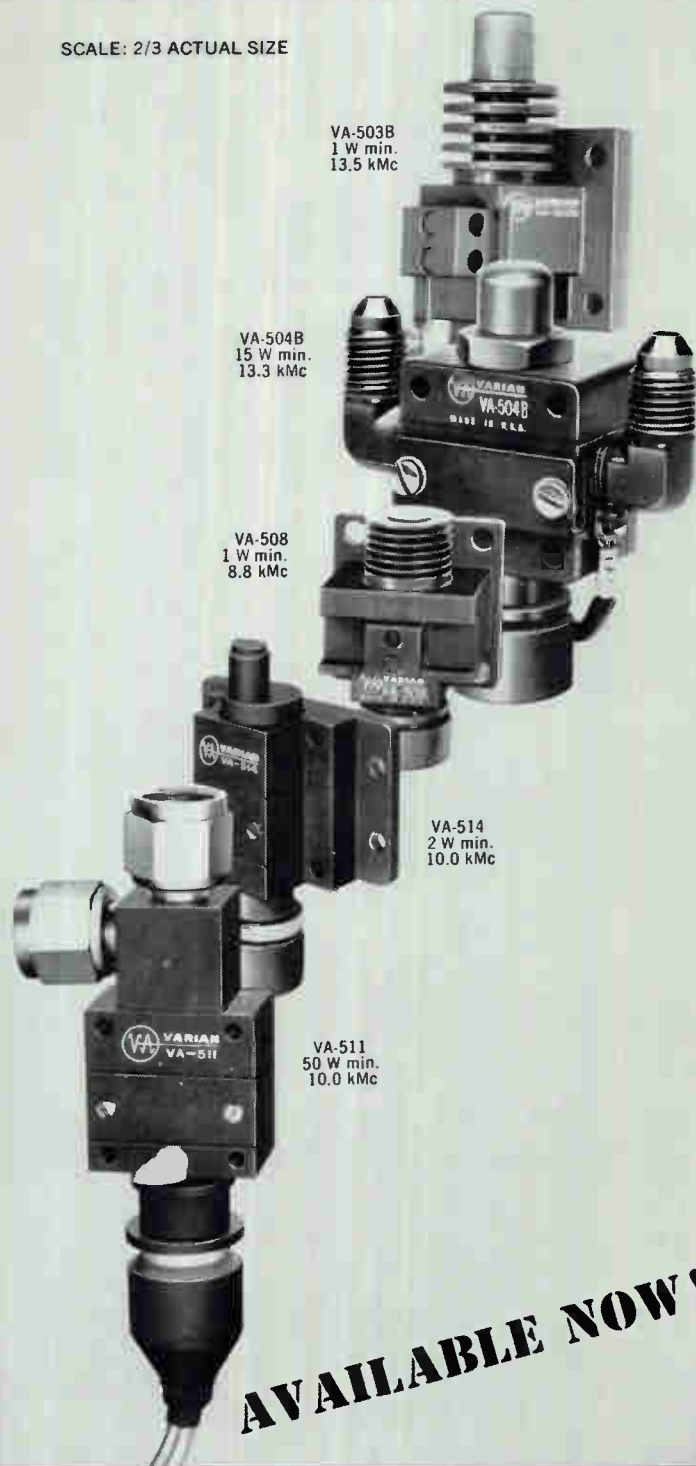

VA-503B
1 W min.
13.5 kMc

VA-504B
15 W min.
13.3 kMc

VA-508
1 W min.
8.8 kMc

VA-514
2 W min.
10.0 kMc

VA-511
50 W min.
10.0 kMc

AVAILABLE NOW!



VARIAN associates

PALO ALTO 1, CALIFORNIA

Subsidiaries:

BOMAC LABORATORIES, INC.
VARIAN ASSOCIATES OF CANADA, LTD.
S-F-D LABORATORIES, INC.
SEMICON ASSOCIATES, INC.
SEMICON OF CALIFORNIA, INC.
VARIAN A. G. (SWITZERLAND)



A
CLOSE LOOK
AT RCA'S
"DARK
HEATER"

*and how
it benefits
you*

You are looking at a major advance in tube technology. The filament at the right in this special demonstration envelope is a new RCA "Dark Heater". The "Dark Heater" operates at a temperature about 350°K below that of the 1500 to 1700°K of a conventional heater (left). Yet at this much lower temperature, the "Dark Heater" can produce the same cathode temperature as the conventional heater. Reason: the superior thermal emissivity of the dark coating.

For additional information on the "Dark Heater" call your RCA Field Representative or write Commercial Engineering, Sec. 1-19-DE-1, RCA Electron Tube Division, Harrison, N. J.

EAST: 744 Broad Street, Newark 2, New Jersey, HUmboldt 5-3900 • MIDWEST: Suite 1154, Merchandise Mart Plaza, Chicago 54, Illinois, WHitehall 4-2900 • WEST: 6801 E. Washington Blvd., Los Angeles 22, Calif., RAYmond 3-8361.

The cooler operating "Dark Heater" offers many receiving tube advantages to equipment manufacturers, including:

- Longer heater life—because of the inherently greater tensile strength of heater wire at lower temperatures.
- Reduced chance of heater failure—because the smaller thermal change during heater cycling and the greatly reduced operating temperatures minimize tendency toward recrystallization and burnout.
- Heater-current stability on life—especially desirable in maintaining a constant cathode temperature.
- Reduced AC heater-cathode leakage and hum—due to elimination of "spike" or pulse leakage currents.
- Greater safety factor in established heater-cathode voltage ratings
- Improved mechanical stability—cooler operation of the "Dark Heater" minimizes changes in heater shape during life, reducing the possibility of heater damage and heater shorts.

The revolutionary "Dark Heater" is the key to improved performance and longer life for receiving tubes. Now available in an increasing number of RCA receiving tubes, the "Dark Heater" will be incorporated in those RCA receiving types where potential benefits of increased life and reliability can be realized.



The Most Trusted Name in Electronics