

electronics

Compact computer memories with 0.2 microsec cycle times are made reproducibly by vacuum depositing 80-20 nickel-iron film 2,000 Å thick on glass substrate under influence of a magnetic field, p 39

A McGraw-Hill Publication 75 Cents

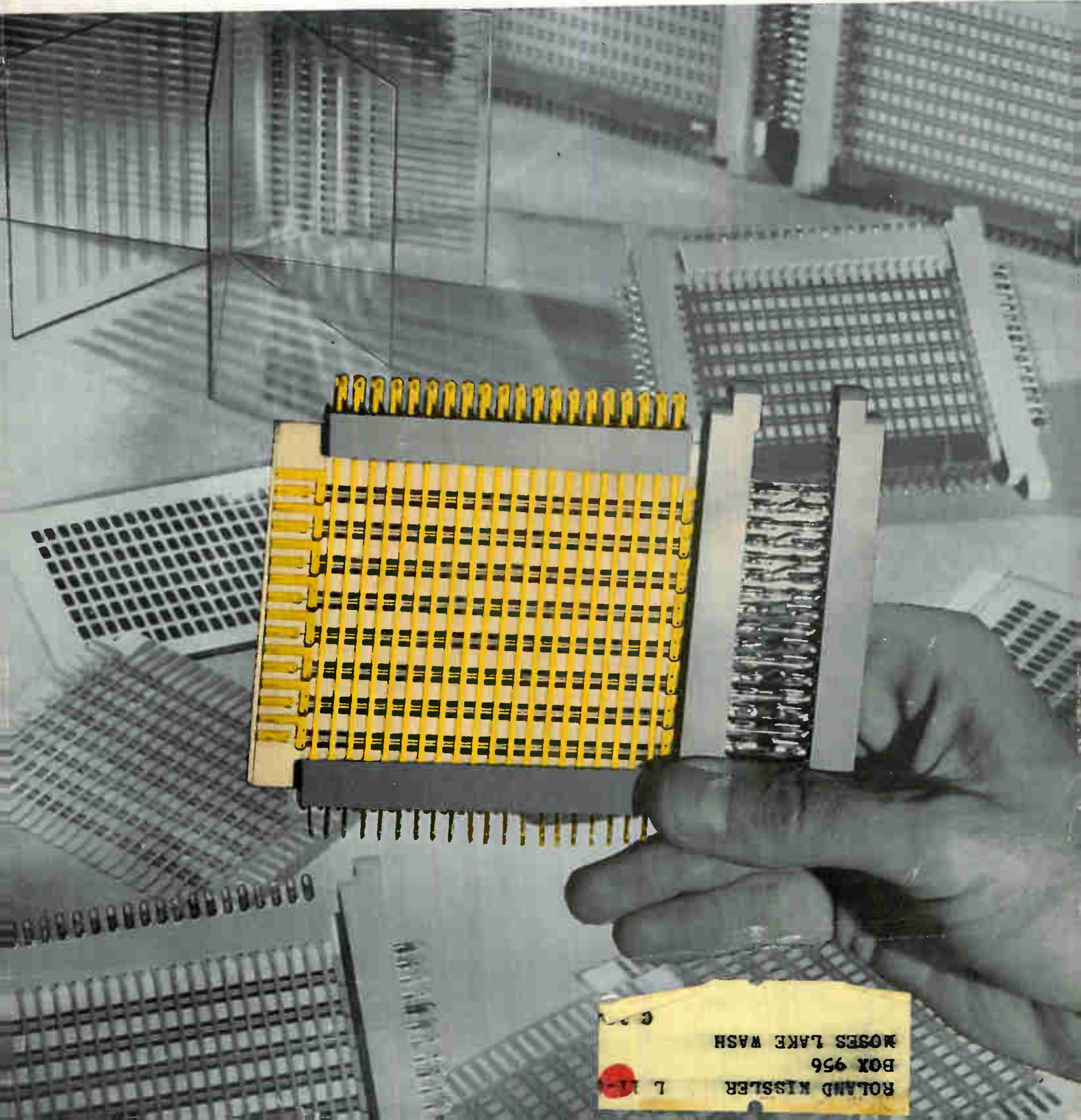

ROLAND KISSLER
BOX 956
MOSES LAKE WASH



NEW*

Revolutionary† DO-T and DI-T TRANSISTOR TRANSFORMERS

FROM STOCK—Hermetically Sealed to MIL-T-27A Specs.

There is no transformer even twice the size of the DO-T and DI-T series which has as much as 1/10th the power handling ability... which can equal the efficiency... or equal the response range. And none to approach the reliability of the DO-T and DI-T units (proved to, but exceeding MIL-T-27A grade 4).

- High Power Rating up to 10 times greater.
- Excellent Response twice as good at low end.
- Low Distortion reduced 80%.
- High Efficiency up to 30% better... compare DCR.
- Moisture Proof hermetically sealed to MIL-T-27A.
- Rugged completely metal cased.
- Anchored Leads will withstand 10 pound pull test.
- Printed Circuit Use (solder melting) plastic insulated leads.
- Suited to Clip Mounting use Augat #6009-8A clip.



TRANSFORMERS PICTURED ACTUAL SIZE
DO-T: 3/8 Dia. x 1 1/2", 1/10 Oz.; DI-T: 3/8 Dia. x 1/4", 1/20 Oz.

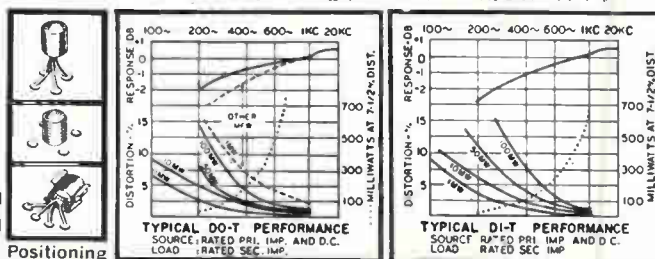

Typical Printed Circuit Positioning

DO-T No.	Pri. Imp.	D.C. Ma.‡ in Pri.	Sec. Imp.	Pri. Res. DO-T	Pri. Res. DI-T	Mw. Level	DI-T No.
DO-T1	20,000	.5	800	850	815	50	DI-T1
	30,000	.5	1200				
DO-T2	500	3	50	60	65	100	DI-T2
	600	3	60				
DO-T3	1000	3	50	115	110	100	DI-T3
	1200	3	60				
DO-T4	600	3	3.2	60		100	
DO-T5	1200	2	3.2	115	110	100	DI-T5
DO-T6	10,000	1	3.2	790		100	
DO-T7	200,000	0	1000	8500		25	
	500	0	100,000				
	Reactor 2.5 Hys./2 Ma., .9 Hy./4 Ma			630			DI-T8
DO-T8		" 3.5 Hys./2 Ma., 1 Hy./5 Ma			630		
DO-T9	10,000	1	500 CT	800	870	100	DI-T9
	12,000	1	600 CT				
DO-T10	10,000	1	1200 CT	800	870	100	DI-T10
	12,500	1	1500 CT				
DO-T11	10,000	1	2000 CT	800	870	100	DI-T11
	12,500	1	2500 CT				
DO-T12	150 CT	10	12	11		500	
	200 CT	10	16				
DO-T13	300 CT	7	12	20		500	
	400 CT	7	16				
DO-T14	600 CT	5	12	43		500	
	800 CT	5	16				
DO-T15	800 CT	4	12	51		500	
	1070 CT	4	16				
DO-T16	1000 CT	3.5	12	71		500	
	1330 CT	3.5	16				
DO-T17	1500 CT	3	12	108		500	
	2000 CT	3	16				
DO-T18	7500 CT	1	12	505		500	
	10,000 CT	1	16				
DO-T19	300 CT	7	600	19	20	500	DI-T19
DO-T20	500 CT	5.5	600	31	32	500	DI-T20
DO-T21	900 CT	4	600	53	53	500	DI-T21
DO-T22	1500 CT	3	600	86	87	500	DI-T22
	600	5	1500 CT				
DO-T23	20,000 CT	.5	800 CT	850	815	100	DI-T23
	30,000 CT	.5	1200 CT				
DO-T24	200,000 CT	0	1000 CT	8500		25	
	500 CT	0	100,000 CT				
DO-T25	10,000 CT	1	1500 CT	800	870	100	DI-T25
	12,000 CT	1	1800 CT				

DO-T No.	Pri. Imp.	D.C. Ma.‡ in Pri.	Sec. Imp.	Pri. Res. DO-T	Pri. Res. DI-T	Mw. Level	DI-T No.
DO-T26	Reactor 4.5 Hys./2 Ma., 1.2 Hys./4 Ma.			2300			DI-T26
	" 6 Hys./2 Ma., 1.5 Hys./5 Ma.			2100			
DO-T27	Reactor .9 Hy./2 Ma., .5 Hy./6 Ma.			105			DI-T27
	" 1.25 Hys./2 Ma., .5 Hy./11 Ma.			100			
DO-T28	Reactor .1 Hy./4 Ma., .08 Hy./10 Ma.			25			DI-T28
	" .3 Hy./4 Ma., .15 Hys./20 Ma.			25			
DO-T29	120 CT	10	3.2	10		500	
	150 CT	10	4				
DO-T30	320 CT	7	3.2	20		500	
	400 CT	7	4				
DO-T31	640 CT	5	3.2	43		500	
	800 CT	5	4				
DO-T32	800 CT	4	3.2	51		500	
	1000 CT	4	4				
DO-T33	1060 CT	3.5	3.2	71		500	
	1330 CT	3.5	4				
DO-T34	1600 CT	3	3.2	109		500	
	2000 CT	3	4				
DO-T35	8000 CT	1	3.2	505		100	
	10,000 CT	1	4				
DO-T36	10,000 CT	1	10,000 CT	950	970	100	DI-T36
	12,000 CT	1	12,000 CT				
*DO-T37	2000 CT	3	8000 Split	195		100	
	2500 CT	3	10,000 Split				
*DO-T38	10,000 CT	1	2000 Split	560		100	
	12,000 CT	1	2400 Split				
*DO-T39	20,000 CT	.5	1000 Split	800		100	
	30,000 CT	.5	1500 Split				
*DO-T40	40,000 CT	.25	400 Split	1700		50	
	50,000 CT	.25	500 Split				
*DO-T41	400 CT	8	400 Split	46		500	
	500 CT	6	500 Split				
*DO-T42	400 CT	8	120 Split	46		500	
	500 CT	6	150 Split				
*DO-T43	400 CT	8	40 Split	46		500	
	500 CT	6	50 Split				
*DO-T44	80 CT	12	32 Split	9.8		500	
	100 CT	10	40 Split				
DO-TSH	Drawn Hipermalloy shield and cover 20/30 db						DI-TSH

‡ DCMA shown is for single ended usage (under 5% distortion—100MW—1KC) . . . for push pull, DCMA can be any balanced value taken by .5W transistors (under 5% distortion—500MW—1KC)

† DO-T & DI-T units designed for transistor application only. Pats. Pend.

* DO-T37 thru DO-T44 newly added to series.

And Special Units to Your Specifications

UNITED TRANSFORMER CORPORATION

150 Varick Street, New York 13, N. Y.

PACIFIC MFG. DIVISION: 4008 W. JEFFERSON BLVD., LOS ANGELES 16, CALIF.

EXPORT DIVISION: 13 EAST 40th STREET, NEW YORK 16, N. Y. CABLES: "ARLAB"

electronics

A McGraw-Hill Publication 75 Cents



W. W. MacDONALD, Editor

J. M. CARROLL, Managing Editor
 SENIOR ASSOCIATE EDITORS: Samuel Weber, Roland J. Charest. ASSOCIATE EDITORS: Frank Leary, Michael F. Tomaino, Sylvester P. Carter, William P. O'Brien, John F. Mason, William E. Bushor, Thomas Emma, Sy Vogel, Leslie Solomon, M. M. Perugini, George J. Flynn. ASSISTANT EDITORS: Michael F. Wolff, Nilo Lindgren, Stanley Froud, Stephen B. Gray, Roy J. Bruun, George V. Navotny, Leon H. Dulberger.
 REGIONAL EDITORS: Harold C. Hood (Pacific Coast, Los Angeles), Thomas Maguire (New England, Boston), Cletus M. Wiley (Midwest, Chicago). BUYERS' GUIDE EDITOR: George Sideris. ART DIRECTOR: Harry Phillips; Howard R. Berry. PRODUCTION EDITOR: John C. Wright, Jr. EDITORIAL ASSISTANTS: Gloria J. Fillipone, Arlene Rudd, Bernice Duffy, Lorraine Rossi, Virginia T. Bastian, Lynn Emery, Avis Pomeranz, Florence Hajaistron.

JAMES GIRDWOOD, Publisher

BUSINESS

Military Needs New Space-Tracking Gear. For silent satellites	20
Engineers Take 'Second Look' at Microcircuits	22
Electronic Surveillance: The Hidden Ear. What is going on	24
Railroad Microwave Expands. To cover 6,000 miles more in year	26
Japan Asks Curb On Okinawan Exports. Transistor radios	28
Crosstalk	4
Washington Outlook	14
Comment	6
Meetings Ahead	31
Electronics Newsletter	9

ENGINEERING

Magnetic film memory plates form part of a 2,560-bit memory module. See p 39	COVER
Designing Thin Magnetic Film Memories for High-Speed Digital Computers. They operate in the megacycle frequency range. By E. E. Bittmann	39
Direction Finder Helps Recover Discoverer Capsules. Locating reentering satellite capsules. By A. T. Lloyd	42
Logic Combines Tunnel Diodes with Transistors. Switching speeds of 0.7 nanosecond are obtained. By R. W. Lade	46
Designing Chopper-Stabilized Operational Amplifiers. Analysis of stabilizing technique. By R. B. Fradella	48
Probe Identifies Cable Wiring. Locates individual wires in multiconductor. By J. S. Ruston	51
Epitaxial Process Improves Transistor Characteristics. Conventional and epitaxial mesa transistors are compared. By W. D. Roehr	52
Electromechanically Scanned Trough-Waveguide Array. Permits scanning without swinging the whole antenna. By W. Rotman and A. Maestri	54
Optically Projecting Data on a Cathode-Ray Tube Face. Avoids parallax problem in map superposition. By H. H. Naidich	58

DEPARTMENTS

Research and Development. Tunnel Diodes	62
Components and Materials. Removing Oxidation	66
Production Techniques. Preparing Parts Leads Quickly	70
New on the Market	74
People and Plants	92
Literature of the Week	90
Index to Advertisers	97

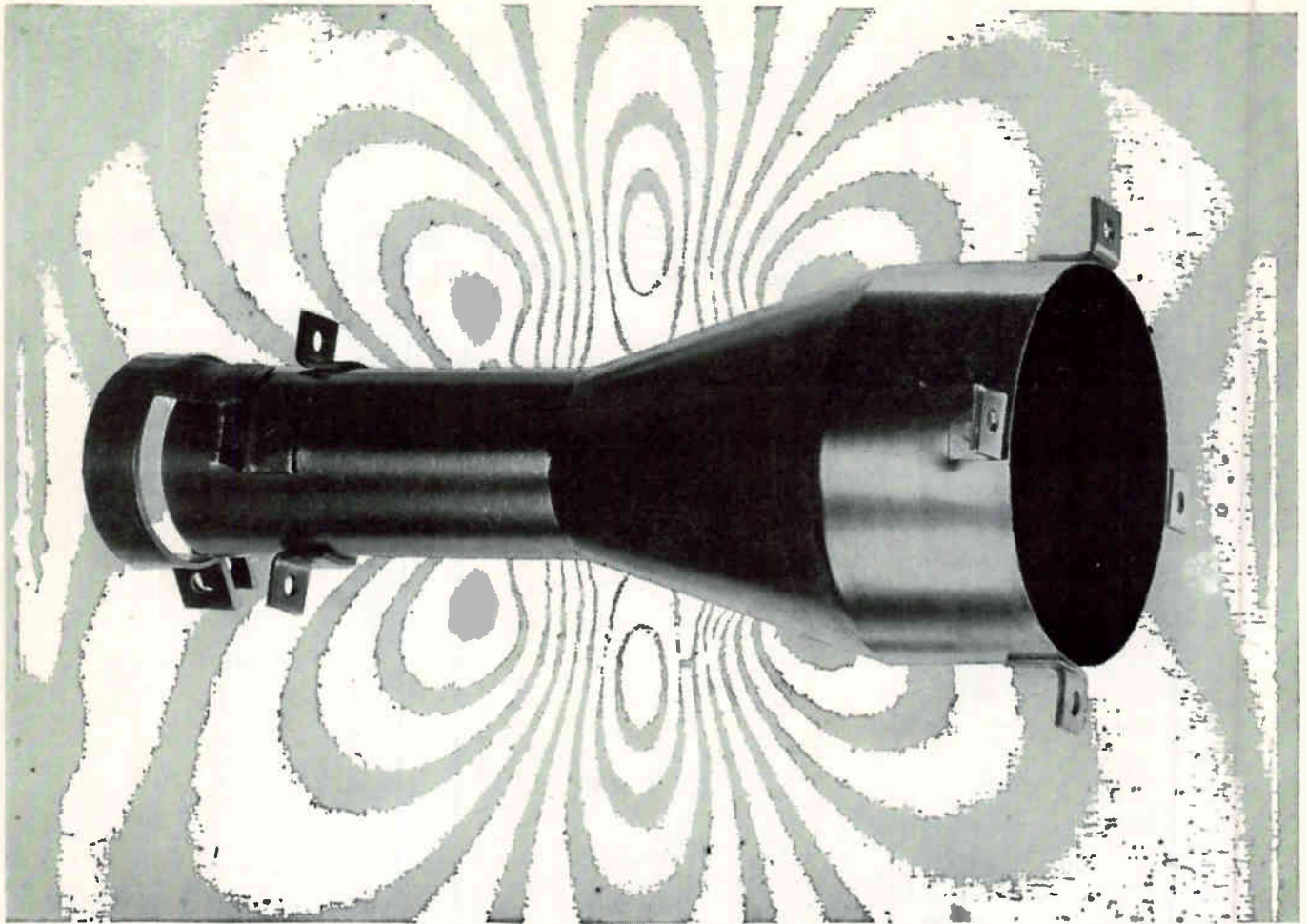

keep your signals clean with engineered magnetic shielding

Keep stray magnetic fields out of your high gain input transformers and cathode ray tubes. Keep your signals free of noise, hum, cross-talk and distortion. You can do it only with *engineered* magnetic shielding.

These high-permeability shields are made from existing tools in a broad variety of single and multiple structures—cylinders, spheres, truncated cones—for applications ranging from dc into the audio range and higher. They can be used with almost all conventional transformer core and coil assemblies to provide any degree of magnetic, electrostatic or RF shielding against undesired signals of

all classes. Reduction of field strengths to 100 db and beyond is common.

With **Magnetic Metals shielding**, both the electrical and mechanical engineering is already done for you. Simply let us know your requirements . . . We'll engineer the exact type of shielding you need. In selection of raw material, design, fabrication, annealing, testing and gaging, Magnetic Metals has amassed a great backlog of shielding experience. For a better understanding of shielding and help in specifying it, write for our informative booklet, "Magnetic Shielding of Transformers and Tubes."

See us at the IRE Show—Booth 1625

MMAGNETIC
METALS

Magnetic Metals Company

Hayes Avenue at 21st Street, Camden 1, N.J.

853 Production Place, Newport Beach, California

*transformer laminations • motor laminations • tape-wound cores
powdered molybdenum permalloy cores • electromagnetic shields*



Shrinker Cum Laude



Know ye that we, the corporation of Burnell & Co., upon the recommendation of our customers in the electronics industry do hereby inaugurate the esteemed order of Shrinker Cum Laude.

Be it further known that, (without undue modesty), the Shrinker Cum Laude award has been made to Burnell for displaying the highest degree of shrinkmanship in the design and utilization of microminiature, subminiature and miniature toroids, filters and related networks.

The Shrinker Cum Laude award has also been tendered for signal

achievement in reducing developmental costs while increasing performance range—a feat accomplished by the designers of the new Burnell high selectivity, high attenuation, 1 kc crystal filter which possesses the following unique characteristics:

Attenuation — 3 db bandwidth — 3.8 cps

Shape Factor 60/6 — 4½:1

Input — 500 ohms

Output Impedance—500,000 ohms

Meets MIL-C 3908 B vibration standards

Other Burnell crystal filters available in frequencies up to 30 mcs with

considerable latitude in impedance range. Write for Bulletin XG 455.

See the complete line of Burnell components at Booths 2909-2910 IRE Exhibit, March 20-23.

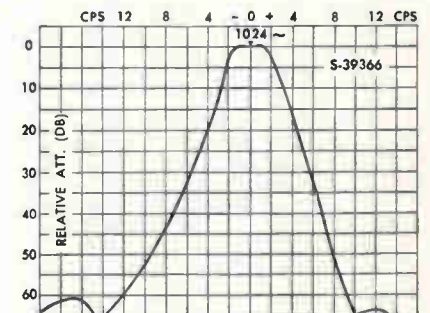

COPYRIGHT 1961 - BURNELL & CO., INC.

Burnell & Co., Inc.

PIONEERS IN microminiaturization OF TOROIDS,
FILTERS AND RELATED NETWORKS

EXECUTIVE OFFICE
AND PLANT
DEPT. E-32
PELHAM, NEW YORK
PELHAM 8-5000
TELETYPE PELHAM 3633



PACIFIC DIVISION
SOUTH PASADENA, CAL.
MFD. IN CANADA
BY EDO (CANADA) LTD.
CORNWALL, ONT.
WELLINGTON 2-6774

Published weekly, with Electronics Buyers' Guide and Reference issue, as part of the subscription, by McGraw-Hill Publishing Company, Inc. Founder: James H. McGraw (1860-1948).

Title registered U.S. Patent Office; Copyrighted 1961, McGraw-Hill Publishing Company, Inc. All rights reserved, including the right to reproduce the contents of this publication, in whole or in part.

Executive, editorial, circulation and advertising offices McGraw-Hill Building, 330 West 42nd Street, New York 36, N. Y. Telephone Longacre 4-3000. Teletype TWX N.Y. 1-1636. Cable McGrawhill, N.Y. Printed in Albany, N. Y.; second class postage paid.

OFFICERS OF THE PUBLICATIONS DIVISION: Nelson L. Bond, President; Shelton Fisher, Wallace F. Troendly, Senior Vice Presidents; John R. Callahan, Vice President and Editorial Director; Joseph H. Allen, Vice President and Director of Advertising Sales; A. R. Venezian, Vice President and Circulation Coordinator.

OFFICERS OF THE CORPORATION: Donald C. McGraw, President; Joseph A. Gerardi, Hugh J. Kelly, Horry L. Waddell, Executive Vice Presidents; L. Keith Goodrich, Vice President and Treasurer; John J. Cooke, Secretary.

Subscriptions are solicited only from those actively engaged in the field of the publication. Position and company connection must be indicated on orders. Subscription rates: United States and Possessions, \$6.00 one year; \$9.00 two years; \$12.00 three years. Canada, \$10.00 one year. All other countries \$20.00 one year. Single Copies, United States and Possessions and Canada 75¢; Buyers' Guide \$3.00; Single Copies all other countries \$1.50; Buyers' Guide \$10.00.

The Publisher, upon written request from any subscriber to our New York Office, agrees to refund that part of the subscription price applying to copies not yet mailed.

Subscribers: Please address all correspondence, change of address notices, subscription orders or complaints to Fulfillment Manager, Electronics, at above address. Change of address notices should provide old as well as new address, including postal zone number if any. If possible, attach address label from recent issue. Allow one month for change to become effective.

Postmaster: Please send Form 3579 to Fulfillment Manager, Electronics, 330 West 42nd Street, New York 36, New York.



Audited Paid Circulation

CROSSTALK

DISCOVERER. Accompanying photo shows Agena satellite being hoisted into test stand for firing at Lockheed Missiles and Space division's Santa Cruz, Calif. test facility. These satellites are being used in the Discoverer series of launchings. In this program, reentry nose cone capsules are located by an azimuthal direction finder described in the article beginning on p 42. The author is A. T. Lloyd of Lockheed Aircraft Service, Inc. in Ontario, Calif.



TRACKING EQUIPMENT. Many observers in our industry feel the time is ripe to stop depending on the Russians to give us telemetered data from Soviet space probes, and on Jodrell Bank in England to tell us where our own space vehicles are and what data they're sending back.

Both the Defense Department and the National Aeronautics and Space Administration have a good start in ground facilities to take care of our defense needs and scientific experiments. But more and better equipment is needed.

There is a growing market in both R&D and hardware production of ground facilities to detect, track, identify, catalog, predict the orbital patterns of, instruct and listen to vehicles in space. U. S. space vehicles now being developed will acquire more data and penetrate deeper into space than before. Ground facilities must keep pace.

The article on p 20 describes the military's existing ground facilities and points out future needs. Last week, we covered NASA's networks and plans on p 20.

HIDDEN EAR. Electronic surveillance is hinted at but its existence is usually denied. Many states now invoke severe penalties against users of clandestine equipment. After talking to many people, but not receiving many quotable answers, ELECTRONICS gathered enough information to assemble the story on p 24. For obvious reasons, much of the information gathered cannot be published, but enough was learned to show this is an interesting area.

Coming In Our March 10 Issue

IRE HIGHLIGHTS. With approximately 300 papers to be presented at 54 sessions, this year's IRE show in New York looks like it will be just as hectic as in previous years. To help you direct your footsteps, ELECTRONICS editors have put together for our next issue a roundup of some of the new engineering developments slated for discussion. These include laser radar, log-periodic monopole antennas, tunable tunnel-diode amplifiers and semiconductor filters.

3 new additions to the

SPRAGUE MADT* transistor line!

High-speed switching transistors in TO-18 cases are now being mass-produced by Sprague. These hermetically-sealed germanium Micro-Alloy Diffused-base Transistors are made by a controlled-etch process to insure extreme uniformity. Maximum frequency capabilities have been improved by graded-base construction. Automated manufacturing techniques have brought about increased production efficiency, permitting favorable reductions in prices. This is why Sprague MADT Transistors can offer you greater performance per dollar than other high-speed devices in low-current switching circuits.

*Trademark of Philco Corporation

SPRAGUE COMPONENTS

TRANSISTORS
CAPACITORS
RESISTORS
MAGNETIC COMPONENTS

INTERFERENCE FILTERS
PULSE TRANSFORMERS
PIEZOELECTRIC CERAMICS
PULSE-FORMING NETWORKS

HIGH TEMPERATURE MAGNET WIRE
CERAMIC-BASE PRINTED NETWORKS
PACKAGED COMPONENT ASSEMBLIES
FUNCTIONAL DIGITAL CIRCUITS

March 3, 1961

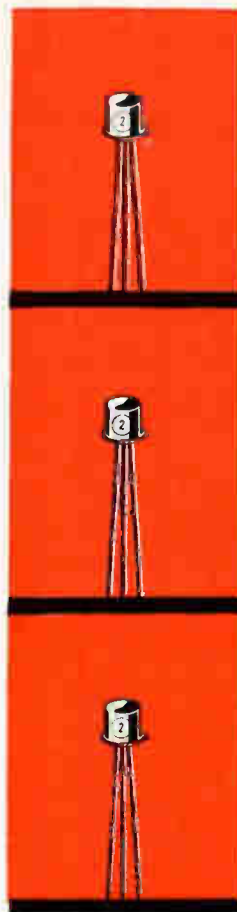

TYPE 2N768

- Micro-energy switch—designed for low current, low voltage, high speed applications
- 10 mc pulse rates, collector currents as low as 1 ma, collector supply voltages as low as 1 volt
- No reduction in switching speed, as with ordinary low current, low voltage devices. Permits higher density packaging
- Typical DC beta of 40 @ $V_{CE} = -0.20$ v, $I_c = -2$ ma

TYPE 2N769

- World's fastest switch—will operate reliably at speeds in excess of 100 mc
- Gain bandwidth product (f_T) typically 900 mc
- Low capacitance, low saturation voltage, high beta—ideal for low-level, high-frequency logic circuits
- Extremely low hole storage factor (K'_s) typically 18 nsec

TYPE 2N779

- Manufactured with tighter parameter control than any other transistor in the industry
- Designed to meet rigid specifications of 16 electrical characteristics—ideal for NOR logic and other super-critical applications
- Low saturation voltage—typically 0.12 volts
- Higher in performance, lower in price than mesa transistors with lesser specifications

Other Sprague Micro-Alloy Diffused-Base Transistors

TYPE	APPLICATION
2N499	Amplifier, to 100 mc
2N501	Ultra High Speed Switch (Storage Temperature, 85 C)
2N501A	Ultra High Speed Switch (Storage Temperature, 100 C)
2N504	High Gain IF Amplifier
2N588	Oscillator, Amplifier, to 50 mc

For complete engineering information on the types in which you are interested, write Technical Literature Section, Sprague Electric Company, 35 Marshall Street, North Adams, Massachusetts.



"Sprague" and "®" are registered trademarks of the Sprague Electric Co.

CIRCLE 5 ON READER SERVICE CARD 5

RCA SERVICES



—YOUR KEY TO COST CONTROL

Skilled manpower means investment ... in recruiting expenses, training and time.

Your key to manpower cost control is the pool of technical talent available through specialized assistance of RCA Service Company—RCA's military and industrial service arm.

You can "lease" expert manpower for specific needs—thereby cutting costs you would ordinarily incur because of recruiting, training and idle time.

Depending on your requirements, RCA can provide one... five... 100 specialists or more, to give you the support that will help you use your time more efficiently and control your costs.

Regardless of project scope, look to RCA Service Company for assistance in any, or all, of these services:

- Field Engineering
- Systems Engineering Services
- Equipment Installation, Check-out, and Maintenance
- Equipment Repair and Calibration

RCA Service Company has been providing such technical support services on complex equipment and systems to branches of the U. S. Armed Forces, governmental agencies, and prime contractors. This experience and skill assure you of the results you require.

There are times it makes good business sense to utilize outside capabilities to assist you in reaching your project goal more efficiently and economically. Look to RCA for the cost-controlling, technical excellence you require.

For complete information, contact
J. R. Corcoran, Location 206-2
RCA Service Company,
Camden 8, N.J.



The Most Trusted Name
in Electronics
RADIO CORPORATION OF AMERICA

COMMENT

Medical Electronics

Your issue of Jan. 20 contained one of the best editorial summations of medical electronics I have had the pleasure of reading (on p 49). *ELECTRONICS* is to be complimented for publishing so thorough a treatment of what is becoming an increasingly important field of activity for the industry. We at Gulton look forward to the upcoming articles in the series.

Congratulations to you, author Bill Bushor, and everyone connected with this idea.

ANDREW J. LAZARUS
GULTON INDUSTRIES
METUCHEN, N. J.

The other articles in the series appeared on p 46, Feb. 3, and p 54, Feb. 24.

... Am a subscriber to *ELECTRONICS*. I read your treatment of medical electronics—and it's good ...

HARRIS SKLAIRE, M. D.
PLATTSBURGH, N. Y.

Our thanks to you and Bill Bushor for the wonderful coverage in *ELECTRONICS* of medical electronics. Our thanks also for the cover of the Jan. 20 issue, together with the mentions in the article of AIL and our achievements. We think the article was grand ...

HAROLD HECHTMAN
AIRBORNE INSTRUMENTS
LABORATORY
DEER PARK, N. Y.

Square Deal From Government

Reader A. E. Lander of Washington, D. C., was somewhat alarmed by the Navy's failure to contact the *Santa Maria* immediately (Comment, p 6, Feb. 10).

I wonder if the Navy played square with us. Seems to me they not only found the ship but found it within three or four hours of the initial alarm. I believe this controversy does not lie within the realm

of adequate defenses, but rather some misguided sense of secrecy in Washington. We undoubtedly did not want the pirate captain to know we had located the vessel until a better insight into his plans for the passengers was gained. Considerable radio traffic would have been generated by persons outside the guarded government channels if every newspaper in the U. S. carried the story that the ship had been found and was being shadowed.

When it became apparent that no harm was to befall the passengers or that other steps would have to be taken, the Navy released a series of reports leading up to the actual interception. In other words, to keep the pirates from knowing we had intercepted their ship, the Navy took the rap that they had not found her.

A similar instance is unfolding right now about the large Soviet spaceship currently circling the globe. We did not release any information about this craft, yet when foreign observers pointed this out we immediately told the world we had been tracking the thing almost from the launch.

Our defenses are not what they should be, but I think these two cases were stupidly handled by the people in charge of telling the public.

WAYNE S. BECK
WHITNEY METAL TOOL CO.
ROCKFORD, ILL.

In our position close to these "people in charge of telling the public," we have become aware of an apparent trend in the last two months for government spokesmen to withhold information that might raise embarrassing questions. This tendency has been building up for some time. It has reached a point where the people who are really in charge of informing the public—the press, including the industrial press—are frequently denied access to the truth at the source. Many space-tracking people, for instance, have been gagged; all questions on the subject of the Soviet space ship are relayed to a government agency in Washington.

NEW FASTER WAY TO ANALYZE TRACES

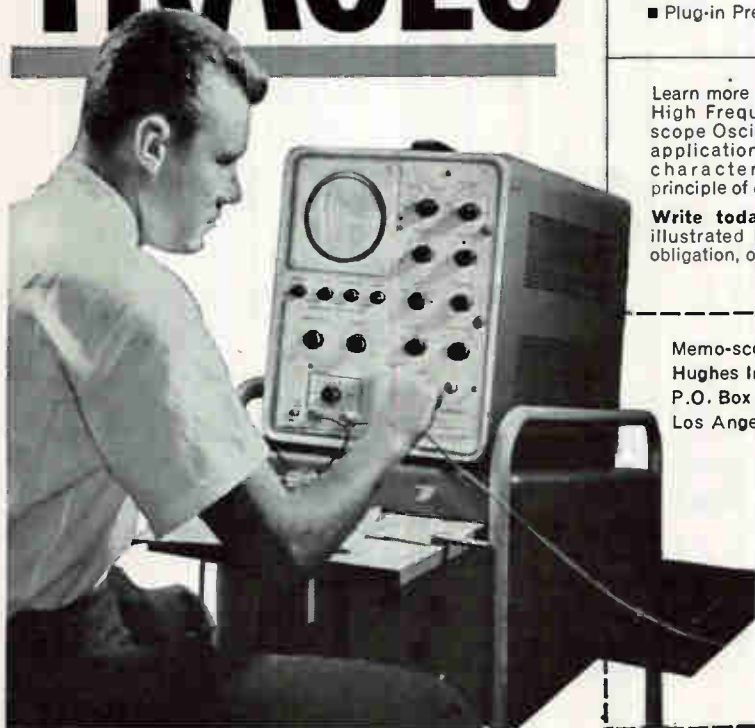

The all-new Hughes High Frequency Memo-scope® Oscilloscope saves you time and money in transient analysis. With its 10 mc bandpass and one million inches per second writing speed, it can store fleeting phenomena for an indefinite period of time. It displays these non-recurring transients for thorough study until intentionally erased. In this way, you can eliminate expensive "hit or miss" methods of transient analysis.

This is the *only* measuring instrument that can give you stored response at these fast writing speeds!

An added benefit: you can also use this unique new instrument as a precision laboratory oscilloscope. Thus, you get two precision instruments for the price of one.

SPECIFICATIONS:

CONVENTIONAL MODE:

- DC to 10 mc Band Pass
- Sweep Range: 0.1 μ secs/division; 5X Magnifier for speeds to .02 μ secs/division; Multiplier for sweeps long as 10 secs/division
- Rise Time: 35 nanoseconds
- Built-In Delay Line (0.25 μ secs)
- Numerous Trigger Selections
- Electron Beam Position Indicators
- Plug-in Preamplifiers

STORAGE MODE:

(All features of Conventional Mode, PLUS:)

- One million inches per sec Writing Speed
- Unlimited Storage Time
- Fast Erase (less than 150 milliseconds)
- X-Y Plotting
- Single Shot Trigger
- Photograph or Trace Directly Off Scope Face

Learn more about the new High Frequency Memo-scope Oscilloscope—its applications, operating characteristics, and principle of operation.

Write today for a free illustrated brochure. No obligation, of course.

CREATING A NEW WORLD WITH ELECTRONICS

HUGHES

HUGHES AIRCRAFT COMPANY
INDUSTRIAL SYSTEMS DIVISION

Memo-scope Oscilloscope
Hughes Industrial Systems Division
P.O. Box 90904
Los Angeles 45, California

- Please send me a copy of your 8-page brochure.
- Please arrange for an in-plant demonstration.

Name _____

Company _____

Address _____

City _____ Zone _____ State _____

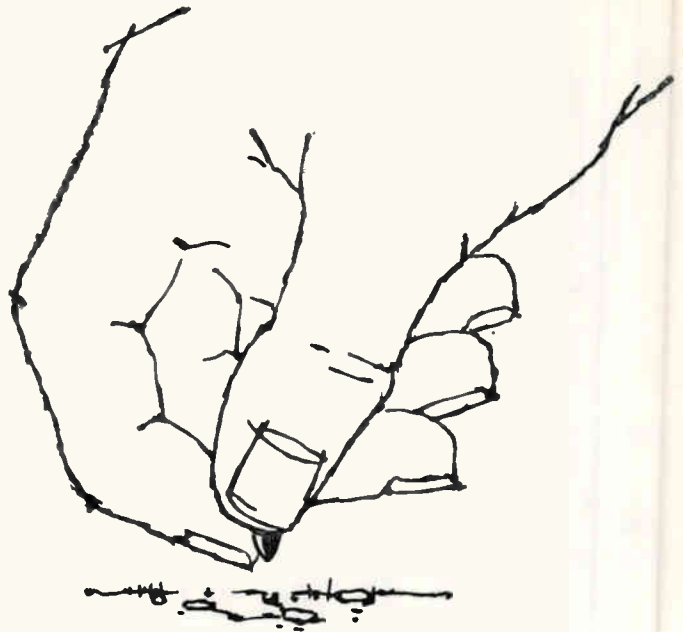

planting for tomorrow

You've heard of the "hard sell" and the "soft sell" — but many of our advertisers are also interested in the "long sell".

This is *planned* advertising. You might call it "planting for tomorrow".

The sales seed in an advertising message bears abundant fruit if sown in fertile ground . . . readers of this publication, for example, who, in *buying* this issue, have demonstrated their interest in what we have to say.

As a member of the Audit Bureau of Circulations*, our circulation records have been audited and the facts published — by this impartial organization of advertisers, advertising agencies, and publishers. These bedrock facts about our circulation audience can help you to plan more productive advertising.

Is your own planned selling based on circulation facts? You can be ABC-sure. Ask to see a copy of our latest circulation report.



electronics

A MCGRAW-HILL PUBLICATION • 330 W. 42nd ST. • NEW YORK 36, N. Y. 

*Through the reports issued by the Audit Bureau of Circulations, this publication, along with other publisher members of ABC, voluntarily and regularly give the buyers of advertising more verified factual information than is available for any other advertising media at any time.

ELECTRONICS NEWSLETTER

Transistor Sales Increased 36 Percent in 1960

YEARLY GROWTH PATTERN in transistor sales was sustained in 1960 as U. S. producers rang up \$301,432,285 in factory sales. The figure represents an increase of 36 percent over the \$222-million in sales recorded in 1959. Final 1960 figures were released last week by Electronic Industries Association's marketing data department.

A total of 127,928,586 transistors were sold in 1960; this is 55 percent above 1959's sales of some 82 million units. December was 1960's high month in numbers of transistors sold; over 13 million units were delivered for \$27,915,649. March was high month in dollar volume; 12,021,506 transistors were sold that month for \$28,700,129.

Japanese Electronics Still Going Strong

ELECTRONICS PRODUCTION in Japan for the first nine months of 1960 totaled \$856 million, the Business & Defense Services Administration reported last week. Figure is 31 percent over the \$655 million reported for the first nine months of 1959. Tv and radio made up about half the output, leveling off somewhat from 1959's upsurge. Tape recorders and phonographs continue a strong upward trend. Computers, control and measuring equipment, and special-purpose tubes are responding to government stimulus with production gains. Transistor production increased 34 percent and receiving-tube production increased 45 percent over the 1959 period.

Mitsubishi Electric announced last week that trial production is being undertaken on electronic instruments employing molecular electronic techniques. Instruments include notch filters, sawtooth generators, diode matrices, multivibrator units, multicontact electronic switches and audio preamps. Mitsubishi is affiliated with Westinghouse, imported the molecular

electronic technology last May, revised it locally. Weight of molecular units is said to be a ten-thousandth that of a transistor.

In another development, Tokyo Shibaura last Monday announced that a silicon-controlled rectifier capable of putting out 200 amperes has been produced by a double-diffusion process.

Epitaxial Mesa Transistor Switches in 110 Nanoseconds

DEVELOPMENT of a germanium transistor with a maximum switching time of 110 nanoseconds was announced last Friday by Sylvania Electric. The new transistor, an epitaxial mesa unit designated 2N781, has a maximum turn-on time of 60 nsec, maximum turn-off time of 50 nsec. Storage time is reduced to 20 nsec, the company says.

Saturation voltage is -0.16 v max. Collector-emitter and collector-base voltages are rated at -15 v. Collector current at 25 C is 100 ma and power dissipation is 150 mw.

Echo II May Herald Passive Relay Chain

ECHO II, passive satellite one third bigger and 20 times more rigid than the still orbiting Echo I, is being developed by G. T. Schjeldahl Co. under \$400,000 contract with National Aeronautics & Space Administration. Satellite is scheduled for launch in 1962.

Second-generation Echo will be 135 ft in diameter, use stretchable aluminum laid over a Mylar base. It will be 0.00077 in. thick, will yield evenly under inflation pressure, forget packaging folds and wrinkles, stay smooth and spherical longer than its predecessor. Black inner surface will distribute heat uniformly to keep skin temperature steady around 122-140 F even in direct sunlight.

If successful, Echo II may be followed by a string of Echo satellites

encircling the globe by 1963, possibly for radio-tv relay. Launching method now under consideration would kick balloons out at intervals—three from first rocket, six from another, and so forth—until the relay chain is complete.

Meanwhile, from Germany ELECTRONIC: editor W. W. MacDonald cables that European companies exhibit considerable interest in Bell System's proposed communications relay satellite. Several Telefunken executives, for example, will visit the U. S. in late March or early April to discuss mutual use of such a relay if and when it goes into orbit.

There is less interest in possible use of a satellite for radio-tv relay because of the time difference; feeling in Europe is that fast filming, kinescoping, video tape may do the job satisfactorily.

Tv Probe Observes Drilled Hole, Deep Lake

TELEVISION PROBE 25 inches in outer diameter has been developed by four engineers of Eastman International GmbH in Hanover, Germany, in cooperation with Grundig of Fuerth and the Austrian Engineering Bureau for Geology & Construction. Probe permits observation and photographic recording of geological conditions in drilled holes as deep as 1,312 ft, works faster and more accurately than coring procedures. Probe is 4.6 ft long, can withstand 735 psi.

Meanwhile, the Soviets announce that an underwater tv camera has been used to explore Lake Baikal in southeastern Siberia. The lake is one of the largest in Asia, is the deepest in the world.

Defense Contracts Stress Thermionics, Thermoelectrics

DIRECT CONVERSION of one energy medium to another is the research objective of a number of defense contracts disclosed last week.

General Electric in Lynn, Mass., has received two contracts from Army's Quartermaster Research & Engineering Command to study thermionic conversion systems and develop a self-contained heating-

ventilating system for combat clothing which can operate off a thermionic generator. Westinghouse has a parallel contract to develop a thermoelectric system for the same purpose. Meanwhile, Naval Research Laboratory has given itself a contract to explore fundamental heat-transfer processes in electro-mechanical, thermoelectric and magnetohydrodynamic devices.

In plasma research, Rome Air Development Center has asked Pratt & Whitney to investigate use of MHD principles for generating large quantities of electrical power. P&W is to evaluate both open- and closed-cycle systems, select one on the basis of feasibility studies, provide a conceptual design. Contract is due to be completed soon. Norair division of Northrop Corp. is winding up an RADC contract to study the generation of coherent electromagnetic radiation by a pulsating plasma. Norair was asked to analyze electron density at plasma interfaces and the modes of oscillation at such interfaces, study the behavior of pulsating plasmas, evolve the mathematics for the behavior, design experiments to demonstrate coherent radiation.

Westinghouse has completed its RADC contract for design and fabrication of a fossil-fueled convection-cooled thermoelectric generator of 100-w rating at 12 v. The generator, dubbed TAP-100, weighed 47 lb, exceeded its spec to produce 102.5 w, developed 19.7-v open-circuit potential, was tested to failure at RADC; initial failure came at 210 hrs. Texas Instruments continues its Office of Naval Research study of heat transfer and nuclear characteristics of thermoelectric direct-conversion nuclear reactors. Studies aim to find optimum design for a water-moderated uranium-dioxide reactor.

Electronics Still Attracts Venture-Capital Firms

DECISION of a major venture-capital firm to hire a hotel suite for the International Convention of the Institute of Radio Engineers indicates that financing of electronics ventures is still something of a buyers's market. The capital company is warming up for IRE week

with a campaign of promotions. Previous IRE shows have seen many aisle-roamers looking for merger, acquisition or stock-issue possibilities.

Organizations with money to invest still look for managerial talent (all-scientific management is taboo), product or prospect with a predictable market, preferably a sturdy profit position. They shy away from fast-buck operators, dreamers, or the man with nothing but plans.

New Entry Is Coming In Color Set Production

AFTER MARKING TIME for a couple of years, color television is on the move again. Profits from set manufacture are stabilizing, and several setmakers are cautiously planning to enter—or reenter—the field.

Zenith Radio announced last week that it will begin producing color receivers in the fall. Details are presently limited. Among innovations, the sets will include a color-demodulation technique employing the Zenith-developed Adler switching tube. Three-gun shadow-mask picture tube of advanced design will be used. Console models will be priced above \$600, the company says.

Self-Clocking Permits High-Density Recording

PACKING DENSITIES of 1,500 bits to the inch on standard digital recording tape are achieved in Potter Instrument's new tape units by means of self-clocked information pulses. A clock pulse is added to each information bit on each channel; the system helps account for tape skew, normally a severe hindrance to high packing densities. Skew causes an interchannel time displacement that makes it difficult to detect with adequate certainty which pulses in a parallel record go together.

In Potter's system, the clock pulses control the loading and unloading of a deskewing buffer; when a line is filled in the buffer, there is a clock pulse in each channel; the line is then read out and

the buffer is refilled. Other compensating systems use a single clock pulse per line (across the width of the tape; that is, there is one clock channel on a multichannel head); tolerance requirements of such a system are high.

Potter system permits packing densities up to 1,500 bits to the inch and higher; tape handler made for Bendix's G-20 by Potter uses a density of 1,100 bits to the inch. Potter says maximum permanent error is one lost bit in 10¹⁰, transient error is less than one in 10⁹. Recent 40-hour test showed no permanent errors; one second was lost when a reread was necessary because of a transient error.

Germans, Russians Use Microwave "Blasting"

ELECTRONIC BLASTING is being used by the Soviets with some success and is also under study in Canada, *ELECTRONICS* editor W. W. MacDonald reports from Hamburg, Germany. In an interview with an executive of German tubemaker Valvo, MacDonald learned that that company, on the suggestion of German Mining Research Institute, is experimenting with microwave to heat up moisture in hard-coal seams.

In the coalmining application, 2 to 5 Kw of c-w power at 2.4 Gc is fed to an antenna in a drilled hole. R-f converts trapped moisture to steam, loosens coal deposits. Similar technique has previously been used to liquefy viscid oil deposits.

Three-Screen Tv Bows in Chicago

TELEVISION SET with three independent screens and separate, remotely controlled audio—record player and f-m, both stereo—was put on the market recently by De Forest of Chicago. Set permits the viewer to watch three shows at once, listen to one—or to something else, if he prefers. Separate ear-phones are provided to keep the audio ambient bearable.

Said one Chicago tv commentator: "the answer to the prayer of vidiots . . ."

TUNG-SOL ANNOUNCES:

NEW MEDIUM-MU SERIES REGULATOR TUBE 7802WB

Brings together an optimum combination of characteristics that makes it ideal for applications in tough environmental extremes.

The 7802WB twin-triode, medium MU companion to the popular 6080WB, is the newest in the broad Tung-Sol line of rugged, high temperature, long-life series regulators. It combines many outstanding operational and design features in an optimum package of peak efficiency and dependability.

CONSIDER JUST THESE FEATURES:

- High perveance . . . Makes the 7802WB an excellent choice for applications requiring high plate current at low plate voltage.
- Medium-mu . . . Makes only very small signal voltages necessary for precise 7802WB control.
- Extra-tight tolerances . . . Plate current and transconductance are held to rigid limits to provide greater balance between tube sections. This is of particular significance where many sections are operated in parallel.
- High temperature operation . . . Extensive use of ceramics for heater-cathode insulators, anode standoff insulators and element spacers. The graphite anodes used are warp-free and dimensionally stable regardless of operating temperatures. Non-char, glass-bonded mica material is employed in the tube base.
- Top-performance in environmental extremes . . . Where electronically regulated power supplies must perform under severe conditions of shock vibration and high altitude, the 7802WB demonstrates long, trouble-free life, assured by both tube design and specifications.

Complete technical details on the 7802WB will be furnished immediately on request. A description of the full-line of Tung-Sol series regulator tubes is also readily available. Tung-Sol also invites you to outline your design needs to us. Our application engineers will gladly evaluate your circuit and outline the component which will best meet your requirements. Tung-Sol Electric Inc., Newark 4, N. J. TWX:NK193

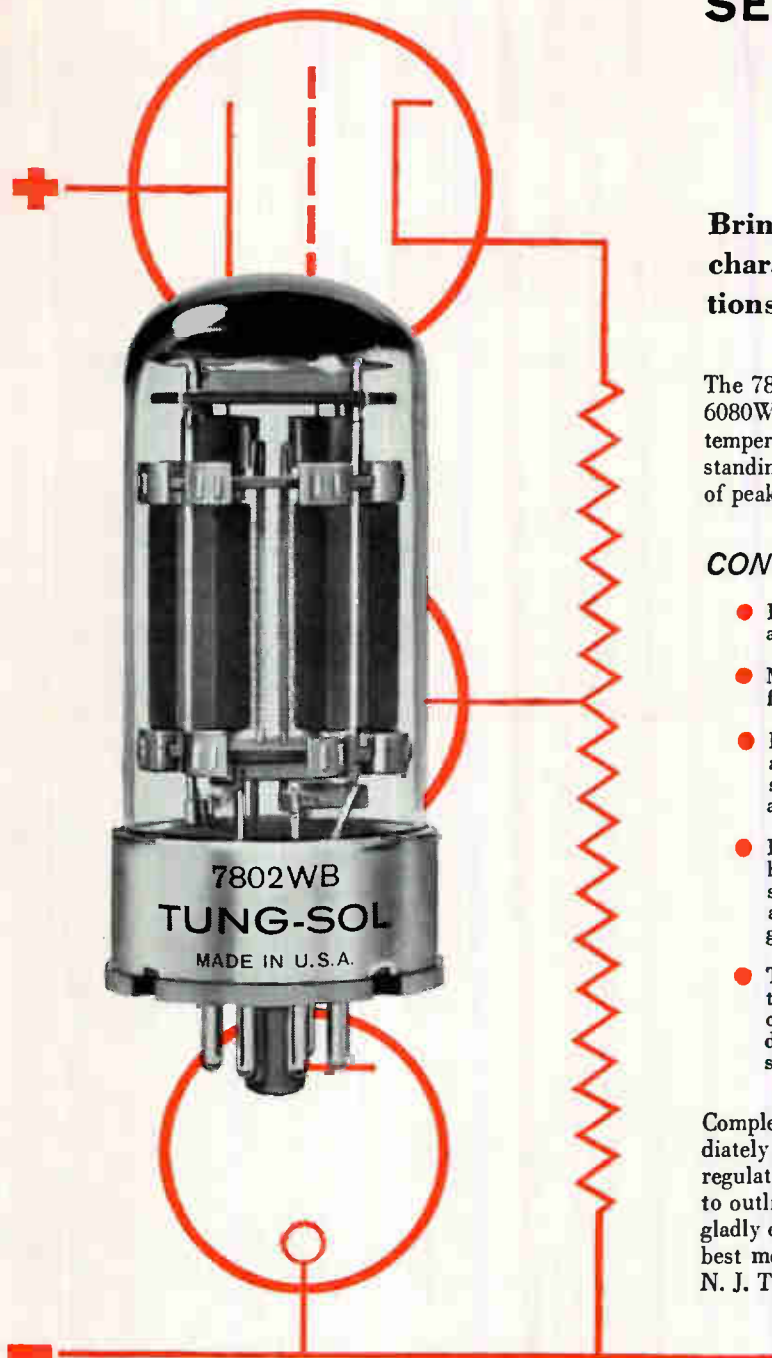

ts TUNG-SOL®

Technical assistance is available through: Atlanta, Ga.; Columbus, Ohio; Culver City, Calif.; Dallas, Texas; Denver, Colo.; Detroit, Mich.; Irvington, N. J.; Melrose Park, Ill.; Newark, N. J.; Philadelphia, Pa.; Seattle, Wash. In Canada: Abbey Electronics, Toronto, Ont.

PRODUCTION QUANTITY TI SIL

MAXIMUM 12 nsec t_{on} MAXIMUM 40 nsec t_{off}

**$V_{CE(sat)}$ PRACTICALLY INSENSITIVE TO TEMPERATURE ...
CONSTANT 1 VOLT FROM -55 to $+170^{\circ}C$**

The fastest silicon switcher in the industry! Design today with Texas Instruments new 2N743 and 2N744 silicon epitaxial transistors and get *two-times faster switching than possible from any other commercially available silicon transistor!* This outstanding new epitaxial series gives you an optimum combination of ultra-fast switching times, temperature-stable R_{CS} , very low collector capacitance, and high f_T , to make the 2N743 and 2N744 *ideal for application in current ranges from 1 to 100 ma.*

Utilize the low R_{CS} /high current characteristics of these new epitaxial units to *replace large size medium-power transistors* and cut your overall switching times as much as two-thirds. Cut cost and reduce the complexity of your NOR logic designs with the new TI 2N743 series — these new epitaxial units give you

a guaranteed I_{CEX} of 30 μa at a V_{CE} of 10 volts and V_{BE} of 0.35 volts to eliminate additional circuits previously required for an I_{B2} turn-off source in your computing systems.

Apply the new 2N743 and 2N744 to your designs today and get *guaranteed d-c betas at three current levels.* The 2N744 gives you a guaranteed h_{FE} of 20 at 1 and 100 ma and a 10-ma beta spread of 40 to 120, while the 2N743 features a minimum h_{FE} of 10 at 1 and 100 ma, and 60 maximum at 100 ma.

New TI 2N743 and 2N744 silicon epitaxial transistors are immediately available from distributor stocks or in mass production quantities at prices competitive with conventional silicon mesa and micro-alloy transistors.

Compare the 2N743 and 2N744 with conventional transistors!

Parameter	Approx. Test Conditions	TI 2N743	TI 2N744	2N834	2N706B	2N708
T_s (nsec)	$I_{B(1)} = -I_{B(2)} = I_C = 10 \text{ ma}$	14	18	25	25	25
t_{on} (nsec)	$I_{B(1)} = 3 \text{ ma}$ $I_{B(2)} = -1 \text{ ma}$ $I_C = 10 \text{ ma}$	11 (TYP)	10 (TYP)	35	40	35
t_{off} (nsec)		22 (TYP)	25 (TYP)	75	75	75
t_{on} (nsec)	$I_{B(1)} = 40 \text{ ma}$ $I_{B(2)} = -20 \text{ ma}$ $I_C = 100 \text{ ma}$	12 6 (TYP)	12 6 (TYP)	NO SPEC	NO SPEC	NO SPEC
t_{off} (nsec)		40 18 (TYP)	45 23 (TYP)	NO SPEC	NO SPEC	NO SPEC
$V_{CE(sat)}$	$I_B = 1 \text{ ma}$ $I_C = 10 \text{ ma}$ $T_A = +170^{\circ}C$	0.35 v	0.35 v	No High Temp. Guarantee (0.19 v MAX. @ 25°C)	No High Temp. Guarantee (0.4 v MAX. @ 25°C)	No High Temp. Guarantee (0.4 v MAX. @ 25°C)
I_{CEX}	$V_{CE} = 10 \text{ v}$ $V_{BE} = +0.35 \text{ v}$ $T_A = 100^{\circ}C$	30 μa	30 μa	No Guarantee	No Guarantee	10 μa (MAX.) @ $V_{BE} = +0.25 \text{ v}$ $V_{CE} = 20 \text{ v}$ $T_A = +125^{\circ}C$

NOTE: All limits are max. unless otherwise noted.

ICON EPITAXIAL TRANSISTORS

@ 100 ma



MAKE YOUR OWN COMPARISON FROM THESE TYPICAL CIRCUITS

50-ma SWITCHING CIRCUIT

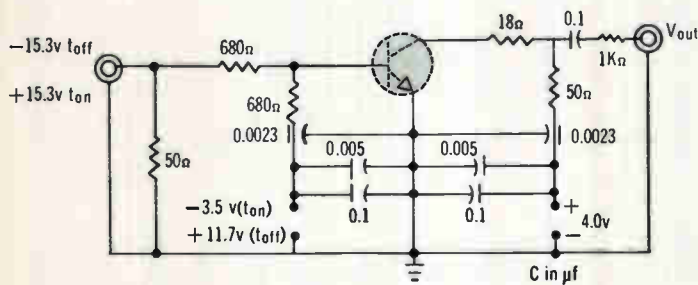

USE THE TI 2N743 TO SWITCH IN 1/3 THE TIME!



2N706

$$t_{on} = 10 \text{ nsecs}$$

$$t_{off} = \frac{50}{60} \text{ nsecs}$$



2N743

$$t_{on} = 7 \text{ nsecs}$$

$$t_{off} = \frac{15}{22} \text{ nsecs}$$

USE THE TI 2N743 TO DOUBLE POWER OUTPUT AND EFFICIENCY!



2N706

$$P_{out} = 225 \text{ mw}$$

$$Eff = 32\%$$

$$P.G. = 6 \text{ db}$$



2N743

$$P_{out} = 500 \text{ mw}$$

$$Eff = 65\%$$

$$P.G. = 6 \text{ db}$$

70-mc POWER AMPLIFIER

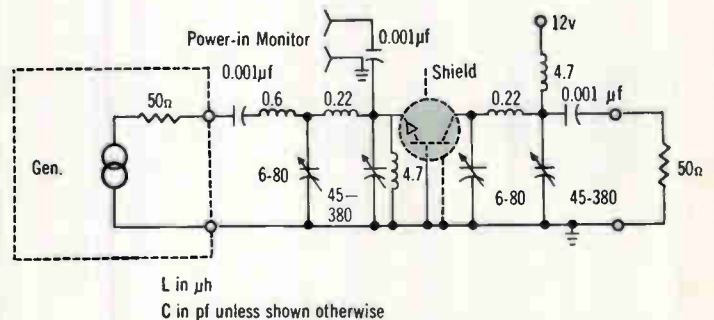

INDUSTRY'S BROADEST LINE OF TRANSISTORS
SEMICONDUCTOR-COMPONENTS DIVISION

TEXAS  **INSTRUMENTS**
LIMITED INCORPORATED
DALLAS ROAD • BEDFORD, ENGLAND P. O. BOX 5012 • DALLAS 22, TEXAS

CIRCLE 13 ON READER SERVICE CARD

JERROLD

R. F. Test Equipment

Quantitative Measurements Using Sweep Frequency Techniques



Model 900A—THE MOST VERSATILE SWEEP GENERATOR \$1,260.00

CENTER FREQUENCY—VHF 0.5 to 400 MC
UHF 275 to 1000 MCS—SWEEP WIDTH—
up to 400 MCS—FLATNESS— ± 0.5 db over
widest sweep!



Model 707—ULTRA FLAT SWEEP GENERATOR \$795.00

Featuring $\pm 5/100$ db flatness—Plug-in osc. heads*; variable sweep rates from 1/min. to 60/sec.; all electronic sweep fundamental frequencies; sweep width min. of 1% to 120% of C.F.

*Heads available within the spectrum 2 to 265 MCS

Models 601/602—PORTABLE GENERAL PURPOSE \$295.00

COVERAGE—Model 601—12 to 220 MCS. Model 602—4 to 112 MCS—FLATNESS— ± 0.5 db
OUTPUT—up to 2.5 V RMS
WIDTH—1% to 120% of C.F.



Model FD-30 \$250.00

High speed DPDT coaxial switch permitting oscilloscope measurements without calibration—all measurements referenced continuously against standard attenuators.



Model AV-50 Variable Precision Attenuator \$150.00

Long life rotary switches; dual wiping silver contacts on "Kel-F" dielectric. 0-62.5 db in $\frac{1}{2}$ db steps; DC to 500 MCS.

Write for catalog and technical Newsletter series on measurements using sweep frequency techniques. Prices and data subject to change without notice.

JERROLD ELECTRONICS CORPORATION
Industrial Products Division Dept. ITE-49
The Jerrold Building, Philadelphia 32, Pa.
Jerrold Electronics (Canada) Ltd., Toronto
Export Representative: Rocke International, N. Y. 16, N. Y.

WASHINGTON OUTLOOK

THE KENNEDY administration has decided to place greater emphasis on readiness to fight limited wars. This is one of the key decisions resulting from the current intensive reappraisal of basic U. S. defense policy.

Another conclusion is to emphasize mobile, low-vulnerability missile systems such as Polaris and Minuteman in building up retaliatory nuclear strike forces.

Both decisions reflect the shift in fundamental deterrence strategy that was discernible in the last years under Eisenhower and which Kennedy will now accelerate.

The stress on limited-war capabilities should produce a spurt in new Army orders for communications and other electronic equipment. These will cover such items as a field army mobile air defense fire-direction system; division-corps forward area communications; a battlefield intelligence analyzer; combat surveillance drones; radar flight-control systems for drones and aircraft; electronic countermeasures for enemy artillery fuzes and f-m command radio for tactical vehicles.

Some details on these projects may be disclosed at EIA's Washington seminar on Planning for Limited War Requirements to be held March 14 prior to the Association's Spring conference.

DEFENSE SECRETARY McNamara has ordered an intensified drive to channel more military orders to small business. Organization of the Pentagon's Small Business Policy Office has been overhauled; the operation will be run by Civil Service experts in procurement rather than by political appointees as has been the case.

The services have been directed to limit the use of noncompetitive, sole-source contracting whenever possible to help give more orders to smaller firms. They have also been ordered to find greater opportunities for small business contract set-aside and to encourage prime contractors to increase competitive opportunities for small firms in subcontract work.

PROTECTIONIST groups are reportedly working against Senate ratification of U. S. membership in a new, 20-nation Atlantic economic alliance. They fear that the proposed Organization for Economic Cooperation and Development might eventually dictate U. S. trade and tariff policy. Representatives of several domestic industries expressed opposition to U. S. affiliation with OECD at recent Senate Foreign Relations Committee hearings.

The Kennedy administration is pushing for U. S. membership in the Organization. Officials say one of OECD's prime goals is to expand world trade on a nondiscriminatory basis, but deny that the organization will have any tariff authority.

The administration views OECD as a forum for working out U. S. economic problems with Western European nations, particularly West Germany. One immediate U. S. aim is to find ways of stemming the balance of payments deficit.

But protectionist spokesmen here refuse to accept administration assurances and are trying to convince the Senate that OECD will infringe on Congress's own powers in formulating trade policy.

ELECTRONIC INSTRUMENTATION figures prominently in a drive now under way in Congress to expand government-financed oceanographic research. Sen. Warren G. Magnuson (D., Wash.) and others are pushing a 10-year program designed to match our reach into space for new scientific knowledge.

Cost of the program is estimated at \$650 million, of which \$59 million would be spent the first year. A bill to set up the program passed the Senate last year but never came to a vote in the House. Pres. Kennedy has singled out oceanography as an area which has been neglected in the past. This could be a tip-off to a more favorable outlook this year.

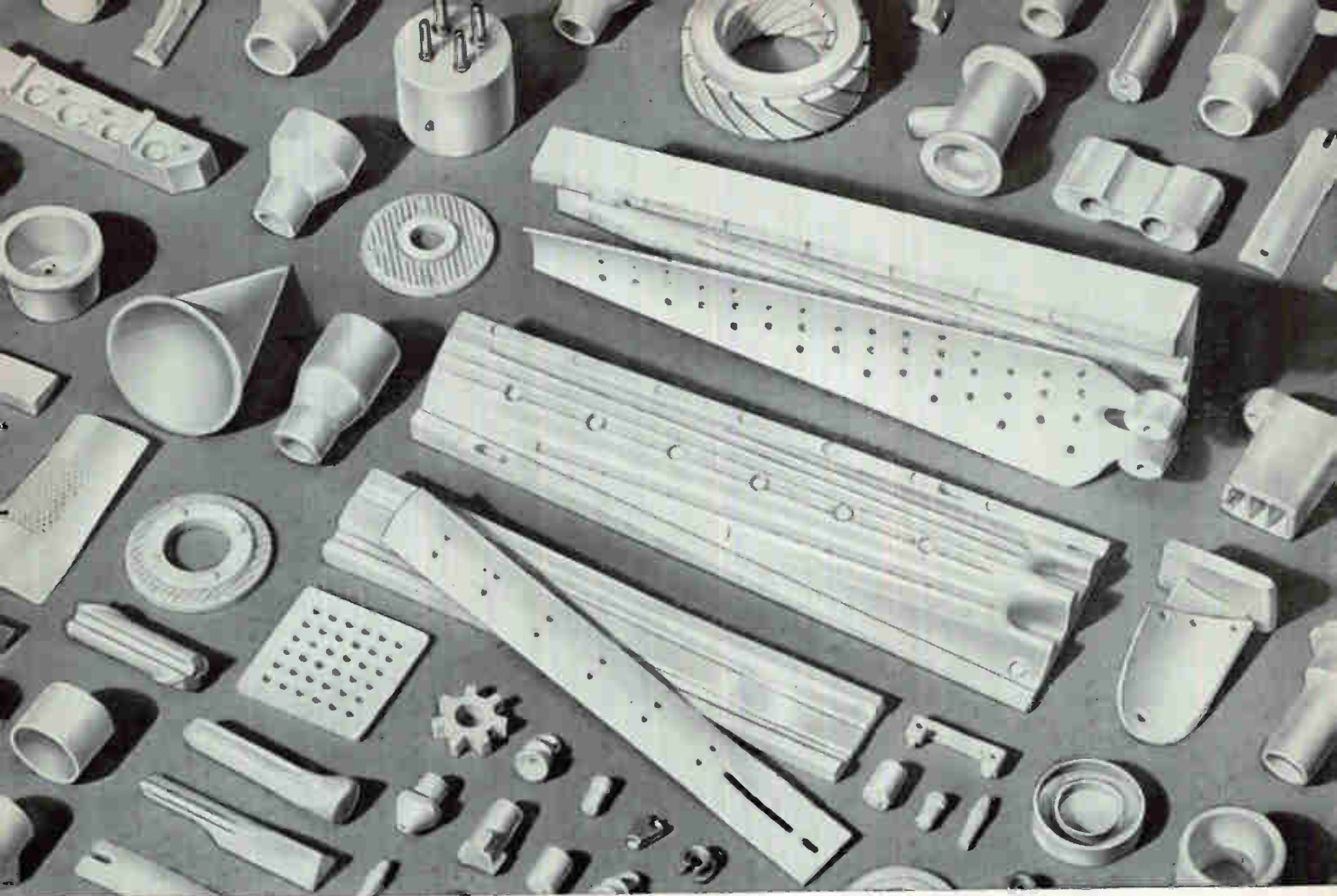

Highly complex shapes,

internal and external, formed in one operation to close tolerances in

ALSiMAG CERAMICS

NEW SHAPES NOW PRACTICAL

Technical ceramic parts formerly impossible or available only by expensive machining and grinding are now practical and can be produced in volume to close tolerances and with great uniformity. They include complex and compound curves, thin walls and other difficult design features. This injection molding process is particularly suited to volume production which readily permits amortization of initial tooling costs.

MATERIALS

ALSiMag 614 (High Alumina) and
ALSiMag 704 (Porous and Leachable)

have found widest use. Other ALSiMag ceramic compositions are available. See Property Chart, sent on request.

APPLICATIONS

include but are not limited to:

Electronic and Electrical, such as conical micro-wave tube windows, envelopes, complex internal insulators, cups, encapsulating devices, semi-conductor assembly boats and plugs.

High Temperature, Mechanical and Heat Shock uses such as welding nozzles.

Precision Investment Casting cores of great dimensional accuracy.

Guides for wire and textile machinery.

The use of these ALSiMag ceramics is indicated when high frequencies, high temperatures, heat shock, chemical attack or mechanical wear are involved.

EXPERIENCE

More than two years of steadily increased production from this equipment has given us practical experience which enables us to promptly and accurately answer most inquiries involving complex and difficult shapes. Send blue prints or sketches. Chances are that your "impossible" designs are now practical in ALSiMag ceramics.

A Subsidiary of
Minnesota Mining and
Manufacturing Company

AMERICAN LAVA CORPORATION

CHATTANOOGA 5, TENN.
60TH YEAR OF CERAMIC LEADERSHIP

For service, contact American Lava representatives in Offices of Minnesota Mining & Manufacturing Co. in these cities (see your local telephone directory): Boston: Newton Center, Mass. • Chicago: Bedford Park, Ill. • Cleveland, Ohio • Dallas, Texas • Los Angeles, Cal. • New York: Ridgefield, N. J. • Philadelphia, Pa. • St. Louis, Mo. • St. Paul, Minn. • So. San Francisco, Cal. • Seattle, Wash. All other export: Minnesota Mining & Manufacturing Co. International Division, 99 Park Ave., New York, N. Y.

Booth 4401 at IRE—Also see our Titania and Barium Titanate Specialists at Suite 1700, Commodore Hotel, during IRE

The true scientist, the creative engineer,
buy. Since this is a realistic world, money is an important
of attainment—does not begin and end with his pay
and creative climate—to rub elbows with men who are
participant in the Great Adventure of Tomorrow
these rewards-within-rewards impel men of outstanding
For here they can work on the POLARIS FBM;
and on new, advanced contributions to the Space Age.
they find a sense of being, of doing, of accomplishing.

Lockheed / MISSILES AND SPACE DIVISION DEPT. M-12B, 962 WEST EL CAMINO REAL,

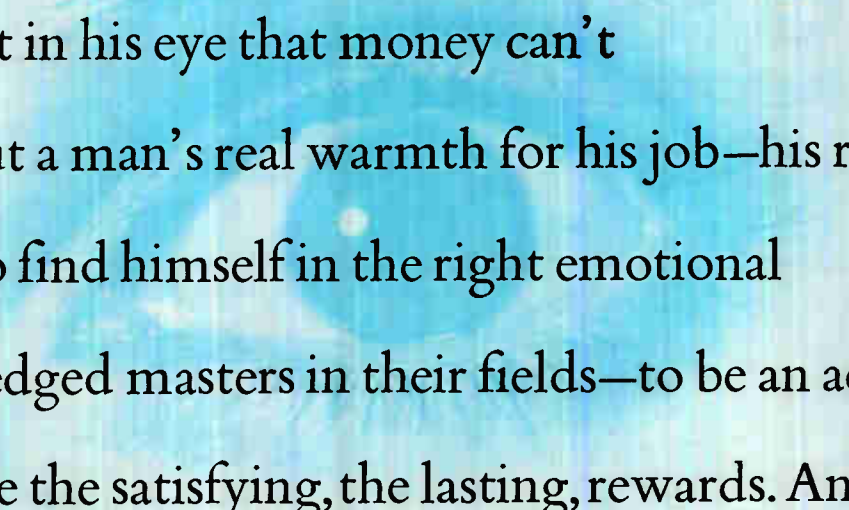

has a light in his eye that money can't
factor. But a man's real warmth for his job—his real measure
check. To find himself in the right emotional
acknowledged masters in their fields—to be an active
—these are the satisfying, the lasting, rewards. And
talent to come to Lockheed Missiles and Space Division.
on the DISCOVERER and MIDAS satellites;
Here they find inventive and creative freedom. Here
We invite you to join their proud company.

WANTED

IN FLORIDA

YOUR COMPANY TO JOIN WITH US IN PINELLAS COUNTY

Here's one of the few areas in America where it is possible to attract personnel in every category without difficulty.

Why? — No executive or employee need be more than 15 minutes away from home and garden, from fresh and salt water, fishing, bathing, boating, water skiing . . . no more than 15 minutes away from schools, churches, shopping centers, recreational and social activities.

All this, plus a favorable business climate . . . and SUN-sational living all year, in this enchanting land of flora and fauna.

Executive decisions, after extensive site location surveys in many areas of the nation, have resulted in major companies locating here. Their managements will gladly give you the result of their findings.

NOTE: Persons seeking positions please write Florida State Employment Service, 1004 First Avenue North, St. Petersburg.



For complete information communicate in confidence with:

GREATER ST. PETERSBURG - CLEARWATER INDUSTRY COUNCIL
GREATER ST. PETERSBURG CHAMBER OF COMMERCE

Jack Bryan, Industrial Director / Department E, St. Petersburg, Florida

Clearwater
Dunedin
Gulfport
Indian Rocks
Largo
Madeira Beach
Oldsmar
Pass-a-Grille Beach
Pinellas Park
Safety Harbor
St. Petersburg
St. Petersburg Beach
Tarpon Springs

new!
NARDA
ferrite isolators
 designed and manufactured
 by **NARDA MICROWAVE!**

• broadband coaxial
ferrite isolators

Excellent electrical characteristics with extreme versatility! $\frac{1}{8}$ " coaxial line construction allows higher power operation with $\frac{1}{8}$ " connectors, up to 20 kw peak, 400 watts average. (Normally supplied with Type N, $\frac{3}{8}$ " connectors; 10 kw peak, 10 watts average.) Features 15 db isolation and 1 db max. insertion loss. VSWR is 1.25 max. based on 2:1 load mismatch; 1.15 max. into matched load. Model 1233: 2.0-4.0 kmc; model 1233-1: 3.0-5.5 kmc; \$450. each.



• low power broadband waveguide
ferrite isolators

Provide maximum load isolation and minimum insertion loss over full standard waveguide frequency ranges. Extremely useful for maintaining signal source stability and eliminating long line and frequency pulling effects. Front-to-back ratios are the highest available on the market today: C Band-26:1, \$250; XN Band-28:1, \$225; XB Band-60:1, \$235; X Band-30:1, \$220.

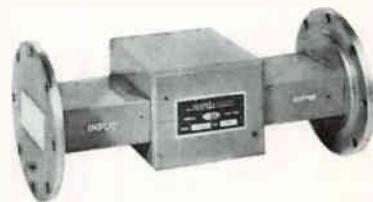

• high power broadband waveguide
ferrite isolators

The only line of high power isolators that covers all of X Band with just two models (8.2-10.0 kmc and 10.0-12.4 kmc), each with front/back ratio of 40:1. Input power rating: 250 kw peak, 300 watts average, achieved through use of special high Curie temperature ferrite materials. VSWR is 1.05 max. with matched load; 1.10 max. with 3:1 mismatch. Only \$175 each. Model with same VSWR, 28:1 front/back ratio, 300 kw peak, and 300 watts average, for 7.05-10.0 kmc, \$195.



• other ferrite devices—
 consult **NARDA** for:

• Circulators • Phase shifters • Modulators • Attenuators • Special Isolators

For more information, write to Dept. E-1.



the **narda** microwave
 corporation

118-160 HERRICKS ROAD, MINEOLA, L. I., N. Y. • PIONEER 6-4650

**ON DISPLAY
 AT THE
 IRE SHOW!**

Military Needs NEW SPACE-TRACKING

By JOHN MASON,
Associate Editor

THE AIR FORCE may soon ask industry to come up with some fresh new ideas for designing a new radar that will detect and track silent earth satellites. This radar would be the initial piece of equipment for a new satellite detection and tracking network. It would be the first radar designed for both detecting—the big problem—and tracking vehicles in space.

The North American Air Defense Command (NORAD), which has the job of detecting, tracking and identifying non-radiating objects in space—and when technologically possible, intercepting those that are hostile—is now conducting studies to come up with requirements for a new system.

Spacetrack, the Air Research Development Command's National Space Surveillance Control Center, has already submitted to ARDC and to USAF its proposals for a new system. The proposal describes what is needed, leaving it to industry to come up with the answer.

As with NASA (see *ELECTRONICS*, p 20, Feb. 24), the DOD's existing tracking networks all require replacements and updating. Future networks represent R&D and new production business.

Spacetrack is an important part of NORAD's present operational network. The center analyses, catalogs and sends to NORAD and other agencies orbital data received from more than 100 sources all over the world. Sources include detection stations operated by government agencies, industry, universities, cooperating foreign observatories and the Ballistic Missile Early Warning System in Greenland, Alaska and, eventually, England.

Many facilities, both existing and being built, while designed for purposes other than tracking satellites, will be used for space tracking and communications. DOD operates FPS-17 radars in Canada, Texas, Aleutians, Puerto Rico and Turkey. The 600-ft maneuverable dish Navy

is building in Sugar Grove, W. Va. and USAF's 1,000-ft bowl in Arecibo, P. R. will also be used.

Main DOD detecting net is the U. S. Naval Space Surveillance System (Spasur)—an east/west fence located on a great circle from San Diego, Calif. to Fort Stewart, Ga. Spasur reports directly to NORAD but also sends its data to Space-track and other government agencies. The fence, designed to detect non-radiating spacecraft, is divided into two complexes, one east, one west.

Each complex has two 108-Mc receivers about 500 mi apart and one 50-Kw transmitter equidistant between the receivers. To fill the gap between the two complexes, a new 560,000-watt transmitter will be built this year near Wichita Falls, Tex.

Each transmitter emits c-w radio energy creating vertical fan-shaped coplanar detection zones. The two interferometer receivers on either side of the transmitter measure the angle of reception of the reflected signals, determining the satellites position by triangulation.

The receiving stations transmit the measurement signals over a land-line to the Space Surveillance Operations Center, Dahlgren, Va. Here, signals are read visually and interpreted and inserted into the Naval Ordnance Research Computer (NORC) for orbit determination. Eventually the data will be automatically collected and conveyed from the transmission lines to the newly installed 7090.

Another source that contributes to Spacetrack is Army's Astro-Observation Center, operated by the Army Signal Research and Development Laboratory, Fort Monmouth, N. J. Besides the center's operational tracking function, R&D is carried out for new spacetracking systems, ionospheric research and space communications. The center is located at two main sites, the Deal station and the Diana site at Evans, N. J. (*ELECTRONICS*, p 40, Sept. 11, 1959).

Facilities at the center include

the 50-ft Diana antenna equipped with parametric amplifier, a 60-ft dish at Evans, one of the two 28-ft Courier communications antennas, one of the two main read-out stations for both of NASA's Tiros meteorological satellites, and six large conical-helix antennas.

The Deal station can presently make doppler measurements on random frequency up to 1,000 Mc and is equipped to extract telemetry on any one of 44 assigned missile frequencies in the 215 to 260-Mc band. There is immediate need for uhf precision tracking systems which could measure doppler up to 3,000 Mc—and eventually up to 10,000 Mc.

Each military service is responsible for specific satellite experiment programs.

Army built two 28-ft dish antenna tracking sites for its low-altitude delayed repeater communications satellite Courier (*ELECTRONICS*, p 38, July 22, 1960). One, mentioned above, is at Deal, N.J. and the other in Puerto Rico. Army's high-altitude active relay communications satellite Advent will use two 60-ft antennas (on the east and west coasts of the U.S.) and a smaller shipboard antenna. Sylvania is building the landbased antennas. Navy, responsible for the shipboard antenna system, has not yet awarded a contract.

Navy's navigational aid satellite, Transit, is tracked by small air transportable doppler stations located at five points in the U.S. and an undisclosed number overseas. Ultimately, stations may not be needed overseas although they will be maintained for byproducts of the satellite's data such as geodetic information. When the Navy puts up a series of operational Transit satellites, ground equipment will go from R & D to limited production.

USAF is responsible for three earth satellite systems.

The Discoverer series is designed to study problems of launching, communications, guidance, orbital performance and recovery. Ground

GEAR

station facilities are housed in vans or in permanent structures.

They include: administration and control van—master-control console, plotting board and communications; Verloft radar van—radar transmitter, receiver power supplies and orbital computer, outside antenna is 10-ft in diameter; instrumentation van for doppler tracking—phase-lock receiver, doppler-frequency measuring equipment, digital-to-teleprinter converter, master ground timing generators, tri-helix antenna; telemetry van—complete f-m/f-m telemetry facility composed of receivers, subcarrier discriminators, decommutators, tape recorders and an oscillograph recorder, a TLM-18 60-ft antenna; data transmission van—digital-to-teleprinter converter, digital-to-analog converters, polar-to-Cartesian connector, Cartesian-to-polar converter, acquisition programmer and checkout equipment.

Equipment is operating at Vandenberg AFB, Calif. where the satellites are launched; Point Mugu, Calif.; a tracking ship some 900 mi downrange; Kodiak, Alaska; Kaena Point, Hawaii; and New Boston, N.H. Tern Island in the Pacific uses only the TLM-18 and tri-helix antenna. Orbit projection is computed by the Air Force Satellite Test Center, Sunnyvale, Calif.

Samos, the photographic reconnaissance satellite, is using during its R&D phase the Discoverer tracking net with added special equipment plus Pt. Arguello (launch site) and St. Nicholas Is., Calif. Additional stations are planned in Iowa and Oregon.

Midas, the early warning satellites series to detect by infrared sensors enemy launchings of ballistic missiles, also uses both Discoverer and Samos tracking stations. Once operational, both Samos and Midas will undoubtedly need extensive permanent tracking and communications networks.

Another big market coming up is the worldwide ground tracking/data acquisition network for Dyna-

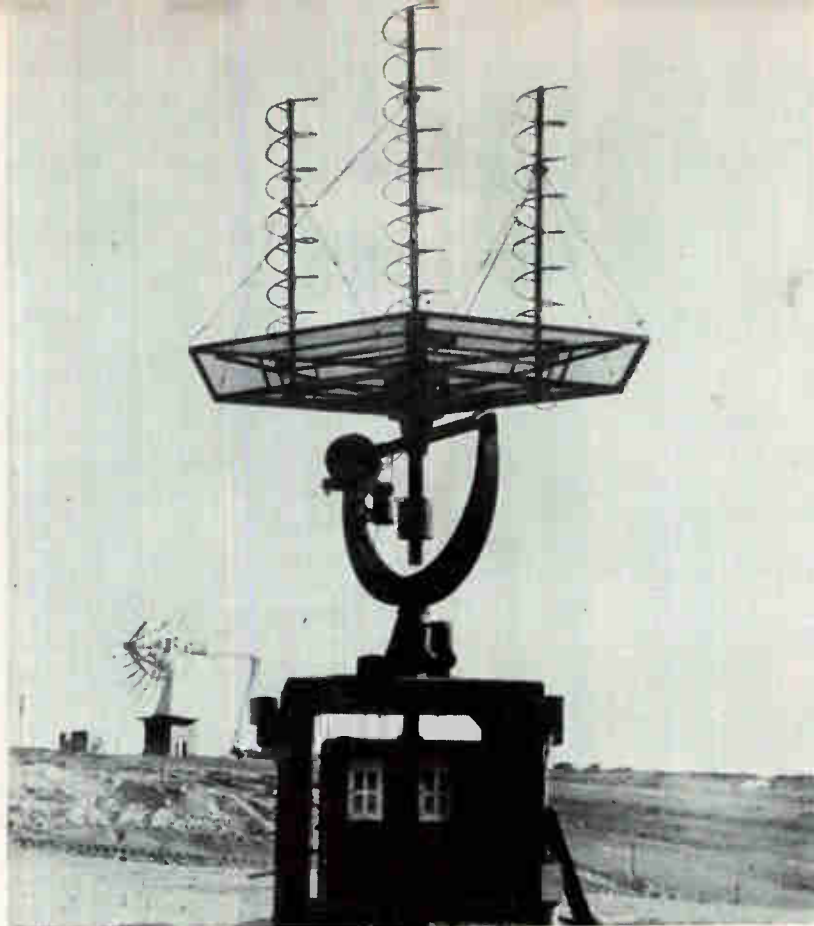

Manually controlled doppler-telemetry receiver antenna system for Discoverer may be replaced by automatic unit being developed

soar, the manned boost-glide vehicle. RCA has the contract, USAF and NASA the responsibility for the program (ELECTRONICS, p 26, Feb. 24). In its early phase, Dynasoar will be tested along

the Atlantic Missile Range and will use existing Air Force and NASA's Mercury facilities—some on shipboard, some on islands. Super-high frequency tracking stations in the 13.5 gigacycle band will be used.

Analog Simulator Helps Control Flood Waters

ANALOG SIMULATOR designed and built by engineers at UCLA, Berkeley, will optimize use of a complex system of reservoirs within the Kansas River basin to combat flood conditions.

The reservoir system includes some 1,000 miles of river channel and ten reservoirs and is used during periods of heavy rainfall in a manner so various parts of the system are used to prevent overflow.

The analogue simulator will predict river stages and flow at all points on the basis of data from 70 rain gages, rainfall predictions, and reports of thunderstorm activity. This will enable opening of floodgates to control the effects of sudden flash floods.

Financial support of the simulator project was given by the Kan-

sas City District of the U. S. Army Corps of Engineers.

Russia Announces I-R Hot Box Detector

MOSCOW—Soviet engineers here have announced development of an infrared hot box detector which is incorporated in a system to alert railway maintenance crews.

The device is installed several kilometers from the station and detects the overheated bearings on outgoing or incoming trains. A computer alerts an information desk in the train station and at the same time automatically switches on apparatus to spray the heated axle with white paint for identification.

Engineers Take 'Second Look' at Microcircuits

By JOHN M. CARROLL
Managing Editor
SAMUEL WEBER
Senior Associate Editor

A "SECOND LOOK" at microcircuits touched off the expected controversy at the 1961 International Solid-State Circuits Conference held recently in Philadelphia. Emphasis in the informal evening discussion session was on microsystems design to come to grips with problems of interconnection.

R. Alberts of Wright Field implied the day of microcircuit stunts is over and it is now time to do some real work.

W. Gaertner of CBS Labs posed the question of whether the component maker of the systems company will be the major factor when microcircuits come of age. R. Rice of IBM stated that some companies have the resources to cover both the components and systems aspects. A significant comment in that his firm is now energetically recruiting for a new components division.

R. G. Counihan of IBM said the concept of Boolean circuit blocks is wrong; what is needed is batch fabrication of devices at the systems level with interconnections engineered in. He concluded that "circuit designers must become systems oriented or find new jobs."

Talking about hardware, a Fairchild Semiconductors spokesman said that microcircuit computers made with several different techniques may be expected in 18 months. J. Nall of Fairchild said his company has worked with silicon circuit blocks using the planar technique. He predicted such a flip-flop in a 3 by 75-mil can selling at silicon-transistor prices.

R. E. Lee of Texas Instruments spoke of a $\frac{1}{4}$ by $\frac{1}{8}$ in. by 80 mil rectangular can containing 20 elements including bipolar, unipolar and field-effect transistors. He remarked that last year his firm sold 2,000 Solid Circuits of some 20 different varieties. Counihan announced that IBM has made 4 by 4 in. thin film circuit plates with 4,900 elements interconnected for a cryogenic system.

Questioned about new technical trends, T. Stanley of RCA mentioned use of ceramics such as barium titanate and ferrites for their magnetic, resistive and capacitive effects, use of electroluminescent-photoconductive (EL-PC) panels for neighborhood logic circuits of high reliability and cryogenic memories.

Gaertner mentioned use of electron beam machining. E. Fletcher of MIT, when questioned about sublimation decomposition, remarked that electron beams are being used for both machining and evaporation and that electron-beam decomposition for thin-film production looks promising. He also observed that ultraviolet optics are being used for demagnification.

Some of the more immediate problems of microcircuits were explored in another informal session dealing with micropower circuits. Micropower implies performing logical operations at greatly reduced power levels and later amplifying up to operate output devices. Present level for computer circuit operation is about 12 v collector voltage, 100 ma collector current or

120 mw. Existing micropower techniques can reduce this to 5 or even 2 mw. Goal of micropower designers is 30 microwatt operation.

Micropower circuits could be used to do digital logic in space vehicles, satellites and compact computers, work in internally planted biomedical devices working off neuromuscular potentials, drive underwater hydrophones powered by high radiated r-f power and to reduce heat in microcircuits.

It was noted that low collector voltage permits low collector load resistance which decreases the collector R-C time constant and improves switching time, and that low collector current reduces self-induced transistor noise. However, collector capacitance increases at low voltages and emitter capacitance becomes an important factor at low currents.

Limit is set on collector voltage by the band gap of the material. Lowest collector voltage would seem to be 1 v for germanium, 2 v for silicon. Leakage current of the transistor sets a lower limit on current. Participants called for transistors with 0.6 pf collector capaci-

Space Drum Stores 358,000 Bits

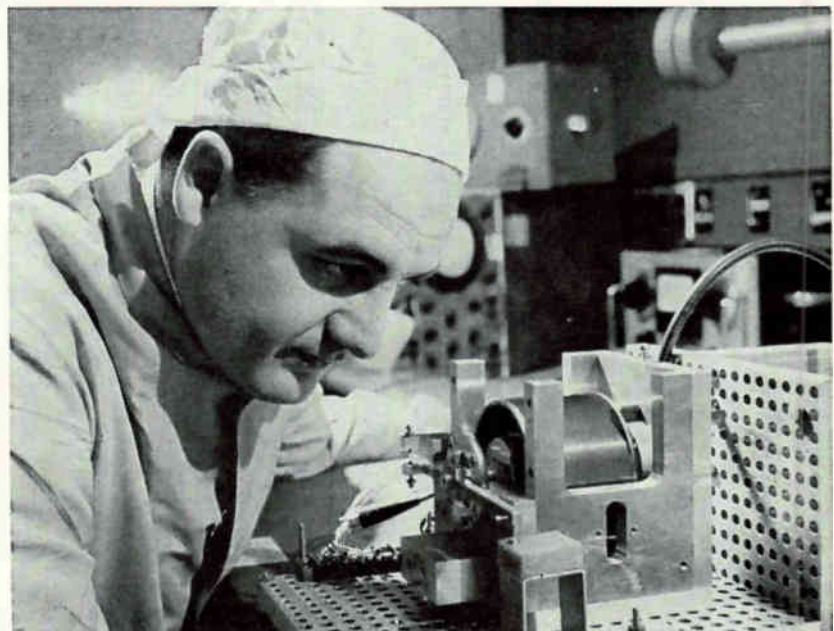

Miniature memory drum for Sperry navigation system has floating heads one ten-thousandths of an inch above the drum surface

tance at 5 v collector potential and 10 pa leakage current.

Engineers suggested transistor-diode circuits for micropower, remarked that tunnel and backward diodes may be used as coupling devices. One man called for a thin-film pulse transformer.

In talking about present-day accomplishments, conferrees discussed a 6-mw 200 Mc amplifier with 15 db gain and a noise figure of 4 db; 3-mw logic circuits are also available for clock rates from 1 to 4 Mc.

At the informal session on microwave applications, B. C. DeLoach of Bell Telephone Laboratories brought whistles from the crowd with his report of a test on a new varactor diode which exhibited zero-bias cut-off at 360 Gc and reverse-bias cut-off at 500 Gc.

DeLoach told the group that the greatest limitation to use of diodes in parametric amplifiers was not the diode itself, but the lack of suitable pumping devices.

He called for more development activity in the area of higher power pumping devices in the 50 to 100-Gc region, without which it would be useless to develop varactor diodes with higher frequency capabilities.

Gallium arsenide diodes came under critical scrutiny at the microwave session and also at the session on tunnel diodes. Reports of deterioration of these devices after prolonged service was mentioned by one panel member of the microwave session. However, speaking from the floor, a Texas Instruments spokesman reported that 2,000-hr life tests at 100 C and reverse-bias of 5 v had yielded no change in characteristics.

At the tunnel diode discussion, the question of GaAs deterioration was again brought up. J. Tiemann of GE's Research Lab acknowledged that behavior of GaAs diodes under forward-bias conditions was not completely understood, and that work was being done to eliminate gaps in our knowledge.

He said there are apparently several independent mechanisms by which deterioration in tunneling characteristics take place. For example, in zinc-doped GaAs, the peak current decreases with age, while in cadmium doped material, the valley current goes up.



45
TO
600
CPS



*Dual Frequency
Without Switching*
**FANS AND
BLOWERS**

Specifically for instruments and test consoles which must operate on 50-60 cps in the lab and on aircraft 400 cps power supply. Continuous operation over a frequency range from 45-600 cps without the use of switching components or duplicate power connectors. Long operational life. Meets both military and federal specifications.

Model	Type	Series	Capacitor MFD Rated 220 vac	CFM		Total Net Pounds	Approximate Dimensions
				60 cps/400 cps			
DF	KRS-301	433A	0.25	28	41	1.1	3"x3"x3"
DFE	KRS-401	434A	0.5	82	102	1.7	4"x4"x3½"
DFE	KRS-4501	435A	1.0	115	160	2.7	4½"x4½"x5"
DRPP	KRS-1504	433A	0.25	9	14	1.2	3"x3"x3½"
DR	KRS-202	434A	0.5	20	25	1.7	4"x3½"x4"
DR	KRS-2501	435A	1.0	33	40	3.0	5"x4½"x5"

Write today for detailed technical information to . . .

ROTRON mfg. co.,
inc.
WOODSTOCK • NEW YORK

Electronic Surveillance: The Hidden Ear

By **LESLIE SOLOMON**,
Associate Editor

A CLANDESTINE but nonetheless growing area in electronics is the shadow world of surveillance. Surveillance encompasses all the techniques whereby electronics can be used to eavesdrop on another party to find out what is being said or done so advantage can be taken.

Severe legal penalties can be invoked for those involved in certain uses of electronic equipment for surveillance. Yet such uses exist and in many cases make use of excellent electronic engineering talent gone astray.

The main areas of surveillance are wire tapping and bugging. Wire tapping means gathering information from telephone lines. Bugging uses hidden microphones and radio equipment.

Other surveillance apparatus includes highly directional microphones, concealed tape recorders, infrared gear modeled after the sniper scopes of World War II, hidden photographic and television cameras making use of fiber optic lenses and remote controls.

The arrangement of any telephone line is recorded in a central office. When a tap is suspected, telephone company experts can make several different types of tests. For example: capacitance measurements are made between junction boxes. Knowing exactly what is attached to the line, the capacitance of the system is measured.

If the total capacitance is greater than normal, a physical search is then made of the section of line displaying the extra capacitance. Contrary to popular belief, taps do not cause noise on the telephone line.

A new development being used is pressurization of underground telephone cables. This system maintains air pressure within the cable and in case of a leak, the compressed air keeps out any moisture that may get in to damage the insulation. As the air pressure is monitored, any natural or manmade leak will be signalled.

One method of maintaining secrecy in sensitive areas is the use

of tricoaxial line. The outside braid carries high-level white noise. This discourages induction tapping. Electrically disturbing the coaxial cable (such as with a direct metallic tap) is automatically signaled by a balanced bridge arrangement.

The use of speech scramblers is becoming popular as a countermeasure to wire tapping. These scramblers fit on the exterior of the telephone, making no direct wire connection. They are sold in matched sets and permit a reasonable degree of security.

One clandestine communications system exposed by the authorities is called the cheesebox. It was popular with bookmakers and operated as follows: One member of the gang rents a store and whitewashes the windows. Two telephones are interconnected by a circuit that contains an automatic timer.

One phone number is given out to regular customers and the other kept secret. Once the system is operating, the store is completely wired with burglar alarms so that if anyone forced the door or windows, the second phone connection is broken. When the gang opens for business, they are located many miles away from the store. One of

them dials the second phone at the wired store and is interconnected to the first phone. When anyone calls the first phone, a signal is transmitted through the second phone. The automatic timer breaks the phone connection after a few minutes to throw off line tracing. Seven minutes is the time that some police departments say they need to trace a phone call. New techniques permit authorities to trace a call within moments if forewarned. It is also possible to "hold" a line even though both parties have hung up.

Radio bugs assume many different shapes. Most use transistors and miniature components. Operating at relatively quiet spots in the short-wave spectrum, these transmitters can have ranges up to several miles, using a-m or f-m.

One of the drawbacks to the use of bugs used to be battery replacement. This usually means accomplices. Radio bugs now use free-power circuits. Thus a concealed bug can operate as long as the components hold out and the broadcast station stays on the air.

Locating radio bugs can be done with receivers or spectrum analyzers equipped with a small antenna fixed to the end of a coaxial cable. With the detection equipment operating, one person whistles loudly around the room while observing the receiving equipment. The other person probes the room walls, ceiling, floor and furniture.

Another system that can be used for electronic snooping is the concealed tape recorder. With the advent of miniature battery-powered tape recorders, concealment becomes relatively easy. Tape recorders can be supplied with shoulder holsters and concealed lapel or wrist watch microphones. They can also be built into an attache case.

In the latter case, the snooper pays a visit to his victim and forgets his attache case. The recorder is left running and will record conversations in the room for $\frac{1}{2}$ hour or more. Then the snooper returns and reclaims the briefcase he "forgot".

Cool Device

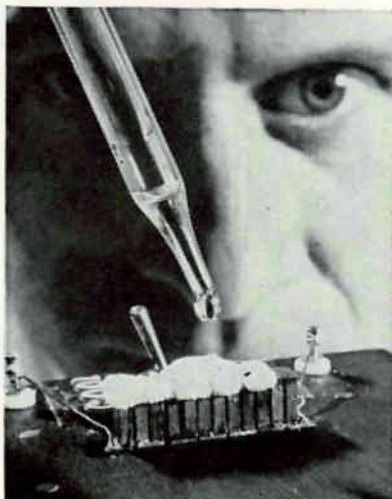

Two flashlight batteries power three-stage cascaded Peltier device (Hughes) which brings temperatures down to -100°F

■ A production reality based on 20 years of crystal engineering experience...

Miniature Wide Band-Pass Crystal Filters Delivered In Quantity...To Specification

Filters just recently considered as "state of the art" are now a *production* reality. In addition to its many stock narrow band filters, Midland offers prototype and production quantities of practical Miniature Wide Band Filters in the .5 to 30 mc range. These filters are of exceptional quality.

They are essentially free from unwanted spurious modes which have previously limited the realization of many types of wide band filters. Small quantities for engineering evaluation are available *immediately* from stock. Consultation is available at any time to potential filter users.

Shown below are specifications for ten of our stock wide band filters, as well as actual characteristic response curves. These filters are actually being delivered to major weapons system manufacturers in quantities — to specification.

THESE ARE NOT LABORATORY CURIOSITIES OR IN PROTOTYPE DEVELOPMENT STAGE

Type	Center Freq.	3db Bandwidth Minimum	40db Bandwidth Max.	60db Bandwidth Max.	75db Bandwidth Max.	Ultimate Discrim. Minimum	Insertion Loss Max.	Impedance ohms	Inband Ripple Max.	Package Type
NJ-1	7.2MC	160KC	300KC			60db	6db	13K	1db	A
NJ-1B	7.2MC	160KC	300KC			60db	6db	13K	.5db	B
NJ-2	7.4MC	160KC	300KC			60db	6db	13K	1db	A
NJ-2B	7.4MC	160KC	300KC			60db	6db	13K	.5db	B
NG-1	5.09MC	160KC	350KC			60db	6db	20K	1db	A
NG-1B	5.09MC	160KC	350KC			60db	6db	20K	1db	B
NB-1	10.7MC	200KC		450KC		75db	12db	50	1db	A
NB-1B	10.7MC	200KC		450KC		85db	8db	50	.5db	B
RL-1	11.5MC	80KC		160KC	200KC	85db	6db	50	.5db	C
RL-1B	11.5MC	80KC		160KC	200KC	90db	5db	50	.5db	B

Operating Temp.: -55°C to +90°C

Shock: 100g

Vibration: 15g to 2KC

Units hermetically sealed

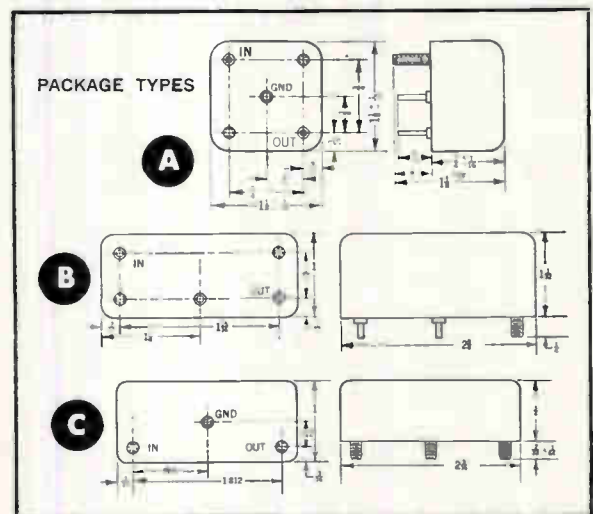
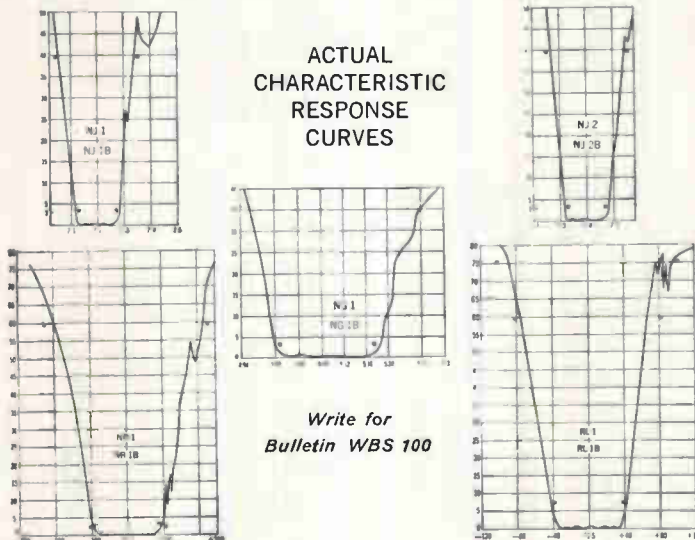

A limited number of opportunities for filter and communications engineers and technicians are available. Write Mr. Robert A. Crawford, Chief Engineer, Filter Division.

Midland

MANUFACTURING COMPANY • 3155 Fiberglas Road, Kansas City 15, Kansas

WORLD'S LARGEST PRODUCERS OF QUARTZ CRYSTALS
DIVISION OF PACIFIC INDUSTRIES, INC.

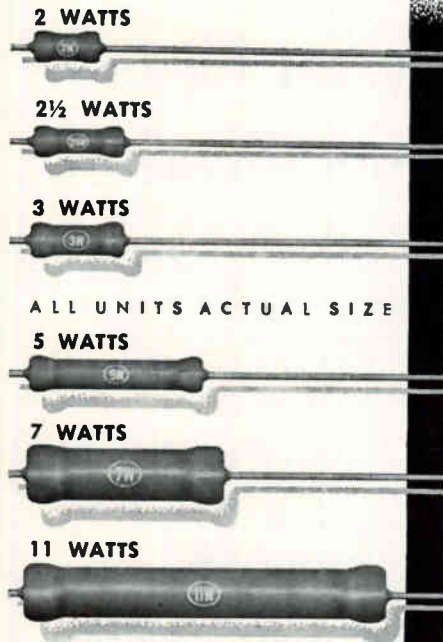

NEXT TIME ... USE TINY *Blue Jacket* WIREWOUND RESISTORS

Sprague builds reliability... efficiency... economy right into minified Blue Jackets with these important features:

- * All-welded end-cap construction with special vitreous-enamel coating for total protection against humidity, mechanical damage, heat, corrosion gives long-term dependability under severe environmental conditions
- * Available in resistance tolerances as close as $\pm 1\%$
- * Low in cost... quick and easy to install

Tiny axial-lead Blue Jackets are specially designed for use with conventional wiring or on printed boards in miniature electronic assemblies. Write for complete technical data in Sprague Engineering Bulletin 7410B.

SPRAGUE ELECTRIC COMPANY
35 Marshall Street, North Adams, Mass.



Santa Fe railway workers align a microwave antenna

Railroad Microwave Expands

MICROWAVE CONSTRUCTION projects now underway in the U. S. and Canada will see some 6,000 more rail miles covered by radio within the next year.

This prediction by Association of American Railroads points up the mushrooming growth of railroad microwave relay systems in the recent past.

Experimental work in this field was undertaken on the Rock Island Line in 1946, according to AAR, for point-to-point service. By 1950, the net was in full commercial use. The Long Island Rail Road had an experimental point-to-point system operating in 1948-49. The Santa Fe line began to work with microwave in 1952.

From these early beginnings, railroad microwave systems have expanded to a present figure of about 2,100 route miles of radio relay involving several hundred frequencies within the 6,000 Mc band.

In addition to routine traffic uses, today's railroad microwave nets are transmitting signals that control switches, activate signals, govern electric power flow and even operate infrared hotbox detection systems. Also growing in importance is data transmission equipment giving a steady flow of traffic

information, car movements and other data. The Denver and Rio Grande Western has recently installed facsimile equipment within its microwave complex. The facsimile is now being used to transmit waybills. A spokesman for AAR says other railroads will probably be installing facsimile equipment in the near future. The DRGW system occupies 120 voice channels.

The one early attraction to microwave by railroads was the relief it offered from wire-system failures due to heavy storms. Later, the advantages of bridging rugged terrain with more reliability and less expense became evident in many cases.

Because of the distances involved in railroad microwave systems, costs are often hard to determine in advance. Canada's Pacific Great Eastern Railway operates without wirelines. The microwave system to make this possible cost about \$2 million. The route runs over the Canadian Rockies.

Southern Railway is now constructing a multichannel, transistorized microwave system between Washington, D. C. and Atlanta, Ga. The network will run 637 miles, have 54 relay stations, and will cost

\$5.3 million. Southern Pacific operates a 120-mile system that cost \$120,000. Rio Grande Western is building a 700-mile system integrating facsimile and voice channels. The system will serve 21 stations at a cost of \$1,803,240.

Indications from AAR are that six more railroads are planning microwave systems at present.

A survey taken at midyear 1960 showed the following mileage figures:

RAILROAD	MICROWAVE MILAGE
Alaska Railroad	50
Canadian National.....	550
Canadian Pacific.....	40
Pacific Great Eastern....	750
Pennsylvania	41
Rock Island	106
Santa Fe	396
Southern	158
Southern Pacific	23

2,114

Systems now under construction are:

RAILROAD	MICROWAVE MILAGE
Denver & Rio Grand	
Western	700
New York Central	12
Santa Fe	1,988
Southern	637
Union Pacific	563

Total Miles

3,900

In addition, the Frisco Lines; Spokane, Portland and Seattle; Northern Pacific; Missouri-Kansas-Texas; Louisville & Nashville, and the Texas and New Orleans Railroad are reported to be studying possible use of microwave in their systems.

Studying Requirements Of Electronic Checkout Gear

BUREAU OF NAVAL WEAPONS has awarded a contract to PRD Electronics, Brooklyn, N. Y., to make basic engineering studies of electronic checkout equipment for aircraft weapons systems.

Contract covers work extending into 1964, aims to coordinate development of automatic checkout gear to enable Navy technicians without advanced training to detect and identify troubles in complex electronic systems with minimum wasted time and motion.

March 3, 1961

PRECISE *MicroMatch*[®] COAXIAL TUNERS TUNE TO VSWR 1.000 200-4000 MCS.

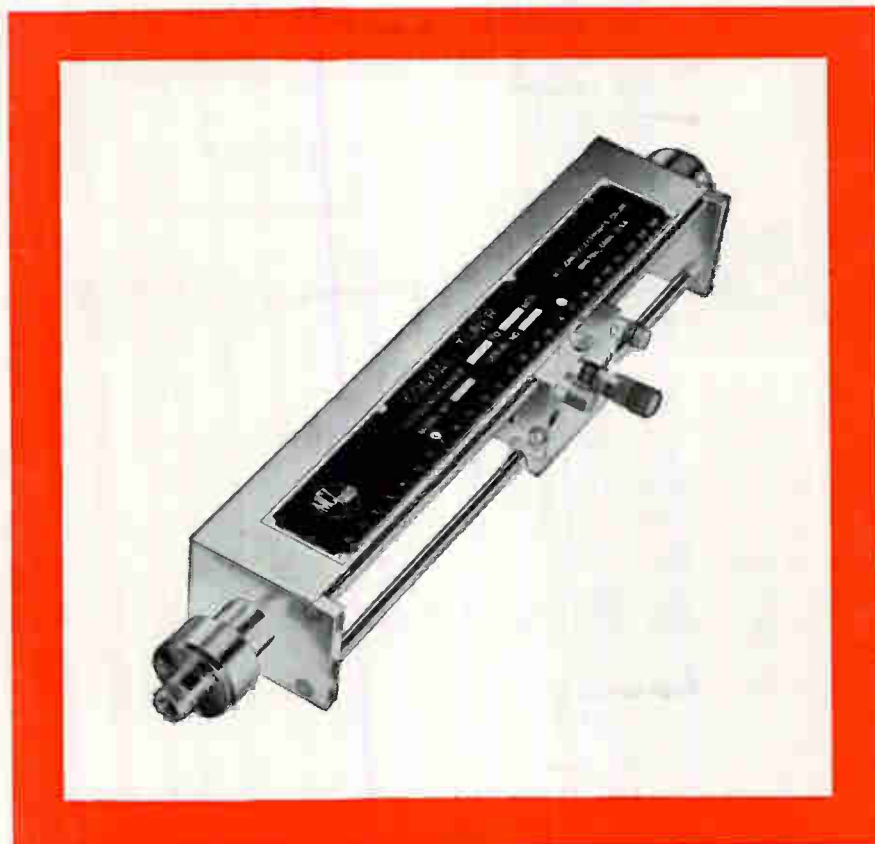

MAKES YOUR LOAD A REFLECTIONLESS TERMINATION

DESIGNED FOR USE whenever extremely accurate RF power terminations are required. This laboratory type Coaxial Tuner will tune out discontinuities of 2 to 1 in coaxial transmission line systems or adjust residual VSWR to 1.000 of loads, antennas, etc. May also be used to introduce a mismatch into an otherwise matched system.

M. C. JONES COAXIAL TUNER is designed for extreme ease of operation, with no difficult laboratory techniques involved. Reduces tuning time to a matter of seconds. Graduations on carriage and probe permit resetting whenever reusing the same termination.

SPECIFICATIONS

Impedance	50.0 ohms
Frequency Range	Model 151N 200-1000 Mcs. Model 152N 500-4000 Mcs.
RF Connectors	E1A 7/8" 50.0 ohm Flange plus adapters to N female connector
Power Rating	100 watts
Range of Correction	VSWR as high as 2 may be reduced to a value of 1.000

FOR MORE INFORMATION ON TUNERS, DIRECTIONAL COUPLERS, R. F. LOADS, Etc., PLEASE WRITE TO:



M. C. JONES ELECTRONICS CO., INC.

185 N. MAIN STREET, BRISTOL, CONN.

SUBSIDIARY OF



CIRCLE 27 ON READER SERVICE CARD

27



We deal in

ULTRA-LOW FREQUENCY LEVEL AMPLITUDE

- VIBRATION MEASUREMENT
- DATA INSTRUMENTATION
- DATA TRANSMISSION, RECORDING AND PROCESSING

every day

001 rpm

1000 cps

100 cps

10 cps

1 cps

0.1 cps

0.01 cps

Many space age customers now benefit from our unique capabilities in R&D and manufacturing. These capabilities stem from years of experience in dealing with the demanding, classical problems in the earth sciences. Our competent staff of 250, and our complete electromechanical manufacturing facilities in our new 60,000 sq. ft. plant are ready to serve you. We invite inquiries concerning your specific problems.

GEOTECH

The Geotechnical Corporation
3401 Shiloh Road, Garland, Texas
Phone BR 8-8102

Japan Asks Curb On Okinawan Exports

JAPAN'S Ministry of International Trade & Industry has asked the local government of Okinawa to curb the export of transistor radios to the United States.

Since last summer, when Japan's self-imposed quota system went into effect, three Okinawa shops have been turning out transistor radios using Japanese components,

and shipping them to the U. S. under English-language brand names. Magnitude of the enterprise is unconfirmable; one shop reportedly ships 20,000 sets a month.

Japan feels Okinawan authorities should impose a quota similar to Japan's on their shipment of sets to Occidental markets, should seek wider markets elsewhere.

Yugoslavia to Produce Two-Stage Rocket

YUGOSLAV scientists expect to produce a two-stage sounding rocket dubbed Selenit within two years. The rocket will be used for scientific exploration of the atmosphere and ionosphere.

Rocket will have a solid-fuel first stage and liquid-fuel second stage, should have a range of about 65 miles. While Selenit is being built (plans are completed), the Yugoslav Aeronautical Federation will use Japan's Kappa-6 sounding rocket.

Russian Computer Translates Mayan

MOSCOW—Siberian scientists have disclosed progress in translating ancient Mayan manuscripts with the aid of an electronic computer. The Central American hieroglyphic language has been a mystery since the sixteenth century.

Researchers say the symbols, figures and dates were written in mathematical form along with drawings used by the Mayans, as a preliminary to the computer processing.

Two-thirds of the manuscripts were translated in some 20 computer hours. It is expected another 200 hours will be needed to clear up remaining text.

Study Local Geology Effect On Low-Frequency Noise

CAUSE OF NOISE at frequencies well below radio channels will be the

subject of research directed by James R. Heirtzler of Columbia University's Lamont Geological Observatory.

Work is supported by a National Science Foundation grant of \$25,000.

Natural noise generators other than lightning effects are operative below 1 cps. Propagation of the disturbances will be studied to determine the effect of local geology and other natural phenomenon and thus find the origin of these waves.

In 1958, Russian scientists detected at these low frequencies a U. S. high-altitude nuclear explosion above the South Atlantic, according to a recent article which appeared in the Russian newspaper Izvestia.

Displaying Navy Data



New battle display console (foreground) by Hughes Aircraft shows aspects of air, surface and submarine action for fleets. Rear: the grease-pencil method



DALE

*...recognized by
standards engineers
as the mark of
resistor reliability*

Each incoming inspection adds weight to the conviction already held by standards engineers: You can depend on Dale resistors for performance as specified.

Dale resistor reliability is the result of Dale's advanced design and stringently controlled methods of manufacture . . . methods which have reached new levels of achievement as part of Dale's super-high reliability development program.

SPECIAL PROBLEMS? Let us help you with your requirements for special resistance products. We make modifications of standard products, resistor networks, matched pairs, etc. Send us your specs.

PROMPT DELIVERY: Whether your need is for a short "test run" or a large production release, Dale offers prompt service, direct from the factory and through a widespread network of distributors.

Write for Bulletin R-21 with handy cross reference file card



DALE ELECTRONICS, INC.

1300 28th Ave., Columbus, Nebr., U.S.A.

A subsidiary of HATHAWAY INSTRUMENTS, INC.

DALE TYPE RH RESISTORS

WIRE WOUND • MINIATURE • HIGH POWER

Designed primarily for application with high power requirements, coupled with precision tolerance. Mount on chassis for maximum heat dissipation. Operate under severe environmental conditions, offering complete protection from salt spray, moisture, vibration and shock.

- RATED AT 5, 10, 25, 50, 100 and 250 watts
- RESISTANCE RANGE from 0.1 ohm to 175K ohms, depending on type
- TOLERANCES: $\pm 0.05\%$; $\pm 0.1\%$; $\pm 0.25\%$; $\pm 0.5\%$; $\pm 1\%$; $\pm 3\%$
- TEMPERATURE COEFFICIENT 20 P.P.M.
- OPERATING TEMPERATURE RANGE from -55°C. to 175°C.
- WELDED CONSTRUCTION from terminal to terminal
- RUGGEDLY HOUSED; sealed in silicone and inserted in radiator finned aluminum housing
- SMALLEST IN SIZE, ranging from $\frac{3}{8}''$ x $\frac{5}{8}''$ to $3''$ x $4\frac{1}{2}''$
- SURPASS applicable paragraphs of MIL-R-18546B (Ships)



NEW

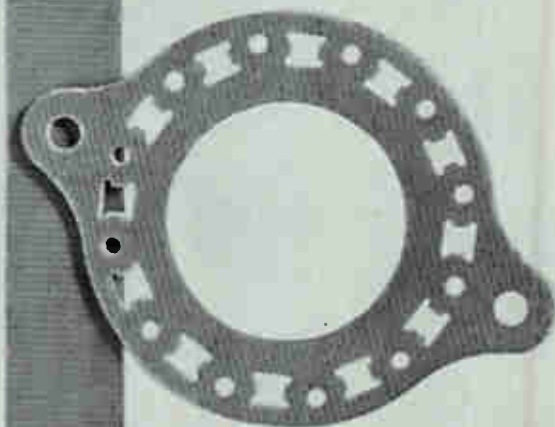

Zero burnout time and minimum "haloing" are combined in CDF's new grade 614 glass fabric epoxy laminate at no increase in price over conventional NEMA G-10 grades. Available plain or copper-clad, 614 is a cold punch material that is also superior in flame retardancy, has excellent trichloroethylene vapor resistance and low moisture absorption. The grade is distinguished by its opacity and its tan color.

Result: Another example of CDF leadership in meeting critical military and industrial applications while effecting important customer savings!

Typical properties of 614 (1/16" thickness):

Burnout Time, sec. 0
Water Absorption 0.10
Flexural strength, psi, lw 75,000

(Copper-clad 614 meets MIL-P-13949B, Type GF
Plain meets NEMA G-10; approval pending for
MIL-P-18177B, Type GEE. Also pending under
NEMA proposed FR-4)



CONTINENTAL-DIAMOND FIBRE

MEETINGS AHEAD

Mar. 6-8: Data Processing Conf. & Exhibit, AMA; Statler-Hilton Hotel, Wash., D. C.

Mar. 9: National Federation of Science, Abstracting & Indexing Services; Manger Hotel, Cleveland.

Mar. 9-10: Engineering Aspects of Magnetohydrodynamics, PGNS of IRE, AIEE, IAS; University of Penn., Philadelphia.

Mar. 11: Quality Control, American Society for; Hart House, Univ. of Toronto, Ontario.

Mar. 14: Defense Planning Seminar, EIA; Statler-Hilton Hotel, Wash., D. C.

Mar. 15-19: High-Fidelity Show, Magnetic Recording Industry Assoc.; Cow Palace, San Francisco.

Mar. 20-23: Institute of Radio Engineers, International Convention, All PG's; Coliseum & Waldorf-Astoria Hotel, New York City.

Mar. 21-22: Institute of Printed Circuits, Annual; New York City.

Mar. 27-31: Temperature, Its Measurement and Control, ISA, AIP, NBS; Veteran's Memorial Auditorium, Columbus, O.

Mar. 28: Rochester Soc. for Quality Control, ASQC; Univ. of Rochester, Rochester, N. Y.

Mar. 28-29: Nuclear Aspects of Atmospheric and Space Systems, ANS; Statler-Hilton Hotel, Dallas.

Apr. 4-6: Electromagnetics and Fluid Dynamics of Gaseous Plasma, IRE, IAS, U. S. Defense Research Agencies; Engineering Societies Bldg., New York City.

Apr. 4-7: Audio Engineering Society; Ambassador Hotel, Los Angeles.

Apr. 5-7: Global and Space Environments, Institute of Environmental Sciences; Sheraton Park Hotel, Wash., D. C.

Apr. 5-7: Materials and Electron Device Processing, ASTM Committee F-1; Benjamin Franklin Hotel, Phila.

BIRD

"Termaline" 50 ohm Coaxial Line 5-WATT LOAD RESISTORS



Model
80-M



Model
80-F



Model
80-CM



Model
80-CF



Model
80-BNCM



Model
80-8NCF

A Known Factor

In measurements of 50-ohm coaxial systems, the Bird 5-watt coaxial terminations provide a known factor.

As primary test equipment in field or laboratory, they are used as . . .

- 50-ohm impedance standards;
- terminations for slotted lines;
- measurements of filter characteristics.
- terminations for insertion loss measurements, and;
- other measurements where an accurate and reliable 50-ohm termination is required.

The low VSWR of the 5-watt "Termaline" resistors, their ability to withstand vibration, and their compactness in size makes their use applicable to a variety of electronic systems where a reliable 50-ohm termination is required.

SPECIFICATIONS

POWER RATING: 5 Watts Max.

NOMINAL IMPEDANCE: 50 ohms

USEFUL FREQUENCY RANGE: 0 to 11,000 mc

VSWR: 1.2 Max. to 4000 mc
1.1 Max. under 1000 mc

SPECIAL VSWR: Can be provided

OPERATING POSITION: Any

CASE: Brass **FINISH:** Silver Plated

LENGTH: 3-3/8" Max.

WIDTH: 11/16 Hex.

WEIGHT: 4 ounces

OTHER BIRD PRODUCTS



"Termaline"
RF Load
Resistors



Coaxial
RF Filters



"ThruLine"
Directional
RF Wattmeters



Coaxial
RF Switches



"Termaline"
RF Absorption
Wattmeters



BIRD

ELECTRONIC CORP.

Churchill 8-1200

30303 Aurora Road, Cleveland 39, Ohio

Western Representative:

VAN GROOS COMPANY, Woodland Hills, Calif.

See us at the IRE Show—Booths #3217 & 3219

▶ "addo-x" model 3541 printing calculator with accumulating register



Versatility—that's what printing calculator 3541 can give you. Multiply—add—subtract—fast, with this quiet operating, compact, double register machine. No re-entry problems, accumulates totals. Has decimal point indicator, saves time on percentage calculations. Just one of time-proven "addo-x" adding and calculating machines—backed by nation-wide service facilities. Demonstrations, without obligation, arranged at your convenience. Just see your dealer for on-your-job proof or write directly to "addo-x" 300 Park Avenue, New York 22, NY

[pronounced: add-oh-ex]

addo-x

SIEGLER:

...outstanding performance through a family of talents

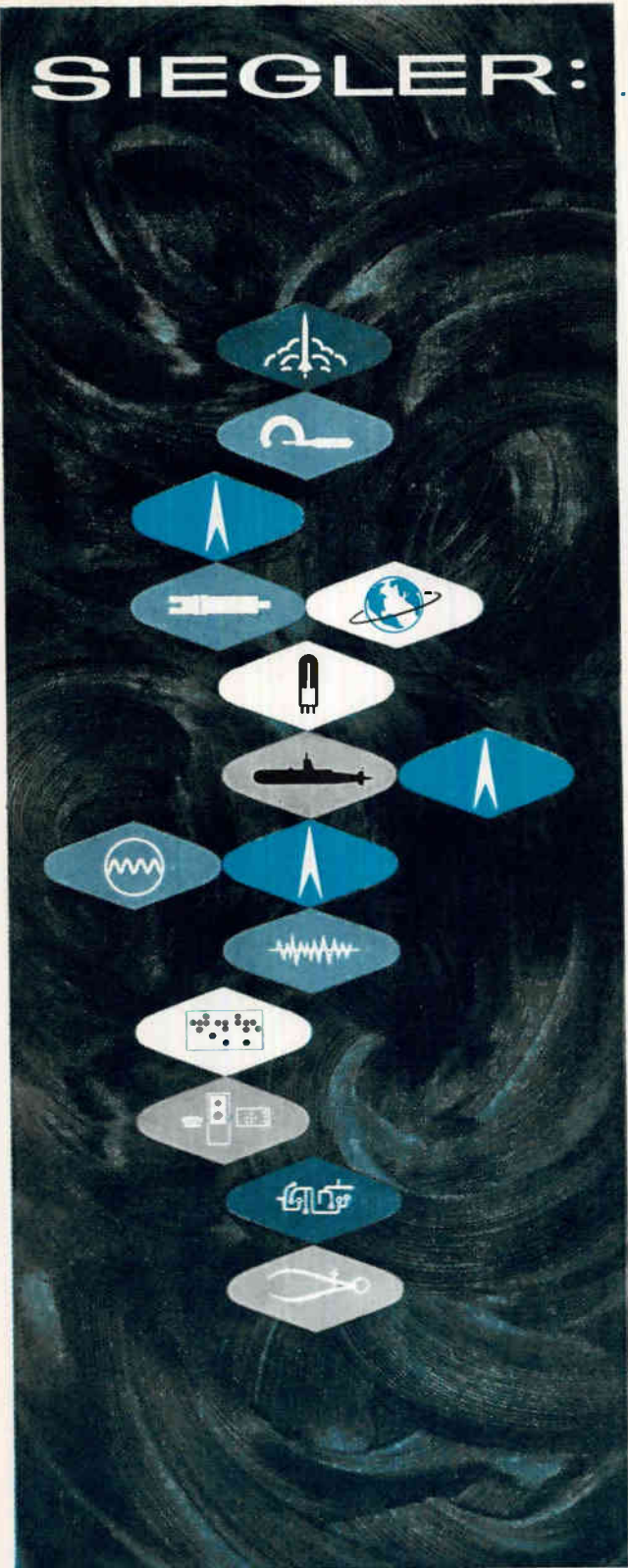

Announcing the new Siegler

SPACE SYSTEMS TECHNOLOGY GROUP

A New Range of Specialized
Technical Services in Missiles and Space
Program Operations and Planning

UNIQUE SCIENTIFIC CAPABILITIES. Now, one single industrial organization offers a broad scope of instrumentation and missile firing range capabilities. This means you can count on Siegler for outstanding performance. In every phase Siegler can serve you best, because Siegler leads in scientific planning and systems engineering of complete range instrumentation complexes.

THE GROUP THAT MAKES THIS POSSIBLE. For more than five years the Space Systems Technology Group worked closely as an integrated team in the U.S. Air Force ICBM and space programs. It was this Group that was responsible for advances extending from a single-purpose technical study of the problem of continuous telemetry communications with the Atlas nose cone during re-entry to the technical planning, systems engineering, and technical direction of the establishment of a complete instrumentation and range safety system at Vandenberg Air Force Base.

THE MANY TALENTS OF SIEGLER SERVE YOU. When you call on Siegler, you get the services of a family of talents. Such outstanding performance is accomplished through the combined capabilities existing in the Space Systems Technology Group and the wide range of talents and facilities of Hallamore, Hufford, Magnetic Amplifiers, Olympic Radio and Television, and Bogen-Presto - all divisions of the Siegler Corporation.

Formation of the new Space Systems Technology Group adds a further dimension to the high caliber performance already available from all Siegler divisions—deriving from the dynamic Siegler basic corporate concept: *Progressive management of diverse activities with outstanding military, industrial, commercial, and consumer capabilities—in order to bring to each of these fields the strengths of the others.*

For information concerning the capabilities of the new Space Systems Technology Group and other Siegler divisions in your field, address The Siegler Corporation, at the address below.

CAREER OPPORTUNITIES
are available for
engineers and scientists.
Write for complete information.



THE SIEGLER CORPORATION
610 South Harvard Boulevard, Los Angeles 5, California

PLANT LOCATIONS: SPACE SYSTEMS TECHNOLOGY GROUP, INGLEWOOD, CALIFORNIA • JACK & HEINTZ DIVISION, CLEVELAND, OHIO • HALLAMORE ELECTRONICS DIVISION, ANAHEIM, CALIFORNIA • HUFFORD DIVISION, EL SEGUNDO, CALIFORNIA • OLYMPIC RADIO AND TELEVISION DIVISION, LONG ISLAND CITY, NEW YORK • MAGNETIC AMPLIFIERS DIVISION, NEW YORK, NEW YORK • BOGEN-PRESTO DIVISION, PARAMUS, NEW JERSEY • SIEGLER HEATER DIVISION, CENTRALIA, ILLINOIS • HOLLY-GENERAL DIVISION, PASADENA, CALIFORNIA • VAC-U-LIFT DIVISION, SALEM, ILLINOIS • COMET MANUFACTURING DIVISION, LOS ANGELES, CALIFORNIA • COMMUNITY ANTENNA CO., INC., RENO, NEVADA

from
added
&

TELEMETRICS PRECISION FLEXIBILITY



Model 301

THE NEW SERIES 300 PULSE SIMULATORS SOLID STATE PAM, PDM PAM/NRZ

The Telemetrics 300 Series of Solid state Electronic Signal Simulators offers a selection of PAM, PDM, and PAM/NRZ units with extreme flexibility for precision calibration and checkout of telemetry ground stations, data transmission systems, and data reduction equipment . . . in the field . . . in the laboratory. The four models in the series: ESS-301, with PAM, PAM/NRZ only, 8-channel subcommutation; ESS-302, with all the PAM features except subcommutation; ESS-303, with PAM, PAM/NRZ, PDM, subcommutation; ESS-304 with PDM only, and subcommutation. In all models, "pre-programmable" patch panels provide complete flexibility to create any form of signal output within the unit's design limits. Standard plug-in digital logic units simplify maintenance. Standard rack mounting; 7" front panel height.

SPECIFICATIONS, ESS-301

INPUT115v, 3 amp
OUTPUT0 to +10v variable 0 to -10v variable 0 to +1v fixed
BASE LINEReference level: 0 Adjustable -2v to +2v
MASTER PULSEIRIG Standard 2 or 3 full scale or absence of 2 pulses.
CALIBRATIONSwitchable in steps of 0, 50%, 100% Continuously variable 0 to 100%
OUTPUT WAVE TRAINPAM, PAM/NRZ, optional PDM
FRAME LENGTHAny number of pulses, up to 1054 channels per frame by patching
SUBCOMMUTATOR8 Channels
RATES10 pps to 60,000 pps
ACCURACYSelectable information accurate within $\pm 1.5\%$ full scale.

Telemetrics, Inc.

12927 SOUTH BUDLONG AVENUE, GARDENA, CALIFORNIA



*it's read
more
by all 4!*

electronics is specially edited to keep you informed about the entire industry. With special issues on Electronic Markets, Modern Microwaves, Search and Probe Systems, and other reports you'll want to file and keep

subscribe today to **electronics**

Every Friday, **electronics** gives you the latest engineering developments and technically interpreted market trends. So don't wait till everyone on the routing slip has read it. Subscribe now and read **electronics** first. Mail the reader service card (postpaid) to **electronics**, the magazine that helps you to know and to grow! Rates: three years for \$12, one year for \$6; Canadian, one year for \$10; foreign, one year for \$20. Annual **electronics** BUYERS' GUIDE (single issue price \$3.00) included with every subscription.

New performance
New design
New appearance

SEE IT AT I.R.E.
THIRD FLOOR
JUST BEHIND
ESCALATORS



TUNABLE, dual selectivity
plus
Flat VTVM feature

Sierra Model 125A
**FREQUENCY
SELECTIVE
VOLTMETER**

Model 125A is an all-new vacuum tube voltmeter incorporating features of several previous Sierra instruments in one compact, high-performance instrument.

Covering the frequency range of 3 to 620 KC, this new voltmeter has both narrow and wide selectivity settings plus a flat voltmeter position. This triple mode measurement capability makes the Model 125A an extremely versatile instrument for carrier measurements, wave analysis and general laboratory use. Brief specifications are listed at the side. For full information and demonstration, call your Sierra representative or write direct.

SPECIFICATIONS

Frequency Range

Tunable Mode: 3 KC — 620 KC
Flat Mode: 1 KC — 620 KC

Measurement Range

Tunable Mode: -90 dbm to + 32 dbm
Flat Mode: -30 dbm to + 32 dbm

Selectivity

Narrow: down 3 db 125 cps off resonance
down 45 db 500 cps off resonance
Wide: down 3 db 1.25 KC off resonance
down 45 db 5 KC off resonance

Construction

Modular with etched glass epoxy circuit boards

Price

\$895.00
Delivery from stock

Data subject to change without notice

Sierra

SIERRA ELECTRONIC CORPORATION

A Division of Philco Corporation

6307A BOHANNON DRIVE • DAVENPORT 6-2060 • MENLO PARK, CALIFORNIA, U.S.A.

Sales representatives in all principal areas

Canada: Atlas Instrument Corporation, Ltd., Montreal, Ottawa, Toronto, Vancouver
Export: Frazer & Hansen, Ltd., San Francisco, Los Angeles

6308

By our method of reporting unemployment...

We're Giving The United States A Black Eye That Is Not Deserved

The way in which our unemployment is reported is giving the United States an undeserved black eye around the world. The broad concept of unemployment we use exaggerates the amount of unemployment in the United States as compared to most other countries. Our reporting system also falls short of presenting a balanced picture by concentrating on people who are idle, while neglecting jobs that are idle because people cannot be found to fill them. This editorial explains these defects and suggests improvements.

The *Monthly Bulletin of Statistics*, issued by the Statistical Office of the United Nations, has become a standard reference for international comparisons of economic performance, including employment and unemployment. Here, from the November, 1960 issue, is part of a table giving comparative figures on the rate of unemployment for the United States and a group of European countries:

	UNEMPLOYMENT RATE	
	Annual Average 1959	Jan.-June Average 1960
West Germany	2.4%	1.0%
Netherlands	1.8	1.4
Sweden	2.0	1.8
United Kingdom	2.3	1.9
United States	5.5	6.1

A Distorted Picture

If taken at face value the table clearly says that the United States is doing far worse in providing jobs for its citizens than the other countries whose unemployment records are listed.

But the figures are deceptive. They are made so, in part, by our government's use of a much broader concept of what constitutes unemployment than is used by most other countries.

Sweden provides a clear case in point. The table indicates that during 1959 Sweden had an unemployment rate of 2.0%, while the rate in the

United States was 5.5%. But a report from Sweden, published in the U.S. Department of Labor's *Labor Developments Abroad*, indicates that if they had used the same methods of calculating unemployment as we, the reported jobless rate in Sweden would have almost doubled. Thus a large portion of the gap between the unemployment rate in the United States and the unemployment rate in Sweden would have been eliminated.

Graduation To Unemployment

In general, countries listed in the table use registrations at public employment agencies as the basis for calculating their unemployment. Our Department of Labor, in making its sampling of unemployment, includes unregistered young people who are waiting for jobs or training opportunities as well as housewives who are looking for jobs in a general sort of way but who have not registered anywhere in search of them.

It used to be that graduation from college was regarded as a day for great celebration and rejoicing. But, because of the way the Labor Department does its counting of unemployment, it is now a day of sorrow. For unless our young people immediately rush off to jobs, they graduate into unemployment and swell our jobless figures.

While our government very expansively counts all the unemployed, there is no offsetting report on the number of jobs that are unfilled because no one qualified can be found to fill them. Currently there are many jobs in this category, and it is to be expected that there will be more as the technological revolution picks up momentum.

A properly balanced report on unemployment would include a record both of people who are idle, as conceived on some standard international basis, and jobs that are idle. A combination of the two sets of data would provide a much better indication of the economic health of a nation than unemployment alone.

The United Kingdom regularly collects figures on unfilled jobs as well as the number of unemployed. Thus it is not an impossible task to collect information on idle jobs. **For a fast**

moving economy, such as ours, the collection of statistics on unfilled jobs presents special difficulties. But this information is so important that Congress should see that it is added to our employment and unemployment records.

A National Disservice

There is not the slightest inclination here to minimize the amount of unemployment in the United States at any time, or the crucial importance of doing everything possible to keep it at rock bottom. If the reporting of unemployment were simply for domestic consumption, it would be possible to make an appealing case for using a very broad conception of it. This is one way of underlining the importance of the problem.

But when, as is the case, international comparisons of unemployment are treated as key gauges of the effectiveness of different economies, we do ourselves an important national disservice by using an exceptionally commodious concept of unemployment. American travelers abroad can testify that they are continuously being called upon to explain why the United States does such a relatively poor job in providing employment for its people. This is an unwise and unfair burden to impose upon the nation. **We make enough mistakes of economic commission and omission without issuing reports that distort our economic performance to our own discredit abroad.**

This message was prepared by my staff associates as part of our company-wide effort to report on major new developments in American business and industry. Permission is freely extended to newspapers, groups or individuals to quote or reprint all or part of the text.



PRESIDENT

McGRAW-HILL PUBLISHING COMPANY

COMPARE THIS HIGH-SPEED, LOW-COST SWITCH WITH ANY OTHER



Philco's Improved 2N1499A MADT®

ABSOLUTE MAXIMUM RATINGS

Storage Temperature	-65 to +100°C
Collector Voltage, V_{CB}	-20 volts
✓ Collector Voltage, V_{CES}	-20 volts
✓ Collector Current, I_C	-100 ma
Total Device Dissipation at 25°C	60 mw

ELECTRICAL CHARACTERISTICS (T = 25°C)

Static Characteristics	Min.	Typ.	Max.	
Collector Cutoff Current, I_{CBO} ($V_{CB} = -5v$) ..		1	3	μa
✓ Collector Cutoff Current, I_{CBO} ($V_{CB} = -5v, T = 55^\circ C$)			18	μa
✓ Collector Breakdown Voltage, BV_{CBO} ($I_C = -25 \mu a$)	20			volts
✓ Collector Breakdown Voltage, BV_{CES} ($I_{CES} = -25 \mu a$)	20			volts
DC Current Amplification Factor, h_{FE} ($V_{CE} = -0.5v, I_C = -40 ma$)	20	50		
✓ DC Current Amplification Factor, h_{FE} ($V_{CE} = -0.3v, I_C = -10 ma$)	30	70		
Base Input Voltage, V_{BE} ($I_C = -10 ma, I_B = -1 ma$)	0.25	0.32	0.40	volt
Collector Saturation Voltage, $V_{CE(SAT)}$ ($I_C = -10 ma, I_B = -1 ma$)		0.12	0.20	volt
Collector Saturation Voltage, $V_{CE(SAT)}$ ($I_C = -10 ma, I_B = -0.5 ma$)		0.15	0.25	volt
✓ Base Input Voltage, V_{BE} ($I_C = -10 ma, I_B = -0.5 ma$)			0.34	volt
Dynamic Characteristics				
Output Capacitance, C_{ob} ($V_{CB} = -6v$)		1.5	3	pf
Rise Time, t_r ($V_{CC} = -5v, I_C = -10 ma, I_{B1} = -2 ma$)		25	60	nsec
Minority Carrier Storage Time Constant, τ_s ($K' s) I_B = -1 ma$		100	120	pcb/ma
✓ Gain Bandwidth Product, f_T ($V_{CE} = -3v, I_C = -5 ma$)	100			mc

✓ Checks indicate specification improvements

Now with New, Tighter "Specs"

In high-speed switching circuits, this Philco MADT has a long record of reliable performance. It has always been manufactured to meet rigid specifications . . . not selected as a fall-out device.

Now . . . the 2N1499A is being produced to still tighter specifications, making it far more versatile and permitting greater freedom in circuit design.

New high current rating makes it suitable for line drivers, blocking oscillators, etc. Higher amplification factor (h_{FE}), makes NOR circuit design much easier. V_{BE} and $V_{CE(SAT)}$, guaranteed at 2 drive conditions, give tight control for all saturated circuit designs.

For logic circuits operating at rates up to 10 mc, it will pay you to get the facts on the improved Philco 2N1499A. Compare it . . . you'll find it impossible to beat in performance, reliability, versatility and price. Write Dept. E3361.

PHILCO
Famous for Quality the World Over®

LANSDALE DIVISION, LANSDALE, PENNSYLVANIA

Immediately available in quantities 1-999 from your Philco Industrial Semiconductor Distributor

See us at IRE—Booths 1302-1308



Memory planes using nickel-iron films 2,000 angstroms thick are made reproducibly by vacuum deposition on glass under influence of a magnetic field. Design of driving circuits is discussed

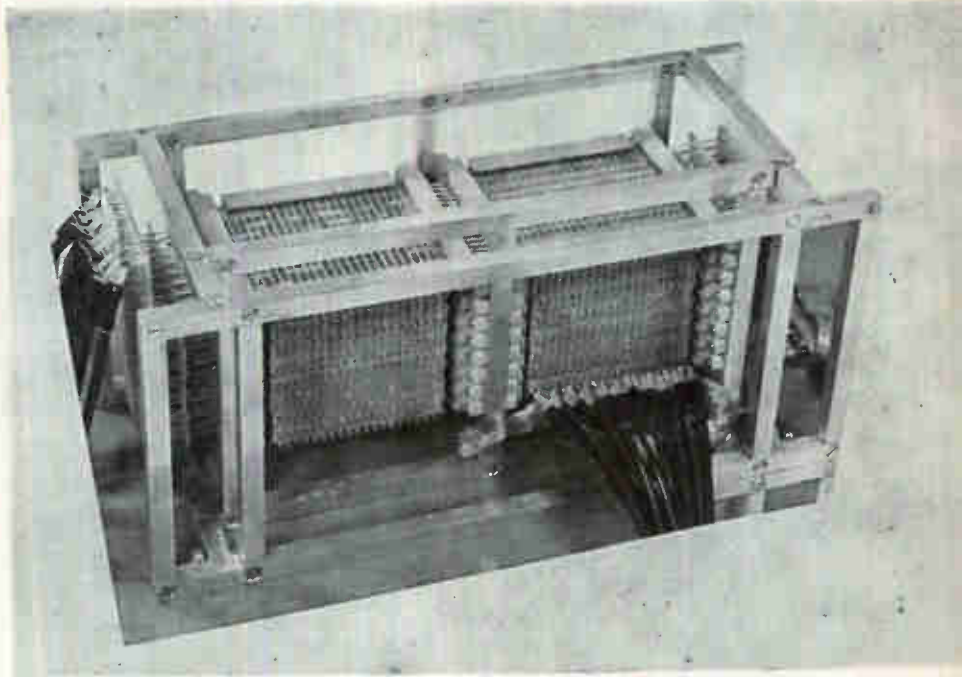

Assembled memory package with 16 memory planes capable of storing 2,560 bits, equivalent to 320 words of 8 bits each

DESIGNING

Thin Magnetic Film Memories For High-Speed Computers

By E. E. BITTMANN,
Burroughs Research Laboratories,
Paoli, Pa.

UNTIL RECENTLY, advances in high-speed computer memory systems were limited by the upper frequency characteristics of ferrite cores. Such devices, while capable of operation at speeds to 500 Kc, suffer from hysteresis losses due to internal heating when used at high frequencies. Attempts to overcome the problem and obtain greater speeds by using smaller cores have met with difficulties with regard to interwiring the resulting miniature elements.

One answer to these limitations has been known for some time to be deposited thin-film memory systems. Heretofore, problems of uniformity have made the commercial application of thin-film devices difficult; now, by using new techniques in vapor deposition, the

problem of uniformity has been overcome and thin-film-memory building blocks are available.

The memory planes have cycle-time capabilities of 0.2 μ sec and can be produced in large quantities at relatively low cost. They can accept greater drive tolerances than do ferrite cores; they yield bipolar outputs automatically, and can be driven by single polarity pulses for information entry and readout. Film planes are expected to find immediate use in scratch pad computer memories.

The storage elements in these thin-film memory planes are planar 80-20 Ni-Fe films approximately 2,000 angstroms thick, and are obtained by vacuum deposition onto a glass substrate under the influence of a magnetic field.

These thin films remagnetize predominantly by a spin-rotational mechanism rather than by a domain wall movement, as is usual in the

more common material configurations. The spin-rotational switching is fast, having been measured in the nanoseconds (10⁻⁹ sec) range.

Thin-film memories with cycle times of 0.2 μ sec or less are possible, owing to the films' fast operating speed, while fabrication simplicity of the wired film memory planes reduces memory cost. These two factors—high speed and low-cost—make thin films a desirable component in digital computer memories.

Films that are deposited on a substrate while under the influence of a magnetic field of 10 to 50 oersteds show a preferred or easy direction of magnetization, with all domains of an area of such a film lying parallel to the direction of this field. The magnetic characteristic of this deposited film in the preferred direction shows a square hysteresis loop, but perpendicular

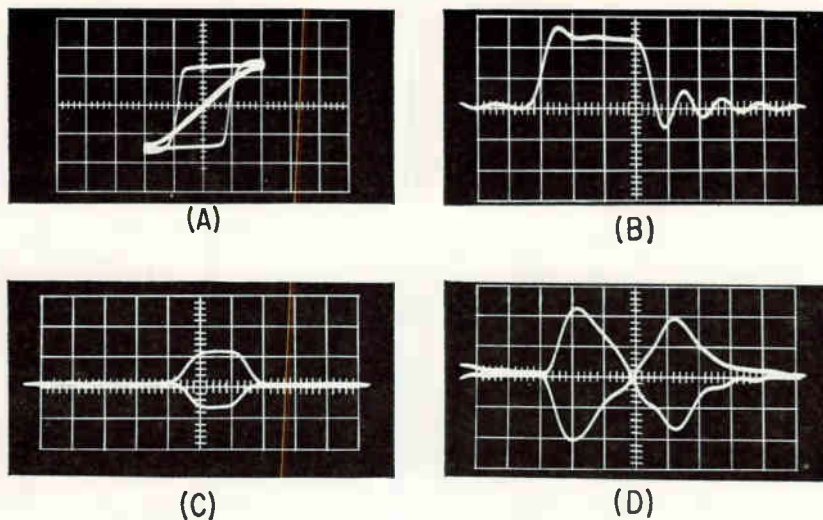

FIG. 1—Magnetic characteristics of film superimposed for both easy and hard directions of magnetization (A); word-drive current (B); information drive current (C); sense readout signals (D)

to the easy direction, called the hard direction, the film shows a linear loop, Fig. 1A.

If the sample is continually rotated from the easy to the hard direction, the characteristic changes from the square loop to the linear loop without interruptions. From these two characteristics, can be obtained: (1) the wall coercive force in the easy direction, H_c , and (2) the saturation magnetization force in the hard direction, H_K .

Any magnetic square-loop material can be used as a storage element in a random-access memory. The unique geometry, directional magnetic properties, and rotational remagnetization process must be considered in the design of thin-film memories. Their behavior can be compared with a magnetic dipole having two states, N and P, both of which are parallel to the preferred, or easy, direction. These two states represent the storage of a ONE or a ZERO in each thin-film element.

The principles of the memory operation are best explained by the discussion of a single bit. Three conductors are associated with such a bit, Fig. 2A with the word drive conductor parallel to the preferred direction and information and sense conductors parallel to the hard direction. The information conductor is split because: (1) it reduces the mutual capacitance between the information and the sense conductors and (2), it reduces eddy currents in the informa-

tion conductor induced by the word drive current.

A current in the word drive conductor generates a transverse field H_r , which, if greater than the saturation force in the hard direction, H_K , rotates the magnetic moments or dipoles to the hard direction. This rotation induces a sense signal of positive polarity if the rotation originated from the ONE state and of opposite polarity if it originated from the ZERO state.

To magnetize an area of thin-film to the ONE or ZERO state, two magnetic fields, perpendicular to each other, are applied—the drive field lying in the hard direction and the information field in the easy direction. The resultant field lies between the hard and easy directions, oriented toward either ONE or ZERO, depending upon the direction of the information field. Removal of the drive field allows the dipoles to fall to the desired ONE or ZERO state, after which the information field can be terminated.

Waveforms of drive, information currents, and sense signal are shown in Fig. 1B through 1D.

The thin-film plane is sandwiched between two printed circuit boards. The boards are 10 mils thick and contain 20 word drive conductors and 8 sense and 8 information conductors. The wired plane measures $4 \times 3\frac{1}{4}$ inches and is about 70 mils thick; it matches the nominal 0.063 inch wide printed circuit connectors having 0.156 inch contact spacings.

The thin film rectangles are $\frac{1}{8}$ inch wide, $\frac{1}{8}$ inch high and their thickness is nominally 2,000 angstroms. Minimum sense output signal with a word drive current of 1 amp and 0.05 μ sec rise time is 5 mv.

Minimum noise results if the sense and information line of pairs of planes are interconnected in a noise cancelling manner as shown in Fig. 2C. This wiring arrangement minimizes noise, but the sense readout signal for a stored ONE in one plate and from a stored ONE of the other plate will be of opposite polarity. The logic circuits in either the sense amplifier or in the information driver can be designed to compensate automatically for this polarity reversal.

Noise originating from ground currents can best be minimized by a common ground plane, such as a thin copper or aluminum plate.

Shielding against earth's magnetic field is recommended—a single layer of soft iron material helps considerably; signals can be observed without this shield, but memory storage units will need shielding. Magnets or Helmholtz coils also can eliminate the earth's field's influence.

A differential-type sense amplifier helps to reject the common mode noise signal while transformers are also used successfully. For example, a type F304 ferrite core (General Ceramics) T-1 type material with a 4-turn primary and 8-turn secondary gives good results. Sector windings or distributed windings are used too; sector wound cores have a slower response, but their fabrication is easier.

Signals from a memory plane can be observed if a fast-rise-time current generator is available. The current driver should deliver a 1 amp pulse into a terminated line. This current is applied to one of the word drive conductors. A d-c bias of 200 ma can be applied to one of the information conductors. A signal should appear on the corresponding sense winding. When reversing the polarity of the bias current a reversal of the sense signal should be noticeable. Oscilloscope sensitivity should be 5 mv per cm. Short cables and leads, and elimination of ground current loops will produce clean thin-film switching signals.

The typical 8×20 memory planes can be interconnected into a stack of 16 plates as shown in Fig. 1. This memory can store 320 words of 8 bits each.

Transmission line principles must be used when high-speed current pulses are to be transmitted through long conductors to prevent ringing in these lines that might obscure the output signal.

It is sometimes preferable to drive the films with short current pulses rather than longer rectangular ones, so that power dissipation in the transistor is reduced. Owing to the film's fast switching mechanism this can easily be done. The film is read out during the rise time of the word drive pulse and written into during the fall time, so that only two short pulses coinciding with the rise and fall times are necessary. This is shown in Fig. 3.

The information current also can be modified, by application of a d-c bias that returns the film automatically to the ZERO state, unless the write ONE current pulse is applied. This eliminates the need for a bipolar information driver. Sense readout signals thus obtained are not of the same amplitude when a ONE or ZERO is interrogated.

The word addressing drivers are of two types: one is the actual driver that furnished the current pulse, and the other a circuit that absorbs this current pulse.

The driver and switch in Fig. 4 handle current pulses of 1 amp with rise and fall times of 35 nanoseconds. When continuous operation of these circuits at a rate above 1 Mc is desired, precautions against overheating have to be taken.

The driver input is a 2-input AND gate. When both inputs are at +3 volts, the transistor, Q_1 , is cut off; its collector tends to go negative but the diode holds it to about ground level. This drives the second transistor, Q_2 into saturation and its collector towards the +3 volt level in turn forward biasing the two npn output transistors (Q_3 and Q_4), each of which can handle up to $\frac{1}{2}$ amp. A negative current pulse appears in the output. These drivers can drive a diode selection matrix, where the diodes are arranged in rows and columns. One such diode of a given row is indicated.

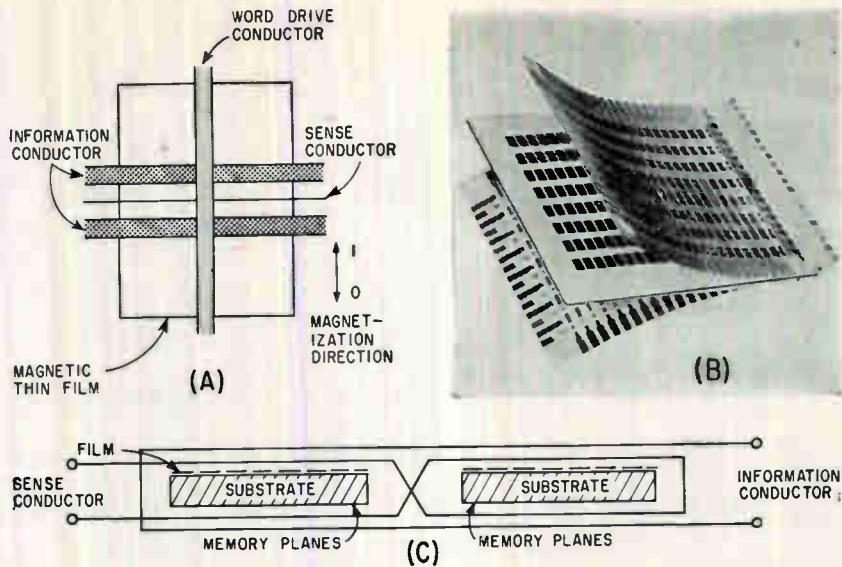

FIG. 2—Conductor orientation for control of one magnetic bit (A), and arrangement of conductors in a complete magnetic plane (B); interconnection of conductors to minimize noise signals (C)

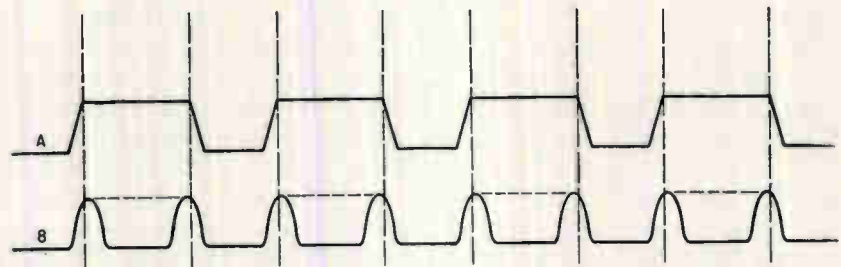

FIG. 3—Word-drive current pulses with (A) showing the conventional arrangement of rectangular pulses and (B) showing how transistor dissipation is reduced by using short pulses coincident in time with the edges of the conventional rectangular pulses

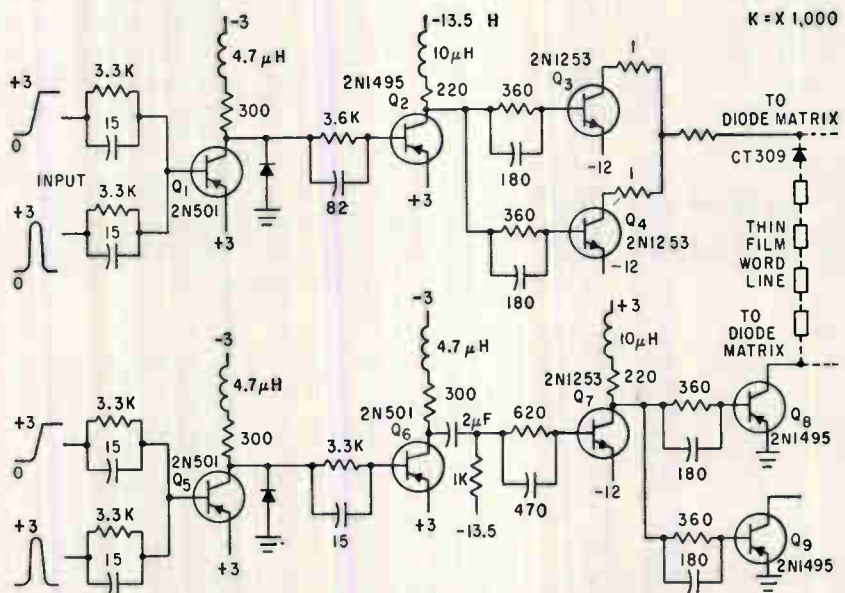

FIG. 4—Driver circuit generates 1 amp pulses with rise and fall times of 35 nanoseconds, and can operate continuously to nearly 1 Mc

Direction Finder Helps Recover Discoverer Capsule

Azimuthal direction finder locates reentry nose cone capsules within 70-degree sector from 50,000 ft to sea level.

Outputs of two Yagi antennas appear side-by-side on an indicator to give visual indication of signal source direction

By A. T. LLOYD, Senior Project Engineer, Lockheed Aircraft Service, Inc., Ontario, California

THIS DIRECTION FINDING system is an extended-range, single-station azimuthal unit that provides continuous, positive and visual-display homing in the vhf spectrum on low-intensity a-m, f-m and c-w signals. The system consists of a special-purpose, high-gain receiver fed by high-gain antenna arrays, and a waveform analyzer to provide direction-correlated analysis of the receiver output.

The system was developed for reentry capsule recovery operations in the Hawaiian area and has demonstrated long-range target acquisition performance during numerous and extensive recovery operations.

Many antenna types were investigated before the final selection was made. The antenna gain and

radiation pattern design characteristics are based upon the operational requirement for a specified sector scan coverage consistent with long-range target acquisition.

A matched dual antenna configuration was developed to produce two 35-degree radiation patterns intersecting at approximately 2.5-db below the maximum 12-db gain point of the antenna and having an azimuth sector scan of 70-degrees forward of the aircraft heading.

The direction finding system (called Retriever), is a lobe-switching direction finder as shown in Fig. 1A. Direction is determined by comparing the amplified outputs of two Yagi antennas whose main lobes are displaced from the center axis. The antenna outputs are fed into a delay cable that displaces

the antenna beam from the horizontal axis. These outputs are alternately switched to the receiver input. At the same time, sweep circuits of the indicator unit connected to the receiver output are reversed in synchronism with the antenna switching so that the output of each antenna lobe appears side by side on an indicator to give the operator a positive visual indication of the direction of the signal source. The crystal-calibrate oscillator presets the receiver to the fine increment frequency setting required for direction finding.

The dual Yagi antenna sections are vertically polarized. In addition to the driven element, which is a trombone-tuned, tee-matched folded dipole, each section has two parasitic director elements and one parasitic reflector element. The folded dipoles of each section are connected through a phase loop to the lobe-switching network. Each Yagi array is balanced and matched for optimum gain and lobe pattern displacement. A sensitive balun is part of the antenna matching network.

In operation, the directors and reflector are excited by the received signal. The re-radiation from these elements induces voltages in the driven element. The voltage phases, determined by the lengths and spacing of the elements, result in an essentially uni-

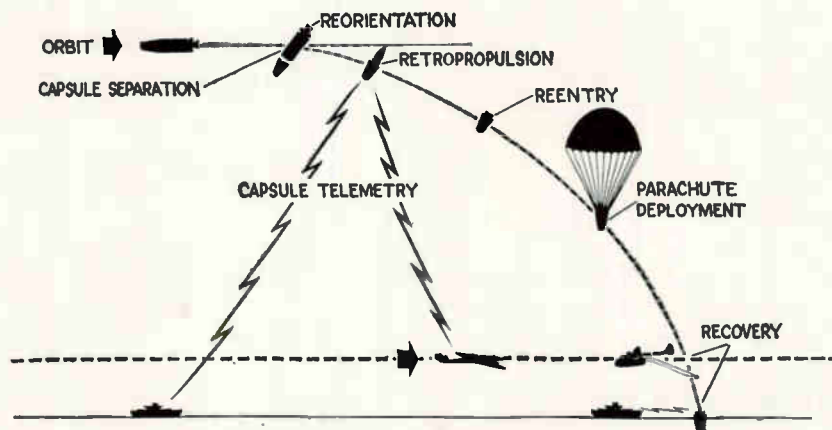

Satellite orbits in tail-first position, tilts 60-degrees and separates capsule. Retro rocket slows capsule for reentry and recovery

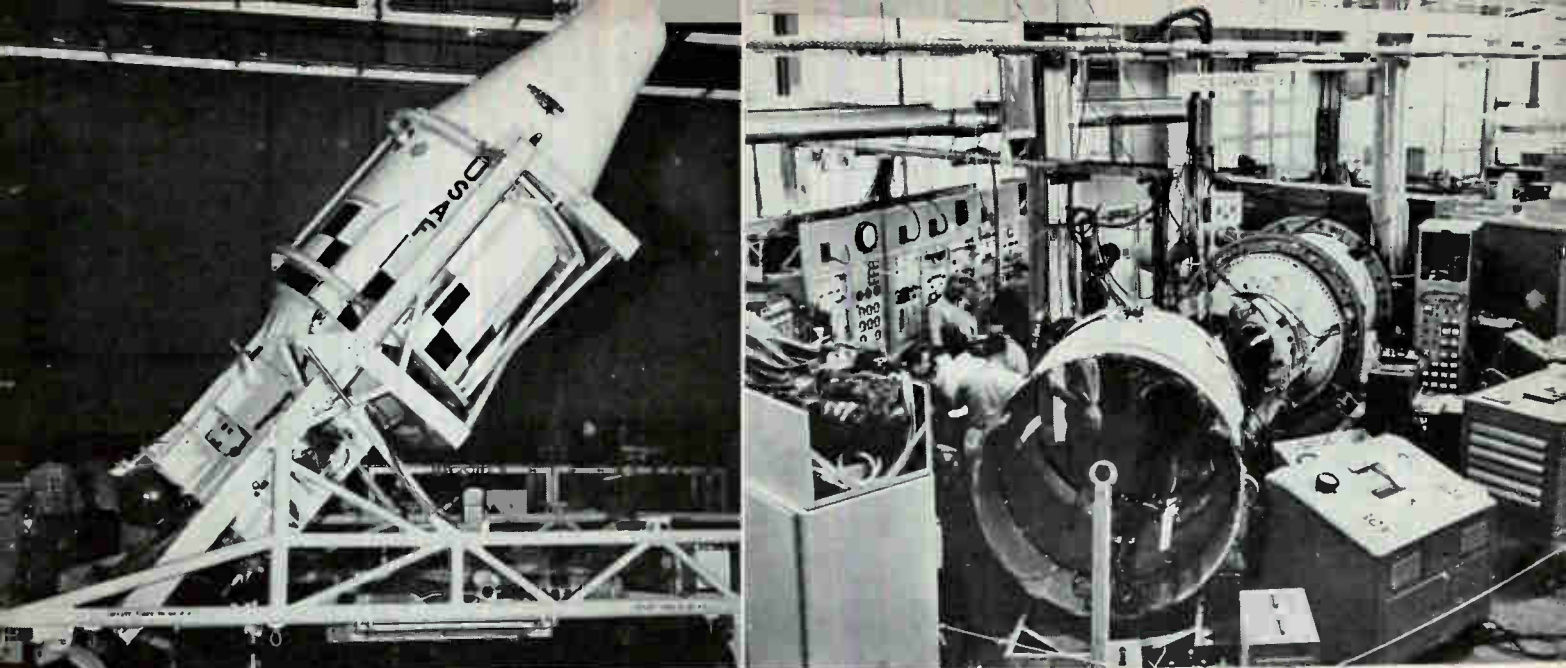

Agena satellite, used in Discoverer program, weighs 8,500 lb at launch and requires a maze of checkout equipment

directional radiation pattern. The balun is incorporated to transform the balance voltage at the center of the driven element to the unbalanced coaxial cable. The design and construction of the balun is very critical so as to maintain symmetry in the radiation patterns of the antennas as the operating frequencies are changed.

Outputs of the antenna arrays are combined through a phase-delay cable as shown in Fig. 1B, to horizontally displace the maximum of the antenna radiation pattern. Simultaneously, the indicator unit sweep is synchronously switched so that the sweep, starting approximately at the center of the cathode ray tube, is deflected in the same direction as the maximum of the antenna radiation pattern.

Amplified and detected signals from two radiation patterns are compared in amplitude on the indicator. Receiver output is connected to the left-hand sweep when the lobe switch displaces the antenna radiation pattern to the left of the centerline and to the right-hand sweep when the lobe switch is in the opposite position. In Fig. 1C, the signal source is to the left of the centerline and the received signal strength is substantially greater on the left side of the indicator than on the right. In Fig. 1D, the opposite is true. In Fig. 1E, the received amplitudes of the two antenna lobes are equal. The

indicator presentation shows this by the height of the display on both sides being equal. This is the condition of the signal source being on centerline of antenna array.

The calibration test oscillator shown in Fig. 4, is transistorized and crystal-controlled. It provides an accurate, fixed frequency c-w signal used to tune the receiver. The receiver dial is quickly and accurately set to the precise frequency involved in the operation of this system.

A tetrode transistor is used in a Pierce oscillator circuit tuned to the third overtone of the fundamental crystal frequency. The fifth harmonic of the oscillator is the calibration frequency. Excellent results have been realized with this arrangement.

A block diagram of the indicator is shown in Fig. 5. The indicator is driven by the receiver, whose video output is amplified by the vertical amplifier and applied through pulse stretchers to the vertical deflection plates of the cathode-ray tube. A signal taken from the vertical amplifier triggers the sweep generator; the sweep voltage is then amplified by the horizontal amplifier and applied to the horizontal deflection plates of the cathode-ray tube through the sweep-reversing relay. The sweep-reversing relay and the lobe-switching relay are driven in synchronism by the switching am-

plifier, which receives a square-wave input signal from the lobing rate multivibrator.

The airborne direction finding system uses a special-purpose receiver having exceptionally high sensitivity with circuit function switching to select 300 Kc, a-m or f-m signals through a single superheterodyne channel having an i-f of 21.4 Mc. The receiver also is equipped with a function switch which has a 10 Kc position and a dual conversion circuit having a 21.4 Mc first i-f followed by a 1 Mc second i-f.

The r-f tuner produces the lowest possible noise figure and has a practical tuning structure capable of tuning with reasonably uniform performance over the uhf band.

The installation requirements for a direction finding system in aircraft created problems involving the effect of the aircraft configuration on the target signal. The optimum position on the aircraft for the location of the direction finding antenna is determined by scale model studies on an antenna pattern range.

Radiation patterns were measured at eleven locations to establish the optimum operating location. Tests were made on a corner reflector, log-periodic, and Yagi-type antennas. The Yagi-type antenna best fulfilled the direction finding requirements. The gain and lobe pattern proved exceptionally well

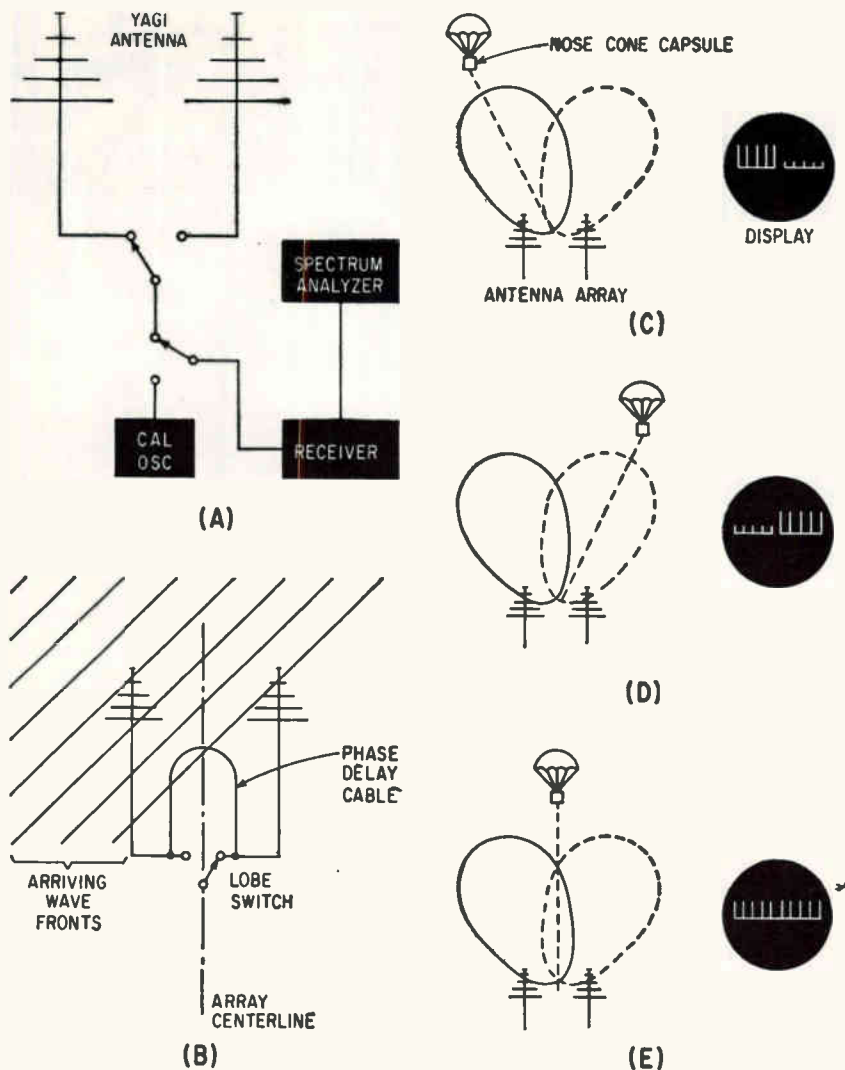

FIG. 1—Functional block diagram (A) and principle of operation (B) showing phase delay cable. Azimuth determination in the airborne system shown in (C), (D) and (E)

adjusted for lobe switching target acquisition. The beam crossover point was adjusted to 2.5 db below maximum signal level.

A 1/14 scale-model aircraft was used for the final test measurements. Some preliminary patterns were measured using a 1/20 scale-model C-130-B Aircraft. The airplane was mounted on a 21-foot polyester glass fiber honeycomb tower and spaced a distance exceeding 25λ from the transmitting horn.

The scale-model antennas were tuned and matched for agreement with the full scale Yagis. Normal procedure has been to adjust the full scale antennas on frequency A and use them on frequency B. The 1/14 scale-model antennas used in the test were adjusted to have the

same pattern on scaled frequency B as the full-scale antenna had on frequency A.

Preliminary patterns were measured in sets of principal planes and 30-degree cone angle patterns for eleven mounting configurations to determine the optimum location of a scaled Yagi antenna. When the optimum location was determined, complete sets of cone angle patterns were measured, using a scaled Yagi, a 60-degree corner reflector and an 8-element log-periodic array. The cone angle sets were then integrated and further calculations determined the radius of each pattern group.

Preliminary patterns on the Yagi antennas indicated that only small pattern variations resulted from moving the antenna along a C-130

aircraft longitudinal axis between certain stations. Moving the antenna between other stations changed the maximum lobe of the pitch plane pattern from in-line with the longitudinal axis of the airplane to 15-degrees above the horizon. Spacings from $\lambda/4$ through $\lambda/2$ between the driven element on the Yagi and the aircraft skin were tested. Using a spacing of $5\lambda/16$, excellent crossovers of between -2 and -3 db were obtained with no detrimental lobing or pattern variations in the area of the crossover point. The rear lobe was virtually unaffected by changes in Yagi location, and was 25 db below the main lobe maximum as shown in Fig. 4.

The patterns on the corner reflector were measured using a 60-degree corner reflector. The skin of the aircraft was used as one side of the corner and the other side was constructed of a 0.9λ boom with 8 equally spaced, 0.6λ vertical elements. An antenna corner-to-exciting-dipole spacing of 0.45λ was used. The side of the corner that used the aircraft skin apparently caused unbalance of the antenna pattern, resulting in radiation perpendicular to the line of flight. Although this is not desirable from a directional ambiguity standpoint, the broad pattern reduced the forward gain of the antenna to a level below the desired requirement.

The radiation patterns of the 4-element Yagi indicated excellent operation of the homing system when using two such antennas. Antenna gain calculations showed the maximum lobe to have a gain of 12.6 db above an isotropic source, and the crossover point approximately 2.5 db below maximum signal level. Variation in placement was not considered serious if the antenna on a particular airplane had to be relocated as much as several inches for structural reasons.

A series of performance tests were conducted at the Pacific Missile Range to evaluate the airborne and shipboard direction finding systems. The tests were conducted with one simulated airborne entry capsule and one test nose cone capsule floating in the water. Two C-119 aircraft and one destroyer equipped with a prototype direction finding system performed

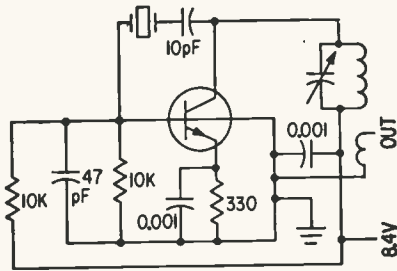

FIG. 2—Calibration oscillator uses tetrode transistor in Pierce oscillator circuit

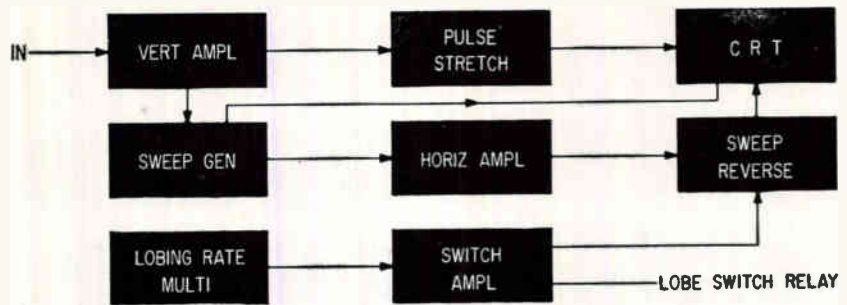

FIG. 3—Sweep reverse circuit and lobe switching relay are driven in synchronism to produce directional information

simulated recovery operations of the capsule from the water. Dual Yagi antennas were installed on the mainmast of a destroyer, 80 feet above the water line. The test nose cone used an antenna constructed of $\lambda/4$ flexible steel ribbon mounted in a vertical position approximately 18 inches above the water line. Shipboard reception in excess of 59 miles was realized on the Retriever direction finding system. Day and night signal reception was observed to be of uniform intensity.

The ship's original direction finding equipment intended for backup and comparison purposes received the nose cone capsule signals for approximately 12 miles before signal fadeout occurred.

To test the effect of antenna gain on the long-range signal reception exhibited by the direction finding system, the Yagi antenna on the left-hand side was attenuated below the half-power gain of the right-hand antenna. On repeated test operations moving toward and away from the floating nose cone capsule target, the low-gain left-hand antenna caused the receiver to lose the signal for approximately 2 to 5 miles between 15 and 20 mile ranges. The high-gain right-hand antenna received the signal through the low-intensity signal region. Once past the 20-mile range, the signal level increased in amplitude on both left and right-hand antennas. The second low-intensity signal area started at 50 miles with the left-hand low-gain antenna losing the signal. The right-hand antenna continued to receive the signal with the background noise level increasing, until the noise exceeded

the target signal at a 60 mile range from the target.

Homing and recovery operations were conducted at Edwards Air Force Base using dummy capsules. Capsules dropped at an altitude of 47,000 ft were successfully identified and recovered using prototype direction-finding equipment. Homing accuracies of ± 1 -degree were realized. At distances of 40 and 50 miles, target detection was achieved before radar acquisition and sector information were furnished to the C-119 navigator. Airborne target acquisition in excess of 200 miles was achieved during the prototype field tests conducted during this period; 400 mile air-to-air target acquisition was observed with the direction finding aircraft flying at 35,000 feet during preliminary evaluation testing of the C-130 prototype installation.

A squadron of C-119 aircraft equipped with the direction finding system are on daily operational duty in the Hawaiian area. Training flights with this direction finding equipment are conducted between Hilo, Hawaii and the island

of Oahu, a distance of 190 miles. C-119 aircraft flying at 15,000 ft receive strong signals from the ground target 190 miles away. Line-of-sight distance is less than 150 miles and quasi-optical distance is approximately 172 miles. Actual reentry nose cone capsule acquisition and recovery have resulted from the long-range direction-finding performance of the Retriever system.

The development and field tests covered in this article are only a representative sample of numerous investigations and experimental data acquired during this overall program. The data obtained indicate the need for even better direction-finding systems capable of locating the reentry vehicle as quickly as possible.

Direction finding systems for reentry vehicles, consistent with the present state of the art, would include a long-range 360-degree target acquisition antenna and a narrow-beam homing provision for tracking and target recovery after the initial locating contact

The direction finding system functions and characteristics dictate and prove the need for an exceptionally high receiver sensitivity with a noise figure (inherent receiver noise) reduced to the best figure obtainable. Eventually there will be the elimination of all mechanical and/or electromechanical switching devices by the use of electronic or solid state switches.

Increasing antenna gain to the maximum level attainable will improve reception and overall system performance when operating under conditions of low-intensity signals, resulting in target acquisition at even greater distances.



FIG. 4—Antenna pattern of the dual Yagi array mounted on a C-130A aircraft

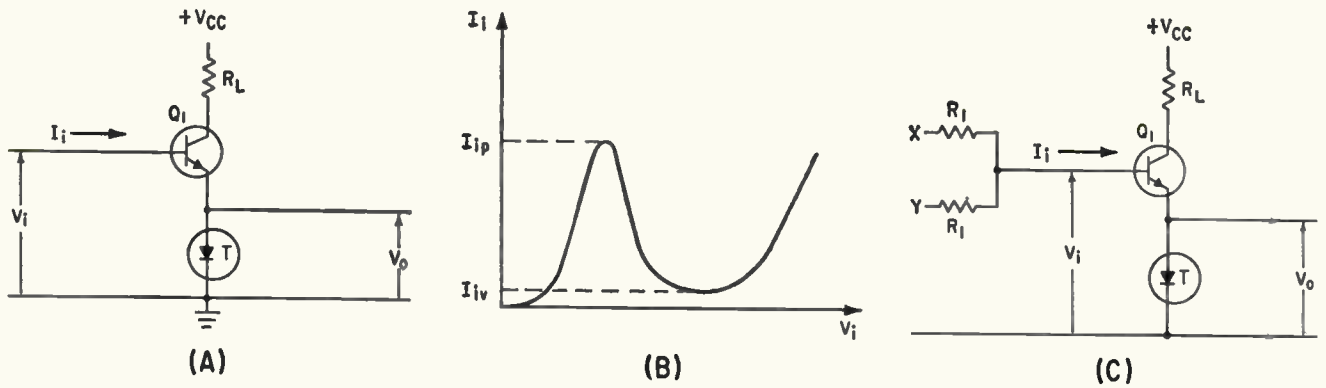

FIG. 1—Basic TDTL circuit (A) has input characteristics of (B). Two input AND gate (C) action is shown in

Logic Combines Tunnel Diodes

Switching speed of tunnel diodes and isolation capabilities of transistors are combined to obtain logic having switching times of 0.7 nanosecond

By R. W. LADE, Marquette University, Milwaukee, Wisconsin

CIRCUIT ENGINEERS have used tunnel diodes in high-speed logic switching circuits with some success. There remains, however, the basic drawback of isolation, a problem partly solved with coupling diodes and resistance decoupling. A logical building block termed tunnel diode-transistor logic (TDTL), that combines the high switching speed of the tunnel diode with the isolation properties of conventional transistor circuits, will be described.

The basic circuit is in Fig. 1A with the input voltage-current characteristic shown in Fig. 1B. This circuit was reported earlier in connection with controlling the effective peak and valley currents at the input terminals of the circuit.¹ The input characteristic consists of the series connection of a forward biased $p-n$ junction (the emitter-base junction Q_1) and the normal tunnel diode v - a characteristic.

Observed input peak and valley currents are found to be less than the actual peak and valley values of the tunnel diode. This is true because the base current is always $(1-\alpha)$ times the emitter current. Thus when the emitter current is at the peak current level of the tunnel diode, I_e ; the peak input (I_{ip}) current is $I_{ip} = (1-\alpha) I_e$, and the input valley current is $I_{iv} = (1-\alpha) I_v$, where I_v is the actual tunnel diode valley current.

Operations involved in TDTL gating can be explained by considering the two-input AND gate of

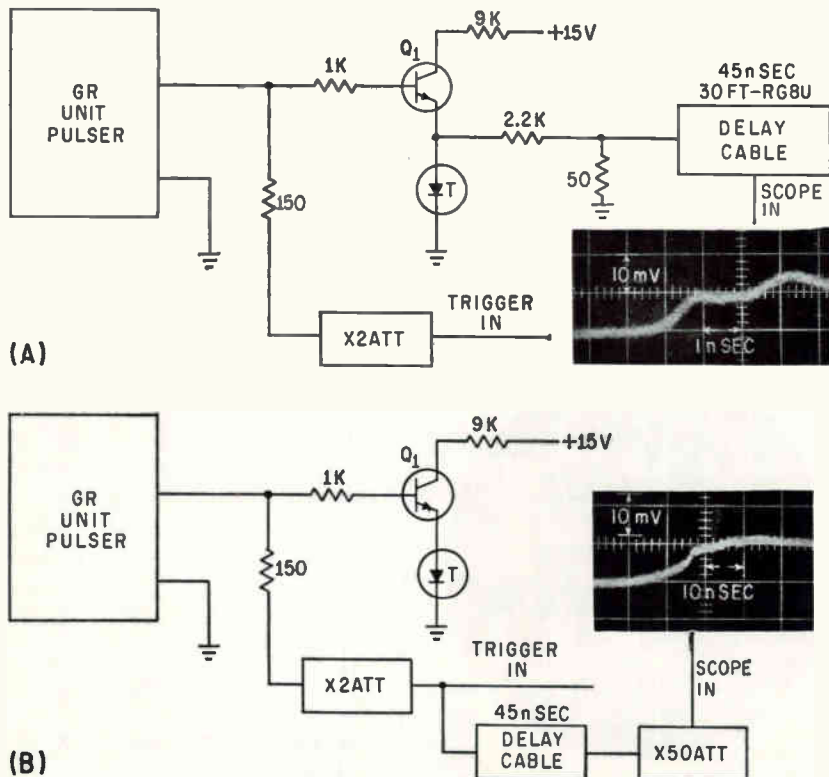
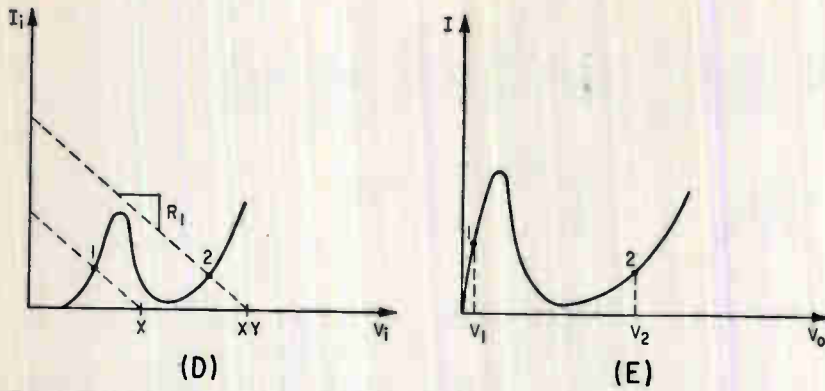

FIG. 2—Output of TDTL gate in (A) has rise time of 0.7 nsec. Waveform in (B) shows input to gate



(D) and output across tunnel diode in (E)

With Transistors

Fig. 1C. With inputs X and Y absent, $v_i = i_i = 0$ and the operating point is at the origin in Fig. 1D. With X present and Y not present, the operating point is at position 1, and correspondingly, the output across the tunnel diode is V_1 , as shown in Fig. 1E. With both X and Y present, the operating point shifts to position 2 and the output voltage becomes V_2 .

Voltage across the tunnel diode changes fast in the transition between the peak and valley points. When the circuit is driven by a constant current source, the speed is independent of transistor performance since a constant current is maintained throughout. Unfortunately, near ideal current drive requires high signal voltages and would not permit logic buildup without interstage amplification. Thus a compromise must be reached wherein the transistor cutoff frequencies play a minor role in circuit performance.

Asynchronous operation for the AND gate (Fig. 1C) requires that with either X or Y present (but not both) the load line must intersect only the low-voltage region of the input characteristic. This insures that the circuit will be self-resetting. For OR gating either the driving signal or the series resistance is adjusted to permit triggering of the gate with one signal.

Switching time of a typical TDTL gate is shown in Fig. 2A. In the OR circuit shown, the transistor

was an experimental germanium $n-p-n$ mesa device and the tunnel diode, a GaAs unit. The output was attenuated and matched to a 50-ohm line to get a 45-nsec delay of the signal with respect to trigger. A Tektronix 545A oscilloscope with the type N sampling attachment was used to observe the waveform. Risetime of the gate is seen from the scope trace to be approximately 0.7 nsec. Computer circuits using TDTL logic can be operated at a clock rate of at least 500 Mc.

The test circuit for the driving signal is shown in Fig. 2B. The observed wave form has a risetime of approximately 14 nsec. Risetime of the output signal is essentially independent of the trigger risetime. However, circuit propagation time is certainly influenced by the leading edge of the trigger and amount of overdrive present. For small turnoff times, V_{cc} , R_L and the tunnel diode peak current value must be selected so that the transistor does not saturate with base currents of I_b (Fig. 1A and B). For non-ideal current drive in which a significant collector current change occurs, the negated signal may be developed between collector and ground. There is a d-c offset to consider in this arrangement and it is generally not preferred.

A negated exclusive OR logic can be achieved with a slight modification (Fig. 3) of the basic TDTL circuit. Here the external circuit impedance as viewed between the

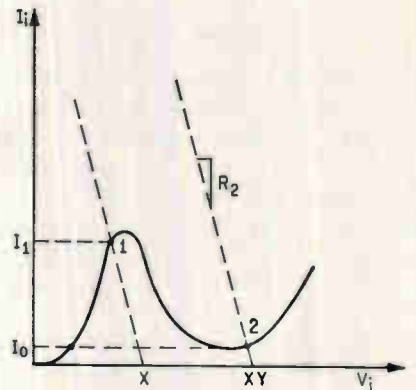
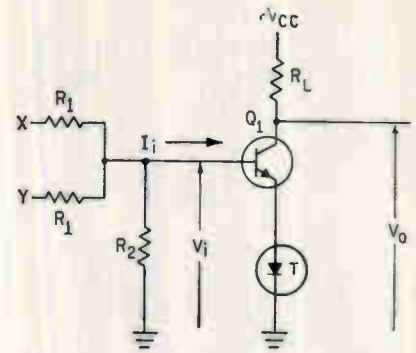

FIG. 3—Exclusive OR gate has computer applications

base of Q_1 and ground must be less than the magnitude of the tunnel diode negative resistance. Output is taken between collector and ground. The logical function of the negated exclusive OR circuit in the Boolean form is $\bar{0} = XY + \bar{X}Y$. Or, an output is not present if X and not Y , or, not X and Y are present, but exists for all other cases.

In Fig. 3 with X and Y not present, operation is at the origin and the collector of Q_1 is at $+V_{cc}$ which, by definition, gives an output. If X and not Y , or, not X and Y are present, operation moves to point 1. This causes Q_1 to conduct and the collector voltage to fall, corresponding to no output. With X and Y present, the load line moves to position 2 and the collector current falls to near zero, moving the collector voltage to near V_{cc} and an output is again present. Care is taken to insure that a base current of I_b will not saturate Q_1 .

The author acknowledges the suggestions made by James D. Horgan during the writing of this paper.

REFERENCE

- (1) C. D. Todd, Combining Transistors With Tunnel Diodes, *ELECTRONICS*, p 59, August 19, 1960.

Designing Chopper-Stabilized Operational Amplifiers

By R. B. FRADELLA,

United ElectroDynamics, Inc.,
Pasadena, California

TRANSISTOR operational amplifiers are small, reliable, and have low drift. These features are particularly attractive for airborne control systems and mobile analog computers. This article deals with drift stabilization techniques, with emphasis on practical design application.

Figure 1A shows a block diagram of a drift-stabilized amplifier. The differential amplifier $G_d(s)$ has drift D referred to its input. The chopper amplifier section $G_c(s)$ has negligible drift. $Y_{fb}(s)$ is the feedback admittance $1/Z_{fb}$. Time constants τ_1 , τ_2 and τ_3 are necessary.

For low frequencies, that is drift frequencies, the time-dependent terms can be neglected. Without the stabilizing amplifier ($K_c = 0$), the drift component at the output is

$$E_{oD} = DK_d / (1 + Y_{fb}K_d) \approx D/Y_{fb} \quad (1)$$

With the stabilizing amplifier,

$$E_{oD}' = DK_d / [1 + (1 + K_c) Y_{fb} K_d] \approx D / Y_{fb} K_c \quad (2)$$

The approximations are dependent upon $Y_{fb} K_d \gg 1$ and $K_c \gg 1$. Comparing E_{oD} and E_{oD}' in Eqs. 1 and 2, the drift component at the output is seen to be reduced by the factor K_c . When Y_{fb} has a series capacitor, it is convenient to refer the drift D to the E_i input. Thus, $D' = R_i D / (1 + K_c)$ is the equivalent drift voltage referred to the input, and is integrated the same as the input signal E_i .

The closed loop transfer function of the operational amplifier is

$$\frac{E_o}{E_i}(s) = \frac{\frac{K_d/R_i}{(\tau_2 s + 1)} \left[1 + \frac{K_c}{(\tau_1 s + 1)(\tau_2 s + 1)} \right]}{1 + \frac{Y_{fb} K_d}{(\tau_2 s + 1)} \left[1 + \frac{K_c}{(\tau_1 s + 1)(\tau_2 s + 1)} \right]} \quad (3)$$

Within the passband frequency $1/\tau_3$, $E_o/E_i = Z_{fb}/R_i$.

Note from Eq. 3 that a transmission zero will result if the bracketed term goes to zero. This will happen if the gain of the chopper amplifier $G_c(j\omega)$ is unity at 180 deg phase lag (at ω_c). This dictates $1/\tau_1 > \omega_c$. To make the sampling frequency ω_s at least double $1/\tau_1$, with K_c large, τ_3 must be large. These considerations lead to the frequency response in Fig. 1B.

The feed-forward gain and phase of $[1 + G_c(j\omega)] [G_d(j\omega)]$ are plotted on Fig. 1C. The differential amplifier roll-off at $1/\tau_3$ is necessary to prevent high frequency oscillations. It allows a drop in gain at 90 deg phase lag so that the transistor frequency cut-off characteristics appear only at loop gains less than one. Transistors for the differential amplifiers must have a high cut-off frequency if a high K_d and system bandwidth are required.

Three typical operational amplifiers include a simple d-c amplifier, integrator and integrator plus proportional.

Simple d-c amplifier:

$$\frac{E_o/E_i(s)}{Y_{fb}} = -R_{fb}/R_i = -K_1; \quad (4)$$

Integrator:

$$\frac{E_o/E_i(s)}{Y_{fb}} = -1/R_i C_{fb} s = -K_2/s; \quad (5)$$

Integral plus proportional:

$$\frac{E_o/E_i(s)}{Y_{fb}} = -(R_{fb}/R_i + 1/R_i C_{fb} s) = -K_1 + K_2/s; \quad (6)$$

$$Y_{fb} = C_{fb} s / (R_{fb} C_{fb} s + 1)$$

Figure 1C and Eqs. 3, 4, 5 and 6 show that $\arg [(1 + G_c) G_d Y_{fb}] \approx 90$ deg and no instabilities will occur for the conditions assumed. Loop gain is high at all frequencies below $1/\tau_3$.

A practical circuit with a spdt chopper is shown in Fig. 2. The positive and negative supplies are 100 v. Assume all transistors have $\beta = 30$.

First consider d-c bias conditions. So that transistors Q_1 and

Q_2 have the same stability factor, their bases should see the same resistance to ground. Therefore, $R_{i1} \parallel (2R_2 + R_{i2}) = R_{i2}$. Considering relative values,

$$R_{i1} \approx R_{i2} \quad (7)$$

An important observation is that node g is a virtual ground. This is due to the high loop gain. Thus

$$I_{c1} = E_i/R_i \quad (8)$$

$$I_{fb} = E_o/Y_{fb} \quad (9)$$

Therefore, the currents feeding node g can be represented as current generators.

For the differential amplifier section, define K_d as E_o/I_c , with the chopper amplifier killed and the feedback open. This leads to the approximate partial equivalent circuit of Fig. 3A. This is a good approximation because K_d is important primarily at frequencies between ω_c and $1/\tau_3$, where C_1 and C_2 are essentially short circuits and $R_1 \ll R_2$ (Fig. 2).

The output of the chopper amplifier section has been represented by its equivalent source impedance (approximately R_{i1}).

Since R_{i1} is much larger than the other resistances in the $Q_1 - Q_2$ emitter circuit, the resistance looking into the base of Q_1 is

$$R_{i1A} \approx \beta \left[R_p + \frac{1}{\beta} R_{i1} \right]$$

$$R_{i1A} \approx \beta R_p + R_{i1} \quad (10)$$

The transistor internal collector resistances will be assumed to be much greater than R_{i1} , R_{i2} , and R_{i3} . Thus the differential mode collector currents of Q_1 and Q_2 are

$$I_{c1} = I_{cA} = I_{cB} = \frac{R_1 \parallel R_{i3}}{(R_1 \parallel R_{i3}) + R_{i1A}} I_i \beta \quad (11)$$

Neglecting the common mode component, and replacing the current generators I_{c1} in parallel with R_{i1} by the Thevenin equivalent, Fig. 3B results.

From this circuit the differential mode collector currents of Q_1 and

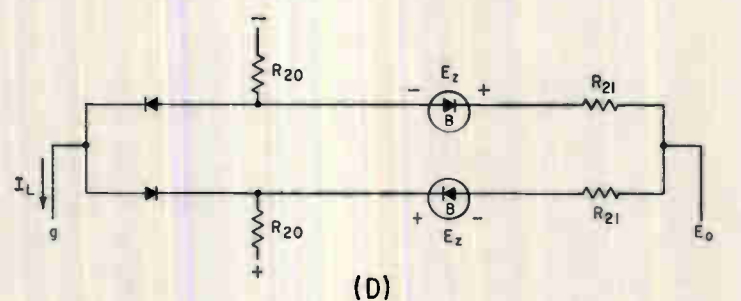
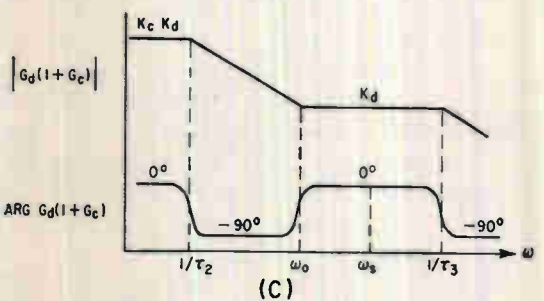
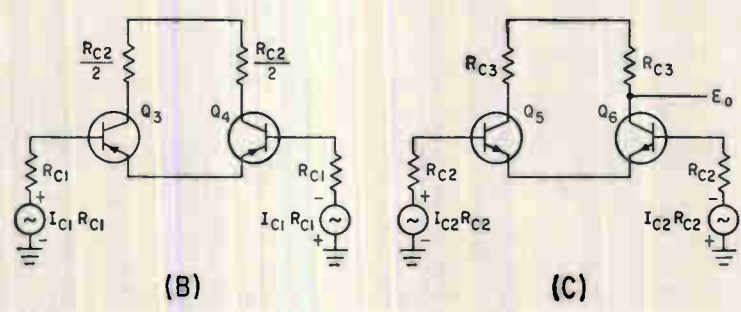
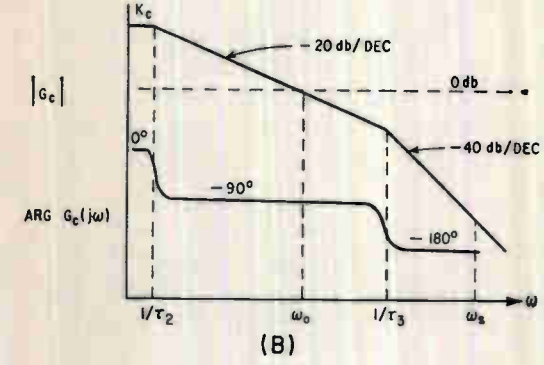
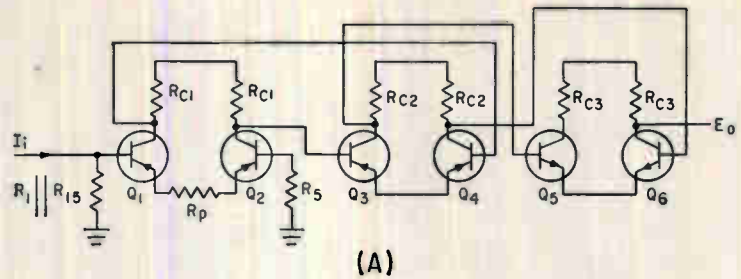
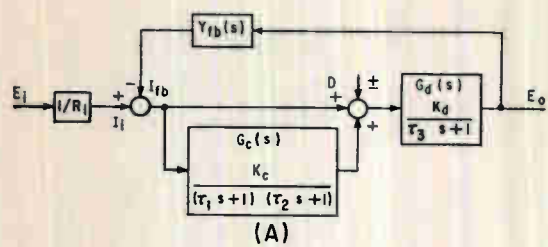

FIG. 1—Schematic block diagram of drift-stabilized amplifier (A); plot of gain and phase against frequency for chopper amplifier (B); and plot of feed-forward gain and phase against frequency (C)

FIG. 3—Approximate partial equivalent circuit for differential amplifier section (A); after replacing current generators I_{c_i} with R_{c_i} by Thevenin equivalent (B); circuit equivalent of last differential stage (C); and a limiter circuit (D)

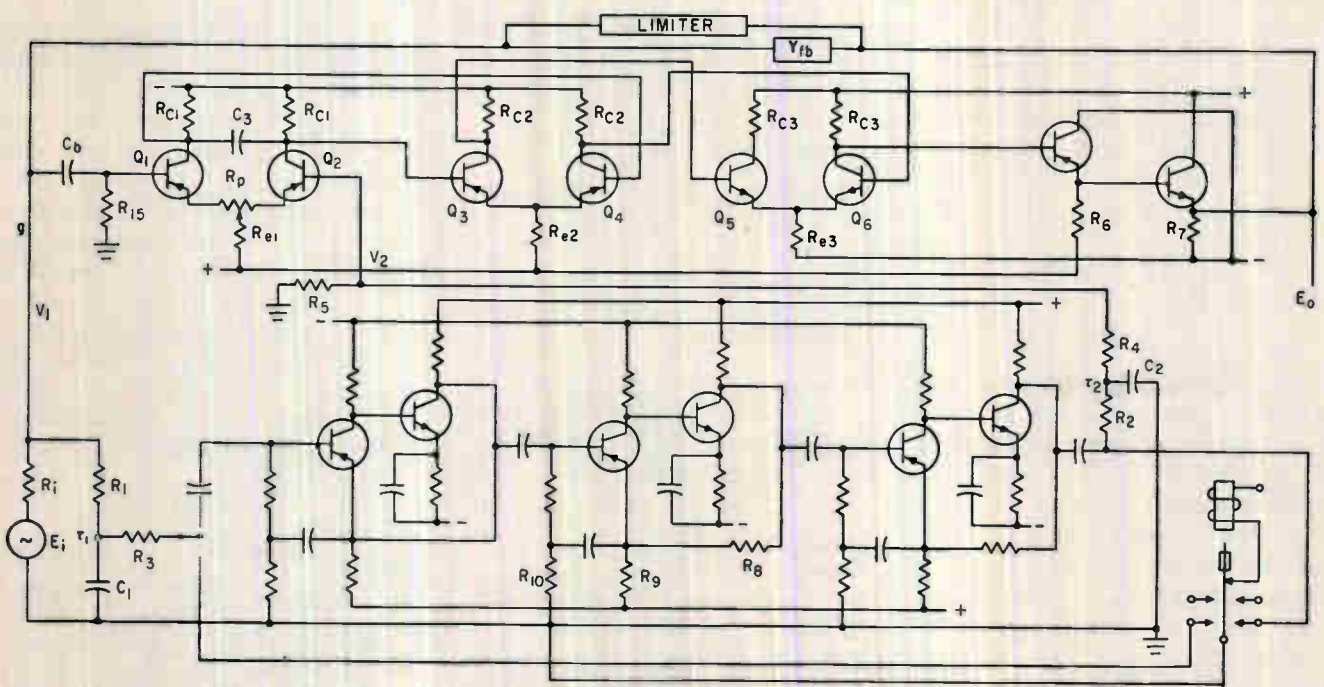

FIG. 2—Practical circuit diagram with a spdt chopper

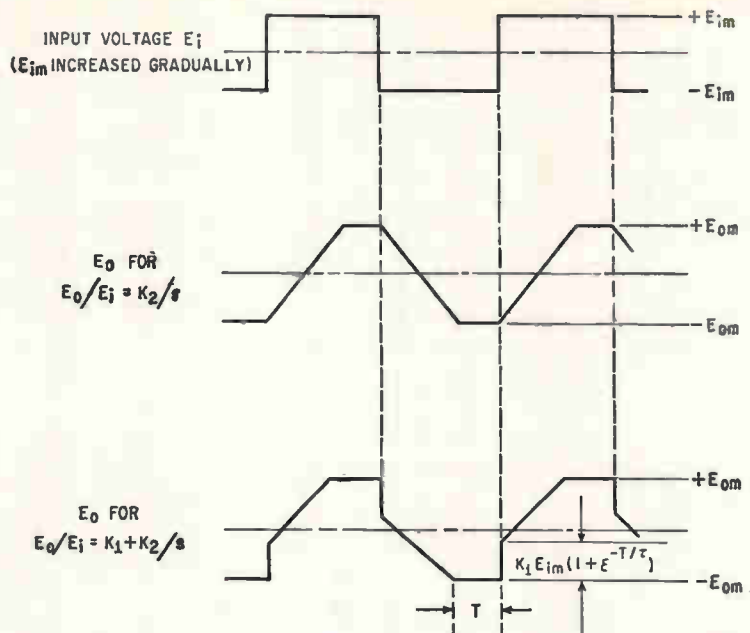

FIG. 4—Response of operational amplifiers to square-wave input

Q_1 are therefore seen to be

$$I_{c2} = I_{c2A} = I_{c2B} = \beta I_{c1} \quad (12)$$

Finally, the circuit equivalent of the last differential stage, Fig. 3C results. Note that $R_{c2} = R'_{c2} \parallel \beta (R_o \parallel \beta R_i)$. See also Fig. 2. The single-ended differential amplifier output is essentially E_o .

From Fig. 3C

$$E_o = R_{c2} \beta I_{c2} \quad (13)$$

Combining Eq. 7, 10, 11, 12 and 13

$$K_d = E_o/I_i = \frac{(R_1 \parallel R_{1b}) R_{c2} \beta}{(R_1 \parallel R_{1b}) + R_i + \beta R_p} \quad (14)$$

Gain K_d is essentially independent of R_{c1} and R_{c2} .

Typically, the quiescent collector currents might be 0.5 ma, 1 ma, 1.5 ma, 2 ma and 4 ma for the 3 differential and 2 common emitter stages respectively. This determines $R_{c1} \cong 100,000$ ohms, $R_{c2} \dots$ etc. Experimentally it was found that R_p should be about 2,500 ohms for effective balancing.

For Eq. 4, 5 and 6 to be valid within 1 percent in the passband and to realize proportional gains K_1 on the order of 5, determine what value of K_2 will suffice and if it can be accomplished with 3 differential stages. Choose $R_1 = R_2 = R_{1b} = 250,000$ ohms. Then Y_{fb} is $(5 \times 250 \times 10^3)^{-1} = 8 \times 10^{-7}$. From Eq. 3

$$Y_{fb} K_d > 100$$

and

$$K_d > 12 \times 10^7 \text{ volts/amp} \quad (15)$$

Nominally, $R_1 \cong 50,000$ ohms and $R_{c2} \cong 60,000$ ohms. Substituting these values in Eq. 14 gives $K_d \cong 30 \times 10^7$ volts/amp.

Amplifier gain A_c of the chopper amplifier section and approximate component values to realize K_c must be determined.

The base impedance of Q_2 at low frequency is

$$R_{b1B} \cong \beta R_p + R_{1b} \quad (16)$$

The chopper amplifier section gain can be defined as

$$K_c = V_2 R_{b1A} / V_1 R_{b1B} \quad (17)$$

$$V_2 = \frac{R_{b1B} \parallel R_b}{R_2 + R_4 + (R_{b1B} \parallel R_b)} (1/2) A_c V_1$$

$$V_2 \cong \frac{(R_{b1B} \parallel R_b) A_c V_1}{2 (R_2 + R_4)} \quad (18)$$

Combining Eq. 10, 16, 17 and 18

$$A_c \cong 2 K_c (R_2 + R_4) / (R_{b1B} \parallel R_b) \quad (19)$$

For maximum K_c with minimum amplifier gain A_c and maximum τ_2 with minimum C_2 ,

$$R_2 \cong R_4 \quad (20)$$

A comparison of relative component values shows that, roughly

$$\tau_1 \cong R_1 C_1 \quad (21)$$

$$\tau_2 \cong (R_2 \parallel R_4) C_2 \quad (22)$$

Choose $K_c = 1,000$. Then $\tau_2 \cong 3$, $1/\tau_2 \cong 0.3 \cong 0.05$ cps, and $1/\tau_1$ can be 100 cps. For $R_1 = 50,000$ ohms, $C_1 \cong 0.03$ microfarad. For $R_2 = R_4 = 1$ megohm, $C_2 \cong 6$ microfarad. A_c must be 32,000. Four amplifiers should be used. Since the gain of the first, $A_1 = 1$, the other three

should have gains $A_2 = A_3 = A_4 \cong 32$ volts per volt.

It can be shown that for these amplifiers

$$A_2 \cong \frac{R_o + (R_o \parallel R_{1b})}{R_o \parallel R_{1b}} \quad (23)$$

All capacitors in this circuit except C_1 , C_2 , and C_3 are for a-c bypass. Selection of resistor values for a given circuit is straightforward.

When the input impedances to the base of Q_3 and Q_4 are considered, ($R_{b2A} = R_{b2B} \cong R_{c1}$) and

$$\tau_3 \cong R_{c1} C_3 \quad (24)$$

A limiter circuit is shown in Fig. 3D. During linear operation, current circulates from plus to negative through the zener diodes. The silicon or vacuum diodes are blocked (reverse biased). The only effect of the limiter on the circuit for this mode is to load the output with the equivalent resistor $(R_{z1} + R_{z2})/2$.

When E_o exceeds the small drop across R_{z1} , plus the zener and forward conduction voltages of the diodes, I_{fb} will be augmented by current I_L through the limiter. E_o is held at the maximum value E_{om} and

$$(I_L + I_{fb}) R_i = E_i \quad (25)$$

The input-output relation can be characterized by observing the response to a square-wave that is gradually increased in amplitude to $\pm E_{im}$. This gradual increase does not unbalance the output.

It is helpful to remember that before limiting $I_{fb} = I_i$ and the output voltage is merely $E_o = I_{fb} Z_{fb}$ plus initial condition Q/C_{fb} (where Q is the initial charge on the feedback capacitor C_{fb}).

The transition from the limited mode to the linear mode for the integral plus proportional amplifier is not as simple as the other two types. For this amplifier, after limiting $I_{fb} = I_o e^{-t/\tau}$ where $\tau = R_{fb} C_{fb}$ and I_o is I_{fb} just before limiting. This results in the waveforms shown on Fig. 4.

REFERENCES

- (1) R. H. Okada, Stable Transistor Wide-Band D-C Amplifiers, *Communications and Electronics*, 47, March 1960.
- (2) D. W. Slaughter, Feedback Stabilized Transistor Amplifiers, *ELECTRONICS*, 28, p 174, 1955.
- (3) G. B. B. Chaplin and A. R. Owens, Some Transistor Input Stages for High Gain DC Amplifiers, *Institution of Electrical Engineers*, London, England, 195, p 249, 1958.

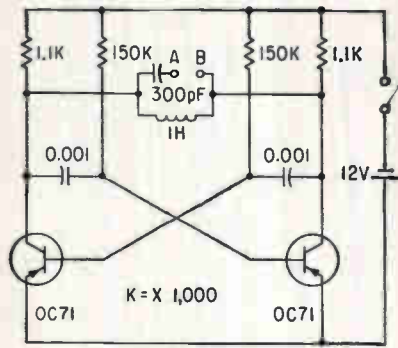
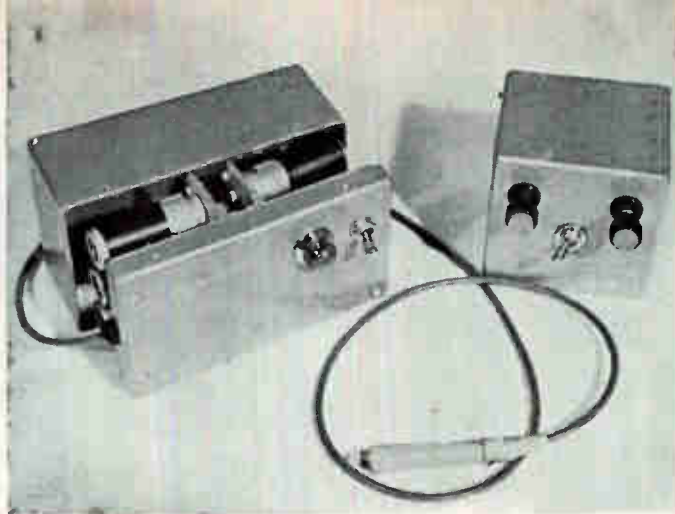

FIG. 1—Multivibrator provides the wire-tracing signal



Wire identifier assembly consists of two units

Probe Identifies Cable Wiring

Transistor circuits and a magnetic probe are used to locate individual wires in cables having a large number of wires

By J. S. RUSHTON,

Electronics Dept.,
English Electric Aviation Ltd.,
Warton, England

THE PROBLEM of identifying a particular wire in a multiwire cabling run often arises. In the aircraft industry, for example, it may be necessary to splice into a cable run to connect experimental apparatus. In simple circuits, color coding can be used, but if the cable run contains a large number of wires this is not practical and a wire identifier is necessary.

An earlier type of wire identifier used a capacitance pickup, but proved inconvenient because of the need to ground all wires in the cable except the desired wire, which carried a 1-Kc alternating current.

The identifier described here uses a magnetic pickup to sense an alternating current in the wanted wire. This pickup simplifies application of the identifier, since it is only necessary to ground one end of the wanted wire and to connect the a-c source between the other end of the wire and ground.

The 20-Kc frequency of the source was determined experimentally. This frequency gave a satisfactory signal in the pick-off and was not too high to cause

losses in the transistor amplifier when using cheap readily available transistors.

The signal source (Fig. 1) consists of a parallel-tuned circuit driven by an astable multivibrator. Connecting the tuned circuit to the output terminals (A, B) puts the wire being identified in the path of the circulating current, thus making use of the Q of the tuned circuit.

The amplifier pickup probe is made of about 600 turns of 40-gage enamelled wire wound on two lamina of 3/4 x 3/16 in. transformer steel, the steel forming a U-shaped probe end; the cable wires fit into the U-shaped end, sometimes several at a time, depending upon the core size. This shape has the advantage of speeding up the search since small

bunches of the wires can first be checked to reveal the bunch containing the wanted wire and then the individual wires in the bunch can be checked. The pickup is connected to a length of coaxial cable, the cable end having been potted in Araldite to a length of about 3 in. to give a pencil grip.

The coaxial cable goes to the amplifier (Fig. 2). Output of the two-stage a-c amplifier (Q_1 , Q_2) is rectified and then amplified by Q_3 , whose output energizes relay K_1 . The relay's contacts light a lamp mounted on the cover of the amplifier package.

The battery power supplies of each unit provide about 200 hours of continuous operation.

The permission of English Electric Aviation Ltd. to publish this article is acknowledged.

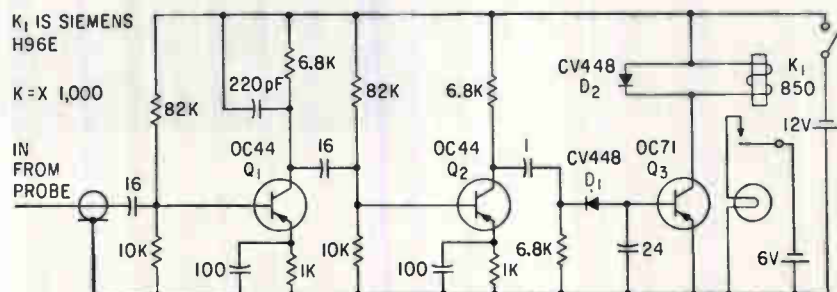

FIG. 2—Amplifier energizes relay when wire is located

Epitaxial Process Improves Transistor

Comparison of epitaxial and conventional mesa transistors

shows advantages of incorporating the epitaxial

growth process in manufacturing the mesa

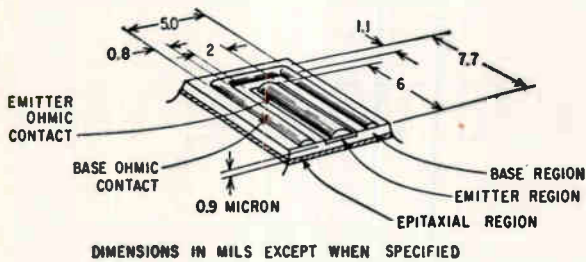

(A)

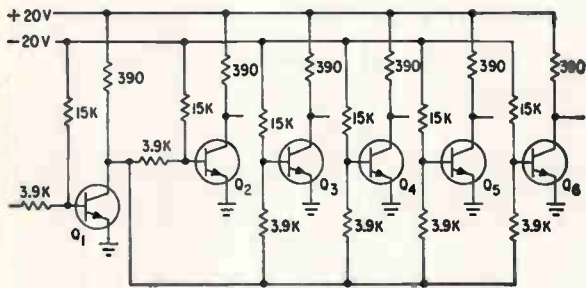
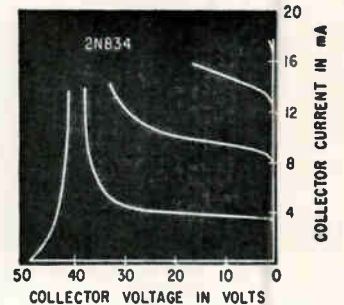
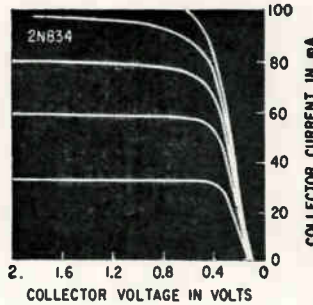

(D)

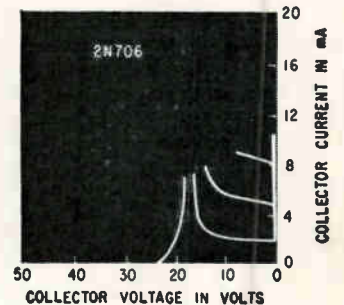
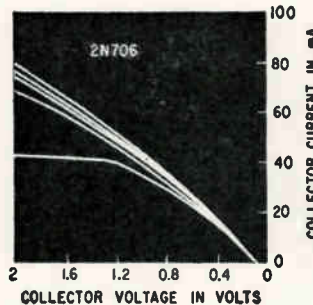

(B)

(C)

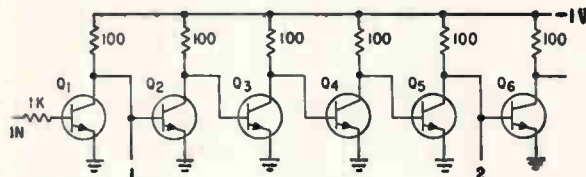

(E)

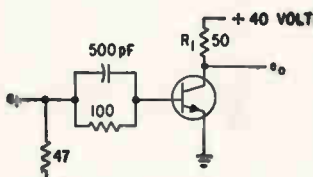

(F)

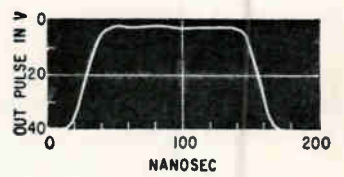

(G)

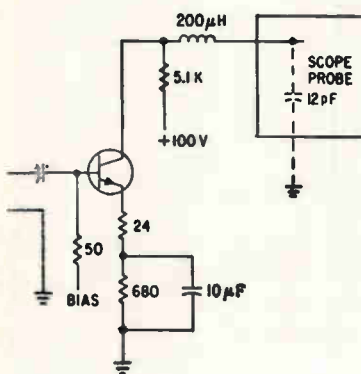

(H)

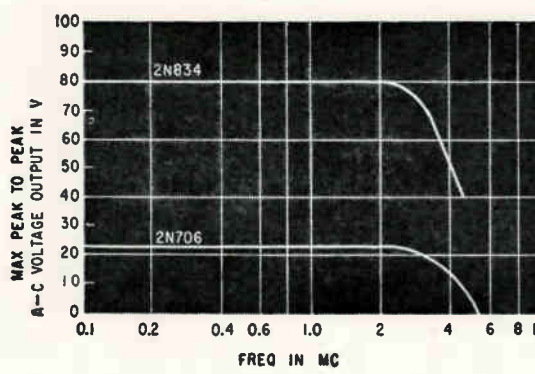

(I)

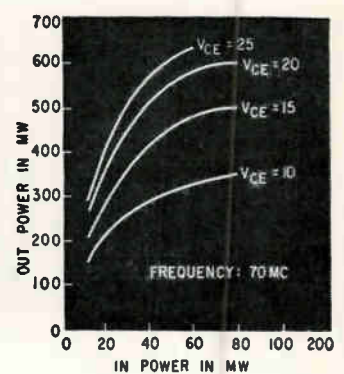

(J)

Using epitaxial mesa structure (A) results in improved collector characteristics in saturation (B) and breakdown (C) regions; NOR circuit (D) is for transient tests while (E) is used to determine propagation time. Pulse circuit (F) has output of (G) and video output amplifier (H) has frequency response of (I). Performance of 2N834 as r-f power amplifier is shown in (J)

Characteristics

By W. D. ROEHR,

Applications Engineer, Motorola, Inc., Phoenix, Arizona

EPITAXIALLY GROWN MESA transistors combine the mesa transistor advantages of high-frequency cut-off and rugged physical structure with the alloy transistor advantage of low saturation resistance. Figure A shows why this is so.

Normal mesa transistors have a high saturation resistance (R_s) because the mesa wafer must be relatively thick for physical rigidity. Lower resistivity collector material permits a lower R_s , but at the expense of a lower breakdown rating. With epitaxial transistors this compromise is not necessary. Most of the wafer thickness is of low resistivity, hence R_s is negligible. The thin epitaxial layer is of high-resistivity material, giving a high voltage rating, but adding little to R_s .

The 2N834 and its nonepitaxial cousin, the 2N706, are compared in B and C. At high currents, saturation voltage of 2N834 is improved by a factor of four and breakdown voltage by a factor of two.

The higher resistivity material also reduces collector capacitance and thus increases the frequency limits. Furthermore, the physical area of the emitter may be reduced, since smaller area devices now yield acceptable saturation resistance. This results in still higher frequency transistors.

The NOR circuit in D allows a direct comparison of the epitaxial 2N834 and the 2N706. Here, circuit design was a compromise between 2N834 and 2N706 specifications. Collector saturation voltage of the 2N834 at 50 ma is only 0.25 v while for the 2N706 it is 1 v. Minimum h_{fe} of the 2N834 is 25, compared to 20 for the 2N706. No attempt was made to speed up this circuit as it is used primarily to compare transient response of the transistors.

A positive pulse of 20 volts is applied to Q_1 , which drives the five load transistors. Typical results for a random sample of transistors

are shown in the table. In this table, t_{d1} is the delay between the leading edge of the input pulse and the leading edge of the output pulse. Similarly, t_{d2} refers to the trailing edges of the same pulses. The 2N834 has a 50 percent shorter turn-on time and a 60 percent shorter turn-off time than the 2N706. Transient response is improved in all respects using the 2N834, and the output voltage levels show its low collector saturation voltage.

This low collector saturation voltage gives the epitaxial transistor an advantage in DCTL (direct-coupled transistor logic) circuits. Figure E illustrates the fast propagation time of the 2N834 operated in a chain of inverters. If the voltage on the base of the transistor is low enough, the transistor will remain cut off. The low collector saturation voltage of the 2N834 makes this possible, yielding an output signal of 0.65 volt.

An input signal of 10 volts was applied to driver Q, and waveforms were observed at the collector of each stage. The average propagation time for one stage is found by averaging the turn-on and turn-off delay times. The average propagation time per stage $t_{pd} = (t_{d1} + t_{d2})/2m$, where t_{d1} is the time delay between the 50-percent points of the leading edge of the pulse, t_{d2} is the delay between the same points on the trailing edge, and m is the number of stages between measurement points.

To find the propagation time per

stage, the outputs at points 1 and 2 were compared. The delay between the two pulses was then due to a four-stage shift. Typical propagation time using 2N834's was slightly over 4 nsec per stage.

Figure F illustrates the high power capabilities of the 2N834. A 15-v pulse, e_1 , is applied at the input. The 40-v pulse across R_1 , the 50-ohm load, is shown in G. The rise and fall times are approximately 20 nsec each. The input network of F yields a storage time of 10 nsec. Average saturation voltage drop is 1.1 volts at the peak collector current of 800 ma. Although current gain is low at this high current, performance is good.

Because of its high collector voltage breakdown, a 2N834 can serve as a video output amplifier in a commercial tv receiver as shown in H. The results of using a 2N834 and 2N706 in this circuit are shown in I. The bandwidth is nearly the same for both units, but the 2N834 develops sufficient voltage to drive a crt.

The 2N834 also makes a useful r-f power amplifier. Power of 600 mw can be obtained at 70 Mc with power gain over 10 db. Figure J shows c-w output power at 70 Mc under various conditions.

The 2N834 is useful as an a-m collector-modulated power amplifier operating from a 12-v supply where peak voltage during upward modulation would be 48 volts. Generally, h-f transistors have low voltage ratings, necessitating a low secondary voltage supply derived from a resistor divider or a zener diode regulator. The 2N834 transistor eliminates the need for these components and improves circuit efficiency.

The results presented in these varied applications are evidence of the great improvement in transistors made possible by the epitaxial process. Of prime importance is the fact that no trading off is necessary; most characteristics are significantly improved.

TIME DELAY COMPARISON

Transistor	2N834	2N706
Turn On		
t_{d1}	80 nsec	111 nsec
t_r	40 nsec	72 nsec
Turn Off		
t_{d2}	90 nsec	140 nsec
t_f	60 nsec	100 nsec
Output Level		
ZERO	0.25 v	1 v
ONE	20 v	20 v

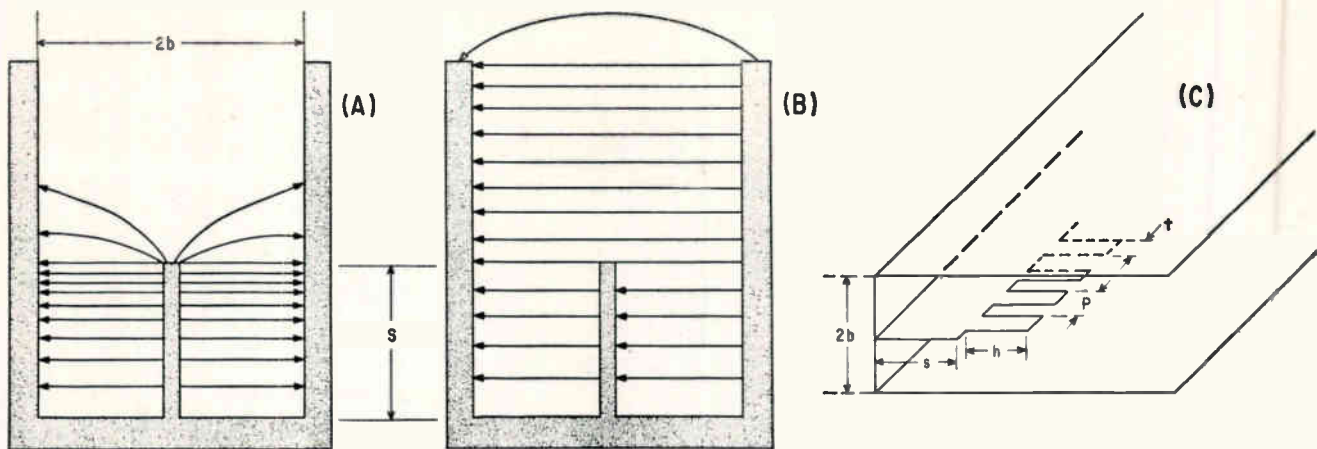

FIG. 1—Dimensions of trough waveguide showing nonradiating TE mode (A), radiating TEM mode (B), and the method of periodic loading (C)

Electromechanically Scanned Trough Waveguide Array

Obstacles deliberately introduced into trough waveguide change its transmission from a nonradiating to a radiating mode.

Motor driven obstacles produce a continuously varying radiation pattern giving a 50-degree scan of radiated energy

By W. ROTMAN and A. MAESTRI, Melpar Inc., Falls Church, Va.

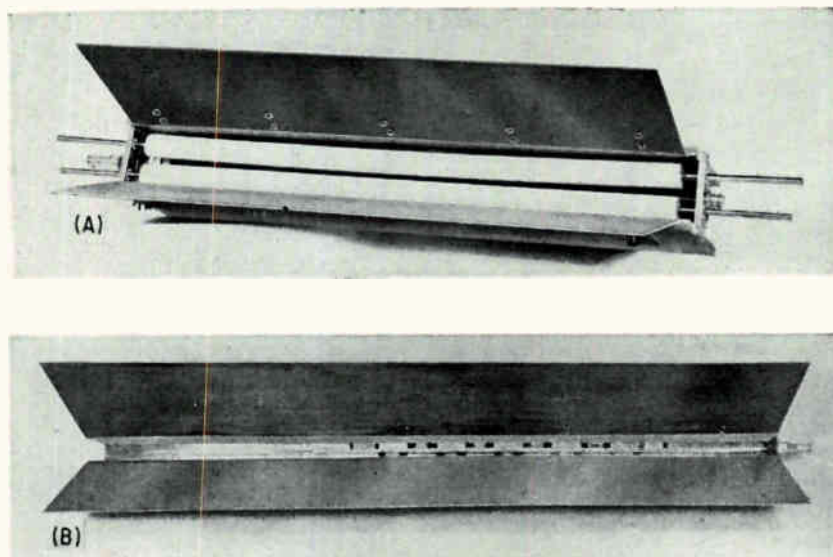
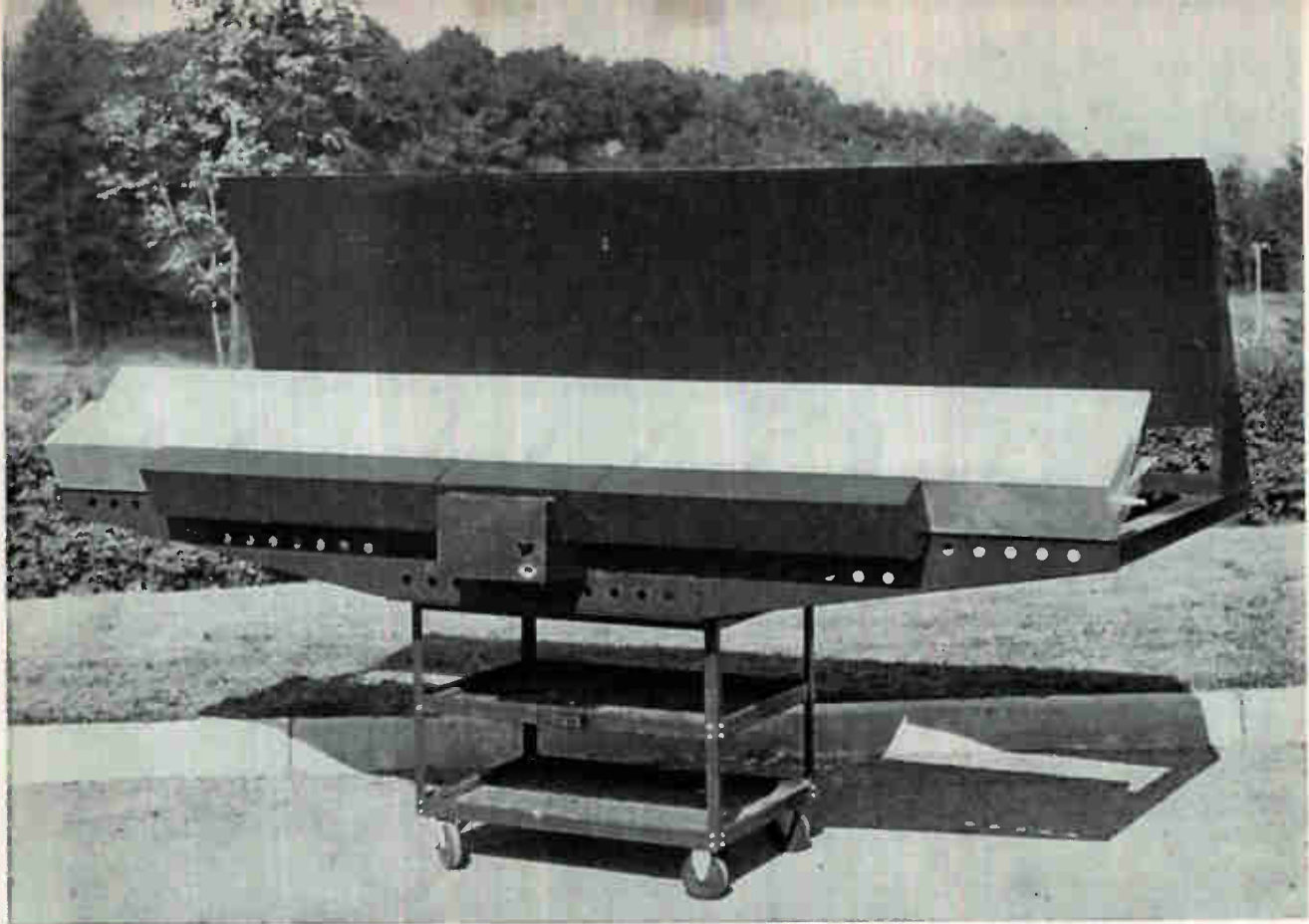

FIG. 2—Trough waveguide with anisotropic artificial-dielectric structures (A) and an array that was developed from this trough waveguide (B)

TROUGH WAVEGUIDES — relatively unexploited for antenna use—have several desirable features as r-f energy radiators, including strip transmission line simplicity, waveguide propagation, wide-band response, and radiation that is easily controlled. These characteristics, coupled with electromechanical scanning, make the trough waveguide an interesting feed for microwave antennas.

Possibly the most suitable line source (primary feed) for a cylindrical reflector or lens, the trough waveguide consists essentially of a channel with a center fin parallel to the outer walls, as shown in Fig. 1. Although physically open on one side, the structure acts as a non-radiating transmission line un-



Complete array with motor driven obstacles in the trough waveguide that change transmission mode from a non-radiating one to a radiating one

til some obstacle introduces an asymmetry into the guide. The trough waveguide combines the mechanical simplicity of a strip transmission line with the propagation characteristics of a waveguide. Its bandwidth for single-mode propagation exceeds that for a rectangular waveguide by a factor of 3 to 2.

Two methods can be used to continuously vary the guide wavelength at a suitable rate: rotation of symmetrical structures along a longitudinal axis within the trough waveguide and mechanical variation of the height of periodic structures located on the top of the center fin of the trough. A combination of both methods in short arrays was studied but emphasis was placed on the latter method to effect scanning of a 10-foot linear array.

Properties of the trough waveguide were discovered by the antenna laboratory of the Air Force Cambridge Research Center. The waveguide configuration can be derived from either a symmetric bisection of a strip transmission line carrying the first higher-order

transverse electric (TE) mode, or from folding a rectangular waveguide carrying the TE₁₀ mode. The latter derivation also allows two different modes of propagation to coexist when the width of the trough waveguide is less than a half wavelength. The first, or TE mode propagates energy along the axis of the guide, with field intensity decreasing exponentially as a function of the distance from the center fin. This TE mode is bound to the center fin, and being non-radiating, satisfies the waveguide equation—a definite cutoff wavelength plus a phase velocity greater

in the guide than in free space. The second and coexisting mode is the transverse electromagnetic (TEM) which can propagate. Its field configuration is antisymmetric with respect to the center fin and produces radiation whenever energy strikes the open side, or aperture, of the trough waveguide.

Placing an asymmetrical obstacle in the trough waveguide converts some energy from the non-radiating TE mode into the TEM mode. The energy in this TEM mode then radiates into space. The size and orientation of these obstacles controls the radiation along the length of the trough waveguide. Symmetrical obstacles, by contrast, have no mode-coupling effect, thus may be used as tuning elements.

A traveling-wave linear array can be obtained in the trough waveguide. If a continuous asymmetry exists in the guide, the nonradiating mode gradually converts to the radiating mode as it progresses along the trough.

Radiation from the continuously asymmetric trough waveguide is restricted in the range of angles

Design Parameters for Trough Waveguide Antenna

Design Frequency	$f_0 = 3.0$ Gc
Guide Wavelength Ratio	$\lambda_0/\lambda_g = 0.7$
Angle of Beam Maximum	$\theta = -22$ degrees
Proportion of Input Radiated	90 percent
Length of Array	78 in.
Length of Individual Blocks	1.75 in.
Trough Waveguide Width	$2d = 1.22$ in.
Amplitude Distribution	$A = 2.2 + 0.8 \cos \pi/2 (Z/L)$

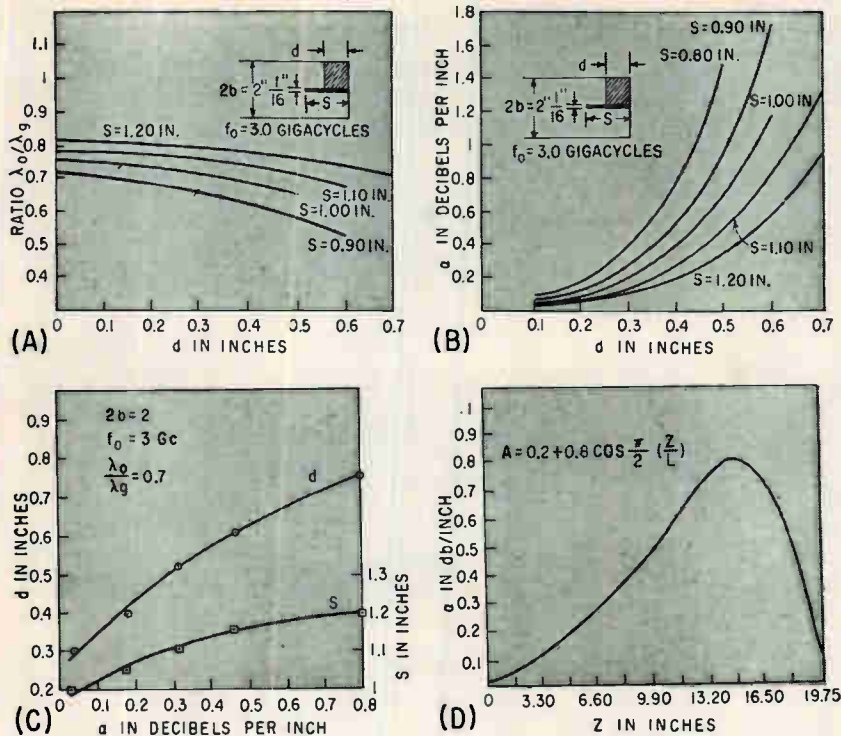

FIG. 3—Wavelength in asymmetrical trough waveguide (A), attenuation constant in asymmetrical trough waveguide (B), dimensions of periodically asymmetrical trough waveguide against a (C), and attenuation-constant against discrete points Z along the array (D)

over which it can scan. The relation between the guide wavelength and the direction of the beam maximum is given by

$$\sin \theta = \lambda_0 / \lambda_g \quad (1)$$

where θ is the angle of the emerging beam with respect to the normal to the array, λ_0 is the free space wavelength and λ_g is the guide wavelength. This equation limits the practical scan to a range of angles near endfire.

Broadside and near-broadside beams can be produced, however, if the traveling wave undergoes a 180-degree phase reversal in the guide. This phase reversal can be accomplished by periodically varying the asymmetry about the center fin, or by placing blocks of uniform length along the base of the guide, alternating them from side to side.

The angle of the beam maximum in the periodically asymmetric trough waveguide is given by

$$\sin \theta = \lambda_0 / \lambda_g - \lambda_0 / 2a \quad (2)$$

where a is the length of one base block. From this equation the beam maximum will occur at broadside ($\theta = 0$ deg) when a is made equal to one-half wavelength. In general, no other principal maxima appear if the beam is restricted to broad-

side and near-broadside conditions and the guide wavelength is less than twice the free-space wavelength. The beam can be scanned from the near-broadside direction through the normal direction, thus so radiators of this type have an advantage over the conventional linear array of discrete resonant elements.

A linear trough waveguide with a periodically asymmetric base can be viewed and designed as a lossy transmission line. The designer can specify phase constants and attenuation constants (radiated energy) for each section of line, even though the line itself is not continuous. Because the asymmetrical base blocks represent periodic, nonresonant impediments, the trough waveguide approximates a traveling wave array of nonresonant elements.

For scanning purposes the principal maximum of the radiated beam is at an angle expressed by Eq. (2). Rewriting the equation in terms of a and λ

$$\lambda_g = \frac{(2a) (\lambda_0)}{(2a \sin \theta) + \lambda_0} \quad (3)$$

reveals that the maximum value of a occurs when trough waveguide

dimensions make λ , as short as possible.

A trough waveguide can achieve effective scanning if a suitable longitudinal distribution of radiating elements is used, and if the guide wavelength is continuously varied while maintaining a constant input frequency.

Wavelength can be varied by rotating a conducting, anisotropic structure about its longitudinal axis within and parallel to the trough waveguide. Such anisotropic structure—artificial dielectrics—embody a number of discrete, conducting objects that alter the speed of the traveling wave.

Two artificial dielectrics (24-inch long cylinders) were placed side by side in a trough waveguide. These anisotropic structures presented a soldier-like formation of beryllium-copper pins in cylindrical castings of low-loss isocyanate foam. Because wave velocity generally increases with element (pin) length, for electrically short elements an artificial dielectric of rectangular cross section will give the longest element and the greatest variation in element length. To provide the longest average element length plus a consistently and continuously variable dielectric constant, a circular cross-section was selected. Structures of this type located along the axis of a slotted line (Fig. 2A) were found to yield smooth standing-wave patterns at all angles of rotation and to provide a practical amount of variation in the guide wavelength.

Scanning can also be accomplished by mechanically varying a critical dimension within the guide, for example the height s of the center fin. Such a variation will change the wavelength within the guide and shift the phase relations in an array of radiating elements, thereby causing the beam to scan.

Since the variation of the trough waveguide propagation characteristics with frequency is similar to that of an ordinary waveguide, the existing fast wave can be accelerated by periodic loading introduced into it. This periodic loading can be accomplished by modification of the center fin only; that is, by a series of teeth in the top of the fin. Parameters affecting variation in wavelength (Fig. 1C) are the height, s , of the center fin, the

height, h , and the periodicity, t/p , of the teeth.

Antenna models were constructed as shown in Fig. 2B using periodic asymmetry to produce radiation from the trough waveguide. Short arrays successfully incorporated both methods of scanning. A final antenna of aluminum was designed and fabricated with an overall length of 10 feet, the array of radiating elements being approximately 6.5 feet. These dimensions gave a three-degree beamwidth in the plane of scan. Array width (Fig. 1B) was determined from the required amplitude distribution to be 1.22 in.

To secure proper amplitude distribution, the attenuation constant in nepers per unit length is computed using the following equation

$$2\alpha(Z) = A^2 \left[\left(\int_z^L A^2 dz \right) + \left(\frac{P(L)}{P(o) - P(L)} \int_0^L A^2 dz \right) \right]$$

when $P(L)/P(o) = 1/10$.

Theoretical values of attenuation constant α and ratio λ_o/λ_g obtained from previous derivations are plotted in Fig. 3A and 3B as functions of asymmetry d and fin height s for the continuously asymmetrical case. Using these data as design parameters, the relation λ_o/λ_g was chosen for the final trough waveguide. Dimensions of the periodically asymmetrical trough waveguide (Fig. 3C) are a function of attenuation constant for a constant phase velocity ratio, $\lambda_o/\lambda_g = 0.7$. These dimensions can not be easily computed, but are readily measured.

For a given cross section the guide wavelength is almost identical for both continuous and periodic asymmetry; however, the attenuation for the periodic case is less than for the continuous structure. Near each interface the periodic type behaves as a symmetrical structure and radiates less, thus reducing the average attenuation rate.

Attenuation data for the periodic asymmetry was obtained by measuring the insertion loss of a uniform section of trough waveguide with and without the periodic asymmetry. Amplitude distribution across the aperture of the array appears in Fig. 3D as a plot

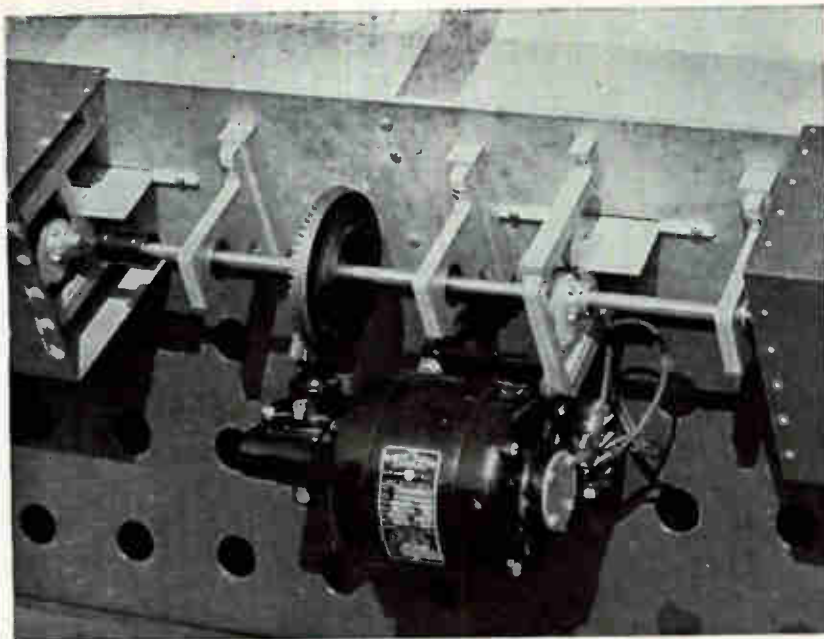

FIG. 4.—Motorized cams drive obstacles into the trough waveguide to change its transmission characteristics according to a predetermined pattern

of attenuation constant α at discrete points Z along the array. The equation for amplitude distribution A includes total length L of the array.

The final array was scanned during periodic loading of the center fin, this loading being done by serrating the top of the center fin (Fig. 3). Continuous variation in the height of the serrations (a necessity for varying the guide wavelength) was permitted by constructing the center fin in three sections—two stationary side pieces and a movable serrated center piece. Capacitive coupling linked both movable and fixed pieces.

Augmenting the scan capability of the waveguide, a parabolic cylinder restricted the issuing beamwidth to ten degrees in the nonscan (elevation) plane. Thus the final antenna consisted of a trough waveguide array feeding a parabolic reflector, with scanning action accomplished by mechanically changing the height of periodic structures on the center fin of the waveguide.

Variation of center fin periodic loading was accomplished smoothly and continuously by a cam-link arrangement which transformed rotary motion of a drive shaft into reciprocating motion of the serrated portion of the center fin. Positive-action cams eliminate the

use of springs or gravity to maintain contact between the cam and follower. The mechanism and drive motor are shown in Fig. 4. Speed of the scanning mechanism can be varied from zero to 120 rpm, a speed of 60 rpm yielding a scan rate of 90 degrees a second. The design of the final antenna includes the parameters listed in the table.

Radiation patterns of this antenna were measured over the frequency range: 2.8 Gc to 3.2 Gc, for both scan plane (azimuth) and elevation. Scanning can be done either by rotating an anisotropic dielectric structure within the guide, or by periodic loading of the center fin.

The trough waveguide offers a new geometry in the designing of arrays, and also offers additional possibilities for rapid, wide-angle scanning. This type antenna should prove useful since the geometry of the trough waveguide provides a scanner operating within a minimum volume.

The research discussed in this article was sponsored by the Electronic Research Directorate of the Air Force Cambridge Research Center, Air Research and Development Command, under contract AF19(604)-4056.

BIBLIOGRAPHY

W. Rotman and A. Maestri, An Electromechanically Scannable Trough Waveguide Array, *IRE Conv Rec* 1, p 67, 1960.

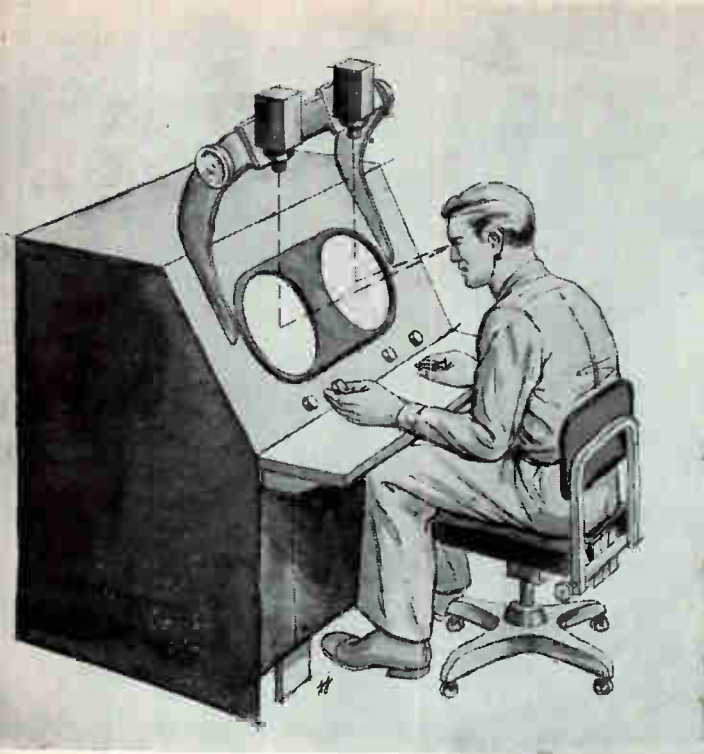

FIG. 1—Projector is positioned above console to avoid interference with observer, and to prevent reflections visible in normal operating position

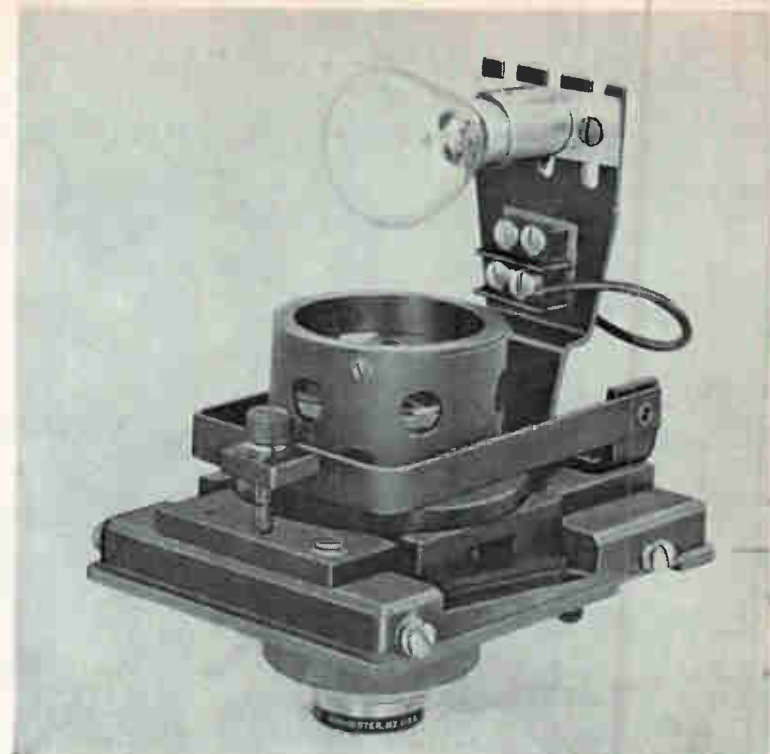

FIG. 2—Projector/camera unit with cover removed. Note the inclined film plane for focusing on the standard screen

Optically Projecting Data On a Cathode-Ray Tube Face

Avoids parallax in superimposing maps and grids on radar display

By HERBERT H. NAIDICH,*
ITT Laboratories, Nutley, N. J.

RADAR AND NAVIGATION CONSOLES and other devices using cathode-ray tube displays often require maps or grids superimposed over the cathode-ray image. Ideally, such overlay should appear in the same plane as the phosphor image, and its brilliance should be adjustable independently of the crt image intensity. For clarity, the overlay should also have a contrasting color or colors.

Mechanical methods of overlay range from the edge-lighted Plexiglass graticule on service oscilloscopes to complex optical devices

that give the illusion that the map is superimposed on the electronic display. However, mechanical methods always encounter the parallax problem; and because of the crt face curvature the solution is often a compromise. A limited viewing angle often restricts the number or position of observers.

Video mapping is another method used for map superposition. By flying-spot scanner techniques, the map is converted into electrical signals and mixed with the target video. In this way, the map presentation resembles normal video. Although video mapping eliminates the parallax problem, it involves complex electronic equipment and this often makes it prohibitive.

A new approach to solving these problems is the map projection tech-

nique. Using a conventional incandescent light source, the map or grid is projected directly on the crt, whose phosphor face makes a reflecting screen. To avoid interfering with observer, the projector is placed at top of the display console; its optical axis forms a sharp angle with screen (See Fig. 1).

Oblique projection, of course, implies an optical distortion of the map. To compensate for this, a severe predistortion must be introduced into the map slide. The following problems must be considered:

(1) Lens magnification is a function of lens-to-image length, that is, portions of the map at the bottom of the crt receive greater magnification than portions at the top.

(2) Projected light must pass

* Formerly with Radio Division, Bendix Corporation

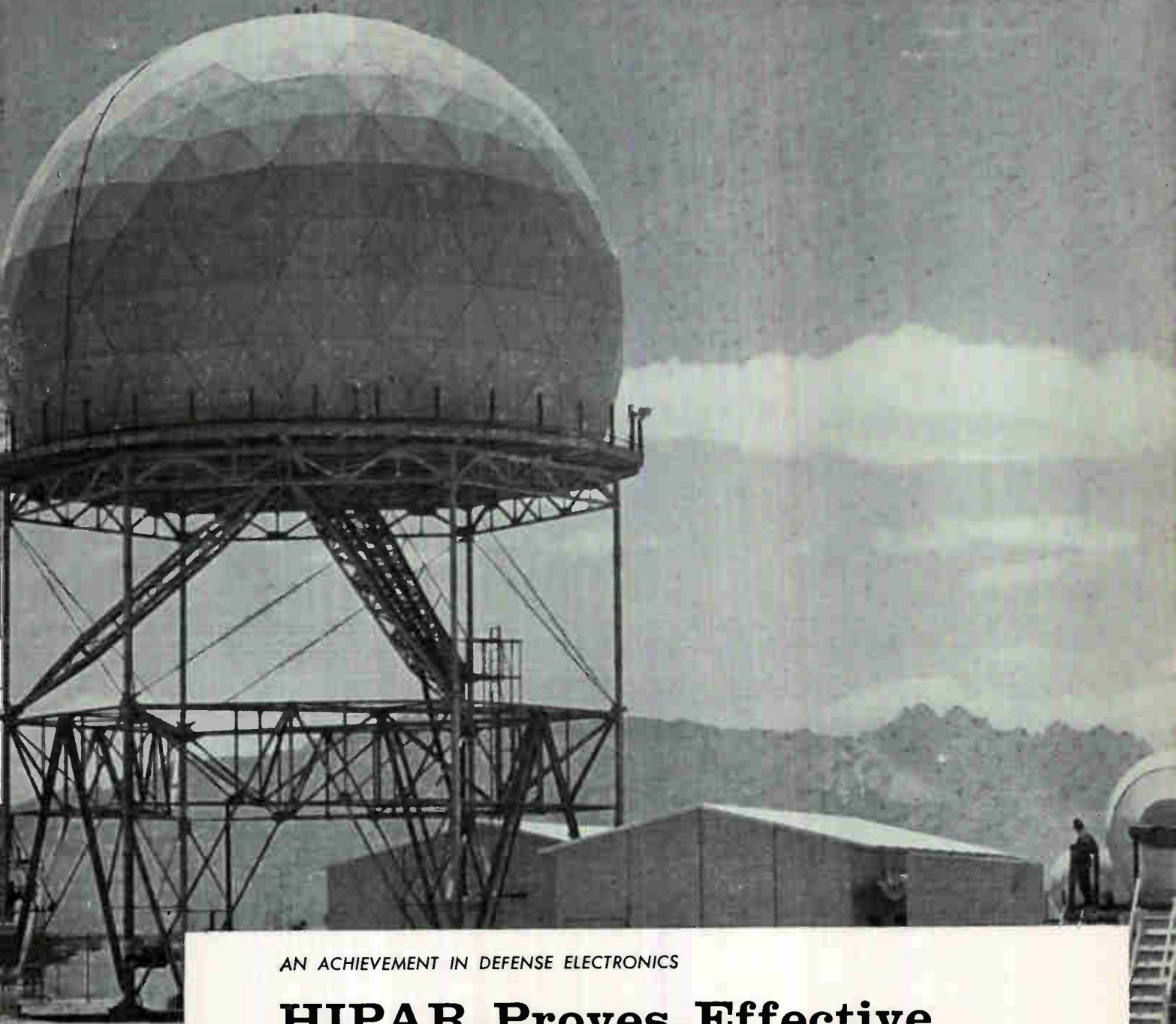

AN ACHIEVEMENT IN DEFENSE ELECTRONICS

HIPAR Proves Effective In Hercules Anti-Missile Test

This new General Electric *High Power Acquisition Radar* (HIPAR) more than triples the detection capability of the U. S. Army's Nike-Hercules System. Produced for Western Electric, Nike-Hercules System Prime Contractor, this General Electric radar provides high resolution target data at long range and high altitudes on bomber and fighter aircraft, air-launched missiles and tactical ballistic missiles. The effectiveness of this Improved System was demonstrated at the White Sands Missile Range on June 3, 1960, with the successful intercept and destruction of a Corporal Missile, and in August and September, 1960, when target Nike-Hercules Missiles were destroyed by their defending counterparts at altitudes to almost 100,000 feet and closing speeds near Mach 7.

176-06

HEAVY MILITARY ELECTRONICS DEPARTMENT
DEFENSE ELECTRONICS DIVISION • SYRACUSE, NEW YORK

Progress Is Our Most Important Product

GENERAL  ELECTRIC

through the Plexiglass overlay (normally amber for a P7 phosphor) and through the glass faceplate of the crt. Both these factors may bring in objectionable reflections.

(3) Light intensity falls off as the square of the projected distance, therefore the projected map has nonuniform brightness.

(4) As the light rays pass through the overlay and the glass faceplate at varying angles of incidence, refraction will displace portions of the map by different amounts. The lower portions of the map would be shifted downward more than the upper portions, since the light rays forming the bottom portion enter the refracting surfaces at greater angles of incidence than the rays forming the upper portions of the map.

(5) The curved surface of the screen would cause pincushion distortion even if projection were normal to the crt face. Oblique projection complicates this distortion still further.

(6) The entire projected image must be sharp, but large depth of field in the lens system would make for uncritical focusing. The focusing adjustment would cause changes in magnification, thus producing distortion.

(7) Sharp focusing and a large depth of field are indicated, but these are conflicting requirements. Large depth of field would make for uncritical focusing. The focusing adjustment, however, would cause changes in magnification, and this would cause distortion on the curved screen surface.

To take care of the distortion problems, the map slide must be predistorted. However, it would be impractical to calculate the magnitude of each error introduced by projection and to try to compensate for all errors when preparing the slide.

With the new system, predistortion is introduced into the slide by reversing the projection process and using the projector as a camera. The map or grid, full size and undistorted, is placed on the inside surface of a glass faceplate cut from a crt of the proper size. This dummy tube is then placed in the crt mount, and the Plexiglass overlay is put in place. The projector then photographs the map and the

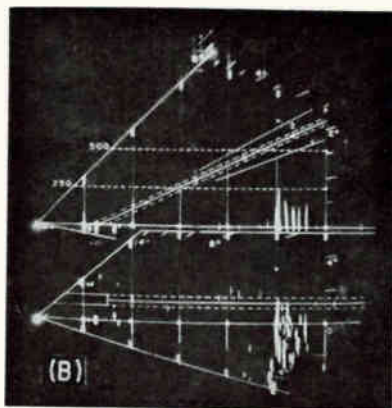
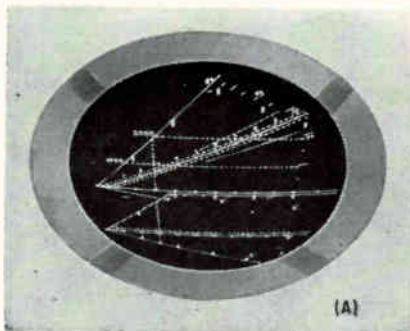

FIG. 3—A predistorted slide, slightly enlarged, is seen in (A). Projected map as seen on crt is shown in (B). The map is for a precision approach (GCA) radar display

slide is suitable for distortionless projection.

The projector/camera unit (see Fig. 2) has a film plane tilted with respect to the optical axis. The tilt is in agreement with the lens equation, $1/f = 1/u + 1/d$, where f is the focal length of the lens, u is the subject distance and d the image distance. The tilt produces critical focusing across the entire face of the crt, and the depth-of-field problem becomes negligible. However, the tilt is in a direction to increase the magnification distortion on the negative. A 6-volt automobile lamp serves as projection lamp, and the condensing lens system is conventional. A locking bracket secures the slide in place after accurate positioning.

To prepare the map for photographing, the lines and numbers of the map are pasted on the inside of the dummy crt surface. Then the entire surface is covered with a white cloth as a contrasting background. A test slide helps for focusing, centering and adjusting the projector. It is necessary to have the optical axis of the pro-

jector intersect the axis of the crt, and to keep the film plane and map plane positioned with respect to each other.

Once the projector is in position, its outer cover, condensing lens and lamp are removed. The map blank is illuminated by two photo-flood lamps, and the film is exposed by turning on the floods. Kodalith film has proved to be satisfactory: it gives high contrast and fine detail. A red safelight may be used, but otherwise the photography process takes place in a darkened room. Figure 3 is a sample of the predistorted slide that results.

When the dummy tube is removed and the crt installed, the projector is again centered and focused by a test slide. Five small dots on the crt face—one at the center and four on the X and Y axes—correspond to similar dots on the slide. Once centered, the slide is locked in place.

The projected map appears in the same plane as the cathode-ray information on the curved phosphor surface. The map presentation is pleasing and can be improved by a colored filter; a red filter gives especially good results. Reflections from the surfaces of the Plexiglass and the crt outer surface are not apparent to the observer in his normal viewing position, unless the reflecting surfaces become dirty. The reflections become visible if the viewing angle equals the angle of incidence of the projected light, but this does not include the normal viewing angle and so reflections are not a problem.

This method of map presentation is highly accurate. Quantitative errors are difficult to measure here for the map appears on the inside of the crt glass faceplate that is behind the Plexiglass overlay. Map specifications are usually in terms of flat surfaces, and one of the compromises that must be made is in the method of preparing the original map on the inside of a curved surface.

The author wishes to acknowledge the encouragement of W. Hicks, W. O'Hara and J. Nolen on this project.

BIBLIOGRAPHY

Sollar, Cathode Ray Tube Displays, *Radiation Laboratory Series*, 22. Hall, Radar Aids to Navigation, *Radiation Laboratory Series* 2. Anti-parallax Mapping Device, U. S. Patent 2,546,510. Projecting Methods for Cathode Ray Tubes, U.S. Patent 2,843,844.

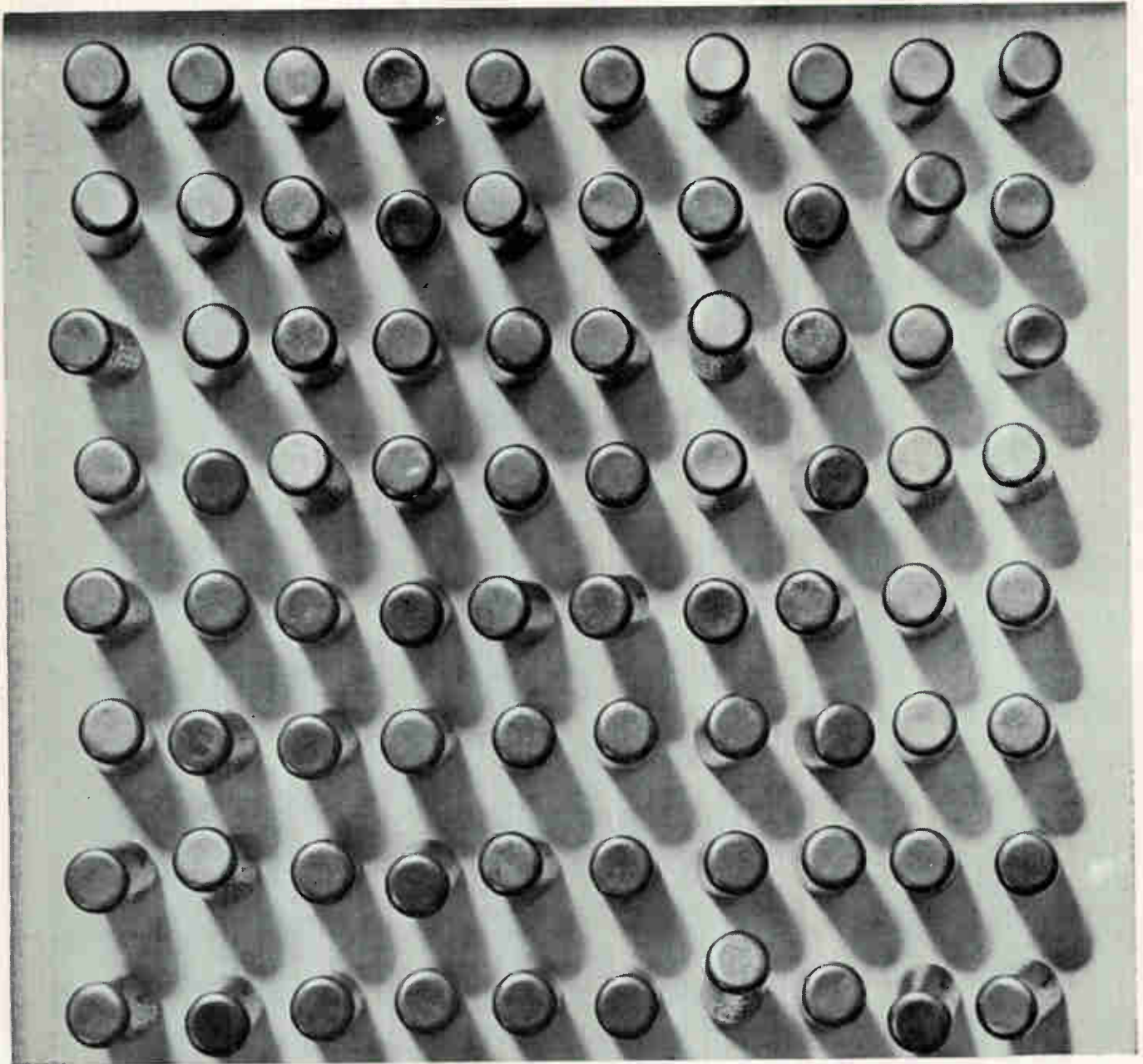

Semiconductors for Radio and TV

Germanium PNP Alloy Type Transistor

- 2SA49 For Intermediate Frequency Amplification (455Kc)
- 2SA52 For Converter Service (1.5Mc)
- 2SA53 For Intermediate Frequency Amplification (455Kc)
- 2SB26 For Audio Frequency Power Amplification
- 2SB54 For Audio Frequency Amplification
- 2SB56 For Audio Frequency Power Amplification
- 2SB189 For Audio Frequency Power Amplification
- 2SB200 For Audio Frequency Power Amplification
- 2SB202 For Audio Frequency Power Amplification

Germanium PNP Drift Type, Transistor

- 2SA57 For High Frequency Amplification (18Mc)
- 2SA58 For High Frequency Amplification (12Mc)
- 2SA60 For Converter Service (12Mc)
- 2SA72 For High Frequency Amplification (1.5Mc)
- 2SA73 For Converter Service (1.5Mc)

- 2SA92 For Local Oscillator Service (18Mc)
- 2SA93 For Mixer Service (12Mc)
- 2SA76 For High Frequency Amplification (VHF•FM)
- 2SA77 For High Frequency Amplification (VHF•FM)
- 2SA175 For High Frequency Amplification (22.5Mc)
- 2SA236 For Intermediate Frequency Amplification (455Kc)
- 2SA237 For Intermediate Frequency Amplification (455Kc)

Germanium PNP Mesa Type Transistor

- 2SA299 For Mixer & Local Oscillator Service (TV Tuner)
- 2SA230 For High Frequency Amplification (TV Tuner)
- 2SA239 For Converter Service (VHF•FM)
- 2SA240 For High Frequency Amplification (VHF-FM)

Germanium Point Contact Diode

- 1N60 For AM/FM Radio & Video Detector Service
- 1S50 For AM/FM Radio Detector Service (Single End)
- 1S34 For General Service

Toshiba

TOKYO SHIBAURA ELECTRIC CO., LTD.

2, Ginza Nishi 5-chome, Chuo-ku, Tokyo, Japan

Microwave Figure of Merit for Tunnel Diodes

By HATSUAKI FUKUI,
Sony Corp., Tokyo, Japan

FIGURE of merit for tunnel diodes at microwave frequencies can be determined from an equivalent circuit. Comparisons of actual and calculated values demonstrate accuracy of the circuit from low to microwave frequencies. By permitting separation of characteristics, the circuit provides a means of evaluating tunnel diode performance at high frequencies.

Tunnel diode admittance was measured at frequencies from 0.3 to 4.6 Gc using the standing-wave method. The tunnel diode was terminated in a purely resistive load to avoid oscillations when the diode operated in the negative conductance region.

A solid brass block having the same dimensions as the tunnel diode was used. It was mounted in place of the diode to determine the point of minimum standing wave voltage, which was used as a reference to indicate infinite admittance. The diode was then inserted in place of the block and its admittance was measured with input level limited to 1 microwatt. The measurements demonstrated that within this level, tunnel diode admittance was independent of input. From measured swr and the minimum voltage point, admittance at the reference was calculated. This value of admittance is equivalent to tunnel diode admittance.

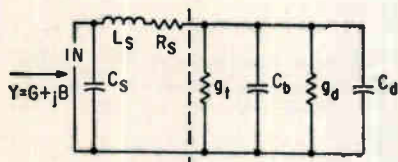

FIG. 1—Small signal equivalent circuit represents tunnel diode characteristics

In the negative conductance region, swr can be expressed by negative values. The presence of negative conductance was apparent

from amplitude of the standing wave, which exceeded that of total reflection. For a Sony 1T1103 tunnel diode, negative conductance was observed at the input terminals at 4.6 Gc.

The equivalent circuit for a tunnel diode is shown in Fig. 1. Values that are dependent on bias voltage are tunnel conductance g_t , barrier capacitance C_b , diffusion conductance g_d , and diffusion capacitance C_d . The negative region for g_t is in the direction of easy flow. In regions of small bias voltage, g_d and C_d can be neglected for either direction of flow because of their insignificance compared with tunnel current.

To determine capsule capacitance C_d , measurements were made on a number of burned out tunnel diodes. The most probable value of C_d was estimated to be 0.85 pf. Bulk resistance R_s and capsule inductance L_s were determined by increasing bias to produce a large value of g_t . The value of R_s was found to be $2.5 + 0.5(f)^{1/2}$ ohms, where f is frequency in Gc, and L_s was 0.21 ph.

Junction admittances ($g_t + g_d$ and $C_b + C_d$) are essentially independent of frequency. For capacitances C_b and C_d the relationship between bias voltage and $1/(C_b + C_d)^2$ was plotted as shown in Fig. 2A. Capacitance in the linear region resulted from C_b , which satisfies the barrier capacitance equation in the case of a step junction. In the diffusion current region, the relationship deviates from a straight line because of added capacitance C_d . The values obtained from the plot agree well with the calculated values for a comparable germanium pn junction. The values of C_d shown in Fig. 2B also agree closely with the calculated value for diffusion capacitance in the high bias region.

Because of the close agreement between calculated and observed results, the equivalent circuit can be used to represent tunnel diode characteristics with sufficient ac-

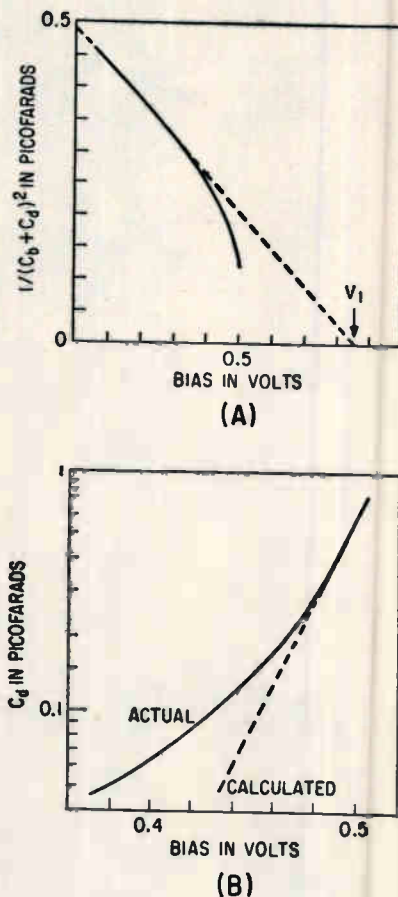

FIG. 2—Plot at (A) shows agreement with capacitance of comparable germanium pn junction with plot at (B) also agreeing with calculated C_d at high bias region

curacy to be used from low to microwave frequencies.

The tunneling that is responsible for negative conductance requires little time. Because of junction capacitance, however, time constant C_b/g_t limits response time. Therefore, a minimum value of C_b/g_t is of primary interest as a figure of merit for a tunnel diode at microwave frequencies. The minimum value of C_b/g_t was found to be about 1.1×10^{-10} sec. Approximate calculation indicates that this value corresponds to that of the germanium pn junction.

Time constant C_b/g_t accounts for only the junction, but total time constant for the tunnel diode must include bulk resistance R_s and capsule inductance L_s . Using the

KEARFOTT SIZE 5 COMPONENTS

FOR SERVO SYSTEM MINIATURIZATION



A complete family of Size 5 components for every servo system function is now available from Kearfott. This series offers the system designer complete latitude in miniaturization of his second-generation systems, with the performance and reliability heretofore found only in much larger units.

Stainless steel housings, shafts and bearings protect the units against environmental extremes and contribute to stability under shock, vibration, and temperature fluctuations. • Standard 26-v, 400 cps excitation. • Synchro and resolver accuracy ± 10 min. • Operating temperature range -55° to $+125^{\circ}$ C. Computer-designed for optimum performance.

CHARACTERISTICS

SYNCHROS

	VOLTAGE (400 cps)	CURRENT (amps)	IMPEOANCE		T.R.	NULL (mv)	ERROR (min)
			INPUT	OUTPUT			
Transmitter CJO 0565 100	26	.045	576 /74.7	94.2 /71.4	.454	34	10
Control Transformer							
Low Z-CJO 0555 100	11.8	.0408	250 /73	1085 /72	1.765	34	10
High Z-CJO 055 900	11.8	.0202	550 /74	2390 /73	1.765	34	10
Differential CJO 0595 100	11.8	.0408	250 /72	313 /69.8	1.154	34	10
Resolver							
Low Z-CJO 0585 100	26	.0485	537 /64.7	677 /74	1.0	34	10
High Z-CJO 0589 100	26	.0145	1795 /68.1	2210 /76	1.0	34	10

Weight: 0.90 oz; Length: 1.250 in.

SERVO MOTORS

	J126-06	J126-02
No-Load Speed	9800 rpm	9800 rpm
Stall Torque	0.10 in. oz	0.10 in. oz
Rotor Moment of Inertia	0.175 gm cm ²	0.175 gm cm ²
Voltage $\phi 1 / \phi 2$ (400 cps)	26 /36-CT	26 /26
Power Input/Phase	1.7 w	1.7 w
Duty	continuous at stall	

MOTOR GENERATORS

MOTOR	CJ40812001	CJO0812650	CJO0813200
Voltage $\phi 1 / \phi 2$ (400 cps)	26 /36-CT	26 /36-CT	26 /26
Power / ϕ	1.5 w	1.5 w	1.5 w
No-Load Speed	8000 rpm	8000 rpm	8000 rpm
Stall Torque	0.10 in. oz	0.10 in. oz	0.10 in. oz
GENERATOR			
Voltage (400 cps)	26 v	26 v	26 v
Power	1.5 w	1.5 w	2.0 w
Volts /1000 RPM	0.1 v	0.1 v	0.5 v
Null	1.3 mv	10 mv	6.7 mv

Weight: 1.05 oz; Length: 1.507 in.

SYNCHRONOUS MOTOR

	CJO 0172 200
Pull-In Torque	0.06 in. oz
Pull-Out Torque	0.10 in. oz
Pull-Out Power	4 w
Length	1.24 in.

GEARHEADS, BRAKES, CLUTCHES

Size 5 gearheads range in reduction ratios from 20:1 to 1019:1 for servomotors and motor tachometers above. In addition, Size 6 clutches, brakes, and brake-clutches are available.

Write for complete data

KEARFOTT DIVISION
Little Falls, New Jersey



GENERAL PRECISION, INC.
Other Divisions: GPL, Librascope, Link

AEROVOX CAPACIBILITY*



COMPUTER GRADE AND TELEPHONE TYPE ELECTROLYTIC CAPACITORS

Available right now—from Aerovox—electrolytic capacitors with useful life expectancies of better than 10 years! Premium materials and precisely controlled manufacturing processes result in extra long life especially adaptable to the needs of critical equipments such as computers and telephone systems. Units are rated for operation at temperatures from -20°C to $+85^{\circ}\text{C}$ where operation above 65°C does not exceed 15% of total operating time.

TYPE AFT. Twist-prong mounting ears and pillar type mounting terminals. Bossed terminals and special vent construction are molded in can cover. Corrosion-resistant paint finish. Available in voltage ratings from 6 to 450 VDC in wide range of capacitance values including dual and triple sections.

TYPE QE. Drawn aluminum cases in four diameters and one standard height ($4\frac{1}{2}''$ over insulating tube). Ideal for ganging in banks. Available in wide range of capacitances at voltage ratings from 5 to 450 VDC. Screw type terminals for bus bar connections.

WRITE FOR COMPLETE TECHNICAL SPECIFICATIONS AND QUOTATIONS ON ANY QUANTITY...

*CAPACIBILITY An Aerovox characteristic. Capability to design, develop, and manufacture capacitors to best meet customers' requirements.

equivalent circuit, resistive cutoff frequency and self-resonant frequency are 5.6 Gc and 8.7 Gc, respectively.

Polarity Protection for Transistor Circuits

By F. W. KEAR, Supervisor, R & D Lab.,
Lytle Corp., Albuquerque, N. M.

PROTECTION of polarity-sensitive equipment is provided by a simply constructed relay. It functions reliably over a wide range of power loads and can be easily miniaturized. Heavy-duty applications only require that current through the relay coil be limited.

Primary need for the polarity-seeking relay was for use with battery-operated transistor receivers and test equipment. However, it is expected to be useful in many applications where incorrect polarity can damage equipment or interfere with its operation, particularly when the result of incorrect polarity may not be readily apparent.

Voltage to the equipment is applied across the armature coil in the figure. The field produced by current through the coil reacts with the field of the permanent magnets imparting torque to the armature. Direction of rotation of the armature is dependent on polarity of the input voltage.

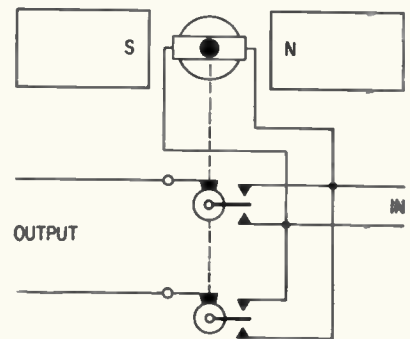

Polarity of output is always the same regardless of input polarity

Two slip rings are mounted on the armature, and a brush wiping each ring is connected to the output terminals of the polarity-sensing relay. Two switching arms are also mounted on the armature, and each arm is electrically con-

AEROVOX CORPORATION

NEW BEDFORD, MASS.

nected to a slip ring. Rotation of the armature in either direction completes circuits between the input and output terminals. However, polarity at the output terminals is always the same because direction of rotation of the armature will be reversed if input polarity is reversed.

Two helical springs keep the armature at a neutral position in which no contacts are completed by the switching arms when no input is applied. When voltage is applied to the input, armature torque overcomes the slight force of the springs rotating the armature in the appropriate direction for correct input polarity.

Phase-Lock Receivers For Ionosphere Study

PROPAGATION of radio frequencies through the ionosphere will be investigated using a six-receiver system. Each receiving station will operate at 20, 40, 41, 108, 360 and 960 Mc.

The high-sensitivity receivers were designed by the Electronics and Ordnance division of Avco for the National Aeronautics and Space Administration. Two large cabinets each house three of the receivers, power supplies, tuning controls and frequency synthesizers.

The equipment will be used in conjunction with a NASA satellite that will transmit on all six frequencies. It is hoped that much more information can be obtained about affects of the ionosphere on radio transmissions at different frequencies and times. The satellite will be launched in an elliptical orbit having an average altitude from the earth of 500 miles.

Each receiver can be locked in phase on a signal of the particular frequency transmitted from the satellite. Phase comparators will detect and measure the relative phase shift or delay between any two of the six received signals.

Plans for the project are to gather data over the next year. The receiving systems will be installed at Cape Canaveral, Huntsville, Stanford University, Boulder Laboratories, University of Illinois and Pennsylvania State University.

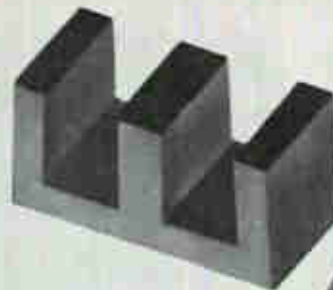

SHOWN TWICE NORMAL SIZE

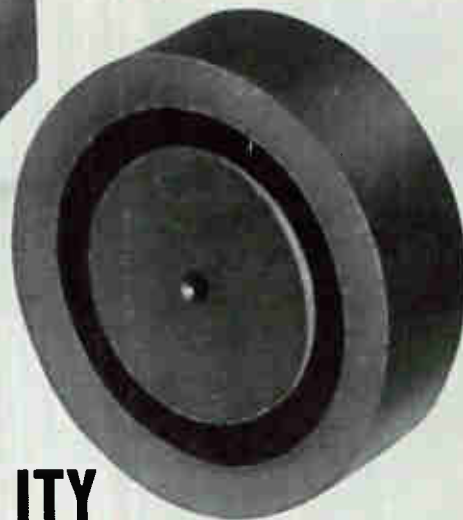

HIGH PERMEABILITY FERRITE

Kearfott's MN-30 ferrite is a highly machinable, high-permeability ferrite for use in magnetic cores. Its low losses and high saturation magnetization permit efficient application at frequencies up to 500 kc, while eddy current losses are minimal due to the material's high resistivity. Custom shapes and sizes available with dimensional tolerances within $\pm .001$, density ranges from 4.9 to 5.0 gm/cm³. High quality and uniformity are assured through special compounding techniques, automatic control of firing, and rigid quality control.

TYPICAL CHARACTERISTICS

Initial Permeability at 21°C and 5 kc	3000 Min.
Maximum Permeability, measured at 2000 gauss	6000
Flux density at 7 oersteds, using Rowland Ring Test Circuit and Fluxmeter	4600 gauss
Flux Excursion for 1 oersted	3500 gauss
Retentivity (B _r)	1300 gauss
Coercivity (H _c)	0.13 oersteds
Loss Factor 1 μ Q at 50 kc	7.5×10^{-6}
Loss Factor 1 μ Q at 500 kc	30×10^{-6}
Temperature Coefficients of initial permeability (% per °C):	
From -30°C to +125°C	0.28
Curie Temperature	over 180°C
D. C. Resistivity	250 ohm-cm

(All magnetic properties are held within a tolerance of $\pm 15\%$)

Write for complete data



**KEARFOTT DIVISION
GENERAL PRECISION, INC.**

Little Falls, New Jersey

Removing Oxidation from Conductive Paths

A SIMPLE PROCESS for depositing a pure tin coating onto copper, copper-based alloy and lead-tin electroplate is eliminating production bottlenecks in printed circuit manufacturing operations where oxidation, and its resulting effects on solderability, are a problem.

In another application, the same process eliminates soldering problems with lead wires on resistors and capacitors caused by nonuniformity of hot tin dipping. Simple treatment makes the wires solderable.

One manufacturer of soldering irons uses this process to deposit tin onto soldering iron tips, thus eliminating the necessity of tinning the iron to make the tip wet more easily.

Another company uses the process to restore or impart brightness to electronic parts and assemblies, especially where appearance is an important consideration.

Solving these wide spread solder problems is the work of CUPOSIT LT-26, made by Shipley Company, Inc., of Wellesley, Mass. The new process is so simple that parts can be treated in bulk by inexperienced operators, with great advantages in production rates and savings in labor costs for the user. Immersion in the solution cleans lead-tin electroplate, even after it has been etched by ammonium persulphate, and makes the printed circuits solderable.

In most circuit manufacturing or assembly, cleaning is done in three-stages beginning with dipping the part for 5 to 10 minutes in a cleaning solution. Then each part gets a vigorous wire brushing by hand, followed by a hot water rinse. Holes, in through-hole circuits, are inadequately cleaned by this method. At a normal production rate of 25 to 30 average boards per man-hour, a number of cleaning stations are required to provide the cleaned parts for the assembly lines.

By contrast, the Shipley process is fast and simple. A solution, made up of water, hydrochloric acid and LT-26 concentrate, is heated to 160F. Copper parts need to be pre-cleaned before immersion, but lead-tin plated parts do not. Dry parts are placed on a rack, immersed in the solution for 30 seconds to 5 minutes depending on the thickness of the tin coating required, then removed and agitated for one to two minutes in a warm water rinse. The oxidized areas have been cleaned and a uniform coating of pure tin covers all the metal surfaces including the copper edges of the conductive paths as well as the plated surfaces on the sides of the holes in through-hole circuits. The number of parts which can be processed at one time is limited only by the capacity of the bath.

Since tin is not deposited over non-conductive surfaces, the solution does not affect dielectric materials. Printed circuit panels of glass-cloth epoxy, paper-based epoxy and paper-based phenolic materials showed no adverse effect on insulation resistance when tested

according to A.S.T.M. E. 104-51.

The tin deposited coatings are sufficiently dense to withstand immersion in hot chromic sulphuric acid, but they will be attacked by ammonium persulphate, ferric chloride and proprietary chromic acid etching solutions. Thickness of the deposits increase with the length of immersion time:

0.000010 in.	thickness in	1 min.
0.000015 in.	"	in 2 "
0.000030 in.	"	in 5 "
0.000050 in.	"	in 10 "
0.000100 in.	"	in 60 "

In addition to cleaning oxidized surfaces of lead-tin electroplate, the solution provides excellent resistance to oxidation on copper and lead-tin electroplate. In accelerated life tests in a 95 percent humidity chamber in the presence of an oxidizing agent, copper and lead-tin electroplate treated with LT-26 showed no adverse effects, but untreated lead-tin electroplate became badly oxidized and unsolderable. This last part was later treated and restored to solderable condition.

With such protection against oxidation, printed circuit users either

Microcomponent Packaging Concept

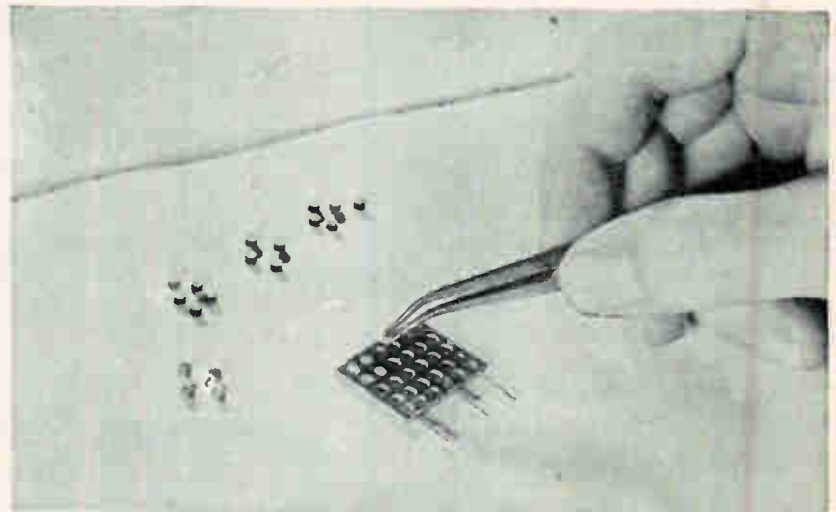

This unitized component assembly, in which all components are of uniform size and shape regardless of function, illustrates the Mallory Company's packaging concept.



How to get accurate data on a small recorder

Ampex's new CP-100 nicely balances four desirable qualities

Compact. Definitely, and a great advantage in trailers, in airplanes, in submarines, or even in regular laboratory use. There's complete front access to everything. All-transistor amplifiers and power supplies cut power needs and keep down the heat — an advantage in tight equipment layouts.

Portable. We'll frankly admit it takes two men to carry it — not just one and a half. But by calling in an occasional fractional man (or by using an accessory dolly) you gain exactly the needed performance that portables have lacked until now. In laboratory use, the CP-100 is "bench-top equipment."

Precise. Let the numbers talk. Though compact, the CP-100 is a full-fledged, uncompromised laboratory recorder: 200 kc response at 60 ips tape speed (and proportional at others); flutter well within telemetered-data requirements; intermodulation distortion so low it never adds spurious data of its own.

Universal. Yes, in numerous ways. The CP-100 isn't fussy about power; takes 115 or 230-volt AC at 50, 60 or 400 cycles or 28-volt DC from batteries or generator. Kinds of data: direct or FM-carrier, by interchangeable plug-in amplifiers. And it records and plays back as well.

The essential data

Model: CP-100 Compact Recorder/Reproducer. **Reel size and tape width:** 10½-inch reels with ½- or 1-inch tape (as specified). **Types of recording:** direct or FM carrier by plug-in interchangeable amplifiers. **Tape speeds:** 60, 30, 15, 7½, 3¾ and 1½ ips. **Frequency response:** direct, 300 to 200,000 cps ± 3 db at 60 ips; FM carrier, 0 to 20,000 cps at 60 ips; response at other speeds proportionate. **Tape compatibility:** yes, with Ampex FR-600, AR-200 or interchangeable with FR-100, FR-1100, 300 and 800 series.

May we tell you more? Please write



AMPEX DATA PRODUCTS COMPANY
Box 5000 • Redwood City, California • EMerson 9-7111

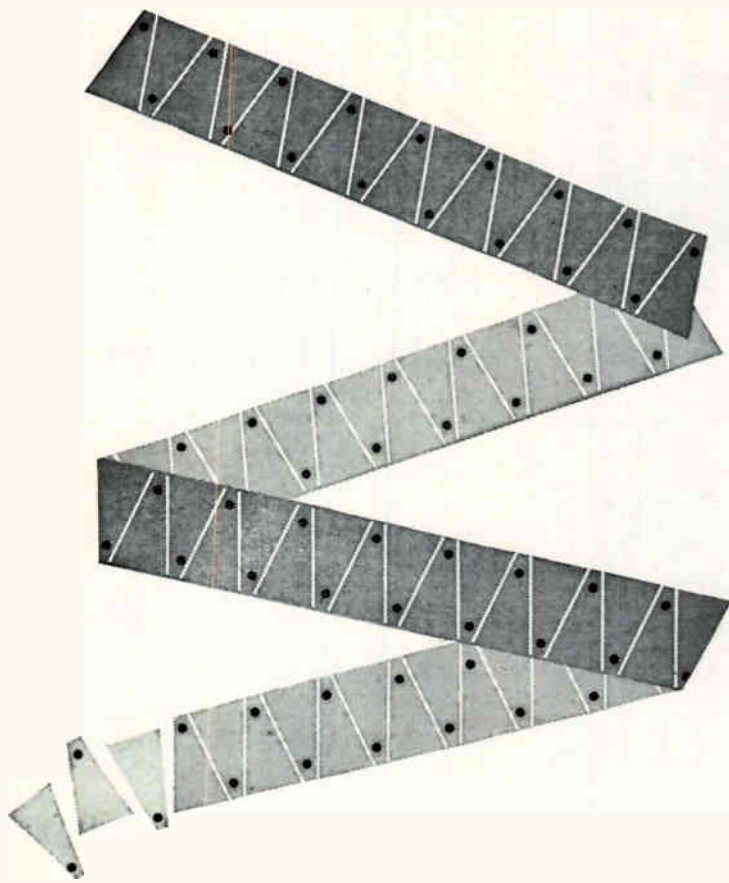

MICROMINIATURE CONTACT ASSEMBLIES... BY THE YARD



* Here's a production-simplifying way to get tiny contact assemblies for your miniature electronic devices. We can supply them to you in strip form, readily snapped apart for assembly, easily fed into your automatic assembly equipment.

End scrambling of parts in tote boxes, speeds positioning, eliminates waste. It's another way our long experience with contact materials and contact assembly fabrication can untangle your nastiest production snags. Try us . . . we're loaded with ideas. Write Mallory Metallurgical Company, P.O. Box 1582, Indianapolis 6, Indiana . . . a Division of P. R. Mallory & Co. Inc.

*Actual size

P. R. MALLORY & CO. Inc.
MALLORY

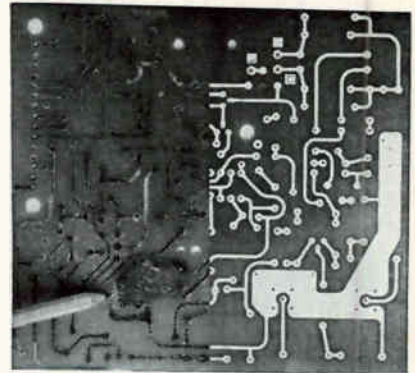

The right half of this badly oxidized printed circuit was cleaned by immersion in a solution which removed oxidation from the conductive paths, covered them with a coating of pure tin and made the part solderable. The dielectric materials are not affected. All metal surfaces are coated and protected against oxidation.

purchase or manufacture circuits for inventory, knowing that these parts will be useable without further treatment when they are needed.

The solution is easily mixed in containers of pyrex, ceramic, high-temperature plastic or plastic-lined steel. It does not contain cyanides. In mixing a 10-gallon solution, a half-gallon of 22 deg. Baumé hydrochloric acid is added to 8½ gallons of water and heated to 180 F. Then 12½ lbs. of concentrate is stirred in until dissolved. The solution is highly stable. It may be cooled to room temperature when not in use, then reheated for reuse.

In addition to use with printed circuits, LT-26 has many other applications. Typical uses are for preventing oxidation and improving solderability of terminal lugs, eyelets, electronic hardware and fabricated parts made of copper, copper-based alloys or lead-tin plate.

Silicon Threads Grown For Strain-Gage Uses

A GROUP OF SCIENTISTS at Picatinny Arsenal is finding silicon whiskers useful in their research work.

Made from silicon crystals, the whiskers are used as strain gages for detecting weaknesses in mechanical parts. Short lengths of the whiskers are attached at various points on airplane landing gear and wired into electrical circuits containing indicating meters.

As the part bends imperceptibly

under normal use, the whiskers are stretched and compressed. Subsequently, the resistance of the whisker is either increased or reduced, registering the amount of strain of the landing gear. If, because of the design or shape of the part, it becomes weakened or breaks, the part is redesigned to eliminate the weakness.

The whiskers are grown by placing crystals of silicon mineral in one end of a sealed quartz tube and heating it until it vaporizes. The vapor condenses at the cool end of the tube, forming whiskers about one-half inch long and one thousandth of an inch in diameter, small enough to be threaded through the eye of a needle.

Similar whisker-like growths sometimes form on telephone relays, causing malfunctions. The growths possess remarkable tensile strength, as much as one million pounds per square inch. Investigation led to present application.



In view magnified 10 times, mineral thread easily slips through eye of needle for size comparison

Silicon was selected as the best material for manufacturing the whiskers because when it is compressed or stretched, its electrical resistance changes, causing more or less current to flow in its electrical circuit. Other materials have this property, but to a lesser degree. Gages of silicon whiskers are 50 to 60 times more sensitive than those using conventional materials.

The development of Picatinny's use of silicon was directed by Edward D. Padgett.

Picatinny Arsenal is the U. S. Army Ordnance Corps' principal research and engineering center for ammunition and special weapons and has developed warheads for the country's most formidable nuclear and non-nuclear missiles.



P. I. tape recorder secret is an open book

A unique stacked-reel tape magazine is one of many space-saving secrets which enable Precision instrumentation recorders to out-perform conventional magnetic tape instruments many times their size. Other design secrets are push-button selection of function and speed, light beam end-of-tape sensing, front panel calibration and testing, interchangeable tape loop magazines, and all-solid-state plug-in electronics.

All the secrets of these recorders are unveiled in detailed new brochure 55B. Write for your copy today.

P. S. - Here's an installation secret - two complete 14-channel analog (or 16-channel digital) recorders mount in only 51" of vertical rack space.



**14-CHANNEL
PRECISION RECORDER**
Loaded magazines can be
interchanged in 5 seconds.

P. I. Invites Inquiries from senior engineers seeking a challenging future.



PRECISION INSTRUMENT COMPANY
1011 Commercial Street • San Carlos • California
Phone LYtell 1-4441 • TWX: SCAR BEL 30

REPRESENTATIVES IN PRINCIPAL CITIES THROUGHOUT THE WORLD

Cutters, Benders Prepare Parts Leads Quickly

ROLLERS, PRESSES, BARS and cams can all be used as well as the more familiar knives and shears to rapidly cut and form component leads. All are being used at Erie Resistor Corporation's Elgin Laboratories, Waterford, Pennsylvania,

in addition to commercially-available component preparation devices.

The first devices described below are loaded in bulk from the packages in which the components are supplied. The others handle loose components. Although most of the

strip packages and printed wiring assemblies made in quantity by the firm are hand assembled, component preparation helps maintain uniformity and speed assembly.

A roller-cutter for components supplied on adhesive tape belts will trim leads at a maximum rate of 150,000 components an hour. The cutter is operated by a hand crank.

Its roller arrangement is shown in Fig. 1A. The crank turns the axle of the square-edged cutter, which is geared to drive the other cutter. A belt from the axle drives the takeup reel, which pulls the tape through. The leads are sheared as they reach the contacting edges of the cutters. As the components pass between the cutters, they compress a corded rubber drum in the knife-edged cutter. The friction of the rubber keeps the components moving with the tape. Springback frees the components from the cutters as they emerge. Components can be re-reeled on the same tape. To drop them loose into a box a fork-shaped stripper plate is mounted with a tine on either side of the tape to push off the components.

Arbor presses provide shearing force when relatively small amounts of components packed in cardboard strips are to be trimmed. The strips are placed in the recessed bed of the lower die Fig. 1B. Leads extend over the outer plates, which are positioned by spacers to the desired lead length. The knives are set at an angle (side view) so they shear the leads one at a time as the press ram is lowered. Springs above the upper plate prevent the component bodies from being crushed.

Another arbor press is used to bend the leads of strip-packaged components. The setup is the same, except that plates with dull, parallel edges are used instead of the knives. If the lower, outer plates and all the spacers are removed, leads can be accurately bent next to the component bodies.

The leads of strip-packaged com-

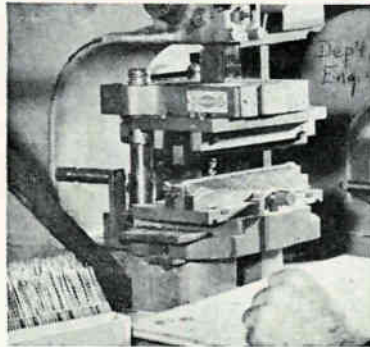
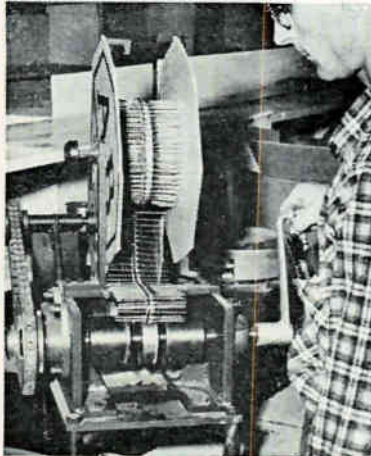

Arbor press set up for lead shearing

Hand crank operates roller-cutter

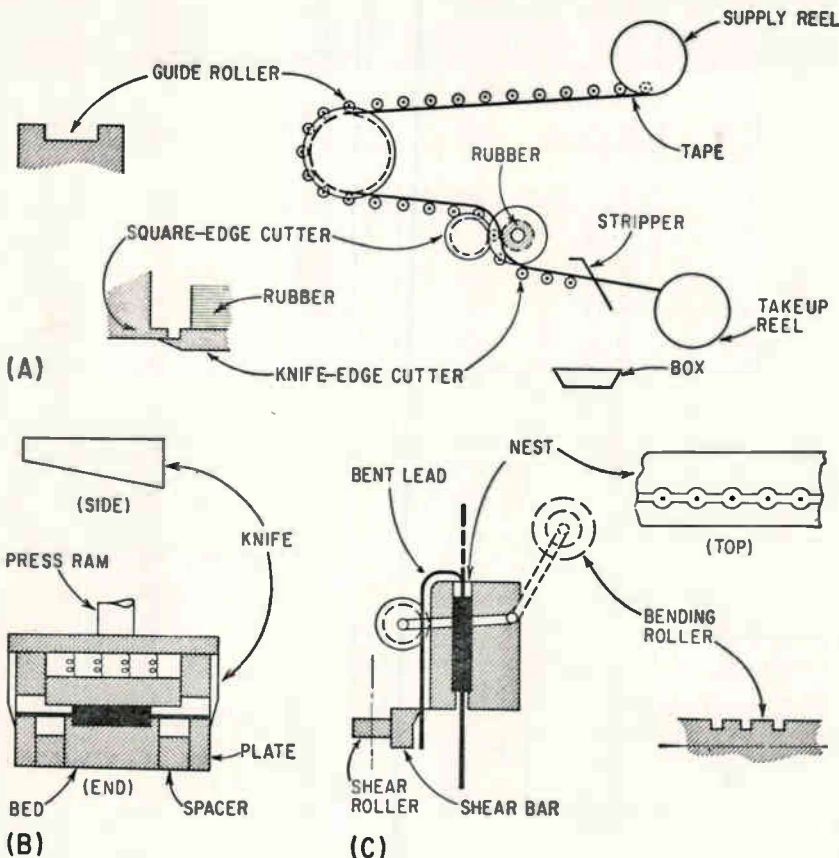

FIG. 1—Sketches illustrate the operation of the roller-cutter for tape-packaged components (A), cutter (B) and cutter-bender (C) for strip-packaged components

Weller
MAGNASTAT
 Soldering Irons
 are available from
 these Franchised
 Distributors

IN THE EAST

- Baltimore, Maryland**
 Kann-Ellert Electronics, Inc.
 2050 Rock Rose Avenue
- Boston, Massachusetts**
 Cramer Electronics, 811 Boylston St.
- Detroit, Michigan**
 Radio Specialties Co., 12775 Lyndon
- Newark, New Jersey**
 Lafayette Radio Corp. of N. J.
 24 Central Avenue
- New York, New York**
 Harrison Radio Corporation
 225 Greenwich Street
 Terminal-Hudson Corporation
 236 West 17th Street
- Paterson, New Jersey**
 Pop's Tool Shop, 76 River Street
- Philadelphia, Pennsylvania**
 Almo Radio Co., 913 Arch Street
 Philadelphia Electronics, Inc.
 1211 Vine Street
- Pittsburgh, Pennsylvania**
 Radio Parts Co., 6401 Penn Ave.

IN THE MIDWEST

- Chicago, Illinois**
 Allied Radio Corporation
 100 North Western Avenue
 Newark Electronics Corporation
 223 West Madison Street
- Cincinnati, Ohio**
 United Radio, Inc., 1314 Vine St.
- Dayton, Ohio**
 Srepcu, Inc., 314 Leo Street

IN THE SOUTHWEST

- Alamogordo, New Mexico**
 Radio Specialties Co., 209 Penn Ave.
- Albuquerque, New Mexico**
 Radio Specialties Company, Inc.
- Houston, Texas**
 Busacker Electronic Equipment Co.
 1216 West Clay Street

IN THE WEST

- Denver, Colorado**
 L. B. Walker Radio Co., 300 Bryant St.
- Glendale, California**
 Claude Michael, Inc., 704 West Ivy St.
- Grand Junction, Colorado**
 L. B. Walker Radio Company
 537 North First Street
- Inglewood, California**
 Newark Electronics Co., Inc.
 4747 West Century Blvd.
- Los Angeles, California**
 Garrett Supply Company
 3844 South Santa Fe Avenue
 Kierulff Electronics
 820 West Olympic Blvd.
 Radio Products Sales, Inc.
 1501 South Hill St.
- Phoenix, Arizona**
 Garrett Supply Company
 2950 West Thomas Road
- Pueblo, Colorado**
 L. B. Walker Radio Company
 100 North Victoria
- Salt Lake City, Utah**
 Strevell-Paterson Hardware Co.
 1401 South Sixth—West
- San Francisco, California**
 Sloss & Brittain, 100 Potrero Avenue
- Seattle, Washington**
 Western Electronic Supply Co.
 717 Dexter Avenue

Only *Weller*
MAGNASTAT® Soldering Irons
 offer all these features!

HALF THE
WEIGHT OF
UNCONTROLLED
IRONS

2 SOLDERING
TEMPERATURES
WITH MODEL
TC552

2 OR 3-WIRE
CORDS ARE
AVAILABLE
FOR ALL
MODELS

HEAT CONTROL
IS IN THE TIP

AUTOMATICALLY
MAINTAINS
CORRECT
SOLDERING
TEMPERATURE

GREATER HEAT
EFFICIENCY
WITH LOWER
WATTAGE

COOLEST
HANDLE



Various tip types are also available—made of copper for fast heat transfer and premium iron plated for long life. Advanced cord connection locks securely, yet permits easy replacement. Rubber shock absorber prevents iron from sliding off bench.

3 models cover all electrical and production line requirements

- Model TC552** - 55 watts \$9.00 list
- Model TC602** - 60 watts \$10.00 list
- Model TC1202** - 120 watts \$11.50 list

(prices shown are for irons with tip and 2-wire cord)

Send for NEW Magnastat Soldering Iron literature

WELLER ELECTRIC CORP. 601 STONE'S CROSSING RD., EASTON, PA.

NOW! 'SCOPE TRACES ON POLAROID® AND OTHER 4 x 5 FILM



ALSO DATA RECORDING *with these new Oscilloscope Accessories*

The Beattie Oscilloscope camera, America's largest selling oscilloscope camera, is even more versatile with these fine new attachments:

4x5 FILM ADAPTER This adapter enables Beattie Oscilloscopes to accept standard holders for films shown at right. Permits ground glass focusing. Quickly interchanged with regular Polaroid® back without re-focusing.

USES
4x5 Polaroid® Packet
4x5 Cut Film
4x5 Film Pack
4x5 Glass Plate Holders
120 Roll Film

DATA CHAMBER Available as accessory with 4x5 film adapter. Records written data on corner of film. Quick, easy push-button control. The permanently-focused optical system is completely independent of camera lens and shutter. Battery powered. Or can be adapted to an external power source. Choice of direct or remote control facilities.

Write for full details on these fine new accessories and on the complete Beattie Oscilloscope camera line.

SEE US AT I.R.E., BOOTH 3822



BEATTIE-COLEMAN, INC.
1000 N. Olive St., Anaheim, Calif. • PR 4-4503

BRANCHES: 437 5th Ave., N.Y. • OR 9-5955 / 5831 Tomberg, Dayton, Ohio • BE 3-1916

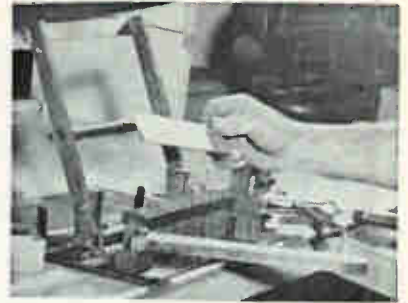

This device bends and shears leads

ponents are bent and sheared for standup mounting (body at right angles to circuit board) with the device illustrated in Fig. 1C. The card is held in both hands and all the leads on one side of the card started in the row of nests. The card is shaken so the components drop into the nests.

The bending roller is pulled forward so each of the circular grooves engages one of the top leads. Continuing the pull bends each of the top leads down across the face of the nest block. The shear bar is swung in place against the leads and the shear roller placed against the bar. The roller is mounted on a lever arm. As the lever is pulled, the roller travels from right to left along the bar, so force is applied to each lead in turn. The bar is provided with overtravel so it will shear the straight leads after the bent leads. To remove the components, the operator puts a thin metal strip under all the leads and lifts the strip. When the components are clear of the nests, the components are slid from the strip into a box.

Fig. 2 shows how Elgin loops the ends of leads to prepare components for cage-type assemblies. The loops fit over the cage's riser wires. There are several variations of this device, each forming the loops by rolling the ends of the leads around pins.

Leads are placed against the center pins. The operator holds the component body with his thumb

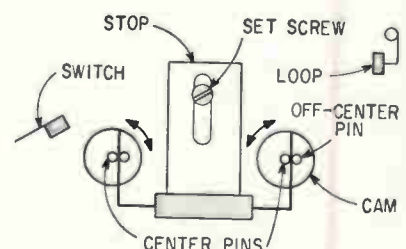
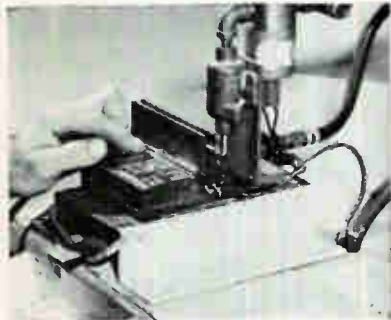

FIG. 2—Component lead looper

while tripping the air cylinder cam drive with a finger switch. The cam revolves the off-center pin around the center pin, looping the lead. The cam returns the off-center pin to loading position. The center pins are retracted, freeing the loop. The machine is sloped so that the component slides off it and into a box while the operator is picking up another component.



Looper with knife to precut leads

Another version also cuts leads to length before looping. The cuts are made by small guillotine knives near the cams. When the operator touches the switch, the knives are actuated first. After a time delay, the cams revolve.

Pliers Put Relief Bend in Part Leads

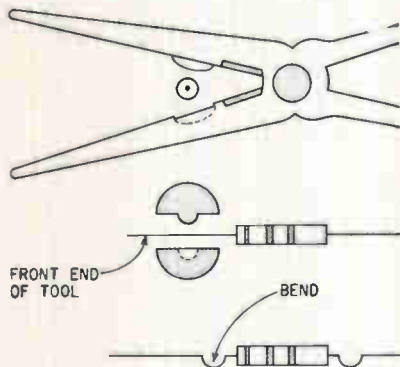

SPECIFICATIONS frequently require that component leads be provided with relief bends to minimize strain and allow for thermal contraction and expansion. A long nose plier can be adapted to perform this operation. With the same tool, the technician can cut component leads to length, form the relief bend and wrap the component lead to the terminal. The sketch shows preparation of a resistor. This technique was submitted by Ralph Rinaldi, Theta Instrument Corp., Saddle Brook, N. J.



Predict the sun's effect on space vehicles ... in your lab!

B&L Optical/Electronic/Mechanical Capabilities Bring the Sun Into the Laboratory

Interplanetary flight will expose our astronauts to direct radiation from the sun, and to direct and reflected radiation from the earth and clouds. To find the effects of this solar radiation on man and vehicles in outer space, Bausch & Lomb has designed a unique Sun Simulator System.

A special combination of lamps, filters, optical system and programmed control accurately simulates the intensity and distribution of these radiation wavelengths duplicating the conditions that exist in actual flight.

The same B&L skills are ready to help on *your* project. Write us for full details. Bausch & Lomb Incorporated,

Military Products Division,
61415 Bausch Street,
Rochester 2, New York.



New On The Market

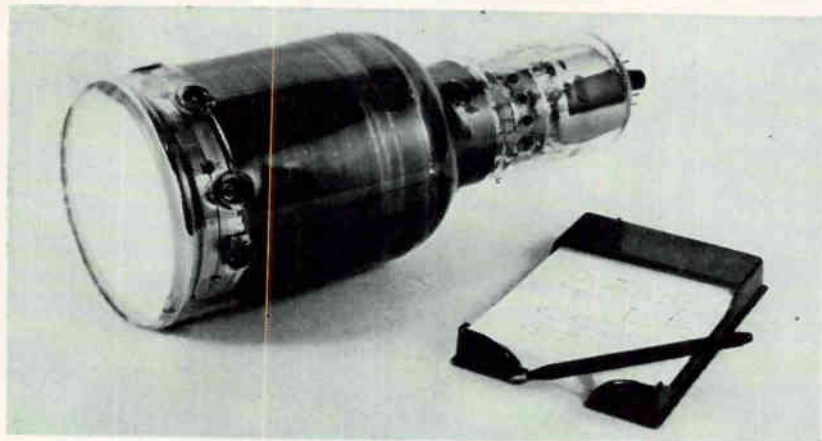

Selective Erasure Tube HAS HIGH RESOLUTION

A DISPLAY STORAGE tube capable of high-speed selective erasure, simultaneous display of stored and non-stored information and high resolution light or dark trace displays has been announced by Hughes Aircraft Company, 2020 Short St., Oceanside, Calif.

The tube, (Multi-Mode Tonotron storage tube) incorporates a special dual effects target employing bombardment induced conductivity effects in addition to secondary electron emission effects.

Information may be written stored or nonstored or rapidly and selectively erased depending on the energy level of electrons striking the target. High-energy electrons erase the display, low-energy elec-

trons write stored information, and intermediate energy electrons write nonstored information. The tube has resolving power up to three times better than tubes now in use while maintaining the brightness and halftone capabilities of conventional tubes, the company claims.

As a display in radar systems the tube will enable a second, or nonstored trace, to be superimposed over the scan. Programming makes it possible to erase or change any undesired parts of the display.

In slow-scan tv systems the tube allows all data to be present on the tube at all times. Erasing takes place while the new scan is being written.

CIRCLE 301 ON READER SERVICE CARD

L & S Band Amplifiers MINIATURIZED

A SERIES of four miniature continuous wave L&S band cavity amplifiers have been developed by Resdel Engineering Corp., 330 South Fair Oaks Ave., Pasadena, Calif. The firm claims these are the smallest and lightest vhf-uhf cavity amplifiers available. They operate in the frequency range of 215 Mc through 2,325 Mc. For space applications and ground support equipment, the units are precision fabricated from light metal alloys and are gold-plated for optimum surface conductivity and corrosion protection. Filtering and shielding of power



supply leads is provided in each model. All units are designed for heat sink type mounting and components are derated to provide extended trouble-free operation. Mechanical tuning adjustments are

stable and have negligible backlash.

Model numbers are P-30 X2-30, X3-30 and P31. Model P-30 and P-31 are power amplifiers; model X2-30 is a frequency doubler; model X3-30 is a frequency tripler.

CIRCLE 302 ON READER SERVICE CARD

Subminiature Tubes

HAVE STRAP FRAME GRIDS

FOUR high-gain, low-noise, subminiature receiving tubes using a strap frame-grid construction have been developed by Sylvania Electric Products Inc., 730 Third Ave., New York 17, N. Y. The four tubes have Sarong cathodes.

Two medium- μ uhf double triodes and two high- μ uhf triodes have been introduced. Features of the medium- μ triodes, compared

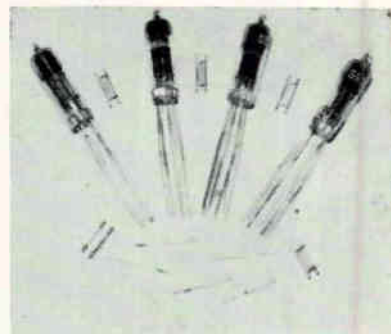

with their prototypes, are: one exhibits a 100 percent increase in g_m and g_m per milliamper of I_b , the other has 80 percent higher g_m at 40 percent lower plate voltage and 20 percent lower heater power. Features of the high- μ triodes are: one has a 1,300:1 ratio of g_m to I_b , while the other employs one-third the heater power with a 3 db improvement in noise figure.

CIRCLE 303 ON READER SERVICE CARD

Time Quantizer TO NANoseconds

A COMPLETELY solid-state automatic high-speed system that measures or quantizes time intervals to a resolution of 10 nanoseconds has been announced by Computer Equipment Corp., 11612 Olympic Blvd., Los Angeles 64, Calif. The system, designated LFQ-10, is expected to find wide application in nuclear physics, calibration of radar navigation systems, high density pcm

THIRD EXPANSION IN 15 YEARS

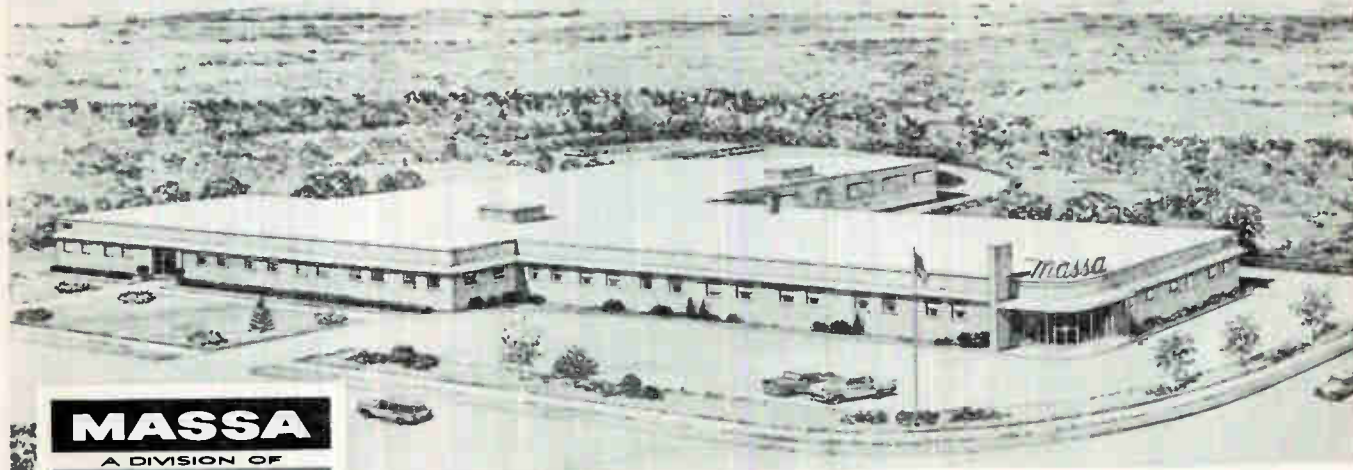

MASSA
A DIVISION OF
COHU
ELECTRONICS, INC.

The MASSA DIVISION of Cohu Electronics, Inc., is a pioneer in the field of electroacoustics, and its contribution to the basic science of acoustics and research accomplishments has established many fundamental concepts upon which this important industry has advanced.

As a result of its diversified electronic developments, the company has just completed its third expansion since its establishment in 1945.

Through contract and proprietary efforts, the company is deeply engaged in the design and production of electronic detection equipment required as a pivotal part of the Nation's Anti-Submarine activities.

MASSA DIVISION is interested in the future, and as the new expansion program progresses, there will be many excellent opportunities for qualified men who are invited to forward their confidential inquiries to the personnel director.

precision in electroacoustics

- Accelerometers
- Microphones
- Recording Systems
- Hydrophones
- Sonar Transducers

RECORDERS — The complete line of Massa multichannel and portable High-Speed Rectilinear ink writing Recording Systems, is highly regarded in an exceptionally large and competitive market:



UNDERWATER SOUND

— In addition to its basic SONAR contributions to the U. S. Navy, Massa Hydrophones are used as reference standards by military and industrial organizations engaged in Sonar research and manufacture.

VIBRATION & SOUND PRESSURE

— Massa has developed a wide line of precision acceleration (Accelerometers), Sound Pressure (Microphones) measuring systems. These instruments find wide application in ground and airborne missiles, space and aircraft projects.



At I.R.E. Visit Booth #3603 — 3605

MASSA DIVISION
COHU ELECTRONICS, INC. HINGHAM, MASS.

telemetry, semiconductor switching time evaluation, etc.

One version of the quantizer, developed for three dimensional missile tracking systems, permits high altitude measurements to a resolution of plus or minus $2\frac{1}{2}$ feet.

The system may be used with high-speed digital computers for real-time analysis of the physical phenomena being measured. Output may be binary, BCD or decimal.

Time intervals of interest may be transient, repetitive, or varying in their duration.

The LFQ-10 fits in a cabinet measuring 35 in. high, 24 in. wide and 24 in. deep. Another version, model LFQ-80, which yields a resolution of 80 nanoseconds, fits in a cabinet measuring $24\frac{1}{2}$ in. high, 24 in. wide and 24 in. deep. Prices of these systems being at \$5,000.

CIRCLE 304 ON READER SERVICE CARD

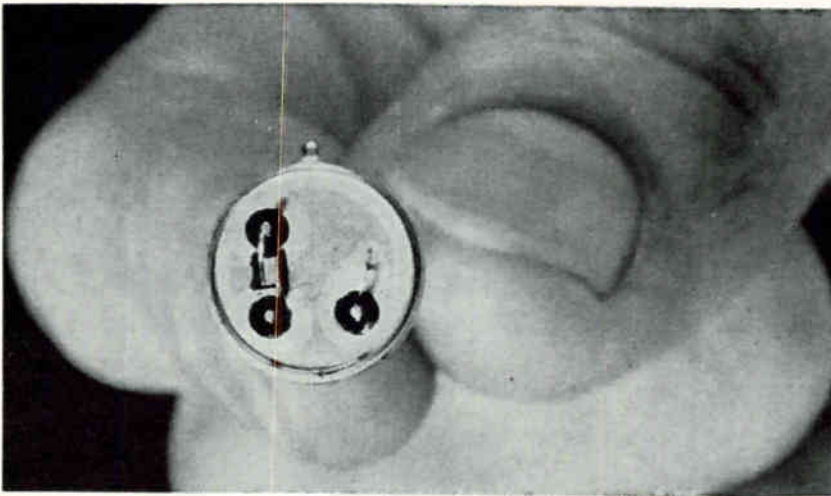

200 Mc Transistor

WITH 3 WATT OUTPUT

A TRIPLE DIFFUSED silicon mesa *npin* transistor designed specifically for very high frequency applications has been developed by RCA, Somerville, N. J. Designed as a large signal power amplifier capable of operation up to 200 Mc, the device (TA-2084) is intended for use in Class A, B or C power amplifier and power oscillator applications for both military and industrial electronic equipment.

Maximum ratings announced include a collector-to-base voltage (emitter open) of 140 v, a collector-

to-emitter voltage (base open) of 140 v and emitter-to-base voltage (collector open) of 1 v. Peak collector current is 1 ampere and transistor dissipation (100 C case temp) is 5 watts. R-f power output (measured in a class C, common-emitter unneutralized power-amplifier circuit) is 3 watts at a frequency of 200 Mc, making possible complete transistorization of many communication systems operating at up to 200 Mc.

CIRCLE 305 ON READER SERVICE CARD

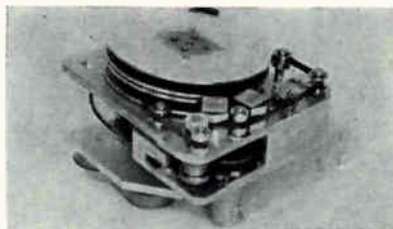

Satellite Recorder

WITH LOW-POWER DRAIN

A MINIATURE MAGNETIC tape recorder/reproducer for satellite and missile application has been developed by the Datalab Division of Consolidated Electrodynamics Corp., 360 Sierra Madre Villa, Pasadena, Calif. Power consumption of the device is considerably less than 1 watt. Size is about 40

percent smaller than the 10-watt recorder/reproducer unit used in the Courier communication satellite program.

The unit will record for approximately $2\frac{1}{2}$ hours at one inch per second and playback in about eight minutes. The system has a reproduce frequency range of 1 Kc to 25 Kc.

One of the principal means of improving power economy has been to use a new d-c motor for primary drive. Rolling rather than sliding brushes are used in the motor. The brush design reduces friction and increases brush life. An electronic speed control system which consumes less than 40 mw controls motor speed to better than $\frac{1}{4}$ percent.

CIRCLE 306 ON READER SERVICE CARD

Infrared Detectors

PEAK AT 6.8 MICRONS

ROOM TEMPERATURE photoconductive InSb infrared detectors which peak at 6.8 microns are now available from Block Associates, Inc., 385 Putnam Ave., Cambridge 39, Mass. With a time constant of less than 1 microsecond, these inexpensive InSb detectors are claimed to be the longest wavelength room

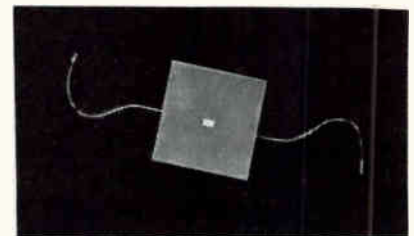

temperature semiconductor ir detectors presently manufactured. Custom built, InSb ir detectors will be supplied in any configuration, including arrays, to suit customer requirements. Specifications for a typical cell 1.5 mm \times 6 mm are: black body response, D^* (500 deg K, 1,000, 1) 3×10^7 cm-cps^{1/2}/watt; NEP (500 deg K, 1,000, 1). 10^{-6} watts/cps^{1/2}; resistance, 20 ohms; time constant \leq 1 microsecond; and peak response, 6.8 microns.

CIRCLE 307 ON READER SERVICE CARD

Null Indicator

MINIATURE AND EDGEWISE

MINIATURE AND EDGEWISE null indicators have been added to the line of precision meters for the

- Operate in any position
- Hermetically sealed against moisture and explosions
- Not affected by high or low temperature, nor pressures
- Small, compact, rugged

DRS-5
Silver plated in 20 lb. hydrogen pressure
Rated: 50V amp up to 250 volts

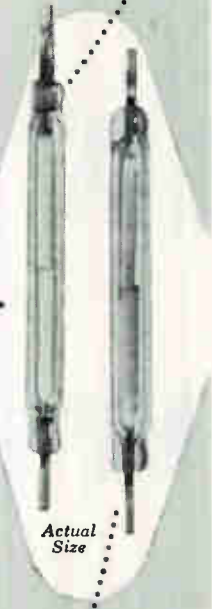

Actual Size

HAMLIN
magnetic reed switches

- High sensitivity
- Rapid cycling, up to 400 cycles
- Long, dependable life

for relays, timers, limit switches, commutators, flow meters, etc.

Send for bulletin

DRG-1
Gold plated in inert atmosphere
Rated: 15V amp up to 250 volts

HAMLIN

Dept. EL • Lake and Grove Streets • Lake Mills, Wisconsin
CIRCLE 201 ON READER SERVICE CARD

ONLY THE LARGE IEE READOUT OFFERS ALL FOUR



Series 80000
PRICE COMPLETE
\$3300 QUANTITY PRICES ON REQUEST

Write today for complete specifications
Representatives in principal cities

Over 1000 firms throughout the world in just a few years prove unprecedented acceptance of IEE digital readouts.

INDUSTRIAL ELECTRONIC ENGINEERS, Inc.
IEE 5528 VINELAND AVENUE
NORTH HOLLYWOOD, CALIFORNIA

1. ALL DIGITS CAN BE READ FROM ANY ANGLE

2. WORDS May be displayed individually or simultaneously

3. COLOR Colored digits or words and/or color background available

4. DISTANCE Large 3 3/8" digit can be viewed from over 100 feet away

CIRCLE 202 ON READER SERVICE CARD

SOLVES CAPACITOR PROBLEMS WITH ONE SETTING...

OHMITE CAPACITOR Calculator

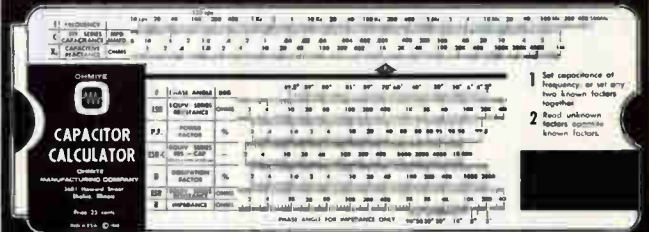

Pocket Size 2 3/8" x 7"



One setting of the slide solves problems in capacitance, frequency, capacitive reactance, power factor, dissipation factor, impedance and phase angle. Use it for all types of capacitors from 1 mmf to 1000 mfd. Also includes slide rule scales A, B, C, D; capacitance formulas; comparison table on different types of capacitors. Constructed of heavy, varnished cardboard. **25¢**

OTHER OHMITE ENGINEERING AIDS

OHM'S LAW CALCULATOR



Solves Ohm's Law and parallel resistance problems. Includes A, B, C, D slide rule scales. . . **25¢**
Vinylite model. . . **\$1.50**

COLOR CODER FOR COMPOSITION RESISTORS



Set color wheels to match EIA color bands on resistors . . . read ohms directly. Also lists std. "Little Devil" and MIL values. **10¢**



OHMITE MANUFACTURING COMPANY
3610 Howard Street, Skokie, Illinois

I am enclosing \$_____ for _____ engineering aids as follows:

- Capacitor Calculator
- Ohm's Law Calculator
- Color Coder

Name _____
Title _____
Company _____
Street _____
City _____ Zone _____ State _____

CIRCLE 77 ON READER SERVICE CARD **77**

For that

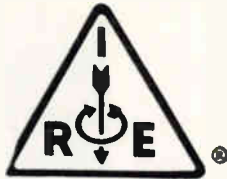

NEW IDEA

visit the

IRE SHOW

March 20-23, 1961

New York

Coliseum and Waldorf-Astoria Hotel

Members \$1.00, Non-members \$3.00

Age limit—over 18

CIRCLE 203 ON READER SERVICE CARD



ANALOG CIRCUIT DESIGN

The strictly realistic art of analog circuit design relates directly to our projects in inertial guidance. If you have fine-line experience in the design and development of transistorized circuits for servo and analog computer applications used in I.G. systems, write to Mr. Donald E. Krause.



LITTON SYSTEMS, INC. Guidance & Control Systems Division
Beverly Hills, California

electronics and aircraft industries by the Precision Meter Division of Minneapolis-Honeywell Regulator Company, Grenier Field, Manchester, N. H. Designated MM-1 (Medalist) and MCE-1 (edgewise),

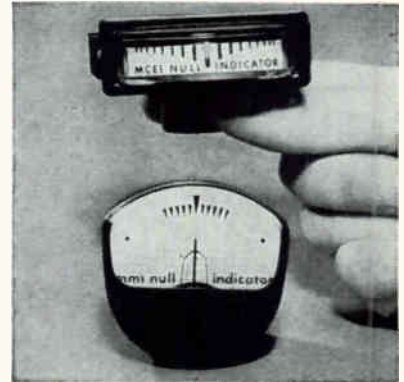

both meters employ core magnet, self-shielded mechanisms in structures providing high sensitivity at the null point and sharp square-law attenuation as the pointers deflect from centers.

The meters, which can indicate large amounts of unbalance in bridge or other detection circuits without damage, are available with sensitivities of one-half, one and two microamperes at the null point, with end scale values of 100, 200 and 500 microamperes. Other sensitivities can be supplied to meet specific circuit requirements. The instruments will be available within 60 days.

CIRCLE 308 ON READER SERVICE CARD

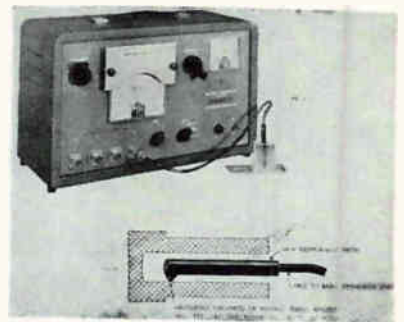

Thickness Tester FOR COATINGS

UNIT PROCESS ASSEMBLIES, INC., 61 E. 4th St., New York, N.Y. The Dermatron model D-2 nondestructive coating thickness tester is a portable instrument for both lab and production use. It gives fast, accurate and direct readings of virtually any coating on any base. The unit comes with four measuring probes for extra wide thickness

ranges from thin to thick deposits, and requires only a $\frac{1}{8}$ in., circle-area for measurement.

CIRCLE 309 ON READER SERVICE CARD

Pressure Transducers LIGHTWEIGHT

DAYSTROM-WIANCKO ENGINEERING CO., 255 N. Halstead St., Pasadena, Calif. The small size and low power requirement of the P2-3000 series variable-reluctance d-c pressure transducers are suited to applications with critical weight limitations. Type P2-3076, for pressure ranges up to 5,000 psig, weighs 5 oz and requires only 3 ma at 28 v d-c for 0 to 5 v d-c output.

CIRCLE 310 ON READER SERVICE CARD



Dual-Outlet Blower FOR HEAT DISPERSION

RIPLEY CO., INC., Middletown, Conn., announces the model 8481 dual-outlet blower for heat dispersion. The one-piece, impact resistant phenolic plastic housing with aluminum motor-plate is $6\frac{3}{4}$ in. from top to bottom. Total width of motor and blowers assembly is $7\frac{3}{4}$ in. Motor is 150 v, 60 cps. Incorporates sealed ball bearings requiring no maintenance. Total free air delivery is 150 cfm.

CIRCLE 311 ON READER SERVICE CARD



Latch Relay MICROMINIATURE

HI-G. INC., Bradley Field, Windsor Locks, Conn. Relay features a magnetic latch system that main-

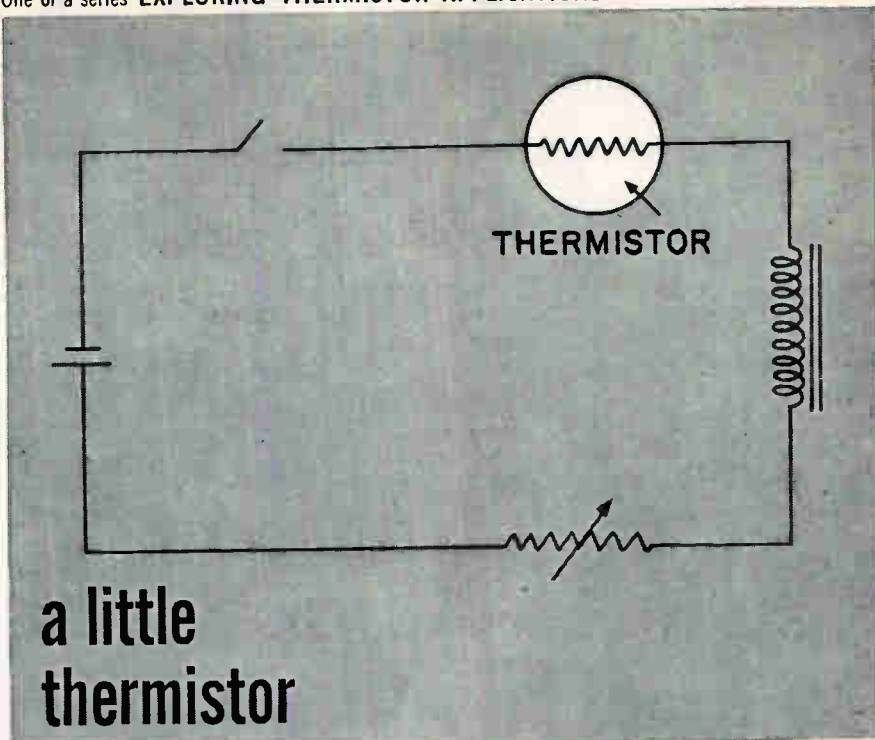

a little thermistor makes a big difference in a time delay circuit

Circuits like the one above are often used where variable or fixed delay are required. Circuit ingredients: a thermistor and a variable resistor, in series with a battery and a relay.

With the switch closed, current flow is limited by the high resistance of the thermistor. The thermistor then heats up, permitting sufficient current flow to close the relay. Delay time can be increased or decreased by increasing or decreasing series resistance.

This is just one example of putting the thermistor to work. There are hundreds more — including temperature control, liquid level measurement, remote control, switching, power measurement, voltage control — or you name it.

There are just two kinds of thermistors, really: ordinary, which are good; and FENWAL ELECTRONICS', which are a little bit better. One reason is that FENWAL ELECTRONICS has the edge in experience. We pioneered in this field. Another reason is that we can suit your application exactly — FENWAL ELECTRONICS has the most complete line of thermistors available anywhere.



For details, application assistance, and new Thermistor Catalog EMC 4, write:

51 Mellen Street, Framingham, Massachusetts

VISIT US AT THE IRE SHOW — BOOTH #1204

THE MOST COMPLETE LINE ANYWHERE. beads and glass probes . . . discs . . . washers . . . rods . . . probe assemblies . . . El matched pairs



new GEN-PRO®

REPICON® REMOVABLE CONTACT CONNECTOR

New from Gen-Pro: Repicon "C" high density removable contact connector offers unlimited application in wiring installations. Available in 34, 42, 50 and 104 contacts. Interchangeable with other connectors of MIL-C-8384 configuration and contact pattern.

Repicon Removable Contacts in crimp or solder type give higher contact retention, closely controlled engagement and separation forces and low millivolt drop. Usable in other existing connector body sizes and configurations. Contacts are ordered separately for assembly by user.

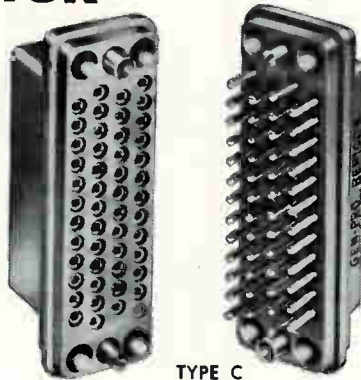

TYPE C
50 CONTACTS



SOCKET CONTACT

PIN CONTACT

Write today for bulletin illustrating types in stock with specifications

GENERAL PRODUCTS CORPORATION

Over 25 Years of Quality Molding

UNION SPRINGS, NEW YORK TWX No. 169

CIRCLE 204 ON READER SERVICE CARD



KITS AND WIRED

- STEREO
- AND MONO
- HIGH FIDELITY
- TEST INSTRUMENTS
- HAM EQUIPMENT
- CITIZENS' TRANSCEIVERS
- RADIOS

LABORATORY PRECISION AT LOWEST COST
Easy cranking fun to build

FREE

New 1961
EICO Electronics Catalog

EICO, 3300 N. Blvd., L.I.C. 1, N. Y. E-3A

Send free 32-page catalog & dealer's name

Send new 36-page Guidebook to HI-FI for which I enclose 25¢ for postage & handling.

Name _____

Address _____

City _____ Zone _____ State _____

EICO 3300 N. Blvd., L.I.C. 1, N.Y.
...praised by the experts
as **BEST BUYS IN ELECTRONICS**

See EICO at I.R.E. Booth 3509

Colorado ...CENSUS- PROVEN OUTSTANDING NEW INDUSTRIAL MARKET

Census-proven one of the fastest growing states in the nation ... survey-proven one of the outstanding new industrial markets, Colorado offers new industry Profits with Pleasant Living.

Discover the new markets and opportunities awaiting your company in Colorado. "Site-See" Industrial Colorado now...right at your desk.

Send for Free Executive Portfolio "INDUSTRIAL COLORADO"

Newly revised 9-booklet portfolio with up-to-the-minute data on Colorado's industrial sites, assets, opportunities and weekend vacation wonderlands. All inquiries held confidential.

COLORADO DEPT. OF DEVELOPMENT

20 STATE CAPITOL • DENVER 2, COLO
CIRCLE 205 ON READER SERVICE CARD

tains an actuated condition without continuous power drain; uses rotary balanced armature construction, allowing relay to meet extremes of vibration and shock. Microminiature sensitive d-c magnetic latch relay, spdt, sensitivity at pull-in at 25C, 25 mw or better; 40 mw or better for dpdt.

CIRCLE 312 ON READER SERVICE CARD

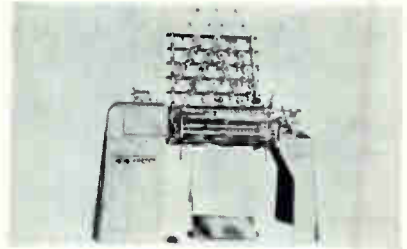

Transformer Winder COMPACT UNIT

GEO. STEVENS MFG. CO., INC., Pulaski Road at Peterson, Chicago 46, Ill., offers a compact multiple transformer winding machine suitable for long production runs. Model 407-AM multiple winds paper section power, audio, fluorescent ballast and similar types of transformer coils at speeds up to 2,000 rpm using 18 through 44 Awg wire. Maximum coil o-d is 9 in. if round and 4½ in. if rectangular.

CIRCLE 313 ON READER SERVICE CARD



Resolvers HIGH ACCURACY

KEARFOTT DIVISION, General Precision, Inc., 1150 McBride Ave., Little Falls, N. J., introduces the Z5153-004, Z5163-001, and Z5193-001 size 28 high accuracy resolvers whose maximum error from electrical zero does not exceed 20 sec. They also

Bird JEWEL BEARINGS

TINY ENOUGH



TO DO THE **BIG** JOB
OF ASSURING
POSITIVE ACCURACY

Aircraft and electrical instruments, measuring and timing devices, testing and recording equipment — they all require the services of sub-miniature bearings that insure a fine degree of accuracy. Bird Precision Jewel Bearings fulfill this need because they are designed to provide peak accuracy in minimum space.

Available in a wide range of standard glass and sapphire types and sizes, including complete jewel assemblies and cushion jewel assemblies, Bird Jewel Bearings can save you money on your next design. Our engineering staff is at your service to aid you with your special requirements.

Write for your free copy of our catalog, which completely describes the types, features and applications of jewel bearings.

Richard H. Bird & Co., Inc.
1 SPRUCE ST., WALTHAM, MASS.

serving industry with fine jewels since 1913

CIRCLE 206 ON READER SERVICE CARD
March 3, 1961

feature high versatility since the same basic design permits their function as four-wire control transmitters, control differential transmitters, and control transformers.
CIRCLE 314 ON READER SERVICE CARD



Power Diode RUGGED UNIT

CENTRAL ELECTRONIC MANUFACTURERS DIVISION, Nuclear Corp. of America, Denville, N. J., announces the 7030 high-vacuum diode. Rugged construction is free of internal insulators, spring tensioning devices and fragile elements, and features a cathode that is a thoriated tungsten bifilar helix.

CIRCLE 315 ON READER SERVICE CARD

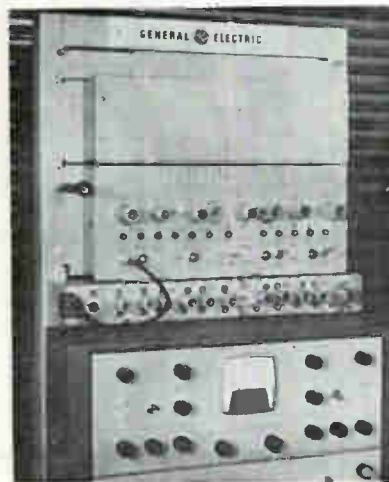

Microwave System FOR 5,925-7,450 MC

GENERAL ELECTRIC COMMUNICATION PRODUCTS DEPT., P. O. Box 4197, Lynchburg, Va., announces a new microwave system, type UA-6B, accommodating up to 240 voice channels, for point-to-point com-

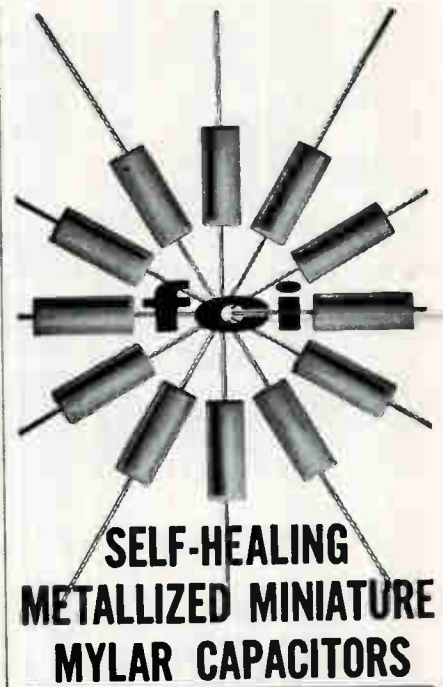

SELF-HEALING METALLIZED MINIATURE MYLAR CAPACITORS

...the ultimate in
precision self-healing capacitors

FCI presents a wide range of new metallized mylar capacitors employing the principle of self-healing. These capacitors offer the ultimate in miniaturization and reliability. They can withstand operating temperatures up to 125°C without derating.

Standard units are available up to 600 VDC in any capacity desired and have insulation resistance of 25,000 megohms per microfarad.

The new FCI Self Healing Metallized Mylar Capacitors are furnished in bathtub cases, CP70 cases, or metal shell cases. A typical size is a 4MFD/400 VDC capacitor in a hermetically sealed metal shell 1½" O. D. by 2¼" L.



FILM CAPACITORS, INC.
3404 PARK AVENUE • NEW YORK 56, N. Y.

A full line of industry standard metallized paper capacitors are also available.

CIRCLE 83 ON READER SERVICE CARD 83

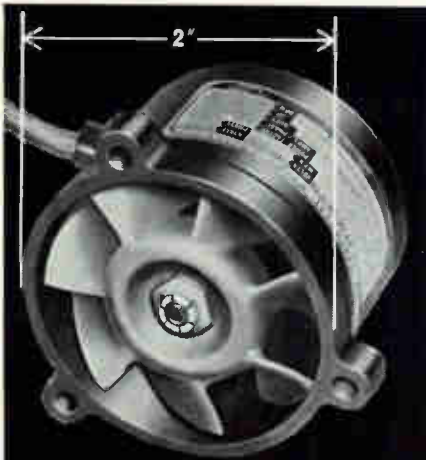

**HIGH
PERFORMANCE
2-Inch
Cooling Fan**

AiResearch Minifan* is an extremely high performance 400-cycle AC motor-driven fan used for cooling airborne or ground electronic and electrical equipment. Model shown has a flow capacity of 53.5 cfm at a pressure rise of 3.44 H₂O, and requires only 69 watts.

Minifan operates up to 125°C. ambient. Its size and weight make it ideal for spot cooling, cold plates or as a cooling package component. The fan can also be repaired, greatly increasing its service life.

Range of Specifications

- Volume flow: 21.5 to 53.5 cfm
- Pressure rise: .6 to 3.44 H₂O
- Speed: 10,500 to 22,500 rpm
- Single, two or three phase power
- Power: 16 to 69 watts
- Standard or high slip motors
- Weight: .36 to .48 lb.

A world leader in the design and manufacture of heat exchangers, fans and controls, AiResearch can assume complete cooling system responsibility. Your inquiries are invited.

*Minifan is an AiResearch trademark.



AiResearch Manufacturing Division
Los Angeles 45, California



ELECTROPLATED WIRES

Gold plated Copper wire has recently found increasing application in the missile field where corrosive atmospheres are likely to occur. Our equipment permits handling wire in the size range of .001" to .060" . . . Electroplated wires are frequently used as electrical contacts. For this application it is often desirable to combine the spring characteristics of a metal such as Phosphor Bronze with the corrosion resistance of a noble metal.

Write for Latest Brochure.

SIGMUND COHN MFG. CO., INC.
121 SOUTH COLUMBUS AVENUE, MOUNT VERNON, N.Y.

Since 1901

BOOTHS
4322-4324
IRE SHOW

CIRCLE 207 ON READER SERVICE CARD

inter-industry conference on ORGANIC SEMICONDUCTORS

April 18 and 19, 1961, The Morrison Hotel, Chicago

co-sponsored by

ARMOUR RESEARCH FOUNDATION

of Illinois Institute of Technology

and **electronics** a McGraw-Hill publication

Technical sessions on the present state and future potential of organic semiconductors in the electronics, chemical, and semiconductor industries.

For further information contact:

James J. Brophy, Co-Chairman, Physics Division
Armour Research Foundation
Technology Center, Chicago 16, Illinois

munication. Basically a duplex radio transmission set, the new equipment operates over the range of 5,925-7,450 Mc.

CIRCLE 316 ON READER SERVICE CARD

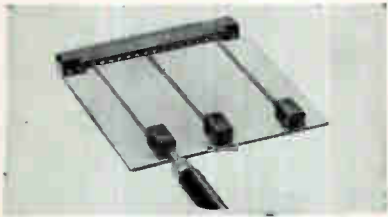

Test Point Connectors FOR P-C USES

DEJUR-AMSCO., 45-01 Northern Blvd., Long Island City 1, N.Y. These test point connectors can be located at convenient positions on a printed circuit board, or in critical p-c applications for easy test takeoff points. Single contact and multiple contact types with 4, 6, 8, 28 and 42 test points are available for right angle dip soldering to p-c boards.

CIRCLE 317 ON READER SERVICE CARD



V-R Tubes GLOW DISCHARGE TYPE

THE VICTOREEN INSTRUMENT CO., 5806 Hough Ave., Cleveland 3, Ohio. Types VX62 and VX64 glow discharge type voltage regulator tubes are enclosed in standard T-3 glass envelopes. They provide a miniature and inexpensive means of regulating at 95 and 150 v respectively with current ranges from 100 μ a to 50 ma.

CIRCLE 318 ON READER SERVICE CARD



Trimming Pots TWO MODELS

INTERNATIONAL RESISTANCE CO., 401 N. Broad St., Philadelphia 8, Pa.,

March 3, 1961

For that

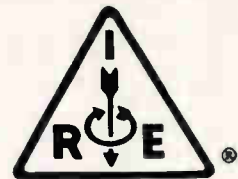

NEW IDEA

visit the

IRE SHOW

March 20-23, 1961

New York

Coliseum and Waldorf-Astoria Hotel

Members \$1.00, Non-members \$3.00

Age limit—over 18

CIRCLE 208 ON READER SERVICE CARD

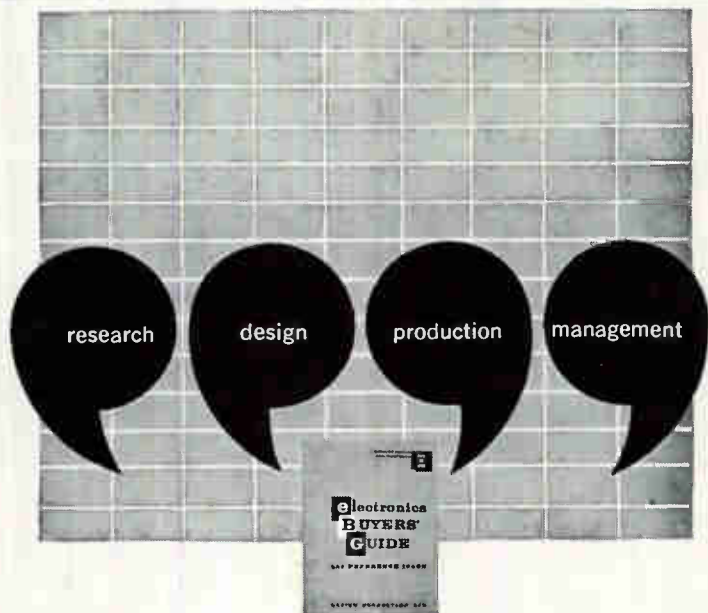

FIRST CHOICE OF ALL 4!

Because it is organized and edited to serve all four segments of the industry. It contains *more advertisers* than any other industry guide... gives more information. No wonder it is the accepted buying book of the industry.

gives more to all 4!

electronics BUYERS' GUIDE
and REFERENCE ISSUE

**Rexolite® and Brand-Rex
Technical Service
Answer Most Microwave
Insulation Problems**

Across the microwave spectrum, from anode toppers to timing blocks; from antennas to duplexer pins, to filament cores, to light pipes, phaser assemblies and probe insulators; from slot arrays to slip ring disks and sweep arms, to transformer locks and cores, to timers and tubes . . . Rexolite plastic dielectrics and Brand-Rex technical service have teamed to stamp "solved" on a long list of complex microwave insulation problems.

And, it's an impressive reason why! Rexolite thermo-setting materials offer a wide range of UHF electrical properties and advantages . . . low loss factor, low dielectric constant, and exceptional resistance to radiation. Pure research into dielectrics at the Enka Research Center in North Carolina and applied research and development by the Technical Development Group at the Acton, Mass., plant have resulted, and will continue to result, in significant new Rexolite types. Adding to its usefulness, Rexolite is available in rods and both plain and copper clad sheets which can be machined into an infinite number of simple or complex shapes.

**BRAND-REX
REXOLITE**

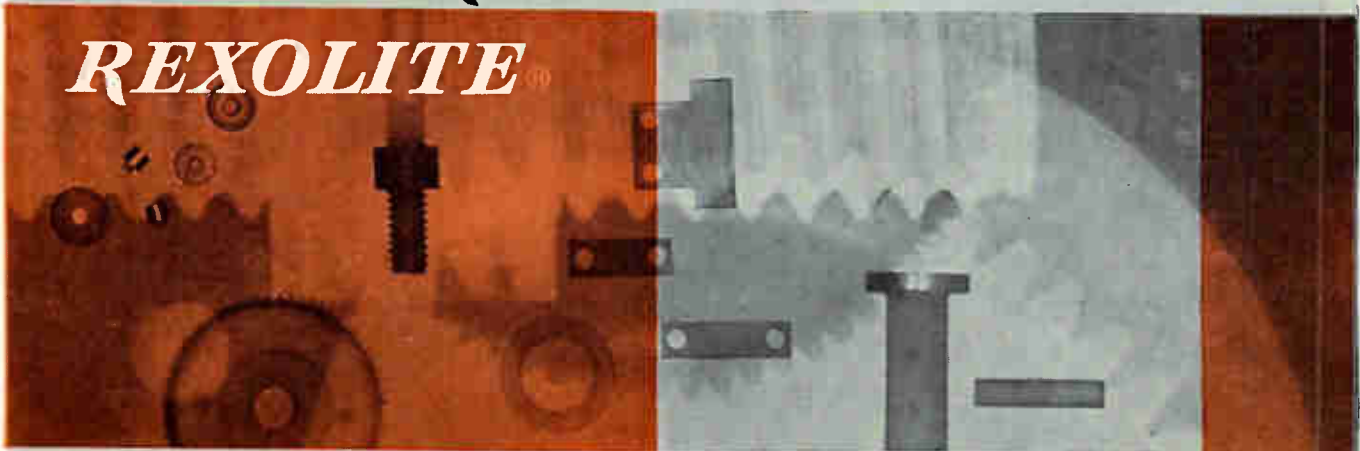

A few minutes spent with samples and comprehensive Rexolite technical data will most surely be a profitable investment for you. Brand-Rex technical service engineers will gladly help, too. A note or call from you is all we need.



WILLIAM BRAND-REX DIVISION

American ENKA Corporation

DEPT. R, 38 SUDBURY ROAD, CONCORD, MASSACHUSETTS

Telephone: EMerson 9-9630

See us at the IRE Show
Booth 4308

Vinyl, Teflon, Polyethylene, Nylon and Silicone Rubber Wires and Cables
Electrical Tubing and Sleeving — UHF Cast Plastics — Plastic Extrusions

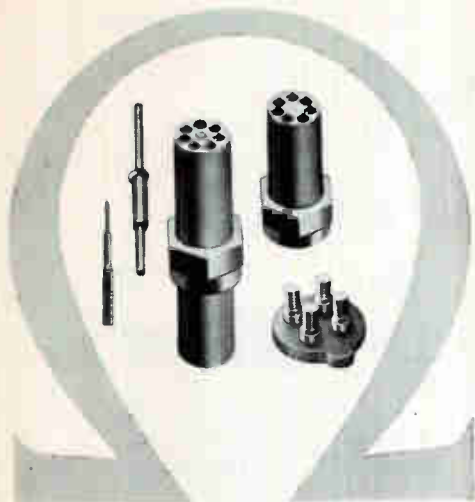

TRAN-GRIP miniature and microminiature COMPONENT SOCKETS

—eliminate hand solder operations
and heat damage to components

—adaptable to standard and
special connector arrangements

Units accept wire diameters as small as .004". About 400 fit into an area 1" square. Sockets can be mounted by staking or dip soldering. You can plug in diodes, transistors . . . any sub-miniature components. A wide variety of socket arrangements is available:

Individual socket—you mount on P.C. board to suit your spacing needs.

Mounted for transistors—2 or more units accurately spaced on a board by Omega to fit standard arrangements.

Special connector assemblies—sockets arranged on a mounting to suit any needs. The connector is assigned a part number for quick ordering from Omega.

Standard and feedthru types. High tie point density in extremely small size. Units hold 7 sockets in a .190" diameter. Whole circuits can be switched around without soldering.

Write for TRAN-GRIP literature.



omega precision, inc.

757 N. Coney Ave., Azusa, Calif.

CIRCLE 209 ON READER SERVICE CARD
March 3, 1961

announces two new types of precision trimming potentiometers. The CT-100's tap adjust feature eliminates the need for expensive mechanical components with no sacrifice of electrical characteristics. Electrical and mechanical rotation are 320 deg \pm 5 deg. Type CT-200 is a $\frac{1}{2}$ by $\frac{1}{2}$ in. square unit and is available with p-c terminals or Teflon-coated wire leads.

CIRCLE 319 ON READER SERVICE CARD



Tape Recorder AND PLAYBACK UNIT

ELECTRO-TECHNICAL LABS, P. O. Box 13243, Houston 19, Texas. Model DS-7 flatbed recorder and playback unit is a self-contained lightweight, direct-recording, magnetic-tape device. Static and/or dynamic time correction can be introduced on playback. Reliable operation under field and office conditions is provided by the simplified plane-surface head carriage system.

CIRCLE 320 ON READER SERVICE CARD

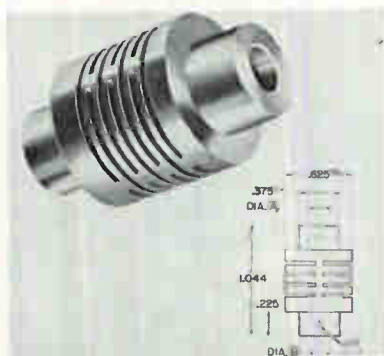

Instrument Coupling SUPERPRECISION UNIT

SANTA FE INSTRUMENTS, INC., 2343 Jerome Ave., New York 68, N. Y., introduces a superprecision flexible instrument coupling for missile systems. It answers the need of designers and engineers of servo gear trains, computer mechanisms and other rotating precision devices, for

BRAND-REX TURBO® INSULATING SLEEVINGS

Circle the entire range of
Tubular Dielectrics

To spot the insulation materials that will solve your problem, just glance through this list of Turbo tubings and sleeveings:

Applicable Specifications	Operating Temperature
TURBO† Varnished Cotton and Rayon MIL-I-3190A NEMA VSI-1957, Type 1 A.S.T.M. D-372	-10° to +105°C
TURBOGLAS† Varnished Glass MIL-I-3190A NEMA VSI-1957, Type 2 A.S.T.M. D-372	-10° to +130°C
TURBOTUF† Vinyl Coated Glass MIL-I-21557 MIL-I-3190A NEMA VSI-1957, Type 3	-10° to +130°C
TURBONITE† Isocyanate Coated Glass CLASS F MATERIAL	-10° to +155°C
TURBOSIL† Silicone Varnished Glass MIL-I-3190A NEMA VSI-1957, Type 4	-10° to +200°C
TURBO 117† Silicone Rubber Coated Glass NEMA VS2-1957 TYPE 5*	-73° to +200°C
TURBOTHERM 105† Vinyl U/L A.S.T.M. D-922 GRADE C	-17° to +105°C
TURBOLEX 105† Vinyl MIL-I-631C GRADE C	-20° to +105°C
TURBOLEX 85† Vinyl A.S.T.M. D-922 GRADE A	-32° to +60°C
TURBOLEX 78† Vinyl MIL-I-631C GRADE A	-39° to +80°C
TURBOLEX 40† Vinyl MIL-I-22076	-55° to +80°C
TURBOZONE 40† Vinyl MIL-I-7444B	-67° to +75°C
TURBOTEMP Teflon MIL-I-22129A AMS-3653 B**	-200° to +250°C

**Also meets applicable performance requirements of MIL-I-631C and MIL-I-3190A

*Meets performance requirements of MIL-I-3190A

†Registered trade mark

Turbo Tubings are available in all sizes from #24 to 2½". Write for complete information.



WILLIAM
BRAND-REX
DIVISION

American ENKA Corporation
SUDBURY ROAD, CONCORD, MASS.

CIRCLE 87 ON READER SERVICE CARD

87

GREEN PANTOGRAPH ENGRAVERS

● ELIMINATE DELAYS!

● KEEP YOUR OPERATING COSTS WHERE THEY SHOULD BE!



**PORTABLE
40-POUND
BENCH MODEL 106**

*You Make
Your Own
Engraved
Nameplates!*

Here is a speedy, economical 2 or 3-dimensional engraver used by thousands of dollar-conscious companies. It features 5 positive, accurate pantographic ratios; ball bearing spindle with 3 speeds up to 14,000 rpm. Is supplied with one copy carrier that accepts all standard master type sizes. Will actually work up to 10" by any width. Height of pantograph and position of cutter are continuously adjustable.

MODEL D-2 HEAVY-DUTY 2-DIMENSIONAL

Pantograph for milling, drilling and engraving.

Vertical adjustment of copy table automatic with Pantograph. Features: unobstructed on 3 sides to take large work; micrometer adjustment for depth of cut; ball bearing construction throughout; spindle speeds up to 26,000 rpm for engraving or machining, vertical range over 10"; ratios 2 to 1 to infinity — master copy area 26" x 10"

NEW

**MODEL D2-201
PNEUMATIC
ATTACHMENT**



for use with Model D2 Pantograph Engraver to rapidly drill holes in printed circuits by tracing templates. Drills as many as 100 holes per minute. Equipped with foot switch, spindle air cylinder; regulating valve and pressure gauge; filter and oiler. It's ready to use as soon as it's attached to an air compressor

Write or call for full details and prices.

**GREEN INSTRUMENT
COMPANY, INC.**

Dept. 363, 295 Vassar St.,
Cambridge 39, Mass. Tel. Eliot 4-2989

an efficient, precise, all speed, flexible coupling. There are no moving and wearing parts.

CIRCLE 321 ON READER SERVICE CARD



D-C Voltmeter HIGHLY ACCURATE

CALIBRATION STANDARDS CORP., 1025 Westminster Ave., Alhambra, Calif. Model DC200AR is an all-transistorized d-c voltmeter with accuracy to ± 0.01 percent $+5 \mu\text{v}$. Other features include self-calibration and complete warm-up in less than 30 minutes. Range is 0 to 1,000 v d-c; potentiometer accuracy, ± 0.002 percent; temperature stability, 2 ppm/deg C from 10 to 40 C; and regulation, ± 0.001 percent for a 10 percent line change.

CIRCLE 322 ON READER SERVICE CARD

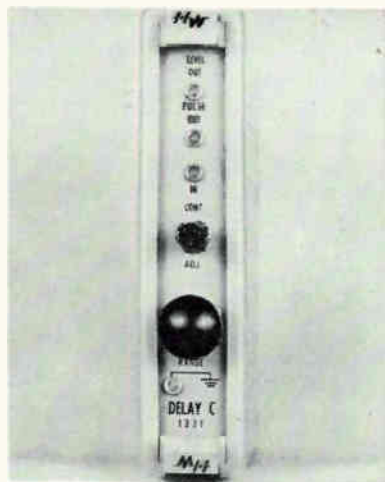

Logic Module VARIABLE DELAY

HARVEY-WELLS ELECTRONICS, INC., 14 Huron Drive, Natick, Mass., announces a dual-output variable delay logic module for use in digital systems where adjustable and/or long delays are required. Model 1321 Delay C is variable from 0.1 μsec to 0.7 sec in five incremental steps, by means of a front-panel selector, and continuously variable between steps, by means of a front-panel vernier control. Price, \$205.

CIRCLE 323 ON READER SERVICE CARD

Relays by Stromberg- Carlson

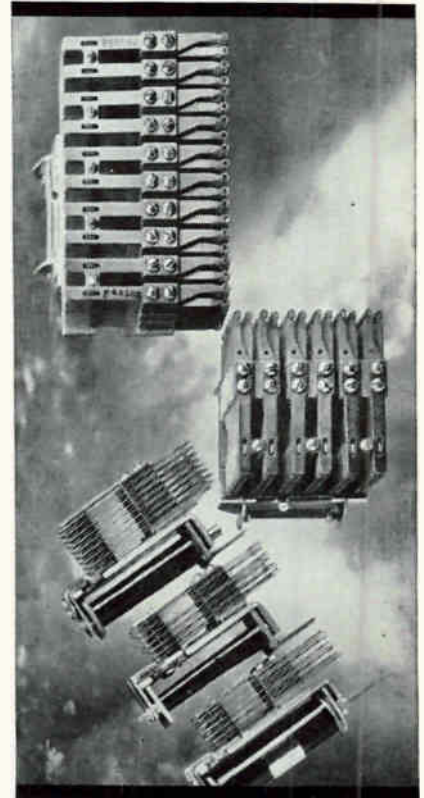

Telephone-type quality • reliability durability

TYPE A: general-purpose. Up to 20 Form "A" spring combinations.

TYPE B: gang-type. Up to 60 Form "A" spring combinations.

TYPE BB: up to 100 Form "A" springs.

TYPE C: two on one frame. Ideal where space is tight.

TYPE E: characteristics of Type A, plus universal mounting. Interchangeable with other makes.

Types A, B, and E are available in high-voltage models. Our assembly know-how is available to guide you in your specific application. If you desire, we can also provide wired mounting assemblies.

Details on request from these Stromberg-Carlson offices: Atlanta—750 Ponce de Leon Place N.E.; Chicago—564 W. Adams Street; Kansas City (Mo.)—2017 Grand Avenue; Rochester—1040 University Avenue; San Francisco—1805 Rollins Road.

STROMBERG-CARLSON
A DIVISION OF
GENERAL DYNAMICS

CIRCLE 210 ON READER SERVICE CARD
electronics



Wrapped up in a sticky **TEFLON** tape problem?

Joclin's 16 basic types of Fluorolin® pressure-sensitive Teflon tapes are the broadest line available. When you need a non-stick surface with chemical resistance, rated at 1000 to 4000 v/mil, that withstands

temperatures of -100° to $+500^{\circ}$ F., there's a Joclin tape ideal for your application.

Johnny Joclin sez:

Send for 6 pg. brochure loaded with engineering data on 16 basic Teflon tapes!

JOCLIN
SPACE-AGE PLASTICS

COlony 9-8708

JOCLIN MFG. COMPANY, INC. • LUFBERY AVE. • WALLINGFORD, CONN.
CIRCLE 211 ON READER SERVICE CARD



LEADS THE FIELD WITH ADVANCED DESIGN!

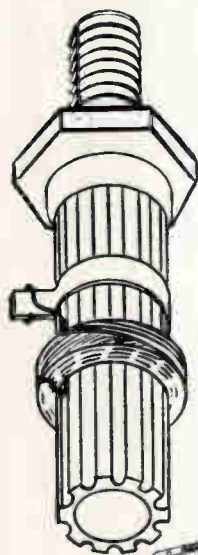

Waters

RIBBED CERAMIC COIL FORMS with internal torque

Ribbed ceramic eliminates loose leads — permits you to feed wire lead under pie winding to terminal lug, when necessary.

DELIVERY FROM STOCK! NO WAITING!



SEND FOR THIS EXPERIMENTAL PROTOTYPE KIT

Why guess? Develop production requirements accurately. Contains 8 samples with a frequency range of 0.1 to 200 mc, in both ribbed and plain round designs. Sizes .205 dia. to .500 dia. Price \$5.00

WATERS MANUFACTURING, INC. • WAYLAND, MASS.

CIRCLE 212 ON READER SERVICE CARD



March 3, 1961

In RF Connectors **GREMAR** superiority can be demonstrated on 3 counts!



* **QUALITY!**

All Gremar RF connectors are manufactured in accordance with MIL-Q-9858 or better . . . 142 separate quality control checks guarantee 100% conformance to your most exacting specs.

* **ECONOMY!**

Gremar makes and stocks more than 2000 types of quality-controlled RF connectors. So, your costs of "specials", inventories, and inspection are drastically reduced.

* **DELIVERY!**

Gremar always has more than 750,000 assembled RF connectors on the shelf . . . and more than 8,000,000 parts ready for assembly. So, you get what you need in hours instead of days . . . in days instead of weeks.

**Q. E. D. = Quod erat demonstrandum (what was to be proved)*

Connectronics . . . the concentration of engineering, production and quality control . . . is the key to Greomar superiority. For further evidence, contact:



GREMAR

MANUFACTURING COMPANY, INC.
RELIABILITY THROUGH QUALITY CONTROL

Dept. A Wakefield, Mass. CRystal 9-4580
See us at Booth #2811 IRE Show

CIRCLE 89 ON READER SERVICE CARD

89



What's new about this Primary Pressure Standard?

TWO THINGS. Continuing engineering studies have produced two remarkable improvements in the performance of CEC's Type 6-201 Primary Pressure Standard.

First: resolution has been improved to 0.002% of reading. Second: new and greater accuracy is 0.015% of reading in ranges to 150 psi and 0.025% of reading in ranges of 150 to 500 psi. (Both percentages formerly were *full scale*.)

Accuracy in the calibration of gage or absolute pressure measuring instruments – such as CEC's new Miniature Electromanometer System – begins with the 6-201. This pneumatic dead-weight piston gage covers six pressure ranges from 1.5 to 500 psi. A portable, true primary standard, the 6-201 utilizes mass, length and time for its references. Accuracy depends only upon the dimensional accuracy of its component parts.

For complete information, call your nearest CEC sales and service office or write for Bulletin CEC 1581-X32.

Transducer Division **CEC**

CONSOLIDATED ELECTRODYNAMICS / pasadena, california

A SUBSIDIARY OF Bell & Howell • FINER PRODUCTS THROUGH IMAGINATION

Literature of

SOLDER PREFORM ALLOY Accurate Specialties Co., Inc., 345 Lodi St., Hackensack, N. J. Technical data bulletin Z-105 describes Alloy D-800, a high-strength low-temperature solder alloy.

CIRCLE 324 ON READER SERVICE CARD

RELAYS Brook Electronics Co., 1005 Brook Ave., New York 51, N. Y., has published a four page folder fully describing its compact heavy-duty industrial relays.

CIRCLE 325 ON READER SERVICE CARD

PATCH PANELS Trompeter Electronics, 7713 Oakdale, Canoga Park, Calif., has available a bulletin illustrating and describing a line of r-f and video patch panels. Prices are included.

CIRCLE 326 ON READER SERVICE CARD

KLYSTRON POWER SUPPLY Microwave Associates, Inc., Burlington, Mass. A four-page folder covers the MA-2-S klystron pump power supply designed for use with parametric amplifiers and other high-stability applications.

CIRCLE 327 ON READER SERVICE CARD

SILICONE RUBBER General Electric Co., Silicone Products Department, Waterford, N. Y. Four-color silicone rubber selector chart contains data on applications, typical properties, primary classes and standard industry and military specifications.

CIRCLE 328 ON READER SERVICE CARD

PLASTICS Synthane Corp., Oaks, Pa. Technical data sheet gives information on Synthane Grade FR-2, a flame-retardant industrial thermosetting laminated plastic.

CIRCLE 329 ON READER SERVICE CARD

SWITCHES Micro Switch, a division of Minneapolis-Honeywell, Freeport, Ill. Bulletin displays precision switches for machine tools and other industrial equipment.

CIRCLE 330 ON READER SERVICE CARD

ACCELEROMETER — AMPLIFIER Columbia Research Laboratories, MacDade Blvd. and Bullens Lane, Woodlyn, Pa. Data sheet de-

← CIRCLE 90 ON READER SERVICE CARD

the Week

scribes the model 50X2 accelerometer-amplifier system and lists all physical, electrical and environmental specifications of the system.

CIRCLE 331 ON READER SERVICE CARD

ALARM UNIT San Diego Scientific Corp., 3434 Midway Drive, San Diego 10, Calif., has available a brochure describing a solid state alarm unit, Magne-Alarm, designed to provide engineers with a solution to temperature monitoring problems.

CIRCLE 332 ON READER SERVICE CARD

TRANSDUCERS Clark Electronic Laboratories, CELAB Research Division, Palm Springs, Calif. "Micro-ducer News", a condensed catalog of components and materials, covers a full line of transducers including CELAB pressure-sensitive paints.

CIRCLE 333 ON READER SERVICE CARD

CHART RECORDERS Curtiss Wright Corp., P. O. Box 110, Princeton, N. J. Features of rectangular strip chart recorders are listed in a single sheet.

CIRCLE 334 ON READER SERVICE CARD

THYRATRONS CBS Electronics, Danvers, Mass., has released two bulletins in the "Tech Tips" series, entitled "Thyratrons Are Different" and "The Care and Control of Thyratrons".

CIRCLE 335 ON READER SERVICE CARD

ATTENUATORS PRD Electronics, Inc., 202 Tillary Street, Brooklyn 1, N. Y. A 4-page bulletin describes fixed and variable microwave waveguide and coaxial attenuators, including mil spec, precision dial, precision gage; level set, and variable cutoff types.

CIRCLE 336 ON READER SERVICE CARD

CHECK-OUT SYSTEMS Audioelectronics Co., Box 2187, Dayton 29, Ohio, has published a bulletin on the Speed-Tronik automatic check-out system, an all-parameter testing system capable of checking any characteristic convertible to an electrical equivalent.

CIRCLE 337 ON READER SERVICE CARD

CIRCLE 91 ON READER SERVICE CARD →



What's new about this Secondary Pressure Standard?

EVERYTHING. CEC's Miniature Electromanometer System is all new. Either of its two components can be held in the palm of your hand.

Its Type 4-333 Precision Pressure Balance is designed to measure differential, gage and absolute pressures to 100 psi. The system's Type 1-156 Servo Amplifier is 100% solid-state in design and is fabricated on circuit card modules. It includes an integral power supply for operation on 115v, 60 cps line voltage. A multi-channel adapter, available as an accessory for the system, can be used as a switching unit for two to six pressure balances sharing a single servo amplifier.

This precise new CEC system provides secondary pressure standard accuracies for laboratory, field or industrial applications ranging from process control to calibration service. Its small size and high-level output assure easy integration into major system designs.

For complete information, call your nearest CEC sales and service office or write for Bulletin CEC 1156-X 3.

Transducer Division **CEC**

CONSOLIDATED ELECTRODYNAMICS / pasadena, california

A SUBSIDIARY OF Bell & Howell • FINER PRODUCTS THROUGH IMAGINATION



Collins: advocate, not a referee

NEW PRESIDENT of the National Association of Broadcasters is a quiet, soft-spoken man with a talent for making those around him feel at ease. This characteristic alone would well qualify LeRoy Collins to head the key organization of today's broadcast industry, but he also brings many other traits to the job.

The former governor of Florida talks of technical innovations, of legislation that may help or hinder station operations and seems as eager to learn the technical environment as well as he knows the political. An NAB staff member, hearing Collins deplore his lack of technical knowledge, chuckled and shook his head: "In a couple of months he'll probably know more than all of us" he said.

Collins is no stranger to broadcasting. As governor he made monthly reports on statewide tv hookups and amazed studio personnel with his sense of timing. Although scorning the use of a script, he managed to cover a variety of subjects and always wind up broadcasts exactly on time.

"I'm really just a patron of broadcasting," he says with a smile, "I like to listen to the radio and watch tv. On some matters I feel that, right now, I'm a patient addressing the surgeons, but I am learning."

Despite this modesty, Collins shows a dedication to the future of broadcasting that bodes well for the industry. He is a firm believer

in freedom from censorship and excessive government regulation of broadcasting, but infers what he expects from broadcasters in a comment he once made on states' rights: "If more people would be concerned with responsibilities instead of rights, there would be little loss of those rights."

Known as "Roy" to thousands of Floridians, Collins is the son of a grocer and grandson of a circuit-riding Methodist minister. One of six children, he was born in Tallahassee in 1909.

He graduated from high school in 1927 and took up his father's offer to match whatever he could save towards his education. In 18 months he saved \$500 as a grocery clerk and delivery boy, went to New York to study at the Eastman Business School in Poughkeepsie. Another two years as a bank teller yielded \$500 more and bought a one-year law course at Cumberland University in Tennessee. That same year he passed the Florida bar examinations with the second highest grade scored up to that time. Describing his next step Collins grins, "I boldly hung out my shingle . . . then proceeded to starve."

In 1932 he married and two years later entered politics by being elected to the Florida House of Representatives. For almost 25 years he has served his home state, the last six as governor.

Collins recently told an annual assembly of the FCC Bar Association: "I believe in broadcasting—

not just as a business or as a great industry. It is far more than that. Broadcasting, like America, has not "arrived". It too has only begun, and ahead it also faces goals which demand resourcefulness and loyalty and hard effort, better to serve mankind's needs. He added that "No segment of American life has a greater responsibility towards helping American life succeed than American broadcasting" and said "Nothing touches with such intimacy and effectiveness the lives of so many Americans as does electronic mass communications."

Concerning future policies in his new position Collins considers himself an advocate, not a referee. "Broadcasting," he says, "no less than an individual, has legitimate interests. I shall, to the best of my abilities articulate and advance these legitimate interests with reason, clarity and vigor."

In speaking of his move to Washington, the former governor says he admits to some jitters but sees them dissipating. Except for family get-togethers, Collins and his wife Mary lead quiet social lives. His son, LeRoy Jr., 26, is a Lt. (JG) in the submarine service. Three daughters, Jane, 22, Mary Call, 18, (freshman at Florida State) and Darby, 10, complete the family.

For relaxation, the 6-ft, 197-lb NAB president enjoys hunting and fishing.



Monitor Systems, Inc.
Names Project Manager

G. ROBERT JACOB has joined Monitor Systems, Inc., Fort Washington, Pa., designer and manufacturer of

TRIPLETT

ACTUAL SIZE

USES UNLIMITED:

- Field Engineers
- Application Engineers
- Electrical, Radio, TV, and Appliance Servicemen
- Electrical Contractors
- Factory Maintenance Men
- Electronic Technicians
- Home Owners, Hobbyists



MODEL 310

complete
VOLT-OHM-
MILLIAMMETER



World's Largest Selling POCKET SIZE V-O-M

FEATURES:

- 1 Hand size and lightweight, but with the features of a full-size V-O-M.
- 2 20,000 ohms per volt DC; 5,000 AC.
- 3 EXCLUSIVE SINGLE SELECTOR SWITCH speeds circuit and range settings. The first miniature V-O-M with this exclusive feature for quick, fool-proof selection of all ranges.

SELF-SHIELDED Bar-Ring instrument; permits checking in strong magnetic fields • Fitting interchangeable test prod tip into top of tester makes it the common probe, thereby freeing one hand • UNBREAKABLE plastic meter window • BANANA-TYPE JACKS—positive connection and long life.

■ Price—only \$34.50; leather case \$3.20.

Available For Immediate Delivery From Your Triplett Distributor's Stock



MODEL 100

The most comprehensive test set in the Triplett line is Model 100 V-O-M Clamp-On-Ammeter Kit, now available at distributors. The world's most versatile instrument—a complete accurate V-O-M plus a clamp-on-ammeter with which you can take measurements without stripping the wires. Handsome, triple-purpose carton holds and displays all the components: Model 310 miniaturized V-O-M, Model 10 Clamp-On-Ammeter, Model 101 Line Separator, No. 311 Extension leads, and a leather carrying case, which neatly accommodates all the components. Model 101 literally makes it possible to separate the two sides of the line when using Model 10. Extension leads permit use of Model 10 at a distance from the V-O-M. Complete Model 100 is only \$59.50

THE TRIPLETT ELECTRICAL INSTRUMENT COMPANY, BLUFFTON, OHIO

MANUFACTURERS OF PANEL AND PORTABLE INSTRUMENTS; ELECTRICAL AND ELECTRONIC TEST EQUIPMENT



FOR EVERY PURPOSE—THE WORLD'S MOST COMPLETE LINE OF V-O-M'S

Professional Opportunities Are Available For

Electrical Engineers

with interest and experience
in the following fields:

- Design and Development of:
Industrial Electronics and Power
Controls and Instrumentation
Electronics
- Operation & Maintenance of
Nuclear Devices

For information please write to:

Personnel Manager

Brookhaven National Laboratory

UPTON, LONG ISLAND, N. Y.



CIRCLE 377 ON READER SERVICE CARD

advanced high-speed electronic data systems for defense and industry, as project manager.

Prior to joining MSI, a subsidiary of Epsco, Inc., he was chief engineer for Measurements Research Co., where he proposed new designs and was responsible for the development of all designs of a contractual nature.

Ling-Temco Sets Up New Division

LING-TEMCO ELECTRONICS, INC., has announced the establishment of a new micromodular components division in Anaheim, Calif. This division will specialize in the manufacture of subminiaturized high and low-voltage rectifiers, semiconductor logic circuits and custom miniaturized modular packaging.

Design counseling, relative to circuit configuration, choice of component, subminiaturization and reliability problems, will be provided at no additional cost.

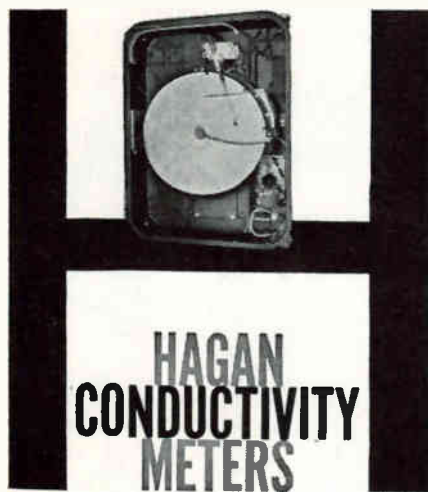

The Hagan Model H-O may be used as a single instrument, or up to four different conductivity measurements may be recorded in a single meter case. Provides continuous reliable measurement for a moderate investment.

Temperature compensation is continuous and automatic, and limit switches may be installed for applications where drastic changes in dissolved solids may damage equipment.

Write for Bulletin OE-10004

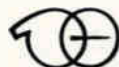

HAGAN

CHEMICALS & CONTROLS, INC.
HAGAN CENTER, PITTSBURGH 30, PA.

New . . .

LABORATORY STANDARD

R. F. VOLTMETERS



- Flat response to 100 megacycles/sec.
- Ideal for checking V T V M's
- Calibrate on D.C. or 60 cycles/sec.
- Can be certified by Bureau of Standards
- Separate thermocouple units available in ranges 1 volt, 3 volts and 10 volts
- Also units for 30 volts and 100 volts with less frequency range

Write for Bulletin 800.



Rawson
ELECTRICAL INSTRUMENT CO.
fine instruments since 1918

111 Potter Street • Cambridge, Mass.

CIRCLE 213 ON READER SERVICE CARD



Motorola Promotes John Gray

JOHN L. GRAY has been named vice president and eastern area sales manager for Motorola Semiconductor Products Inc., Phoenix, Ariz. He was formerly central area sales manager for the firm.

General Electric Reassigns Erlandsen

CHARLES F. ERLANDSEN has been appointed manager of quality control at GE's semiconductor products department plant in Buffalo, N. Y.

With GE for the past 21 years, Erlandsen's last position prior to

his present assignment was manager of quality control at the selenium and copper oxide rectifier plant in Lynchburg, Va.

Audio Devices, Inc. Erecting New Plant

AUDIO DEVICES, INC., manufacturer of magnetic tapes, recently broke ground for a two-story, 20,000 sq ft building in Stamford, Conn. The structure when completed will house the company's expanding research and development, and engineering departments.

The new building will provide added laboratory and pilot production facilities for video, seismic, computer, and other specialized tapes to meet the critical demands of the magnetic tape market.

PEOPLE IN BRIEF

Myron C. Pogue, formerly with Eitel-McCullough, joins Philco Corp. as manager of planning for the Western Development Labs. Robert J. Erickson, ex-Centronix and Bell Aircraft, chosen associate director of production by Astronautics, Inc. Everett Babbe leaves Marquardt Corp. to become chief engineer for Temtron, Inc. F. Beringer Fank advances at General Electric to manager of the company's low power traveling wave tube engineering. Jim Hinsdale, from Motorola, appointed director of engineering at Dynamic System Electronics Corp. H. Raymond Jacobus leaves Tung Sol Electric to become manager of the negative grid tube division at Eitel-McCullough, Inc. Charles K. Krill promoted by General Precision to plant manager of the Librascope Division's Burbank Branch. Louis Friedman, previously with Polarad Electronics and CBS-Columbia, takes the post of plant manager at Transdyne Corp. Phillip N. Buford, ex-Westinghouse Electric, joins Page Communications Engineers as senior staff engineer in their research and development directorate. Ludwig P. Reiche, formerly of Stanford Research Inst. named manager of the microwave communications branch at Melabs.

Engineers

MEMO FROM: W. M. JENKINS
Manager, GECS Systems

TO: George B. Callender
Engineering Administration

SUBJECT: Manpower Requirements for
Project Management Teams

*eg. 422,
TAMS, FABMDS*

To handle our increased work in Command & Control Systems, I'm forming separate Management Teams for individual projects. Need multi-discipline people to staff these teams--men with a good grasp of mathematics / information theory / statistical theory / military operations analysis. Work requires application of this broad background to specific problems in information acquisition / information transmission / information processing and display / systems analysis operations support. Should appeal to technically sharp engineers who want to broaden their management experience.

(not just a superficial knowledge)

management in the PBM sense

P.S. Honestly believe these openings will be good incubators for a number of future managers.

WMJ

Bill

Engineers with experience in most of the following fields:

physics (including nuclear) / circuit theory & design / radar theory / communications theory / computer programming & utilization are invited to forward their resumes to: George Callender, Division 69-W1

HEAVY MILITARY ELECTRONICS DEPARTMENT

GENERAL ELECTRIC

Court Street, Syracuse, New York

From
Applied Research
to
Precision Manufacturing
Kollsman

provides broad-based professional opportunities

Producer of more automatic star trackers and more air data computers than all other U.S. companies combined, Kollsman has now established a new Research Division—pointing the way to still more advanced engineering concepts.

Opportunities are available now for graduate EE's, ME's and Physicists in:

- | | |
|--|----------------------|
| DIGITAL SYSTEMS | PULSE TECHNIQUES |
| SOLID STATE PHYSICS | DIGITAL SENSORS |
| LOGICAL DESIGN | ELECTRONIC DISPLAYS |
| SYSTEMS ANALYSIS & SYNTHESIS | MICROMINIATURIZATION |
| LIGHT GENERATION, MODULATION & DETECTION | |



To arrange a confidential interview,
forward a brief resume to Mr. John Whitton.

Kollsman Instrument Corporation

A Subsidiary of Standard Kollsman Industries Inc. 80-08 45th AVE., ELMHURST 73, QUEENS, NEW YORK

CIRCLE 381 ON READER SERVICE CARD

Immediate Openings

OVERSEAS
AND IN THE
UNITED STATES
FOR

ENGINEERS

- TELEPHONE ENGINEERS, SYSTEM DESIGN
- TELEPHONE INSIDE PLANT ENGINEERS
- TELEPHONE OUTSIDE PLANT ENGINEERS
- TELEPHONE TRAFFIC ENGINEERS
- RADIO RELAY SYSTEMS ENGINEERS
- RADIO RELAY ENGINEERS
- RADIO ENGINEERS
- TELETYPE ENGINEERS
- MULTIPLEX ENGINEERS
- MICROWAVE TECHNICIANS
- POWER ENGINEERS
- SPECIFICATION ENGINEERS
- TRAINING SUPERVISORS

U. S. CITIZENSHIP REQUIRED

(FAMILIES MAY ACCOMPANY)

Submit detailed resume of schooling and experience and definite basic salary requirements to:

P6163 Electronics
520 N. Michigan Ave., Chicago 11, Ill

CIRCLE 382 ON READER SERVICE CARD

POSITION WANTED

Electronics technician, U.S. citizen, desires overseas employment in Middle East (preferably Israel). Background includes radar, communications, industrial controls and digital computers. Also, teaching and technical writing experience. PW-6220, Electronics, 520 N. Michigan Ave., Chicago 11, Ill.



MANUFACTURERS' REPRESENTATIVES

IN THE ELECTRONIC INDUSTRY

SAMUEL K. MACDONALD, INC.

manufacturers representatives over 25 years
1531 SPRUCE STREET, PHILA. 2, PA.

Territory: Pennsylvania • New Jersey Delaware • Maryland Virginia • West Virginia District of Columbia	Other Offices: Pittsburgh Baltimore Washington, D.C.
---	--

CIRCLE 383 ON READER SERVICE CARD

**"Put Yourself in the Other Fellow's Place"
TO EMPLOYERS
TO EMPLOYEES**

Letters written offering Employment or applying for same are written with the hope of satisfying a current need. An answer, regardless of whether it is favorable or not, is usually expected.

MR. EMPLOYER, won't you remove the mystery about the status of an employee's application by acknowledging all applicants and not just the promising candidates.

MR. EMPLOYEE you, too, can help by acknowledging applications and job offers. This would encourage more companies to answer position wanted ads in this section. We make this suggestion in a spirit of helpful cooperation between employers and employees.

This section will be the more useful to all as a result of this consideration.

Classified Advertising Division
McGraw-Hill Publishing Co., Inc.
330 West 42nd St., New York 36, N. Y.

FOR INFORMATION

About Classified Advertising
Contact The McGraw-Hill
Office Nearest You

- | | |
|--|----------------------------------|
| ATLANTA, 9
1375 Peachtree St. N. E.
M. MILLER | TRinity 8-0523 |
| BOSTON, 16
Capley Square | COngress 2-1160 |
| CHICAGO, 11
520 No. Michigan Ave.
W. J. HIGGINS—W. SONZSKI | MOhawk 4-5800 |
| CLEVELAND, 13
1164 Illuminating Bldg.
W. B. SULLIVAN | SUperior 1-7000 |
| DALLAS, 2
1712 Commerce St.,
J. GRANT | Vaughn Bldg.
Riverside 7-5117 |
| DENVER, 2
1700 Broadway—Tower Bldg.
J. PATTEN | ALpine 5-2981 |
| DETROIT, 26
856 Penobscot Bldg.
P. HAMMOND | WOodward 2-1793 |
| HOUSTON, 25
Prudential Bldg., Holcombe Blvd., Rm. W-724
GENE HOLLAND | JAckson 6-1281 |
| LOS ANGELES, 17
1125 W. 6th St.
W. C. GRIES | HUntley 2-5450 |
| NEW YORK, 36
500 Fifth Ave.
H. T. BUCHANAN—R. P. LAWLESS
T. W. BENDER | OXford 5-5959 |
| PHILADELPHIA, 3
Six Penn Center Plaza
H. W. BOZARTH—P. PASCHALL | LOCust 8-4330 |
| PITTSBURGH, 22
4 Gateway Center
P. PIERCE | EXpress 1-1314 |
| ST. LOUIS, 8
3615 Olive St.
R. BOWMAN | JEfferson 5-4867 |
| SAN FRANCISCO, 11
255 California St.
D. GARDNER | DOuglas 2-4600 |

INDEX TO ADVERTISERS



Audited Paid Circulation

Addo-X	32	*Heyman Mfg. Co.	98
Aerovox Corp.	64	*Hughes Aircraft Co.	7
*American Lava Corp.	15		
Armour Research Foundation.....	84	*Industrial Electronic Engineers, Inc.	77
Ampex Data Products Co.....	67	Institute of Radio Engineers....	78, 85
Bausch & Lomb Optical Co.....	73	*Jerrold Electronics Corp.	14
Beattie-Coleman, Inc.	72	Joelin Mfg. Co. Inc.	89
*Bird & Co. Inc., Richard H.....	83	*Jones Electronics Co., Inc. M.C....	27
*Bird Electronics Corp.	31		
Brand-Rex Div.	86, 87		
Brookhaven National Laboratory ...	94	Litton Industries	
*Burnell & Co. Inc.....	3	Guidance & Controls Systems Division	78
		Lockheed Electronics Co.	
		Missiles & Space Division....	16, 17
*Cohn Corp., Sigmund	84	McGraw-Hill Book Co.....	97
Colorado State of, Industrial Development.	80	Magnetic Metals Co.	2
Consolidated Electrodynamics Corp.	90, 91	Mallory & Co. Inc. P. R.....	68
*Continental-Diamond Fibre Subsidiary of the Budd Company..	37	*Massa, Division of Cohu Electronics, Inc.	36
		Midland Mfg. Company	25
*Dale Electronics Inc.	29	*Narda Microwave Corp.	19
*Daven Co.	3rd Cover		
		Ohmite Mfg. Co.....	77
*Electronic Instrument Co. Inc. (EICO)	80	Omega Precision, Inc.	87
		*Philco Corp.	
		Lansdale Tube	38
		Precision Instrument Co.	69
Garrett Corp., The Airesearch Mfg. Division	84	*Radio Corp. of America	6, 4th Cover
*General Electric Co. Defense Electronics Div.	59	*Rawson Electrical Instrument Co... ..	94
General Products Corp.	80	Rotron Mfg. Co. Inc.	28
*General Precision Eqpt. Corp. Kearfott (NY)	68, 65		
Geotechnical Corporation, The	28	St. Petersburg (C of C).....	18
*Green Instrument Co.	88	Siegler Corp.	38
*Gremar Mfg. Co.....	89	*Sierra Electronic Corporation.....	35
Hagen Chemicals & Controls, Inc... ..	94		
Hamlin, Inc.	77		

* See Advertisement in the July 20, 1960 issue of Electronics Buyers' Guide for complete line of products or services.

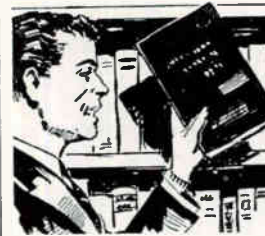

CHECKLIST OF HELPFUL McGraw-Hill Books

MAGNETIC TAPE INSTRUMENTATION

Just Out. Explains how to specify, purchase, and use magnetic tape equipment. Describes tape-transport mechanisms, tape-motion irregularities, flutter and skew errors, speed-control systems, magnetic drums, disks, and other devices. Gives effective techniques for recording and reproducing data. By G. L. Davies, Consult. Engr. 257 pp., 86 illus., \$8.50.

NONDESTRUCTIVE TESTING

Just Out. Covers modern techniques for measuring physical properties and variations in materials. Discusses advantages and limitations of such techniques as visual testing, industrial radiography, pressure and leak tests, penetrant inspection, eddy current methods, and others. By W. J. McGonnagle, Argonne Nat. Laboratory. 457 pp., 413 illus., 65 tables, \$15.00.

HANDBOOK OF NOISE CONTROL

A practical handbook of noise—its nature, measurement and techniques of control. Treats vibration damping materials, system considerations in noise control problems, acoustical filters and mufflers, plus hundreds of other important topics. Edited by C. M. Harris, Columbia Univ. Prepared by a Staff of Specialists. 1053 pp., 763 illus., \$16.50.

TIME-HARMONIC ELECTROMAGNETIC FIELDS

Just Out. Provides essential mathematical techniques for solving electromagnetic engineering problems. Contains important discussions of microwave circuit theory... gives detailed treatments of plane, cylindrical, and spherical wave functions, complex permittivities, and more. By R. F. Harrington, Syracuse Univ. 496 pp., 224 illus., \$13.50.

TABLE FOR THE SOLUTION OF CUBIC EQUATIONS

An extensive, easy-to-use reference table that includes all three roots of any equation. Gives interval of 0.001 for linear or quadratic interpolation, and provides 7-decimal or 7-significant-figure accuracy. Includes helpful explanations. By H. E. Salzer, C. H. Richards, both Convair Astron.; and I. Arsham, Diamond Ord. Fuse Lab. 161 pp., \$4.50.

10 DAYS' FREE EXAMINATION

McGraw-Hill Book Co., Dept. L-3-3
327 W. 41st St., New York 36, N. Y.

Send me book(s) checked below for 10 days' examination on approval. In 10 days I will remit for book(s) I keep plus few cents for delivery costs, and return unwanted book(s) postpaid. (We pay delivery costs if you remit with this coupon—same return privilege.)

- Davies—Mag. Tape Instrument.. \$8.50
- McGonnagle—Nondest. Testing, \$15.00
- Harris—Hndbk. of Noise Cont.. \$16.50
- Harrington—Time-Har. Elec. Fields, \$13.50
- Salzer et al—Table for the Sol. of Cubic Equat., \$4.50

(Print)

Name

Address

City Zone..... State.....

Company

Position

For price and terms outside U.S.

Write McGraw-Hill Intl., N.Y.C. 36 L-3-3

Heyco Nylon BUSHINGS

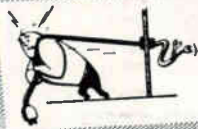

STRAIN RELIEFS
The insulating bushing that anchors a cord set to an electrically operated machine or appliance.



JUNCTION-TERMINAL BUSHINGS

Eliminate "pig-tails" - Miniature size. Snap-in assembly, color or number coded. Can be used as plug-in receptacle. Simple quick disconnect.

ACCORDIAN TYPE

Fit curved surfaces

Nylon bushing - brass tab



HEYCO NYLON Snap Bushings

10 Sizes for holes from 3/8" to 1 3/8" dia. - various inside diameters. Snap locks into panels up to 3/8" thick.



FREE SAMPLES! BUSHINGS OF YOUR CHOICE

HEYMAN MANUFACTURING COMPANY
KENILWORTH 3, NEW JERSEY

CIRCLE 214 ON READER SERVICE CARD

**FOR
FREE
REPRINT
OF THE
MONTH
TURN TO
READER
SERVICE
CARD**

Sprague Electric Co. 5, 26
Stromberg-Carlson 88

EMPLOYMENT OPPORTUNITIES 95, 96

Telemetrics, Inc. 84

*Texas Instruments Incorporated
Semiconductor Components
Div. 12, 18

Tokyo Shibaura Electric Co. Ltd. 61

Triplett Electrical Instrument Co.,
The 98

*Tung-Sol Electric, Inc. 11

*United Transformer Corp. 2nd Cover

*Waters Mfg. Inc. 89

Weller Electric Corp. 71

MANUFACTURERS REPRESENTATIVES
MacDonald Inc., Samuel K. 96

ADVERTISERS INDEX

General Electric Co. 95

Kollsman Instrument Corp. 96

CLASSIFIED ADVERTISING
F. J. Eberle, Business Mgr.

This index and our Reader Service Numbers are published as a service. Every precaution is taken to make them accurate, but ELECTRONICS assumes no responsibilities for errors or omissions.

electronics



Audit Bureau
of Circulations



Associated Business
Publications

Audited Paid Circulation

BRUCE A. WINNER
Advertising Sales Manager

R. S. QUINT, Assistant Publisher Buyer's Guide and Business Manager; FRED STEWART, Promotion Manager; B. ANELLO, Marketing Service Manager; RICHARD J. TOMLINSON, Production Manager; GEORGE E. POMEROY, Classified Manager; HUGH J. QUINN, Circulation Manager.

ADVERTISING REPRESENTATIVES: NEW YORK Donald H. Miller, Henry M. Shaw, George F. Werner; BOSTON William S. Hodgkinson, Donald R. Furth; PITTSBURGH David M. Watson; PHILADELPHIA Warren H. Gardner, William J. Boyle; CHICAGO Harvey W. Wernecke, Martin J. Galloway; CLEVELAND P. T. Fegley; SAN FRANCISCO T. H. Carmody, R. C. Alcorn; LOS ANGELES D. A. McMillan, Marshall Freeman; DENVER J. Patten;

ATLANTA M. Miller; DALLAS Robert T Wood; LONDON Edward E. Schirmer; FRANKFURT Stanley R. Kimes; GENEVA Michael R. Zeynel.

BRANCH OFFICES: National Press Bldg., Washington 4, D.C.; McGraw-Hill Bldg., Copley Square, Boston 16; Four Gateway Center, Pittsburgh 22; Six Penn Center Plaza, Philadelphia 3; 520 North Michigan Avenue, Chicago 11; 55 Public Square, Cleveland 13; 68 Post Street, San Francisco 4; 1125 West Sixth St., Los Angeles 17; 1740 Broadway, Denver 2; 1301 Rhodes-Haverty Bldg., Atlanta 3; 901 Vaughn Bldg., Dallas 1; McGraw-Hill Publishing Co., Ltd., 34 Dover Street, London, England; B5 Westendstrasse; Frankfurt/Main; 2 Place de Port, Geneva.

Convert Invert Change

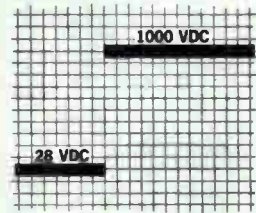

Daven solves your solid-state power supply problems!

Take advantage of Daven's experience in designing extremely compact, light-weight, high temperature units, which can withstand the most severe altitude, shock, and vibration environments. Let us engineer solid-state supplies for your missile-borne, airborne, shipborne, underwater or ground support equipment.

Converters

- DC input voltage from 6 volts to 230 volts
- DC output voltage from 1 volt to 15 kilovolts
- DC output current from microamperes to 100 amps
- Dynamic regulation, ripple, stability as required

Inverters

- DC input voltage from 6 volts to 230 volts
- AC output from 20 VA to 2500 VA
- 60-400-800-1600-2000 cycles per second
- One, two or three phase, any voltage level
- Voltage and frequency regulation 0.1% to 10% as required
- Output waveform — sine or square wave

Frequency Changers

- 20 VA to 2500 VA
- Change to or from any of these frequencies: 60-400-800-1600-2000 cycles per second
- Voltage and frequency regulation 0.1% to 10% as required

Write for complete information, including your application and requirement data.



THE **DAVEN** CO.



LIVINGSTON, NEW JERSEY

TODAY, MORE THAN EVER, THE DAVEN © STANDS FOR DEPENDABILITY



RCA announces
a major advance
in Tube Technology,
assuring

IMPROVED PERFORMANCE AND LONGER LIFE IN RECEIVING TUBES...

THE "DARK HEATER"

From RCA—which in recent months has brought you the revolutionary nuvistor tube, the dramatic Novar receiving tube, new super-strength metallized ceramics, the vacuum-melted cathode, and S-311 high-dissipation plate material—now comes the latest in a proud list of contributions to tube making: "DARK HEATER".

The "DARK HEATER" is a key to greatly extended life and improved performance of receiving tubes.

The "DARK HEATER" operates at greatly reduced temperatures—as much as 350°K below the 1500 to 1700°K of the "White" heater. The unique dark surface radiates heat more efficiently and improves the transfer of heat to the cathode. Thus the required cathode temperature is attained with the heater operating temperature lowered to approximately 1350°K.

For more information on what this dramatic advance in heater design can mean to you in your equipment, see your RCA Field Representative.

SPECIFIC ADVANTAGES TO YDU INCLUDE:

EXTENDED HEATER LIFE—Heater wire strength is much greater at lower operating temperatures. For example, a reduction of 350°K in operating temperature results in a 50% increase in ultimate tensile strength of the wire, and a reduction of as much as 25% in internal stresses which may occur during heater cycling.

REDUCED LIKELIHOOD OF HEATER FAILURE—The smaller thermal change during heater cycling, and the greatly reduced operating temperatures minimize the tendency toward recrystallization and burnout.

CONSTANT HEATER CURRENT—The "DARK HEATER" exhibits an exceptionally stable current characteristic throughout its life. This feature is especially desirable in maintaining a constant cathode temperature.

REDUCED HEATER-CATHODE LEAKAGE AND HUM—AC leakage and hum are significantly reduced through the use of the "DARK HEATER". This improvement is most startling because it eliminates "spike" or pulse leakage currents sometimes present in other heaters. In addition, the reduction of heater temperature serves to reduce both AC and DC leakage from heater to cathode, and heater emission to other tube electrodes.

IMPROVED MECHANICAL STABILITY—The cooler operation of the "DARK HEATER" minimizes changes in heater shape during life, reducing the possibility of heater damage and heater shorts.

GREATER SAFETY IN VOLTAGE RATINGS—Cooler heater operation provides a greater margin of safety in present H-K voltage ratings.



The Most Trusted Name in Electronics
RADIO CORPORATION OF AMERICA

RCA FIELD OFFICES: East: 744 Broad St., Newark 2, New Jersey, HUmboldt 5-3900
Midwest: Suite 1154, Merchandise Mart Plaza, Chicago 54, Ill., WHitehall 4-2900
West: 6801 East Washington Boulevard, Los Angeles 22, Calif., RAymond 3-8361