

December 16, 1960

# electronics

*Recording engine parameters during road checks. The tape is used to program a laboratory engine for dynamometer tests, p 74*  
*Proposed system for broadcasting television stereo sound, p 71*

A McGraw-Hill Publication 75 Cents



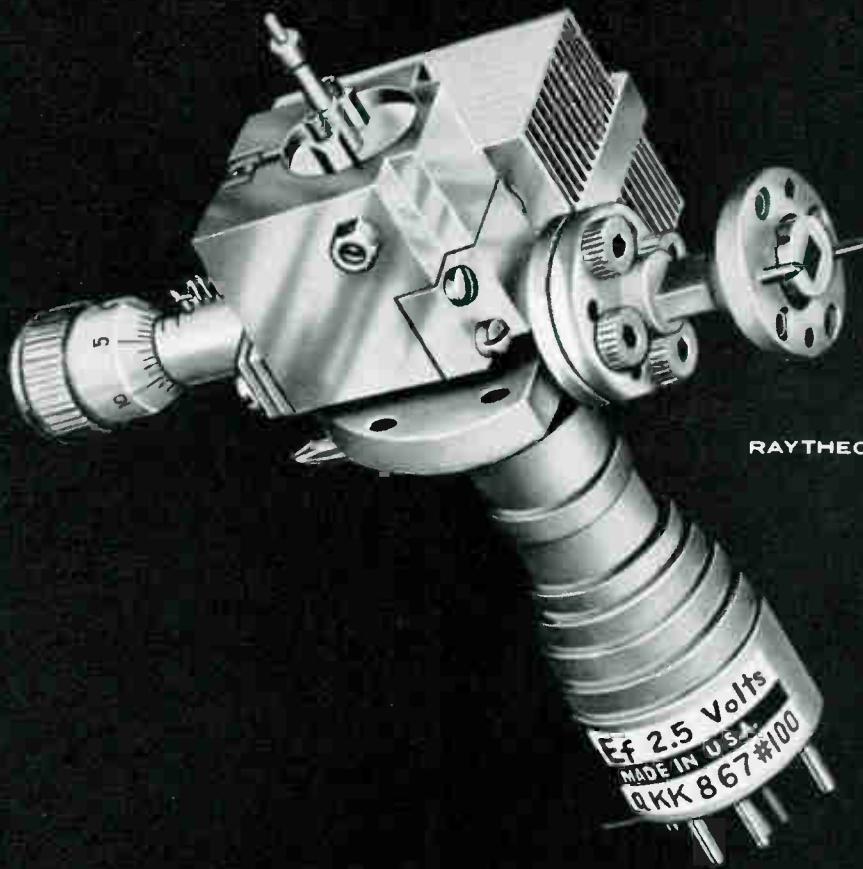

RAYTHEON QKK 867 KLYSTRON

## Now Raytheon offers 250-hour life with new klystrons for 50-101 kMc range

Raytheon's new QKK 867 Klystron, slightly enlarged to show construction details. Actual maximum dimension: 4 7/8 inches.

Raytheon announces five new reflex klystrons in the 50 kMc to 101 kMc frequency band. Featuring smooth vernier tuning, these integral-cavity tubes require unusually low voltages and can be operated from a single power supply. They are designed and constructed to withstand vibration of 10 G's (60 cps)—and

are rated by Raytheon for 250 hours of operation.

Write for detailed application information and special development service to: Microwave and Power Tube Division, Raytheon Company, Waltham 54, Massachusetts. In Canada: Waterloo, Ontario.

TYPICAL OPERATING CHARACTERISTICS			FREQUENCY RANGE IN KMC	
	QKK863 thru QKK866	QKK867		
Anode voltage	1400V	1700V		
Anode current	40ma	50ma		
Power output	40-400mW	15-40mW		
Reflector voltage	— -100 to -300V —			
Focus voltage	— -150V —			
Heater voltage	— 2.5V —			
Heater current	— 1.5A —			
Tuner turns	— 10 —			
Power output (min)	25 mW	10 mW		

RAYTHEON COMPANY

MICROWAVE AND POWER TUBE DIVISION



# electronics

A McGraw-Hill Publication 75 Cents



W. W. MacDONALD, Editor

J. M. CARROLL, Managing Editor  
 SENIOR ASSOCIATE EDITORS: Samuel Weber, Roland J. Charest. ASSOCIATE EDITORS: Frank Leary, Michael F. Tomaino, Sylvester P. Carter, William P. O'Brien, John F. Mason, William E. Bushor, Thomas Emma, Sy Vogel, Leslie Solomon, M. M. Perugini, George J. Flynn. ASSISTANT EDITORS: Michael F. Wolff, Nila Lindgren, Stanley Froud, Stephen B. Gray. REGIONAL EDITORS: Harold C. Haad (Pacific Coast, Los Angeles), Thomas Maguire (New England, Boston), Cletus M. Wiley (Midwest, Chicago). MARKET RESEARCH EDITOR: Edward DeJongh. BUYERS' GUIDE EDITOR: George Sideris. ART DIRECTOR: Harry Phillips; Howard R. Berry. PRODUCTION EDITOR: John C. Wright, Jr. EDITORIAL ASSISTANTS: Gloria J. Filippone, Arlene Rudd, Bernice Duffy, Lorraine Rossi, Virginia T. Bastian, Lynn Emery.

JAMES GIRDWOOD, Publisher

## BUSINESS

Space Plans for Next Decade. Exclusive report from JPL	38
How Tell-Tale Signs Can Help Kill Ballistic Missiles.	46
New England Sees Upswing. Semiconductor firms expanding	48
Underground Minuteman Antennas Pass Tests. Jam-resistant	49
Electronic Plotter Draws Weather Maps. Reduces drawing time	51
Crosstalk	4
Comment	6
Electronics Newsletter	9
Electronics Abroad	12
Washington Outlook	14
Financial Roundup	22
25 Most Active Stocks	22
Marketing	24
Current Figures	25
Meetings Ahead	52

## ENGINEERING

Actual driving conditions encountered by automobile engine are recorded for later playback on laboratory engine. See p 74	COVER
Stereophonic System for Television Broadcasting. Proposed compatible system for adding stereo sound to tv. By R. B. Dome	71
Tape Recorder Programs Engine Dynamometer Tests. Simulates driving. By V. C. Vanderbilt, Jr. and C. L. Zimmer	74
Digital Conversion of Electroencephalograph Records. Automatic conversion from graph to computer tape. By M. G. Saunders	78
Gas Clipper Tubes for Radar Service. Eliminate inverse voltage on pulse-forming network. By W. W. Watrous and J. McArtney	80
Measurement of Transistor Admittance Parameters. Instrumentation for measuring Y parameters. By K. Redmond	84
Designing Magnetostriction Filters. Nickel-iron rod filters have advantages over conventional forms. By E. J. Neville, Jr.	88
One-Transistor Linear Sweep Generator. No critical values or adjustments. By F. Lee	90

## DEPARTMENTS

Research and Development. Infrasonic Waves Provide Data	92
Components and Materials. Progress Report on Silicones	98
Production Techniques. Tape Cuts Wire Test Time, Errors	104
New on the Market	110
Literature of the Week	126
People and Plants	128
Index to Advertisers	135



## Chart new paths in printed circuits with Panelyte®

As new uses for printed circuits are developed, and new, more demanding designs are specified—count on Panelyte Copper-Clad Laminates for consistently superior quality.

At present, you can choose from a wide range of properties in four different grades. But St. Regis® Panelyte is working to perfect structural qualities which will meet your *future* needs, as well.

Whether you're looking for better machinability and adhesion, superior chemical resistance, closer thermal

tolerances or any special combination of characteristics, bring your copper-clad laminate specifications to Panelyte. We can supply Panelyte in the following grades: Paper Phenolic Base—XP, XXP, XXXP; Glass Melamine—G5; Glass Silicone—G7; Glass Epoxy—G10, G11. For complete information and the address of your nearest Panelyte distributor, write Dept. EL-1216, St. Regis Paper Co., 150 E. 42nd St., N. Y., N. Y.



# LAMBDA

## Transistorized Regulated Power Supplies

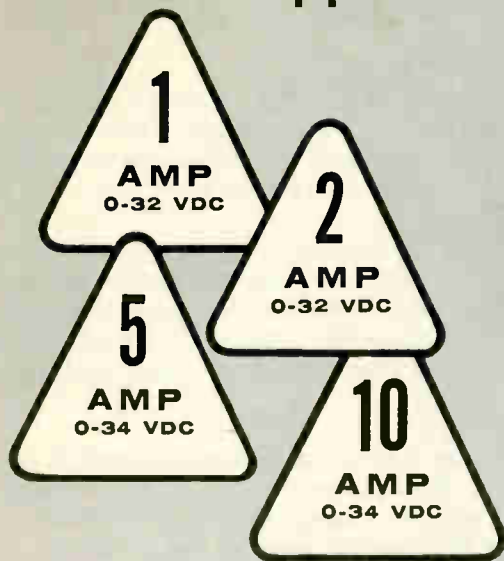

- Convection cooled—no internal blowers to wear out.
- Guaranteed for a full 5 years.
- Compact. 1, 2, and 5 Amp only 3½" high, 10 Amp 7" high.
- Ambient temperature 50°C.
- Excess ambient thermal protection.
- Special, high purity foil, hermetically sealed long-life electrolytic capacitors.
- Hermetically sealed transformer designed to MIL-T-27A.
- Remote sensing and DC vernier.



### CONDENSED DATA ON LT SERIES

LT 1095M (with meters)	0-32 VDC, 0-1 AMP	\$315
LT 2095M (with meters)	0-32 VDC, 0-2 AMP	395
LT 1095 (without meters)	0-32 VDC, 0-1 AMP	285
LT 2095 (without meters)	0-32 VDC, 0-2 AMP	365

MODEL	VOLTAGE BANDS
LT 1095, LT 1095M	0-8, 8-16, 16-24, 24-32
LT 2095, LT 2095M	0-8, 8-16, 16-24, 24-32

**Regulation:** Line: Better than 0.15 per cent or 20 millivolts (whichever is greater). For input variations from 105-125 VAC. Load: Better than 0.15 per cent or 20 millivolts (whichever is greater). For load variations from 0 to full load.

**AC Input:** 105-125 VAC, 50-400 CPS.

**Ripple and Noise:** Less than 1 millivolt rms.

**Ambient Temperature:** 50°C—continuous duty.

**Remote DC Vernier:** Provision for remote operation of DC Vernier.

**Remote Sensing:** Provision is made for remote sensing to minimize effect of power output leads on DC regulation, output impedance and transient response.

**Size:**  
LT 1095 3½" H x 19" W x 14¾" D  
LT 2095 3½" H x 19" W x 14¾" D

### CONDENSED DATA ON LA SERIES

LA 50-03AM (with meters)	0-34 VDC, 0- 5 AMP	\$425
LA100-03AM (with meters)	0-34 VDC, 0-10 AMP	540
LA 50-03A (without meters)	0-34 VDC, 0- 5 AMP	395
LA100-03A (without meters)	0-34 VDC, 0-10 AMP	510

MODEL	VOLTAGE STEPS
LA 50-03A, LA 50-03AM	— 2, 4, 8, 16 and 0-4 volt vernier
LA100-03A, LA100-03AM	— 2, 4, 8, 16 and 0-4 volt vernier

**Regulation:** Line: Better than 0.15 per cent or 20 millivolts (whichever is greater). For input variations from 100-130 VAC. Load: Better than 0.15 per cent or 20 millivolts (whichever is greater). For load variations from 0 to full load.

**AC Input:** 100-130 VAC, 60 ± 0.3 cycle. This frequency band amply covers standard commercial power lines in the United States and Canada.

**Ripple and Noise:** Less than 1 millivolt rms.

**Ambient Temperature:** 50°C—continuous duty.

**Remote DC Vernier:** Provision for remote operation of DC Vernier.

**Remote Sensing:** Provision is made for remote sensing to minimize effect of power output leads on DC regulation, output impedance and transient response.

**Size:**  
LA 50-03A 3½" H x 19" W x 14¾" D  
LA100-03A 7" H x 19" W x 14¾" D

LA 115

SEND TODAY FOR COMPLETE DATA.



# LAMBDA ELECTRONICS CORP.

11-11 131 STREET • DEPT. 1 • COLLEGE POINT 56, N. Y. • INDEPENDENCE 1-8500

Published weekly, with Electronics Buyers' Guide and Reference annually, as part of the subscription, by McGraw-Hill Publishing Company, Inc. Founder: James H. McGraw (1860-1948).

Title registered U.S. Patent Office; Copyrighted 1960, McGraw-Hill Publishing Company, Inc. All rights reserved, including the right to reproduce the contents of this publication, in whole or in part.

Executive, editorial, circulation and advertising offices McGraw-Hill Building, 330 West 42nd Street, New York 36, N. Y. Telephone Longacre 4-3000. Teletype TWX N.Y. 1-1636. Cable McGrawhill, N.Y. Printed in Albany, N. Y.; second class postage paid.

OFFICERS OF THE PUBLICATIONS DIVISION: Nelson L. Bond, President; Shelton Fisher, Wallace F. Traendly, Senior Vice Presidents; John R. Callahan, Vice President and Editorial Director; Joseph H. Allen, Vice President and Director of Advertising Sales; A. R. Venezian, Vice President and Circulation Coordinator.

OFFICERS OF THE CORPORATION: Donald C. McGraw, President; Joseph A. Gerardi, Hugh J. Kelly, Harry L. Waddell, Executive Vice Presidents; L. Keith Goodrich, Vice President and Treasurer; John J. Cooke, Secretary.

Subscriptions are solicited only from those actively engaged in the field of the publication. Position and company connection must be indicated on orders. Subscription rates: United States and Possessions, \$6.00 one year; \$9.00 two years; \$12.00 three years. Canada, \$10.00 one year. All other countries \$20.00 one year. Single Copies, United States and Possessions and Canada 75¢; Buyers' Guide \$3.00; Single Copies all other countries \$1.50; Buyers' Guide \$10.00.

The Publisher, upon written request from any subscriber to our New York Office, agrees to refund that part of the subscription price applying to copies not yet mailed.

Subscribers: Please address all correspondence, change of address notices, subscription orders or complaints to Fulfillment Manager, Electronics, at above address. Change of address notices should provide old as well as new address, including postal zone number if any. If possible, attach address label from recent issue. Allow one month for change to become effective.

Postmaster: Please send Form 3579 to Fulfillment Manager, Electronics, 330 West 42nd Street, New York 36, New York.



Audited Paid Circulation

# CROSSTALK

**INFORMATION CENTERS.** The quest for knowledge characterizes the whole history of man and, even more, the history of science. As we learn more, we need to know more. And one of the most wasteful activities in which man can engage is the search for knowledge which has already been discovered.

William G. Alexander of Ryan Transdata recently told a meeting of the Armed Forces Communications Electronics Association that this country spends \$1 billion a year on research for scientific and technological information that is already available. We can't vouch for the figure, but our own experience indicates that much research is wasted on ground that has already been well plowed.

Partly this is due to government security regulations; the services are gradually coming to see this, and are beginning to make information available when the need to know clearly exists. Partly the waste is due to corporate security measures taken to guard proprietary data.

Mr. Alexander wants to see the establishment of information centers that would make scientific information available to people who need it. He points out that if the duplication of research effort could be eliminated it would add 50,000 experienced man-years to the U. S. technological effort. He also comments that the Soviet Union has set up a global network that feeds scientific data to Moscow.

We like Mr. Alexander's idea, and we agree with his implicit proposal that the federal government, having done so much to keep technological data under its brass hat, should be among the first to disseminate it to industry. We also feel that the scientific societies and industrial associations could do much to implement the free exchange of information.

A great industrialist once said: "When you lock the doors of the research laboratory, you lock out far more information than you lock in."

## Coming In Our December 23 Issue

**LAST-HALF INDEX.** As an authoritative technical and industrial journal, ELECTRONICS publishes hundreds of feature articles every year. Since we pride ourselves in the fact that many of our subscribers find this material not only timely but useful for future reference, we devote considerable effort to our index.

Beginning with our July 1 issue, we indexed ELECTRONICS articles for the first half of 1960. Next week's issue contains the index for the last six months of 1960. You'll find more than 100 topic headings and several thousand entries that will help you locate specific departmental and feature articles by title, subject or author.

**SOLAR POINTING CONTROL.** Rocket-borne instruments for solar studies must be maintained in a fixed orientation with respect to the sun. A control system for this purpose is described in our next issue by C. H. Reynolds of Geophysics Research Directorate in Bedford, Mass., and M. Reisbeck of Ball Brothers Research Corp. in Boulder, Colo. Servo system uses photodetectors to position the nose cone containing instruments for studying solar ultraviolet, infrared and x-ray spectra.

ALL UNITS ACTUAL SIZE

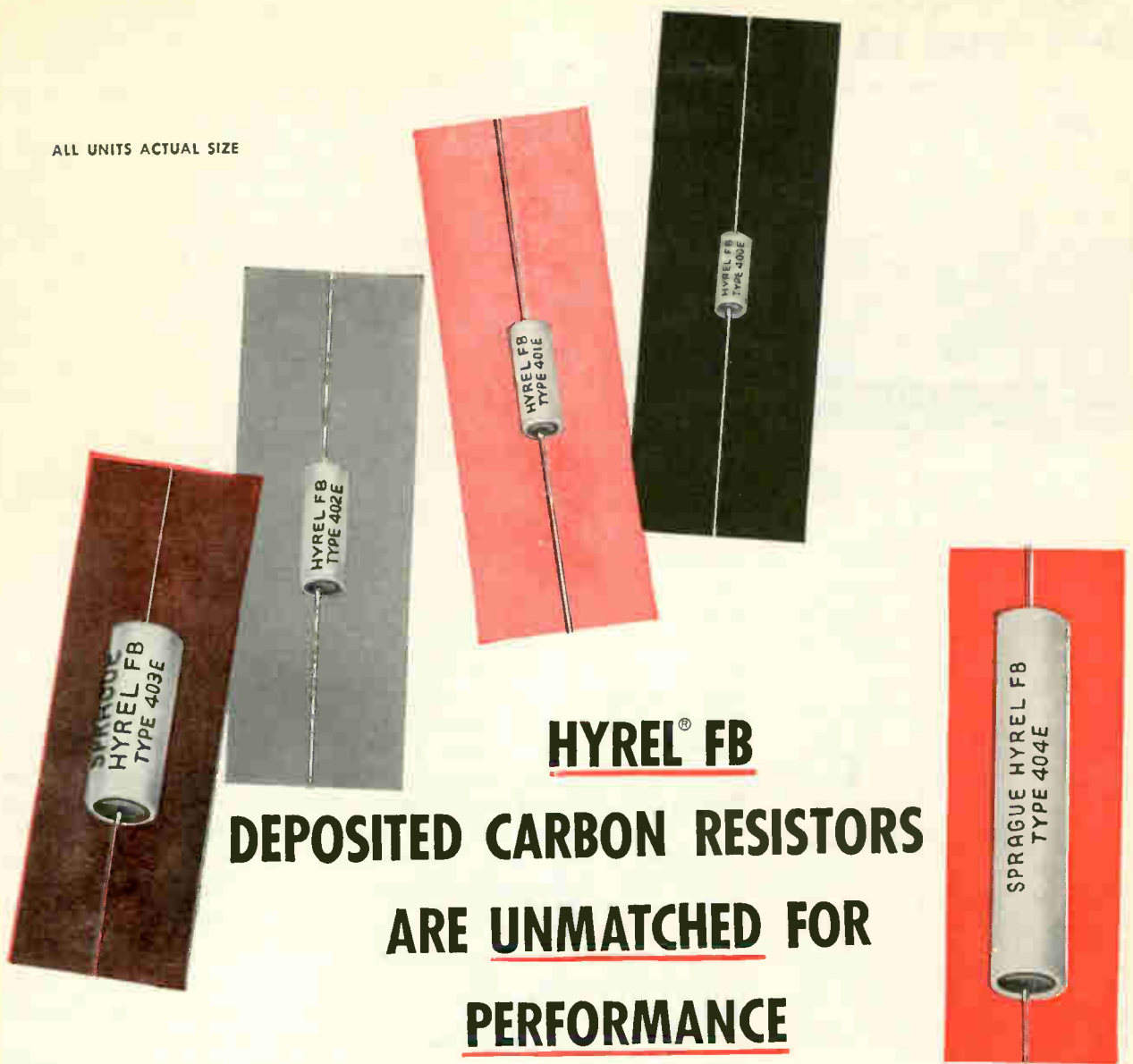

**HYREL<sup>®</sup> FB**  
**DEPOSITED CARBON RESISTORS**  
**ARE UNMATCHED FOR**  
**PERFORMANCE**

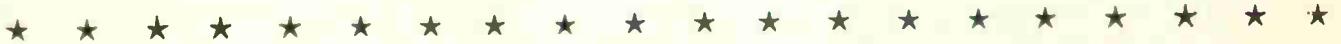

**HYREL<sup>®</sup> FB DEPOSITED CARBON RESISTORS**

are hermetically sealed in ceramic jackets against moisture and vapor ... **safely protected** against mechanical abuse.

The Hyrel FB series is intended for applications in military, commercial and telephone equipment where **long life under high humidity, small size, and stability of electrical characteristics** are important.

WRITE FOR ENGINEERING BULLETIN 7010B  
**SPRAGUE ELECTRIC COMPANY**  
 35 MARSHALL STREET • NORTH ADAMS, MASS.



Made to far exceed MIL-R-10509C Specifications

**SPRAGUE COMPONENTS**  
 CAPACITORS • RESISTORS • MAGNETIC COMPONENTS • TRANSISTORS • INTERFERENCE FILTERS • PULSE NETWORKS  
 HIGH TEMPERATURE MAGNET WIRE • CERAMIC-BASE PRINTED NETWORKS • PACKAGED COMPONENT ASSEMBLIES

# NEW DI-ACRO POWER SHEAR NO. 48

up to 160 strokes per minute



**A BREAK THRU IN PRECISION  
PRODUCTION SHEARING!**

The all new Di-Acro Power Shear No. 48 is a high speed, high production machine. Material capacity is 14 gauge mild steel across a 50 inch blade length. Standard equipment includes a micrometer operated ball bearing back gauge graduated in .001". This back gauge is double bracketed. An optional front operated control includes a counter with direct readings in both inches and thousandths.

The high-torque, high-slip totally enclosed motor of the Shear drives a fly-wheel with a built-in self-adjusting electric clutch. Triple V-belt drive is quiet, gearless. Because the electric clutch engages instantly without pausing for pins, splines or valves, the No. 48 shears at up to 160 strokes per minute on single cycling . . . ideal for use in conveyor and run-out lines. An adjustable cam operated brake engages only at the top of the stroke—no drag to wear out linings and absorb power.

Inclined ram keeps only the blade edge in contact with the material to be sheared. The angle of the blade counteracts thrust, keeps the blade straight and reduces force needed to shear material. It also permits the use of easy-to-sharpen straight sided blades which can be rotated to use all four edges for shearing.

The hold-down bar operates automatically and acts both as a safety guard and a material clamp. Individually spring loaded feet compensate for variations in material thickness and for shorter than full width sheets.

Standard equipment includes motor, automatic hold-down, micrometer operated back gauge, front gauge bar and brackets, side squaring gauges, reversible protractor gauge, one set of alloy tool steel four-edged blades, and a movable foot trip pedal.

For complete information consult the yellow pages of your phone book under Machinery: Machine Tools for the name of your nearest distributor or write us.

See complete Di-Acro line in Sweet's Machine Tool Catalog



pronounced  
die-ack-ro

**O'NEIL-IRWIN  
MFG. COMPANY**  
321 8th Avenue  
Lake City, Minnesota



Micrometer operated ball bearing back gauge graduated in .001".

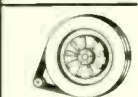

Electric clutch provides instantaneous action.

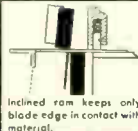

Inclined ram keeps only blade edge in contact with material.



Spring loaded feet compensate for variations in width and thickness of material.

## COMMENT

### Solid Sound

I suppose I'm rendering a futile protest, but one must speak.

We have the habit in this industry of coining neologisms and misusing words by subjecting them to semantic shift; for example, we say *binary* when we mean *dyadic* and *octal* when we mean *octonary*, and we've coined such neologistic horrors as *microminiaturization* and *superheterodyne*. But now we're about to overstep reason and begin using a term—*monophonic*—in a sense that is not only alien to the word, but which denies it its necessary meaning in another field.

*Binaural* and *monaural* were acceptable terms, being analogous to *binocular* and *monocular* and referring to the directional discrimination afforded by hearing (or seeing) with two organs as compared with the lack of discrimination produced by using only one. Both terms suddenly seem to be out of fashion. *Stereophonic* is all right; it is an analogous extension of *stereoscopic*, and means "solid sound," which is to say, sound with three dimensions.

Now the comparative term for sound coming from a single source is not *monophonic*. *Monophonic* means *one-voiced*, and is the logical correlative of *polyphonic*, a musical term describing many-voiced music such as Bach and his contemporaries wrote. Most of the symphonic music of Berlioz and Tchaikovsky, for instance, is monophonic, even if played on a stereophonic system.

The logical correlative of *stereophonic* should use a root comparing to *stereo-* (from Greek *stereos*, meaning *solid, three-dimensional*). *Platy-* (from Greek *platys*, meaning *flat, two-dimensional*) is an acceptable scientific root; *platyphonic* is one possible term.

If we want to suggest a two-dimensional source, we'd introduce a confusion; the Greek for *a line* is *gramma* (literally, a thing drawn or written), which comes from *graphein*, to write or draw. The word is also the source of *grammar*, and is rooted in other words suggesting writing (telegram), drawing (diagram), and so forth. *Gramophone* already uses the two

needed roots in the sense of "writing with sound;" so does *phonograph*. *Grammiphonic* would be the correct construction, but might be quite confusing.

A single-point source might also be suggested as a logical opposite of *stereophonic*; this would require using the Greek *acme*, a point. Unfortunately, *acme* (which also means a *high point, prime*) suggests an excellence that the stereophonists do not wish to suggest, which probably rules out *acmiphonic* or *acmatiphonic*. Anyway, they're hard to pronounce.

*Platyphonic*—"flat sound"—not only means what it says but even sounds dull and uninteresting. I suggest this coinage, if it's not too late; I also implore you, as an acceptable authority, to save *monophonic* for its original purpose, which is to provide a logical opposite to *polyphonic*.

K. MELONAS

NEW YORK

*We're overwhelmed by all the etymology! Any takers for platyphonic sound? Why not just abandon all the descriptive terms within five years, since by then all sound systems will probably be stereophonic high-fidelity anyway. Or at least they'll claim to be.*

### Telemetering Radiation Data

Ref.: "Telemetering Radiation Data by Frequency Variation," p 84, Nov. 11 . . .

I have to bring to your attention several errors . . .

In the circuit shown in Fig. 1B, the resistance should be marked 10 M, not 10 F. On p 84, col. 3, lines 8-10 should read "The decrease of capacitance through vane movement produces a frequency increase . . ." etc., not "The increase of capacitance . . ."

In addition . . . there is the omission of the statement distinctly shown on the title page of the original paper sent to your office that the work was done at Oak Ridge National Laboratory, which is operated for the Atomic Energy Commission by Union Carbide Nuclear Co. As you will know, such a statement is required by AEC . . .

HANS K. RICHARDS  
ARGONNE NATIONAL LABORATORY  
ARGONNE, ILL.



New!

# POWER, SIZE, VERSATILITY,

## IN A 5¼" PANEL POWER SUPPLY



- Fully Transistorized
- Remote Sensing
- Parallel Operation
- Low Cost
- Remote Programming
- Constant Current #
- Series Operation

**NJE extends its widely accepted 3½" QR line to include the 5¼" models.**

Output		Model No.	Input Power		Max. Ripple mv	Static Regulation		Dimensions	Approx. Weight Pounds	Price
Volts	Amps		Volts	Freq.**		Load*	Line*			
0-15	0-20	QR-15-20	105-125	55-65	3 P-P	±0.01 % or ± 1 mv	±0.02% or ±0.5 mv	5¼" 19" w x 16⅝" d	60	\$585
0-36	0-10	QR-36-10	105-125	55-65	3 P-P	±0.01 % or ±0.5 mv	±0.02% or ±0.5 mv		60	585
0-60	0-6	QR-60-6	105-125	55-65	3 P-P	±0.005% or ±0.5 mv	±0.02% or ±0.5 mv		60	610
0-10	0-10	QR-10-10	105-125	55-65	1 RMS	±0.005% or ±0.5 mv	±0.02% or ±0.5 mv	3½" 19" w x 16⅝" d	41	485
0-18	0-6	QR-18-6	105-125	55-65	1 RMS	±0.005% or ±0.5 mv	±0.02% or ±0.5 mv		41	485
0-36	0-4	QR-36-4	105-125	55-65	1 RMS	±0.005% or ±0.5 mv	±0.02% or ±0.5 mv		41	485
0-60	0-2.5	QR-60-2.5	105-125	55-65	1 RMS	±0.005% or ±0.5 mv	±0.02% or ±0.5 mv		41	510

\*Whichever is greater.

#Contact factory or local representative.

\*\*Available for 400 cps operation.

WRITE TODAY FOR COMPLETE TECHNICAL DATA



# NJE

## CORPORATION

20 Boright Avenue • Kenilworth, New Jersey

BR. 2-6000 • TWX Cranford, NJ 51 • FAX-FFP

# NEW!

From MAC Panel Co.

Available immediately . . . MAC Panel's new plugboard programming systems complete with lightweight removable plugboard and complete line of plugwires. There are six systems ranging in size from 160 contacts to 5120. All economically priced.

MAC / PANEL

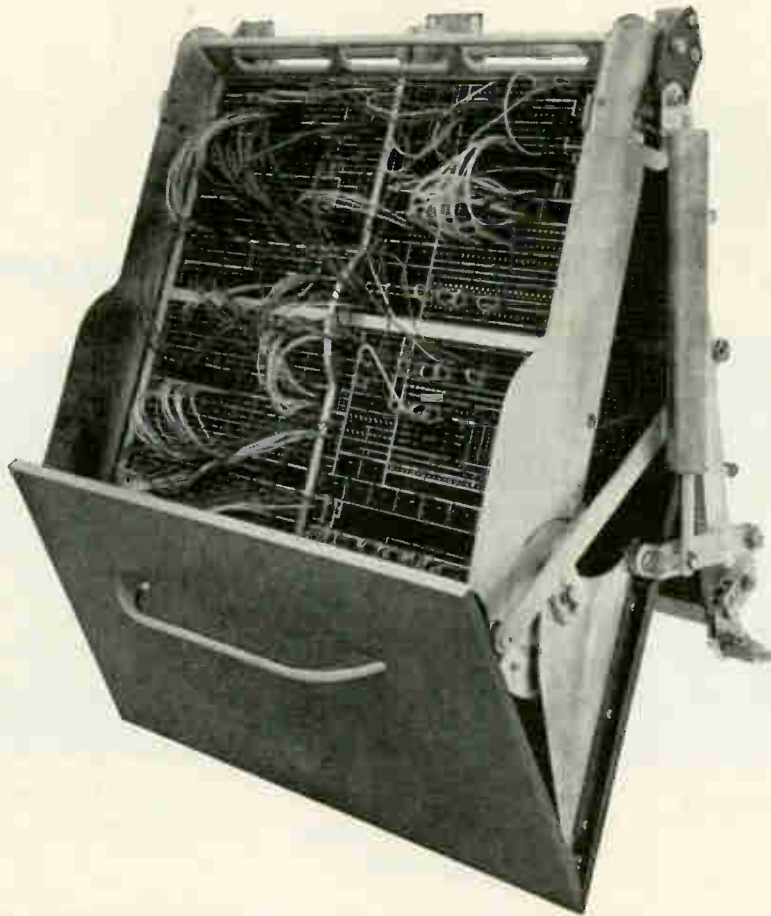

## Plugboard Programming Systems

■ Rugged, reliable, time proven receiver mechanism ■ Easy plugboard insertion ■ Integral door for flush cabinet mounting ■ Plugboards silk-screened to order and printing then baked to a chip-proof hardness ■ Single, dual and dual shielded plugwires in numerous lengths with manual or fixed tips ■ Plugwire tips and contacts, gold or nickel plated

For More Information  
Use The Handy Coupon

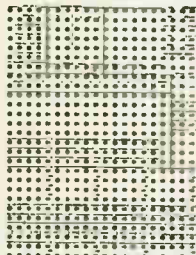

MAC / PANEL

J. V. Simone, OEM Division, MAC Panel Co.,  
124 College St., High Point, North Carolina

I am interested in your Programming Systems. Please send your catalog.

NAME \_\_\_\_\_ TITLE \_\_\_\_\_

COMPANY \_\_\_\_\_

STREET \_\_\_\_\_

CITY \_\_\_\_\_ STATE \_\_\_\_\_

# ELECTRONICS NEWSLETTER

## Rash of New Computers Expected to Come Soon

ON THE HEELS of the demonstration in Boston last week of the first Honeywell 800, you can reasonably expect a rash of new computer types to enter the marketplace within the next few months. Among them:

Remington Rand Univac will shortly announce three new systems ranging in size from small to large and including a few departures in both logic and hardware. One of the systems will be dubbed a realtime computer and will stress input-output flexibility for industrial uses. Another, now in production at Rem-Rand's big St. Paul, Minn., facility, is a system assembled from the best elements of several systems built previously by RemRand for government agencies and industry.

Control Data Corp. is readying a giant computer of the Larc-Strech class for probable release early in the Spring. The program is CDC's major engineering effort at the moment. Computer will sell for around \$8-10 million.

## Missile Cruisers Get Three-Dimensional Radar

NAVY and Hughes Aircraft simultaneously announced last week that radar systems capable of pinpointing supersonic targets in range, bearing, and altitude have been installed on missile cruisers and destroyers. Further details were not available as ELECTRONICS went to press.

## Association Acts To Stem Import Tide

ELECTRONIC INDUSTRIES ASSOCIATION's board of directors has embarked on a long-range program to combat increased imports of electronic products. The board has directed the Association's imports committee to figure out how to tell the public and Congress of the "damaging effects of foreign competition."

Board action came at the end of

EIA's winter conference in San Francisco last week. The conference also approved "in principle" a proposal to improve the reliability of electronic components used in military equipment, and authorized the engineering department of EIA to join the Institute of Radio Engineers in financing an investigation of space-communications frequency requirements and facilities for the Federal Communications Commission.

## British Produce Infrared Vidicon

VIDICON tube sensitive to both infrared and visible light is now being manufactured commercially by EMI Electronics of England. Tube is of standard dimensions and will fit an ordinary vidicon pickup camera.

EMI figures the tube will be useful for making temperature measurements. Tube can see an object as it reaches 450 C, at which temperature the object would just be entering the region of visible incandescence. With ir illumination from an external source, the ir vidicon could be used for burglar alarms and nocturnal studies.

EMI has also developed a vidicon pickup sensitive to ultraviolet for use in getting tv pictures from an ultraviolet microscope. The uv pickup is also sensitive to visible light.

## Plan Second Center For Space Surveillance

AIR FORCE is training new specialists in the problems of space surveillance against the forthcoming establishment of a second space-surveillance control center. The second center will be used by Continental Air Defense, will permit the original SSCC at Bedford, Mass., to go back to work on R&D problems.

Recent symposium of Air Research & Development Command pointed up need for extensive research in this area. Air Force

officers stated that present systems, using angular data for orbit determinations, are restricted to low-altitude satellites, and that new techniques using range or range-rate data are needed. Systems now in use have not always been able to fix orbits of USSR satellites on their first circuits, have sometimes produced contradictory orbit calculations, would be confounded by simultaneous passage of more than one satellite.

## U. S. Industry Employing 800,000 Engineers, Scientists

PRELIMINARY ESTIMATES from a recent government survey show that U. S. industry employed some 800,000 scientists and engineers in January 1960, up seven percent over the January 1959 figures. Reliable projections indicate that the number stands at about 850,000. Self-employed engineers and some small firms were not included; neither was the government.

Survey was conducted for National Science Foundation by Bureau of Labor Statistics, used a 10,000-company base. Proportionate increase from 1959 to 1960 was greatest for physical scientists; numerical increase was greatest for engineers, who added 40,000 to their ranks. About 80 percent of the people surveyed were engineers; of the scientists remaining, almost half were chemists. Forty percent of total surveyed were engaged in R&D activities including R&D administration.

Total engineer workforce (unclassified by type) in the U. S. numbered 656,300 in January; total physical scientists numbered 57,100.

## Soviet Computer Aids Aircraft, Tool Design

ELECTRONIC COMPUTER designated the MN-8 is being used by aircraft designers in the Soviet Union, judging from a report by cybernetician A. Prokhov to the USSR Academy of Sciences. The computer simulates 100 flight variables in all reasonable configurations in seven days, where normal "designing bureaus" would take seven

months to work out similar design problems using only ten variables.

The computer can also be used to test designs for surface and sub-surface ships, turbines, and machine tools.

### Plan Joint Action For Space Research

INTERGOVERNMENTAL Conference on Space Research, meeting in Geneva at the end of November, set up a commission to study the feasibility of a European organization for cooperation in space research. Accord was signed by nine of the 10 nations invited (Belgium, Denmark, France, Italy, the Netherlands, Norway, Sweden, Switzerland and the United Kingdom), and by Spain, which became a member state during the conference. Federal Republic of Germany attended, but its delegation was not empowered to sign. The European organization hopes to begin work in about a year.

### Thermoelectric Material Has High Efficiency

GADOLINIUM SELENIDE elements for thermoelectric conversion have demonstrated conversion efficiencies of 55 percent, according to Electronic Materials Corp. of Los Angeles. Previously announced efficiencies have been about 15 percent.

Material is also useful as a high-temperature semiconductor and an infrared detector. It is currently both expensive and tedious to produce, is in about the same exploratory stage as silicon and germanium were ten years ago. Recent Navy tests show that it is quite stable, doesn't easily degenerate. A single ounce of high-quality gadolinium selenide heated at one end to 800 C is said to be capable of producing 500 w.

### Facility Will Test Super-Power Klystrons

HIGH-POWER tube test facility will be built by Levinthal Electronic Products in Palo Alto, Calif., under \$1.2-million contract from Varian Associates. Varian needs the facil-

ity to test a new klystron, now being designed, that will be "far beyond" the present state of the microwave art. The klystron is known to have output specifications exceeding by several times the power output of the klystron used in the ballistic-missile early-warning system.

ELECTRONICS learns that the Levinthal facility will also be used by Sperry on that company's super-power klystron project. The advanced oscillator tubes are believed to be part of Project Defender.

### Air Force Investigates Atmospheric R-F Ducts

LONG-RANGE radio and radar transmission by natural ducts in the atmosphere is being investigated by USAF's project Tradewinds.

The project gets its name from the fact that the ducts seem to occur in the trade-wind belts, where trades of one temperature gradient and antitrades of another set up between them a duct—a sort of waveguide—whose walls are the temperature interfaces. Experimental reception of radar signals by aircraft 1,400 miles apart was reported recently to Air Research & Development Command.

### Stable Oscillator Uses Rubidium

OSCILLATOR stable to one part in  $10^{10}$ —equivalent to a shift of one second in 700 years—will be produced by Space Technology Laboratory's new products division starting early in 1961. The oscillator is regulated by the atomic frequency of rubidium, is said to be accurate to one part in  $10^9$ .

Optically pumped rubidium is affected neither by thickness of material nor by environment, will hold stable for two or more years. Output frequencies of 100 Kc and 1 and 5 Mc are all coherent. Solid-state device weighs 30 lb, will cost \$25,000.

### Consultant Firm Advances Enhanced Radar Theory

THEORETICAL STUDY of "enhanced-accuracy radar" has been turned

over to the Air Force by General Atronics Co., Bala-Cynwyd, Pa. The consultant firm has developed a mathematical demonstration that comparatively simple signal enhancement can produce an echo from which direct measurements can be made of speed, acceleration, and spin of targets. Proposed system would be applicable to existing radars, could be applied also to sonar and pulsed communications systems.

Nature of the enhancement was not disclosed. Study was undertaken for the signal-processing branch of USAF's Rome Air Development Center.

### Pentagon Is Setting Up Computer "Shopping List"

DEFENSE DEPARTMENT is turning over the recordkeeping chore for procurement and control of 3.5 million supply items to a computer system. In effect, the system will hold a catalog of Pentagon's enormous shopping list.

An IBM705 at the Armed Forces Supply Support Center in Washington, D. C., will keep the records, providing a single information source for control of the Department's resources. The system will let service users know what's in the catalog, who uses it (for burning off excess inventory), and who makes it. Equipment can handle 100,000 individual supply-management actions a day. A communications system using teleprinter lines connects the center to 35 inventory control points and 7 single-manager operating agencies around the country.

### Home Air-Cleaner Uses Two-Stage Precipitation

DOMESTIC air-cleaner unit to be put on the market by Minneapolis-Honeywell in January will employ two stages of precipitation, commonly found in units meant for commercial use. Selenium rectifiers and a leakage transformer maintain constant voltage on electrostatic charging and collecting elements in the precipitation cell. M-H says the unit removes 70 to 90 percent of airborne dust, is designed to be installed in forced-air heating and cooling systems.



## SPECIALISTS IN THE 3 C's OF ELECTRONICS

### CABLES

Complete versatility of design plus extra reliability characterize Bendix® Cable Assemblies. Types include encapsulated or braided missile control cable, thermo-couple harness, fuel cell, ground cabling, high temperature, and flat conductor cable.

### CAPACITORS

Count on Bendix High Temperature Capacitors for premium performance on missile and high-speed aircraft applications. Proved operation from  $-55^{\circ}\text{C}$ . to  $+400^{\circ}\text{C}$ . with no voltage derating and low capacitance variation.

### CONNECTORS

Can you use the finest electrical connectors in the business? Then try ours. Wide range of sizes and types available, including Pygmy® Miniature, Rack and Panel, QWL, and MS-R, and connectors for special applications.

For fast service on Cables, Capacitors, and Connectors, contact:

Scintilla Division  
SIDNEY, NEW YORK



# ELECTRONICS ABROAD



## Closed-Circuit Television Trains Mexican Physicians

MEXICO CITY—Physicians at last week's Pan-American Congress of Public Health saw demonstrations of the latest surgical and public health techniques here over closed television circuit. Last month, similar presentations were made by closed circuit with telecasts beamed from Mexico's Juarez hospital. Among treatments observed by doctors at that time was cessation of tremors in a patient suffering from Parkinson's disease after a staff member of the hospital's neurosurgical unit made a chemical injection into the patient's brain. The event was viewed on a 15 × 20-ft screen on which the picture was beamed by an Eidophor projector (pictured). The sessions were produced by Teletalent Inc., New York, in cooperation with the Mexican Ministry of Health, and sponsored by Ciba de Mexico. Bilingual camera crews were used; telecast was narrated in Spanish.

## Czech Transmitter Sold To United Arab Republic

DAMASCUS—Syrian Broadcasting System officials have signed a contract with KOVO, Czechoslovakia's foreign trade organization, for delivery of a medium-wave 2-by-150 radio transmitter that can operate either as two units, each with a power output of 150 Kw, or in parallel at 300 Kw. Manufactured by Tesla, the equipment resembles similar gear sold to Egypt. Czech

sources say the Syrians will also purchase a 2-by-300 unit for later installation. Sales contract calls for delivery within seven months with payment being made entirely in Syrian products.

## Rise Noted in Swiss Television Audience

ZURICH—Survey made in October showed 119,127 television license holders at the end of the month, of which 112,133 were home receivers and 6,994 were for public establishments and institutions. At the end of September Swiss license holders numbered 114,226. Swiss sources have no explanation for the rise of 4,901 set owners within the 30-day period.

## Indian Government Subsidizes Low-Cost Radio Receivers

NEW DELHI—Decision to popularize radio listening by poorer Indian masses has led this nation's government to increase foreign-exchange allocations to any radio manufacturer who devotes 10 percent of production to receivers costing \$25 or less (125 rupees). For every five percent of production of the low-cost units, manufacturers will be given five percent additional foreign exchange to import components and raw materials. A maximum production of 20 percent over and above the initial ten percent of low-cost set production has been imposed.

First sets are expected to be on the market by the end of this month or early in January; India hopes to produce between 50,000 and 60,000 during 1961.

## British Firm Develops Sonar Receiver for Blind

LONDON—Sonar-type obstacle detector enabling blind people to detect objects including small steps and sidewalk curbs up to 20 ft away was shown here last month. The unit, about the size of a box camera, emits a narrow beam of high-fre-

quency sound which bounces off objects in its path. Called the Sondar Signal, it emits the sound pulses in bursts of 50 to 100 per second. The pulse is modulated at about 10,000 cps to make it audible. The emitter is transistorized and operates from a dry battery or storage battery of 9 to 12 v. Peak output on bursts is at 20 watts with an average battery drain of one watt. Valradio, Ltd., the manufacturers, say present units are prototypes which can be made smaller.

## Scots Use Underwater Tv For Loch Inspections

EDINBURGH—An underwater television camera will be used for research into fish habits and hydraulic problems in Scottish lochs. Among other things, the cameras will inspect screens on the huge intakes of hydroelectric turbine systems that prevent young salmon from being swept into the mechanisms. The job of inspecting the screens had been previously done by divers. The camera will also be used to inspect tunnels linking dams and power stations according to the Scotland Hydroelectric Board. Inspections at depths of 120 ft have already been conducted with reports that tv monitors allow better viewing of conditions than divers can rely on in murky water. The underwater camera is made by Marconi.

## Canada Adopts New Ground Conductivity Map

OTTAWA—Officials of the Department of Transport have adopted a revised map of ground conductivities for the Dominion effective the first of next month. The map will supersede appendix H to the North American Regional Broadcasting Agreement signed in Washington, D. C., in 1950. It will be used in transborder interference calculations involving Canada. Copies of the new map may be bought for \$5.00 through the Director of the Telecommunications & Electronics Branch of the Department of Transport in Ottawa.

# FROM .2 WATT TO 120 WATTS ...FROM 5 MC TO 225 MC

## a **PSI POWER AMPLIFIER** **FOR EVERY APPLICATION!**

This Great New Line of Triple Diffused Silicon Mesas Provides a Transistor for Almost Every Communications Need!

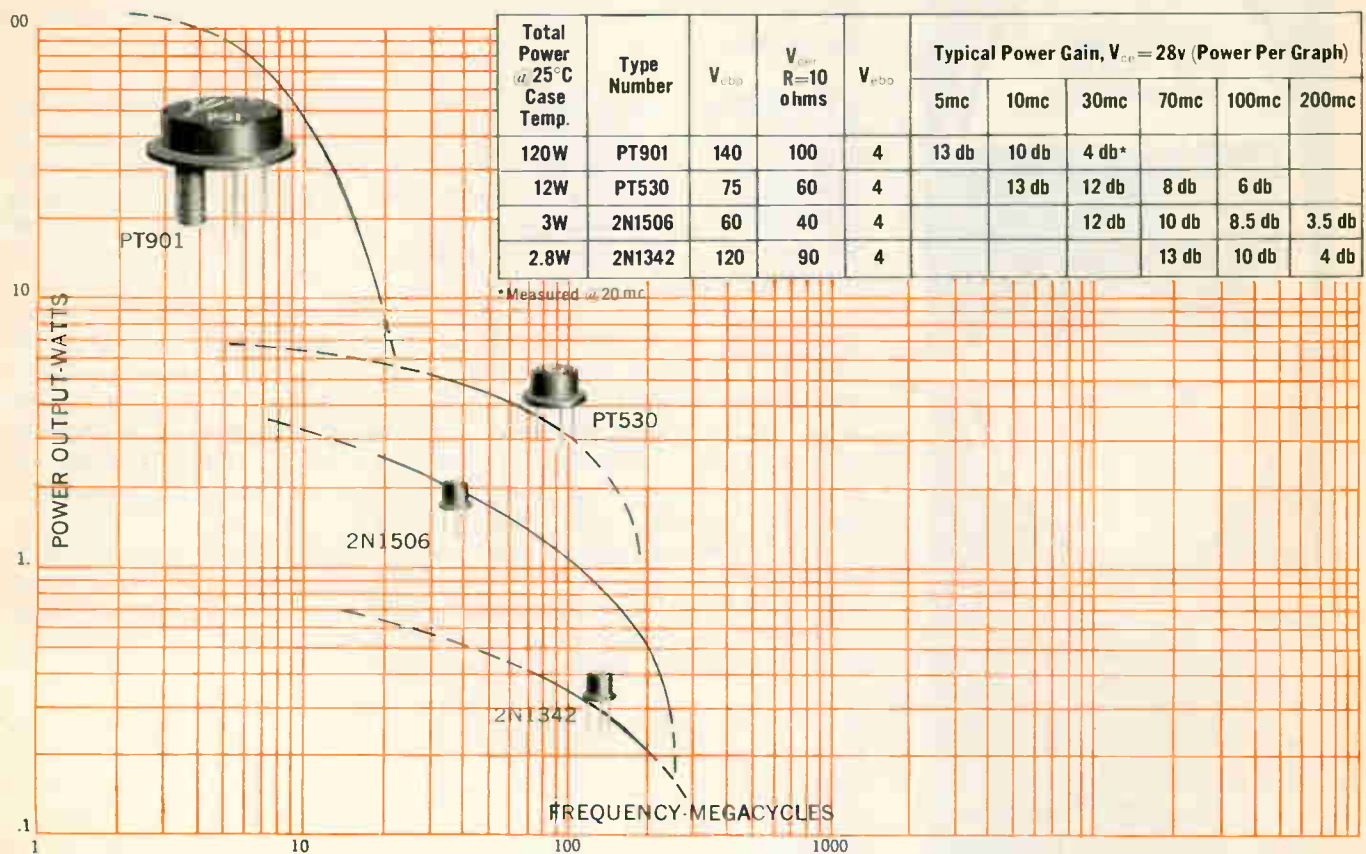

Designers of advanced communications equipment can now take a totally new approach to engineering of high performance transmitters in power and frequency ranges never before possible.

A PT530, for example, will furnish 5 watts RF power output at 30 mc (12 db power gain) or 3 watts at 70 mc (8 db power gain). It is the only silicon transistor capable of driving the PSI type PT901 power amplifier transistor to its full 100 watts output. The new 2N1342 furnishes a substantial amount of power for the designer working in the UHF region

... 200 mW RF output at 225 mc.

There are lower cost oscillator versions of the above types, too. The 2N1505 performs admirably in a circuit where you don't need the high gain characteristics of the 2N1506.

Immediate delivery is being made on evaluation quantities of types PT530 and PT901. Large quantity delivery is being made on all other PSI communications and switching transistors... including the remarkable new 2N1837 high performance switch.



PHONE, WIRE OR WRITE ANY PSI SALES OFFICE FOR FULL DETAILS.

### *Pacific Semiconductors, Inc.*

A SUBSIDIARY OF THOMPSON RAMO WOOLDRIDGE, INC.

12955 CHADRON AVENUE • HAWTHORNE, CALIFORNIA • TWX: HAW CAL 4270  
Facilities in Hawthorne, Culver City and Lawndale, California

# WEINSCHEL

## ANTENNA PATTERN ANALYZER MODEL BA-7

Measure 45 db (r. f.) in one step using a maximum of 1 microwatt r. f. power\*

\*100% square wave modulated at 1000 cps  $\pm$  .1 cps. Observation time approximately 45 seconds for 45 db; only .2 seconds for 30 db.

Bandwidth variable from 2 to 15 cps with constant gain



MODEL BA-7

The BA-7 is the heart of a video detector system designed primarily for r. f. crystals. For greater versatility, a d. c. biasing circuit is included to permit use of conventional diodes, requiring a d. c. bias between 0 and 10 ma. The unit can be used to measure very high power ratios such as 40db in making antenna pattern measurements, to determine the rejection coefficients of r. f. filters, and to calibrate attenuators. It has a wide dynamic linear range, a low noise level, and a wide r. f. frequency range where video crystal mounts are available.

For complete specifications, write for Bulletin No. 141.

Weinschel Fixed Coaxial Attenuators cover the frequency range of DC to 12.4 KMC. Write for complete catalog, specifying frequency range of interest.



**Weinschel Engineering**  
KENSINGTON, MARYLAND

# WASHINGTON OUTLOOK

WIDESWEEPING plan to reorganize the Defense Department has been submitted to President-designate Kennedy by a committee headed by Sen. Stuart Symington (D., Mo.). In essence, the plan follows proposals laid out in a bill introduced by Symington earlier in the year.

*For the electronics industry, the plan would mean far greater centralization of research, engineering, procurement and production in the military services. The plan would downgrade the roles of the individual services in these fields (it proposes abolition of the service secretaryships), and would provide more unified control over contracting through a new Undersecretary of Defense for Weapons Systems.*

Symington claims the plan would cut defense costs by 20 percent and shorten lead times on weapons systems development by streamlining the Pentagon's decisionmaking machinery and by minimizing duplication of effort. The plan is based on the thesis that "there is no longer validity in separating (weapons system) development and production cycles," and that "rigid distinctions" between R&D and production organizations are no longer needed.

U. S. TAX COURT trial of Boeing's appeal from a renegotiation board ruling that the company made \$9.8 million in excess profits (before taxes) in 1952 will resume shortly here. The case is the largest negotiation appeal by a defense contractor ever to come into the court, and puts into sharp public focus the fundamental issues of the controversial law. The trial has dragged on for more than three years, and has been in recess for almost two years.

*A U. S. District Court judge has just submitted a final ruling on Boeing's attempt to see government records relating to the case. The government had fought the company's move, arguing that such papers are protected by executive privilege. The judge supported the government's claim that all internal documents of the board that relate to the decision-making process are matters of executive privilege. But he ordered the government to allow Boeing to see Air Force reports to the board on the company's contract performance.*

This is the first time a renegotiation appellant will have access to official papers. Government spokesmen, however, say they will continue to withhold records from contractors on future cases, that individual appellants will have to go to the court to obtain access to official documents regarding excessive profit determinations.

NIKE ZEUS guidance system has had its first successful test firing. In a recent experimental launching, the Army says control commands were sent to the missile as it raced through the sky. The missile "responded to them successfully to perform a planned drive in the trajectory." Western Electric is Nike Zeus guidance prime contractor; Lear is a major subcontractor.

But while the Army is meeting test schedules successfully, it has failed once again to get Pentagon approval to begin production of major missile components prior to the 1962 full-scale tests at Kwajalein.

ALL SPACE EXPERIMENTS from now on will use 136-137 Mc to transmit data back to earth. National Aeronautics and Space Administration has added the necessary antennas and electronic equipment at eight of its Minitrack stations. Dual capability—on both 108 Mc and 136-137 Mc—is being retained to accommodate space experiments still transmitting on 108 Mc.

*Reason for the shift is that the 108 Mc is too close to existing television channels and interference has been a nuisance. Space use of 108 Mc was approved by Federal Communications Commission only as a temporary measure for the International Geophysical Year.*

NASA expects to have all of its 13 Minitrack stations converted to the new frequency by next May. Cost to change the Minitrack stations is about \$250,000 apiece.



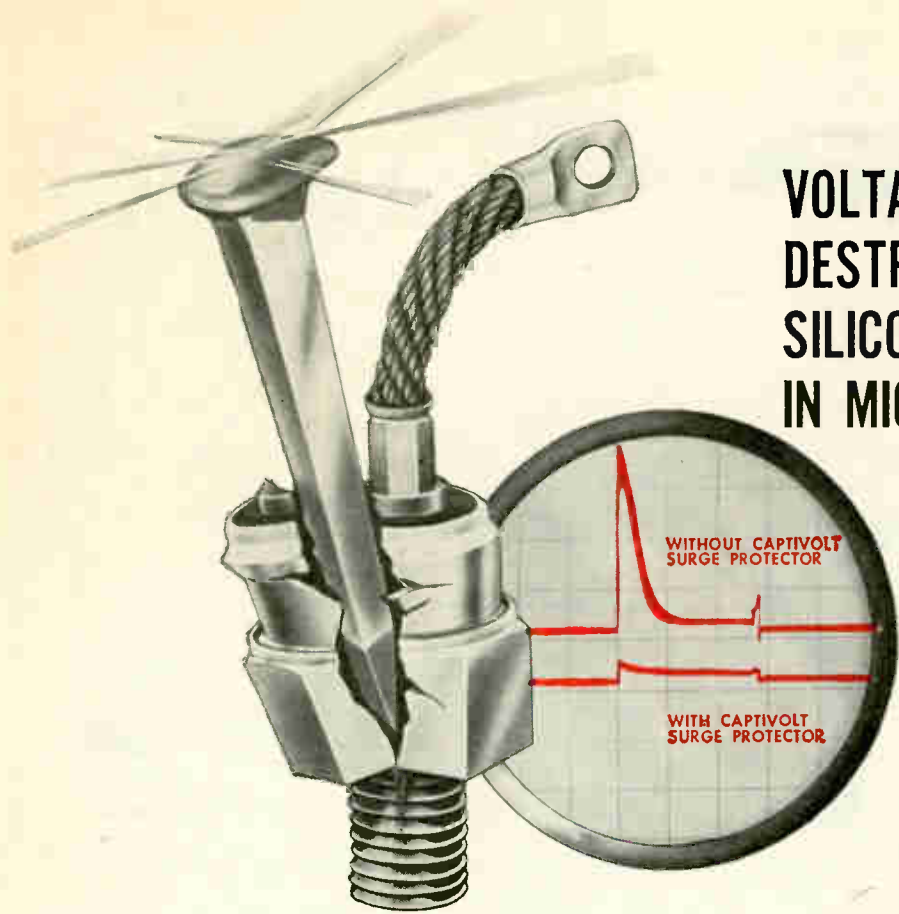

# VOLTAGE "SPIKES" DESTROY SILICON RECTIFIERS IN MICRO-SECONDS!

Silicon power rectifiers are sensitive to transient voltage spikes . . . furthermore, the magnitude of these spikes is often unpredictable—derating of rectifier cells doesn't necessarily prevent rectifier breakdown!

In the new Surge Protector, CAPTIVOLT<sup>™</sup>, Vickers has combined in a single simple component the best features of several methods of voltage surge protection . . . Captivolts provide rectifier reliability, assure extended life, and eliminate the need for expensive derating of costly rectifier cells . . . yet, the Captivolt, itself, is a dependable low-cost unit which can be easily installed by simply connecting across the transformer secondary supplying AC to the rectifier. Captivolts capture and absorb unpredictable surge energy up to 3000 watts with 0.05 micro-second response.

Under normal steady-state operation, the Captivolt Surge Protector appears as a very high resistance shunted by capacitance. The capacitance provides rectifier protection by absorbing very fast transient wave-fronts. When a critical voltage level is reached, the normal high resistance falls abruptly to a very low value so that long-duration destructive voltage transients are shunted — resistance decreases almost logarithmically with increase in voltage. (Under normal operating voltage, the high resistance of the Captivolt Surge Protector consumes less than five watts).

In summary, Captivolt Surge Protectors have two significant virtues:

- They provide rectifier reliability and extended life . . .**
- They save real money — often more than \$50.00 initial rectifier cost with a Captivolt cost of less than \$3.00 . . .**

If you use silicon power rectifiers, be positive . . . protect with CAPTIVOLTS. For more information on Captivolts, call our nearest Sales Engineering Office or write us direct.

*P. S. Captivolts have many other applications! We recommend you use them wherever there is a surge suppression need.*

**ORDER SAMPLES TODAY — One day shipment**  
(Bulletin 3135-1 available upon request)

EPA 3130-2

ARNPRIOR, ONTARIO (REP.), ARnprior 400  
 BOSTON (REP.), CEdar 5-6815  
 CHICAGO, JUniper 8-2125  
 CLEVELAND, EDison 3-1355  
 DALLAS (REP.), FLeeewood 1-1837  
 DETROIT, TOWnsend 8-5100  
 SAN FRANCISCO (REP.), DIamond 2-7494

ST. LOUIS, CEntal 1-5830  
 (REP.), JACkson 1-4877  
 SYRACUSE (REP.), GRanite 4-4889  
 LOS ANGELES, SPRuce 5-2401  
 NEW YORK CITY, LEnnox 9-1515  
 WASHINGTON, D. C., EXecutive 3-2650

## STANDARD TYPES AND RATINGS

Type No.	Rated Peak Volts, Recurrent Continuous Duty Across AC Line	Rated RMS Volts, Continuous Duty Across Sinusoidal AC Line	Maximum Dissipation, Average Watts	Price Each (Net)
SP102	25	17.5	10	\$1.80
SP105	50	35	12	1.95
SP110	100	70	14	2.20
SP115	150	105	17	2.50
SP120	200	140	20	2.70
SP125	250	175	23	2.95
SP130	300	210	26	3.15
SP140	400	280	32	3.70
SP150	500	350	38	4.20
SP160	600	420	44	4.65

<sup>1</sup> If fan cooling at velocity of 600 LFM is employed, multiply watts by two (2).

<sup>2</sup> Maximum recommended surge amperes, instantaneous convection cooling five (5) amperes.

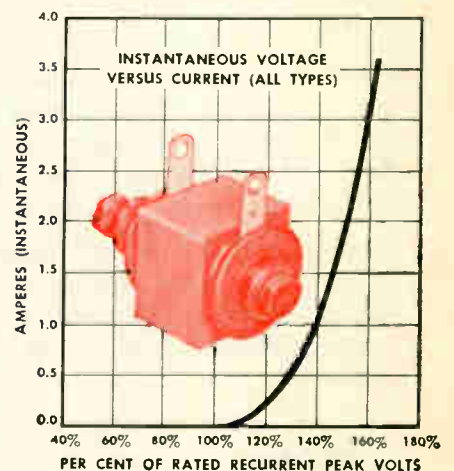

## VICKERS INCORPORATED

DIVISION OF SPERRY-RAND CORPORATION

**ELECTRIC PRODUCTS DIVISION**

1801 LOCUST STREET • SAINT LOUIS 3, MISSOURI

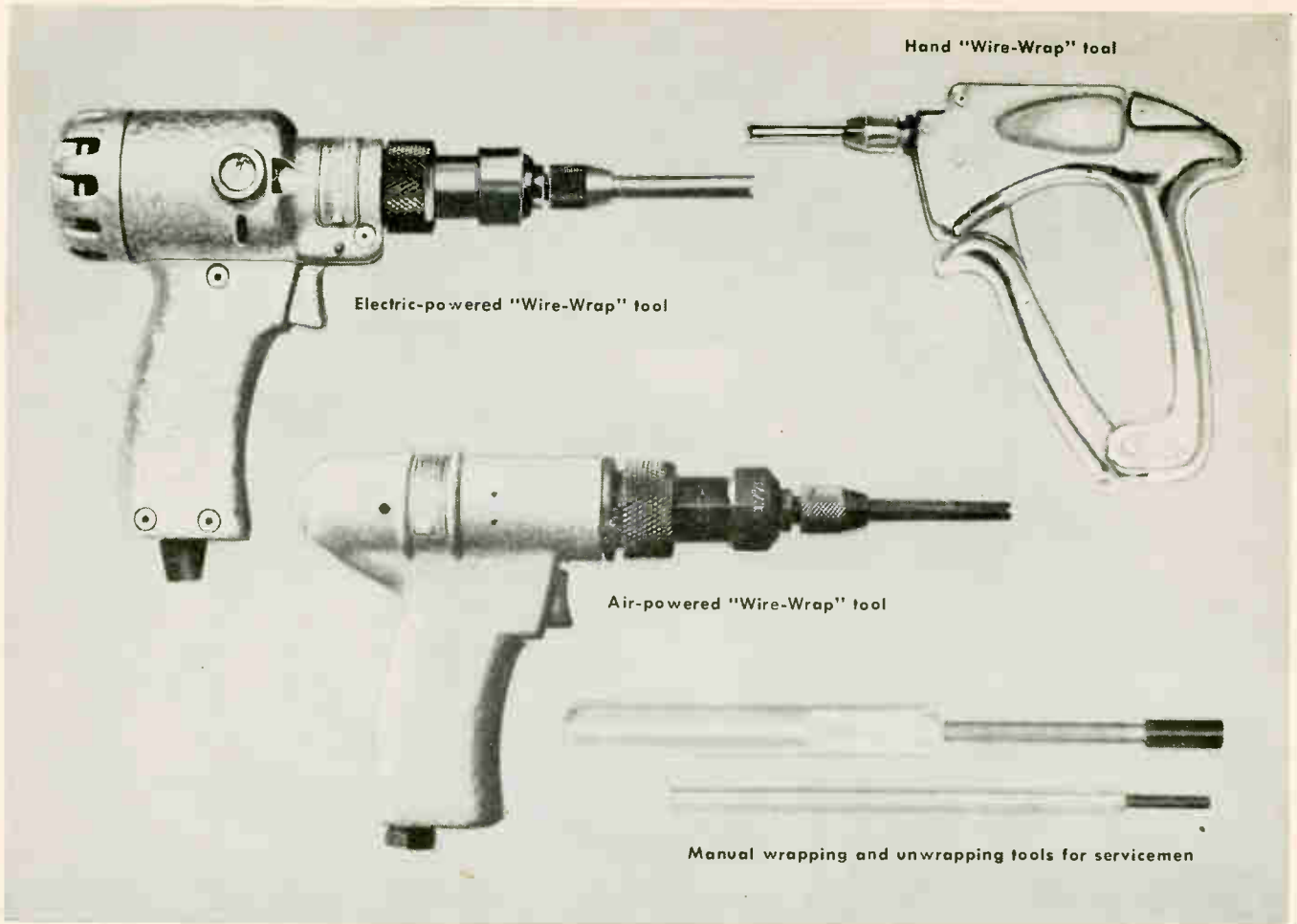

## Gardner-Denver Wire-Wrap® roundup

Choose from Gardner-Denver's complete line of hand-held "Wire-Wrap" tools and put your electrical connections on a 3-second production schedule. That's all the time it takes to make a permanent electrical connection using the solderless wrapping method.

Proved superior by leaders in communications and electronics, these connections are lastingly secure, conquer vibration failure and corrosion. Only Gardner-Denver offers a complete line of equipment to make such connections, including . . .

**automatic "Wire-Wrap" machines** like the one at right. If you have a special problem in multiple operations of connecting wires, it'll pay you to see Gardner-Denver first. Want details? Write for bulletins.



Operated manually or automatically by punched cards or tapes, machine can place 10,000 wires on a 20" x 20" modular terminal board. Wraps terminals in a 10" x 10" wrap area—puts as many as three connections on each terminal. Completes entire wrapping cycle to interconnect two terminals in six seconds.



EQUIPMENT TODAY FOR THE CHALLENGE OF TOMORROW

# GARDNER - DENVER

Gardner-Denver Company, Quincy, Illinois

In Canada: Gardner-Denver Company (Canada), Ltd., 14 Curity Ave., Toronto 16, Ontario

# ELECTRON TUBE NEWS

...from SYLVANIA

Sylvania  
**STRAP FRAME  
GRID** boosts tube  
performance  
vital to  
critical designs

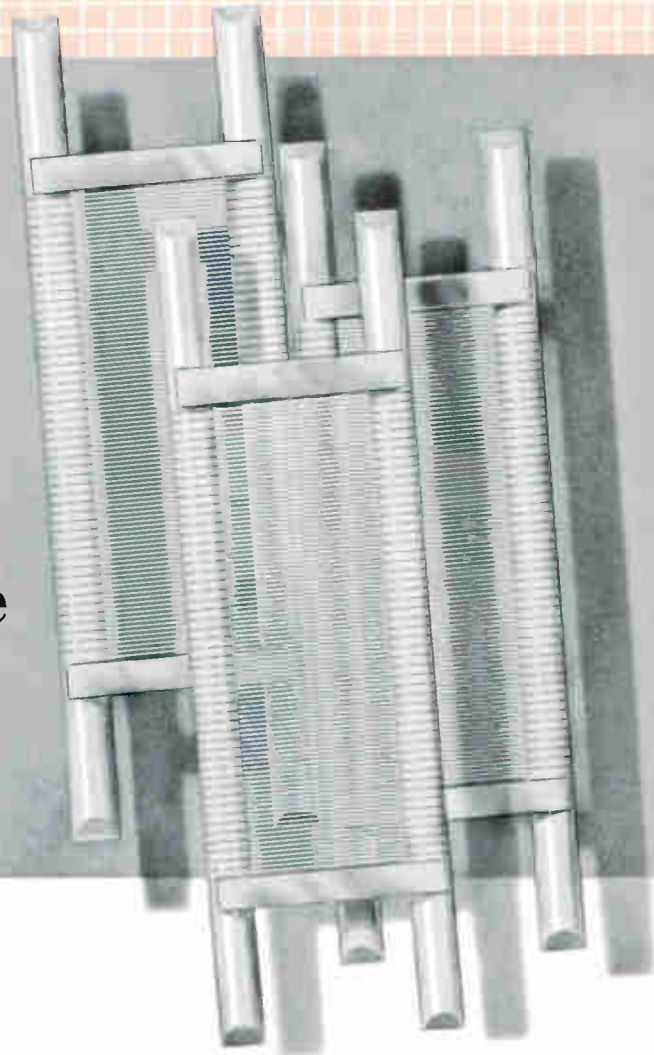

- **HIGH Gm PER mA Ib**
- **HIGH UNIFORMITY**
- **HIGH ELECTRICAL STABILITY**
- **HIGH MECHANICAL STRENGTH**
- **LOW NOISE**
- **LOW MICROPHONICS**

Sylvania *strap frame grid* structure brings remarkable uniformity to grid characteristics, delivers significant improvements to tube performance. Here's why: *strap frame* design enables use of very fine diameter grid wire and higher T.P.I. Mechanical strength and dimensional control are improved by precise fabrication of sturdy lateral straps to side rods. Automated machinery accurately disciplines grid pitch and alignment to exacting tolerances; tightly winds grid wires to form a "flat," uniform, minor grid dimension.

Result: Sylvania *strap frame grid* provides high transconductance, enables uniform grid-cathode spacing and resultant low dispersion of characteristics from tube to tube. It affords much improved control of cut-off characteristics. Too, it contributes significantly to high electrical stability, minimal noise and microphonics, high resistance to vibration and shock.



# SYLVANIA TUBES...FOR TEST EQUIPMENT APPLICATIONS

feature strap frame grids

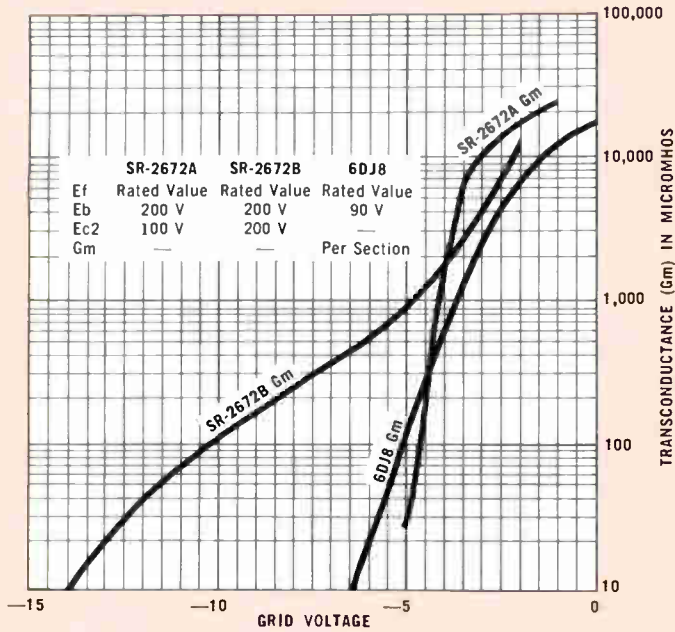

**SYLVANIA-6DJ8** . . . sharp cutoff double triode designed for amplifier service. Sylvania-6DJ8 features transconductance of 12,500  $\mu$ mhos, low noise and microphonics.

**SYLVANIA-SR-2672A** . . . semi-remote cutoff pentode for IF amplifier service. The new SR-2672A offers a transconductance of 12,500  $\mu$ mhos, and low input capacitance. It employs a special mica design and outer shield for added structural strength.

**SYLVANIA-SR-2672B** . . . sharp cutoff pentode designed for IF amplifier service. The new SR-2672B features transconductance of 15,000  $\mu$ mhos, low input capacitance. It utilizes specially designed mica to keep cathode rigidly in position, and an outer shield to strengthen mount structure.



DESIGN CENTER RATINGS	6DJ8*	SR-2672A	SR-2672B	UNITS
Plate supply voltage	550	550	550	V
Plate voltage	130	250	250	V
Plate dissipation	1.8	2.5	2.5	W
Cathode current	25	25	20	mA
Negative grid #1 voltage	50	—	—	V
Grid #1 circuit resistance	1.0	1.0	1.0	Megohm
Grid #2 voltage	—	250	250	V

\*Max. ratings for each section

# SYLVANIA LOW NOISE TUBES...FOR TV TUNER APPLICATIONS

feature strap frame grids



**SYLVANIA-6ES8** . . . semi-remote cutoff double triode for RF cascode amplifier service. Transconductance is 12,500  $\mu$ mhos. 6ES8 uses *Sarong Cathodes* as well as *strap frame grids*. This combination achieves greater uniformity in grid-cathode spacing for improved cutoff characteristics, high stability, exceptional uniformity.



**SYLVANIA-6FQ5A** . . . new semi-remote cutoff triode designed for VHF RF amplifier service at a B+ of 135 volts. 6FQ5A features low noise figures and high Gm per mA of plate current. Its transconductance is 15,000  $\mu$ mhos. The transfer curve is controlled at 4.2 volts and 2.5 volts to remove points of inflection, thereby reducing cross modulation. Sylvania-6FQ5A employs a partial shield between grid and plate for low capacitance and dual cathode leads to reduce input loading.

DESIGN MAXIMUM RATINGS	6ES8*	6FQ5A	UNITS
Plate supply voltage	550	—	V
Plate voltage	130	200	V
Plate dissipation	1.8	2.5	W
DC cathode current	22	22	mA
Negative grid voltage	50	50	V
Grid circuit resistance	1.0	1.0	Megohm

\*Each section

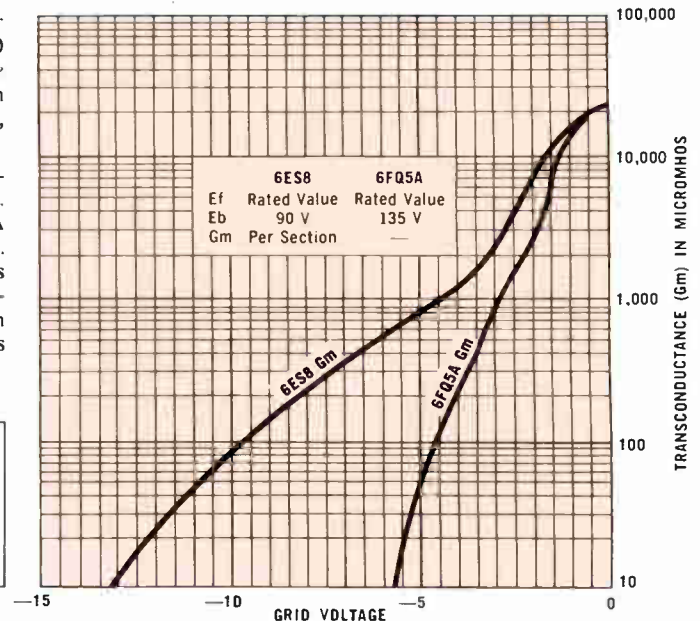

Ask your Sylvania Sales Engineer about the advantages of high-quality, domestically produced, Sylvania *strap frame grid* tubes. For data on specific types, write Electronic Tubes Division, Sylvania Electric Products Inc., Dept. L, 1100 Main St., Buffalo 9, N. Y.

# SYLVANIA



## Important facts to know about Laminated Plastics

# LAMINATED PLASTICS *What they are, where they can be used*

Taylor laminated plastics, also known as reinforced plastics, are thermosetting-type materials formed by impregnating paper, cotton cloth, asbestos, glass cloth, nylon or other base materials with synthetic resins and fusing them into sheets, rods, tubes and special shapes under heat and pressure. These materials exhibit a valuable combination of characteristics, including high electrical insulation resistance, structural strength, strength-to-weight ratio, and resistance to chemical reaction; also adaptability to fabricating operations.

### Types of laminated plastics made by Taylor

There are four basic types of Taylor laminated plastics commonly specified and used throughout industry today. They are as follows:

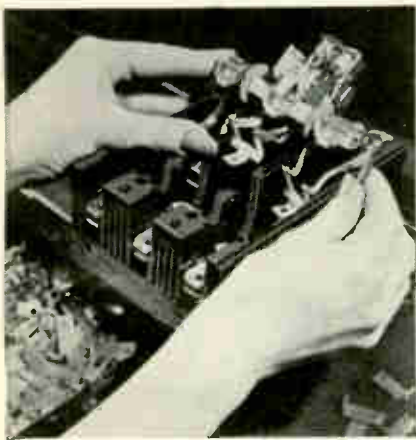

**Phenolic Laminates.** Paper, cotton fabric or mat, asbestos, glass cloth or nylon bases impregnated with phenol formaldehyde resins. These provide strength and rigidity, dimensional stability, resistance to heat, chemical resistance, and good dielectric characteristics. Some Taylor grades are excellent basic materials for gears, cams, pinions, bearings and other mechanical applications. Others are widely used in terminal boards, switchgear, circuit breakers, switches, electrical appliances and motors. Also in radios, television equipment and other electronic devices; and in missiles as nose cones, exhaust nozzles, and combustion chamber liners.

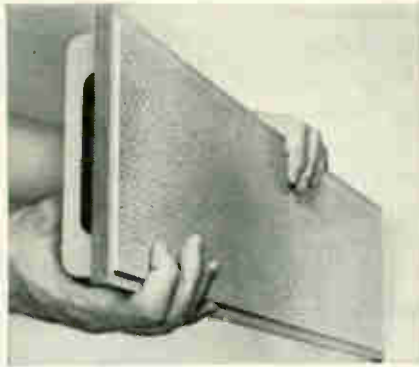

**Melamine Laminates.** Glass cloth or cotton fabric impregnated with melamine formaldehyde resin. Taylor melamine laminates have superior mechanical strength and are especially desirable for their arc-resistant qualities. Good flame and heat resistance, good resistance to the corrosive effects of alkalis and most other common solvents, besides other favorable characteristics. Typical applications include arc barriers, switchboard panels, and circuit-breaker parts in electrical installations.

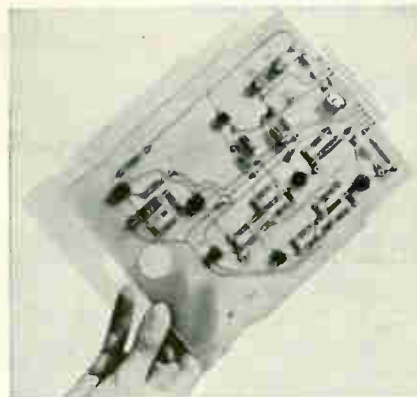

**Silicone Laminates.** Continuous-filament woven glass fabric impregnated with a silicone resin. These laminates combine high heat resistance (up to 500°F. continuous) with excellent electrical and mechanical properties. They are primarily used in high-temperature electrical applications and high-frequency radio equipment.

**Epoxy Laminates.** Continuous-filament woven glass fabric or paper impregnated with epoxy resin. Glass-fabric grades are designed for use in applications requiring high humidity-resistance, good chemical resistance,

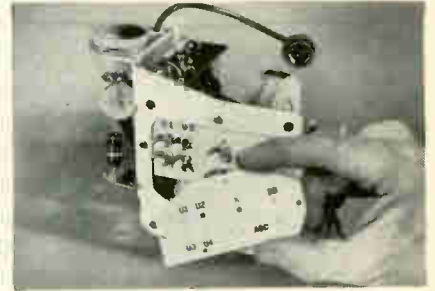

and strength retention at elevated temperatures. Paper grades are used under high-humidity conditions where resistance to acids and alkalis is required. Both grades are characterized by good dielectric strength, low dielectric losses, and high insulation resistance even following severe humidity conditions.

Recent technical advances in the bonding of various metallic and nonmetallic materials to laminated plastics have opened up new design opportunities. It is now possible to bond virtually any compatible material with a laminated plastic to form a composite which combines the advantages of both. One of the first composite materials was a copper-clad laminate used for printed circuits. More recent composite laminates, usually manufactured to customer specification, include the following: Taylorite® vulcanized fibre-clad, rubber-clad, asbestos-clad, aluminum-clad, beryllium-copper-clad, stainless-steel-clad, magnesium-clad, and silver- and gold-clad. Any one of these materials can be sandwiched between sheets of laminates, too, and can be molded to fit specific requirements.

Send for complete information about any or all of these Taylor laminates. And remember Taylor's new selection guide will simplify your problems in choosing the right laminate for your specific application. Taylor Fibre Co., Norristown 40, Pa.

# Taylor

LAMINATED PLASTICS VULCANIZED FIBRE

# HERMACH-ENGELHARD multi-range transfer volt-ammeter with 0.05% accuracy through a frequency range d-c to 50,000 cps.

This multi-range instrument satisfies the exacting calibration requirements over a wide range of currents and voltages. High accuracy is attained without use of correction factors.

The functional design of this transfer standard, employing the null principle, provides operation sufficiently simple for non-technical operators. Results are read on the external d-c potentiometer in a conventional way and multiplied by convenient round numbers to give measured current or voltage to 0.05%, without correction, continuously over the frequency spectrum from d-c to 50,000 cps. To achieve the accuracy which the Hermach-Engelhard Transfer Volt-Ammeter provides across the whole audio frequency range, a whole battery of the usual measuring devices would be needed.

To provide efficient adaptability to various conditions of application, several models can be obtained. They are portable, simple and economical to maintain.

INSTRUMENTS AND SYSTEMS DIVISION • 850 PASSAIC AVENUE  
EAST NEWARK, N. J.

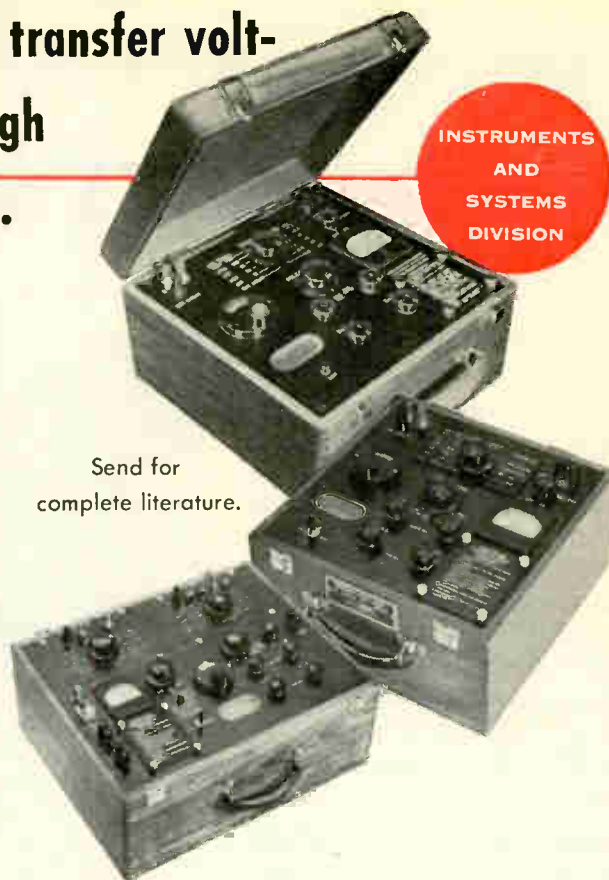

Send for complete literature.

# a complete range of brush materials for printed circuit applications.

Because the correct choice of contact materials for use on printed circuits is wholly dependent upon such factors as type of circuit, circuit function and mechanical design, the final selection of materials is generally obtained on an empirical basis.

Baker engineers and metallurgists are prepared to offer very broad, specialized experience, together with extensive records of performance data that can be extremely useful to you. They will be pleased to assist in resolving your particular problems in this field.

Baker-developed alloys and powdered metal products meet the full range of brush material requirements for printed circuit applications. Complete facilities are available here for reliable design and manufacture. Send for literature.

BAKER CONTACT DIVISION • 207 GRANT AVE., E. NEWARK  
HARRISON P. O., N. J.

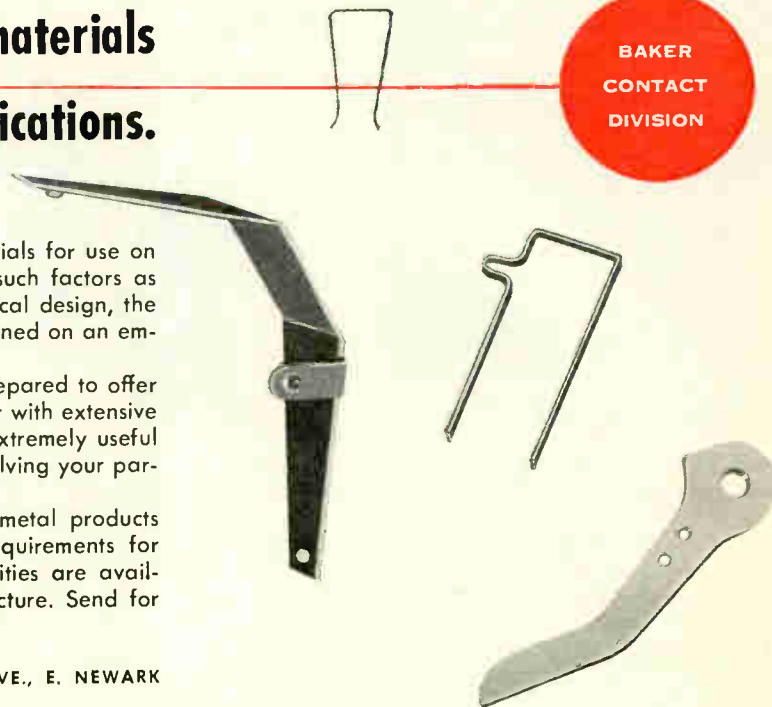

DOMESTIC DIVISIONS: AMERICAN PLATINUM & SILVER DIVISION • AMERSIL QUARTZ DIVISION • BAKER CONTACT DIVISION • BAKER DENTAL DIVISION • BAKER PLATINUM DIVISION • BAKER SETTING DIVISION • CHEMICAL DIVISION • HANOVIA LIQUID GOLD DIVISION • INSTRUMENTS & SYSTEMS DIVISION • IRVINGTON-BAKER REFINING DIVISION • D. E. MAKEPEACE DIVISION • RESEARCH & DEVELOPMENT DIVISION • H. A. WILSON DIVISION. COMPANIES ABROAD: ENGELHARD INDUSTRIES OF CANADA, LTD., TORONTO • ENGELHARD INDUSTRIES LTD., BAKER PLATINUM DIVISION, HANOVIA PRODUCTS DIVISION, LONDON • SOCIEDAD SURAMERICANA DE METALES PRECIOSOS S.A., BO-

PROMPT PRECIOUS METAL SCRAP RECOVERY SERVICE • ENGELHARD PROCEDURES RECOVER

CHEMICAL  
DIVISION



**SUPER-SENSITIVE  
DEOXO INDICATOR**



**MINOXO  
INDICATOR**

## for detection and measurement of oxygen or hydrogen impurities in other gases

**MINOXO INDICATOR** . . . measures traces of molecular oxygen in other gases—from 1 to 10 parts per million, and from 1 to 100 PPM. High sensitivity and rapid speed of response enable it to be used for laboratory investigation and production quality control.

**SUPER-SENSITIVE DEOXO INDICATOR** . . . measures oxygen or hydrogen present as impurities in other gases—from 2 to 200 parts per million oxygen and 4 to 400 parts per million hydrogen. Dual range permits measurement up to .25% oxygen or .50% hydrogen. Send for literature.

CHEMICAL DIVISION • 113 ASTOR STREET  
NEWARK, N. J.

**ENGELHARD**  
INDUSTRIES, INC.

EXECUTIVE OFFICES:

113 ASTOR STREET • NEWARK 2, NEW JERSEY

CHEMICAL  
DIVISION

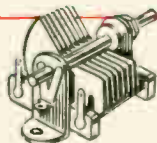
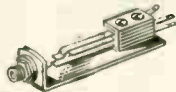

## corrosion-resistant rhodium plating

The properties of Rhodium are particularly well-suited to many electrical and electronic applications. In general, Rhodium improves efficiency whenever a low-resistance, long-wearing, oxide-free contact is required. Rhodium plate assures low noise level for moving contacts, no oxide rectification, low and stable contact resistance. Rhodium plated slip rings and commutators show negligible wear. The positive action of plated contacts subjected to long periods of inactivity emphasizes the efficiency of Rhodium for safety alarm contacts. Excellent protection against atmospheric corrosion is obtained for printed circuits by plating Rhodium over nickel to assure long wear and low noise, or Rhodium over Silver to protect against tarnish and corrosion.

In the realm of high and ultra-high frequency the high resistance of Rhodium to surface corrosion under all atmospheric conditions is specially useful. Oxide-free contacts eliminate partial rectification and unwanted signals.

Call for technical assistance or write for literature.

CHEMICAL DIVISION • 113 ASTOR STREET  
NEWARK, N. J.

CRYSTAL STRUCTURE	FACE CENTERED CUBIC A° 3.7954
ATOMIC WEIGHT	102.91
DENSITY	12.44
MELTING POINT	1966°C
COEF. OF LIN. EXPANSION	8.19 X 10 <sup>-6</sup> °C, PER °C
THERMAL CONDUCTIVITY	(0°C) 213 C.G.S. UNITS
REFLECTIVITY ELECTROPLATE	78% AT-620 MU
HARDNESS ELECTROPLATE	540-640 V.H.N. 20 GRAM LOAD



GOTA • ENGELHARD INDUSTRIES S.A.R.L., PARIS • ENGELHARD INDUSTRIES A/S, COPENHAGEN • GLOVER & GOODE PTY., LTD., MELBOURNE • ENGELHARD INDUSTRIES, K.K., TOKYO • ENGELHARD INDUSTRIES, PTY., LTD., MELBOURNE • ENGELHARD INDUSTRIES, LTD., ZURICH • INDUSTRIE ENGELHARD S.P.A., ROME • GIULIANO STACCIOLI-METALLI PREZIOSO S.P.A., ROME • INVERSIONES EN INDUSTRIAS NACIONALES, S.A., BOGOTA. ASSOCIATED COMPANIES: KALIE-CHEMIE-ENGELHARD KATALYSATOREN G.M.B.H., HANOVER

**100% OF ASSAYED PRECIOUS METAL CONTENT • IRVINGTON-BAKER REFINING DIVISION**

# Blue Jacket

MINIATURE AXIAL LEAD RESISTORS

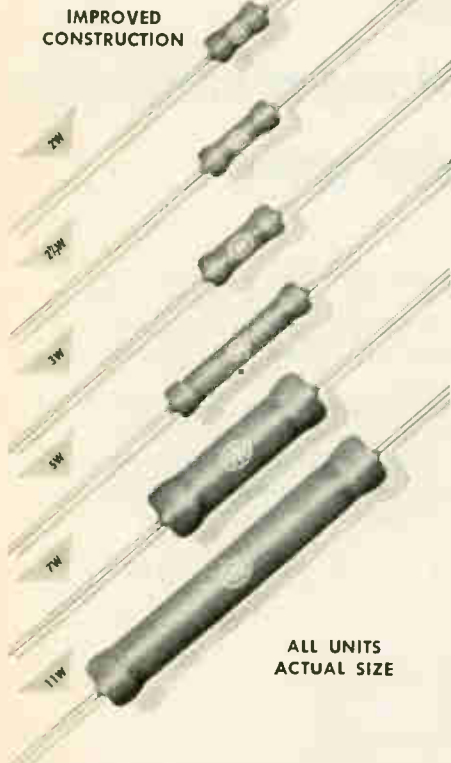

## VITREOUS-ENAMEL POWER RESISTORS

Sprague reliability is built-in these dependable Blue Jacket miniature axial lead resistors. New all-welded end-cap construction gives improved reliability under severe environmental conditions.

Blue Jackets are ideal for use in miniature electronic equipment with either conventional wiring or printed wiring boards.

Get complete data on these dependable minified resistors, write for *Engineering Bulletin 7410A*.

**SPRAGUE ELECTRIC COMPANY**  
35 Marshall Street, North Adams, Mass.



## FINANCIAL ROUNDUP

### Reeves Plans New Stock Issue

REEVES SOUNDCRAFT CORP., Danbury, Conn., has filed with Securities & Exchange Commission for registration of a block of 150,000 shares of common stock. These shares will be purchased by the Prudential Life Insurance Co. of America in accordance with a warrant agreement concluded with Reeves in 1958. Reeves will receive payment of \$3.00 a share from the insurance company. The Prudential will then place the shares up for public sale through Emanuel, Deetjen & Co. at market prices. Prudential acquired the warrants in connection with a sale to Reeves of \$600,000 in promissory notes. The electronics company now has 3,054,815 shares of stock outstanding of which company officials hold 324,538 shares.

Siegler Corp., Los Angeles, has filed with SEC for registration of 410,000 shares of common stock and 105,000 shares of no par cumulative convertible debentures to be offered to stockholders of another company with which Siegler is studying merger plans. Stockholders of the other firm, Jack & Heintz, will receive one share of Siegler for each 0.55 shares of J&H they now hold, if the merger transaction is completed. J&H manufactures electric power generating equipment.

Laboratory for Electronics, Boston, reports record six-month earnings of \$911,000 on gross sales of \$20,725,000 for the period ended Oct. 28, this year. This is equivalent to earnings of \$1.30 per share of common stock. In the previous six-month period, earnings of \$423,000 on gross sales of \$17,205,000, or 81 cents per share were reported. H. W. Harding, LFE president says new orders received during the current period amounted to \$22,016,000 resulting in a contract backlog of \$29,574,000 with increases to about \$40 million expected.

Electro-Science Investors, Inc., Dallas, Tex., reports acquisition of a potential equity in excess of 65 percent in Rawco Instruments.

ESI's commitment of nearly \$440,000 is in the form of convertible debentures and common stock. The Texas-based Small Business Administration investment company has assets in excess of \$14 million. With the investment in Rawco, ESI's total investment commitment has reached nearly \$1½ million since Oct. 27 of this year.

Electro-Logic Corp., Venice, Calif., manufacturer of electronic instruments has just issued \$125,000 in common stock with 40 percent of the shares being purchased by individual investors. A major portion of the original capitalization of the California company was supplied by Midwest Technical Development Corp., Minneapolis-based investment firm licensed by SBA. MTDC president, A. J. Ryden says the new stock issue will not only add to Electro-Logic's working capital, but will also permit his company to revert to a minority interest, a position he prefers. Investors in the new stock issue bought a total of 12,500 shares at \$10 per share.

### 25 MOST ACTIVE STOCKS

	WEEK ENDING DECEMBER 2, 1960			
	SHARES (IN 100's)	HIGH	LOW	CLOSE
Transitron	1,970	38¾	35¼	36¾
Ampex	1,847	23½	20¾	23¼
Sperry-Rand	1,053	19½	18½	18½
Polarad	981	24	19½	23
Gen Tel & Elec	918	26½	25¼	25¼
Gen Inst	878	42¾	38¾	39¾
Int'l Tel & Tel	828	43¾	41¾	43
RCA	759	57¾	54¾	55¼
Loral	706	32½	29	31
Gen Elect	689	77½	74¾	74¾
Avco Corp	679	14¼	13¼	14¼
Martin Co	619	62¾	59	59¾
Univ Controls	585	15¾	14½	15
Siegler Corp	467	30¼	27	29¼
Westinghouse	457	50½	49	49¾
Collins Radio	455	53¾	48¾	49½
Philco Corp	433	18	16¾	16¾
EI-Tronics	432	8¼	6¼	6½
Lockheed	422	27¾	25¾	25¾
Gen Dynamics	414	42¾	39¾	39¾
Stand'd Kollsman	406	24¾	22¾	22¾
Litton Ind	360	89¾	82¾	85¾
Varian Assoc	347	49¾	46¼	47¾
Amer Electrnics Inc	306	12¼	10¼	11¼
Raytheon	305	35½	32¾	33

The above figures represent sales of electronics stocks on the New York and American Stock Exchanges. Listings are prepared exclusively for ELECTRONICS by Ira Haupt & Co., investment bankers.



Another *NARDA* exclusive!

# DIGITAL

1-8-6-50

## Direct- Reading Frequency Meters



*No interpolations needed!*

New — and only from Narda! Microwave frequency meters you can read at a glance! The digital counter permits even the least-experienced to get rapid, precise readings without interpolations, charts or curves. And, because the tuning rate is linear with frequency, the new meters are readily adaptable for remote indication. May be panel-mounted, too, if you have a system application.

Best of all, you get these features with no sacrifice of quality or accuracy (0.1% or better): The high-Q cavities are precision-bored; the cast housing is extremely rugged; the mechanism is carefully and accurately constructed. Electrically, the unit is equivalent to a straight section of waveguide when detuned. Dip at resonance is at least 10%. Complete specifications are shown at right.

This is just one of many precision Narda microwave products. For a free copy of our complete catalog, write to: Dept. E-12.

### SPECIFICATIONS

Band	X	KU	K
Frequency (KMC)	8.20-12.4	12.4-18.0	18.0-26.5
Waveguide (in.)	1 x 1/2	.702 x .391	1/2 x 1/4
Accuracy	0.08%	0.1%	0.1%
Loaded Q	7000	5000	4000
Length (in.)	4	4	4
NARDA Model Number	840	839	838
Price	\$195.	\$250.	\$275.



the **narda** microwave  
corporation

118-160 HERRICKS ROAD, MINEOLA, L. I., N. Y. • PIONEER 6-4650

# Answering Sets Show Growth



## Precision Instrument Company Engineering Sales Representatives

- |  |  |
|--|--|
| <b>ALBANY, New York</b><br>SBM Associates, Inc.<br>HEmlock 8-5381                        | <b>SALT LAKE CITY, Utah</b><br>Williams & Associates, Inc.<br>EMpire 4-6844                          |
| <b>ALBUQUERQUE, New Mexico</b><br>V. T. Rupp Company<br>ALpine 6-0798                    | <b>SAN CARLOS, California</b><br>R. L. Pflieger Company, Inc.<br>LYtell 1-0396                       |
| <b>ATLANTA, Georgia</b><br>Scientific Sales Engrg. Co.<br>TRinity 3-2475                 | <b>SAN DIEGO, California</b><br>V. T. Rupp Company<br>CYpress 8-9835                                 |
| <b>BALTIMORE, (Towson 4) Maryland</b><br>Gawler-Knoop Company<br>ENterprise 9-3151       | <b>SEATTLE, Washington</b><br>Rush S. Drake Associates, Inc.<br>EASt 3-8545                          |
| <b>BOSTON, (Arlington) Massachusetts</b><br>Instrument Associates<br>MISsion 8-2922      | <b>ST. LOUIS, Missouri</b><br>Harris-Hanson Company<br>MISsion 7-4350                                |
| <b>CHICAGO, Illinois</b><br>Pivan Engineering Company<br>KEYstone 9-4383                 | <b>WASHINGTON, D. C.</b><br>(Silver Spring, Md.)<br>Gawler-Knoop Company<br>JUUniper 5-7550          |
| <b>CLEVELAND, Ohio</b><br>Electro Sales Associates<br>REDwood 2-7444                     | <b>WINSTON-SALEM, (Pffafftown) N. Carolina</b><br>Scientific Sales Engineering Co.<br>WABash 4-2182  |
| <b>DALLAS, Texas</b><br>Dannemiller-Smith, Inc.<br>FLEetwood 7-8249                      | <b>ARGENTINA, Buenos Aires</b><br>Mauricio A. Suarez<br>Telecomunicaciones<br>Phone: 30-6312 34-9087 |
| <b>DAYTON, Ohio</b><br>Electro Sales Associates<br>CHapel 4-5551                         | <b>AUSTRALIA, Melbourne</b><br>Geo. H. Sample & Son Pty. Ltd.<br>17 Anthony Street                   |
| <b>DENVER, Colorado</b><br>Williams & Associates, Inc.<br>SKYline 6-9403                 | <b>AUSTRALIA, Sydney</b><br>Geo. H. Sample & Son Pty. Ltd.<br>Phone: MA 6281                         |
| <b>DETROIT, (Mt. Clemens) Michigan</b><br>Electro Sales Associates<br>HOWard 8-2461      | <b>BELGIUM, Brussels</b><br>Inelco<br>Phone: 11.22.20  |
| <b>HARTFORD, Connecticut</b><br>Instrument Associates<br>CHapel 6-5686                   | <b>CANADA: Montreal, Quebec</b><br>R-O-R Associates, Ltd.<br>HUNter 1-0700                           |
| <b>HOUSTON, Texas</b><br>Dannemiller-Smith, Inc.<br>HOMestead 5-8347                     | <b>CANADA: Toronto, Ontario</b><br>R-O-R Associates, Ltd.<br>HICKory 4-4429                          |
| <b>HUNTSVILLE, Alabama</b><br>Scientific Sales Engrg. Co.<br>JEfferson 9-5552            | <b>ENGLAND: London, W. f.</b><br>B & K Laboratories, Ltd.<br>GROsvenor 4567                          |
| <b>IDAHO FALLS, Idaho</b><br>Rush S. Drake Associates, Inc.<br>JACKson 2-7992            | <b>FRANCE, Paris 2e</b><br>Radio Equipements<br>RIC. 49-88   |
| <b>INDIANAPOLIS, Indiana</b><br>Pivan Engineering Company<br>VICTor 6-1532               | <b>GERMANY, Hanover</b><br>Vibro-Meter Hannover GMBH<br>Phone 13367                                  |
| <b>KANSAS CITY, Missouri</b><br>Harris-Hanson Company<br>HILand 4-9494                   | <b>HOLLAND: Rijswijk (Z. H.)</b><br>C. N. Rood, N. V.<br>The Hague 98-51-53                          |
| <b>LOS ANGELES, California</b><br>V. T. Rupp Company<br>DUUnkirk 7-8224                  | <b>ISRAEL, Tel-Aviv</b><br>Landseas-Eastern Co. Ltd.<br>Phone: 66890                                 |
| <b>MINNEAPOLIS, (St. Paul) Minnesota</b><br>Northport Engineering, Inc.<br>MIDway 6-2621 | <b>ITALY, Milano</b><br>Dott. Inc. Mario Vianello<br>Phone: 553.081                                  |
| <b>NEW YORK CITY (Roseland, N.J.)</b><br>Gawler-Knoop Company<br>CALdwell 6-4545         | <b>JAPAN, Tokyo</b><br>Seki & Company, Ltd.<br>Phone: (866) 3136-9                                   |
| <b>ORLANDO, Florida</b><br>Scientific Sales Engrg. Co.<br>GARden 4-0730                  | <b>NEW ZEALAND, Auckland</b><br>Geo. H. Sample & Son (N.Z.) Ltd.<br>Mount Roskill S. 1               |
| <b>PHILADELPHIA, (Wyncote) Pennsylvania</b><br>Gawler-Knoop Company<br>WAverly 7-1820    | <b>SOUTH AFRICA, Johannesburg</b><br>Protea Holdings, Ltd.<br>Phone: 33-2211                         |
| <b>ROCHESTER, New York</b><br>SBM Associates, Inc.<br>GRGreenfield 3-6506                | <b>SWEDEN, Bromma</b><br>Erik Ferner AB<br>Phone: 252870   |
|  | <b>SWITZERLAND</b><br>Fribourg/Moncor<br>Vibro-Meter Corporation<br>Phone: 2.61.08                   |

ONE LEADING manufacturer of telephone answering sets expects the number of his sets in service will at least triple during the next five years.

George W. Danner, President of Electronic Secretary Industries, Inc., a subsidiary of General Telephone and Electric, estimates there are 60,000 Electronic Secretary units now in service, and that this number will jump to 200,000 or more by 1965.

Danner feels three factors will stimulate rapid growth of these devices: an increased promotion and advertising campaign to point up applications and advantages of the devices, introduction of new models adaptable to home use to expand the potential market, and public education and awareness to uses of the device.

Two basic sets are present in use: answering-only, and answering-recording combination.

Answering-only sets give a recorded message and have no provisions for taking a message from the caller.

The answering-recording combination gives a message and also allows the caller to dictate.

Of 66,000 sets being used in the Bell System territory last month, over 75 percent were equipped with recording devices. Sets in use by the Bell System at the end of 1958 totaled 58,800. At the end of 1959, there were 64,800.

Monthly rental charges vary with the telephone company and the type of equipment. Typical charges are \$10 per month for answer-only sets and \$12.50 for answering-recording equipment. Initial installation charges also vary.

Most set users are professional and business people or firms—such as doctors, salesmen, realtors, department stores and pharmacists—who don't want to miss calls while their phones are unattended. An analysis of Bell System users indicates that only a small percentage of the sets are used for the public announcement (Dial-A-Prayer, sport results) type of service.

Railway Express uses answering sets in offices with a single employee



Lawyer plays back telephone messages recorded on his Electronic Secretary answering set during his absence

**Precision Instrument Company**  
SAN CARLOS, CALIFORNIA

# Potential

to avoid loss of business. Meeting trains, making pickups and deliveries keep the employee out of the office at frequent intervals. The unattended office telephone often meant dissatisfied customers and lost business, and the company was faced with the prospect of closing such offices.

As an alternative, answer sets were installed in a few test locations. Now more than 250 units are in Railway Express offices.

At General Electric's Morrison, Ill., plant all outgoing telegrams are handled by an answering set. Telegrams are dictated to a special number and transcribed by the teletype operator, who puts them on the wire. Centralized control saves time and interruptions, speeds transmission, and furnishes a record of each telegram as dictated.

Tobin Packing Company, Rochester, N. Y., uses 30 sets to take orders from salesmen and customers. Sets are stacked in batteries of three. Two units take orders while the third is being transcribed. Units average about 700 order calls per eight-hour day.

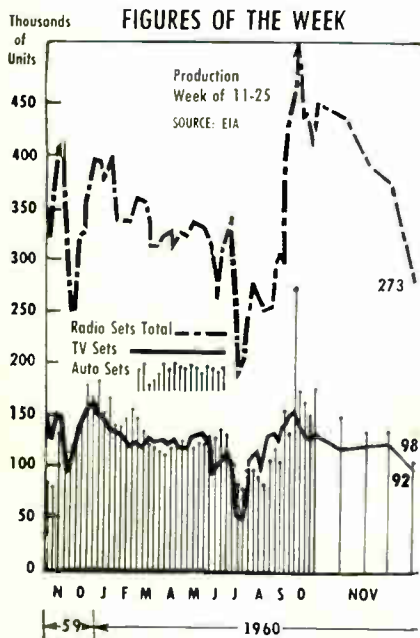

## Is on-the-spot service part of your instrumentation?

You seldom hear the phrase "down time" used with reference to P. I. instrumentation magnetic tape recorders. One reason is that they're built for rugged, around-the-clock recording duty, on tough assignments in extreme environments. Another reason is that a replacement unit is available less than 24 hours away, as part of P. I. on-the-spot service.

Precision recorders carry an exceptional 1-year warranty, backed by factory-trained service engineers available throughout the world. This assures P. I. recorder users maximum performance and longer service life from their equipment.

Would you like to know more about P. I. all-solid-state, high performance tape recorders? Contact the representative nearest you, listed on the opposite page, or write direct.

Seven-channel Precision  $\pi$  Recorder. Also available in other configurations up to 14 channels.

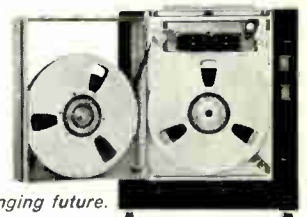

*P. I. Invites Inquiries from senior engineers seeking a challenging future.*



**PRECISION INSTRUMENT COMPANY**

1011 Commercial Street • San Carlos • California  
Phone LYtell 1-4441 • TWX: SCAR BEL 30

REPRESENTATIVES IN PRINCIPAL CITIES THROUGHOUT THE WORLD

# new µmesa\* transistors...

*450-mw free-air dissipation  
in one-tenth the volume  
of a TO-18 package*

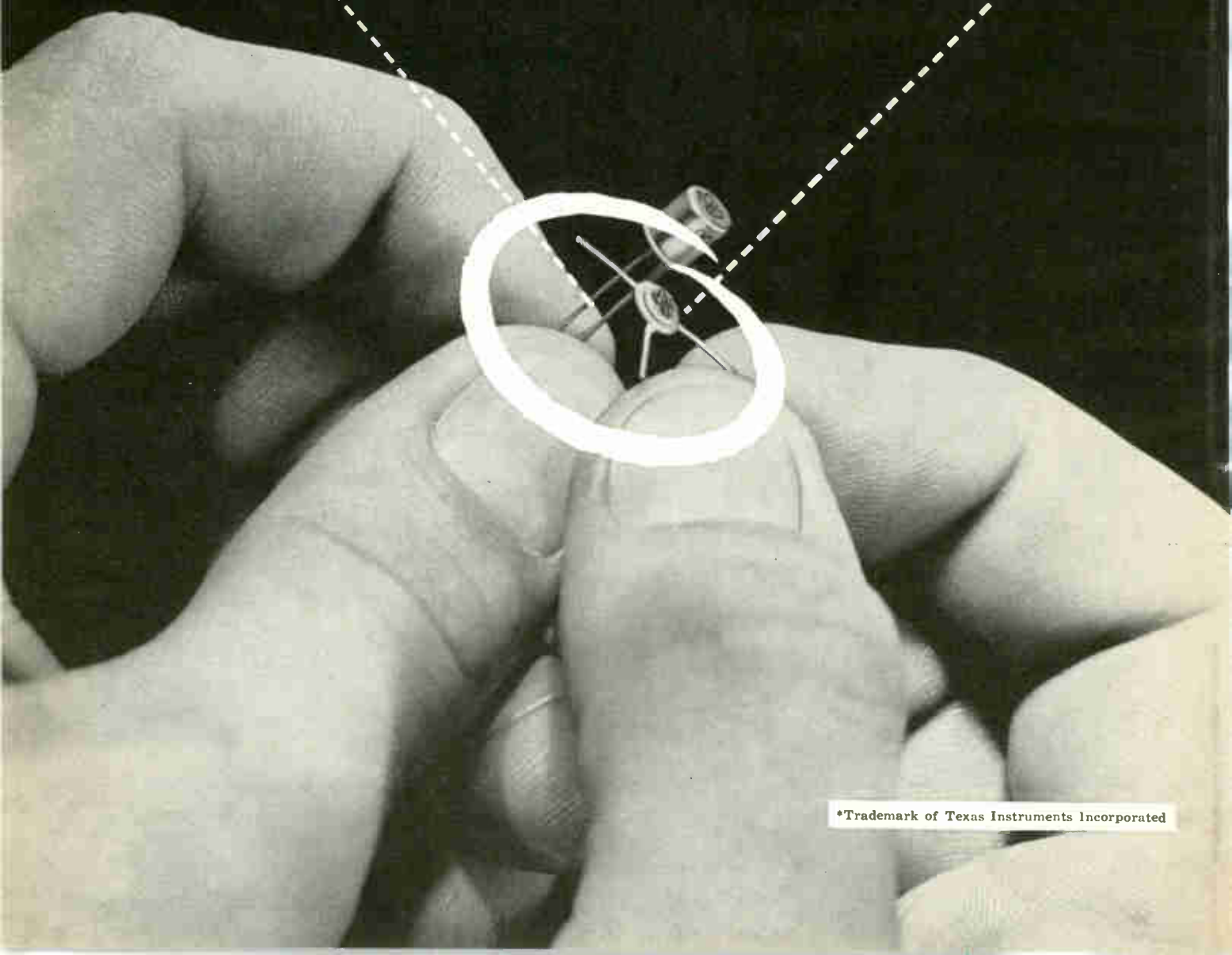

\*Trademark of Texas Instruments Incorporated

# TI 450/451

## silicon transistors give you more power per package volume than any other silicon transistor

Use these TI *second generation* transistors to complement your *second generation* high-speed computers.

Check the outstanding advantages of the TI 450 and TI 451 . . .

- ✓ 1/10 the volume of a TO-18 package
- ✓ 450-mw free air dissipation @ 25°C
- ✓ hermetically-sealed-in reliability
- ✓ backed by a full year's warranty
- ✓ electrically the same as 2N706A and 2N753
- ✓ ribbon leads for "two-dimensional" mounting
- ✓ 1/5 the weight of a TO-18 package — only 0.07 gms
- ✓ heat sinking simplified by electrically isolated case

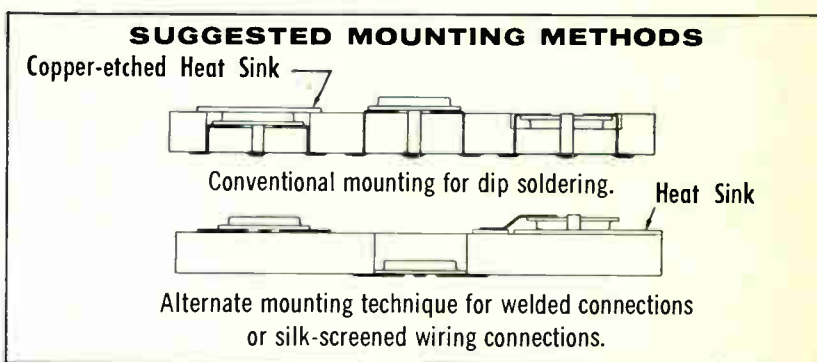
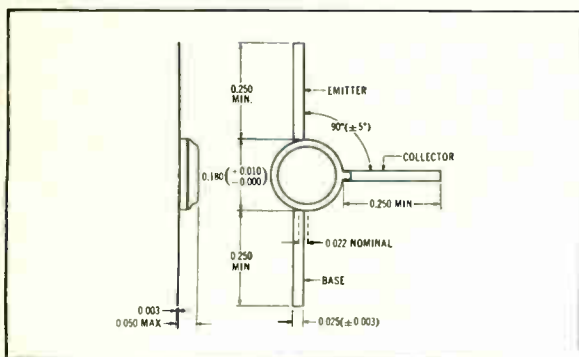

Electrical characteristics @ 25°C ambient						
Symbol	Parameter	Test Conditions	Type	Min	Max	Units
$t_{on}$	Turn-On Time	$I_{B1} = 3 \text{ ma}, I_{B2} = 1 \text{ ma}$ $V_{CC} = 3 \text{ v}, R_L = 270 \Omega$			40	nsec
$t_{off}$	Turn-Off Time	P. W. $\geq 400 \text{ nsec}$ , less than 2% duty cycle			75	nsec
$V_{CE(sat)}$	Collector-Emitter Saturation Voltage	$I_C = 10 \text{ ma}, I_B = 1 \text{ ma}$ (Pulse Test)			0.6	v
$h_{FE}$	DC Forward Current Transfer Ratio	$V_{CE} = 1 \text{ v}, I_C = 10 \text{ ma}$	TI 450 TI 451	20 40	60 120	

Specify TI for all your silicon transistor requirements—small signal • switching • medium power • power



SEMICONDUCTOR-COMPONENTS DIVISION

TEXAS INSTRUMENTS LIMITED INCORPORATED

DALLAS ROAD • BEDFORD, ENGLAND 13500 NORTH CENTRAL EXPRESSWAY • DALLAS, TEXAS

CIRCLE 27 ON READER SERVICE CARD



# “VARIATIONS ON A THEME”

The talented conductor must know the score and interpret it brilliantly, calling upon the instruments at his command to produce the exact shadings and tonal values to enhance the inherent beauty of the composition.

So, too, must the talented design engineer have the “feel” and talent to utilize the “instruments” at his command to bring a system concept to new heights of performance and efficiency.

The design engineer’s talent is dependent upon the scope and range he is permitted by the components he may utilize.

Here are three “instruments” to broaden his interpretations—to give him added range and scope—to allow him full freedom for his talent.

The standard North Crossbar switch, with 1200 switching points in a 10x12x10 matrix, allows maximum switching capacity within minimal space.

The new 5x12x10 switch gives him a new “instrument”, with all the reliability and versatility of its big brother, for application where capacity requirements can be satisfied with 600 switching points!

The factory-wired Crossbar switch with North Multi-Purpose, Multi-Terminal Connectors allows new range and economy.

These three instruments will give you wider latitude in your interpretation of design problems—with proven reliability, versatility and economy.

For full details on North Crossbar switches, write

*ELECTRONETICS DIVISION*

**NORTH ELECTRIC COMPANY**

6413 South Market St., Galion, Ohio

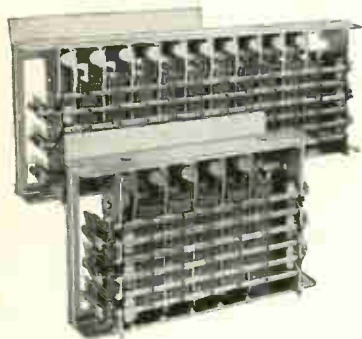
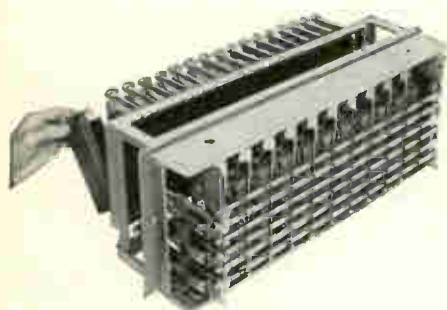

From Allegheny Ludlum

# NEW VALUES IN SILICON STEELS

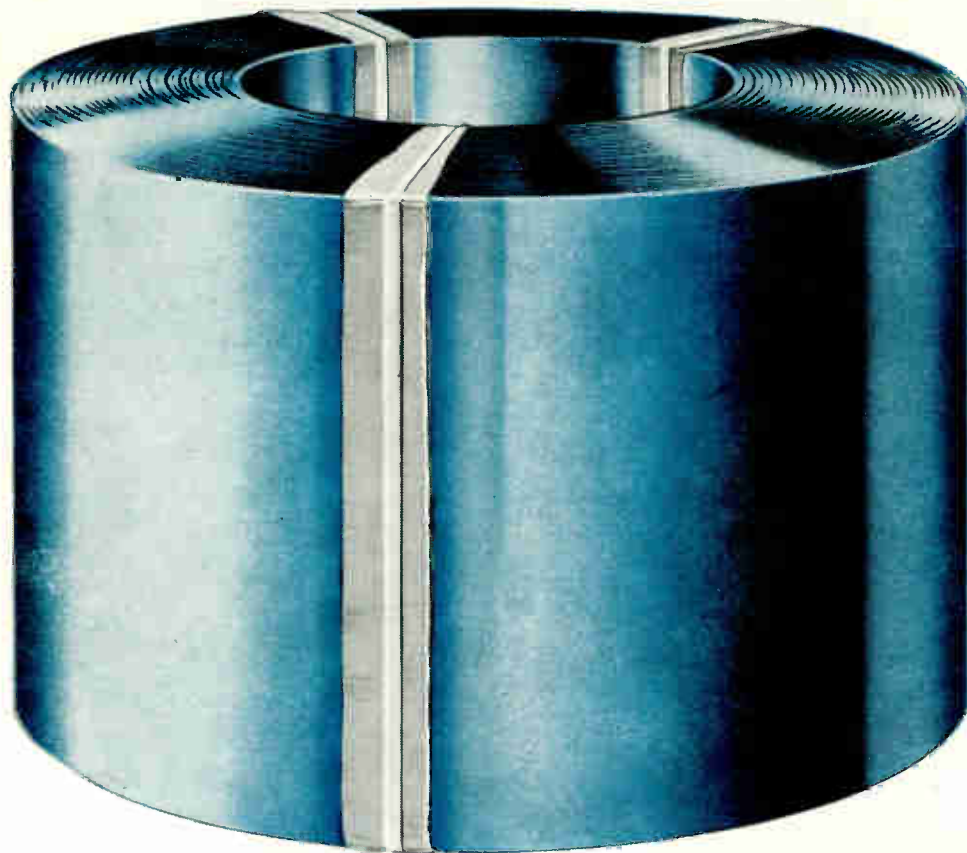

In the intermediate silicon grades Allegheny Ludlum consistently furnishes the largest coils available—7000 to 9000 pounds. Wider widths open up opportunities for new applications using superior cold reduced electrical steel strip.

You can count on consistent magnetic results when you use A-L steels. Quality is checked and maintained in each coil to insure consistent results from shipment to shipment. Consistent gage uniformity is maintained throughout each coil.

Permeability is excellent—A-L processing gives you the maximum values consistent with AISI watt loss grades. Core loss guarantees are available according to AISI published values for as sheared or stress relief annealed samples.

In the grain oriented Silectron<sup>®</sup> grades Allegheny Ludlum carefully controls flatness—to insure minimum noise levels. Excessive noise levels and magnetostriction is held down to a minimum.

Because of the excellent gage consistency, A-L Silectron grades mean more uniformity in making stacked and wound cores.

The absence of brittle material is a must in making wound cores. You will appreciate the ductility of Allegheny Ludlum Silector grades.

For high quality electrical steels and the technical data you need in design and manufacture call your Allegheny Ludlum salesman, or write: *Allegheny Ludlum Steel Corporation, Oliver Building, Pittsburgh 22, Pennsylvania. Dept. E-12-2.*



**ALLEGHENY LUDLUM**

PIONEERING ON THE HORIZONS OF STEEL



# STORAGE TIME:

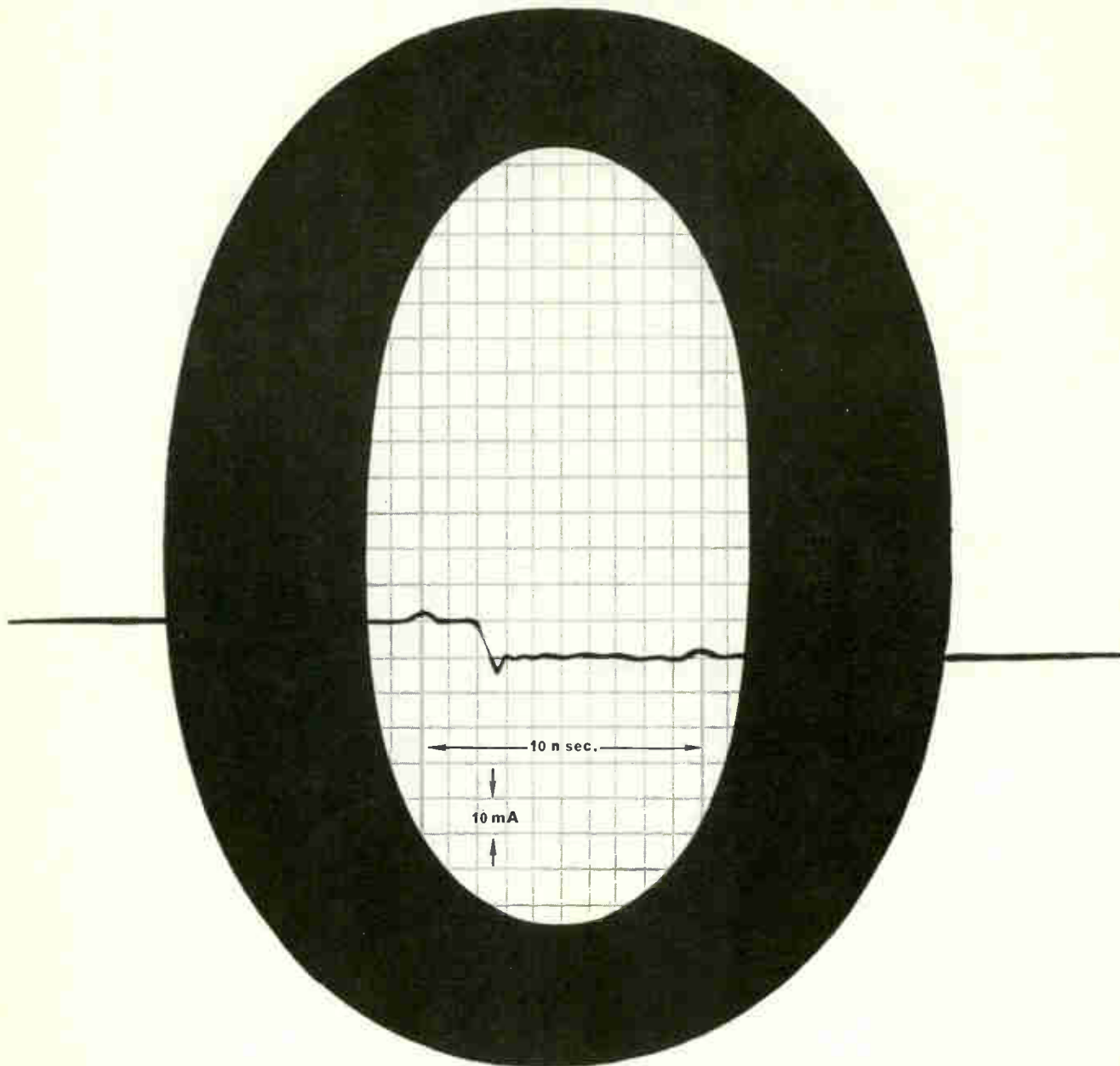

## RECOVERY TIME, GUARANTEED LESS THAN A HALF A NANOSECOND!

The new HUGHES® HD-5000 diodes are the fastest switching devices commercially available today. They are so fast, in fact, that storage time can't even be measured. ■ Think what this means. Now computer circuits can be designed that work 10 times faster than ever before. ■ This important speed breakthrough was made possible through an exclusive bonding process developed by Hughes research. The result is a low-capacity diode that completely solves the storage-time problem. ■ The HD-5000 Diode Series is available now from Hughes. Call your local Hughes Semiconductor sales engineer or distributor. Or write Hughes Semiconductor Division, Marketing Department, 500 Superior Avenue, Newport Beach, California. For export write: Hughes International, Culver City 5, California

Type	$I_f@1V$ (mA)	$E_s@100\mu A$ (volts)	$I_B(\mu A)$ @25°C	@-5V @100°C	Recovery n sec.
HD 5000	5	20	0.2	2.0	<0.5
HD 5001	5	20	1.0	10.0	<0.5
HD 5002	2	20	0.2	2.0	<0.5
HD 5003	2	20	1.0	10.0	<0.5
HD 5004	2	15	1.0	20.0	<0.5

The recovery circuit uses a high-speed sampling scope and attachments. The switching is 10 mA forward to 6V reverse; recover to 1mA reverse. Loop impedance is 100 ohms. Typical capacitance: 0.8 pf. Typical rectification efficiency: 80% at 100 Mc.

Creating a new world with ELECTRONICS

## HUGHES

SEMICONDUCTOR DIVISION  
HUGHES AIRCRAFT COMPANY



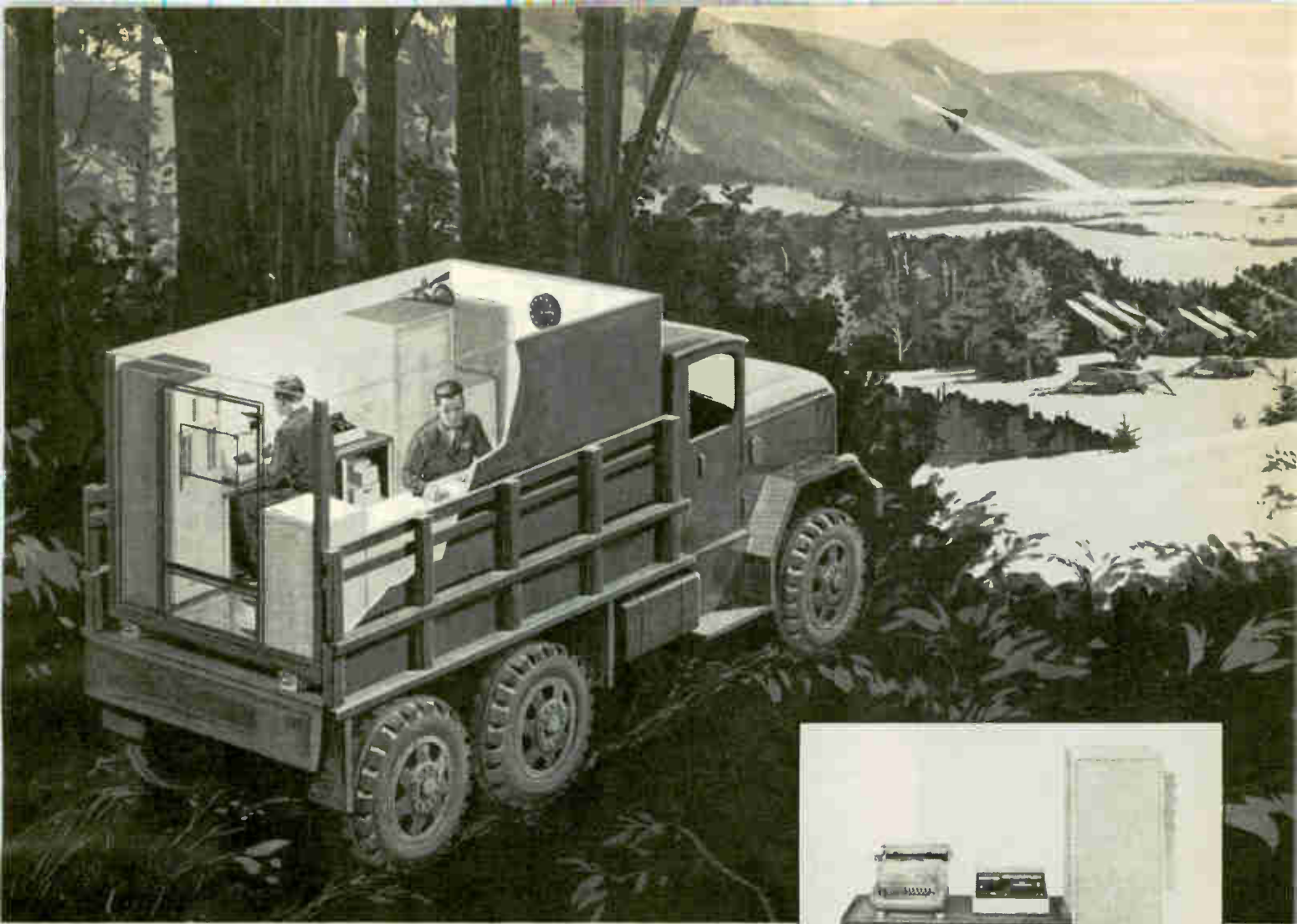

# BASICPAC

## The Tactical FIELDATA Computer Designed and Built by Philco

Basicpac is a rugged, mobile, solid state data processing system, being developed by Philco in conjunction with the U.S. Army Signal Corps for use in forward area tactical situations.

This unique development is directed towards an integrated automatic data processing system for the entire field army . . . in logistics, administration, intelligence, command support and fire support. Basicpac can be transported and operated in an S-109 shelter mounted on a 2½-ton truck or operated from a fixed installation.

In the development of Basicpac, Philco made full use of the most advanced techniques in solid state circuitry and semiconductor components. The goal is a compact general purpose data processing system that will be rugged, flexible, reliable, easy to operate and maintain under the severe conditions of field operation.

Basicpac is capable of handling such diverse applications as weapon-target allocation, converting raw surveillance and intelligence data into effective decision making forms and providing logistics and other administrative support activities in combat.

Basicpac will be delivered in December to the U.S. Army Signal Research and Development Laboratory for final acceptance testing.

Basicpac represents still another major achievement by Philco that will help to make the U.S. Armed Forces the most efficient and capable fighting group in the world today.

Government and Industrial Group, Philadelphia 44, Pennsylvania

# PHILCO®



*Famous for Quality the World Over*

Communications and Weapons Division • Communications Systems  
Division • Computer Division • Sierra Electronic Division •  
Western Development Laboratories

CIRCLE 31 ON READER SERVICE CARD



FCC-ACCEPTED  
TYPE AVAILABLE

## The world-famous **AEROCOM 1046 TRANSMITTER**

# 1000 W CARRIER POWER WITH HIGH STABILITY

The AeroCom 1046 Transmitter is designed to give superior performance for all point-to-point and ground-to-air communications. It is now in use throughout the world in climates ranging from frigid to tropical (operates efficiently at  $-35^{\circ}$  to  $+55^{\circ}$  Centigrade).

As a general purpose High Frequency transmitter, the 1046 supplies 1000 watts of carrier power with high stability (above  $-10^{\circ}$  Centigrade:  $\pm .003\%$  for telegraph and telephone. Temperature controlled oven for FSK). Multi-channel operation is provided on

telegraph A1, telephone A3 and FSK (Radio Teletype). It can be remotely controlled using one pair of telephone lines plus ground return with AeroCom Remote Control Equipment. Front panel switches and microphone are included for local control.

Four crystal-controlled frequencies (plus 2 closely-spaced frequencies) in the 2.0 - 24.0 megacycle range can be used one at a time, with channeling time only two seconds. Operates into either balanced or unbalanced loads. The power supply required is nominal 230 volts, 50 - 60 cycles, single phase.

The housing is a fully enclosed rack cabinet of welded steel, force-ventilated through electrostatic filter on rear door.

Telegraph keying (A1): Up to 100 words per minute. Model 1000 M Modulator (mounts in trans-

mitter cabinet) is used for telephone transmission; a compression circuit permits the use of high average modulation without over-modulation. Model 400 4 Channel exciter is used for FSK.

Output connections consist of 4 insulated terminals (for Marconi antenna) and 4 coaxial fittings Type SO-239, which can be used separately or in parallel in any combination. For 600 ohm balanced load, Model TLM matching network is used, one for each transmitter channel.

As in all AeroCom products, the quality and workmanship of Model 1046 are of the highest. All components are conservatively rated. Replacement parts are always available for all AeroCom equipment.

Complete technical data on AeroCom Model 1046 available on request.



3090 S. W. 37th AVENUE

MIAMI 33, FLORIDA

# HERE'S ONE WAY TO SOLVE SERVO "HUNTING" PROBLEMS...

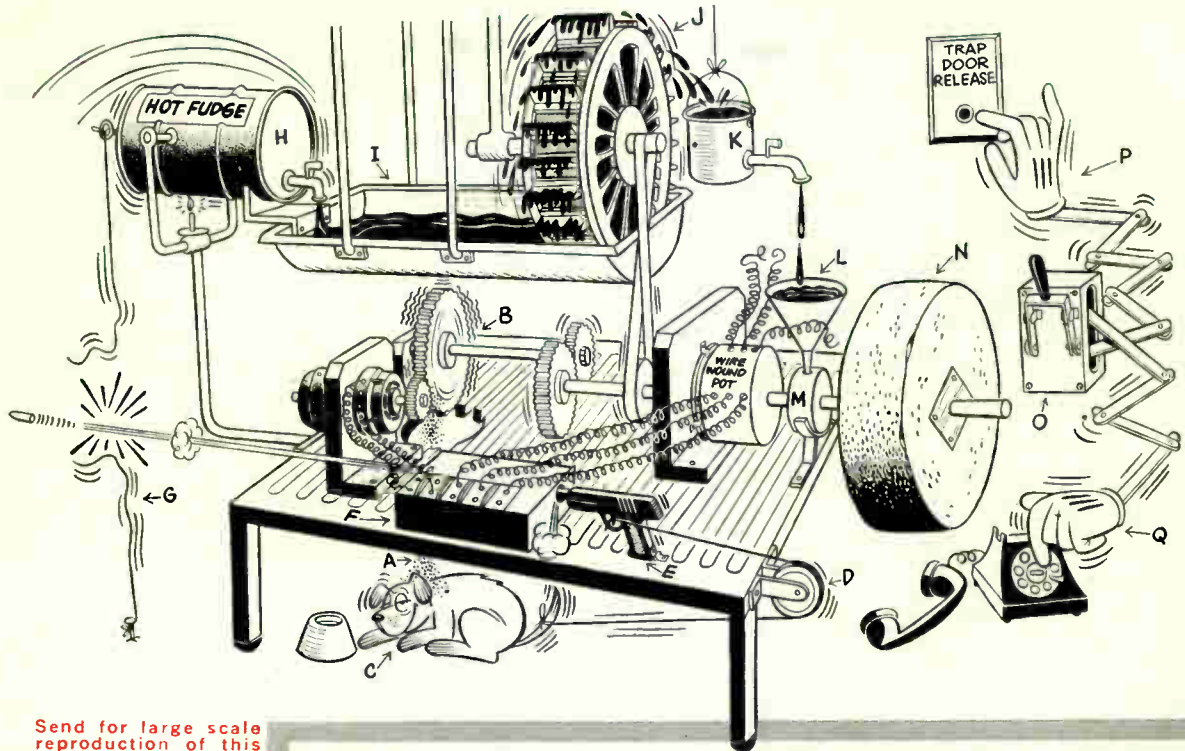

Send for large scale reproduction of this unique Servo System.

ENERGIZED SERVO SYSTEM IMMEDIATELY STARTS "HUNTING" AS A RESULT OF POOR RESOLUTION WIRE-WOUND POT. METALLIC DUST (A), CREATED BY WEARING DOWN OF OSCILLATING GEARS (B) IN "HUNTING" SERVO SYSTEM, FALLS UPON HEAD OF OFFICE DOG (C). DOG ENJOYS PLEASANT SENSATION AND PROCEEDS TO HAPPILY WAG TAIL. STRING ATTACHED TO DOG'S TAIL RUNS AROUND PULLEY WHEEL (D) AND ACTUATES TRIGGER OF "AUTOMATIC GAIN KILLER" (E) ATTACHED TO AMPLIFIER (F). [FIRST STEP IN REDUCING SERVO HUNTING.] PROJECTILE, AFTER LEAVING AMPLIFIER, BREAKS STRING (G) THEREBY ALLOWING DRUM (H), FILLED WITH SPECIAL VISCOUS DAMPING FLUID, TO TILT FORWARD. FLUID FLOWS INTO TROUGH (I). DAMPING PADDLE WHEEL (J) TAKES EFFECT. [SECOND STEP IN REDUCING SERVO HUNTING.] EXCESS FLUID ON PADDLE WHEEL DRIPS INTO RESERVOIR (PAINT CAN—K), THEN PASSES THROUGH FUNNEL (L) INTO FLUID CLUTCH (M) CONNECTING SCIENTIFICALLY SELECTED INERTIAL LOAD (GENUINE MILLSTONE, ON LOAN FROM SMITHSONIAN INSTITUTE—N.) [FINAL STEP IN REDUCING SERVO HUNTING.] IF SYSTEM STILL "HUNTS"—ENGINEER THROWS EMERGENCY SWITCH (O) ACTIVATING HAND (P) WHICH PASSES TRAP DOOR RELEASE, DUMPING ENTIRE SYSTEM INTO LOCAL RIVER (NOT SHOWN). HAND (Q) PROCEEDS TO DIAL C.I.C.'S PHONE NUMBER (IVANHOE 3-8200) FOR AN INFINITE RESOLUTION "NON-HUNTING" FILM POT.

## BUT THE BEST WAY YET...

Use **C. I. C.** Film Pots for High Performance Servo Systems!



1/2" to 5" Diameters.

- INFINITE RESOLUTION
- INHERENT RELIABILITY
- PRECISION LINEARITY
- LOW OPERATIONAL NOISE
- MULTI-MILLION CYCLE LIFE
- VIDEO FREQUENCY OPERATION

Not only do C. I. C. Film Pots offer the infinite resolution necessary to eliminate servo hunting problems, but they guarantee you the greatest linearity possible in any given size or diameter. They provide the reliability inherent in a single broad band film element as opposed to the high failure rate of today's wire wound pots. C.I.C. Film Pots do even more... They actually run as high as 1000 rpm and still retain reliability, while assuring many millions of cycles of operation.

FIRST IN FILM POTS



**COMPUTER INSTRUMENTS CORPORATION**  
92 MADISON AVENUE • HEMPSTEAD, L. I., NEW YORK



**Down in Lubbock, Texas he hasn't missed a shot for over 12,800 hours!**

Every time he pulls the trigger the sound is brought faithfully to KDUB-TV viewers by a pair of Eimac 4W20,000A tubes. According to KDUB's Chief Engineer Rudy Starnes, each tube has more than 12,800 hours in aural power output under its belt and is *still going strong!* At the same station, two other Eimac 4W20,000A's have each delivered over 8,000 hours in visual service and are *still going great guns!* Records to shoot for—but typical of what you can expect from Eimac . . . the most advanced name in negative grid tubes, microwave tubes, amplifier klystrons. Eitel-McCullough, Inc., San Carlos, California.



**Typical Operation Eimac 4W20,000A.** The water-cooled, ceramic and metal 4W20,000A has coaxial terminals and a long-life unipotential thoriated tungsten cathode heated by electron bombardment. Its maximum plate dissipation rating is 20kw. You'll also find it ideal for use in radar picket-ship duty delivering 750kw ( $\frac{3}{4}$  megawatt) pulse output.

Service	Frequency	Plate Voltage	Plate Current	Useful Power Output
FM Amplifier	220	7 kv	3.4 amps	13 kw
TV Amplifier	216	7 kv	6.0 amps*	25 kw*
Pulse RF Amp (Radar)	230	25 kv	60 amps	750 kw
Pulse Modulator		20 kv**	200 amps	3 Mw

\*Peak Sync

\*\*30kv in oil

negative grid tubes • microwave tubes • amplifier klystrons



*Reliability in volume...*



**CLEVITE**  
TRANSISTOR  
WALTHAM, MASSACHUSETTS



Clevite's rectifiers find broad use as general purpose diodes in computers and as rectifiers in magnetic amplifiers, dc to dc converters and power supplies.

They are particularly useful in airborne applications where switching of equipment may generate high voltage transients in the line which would burn out ordinary diodes. Designed for maximum reliability, Clevite rectifiers provide high dissipation — 600 mw . . . high voltage — up to 600 v . . . high temperature — up to 150 ma at 150°C.

Where fast switching is not required, these rectifiers offer definite advantages in size, costs and superior overload protection. They are available in military types conforming to MIL-E-1/1143 (USAF).

Send for bulletin B217-3B

# DIFFUSED SILICON RECTIFIERS

Diode Type	Maximum DC Inverse Operating Voltage (volts)	Maximum Average Forward Current @ 25°C (ma)	Maximum Forward Voltage Drop @ 25°C (volts @ ma)
1N645	225	400	1.0 @ 400
1N647	400	400	1.0 @ 400
1N649	600	400	1.0 @ 400
1N677	100	400	1.0 @ 400
1N681	300	200	1.0 @ 200
1N683	400	200	1.0 @ 200
1N685	500	200	1.0 @ 200
1N687	600	200	1.0 @ 200

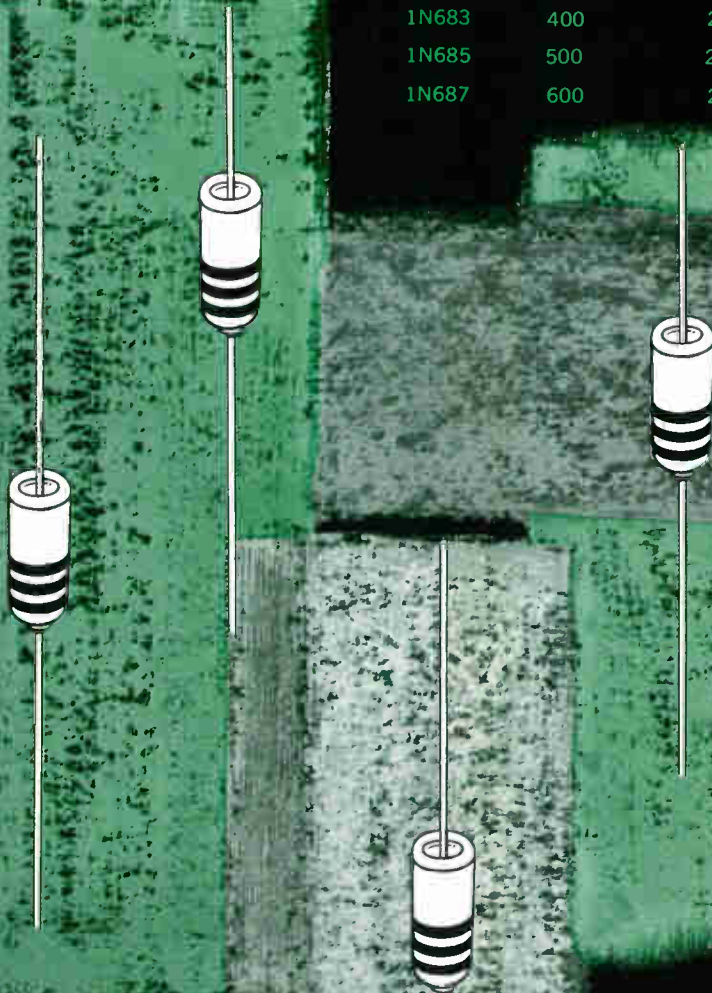

A DIVISION OF

**CLEVITE**  
CORPORATION

*Reliability In Volume*

**CLEVITE TRANSISTOR**

200 Smith Street, Waltham, Mass. Telephone 4-7781

# How many design problems can these special resistors solve for you?

Speer special resistors are made in a special way by a special process, but they solve many of the problems that are standard in electronics...problems of design...size...shape...fabrication.

Note the ends. Speer special resistors are made by a unique, patented\* process whereby metal face ends are molded integrally with the resistor body to provide excellent contact. They can be made in many shapes...as tubes, rods, discs, thin plates...in circular or rectangular shapes, miniature in size, if desired. They are, in short, adaptable to many design requirements. The ends are made for easy solderability, but they can, of course, be provided for pressure connections or other modes of fastening.

Speer special resistors are presently being used for new design freedom by manufacturers of such varied items as automotive horns, fuses, electric blankets, lightning arrestors and control units. Perhaps they can solve your problems, too. Why not give us a call? We'll be glad to supply further details.

Other Electronics Divisions of Speer Carbon Company—Jeffers Electronics, Du Bois, Pa. • Onondaga Electronics, Syracuse, N. Y.



**Speer Carbon Company**  
Bradford, Pennsylvania

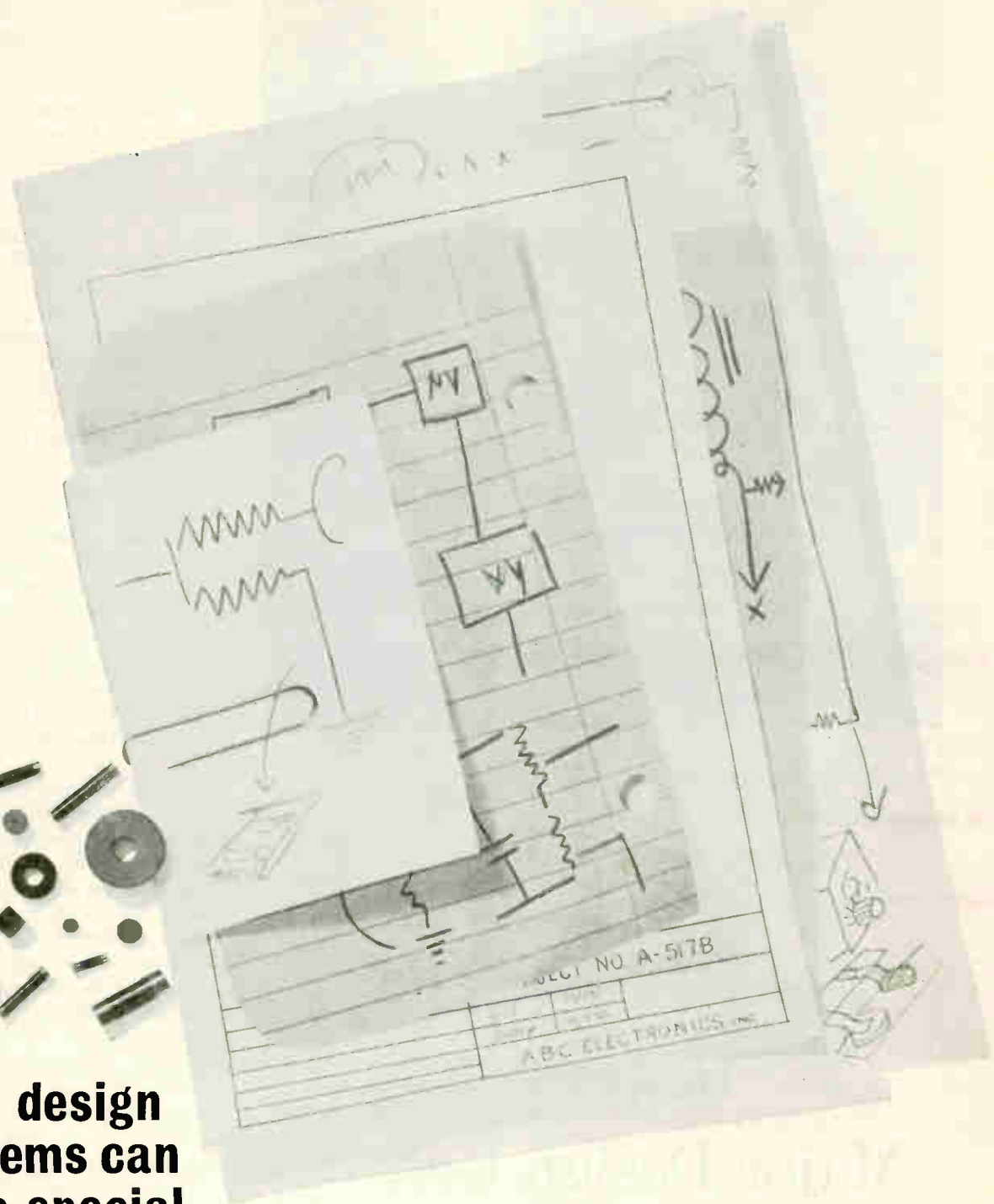

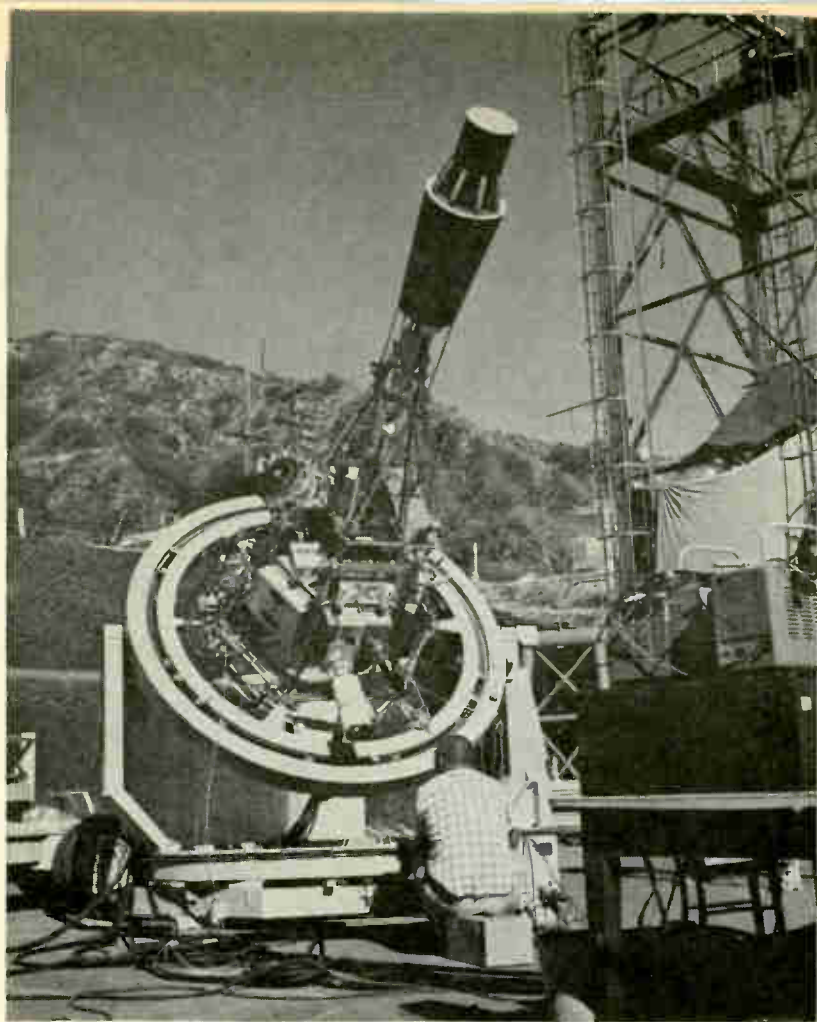

*Proof test model of Ranger I and II instrument payload undergoing test at Cal Tech's Jet Propulsion Lab*

## Space Plans For Next Decade Require Major Design Gains

*Exploration of the moon and planets will require special instruments, communications and data-processing equipment. It all must resist high temperatures and impact shock. Here's a rundown on space plans for the next 10 years*

By HAROLD C. HOOD  
Pacific Coast Editor

PASADENA, CALIF. — Both the National Aeronautics and Space Administration and its contractor, Cal Tech's Jet Propulsion Laboratory are banking on electronics ingenuity to back up their lunar and planetary exploration plans for the 1960's. Technical capabilities for accomplishing some of the assignments do not now exist, but program directors believe technology will catch up in time.

Upcoming lunar shots include Ranger I and II, scheduled for the latter half of 1961; Ranger III, IV and V in 1962; Surveyor during 1963-1965; and Prospector in 1966. Atlas Agena B vehicles will be used for all Ranger launchings. Boosters for Surveyor and Prospector will be Centaur and Saturn, respectively.

Planetary shots include those called Mariner, to be boosted by Centaur rockets and those called Voyager using Saturn vehicles. Two Mariner missions are slated for 1962. First is a Venus fly-by, to be followed by a deep-space probe. Initial try at Mars will be in 1963, followed by Venus shots in 1964 and 1965.

The Voyager spacecraft is an extension of Mariner. It will make developmental sorties to Venus in 1965, followed by a flight out of the earth's orbital plane in 1968. Year 1970 is the target date for a Mercury or Jupiter fly-by. Venus shot will be powered by Saturn C-1, with Saturn C-2 being used in subsequent missions.

Primarily for evaluation of the spacecraft vehicle configuration, Ranger I will help scientists evaluate spacecraft configuration. It will have a highly elliptical earth-satellite orbit with a 650,000-mile apogee. Present plans call for Ranger II to come within 4,000 miles of the moon. A midcourse guidance system carried on Ranger III will enable it to modify its trajectory after 17 hours of flight and thus hit the desired impact point on the moon. Rangers III, IV and V will have detachable instrument capsules for moon landings. Each Ranger vehicle will be space-stabilized, with an attitude sensor keeping its primary axis pointed directly at the sun. Thus, maximum energy will be picked up by solar cell panels that fold out perpendicular to primary axis. A motorized, high-gain direc-



tional antenna searches for and locks onto the earth shortly after launch. After Ranger III, IV and V vehicles go through midcourse maneuver, the antenna again seeks and locks onto earth. Primary axis remains pointed at the sun until shortly before capsule is jettisoned, at which time the capsule and vehicle home on the moon and point at approximate impact point.

In an exclusive interview with ELECTRONICS, chief of JPL's space instruments section Raymond L. Heacock stated that the instrument package for Ranger I and II will weigh slightly over 50 lb and will contain eight scientific experiments designed to obtain information on magnetic fields, charged particles, solar X-rays and micrometeorites in interplanetary environments.

(1) The solar corpuscular radiation experiment will use electrostatic analyzers for studying quantity, energy ranges and direction of flow of solar plasma particles. Six open-mouth analyzers, pointed at right angles in the six directions of space, will collect electrons and protons in the energy range from 10 to 100 e-v electrons to 10 to 5,000 e-v protons. The detectors, one of which points directly at the sun, are packaged in three boxes and use curved-plate electrostatic focusing systems. Charged particles of appropriate energies entering the analyzer are picked up on a charge-collecting plate, the current to which is sensed with a transistorized vibrating-reed capacitor electrometer.

Thermonic diodes are used in a feedback system for dynamic range compression and seven decades from  $10^{-6}$  to  $10^{-13}$  amp are covered. Total power requirement of the six detectors is three watts.

(2) The medium-energy particle experiment will use three different types of detectors. The range of one model, using the photoconducting characteristics of cadmium sulfide crystals and supplied by University of Iowa's Van Allen, will slightly overlap the upper proton-energy area of solar-particle experiment. Since medium-energy particles impinging upon the crystals have the same effect as light, a resistance modulation as a function of particle flux and energy may be obtained. A second detector, cover-

ing the range from 0.5 to 10 Mev protons, and developed by University of Chicago's Simpson, is a gold-silicon solid-state device. Third detector is a mica-window, thin-walled Anton 213 Geiger-Mueller tube, also built under the supervision of Dr. Van Allen. Electron cut-off in this device is at 30 Kev, slightly higher for protons. In Ranger II, a second Geiger tube will replace a cadmium-sulfide detector. The tubes will be mounted at 90 degrees to each other to sense directionality of flow of particles.

(3) The ionization chamber experiment will measure proton particle energy ranges in excess of 10 Mev. Instrument was developed by CalTech's Neher, and is an energy-flux measuring device. The charge on a quartz fiber is reduced as particles ionize gas within the chamber and the fiber ultimately recharges itself. It is the tick of the charging current that is counted and provides a highly accurate increment of total energy.

(4) The triple-coincidence cosmic-ray telescope experiment will get an accurate determination of particle density of low-energy cosmic rays or energetic particles from the sun. Spectrum differentiation is obtained by using one assembly with a 10-Mev low-energy threshold, and another with a 75-Mev threshold. Seven semi-proportional counter tubes are mounted in two groups of three and a single center tube. To register a triple count, particle must enter three tubes in coincidence. By isolating the center tube count from the triple count, secondary radiation effects may be eliminated.

(5) The magnetometer experiment will measure magnetic fields in space. This extremely sensitive rubidium-vapor instrument can measure thresholds from less than 1 gamma to 100 gamma. The magnetic-field measurements will be correlated with the low-energy particle measurements.

Ranger will be the first space-stabilized craft to fly a magnetometer. Care must be taken in selecting shielding materials used in construction and in the layout of wiring so that magnetic effects on the magnetometer are negligible. Instrument is mounted as far away from main body of vehicle as pos-

sible to minimize these effects. Goddard Space Flight Center is the cognizant agency and Varian Associates, the fabricator.

(6) The Lyman-Alpha telescope experiment is focused to take a picture of earth at Lyman-Alpha frequency to determine whether there is a neutral hydrogen cloud encompassing the earth. System is servo-slaved to the spacecraft's high-gain directional antenna. Telescope will perform a mechanical 20-line-raster scan of the earth. A digital stepper motor steps each line after it has been scanned twice, once at low gain sensitivity and again at high gain. Naval Research Lab is supplying the detection cell and JPL the telescope package, including the mechanical scanning servo system and amplifier to go with the detection cell.

(7) The interplanetary dust experiment will measure number, size and energy level of micrometeorites. Equipment will include a scintillation system using a multiplier photo-tube in addition to the usual microphone.

(8) The X-ray radiation experiment will investigate the possibility of detecting an atomic explosion on earth's surface from space. Codenamed Vela Hotel, this experiment is being supervised by the Atomic Energy Commission's Los Alamos Lab.

Equipment for a secondary experiment includes a rotating metal platter contacted by several metal fingers. It will investigate the effect of space vacuum on coefficient of friction of various materials for optimum selection of materials for moving parts in future spacecraft.

Since Ranger I and II will each carry over 15 instruments for its eight experiments, a data handling system will be required. All experimental data, except for Lyman-alpha and magnetometer data, will be processed for commutation onto three binary telemetry channels. These are non-standard deviation channels using a four-cycle frequency shift for a binary 1.

Analog outputs from the six solar corpuscular detectors are sampled simultaneously, encoded into seven-bit digital words in a half second, split into two groups of three, and during a nine-second integrating

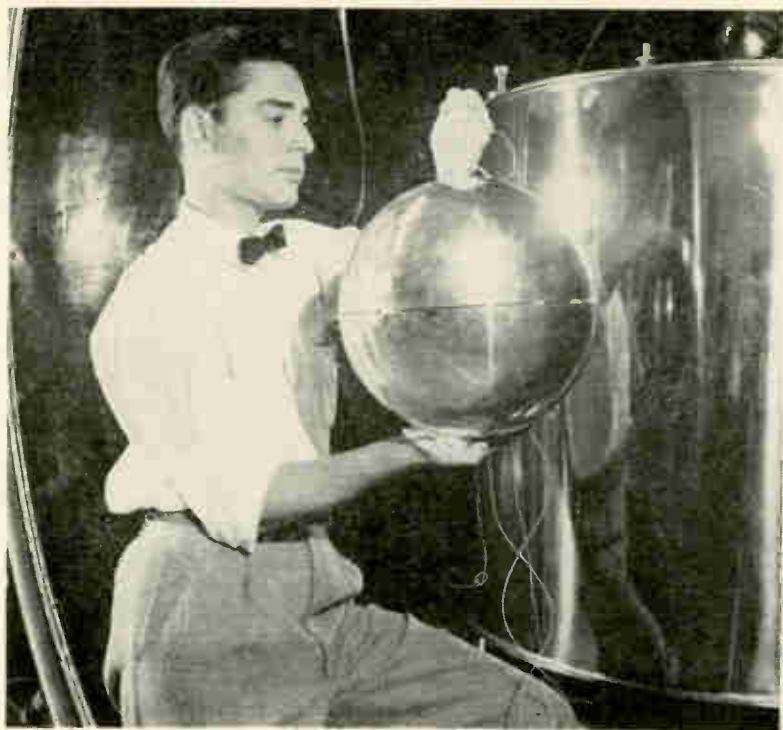

*Cold-testing Ranger capsule to be landed on moon. Test takes place at Ford Motor Co.'s Aeronutronic division*

interval, commutated out onto two of the binary channels. The experiment's package goes through 12 discreet energy levels and the output reading for each level is telemetered each nine seconds with a nine-second interval for analyzer recovery.

Output data from all other experiments is of the pulse-rate type, and is put into 14-bit word accumulators, which in turn are sampled into a shift register and clocked onto the third telemetry channel once each minute. Ranger III, IV and V vehicles will accommodate a different set of experiments, mid-course guidance system and motor, and a survivable capsule. Shortly before leaving the spacecraft (called the bus), the capsule will be spun up by small spin rockets for directional stabilization during its descent to the moon. Spherical capsule is made of balsa for maximum shock absorption upon impact. Separation from parent craft is triggered by altimeter developed by Ryan Electronics.

After jettisoning its capsule, the bus will go to 3,000-mph destruction on surface of moon. A retrorocket, actuated in the capsule as it approaches the moon, eases capsule impact velocity to less than 200

mph. Scientific experiments to be carried in the bus are two-fold:

(1) A vidicon television experiment will obtain pictures of moon's surface. This 200-line-raster system, developed by RCA, uses a slow scan tv and a storage-type vidicon, and will take between 100 and 200 pictures with steadily increasing resolution as moon is approached. Last picture before impact is expected to have a surface resolution of 3 to 4 meters and should have useful details of moon's surface texture. One picture will be taken every 13 seconds. Transmission time for each is 10 seconds, allowing three seconds of telemetry time for other scientific and engineering information. First picture will be taken 4,000 Km from moon's surface so that impact point can be identified photographically.

(2) The gamma-ray spectrometer experiment will analyze the surface of the moon. Gamma radiation will be measured from mid-course maneuver to impact. JPL scientists hope to determine whether isotopes of uranium, thorium and potassium exist on the moon in the same proportions as on the earth. Background counts in space will be taken and subtracted from total to get only those due to

lunar composition. Spectrometer has a 32-channel analyzer, developed by Radiation Instrument Development Laboratory of Chicago, that sorts the energies of particles coming into system to isolate the various isotopes. Equipment includes a large scintillation crystal with phoswich (a plastic material which filters out certain types of rays and in which crystal is encased), multiplier photo-tube, high-voltage supply discriminator and multichannel analyzer. Ford's Aeronutronic division is developing the capsule. These instruments are expected to survive the impact of landing on the moon: a seismometer, amplifier, voltage-controlled oscillator, transmitter and temperature control equipment.

Purpose of the seismometer is to determine lunar seismic activity, the incidence and energy of meteoric impact on the moon, and to give an indication of the thermal stressing on the moon as it goes through its day-to-night transition. The capsule transmitter is a low-power system since the seismometer data varies in frequency from 0.05 to 5 cps. Low-power communication makes possible 60 to 90 days of battery-powered operation. Early models of the seismometer, developed by CalTech and Columbia's Lamont Labs, have survived 5,000g deceleration in helicopter drops.

*Surveyor*—Because of the increased available weight and capacity for decision and control devices and advanced retrorocket system, Surveyor is expected to ease its instrument package to the moon's surface at less than 30 mph. Scientific experiments will involve physical and chemical analysis. Under study by various contractors are techniques using advanced seismometers and gravity measuring devices, X-ray diffraction for mineral analysis, and X-ray fluorescence, neutron activation, proton bombardment, mass spectrometers and gas chromatography for elemental analysis.

Even with a 30-mph landing, instruments will be subjected to shocks in excess of what presently available models can survive. Required control devices to guarantee a completely soft landing are within the present state-of-the-art, but their inclusion in the spacecraft

would decrease the instrument payload weight to almost zero.

Prime Surveyor spacecraft study contractors are McDonnell Aircraft, Hughes, Space Technology Labs and North American Aviation. From the four approaches, JPL will select the one it considers best, and the prime contract for the spacecraft will go to the submitting company.

Besides having responsibility to study the overall system injected into trajectory to the moon, the Centaur soft landing system and any midcourse guidance system required, these four companies were asked to include studies on lunar drilling problems and area surveying equipment. The latter will be a tv system capable of looking at lunar surface with millimeters of resolution, so that grain size of materials can be determined. At the same time, it must be able to survey the surrounding area to the horizon, using telescopic capabilities.

Subsurface physical and chemical analysis calls for drilling a hole approximately four feet deep in the moon's surface and instrumenting the hole. Drilling equipment was included in the prime study contracts so that the device selected would be compatible with spacecraft restrictions. Answers sought: What are the chemical constituents of lunar material as a function of depth? What are the physical properties of the material? Also to be determined are the thermal gradient from surface to bottom of hole, velocity propagation, dielectric constant and magnetic permeability of materials. JPL is aware of the vast number of techniques that may be applied to instrumenting the hole. Fourteen companies, out of 54 which submitted bids, now have study contracts.

Communications systems will be similar to that used for Ranger, using the same Deep Space Instrumentation Facility network.

*Prospector*—This project will use extensions of principles developed for Surveyor, will have added capabilities inherent with greater weight availability. A completely soft landing, roving exploratory lunar surface vehicle and spacecraft to return samples to earth will be added features of *Prospector*. Rov-

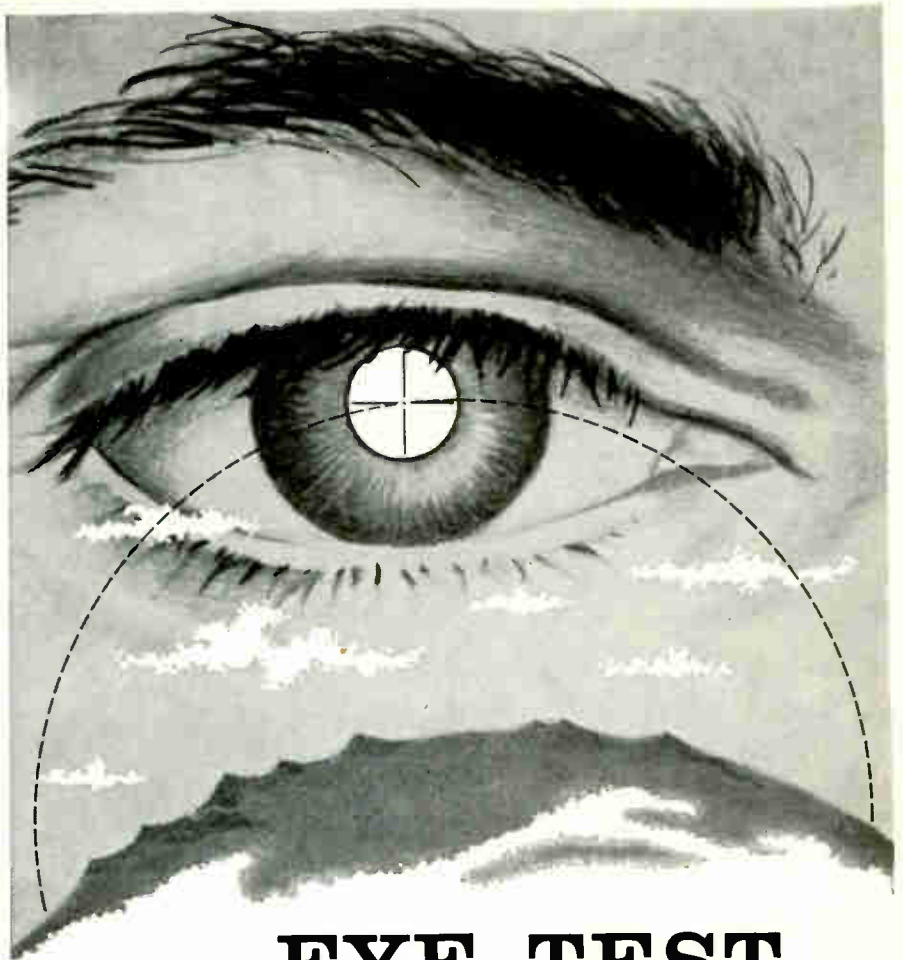

## EYE TEST FOR RADAR

*B&L optical-electronic-mechanical capabilities assure accuracy in missile tracking system*

The strength of our missile defense program depends in part on extreme accuracy of radar tracking.

Bausch & Lomb has developed a camera lens for boresighting a radar antenna—in essence, this lens checks the performance of radar just as one's vision is checked in an eye examination.

Accuracy of this lens system easily meets the most extreme requirements.

The same skills that made possible this missile track radar camera lens are available to assist on your project. Write us for full details. Bausch & Lomb Incorporated, Military Products Division, 99712 Bausch St., Rochester 2, N. Y.

**BAUSCH & LOMB**

SINCE  1853



## OVER AND UNDER THE TOP OF THE WORLD

In early 1960, American craft pierced the North Pole in two elements. Fathoms below solid ice, the USS Sargo probed unerringly to "90 North"; miles above, a GAM-77 missile on a B-52 pinpointed the featureless goal. Both used Inertial Navigation systems by Autonetics—where today's results pave the way for tomorrow's breakthroughs.

Electromechanical Systems by **Autonetics**  Division of North American Aviation

ing vehicle will have tv cameras to show earth-bound operator where it is going, and to permit circumvention of physical obstacles. It will carry materials analysis instruments and material sampling devices. Whereas Surveyor can explore only the area near where it touches down, Prospector will be able to move around and sample different sections of the moon's topography. Sample-return vehicles will probably be guided to earth by radio commands based upon DSIF tracking.

*Mariner*—NASA's practice is to give lunar shots names designating exploration on the ground and use nautical terms for its planetary vehicles. First shot in the latter category is the Mariner shot to Venus in 1962. Two primary scientific experiments of about fifteen scheduled to be flown will use an ultraviolet spectrophotometer and a radio-frequency radiometer. The latter is tailored to look at wavelengths of 4, 8.5, 13.5 and 19 millimeters. To date, measurements from earth indicate a temperature of approximately 450° F on Venus, and it is hoped that the radiometer experiment will result in more accurate readings of the planet's surface, various layers of its atmosphere and its ionosphere. Instruments will be able to get information as a function of latitude and longitude, scanning up and down, as the spacecraft passes the planet. Three principal objectives of the ultra violet spectrophotometer experiment are to look for aurora and for determination of location of Venus' magnetic poles; to learn something of the chemical composition of the planet's atmosphere by analyzing ultraviolet reflection; and to learn something of Venus' night glow. The system will scan the dark side on approach, cross the terminator and scan the light side of the planet.

Radiometer and ultraviolet spectrophotometer will be mounted on a horizontal arm pointed at the planet by an optical-seeking system.

Other instruments to be carried on this flight and subsequent deep-space probe will include more sophisticated versions of the Ranger I and II charged-particle experiments. A highly sensitive solar corpuscular radiation experiment and additional low-energy particle

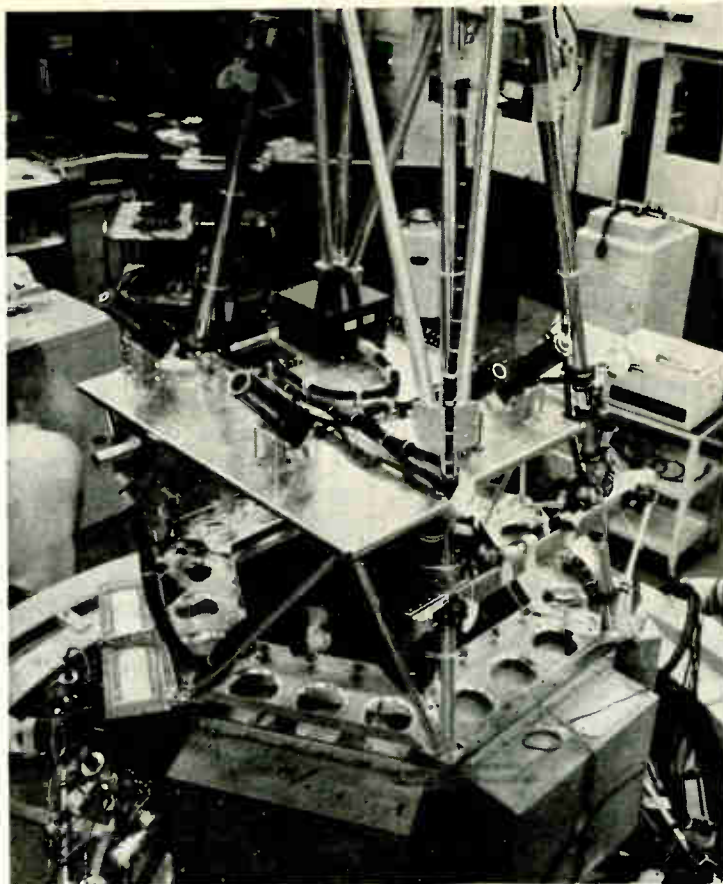

*Instrument section for Ranger I and II (JPL)*

detectors, currently being developed by MIT, University of Maryland, University of Iowa, University of Chicago and Goddard Space Flight Center are proposed.

A much finer spectrum break down of energy ranges will be obtained, using complex new detectors in addition to those in Ranger.

Other experiments to be included are advanced magnetometer and cosmic-dust investigation packages. Magnetometer will be a two-range instrument, one for interplanetary space and one for approach to Venus.

Venus was chosen for this first flight because the down hill trip toward the sun is easier, a factor of two in power efficiency of solar cells is realized, and the 60 million mile distance as against the 100 million miles to Mars eases communications problems. Mariner I is expected to pass within 16,800 miles of Venus. The trip will take about three months. Vehicle attitude will be similar to that of Ranger, with its main axis pointing at the sun and its directional antenna homing on

the earth. To cope with greater communication distances, JPL hopes to change the 960 Mc DSIF system to 2,300 Mc operation. Advantages: higher gain, higher signal-to-noise ratio, increased bandwidth.

Primary scientific experiments to be carried in the first Mariner-Mars vehicle will be an infrared spectrophotometer for examination of organic life on Mars, and a high-resolution tv system to look at the planet. Perkin-Elmer and Block Assoc. are performing studies to determine the best approach for the former and hope instrumentation developed can ascertain whether the dark areas of Mars, previously investigated by the Palomar 200-inch telescope, are actually vegetation.

Surface structure determination is the goal of the 200 to 500-line tv experiment. Equipments for both experiments will be severely weight-limited, to be compatible with the 50 to 100-lb instrument-package. Experiments other than planet-oriented ones will be similar to those carried on the first Mariner

## How to get very precise data... anywhere



Ampex's new CP-100 ideally balances size and performance in a magnetic tape recorder. It meets laboratory standards in all the critical parameters—cumulative peak-to-peak flutter is well below 0.2% (60 ips, 300 cps cut-off);  $\pm 0.25\%$  maximum tape-speed variation; frequency response from DC to over 200 kc. Yet it's compact enough (4.7 cu. ft.) to go virtually anywhere on land, sea or air where you need to recover critical data.

Like the rest of the facts? Write:

# AMPEX

AMPEX DATA PRODUCTS COMPANY  
Box 5000 Redwood City, California

flight to Venus.

Data handling system for Mariner, because of vast number of inputs and long-distance communications problems, will use a small computer and is far more complex than its Ranger counterpart. It will have a logic capability, greater storage capacity and ability to process scientific data of varying rates, depending upon mode of operation of instruments. For example, during a solar flare the increased density of cosmic-ray particles make it desirable to turn off all radiation detecting instruments except those used for determination of planet radiation belts. Data system will have a 10-bit program stored in it, and present planning calls for reprogramming this in flight. Such a system permits use of telemetering devices with relatively small dynamic range.

Outputs from scientific experiments will be stored in the data system over 24 hours, and at a determined time, will be clocked out to the communications system. Transmission of scientific data may take from one hour per day to several, depending upon activity observed. Remainder of the communications system's time will be devoted to transmitting engineering-type measurements.

Communication rate from vicinity of Venus is expected to be a maximum of 60 bits a second, so data that comes in at 1,000 bits a second from multiple instruments will have to be stored during encounter and transmitted at a retarded rate. Storage of data and limited transmission periods will also simplify the traffic problem in the DSIF network with, for example, Surveyor and Mariner being tracked simultaneously by the three 85-foot dishes. Command functions aboard Mariner will include those of guidance and control equipment as well as to data-handling system.

*Voyager*—No study contracts have been let on instruments for *Voyager* as yet, but in-house planning at JPL indicates some areas in which concentration of effort is expected. Venus and Mars will be within easy reach with this vehicle, and Mercury, Jupiter and the extreme reaches of the solar system will probably be attainable.

One hope lies in putting a vehicle in orbit around a planet and letting

it remain there as the planet goes around the sun for one of its years. The satellite would be interrogated periodically to determine phenomenon associated with change of seasons, or change in spacial relationships. Additional capability anticipated would permit entering the planet's atmosphere with a survivable capsule and running simple experiments associated with surface conditions.

An early experiment with *Voyager* will investigate the possibility of life on Mars. Techniques of culture growth will be used in conjunction with an infrared spectrophotometer to detect organic life. Samples of dust, injected into culture media, will be viewed for signs of growth. Another proposed exobiological experiment consists of using selected dyes on Martian samples and viewing through a slow-scan tv microscope system using an ultraviolet light source.

Mercury is on JPL's list of places to visit. Surface temperature of the side continually facing the sun is equivalent to molten lead, and the twilight zone and dark side are expected to yield some interesting phenomena. *Voyager*-Mercury spacecraft will have sophisticated temperature control system, and new design techniques for electronic components, enabling them to survive several hundred deg C temperatures, must be developed.

A high priority experiment on the Jupiter shot would be determination of deadly radiation levels surrounding the planet. Present indications put this at 1,000 times that of Earth's belt.

Another subject eyed by JPL scientists is the asteroid belt, the origin and make-up of which have puzzled astronomers.

The feasibility of replacing 85-foot antennas at Goldstone, Calif., Woomera, Australia, and Krugersdorp, S. Africa by new 250-foot units is being investigated. Adoption of such a plan would permit the DSIF net, using low bit rates, to communicate to the edge of the solar system—a distance of 4 billion miles. To make this possible, communicating spacecraft will be equipped with high-power transmitters and high-gain directional antennas.

Nuclear power sources will be used aboard.

# "NO NEEDLESS NINES"

For Speed Where It Counts in New 'NLS 30' Digital Voltmeters



Transistorized "no-needless-nines" logic makes the new V35A and V34A digital voltmeter-ratiometers at least three times faster than meters with older type logic . . . and you get this speed where it counts, in systems applications with varying input signals. The five-digit V35A's *maximum* balancing time is 2.3 seconds and the four-digit V34A's 1.9 seconds — no matter how much the input signal varies. Under like conditions, all other stepping switch digital voltmeters require 10, 15, 20 seconds or more — depending on variation of inputs. Only NLS new Series 30 instruments offer you the many other benefits of "no-needless-nines" logic, plug-in oil-bath stepping switches, 99% plug-in modular construction, and eight other *new* features. Contact NLS today for the full story on "no-needless-nines" logic and Series 30 instruments.

*V35A SPECIFICATIONS: Measures DC voltage from  $\pm 0.0001$  to  $\pm 999.99$ , DC voltage ratio from  $\pm 0.001\%$  to  $\pm 99.999\%$  . . . accuracy:  $\pm 0.01\%$  of reading or  $\pm 1$  digit for DC voltage,  $\pm 0.005\%$  of reading or  $\pm 1$  digit for DC ratio . . . output and internal automatic controls for data recording . . . measures AC voltage and low-level DC with accessories . . . completely automatic . . . plug-in transistor circuitry throughout, including logic . . . no adjustment needed to read noisy signals or to change ratio reference voltage value . . . interchangeable plug-in stepping switches sealed in oil . . . the "Factual Fifth Figure", which means a full 5-digit resolution of 0.001% over the entire range . . . "No-Needless Nines" logic . . . remote, local, or automatic AC/DC switch-over and range changing . . . front and rear input connectors . . . 10 megohms impedance on DC voltage, 1000 megohms on voltage ratio . . . \$3,750, complete. V34A (4-digit version) is \$3,150, complete.*



Originator of the Digital Voltmeter

**non-linear systems, inc.** DEL MAR, CALIFORNIA

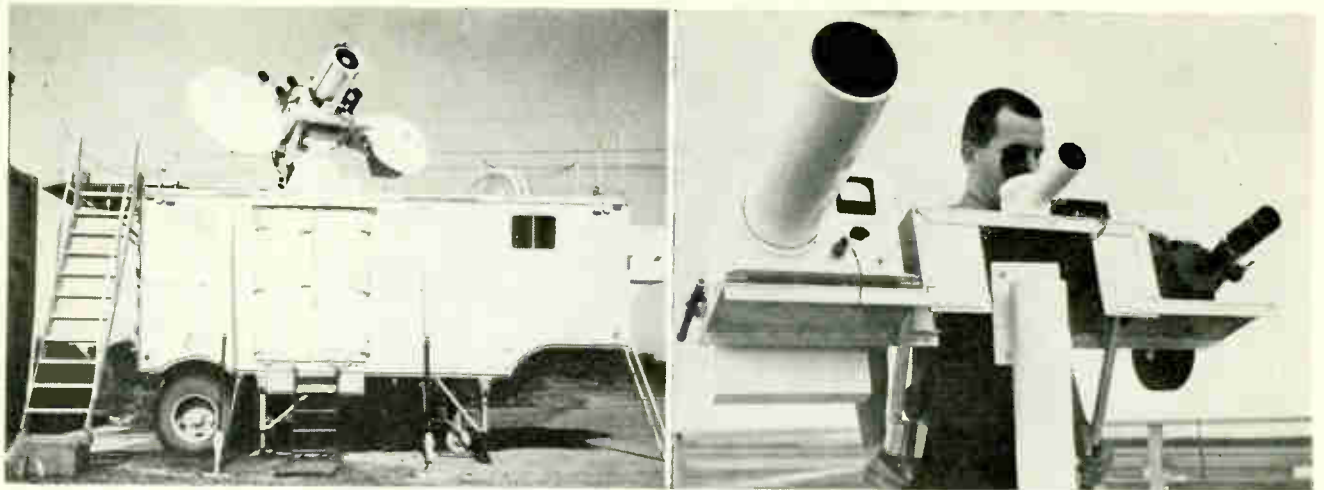

RCA's system (left) measures radiation during entire boost phase. Radiation, Inc.'s equipment (right) studies spectral and configurational data on missile bloom

## How Tell-Tale Signs Can Help Kill Missiles

THE DEFENSE DEPARTMENT MAY be moving closer to a workable technique for identifying an enemy ballistic missile during its power flight by the radiation it emits.

Work on this technique at Cape Canaveral, Fla. is moving along at a healthy pace with the completion of two new radiation measurement systems.

RCA built and operates the Mobile Missile Measurement System that detects, makes passive measurements and records incident radiation from missiles over the spectrum from ultraviolet to microwave. Tests concern only the powered phase of missile flight. The system could measure, from a down-range station, radiation on reentry.

Radiation, Inc. built and operates a radiation measuring system to study the missile bloom effect that occurs during night launchings when the missile reaches about 120 kilometers.

Ability to identify a missile during its first 100 seconds after launch and to know its probable range, would be a big step beyond present techniques.

Coming up with detection and interception techniques beyond present concepts is the special task of the Advanced Research Projects Agency's group called Project Defender (ELECTRONICS, p 42, Feb. 26; p 36, May 13).

RCA's system is contained in an air-transportable trailer and may also be used on board ship. The

array of sensors is mounted on a servo-controlled pedestal, that provides for full and vertical and 360-degree horizontal pointing. The pedestal may be controlled automatically by a self-contained infrared angle tracker mounted on the pedestal. It can also be commanded from an adjacent manually controlled visual tracking station or by antenna synchro outputs from a nearby tracking radar.

The optical tracker (see astradome, top right in photo on the left) includes a tracking telescope and multiple filter inserts. It can control the sensor pedestal through a servo system. The ir automatic angle tracker (the large cylinder between the two microwave dish receivers) provides milliradian tracking accuracy. Six ir radiometers surround the tracker. A variety of cooled or uncooled detectors and filters with spectral coverage to 15 microns can be used. A 28-channel magnetic tape recording system is provided for recording measurement and timing data and verbal commentary. A high-gain, broadband Amplidyne control system provides for automatic control of the sensor pedestal. Range timing inputs can be accepted either by land line or radio.

Radiation, Inc.'s equipment, located on the roof of the Technical Laboratory at Patrick AFB, obtains spectral and configuration information on the missile bloom effect—a phenomenon that appears to the

beachwatcher as a whitish glow. The light grows rapidly to a diameter of several miles.

The gear consists of a 35-mm cine camera with an eight-inch focal length, f/3.5 lens to obtain the configuration data. The spectral information is obtained by a radiation spectral-visual photometer.

The photometer uses a five-inch aperture, 24-in. focal length lens and multiplier phototube detector. Spectral information is provided by a series of interference filters that are mounted on a wheel and rotate in front of the detector. A total of 13 interference filters are used, providing spectral information from 0.385 to 0.572 micron, with an average bandwidth of .01 micron.

The signal from the multiplier phototube is amplified and recorded and the whole system is calibrated in radiometric units. Range timing is supplied to both the camera and the photometer for correlation. The photometer and camera are mounted on a manual tracking head and pedestal mount.

The spectral and configuration data are correlated to give an indication of the quality of track and the relation between the spectra and the shape of the bloom. In addition, these data are correlated with missile type, ionosphere back scatter signals and ambient meteorological conditions to give an understanding of the mechanisms and energies involved in the production of the missile bloom.



INDUSTRY'S  
MOST COMPLETE  
STANDARD LINE



**E-I SEALED TERMINALS AND HEADERS** provide you with the widest possible design latitude. E-I offers the engineer/designer the industry's most complete line of sealed terminals and miniature components at prices that reflect the economies derived from standardized production. E-I seals are specified industry-wide for today's most critical military and commercial equipment... proof of their complete reliability in the most severe environments.

**Multi-Lead Headers**

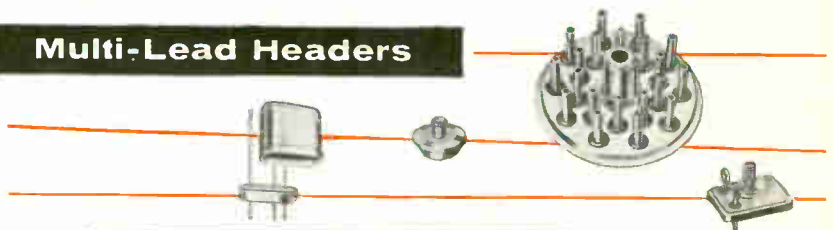

**Condenser Seals**



**Individual Terminals**

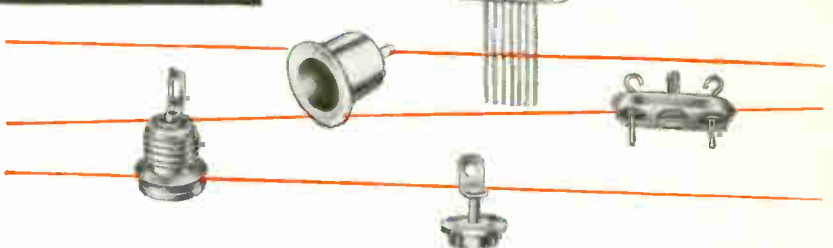

IF YOU HAVE A SEALING PROBLEM...call or write for complete information on the E-I standard line, or ask an E-I field engineer to make recommendations on your application.

Patented in Canada, No. 523,390;  
in United Kingdom, No. 734,583;  
licensed in U.S. under No. 2561520



**ELECTRICAL INDUSTRIES**

MURRAY HILL, NEW JERSEY, U. S. A.

*A Division of Philips Electronics and Pharmaceutical Industries Corp.*



ENGINEERING  
**REPORT**  
ON BENDIX COMPONENTS



## PRECISION SIZE 5 MOTORS NOW AVAILABLE FROM STOCK

Available for immediate delivery, these miniaturized Bendix® motors (type number CK 1066-40-A1) are designed for applications where space and weight requirements are at a minimum. So small that four can be packaged in a square inch, these motors are ideally suited for missile instrumentation and similar miniaturized applications. The motor has a tapered shaft; however, units may be obtained with other type shafts and with center tapped control windings.

### TYPICAL MOTOR CHARACTERISTICS

Voltage	
Fixed phase	26 volts
Control phase	26 volts
Frequency	400 cycles
Stall Current*	
Fixed Phase	100 ma
Control Phase	100 ma
Stall Impedance*	
Fixed Phase	260 = 184.5 + j183.5 ohms
Control Phase	260 = 184.5 + j183.5 ohms
Stall Power Input* (Total)	3.69 watts
Stall Torque	0.138 oz.-in.
No Load Speed	9900
Torque-to-Inertia Ratio	44,400 rad sec <sup>2</sup> (Stall Acceleration)
Operating Temperature	
Range	-55°C. to +70°C.
Weight	0.88 oz.

\*With rated voltage applied to each phase.

For information on these motors—  
or similar motors in sizes 8, 10, 11, 15,  
20, and 28—write:

**Eclipse-Pioneer Division**

Teterboro, N. J.



District Offices: Bu'bank, and San Francisco, Calif.; Seattle, Wash.; Dayton, Ohio; and Washington, D. C.  
Export Sales & Service: Bendix International, 205 E. 42nd St., New York 17, N. Y.

## New England Sees

By **THOMAS MAGUIRE**  
New England Editor

BOSTON—A fresh ripple of optimism gained amplitude and momentum over the New England electronics landscape this week as an upturn in component orders, especially semiconductors, was recorded.

Softening of the national economy in recent months was reflected less in New England, principally because the area's long-range government-subsidized research and development activities are not immediately responsive to production trends. The R&D volume provides a cushion.

Semiconductor firms in N. E. report increases in orders started 4 to 5 weeks ago, but the components people's bullishness is really long-term. Most dramatic reflection of this is in expansion of semiconductor production facilities in the area. Moving into new automated plants, or about to move, are Clevite, CBS Electronics, Transitron and Raytheon. Sylvania's Semiconductor division is expanding operations at its Hillsboro, N. H., plant.

"They can't all be wrong about business prospects," said one executive this week.

N. E. semiconductor people see that segment of the industry expanding about three times its present volume in the next 5 years—and the area is planning to boost its already healthy share of this business.

At the same time, signs point to lower prices for components, a tighter profit squeeze and narrower product lines. And predictions of an imminent shakeout of semiconductor companies are becoming widespread.

A note of warning is sounded by the president of a N. E. electronics firm which deals in devices and systems across the board. Noting a "very decided slippage" nationally in electronics during the past six months, he says: "Companies with good selling organizations are the ones which can survive these dips. If a company has weaknesses, this is the time they show."

He cites the increased availability of engineers as a good index to con-

### AVERAGE PERFORMANCE CURVES

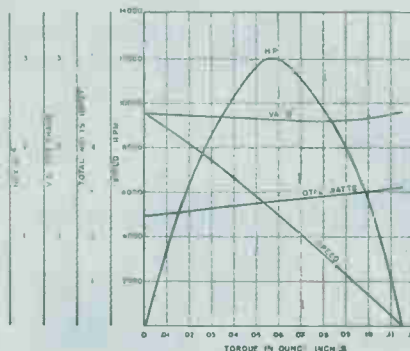

## Business Upswing

ditions in the industry. "Jobs mean something to engineers now," he says. "There are more of them looking for jobs."

He also cites weakened positions of some smaller companies. "We've been on the prowl for acquisitions," he says. "Suddenly, we're deluged with offers—from small firms in difficulty. Also, larger firms are pulling back much subcontracting work."

Simultaneously, however, recent months have seen a rash of new electronics firms in N. E., many of them obviously formed to take advantage of heavily financed new R&D programs in New England academic and government laboratories.

Electronics executives see the glamour rubbing off industry stocks, and the prospects for narrowing the gap between earnings and listings.

Overseas business prospects are playing an increasing role in projections.

Raytheon Co., largest electronics employer in N. E., hopes to increase overseas sales from \$4 million to \$20 million per year during the next three years.

## Underground Minuteman Antennas Pass Tests

SEATTLE, WASH.—After 18 months of experimental work with underground radio antennas in a jam-resistant launch control system for the Minuteman intercontinental missile, the Boeing Airplane Co. is preparing for further testing.

Preliminary testing has been done in the Auburn area south of Seattle but, by Christmas, Boeing engineers will be operating another site to study the system under operating conditions.

The company hopes the tests will provide Minuteman with a launch communication system virtually impossible to destroy and will substantially reduce installation costs at missile bases. Boeing has an Air Force contract to develop a radio launch control system for the silo-stored missiles; it is concentrating

on radio antennas and system integration. Sylvania Electric Co. has a subcontract for special transmission and receiving instruments, the latter also to be installed underground. RCA has a subcontract for data processing equipment to coordinate firing information.

Radio equipment and antennas, as well as missiles, will be underground, eliminating the costly process of burying miles of communication cable.

Boeing is studying how various types of soils and their moisture content affect signal transmission, how underground location determines antenna shape and how much power is required. From a plywood-lined pit about 10 ft below the control shack at the Auburn site, engineers transmit signals to mobile monitoring receivers. Transmission antennas stretch in four directions, at a depth of 4 ft.

The transmitting and receiving equipment, being developed by Sylvania, will use a spread spectrum, where radio waves will be broadcast on a wide range of frequencies, to be gathered and decoded at the receiving end. The tremendous power necessary to jam this broadcast range makes radio launching virtually sabotage-proof.

The radio launch control system will control as many as 50 underground missiles from launch control centers. Each Minuteman squadron will contain 50 missiles and five launch control centers.

## Radar for Coasting Missiles



Project Defender's ESAR (electronically steerable array radar), Bendix, studies coasting missiles

## ENGINEERING REPORT

ON OTHER BENDIX COMPONENT PACKAGES



## AUTOSYN SYNCHROS

Dependable in miniaturizing control circuitry

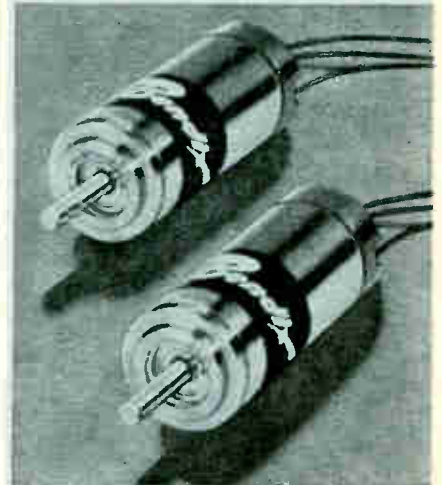

These Bendix® size 5 Autosyn synchros are well suited to the needs of missile instrumentation and similar applications requiring miniaturization and weight reduction. Typical characteristics are listed below. For additional information, including comprehensive data on transmitter, control transformer, and differential characteristics, write today.

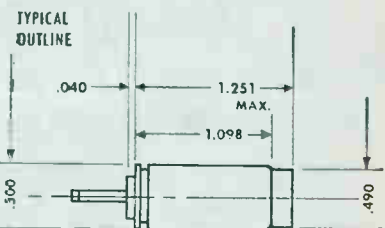

### TYPICAL CHARACTERISTICS

Operating temperature range — 55°C. to 95°C.  
 Rotor moment of inertia . . . . . 0.25 gm cm<sup>2</sup>  
 Weight . . . . . 0.8 oz.  
 Accuracy . . . . . ± 15 minutes

Available as transmitter, control transformer and differential.

Manufacturers of

GYROS • ROTATING COMPONENTS  
 RADAR DEVICES • INSTRUMENTATION  
 PACKAGED COMPONENTS

Eclipse-Pioneer Division



Teterboro, N. J.

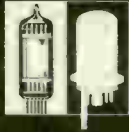

*Bendix Craftsmanship at work for you*



#### AVAILABLE TYPES

##### Solenoid Focused

- Type TWO-88 with frequency range of 30 KMC to 40 KMC
- Type TWO-75 with frequency range of 40 KMC to 50 KMC
- Type TWO-67 with frequency range of 49 KMC to 59 KMC
- Type TWO-82 with frequency range of 50 KMC to 60 KMC
- Type TWO-66 with frequency range of 61 KMC to 71 KMC
- Type TWO-83 with frequency range of 65 KMC to 75 KMC
- Type TWO-85 with frequency range of 70 KMC to 85 KMC
- Type TWO-87 with frequency range of 85 KMC to 100 KMC
- Type TWO-90 with frequency range of 100 KMC to 120 KMC

AVAILABLE NOW PERMANENT MAGNET FOCUSED TYPE  
TWO-89 WITH FREQUENCY RANGE OF 50 KMC TO 60 KMC

## LARGEST LINE OF MILLIMETER WAVE LENGTH BWO

Bendix® BWO tubes for higher frequency transmission. These Backward-Wave Oscillator Tubes—exclusive with Bendix—generate microwave energy over the largest continuous frequency range. Ideal for advanced multichannel telephone and television systems, microwave spectroscopy, high definition short range radar, highly directive communications, and many other applications needing low power, voltage-tuned millimeter wave length radio frequency energy. Write today for complete information.

#### ELECTRICAL DATA

Frequency Range.....	30 KMC-120 KMC (see specific type)
Anode Voltage.....	1000-4000 volts
Power Output.....	Up to 20 mw average (depending on frequency)
Beam Current.....	10 MA
Magnetic Field.....	2000 gauss
Heater Voltage.....	6.3 ±10%

#### MECHANICAL DATA

Output Flange.....	Special adapter to RG-98/U (50-75 KMC)
Maximum Diameter.....	0.625"
Length.....	8"
Mounting Position.....	Any
Weight.....	5 oz.*

\*Without magnet (tube only). Magnets are available.

ELECTRON TUBE PRODUCTS

**Red Bank Division**

EATONTOWN, NEW JERSEY





Vacuum system holds paper in place as transistorized weather plotter draws isobar patterns for forecasting use

## Electronic Plotter Draws Weather Maps

IN AN IMPORTANT STEP toward mechanizing operations, the U. S. Weather Bureau is now using an electronic computer-plotter to draw forecast maps of the Northern Hemisphere.

Installed at the National Meteorological Center, Suitland, Md., the instrument reduces drawing time of first approximation maps from 20 minutes using manual techniques to under three minutes.

Data gathered from over 500 stations is processed by the center, and distributed by facsimile to over 600 Weather Bureau stations, military installations, airlines, and others requiring the service.

The Weather Bureau says it worked with industry for eight years in developing the new technique. Two units delivered to the Bureau (one for standby), were designed and developed by Electronic Associates, Inc., Long Branch, N. J. The firm produces a line of automatic plotting units for scientific and industrial use, as well as analog computers.

The weather plotter at the Bureau will produce 64 maps in a 24-hour day. Maps are drawn for different altitudes up to 40,000 ft. Isobars, lines of equal barometric pressure, are drawn on prepared maps by the plotter's stylus.

Information from weather obser-

vation stations is edited by Bureau personnel and put into punched card form. After being checked, it is used by weather analysts to update forecasts, which are programmed on a computer and recorded on magnetic tape.

The weather plotter employs its own tape reader, accepts digital information for analog conversion.

Completely transistorized, the converter controls the plotting board pen. A parity check minimizes chance of error. It can be set to reject questionable data, or to stop plotting for examination.

Increased accuracy is achieved because the plotter produces a map without fatigue problems encountered with hand-drawn maps. Dynamic filters to smooth data flow are adjustable manually, and contribute to accuracy, along with the use of chopper stabilized operational amplifiers and thermostatic controlled ovens for stabilization of critical resistors and diodes.

Electronic Associates is delivering similar units to Monterey and Point Mugu, Calif., for use in weather forecasts for Vandenberg Missile Range; and to SAC headquarters, Offut Air Force Base, Omaha, Neb.

Similar plotting equipment is being introduced for highway planning, and automatic drafting.

## SAFE! SIMPLE! ACCURATE!



### AC BREAKDOWN TESTERS

Complete line of units designed for testing in accordance with ASTM D-149 and Federal Spec. LP-406, Method 4031, used for determination of dielectric strength and breakdown voltage safely, simply and accurately in the laboratory or on the production line.

#### FEATURES

- Completely self-contained
- Automatic rate of voltage rise
- Plug-in test electrodes
- Retention of voltmeter reading after breakdown
- Dual range units available for maximum versatility, up to six voltmeter ranges

In addition to the standard models noted below, special models incorporating higher output ratings and a number of metering systems including primary metering, direct secondary metering, and digital output with recording can be provided.

Single Range	Dual Range Unit
15 KV, 2 KVA	50 KV, 2 KVA
15 KV, 5 KVA	and 10 KV, 2 KVA
25 KV, 2 KVA	25 KV, 2 KVA
25 KV, 5 KVA	and 5 KV, 2 KVA
50 KV, 2 KVA	100 KV, 5 KVA
50 KV, 5 KVA	and 20 KV, 5 KVA
100 KV, 5 KVA	

#### ARC RESISTANCE TESTER



Used for measuring the ability of insulating material to withstand high-voltage low-current arcs. Supplied in conformance with ASTM D-495 and Federal Spec. LP-406 Method 4011.2. Simplified operation includes automatic stepping and timing, and improved electrode holder. Operable by unskilled personnel.

Complete catalog of Electrical Test Equipment available on request.



**Industrial  
Instruments Inc.**

89 Commerce Road, Cedar Grove, Essex County, N. J.

# LAPP STAND-OFF INSULATORS FOR MODERATE OR HEAVY DUTY



For years, Lapp has been a major supplier of stand-off insulators to radio, television and electronics industries. Wide knowledge of electrical porcelain application, combined with excellent engineering and production facilities, makes possible design and manufacture of units to almost any performance specification. The insulators shown on this page are representative of catalog items—usually available from stock—and certain examples of special stand-offs. The ceramic used is the same porcelain and steatite of which larger Lapp radio and transmission insulators are made. Hardware is brass or bronze; brush nickel plating is standard.

Write for Bulletin 301 with complete description and specification data. Lapp Insulator Co., Inc., Radio Specialties Division, 174 Sumner St., Le Roy, N. Y.

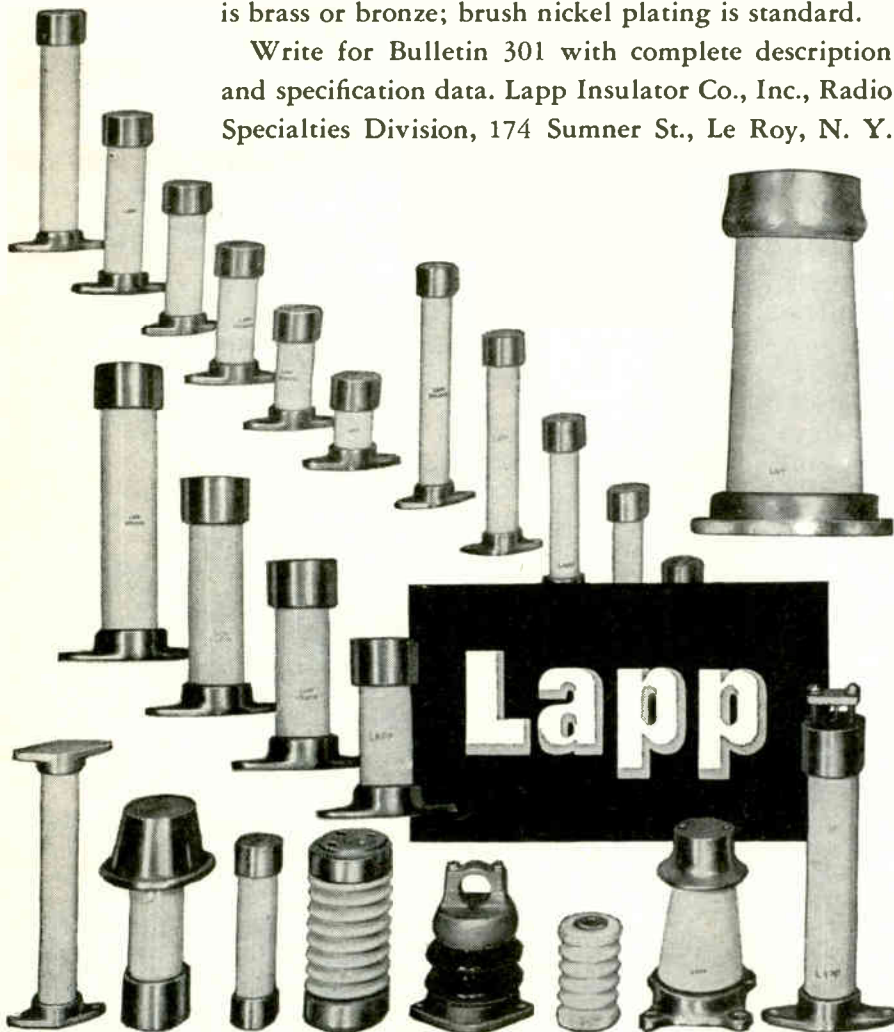

## MEETINGS AHEAD

- Dec. 16-17: Combined Analog Digital Computer Systems Symposium, Simulation Councils, Inc., General Electric; Sheraton Hotel, Phila.
- Jan. 8-12: Thermoelectric Energy Conversion, Dept. of Defense, Joint Technical Society; Statler-Hilton Hotel, Dallas.
- Jan. 9-10: Plasma Dynamics; Southern Methodist Univ., Dept. of Mech. Engineering, Dallas.
- Jan. 9-11: Reliability & Quality Control, ASQC, AIEE, EIA, PGRQC of IRE; Bellevue-Stratford Hotel, Phila.
- Jan. 12-13: Reliability of Semiconductor Devices, Working Group on Electron Tubes; Western Union Auditorium, New York City.
- Jan. 17-19: Instrument Automation Conf. & Exhibit, ISA; Sheraton-Jefferson Hotel, Kiel Auditorium, St. Louis, Mo.
- Jan. 31-Feb. 2: Cleveland Electronics Conference; Engineering & Scientific Center, Cleveland.
- Feb. 1-3: Military Electronics, PGMIL of IRE; Biltmore Hotel, Los Angeles.
- Feb. 1-4: Electronic Representatives Assoc., Annual Convention; Ambassador Hotel, Los Angeles.
- Feb. 7-9: Electrical Manufacturers Assoc., Veteran's Memorial, Columbus, O.
- Feb. 14-16: Nondestructive Testing of Aircraft & Missile Components, Southwest Research Institute, South Texas Section of the Society for Nondestructive Testing Inc.; Gunter Hotel, San Antonio, Tex.
- Feb. 15-17: Solid State Circuit Conf., International, PGCT of IRE, AIEE; Univ. of Pa. & Sheraton Hotel, Philadelphia.
- Mar. 20-23: IRE, International Convention, All PG's; Coliseum & Waldorf-Astoria Hotel, New York City.

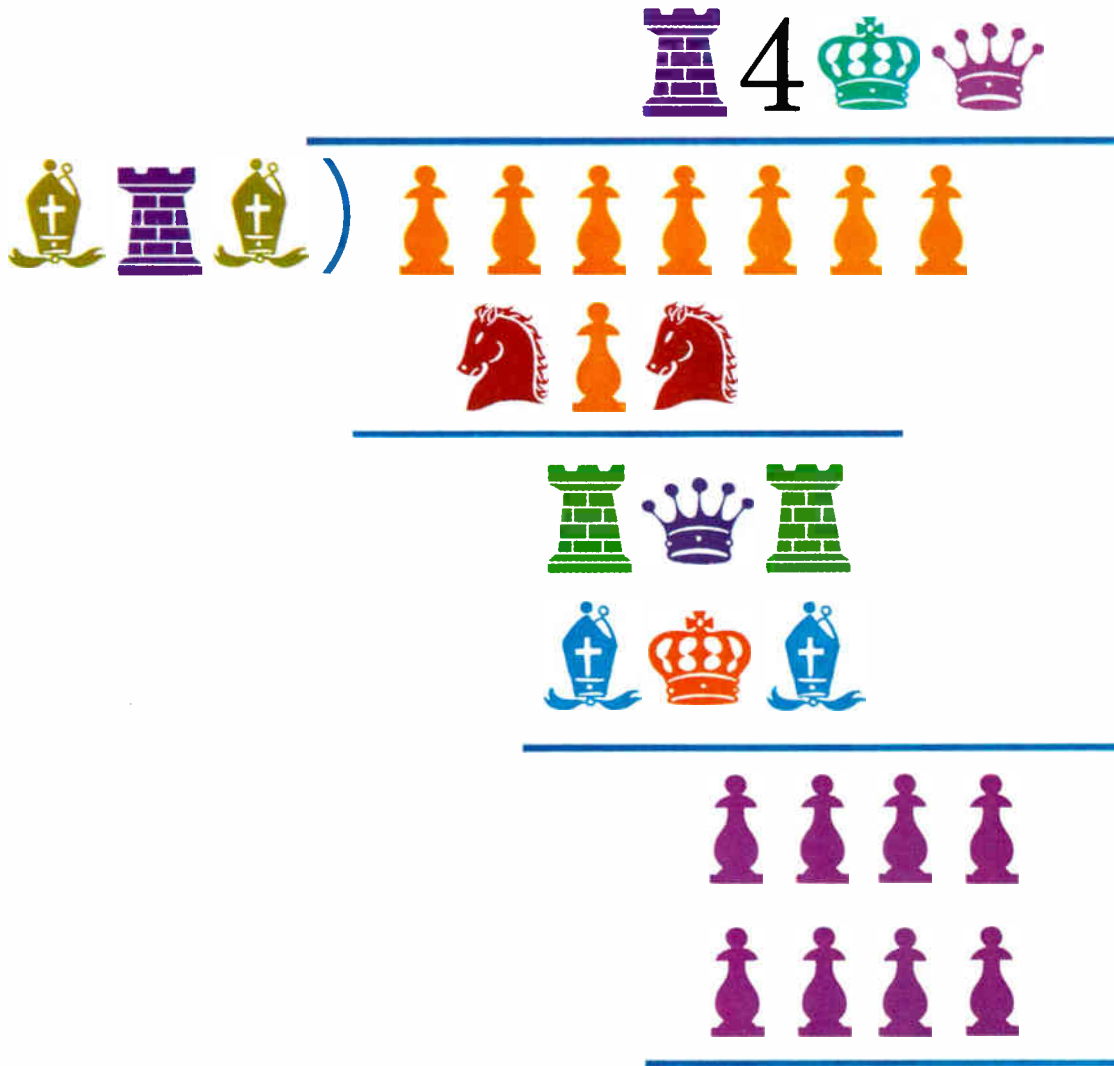

CLUE: The sum of the digits of the divisor leaves a remainder of seven when divided by nine, and the sum of the digits of the quotient leaves a remainder of three when divided by nine.

**AND LET'S CONSIDER ANOTHER QUOTIENT.** It takes shape as men's minds go deep into space. One center of these calculations is Martin-Denver, where successful professionals enjoy full scope from basic research to vehicle design. You will find range, reward, and stature here. Write N. M. Pagan, Director of Technical and Scientific Staffing, Martin-Denver, P.O. Box 179A2, Denver, Colorado.

**MARTIN**  
DENVER DIVISION

# NEW BORG LOW-INERTIA MOTORS

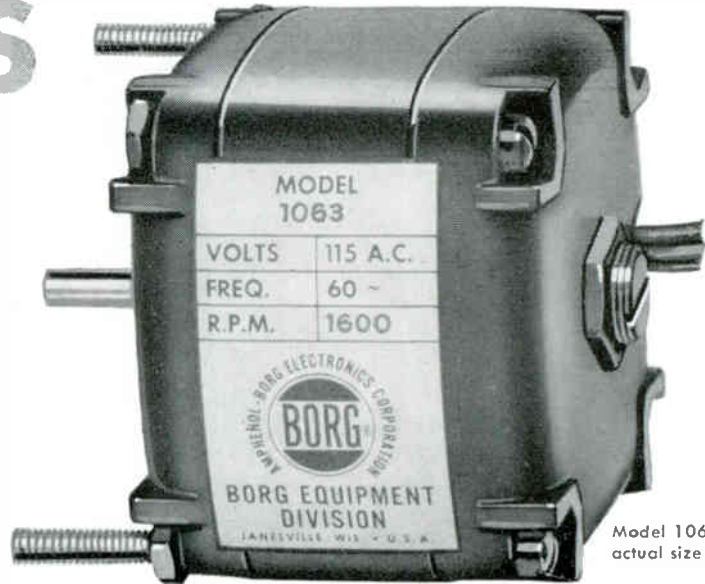

Borg's new 1060 Series Low-Inertia, Sub-Fractional Horsepower Instrument Motors are specifically designed for applications where *exceptionally rugged and reliable* control motors are demanded! They can be operated two-phase, or split-capacitor connected for single-phase operation, from a 115 volt, 60 cycle source. Extended rotor-bearing preload-adjustments are provided for minimum starting voltages. Ample electrical and mechanical safety margins are included for critical instrument applications such as medical equipment. Gear train models are also available in twenty gear ratios from 6 : 1 to 1800 : 1. Upgrade your precision equipment now . . . investigate new Borg 1060 Series Low-Inertia Motors!

CONTACT YOUR BORG DISTRIBUTOR OR TECHNICAL REPRESENTATIVE FOR CATALOG SHEET BED-A165

## SPEED/TORQUE CHARACTERISTICS

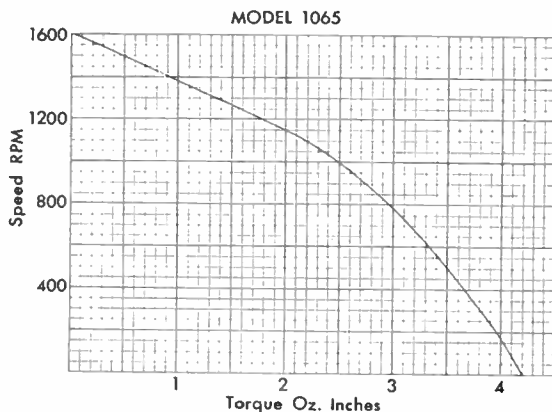
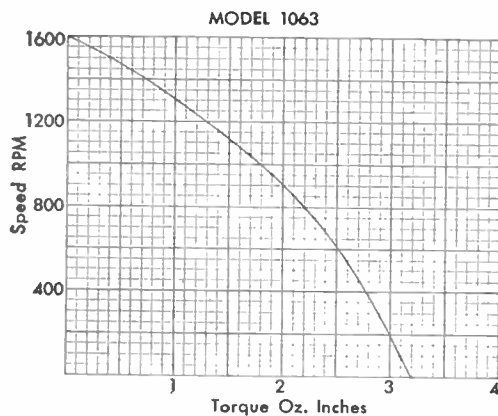

**BORG EQUIPMENT DIVISION**  
 Amphenol-Borg Electronics Corporation  
 Janesville, Wisconsin • Phone Pleasant 4-6616



Micropot Potentiometers • Turns-Counting Microdials • Sub-Fractional Horsepower Motors • Frequency and Time Standards



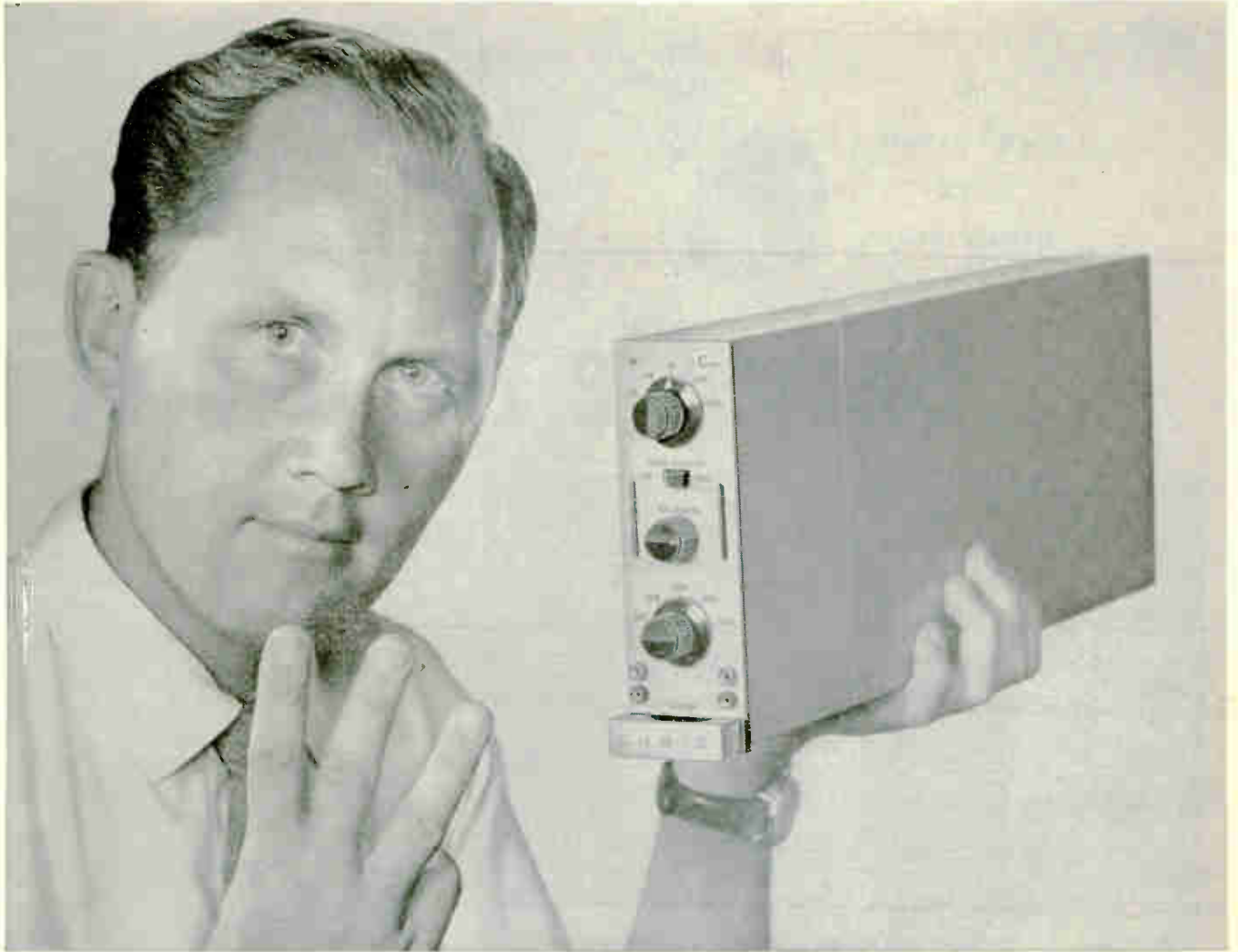

## New Cubic 3-in-1 d-c amplifier has built-in strain-gauge power supply

Important savings in cost, space, and setup time are now possible for users of strain gauges with the Cubic Model 1100 d-c wideband amplifier. This newest addition to the Cubic line of instrumentation amplifiers is really three units in one. It is (1) a differential-input, wideband d-c amplifier, (2) a bridge balance circuit, and (3) a well regulated strain-gauge power supply.

For applications not requiring the self-contained power supply, modules which contain two d-c amplifiers can be supplied. You can mount 8 of these modules abreast (16 amplifiers) in a single standard rack.

Model 1100 amplifiers with built-in power supplies eliminate the hookup problems formerly encountered in multiple-strain-gauge operations. Even more important, they permit saving \$200-400 per channel since separate power supplies and bridge balance circuits are no longer needed.

### ALSO THE 1000-SERIES

The Cubic line of d-c wideband amplifiers also includes the

Model 1000 series. These highly sophisticated solid-state instruments incorporate all the design improvements of 1960's state-of-the-art. Key to their versatility is the *Cubi-plug*, a module that plugs into the 1000-series amplifier chassis to provide any required gain, fixed or variable, and single-ended or differential input.

### SPECIFICATIONS AVAILABLE

Write for complete specifications and ordering information on Cubic's complete line of instrumentation amplifiers. Dept. E-5, Industrial Division, Cubic Corporation, San Diego 11, California.



A  
CUSTOMER  
SAYS:  
"SHOW ME!"



...We like customers who say "show me" because we can prove that Fansteel does more than just talk reliability. We can prove that Fansteel *does something about it!* Paul Weirich, Assistant General Manager, Rectifier-Capacitor Division, directs the customer "from Missouri" on a tour highlighting the Fansteel equipment, facilities, methods and skills which contribute to reliability in rectifiers and capacitors.

# "...Show Me the Secret of

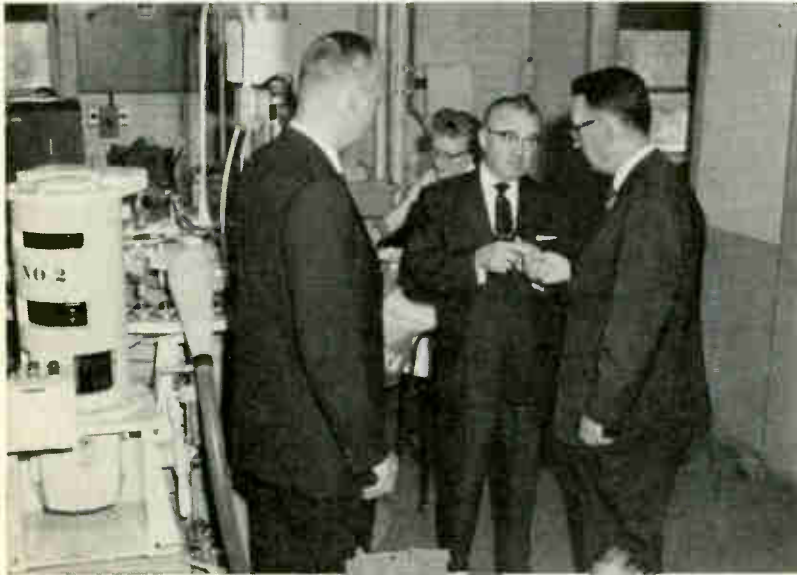

Here's the man who helped this miniaturization age get its start—Glen Ramsey, V.P. and General Manager, R-C Division, who developed the first porous tantalum anode back in 1936. Holding a new tantalum capacitor, he explains why the original Fansteel shoulder and curl design\* is still the *best* ever developed—proved by millions of applications in the field.

\* Patent No. 2,744,217



The customer "from Missouri" is introduced to Fansteel's new 240 amp. silicon rectifier by Bill Brown, Chief Engineer. Bill's staff of engineers, whose experience dates back to the beginning of the tantalum capacitor and the earliest selenium rectifier, is recognized as one of the most capable, creative teams in the electronic component field. (Incidentally, Bill Brown and staff promise more important product news soon.)

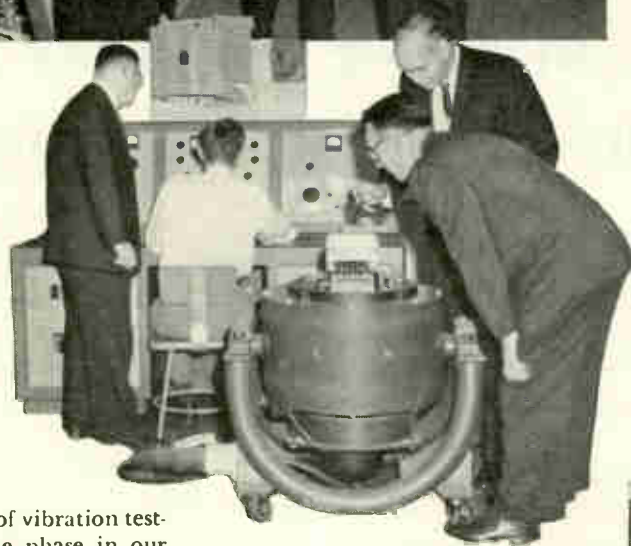

Hours and hours of vibration testing form just one phase in our reliability program. Consider our Gold-Cap\*\* line of capacitors, for example. It takes almost 8000 readings, calculations, examinations and comparisons...and 27 days of testing...to certify each 100 Gold-Caps for pre-tested reliability.

\*\*Trademark

Howard Brauer, Manager of Quality Control, gives a quick run-down on this 2500-unit tantalum capacitor life test chamber. "It's where we separate the 'men' from the 'boys'. 1000 hours of rugged electrical and thermal torture tells us how all units in each lot measure up to approved specs."



Here's an operation that'll either make or break a silicon rectifier. As you know, the silicon slices in rectifier junctions must be perfect in every respect ... uniformity in flatness, finish and parallelity is positively essential! Florian Schardt, Superintendent, Rectifier Plant, puts the 'mike' to a silicon slice to demonstrate the accuracy possible from the automatic lapping machines handling this job.



# FANSTEEL Reliability!"



Using what he calls "the world's fastest shoe shine machine", Technical Director Stan Fry prepares for work in the "white room"—silicon rectifier assembly area. Besides dustless shoes, precautions for all authorized personnel include special, lint-free clothing, personal vacuum cleaning and removal of cosmetics.



Dust, dirt and other contaminants simply can't penetrate "white room" barriers. Because it takes only one microscopic dust speck to destroy a rectifier's reliability, a special air system filters out foreign matter actually 1000 times smaller than the thickness of human hair. This near-sterile atmosphere alone almost guarantees high reliability... automatic equipment and skilled operators do the rest.



The "white room" must have a constant supply of super-clean water for cleaning rectifier junctions. Here's where that water is processed. This is one of the filters in the system. It can "weed" out matter even as small as virus from the water. This water becomes so pure that we've measured its electrical resistivity at 18 million ohm-centimeters!



What you saw here is typical of the over-all Fansteel reliability picture. The real secret—if there is one—is found in the *attitude* of our people towards our reliability efforts. They believe in it. They work hard to make it a success. Another factor—care and stubborn attention to detail every step of the way, from raw material ordering to packaging. No detail is too small to risk half-way measures or compromise of any sort.

When we state that reliability dictates our standards, we mean just that. And when we say Fansteel capacitors and rectifiers are reliable, we mean they rank second to none! Meanwhile, we're exploring ways to do even better. FANSTEEL METALLURGICAL CORPORATION, North Chicago, Illinois.



WHERE RELIABILITY DICTATES STANDARDS



For more than a quarter century, Hallicrafters has worked in close partnership with our armed forces on fast solutions to critical military electronics problems. Out of this priceless experience are emerging startling new ideas and hard-hitting, fast-moving techniques to keep our country one jump ahead in electronic warfare . . .



B-52 and other military aircraft will be protected by the most potent Electronic Countermeasures equipments yet devised. These equipments were developed in close teamwork with the Air Force under Hallicrafters' QRC (Quick Reaction Capability) program. Now qualified to meet full environmental specifications, they are in quantity production.



New levels of speed and efficiency are being reached in equipment modernization, retrofit and technical support programs with Hallicrafters' radical new "Blue Streak" project. Specially-trained Maintenance and Technical Support Teams, close-knit and flexible, can be tactically deployed to accomplish maintenance, installation and testing of electronics weapons systems anywhere in the world.

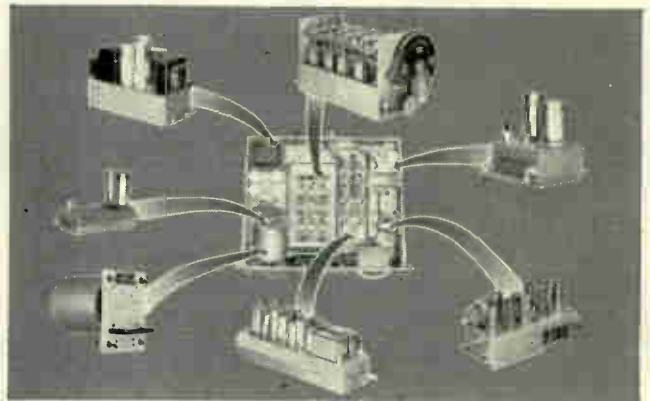

Hallicrafters communications leadership is exemplified by new high frequency Single Sideband receiver, (model no. SX-116). 100% modular design permits simple modification for compatibility with existing and future communications systems. Stability, with proper available plug-ins, is better than one part in 10,000,000 per month. Hallicrafters also offers an existing capability in receiving and transmitting techniques up to frequencies of 50,000 megacycles.



Hallicrafters participation in the Atlas missile project helped to develop capability for many areas of the complex missile field, including code translator data systems; ground support equipment; ECM testing and antenna systems. Current explorations involve latest Infra Red techniques.

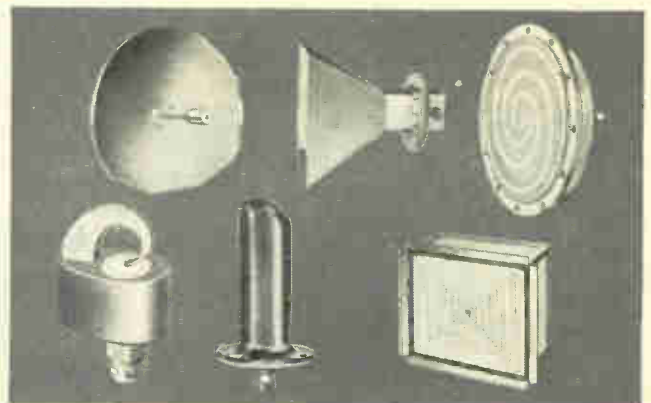

Airborne antennas and micro-wave components with power capability in excess of 1,000 watts, can be made available to solve tomorrow's very high power handling requirements. Testing of microwave components is possible with special high power generators, designed and built by Hallicrafters.

Looking for a challenging new opportunity? We are interested in qualified engineers at all levels. For full details in confidence, contact William F. Frankart, Director of Engineering.

For further information on Hallicrafters facilities and experience in military electronics research, development and production, please write to:

**hallicrafters h company**

Military Electronics Division,  
Chicago 24, Illinois



**YOUR BEST BUY  
FOR APPEARANCE  
AND PERFORMANCE...  
WESTON 301 PANEL METERS**

*Now...modern 3½-inch meters  
with time-tested Weston movements*

You'll find new design advantages in the familiar, reliable Weston 301 panel instruments. Case and mechanism are redesigned for modern needs—more reliable than ever before—at no increase in cost!

**The exclusive Cornag®** mechanism makes the 301 immune to the effects of stray magnetic fields. Instruments can be mounted on magnetic or nonmagnetic panels, close to other instruments, *without* special adjustments. Choose between round or rectangular case, modernistically styled in phenolic plastic.

**Another design advantage...** New 2½-inch Weston panel instruments—the 201 series—are designed with matching cases and incorporate the same advanced features!

For specifications...information...or the address of your nearest distributor, contact your local Weston representative, or write to: Daystrom, Incorporated, Weston Instruments Division, Newark 12, New Jersey.

*International Sales Division, 100 Empire Street,  
Newark 12, New Jersey. In Canada: Daystrom Ltd.,  
840 Caledonia Rd., Toronto 19, Ontario.*



Weston 301 Series is available in ac, dc, and RF types... voltmeters, ammeters, milli- and micro-ammeters... in dozens of ranges. Both round and rectangular meters are flush mounted. 301 Series requires 2.82" diameter cutout, 201 Series requires a 2.22" cutout.

**DAYSTROM, INCORPORATED**  
WESTON INSTRUMENTS DIVISION  
*Reliability by Design*

ANOTHER G-C SPACE SAVER!

## Threaded Cup Core and Bobbin for Miniaturized IF Transformer and Coil Applications

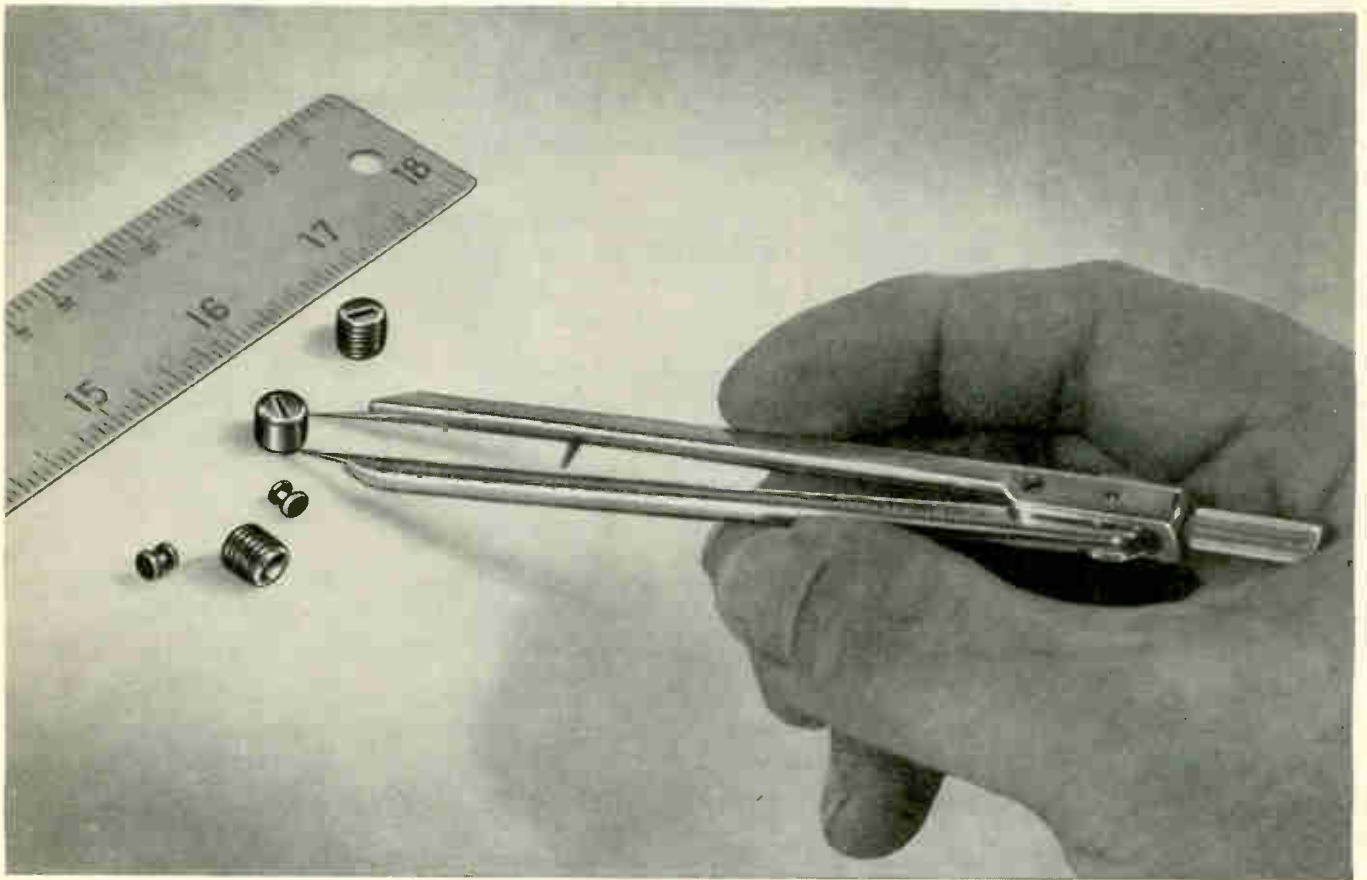

Now you can design miniaturized IF transformers and coils for AM-FM radio and television applications, and maintain high "Q" and effective permeability factors.

This new G-C threaded cup core and ferrite bobbin assembly has closely held mechanical tolerances for precision screw adjustment, and allows close cou-

pling factor between the coil and core.

For RF coil applications, G-C offers a complete line of threaded cores operating in frequency ranges up to 65 mcs. G-C threaded cores are available from stock in Q-1 and Q-2 material; pitch sizes from 1/4-28, 10-32 and 8-32; lengths from 1/4" to 1 1/8" with hex, square or screw-driver holes.

---

*Write for additional information on the miniaturized threaded cup core F1266 and bobbin F1270 and data on G-C stock cores. Please address inquiries to Section E.*

---



**GENERAL CERAMICS**

KEASBEY, NEW JERSEY, U.S.A.

TECHNICAL CERAMICS, FERRITE AND MEMORY PRODUCTS

**5/8" DIA.**

# CONTROLS



## ... Everything's small but the ratings

When the "package" calls for something smaller . . . when the circuit calls for dependability . . . Stackpole F-Series Controls lead the way. Used on everything from transistor auto sets and pocket portables to electronic organs, these fully-proved miniature variable resistors provide quiet, reliable operation.

Stackpole F Controls are conservatively rated at 0.3-watts. They're available with threaded bushings or fold-tab mounts as well as with standard lugs or printed wiring terminals.

DP-ST and SP-ST "B"-Series Switches perfectly complement the small size of F Controls and give the tease-proof, positive feel and audible "click" only a true snap-action switch can provide. They're U.L. Inspected for 1 ampere at 125 volts ac-dc; 4 amperes at 25 volts dc.

For those who have no miniaturization problems, however, Stackpole also produces a complete line of standard-size single and dual controls. Send today for full details. *Electronic Components Division, STACKPOLE CARBON COMPANY, St. Marys, Pa.*

# STACKPOLE

**VARIABLE  
composition  
RESISTORS**

CERAMAG® FERROMAGNETIC CORES • SLIDE AND SNAP SWITCHES • FIXED COMPOSITION CAPACITORS • COLDITE 70+®  
FIXED COMPOSITION RESISTORS • ELECTRICAL CONTACTS • CERAMAGNET® CERAMIC MAGNETS • BRUSHES FOR  
ALL ROTATING ELECTRICAL EQUIPMENT • HUNDREDS OF RELATED CARBON GRAPHITE AND METAL POWER PRODUCTS



# 500-TIMES MAGNIFICATION—VERTICALLY

...for detailed waveform analysis

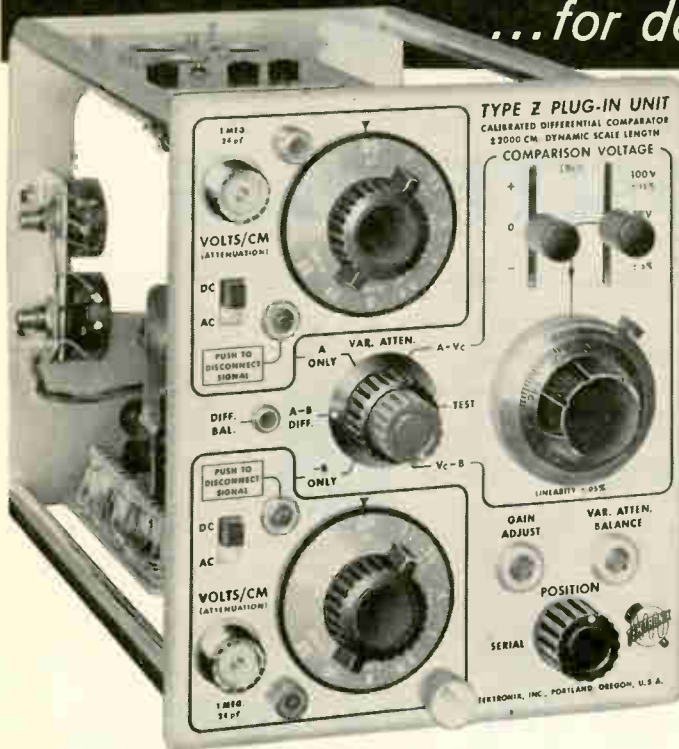

## Waveform Details of a 100-v Staircase

Vertical Expansion  
500 Times

Horizontal Expansion  
500 Times

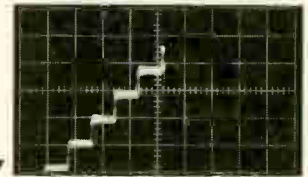

Vertical	Horizontal
50 mv/cm	10 µsec/cm
$V_C = +92.5$	

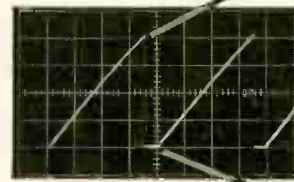

Vertical	Horizontal
25 v/cm	5 ms/cm
$V_C = 0$	

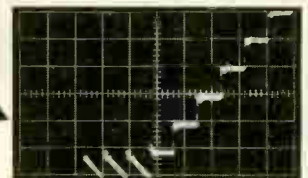

Vertical	Horizontal
50 mv/cm	10 µsec/cm
$V_C = -5.5$	

## TYPICAL APPLICATIONS

- FAST-RECOVERY AMPLIFIER**—observe small signals riding with large gates.
- MODULATION MONITOR**—measure amplitude modulation on a digital train pulse.
- HIGH-AMPLITUDE HUM REJECTION**—reject up to 200 volts peak-to-peak common-mode hum.
- SEMICONDUCTOR CHARACTERISTICS**—measure Zener diode ac impedance and Zener voltage together, measure transistor output impedance.
- PULSE-HEIGHT ANALYSIS**—select any pulse above a preset dc level.
- COMPONENT MATCHING**—check components to easily-interpreted tolerances.

## MAIN CHARACTERISTICS

- 3 Modes of Operation**—as a conventional preamplifier, as a differential-input preamplifier, or as a calibrated differential comparator.
- 50-mv/cm Sensitivity**—nine calibrated attenuation steps to 25 v/cm.
- Wide Passband**—dc to 13 mc with Tektronix fast-rise scopes.
- ±100-volt Dynamic Range**—permits common-mode signals up to 100 volts to be applied to the unit without attenuation.
- 40,000 to 1 Common-mode Rejection Ratio**—allows measurement of differential signals less than 50 millivolts.
- Comparison Voltage Accuracy**—within 0.25% on the ±1-volt scale; within 0.20% on the ±10-volt scale; within 0.15% on the ±100-volt scale.
- Safety Feature**—the Type Z eliminates “floating oscilloscope” operation.
- AC and DC VTVM**—extends oscilloscope accuracy in both ac and dc voltage measurements to 0.2%.

Price, Type Z Plug-in Unit, f.o.b. factory . . . . . \$525



*New differential plug-in preamplifier rejects up to 100 v of an input signal . . . accepts 100-v waveforms for oscilloscope display at 50-mv/cm sensitivity . . . provides an equivalent vertical scale length of ±2000 centimeters.*

You can now display small segments of large waveforms at maximum oscilloscope sensitivity, with vertical expansion equivalent to as much as 500 times. You can select magnified “window” displays of all portions of a waveform, and make amplitude measurements with a degree of accuracy that closely approaches the possibilities of digital techniques. The flexibility and simplicity of the analog (oscilloscope) presentation is retained for accurate analyses of complex waveforms.

The new Type Z Plug-In Unit is a triple-purpose device, acting also as a conventional preamplifier and a differential-input preamplifier. It can be used in all Tektronix Type 530, 540, 550, and \*580 Series Oscilloscopes. Ask your Tektronix Field Engineer to demonstrate the dynamic range, waveform resolution, and amplitude accuracy of the Type Z in your application.

*\*with Type 81 Adapter.*

## Tektronix, Inc.

P. O. Box 500 • Beaverton, Oregon  
Phone Mitchell 4-0161 • TWX—BEAV 311 • Cable: TEKTRONIX

**TEKTRONIX FIELD OFFICES:** Albuquerque, N. Mex. • Atlanta, Ga. • Baltimore (Towson, Md.) • Boston (Lexington, Mass.) • Buffalo, N.Y. • Chicago (Park Ridge, Ill.) • Cleveland, Ohio • Dallas, Texas • Dayton, Ohio • Denver, Colo. • Detroit (Lathrup Village, Mich.) • Endicott (Endwell, N.Y.) • Greensboro, N.C. • Houston, Texas • Indianapolis, Ind. • Kansas City (Mission, Kan.) • Los Angeles Area (East Los Angeles, Calif., Long Beach, Calif. • West Los Angeles, Calif.) • Minneapolis, Minn. • New York City Area (Albertson, L.I., N.Y. • Stamford, Conn. • Union, N.J.) • Orlando, Fla. • Philadelphia, Pa. • Phoenix (Scottsdale, Ariz.) • Poughkeepsie, N.Y. • San Diego, Calif. • San Francisco (Palo Alto, Calif.) • St. Petersburg, Fla. • Syracuse, N.Y. • Toronto (Willowdale, Ont.), Canada • Washington, D.C. (Annandale, Va.).

**TEKTRONIX ENGINEERING REPRESENTATIVES:** Hawthorne Electronics, Portland, Oregon • Seattle, Washington. Tektronix is represented in twenty overseas countries by qualified engineering organizations. In Europe please write Tektronix Inc., Victoria Ave., St. Sampsons, Guernsey C.I., for the address of the Tektronix Representative in your country.





# The Avnet System

## creates a new Concept of Supply

Avnet's supply of electronic components is vast. At this moment, for example, Avnet's total inventory of connectors is somewhere over 4¾ million. The Manufacturers whose lines Avnet assembles and/or makes available are in constant awareness of your present and future requirements. The Avnet System is geared to meet your demands of tomorrow, next month, next season, because unique Customer-Avnet-Manufacturer planning goes on daily.

This new Concept of an overwhelming Supply is one of many advantages in The Avnet System. *Avnet maintains a network of Sales Engineers traveling the U.S. Each engineer has his counterpart in a Service Center Expediter. Tremendous stocking facilities are maintained strategically throughout the country. Avnet maintains and operates complete assembly facilities for Connector Prototype requirements.* For the most reliable, most constant, steadiest source of Supply, contact your nearest Service Center in The Avnet System.

**AVNET**



**THE AVNET SYSTEM**  
 Men / Methods / Materials / Management  
 AVNET ELECTRONICS CORP.

*Avnet Service Centers and Stocking Facilities are located in Los Angeles, Cal.; Sunnyvale, Cal.; Chicago, Ill.; Dayton, Ohio; Westbury, L. I.; Burlington, Mass.*

AVNET SYSTEMS HAS ASSEMBLING FACILITIES: BENTON SCHEIDTLE CONNECTORS, SPERRY SEMICONDUCTORS, INSEM SEMICONDUCTORS, ELECTRONIC AND INSTRUMENTAL SWITCHES, SHERMAN CONNECTORS, CLARE KILPATRICK ROBERTSON SPLICE & CONNECTOR CASES, PARCOCK M-LAY, KING STRUCTURE IN-TEMP CERAMIC COATING, THE PROTONS THERMITE, THREE WELDERS BY GENERAL TIME & RUBBER CO., U.S. SPECTRON SEMICONDUCTORS, SANDYBAY TRANSISTORS, SPANCOE ELECTRONICS

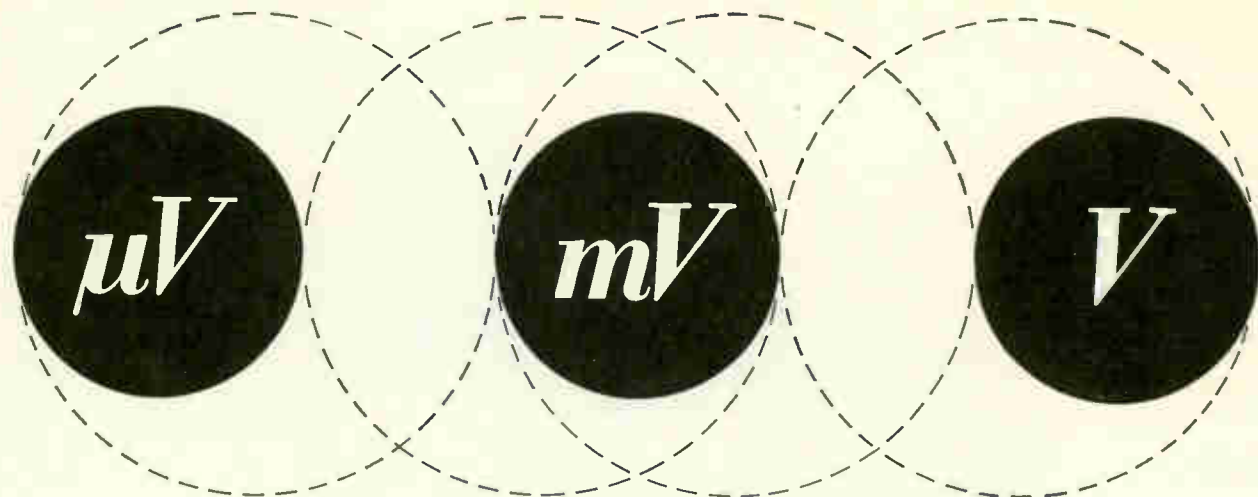

# electronic millivoltmeters

## internal calibration

It should be noted that all Philips electronic voltmeters contain calibration standards which enable the user easily and rapidly to check, and, if necessary, to re-calibrate his voltmeter at any time without the use of additional instruments.

### VHF Voltmeter, type GM 6025

**Frequency range:** 0.1 Mc/s - 800 Mc/s  
flat from 1 Mc/s - 300 Mc/s  
-1 dB at 0.1 Mc/s  
+1 dB at 800 Mc/s

**Measuring range:** 10 mV (f.s.d.) - 10 V divided into 7 ranges in a 1-3-10 sequence

**Overall accuracy:** < 5% with respect to full scale

**Input resistance:** 65 kΩ at 1 Mc/s ; 50 kΩ at 100 Mc/s ;  
35 kΩ at 200 Mc/s

**Input capacitance:** 1 μF

**Replacement of the probe crystal:**

the probe crystal can be easily replaced and the instrument rapidly re-calibrated by the user

For measurements on 50 Ω -coaxial lines the T-connector, type GM 6050T, can be ordered



# PHILIPS *electronic measuring*

Sold and serviced by Philips Organizations all over the world

Further information will gladly be supplied by:

N.V. Philips' Gloeilampenfabrieken, EMA-Department, Eindhoven, the Netherlands

For Canada: Philips Electronics Ind. Ltd., 116 Vanderhoof Ave., Toronto 17, Ont.



### DC Microvoltmeter, type GM 6020

	input I	input II
<b>Measuring range:</b>	100 $\mu$ V (f.s.d.) - 10 V in 11 steps	10 mV (f.s.d.) - 1000 V in 11 steps
<b>Input impedance:</b>	1 M $\Omega$ ( $\pm 1.5\%$ ) in parallel with 20 $\mu$ F	100 M $\Omega$ ( $\pm 1.5\%$ ) in parallel with 10 $\mu$ F
<b>Overall accuracy:</b>	with respect to full scale $\pm 3\%$	
<b>Pre-deflection:</b>	< 5 $\mu$ V	
<b>Drift:</b>	1 $\mu$ V per hour after 1 hour of warming-up	

Automatic polarity indication  
DC currents may be measured directly from 100  $\mu$ A (f.s.d.) up to 10  $\mu$ A

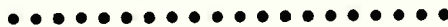

### LF Millivoltmeter, type GM 6012

**Frequency range:** 2 c/s - 1 Mc/s  
**Measuring range:** 1 mV (f.s.d.) - 300 V in 12 steps  
**dB scale:** -80 dB up to +52 dB  
(0 dB = 1 mW into 600  $\Omega$ )  
**Input impedance:** 4 M $\Omega$  in parallel with 20  $\mu$ F (up to 3 V);  
10 M $\Omega$  in parallel with 10  $\mu$ F (in the other ranges)  
**Overall accuracy:** with respect to full scale  
 $\pm 2.5\%$ , 5 c/s - 100 kc/s  
 $\pm 5\%$ , 2 c/s - 1 Mc/s  
**Pre-deflection:** < 100  $\mu$ V



### HF Millivoltmeter, type GM 6014

	without pre-attenuator	with pre-attenuator
<b>Frequency range:</b>	1 kc/s - 30 Mc/s	10 kc/s - 30 Mc/s
<b>Measuring range:</b>	1 mV (f.s.d.) - 300 mV in 6 steps	100 mV (f.s.d.) - 30 V in 6 steps
<b>dB scale:</b>	-80 dB up to -8 dB	-40 dB up to +32dB
<b>Damping at 10 kc/s:</b>	1 M $\Omega$	50 M $\Omega$
1 Mc/s:	700 k $\Omega$	10 M $\Omega$
30 Mc/s:	50 k $\Omega$	2 M $\Omega$
<b>Input capacitance:</b>	7 $\mu$ F	2 $\mu$ F
<b>Pre-deflection:</b>	compensated by electrical zero setting	
<b>Variations of the frequency characteristic:</b>	< 5% over the whole range, with respect to the response at the frequency of the calibration voltages	
<b>Overall accuracy:</b>	$\pm 3\%$ with respect to full-scale and with reference to the frequency characteristic	

**instruments:**

**quality tools for industry and research**



*Designed for*



*Application*



#### BINDING POSTS AND PLUGS

Miniature binding posts, plates and plugs are available in addition to the regular line of standard size units. The plates, plugs, and insulated binding posts are available in black or red. The plugs and plates are also available in low loss mica filled phenolic.

**JAMES MILLEN MFG. CO., INC.**

**MALDEN  
MASSACHUSETTS**

CIRCLE 200 ON READER SERVICE CARD

## BIG NEWS FOR USERS OF INSTRUMENT LATHES

**LEVIN® LATHES**

**PRODUCE SMALL INSTRUMENT  
PARTS MUCH BETTER**

We present the latest in the series of Levin Instrument Lathes, a new model with a half inch collet capacity but with the same sensitivity and precision for which Levin Lathes are so well known.

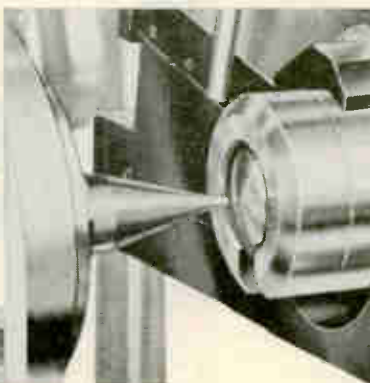
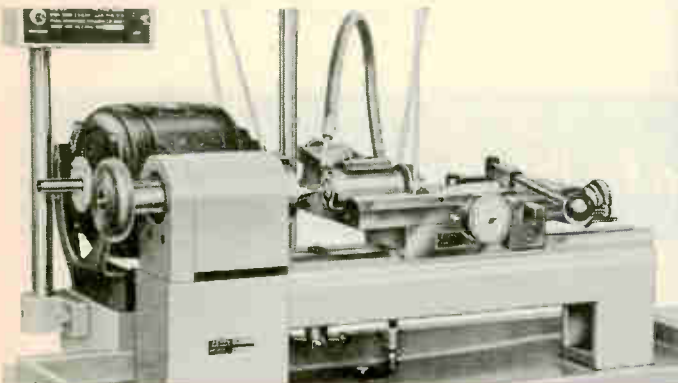
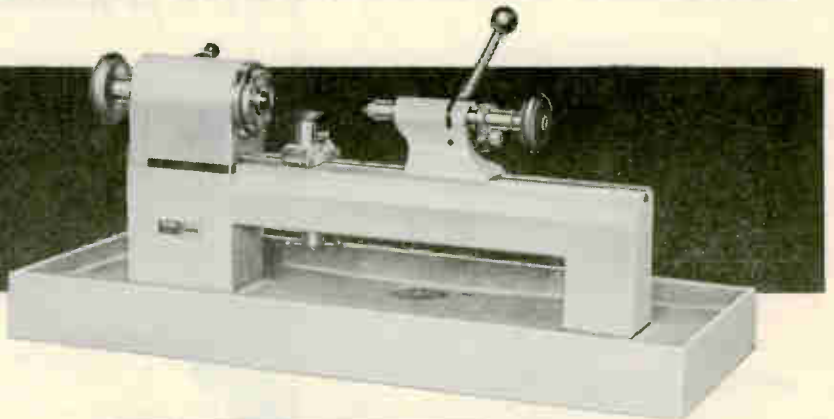

Here is a typical example of work which can be done in the new Levin 1/2" capacity lathe. A hole .002" in diameter is being drilled in a nozzle.

Send for literature describing the 1/2" capacity instrument lathe and accessories.

**LOUIS LEVIN & SON, INC., 3573 HAYDEN AVE., CULVER CITY, CALIF.**

66 CIRCLE 66 ON READER SERVICE CARD

electronics

In **PRECISION FILM RESISTORS**

if it's news, expect it first from IRC

**NEW...**  
exclusive  
**M\*** COAT

Most moisture-resistant coat ever achieved ...  
withstands 30 cycles of MIL moisture!

IRC precision film resistors with M Coat take 30 cycles of moisture, 300% of the MIL-R-10509C Characteristic B requirement, tested in accordance with MIL standard 202.

M Coat adds greater protection for the resistance element, eliminates handling and assembly damage. Insulation resistance after 30 cycles of moisture is over 100 megohms.

Rating:  $\frac{1}{2}$  watt at 70°C ambient. Standard tolerance:  $\pm 1\%$ . Range: 10 ohms to 2.49 megohms. Maximum continuous working voltage: 350.

Write for Bulletin AE-15, International Resistance Co., 401 N. Broad St., Philadelphia 8, Pa.

\*Trademark exclusive IRC moisture-proof coating



Leading supplier to manufacturers of electronic equipment

# HERE YOU SEE IT

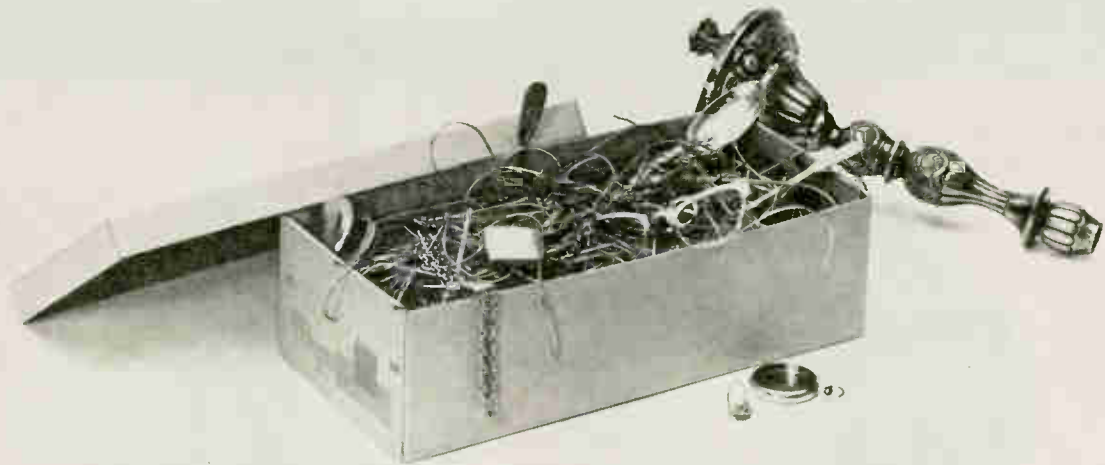

# HERE YOU DON'T!



Value is what we're talking about. There isn't a soul alive who would knowingly throw away a gold or silver or platinum watch case or pin or eyeglass frame. Because they're *worth money*. This sense of value is responsible for a considerable part of Handy & Harman's Refining activity. Constantly, we are sent precious metal scrap from retail jewelers all over the country. (Yes, often in shoe boxes.)

And just as constantly we wish that industry had the same sense of value when it comes to their precious metal "waste." Just because it doesn't *look* like anything doesn't mean that it isn't *worth* something.

To show you where profits lurk, we've included a list showing the various forms of precious metal waste.

It is by no means complete (it is possible that you have other forms). May we suggest that—should you be in doubt—you contact the Handy & Harman Refining Center nearest you. Further, if you are not in doubt about your waste bearing precious metals, but you are (or have been) in doubt as to its full value, it will profit you to send it to us. Our Bulletin 24 describes our Refining Division in detail. A copy awaits you at

Plating Solutions  
Precipitates, Sludges and Sediments  
Coated Copper Wire & Racks  
Filter Pads  
Anode Ends  
Tank Scrapings  
Electrolytic Silver  
Hypo Solutions  
X-Ray Film  
Coated Plastics, Ceramics, Glass, Mica, Quartz, etc.  
Chemicals  
Mirror Solutions—Silver Nitrate  
Turnings, Chips, Shavings

Silver on Steel Bearings  
Silver Steel Turnings  
Grindings  
Blanking Scrap, Stampings, Strip, Wire  
Powder Mixtures  
Screen Scrap  
Solder Scrap  
Brazing Alloy Scrap  
Contact Alloy Scrap  
Silver on Steel, Tungsten, Moly Scrap  
Bi-Metal Scrap  
Silver Paint Waste, Wipe Rags, Paper Cans  
Platinum-Bearing Material  
Gold on Moly, Tungsten, Wire

Your No. 1 Source of Supply and Authority on Precious Metals

**HH**  
**HANDY & HARMAN**

General Offices: 82 Fulton Street, New York 38, N.Y.

BRIDGEPORT 1, CONNECTICUT  
Clearwater 9-8321

LOS ANGELES (El Monte), CALIF.  
330 N. Gibson Rd.  
Cumberland 3-8181

CANADA: Toronto 2B  
141 John St.  
Empire 8-6171

PROVIDENCE 3, R. I.  
425 Richmond St.  
Jackson 1-4100

CHICAGO 22, ILL.  
1900 West Kinzie St.  
SEely 3-1234



## United Eyelets and Eyeleting Machines Keep this Princess on Constant Call

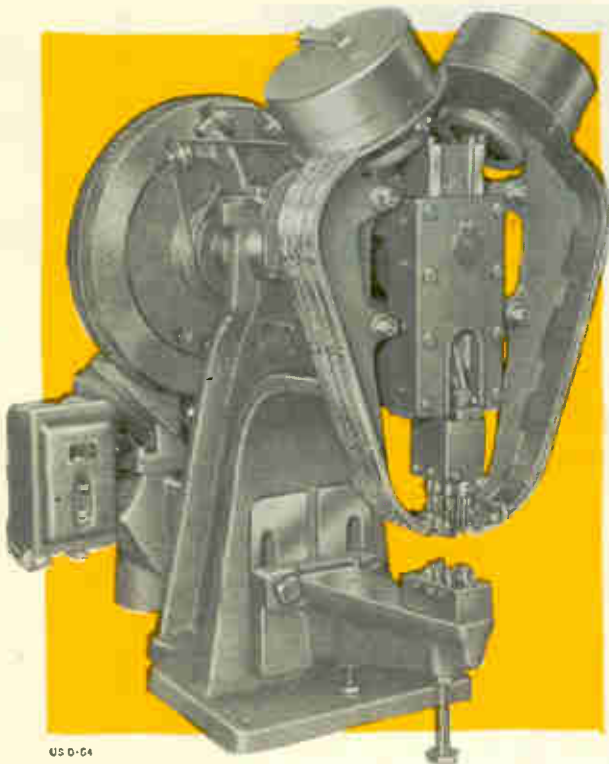

US D-04

The new Princess telephone — a product of the Western Electric Company — is an achievement in communication design **INSIDE** as well as out, thanks in part to a United Eyeleting Machine that automatically feeds and sets six twin United Eyelets in a plastic insulating terminal board no bigger than a cigarette lighter.

United achieved automation of terminal board production. Accurate alignment of the setting bar and an especially rigid frame — unique with the Model F United Eyeleting Machine — brings uniform pressure to bear on all six twin United Eyelets scattered over a broad pattern range. Reliability for the lifetime of the Princess was thus assured.

If you want faster production using greatly simplified setups of multiple mechanisms plus absolute reliability in multiple eyelet patterns, call on United . . . where over sixty years' experience in the design, development and production of eyelets and eyeleting machines, is at your service.

Your nearest United sales office has full information on the complete line of United Eyelets and Eyeleting Machines. Call or write today.

# United

**UNITED SHOE MACHINERY CORPORATION**

140 FEDERAL STREET, BOSTON 7, MASSACHUSETTS

Branches: ATLANTA, GA. • CHICAGO, ILL. • CINCINNATI, CLEVELAND and COLUMBUS, OHIO • DALLAS, TEXAS • HARRISBURG, PA. • JOHNSON CITY, N.Y. • LOS ANGELES, CALIF. • LYNCHBURG, VA. • MILWAUKEE, WISC. • NASHVILLE, TENN. • NEW YORK, N. Y. • PHILADELPHIA, PA. • ROCHESTER, N. Y. • ST. LOUIS, MO.

WHEN IT COMES TO SHIELDED WIRE

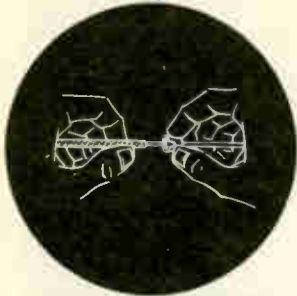

**SLIDE**  
on the ferrule



**SLIP**  
in the ground taps

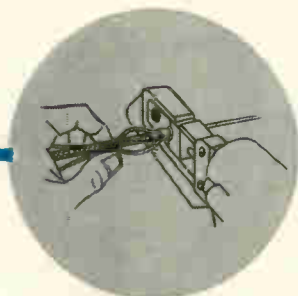

**CRIMP**  
the three together



**SNAP**  
on the insulation

**PRESTO!**

the best insulated ferrule you can buy

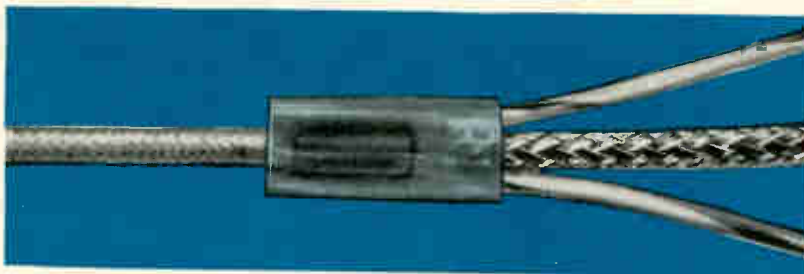

How's that for speed! And the post-insulation of the Termashield Shielded Wire Ferrule is easily and quickly accomplished . . . you eliminate close tolerance cable stripping required by other techniques . . . you eliminate blind probing of taps into other type ferrules . . . you eliminate solder and burnt cable . . . you eliminate lost time . . . you eliminate doubt.

For positive attachment, top reliability, unbeatable speed and tangible economy, get A-MP Post-Insulated Termashield Shielded Wire Ferrules.

Write for more information.

**AMP INCORPORATED**

**GENERAL OFFICES: HARRISBURG, PENNSYLVANIA**

A-MP products and engineering assistance are available through subsidiary companies in: Australia • Canada • England • France • Holland • Japan



## Stereophonic System For Television Broadcasting

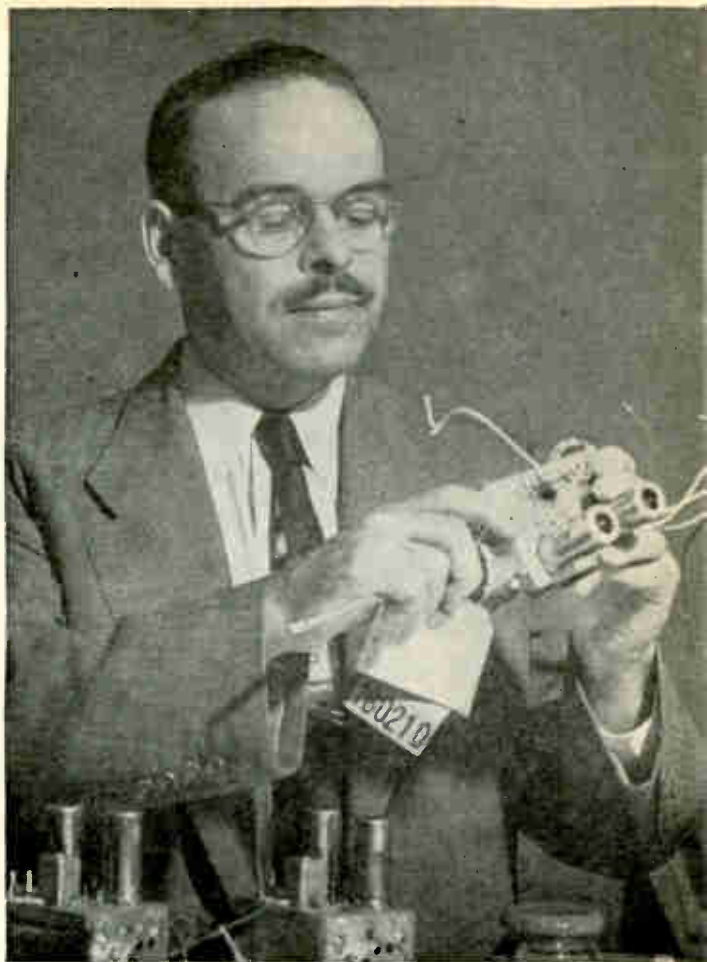

Author studying physical layout of television tuner components for stereophonic conversion

*Double sideband suppressed subcarrier is used to transmit stereo information in proposed system for compatible television stereophony*

By **ROBERT B. DOME,**

General Electric Co.,  
Electronics Park,  
Syracuse, N. Y.

STEREOPHONIC SOUND TRANSMISSION requirements for television broadcasting differ somewhat from those for either f-m or for broadcast-band a-m stereophony. This is because television receivers contain intense potentials at horizontal sweep frequency and its harmonics, and these frequencies can have serious effects on the reproduced sound. Stereo information must, therefore, be carefully placed in the frequency spectrum to avoid such effects. This is equally true whether the stereo information is transmitted by frequency-modulating the subcarrier, or by amplitude-modulating it.

In a manner similar to the proposals for f-m stereophonic standards, for reasons of compatibility,

the audio signal  $L$  from the left side microphone and the audio signal  $R$  from the right side microphone are combined to form an  $L + R$  audio signal as the principal modulation of the aural channel, replacing the present audio input signal. It remains therefore to transmit a directional signal, such as  $L - R$ , by other means.

A separate transmitter for such transmission is not attractive for reasons of compatibility. It was decided to transmit the  $L - R$  information on a subcarrier as part of the aural transmitter output.

Choice must now be made between an f-m modulated subcarrier and an a-m modulated subcarrier. When f-m is used, the subcarrier cannot be suppressed, so that the total system frequency swing is measured by the sum of the amplitudes of the  $L + R$  signal and the

subcarrier. The subcarrier frequency must be midway between sweep frequency harmonics; this limits the choice of subcarrier frequencies to 23.65 Kc, 39.375 Kc, etc. The lower subcarrier frequency will cause less noise so that in practice the frequency is limited to 23.65 Kc, that is,  $1\frac{1}{2}$  times the sweep frequency. The highest audio frequency is then limited to about 8 Kc and the maximum deviation to  $\pm 8$  Kc so as not to cause the appearance of  $L - R$  signal components in the  $L + R$  band of 50-15,000 cps.

The signal-to-noise degradation of such a system compared to a monaural system is given by

$$R_1 = \frac{1}{\sqrt{K_1^2 + \frac{K_2^2 F_a^2 [(f_s + F_a)^3 - (f_s - F_a)^3] \delta_1^2}{3 f_a^2 F_s^3 \delta_2^2}}} \quad (1)$$

Where  $\delta_1$  = improvement factor for

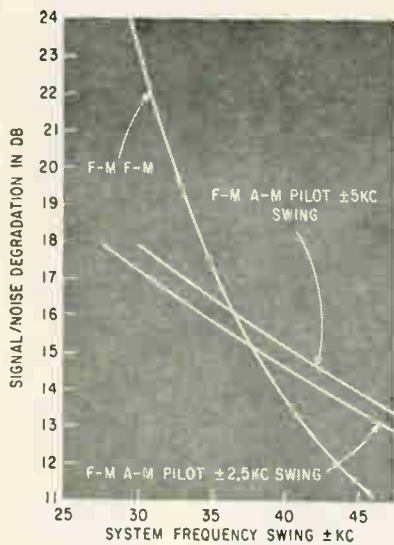

FIG. 1—Degradation of monaural signal-to-noise ratio by stereo is plotted against maximum system swing;  $L + R$  deviation is  $\pm 25$  Kc on peaks. Three curves compare different systems

deemphasis for  $F_a$ ;  $\delta_2$  = improvement factor for deemphasis for  $F_a$ ;  $K_1$  = Deviation of Monaural System/Deviation of  $L + R$  signal on Main Carrier;  $K_2$  = Deviation of Monaural System/Deviation of Subcarrier on Main Carrier;  $f_s$  = subcarrier frequency;  $F_m$  = maximum audio frequency of  $L - R$  signal;  $f_a$  = maximum swing of  $F_m$  on  $f_s$  (one way); and  $F_m$  = maximum audio frequency of  $L + R$  signal.

In the example,  $f_s = 23.625$  Kc,  $F_m = 8$  Kc,  $f_a = 8$  Kc,  $F_m = 15$  Kc,  $\delta_1 = 4.56$ ,  $\delta_2 = 2.66$ , so Eq. 1 becomes

$$R_1 = \frac{1}{\sqrt{K_1^2 + 8.13 K_2^2}} \quad (2)$$

Now consider an a-m modulated subcarrier system using suppressed subcarrier. Assume that the subcarrier will be regenerated in the receiver from a pilot carrier sent out at the transmitter. A subcarrier frequency of 23.625 Kc will be assumed. The equation for the signal-to-noise degradation as compared to a monaural signal is

$$R_2 = \frac{1}{\sqrt{K_1^2 + \frac{K_2^2 [(f_s + F_a)^2 - (f_s - F_a)^2] \delta_1^2}{F_a^3 \delta_2^2}}} \quad (3)$$

Where  $\delta_1$  = improvement factor for deemphasis for a-m for  $F_a$ .

Letting  $f_s = 23.625$  Kc,  $F_a =$

8 Kc,  $\delta_1 = 4.56$ ,  $\delta_2 = 1.68$ , Eq. 3 becomes

$$R_2 = \frac{1}{\sqrt{K_1^2 + 61 K_2^2}} \quad (4)$$

This appears worse than the f-m f-m case, but since nesting takes place between the  $L + R$  signal and the double-sideband  $L - R$  signal.  $K_2$  need never be larger than  $K_1$ , so that noise conditions can be more favorable for total system deviations less than  $\pm 37.5$  Kc.

Figure 1 shows a plot of  $R_1$  and  $R_2$  against total system swing. Representative swings have been allocated to the pilot frequency and  $K_1 = 1$  both for the f-m f-m case and for the f-m/a-m case. The curves remain practically identical when  $L + R$  is reduced to 90 percent or to  $\pm 22.5$  Kc swing. However, the minimum peak swing for the f-m/a-m case is equal to the sum of the pilot frequency amplitude and the maximum amplitude allocated to  $L + R$ .

In the f-m/a-m case, a subcarrier frequency of 23.625 Kc was chosen midway between sweep harmonics. This will permit the use of  $L - R$  frequencies up to half the horizontal scan frequency, or up to 7.875 Kc. This means the stereo effect is limited to frequencies below 7.875 Kc. A filter to remove 7.875 Kc from the  $L - R$  detector in the receiver is desirable to eliminate a

steady 7.875-Kc tone in the loudspeakers. A filter having an  $m$  of 0.6 will have a cutoff of 80 percent of the infinite attenuation frequency, in this case at about 6,400 cps. The stereo effect is, therefore, best for frequencies below 6,400 cps and tapers off to zero as the frequency approaches 7,875 cps.

One of several frequencies may be chosen as the pilot frequency for regenerating the 23.625-Kc subcarrier. However, frequencies in the audible range of 50 to 15,000 cps cannot be used; this makes it impossible to use for this purpose half the subcarrier frequency. A small amount of the 23.625-Kc subcarrier itself may be used, but the problem of regenerating a full-strength subcarrier from a signal having sidebands close to the subcarrier is serious. Although this has been done, it is complicated and usually includes an oscillator controlled by a reactance tube that is in turn controlled by a phase-comparison detector and filter; three tubes may have to be used for this auxiliary function alone.

At first thought, it might seem feasible to use the sweep frequency in the video portion of the receiver to generate the 23.625-Kc signal. For example, suppose the third harmonic of 15.75 Kc is selected from the scanning wave. This frequency is 47.25 Kc. Then this frequency

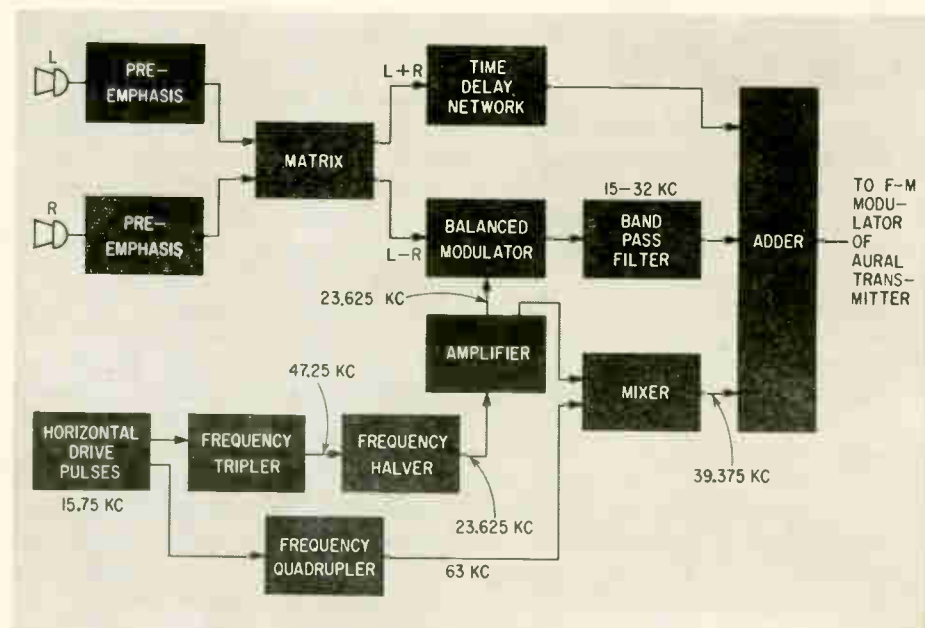

FIG. 2—Block diagram of transmitter multiplexer includes circuits for transmitting pilot frequency of 39.375 Kc

may be used to synchronize a multi-vibrator operating at half the frequency, or at 23.625 Kc, to furnish the subcarrier. The desired frequency will be produced, but its phase is ambiguous and could be either right, or wrong by 180 deg, depending on the synchronizing position. The acoustic effect of this ambiguity would be to produce correct stereo or reversed stereo. Furthermore, the mode could switch back and forth at random during a program or during network switching.

An economical way of bypassing these problems is to use 39.375 Kc for the pilot frequency. This is 2½ times the line frequency of 15.75 Kc. At the receiver, the pilot frequency is recovered by a selective circuit. It is then combined with 15.75 Kc from the sweep system to produce 23.625 Kc, since  $23.625 = 39.375 - 15.75$ . A triode will perform this mixer function and produce a 23.625-Kc signal of sufficient amplitude to be a subcarrier for demodulating the 23.625 Kc sidebands.

Figure 2 shows a block diagram of the transmitter multiplexer. The receiver demultiplexer circuit appears in Fig. 3.

In the receiver demultiplexer, the  $L - R$  detector may be balanced so that noise components from the subcarrier channel will be mini-

mized in the detected output. The aural channel 4.5-Mc detector is shown as a ratio detector with balanced outputs  $L + R$  and  $-L - R$ . Each is provided with deemphasis networks,  $R_1C_1$  and  $R_2C_2$ . The 23.625-Kc sidebands are selected by a tuned circuit  $L_3C_3$  and this circuit is made to have a loaded  $Q$  of  $Q = \pi f \tau$ , where  $f$  = resonant frequency and  $\tau$  = deemphasis time constant.

This provides for proper deemphasis of the  $L - R$  signals. When  $f = 23,625$  cps and  $\tau = 75$  microseconds,  $Q = 5.57$ . The tuned circuit is balanced to use a balanced detector including diodes  $D_1$  and  $D_2$ . The subcarrier is generated by selecting 39.375 Kc in the circuit  $L_2C_4$  and feeding the grid of the mixer triode  $V_1$ . The cathode is fed a 63-Kc signal obtained from tuned circuit  $L_3C_6$  connected to the horizontal output transformer. The difference frequency of  $63 - 39.375 = 23.625$  Kc appears in the plate circuit and excites the tank circuit  $L_4C_7$  to provide the subcarrier required to demodulate the sidebands in the balanced detector. The output of the detector is passed through filter  $L_5C_8C_9R_3$  to reject 7.875 Kc and delivered to resistive matrixer  $R_4$  and  $R_5$  as the  $L - R$  signal from which the  $L$  and  $-R$  signals are derived.

The separation of  $L$  and  $R$  as measured for this circuit is ap-

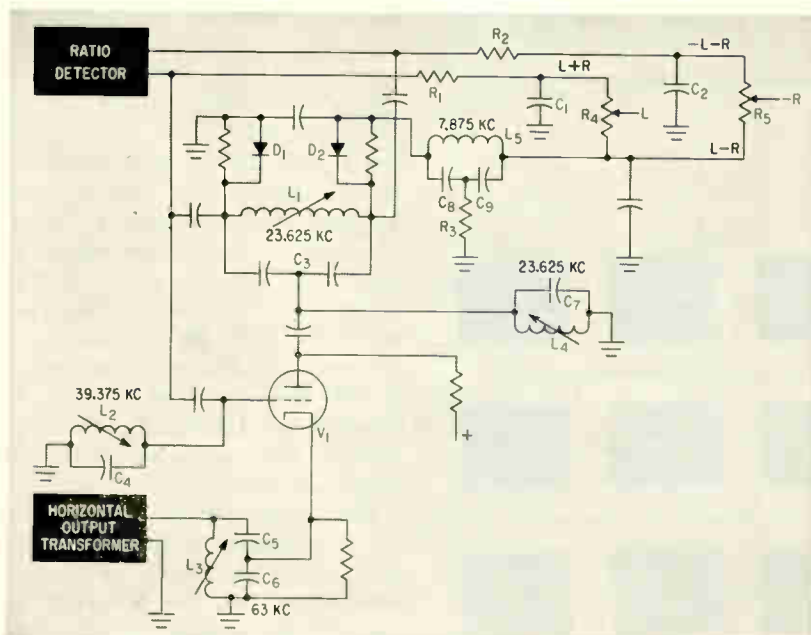

FIG. 3—Receiver demultiplexer, with aid of sweep frequency already present in receiver, reconstructs pilot frequency and separates signals

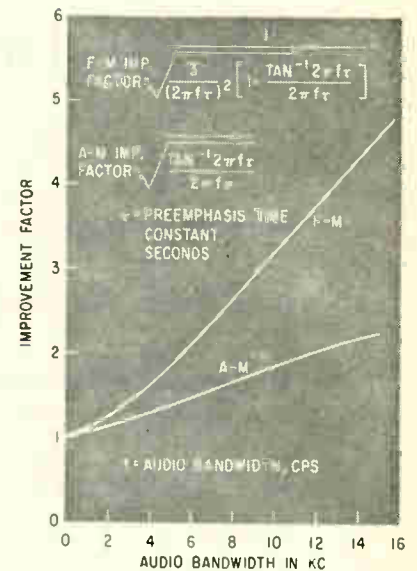

FIG. 4—Improvement factors plotted against audio bandwidth for systems using 75-microsecond preemphasis time constant

proximately 23 db from 100 to 5,500 cps, falling off to about 19 db at 6,500 cps as the 7.875-Kc filter resonant frequency is approached.

The amplitude of the 39.375-Kc pilot signal for these tests was 10 percent, or the swing was  $\pm 2.5$  Kc. It is recommended, however, that a swing of  $\pm 5$  Kc be adopted to provide for circuit inefficiencies with production-line receivers. It is also recommended that the  $L + R$  signal amplitude have a peak deviation of  $\pm 25$  Kc to produce a fully compatible signal in existing receivers. Using a maximum system swing of  $\pm 30$  Kc, this system, as seen from Fig. 1, will produce a stereo signal with a signal-to-noise degradation of about 17.9 db.

The noise improvement factors  $\delta_1$ ,  $\delta_2$ , and  $\delta_3$  used in the text are obtained by integration and are given for convenient use in the form of curves in Fig. 4, for the cases where the preemphasis-deemphasis time constant is 75 microseconds.

A summary of the principal characteristics of this proposed system follows:

Main channel signal	$L+R$
Subcarrier signal	$L-R$
Preemphasis time constant (each)	75 microsec.
Subcarrier frequency (suppressed)	23.625 Kc
Pilot frequency signal	39.375 Kc
Deviation of pilot signal	$\pm 5$ Kc
Maximum deviation of $L+R$ signal	$\pm 25$ Kc
Maximum deviation of $L-R$ sidebands	$\pm 25$ Kc
Maximum deviation of system	$\pm 30$ Kc

# Magnetic Tape Recorder Programs

*Engine parameters are recorded while an automobile undergoes road tests. The magnetic tapes then program a laboratory engine so further tests can be made under actual road conditions*

By VERN C. VANDERBILT Jr., CLARENCE L. ZIMMER,  
Engineering Division, Perfect Circle Corp., Hagerstown, Indiana

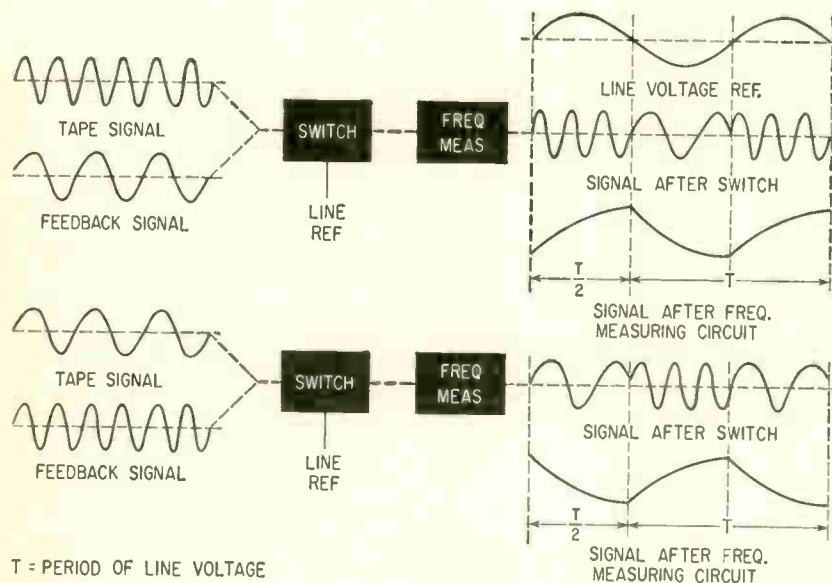

T = PERIOD OF LINE VOLTAGE

FIG. 1—Frequency measuring circuit develops d-c voltage proportional to frequencies of input signals

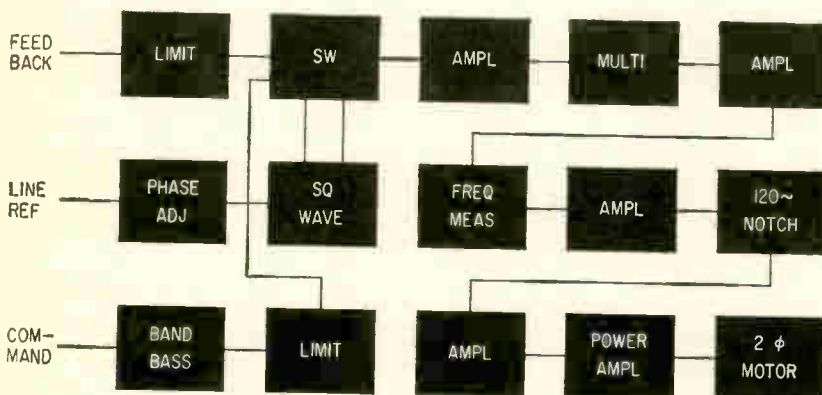

FIG. 2—Command signal from tapes is combined with feedback signal from engine. Each engine test has its own bandpass filter

CONVENTIONAL steady-state dynamometer testing of an internal combustion engine to determine service oil economy or engine wear is comparable to testing a material in a short-time tensile test. Only a few properties of the material may be determined. To obtain more complete information, a test that duplicates the service must be used.

The usual day to day trial in a customer's service is random because of variations of weather, driver and traffic conditions. These variables make comparisons of different procedures virtually impossible. The usefulness of service testing is therefore most often limited to final evaluation of designs that have already been evaluated. The time needed to simulate customer usage is considerable, so the first departure from a customer service test is made in the accelerated road test, which usually duplicates the toughest customer service. Round-the-clock accelerated testing causes additional differences. The time-temperature reactions that normally occur in the oil and engine parts, cannot be duplicated because of the time required. Again, the answers are random for the same reasons that customer service answers are random.

The programmed dynamometer test is similar to the accelerated road test. The fidelity of the test depends on how the program that controls the engine on the dynamometer is obtained and used. The program is generated here by re-

# Engine Dynamometer Tests

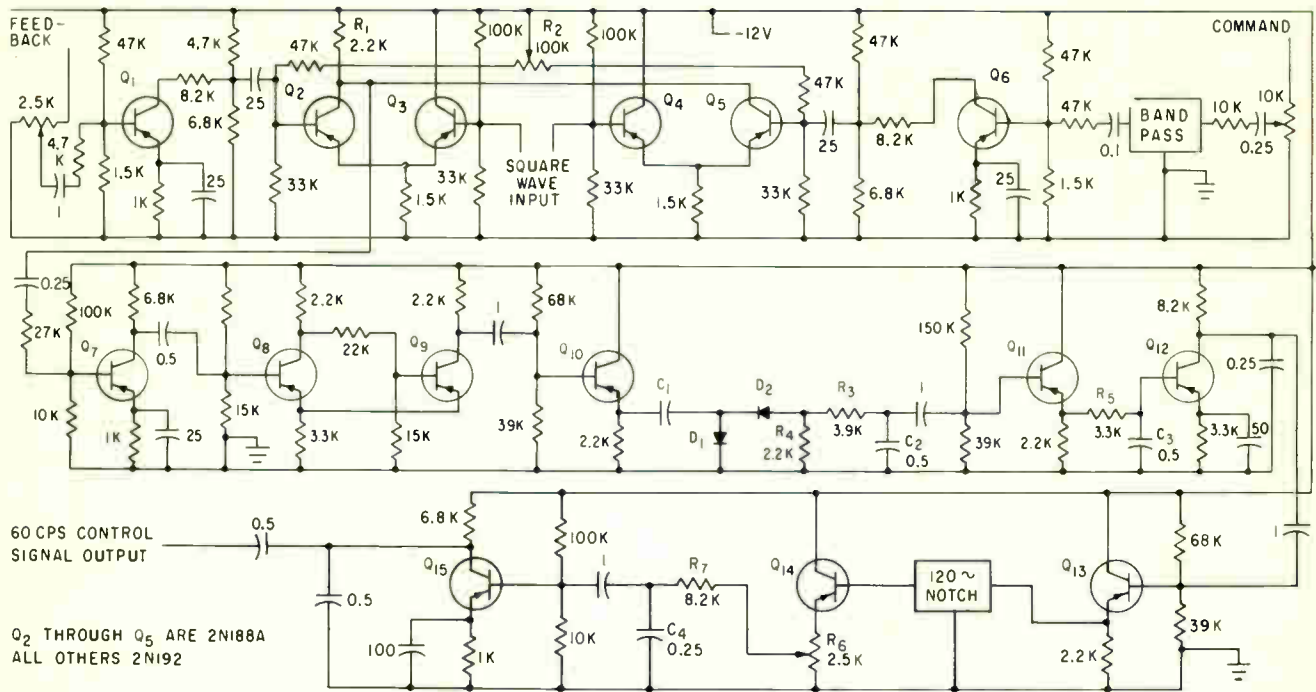

FIG. 3—One channel of the frequency comparator. All channels are identical except for bandpass filter and capacitor  $C_1$ .

ording on tape the actual engine parameters as the engine is tested under road conditions. This same tape controls the engine undergoing dynamometer test.

The system uses a series of transducers to measure engine parameters during road test. This information is stored on magnetic tape as f-m signals.

The transducer that converts engine speed to an f-m signal is an a-c tachometer belted to the fan belt such that the generator develops 24 alternations of current for every revolution of the engine. Thus, at 600 rpm of the crankshaft, the generator produces a 240-cps voltage. With this generator ratio, a 5,000-rpm signal represents a 2,000-cps signal.

The coolant temperature, manifold air pressure and oil temperature are converted to f-m signals with center frequencies at 3,000 cps, 5,400 cps and 7,350 cps. The four signals are mixed and recorded on one track of tape.

Deviation of the velocity of the recording tape from a standard would produce an error either during recording or reproducing. Most quality tape recorders use a syn-

chronous motor to maintain constant tape speed over the head. If the supply frequency varies, so does the tape speed. A one-percent variation of velocity produces a similar frequency error.

This error is serious when a narrow band of frequencies represents 100 percent of the variations of a recorded factor. If the frequency bandwidth is 15 percent of the center frequency, a one percent variation in all recorded frequencies will result in a  $6\frac{2}{3}$ -percent error of total parameter variation, since 100 percent of the parameter occupies only 15 percent of the frequency band. The error is multiplied by 100/15 or  $6\frac{2}{3}$  times. To compensate for line-frequency variation, the portable tape recorder contains a speed servo loop that controls the d-c capstan motor.

For playback the command signal is contained in the frequency band representing the parameter, while the feedback is a signal derived from the engine on the test stand. The error detector compares the two signals and causes an actuator to change the parameter control to eliminate the error.

The error detection or compari-

son of two frequencies, command and feedback, could compare two d-c voltages that have been derived from the two frequencies. However, if each frequency to d-c analog voltage conversion is not performed exactly the same for each signal, an apparent error will exist and cause a real error.

The comparator circuit is designed so that component variations and changes with time do not affect the error signal. Figure 1 shows the frequency comparator circuit. The synchronous switch causes first the tape signal, then the feedback signal to be placed on a line alternately and synchronously with the power line voltage. Thus, the tape signal is placed on the output terminals when the line is positive with respect to ground. When the line is negative, the feedback signal is on the output line. This is represented by the small graph following the synchronous switch. The frequency-measuring circuit develops a d-c voltage proportional to the frequency of the input signal. Since this signal may consist of a half period of high-frequency signal followed by one of low frequency, the d-c output will vary with time and

have the same period as the line. Figure 1 is a representation of two conditions, one where the tape signal has a higher frequency than the feedback signal, and one where the opposite is true. The signal, after the d-c conversion, contains a 60-cycle component, which changes phase 180 degrees when the tape and feedback signals reverse frequency relation. The amplitude of the 60-cycle component is proportional to the magnitude of the difference in frequency.

At the null point when the frequency of each input is the same, the 60-cycle signal vanishes, even if the frequency to d-c conversion drifts with time. This is the signal needed to control a two-phase induction motor with a high resistance armature.

The frequency comparator is shown in Fig. 2. The command input, supplied from the magnetic tape, consists of four f-m signals in their respective portions of the audio spectrum. The frequency band containing the information for the variable to be controlled is selected by the bandpass filter. The signal then passes through the limiter to the command portion of the synchronous switch.

The feedback signal from the transducer measuring the controlled variable is fed to a limiter and switch section identical to those in the command section. A filter is not necessary because the feedback signals are separated, each coming from its own transducer.

The two switch sections driven by the line frequency square-wave generator operate as a line-synchronous single-pole double-throw switch.

After amplification, the sampled signal triggers a bistable multivibrator. The square wave output is amplified and drives the frequency measuring circuit. Thus, the frequency to d-c conversion yields a wave whose fundamental component is line (carrier) frequency. This signal, when amplified and phased, will drive the servo motor to change the controlled variable. Thus, the frequency of the feedback signal is brought into coincidence with that of the command.

One channel of the frequency comparator is shown in Fig. 3. All channels are identical, except for the command signal bandpass filter and capacitor  $C_1$ .

Limiters  $Q_1$  and  $Q_2$  clip at a level corresponding to 0.5 peak-to-peak in the feedback section and 5 v peak-to-peak in the command section. They prevent overloading of the switch and spillover of one signal into the sample period of the other. An amplitude change at the input to the limiter of greater than 100 to 1 can be tolerated without introducing error into the system. The emitters of switch transistors  $Q_3$  and  $Q_4$  are driven in push pull with the 60-cycle square wave by  $Q_5$  and  $Q_6$  so that they are alternately conducting and cut off. The combined outputs of  $Q_3$  and  $Q_4$  appear across common load resistor  $R_1$ . The d-c levels of the two transistors are balanced by  $R_2$ . This control is adjusted for no 60-cycle square-wave component at the input to  $Q_7$  with no command or feedback signal.

Transistor  $Q_7$  amplifies the sampled signal to a level that will insure reliable triggering of multivibrator  $Q_8$ - $Q_{10}$ . All coupling capacitors that handle the sampled signal must be large enough to pass the 60-cycle square wave or small enough to definitely reject it.

The multivibrator duplicates with a square wave each cycle of the sampled signal. Its output waveform is required to be of constant slope and constant amplitude only from one 1/120 second sampling period to the next. Slow changes in collector voltage or operating point shift with temperature have no effect on the system. Power amplifier stage  $Q_{10}$  prevents loading of the multivibrator and furnishes sufficient drive for the frequency-measuring circuit.

The frequency to d-c conversion is accomplished by  $C_1$ , diodes  $D_1$  and  $D_2$ , and the low-pass section  $R_3$ - $C_2$ . A sharp pulse appears across  $R_1$  for each negative going leading edge of the square wave. If  $C_1$  is kept small, so that no pulse overlap occurs, the combined area of pulses is proportional to frequency.

The  $R_3$ - $C_2$  combination and all succeeding low-pass networks must pass the 60-cycle component, but should attenuate the command and feedback frequencies.

Emitter follower  $Q_{11}$  prevents excessive loading of the frequency-measuring circuit. It also gives a low-impedance output, allowing an-

other low-pass network  $R_5$ - $C_3$  to be placed between stages. Voltage gain is provided by  $Q_{12}$ .

Regardless of the type of switching used, when the command and feedback frequencies are equal but not in phase, a discontinuity will occur at the instant of switching. These discontinuities appear as pulses in the output and occur at a 120-cps rate. This 120-cps component cannot operate the servo motor and cannot directly introduce an error into the system. However, when high gain is desired, the 120-cps noise can saturate the amplifiers and prevent the system from responding to a real error input. The signal-to-noise ratio in the 60-cycle amplifier determines the amount of error needed to cause a response from the servo motor. The 120-cps notch filter improves the signal-to-noise ratio by greater than 100 to 1. An input frequency difference of less than 0.1 percent can be detected. Transistors  $Q_{13}$  and  $Q_{14}$  provide the impedances for operation of this notch filter.

Gain control  $R_4$  and low-pass network  $R_7$ - $C_4$  further improve the waveform. The signal is amplified by  $Q_{15}$ , which is biased to handle the highest possible signal swing without saturation. The output of  $Q_{15}$  is fed to the power-amplifier.

In the power amplifier, two vacuum-tube voltage amplifiers increase the signal amplitude sufficiently to drive the tube power amplifier. A 60-cycle notch filter can be adjusted to act upon the desired portion of the signal to provide lead network stabilization.

The current delivered to the control winding of the two-phase motor must have a 90-degree phase relationship to that of the reference winding. Because the reference winding is in series resonance and the control winding is in parallel resonance, this relationship occurs when the control voltage is in phase with the line. Low-pass filtering of the control signal introduces a phase shift, and a correction for this shaft must be made. This may be done at the switches by shifting the phase of the 60-cycle square wave or before the power amplifier by shifting the phase of the control signal itself. Both methods have been used with equal success. Shifting the 60-cycle square wave affects all channels switched by it, while



# DIGITAL CONVERSION OF ELECTROENCEPHALOGRAPH

*Automatic system translates graph records directly to punched-tape input*

By M. G. SAUNDERS, M.D.,

EEG Department, Winnipeg General Hospital,  
and Department of Physiology, University of Manitoba, Winnipeg, Manitoba

THE ELECTROENCEPHALOGRAPH (EEG) records electrical changes in the brain. Its record localizes and demonstrates disturbed functions of the brain in cerebral tumors, psychiatric disorders, convulsions and the like. About a quarter million electroencephalograms are made each year in North America alone. Since these are analyzed by visual examination, this number represents a considerable mass of data; any procedure that can assist the interpreter in picking out abnormalities and relating them to disease is of great value. The work can be simplified by computer processing of EEG data. Since records are made as curve tracings they first have to be converted into a digital form suitable for feeding into a computer.

The electroencephalograph used has eight channels, each recording activity in a different area of the brain. The chart moves at 30 mm a second, while the pens register voltage on it. Each trace may have a peak-to-peak amplitude up to 2.5 cm, and the traces are about one inch apart.

The digital converter (Fig. 1), has three main parts. A reading area of frosted glass, on the left, is lighted from below by fluorescent lamps. The EEG record is placed on it and scanned by a photocell unit moving over it. The rack assembly includes a digital voltmeter, relays and power packs. On the right of the rack is a Clary printer and a computer tape punch. The converted digital data is then fed to an LGP30 computer.

Figure 2 shows the scanning head assembly in detail. It consists of eight small light-tight cases, on

phosphor-bronze arms, which are attached to spindles of potentiometers. To correct the curvilinear distortion caused by the swing of the recording pens, the scanning head arms are exactly the same length as the pen arms.

Figure 3 shows how the scanning heads are constructed. The small case contains a solar battery, insulated from the walls by Plexiglass. A small hole in the case, about 0.3 mm in diameter, sweeps across the EEG records and, as it moves across an ink line, a pulse is generated. This pulse is then amplified. The photocell is moved back and forth across the record by a small remotely mounted motor driving a reciprocating slider arm through a Bowden cable. Since the slider arm of the potentiometer follows exactly the position of the photocell, the voltage on the slider is proportional to the photocell displacement. Each potentiometer forms part of a Wheatstone bridge and each potentiometer arm is connected, through a high-speed relay, to a Mylar capacitor (Fig. 4). One potentiometer is for scanning, the other for zero adjusting. With the relay contacts closed, the capacitor voltage is directly proportional to the displacement of the scanning head. The pulse produced when the cell passes an ink line, opens the relay and leaves on the capacitor a charge proportional to the amplitude of the EEG record at that instant.

Each channel has a similar scanning unit; thus the amplitude of all eight curves can be sampled at the same moment. When all eight capacitors have been switched out of the circuit, another relay closes and

a stepping relay connects each capacitor in turn to a high-impedance, unity-gain amplifier. Its output is fed to the digital voltmeter. As soon as the meter balances, the voltage or equivalent amplitude of the channel is printed by the printer and punched on computer tape.

It is possible to read out from one to eight channels of the EEG record. A Nixie indicator tube lights up to show which channel is being read, and the amplitude between minus 99 and plus 99 appears on the digital voltmeter, the printer and punch, thus reading out channel number, sign and amplitude. When all channels have been read out a 9 + 00 is printed and punched. At this point, the scanning head moves forward one-half mm on tooth rails, the capacitors are reconnected to their potentiometers and the scanning motor starts. As soon as all high-speed relays to the capacitors have tripped, the readout cycle starts again.

Originally, the record was lighted by incandescent lamps fed by smoothed d-c. However, the solar batteries used as photocells are sensitive to infrared and the majority of EEG inks are transparent to infrared; as a result the signal-to-noise ratio was poor. Better results are obtained with fluorescent lamps run at saturation and fed by d-c. A polarity-changing switch must be used to avoid building up of glow at one end of the tubes after several hours of use.

Backlash in potentiometers made it necessary to allow the pulses to trigger the relays only on the up-stroke; to do this, a microswitch was inserted on the scanning motor to short the grids of the relay—



# RECORDS

## of a digital computer

pulsing amplifiers during the scan downstroke. Due to polarization effects all capacitors connected to the potentiometers must be Mylar; these do not introduce any noticeable polarization errors.

In an accuracy test, a sloping line was drawn on a blank sheet of EEG paper and scanned three separate times. The three digital representations were then superimposed and found to agree within one thickness of the original line.

A test was made for the total error, produced by the EEG amplifier, pen recorders and digital converter. A sine wave was fed into the EEG amplifier input, recorded and converted into digital form. The figures were plotted on an x-y recorder and a superimposed plot made from sine tables. Distortion was little more than the thickness of the line of the original electroencephalogram.

This digital converter is incapable of reading records on paper with printed scale lines or grids, unless these are exceptionally faint. Weak inks do not give a sufficiently large pulse to trip the relays, nor will excessively thick paper permit enough light to come through to make a good pulse. In its present form, the device can scan continuously only ten inches of record, and is slow in conversion. This slowness is mainly due to the balancing time taken by the digital voltmeter; at present it takes about one and a half seconds to read out one point. However, the system is automatic and does not require continuous attention during operation.

This equipment was developed under a Canadian Public Health Grant, Mental Health Division.

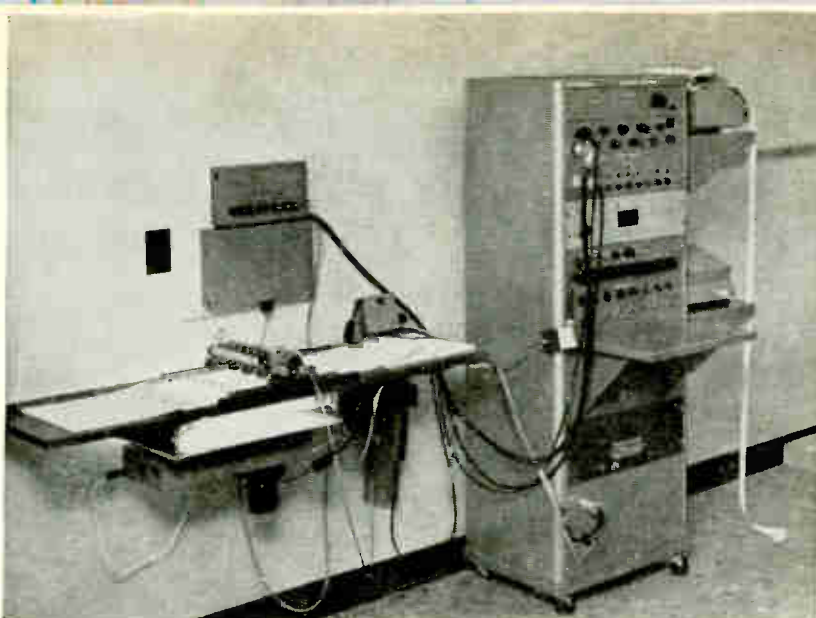

FIG. 1—Table at left carries record-reading device. Fluorescent lamps light record from below, photocell units scan it from above

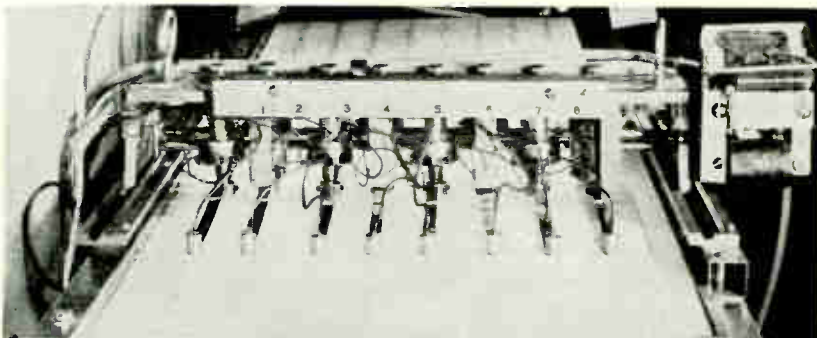

FIG. 2—Scanning device has special photocell and arm for each graph channel. Conversion is made point by point at 1/2-mm intervals

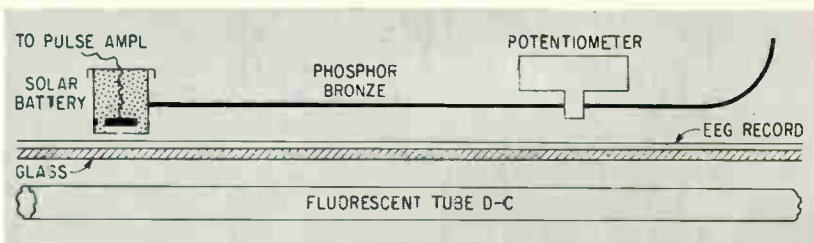

FIG. 3—Cross section shows construction of scanning head. Solar battery unit serves as photo cell

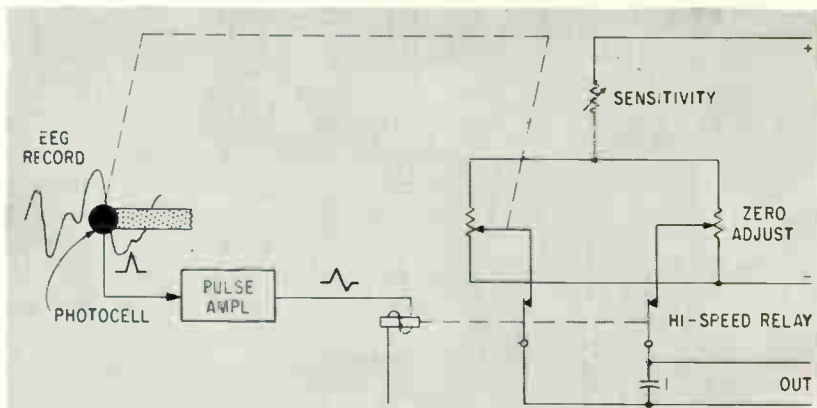

FIG. 4—Wheatstone bridge arrangement provides a voltage signal proportional to amplitude of graph. Capacitor charges to this voltage, later feeds it into converter

# Gas Clipper Tubes for Radar Service

*Thyratron clipper tubes are used in high-power radar modulators to prevent dangerous voltages from building up in the pulse-forming network. Example using design charts shows how to select correct tube for an application*

By W. W. WATROUS,  
J. McARTNEY,

Chatham Electronics Div.,  
Tung-Sol Electric Inc.,  
Livingston, New Jersey

REMOVAL OF INVERSE voltage across the switching tube after a load pulse is required in most line-type radar modulators. High-power modulators have used either vacuum diodes or conventional hydrogen thyratrons for this. Because of limitations in both these devices an investigation into the general problems of inverse voltage removal was undertaken.<sup>1</sup> The objective was to determine the optimum method and most effective device for suppression of inverse voltage. A major

finding of this study indicated that a hydrogen-filled triode at the far end of the pulse-forming line provided the most effective clipping. The 7454 (12.5 megawatt level) and the 7455 (33 megawatt level) clipper tubes were developed for such use.

Basic line-type radar modulators consist of a switch tube, load and pulse-forming network (PFN). The load is usually a magnetron or klystron, coupled to the circuit through a pulse transformer. The network is negatively matched, that is, the load has a smaller impedance than the characteristic impedance of the pulse-forming network. Such mismatch results in a negative voltage remaining on the network after the main discharge pulse. This voltage adds to the power supply voltage on the next charging cycle.

When a load fault occurs, the mismatch ratio is increased and the negative voltage rises forcing the line to charge to a higher voltage. A number of successive faults can produce dangerously high voltages on the circuit components. If equilibrium is reached, the final network voltage is<sup>2</sup>

$$V_n = E_{bb} (1 + \gamma) / (1 + \gamma K)$$

where  $\gamma = e^{-\pi/2Q}$

$$\text{and } K = (R - Z_o) / (R + Z_o) \quad (1)$$

In these equations  $E_{bb}$  is the power supply voltage,  $Q$  is the quality factor for a d-c resonant charge circuit,  $Z_o$  is the network characteristic impedance and  $R$  is the total series resistance in the discharge loop when the load is shorted. Spasmodic faults can result in unequal line charging voltages that

may cause serious amplitude modulation.

The negative mismatch voltage also produces an inverse current pulse in the switch tube immediately following the main discharge pulse. As deionization proceeds, this current decays rapidly producing an inverse voltage spike across the switch tube. Its energy is dissipated at the switch-tube anode.

Thus, the rapid removal of excessive inverse voltage in a line-type modulator by a clipping device results in: protection of circuit components from the abnormal voltage during load faulting, improved regulation of the amplitude of the output pulse under faulting conditions and reduction of inverse-spike energy that must be dissipated by the switch-tube anode.

Hydrogen thyratrons connected across the PFN are the most effective type of clipper at higher power levels.

A typical switch-tube anode voltage waveform, without clipping, is shown in Fig. 1. The large negative voltage spike appears immediately after switch-tube current falls to zero. The product of this inverse voltage and the concurrent inverse current produces power that may constitute a large percentage of the allowable anode dissipation in the switch tube. Thus, any reduction of spike power permits increased input power to the modulator. Remaining inverse voltage is the normal mismatch inverse and does not directly contribute to anode dissipation.

A thyratron clipper offers several major advantages over a vacuum clipper. Most important is the inherent low dynamic tube impedance

*Hydrogen clipper thyratron 7455 operates at 33-Mw switch-tube level*

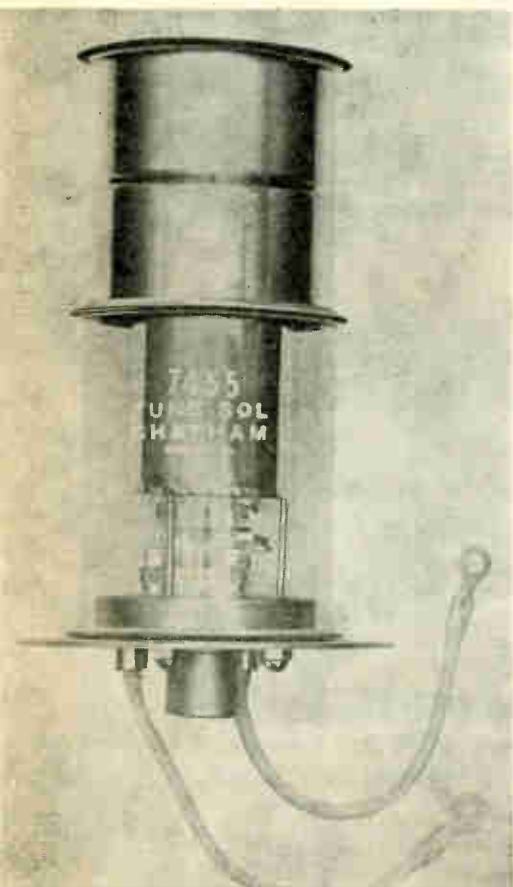

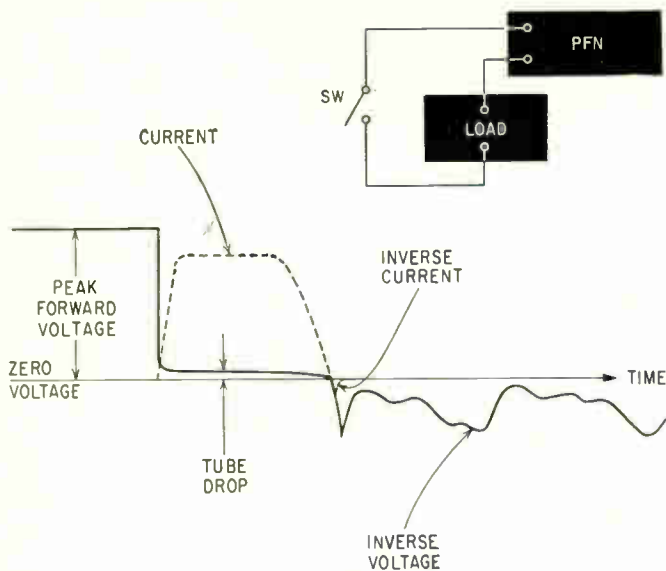

FIG. 1—Switch tube anode voltage and current have inverse peaks when clipping is not used

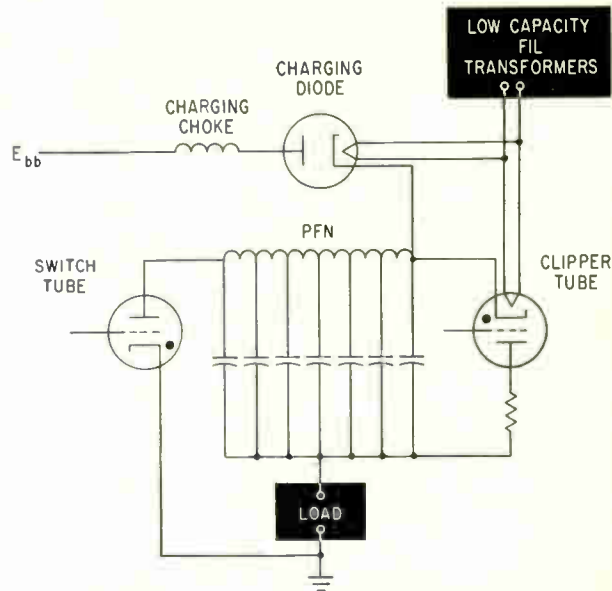

FIG. 2—In end-of-line clipping circuit, common filament transformer can charge diode and clipper tube

of a thyratron, which not only is essential for effective clipping, but reduces power loss as well, permitting the use of smaller and less costly clippers. Further, a thyratron clipper reduces the network voltage to zero immediately following the main current pulse, regardless of the value of load impedance. This accounts for the excellent regulative and protective properties of a gas clipping device. Vacuum-tube clippers with their series resistors, or inductors, require a time equivalent to a large number of pulse widths. Thus, to remove the inverse voltage the time constant for the discharge of the network capacitance may be an appreciable fraction of the charging period, resulting in poor voltage regulation. It is impossible to remove completely the inverse spike voltage from a switch tube using a conventional vacuum clipper.

High cost and relatively low voltage ratings of contemporary solid-state devices, together with the inability to recover from high transient voltages, have limited their application to low-power clipping.

There are a number of places where clipper tubes have been used in line-type modulators. These include directly across the switch tube across the front end of the pulse-forming network and across the far end of the pulse-forming network.

Probably the most commonly used clipping location has been directly

across the switch tube. However, circuit analysis proves that it is impossible, even when using a thyratron clipper, to effectively remove the spike inverse voltage by using this circuit. Further, if the pulse transformer impedance is high during the interpulse interval, as is usually the case, it is even difficult to rapidly remove mismatch inverse voltage.

The clipper tube is preferably inserted across the far end of the pulse-forming network in series with a resistive load whose value approximates that of the network impedance. Here the inverse spike can be almost completely eliminated and simple triggering can be used. A typical, end-of-line clipping circuit, using a clipper thyratron is shown in Fig. 2.

The switch tube anode voltage waveform with a clipper thyratron at the far end of the line is shown in Fig. 3.

This shows complete removal of both mismatch voltage and spike voltage.

The tube may be triggered in a number of ways (Fig. 4). A coil can be inserted either around the connecting lead from load to network, or around a capacitor leg (preferably the last capacitor), thus creating a pulse transformer with a one-turn primary. Triggering can be done directly from the line or by placing a divider across the last section of inductance. External triggering is possible using a

high-voltage, insulated transformer.

The one-turn primary trigger transformer is preferable because: (1) A unipotential pulse is easily obtained. (2) If installed at position 2 of Fig. 4 the coil insulation must withstand only the trigger pulse voltage. (3) No energy is lost in a dividing resistance. (4) The lead time and pulse shape are easily optimized.

With all triggering methods, it is necessary to insert resistance in the clipper thyratron grid lead to limit the grid pulse current. It may be necessary also to add an integrating network across the grid pulse transformer to produce the desired pulse shape.

The energy dissipated in the clipper load resistor is:  $I_{rms}^2 R_T T$ , where  $R_T$  is the clipper load and  $T$  is the interpulse interval. Of course, this energy must be delivered by the power supply. However, the energy dissipated by the load does not necessarily dictate a larger power supply. The ratio of power input for no clipping versus clipping is

$$E_{bb1} I_1 / E_{bb2} I_2 = (1 + \gamma K) (1 - K) \quad (2)$$

Here  $I$  is the power supply average current, and the  $R$  that appears in the definition of  $K$  (Eq. 1) is the load resistance plus any additional series resistance.

Assuming typical values such as  $Q = 20$  and  $K = 0.184$ , the ratio equals 0.983. It is not unusual to have ratios equal to or greater than 1. Thus, in many applications, the

power dissipated in the clipper load resistor may be more than compensated by increased circuit charging efficiency.

A clipper tube, to be completely effective, must: (1) hold off an inverse voltage equal to the peak network voltage; (2) have a dynamic tube impedance equal to or less than the characteristic impedance of the network; (3) have a firing time small compared to the rise time of forward voltage across the tube and (4) have a cathode capable of delivering many times its normal current during periods of load fault.

These four design criteria elimi-

nate certain tube classes from consideration in high power modulators. Requirement 2 demands a tube capable of operation at more than 25 Kv with a dynamic impedance of 5 to 25 ohms—an impracticability with vacuum diodes. Requirement 3 dictates a gas tube with unusually fast ionization time if the short-duration inverse-spike voltage is to be clipped. This precludes the use of a gas diode as the ionization time of a gas diode is too long for effective spike clipping. A thyatron permits the use of a prefired grid that ensures rapid anode ionization.

A further advantage of a thya-

tron clipper is that it is considerably simpler to achieve a given inverse voltage rating in a thyatron than in a gas diode. In gas-diode design, low firing voltage and high hold-off voltages are mutually antagonistic. Thus, a thyatron clipper exhibits a superior safety factor.

Establishing electrical ratings for a clipper tube is difficult, due primarily to one of its major uses—fault protection. A determination of typical fault rates, together with their duration and magnitude, is almost impossible as each application is different.

To establish suitable ratings for

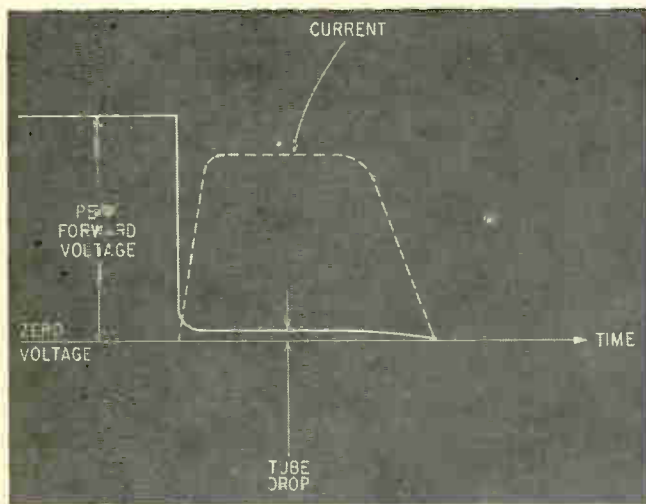

FIG. 3—Far-end-of-line clipping removes all inverse voltage and current

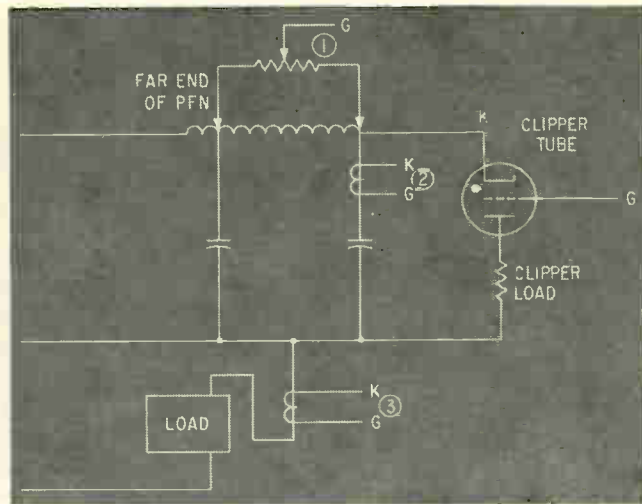

FIG. 4—One-turn primary transformer is preferred method of triggering clipper

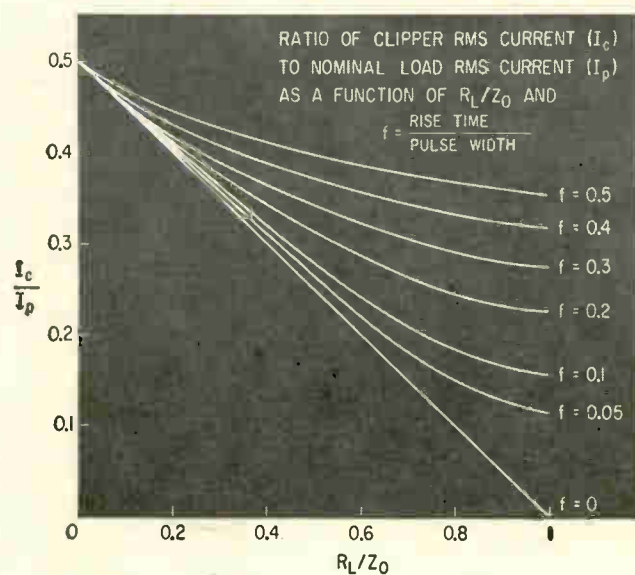
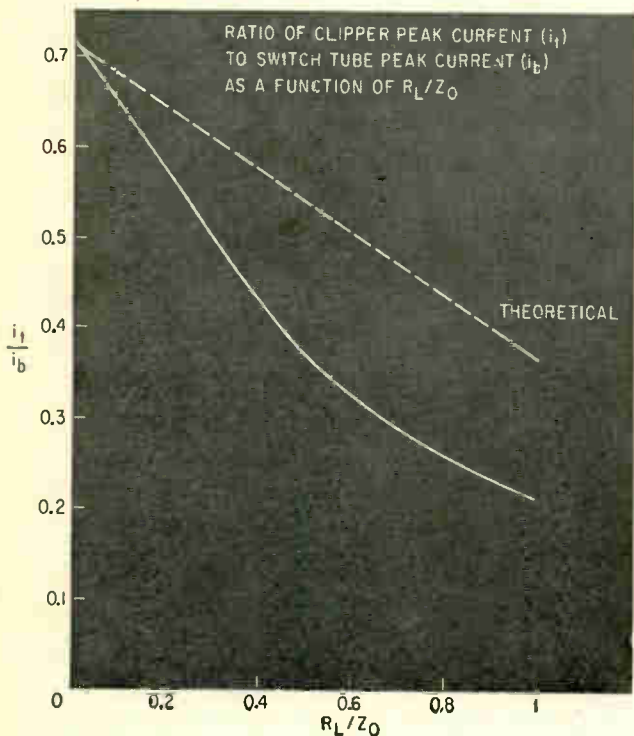

FIG. 6—Ratio of rise time to pulse width has a pronounced effect on current ratio

FIG. 5—Solid line represents empirically determined values for various modulators. Dotted line is calculated for an ideal circuit

clipper thyratrons, it was necessary arbitrarily to establish faulting rates that were known to be far higher than would be acceptable in any radar system. Once a value for faulting rate had been selected, the electrical ratings could be determined. The rating parameters for a thyatron clipper are common with that of any hydrogen thyatron. There are, however, new rating requirements that must be included:

**PEAK FAULT CURRENT** — Under certain conditions of fault, the magnitude of peak current may be as high as four times the rated continuous peak current, for as long a period as the fault exists.

**RMS FAULT CURRENT**—As with peak current, rms fault current can reach approximately four times the value of continuous rms current.

**AVERAGING TIME** — To prevent damage to the clipper tube, because of too long or too frequent application of fault current, a fault-current averaging time must be included in the rating.

**TRIGGER REQUIREMENTS** — The trigger voltage pulse requirements although similar to the pulse requirement of an ordinary hydrogen thyatron differs in that the trigger voltage must be advanced in phase with respect to anode voltage but the lead time must be held within maximum and minimum limits and the trigger voltage amplitude must be sufficient to insure rapid ionization.

To help determine peak and rms current, graphs have been prepared showing the ratio of clipper-tube current to switch-tube current as a function of  $R_L/Z_o$  (Fig. 5 and 6). From these graphs, it is possible to determine the conditions imposed on the clipper thyatron for any line-type modulator, and thus choose the proper size clipper thyatron. The design example shows how these graphs are used.

A gas clipper tube may also be used across the pulse transformer to prevent undesirable back-swing voltage. Here it is called a damper or tail biter. If the characteristics of the pulse transformer are such that large post-pulse-voltage swings occur, dampers are essential, as the switch-tube voltage will swing positive immediately after the main pulse and false firing may occur. This is exaggerated when a clip-

### EXAMPLE ILLUSTRATING USE OF THE CHARTS

Assume the following modulator parameters are known:

Peak forward network voltage ( $e_{pv}$ ).....	25 kv
Peak load current ( $i_b$ ).....	1,000 amp
Pulse repetition rate (prf).....	360 pps
Rise time of load current ( $t_r$ ).....	0.1 $\mu$ sec
Pulse width ( $\tau$ ).....	2.5 $\mu$ sec
PFN characteristic impedance ( $Z_o$ ).....	15 ohms
Load impedance ( $R_L$ ).....	10 ohms

Determine: (1) peak clipper current ( $i_t$ ); (2) peak fault clipper current ( $i_{t\text{ fault}}$ ); (3) rms clipper current ( $I_c$ ); and (4) rms fault clipper current ( $I_{c\text{ fault}}$ ).

(1) **Peak Clipper Current**

Since  $i_b = 1,000$  amp and  $R_L/Z_o = 10/15 = 0.667$ , from Fig. 5

$$i_t/i_b = 0.3$$

$$\text{Therefore } i_t = (0.3)(1,000) = 300 \text{ amp}$$

(2) **Peak Clipper Fault Current**

Under fault conditions  $R_L = 0$  and peak load current  $i_b$  increases to

$$i_b = e_{pv}/Z_o = 25,000/15 = 1,666 \text{ amp} \quad \text{From Fig. 5 with } R_L = 0$$

$$i_t/i_b = 0.72$$

$$\text{Therefore } i_{t\text{ fault}} = (0.72) \times 1,666 = 1,200 \text{ amp}$$

(3) **RMS Clipper Current**

The load rms current is

$$I_p^2 = \frac{1}{T} \int_0^T i_b^2 dt$$

where  $T = 1/\text{prf}$

If the load current pulses approaches a square wave this becomes

$$I_p^2 = i_b^2 \tau / T \quad \text{therefore}$$

$$I_p = [(1,000)^2 (2.5 \times 10^{-6}) (360)]^{1/2}$$

$$= 30 \text{ amp}$$

Before using Fig. 6, it is necessary to know the ratio of the rise time to the pulse width.

This is

$$f = t_r/\tau = 0.1/2.5 = 0.04$$

From Fig. 6, for  $R_L/Z_o = 0.667$  and  $f = 0.04$

$$I_c/I_p = 0.19. \quad \text{Then } I_c = (0.19)(30) = 5.7 \text{ amp}$$

(4) **Clipping RMS Current during Faulting**

During faulting, the rms currents will increase. The magnitude of rms current will depend on the number of faults in a given period. A fault on every cycle would increase the clipper rms current to one half the switch-tube fault rms current. The number of fault pulses must be determined to insure that the clipper tube rms current does not exceed its rated value.

For continuous faulting

$$I_{p\text{ fault}} = [(1,666)^2 (2.5 \times 10^{-6}) (360)]^{1/2}$$

$$= 50 \text{ amp}$$

And from Fig. 6 with  $R_L = 0$  and  $f = 0.04$

$$I_{c\text{ fault}} = (0.5)(50) = 25 \text{ amp}$$

If a 1-percent faulting rate is assumed, the new clipper rms current is

$$I_{c\text{ fault}}^2 = (0.01)(25)^2 + 0.99(5.7)^2$$

$$= 38.4 \text{ amp}^2$$

$$\text{Then } I_{c\text{ fault}} = 6.2 \text{ amp}$$

Hence a 1-percent sparking rate increases the clipper tube rms current by almost 10 percent. If the faulting occurs on every cycle, it is necessary to remove anode voltage as the rms current rating will be exceeded unless a clipper tube much larger than necessary is used.

For this example, basic clipper-tube requirements become

$$e_{pv} = 25 \text{ Kv} \quad i_{t\text{ fault}} = 1,200 \text{ amp}$$

$$i_t = 300 \text{ amp} \quad i_c = 5.7 \text{ amp}$$

$$i_{c\text{ fault}} = 6.2 \text{ amp assuming a 1-percent faulting rate}$$

ping device removes all inverse voltage.

It should not be construed that solid-state, vacuum or gas diodes, and conventional thyratrons will not clip inverse voltage. These devices do work and are used. However, there are disadvantages such as high cost, low safety factor, low efficiency and poor clipper effective-

ness inherent in all these devices, and investigation has shown that a thyatron clipper designed for matched impedance clipping service is the best solution.

### REFERENCES

- (1) Chatham Electronics, Phase I Final Report, Clipper Tube Gas Filled, Contract DA-36-039-SC-64621.
- (2) Glasoe and Lebacqz, "Pulse Generators", p 424, McGraw-Hill, New York, N. Y.

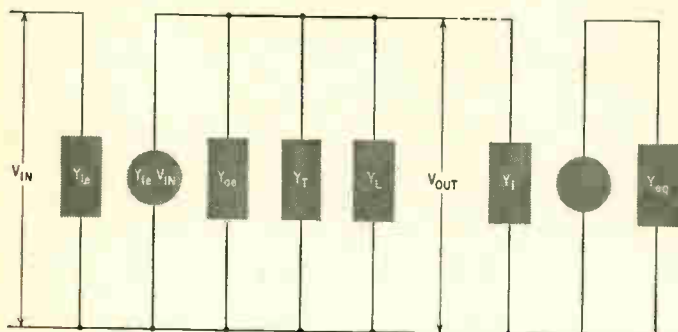
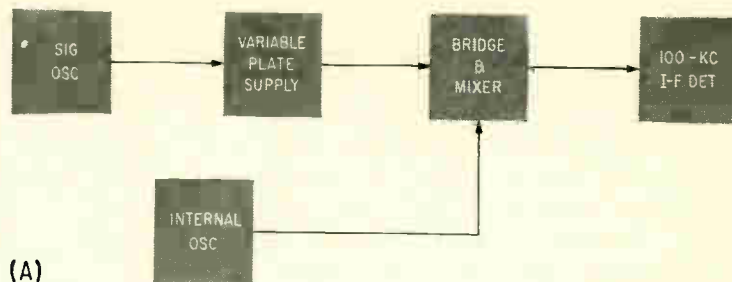
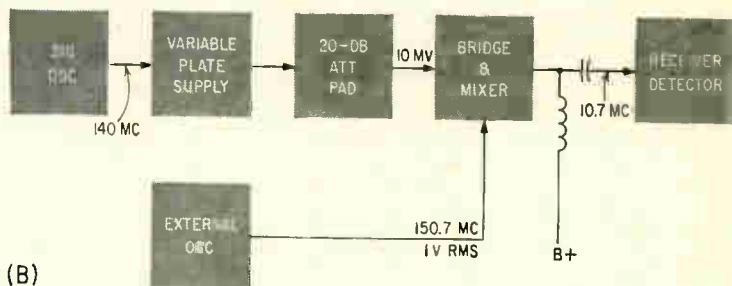

FIG. 1—Equivalent circuit of transistor stages, using admittance parameters



(A)



(B)

FIG. 2—Normal measuring arrangement (A) is shown modified in (B)

*Techniques for adapting and using instrumentation to measure the admittance parameters of high-frequency transistors*

# MEASUREMENT of TRANSISTOR

By KEVIN REDMOND,  
Section Head, Semiconductor Applications,  
Amperex Corp., Hicksville, N. Y.

IN MEASURING transistor parameters, the test input signal must not be so large that it overdrives the transistor. With the Boonton RX instrument, which measures parallel resistance and parallel capacitance of transistors to obtain their admittance parameters, the way to reduce the drive signal is to adjust a potentiometer in the plate circuit of the instrument's oscillator.<sup>1</sup> Doing this sometimes results in faulty operation of the instrument's internal oscillator or detector.

This article describes an improved method of measuring admittance parameters. Admittance parameters are easy to measure and manipulate in designing circuits. Ease of measurement is inherent since these parameters are short-circuit parameters. This means that a short is required in making

parameter measurements. A short is easily obtained at r-f frequencies by a capacitor. In addition, oscillations are less likely to occur when the transistor is shorted. The only required open-circuit measurement is used to obtain the feedback admittance, and in this measurement the low-impedance input circuit is

open. Since the transistor input impedance is low, the effective open is easily obtained by adding an r-f choke. If the transistor is neutralized the feedback admittance measurement is not necessary, since feedback admittance does not affect the power gain.

The use of admittance param-

## GLOSSARY

$Y_{ie}$	Common-emitter input admittance, output short circuited
$Y_{oe}$	Common emitter output, admittance, input short circuited
$Y_{re}$	Common emitter, reverse-transfer admittance
$Y_{fe}$	Common emitter, forward-transfer admittance (approximate)
$Y_{fe}$	Common emitter, forward-transfer admittance (exact)
$Y_{bes}$	Admittance base to emitter with output shorted
$Y_{ces}$	Admittance collector to emitter with the input shorted
$Y_{ebcb}$	Admittance emitter to base with a short collector to base
$Y_{eo}$	Output admittance with the input open
$Y_T$	Transformer admittance
$Y_L$	Reflected load admittance
$R_p$	Parallel-resistance measured by bridge
$C_p$	Parallel-capacitance measured by bridge
$G_L$	Load conductance
$Y_{eq, out}$	Total equivalent admittance of output
$G_{ie}$	Input conductance

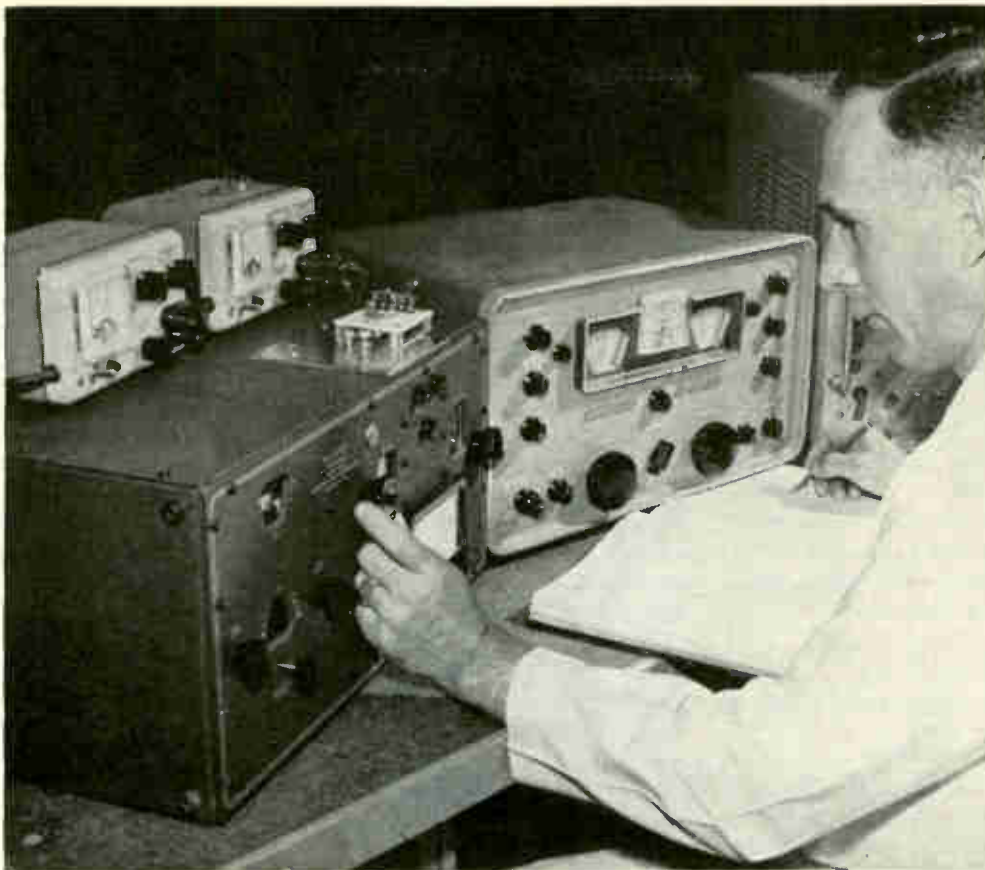

Test setup for measuring admittance parameters. Transistor jig is mounted on top of left-hand cabinet

## ADMITTANCE PARAMETERS

eters in circuit design is indicated in Fig. 1, an r-f transistor stage. The *glossary* defines symbols used in this schematic, as well as other symbols in other schematics and in equations. If the stage is neutralized, feedback is eliminated; therefore a  $Y_{r, V}$  generator is not shown. When using admittance parameters, all the output admittance can be added to produce one equivalent admittance. The same procedure is used for input admittance. With hybrid parameters the current must be calculated through  $h_{11}$ , before the current through output generator  $\beta I_b$ , can be calculated.

In unneutralized circuits, the feedback-generator admittances are easily converted to an equivalent admittance and all admittances in the input circuit are added to find the total equivalent input admittance. With hybrid parameters the voltage-generator parameter must be converted to an impedance, added

to  $h_{11}$ , and the combination converted to an admittance before it can be added to the rest of the admittances in the input circuit. Again,  $I_b$  must be computed before the output-voltage-generator parameter can be used.

Figure 2 illustrates the original (A) and improved (B) methods of measuring admittance parameters. In the normal arrangement the signal oscillator level is attenuated by a potentiometer in the plate circuit of the oscillator and then fed to the bridge. In the new arrangement the r-f input is attenuated by a 20-db attenuator. Thus operation of the oscillator is unaffected by the attenuation.

The internal 100-Kc detector used in Fig. 2A could cause some difficulty, if it were used in Fig. 2B, to detect the low signal that results from use of the attenuator. Thus, Fig. 2B uses a more sensitive external detector. The detector is a

Hammarlund HG160 communications receiver tuned to the difference frequency and operated in its agc mode.

The external oscillator of Fig. 2B alters the detector frequency to any frequency. For example, in measuring the 140-Mc parameters of a transistor, the external oscillator can be set to 150.7 Mc, providing an intermediate frequency of 10.7 Mc for the receiver.

In selecting the intermediate frequency be sure that: it is not a communication frequency or any other frequency that may cause the receiver to give readings generated by signals other than the desired signal; it is not near the fundamental or harmonics of any of the frequencies used in the instrument.

The equivalent circuit for admittance parameters is shown in Fig. 3. The *glossary* defines the symbols used.

The following equations are suffi-

cient to obtain all the admittance parameters from measurements with the setup of Fig. 2B:

$$Y_{ie} = Y_{bes} \quad (1)$$

$$Y_{oe} = Y_{ces} \quad (2)$$

$$Y_{fe}' = Y_{ebacb} - Y_{ie} + Y_{oe} \quad (3)$$

$$Y_{fe} = Y_{ebacb} - Y_{ie} + Y_{oe} + Y_{re} \quad (4)$$

$$Y_{re} = -Y_{ie}(Y_{oeo} - Y_{oe})/Y_{fe} \quad (5)$$

Equation 3 is the approximate, and Eq. 4 the exact, value of forward transfer admittance.

Measurements will be carried out on a PADT-30 transistor operating at 140 Mc. 12 v and 1 ma to determine its admittance parameters. These steps are indicated in Fig. 4.

In measuring  $Y_{ies}$ , that is,  $Y_{bes}$ , the output is shorted and the instrument's bridge connected to the test-circuit input (Fig. 4A). These readings were obtained:

$$Y_p = 40 \text{ ohms}, \quad C_p = 7 \text{ pf}$$

$$Y_{bes} = Y_{ie} = (1/R_p) + j\omega C_p$$

$$Y_{ie} = (1/40) + j(6.28)(140)(10^6)(7)(10^{-12})$$

$$Y_{ie} = 25,000 + j6,160$$

$$= 25,900 \angle 13.8^\circ \mu\text{mho}$$

In measuring  $Y_{oes}$ , the base is shorted to the emitter and the bridge connected between the collector and emitter (Fig. 4B). These measurements were obtained:

$$R_p = 2,700 \text{ ohms}, \quad C_p = 4 \text{ pf}$$

$$Y_{oes} = Y_{ces} = 3,535 \angle 84^\circ \mu\text{mho}$$

In measuring  $Y_{fe}'$ , the collector is shorted to the base and the bridge connected between either the emitter and base or the collector and emitter (Fig. 4C). The following measurements were obtained:

$$R_p = 59 \text{ ohms}, \quad C_p = -28 \text{ pf}$$

$$Y_{ebacb} = 16,940 - j24,600$$

$$Y_{fe}' = Y_{ebacb} - (Y_{ie} + Y_{oe})$$

$$Y_{fe}' = 16,940 - j24,600 - 25,000 - j6,160 - 370 - j3,510$$

$$Y_{fe}' = -8,430 - j34,270$$

$$= 36,800 \angle 256.2^\circ \mu\text{mho}$$

In measuring  $Y_{re}$ , the emitter-to-base circuit is open and the bridge connected between the collector and emitter (Fig. 4D). These measurements were obtained:

$$R_p = 425 \text{ ohms}, \quad C_p = 2.3 \text{ pf}$$

$$Y_{oeo} = 2,350 + j2,022$$

$$Y_{oeo} - Y_{oe} = 1,980 - j1,488$$

$$= 2,490 \angle -36.70^\circ \mu\text{mho}$$

$$Y_{re} = -Y_{ie}(Y_{oeo} - Y_{oe})/Y_{fe}$$

$$Y_{re} = 1,750 \angle 260.9^\circ$$

$$= 278 - j1,730 \mu\text{mho}$$

The  $Y_{fe}'$  term was calculated assuming  $Y_{re}$  much greater than  $Y_{re}$ . This assumption is borne out by the calculated value of  $Y_{re}$ . If more accuracy is desired,  $Y_{re}$  can be used to obtain a more nearly correct value of  $Y_{fe}$ . However it is pointless

to take the corrected value of  $Y_{re}$  and using it to determine a more correct value of  $Y_{re}$  since there will be little change from the one found in the fourth step (Fig. 4D) that uses the first approximate value of  $Y_{re}$ . Using Eq. 4 to obtain a more accurate second approximation for  $Y_{fe}$ ,

$$Y_{fe} = Y_{fe}' - Y_{re}$$

$$Y_{fe} = -8,430 - j34,270 - 278 + j1,730$$

$$Y_{fe} = -8,708 - j32,540$$

$$= 33,800 \angle 255.0^\circ \mu\text{mho}$$

In designing the measuring jigs shown in Fig. 4, use was made of the fact that the instrument could pass current through the test terminals. This is advantageous in supplying bias voltage to the transistor. All bias-supply leads are choked to insure that they do not affect r-f measurements. The value of the choke depends on the frequency and the impedance at the point they are connected. They should be at least ten times the circuit impedance. Similarly the capacitors are a-c short circuits and should be one-tenth the circuit impedance.

To reduce capacitive and inductive coupling, all chokes and other components leading away from the transistor socket were fanned out as can be seen in Fig. 5. The capacitors used as a-c short circuits are soldered directly across the transistor pin sockets to avoid producing parasitic tanks with long lead lengths. Similarly, the bridge terminal connectors come directly from the pins of the transistor socket at the end of the jig. To further reduce the length of the bridge-terminal connections, the jig was constructed on blocks, the height of which places the pins of the transistor socket directly in line with the connection point of the instrument's bridge terminals.

The transistor socket and circuit

introduce measurement errors. Measuring equipment using coaxial fixtures could reduce these errors; however, readings obtained with the method described are often more useful to circuit designers than those describing only the device because these are the parameters he will encounter in a circuit. Few coaxial circuits are used at 140 Mc. The circuitry used here will usually be encountered at this frequency. For frequencies below 30 Mc, the effect of a well-designed jig upon the measurements can become negligible. A good check on the quality jig is to measure the jig without any transistor in the socket. If a large value of capacitance or low value of  $R_p$  is obtained, reworking of the jig is required.

Often the input capacitance of a transistor may exceed the range of the instrument. The range can be extended by placing a coil across the bridge terminals, thus causing the instrument to read in the inductive range. When the transistor is connected back into the circuit, a reading may be obtained within the range of the instrument. The capacitance of the transistor is then the difference between the reading in the inductive range caused by the inductor and the new capacitive reading obtained with the transistor-inductor combination. For example, if the inductor caused a reading of -20 pf and the transistor and the inductor in combination gave a reading of +25 pf, the capacitance for the transistor would be 45 pf. The  $R_p$  reading of the inductor must be deducted from the combined inductor and transistor reading thusly

$$R_x = R_i R_c / (R_i - R_c) \quad (6)$$

where  $R_x$  is the desired transistor  $R_p$ ,  $R_i$  is the  $R_p$  of the inductor alone, and  $R_c$  is the  $R_p$  of the inductor-transistor combination.

The range can be further extended by using a larger inductance. The value of the inductance can be found by placing known capacitors across the inductance until a reading can be obtained with the instrument. The amount of known capacitance removed to obtain a reading within the instrument's range when the transistor is added will give the correction. If air-dielectric or other high-Q capacitors are used, their resistance component may be

## CONVERSION OF PARAMETERS

### Common Base to Common Emitter

$$Y_{ie} = Y_{ib} + Y_{rb} + Y_{fb} + Y_{ob}$$

$$Y_{re} = (Y_{rb} + Y_{ob})$$

$$Y_{fe} = -(Y_{fb} + Y_{ob})$$

$$Y_{oe} = Y_{ob}$$

### Common Emitter to Common Base

$$Y_{ib} = Y_{ie} + Y_{re} + Y_{fe} + Y_{oe}$$

$$Y_{rb} = -(Y_{re} + Y_{oe})$$

$$Y_{fb} = -(Y_{fe} + Y_{oe})$$

$$Y_{ob} = Y_{oe}$$



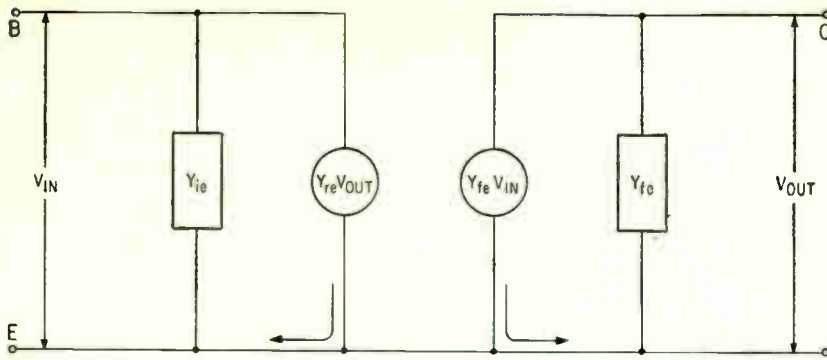

FIG. 3—Equivalent circuit of transistor

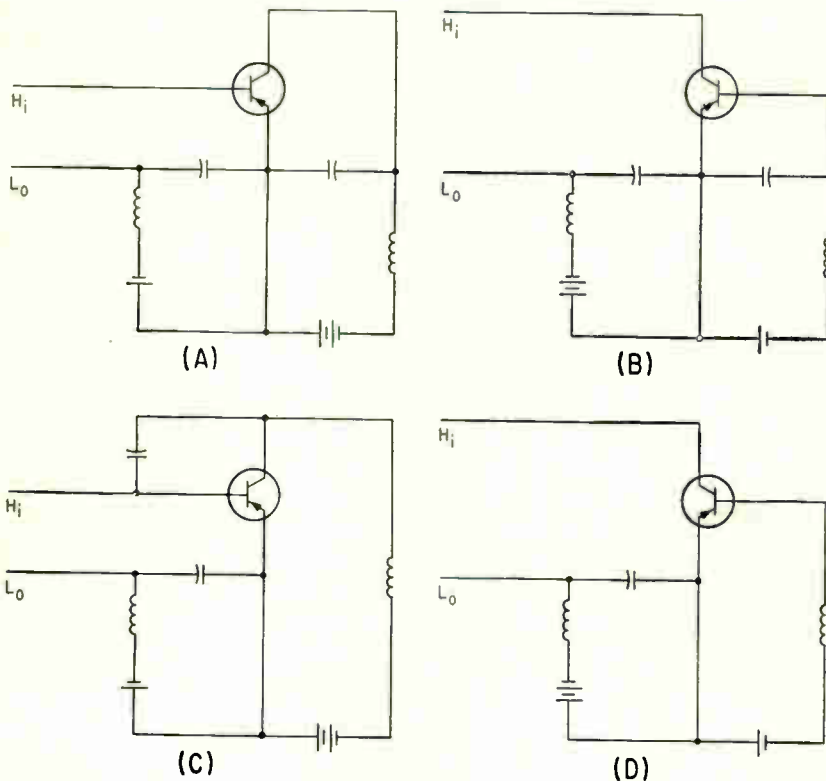

FIG. 4—Jig arrangements for measuring  $Y_{bes}$  (A),  $Y_{ces}$  (B),  $Y_{besob}$  (C) and  $Y_{oes}$  (D)

extremely high compared to the inductor or transistor  $R_p$ ; hence no correction need be made to the  $R_p$  reading obtained without the capacitors.

After the admittance parameters have been determined power gain may be calculated.

The maximum neutralized power gain occurs when the input and output admittances are conjugate matched. The gain is

$$G = Y_{fe}^2 / 4 Y_{ie} Y_{oe}$$

If the stage is neutralized the power is given by  $P_{out} = V_{out}^2 G_L$  and  $P_{out} = (Y_{fe} V_{in} / Y_{eq out})^2 G_L$ . The power input is  $P_{in} = V_{in}^2 G_{ie}$ . The

gain is given by

$$G = (Y_{fe} / Y_{eq out})^2 \times G_L / G_{ie}$$

If the stage is unneutralized the input admittance is affected by the feedback generator, whose current is  $I_{fb} = Y_{re} V_{out}$ .

Admittance of the feedback generator is  $Y_{fb} = I_{fb} / V_{in}$ . Hence

$$Y_{fb} = Y_{re} Y_{ce} / Y_{eq out}$$

Input impedance is then the sum of  $Y_{fb}$  and  $Y_{ie}$ . If the input is tuned, the reactive component of the total input impedance is tuned-out at resonance and the power input is

$$P_{in} = (V_{in})^2 (G_{ie} + G_{fb})$$

where  $G_{fb}$  = the real part of  $Y_{fb}$ .

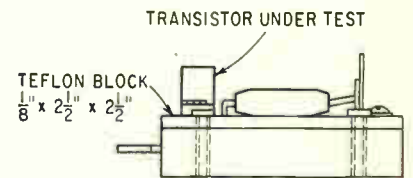
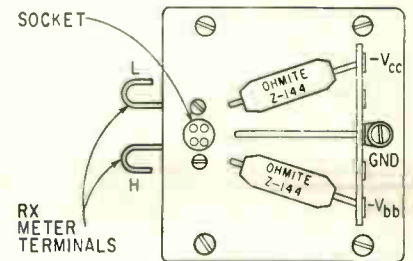
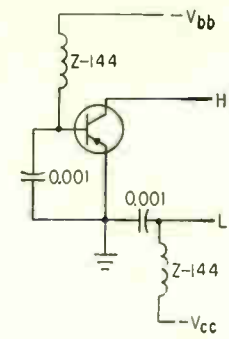

1/4" x 1/2" x 2 1/2" TEFLON

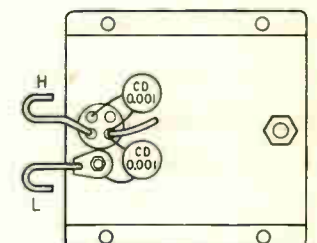

FIG. 5—Hookup of test jig for testing of  $Y_{ces}$

If the input is not tuned the reactive portion of the input admittance draws current that dissipates power in the source resistance. The power gain in the unneutralized case is

$$G = (Y_{fe} Y_{eq out})^2 [G_L / (G_{ie} + G_{fb})] \quad (7)$$

Equation 7 shows that if the output is not tuned,  $Y_{eq out}$  increases, resulting in a loss in gain. This is caused by the untuned reactive portion of  $Y_{eq out}$  shunting the output load, thus lowering the output voltage and hence the power gain.

#### REFERENCE

(1) Boonton Radio Corp. Notebooks, N019, Fall, 1958.

# Designing Magnetostriction Filters

*Bandpass filters using magnetostrictive resonance units are small, rugged and inexpensive, have sharp response and a high order of reliability in use*

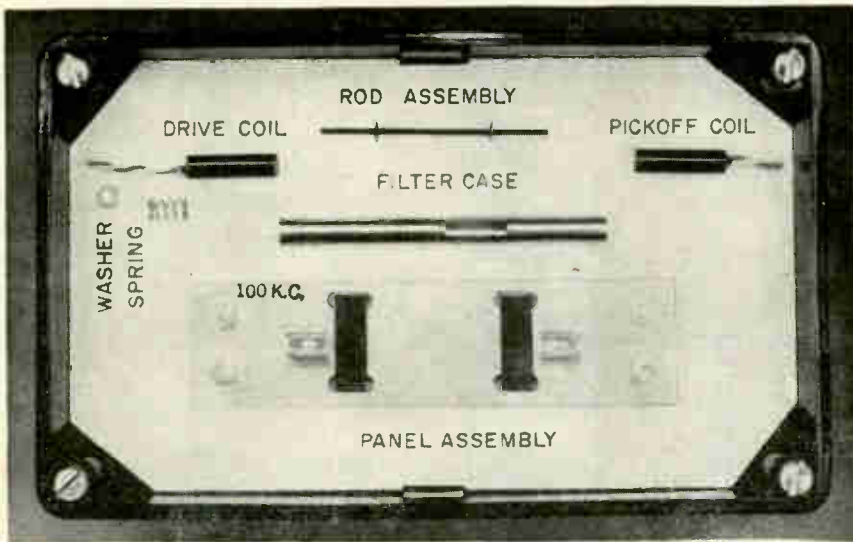

FIG. 1—Exploded view displays components of magnetostrictive bandpass filter, using a single nickel-iron rod element

By EDWARD J. NEVILLE, JR.,

Department Manager,  
Rayspan Department,  
Industrial Components Division,  
Raytheon Company,  
Watertown, Mass.

About 14 different lengths are cut to cover a 10-Kc band between 170 and 180 Kc. For this frequency range, the average length is about 1.2 inches; the groups are cut at intervals of about 0.006 inch. For any given length in this range, the resonant frequency varies about 700 to 800 cps, due mostly to nonuniform mass distribution in the rod. Changing the mass distribution along the rod, by removing metal near the nodes, increases the effective wavelength and lowers resonant frequency, while removing metal near the antinodes (maximum displacement points) has the opposite effect. This is used to adjust the frequency of a rod filter. A window in the case gives access to the rod in the middle and near one node. One light stroke with a file will change frequency about 0.5 cps in 100 Kc, or one part in 200,000. A 100-Kc rod can thus be adjusted at least 100 cps up or down with no apparent effect on bandwidth or insertion loss.

Rod filters have been built for frequencies from 20 to 450 Kc, but for practical purposes the range is limited to between 45 and 300 Kc. Below 45 Kc the rod becomes too long, and above 300 Kc it is so short that there is excessive feed-through between the drive and pickup coils.

Frequency-amplitude response for a single-element rod filter falls off 6 db per bandwidth octave, that is, the bandwidth doubles for every 6 db of attenuation. If a single-

MAGNETOSTRICTION is the change in dimensions of a ferromagnetic material when placed in a magnetic field. The name also applies to the inverse effect: the change in magnetization when dimensions are changed by an external force.

Magnetostriction bandpass filters can be made as rods, bars, slugs, disks or rings. They can be operated in the torsional, transverse or longitudinal mode of vibration. A single rod is used in this magnetostriction filter, and is driven in the longitudinal mode. Two support washers are crimped on the rod at the vibrational nodes (Fig. 1), and two solenoids—the drive and pickup coils—are placed around the rod; this subassembly is set in a case and held by a compression spring. The assembly is mounted in clips on an aluminum panel, and two bias magnets are placed approximately under the nodal points of the rod.

When alternating current is applied to the drive coil, it generates a magnetic field, causing strain waves to propagate along the rod (at the speed of sound in the material) and reflect from the ends. When the driving frequency causes

the applied waves to reinforce with the reflected waves, the filter resonates. Since the lengthening of the rod is independent of the direction of the magnetic field, the resonant frequency is twice the applied field frequency. To compensate for this, it is necessary to apply a polarizing field to the rod either by d-c field or by permanent magnets. In this case two barium-ferrite bias magnets are used. This also improves filter stability.

The resonating rod is the critical part of the filter. It requires a material with high  $Q$  (from 5,000 to 10,000) and frequency stability over a wide temperature range. A complex nickel-iron alloy has been found most suitable.

The  $Q$  of a bandpass filter is  $Q = f_0/\Delta f$ , where  $f_0$  = resonant frequency and  $\Delta f$  = half-power (3-db) bandwidth.

Temperature coefficient of frequency is defined by  $T^1 = 1/f_0 \times df_0/dt$  where  $T^1$  is in cps/cps/deg C.

Resonant frequency of a rod filter is roughly  $f_0 = nV/2L$ , where  $n$  is the harmonic of operation,  $L$  the length of the rod and  $V$  the velocity of sound in the material.

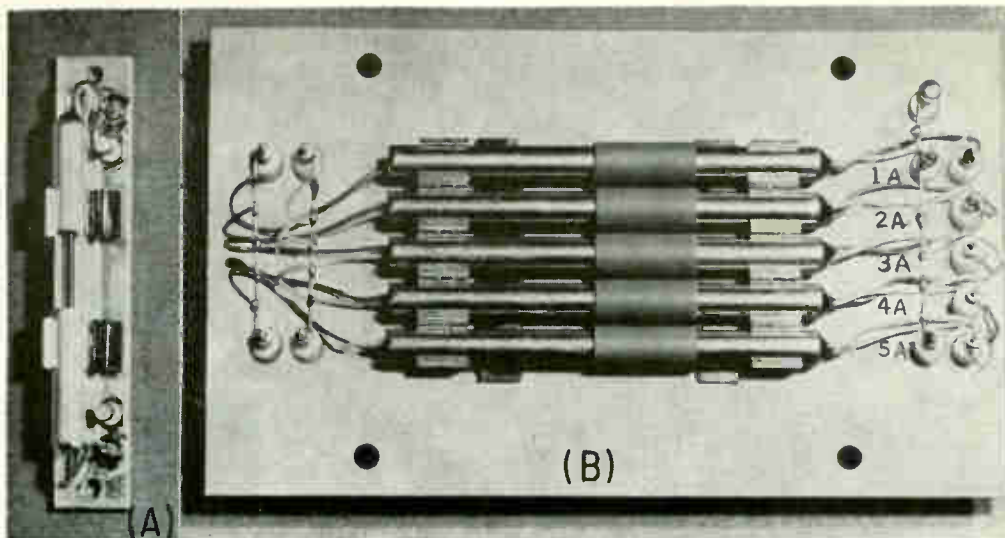

FIG. 2—An assembled single-rod filter (A) has an adjusting window in rod case. A bank of five rod element filters (B) is provided with protective covers over adjusting windows

element rod filter has a 3-db bandwidth of 25 cps, at 9 db its bandwidth will be ideally 50 cps, at 15 db 100 cps, and so on.

For sharper response, a dual filter is used. The dual filter is two complete rod filter elements summed out-of-phase at the output, with response that falls off about 12 db per bandwidth octave.

The rods operate best at input levels from 10 millivolts to one volt rms, with power input up to 0.05 watt. Their normal temperature range is  $-60$  to  $+80$  C. but a rod filter has been operated in liquid nitrogen ( $-194$  C). The high-temperature limit is determined by the Curie temperature of the rod material, usually about 150 C.

No appreciable distortion is introduced over the linear range of the filters. The maximum linear output is 1.0 volt rms, and transistorized amplifiers for use with the filters have a 20-db gain.

One use of magnetostriction filters is in test equipment, such as spectrum analyzers. In a spectrum analyzer, a complex waveform is broken up into frequency components by bandpass filters. A fixed-frequency oscillator translates input signals to the frequency band covered by the filters. With different fixed-frequency oscillators, the instrument can cover any frequency band as wide as that covered by the filters.

Magnetostriction rod filters are ideal for this application because they are small, rugged and econom-

ical: 400 filters can easily be assembled in half a cubic foot, they cost about \$25 per filter element and can withstand 20 g rms vibration in all three planes. The fact that frequency and insertion loss can be adjusted after assembly permits compensation for errors in other parts of the analyzer.

The Rayspan spectrum analyzer uses 420 32-cycle rod filters, spaced 25 cycles apart and simultaneously excited by the input signal. The filter outputs are swept in sequence by a commutator, so that the entire filter bank is sampled 200 times a second. After switching, the filter outputs are amplified and detected into a d-c pulse. This is usually displayed on an oscilloscope. A synchronizing pulse enables the scope to retrace for every sweep.

The instrument can analyze any 10.5-Kc band between 50 cps and 50 Kc, with frequency resolution of 75 cps over the entire band. Resolution can be improved by using narrower filters but this also narrows the band covered. The instrument is used in vibration analysis, industrial noise reduction, Fourier analysis and speech analysis.

Combined with a vacuum tube or a transistor, a magnetostriction filter makes a stable fixed-frequency oscillator. Typical oscillator circuits are shown in Fig. 3. Their high Q, frequency stability with temperature, small size and ruggedness make the rod filters suitable for use in command receivers for telemetry applications.

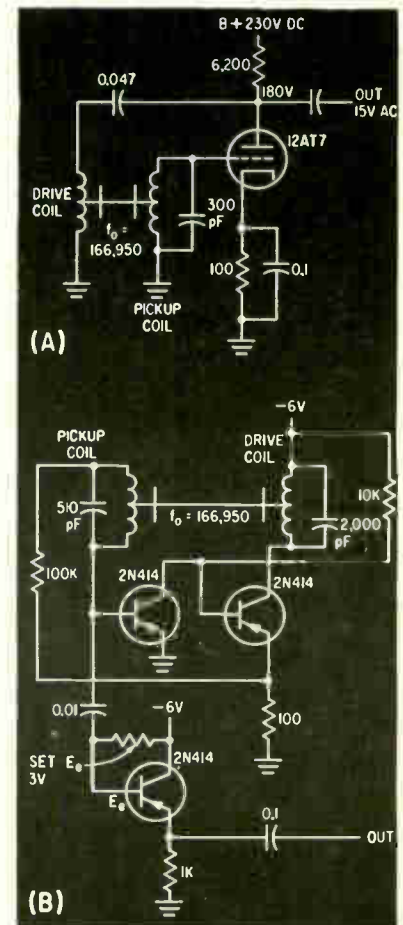
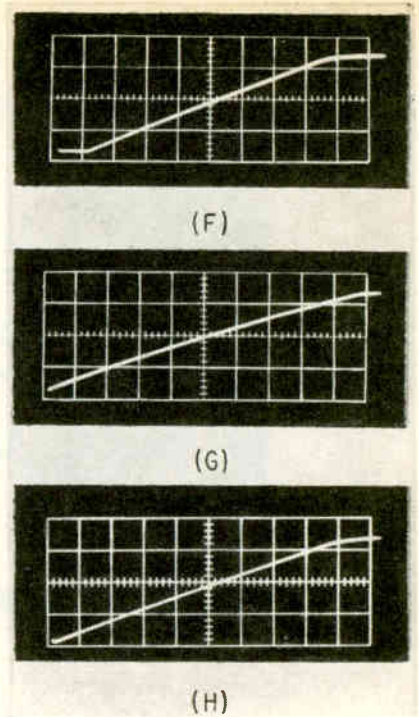
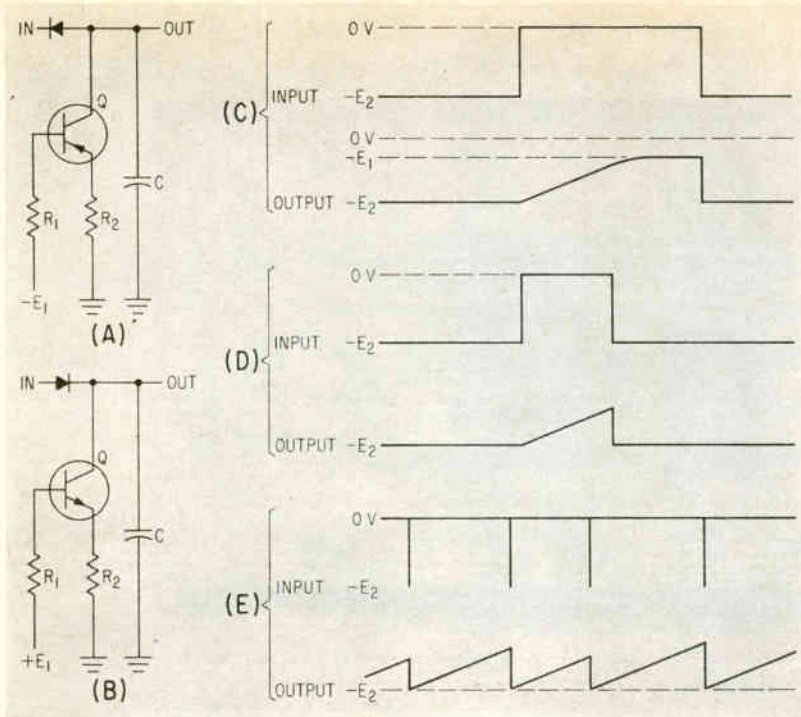

FIG. 3—Magnetostrictive filter can be used in a stable fixed-frequency oscillator, in a vacuum-tube circuit (A) or in transistorized version (B). Another use is in spectrum equalizers, for rapid, accurate compensation of the output of a vibration system



Sweep generator circuit using a pnp transistor (A) or an npn transistor (B) generates output waveforms (C, D and E) for three types of input signals. Oscillograms show generator output at a vertical scale of 5 v per cm with  $C = 0.1 \mu\text{f}$  and horizontal scale 10 msec per cm (F),  $C = 3 \mu\text{f}$  and horizontal scale of 200 msec per cm (G), and  $C = 3 \mu\text{f}$  and horizontal scale 1 sec per cm (H).

# Transistor Linear Sweep Generator

By FRED LEE,

Sylvania Electronic Systems,  
Mountain View, California

GENERATION of linear sweep voltages generally requires relatively complicated circuits such as Miller integrators and bootstrap devices. This circuit provides sweeps of excellent linearity and requires only one transistor and no critical circuit values or adjustments. This sweep generator is used in a pulse interval monitor<sup>1</sup> that measures the time between two pulses. The sweep voltage is started by the first pulse and stopped by the second, at which point the voltage level is proportional to the pulse interval.

The constant-current characteristics of a transistor can be used to produce a linear sweep voltage. Circuits (A) and (B) generate sweeps of up to 10 sec duration. Outputs (C), (D) and (E) are obtained with three types of input signals using the pnp circuit (A). Waveforms associated with the npn circuit (B) would be identical, but of opposite polarity.

The input consists of two voltage levels. For the pnp circuit, lower level  $-E_2$  determines the starting

point of the sweep. It is limited by the collector voltage rating of the transistor. The upper level should be zero volts or higher.

As long as  $-E_2$  is present at the input, the collector current is supplied through the forward-biased silicon diode. Magnitude of this current is determined by the forward bias voltage  $-E_1$ , and by  $R_1$  and  $R_2$ . It is relatively independent of the value of  $-E_2$ . Capacitor  $C$  is fully charged so that the potential across it, which is the output, is  $-E_2$ .

Input level 2  $-E_2$  might be applied in the form of pulses (E). The pulses must be long enough, or the source impedance low enough, to fully charge  $C$  before the pulse ends.

When the input level becomes zero or positive, the diode is reverse biased so that it becomes practically an open circuit. The collector voltage for transistor  $Q$  is then that due to the charge on  $C$ . The collector current must also come from  $C$ . As  $C$  discharges, the potential across it is reduced at a rate proportional to the discharge current. Since this current is relatively independent of the collector voltage, it remains nearly constant. The

output voltage continues to become less negative at a linear rate until it approaches bias voltage  $-E_1$ . At that time, conduction through  $Q$  tapers off and stops. The remaining charge on  $C$  then stays constant until the input level is again low.

Output waveforms of the pnp circuit are shown in (F), (G) and (H). The input consists of negative pulses at about  $-19$  v, spaced sufficiently far apart to allow the transistor to reach cut-off. The bias voltage  $-E_1$  is adjustable by a potentiometer. Resistor  $R_1$  is 47,000 ohms, and  $R_2$  is variable from zero to 1 megohm. No measurements were taken to determine the exact values of  $R_2$ . The values of  $C$  are indicated in the caption. The duration of the linear portion of the sweep (F) is about 70 msec. In (G), the sweep is about 1.7 sec. The noticeable non-linearity in this sweep results from too high a value of  $R_2$  being used to obtain the long sweep duration. The sweep can be lengthened, and good linearity maintained, by increasing  $C$  instead of  $R_2$ .

## REFERENCE

(1) Fred Lee, A Pulse Interval Monitor, *The Sylvania Technologist*, p 66, Apr. 1960.

NEW...  
from  
Cinch

# SUB-MINIATURE SOCKETS

for NUVISTORS



## for Mechanical Mounting

the 133-65-10-001 tube socket is fastened to the chassis by these two tabs rolled against the underneath side of the chassis.

- Impossible to Insert Tube Incorrectly or Damage the Contacts . . . The socket provides two slots of different widths. These mate with the two corresponding legs depending from the metal envelope of the tube to index the tube and socket contacts.
- Sub-Miniature Size Requires Minimum Space.
- Socket Body is Low Loss; Type MFE, Phenolic Insulation.

Saddle is of cold rolled steel, cadmium plated. Contacts are of copper alloy with cadmium plating.



## or Solder Mounting

the tube 133-65-10-002 socket is furnished with solder washer which solders directly to the chassis at 430°F. Resists minimum pressure of 20 lbs.



### Dimensions of Chassis Aperture

Here is shown the size of the Chassis hole for the sockets, either solder or mechanically fastened.

The thickness of the chassis may vary between .032 and .082 Inches. The tube socket will resist a minimum pressure of 20 lbs. before dislodging.

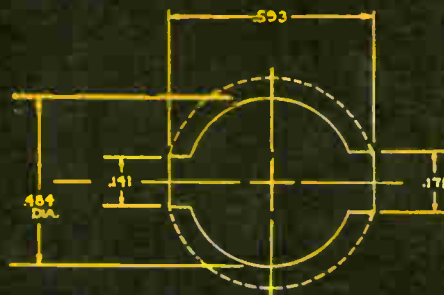

**Cinch**  
ELECTRONIC  
COMPONENTS

**CINCH MANUFACTURING COMPANY**

1026 SOUTH HOMAN AVENUE, CHICAGO 24, ILLINOIS

Division of United-Carr Fastener Corporation, Boston, Massachusetts

Centrally located plants at Chicago, Illinois; Shelbyville, Indiana; City of Industry, California, and St. Louis, Missouri



Available Now! Complete engineering data and detailed specifications on both of these Nuvistor sockets are yours for the asking. Phone NE. 2-2000 today or write/wire

# Infrasonic Waves Provide Atmospheric Data

TORNADOES could be tracked, origin of earthquakes determined and interactions of the sun on the earth's magnetic field investigated. Also, very low-speed pressure waves, possibly gravitational waves resulting from shifts among atmospheric layers of varying temperatures or wind speeds, might be studied. These potentialities stem from a system of detectors used to study infrasonic waves—sound at frequencies below the human auditory threshold of about 15 cps. The waves result from a variety of disturbances in the earth's atmosphere.

The detection system installed near Washington is being used by the National Bureau of Standards. Recordings of the waves are being made to determine the quantitative relation between source of disturbance and incident sound pressure, direction of approach of incident wave and wave velocity across the earth's surface (trace velocity). A second installation is planned near Boulder, Colo.

Natural sounds of substantial intensity at infrasonic frequencies are always present in the atmosphere. In a homogenous atmosphere free of winds and temperature variations, sound velocity varies as the product of the square root of absolute temperature and a constant related to transmission medium, and is equal to frequency times wavelength.

The rate of absorption and dissipation of sound power in heat is very dependent on frequency. Sound power absorbed per unit distance of propagation is roughly proportional to the square of frequency so that only very low-frequency sound can be propagated long distances.

Ten years of development at the Bureau has resulted in a microphone and recording system for studying vlf sounds in the atmosphere that is highly reliable and flexible. Band-pass filters in the amplifiers can increase signal-to-noise ratio to study desired sound

frequencies. For example, earthquake waves are best studied by passing sounds having periods between 0.4 and 20 sec.

The system consists of four microphones at ground level at about the same plane. Effects of pressure fluctuations on each microphone from local turbulent wind conditions are minimized by noise-reducing pipe lines about 300 meters long.<sup>1</sup> For sound waves of periods greater than about 10 sec, this pickup is essentially nondirectional and does not appreciably attenuate sound pressure. However, noise from random pressure fluctuations in the period range from 1 to 30 seconds, such as that caused by wind turbulence, is reduced considerably.

The microphones produce f-m voltages proportional to incident sound pressures, which are transmitted over telephone wires to be demodulated, amplified and recorded. Sound waves of sufficient intensity produce similar traces on each of four paper records. Direction of approach and trace velocity are obtained by comparing the different arrival times at each microphone. Although wind pressures are also recorded, they are only local effects on each microphone.

Sound radiated into the atmosphere by an earthquake wave as it proceeds over the surface of the earth has been observed. Vertical motions of the earth's surface give rise to sound radiations like a loudspeaker diaphragm. Since the wave velocity is much greater than that of sound in air, radiations are propagated almost perpendicularly upward.

With low background noise a sound was observed that originated near severe tornadic storms up to 1,200 miles away. Weather reports for that day show 19 tornadoes and funnel clouds in Oklahoma and Texas and one tornado in northwestern Kansas that could have produced the sound waves that lasted for 4½ hours. Similar waves were received during eight such times in

May 1960. Such signals on arrival have periods between 12 and 50 sec, speeds about equal to sound in air and sound pressures less than 1 dyne/cm<sup>2</sup> at these distances.

Particle streams from the sun interacting with the earth's magnetic field cause disturbances that strongly suggest that the interactions involve the upper atmosphere. These waves usually have periods greater than 20 sec, velocity greater than and sometimes three times that of sound, and usually arrive from the north with pressures of about 1 to 3 dynes/cm<sup>2</sup>. Their high trace velocity indicates arrival from above the earth at a large angle to the surface.

These waves are closely associated with large magnetic storms. Direction of arrival varies with time of day changing from northeast to northwest between noontimes and coming approximately from the north at midnight.

## REFERENCE

- (1) F. B. Daniels, Noise-Reducing Line Microphones for Frequencies Below 1 Cps, *J. Acous Soc Am*, 31, 1959.

## Electrically Suspended Gyroscope Coming

GYROSCOPE, having its centrally located gyro-rotor—the only moving part—electrically suspended, is being developed for the Navy Polaris program by Minneapolis-

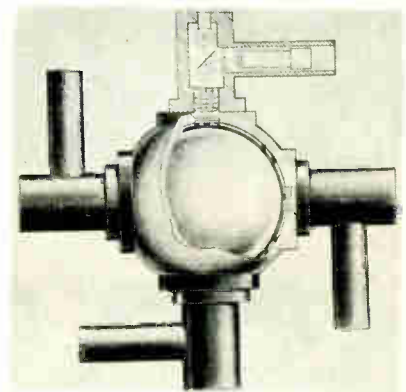

Design details of gyroscope showing suspended central rotor

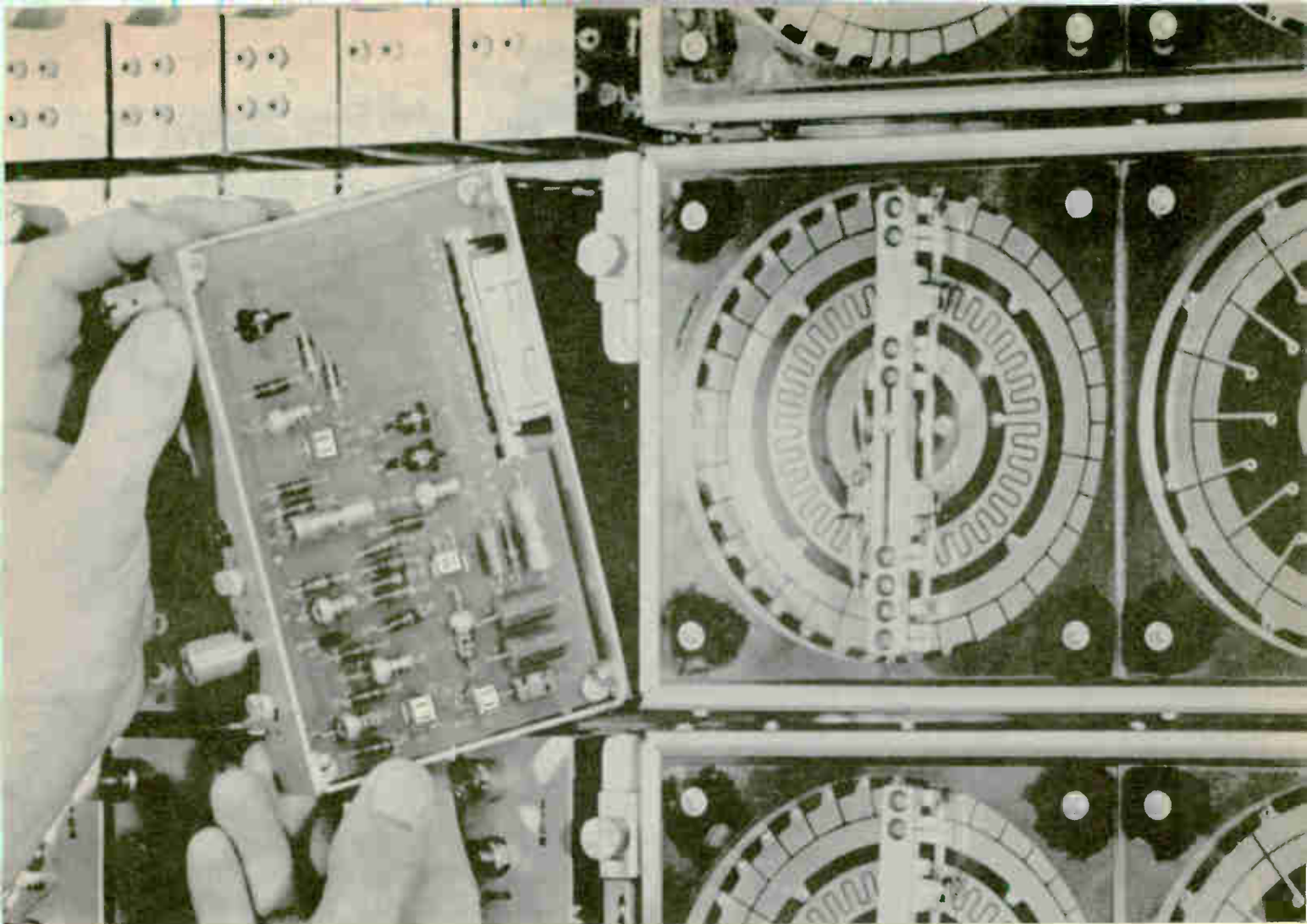

## chooses Tung-Sol transistors for automatic air traffic control vocal system

The Cook Electric Automatic Voice Relay is an integral part of a highly advanced system known as Volscan which is designed to relieve the hazards of air traffic congestion over modern airports. The AVR automatically generates flight path instructions vocally to pilots waiting to land, on the basis of data submitted to it by radar. A plane can be brought in every 30 seconds by the system.

Naturally, the highly critical nature of the system's function demanded that components selected to operate in the system meet the highest reliability standards. For this critical amplification and detection circuits in the AVR, Cook specified Tung-Sol transistors. More than 2000 Tung-Sol 2N461 germanium transistors were assigned to these significant tasks. Cook stipulated the reasons for selecting Tung-Sol: "We found

that Tung-Sol transistors more than satisfied the high reliability requirements for this operation. Moreover, Tung-Sol was able to meet a rapid delivery schedule."

Why don't you get the benefit of Tung-Sol component knowledge and experience too? Tung-Sol components — whether transistors, tubes or silicon rectifiers — fill virtually every commercial and military application with unexcelled dependability. Tung-Sol applications engineers will be glad to recommend the best components for your design. Tung-Sol Electric Inc., Newark 4, New Jersey. TWX:NK 193.

Technical assistance is available through the following sales offices: Atlanta, Ga.; Columbus, Ohio; Culver City, Calif.; Dallas, Texas; Denver, Colo.; Detroit, Mich.; Irvington, N. J.; Melrose Park, Ill.; Newark, N. J.; Philadelphia, Pa.; Seattle, Wash. Canada: Toronto, Ont.

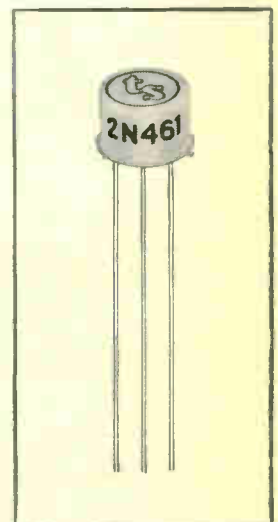

 **TUNG-SOL®**

3 5 8 4 1 7 9 :  
**DIGITAL or ANALOG  
 PROGRAMMING**

2 8 4 9 3 1



*made better,  
 easier,  
 more economical—  
 with the new*



TM

**SEALECTOBOARD**



Programming pins for use with Sealectoboard include both shorting type and component holders. Available in all standard EIA colors.

A new and better way to do it — cordless programming of functions, with or without diode or other component interpositioning . . . the Sealectoboard offers the ease and speed of single pin insertion opening new horizons to the design engineer and equipment manufacturer concerned with multi-point switching. The Sealectoboard is available in any X- and Y axis configuration, handling an unlimited number of functions.

**PROTO-KIT** Try this wonderful new concept. Proto-Kit contains a 3 x 10 board, shorting pins, and component holders . . .

Send purchase order, check or money order to . . . **\$19.95**

**Sealectro CORPORATION**  
 139 HOYT STREET • MAMARONECK, N. Y.

**PRESS-FIT**  
 TEFLON TERMINALS

**ON-HEX**  
 RF CONNECTORS

British Branch: Sealectro Corporation,  
 Hersham Factory Estate, Lyon Road,  
 Walton-on-Thames, Surrey, England.

Honeywell. Suspended in a vacuum, the rotor is almost free of friction. Optical pickoffs give information on the rotor's position. The gyroscope together with a specially designed inertial system using other inertial sensors and digital computer equipment is intended for application in atomic submarine navigation.

**X-Ray Film Developed For Electron Microscope**

X-RAY MICROSCOPE FILM suitable for enlargement in an electron microscope has been developed by a Finnish physicist fellow at Stanford University's Biophysics Laboratory.

By recording x-ray images on the film and enlarging them in the electron microscope, Dr. Saara Asunmaa gets x-ray microscope pictures about four times sharper than by normal development. Details are resolved down to less than 600 angstroms (below two-millionths of an inch), or clear enough to stand a magnification of about 40,000 diameters.

Her method combines physics and radiochemistry, taking advantage of the x-ray microscope's variable penetrating power and of the electron microscope's high resolving power. Previously researchers had developed five different kinds of x-ray microscopes but the best resolution obtainable was around 2,000 angstroms—about the same as the best light scope. Several investigators had tried the marriage of x-ray and electron microscope techniques. The necessary lacking ingredient was the practically grainless x-ray film Dr. Asunmaa supplied. She cast an ultra-thin film of nitrocellulose (guncotton) onto a glass surface—being less than 1,000 angstroms thick (about 1/250,000th of an inch), the film is too fragile to support itself. Mixed with the guncotton was a silver compound making the film more sensitive to x-rays.

After being placed in an x-ray contact microscope with the specimen examined and being x-ray exposed, the film is treated with a solution of alcohol and sodium cyanide to dissolve radiochemical compounds formed on its surface. The resulting specimen image can be



**tensor**

# PRECISION WORK LAMP



2 1/2" DIA.

Illumination  
to 1000 F.C.—  
5 stage lighting  
—Independent Power  
Outlet — Standard GE  
1133 Bulb—7 1/2' ex-  
tension cord.

MODEL 5900

Telephone jack  
connectors\*

UNIT COST

\$46<sup>50</sup>

discounts in quantity

**TENSOR ELECTRIC DEVELOPMENT CO., INC.**  
1873 EASTERN PARKWAY, BROOKLYN, N. Y.

CIRCLE 201 ON READER SERVICE CARD

# CONANT

where stability  
and miniaturization  
are primary

**SEMICONDUCTORS  
COPPER OXIDE  
AND SELENIUM**

**INSTRUMENT RECTIFIERS  
RING MODULATORS  
HIGH-VOLTAGE RECTIFIERS  
VOLTAGE REGULATORS  
SWITCHED RECTIFIERS  
CHOPPERS**

**SPECIAL PURPOSE UNITS  
LIST PRICES FROM .42c**

5 COPPER OXIDE CELL STYLES FROM  
.080" to .500" DIA. ACTIVE AREAS .0012 to  
.125 SQ. IN.  
SELENIUM CELL SIZES FROM .080" round  
TO 2" SQUARE. .020" TO .045" THICK.

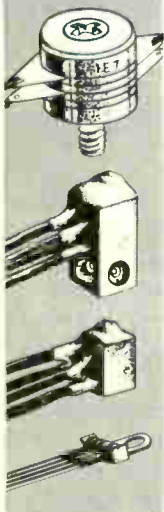

Write for  
Free Bulletins  
Dept. 20

**CONANT LABORATORIES  
LINCOLN, NEBRASKA**

CIRCLE 202 ON READER SERVICE CARD

December 16, 1960

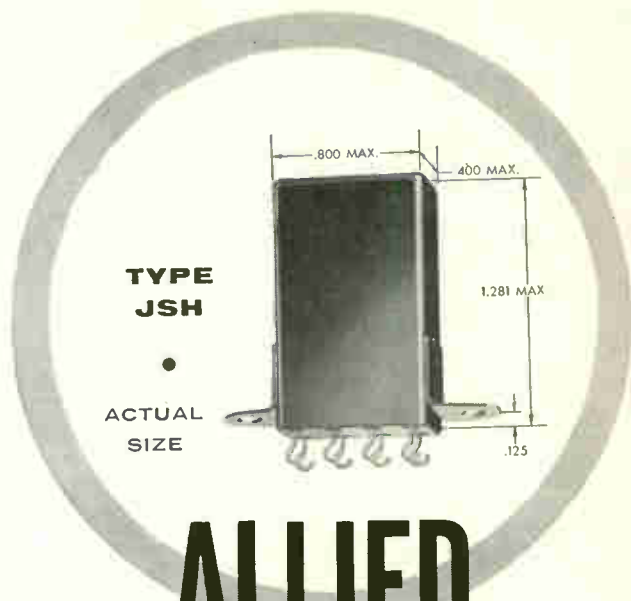

# ALLIED CONTROL'S NEW

**SENSITIVE 2 AMP RELAY**  
for  
**\*15 g to 2000 cps vibration**

**OPERATING CONDITIONS:**

**AVERAGE PULL-IN POWER:**

SPDT 25 milliwatts at 25°C  
DPDT 40 milliwatts at 25°C

**CONTACT RATINGS:**

Non-inductive — 2 amperes at 29 volts d-c  
or 1 ampere at 115 volts a-c  
Low level contacts are available on request

**VIBRATION:**

5-55 cps at 0.12 inch double amplitude  
55-2000 cps at a constant 15 g  
\*20 g available on request

**SHOCK:**

50 g operational

**TERMINALS:**

0.2 inch grid spaced

**WEIGHT:**

1.1 ounce maximum

Write for Bulletin JSH #62



# ALLIED CONTROL



**ALLIED CONTROL COMPANY, INC.**  
2 EAST END AVENUE, NEW YORK 21, N. Y.

AL206

CIRCLE 95 ON READER SERVICE CARD

96



# 7000 SHORT CIRCUITS WITHOUT A SINGLE FAILURE

**Wide Range Transistorized High Current  
Power Supplies Set New High In Reliability**

Con Avionics proves extreme reliability of its zero to 50V rack mounted power supplies with a graphic demonstration at the 1960 I.R.E. Show.

Throughout the Show a new model Z50-15 Power Supply was short-circuited every 30 seconds, yielding a total of 7,000 short circuits without a single failure. Several thousands more shorts were applied during laboratory tests.

The company's new line of power supplies was designed under a "worst case analysis" program. The supplies are designed using standard non-selected components; performance is then mathematically and experimentally checked with the worst possible combination of component characteristics. This design technique is largely responsible for the new high set in reliability and insures long life and easy field maintenance.

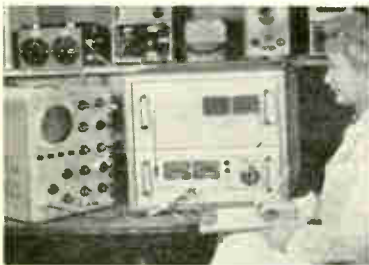

"Worst Case Analysis" Program Helps Set New High In Reliability

**Wide Voltage Range, High Current Capacity, Among Electrical Features** • The units are available in two series with 0.1% and 0.01% regulation. They have an unusually wide range of output voltage: 0 to 50 V.D.C., and an output current of 2, 5, 10 and 15 amperes.



"Flip Top Box" Permits Accessibility For Maintenance

**Mechanical Features Highlight Flexibility** • The new units are constructed with remote sensing to maintain regulation at the load and remote programming to permit output adjustment at remote control point. A floating output is also provided, through which either positive or negative terminals may be grounded. All the power supply units have a voltmeter and an ammeter. The front panel has a power switch, circuit breaker, coarse and fine voltage adjustment knobs, input fuse, pilot light and output terminals. Rear panels have an input line cord, output, remote sensing, and programming terminals.

**Specifications**

**Input Power**  
**Output Voltage**  
**Output Current**  
**Regulation**  
a) for line variations  
b) for load variation  
no load to full load  
**Stability for 8 hours after 30 minute warm up**  
**Ripple (rms)**  
**Response time**  
**Ambient temperature range**  
**Temperature coefficient (% per °C)**  
**Output impedance at 10 KC (ohms)**

	Y Series	Z Series
Input Power	105 to 125 VAC, single phase,	48 to 62 cps.
Output Voltage	0 to 50 VDC	
Output Current	2, 5, 10 and 15 amperes	
Regulation	± 0.1%	± 0.01%
a) for line variations	0.1% or 5 mv	0.01% or 1 mv
b) for load variation	(whichever is greater)	(whichever is greater)
no load to full load	± 0.25%	± 0.05%
Stability for 8 hours after 30 minute warm up	2 mv	1 mv
Ripple (rms)	50 microseconds	
Response time	0°C to +50°C	
Ambient temperature range	0.02	0.01
Temperature coefficient (% per °C)	0.003	0.0003
Output impedance at 10 KC (ohms)		

examined in a more varied pattern of film densities than can be seen with the electron microscope.

Other film media including glass is being investigated by Dr. Asunmaa in order to obtain further contrast and better definition.

## Radar May Free Oil

DEEP-PENETRATION radar beams may soon help unlock oil reserves trapped in rock thousands of feet beneath the earth's surface.

Engineers of Raytheon's Commercial Apparatus and Systems Division are packaging 5,000 to 10,000 watts of microwave power into a capsule just six inches in diameter, small enough to permit the experimental device to be lowered into a low-producing well in northwestern Montana. The microwaves emitted are intended to provide the quick-acting, penetrating heat that petroleum engineers say is needed to raise by 20 degrees the temperature of the molasses-like oil located within two feet of the well-bore. When this is done, the engineers say, the oil will rise to the surface. The effort is a combined operation between Raytheon and the Petro-Electronics Corp. of Denver, Colorado. Engineers of the latter company are contributing their geological and oil-production experience to the venture.

Significance of the operation lies in the possible recovery of a large share of U. S. oil reserves of 182 billion barrels which are beyond the reach of conventional petroleum industry techniques.

## Cosmic Ray Collisions

HIGH ENERGY cosmic ray collisions are being studied at the University of Arizona by Dr. Albert B. Weaver, physics department head. Results of his investigations may help determine what happens when cosmic ray protons collide with hydrogen nuclei.

Using the physics department's cloud chamber laboratory for the experiments, Weaver is attempting to establish how many particles are created by such high energy nuclear reactions and the angular distribution of the resulting particles.



# CON AVIONICS

**Consolidated Avionics Corporation**  
800 Shames Drive, Westbury, New York  
EDgewood 4-8400

# Go Ahead, TRIM SQUARE

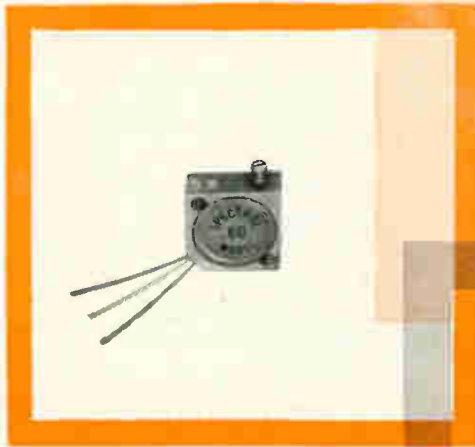

Trimmers  
shown actual size

with **NEW**  
**SPECTROL**  
Trimming  
Potentiometers

- SIZE
- PERFORMANCE
- RELIABILITY
- ECONOMY

## ■ SIZE

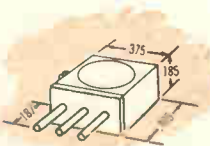

**THE MODEL 50**  
3/8" square, 3/16" high, and weighing 1 gram, the Model 50 is available in standard resistances of 50 ohms to 20K ohms.

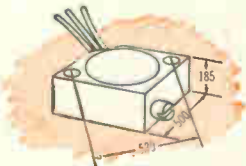

**THE MODEL 60**  
1/2" square, 3/16" high, and weighing 2 grams, the Model 60 is available in standard resistances of 50 ohms to 50K ohms.

## ■ PERFORMANCE

Stack 'em . . . up to 35 Model 50 trimmers in one cubic inch. Adjust 'em, 25 turns for full electrical travel . . . take your choice of side or top adjustment, slotted fillister head screw, Allen hex socket, or slotted headless screw flush mounted. Dissipates 1 watt—Model 50 and 2 watts—Model 60. Dual wiper provides double assurance of positive contact under all conditions. High resolution, typically 0.061% for the 50K ohms model. Resistance tolerance,  $\pm 5\%$ , temperature range,  $-55$  to  $+150^\circ\text{C}$ .

## ■ RELIABILITY

At no extra cost, Spectrol trimmer potentiometers meet or exceed all applicable military specifications for altitude, fungus resistance, salt spray, sand and dust, humidity, temperature cycling, shock and vibration. Guaranteed load life, 1000 hours minimum.

## ■ ECONOMY

Prices in 1-9 quantities: Model 50—\$7.50 each, Model 60—\$6.50 each. Spectrol trimmers are ready now for immediate delivery from your local distributor. For complete technical information, call your Spectrol representative or write Dept. 42.

**SPECTROL** ELECTRONICS CORPORATION

1704 South Del Mar Ave. • San Gabriel, California  
Atlantic 7-9761 • CUMberland 3-5141  
1250 Shames Drive • Westbury, Long Island, N. Y.  
EDgewood 3-5850

28

HOW NEW VALUES OF SILICONE RUBBERS COMPARE WITH OLD

Physical and Electrical Properties Of Silicone Rubber Materials	Typical Values	
	Old	New
Tensile strength, —psi	300	1,200 — 1,500
Elongation, %	375	400 — 600
Tear strength, $\phi$ in, die B	70	125 — 250
Compression set, 70 hrs @ 150 C	65	20
Low temp flex	-65 F	-65 to -150 F
Moisture pickup 70 hrs in H <sub>2</sub> O @ 100 C — %	30	0 — 1
Electric strength astm—75 mil sheet, vpm, rms	400	500
Power factor		
dry (after 1 hr @ 150 C)	0.003	0.001
after 4 days @ 95% rh	0.036	0.001
Dielectric constant		
60 cycle, dry (after 1 hr @ 150 C)	3.5	3
after 4 days @ 95% rh	3.5	3
Vol resistivity, ohm cm		
dry (after 1 hr @ 150 C)	$2 \times 10^{14}$	$5 \times 10^{15}$
after 4 days @ 95% rh	$2 \times 10^{13}$	$1 \times 10^{15}$

HOW SILICONE FLUIDS RATE AS DIELECTRIC COOLANTS

Important Physical and Electrical Properties Required of Coolant	Values Desirable	Values Attained by Silicon Fluids
Viscosity —30 F	100 ctsks	230 — 1,000
+100 F	1 ctsks	1 — 15
Vapor pressure @ 100 F mm hg	100	10 — 300
Surface tension, dynes/cm	30	20
Flash point (min)	100 F (min)	300 — 600 F
Dielectric constant	3 (max)	2.6 — 2.71
Dissipation factor	0.0005	0.00037
Dielectric strength, vpm, (rms.)	360	370
Vol resistivity, ohm-cm (min.)	$10^{11}$ (min)	$10^{12}$
Hydrolytic stab., (MIL-H-31116B)	pass.	excellent
Specific heat	high as possible	0.35 — 0.37
Coeff. of thermal expan.	$7 \times 10^{-3}$	$5 \times 10^{-3}$
Viscosity shear stab., (after 5,000 cycles)	unchanged	unchanged

Improvements in silicone fluid technology has produced excellent dielectrics and heat transfer media for use in capacitors, pulse transformers, radar equipment, electronic modules, microwave tubes, power rectifiers, junction tube transformers, magnetrons, klystrons and deflection amplifiers, just to name a few applications.

# Progress Report on Silicones

By J. SCOTT HURLEY, JR., Specialist—Electrical Insulation  
Silicone Products Department, General Electric Company, Waterford, New York

RECENT DEVELOPMENTS in silicone technology have brought about new and improved silicone materials that now meet more critical requirements faced by the electronics engineer. Electrical properties of silicones are generally comparable to those of the best insulators and these properties are retained over wide temperature ranges. Well known for their moisture resistance, silicones are often used for this reason alone. Resistance to ozone and corona is excellent and is extremely important in high altitude operation.

In recent years, improved compounding techniques have brought forth improved silicone rubbers with physical properties comparable to most organic rubbers, and thin wall silicone rubber wire constructions are available from most manufacturers.

The accompanying tables and charts indicate the progress that has been made to meet many needs. With these improved properties comes use for a wide range of electronics products, made by molding, extruding, calendaring or by any of the standard techniques employed

in making such constructions.

The recent introduction of low temperature curing silicone insulating varnishes has greatly simplified application. The new varnishes can be cured at 150 C in two to six hours. Thermal endurance of these new varnishes is actually better than that of conventional high-temperature curing silicone varnishes. Both air drying and heat curing are used in other silicone varnishes to overcoat printed-circuit boards and other components to improve moisture resistance and also provide solder marks as required. A properly selected silicone insulating varnish is used for conformal coatings. Such a varnish can be cured to a bubble-free film at temperatures that will not damage the electronic components.

An example of this is a circuit board which was tested 240 hours with 12.5-v per mil continuous voltage applied at 60 C with continuous monitoring. Excellent protection offers the additional advantage of being non-nutrient to fungus. Care should be taken, however, in the choice of the amount of catalyst used.

Silicone varnishes help miniature systems survive the resulting increase in temperature. Size reduction of transformers up to 50 percent are common, and reductions up to one third of the original size has been achieved.

Improvements in silicone fluid technology are outlined in the table above, right.

While certain other fluids may be more desirable than silicones from the standpoint of heat transfer because of higher density, silicone fluids are particularly suitable for dielectric coolants by virtue of their resistance to temperature extremes, flat viscosity and temperature cure, and general inertness.

Silicone resins, excellent in radiation resistance, are considered unaffected by doses as high as  $10^7$  to  $10^8$  rep. Exposures to  $10^8$  rep indicate no serious loss of electrical properties. While silicon rubbers are not quite as effective in this respect, silicone rubber is finding increasing use where extreme heat is also present, as heat is often the deteriorating factor in materials exposed to radiation.

Silicones, both rubbers and resins, are combined with inorganic materials such as glass cloth, mica or asbestos to form fabricated in-

# An Invitation to Come Alive

Not to suggest that you're dead if you aren't on the TI team!

➔ We are suggesting, though, that you consider some of the factors that make Semiconductor-Components division of TI an unusually lively atmosphere for achieving a keen sense of personal, professional accomplishment. Consider, for example...

## TI PRODUCTS

... they pace the industry

TI manufactured the first commercially-available silicon transistors... developed the first semiconductor network... originated high voltage silicon rectifiers... produced the first VHF transistors... made the first high-gain low-cost radio frequency transistor (making possible the first "pocket" radio)... developed the first 400 milliamper 200-600 volt diffused silicon glass diodes.

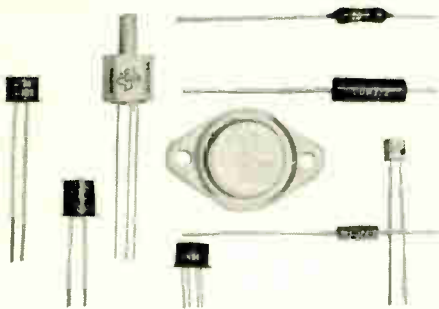

## TI LOCATION-IT ENCOURAGES RELAXED LIVING

Dallas provides many advantages for wholesome family living. It's an outdoor, informal way of life... combined with the convenience and stimulation of one of America's most modern cities.



## TI PEOPLE-- they pioneer, invent, succeed

"It's a fact that an individual's opportunities at TI S-C are limited only by his own ability. That — and the highly interesting work and good people — makes this company unique in my opinion." — Harry Goff (BS/EE, Texas '51), Manager of Silicon Power Transistor Department (upper right).

"I've enjoyed my 10 years with TI because of the constant challenge, growth opportunities, association with creative people who don't depend on handbooks for answers." — Art Evans (BS/EE, SMU '49) Section Head, Semiconductor Networks Department, holder of patent for Temperature Control System for S/C Crystal Puller (upper left).

"The most appealing thing about working at TI S-C is the freedom I have on technical programs. To an engineer this is all-important." — Elmer Wolff (BS/EE, SMU '52) Project Manager, Silicon Design Engineering, participant in development of the first silicon mesa transistor (lower photo).

## TI MANAGEMENT -- It Stresses Research, Creates Markets

"Texas Instruments leads the industry in sales, and in technology it's considered second only to Bell. In 1959, it scored net sales of \$193-million, about half attributable to its broad line of semiconductors which includes silicon and germanium transistors of all types, silicon diodes and rectifiers, and silicon controlled rectifiers... Most of this growing has been

done on self-generated capital, thanks to the Semiconductor-Components division, undoubtedly TI's most profitable operation. The company has won its eminence by astute assessment of new products and canny timing. Its broad technological skills have made it first with many semiconductor devices." — *Business Week*, March 26, 1960.



Scientists and engineers in semiconductor and related fields are invited to investigate TI's opportunities for professional advancement and personal accomplishment. The coupon below will bring you our booklet detailing the TI and Dallas stories.

TEXAS INSTRUMENTS INCORPORATED  
Semiconductor-Components Division  
Box 312, Dept. 155, Dallas, Texas

NAME \_\_\_\_\_

ADDRESS \_\_\_\_\_

CITY \_\_\_\_\_ STATE \_\_\_\_\_

My professional field is \_\_\_\_\_

My specialty is \_\_\_\_\_

TEXAS  INSTRUMENTS  
INCORPORATED

SEMICONDUCTOR - COMPONENTS DIVISION  
POST OFFICE BOX 312 • DALLAS 1, TEXAS

CIRCLE 378 ON READER SERVICE CARD

44 44 44 44

the number to remember

44 44 44 44

for faster soldering!

# KESTER "44" RESIN-CORE SOLDER



You get the fastest possible soldering action with Kester "44" Resin-Core Solder, created for today's high speed requirements. "44" Resin meets all applicable MIL and Federal specifications, latest amendments, Army, Navy, Air Force. Flux-residue non-corrosive and non-conductive. All alloys, cores and diameters . . . on 1 lb., 5 lb. and 20 lb. spools.

**FREE. WRITE** for 78-page Technical Manual "SOLDER . . . Its Fundamentals and Usage."

# Kester Solder

COMPANY

4204 Wrightwood Avenue, Chicago 39, Illinois

Newark 5, New Jersey • Anaheim, California • Brantford, Ontario, Canada

Over 61 Years' Experience in Solder and Flux Manufacturing

100 CIRCLE 100 ON READER SERVICE CARD

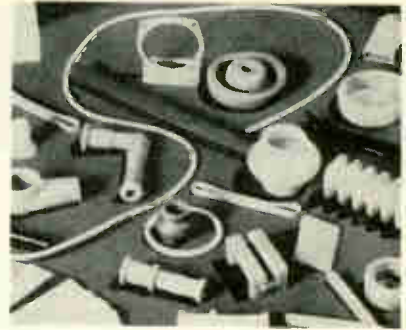

*Improved properties of silicone rubber have made possible a wide range of products including grommets, bushings, seals, insulating barriers and numerous applications where an elastomeric insulating structure is desired*

insulating components. Silicone glass laminates are used as terminal boards, printed circuit boards, and similar applications. Silicone-coated glass sleeving is widely used, made with both varnishes and rubber. Also available is extruded silicone rubber tubing. All possess good electrical properties, and selection is usually made on the basis of physical strength and flexibility needed. The silicone rubber sleeving withstands rough handling during installation and yet maintains good electrical properties.

Silicone electrical tapes are available in a wide variety of constructions. A straight weave glass cloth is widely used with silicones, and more recently a combination of polyester fiber warp and glass fill provides a reinforced tape with a controlled stretch, tough as reinforced glass with some of the conformability of the unsupported rubber. These tapes are available in the fully cured form, or as a semicured product, which after ap-

### IMPROVEMENT OF STRESS-STRAIN PROPERTIES OF SILICON RUBBER

	1945	1950	1955	1960
160—				147
140—				
120—				
100—				
80—				
60—			60	
40—				
20—		24		
0	6			

Tensile Product = Tensile Strength × % Elongation

No space  
too tight for

## RMC "SM" DISCAPS



When your product design requires ceramic capacitors in sizes that squeeze into the tightest places it's wise to specify RMC Type SM DISCAPS.

Type SM DISCAPS show a minimum capacity change between  $+10^{\circ}\text{C}$  and  $+85^{\circ}\text{C}$  and meet the specifications of EIA-RS-198 for Z5U capacitors. Their miniature size and high quality are combined with low cost for production savings.



DISCAP  
CERAMIC  
CAPACITORS

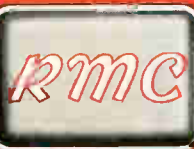

**RADIO MATERIALS COMPANY**  
A DIVISION OF P. B. MALLORY & CO., INC.  
GENERAL OFFICE: 4242 W. Bryn Mawr Ave., Chicago 46, Ill.  
Two RMC Plants Devoted Exclusively to Ceramic Capacitors  
FACTORIES AT CHICAGO, ILL. AND ATTICA, IND.

# 50-G WHIZ!

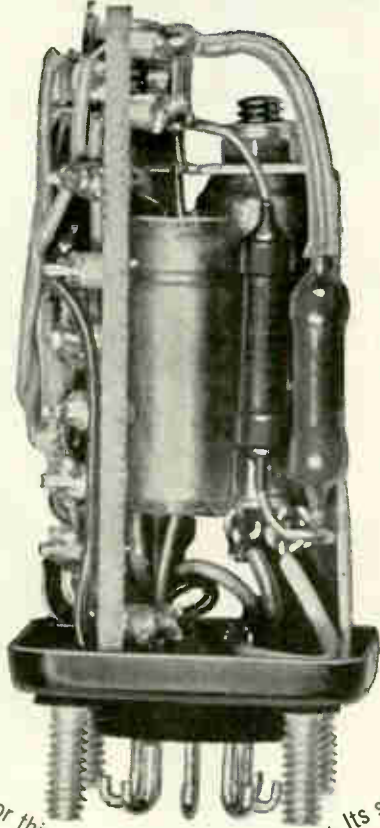

**RUGGED IS THE WORD** for this A. W. Haydon time delay relay. Its sealed relay will withstand shock up to 50 g for 11 milliseconds, and vibration up to 2000 cps at 20 g. It is also precise... with delays up to 120 seconds before starting or stopping. This little giant is our Series 31300 electronic time delay relay and you ought to know about it, particularly if you're in the missile field. ■ Every favorable adjective in the book has been used by our customers to specify one or another of our electronic time delay relays. Fixed or variable delays from a few milliseconds to days, weeks or months. Our solid state switches resist up to 150 g shock, vibrations up to 3000 cps at 100 g... accuracies run to 0.05% or better. We could go on. But if you will simply write for information about the Series 31300 or any other timing devices you need, whether electronic or motor driven, we will be happy to tell all.

**AWHAYDON**  
THE COMPANY  
4035 INCE BLVD., CULVER CITY, CALIFORNIA

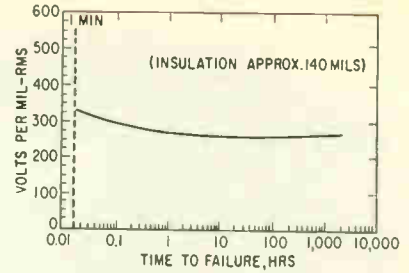

*Silicone rubber endurance*

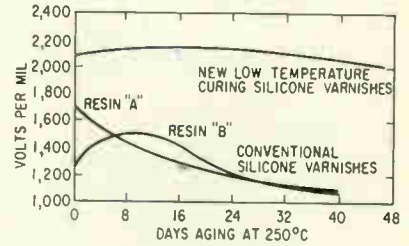

*Silicone varnish endurances*

plication may be fused with heat and pressure to form a tough, homogeneous insulating barrier.

Perhaps the most significant development is a new material and process that has made possible a silicone rubber glass-supported tape in which penetration of the rubber into the fabric is so complete that the electrical properties, and in particular voltage endurance, are essentially those of unsupported rubber tapes. Silicone rubbers find applications in molded and extruded insulating components, and in shock mounts, seals, gaskets and supports. Self-bonding tapes also find applications in splicing and for rapid sealing against environmental contaminants. Pressure sensitive tapes are made either on a silicone rubber or resin-coated glass base, or the adhesive is used alone on glass cloth or tapes.

Room-temperature vulcanizing silicone rubbers provide materials in a form easily applied for potting, encapsulations, sealing and impregnating. RTV silicone rubber is available in viscosities from 80 poises (liquid) to 15,000 poises (spreadable paste). This material cures at room temperature after the addition of a catalyst, and cure times can be varied from a few minutes to a few days. Since RTV silicone rubber contains no solvents, it cures with virtually no shrinkage. This is particularly important in potting applications where the formation of voids during cure might lead to corona damage and eventually electrical failure.



# The Mesh Cathode

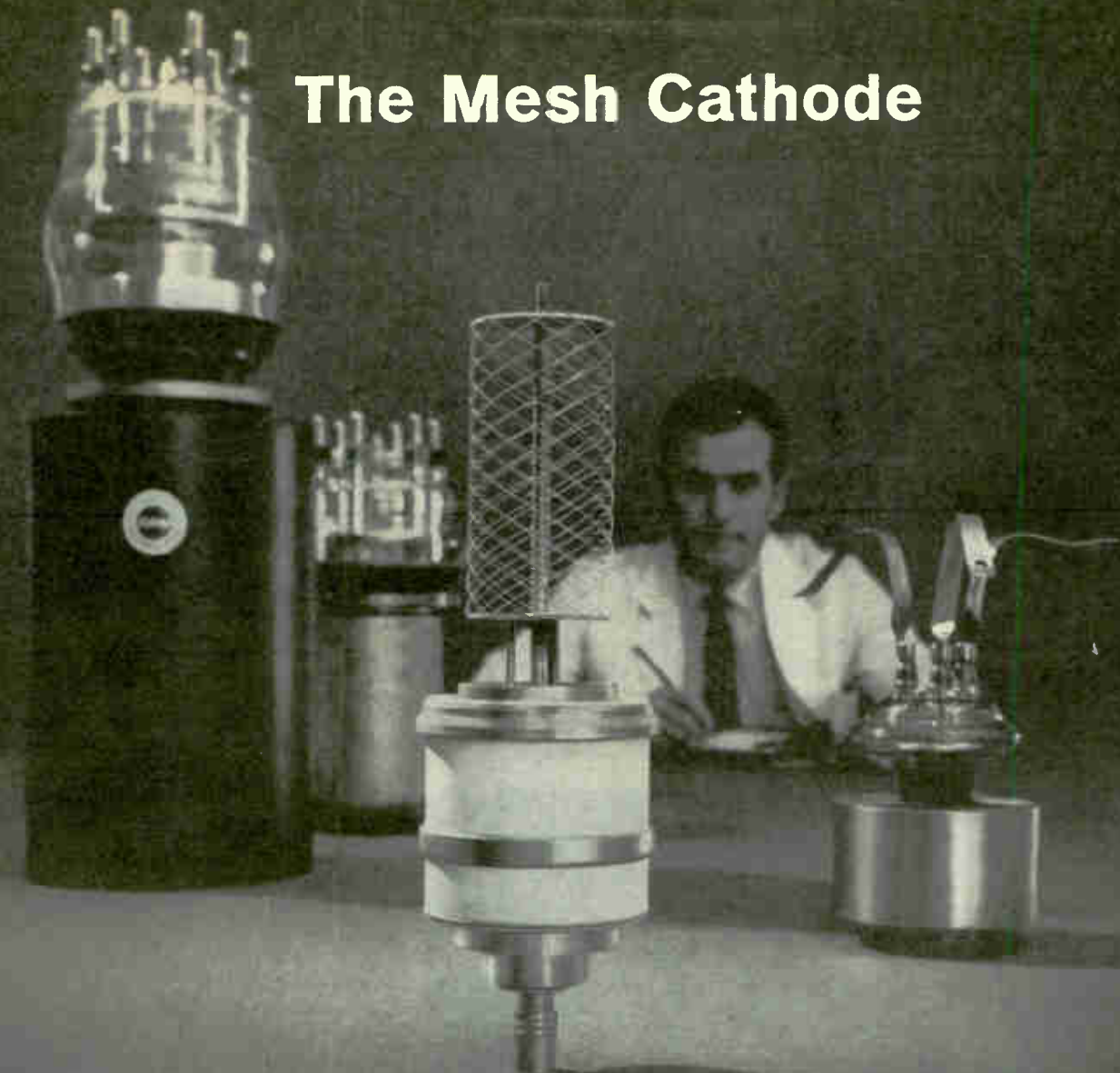

## AN ITT BREAKTHROUGH IN RADAR SWITCH TUBE DESIGN

This seemingly delicate web of wire is actually the most rugged and structurally stable construction ever developed for power tube cathodes. Consisting of a fine cylindrical mesh instead of the usual filament configuration, the exclusive ITT mesh cathode is now available in a number of high-performance pulse triodes and power diodes. The triodes are specifically designed for radar switching applications; the diodes are ideally suited for rectifier, clipper and charging service.

Mesh cathode construction, in addition to its mechanical advantages, offers improved emission per watt in comparison with conventional cathodes, as well as quick heating and superior temperature stabilization. The cylindrical design results in an emission pattern that uses more of the available grid surface and thus reduces grid emission problems. This latest ITT power tube "first" is probably the closest existing approximation of a theoretically ideal "physicist's cathode."

Write for information on the complete line of ITT pulsed modulator triodes and power diodes. Application assistance is available for your specific requirements.

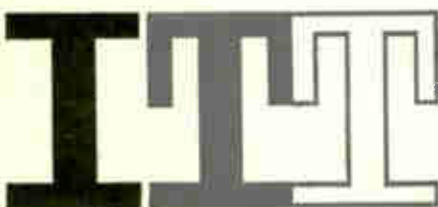

MODULATOR TRIODES - PULSED OPERATION				
TYPE	PULSE POWER OUTPUT <sup>1</sup> (kw)	D.C. PLATE VOLTAGE (kv)	PULSE CURRENT <sup>1</sup> (amperes)	PULSE CURRENT <sup>2</sup> (amperes)
F-7206	2200	18	220	350
F-7328	900	20	100	160
F-7839	7800	65	160	230
D-1037	30000	65	650	1000
F-6926	4000	35	140	200
F-7012	90	18	40	65

<sup>1</sup> At rated filament voltage  
<sup>2</sup> At elevated filament voltage

HIGH VACUUM POWER DIODES				
TYPE	APPLICATION	PEAK INVERSE VOLTAGE (kv)	PEAK CURRENT (amperes)	AVERAGE CURRENT (amperes)
D-1033	Rectifier	60	36	12
	Shunt or Charging	60	150	—
D-1034	Rectifier	50	45	15
	Shunt or Charging	50	200	—
D-1038	Rectifier	40	18	6
	Shunt or Charging	40	100	—
D-1039	Rectifier	65	21	7
	Shunt or Charging	65	100	—

**ELECTRON TUBE DEPARTMENT ■ COMPONENTS DIVISION**  
 INTERNATIONAL TELEPHONE AND TELEGRAPH CORPORATION, CLIFTON, NEW JERSEY

ITT COMPONENTS DIVISION PRODUCTS: POWER TRIODES AND DIODES ■ IATRON STORAGE TUBES ■ HYDROGEN THYRATRONS  
 TRAVELING WAVE TUBES ■ SELENIUM RECTIFIERS ■ SILICON DIODES AND RECTIFIERS ■ TANTALUM CAPACITORS

CIRCLE 103 ON READER SERVICE CARD

# Tape Cuts Wire Test Time, Errors

POINT-BY-POINT INSPECTION of complex wiring assemblies is faster, more accurate and less tedious when inspection instructions are given by a tape recording rather than the conventional wiring list.

Daystrom Military Electronics Division, Archbald, Pa., reports that recordings have halved inspection time while reducing errors 750 percent. When inspectors used a wiring list, errors averaged about six per panel with 1,200 test points; errors using recordings averaged 0.8 per panel.

When the inspector listens to recorded instructions, he does not

have to take his eyes from the panel to look for the next instruction. The recording technique also points out other wasted motions and errors in instruction preparation that were not apparent with wiring lists.

The sketch shows a simplified version of a panel wiring assembly. The conventional wiring list is prepared according to wire lengths and color and is intended for assembly, not inspection. One instruction might call for a test between points A<sub>5</sub> and K<sub>2</sub>, the next between points C<sub>3</sub> and J<sub>1</sub>, the third between points A<sub>5</sub> and D<sub>1</sub>, etc. Jumping from one part of the assembly to another



*Wiring list requires inspector to look for new instruction*

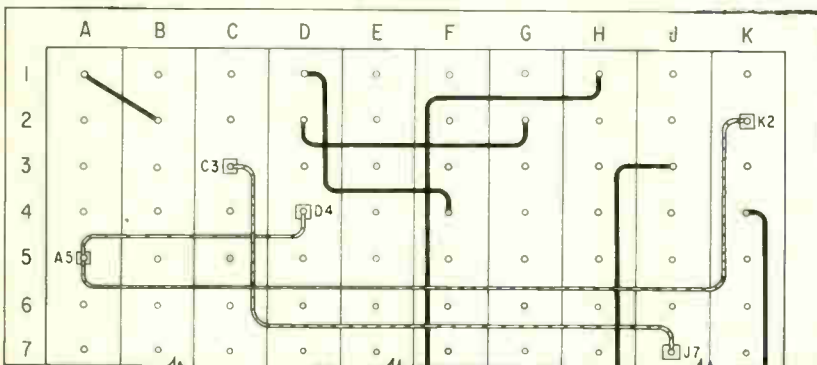
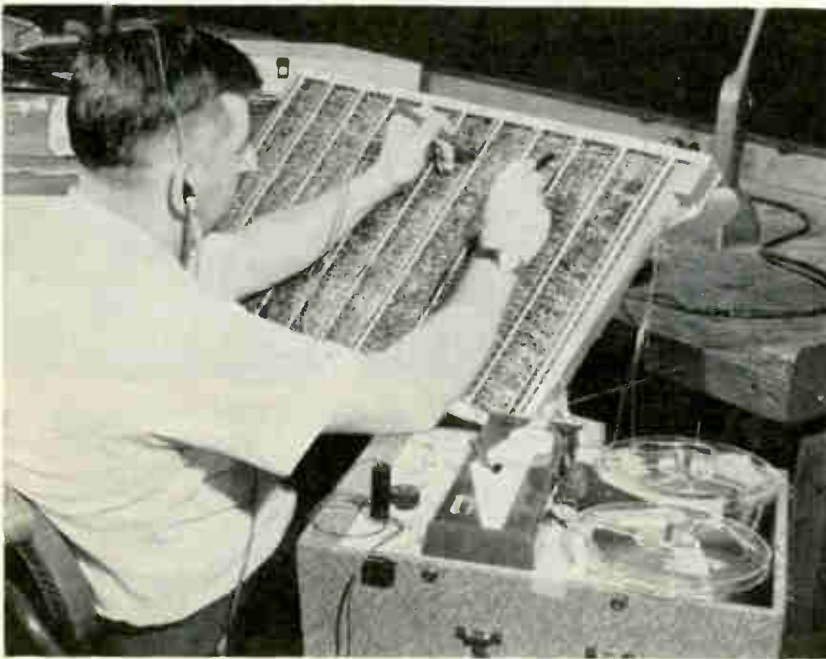

*Inspector listening to instructions never has to take eyes from panel. Recording is prepared so test probes move in sequence from top to bottom and left to right*

wastes motions and time.

To correct this, instructions (known as "calls") are arranged while they are recorded. All the A points are recorded first, all the B points next, and so on. A further breakdown is made so that all A points which have their origin and termination in the A section appear first, A points which terminate in B appear next, and so on.

The calls proceed from top to bottom and left to right in an order that does not require the inspector to cross his arms. For many tests, the inspector need move only one test probe. In all cases, testing sequence minimizes arm motion.

Sequential arrangement of the instructions also provides a visual check on the wiring. The inspector knows that he is to check each terminal in order. If the tape skips a terminal with a wire on it, he knows that a recording error has been made (or, possibly, a wiring error) and he can take the necessary action to correct it.

Engineering changes can be incorporated easily into the tape. The new information is simply cut into the tape at the appropriate spot, without additional drawings or paper work. Two or more identical panels can be inspected at the same time by preparing duplicate tapes from the original.

On completion of a test, the tape can be stored. Three complete lists of instructions can be stored on a 1,200-foot roll of tape costing about

General Instrument Semiconductor... Design Breakthrough

# NEW **G** 2N1678 "DYNAMIC DRIFT"

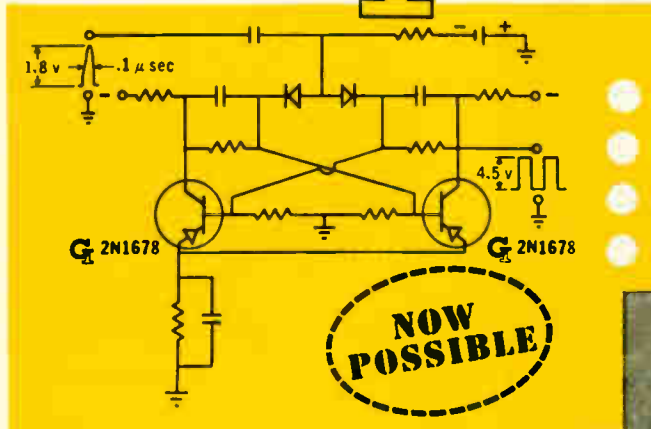

High Voltage  
High Speed  
Saturated Circuitry  
At Low Cost

General Instrument proudly presents the 2N1678 "Dynamic Drift"... ideally suited for high speed, high voltage saturated circuit applications. The 1 Mc bistable multivibrator, above, is only one example of the multitude of applications for this attractively-priced transistor family.

Life test data proves reliability of the new General Instrument 2N1678 "Dynamic Drift". Close quality control guarantees extremely high electrical uniformity, shipment to shipment.



2N1678 PNP Germanium "Dynamic Drift"				
Parameter	Conditions	Min.	Typ.	Max.
T <sub>c</sub>		-65°C		+85°C
P <sub>c</sub>	T <sub>c</sub> = 25°C			120 mw
V <sub>CE(s)</sub>	I <sub>c</sub> = 100 μa	60 v		
V <sub>CE(O)</sub>	I <sub>CEO</sub> = 25 μa	60 v		
V <sub>EB(O)</sub>	I <sub>EB(O)</sub> = 100 μa	4 v		
h <sub>FE</sub>	I <sub>c</sub> = 20 ma; V <sub>CE</sub> = 0.25 v	25	40	
I <sub>CEO</sub>	V <sub>CE</sub> = 10 v			5 μa
V <sub>BE</sub>	I <sub>c</sub> = 20 ma; V <sub>CE</sub> = 0.25 v			0.6 v
f <sub>αrb</sub>	I <sub>c</sub> = 1 ma; V <sub>CE</sub> = 5 v	25 Mc	35 Mc	
f <sub>βrb</sub>	I <sub>c</sub> = 1 ma; V <sub>CE</sub> = 10 v		50 Mc	
h <sub>rb</sub>	I <sub>c</sub> = 1 ma; V <sub>CE</sub> = 5 v; f = 1 kc		30 Ω	
h <sub>ob</sub>	V <sub>CE</sub> = 5 v; I <sub>c</sub> = 1 ma; f = 1 kc		0.5 μ mho	2 μ mho
C <sub>ob</sub>	V <sub>CE</sub> = 5 v; I <sub>c</sub> = 1 ma; f = 5 Mc		3.5 pf	5 pf
t <sub>r</sub> + t <sub>f</sub>	I <sub>c</sub> = 20 ma; I <sub>1</sub> = I <sub>2</sub>		0.4 μ sec	
t <sub>r</sub> - t <sub>f</sub>	I <sub>c</sub> = 1 ma; R <sub>L</sub> = 1K		0.4 μ sec	

## FULL LINE OF QUALITY **G** COMPUTER SEMICONDUCTORS

General Instrument is your major source for high quality computer semiconductors... transistors, as well as companion diodes, rectifiers and logic encapsulations for every type of circuit application. The transistor families shown below indicate the broad range of superior quality units offered by General Instrument.

Write General Instrument for complete engineering and life test data, design curves, and typical circuitry which takes advantage of the unique combination of characteristics offered by the new **G** 2N1678. Data is available, of course, on our full line of computer semiconductors. Our engineers will gladly discuss your specific circuit requirements.

All speeds shown have been attained with conventional saturated circuitry. Total bar length represents rate (period) using speed-up capacitors; broken bar indicates maximum speed without capacitor.

Representative transistors shown are alloyed-junction devices. Types 2N501A, 2N604, and 2N1678 are MADT, Drift, and High-Voltage Drift, respectively.

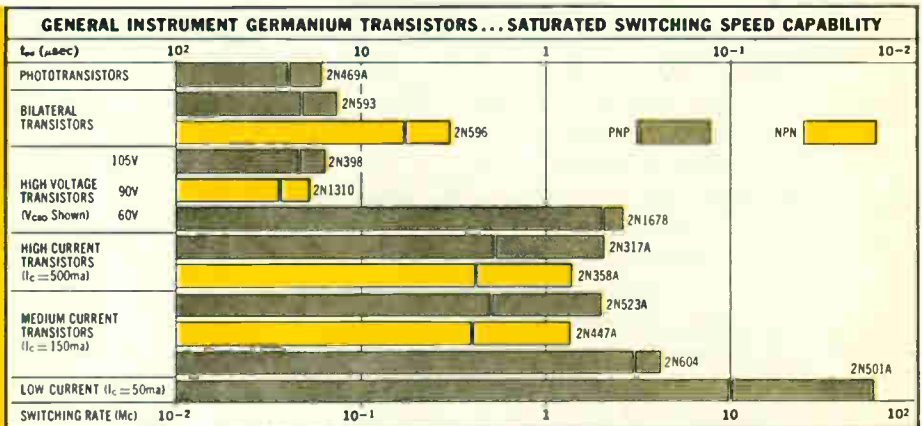

**GENERAL INSTRUMENT**  
**GENERAL TRANSISTOR**  
TRANSISTORS, DIODES, RECTIFIERS



**SEMICONDUCTOR**  
DIVISION OF GENERAL INSTRUMENT CORPORATION  
65 Gouverneur Street, Newark 4, New Jersey



IN CANADA: General Instrument—F. W. Sickles of Canada Ltd., P.O. Box 408, 151 S. Weber Street, Waterloo, Ontario, Canada. Sherwood 4-8101.

*S.S. White*  
**PLASTIC  
 PROTECTORS**

**REALLY PROTECT!**

**Driven through a 4x4...threads unhurt!**

Yes, we actually did it! We fitted an S. S. White Quality Line plastic protector to this test piece (a spike with one end threaded). Then we drove the spike through a four-by-four by *hammering on the rigid acetate protector.*

We found that despite the terrific pounding, both the protector and *the delicate threads it was assigned to protect came through undamaged!*

Here is the ultimate in security for your products during shipping, storage, processing... quality protection your customers will appreciate!

Check our **Economy Line** too. Elastic vinyl plastic protectors that have a stay-put fit and a non-slip grip for quick, easy removal. Absolutely non-shredding.

**WRITE FOR BULLETIN**

*P-5708 and Free Samples*

1142

*S.S. White*

**PLASTICS  
 DIVISION**

Dept. 27P, 10 East 40th Street, New York 16, N. Y.



\$3. The storage cost is considerably less than that of cabinets and print material.

**New Silver Brazing  
 Wire, Torch Offered**

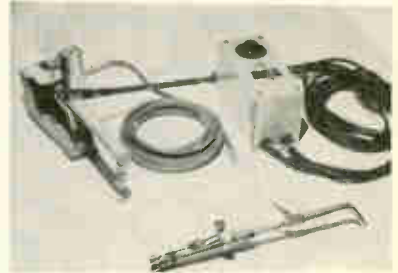

*Torch is equipped with powder and gas control on torch*

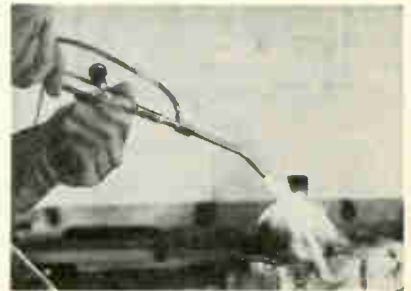

*Torch in use for a brazing application*

**TORCH BRAZING** aids in the form of flux-cored silver brazing wire and a metal spraying torch for silver alloy or bronze brazing were introduced recently by Air Reduction Co., New York.

The cored wire is reported to minimize precleaning of parts, prevent flux inclusions in the joint and give the brazer a visual indication of the proper brazing temperature. As the workpiece is heated, the wire is wiped across the joint. When a temperature of approximately 950 F is reached, the flux spews out of the core and onto the joint. The filler metal follows the flux into the joint, resulting in a small fillet. The wire is self-sealing after cooling, so the remaining flux is saved for the next use.

The wire is made by placing flux on silver alloy strip, which is then formed into a tubular sheath around the flux.

The new torch is an oxy-acetylene model equipped with a metal powder dispenser and a modified tip. The powder is fed by a carrier gas into the flame, where it fuses on its way to the working surface. Liquid flux



# BENDIX-PACIFIC

*in Southern California*

## needs ENGINEERS with DOCTORS' - MASTERS' - BACHELORS' DEGREES

*for electrical and systems work in fields of  
Missile Guidance—Instrumentation—Telemetry  
Anti-Submarine Detection Systems/Operations Research  
Military Navigation*

Advanced positions are open in our "Eagle" Missile Program in Electrical Engineering for the design of transistor circuits, servo-mechanisms, microwave electronics and data links.

Please send resume to W. C. WALKER  
ENGINEERING EMPLOYMENT MANAGER

*Other High-Level Electronic  
Engineering Positions Available*

Bendix-Pacific  
Division  
11602 SHERMAN WAY  
NORTH HOLLYWOOD CALIF.



CIRCLE 377 ON READER SERVICE CARD

# RACAL RADIO-TELETYPEWRITER TERMINAL

FOR AVIATION AUTHORITIES  
METEOROLOGICAL SERVICES  
PRESS RADIO STATIONS  
ARMED FORCES INSTALLATIONS  
THIS IS IDEAL FOR YOUR  
PURPOSES+THE EQUIPMENT  
PROVIDES A FIRST CLASS  
TELETYPEWRITER SERVICE+  
THE RA129 IS SIMPLE TO  
OPERATE QUICK TO ALIGN  
ACCURATE AND DEPENDABLE  
YET VERY LOW IN COST+

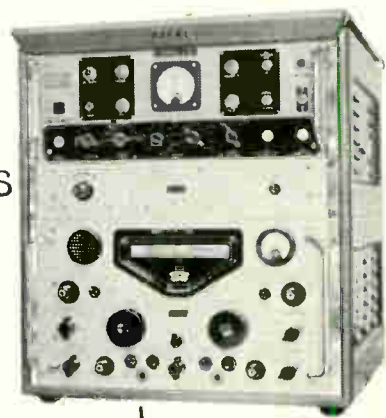

**TYPE RA.129**  
Single Channel

**TYPE RA.103**  
Dual Diversity

**Frequency Range:**  
1—30 Mc/s

**Tuning:**  
Continuous without  
band-switching

**Frequency Shift:**  
150 to 1000 cycles total

**Output:**  
Polarised or neutral  
Suitable for all tele-  
printers

**Signalling Speeds:**  
Up to 300 bauds

**Power Supply:**  
100/125 and 200/250  
volts  
45/65 c/s AC. 220 watts

Write for details to:  
RACAL'S REPRESENTATIVE in the  
UNITED STATES, Mr. W. J. ZULLO; 104,  
Highland Avenue, Somerville 43, Mass.

CANADIAN AGENT, INSTRONICS LTD. P.O. Box 100, Stittsville, Ontario, Canada

## RACAL ENGINEERING LIMITED

WESTERN ROAD, BRACKNELL, BERKS. ENGLAND Tel.: Bracknell 941 Grams/Cables: RACAL BRACKNELL BERKS

*Overseas agents in most territories*



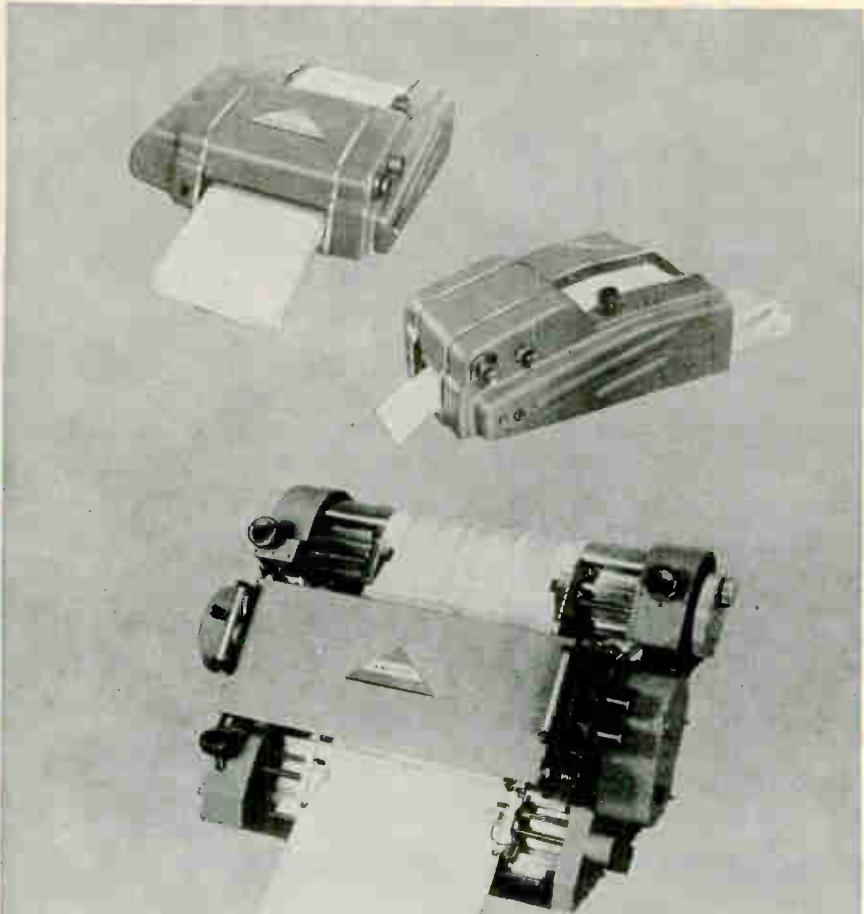

## What is ANELEX High Speed Printing?

- △ Up to 320,000 numeric or 240,000 alpha-numeric characters per minute.
- △ Perfect alignment, fully formed characters, multiple copies and precise conformity to the most complex preprinted forms.
- △ Reliability proven by ten years' experience and assured by use at Scientific, Military, Commercial, Industrial, Insurance and Banking installations.

Anelix High Speed Printers print from magnetic tape or "on-line" from data processing systems . . . on single or multiple carbons, pressure sensitive papers, heat transfer type paper, preprinted forms or card stock. All Operator Controls are easily manipulated by office personnel without specialized experience or skills.

For systems designers, Anelix Printers provide the widest possible choice of capabilities, because standard production modules can be combined to meet almost any specifications as to: operating speeds (up to 2,000 lines per minute), number of columns (8 to 160), number and type of characters per column (up to 66) dimensions of preprinted forms (up to 20" x 22").

*for further information, write or telephone*

# ANELEX CORPORATION

150-F CAUSEWAY ST., BOSTON 14, MASS.

is used. The torch can also be used for hardfacing and coating.

## Twist and Heat Seals Wire Connections Fast

**SIMPLE METHOD** of producing effective sealed wire joints with plastic insulated conductors has been developed by the Australian Post Office, Sydney, reports McGraw-Hill World News.

The unstripped wires are loosely twisted together. Heat is applied to soften the plastic. The wires are then twisted together with a normal crank twist.

The wires move through the softened plastic and make a good electrical joint while the plastic re-seals itself around the wire twist. As surplus wire is cut off, the plastic is pushed back over the twist for about a half inch to form a blob of plastic at the end of the joint.

The exposed wire ends are then sealed by heating the blob of plastic, causing it to seal itself over the end of the joint.

Standard acetylene torches are being used by the Australians, but effective joints can be made using a heat source as small as a cigarette lighter. Any heat source can be used on polyethylene, but radiant heat is required for pvc insulations, since a bare flame is unsatisfactory.

Experience with plastic cables in Australia, England and the United States indicates, according to the report, that almost all faults occur at joints. It is claimed that the twist and heat method reduces the possibility of bad joints and thus cuts down fault occurrence in cables.

Advantages cited are: a permanent waterproof seal is produced, wire stripping is unnecessary, soldering is unnecessary, no special sleeve is required, and the technique is simple.

## Tubes Cushion Packages

**SMALL PAPER TUBES** are offered as reusable packing material by Safe-T-Flo-Pak, Redwood City, Calif. The tubes are poured to surround and suspend objects in the container. A resin coating prevents migration of packed items.





## COMMUNICATION SYSTEMS . . . *the ultimate integration of the electronic arts*

Among the great names in the telecommunications and electronics industry, Kellogg today is one of the country's strongest sources of advanced communications equipments and systems. We have one major goal — to provide the finest communications that the electronic arts make possible . . . for industrial, commercial and military needs.

The Communication Systems Department of Kellogg, growing by leaps and bounds to keep pace with demands for wholly integrated communications means, provides large-scale communications systems from Alpha to Omega . . . from systems studies through engineering and production. Engineering is concerned with all phases of telephone, radio, data communications and automatic control circuit design. Principal areas of engineering organization include Project Engineering, Applications Engineer-

ing, Development and Systems Evaluation and Utilization and Reliability.

Typical of Kellogg's major systems engineering achievements is the provision of complete ground communications for the firing of Titan and Thor ballistic missiles and Discoverer and Samos space satellites at Vandenberg Air Force Base. Similarly, Kellogg has provided for the Atlas ICBM program nine separate systems for communication, control, maintenance and check-out, count-down, voice-recording and fire alarm — all functioning as an integrated system.

*If you seek a dynamic organization in which to further your future, write Manager of Technical Staffing, Communication Systems Department, Dept. M-03(04).*

**ITT KELLOGG** Communications Division, International Telephone and Telegraph Corporation  
500 North Pulaski Road, Chicago, Illinois



# New On The Market

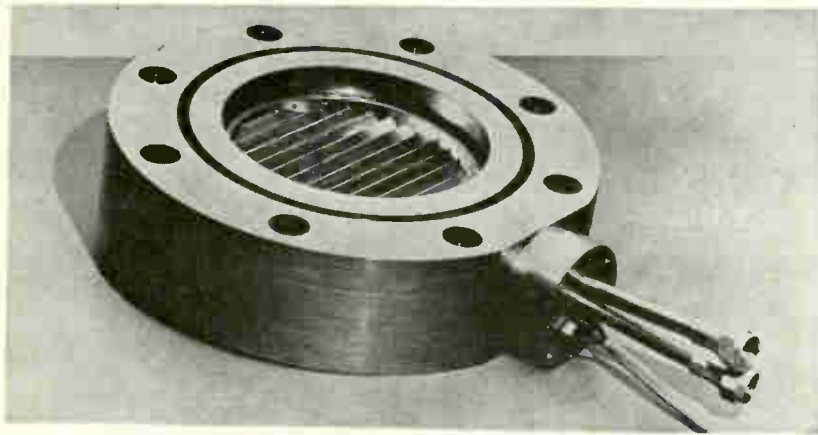

## Thermoelectric Vacuum Baffle USES SEMICONDUCTOR ELEMENTS

THERMOELECTRIC BAFFLE for use with vacuum systems is available from General Thermoelectric Corp., Princeton, N. J. This baffle is a completely solid-state device—the basic cooling elements are Frigistors—eliminating the need for conventional, mechanical, refrigeration equipment. It is noiseless, has no moving parts, and does not require major maintenance. Power consumption is small compared with that of freon-type baffles. The price

range contemplated for these thermoelectric baffles is low.

The baffle concept is the result of the development of Frigistors by Needco Cooling Semiconductors, Ltd., an affiliated company. The baffle is available in sizes ranging from 2 inches to 32 inches in diameter, compatible with existing vacuum-system equipment. Delivery can be made in 60 to 90 days for common sizes.

**CIRCLE 301 ON READER SERVICE CARD**

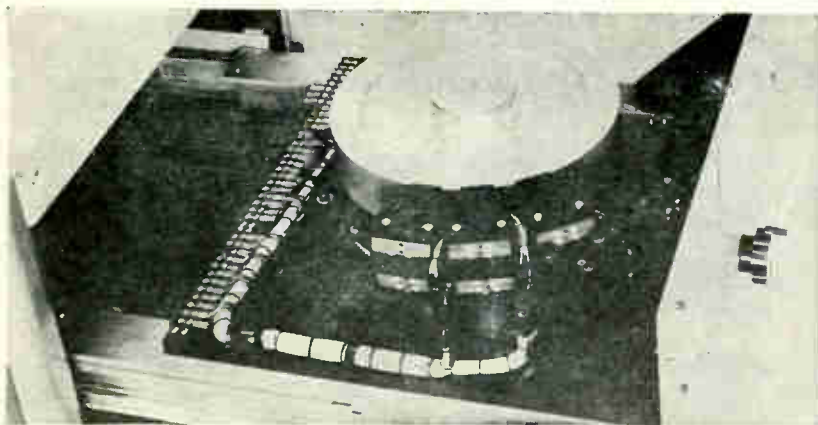

## Magnetic Storage Drums ACCURATE, ADJUSTABLE DELAYS

MAGNETIC storage drums are available from Instrument Systems Corp., College Point 56, L. I., N. Y. A typical custom-designed model includes 4 complete channels, two of which provide adjustable delays of

up to six seconds accommodating either complex waves or pulses. The unit uses a synchronous drive motor and hydraulically damped gear box which results in smooth and uniform drum motion. Means for

isolation from vibrational disturbances and bending moments are incorporated, allowing head spacings of as small as 0.0005 inch to be employed.

Delay is varied by angularly traversing the adjustable heads from a front panel knob which also actuates a mechanical counter for direct readout. The design provides for addition of a servo drive to this delay control. Recording, playback and erasing heads can be individually positioned for spacing from the drum and for angular zero. The adjustable delay heads can also be set for concentricity and tracking accuracy.

The unit provides accurate, continuous duty, adjustable and reference signal delays for such applications as correlation processing, pulse comparison, vibration studies, reverberation effects, sonar investigations and other situations where fixed and variable delay requirements are found. Design and assembly features allow the unit to be supplied in a wide variety of frequency responses, delay adjustments, head configurations and number of recording tracks.

**CIRCLE 302 ON READER SERVICE CARD**

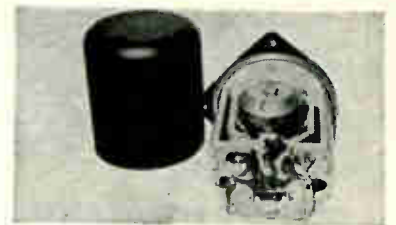

## Spring-Energized Gyro FOR BALLISTIC DEVICES

A LOW-COST SPRING-ENERGIZED gyro for inertial reference in short duration missiles and other ballistic devices has been developed by Model Engineering and Manufacturing Corp., Memcor-Courter Products Division, Boyne City, Michigan. Called model 1091, the entire self-contained package weighs about 3½ pounds and measures 5 inches long by 4.2 inches in diameter. The hermetically sealed gyro gives full performance for a minimum of 100 firings, and may be used in any application requiring a short duration mechanically energized gyroscopic component. Variations in winding methods may be incorpo-



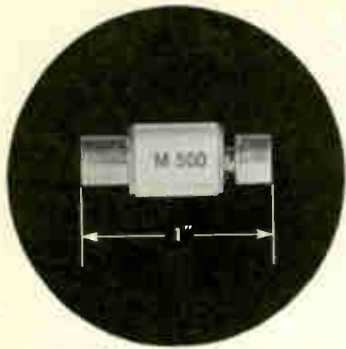

**First commercially priced  
silicon rectifier**

**More in use than any  
similarly rated unit**

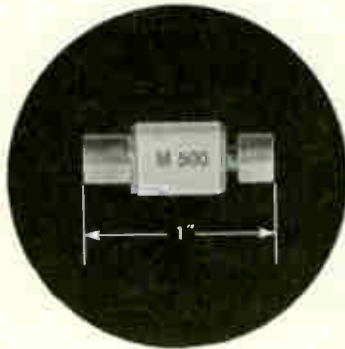

**One of the first silicon rectifiers  
in volume production**

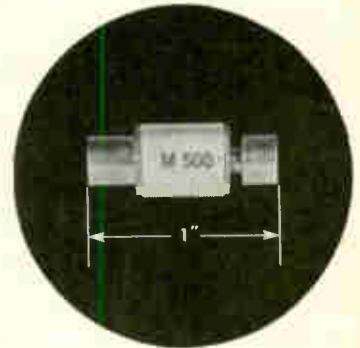

# TARZIAN M-500 Silicon Rectifier

The Sarkes Tarzian M-500 silicon rectifier is rated at 500 milliamperes dc, with a peak inverse voltage rating of 400 volts. This was the first commercially priced silicon rectifier, and more M-500's are now in use than any similarly rated unit.

The Tarzian M-500 is a cartridge type rectifier with end ferrules that snap quickly and easily into standard clips. The M-500 is made by a special Tarzian process that provides optimum forward to reverse ratios and long, useful life.

For additional information, practical application assistance, and prices on the M-500, write Sarkes Tarzian, Inc., Semiconductor Division, Bloomington, Indiana

DC amps (100° C)	Peak Inv. Voltage	Tarzian Type	Max. RMS Volts	Max. Recurrent Peak Amperes (100° C)	Max. Surge Amps 4MS	JEDEC No.
0.5	400	M-500	280	5	30	1N1084

Other voltage and current ratings also available in this style.



## SARKES TARZIAN, INC.

World's Leading Manufacturers of TV and FM Tuners • Closed Circuit TV Systems • Broadcast Equipment • Air Trimmers • FM Radios • Magnetic Recording Tape • Semiconductor Devices

**SEMICONDUCTOR DIVISION • BLOOMINGTON, INDIANA**

*In Canada: 700 Weston Rd., Toronto 9 • Export: Ad Aulema, Inc., New York*

rated when the gyro is to be used repeatedly.

The gyro has segmented pickoff commutators on its outer gimbal for roll reference information. Unlatching is by either one or two 28

v d-c dimple motors, followed automatically by uncaging.

Full speed of 3,330 rpm is attained in 100 milliseconds, and run-down time is 7 to 9 minutes.

**CIRCLE 303 ON READER SERVICE CARD**

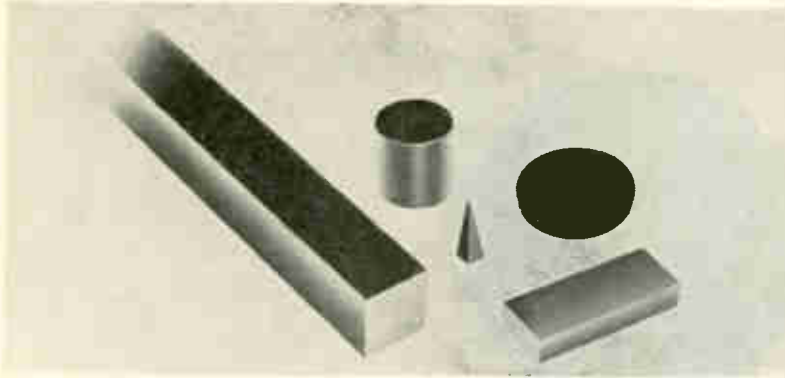

## New Plastic

### ABSORBS MICROWAVES

MICROWAVE absorbing plastic that can be used for power-level control in the uhf and microwave regions has been developed by Coax Devices, Box V, Chelsea 50, Mass. Called Microloss, this material can be fabricated to form medium power attenuators, mode absorbing rings, cavity damping rings, absorbing covers for probing antennas and as a control for amplitude distribution in antennas.

Microloss can be used from minus 70 deg C to plus 150 deg C without deterioration. It will not support fungus growth. It is available in 12 inch lengths in rectangular rods conforming to many waveguide internal dimensions. Round rods are also available. Other shapes can be furnished upon request.

Prices on standard shapes vary from \$30 to \$60.

**CIRCLE 304 ON READER SERVICE CARD**

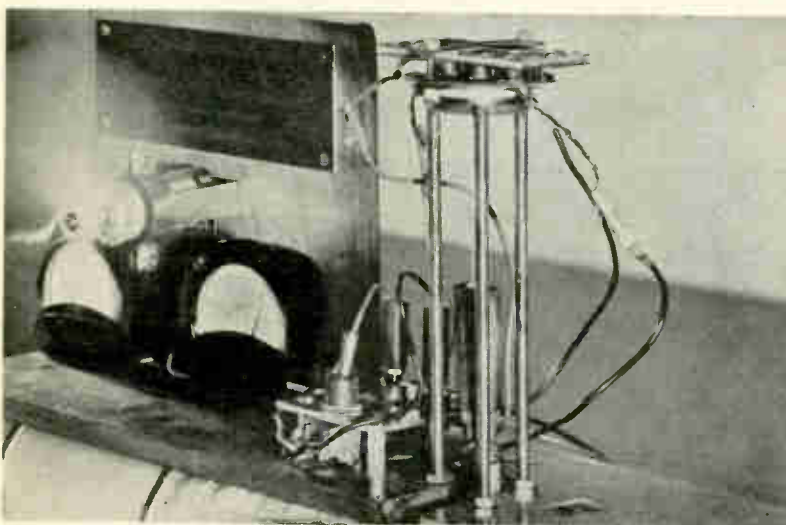

## Energy Converter

### THERMIONIC-THERMOELECTRIC DEVICE

A COMBINATION thermionic-thermoelectric energy converter, which

without additional heat input produces twice as much power as a

thermionic converter alone, has been developed by the General Electric Co., Schenectady 5, N. Y. The new device takes advantage of the fact that thermionic conversion is most efficient at higher temperatures while a thermoelectric generator works best at relatively lower temperatures.

In tests, a General Electric production-type vacuum thermionic converter (Z-5386) was sandwiched with a zinc-antimonide constantan thermoelectric generator. The thermionic converter, running at a cathode temperature of 875 deg C, produced 0.2 watt. At the same time, the thermoelectric generator produced 0.34 watt at a hot-junction temperature of 350 deg C and a heat sink temperature of 100 deg C. This increase in system power output without more heat input doubled the efficiency of the system. The heat source was propane gas.

Studies indicate that efficiencies of 16 percent and better may be attainable using vapor thermionic converters operating at a cathode temperature of 1,325 deg C, cascaded with lead telluride thermoelectric generators, operating at a hot-junction temperature of 650 deg C and heat sink temperature of about 75 deg C.

Such temperature ranges would be available with solar, nuclear or chemical energy used as the heat source, and water as the heat sink. Thus, with further development, the cascaded device might be used for power supplies in ships, submarines and navigational aids, where the lower temperature is easy to obtain.

**CIRCLE 305 ON READER SERVICE CARD**



## Variable Attenuator

### FROM 0-500 MC

AS A result of merging low-frequency potentiometer and microwave resistive techniques, the Radar Design Corp., Pickard Dr., Syracuse 11, N. Y., has developed a coaxial attenuator that is continu-

# A HISTORIC TELEPHONE EXPERIMENT BEGINS IN AN ILLINOIS TOWN

**New technology brings the dream of an electronic central office to reality . . . foreshadows new kinds of telephone service.**

Today, the science of communications reaches dramatically into space, bouncing messages off satellites. But an equally exciting frontier lies closer to home. Bell Telephone Laboratories engineers have created a revolutionary new central office. At Morris, Illinois, an experimental model of it has been linked to the Bell System communications network and is being tried out in actual service with a small group of customers.

This is a special electronic central office which does not depend on mechanical relays or electromagnets. A photographic plate is its permanent memory. Its "scratch pad," or temporary memory, is a barrier grid storage tube. Gas-filled tubes make all connections. Transistor circuits provide the logic.

The new central office is versatile, fast and compact. Because it can store and use enormous amounts of information, it makes possible new kinds of services that will be explored in Morris. For example, some day it may be feasible for you to ring other extensions in your home . . . to dial people you frequently call merely by dialing two digits . . . to have your calls transferred to a friend's house where you are spending the evening . . . to have other numbers called in sequence when a particular phone is busy.

The idea behind the new central office was understood 20 years ago, but first Bell Laboratories engineers had to create new technology and devices to bring it into being. A Bell Laboratories invention, the transistor, is indispensable to its economy and reliability.

This new experiment in switching technology is another example of how Bell Telephone Laboratories works to improve your Bell communications services.

## **BELL TELEPHONE LABORATORIES**

World center of communications research and development



Part of a memory plate of the new electronic central office is shown at right (enlarged 8 times). Spots are coded instructions which guide the system in handling calls and keeping itself in top operating form. Over two million spots are required. Logic and memory are physically separated in the machine, so new functions can be easily added. The experiment is being conducted in co-operation with the Illinois Bell Telephone Company and the Western Electric Company.

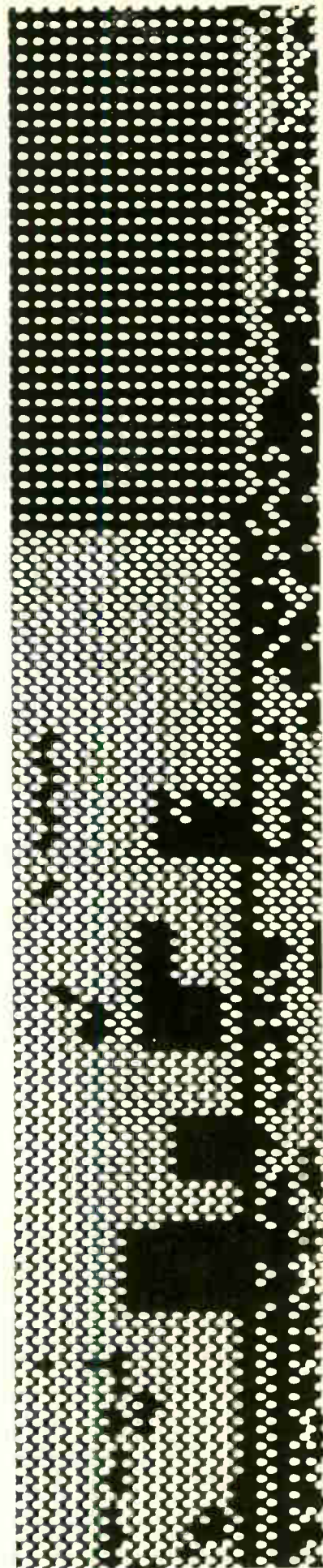

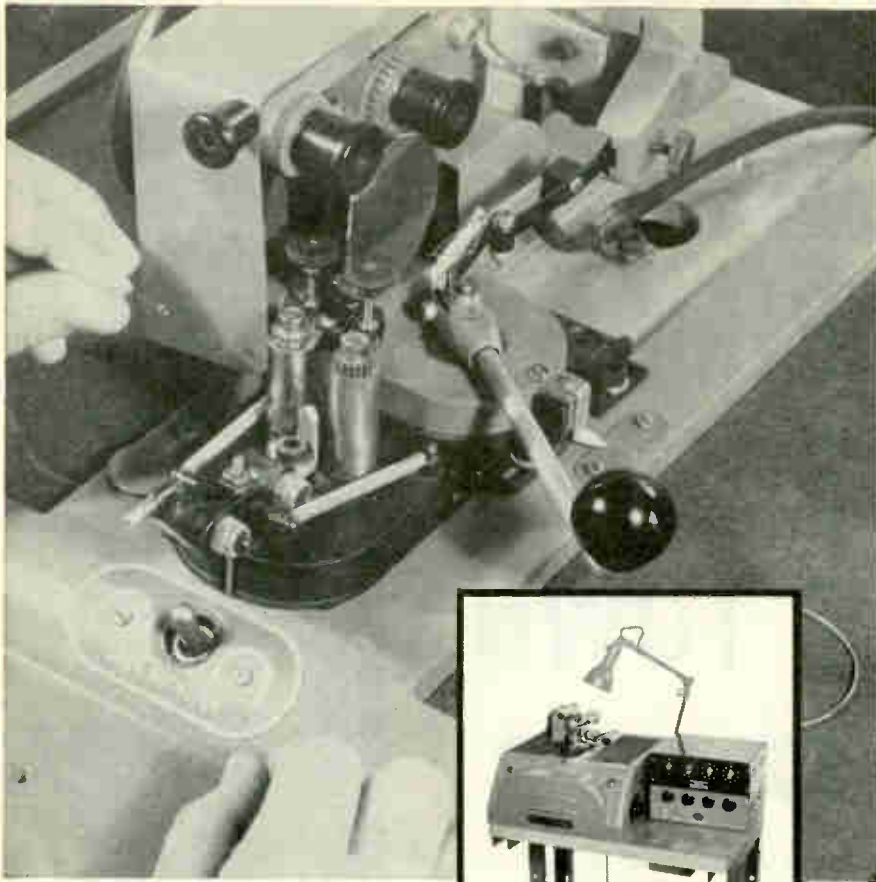

## NEW BOESCH MINITOR

*. . . machine - winds  
1/32" toroids*

The coil shown above is a 1/32" residual I.D. toroid being wound by machine on Boesch's new Model MW400 MINITOR. It's the smallest machine-wound coil ever made (only half as large as the smallest previously available), and it can only be wound on MINITOR!

This achievement reflects a completely new, unique method of coil winding perfected by Boesch. The wire is loaded *inside* a hollow, round cross-section shuttle, and the winding is spun out. A single loading of this unique shuttle is usually enough to wind several coils.

MINITOR handles wire sizes from #36 to #50 AWG, and winds up to 500 turns per minute. Maximum finished coil size is 3/4".

Shuttles for MINITOR are loaded by a Boesch PW-100 Loader. This machine can service as many as 20 winding machines, and it can load needles for hand winding as well.

If you now own a Boesch SM series machine, you can convert it to MINITOR operation economically by buying a 400-200 Head, a 400-300 Core Rotating Assembly, and the PW-100 Loader.

*WRITE TO US TODAY for complete specifications, delivery schedules and prices on MINITOR.*

**B** BOESCH MANUFACTURING  
COMPANY, INCORPORATED  
BOESCH DANBURY, CONNECTICUT



ously variable 0-25 db above a maximum 1 db insertion loss. For any setting, attenuation does not change with frequency greater than plus or minus 0.5 db. Knob may be removed for servo-drive applications. Price and delivery \$185.00 each (Model RDA-1196), shipped from stock after January 1, 1961. BNC connectors standard. TNC and Type N available.

**CIRCLE 306 ON READER SERVICE CARD**

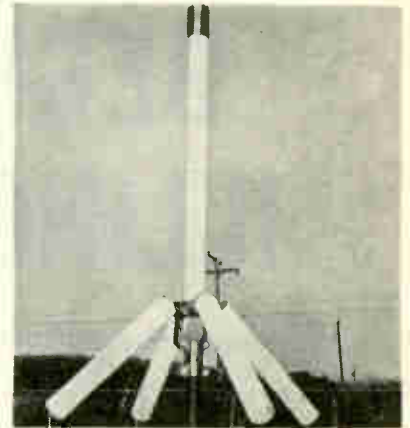

## Communication Antennas FEATURE NEW DESIGN

A BASICALLY new 30 to 50-Mc fixed station antenna for two-way communications is being offered by the Andrew Corp., P. O. Box 807, Chicago 42, Illinois.

Called Helipole, type 902, the antenna employs a bifilar helical element in the Fiberglass encased radiator. The ground rods use single helix conductors. Lightweight (13 pounds) and durable (30 psf with 1/2 inch ice), the Helipole is 40 percent smaller than conventional antennas at the same frequency.

**CIRCLE 307 ON READER SERVICE CARD**



## Fiber-Optics CRT GIVES HIGH RESOLUTION

DEVELOPMENT of a five-inch cathode ray tube faceplate formed of 140 million super-fine glass threads has

been announced by Mosaic Fabrications, Inc., Southbridge, Mass. Called fiber optics, the tiny strands carry light and images from one end to the other. Total resolution, or picture quality, of this faceplate is claimed by the company to be 560 times better than existing tv pictures.

CIRCLE 308 ON READER SERVICE CARD

### Photomodulator MINIATURE SIZE

PHOTOCHRON RESEARCH, INC., Two Howard St., New York 13, N. Y. Miniature chopper is designed to alternately connect and disconnect a load from a signal source. It may also be used as a modulator to convert an a-c signal to d-c. It is an inertialess device that can be driven from d-c to 1 Kc by sine or square wave sources of suitable voltage. Model PG-4 is a nonmechanical device which uses light-modulated photosensistors as the switching element. The switching circuitry operates the photosensistors in a manner which provides stability, freedom from drift, and low noise. The unit having no moving parts is practically immune to the effects of shock and vibration, making it ideal for military, missile, and portable applications or where miniaturization and elimination of maintenance are a necessity. Units are available in both spst and dpst, in a choice of high or low impedance. The chopper uses a standard 7-pin base so that it may be plugged into any standard 7-pin miniature tube socket or used on a p-c board.

CIRCLE 309 ON READER SERVICE CARD

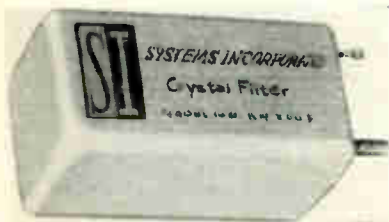

### Crystal Filters HIGHLY RELIABLE

SYSTEMS INC., 2400 Diversified Way, Orlando, Fla., offers upper and lower sideband filters designed for ssb equipment at 4 Mc. Symmetrical passband characteristics also make these filters suitable for bandpass

# MARCONI

## Carrier Deviation Meter

uses multi-crystal stability-lock



#### Direct indication of fm deviation

From 200 cps to 125 kc makes this latest model in the Marconi 791 series applicable to both communication and broadcast fm systems.

#### Crystal locking

at any point in its 4- to 1024- mc carrier range brings new, exceptional stability and freedom from microphony in low-deviation measurements. Use of an external indicator extends the deviation range down to 10 cps, allowing fm hum and noise on uhf close-channel transmitters to be measured with ease and certainty.

An in-built deviation standard, crystal governed, insures full rated accuracy at all times.

Send for leaflet B143

#### ABRIDGED SPECIFICATIONS

CARRIER DEVIATION METER 791D  
Carrier Frequency Range: 4 to 1024 mc.  
Modulation Frequency Range: 50 cps to 35 kc.  
Measures Deviation: 200 cps to 125 kc in four ranges. Measures down to 10 cps using external readout.  
Measurement Accuracy: ± 3% of full-scale for modulation frequencies up to 25 kc.  
Internal FM: Due to hum, noise and microphony, less than -55 db relative to 5 kc deviation.  
Tubes: 6AK5, 6AS7, 6C4, 6CD6G, 5651, 5647, 5Z4G, OB2.

## MARCONI INSTRUMENTS

Marconi  
for fm  
test gear

111 CEDAR LANE ENGLEWOOD NEW JERSEY

Tel: Lowell 7-0607

CANADA: CANADIAN MARCONI CO · MARCONI BUILDING · 2442 TRENTON AVE · MONTREAL 16

MARCONI INSTRUMENTS LTD · ST. ALBANS · HERTS · ENGLAND

As tall as a  
7-story  
building...  
but it uses  
tiny BRISTOL  
CHOPPER

More than 40,000 parts, each of which must meet the most stringent reliability standards, make up the U. S. *Atlas* intercontinental ballistic missile, built by prime contractor Convair (Astronautics) Division, General Dynamics Corporation.

Among these parts is the Bristol Syncroverter\* chopper . . . adding to its record of service in U. S. guided missile systems of almost every type since their very beginnings.

**Billions of operations.** To insure the reliability so necessary in aircraft and missile operations, Bristol Syncroverter choppers are constantly under test at Bristol, with and without contact load. One example: We've had five 400-cycle choppers operating with 12v, 1ma. resistive contact load, for more than 26,000 hours (2.96 years) *continuously* without failure—over 37-billion operations!

Many variations of Bristol Syncroverter choppers and high-speed relays are available—including external-coil, low-noise choppers. Write for full data. The Bristol Company, Aircraft Equipment Division, 152 Bristol Road, Waterbury 20, Conn.

\*T.M. Reg. U. S. Pat. Off.



actual size

**BRISTOL** FINE PRECISION INSTRUMENTS FOR OVER SEVENTY YEARS

filter applications. Specifications are: center frequency insertion loss (max), 6 db; passband ripple  $\pm 1$  db; stopband loss, at least 80 db; impedance, input 10,000 ohms balanced, 3,000 ohms unbalanced; dimensions, 2 in. by 2 in. by  $3\frac{1}{2}$  in.

CIRCLE 310 ON READER SERVICE CARD



### Preprinted Symbols SAVE MAN-HOURS

ENGINEERING AND SCIENCE AIDS CO., 392 Jackson Ave., Jersey City 5, N. J., has introduced a new product intended to reduce substantially the valuable time presently spent in drafting electronic circuit diagrams for technical articles and production drawings. Called Select-A-Circuit due to its versatility, it consists of all ASA and IRE electrical symbols, individually printed on self-adhesive matte acetate. Select-A-Circuit is available by individual component symbol in pads of 100 symbols. Coordinated assortments, individually boxed, permit circuit designers to construct many circuit illustrations of transistors, relays, diodes or vacuum tubes. Company offers samples and catalog on request.

CIRCLE 311 ON READER SERVICE CARD



### Miniature Amplifiers PROPORTIONAL TYPE

MAGNETIC CONTROLS CO., 6405 Cambridge St., Minneapolis 26, Minn.,

announces a line of miniature, solid state proportional amplifiers designed to control up to 100 w of d-c power (while drawing only 2 va a-c) for precise temperature controls. Advantages of the PA8 amplifiers include: small size (4.5 cu in.); light weight (6.8 oz); varied power ranges (25 to 100 w output); standard 400 cps power source; absolute sensing element protection and control accuracy of 0.2 F to 0.5 F under varying conditions of line voltage, frequency and ambient. A built-in reset function helps insure maximum control accuracy by removing the temperature droop which is inherent in ordinary proportional systems. Each of the units is epoxy encapsulated to offer maximum resistance to extreme environmental conditions.

CIRCLE 312 ON READER SERVICE CARD



### Water-Cooled Triode GENERAL-PURPOSE

THE MACHLETT LABORATORIES, INC., 1063 Hope St., Springdale, Conn. The ML-7560 general-purpose, water-cooled triode is designed for 400 Kw continuous output as a class C amplifier or as an oscillator at frequencies up to 30 Mc. It is also designed to deliver 2.5 megawatts in a pulsed r-f amplifier and can switch 14 megawatts in a pulse modulator at relatively long pulse duration with high duty factors. The anode incorporates an integral water jacket and can dissipate 175 Kw. Low-inductance and high-dissipation r-f terminals are provided by a sturdy coaxial grid and cathode mounting structures. The cathode is a self-supporting, stress-free, thoriated-tungsten filament. Ceramic cylinders insulate the envelope. Maximum ratings are 20 Kv d-c plate voltage and 600 Kw

# now... find, identify, analyze noise & interference 1kc—25mc FAST!



...just one of the many ways to use

## PANORAMIC's economical SPA-3/25 SPECTRUM ANALYZER

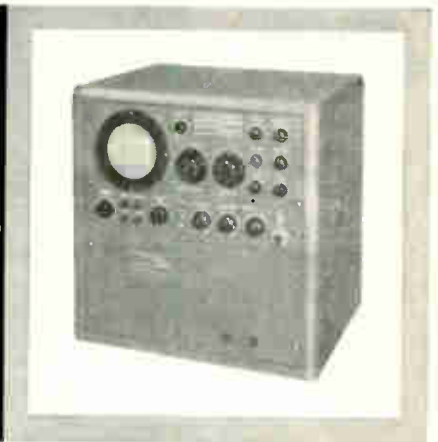

Widely used for high-speed location, identification and analysis of random and discrete signals, the SPA-3/25 automatically separates and measures the frequency and amplitude of signals in spectrum segments up to 3mc wide, selectable anywhere between 1 kc and 25mc (usable down to 200 cps). Direct readouts of frequency distributions and amplitudes of signals are provided respectively on calibrated X and Y axes of a 5" long-persistence CRT. The SPA-3/25 samples the spectrum at a 1-60 cps rate.

### Panoramnic presentation of the Model SPA-3/25

1. permits quick location of signals, minimizes chances of missing weak signals or holes in the spectrum
2. speeds up measurements by eliminating tedious point-by-point plots
3. enables fast, reliable detection of comparatively low level discrete signals present in random spectra through use of adjustable narrow IF bandwidths and correlation techniques
4. allows identification and subsequent analysis of dynamic characteristics of modulated signals and noise.

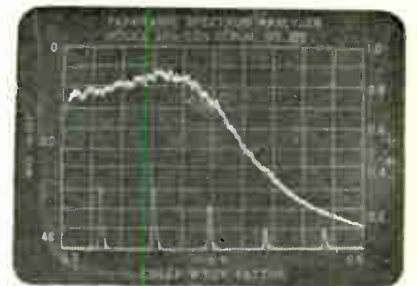

Noise spectrum analysis using internal video smoothing filter presents noise envelope average versus frequency in readily appreciated form. Internal marker pips are 500kc apart.

#### SPECIFICATIONS:

**Frequency Range:** 1 kc—25mc in 2 bands  
**Sweepwidth:** Variable, calibrated from 0 to 3mc  
**Center frequency:** Variable, calibrated from 0 to 23.5mc  
**Markers:** crystal controlled, 500kc and harmonics to 25mc  
**Resolution:** Variable, 200 cps to 30 kc  
**Sweep rate:** Variable, 1 cps to 60 cps  
**Amplitude Scales:** 20 db linear, 40 db log, 10 db square law (power)  
**High sensitivity:** 20  $\mu$ v full scale deflection  
**Attenuator:** 100 db calibrated  
**Response Flatness:**  $\pm$  10% or  $\pm$  1 db  
**Input Impedance:** 72 ohms. High impedance probe-PRB-1—Optional

The SPA-3/25's great flexibility makes it a valuable tool in a wide range of applications. Write, wire or phone NOW for detailed specifications and NEW CATALOG DIGEST.

Put your name on our mailing list for "THE PANORAMNIC ANALYZER," featuring application data.

530 So. Fulton Avenue, Mount Vernon, N.Y.  
 Phone: OWens 9-4600. TWX: MT-V-NY-5229  
 Cables: Panoramnic, Mount Vernon, N.Y. State



Sec. 2900

**NYLON TIP JACK**  
Available in all nylon body or as a metal-clad type to meet military specifications. Completely insulated—no auxiliary mounting hardware needed.



**NYLON BANANA PLUG**  
Rugged, high voltage insulated plug for a wide variety of applications.



**NYLON BINDING POST**  
Compact, completely insulated, pre-assembled 6-way binding post.



# NYLON CONNECTORS

Voltage breakdowns up to 12,500 volts DC!

These rugged Johnson connectors are molded of tough, low-loss shockproof nylon—and will not chip or crack, even when subjected to extreme temperature changes or severe mechanical stress. Nylon provides high voltage insulation, with voltage breakdowns up to 12,500 volts DC. Metal clad tip jack meets MIL specifications (full specifications available on request). All connectors are designed for fast, easy mounting—and are available in 13 bright colors for coded applications.

**NEW**



**DUAL BANANA PLUG**

Solderless design, tough shock resistant nylon body retains strength and low-loss characteristics over a wide range of temperature and high relative humidity conditions. Available in 13 colors.

**OTHER CONNECTORS**  
Johnson also manufactures a complete line of standard connectors. For information, write for our newest components catalog.



## New Catalog

Write today for our newest electronic components catalog—complete specifications, engineering prints and current prices on:

- Capacitors • Tube sockets • Connectors • Pilot lights
- Insulators • Knobs, Dials • Inductors • Hardware



**E. F. JOHNSON CO.**  
230 8 2nd Ave. S.W. • Waseca, Minn.

plate input at frequencies up to 30 Mc, although useful power output can be obtained at frequencies up to 100 Mc at reduced plate voltage and plate input.

**CIRCLE 316 ON READER SERVICE CARD**

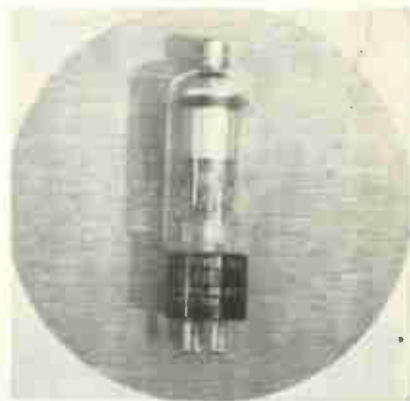

## Rectifier Tube INERT GAS FILLED

NATIONAL ELECTRONICS, INC., Geneva, Ill. A new 2.5 ampere, 920 piv rectifier is announced. The NL-610/7723 was especially designed for industrial power rectifier applications where a high commutation factor tube is required. The tube is xenon-filled for quick starting, compactness, and the ability to operate within very wide temperature limits. Other ratings: filament volts, 2.5; filament current, 9 amperes; peak anode current, 30 amperes; and condensed mercury temperature limits of -55 to +75 C.

**CIRCLE 317 ON READER SERVICE CARD**

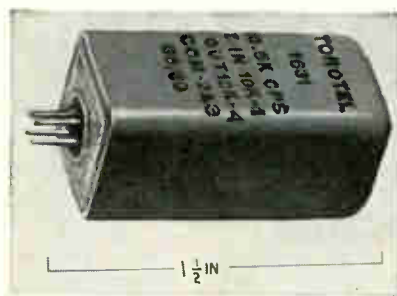

## Subminiature Filters FOR TELEMETERING

TOROTEL, INC., 5512 E. 110th St., Kansas City 37, Mo., has released a new line of 22 subminiature filters having a center frequency from 400 cps to 70 Kc. Input and output impedance is 100 K with an insertion loss less than 6 db. Attenuation characteristics are 3 db at a bandwidth of  $\pm 7\frac{1}{2}$  percent, 20



**pick the  
best pilot light  
for your application  
in seconds!**

**Johnson pilot lights**  
*immediately available  
for original equipment  
or in-the-field replacement!*

Choose your next group of panel indicators from E. F. Johnson's "preferred" line—over 47 separate assemblies carefully selected from Johnson's standard line by many of the nation's top design and development engineers. Available in a wide variety of types, these "preferred" units may be obtained from stock at parts distributors throughout the country for original equipment or in-the-field replacement. Write for your free copy of Johnson's newest pilot light specification catalog—see how easy it is to select the *right* pilot light . . . fast!

### Select the right pilot light...fast!

Complete pilot light catalog 750a contains detailed specifications, prices, and technical data . . . everything you need to select the best unit for your particular application. Write for your free copy of Catalog 750a today!



Available types include: continuous indication neon types; models for high and low voltage incandescent bulbs; standard or wide angle glass; and lucite jewels in clear, red, green, amber, blue, or opal. Specials, including those meeting military specifications, also available in production quantities.



**E. F. Johnson Company**  
2211 Second Ave. S.W. • Waseca, Minnesota

**CIRCLE 204 ON READER SERVICE CARD**  
electronics



db at  $\pm 25$  percent bandwidth and 40 db at 0.58 and 1.75 times the center frequency. Sizes available are  $\frac{1}{8}$  by  $1\frac{1}{2}$  by 2 in. high and  $\frac{3}{4}$  by  $1\frac{1}{2}$  in. high. Applicable MIL spec, MIL-F-18327 and MIL-T-27A.  
**CIRCLE 318 ON READER SERVICE CARD**



### Precision Switches HEAVY-DUTY

UNIMAX SWITCH DIVISION, The W. L. Maxson Corp., Ives Road, Wallingford, Conn. Available in basic form, with a wide variety of leaf, hinged-lever, and plunger actuators, and with solder-lug, screw type, or snap-on terminals, the new 2HL series of precision snap-acting switches is built to meet hard-service performance requirements. They are listed by UL, Inc. for spdt operation at 2 h-p 250 v a-c, 1 h-p 125 v a-c, 20 amperes 125 v a-c. The basic 2HL-1 switch is  $\frac{1}{8}$  in. wide,  $1\frac{1}{8}$  in. long, and  $\frac{1}{4}$  in. high; mounting holes are on 1-in. centers.

**CIRCLE 319 ON READER SERVICE CARD**

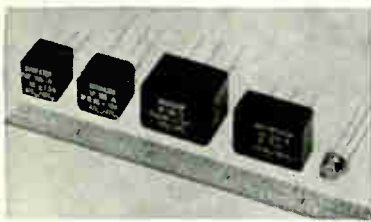

### Miniature Filters EPOXY ENCAPSULATED

DATAFILTER CORP., 5921 Noble Ave., Van Nuys, Calif., announces a new subminiature line of band pass filters for incorporation in transistorized subminiature telemetering oscillators. Units range in volume from 0.125 cu in. for the upper IRIG channels to 0.625 cu in. for the lowest channels. In spite of their small size, these filters equal or exceed the performance of previously available larger units for this application. Each filter is epoxy

# IERC TRANSISTOR HEAT DISSIPATOR



actual size

accepts .305 to .335 variations in TO-5 cases!

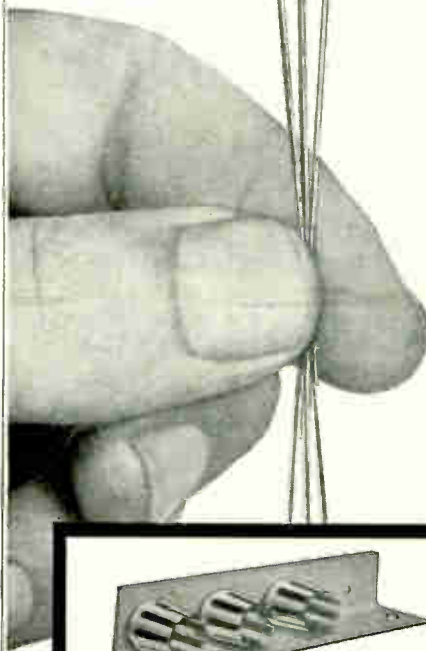

IERC Transistor Heat-dissipating Retainer readily accommodate diameter variations up to .030" found in TO-5, TO-9, TO-11, TO-39 transistor cases. This single IERC part saves you time and costs in specifying, stocking and application.

IERC's exclusive design features maximum thermal contact with transistor case for efficient transfer of heat to the dissipator and heat sink. Attaching methods suitable for printed circuit boards, chassis and heat sinks provide thermal benefits and retention in extreme shock and vibration environments.

Installation is a smooth, tension fit—eliminating the possibility of "snap-fit" impact injuries to the transistor!

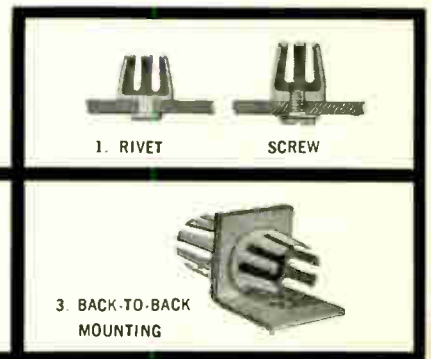

Simplified installation for effective heat dissipation with IERC Transistor Heat Dissipators are illustrated: 1. Parts available in rivet or screw attaching types. 2. Single or multiple mounting on heat sink angle. 3. Back-to-back mounting.

*Detailed information, performance graphs, etc. are available in latest IERC Technical Bulletin. Write for a copy today!*

## IERC DIVISION

INTERNATIONAL ELECTRONIC RESEARCH CORPORATION  
 135 West Magnolia Boulevard, Burbank, California

Foreign Manufacturers: Europelec, Paris, France. Garrard Mfg. & Eng. Co., Ltd., Swindon, England.

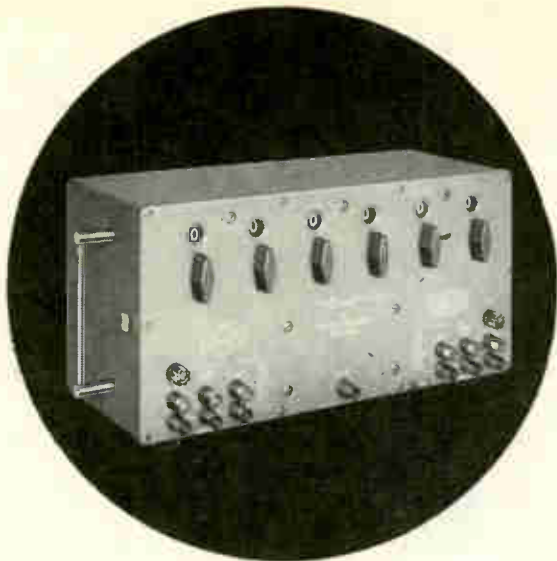

*Gertsch Ratio Standards 1000 Series*  
**NBS Certified AC**  
**ratio accuracy to 0.0001%**  
 —certification provided in terms  
 of a Gertsch standard traceable  
 to the National Bureau of Standards

Three basic ratio sections are available: high frequency AC, low frequency AC, and DC, supplied in a variety of combinations.

You can obtain maximum AC ratios up to 1.111111, or minimum down to  $-.111111$ . AC sections feature transient suppression, 6- or 7-place resolution, and terminal linearity of .0001%.

DC sections employ a Kelvin-Varley resistive divider with 6-place resolution and terminal linearity of .001%. All units available for case or rack mounting. Request Bulletin 1000.

If you require NBS traceability on your present RatioTran<sup>®</sup>, we will calibrate your unit and supply certification, for a nominal charge.

*—Gertsch—*

**GERTSCH PRODUCTS, Inc.**

3211 S. La Cienega Blvd., Los Angeles 16, Calif. • UPTon 0-2761 • VERmont 9-2201

encapsulated and provided with leads for standard etched circuitry mounting. A set or partial set can be ordered as a single package when required by a customer.

**CIRCLE 320 ON READER SERVICE CARD**

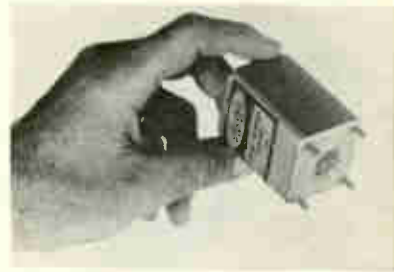

**Voltage Standard**  
**SOLID-STATE**

VIKING INDUSTRIES, INC., 21343 Roscoe Blvd., Canoga Park, Calif. This solid-state voltage reference standard series 200/210 features temperature coefficient of better than  $\pm 0.001$  percent/deg C over a range of  $-25$  C to  $+75$  C. These units operate directly on a 115 v, 60 cps and deliver 10 ma into load. Regulation is  $\pm 0.001$  percent of output voltage for  $\pm 10$  percent line variation. Output voltage of 5.7, 8.5 and 10.5 v d-c are available. Aged and selected Zener reference used throughout. Price ranges \$100 to \$129.

**CIRCLE 321 ON READER SERVICE CARD**



**Dual Power Supply**  
**BALANCED REFERENCE**

POWER-TRONIC SYSTEMS INC., Pine Court, New Rochelle, N. Y. Model 4010 dual power supply delivers a balanced  $+10$  and  $-10$  v d-c reference at 10 ma from a 115 v 400 cps supply. The output ripple is less than 2 mv rms at the rated output load. The output voltage varies less than 0.1 percent for load variations between 1 ma and 10 ma or line variations between 120 v and 110

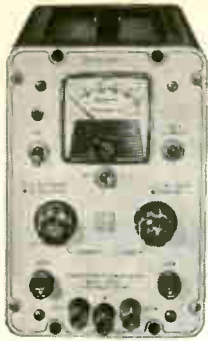

MODEL  
4005  
with



## CONSTANT VOLTAGE CONSTANT CURRENT

from the

**SAME TERMINALS!**

**\$143<sup>50</sup>**

F.O.B.  
FACTORY

Other Models  
Available  
Write For  
Catalog

\*TM

**Power Designs inc.**

1700 SHAMES DRIVE  
WESTBURY, NEW YORK

Edgewood 3-6200 (LD Area Code 516)

CIRCLE 205 ON READER SERVICE CARD

## DYNASERT

**Increase  
Hourly Output  
up to 10 Times Over  
Hand Inserting**



If you insert only a few hundred components a week, Dynasert component inserting machines should be considered. Big or small boards, long or short runs, Dynasert handles all.

Automatically feeds, trims, bends leads, inserts component, and clinches with uniform results. Little operator training. Highly engineered single or multi-stage production machines available. Write for descriptive 12 page booklet.

**United**

UNITED SHOE MACHINERY CORPORATION  
140 Federal Street, Boston, Mass.

CIRCLE 206 ON READER SERVICE CARD

December 16, 1960

## DON'T MISS THIS



New, Miniaturized  
**1-MC PRECISION  
CRYSTAL OSCILLATOR**  
with transistorized,  
proportional-controlled oven

**BULLETIN S-1159**

contains typical specifications and  
characteristics. Write for your copy.

**REEVES-HOFFMAN**

DIVISION OF DYNAMICS CORPORATION OF AMERICA

CARLISLE, PENNSYLVANIA

CIRCLE 207 ON READER SERVICE CARD

Another reason...  
the world becomes smaller

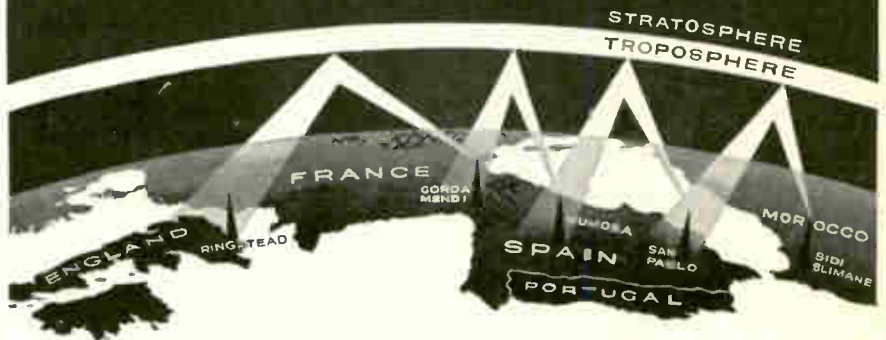

Troposcatter network, providing multi-channel Telephone, Teleprinter, and Data Transmission, linking England, Spain and North Africa is being designed and built for the Air Force

by

**Page**



**COMMUNICATIONS  
ENGINEERS, INC.**

Subsidiary of Northrop Corporation

2001 WISCONSIN AVENUE, N.W., WASHINGTON 7, D.C.

CIRCLE 123 ON READER SERVICE CARD 123

# 1 DIGITAL DISPLAY DOES THE WORK OF 15



ACTUAL SIZE

## NEW KEARFOTT DIGISTROBE\* DISPLAY

Kearfott's new, highly compact Digistrobe digital display utilizes the stroboscopic principle to produce an exceptionally high-definition readout in the actual size shown here.

Through the use of a unique shutter arrangement, a single diode-encoding matrix is shared by all columns (5 in the standard model), resulting in substantial savings in electronic components and circuitry. The fast response time of the Digistrobe (56 milliseconds transition from one five-digit quantity to a totally different one) permits a single unit to sample several different inputs on command through an input selector switch. Up to 15 individual displays of existing types can thus be replaced by a single Kearfott Digistrobe!

Incorporating only two moving parts and exclusively solid-state switching circuitry, the Digistrobe has extremely long life expectancy and requires minimum maintenance and service. Operation is directly from the output register of a computer, counter or allied equipment, eliminating the cost of intervening circuitry. Two years of extensive laboratory tests assure compliance with Kearfott's rigid standards of quality. For complete data and specifications, write for Digistrobe bulletin.

\*Kearfott Trademark



**KEARFOTT DIVISION  
GENERAL PRECISION, INC.**

*Little Falls, New Jersey*

124 CIRCLE 124 ON READER SERVICE CARD

v. The output voltages track each other in magnitude within 1 mv for 5 percent variations in input voltage and 1 percent variation in input frequency. The supply occupies a volume 4 in. by 5 in. by 7 in. and weighs 6 lb.

CIRCLE 322 ON READER SERVICE CARD



## Digital Telemeter COMPACT UNIT

APPLIED ELECTRONICS CORP. OF NEW JERSEY, 22 Center St., Metuchen, N. J., has produced a high speed solid state pcm multicode, said to be one-fifth the size of existing equipment. The MCH series multicode are solid state digital commutator coders capable of accepting data in three forms: time multiplexed analogs and digital data, both serial and parallel. This compact, minimum weight, product is characterized by a high degree of reliability, low power consumption, and is compatible with the wide range of environmental conditions met in missile applications—systems accuracy: an honest tenth of 1 percent from input to coded output.

CIRCLE 323 ON READER SERVICE CARD

## Ceramic Capacitors SUBMINIATURE

MUCON CORP., 9 St. Francis St., Newark 5, N. J. Narrow-Caps subminiature ceramic capacitors, stocked in 19 capacitance values, are designed for use in modular spacing as small as 0.100 in. Part NC-01 has capacitance of  $0.01 \mu\text{f} \pm 30$  percent, and is 0.095 in. wide max, by 0.095 in. thick max, by  $\frac{1}{8}$  in. long max. Narrow-Caps from  $5 \mu\text{f}$  through  $750 \mu\text{f}$  are  $\frac{1}{2}$  in. long max, and those from  $1,000 \mu\text{f}$  through  $0.01 \mu\text{f}$  are  $\frac{3}{8}$  in. long max. Thickness and width are 0.095 in. max.

CIRCLE 324 ON READER SERVICE CARD

electronics

**Malco** IS YOUR  
**BEST SOURCE**  
 FOR  
 SOLDERING LUGS  
 TERMINALS  
 PRINTED CIRCUIT  
 HARDWARE

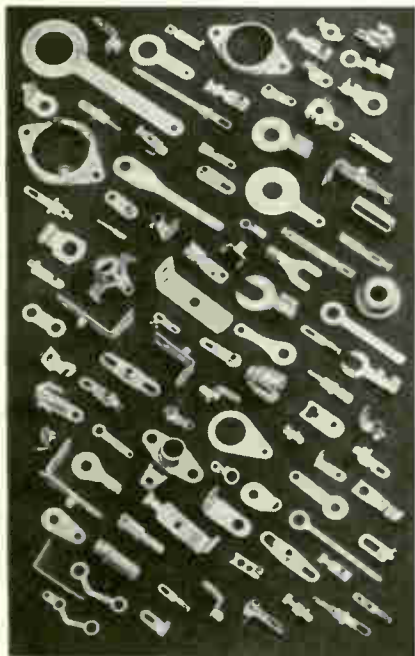

**HERE'S WHY:**

- Specialized high production techniques afford lowest possible unit cost.
- Precision tooling, rigid quality control assure tolerances to critical specifications.
- Ample stocks of over 1000 different parts permit prompt delivery.
- Malco specializes in a complete line of small stampings for Radio-TV, electrical/electronic and automotive industries.
- Our line includes terminals and printed circuit hardware in loose or in chain form for automatic insertion.

Let Malco show you how you can save on production time and costs. Contact us today.

REQUEST  
 BULLETIN  
 592



**Malco** MANUFACTURING COMPANY

4023 W. LAKE ST. • CHICAGO 24, ILL.  
 CIRCLE 208 ON READER SERVICE CARD

December 16, 1960

# RESOLVER NEWS!

**VERNITRON .05% ACCURACY PRECISION RESOLVERS  
 DELIVERED ON REGULAR  
 PRODUCTION BASIS**

60 THROUGH 10,000 CYCLE

ALL SIZES—8 through 23  
 ALL STANDARD TYPES—Computing, Data Transmission, Phase Shifters and Sweep  
 ALL ENGINEERED & MANUFACTURED TO:  
 MIL-R-14346

- ALL AVAILABLE WITH
- Thru-Bore Design
  - High Reliability Exclusive Brush Block
  - Stainless Steel housings, shaft, bearings
  - High voltage capabilities between stator and compensator windings (on feedback units)

A major break-through, made possible by VERNITRON specialization in precision synchro and resolver design and manufacture.



**WRITE, WIRE,  
 PHONE NOW** for  
 complete price,  
 delivery and specification  
 data; ask for  
**NEW Vernitron  
 Condensed Catalog**

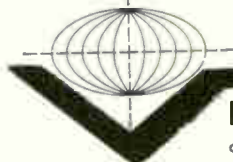

**VERNITRON**

CORPORATION

THE QUALITY NAME IN PRECISION SERVO COMPONENTS  
 129 Old Country Rd., Carle Place, N. Y.—Pioneer 1-4130 • TWX: G-CY-NY-1147  
 West Coast Plant: 1742 S. Crenshaw Blvd., Torrance, Cal.—FAirfax 8-2504 • TWX: TNC-4301

CIRCLE 209 ON READER SERVICE CARD

Another reason...  
 the world becomes smaller

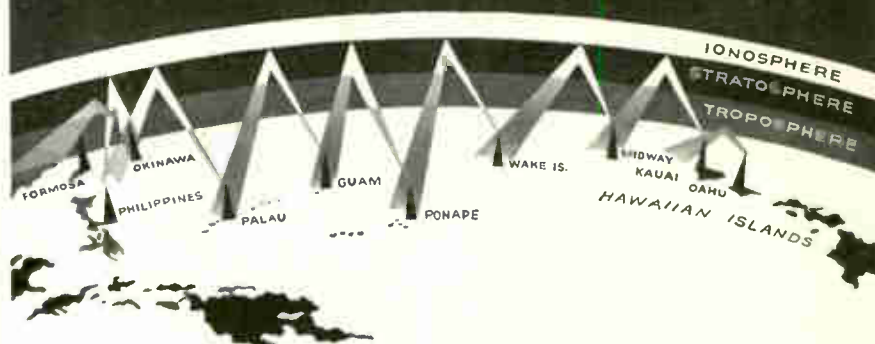

7,500-mile Pacific Scatter Communication System linking major command posts from Hawaii to Formosa was recently designed and built for the U. S. Army Signal Corps

by  
**Page** COMMUNICATIONS  
 ENGINEERS, INC.

Subsidiary of Northrop Corporation

2001 WISCONSIN AVENUE, N.W., WASHINGTON 7, D.C.

CIRCLE 125 ON READER SERVICE CARD

125

# ANNOUNCING

## ANOTHER FIRST!



The Model 230

## TAPE-PROGRAMMED CABLE HARNESS ANALYZER

- Automatic Testing by Tape Control
- Search and Fault Print-Out
- Capacity up to 9600 Wires
- Each Leakage Circuit Tested to All Others
- 100% Branch Testing Capabilities

CTI has scored another successful breakthrough in the challenging problem of cable harness testing . . . with the Model 230 Tape-Programmed Cable Harness Analyzer. This is the most flexible testing unit yet designed for programming and performing accurate tests on cable harnesses. Operation is fully automatic and unattended. Simultaneous programmable continuity and leakage measurements with go/no-go precision bridge tests assure accurate analysis. Any combination of branch or standard circuits can be selected. A unique "Search-Out" feature provides a printed record of test failures and the actual location of all circuits associated with each failure. Test circuit capacity of up to 9600 wires is available in 600 wire switch unit increments. Engineering changes in the cable harness under test are quickly handled by paper tape programming. Programming costs are minimized. The CTI Tape-Programmed Cable Harness Analyzer enhances competitive position by speeding testing operations and by assuring the quality of products.

*Write for full information*



### CALIFORNIA TECHNICAL INDUSTRIES

DIVISION OF TEXTRON INC.  
BELMONT 5, CALIFORNIA

*Foremost in Automatic Testing*

## Literature of

**FABRICATED CASES** Sexton Can Co., Inc., 31 Cross St., Everett, Mass. Fabricated cases and seamless drawn shells are illustrated and described in the 4-page bulletin No. 2.

CIRCLE 330 ON READER SERVICE CARD

**PLUG-IN UNITS FOR SCOPES** Tektronix, Inc., P. O. Box 500, Beaverton, Ore. A colorful 32-page booklet gives a detailed presentation of all 16 presently available Tektronix "A-to-Z" plug-in units.

CIRCLE 331 ON READER SERVICE CARD

**TRAFFIC OPERATION PUNCH** Fischer & Porter Co., 703 Jacksonville Road, Warminster, Pa. A four-page catalog describes a new traffic recorder and data handling equipment designed to automatically transfer traffic data into punched-card information for automatic entry into computers for traffic surveys.

CIRCLE 332 ON READER SERVICE CARD

**STAND-OFF INSULATORS** Thor Ceramics, Inc., 225 Belleville Ave., Bloomfield, N. J. Bulletin 155 covers a standard line of stand-off insulators (to JAN-I-10) normally available from stock. It shows specifications and prices.

CIRCLE 333 ON READER SERVICE CARD

**CAPACITORS** John E. Fast & Co., 3958 N. Elston Ave., Chicago 18, Ill. A bulletin on high reliability capacitors that comply with the new MIL-C-14157B specification, embodying extended reliability and physical requirements, was recently issued.

CIRCLE 334 ON READER SERVICE CARD

**SWEEPING POWER SUPPLY** Alfred Electronics, 897 Commercial St., Palo Alto, Calif. A two-page bulletin illustrates and describes model 610C sweeping power supply, a versatile general purpose power source for either swept or single frequency operation of voltage tunable magnetrons.

CIRCLE 335 ON READER SERVICE CARD

**SERVO MOTOR** John Oster Mfg. Co., Racine, Wisc., has issued a technical data sheet on its type E 131A,

# the Week

size 15 precision high temperature low inertia servo motor which meets military environmental specifications.

CIRCLE 336 ON READER SERVICE CARD

**SYNCHROS AND RESOLVERS**  
Vernitron Corp., 125 Old Country Road, Carle Place, L. I., N. Y. Designed to save time and simplify selection of precision control and torque synchros and resolvers. a new 4-page condensed catalog lists over 100 standard MIL-S and high accuracy units now available for immediate delivery.

CIRCLE 337 ON READER SERVICE CARD

**WATER COOLED BAFFLES**  
Vacuum-Electronics Corp., Terminal Drive, Plainview, N. Y. Water-cooled baffles for use in high vacuum systems are described in a recent bulletin now available.

CIRCLE 338 ON READER SERVICE CARD

**TRANSISTOR SPECIFICATIONS**  
Sperry Semiconductor Division, Sperry Rand Corp., Norwalk, Conn., has available a specifications sheet covering the types 2N1118, 2N-1118A and 2N1119 *pn*p alloy junction transistors.

CIRCLE 339 ON READER SERVICE CARD

**RADAR PULSE MODULATOR**  
Magnetic Research Corp., 3160 W. El Segundo Blvd., Hawthorne, Calif., has released a new engineering data sheet covering details of MRC solid-state radar pulse modulator model 30-116-1 designed for shipboard use.

CIRCLE 340 ON READER SERVICE CARD

**AUTOGRAPHIC PLOTTERS**  
Gilmore Industries, Inc., 13015 Woodland Ave., Cleveland 20, Ohio, is offering a new brochure, bulletin PG-100, on its complete line of multi-record autographic plotters.

CIRCLE 341 ON READER SERVICE CARD

**PRECISION COOLING EQUIPMENT**  
IMC Magnetics Corp., 570 Main St., Westbury, L. I., N. Y., has published a new condensed eight-page catalog titled "Blowers, Fans, & Vaneaxials." Copies can be obtained by writing on company letterhead.

## STANDING WAVE DETECTORS

—exceptionally accurate

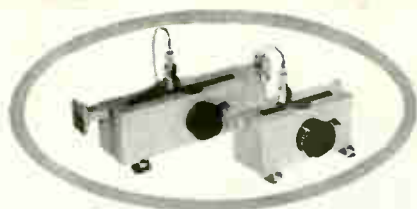

You get the accuracy that results from perfect parallelism between slot and waveguide axis . . . between probe travel and waveguide axis. Only 30 seconds needed to equip a D-B slotted line to measure adjacent frequency bands. Range: 5.8 KMC to 140 KMC—covered by a *minimum* of units, to stretch your budget. Literature on request.



**DE MORNAY-BONARDI**  
780 SOUTH ARROYO PARKWAY • PASADENA, CALIF.

CIRCLE 210 ON READER SERVICE CARD

25 years of progress in tiny parts

**GRC**

**GRC MOLDED NYLON SCREW INSULATORS**

These insulators and bushings are designed with wide flanges—larger than the head size of all standard commercial screws—so that they will completely isolate the screw from its mounting surface. Molded of nylon they have a low dielectric constant, relatively high dielectric strength . . . resist high voltages at commercial frequencies . . . are particularly suited for screw insulator application, where high tensile and torque requirements call for non-insulating screws. Naturally elastic and resilient, they can also be used as light-load bearings. Available from stock in 1/4" and 3/8" lengths for use with screw sizes No. 4 thru 1/4".

Write now for samples, prices and new GRC Fastener Catalog

**GRIES**

**GRIES REPRODUCER CORP.**  
World's Foremost Producer of Small Die Castings  
151 Beechwood Ave. • New Rochelle, N.Y.  
Phone: NEw Rochelle 3-8600

CIRCLE 211 ON READER SERVICE CARD

## Another reason . . . the world becomes smaller

STRATOSPHERE  
TROPOSPHERE

BLACK SEA  
TURKEY  
MEDITERRANEAN SEA  
SYRIA  
IRAQ  
IRAN

Turkey trot . . . tropospheric scatter network employing fixed and mobile stations . . . linking eight strategic areas through Turkey with more than 99% reliability . . . is being designed and built for the U. S. Air Force

by

**Page** **COMMUNICATIONS ENGINEERS, INC.**

Subsidiary of Northrop Corporation

2001 WISCONSIN AVENUE, N.W., WASHINGTON 7, D.C.



## Paraplegics Company Moves

PARAPLEGICS MFG. CO., INC., has moved its offices and manufacturing facilities to a newly-completed, 21,000-sq-ft plant in Bensenville, Ill.

Under construction for six months, the new plant provides more space, all under one roof, than was available in three plants the company has been operating.

Construction is modern face brick and steel, planned for easy expansion on the several-acre tract that has been purchased.

Designed to meet the needs of the electronic, electrical, and mechanical assembly work performed by Paraplegics Mfg. Co., the new plant has exceptional provisions for efficient production by the physically-handicapped workers. Special wiring ducts for fluorescent lighting will permit rapid adjustment of lighting from 10 to 70 foot-candles at any point in the plant. Year-round air conditioning and acoustical tiling in the offices, and gas heating, are a few additional features.

Special considerations incorporated for the physically-handicapped employees include ramps instead of stairs, extra-wide doorways to facilitate the easy passage of wheelchairs, and special guard rails. Individually-engineered tools, jigs and fixtures are available to accommodate each worker for the type of job performed.

A nine-year-old concern, Paraplegics Mfg. Co., Inc., fills electrical, electronic and mechanical subcontracts from more than 100 companies, including Stewart-Warner,

Bell and Howell, Western Electric, Goss Press and Motorola.

Last year's sales totaled slightly over three-quarters of a million dollars. With this new plant, the company is seeking to double its sales and thus provide employment for an additional 100 physically-handicapped workers.



## Borg-Warner Controls Appoints Wolfe

C. M. WOLFE has joined Borg-Warner Controls, Santa Ana, Calif., as head of transducer engineering. A specialist in instruments and devices, he will supervise transducer research and development programs.

Wolfe was formerly a research specialist at United Electrodynamics.

## Collins Radio Company Erecting New Plant

CONSTRUCTION of a \$1.8-million plant for Collins Radio Company's

manufacturing and assembly functions has begun at Richardson, Texas. Completion of the 117,000-sq ft, one-story building is due in August, 1961. It will complement a \$1.7-million research and development building completed in 1957.



## Sanders Associates Advances St. Jean

LLOYD E. ST. JEAN, chief engineer in the equipment design department of Sanders Associates, Inc., Nashua, N. H., was recently named general manager of the company's new facility recently purchased in Plainview, L. I., N. Y.

He will head up a staff of engineers which is expected to grow to 75 within a few months, and a total plant complement of 400-500 within a year.



## Stromberg-Carlson Hires Krassner

GEORGE N. KRASSNER has been appointed product manager for astronautics equipment in the electronics division of Stromberg-Carlson, Rochester, N. Y.

He comes to S-C from the U. S. Army Signal Research and De-



Now...

ONE dual-voltage line regulator stabilizes 110 or 220 V ac lines



\$425  
unmetered

6 KVA  
Capacity

This heavy-duty, industrial voltage regulator puts an end to line voltage fluctuations... whether your power line is 110 or 220 V. Switchover to either line voltage is made in seconds. Fail-safe overvoltage protection included.

**BRIEF SPECIFICATIONS**  
NOMINAL INPUT: 115 or 230 V, 47 to 63 cps.  
OUTPUT WITH 115 V LINE: Adjustable, 110-120 V  $\pm$  1% at 6 KVA  $\pm$  15 V correction. (3 KVA  $\pm$  30 V correction)  
OUTPUT WITH 230 V LINE: Adjustable, 210-220 V  $\pm$  1% at 6 KVA  $\pm$  30 V correction.  
**DIMENSIONS:**  
Wall mounting type; 17" H x 13½" W x 8¾" D, approx.  
Rack mounting type; 8¾" H x 19" W x 13½" D, approx.



**ELECTRONIC MEASUREMENTS COMPANY, INCORPORATED**  
EATONTOWN · NEW JERSEY

U. S. PATENT ISSUED

REQUEST SPEC SHEET 3060

CIRCLE 212 ON READER SERVICE CARD

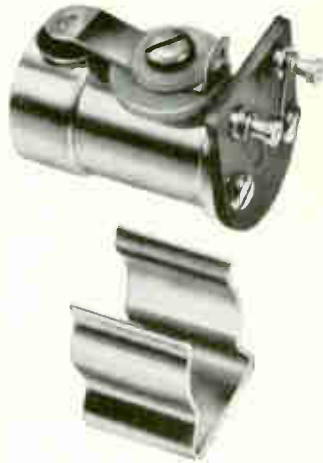

LOW  
COST

## MINIATURE LIGHT-OPERATED RELAY

has no moving parts. Useful in numerous circuit applications requiring transient-free switching, high isolation between control and signal voltages, and low-power control voltages.

### TYPICAL USES:

Remote potentiometers  
Noiseless audio switching  
Feedback loop and AGC circuits  
May be effectively ganged for multi-pole relay or control applications.

Miniature lamp is quickly replaceable. Completely wear-proof and non-mechanical, cannot develop contact failures. Clips to chassis, only four connections to solder.

### NOMINAL SPECIFICATIONS

Rmax—20 megohms  
Rmin—75 ohms  
Emax—30 VDC or AC peak  
Pmax—75 mw.  
Control Emax—14 VDC  
Imax—80 ma.

## UNIVERSAL-RELAY

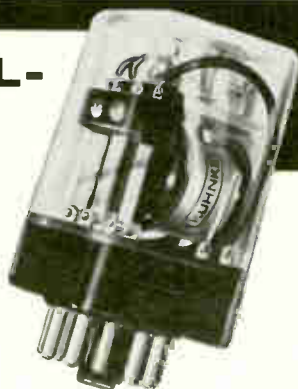

- Coil voltage: up to 250 V AC or DC
- Contact rating: 1 to 3 poles, 6 amps. max.
- Plug-in-type: 1 <sup>6</sup>/<sub>16</sub>" x 1 <sup>6</sup>/<sub>16</sub>" x 2 <sup>5</sup>/<sub>16</sub>"
- Solder connection
- Faston connection
- Screw connection

**KUHNKE**

Elektrotechnische Fabrik GmbH  
Malente/Holstein WEST-GERMANY

CIRCLE 213 ON READER SERVICE CARD

*investigate this versatile, reliable relay!*  
**Allen** ORGAN COMPANY, INC.  
*the most respected name in electronic organs*  
COMPONENTS DIVISION  
DEPT. 2312, MACUNGIE, PA.

CIRCLE 129 ON READER SERVICE CARD 129

performance  
meets  
or exceeds

**iei**

MIL-C-26655-A  
specifications

**iei**

Solid Tantalum, Dry Slug, electrolytic capacitors (Series TD) give unusual stability over the wide temperature range of  $-55^{\circ}$  to  $+125^{\circ}\text{C}$ . Long operating and shelf life, low dissipation factor and low leakage current. Capacities from 1.0 to 330 microfarads. Voltage range from 6 to 35 WVDC. As standard procedure, all **iei** capacitors are stabilized for 250 hours.

**iei**

Series TD, Polar type capacitors owe their fine performance to sintered tantalum anodes, solid inorganic electrolytes and counter electrodes bonded into hermetically sealed units. The doubly anchored leads and shock-defying construction are other features you can rely on.

**Applications:** computers, transistor amplifiers, data processing systems, and other electronic equipment demanding the utmost in reliability and space conservation. Write for 4-page bulletin.

International Electronic Industries, Inc.  
Box 9036-Y, Nashville, Tenn.

**iei**

AN **SPS** COMPANY

where reliability replaces probability

velopment Laboratory at Fort Monmouth, N. J., where he was chief of the satellite equipment section, Radio Relay Branch, and later chief of the technical staff, Astro-Electronics Division.



### Raytheon Advances Emidio DeLollis

NEWLY APPOINTED engineering manager of Raytheon Company's receiving tube operations in Newton, Mass., is Emidio A. DeLollis.

Assistant head of the receiving tube design department since 1957, he joined Raytheon as a design and development engineer in 1946.

DeLollis replaces Niles P. Gowell, who has been promoted to division engineering manager for Raytheon's industrial components division.



### Dresser Electronics Appoints Bond

APPOINTMENT of Howard A. Bond as vice president of systems and development in Dresser Electronics, SIE division, Houston, Texas, has been announced.

Bond has been serving on one of the panels of the Scientific Advisory Board of the National Security Agency and as an advisor to the deputy director for research and development. He was formerly



a spot is a spot  
is a high  
resolution spot  
with

## CELCO YOKES

- Celco YOKES  
keep spots **smallest**
- Celco YOKES  
keep spots **roundest**
- Celco YOKES  
keep spots **sharpest**

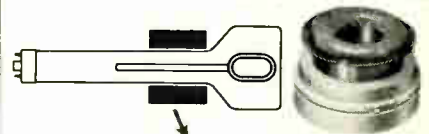

Use a CELCO DEFLECTION YOKE for your high resolution applications.

In a DISPLAY SPOT? call **Celco!**

**Celco**  
*Constantine Engineering  
Laboratories Co.*

Main Plant: MAHWAH, N. J. Davis 7-1123

• Pacific Division - Cucamonga, Calif. - YUkon 2-2688

CIRCLE 214 ON READER SERVICE CARD  
electronics

# "Telephone Quality" Stromberg-Carlson RELAYS

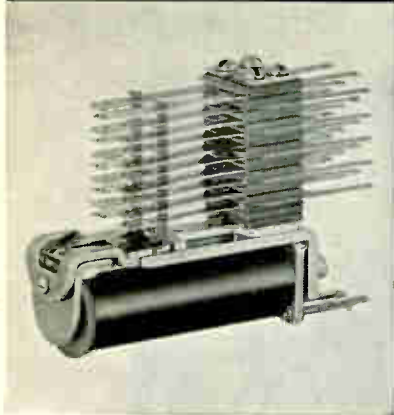

... featuring new high-voltage types for test equipment or other high-voltage applications.

THE insulation in the new relays withstands 1500 volts A.C.—three times normal. These high-voltage models are available in Types A, B and E. They are the latest additions to the Stromberg-Carlson line of twin contact relays—all available for immediate delivery.

The following regular types are representative of our complete line:

**Type A:** general-purpose relay with up to 20 Form "A" spring combinations. This relay is excellent for switching operations.

**Type B:** a gang-type relay with up to 60 Form "A" spring combinations.

**Type BB:** relay accommodates up to 100 Form "A" springs.

**Type C:** two relays on the same frame. A "must" where space is at a premium.

**Type E:** has the same characteristics as the Type A relay, plus universal mounting arrangement. Interchangeable with many other makes.

Details on request. In Atlanta call TRINITY 5-7467; Chicago: STATE 2-4235; Kansas City: HARRISON 1-6618; Rochester: HUBBARD 2-2200; San Francisco: OXFORD 7-3630. Or write to Telecommunication Division, 114 Carlson Road, Rochester 3, New York.

**STROMBERG-CARLSON**  
A DIVISION OF  
**GENERAL DYNAMICS**

CIRCLE 215 ON READER SERVICE CARD  
December 16, 1960

manager of reconnaissance systems at Stromberg-Carlson.

## Belock Instrument Picks Donald Herr

HARRY D. BELOCK, president of the Belock Instrument Corp., College Point, N. Y., recently announced the appointment of Donald L. Herr as director of new products planning and engineering.

Herr returns to the East coast after a decade in California where he was senior research scientist and technical adviser of the Hughes Aircraft Co., president and founder of American Electronic Mfg. Inc. and president of Mark Instrument Co., Inc.



## Shank Heads Up New Corporation

SHAFFORD ELECTRONICS & DEVELOPMENT CORP. is a new company recently set up in Santa Monica, Calif. President and chairman of the board is Clifford A. Shank who for years was associated with the controls and air data successes at the AiResearch Mfg. Co.

Shafford will engage in precision design and manufacture of commercial, industrial and military servo control systems.

## USI Board Elects Rockwood President

THE BOARD of directors of the United States Instrument Corp., Charlottesville, Va., has elected William A. Rockwood as president of the company. The firm manufactures communication equipment.

Herbert R. Warnke, a founder of the company and president since it

Just Published

## WAVE PROPAGATION in a TURBULENT MEDIUM

By V. I. TATARSKI  
*The Academy of Sciences of the USSR*

Integrates theory and experimental results in the treatment of phenomena associated with the propagation of electromagnetic and acoustic waves through atmospheric turbulence. Covers such areas as theory of random fields and of turbulence, scattering, and parameter fluctuations. 285 pp., 45 illus., \$9.75

## DIGITAL COMPUTER FUNDAMENTALS

By THOMAS C. BARTEE  
*Massachusetts Institute of Technology*

Describes the principles of electronic digital computers; shows how, when, and where they may be used most effectively; and explains basic techniques of programming. Includes a survey of applications in research, science, business, and real-time control systems. 335 pp., 131 charts, tables, and illus. \$6.50

## REACTOR ANALYSIS

Modern analytical methods for describing the nuclear behavior of reactors by means of mathematical models. By R. Meghrebian, Cal. Inst. of Tech.; and D. Holmes, Oak Ridge National Lab. 832 pp., 202 illus., \$19.50

## DIGITAL COMPUTER AND CONTROL ENGINEERING

Explains digital computers and controls from an engineering point of view. By R. Ledley, The George Washington Univ. 835 pp., 398 illus., 62 tables, \$14.50

## SELF-SATURATING MAGNETIC AMPLIFIERS

A fresh engineering approach to self-saturating magnetic amplifiers—principles, design, applications. By G. Lynn, T. Pula, J. Ringelman, and F. Timmel, Westinghouse Electric Corp. 232 pp., 152 illus., \$8.00

## FREE EXAMINATION

McGraw-Hill Book Co., Dept. L-12-16  
327 W. 41st St., New York 36, N. Y.

Send me book(s) checked below for 10 days' examination on approval. In 10 days I will remit for book(s) I keep, plus few cents for delivery costs, and return unwanted book(s) postpaid. (We pay delivery costs if you remit with this coupon—same return privilege.)

- Tatarski—Wave Prop. in a Random Med., \$9.75
- Bartee—Digital Computer Fund., \$6.50
- Meghrebian & Holmes—Reactor Analysis, \$19.50
- Ledley—Digital Computer & Control Eng., \$14.50
- Lynn et al.—Self-Saturating Magnetic Amplifiers, \$8.00

(PRINT)  
Name .....  
Address .....  
City ..... Zone ..... State .....  
Company .....  
Position .....  
For price and terms outside U. S.  
write McGraw-Hill Int'l, N.Y.C. L-12-16

CIRCLE 131 ON READER SERVICE CARD 131

Install...



## NATIONAL Molded Activated Carbon Getters

in your sealed electronic relay.

Here's why:

- **LARGE CAPACITY** — For contaminants which contribute to contact point failure.
- **STRONG** — Will not break down or dust even under severe mechanical operating conditions.
- **MOLDED** — Getter can be formed to fit your relay.

"National" and "Union Carbide" are registered trade-marks for products of

**NATIONAL CARBON COMPANY**

Division of Union Carbide Corporation

270 Park Avenue, New York 17, New York



CIRCLE 216 ON READER SERVICE CARD

was organized in 1937, becomes chairman of the board.

Rockwood, former general manager for operations of Stromberg-Carlson's telecommunication division, has had 19 years' experience in the field of communication equipment.



### U. S. Time Corp. Hires Division Director

NORMAN C. ZATSKY has been appointed director, research and development division, U.S. Time Corp. at Irvington-on-the-Hudson, N.Y.

He was formerly chief, components engineering, Reeves Instrument Corp., Garden City, N.Y.

# NEW IDEAS FOR SALE!

Words and pictures tell you about the top new product ideas each week in "On the Market". Who makes 'em and what they'll do for you. Easy way to keep in touch with the latest and best.

FIND WHAT YOU NEED IN...

## electronics

## Coils for Contact Capsules

SINGLE • DOUBLE • TRIPLE

For Class B  
Class F  
Class H  
operation  
(Please specify)

# Coto-Coils

COTO-COIL CO., INC., 65 Pavilion Avenue, Providence 5, R. I.

132 CIRCLE 132 ON READER SERVICE CARD

### Sprague Electric Elects President

ERNEST L. WARD has been elected president of Sprague Electric Co., North Adams, Mass. He replaces the late Julian K. Sprague.

Ward joined the company in 1946 as a vice president. He was elected to the board of directors in 1947 and, in 1953, was appointed executive vice president in charge of all the company's manufacturing activities.

### Portmann Assumes New Position

PAGE COMMUNICATIONS ENGINEERS, INC., Washington, D. C., has appointed Pierre A. Portmann as senior staff engineer in its research and development directorate.

He came to Page from the electronics division of Westinghouse Electric Co. where he conducted research programs for the development of system concepts capable of

yielding improved reliabilities by integrating concepts in the fields of information theory, propagation, and signal detection, with automatic processing and display.

### Transis-Tronics, Inc. Appoints Allee

RUSSELL V. ALLEE has been named chief engineer of Transis-Tronics, Inc., Santa Monica manufacturer of solid state electronic components.

He was formerly senior engineer at Hoffman Electronics.

### WacLine Announces Personnel Changes

WACLINE, INC., Dayton, O., announces several internal appointments.

Richard G. Swanson is factory manager of the panel meters division, and Burdette L. Bailey is factory manager of the special products division.

Melvin L. Hartman becomes chief electrical engineer and Alvin Forsythe, chief mechanical engineer, serving both divisions under the director of engineering, Miles E. Goll.

Except for engineering, the two divisions will operate independently, and expanded activities in 1961 are planned for both groups.



### G. H. Hudson Takes Managerial Post

GEORGE H. HUDSON has recently been appointed manager of manufacturing controls at Perkin Electronics Corp., El Segundo, Calif.

He was formerly associated with Topp Industries and Inet, Inc., in production management.

Perkin manufactures d-c power supplies and a-c line regulators.

## Which of these Craig skills and services can help you ?

- ▶ Systems housing — light weight, high strength aluminum shelters, vans and trailers.
- ▶ Systems components — telescoping antenna masts, transit cases, cabinets, equipment racks.
- ▶ Systems installation service — layout and installation of transportable systems, through final checkout.
- ▶ Systems packaging research — engineering design and development for ground support and electronic equipment protection.
- ▶ Complete production facilities — to handle your complete packaging assignment.
- ▶ A unique "aluminum-chemical research" service — engineering "brainpower pool" for solving virtually any problem in aluminum and foamed plastic fabrication.

WRITE TODAY FOR CRAIG'S  
CAPABILITIES BROCHURE



# Craig

SYSTEMS, INC.

Dept F-10, 360 Merrimack St., Lawrence, Mass. - Tel. MUdock 8-6961  
Business systems and equipment are another Craig specialty through LeFebure Corporation, Cedar Rapids, Iowa — a Craig subsidiary.

CIRCLE 218 ON READER SERVICE CARD



## WHO DROPPED THE BINOCULARS?

With everybody watching each other along the DEW line and the Iron Curtain these days, electronics has replaced binoculars.

What's happening in the giant markets for missile controls, radar and communications equipment?

electronics tells how things are going, keeps you informed of developments as they occur. This is a good time to subscribe or renew your subscription. Just fill in box on Reader Service Card. Easy to use. Postage free.

## FIND WHAT YOU NEED IN... electronics

# reliability

...based  
on  
experience



## ultra-high precision capacitors

Southern Electronics high-precision capacitors are demonstrating their proven reliability today in twelve different missiles, analog computers, and many radar and communications applications.

SEC high-precision capacitors utilize polystyrene, providing .01% tolerances, and mylar and teflon to meet .5% requirements. They show excellent stability characteristics over an extended temperature range, and tolerances are unaffected even at extreme high altitudes.

The unusual accuracy, stability and reliability of SEC capacitors are the result of engineering experience concentrated on the design and manufacture of precision capacitors only, plus rigid quality control standards subjecting each capacitor to seven inspections during manufacture, plus final inspection.

Our engineering experience enables us to meet your size requirements, while holding to exact capacitance and tolerance specifications.

SEC capacitors are manufactured in a wide range of capacitance to meet your needs from 100 mmfd. to any higher value, and meet or exceed the most rigid MIL-SPECS.

Write today for detailed technical data and general catalog.



Pioneers in custom precision  
capacitor engineering

# SOUTHERN ELECTRONICS Corporation

150 WEST CYPRESS AVENUE  
BURBANK, CALIFORNIA

# Electronic Engineers

for assignments  
on APL's  
satellite program

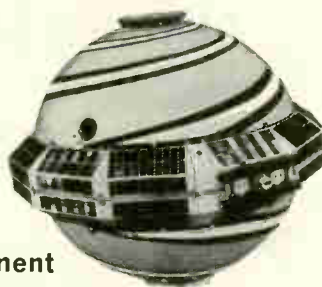

## Research • Development Systems Engineering

You will find association with APL particularly rewarding if you appreciate an atmosphere conducive to original thinking, and if you are capable of making contributions to advance the state-of-the-art.

### Satellite Development Group

The group is concerned with research and development of satellite-borne equipment, which will be capable of performing highly complex functions. The instruments have to operate in a space environment on exceedingly low power sources, and they have to work for five to ten years without malfunction.

Emphasis is on conceptual design rather than hardware fabrication. Engineers will work without close supervision, will enjoy freedom to create and investigate, and do not have to spend much time writing proposals. BS or more in physics or electronic engineering required. Two or more years of experience in transistor switching circuits and familiarity with utilization of memory and/or logical devices desired.

### Satellite Ground Systems Group

This group is responsible for the design of data handling systems for use in shipboard and airborne navigational equipment, and for ground tracking equipment. Assignments involve development of novel and highly sophisticated data processing systems, systems coordination, and technical supervision of contractors.

BS or more in physics or electronic engineering plus four to five years of experience in data processing systems required.

For details about these career opportunities, address your inquiry to:  
Professional Staff Appointments

The Applied Physics Laboratory  
The Johns Hopkins University

8633 Georgia Avenue, Silver Spring, Md.  
(Suburb of Washington, D. C.)

CIRCLE 384 ON READER SERVICE CARD

#### FIELD SERVICE ENGINEERS (25)

\$9,000 to \$10,000

BS Degree desirable but not mandatory. Renders technical assistance in resolving problems. Three years exp. with electronic hardware. Liaison with customers on service and maintenance. Excellent opportunity. Fee paid.

Contact Lew Musgrave

MONARCH PERSONNEL

28 East Jackson Blvd. Chicago 4, Illinois

CIRCLE 385 ON READER SERVICE CARD

#### SECTION HEAD

Salary \$18,000 PER YEAR

Heavy digital circuitry with computer application and magnetic core experience. Advanced E.E. Degree and minimum of 5 years experience in supervising engineers and technicians. Company client assumes all employment expense.

ESQUIRE PERSONNEL

202 S. State St. Chicago 4, Ill.

CIRCLE 386 ON READER SERVICE CARD

ADDRESS BOX NO. REPLIES TO: Box No.

Classified Adv. Div. of this publication.

Send to office nearest you.

NEW YORK 36: P. O. Box 12

CHICAGO 11: 520 N. Michigan Ave.

SAN FRANCISCO 4: 68 Post St.

#### SELLING OPPORTUNITY AVAILABLE

Agent Required to cover entire U.S.A. for the sale of a new universal wiring board, meeting with great success in Europe. For full particulars apply RW-5744, Electronics.

#### SELLING OPPORTUNITY WANTED

Agent, with suitable connections, available for sales and service of Electronic products. Write John Bisco, 349 High Street, Cheltenham, England.



### MANUFACTURERS' REPRESENTATIVES

IN THE ELECTRONIC INDUSTRY

### SAMUEL K. MACDONALD, INC.

manufacturers representatives over 25 years  
1531 SPRUCE STREET, PHILA. 2, PA.

Territory:

Pennsylvania • New Jersey  
Delaware • Maryland  
Virginia • West Virginia  
District of Columbia

Other Offices:

Pittsburgh  
Baltimore  
Washington, D.C.

CIRCLE 387 ON READER SERVICE CARD

#### PROFESSIONAL SERVICES

### JOHN LESSER & STAFF

ENGINEERING—DESIGN—  
DEVELOPMENT—PRODUCTION

For Edge Light Panels Qualified to MIL-P-7788A  
and Instruments Illuminated To MIL-L-25407A

BODNAR PRODUCTS CORP.

236 Huguenot St., New Rochelle, N. Y. NE 6-4664

### SEARCHLIGHT SECTION

(Classified Advertising)

BUSINESS OPPORTUNITIES

EQUIPMENT - USED or RESALE



### DIAL TELEPHONE \$8.95!

Gov't surplus-factory reconditioned. Standard type with coil cord, complete with wire, fully guaranteed. Add \$2.00 if plug is required. Write for list. Shipments F.O.B.

SURPLUS SAVING CENTER

Waymart Dept. E-130 Penna.

CIRCLE 460 ON READER SERVICE CARD

#### CONTRACT WORK WANTED:

Plastics compression molding firm desires contract work. Skilled labor, quality production of components, excellent facilities, modern plant. Located vicinity New York City. Write:

CWW-5682, Electronics

Class. Adv. Div., P.O. Box 12, N.Y. 36, N.Y.

CIRCLE 461 ON READER SERVICE CARD

electronics

# INDEX TO ADVERTISERS



## Audited Paid Circulation

*AMP Incorporated .....	70	*Hallcrafters Company, The.....	58
Aeronautical Communications Equip- ment, Inc. ....	32	*Handy & Harman .....	68
Allegheny Ludlum Steel Corp.....	29	*Haydon Co., Inc., A. W. ....	102
Allen Organ Company, Inc.....	129	*Hughes Aircraft Company .....	30
*Allied Control Company, Inc.....	95	Industrial Instruments, Inc. ....	51
Ampex Data Products .....	44	*International Electronics Industries, Inc. ....	130
*Amphenol-Borg Electronics Corp. Borg Equipment Division .....	54	International Electronic Research Corp. ....	121
Anelex Corporation .....	108	International Resistance Co. ....	67
Autonetics Division of North American Aviation Inc. ....	42	*International Telephone and Telegraph Corp. ....	103
Avnet Electronics Corp.....	63	Communications Division .....	109
Bausch & Lomb Inc. ....	41	Johnson Company, E. F.....	118
Bell Telephone Laboratories.....	113	*Kester Solder Co. ....	100
Bendix Corp. Bendix Pacific .....	107	Kuhnke, H. ....	129
Eclipse Pioneer .....	48, 49	*Lambda Electronics Corp.....	3
Red Bank .....	50	*Lapp Insulator Co., Inc.....	52
Scintilla .....	11	Levin and Son, Inc., Louis.....	66
Boesch Mfg. Co., Inc.....	114	Mac Panel Company .....	8
Bristol Company, The .....	116	Malco Manufacturing Company.....	125
California Technical Industries....	126	*Marconi Instruments, Ltd.....	115
*Celco-Constantine Engineering Laboratories .....	130	Martin Co. ....	53
*Cinch Manufacturing Company.....	91	McGraw-Hill Book Co. ....	131
*Clevite Transistor, A Division of Clevite Corp. ....	35, 36	Microwave Dynamics Corp.....	3rd cover
*Computer Instruments Corp.....	33	Millen Mfg. Co., Inc., James.....	66
Conant Laboratories .....	95	NJE Corp. ....	7
Consolidated Avionics Corp.....	96	*Narda Microwave Corporation.....	23
*Constantine Engineering Laboratories .....	130	National Carbon Company.....	132
*Coto-Coil Co., Inc. ....	132	*Non-Linear Systems, Inc.....	45
Craig Systems Inc.....	133	*North Atlantic Industries, Inc.....	136
Cubic Corp. ....	55	North Electric Company .....	28
*DeMornay-Bonardi .....	127	O'Neil-Irwin Mfg. Co. ....	6
Dynacor Inc. A Subsidiary of Sprague Electric Co.....	135	Pacific Semiconductors, Inc.....	13
*Eitel-McCullough, Inc. ....	34	Page Communication Engineers Inc..	123, 125, 127
*Electrical Industries, Inc.....	47	*Panoramic Radio Products, Inc....	117
Electronic Measurements Co. Inc....	129	*Philco Corp. Government Industrial, Div.....	31
Englehard Industries, Inc.....	20, 21	Philips Gloeilampfabriek, N. V....	64, 65
Fansteel Metallurgical Corp.....	56, 57	*Power Designs, Inc. ....	123
Gardner-Denver Company .....	16	Precision Instrument Co.....	24, 25
*General Ceramics Division of Indiana General Corporation....	60	*See Advertisement in the July 20, 1960 issue of Electronics Buyers' Guide for complete line of products or services.	
*General Instrument Co. Semiconductor Div. ....	105		
*General Precision Eqpt. Corp. Kearfott Div. ....	124		
Gertsch Products .....	122		
Gries Reproducer Corp. ....	127		

# TOUGH

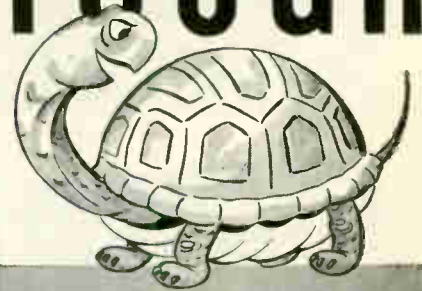

## ... AS A TURTLE'S BACK



### ARMAG\*-PROTECTED DYNACOR® BOBBIN CORES AT NO EXTRA COST!

Tough-as-tortoise-shell Armag armor is an exclusive Dynacor development. It is a thin, non-metallic laminated jacket for bobbin cores that replaces the defects of nylon materials and polyester tape with very definite advantages—and, you pay no premium for Armag extra protection.

Tough Armag is suitable for use with normal encapsulation techniques on both ceramic and stainless steel bobbins. It withstands 180°C without deterioration—is completely compatible with poured potted compounds—has no abrasive effect on copper wire during winding—fabricates easily to close-tolerance dimensions—inner layer is compressible to assure tight fit on bobbin—does not shrink, age or discolor.

Write for Engineering Bulletins DN 1500, DN 1000A, DN 1003 for complete performance and specification data covering the wide range of Dynacor low cost Standard, Special and Custom Bobbin Cores—all available with Armag non-metallic armor.

\*TRADEMARK

# DYNACOR

**DYNACOR, INC.**  
A SUBSIDIARY OF SPRAGUE ELECTRIC CO.

1006 Westmore Ave. • Rockville, Maryland

# North Atlantic Series RB500 Ratio Boxes



Model RB-504  
Bench mount

Measure A.C. Ratios  
From -0.11111  
To +1.11111...with  
accuracy to 1 ppm

With any of North Atlantic's RB500 Ratio Boxes you can now measure voltage ratios about zero and unity—without disrupting test set-ups.

And—a complete range of models from low cost high-precision types to ultra-accurate ratio standards—in portable, bench, rack mount, binary and automatic stepping designs—lets you match the model to the job.

For example, characteristics covered by the RB500 Series include:

- Frequency: 25 cps to 10 kc.
- Accuracy: 10 ppm to 1.0 ppm
- Input voltage: 0.35f to 2.5f
- Input impedance: 60 k to 1 megohm
- Effective series impedance: 7.5 ohms to 0.5 ohms
- Long life, heavy duty switches

Name your ratio measurement and its probable there's a North Atlantic Ratio Box to meet them—precisely. Write for complete data in Bulletin 11U.

Also from North Atlantic  
...a complete line of  
complex voltage ratio-  
meters...ratio test sets...  
phase angle voltmeters



**NORTH ATLANTIC**  
industries, inc.  
Terminal Drive, Plainview, L. I., N. Y.  
OVerbrook 1-8600

Racal Engineering Ltd.....	107	Weinschel Engineering .....	14
*Radio Corporation of America..	4th cover	Weston Instruments .....	59
*Radio Materials Company.....	101	White S. S. ....	106
*Raytheon Company .....	2nd cover		
*Reeves-Hoffman Division of Dynamics Corp. of America.....	123	<b>PROFESSIONAL SERVICES .....</b>	<b>134</b>
Sarkes Tarzian Inc. ....	111	<b>MANUFACTURERS' REPRESENTATIVES</b>	
Sealectro Corp. ....	94	MacDonald Inc., Samuel K.....	134
*Southern Electronics Corp. ....	133		
Spectrol Electronics Corporation....	97		
Speer Carbon Co. ....	37		
Sprague Electric Co. ....	22		
St. Regis Paper Co. ....	2		
Stackpole Carbon Co. ....	61		
Stromberg-Carlson .....	131		
*Sylvania Electric Products, Inc. Electronic Tube Division.....	17, 18		
Taylor Fibre Co. ....	19		
Tektronix, Inc. ....	62		
Tensor Electric Development Co., Inc. ....	95		
*Texas Instruments Incorporated Semiconductor Components Division .....	26, 27, 99		
*Tung-Sol Electric, Inc.....	93		
United Shoe Machinery Corp....	69, 123		
Vernitron Corporation .....	125		
Vickers Incorporated Division of Sperry-Rand Corp. ....	15		

\* See Advertisement in the July 20, 1960 issue of Electronics Buyers' Guide for complete line of products or services.

## CLASSIFIED ADVERTISING

F. J. Eberle, Business Mgr.

**EMPLOYMENT OPPORTUNITIES... 134**

## SPECIAL SERVICES

Contract Work ..... 134

## EQUIPMENT

(Used or Surplus New)

For Sale ..... 134

## ADVERTISERS INDEX

Applied Physics Laboratory—  
Johns Hopkins University..... 134  
Esquire Personnel ..... 134  
Monarch Personnel ..... 134  
Surplus Saving Center..... 134

This index and our Reader Service Numbers are published as a service. Every precaution is taken to make them accurate, but ELECTRONICS assumes no responsibilities for errors or omissions.

## electronics



Audit Bureau  
of Circulations



Associated Business  
Publications

## Audited Paid Circulation

**BRUCE A. WINNER,**  
Advertising Sales Manager

R. S. QUINT, Assistant Advertising Sales Manager and Buyers' Guide Manager; FRED STEWART, Promotion Manager; RICHARD J. TOMLINSON, Production Manager; GEORGE E. POMEROY, Classified Manager; HUGH J. QUINN, Circulation Manager.

J. Patten; ATLANTA M. Miller; DALLAS Robert T. Wood; LONDON Edward E. Schirmer; FRANKFURT Stanley R. Kimes; GENEVA Michael R. Zeynel.

ADVERTISING REPRESENTATIVES: NEW YORK Donald H. Miller, Henry M. Shaw, George F. Werner; BOSTON William S. Hodgkinson, Donald R. Furth; PITTSBURGH David M. Watson; PHILADELPHIA Warren H. Gardner, William J. Boyle; CHICAGO Harvey W. Wernecke, Martin J. Gallay; CLEVELAND P. T. Fegley; SAN FRANCISCO T. H. Carmody, R. C. Alcorn; LOS ANGELES Carl W. Dysinger, D. A. McMillan, Marshall Freeman; DENVER

BRANCH OFFICES: National Press Bldg., Washington 4, D.C.; McGraw-Hill Bldg., Copley Square, Boston 16; Four Gateway Center, Pittsburgh 22; Six Penn Center Plaza, Philadelphia 3; 520 North Michigan Avenue, Chicago 11; 55 Public Square, Cleveland 13; 68 Post Street, San Francisco 4; 1125 West Sixth St., Los Angeles 17; 1740 Broadway, Denver 2; 1301 Rhodes-Haverty Bldg., Atlanta 3; 901 Vaughn Bldg., Dallas 1; McGraw-Hill House, London E.C.4; 85 Westendstrasse; Frankfurt/Main; 2 Place de Port, Geneva.



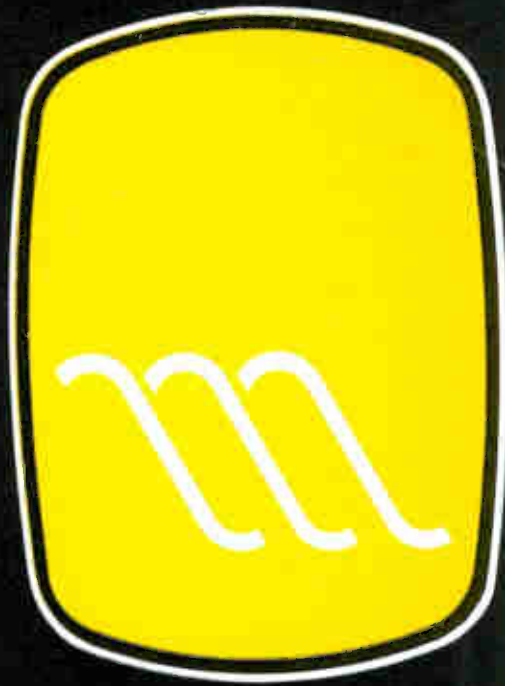

## A Symbol of Reliability

### IN THE MICROWAVE FIELD

Microwave Dynamics Corporation is achieving new standards of reliability through imaginative use of advanced concepts and techniques in:

### MICROWAVE *Systems... Components... Test Equipment*

ANOTHER EXAMPLE of creative engineering by Microwave Dynamics Corporation... the advanced Microwave Power Supply, Model 500... the FIRST microwave power supply permitting integration into the measurement system.



- Integral dc oscilloscope with sweep functions derived from internal modulator.
- Flexible operation with 4 floating 2-terminal outputs, plug-in precision modulators and voltage range extension units.
- Forestalled obsolescence with wide range of outputs including continuously variable dc filament supply.
- Load protection with overload relays and meter range selectors slaved to output range.
- Low noise with low ripple and excellent isolation from line noise.
- Stable with excellent regulation and minimized long-term drift.

### Model 500 MICROWAVE POWER SUPPLY SPECIFICATIONS

	VOLTAGE	REGULATION From 105-125 vac	INTERNAL IMPEDANCE	RMS RIPPLE	DIAL ACCURACY
Beam	Continuously variable 0-2.2 kv dc at 0-200 ma max. (2.2-4.2 kvdc optional)	±0.005%	< 0.2 ohms	1 mV	0.05% resolution 0.5% resettability
Grid	-250 to +100 vdc continuously variable 0-20 ma	±0.005%	< 0.5 ohms	1 mV	0.05% resolution 1% resettability
Filament	0-12.6 vdc continuously variable 0-5 amp dc	1%		1%	
Repeller	1) 1000 vdc fixed 2) 20-1000 vdc continuously variable 3) 20-1000 vdc continuously variable	±0.005%	< 100 k ohm	0.5 mV	0.05% resolution 0.5% resettability

Modulation • Plug-in capability including square-wave at 1000.0 cps and 1000 cps ±10%, sawtooth at 40-400 cps, and variable frequency square wave 200-4000 cps.  
• Synchronization and external CRO drive outputs available.

For complete information, circle inside back cover on reader service card.

**MICROWAVE DYNAMICS CORPORATION**  
a subsidiary of Talley Industries, Inc.

PLAINVIEW INDUSTRIAL PARK, PLAINVIEW, L. I., N. Y. • Overbrook 1-6811



90 Watts CW Input (ICAS) up to 60 Mc; 69 Watts CW Input (ICAS) at 175 Mc.



# FULL "TALK-POWER" IN LESS THAN A SECOND

NEW RCA-4604 QUICK-HEATING BEAM POWER TUBE FOR MOBILE COMMUNICATIONS SERVICE ELIMINATES POWER DRAIN DURING STANDBY PERIODS.

Containing a unique oxide-coated filament that heats up faster than an operator can raise a microphone to talk, RCA-4604 makes it practical to reduce the stand-by load on the battery-generator system—*right down to zero!* Filament voltage is 6.3 volts; current is 0.65 ampere. Heating time is less than a second. RCA-4604 can deliver 30 watts of power in CW or FM service at 175 Mc and will give proportionally greater power output at lower frequencies. It incorporates the same basic construction of the RCA-6146—popular favorite for mobile communications equipment. And the RCA-4604 is popularly priced for wide application. For sales information contact your nearest RCA Field Office. For free technical bulletin on the RCA-4604, write Section L-19-Q-3, Commercial Engineering, RCA Electron Tube Division, Harrison, N. J.



The Most Trusted Name in Electronics  
RADIO CORPORATION OF AMERICA