

electronics

Dendritic ribbon of controlled thickness provides dice for 600 MADT transistors a minute with no waste. Growth and etching process has made possible complete use of germanium ingot. See p 98

A McGraw-Hill Publication 75 Cents

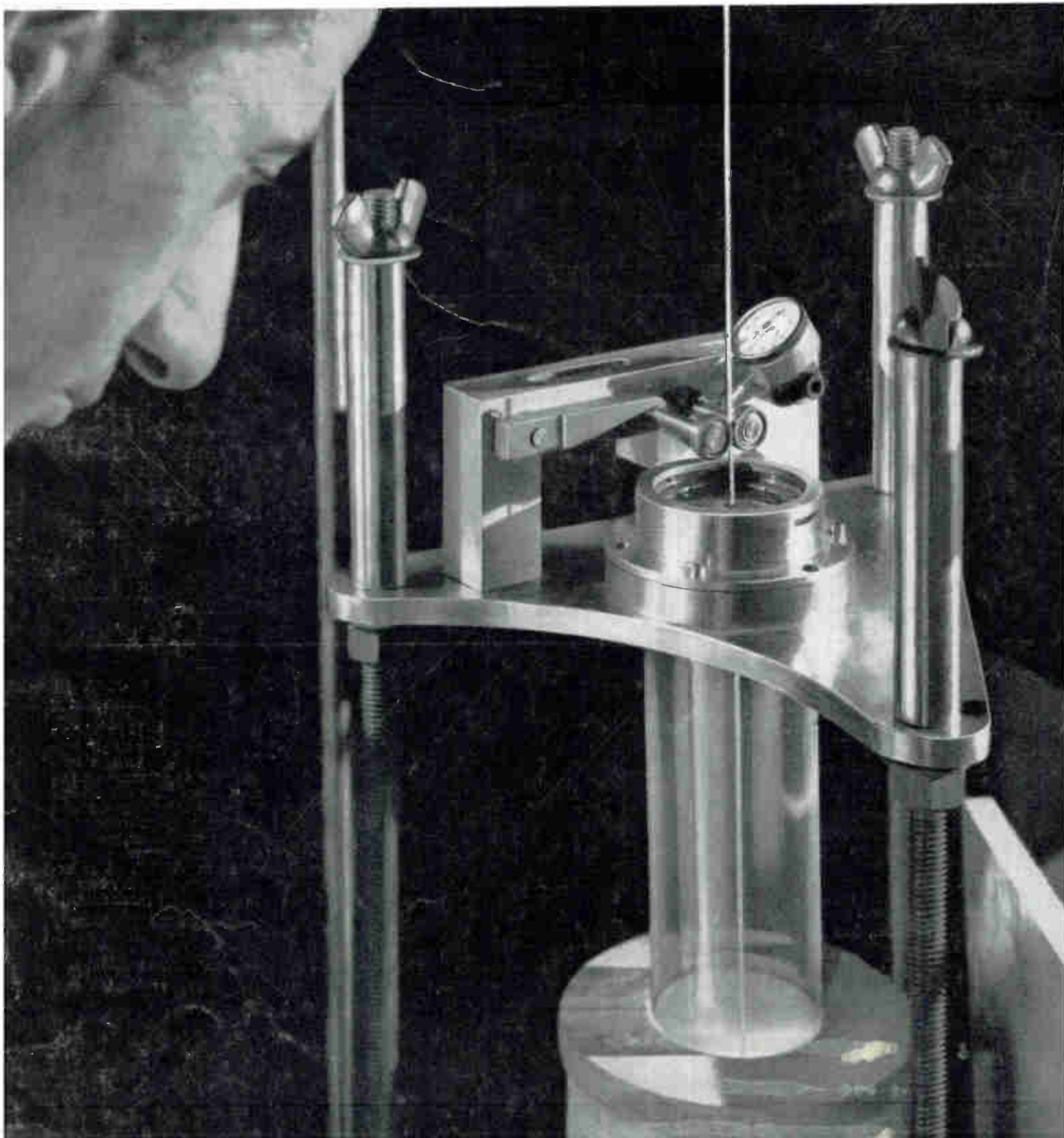

TESTED waveguide and coaxial equipment



hp 752 Multi-Hole Coupler

Precision directional couplers, 3 models, coupling factors 3, 10 and 20 db. Coupling accuracy ± 0.4 db or 0.7 db. Directivity better than 40 db full range, SWR less than 1.1 (752A), 1.05 (752C/D). S through R bands, 2.6 to 40.0 KMC. \$100.00 to \$375.00.

hp 764D-767D Dual Directional Couplers



High directivity dual coaxial couplers make reflectometer measurements practical in vhf and uhf coax systems. Flat response, high power capacity, low insertion loss. Four models, covering 216 to 4,000 MC collectively. 764D/765D \$160.00. 766D/767D \$150.00.



870A Slide Screw Tuners

For flattening waveguide systems, matching, etc. Probe position, penetration adjusts to set up reflection canceling existing reflection. Precision lead screw or micrometer varies probe insertion; vernier adjusts probe position. Corrects SWRs of 20 with accuracy of 1.02 SWR. For S, G, J, H, X, M, P, K, R bands, 2.6 to 40.0 KMC. \$125.00 to \$300.00.



hp 372 Precision Attenuators

Rugged, broadband fixed attenuators retaining precise calibration regardless of humidity, temperature or time. Invariant attenuation assured by permanent, "multi-hole coupler" joining of two waveguides. 10 and 20 db models for S, G, J, H, X and P bands, 2.6 to 18.0 KMC. \$100.00 to \$375.00.



hp 375A Variable Flap Attenuators

Simple, convenient for adjusting waveguide power or isolating source and load. Max. SWR less than 1.15 full range; attenuation variable 0 to 20 db, dissipates average powers up to 0.5 or 1 watt. S through R bands, 2.6 to 40.0 KMC. \$90.00 to \$180.00.

362A Low Pass Filter

Compact models increase SWR measurement accuracy by suppressing harmonics; feature low insertion loss, broad stop band; M, N Band models, each \$125.00.

WR75 Components—10 to 15 KMC

An increasing number of precision waveguide instruments shown here are available in the M-band, recently allocated for private microwave communications.

See your **hp** catalog for general description, call your **hp** rep for prices, details.



hp 476A, 477B Detector Mounts

hp 476A Universal Bolometer Mount, for rf power measurement 10 to 1,000 MC; no tuning, SWR less than 1.25. \$85.00. **hp 477B Coaxial Thermistor Mount** (shown) for rf power measurement 10 MC to 10 KMC; no tuning, SWR less than 1.5, \$75.00.



hp 485 Detector Mounts

Three basic series offered: S485A for S band (no tuning, 1.35 SWR, 821 element); 485B, for G, J, H, X bands (tunable, uses 1N23, 1N21, 821 element, 1.25 SWR using barretter); 485D for S, G, J bands (factory-installed 821 barretter). \$75.00 to \$170.00.



hp 487B Thermistor Mounts

Each covers full range of its waveguide. No tuning, SWR 1.5 or 2.0 max. Max. power 10 mw. Rugged construction, negative temperature coefficient thermistors virtually eliminate burnout. G through R bands, 3.95 to 40.0 KMC. \$75.00 to \$225.00.

hp 810/815B Slotted Sections

hp 810B Slotted Sections hp 810B, for 809B carriage, flanged, waveguide section with accurately machined slot. Slot tapered at ends to minimize reflection. Available in 6 waveguide bands (including M-band), 3.95 through 18.0 KMC. \$90.00 to \$110.00.

hp S810A. Complete slotted section assembly including probe carriage. In 2.6 to 3.95 KMC (S-band) size only. \$450.00.

hp 815B Slotted Sections For mounting in 814B carriage. Available in K and R bands, 18.0 to 40.0 KMC. Accurately machined; easy interchange, precise positioning. \$265.

hp 806B Coaxial Slotted Section 3 to 12 KMC, mounts in 809B, has Type N connectors. \$200.00.

hp 805A/B Slotted Lines

Utmost mechanical rigidity, less leakage, greater accuracy, SWR 1.02 or 1.04. Range 500 MC to 4 KMC, reads in cm and mm to 0.1 mm. **hp 805A**, for 50 ohm Type N, **hp 805B**, for 46.3 ohm RG 44/U. **hp 805A/B**, \$450.00.



hp 415B Standing Wave Indicator

For all waveguide and coaxial slotted sections. Gives readings in SWR or db. Single frequency operation; 315 to 2,020 cps. Low noise level, 0.1 μ v (full scale) sensitivity, 60 db calib. attenuator. \$200.00 (cabinet), \$205.00 (rack mount).



hp 416A Ratio Meter

Displays ratio between two signals, irrespective of common amplitude variations. Ideal with directional couplers and swept frequency sources for swept frequency measurement of VSWR, reflection coefficient, gain, insertion loss and other microwave parameters. Calibrated in VSWR, % reflection, db. Oscilloscope, recorder output. \$475.00 (cabinet) \$460.00 (rack mount)

HEWLETT-PACKARD COMPANY

1032A Page Mill Road
Cable "HEWPACK"

Palo Alto, California, U.S.A.
Davenport 6-7000

Field representatives in all principal areas

HEWLETT-PACKARD S.A., Rue du Vieux Billard No. 1,
Geneva, Switzerland

Cable "HEWPACKSA"

Tel. No. (022) 26. 43. 36

presenting 182 high quality







FULL-RANGE TESTED

microwave measuring instruments

Your  representative offers two very important advantages



- the world's most complete (and rapidly expanding) microwave line
- complete assurance that the equipment will perform precisely as specified

 makes sure you get what you pay for by rigid quality control plus 100% electrical testing using  developed methods including reflectometer and swept frequency techniques.  knows when a parameter is out of spec; never gambles your money and time that 3 or 4 sample measurements taken across an instrument's range truly indicate its full-range performance.

See your  rep now for FULL-RANGE TESTED microwave equipment . . . *get what you pay for.*



FREE
TEST METHOD
DESCRIPTION

Interested in swept frequency testing? Ask your rep, or write direct for "Application Note 42"  416A Ratio Meter, describing reflectometer systems and  swept frequency measuring techniques.

NEW NOISE MEASURING EQUIPMENT



 344A Noise Figure Meter

Quickly, accurately measures noise figure of operating radar sets. Automatic operation; simple front panel calibration. Militarized, transistorized, reliable in extreme environments, minimum size and weight. Continuous noise figure presentation on most radar receivers. Extremely high sensitivity permits decoupling noise source up to 20 db from main transmitter line to minimize system degradation. Provision for automatic alarm, remote noise figure monitoring, modulating. Meter scale/excess noise options; 25 or 30 MC input frequency, 1 MC bandwidth, 75 ohms input impedance. Approx. \$1,600.00 (depending on options and modifications selected).



 340B/342A Noise Figure Meters

General-purpose instruments making possible, in minutes, receiver and component alignment jobs that once took hours. Simplifies accurate alignment; encourages better maintenance; better performance.

 340B automatically measures, continuously displays IF or receiver noise figure at 30 or 60 MC; other freq. on order. \$715.00 (cabinet) \$700.00 (rack).

 342A, similar, operates on 30, 60, 70, 105, 200 MC. 30 MC and 4 other frequen-

cies between 38 and 200 MC on order. \$815.00 (cabinet) \$800.00 (rack). (Note: Models 340B and 342A available only in the U.S.A. and Canada)

 343A vhf Noise Source, temperature limited diode broadband source, 10 to 600 MC, 5.2 db excess noise, \$100.00.

 345B IF Noise Source, 30 or 60 MC (others to order); 4 impedances, 5.2 db excess noise. \$75.00.

 347A Waveguide Noise Source, Argon gas discharge tubes in waveguide section; for bands S, G, J, H, X, P, 2.6 to 18.0 KMC, 15.2 db excess noise. \$190.00 to \$250.00.

Basic test, power and
impedance measuring
equipment



World's largest line of FULL-RANGE

BASIC TEST EQUIPMENT



Ⓢ 382A Precision Attenuators

Popular Ⓢ 382A series precision attenuators now include in "K" and "R" bands, 18.0 to 40.0 KMC. "K", "R" band attenuators are of new, space-saving design (see photo). Direct reading, one-control setting, high power handling capacity. Attenuation 0 to 50 db full range, independent of frequency. Phase shift constant with attenuation. G, J, H, X, M, P, K, R bands. \$275.00 to \$500.00.



Ⓢ 421A, 420A/B Crystal Detectors

Ⓢ 421A (shown), silicon crystal detector of rf signals in waveguide systems. High sensitivity, for H, X, M, P bands, 7.05—18 KMC. Ⓢ 421A, \$75.00 to \$135.00 Ⓢ 420A, similar but for Type N coax lines, 10 MC to 12.5 KMC. \$50.00 each. Also Ⓢ 420B, same in matched pairs, \$150.00 pair.

Ⓢ 532 Waveguide Frequency Meters

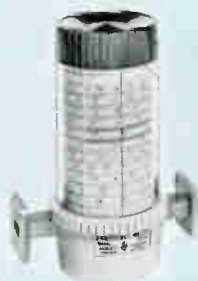

New design for G, H, J, M, P, K, R bands. Wide band, direct reading, no interpolation or charts. Has a high Q resonant cavity tuned by choke plunger; no sliding contacts. Transmits almost full power at resonance; resonance indicated by 1.5 db dip in output. Similar model for X-band. \$150.00 to \$275.00.



Ⓢ 914 Moving Loads

Waveguide section containing sliding, tapered, low-reflection load. Plunger controls load position, travels 1/2 wavelength at lowest frequency to reverse phase of residual load reflection. Models for S, G, J, H, X, M, P, K, R bands. 2.6 to 40.0 KMC. \$55.00 to \$250.00.



Ⓢ P932A/934A Harmonic Mixers

Mixer for wide band beat detecting, beat frequency mixer for stabilizing a signal source. Ⓢ P932A 12.4 to 18.0 KMC; Ⓢ 934A (coaxial) covers 2 to 12.4 KMC. Both models: max. input power 100 mw. Ⓢ P932A, \$250.00 Ⓢ 934A, \$150.00.

POWER MEASURING EQUIPMENT



Ⓢ 434A Calorimetric Power Meter

Connect and read powers 10 mw to 10 watts, dc to 12.4 KMC. No barretter, thermistor needed, no external terminations or plumbing. Measures CW or pulsed power. Two simple controls. Dc input impedance 50 ohms approx.; input SWR less than 1.7 full range, less than 1.3 to 5 KMC. Accuracy within 5% full scale. \$1,400.00 (cabinet) \$1,385.00 (rack mount).



Ⓢ 430C Microwave Power Meter

No computations! Provides instantaneous, automatic power readings *direct* in dbm or mw at all frequencies for which there are suitable bolometer mounts. For CW measurements, uses either 1/100 amp fuse or Sperry 821 barretter. Also measures CW or pulsed power with negative coefficient thermistor. Provides up to 16 ma bias current. Operates with Ⓢ 475, 476, 477, 485, 487 mounts. Range 0.01 to 10 mw. \$250.00 (cabinet) \$255.00 (rack mount).

IMPEDANCE MEASURING EQUIPMENT

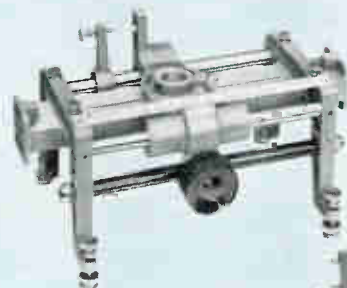

-hp- 809B and 810B



-hp- 814B, 815B, 446B

Ⓢ 809B/814B Universal Probe Carriages

Models 809B and 814B are precision built mechanical assemblies operating, respectively, with Ⓢ 810B and 815B series slotted sections.

Combination of the 809B carriage and 810 slotted sections covers 2.6 to 18.0 KMC. Combination of 814B carriage and 815B series sections covers 18.0 to 40.0 KMC.

On either carriage, waveguides can be interchanged in seconds. Only one probe (for each carriage) covers full frequency range. Manufacture is of highest quality, assures positive mechanical positioning of interchangeable waveguides and precise installation of mating Ⓢ probes. Ⓢ 809B has vernier scale reading to 0.1 mm, is equipped for dial gauge mounting. Ⓢ 814B has dial read directly to 0.1 mm.

Ⓢ 809B, \$160.00, Ⓢ 814B, \$200.00.

Ⓢ 444A/446B Untuned Probes



Ⓢ 444A (shown) is modified crystal (1N76 or 1N26) plus small antenna in convenient housing. Probe penetration easily variable; locks in position. No tuning; sensitivity superior to elaborate single, double tuned probes. Range 3.0 to 18 KMC; fits 3/4" bore. New Ⓢ 446B for Ⓢ 814 Probe Carriage, similar but covers K and R bands, 18.0 to 40.0 KMC. Ⓢ 444A, \$40.00. Ⓢ 446B, \$145.00. Ⓢ also offers model 440A, for barretter or crystal, Type N coaxial, \$85.00.

Quick, easy waveguide interchange



electronics

A McGraw-Hill Publication 75 Cents



W. W. MacDONALD, Editor

J. M. CARROLL, Managing Editor
 SENIOR ASSOCIATE EDITORS: Samuel Weber, Roland J. Charest. ASSOCIATE EDITORS: Frank Leary, Michael F. Tomaino, Sylvester P. Carter, William P. O'Brien, John F. Mason, William E. Bushor, Thomas Emma, Sy Vogel, Leslie Solomon, M. M. Perugini, George J. Flynn. ASSISTANT EDITORS: Michael F. Wolff, Nilo Lindgren, Stanley Froud, Stephen B. Gray. REGIONAL EDITORS: Harold C. Hood (Pacific Coast, Los Angeles), Thomas Maguire (New England, Boston), Cletus M. Wiley (Midwest, Chicago). MARKET RESEARCH EDITOR: Edward DeJongh. BUYERS' GUIDE EDITOR: George Sideris. ART DIRECTOR: Harry Phillips; Howard R. Berry. PRODUCTION EDITOR: John C. Wright, Jr. EDITORIAL ASSISTANTS: Gloria J. Filippone, Arlene Rudd, Bernice Duffy, Patricia Martine, Lorraine Rossi, Virginia T. Bastian, Lynn Emery.

JAMES GIRDWOOD, Publisher

BUSINESS

Fort Huachuca: Arbiter of Army Electronics. Visit to center	38
Electronic Organ Sales Surge. Tempt New Companies.	40
Soviet Nuclear Icebreaker Uses Helicopter Tv. Photo story	43
Epitaxial Techniques Lure Device Designers. New 'glamor' field?	44
AF Blueprints Key Role for New England. Hanscom grows	46
Twin Cities Echoes Call for Research. Urges more investments	50
So Much to Read—So Little Time to Read It	132
Crosstalk	4
Comment	6
Electronics Newsletter	11
Washington Outlook	14
Financial Roundup	20
25 Most Active Stocks	21
Marketing	24
Current Figures	25
Meetings Ahead	52

ENGINEERING

Engineer at Philco checks dendritic ribbon emerging from a pull furnace. See p 98	COVER
New Memory Devices Highlight Research Trends. Preview of NEREM meeting By T. Maguire	73
Using Digital Techniques in L-F Spectrum Analysis. New analyzer handles transient inputs. By B. Grand, L. Packer and J. L. West	78
Atomic Clock Accuracy for Crystal Oscillators. Locking to radio broadcast gives low-cost standard. By K. Nygaard	82
Telemetry Radiation Data By Frequency Variation. Equipment includes both radiation monitor and transmitter. By H. K. Richards	84
Tracking Missiles at Night by Light Flashes. Operates up to 400 miles. By A. Finlay, R. E. Demuth and W. D. Hall	88
How to Extend Operational Amplifier Response. Plug-in analog computer units. By H. Koerner	90
Nomograph Gives Receiver Noise Figure. Graph facilitates calculation of microwave receiver noise. By M. Engelson	93

DEPARTMENTS

Research and Development. Rockets Study D-Layer Density	95
Components and Materials. Dendritic Growth Techniques	98
Production Techniques. Turntable Motor Grinds Own Pulley	102
New On the Market	106
Literature of the Week	118
People and Plants	120
Index to Advertisers	130

**Your most
effective dollars
may be
life insurance
dollars!**

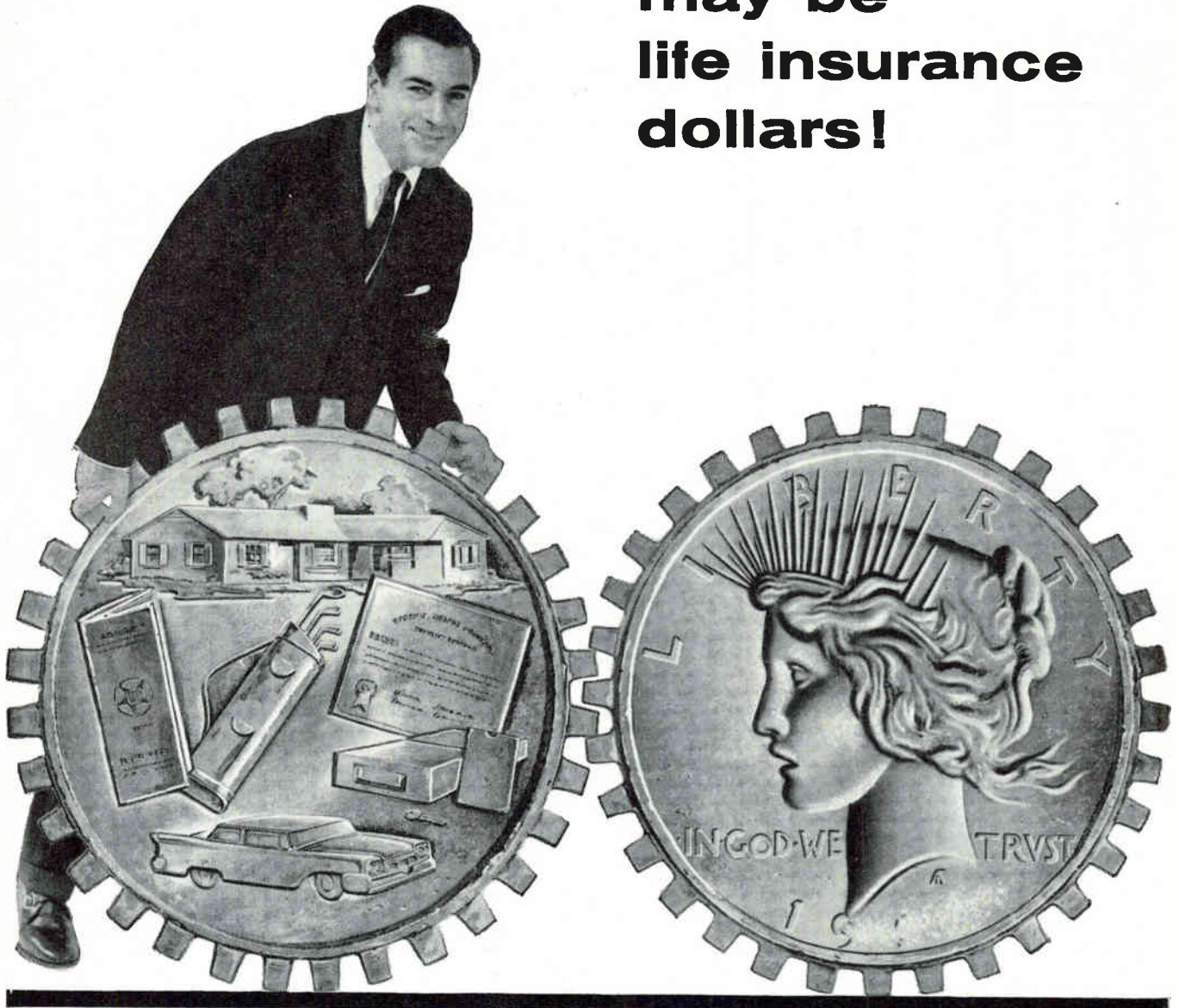

Chances are the dollars you are now putting into life insurance can be stretched further with no increase in cost to you!

The Aetna Life Estate Control Plan coordinates your life insurance with *all* the assets that go into your estate. Then it develops the plan that uses everything to maximum advantage. You'll find your life insurance dollars are more effective dollars.

The Estate Control Plan is exclusive with Aetna Life, a pioneer in family programming. It is available to you through your local Aetna Life representative.

**Aetna Life's Estate Control
Plan works for you!**

- Assures maximum effectiveness from your present life insurance
- Coordinates all your assets
- Balances need with income
- Gives you complete private record



AETNA LIFE
INSURANCE COMPANY

Hartford 15, Connecticut

Affiliates: Aetna Casualty and Surety Company
Standard Fire Insurance Company

OHMITE PRECISION RESISTORS

5 TYPES ... TOLERANCES TO 0.1%

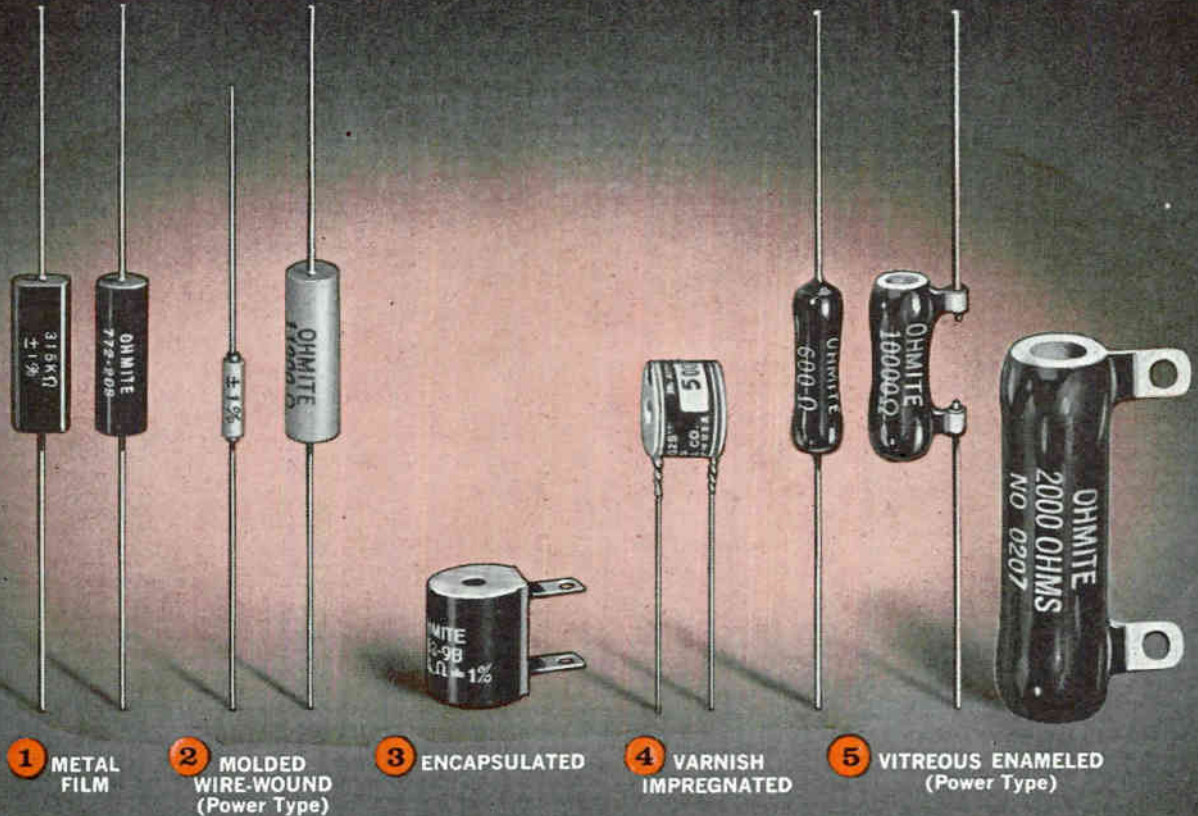

This large family of precision resistors offers you flexibility for varied applications and traditional Ohmite quality for the most exacting requirements. Many of these styles are stocked in a wide range of values by the factory and Electronics Distributors throughout the country.

1 METAL FILM (SERIES 77) Units consist of metal film on glass substrate, hermetically sealed in high temperature resin. They possess long load and shelf life, low noise level, excellent high-frequency characteristics, and exceed military specifications. Rated at 125°C and 150°C. Resistances from 25 ohms to 2.5 megohms. Wattages from 1/4 to 2 watts. Cylindrical, semicylindrical, or flat-sided shapes with radial or axial leads. Tolerances are 0.1%, 0.25%, 0.5%, and 1%. *Bulletin 155.*

2 MOLDED WIRE-WOUND (SERIES 88, Power Type) These resistors utilize a single-layer winding on a ceramic core, welded connections throughout, and a molded silicone ceramic jacket. Uniform physical size in each rating. Supplied in 1, 3, 5, 7, and 10-watt sizes; resistances to approximately 50,000 ohms. Units meet MIL-R-26C specifications. Tolerances are

0.1%, 0.25%, 0.5%, 1.0%, and 3.0% (at 25°C). *Bulletin 153.*

3 ENCAPSULATED (SERIES 85 AND 86) Resistance wire, pie-wound on a steatite bobbin, is enveloped in an epoxy type resin. Welded connections throughout. Units meet and surpass military specifications. Series 85 has axial leads; Series 86, lug-type terminals. Designed to meet the requirements of MIL-R-93B. Resistance values to 3.1 megohms. Tolerances are 0.1%, 0.25%, 0.5%, and 1%.

4 VARNISH IMPREGNATED (SERIES 83, 84) Enameled wire is pie-wound or non-hygroscopic ceramic bobbin, and entire unit is vacuum impregnated. Radial wire lead, or radial lug terminals. Made to order only. Resistances from 0.1 ohm to approximately 5 megohms; 1/2 and 1-watt sizes. Tolerances are 0.1%, 0.25%, 0.5%, and 1%.

5 VITREOUS ENAMELED (POWER TYPE) Most Ohmite power resistors can be provided to close tolerances when precision as well as high wattage is desired. Depending on the requirements, the units are generally derated (often to 10% of free air watts) to minimize the effect of TC and maintain the best stability.

OHMITE

MANUFACTURING COMPANY

3610 Howard Street
Skokie, Illinois

RHEOSTATS • RELAYS • POWER RESISTORS
PRECISION RESISTORS • MICROMODULES
TAP SWITCHES • GERMANIUM DIODES
TANTALUM CAPACITORS • R. F. CHOKES
VARIABLE TRANSFORMERS



CROSSTALK

WE DERIVE considerable satisfaction from a trend detected in recent company-union negotiation, in this industry and others. In offers to bargaining units, management is taking its first step toward solving the difficult problem of negotiating smooth transition to more automated plants.

It is clear that U.S. companies must use more automatic controls and equipment to increase productivity in order to compete effectively in world markets and even at home. It has not been so clear that management also has a responsibility to prevent mass dislocations in the labor market. We note, however, that some new contract proposals contain programs for retraining and reassigning workers displaced by the introduction of labor-saving equipment.

The electronics industry has an enormous stake in this area, professionally, economically and personally. Professionally, the industry's engineers are responsible for many of the more sophisticated controls and systems. Economically, the industry stands to profit handsomely from widespread automation. Personally—well, it's safe to say that most of us would sooner see our inventions used for the betterment of our fellows than see them cause more hardship.

Electronics industrialists, then, have good reason to take the lead in showing industry in general how to make automation work to the advantage of the whole community. Automatic controls and mechanized production can bring about a better life for everyone if their fruits are equitably distributed. If they are exploited for the sole good of capital, then labor can be expected to exert pressure on government to stop or control the introduction of labor-saving equipment.

Perhaps the most important thing each company can do is to help its own workers find new niches in the world of automation. Retraining them into higher skills is one way.

Unions, too, have a responsibility to cooperate in finding ways to ease the changeover. If a union is truly interested in protecting the long-term welfare of its members it will help management intelligently introduce labor-saving machinery; a healthier company is better for worker and shareholder alike. It will encourage its members to retrain themselves for the higher orders of responsibility that automated plants will require. It will actively participate in retraining programs. When unions try to stop the course of progress by featherbedding or other unrealistic practices they succeed merely in pricing American goods out of world markets, and so ultimately put many of their own members out of work.

NEREM HIGHLIGHTS. Northeast Electronics Research and Engineering Meeting in Boston next week will feature nearly 400 exhibits and 40 technical sessions at which more than 300 papers will be presented. Thus visitors, as well as those unable to attend, should find this issue's two-part conference preview by New England Editor Maguire helpful. His story on p 46 takes a look at business implications. And in the engineering section, his article (p 73) gives a penetrating analysis of technical developments and spotlights several significant papers.

Coming In Our November 18 Issue

STEREO. Report on six proposed systems for compatible f-m stereo broadcasting was filed recently with the FCC by the field-test panel of the National Stereophonic Radio Committee. In our next issue, panel chairman A. P. Walker summarizes the engineering performance of the six systems. Walker, who is director of engineering for the National Association of Broadcasters, presents data relevant to frequency response, distortion, separation, crosstalk and spectrum utilization.

CIRCLE 5 ON READER SERVICE CARD→

electronics

Nov. 11, 1960 Volume 33 Number 46

Published weekly, with Electronics Buyers' Guide and Reference annually, as part of the subscription, by McGraw-Hill Publishing Company, Inc. Founder: James H. McGraw (1860-1948).

Title registered U.S. Patent Office; Copyrighted 1960, McGraw-Hill Publishing Company, Inc. All rights reserved, including the right to reproduce the contents of this publication, in whole or in part.

Executive, editorial, circulation and advertising offices McGraw-Hill Building, 330 West 42nd Street, New York 36, N. Y. Telephone Longacre 4-3000. Teletype TWX N.Y. 1-1636. Cable McGrawhill, N.Y. Printed in Albany, N. Y.; second class postage paid.

Subscribers: Please address all correspondence, change of address notices, subscription orders or complaints to Fulfillment Manager, Electronics, at above address. Change of address notices should provide old as well as new address, including postal zone number if any. If possible, attach address label from recent issue. Allow one month for change to become effective.

For subscription information see last page of this issue.

Postmaster: Please send Form 3579.

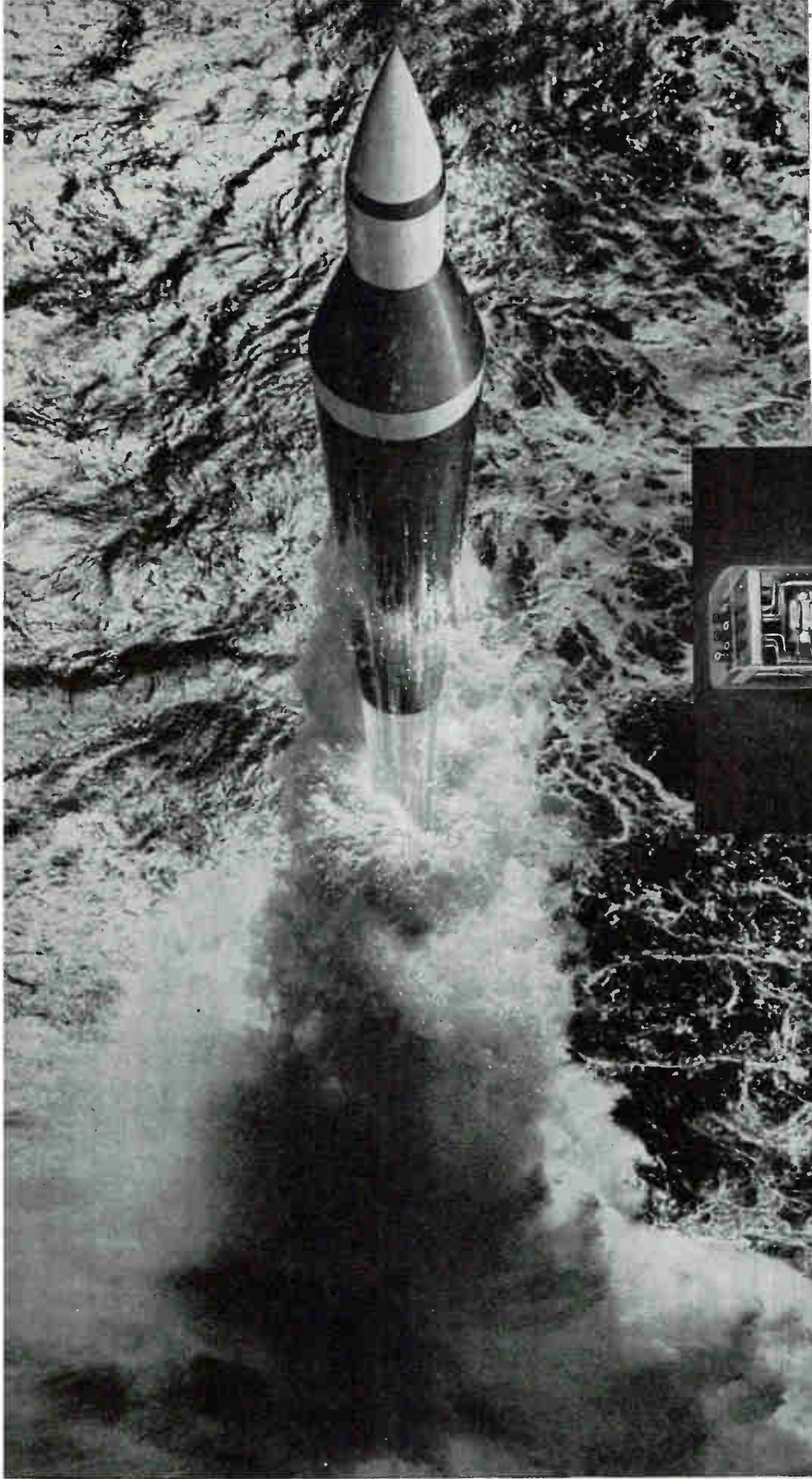

RAYTHEON
WELD-PAK
CIRCUIT
MODULES

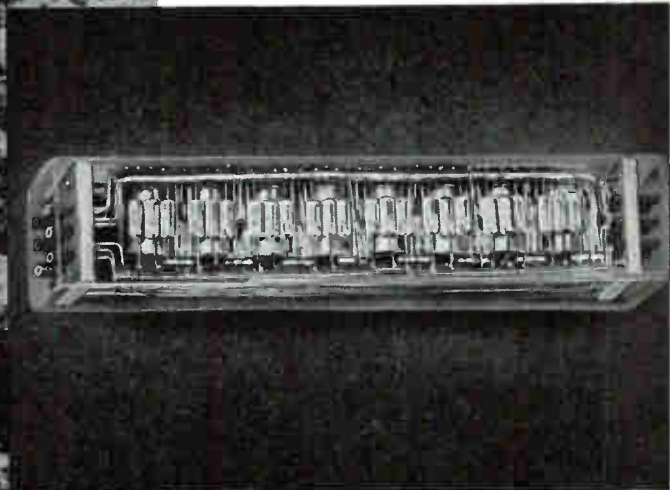

will help guide
POLARIS
to its target

Investigate the many advantages of custom or standard Weld-Pak high density circuit modules for your equipment design. Based on an MIT Instrumentation Laboratory packaging concept, Raytheon Weld-Pak modules provide exceptionally high reliability. For information please write Raytheon Company, Industrial Components Division, 55 Chapel St., Newton 58, Mass.

RAYTHEON COMPANY

.....
INDUSTRIAL COMPONENTS DIVISION



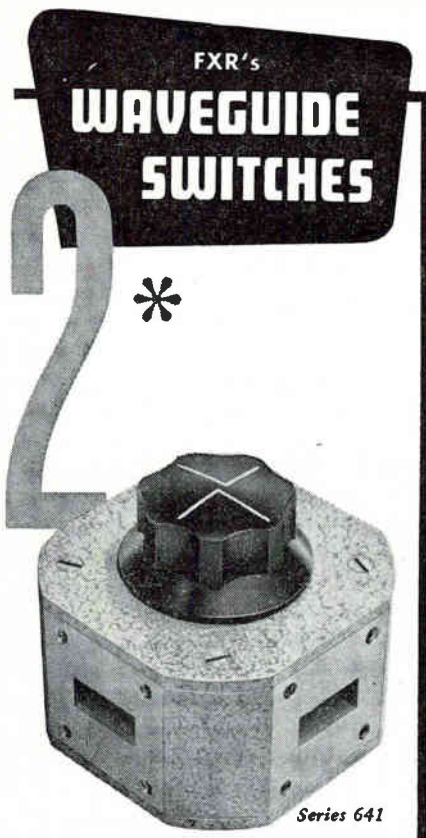

- OPERATION: Full waveguide bandwidth
- RANGE: 3.95 KMc to 40.00 KMc (in 7 sizes)
- CROSSTALK: 60 db min
- VSWR: 1.10 max
- Choice of manual or electrical drive
- High-power capacity

No. 2 of a series of FXR's new precision microwave components designed to meet the ever-growing needs of the microwave industry.

FXR's Waveguide Switches find applications on the test bench and in microwave systems. Operating over the full waveguide frequency ranges, these switches provide trouble-free operation with high isolation and high-power capacity. The milled aluminum waveguide rotor assures low VSWR. For long life it is mounted on ball bearings and is electrically connected to the stator through non-contacting choke sections.

MODEL NO.	FREQUENCY RANGE KMc	WAVEGUIDE TYPE RG-()/U	*PRICE (MANUAL)
H641A	3.95- 5.85	49	\$350.00
C641A	5.85- 8.20	50	300.00
W641A	7.05-10.00	51	265.00
X641A	8.20-12.40	52	225.00
Y641A	12.40-18.00	91	250.00
K641A, AF	18.00-26.50	53	275.00
U641A, AF	26.50-40.00	96	300.00

*Slightly higher for electrically driven units.
Write for Catalog Sheet No. 641

FXR, Inc.
Design-Development-Manufacture
25-26 50th Street / RA, 1-9000
Woodside, N. Y. / TWX: NY-43745

COMMENT

Ions, Music and Health

Since it's a pretty well established fact that free ions in the air affect one's mood (see "Ions Affect Health, Behavior," p 45, Feb. 26, and subsequent Comment), the next logical step in the development of that Ionovac speaker ("Hi-Fi Ions Impress Chicago Crowds, p 53, Oct. 14) is a circulating and filter system whereby one can select the polarity of the ions given off to match his mood to that of the material to which he is listening.

I suggest that safeguards be included, however, to negate the possibility of being exposed to high degrees of ionization and extremes of mood music at the same time.

It is conceivable that large amounts of positive ions plus *Valse Triste* could lead to wrist-slashing, while a teenager exposed to a rock-and-roll beat and negative ions could find himself in such a state of euphoria that the walls couldn't contain him.

GUY C. RAUER

WEJL RADIO
SCRANTON, PENNA.

The euphoria of the teenager we don't doubt; but positive ions might, if we interpret the evidence correctly, nullify rather than amplify the effect of a moody piece. The effect is to slow up the system, decrease the sensitivity to emotional stimuli of other than a thalamic type; one might be irritable, cross, prone to anger, quick to fight—but would probably not be extremely sad.

We hope that all the ions produced by the Ionovac are negative; not only do we regard euphoria as preferable to depression, but we also remember that negative ionization favorably affects health as well as behavior.

Upgrading Tv

In your Crosstalk ("Upgrading the Consumer," p 4, Oct. 21) it seems to me that you did not mention the main issue. You discuss upgrading the consumer to appreciate better technical quality of tv reception. What is really needed is an upgrading of television pro-

grams in this country.

I spent four years in England myself, and the reason why travelers come back singing the praises of British television is not because of its technical performance but because of the high quality of its programs.

After all, why bother to include d-c restoration, 4.5-Mc bandwidth, and so forth in order to see the same poor show? I think the basic mistake which the radio and television producers make is underestimating the intelligence of the American public. There are of course many fine programs on the air, but what is needed is upgrading the tv industry rather than upgrading the consumer.

C. V. NELSON

GORHAM, ME.

Although broadcasters may—it is a moot point—operate at the low end of the curve, they do follow a kind of free-market process in arriving at programs; they do, as they must, give the viewer what he seems to want.

As far as we're concerned, this argument is of only personal interest. Our professional interest, as we indicated in our Crosstalk, is in the technological improvement of broadcasting.

Comlognet

In your Oct. 21 issue is an article on the USAF Comlognet ("USAF to Get Fast Data Link Net," p 37). In this article is the statement "The switching centers, in conjunction with the station terminals, will handle digital information of any type including digitalized voice for graphics."

What is the meaning of the word *graphics* as used here? What is "digitalized voice for graphics"?

WILLIAM W. DEAN

GENERAL ELECTRIC
SYRACUSE, N. Y.

It was a typo; the statement should have read "... digitalized voice or graphics." Graphics, of course, are graphical data in any form—pictures, charts, graphs and so forth.

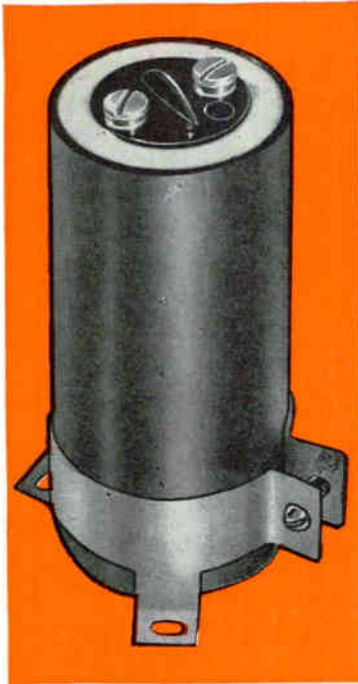

Need high capacity, heavy duty electrolytics ?

...see *Mallory!*

**Premium performance
without premium price ...**

is what you get with Mallory HC (high capacity) and NP (non-polarized) plastic-case electrolytic capacitors. Developed especially for heavy duty industrial applications, they offer you design features developed during 28 years of Mallory leadership in capacitor engineering.

leak-proof seal ...

new silicone vent protects against explosion due to overloads or accidental reverse polarity, yet maintains correct electrolyte level. Optional epoxy end seal gives greatest protection and life.

cool operation ...

Rated for high ripple currents, HC and NP capacitors run 5 to 10 degrees cooler than aluminum case, cardboard sleeve capacitors under identical conditions.

compact size ...

fit standard mounting arrangements, interchangeable with other style capacitors of same ratings.

self-insulated ...

needs no further external insulation, not sensitive to moisture.

high stability ...

proved by tests to 30,000 hours.

For complete information, write to Mallory. For prompt delivery, call the nearest distributor listed in the column at right.

Maximum capacity available in each case size at indicated voltage rating (additional voltage ratings available as required):								
Case Size	HC Type				NP Type			
	3 V	15 V	150 V	450 V	3 V	15 V	150 V	450 V
1 3/16 x 2 3/8	6,700	2,720	322	46	3,200	1,190	128	19
1 7/16 x 3 3/8	8,700	3,550	418	60	4,150	1,550	166	25
1 7/8 x 4 3/8	11,800	4,780	568	82	5,700	2,080	225	34
1 13/16 x 3 3/8	15,900	6,500	760	110	7,700	2,860	308	46
1 13/16 x 4 3/8	21,800	8,820	1,030	150	10,400	3,900	415	62
2 1/16 x 3 3/8	22,500	9,050	1,060	154	10,750	4,000	430	65
2 1/16 x 4 3/8	30,500	12,300	1,430	208	14,500	5,400	580	88

Popular and standard values available on the shelf. Other values available on special order.



**MALLORY HC and NP
capacitors are stocked
by these distributors:**

- Baltimore, Md.**
D & H Distributing Co.
- Binghamton, N. Y.**
Federal Electronics, Inc.
- Boston, Mass.**
Cramer Electronics
DeMambro Radio Supply
Lafayette Radio
- Buffalo, N. Y.**
Wehle Electronics
- Camden, N. J.**
General Radio Supply
- Chicago, Ill.**
Allied Radio Corp.
Newark Electric
- Cleveland, Ohio**
Pioneer Electronics Supply Co.
- Clifton, N. J.**
Eastern Radio
- Dallas, Texas**
Engineering Supply
- Denver, Colo.**
Denver Electronic Parts
- Houston, Tex.**
Harrison Equipment
Lenert Co.
- Indianapolis, Ind.**
Graham Electronics
- Inglewood, Calif.**
Newark Electric
- Jamaica, N. Y.**
Peerless Radio Distributors
- Kansas City, Mo.**
Burststein-Applebee
Walters Radio Supply
- Los Angeles, Calif.**
California Electronic Supply
Federated Purchaser, Inc.
Kieruff Electronics
Radio Product Sales
- Miami, Fla.**
Electronic Equipment
- Mountainside, N. J.**
Federated Purchaser, Inc.
- Newark, N. J.**
Lafayette Radio
- New York, N. Y.**
Bruno-New York
Electronic Center
Harrison Radio
Harvey Radio
Hudson Radio
Lafayette Radio Electronics
Milo Electronics
Terminal Electronics
- Oakland, Calif.**
Brill Electronics
Elmar Electronics
- Oak Park, Ill.**
Melvin Electronics
- Orlando, Fla.**
East Coast Radio
- Palo Alto, Calif.**
Zack Radio
- Paramount, Calif.**
Elwyn W. Ley
- Pasadena, Calif.**
Electronic Supply
- Perth Amboy, N. J.**
Atlas Electronics
- Philadelphia, Pa.**
Almo Radio
Philadelphia Electronics
Radio Electric Service Co.
- Pittsburgh, Pa.**
Radio Parts Co.
- Reading, Pa.**
Geo. D. Barbey Co.
- Syracuse, N. Y.**
Morris Electronics
- Washington, D. C.**
Capitol Radio
Electronic Industrial Sales
- Whippany, N. J.**
State Electronics

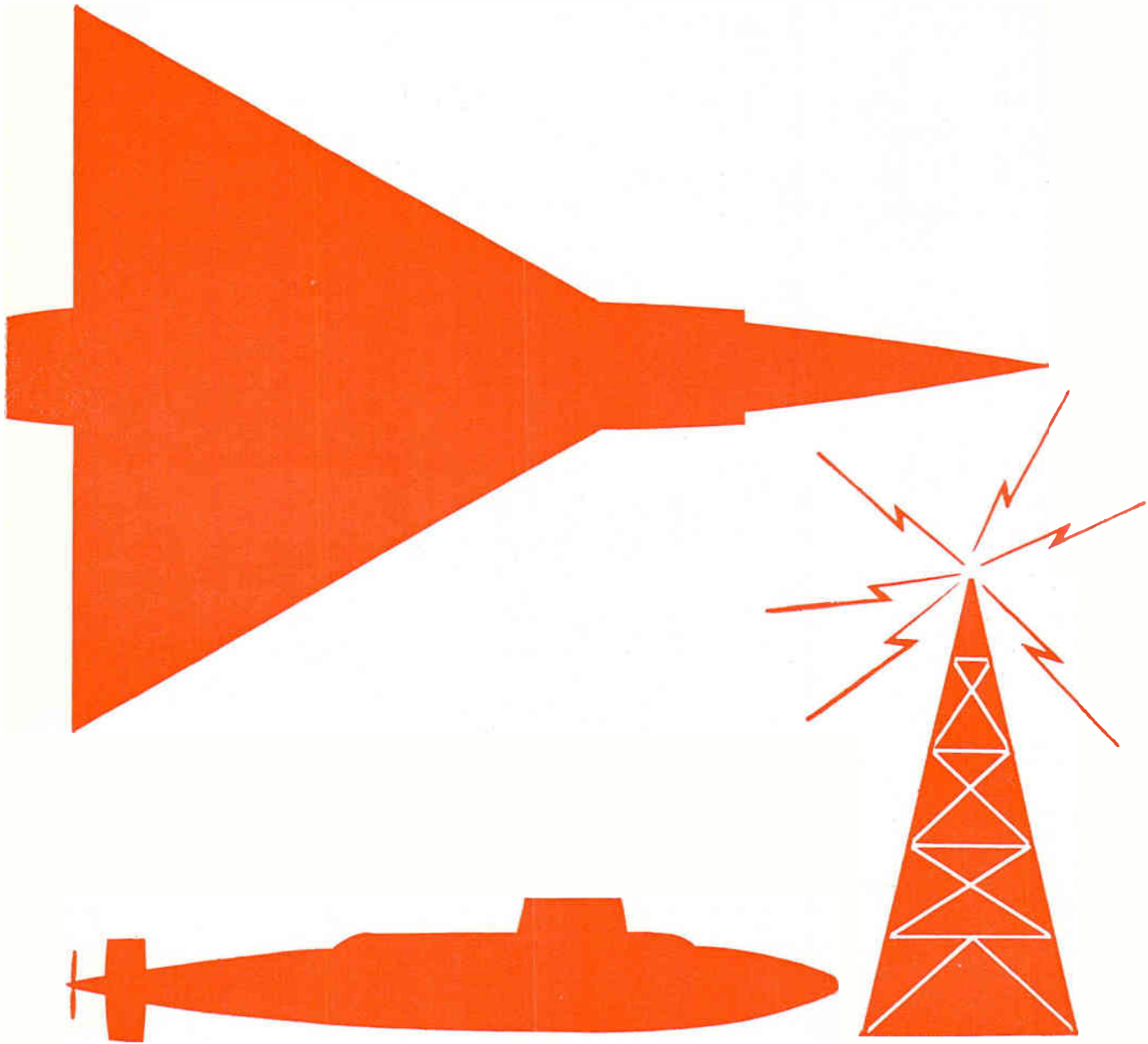

CANNON PLUGS ... WORLD

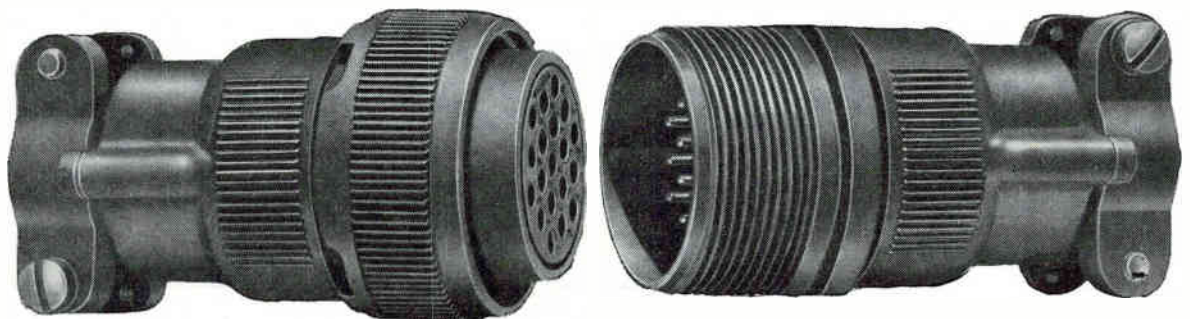

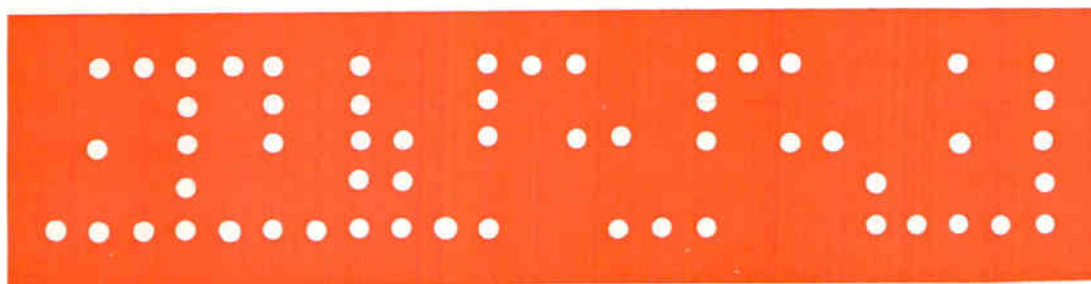
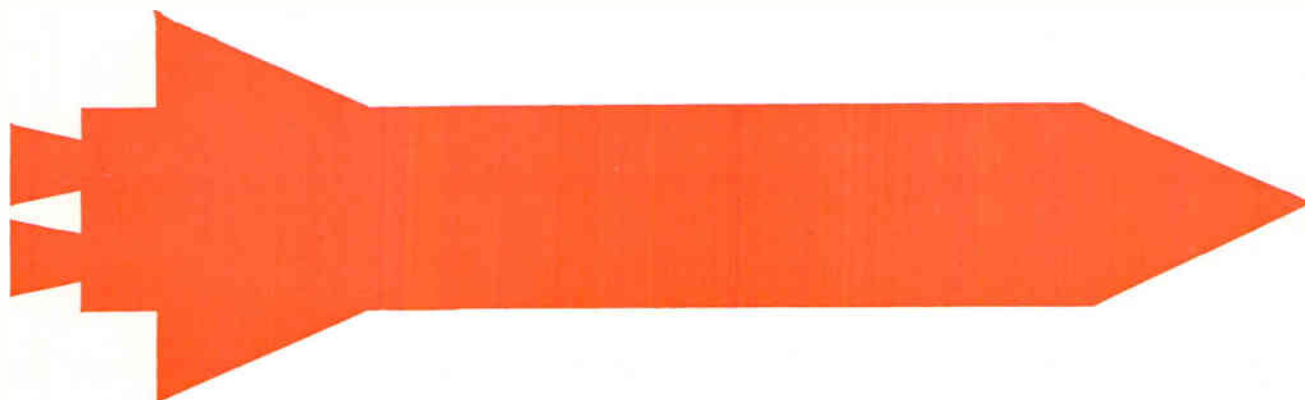
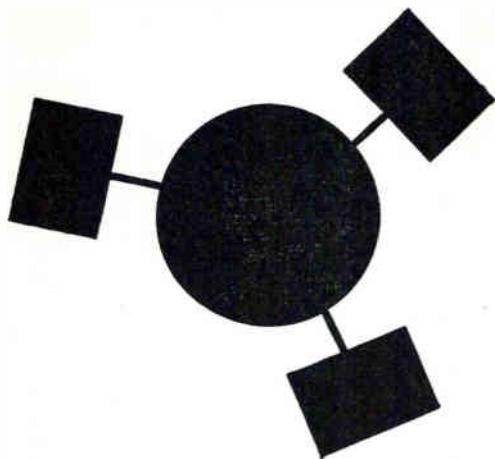

STANDARD FOR RELIABILITY

For almost half a century Cannon products have been accepted as the highest standard of performance in the industry. From the first plug design for "talking pictures" to the latest highly specialized equipment for space-age projects, our prime objective has been to meet or exceed the ever changing needs of our customers. We are dedicated to maintaining the reputation that has made Cannon Plugs synonymous with quality and reliability. For information on Cannon Plugs—for any application—write to:

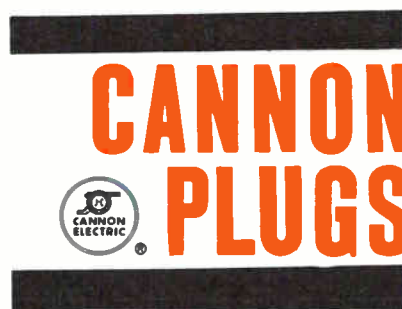

CANNON ELECTRIC COMPANY, 3208 Humboldt Street, Los Angeles 31, California

Delivery from stock

NEW VHF-UHF POWER SOURCES

FULL-RANGE STABILITY

50 WATTS OUTPUT

25 to 1,000 MC!

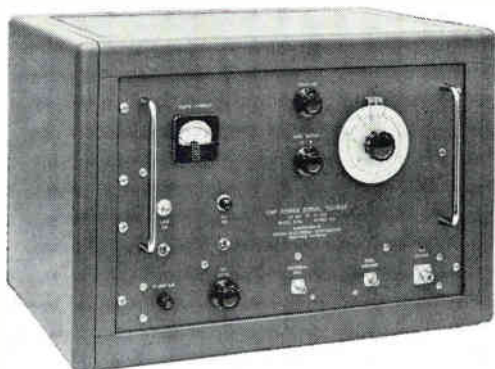

SPECIFICATIONS

Frequency range:	Model 215A-50, 25 to 50 MC Model 215A-150, 50 to 150 MC Model 215A-470, 150 to 470 MC Model 215A-1,000, 470 to 1,000
Power output:	50 watts \pm 1.5 db, into 50-ohm load, adjustable 20% to 100% of full power
Output stability:	\pm 5% after warmup
Frequency stability:	\pm 0.05% after warmup
Dial accuracy:	\pm 2% Models 215A-50/150 \pm 3% Models 215A-470/1,000
Resetability:	0.1%
Modulation:	External AM
Price:	\$3,300.00.

Data subject to change without notice. Price f.o.b. factory

Available in four off-the-shelf models covering the frequency range 25 to 1,000 MC, the new Sierra Electronic Corporation Model 215 Series VHF-UHF Power Sources provide extremely stable output to 50 watts. This unusual stability insures high repeatability for both routine check-out and precision laboratory work.

The instruments are continuously tunable over their respective ranges, offer high frequency stability and dependable operational stability under line voltage variation. Output power is adjustable 20% to 100% of rating. A plate current meter is provided for coupling adjustment, and a front-panel jack permits frequency monitoring with an external counter.

Sierra 215 Series Power Sources are easy to operate, completely self-contained and housed in sturdy bench cabinets. Rack mountable models also are available. They are ideal for accurate calibration of bi-directional power monitors and termination wattmeters, as well as for work in antenna design or other applications involving high attenuation of input signals.



For complete details, see your Sierra Representative or write direct.

SIERRA ELECTRONIC CORPORATION

A Division of Philco Corporation

6755A BOHANNON DRIVE • DAVENPORT 6-2060 • MENLO PARK, CALIF., U.S.A.

Sales representatives in all principal areas.

Canada: Atlas Instrument Corporation, Ltd., Montreal, Ottawa, Toronto, Vancouver.

Export: Frazar & Hansen, Ltd., San Francisco, Los Angeles

6755

ELECTRONICS NEWSLETTER

B-70 Reinstatement Means Big Business

REINSTATEMENT of a significant part of the B-70 Mach 3 Valkyrie bomber program means about \$85 million in business for electronics subcontractors. Prototype program had called for expenditure of \$110 million; this figure has now been boosted to \$265 million to account for building a dozen planes.

North American Aviation, prime contractor on the program, estimates that electronics firms will get 32 percent of the contract funds. Main electronics subcontractors are IBM for the bomb-navigation system, Westinghouse Electric for the defensive subsystem including counter measures, and Motorola for the mission and traffic control system including identification, operational communications, and flight navigation equipment. First B-70 is scheduled to fly late in 1962.

Besides its major role in air defense as a bomber, the B-70 eventually will provide a launching platform for the air-launched ballistic missile. Planes will carry long range search and fire-control radar.

Improved Tunnel Diodes Quintuple Trigger Speeds

GREATLY IMPROVED tunnel diodes have resulted from research programs in controlled production techniques at IBM. Developmental units announced last week switch at speeds faster than 0.4 nanosecond, permit operation of binary trigger circuits at speeds 5 to 10 times faster than presently possible. IBM spokesmen say the new diode also requires less power.

Key to the design advances is a new fabrication method involving an electronically monitored and controlled etch. The germanium is etched away under servo control to a junction diameter of 0.4 mil, reproducible to a tolerance of ± 1 percent. Peak current from the unit is 5 ma.

Binary trigger circuits using the improved tunnel diodes have been operated at repetition rates as high as 300 Mc. Resistance cutoff frequency is 23 Gc.

Air Agency Tower Rule Rouses Broadcaster Ire

NATIONAL ASSOCIATION of Broadcasters has filed a statement with Federal Aviation Agency stating that FAA's claim of jurisdiction over antenna towers is "contrary to law, precedent and the public interest."

The air agency has proposed a new rule (see *ELECTRONICS Cross-talk*, p. 4, Oct. 14) which would require broadcasters to get FAA approval for antenna constructions, on the grounds that high antennas might constitute a hazard to air navigation. NAB claims that Federal Communications Commission alone has the authority to rule on antenna locations and heights.

Nickel-Cadmium Battery Will Last Ten Years

RECHARGEABLE nickel-cadmium battery designed for use in spacecraft will be announced this week by Gulton Industries. On accelerated life test, the battery showed a lifetime of ten years, according to Gulton spokesmen. It can be charged and discharged 20,000 times.

The battery is hermetically sealed, operates at low pressure to prevent bursting or leakage. It can withstand continuous overcharge at high rates. The design features claimed for the new battery include a ceramic-to-metal case seal which forms a molecular bond, porous synthetic plate separators, and a novel method of assembly. Battery can be recharged in space by solar cells, can also be used to supply power in remote locations on the earth.

Image Intensifier Sharpens Balloon-Borne Telescope

PHOTOELECTRIC image intensifier used with balloon-borne telescope is expected to make the 12½-in. telescope the equivalent of a 125-in. unit, says J. A. Hynek, chairman of Northwestern University's astronomy department.

Researching image conversion

and balloon astronomy under two Air Force contracts, Hynek reports photoelectric intensifier has increased image brightness 30 times. Project is aimed at 100-fold brightness improvement.

Early next year Hynek plans to send two men and a small telescope 19 miles up in a sealed gondola. The experiment will use MIT-developed instrumentation to cancel balloon motion and permit tracking of a star. Height will eliminate atmospheric twinkle, add to precision of sighting. Tests in the infrared region may even show whether Mars' atmosphere contains water vapor.

Tracking Radar Planned for Thule

DEFENSE DEPARTMENT has decided to install RCA's tracking radar AN/FPS-49 at the ballistic-missile early-warning system site at Thule, Greenland (*ELECTRONICS*, p. 47, Mar. 18). Up until now, BMEWS plans called for three RCA tracking radars at the Flyingdales site in England, but none at Thule or Clear, Alaska. Thule and Clear are equipped with GE's stationary surveillance radar systems AN/FPS-50. Whether Clear will get both systems, as Thule will, has not been announced. The 84-ft-dish tracking radar costs \$15 million.

Institute Studies Rare-Earth Cathodes

IMPROVED CATHODE design is being sought for tube applications requiring high resistance to sparking and high emission density. Under contract with AF Cambridge Research Labs, Batelle Memorial Institute is evaluating thermal electron emission of rare-earth oxides, particularly gadolinium and neodymium oxides and mixtures of these.

The oxides are being put on refractory metal wires by electrophoresis. BMI is looking for a process to keep the particles from forming large agglomerates, so as to realize a dense and smooth coating. Study includes emission behavior of rare-earth oxide mixtures on refractory-metal bases, particularly rhenium, molybdenum, tungsten and tantalum.

(Continued on page 12)

Illinois Bell to Dedicate Electronic Central Office

ELECTRONIC CENTRAL OFFICE will be dedicated by Illinois Bell Telephone Co. in the little town of Morris, Ill., next Thursday afternoon.

The new concept in telephone switching uses no moving parts, functions in microseconds. System is the product of a massive research and development program, perhaps one of the largest ever sponsored by commercial enterprise, tracing back to Bell Labs' development of transistor.

Electronic Probes Test Body's Thermostat

ELECTRODES radiating a 3.7-Mc signal into the brain are helping Dr. Madelaine Fusco, physiology instructor at University of Michigan's Medical Center, study the thermostat controls in the nervous systems of all higher animals, including man.

Hypothalamus, deep inside the brain, maintains body temperatures within close tolerances. Hollow needle electrodes implanted in the hypothalamus of dogs short-circuit the usual nerve network that reports changes in internal and surface temperatures. One-watt radiation from transmitter warms the dog, making him pant. Cold signal from circulating cool water causes shivering.

Information gathered in Dr. Fusco's experiment may help doctors interpret and control fever and other temperature abnormalities that are symptoms of disease.

New Device Attacks Wrong-Number Problem

AUTOMATIC dialing systems for interstate and nationwide long-distance telephone calls magnifies the problems of dialing errors. In the Netherlands, where the error rate for automatic long-distance calls is 14 percent, the Dutch firm of Reumhelm Electronics has developed an automatic system that prevents wrong connections.

Reumhelm spokesmen say their attachment can be used with telephone exchanges or individual telephones. The device is said to prevent a connection when the caller dials the wrong digit, when he erroneously makes a transposition of two adjoining digits, or when other common dialing errors are made.

New Currency Changers: Magnetic, Photoelectric

TWO NEW automatic currency changers were shown at the Automatic Merchandising Association show in Miami Beach, Fla., last week.

A solid-state device by ABT Manufacturing division of Automatic Canteen Co. of America uses ten transistors and diodes. It operates on photoelectric principles, giving a static check on the bill. The device will go into production about the first of the year. It will change bills up to \$10, can recognize counterfeit currency. The company is working on changers to handle foreign currency.

An electron-tube device made by National Rejectors division of Universal Match can change bills up to \$20. The device operates on magnetic principles, performs a moving check as the bill passes longitudinally over a single reading head. Trick is that the green ink used on currency is magnetically susceptible.

Also interested in currency changing are Lionel Corp., Vendo of Kansas City, Mo., and Rescon of Waltham, Mass.

Reveal Cable Connectors To Withstand 1,700 F

SOME REENTRY PROBLEMS of such projects as Dynasoar may be solved by a coaxial cable and connector combination to be marketed by Technicraft division of Electronic Specialty Co. The cable is made by McGraw-Edison.

Cable is now rated at 1,000 F, is expected to take 1,700 F. It comes in 0.170 and 0.270-in. outside diameters, can carry signals up to 5 Gc. Inner and outer conductors are copper. Dielectric is of the mineral

type. Outer conductor is the outside of the cable. Connectors use a glass dielectric, are made from Invar.

Resonant-Reed Relay Locks and Latches

SELF-HOLDING resonant-reed relay for remote switching is under development by Mallory Electromagnetic division of P. R. Mallory. One model has four reeds tuned to 75, 95, 115 and 135 cps with bandwidth of ± 3 cps. However, reeds tuned to any nonharmonically related frequencies between 50 and 400 cps can be used. A small permanent magnet locks the relay out until a signal is received. After 0.5 sec, the coil holds the reed firmly until excitation current is removed.

The relay coil is rated at 75 to 225 mw; contacts are designed for 2 amperes, 110-v, 60-cps resistive load. Enclosure is roughly 2 x 2 x 1 in.

Japanese Disclose Infrared Microscope

COUPLING AN INFRARED projector to an electron microscope permits study of displacement lines in silicon. Developed by Nippon Electric, ITT affiliate, the unit measures 70 by 40 by 18 cm, weighs 20 Kg. Its first applications will be in production of high-purity silicon. Wide use in medical and biological sciences also is predicted. The company plans to couple a television system to the microscope.

Special Computer Quotes Stock Prices

INSTALLED in the new offices of Los Angeles broker Waltston & Co. is the Quotron, a special-purpose digital computer made by Scantlin Electronics. Computer's magnetic-drum memory hooks into ticker-tape circuits, stores daily stock-exchange transactions. Interrogation and readout units complete the system. Desired information is received on paper tape.

Large • small • any size between—

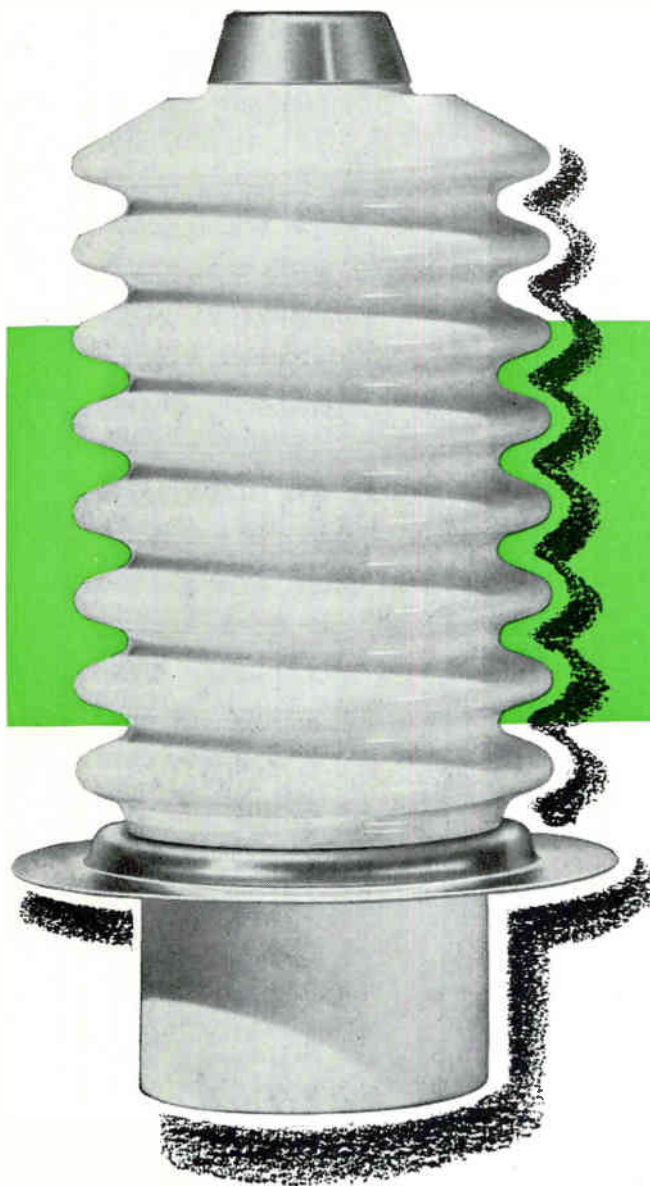

ALITE is geared to meet your requirements for **CERAMIC-TO-METAL SEALS**

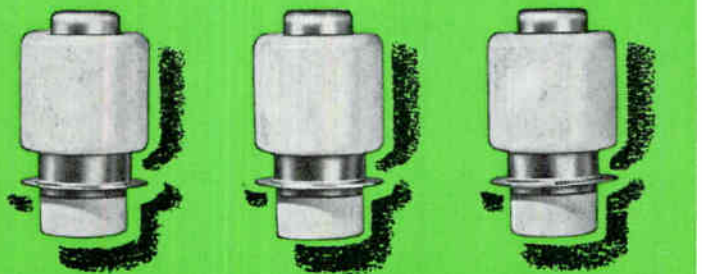

Alite offers completely integrated facilities and expert engineering assistance for producing high quality, vacuum-tight, ceramic-metal components for all your mechanical and electrical requirements.

Hermetic seals and bushings embodying Alite—the high-alumina ceramic developed by U. S. Stoneware—have the ability to withstand severe physical and thermal shock without leaks or cracking. Produced to precision tolerances, Alite units have high impact and tensile strengths for grueling environmental conditions. They maintain excellent electrical and mechanical characteristics over a wide range of frequency and temperature. The extra-smooth, hard, high-fired glaze gives superior surface resistivity.

Every manufacturing step is closely supervised in our own plant. Positive quality control assures strict adherence to specifications, absolute uniformity and reliability of completed components.

At no obligation to you, send us your drawings for recommendations or quotation.

FREE Technical Data



For complete technical data on Alite and Alite Ceramic-to-Metal Seals, write for Bulletins A-7R and A-40.

ALITE DIVISION

U. S. STONWARE

BOX 119 ORRVILLE, OHIO

New York Office
60 East 42nd St.

118F-1

BARNSTEAD ENGINEERS PURE WATER TO YOUR SPECIFICATIONS

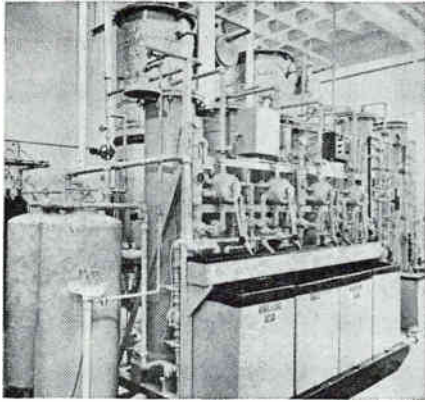

PHILCO'S Lansdale Tube Division uses this Water Purification "Train" equipment in processing components. Costs are reduced as most of the process water is repurified and fed back to the system for re-use. Barnstead equipment includes a 20 GPH High Purity Still, 150 gallon heated ultra-violet equipped tank to prevent growth of bacteria, two BD-10 Holders with special high purity Supercartridges®, an MF-200 Submicron® Filter, and heat exchanger. Barnstead makes water versatile.

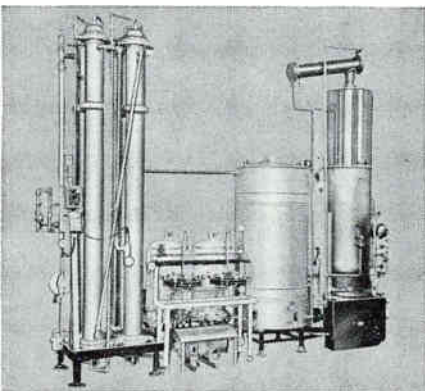

IBM installation . . . at Poughkeepsie, New York, produces 200 gallons of extremely pure water per hour, 18 megohms resistance at 25° C. and free of all types of impurities. Equipment consists of Sand and Carbon Filters, Four-Bed Demineralizer, Two High Purity Stills, 1000 gallon storage tank, Mixed-Bed Demineralizer, Submicron Filter, and Heat Exchanger.

HAVE A PURE WATER PROBLEM? Bring it to Barnstead . . . with over 80 years of experience in all kinds of Water Purification problems. Write for Catalogs; #160 on Barnstead Water Demineralizers, and Catalog "G" on Water Stills.

Barnstead
STILL AND STERILIZER CO.
84 Lanesville Terrace, Boston 31, Mass.

WASHINGTON OUTLOOK

THE COMMERCE DEPT. reports a 40 percent increase in Japanese electronics production during January-June 1960 as compared to the previous six-month period. Total output was valued at \$565 million, of which \$320 million covered consumer products. Television receiver production in first-half 1960 rose 36 percent over the same period last year, radio receivers with three or more transistors increased 80 percent, radio-phonographs 139 percent.

Japanese production of electron tubes in January-June 1960 amounted to \$90.4 million, 63 percent over last year. Output of semiconductors was valued at \$37.2 million, a gain of 48 percent.

Relaying information from the U. S. embassy in Tokyo, the Department also reveals a sharp upward revision in estimated Japanese production over the next five years. Output of \$1.3 billion is envisaged in 1964, 30 percent over 1959 production.

U. S. trade experts predict a big boost in exports to this country of Japanese stereo phonograph consoles, color television sets and tv sets using transistors.

THE POST OFFICE DEPT. has begun testing high-speed facsimile mail transmission between Washington, Chicago and Battle Creek, Mich. The speed-mail system is seen as a forerunner of a nationwide network of facsimile mail transmission linking 74 major cities, with trunklines to hundreds of smaller areas.

The project's major contractors: ITT's Intellex Systems, Inc., which has a development contract to design and build 14 high-speed facsimile printers and eight mail scanners; General Dynamics' Stromberg-Carlson Div., which is developing high-speed scanners capable of reading and transmitting a standard letter-size page every four seconds by commercial coaxial cables or microwave links; Haloid Xerox and Pitney-Bowes.

STILL MORE PRESSURE to consolidate military procurement comes from a new Congressional report on economic aspects for military procurement and supply. The report was made by a joint economic subcommittee headed by Sen. Paul Douglas (D., Ill.), which investigated military contracting policies earlier in the year. Says the report: "If common supply and service activities were properly consolidated and organized under existing legislation" there would be vast savings in defense buying.

The report comes in the midst of a Defense Dept. study on the advisability of consolidating military procurement of many types of electronic end-items, components, spares and replacement parts. The study is due to be finished by the end of the year and covers an estimated \$2 billion worth of annual electronics procurement.

U. S. MANUFACTURERS—including electronics firms—are still boosting capital outlays in production facilities abroad, especially in Europe. For all manufacturers, overseas spending on production facilities now averages 14 percent of the amounts invested at home.

There's no specific breakdown on electronics, however. The industry is lumped under electrical machinery manufacturing. This category shows \$129 million worth of plant and equipment spending abroad in 1960, compared to \$88 million last year.

EIA HAS STARTED a survey to determine the number of scientists and engineers in the electronics industry. Results will be turned over to the Pentagon to help determine possible adverse effects which major shifts in defense programs could have on the reservoir of professional electronics manpower.

Preliminary Pentagon estimates show about 140,000 electronics engineers and scientists in the U. S. Of the total, 110,000 are believed to work for private industry and from 80 to 90 percent in defense-related work.

A cross-section of disciplines directed toward **Space Technology Leadership**

The technical staff at Space Technology Laboratories is the free world's most experienced group devoted exclusively to advances in the civilian and military applications of space technology. • Among STL's strengths is a versatile capability created by a cross-section of the scientific and engineering disciplines. This enables the technical staff to anticipate and solve new problems in every area of space technology from fundamental research to complex hardware design and fabrication. • Today, STL's growth and diversification are opening up exceptional opportunities for outstanding scientists and engineers. Their talents and training will bring strength to, and gain strength from, an organization devoted to a single purpose: constant advancement of the state-of-the-art in the exploration and understanding of space. • STL invites the outstanding scientist and engineer to investigate the dynamics of a career in this atmosphere of Space Technology Leadership. Resumes and inquiries will receive meticulous attention.

SPACE TECHNOLOGY LABORATORIES, INC. P.O. BOX 95005J, LOS ANGELES 45, CALIFORNIA
a subsidiary of *Thompson Ramo Wooldridge Inc.*

Los Angeles • Santa Maria • Edwards Rocket Base • Cheyenne



Cape Canaveral • Manchester, England • Singapore • Hawaii

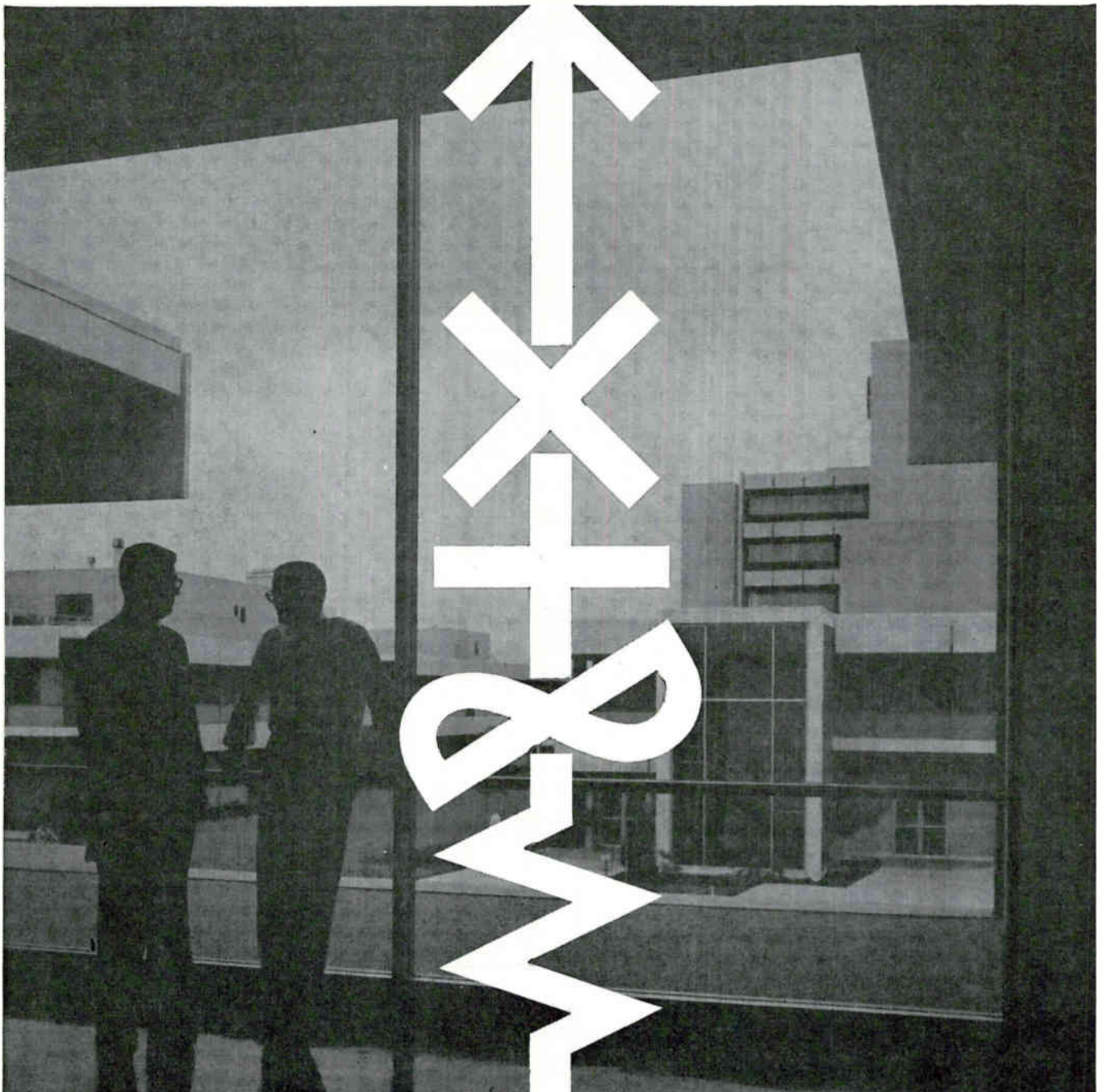

"All Washington's just across the river from our new lab!"



Locating your laboratory or light, technical industry in Northern Virginia pays double dividends. For it puts you close to both the matchless research facilities and the rich cultural life of the Nation's Capital, with its colleges, universities, technical schools, museums, concert auditoriums and theaters. ■ Next door, too, are the great Potomac rail yards, the Alexandria deep-water steamship

channel, and the new Dulles International Airport that will soon give you the key to the jet age. Without cost or obligation, let VEPCO do a bit of confidential plant site scouting for you in or near some of Northern Virginia's many pleasant communities. Write, wire or phone VEPCO today.



VIRGINIA ELECTRIC and POWER COMPANY

Clark P. Spellman, Manager—Area Development, Electric Building, Richmond 9, Virginia • MILton 9-1411

SERVING THE TOP-OF-THE-SOUTH WITH 1,990,000 KILOWATTS → DUE TO REACH 2,580,000 KILOWATTS BY 1962



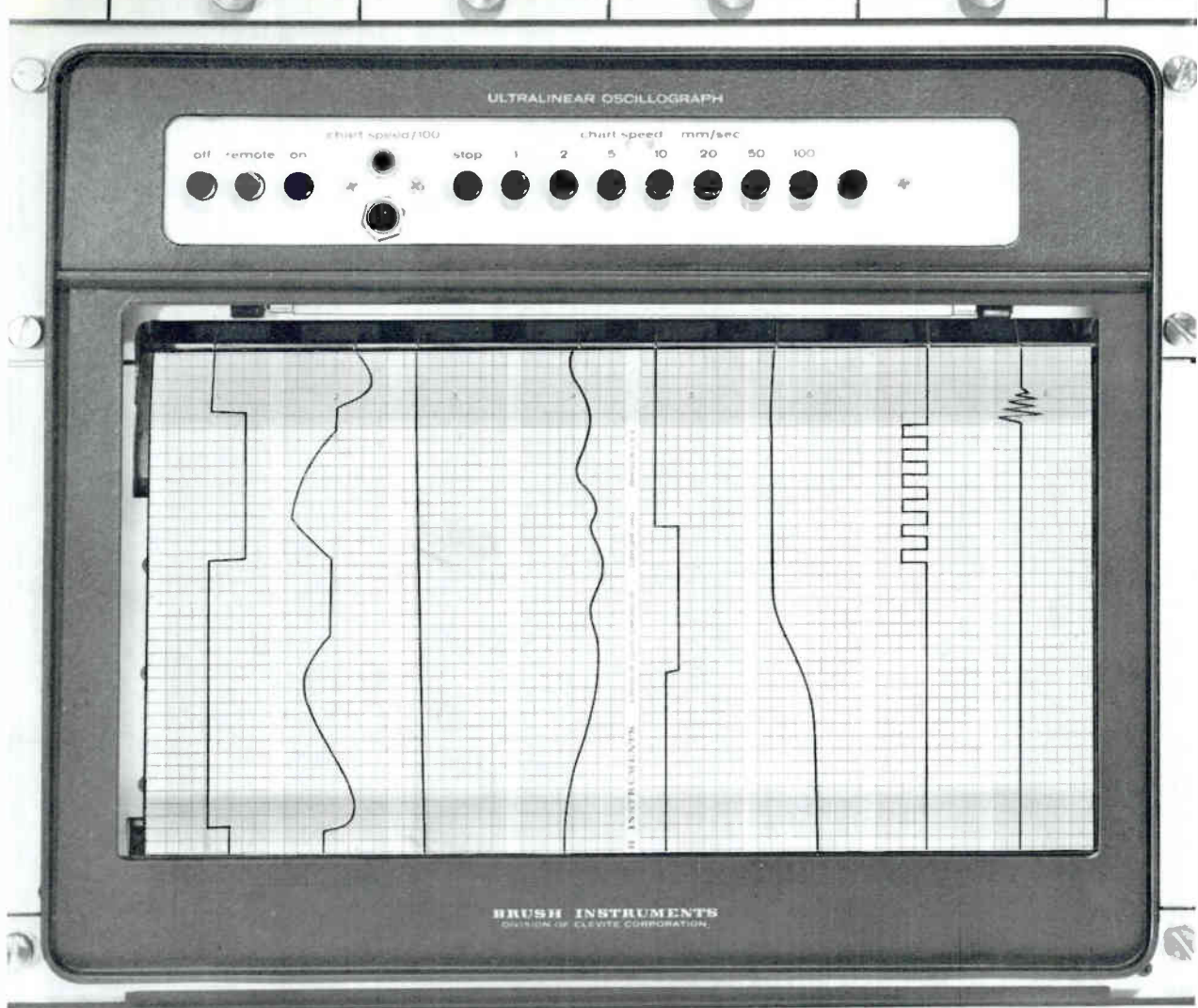

in multi-channel
recording systems
there is

nothing newer

It's no wonder this recorder has been chosen for today's most advanced telemetry and computer systems. Providing the highest precision and proven reliability, Brush's newest oscillograph instantaneously displays eight 40mm channels of analog data, plus two event markers. Sharp, easy-to-read traces on rectilinear coordinates. Accurate resolution of all signals and positive interpretation of amplitude is assured with 13 electrically controlled, precise chart speeds. All functions are operated by pushbutton and may be remotely controlled if desired. Unique auto-load system locks unit in any position for greatly simplified chart changing . . . without disturbing the styli. Take advantage of industry's most advanced techniques in this space-saving vertical panel oscillograph. Get *all* the facts. Call, write or wire.

brush INSTRUMENTS
DIVISION OF

37TH AND PERKINS

CLEVITE
CORPORATION

CLEVELAND 14, OHIO

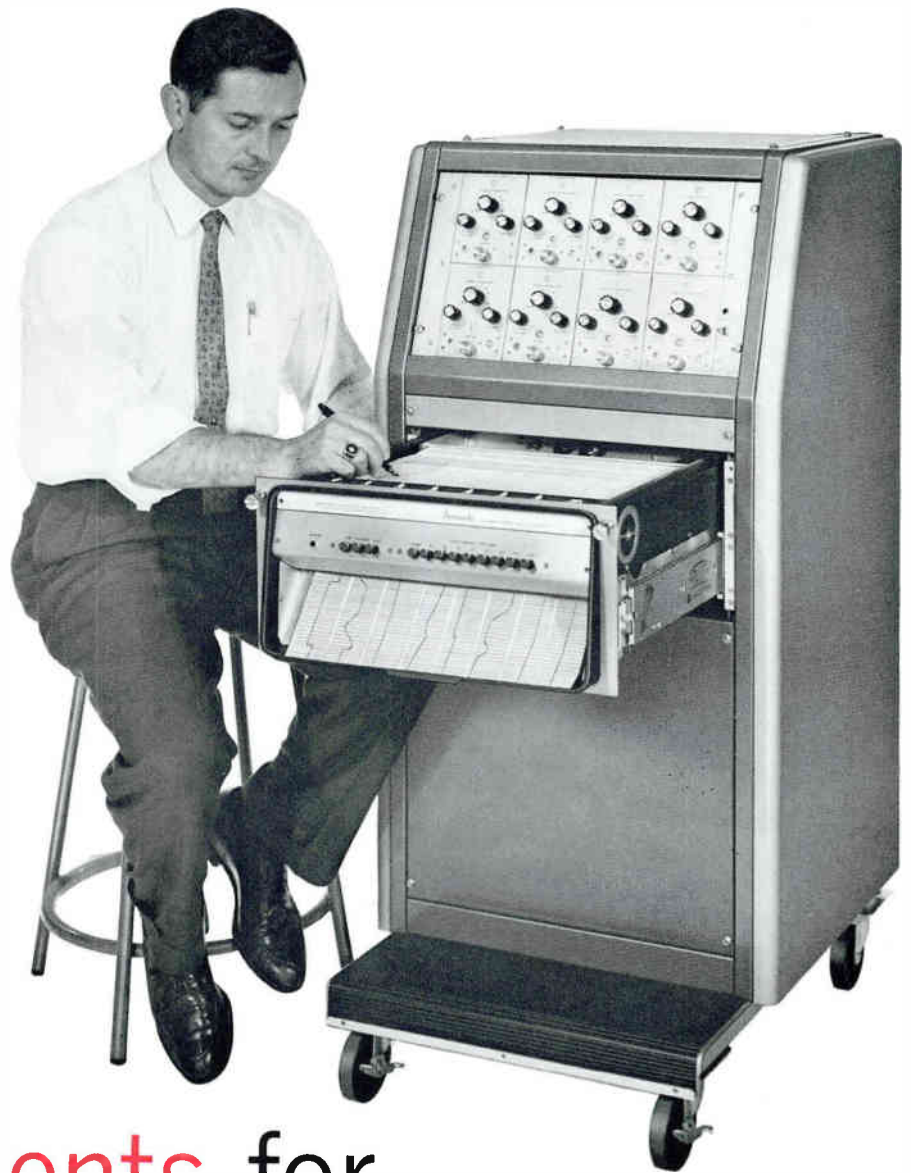

only
Brush
fills all
requirements for
multi-channel, multi-purpose
recorders

If it's precise, instantaneous data acquisition in writing . . . Brush versatile recording systems provide the answer. Whether your requirements call for this "pull-out", horizontal model for convenient annotation and reading . . . or the newest in vertical panel recorders . . . you'll find all of the known refinements in the art of recording by direct writing. Rectilinear presentation gives clear, uniform, reproducible traces for precise readout. Up to 16 chart speeds are selected by pushbutton; jam-proof transmission provides quick response. Interchangeable "plug-in" signal conditioners permit four vital functions in addition to amplification—high input impedance, zero suppression, attenuation and calibration. Event markers, internal timers, remote control and chart take-up are some of the available accessories. Check these advanced recording systems for yourself and you'll see why no one is as qualified as Brush. Write for complete details.

brush INSTRUMENTS
DIVISION OF
37TH AND PERKINS **CLEVITE** CLEVELAND 14, OHIO
CORPORATION

MODEL P-25

MODEL EW-16

MODEL FL-202

MODEL VO-38

MODEL TK-20A

MODEL TR-A

MODEL VR-2P

MODEL TR-B

MODEL TR-C

MODEL TK-70B

MODEL VTVM-500

KEW

Around the world it's KEW

KYORITSU ELECTRICAL INST. WORKS, LTD.
 No. 120, Nakane-cho, Meguro-ku, Tokyo, Japan
 Cable Address: "KYORITSUKEIKI TOKYO"
 Tel: (717) 0131-5

CIRCLE 212 ON READER SERVICE CARD

Did you know that your 1960 **electronics BUYERS' GUIDE** includes . . . Missiles in Production - p. R5, List of Military Procurement Locations and Personnel - p. R7, Characteristics of Plastics - p. R34, Characteristics of Laminates - p. R36, Wire, Tape and Foam Specifications - p. R38, Symbols Dictionary - p. R42, List of Industry Organizations, Services and Standards - p. R47, Military Standards - p. R50, Military Nomenclature - p. R53.

The only directory in the electronics industry with a Reference Section. It contains Market Data, Materials for Components, Specifications and Services, Design Data.

First choice of all 4!



gives more to all 4!

electronics BUYERS' GUIDE
and REFERENCE ISSUE

← CIRCLE 18 ON READER SERVICE CARD

*Airborne
D. C. Amplifiers
in a
modular
system*

100
10
COARSE
FINE 1-10
GAIN
BAL
D. C. AMP.

...the Neff **SCAMP** System

Broadband differential d.c. amplifiers, narrowband d.c. amplifiers and a.c. amplifiers can be combined in this miniature airborne system.

The Signal Conditioning AMPLIFIER (SCAMP) System is completely transistorized, operates from any unregulated 28-volt d-c supply, produces 0-5 volts from millivolt inputs.

Performance is unmatched by any other commercially available equipment.

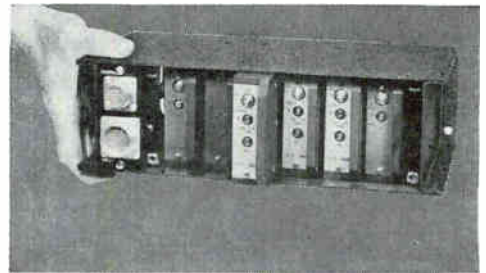

Each amplifier measures only 1¼" wide, 3³/₁₆" high, and 4³/₁₆" long.

WRITE for full information . . . including the complete line of amplifiers and power supplies for ground and airborne use.

NEFF

instrument

corporation

1088 E. Hamilton Road,
Duarte, Calif.

Offering a complete line of airborne and ground amplifiers and power supplies.

CIRCLE 19 ON READER SERVICE CARD

19

ALL UNITS ACTUAL SIZE

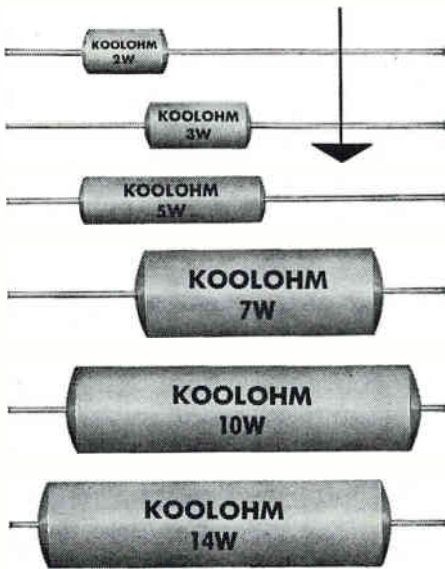

KOOLOHM® INSULATED SHELL POWER RESISTORS

Sprague's Koolohm Resistors are designed to meet military and industrial requirements for insulated power wirewound resistors that will perform dependably.

New axial-lead Koolohm construction features include welded leads and winding terminations. Exclusive Ceron® ceramic-insulated resistance wire, wound on special ceramic core makes possible multilayer non-inductive windings and extra-high-resistance-value conventional windings. Dense, non-porous ceramic outer shells provide both humidity and mechanical protection for resistance elements. All resistors are aged-on-load to stabilize resistance value.

The advanced construction of these improved Koolohm Resistors allows them to operate at "hottest spot" temperatures up to 350°C. You can depend upon them to carry maximum rated load for any given physical size.

Send for Engineering Bulletin 7300A for complete technical data.

SPRAGUE ELECTRIC COMPANY
35 Marshall Street, North Adams, Mass.



FINANCIAL ROUNDUP

New Mergers Announced

GENERAL INSTRUMENT CORP., Newark, N. J., has announced acquisition of a 30-percent ownership in **Materials Research Corporation**. The Yonkers, N. Y., firm is engaged in both basic research in metallurgy and electronics, and manufacture of scientific instruments. Cash obtained from the purchase of 42,857 of MRC's outstanding 142,857 shares will be used to expand the research company's laboratory and production facilities.

Houston-Fearless Corp., Los Angeles, announces acquisition of 100 percent of the stock and all assets of four companies in electronics and related industries. The expansions move HF into the fields of gyroscope design and manufacture, nuclear instrumentation, ground support systems and digital data systems for military and industrial use. The four companies are, **Uniconn Inc.**, Plymouth, Conn., gyroscope manufacturer; **Nuclear Research Instruments**, Berkeley, Calif.; **Parabam, Inc.**, Hawthorne, Calif., (digital data systems) and **Allen Research and Development**, Buena Park, Calif. The acquisitions were made by stock and cash transfers.

Gulton Industries, Metuchen, N. J., has acquired the electronics business interests of **Electric Machinery Manufacturing Company's Mullenbach division** in Los Angeles. Electric Machinery is a subsidiary of **Worthington Corp.** The newly-acquired group manufactures thin ceramic sheet material used in switches, subminiature capacitors and relays. Gulton, in a similar field of manufacture, acquired **Systems Research Group Inc.**, Mineola, N. Y., last July.

Hermetite Corp., Boston, and **Accurate Specialties**, New York, report they are holding exploratory talks on merger possibility. Hermetite manufactures glass-to-metal and ceramic seals for the

electronics industries. **Accurate Specialties** manufactures high-purity metals and ceramics.

Spectrol Electronics Corp., San Gabriel, Calif., a wholly-owned subsidiary of **Carrier Corp.**, announces purchase of the assets of **Bamford Corp.**, Santa Monica, Calif. The newly-acquired company produces miniature trimmer potentiometers. Spectrol manufactures a variety of components, including solid-state converters. The acquired facilities will be moved to San Gabriel and integrated with Spectrol's operation.

Megadyne Electronics, Inc. and **CWS Waveguide Corp.** will hold shareowner meetings next week in Wilmington, Del., to vote on the proposed merger of the companies into **Megawave Electronics Corp.** The managements and directors of both companies have already approved the combination. Megadyne, situated in Port Chester, N. Y., manufactures magnetic amplifiers, saturable reactors, power supplies and other items. CWS, of Lindenhurst, Long Island, N. Y., manufactures microwave components for radar and communications applications.

National Cash Register Co., Dayton, O., for the third quarter of 1960 reports sales of \$109,990,886, a rise of six percent over the same period of 1959. Net income for this year's third quarter was \$4,591,504, up three percent over last year's third-quarter earnings of \$4,475,345. For the first nine months of 1960, sales totaled \$315,768,220, compared with \$298,953,356 for the same portion of 1959.

Siegler Corporation, Los Angeles, reports earnings for the quarter ended Sept. 30, were \$746,531 on sales of \$20,218,288, a decline of eight percent from earnings of \$815,616 on sales of \$21,189,245 for the similar period last year. Per-share earnings for this year's first

quarter were 40 cents on 1,872,466 shares outstanding as of Sept. 30, 1960. A year ago, the figure was 50 cents on 1,634,026 shares. The increase in shares this year is due to a four-percent stock dividend, conversion of outstanding debentures and issuance of common shares following the merger of Magnetic Amplifiers, Inc., with Siegler. Decline in earnings is partially attributed to a falling off of the company's heater business.

Standard Kollsman, Melrose Park, Ill., reports substantial increase in sales and earnings for the nine months ended Sept. 30. Consolidated net sales were \$71,815,551, compared with \$54,227,527 in a similar 1959 period. Net income for the nine months was \$2,203,580, equal to \$1.10 per share as against \$1,039,497, or 52 cents a share, in the year preceding.

Burnell and Co., Pelham Manor, N. Y., reports record highs during the first six months of the current fiscal year ended Sept. 30, in both sales and income. Sales were \$1,805,610, up 24 percent over last year. Income of \$80,678 was up 41 percent over 1959 and was equal to 12 cents a share.

25 MOST ACTIVE STOCKS

	WEEK ENDING OCTOBER 28, 1960			
	SHARES (IN 100's)	HIGH	LOW	CLOSE
Gen Tel & Elec	2,884	25 $\frac{7}{8}$	23 $\frac{3}{4}$	25 $\frac{1}{4}$
Avco Corp	1,291	13 $\frac{7}{8}$	12 $\frac{3}{4}$	13 $\frac{5}{8}$
Texas Inst	1,006	165 $\frac{3}{8}$	148 $\frac{1}{4}$	160 $\frac{1}{4}$
RCA	959	50 $\frac{3}{4}$	46 $\frac{1}{2}$	50 $\frac{1}{4}$
Gen Electric	922	73 $\frac{7}{8}$	70 $\frac{7}{8}$	73
Sperry Rand	890	19 $\frac{3}{8}$	18 $\frac{1}{2}$	18 $\frac{5}{8}$
Amer Tel & Tel	868	91 $\frac{7}{8}$	89 $\frac{5}{8}$	91 $\frac{5}{8}$
Litton Ind	753	75 $\frac{5}{8}$	68 $\frac{7}{8}$	72 $\frac{1}{2}$
Int'l Tel & Tel	751	37 $\frac{7}{8}$	36 $\frac{3}{8}$	37 $\frac{5}{8}$
Gen Inst	669	34 $\frac{7}{8}$	30 $\frac{1}{2}$	32 $\frac{7}{8}$
Varian Assoc	665	42	38 $\frac{1}{8}$	40 $\frac{3}{4}$
Elec & Mus Ind	641	6 $\frac{1}{4}$	5 $\frac{7}{8}$	6
Beckman Inst	546	80 $\frac{3}{4}$	75 $\frac{1}{4}$	78
Western Union	533	43 $\frac{1}{8}$	40 $\frac{1}{4}$	40 $\frac{3}{8}$
Bell & Howell	524	41 $\frac{3}{8}$	39	40 $\frac{1}{4}$
Fairchild Camera	522	162	145 $\frac{1}{4}$	151 $\frac{1}{8}$
Univ Controls	506	15 $\frac{3}{8}$	14 $\frac{3}{8}$	14 $\frac{5}{8}$
Polarad Elec	502	21	17	19 $\frac{5}{8}$
Raytheon	490	32 $\frac{7}{8}$	30 $\frac{1}{4}$	31 $\frac{3}{8}$
Dyn Corp of Amer	461	7 $\frac{3}{4}$	6 $\frac{5}{8}$	7 $\frac{3}{8}$
Collins Radio	455	45 $\frac{1}{4}$	41 $\frac{3}{4}$	43 $\frac{3}{4}$
Gen Dynamics	394	37 $\frac{1}{4}$	35 $\frac{3}{4}$	36 $\frac{3}{4}$
Barnes Engin	357	30 $\frac{3}{4}$	25	29 $\frac{1}{8}$
Telecro Ind	341	14	11 $\frac{1}{8}$	12 $\frac{7}{8}$
Cubic Corp	338	53	39 $\frac{5}{8}$	42 $\frac{7}{8}$

The above figures represent sales of electronics stocks on the New York and American Stock Exchanges. Listings are prepared exclusively for ELECTRONICS by Ira Haupt & Co., investment bankers.

AIRPAX

EXPANDED-SCALE FREQUENCY METERS



TYPE 5907 for use on
400 CPS supply sources



TYPE 5908 used on
60 CPS power source

These highly accurate, dependable Frequency Meters by Airpax, are completely self-contained. Connection is simple. Two meter terminals protruding from back of case connect directly across 100 - 130 volt source. Airpax MAGMETER® frequency sensing circuit is insensitive to voltage variations, responding only to frequency changes.

The 4½ inch meter, with mirror scale and combination pointer permits "quick look" indication at a distance and precise "close up" readings. Extension behind panel is approximately 2½ inches. Power consumption is less than 5 watts. Overall accuracy of frequency reading is 0.1% or .4 cycle in the 400 CPS model.

Ask for Bulletin F-06



SB23

SEMINOLE DIVISION • FORT LAUDERDALE, FLA.

Microwave equipment

for the **X** and **Q** band

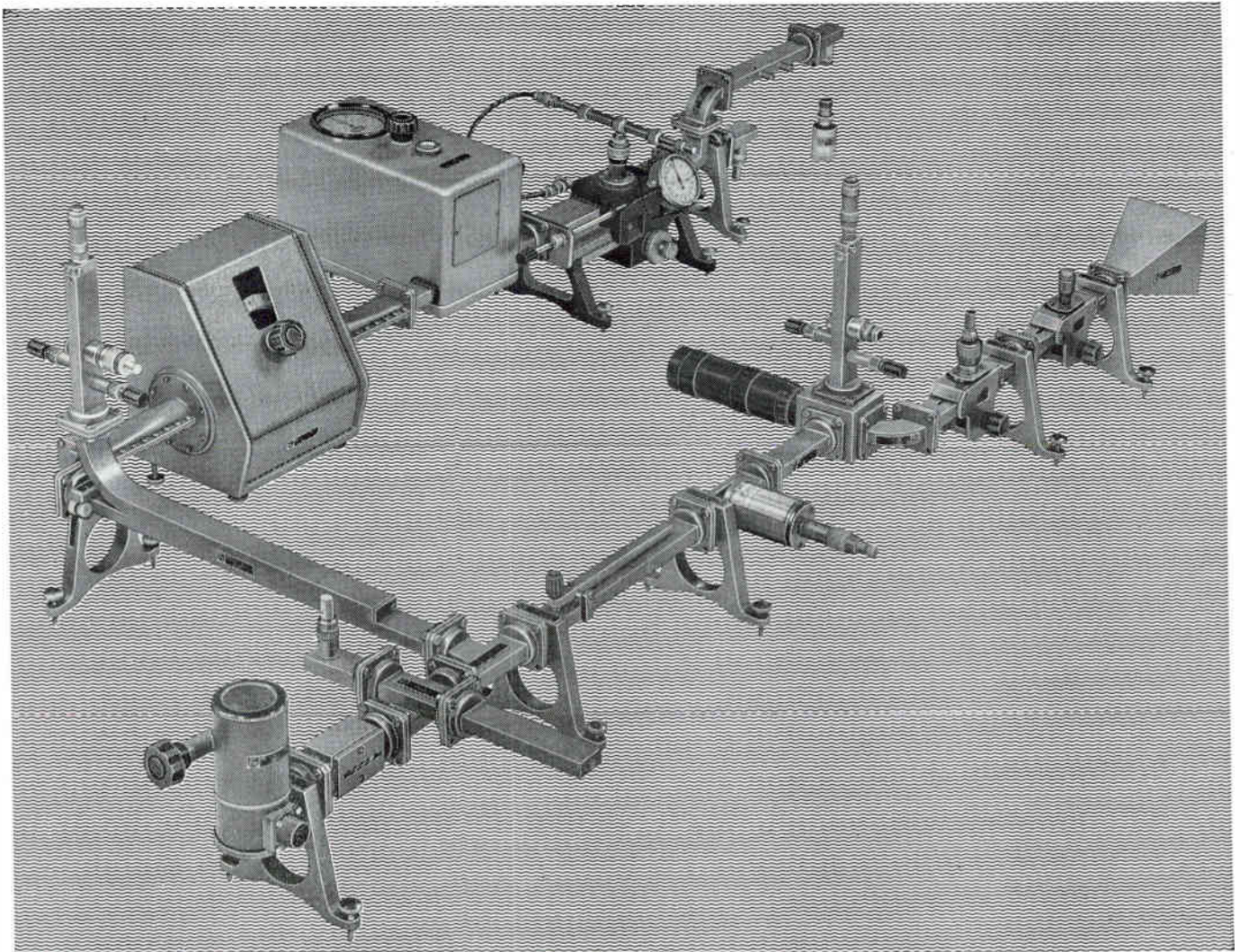

Measuring bench for 8.2-12.4 kMc s

PHILIPS *electronic measuring*

Sold and serviced by Philips Organizations all over the world

Further information will gladly be supplied by:

N.V. Philips' Gloeilampenfabrieken, EMA-Department, Eindhoven, the Netherlands

For Canada: Philips Electronics Ind. Ltd., Leaside, Toronto 17, Ont.

X TYPE	DESCRIPTION	MAX. VSWR.	
PP 4020 X	Straight Waveguide Section	—	Length 10, 20, and 40 cm
PP 4025 X	E-plane Bend	1.07	Radius of curvature 29 mm
PP 4030 X	H-plane Bend	1.07	Radius of curvature 29 mm
PP 4035 X	Twist	1.10	Length 187 mm
PP 4040 X	Shunt Tee	—	Length 80 mm
PP 4045 X	Series Tee	—	Length 80 mm
PP 4050 X	Hybrid Tee	—	Decoupling >40dB
PP 4070 X	Waveguide/Coaxial Adapter	1.50	50 Ω N-connector
PP 4080 X	Horn	1.25	Directivity: E-plane 20°, H-plane 25°
PP 4090 X	Multi-hole Directional Coupler	1.05	Directivity: >40dB, coupling factor 10dB or 20dB (± 0.2dB)
PP 4095 X	Cross-guide Directional Coupler	—	Directivity: 20dB, coupling factor 26dB (± 0.5dB)
PP 4110 X	Fixed Attenuator	1.10	Attenuation 6, 10 or 20dB (± 0.2dB), max. peak power 1 kW
PP 4130 X	Variable Flap Attenuator	1.15	Max. attenuation >20dB
PP 4150 X	Variable Rotary Attenuator	1.15	Max. mean power 1 W, max. attenuation 50dB, accuracy ± 2%
PP 4170 X	Low-power Matched Load	1.05	Max. mean power 2 W
PP 4200 X	Klystron Mount	—	When using klystron 2K25 the output power is >20 mW
PP 4220 X	Adjustable X-tal Mount	1.10	Sensitivity: 1 mV D.C. for 0.1 μV, 50 Ω N-connector
PP 4225 X	Broadband X-tal Mount	1.50	Sensitivity: 1 mV D.C. for 10 μV, 50 Ω BNC-connector
PP 4245 X	Tunable Thermistor Mount	1.10	Freq. range 8.2-11 kMc/s, 50 Ω BNC-connector
PP 4260 X	Calibrated Short Circuit	>100	Accuracy of the displacement 0.02 mm
PP 4280 X	Sliding Screw Tuner	from 20 to >1.02	Insertion loss for a VSWR of 20 is >2dB
PP 4290 X	Direct Reading Wavemeter	—	Freq. range 8.5-9.8 kMc/s, absolute accuracy ± 2 Mc/s, loaded Q 10,000
PP 4300 X	Broadband Wavemeter	1.10	Relative accuracy 3.10 ⁻⁴ , loaded Q >3,000
PP 4360 X	Measuring Cavity	—	Freq. range 8.65-8.95 kMc/s, loaded Q >3,000, magnetic field for electron resonance 3,300 gauss
PP 4380 X	Standing Wave Detector	1.05	Accuracy of the probe displacement 0.01 mm, 50 Ω BNC-connector
PP 4385 X	High Precision Standing Wave Detector	—	Measurable VSWR between 1.005-2.000, accuracy probe displacement 2 μ, probe penetration 0-3 mm
PP 4421 X	Ferrite Isolator	1.15	Freq. range 8.5-9.6 kMc/s, forward att. < 0.8dB, reverse att. >13dB, max. peak power 50 kW
PP 4422 X	Ferrite Isolator	1.20	Freq. range 8.5-9.6 kMc/s, forward att. < 0.5dB, reverse att. >20dB, max. mean power 1 W
PP 4500 X	3 cm Noise Generator	>1.20	Noise factor 18.7dB (K50A), attenuation 0-13dB

Additional Instruments: D.C. Microvoltmeter, type GM 6020 - Klystron Supply, type GM 4561 - Bolometer Bridge, type GM 4460

Q TYPE	DESCRIPTION	MAX. VSWR.	
PP 4020 Q	Straight Waveguide Section	—	Length 5, 10 or 20 cm
PP 4025 Q	E-plane Bend	1.07	Radius of curvature 35 mm
PP 4030 Q	H-plane Bend	1.07	Radius of curvature 37 mm
PP 4035 Q	Twist	1.07	Length 50 mm
PP 4050 Q	Hybrid Tee	—	Decoupling >35dB
PP 4080 Q	Horn	1.15	Directivity: E-plane 15°, H-plane 16°
PP 4130 Q	Variable Flap Attenuator	1.15	Max. attenuation >20dB
PP 4150 Q	Variable Rotary Attenuator	1.15	max. mean power 200 mW
PP 4170 Q	Low-power Matched Load	1.05	Max. attenuation 50dB, accuracy ± 3%
PP 4200 Q	Klystron Mount	—	Max. mean power 1 W
PP 4222 Q	Adjustable X-tal Mount	1.25	When using klystron 55,335 the output power is 100 mW
PP 4260 Q	Calibrated Short Circuit	50	50 Ω BNC-connector
PP 4270 Q	Sliding Screw Tuner	from 10 to 1.03	Accuracy of the displacement 0.02 mm
PP 4300 Q	Broadband Wavemeter	1.20	Insertion loss for a VSWR of 10 is >2dB
PP 4382 Q	Standing Wave Detector	1.03	Relative accuracy 5.10 ⁻⁴ loaded Q >3000
PP 4420 Q	Ferrite Isolator	1.15	Accuracy of the displacement 0.01 mm
			max. probe penetration 1 mm, 50 Ω BNC-connector
			Freq. range 33-36 kMc/s, forward att. < 1dB
			reverse att. 13-26dB, max. mean power 200 mW

Additional Instruments: Klystron Supply, type 4485 - D.C. Microvoltmeter, type GM 6020

instruments: quality tools for industry and research

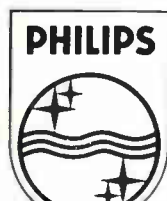

CIRCLE 23 ON READER SERVICE CARD

NEVER BEFORE AVAILABLE!...

COMPLETELY
TRANSISTORIZED
AND MILITARIZED
**AC VOLTAGE
STANDARD**



0.035%
ABSOLUTE ACCURACY
0.015%
TOTAL HARMONIC
DISTORTION
0-511.11 VOLTS
MILLIVOLT RESOLUTION
SIX DECADES

FOR

- STANDARD LABS
- SYSTEM CALIBRATION
- FIELD CALIBRATION
- MISSILE CHECKOUT

Rotek's advanced design uses the latest analog computer techniques to create an AC reference source with accuracies never before possible. Because of its mil spec design, 0-52°C and hi-shock, the instrument may be used in all environments with complete reliability assured. Employment of the latest calibration methods, together with the Rotek AC/DC to DC Comparator, permits calibration of the instrument to 0.019%. Accuracy of the Rotek AC Voltage Standard is guaranteed for one year without recalibration.

Please write for Bulletin 146

Other Rotek instruments:
AC/DC to DC Comparators
Electronic Standard Cells
DC References

NEREM SHOW — BOOTH 55



ROTEK INSTRUMENT
CORPORATION

733 CONCORD AVE., CAMBRIDGE 38, MASS.
Kirkland 7-0175

MARKETING

Impact of Technology on Marketing

By BRUCE HENDERSON,
Vice President, Arthur D. Little, Inc.

CRITICAL IMPORTANCE of marketing today is due to the impact of technology.

If it were not for technology, marketing could settle down into a well-known established pattern in which only the skill of the salesman was really important. But technology is introducing ever more rapid change—change in products—change in the production cycle—change in risk—change in consumer behavior—change in physical distribution—change in competitor's capability—and perhaps most important of all—change on our insight into the relations between these complex forces in the marketing equation.

Fortunately, technology not only creates marketing problems by introducing change, but in turn, it provides the tools to deal with the problem.

Let's catalogue some of the impact:

First, new products—The birth rate of new products from new technologies like electronics was never higher and the variety was never greater. The introduction and the customer recognition of the values and the rapid obsolescence of the many old products becomes a marketing problem.

For the last 10 years industry has been pouring into R&D sums that increased each year. In 1953-54, this amounted to some \$2,240,000,000, and six years later it is estimated at \$4,426,000,000. Since from three to eight years elapse before the effects of R&D investment are felt, we shall see new products and the resultant obsolescence growing rapidly.

The food industry, aided by electronic & nucleonic techniques, offers examples with astounding changes. For example, yesterday taking a visitor through one of our labs, I ate some raspberries and some strawberries that looked fresh, smelled fresh, tasted fresh and felt



Henderson

fresh, but had been stored over a year at room temperature.

Second, technology is generating more complex and more sophisticated products at an increasing rate. Some of these are more complex in nature for industrial application, particularly electronics. Some are far more sophisticated for discriminating consumers.

Third, longer development cycles and greater capital commitment to the production facility are the natural result of the increased complexity both of products and of more highly automated production. Balancing the resulting increase in risk and inflexibility against the potential rewards becomes a marketing problem.

Fourth, since change is large but uneven, consumer behavior and values must change too. With the greater choice and complexity of products, the consumer becomes less the "economic man" seeking to satisfy his elementary needs and becomes more the "social man" striving for maximum satisfaction of cultural, psychological and social motivation.

Marketing must identify these even more subtle motivations and convert them into marketing plans, recognizing the greater cyclical vulnerability of some types of non-elementary needs. Russell Lynes has pointed out the problems cre-

ated for marketing men by the "taste-makers."

Their whims and desire to be individual become tomorrow's fashion—whether it be vodka, martinis, sports cars or grey flannel suits.

Because technology makes possible an almost infinite variety of products, consumer wants are not always easily interpreted, measured and forecast. They change for no apparent reason, requiring a high degree of sensitivity and flexibility in the marketing profession.

Fifth, the logistics of physical distribution are being changed. Personal services are becoming more expensive. Automatic pre-planned data processing and handling equipment are becoming more effective. Alternative transport methods become more numerous and competitive (air—rail—barge—truck).

Both the costs and the rules of the game are changing for the marketing man who would optimize the marketing process. All of these things mean that marketing today is faced with ever more complex, ever more sophisticated, ever more rapidly changing problems. Solution by "feel" or by intuitive insight becomes less and less reliable except as checked and modified by intensive, fact-based analysis. While past experience is a valuable guide to the future, it is not sufficient to deal with change of this magnitude.

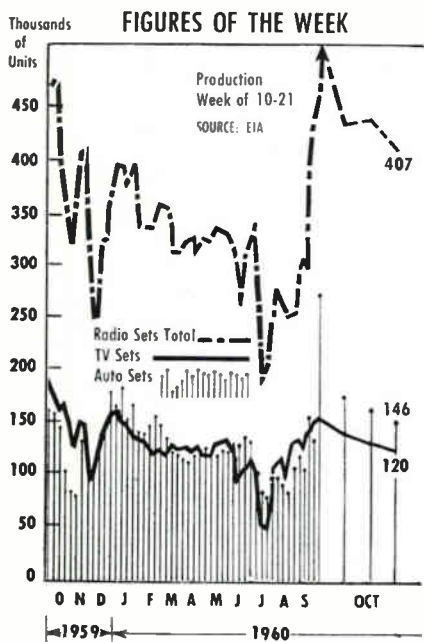

November 11, 1960

MicroMatch

RF LOAD RESISTORS COVER THE RANGE:

TO 6000 WATTS AND 3000 MCS.

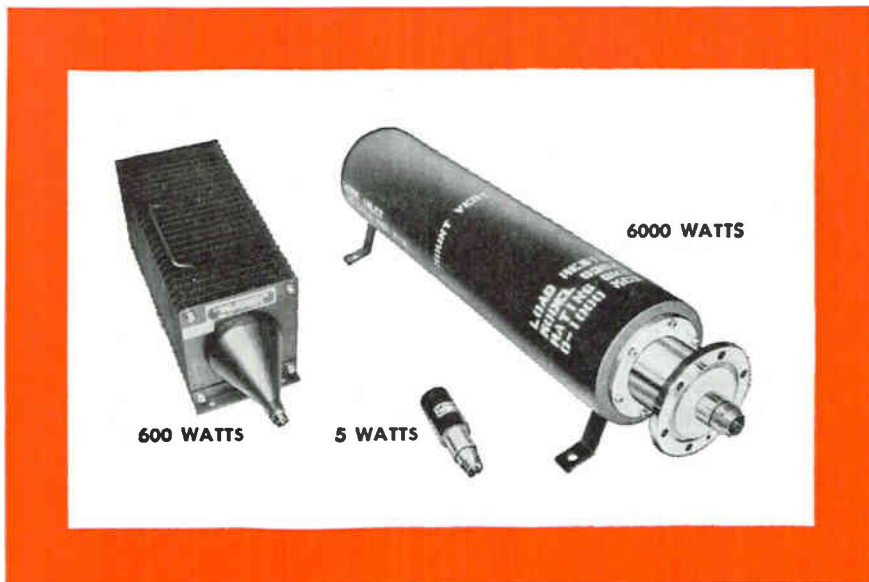

MicroMatch

RF Load Resistors provide the virtually reflectionless terminations needed for accurate RF power measurement. They serve many useful purposes as non-radiating RF power absorbers, particularly in lieu of antenna systems during the measurement and alignment phase of transmitter operation.

Other useful functions are in conjunction with feed-through wattmeters to form excellent absorption-type wattmeters, and as a load for side-band elimination filters or high power directional couplers.

SPECIFICATIONS		RF LOAD RESISTORS	
MODEL NO.	FREQUENCY RANGE (mcs)	RF POWER DISSIPATION (watts)	RF CONNECTORS
601	0-3000	5	N, C or BNC
603	0-3000	20	N, C or BNC
633	0-3000	50	N, C or HN
634	0-3000	150	N, C or HN
635	0-3000	200	N, C or HN
636	0-3000	600	N, C or HN
638	0-2000	6000	3/8" flange

Many other special models have been designed and manufactured to meet your particular space and input connection requirements.

For more information on RF Loads, Directional Couplers, Tuners, and RF Wattmeters, write:

M. C. JONES ELECTRONICS CO., INC.



185 N. MAIN STREET, BRISTOL, CONN.
SUBSIDIARY OF



CIRCLE 25 ON READER SERVICE CARD

25

TIGHTLY PACKED

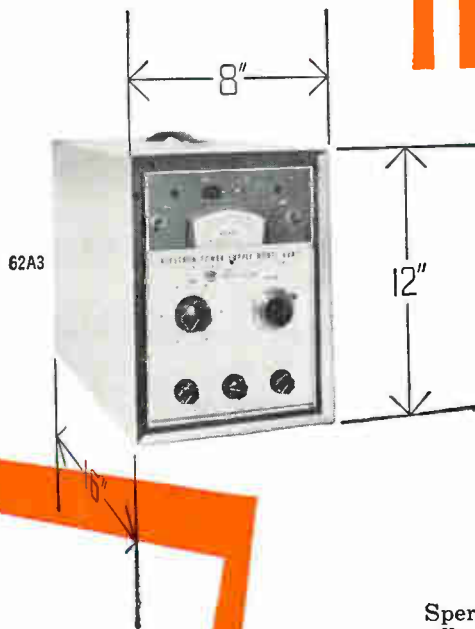

Smallest
and lightest
for its power
on the market



Sperry Klystron Power Packages are offered in two sizes to meet any laboratory requirements.

Model 62A1 Universal Klystron Power Supply delivers -200 to -4,000 volts from 0 to 150 ma. Extremely compact: 12 $\frac{1}{4}$ " high, 19 $\frac{1}{4}$ " wide, 17 $\frac{3}{4}$ " deep. Weighs only 125 lbs.

Model 62A3, is today's most versatile 700 volt Klystron Power Supply. It is the smallest and lightest package of its power on the market. Delivers up to 70 ma. Ideal for average laboratory use—and at a moderate price. Weighs only 32 lbs. and measures 8" x 12" x 16".

Both units designed for ready adaptability to accessory connections. Excellent regulation, low ripple, stable operation.

Write for detailed information and applications of these packed-with-power units for general laboratory use.

POWER!

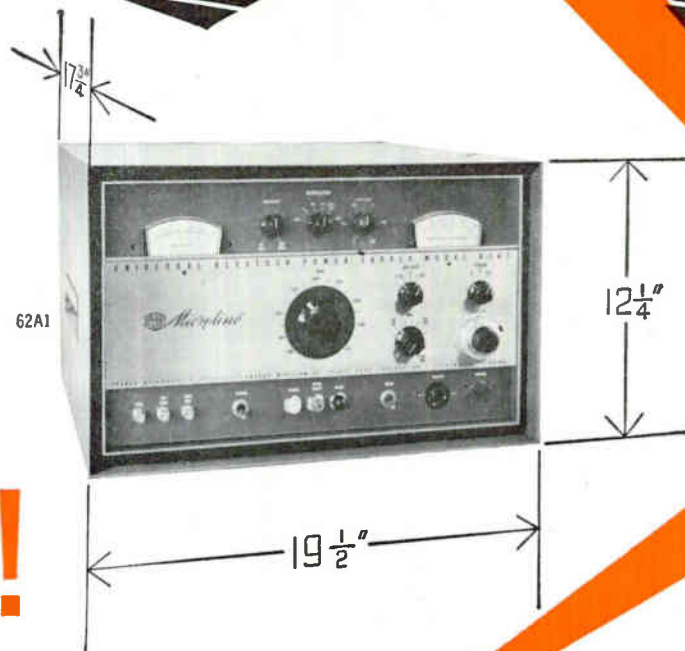

SPERRY *Microline*® KLYSTRON POWER SUPPLY

MODEL 62A3		MODEL 62A1
-200 to -700 volts Continuously adjustable 0-70 ma. ± 1 volt line regulation 5 mv. max. ripple	BEAM	-200 to -4000 volts Continuously adjustable 0-150 ma. ± 1 volt line regulation 3 mv. max. ripple
0-1000 volts 0.1% regulation 5 mv. max. ripple 6.3 volts @ 0-2 amp.	REFLECTOR	0 to -1000 volts .01% regulation 3 mv. max. ripple
2% accuracy	FILAMENT	6.3 volts @ 4 amp., with provision for external filament supply
0-150 v., peak to peak, all waveforms <i>Sawtooth:</i> 40-400 cps. <i>Square Wave:</i> 200-2000 cps. <i>Sine Wave:</i> line frequency <i>External Modulation:</i> direct or amplified	METERING MODULATION	2% accuracy 0-250 v., peak to peak, all waveforms <i>Sawtooth:</i> 40-400 cps. <i>Square Wave:</i> 200-2000 cps. <i>Sine Wave:</i> line frequency <i>External Modulation:</i> direct or amplified
8" x 12" x 16"	DIMENSIONS	12 1/4" x 19 1/2" x 17 3/4"
32 lbs.	WEIGHT	125 lbs.
\$550	PRICE	\$1300

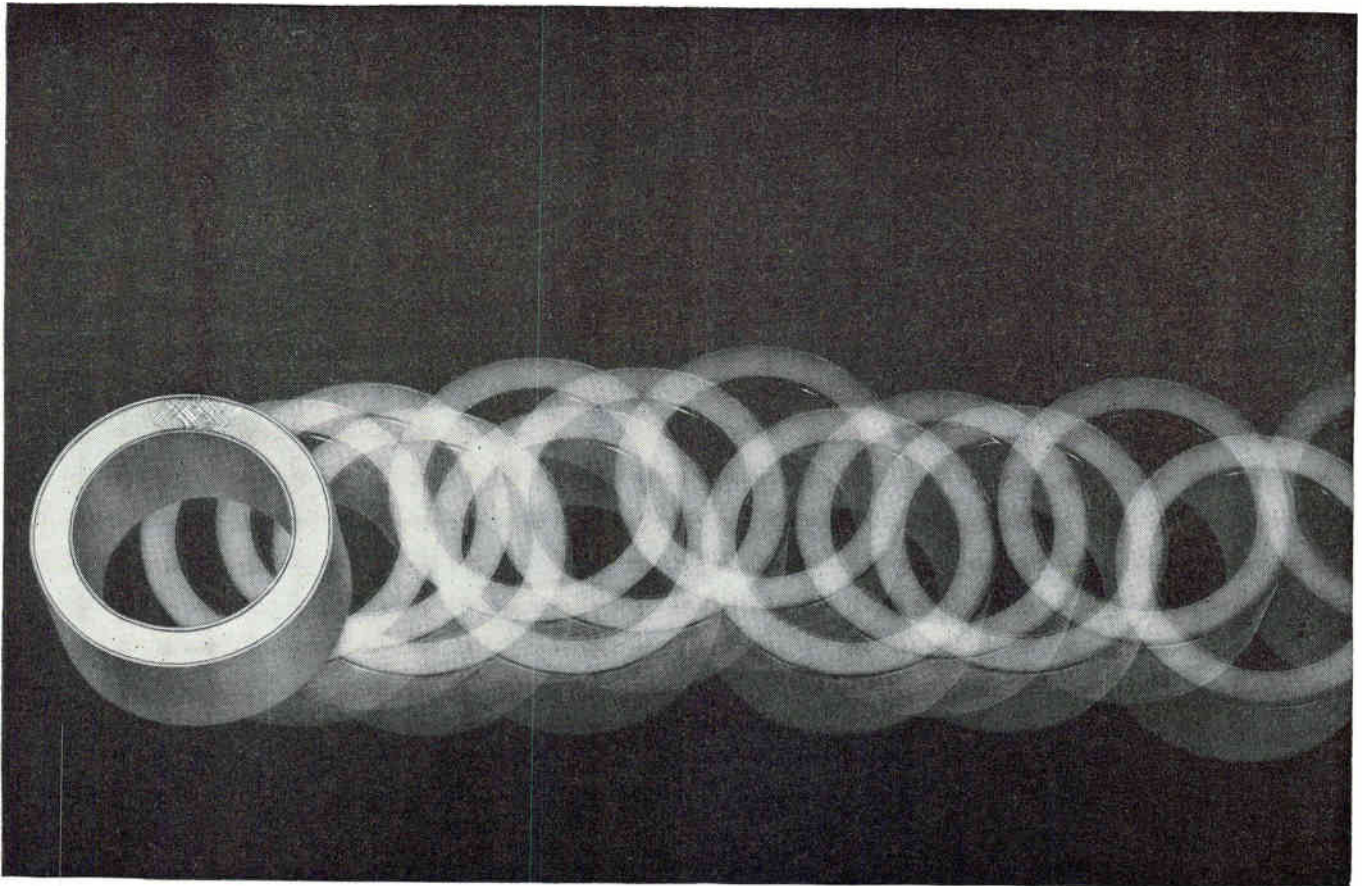

the strong case for Centricores[®]

When you're considering magnetic cores it pays to get down to cases. The sturdy aluminum case for Centricores assumes special importance where impact, vibration, heat or mechanical pressure could cause trouble in a control loop you're designing, or where you want to miniaturize an inductive component.

The case is ruggedly rigid, so that you can apply your circuit windings without danger of distorting the core's magnetic properties. And the case is absolutely leakproof. You can vacuum-impregnate Centricores without danger of their damping oil leaking out or foreign matter leaking in. The tightly sealed case also guards against leakage in applications where high ambient temperatures are present, or where Centricores are used in rotating equipment.

Here's a tip on miniaturization. The rugged design of the Centricore case permits use of a thinner gage aluminum that shaves fractions of an inch off their size—fractions that can add up to precious inches where you want to scale down component dimensions. *Centricores are the slimmest magnetic cores on the market.*

Centricores are the most uniform. They give the exact performance you want, from core to core and lot to lot. Their remarkable consistency in insulation, dimensions, squareness, thermal stability and gain is the product of unique quality controls that begin with the very selection of raw materials and extend through final testing.

Write for complete data. Centricores are available from stock from our East and West Coast plants in all standard sizes and magnetic qualities, and in both aluminum and phenolic cases. We will match them within 5 per cent over the entire voltage-current loop, in sets, units or in multiples up to twelve. Write for detailed specifications today.

MMAGNETIC
 **M**ETALS

Magnetic Metals Company

Hayes Avenue at 21st Street, Camden 1, N.J.

853 Production Place, Newport Beach, California

*transformer laminations • motor laminations • tape-wound cores
powdered molybdenum permalloy cores • electromagnetic shields*

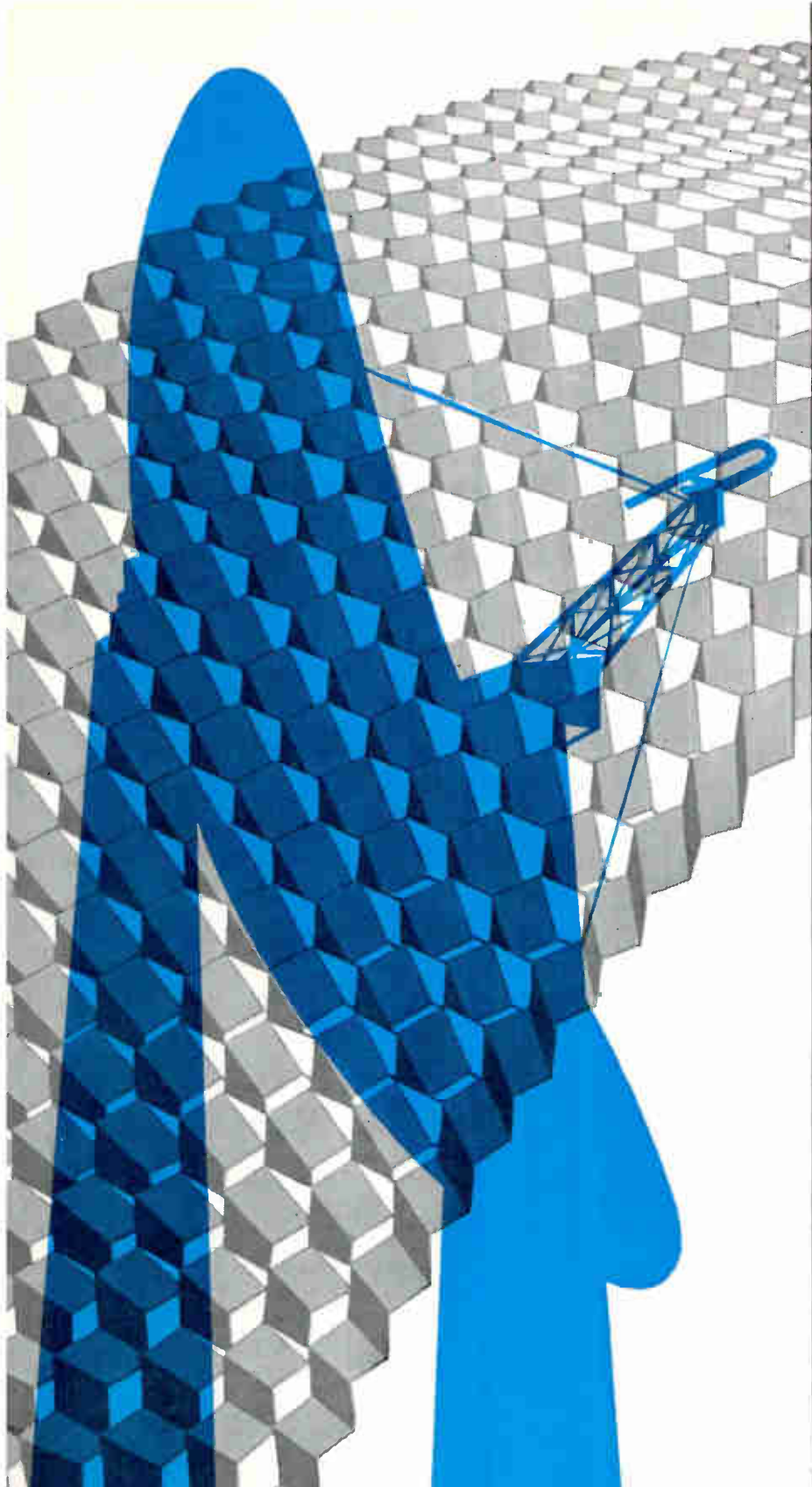

Three stories high.. the FPS-26 tells a story of **Avco/Nashville** radar capability

Now in production at Avco/Nashville is a huge reflector for the Air Force's FPS-26 height-finder radar. Researched and developed by Avco's Electronics and Ordnance Division, the entire FPS-26 stands three stories high. The reflector, made of high-rigidity, low-weight honeycomb sandwich construction, is housed in a radome 50 feet in diameter.

In contrast is another radar reflector also made by Avco/Nashville. It is a small, highly developed, carefully finished reflector for Mach 3 military aircraft. It is made of *Avcomb* stainless steel honeycomb.

These two reflectors indicate the range and scope of Avco/Nashville's capabilities in the field of radar reflectors as well as other structures with high-strength, light-weight materials.

In its large plant in Nashville, Tennessee, Avco/Nashville has specialists experienced in the design, tooling, and construction of radar antennas or reflectors. It also has facilities for producing pedestals for large radars.

Conventional radar antennas and those of sandwich construction are all within the demonstrated engineering and production capability of Avco/Nashville.

Inquiries about radar structures are invited from prime contractors. Write to: General Marketing Manager, Nashville Division, Avco Corp., Nashville, Tenn.

UNUSUAL CAREER OPPORTUNITIES FOR QUALIFIED SCIENTISTS AND ENGINEERS... WRITE AVCO/NASHVILLE TODAY.

Avco // **Nashville**

CIRCLE 29 ON READER SERVICE CARD





NEW **D** SANGAMO RESIN-COATED SILVERED-MICA CAPACITORS...

are significantly smaller ... operate to +150° C ... exceed proposed dipped-mica capacitor military specifications

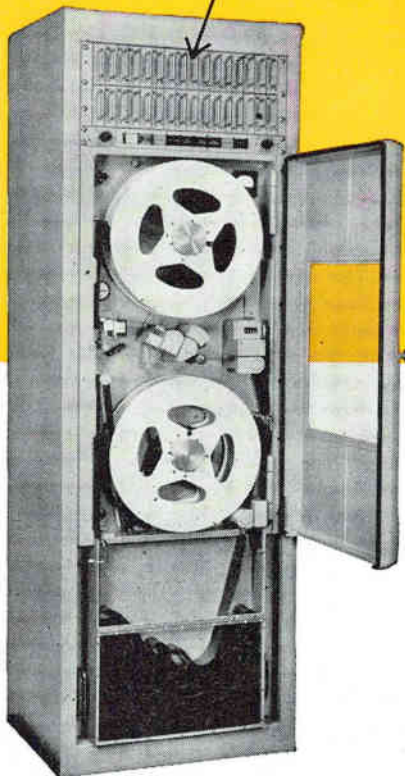
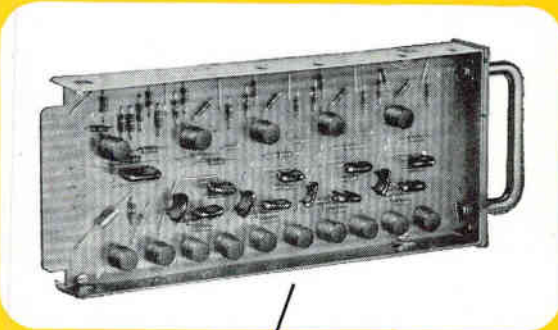

Sangamo experience with mica capacitors and years of engineering know-how and quality development underline two new Type D Resin-Coated Silvered-Mica Capacitors. Designed for operation at temperatures of +125° C and +150° C, both offer the advantages of radial leads, small size, full rated working voltage without derating, and a clean, moisture-sealed protective resin coating. Physical and electrical features of the Type D capacitor are ideal for etched circuits, high component-density equipments, missiles, computers, and instrumentation devices. Type D capacitors are available with characteristics C, D, E, or F, in nearly all capacitance values.

Test these new Sangamo Type D Resin-Coated Silvered-Mica Capacitors — they more than meet proposed military specifications. Try them in your own circuits — they will fulfill all expectations of today's most critical applications. Those who know capacitors choose Sangamo for outstanding performance and long life.

... Type D Resin-Coated Silvered-Mica Capacitors are an important part of the transistorized circuitry of this Sangamo Type 460 Tape Transport System. Their small size, high-temperature performance, and reliability contribute materially to the transport's recording uniformity and play-back accuracy —

SC60-7

SANGAMO ELECTRIC COMPANY, Springfield, Illinois
— designing toward the promise of tomorrow

after routing,
clip and save

a continuing series on technical topics
of specific interest to engineers

Folio 13

REFERENCE
DATA FILE



What constitutes a superior dipped-mica capacitor?

Silvered-mica capacitors have achieved a reputation over many years of use for high stability and high reliability. Mica's inherent low power factor, high dielectric strength, low dielectric absorption and high insulation resistance have made mica capacitors most desirable in electronic circuits where good stability with respect to temperature, frequency, and aging are required.

But refinements of mechanical features were required for today's high component-density equipment utilizing etched-circuit construction. Some of the requirements that led to development of the dipped mica capacitor were:

1. A protective covering, that is thermally and mechanically rugged, impervious to moisture, and non inflammable.
2. Radial leads for rapid assembly, rigid mounting, and cool operation.
3. Small size and dimensional uniformity for more compact and standardized assemblies.
4. A glossy surface to which dirt does not adhere and which also enhances appearance.
5. Lower cost through improved automated manufacturing techniques.

Considering these requirements, Sangamo has designed two new Type D resin-coated, silvered-mica capacitors. They have a better coating resulting from finer materials used in the dipping process, and also possess the excellent performance characteristics previously established by other types of Sangamo silvered-mica capacitors.

MECHANICAL DESCRIPTION: The mica is carefully selected for electrical excellence and dimensional uniformity. The silver is screened on the mica and fired to effect a positive bond. A positive low-resistance connection is assured by clips and leads of tinned brass pressure clamped to the section.

Good thermal shock characteristics, moisture resistance, and a glossy surface are provided by five separate resin coatings that do not appreciably alter the electrical characteristics of the silvered-mica section.

OPERATIONAL PERFORMANCE:

Type D capacitors are available in two maximum temperature ratings, +125° C or +150° C. Both can be operated at rated voltage without derating.

The insulation resistance for capacitance values is shown in Figure I for +25° C, +125° C, and +150° C.

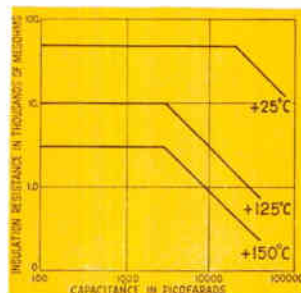

These capacitors are available in C, D, E, or F characteristics over the temperature range of -55° C to +125° C or +150° C as shown in the following table:

Characteristic	Temperature Coefficient ppm/° C	Capacitance Drift Per Cent	Availability of Characteristic
C	±200	±0.5	All Values
D	±100	±0.3	All Values
E	-20 to +100	±(0.1 + 0.1 pf.)	Above 20 pf.
F	0 to +70	±(0.05 + 0.1 pf.)	Above 50 pf.)

The moisture resistance is given as an insulation resistance greater than 10,000 megohms after a ten day cycle outlined in Method 106A, Figure 106-1 of Mil-Std-202B.

Thermal and immersion cycling is given as an insulation resistance greater than 10,000 megohms when subjected to temperatures between -55° C and +125° C or +150° C as outlined in Method 102A, test condition D and Method 104A, test condition B of Mil-Std-202B.

These capacitors will withstand a constant acceleration of 20 G's in accordance with Mil-Std-202B, Method 204A, test condition D.

Values of Q at various frequencies are shown in Figure II.

Type D capacitors can be stored at -55° C without injury. Case insulation strength is 200 per cent of rated voltage.

They will have an insulation resistance of 10,000 megohms at +25° C after an accelerated life test of 2,000 hours duration at 150 per cent of rated voltage, at high ambient test temperatures of +125° C or +150° C.

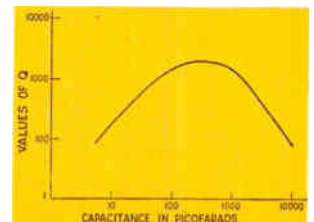

Acceptable Quality Levels (AQL) of completed units are fully met using the sampling plan set forth in Mil-Std-105A. This limits visual and mechanical AQL to 1.5%; Electrical AQL to 0.65%; and environmental AQL to 2.5%.

Sangamo also supplies the Type D as a non-standard capacitor in accordance with special requirements. Where maximum dimensions are critical and military humidity specifications do not apply, Type D capacitors are available with fewer resin coats. If circuit design requires a lower temperature coefficient, it can be provided when specified. Where improved reliability is an important factor, Type D capacitors can be 100 per cent short-term, accelerated life tested. In addition to straight lead design, Type D is also available with crimped leads which provide a positive stop when capacitors are mounted on etched-circuit boards.

SC60-8

SANGAMO ELECTRIC COMPANY, Springfield, Illinois
— designing toward the promise of tomorrow

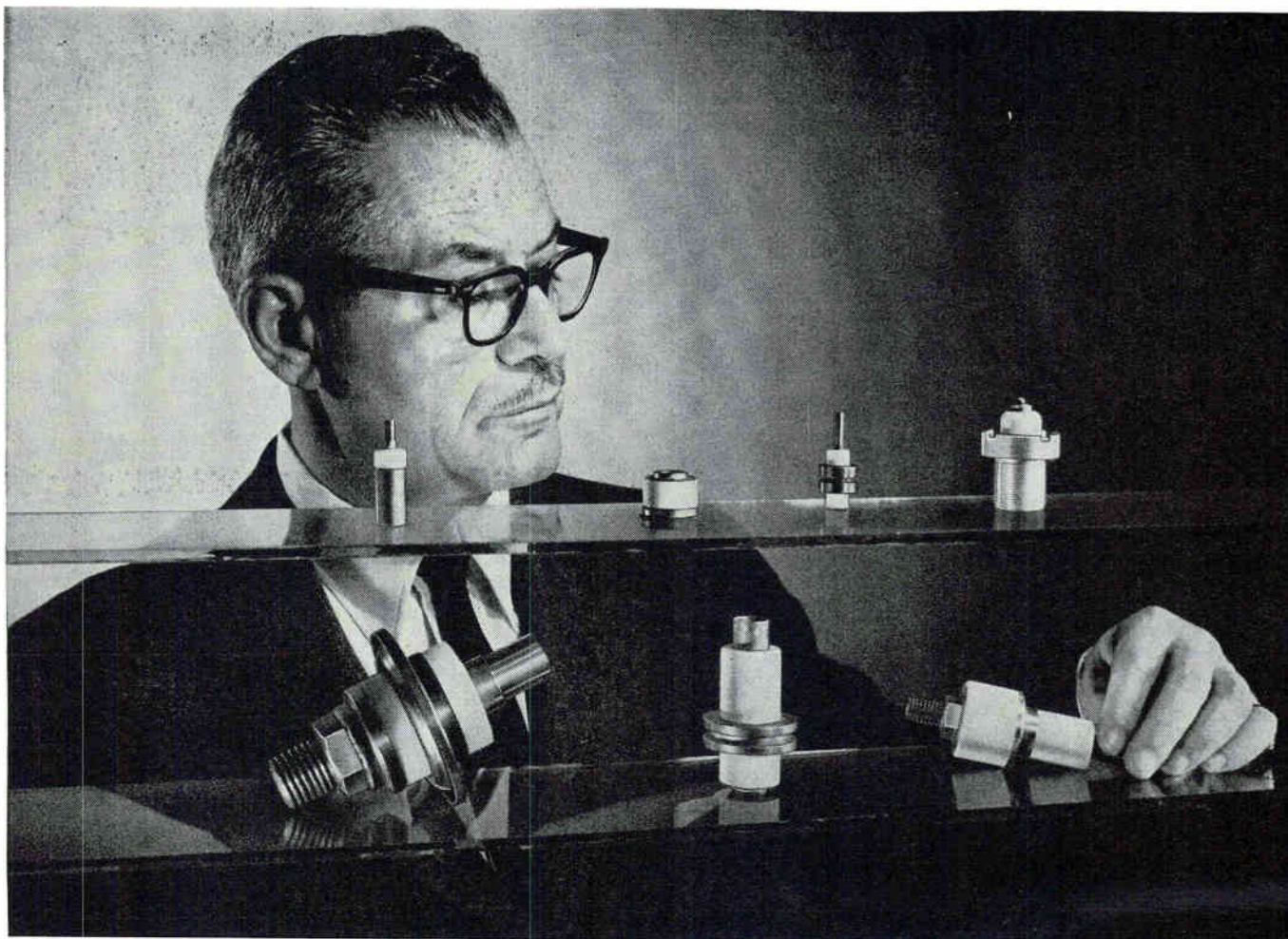

Engineering hints from Carborundum

Use KOVAR® Alloy to solve problems in sealing to ceramics

KOVAR, the original 29% nickel, 17% cobalt, 54% iron alloy, was developed for sealing to low expansion glass, but is now being used extensively for making pressure and vacuum tight seals with metallized ceramics of the low expansion type.

The curves at right show the expansion of KOVAR compared with a representative high alumina ceramic body. The expansivity match up to 500 C is very close, and the difference in expansion at higher temperatures is closer than with most common metals and alloys.

The fact that KOVAR is slightly higher in expansion at elevated temperatures is an actual advantage when the ceramic is on the inside of the unit since the resulting joint is placed in compression. The degree of compression is slight compared with that resulting from the use of a metal of higher expansion.

While a considerable difference in expansivity can sometimes be tolerated with the metal on the outside of thick sections of ceramic, this is not the case when the ceramic section is thin. Closer compatibility of expansivity, such as is obtained with KOVAR, is also required when the metal is on the inside of the ceramic or for sandwich or end type seals where both tensional and shear stresses must be kept to a minimum.

KOVAR alloy is stocked in a variety of sizes of rod, wire, tubing, sheet, cups and eyelets. Your inquiries are invited for prices, technical information and recommendations on specific problems. Write Dept. E-100 Latrobe Plant, Refractories Division, The Carborundum Company, Latrobe, Pa.

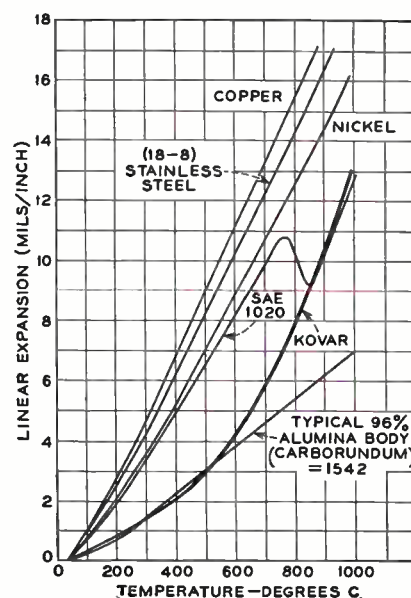

For permanent vacuum and pressure-tight sealing...count on

CARBORUNDUM®

In **PRECISION FILM RESISTORS**

if it's news, expect it first from IRC



**Most moisture-resistant coat ever achieved...
withstands 30 cycles of MIL moisture!**

IRC precision film resistors with M Coat take 30 cycles of moisture, 300% of the MIL-R-10509C Characteristic B requirement, tested in accordance with MIL standard 202.

M Coat adds greater protection for the resistance element, eliminates handling and assembly damage. Insulation resistance after 30 cycles of moisture is over 100 megohms.

Rating: $\frac{1}{2}$ watt at 70°C ambient. Standard tolerance: $\pm 1\%$. Range: 10 ohms to 2.49 megohms. Maximum continuous working voltage: 350.

Write for Bulletin AE-15, International Resistance Co., 401 N. Broad St., Philadelphia 8, Pa.

**Trademark exclusive IRC moisture-proof coating*



Leading supplier to manufacturers of electronic equipment

Highly Reliable

HITACHI "SEMI-CONDUCTORS"

For Industrial Use
Switching Transistors and Diodes

2SA18
2SA41
2SA42
2SA86
2SA208
2SA209
2SA210
2SB66
2SB67
2SB68
2SB81
2SB82
2SC89
2SC90
2SC91

Hitachi semi-conductors provide the basis for the excellent capacity of the Hitachi Electronic Computer HITAC 103.

1N34A
1N35
1N38A
1N56A
1N60
1S77
1S78
1S79
1S84

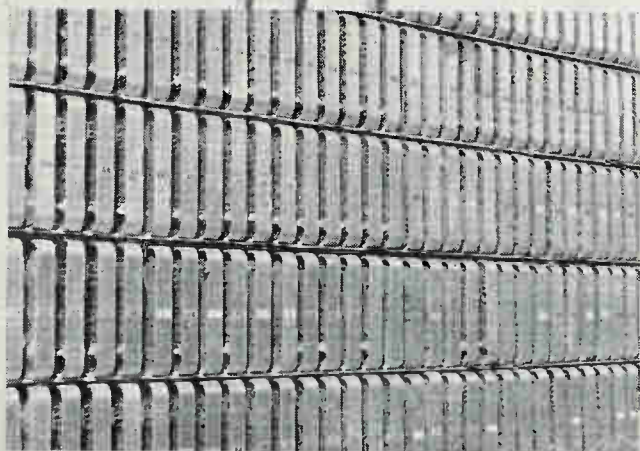

Back of HITAC 103.



Hitachi, Ltd.

Tokyo Japan

Cable Address: "HITACHY" TOKYO

STANDOUT PERFORMER

in R-F Attenuation

Telonic®

INDUSTRIES INC.

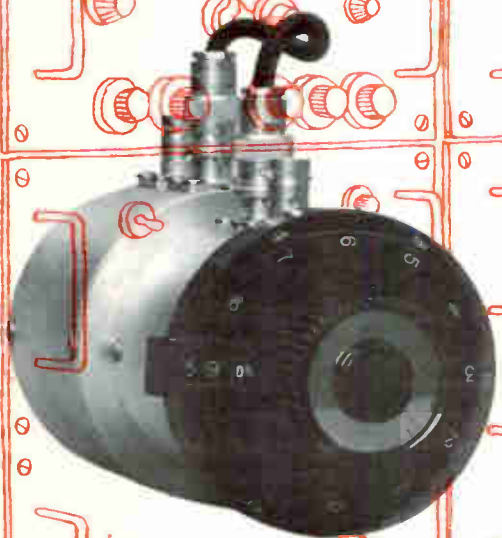

Telonic Industries presents the new, compact TAB-50 RF signal attenuator for operation from DC to 1250 mc with an attenuation range of 0 to 59 db in 1 db increments. TAB-50 DC to 1250 mc RF Attenuator

The new Model TAB-50 is a precision-built unit that fills the electronic design engineer's need for the universal RF attenuator. It can be used unmounted as a laboratory unit, or panel mounted as a component in instruments or systems.

Performance is unique — it exhibits low VSWR ratios, low insertion loss at the 0 db position, and high accuracy across its entire operating range.

SPECIFICATIONS

Attenuator steps	0 to 59 db (in 1 db steps through a dual, concentric knob and dial arrangement)
Impedance	50 ohms
Frequency range	DC to 900 mc (reduced accuracy to 1250 mc)
Accuracy	0 to 10 db ± 0.2 db to 200 mc ± 0.3 db at 400 mc ± 0.5 db at 900 mc 11 to 59 db $\pm 2\% \pm 0.2$ db to 200 mc $\pm 3\% \pm 0.3$ db at 400 mc $\pm 5\% \pm 0.3$ db at 900 mc
VSWR	1.2:1 to 300 mc 1.35:1 to 900 mc
Insertion loss	0.1 db to 300 mc 0.2 db to 500 mc 0.4 db to 900 mc
Power rating	1 watt
Dimensions	Case Diameter: 3" Case Length: 4 $\frac{3}{4}$ "
Weight	44 ounces
Price	\$225.00

Telonic also manufactures other RF turret attenuators for various applications. Two typical units are the TA-50 and the TB-50 shown below.



Model TA-50
Attenuator steps:
0, 10, 20, 30, 40, 50 db
Price \$65.00



Model TB-50
Attenuator steps:
0, 1, 2, 3, 4, 5, 6, 7, 8,
9, 10 db—Price \$95.00

FIRST CLASS
PERMIT NO. 25
BEECH GROVE, IND.

BUSINESS REPLY CARD
NO POSTAGE STAMP NECESSARY IF MAILED IN THE UNITED STATES

POSTAGE WILL BE PAID BY

TELONIC INDUSTRIES, INC.

BEECH GROVE, INDIANA

FOR COMPLETE DATA ON TELONIC TURRET ATTENUATORS OR OTHER RF COMPONENTS AND TEST EQUIPMENT FILL OUT THE REPLY CARD AND DROP IT IN THE MAIL.

SWEEP GENERATORS

In RF Circuit Testing the ultimate quality check is frequency response —

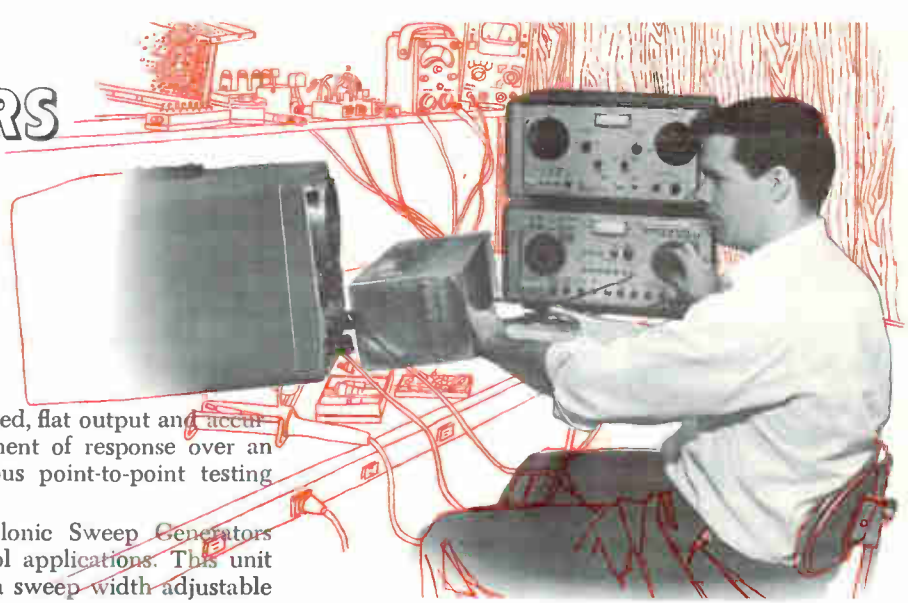

— and Telonic Sweep Generators, featuring regulated, flat output and accurate attenuation, provide rapid, precision measurement of response over an entire frequency range at a single glance. Tedious point-to-point testing techniques are completely eliminated.

The model HD-1A shown here is typical of Telonic Sweep Generators available for both development and quality control applications. This unit has a center frequency range of 1 to 900 mc and a sweep width adjustable from 200 kc to 200 mc.



RF output of the instrument is .75 volts, peak to peak, in the low band, and 2.0 volts, peak to peak, in the high band — all voltages adjustable by the panel-mounted turret attenuator. Toggle switches on the front panel introduce birdy markers into the scope trace, and up to eight plug-in single frequency or harmonic markers may be used. Price — \$995.00

Telonic Industries provides a complete line of sweep generators for use in the laboratory or on the production line. These instruments may be used for rapid frequency response testing of filters, tuners, mixers, amplifiers and all other types of RF equipment. The following chart shows some of the other models available.

Model	Center Frequency	Sweep Width	Range	Attenuation (db) (T) Turret (S) Toggle Switch	Output (into 50 ohms)	Remarks	Bulletin Number	Price List
HD-3	1-200 mc	200kc-200 mc	1-300 mc	T-0, 10, 20, 30, 40, 50	.75, p to p	Heterodyne type — wide sweep width and tunable center frequency	T-210	835.00
HD-4	10kc-10 mc	25kc-10 mc	10kc-15 mc	S-20, 20, 20, 10, 6, 3	1V, p to p	Video sweep — wide or narrow applications	T-213	695.00
HD-7	100kc-75 mc	250kc-50 mc	100kc-100 mc	S-20, 20, 20, 10, 6, 3	1V, p to p	Video and IF frequencies Higher video and IF frequencies		
LD-5	20-75 mc	.05-40% of CF	16-90 mc	S-20, 20, 20, 20, 20, 10, 5, 3, 2, 1	1uV-1V, RMS	Electronically swept • Fundamental frequency type • Wide range of output levels • Exceptionally stable, flat and free from spurious content	T-214	695.00
SD-2	215-450 mc	.02-10% of CF	200-460 mc	T-0, 10, 20, 30, 40, 50	.75V, RMS	Capacitive sweep Center frequency tuning Exceptionally flat	T-207	745.00
SD-3	440-920 mc	.01-6% of CF	425-930 mc	T-0, 10, 20, 30, 40, 50	.75V, RMS	VHF — UHF — low microwave applications		
ED-1A	1000-1700 mc	.25-100 mc	975-1515 mc	Vernier 0-10db	.25VRMS	Output is result of 2nd harmonic generation and filtering — and thus these ranges are obtained from the highly reliable SD type of oscillator	T-216	1495.00
ED-4A	1700-2500 mc	.25-100 mc	1675-2320 mc					

Complete information on sweep generators, accessories and other RF equipment made by Telonic is available on request; use the reply card below.

Telonic Industries, Inc. Beech Grove, Indiana

Please send complete data on the following:

- RF Turret Attenuators RF Detectors
 Sweep Generators RF Toggle Switch Attenuators
 Model No. _____ RF Filters

Name _____ Title or Dept. _____

Company _____

Address _____

City _____ State _____

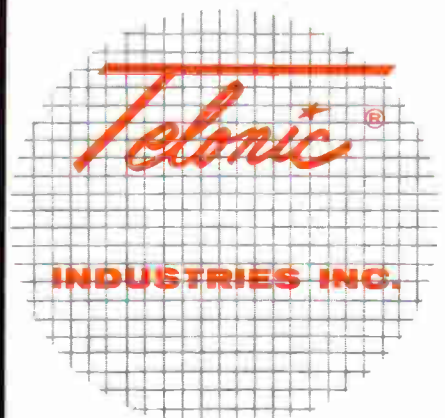

Q & A

ABOUT DVST's

Q: Do you know the important differences between DVSTs (Direct View Storage Tubes) and conventional CRTs (Cathode Ray Tubes)?

A: The obvious answer concerns construction differences in the DVST (flood gun, various front-end meshes, etc.). But, more important is the new range of applications available to DVST users. These new applications result from DVST's high brightness, controllable persistence, storage capability, integrating properties—and the human factors compatibility which accompanies all of these advantages.

Q: Are all DVSTs alike?

A: Where storage time and brightness characteristics are concerned, most DVSTs are fundamentally similar. Significant differences exist, however, in other important criteria.

Q: What criteria should you look for in a DVST?

A: It depends, of course, on your particular application—but there are at least three important qualities you should check:

1. **Half-tone rendition:** When operating in the storage mode, DVSTs differ greatly in their ability to produce enough half-tones for photographic-quality detail.

2. **Resolution:** This important factor (together with half-tone rendition) is a measure of a DVST's ability to display a detailed, accurate picture. As a function of writing gun spot size, proper resolution depends on advanced developments in the field of high-performance electron guns.

3. **Uniformity of writing, storage and erasure:** DVSTs must present displays free from unwanted highlights—displays which will erase evenly and completely. Most important in influencing this capability is collimation (ability to arrange flood electrons in parallel array and then to strike the target assembly at a 90° angle).

Q: What does Hughes offer in the DVST line?

A: Everything you could ask for. (Warning! This is the commercial):

1. Outstanding half-tone rendition with DVSTs which store up to 7 shades of gray. (More than any competitive DVST!) They produce detail unmatched by any other storage tube.

2. Higher resolution resulting from advancements in electron gun design perfected by the famed Hughes Research Laboratories.

3. Exact collimation for uniformity of writing and erasure through the use of an advanced, Hughes-developed electronic lens system. This system features a precision machined metal lens integrated with the target assembly.

4. Brightness and storage time—more than competitive with any other DVST on the market today.

5. World's most complete line of DVSTs. Sizes: 3", 4", 5", 7", 10", 21"; electrostatic or electromagnetic deflection. Available with 1, 2 or 3 write guns.

Our engineers will be happy to assist you with specific applications. Telephone, wire or write today for information: HUGHES, Vacuum Tube Products Division, 2020 Short St., Oceanside, Calif.

For export information, please write: Hughes International, Culver City, California.

HUGHES

*Creating a
new world with
Electronics*

VACUUM TUBE PRODUCTS DIVISION
HUGHES AIRCRAFT COMPANY

Fort Huachuca: Arbiter of Army Electronics

By JOHN F. MASON,
Associate Editor

FORT HUACHUCA, ARIZ.—The 250 miles of desert wasteland stretching west from here is a gigantic proving ground for hundreds of millions of dollars worth of electronic equipment for the U. S. Army.

Army's mission here is to create an entirely compatible array of battlefield electronic equipment. This job is being tackled in three steps.

First, engineering tests are run on Signal Corps equipment to evaluate performance, reliability and maintainability. Equipment may go back to the manufacturer as a rejection or for modification.

If the equipment answers Signal Corps' needs, it goes on to testing within the battlefield environment for electromagnetic compatibility with other devices.

The final responsibility at Huachuca is to develop and propose complete command control systems for the modern army.

Fort Huachuca, which was established in 1877 to thwart the plans of the Apache chief Geronimo, is an ideal location for the U. S. Army Electronic Proving Ground (USAEPG). In spite of the impressive sunsets, the dry plains and rock mountains have still not attracted many settlers. As a result, the Army walked into a 75,000-acre, open-air laboratory, relatively free of manmade radiation.

Called the Electromagnetic Environmental Test Facility (EETF), the laboratory is in three parts:

The Electromagnetic Environment area (EME), located near Gila Bend, Ariz. at the north-west end of the installation, will investigate radio frequency interference.

The Drone Test Facility (DTF) runs the 250-mile stretch from Fort Huachuca westward to Yuma.

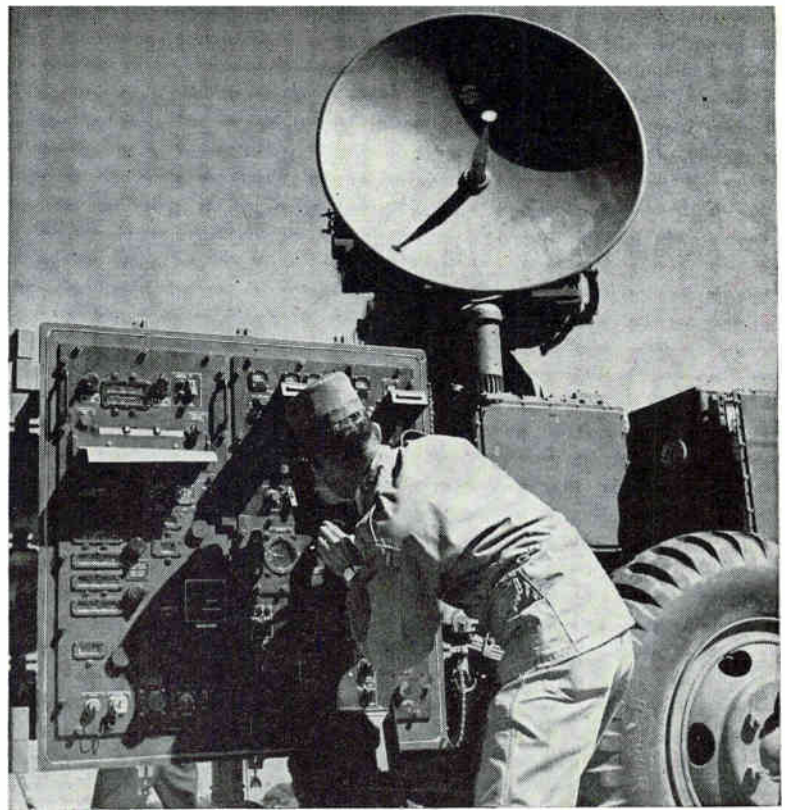

Drones are tracked by Sperry's N/USD-1 radar out to 60 mi

The Common Test Facility (CTF), at Fort Huachuca, provides communication and test facilities for the entire complex.

Pan American World Airways is prime contractor for engineering, installing equipment and operating the facility (EETF) under the supervision of the Proving Ground's commander, Major General F. F. Uhrhane. As major subcontractor, Bell Aerosystems is responsible for the EME area where radio interference is studied. Pan Am's two-year contract began in March and amounts to \$18.8 million. Operating cost for the first five years is expected to total \$90 million. Not included in this cost is the prototype gear being tested. This equipment, which includes almost every electronic device used by a modern army, is channeled into five departments:

The Combat Surveillance and Avionics dept. tests, evaluates and integrates all equipment to acquire combat intelligence. The payload is sensory equipment. Associated gear includes vehicles to put the sensors in the right place to spy on the enemy and equipment to record information and get it back home.

Army has four types of drones, ranging in readiness from operational to developmental. Sensors used in drones and in manned air-

craft—fixed and rotary wing—may include: tv, infrared, magnetic mine detectors, radiation smellers, sidelooking radar, and radio-controlled cameras—still and movie—with automatic transmission back to the ground (for Fairchild Camera and Instrument's camera now undergoing tests, see *ELECTRONICS*, p 47, June 5, 1959).

Related airborne equipment includes navigation and communication systems, flight instrumentation and stabilization devices, data processing and ecm.

Ground equipment for aerial surveillance vehicles includes radio, data processing and reduction gear, magnetic recorders, display units, communications network, radar and theodolites.

The surveillance department is testing three types of point-to-point hypersensitive surveillance radar that pick up enemy vehicles and even troops, the AN/TPS-33, AN/TPS-25 and AN/PPS-4 (the last two are described in *ELECTRONICS*, p 33, Aug. 14, 1959).

The Signal Communications dept. will soon field test its new Automatic Electronic Switching system. Mounted on a 2½-ton truck, the system will replace the manual system that required several large vans.

Equipment in this system, Army says, includes: a transistorized tele-

phone (TA-341) developed by Stromberg-Carlson—a 4-wire local battery unit on which the conventional dial is replaced by key-set dialing; a lower echelon automatic telephone central (AN/TTC-14) developed by Kellogg Switchboard and Supply—a transistorized 20-line local switchboard expandable to 60 lines; automatic electronic telephone central (AN/TTC-13) developed by Stromberg-Carlson—transistorized, used for trunk switching only; and an automatic electronic telephone central (AN/TTC-12) by Stromberg-Carlson that serves 200 local subscribers and provides 50 trunks to other local switchboards and 30 trunks to the long-distance switching system.

The communications dept. is also testing other equipment:

Radio relay terminal set, AN/MRC-69, provides facilities for one or two 12-channel carrier telephone systems or a radio relay repeater. Major components are two f-m radio sets (AN/TRC-24) and two 12-channel telephone terminals (AN/TCC-7).

Another radio relay repeater (AN/MRC-54) that will use the TRC-24 radio is also being tested.

The antenna for the TRC-24 was developed at Huachuca's model shop and is now in operation in Germany. After formal acceptance of the equipment by the Continental Army Command the antenna will be farmed out to industry for large-scale production.

Weight of the antenna is about 40 lb. It consists of a folding-mast assembly carried on the roof of the equipment shelter and a lightweight broadband antenna array. The structure was erected at a demonstration here (see photo) in one minute and 53 sec. Each antenna consists of a logarithmically periodic structure comprised of a series of dipole elements cantilevered from a common boom. The antenna has a medium gain of 6 db over the 100 to 600-Mc band.

Huachuca has awarded an initial production contract to Motorola for about \$11 million for a vhf, multiplexed ssb communications central, AN/MRC-66. The central is on a $\frac{3}{4}$ -ton truck. Subscriber stations are mounted in jeeps. The system transmits voice, facsimile and teletypewritten messages.

Huachuca-developed troposcatter equipment (AN/TRC-80) provides 24 voice channels up to 150 miles and operates on a frequency of 1,700-2,400 Mc.

The Meteorology dept. studies the highly variable weather conditions from ground up to 2,500 ft. Instruments study energy balance, turbulence and movement of heat and moisture at the earth's surface. The Huachuca station works with 12 other micrometeorology stations in the northern half of the Western Hemisphere. Findings will affect missile operation and design.

The Automatic Data Processing dept.'s objective is to provide the field army with completely automatic data processing facilities. Realization of this goal will be delivery of the Army's Fielddata family of computers (ELECTRONICS, p 37, Apr. 3, 1959). The family will include small computers for the lower echelons, the Basicpac for more complex applications, and the large Mobidic, a general-purpose, completely transistorized computer. Huachuca now simulates battle problems with an IBM 709. Ramo-Wooldridge supplies technical assistance.

The Electronic Warfare dept. (EWD) is developing a family of multipurpose ecm sets in three basic configurations: $\frac{3}{4}$ -ton truck, armored personnel carrier and the Otter aircraft. In addition, a series of air-deliverable, expandable ecm devices is being developed and tested. Ultimately these will be de-

livered by manned aircraft, drones and artillery. Army also has a classified miniaturized self-contained Manpack ecm transceiver for front-line troops.

The Electromagnetic Environmental Test Facility, run by Pan Am and Bell Aerosystems, tests all electronic equipment in a battlefield environment for compatibility. The new army estimates a preponderance of 75,000 emitters in a 100-mile square area as opposed to 23,000 during World War II.

The test facility's task is to reveal incompatibilities, suggest modifications, provide realistic standards for new equipment, test Army frequency assignment plans, and test all electronic-communication gear prior to acceptance by the Army. Ultimately it is hoped to evolve a mathematical model to predict interference.

The model will be a storehouse of equipment characteristics and propagation phenomena and will contain the equations that interrelate them.

As testing continues the battlefield complexity will be increased. Eventually Army would like to test systems in an Army, Navy and USAF environment.

Interference testing is now a manual operation. For example, a man-carried transceiver might be tested with radar, telemetry, ecm gear and troposcatter equipment. In case of interference, environmental equipment is turned off one by one until the culprit is found. In some cases two or more transmitters may be heterodyning.

The recommendation may be modification of the equipment, a change of frequency, recommendation to use intermittently, or to simply live with the situation. The latter is especially true of equipment soon to be phased out.

Incompatibility tests will soon be accomplished by punched-card and computer automation.

The Army foresees a continuing need for the work going on at Huachuca. Results obtained here will benefit both military and civilian users of electronic equipment.

Pan Am will award a number of subcontracts as the program continues. They will be for gear such as: radar, microwave, telemetry, command control, recording, communications and data processing.



Industry will soon bid for large-scale production contracts on this Army-developed antenna



The final assembly line at Thomas Organ. Instruments are tuned with electronic stroboscopes in five minutes by factory workers

Electronic Organ Sales Surge, Tempt New Companies

MANUFACTURERS of electronic organs feel that 1960 will wind up as an outstanding year for sales. Market saturation to date is only a few percent. According to several industry marketing experts, retail sales for 1959 were \$140 million. And profit margins are generous. Several companies are looking the field over and most manufacturers have design innovations in the works. Many new model organs use transistors. Tunnel diodes are being considered, based on their harmonic generation properties.

There are many reasons for the popularity of electronic organs. Tone and note sustention qualities make music played by an amateur sound more professional than with other instruments. The organs are easy to play; keyboard learning techniques help the beginner.

Several large electronics firms have been watching organ sales. The Magnavox Company, Fort Wayne, Ind., states it plans to produce a line of instruments. Westinghouse admits an interest in the field, gives no details. AMF gave the electronic organ market a look three years ago, built a model, has decided against entering the field. Two electronics giants and a motion-picture company have been linked with the organ market.

Here's what typical firms now in the business are doing:

Hammond Organ Company, Chicago, maintains a full line of instruments. They employ a mechanical tone-wheel system, which produces the magnetic variation needed for the original note, which is then amplified.

Baldwin Piano Company, Cincinnati, O. uses tuned-grid vacuum-tube oscillators and frequency-division blocking oscillators for producing tones beyond the basic twelve notes. Its line includes spinets and consoles. Firm experimented with a transistor model as early as 1952, still is active evaluating solid-state techniques.

The Lowery Organ Company, Chicago, produces a full line of organs, from spinet through church models. Firm's latest is the Holiday Duo. It has two full 44-note manuals and a 13-note pedalboard, at \$995. The three largest models have two 61-note manuals, a 25-note pedalboard and keyboard control of the organ stereo effect, whereby any manual or the pedalboard can be switched to a remote tone cabinet.

Conn Organ Corp., Elkhart, Ind., has recently introduced transistor keying in their line of instruments. The tones are generated by a vacuum tube, normally one for each note. In some models, a sharing system is employed, wherein a diode assures keying preference when

several adjacent keys are pressed down.

An accessory instrument by the Wurlitzer Company, DeKalb, Ill., who also manufactures electronic organs, is known as the Side Man. It is a self-contained unit that provides a constant rhythm section sound effect for accompaniment in any of several patterns, including cha cha, tango, western, waltz and others. The tempo can be set by the user and rhythm patterns not built in may be created with a bank of ten push buttons, usable with the automatic patterns or independently.

Thomas Organ Company, a division of Pacific Mercury Electronics, Sepulveda, Calif., has announced three new transistor organs, using vacuum tubes only in the power amplifier. A recent slimline model priced at \$1,495 includes a built-in Leslie speaker, stereo organ sound system, and controlled attack percussion which can be applied to one or all families of voices, and sustain to hold the note after it is keyed. The firm also produces an organ-phonograph combination. Stereo operation of either instrument, or one channel for each allows the use of a recorded lesson plan for training beginners.

Kinsman Electronic Organs, Laconia, N. H., has brought out two new models this year, one featuring two full 61-note manuals (keyboards), below the \$2,000 figure. The firm is among those employing printed circuits, and features modular electronic construction. Their design uses vacuum-type tone oscillators and neon dividers.

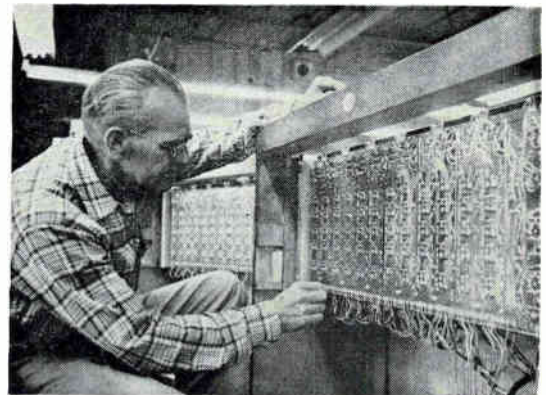

Modular construction of Kinsman organ facilities assembly and service

The Allen Organ Company, Mauncie, Pa. has been producing solid-state designs for 18 months. Its production includes many large custom organs. Toroids are used in the tank circuit of each tone oscillator, to assure frequency stability down to 16 cps. A separate transistor oscillator generates each note. The firm also employs a rotating speaker system. The speed of rotation is controlled by the performer to introduce activity into the distribution of sound, as occurs normally in a pipe organ.

Electro-voice, Buchanan, Mich., a recent newcomer, announced a two-manual spinet this year, in the \$500 range. It uses neon divider chains following vacuum-tube tone generators. A full organ line is planned.

The W. W. Kimball Co., Melrose Park, Ill. produces a line of large organs that obtain their basic tone from optical recordings of a pipe organ, and reproduces them with a lamp for each key, a scanning system and photocells. They have also introduced a line of home organs featuring transistor circuits.

Organ kits are finding a receptive market. Electronic Organ Arts Corporation, Los Angeles, Calif., puts out a full line of kit organs. An independent Hartley vacuum-tube oscillator, stable to 0.08 percent in frequency, is used for every key, with an independent preamp for every stop. An external hi-fi system can thus be hooked into any preamp or any number tied together to separate channels allowing organ stereo operation.

Schober Organ Corp., New York, N. Y., plans to add a spinet organ kit in the \$300 range sometime in the future, with vacuum-tube oscillators and neon divider chains. They have recently come out with an inexpensive strobe-disk tuner, available built, or as a kit. It is accurate to 1/100 semitone.

National Sonic Corporation, Sunnysvale, Calif., produces a kit spinet with two 44 note manuals. The keyboards are supplied wired, cables preformed, the printed circuit boards are left unfinished. Their circuit format employs vacuum-tube-oscillators and dividers, with a photoelectric system for the expression pedal control element to reduce wear.

AC POWER WITH PURE WAVE FORM

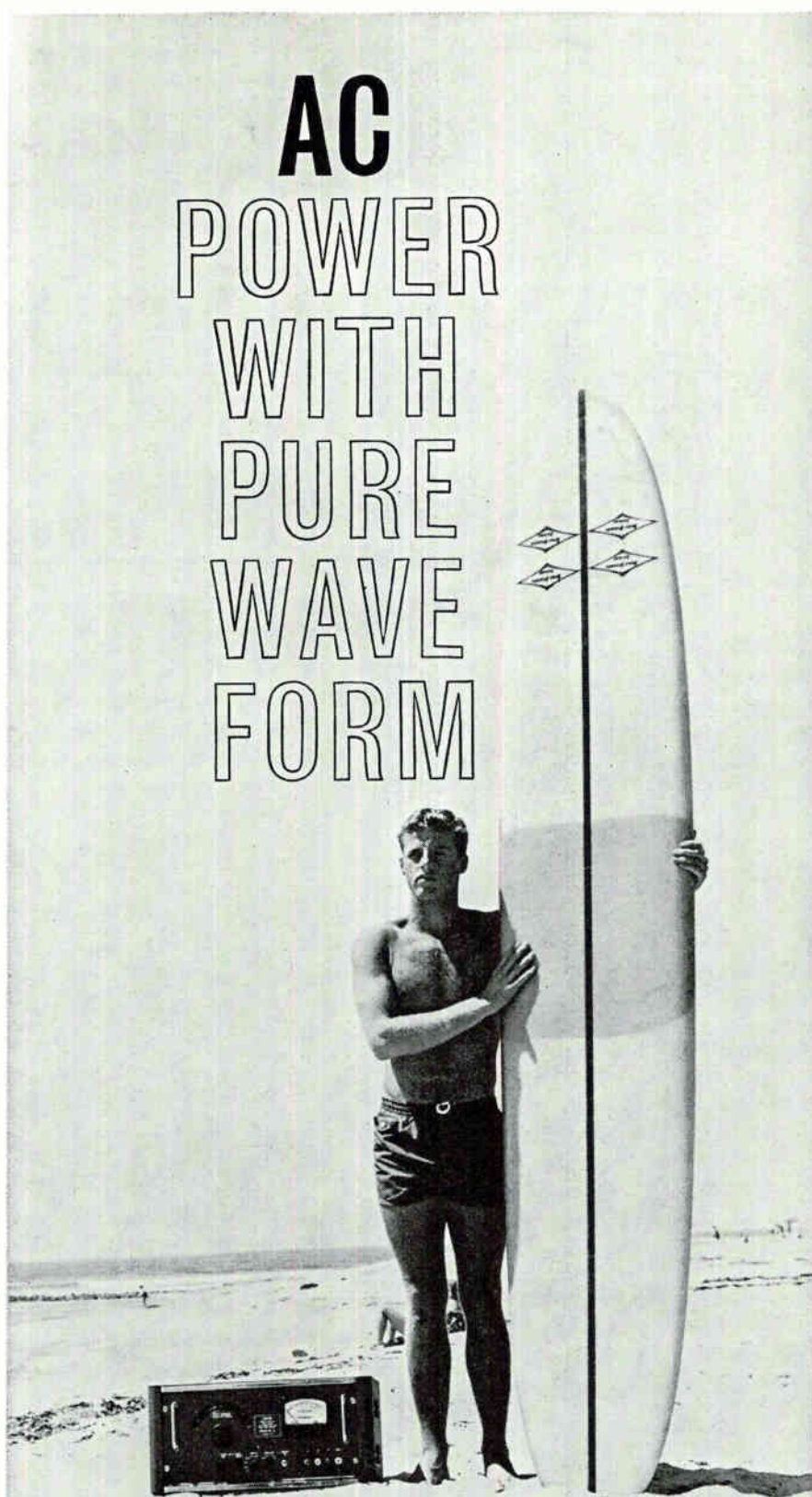

FOR THOSE SEEKING PURE WAVE FORM, the Behlman INVERTRON® provides, among many other things, the best. Harmonic distortion remains an absolute minimum throughout the frequency range despite wide variations of line and load. Behlman provides exceptionally stable sources of AC power from 20va to 100,000va in 1, 2, and 3 phase outputs—from 1 cycle to 100KC with less than 1% distortion and frequency accuracies up to 0.00001%.

For those "at sea" about AC power sources, Behlman will send a free copy of its new guide, "AC Power Supplies."

BEHLMAN

BEHLMAN ENGINEERING COMPANY
• 2911 Winona Avenue, Burbank, Calif.

A subsidiary of Electronic Energy Conversion Corporation

IF YOU WANT TO TAKE A CHANCE ON FALLING IN LOVE WITH A COMPUTER

When we designed Recomp we had just two people in mind: the man who would use it and the man who would approve the investment.

We told our design engineers we wanted Recomp to 1] have a large capacity, 2] be versatile, and 3] be easy to program. Then we urged our cost engineers to see to it that Recomp stayed in the lower price range.

Quite honestly, this posed some problems. On occasion a designer would plead for his brainchild while the cost analyzers demurred.

No coins were tossed to settle such disagreements. If the designer could prove his idea made Recomp a better computer it was incorporated. That's how Recomp came to be the first solid-state digital computer on the market. And also why it was (and still is) the only compact computer with built-in floating-point arithmetic.

Fortunately when we were all through we found Recomp would sell at a sensible price. So, due to this strict attention to the computer's capability and cost, we're truly able to say Recomp is the very best computer in the low-cost computer field.

While they were at it, our engineers had some rather original ideas on how to present Recomp to you. "No gobbledygook," they said, "just give them the facts." So we painstakingly winnowed down a mass of superlatives to these plain facts:

- 1] Exclusive built-in floating point arithmetic.
- 2] Easy to program.

- 3] Efficient programming; 49 basic instructions expandable to 72.
- 4] Fast access time due to high-speed loops.
- 5] Magnetic disk memory with large capacity—up to 8192 instructions.
- 6] Large word length of 40 binary bits.
- 7] Each word contains two instructions.

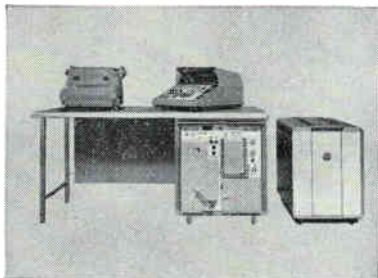

- 8] Solid-state reliability.
- 9] Built-in square root command.
- 10] Large sub-routine and program library.
- 11] Active users group.
- 12] Built-in automatic conversion from decimal to binary.
- 13] Visual display of any word in memory.
- 14] Simple correction of errors.
- 15] Easily installed anywhere.
- 16] Can use conventional teletype equipment.
- 17] Low cost per computation.
- 18] High-speed input and output.
- 19] Programming training provided.

- 20] Large program exchange.
- 21] Coast-to-coast sales & service.

With all respect to our engineers, facts are fine but they can hardly do full justice to Recomp. For example, it's only fair to mention Recomp's appearance. Its soft color and modern shape bespeaks quiet efficiency; blends in the finest of surroundings. In this case you *can* tell the book by the cover. Recomp is truly a masterpiece of design (both in function and form). It's built to look as good as it is; a genuine pleasure to have around.

By the way, many of the points we listed above can be claimed by some other compact computers—but Recomp is the *only one* that can claim them *all*, and as standard equipment. You're never hemmed in on a problem by a lack of equipment.

True, you can get a computer that does more than Recomp, but this should only be if the size of the job justifies a much larger investment (and Recomp *does* have features you won't find in computers costing three times as much). Naturally, you can always find a computer that costs less.

But if you want a low-cost compact computer that performs favorably with the giants in size and cost, you should make a date to see Recomp. However, it's only fair to warn you, unless you want to take a chance on falling in love with a computer, don't write AUTONETICS INDUSTRIAL PRODUCTS, Dept. 115, 3400 East 70th Street, Long Beach, California. The Autonetics Division of North American Aviation, Inc.



Russian icebreaker Lenin, shown here moving through Baltic ice, employs a television-equipped helicopter for ice formation reconnaissance



SOVIET

Nuclear Icebreaker Uses Helicopter Tv

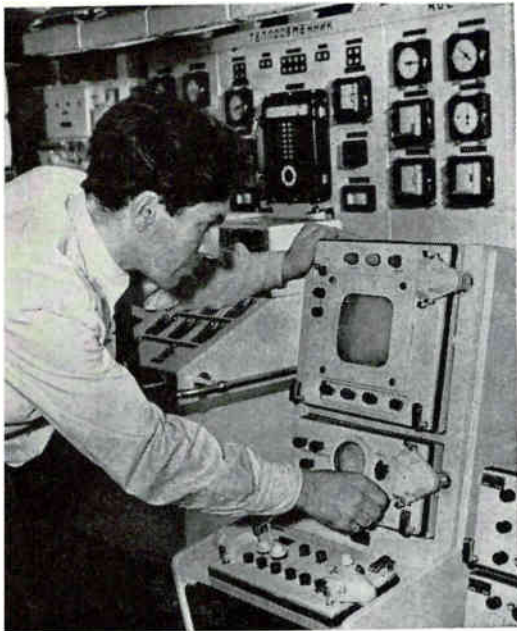

Closed-circuit television is used aboard the Lenin. This provides continuous observation of the icebreaker's nuclear power plant installation

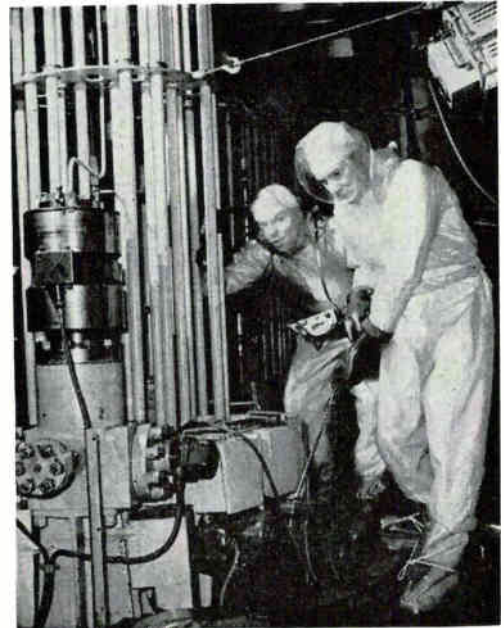

Soviet crewmen wear special plastic pneumatic clothes while checking radiation. Decontamination of the clothing is performed after use. As a safety measure, no regular duty watch is maintained in various active compartments

THE SOVIET icebreaker Lenin, powered by a 44,000-horsepower atomic-steam plant, is in regular service in the arctic. Power is developed in three reactors, with one normally on standby.

The ship can operate on six-foot ice, with a maximum thrust of 330 tons. Steam and a metal ram are employed for difficult ice formations. The crew and equipment spend long periods at sea, when the ship is on duty maintaining navigable shipping channels in the arctic. Refueling of the reactors is accomplished every two years.

Accompanying photos show the use of closed-circuit television aboard ship, the checking of radiation, and a section of the control room.



A view of part of the big ship's control room. The Lenin is equipped with a reserve control panel, was launched at Leningrad in December 1957

Epitaxial Techniques Lure Device Designers

WASHINGTON — Epitaxially grown semiconductor devices have replaced tunnel diodes as the glamor field of solid-state electronics.

So it seemed at the 1960 Electron Devices Meeting here late last month; 1,200 attended.

In 1959 tunnel diodes were the major topic at this meeting; this year only two of 18 papers in the semiconductor category dealt with tunnel diodes. Meanwhile, a complete session devoted to epitaxial devices was well attended and marked by spirited questioning of speakers.

Most of the papers in this category dealt with technique for growing films of germanium and silicon epitaxially on substrates of these materials. Intensive work is being carried on in this field. Speakers from Bell Labs, IBM, Fairchild Semiconductors, Motorola and Pacific Semiconductors represented a broad industry cross section and other semiconductor manufacturers were represented in the audience.

Majority of companies use variations of the vapor-deposition technique using hydrogen reduction of tetrachlorides of silicon and germanium. A. P. Hale told of experiments at Fairchild where evaporation techniques are being tried in a search for a simpler, more economical method. Although devices have been built, the advantages of evaporation remain to be proved, Hale said.

Most speakers held back detailed results obtained with epitaxial devices. However, George Russell of Motorola announced the availability of a germanium epitaxial transistor type 2N828, designed to replace the type 2N705 high-speed mesa switching transistor.

In another solid-state area, a new type of parametric amplifier was introduced by K. K. N. Chang and D. L. Cuccia of RCA. It uses a helix as a slow-wave structure, has variable capacitance diodes connected at intervals between the helix turns. Proper spacing of the diodes causes the helix to act as a filter with pass and stop bands that provide resonances at signal, idler

and pump frequencies. Small and lightweight (less than 6 ounces), the new amplifier is simply constructed, needs no moving parts like stubs or slides. The amplifier is stable. Its developers claim it cannot be made to oscillate. Gain of 15 db across a 10-percent bandwidth has been achieved with noise figures from 4.5 to 6 db.

Advances in devices other than solid-state were also described. Improvements in the Zenith electron-beam parametric amplifier have boosted performance into the L-band region. As reported by C. B. Crumley and R. L. Cohoon of Zenith, noise figures of 1.3 to 1.6 db with 40-Mc bandwidth have been obtained at 1,300 Mc with substantial gain. Crumley says it seems feasible to operate tubes like this in the X-band region or even higher.

Bell Laboratories introduced a new beam deflection tube for their pulse-code-modulated digital television system. The new encoding tube converts the amplitude of an analog voltage into an 8-digit binary signal at sampling rates up to 10 Mc.

M. H. Crowell, who described the tube, showed typical off-the-air pictures of color tv transmissions encoded into 7-digit signals. The pictures showed no degradation of the signal after digital transmission.

Tech Manpower Shortage To Continue for Decades

TECHNICAL MANPOWER will continue to be in short supply, perhaps for centuries, says J. R. Weir of California Institute Technology.

Speaking at a symposium on management planning at the Fall meeting of American Institute of Electrical Engineers in Chicago recently, Weir said "the demand for technical know-how must inevitably increase for many decades . . . probably at a geometric rate."

Worldwide living standards will depend on the number and quality of trained technologists. If populations continue to explode, only increased productivity and higher orders of production efficiency can keep pace—and the broadest possible application of all technologies will be necessary, Weir says.

Evaluator Missile Records Launches

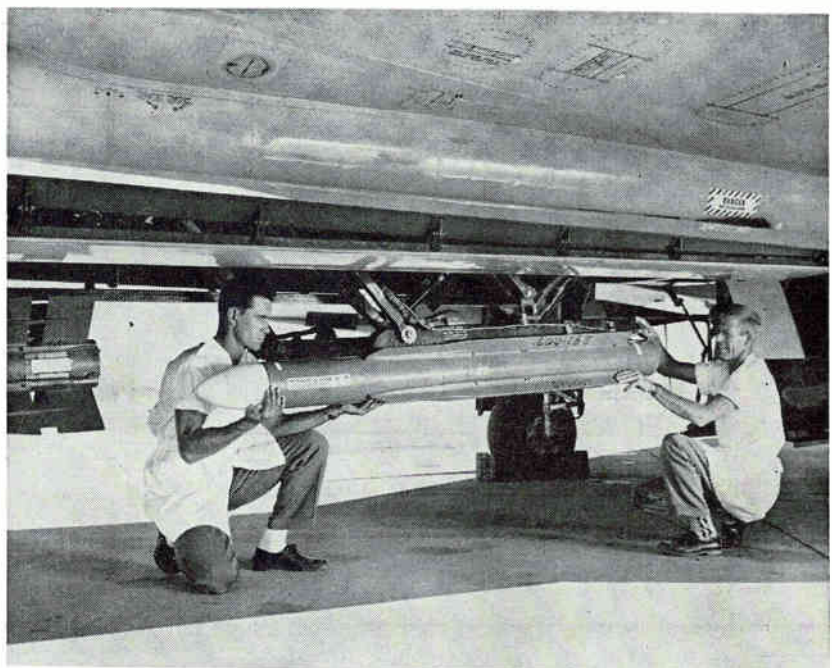

Standard configuration of Falcon missile developed by Hughes contains signal recorder to check armament control and missile guidance systems

Choose ALLEN-BRADLEY QUALITY POTENTIOMETERS for your critical circuits

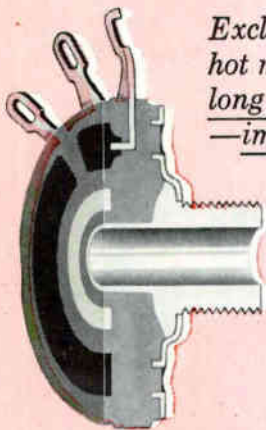

*Exclusive one-piece
hot molded element assures
long life, quiet operation
—improving with age!*

With this solid molded resistance element, control is always smooth—there are never any abrupt changes. This also assures low “noise” even after long use. The sectional view of the Type “J” shows how the terminals, resistance element, faceplate, and threaded bushing are all molded together into *one* integral structure.

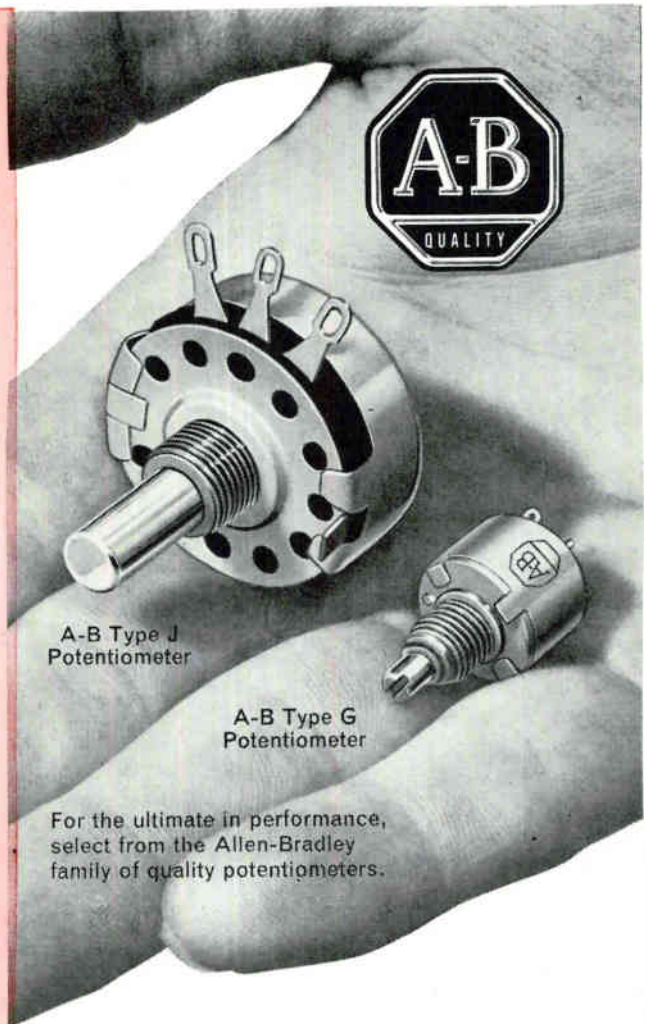

A-B Type J
Potentiometer

A-B Type G
Potentiometer

For the ultimate in performance, select from the Allen-Bradley family of quality potentiometers.

THE ALLEN-BRADLEY FAMILY OF POTENTIOMETERS



TYPE J—rated 2 watts at 70°C. Total resistances to 5 megohms. Single, dual, and triple units. *Many RV-4 types in stock for overnight shipment of prototype quantities. Send for list.*



TYPE K—like Type J, but rated 1 watt at 125°C, 2 watts at 100°C, and 3 watts at 70°C. Can be used to 150°C under “no load.”

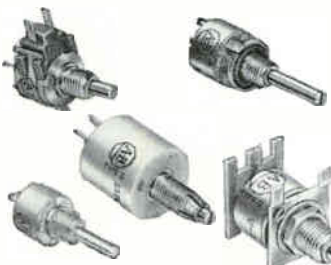

TYPE G—rated ½ watt at 70°C. Total resistances to 5 megohms. Wide selection of styles and various optional features, including switch. *Many RV-6 types in stock for overnight shipment of prototype quantities. Send for list.*

TYPE L—similar to Type G, but rated at ½ watt at 100°C. Can be used to 150°C under “no load.”



TYPE R—adjustable fixed resistor. Rated ¼ watt at 70°C. Total resistance ranges from 100 ohms to 2.5 megohms. Self-locking features hold settings under extremes of shock.



TYPE F—rated ¼ watt at 70°C. For printed wiring boards. Has screwdriver adjustment.

TYPE T—rated ½ watt at 70°C. Extremely thin; plastic cover serves as actuator.



TYPE H—rated 5 watts at 40°C, with a maximum continuous voltage of 750 volts. Designed for industrial applications. Total resistances to 2.5 megohms.

Allen-Bradley Co., 110 W. Greenfield Ave. Milwaukee 4, Wis. • In Canada: Allen-Bradley Canada Ltd., Galt, Ont.

ALLEN-BRADLEY

Quality
Electronic
Components

TWO OUTSTANDING HIGH-TEMPERATURE MAGNET WIRES



Tetroc

FOR CONTINUOUS OPERATION AT
HOTTEST SPOT TEMPERATURES
UP TO 200°C

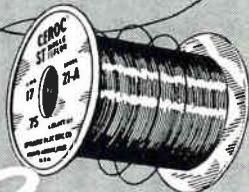

Ceroc

FOR CONTINUOUS OPERATION AT
HOTTEST SPOT TEMPERATURES
UP TO 250°C

For continuous operation at hottest spot temperatures up to 200°C (392°F) and up to 250°C (482°F) for short periods of time—depend upon TETROC—an all Teflon-insulated wire available in both single and heavy coatings.

CEROC is Sprague's recommendation for continuous operation at hottest spot temperatures up to 250°C (482°F) and up to 300°C (572°F) for short periods of time. Ceroc has a flexible ceramic base insulation with either single silicone or single or heavy Teflon overlays. The ceramic base stops "cut-through" sometimes found in windings of all-fluorocarbon wire. Both Tetroc and Ceroc magnet wires provide extremely high space factors.

Write for Engineering Bulletins 405 (Tetroc Wires) and 400A (Ceroc Wires).

SPRAGUE ELECTRIC COMPANY
35 Marshall Street, North Adams, Mass.

SPRAGUE[®]
THE MARK OF RELIABILITY

AF Blueprints Key Role for

Mushrooming Hanscom Complex quickens regional growth; national pay rate ruling poses threat

BOSTON—The Northeast Electronics Research and Engineering Meeting (NEREM) will be held Tuesday through Thursday next week in an atmosphere charged with extraordinary promise—and a threat.

Focal point of the New England area's continued ascendancy in electronics is "The Hanscom Complex", the Air Force installation off Route 128 in Bedford, some 20 miles from Boston.

On the threshold of becoming the design-development management center for military automation, the Hanscom Complex will control allocation of \$1.5 billion in fiscal '61, notably for the "L" systems. The grand design of aerospace command-control systems of the '60s and '70s will be blueprinted at Bedford, if a proposal now before the AF general staff is approved.

Impact of the mushrooming of the Hanscom Complex is being in-

creasingly felt in Greater Boston and New England as electronics firms rooted in other sections of the U. S. set up research labs and technical offices close to Hanscom.

The threat aimed at the N. E. electronics industry flows from the U. S. Labor Department's tentative decision to set nationwide minimum-pay rates for electron tube and semiconductor workers under the Walsh-Healey Act (ELECTRONICS, p 14, Oct. 14).

With a traditionally skilled labor force and lower wage rates than on the West Coast and other sections, New England has some of the fastest-growing semiconductor plants in the U. S. And components production is counted on for a big share of the projected \$2 billion factory sales for N. E. electronics by 1970 (ELECTRONICS, p 45, Apr. 22).

Individually and through the EIA, New England producers are

Radars Guide Tartar Missiles

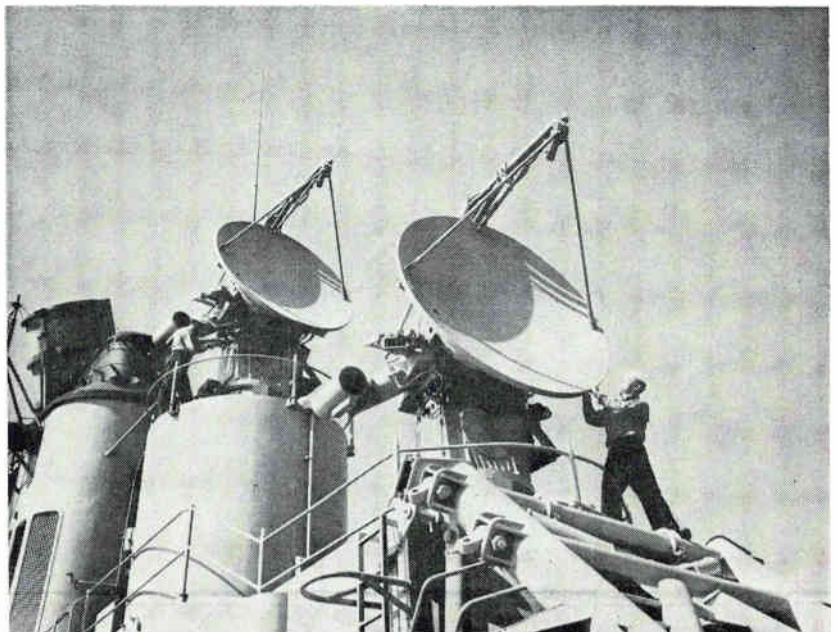

Raytheon-produced radars on guided missile destroyer can also be used as part of ship's overall fire control system

New England

fighting for regional rather than national minimum rates.

On the brighter side of the regional picture, the Hanscom Complex now has a staff of 6,000, and this level rises monthly. Headquartered there are such electronic systems management organizations as ARDC's Command and Control Development Division, AMC's Electronic Systems Center and ADC's Command and Control Defense Systems Office which embraces user commands like SAC and TAC. The complex includes the Space Surveillance and Control Center, U. S. clearing house for identification and tracking of all orbiting objects.

Also members of the complex are AF Cambridge Research Laboratories, MIT Lincoln Laboratory and Mitre Corp., engineering systems adviser. In addition, Rome Air Development Center, although geographically removed, is part of the complex and is its primary development agency for sub-systems and components.

Rounding out the command-control team are representatives from industry, from the Army, Navy, FAA and other government agencies and from the Royal Canadian Air Force.

One of the new jobs being proposed for the complex is training the Air Force officers of the future in electronics, data processing and command-control technology, the tools of military automation.

A companion trend in N. E. electronics in recent years is an increasing emphasis on R&D in automatic controls—industrial automation. Two of the NEREM sessions next week will be devoted to electrohydraulic and electro-pneumatic controls. "The mechanical engineers are more and more invading the electronics field," comments an MIT professor.

The N. E. which has seen abandoned textile plants refurbished for the new industrial giant of electronics is now witnessing another development: advent of jewelry pro-

(Continued on p 49)

PULSE-FORMING NETWORKS

FROM WATTS

to

MEGAWATTS

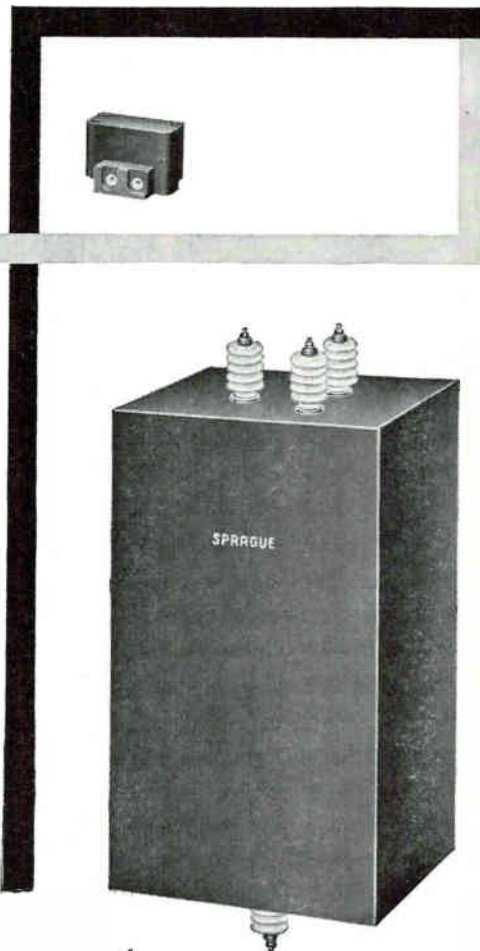

... and everything in between!

When it comes to pulse capacitors and pulse-forming networks, many complexities in parameters and design factors must be considered. These specialized units must be designed and manufactured by a specialized organization. And because Sprague maintains a highly-technical special engineering section devoted exclusively to pulse capacitors and networks, it has been, from the very beginning, a major supplier of these complex units for radar equipment (ground, marine, aircraft, missile), tube testing, and similar pulse circuit applications.

This special engineering section performs four important functions: One group designs custom units in accord-

ance with required parameters. Another group builds pulse capacitors and networks to these precise specifications. In another area, a group of specially-trained field engineers provides application assistance wherever needed. And yet another independent group works toward the future developing new materials, new design concepts, and new techniques for manufacture.

This concentration on pulse capacitors and pulse-forming networks has enabled Sprague to introduce product improvements such as heliarc sealing of cases, rugged alumina bushing assemblies, Fabmika[®] dielectric, and improved hermetic sealing of closures.

Save time and money by working with Sprague from the start. Write for Engineering Bulletin No. 10,001 to Technical Literature Section, Sprague Electric Company, 35 Marshall St., North Adams, Massachusetts.

SPRAGUE[®]
THE MARK OF RELIABILITY

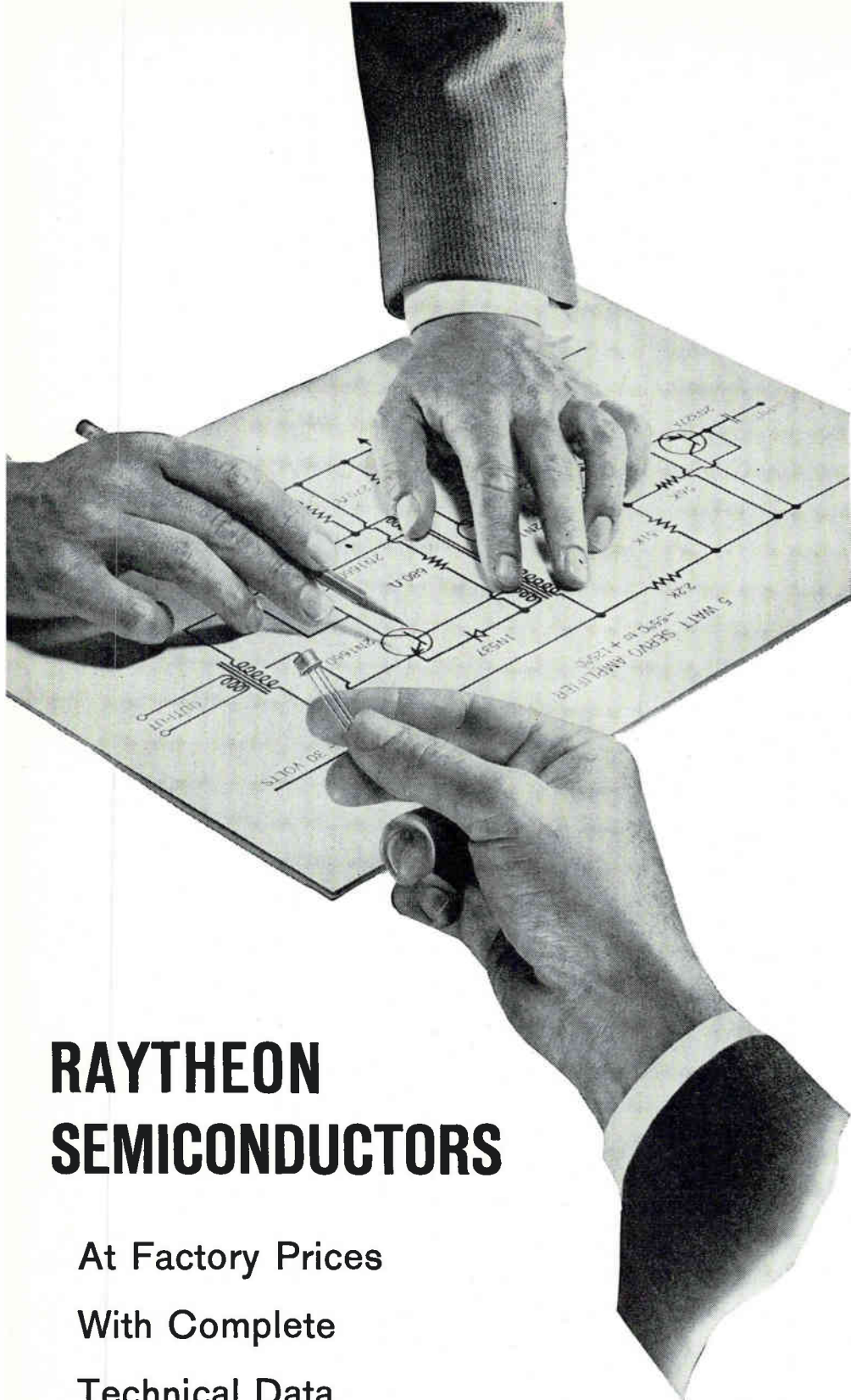

RAYTHEON SEMICONDUCTORS

At Factory Prices
With Complete
Technical Data
Available From These
Raytheon Distributors In Your Area.



RAYTHEON COMPANY

DISTRIBUTOR PRODUCTS DIVISION

Raytheon Distributors Serving Key Markets Include:

- Alabama**
Birmingham
Forbes Distributing Company
AL 1-4104
MG Electrical Equipment Company
FAirfax 2-0449
Mobile
Forbes Electronic Distributors, Inc.
HE 2-7661
- Arizona**
Phoenix
Radio Specialties & Appl. Corp.
AL 8-6121
Tucson
Standard Radio Parts, Inc.
MA 3-4326
- California**
Burbank
Valley Electronic Supply Co.
Victoria 9-3944
Glendale
R. V. Weatherford Co.
Victoria 9-2471
Hollywood
Hollywood Radio Supply, Inc.
HO 4-8321
Inglewood
Newark Electronics Company
ORchard 7-1127
Los Angeles
Graybar Electric Company
ANGelus 3-7282
Kierulff Electronics, Inc.
RICHmond 8-2444
Oakland
Brill Electronics
TE 2-6100
Elmar Electronics
TEmpier 4-3311
Palo Alto
Zack Electronics
DA 6-5432
San Diego
Radio Parts Company
BE 9-9361
San Francisco
Fortune Electronics
UN 1-2434
Santa Monica
Santa Monica Radio Parts Corp.
EXbrook 3-8231
- Colorado**
Denver
Ward Terry Company
AMherst 6-3181
- Connecticut**
East Haven
J. V. Electronics
HObart 9-1310
- District of Columbia**
Electronic Industrial Sales, Inc.
HUdson 3-5200
Kenyon Electronic Supply Company
DEcatur 2-5800
- Florida**
Miami
East Coast Radio & Television Co.
FRanklin 1-4636
Electronic Equipment Co., Inc.
NEwton 5-0421
West Palm Beach
Goddard Distributors, Inc.
TEmpie 3-5701
- Illinois**
Chicago
Allied Radio Corporation
HAYmarket 1-6800
Newark Electronics Corp.
STate 2-2944
- Indiana**
Indianapolis
Graham Electronics Supply Inc.
MEIrose 4-8486
- Maryland**
Baltimore
Wholesale Radio Parts Co., Inc.
MUIberry 5-2134
- Massachusetts**
Boston
Cramer Electronics, Inc.
COpley 7-4700
DeMambro Radio Supply Co., Inc.
AL 4-9000
Graybar Electric Co.
HUbbard 2-9320
Lafayette Radio Corp. of Mass.
HUbbard 2-7850
- Cambridge**
Electrical Supply Corporation
UNiversity 4-6300
- Michigan**
Ann Arbor
Wedemeyer Electronic Supply Co.
NOrmandy 2-4457
- Detroit**
Ferguson Electronics, Inc.
UN 1-6700
- Minnesota**
Minneapolis
Electronic Expeditors, Inc.
FEderal 8-7597

Mississippi—Jackson
Ellington Radio, Inc.
FL 3-2769

Missouri
Kansas City
Burststein-Applebee Company
BAltimore 1-1155

St. Louis
Graybar Electric Company
JEfferson 1-4700

New Hampshire—Concord
Evans Radio
CApital 5-3358

New Jersey
Camden
General Radio Supply Co.
WO 4-8560 (in Phila.: WA 2-7037)

New Mexico
Alamogordo
Radio Specialties Company, Inc.
HEmlock 7-0307

Albuquerque
Radio Specialties Company, Inc.
AM 8-3901

New York
Binghamton
Stack Industrial Electronics, Inc.
RA 3-6326

Buffalo
Genesee Radio & Parts Co., Inc.
DElaware 9661
Wehle Electronics Inc.
TL 4-3270

Elmira
Stack Industrial Electronics, Inc.
RE 3-6513

Ithaca
Stack Industrial Electronics, Inc.
IThaca 2-3221

Mineola, Long Island
Arrow Electronics, Inc.
Pioneer 6-8686

New York City
H. L. Dalis, Inc.
EMpire 1-1100
Milo Electronics Corporation
BEEkman 3-2980
Sun Radio & Electronics Co., Inc.
OREgon 5-8600
Terminal Electronics, Inc.
CHelsea 3-5200

Ohio
Cincinnati
United Radio Inc.
CHerry 1-6530

Cleveland
Main Line Cleveland, Inc.
EXpress 1-4944
Pioneer Electronic Supply Co.
SUprior 1-9411

Columbus
Buckeye Electronic Distributors, Inc.
CA 8-3265

Dayton
Srepco, Inc.
BAldwin 4-3871

Oklahoma—Tulsa
S & S Radio Supply
LU 2-7173

Oregon—Portland
Lou Johnson Company, Inc.
CApital 2-9551

Pennsylvania
Philadelphia
Almo Radio Company
WAInut 2-5918
Radio Electric Service Co.
WAInut 5-5840

Pittsburgh
Marks Parts Company
FAirfax 1-3700

Reading
The George D. Barbey Co., Inc.
FR 6-7451

Tennessee
Knoxville
Bondurant Brothers Company
3-9144

Texas
Dallas
Graybar Electric Company
Riverside 2-6451

Houston
Busacker Electronic Equipment Co.
JAckson 6-4661
Harrison Equipment Company
CApital 4-9131

Utah—Salt Lake City
Standard Supply Company
EL 5-2971

Virginia—Norfolk
Priest Electronics
MA 7-4534

Washington—Seattle
Western Electronic Company
AT 4-0200

West Virginia—Bluefield
Meyers Electronics, Inc.
DAvenport 5-9151

Wisconsin—Milwaukee
Electronic Expeditors, Inc.
WOodruff 4-8820

New England . . .

(Continued from p 47)

duction companies into electronics, particularly in southern Massachusetts and Rhode Island. And the growth of the industry continues to spread into northern N. E., especially New Hampshire.

NEREM 1960 has been planned as more of a national technical meeting than a show, although there will be nearly 400 exhibits at Commonwealth Armory in Boston.

The technical program at the armory will feature papers of an application nature. The research-type reports will be delivered at the Sheraton-Plaza Hotel, a short distance from the armory. The NEREM committee, comprising IRE members of the Boston, Connecticut and Western Massachusetts sections, has planned a bus shuttle service between the armory and the hotel.

"Sales promotion papers" have been excluded, says the committee,

and the technical program has been shaped to reflect the research and advanced development emphasis of the industry in N. E.

Keynote address at the formal opening of NEREM Tuesday will be delivered by Jerome B. Wiesner, director of the MIT Research Laboratory for Electronics. Evening speaker will be Rear Adm. Rawson Bennett, chief of Naval research.

For the first time in the history of NEREM, a digest of papers will be available when the conference opens. The booklet will be less than a proceedings, but more than a collection of abstracts. Authors have submitted 800-word summaries which preserve technical content.

No employment recruitment will be permitted within the confines of NEREM, the committee says. "Help Wanted" ads will not be permitted on message boards, nor will solicitation be allowed at the booths—the committee thus hopefully restricting recruitment activity to hotel suites and advertising.

Report Breakthrough In Thermoelectricity

RESEARCH BREAKTHROUGH in the field of thermoelectric conversion was reported by Naval Research Laboratories last week at the IRE Electron Devices Meeting in Washington. Breakthrough was announced by NRL on behalf of its contractor Nuclear Corp., whose research chemical division developed the new device.

The thermoelectric converter uses gadolinium selenide elements for direct conversion of heat energy to electricity. Figure of merit for the new device is said to be 45×10^{-3} compared with conventional figure of merit of about 0.8×10^{-3} . The gadolinium selenide converter combines high voltage output with high conductivity. Although NRL spokesmen think that the ultimate figure of merit for production units will be less than that given for the laboratory device, they are strong in the belief that results so far indicate a significant breakthrough.

In a report on other developments in thermoelectricity, P. H. Egli of

NRL told of experiments in the conversion of the excess heat of jet aircraft engines to electric power, for use with electronic equipment.

Courier Recorder

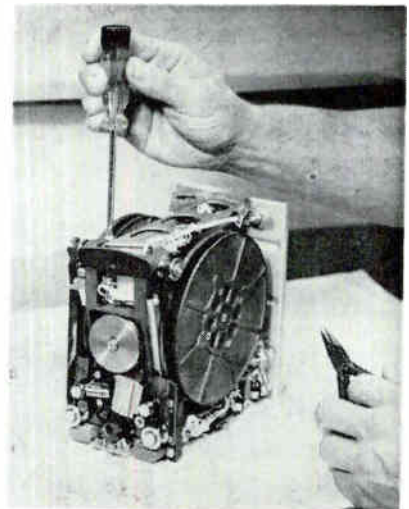

Device, developed by Consolidated Electrodynamics, uses 3-M's tape resistant to -40 to 250 F changes

Twin Cities Echoes Call for Research

ST. PAUL—Newest midwestern demand for additional investments in research came out of University of Minnesota's latest meeting of Institute of Radio Engineers.

Ronald McFarlan, IRE president, stressed need for dynamic leaders like Charles Kimball, director of Midwest Research Institute at Kansas City.

Pointing with pride to Twin Cities area's tremendous growth in technical fields during past 10 years, Byron Smith, president of St. Paul's Telex, Inc., said data processing is really about the only technical area where Twin Cities are in the lead.

"We have far too many small companies making power supplies," he said. "We are doing very little or nothing in microwave, cryogenics, masers and the solid-state fields."

Smith concluded with hope that

the governor's committee to expand the electronics industry, headed by the university's Neal Amundson, can provide leadership for setting up needed research facilities.

Setmaker Training Men For Transistor Television

TO GET READY for predicted increase in number of transistorized television sets reaching the market, some hundred tv service specialists are currently taking two-day courses in eight cities around the country.

Motorola field engineers are giving the courses. The Chicago firm introduced an all-transistor tv with large screen last May, is now predicting that "within four to five years" the majority of tv sets coming off U. S. assembly lines will be transistorized.

Reads Badges, Job-Data Cards

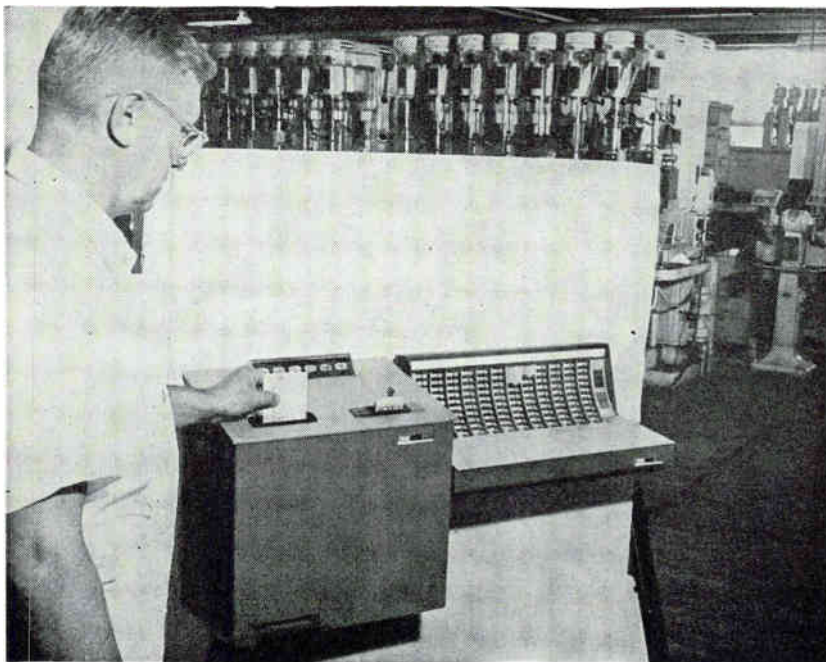

Factory data-collection system designed by IBM is used for reporting job location and status for centralized production control. This production-floor station reads regular punch card containing job data, also reads man's number, department number off badge into which these data are permanently punched. Keyless "keyboard" at right enters other variable data

Call these authorized Simpson DISTRIBUTORS

for an immediate demonstration or delivery of Simpson Laboratory Test Equipment.

CALIFORNIA

R. V. WEATHERFORD COMPANY
6921 San Fernando Road
GLENDALE 1, Victoria 9-2471
NEWARK ELECTRONICS CORP.
4747 W. Century Blvd.
INGLEWOOD, OREGON 8-0441
ELECTRONIC SUPPLY CORPORATION
2085 East Foothill Blvd.
PASADENA, SYcamore 5-5901

COLORADO

WARD TERRY & COMPANY
70 Rio Grande Blvd.
DENVER, AMherst 6-3181

FLORIDA

THUROW DISTRIBUTORS
121 South Water Street
TAMPA 1, Phone: 2-1885

GEORGIA

ELECTRO TECH EQUIPMENT COMPANY
690 Murphy Avenue S.W.
ATLANTA 10, PLaza 2-4128

ILLINOIS

ALLIED RADIO CORPORATION
100 N. Western Avenue
CHICAGO 80, HAYmarket 1-6800
NEWARK ELECTRONICS CORP.
223 W. Madison Street
CHICAGO 6, State 2-2944

INDIANA

WARREN RADIO COMPANY
1716 S. Harrison St.
FORT WAYNE, HArrison 1232

MASSACHUSETTS

RADIO SHACK CORPORATION
730 Commonwealth Avenue
BOSTON, RE 4-1000

MICHIGAN

RADIO DISTRIBUTING COMPANY
15600 Woodrow Wilson
DETROIT, TO 9-7900
RADIO SPECIALTIES COMPANY
456 Charlotte Avenue
DETROIT 1, TEmple 3-9800

MINNESOTA

NORTHWEST RADIO &
ELECTRONICS SUPPLY CO.
52 South Twelfth Street
MINNEAPOLIS 3, FEderal 9-6346
GOPHER ELECTRONICS COMPANY
370 Minnesota Street
SAINT PAUL 1, CApitol 4-9666

MISSOURI

SCHERRER INSTRUMENTS
5449 Delmar Blvd.
ST. LOUIS 12, FOrest 7-9800

NEW YORK

STACK INDUSTRIAL ELECTRONICS, INC.
25 Susquehanna Street
BINGHAMTON, Phone: 3-6326
SUMMIT DISTRIBUTORS INC.
916 Main Street
BUFFALO 2, Phone: GRant 3100
HARRISON RADIO CORPORATION
225 Greenwich Street
NEW YORK 7, BArcley 7-7777

NORTH CAROLINA

DALTON-HEGE RADIO SUPPLY CO., INC.
938 Burke Street
WINSTON SALEM, Phone: 5-8711

OHIO

PIONEER ELECTRONIC SUPPLY CO.
2115 Prospect Ave.
CLEVELAND, SUperior 1-9411

OREGON

LOU JOHNSON
1506 N.W. Irving St.
PORTLAND, CApitol 2-9551

PENNSYLVANIA

CONSOLIDATED RADIO COMPANY
612 Arch Street
PHILADELPHIA 6, WAInut 5-7871
SUNSHINE SCIENTIFIC INSTRUMENTS
1810 Grant Avenue
PHILADELPHIA 15, ORchard 3-5600

TEXAS

ENGINEERING SUPPLY COMPANY
6000 Denton Drive
DALLAS 35, FLEetwood 7-6121
MIDLAND SPECIALTY COMPANY
500 W. Paisano Drive
EL PASO, KEystone 3-9555
BUSACKER ELECTRONIC EQUIP. CO., INC.
1216 West Clay
HOUSTON 19, JAckson 9-4626
HARRISON EQUIPMENT COMPANY, INC.
1422 San Jacinto Street
HOUSTON 1, CApitol 4-9131

CIRCLE 50 ON READER SERVICE CARD
electronics

DON'T INVEST IN TEST EQUIPMENT 'TIL YOU COMPARE FEATURES WITH THE

NEW *Simpson* LABORATORY LINE



PULSE GENERATOR . . . model 2620

No Other Unit Offers Such Accuracy, Versatility, and Set-Up Speed Within This Price Range

Twin meters read pulse repetition frequency and pulse duration simultaneously. Rise time is 0.02 microseconds; decay time, 0.03 microseconds. Pulse duration, continuously variable from 0.1 to 1000 microseconds. Jitter, less than 0.005 microseconds. Pulse repetition rate, continuously variable from 10 to 100,000 pps in four ranges. Price **\$625**



WRITE FOR COMPLETE SPECIFICATIONS

WIDE-BAND OSCILLOSCOPE . . . model 2610

For the 1001 Jobs Where You Don't Need an Expensive Specialized Scope

Here's a high-gain scope that makes your test equipment appropriation go farther. Vertical sensitivity, 6 mv RMS. Vertical calibration accuracy, $\pm 3\%$. Response (linear position): DC to 5.0 mc/sec, ± 0.5 db; DC to 8.0 mc/sec, ± 1.5 db. Response (transient position): DC to 3.5 mc/sec, -3 db, and -6 db at 5.0 mc/sec. Triggered and recurrent sweeps. Precalibrated sweep positions of 5, 50, 500, 5000 microseconds. Price **\$575**



WRITE FOR COMPLETE SPECIFICATIONS

LABORATORY STANDARD

VOLT-OHM-MILLIAMMETER . . . model 2600

A Self-Powered Calibrator for Electrical Instrument Maintenance and High Accuracy Testing

Two terminal connections cover all 49 ranges for unusually fast operation. DC accuracy is $\pm 0.5\%$ F.S.; AC, $\pm 0.75\%$ F.S. (at 77°F, 25°C). Separate meters (*self shielded* movements) for DC and AC readings. Price **\$1620**



WRITE FOR COMPLETE SPECIFICATIONS

AVAILABLE FROM MANY INDUSTRIAL ELECTRONIC DISTRIBUTORS COAST-TO-COAST

Write to Factory for Details

MANUFACTURERS OF
ELECTRONIC TEST
EQUIPMENT FOR OVER
50 YEARS

Simpson ELECTRIC COMPANY

5203 West Kinzie St., Chicago 44, Illinois • Telephone: EStebrook 9-1121
In Canada: Bach-Simpson Ltd., London, Ontario

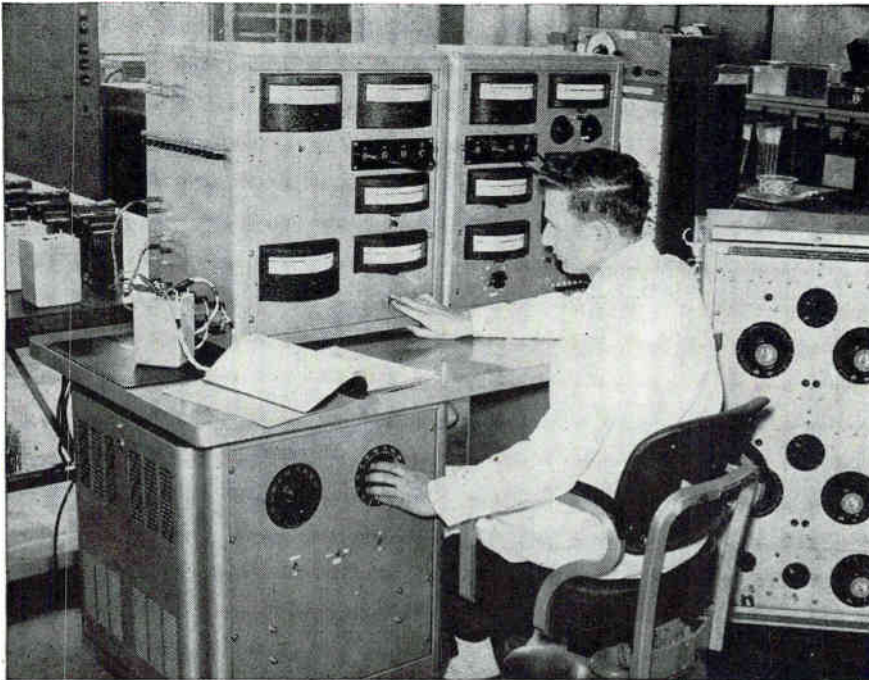

It costs less to RENT AN
ELECTRONICS LABORATORY
 than to buy one

You can save costly investment in laboratory equipment and staff... and still get top-quality R/D services... by using the complete product testing and evaluation facilities of United States Testing Company. Since 1880 thousands of clients in all industries have used our services to get:

Improved Product-Design Through Testing

Our test engineers will set up an evaluation program that "locks in" with each step of your product development from design to prototype to finished product.

An Independent Laboratory

We present a completely objective, unbiased approach to your design evaluation problems. All reports to clients are impartial, factual and confidential.

Economical Handling of Peak Loads

We are equipped to take over your peak loads *immediately* at a fraction of what it would cost your company to maintain a staff of the necessary calibre.

Product Qualification

Tests run by United States Testing Company are recognized by military and government procurement agencies in placing a product on the Qualified Product list.

Facilities and Services

Electronic Laboratory—evaluates electronic components and systems in communications and industrial fields; includes automated facilities for low-cost collection of reliability data.

Environmental Laboratory—simulates high-low temperatures, humidity, altitude, immersion, salt spray, sand and dust, rain, fungus, vibration, shock, acceleration, etc.

Materials Testing Laboratory—conducts tension, compression and transverse tests on metals, ceramics, plastics, rubber and wood materials; spectographic analysis and X-ray also available.

Mechanical Laboratory—evaluates mechanical, electro-mechanical hydraulic and pneumatic devices.

Chemical Laboratory—covers all fields including physical and biological chemistry; also infrared spectrophotometry.



Send for your free copy of bulletin 5801 describing our complete services and facilities.



United States Testing Co., Inc.
 1415 Park Avenue, Hoboken, N. J.

Branch Laboratories

BOSTON • BROWNSVILLE • DALLAS • DENVER
 LOS ANGELES • MEMPHIS • NEW YORK
 PHILADELPHIA • TULSA

MEETINGS AHEAD

Nov. 14-17: Magnetism & Magnetic Materials, AIEE, AIP, ONR, IRE, AIME; Hotel New Yorker, New York City.

Nov. 15-16: Mid-American Elect. Convention, MAECON; Hotel Muehlebach, Kansas City, Mo.

Nov. 15: Product Engineering & Production, PGPEP of IRE; Contact D. Ehrenpreis, 325 Spring Street, New York City.

Nov. 15-17: Northeast Electronics Research & Engineering Meeting, (NEREM), IRE; and PGPT National Conference; Commonwealth Armory and Sheraton-Plaza Hotel, Boston.

Nov. 15-16: Engineering Application of Probability & Random Function Theory, PGIT of IRE; Purdue Univ., Lafayette, Ind.

Nov. 20-21: Electro-Optical & Radiation Devices, PGED of IRE, AIEE; Stanford Research Inst., Menlo Park, Calif.

Nov. 28-29: National Association of Broadcasters, Fall Conference; Biltmore Hotel, New York City.

Nov. 30-Dec. 2: Electronics Exposition, Long Island Electronics Manufacturers Council; Roosevelt Raceway Exhibit Hall, Westbury, Long Island, N. Y.

Dec. 1-2: Vehicular Communication, Annual Meeting, PGVC of IRE; Sheraton Hotel, Phila.

Dec. 5-7: Electronic Equipment Maintenance, EIA; Hilton Hotel, San Antonio, Texas.

Dec. 5-8: Electrical Insulation, National Conf., AIEE, NEMA; Conrad Hilton Hotel, Chicago.

Dec. 12-14: USA National Committee, URSI, Fall Meeting; National Bureau of Standards, Boulder, Colo.

Dec. 13-15: Eastern Joint Computer Conf., PGEC of IRE, AIEE, ACM; New Yorker Hotel, New York City.

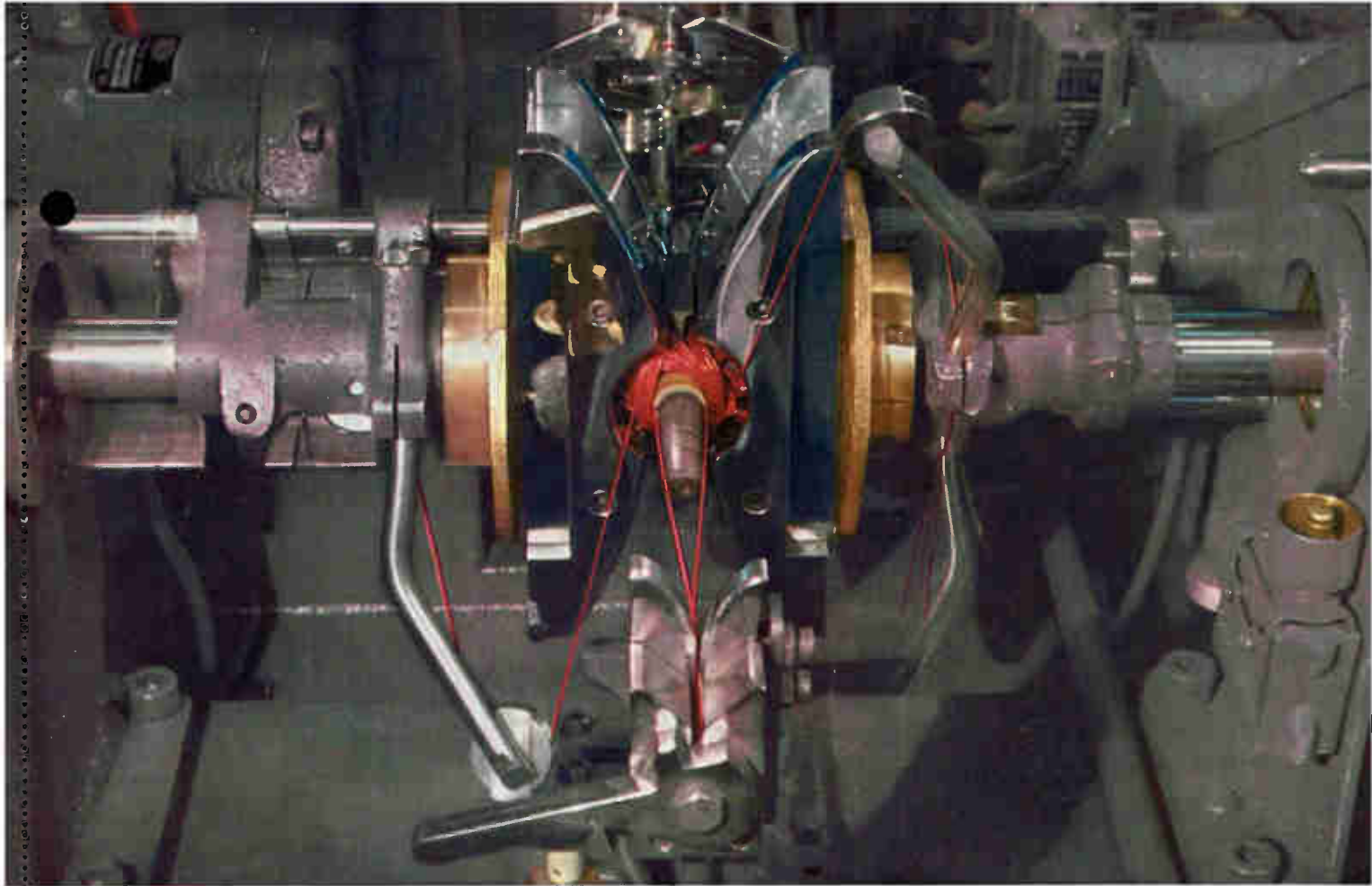

For more details on Anaconda Nylac's unique combination of useful characteristics, please turn the page—

When you must wind fast, tight, and meet high temperatures, too, **SPECIFY NYLAC SOLDERABLE MAGNET WIRE**

The faster you wind and the tighter your space factor—the more you should consider the advantages offered you by Anaconda Nylac Magnet Wire.

For Nylac is Anaconda Analac with a tough, Nylon film outer covering. The Nylon provides outstanding slipperiness and abrasion resistance—these tight-winding characteristics enable you to make compact, easily shaped, uniform coils.

Yet Nylac incorporates many features of Analac. For example, it gives you easy, fast solderability without stripping. It also has excellent moisture resistance.

In addition, Nylac offers you high dielectric strength, high thermoplastic flow temperatures, excellent flexibility, resistance to hot varnishes and potting compounds. *And—it meets all 130°C (AIEE Class B) requirements.*

So by combining Nylon, an old and industry-accepted insulation, with a newer but thoroughly proven film covering—*Analac*—Anaconda's *Nylac* is a new solderable Class B Magnet

Wire especially designed to overcome the strains of today's high-speed winding equipment and tight space factors.

The next time you face these and other winding problems, contact your nearest Anaconda Wire & Cable Sales Office. Our technical staff and Research and Development Laboratory facilities are available to give you every assistance possible. See the Man from Anaconda. Or write: Anaconda Wire & Cable Company, 25 Broadway, New York 4, N. Y.

60253

Ask the man from

ANACONDA[®]

about

NYLAC MAGNET WIRE

ANATHERM 155°C (AIEE Class F)
high temperature resistance



EPOXY 130°C (AIEE Class B)
superior compatibility



PLAIN ENAMEL 105°C (AIEE Class A)
low-cost enameled magnet wire



FORMVAR 135°C (AIEE Class A)
proven dependability



ANALAC 105°C (AIEE Class A)
solderable magnet wire

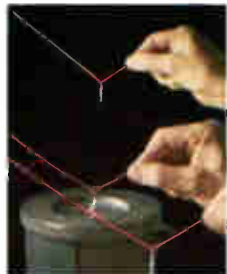

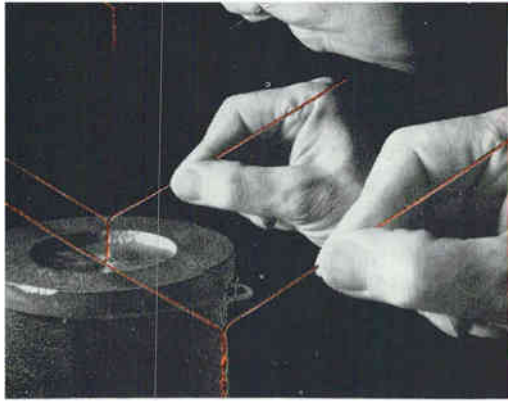

Important Facts about NYLAC MAGNET WIRE

Anaconda® Nylac film-coated magnet wire has a Nylon enamel outer surface over a film of Anaconda Analac (polyurethane) insulation. Nylac is a solderable wire that meets 130°C (AIEE Class B) thermal test requirements. It has outstanding windability and varnishability for severe process conditions, and exhibits excellent heat shock characteristics.

TECHNICAL PROPERTIES

ELECTRICAL PROPERTIES

Nylac has high dielectric strength. It has excellent electrical properties for all applications except high "Q" coils where dissipation factor should be as low as possible.

DIELECTRIC STRENGTH

Moisture environment of sample	Volts per mil of insulation
Dry	3580
Room Conditions	2560
Six hours at 100% relative humidity at 100°F	1310

DIELECTRIC CONSTANT AND DISSIPATION FACTOR

(Measured with capacitance bridge)

Frequency Cycles Per Second	Dielectric Constant		% Dissipation Factor	
	35°C	100°C	25°C	100°C
10 ²	3.5	10.7	2.4	11.4
10 ³	3.4	8.9	2.2	21
10 ⁴	3.5	6.2	2.8	18
10 ⁵	3.3	4.8	2.8	6

MECHANICAL PROPERTIES

Nylac is a strong flexible insulation. It adheres well to the conductor. Nylac wire survives severe abrasion, stretch and flex-

ing in high-speed, high-tension winding operations due to the tough Nylon overcoat. The wire will take short radius corner bends without cracking.

CHEMICAL PROPERTIES

Nylac has outstanding resistance to chemical attack. It will withstand 24 hours' immersion at room temperature in solvents including naphtha, Xylol, ethyl alcohol, chlorothene, methanol, and in 5% sulfuric acid and 1% potassium hydroxide.

THERMAL PROPERTIES

THERMAL STABILITY

Nylac meets the 130°C (AIEE Class B) requirement. Graph 1 indicates 20,000 hours' life at 135°C for unvarnished samples. Varnished sample data, available on request, indicates over 30,000 hours at 130°C.

Nylac is not recommended for use where severe thermal overloads may be encountered.

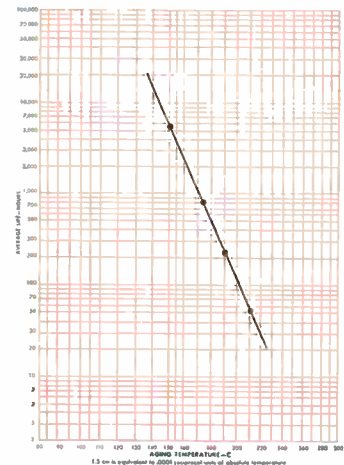

NYLAC MAGNET WIRE
UNVARNISHED AIEE 57 TEST

HEAT SHOCK

1 HR. AT 155°C

Mandrel Diameter (Multiple of Wire Diam.)

Prestretch	1x	3x	5x	10x
0%	pass	pass	pass	pass
10%	pass	pass	pass	pass
15%	pass	pass	pass	pass
20%	pass	pass	pass	pass
25%	pass	pass	pass	pass

Thermoplastic flow temperature

265°C using 5°C per minute rate of rise

SOLDERABILITY

Nylac wires solder without pre-stripping at practical solder temperatures.

Wire Size	Time-Seconds	Solder Temperature	Sample
15—18	15	360°C	Twisted Pair
19—25	10	360°C	
26—30	4	360°C	Wrap on 20 gage mandrel
31—46	4	360°C	

New Nylac Booklet—yours for the asking.
Latest information—full technical data.
Mail coupon for your copy.



ANACONDA WIRE & CABLE COMPANY
25 Broadway, New York 4, N. Y.

I am interested in learning more about the excellent properties of Nylac Magnet Wire. Please send me your new technical booklet DM5928.

NAME & TITLE
COMPANY
ADDRESS
CITY ZONE STATE

Measure transistor characteristics —

Alpha (h_{fb})
Beta (h_{fe})
Input Resistance (h_{ib})

— with the new BRC Type 275-A Transistor Test Set



Price: \$935.00 F.O.B. Boonton, N. J.

The BRC Type 275-A is an exceedingly flexible and efficient instrument for the precise measurement of basic transistor parameters over an extended range of operating conditions. It can also be used to measure the characteristics of diodes and other semi-conductor devices. Direct readout of the following parameters —

- Alpha (h_{fb}) • Beta (h_{fe})
- Input Resistance (h_{ib})

is presented on a large, easy-to-read dial without correction or interpolation. Two built-in, fully regulated, low ripple power supplies furnish completely variable emitter current and collector voltage.

Exclusive BRC features —

- Unique null-type measuring circuit completely unaffected by signal level fluctuations
 - Reads Alpha to three significant figures
 - Accurately measures at extremely low emitter currents
- plus
- Permanent Calibration
 - Direct Readout of Alpha, Beta, and Input Resistance on large easy-to-read dial
 - Built-in adjustable, metered collector and emitter power supplies
 - Handles up to 5 amperes emitter current
 - Measures both NPN and PNP transistors
 - Special test circuit guards against transistor burnout

Precision Electronic Instruments since 1934



BOONTON RADIO CORPORATION

BOONTON • NEW JERSEY • U.S.A.

SPECIFICATIONS

Alpha Measurement (h_{fb}):

RANGE: (a) 0.100 to 0.999 (b) 0.9001 to 0.9999

ACCURACY: (a) $\pm (0.1 + \frac{0.09}{h_{fb}}) \%$ * (b) $\pm 0.2 \%$ *

*when $f_{\alpha} \geq 500$ Kc.

Beta Measurement (h_{fe}):

RANGE: 7 to 200

ACCURACY: $\pm (0.6 + \frac{30}{h_{fe}}) \%$ *

*when $f_{\alpha} \geq 500$ Kc.

Input Resistance Measurement (h_{ib}):

RANGE: (a) 0.30 to 30 ohms (b) 3.0 to 300 ohms

(c) 30.0 to 3000 ohms

ACCURACY: (a) $\pm 3 \%$ * (b) $\pm 3 \%$ * above 30 ohms (c) $\pm 3 \%$ *

* for linear impedances

Collector Voltage Supply:

RANGES: Internal: 0 to 100 V.D.C.

External: 0 to 100 V.D.C.

METERING: Range: 0 to 2, 5, 10, 20, 50, 100 volts

Accuracy: $\pm 1.5 \%$ full scale

Emitter Current Supply:

RANGE: Internal: 0 to 100 ma D.C.

External: 0 to 5 amp. D.C.*

* h_{fb} only; $I_b \geq 100$ ma D.C.

I_E and I_C metered externally

METERING: Ranges: 0 to 0.1, 0.2, 0.5, 1, 2, 5, 10, 20, 50, 100 ma.

Accuracy: $\pm 1.5 \%$ full scale

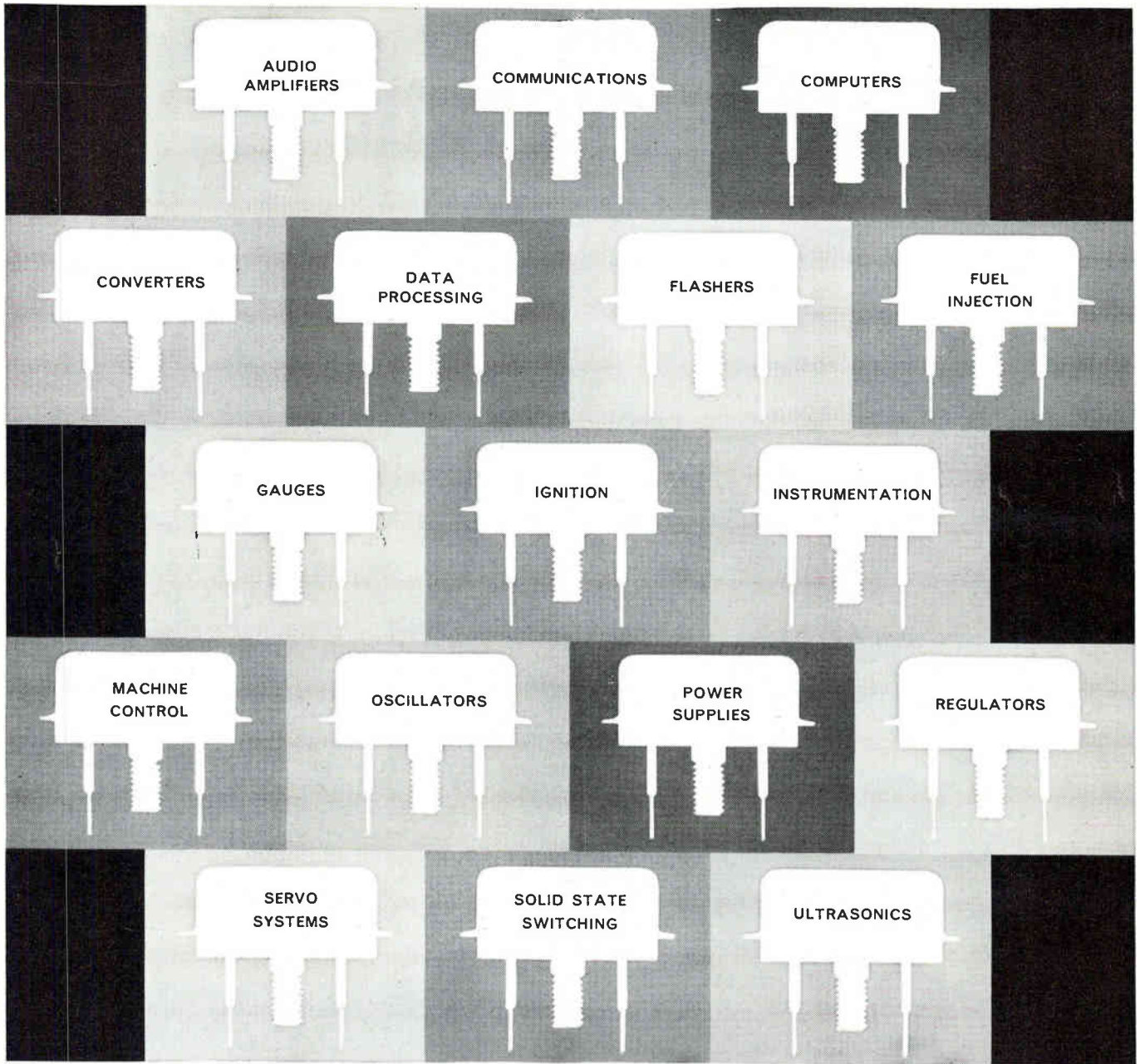

DELCO RADIO — THE LEADER IN POWER TRANSISTORS

For top performance in a wide, wide range of applications, specify Delco Radio's 2N174. ■ This multi-purpose PNP germanium transistor is designed for general use with 28-volt power supplies, and for use with 12-volt power supplies where high reliability is desired despite the presence of voltage transients. ■ It has a high maximum emitter current of 15 amperes, a maximum collector diode rating of 80 volts and a thermal resistance below $.8^{\circ}\text{C}$ per watt. The maximum power dissipation at 71°C mounting base temperature is 30 watts. Low saturation resistance gives high efficiency in switching operations.

■ The 2N174 is versatile, rugged, reliable, stable and low priced. For more details or applications assistance on the 2N174 or other highly reliable Delco transistors, contact your nearest Delco Radio sales office.

Newark, New Jersey
1180 Raymond Blvd.
Mitchell 2-6165

Santa Monica, California
726 Santa Monica Blvd.
Upton 0-8807

Chicago, Illinois
5750 West 51st Street
Portsmouth 7-3500

Detroit, Michigan
57 Harper Avenue
TRinity 3-6560

Division of General Motors • Kokomo, Indiana

DELCO
DEPENDABILITY
RADIO
RELIABILITY

SURGICALLY CLEAN IS NOT CLEAN ENOUGH...

FOR the fabrication of Saratoga Semiconductors, we use:

Cleansing solvents, so pure that one drop of water in 55 gallons would reject them; processing acids of hyper-pure reagent grade or specifically developed semiconductor grade; purest water refined to 20 megohms resistivity.

Temperature and humidity in the air locked fabrication room are controlled to a plus or minus 2%; air with 99.3% of impurities as fine as 1/10 micron removed floods the work area.

These are reasons why Saratoga Semiconductors are rated Thoroughbreds. They outdistance all others for reliability, ruggedness and performance.

Send for our new catalogue SS-2001 outlining details, specifications, and applications of Saratoga silicon zener regulators* and silicon power rectifiers.*

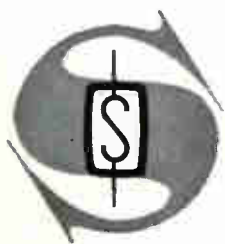

SARATOGA SEMICONDUCTOR DIVISION, Saratoga Springs, N. Y.

ESPEY MFG. & ELECTRONICS CORP.

* Meet all requirements of MIL S-19500B

SUPRAMICA® 560 ceramoplastic

from the family of the world's
most nearly perfect insulation

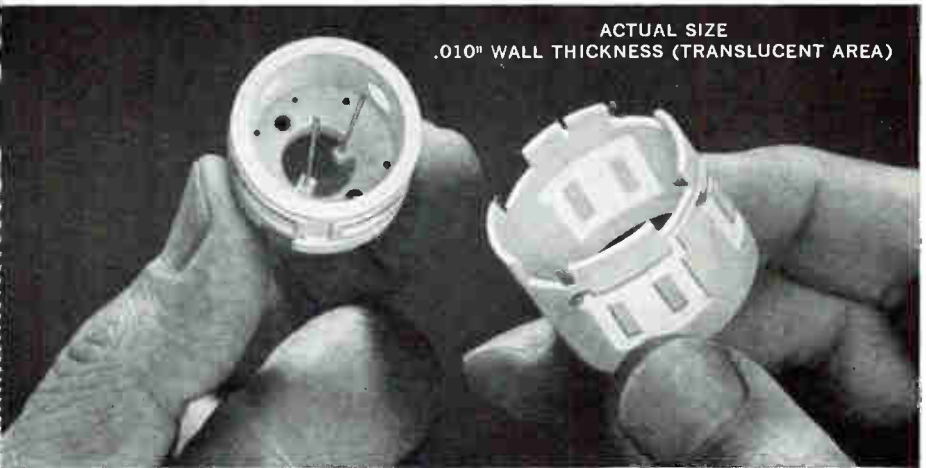

helps to maintain peak gyro efficiency

Leading gyro producers design parts made of precision-molded SUPRAMICA 560 ceramoplastic, an *exclusive formulation* of MYCALEX CORPORATION OF AMERICA capable of retaining absolute dimensional stability at a maximum temperature endurance up to +932°F (unstressed) . . . in complex but lightweight designs. These small parts function as vital components of miniature gyros . . . critical applications where the highest standards for precision accuracy must be met.

SUPRAMICA 560 ceramoplastic having the same thermal expansion coefficient of many insert metals, can tightly bond and permanently anchor gold leads, stainless steel contacts and stainless steel threaded inserts . . . in parts with wall thicknesses of only .010".

SUPRAMICA 560 ceramoplastic offers premium insulating properties with excellent economy in production scale runs. SUPRAMICA 560 ceramoplastic is but one of a family of versatile electrical and electronic insulating materials produced by MYCALEX CORPORATION OF AMERICA . . .

- MYCALEX® glass-bonded mica,
maximum temperature endurance (unstressed)—up to +700°F
heat distortion temperature * —up to +850°F
- SUPRAMICA® ceramoplastic,
maximum temperature endurance (unstressed)—up to +1550°F
heat distortion temperature * —up to +1360°F
- SYNTHAMICA® synthetic mica,
maximum temperature endurance (unstressed)—up to +2000°F

* ASTM test method D 648 (modified) at stress of 264 psi.

Write for technical information today.

General Offices and Plant: 120 Clifton Blvd., Clifton, N. J.
Executive Offices: 30 Rockefeller Plaza, New York 20, N. Y.

World's largest manufacturer of glass-bonded mica, ceramoplastic and synthetic mica products

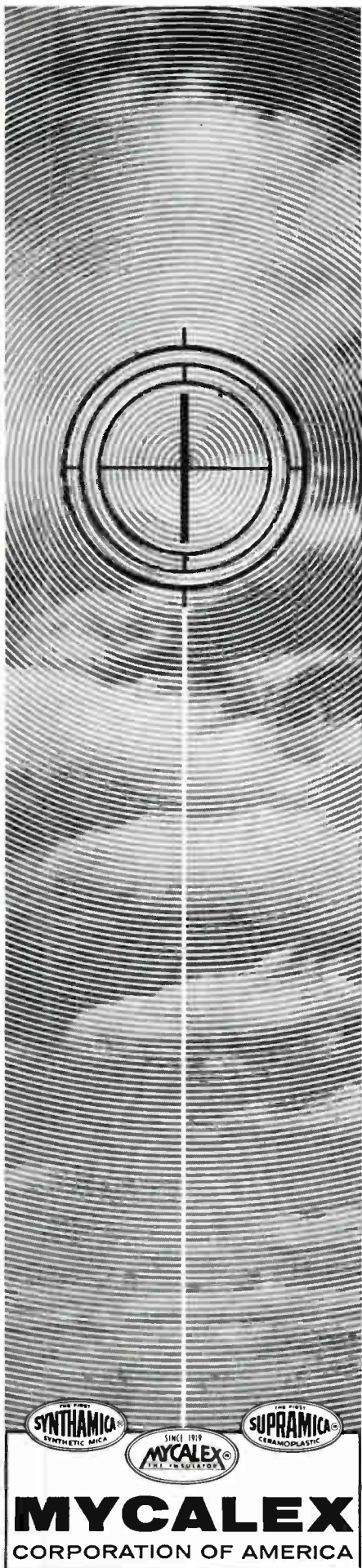

NEW from

MELABS-

seasoned microwave designers and builders



Model SGO-2, common power supply

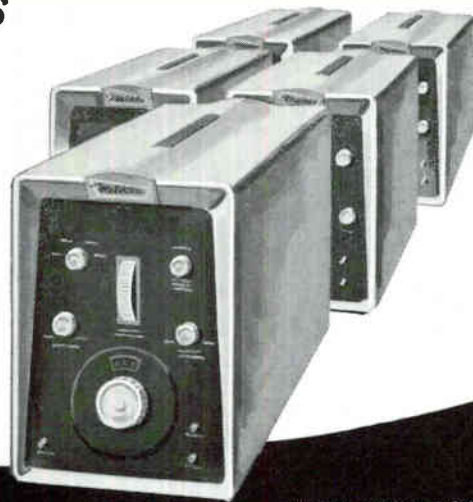

Model SGL-2, 1-2 KMC
Model SGS-2, 2-4 KMC

Model SGC-2, 4-8 KMC
Model SGX-2, 8-12 KMC
Model SGK-2, 12-18 KMC

Swept Signal Generators offering Constant Power Output over Entire Band

A common power and sweep supply can be used with any of the new Melabs electronically tuned signal generators covering, respectively, L, S, C, X and K band frequencies.

All five units are compatible with Melabs' radiometer and panoramic display unit. Addition of a receiver box creates a swept receiver or panoramic analyzer. TWT amplifiers with power outputs up to 1 watt can be supplied.

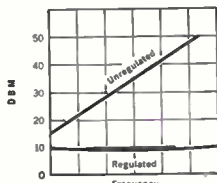

Power output

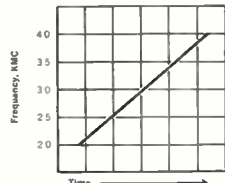

Linear time/frequency characteristic

SPECIFICATIONS

Model SGS-2, S Band, with SGO-2 Power Supply

Power output: Regulated, 10 mw \pm 1 db; unregulated, 10 mw at 2 KMC, rising to 300 mw at 4 KMC; manual adjustment range, 30 db.

Internal modulation: For regulated power, pulse, 1-10 μ sec; square wave. Rep rate, 100-5000 cps.

External modulation: Any type, unregulated only.

Sweep: 0.3 to 30 cps; cw through 100% of band.

Price: { Model SGS-2, \$2,300.00; Model SGO-2, \$900.00;
Model SGL-2, \$2,600.00; Model SGC-2, \$2,400.00;
Model SGX-2, \$2,600.00; Model SGK-2, \$4,500.00.

Specifications similar

Data subject to change without notice. Prices f.o.b. factory.

Employment opportunities at Melabs are exceptional for ambitious engineers and physicists; write in confidence.

Melabs

(pronounced MEL-LABS) · Dept. M7, 3300 Hillview Ave.
Palo Alto, California · Davenport 6-9500

6709

MOSELEY AUTOGRAF INSTRUMENTS

X-Y Recorders

Most complete line available
14 different models including portable
8½" x 11" or 11" x 17"
Rack or table mounting
2-pen designs
Automatic chart advance
All needed versatility features

Strip-Chart Recorders

3 different models
¼-second full-scale response
6 push-button chart speeds

Program Controllers

Optical line followers
Electromagnetic curve followers
Function Generators

Servo Voltmeters

Drive digitizers, printers
High accuracy

Analog Converters

Log converters, 60 db range
AC/DC converters

Digital to Analog Translators

Convert data from punched cards,
perforated tape, magnetic tape
by transistor switching

Digital and Analog Accessories

Keyboards
Character printers, 3 models
Time bases

Systems

Magnetic tape digital data plotting
Transmissibility plotting
Strain, temperature plotting

**KNOWN FOR
QUALITY
AROUND
THE WORLD**

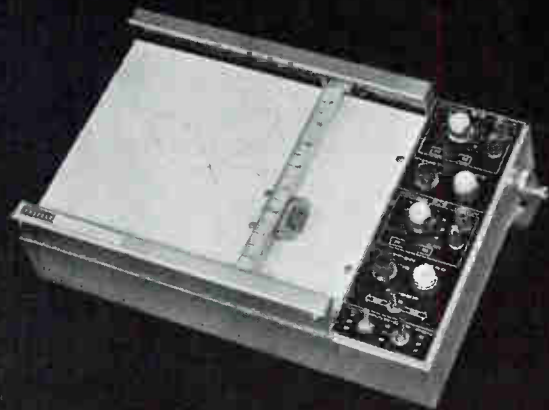

Write today for data sheets and application information

AUTOGRAF *recorders*

F. L. MOSELEY CO.

Dept. A-11, 409 N. Fair Oaks Avenue, Pasadena, California
Murray 1-0208 TWX PASA CAL 7687, Cable MOCOPAS
Field representatives in all principal areas

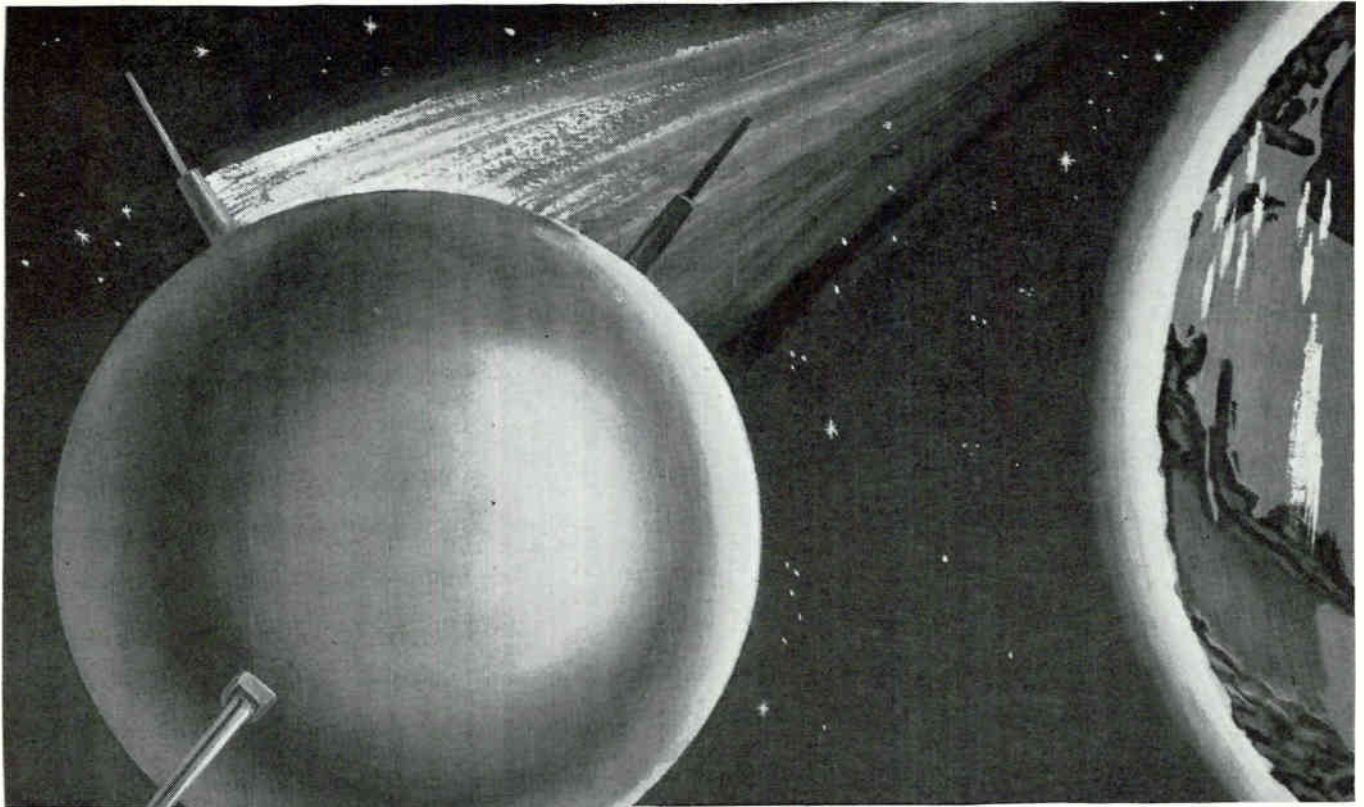

THE BIG **A** LEADS THE WAY TO *INTEGRATED* COMMUNICATIONS SYSTEMS

SATELLITE RELAY SYSTEM – A reliable, worldwide network for telegraphy and teletype communications will be realized through PROJECT COURIER of the Advanced Research Projects Agency and U. S. Army Research & Development Laboratories. Each of the Courier's air-ground transportable stations duplex transmit and receive 15 million bits of stored information in the 4-minute contact with the satellite. As subcontractor to ITT Laboratories, ADLER is responsible for design, manufacture and equipment installation of the ground station trailers of this earth-satellite relay system.

TRANSPORTABLE TROPOSPHERIC SCATTER SYSTEM

A new concept in continent-spanning tropospheric scatter communications soon will be available to the U. S. Air Force. For the first time, the full multichannel capability and reliability of a large, fixed installation will be provided in a compact, air-ground transportable package. The all-environment, 10KW, AN/MRC-85 is being designed, system integrated and manufactured by Adler under subcontract to Page Communications

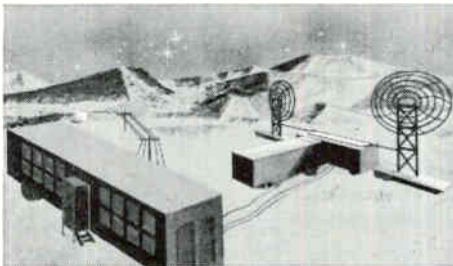

SPECTRUM-STRETCHING COMMUNICATIONS SYSTEM

Through Adler pioneering in heterodyne repeating, a wide range of UHF channels have been opened to the U. S. Army for NIKE Missile field communications. The Adler "F-Head" unit permits the basic AN/TRC-24 VHF system to be used for UHF relaying in areas where VHF spectrum congestion is a problem. Designed for plug-in use, the "F-Head" heterodynes the VHF output of the AN/TRC-24 to the usable UHF range. Adler heterodyne techniques are finding an ever-growing place in military, industrial and commercial communications.

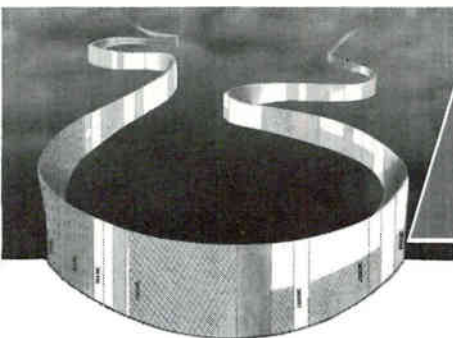

Write for all the facts on how Adler experience can help solve your communications problems.

ADLER
ADLER ELECTRONICS, INC.
New Rochelle, N. Y.

Engineering opportunities available at all levels. Write to Personnel Manager.



Bendix Craftsmanship at work for you



Phase Shifter



Y-Circulator



Attenuator

TYPICAL SPECIFICATIONS

	Phase Shifter	Y-Circulator	Attenuator
Frequency Range	5200 to 5800 mc	4700 to 5700 mc	4900 to 5800 mc
Insertion Loss	1 db max.	0.4 db max.	1 db max.
Impedance	50 ohms	50 ohms	50 ohms
VSWR	1.30 max.	1.20 max.	1.25 max.
Power Handling Capacity			
Average	5 watts	10 watts	5 watts
Peak	5 kilowatts	10 kilowatts	5 kilowatts
Temperature Range	-55°C. to +85°C.	-55°C. to +85°C.	-55°C. to +85°C.
Diameter	1.12"	2.375"	1.12"
Weight	6 oz.	11 oz.	6 oz.

NEW BENDIX® MICROWAVE FERRITE DEVICES.* **1** The Electrically Variable Phase Shifter, TFP-1, can produce phase shifts in excess of 90° over a minimum bandwidth of 10%. Chief uses are as phase modulator, fast shift, and in a wide variety of r-f direction finding devices. **2** The Y-Circulator, TFC-1, offers at least 20 db isolation with less than 0.4 db insertion over bandwidth exceeding 20%. Ideal for use with masers, and parametric amplifiers. **3** The Electrically Variable Attenuator, TFA-1, has a range exceeding 25 db over a minimum bandwidth of 15%. Useful in fast AGC circuits and remote level control applications. Write today.

*PAT. PENDING

ELECTRON TUBE PRODUCTS

Red Bank Division

EATONTOWN, NEW JERSEY



COMPUTERS

1961

SPECIAL JANUARY ISSUE

Proceedings of the IRE

Electronic computers are the "time machines" of today — they bring to man the precious gift of time. They think, relate, evaluate and solve fantastic problems in millionths of a second. Each operation they perform releases you, the radio-electronics engineer, the mathematician, the physicist, the chemist — for work that calls for the human mind and heart.

Obviously, you should know about computers. Computers, today, are more compact, more complex, and about 50,000 times faster than those made just a few years ago. Progress such as this means constant and dramatic changes. It would take precious hours each day to keep abreast of all developments.

You can, however, learn about computers far more easily — by reserving your copy now, of this special January issue of **Proceedings**. In it you will find the sum of all that's new in computers. You get 360 pages of brilliant research and authoritative writing (of course at engineering levels), made up of some 40 separate papers; 12 of these specially-invited.

Like other special issues of **Proceedings**, the computer issue promises to remain definitive for years to come. If you're not already an IRE member, make sure you get a copy of the **Proceedings** Special Computer Issue by sending in the coupon below.

INVITED PAPERS FOR COMPUTER ISSUE INCLUDE:

- Adaptive Control — Present and Future**
J. G. Truxall (Poly. Inst. of Brooklyn)
- State of the Art of Perceptron Machines**
J. R. Hawkins (Aeronutronic Systems)
- Survey of Artificial Intelligence**
Marion Minsky (MIT Lincoln Lab.)
- Organization of Arithmetic and Control Sections of Computers**
W. L. Lawless, Jr. (IBM)
Jan Rajchman (RCA)
- Survey of Storage Devices**
Automatic Programming
W. Orchard-Hays (Corp. for Economic Industrial Research)
- State of the Art of Digital Communication**
J. M. Wier (Bell Telephone Labs.)
- Computer Developments in Europe**
Isaac Auerbach (Auerbach Electronics)
- New Applications of Computers**
W. F. Bauer (Ramo-Wooldridge)
- State of the Art of Display Equipment**
Roger Sisson (Aeronutronic Systems)

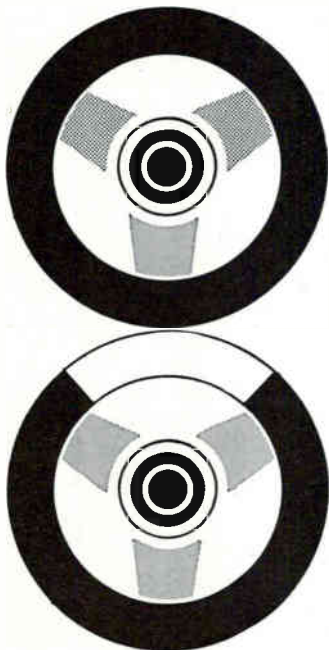

Proceedings of the IRE

1 East 79th St., New York 21

- Enclosed is \$3.00
- Enclosed is company purchase order for the January, 1961, issue on Computers 1961.

All IRE members will receive this January issue as usual. Extra copies to members, \$1.25 each (only one to a member).

Name _____

Company _____

Address _____

City & State _____

THE INSTITUTE OF RADIO ENGINEERS
1 East 79th Street, New York 21, New York

Vitramon®

SOLID-STATE PORCELAIN CAPACITORS

...chosen for reliability by

AUTONETICS* in

HOUND DOG'S Verdan Computer



Vitramon® Capacitors adapt easily to the printed circuit boards used in VERDAN. Note how square configuration and axial-radial design of capacitors permits flush mounting and easy insertion. Solid-state construction — fine silver electrodes molecularly fused with dense porcelain dielectric — give Vitramon® Capacitors outstanding stability, extremely low loss, and high pulse rate.

Autonetics' air-borne VERDAN is an extremely high speed computer with relatively high capacity, great flexibility of application, and extensive input-output provisions. Occupying less than 1½ cubic feet of space, VERDAN is designed with a general purpose section and a digital differential section, both of which share a common magnetic disk memory and have complete intercommunication. VERDAN was developed by Autonetics for its air-to-ground "Hound Dog" guidance control and REINS nav-bomb systems.

* a division of North American Aviation, Inc.

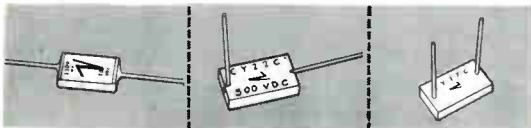

VITRAMON
INCORPORATED
BOX 544 • BRIDGEPORT 1, CONN.

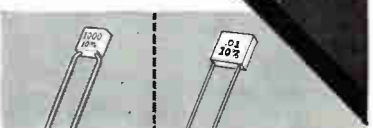

In Arctic cold...

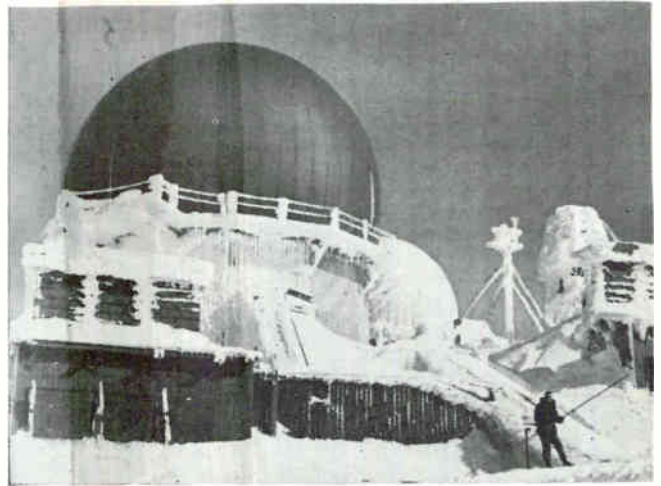
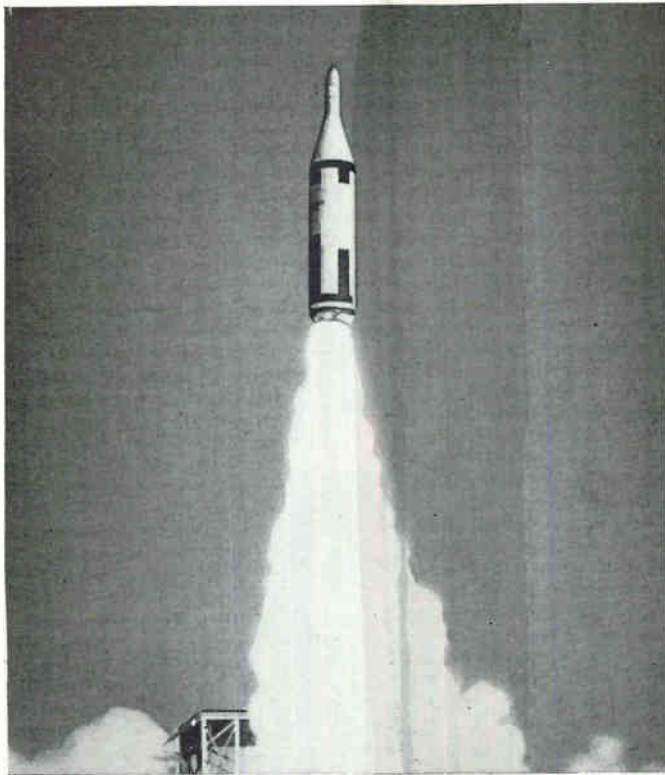

General Electric Silicone Fluids offer reliability from -65°F to 400°F as liquid dielectrics and heat transfer media in aircraft, missiles and ground installations. Excellent dielectric properties are virtually unchanged over wide ranges of temperature and frequency.

or missile heat...

G-E Silicone Rubber Insulation is used in missiles and space vehicles because of its excellent insulating properties, resistance to temperature extremes, moisture and ozone and its long-time stability in storage.

G-E silicone insulations do the job!

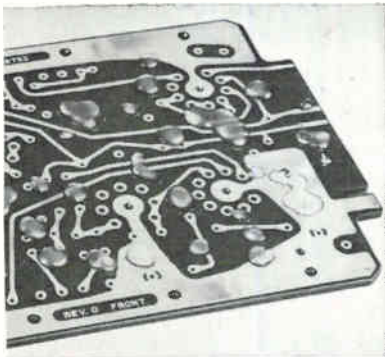

▶ **RTV* Liquid Silicone Rubber** comes in a wide range of viscosities for potting, encapsulating, impregnating and sealing. RTV resists heat, cold, ozone, moisture; protects against high-altitude arc-over.
*Room Temperature Vulcanizing

◀ **G-E Silicone Varnishes** provide excellent protection against moisture and high operating temperatures. Applications include conformal protective coatings for printed circuits, resistor coatings, transformer impregnation, etc. New varnishes cure at low temperatures.

▶ **New Silicone Dielectric Greases** maintain physical and electrical properties from -65°F to 400°F , offer protection against moisture and oxidation. Used as corrosion inhibitors, lubricants, heat transfer media and release agents.

◀ **Silicone Rubber Wire Insulation** withstands soldering heat without damage; matches or exceeds vital properties of insulation costing three times as much. Provides long service life at 500°F ; momentarily withstands temperatures up to 5500°F . Flexible as low as -150°F , it resists moisture, ozone, nuclear radiation.

Send for technical data, "Silicones-for-Insulation." Section N1131, Silicone Products Department, Waterford, New York.

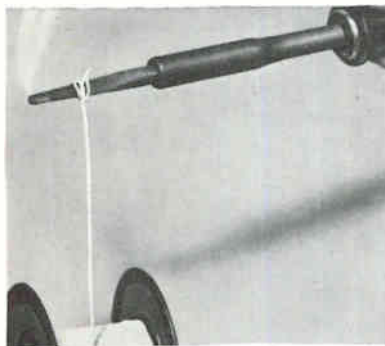
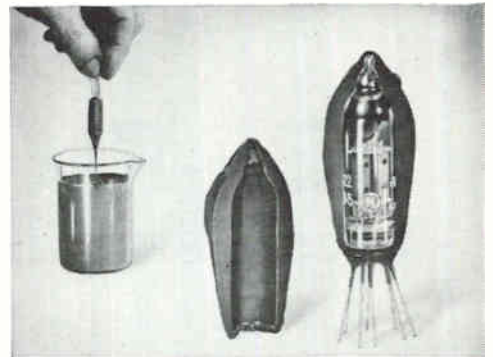

GENERAL  ELECTRIC



THE RAW MATERIALS OF PROGRESS

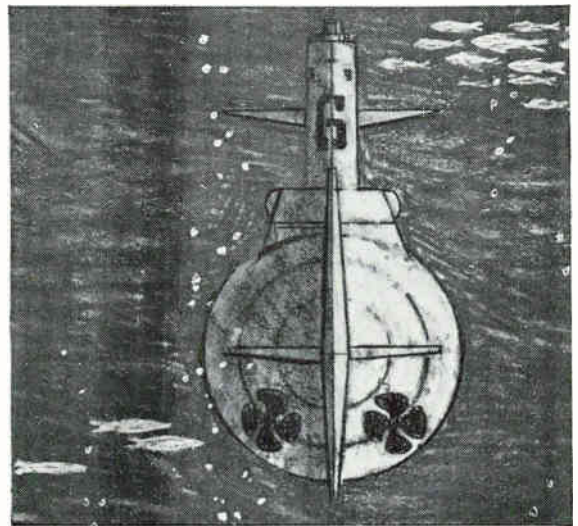
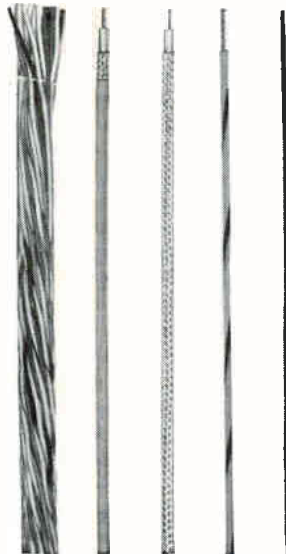
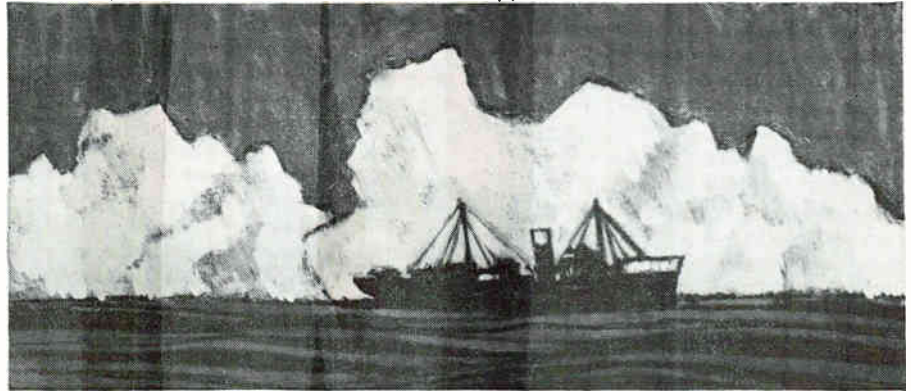
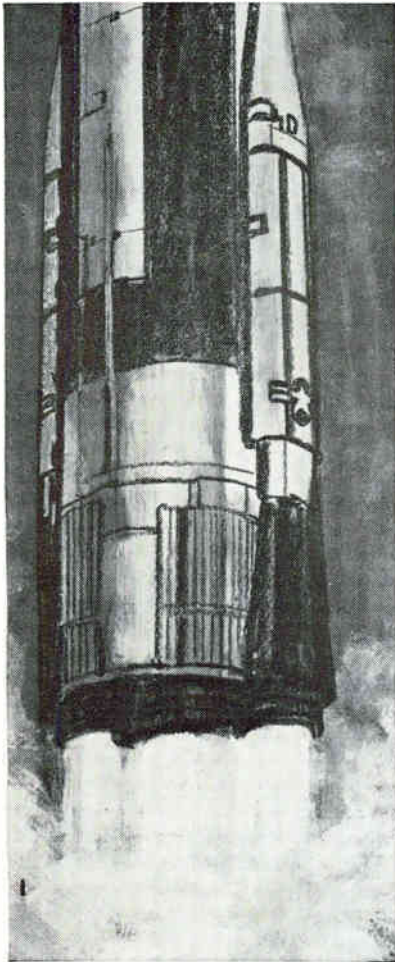

KEL-F[®] Brand Plastic wire coating—tough skin for problem environments

Rattling vibration . . . shattering cold . . . water immersion—even problem environments like these are overcome by electrical wiring and cable utilizing KEL-F Brand Plastic as the coating.

The Surprenant Mfg. Co., Clinton, Massachusetts, has been using KEL-F Plastic as a wire coating for the past 10 years. The reason? It meets their own high quality standards and rigid requirements, as well as military specifications.

They have developed cable jacketing and wire coating of KEL-F Plastic with resistance to extreme vibration, acceleration, shock and cut-through, even at temperatures as low as -69.5°F. This non-flammable insulation exhibits good dielectric qualities and has a low dissipa-

tion factor, with zero moisture absorption and excellent compressive strength with resultant resistance to cold flow.

In areas where space is at a premium, Surprenant Mfg. Co. has found that it is easy to achieve excellent concentricity, even at very thin extrusions, using KEL-F Plastic. It extrudes at 475-625° F., and is melt-processible. The plastic may be custom-colored too, and Surprenant coatings and jackets are available in 9 stock colors (including white), and transparent.

If environment is a problem for your electrical wiring, a skin of KEL-F Plastic may well be the answer. For complete performance data, write today to: 3M Chemical Division, Dept KAX-100, St. Paul 6, Minnesota.

"KEL-F" is a Reg. T.M. of 3M Co.

CHEMICAL DIVISION
MINNESOTA MINING AND MANUFACTURING COMPANY

... WHERE RESEARCH IS THE KEY TO TOMORROW



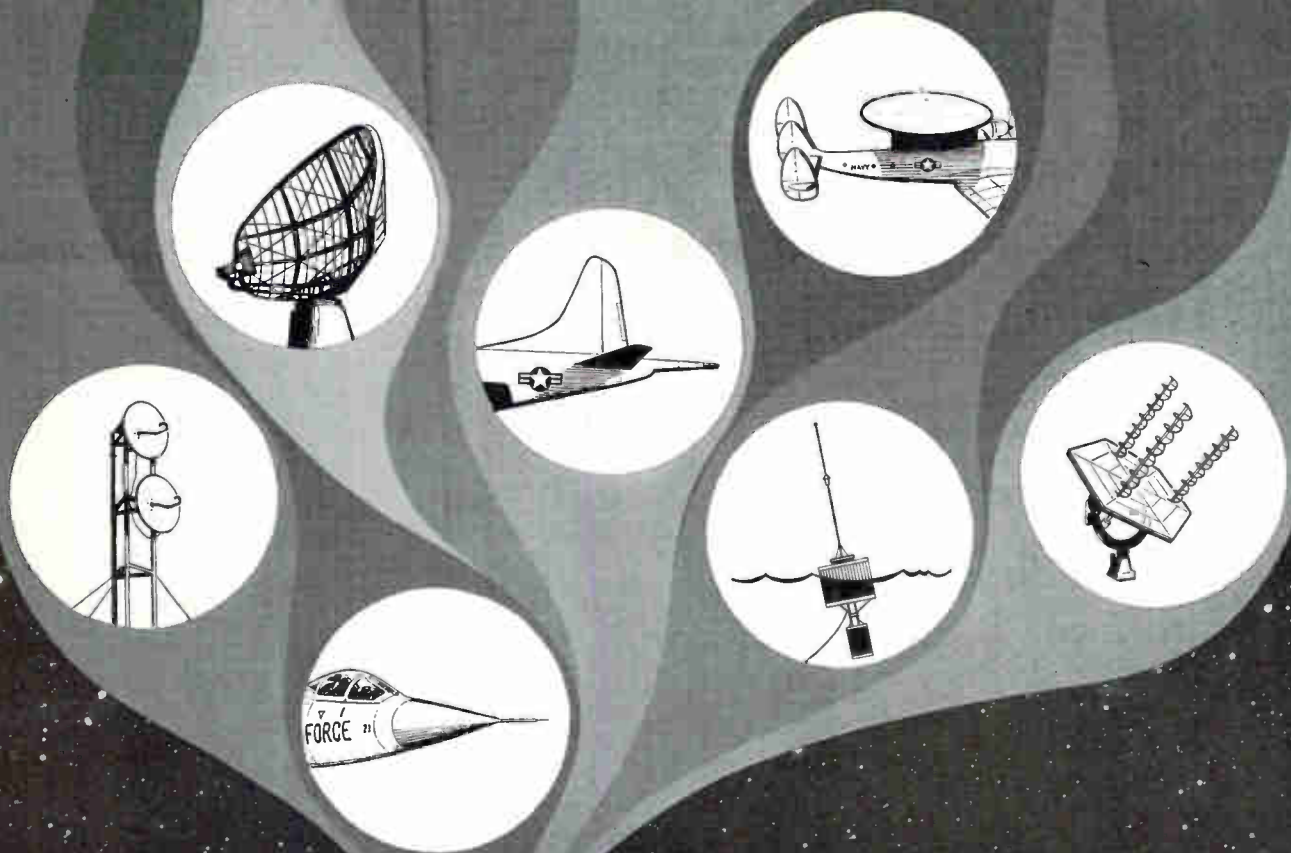

Advancing the Science of Communications through Electronic R & D at Lockheed

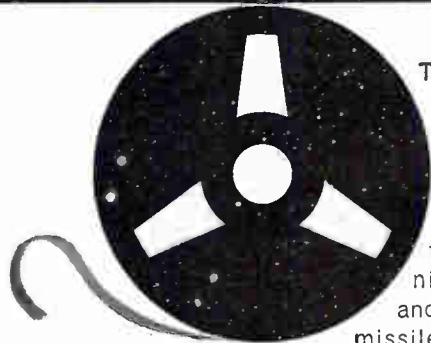

The science of communications is vast as the universe itself. Fresh areas in this science are being explored at Lockheed. These cover the spectrum of communications problems—on and under water to tracking missiles and satellites—from components to complete systems.

An essential phase in the electronics communications R & D program is the development of antennas and supporting equipment to receive telemetered, tracking and relay data. Each is designed to meet a specific need. This program is vital to our sophisticated spacecraft projects—now and in the future.

Areas under investigation in electronics and other fields stir the creative mind:

Design and development of data processing equipment; V/STOL design and development; electromagnetic research in corona and high-altitude breakdown studies, surface wave generation, antenna vehicle interaction, millimeter wave radiometry; electrical instrumentation; infrared and solid state physics; biophysics research (on radiation hazards coincident with space flight); solid state electronics; aerothermodynamics; dynamics; auto-controls; and servosystems.

Scientists and Engineers: If you are experienced in any of the areas mentioned above; if you are interested in joining a company that looks far into the future, you are invited to investigate the opportunities offered. Write today to: Mr. E. W. Des Lauriers, Manager Professional Placement Staff, Dept. 1511, 2408 No. Hollywood Way, Burbank, California.

LOCKHEED / CALIFORNIA DIVISION



BENDIX-PACIFIC

in Southern California

needs ENGINEERS with DOCTORS' - MASTERS' - BACHELORS' DEGREES

*for electrical and systems work in fields of
Missile Guidance—Instrumentation—Telemetry
Anti-Submarine Detection Systems/Operations Research*
Advanced positions are open in our "Eagle" Missile Program in
Electrical Engineering for the design of transistor circuits, servo-
mechanisms, microwave electronics and data links.

Please send resume to W. C. WALKER
ENGINEERING EMPLOYMENT MANAGER

*Other High-Level Electronic
Engineering Positions Available*

Bendix-Pacific
Division
NORTH HOLLYWOOD, CALIF.



CIRCLE 377 ON READER SERVICE CARD

PEAK POWER



A NEW KIND OF PRECISION ULTRASONIC CLEANING

The new L & R Ultra-Clean '320' has an electronic circuit that transmits peak power directly to the transducerized tank. The transducerized cleaning tank and the rinse tank are 5½" square by 3" deep. Just set the electrical timer to blast away all dirt, grease, foreign particles—get components microscopically clean. . . . Unconditionally guaranteed for 1 year. Write today for complete data on the '320' and other ultrasonic cleaning equipment. . . . **\$187.50**
Second tank transducerized (at factory), \$74.50.

L & R MANUFACTURING COMPANY

588 Elm Street, Kearny (Arlington), New Jersey
29 EAST MADISON STREET, CHICAGO 2, ILLINOIS
406 SOUTH MAIN STREET, LOS ANGELES 13, CALIFORNIA

68 CIRCLE 68 ON READER SERVICE CARD

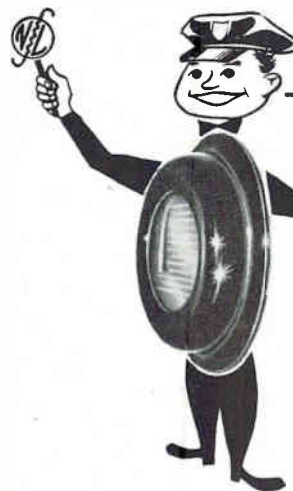

I have a feeling in the pit of my photocell that you are open to this page. Why not have a look at these data while you are here.

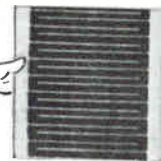

CdS- Photoconductive CELLS

Capable of dissipating especially high power up to one watt.

- RUGGED
- ECONOMICAL

Various standard types with different electrical and physical characteristics available to meet your specifications.

WRITE:

NATIONAL SEMICONDUCTORS LTD.

230 AUTHIER ST. Montreal 9, P. Q.
Phone: RI: 4-2946

CIRCLE 200 ON READER SERVICE CARD

electronics



Avco environmental test fixtures offer repeatable test results at lower cost

Avco's multipurpose environmental test fixtures were developed for vibration, shock and acceleration testing. These rugged, T-type fixtures can benefit your test results in two ways: They provide a standardized fixture environment that does not vary from month to month or year to year. And by minimizing your design and setup time, they reduce the cost of obtaining test results.

The Avco TF-006 fixture is designed for use as an integral part of such environmental test equipment as vibration exciters, shock machines and centrifuges. It permits simultaneous testing of components in each of

three mutually perpendicular planes. Relocation of the test specimen to change axes is easily accomplished.

Avco test fixture TF-006 offers these important advantages:

- Insures flat vibration response in the 0-2000 frequency range.
- Eliminates need for fixture equalization runs and improves test efficiency as a result of its flat response.
- Saves valuable engineering time previously spent in designing new fixtures for conventional tests.

Avco test fixtures are available in two sizes—the TF-006 and the larger

TF-025—in both magnesium and beryllium. Avco offers you a 30-day free trial of the TF-006 fixture, with no obligation. For more information, contact your nearest representative. Offices are located throughout the continental United States and the world. Or write: *Industrial Products Subdivision, Research and Advanced Development Division, Avco Corporation, Wilmington, Mass.*

AVCO
Research & Advanced Development

TRUE DIFFERENTIAL DC TO 20 KC AMPLIFIER

A true differential 4-terminal amplifier by our AMPLIFIER-ISOLATOR combination: both input to output isolation and circuitry to ground isolation.

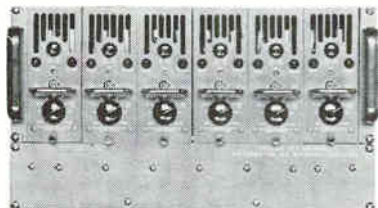

Amplifies DC to 20 kc signals from strain gages; thermocouples; resistive transducers and similar data acquisition systems. Input impedance: 100,000Ω. CMR 130 db to 100 cps. Low noise: 10 μV to 20 kc. Gain: 10 to 1,000 continuously adjustable. Output ±5 v at ±30 ma or ±10 v at ±20 ma.



Two-in-one value!
Converts to DC to 40 kc floating amplifier with ±50 V ±50 ma by a simple disconnect.

"The Source for Noise-free Instrumentation"



 **COMPUTER ENGINEERING ASSOCIATES, INC.**
350 North Halstead • Pasadena, California
Elgin 5-7121

Write today for our Bulletin SCE-1
CIRCLE 203 ON READER SERVICE CARD

GREEN PANTOGRAPH ENGRAVERS

- ELIMINATE DELAYS!
- KEEP YOUR OPERATING COSTS WHERE THEY SHOULD BE!



PORTABLE 40-POUND BENCH MODEL 106

You Make Your Own Engraved Nameplates!

Here is a speedy, economical 2 or 3-dimensional engraver used by thousands of dollar-conscious companies. It features 5 positive, accurate pantographic ratios; ball bearing spindle with 3 speeds up to 14,000 rpm. Is supplied with one copy carrier that accepts all standard master type sizes. Will actually work up to 10" by any width. Height of pantograph and position of cutter are continuously adjustable.

MODEL D-2 HEAVY-DUTY 2-DIMENSIONAL

Pantograph for milling, drilling and engraving.

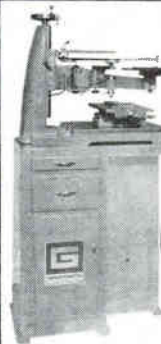

Vertical adjustment of copy table automatic with Pantograph. Features: unobstructed on 3 sides to take large work; micrometer adjustment for depth of cut; ball bearing construction throughout; spindle speeds up to 26,000 rpm for engraving or machining; vertical range over 10"; ratios 2 to 1 to infinity — master copy area 26" x 10"

NEW

MODEL D2-201 PNEUMATIC ATTACHMENT



for use with Model D2 Pantograph Engraver to rapidly drill holes in printed circuits by tracing templates. Drills as many as 100 holes per minute. Equipped with foot switch; spindle air cylinder; regulating valve and pressure gauge; filter and oiler. It's ready to use as soon as it's attached to an air compressor

Write or call for full details and prices.

GREEN INSTRUMENT COMPANY, INC.

Dept. 363, 295 Vassar St.,
Cambridge 39, Mass. Tel. ELiot 4-2989
CIRCLE 202 ON READER SERVICE CARD

electronics

Reliable products depend on reliable parts

The worldwide success of Japan's transistor radios is a tribute to their highly efficient yet minute components, of which the ultra-small Mitsumi FT Poly-vari-con is typical. With other superb Mitsumi parts, it is being extensively used by leading radio manufacturers.

For Transistor Radio Parts



IFT
Intermediate Frequency Transformer



POLY-VARI-CON
Variable Capacitor

Mitsumi Parts

MITSUMI ELECTRIC CO., LTD.

1056-1, Kaadachi, Komae-cho, Kitatama-gun, Tokyo, Japan
TEL: (416) 2619 2692 2219

At 00^h00^m01^s GMT, November 1, 1960, Martin logged its 724,620,000th mile of space flight

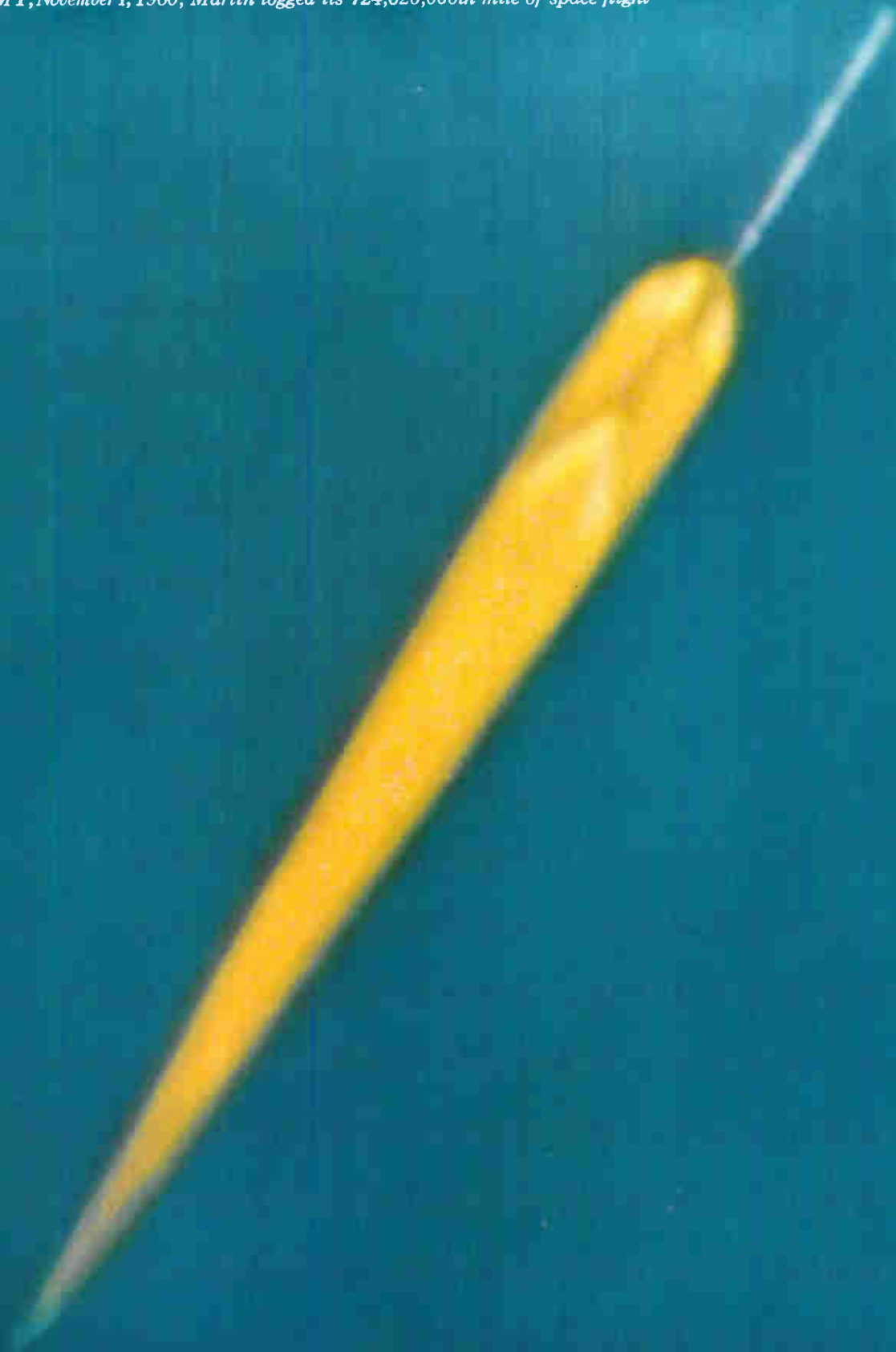

TITAN—50 miles up: Official USAF Photo

Air Force-Martin Titan, giant American ICBM, has been chosen for a key role in space exploration. One of its first missions will be to launch USAF Dyna-Soar — manned aerospace craft.

MARTIN

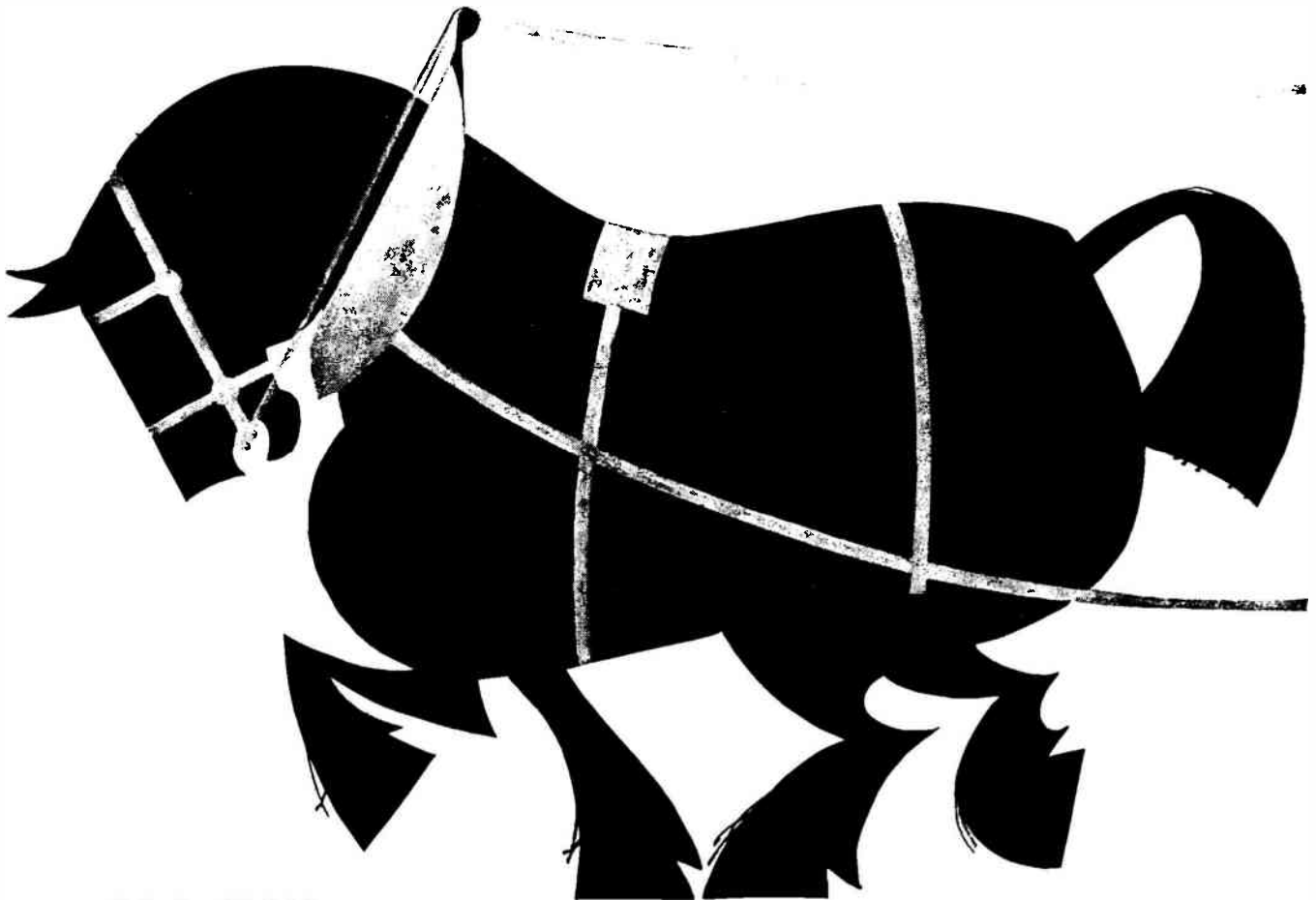

are you
using
**North
Electric's
Workhorse
"E" relay?**

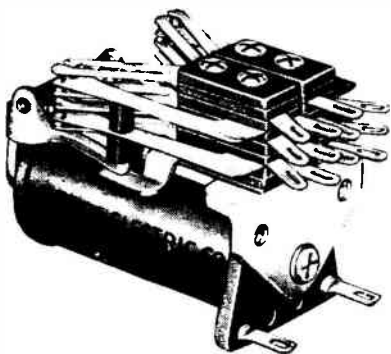

Expanded production facilities and increased efficiency in manufacturing methods have enabled North Electric to step up production of "E" relays to provide prompt delivery (at a new low cost, too) to an ever-growing list of steady customers.

If you need a relay that incorporates the inherent proven dependability of a telephone-type relay with minimal spatial requirements, this "little workhorse" from North can be your answer!

GENERAL CHARACTERISTICS:

Light Weight (2½ ozs.)
Compact (Length 2¼"; Width 1⅞"; Height 1¾" max. with
10 springs in either pile-up)
Long Life (over 100 million operations)

SPECIFICATIONS:

Coil Voltages: Up to 250V DC
Contacts: Independent action twin contact springs
Contact Materials: Palladium, Gold, Platinum
Forms: A to C
Speed: 3 ms. minimum
Residual: Lock Screw (adjustable)—Fixed (nylon flap type)
Time Delay: Available for both operate and release
Coil: Single or Double wound
Mountings: 2 #6-32 Screws on ¾" spacing
Accessories: Dust Cover and Hold Down Bracket

ELECTRONETICS DIVISION

NORTH ELECTRIC COMPANY

6411 S. Market St.

Galion, Ohio



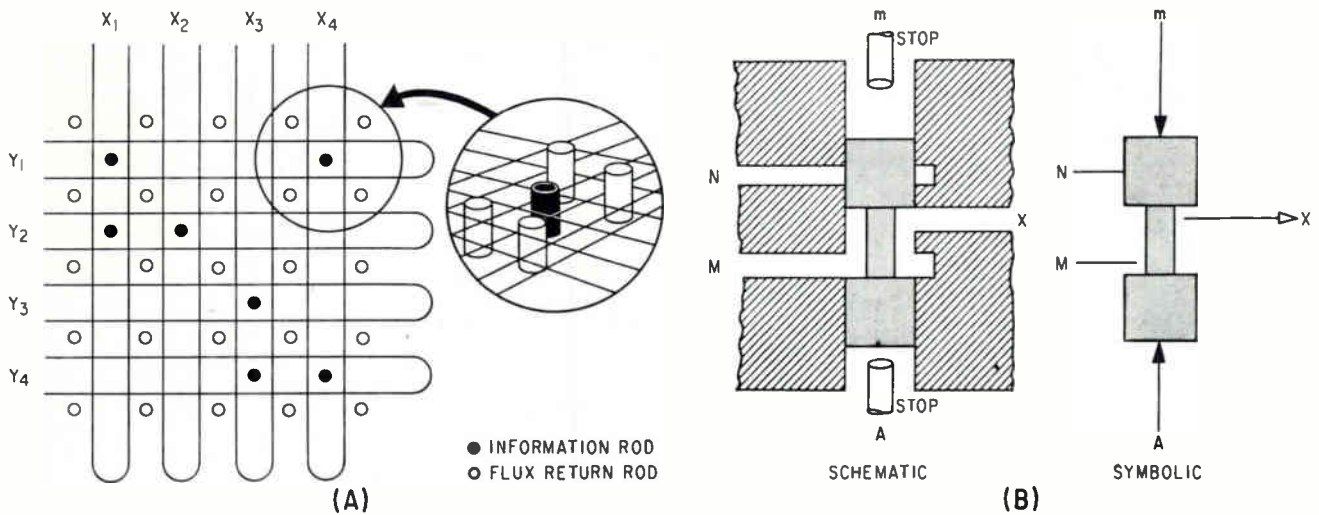

FIG. 1—Fixed-rod memory (A) and spool valve (B) are new steps in Western European information technology

New Memory Devices Highlight Research Trends

NEREM papers spotlight recent progress in space and ocean electronics, information technology and microminiaturization

By THOMAS MAGUIRE,
New England Editor

SOME 15,000 VISITORS to Boston next week will get a panoramic view of the vanguard of electronics industry transformations both here and in Western Europe.

The Northeast Electronics Research and Engineering Meeting (NEREM), third largest electronics show in the U. S., will highlight fast-evolving theories and techniques in information technology, new energy sources, exploration of the oceans and of space,

military command and control systems, very high microwave power and the emergence of interdisciplinary technologies in: materials, microwave-optical phenomena, electro-hydraulic and electro-pneumatic developments.

Engineers visiting NEREM will hear a report on information technology in Western Europe today.¹

At IBM in Zurich, for example, where metallurgical methods for depositing and heat-treating ferromagnetic thin films are being studied, experiments on nanosecond switching of film 1,000 angstroms thick and 1 cm² have yielded out-

put signals of up to 1 volt.

In England, International Computers and Tabulators Ltd. uses a new alloy which can be deposited by vacuum evaporation onto an aluminum substrate, for improved signal-to-noise ratio and reduced drive impedance.

A fixed-rod memory developed by T. Kilburn of the University of Manchester in England has been laboratory-operated at 0.3-microsecond cycle time, is expected to operate in the MUSE computer with 0.4-microsecond cycle, 0.2-microsecond access time. The memory is constructed from a woven mesh of cop-

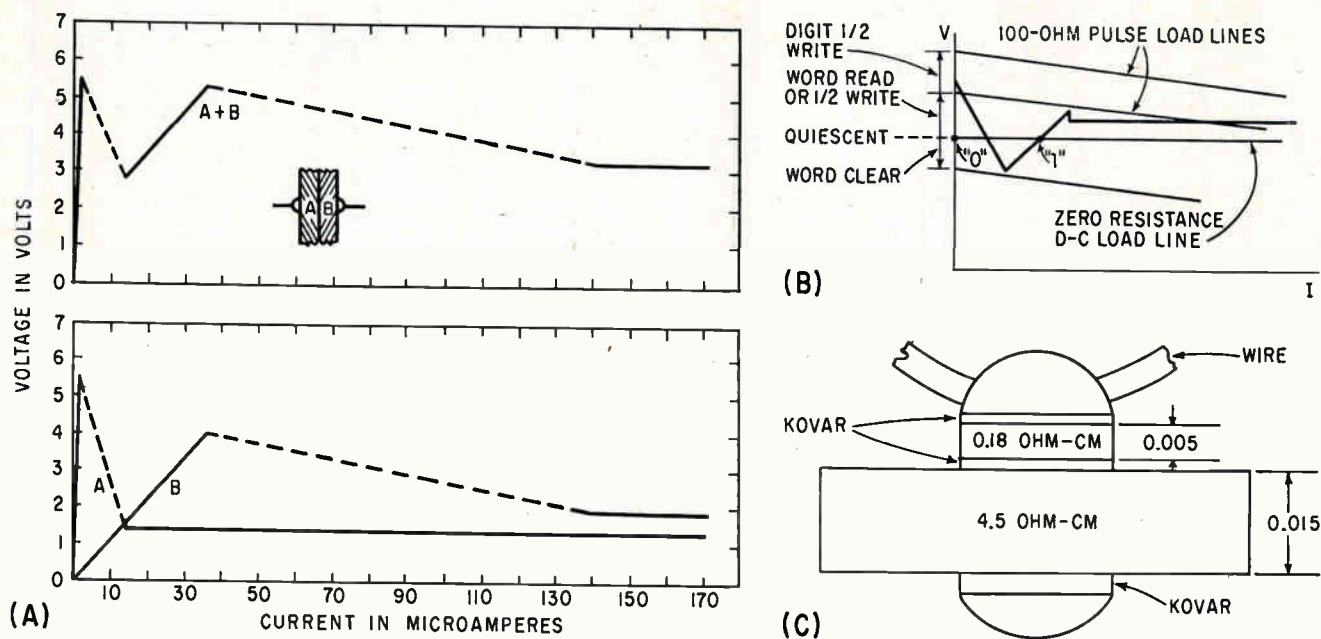

FIG. 2—Double-break cryosar is formed by placing two bistable cryosars with different prebreakdown conductivities in series (A); device can be used in a coincident-voltage memory (B) and is fabricated as shown in (C)

per wire mounted over a soft plastic, as shown in Fig. 1A.

Ferrite rods 1-mm in diameter and 5-mm long are placed in the interstices of the mesh wherever a ONE is to be stored. The mesh is formed into loops by cutting one horizontal and one vertical edge of the screen. A ferrite rod inserted within both a horizontal and vertical loop provides coupling to the loops for detection. To provide a flux return path for the magnetic field, identical rods are inserted in all non-coupled loops.

An acoustic memory developed by Elliott Brothers in England uses non-destructive nickel delay line storage. A bit is stored in the nickel wire by discharging a capacitor through the wire at a fixed point, applying a permanently stored circular magnetization to the wire. Passing a current pulse through the wire sets up an acoustic wave from each bit stored so that an acoustic coil transformer mounted on the wire past the current output receives the sequence of signals corresponding to stored discharges.

Also at IBM Zurich, hydraulic logic is under development. Laboratory models of hydraulic multi-vibrators have been operated at 300 cps. The devices use spool valves, shown in Fig. 1B. In this simple building block, three inputs (A, M

and N) and one output (X) are provided. Logical signals in the form of high and low pressure are applied to the inputs. A static medium pressure is applied to M. Pressure at A determines the position of the valve which in turn defines, together with the input at M or N, the pressure at X. By providing a feedback path from X to A, a bistable element is created.

Among U.S. computer developments which will be discussed at NEREM is a random-access cryosar memory at MIT Lincoln Laboratory.² The device reportedly gives promise of good yields and ease of mass fabrication, competitive speed and relatively large, noise-free, non-destructive pulses. But work to date indicates the difficulty of circuit development with liquid helium temperatures.

The cryosar is a negative-resistance, two-terminal device using impact ionization of impurities (a bulk effect) in germanium at liquid helium temperatures. These elements have a large resistance until a critical field is reached, after which the current increases by many orders of magnitude. If compensated Ge is used, a negative resistance occurs between the high- and low-resistance states, permitting bistable operation.

For a coincident voltage memory, a resistor is provided in series

with each cryosar to decrease sneak path noise. The desired V-I characteristic is obtained at present by adding two cryosars in series as shown schematically in Fig. 2A. The resultant "double-break" cryosar then may be used in a coincident-voltage memory as shown in Fig. 2B. This is a word-organized memory in which a negative pulse on a word line clears the entire word, then the coincidence of a positive pulse on the word line and positive pulses on the desired digit lines write "ones" into the desired digits. The entire word is read at once nondestructively by a positive pulse on the word line.

The complete system envisioned is shown in Fig. 3. The memory matrix is composed of double-break cryosars and the decoder matrix passes pulses of both polarities. Latter cryosars are of the simple, no-negative-resistance type with a one-volt breakdown voltage. All the word lines but two are clamped by cryosars leading to opposite polarities. One line is able to pass a positive pulse while the other (its address complement) is able to pass a negative pulse.

Present experimental double-break cryosars are made as indicated in Fig. 2C. The low-resistivity pillbox is cut from a wafer ultrasonically and soldered on. Figure 4 shows a matrix of 25 cryosars

made in this manner.

Progress on microminiaturization using thin film technology will be presented at NEREM. Fabrication of circuit networks by multi-layered vacuum evaporation has yielded significant size reductions, circuit performance comparable to existing methods and a high degree of reproducibility for individual circuit functions.³

Microminiaturization experiments using thin films in a three-dimensional structure encompass switching and communications applications. Six circuit types have been fabricated employing multi-layered films as the resistive, capacitive and inductive networks. Nichrome was chosen for resistors, silicon monoxide for insulation and dielectric use, aluminum for conductors. A thin glass plate serves as the substrate.

Experimentation showed that use of three evaporators, one for each material, is superior to other methods. The substrates are manually changed from one evaporator to the other. Eight substrates are handled in each evaporator, and only one evaporation is performed for each pumpdown.

For dynamic evaluation of the film network, unencapsulated transistors have been attached to the wafers by thermo-compression bonds. Future use of deposited active elements is envisioned, also multi-layered film interconnections.

Use of optical Doppler for navigation in the midcourse phase of space flight is under investigation

at Franklin Institute and will be outlined at NEREM.' Researchers conclude that natural radiation in optical frequencies shows promise because of the excellent detectors available in this range and the relatively small size and weight of optical equipment. Major problem is low signal level.

In one method of velocity determination, two balanced detectors are placed on the sides of a spectrum line. A change in the position of the line such as would be caused by the Doppler effect results in an imbalance of the detectors. Use of template spectroscopy simultaneously would be required when light is very weak, as is the case for the majority of the stars. A template consisting of an appropriate negative placed in the focal plane of the spectrograph is matched with the spectrum of the star at zero velocity. Any shift of the lines due to motion of the observer is detected by a change in the light transmitted by the template.

Propagation phenomena induced by very high microwave radar power will be discussed at NEREM by a Cornell Aeronautical Laboratory researcher.⁵ There is reason to believe that the signal-to-noise ratio of microwave radar systems cannot be indefinitely improved merely by increasing the power level. At some level, for a given receiver sensitivity, a point will be reached at which the energy backscattered from the ionosphere becomes the limiting noise.

The receiver used in the experi-

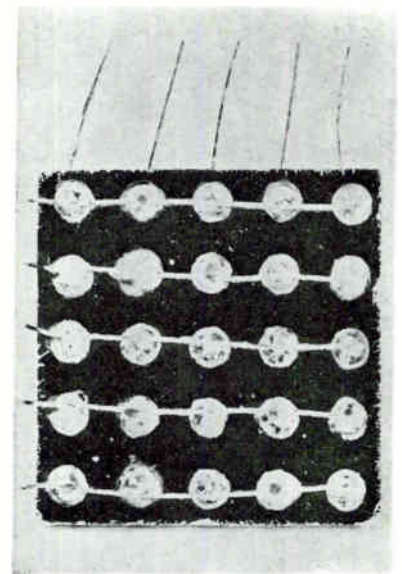

FIG. 4—Matrix of 25 experimental double-break cryosars fabricated by pillbox method

ments employs a parametric amplifier input, and adjustable bandwidth to optimize the system for the ionospheric clutter—instead of for target return.

Project HIGH POWER is seeking techniques for radiating very high microwave radar power, in addition to investigating limits to the concept of amplitude discrimination of a target in or beyond the ionosphere.

Such limits may occur when the radar cross-section of the target approaches the background clutter of the medium. Two known sources of such clutter are: auroras, and incoherent backscattering from free electrons, both of which need to be taken into account for effective defense systems.

Auroral returns are important in the case of targets approaching from the polar regions. The absolute magnitude of backscatter at microwave frequencies remains to be determined. The HIGH POWER experiments are studying these effects for the radar case.

A new transmitter for the program is capable of 50 Mw peak power, 50 Kw average. Pulse repetition rate is adjustable from 50 to 250 pulses a second, pulse length from 1 to 8 microseconds. Transmitter operates at 2.850 ± 10 Mc. Figure 5 shows radar site at Newstead, N. Y.

Eight parallel VA 820 klystrons

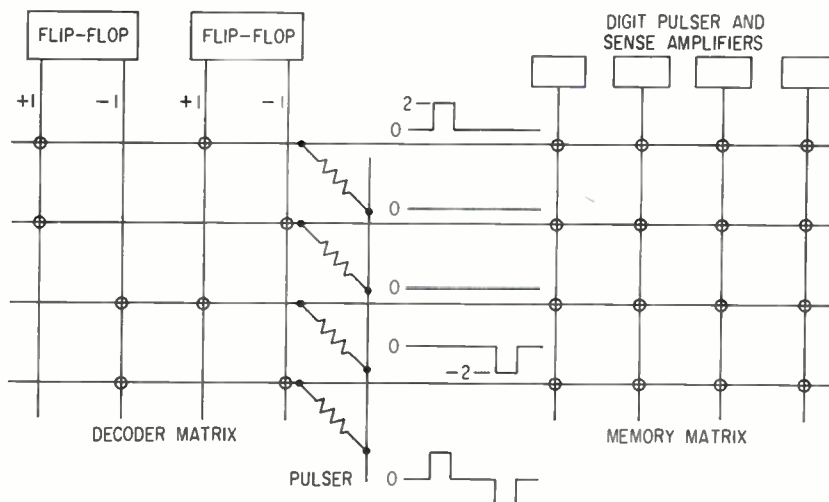

FIG. 3—Proposed memory system employs monostable cryosars in the decoder and double-break cryosars in the memory

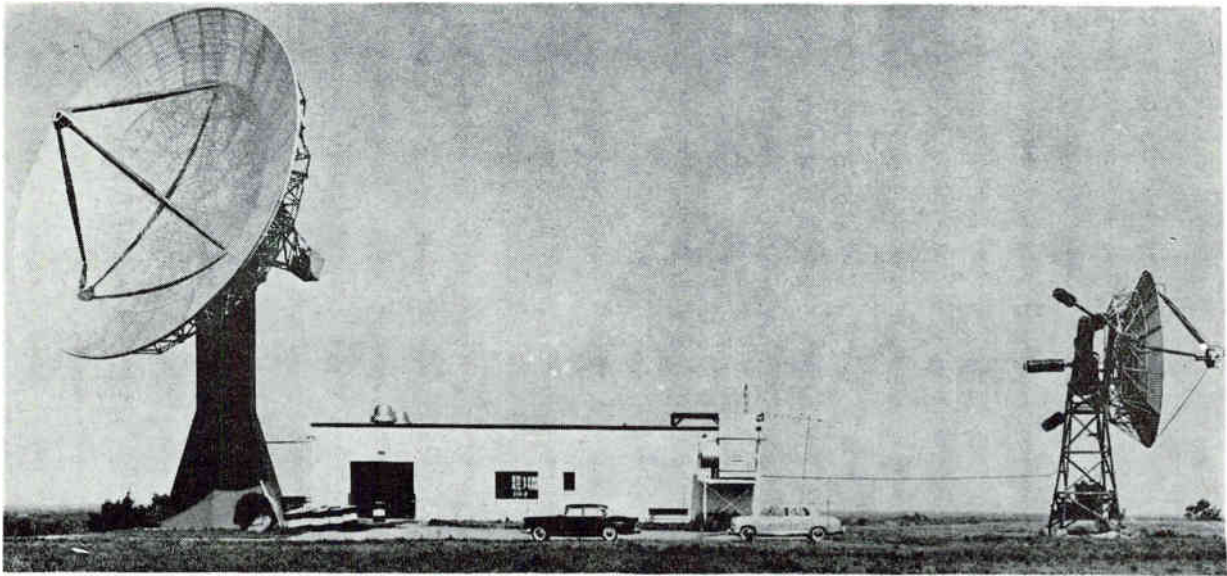

FIG. 5—Radar site at Newstead, N. Y. has 60-ft antenna on left and building housing 50-Mw S-band transmitting and receiving equipment

are used in the output amplifier. The inputs are fed in phase, and their outputs are combined by means of a special output combiner system so as to produce a single power output that is equivalent to the summation of the individual sources. Each VA 820 klystron is operated at 6.25 Mw peak power and 6.25 Kw average.

The transmitter is used in conjunction with a 60-foot parabolic antenna, which provides a $\frac{1}{3}$ -degree beam at the operating frequency.

Telemetry ocean buoys provide a relatively inexpensive tool for measuring currents, temperature at many depths and other parameters of the ocean. Emphasis has been given to the precise measurement of temperature and salinity, since from these variables can be calculated density as a function of depth. And density is perhaps the most significant parameter for understanding oceanic circulation. Temperature must be measured to 0.01 C and salinity to 0.01 part of salt per 1,000, an accuracy which has been obtained in the laboratory and aboard ship.

FIG. 6—In radio acoustic ranging system, sound impulses from hydrophone towed by the ship are received by the ship directly and by bottom reflection. In addition, sound energy is picked up by buoys and telemetered to ship

Strides are being made toward measurement with this accuracy from unattended buoys. In one experiment, a thermistor 15 feet below the surface controlled the frequency of a resistance-controlled oscillator, modulating a buoy transmitter. Instrumental accuracy was ± 0.2 C. Results better than 0.1 C have been obtained by using servo balancing methods and digitizing the data before transmission.

Telemetry buoys have been used as long-life anchored sono-

buoys in a radio acoustic ranging system shown in Fig. 6. Detailed topography studies are possible using the buoys as navigational controls.

Buoys also measure ocean waves. One type uses an insulated mast, extending above and below the surface of the water. The aluminum mast acts as one plate of a capacitor while the sea water is the other. The resulting capacitance variation varies the frequency of a subcarrier oscillator modulating a transmitter.

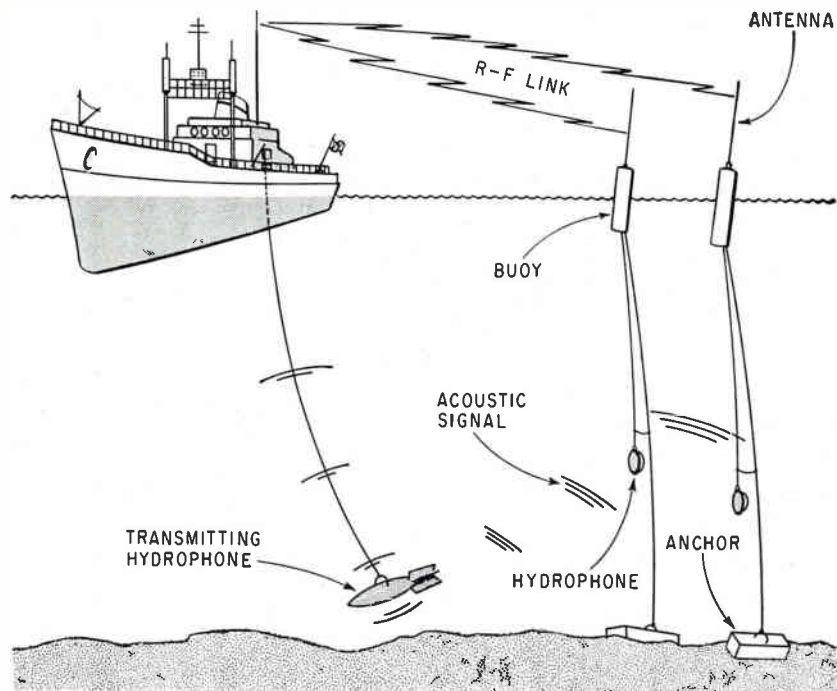

Another approach has been taken recently. A stainless steel wire is held in suspension vertically through the surface of the water. Waves rising and falling around the wire change its effective resistance due to the shunting effect of the sea water. The buoys are set adrift by ships and located by direction-finding techniques from long-range aircraft.

Retiming with a local clock has proven effective in removing virtually all jitter from pulse signals in a digital transmission system.⁷

Causes of jitter in digital systems include thermal noise, crosstalk, multipath transmission in radio links, and pattern effects in regenerative repeaters.

System is shown in Fig. 7A. The jitter may exceed one pulse interval, so a digital memory with a capacity of four bits is used as a buffer. As bits come in from the signal, they are written cyclically into the memory locations. The address of the write operation is controlled by a counter working from a timing signal derived from the input. The data is read out of the memory at demand of a local clock signal in the same order as it was written. The address of the read operation is controlled by another counter, driven by the clock signal.

The buffer memory circuit, with the write address selector, is shown in Fig. 7B. The outputs of the write counter control the resistor diode logic chain to hold all outputs of the selector at ground, except one. If the digital signal is ONE, the driver signal will go negative, causing the selected storage capacitor to be charged negatively. This capacitor will hold its charge until it is selected by the read circuit.

Read and write functions are independent, so the delay between input and output can be any value, as long as the same capacitor is not selected simultaneously by both. Range of the delay is between $\frac{1}{2}$ and $3\frac{1}{2}$ pulse intervals.

To avoid exceeding the memory capacity, it is necessary that the local clock be synchronous with the long time frequency of the input. Figure 7A indicates how the clock can be synchronized to the input signal by a phase controlled loop with a long response time.

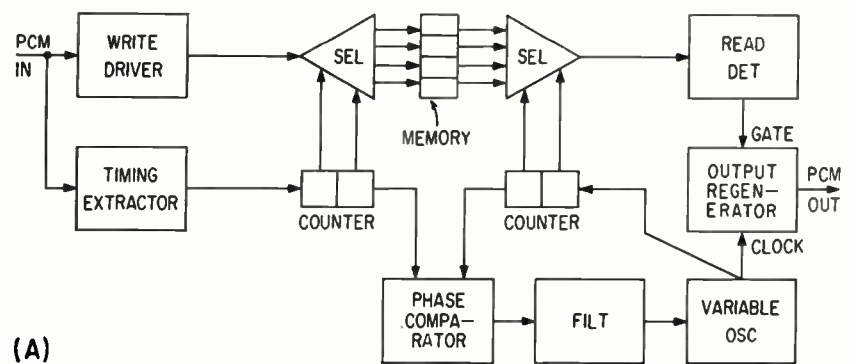

(A)

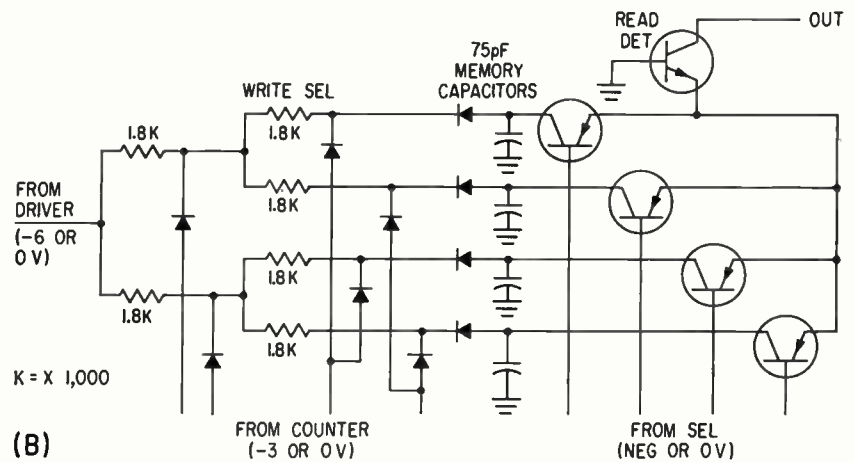

(B)

FIG. 7—System for retiming digital signals with a local clock (A) employs the buffer circuit shown in (B)

Automatic transistor tester developed in England carries out 18 checks in two seconds.⁸ An additional second is allowed to carry the transistor into the test station, thus giving a rate of 20 transistors a minute.

Magazines, each holding 25 transistors, are fed into the input storage mechanism and then proceed through the machine automatically. At the first test station, noise measurements are carried out; at the second, all other d-c and a-c measurements are performed. The machine analyzes results obtained on each transistor, grades them and conveys them pneumatically through one of a number of electrically-operated flaps to the appropriate output bin.

Results of selected tests can be displayed on electromechanical counters, so that immediate information can be obtained regarding the spread of selected parameters. If necessary, information can be fed back to the production line to

correct any adverse trends in the parameter values. Also, results can be recorded in digital form on punched paper tape.

Rapid switching necessary to set up and complete all tests within two seconds is carried out by dry-reed relays controlled by logic switching circuits.

REFERENCES

- (1) I. L. Auerbach, Auerbach Electronics Corp., The Current State of Western European Information Technology.
- (2) R. C. Johnston, MIT Lincoln Laboratory, A Random-Access Cryosar Memory.
- (3) W. N. Carroll and F. F. Jenny, IBAI Microminiaturization Utilizing Thin Film Technology.
- (4) R. G. Franklin and D. L. Birx, Franklin Institute Laboratories, Optical Doppler for Space Navigation.
- (5) R. C. Beltz, Cornell Aeronautical Laboratory, High Power Microwave Radar Research.
- (6) R. G. Walden, Woods Hole Oceanographic Institution, Data Acquisition from Unattended Buoys.
- (7) C. J. Byrne, M. Karnaugh and J. V. Scattaglia, Bell Telephone Laboratories, Retiming of Digital Signals With A Local Clock.
- (8) H. F. L. Cameron, British Telecommunications Research Ltd. and P. M. Tipple, Associated Transistors Ltd., An Automatic Transistor Tester.

Analyzer determines frequency spectrum of nonperiodic as well as periodic inputs. Digital circuits use speed-up process in modifying input wave for analysis

Using Digital Techniques

By
BERNARD GRAND
LEROY PACKER
JAMES L. WEST

General Applied Science Laboratories, Inc.,
 Westbury, N. Y.

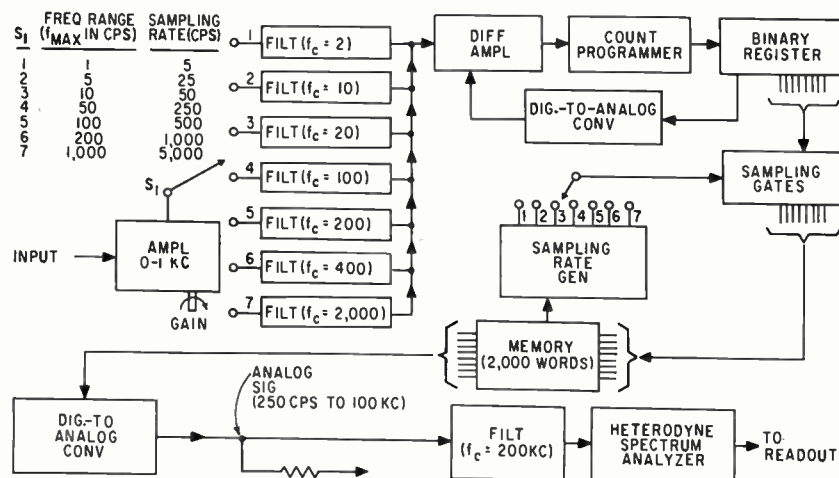

FIG. 1—Speed-up circuits of analyzer process the input wave, readying it for conventional analysis by the heterodyne-analyzer block

THE PRIMARY function of this instrument is to analyze spectra in the sub-audio and audio frequency region. Its readout method is fast and simple, unlike those of other l-f analysis instruments. Its ability to analyze l-f components of the transient as well as harmonic content of a waveform record should extend the use of spectrum analysis in the study of heart beats, brain waves and seismic waves.

The analyzer is shown in Fig. 1. Before the heterodyne-analyzer block determines the frequency spectra of the input signal, other circuit blocks convert the analog input to a digital signal, which is stepped up in frequency, reconverted to an analog signal, and delivered to the heterodyne analyzer block. The analyzer operates on a change-of-time-scale principle; at the lowest operating range (0.0025-cps to 1-cps) the input frequency is multiplied by 100,000. The multiplication process is accomplished with extreme accuracy both in amplitude and frequency. Spurious signals generated by the speed-up process are attenuated at least 60 db. The multiplied signal allows the use of conventional heterodyne frequency analysis methods, using scanning rates 1,000 times faster than those required without the speed-up process to obtain equivalent resolutions.

The system analyzes the spec-

trum of signals over the range 0.0025-cps to 1,000-cps in seven scales. Each scale has a resolving power of 0.25 percent of the full-scale frequency and the dynamic range in amplitude is 48 db.

The input signal is amplified in a variable-gain amplifier having a bandwidth from d-c to 1 Kc. Amplifier gain is adjusted to obtain a peak-to-peak signal of approximately 40 v. The amplified input is fed to the appropriate low-pass filter for each frequency range. These filters attenuate all frequencies above the frequency range of interest, reducing the amplitude of frequency components in the input signal in the vicinity of the sampling frequency. This procedure eliminates errors in the power spectrum which would otherwise be objectionable. The bandwidth-limited output of the low-pass filter is fed to a feedback-type analog-to-digital converter. The difference amplifier compares the input analog voltage to a feedback analog voltage which is proportional to the binary number in the binary register. The parallel binary number at the register output is sampled at a rate determined by the sampling-rate generator. The sampled binary number is fed to the main memory which consists of eight 4,000- μ sec magnetostrictive delay lines. Timing of the sample rate pulses is such that

digital data enters the magnetostrictive storage delay lines sequentially.

Output of the memory is read at a 500-Kc rate. The binary number is fed to a digital-to-analog converter which activates binary-weighted constant-current sources. The resulting currents are fed to a single resistor. The voltage developed across the resistor is an analog signal proportional to the digital numbers read out of the memory unit. This signal goes to a low-pass filter which attenuates the unwanted output sampling frequency of 500 Kc. Frequencies of interest vary from 250 cps to 100 Kc.

Figure 2A is the logic diagram of the analog-to-digital converter which converts the input signal to an 8-bit word. The analog input goes to a sample and hold circuit. During the sample time a capacitor in this circuit is charged; when a sample rate pulse occurs, the sample gate is turned off. The capacitor is now charged to a d-c voltage equal to the amplitude of the input signal at the sample time. Gating signal SHG controls the turn-on and turn-off time of the sample and hold circuit. The output d-c of the sample-and-hold amplifier goes to a decoder d-c amplifier which compares the sampled analog input voltage and the 8 binary-weighted bits (AD_1 to AD_8). The result of this comparison

in L-F Spectrum Analysis

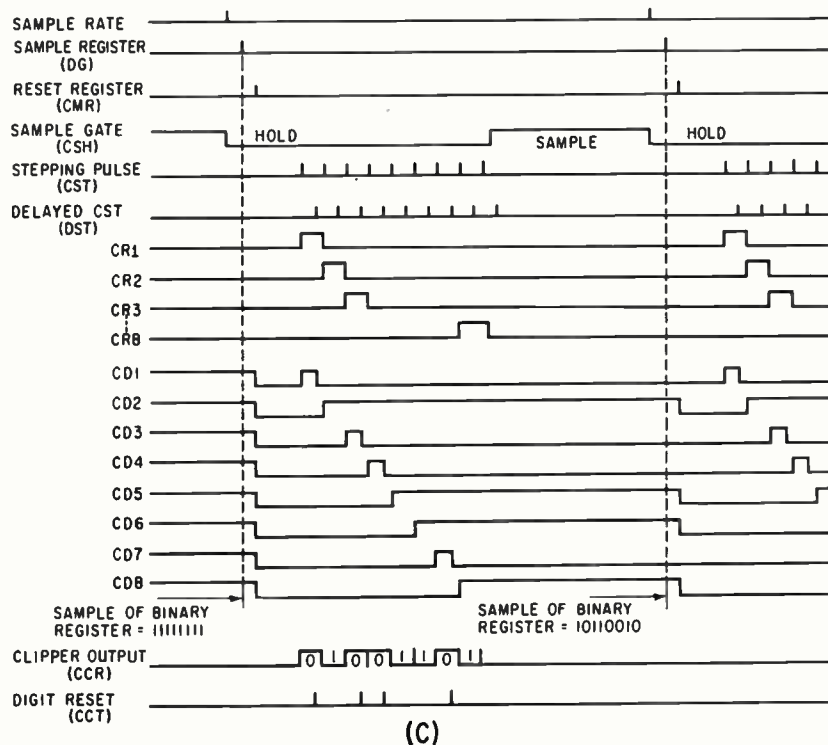
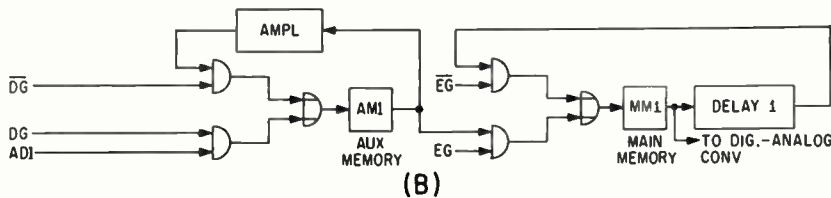
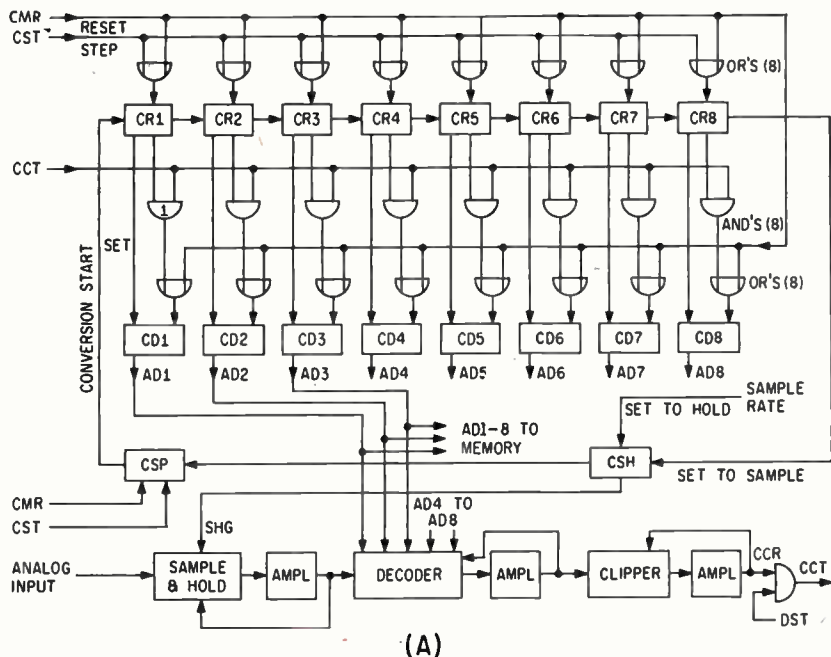

FIG. 2—Outputs AD_1 to AD_8 of analog-to-digital converter (A) go to memory (B). Timing diagram of operation is shown in (C)

is to set binary register CD_1 to CD_n to a digital number which is accurate to ± 0.4 percent of the input voltage at every sample time.

Immediately after the sampling-rate pulse is generated, the strobe pulses (DG of Fig. 2B) gate the 8-bit digital word (AD_1 to AD_n) of the previous analog-to-digital conversion into the main memory. Figure 2C, the timing diagram of Figs. 2A and 2B, indicates the operating sequence. The ring-counter (CR_1 to CR_n) and binary register (CD_1 to CD_n) are reset by CMR . The sample rate pulse sets sample-and-hold flip-flop CSH to the HOLD state. A delayed sample-rate pulse is fed to an AND gate (not shown) at a 25-Kc pulse rate to generate CST , the ring counter stepping pulses. The first CST pulse triggers CSP which in turn sets CR_1 , the first stage of the ring counter, ON. The first stage of the binary register, CD_1 , representing the most significant digit, is set by CR_1 . At this time the actual conversion begins.

Output AD_1 , which goes to the decoder, switches in the most-significant binary digit of the analog-to-digital conversion. This digit has a weight of one-half the total possible analog input signal. Depending upon the magnitude of the analog input signal, the output of the decoder d-c amplifier is above or below zero, signifying that the analog input signal is larger than or less than the first significant digit. The decoder output is fed to a clipper d-c amplifier whose output either inhibits or passes a delayed stepping pulse (DST), which forms CCT , the binary-register digit reset. If the analog input is larger than the first decoded digit, CCT resets CD_1 via AND gate No. 1. If the analog signal is greater than the first decoded digit, CCT fails to develop and digit-control flip-flop CD_1 remains ON.

Several microseconds after the first digit-control flip-flop is sampled for resetting, the ring counter is stepped to the next position, that is, CR_1 is turned OFF and CR_2 is turned ON. As CR_2 is turned ON,

CD_2 is turned ON. Output AD_2 turns on the second digit, which has a weight of one quarter the maximum analog voltage.

The process for resetting and stepping continues in the manner outlined above, thus determining the remaining digits. Each DST pulse samples the next least-significant digit of the digital conversion and either generates CCT to then reset the appropriate digit control flip-flop or allows it to remain in the ON state. As the last ring counter stage (CR_8) is turned OFF, an output of CR_8 is fed to CSH , resetting this flip-flop to the SAMPLE state. The sample and hold gate goes ON and remains ON until the next sample-rate pulse turns CSH OFF. Until the next register-reset pulse (CMR) is generated, the binary register holds the digital number representing the analog voltage of the last conversion.

The digital word held in the binary register is fed to the main memory in a parallel form synchronous with the generation of every sample pulse. Figure 2B shows one of the eight identical sections of the memory. The main memory contains eight magnetostrictive delay lines (D_1 to D_8) each of which is 4,000- μ sec long. The bit rate is 500-Kc, yielding a storage capability of 2,000 eight-bit words. The main memory access at sample rates above 250 cps is made possible by the use of eight auxiliary memory storage units (AM_1 to AM_8), each with a storage capability of 20 bits.

Pulse DG strobes the binary register outputs (AD_1 to AD_8). Output AD_1 , a d-c voltage defining the state of CD_1 , and DG are fed to an AND gate. If CD_1 is ON, a ONE is entered in AM_1 . At the time that a digit is being entered DG (NOT DG) is fed to the recirculation input of AM_1 , thus erasing the oldest bit in storage. Since AM_1 has a 20-digit storage capacity, the enter and erase gating cause AM_1 to hold the last 20 most-significant digits. Auxiliary memories AM_2 through AM_8 successfully store the last 20 lesser-significant digits. The result of the last analog-to-digital conversion is represented by the last digits entered into AM_1 through AM_8 . The main memory units MM_1 through MM_8 are gated by entry and erase gates EG and \overline{EG} . The logic applied here is similar to

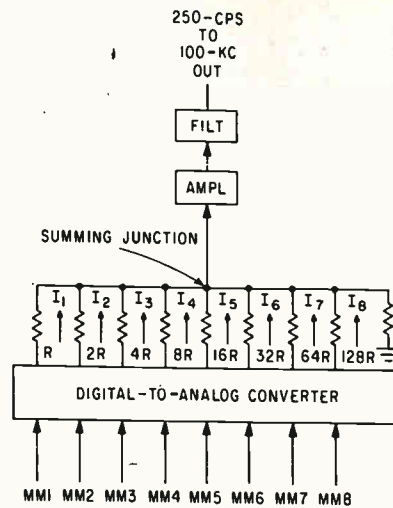

FIG. 3—Digital-to-analog converter output is amplified and filtered before going to heterodyne analyzer

that employed in the auxiliary storage. Entry gate EG is generated once for every 20 DG pulses, at sample rates above 250 cps. Hence, for a sampling rate of 5,000 cps, the main memory receives new information every 4,000 μ sec. At sampling rates of 1,000 cps and 500cps, new data enters the main memory at a rate of 20 words every 20 and 40 millisecc, respectively. At sample rates of 250 cps and lower, the auxiliary memory is not used; appropriate logic strobes the analog-to-digital binary register directly into the main memory storage.

The output of the main-memory storage is a parallel digital representation of the analog input signal. As an example, consider a 100-cps input c-w signal. Using the appropriate 500-cps sample rate (see table in Fig. 1) for the 0.25-cps to 100-cps range of spectrum components, five samples are taken of each cycle of the input 100-cps signal. These five samples occupy $(5/2,000) \times 4,000$ or 10 μ sec in the main memory (word capacity of the storage is 2,000 and the storage line is 4,000- μ sec long). This is equivalent to a 100-Kc signal, thereby effecting a speed-up of $100Kc/100cps = 1,000$.

The parallel digital output of the main memory is fed to a digital-to-analog converter (Fig. 3). The converter feeds into a summing junction, current directly proportional to the digital word being converted. The envelope of voltage generated at the summing junction

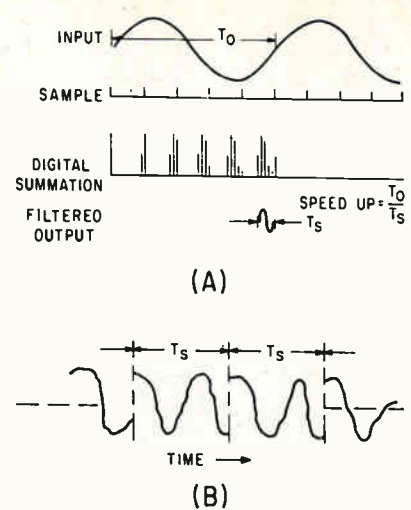

FIG. 4—Sampling and speed-up process (A) and waveshape at storage output (B)

is the sped-up input signal. The summing junction feeds a low-pass filter which suppresses all frequencies above 200 Kc by at least 60 db, thereby eliminating the 500 Kc carrier of the storage. The 500-Kc carrier component is caused by the 2- μ sec spacing between successive sample bits.

Figure 4A shows the sample process and resultant frequency multiplication. A sine wave of period T_0 is sampled with a minimum of five samples for every cycle of the input. Referring to the example outlined above, the digital summation of the main-memory storage consists of sample voltages corresponding to the levels of the input wave at the sample time, and occurring at 2- μ sec intervals. The output filter yields the sped-up envelope of the input with a period equal to T_s . The analog signal goes to the heterodyne spectrum analyzer, which is conventional.

In the speed-up process, signals are represented in the time interval determined by the magnetostrictive storage access time. The heterodyne frequency analyzer receiving the decoded and demodulated output of the magnetostrictive storage perceives it to be a succession of samples of the signal in duration of time equal to the access time of the delay lines, as shown in Fig. 4B. Consequently, the spectrum of the transformed signal appears as a line spectrum, each line being a multiple of the frequency corresponding to the storage access time. Due to the 4,000- μ sec delay line,

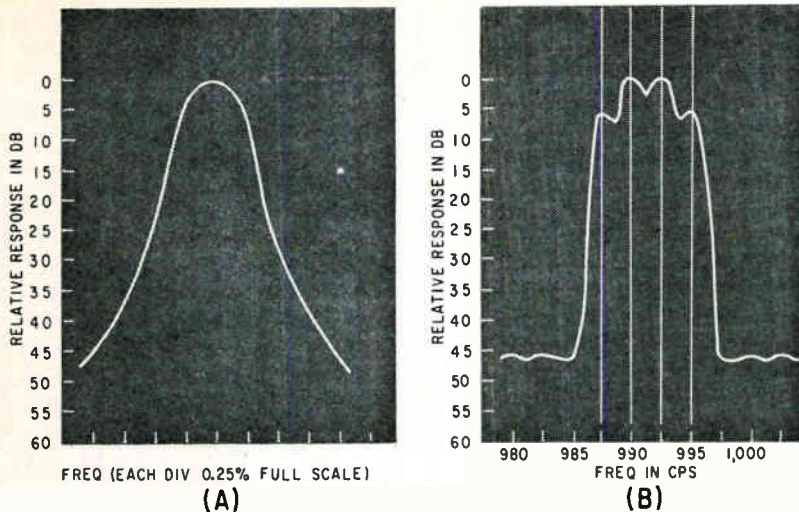

FIG. 5—Response with cosine weighting (A). Spectrum display of two sinusoidal signals at 990 and 998.5 cps which is shown in (B) is obtained with cosine weighting

this frequency is 250 cps. Since all transformed signals lie in the range 250 cps to 100,000cps, spectral lines are separated by 1/400 full scale.

It can be shown that an input sine wave (to the speed-up section) of a frequency, f_s , which lies exactly between spectral lines, produces an output from the frequency-multiplying section with a spectrum of the form $\sin x/x$. By weighting the samples in the magnetostrictive storage, these signals can cause the display shown in Fig. 5A. The latter weighting is a cosine function weighting, producing a selectivity curve such that adjacent spectral lines (0.25-percent of full scale) for a sine-wave input are down 6 db. As representative numbers, on the 1,000-cps scale the selectivity curve is 3.75-cps wide at the 3-db points and 19-cps wide at the 40-db points. The display of two signals 2.5-cps apart near 1,000 cps with cosine weighting is shown in Fig. 5B. Other types of weighting, including triangular, may be employed.

The selectivity discussed previously for the speed-up section is determined by the type of weighting used in the magnetostrictive storage and by the length of the information held in storage. The heterodyne spectrum analyzer (Fig. 6) which receives information from the speed-up section utilizes a filter bandwidth of 150 cps to obtain the maximum available resolving power. The 3-db bandwidth is 5 cps for the 1,000-cps maximum-fre-

quency scale. Since the speed-up for the scale is 100, the 3-db bandwidth for the frequencies at the output of the speed-up device is 500 cps. Therefore, an i-f bandwidth in the spectrum analyzer portion of the system of 150 cps provides adequate resolution. The narrowest filter bandwidth is 150 cps at the 3-db points and the scan time for this i-f bandwidth can be set to a minimum time of 1.6 seconds. Other i-f filter bandwidths provided are 1,000 cps and 5,000 cps with respective scanning times of 0.1 sec and 0.05 sec for the full 100,000 cps band.

Incoming signals in the range 100 cps to 100,000 are mixed with a local oscillator and heterodyned to the frequency range 850 to 950 Kc. The band-pass filter eliminates unwanted side bands. The result-

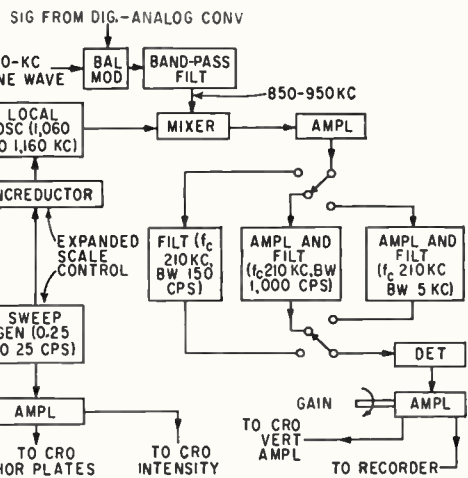

FIG. 6—Heterodyne spectrum analyzer receives input from digital-to-analog converter

ing signal is mixed with a sweep-frequency oscillator and filtered in the i-f strip at 210-Kc. Output of the i-f stage is detected and amplified. This output may be fed to a cro and/or recorder.

Sampling of a signal may be interrupted at any time and the contents of the storage repeatedly analyzed. The contents of the storage may also be emptied at any time for replacement by fresh data.

Figure 7A shows a complex test signal composed of a mixture of a 1.5-cps square wave and a 6-cps sine wave. In Fig. 8A a $\frac{1}{2}$ cycle sample of a 5-cps c-w signal was gated into the analyzer. Figure 8B shows the spectrum resulting from a 4-cycle sample of a 5-cps c-w input. Here the scale was set to 5 cps; 3-db resolution was 1/80 cps.

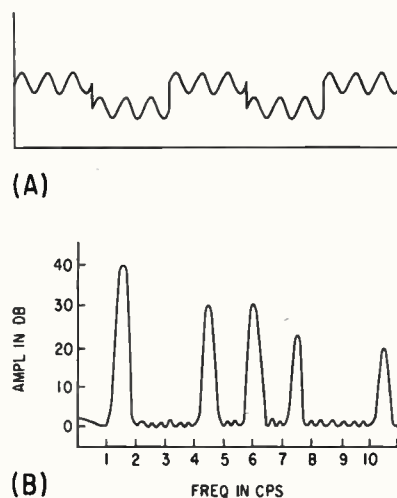

FIG. 7—Spectrum of complex-wave input (A) is shown in (B)

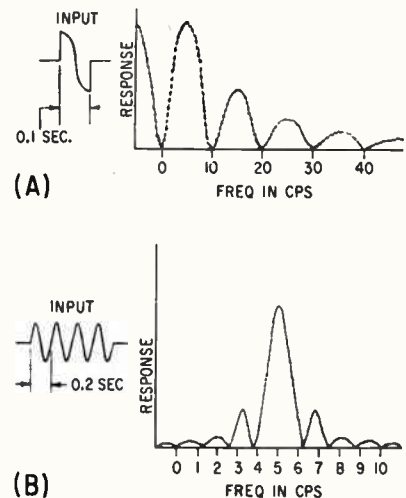
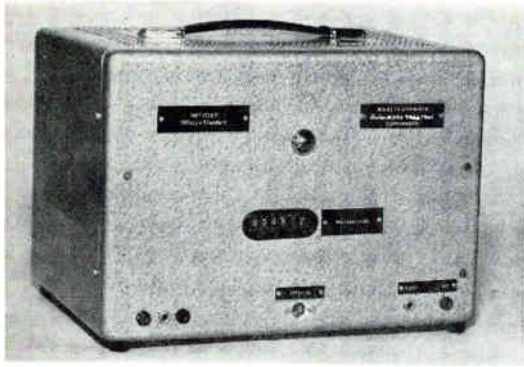

FIG. 8—Analyzer scale is set for 100 cps in (A), 5 cps in (B)



Crystal clock locked to atomic standard through radio signals produces accuracies of one part in 10^9 at moderate cost

ALTHOUGH the precisely controlled signals from transmitters such as WWV or WWVH are influenced by doppler variations and suffer interruptions, the transmissions can be used to control crystal clocks to obtain an accuracy almost as high as that of the transmitted signal. As at least one of these high-accuracy standard frequencies can be received any place in the world, a frequency standard controlled to one part in 10^9 is available at low cost to those who require it. The system can be applied to existing crystal clocks.

The principle of the system is simply explained if it is assumed that the frequency of the crystal oscillator being controlled is the same as the standard frequency being received, although in practice this assumption is not necessary.

A block diagram of the circuit is shown in the figure. Frequency f_c from the crystal oscillator is mixed with the received frequency f_r . The receiver has a narrow bandwidth so that only the standard frequency is received. The mixer, known as a Nygaard discriminator (Fig. 1B), delivers two outputs, each equal to the difference frequency $f_c - f_r$ but 90 degrees apart in phase. After amplification the signals drive a small synchronous motor. Motor speed is thus dependent on the difference frequency, including the sign. The motor drives the trimmer capacitor of the crystal oscillator in a typical servo loop to bring the difference frequency to zero. Time needed for error correction depends on the gear ratio. Short term errors, doppler variations, in the received frequency

Atomic Clock Accuracy

Crystal oscillators can be locked to atomic clock-controlled

have only small influence on the oscillator frequency if error correction time is much longer than the time in which the errors occur. Interruptions in the received frequency have no influence on oscillator frequency because the motor is motionless without both signals present.

Let the received frequency be defined by

$$f_r = f_n + \Delta f_n \quad (1)$$

where f_n is the nominal transmitted frequency and Δf_n is the error caused by doppler variation. Doppler effects depend chiefly on variations in the ionosphere, and mainly in the E-layer and F-layer, from which the radio wave is reflected. Magnitude of Doppler shift is given by

$$\Delta f_n = -(f_n/c)(ds/dt) \quad (2)$$

where c is the velocity of light, s is distance signal has traveled and t is time. The difference between the longest and shortest possible signal path is termed S and thus

$$\left| \int_{t_1}^{t_2} \Delta f_n dt \right| \leq \frac{f_n S}{c} \quad (3)$$

for all values of t_1 and t_2 . The quantity S/c , for high frequency signals close to the transmitter, can be as large as 10^{-3} sec.

The crystal is assumed to be resonant approximately at f_n , and to have an ageing rate $g(t)$. Oscillator frequency is varied with a trimmer capacitor and frequency deviation per turn of the trimmer axis is $-af_n$. The number of turns of the trimmer axis counted from zero is called m . Crystal frequency f_c then is determined by

$$df_c/dt = g(t) - af_n dm/dt \quad (4)$$

Received frequency $f_n + \Delta f_n$ is mixed with crystal frequency f_c in the Nygaard discriminator. Both discriminator outputs deliver the same frequency, $f_c - f_n - \Delta f_n$, but the two voltages are 90 degrees out of phase. After amplification the two voltages are fed to a synchronous motor, the rotational speed of which is thus equal to the differ-

ence frequency providing the motor has only two poles. If the motor has more than 1 pair of poles, motor speed will be reduced accordingly. Motor speed is equal to the difference frequency for all frequencies lower than cutoff, since there is an upper limit for motor speed depending on electrical and mechanical details. The upper limit is usually not significant, since the motor operates at low speed. The motor drives the trimmer capacitor through step down gear ratio r , giving the equation

$$dm/dt = (f_c - f_n - \Delta f_n) r \quad (5)$$

Equations 4 and 5 together give an equation for crystal frequency f_c

$$df_c/dt = g(t) - (f_c - f_n - \Delta f_n) \alpha f_n / r \quad (6)$$

Defining the time constant as

$$T = r/\alpha f_n \quad (7)$$

the solution of Eq. 6 becomes

$$(f_c - f_n)/f_n = A + B + C \quad (8)$$

where A , B , and C are defined as

$$A = \frac{1}{T f_n} \exp\left(-\frac{t}{T}\right) \int_0^t \Delta f_n \exp\left(\frac{t}{T}\right) dt \quad (9)$$

$$B = \frac{1}{f_n} \exp\left(-\frac{t}{T}\right) \int_0^t g(t) \exp\left(\frac{t}{T}\right) dt \quad (10)$$

$$C = k \exp(-t/T) \quad (11)$$

where k is a constant equal to the initial error. The last term C , may be disregarded as it tends to zero.

Equation 3 together with 9 shows that $|A|$ cannot exceed S/cT . If G , without regard to its sign, is the highest aging rate within the time interval of interest, $|B|$ cannot exceed TG/f_n and thus

$$|(f_c - f_n)/f_n| \leq TG/f_n + S/cT \quad (12)$$

assuming C is zero. Equation 12 then gives the maximum value for the deviation between crystal frequency and nominal transmitted standard frequency. This maximum value is as small as possible if

$$T = \sqrt{f_n S / c G} \quad (13)$$

Then Eq. 12 becomes

$$|(f_c - f_n)/f_n| = 2 \sqrt{G S / c f_n} \quad (14)$$

For Crystal Oscillators

By K. NYGAARD,
Bruel & Kjaer A/S, Naerum, Denmark

radio stations to produce high-accuracy, low-cost frequency standard

For a fairly good oscillator G/f_n may be 10^{-14} ; assuming $S/c = 10^{-3}$ the worst conditions of doppler variations are covered. For the assumed values of G and S/c , maximum deviation of crystal frequency from nominal transmitted frequency is 6.3×10^{-6} and the time constant T is 3×10^5 sec or 3.7 days. The figures are computed under the assumption that there are no interruptions in reception. With reception only 50 percent of the time this system cannot ensure an accuracy higher than approximately one part in 10^8 .

Frequency errors in the crystal depend only on short term accuracies, as can be seen by examining the quantities A and B , or rather, the maximum values S/cT and TG/f_n . By connecting the motor to the trimmer as shown in Fig. 1C, A can be set equal to zero; then a small time constant will keep TG/f_n small.

If crystal aging rate G is zero and $f_c = f_n$, only the Doppler effect is effective in causing motor rota-

tion; motor speed is $-\Delta f_n$. Taking speed reduction into account,

$$dN/dt = -\Delta f_n/f_n \quad (15)$$

where N is the number of turns of the output shaft of the motor-gear reducer combination. From Eq. 2 and 15

$$dN/dt = (f_n/cr) ds/dt \quad (16)$$

Equation 16 is integrated to give

$$N = f_n s/cr + N_0 \quad (17)$$

where N_0 is a constant. Since the maximum difference in transmission distance is S , N_0 can be selected to give

$$0 \leq N \leq f_n S/cr \quad (18)$$

The arrangement shown keeps Doppler variations from affecting crystal frequency as long as other errors are not present. But if f_c shifts away from f_n , the motor will turn through the dead zone and make the correction. To make the correction time small, T is made small. To maintain stability, one revolution of the motor should not change crystal frequency by more

than about 10^{-10} . Thus $a/r \leq 10^{10}$; which gives $T \geq 10^{10}/f_n$.

With $f_n = 10$ Mc, $S/c = 10^{-3}$ sec., $G/f_n = 10^{-14}$ sec. and $T = 10^3$ sec., the following figures, based on 50-percent reception, are obtained for $(f_c - f_n)/f_n$: one part in 10^7 is reached in 3 hours, one part in 10^8 in 1 day, one part in 10^9 in 10 days; with 80 percent reception, one part in 10^{10} is reached in three months.

Accuracy of the crystal frequency is easily measured by a revolution counter connected to the motor shaft. Speed of the motor shaft dM/dt , is given by

$$dM/dt = f_c - f_n - \Delta f_n \quad (21)$$

and

$$M = \left(\int_0^t f_c - f_n dt - \frac{s}{c} \right) f_n + \text{constant} \quad (22)$$

From Eq. 22, time delay M/f_n can be calculated. For the example used, one revolution of the motor indicates that the time delay has changed $0.1 \mu\text{sec}$, or that s has changed by 30 meters.

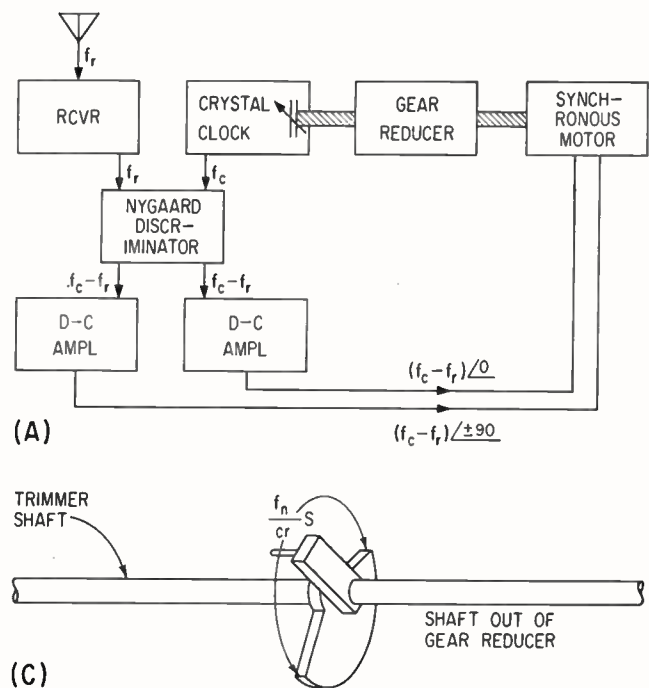
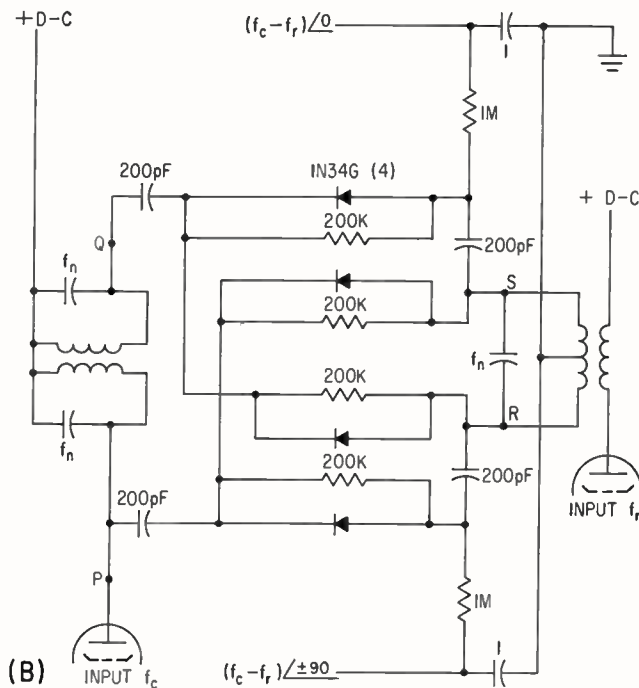

Synchronous motor in (A), driven by the error frequency, brings crystal clock into synchronism with f_r . Discriminator (B) produces difference frequencies that are 90 degrees out of phase, with the sign of the angle depending on whether f_c is lower or higher than f_r . Short-term Doppler variations can be filtered with mechanical connections (C)

Telemetering Radiation Data By

Three types of radiation monitor are discussed, with information about their relative

THE METHODS described have two major objectives: the first is detection of ionizing radiation, the second is the transmission of the resulting information by radio frequency to the monitoring station. Both requirements are satisfied by the same operation and equipment.

The first requirement can be fulfilled in many ways: with an electrometer, an ion chamber, extrapolation chamber, a Geiger counter or a crystal detector. These instruments when connected with the proper electronic, optical or acoustical instrumentation give information readout.

The methods described in the following pages use the ionization currents of ion chambers, or the pulses from Geiger counters, to vary the reactance of a frequency determining network of a high frequency oscillator. In accordance with signal strength the reactance variation will produce a frequency modulation.

If the oscillator is connected to an antenna, the information is transmitted directly.

At the receiver end, the information can be recovered by beating the incoming signal with a crystal controlled local oscillator, or alternatively, the transmitter itself can produce the reference and signal frequencies simultaneously. The last method is preferable, since the frequency difference between the center frequency and the reference can be kept nearly constant by suitable methods.

During the experiments described, the audio signal was detected as a beat frequency, using a quartz crystal oscillator, and was displayed on an oscilloscope by means of an interpolation oscillator. The following features are desirable for detection and telemetering of ionizing radiation:

The center frequency must not drift appreciably through temperature variations; the signal must be large enough to be easily observable; low power consumption is es-

sential if located at remote positions or in space; stability against mechanical vibrations is required; minimum volume and weight is necessary for space applications.

The first detection method to be discussed is the reactance variation of a movable-vane electrometer; its readings are susceptible to vibration, whereas the following ones are not.

An ionization chamber (Fig. 1) includes an electrometer section with a movable vane suspended by a silverplated quartz fiber. The capacitance between the electrode pairs is maximum when the vane position is in the direction of the electrode pairs. The frequency is determined by the inductance L , the capacitances C_1 and C_2 , and the capacitance of the electrometer system. If the vane is charged electrically and ionizing radiation enters the chamber, the vane loses its charge and turns out of the space between the two electrode pairs. (This is because the air between the plates becomes ionized and so loses its insulating properties.) Change of vane position decreases the effective vane capacitance and increases the frequency of the oscillator. When the ionization chamber is connected as shown in Fig. 1B the capacitances of the first electrode pair, vane and second electrode pair are in series for the rf circuit (see the r-f equivalent circuit) electrostatically, however, the two capacitances are in parallel since both electrodes are at ground potential. The resultant rf capacitance is about 1 pf, the electrostatic capacitance being 4 to 5 pf.

If the vane is just outside of the space between the electrode pairs, and a voltage is applied to it, while the electrodes are electrostatically grounded, the vane will resist the torsion of the quartz fiber and turn into the space between the two electrode pairs, thereby increasing the capacitance of the system. The maximum capacitances between the vane and each electrode pair is

about 2 picofarad.

Figure 1B circuit provides high stability, since the parallel capacitance between grid and cathode is approximately 1,000 pf thus eliminating the effect of grid-cathode capacitance fluctuations.

The increase of capacitance through vane movement produces a frequency increase $\Delta F = \Delta C f_o / 2 C_T$, where f_o is the operating frequency and C_T the total frequency-controlling capacitance. For an optimum condition, C_T should remain as small as possible.

The total range of frequency variation at a center frequency of 2.3 Mc is about 10,000 to 20,000 cycles. By measuring the third harmonic this range can be tripled, but mechanical conditions impose a practical limit to the sensitivity.

In a test, the aluminum ion chamber contained about 100 cm³ of air under normal pressure, a 25-cm² window of 0.001 inch copper-foil permitted practically all gamma radiation and hard beta particles to enter the chamber, and the vane system was charged to about 300 v. A radiation dose rate of 1.58 mr/hr produced a frequency variation of 35 cps during an exposure of one minute. Saturation current is about 1.75×10^{-14} amp for 100 cm³ of air at this gamma ray dose rate.

The operation requires a minimum leakage of the charge when not exposed to radiation. The use of polyethylene or teflon for suspension of the quartz fiber and moving vane reduces the leakage so that the frequency drift amounts to only a few cycles/second an hour.

In a later model, a crystal-controlled oscillator was used for better frequency stabilization. The fundamental frequency was 5 Mc (Fig. 1C) but the frequency was multiplied to 15 Mc in the plate circuit of tube V_1 . The frequency can be varied within a range determined by the ratio of the electromechanical equivalent capacitance C to the parallel capacitance C_o , both shown in the equivalent quartz

Frequency Variation

By HANS KOHN RICHARDS
Argonne National Laboratory, Argonne, Illinois

advantages and the way in which they are connected to the telemetry transmitters

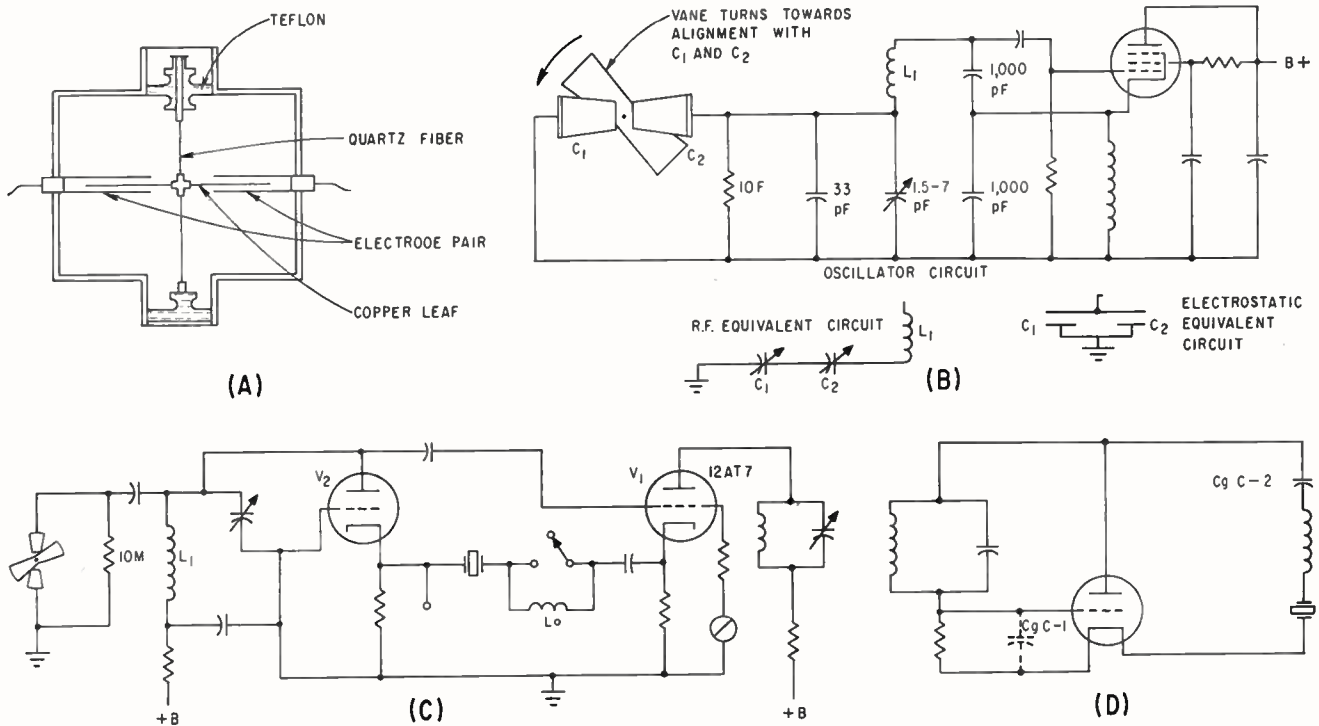

FIG. 1—Ion chamber with movable-vane electrometer (A) is coupled to the basic oscillator circuit (B) to vary its frequency in proportion to vane rotation and thus in proportion to the incident radiation. Circuit of (C) uses a crystal for oscillator stability and (D) is the equivalent circuit of (C)

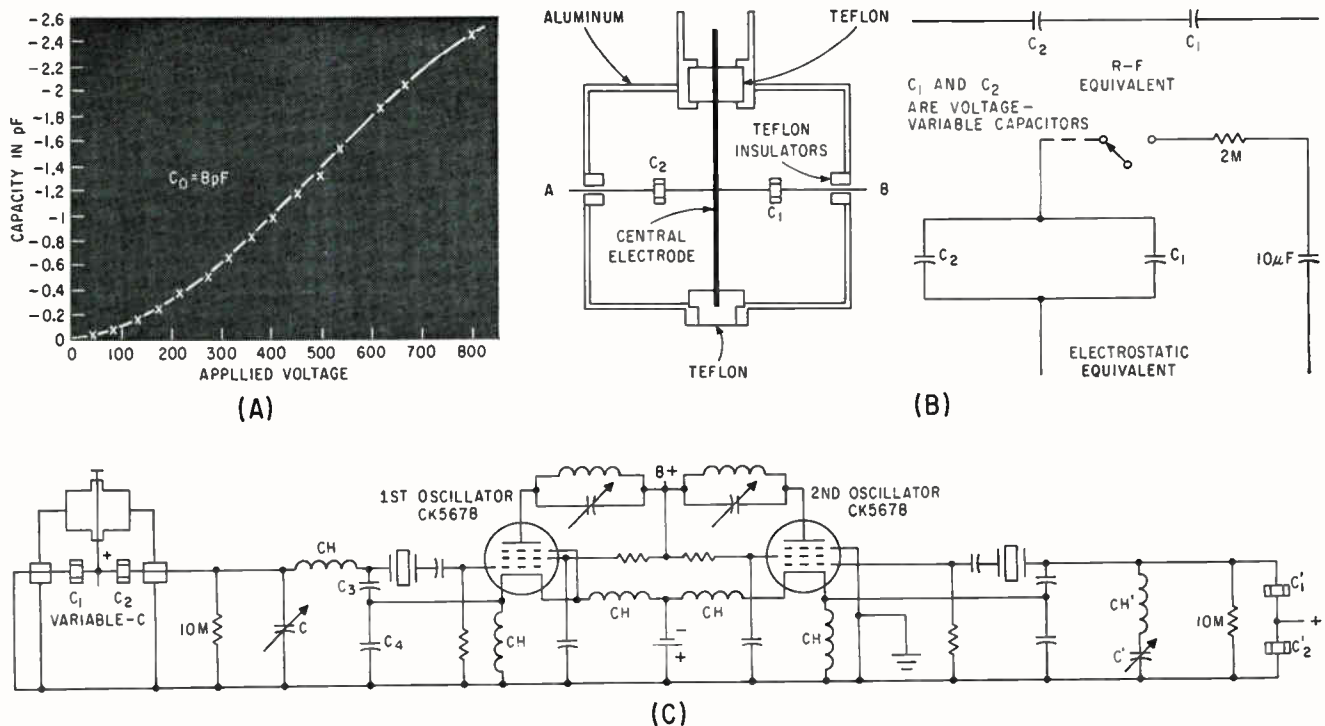

FIG. 2—Graph shows that linear range of voltage dependent capacitor lies in 300 to 600-v region (A); ion chamber construction using barium titanate capacitors (B), and the final circuit with wind drift compensating oscillators (C)

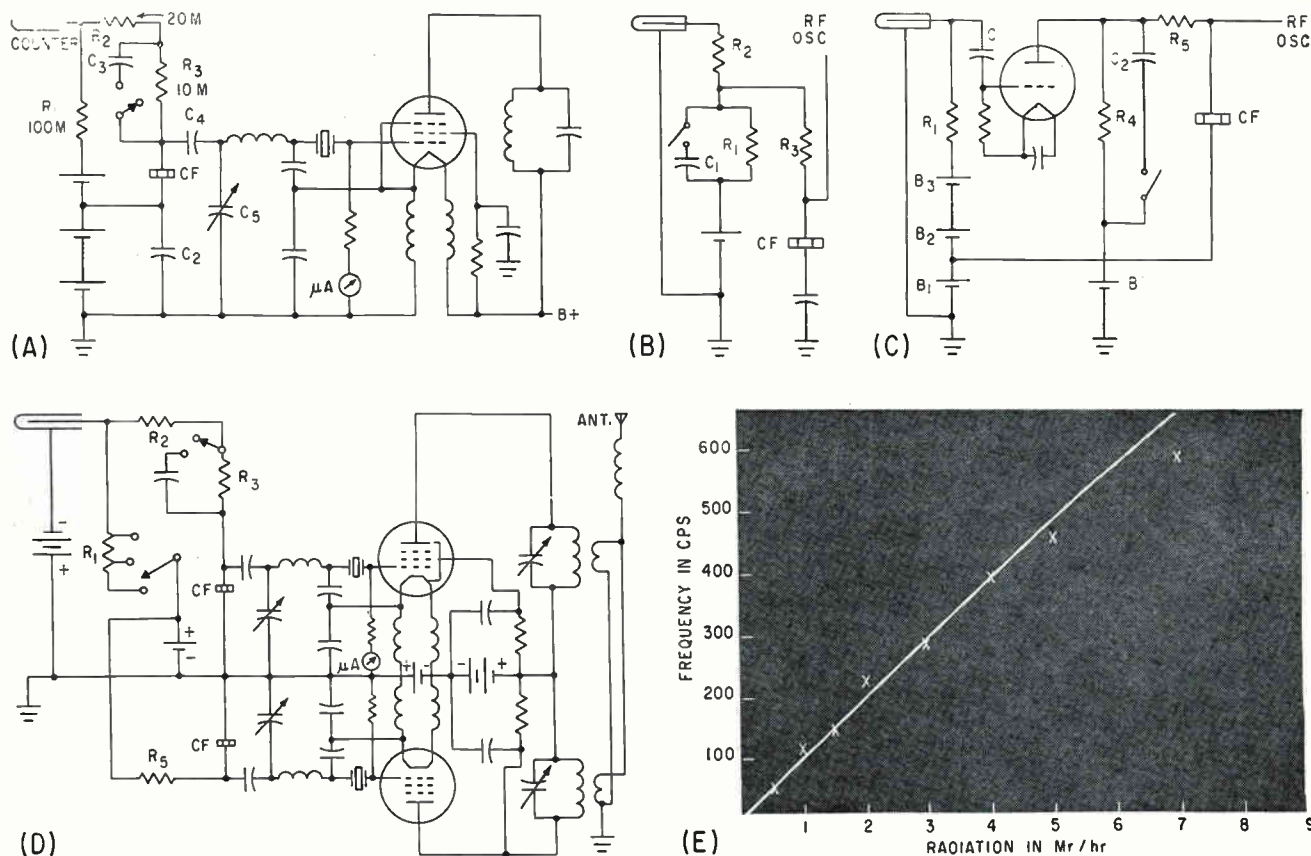

FIG. 3—Circuit (A) provides a pulsed change in transmitted frequency for every Geiger tube discharge; circuit (B) integrates the effects of the Geiger tube discharges to give reading proportional to dose-rate; circuit (C) uses a buffer amplifier between counter-tube and the oscillator; final circuit of (D) incorporates a second oscillator to compensate for frequency drift, while the graph (E) is the telemeter characteristic before drift compensation

crystal circuit, Fig. 1D. By adding an inductance in series with the quartz crystal, this range can be extended, but some control is sacrificed.

The second detection method uses voltage variable capacitors instead of the movable vanes.

Moving parts are eliminated by replacing the electrometer section with a nonlinear capacitance. Non-linear capacitances can be made from ferroelectric materials having high dielectric constants that are functions of the applied electrical field. Barium titanate was used in all the designs described below. This material has a dielectric constant of about 6,000 at 25 degrees C. A major disadvantage is the dependence of the dielectric constant on temperature, necessitating a thermostatic control if the ambient temperature varies. Later developments have produced combinations of barium-titanate with calcium-titanate and other compounds that give nearly a zero temperature coefficient over certain temperature ranges. A compensation method to

overcome the temperature variation of the material is discussed later. A disk barium titanate about 1.2 cm diameter and $\frac{1}{2}$ mm thickness was silverplated on both sides by evaporation in vacuum. The disk was afterwards broken into small pieces, and those pieces with freshly broken sides were used as ferroelectric capacitances after tests for leakage resistance. On removal of the test voltage source, the decay of capacitor voltage was observed with a low-capacitance electroscop. For capacitances of 15 to 20 pf, the voltage decay time was several hours. Leakage resistance is of major importance in this application since it determines the minimum dose-rate that can be measured.

The voltage-variable capacitors are mounted between metal springs and coated with ceresin wax.

The dielectric characteristic of the material was measured by applying voltages from zero to 900 v. As shown in Fig. 2A, there is a section of the curve from 300 to 600 v with an approximately linear

voltage-capacitance characteristic.

The ferroelectric capacitance is placed in an ionization chamber as shown in Fig. 2B. Capacitor C_1 is the ferroelectric capacitance, C_2 is either a common capacitance of the same magnitude as C_1 , or another ferroelectric capacitance. Together, C_1 and C_2 have capacitances of 15 to 20 pf and the resulting series r-f capacitance is therefore 7.5 to 10 pf.

One electrode of each capacitance (C_1 and C_2) is connected to the central electrode of the ion chamber, the remaining electrode of C_1 being grounded while that of the other capacitance C_2 is connected to an element of the oscillator circuit.

As Fig. 2B shows, C_1 and C_2 are electrostatically connected in parallel, since (Fig. 2C) the side connected to the r-f circuit is grounded through a 10-megohm resistance. The control electrode is charged during the operation to about 300 volts positive, resulting in a capacitance reduction of about 8 percent.

Fig. 2C shows the modified Clapp circuit with quartz crystal fre-

quency control. Tubes used are sub-miniature types.

Since C_3 and C_4 are about 100 pf each, and the series capacitance of C_1 and C_2 amounts to about 8-10 pf, the frequency is determined essentially by C_1 and C_2 as far as the crystal control permits. Capacitor C is in parallel with the resultant control capacitance and serves for the exact adjustment of frequency; it can be varied from about 3 to 20 pf.

A voltage applied to the center electrode of the ion chamber reduced the controlling capacitance and, therefore, increased the frequency. The quartz crystal frequency is about 2 Mc, and the resonant plate circuit is tuned to 6 Mc, the 3rd harmonic.

To eliminate or reduce the effect of temperature variation on the ferroelectric material, as well as the capacitance variation due to charge leakage, a second oscillator of the same design is added, as shown in Fig. 2C. The two oscillators have approximately the same drift through charge leakage or temperature variation and this drift can be made the same in each by adjustment of capacitance C . Since the second oscillator is not connected to any ionization chamber, its frequency is not affected by radiation.

Each oscillator transmits a frequency of approximately 2 Mc or 6 Mc. These two frequencies differ by some few hundred or thousand cycles sec depending upon the radiation received. The second oscillator serves as a reference. As long as no radiation enters the chamber, the difference of frequency between oscillators appears after detection as a constant audio tone or an ellipse on the screen of an oscilloscope. If ionizing radiation discharges the ferroelectric capacitances connected to the center electrode of the ionization chamber, the two oscillator frequencies drift apart in proportion to the radiation dose-rate. Use of this second oscillator eliminates need for a secondary standard at the receiver.

Temperature variations can be eliminated by thermostatic control of the ferroelectric material, the small volume of this material needing little power and space. A further improvement can be obtained by reduction of the ferroelectric

capacitances. The sensitivity would be increased by using a large-volume chamber or a pressure chamber.

As pointed out, the chamber has to be recharged after some few hours. This is done automatically by a clock controlled relay.

The disadvantage of the methods so far discussed is the dependence on high grade insulation to combat electrostatic leakage. It should be emphasized, however, that at large dose rates, one r/hr and higher, this disadvantage disappears and an improvement of insulation will extend the usefulness to lower dose rates. There is no limit for high dose rates since the sensitivity can be reduced by capacitances electrostatically coupled to the ferroelectric capacitance.

A Geiger counter provides radiation detection in the third method.

The disadvantage of electrostatic leakage disappears completely by replacement of the ionization chamber by a Geiger counter. Insulation problems are eliminated even for ferroelectric materials with a resistance of 1,000 megohms and less. This improvement is due to the fact that the counter discharge produces a dynamic characteristic and the electrostatic charges required for the polarization of the ferroelectric capacitances become negligible quantities. It should be noted, however, that the Geiger counter serves as a detector of radiation only, and does not measure dose rate directly.

The design, shown in Fig. 3, can be separated into counter and oscillator circuits. These circuits are coupled electrostatically, but are separated for r-f.

A counter operated at about 900 v is connected by R_1 to the supply battery. Resistor R_2 decouples the counter from the r-f circuit. Capacitor C_F is the ferroelectric capacitance of about 30-60 pf. The rest of the oscillator is the modified Clapp circuit as described previously. As shown in Fig. 3A C_F is connected to C_2 and grounded for r-f by C_3 . When no counter discharge occurs, the polarization voltage applied to C_F is 300 volts.

Any discharge through the counter and R_1 will lower the voltage across C_F . With C_3 disconnected, each current pulse will vary the capacitance of C_F and hence the fre-

quency of the oscillator.

On the screen of an oscilloscope at the receiver end the ellipse will disappear with every pulse due to the frequency change. Thus, a count of the number of discharges of the Geiger tube is provided.

The time constant of the pulse circuit depends primarily on the resistance R_1 and the combined capacitance of C_F and those in parallel with it. This total capacitance is of the order of 100 pf. Time constant $C_F R_1$ is therefore about 10^{-2} seconds.

For high intensities the observation of single counts can be replaced by integration. A capacitance C_1 (Fig. 3B) is connected in parallel to R_1 , and any frequency change represents the average of many counts.

Figure 3C shows the application of an intermediate amplifier stage between the counter and transmitter circuit. The low coupling capacitance C_1 reduces the time constant for the single counts and the amplified pulses may be integrated by the network R_1 and C_2 . The voltage through R_2 will vary in accordance with the amplified pulses.

The transmitter circuit is identical with those described previously. Figure 3D shows the transmitter with drift compensation incorporated to establish the reference frequency. An antenna is coupled with the 3rd harmonic circuit as seen in Fig. 3D. Figure 3E shows the frequency deviation against incident radiation characteristic.

BIBLIOGRAPHY

H. K. Richards, Measurements of Ionizing Radiation by High Frequency Variation. *ORNL Health Physics Division, Semiannual Report for Period Ending July 31, 1953.*

H. K. Richards, Measurement of Ionizing Radiation by Frequency Variation Using Ferroelectric Effect. *ORNL Health Physics Division, Semiannual Report for Period Ending Jan. 31, 1954.*

H. K. Richards, Detection of Ionizing Radiation by Frequency Variation with the Use of the Ferroelectric Effect. *ORNL Health Physics Division, Semiannual Report for Period Ending Jan. 31, 1955.*

H. K. Richards, *Phys. Rev.*, **89**, 897 A, 1953.

E. D. Denmar, Radiation Measurements by Frequency Variation. M. S. Thesis, Vanderbilt University, 1954-55.

H. K. Richards, Measurement of Ionizing Radiation by Frequency Variation Using Ferroelectric Material. *Am. Phys. Soc. Chicago* Nov. 25, 1954.

P. A. Bordon and W. M. Wells, "Telemetering Systems," Reinhold Publishing Co., New York, 1959.

H. K. Richards, Detection and Telemetering of Ionizing Radiation by Frequency Variation, ORNL CF-55-9-122.

H. K. Richards, Radiation Detection and Telemetering System, Pat No. 2,917,633, Dec. 15, 1959.

Tracking

By ALEXANDER FINLAY,
ROBERT E. DEMUTH,
Buttelle Memorial Institute, Columbus, O.
and WILLIAM D. HALL,
Grimes Manufacturing Co., Urbana, O.

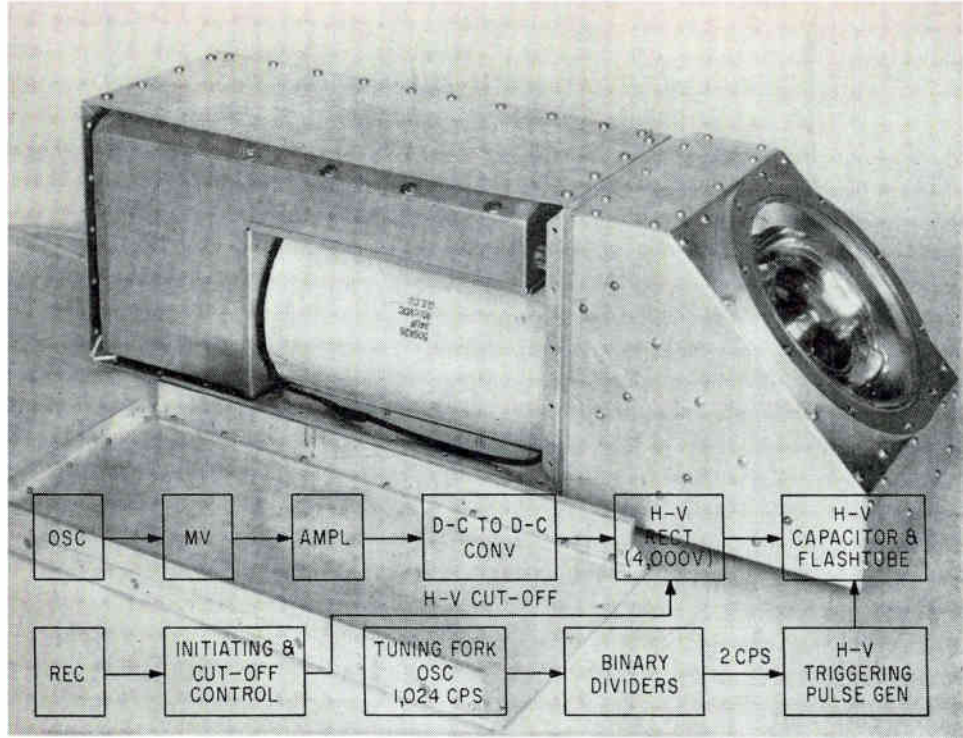

Prototype of airborne optical beacon (photo). When placed in a missile, the lens becomes an integral part of the missile surface

Block diagram of airborne optical beacon (overprint). The flashing light operates on command from a ground station, through the initiating circuit

OPTICAL TRACKING BEACONS can be used to track missiles launched at night. If a light of high intensity is flashed from a missile at a precisely controlled repetition rate, the flight of the missile can be recorded as a series of dots on a photographic plate. From the plate, the trajectory of the missile can be determined.

The stringent requirements for a compact, lightweight optical tracking beacon dictate the use of solid-state devices that can be assembled into a small unit.

The optical beacon flashes a high-intensity light twice a second for 25 seconds. The flash duration does not exceed 100 μsec as measured at the 30 percent power points. The required accuracy of the flash rate is ± 0.001 second. The radiated light emitted by the flash tube is produced by a minimum electrical input of 150 watt-seconds per flash to the flash tube. The unit is powered by a 28-volt battery. The battery is a three ampere-hour unit that has a terminal voltage ranging from 45 to 22 v from no-load to full-load conditions. This large variation in supply voltage is compensated for by Zener diodes that regulate the voltage applied to critical sections.

In addition to these operating requirements of the optical beacon, special test circuits are provided for measuring the operating parameters. These circuits include a photoelectric detector, flash-rate detector for telemetering, and flashtube ignition pulse test circuit.

High-intensity light is obtained by discharging instantaneously a high-voltage charge from a capacitor into a flashtube. In the design, as shown in the figure, a 4,000-v charge from a 21- μf capacitor is delivered to a flashtube. The energy input to the lamp is represented by the equation $J = \frac{1}{2} CV^2$ wattseconds. At 4,000 v and 21 μf , $J = 168$ wattseconds, which is the average energy delivered. The capacitor is charged through a 5,000-ohm resistor from a d-c to d-c converter. This converter changes the nominal 28-v from the battery to 4,000 by a static inverter and high-voltage rectifier. The inverter is driven by an amplifier controlled by a relaxation oscillator and multivibrator circuit. The multivibrator operates at 400 cps, the operating frequency of the inverter stage. The multivibrator is turned on by a low-level signal and does not require mechanical relays. The entire system is static in operation. All switching devices are semiconductors, which are necessary to keep radio interference at a low level and to assure high system reliability.

To control the point at which the capacitor stops charging, a voltage feedback system turns off the multivibrator when the capacitor is charged to 4,000 v. This stops the operation of the converter circuit

and the charging of the capacitor. The flashtube timing circuit obtains its pulses from a tuning-fork oscillator. The oscillator circuit and countdown stages produce a two-pulse-per-second flash repetition rate.

The initiating stage turns on the optical beacon when energized with a radio-controlled d-c voltage of 4.5 to 5.5 v. The beacon operates continuously as long as the initiating signal is present.

The converter is driven by a low-power square-wave signal generator (bistable multivibrator), which controls the converter. The advantage of this method is that the initiating stage controls a low-power circuit, in this case about 600 mw.

A relaxation oscillator drives a standard bistable multivibrator, that feeds the amplifier; the amplifier in turn, drives the d-c to d-c power converter. This circuit assures symmetry in the signal driving the converter. Such symmetry is vital to insure proper transformer operation.

The amplifier circuit consists of two direct-connected push-pull stages. The first stage consists of two 2N656 *npn* silicon transistors, the bases of which are direct-coupled to the output of the multivibrator. Emitter resistors of 8.2 ohms provide a small amount of bias at the bases of the transistors to keep them cut off when no signal is present. Voltage dividers between the

Missiles at Night by Light Flashes

Precisely timed, high intensity light flashes from beacon in missile permit trajectories to be determined from distances to 400 miles

two stages of the amplifier permit the first stage to be saturated when the signal from the multivibrator is at its maximum value.

The second stage of the amplifier consists of two 2N1100 *pnp* germanium transistors, also in push-pull. The collectors are connected to the primary of a driver transformer, with d-c fed to the transistors through the centertap. In normal operation the transistors are alternately driven from cut-off to saturation, which effectively supplies a square wave to the driver transformer.

Two diodes are connected across each side of the output stage of the amplifier. One is a Zener diode to provide voltage limiting and the other is an ordinary diode for current blocking. These diodes suppress spikes in the transformer primary circuit to a voltage level that will not damage the 2N1100 transistors. The spikes appear on the trailing edge of the square wave when the transistor collector current is suddenly switched off. The magnitude of the spike will vary from one unit to another, depending largely on the amount of leakage reactance in the power transformer. The Zener diodes limit the peak of the spikes to approximately the same value in all units and well below the maximum permissible value for the transistors.

The converter stage changes d-c from the 28-v battery supply to a-c. The battery voltage can then be stepped up through a transformer to a much higher voltage. The basic circuit of the converter uses two transistors in push-pull so that they are alternately driven from saturation to cut-off. The operation of this circuit is similar to the operation of the second stage of the amplifier.

To control enough power to give the output, four push-pull stages are connected in parallel, so that a total of eight 2N1100 transistors

is used in the converter stage. Series resistors of 0.1 ohm in the emitter circuit of each transistor equalize the currents in the transistors on each side of the converter. This is necessary because the collector-to-emitter voltage drop at saturation varies from transistor to transistor and there would be a tendency for the transistor with the lowest voltage drop to carry the largest current.

The output transformer provides a step-up from 20 to about 4,500 v. The d-c input to the converter at the start of each charging cycle is about 70 amp.

The high-voltage circuit consists of a full-wave bridge rectifier, a series resistor, and an energy storage capacitor. It rectifies the high-voltage output from the converter stage and stores the energy in the capacitor until enough is available to operate the flashtube. The bridge rectifier consists of four sections, each of which contains 16 IN444B diodes. It will withstand inverse voltages greater than 7,000 v and will handle currents up to 500 ma.

The storage capacitor, special-constructed of laminated Mylar film, has a nominal capacitance of 21 μf , and an operating voltage of 4,000 v. Energy furnished by the converter and the rectifier is stored until it is desired to operate the photo flashtube, which is then connected directly across the capacitor. The 5,000-ohm charging resistor limits the current drawn by the converter stage when the capacitor is recharging.

A voltage divider consisting of a five megohm fixed resistor and a variable resistor having a maximum resistance of 50,000 ohms are connected across the energy storage capacitor. The divider provides a reference voltage that turns off the multivibrator and ultimately the converter when the capacitor has been charged to the desired voltage. The variable resistor is adjusted

so that the multivibrator cuts off when the desired charging voltage is reached on the capacitor.

The flashtube used on the optical beacon is a specially designed tube similar to those used in photography. The flashtube, a highly efficient photographic light source, is a quartz arc-tube with an electrode sealed into each end. Quartz is used because high levels of energy are dissipated at each flash. The arc chamber is a flash coil about 3½ inches in diameter. It is filled with xenon and has a trigger electrode on the external wall. The flashtube is triggered by applying a high-voltage pulse to the trigger electrode that ionizes the gas and makes it conductive. The main storage capacitor then discharges its energy into the flashtube. The energy levels at which the flashtube is operating are about 7,500 lumenseconds at a peak of 82 megalumens.

The overall system of the optical beacon meets an estimated reliability of 0.998. The static semiconductor elements insure accurate, stable operation. The high-powered d-c to d-c transistorized converter is larger than most developed to date. The precisely timed flash repetition rate is accurate to within several microseconds, which is far superior to that required for useful data. The unit is compact and relatively light; the production model weighs 33 pounds and measures 27 inches long by 8 inches square.

Smaller and more powerful systems will be feasible with transistors capable of handling higher power than those used in this design.

In a paper written in 1956 on a miniaturized airborne optical beacon, a system is envisioned that has characteristics similar to this unit. With the optical and electronic system developed during this program, it is believed that a satisfactory optical beacon is now available for tracking missiles.

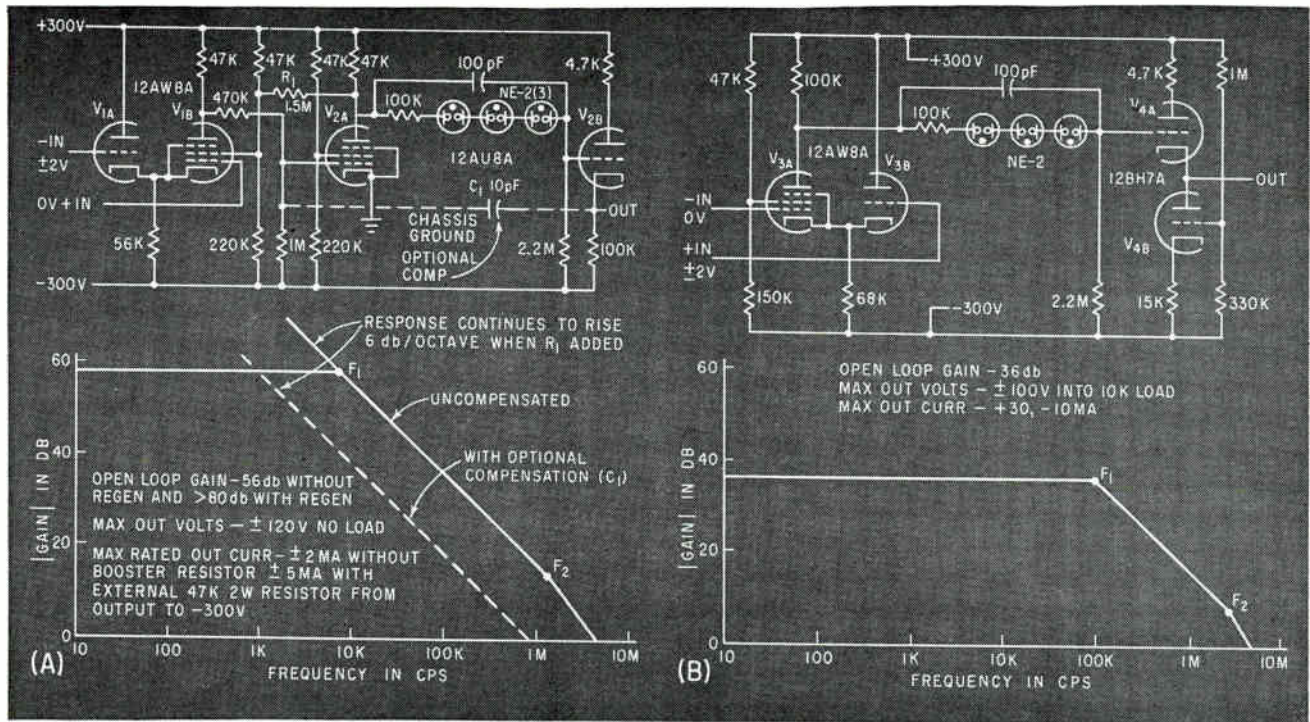

FIG. 1—Both model 1 (left) and model 2 (right) operational amplifiers use differential input circuits and may be used with external chopper-stabilizing amplifier. Gain-frequency response curves for each amplifier are also shown

How to Extend Operational

By HENRY KOERNER,

Department of Electrical
Engineering, University of Arizona,
Tucson, Arizona

THE DEVELOPMENT of a series of simple, plug-in operational amplifiers having extended high-frequency response and high output current capabilities was recently undertaken for use in high-speed switching circuits or as operational amplifiers in a repetitive computer installation. This development has resulted in the design of two amplifiers which may be used separately or operated in tandem combination to provide higher loop gain.

Both models feature differential inputs and may be used with an external chopper-stabilizing amplifier. In each case, two tubes are mounted on a turret structure which plugs into an octal socket through which all signal and power supply connections are made.

Circuit diagrams of the two amplifiers with their gain-frequency response characteristics are shown in Fig. 1. The two models differ both in their open-loop gain characteristics and in their output current capabilities.

Both amplifiers use a triode-pentode tube (V_1 , V_2) as a dissimilar difference amplifier. For analysis purposes it is convenient to regard this stage as a triode cathode follower direct-coupled to a grounded-grid pentode amplifier. The gain from triode grid to pentode plate is approximately 30 db.

In model 1, the signal from the input stage is fed to V_{2A} through a resistance divider network which establishes the proper operating bias at the control grid of V_{2A} . This pentode is used as a voltage amplifier to provide up to 140 v peak signals at the grid of V_{2B} connected as an output cathode follower.

Coupling from the plate of V_{2A} to the grid of V_{2B} is through three neon lamps connected in series. The

constant voltage drop across these lamps maintains the correct d-c operating voltages without loss of signal level.

The signal gain through the driver and output stages is approximately 30 db. A drop of radioactive paint ensures ionization.

An optional capacitor C_1 connected from the amplifier output to the control grid of pentode V_{2A} provides high-frequency attenuation so that the amplifier open-loop gain and phase characteristics yield stable operation at any closed-loop gain setting with resistive feedback ratios between zero and unity. For stability at unity gain this capacitor should be 10 pf, and for best recovery time in high-speed switching circuits it may be as low as 1.8 pf.

Regeneration from the plate of V_{2A} to the screen grid of V_{1B} increases the low-frequency gain without affecting high-frequency performance.

In model 2, signals from the plate

Simple plug-in units
 designed for fast time-scale
 analog computers, feature
 increased high-frequency
 response and higher
 output current capabilities

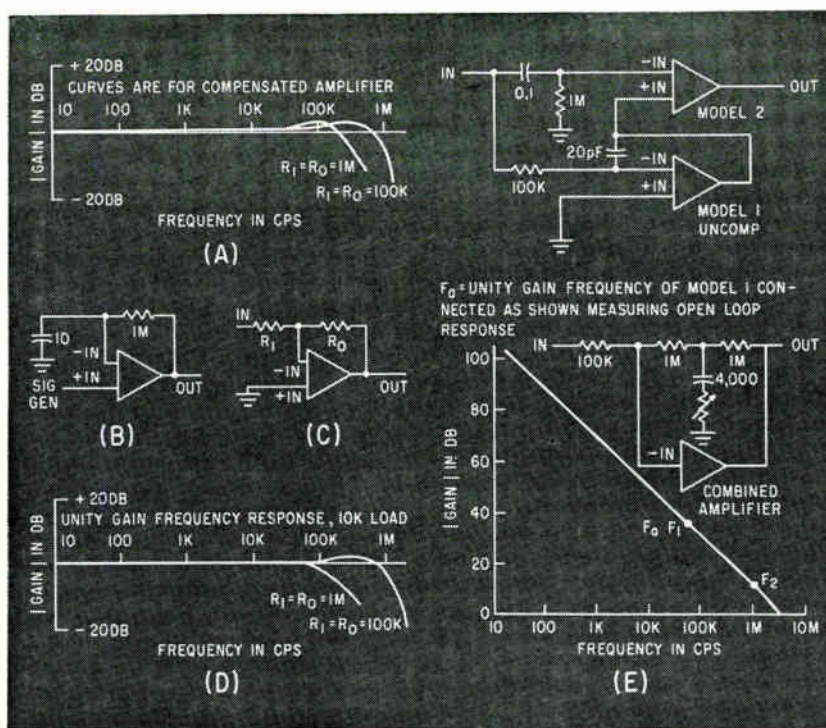

FIG. 2—Unity-gain frequency response (A) of model 1 amplifier connected as shown in (C). Open-loop amplifier is shown at (B). Unity-gain frequency response of model 2 amplifier (D) obtained when connected as shown in (C), tandem connection open-loop response and amplifier (E)

Amplifier Response

of V_{SA} are coupled to the control grid of V_{c1} , connected as a dynamically-loaded cathode follower, through neon lamps that (as in model 1) maintain correct operating voltages without producing signal loss. Open-loop gain of this model is low enough that no additional phase correction is needed to assure stability under closed-loop conditions.

Maximum d-c output current is 5 ma with a 47 K booster resistor.

Maximum frequency of model 1 amplifier (Fig. 2B) at which ± 100 v (no load) can be developed is 16 Kc with optional compensation and 50 Kc without compensation. The open-loop phase shift (without regeneration) reaches 5 degrees at 630 cps for the uncompensated amplifier.

The closed-loop characteristics of the circuit shown in Fig. 2C are shown in Fig. 2A. Here, maximum shunt capacitance from the output to ground (for stability) is 4,000 pf when $R_1 = R_0 = 1$ megohm, and 1,000 pf when $R_1 = R_0 = 100,000$

ohms. Square-wave response at unity gain with $R_1 = R_0 = 100,000$ ohms with a large signal ($+80$ v, 0 v) shows a positive rise time of $12 \mu\text{sec}$ and a negative rise time of $2 \mu\text{sec}$. With a small signal ($+20$ v, 0 v), the positive rise time is $4 \mu\text{sec}$ and the negative rise time is $2 \mu\text{sec}$. Maximum d-c output current is $+30$ and -10 ma.

The maximum frequency of the model 2 amplifier at which full rated output (± 100 v) developed into rated load is 50 Kc. The open loop phase shift reaches 5 degrees at 10 Kc.

The closed-loop characteristics of the circuit shown in Fig. 2C are shown in Fig. 2D. Here, the maximum shunt capacitance from the output to ground (for stability) is > 0.01 pf when $R_1 = R_0 = 1$ megohm and 1,500 pf when $R_1 = R_0 = 100,000$ ohms. Square-wave response at unity gain with $R_1 = R_0 = 100,000$ ohms and a 10,000-ohm load with either a large signal (± 80 v, 0 v) or a small signal (± 20 v, 0 v)

shows both positive and negative rise times of $2 \mu\text{sec}$.

The performance characteristics of a tandem (feed forward) combination of these amplifiers (with no internal compensation in model 1) shows an open-loop gain > 100 db at d-c without chopper stabilization, maximum output voltage of ± 100 v into a 10,000-ohm load and a maximum output current of $+30$ and -10 ma.

Open-loop response is shown in Fig. 2E.

The cascaded combination makes a very fast and reasonably powerful operational amplifier for modern multipurpose analog computers incorporating repetitive operation and storage.

The new amplifiers were developed in the course of a repetitive analog computer project directed by G. A. Korn. Acknowledgement is due the Electrical Engineering Dept. of the University of Arizona and Dr. P. E. Russell for continuing support of this work.

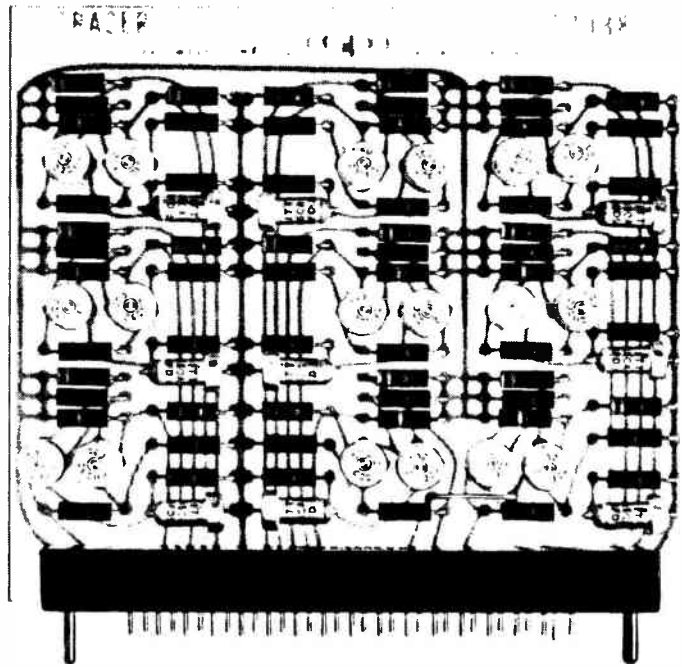
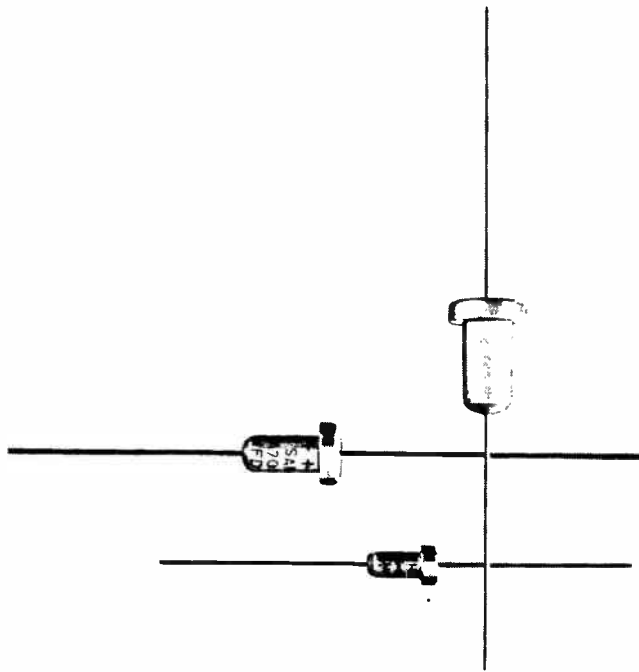

Link Division of General Precision, Inc. specified ITT capacitors for this vital portion of its Tracer Identification and Control System, which demands utmost reliability and long life expectancy from every component.

TOTAL PROCESS CONTROL AND DISCIPLINED PRODUCTION DELIVER

HIGH-RELIABILITY WET-ANODE TANTALUM CAPACITORS FROM ITT

ITT wet-anode tantalum capacitors meet MIL-C-3965B—a fact proved by independent laboratory qualifications tests on ITT capacitors. The reliability and long life expectancy of these competitively-priced capacitors are direct results of ITT's total process control and disciplined production procedures, above and beyond testing standards more stringent than normal industry practice—and backed by ITT's world-wide facilities and experience.



Phone these ITT-CD Capacitor Sales Offices:

Albuquerque AX 9-8013	Los Angeles HI 6-6325
Boston CA 7-2980	Miami MI 4-3311
Chicago SP 7-2250	Minneapolis WE 9-0457
Cleveland GR 5-3080	New York LO 5-1820
Dallas EM 1-1765	Philadelphia TR 8-3737
Dayton BA 8-5493	Phoenix WH 5-2471
Denver KE 4-5091	Rochester FI 2-1413
Detroit TO 8-3322	San Francisco LY 1-7321
Fort Wayne HA 0641	Seattle MA 2-5433
Kansas City JE 1-5236	St. Louis EV 2-3500

IN STOCK AT ITT DISTRIBUTORS:

- TWO TYPES— M-Type and P-Type, for applications from 55 to 85 and 125 C, respectively
- 29 VALUES—from 1.75 to 330 mfd's over a working voltage range to 125 VDC and maximum surge voltages to 140 VDC
- COMPACT AND RUGGED—sintered tantalum slug in fine-silver cases for 2000-hour life at maximum temperature and working voltage
- GUARANTEED—to 80,000 fl. and accelerations of 20 G's with a 0.1 in. excursion in 50-2000 cps range
- LONG STORAGE LIFE—tantalum-oxide dielectric is completely stable; assures trouble-free operation

COMPLETE SPECIFICATIONS ON ITT wet- and solid-anode tantalum capacitors are available on request. Write on your letterhead, please, to the address below.

ENGINEERS: Your ITT representative has a complete set of qualifications and quality control tests for your inspection.

Nomograph Gives Receiver Noise Figure

By MORRIS ENGELSON,
Polarad Electronics Corp., Long Island City, N. Y.

IN DESIGNING MICROWAVE RECEIVERS it is often necessary to determine front-end noise figure before a unit is available for measurement. Such a computation can be based on the expected i-f noise figure (NF_{i-f}) and the crystal parameters, temperature noise ratio N_r , and conversion loss CL . The graph expedites calculations by presenting a graphical solution to the equation

$$NF = CL [N_r + (NF_{i-f} - 1)]$$

First go to the proper I-F Noise

Figure line (heavy lines) numbered 1 to 10. Move along this line to the given temperature noise ratio (vertical N_r axis). Here switch to a light line marked NF_{i-f} , N_r constant. Move along this line to the given conversion loss (vertical scale) and read receiver noise figure on horizontal scale.

Example: Given $CL = 16$ db, $N_r = 2$, $NF_{i-f} = 7$ db. Start at $NF_{i-f} = 7$ (point A), go to $N_r = 2$ (point B), then to $CL = 16$ (point C) and read NF as 23.8

db on the horizontal scale.

The quantities in the equation are ratios while noise figure and conversion loss are usually in db. Therefore, when using the equation, the conversion loss and i-f noise figure have to be converted from db to power ratios, then combined with the crystal noise temperature ratio, and the resulting receiver noise figure then must be reconverted to db. The graphical solution presented here saves time by eliminating these conversions.

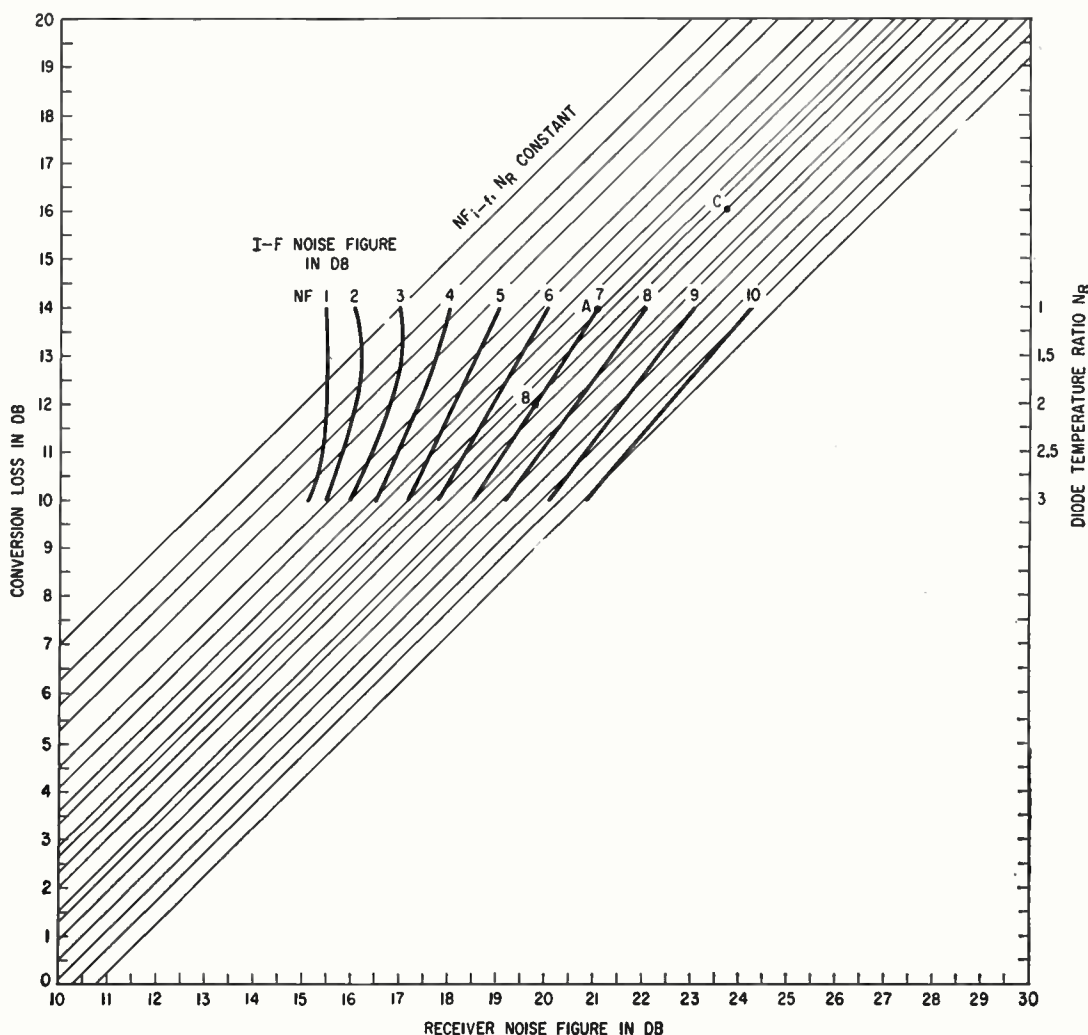



BUT, SIR ISAAC, WE'RE NOT GUIDING APPLES!

Until a ballistic missile is in free fall, our inertial guidance systems must be able to account for both rocket thrust and gravity. Making them this smart is a tough job, but we hit the mark so well on Thor that all of this country's long range missiles will soon be guided inertially. If you would like to help us keep pioneering new guidance systems, and have a BS, MS or PhD in Physics or Math, or an ME or EE, please contact Mr. B. C. Allen, Director of Scientific and Professional Employment, 7929 S. Howell Ave., Milwaukee 1, Wisconsin.

AC SPARK PLUG  THE ELECTRONICS DIVISION OF GENERAL MOTORS

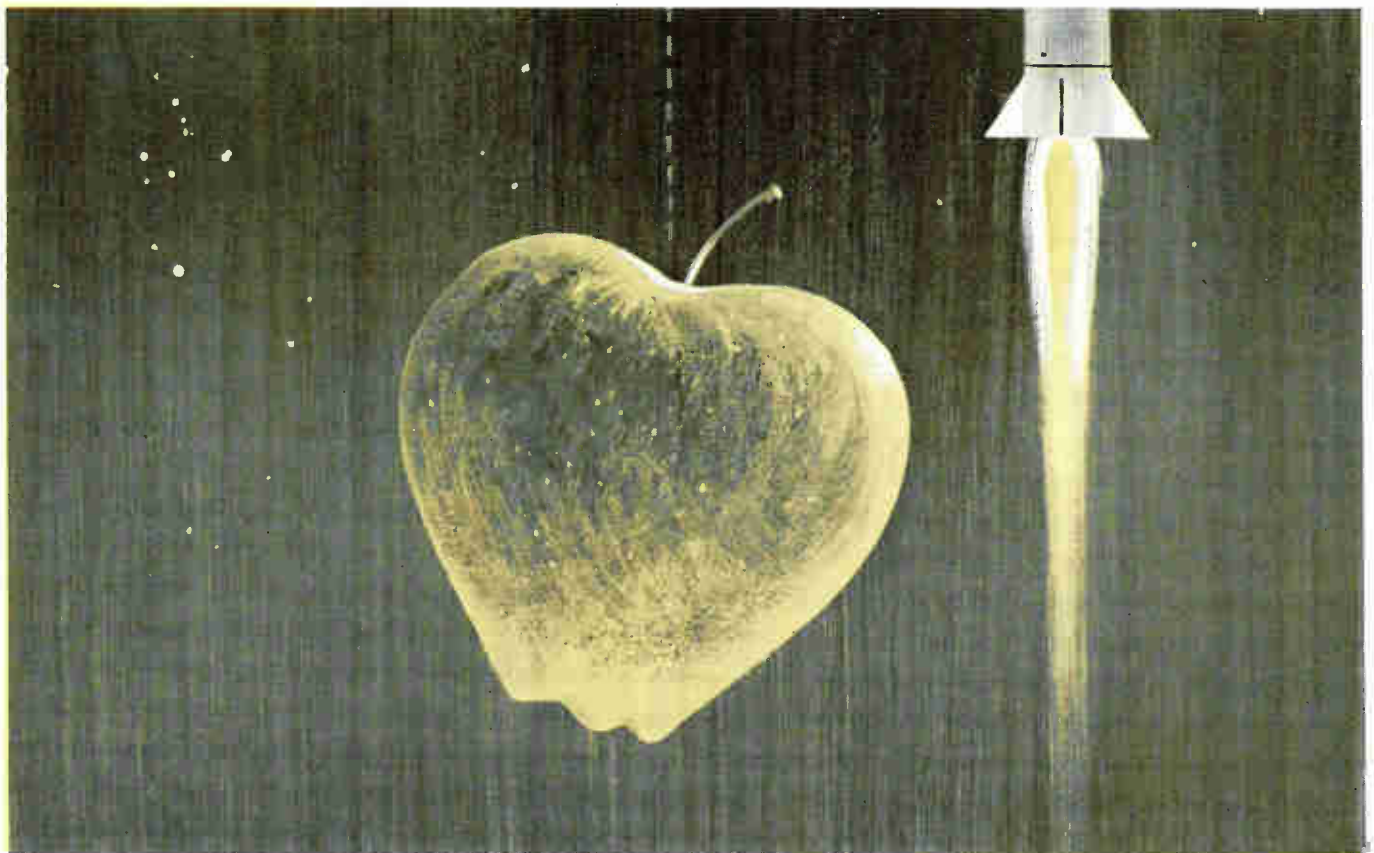

Rockets Study Night-to-Day D-Layer Density

DECREASE in ion density in the D layer of the ionosphere going from day to night is apparently much less than had been expected. The limited day-to-night difference is particularly noteworthy compared to that of the E and F regions. This condition was inferred from data gathered in two Nike-Asp rocket flights on June 7. Detailed analyses of the data are now being carried out. Information obtained in the flights is also being used to study recombination of charged particles at these altitudes.

Knowledge of upper atmospheric ionization has usually been obtained from propagation measurements, which provide integrated rather than local values. Techniques developed previously at the Photochemistry Laboratory, Air Force Office of Scientific Research, for investigation of ion densities at lower altitudes have now been adapted for the upper atmosphere.

A spherical ion counter similar to the Russian ion trap¹ has been developed and flown successfully in ICBM's and in-house research vehicles. It consists of two concentric

spheres mounted on an arm that keeps the counter well outside the electrically charged sheath around the vehicle. The outer sphere is perforated so that the ratio of open to surface area is high. It is kept at vehicle potential except during periodic application of a sawtooth sweep voltage.

The highly insulated inner sphere is kept at a high negative potential with respect to the vehicle. Therefore all positive ions entering the outer sphere are collected by the inner sphere. The resulting current is measured using a highly stable logarithmic d-c amplifier operating through a current range of 10^{-11} to 10^{-6} amp.

To find ion densities from current, vehicle potential with respect to its surroundings must be known. This value was calculated by applying Langmuir probe theory to the current-voltage curves obtained when the sawtooth voltage was applied to the outer sphere. Ion temperatures and energy distribution are also determined by periodically sweeping potential of the inner-outer sphere with the sawtooth volt-

age and studying its Langmuir characteristics. Depending on instrument time constant in relation to vehicle velocity, the counter thus directly indicates positive ion density and indirectly indicates vehicle potential, ion temperature and energy distribution.

Purpose of the two rocket firings was to study day-to-night variations in these quantities at altitudes from 50 to 200 Km. The first shot made at ion density maximum reached 125 statute miles altitude; the second at ion density minimum attained 108 miles altitude.

Rough estimates made from the data gathered indicate a peak density on both day and night flights at an altitude of 65 Km, a reduction factor of only about 10 from day to night. Above this peak, daytime ion density decreased slightly to a minimum at 85 Km. It then increased steadily to 200 Km except for a sudden increase at 100 Km on entering the E region. Above this altitude, it decreased so that at 125 Km ion density was reduced by a factor of 20 to 30 from the peak value in this region.

REFERENCE

- (1) V. I. Krassovsky, Exploration of the Upper Atmosphere with the Help of the Third Soviet Sputnik, *Proc IRE*, 47, Feb. 1959.

High-Speed Shock-Wave Collision

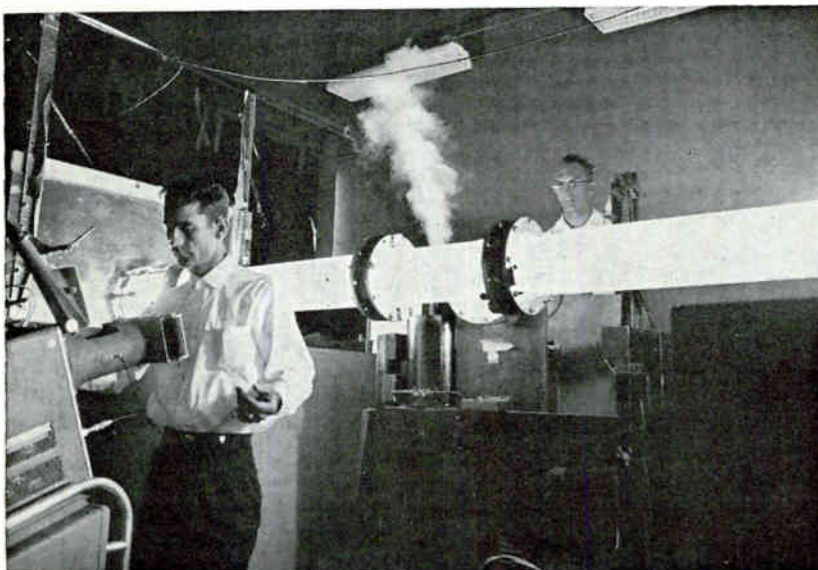

Impact of two shock waves, each traveling at Mach 80, illuminates Boeing hydromagnetic shock tube. High-temperature gas experiments may aid development of effective ion propulsion system

Induction Plasma Torch May Provide New Devices

INDUCTION plasma torch that generates extremely high temperatures is expected to have a wide variety of applications in the production of electronic devices. It will also permit research in the area of solid-state materials that could result in new electronic components.

The new torch, invented at MIT Lincoln Laboratory by T. B. Reed, was described at the Gaseous Electronics Conference, Monterey, Calif., at the U. S. Navy Postgraduate School. The meeting was sponsored jointly by the school, the Division of Electronic Physics of the American Physical Society and

OFF THE SHELF!

FROM YOUR **AMPHENOL** DISTRIBUTOR



MS
CONNECTORS



BLUE Ribbon[®]
CONNECTORS



RACK & PANEL
CONNECTORS



RF
CONNECTORS



Min Rac 17
CONNECTORS

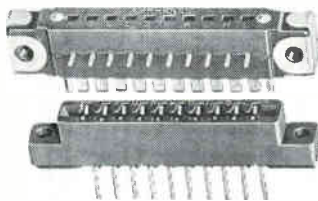

PRINTED CIRCUIT
CONNECTORS



COAXIAL CABLES

These and all other standard AMPHENOL components are available through your Authorized AMPHENOL Distributor at factory prices. Make use of his excellent service!

AMPHENOL DISTRIBUTOR DIVISION

BROADVIEW, ILLINOIS

Amphenol-Borg Electronics Corporation

the Office of Naval Research.

Temperatures up to 19,000 K have been produced by the torch using only 3 Kw of electrical power. As much as 57 percent of the total energy was transferred to the plasma. Generation of temperatures approaching 100,000 K seems feasible without excessive power requirements if a method can be developed for containing the plasma.

The basic plasma torch in the diagram is a quartz tube open at one end with gas supplied to the other end. An r-f coil of a few turns around the tube provides power. A commercially available 4-Mc power supply of the type used for r-f heating was used. Although maximum rated output is 10 Kw, temperatures produced by more than 3 Kw melt the quartz tube. As little power as 500 watts can maintain the plasma. The more recent model of the plasma torch shown in the photograph uses a flat pancake coil.

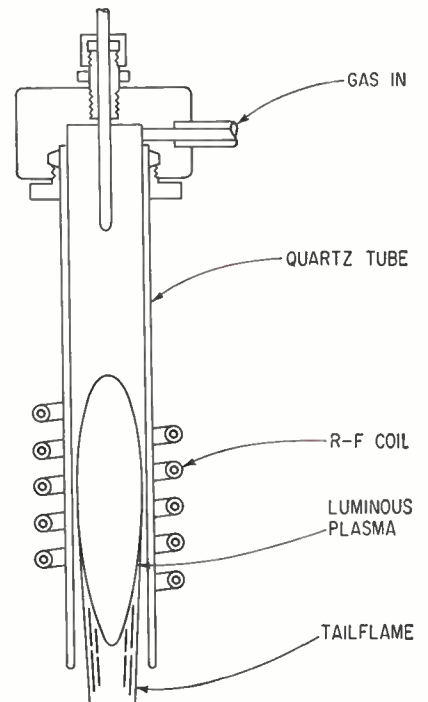

Developmental model induction plasma torch is simply constructed and produces no combustion products to contaminate materials

No combustion occurs in the inductively coupled plasma torch. A variety of gases and gas mixtures can be used, and the high-temperature region is not contaminated by combustion products. This high-temperature region is not just a



Artificial sapphire is produced by melting end of aluminum oxide rod

point focus but extends throughout an appreciable working space. It is completely accessible for introduction or manipulation of materials to be heated.

The primary value of generating and maintaining high temperatures to electronics is in research and production of solid state materials. Crystals of germanium and silicon can be produced economically in crucibles at temperatures below 2,000 K, which is one reason for their widespread use.

Artificially grown sapphire or ruby for phonograph styli and masers, rutile and other crystals cannot be produced in crucibles. The crucibles would melt or contaminate the crystal material. Crystals of some of these materials can be produced with the Verneuil method in which the material itself acts as the crucible. A torch melts a puddle at the center of a large piece of the material or a drop at the end of the material.

Even with this method, few combinations of combustible gases exist that do not contaminate the material. Also, gas flow velocity must be rather high to maintain the high temperature, which can stir up or splatter the material. Electric arcs and d-c plasma torches are free from some of these limitations but the electrodes produce contamination. The induction plasma torch does not have these disadvantages, is simple in construction and requires only a reasonable amount of power for high temperatures.

November 11, 1960

NEW LOW PRICES!

ON CHARACTRON® SHAPED BEAM TUBES

Economies made possible by increased production now permit drastic price reductions on almost all types of CHARACTRON Shaped Beam Tubes. These unusual cathode ray tubes have the spot writing capabilities of conventional tubes and also have a unique capability for high speed display of exceptionally clear characters. Some typical CHARACTRON Shaped Beam Tubes are shown below. Write today for complete list of tubes and new low prices. Stromberg-Carlson-San Diego, Department A-70, P. O. Box 2449, San Diego 10, California.



C19R 19-INCH

Used for situation display applications. Features the highest character quality. Type G3049 is similar to the C19R, but uses fewer external components for faster setup, easier maintenance.



C21Q 21-INCH

Used for situation display applications. Character size may be dynamically changed by varying a single tube voltage. This same voltage also produces a focused spot for spot writing.

C7F11 7-INCH

For data recording. Capable of displaying more than 10,000 characters within a 4½ inch square on its screen. Adjustable character size. Low voltage Type C7D11 also available.



C5G 5-INCH

For data recording. Designed for minimum size and ease of operation, this tube requires only one external component and is only 15" long.



STROMBERG-CARLSON-SAN DIEGO
A DIVISION OF **GENERAL DYNAMICS CORPORATION**

CIRCLE 97 ON READER SERVICE CARD

97

Report on Dendritic Growth Techniques

USED FOR FABRICATION OF MADT TRANSISTORS

By C. G. THORNTON, Director of Semiconductor Research & Development, and

R. C. MUSA, Manager, Chemistry & Metallurgy Departments, Philco Corporation, Lansdale, Pa.

GERMANIUM MICRO ALLOY Diffused-Base Transistors (MADT's) prepared by special dendritic growth techniques developed at Philco's Lansdale Division demonstrate performance comparable with conventionally manufactured military-type devices. This performance level has been achieved despite the inherent defects in dendritic material, as a result of a simple and economical precision-etch fabrication process.

In conventional manufacture, semiconductor material is prepared in the form of a monocrystalline bar, or ingot, approximately one-inch diam. and 12-in. long. The

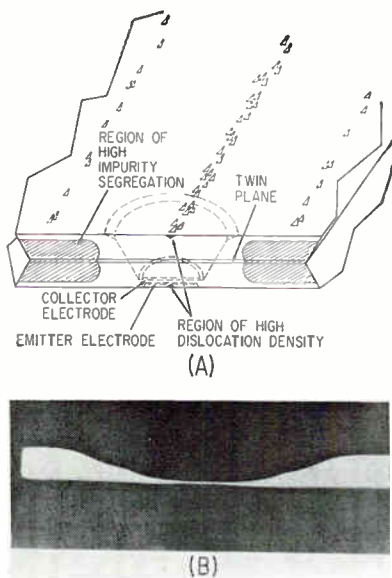

FIG. 1—Cross section of germanium dendrite with MADT geometry superimposed (vertical scale exaggerated), (A), shows that imperfections commonly associated with dendrites can be etched away (B) leaving relatively perfect areas (pits) where collector and emitter electrodes can be precisely positioned. Regions of high crystal dislocations, twinning and high impurity segregations are avoided.

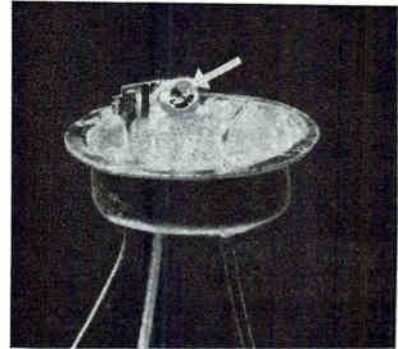

FIG. 2—Rows of dendrites are fed through a scribing machine, (left), each strip being cut into tiny germanium dice approx. 50/1,000-in. long. Each wafer forms a single transistor (right)

ingot is sliced into 0.015-in thick wafers. The wafers are lapped and etched to a thickness of 0.008 in., and scribed into dice measuring 0.072×0.005 in. The material is then ready for diffusion, if required, and transistor fabrication. Philco's dendritic growth process eliminates most of the operations associated with this conventional crystal growth.

Essentially, dendritic growth is a method of preparing a continuous ribbon of semiconductor material to a thickness required for device fabrication. As in standard crystal growth, lumps of high purity, polycrystalline material are melted, and dopant added in controlled amounts.

However, in dendritic growth, the temperature of the melt is reduced until it is considerably supercooled. A seed crystal is introduced, then withdrawn at an extremely rapid rate. The supercooled liquid surrounding the seed solidifies, and as the seed is removed, a thin dendrite of semiconductor is formed.

Using this technique, dendrite ribbons 0.060-in. wide, 0.005-in. thick, and up to 12-ft long have been grown. Lengths are limited only by height of the pulling apparatus.

Recently, improved growth techniques have made possible smooth dendrites without surface irregu-

larities or edge facets. This has been achieved by having the growth process more nearly approach a true steady state equilibrium process.

A significant aspect of Philco's production technique is that the dendrites grown do not need modification before being employed for transistor fabrication. The dendritic growth technique has two advantages over conventional growth processes: speed and economy.

The over-all process of dendritic growth is many times faster than the standard pull furnace technique. Dendritic withdrawal, measured in inches per minute, eliminates the elaborate sawing, slicing, lapping, etching, and scrubbing operations necessary when conventional growth techniques are used. It is simply necessary to scribe the 0.005-in. wide dendrite into dice of desired lengths, and briefly etch the dice to the desired thickness. Great wastes of material are obviated as the dendritic process makes possible 100 per cent usage of the original germanium ingot.

Unfortunately, defects in the quality of dendritic material are sufficient to make the material impractical for many uses. In cross-section, undiffused conventionally-prepared dice are homogenous; dopant is distributed evenly throughout the single-crystal mate-

A NEW CONCEPT IN SCAN CONVERSION

from **G E C**

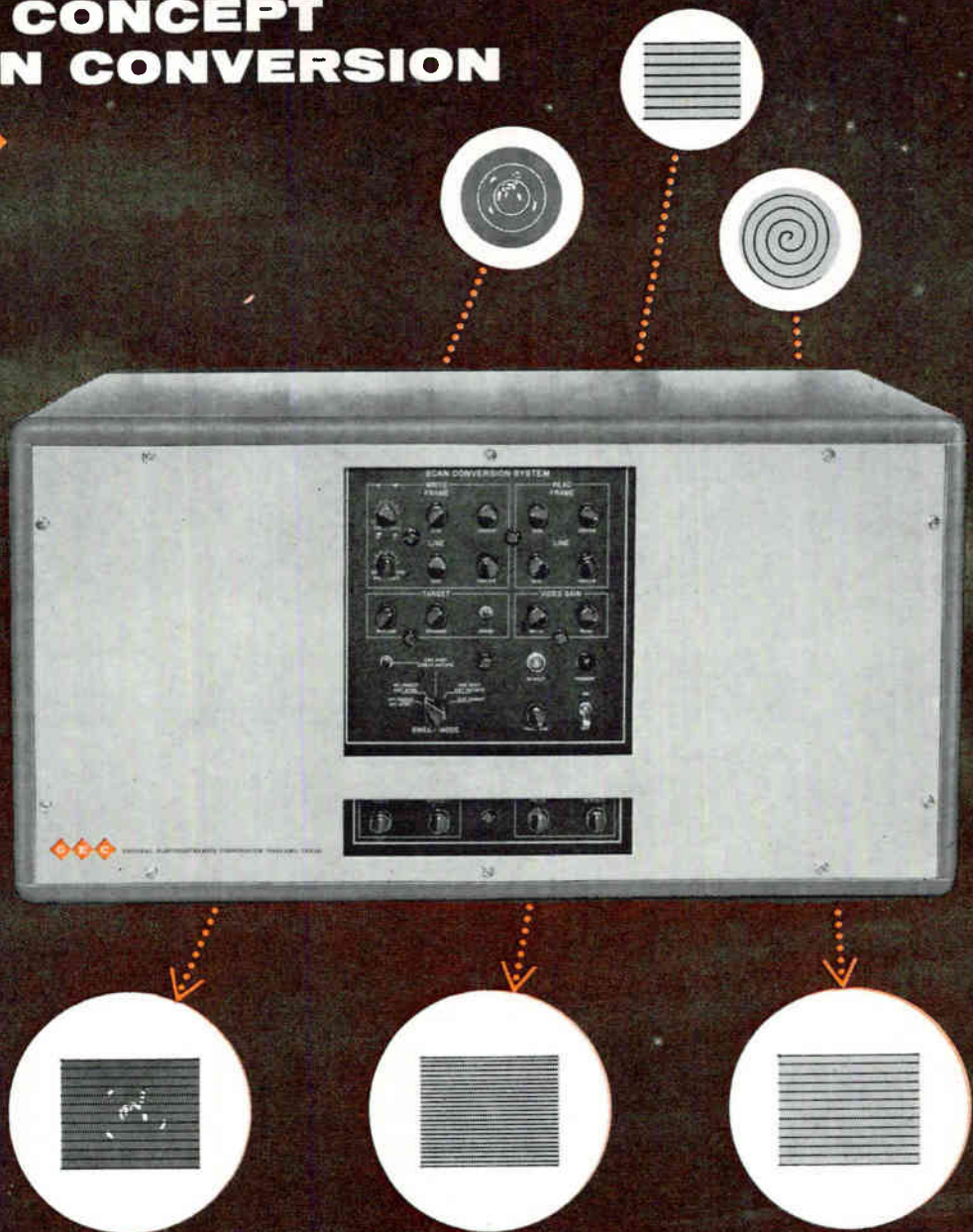

Now a low cost completely transistorized Scan Conversion unit is available which is capable of:

- ◆◆◆ TRANSLATION of video information from one scanning mode to another;
- ◆◆◆ STORAGE and INTEGRATION of video information;
- ◆◆◆ Expansion or reduction of bandwidth through TIME—COORDINATE TRANSFORMATION.

This completely transistorized, versatile system can be readily tailored to your specific needs through its plug-in printed circuits. For more information about conversion of radar PPI to TV, TV standards conversion or conversion of slow scan narrow band systems to standard TV or vice versa, contact GEC today.

...advanced electronics at work



GENERAL ELECTRODYNAMICS CORPORATION
4430 FOREST LANE • GARLAND, TEXAS • BROADWAY 6-1161

HST MAGNETIC MODULATOR

furnishes stable signal amplification

THEORY & APPLICATION: Since certain control and instrumentation systems require amplification of DC signals, it is desirable to employ a static signal converter. Magnitude of these available DC signals is so small that instability of DC amplifying systems results when signal is brought to usable level. Therefore a stable AC amplifier is required to convert low level DC to AC. A magnetic modulator serves this function with the added advantage that a "polarity reversible" DC input is converted to a "phase reversible" output. The output can be rectified to a "polarity reversible" pulsating DC or can be applied to a phase sensitive indicating device. Input impedance is relatively high while the output impedance is inherently low.

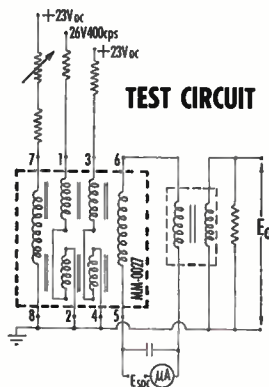

SPECIFICATIONS: Model MM-0027

ELECTRICAL CHARACTERISTICS:

Maximum Output	>.4 V _{RMS} @ I _s 100μa
Minimum Output	<.05 V _{RMS} @ I _s 0μa
Voltage Unbalance	< 35%
DC Resistance	1-2 7.3Ω ±20%
	3-4 500Ω ±20%
	5-6 1200Ω ±20%
	7-8 60Ω ±20%

Frequency 400 cycles

MECHANICAL CHARACTERISTICS:

Diameter	1.13" maximum
Height	.68" maximum
Lead Length	2.00" minimum
Mounting	.125" clearance hole

ENVIRONMENT CONDITIONS:

Storage Temperature	-65° to +100°C
Operating Temperature	-40° to +70°C
Vibration	.060" total excursion 10-5cps
Shock	15 g's
Altitude	50,000 feet
Humidity	95% relative

Prices on request. Quotations without obligation on your other special components.

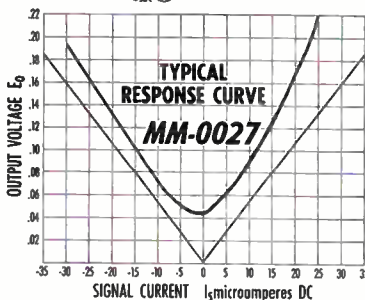

rial. In contrast, a cross section of dendritic dice reveals considerable inhomogeneity.

Figure 1A shows the kinds of imperfections which can occur in germanium dendrites making the material unsuitable for many transistor types. Twin planes exist at the center of the dendritic dice, thus a differentiation in crystal orientation may exist between upper and lower halves. In addition, severe crystal dislocations exist in localized regions at the surface of the dendrite, and considerable impurity segregation occurs at the edges. Difficulty in obtaining reproducible device properties occurs whenever the impurity segregation regions are incorporated in the transistor.

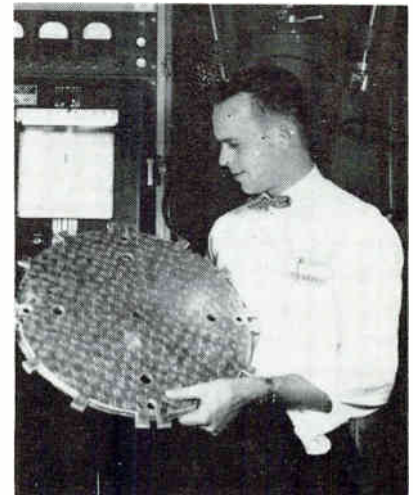

Engineer holds spool of 200 feet of germanium dendritic ribbon used to make MADT's

However, fabrication of MADT transistors can circumvent this situation. A precision etch technique is used to etch depressions into specific carefully chosen areas in the semiconductor materials.

Electrodes are deposited in depression (Fig. 1B) to form emitter and collector. This surface region generally comprises high-quality material. The regions of high crystal dislocation, twinning, and high impurity are avoided. The remaining material that forms the base region of the transistor is located close to one surface so that uniformity in the semiconductor material is required only in the one area.

The result of the large-scale use of dendritic material can easily be

Hermetic Seal
transformer co.

MAGNETIC IRON-CORE COMPONENTS
ENVIRONMENTAL TESTING
POWER SUPPLIES—SERVO AMPLIFIERS

DRESSER INDUSTRIES INC.

ELECTRONIC
OIL • GAS
CHEMICAL
INDUSTRIAL

TEXAS COMPONENTS DIVISION
555 N. Fifth St. P. O. Box 978
Garland, Texas
Dallas phone BRoadway 6-5141

PACIFIC COMPONENTS DIVISION
18151 Napa St. P. O. Box 161
Northridge, California
Phone Dickens 5-2250

Dendritic MADT's show performance characteristics similar to those made by standard growth techniques: i. e.

TYPICAL

Collector voltage, V_{CB} 10 v
 Emitter voltage, V_{EB} 2 v
 Collector current, I_{CBO} $< 1 \mu a$
 Cutoff frequency, F_T > 500 mc
 Power gain (200 mc)..... 11 db

predicted. Because of the relative simplicity of the etching technique, semiconductor devices can be made and sold more cheaply. In addition, the technique is well suited to automatic production. Dendrites can be fed into a high-speed automatic production line, and emerge as completed transistors.

Introduction of these preparation techniques is expected to result in a major contribution in the form of economy and productivity.

Zener Diodes for Voltage Regulation

"DEVELOPMENTS in the semiconductor art have made the reverse breakdown characteristic of silicon diodes extremely useful for close tolerance voltage regulation," according to J. S. McGee, vice president in charge of Hoffman's Zener diode production facilities, Evanston, Illinois. "In particular, the techniques employed in solid state diffusion have enabled these Zener devices to provide stable voltage over wide variations in current and temperature. This makes possible, simplified, reliable circuitry."

Hoffman Electronics now has added nine EIA types to its 250-milliwatt regulator series, 36 types each to the 500-mw and 1-w series, and 37 types to the 10-w regulator line. The company has also extended its line of 400-mw subminiature "glass" Zener reference diodes by the addition of two types—1N823 and 1N824—to the recently introduced types 1N821 and 1N822. Addition of the 120 new types brings to 2137 the total number of Zener diodes offered by Hoffman.

All of the new regular types have a standard voltage tolerance of plus or minus 10 percent with plus or minus 5 percent types available. Operating temperature is from minus 65 C to plus 175 C.



COUCH ROTARY RELAYS

Start with a unique and simple design — manufacture within a narrow range of tolerances — specify performance on the *conservative* side — this is how Couch solves the problem of supplying relays that meet the present and future needs of our aircraft and missile programs.

The record shows that this technique is successful: many thousands of Couch CVE type rotary relays are providing consistent flight insurance in complex systems under the most severe environmental conditions.

IMPORTANT SPECIFICATIONS

- Contacts:** 4PDT (dry circuit to 10 amps)
- Size:** $1\frac{3}{32}$ " D x $1\frac{1}{2}$ " H
- Weight:** 3.2 oz. max.
- Pull-in power:** $\frac{1}{2}$ watt
- Ambient temperature:** -65° to $+125^\circ\text{C}$
- Vibration resistance:** 20G's, 5 to 2000 cps
- Shock resistance:** 75G's operating, 200G's non-operating

Write for complete specifications.



COUCH ORDNANCE, INC.
 A Subsidiary of S. H. Couch Company, Inc.

3 Arlington St., North Quincy 71, Mass. Tel.: (Boston) BLuehills 8-4147

Turntable Motor Grinds Its Own Pulley

REVOLVING TURNTABLE parts must be round and concentric to avoid rumble and wow in the record player. The effect of slight eccentricities is magnified when the parts revolve against each other in the operating assembly.

A basic solution is precision machining to insure that parts have the same centerlines as their shafts. Several machining techniques following this principle are employed by Rek-O-Kut Company, Inc., Corona, N. Y., in preparing motor drive pulleys, idler wheels and turntables used in their record players.

Drive pulleys are mated to motor shaft bearings by using each motor as an individual pulley lathe. Motors with an original shaft eccentricity within 0.0005 inch are selected, run-in and balanced. Pulleys with oversized outside diameters are press-fitted onto the shafts.

Each motor is fastened in a fixture which allows the shaft to turn under its own power. The fixture is on a cylindrical grinder. The motor is turned on and the grinder used to make a cut on a portion of the pulley not used as a bearing surface. The cut portion is measured at each end with a micrometer. A taper would cause a speed variation in the drive (tapered pulleys are used in one of the firm's variable speed record players, but are not desirable in single-, two- and three-speed models).

Taper is corrected by pivoting the fixture. A pin type feeler gage fixed on the bed of the grinder so it contacts the fixture guides the

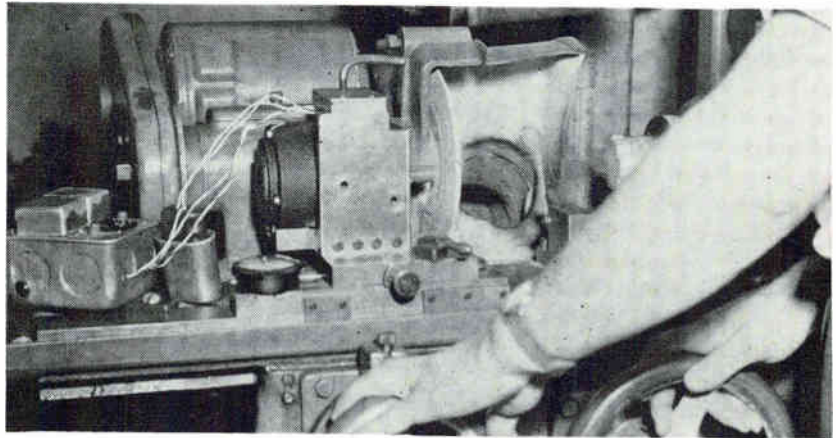

Pulleys are mated to motors by using each motor as individual grinder after pulleys are placed on motor shaft



Idler wheels are trued on grinding machine

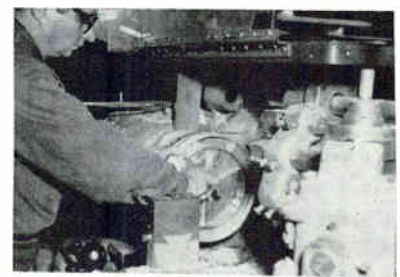

Turntable blanks are bolted to turret lathe

machinist in making this adjustment. When the cuts are no longer producing a taper, the bearing surfaces are ground to size. This method assures concentricity of the pulley surfaces with the motor shaft bearings despite any slight eccentricity or bow in the shaft. The same method is used for pulleys of belt-driven turntables.

Idler wheels of rim-driven turntables are also trued by grinding, using their center hole as a reference. The wheel is placed on a pin which is held in the grinder. The pin is precision ground on the same grinder at the start of a production run. It is discarded at the end of the run, since rechucking the pin could be a cause of eccentricity.

Turntables are machined from aluminum castings. Finish machining follows normalizing after rough machining. The turntables are fastened to the headstock of a turret lathe with several bolts placed

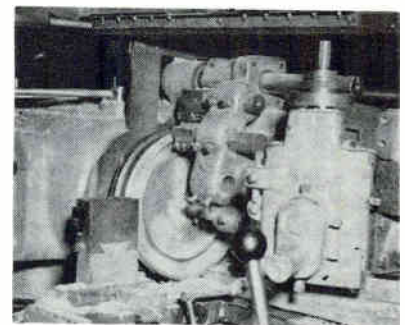

Mounting hole and rim are machined simultaneously

halfway between the shaft hole and rim. Cuts are made simultaneously on the rim and in the hole. Light cuts are used since tool "give" caused by heavy cuts could produce out-of-roundness.

The turntable bearing shaft is a hardened and ground rod with a spiral oil groove. The shaft well is prepared with an inside diameter about 0.0005 inch undersize. The

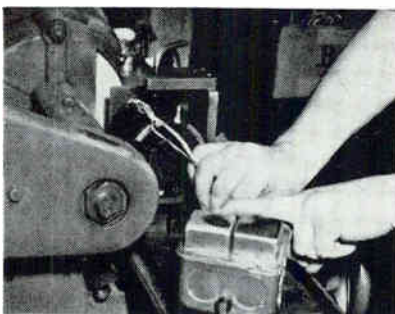

Motor leads are connected to power supply next to fixture

SIEGLER:

...outstanding performance through a family of talents

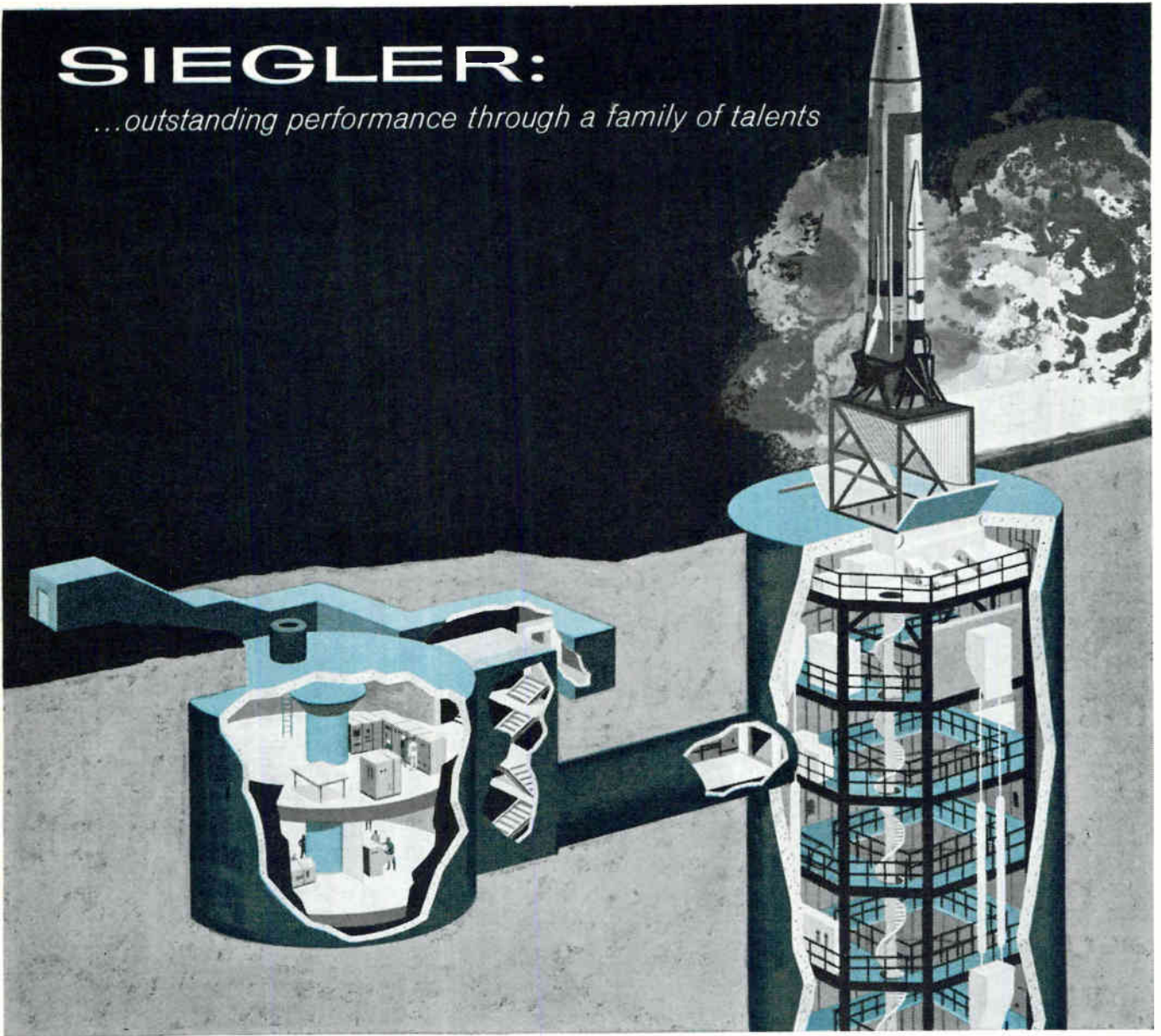

***Siegler selected
to produce electronic
launch control system
for silo-launched
ATLAS ICBM***

Convair-Astronautics Division of General Dynamics and the U.S. Air Force have selected Siegler for production of the automatic electronic launch control system of the mighty Atlas. Production is now in progress under a major multi-division contract awarded The Siegler Corporation.

The Siegler team in this top-priority project includes Siegler's Hallamore, Hufford, and Magnetic Amplifiers divisions.

Selection of Siegler for this vital defense requirement demonstrates recognition of Siegler's superior performance...outstanding performance deriving from divisional coordination under the dynamic Siegler basic corporate concept: *Progressive management of diverse activities with outstanding military, industrial, commercial and consumer capabilities - in order to bring to each of these fields the strengths of the others.*

For information concerning Siegler's capabilities in your field, address The Siegler Corporation, at address below.

*CAREER OPPORTUNITIES
are available for
engineers and scientists.
Write for complete information.*



THE SIEGLER CORPORATION

610 South Harvard Boulevard, Los Angeles 5, California

PLANT LOCATIONS: HALLAMORE ELECTRONICS DIVISION, ANAHEIM, CALIFORNIA • HUFFORD DIVISION, EL SEGUNDO, CALIFORNIA • OLYMPIC RADIO AND TELEVISION DIVISION, LONG ISLAND CITY, NEW YORK • MAGNETIC AMPLIFIERS DIVISION, NEW YORK, NEW YORK • BOGEN-PRESTO DIVISION, PARAMUS, NEW JERSEY • SIEGLER HEATER DIVISION, CENTRALIA, ILLINOIS • HOLLY-GENERAL DIVISION, PASADENA AND BURBANK, CALIFORNIA • VAC-U-LIFT DIVISION, SALEM, ILLINOIS • COMET MANUFACTURING DIVISION, LOS ANGELES, CALIFORNIA • COMMUNITY ANTENNA CO., INC., RENO, NEVADA

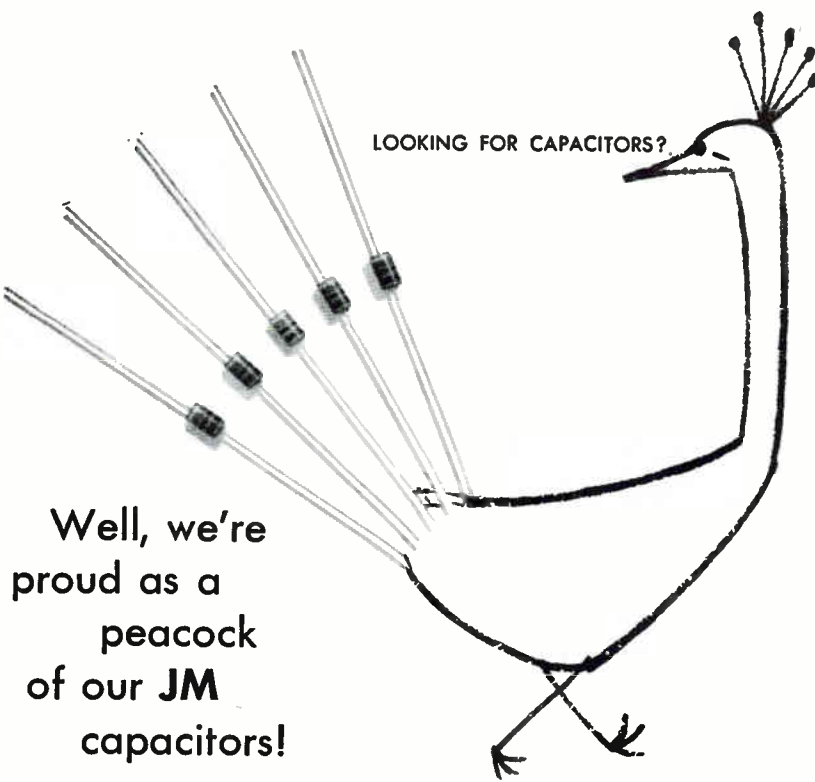

Well, we're proud as a peacock of our JM capacitors!

Choose from 49 EIA values. All have these characteristics:

Working voltage: 500 VDC

Insulation Resistance: 50,000 megohms minimum (500 VDC test)

Q Value: 100 minimum

Body Dimensions:

0.1 to 10.0 mmf .160 ± .005 dia. x .400 max. L

10.0 to 18.0 mmf .187 ± .005 dia. x .230 max. L

Leads:

No. 20 AWG Copper, heavily tinned to insure good solderability. 1 1/2 ± 1/8 long

Tolerance Color Code:

Under 10.0 mmf 10.0mmf and Over

20% None	20% Black
10% Silver	10% White
5% Gold	5% Green



Jeffers Fixed Composition JM Capacitors are ideal for a broad range of circuit applications. They offer operating stability, moderate Q—and those other two indispensable characteristics, dependability and economy! Use them as coupling capacitors between RF amplifiers, AVC circuits, oscillators, IF stages—and in many other circuits where low capacitance is a requirement.

The insulated JM body consists of a molded thermosetting resin with a ceramic dielectric material dispersed throughout. The firmly embedded lead wires serve as electrodes.

For all the facts about the Jeffers line of JM Capacitors, write today!

JEFFERS ELECTRONICS DIVISION
Speer Carbon Company
Du Bois, Pennsylvania

i.d. is peened to size, smoothed and hardened with a roller-peener on a drill press.

To assemble the turntable, the shaft is press-fitted into the turntable hole. When the shaft is placed in a level well, it should revolve freely without wobble or play. Flatness of the turntable is checked by a feeler gage mounted on an optical flat. Squareness to shaft is checked by indicators. After the player has been assembled and run-in for about 36 hours, its operation is checked again.

Leakage Tester Range Is 0.1 to 10¹² Ohms

LEAKAGE TESTS on oil and paper capacitors can be made at very high resistance levels with a voltmeter by the test set pictured in Fig. 1. The test set is used by Ballantine Laboratories, Inc., Boonton, N. J., to test components for high resistance circuit performance.

The indicating instrument is a Ballantine Model 300 vacuum tube voltmeter. The meter scale, which is logarithmic, is inverted so that it will read in ohms from right to left

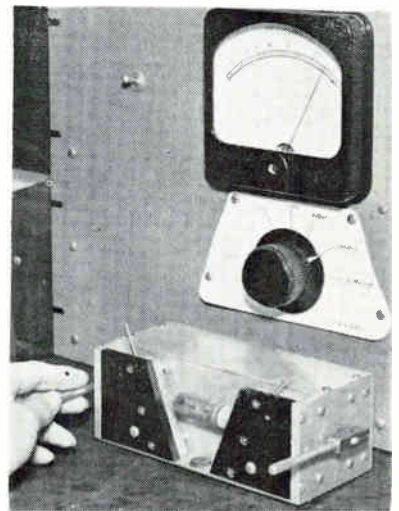

Voltmeter scale is inverted to read in megohms

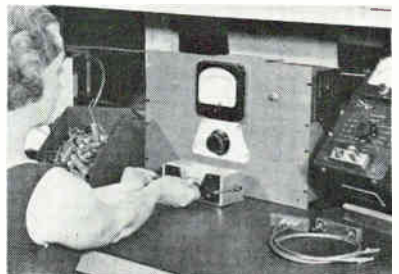

Bench setup includes capacitance meter at right

Capacitance in mmfd Standard Values in			Color Bands			Max. Body Length
20%	10%	5%	1st	2nd	3rd	
.10	.10		Brown	Black	Gray	.400
.12	.12		Brown	Red	Gray	.400
.15	.15		Brown	Green	Gray	.350
.18	.18		Brown	Gray	Gray	.281
.22	.22	.20	Red	Black	Gray	.281
.22	.22	.22	Red	Red	Gray	.281
.24	.24	.24	Red	Yellow	Gray	.281
.27	.27	.27	Red	Violet	Gray	.281
.30	.30	.30	Orange	Black	Gray	.281
.33	.33	.33	Orange	Orange	Gray	.281
.36	.36	.36	Orange	Blue	Gray	.281
.39	.39	.39	Orange	White	Gray	.281
.43	.43	.43	Yellow	Orange	Gray	.281
.47	.47	.47	Yellow	Violet	Gray	.281
.51	.51	.51	Green	Brown	Gray	.281
.56	.56	.56	Green	Blue	Gray	.281
.62	.62	.62	Blue	Red	Gray	.281
.68	.68	.68	Blue	Gray	Gray	.281
.75	.75	.75	Violet	Green	Gray	.281
.82	.82	.82	Gray	Red	Gray	.281
.91	.91	.91	White	Brown	Gray	.281
1.0	1.0	1.0	Brown	Black	White	.281
		1.1	Brown	Brown	White	.281
		1.2	Brown	Red	White	.281
		1.3	Brown	Orange	White	.281

Capacitance in mmfd Standard Values in			Color Bands			Max. Body Length
20%	10%	5%	1st	2nd	3rd	
1.5	1.5	1.5	Brown	Green	White	.281
		1.6	Brown	Blue	White	.281
		1.8	Brown	Gray	White	.281
		2.0	Red	Black	White	.281
2.2	2.2	2.2	Red	Red	White	.230
		2.4	Red	Yellow	White	.230
		2.7	Red	Violet	White	.230
		3.0	Orange	Black	White	.230
3.3	3.3	3.3	Orange	Orange	White	.230
		3.6	Orange	Blue	White	.230
		3.9	Orange	White	White	.230
		4.3	Yellow	Orange	White	.230
4.7	4.7	4.7	Yellow	Violet	White	.230
		5.1	Green	Brown	White	.230
		5.6	Green	Blue	White	.230
		6.2	Blue	Red	White	.230
6.8	6.8	6.8	Blue	Gray	White	.230
		7.5	Violet	Green	White	.230
		8.2	Gray	Red	White	.230
		9.1	White	Brown	White	.230
10.	10.	10.	Brown	Black	Black	.230
		12.	Brown	Red	Black	.230
15.	15.	15.	Brown	Green	Black	.230
		18.	Brown	Gray	Black	.230

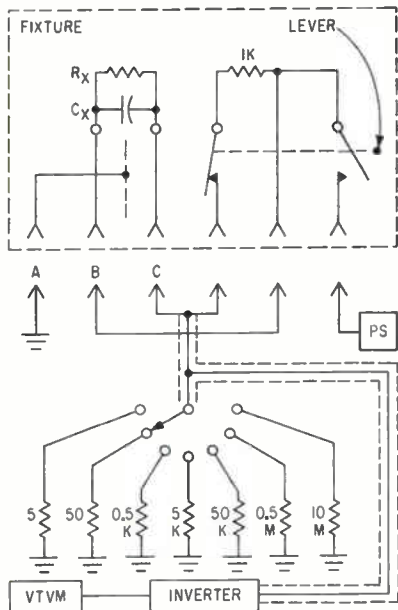

FIG. 1—Megohm measuring range is determined by resistor selected

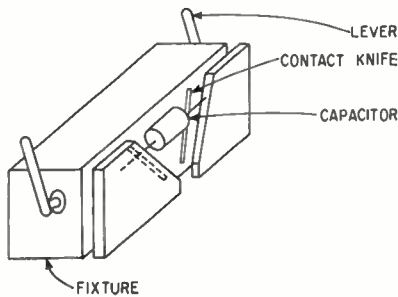
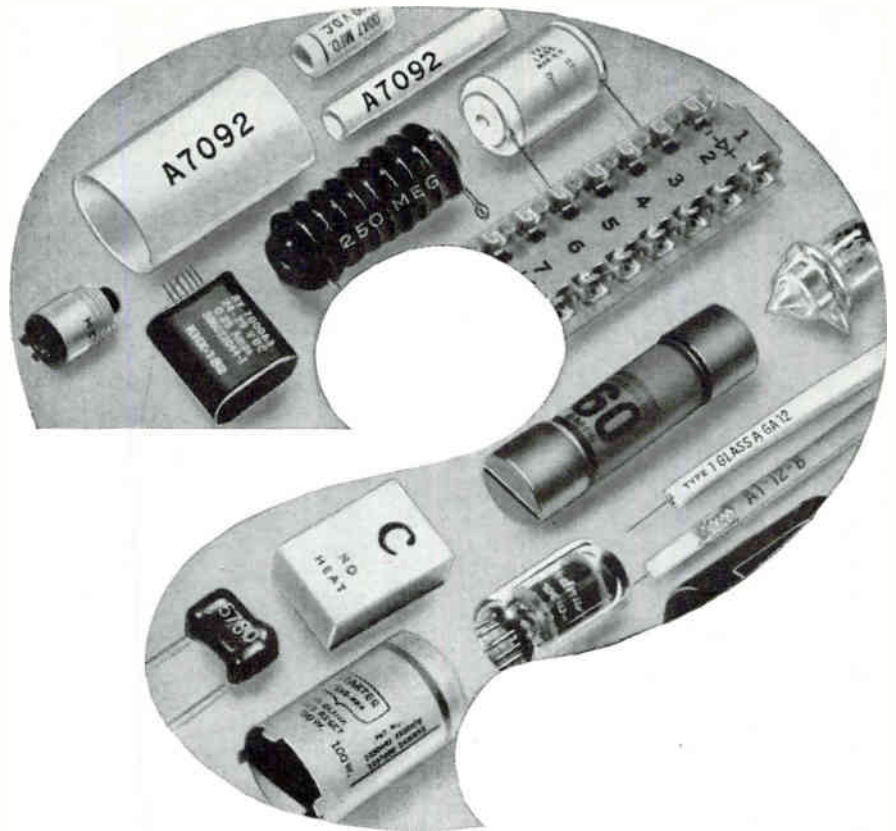

FIG. 2—Fixture is plugged into test set

instead of volts from left to right. The range of the scale is 1 to 10 megohms. Through the selector switch, resistances of 0.1 to a million megohms may be made.

The power supply provides 200 v d-c, ± 1 percent. A Ballantine Model 700 inverter with a 1:100 range is placed in front of the vtvm. A 10-megohm resistor rather than a 5-megohm resistor is used in the higher range since the parallel input resistance of the inverter is also 10 megohms.

The test fixture is designed so it can be rapidly loaded and unloaded by hand. The operator holds the capacitor by its body and places the leads as shown in Fig. 2. The hand levers are pulled to close the contacts, placing the capacitor in the measuring circuit. When the levers are in the unlocked position indicated in Fig. 1, the capacitor is discharged through a kilohm resistor. In Fig. 1, A is a guard which prevents leakage current in the jig from flowing between terminals B and C.



practical answers to your marking problems



This 12-page booklet explains how the electrical or electronic product *you* make can be marked — at production speeds — with clear imprints that hold. Are you looking for a way to mark odd shapes — a *practical* short-run marking method — an ink that will hold on an unusual surface, or withstand temperature, handling, moisture or other conditions? This catalog describes machines, printing elements and inks that will meet *your* requirements in the marking of products ranging from subminiature components to panels and chassis. There are special sections with practical answers to color banding, Underwriters' Laboratories manifest label legend marking, tape and label printing, wire and tube marking, efficient "in-line" marking. For your copy of the Markem Electrical Catalog, write Markem Machine Co., Electrical Division, Keene 5, New Hampshire.

MARKEM

EVERYTHING INDUSTRY NEEDS . . . FOR PROFITABLE MARKING . . . SINCE 1911

New On The Market

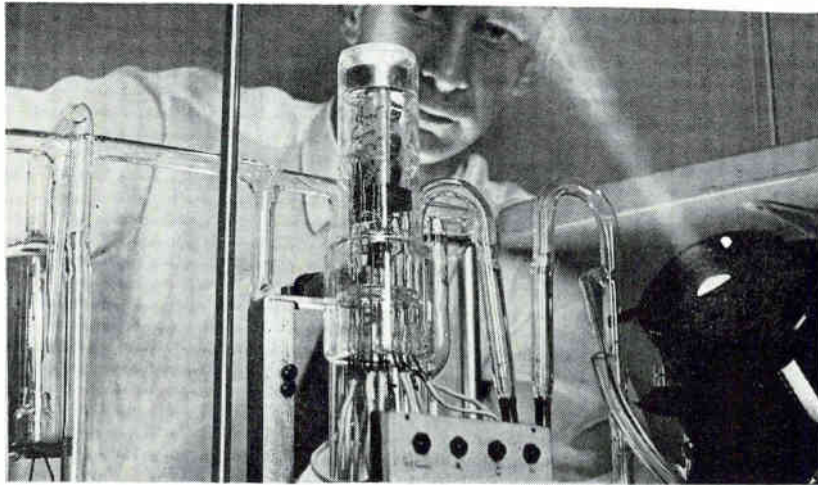

Laboratory Tool

MEASURES ULTRA-LOW PRESSURES

A LABORATORY TOOL for measurement of pressures less than one-thousandth of one-billionth of atmospheric pressure at the earth's surface has been announced by Westinghouse research laboratories, Pittsburgh, Pa. The device, known as a photomultiplier ion gage, was developed for the U. S. Atomic Energy Commission's Project Sherwood, a long-range research program aimed at controlled nuclear fusion.

Conventionally, the instruments which measure extremely low pressures do so by placing electrical charges upon the gas particles remaining in a vacuum system and counting the rate at which these charged particles, or ions, form. Usually, these charges come from electrons that are boiled off the surface of a hot tungsten filament located inside the vacuum system and in contact with the gas being measured.

However, gas interactions with the hot filament surface contaminate the gas and upset such experiments.

The new pressure-measuring device does away with the heated filament. To produce the required ionization of the gas, it uses a beam of ultraviolet light. The light is beamed onto a metal surface which releases electrons under ultraviolet. These electrons are guided onto a series of similar surfaces (photomultiplier) which multiply the electrons in speed and number. These electrons then are used to form the ions that are collected and counted in the usual fashion.

The photomultiplier ion gage will be useful in key ultrahigh vacuum research experiments, being ideally suited to low-pressure studies of hot filament-gas interactions such as those encountered in ordinary fluorescent lamps, in electronic tubes and in thermionic energy converters. The gage is linear with pressure over the range from one-thousandth (10^{-3}) to one-tenth of one-billionth (10^{-10}) millimeter of mercury, equivalent to distances between 50 and 650 miles above the surface of the earth.

CIRCLE 301 ON READER SERVICE CARD

Airborne Oscillator

ELIMINATES SEPARATE AMPLIFIER

A NEW APPROACH to the transmission of research data from an aircraft or missile (or any other remote location) to the control point is represented by an airborne voltage-controlled oscillator, Model

AOV-10, which has been introduced by Data-Control Systems, Inc., 39 Rose St., Danbury, Conn. Low level output of strain gages, thermocouples, or other low level transducers is directly converted to a

frequency-modulated subcarrier signal (standard approach is to amplify the signal derived from the strain gages or thermocouples, then use it to modulate the carrier frequency). A true floating input is provided, which makes it possible to use a common bridge supply for many strain gage channels, eliminating the effects of potential differences that may exist in an airframe. The AOV-10 can be used with a low level mechanical commutator. It is a rugged transistorized unit (silicon transistors) which can be used at ambient temperatures up to 100 deg C.

Circuits in the AOV-10 include a multivibrator controlled by a square-loop core, and a feedback amplifier-modulator.

Performance specifications: For modulation index of 5 or greater, the intelligence frequency response is within 0.2 db of the d-c response, and is down less than 1 db at a modulation index of 1. Input voltage is plus or minus 10 millivolts for full deviation. Common mode rejection is 100 db at d-c and 94 db at 400 cps. Grounding one side of open input produces a frequency change of less than 2 percent of full bandwidth. Linearity is plus or minus 0.25 maximum deviation from best straight line. Continuous operation may be obtained in ambient temperatures up to 100 deg C. Power requirements are plus 18 or plus 28 volts d-c plus or minus 10 percent for stated specifications at 25 ma.

The unit measures 1.87 x 1.44 x 1.63 inches high, and weighs 5.5 ounces.

CIRCLE 302 ON READER SERVICE CARD

Ka-Band Mixer Diodes

FOR HIGH ALTITUDE

A MATCHED PAIR of high altitude silicon microwave mixer diodes designed for ultrasonic aircraft and



missile applications is available from Sylvania Electric Products,



64-IN-1 ELECTROMETER

You can measure dc voltage, current, and resistance over 64 ranges with the Keithley 610A Electrometer. Some examples of its extreme versatility are voltage measurements of piezo-electric crystals and charged capacitors; currents in ion chambers, photocells, and semi-conductors; and resistance measurements of insulation.

The input resistance of the 610A can be selected from one ohm to over 10^{14} ohms; it checks its own resistance standards and is a stable dc preamplifier. Brief specifications are:

- **9 voltage ranges** from 0.01 to 100 v full scale, 2% accuracy all ranges.
- **current ranges** from 3 amperes to 1×10^{-13} ampere full scale with 2 ranges per decade.
- **resistance ranges** from 10 ohms to 10^{14} ohms full scale on linear scales.
- **gains to 1000** as a preamplifier, dc to 500 cps bandwidth, 10 volts and one milliamper outputs.
- **accessory probes** and test shield facilitate measurements and extend upper voltage range to 30 kv.
- **price**, \$480.00.

Write for complete details



**KEITHLEY
INSTRUMENTS**

12415 EUCLID AVENUE
CLEVELAND 6, OHIO

CIRCLE 204 ON READER SERVICE CARD
November 11, 1960

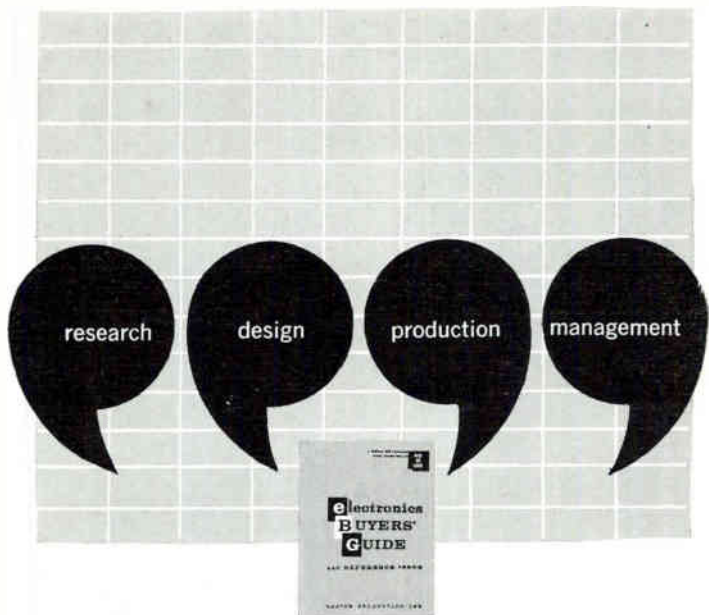

FIRST CHOICE OF ALL 4!

Because it is organized and edited to serve all four segments of the industry. It contains *more advertisers* than any other industry guide... gives more information. No wonder it is the accepted buying book of the industry.

gives more to all 4!

**electronics BUYERS' GUIDE
and REFERENCE ISSUE**

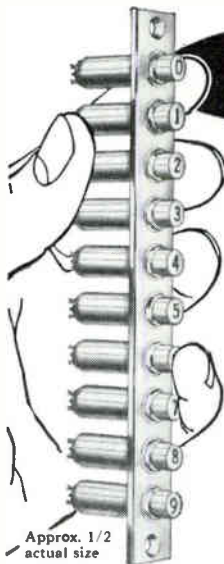

Approx. 1/2 actual size

DATA STRIP No. DSV-7538-10
Vertical... complete with ten No. 39-28-1475 Lamp Cartridges. Other configurations to order.

Shown actual size, left to right: Lamp Cartridges—Nos. 39-6-1471, 38-1531, 38-931... Lampholder No. 7538... Datalite No. 249-7841-931 with built-in Neon Lamp and resistor.*

Most Adaptable and Effective
For **COMPUTERS, DATA PROCESSING,
AUTOMATION, INSTRUMENTATION**
and MINIATURIZATION

DATALITES®

FOR USE AS SINGLE INDICATOR LIGHTS, OR GROUPED AS A
DATA STRIP® OR **DATA MATRIX®**

DATALITES by DIALCO are ultra-miniature Indicator Lights, made in 2 basic styles: *Lampholders* with DIALCO's own *replaceable Lamp Cartridges*; or integrated DATALITES with *Built-in Neon Lamps**... Mount in $\frac{3}{8}$ " clearance hole... LAMPS USED: T-1 $\frac{3}{4}$ Incandescent; also Neon NE-2E or NE-2H.

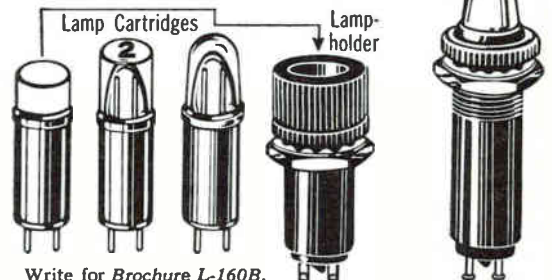

Write for Brochure L-160B.

DIALCO®

PILOT LIGHTS
"The Eyes of
Your Equipment"



Foremost Manufacturer of Pilot Lights

**DIALIGHT
CORPORATION**

58 Stewart Avenue, Brooklyn 37, N. Y. • HYacinth 7-7600

CIRCLE 107 ON READER SERVICE CARD 107

Inc., a subsidiary of General Telephone & Electronics Corp., Woburn, Mass.

These hermetically sealed diodes (Type 1N53D and its reversed polarity version 1N53RD) are Ka-band (34,000 Mc) units with maximum operating temperature of 150 C, overall noise figure of 9 db, and an amplifier noise figure of 1.5 db. Both feature vswr maximum (to a

65 ohm holder) of 1.5 at 34,860 Mc, and 2.5 maximum at ± 6 percent. Use of the matched pair is said to eliminate local oscillator noise.

In quantities of 1-99, Type 1N53D is priced at \$75, Type 1N53RD at \$110. Sample and production quantities are available.

CIRCLE 303 ON READER SERVICE CARD

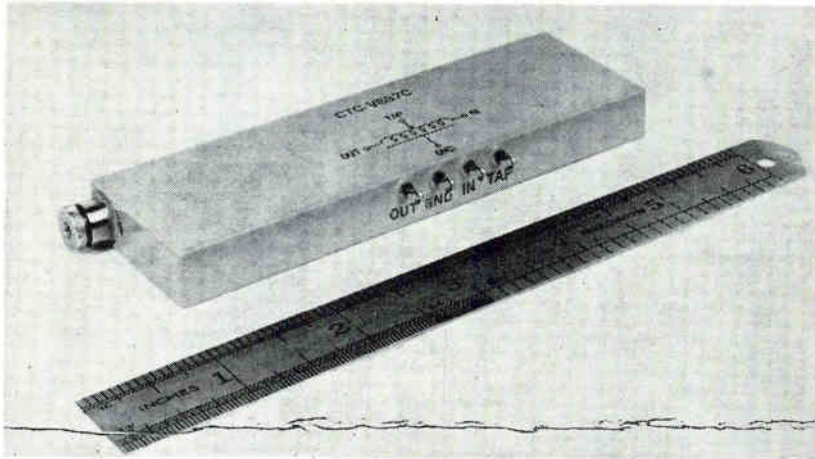

Miniaturized Delay Line

FOR PRINTED CIRCUITS

A MINIATURIZED compact delay line with a special locking device for printed circuit applications has been developed by Columbia Technical Corporation, 24-30 Brooklyn-Queens Expressway West, Woodside 77, N. Y. The unit is continuously variable from 0 to 0.5 microsecond.

Designated type V887, the delay line is hermetically sealed, and has

a specially designed locking device that prevents delay changes under vibration without affecting the initially set delay.

It has a characteristic impedance of 1,000 ohms. Rise time is 0.08 microsecond, attenuation 0.3 db, resolution of 0.001, and a temperature coefficient of better than 150 ppm.

CIRCLE 304 ON READER SERVICE CARD

Frequency-Shift Converter

TELEPRINTER SERVICE

A FREQUENCY-SHIFT converter introduced by the Western Division of Collins Radio Company, Burbank, Calif., makes possible teletype service from radio-equipped aircraft, ships, submarines, trains, motor vehicles or fixed stations.

The unit (designated the 700B-1) provides a single channel of half-duplex teletype communications at speeds up to 100 words-per-minute via any single sideband or a-m radio circuit. The converter can be used in airborne data systems for transmitting digital information at up to 75 bits-per-second.

For airborne applications, the



converter accommodates a doppler shift for speeds up to 600 knots. In fixed station operation, the teletypewriter can be located up to one mile from the converter.

The all-solid-state 700B-1 is a

commercial version of a unit now in production for a military jeep-transportable communications system. Features include electronic keyer and built-in loop-current power supply.

CIRCLE 305 ON READER SERVICE CARD

Magnetic Tape Cleaner

AUTOMATIC TYPE

AN AUTOMATIC TYPE cleaner of magnetic recording tape has been introduced by Computer-Measurements Company, 12970 Bradley Ave., Sylmar, California. Operation is completely automatic. Once the tape is in place and the solvent tank filled, the cleaner completes all operations. Dirt, lint, oil, fingerprints and wax are removed without disturbing information on the tape. Cleaners are available for $\frac{3}{4}$ inch, 1 in. and 2 in. tape.

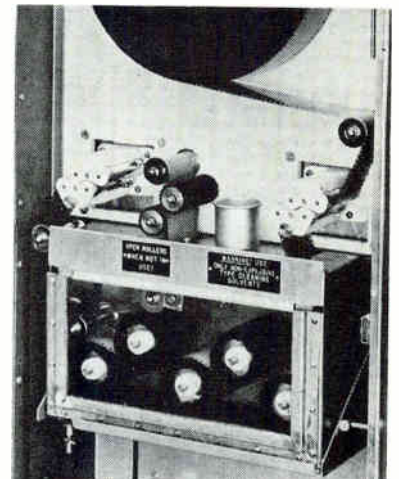

Speed is adjustable from 0-300 feet per minute, with automatic shut-off that leaves the machine threaded with leader for continuous operation. The unit uses non-inflammable, non-explosive solvents.

Model T-7070 for 2 in. tape is priced at \$6,575.

CIRCLE 306 ON READER SERVICE CARD

Pulse-Control Relay

FOR CLOSE-PULSE WORK

A NEW ratchet relay provides the designer of pulse-operated control circuits with a device for counting, absorbing, or controlling the pulses

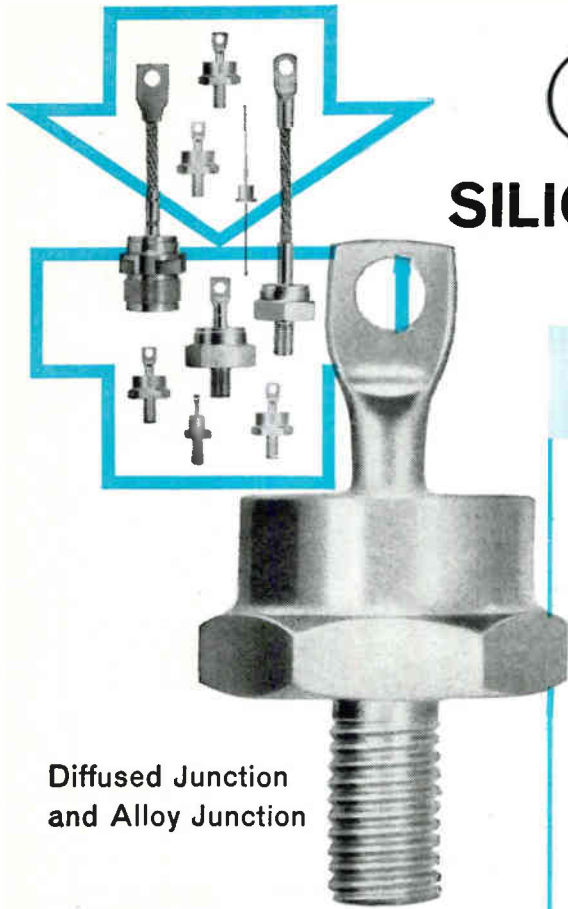

Diffused Junction
and Alloy Junction



TUNG-SOL®

SILICON POWER RECTIFIERS

250 ma to 100 amps

This select line fits the broadest variety of applications. Each unit delivers cross-the-board versatility and directly replaces many existing types.

Tung-Sol silicon rectifiers were designed to serve with unqualified dependability in the most exacting military and commercial applications. They're precision engineered to assure the utmost in top-performance uniformity and stability . . . and to function at maximum capacity even under the most severe environmental and electrical overload conditions. Write for the new Tung-Sol silicon rectifier interchangeability chart and complete technical information. Tung-Sol Electric Inc., Newark 4, New Jersey.

Standard JEDEC configurations and with Tung-Sol's unsurpassed Standard and reliability.

	Type	Peak Reverse Voltage (Volts)	Average Forward Current	Maximum Reverse Current *	Max. Full Load Voltage Drop (Volts)	Surge Current† (Amps)
250-mA 150°C Ambient Temperature	1N538	200	750 mAdc @ 50°C	250 µAdc	0.5	
	1N540	400	250 mAdc @ 150°C	250 µAdc	0.5	
	1N547	600	750 mAdc @ 50°C 250 mAdc @ 150°C	250 µAdc	0.5	
1 Amp 150°C Case Temperature	1N253	100	1.0 Adc	100 µAdc	—	
	1N254	200	0.4 Adc	100 µAdc	—	
	1N255	400	0.4 Adc	150 µAdc	1.0 ▲	
	1N256	600	0.2 Adc	250 µAdc	—	
20 Amp 140°C Case Temperature	1N1191	50	20 Adc	5 mAdc	.55	Full cycle avg. 150°C case temp.
	1N1192	100	20 Adc	5 mAdc	.55	
	1N1193	150	20 Adc	5 mAdc	.55	
	1N1194	200	20 Adc	5 mAdc	.55	
	1N1195	300	20 Adc	5 mAdc	.55	
	1N1196	400	20 Adc	5 mAdc	.55	
	1N1197	500	20 Adc	5 mAdc	.55	
1N1198	600	20 Adc	5 mAdc	.55		
25 Amp 150°C Case Temperature	CS-120Z	50	25 Adc	5 mAdc	.55	Full cycle avg. @ 150°C case temp.
	CS-120A	100	25 Adc	5 mAdc	.55	
	CS-120B	200	25 Adc	5 mAdc	.55	
	CS-120C	300	25 Adc	5 mAdc	.55	
	CS-120D	400	25 Adc	5 mAdc	.55	
	CS-120E	500	25 Adc	5 mAdc	.55	
CS-120F	600	25 Adc	5 mAdc	.55		
35 Amp 140°C Case Temperature	1N1183	50	35 Adc	10 mAdc	0.6	full cycle avg. 140°C case temp.
	1N1184	100	35 Adc	10 mAdc	0.6	
	1N1185	150	35 Adc	10 mAdc	0.6	
	1N1186	200	35 Adc	10 mAdc	0.6	
	1N1187	300	35 Adc	10 mAdc	0.6	
	1N1188	400	35 Adc	10 mAdc	0.6	
	1N1189	500	35 Adc	10 mAdc	0.6	
	1N1190	600	35 Adc	10 mAdc	0.6	

	Type	Peak Reverse Voltage (Volts)	Average Forward Current	Maximum Reverse Current*	Fwd. Voltage Drop** (Volts)	Surge Current† (Amps)
50 Amp 150°C Case Temperature	CH116Z	50	50 Adc	20 mAdc	1.1	500
	CH116A	100	50 Adc	20 mAdc	1.1	500
	CH116B	200	50 Adc	20 mAdc	1.1	500
	CH116D	400	50 Adc	20 mAdc	1.1	500
	CH116E	500	50 Adc	20 mAdc	1.1	500
	CH116F	600	50 Adc	20 mAdc	1.1	500
70 Amp 150°C Case Temperature	1N1396	50	70 Adc	15 mAdc	1.3	1500
	1N1397	100	70 Adc	15 mAdc	1.3	1500
	1N1398	150	70 Adc	15 mAdc	1.3	1500
	1N1399	200	70 Adc	15 mAdc	1.3	1500
	1N1400	300	70 Adc	15 mAdc	1.3	1500
	1N1401	400	70 Adc	15 mAdc	1.3	1500
	1N1402	500	70 Adc	15 mAdc	1.3	1500
70 Amp 150°C Case Temperature	CH109Z	50	70 Adc	30 mAdc	1.3	1500
	CH109A	100	70 Adc	30 mAdc	1.3	1500
	CH109B	200	70 Adc	30 mAdc	1.3	1500
	CH109C	300	70 Adc	30 mAdc	1.3	1500
	CH109D	400	70 Adc	30 mAdc	1.3	1500
	CH109E	500	70 Adc	30 mAdc	1.3	1500
80 Amp 150°C Case Temperature	1N1291	50	80 Adc	30 mAdc	1.3	1500
	1N1292	100	80 Adc	30 mAdc	1.3	1500
	1N1293	200	80 Adc	30 mAdc	1.3	1500
	1N1294	400	80 Adc	30 mAdc	1.3	1500

▲ Max. fwd. voltage drop @ 0.5 amp., 25°C case temperature
 * Full cycle average for rectifier operating into inductive or resistive load at rated current and voltage
 ** 50 amp units @ 100 amps D.C. and 25°C;
 70 and 80 amp units @ 150 amps D.C. and 25°C
 † Max. half sine wave peak current for one cycle @ 60 cps
 Storage temperature range for all types . . . -65° to 200°C

Technical assistance is available through the following sales offices: Atlanta, Ga.; Columbus, Ohio; Culver City, Calif.; Dallas, Texas; Denver, Colo.; Detroit, Mich.; Irvington, N. J.; Melrose Park, Ill.; Newark, N. J.; Philadelphia, Pa.; Seattle, Wash. Canada: Toronto, Ont.



TUNG-SOL®

as required. Called Genalex ratchet relay, the unit is made by General Electric Co., Ltd. of England, is available in the U. S. from IMTRA

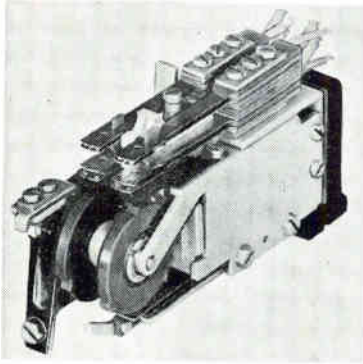

milliamperes at 50 volts depending on the springset loads. Magnet coil power is restricted to 10 watts to avoid overheating.

The relay contains two separate springsets (operated by separate cams), each accommodating up to six contact springs in any combination of makes, breaks, or change-overs. Auxiliary armature springs are fitted to allow the relay to return to its home position by self-interruption or self-cycling. Most service adjustments are possible without removing the relay from its mounting.

CIRCLE 307 ON READER SERVICE CARD

switch, designated 6UO-200 (Milli-Mite), is designed with only one moving part, a precision-ground steel ball held against a solid base by a uniform magnetic field. When the opposing force of acceleration exceeds the magnetic force, the ball moves to close a normally open electrical contact. The switch automatically resets itself when acceleration is removed. Response time is 0.015 sec; electrical rating is 2



Corp., 11 University Rd., Cambridge 38, Mass. Designed for application in automatic telephone systems, recording of aircraft instruments, control components in data processing systems, and the like, the relay is about 4¼ in. x 2¼ in. x 1¾ in. and weighs 10½ ounces.

The relay is a cam-and-ratchet type with an operating coil consumption ranging from 150-200

Inertia Switch

ONE MOVING PART

A MINIATURE inertia switch that is accurately preset to respond to acceleration forces up to 250 g within a tolerance of plus or minus 15 percent of setting is now available from Inertia Switch, Inc., 311 West 43 Street, New York 36, N. Y. The

amps at 28 v d-c resistive. Switch is 0.75 in. in length, 0.25 in. in diameter.

*Lockheed
Electronics
offers:*

*Complete
Circuitry
Facilities*

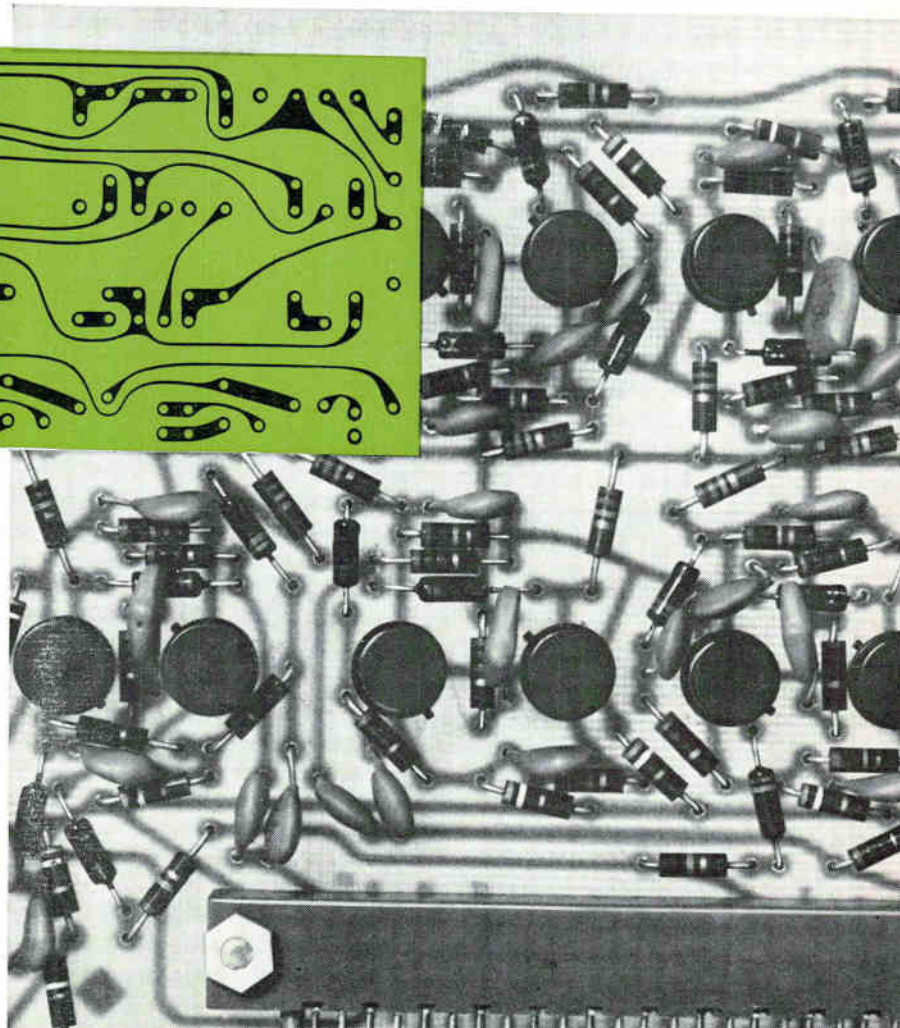
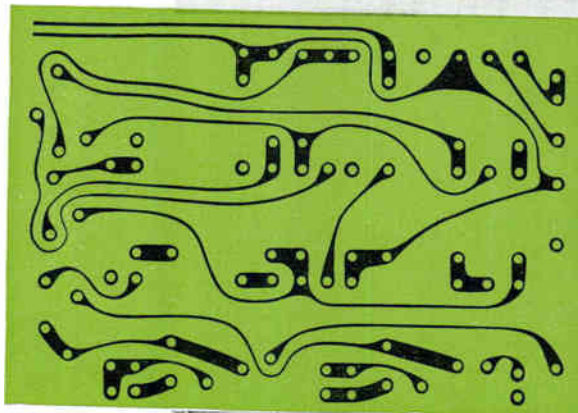

The switch meets all environmental specifications of MIL-E-5272, including an operation range of minus 65 deg F to plus 200 deg F. Miniature switches of this type can be used for control or limiting applications when actuated by acceleration, deceleration, impact and/or shock.

CIRCLE 308 ON READER SERVICE CARD

D-C Blower VANEAXIAL

GLOBE INDUSTRIES, INC., 1784 Stanley Ave., Dayton 4, Ohio. New VAX-3-BD vaneaxial blowers operate from direct current to produce an optimum output of 90 cfm at 1 in. H₂O back pressure. A 28-v d-c maximum current is 1.7 amperes at free air delivery; motor windings may be provided for 4 to 115 v d-c operation. Precision aluminum castings are black anodized and designed to provide adequate environmental protection to meet pertinent MIL specifications. Mounting is made by

clamping to servo flange on either end. Life exceeds 500 hours. Dimensions: 3 in. diameter by 3.4 in. maximum length. Weight: 16 oz.

CIRCLE 309 ON READER SERVICE CARD

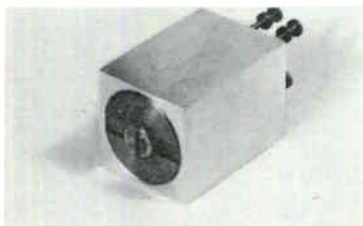

Acceleration Switch SMALL AND LIGHT

EASTERN TECHNICAL ASSOCIATES, INC., Main St., North Acton, Mass. Model AS-4 switch is responsive to acceleration in one direction along a single axis. Resetting is by means of high acceleration in the opposite direction or manual reset. The design is rugged and simple consisting of only one moving unit within the switch housing. The housing is constructed of aluminum and in-

terior construction can be of non-magnetic materials resulting in a completely nonmagnetic component. Accuracy of the switch is under 0.2 g; response time less than 50 milliseconds; range, 0.2 g to 1000+ g. Unit is suited for commercial, industrial and military applications where acceleration sensitive switching is desired.

CIRCLE 310 ON READER SERVICE CARD



Power Supply ULTRA-PRECISION

VIDEO INSTRUMENTS CO., INC., 3002 Pennsylvania Ave., Santa Monica, Calif. Model SR-200EP features 0.01 percent regulation for line volt-



COMPLETE CIRCUITRY FACILITIES from artwork to finished boards... on both inexpensive commercial etched-copper circuitry through the most sophisticated "plated through hole" (mil. spec.) type boards.

ENGINEERING AND DESIGN assistance in the development of printed circuit artwork.

ASSEMBLY OF COMPONENTS of all types — commercial, miniature and sub-miniature, using either hand soldering, automatic flow soldering, or welding techniques.

MAXIMUM QUALITY CONTROL is maintained in every phase of operation with individual inspectors specializing in artwork, photography, plating and etching, fabrication and assembly.

For further information regarding your printed circuitry requirements write Marketing Department, Lockheed Electronics Company, Avionics and Industrial Products Division, 6201 E. Randolph Street, Los Angeles, California.

LOCKHEED ELECTRONICS
COMPANY



CIRCLE 111 ON READER SERVICE CARD

This is not an offer of these securities for sale. The offer is made only by the Prospectus.

NEW ISSUE

772,000 Shares

Electro-Science Investors, Inc.

(A Federal Licensee Under the Small Business Investment Act of 1958)

Common Stock

(Par Value \$1)

Price \$11 per Share

Copies of the Prospectus may be obtained in any State in which this announcement is circulated from only such of the underwriters, including the undersigned, as may lawfully offer these securities in such State.

Kidder, Peabody & Co.

Rauscher, Pierce & Co., Inc.

Lee Higginson Corporation

Paine, Webber, Jackson & Curtis

Bache & Co. Francis I. duPont & Co.

Equitable Securities Corporation

Goodbody & Co.

Shearson, Hammill & Co.

Walston & Co., Inc.

J. A. Hogle & Co.

Parker, Ford and Company, Inc.

Peters, Writer & Christensen, Inc.

Warner, Jennings, Mandel & Longstreth

October 27, 1960.

CIRCLE 233 ON READER SERVICE CARD

any size panels

engraved in your own plant

- Engrave 1-inch nameplates or 6-foot panels by unskilled labor.
- Spindle covers 18¼" x 6" in one set-up — more than any other machine of its kind.
- Bench type model I-R — \$685.

Send for complete catalog ZR-4, illustrating other models from \$325 up

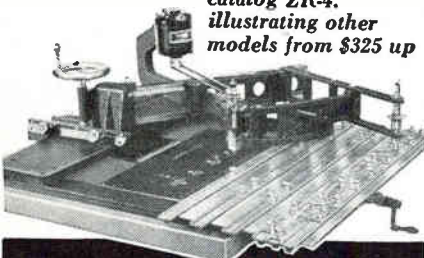

new hermes

ENGRAVING MACHINE CORP.

154 WEST 14TH STREET NEW YORK 11, N. Y.

IN CANADA: 359 St. James Street West, Montreal, P. Q.



WHO DROPPED THE BINOCULARS?

With everybody watching each other along the DEW line and the Iron Curtain these days, electronics has replaced binoculars.

What's happening in the giant markets for missile controls, radar and communications equipment?

electronics tells how things are going, keeps you informed of developments as they occur. This is a good time to subscribe or renew your subscription. Just fill in box on Reader Service Card. Easy to use. Postage free.

FIND WHAT YOU NEED IN... electronics

age fluctuations from 95 to 135 v, and 0.01 percent regulation for load changes from no-load to full-load. The d-c output voltage is variable from 0 to 15 v. Maximum output current is 200 ma. Special consideration has been given to isolation from the power line in order to obtain minimum noise from possible ground loops. The effect of this isolation is that the noise measured with a grounded 350 ohm bridge is only 1 μ v, peak to peak. Six of these units mount side by side in a 19-in. rack module, requiring 3½ in. of panel height. Also available in the same configuration is model SR-200EHP, with an adjustable voltage range from 0 to 24 v.

CIRCLE 316 ON READER SERVICE CARD

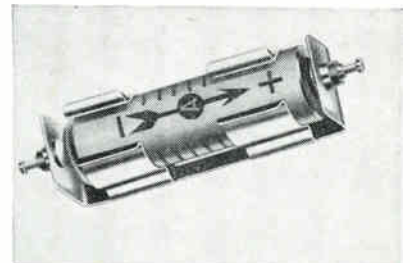

Battery Holder

COMPACT DEVICE

AUGAT BROS., INC., 33 Perry Ave., Attleboro, Mass. New battery holder, designed for use with Eveready E91, Mallory RM-502, and Burgess CD-6 size batteries, fills the need for a compact, dependable holder in portable equipment. Made of either cadmium plated steel, or beryllium copper, the holder features silver plated contacts pressed into nylon insulators. With both contacts insulated, the battery is completely insulated from the holder and chassis.

CIRCLE 317 ON READER SERVICE CARD

Vibration Calibrator

BATTERY-OPERATED

GENERAL RADIO CO., West Concord, Mass. Type 1557-A vibration calibrator is a small compact instrument for the calibration of a variety of accelerometers, from the small 3-4 gram high-frequency type to linear, limited-response, 300-gram models. It is also possible to obtain 1 g at 100 cps with this calibrator, via a pair of pill-boxed-shaped 50-

gram disks, that are at opposite sides of the instrument. Both velocity and displacement-type pickups can be calibrated, as well as the acceleration types. Mercury cells, with 100-hr life, are used.

CIRCLE 318 ON READER SERVICE CARD

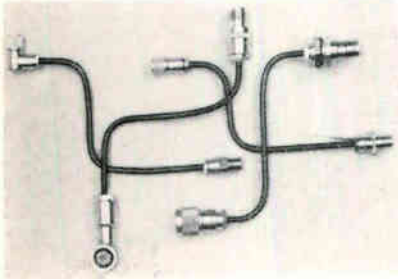

Coax Connectors POSITIVE CLAMPING

GENERAL RF FITTINGS, INC., 702 Beacon St., Boston 15, Mass., announces a new series of TNC Coaxitube (semi-rigid) connectors. They feature Collett clamp construction—an extremely reliable method of positive cable clamping so cables cannot turn or pull out. The connectors are also available in TM series—miniaturized versions of TNC—for use where size and weight are critical considerations. Weatherproof, the metal parts of all Coaxitube connectors are silver plated; contacts have gold plate over silver plate. All are immediately available from stock. Specifications include impedance matched, 50 ohms; operating temperatures — 65 F to + 260 F; voltage: 1500 v rms, 60 cycles (TNC), and 500 v rms, 60 cycles (TM).

CIRCLE 319 ON READER SERVICE CARD

Scatter Antenna MEETS MIL SPECS

ANTENNA SYSTEMS, INC., Hingham Industrial Center, Hingham, Mass., has designed a new 60-ft scatter antenna which features low cost. It is fabricated out of galvanized steel to minimize maintenance and the overall design stresses maximum interchangeability and standardization of the various members. It is easy to erect, is an all-bolted construction, and meets the necessary military specifications. A complete line of r-f components is available for the antenna.

CIRCLE 320 ON READER SERVICE CARD

MICO *Precision Apparatus*

NEW HEAVY DUTY 2 & 3 DIMENSIONAL ENGRAVER

FOR Engraving Nameplates Fine Routing Work Profiling Small Objects Making Small Dies and Molds



UHF COAXIAL WAVEMENERS



2-75 Centimeter Range

Send for Illustrated Catalogs
MICO INSTRUMENT CO.
77 Trowbridge St. Cambridge 38, Mass.
CIRCLE 205 ON READER SERVICE CARD

For HIGHEST ELECTRICAL & MECHANICAL EFFICIENCY! *New* **JONES** SERIES 2400 **PLUGS & SOCKETS**

● Improved Socket Contacts—4 individual flexing surfaces. Positive contact over practically their entire length.

● Cadmium plated Plug and Socket, Contacts mounted in recessed pockets, greatly increasing leakage distance. **INCREASING VOLTAGE RATING**

● Interchangeable with 400 Series



P-2406-CCT



S-2406-SB

Send for complete Catalog No. 22, Plugs, Sockets, Terminal Strips.

Jones HOWARD B. JONES DIVISION
CINCPAC MANUFACTURING COMPANY
CHICAGO 24, ILLINOIS
DIVISION OF UNITED-CARR FASTENER CORP.

CIRCLE 207 ON READER SERVICE CARD

OPPORTUNITIES IN ASTRO ★ NAUTICS

Bendix Systems Division, prime contractor for major satellite communications programs including ADVENT for the Signal Corps and STEER for the Air Force, and major missile weapons systems such as the Navy's EAGLE, offers career opportunities in:

COMMUNICATIONS

Development Engineers, 3-10 years' experience, for systems design operational analysis theoretical analysis microwave antenna design microwave circuit design mechanical design satellite packaging propagation

Also, Project Engineers, 3-10 years' communication experience, for satellite, ground, anti-jam, and antenna subsystems.

MISSILE DEVELOPMENT

Engineers, 5-15 years' missile experience (preferably air-to-air) as Project Engineers in systems engineering carrier a/c installation guidance systems analysis airborne intercept radar solid rocket propulsion airframe design warheads weight control guidance equipment cockpit displays operational analysis flight test

DATA PROCESSING AND DISPLAY

Engineers, with 5-8 years' experience for senior programmers systems analysis computer design human factors digital package design display circuit design

Also, Project Engineers for data processing and display subsystems.

DESIGN DRAFTSMAN

6-10 years' experience in airborne electronics electronic packaging



Write: Personnel Manager
Dept. B11-7

BENDIX SYSTEMS DIVISION

Ann Arbor, Michigan

CIRCLE 378 ON READER SERVICE CARD

**IN LESS THAN
4 SECONDS**

FROM THIS

TO THIS

OR THIS

WITH THE REVOLUTIONARY
PRODUCTION AID TOOL!

"PIG-TAILOR"®



Foot operated
No accessories
3 minute set up

\$125.00

"PIG-TAILORING"

a revolutionary new mechanical process for higher production at lower costs. Fastest PREPARATION and ASSEMBLY of Resistors, Capacitors, Diodes and all other axial lead components for TERMINAL BOARDS, PRINTED CIRCUITS and MINIATURIZED ASSEMBLIES.

PIG-TAILORING eliminates: • Diagonal cutters • Long nose pliers • Operator judgment • 90% operator training time • Broken components • Broken leads • Short circuits from clippings • 65% chassis handling • Excessive lead tautness • Haphazard assembly methods.

PIG-TAILORING provides: • Uniform component position • Uniform marking exposure • Miniaturization spacing control • ".5" leads for terminals • "U" leads for printed circuits • Individual cut and bend lengths • Better time/rate analysis • Closer cost control • Invaluable labor saving • Immediate cost recovery.

Pays for itself in 2 weeks

"SPIN-PIN"®

Close-up views of "SPIN-PIN" illustrate fast assembly of tailored-lead wire to terminal.

- No Training
- No Pliers
- No Clippings
- Uniform Crimps
- 22 Sizes

**PAYS FOR ITSELF
THE FIRST DAY!**

\$500
EACH

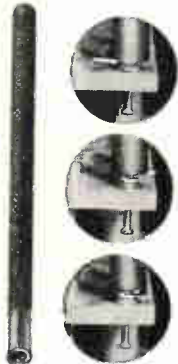

Write for illustrated book to Dept. E-12



BRUNO-NEW YORK INDUSTRIES CORP.

DESIGNERS & MANUFACTURERS OF ELECTRONIC EQUIPMENT

460 WEST 34th STREET • NEW YORK 1, N. Y.

Colorado
...CENSUS-
PROVEN
OUTSTANDING
NEW
INDUSTRIAL
MARKET



Census-proven one of the fastest growing states in the nation ...survey-proven one of the outstanding new industrial markets, Colorado offers new industry Profits with Pleasant Living.



Discover the new markets and opportunities awaiting your company in Colorado. "Site-See" Industrial Colorado now...right at your desk.

**Send for Free Executive Portfolio
"INDUSTRIAL COLORADO"**

Newly revised 9-booklet portfolio with up-to-the-minute data on Colorado's industrial sites, assets, opportunities and weekend vacation wonderlands. All inquiries held confidential.

COLORADO DEPT. OF DEVELOPMENT
20 STATE CAPITOL • DENVER 2, COLO

CIRCLE 208 ON READER SERVICE CARD



FOREMOST

in

SONAR

EDO CORPORATION

College Point, L.I., N.Y.

Since 1925

CIRCLE 209 ON READER SERVICE CARD



Mixer-Preamplifier
LOW NOISE

LEL, INC., Akron St., Copiague, N. Y. This latest addition to the series of matched microwave-mixer-amplifier units further extends the range of the company's microwave receiver front ends to include coverage of the 34,000 to 36,000 Mc band. The MMK-2 combines a K_u band waveguide mixer with a matched preamplifier and provides an overall gain of 25 db, an i-f bandwidth of 8 Mc and a noise figure of 10 db maximum.

CIRCLE 333 ON READER SERVICE CARD



Subcarrier Oscillator
FOR F-M TELEMETERING

DORSETT ELECTRONICS LABORATORIES INC., 119 West Boyd, Norman, Okla. Excellent data stability for f-m telemetering applications ranging from -55 C to +125 C is possible with the model 0-20 voltage controlled subcarrier oscillator. Utilizing silicon semiconductors, it is packaged in a die cast aluminum configuration that features a unique captive screw hold down and removal device. The package measures 2.25 in. high by 1.875 in. wide by 0.875 in. deep. The 0-20 is designed to meet a wide range of missile, satellite, aircraft, land line and industrial applications. Adjustment controls for centering, deviation sensitivity, and output, are utilized, with accessibility provided at the top of the unit. Model 0-20 is available in all standard

IRIG channels with inputs of either 0 to 5 v, or $-2\frac{1}{2}$ v to $+2\frac{1}{2}$ v. Priced at less than \$300 in quantity, normal delivery is 30 to 60 days.

CIRCLE 334 ON READER SERVICE CARD

Vibration Exciter HIGH FORCE OUTPUT

VIBRASONICS INC., 10 High St., Boston, Mass. The VS-10 vibration exciter has been used extensively for the production vibration testing of vacuum tubes and other small components. Unit is supplied with a permanent magnet which makes it convenient for portable use, or can be supplied with an electro-magnet on special order where precision of repeatability is desired. The unique spider suspension virtually eliminates all motions other than the axis of excitation. The armature eliminates multiple resonances and supplies virtually a point source of vibration. A specially designed h-f accelerometer can be built into the vibration platform on special order which, when used with a feedback controlling system, will give a constant (± 1 db) frequency response from 20 cps in excess of 20,000 cps.

CIRCLE 335 ON READER SERVICE CARD

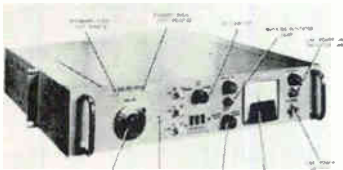

Frequency Standard TRANSISTORIZED

MANSON LABORATORIES, INC., 375 Fairfield Ave., Stamford, Conn., has introduced a transistorized, low-cost frequency standard, model RD-180, which provides highly stable output frequencies of 5 Mc, 1 Mc and 100 Kc for use in frequency control systems. The design objective in this new, ultrastable timing device was to construct a precision-engineered unit with uncompromised reliability and performance. It offers a stability of ± 5 parts in 10^{10} per day. Included is an emergency battery source to provide continuous operation with automatic switchover in the event of line failure.

CIRCLE 336 ON READER SERVICE CARD

THERE'S A NORTH ATLANTIC INSTRUMENT TO MEET YOUR REQUIREMENTS, TOO...

Now— from North Atlantic—you get the complete answer to AC ratio instrumentation problems—in the laboratory, on the production line, in the field.

Specialists in ratiometry, North Atlantic offers a complete line of precision instruments to handle any ratio measurement task. All are designed to meet the most demanding requirements of missile age electronics— provide high accuracy, flexibility, component compatibility and service-proven performance. Some are shown above.

If your project demands total solution to ratio measurement problems, write for Data File No. 10V It provides complete specifications and application data and shows how North Atlantic's unparalleled experience in ratiometry can help you.



1. RATIO BOXES

Both laboratory standards and general duty models. Ratio accuracies to 0.0001%. Operation from 25 cps to 10 kc.

2. COMPLEX VOLTAGE RATIOMETERS

Integrated, single-unit system for applications where phase relations are critical. Accuracy to 0.0001%, unaffected by quadrature. Three frequency operation. Direct reading of phase shift in milliradians or degrees.

3. PHASE ANGLE VOLTMETERS

Versatile readout system for all ratiometry applications, providing direct reading of phase, null, quadrature, in-phase and total voltage. Broad-band, single-, or multiple-frequency operation.

4. RATIO TEST SETS

Ratio reference and readout in one convenient package for production line and similar applications. Can be supplied with any desired combination of ratio box and phase angle voltmeter.

NORTH ATLANTIC INDUSTRIES, INC.
TERMINAL DRIVE, PLAINVIEW, L. I., N. Y. • Overbrook 1-8600

Mighty Useful

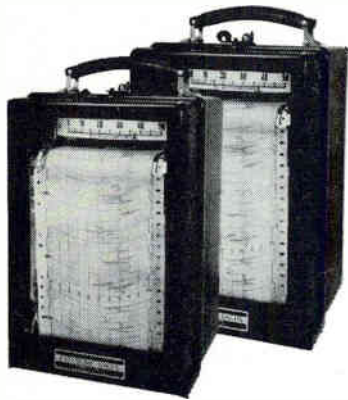

E-A Recording

DC MILLIAMMETERS DC MICROAMMETERS

For a thousand and one uses in every field of research and production of which the following are typical:

- Performance tests**
- Life tests**
- Tracer element studies**
- Photronic measurements**
- Medical electronics**
- Quality control in production**

On some of the above, the recorder is used direct. On others it operates in conjunction with additional equipment.

DC Range	Approximate Input Resistance	Response
0-50 (A) Microamperes	200 ohms	1 sec.
0-1 Milliamperes	1400 ohms	½ sec. (B)

(A) Power required: 120 volts, 60 cycles.
(B) With 50,000 ohms in external circuit.

Here's a versatile team of direct writing instruments that combines extreme sensitivity with simplicity of design and ruggedness of construction for long, trouble-free life. The simple, direct-writing movement eliminates maintenance associated with servo or linkage driven systems.

Like all E-A recording meters, E-A Milliammeters and E-A Microammeters are guaranteed for two years.

Send for Catalog Sections 41 and 42

The ESTERLINE-ANGUS Company

*No. 1 in fine Recording Instruments
for more than 50 years.*

DEPT. E, BOX 596, INDIANAPOLIS 6, INDIANA

Literature of the Week

TUNING FORK OSCILLATOR Industrial Test Equipment Co., 55 E. 11th St., New York 3, N. Y. Description and specifications for the model JF400 tuning fork oscillator are given in a recent bulletin. Unit described consists of an electronically driven tuning fork and output filter.

CIRCLE 321 ON READER SERVICE CARD

MICROWAVE TEST INSTRUMENTS PRD Electronics, Inc., 202 Tillary St., Brooklyn 1, N. Y. Four-page, two-color bulletin 400 categorizes hundreds of PRD products by frequency range, waveguide size, and price.

CIRCLE 322 ON READER SERVICE CARD

VIBRATION TESTING MB Electronics, 781 Whalley Ave., New Haven 8, Conn. A new 16-page brochure describing the complete line of products manufactured by the company to excite, measure and control vibration is now available.

CIRCLE 323 ON READER SERVICE CARD

P-C BOARD Elgin Laboratories, Inc., Waterford, Pa. "Econo-Grid", a stock, paper base epoxy, printed circuit board is discussed in a newly published catalog sheet. Applications, technical description, stock sizes available, and prices are given.

CIRCLE 324 ON READER SERVICE CARD

R-F CHOKES Cinema Engineering, division of Aerovox Corp., 1100 Chestnut St., Burbank, Calif., has released a new data sheet, catalog 22CA, on custom quality encapsulated radio-frequency chokes.

CIRCLE 325 ON READER SERVICE CARD

MASS SPECTROMETER Consolidated Electrodynamics Corp., 360 Sierra Madre Villa, Pasadena, Calif. An eight-page, illustrated bulletin describes in detail the specifications and applications of the type 21-110 mass spectrometer.

CIRCLE 326 ON READER SERVICE CARD

INDUSTRIAL DIGITAL VOLT-METER Non-Linear Systems, Inc., Del Mar, Calif. A two-color, four page bulletin explains how the model 484 industrial digital volt-meter can be used with plug-in ac-

cessories to build low cost, reliable and highly accurate measuring and data logging systems.

CIRCLE 327 ON READER SERVICE CARD

BASIC SWITCH Micro Switch, Freeport, Ill. Data sheet No. 181 contains two pages of information on the type E basic switch which feature a steady state current rating of 25 amperes without sacrificing accurate repeatability and precision performance.

CIRCLE 328 ON READER SERVICE CARD

DELAY LINE COIL FORMS Corning Electronic Components, Bradford, Pa. Delay line coil forms made of low expansion, low loss glass are described in Engineering Reference File CE-7.00. The sheet should be requested under company letterhead.

SINUSOIDAL OSCILLATOR Solid State Electronics Co., 15321 Rayen St., Sepulveda, Calif., has published a bulletin describing the model S-200 silicon transistor sinusoidal oscillator, an epoxy encapsulated unit designed to create a sine wave signal source.

CIRCLE 329 ON READER SERVICE CARD

CAPACITORS Marshall Industries, 430 North Halstead St., Pasadena, Calif., has available two new engineering data sheets giving complete performance characteristics, specifications, illustrations and order information about metallized Mylar capacitors.

CIRCLE 330 ON READER SERVICE CARD

TRIODE OSCILLATOR John Gombos Co., Inc., Webro Road, Clifton, N. J. A technical data sheet illustrates and describes model 151C miniature C-band triode oscillator which covers from 4,200 Mc to 6,000 Mc in 50 Mc steps.

CIRCLE 331 ON READER SERVICE CARD

SPECIAL PURPOSE COMPUTERS Lockheed Electronics Co., U. S. Highway 1, Metuchen, N. J. Advantages of special purpose computers in terms of low initial investment and minimum upkeep are described in a 4-page brochure.

CIRCLE 332 ON READER SERVICE CARD

Lepel

HIGH FREQUENCY INDUCTION

HEATING EQUIPMENT

for Hardening • Annealing • Soldering
Brazing • Zone Refining • Crystal Growing

ELECTRONIC TUBE GENERATORS:

1 kw; 2½ kw; 5 kw; 10 kw;
20 kw; 30 kw; 50 kw;
75 kw; 100 kw.

SPARK GAP CONVERTERS:

2 kw; 4 kw; 7½ kw;
15 kw; 30 kw.

WRITE FOR THE NEW LEPEL
CATALOG 36 illustrated pages
of valuable information.

Lepel HIGH FREQUENCY
LABORATORIES, INC.

55th ST. & 37th AVE., WOODSIDE 77, N. Y.

CIRCLE 210 ON READER SERVICE CARD

ALL DIGITS
CAN BE
READ FROM
ANY ANGLE

IN-LINE DIGITAL READOUT

featuring

ONE-PLANE PRESENTATION

Series 10000

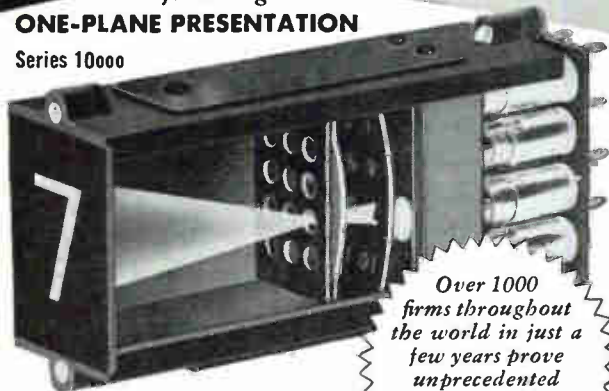

The IEE digital readout puts the digit right up front, visible from any angle. Vision is unimpaired by stacked characters and sharp, clear-white digits provide high-contrast, error-proof reading. Use of words, color, and multiple projections offer utmost versatility.

Binary-To-Decimal Decoders Available.
Representatives in Principal Cities

Over 1000
firms throughout
the world in just a
few years prove
unprecedented
acceptance of
IEE digital
readouts.

PRICE **\$18⁰⁰**
COMPLETE
QUANTITY PRICES ON REQUEST
WRITE TODAY FOR
COMPLETE SPECIFICATIONS.



INDUSTRIAL ELECTRONIC ENGINEERS, INC.
Engineers and Manufacturers of Fully Automatic Systems and Digital Readouts
5528 Vineland Avenue, North Hollywood, California

CIRCLE 211 ON READER SERVICE CARD

November 11, 1960

digital simulation

Realistic Tests .. mean Reliable Results



will simulate any digital code

Solid State PCM Simulator ESS-500 by Telemetry

Realistic preliminary checkout of PCM telemetry ground stations assures reliable results in performance. The Electronic Signal Simulator ESS-500 by Telemetry, Inc. gives this assurance . . . simulates the digital output of an airborne or ground multiplexer and digitizer for both calibration and checkout . . . presents serial input data . . . applicable also in research and development of pulse coded systems.

Versatile Signal Simulator provides for word length selection, master sync code, 0-to-full scale coding, and 11 special data codes . . . through use of plug-in units, can generate binary, binary-coded-decimal, excess three, biquinary, or any other digital code. NRZ and RZ output signals are provided at +20 volts and -10 volts for full scale; with zero volts for zero scale. Completely transistorized unit occupies only 5¼-inch panel space in standard 19-inch relay rack.

Telemetry, Inc.

12927 S. Budlong Avenue, Gardena, California

CIRCLE 119 ON READER SERVICE CARD

119

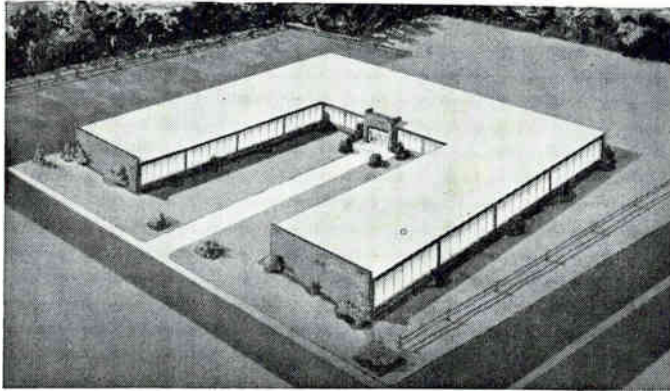

Bomac Erecting New Laboratory

BOMAC LABORATORIES, INC., Beverly, Mass., has under construction a new building to house the research division, which will be under the direction of Wellesley J. Dodds, vice president, engineering.

This new addition, the seventh for Bomac since 1951, will be situated on Route 128, adjacent to the present facilities. It will be a 20,000 sq ft, U-shaped, one story, brick building, and is scheduled for completion late in the fall. With this addition, Bomac's facilities will total over 135,000 sq ft.

Bomac became a subsidiary of Varian Associates of Palo Alto, Calif., in March, 1959. Besides Bomac, Varian's present corporate structure includes Varian of Canada Ltd. in Georgetown, Ontario; S-F-D Laboratories, Union, N. J.; Semicon Associates, Inc. in Lexington, Ky., and Watsonville, Calif.; and Varian A. G. in Zurich and Zug, Switzerland.

Harold C. Booth, Bomac's executive vice president and board member of Varian Associates, says: "Under Varian's policy of broadening and strengthening its product lines and fields of interest by sponsoring research programs, Bomac will also enter into programs of basic research. Research has been the most important factor in putting Varian where it is today, and this addition at Bomac is only part of the overall company research program. Plans were recently approved by Varian's board of directors for 225,000 sq ft of new space

to be constructed in the next year at the Palo Alto facilities. S-F-D Laboratories is also expanding to undertake further research programs."

Edward L. Ginzton, board chairman of Varian, had the following to say on the new Bomac division: "It has always been Varian's policy to carry on an R&D program far more extensive than necessary for immediate manufacturing purposes. The value of this policy has been demonstrated by the company's rapid growth during the 12 years since its founding. We believe that this policy must be applied at each of Varian's affiliated companies. Bomac's location in the Boston electronics community should facilitate rapid expansion in research and development."



Stewart-Warner Corp. Elects Vice President

DONALD A. POTTER, general manager of the electronics division of Stewart-Warner Corp., Chicago, Ill., was

recently elected a vice president. He has been with Stewart-Warner since 1947.

Prior to becoming head of Stewart-Warner Electronics in January, 1959, Potter was an executive of S-W's South Wind division at Indianapolis, Ind.

Raytheon Opens New Canada Plant

RAYTHEON CANADA LTD., Waterloo, Ontario, which started business there in 1956 with three employees and now has 190, has opened a new \$400,000 plant.

John R. Cann, executive vice president and general manager, said the 25-acre site on which the new plant is built provides room for substantial expansion. By 1963 the firm plans to have 270 employees and a \$1 million annual payroll.



Dunbar Will Direct Electronic Research

THE CONVAIR (SAN DIEGO) DIVISION of General Dynamics Corp. recently named A. S. Dunbar chief of electronic research. He formerly was manager of electromagnetics research at Lockheed missile and space division.

EIA Renames Borth Committee Chairman

REAPPOINTMENT of Robert T. Borth, General Electric Co., Washington, as chairman of the Electronic Industries Association's Congressional Information Committee has been announced.

The committee is responsible for



SQUARE-LOOP TAPE CORES TO MEET YOUR TOUGHEST SPECIFICATIONS

Speed your specs to Dynacor when you want square-loop tape cores to exact requirements—fast! Here you'll find a dependable combination of personnel, experience and facilities—the know-how to deliver parameters to your very tightest tolerance requirements for switching time, flux, and noise.

Dynacor Square-Loop Tape Cores are manufactured with the high permeability alloys—Grain-Oriented 50-50 Nickel Iron, 4-79 Molybdenum Permalloy, and Grain-Oriented 3% Silicon Iron . . . with fully guaranteed uniformity . . . under rigid standards of control and inspection.

Look to Dynacor for reliable production and swift delivery of your tape core requirements. For your convenience a full line of standard units are stocked for immediate off-the-shelf delivery—Send for bulletins DN 2000, DN 2001, DN 2002.



DYNACOR

DYNACOR, INC.
A SUBSIDIARY OF SPRAGUE ELECTRIC CO.

1006 Westmore Ave.
Rockville, Maryland

CIRCLE 213 ON READER SERVICE CARD
November 11, 1960

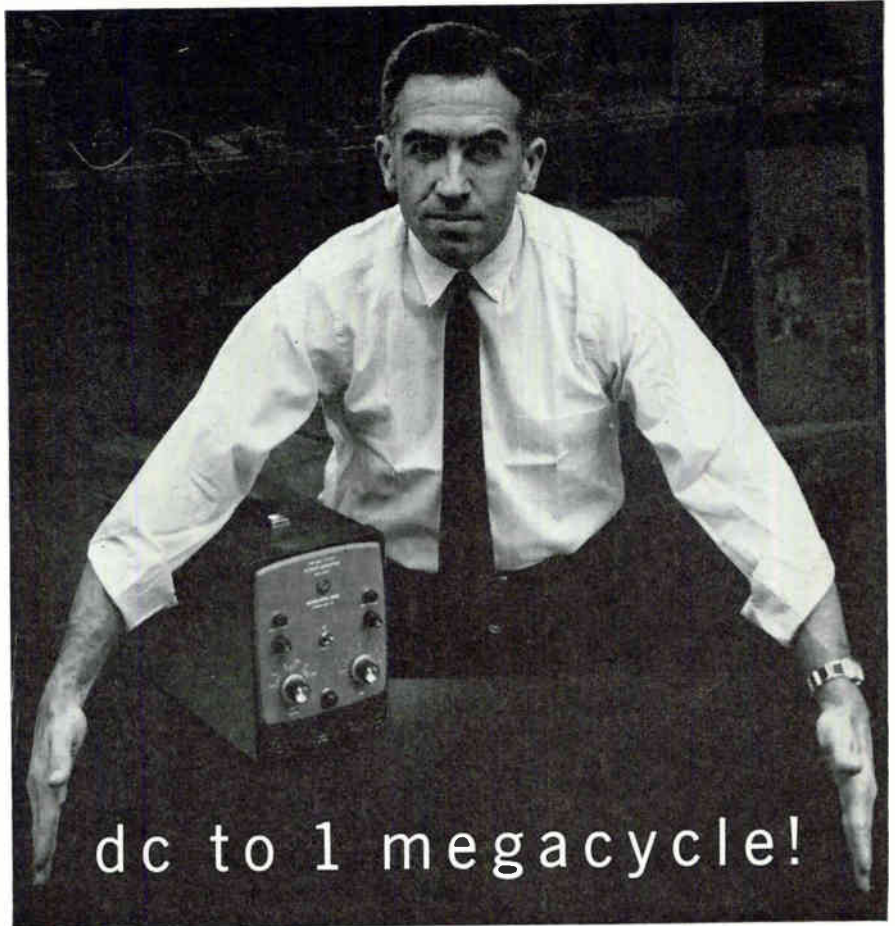

dc to 1 megacycle!

. . . and 10 watts of power

with this direct-coupled amplifier!

New from Krohn-Hite: this unique combination of power and bandwidth! The Model DCA-10 direct-coupled amplifier allows you to increase power of all sources from dc to one megacycle, without the bother of changing amplifiers or bandswitching!

The DCA-10's low distortion (0.1%) makes it the perfect complement for low-distortion, quality oscillators — for unexcelled performance over the entire frequency range.

Output — to 300 volts peak to peak, to 600 milliamperes peak to peak. Frequency response is flat, within one db, from dc to 1 mc. Stability is excellent for both output DC level and gain.

The Model DCA-10 direct-coupled amplifier provides high, distortion-free power over the entire range, from sub-sonic into radio-frequencies. 20 watts of push-pull power can be obtained from two DCA-10's cascaded. If this high-quality, flexible amplifier can fill a need for you, write for full information.

Other Krohn-Hite amplifiers include the direct-coupled 50 watt DCA-50, and the ultra-low distortion (0.005%) 50 watt UF-101A. Also, Krohn-Hite Oscillators, Filters and Power Supplies.



KROHN-HITE CORPORATION

580 Massachusetts Avenue • Cambridge 39, Mass.
Pioneering in Quality Electronic Instruments

CIRCLE 121 ON READER SERVICE CARD 121

FOR MAXIMUM RELIABILITY

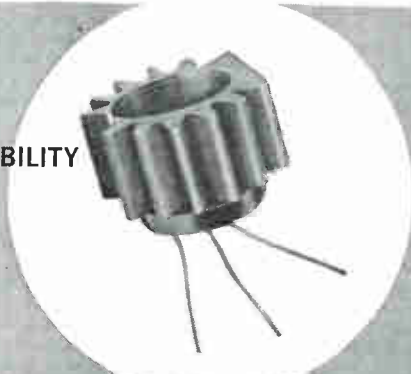

INCREASE TRANSISTOR EFFICIENCY
25% - 27% and prevent thermal runaway

THERE'S A BIRTCHER RADIATOR FOR MOST TRANSISTORS!

Birtcher transistor radiators for most sizes of transistors permit you to get up to 25% to 27% better output efficiency. You can now either increase your input wattage up to 27%, or eliminate up to 27% of the heat with Birtcher radiators.

and thermal runaway is prevented!

To assure circuitry reliability... specify Birtcher radiators. Birtcher qualification tests conducted under MIL standards prove these performance results.



FOR CATALOG and TEST REPORTS write: **THE BIRTCHER CORPORATION** industrial division

745 S. Monterey Pass Rd.
Monterey Park, Calif.
ANGelus 8-8584

*Sales engineering
representatives in
principal cities.*



CIRCLE 214 ON READER SERVICE CARD

keeping EIA members informed on major questions before Congress affecting the electronics industry.



**Lagerstrom Joins
Eitel-McCullough**

RICHARD P. LAGERSTROM has joined Eitel-McCullough, Inc., San Carlos, Calif., as a senior scientist in the company's research division.

As a research assistant and associate with Stanford University's Electronics Research Laboratories since 1951, and with Hughes Aircraft Co. from 1946 to 1951, Lagerstrom has worked on the development of various new techniques and methods in the field of tvt's and microwave devices.

**Adler Electronics
Adds New Plant**

ADLER ELECTRONICS, INC., New Rochelle, N. Y., has more than doubled its production capacity with the addition of a new 55,000 sq ft plant in Pelham, N. Y. This facility, which recently opened with a pilot force of 150 employees, houses a major portion of the company's manufacturing operations.

Adler produces transportable communications systems, missile ground support systems, and low power tv transmitters and repeaters.

**Holtzman Takes Post
Of R&D Director**

APPOINTMENT of Sidney M. Holtzman to director of research and development for Fidelity Electronic Corp., Riverside, N. J., is announced. He has been directing research and development activities for the firm since July, and will now



**INERTIAL
SYSTEM
TEST**

Can you measure a movement several thousand times slower than the hour hand of your watch? With the skills of an expert organization behind you, could you design and develop your own test methods, equipments, and procedures? These would be for the evaluation of servo, gyro, and accelerometer performance and early prototype inertial systems, and would include precision voltage analog measurements. Write to Mr. S. L. Hirsch.



LITTON SYSTEMS, INC. Electronic Equipments Division
Beverly Hills, California

take part also in production and marketing activities.

Holtzman has been associated with Trylon Radio Labs, Inc., and RCA in product engineering.

Industro Transistor Appoints E. S. Davis

EDWIN S. DAVIS was recently named device design engineer by Industro Transistor Corp., Long Island City, N. Y. Previous to joining Industro, he was supervisor of pilot engineering for CBS Electronics, Lowell, Mass., supervising project engineers in germanium power transistor device design.



CMC Names Manager Of Manufacturing

JAY SCHWALBE has been appointed manager of manufacturing of Computer Measurements Co., Sylmar, Calif.

Prior to joining CMC, he was plant and production manager of Electric Cords and Supply Co., a division of ITT.

Frederick Joins Epsco, Inc.

ARDEN H. FREDERICK has recently joined the instruments division of Epsco, Inc., Cambridge, Mass. He was formerly director of engineering at Production Research Corp., subsidiary of Radio Condenser Co.

Sperry Products Appoints Main

ROBERT C. MAIN has joined Sperry Products Co., a division of Howe Sound Co., Danbury, Conn., to assume the duties and responsibilities

Actual test data proves the Broader Band Operation of this **HUGGINS TWT**

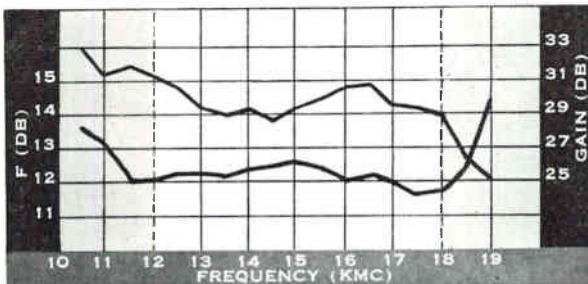

Test graph of our HA 43, medium noise amplifier tube illustrates how Huggins tubes often perform even better than advertised specifications. Huggins equipment consistently "gives the customer more."

Maximum noise figure here is 12.6 DB for 12-18 KMC and 14.3 for 10.5-19 KMC. Both are well below the catalog maximum of 15 DB. A 25 DB minimum gain is present for an 8½ KMC bandwidth, with

greater than 28 DB in the catalog frequencies. Write us for further information on Huggins TWT's, the industry's most complete line.

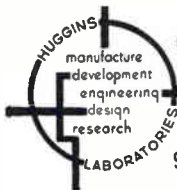

HUGGINS

LABORATORIES INC.

999 East Arques Avenue Sunnyvale, California Regent 6-9330



CIRCLE 215 ON READER SERVICE CARD

NEW

LOW COST STROBOSCOPE

60-14,400 RPM Direct Reading

\$149.50



MODEL 451-AL
Laboratory Stroboscope

Range:

The fundamental range of flashing speed is from 60 to 14,400 per minute. The speed is read directly from a dial calibrated in RPM.

Accuracy:

±1% of the dial reading above 900 RPM when the stroboscope is standardized in terms of a frequency-controlled power line.

Duration of Flash:

Between 5 and 10 microseconds.

Line Input:

105 to 125 volts, 50-60 cycles.

Mercury

For prompt delivery or further information telephone Atlantic Highlands 1-1600. Catalogue on Request.

ELECTRONIC COMPANY / RED BANK, NEW JERSEY

CIRCLE 216 ON READER SERVICE CARD

NEW IDEAS FOR SALE!

Words and pictures tell you about the top new product ideas each week in "On the Market". Who makes 'em and what they'll do for you. Easy way to keep in touch with the latest and best.

Another reason why it will pay you to subscribe to *electronics* (or renew your subscription) right now. Fill in the box on Reader Service Card. Easy to use. Postage free.

**FIND WHAT
YOU NEED IN...**

electronics

New PRECISION
FREQUENCY

STATIC INVERTER SUPPLY

INPUT 28V D.C. \pm 10%
OUTPUT Nom. 115V \pm 2%
400 CPS \pm 0.01%
1 ϕ (2- or 3-phase output available)
RATINGS: 30VA 50VA 100VA
Higher ratings available.

APPLICATION:

For gyro wheel supplies and where precise 400 cycle voltages are required in aircraft, radar and missile computers.

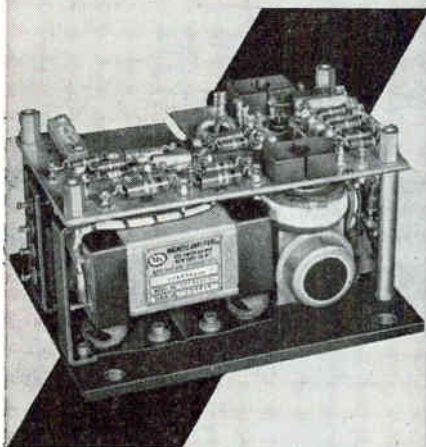

FEATURES:

PRECISION OUTPUT FREQUENCY
RUGGED
EXCELLENT WAVEFORM
SIMPLICITY OF CIRCUITRY
FAST STARTING TIME
GOOD VOLTAGE REGULATION
throughout an adjustable range
ISOLATED CASE DESIGN
HIGH RELIABILITY
VIBRATION ISOLATED
COMPACT
LIGHTWEIGHT
MILITARY SPECIFICATIONS
(Send for Bulletin S-864)



THE SIEGLER CORPORATION

MAGNETIC AMPLIFIERS DIVISION

632 TINTON AVE., NEW YORK 55, N. Y.
CYPRESS 2-6610

of manager of engineering, a newly created position. He was formerly with United Aircraft as engineering manager of the missiles and space systems division.

Wise Becomes ITA Board Chairman

BERNARD WISE has been elected to the chairmanship of the board of directors of Industrial Transmitters & Antennas, Inc., Lansdown, Pa. He will also continue in his capacity as president.

Wise has been associated with RCA in its broadcast marketing and engineering divisions.



Aero Geo Astro Hires Peeler

GEORGE D. M. PEELER has been named senior laboratory director of the Aero Geo Astro Corp., Alexandria, Va.

Prior to this appointment he had been manager of the microwave development department, missile systems division of the Raytheon Company in Bedford, Mass.

Shockley Adds Ewing To Research Staff

RICHARD E. EWING recently joined the senior research staff of Shockley Transistor Unit of Clevite Transistor, Palo Alto, Calif.

Before joining this research team, Ewing was working in the field of nuclear fuels with General Electric in Richland, Wash.

Pacific Scientific Changes Division Name

THE AERONAUTICAL DIVISION of Pacific Scientific Co., Los Angeles,

Calif., will now be known as the "aerospace" division. This division manufactures cable control systems, pilot safety equipment, electrical rotary couplings, 6 pdt relays and a variety of electromechanical components.



Rogers Takes Over Newly-Created Post

APPOINTMENT of Gordon F. Rogers as manager of advanced development for RCA communications equipment is announced.

In the newly-created position, he will head an advanced development group at RCA's David Sarnoff Research Center at Princeton, N. J.

Rogers, who joined RCA thirteen years ago, has served in RCA activities at New York, Hollywood, Chicago and Camden.



Hartman Moves Up At Philco Corp.

LAWTON M. HARTMAN was recently appointed associate director of research—operations at Philco Corp., Philadelphia, Pa.

With the research division since 1958 when he joined Philco as a consultant and member of the technical systems planning group, Hartman has recently been responsible for directing one of Philco's important space communications programs.

ENGINEERS:

A NEW CONCEPT IN PROFESSIONAL JOB SELECTION

New technical tests enable you to calculate your probability for success at LMED — in 1 hour at your own home!

BY GENERAL ELECTRIC'S LIGHT MILITARY ELECTRONICS DEPARTMENT

If you've been thinking of changing your job some day—or in the near future—but have hesitated because of the many uncertainties involved, Light Military's new concept in professional job selection will be of paramount interest to you.

What is it?

The new concept is based on a series of technical tests developed and pre-tested by Light Military engineers. They are designed to be taken, scored and evaluated by the individual engineer, all in the privacy of his own home. And, because the sole purpose is to provide you with a novel, objective means for self-appraisal, your score need not be divulged to us at any time.

Here's how it works:

First, fill out the coupon below and check off the tests which apply to your training and professional experience. Forward the completed coupon to us and in a few days you will receive the tests, a sealed answer sheet and explanatory material.

During a convenient hour at home, take the test and score it with the answer sheet provided. Then, compare your performance with the criterion group composed of Light Military engineers at all levels who took the same test. In most cases you will be able to relate your score to years of experience, from 2 to more than 10.

What it measures:

If your adjusted score is equal to, or more than the years of experience you

possess, the probability is excellent that a significant community of technical interest exists between you and The Light Military Department. In addition, a valid assumption can be made that a high probability for success awaits you here. And remember, your score need not be divulged to us at any time; it is for your own guidance exclusively!

CURRENT AREAS OF ACTIVITY AT THE LIGHT MILITARY DEPT.

- SPACE COMMUNICATIONS & TELEMETRY
- MISSILE & SATELLITE COMPUTERS
- SPACE VEHICLE GUIDANCE
- UNDERSEA WARFARE SYSTEMS
- THERMOPLASTIC DATA STORAGE
- SPACE DETECTION & SURVEILLANCE
- COMMAND GUIDANCE & INSTRUMENTATION
- INFRARED MISSILE APPLICATIONS

MAIL THIS COUPON FOR YOUR TESTS

Mr. R. Bach
Light Military Electronics Dept.
General Electric Company, French Road, Utica, New York

Please send me tests (limited to 2 subjects per individual) answer and self-evaluation sheets covering the areas checked:

- RADAR MICROWAVE ELECTRONIC PACKAGING (ME)
 COMMUNICATIONS ADMINISTRATIVE ENGINEERING

NAME _____
HOME ADDRESS _____ HOME PHONE _____
CITY _____ ZONE _____ STATE _____
DEGREE(S) _____ YEAR(S) RECEIVED _____



LIGHT MILITARY ELECTRONICS DEPARTMENT

69-WS

GENERAL  ELECTRIC

Facts

about the tests

- 1 Each technical test is composed of 40 multiple choice questions.
- 2 To find answers for some questions, mathematics is involved—but only to the degree normally associated with the work.
- 3 The "mix" of questions includes some easy ones, some bordering on the state of the art.
- 4 None of our engineers achieved a perfect score.
- 5 The test for Engineering Administration is psychological, designed to reveal aptitudes and abilities most often found in good engineering managers or administrators.



EMPLOYMENT OPPORTUNITIES

The Advertisements in this section include all employment opportunities—executive, management, technical, selling, office, skilled, manual, etc.

Positions Vacant	Civil Service Opportunities	Employment Agencies
Positions Wanted	Selling Opportunities Wanted	Employment Services
Part Time Work	Selling Opportunities Offered	Labor Bureaus

DISPLAYED

---RATES---

UNDISPLAYED

The advertising rate is \$34.33 per inch for all advertising appearing in other than a contract basis. Contract rates quoted on request.

An advertising inch is measured 3/4" vertically on a column—3 columns—30 inches to a page.

Subject to Agency Commission.

\$2.40 per line, minimum 3 lines. To figure advance payment count 5 average words as a line.

Box Numbers—counts as 1 line.

Discount of 10% if full payment is made in advance for 4 consecutive insertions.

Not subject to Agency Commission.

Send NEW ADS to CLASSIFIED ADV. DIV. of ELECTRONICS, P.O. Box 12, N. Y. 36, N. Y.

PROFESSIONAL SERVICES

Electronics Reliability Engineer

Republic Aviation has an exceptional opening for an Electronics Reliability Engineer. He will be responsible for analyzing electronic circuits and predicting the theoretical reliability of electronic equipment. He will also perform failure effect analysis, review proper parts application, and recommend piece part utilization.

An EE degree and 5-10 years experience in electronics, with at least 2-3 years in reliability required.

Forward replies in complete confidence to

Mr. James Hunter
Technical Employment Supervisor

REPUBLIC AVIATION

Farmingdale, Long Island, N. Y.
(Less than 1 hour from New York City)

CIRCLE 383 ON READER SERVICE CARD

ELECTRICAL ENGINEERS

An unusual opportunity awaits a qualified engineer who will assume an important area of responsibility in a well established electronic equipment manufacturing firm.

Minimum requirements: Bachelor Degree in Electrical Engineering plus experience in the development of electronic equipment.

Salary to be commensurate with qualifications.

G.L.A. is located in a pleasant mid-state New York community.

Send resume or wire:

MR. R. E. POWERS

GENERAL LABORATORY ASSOCIATES, INC.

1 Lee Avenue Norwich, New York

CIRCLE 385 ON READER SERVICE CARD

OFFICE OF JOSEPH R. PERNICE ELECTRONIC and INDUSTRIAL CONSULTANTS

Specializing in electronics, missiles and aviation industries in Europe and United Kingdom: Consultations on military, professional and commercial products; Representation of U. S. companies on technical, industrial and sales matters and on contract negotiations; Investigations and recommendations on manufacturing possibilities, licensing, patents, acquisition of plants and financial industrial interests; Exploration of research & development possibilities; Recommendations on maintenance and repair of equipment and field engineering projects; Organizing and implementing sales promotion programs, market surveys, demonstration and symposiums; Setting up of dealers and sales representatives in Europe.

15 rue de la Faisanderie Paris (16) France
Phone: POIncare 3274

EUGENE MITTELMANN, E.E., Ph.D.

Consulting Engineer, Physicist
ELECTRONICS FOR INDUSTRY
Analysis, Research and Development
549 West Washington Boulevard
Chicago 6, Illinois
Central 6-2983

ERCO RADIO LABORATORIES, INC.

Radio Communications Equipment
Engineering - Design - Development - Production
Our 30th Year in Air to Ground
Communication and Radio Beacons
Garden City • Long Island • New York

Creative Advertising Man who knows

TECHNICAL ELECTRONICS

Stimulating responsibilities as Creative-Contact Executive in Gardner's exclusive Creative-Contact Department:

- discovering and developing advertising opportunities for nationally-famous clients.
- writing and visualizing complete campaigns on electronic/electrical products.
- working and growing with outstanding creative and account men.

If you have a solid background in technical electronics, at least 2 years of experience in advertising and writing, and a deep ambition to advance yourself, this is an opportunity you should investigate immediately.

Write P. R. SMITH, Personnel Director

GARDNER ADVERTISING CO.

915 Olive Street St. Louis 1, Missouri

CIRCLE 384 ON READER SERVICE CARD

SELLING OPPORTUNITIES AVAILABLE

Representatives desired by manufacturer of Industrial Electronic Instruments and Controls. P.O. Box 8246, Tulsa 15, Oklahoma.

Manufacturers Representative Wanted. New low cost epoxy resin processing unit. Unique equipment for metering, mixing, and dispensing reactive resins. All territories open. CPM Special Machinery Corp., 324 Butler Street, Brooklyn 17, N. Y.

"Put Yourself in the Other Fellow's Place"

TO EMPLOYERS

TO EMPLOYEES

Letters written offering Employment or applying for same are written with the hope of satisfying a current need. An answer, regardless of whether it is favorable or not, is usually expected.

MR. EMPLOYER, won't you remove the mystery about the status of an employee's application by acknowledging all applicants and not just the promising candidates.

MR. EMPLOYEE you, too, can help by acknowledging applications and job offers. This would encourage more companies to answer position wanted ads in this section. We make this suggestion in a spirit of helpful cooperation between employers and employees. This section will be the more useful to all as a result of this consideration.

Classified Advertising Division

McGraw-Hill Publishing Co., Inc.
330 West 42nd St., New York 36, N. Y.

WHEN TIME IS SHORT....

put the solution of your problems up to a specialized Consultant. His broad experience may save you months of costly experimentation.

SALE
NEW RELAYS
IN LARGE QUANTITIES
AT FRACTION OF COST

Maker	Type	Contact Arrangement	Resistance	Voltage	Price
Advance	#A8769-ly	3A	39 Ohm	6VDC	1.50
		2A2C	39 Ohm	6VDC	1.50
Sigma	52-JOCA-80110	1A1C	16,000 Ohm	28VDC	3.00
Sigma	7-JOZ-80030	SPDT	5000 Ohm	28VDC	2.50
	None Pile Up Cont.				
		3A3B	144 Ohm	12VDC	1.00
		3B	144 Ohm	12VDC	1.00
		1A1B2C	39 Ohm	6VDC	1.00
Phillips	2QA316A	1C1A	200 Ohm	12VDC	1.50
Control					
		SPST	300 Ohm	24VDC	1.50
Clare	B65369	1A1B	125 Ohm	12VDC	1.50
RBM	RB22300-14	1A1B	280 Ohm	28VDC	1.50
Potter-Bromfield	KF-1012-4	SP5T	200 Ohm	12VDC	1.50

LIBERTY ELECTRONICS, INC.

582 Broadway New York 12, N. Y.
Phono: WA 5-6000 Cables: Telsersup

CIRCLE 460 ON READER SERVICE CARD

MANUFACTURER'S SURPLUS

Type 6292—2" Photomultiplier Tubes
Tested But Unused

Manufacturer's product requires unusually critical dark noise characteristics. 85% of originally purchased tubes, which do not have these characteristics but meet all of tube manufacturer's specifications, are offered for sale.

QT: 1-9 at \$40.00 each
QT: 10-49 at \$35.00 each
QT: 50 and over at \$30.00 each
Terms f.o.b. plant. Net 30 days.

PACKARD INSTRUMENT COMPANY, INC.
P. O. Box 428, La Grange, Illinois

CIRCLE 461 ON READER SERVICE CARD

14 VOLT-DC POWER SUPPLY

● BRAND NEW ... IN ORIGINAL CASES ●

INPUT:
115 Volts-60
Cycles

OUTPUT:
14 Volts @ 2
Amps

Filtered and
Completely Housed

Excellent for
Industrial, Lab and
Institutional use...

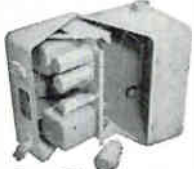

\$14.95 Complete
F.O.B.—N.Y.

Advance Electronics

6 West Broadway • New York 7, N. Y. • REctor 2-0270

CIRCLE 462 ON READER SERVICE CARD

MINIATURE

CONNECTORS

- * WINCHESTER
- * CONTINENTAL
- * U. S. COMPONENTS

Tremendous Inventory ...
At Below Factory Prices

A. MOGULL CO.
17 Warren St. N.Y.C. 7 W0 4-0865



CIRCLE 463 ON READER SERVICE CARD

lab grade TEST EQUIPMENT for sale

standard brands—military surplus
(new or professionally reconditioned)
experienced problem solvers and budget-cutters

ENGINEERING ASSOCIATES

434 Patterson Road Dayton 19, Ohio

CIRCLE 464 ON READER SERVICE CARD

Antique
TELEPHONES

As is complete, decorative purpose \$12.00. Working order, inter-comm. \$15.00. Ext. on dial \$17.50, talking circuit only. Write for complete list. All shipments FOB, Simpson, Pa. TELEPHONE ENGINEERING CO. Dept. E-110, Simpson, Pa.



CIRCLE 465 ON READER SERVICE CARD

November 11, 1960

SEARCHLIGHT SECTION

(Classified Advertising)

BUSINESS OPPORTUNITIES

EQUIPMENT - USED or RESALE

DISPLAYED

The advertising is \$24.75 per inch for all advertising other than on a contract basis. AN ADVERTISING INCH is measured 7/8" vert. on a column, 3 cols.—30 inches—to a page. EQUIPMENT WANTED or FOR SALE ADVERTISEMENTS acceptable only in Displayed Style.

RATES

\$2.40 a line, minimum 3 lines. To figure advance payment count 5 average words as a line. BOX NUMBERS count as one line additional.

UNDISPLAYED

DISCOUNT of 10% if full payment is made in advance for four consecutive insertions.

Send NEW ADVERTISEMENTS or Inquiries to Classified Adv. Div. of Electronics, P. O. Box 12, N. Y. 36, N. Y.

The publisher cannot accept advertising in the Searchlight Section, which lists the names of the manufacturers of resistors, capacitors, rheostats, and potentiometers or other names designed to describe such products.

SPECIAL PURPOSE TUBES

OA2	.80	4X150A	12.50	348A	2.50	5545	12.50	5896	1.50
OA3	.85	4X250B	30.00	349A	2.00	5550	30.00	5899A	2.50
OB2	.50	5B2P1A	9.50	350A	3.50	5552/FG-235	40.00	5902	2.35
OB3	.70	5C22	15.00	350B	3.50	5557/FG-17	4.25	5903	4.00
OC3	.50	5CP1A	9.50	352A	6.50	5558/FG-32	7.50	5927/6L6WGA	5.00
OD3	.30	5LP1A	17.50	354A	10.00	5559/FG-57	10.00	5948/1754	150.00
1AD4	1.25	5R4GY	.90	355A	10.00	5560/FG-95	12.50	5963	.85
1B24A	10.00	5R4WGB	5.00	393A	3.50	5586	100.00	5964	.75
1B35A	3.00	5R4WGY	2.50	394A	2.50	5632/C3J	8.50	5965	1.00
1B58	35.00	5RP1A	10.00	396A/2C51	2.50	5636	1.00	5975	2.00
1B59/R1130B	9.00	5Y3WGT	1.15	398A/5603	4.00	5639	2.00	5977/6K4A	1.25
1B63A	12.50	5AC7W	.35	401A/5590	1.50	5641	2.25	5981/5650	25.00
C1K	6.00	6AG7Y	.75	403A/6AK5	1.00	5642	1.25	5992	2.00
1P21	25.00	6AK5W	1.00	403B/5591	3.00	5643	4.50	5993	4.00
1P25	10.00	6AN5WA	3.00	404A/5847	10.00	5644	2.50	6005/6AQ5W	1.25
2-O1C	12.50	6A57G	2.35	407A	3.50	5646	2.00	6012	3.75
2AP1A	3.50	6B4G	2.50	408A/6028	2.00	5647	2.25	6021	2.00
2BP1	6.00	6BL6	30.00	409A/6A56	2.00	5651	.70	6032	25.00
2C39	2.50	6BM6	30.00	412A	4.00	5654/6AK5W	1.00	6037/QK-243	25.00
2C39A	7.50	6BM6A	30.00	415A	3.00	5656	3.50	6045	1.25
2C40	6.50	6C21	10.00	416B/6280	30.00	5665/C16J	25.00	6072	1.75
2C43	6.50	6C6J	12.50	417A/5842	10.00	5670WA	1.35	6073	.80
2C50	4.00	6J4WA	1.25	418A	15.00	5675	7.50	6080	3.00
2C51	1.50	6J6G	.60	420A/5755	5.00	5676	1.25	6080WA	4.00
2C52	1.50	6L6GAY	.75	421A/5998	7.50	5678	1.25	6080WB	10.00
2D21	.50	6L6WGB	1.75	422A	10.00	5684/C3J/A	11.80	6082	3.00
2D21W	1.00	6Q5G	2.50	423A/6140	5.00	5686	1.85	6087/5Y3WGTB	3.00
2E24	2.50	6S17WGT	1.00	429A	9.00	5687WA	2.50	6099	.75
2E26	2.50	6S17WGT	.75	450TH	30.00	5691	5.00	6100/6C4WA	1.25
2E30	1.85	6SN7WGT	5.00	450TL	30.00	5692	2.00	6101/6J6WA	1.00
2J42	35.00	6V6GTY	.75	575A	12.50	5693	4.00	6111A	2.00
2J51	75.00	6X4W	.75	631-P1	5.00	5702WA	2.75	6112	2.50
2K25	8.50	6X5WGT	1.00	673	12.50	5703WA	3.00	6115/QK-351	40.00
2K26	25.00	7MP7	17.50	676	27.50	5704	1.00	6130/3C45	8.50
2K29	25.00	10KP7	20.00	677	27.50	5718	1.00	6136/6AU6WA	1.25
2K30	75.00	12AT7WA	1.40	714AY	10.00	5719A	1.50	6137/6SK7WA	1.50
2K34	100.00	HK-24	1.00	715C	10.00	5720/FG-33	17.00	6146	3.50
2K35	250.00	25T	7.50	719A	7.50	5721	125.00	6252	4.00
2K41	25.00	26Z5W	1.25	721B	3.00	5725/6A56W	1.00	6186/6AG5WA	1.50
2K42	125.00	35T	7.50	723A/B	2.50	5726/6AL5W	.60	6189/12AU7WA	1.50
2K43	125.00	35TG	2.50	725A	7.50	5727/2D21W	1.00	6197	1.75
2K44	125.00	FG-105	17.50	726B	3.25	5728/FG-67	7.50	6199	35.00
2K47	125.00	FG-172	17.50	750TL	87.50	5740/FP-54	50.00	6201/12AT7WA	1.75
2K50	65.00	212E	25.00	BL-800A	50.00	5744WA	2.75	6202/6X4WA	1.50
2X2A	1.00	244A	2.50	802	4.50	5749/6BA6W	.75	6211	.65
3AP1A	7.50	245A	3.50	804	15.00	5750/6BE6W	1.35	6216	2.50
3B24W	3.50	249B	10.00	805	3.00	5751/12AX7W	1.35	6236	150.00
3B25	3.00	249C	5.00	807	1.25	5763	1.50	6263	9.00
3B28	4.00	250R	7.50	810	12.50	5777	100.00	6264	9.00
3BP1A	7.50	252A	6.00	811A	4.75	5778	125.00	6265	2.25
3C22	30.00	254A	2.00	813	8.50	5783	2.00	6293	4.50
3C23	5.00	257A	3.50	814	1.50	5784WA	3.50	6299	37.50
3C24/24G	2.50	259A	3.50	815	1.50	5787	2.50	6336	9.50
3C45	3.00	262B	3.50	816	1.75	5799/VX-21	3.00	6352	8.50
3D22	8.00	267B	7.50	828	7.00	5800/VX-41	3.50	6364	150.00
3E29	3.50	271A	10.00	829B	7.25	5801/VX-33A	3.00	6390	150.00
3J21	35.00	272A	4.00	832A	6.00	5802/VX-32B	3.50	6438	4.00
3J31	50.00	274A	2.50	833A	33.00	5803/VX-55	1.50	6463	1.25
3K21	125.00	275A	4.00	836	1.00	5814A	1.25	6517/QK358	500.00
3K22	125.00	283A	3.50	837	.90	5819	45.00	6533	6.50
3K23	250.00	287A	2.50	845	7.50	5824	2.50	6544	250.00
3K27	150.00	293A	4.50	866A	1.85	5828	3.00	6550	4.25
3K30	50.00	300B	5.00	872A	1.65	5829WA	1.50	6626/OA2WA	2.00
3KP1	8.85	304TH	30.00	884	1.00	5836	60.00	6627/OB2WA	2.00
3X2500A3	148.00	304TL	30.00	913	8.50	5837	60.00	6655	40.00
4-65A	9.50	310A	3.50	927	1.00	5839	2.50	6754	10.00
4-125A	20.00	311A	2.50	931A	3.00	5840	2.00	6784	250.00
4-250A	30.00	313C	1.00	959	.50	5845	4.85	6897	18.75
4-400A	32.50	323A	6.50	1000T	97.50	5852	2.50	6901	10.00
4-1000A	90.00	328A	2.50	1500T	150.00	5854	1.50	8005	5.00
4AP10	10.00	329A	3.50	1614	2.50	5876	7.50	8013A	3.00
4B31	15.00	336A	2.50	1620	3.50	5879	1.00	8020	1.50
4C35	15.00	337A	3.50	1624	.75	5881/6L6WGB	1.75	8025	3.00
4E27	7.50	339A	4.00	2050	1.00	5886	3.00	9002	.35
4J52	25.00	347A	1.50	2051	.50	5894	15.00	9005	3.00

ALL TUBES ARE NEW, INDIVIDUALLY CARTONED, FULLY GUARANTEED

western engineers

ELK GROVE, CALIFORNIA

SUPPLIERS OF ELECTRON TUBES SINCE 1932

Orders for less than
\$10 cannot be
processed

CIRCLE 466 ON READER SERVICE CARD

AN/AAS-6 Infrared Detection System, complete. New \$5500.

**MIT MODEL 9 PULSER
1 MEGAWATT-HARD TUBE**

Output pulse power 25KV at 40 amp. Max duty ratio: .002. Uses 6C21 pulse tube. Pulse duration .25 to 2 microsec. Input 115 volts 60 cycle AC. Includes power supply in separate cabinet and driver. Fully guaranteed as new condition. Full Desc. MIT. Rad. Lab. series "Pulse Generators." Vol. 5 pg. 152.

MIT MODEL 3 PULSER

Output: 144kw (12kv at 12 amp). Duty ratio: .001 max. Pulse duration: .5, 1 and 2 micro sec. Input: 115v 400 to 2000 cps and 24vdc. \$325 ea. Full desc. Vol. 5 MIT Rad. Lab. series pg. 140.

AN/TPS-1D RADAR

500 KW. 1220-1350 MCS. 160 nautical mile search range P.P.I. and A Scopes. MTI. Thyatron Mod. 5126 Magnetron. Like new. Complete system incl. Spare parts and gas generator field supply.

**RADIO RESEARCH
INSTRUMENT CO.**

550
FIFTH AVE.
NEW YORK
JUDSON
6-4691

**ANTENNA PEDESTAL
SCR 584—MP 61B**

Full azimuth and elevation sweeps. 360 degrees in azimuth. 210 degrees in elevation. Accurate to 1 mil. or better over system. Complete for full tracking response. Angle acceleration rate: AZ. 9 degrees per second squared EL. 4 degrees per second squared. Angle slewing rate: AZ 20 degrees per sec. EL. 10 degrees per sec. Angle tracking rate: 10 degrees per sec. Quantity in stock for immediate shipment.

Complete description in McGraw-Hill Radiation Laboratory Series, Volume 1, page 284 and page 209, and Volume 26, page 233.

AUTOMATIC TRACKING RADAR

SCR 584 is in like new condition, ready to go, and in stock for immediate delivery. Fully Desc. MIT Rad. Lab. Series, Vol. 1, pp. 207-210, 238, 284-286.

DUAL BALANCED CRYSTAL MOUNT
X Band 1" x 1/2" dual balanced crystal mount. Mfg. Microwave Development Laboratories. \$21.50

BROAD BAND BAL MIXER

Using short slot hybrid. Pound type broad band dual balanced crystal holder. 1x5 wg. size. \$25 new.

2C40 LIGHTHOUSE CAVITY

AN/APW11A transmitter cavity for 2C40. Complete S band coverage at max. power. Temperature compensated. New \$77.50 ea.

**CIRCLE 467 ON READER SERVICE CARD
"TAB"**

**SILICON *750 Ma DIODES
GENERAL PURPOSE 400 Piv at 250 Ma**



SPECIAL 2 for \$1. 25 for \$10

rms/piv	rms/piv	rms/piv	rms/piv
35/50 25c	70/100 35c	140/200 45c	210/300 55c
280/400 65c	350/500 85c	420/600 \$1.10	490/700 \$1.35

*Derate 20% for capacitive input
EXPORTERS—OEM—DISTRIBUTORS . . .
WRITE FOR QUANTITY PRICES

WRITE FOR NEW...36 PAGE PARTS CATALOG

"TAB" 111 Liberty St., New York 6, N. Y.

**RECTOR 2-6245
CIRCLE 470 ON READER SERVICE CARD**

CAPACITORS

MFD	VOLTS	PRICE	MFD	VOLTS	PRICE
*.001	50KV	24.75	2	10KV	55.00
*.125	27.5KV	24.50	3	20KV	125.00
.25	32.5KV	44.50	4	15KV	125.00
.25	50KV	69.50	4	10KV	67.50
.25	80KV	109.00	5	10KV	70.50
1	10KV	22.50	9	10KV	115.00
1	25KV	59.50	10	5000V	49.50
1	37.5KV	159.50	15	5000V	54.50
			† 100	4000V	49.50
			120	3000V	49.50

* Case Common.
† Photo Flash.

Write for complete listing of capacitors of all types, plus other electronic components.

MONMOUTH RADIO LABS.

BOX 159—OAKHURST, N. J.
CAPITOL 2-0121 ART HANKINS, Prop.

CIRCLE 471 ON READER SERVICE CARD

Large stock of generators on hand. Various frequencies, and Control Panels.

Write for catalogs.

Reliable Electric Motor Repair Co., Inc.
19-21 California Ave. Paterson 3, N. J.

CIRCLE 472 ON READER SERVICE CARD

TUBES

FOR INDUSTRY . . .

★ NAME BRANDS ★ TOP QUALITY ★ FULLY GUARANTEED

Thousands of industrial . . . special purpose . . . transmitting . . . and receiving tubes in stock. At BARRY ELECTRONICS . . . your inquiry is processed the day it is received. Send us your request for quotation . . . today!

If we do not have your name, Circle Reader Service Card # for future *GREEN-SHEET Catalogs.

*A complete catalog of specialized industrial ELECTRONIC TUBES and COMPONENTS . . . featuring BARRY ELECTRONICS savings to industry.

"11 YEARS OF BUYERS' CONFIDENCE"

WALKER 5-7000
TWX: NY1-3731

BARRY ELECTRONICS

CORPORATION

512 BROADWAY NEW YORK 12, N. Y.
CIRCLE 469 ON READER SERVICE CARD

**SEARCHLIGHT
Equipment
Locating Service**

NO COST OR OBLIGATION

This service is aimed at helping you, the reader of "SEARCHLIGHT", to locate Surplus new and used electronic equipment and components *not currently advertised*. (This service is for USER-BUYERS only).

How to use: Check the dealer ads to see if what you want is not currently advertised. If not, send us the specifications of the equipment wanted on the coupon below, or on your own company letterhead to:

**Searchlight Equipment
Locating Service
Classified Advertising**

c/o ELECTRONICS
P. O. Box 12, N. Y. 36, N. Y.

Your requirements will be brought promptly to the attention of the equipment dealers advertising in this section. You will receive replies directly from them.

**Searchlight Equipment Locating Service
Classified Advertising**

c/o ELECTRONICS

P. O. Box 12, N. Y. 36, N. Y.
Please help us locate the following equipment components.

.....
.....
.....
.....
NAME

TITLE

COMPANY

STREET

CITY11/11/60



Audited Paid Circulation

BRUCE A. WINNER,
Advertising Sales Manager

R. S. QUINT, Assistant Advertising Sales Manager and Buyers' Guide Manager; FRED STEWART, Promotion Manager; RICHARD J. TOMLINSON, Production Manager; GEORGE E. POMEROY, Classified Manager; HUGH J. QUINN, Circulation Manager.

ADVERTISING REPRESENTATIVES: NEW YORK Donald H. Miller, Henry M. Shaw, George F. Werner; BOSTON William S. Hodgkinson, Donald R. Furth; PITTSBURGH David M. Watson; PHILADELPHIA Warren H. Gardner, William J. Boyle; CHICAGO Harvey W. Wernecke, Martin J. Gally; CLEVELAND P. T. Fegley; SAN FRANCISCO T. H. Carmody, R. C. Alcorn; LOS ANGELES Carl W. Dysinger, D. A. McMillan, Marshall Freeman; DENVER J. Patten; ATLANTA M. Miller; DALLAS Robert T. Wood; LONDON Edward E. Schirmer; FRANKFURT Stanley R. Kimes; GENEVA Michael R. Zeynel.

BRANCH OFFICES: National Press Bldg., Washington 4, D.C.; McGraw-Hill Bldg., Copley Square, Boston 16; Four Gateway Center, Pittsburgh 22; Six Penn Center Plaza, Philadelphia 3; 520 North Michigan Avenue, Chicago 11; 55 Public Square, Cleveland 13; 68 Post Street, San Francisco 4; 1125 West Sixth St., Los Angeles 17; 1740 Broadway, Denver 2; 1301 Rhodes-Haverty Bldg., Atlanta 3; 901 Vaughn Bldg., Dallas 1; McGraw-Hill House, London E.C.4; 85 Westendstrasse, Frankfurt/Main; 2 Place de Port, Geneva.

OFFICERS OF THE PUBLICATIONS DIVISION: Nelson L. Bond, President; Shelton Fisher, Wallace F. Traendly, Senior Vice Presidents; John R. Callahan, Vice President and Editorial Director; Joseph H. Allen, Vice President and Director of Advertising Sales; A. R. Venezian, Vice President and Circulation Coordinator.

OFFICERS OF THE CORPORATION: Donald C. McGraw, President; Joseph A. Gerardi, Hugh J. Kelly, Harry L. Waddell, Executive Vice Presidents; L. Keith Goodrich, Vice President and Treasurer; John J. Cooke, Secretary.

Subscriptions are solicited only from those actively engaged in the field of the publication and in a manner served by its contents. Position and company connection must be indicated on subscription orders. Subscription rates for individuals within the field of the publication: United States and United States Possessions, \$6.00 one year; \$9.00 two years; \$12.00 three years. Canada, \$10.00 one year. All other countries \$20.00 one year. Single Copies, United States, United States Possessions and Canada 75¢; Buyers' Guide \$3.00; Single Copies all other countries \$1.50; Buyers' Guide \$10.00.

The Publisher, upon written request from any subscriber to our New York Office, agrees to refund that part of the subscription price applying to copies not yet mailed.

So Much
to Read -



So Little Time to Read It

NO LONGER is it sufficient for a business magazine to demonstrate editorial superiority. To that superiority must be added the ingredient of readability. Toward that end, *ELECTRONICS* began early this year a series of typography and format changes.

Improvement is a continuing program with us, not an experiment or an all-at-once change to another static dimension. We're making the magazine faster and easier to read—no mean chore, considering the scope and depth of the editorial content. Your reading habits must be selective. That's why we intend not only to warrant your reading time, but to conserve it as far as possible.

After all, we have little choice. *ELECTRONICS* is bringing you more than twice the number of feature articles, and 73 percent more editorial pages than you received in 1956, a short four years ago. This increase was necessary to keep you fully informed concerning our rapidly expanding electronics technology.

You can, by the way, help us to help you. Just how good are your reading habits? How fast do you read and absorb a written page? Want to know some simple procedures which can cut your reading time in half? Send for the booklet "How to Cut Your Reading Time." Circle number 259 on our reader service card. No charge, of course.

James Gidwood

PUBLISHER

Ohmite Mfg. Co.....	3
Phillips Gloeilampenfabrieken N. V.	22, 23
*Raytheon Company.....	5, 48, 49
Rotek Instrument Corp.....	24
Sangamo Electric Co.....	30, 31
Seigler Corp., The.....	103
Magnetic Amplifier Div.....	124
*Sierra Electronic Corp.....	10
Simpson Electric Company.....	50, 51
Space Technology Laboratories, Inc.	15
Speer Carbon Co Jeffers Electronics Div.....	104
*Sperry Microwave Electronics Com- pany, Division of Sperry Rand Cor- poration	26, 27
Sprague Electric Co.....	20, 46, 47
Stromberg-Carlson, A Division of General Dynamics Corporation...	97
Telemetry, Inc.	119
*Telonic Industries, Inc.....	35, 36
*Tung-Sol Electric, Inc.....	109
U. S. Stoneware.....	13
United States Testing Co.....	52
Virginia Electric & Power Co.....	16
*Vitramon, Inc.	64

* See Advertisement in the July 20, 1960 issue of Electronics Buyers' Guide for complete line of products or services.

CONTRACTS

Aristo-craft	129
Lifschultz Fast Freight.....	129

CLASSIFIED ADVERTISING
F. J. Eberle, Business Mgr.

EMPLOYMENT

OPPORTUNITIES	125, 126
---------------------	----------

EQUIPMENT

(Used or Surplus New)	
For Sale	127-129

CLASSIFIED ADVERTISING INDEX

Advance Electronics	127
Astronetics, Inc.	129
Barry Electronics Corp.....	128
Engineering Associates	127
Gardner Advertising Co.....	126
General Electric Co.....	125
General Laboratories Associates.....	126
Goodheart Co., R. E.....	129
Klein Industries, Inc., Manuel.....	129
Liberty Electronics Inc.....	127
Mogull Co., A.....	127
Monmouth Radio Labs.....	128
Packard Instrument Co., Inc.....	127
Radio Research Instrument Co.....	128
Reliable Electric Motor Repair Co., Inc..	128
Republic Aviation	126
TAB	128
Telephone Engineering Co.....	127
Universal Relay Corp.....	129
Western Engineers	127
Wilgreen Industries Inc.....	128

This index and our Reader Service Numbers are published as a service. Every precaution is taken to make them accurate, but ELECTRONICS assumes no responsibilities for errors or omissions.

The future... from your point of view

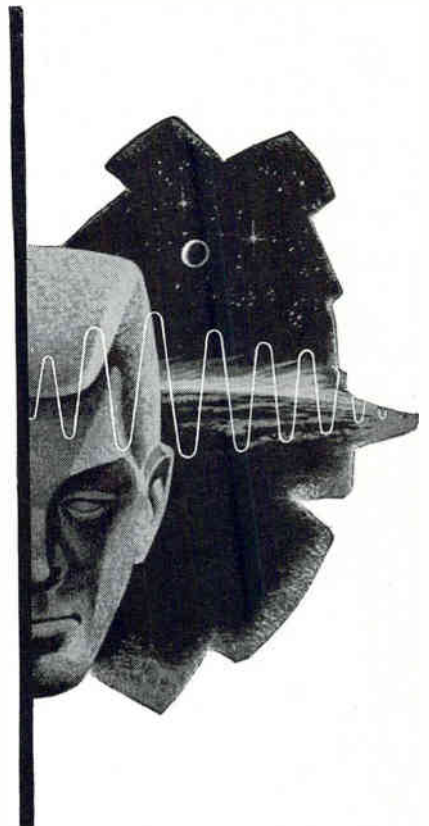

A good day's growth for a hard day's work.

A position to suit your talents, experience and ambition.

Opportunity to exercise full initiative in Research, Radar, Doppler Navigational Systems, Magnetic Memory Systems, Microwave and Computers.

PLUS

Management awareness encouraging exploration beyond the range of present knowledge.

APPOINTMENTS NOW AVAILABLE:

DESIGN ENGINEER

Radar Circuitry

Experience and state-of-the-art knowledge in one or more of these: oscillators, cw or pulse modulators, video, IF or microwave amplifiers, differentiators, integrators, power supplies, pulse coders and decoders, phase detectors, MTI cancellers. Projects include: R&D of advanced techniques; ground, airborne, space equipment.

PHYSICIST

Applied Research

Advanced degree in physics or engineering physics, plus an appreciation of theory. To design a series of experiments in plasma physics, taking responsibility for equipment specification and installation plus all other experimental considerations.

For a confidential discussion, please write:

C. E. Fitzgerald
Laboratory For Electronics
1079 Commonwealth Avenue
Boston 15, Massachusetts



Laboratory For Electronics

CONTACTS FOR THE FIELD OF ELECTRONICS

LIFSCHULTZ
FAST FREIGHT
FASTEST TO BOTH COASTS!



2nd DAY SERVICE
between NEW ENGLAND STATES
and CHICAGO
SPEED—DEPENDABILITY SINCE 1899

Specify **LIFSCHULTZ**
and Be Sure It's On Time!

CIRCLE 478 ON READER SERVICE CARD

TINY GRAIN OF WHEAT LAMPS

VARIOUS VOLTAGES
STOCK & MADE
TO ORDER SIZES

For PILOT LITES, PANELS,
TEST RIGS, ETC. Many
Different Shapes, Sizes &
Voltages. Write for Partic-
ulars and Quantity Prices.



ARISTO-CRAFT
Distinctive Miniatures

184 Pennsylvania Ave., Dept. E, Newark 2, N.J.

CIRCLE 479 ON READER SERVICE CARD

Just say:

"Information, please"

whenever you need products or
services not advertised in a par-
ticular issue of this magazine.

Each issue is only part of the
complete service we are organ-
ized and glad to render to reader
and advertiser, alike. We want
you to consider this publication
your primary source of informa-
tion in this field.

ELECTRONICS
Classified Advertising

P. O. Box 12 New York 36, N. Y.

SAVE TIME & EXPENSE ON PURCHASING RELAYS

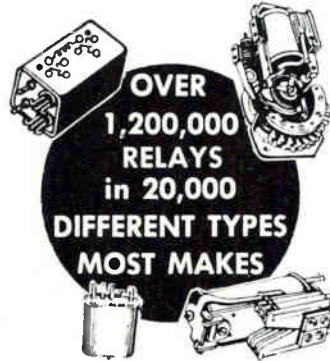

OVER
1,200,000
RELAYS
in 20,000
DIFFERENT TYPES
MOST MAKES

- PRODUCTION QUANTITIES IN STOCK
- DELIVERY ON OFF-THE-SHELF ITEMS WITHIN 48 HOURS. DELIVERY WITHIN ONE WEEK ON RELAYS REQUIRING ASSEMBLY AND/OR ADJUSTMENT.

**WE DELIVER RELAYS
NOT PROMISES**

SEND FOR CATALOG E

Universal RELAY CORP.

42A White St., New York 13, N. Y. • Walker 5-9257

CIRCLE 473 ON READER SERVICE CARD

- ALL NEW EQUIPMENT**
- 1,500 BODINE MOTORS •
 - KCI-43 115V-1-60
 - 1/40 HP 1300/1600 RPM
 - \$8.00 each-FOB-NYC
 - 50 MARATHON BALL BEARING MOTORS •
 - WQJ155M85W 115V-1-60
 - 1/2 HP 3450 RPM
 - \$15.00 each-FOB-NYC
 - 200 G. E. STEPDOWN TRANSFORMERS •
 - CONSTANT VOLTAGE Type
 - Model No. 9T 91Y1033G2
 - KVA. 1.36 EPS. CY-60 Ph. 1
 - HV. 115, 208, 230 V Input
 - LV. 47.5, 48, 50 V-25A.
- Resonant capacitor permanently attached to coil and core. Transf. leads connected to terminal board. Sh. Wt. 60 lbs. App. dim. 10x8x3-MT; Holes fixed. Brand new—200 available. Single units \$25.00 FOB-NYC.
- We Buy & Sell Surplus Inventories
MANUEL KLEIN INDUSTRIES, INC.
56 Warren St. Cortland 7-2420 N. Y. 7, N. Y.

CIRCLE 474 ON READER SERVICE CARD

U.S.M.C. DYNASERT

ASSEMBLY SYSTEM, 12 Stations, Auto-
matic Board Loading and Unloading,
Automatic Pallet Conveyor, 4 Years old.
P. O. Box 2053 Newark 12, N. J.

CIRCLE 475 ON READER SERVICE CARD

NOW IN NEW JERSEY TUBES and SEMI-CONDUCTORS

From the largest facility and stock in the
country at lowest prices. Delivery on first
class NEW special purpose tubes and tran-
sistors from stock in production quantities.

SPECIALS

- 500 Eimac 4-65A \$15.50 ea.
- 1200 Transitron SV-3141A voltage refer-
ence 1.5V ± 2% at \$1.75 ea. lot
price.
- 250 Texas 2N338 \$7.50 ea.

Astronetics, Inc.
Red Bank, N. J.
AT 1-2700

CIRCLE 476 ON READER SERVICE CARD

GET IT FROM GOODHEART!

0.1% SORENSEN Line Voltage Regulator

#5000S. Brand new at low surplus price! Input 95-130 V, ph. with taps for 50 or 60 cy. Use for any power up to 5000 watts. Output adjustable 110-120 V and holds to ±0.1% at line frequency, or to ±0.25% if line frequency drifts 5%. Regulates against line changes of 95-130 V and against load changes from 0 to 5 KVA. Maximum harmonics less than 3%! Recovery time 0.15 seconds. Input to the control section can be moved to the point where you will use the power, thus compensating for line drop. In rack cabinet 22" x 22" x 15" dp. Net wt 190 lbs. Shpg wt 285 lbs FOB Utica, N. Y. In original factory pack suitable for export, including SPARE PARTS group. Sorensen catalog net price is \$695.00 \$349.50 less spares. Our price, WITH SPARES...



It is smart planning to buy this 5 KVA capability even if your present need is for lower power, because: 1. It works just as well at lower power. 2. Price is as low as a 1 KVA unit (Sorensen's price). LESS as low as \$320.00 for 1 KVA, \$460.00 for 2 KVA, \$520.00 for 3 KVA, and \$695.00 for 5 KVA.)

WRITE for DETAILS ON OTHER C-V UNITS

Raytheon unit has harm. filter, output 115 V 1/2% at 7.1 A and 1 other fixed load. \$49.50. Following units regulate for any load within ratings: Superior servo-driven Powerstat. 1.2 KVA, \$125.00, and 2.5 KVA \$150.00; no harmonics in either. Sola 1 KVA at \$79.50, 2 KVA w/dual input \$147.50, 3 KVA w/dual input and output \$187.50. G.E. 2.3 KVA \$49.50.

130 DC AMPS at LESS THAN \$1.00/AMP

Complete DC power supply ready to plug in and use. Outputs 15 and 30 volts DC at 130 and 60 amps continuous, or 500 and 300 amps intermittent for 100 seconds with 16 such int. operations per hour permissible. Metered for V and A. Input 220 V 60 cy. Brand new! 550 lbs fob Topeka, Kansas. \$129.50

SURPLUS BARGAINS in TEST EQUIPMENT

Gen. Radio 715-AM combination DC Amplifier and VTVM with 1% accuracy. Output 5 ma into 1000 ohms with inputs 8-100 mv and X2, X5, X10. Has 9 cali-
brated input res. so can be used as mv, uA, or power meter. Input current less than .002 uA. Brand new w/instr. book. G.R. Price \$340.00. Our price \$150.00 low price only.

Brush BL-905, -913, -932 DC Amplifiers, \$79.50 your choice, certified.

Brush Piezo-Electric-drive 2-pen recorder complete with two tailor-made DC amplifiers, certified and ready to use, the set. \$375.00

Brush BL-206 6-pen recorder is part of Fairchild REAC Mod. R-101, mounted eye-high on rack cabinet on roller dolly, with all power supplies and differential DC amplifiers, gain-control switches, etc. Certified as new. Fairchild price is \$7350.00. Our low price only \$1500.00

Gen. Elect. 0-100 Microamp Recorder uses self-contained optical servo amplifier, certified perfect, 1/5 G.E. price. \$295.00

Write for bargains in other G.E., West., Est. Angus recording DC and AC volt and current meters.

Hewlett-Packard 100-D Low Freq. Standard gives sine waves at 10, 100, 1 K & 10 K cy. w/harm. to 5 mc; and marker pipe spaced 100, 1 K, and 10 K cps. Accuracy 2 millionths/week. Built in scope, see List-ious to check count from the 100 KC crystal in oven. Certified. H.P. price \$750.00. Our low price only \$349.50

Meas. Corp. Mod. 79-B Pulse Generator 60-100,000 cy pulses 1/2-40 uscs wd, and sync pulses delayed 1/2 period. Can pulse-modulate an ext. RF source and can be synced by an ext. sine source. This is the model preceding the current catalog model which sells for \$495.00. Good used. Navy recon- \$40.50 ditioned, fob Seattle.

New in orig. pack, w/instr. book. 40 lbs. \$97.50 fob Harrisburg, Pa.

Meas. Corp. Mod. 80 microvolter, 2-400 mc, as made by the Armed Forces is TS-497A/U. Guaranteed 100% OK, fob Los Angeles. \$349.50

Meas. Corp. Mod. 84, 300-1000 mc micro volter, certified OK fob Los Angeles. \$179.50

Navy LAE-2 microvolter 520-1300 mc, brand new in orig. pack w/instr. book, cords, calib. \$119.50 charts etc. fob Los Angeles.

Gen. Radio 651-AE oscilloscope recorder, \$199.50 like new, fob Los Angeles.

Gen. Rad. 620-A Met. Freq. Meter. W/Harmonics range is 300 kc-300 mc, ±0.1%. Old cat. \$199.50 price \$625.00. Our price, certified.

Gen. Rad. 561-D Vacuum-tube Bridge measures every tube and transistor parameter. G.R. price \$850.00. Our price, like new, but less cords and \$199.50 small accessories is only.

Meas. Corp. Mod. 31 Intermodulation Analyzer, excellent cond. only. \$99.50

Stoddart NMA-5A (TS-587 U) Radio Interference and Field Intensity Meter, 15-420 mc, with tripod, 2 diodes, cords, coupler, 2 cases, and 2 RF leads, in apparently excellent condition, \$499.50 complete.

Test Oscilloscope OS 4B/USM-25B has freq. response 3 db, 10 cy-8 cm; Pulse rise time less than 0.1 us; 10 cm marker crystals, 10 us or counted to 50 us; and 12.2 us (2 K yards) or counted to 61 us (10 K vds), w/accuracy ±0.3%. Calibrated range stop, internal sweep 82-820,000 cy, or sync w/ext. sine source 20 cv to 1 mc. Certified, \$349.50 w/Mat instr. book.

DuMont 256B is commercial version of \$199.50 above w/5" CRT, certified, fob Los Angeles.

DuMont 294A, w/pwr supply, certified \$249.50 100% OK, fob Los Angeles.

TS-34/AP combination test and synchroscope, in exc. cond., w/case and 16-page instr. book \$29.50 reprint, fob Los Angeles.

R. E. GOODHEART CO.

P. O. Box 1220-E Beverly Hills, Calif.

CIRCLE 477 ON READER SERVICE CARD

Give your Products

**MORE RELIABILITY and
BETTER PERFORMANCE with**

FREED

**HERMETICALLY SEALED
MIL-T-27A
PULSE TRANSFORMERS**

- Maximum power efficiency and optimum pulse performance.
- For use in blocking oscillator, interstage coupling and low level output circuits.
- Ruggedized construction — Grade 4.
- Series or parallel connection of windings for optimum turns ratio.



Cat. No.	MIL Type	Pulse Voltage Kilovolts	Char. Imp. Ohms
MPT-1	TF4RX35YY	0.25/0.25/0.25	250
MPT-2	TF4RX35YY	0.25/0.25	250
MPT-3	TF4RX35YY	0.5/0.5/0.5	250
MPT-4	TF4RX35YY	0.5/0.5	250
MPT-5	TF4RX35YY	0.5/0.5/0.5	500
MPT-6	TF4RX35YY	0.5/0.5	500
MPT-7	TF4RX35YY	0.7/0.7/0.7	200
MPT-8	TF4RX35YY	0.7/0.7	200
MPT-9	TF4RX35YY	1.0/1.0/1.0	200
MPT-10	TF4RX35YY	1.0/1.0	200
MPT-11	TF4RX35YY	1.0/1.0/1.0	500
MPT-12	TF4RX35YY	0.15/0.15/0.3/0.3	700



**Ruggedized,
MIL STANDARD
POWER & FILAMENT TRANSFORMERS**

Primary 105/115/125 V 50-60~

Cat. No.	Appl.	MIL Std.	MIL Type
MGP 1	Plate & Fil.	90026	TF4RX03HA001
MGP 2	Plate & Fil.	90027	TF4RX03JB002
MGP 3	Plate & Fil.	90028	TF4RX03KB006
MGP 4	Plate & Fil.	90029	TF4RX03LB003
MGP 5	Plate & Fil.	90030	TF4RX03MB004
MGP 6	Plate	90031	TF4RX02KB001
MGP 7	Plate	90032	TF4RX02LB002
MGP 8	Plate	90036	TF4RX02NB003
MGF 1	Filament	90016	TF4RX01EB002
MGF 2	Filament	90017	TF4RX01GB003
MGF 3	Filament	90018	TF4RX01FB004
MGF 4	Filament	90019	TF4RX01HB005
MGF 5	Filament	90020	TF4RX01FB006
MGF 6	Filament	90021	TF4RX01GB007
MGF 7	Filament	90022	TF4RX01JB008
MGF 8	Filament	90023	TF4RX01KB009
MGF 9	Filament	90024	TF4RX01JB012
MGF 10	Filament	90025	TF4RX01KB013



**Ruggedized,
MIL STANDARD
AUDIO TRANSFORMERS**

Cat. No.	Imped. level—ohms	Appl.	MIL Std.	MIL Type
MGA 1	Pri. 10,000 C.T. Sec. 90,000 Split & C.T.	Interstage	90000	TF4RX15AJ001
MGA 2	Pri. 600 Split Sec. 4, 8, 16	Matching	90001	TF4RX16AJ002
MGA 3	Pri. 600 Split Sec. 135,000 C.T.	Input	90002	TF4RX10AJ001
MGA 4	Pri. 600 Split Sec. 600 Split	Matching	90003	TF4RX16AJ001
MGA 5	Pri. 7,600 Tap @ 4,800 Sec. 600 Split	Output	90004	TF4RX13AJ001
MGA 6	Pri. 7,600 Tap @ 4,800 Sec. 4, 8, 16	Output	90005	TF4RX13AJ002
MGA 7	Pri. 15,000 C.T. Sec. 600 Split	Output	90006	TF4RX13AJ003
MGA 8	Pri. 24,000 C.T. Sec. 600 Split	Output	90007	TF4RX13AJ004
MGA 9	Pri. 60,000 C.T. Sec. 600 Split	Output	90008	TF4RX13AJ005

PARTIAL LISTING ONLY

Send for NEW 48 page transformer catalog. Also ask for complete laboratory test instrument catalog.

FREED-TRANSFORMER CO., INC.

1722 West 64th St. Brooklyn (Bixenwood) 27, N.Y.

INDEX TO ADVERTISERS



Audited Paid Circulation

*AC Electronics	94	Huggins Laboratories, Inc.	123
Adler Electronics, Inc.	61	*Hughes Aircraft Co.	37
Aetna Life Insurance Co.	2	*Industrial Electronic Engineers, Inc.	119
*Airpax Electronics, Inc.	21	Institute of Radio Engineers	63
Allen-Bradley Co.	45	International Resistance Co.	33
*Amphenol-Borg Electronics Corporation, Amphenol Distributor Division	96	*International Telephone and Telegraph Corp. Components Div.	92
Anaconda Wire & Cable Co.	53, 54	Jones Division, Cinch Mfg. Co., Howard B.	115
Autonetics, A Division of North American Aviation, Inc.	42	*Jones Electronics Co., Inc., M. C.	25
Avco Corp.	69	Keithley Instruments, Inc.	107
Avco Corp., Nashville Division	29	Kidder, Peabody & Co.	112
*Barnstead Still & Sterilizer Co.	14	Kintel, A Division of Cohu Electronics Inc.	3rd Cover
*Behlman Engineering Co.	41	*Krohn-Hite Corp.	121
*Bendix Corporation Bendix-Pacific Division	68	Kyoritsu Electrical Instruments, Works, Ltd.	19
Red Bank Division	62	L & R Manufacturing Company	68
Bendix Systems Division	115	Laboratory for Electronics Inc.	131
*Birtcher Corporation, The	122	*Lepel High Frequency Laboratories, Inc.	119
*Boonton Radio Corp.	58	Litton Industries Electronic Equipment Div.	122
Bruno-New York Industries Corp.	116	Lockheed Electronics Company	67, 110, 111
*Brush Instruments Division of Clevite Corp.	17, 18	Magnetic Metals Co.	28
Cannon Electric Co.	8, 9	Mallory and Co., Inc., P. R.	7
*Carborundum Company, The	32	*Markem Machine Co.	105
Colorado Dept. of Development	116	Martin Co.	71
Computer Engineering Associates, Inc.	70	Melabs	59
*Couch Ordnance, Inc.	101	Mercury Electronic Company	123
Delco Radio	56	*Mico Instrument Co.	115
*Dialight Corporation	107	Minnesota Mining & Mfg. Co., Chemical Division	66
Dynacor Inc., A Subsidiary of Sprague Electric Co.	121	Mitsumi Electric Co., Ltd.	70
Edo Corporation	116	*Moseley Co., F. L.	60
Espey Mfg. and Electronics Corp.	57	*Mycalex Corp. of America	58
Esterline-Angus Company, Inc.	118	National Semiconductor, Ltd.	68
*FXR Inc.	6	Neff Instrument Corporation	19
*Freed Transformer Co., Inc.	130	*New Hermes Engraving Machine Corp.	112
*General Electric Co. Silicone Products Dept.	65	*North Atlantic Industries, Inc.	117
*General Electrodynamics Corporation	99	North Electric Co.	72
*Green Instrument Co., Inc.	70	Hermetic Seal Transformer Co.	100
Hewlett-Packard Company	Fold-Out Cover	*Hewlett-Packard Company	Fold-Out Cover
Hitachi, Ltd.	34	* See Advertisement in the July 20, 1960 issue of Electronics Buyers' Guide for complete line of products or services.	

← CIRCLE 130 ON READER SERVICE CARD

electronics

(picture of a KIN TEL differential amplifier at work)

6 volts of 60^{Hz} common-mode noise and
6 millivolts of signal in here

2 microvolts of 60^{Hz} noise (equivalent input)
and 6 volts of signal out here

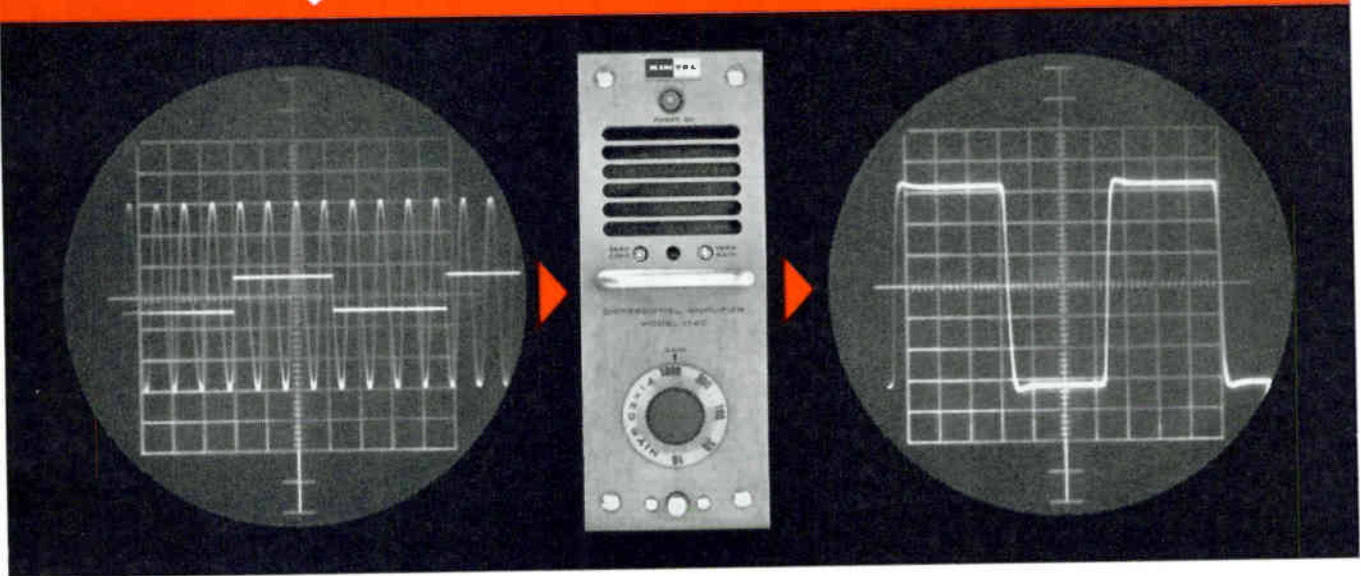

If you measure the output of thermocouples, and the thermocouples are bonded to a rocket engine or almost any other grounded object, and the distance between thermocouples and amplifiers is more than a few feet, you should consider the above illustration carefully. While we'll admit your thermocouples probably aren't producing square waves, nine chances out of ten you *do* have a problem with 60-cycle common-mode noise. Nearly everybody does.

What can be done about it? Well, KIN TEL differential amplifiers reject ruinous 60-cycle common-mode hum and noise by a factor of 3,000,000 to 1 with any unbalance up to 1000 ohms in series with either side of the input, 1,000,000 to 1 with 10,000 ohms unbalance. Rejection for DC is practically infinite and both input and output can be floated up to ± 300 volts DC or peak AC. The secret of this exceptionally high common-mode rejection in the presence of high input unbalance is isolation. Input signal terminals are isolated from chassis ground by 10,000,000 megohms and 0.6 micromicrofarads. Input and output signal terminals are completely isolated from each other. Output signal terminals are isolated from ground to almost the same extent as the input. With this virtually perfect isolation, you can rescue microvolt level signals from volts of common-mode noise, regardless of whether load and transducer are floating or grounded, balanced or unbalanced.

Before you send us that letter... the input scope photo is a double exposure. The square wave input signal was taken with the scope connected across points 1 and 2 (see drawing below) with 5 mv/division sensitivity. To show the noise, the scope was connected between points 2 and 3, and sensitivity was 1 v/division. The scope on the output was set for 1 v/division sensitivity and, of course, no noise is evident.

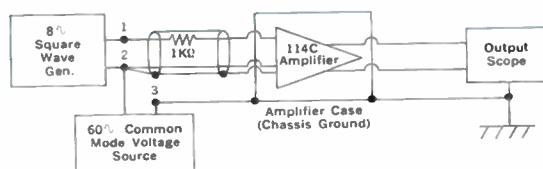

Specifications other than common-mode rejection are equally impressive. Linearity is 0.01% of full scale (10 volt) output for either polarity, 0.02% of full scale for plus-to-minus or minus-to-plus polarities. Equivalent input drift is less than $2\mu v$; noise at full amplifier bandwidth is less than $6\mu v$. Input impedance is 30 megohms, output impedance less than 0.25 ohms. Standard bandwidth is less than 3 db down at 80 cps, and the amplifier settles to within 99.9% of final value within 50 milliseconds for an output change of 5 volts. Plug-in input and output filters allow bandwidth options from 3 cps to 120 cps, transient response as good as 25 milliseconds. Gain is 10 to 1000 in 5 steps. A front panel vernier control provides 1 to greater than 3.3 times continuous adjustment of each gain step. Gain stability is $\pm 0.05\%$. Output capability is 10 volts at 10 milliamps. Amplifiers have integral power supplies. Enclosures include six-amplifier and single-amplifier 19-inch rack modules, and portable single amplifier cabinets.

To meet your exact requirements at minimum cost, two models are now available: the 114A at \$775, and the 114C (described) at \$875. Delivery on both models is currently from stock. Write for detailed technical data or a demonstration. Engineering representatives in all major cities.

KIN TEL
A DIVISION OF
COHU
ELECTRONICS, INC.

5725 Kearny Villa Road, San Diego 11, California
Phone: BRowning 7-6700

*Unequaled Light Sensitivity
and Low Lag*



*New RCA photoconductor utilized
in world's most sensitive vidicons*

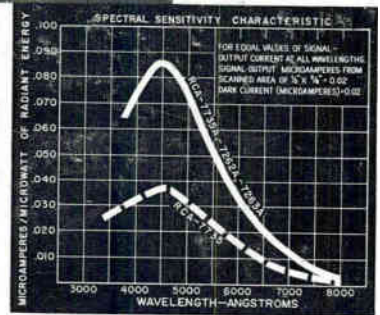

Now, an RCA exceptionally sensitive photosurface ushers in a new family of advanced vidicons unequaled anywhere for their light sensitivity and closely-controlled characteristics.

The RCA-7735-A—double the sensitivity of the 7735—provides good pictures at lower light levels with less lag than previously possible! This sensitivity and the tube's lower "lag" make the 7735-A ideal for industrial use.

Two short-length vidicon types featuring the same sensitivity as the 7735-A are offered for use in compact transistorized cameras. RCA-7262-A is intended for normal outdoor-indoor environments. RCA-7263-A is especially designed for military or

other applications involving shock, vibration, humidity, and altitude. Both types operate at 30% less heater power than any other commercially available type of vidicon.

All three of these advanced camera tubes feature a resolution capability of 600 to 900 lines, broad spectral response, and the high tube-to-tube uniformity that has become identified with RCA vidicons.

For complete information about these RCA vidicons—the most sensitive in the world—get in touch with: Marketing Manager, Industrial Tube Products, RCA, Lancaster, Pa. For a technical bulletin on any of these types, write Commercial Engineering, Section K-19-Q-2, RCA, Harrison, N.J.

RCA ELECTRON TUBE DIVISION FIELD OFFICES . . . Industrial Tube Products Sales: Detroit 2, Michigan, 714 New Center Building, TRinity 5-5600 • Newark 2, N. J., 744 Broad St., HUmboldt 5-3900 • Chicago 54, Illinois, Suite 1154, Merchandise Mart Plaza, WHitehall 4-2900 • Los Angeles 22, Calif., 6355 E. Washington Blvd., RAymond 3-8361 • Burlingame, Calif., 1838 El Camino Real, OXFord 7-1620 • Government Sales: Newark 2, N. J., 744 Broad Street, HUmboldt 5-3900 • Dayton 2, Ohio, 224 N. Wilkinson St., BALdwin 6-2366 • Washington 6, D. C., 1725 "K" St., N.W., FEderal 7-5800.



The Most Trusted Name in Electronics
RADIO CORPORATION OF AMERICA